

75 cents

hcr

focus
on
communications
technology . . .

ham radio

magazine

NOVEMBER, 1970

a
solid-state
converter
for
1296
MHz

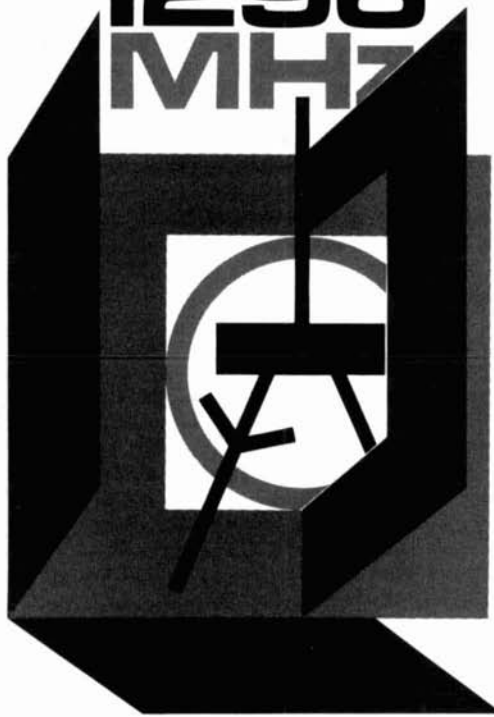

this month

- using the smith chart 16
- injection lasers 28
- radio teletype 38
- 160-meter receiver 44
- vhf tank circuit design 56

THE ALPHA SEVENTY



STAYS COOL AND QUIET...

WHILE IT MAKES *BIG THUNDER* ON THE BAND

The *ALPHA SEVENTY* is a new generation HIGH POWER LINEAR AMPLIFIER, not just another variation on the conventional theme. Major state-of-the-art *technological* advances are incorporated, providing amateur and commercial users with a new standard of performance, versatility, convenience, and quality. A few examples...

- VAPOR PHASE COOLING does away with noisy high speed blowers, yet the rugged Eimac 3CV1500A7 amplifier tube reaches only about 100°C under full load, not 200°C like virtually all air-cooled tubes. Heat – the arch-enemy of electronic components – is quietly flushed out the rear of the cabinet.
- VACUUM VARIABLE TUNING capacitor, combined with husky toroidal inductors in low-frequency and low-Q² circuit areas, yields a highly efficient, wide-tuning-range pi-L output filter of remarkable compactness.
- TAPE-WOUND TRANSFORMER core of Silectron[®] steel makes possible a built-in supply with peak and average power capability to fully complement the RF section and provide ample reserve.

The *ALPHA SEVENTY* is a *no-compromise* powerhouse; designed and rated for continuous commercial service, it is available for use by advanced amateur operators who demand the ultimate in every respect. It is compatible with all modern exciters and transceivers.

A fully-detailed brochure on the *ULTIMATE LINEAR* is available from ETO direct, or contact... EAST – HARRISON RADIO, 20 Smith St., Farmingdale, L.I., N.Y. 11735. MIDWEST – AMATEUR ELECTRONIC SUPPLY, 4828 W. Fond du Lac Ave., Milwaukee, WI. 53216. WEST – AMRAD SUPPLY, Inc., 1025 Harrison St., Oakland, CA. 94607.



EHRHORN TECHNOLOGICAL OPERATIONS, INC.

BROOKSVILLE, FLORIDA 33512

IF YOU'VE EVER USED A REPEATER,

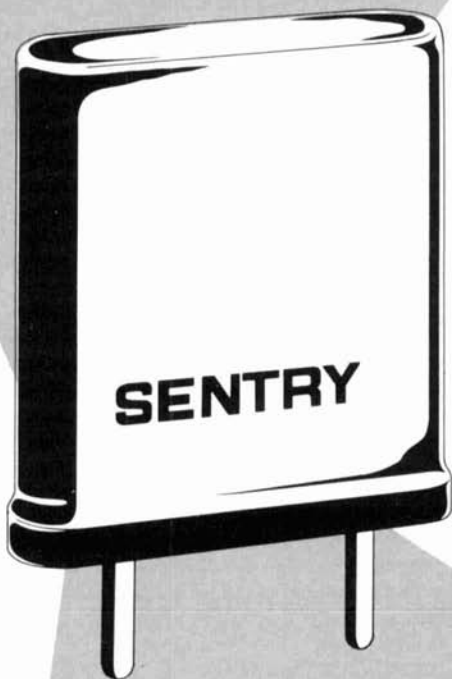

YOU'VE USED A SENTRY CRYSTAL

If you haven't
already received
a copy of our **NEW**
1970 Catalog of Precision
Quartz Crystals & Electronics
for the Communications Industry,
SEND FOR YOUR COPY TODAY!

Somewhere along the line, in virtually every ham repeater in the world, you'll find a couple of Sentry crystals.

Repeater owners and FM "old-timers" don't take chances with frequency—they can't afford to. A lot of repeater users depend on a receiver to be on frequency, rock stable...in the dead of winter or the middle of July. The repeater crowd took a tip from the commercial "pros" a long time ago—and went the Sentry Route.

That's one of the reasons you can depend on your local repeater to be there (precisely there) when you're ready to use it. FM'ers use the repeater output as a frequency standard. And for accuracy, crystals by Sentry are THE standard.

**IF YOU WANT THE BEST,
SPECIFY SENTRY CRYSTALS.**

*"Ask the Hams and Pros
Who Build Repeaters!"*



SENTRY MANUFACTURING COMPANY
Crystal Park, Chickasha, Oklahoma 73018

PHONE: (405) 224-6780

TWX-910-830-6425

At last—Drake quality in a VHF FM Transceiver



Marker Luxury



The best of the Japanese, the Marker Luxury VHF FM Transceiver is built for and distributed and backed by the R. L. Drake Co.

- Exceptional receiver
- Backed by R. L. Drake
- Complete package for . . .

\$329⁹⁵

Includes transceiver, two channels supplied, mobile mount, microphone, coax cable and antenna.

SPECIFICATIONS

General

Frequency Coverage	144-148 MHz
Number of Channels	12 Channels, 2 supplied Channel 1 Receive 146.94 MHz Transmit 146.34 MHz Channel 2 Simplex 146.94 MHz
Modulation	Frequency Modulation
Transmitter Control	Push-to-Talk
Power Drain	AC: Receive 6 Watts Transmit 50 Watts DC: Receive 0.5 Amps Transmit 4 Amps
Power Source	AC: 117 Volts Factory Wired 220/240 Volts 50-60 Hz DC: 13.5 Volts $\pm 10\%$.
Dimensions	7 $\frac{7}{8}$ " W x 2 $\frac{3}{4}$ " H x 10 $\frac{1}{4}$ " D.
Weight	8 $\frac{3}{4}$ lbs.
Standard Accessories	Dynamic Microphone, Antenna, Connector Plug, AC/DC Cord

Transmitter

RF Output Power	10 Watts
Frequency Deviation	15 KHz maximum
Frequency Stability	$\pm .001\%$ or less
Spurious Radiation	Greater than -80 dB below Carrier
Frequency Multiplication	12

Receiver

Receiver Circuit	Crystal-controlled Double Conversion Superheterodyne
Intermediate Frequencies	1st 10.7 MHz, 2nd 455 kHz
Input Impedance	50 to 75 Ohms
Sensitivity	0.5 mV or less for 20 dB S+N/N ratio 1 mV or less (30 dB S+N/N ratio at 10 kHz deviation with 1 kHz modulation)
Intermodulation	Greater than 80 dB
Spurious Sensitivity	At 40 kHz separation
Audio Output	Greater than -80 dB 0.5 Watt with 10% or less distortion.

See at your distributor, or write for details . . .



R. L. DRAKE COMPANY

540 RICHARD ST., MIAMISBURG, OHIO 45342

november, 1970
volume 3, number 11

staff

James R. Fisk, W1DTY
editor

Nicholas D. Skeer, K1PSR
vhf editor

J. Jay O'Brien, W6GDO
fm editor

Alfred Wilson, W6NIF
James A. Harvey, WA6IAK
associate editors

Jean Frey
art director

Wayne T. Pierce, K3SUK
cover

T. H. Tenney, Jr. W1NLB
publisher

John B. Morgan, K1RA
advertising manager

offices

Greenville, New Hampshire 03048
Telephone: 603-878-1441

ham radio magazine is
published monthly by
Communications Technology Inc.
Greenville, New Hampshire 03048

Subscription rates, world wide:
one year, \$6.00, three years, \$12.00.
Second class postage
paid at Greenville, N. H. 03048
and at additional mailing offices

Foreign subscription agents:
United Kingdom:
Radio Society of Great Britain,
35 Doughty Street, London WC1, England.

All European countries:
Eskil Persson, SM5CJP, Frotunagrand 1,
19400 Upplands Vasby, Sweden.

African continent:
Holland Radio, 143 Greenway,
Greenside, Johannesburg,
Republic of South Africa

Copyright 1970 by
Communications Technology, Inc.
Title registered at U. S. Patent Office.
Printed by Wellesley Press, Inc.
Wellesley, Massachusetts 02181, U.S.A.

ham radio is available to the blind
and physically handicapped on magnetic tape
from Science for the Blind,
221 Rock Hill Road, Bala Cynwyd,
Pennsylvania 19440.

Microfilm copies of current
and back issues are available
from University Microfilms,
Ann Arbor, Michigan 48103.

Postmaster: Please send form 3579 to
ham radio magazine, Greenville,
New Hampshire
03048



contents

- 6 solid-state 1296-MHz converter**
H. N. Sandford, VK4ZT
- 16 the smith chart**
James R. Fisk, W1DTY
- 28 injection laser communications**
Ralph W. Campbell, W4KAE
- 36 general-coverage frequency spotter**
Carl C. Drumeller, W5JJ
- 38 radio teletype with ssb transceivers**
Howard Phillips, W6FOO
- 44 160-meter receiver**
F. J. Bauer, Jr., W6FPO
- 48 power-line counter gating source**
E. H. Conklin, K6KA
- 50 unitized voltage-regulated power supply**
Eugene L. Klein, W2FBW
- 56 vhf linear tank-circuit design**
Harry Ferguson, K7UNL
- 62 printed-circuit boards without printing**
Roy C. Corderman, W4ZG
- 65 simple transistor and diode test set**
J. F. C. Johnson, ZL2AMJ
- 4 a second look**
- 88 advertisers index** **83 flea market**
- 68 comments** **88 reader service**

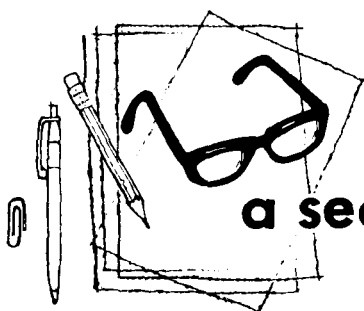

a second look

by Jim
fisk

There's a new integrated circuit on the market that could revolutionize future communications-equipment design. The new IC, the Signetics N565 monolithic phase-locked loop, can be used for a large number of interesting applications, including frequency multiplication and division, fm demodulation and a-m detection. Actually, the phase-locked loop concept dates back nearly 40 years, but amateur applications of the scheme have been few and far between — primarily because of circuit complexity and alignment problems.

The basic phase-locked loop consists of a phase detector, a low-pass filter, an amplifier and a voltage controlled oscillator (vco) in the feedback loop. The input signal is fed into the phase detector where it is compared to the output of the vco. If there is a phase difference between the input frequency and the vco, the phase detector produces a dc output signal which is fed through the low-pass filter and controls the frequency of the vco, locking the phase of the vco signal to that of the input. If a crystal-controlled signal is used at the input, the output of the vco has essentially the same stability as the crystal.

The applications for this new integrated circuit are so diverse that the data sheet is already six pages long. For example, you can generate a wide range of frequencies which are multiples or submultiples of the input reference signal; and the output will have the same percentage of accuracy and stability as the input. Tunable vhf converters take on a

new light with a phase-locked vfo, as do high-frequency ssb receivers and transmitters.

As a frequency-selective fm demodulator, you can use the phase-locked IC in i-f strips and fm detectors and as high-linearity detectors for very wideband fm applications. As a signal conditioner, you can use this new integrated circuit to synchronize signals, or to track noisy or unstable signals — think of the many uses for this handy device in weak-signal vhf work. The phase-locked IC can also be used for frequency selective a-m detection, or as a coherent a-m detector.

The Signetics N565 also has several functions that are directly applicable to vhf fm operation. Since the circuit can detect tones, you can use it for simple, but effective selective-call systems. If your fm repeater uses multiplex to read out various repeater operational parameters via multiplexed fm telemetry, you can use the integrated phase-locked loop to filter and demodulate the signals.

The frequency range of the N565 is 0.1 Hz to 500 kHz; the more expensive N562 works up to 50 MHz. The circuits will operate with signals of 100 μ V to 1 V with best operation at about 5 millivolts. We expect to have a complete applications oriented article on this new device in a coming issue. In the meantime, if you come up with any interesting phase-locked loop circuits, I would like to hear about them.

Jim Fisk, W1DTY
editor



WA7DCU Owns
Varitronics Amateur
FM Equipment . . .
He's never been sorry.

VARITRONICS INCORPORATED

2321 E. University Drive, P.O. Box 20665
Phoenix, Arizona 85036

solid-state 1296-MHz converter

Introducing
a uhf converter
from Australia —
a trough-line mixer,
low-noise pre-amp,
and complete portability
are featured

The converter described in this article was used to establish the 138-mile Australian record with VK4KE on 1296 MHz. From the beginning of the project it was decided to develop a solid-state local-oscillator chain to gain experience with transistors in the uhf range. The improved frequency stability would allow narrow-band operation with a consequent reduction in transmitter output power. To obtain any distance on low power, portable operation from 12 V would be necessary.

In the past, the tendency to build units like a battleship stemmed mainly from having access to a well-equipped workshop. As I now use what is probably a typical ham workshop, consisting of a vise and a few hand tools, I was forced to modify construction methods accordingly. The majority of projects are now built using 26-gauge tinplate. It's easy to work, solders well with a 25-watt iron, and most important of all it provides excellent rf shielding. If care is taken with the mechanical design, this light-gauge metal provides adequate mechanical stability. This metal is available at reasonable prices in most cities and is stocked at technical colleges.

description

The schematic is shown in **fig. 1**. The mixer uses an shf diode in a trough line that feeds an fet low-noise preamp using an MPF-107. The LO chain used five Fairchild AY1119 transistors.* My choice of these devices from an overwhelming number of available types was mainly because of their low cost. I use this

*Type 2N918 and 2N3487 also work well.
editor.

H. N. Sandford, VK4ZT, 18 Loch Street, Toowoomba, Queensland, Australia

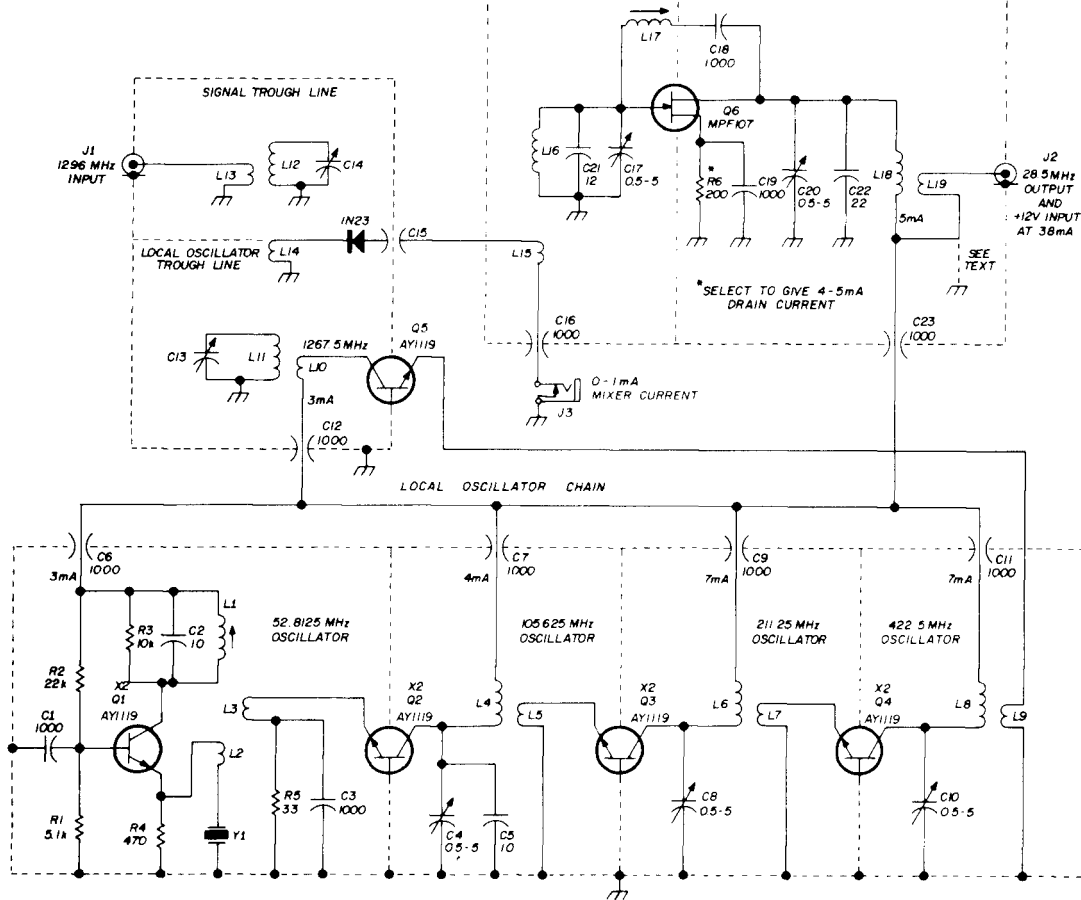

C4, C8, C10, 0.5-5 pF tubular ceramic
 C17, C20 trimmers

C13, C14 no. 8 screws with lock washer and nut

C15 diode bypass capacitor (fig. 2 and text)

D1 1N21, 1N23, or other suitable vhf/shf mixer diode

J1, J2 BNC sockets

J3 miniature close-circuit phone jack

L1 12 turns no. 28 on 5/16" diameter slug-tuned form

L2 1 turn single-strand hookup wire, cold end L1 (see text)

L3 2 turns single-strand hookup wire, center L1

L4 5 turns no. 16, 7/16" ID winding length 1/2"

L5, L7, L9 1 turn single-strand hookup wire 7/16" ID

L6 3 turns no. 16, 7/16" ID winding length 3/8"

L8 1 1/4 turn no. 16, 7/16" ID, winding length 3/8"

L10 1" collector lead of Q5 (Figure 2 and text)

L11, L12 1/4" OD copper tube, 4 1/4" long, Figures 2 & 4

L13 1/2" length no. 18 (see text)

L14 7/8" length no. 18 (see text)

L15 7 1/2 turn no. 28 enam. closewound over cold end L16 (see text)

L16 17 turns no. 28 enam. closewound, 5/16" OD; form mounted over C17

L17 60 turns no. 35 enam. progressive winding on 3/16" OD slug-tuned form (see text)

L18 17 turns no. 28 enam. closewound 5/16" OD form mounted over C20

L19 2 turns single-strand hookup wire over cold end of L18

R6 200 ohm, 1/4 watt (select value to give 4-5 mA Q6 drain current)

Y1 52.8125 MHz 3rd overtone crystal

fig. 1. Schematic of the 1296-MHz converter. A 9.8-dB noise figure is claimed after optimizing the circuits.

inexpensive npn transistor for most i-f and rf applications where noise figure isn't important. The AY1119 has an f_T of around 450 MHz and will produce 20-30 mW in the low vhf range. The AY1114 is its direct pnp counterpart and may be used when a positive ground is desired.

An i-f of 28.5 MHz was chosen, which allows coverage to 0.5 MHz below 1296 MHz with a receiver that tunes the

suitable diode such as the 1N82 on hand. Plenty of output was available from Q4 on 422.5 MHz, so it seemed that an AY1119 would work well as a tripler. Success was immediate and so simple it took some time to convince myself that the output was on the right frequency.

The total collector-lead length of one inch is approximately resonant at 1267.5 MHz to provide maximum drive to the

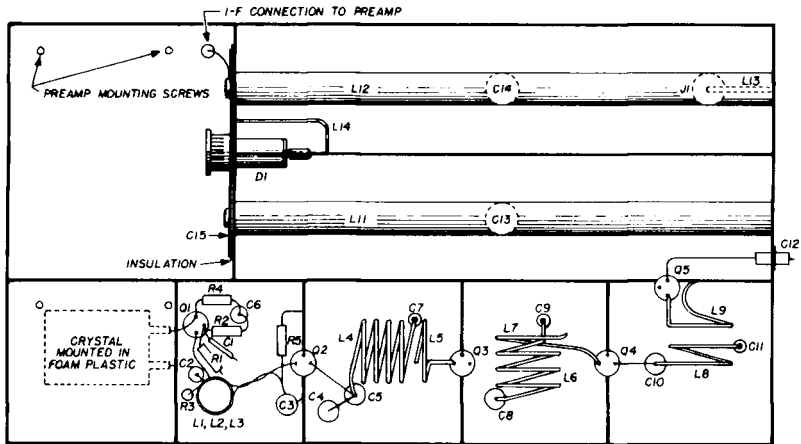

Hole A to clear 0.001-uF feedthroughs

Hole E tapping holes for bottom cover

Hole B to clear 5-pF trimmers

Hole F 3/8" diameter

Hole C to clear L1

Hole G clearance hole for Q5

Hole D to clear C13 and C14 tuning screws

Hole H clearance for Q2 - Q4 (approx. 7/32" square)

fig. 2. Parts layout for mixer, oscillator, and multiplier chain. Arrangement should be followed as closely as possible. Q5 collector lead length is critical; it should not exceed 1 inch.

standard 28-30 MHz band. The third-overtone crystal oscillator, Q1, operates at 52.8215 MHz.

Transistors Q2, Q3, and Q4 are doublers operating at 105.625, 211.25, and 422.5 MHz respectively. Common-base configuration was chosen, as it provides a convenient layout with a minimum of components per stage.

tripler stage

Transistor Q5 triples to 1267.5 MHz, providing up to 1 mA of mixer diode current. I originally intended to use the more common but less efficient diode multiplier. Fortunately, I didn't have a

LO trough line. The trough-line portion of the converter is similar to that described in the ARRL vhf handbook and originally appeared in *QST*, March 1961.

The LO injection signal is coupled to the diode together with the signal to produce the desired i-f output on 28.5 MHz. A neutralized Motorola MPF-107 jfet is used in the i-f preamp to provide the lowest possible noise figure. An MPF-102 could be used for this stage, but it's more difficult to neutralize due to the higher feedback capacitance and may not produce as good a noise figure as the MPF-107. As this type of diode mixer has a considerable conversion loss, the noise

figure of the i-f preamp contributes directly to the overall noise figure of the converter. If a 14-MHz i-f is chosen, then the MPF-102 would probably be suitable, but some degradation of overall noise figure may result due to poor image rejection.

construction

The general layout and dimensions are given in **figs. 2** through **5**.

Some variation may be required to use components on hand. This shouldn't be a problem as long as all leads are kept as short as possible. The LO chain was constructed separately, then soldered to

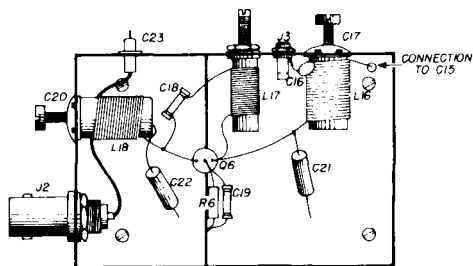

Hole A to clear 0.001-uF feedthrough

Hole B to clear 5-pf trimmer

Hole C 3/8" diameter

Hole D to clear J3

Hole E to clear L17

fig. 3. Preamplifier parts layout. Circuit is mounted in a separate box, which is secured to the top of the main chassis with self-tapping screws.

the main chassis after adjustment (see below). This was convenient for the prototype, but the chassis could be constructed from one piece, if desired, with suitable partitions. I originally intended to construct the i-f amplifier in the compartment at the end of the mixer diode, but this would have made the diode inaccessible, so the preamp was constructed in a separate box and secured to the top of the converter with 1/4 inch no. 2 self-tapping screws.

Type 2 BA or no. 10-32 countersunk screws are used for tuning screws at the center of each trough line. This size

provides a fine thread for tuning, with a large diameter that reduces wobble. A nut is soldered to the top of the chassis. The end of the tuning screw can be slotted before threading into position. Both half-wave lines of 1/4-inch O D copper tubing are soldered centrally in the trough lines after the tuning screws have been fitted. The signal-input loop of no. 18 wire is soldered to the connector, threaded through the mounting hole, out through a small clearance hole in the end plate, then soldered into position after the connector is tightened.

mixer assembly

The mixer diode mount is constructed from tinplate as shown in **fig. 4**. A 3/4 x 3/16-inch strip is cut almost through at intervals of 1/16 inch to form fingers. The strip is then bent around a 1/4-inch drill to fit the diode body. The seam is soldered, then the base of this section is soldered to the capacitor plate, C15. Remove all burrs and form the fingers to provide a firm fit on the diode body.

The capacitor is formed by a thin layer of teflon or polyethylene between C15 and partition 2 (**fig. 4**). The mounting screws land inside the ends of the two 1/4-inch copper tubes, L11 and L12. The heads of the screws are insulated from C15 plate with small washers. The diode pin contact may be salvaged from an old bakelite octal wafer socket or may be fashioned from a small piece of tinplate. Solder a length of no. 18 tinned copper wire to the contact (L14), bend as shown in **fig. 2**, and solder to partition 2 in the signal trough line. It's not advisable to use a good diode while soldering, as it could be damaged by heat. Assemble the diode mount, C15, and check for shorts before inserting the diode.

local-oscillator chain

Construction of the LO chain on the L-section shown in **fig. 4** is straightforward. The holes in the partition shields for Q2-Q5 should be a neat fit. Bend the emitter and collector leads at right angles before insertion, but take care not to

(fig. 6) is used for checking crystal-oscillator performance. Almost any diode will work, but greater sensitivity will be obtained with a detector diode or a

line. If a suitable gdo is available, each circuit may be tuned before wiring the 12-V supply line. Connect a multimeter (0-10 mA range) from C7 to the chassis,

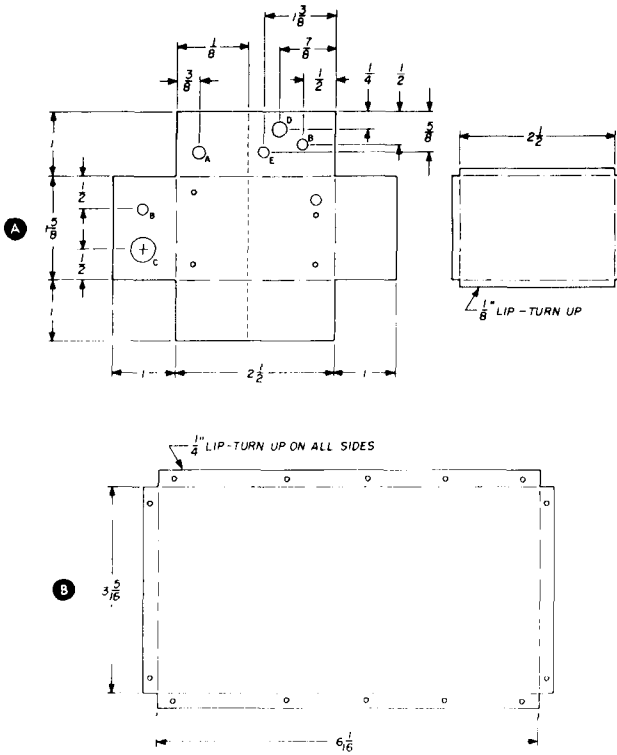

fig. 5. Dimensions for preamp chassis, A, and the main chassis bottom plate.

high-speed computer diode. The diode mixer should be enclosed in a small shielded box, and good-quality coax cable should be used for the coupling line.

The signal-source termination (fig. 7) is used in the procedure for optimizing the converter mixer noise figure. Mount the two connectors on a U-shaped bracket. Use either 75- or 50-ohm resistors, depending on the cable to be used. Make leads as short as possible. Use only carbon-composition resistors, as the spiral-track type are very reactive above 30 MHz or so.

LO-chain adjustment

The LO chain is most conveniently adjusted before soldering to the trough

Slowly bring the gdo up to L4 until a reading of 1-2 mA is obtained on the meter. Tune the gdo for maximum current, taking care not to exceed full scale. The current peak indicates the resonant frequency of L4.

Trimmer C4 should now be adjusted so that the first doubler stage resonates at 105.625 MHz. The turns spacing of L4 may require adjustment if resonance occurs outside the range of C4. Pretune the remaining multiplier stages similarly.

This adjustment method has several advantages. Monitoring the collector current of Q2 ensures that transistor ratings won't be exceeded, especially when using a tube-type gdo with high output. Second, as the application of

power to the transistor changes circuit resonant frequency, compensation may be made by operating the collector at the approximate current to be used in the circuit. Third, many gdo's exhibit a very poor dip, particularly on the higher ranges. This method is not subject to false dips and provides good sensitivity.

crystal oscillator

Connect the 12-V supply to C6 and connect C7 to the supply via a 0-10 mA meter. Adjust crystal-oscillator tuning for maximum current, which should be about 4 mA. L2 should be coupled as loosely as possible consistent with oscillator starting. If the coupling is too tight, the

Carefully check for any spurious oscillations for at least ± 1 MHz. A beat note produced by the crystal oscillator may be confirmed by detuning L1 slightly; or, alternatively, sufficient frequency shift usually occurs if the hand is brought close to L1.

If spurious oscillations are found, it may be necessary to decrease the value of R3 and recheck the coupling of L2. This coupling must be as loose as possible, consistent with reliable oscillator starting, when L1 is tuned slightly to the "slow" side of the peak. When the oscillator is operating correctly, there should be no output on the fundamental frequency (17.604 MHz). Check this by tuning the

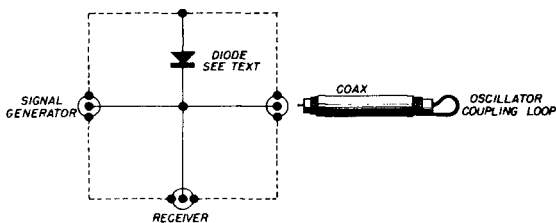

fig. 6. Diode mixer accessory for checking oscillator performance.

oscillator may revert to fundamental operation or even run free.

It's unlikely that a receiver covering this range will be available to check these conditions. This can be resolved by using your station receiver and a signal generator. The signal generator, which should be set to about 0.1-V output, is fed into the simple diode mixer (fig. 6). A one-turn link on the end of a length of coax is used to couple the oscillator signal. The output of the mixer is fed to the receiver tuned, for example, to 14.0 MHz. (Any frequency clear of stray pickup may be used.) The difference between, say, the third-overtone frequency, 52.8125, and 14.0 MHz is 38.8125 MHz. Some signal generators may not operate above 30 MHz, so the second harmonic of 19.406 MHz may be used. When the signal generator is tuned to the correct frequency, a strong beat note should be heard in the receiver with the bfo on.

generator to 3.604 or 31.604 MHz and searching for a beat. The latter frequency is the more desirable, as there is less chance of it being confused with a harmonic from the signal generator. This method may also be used in reverse to check the calibration of a signal generator at several points with known crystal oscillators.

multipliers

When the oscillator is operating satisfactorily, adjust L3 coupling until Q2 collector current is 4-5 mA. L2 and L3 should now be secured into position to prevent any movement.

Connect the 0-10 mA meter from C9 to the 12-V supply, and tune C4 for maximum Q3 collector current. It may be necessary to adjust the turns of L4 for the peak to occur near the center of the range of C4. Adjust L5 coupling to produce 6-7 mA of Q3 collector current.

Proceed with the adjustment of L8 and L9 similarly to give approximately 7 mA of collector current in Q4. It's unlikely that C8 or C10 have sufficient range to tune to the wrong harmonic.

The oscillator section should now be soldered to the trough line portion of the converter. Mount Q5 with the collector lead as shown in fig. 2. The overall length of the lead to the top of the feed-through capacitor should be about one inch. Apply power and peak C10 for maximum Q5 collector current. Adjust link L9 for 2.5-3 mA Q5 collector current, rechecking C10 tuning. Mount the i-f preamp and connect. Tune the LO cavity screw for maximum mixer diode current, which should be 0.5-1 mA. If the tuning

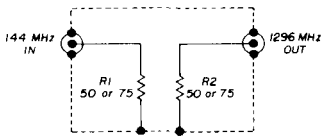

fig. 7. Signal-source termination used for noise-figure optimization adjustments. Resistors are carbon composition types.

of the early LO stages is checked, the tuning may appear very broad because of multiplier saturation. It's safer to check each individual stage collector current, except that L8 and C13 may be tuned for maximum mixer current.

The operating frequencies of L8 and L11 may be checked with Lecher lines by observing a dip in collector current when the lines are link coupled to the appropriate collector tuned circuit. (Lecher lines are described in most handbooks.) If the trough-line peak occurs with a gap of about 1/16 inch for C13, all multipliers are probably operating correctly. This completes the LO chain adjustment.

i-f preamp

Apply power and if necessary adjust the value of R6 to give 4-5 mA drain current. Connect the output of the pre-amplifier to the receiver, which should be tuned to 28.5 MHz. Normally the stage will oscillate over a considerable portion

of L17's range. Adjust L17 until the oscillation ceases, then tune to the center of the "stable area." Peak L16 and L18 for maximum noise in the receiver, and recheck L17. It may help to link couple an external signal to peak the input and output circuits. Due to large variation in fets, it may be necessary to add or remove turns from L17. Final adjustments should be made for best noise figure.

checking mixer noise figure

Most amateurs don't have access to a good noise generator; therefore a weak 1296-MHz signal is necessary to optimize mixer noise figure. The harmonic of a 144- or 432-MHz transmitter will suffice. The resistive termination (fig. 7) is used for this check. Reduce transmitter output to about ¼ watt and connect the transmitter to load resistor R1 of the termination.

If a mixer diode such as the 1N21 or 1N23 is used, it should now be possible to detect a harmonic from a 432-MHz transmitter connected via the terminating unit. The type number of most shf mixer diodes is followed by a letter; e.g., 1N23F. The higher the letter, the lower the noise figure — and also the higher the price. As usual, a compromise is required unless a diode is obtainable free!

Mixer noise figure is best optimized with a signal near the noise level. Connect a low-range ac voltmeter or vtvm across the receiver output. It may be necessary to couple directly across the output transformer via a capacitor to obtain sufficient noise level for a reading on the voltmeter of, say, 0.5 volt. It's not necessary to remove the agc if the signal is kept very low.

Apply the signal to the converter, and tune for maximum indication on the meter. If the indication is more than about 1 V, it will be necessary to reduce transmitter power output or decrease the coupling between R1 and R2 on the terminating unit. If the signal level is much higher, it will be difficult to detect the small changes that indicate if one is proceeding in the right direction.

final adjustments

Tune the receiver a few kHz off the signal and, if necessary, adjust the receiver gain control to give the reference 0.5-V noise-level reading. Retune to the signal and note the signal level. Make an adjustment and note the difference between noise and signal level. As some adjustments affect the overall gain, it will be necessary to make small adjustments to the receiver gain control for 0.5-V reference noise level before noting the signal level. (We are looking for an increase in signal over noise.) When this ratio exceeds 2:1, reduce the signal level slightly and continue. This may sound tedious, but it can be performed quite rapidly with practice.

The mixer trough line may be peaked initially by tuning until a dip is noted in diode current then screwing C14 out slightly, which tunes this circuit higher in frequency.

The adjustments controlling the noise figure are:

1. Signal trough. Normally tuned for maximum signal.

2. Mixer current. Alter injection in increments of $50\ \mu\text{A}$ to find the optimum level, which is normally 0.2-0.3 mA, but will depend on the diode. The injection level may be conveniently controlled initially by detuning C10. Once the optimum level is found, the coupling of L9 may be adjusted to give this value with L8 peaked.

3. Diode coupling. The area enclosed by the link should be close to that shown in fig. 2. Try altering the area by varying lead length in 1/8-inch steps. Once again, this will depend on the diode.

4. Input coupling. The area of the link controls matching and should be close to that shown.

5. I-f preamp. The adjustment of L17 and the input coupling of L15 are critical for best noise figure. Adjust L17 in small steps, repeak C17 and C20, and check signal-to-noise ratio. The number of turns

on the coupling link, L15, should also be varied.

After optimizing these adjustments, I measured the converter noise figure on a commercial noise generator. It was 9.8 dB, which appears to be about as good as can be expected with a simple mixer using this type of diode.

power feed

Note that the bottom of L19 is connected to the 12-V line. This was a simple expedient to feed power to the converter via the coaxial i-f cable, thus allowing the converter to be mounted close to the antenna. I used a modified BC-454 command receiver converted to 28-30 MHz with link coupling to the input of the rf stage. The bottom of the link was returned to the 12-V supply line in the receiver. No degradation of overall noise figure or gain resulted. Also, the problem of a separate battery feed was eliminated. My 144-MHz converter was likewise adapted, so that changing from 144 to 1296 MHz required changing only the i-f cable, which is convenient for portable work.

If you don't wish to modify the i-f receiver, an isolating capacitor and choke may be used to feed the 12 V into the coax. If this feature is not required in the converter, return the bottom of L19 to the chassis in the usual manner.

conclusion

The construction and adjustment of a simple but effective 1296-MHz converter has been described in detail in the hope that its simplicity may encourage some of the dc boys to "have a go." No special test equipment is required and, with the exception of the mixer diode, the set uses inexpensive and readily available components. VK4KE constructed a similar converter using silver-plated brass and obtained almost identical results. There appears to be little advantage in silver plating other than for appearance. Time permitting, I'll describe the construction of the varactor triplers and antennas used on this project.

ham radio

a new name
a new value

...the great new team by **TEMPO**

The TEMPO "ONE" SSB transceiver represents the culminating achievement of many years of experience in the amateur radio field. Modern design, superb performance, high styling, sturdy construction, outstanding reliability, exceptional value . . . all these factors combined for the first time in an amateur SSB transceiver make the TEMPO "ONE" the obvious choice in today's amateur market. Power input: 300 watts PEP SSB, 240 watts CW. Five band coverage: 80 through 10 meters. VFO range: 500 khz. Complete with: Selectable Sideband, Crystal Calibrator, VOX, Receiver Off-set Tuning. Price: \$298.00. AC/ONE power supply 117/230 volt 50/60 cycle . . . \$99.00 DC/ONE power supply 12 volts DC . . . \$107.00



TEMPO "ONE" SSB TRANSCEIVER

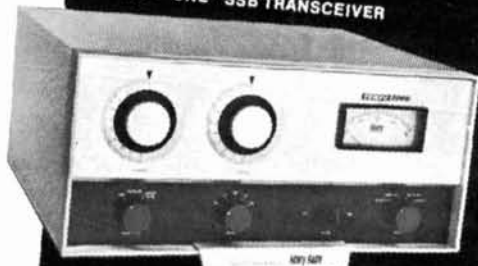

TEMPO "2000" LINEAR AMPLIFIER

The TEMPO "2000" is the smallest self-contained, full legal-limit kilowatt amplifier in its price range. It has an entirely self-contained, solid-state power supply that makes it fully operational within three seconds from turn-on. The "2000" provides full kilowatt input on all modes, band-switched 80 through 10 meters, and grounded-grid input for maximum compatibility with modern transceivers and transmitters. Look at the price . . . look at the features . . . you can't do better for only \$395.00.

Henry Radio has a great antenna package program . . . big savings. Write for literature.

EASY FINANCING • 10% DOWN OR TRADE-IN DOWN • NO FINANCE CHARGE IF PAID IN 90 DAYS • GOOD RECONDITIONED EQUIPMENT • Nearly all makes and models. Our reconditioned equipment carries a 15 day trial, 90 day warranty and may be traded back within 90 days for full credit toward the purchase of NEW equipment. Write for bulletin. Export inquiries invited.

TED HENRY (W6UOU) BOB HENRY (W0ARA) WALT HENRY (W6ZN)

Henry Radio

"World's Largest Distributor of Amateur Radio Equipment"

11240 W. Olympic Blvd., Los Angeles, Calif. 90064 213/477-6701
931 N. Euclid, Anaheim, Calif. 92801 714/772-9200
Butler, Missouri 64730 816/679-3127

how to use the smith chart

Although articles on the Smith chart have appeared in amateur magazines from time to time, amateurs have made little use of this handy transmission-line calculator — probably because it has been difficult to measure complex impedances with simple homebuilt equipment. However, this problem has been solved with the simple impedance bridge described by W2CTK — at least for the high-frequency range.¹ With careful attention to lead dress and component layout his instrument should be usable on six and two meters.

A hasty glance at the Smith chart suggests a formidable array of curved lines and circles that would cause the most hardened technician to go into fits of despair. On the other hand, if you spend a little time with the chart and look at each of its component parts, it's not really very complicated. Perhaps the one thing that scares many prospective users is its unfamiliar circular shape; it's not at all like the straight-line graphs you're accustomed to. However, when you understand the chart and have mastered its use you'll be able to solve complex impedance and transmission-line problems much easier and faster than ever before.

layout of the chart

The Smith chart is basically a circle which contains various circular scales. The horizontal line through the center marked "resistance component" is the only straight line on the chart and is called the "axis of reals" (see fig. 1). Constant resistance circles are centered on the axis of reals, tangent to the rim of the chart at the infinite resistance point.

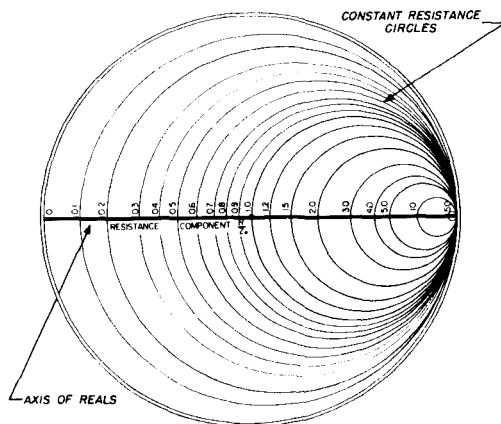

fig. 1. Smith chart resistance scales.

All the points along a constant-resistance circle have the same resistive value as the point where it crosses the axis of reals.

Superimposed upon the resistance-circle pattern are portions of other circles tangent to the axis of reals at the infinite

that a 560 - ohm component would have the value $560/400 = 1.4$ ohms in normalized terminology, while $Z' = 0.9$ in normalized form would actually be $0.9 \times 400 = 360$ ohms.

plotting values on the chart

Any complex impedance, regardless of value, may be plotted on the Smith chart. For example, assume the load on a 50-ohm transmission line is $42.5 - j31.5$ ohms. This is equal to $0.85 - j0.63$ when normalized. To plot this point on the chart, locate 0.85 on the axis of reals and note the corresponding constant-resistance circle (fig. 4). Next locate 0.63 on the periphery of the chart. The quantity (-j) indicates a capacitive-reactive component so the value 0.63 is on the lower half of the chart. Note the constant-reactance circle representing $-j0.63$. The complex impedance $0.85 - j0.63$ is at the intersection of the constant-resistance and constant-reactance circles.

Draw a line from the center of the chart through this point to the outer rim. With the point 1.0 on the axis of reals as the center, scribe a circle that intersects the impedance point. This circle is known as the "constant-gamma circle," and its radius is equal to the coefficient of reflection. The constant-gamma circle crosses the axis of reals at two points; the point of intersection to the right of center is the standing wave ratio (2.0 in this case).

If the voltage were measured at this point on the transmission line, it would be found to be at a maximum. Conversely, the point of intersection one-quarter wavelength away on the left-hand axis of reals is a point of voltage minimum (this point is also equal mathematically to the reciprocal of the swr).

The point at the intersection of the radial line and the angle of reflection coefficient scale represents the phase of the coefficient of reflection. This is the angle by which the reflected wave leads or lags the incident wave. When these two waves add in phase to give maximum voltage, the impedance is resistive and greater than the characteristic impedance

of the line and the angle of the coefficient of reflection is zero. As you move away from the zero-phase-angle point in a clockwise direction toward the generator the reflected voltage lags the incident voltage, and the phase angle is negative for the first quarter wavelength. The reactive component of the impedance in this region is negative or capacitive.

At the quarter-wavelength (90°) point the incident and reflected waves are out

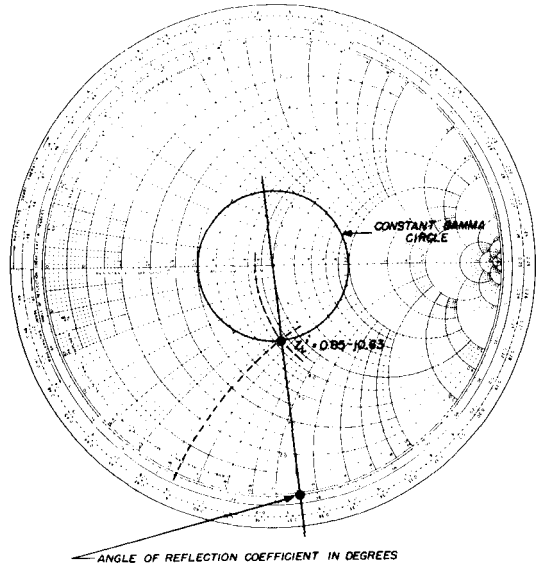

fig. 4. Plotting impedance coordinates on the Smith chart.

of phase and the angle of the coefficient of reflection is $\pm 180^\circ$. As you continue in a clockwise direction the two waves become increasingly more in phase and between one-quarter and one-half wavelength from the voltage maximum the reactive component is inductive, the reflected wave leads the incident wave, and the reflection coefficient has a positive angle.

A number of parameters are uniquely related to one another as well as to the magnitude of reflections from the load and are conveniently plotted as scales at the bottom of the Smith chart. These

parameters are vswr, coefficient of reflection, vswr in dB, reflection loss in dB and attenuation in 1-dB steps.

using the smith chart

The general utility of the Smith chart is best illustrated by showing examples of its more common uses. Use of the radially-scaled parameters will be shown in the same way.

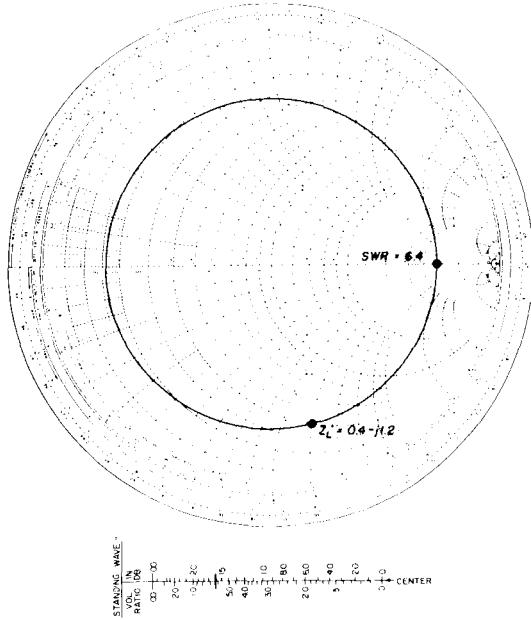

fig. 5. Using the Smith chart to find swr (example 1).

example 1. Finding standing-wave ratio.

A 75-ohm transmission line is terminated with a load impedance $Z_L = 30 - j90$ ohms. What is the swr? (See fig. 5.)

1. Normalize the load impedance by dividing by 75

$$\frac{30 - j90}{75} = 0.4 - j1.2$$

2. Locate this point on the chart.

3. Construct a constant-gamma circle

so its circumference passes through this point.

4. The swr is defined by the point where the constant-gamma circle crosses the axis of reals on the right-hand side. In this case $swr = 6.4$.

5. The swr may also be determined with the radial nomograph. This is simply accomplished by marking a distance equal to the radius of the constant-gamma circle on the radial scale labeled "standing wave voltage ratio." The value of swr in dB may also be determined from this scale.

$$swr_{dB} = 16.1 \text{ dB}$$

example 2. Finding the reflection coefficient (Γ) and angle of the reflection coefficient (α) for voltage and current.

A 50-ohm transmission line is terminated with a load impedance $65 - j75$ ohms. What is the reflection coefficient and angle of reflection coefficient? (See fig. 6.)

1. Normalize the load impedance

$$\frac{65 - j75}{50} = 1.3 - j1.5$$

2. Locate this point on the chart and draw a line from the center of the chart through it to the outer scale.

3. Construct a constant-gamma circle.

4. The reflection coefficient may be calculated by measuring the radii of the constant-gamma circle and the Smith chart to its first periphery and by computing their ratio. Smith-chart radius = $57/16$ inch; constant-gamma radius = $32/16$ inch.

$$\Gamma = \frac{32}{16} \div \frac{57}{16} = 0.56$$

5. The coefficient of reflection may also be found on the radial nomo-

graph. Simply mark the radius of the constant-gamma circle on the scale labeled "reflection coefficient of voltage." The constant-gamma radius intersects the radial scale at 0.56. The "reflection coefficient of power" may also be determined from this same scale at 0.314.

6. The angle of the reflection coefficient is defined by the intersection of the radial line plotted in **step 2** and the "angle of reflection coefficient in degrees" scale on the rim of the chart.

$$\alpha = -46^\circ$$

example 3. Finding input impedance.

A 50-ohm transmission line 20 feet long is terminated with $Z_L = 50 - j50$ ohms. What is the input impedance at the sending end of the line at 14.1 MHz? (See **fig. 7**.)

1. Normalize the load impedance

$$\frac{50 - j50}{50} = 1 - j1$$

fig. 6. Finding reflection coefficient with the Smith chart (example 2).

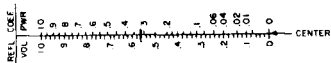
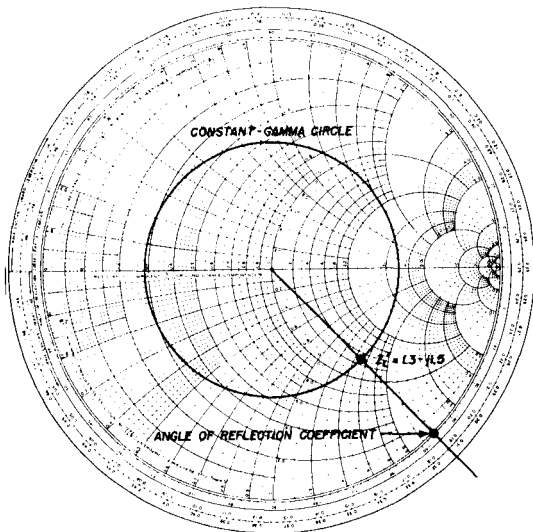

2. Find the length of the transmission line in meters by multiplying by 0.3048.*

$$20 \text{ feet} \times .3048 = 6.096 \text{ meters}$$

3. Find the electrical length of the transmission line at 14.1 MHz. First, determine the wavelength at 14.1 MHz. Free-space wavelength is found

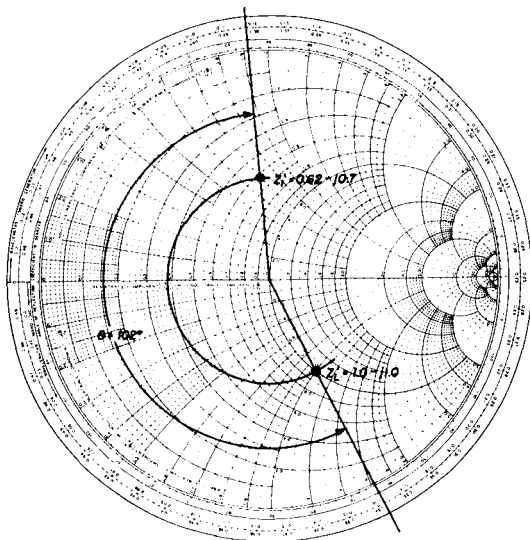

fig. 7. Using the Smith chart to find input impedance (example 3).

by dividing the speed of light by frequency

$$\lambda = \frac{3 \times 10^8 \text{ meters per second}}{14.1 \times 10^6 \text{ cycles per second}} = 21.276 \text{ m}$$

Calculate the electrical length of the transmission line

$$\theta = 360^\circ \left(\frac{6.096 \text{ m}}{21.276 \text{ m}} \right) = 102^\circ = 0.28 \text{ wavelength}$$

4. Plot the impedance coordinates from **step 1** on the chart and draw a line from the center of the chart through this point to the outer scale.

*Although all the computations may be made in feet (or inches) the metric equivalents are somewhat easier to work with. To convert from inches to centimeters, multiply by 2.54.

5. Draw another line from the chart center to the outer scale at a point 0.28 wavelength clockwise (toward the generator) from the line drawn in step 3. Swing an arc from the center of the chart through Z_L' to this line. The intersection is at $Z_L' = 0.62 + j0.7$, the normalized input impedance. To find the actual impedance this value must

3. Swing an arc through Z_L' to the line on the opposite side of the chart. The point of intersection denotes the *normalized admittance*

$$Y_L' = 0.305 - j0.33$$

4. Calculate the actual admittance by multiplying the characteristic admittance of the system times the normalized admittance. The characteristic admittance (Y_0) is equal to the reciprocal of the characteristic impedance

$$Y_0 = \frac{1}{Z_0} = \frac{1}{50} = 0.02 \text{ mho}$$

Therefore, the admittance is

$$Y_L = 0.02(0.305 - j0.33) \\ = .0061 - .0066 \text{ mho}$$

example 5. Determining the effect of a characteristic impedance change.

A 50-ohm transmission line, 0.15 wavelength long, is terminated with $100 - j0$ ohms. The 50-ohm line is fed from a 72-ohm line. What is the *vswr* in the 72-ohm line? (See fig. 9.)

1. Normalize the load impedance

$$Z_L' = (100 - j0)/50 = 2 - j0$$

2. Determine the input impedance at the point where the two transmission lines are connected, 0.15 wavelength from the load. Plot the normalized load impedance on the chart and draw a line from the center of the chart through this point. Note that the line crosses the "wavelengths toward generator" scale at the 0.25 wavelength mark (fig. 9A).

3. Move 0.15 wavelength in a clockwise direction along the "wavelengths toward generator" scale to the 0.40 wavelength mark. Draw a line from this mark through the center of the chart. Swing an arc through Z_L' . The intersection of the arc and the radial line denote the input impedance to the

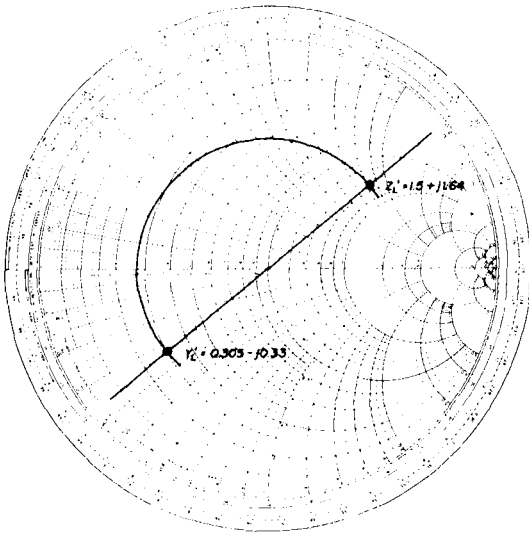

fig. 8. Calculating load admittance (example 4).

be multiplied by the line's characteristic impedance

$$Z_i = 50(0.62 + j0.7) = 31 + j35$$

example 4. Calculating load admittance.

The impedance of a load terminating a 50-ohm transmission line is $75 + j82$ ohms. What is the admittance of the load? (See fig. 8.)

1. Normalize the load impedance

$$Z_L' = (75 + j82)/50 = 1.5 + j1.64$$

2. Plot this point and draw a line through the center to the outer scale on the opposite side of the chart.

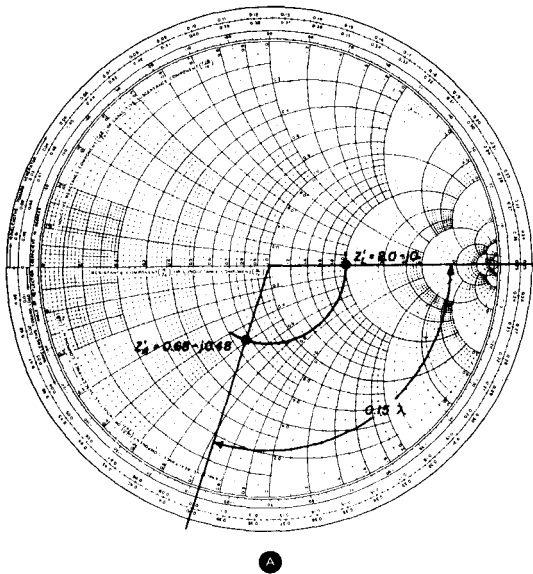

A

50-ohm transmission line 0.15 wavelength from the load

$$Z_{A'} = 0.68 - j0.48$$

4. Find the impedance at point A (fig. 9C) and normalize to the 72-ohm line. The impedance at point A is $50(0.68 - j0.48) = 34 - j24$ ohms. Normalize this value to the 72-ohm line

$$(34 - j24)/72 = 0.47 - j0.33$$

5. Plot this point on the chart (fig. 9B) and draw a circle through Z_A to the "axis of reals." The vswr in the 72-ohm line is 2.5:1. The vswr can also be found with the radial nomograph as outlined in example 1.

In the upper vhf region ordinary capacitors and inductors cannot be relied upon to act as pure reactances, and sections of transmission line are often used in their place since any input reactance may be obtained with the proper length of open- or short-circuited line.

example 6. Transmission lines as circuit elements.

It is desired to obtain +j100 ohms reactance with a 50-ohm short-circuited

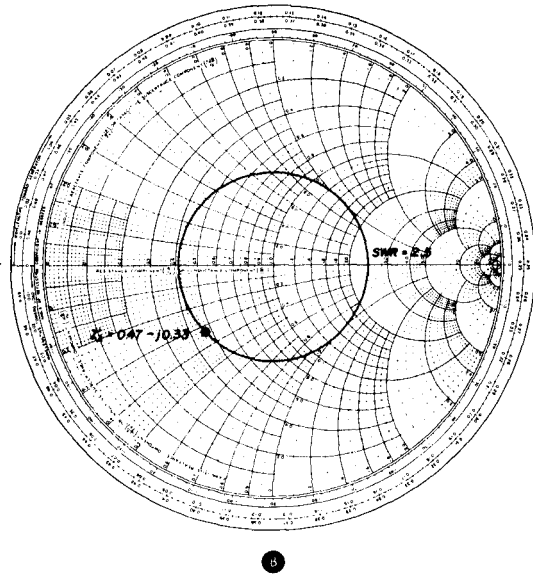

B

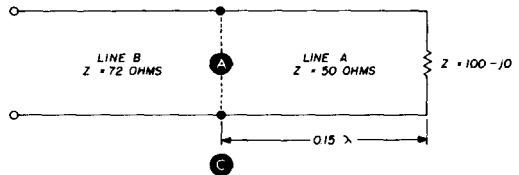

C

fig. 9. Determining the effect of a characteristic impedance change (example 5).

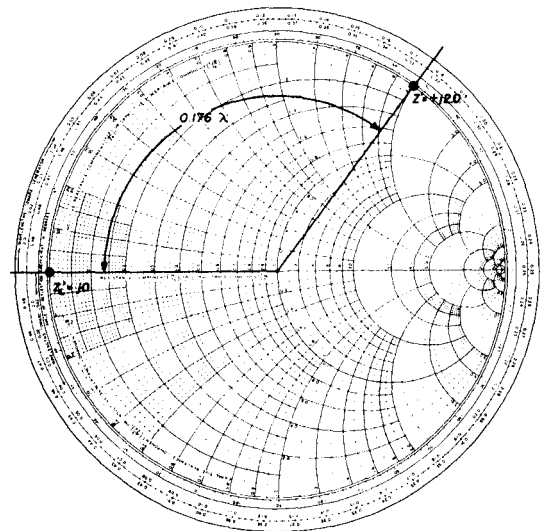

fig. 10. Using a transmission line as a circuit element (example 6).

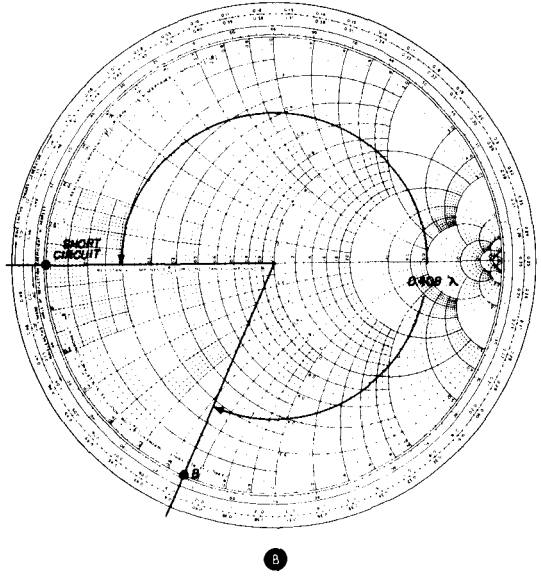
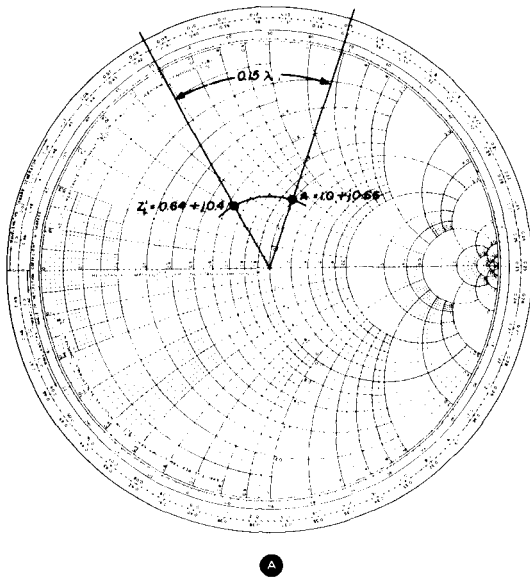

fig. 11. Finding matching stub length and location (example 7).

transmission line as the circuit element. What length is required? (See fig. 10.)

1. Normalize the desired reactance

$$Z' = (+j100)/50 = +j2$$

2. Since the line is short-circuited,

$$Z_L = 0 + j0, \text{ and } Z_L' = 0 \text{ ohms.}$$

3. Plot these two points on the chart and draw lines from the center of the chart through each of them. On the "wavelengths toward generator" scale there is a distance of 0.176 wavelength between the two lines. Therefore, a transmission line 0.176 wavelength long is required for a reactance of +j100. (At 144 MHz, +j100 represents an inductance of 0.11 μH .)

example 7. Finding matching stub length and location.

A 50-ohm transmission line is terminated with a load impedance of $32 + j20$ ohms. A matching stub is to be used to provide a match to the line. Both the length of the stub (L_S) and its distance

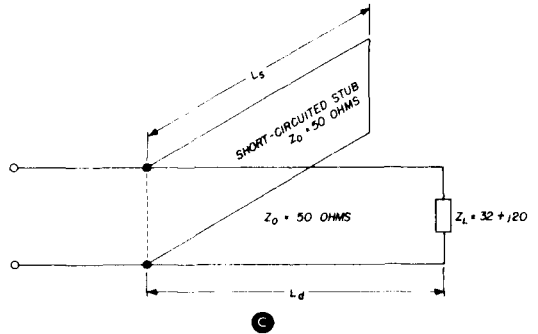

from the load (L_D) are variable; find L_S and L_D . (See fig. 11.)

1. Normalize the load impedance

$$Z_L' = (32 + j20)/50 = 0.64 + j0.4$$

2. Locate this point on the chart and draw a line through it to the outer scale. The line crosses the "wavelengths toward generator" scale at the 0.085 mark.

3. Construct a constant-gamma circle through the impedance point, terminating it at the unity resistance circle (point A in fig. 11B).

4. Draw a line through point A to the outer scale of the chart. This line crosses the "wavelengths toward generator" scale at 0.15. L_d , the position of the matching stub, is the distance between the two lines on the "wavelengths toward generator" scale.

$$L_d = (0.15 - 0.085) = 0.065 \lambda$$

5. To find the length of the stub, determine the amount of reactance necessary to match out the load. The required reactance is the difference between the reactance at point A and the reactance at the center of the chart. The reactance at point A is $+j0.66$; the reactance at the center of the chart is $+j0$. The required stub reactance is

$$j0 - j0.66 = j0.66$$

6. Locate the reactance $-j0.66$ on the rim of the chart (point B, fig. 11C). Determine the distance between the short-circuit point and the required reactance (point B) along the "wavelengths toward generator" scale. $L_s = 0.408$ wavelength.

This matching technique can be used on the high frequencies as well as vhf. On 15 meters for example (21.3 MHz), using 50-ohm coax, a 158-inch stub would be placed 25 inches from the load. On 432 MHz a 7.82-inch stub would be placed 1.24 inches from the load.

lossy lines

All the examples shown so far have assumed no attenuation in the transmission line. Since all lines have some loss, this must be considered to find the actual case. However, at many amateur frequencies loss is low enough to be neglected. Nevertheless, at 144 MHz and above, line loss should be considered when using the Smith chart.

Attenuation along a uniform transmission line causes the impedance point to spiral inward toward the center of the chart when moving toward the generator;

when moving toward the load the impedance point spirals outward toward the rim of the chart. The rate at which the spiral approaches the center (or the rim) depends upon the attenuation as well as the starting point. Impedance points near the rim are affected more per dB of attenuation than points near the center.

The attenuation effect is easily determined with the scale at the bottom of the Smith chart labeled "transmission loss, 1-dB steps." Since the initial point on this scale must apply to any point on the chart, it is laid out without numerical calibration. The opposite attenuation effects of moving toward the load as opposed to moving toward the generator are indicated by arrows on the scale which show the proper direction to move the corrected impedance point. Thus, to determine the effect of 2-dB attenuation, simply mark off two 1-dB intervals in the proper direction along the scale from the initial starting point before reading the actual impedance coordinates.

example 8. Impedance transformation through a lossy line.

A 50-ohm transmission line 24 centimeters long is terminated with $10 - j10$ ohms. What is the input impedance to the line at 250 MHz if the attenuation of the line is 2 dB? (See fig. 12.)

1. Normalize the load impedance

$$Z_L' = (10 - j10)/50 = 0.2 - j0.2$$

2. Find the electrical length of the line at 250 MHz.

$$\lambda = \frac{300 \times 10^8}{250 \times 10^6} = 120 \text{ cm}$$

The electrical length of the line is

$$\theta = 360^\circ \left(\frac{24 \text{ cm}}{120 \text{ cm}} \right) = 72^\circ = 0.2 \text{ wavelength}$$

3. Plot the impedance from step 1 on the chart and draw a line through this point to the outer scale.

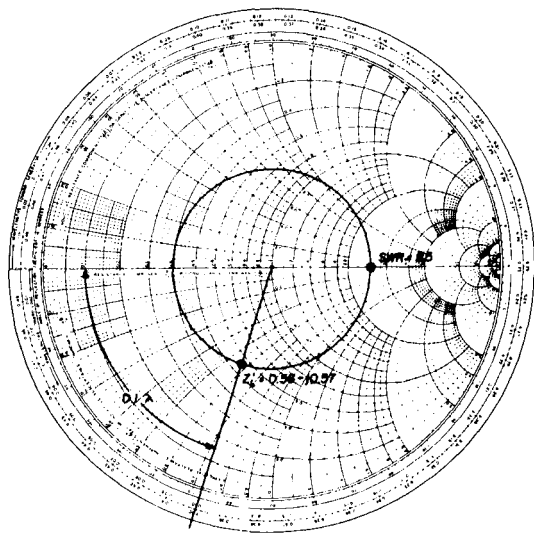

A

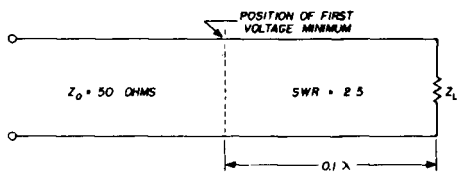

B

fig. 13. Using the Smith chart to find load impedance from vswr and position of the first voltage minimum on a slotted line (example 9).

fig. 14. Use of the expanded Smith chart. Impedance points in A are too close together; expanded chart in B is easier to work with.

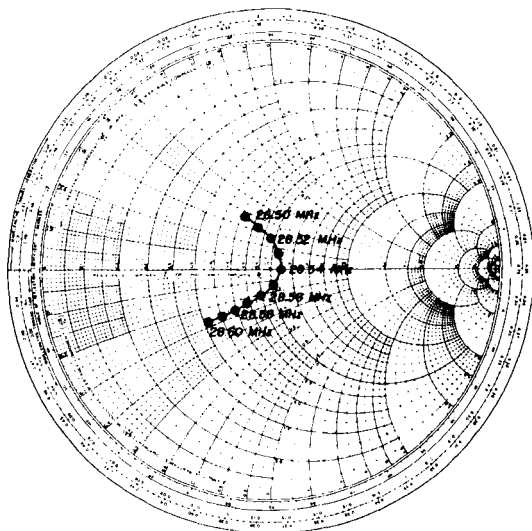

A

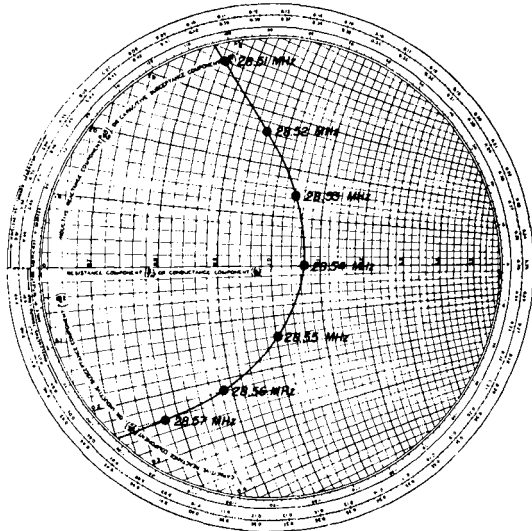

B

line this technique could be used to determine the impedance of your antenna. However, the voltage probe must be held a uniform distance away from the line for all measurements, and must not be so close that it disturbs the electric field around the conductors.

expanded smith charts

The more closely an antenna is matched to a transmission line, the closer the impedance points are to the center of the Smith chart. In a well-designed system the impedance points may be so close to the center of the chart that it's difficult to work with them. When this happens it's best to use an expanded Smith chart. Two versions are commonly available: one with a maximum swr of 1.59, the other with a maximum swr of 1.12.

The use of the expanded Smith chart is shown in fig. 14. In fig. 14A the impedance plot of a well-matched 10-meter beam over the low end of the phone band falls very close to the center of the chart. When these same impedance points are plotted on the expanded Smith chart in fig. 14B they are much easier to read and work with.

where to buy them

Smith charts can usually be purchased at college bookstores in small quantities, or in larger quantities from Analog Instruments Company or General Radio.* If you buy directly from the manufacturer the minimum quantity is a little large so it might be a good idea to get your club to sponsor the purchase.

Another solution is the Smith-chart rubber stamp shown in the photo. This stamp is 10 cm (about 4 inches) in diameter and presents an adequately detailed grid structure for most engineering problems. The rubber surface of these stamps is cast from metal dies, and is dimensionally compensated for rocker-mount ellipticity and shrinkage. The

capacity is well over a million impressions so you should never be able to wear it out. The stamps are available in standard ($v_{swr} = \infty$) or expanded form ($v_{swr} = 1.59$ or 1.12) from the Analog

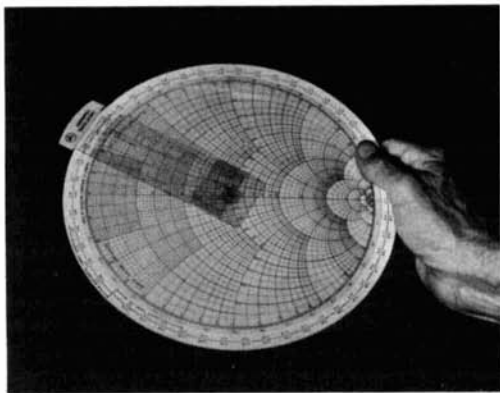
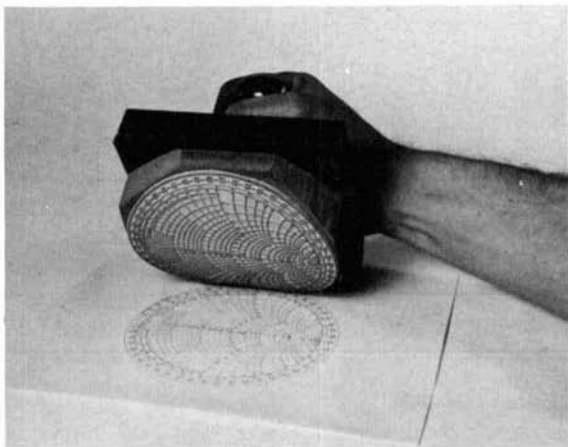

fig. 15. Smith chart calculator provides rapid answers to complex impedance problems.



Smith chart rubber stamp is 10 cm in diameter.

*Smith charts from Analog Instruments come in packages of 100 sheets, \$4.75 the package. For standard charts order 82-BSPR; expanded charts (maximum $v_{swr} = 1.59$), order 82-SPR; highly expanded (maximum $v_{swr} = 1.13$), order 82-ASPR. Analog Instruments Company, Post Office Box 808, New Providence, New Jersey 07974

Smith charts from General Radio are available in pads of 50 sheets, \$2.00 per pad. For standard charts, normalized coordinates, order 5301-7560; 50-ohm coordinates, order 5301-7569; normalized, expanded coordinates, order 5301-7561. General Radio, West Concord, Massachusetts 01781.

Instruments Company. Cost is \$14.75 each.

If you don't need a permanent record of your Smith chart calculations, the calculator shown in fig. 15 provides rapid answers to complex impedance problems. This calculator is constructed from two laminated plastic discs and a radial arm pivoted at the center with a sliding cursor. A circular slide rule is provided on the reverse side. Complete instructions are furnished. Priced at \$3.00 from Amphenol RF Division, 33 E. Franklin Street, Danbury, Connecticut 06810; ask for the Amphenol RF Calculator.

references

1. Henry S. Keen, W2CTK, "A Simple Bridge for Antenna Measurements," *ham radio*, September, 1970, p. 34.
2. Phillip H. Smith, "Transmission Line Calculator," *Electronics*, January, 1939, pp. 29-31; and "An Improved Transmission Line Calculator," *Electronics*, January, 1944, pp. 130-133 and 318-325.
3. Phillip H. Smith, "Electronic Applications of the Smith Chart in Waveguide, Circuit and Component Analysis," McGraw-Hill, New York, 1969.

ham radio

injection laser experiments

A progress report
on further
development
of pulsed-light
circuits for
one-way ranging

Ralph W. Campbell, W4KAE, 316 Mariemont Drive, Lexington, Kentucky 40505

In an earlier article I described my experiments with light-emitting diodes operating in the near infrared.¹ Pulsed power supplies, photodetectors, and optical enhancement devices were also discussed. These early experiments were a first approach toward understanding the more sophisticated injection laser for use in a communications link.

This article describes the results of my work with injection lasers and related devices. I hope it will provide an incentive for further experimentation by amateurs who are interested in exploring new frontiers in electronics.

pulsed-light devices

After almost a year of research, I learned that injection lasers were in their infancy—much like the bipolar transistors of 20 years ago. On the development market a 2-watt (peak) injection laser costs \$36-\$50. RCA's TA-2628 gallium arsenide injection laser (3 watts peak) is listed in their Fall 1969 pricing sheet.* It

*The TA-2628 is "inventory limited" according to information obtained from an RCA field office. Their May 15, 1970 listing shows 166 pieces in stock at \$36.25. Their recommended replacement is TA-7606; same price. **editor**

Injection laser/pulsar power supply.
Sample 4 of RCA's developmental
TA-7535 is used. Total power output is
1W minimum.

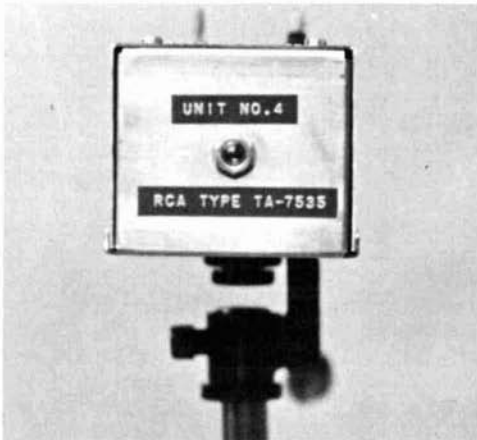

is recommended as the least-expensive injection laser diode for experimental work. Also recommended is the pulsed power-supply circuit included in the TA-2628 data sheet.

As mentioned in my previous article, the limiting element in an LED communications system is the detector. This is equally true for systems using injection lasers. Although other photodetectors are mentioned as substitutes and replace-

shown in table 1. Transmitting optics must be used in all cases. Further range enhancement would require an S1 photo-multiplier with a filter and huge fresnel optics. Average power is 10^{-3} to 5×10^{-3} of the peak values shown in the table.

My PIN-10 detector was operated in the back-biased photoconductive mode. With a special network, it can be used as a photovoltaic detector. I will be happy to

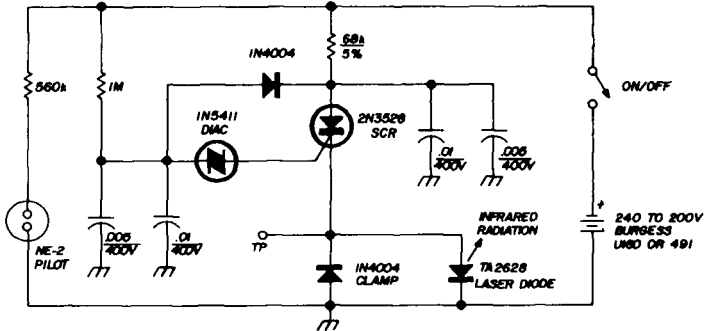

fig. 1. A 30-ampere (peak) pulsed power supply for the RCA TA-2628 injection laser. This circuit is recommended for experimental cut-and-try work. (Courtesy RCA.)

ments in the following circuits, the type PIN-10 broad-area Schottky photodiode, made by United Detector Technology,* is the recommended device for serious work. This is the detector with which I achieved a communication range of more than 1000 feet with my experimental injection laser equipment. I found that it was impossible to detect ambient non-coherent light sources with the PIN-10, so you won't have to worry about street lights overloading the detector.

laser ranging

For amateur work, cw or keyed pulse (like A2 emission) is the best modulation method for use with injection lasers. I expect to see a 2-mile range in as many years using a 10-watt-peak injection laser at 9000 angstroms. Estimated keyed-pulse communication ranges at the present time, based on my research, are

*United Detector Technology, 1732 21 St., Santa Monica Calif. 90404.

furnish this information to serious experimenters upon receipt of a self-addressed stamped envelope.

True photoconductive operation should not be confused with majority-carrier photoresistive detectors, such as the cadmium selenide cells. These devices are sluggish performers when used with pulsed light at pulse repetition rates above 500 Hz. Their only advantage is high sensitivity, which is a worthwhile tradeoff in certain applications.

detector parameters

A handy aid for determining the operating characteristics of a silicon photodiode is the "Silicon Photo Detector Calculator" made by UDT. This is a plastic slide-rule-type device similar to reactance calculators and the like. It allows one to design a thermal-agitation, noise-limited, back-biased network for a specific application. The UDT calculator was indispensable for this project.

fig. 2. Pulsar circuit for a laser array (300 W peak) or a discrete laser diode. Rise time of the scr is important, and winding sense of the transformer must be correct. The trigger module cannot be keyed.

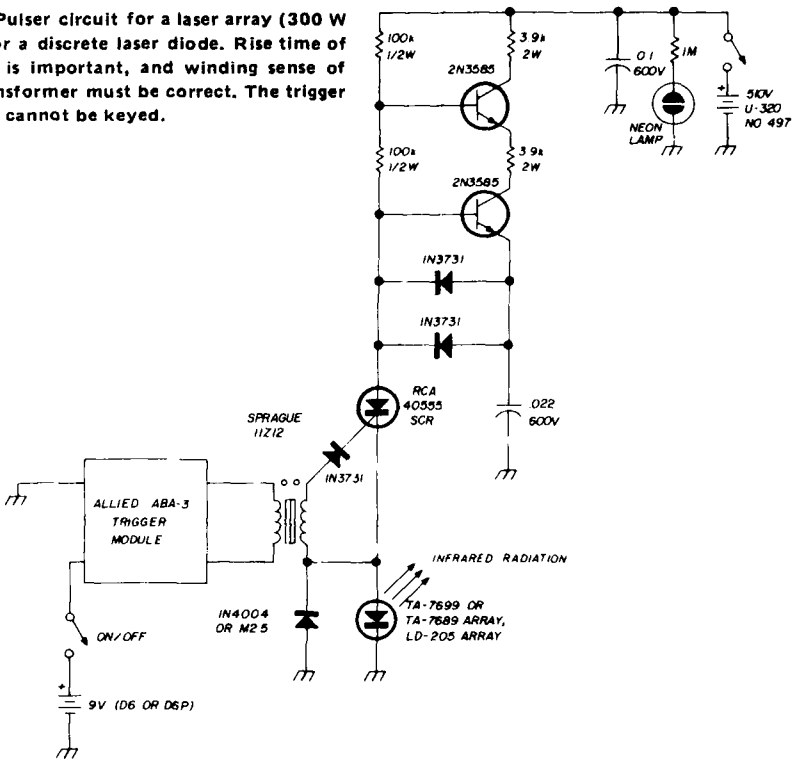

sample calculation

The PIN-10 has the following parameters:

dark current	5×10^{-7} A
junction capacitance	100 pF
responsivity	500 mA/W
minimum load resistance	5k ohms (Johnson-noise limited)

Using the calculator, we find:

rise and decay time	1.1 μ sec
half-power cutoff freq.	300 kHz
noise equivalent power	3.6 μ W (detector shot noise)

My goal was to make the noise equivalent power (nep) of the 5k load equal to the shot noise of the biased detector. The actual nep is only 1.4×10^{-13} watt with the 5k load resistor. To reconcile the difference, it's necessary to increase the value of the load resistor until a true noise match occurs. In this case, I used 500k. This match exists between the resistor shot noise and the detector shot noise. (Resistor noise is of the shot type

when using a load resistor higher than 50k.)

The remaining problem is to determine the frequency response based on the loads. With a 500k load and a 100 pF junction capacitance, the half-power-point cutoff frequency is only 3 kHz. This is too low for applications with a prf of 500 Hz, because frequencies up to 5 kHz must be passed to retain the proper laser pulse shape. By using the lower scale of the calculator, it is found that 330k instead of 500k is the proper load resistance for photoconductive operation of

table 1. Estimated ranges for injection laser systems.

GaAs laser power (watts peak)	bare PIN-10 detector (miles)	PEM detector* (miles)
2	1	6
20	3.2	19.2
200	—	60
2 K	—	192

*Developed by Santa Barbara Research Center

table 2. Summary of injection laser data from manufacturers' sheets.

device type	peak power (watts)	peak reverse voltage (volts)	threshold current (amps)	forward current (amps)	pulse width (nsec)	rep rate (Hz)	duty cycle (%)	wavelength (Å ⁰)
TA-2628*	3	3	12	30	200	20x10 ³	0.02	9050
TA-7535	2	2	4	10	200	5x10 ³	0.1	9050
LD205 array	100	60	25	75	200	500	—	9000

Notes: 1. Maximum values at 25° C

2. Peak reverse voltage should not be exceeded

*replaced by TA-7606; same operating characteristic.

the PIN-10.

For photoresistive applications, such as shown in fig. 4, it's permissible to use a 33k load resistor. However, it should be borne in mind that a bipolar emitter-follower is used here, not an fet. If you'd like to experiment with a 50k low-noise carbon-film load resistor, you'll find that a Johnson/shot-noise match will occur with this input circuit. Back bias should be the same as shown (i.e., 10–15V).

I am now operating my PIN-10 with about 50V back bias into a 330k load resistor. The circuit is coupled to an MPF-107 jfet operating as a source follower. I've had excellent results with this circuit. A shot-noise match of both load resistor and the PIN-10 occurs at 5 kHz.

radiation safety

Much has appeared in the press about the dangers of radiation from lasers. While it's true that a high-power pulsed ruby rod or glass laser presents a health hazard, this is not true of the low-power injection devices described in this article. Looking directly into the sun is much more dangerous than looking into an injection laser, even at what might be considered traumatic levels of 10 mW average power through collimating optics. Authorities on the subject have indicated that external average radiation levels of the order of 10 mW from a pulsed ruby rod are used for surgical work. An upper limit for such use is 2 W average power—not the 1–5 mW used with the injection lasers described here. So there's no reason for apprehension about radiation danger with the circuits shown.

pulsed power supplies

The pulsed power supply shown in fig. 1 is based on the circuit in the RCA data sheet for the TA2628 GaAs injection laser. It evolved from long-distance phone conversations and much correspondence with RCA. I call it the "RCA Classic Pulser." It's the only reliable pulser suitable for extensive experimental work involving "cut, try, and innovate" designs.

The circuit is limited by the rise and fall times of the 1N5411 diac rather than

300W (peak) laser array pulser. This is the highest-powered laser-array pulser suitable for amateur work. Unit uses type LD-205, LD-205S, or TA-7692 array diodes. TA-7689 can be used with about 300V.



scr switching frequency. The 2N3528 scr has a TO-66 case, which is handy for cut-and-try techniques.

The 1N4004 diodes protect the laser and the scr. The 1-meg resistor in the diac circuit is preferable when using battery power, because the 2.2-meg resistor in the RCA data-sheet circuit for the TA-2628

resulted in no oscillation. Another replacement for the TA-2628 is the TA-7535, which I am now using. (See table 2.)

The circuit of fig. 2 is a pulser for a laser array such as the RCA TA-7689 or Laser Diode Laboratories' type LD-205.* The circuit can also be used to drive an

fig. 3. One- or ten-kHz oscillator that can be frequency modulated for voice work. Typical turn-on and turn-off times of the 1N3829 are 20 and 40 nsec. (Courtesy RCA.)

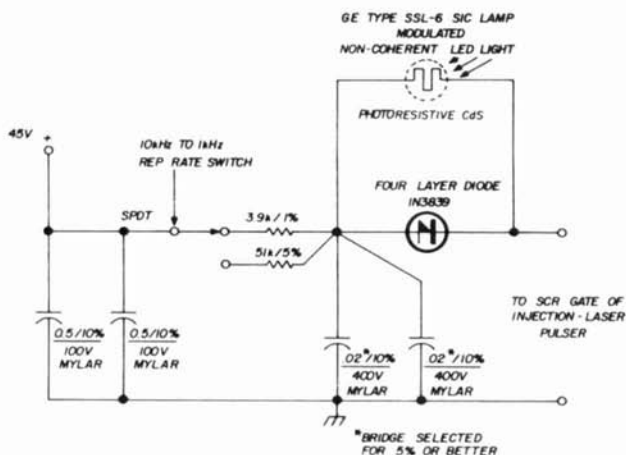

Portable injection laser transmitter and detector. The detector (top) is the same unit described in author's article in ham radio on LED experiments using L14A502 photodiodes, which are replaceable with MRD-500's for best results.

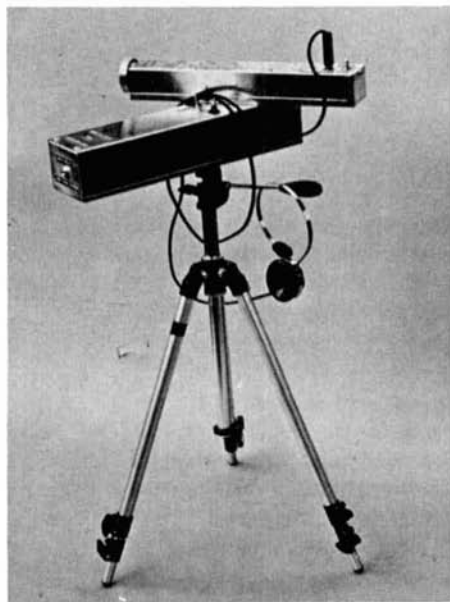

RCA TA-7699 discrete injection-laser diode. The advantage of this circuit is that it provides a better match for an array load (up to 10 ohms impedance). If used with the TA-7699, the circuit will develop 3 to 5.5 times the necessary threshold current for low-impedance applications.

The external trigger circuit, using the Allied ABA-3 module and Sprague 11Z12 pulse transformer, allows random pulse trains to fire the scr. A possible application would be optical radar ranging.

Rise time of the scr is critical. Also, the winding sense of the transformer must be correct or nothing will happen. TO-66 transistors were used, because they simplify the wiring (a must for short leads) and eliminate dependence on terminal strips.

*The source for RCA lasers is Solid-State Optical Engineering, RCA, U. S. Route 202, Somerville, N. J. 08876. Best source for laser pulsers and high-power arrays is Laser Diode Labs, 205 Forrest St., Metuchin, N. J. 08840.

diode oscillator

The circuit of **fig. 3** is strictly for experimental use. It is straight from RCA's research labs and is not one of my innovations. I am presenting it to show the state of the art as of this writing.



The UDT type PIN-10 broad-area detector, recommended for laser diode receivers. The receiving optics were discarded, because surface pickup is important rather than narrow-beam optical gain with these detectors.

An ITT four-layer diode, the 1N3839 (\$7.73), can be used for oscillator service at 1 and 10 kHz. This device (and probably the APD4C50, made by American Power Devices, Inc.) are the only superfast triggers with timing response of less than 50 nsec that will allow injection-laser pulsing at the prf up to 10 kHz. The cadmium selenide cell in parallel with the 1N3839 can be used for voice work by frequency modulating noncoherent light input.

Before attempting to build and operate this circuit, I'd suggest that you write to me. I'll be glad to answer questions on design based on my latest data.

detectors

As pointed out previously, the UDT PIN-10 is a must for serious work with

injection-laser communications systems. The PIN-10 has broad-area response. Aspheric condensing lenses were used at first to gather received laser light from an aperture in space. It soon became obvious that the optics weren't necessary because of the broad-area response of the PIN-10. A better detector is the UDT PIN-25; however its cost may be beyond the resources of the experimental researcher.

A schematic of a bipolar laser detector is shown in **fig. 4**. This circuit was designed for CdSe cells, but will also work with so-called "exotic" devices such as the PIN-10. The 33k load resistor is optimum for an array of three cells. With the larger p-i-n diodes such as the PIN-25, bias would be $-45V$ and the load resistor would be 1 meg. If you use, say, $-9V$ reverse bias on a PIN-10, a 180k low-noise carbon-film resistor would make a satisfactory load.

A broad-area detector for use with type MRD500 photodiodes was developed, based on the circuit shown in **fig. 9** of my previous article¹ on LED experiments. This modified circuit uses 7-10 MRD500s in an array that replaced the

The M3 Sniperscope, battery, and high-voltage power supply. Unit is essential for collimating laser energy and boresighting.



L14A502 phototransistors in the LED detector. Interested readers may obtain a copy of this broad-area detector circuit by sending me a self-addressed stamped envelope.

construction hints

The photos show details for constructing the circuits. Improvisation is used for mounting large components. For example, the high-voltage dry cells were cemented in place. I used Deltabond thermal epoxy type 152 to mount the laser in an MX-1684/U coax termination, which had been drilled to 3/16-inch ID.

Problems with cementing lenses were resolved by mounting, checking beam tilt, returning the unit to an epoxy disintegrating solution, and repeating the work until a satisfactory mount was obtained. Oven curing was used to save time. A Bud MS-3050 minislid box chassis holds the

detector in ranging tests. This Sniperscope was purchased for \$50 from a surplus source. It was barely in working order, and I had to rebuild it. (One source quoted \$325 for a Sniperscope, so it pays to shop around!)

The image tube in the Sniperscope is a type 6032. It has a peak-power conversion/sensitivity loss of 30 dB when used with pulsed devices at 0.1-percent duty cycle; thus it will not respond to peak power.

Since the instrument is basically an infrared telescope, it's difficult to use at distances greater than 100 meters or when the field of view is too narrow. About 450 feet is the practical limit from my experience.

Despite its limitations, the Sniperscope is essential for initial setup and adjustment of equipment before starting extended laser range tests. Instruments

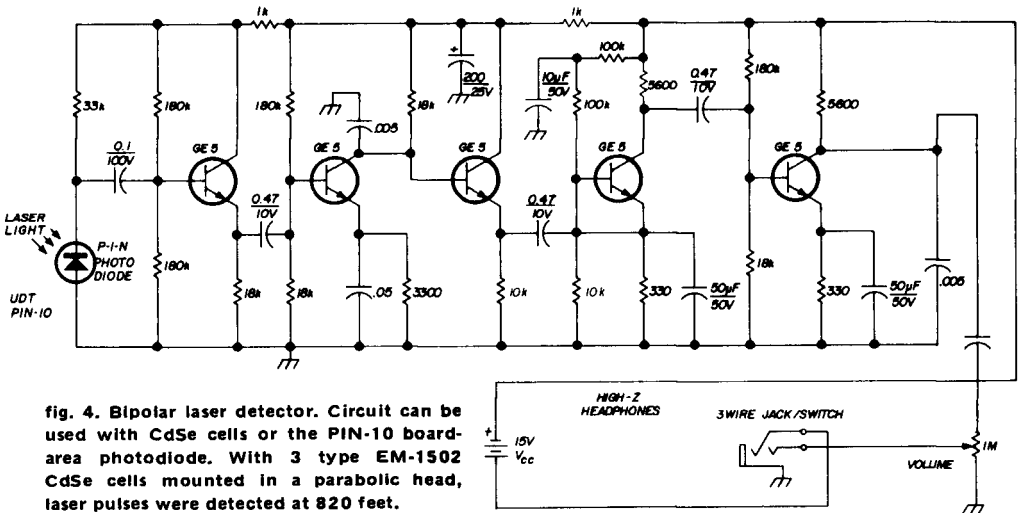

fig. 4. Bipolar laser detector. Circuit can be used with CdSe cells or the PIN-10 board-area photodiode. With 3 type EM-1502 CdSe cells mounted in a parabolic head, laser pulses were detected at 820 feet.

works. Regular-sized terminal strips are preferable for mounting the larger 0.01 and 0.005 μ F capacitors. Epoxy was used to mount the scr in the pulser chassis.

collimating optics

The M3 Sniperscope shown in the photo is used to collimate the near field of the laser and for boresighting laser and

using the 1P25 and British CV-148 tubes aren't recommended for this use. If anyone knows of a surplus instrument using a 6929 or 6914 image tube, I'd appreciate receiving the information.

range tests

A problem in testing this equipment is finding a clear, flat, unobstructed area.

ham radio

1. R. W. Campbell, "Gallium Arsenide LED Experiments," *ham radio*, June, 1970, p. 6.
2. C. H. Gooch, "Gallium Arsenide Lasers," John Wiley & Sons, 22 Worcester Road, Rexdale, Ontario, Canada.
3. "Silicon Photodetector Calculator," United Detector Technology, 1732 21 St., Santa Monica, Calif. 90404.
4. Data sheet, "Gallium Arsenide Laser Diode Array LD200, LD200S Series," Laser Diode Laboratories, 205 Forrest St., Metuchen, N. J. 08840.
5. Data sheet, "RCA Gallium Arsenide Injection-Laser Diodes, TA2628, TA2628R," Solid-State Optical Engineering, RCA, U. S. Route 202, Somerville, N. J. 08876.
6. "Pulsing the Vest-Pocket Laser," *Optical Systems Design*, July/August, 1969.

references

to operate a keyed-pulse temporary communications link over a carefully chosen route with another amateur using a pair of optical transmitters. Any volunteers?

The final tests resulted in 120 feet, using the PIN-10 broad-area detector. My next project, still in the research stage, is

820 feet. The final tests resulted in 120 feet, using the PIN-10 broad-area detector. My next project, still in the research stage, is

My next ranging attempt was made at a closed section of new highway. I expected all sorts of problems here—not with the equipment, but with the local community, earlybirds looking for short-cuts, an unmarked panel truck that put its spotlight on my distant vehicle (resulting in a rapid signal return) and other inconveniences. Fortunately my tests had been completed, resulting in a range of 820 feet.

My first tests were conducted at the local Bluegrass Airport, where I obtained permission to use the runway. While ducking airliners, I was able to achieve 430 feet range. This short range was discouraging; however, I didn't realize at the time that the Sniperscope image tube couldn't detect peak power. Such are the consequences of adversity. But I pressed on.

Author's mobile ranging equipment. Maximum distance of 1/5 mile was obtained on a new section of highway, but not without some problems.

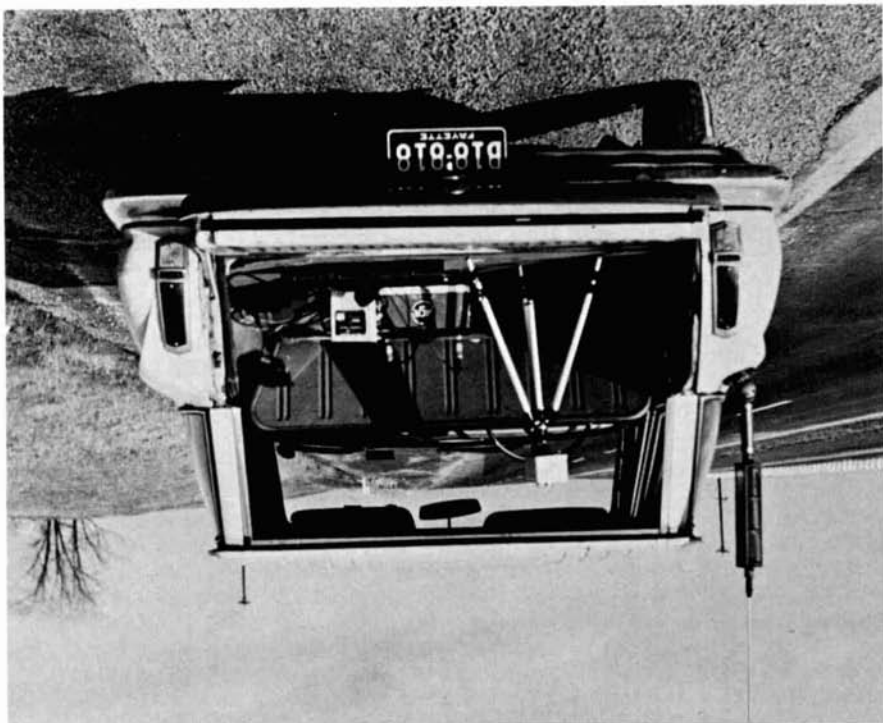

frequency spotter

for
general-coverage
receivers

A marker generator
featuring a sure-fire
oscillator circuit
and easily obtained
parts

Many amateurs have a general-coverage receiver as well as an amateur-band-only receiver or transceiver. This is a desirable item, filling in those in-between band spots for casual listening or for checking for out-of-band radiation. A weak point for most such receivers is that they're usually of a less expensive type and thereby lack the precise frequency read-out you'd like to have.

This lack of precise frequency calibration complicates the use of the more common type of calibrator. A 100-kHz calibrator can cause more confusion than it can resolve when dial calibration on a receiver is such that you can't identify which of the marker signals represents the desired reference signal. In such instances a 1-MHz spotting signal is much more convenient to use. Most often, too, 1-MHz markers are sufficient for setting the bandset dial before using the calibrated bandspread dial.

There are many circuits for low-frequency crystals (100-200 kHz) and even more for the high-frequency spectrum. These circuits, unfortunately, don't always perform satisfactorily in the medium-frequency range.

This article describes a circuit especially adapted to a 1-MHz crystal. It oscillates dependably and produces profuse harmonics to the upper limit of the high-frequency band. Best of all, it can be built with junk-box parts with no requirement to purchase some hard-to-find component.

construction

As the schematic shows (fig. 1), this circuit borrows liberally from the Miller, Colpitts, and Pierce. The coil in the collector-to-emitter circuit suggests the Miller; the use of a capacitive voltage

Carl C. Drumeller, W5JJ, 5824 N. W. 58th Street, Warr Acres, Oklahoma 73122

radio teletype

using ssb transceivers

The advantages
of transceiver operation
for RTTY
can be realized
by using
audio-frequency-shift
keying

Many of us who work the hf ham bands are ssb transceiver operators. The pleasure of transceiver operation may spoil you, since your time is not consumed by making tuning adjustments. However, all is not perfect. Although transceivers are great for phone operation, and acceptable for cw operation, they can be used to transmit RTTY only if unusually good engineering practices are employed.

The FCC does not permit tone-modulated am on the hf ham bands. Consequently, fsk transmission must be accomplished by some carrier-shift technique. In the old days, when we all had transmitters and receivers, RTTY transmission was simple and easy. A "shift pot" circuit could be used to vary the transmitter vfo

frequency to encode RTTY mark and space signals into fsk. Phase continuity of the fsk waveform resulted because the fsk switching signal usually had long rise and fall times (because of RC time constants) compared to the period of the vfo frequency. Independent tuning of the receiver allowed the mark and space tone filters in the receiving converter to be tuned to convenient frequencies, within the receiver audio passband, as long as the two frequencies were separated by the proper deviation (850 Hz for wide shift and 170 Hz for narrow shift).

ssb transceiver rtty

With a single-sideband transceiver, RTTY operation is not so simple. Any vfo modification can affect the frequency stability and degrade the performance of the transceiver on both RTTY and ssb. In addition, a more serious problem associated with transceive operation must be considered. That is, if the vfo frequency is shifted when transmitting, but not when receiving, then retuning may be required to receive an RTTY station that returns your call on *your* transmit frequency. This situation results in both stations "leapfrogging" up or down the band as each station retunes the other during receive intervals.

One rather undesirable method for eliminating leapfrogging is to operate the transceiver with carrier insertion in the transmit mode and in the upper-sideband receive mode. The vfo frequency can be shifted so that the transmitted carrier frequency is shifted up 1.65 kHz for space and up 2.5 kHz for mark. The space carrier will then be transmitted on a frequency 850 Hz lower than the mark carrier, in conformance with standard practice.

Under these conditions, if the vfo frequency is not shifted at all in the

D. H. Phillips, W6FOO, 215 Carlisle NE, Albuquerque, New Mexico 87106

receive mode, the received tones will be 1650 Hz (space) and 2500 Hz (mark) when the received station is zero beat with your transmit frequency. This method isn't very practical and not widely used because of the difficulty in adjusting the carrier shifts. The adjustments must be made when the transceiver is in the transmit mode (receive section disabled); therefore, proper adjustment requires a second receiver.

afsk principles

A far better technique for transmitting RTTY with an ssb transceiver involves the use of audio frequency shift keying (afsk). A transceiver having good primary-carrier suppression can be operated in the ssb mode and modulated with an audio tone. If the primary carrier is adequately suppressed, a listener who tunes his receiver to such a signal hears only a pure carrier. This secondary carrier is displaced from the primary carrier by the audio frequency.

Using this principle, 850-Hz carrier-shift fsk can be transmitted with an ssb transceiver modulated by an audio tone shifted by 850 Hz to encode the mark and space information. If an ssb transceiver is operated in the usb mode and modulated with space and mark tones on 1650 and 2500 Hz, the transmitted space carrier would be 850 Hz below the mark carrier, in conformance with standard practice. In the receive mode, 1650- and 2500-Hz space and mark tones are received from a zero-beat RTTY station.

This popular method is used by many hams because it takes advantage of transceive operation by tracking transmitted space and mark tones. System alignment is straightforward, and no transceiver modifications are required. Although this method is very attractive, good design practices must be observed to ensure a high-quality fsk signal. Problems that must be considered for this method to be used successfully are discussed next.

sideband and carrier suppression

The transmission of two carriers simultaneously is not permitted by the FCC.

Consequently, the ssb exciter must suppress the unwanted sideband and the primary carrier by at least 30 dB, and the exciter must operate with the primary carrier completely balanced out. With 30-dB carrier suppression, a transceiver with 500 watts of secondary carrier (fsk signal) will be transmitting only one-half watt of primary carrier. This is a safe value and won't alarm adjacent channel users or the FCC.

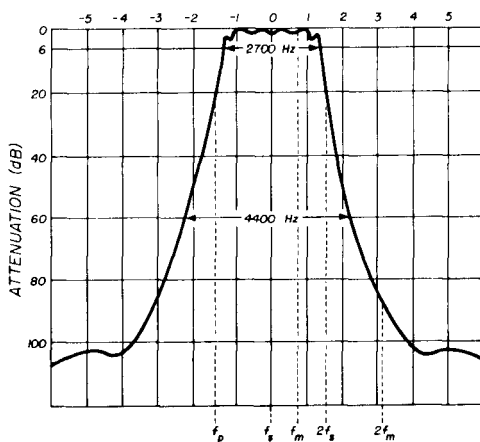

fig. 1. Typical bandpass characteristic for a filter-type ssb (usb) exciter in the RTTY mode. Primary carrier is represented by f_p ; secondary carriers of 1650 Hz (space) and 2500 Hz (mark) are shown by f_s and f_m .

the audio signal

Any noise accompanying the audio tones will be transmitted, resulting in a waste of power and causing adjacent-channel interference, which is illegal. The signal-to-noise ratio of the audio-tone signal that modulates the transceiver should be at least 35 dB to ensure against transmitting appreciable noise.

The audio tone waveforms should be high-quality sinusoids having less than 5% distortion. A nonsinusoidal waveform contains harmonic components of the fundamental frequency. For example if a nonsinusoidal 500-Hz tone modulated the transceiver, several undesirable secondary carriers would be transmitted, which could have frequencies displaced from the

primary carrier by 500, 1000, 1500, 2000, and 2500 Hz.

The crystal- or mechanical-filter band-pass characteristics in filter-type ssb transceivers would attenuate any secondary carrier displaced from the primary carrier

fig. 2. Comparison of low- and high-frequency afsk tones. Signal at B allows use of more selective filters and provides a better leading edge of space or mark signal.

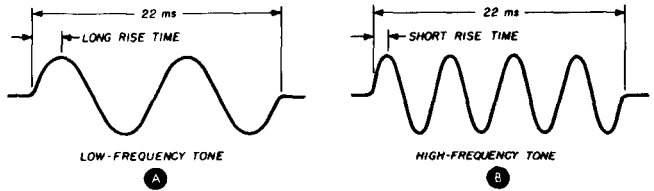

frequency by more than 2.7 kHz. Multiple secondary-carrier transmission is not allowed by the FCC, so a high-quality sinusoidal audio modulation waveform is required.

mark and space tones

The mark and space tone frequencies can be selected to compensate for deviations from a pure sinusoidal audio waveform. Fig. 1 shows a typical crystal-filter bandpass characteristic of an ssb transceiver manufactured for ham use. Shown

Fig. 1 shows the relative position of the primary carrier, f_p , and the secondary carriers, f_s and f_m , for space and mark tones of 1650 and 2500 Hz. These fundamental space and mark frequencies lie within the passband and are not

attenuated. However, the harmonics of the fundamental tones lie outside the passband and will be attenuated. Consequently, the high-frequency-filter selectivity skirt attenuates the secondary carriers produced by any existing harmonic content (distortion) of the audio tones.

Fig. 1 also shows that by selecting 1650-Hz space and 2500-Hz mark frequencies, the second-harmonic space and mark secondary carriers, $2f_s$ and $2f_m$, are attenuated by 20 and 85 dB respectively. Although this technique can be used to

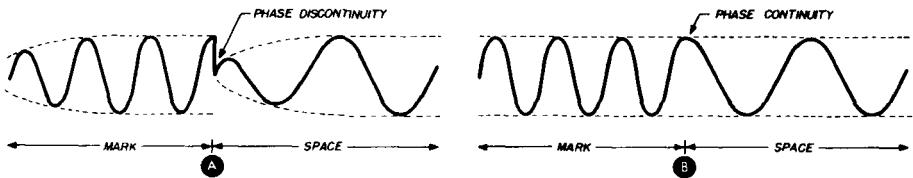

fig. 3. Comparison of mark-to-space waveform transitions. Phase continuity avoids adjacent-channel interference because impulse noise is greatly reduced.

is the position of the primary carrier, f_p , relative to the filter passband. With the primary carrier on the skirt of the filter selectivity curve, the crystal filter attenuates the primary carrier and provides more carrier suppression than can be obtained in the balanced modulator alone. The tone frequencies are chosen so that the associated secondary carriers will be near the high-frequency cutoff point, but within the flat-response region.

compensate partially for audio tones having some harmonic content, every attempt should be made to generate pure sinusoidal modulation-tone waveforms.

There is a second reason for choosing tone frequencies near the high-frequency skirt of the filter-selectivity curve. High tone frequencies are desirable so that more cycles of the tone can be contained within the 22-millisecond space and mark intervals. High tone frequencies allow the

use of more selective tone filters in the receiving converter. Also, a high tone frequency represents a shorter rise time, or a better leading edge, of the space or mark signal, as shown in **fig. 2**.

phase continuity

Finally, perhaps the most important consideration is the requirement for generating a continuous-phase afsk signal. The need for phase continuity is best emphasized by considering the effects of an afsk modulation waveform having phase discontinuities. **Fig. 3** illustrates the difference between the two waveforms. The waveform with phase discontinuity results in (a) amplitude modulation of the fsk signal, and (b) impulse noise being generated and transmitted.

The sharp switching transients have many frequency components, resulting in the transmission of a 3-kHz-wide noise spectrum. The transmitted noise bandwidth is limited by the crystal or mechanical filter frequency response. Because the

transmitted power spectrum is shown in **fig. 4**.

Fig. 5 shows an oscillogram of a discontinuous-phase afsk waveform having a switching frequency of 100 Hz. This switching frequency, which is somewhat faster than the 60-wpm teletype switching frequency of 22.8 Hz, was used for convenience. The waveform of **fig. 5** was used to modulate a Swan 500 ssb transceiver. The Swan 500 was intentionally adjusted for a 3600-kHz primary carrier suppression of only 30 dB, so that the low-power primary carrier could be used as a reference signal on the spectrum analyzer trace. **Fig. 6** is an oscillogram of the spectrum analyzer display. (The blip on the leading edge at the extreme left of the trace was generated within the measuring instrument and doesn't indicate a lack of lower-sideband suppression.) **Fig. 6** shows that the phase discontinuities in the modulation waveform contribute to unequal space and mark power distributions. Impulse noise, although present,

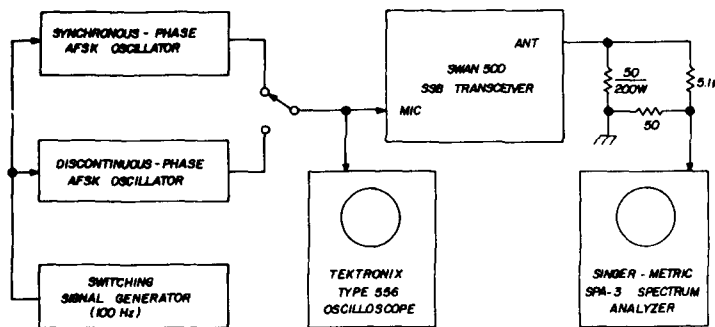

fig. 4. Setup for measuring output-power spectrum of a transceiver modulated by a synchronous- and discontinuous-phase afsk oscillator.

duty cycle of the switching transient is low, the transmitted noise power is much less than the secondary carrier power. However, this impulse noise does cause adjacent channel interference.

measurements

Comparison measurements were made to evaluate continuous- and discontinuous-phase afsk modulation waveforms. The experimental setup for measuring the

can't be seen on a filter-envelope spectrum analyzer trace.

Fig. 7 is an oscillogram of a synchronous-phase afsk waveform, which was used to modulate the Swan 500. The resulting power spectrum, shown in **fig. 8**, illustrates the space and mark power distributions and the low harmonic generation that can be obtained by using a synchronous-phase afsk oscillator. A comparison of **figs. 5** and **6** with **figs. 7** and **8**

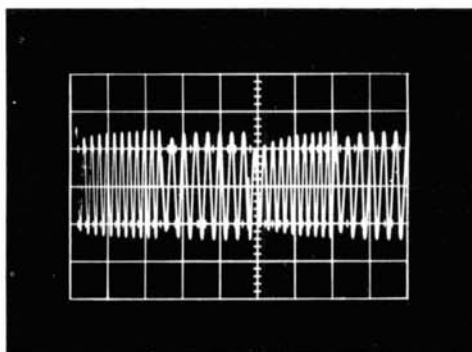

Space Tone 1650 Hz
 Mark Tone 2500 Hz
 Switching Freq 100 Hz
 Vertical dB

fig. 5. Afsk waveform containing phase discontinuities at mark-to-space and space-to-mark transitions.

emphasizes the improvement in RTTY signal quality that can be obtained by using synchronous-phase afsk modulation.

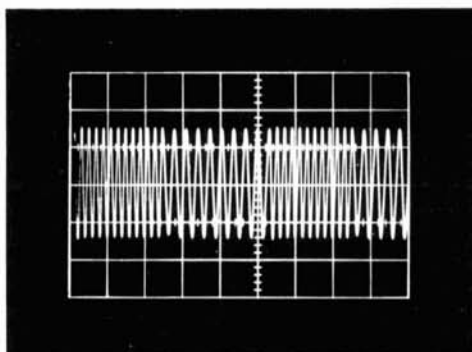

Horizontal kHz
 $f_p = 3600$ kHz
 $f_s = f_p + 1650$ Hz
 $f_m = f_p + 2500$ Hz

fig. 7. Synchronous-phase afsk waveform.

phase-continuity modulation waveforms will minimize adjacent-channel interference and result in a better contact record by improving the printer copy at

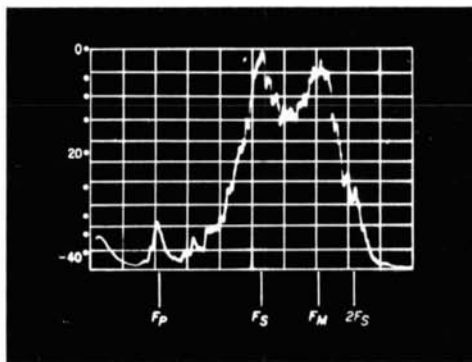

Space Tone 1650 Hz
 Mark Tone 2500 Hz
 Switching Freq 100 Hz

fig. 6. Spectrum-analyzer display of power spectrum from an usb exciter modulated by a discontinuous-phase afsk signal.

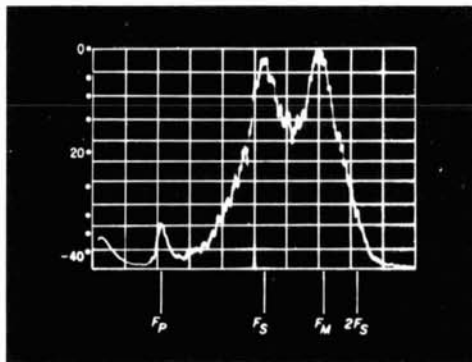

Vertical 10mV/div
 Horizontal 2ms/div

fig. 8. Power spectrum from an usb exciter modulated by a synchronous-phase afsk signal.

the other end of the radio circuit. These improved RTTY transmission techniques will also eliminate FCC citations.

A practical synchronous-phase afsk oscillator using an inexpensive IC flip-flop will be described in a future article.

summary

Properly selected audio-tone frequencies and synchronous-phase afsk modulation can be used to generate high-quality pseudo-carrier-shift RTTY signals with ssb exciters or transceivers. Perfect-

ham radio



**MXX-1 Transistor
RF Mixer \$3.50**

A single tuned circuit intended for signal conversion in the 3 to 170 MHz range. Harmonics of the OX oscillator are used for injection in the 60 to 170 MHz range.

Lo Kit 3 to 20 MHz
Hi Kit 20 to 170 MHz
(Specify when ordering)



**SAX-1 Transistor
RF Amplifier \$3.50**

A small signal amplifier to drive MXX-1 mixer. Single tuned input and link output.

Lo Kit 3 to 20 MHz
Hi Kit 20 to 170 MHz
(Specify when ordering)



**PAX-1 Transistor RF
Power Amplifier \$3.75**

A single tuned output amplifier designed to follow the OX oscillator. Outputs up to 200 mw, depending on the frequency and voltage. Amplifier can be amplitude modulated. Frequency 3,000 to 30,000 KHz.



**BAX-1 Broadband
Amplifier \$3.75**

General purpose unit which may be used as a tuned or untuned amplifier in RF and audio applications 20 Hz to 150 MHz. Provides 6 to 30 db gain. Ideal for SWL, Experimenter or Amateur.

For The Experimenter!

International EX Crystal & EX Kits

OSCILLATOR / RF MIXER / RF AMPLIFIER / POWER AMPLIFIER



Type EX Crystal

Available from 3,000 to 60,000 KHz. Supplied only in HC 6/U holder. Calibration is $\pm .02\%$ when operated in International OX circuit or its equivalent. (Specify frequency)

\$3.95



OX Oscillator

Crystal controlled transistor type. Lo Kit 3,000 to 19,999 KHz
Hi Kit 20,000 to 60,000 KHz
(Specify when ordering)

\$2.95

Write for complete catalog.



auxiliary receiver

for
160 meters

Easy and
inexpensive
conversion of
an auto radio
for emergency
or standby service

F. J. Bauer, Jr., W6FPO, P. O. Box 870, Felton, California 95018

If you have an idle broadcast-band auto radio lying around, why not put it to work as an emergency or standby receiver for 160 meters? It can be converted quickly with a minimum outlay for parts. For a-m reception, all you need are an oscillator coil and a couple of inexpensive adjustable rf chokes. With a few more components you can add circuits for cw and ssb.

basic conversion circuit

The basic conversion consists of reducing the front-end coil inductances with shunt coils so the receiver will cover 1.8 to 2 MHz (fig. 1). If the alignment instructions are followed, this conversion method will result in much better performance than if the receiver were merely misaligned to cover part of the band.

To prepare the receiver for conversion, first check its performance "as is." The receiver can be tested on the bench using an ac power supply after removing the vibrator. Check alignment and make any required repairs. When you're satisfied the receiver is performing as it should, replace the vibrator transformer with a 60-Hz unit of the proper rating.

Next install the rf coils and connect them directly to the tuner coil terminals. The auxiliary coils are designed for single-hole mounting and can be installed anywhere as long as you have access to the slugs. The only precaution is to isolate the antenna coil from the rf stage, or the latter will oscillate. I solved this problem by mounting the antenna coil on the opposite side of the chassis from the rf and oscillator coils.

sponse (dial should be set to about 900 kHz).

6. Repeat steps 3, 4, and 5.

The oscillator-coil slug is adjusted until you hear the oscillator signal in another receiver or frequency meter. Lacking this equipment, the oscillator frequency can be adjusted by injecting an 1800-kHz signal into the converter grid. This is easily done by tuning a bc transistor radio

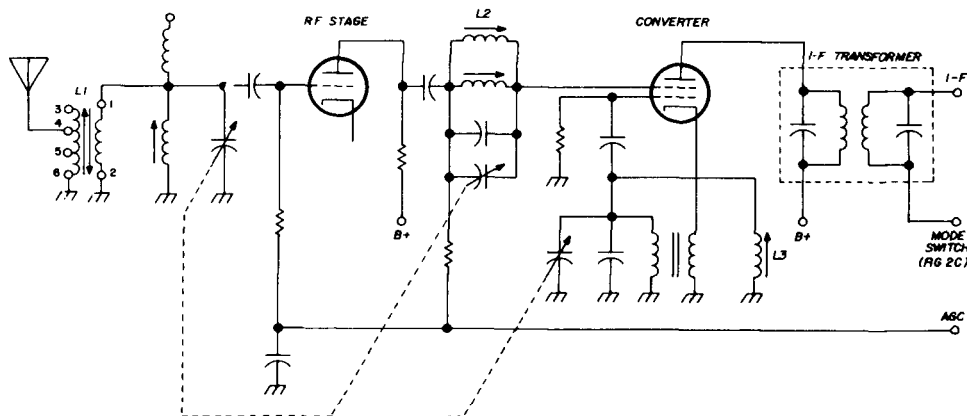

L1 Adjustable BC band oscillator coil, approx. 190-360 μH (J. W. Miller 71-OSC)

L2 50-140 μH (J. W. Miller 4207)

L3 10-25 μH (J. W. Miller 4205)

fig. 1. Basic conversion for 160-meter a-m reception on a bc-band auto radio. Front-end tuned circuits are shunted with outboard coils to lower inductance. Miller 4205 coil can be adjusted for either 455- or 262-kHz i-f.

alignment

The easiest way to align the receiver is as follows:

1. Set receiver dial to 600 kHz.
2. Adjust oscillator coil to:
 - a. 2062 kHz (receiver i-f = 262 kHz).
 - b. 2255 kHz (receiver i-f = 455 kHz).
3. Adjust rf and antenna coil slugs for maximum response to an 1800-kHz signal.
4. Set signal source to 2000 kHz.
5. Tune in signal on receiver and adjust trimmers for maximum re-

to 1340 or 1350 kHz and picking up the oscillator radiation as an 1800-kHz signal. For an approximate 2000-kHz signal source (step 4 above), you can tune the transistor radio to 1540 or 1550 kHz and pick up its mixer signal. Final retouching adjustment of the antenna trimmer with the antenna connected should provide good tracking over the band.

cw and ssb reception

It will be necessary to add a bfo and manual rf gain control for cw and ssb reception (fig. 2). The bfo is powered by the output-tube cathode resistor as shown. A convenient way to mount the gain control and bfo switch is on the speaker cover of the set. All leads to these

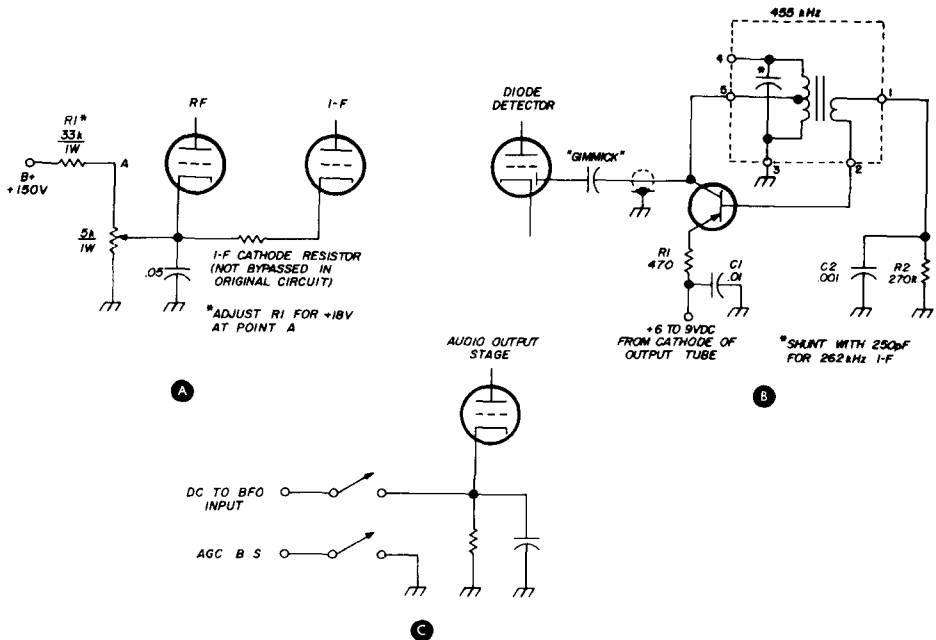

fig. 2. Additional circuits for cw and ssb. Manual rf gain control is shown in A; B and C show bfo and mode switch. The 455 kHz i-f transformer is a miniature transistor type such as the J. W. Miller 2042. Transistor in B is a small-signal pnp type.

circuits carry only dc, so make them long enough so the receiver can be easily serviced.

Note that the bfo switch also disables the receiver agc when the bfo is on. For cw or ssb reception back off the rf gain, set audio gain near maximum, and turn on the bfo switch. This may not be the most elegant way to receive ssb; but considering its simplicity and low cost, it's adequate for this type of receiver.

Almost any small-signal pnp transistor will oscillate in the bfo circuit. For my conversion, the i-f transformer and transistor were lifted from a defunct transistor radio. If the thing won't oscillate, try reversing the i-f transformer secondary leads. If this doesn't work, try another transistor.

bfo adjustment

Before permanently wiring the bfo to the switch, turn on the bfo with receiver agc activated. Adjust the bfo tuning slug for maximum agc voltage. This centers the bfo in the i-f passband. No bfo adjustment control is provided, because

the i-f in these old receivers is so broad that final pitch adjustment can be made with the tuning dial.

For proper injection, the bfo output is coupled to the diode detector through a shielded gimmick. The coupling should be adjusted so that the agc voltage increases by about 0.3 volt when the bfo is turned on. Excessive coupling will overload the detector and may cause motorboating when the audio gain is turned all the way up.

The bfo components can be mounted on a 1- by 2-inch perforated board. The transistor, R1, and C1 are mounted on the left side of the transformer, and C2, and R2 are mounted on the right side. The output lead shield should be grounded at the bfo board. This will ensure against bfo radiation being picked up by the i-f stage, which causes noise.

This conversion admittedly uses none of the latest sophisticated techniques for superb cw and ssb reception, but it does provide a good emergency or standby receiver for minimum effort and cost.

ham radio

BOOKS . . . make outstanding gifts for your friends (or yourself)

RADIO SOCIETY OF GREAT BRITAIN PUBLICATIONS

RADIO COMMUNICATIONS HANDBOOK — An outstanding technical guide to all phases of amateur radio. In 832 pages 20 complete chapters are devoted to such subjects as single side-band, antennas, mobile equipment, RTTY and much, much more. This excellent book has received wide acclaim on both sides of the Atlantic and belongs in your library . . . now. **\$11.95**

AMATEUR RADIO CIRCUITS BOOK — Completely revised — new edition. A very handy collection of many useful circuits for amateur use. Loaded with good ideas for that new converter, exciter or other project you are working on. **Only \$2.00**

VHF-UHF MANUAL — G. R. Jessop, G6JP — Probably the most comprehensive work of its kind ever published. Covers everything from beginners to advanced material. **Only \$3.75**

AMATEUR RADIO TECHNIQUES — Third Edition — J. Pat Hawker, G3VA — Brand new edition — completely revised. A very complete collection of short articles and ideas covering many aspects of amateur radio. Includes new enlarged semiconductor section. 160 Pages. **Only \$3.50**

RADIO DATA REFERENCE BOOK — Second Edition — By G. K. Jessop, G6JP — Here in a 148 page book is one of the most complete compilations of radio and electronic charts, nomographs, formulas and design data available. Whether you design, build or operate, this is a book you must have. **Only \$2.50**

WORLD AT THEIR FINGERTIPS — John Clarricoats, G6CL — A very interesting history of the RSGB and of amateur radio in Great Britain. It gives a great insight into the development of our hobby. **Paper back edition \$2.50
Deluxe edition \$6.50**

Other Important Volumes

RADIO HANDBOOK — 18th Edition — How to design, build and operate the latest types of amateur transmitters, receivers, transceivers and amplifiers. Provides extensive, simplified theory on practically every phase of radio. 848 pages. **Only \$13.50**

ALL ABOUT CUBICAL QUAD ANTENNAS by W6SAI — Construction and tuning data. Multi-band Quads. Charts, drawings and photos for your Quad. Full complete data on homemade Quad antennas. The new X-Q Quad. **\$3.95**

VHF HANDBOOK by Orr W6SAI & Johnson W6QKO — First complete Handbook covering the VHF spectrum! Many VHF construction projects. Design and construction of VHF transmitters, receivers and antennas! Make your VHF station work! **\$3.95**

THE CARE AND FEEDING OF POWER GRID TUBES by Robert Sutherland, W6UOV — Just as

the title says, a very complete rundown on the use of power tubes. Be sure to read this before you start work on your new linear. **Only \$3.95**

BEAM ANTENNA HANDBOOK by William Orr, W6SAI — New edition. Theory, design, construction, and the installation of rotary beam antennas! SWR data! Multi-band beams, 40 meter beams, 20 meter DX beams! How to make your beam work! 200 pages. **\$4.95**

NOVICE & TECHNICIAN HANDBOOK by W6SAI and W6TNS — All about amateur radio in non-technical language! How to learn the code. How to assemble your ham station. Transmitters! Receivers! DX! How to get QSL cards. **\$3.95**

ELECTRONIC CONSTRUCTION HANDBOOK by Robert Lewis, W8MQU — All about design - construction - layout and testing of electronic equipment. Non-technical guide for kit-builders and your best key to better performance of your equipment! **\$3.95**

Christmas Special

DEDUCT 10% FROM ALL ORDERS OVER \$15.00

COMTEC BOOK DIVISION, Box 592, Amherst, N. H. 03031

Please send the books I have checked:

- Radio Communications Handbook \$11.95
- Amateur Radio Circuits Book \$2.00
- Amateur Radio Techniques \$3.50
- VHF-UHF Manual \$3.75
- Radio Data Reference Book \$2.50
- World At Their Fingertips, Paperback \$2.50
- World At Their Fingertips, Deluxe \$6.50
- Radio Handbook, 18th Edition \$13.50

- All About Cubical Quad Antennas \$3.95
- VHF Handbook \$3.95
- The Care and Feeding of Power Grid Tubes \$3.95
- Beam Antenna Handbook \$4.95
- Novice & Technician Handbook \$3.95
- Electronic Construction Handbook \$3.95

Offer expires December 24, 1970.

Name

TOTAL

Address

If over \$15.00 check here
and take 10% discount.

City Zip

All prices postpaid in USA and Canada

a counter gating source

The power-line
frequency
makes an
accurate time base
for many
counter applications

Several articles on simple frequency counters have suggested using the 60-Hz line frequency as a gating source. One commercially built unit uses it, claiming 0.02-percent accuracy compared with the ± 1 -count accuracy of a temperature-controlled crystal source.

The ± 1 -count accuracy is desirable for the ARRL frequency-measuring tests, or when a calibrator is desired for 10, 5, or even 2.5-kHz markers. For other applications, such as a digital counter dial for a transmitter or receiver, the error resulting from using the 60-Hz line frequency shouldn't appreciably affect the final tenth-kHz digit in the readout. Therefore, the idea of the resulting simplification in equipment is intriguing.

Jim Fisk once pointed out that the power-line frequency may follow different patterns in different locations. However, power networks in most parts of the country are quite large, and sophisticated frequency regulators are used. Electric clocks, for example, are quite accurate when driven by power sources in most cities. With this in mind, I decided to get a little first-hand experience with the problem.

60-Hz time base

It is possible to count line frequency in several ways with considerable accuracy. I decided to use the 60-Hz line frequency as a time base to count the

fig. 1. Test circuit using a Fairchild 9093 JK flip-flop as a divide-by-three counter to measure 60-Hz line frequency.

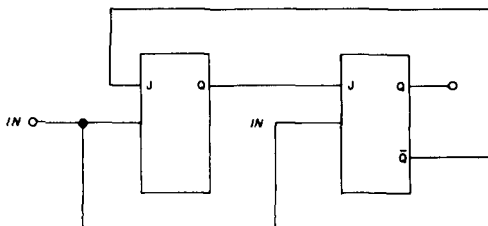

E. H. Conklin, K6KA, Box 1, La Canada, California 91011

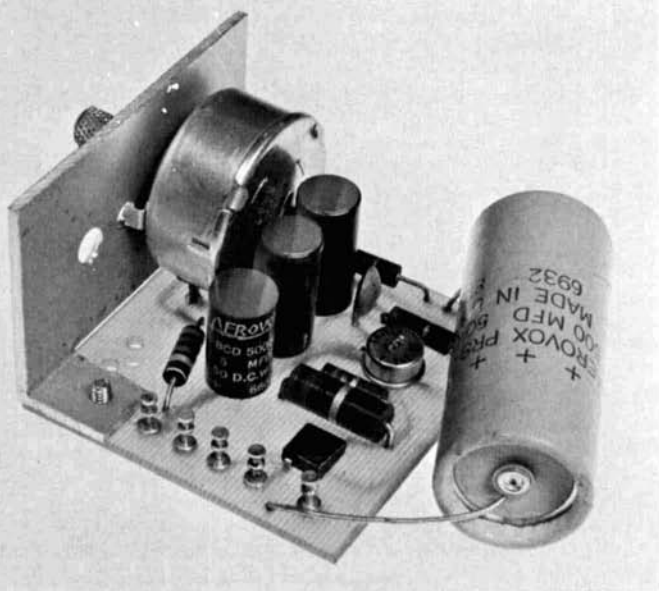

voltage regulation— circa 1970

A new unitized
power supply
using
the CA-3055
integrated circuit

One of the most useful solid-state devices appearing on today's market is the integrated circuit designed for voltage-regulator service. Whereas a score of discrete components formerly were required to obtain a fraction of a volt of regulation, one small device now provides a ten-fold improvement.

A good regulated power supply is essential for experimenting with solid-state circuits. If you have yet to experience the advantages of solid-state technology, this article is for you. The circuits are extremely simple to build, and the experience gained will be helpful if you want to explore further in this area. Recommended reading on solid-state power supplies is an article by Hank Olson, W6GXN.¹

E. L. Klein, W2FBW

the IC regulator

The heart of this modern unitized power supply is RCA's new monolithic

approach for two practical power supplies: one that will regulate load currents up to 100 mA, and a second supply that will handle even higher load currents.

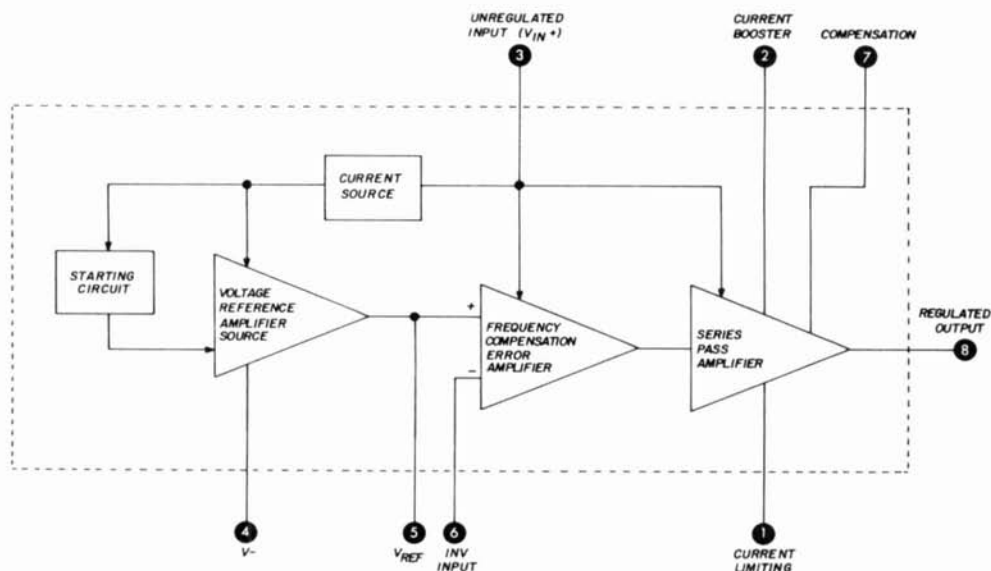

fig. 1. Block diagram of circuit elements in the RCA CA-3055 voltage regulator IC.

IC, the CA-3055 voltage regulator. Packaged in a TO-5 transistor case, the CA-3055 is less than a half-inch in diameter. It has eight leads that can be soldered directly into the circuit or to the terminals of a socket, such as the Cinch-Jones 8-ICS.

The regulator functions are shown in fig. 1. Also given are terminal designations for temperature-compensated reference voltage, booster input, frequency compensation, and short-circuit protection. The super-small construction allows over two-dozen components to be contained on a single silicon chip. Included are fifteen transistors, seven diodes, and four resistors.²

unitized approach

An advanced design such as the CA-3055 deserves some ingenuity in its application. Therefore, I've included a new

Here are the principal features of the unitized approach in regulated power-supply design:

CA-3055 integrated circuit.

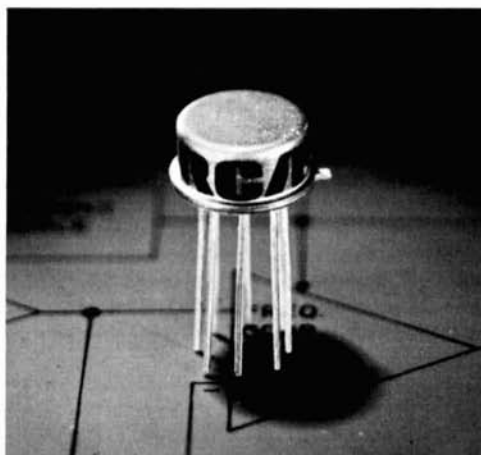

table 1. Output voltages using the CA3055, with input ac voltages supplied by various filament transformers.

input voltage (Vac)	regulated output (Vdc)	
	minimum	maximum
6.3	1.75	4.25
12.6	2.15	10.0
25.2	2.50	18.0

1. Single mounting hole. This makes it easy to mount the power supply on the apron of an existing chassis, for example, or on the front panel of new equipment.

2. No chassis. Sheet-metal work is reduced to a minimum. All you need is a 3/32-inch-thick piece of aluminum, which is easily formed into a mounting bracket that serves as a circuit-board support and heat sink for the external pass transistor used in the high-current supply.

3. Voltage control. A small potentiometer may be included for proportional voltage adjustment—a desired refinement for many transistor circuits.

4. Fixed voltage. By selecting two fixed resistors in place of the potentiometer

(and fixed resistors), discrete voltages are available. These may be switched or otherwise programmed for specific applications.

5. Bench supply. Add a voltmeter, milliammeter, and an on-off switch, and

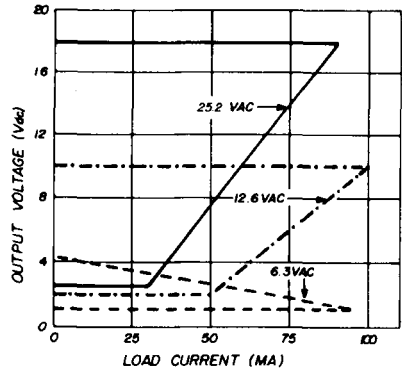

fig. 3. Useful ranges of the 100-mA unitized supply for three input voltages.

a first-class bench power supply is ready to go.

practical supply for 100 mA

The CA-3055 can deliver output currents up to 100 mA without the use of external pass transistors. The IC's internal

fig. 2. Schematic of the 100-mA unitized power supply. Output ranges for three standard ac inputs are given in table 1.

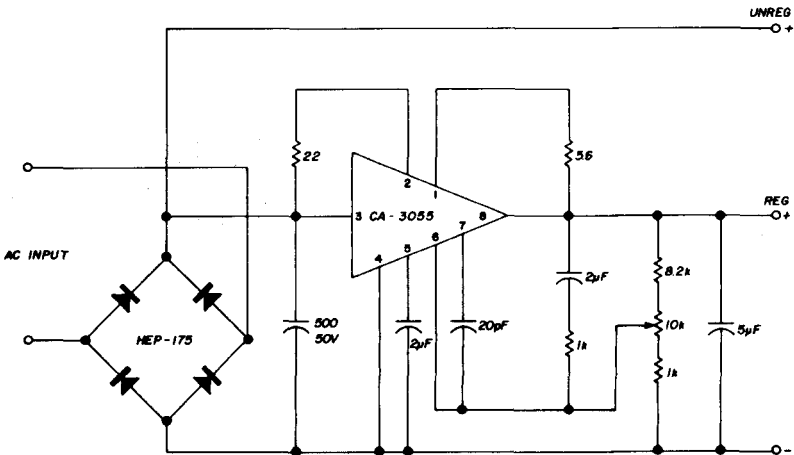

series-pass amplifier handles this current. The only components needed other than the IC are the power source, rectifiers,

depend on your output-voltage requirements. Typical operating ranges of regulated dc output voltages for various fila-

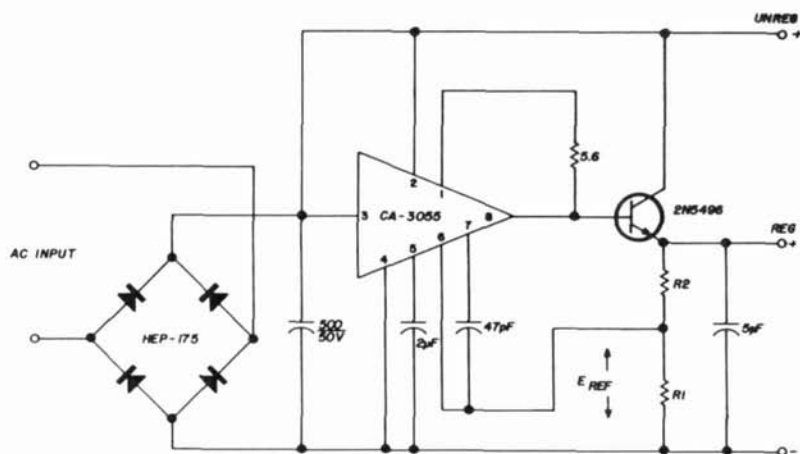

fig. 4. High-current supply. Load currents up to several amperes are possible.

filter capacitors, and voltage-adjusting resistors.

A schematic of the 100-mA supply is shown in fig. 2. Any standard filament transformer may be used as a power source.* The transformer, of course, will

ment-transformer secondary voltages are given in table 1. A plot of the supply's regulation characteristics for various input voltages is shown in fig. 3.

a high-current supply

The CA-3055 can also be used with a suitable external series-pass transistor to provide voltage regulation at loads greater than 100 mA. A typical circuit is shown in fig. 4. The 2N5496 transistor may be used with load currents up to several amperes in this circuit, provided the transistor is heat-sinked to the panel, as shown in the photo. Resistors R1 and R2 are selected for the required output voltage (table 2). If a continuously variable output voltage is desired the potentiometer control, as shown in the 100-mA supply, can be used.

High-current IC-regulated power supply.

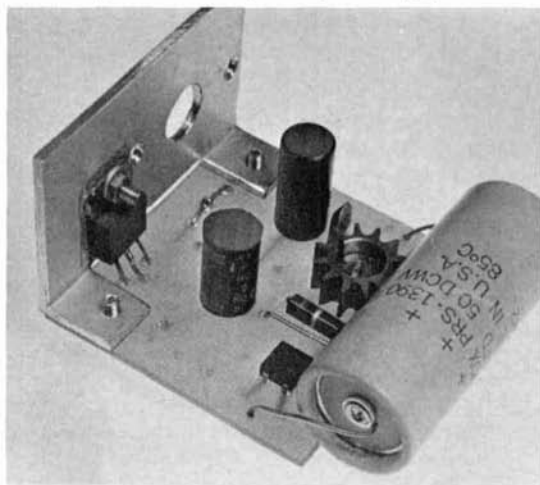

construction

All discrete components, as well as the IC and pass transistor, are mounted on a

*A Stancor type TP3 is suggested in RCA's data sheet for a typical supply (see reference 2). editor.

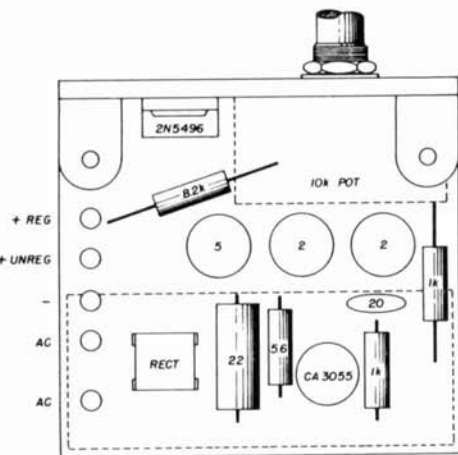

fig. 5. Layout of components on a circuit board.

2 x 2-1/8-inch phenolic board, fig. 5 and 6. The circuit board can be a prepunched board of the Vector board type, or can be built as a printed-circuit board. After all components are mounted and connected, the board is attached to the aluminum bracket (fig. 7) with small machine screws.

To enhance the appearance of the finished unit, I'd suggest sanding the bracket with medium-grit emery cloth, taking care to keep the scratch pattern parallel.

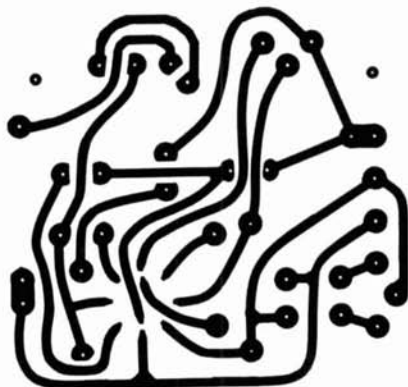

fig. 6. Printed-circuit board layout for the basic regulated supply.

table 2. Selections of resistors R1 and R2 for required output voltage in the high-current regulated supply.

reg. output (Vdc)	operating range (12.6 Vac input)		
	E ref (Vdc)	R1	R2
15	1.5	1.7	17
12	1.5	2.1	16.6
10	1.5	2.5	16.2
8	1.5	3.2	15.5
6	1.5	4.3	14.4
4	1.5	6.4	12.3

$$\text{Reg (out)} = E \text{ ref} \left(\frac{R1 + R2}{R1} \right)$$

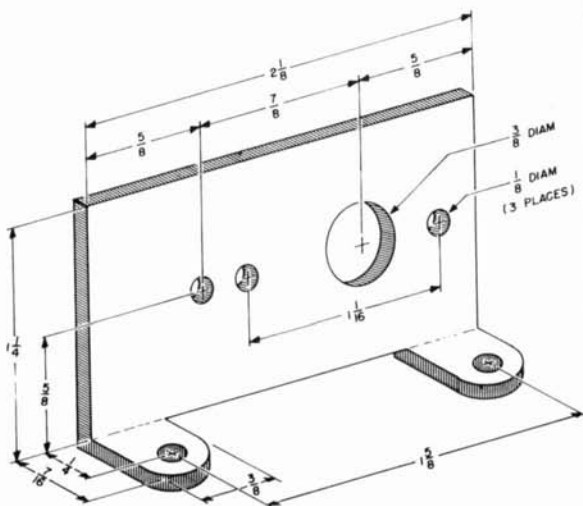

fig. 7. Aluminum mounting bracket.

Four different configurations for the unitized power supply are possible. Select the one to suit your needs. The few hours spent building this supply will be rewarding, and you'll be abreast of the times with your IC voltage regulator—circa 1970.

references

1. Hank Olson, W6GXN, "A Survey of Solid-State Power Supplies," *ham radio*, February, 1970, p. 25.
2. "Linear Integrated Circuits CA3055," RCA data sheet file no. 395, RCA Electronic Components, Harrison, New Jersey 07029.

NRCI's

NCX-1000

the

Transceiver

of the 70's



1 KW Solid-State Transceiver

Rarely is the amateur radio fraternity offered an important new product with the engineered-in reliability found in modern professional and military communications equipment. NRCI's new NCX-1000 is one of these exceptional products. It was conceived and developed for radio amateurs by the same company that gave the Marine Corps its rugged solid-state AN/GRR-17 tactical communications receiver, that gave the Navy its versatile AN/URT-22 exciter-transmitter, and that produced the classic HRO-500 VLF/HF receiver.

The NCX-1000 combines rock-solid design, exceptional performance, and a power punch. It's the finest solid-state, self-contained, 5-band kilowatt transceiver available today — the odds-on choice of the discerning amateur, be he rag-chewer or DX-er. See it now at your dealer's store, or write for complete details.



NATIONAL RADIO COMPANY, INC.
NRCI

111 Washington Street, Melrose, Mass. 02176
617-662-7700

linear vhf tank circuits

Parameters are presented
for designing
single-ended vhf tanks
using nominal
quarter-wave
transmission lines

This article was prompted by a search of various amateur publications and other literature for down-to-earth information on the design and construction of vhf linear tank circuits. I was interested in information that could be used by the amateur to design circuits for his particular needs rather than the "Chinese copy" type of article.

It all started when I decided that my 2-meter transmitter should be rebuilt to incorporate a single-ended linear tank circuit. Since practically all available design information on linear tank circuits was for push-pull output tubes, much time was spent on data research. I felt that the results of this effort, which are

presented here, would interest the 2-meter enthusiast who wants to know a little more about the subject.

equivalent circuits

Most single-ended vhf finals use the conventional parallel- or series-tuned inductance and capacitance plate circuit. The tank circuit discussed here is an adaptation of the parallel-tuned tank. It's basically a shortened $\frac{1}{4}$ -wave coax line, short-circuited (for rf) at one end and resonated with a capacitance at the other.

This combination is equivalent to a parallel-tuned tank (fig. 1). Conventional single-ended circuits are also shown for comparison. The basic theory presented here can be applied to other types of linear circuits for higher frequencies, where the electrical length of the line is an integral number of quarter waves and the output-tube plate capacitance replaces part of one of the quarter waves. This discussion, however, is confined to $\frac{1}{4}$ -wave lines only. Multiple $\frac{1}{4}$ -wave lines used at frequencies higher than 145 MHz are discussed in detail in reference 1.

A coax line is unbalanced because of the way it's constructed. The outer conductor is at ground potential, and the center conductor is contained entirely within the outer conductor. Thus the electric field is confined completely within the shielded enclosure. This is ideal for a vhf tank circuit, since the tank provides its own shield, and radiation can be predicted and controlled. The design

Harry Ferguson, K7JUNL, 20629 5th Avenue South, Seattle, Washington 98148

problem is to choose a piece of transmission line that looks like an inductance and which forms a resonant circuit when connected in parallel with a capacitance.

the line's characteristic impedance and the tangent of the line's electrical length, ϕ , in degrees, where 90 degrees = $\frac{1}{4}$ wavelength. The reactance is

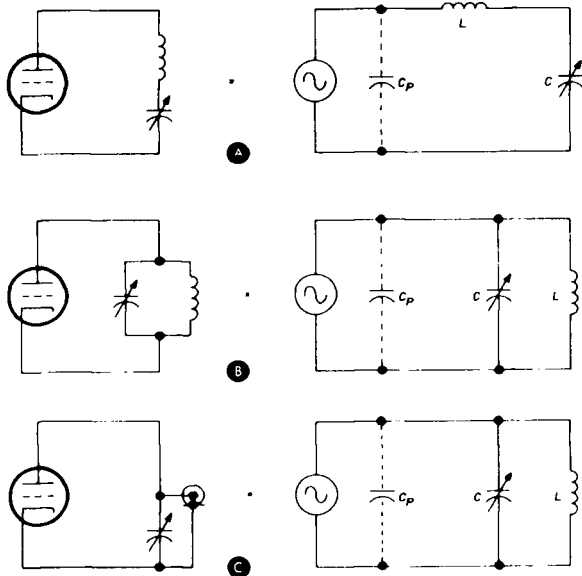

fig. 1. Equivalent tank circuits. Conventional series- and parallel-tuned tanks using lumped constants are shown in A and B; linear parallel-tuned tank, C, is an adaptation of B.

background theory

At this point a property of transmission lines known as characteristic impedance must be introduced, since other factors in the design depend on the magnitude of this property. The characteristic impedance of a transmission line is a function of its physical dimensions (discussed in reference 2). I looked at four different transmission-line configurations to determine which would be easiest to build, consistent with the desired electrical characteristics. These are shown in fig. 2, which gives characteristic impedances for a range of practical values of conductor size and shape.

A coaxial line cut to a $\frac{1}{4}$ wavelength at a given frequency and short-circuited at one end presents an open circuit at the other end to rf at that frequency. Furthermore, for lengths shorter than $\frac{1}{4}$ wavelength, the impedance at the open end of the line is inductive. The magnitude of this impedance is the product of

$$X_L = Z_o (\tan \phi) \quad (1)$$

where

X_L = inductive reactance (ohms)

Z_o = characteristic impedance of line (ohms)

ϕ = electrical length of line (deg)

For shortened $\frac{1}{4}$ -wavelength lines, the electrical length is always less than 90 degrees.

One step further into theory, and we find that electrical length is related to physical length by the constant 2952 for air-dielectric lines. This constant is equal to the velocity of propagation in air (in./ μ sec) divided by 4. So the length in inches of a $\frac{1}{4}$ -wave line is obtained by dividing 2952 by the frequency in MHz. For any dielectric other than air, the length is reduced by the propagation constant of the dielectric.

Returning to the original problem of finding the inductive reactance of an air-dielectric line that is (a) short-circuit-

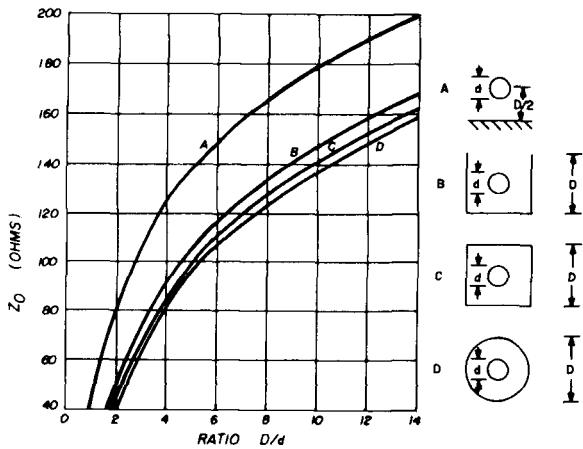

fig. 2. Transmission-line characteristics using air dielectric. Ratio D/d should be chosen in the range from 2.5 to 5.0.

ed at the far end, and (b) shorter than $\frac{1}{4}$ wave, the relationship between inductive reactance and physical length is

$$\begin{aligned}
 X_L &= Z_0 \tan \frac{\text{length in inches} \times 90}{\text{length of } \frac{1}{4} \text{ wave}} \\
 &= Z_0 \tan \frac{\text{length} \times 90 \times \text{freq in MHz}}{2952} \\
 &= Z_0 \tan \frac{\text{length} \times \text{freq in MHz}}{32.8} \quad (2)
 \end{aligned}$$

Fig. 3 shows the relationship of X_L and length, normalized with respect to Z_0 to simplify the curve.

design procedure

The problem is to assemble all this information into something that can be used to design a tank circuit. The first step is to choose one of the configurations shown in fig. 2. The choice will depend on materials available and by the metal work that may be required. For the average workshop, the three- or four-sided square can be built fairly simply from flat metal with angles at the corners.

Next, decide on a suitable ratio of D/d (see fig. 2). The recommended values in fig. 2 were determined from the curves in fig. 4, which shows that ratios between about 2.5 and 5 provide lowest attenuation.

Voltage breakdown and power-handling properties are usually no problem for amateur work. (A further discus-

sion on this subject is contained in reference 3, from which the curves in fig. 4 were obtained.)

From the chosen dimensions, the Z_0 of the line must be determined from fig. 2. Next, the capacitance that will be present at the tube end of the line must be estimated. This capacitance is composed of tube output capacitance, strays, and the tuning capacitance. Tube plate capacitance

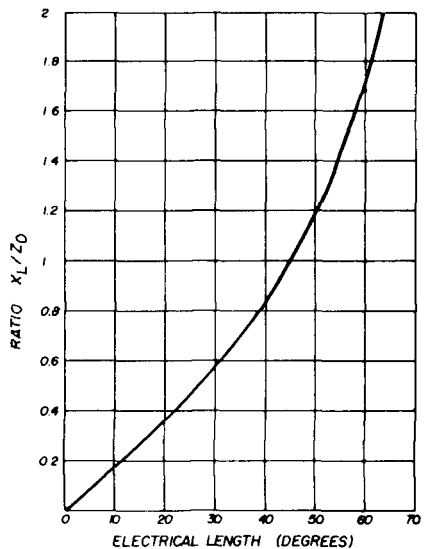

fig. 3. Relationship between line length and inductive reactance.

can be obtained from tube-manual data; stray capacitance can be estimated at a few pF; and the tuning capacitance can be the mid-range value of the capacitor, usually just a few pF.

The capacitance at the tube end of the line is the sum of these capacitances. The capacitive reactance, X_C , of this sum equals the inductive reactance, X_L , required to resonate the circuit at the operating frequency. This value of X_C can be estimated closely enough from fig. 5.

After dividing X_C by the line Z_0 , the line electrical length can be determined from fig. 3, and the physical length can be calculated from

$$L = \frac{32.8 \phi}{f} \quad (3)$$

where

- L = line length (in.)
- ϕ = electrical length (deg)
- f = frequency (MHz)

practical circuit

A means must be provided to feed high voltage to the tube anode. This can be parallel feed through an rf choke, with

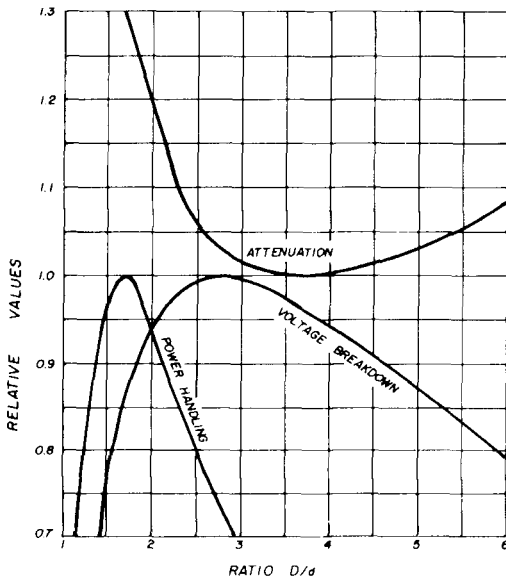

fig. 4. Line Z_0 choices for design.

a plate-blocking capacitor to keep high voltage off the transmission line. However, a better method is to feed the high voltage to the tank through an rf choke at a point on the line where rf voltage is minimum; i.e., at the rf shorted end.

A capacitor is then inserted at the

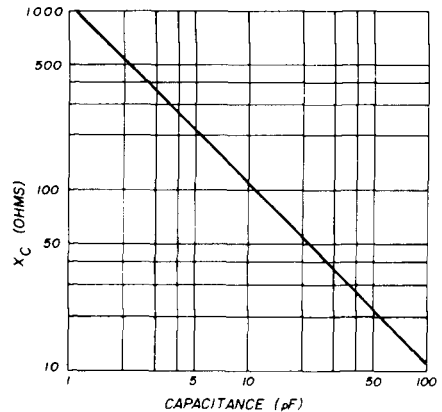

fig. 5. Capacitive reactance as a function of circuit capacitance at 145 MHz.

shorted end to complete the rf short circuit on the line and to provide dc isolation of the inner conductor from ground. The capacitor can be built from a metal sandwich separated by a teflon film and installed into the end of the line. The capacitance value should be between 100-500 pF to present very low reactance. The capacitor should have low losses since it must pass high rf circulating currents. Teflon sheet about 10 mils thick is a good choice for the dielectric. The tuning capacitor can be made from two metal discs with variable spacing between them.

The transmission-line center conductor should be as large as possible, consistent with desired Z_0 , to keep losses down. Silver plating is recommended. (A good

*"Cool-Amp," available from Cool-Amp Co., 8621 S.W. 17 Ave., Portland, Oregon 97219. Also, no. 28-203 electroplating set plus 28-211 silver electrolyte; Radio Shack, 730 Commonwealth Ave., Boston, Mass. 02215.

article on silver plating vhf components is contained in reference 4.) Other alternatives are also available.*

Antenna coupling is provided by a coupling loop inserted into the cavity at the cold end, similar to Figure 2-60B in reference 2.

tank circuit Q

Reference 3 states that a resonant coaxial line optimized for minimum attenuation can have an unloaded Q of about 3000. Since the tank-circuit efficiency is determined by the relationship between unloaded and loaded Q, it's desirable to keep unloaded Q as high as possible. The circuit Q obtainable with a linear tank circuit is much higher than with lumped constants.

design example

An example will illustrate the principles involved. Choose a 4X150 as an output tube, which has 4.5 pF output capacitance. Estimate stray and tuning capacitances as about 4.5 pF. Total output capacitance is then 9 pF. At 145 MHz, X_C is 120 ohms (fig. 5). Now choose a D/d ratio of about 4 and a 3/8-inch diameter inner conductor. This combination gives $D = 1.5$ inches.

For ease in construction, choose a 4-sided square, 1.5 inches on a side. This type and size of line has a Z_o of 87 ohms. Dividing $X_C = 120$ ohms by $Z_o = 87$

ohms yields a ratio of 1.38. From fig. 3, the electrical length is 54 degrees. Multiplying 54 by 32.8 and dividing by 145 gives the physical length of the transmission line as 12.2 inches. This is the total path length above the ground plane or chassis and included the path through the tube and the capacitance at the far end of the line.

conclusion

My philosophy on building home-brew gear has been that a little basic design should be done first, and then the circuit breadboarded to work out specific details. Even yet I am sometimes pleasantly surprised at the results of a little basic theory applied to practice.

For example, a look at fig. 2 shows that the four-sided square configuration has a lower characteristic impedance than the three-sided one. Therefore, when a metal top is put on the three-sided line, the characteristic impedance is reduced. It might appear, at first glance, that adding the fourth side would add capacitance to the circuit and hence lower the resonant frequency, but it doesn't work that way. The line resonates with a fixed tube capacitance, so decreasing the line Z_o increases line electrical length to maintain resonance.

Increasing line electrical length is equivalent to increasing the frequency; therefore the resonant frequency becomes higher. The change, though slight, is apparent on a grid-dip oscillator. This example shows that a little basic design saves a lot of cut and try and helps to understand what goes on in these circuits.

references

1. "Very High Frequency Techniques," Radio Research Laboratory, Harvard University, McGraw-Hill, 1947, Vol. 1, Ch. 15.
2. "Radio Amateurs Handbook," ARRL Staff, 1969, Ch. 13.
3. A. F. Harvey, "Microwave Engineering," Academic Press, 1963, p. 10.
4. R. W. Campbell, W4KAE, "Silver Plating for the Serious Amateur," *ham radio*, December, 1968, p. 62.
5. F. E. Terman, "Electronic and Radio Engineering," McGraw-Hill, 1955, p. 107.

ham radio

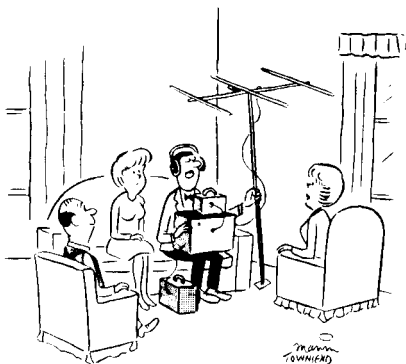

"Hope you folks don't mind me bringing my gear . . . I'm expecting an important CQ from Spratley Island tonight."

A Holiday Special

from

ham radio



What better gift for your amateur friends than a subscription to
HAM RADIO

●
SAVINGS UP TO 50%
●

With our special Holiday Gift Plan the more you buy the greater your savings.

You save at least \$1.00 on any subscription, but you can save as much as \$3.00.



ONE YEAR SUBSCRIPTIONS Anywhere in the world

First Subscription	\$5.00	Save \$1.00
Second Subscription	\$4.50	Save \$1.50
Third Subscription	\$4.00	Save \$2.00
Fourth Subscription	\$3.50	Save \$2.50
Fifth Subscription	\$3.00	SAVE \$3.00

Additional Subscriptions \$3.00 each.

Here is an opportunity to whittle your gift list down in a hurry and save a lot of money doing it.

Order Today - Include your own subscription or renewal while you are at it.

Offer expires December 24, 1970.

HAM RADIO MAGAZINE
GREENVILLE, NEW HAMPSHIRE 03048

DONOR — A gift card will be sent shortly before Christmas announcing your gift.

Name Call

Address

City Zip

FIRST GIFT at \$5.00 for one year.

Name Call

Address

City Zip

SECOND GIFT at \$4.50 for one year.

Name Call

Address

City Zip

THIRD GIFT at \$4.00 for one year.

Name Call

Address

City Zip

FOURTH GIFT at \$3.50 for one year.

Name Call

Address

City Zip

FIFTH GIFT at \$3.00 for one year.

Name Call

Address

City Zip

Additional subscriptions \$3.00 each.

Enclosed is

- 5.00 for one subscription
- 9.50 for two subscriptions
- 13.50 for three subscriptions
- 17.00 for four subscriptions
- 20.00 for five subscriptions

printed-circuit boards without printing

The printed-circuit board is adaptable to quantity manufacture of electronic circuits using small parts operating at low power. For the home workshop, where the quantity is likely to be one board, the conventional process of making the board is tedious and messy. A search was made for an easier and less messy procedure that would result in an attractive product. Here's a report on the result.

construction

Some circuits can be designed satisfactorily without breadboarding and subsequent modification. However, most circuits designed by home craftsmen require such an approach. So I decided at the start of this project that a working circuit should be made before transferring it to a copper-laminate board.

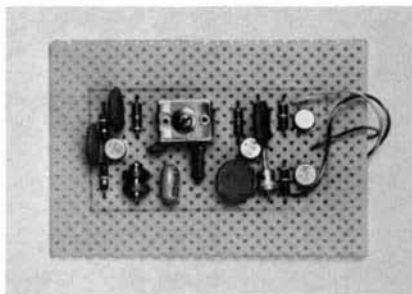

Step 1. A diagram of the circuit is first made on paper, using standard drafting aids. When preparing the drawing, use care to keep the number of crossing wires to a minimum. This will save much time when laying out parts.

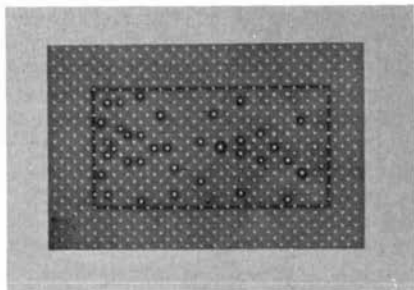

Step 2. Mount the parts on a punched phenolic board (available from electronic parts supply houses) and position the parts as in the drawing you made in step 1. Try to have wires cross underneath parts on the face of the board. Where parts are to be connected, bring the wires together, cut off surplus wire, and solder.

After all parts have been mounted and connected, apply appropriate voltage and check the circuit using temporary terminals and clip leads. Make necessary modifications, then revise the basic drawing.

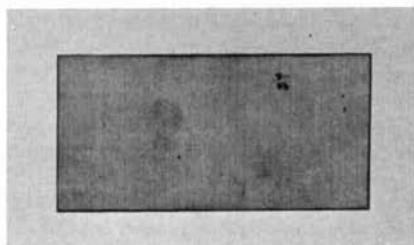

Step 3. Drill any holes to be used for mechanical mounting or for terminals in a

Roy C. Corderman, W4ZG, 730 Yorkshire Road, Winston-Salem, North Carolina

second piece of phenolic board the same size as the board to be used for the finished product. This work is necessary at this point so that final parts layout won't interfere with mounting hardware or terminals.

Next, mark the holes on the face of the phenolic board through which leads of parts are to be inserted. Follow the general placement of parts as in step 2, but relocate parts as necessary to provide an even layout and to avoid crowding.

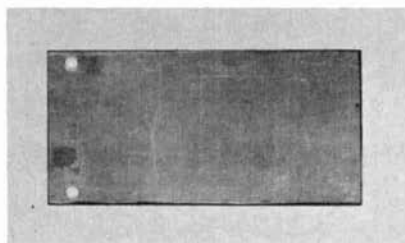

Step 4. Cut the copper-clad board to finished size, deburr rough edges, and drill the mounting holes using the phenolic board in step 3 as a template. Hold the two boards together with C-clamps. The marked side of the phenolic board should face up; the copper side of the copper-clad board should face down.

Step 5. Place a piece of hardwood under the copper-clad board. Use a no. 50 drill, and drill through each of the marked holes on the phenolic board where component leads will be inserted. Sepa-

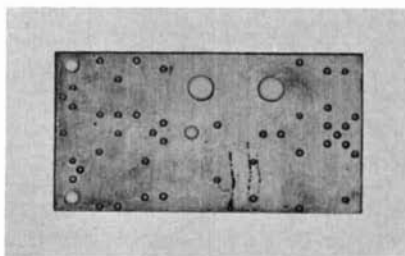

rate the two boards, then remove any burrs with a larger (hand-held) drill bit. Use fine sandpaper to finish.

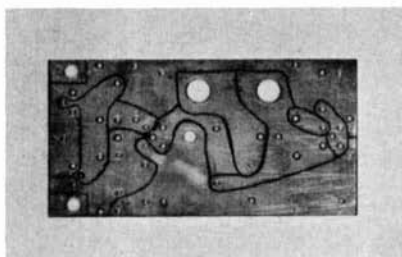

Step 6. This step should be accomplished very carefully and work checked before proceeding further. Using the breadboard model on the first phenolic board (step 2), locate on the back the groups of holes connected together. Find the same holes on the back of the copper-clad board, and draw a pencilled line around them. Do this for each of the interconnections until all have been marked on the copper side of the board. Eliminate duplication of lines between connected areas. Wherever possible, extend the lines to the edge of the board. When this has been done, there will be lines on the board where insulating paths are to be cut into the copper.

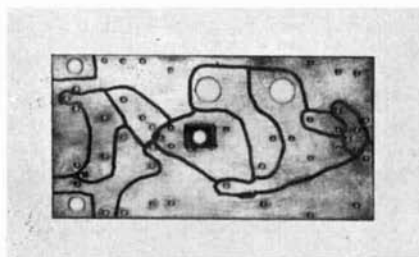

Step 7. The next step is to remove the copper from these insulating paths. This can be done with an engraving drill or a dentist's no. 5 or 6 burr drill held in a drill-press chuck.

Place the copper-clad board on a piece of material of uniform thickness, such as a phenolic board about a half-inch thick. Do not use wood; it varies too much in thickness. Tape or otherwise temporarily attach the copper-clad board to the thick phenolic board. Lubricate the underside of the phenolic board so it slides easily on

the drill-press table. Now move the copper-clad board under the drill tip, which should be running at a medium-high speed. Follow the pencil lines marked in step 6. Adjust the depth of cut so all of the copper is removed but little of the insulating material is removed. This operation will be simplified if the insulating paths have been brought to the edge of the board, as suggested in step 6. When all paths have been cut, sand the work to remove any burrs.

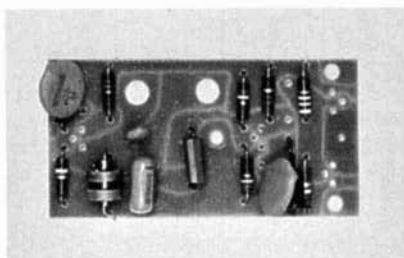

Step 8. The next step is to mount the parts. Place leads through holes from the insulated side, keeping appearance in mind as each part is positioned. Bend

parts on the insulated island to which they connect. Remove any surplus solder flux with alcohol on a soft cloth.

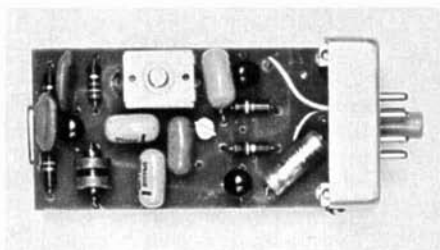

Mount the board in its container or on its plug-in terminal strip, and connect any wire leads.

conclusion

This method of preparing PC boards has been used for circuits operating at and above 150 MHz. No interaction problems have been experienced. By properly positioning the various parts, circuits operating at ground potential can be placed between those carrying differing levels of rf energy, thus decoupling them.

fig. 1. 100-kHz crystal oscillator used to demonstrate printed-circuit construction. Transistor stage Q2 was found unnecessary and was deleted from the final design.

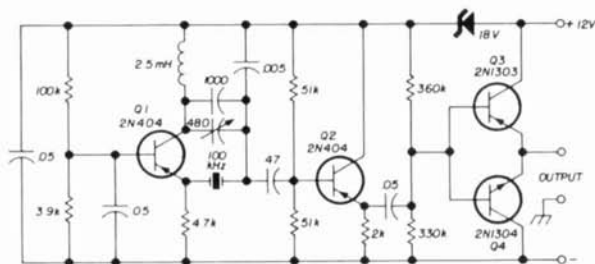

leads close to the copper on the underside and away from the adjacent insulating path. Cut leads to 1/8-inch on the bent part of the lead. Solder all connections using a low-temperature iron. No soldering guns, please! Use minimum heat on diode and transistor leads. Solder these

The finished product looks nice and works well. The boards are much stronger mechanically than those made with the electrolytic process, since much more copper remains on the board. Changes have been made in the circuits to meet revised needs by using a Dremel hand drill* with a burr drill bit to cut an insulating path through an island and thus separate a circuit.

*The Dremel drill is a high-speed 117-Vac unit which operates at 27,000 rpm. Available at hobby shops, or from the Dremel Manufacturing Company, 2420 18th Street, Racine, Wisconsin 53401.

a simple test set

for transistors and diodes

Eight components
are all you need to build
this tester
to determine the go,
no-go status
of unknown devices

Have you ever gazed at a transistor, wondering if it's an npn or a pnp? Or have you ever wondered if, in fact, it exhibits any transistor action at all? The test set described here was developed to answer these questions quickly, directly, and with minimum effort. The tester can be used to sort transistors into good, bad, pnp, and npn categories. It can also identify good and bad diodes and determine anode or cathode polarity.

Fred Johnson, ZL2AMJ, 15 Byron St., Upper Hutt, New Zealand

description

Shown in **fig. 1** are the externally visible components: just two lamps, a transistor socket, and a pushbutton switch. Place a transistor into the socket, note that both lamps are out, quickly press the pushbutton switch—the pnp lamp glows, indicating transistor action and a pnp device. The npn lamp would have lit had the device been an npn transistor. Place a diode between C and E pins on the socket, and only one lamp should light. The panel labels (**fig. 1**) identify the cathode end.

construction

The circuit is shown in **fig. 2**. The 6–8 V supply can be taken from an existing piece of equipment—in fact, the entire unit can be built on a corner of unused panel space in a piece of test gear. It can just as easily be built in a minibox, with a bell transformer for a voltage supply. For these reasons, no construction details are given here. Nothing is critical about construction, layout, or component types.

The resistor in series with the switch should have a lower value if power transistors are to be investigated. A little experimenting will produce the correct value.

limitations

As with any piece of simple test gear, this one has some limitations. However, as a quick tester, it has no equal. The data in **table 1** can be used to interpret the test results.

The collector current required for lamps may be excessive for some transis-

tor types and could cause the device under test to heat faster than expected. Prolonged operation may cause transistor failure. No failures are likely if the switch is operated just long enough to identify lamp operation. The prototype unit has

the E terminal. A transistor will conduct only when its base-emitter junction is forward biased; positive for npn and negative for pnp. So when B is positive, forward biasing the npn base-emitter junction, collector current will flow

table 1. Interpretation of test results

device under test	switch	pnp lamp	nnp lamp	conclusion
diode between E and C pins	—	on	off	good unit; anode connected to E pin
	—	off	on	good unit; anode connected to C pin
transistor: emitter to E	—	off	off	unit open- circuit
	—	on	on	unit short- circuit
base to B	—	on	on	short between collector & emitter
	—	off*	off*	normal—i.e. good unit
collector to C	on	on**	off	good pnp unit
	on	off	on**	good npn unit
	on	off	off	open-circuit collector or a good small- signal unit with low gain

* Some modern (planar) transistors exhibit a breakdown when a reverse potential is applied to the collector with the base circuit open. This may show up as a faint glimmer on one lamp during this test. This is normal, and the other lamp should glow brightly during the next test when the switch is pressed.

** A dim lamp during this test usually indicates that the transistor has a high saturation voltage and should probably be rejected.

been in operation for a long time, and so far as I know, it hasn't been responsible for any device failures.

how it works

The signal applied between base and emitter with the switch pressed is an ac signal; i.e., terminal B voltage changes positively and negatively with respect to

through the npn lamp. The pnp lamp will not light, because its series diode is reverse biased and nonconducting.

On the next half cycle, the base-emitter junction is reverse biased and the transistor is cut off. The transistor therefore only conducts on alternate half cycles, and the lamps indicate accordingly.

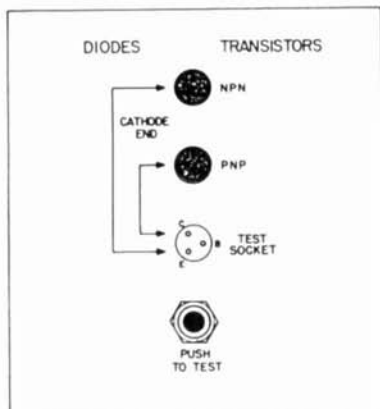

fig. 1. Suggested panel layout for the tester.

A short circuit inside the transistor between emitter and collector will result in both lamps lighting. An open-circuit collector lead will result in neither lamp lighting. With the switch released, the transistor acts as two diodes in series opposing; hence neither lamp will light. When the switch is pressed, transistor action operates a lamp.

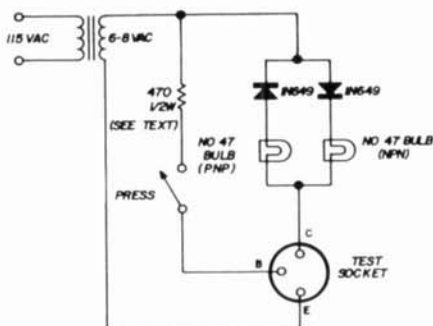

fig. 2. Schematic for the semiconductor device test set.

A diode connected between the E and C pins will conduct on one-half cycle only and only one lamp will light unless it's short-circuited, in which case both lamps will light. The diode connections can be identified from the appropriate lamp indication.

ham radio

NEW

TRI-EX'S MW SERIES

Pound for pound the strongest self-supporting steel towers available.

The new economy MW Series towers are designed to support up to 9½ sq. ft. of antenna area. Featuring Tri-Ex's extra strong torsional twist resistant "W" bracing, the all steel MW crank-up towers come in three sizes, each fully galvanized for carefree maintenance. Models available, by height, are: MW-35', MW-50', and MW-65'. Nested height is between 21' and 22'. Hinged base and wall bracket included with MW tower order! See your local dealer or write for free catalog today. Prices start as low as:

\$157.35

Tri-Ex TOWER CORPORATION
7182 RASMUSSEN AVE., VISALIA, CALIF. 93277

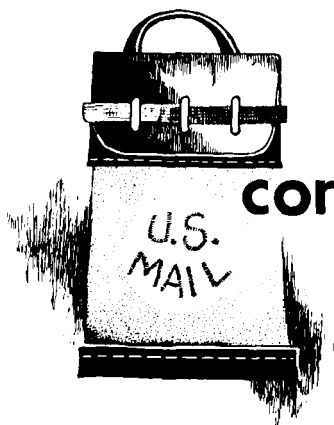

comments

reflected power

Dear HR:

I was very interested in VE3AAZ's very good paper in the May 1970 issue of *ham radio*, "Some reflections on reflected power." In the section on line reflections he asks, "What happens if the load impedance doesn't equal the line impedance and some energy is reflected?" Then he goes on to answer his own question. "It's unlikely that the source and line impedances will be exactly equal. Thus, any energy reflected from the load will travel down the line to the source to be reflected again toward the load. This repeats until the wave's amplitude becomes too small to be of interest."

Thus his concept of the reflected wave being re-reflected from the junction between the source and line depends upon the source and line impedances being unequal. But if this is correct, then one must envisage various situations in which those two impedances differ in various ratios, in which cases one would expect various proportions of the reflected wave to be re-reflected on getting back to the source-line junction. Thus it may be incorrect to say that "any energy reflected from the load will travel down the line to the source to be reflected again toward the load." (That is to say,

any departure from equality of the two impedances at the sending end will cause complete reflection.) But suppose, in the rare case, that these two impedances are exactly equal; will there be no reflection? This seems to be the conclusion to which we are driven by adopting Mr. Anderson's concept which, by the way, has wide acceptance though seldom specifically stated.

However, I do not believe that this is the actual situation. To explain complete re-reflection at the sending end junction, appears to require that the oncoming reflected wave see either zero impedance or infinite impedance as those are the only conditions for complete reflection. What the whole explanation may be I do not know. It may well be that the hypothetical physical model invoked in nearly all discussions of transmission lines differs from the mathematical model sufficiently to be inadequate to explain reflections at the sending end. I would like to see this point discussed in *ham radio*.

Hubert Woods
Guadalajara, Mexico

The statement that "any energy reflected from the load will travel up the line . . ." means simply (in a lossless line) that all the energy reflected from the load goes back to the source end where something happens to it. It does not imply that the energy reflected from the load will go back to the source and then all come back toward the load again.

My original manuscript was in two parts which was condensed for publication. The original said, "And, if we have reflected energy traveling back to the source, then what? When the line looks back into the filter/transmitter, there is scarcely more than one chance in a million that it will see an impedance equal to Z_0 , so at least part of the reflected energy (which cannot simply disappear according to the law of conservation of energy) is reflected again and starts toward the load where it is again reflected (in part) and what's left of it goes back to the source and so on and on, back and forth, until the wave gets too small to interest us... One group (of waves) is moving source-to-load and is called the "forward" or "incident" component: The other group is moving load-to-source and so is called the "reflected" component."

In the interests of brevity I avoided any reference to reflection coefficient in my original paper. This quantity is defined

$$\rho = \frac{Z - Z_0}{Z + Z_0}$$

The customary procedure is to make $Z = Z_L$ (the impedance of the load). However, if one elects to use the "successive reflections" method to find out what is happening on the line, then one must define an additional ρ in which $Z = Z_s$ (the impedance of the source). In any event it is possible, though tedious, to use these coefficients to completely solve for the voltages, currents and power on the line. There is clearly just as much variety possible in the sending end ρ as there is in the load end ρ . But if the load ρ is zero (swr exactly one) there will be no reflected energy and the sending end ρ is only of academic interest. The important point to note is that the load end gets the first "crack" at the energy and so determines how much or how little energy there will be for the sending end to work on. Accordingly, the swr depends upon the load ρ only.

Walter Anderson, VE3AAZ
Toronto, Canada

IT'S WHAT'S INSIDE THAT "COUNTS"

Accuracy and stability has been placed first in the design of the TBL-1 Marker. We feel a marker should be more accurate than the receiver it is going to calibrate — so no compromise has been made with quality.

Fairchild, Motorola, JFD, Jan, Mallory, IRC and Keystone components are used throughout. It costs more, but calibrates with the best. Hundreds have been sold to government, amateurs, SWL's, schools and laboratories around the world.

Try one today.



Frequency marker, less cabinet and switch
Specifications: Glass Epoxy Board. Adjustment to zero beat with WWV. Uses 100 KHz crystal (not supplied). 3 to 4 VDC. Compact — 1.75 x 3.75 inches. Install anywhere!

Complete easy-to-assemble kit \$16.50 Wired and Tested \$19.95

SWITCH \$1.00 CRYSTAL ONLY \$3.50
with purchase of any of above

OR



SELF-CONTAINED UNIT

The TBL Marker is a complete unit including the circuit board shown at left and powered with 3 "C" type flashlight batteries. Merely connect to your receiver antenna — no internal wiring necessary. A front panel control allows zero beat with WWV.

Special introductory price \$29.95
Less crystal and batteries

POSTPAID U.S.A.

SOLD WITH MONEY BACK GUARANTEE

THE RADIO SHOP, LAB 1

48 ELM STREET, NEW CANAAN, CONN. 06840
Tel. 203-966-3553

THE RADIO CONSTRUCTOR

Vol. 22 No. 11

JUNE 1969

THREE SHILLINGS

Top Band "Quartet" Transmitter



**NEXT MONTH
& MATCHING
TOP BAND
TRANSISTORISED
SUPERHET RECEIVER**



**Special
IN THIS ISSUE**

Conductivity-Sound-Operated Switch
Pocket Continuity-Loopback Tester

A New Magazine?

Not really. New in the U.S.A. perhaps, but very well known in Great Britain and now being offered to you here.

RADIO CONSTRUCTOR is almost exclusively construction material. Clearly written, concise articles give you full details on:

- Audio Construction Projects
- Receiver Construction Projects
- Transmitter Construction Projects
- Test Equipment Projects
- Radio Control Projects
- ... and much more

Try a subscription to this interesting magazine, we are sure that you will not be disappointed.

ONE YEAR SUBSCRIPTION — \$5.75

Write
RADIO CONSTRUCTOR
Greenville, N. H. 03048

Name

Address

City State

Zip

active audio filter

Dear HR:

I wanted to let you know that I've constructed the variable bandpass audio filter that you ran in the April issue of *ham radio*. I use a 2N4124 in the filter, and another 2N4124 as a single audio stage for headphone operation. Together, they produce a quite usable level of audio with really great selectivity. The amplifier stage is very simple:

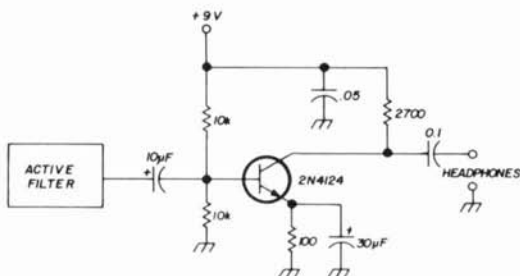

I am in the process of using this filter and audio as a replacement for the filter in the DC-80-10 receiver of *QST*, April 1969. Without exaggerating, the receiver and this filter produce *better* selectivity than I get with my RME-4350 with the crystal filter notched all the way in! With the filter at the point of near-oscillation, S-4 signals will come up to a level equal with an S-9 plus 10-dB signal only 100 cycles or so away. I'm amazed at it! Guess I'll never build that transistor version of the old 'selecto-ject' you ran a few months back.

I found the main problem was lack of skirt selectivity—the bandpass signal was really peaked, but signals off the sides suffered little attenuation. Solution: I cascaded two sections of the filter with some minor modifications to adapt to the cascading. These consisted of eliminating the resistor between input and ground in the second stage, and adding a trimmer-type potentiometer to the first stage instead of the regular potentiometer. With this setup, the first stage is adjusted not quite at minimum bandpass (backed off slightly to the point where the stage

partners in excellence

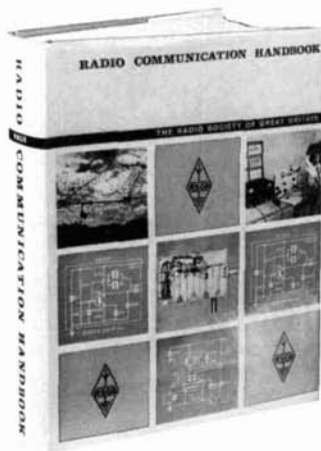

An outstanding technical guide to all phases of amateur radio. In 832 pages 20 complete chapters are devoted to such subjects as single sideband, antennas, mobile equipment, RTTY and much, much more.

This excellent book has received wide acclaim on both sides of the Atlantic and belongs in your library . . . **now.** **\$11.95**

OTHER

POPULAR RSGB PUBLICATIONS

Radio Date Reference Book	\$2.50
VHF-UHF Manual	3.75
Amateur Radio Techniques	2.50
Amateur Radio Circuits Book	2.00
World at Their Fingertips	2.50

All prices postpaid in USA & Canada

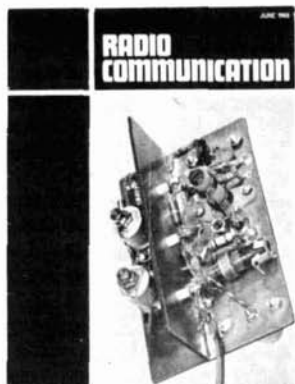

Many thousands of you have become very familiar with the various Radio Society of Great Britain books and handbooks, but very few of you are familiar with their excellent magazine, **Radio Communication.**

This is the oldest and most widely read British amateur radio magazine. Published monthly it provides complete coverage including such popular features as: Technical Topics, a monthly survey of the latest ideas and circuits, Four Meters and Down, a rundown of the latest in VHF and UHF and much more.

It includes numerous technical and construction articles in addition to a complete rundown on the month's events in amateur radio. Surely a most interesting addition to your amateur radio activities.

Act Quickly! A price increase will be announced very soon. Send your subscription to us today while it is still only **\$6.00 per year.**

book division

comtec

Box 592 • Amherst, New Hampshire 03031

"WE ARE THE EXCLUSIVE NORTH AMERICAN DISTRIBUTOR FOR RSGB PUBLICATIONS —
DEALER INQUIRIES INVITED"

The STANDARD, by Heights

THE MOST IMPORTANT FEATURE OF YOUR ANTENNA IS PUTTING IT UP WHERE IT CAN DO WHAT YOU EXPECT.

RELIABLE DX — SIGNALS EARLIEST IN AND LAST OUT.



And now, with motorized options, you can crank it up or down, or fold it over, from the operating position in the house.

The "Standard" can be assembled on the ground with nothing more than a wrench and a spade. No guys, no climbing necessary. Strong and beautiful.

See your local distributor, or write for 12-page brochure giving dozens of combinations of height, weight and wind load.

NOW In New Larger Facilities to expedite your orders.

HEIGHTS MFG. COMPANY

Almont Heights Industrial Park
4516 North Van Dyke, Almont, Michigan 48003

SAVE 10%!

BLULYNE BASIC LOGIC LAB

PS-61C

CONTINUOUSLY VARIABLE POWER SUPPLY

Plus or Minus 1 - 15 VDC, load current 0-700 Ma. Usable up to 1 Amp over 10 VDC. Regulation: 0.0005% VDC per mA load current. Ripple: less than 0.005 Vrms at full load. Floating output: either output terminal may be grounded.



\$49.95

APG-100

PULSE GENERATOR ADAPTOR

Converts your sine or square wave generator to a high quality pulse generator at 25% of the cost of a separate unit. Operation from 1 Hz to 10 MHz. Variable pulse width. For more details see page 73, Sept. 1970 Ham Radio.



\$39.95

Buy both units for only \$80.90

(A \$9.00 SAVING)



Write for illustrated brochure on these
and other BLULYNE PRODUCTS



BLULYNE ELECTRONICS CORP.

3 SAND SPRINGS ROAD
WILLIAMSTOWN, MASS. 01267

SWAN PRODUCT LINE COMPLETE FOR ALL OF YOUR NEEDS — mobile · fixed · portable

See us for the
CYGNET 260/270



and the updated **500-CX**



THE DELUXE **500-CX**

DALLAS HAM CENTER SINCE 1941
YOUR DEPENDABLE HAM SUPPLY HEADQUARTERS
COME SEE — CALL OR WRITE
AL MARKWARDT, MGR., W5PXH

CRABTREE'S ELECTRONICS 
2608 ROSS AVE., DALLAS, TX. 75201, 748-5361

THE ULTIMATE FOR TWO-METERS!!



- TRANSCIVE OR TRANSMIT-RECEIVE
- VFO TUNING OR FIXED FREQUENCY OPERATION (UP TO 9 CHANNELS)
- INDEPENDENT RECEIVER AND TRANSMITTER MODE SWITCHES FOR SSB, AM, FM AND CW
- ALL SOLID STATE EXCEPT POWER OUTPUT STAGE
- RECEIVER NOISE FIGURE: 1.8
- TRANSMITTER OUTPUT 12 W IN AM, FM, CW, 40 W PEP IN SSB
- 115 - 220 VAC OR 12 VDC
- 2 (3) CRYSTAL FILTERS
- MADE BY BRAUN IN WEST GERMANY

Model SE 600 Price \$875.00

si

SPECTRUM
INTERNATIONAL
BOX 87C TOPSFIELD
MASSACHUSETTS 01983



Radio Amateurs
Reference Library
of Maps and Atlas

WORLD PREFIX MAP — Full color, 40" x 28", shows prefixes on each country . . . DX zones, time zones, cities, cross referenced tables postpaid \$1.25

RADIO AMATEURS GREAT CIRCLE CHART OF THE WORLD — from the center of the United States! Full color, 30" x 25", listing Great Circle bearings in degrees for six major U.S. cities; Boston, Washington, D.C., Miami, Seattle, San Francisco & Los Angeles. postpaid \$1.25

RADIO AMATEURS MAP OF NORTH AMERICA! Full color, 30" x 25" — includes Central America and the Caribbean to the equator, showing call areas, zone boundaries, prefixes and time zones, FCC frequency chart, plus informative information on each of the 50 United States and other Countries postpaid \$1.25

WORLD ATLAS — Only atlas compiled for radio amateurs. Packed with world-wide information — includes 11 maps, in 4 colors with zone boundaries and country prefixes on each map. Also includes a polar projection map of the world plus a map of the Antarctica — a complete set of maps of the world. 20 pages, size 8 3/4" x 12" postpaid \$2.00

Complete reference library of maps — set of 4 as listed above postpaid \$3.50

See your favorite dealer or order direct.

WRITE FOR FREE BROCHURE!

RADIO AMATEUR **callbook** INC.
Dept. E 925 Sherwood Drive
Lake Bluff, Ill. 60044

TEN-TEC POWER-MITE TRANSCEIVERS

PORTABLE / LOW POWER / LOW COST

Put more
adventure into
Amateur
Radio

The Power-Mite includes a Synchrodyne direct conversion receiver and solid state CW transmitter. Drift is less than 100 Hz. Adequate receiver sensitivity even for "down under" DX signals. An "M" derived filter provides 2 KHz selectivity. Built-in side-tone, receiver muting. Integral break-in keying with adjustable delay (PM 3A only) makes operating virtually effortless. Keying is clean and wave shaped for easy copy.

A compact Power-Mite transceiver excels as a traveling companion. It needs only an antenna, key, headphones and a lantern battery for instant CW communication wherever you are.

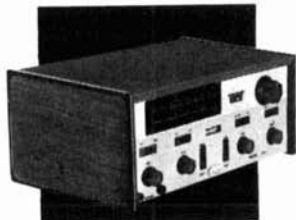

POWER-MITE PM 3 \$69.95
POWER-MITE PM 3A \$79.95

Old timers who are a little bored with high power are finding the Power-Mite a refreshing challenge. Beginners experience all the thrills of conquering distance and making new friends.

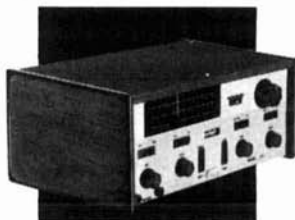

PM 2 \$54.95
PM 2A (with side-tone) \$59.95
PM 2B (with side-tone and 20 meters) \$65.95

Ideal for the Novice, portable operation, QRP work and emergency service. It may be used to drive a linear amplifier.

TEN-TEC, INC.
SEVIERVILLE, TENNESSEE 37862 WRITE DEPT. R

When visiting the Smokies come see us! We're 15 mi. N. of Gatlinburg

SOMETHING Really NEW!

Cir-kit

a name you
will be hearing a good deal of
from now on.

- No Chemicals — No Mess
- No Layout Restrictions
- Flexible — Conforms to any surface shape
- Use for Crossovers — Either insulate with Teflon or Mylar or use other side of board.
- Simple Circuit Changes
- Full Instructions

A revolutionary new material for the construction of experimental and prototype "printed" circuit boards.

Cir-Kit is high purity .002" copper protected by lacquer and coated with an exclusive heat resistant pressure sensitive self adhesive. Just remove backing paper and place in selected position. Press down firmly. If modifications are necessary just rip it up and start over.

Cir-Kit can be used for modifying existing boards or building up new ones. The perfect answer for small quantity applications or one of a kind amateur projects.

Send SASE for Small Sample and Complete Details

or
5 feet 1/16" or 1/8" wide . \$.60 Sheets 6" x 12" — \$2.50 each
100 feet 1/16" or 1/8" wide . \$7.95 or 5 for \$7.95

Order Now
Cir-kit

BOX 592
AMHERST, N. H. 03031

Dealer Inquiries
Invited

The World's Most
Versatile Circuit Building System

NOW at LA Amateur Radio Sales

Galaxy GT-550 Only \$550.00



BONUS COUPON

\$100 VALUE

- AC-400 AC POWER SUPPLY
 - FREE SHIPPING WITHIN USA
- BRING OR SEND WITH YOUR ORDER FOR THE GALAXY GT-550

L. A. AMATEUR RADIO SALES

24214 CRENSHAW BLVD.
TORRANCE, CALIF. 90505
Phone 213-534-4456

Watch for new location approximately
November 15, 1970 at 23044 Crenshaw Blvd.,
Torrance, Calif. 90505
(corner of 231st Street & Crenshaw)

SPACE AGE KEYS

Only
\$67.50



- Planar epitaxial integrated circuits for reliability. No tubes—No separate transistors.
- Precision feather-touch key built-in.
- Fully digital—Dot-dash ratio always perfect.
- No polarity problems—Floating contacts switch $\pm 300\text{-V}$ @ 100-ma.
- Rugged solid construction—will not walk.
- Send QSL or postcard for free brochure.

PALOMAR ENGINEERS

BOX 455, ESCONDIDO, CAL. 92025

GEM-QUAD FIBRE — GLASS

ANTENNA FOR 10, 15, and 20 METERS.

Two Elements \$87.00
Extra Elements \$50.00 ea.
Shipped Freight Collect
INCLUDES U.S. Customs Duty



- KIT COMPLETE WITH
- SPIDER
 - ARMS
 - WIRE
 - BALUN KIT
 - BOOM WHERE NEEDED

SEE OUR FULL PAGE IN MAY ISSUE

Buy two elements now — a third and fourth may be added later with little effort.

Enjoy optimum forward gain on DX, with a maximum back to front ratio and excellent side discrimination.

Get a maximum structural strength with low weight, using our "Tridetic" arms.



MANITOBA DESIGN INSTITUTE
AWARD WINNER

Structural Glass
LIMITED

Canadian Patent No. 794506
U. S. Patent Pending

20 Burnett Avenue, Winnipeg 16, Manitoba, Canada

flea market



■ **RATES** Commercial Ads 25¢ per word; non-commercial ads 10¢ per word payable in advance. No cash discounts or agency commissions allowed.

■ **COPY** No special layout or arrangements available. Material should be typewritten or clearly printed and must include full name and address. We reserve the right to reject unsuitable copy. **Ham Radio** can not check out each advertiser and thus cannot be held responsible for claims made. Liability for correctness of material limited to corrected ad in next available issue. Deadline is 15th of second preceding month.

■ **SEND MATERIAL TO:** Flea Market, Ham Radio, Greenville, N. H. 03048.

GREENE DRAGON FLY . . antenna for 20-40-75 meters . . one feed line . . SWR one to one . . and guaranteed-self construction drawings \$5.00. Greene, Box 423, Wakefield, R.I. 02880.

DON'T BUY QSL CARDS from anyone until you see my free samples. Fast service. Economical prices. Little Print Shop, Box 9848, Austin, Texas 78757.

FOR SALE — HY GAIN TH4 \$50.00. Henry Ingwersen, Topsfield, MA 01983.

"DON AND BOB" NEW GUARANTEED GOODIES. Bug catcher all band mobile KW coil, Icore 2408T 3"/8TPI, less extension, whip \$24.95. Monarch SWR Relative Power Dual Meter Bridge \$15.95; Motorola HEP170 Epoxy Diode 2.5A/1000 PIV 39¢; RCA 6LQ6/6JE6C \$3.50; Jennings vacuum variable capacitor 300PF/7.5KV \$20.00; Model 15 Teletype \$50.00; Typing Reperf. \$35.00; TD \$20.00; Ham-M Rotor \$99.00; TR-44 \$59.95; write for quote new gear, parts, discontinued tubes. Write for quote SPR-4, R4B. All items guaranteed, freight, postage collect. Mastercharge, BankAmericard, GECC. Madison Electronics, 1508 McKinney, Houston, Texas 77002, (713) 224-2668.

SOLID-STATE STRIPLINE transverter 144-432. AM-FM-CW. Silverplated enclosure. Requires 1.2 Watts RF in transmit, 12 VDC in receive. \$37.50. Spectrum International, Box 87C, Topsfield, Mass.

FET CONVERTER KITS: 50, 144, 220. \$10.20. Includes silverplated glass-epoxy p.c. board, crystal, collforms, trimmers. IF 28-30 MHz. VHF Communications, Box 87D, Topsfield, Massachusetts.

SWAN 270 CYGNET new in original carton, \$465 fob A. D. Hensley, Box 20653, Billings, Montana 59102.

TIME BASE CRYSTAL OVEN. Center temp. 75° C. Cycling .05° C. 115 VAC. 1½" dia. x 3" tall. Octal base. Holds HC-6/U xtal. Made by Ovenaire. Replacement for Berkeley Counters. \$10.00 includes shipping. Never used. Guaranteed. Yellow Cab Radio Dept., POB 587, Kansas City, Mo. 64108.

2nd WORLD RTTY CHAMPIONSHIP is announced. At the present time, the Contests which count towards this Award are as follows: 1970 B.A.R.T.G. Spring RTTY Contest; 1970 D.A.R.C. RTTY WAE Contest; 10th World-Wide RTTY DX Sweepstakes; 1970 Alex Volta RTTY Contest; 1971 Giant RTTY Flash Contest. In order to arrive at the final score the following points system will be used for each Contest: 30 points to the winner, 25 points for 2nd place, 22 points for 3rd place, 20 points for 4th place, 18 points for 5th place, 17 points for 6th place, 16 points for 7th place . . . 1 point for 22nd place and all other entrants will be credited with one point. For the final score for the year, only the best 4 scores (Out of a possible 5) will be used for each operator. In order to take part in this Award it is not necessary for entrants to send in a claim as the entries of all competitors will automatically be included. The 1970 World Champion of RTTY will receive a plaque and prizes will be awarded for the leading positions in the final score. The Italian Magazine "CQ Elettronica" will make available the Awards for each year. It will be the responsibility of the British Amateur Radio Teleprinter Group to nominate the winner for the year 1970 and this Society will notify the "CQ Elettronica" Magazine of the results in order that the Awards can be made.

ELECTRONICS YOUR BAG? Looking for an electronics course . . . that you can pay for by the subject AND take ONLY the subjects you NEED? . . . that you can change into ANY PHASE of electronics after completion of basics WITH NO PENALTY? For full information, write: EDCO ENTERPRISES INC., P. O. Box 432, Sparks, Nev. 89431.

QSL'S — BROWNIE W3CJ1 — 3111-B Lehigh, Allentown, Pa. 18103. Samples 10¢. Cut catalogue 25¢.

ORIGINAL EZ-IN DOUBLE HOLDERS display 20 cards in plastic, 3 for \$1.00, 10 for \$3.00 prepaid. Guaranteed. Patented. Free sample to dealers. Tepabco, John K4NMT, Box 198R, Gallatin, Tennessee 37066.

The SIXTH ANNUAL TELEPHONE PIONEER QSO PARTY will start at 1900 hours GMT, Saturday, December 5, 1970, and will end at 0500 hours GMT on Monday, December 7, 1970. All telephone Pioneer ham radio operators in the United States and Canada are invited to participate. All bands may be used and the same station may be worked on more than one band. Phone User: Call "CQ Telephone Pioneers." C. W. User: Call "CQ T.P." Suggested Frequencies: Phone: HF (± 5 KHz) — 3,965KHz; 7,260KHz; 14,295KHz; 21,365KHz; 28,675 KHz. VHF-50.100MHz to 50.250MHz; 144.275MHz to 145.500MHz. C. W.: HF (± 5 KHz) — 3,565KHz; 7,065KHz; 14,065KHz; 21,065KHz. Scoring: One (1) point for signal report exchange with a Pioneer in any chapter. One (1) point for exchanging reports with each different chapter. Exchange: Signal report, contact number, chapter name and number. Reporting: Send log extract showing date, time, station worked, chapter name and number and contact number, not later than January 5, 1971 to: Frank J. Wojcik, W2SNJ, Stanley S. Holmes Chapter, Telephone Pioneers of America, 100 Central Avenue, Kearny, New Jersey 07032.

SSB/CW RIG FOR SALE: Heath SB 300 w/all filters, SB401 w/PTT and VOX mic, SB600 matching speaker, \$450 or offer — Doug Henry, WA70HD, Box 3235, Tacoma, WA 98499.

MANUALS for—R-390/URR, R-390A/URR, BC-639A, R-274/FRR, OS-8C/U, TS-186D/UP, \$6.50 each. Hundreds more. S. Consalvo, 4905 Roanne Drive, Washington, DC 20021.

1916 QST'S wanted. Especially May and June. Any unreasonable price paid! Ted Dames, W2KUW, 308 Hickory Street, Arlington, N. J. 07032.

NORTHERN CALIFORNIA HAMS: Best deals — new and reconditioned equipment. Write or stop for free estimate. The Wireless Shop, 1305 Tennessee, Vallejo, California 94590.



**NIXIE
READ OUT
STAGE**
\$18²⁵

**"NEW"
FROM**



KIT INCLUDES:

- 1—PC BOARD and CONNECTOR
- 1—NL 940S READ OUT TUBE and SOCKET
- 1—MC 9760 DECODER DRIVER
- 1—MC 780P DECADE
- 1—MC 767P QUAD LATCH

USES:

- FREQUENCY COUNTER
- DIGITAL VOLTMETER
- TIME INTERVOLT METER
- DIGITAL CLOCK (has facilities for dividing by six for clock)

PRICE 1 to 2 — \$21.49 EA.
PER 3 to 4 — \$20.49 EA.
KIT 5 or more \$18.25 EA.

R & R ELECTRONICS, 311 E. SOUTH ST., INDIANAPOLIS, IND. 46225

**AT LAST
a SPEECH COMPRESSOR that
REALLY WORKS**

- LOW DISTORTION CIRCUIT
- 5-10 DB IMPROVEMENT IN TALK POWER
- FULLY WIRED & TESTED NOT A KIT
- SEVERAL MODELS TO CHOOSE FROM
- WORKS WITH PHONE PATCH
- Quality construction includes Silicon transistors, FETs Glass circuit boards
- FULL WARRANTY—ONE YEAR
- Performance second to none
- INTRODUCTORY LOW PRICES — \$20.50 to \$34.95 (Illinois residents add 5% sales tax)

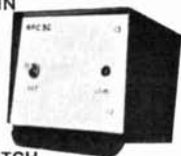

Write for specifications and information sheets (free)

R Electronics

Demonstration Tape cassette available (\$2.00 deposit)

BOX 1201H
CHAMPAIGN, ILL.
61820

**BUG CATCHER
ALL BAND
MOBILE ANTENNA**



STANDARD COIL
SIZE: 3", 8TPI
I CORE 2408T
36" BASE EXTENSION
96" WHIP, preferred
STD 3/8" FITTINGS

COIL ONLY \$24.95

Price FOB Houston

Write for Quote on Custom Coils.
Built to Specifications.

**MADISON ELECTRONICS
SUPPLY**

1508 MCKINNEY
HOUSTON, TEXAS 77002
713-224-2668

SELL: HT37-SX111 — Mint cond. Now in use. \$300.00. J. B. Henriksen, K0K0Y, 431 Frank Avenue SE, Huron, S. Dak. 57350, 605-352-9267.

THE 1970 ARRL ROANOKE DIVISION CONVENTION will be held in Raleigh, North Carolina, sponsored by the Raleigh Amateur Radio Society on Saturday, October 31 and continue through Sunday, November 1. The convention will include a full variety of features for all devotees of amateur radio and their XYL's. Featured speakers will be highlighted throughout the convention. On Friday, October 30 from 1600-2200 EST, a talk-in to convention headquarters will be conducted on 75 meter SSB, 6 meter SSB, and 2 meter FM. The talk-in will continue from 0800-1200 EST on Saturday, October 31 for those arriving on that day. Activities will include items of interest such as a DX forum, MARS programs, RACES and CD programs, manufacturers presentations, NET forum, FM and repeater discussions, state-of-the-art and space communications programs, and the ARRL forum attended by Vic Clark, W4KFC, Roanoke Division Director, and league officials from headquarters. A flea market will be conducted all day Saturday with a CW contest, a home brew contest, and a QSL Card contest on Sunday morning. Highlight of the convention will be the banquet on Saturday night. Latest radio gear and related equipment from several manufacturers will be on display at convention headquarters Saturday. The XYL's are planning a fantastic luncheon, complete with speaker and mementos of your visit, followed by a shopping spree in Raleigh's modern North Hills Shopping Center. Cost of the luncheon and transportation for the shopping spree is \$3.50 for pre-registration or \$3.75 at the time of the convention. Convention headquarters is the Stalter Hilton Inn, located at 1707 Hillsborough Street in Raleigh, just a short drive from all major highways into Raleigh. Pre-registration closes on October 20. Registrations will be available at the time of the convention. Pre-registration \$2.75 with advance banquet tickets \$8.00 per person. Registration at the time of the convention will be \$3.00 and banquet tickets will be \$8.50. Banquet tickets will be sold on a first come-first served basis so get your requests in early. Hotel reservations will be made and confirmed by the pre-registration committee on request. Watch your mailbox for further announcements concerning one of the finest ARRL Roanoke Division conventions ever held.

NOVICE CRYSTALS: 40-15M \$1.38, 80M \$1.83. Free flyer. Nat Stinnette Electronics, Umatilla, Florida 32784.

POLICE — FIRE — AIRCRAFT — MARINE Calls on your broadcast radio with TUNAVERTER S1 Tunable — Crystal Brochure. Salch Company, Woodsboro HMC, Texas 78393.

TELEGRAPH KEYS WANTED: Wire, wireless, Spark or CW. Related books. Ted Dames, W2KUW, 308 Hickory St., Arlington, N. J. 07032.

PARTICIPATE IN THE NORTH CAROLINA QSO PARTY during the 32 hour period from 1800 GMT Saturday, November 7 to 0200 GMT Monday, November 9. Each station may be worked once on each amateur band. The general call will be CQ NC. Phone and CW will be considered separate contests and will require separate logs. North Carolina stations will send QSO number, RS/T and county (total 100). Others send QSO number, RS/T and ARRL section or country. N. C. stations will score one point for each contact multiplied by the number of ARRL sections plus countries. Out of state stations score one point for each contact multiplied by the number of countries worked. Suggested frequencies are: 3565, 3865, 3925, 7065, 7265, 14065, 14300, 21065, 21365, 28065, 28565 KHz. A trophy to the top scorer in N. C. and also to the top scorer outside N. C. High score in each ARRL section will receive a certificate. High novice score will receive certificate. Logs should show total score on last sheet and should be mailed no later than November 30, 1970. Mail to: Raleigh Amateur Radio Society, Post Office Box 12541, Raleigh, North Carolina 27605. — "Y'All Come!" —

CRYSTAL FILTERS

By KVG of West Germany

9 MHz			
Type	No. of Xtals	Bandwidth	Price
XF9A	5	2.5 kHz	\$21.95
XF9B	8	2.4 kHz	\$30.25
XF9C	8	3.75 kHz	\$32.45
XF9D	8	5.0 kHz	\$32.45
XF9E	8	12.0 kHz	\$32.45
XF9M	4	0.5 kHz	\$23.00

Matching crystals for USB, LSB, Carrier, BFO \$2.75 each

10.7 MHz			
Type	No. of Xtals	Bandwidth	Price
XF107A	8	14 kHz	\$30.25
XF107B	8	16 kHz	\$30.25
XF107C	8	32 kHz	\$30.25
XF107D	8	38 kHz	\$30.25



SPECTRUM INTERNATIONAL
BOX 87C TOPSFIELD
MASSACHUSETTS 01983

All Items new with full leads — No Junk

2N3055	\$1.50 each	3 for \$4.00
1N4007	.28 each	50 for \$12.50
2N1305		5 for \$1.00
100 pF Silver Mica		50 for \$1.00
50V PIV Top Hat		33 for \$1.00
1N34A Germanium Diodes, Unmarked		25 for \$1.00, 100 for \$3.00
1000 µF 12V		3 for \$1.00
1000 µF 50V		2 for \$1.00
100 µF 15V		5 for \$1.00
30 µF 15V		5 for \$1.00
5 µF 15V		5 for \$1.00
1 µF 25V		5 for \$1.00
10 µF 6V		5 for \$1.00
3 µF 6V		5 for \$1.00

Prices Ppd. U. S. A.

Pa. Residents add 6% Pa. Sales Tax

M. WEINSCHENKER K3DPJ

P. O. BOX 353 • IRWIN, PA. 15642

NEED CRYSTALS?



We can supply crystals from 2KHz to 80 MHz in many types of holders.

SPECIALS

Color TV crystal (2579, 545KHz) wire leads	\$1.60	4 for \$5.00
100 KHz freq. std. crystal (HC13/U)	4.50	
1000 KHz freq. std. crystal (HC6/U)	3.50	
Any CB crystal TR. or REC. except synthesizer crystals	2.25	
Any amateur band crystal (except 80 & 160 meters) in FT-243 holders	1.50	or 4 for \$5.00
Any marine frequency (HC6/U)	2.85	
80 meter — FT-243 holders	2.50	

We have in stock over six million crystals which include types CR1A/AR, FT243, FT241, MC7, FT249, HC6/U, HC13/U, HC25/U, HC18/U, etc. Send 10¢ for our 1970 catalog with oscillator circuits, listing thousands of frequencies in stock for immediate delivery. (Add 10¢ per crystal to above prices for shipment 1st class mail, 15¢ each for air mail).



Special Quantity Prices to Jobbers and Dealers.
ORDER DIRECT
with check or money order to

2400H Crystal Drive
Fort Myers, Florida 33901

FALL SPECIALS

SIGNETICS CORP. DTL DIP PACKAGE

On boards - You remove 'em .40 ea. 4.00/doz.

ST616A	Dual 4 input expandable mand gate	
ST620A	Dual JK Flip flop	
ST629A	RS/T Binary element	
ST631A	Quad 2 input gate expander	
ST659A	Dual 4 input buffer/driver	
ST670A	Triple 3 input mand gate	
ST680A	Quad 2 input mand gate	

CA3008 RCA OP AMP \$1.50

MOTOROLA DUAL INLINE IC'S

Factory marked, new.

MC724P	Quad 2 input NOR gate	\$1.00
MC725P	Dual 4 input gate	\$1.00
MC790P	Dual JK flip flop	\$1.50
MC792P	Triple 3 input gate	\$1.00
MC799P	Dual buffer	\$1.00
MC826P	JK flip flop	\$1.00

MOTOROLA TRANSISTORS FACTORY MARKED

JAN 2N2907A	1.8 watt 60 volt 125mc	3/\$1.00
2N2218A	3 watt 40 volt 250mc	2/\$1.00

7400 SERIES IC GRAB BAG

Pack of assorted dual inline (10 units) unmarked, untested. Schematics included. Pkg. of 10 IC's \$1

IC SOCKET for DUAL INLINE 50¢

Add 25¢ postage on above orders. New catalog now out.

MESHNA, PO Box 62, E. Lynn, MA 01904

DON'T MISS PAGE 61

radio amateur callbook



GET YOUR NEW ISSUES NOW!

Over 285,000 QTHs in the U.S. edition **\$8.50**

Over 165,000 QTHs in the DX edition **\$6.50**

NEW EDITION EVERY:
MARCH 1 — SEPT. 1
JUNE 1 — DEC. 1

These valuable EXTRA features included in both editions!

- QSL Managers Around the World!
- Census of Radio Amateurs throughout the world!
- Radio Amateurs' License Class!
- World Prefix Map!
- International Radio Amateur Prefixes
- Prefixes by Countries!
- Zips on all QTH's!
- A.R.R.L. Phonetic Alphabet!
- Where To Buy!
- Great Circle Bearings!
- International Postal Information!
- Plus much more!

See your favorite dealer or order direct (add 25¢ for mailing in U.S., Possessions & Canada. Elsewhere add 50¢).

WRITE FOR
FREE
BROCHURE!

RADIO AMATEUR
callbook INC

Dept. E 925 Sherwood Drive
Lake Bluff, Ill. 60044

CALLING ALL HAMS!
get ready for the
SAROC
6th NATIONAL CONVENTION
JANUARY 7 TO 10, 1971
Flamingo
CONVENTION CENTER
LAS VEGAS, NEVADA

SAROC, Flamingo Hotel Room rate \$12.00 plus tax, single or double occupancy. Mail to Flamingo Hotel, Las Vegas.

SAROC, advance registration \$14.50 per person, regular registration at the door, Flamingo Hotel Late Show, Sunday Breakfast, Cocktail Parties, Seminars and Meetings. Mail to SAROC.

SAROC, sponsored by Southern Nevada ARC, Inc., Box 73, Boulder City, Nevada 89005.

Contact SAROC for
Charter Flights from Chicago and New York

THE FABULOUS *Flamingo* HOTEL

FOR SALE: Factory-sealed Collins: 30L1, \$445; 312B4, \$175. Collins 399C-1 (ext. VFO/spkr for KWM2), \$165. 32S3, 516F2, 75S3, 312B4, \$1100. 75S1, 32S1, 516F2, 312B4, \$750. Henry 2KD, \$475. Swan 500C, 117XC, VX2, \$450. R4A, \$275. HW32A, HP23A, \$135. HW22A, HP13, \$150. Tektronix 514D, \$225. Cubex 4-el tri-band quad (3" x 20' boom), less wire, \$125 crated; \$100 pick-up. Lafayette HA460, mike, \$65. B & W 3852 var. inductor, new (used as L401 in KWS1), \$15. Sola constant-voltage transformer, new Model 23-25 203-3 (3 KVVA), \$100. Viking KW Match-Box/meter, \$125. BC221, charts, manual, \$45. Viking Thunderbolt, \$250. Eimac 4CX1000A, new, \$100. Clegg 66'er, \$125. SW140, \$85. Transformers: 12.8VCT @ 20 amp, \$8; 2880 VCT @ 0.5 amp, \$15 ea.; 2/\$25; 6.3 VCT @ 20 amps, \$7; UTC LS121Y (bridge-872's!), \$15; UTC CG305, 312, \$25 ea.; S44, S49, \$15 ea. Waters "Codax" keyer, \$45. Varitronics FDFM-2S, PS1500 p. s. antenna, \$250; FDFM-2, antenna, \$200. Bandit 2000C, \$295. NCL2000, \$325. 100-V, \$250. Ham-M (new), \$110. TA33 (new), \$120. TA36 (new), \$150. TR44 (new), \$60. SR160, \$150. Galaxy-300, PSA300 p. s./spkr, \$185. SP600JX17, factory-reconditioned, \$250. Messenger III, Johnson A. C. supply, \$100. Filter F45Y60 (6kcs for 75S1/S2/S3), new, \$25. Lambda VR supplies (rack-mounting), \$25, write for details. Transformer, 220/3KV (no CT), @ 10.0 amps, \$75. 30L1, \$350. 312B5, \$265. 312B4, \$135. Capacitors, 2 ea @ \$25 ea, 4 MFD/10KV. TR3, AC3, \$395. Swan 500, 117XC, \$400. Hallicrafters CRX-102 VHF Monitor, \$20. HA-1 keyer, \$60. James W. Craig, W1FBG, 29 Sherburne Avenue, Portsmouth, N. H. 03801, (603) 436-9062.

WANTED: Collins 351R1/Rw rack-panels for S1 line (need 2 ea). 30S1, TR4 (late). T4XB, R4B, AC4. C. E. 600L with manual. James W. Craig, W1FBG, 29 Sherburne Avenue, Portsmouth, N. H. 03801, (603) 436-9062.

PC BOARD. 3/32 inch, 2 oz. Copper one side, paper base. Specify size desired. 1.5¢ per square inch plus postage. HAL Devices, Box 365H, Urbana, Illinois 61801.

I AM COMPILING information to publish a Hamfest Directory for 1971. Any club can have their hamfest listed free by having an officer of the club send all information to me before December 1, 1970. Art Collatz, K9JZM, 2127 Market St., Blue Island, Illinois 60406.

SAVE. On all makes of new and used equipment. Write or call Bob Grimes, 89 Aspen Road, Swampscott, Massachusetts, 617-598-2530 for the gear u want at the prices u want to pay.

CIRCUITS for 32 electronic projects, R.F. audio and gadgetry, complete plans \$1.00. P.M. Electronics, Inc., Box 46204, Seattle, Wash. 98146. Dealer inquiries invited.

THE LAKEHEAD AMATEUR RADIO CLUB has made available to all amateurs and SWL's a certificate to be known as: — The Thunder Bay Award —. The requirements are: For VE/VO — Eight (8) different Thunder Bay Ontario Stations must be worked, or heard for SWLS, since January 1, 1970. For all others — Five (5) different Thunder Bay Stations must be worked, or heard for SWLS, since January 1, 1970. All contacts must be with different stations. Contacts may be on mixed modes and bands. No QSLs are required, only the full log information on stations worked or heard. Send one (1) dollar Canadian funds, or 10 IRCs to: Lakehead Amateur Radio Club, Awards Committee, P. O. Box 571, Stn. "P", Thunder Bay, Ontario, Canada.

PACKER'S DISTRIBUTING will specialize in sales and service of Amateur and Citizens Band Equipment, Industrial Communication and Home Entertainment systems. Opening date for the Green Bay, Wisconsin store will be announced within the next thirty days. Packer's Distributing, 6918 Maple Street, Omaha, Nebraska 68104.

TELL YOUR FRIENDS about Ham Radio Magazine.

... THE BEST
**2 METER
CONVERTER**



Model 407
\$39.95
ppd.

144-146 MHz in. 28-30 MHz out
or 146-148 MHz with a second crystal
available for \$4.95 extra

A full description of this fantastic converter would fill this page, but you can take our word for it (or those of hundreds of satisfied users) that it's the best. The reason is simple — we use three RCA dual gate MOSFETs, one bipolar, and 3 diodes in the best circuit ever. Still not convinced? Then send for our free catalog and get the full description, plus photos and even the schematic.

Can't wait? Then send us a postal money order for \$39.95 and we'll rush the 407 out to you. NOTE: The Model 407 is also available in any frequency combination up to 450 MHz (some at higher prices) as listed in our catalog. New York City and State residents add local sales tax.

VANGUARD LABS

Dept. R, 196-23 Jamaica Ave., Hollis, N.Y. 11423

HAL DEVICES

FOREIGN HAMS

**DO YOU NEED AMERICAN
CONSTRUCTION COMPONENTS?**

Send us a list of your needs and we will give you a quotation on any standard American parts which you may require.

No longer need you avoid construction projects in Ham Radio or any other U. S. amateur publication because of hard to find parts. We'll find them and send them to you.

HAL DEVICES

BOX 365 HF
URBANA, ILLINOIS 61801

the permaflex key

- both a twin lever & straight hand key in a pivotless 2 paddle design.
- gives instant choice of automatic semi-automatic & straight hand keying when used through an electronic keyer.
- use directly with any transmitter
- 8 amp. gold diffused silver contacts adjust from 0-.060" & 3-50 grams.
- distinctive blue paddles are of rugged G-10 fiberglass epoxy.
- cabinet is 16 gauge polished chrome steel: 1.56" sq. x 3.75", paddles extend 1.25", weight 10 oz.
- silicone rubber feet for stability.
- 100% US made & guaranteed for 1 yr.



1995 complete, ppd use & can. send a check or m.o. sold by mail only

James Research company, dep't: HQ-K
20 willits road, glen cove n.y. 11542

IC's

MRTL MC 790 P \$1.90 each
10 for \$18.00
μL 914 .55 each
10 for \$5.00
100 KHz FREQ. STD. CRYSTAL HC 13/U \$4.00

PLEASE ADD POSTAGE

LOGIC COMPONENTS

BOX 224
NEW CANAAN, CONN. 06840



PERSONALIZED CUP AND STEIN. GOLD LEAF HANDLE AND PERMANENT BLACK LETTERS MACHINE WASHABLE. ATTRACTIVE AND USEFUL GIFT FOR ANY HAM. SPECIFY RIGHT OR LEFT HANDED, CALL AND NAME. CUP \$2.50. STEIN \$4.75. PP. U.S. AND POSSESSIONS ONLY. CHECK OR M.O. CALIF. ADD 5% SALES TAX. SPECIAL CLUB OR COMMERCIAL INQUIRIES SOLICITED.

DE PIAZZA ENTERPRISES

P. O. Box 1127 Costa Mesa, CA 92626

WE PAY HIGHEST
PRICES FOR ELECTRON
TUBES AND SEMICONDUCTORS

H & L ASSOCIATES

ELIZABETHPORT INDUSTRIAL PARK
ELIZABETH, NEW JERSEY 07206
(201) 351-4200

radio amateur callbook

Radio Amateur Emblems engraved with your call letters.



Charm

Gold
 Rhodium
call letters
\$6.00 Ea.



Tie Bar

Gold
 Rhodium
call letters
\$6.00 Ea.



All illustrations are actual size.

Lapel Pin

Gold
 Rhodium
call letters
\$6.00 Ea.

Two or more emblems at the same time \$5.00 each.

Rush Order To: RADIO AMATEUR CALLBOOK, Inc.
Dept. E. 925 Sherwood Drive, Lake Bluff, Ill. 60044

ELECTRONIC FIST ... THE PROFESSIONAL KEYS

NOW WITH BUILT-IN CW IDENTIFIER!

SENDS CQ CONTEST SEQUENCE PLUS YOUR CALL

EK 39M \$ 179.95
CUSTOM MEMORY \$ 59.95

WRITE FOR SPECIFICATIONS

CURTIS ELECTRO DEVICES Box 4090, Mountain View, California - 94040

19.95 VIDEO / RF SELECTOR CONTROL CENTER FOR SWITCHING SYSTEMS INPUT/OUTPUT



ALCO Order: Box 1348H Lawrence, MA 01842

3-Channels! Use push switches to select TV cameras, monitors, RF antenna systems. "M" type connectors on rear side. No impedance worries. Many audio models too. Shipped postpaid.

THE AMATEUR RADIO

W I T H W2GFP

IS HEARD OVER WHCU

IN ITHACA, NEW YORK EVERY SATURDAY

FOR FURTHER INFORMATION ABOUT HAM RADIO PUBLIC RELATIONS, PLEASE CONTACT DAVID G. FLINN, W2GFP/W2GQK 10 ORANGE ROAD WEST ITHACA, NEW YORK 14850

MULTI-ANTENNA COUPLER

Eliminates Antenna Switching

- Couples several antennas to a single transmission line
- Weatherproof • Compact "black box" plugs into line
- Saves operating time • Saves coax and switches • Works with all types of antennas • Handles full legal power
- Models available for all bands, 2 to 160 meters • Priced from \$24.95 • Write for information.

antennas

POST OFFICE BOX 458, OCEAN BLUFF, MASSACHUSETTS 02065

DERRICK ELECTRONICS will not be undersold on new Swan equipment. We'll beat any legitimate deal. Check around, then write, 108 East El Paso, Broken Arrow, Oklahoma 74012.

SELL HRO-60, A,B,C,D,AC coils and case, "B" slicer, headphones, spare tubes, \$250. Adventurer, 8 40m. novice xtals with switch, \$40. Jon Ahlquist, Room 205 Bender Hall, University of Northern Iowa, Cedar Falls, Iowa 50613.

NEW, 3rd edition, Amateur Radio Techniques by J. Pat Hawker, G3VA. Latest edition of this popular book has 48 more pages and much valuable new material. New deluxe binding. Only \$3.50. Order today from Comtec, Box 592, Amherst, N. H. 03031.

CHARTER JET FLIGHT TO SAROC. Roundtrip New York City - Las Vegas, \$229.00, depart JFK 10:00 a.m., January 7th. Roundtrip Chicago - Las Vegas, \$199.00, depart O'Hare 12:00 noon, January 7th. Return January 10th. Includes meals and drinks aloft, Flamingo Hotel Room, three nights, double occupancy, transportation and baggage in and out of Flamingo Hotel, Dinner Show, Midnight Show, Saturday Buffet Luncheon, Sunday Breakfast, SAROC Tickets, Tax and Gratuity. \$60.00 will confirm reservation, includes one dollar service fee. Final payment due before November 25th. Flight cancellation or written request for deposit refund will be accepted until December 1st. SAROC, Box 73, Boulder City, Nevada 89005.

EDMUND A. WATERS, WM. E. BUNN, WESLEY WIMBERLY — I am attempting to locate these Radio instructors who were stationed in Sioux Falls, SD, during WW II. Robert D. Kirschman, 1812 South Covell Avenue, Sioux Falls, SD 57105.

VISITING ROME? I would be pleased to meet American Hams visiting Rome. As I work in the tourist field I might be of help to them. Dr. Corrado Di Pietro, IIDP, via Pandosia 43, 00183 Rome, Italy.

HAM-M ROTOR AND CONTROL \$94.95. New in factory sealed carton. Ideal Christmas gift for dad. RG8U and RG11U Foam Coax 10¢ foot. F.O.B. Monte Southward, WB8GZQ, R1, Upper Sandusky, Ohio 43351.

AUTO BURGLAR ALARM — Save your rigs and car. Fantastic outfit \$7.75 ppd. Express Traders, P. O. Box 696, Freedom, Calif. 95019.

GALAXY GT-550 transceiver with all accessories. System is practically new — less than 8 hours operation. Accessories include AC-400 ac power supply, SC-550 speaker console, RV-550 remote vfo, PR-550 phone patch, VX-35 vox unit, CAL-25 25-kHz crystal calibrator, and F-3 300-Hz cw filter. List price for this package is over \$900. Must sacrifice for \$600 to keep peace in the family. All units have original warranty cards. Box E, Ham Radio, Greenville, NH 03048.

CIR-KIT — The amazing new pressure sensitive tape that lets you make a "PC Board" in minutes with no chemicals or special equipment. See our ad in this issue.

REVISED REQUIREMENTS for the Okinawa Award, as follows: QSLs required: 25 — KR6 and KR8 applicants; 10 — BV, CR9, DU, HL/HM, JA/KA, KG6, VS6, W/K applicants; Rest of the World send 5. KR6 and KR8 applicants must submit cards. All others, send only a log book extract with signed confirmation that required QSL information had been received and verified by two licensed amateur radio operators, or by an official of a recognized radio club or society. Send all applications and \$1.00 (U.S.) or 10 IRC's, to QSL and Awards Manager, Okinawa Amateur Radio Club, P. O. Box 465, APO, San Francisco, CA 96331.

READ RADIO CONSTRUCTOR for many interesting home-brew projects. Radio Constructor, Greenville, N. H. 03048.

FOR SALE CAP 200W. SSB Transceiver Heath HW-18-1 4602.5 and 4630 kHz. Assembled and tested never used. Insured and shipped for \$120. K5LRC, J. D. Clowdus, Box 73, Springer, Okla. 73458.

REVIEWED IN MARCH, 1968 HAM RADIO

oscillator/monitor

- makes an audible tone to monitor the RF of any CW transmitter from 10Mw to 1 Kw & 100Kc to 1000Mc, using only an 8" pickup antenna.
- can be self-triggered for code practice or the testing of solid state components and circuits.
- aids in tuning up & testing RF oscillator and power circuits.
- 4 transistor, 2 diode circuit.
- speaker, tone adjust, AA pencil.
- test tips, 8" ant., & magnetic base.
- cabinet is 16 gauge black & clear anodized aluminum, 3.4 x 2.3 x 1.2" US made & guaranteed for 1 year.



14.95 complete, ppd usa & can. send a check or m.o. sold by mail only

James Research company, dep't:HQ-M
20 willits road, glen cove n.y. 11542

SURPLUS CRYSTAL FILTERS

10.7 MHZ FILTERS — 2 3/8" LONG, 1.0 WIDE
10.7 MHZ B CRYSTAL FILTER MOD FB5M \$19
6 DB BW 13 KC MIN — 60 DB BW 25 KC MAX
IN & OUT ± 1 KΩ — ULT ATTENUATION 100 DB

MOD 10MA 6 CRYSTAL FILTER \$14
6 DB BW 30 KC MIN — 60 DB BW 75 KC MAX
IN & OUT ± 2 KΩ — ULT ATT 80 DB MIN PPD USA



WE HAVE SURPLUS XTAL FILTERS WITH BANDWIDTHS FROM 400 HZ TO 250 KHZ. CENTER FREQ. 80 KHZ TO 36 MHZ
SEND DIME FOR LIST OF OVER 50 TYPES

TOROID CORES POPULAR T-200-2
2" DIA. CARBONYL IR CORE. MAKE A KW ANT.
BALUN, H.D. FIL. CHOKE, OR A TAPPED TANK
COIL FOR YOUR LINEAR.



T-200-2 EACH \$2.75 DR 3 FOR \$7.00

J. T. McCULLOUGH, W0BHG - TEL. 816-781-5666
E. S. Electronic Labs
301 AUGUSTUS EXCELSIOR SPRINGS, MO. 64024

CQ de W2KUW

5% BONUS PAID FOR
EIMAC AND VARIAN TUBES

ESPECIALLY:

4-65A, 4-125A, 4X150A, 4-250A,
4CX250B-K or R, 4-400A, 445A,
4-1000, 4CX1000, 4CX5000, X13,
etc.

EQUIPMENT:

R390A, GRC 106-108, PRC 9, 10,
25, 74, 77, URC9, VRC 12, etc.

The TED DAMES Co.

308 HICKORY ST., ARLINGTON, N. J. 07032
Phone: 201 998-4246

GET IT from GOODHEART!
EVERYTHING UNCONDITIONALLY GUARANTEED

SPECIAL OF THE MONTH

HEWLITT PACKARD #410B all purpose VTVM less RF probe, and #400C AC-2 MHz VTVM, 1mV to 300V full scale, both in one rack unit with dust cover and cabinet. **\$69.50**

Special-Purpose Receivers, Panadapter

RAK-7 complete, w/dwg, 15-600 khz TRF 125.00
RFI (Noise & Field Strength Meters) are basically radio rcvrs. TS-587/U (no ant. accessories) somewhat modified as an RFI Meter, OK as rcvr, 15-400 mhz, \$195. FERRIS #32A, .15-20 mhz, complete, OHC, w/charts & book, \$175. #32B is later model, \$275. Navy OFI, .15-17½ mhz, OHC, with book, \$75. MORE PROFESSIONAL setups, to \$4000.00, STODDART and EMPIRE DEVICES: ASK! Also ask about SPECTRUM ANALYZERS, if interested.
455 khz Panadapter, various models, all 100% OK, all with instruction books \$57.50

Hi-Sensitivity Wide-Band AM / FM RCVR

38-1000 MHZ: AN/ALR-5 consists of brand-new Tuner/Converter CV-253/ALR in original factory pack and an exc., used, checked OK & grtd. main rcvr R-444 modified for 120 v, 50/60 hz. Packed with each tuner is the factory checkout sheet. The one we opened showed SENSITIVITY: 1.1 uv at 38.3 mhz, 0.9 at 133 mhz, 5 at 538 mhz, 4½ at 778 mhz, 7 at 1 ghz.
With book & pwr-input plug, all for **275.00**

R-390/URR Rcvr: Collins xtl-zero-beating, driftless receiver, grtd 100% perfect. **795.00**

R-390A/URR has mech. filters, grtd perfect. **995.00**

Regul. Pwr Sply for Command, LM, Etc.

PP-106/U: Metered. Knob-adjustable 90-270 v up to 80 ma dc; also select an AC of 6.3 v 5A, or 12.6 v 2½ A or 28 v 2½ A. With mating output plug & all tech. data. Shpg. wt. 50 lbs. **19.50**

BARGAINS WHICH THE ABOVE WILL POWER:
LM-(*) Freq. Meter: .125-20 MHz, .01%, CW or AM, with serial-matched calib. book, tech. data, mating plug. Shipping wt. 16 lbs. **57.50**
Same, less calib. book. **27.50**
A.R.C. R22: 540-1600 khz rcvr w/tuning graph **17.95**
A.R.C. R32: 108-132 mhz rcvr **32.50**

If you don't see it here, ask for it!

But don't ask for a general catalog . . . we believe that is nonsense in surplus . . . we get new things in almost every day! WE ALSO BUY! So tell us what you have, condition, and your asking price!

R. E. GOODHEART CO. INC.

Box 1220-HR, Beverly Hills, Calif. 90213

Phone: Area Code 213, Office 272-5707

(1) GT-550 Galaxy (demo)

with 25Kc. Cal. AC/400-SC550

Regular Price \$704.90

SPEC. PRICE THIS ONE ONLY:

\$543.42

SAVINGS OF \$161.48

Write us for Cash Discount on other lines of New Equipment, Antennas, Etc.

BOB'S DISCOUNT ELECTRONICS

720 N. Hudson, Okla. City, Okla. 73102

Phone 232-1384

NOISE BLANKER

Designed for the serious VHF operator requiring effective suppression of interference generated by auto ignitions, power lines, appliances, radars, etc. Models available for both VHF transceiver and receiver-converter systems.



Model TNB-250, for Swan 250 transceivers. Features include modern solid state design techniques utilizing dual-gate MOSFET transistors and a special gain controlled amplifier circuit yielding excellent cross-modulation characteristics in strong signal locations. Simplified installation requires twenty minutes without drilling holes.

TNB-250 (for Swan 250) **\$32.95**
TNB-250C (for Swan 250C) **\$32.95**

Model TNB Noise Blanker, designed to operate with VHF converters by connecting in the coax between converter and receiver.



Noise suppression characteristics are similar to those of the TNB-250. Choice of 14-18, 100-140, or 125-160 VDC, RCA phono or BNC connectors. Specify for 10 or 20 meter converter output.

Model TNB **\$29.95**

Prepaid orders shipped postpaid. For Air Mail add 80¢. COD orders require \$3.00 deposit. All products are warranted for one year and offered on a satisfaction guaranteed or return basis. Technical brochure available.

WESTCOM
ENGINEERING COMPANY

P. O. Box 1504 San Diego, Calif. 92112

- SPECIAL COUNTER SALE -
Northeastern Eng. 14-20C

\$179.50 FOB MONROE

10 hz - 10 mhz - 8 digit nixie readout. Similar to HP524C and takes same plug-ins. Unchecked but appear exc. Money back (less shipping) if not satisfied. SASE for more data.

GRAY Electronics
P. O. Box 941 Monroe, MI 48161

BARRY PAYS CASH FAST

You can be sure with Barry . . .
Fair dealing since 1938

Send lists of your unused TUBES,
Receivers, Semi-Conductors,
Vac. Variables, Test Equipment, etc.

No Quantity too Small.
No Quantity too Large.

Write or Call now . . . BARRY, W2LNI

BARRY ELECTRONICS

512 BROADWAY • NEW YORK, N. Y. 10012
212 - WA 5-7000

QSLs. Second to none. Same day service. Samples 25¢. Ray, K7HLR, Box 331, Clearfield, Utah 84015.

AUTUMN HOUSECLEANING. Making room for new gear. Amphenol FET voltmeter, \$75. UHF signal generator, LAE2, 500 to 1300 MHz, \$75. Eico 717 electronic keyer, \$40. 3-amp Variac, \$8. Antenna noise bridge, \$20. 8 μ F, 1500 Vdc electrolytics, \$1 each. All items fob. WIDTY, Ham Radio, Greenville, NH 03048.

TOROIDs! Lowest price anywhere. 40/\$10.00 post-paid. Center-tapped 88 or 44mhz. (5/\$2.00). Fan fold page printer paper \$10.00/box/920. Sync motors \$7.00. Model 14TD \$20.00. Model 32KSR reconditioned, perfect page printer \$200. Lorenz 60 speed page printer with reperf and TD built-in \$125. Reperforator tape (11/16") \$10.00/case/40. Stamp for list. Van, W2DLT, 302H Passaic Avenue, Stirling, N. J. 07980.

DRAKE R4A, T4 with AC supply, best offer. Heath HW-17 factory reconditioned and modified to HW-17A, \$98.00. K4CWW, 217 Milton Drive, Carrboro, N. C. 27510.

THE ANNUAL HAMFEST AT LAKE TEXOMA LODGE on Lake Texoma, near Kingston, Oklahoma, will be held November 13, 14 and 15, 1970. All the programs indoors and there will be entertainment for all. Technical discussions and swapland shop. Ray Bryan, W5IQ, Box 246, Kingston, Okla. 73439.

TELETYPE #28 LRXB4 reperforator-transmitter "as is" \$100; checked out \$175. Includes two 3-speed gearshifts. Alltronics-Howard Co., Box 19, Boston, Mass. 02101. 617-742-0048.

WORLD QSL BUREAU — see ad page 85.

TOROIDs 44 and 88 mhz. Unpotted, 5 for \$1.50 ppd. W. Weinschenker, Box 353, Irwin, Pa. 15642.

THE FOLLOWING EQUIPMENT was stolen: 1 — SM-1 Microphone, P.T. #12814, Ser. #2740; 1 — 516F2 Power Supply, P.T. #12809, Ser. #23194; 1 — 32S3 Transmitter, P.T. #12805, Ser. #101254; 1 — 75S-3C Receiver, P.T. #12811, Ser. #13753; 1 — 312B-4 Speaker Console, P.T. #14560, Ser. #60133; 1 — 30L-1 Linear Amplifier, P.T. #12815, Ser. #28517; 1 — Complete Interconnecting Cable Set. Any information pertaining to the above Radio Equipment is respectfully requested by: Fred McMurray, Communications Officer, City of Baton Rouge, P.O. Box 1471, Baton Rouge, LA 70821. 504-344-1723.

TELETYPE PICTURES for sale. Volume 2, 16 pages containing 50 pictures \$2.00. Volume 3 coming \$1.50. Also audio and perforated tapes. W9DGV-d 2210-30th St., Rock Island, Ill. 61201.

SELL SB-33 with mike \$150, Pair 1 watt CB Walkie-talkies \$35. FOB Tucson. Philip Kellogg, PO Box 922, Tucson, Arizona.

DIGITONE TONE CONTROL DEVICES — decoders, encoders, logic. Compact solid-state modules. Application Notes/Catalog. Write Digitone, Box 73-HR, Bellbrook, Ohio 45305.

WANTED: CUSTOMERS: No experience necessary: "HOSS TRADER ED MOORY" says if you don't buy your Ham Gear from him, you might pay too much! Shop around for your best price and then call the "HOSS" before you buy! **Used Equipment:** Swan 270B Cygnet, \$399.00; Swan 500CX, \$418.00; Drake TR-4, \$518.00; R4-B, \$349.00; T4-XB, \$365.00; GT-550, \$395.00; L4-B, \$609.00; Ham-M Rotor, \$85.00; 75A-4, \$319.00; 75S-3, \$399.00; SX-111, \$99.00; 2B, \$175.00; NCX-3, \$155.00; Swan 350, \$275.00. Contact us for Special Deals on New Tower and Beam Packages; Have all new Drake, Swan, Galaxy and many more brands in stock. Moory Electronics Co., Box 506, Dewitt, Arkansas 72042, Phone (501) 946-2820.

YOUR AD belongs here too. Commercial ads 25¢ per word. Non-commercial ads 10¢ per word. Commercial advertisers write for special discounts for standing ads not changed each month.

TYMETER
"Time At A Glance"

9:37

CALL-IDENT

10-MINUTE STATION CALL REMINDER

24 HOUR CLOCK

#124

23:59

10-minute repeating timer buzzes warning to sign in your call letters. Walnut or ebony plastic case. 4" H, 7 3/4" W, 4 1/2" D. 110V, 60 cy. One Year Guarantee. Made in U.S.A.

At Your Dealer, or DIRECT FROM
PENWOOD NUMECHRON CO.
TYMETER ELECTRONICS
7249 FRANKSTOWN AVE. PITTSBURGH, PA. 15208

WORLD QSL BUREAU

PLAN 1. WE FORWARD YOUR QSLs (PLEASE ARRANGE ALPHABETICALLY) TO ANY PLACE IN WORLD, INCLUDING ALL FOREIGN COUNTRIES, AND TO OR WITHIN USA, CANADA, AND MEXICO, FOR 4¢ EACH.

PLAN 2. YOU USE OUR SPECIAL LOG FORM AND SEND US A COPY WE SUPPLY QSL — MAKE OUT QSL — DELIVER QSL ALL FOR 8¢ EACH.

5200 Panama Ave., Richmond, CA USA 94804

STATEMENT OF OWNERSHIP, MANAGEMENT AND CIRCULATION		Publication for this copy of the Act (See instructions on page 2)	
1. Name of publication		2. Issue date	
Sept. 21, 1970		HAM RADIO MAGAZINE	
3. Issue frequency		4. Number of issues published during the preceding 12 months	
MONTHLY		12	
5. Name and complete address of the principal office of the publication			
MAIN STREET, GREENVILLE, N. H. 03048			
6. Name and complete address of the publisher			
T. H. TENNEY, JR., MAIN ST., GREENVILLE, N. H. 03048			
7. Owner (If owned by a corporation, its name and address, together with the names and addresses of all stockholders owning or holding 1 percent or more of total amount of stock. If not owned by a corporation, the names and addresses of all individual owners. If owned by a partnership or other unincorporated firm, its name and address, as well as that of each individual member thereof.)			
T. H. TENNEY, JR., MAIN STREET, GREENVILLE, N. H. 03048			
8. Full name and complete address of the publisher			
COMMUNICATIONS TECHNOLOGY, INC. MAIN STREET, GREENVILLE, N. H. 03048			
T. H. TENNEY, JR., MAIN STREET, GREENVILLE, N. H. 03048			
9. Full name and complete address of the printer			
T. H. TENNEY, JR., MAIN STREET, GREENVILLE, N. H. 03048			
10. Extent and nature of circulation (Give in whole numbers)			
a. Total number of copies (net press run)		b. Total number of copies actually distributed	
33,764		36,000	
11. Total number of copies (net press run)		12. Total number of copies actually distributed	
4,637		4,363	
13. Total number of copies (net press run)		14. Total number of copies actually distributed	
25,733		31,296	
15. Total paid circulation		16. Total paid circulation	
10,372		35,659	
17. Total distribution (including sales) by first class or other means		18. Total distribution (including sales) by first class or other means	
1,062		1,040	
19. Total distribution (net of 17 and 18)		20. Total distribution (net of 17 and 18)	
31,434		36,699	
21. Copies not distributed (including office use, left overs, etc.)		22. Copies not distributed (including office use, left overs, etc.)	
2,330		1,301	
23. Total (net of 17, 18, 21 and 22)		24. Total (net of 17, 18, 21 and 22)	
33,764		36,000	
1. I certify that the information furnished on this form is true and complete. I understand that anyone who furnishes false or misleading information on this form or who omits material or information requested on the form may be subject to criminal sanctions (including fines and imprisonment) and/or civil sanctions (including multiple damages and civil penalties).			

Advertisers check-off

... for literature, in a hurry —
we'll rush your name to the companies
whose names you "check-off"

INDEX

- | | |
|------------------------|--------------------|
| —Alco | —James |
| —AntennaLabs | —L A |
| —Barry | —Logic |
| —Bob's | —Madison |
| —Blulyne | —Meshna |
| —Comtec | —National |
| —Cir-Kit | —Palomar |
| —Crabtree | —Pennwood |
| —Curtis | —R & R |
| —Dames | —RP |
| —DePiazza | —Callbook |
| —Drake | —Radio Constructor |
| —E S | —Radio Shop |
| —Erhorn | —SAROC |
| —Flamingo | —Sentry |
| —Flynn | —Sentry |
| —Goodheart | —Sentry |
| —Gordon | —Sentry |
| —Gray | —Sentry |
| —H & L | —Sentry |
| —HAL | —Sentry |
| —Ham Radio | —Sentry |
| —Heights | —Sentry |
| —Henry | —Sentry |
| —International Crystal | —Sentry |
| —Jan | —Sentry |

November 1970

Please use before January 31, 1971

Tear off and mail to
HAM RADIO MAGAZINE — "check-off"
Greenville, N. H. 03048

NAME.....

CALL.....

STREET.....

CITY.....

STATE..... ZIP.....

Advertisers iNdex

Alco Electronic Products	82
AntennaLabs	82
Barry Electronics	84
Bob's Discount Electronics	84
Blulyne Electronics Corp.	73
Communications Technology, Inc.	47, 72
Cir-Kit	75
Crabtree Electronics	74
Curtis Electro Devices	82
Dames Co., Ted	83
De Piazza Enterprises	82
Drake Co., R. L.	2
E S Electronic Labs	83
Erhorn Technological Operations	Cover II
Flamingo Hotel	80
Flinn, David G.	82
Goodheart Co., Inc., R. E.	84
Gordon Co., Herbert W.	87
Gray Electronics	84
H & L Associates	82
HAL Devices	71, 81
Ham Radio Magazine	61
Heights Manufacturing Co.	73
Henry Radio	15
International Crystal Manufacturing Co.	43
Jan Crystals	80
James Research	82, 83
LA Amateur Radio Sales	76
Logic Components	82
Madison Electronics Supply	78
Meshna, John, Jr.	80
National Radio Co., Inc.	55
Palomar Engineers	76
Pennwood Numechron Co.	85
R & R Electronics	78
RP Electronics	78
Radio Amateur Callbook, Inc.	74, 80, 82
Radio Constructor	70
Radio Shop, Lab 1	69
SAROC	80
Sentry Manufacturing Co.	1
Sentry Electronics	88, Cover III
Spectrum International	74, 79
Structural Glass Ltd.	76
Swan Electronics	Cover IV
Ten-Tec, Inc.	75
Tri-Ex Tower Corp.	67
Vanguard Labs	81
Varitronics, Inc.	5
Weinschenker, M.	79
Westcom Engineering Co.	84
World QSL Bureau	85

LABORATORY QUALITY-POPULAR PRICE -AUDIO SIGNAL GENERATOR



Range 10-100 kHz

Measuring only 7½" x 3¾" x 3¾", and weighing slightly under 2 pounds, the Sansei 6803 Mini-Generator is a completely solid-state sine and squarewave instrument of unusually high quality. Especially suitable for field engineers, broadcast stations, and government agencies, this little beauty is winning favor among our ham fraternity as well.

Of Wein bridge design, using an FET oscillator with both a thermistor and copious amounts of inverse feedback, the output is maintained at minimum distortion and constant level (less than 0.3% for the range 200 Hz-100 kHz with less than 0.8% between 10 and 200 Hz). A stabilized power supply (100-120 VAC 50/60 Hz input) is held to 0.1% against incoming fluctuations.

Squarewave risetime is only 0.2 μ s - the output impedance is 600 Ω \pm 100 Ω unbalanced. This beautifully built miniature instrument can be of incalculable value to audio buffs, technicians, and even those of us on sideband who want proper measurements. Shipped postpaid in U.S. and Canada: only \$75.00.

HERBERT W. GORDON COMPANY

HELPING HAMS TO HELP THEMSELVES

Woodchuck Hill Road  *Harvard, Mass. 01451*

PHONE 617 456 3548

Now you don't have to pay twice the price to get twice the rig.

Picture this pair in your shack. The Yaesu FLdx 400 transmitter and the FRdx 400 receiver. Loaded with power. Loaded with sensitivity. Loaded with features. Loaded with value. Read on, and discover how you can have the most up-to-date receiver-transmitter rig in the world... and at an unbelievably low price.

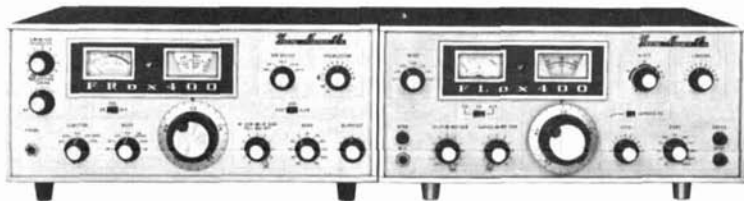

The FRdx 400 Receiver

Get a big ear on the world with complete amateur band coverage from 160 meters through 2 meters, including WWV and CB reception. Four mechanical filters do it — they provide CW, SSB, AM and FM selectivity. Separate AM-SSB-FM detectors are included, along with squelch and transmit monitor controls. Plus a noise limiter and a variable delay AGC. And a built-in notch filter with front panel adjust for notch depth.

The FRdx includes calibration markers at 100 KHz and 25 KHz, with accurate calibrator checks verified by WWV. A solid-state FET VFO for unshakable stability. And a direct-reading 1 KHz dial affords frequency read-out to less than 200 Hertz.

The FRdx 400 sells for \$359.95.

The FLdx 400 Transmitter

Here's how to set yourself up with dual receive, transceive or split VFO operation. The FLdx 400 with its companion receiver brings you the ultimate in operational flexibility. Flexibility like frequency spotting, VOX, break-in CW, SSB, AM and even an optional FSK circuit.

The completely self-contained FLdx 400 features a built-in power supply, fully adjustable VOX, a mechanical SSB filter, metered ALC, IC and PO. A completely solid-state FET VFO provides rock-solid frequency stability.

We rate the FLdx 400 very conservatively. That rating guarantees you 240 W PEP input SSB, 120 W CW and 75 W AM. The FSK option will go all day at a continuous 75 W. And you get full frequency coverage on all amateur bands — 80 meters through 10

meters — with an optional provision for certain other bands that you can personally specify. For all that, you pay just \$299.95.



FL2000 B Linear Amplifier.

Ideal companion to the Series 400, this hand-crafted linear is another example of Yaesu's unbeatable combination of high quality and low cost. Designed to operate at 1500 watts PEP SSB and 1000 watts CW, this unit provides superb regulation — achieved by a filter system with 28 UF effective capacity.

Other features include dual cooling fans (one for each tube), individual tuned input coils on each band for maximum efficiency and low distortion, and a final amplifier of the grounded grid type using two rugged carbon-plate 572 B tubes. Ready to operate at only \$299.95.

SPECTRONICS WEST

1491 E. 28th, Signal Hill, Ca. 90806 / Phone: (213) 426-2593

SPECTRONICS EAST

Box 1457, Stow, Ohio 4424 / Telephone: (216) 923-4567

Please send new color catalog of all Yaesu products.

Enclosed find \$ _____

Please send model(s) _____

Name _____

Address _____

City _____ State _____ Zip _____

All prices F.O.B. Signal Hill, Ca.

The Yaesu FTdx 560 Transceiver. 560 watts PEP SSB. 500 watts CW. \$450 complete. All you add is mike, speaker and antenna.

Incredible.



At \$450 the Yaesu FTdx 560 is an incredible buy. It would be impossible if it weren't for a couple of facts. One, the Yaesu is made in Japan; two, it's sold direct to you—eliminating the big dealer's profit.

These days, when you think of Japanese-built products, think of Nikon, or Sony, or Toyota. And Yaesu. Our transceivers are state-of-the-art engineered and carefully hand-assembled. They're so solid, stable and reliable we guarantee them for one year. Yaesu is quite likely the best transceiver made anywhere in the world today.

The complete Yaesu story is a long one. So we've compiled a comprehensive information packet that gives you the complete picture. Including things like comparative detail photos, a schematic, and a comparison chart that

shows you the FTdx 560's superiority over rigs you're more familiar with. Once you've looked over the FTdx 560 literature we think you'll agree that the amateur operator's impossible dream has become an incredible fact.

SPECTRONICS WEST

1491 E. 28th, Signal Hill, Ca. 90806 / Phone: (213) 426-2593

SPECTRONICS EAST

Box 1457, Stow, Ohio 4424 / Telephone: (216) 923-4567

Please send new color catalog of all Yaesu products.

Enclosed find \$ _____

Please send model(s) _____

Name _____

Address _____

City _____ State _____ Zip _____

All prices F.O.B. Signal Hill, Ca.

**WORLD
TRAVELER**



SWAN *Cygnet* 270B

SSB TRANSCEIVER

The 5 band deluxe 270-B, with a power rating of 260 Watts P.E.P., is a complete self contained radio station with built-in AC power supply and speaker in one compact, portable package. You can take it with you on vacation or business trips, operate from your motel room, your boat, car, or hide-away cabin. All you do is connect to an AC power source and antenna, plug in your mike and you're on the air, with enough power to work the world.

The Swan Cygnet 270B is a world traveler. And the price is a world beater! **\$499**

 **SWAN**
ELECTRONICS

305 Airport Road

Oceanside, California 92054

A Subsidiary of Cubic Corporation

**1200 WATTS
\$295**

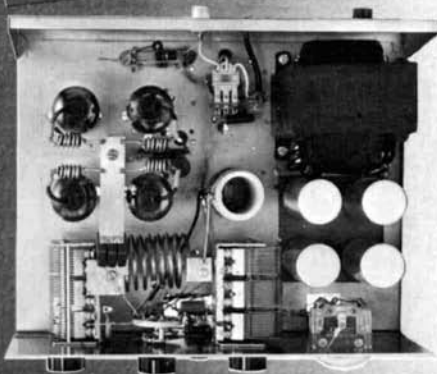

SWAN 1200W 1200 WATT LINEAR AMPLIFIER WITH SELF CONTAINED AC POWER SUPPLY

We built this little gem to go with our Cygnet 270B. But when word got around that Swan had a 1200 Watt amp with a built-in AC power supply, for just two hundred and ninety-five bucks, all h--- broke loose. Production has finally caught up with sales again, so see your dealer soon.

 **SWAN**
ELECTRONICS

305 Airport Road

Oceanside, California 92054

A Subsidiary of Cubic Corporation