

50 cents

*hp*_{mw}

focus
on
communications
technology . . .

ham radio

APRIL 1968

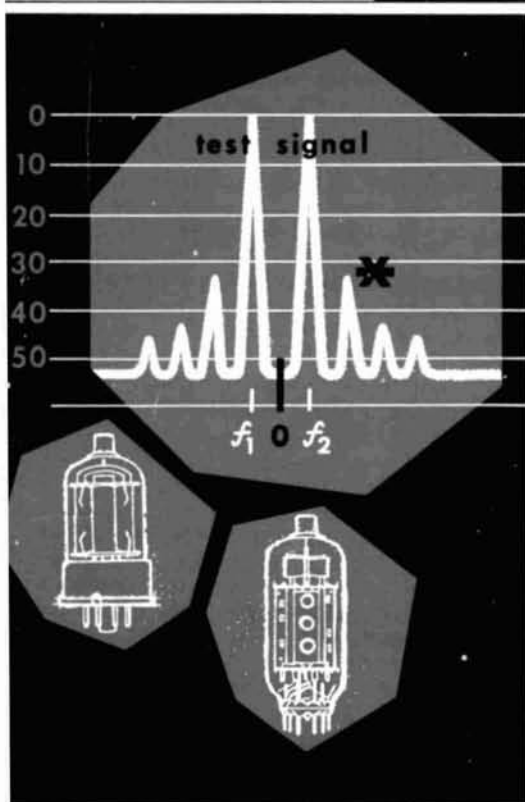

special section

- "full-blast" operation of TV sweep tubes in linear service 8

this month

- linear power amplifiers 16
- low-voltage power supply with short-circuit protection 22
- signal tracing in ham receivers 52
- long-tail transistor biasing 64
- improved transistor voltmeter 74



"S" SERIES

AUDIO & POWER TRANSFORMERS & REACTORS For Complete Ham Systems

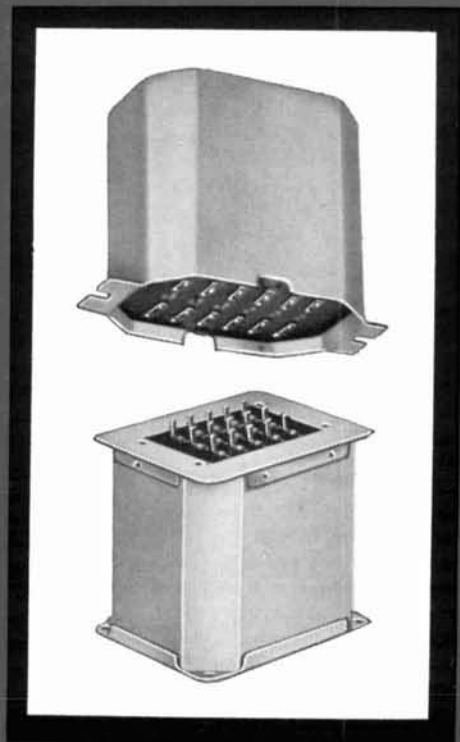

**Popular Priced
Matched Components
for
Power Supplies
Modulation
Pre-Amp &
Power Amplifiers
... for entire ham rigs**

Thirty years of attention to ham requirements have resulted in a complete line of reliable, high quality components geared especially to your needs. The "S" series of audio and power transformers and reactors, designed specifically for ham and PA service, are completely matched for compatibility in constructing a rig. These are popular priced units which afford the ham the full benefits of UTC's established excellence for quality components coupled with high reliability.

Write for catalog of over
1,300 STOCK ITEMS
with UTC top Quality



UNITED TRANSFORMER CO. TRW

DIVISION OF TRW INC. • 150 VARICK STREET, NEW YORK, N. Y. 10013

In CANADA: A. C. SIMMONDS & SONS LTD., Agincourt, Ontario

WE EVEN SURPRISED OURSELVES

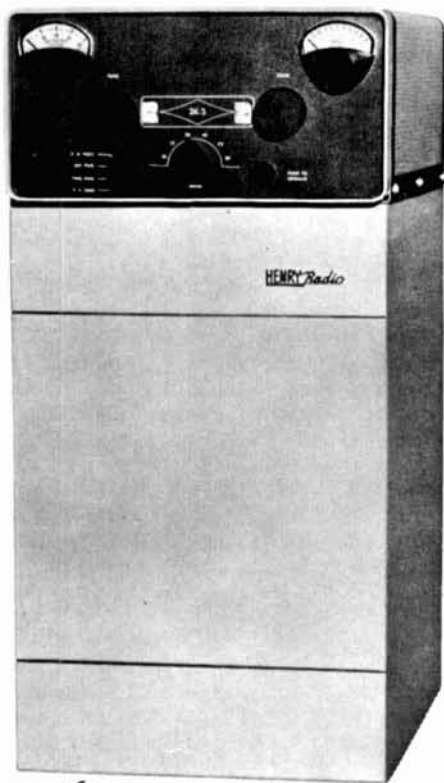

(We improved the 2K-2)

The 2K-2 was good . . . in fact, it was the best linear amplifier for the amateur on the market. But now, thanks to a pair of new and improved Eimac 3-500Z tubes, providing 1000 watts of plate dissipation, the 2K-3 operates with even greater power output and less drive. (Its so much better we're going to call it the 2K-3 now.) Still endowed with the same rugged and reliable mechanical construction, inspired design and using only the very best components, the 2K-3 is unquestionably the finest. You have heard the strong clear signals of the 2K-2 by now. Why not go on the air with an even better signal? You can NOW with the new 2K-3. Console or desk model \$745.00. Let us send you a descriptive brochure.

6% FINANCE CHARGE • 10% DOWN OR TRADE-IN DOWN • NO FINANCE CHARGE IF PAID IN 90 DAYS • GOOD RECONDITIONED APPARATUS • Nearly all makes & models. 15 day trial. 90 day Warranty. 90 day trade back on NEW apparatus. Write for bulletin.

TED HENRY (W6UOU)

BOB HENRY (WØARA)

WALT HENRY (W6NRV)

Henry Radio Stores

CALL DIRECT . . . USE AREA CODE

Butler, Missouri, 64730	816 679-3127
11240 W. Olympic, Los Angeles, Calif., 90064	213 477-6701
931 N. Euclid, Anaheim, Calif., 92801	714 772-9200
East Coast Rep.: Howard Laughrey, 2 Elizabeth St., Chappaqua, N.Y. 10514, (914) CE 8-3683	

"World's Largest Distributor of Amateur Radio Equipment"

NEW Drake R4B Receiver



Amateur Net **\$430⁰⁰**

*Linear permeability tuned VFO with 1 kc dial divisions. VFO and crystal frequencies pre-mixed for all-band stability • Covers ham bands 80, 40, 20, 15 meters completely and 28.5 to 29.0 Mc of 10 meters with crystals furnished • Any ten 500 kc ranges between 1.5 and 30 Mc can be covered with accessory crystals for 160 meters, MARS, etc. (5.0-6.0 Mc not recommended) • Four bandwidths of selectivity, 0.4 kc, 1.2 kc, 2.4 kc and 4.8 kc • Passband tuning gives sideband selection, without retuning • Noise blanker that works on CW, SSB, and AM is built-in • Notch filter and crystal calibrator are built-in • Product detector for SSB/CW, diode detector for AM • Crystal Lattice Filter gives superior cross modulation and overload characteristics • AVC for SSB or high-speed break-in CW • Dimensions: 5½" H, 10¾" W, 12¼" D. Wt.: 16 lbs.

Same specifications as R4A*

PLUS

- New tuning knob and skirt
- PTO indicator light
- Side-mounted head phone jack
- New scratch-proof epoxy finish
- New eye-ease front panel
- Improved audio (low distortion, high output)
- SOLID STATE circuitry used in PTO, Crystal Oscillator, Product Detector, AVC Circuit, BFO, Audio Amplifier, Crystal Calibrator.

25KC Calibrator has a sophisticated design, using integrated circuits and FET's; permits working closer to band edges.

The R-4B RECEIVER is a model of design, using the best combination of transistors and tubes, printed circuits and hand wiring to give maximum performance and minimum maintenance, at the lowest cost.

NEW DRAKE ACCESSORIES



**WATTMETER
W-4 \$49⁵⁰**

Reads forward and reflected power directly in watts (VSWR from nomogram). Two scales in each direction, 200 and 2000 watts full scale. Calibration accuracy ± (5% of reading + 2 watts) on 200 watt scale; ± (5% of reading + 20 watts) on 2000 watt scale. Size: 5½" H x 3¾" W x 4" D.



MN-4 ... \$90.00
200 watts



MN-2000 ... \$160.00
2000 watts PEP

MATCHING NETWORKS

General: With integral VSWR meter and RF wattmeter. Matches 50 ohm resistive transmitter output to coax antenna feedline with VSWR of up to at least 5:1 whether resistive, capacitive or inductive. Covers ham bands 80 thru 10 meters. Has alternate output for tuning up into external dummy load. Meter reads forward power directly and VSWR directly, or can be calibrated to read reflected power directly in watts. Size: 5½" H x 10¼" W x 8" D. Matching network can be switched in or out with front panel switch.

Continuous Duty Output: MN-4, 200 watts; MN-2000, 1000 watts (2000 watts PEP).

Meter reads forward power directly: MN-4, 300 watts full scale with accuracy ± (5% of reading + 3 watts); MN-2000, 2000 watts full scale with accuracy ± (5% of reading + 20 watts), and 200 watts full scale with accuracy ± (5% of reading + 2 watts).

MN-2000 only: Up to 3 antenna connectors can be selected by front panel switch.

Prices and specifications subject to change without notice.

See your distributor. For more information write to:

R. L. DRAKE COMPANY • MIAMISBURG, OHIO 45342

Attn: Dept. 127



ham radio

staff

editor

James R. Fisk,
W1DTY

roving editor

Forest H. Belt

associate editors

A. Norman Into, Jr.,
W1CCZ/K2IEO
Nicholas D. Skeer,
K1PSR
James A. Harvey
WA6IAK

art director

Jean Frey

publisher

T. H. Tenney, Jr.,
W1NLB

offices

Greenville, New Hamp-
shire 03048
Telephone: 603-878-1441

ham radio is published monthly by Communications Technology, Inc., Greenville, New Hampshire 03048. Subscription rates: U.S.A. and Canada, one year, \$5.00, three years, \$10.00. Copyright 1968 by Communications Technology, Inc. Title registered at U.S. Patent Office. Printed in Montpelier, Vermont 05602, U.S.A. Postmaster: Please send form 3579 to ham radio, Greenville, New Hampshire 03048.

contents

Full-Blast Operation of TV Sweep Tubes	William I. Orr, W6SAI	8
Linear Power Amplifiers	Forest H. Belt	16
A Modern Low-Voltage Power Supply	Donald W. Nelson, WB2EGZ	22
A Grand-Daddy Station-Control Center	Howard S. Pyle, W70E	26
Notes on the APX-6 Transponder	L. C. Maurer, Jr., W6OSA	32
How to Use Solenoid Rotary Switches	John J. Schultz, W2EEY	36
The E-Z Impedance Bridge	Robert Starks, WA9QJP	40
CW Monitor and Code-Practice Oscillator	Delbert D. Crowell, K6RIL	46
The Dynistor	Henry D. Olson, W6GXN	49
Signal Tracing in Ham Receivers	Lawrence Allen	53
Replace the Unijunction Transistor	E. R. Davisson, K9VXL	58
The International EX Crystal	Donald W. Nelson, WB2EGZ	60
Quement Circular Electronics Slide Rule	James E. Ashe, W2DXH	62
Long-Tail Transistor Biasing	James E. Ashe, W2DXH	64
An Improved Transistor Voltmeter	R. S. Maddever	74
More 144-MHz Moonbounce to Australia	James R. Fisk, W1DTY	85
A Low-Cost Tiltover Tower Base	F. M. Woolner, WA1ABP	86
departments		
A Second Look	4	Next Month 31
Advertisers Index	96	Repair Bench 52
New Products	88	



a second look

by jim
fisk

Where is amateur radio heading? This is not a new question; I imagine the spark operators on the air before the first big war often wondered the same thing. And down through the years as we make new improvements, we wonder what is ahead.

I'm sure that right after the second war, when the hams had assimilated all of the available technological information that had been generated by the war effort, they thought they had reached the pinnacle of achievement. But, in 1947 came the birth of the transistor. There weren't any big announcements because it was a well-kept secret until the patents had all been secured.

In the early 1950's when the hams started to hear about the transistor and the things it could do, they probably thought that they had really reached the end of the road. But as we can see now, transistors have improved. Many field-effect transistors are now the same price as most of the older bipolar types, and integrated circuits are taking over many of the jobs that were relegated to vacuum tubes less than 20 years ago.

What will we be using for communications next year? Or ten years from now? Do you have any idea? I don't. Next year, of course, won't be that much different from this. Most hams will still be using their sideband trans-

ceivers on the hf bands. On vhf we'll be doing more work with moon-bounce, satellites, meteor scatter and other esoteric modes of communication.

Moonbounce communications, out of the question for most amateurs five years ago, have grown to the point where the EME path can be conquered by any serious experimenter. For example, a few weeks ago, on February 12th, Henry Theobalt, KØIYN, worked VK3ATN in Australia on 144-MHz moonbounce. What makes this QSO interesting is the fact that this was Henry's first moonbounce schedule, and he had **not** received his own echoes from the moon until 15 minutes before schedule time! In addition, although he didn't have a pre-arranged schedule, he called K6MYC and Mike heard him.

Although we depend primarily on the state of the ionosphere for long-distance communications on our high-frequency bands, and there is no reason to think that it will change in the future, right now we have to wait for the sunspots to come around every eleven years. Fortunately, in the future, we may not be quite so dependent upon the sun. Scientists feel that they can produce an artificial ionosphere. This isn't something we will see next month, or even next year, but in ten years it could very possibly be a reality.

With stationary communications satellites, the demand on high-frequency space should be less. With stationary satellites, the large point-to-point communications and foreign broadcast stations could get better coverage and more reliability by using vhf and uhf. If and when that happens, the high frequencies will probably become the domain of the radio amateur and other less-critical users. The vhf and uhf bands will be the targets of international conferences.

We have to think ahead **now** to reserve and save our vhf and uhf bands for the time when they will be even more valuable than they are now. The plight of business radio today will give you an idea of the number of users who will be demanding vhf and uhf space in the next decade. If amateurs don't use the vhf and uhf bands they have, it will be very easy to lose them. They are presently being used on a shared basis with the government, and the government has priority!

There are some bands in the vhf/uhf range that see very little amateur habitation. Consider 220 to 225 MHz for example. On this band you won't hear a single station on in most parts of the country except during the vhf contests in January and September. If we don't populate these frequencies, there are other users who need them desperately.

I have heard a number of amateurs in metropolitan areas complain about congestion on our two-meter band. FM repeaters are in the vogue now and every metropolitan area has at least one FM repeater in operation. If the congestion is that bad, why not put some FM repeaters up on 220 megahertz? This wouldn't pose any problem that I can see, since you have to make slight conversions to surplus commercial equipment anyway.

Rather than decreasing the frequency, all you have to do is raise it a little bit. I will admit that the percent of frequency change

would be greater to put the equipment up on the 220-225 MHz band, but it's still within reason, and within the capability of the commercial units presently being used.

When the amateurs conquered the two-meter band, for some reason they went directly to 432 and didn't stop at 220. I suppose that 220 is too much like two-meters and really didn't seem to offer that much of a challenge. Now is a good time to start thinking about getting some equipment on 220.

How about other modes of communication for the future—new devices and components? Well, it's hard to foresee what we will be using then—who would have predicted the varactor, the laser or the parametric amplifier 15 years ago? Yet today, in some amateur installations, these are rather commonplace. There **are** a few recent advances that will find their way into the ham shack in the next decade, including some of the new diodes, the Gunn oscillator, the plasma amplifier and miniature antennas.

Like I said before, it's hard to make any firm predictions, but based on our previous history and performance, you can bet your bottom dollar that it's going to be a very, very interesting decade.

Jim Fisk, W1DTY
Editor

note to VHFER subscribers

As you were told in the last issue of the **VHFER**, you will now receive **ham radio** magazine for the balance of your subscription. We have tried to catch all of you who have subscribed to both **ham radio** and the **VHFER** so we could combine both subscriptions into a longer one for **ham radio**. If you get two copies of **ham radio**, please send us both mailing labels and we will make the necessary corrections in our records.

Order Waters fine ham gear *direct*



DUMMY LOAD/WATTMETERS

An effective means of measuring and peaking RF power into a dummy load. Four calibrated scales permit accurate readings of RF watts. Protective warning light.

MODEL 334A

1000 watts.
2 to 230 MHz \$135.

MODEL 374

1500 watts.
2 to 30 MHz \$135.

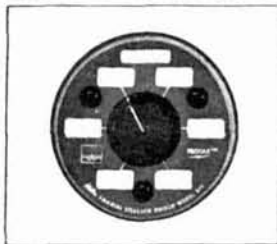

PROTAX™ ANTENNA SWITCHES

Unique coaxial selector switches that automatically ground entire antenna system when station is not in use. Handle 1000 watts; complete with hardware.

MODEL 375 SP6T

Rear Axial Connectors \$13.95

MODEL 376 SP5T

Side Radial Connectors \$12.50

MODEL 380 SPDT

Rear Axial Connectors \$12.45

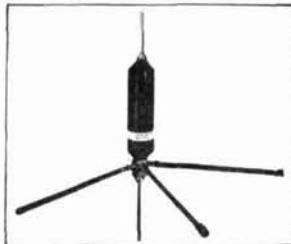

MOBILE BAND-ADDER®

Add 10, 15 and 20 meters to any standard mobile antenna with 40 or 75 meter coil. Pre-tuned for full coverage on each band. Will carry 500 watts PEP . . . lightweight and installs in seconds.

MODEL 370-3 \$19.95

AUTOMATCH ANTENNA \$42.85

Rugged — efficient. (Mast, stainless steel tip and 75 meter coil. Complete)

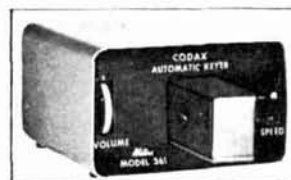

CODAX KEYS

Automatic spacing and timing from 5 to 50 WPM . . . built-in double-paddle key adjusts to any fist. Solid state with sealed "Reed" relay . . . keyed audio output at microphone level allows use of VOX circuit on either sideband. Self-powered — operates with any rig.

MODEL 361 \$92.50

(Less 1.35 volt batteries)



COUPLER/PHONE PATCH

The ultimate in phone patches providing effortless, positive VOX operation. Also connects tape recorder for both IN and OUT. Available with or without built-in Compreamp which may be used independent of patch.

MODEL 3001

(Without Compreamp) \$53.00

MODEL 3002

(With Compreamp) \$72.50



COMPREAMP

Add definite "talk power" to your signal with Compreamp! Self-powered and solid state, it is easily installed in the mike line of either fixed or mobile station. Great for the added punch when QRM and band conditions are tough.

MODEL 359 \$27.95

COAXIAL FILTERS (2 & 6 meters)



Double-tuned, resonant cavity band-pass filters for both 2 and 6 meter transmitters and receivers. Installed in 52 ohm antenna lines, the filter assures an outgoing signal free of spurious frequencies that cause interference problems. High level, out-of-band signals are rejected ahead of the receiver front end. Needs no tuning . . . insertion loss held to 1.5 db maximum.

Model 373-2 (2 meters) \$29.50

Model 373-6 (6 meters) \$32.50



ATTENUATOR

Gives stepped attenuation to 225 MHz from 0 to 61 DB in 1 DB steps. 50 ohms.

MODEL 371-1

(JHF Connectors) . . . \$29.95

MODEL 371-2

(BNC Connectors) . . . \$32.50

MODEL 371-3

(N Connectors) . . . \$38.95



USE THIS CONVENIENT ORDER FORM

Waters Manufacturing, Inc., is a member of Electronics Industries Association.

...from *Waters*

BAND ADDER™

Add 10, 15 & 20 meters to your mobile antenna!



Mod. 370-3
\$19.95

Try it for 30 days

*Your money back if
you're not satisfied!*

Use the Band-Adder 30 days in your mobile operation. If it doesn't fulfill every claim we make and satisfy you completely . . . return it for full refund of the purchase price! Remember — Band-Adder installs in a jiffy, never requires adjustment and handles 500 PEP in a walk. Great for marine mobile, too! Don't miss this no-risk opportunity. Order your Band-Adder today!

*Band-Adder installs instantly on Waters Auto-Match or other standard antennas employing 3/8-24 coil threading.

Or . . .



order from the exclusive Waters Distributor nearest your QTH

The complete Waters line is always in stock at all of these exclusive Waters distributors.

AMATEUR ELECTRONIC SUPPLY
Milwaukee, Wisconsin 53216

AMRAD SUPPLY, Inc.
San Francisco, California 94121
Oakland, California 94607

ARROW ELECTRONICS, Inc.
Farmingdale, Long Island, N.Y. 11735
Norwalk, Connecticut 06850
Totowa, New Jersey 07512
Mineola, New York 11501
New York, N.Y. 10007

ELECTRONICS CENTER, Inc.
Dallas, Texas 75204

ELECTRONICS DISTRIBUTORS, Inc.
Wheaton, Maryland 20902

HARRISON RADIO CORPORATION
Jamaica, Long Island, N.Y. 11435
New York, N.Y. 10007
Farmingdale, Long Island, N.Y. 11735

HENRY RADIO, Inc.
Butler, Missouri 64730
Anahiem, California 92801
Los Angeles, Calif. 90064

STERLING ELECTRONIC SUPPLY
New Orleans, Louisiana 70112

WORLD RADIO LABS, Inc.
Council Bluffs, Iowa 51501

PAYETTE RADIO Limited
Montreal 3, Canada

This order form may be sent direct to the factory or to your nearest Waters Distributor.

WATERS MANUFACTURING, Inc., Wayland, Mass. 01778

Dept. HR

Send Model @ each \$

Send Model @ each \$

Total Order (Mass. Deliveries Include Tax) Check/Money Order Enclosed \$

NAME CALL

ADDRESS

CITY STATE ZIP

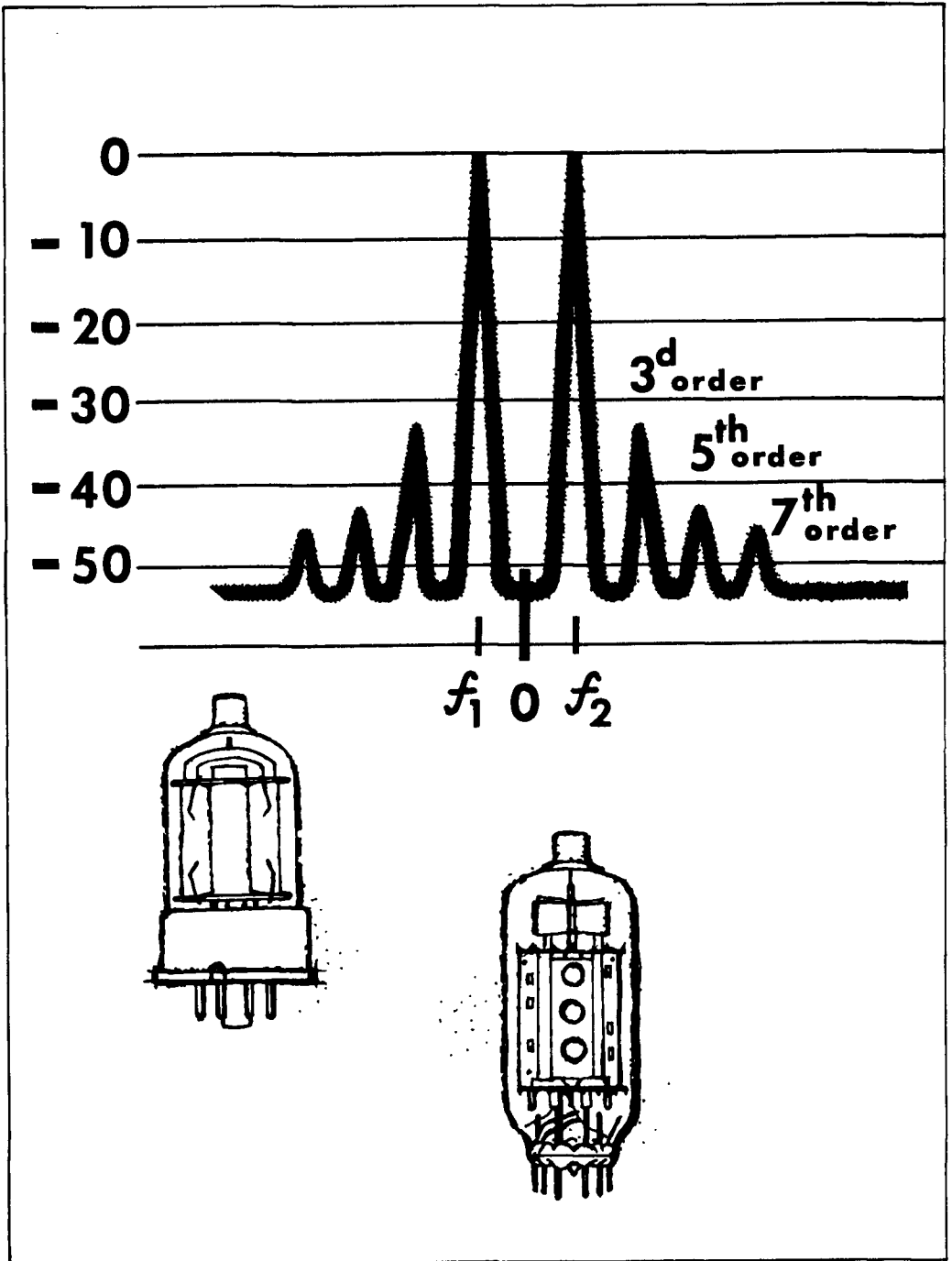

'full-blast' operation of tv sweep tubes in linear service

Although TV sweep tubes are used extensively as linear power amplifiers in amateur equipment, there has been little published data on their use at rf. Here, W6SAI and W6UOV discuss the intermodulation-distortion characteristics of these tubes.

William I. Orr W6SAI, 48 Campbell Lane, Menlo Park, California
Robert I. Sutherland, W6UOV, 4040 Fernwood Street, San Mateo, California

During the past few years, it has become popular to use TV-type deflection-amplifier tubes as linear amplifiers in amateur sideband gear. These rugged, low-cost pentodes and tetrodes provide amazing PEP capability along with reasonable tube life. However, limited operating information is available on the use of the "sweep tube" in amateur service. Most available data is based upon **heuristic** (trial-and-error) experiments. It is the purpose of this article to provide some meaningful data covering the use of TV sweep tubes in linear service and to examine the intermodulation distortion characteristics of some of them.

Modern horizontal deflection amplifier tubes, while not originally designed for rf work, have several attractive characteristics. There are power-supply economies because they are capable of high peak currents at low plate voltages. Further, wide-spread use in TV sets contributes to low cost and general availability.

Sweep tubes can be divided into two general categories, those designed for black and white television, with plate-dissipation ratings from about 17 to 20 watts, and larger 25- to 35-watt tubes designed for color applications. To satisfy specific design requirements, variations occur in electrical characteristics, internal connections and basing.

the linear amplifier

Modern ssb transmitters generate intelligence at a low level; it is increased to the operating level by means of one or more linear-amplifier stages. The linear amplifier is a device with an output envelope amplitude which is directly proportional to the input envelope amplitude. In other words, the linear amplifier has constant gain, independent of signal amplitude up to the point of overload. The perfect linear amplifier, of course, does not exist; to a greater or lesser extent all linears exhibit amplitude distortion and gain variations with changes in signal level.

A previous article¹ discussed envelope or **intermodulation distortion** (IMD) tests run on high-power linear-amplifier tubes and how the tests were made. Carrying this investigation a step further, we have made intermodulation-distortion measurements on various small TV-type tetrode and pentode tubes, particularly under "full-blast" operation commonly used in amateur-type ssb exciters and driver stages. The results of these tests are discussed and tabulated in this article.

intermodulation distortion

Intermodulation distortion is a particularly noxious form of amplitude distortion found in linear amplifiers driven by a complex signal having more than one frequency. Speech, for example, consists of a multiplicity of tones and is susceptible to IMD in a nonlinear system. Intermodulation distortion of course exists to a degree in all ssb amplifiers. The overall excellence of a linear amplifier may be expressed in terms of the level of intermodulation products as compared to that of the output signal.* The distortion products consist of spurious signals, some of which

* For convenience, the ratio between one of the test signals and one of the IMD products is read as a power ratio expressed in dB below the test signal. Other methods of expression can make the IMD products seem as much as 6 dB better than they actually are.

fall close to, and sometimes within, the operational passband of the amplifier. These spurious signals cannot be removed from the signal by the simple tuned circuits of the equipment. These unwanted emissions are called **odd-order products**.

A clean ssb signal generated by a well-designed and intelligently-operated transmitter occupies little more spectrum than the passband of the intelligence. On the other hand, a poorly-designed or badly-adjusted ssb transmitter with high-level odd-order distortion products (splatter) can smear a swath of frequencies many times wider than that required for transmission of intelligence.

The amount of intermodulation distortion a given signal may possess without creating intolerable interference in an adjacent channel or degrading the transmitted intelligence is subjective and debatable. Some forms of transmission, such as multiplex, require extremely low IMD to faithfully preserve the complex intelligence transmitted.

When the intelligence bandwidth is somewhat less, as is the case with voice, a higher level of IMD may be acceptable. This depends upon the degree of fidelity required, the masking-channel noise level, and the degree of interference tolerated in adjacent channels. Severe intermodulation distortion of a voice signal is characterized by "gravelly" audio and excessive adjacent channel splatter.

As an example, a 1000-watt (PEP output) ssb transmitter with an IMD level of -40 dB in a two-tone test will produce 0.1 watt of power in each of the third-order products. A 1000-watt transmitter, on the other hand, having an IMD level of -20 dB in third-order products will have 10 watts power in the third-order products falling outside the intelligence passband. While 0.1 watt may seem miniscule, 10 watts of unwanted signal may be intolerable, especially when it falls on top of that S-3 DX signal you are listening to!

Studies are presently underway to formalize distortion testing techniques for linear amplifiers. Criteria will be established so linear systems may be evaluated in respect to

table 1. 6146/6146B, class-AB₁ service.

test #	dc plate voltage	dc grid voltage (1)	dc screen voltage	zero signal dc plate current (mA)	maximum signal dc plate current (mA)	maximum signal dc screen current (mA)	resonant load impedance (ohms)	plate input power (watts)	plate output power (watts) (2)	third-order IMD products (dB)	approximate plate dissipation (watts)
1	600	-46	200	25	103	9	3570	61	41	-25	16 (CCS)
2	750	-51	200	25	118	7	2825	88	55	-22	28 (ICAS)
3	800	-69	290	30	125	10	3620	100	59	-24	35 (4)
4	800	-77	290	25	180	13	2300	145	91	-19	45 (3)

1. Adjust grid bias for stated zero-signal dc plate current.
2. Does not include tank-circuit losses (about 10%).
3. Applies only to 6146B.
4. Data taken from Collins S-line. Measurements made without rf feedback.
5. Maximum plate and screen currents are listed as single-tone values; voice peaks will run 1/3 to 1/2 this value.

distortion levels acceptable for various transmission circuits. In the meantime, distortion levels are set primarily by the limitations imposed by the state-of-the-art.

The present state-of-the-art in commercial and military ssb equipment calls for third-order IMD products with power levels better than - 40 to - 60 decibels below one tone of a two-tone test signal. The latter degree of linearity may be achieved by proper choice of low-distortion tubes operated in conjunction with rf feedback circuitry. Amateur requirements, as we shall see, are less restrictive by several degrees of magnitude. With an optimum choice of tubes and operating voltages, plus the addition of feedback equipment, designers and users obtain IMD levels (without expensive test equipment) which are acceptable in today's amateur gear.

intermodulation measurements

One industry-wide technique of measuring the intermodulation distortion characteristics of a vacuum tube operating in a linear mode is to run the tube in a two-tone rf test under laboratory conditions where all the parameters are controlled and observed. Various IMD products may be noted on a panoramic analyzer or tunable voltmeter. The circuit parameters and electrode voltages of the tube under test are changed at will to facilitate a search for a condition of low IMD distortion. A typical IMD presentation on the screen of the analyzer is shown in **fig. 1**.

Power tubes up to the 100-kilowatt level or so have been examined in this fashion; a considerable body of literature and test data exist on the linear characteristics of large ceramic and "hard glass" tubes with plate-dissipation ratings of 250 watts and higher. Little data, however, has been formally accumulated on the linearity characteristics of low-power driver tubes. These tubes are usually "soft-glass"*** tetrodes and pentodes that are versions of inexpensive audio or television sweep tubes.

In present design practice, high-power amateur ssb gear is physically divided at the 100- to 200-watt PEP level into an exciter and a high-power linear amplifier. The majority of exciters, moreover, use one or more receiving-type tubes of the 6L6 or 6146 family or TV sweep tubes as a linear amplifier.

the 6146 family of tetrodes

The 6146 family of tetrodes is a descendant of the 1936 "grand-daddy" 6L6 beam tetrode. Of convenience to the radio amateur and engineer is the fact that the 6146 family is rated for rf service. Also, application data covering various modes of rf operation are readily available. This popular family of small tetrodes is characterized by short, low-inductance structures which perform well in proper circuitry up to 150 MHz or so.

** Soft glass refers to lead-silicate glass which normally limits the envelope temperature to 240° C or less. Hard glass (Nonex for example) permits envelope temperatures over 300° C.

table 2. ICAS sweep-tube ratings, class-AB₁ service.

test #	tube type	dc plate voltage	dc grid voltage (1)	dc screen voltage	zero signal dc plate current (mA)	maximum signal dc plate current (mA)	maximum signal dc screen current (mA)	resonant load impedance (ohms)	plate input power (watts)	plate output power (2) (watts)	approximate plate dissipation (watts) signal
1	6GJ5	500	-43	200	30	85	4	3000	42.5	17.5	22
2	6HF5	500	-46	140	40	133	5	1900	66.5	28.8	35
3	6JB6	500	-42	200	30	85	4	3000	42.5	17.5	22
4	6JE6	500	-44	125	40	110	4	2300	55.0	23.4	30
5	6JG6	450	-35	150	30	98	5	2200	44.0	18.9	21
6	6JM6	500	-42	200	30	85	5	3000	42.5	18.3	22

1. Adjust grid bias for stated zero-signal dc plate current.
2. Does not include tank-circuit losses (about 10%).
3. Maximum plate and screen currents listed are single-tone values; voice peaks will run 1/3 to 1/2 this value.

A series of intermodulation distortion tests*** run on the 6146/6146B show that this tube exhibits an intermodulation distortion figure in the area of -22 to -25dB for third order products when operated within its published specifications (table 1). When external rf feedback is used (such as employed in the Collins S-line), equipment using the 6146/6146B achieve IMD levels of -30 dB or better (test #3).

Attempts to drive the 6146 beyond its maximum power capability, of course, represents a simple exchange of tube life and substantially higher distortion levels for more output power (test #4).

The peak ICAS plate current capability of the 6146B in class AB₁ intermittent service is limited to about 125 mA dc. At a reasonable plate potential (750 volts or so), the PEP input level runs about 94 watts. At an efficiency of 65%, plate dissipation is on the order of 34 watts or so, just within the upper rating of the tube.

sweep tubes

Several generations of high-transconductance beam-forming tetrodes and pentodes of 15- to 30-watts plate dissipation have been created for use in TV-deflection circuits. Ex-

amples of this family are the 6DQ5, 6HF5, 6JE6, 6GB5 and others. All of these husky low-cost tubes are descendants of granddaddy 6L6, having more cathode emission, greater gain and higher transconductance than their worthy ancestor.

Generally speaking, these sweep tubes are very nearly identical in overall electrical characteristics, varying mainly in physical configuration, pin connections and power capacity. A study of some of these tubes shows that in many cases the various internal parts of the tubes (plates, grids, cathode and supporting structure) are virtually identical. Perhaps the variations in ratings are determined by the applied pulse voltage and sweep parameters of the TV receiver in which the tube is to be used. In all cases, maximum capability of the tube is limited by glass-envelope temperature; 240° Centigrade or less.

Most of the common TV sweep tubes used in radio amateur ssb linear-amplifier service are not rated for this use by the manufacturer. Furthermore, not all of them are rated for audio service, from which ssb ratings may be derived. Class-AB₁ and class-C operating data for some TV sweep tubes is given in "Sylvania News"² (see table 2). According to the author, W. D. Murphy, maximum plate dissipation for some sweep tubes in intermittent ssb linear amplifier service is estimated to be about 1.25 times that value given for TV service.

Several years experience with sweep tubes in linear amplifier service by various manufacturers of amateur gear proved Murphy's data was conservative. In fact, TV sweep tubes may be deliberately subjected to high

*** All tests described in this article were conducted by the authors using the Intermodulation Distortion Analyzer in the Eimac Power Grid Laboratory. All tests were run at 2.0 MHz.

This article is not an expression of opinion on the part of the Eimac division of Varian, nor does it constitute agreement or guarantee, either expressed or implied, of the data contained in this article.

peak overloads under the proper circumstances without objectionable loss of life when used in intermittent voice operation. A "full-blast" rating for various tubes was derived (mainly by experience) that permitted PEP input levels of 150 to 200 watts to be achieved, still allowing a good balance between power input, tube cost, and tube life.

This power level is based upon the intermittent nature of amateur transmission, plus the high ratio of peak to average power in the human voice. The factors are hard to pinpoint in actual numbers, but a round, vague figure of 6 dB for the peak to average power ratio has been widely used in designing sweep-tube ssb gear for the amateur market.

With a PEP input of 250 watts under these conditions, the average input power is estimated to run about 62.5 watts over a period of time. If we figure that average efficiency runs about 60% or so, average plate dissipation will be about 26 watts. In most instances, the full-blast rating is further restricted by limiting maximum full-power tuneup periods to 30 seconds in each time period of 2 minutes.

While some rather drastic assumptions are made, practice has shown that full-blast ratings are not unrealistic and good tube life may be achieved (a year or so in normal amateur use). This is provided the operator does not "cook" the tubes during tuneup.

Full-blast operation of sweep tubes in this

manner may exceed maximum glass temperature for short periods of time and may eventually lead to seal fractures. When this happens, the tubes go "gassy" after a few hundred hours of operation. Such use, while decidedly uneconomical when applied to a twenty-dollar transmitting tube (especially in commercial gear that stresses reliability), may possibly be considered in a different light when applied to an inexpensive sweep tube that probably will be used only a hundred hours or so during the year. It remains to be seen what happens to the intermodulation distortion level of the small tube when it is subjected to such overload conditions.

Acting upon the assumption that it is economically feasible to operate a sweep tube at a full-blast 100- to 250-watt PEP input level, we ran a series of tests on various types of tubes to determine their linearity characteristics under duress. In order to hold glass temperature to reasonable values, in all cases cooling air was passed over the tube envelope. Typical rf ratings for intermittent voice linear service were tested. In some cases, operating parameters were duplicated from amateur equipment using the tube. Other working data were derived in the laboratory.

Interestingly enough, certain models of the sweep tube, such as some versions of the 6HF5, were found to have the internal cathode connection at the top of the element structure rather than at the bottom. This

table 3. Full-blast ratings for sweep-tubes, class AB₁ service.

test #	tube type	dc plate voltage	dc grid voltage (1)	dc screen voltage	zero signal dc plate current (mA)	maximum signal dc plate current (mA)	maximum signal dc screen current (mA)	resonant load impedance (ohms)	plate power input (watts)	plate power output (2) (watts)	third-order IMD products (dB)	approximate plate dissipation (watts)
1	6DQ5	500	-46	150	48	170	17	1800	85	54	-28	27
2	6DQ5	500	-46	150	48	182	13	1625	91	56	-26	29
3	6DQ5	700	-49	150	35	182	11	2210	127	78	-23	41
4	6DQ5	800	-67	180	30	250	13	1710	200	121	-19	70
5	6GB5	600	-41	200	23	192	14	1900	115	80	-18	27
6	6GE5	600	-45	200	30	132	15	2500	79	51	-22	23
7	6GE5	800	-61	250	25	172	18	2750	138	90	-19	39
8	6HF5	800	-45	125	30	197	7	2170	158	100	-21	48
9	6JE6	750	-63	175	27	218	15	1850	163	102	-20	51
10	6KG6	800	-53	160	30	200	5	1000	160	91	-19	60
11	6LQ6	750	-60	175	25	215	9	1850	161	102	-18	49
12	6LQ6	800	-69	200	25	242	13	1850	197	124	-18	60

1. Adjust grid bias for stated zero-signal dc plate current.
2. Does not include tank-circuit losses (about 10%).

extra-long cathode lead provided built-in de-generation that made the tube difficult to drive on 10 meters.

A summary of operating parameters and intermodulation distortion for various sweep tubes is given in **table 3**. It can be seen from this tabulation that the TV sweep-tube family exhibits IMD figures a bit worse than the 6146 group, being relatively constant in the range of -18 to -23 dB for third-order products. Correspondingly large values of fifth and higher order intermodulation products were also noted. Reasons for the relatively high level of intermodulation distortion products for this class of tubes are complex, but are probably based upon a combination of low-plate dissipation capability (which restricts zero-signal plate current) and nonlinear geometry of grid and screen structures.

The degree of intermodulation distortion in the sweep-tube family does not seem to be a direct function of signal level at which the tube is operating as a class-AB₁ amplifier. Reducing the input level of the sweep tube does not cause a corresponding improvement in intermodulation distortion products; the IMD level holds rather constant as power is reduced.

color sweep tubes

Recent demands for heavy-duty sweep circuits in color television receivers have produced some truly heroic tubes capable of delivering unusually large values of cathode current under conditions of low plate and screen voltage. In particular, the 6KG6, 6KD6 and 6LQ6 seem to be well qualified to deliver large amounts of raw rf under a chosen set of operating conditions. Accordingly, these tubes were examined for IMD characteristics in linear-amplifier service. The results of the tests are tabulated in **table 3**.

The 6LQ6 is rated at 30-watts plate dissipation and the 6KG6 is rated at 34-watts dissipation for TV service. Using the Sylvania rule-of-thumb mentioned earlier, an intermittent rating of 38- and 43-watts dissipation may be expected for intermittent service. Based upon experience with black-and-white sweep tubes, it is reasonable to estimate that the larger sweep tubes may withstand full-blast bursts in excess of twice these values in inter-

mittent amateur voice service. The 6LQ6, moreover, has an additional interesting rating of 200-watts temporary plate dissipation for periods of 40 seconds or less. This allows some latitude in the tuneup process when excessive values of plate dissipation are likely to occur.

The power capability of these compact and inexpensive sweep tubes is impressive. While the plate dissipation under single-tone test conditions is grossly exceeded, if cooling air is circulated around the tube, it is reasonable to assume it is within prudent limits under voice modulation.

The 6DQ5 and 6LQ6 tubes provided the highest level of peak plate current, power output and plate efficiency—about 120 watts PEP output at a PEP input level of approximately 200 watts. Third order intermodulation products ran about -18 or -19 dB below one tone of a two-tone test signal. The physically smaller 6GB5 also gave good account of itself, providing a power output of about 80 watts PEP.

It can be seen from the chart that the family of sweep tubes provides a continuum of conforming data, much alike in important aspects. In some instances, maximum-signal plate current is limited by screen dissipation, but in all cases plate dissipation vastly exceeds the published maximum values.

It should be noted that these tests were conducted at a frequency of 2 MHz. It has been reported to us from another source that some 6KG6 tubes failed in linear-amplifier service at 14 MHz at a power input of about 250 watts PEP. Examination of the damaged tubes showed that the internal connecting lead from the cathode base pin to the element structure had melted. It was conjectured that this lead may be made of some type of resistance wire to inhibit "snivets" (vhf parasitics sometimes found in sweep-oscillator service). No tube failures were encountered in the 2-MHz intermodulation tests.

Finally, it should be mentioned that the efficiency of the 6KG6 ran somewhat lower than that predicted by examination of the constant-current characteristics of the tube. Conjecture on this point leads to the thought that the inductance or resistance of the in-

table 4. 6550, class-AB₁ service.

test #	dc plate voltage	dc grid voltage (1)	dc screen voltage	zero signal dc plate current (mA)	maximum signal dc plate current (mA)	maximum signal dc screen current (mA)	resonant load impedance (ohms)	plate input power (watts)	plate output power (2) (watts)	third order IMD products (dB)	approximate plate dissipation (watts)
1	680	-39	340	48	140	20	3010	95	67	-32	21
2	800	-33	290	45	127	15	3920	102	70	-30	25

1. Adjust grid bias for stated zero-signal dc plate current.
2. Does not include tank-circuit losses (about 10%).

ternal cathode lead of the 6KG6 inhibits high-frequency operation of this husky sweep tube. This is a good example of the risk you run when you operate tubes or components in a manner not specified by the manufacturer.

The newly announced 6LQ6 deflection-amplifier tube seems a good candidate for full-blast linear operation, especially in view of the intermittent plate dissipation rating of 200 watts for 40 seconds or less. The 6LQ6, while physically less robust than the 6KG6, provides a good account of itself, as shown in the tabulated data (tests #11 and #12).

It must be noted that these mass-produced tubes have a normal production spread in electrical characteristics. When they are used in parallel, they should be hand-selected to obtain two tubes of approximately the same dynamic characteristic. This can be approximated by comparing the zero-signal resting plate current of a number of tubes and choosing a pair whose currents are closely matched under a given set of operating conditions, or by pairing the tubes in a mutual conductance tube checker.

a "linear" linear-amplifier tube

The only beam tetrode found during these tests capable of relatively high PEP output and low intermodulation distortion in linear-amplifier service was the type 6550, usually employed in hi-fi audio service. The 6550 is capable of a power output of about 67 watts in grid-driven, class-AB₁ service with third-order products - 32 dB down from one tone of a two-tone test signal. Operating data is summarized in **table 4**. In comparison with TV sweep tubes, the 6550 suffers from low transconductance and limited peak plate current. In addition, the interelectrode capaci-

tances are quite high when compared to those of a 6146. Nevertheless, the use of this tube is nearly mandatory if the equipment designer tries to approach an IMD figure better than - 30 dB without the use of feedback. With feedback, an IMD figure better than - 40 dB should be realizable.

summary

While the use of TV type sweep tubes as linear amplifiers in amateur ssb exciters and transceivers may be justified on an economic basis, putting a high-power linear amplifier (even one having negligible distortion levels) after such gear is bound to result in an increase in the level of the various distortion products. In many cases, the distortion products add in voltage amplitude; in all cases, the sum of all components of each frequency product in the output represents the overall distortion level.

Signal distortion, at least to the listener, is a highly subjective thing. To date, the use of sweep tubes in amateur equipment, regardless of the relatively high distortion level, may perhaps be justified when equated against power output and tube life on a dollar-and-cents basis. In any event, until a low-power driver tube in the five-dollar price range comes along to deliver 100-watts PEP at a magnitude of improvement of intermodulation distortion, we'll just have to make-do with the tubes at hand!

references

1. William I. Orr, W6SAI, "Intermodulation Distortion in Linear Amplifiers," *QST*, vol. 47, p. 52, September 1963.
2. W. D. Murphy, "Sylvania News," vol. 31, Winter 1964, published by Sylvania Electric Products, Inc., 1100 Main Street, Buffalo, New York.

ham radio

One kit-form linear amplifier for 6- and 10-meter ssb uses triode-connected pentodes in grounded-grid class-B.



linear power amplifiers

What they
are and why they're
necessary
for
ssb
operation

Forest H. Belt, 119 Baker Avenue, So. Plainfield, New Jersey 07080

Single-sideband signals are the most complex in voice communications. The frequencies in them bear a whole range of relationships to one another, and the last thing they can bear is to have those relationships upset. Once the frequencies in a single-sideband signal get messed up, there is no hope of unscrambling them properly at the receiver.

Once a clean ssb signal has been formed by a transmitter (or by an **exciter**, as a low-power ssb transmitter is called), amplifying its power isn't as simple as with an ordinary a-m signal. There is no dominating carrier in the ssb signal to maintain relations among the sideband frequencies. A class-C rf amplifier, the kind used for heavy power amplification of a-m signals, is very nonlinear. The tuned output tank circuits do a good job of restoring the balance, but they can do it mainly because of the strong carrier against which the sidebands (on both sides) can beat to keep their "positions." A single-sideband signal, without a carrier, must be power-amplified in a stage that has virtually no nonlinearity. The sideband frequencies must all keep their positions, with no extraneous frequencies developed from beats among the sidebands or added by the stage.

The power-amplifying stage that accomplishes this feat is called a **linear amplifier**. It may contain more than one tube, to develop the power required by the demands of com-

munications. Or, it may use a single high-power tube, driven to full output by the signal from the ssb exciter. (When a ham has decided he wants the distance-shattering "push" of really high power, his ordinary transmitter becomes the exciter. His new linear amplifier is a completely separate unit with the heavy-duty high-voltage power supplies that are necessary.)

efficiency vs. linear operation

As you probably know, truly linear operation of an amplifier is class-A. The bias for the tube is chosen to place the operation on the linear portion of the grid-voltage-plate-current (E_g-I_p) characteristic curve. Fig. 1 is the graph of E_g-I_p in one tube, and an arrow points out the spot on the curve where bias sets class-A operation. As long as the drive voltage doesn't vary the bias beyond the limits of the straight (linear) part of the operating characteristic, the class-A amplifier introduces no distortion.

The only trouble with class A is its inefficiency. At best, it can never exceed 50%; normally, 35% is pretty good. Even with the ad-

Class B is one answer, even though there is quite a bit of distortion. Bias is set near the cutoff point of the tube (fig. 1). You can develop a lot of power amplification with a tube operating at this point on its curve, because it draws plate current only half the time. With that same 1000 watts of dc input power, you can develop up to 2000 watts or so of output PEP. That's good, but what about the distortion? There are ways to reduce it, and so there are several good linear amplifiers using class-B power amplification. Before we study them, though, there's a compromise mode of operation to be considered.

Class-AB operation has one important advantage over class B; less distortion. The improvement is obvious, since distortion can wreck an ssb signal. As you might expect, the operating point for class AB is somewhere between A and B (fig. 1). Class-AB operation is right at the knee of the tube's E_g-I_p characteristic. Almost half of the input waveform runs the tube over the linear portion of its curve. This, and the fact that drive can be quite high in amplitude, make AB especially attractive.

There are two modes of class-AB operation,

fig. 1. Characteristic curve of one tube type, showing operating conditions of various classes of power amplifiers.

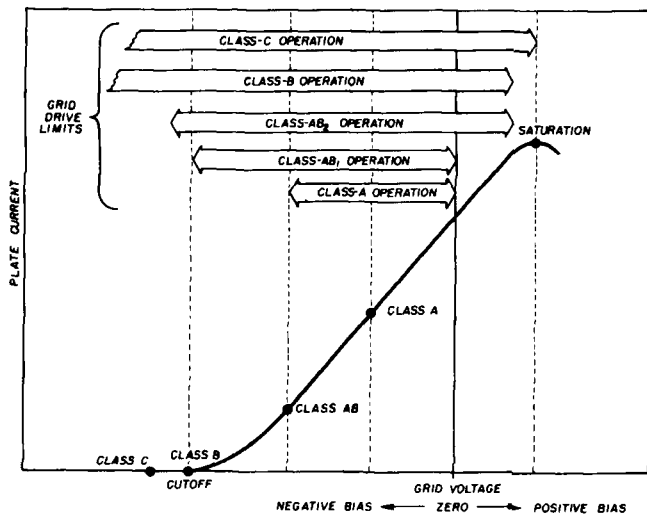

vantages of ssb, a 1000-watt dc input would get you little more than 500 or 600 watts of peak envelope power (PEP). That's not enough. What you need is real power amplification, not merely high-power voltage amplification.

too. One of them—class AB₁—takes full advantage of linear operation over half of each input cycle. The input (drive) signal is kept low enough that it never swings the grid voltage into the positive region, so grid current (which upsets tube operation) never

gets a chance to flow. The result is low distortion, while still enjoying the efficiency of operating at class AB. When the drive-signal voltage is raised to a level that causes grid current during a short portion of each positive input cycle, operation is called class AB₂; distortion is much higher.

For efficiency, then, along with linear (distortionless) operation, a good compromise is to run a tube in class AB₁. This mode is popular among commercial linear amplifiers. There are even special power tubes designed for this type of operation. Nevertheless, the attraction of even greater efficiency (more output power from less dc input power) leads some designers back to the class-B power amplifier, using special circuit designs (and special tubes) to overcome the distortion drawback.

designs for linearity

When the need for efficiency overrides the advantages of operating a tube at low distortion, special steps must be taken to combat nonlinearity. Under all circumstances, the ssb signal must not be made to introduce spurious frequencies during power amplification.

One common way to smooth out distortion is through careful choice of the L and C values in the output tank circuit. The Q of the tank should be 12 or more, because the flywheel effect in the tank returns the undistorted sine shape to each cycle of the signal. If the Q is too high, bandwidth is sacrificed, and distortion occurs from that source. Between 12 and 15 is best for tanks in most class-B or class-AB₂ linear amplifiers.

The most popular tubes for high-efficiency class-B rf amplification are triodes. Operating triode tubes at high power levels introduces new problems. There is a tendency to self-oscillation caused by some of the output signal getting back to the grid, in phase. **Fig. 2** shows a way this is combatted in some linear amps. Capacitor C3 from the bottom of the output tank feeds enough output signal back to the grid, out of phase, to prevent any oscillation.

One problem with tubes driven in class B or AB₂ arises during high excitation, when a small part of each positive input cycle momentarily drives the grid positive. That quick

burst of grid current can really mess up the output signal for that short time. The reason is traceable to the sudden change of input impedance when the grid draws current. One way around this problem is to keep the input impedance low at all times. Resistor R1 across the input coil (**fig. 2**) loads it down and overcomes this difficulty to an acceptable degree.

Self-oscillation in triodes is caused by **Miller effect**, a result of inter-electrode capacitance between the plate and grid. The effect occurs most readily when grid and plate are tuned to the same frequency. One cure is to operate the triode with its grid grounded (**fig. 3**). The cathode is driven, and the grid makes a handy shield between input and output circuits. Furthermore, any plate-grid ca-

fig. 2. Grounded-cathode triode power amplifier with neutralizing-type feedback to overcome any oscillation.

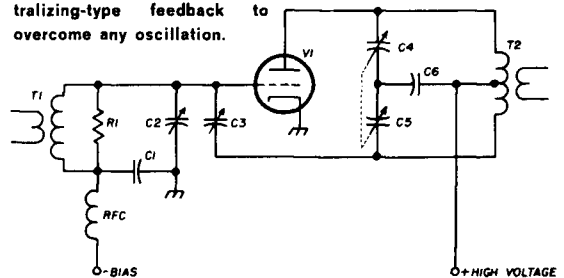

pacitance now feeds the signal back in wrong phase to regenerate. Most present-day triode linear amplifiers use the grounded-grid circuit configuration.

Tetrode rf power tubes eliminate Miller effect. The screen grid isolates the input grid from the output plate, at the same time greatly improving power gain in the tube. Introducing this additional element creates the problem of another power supply. The screen grid in most rf power amplifiers takes several hundred volts of positive dc. Because of the dynamic effect the screen has on plate current through the tube, it is important that the screen supply be well regulated. Virtually no fluctuations can be allowed under load, or else that old bugaboo of distortion will rise up to plague the single-sideband signal.

There are three ways to accomplish good regulation: use an electronic regulator of some kind, "tune" the screen-supply filter

choke, or put such a low-value bleeder across the voltage supply that the screen current is a light load by comparison. Each is found in modern tetrode-tube linears. As one example, the screen supply in the Collins 30S-1 linear amp is nearly 500 volts, bled by a 5000-ohm resistor. That makes the bleeder draw 100 mA, while the screen (of a 4CX-1000A tetrode) averages 15 or 20 mA.

Some caution has to be used with shunt-type regulator tubes: the range of screen-current variations is wide in ssb linears: the range of firing voltages for the regulators may be too narrow to cover the changes adequately. Much care goes into the design of the screen power supply in a single-sideband linear amplifier.

One effective distortion-limiting device is used in both triode and tetrode linear amplifiers. That is **feedback**. Negative, or degenerative, feedback is probably the best single deterrent to distortion used in any of the linear power amplifiers. You can see the feedback configuration of one tetrode stage in **fig. 4**.

This stage is an exceptionally stable one anyway. The screen is operated at dc ground (with negative of the screen supply going to cathode); thus it makes an extremely effective shield against any possibility of Miller-effect oscillation. The grid is at rf ground—an even further assurance of stable operation at high frequencies and high power. The cathode is the input circuit, driven through a broadband pi-network to keep the input impedance low for stability. An output-tuning system with Q of about 14 assures a clean sine-wave output. The whole stage is operated class AB₁, eliminating distortion problems that might arise from class-B bias levels or class-AB₂ drive.

Yet, on top of all that, a small amount of negative feedback is included. The 220-pF capacitor (C4) at the grid naturally doesn't bypass rf completely. Instead, C3 is part of an rf voltage divider with C4, coupling some out-of-phase rf signal to the grid. The net effect, even though the grid is not the driven element, is to oppose any distortion that has been introduced by amplification in the tube. Coil L3 and resistor R1 are a suppressor to keep parasitic oscillation from forming in the high-energy feedback circuit from the plate.

The stage in **fig. 4** is a simplified version of that used in the Collins 30S-1. It was chosen as an example because it uses so many of the designs already mentioned as useful in keeping a linear amplifier true to its name. Other commercial linears use many of the same techniques. Triodes, being less expensive, are used more than tetrodes; but both types can furnish a powerful boost to a single-sideband signal without too much distortion, if the proper correctives are designed into the circuit.

tuning up a linear

With modern designs, the guesswork is already taken out of tuning up a linear. Still, most hams like to know what it is they're really doing when they're twisting those knobs.

Only in elaborate linear amps is the procedure much different than in an ordinary power amplifier. So, let's start simple. Tune up the exciter first, and set it for cw opera-

fig. 3. The grounded-grid configuration is one way to overcome Miller-effect oscillation in triode power amps.

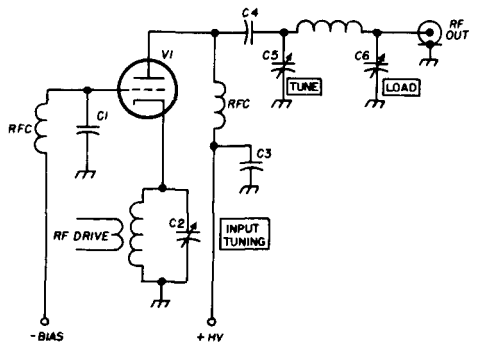

tion; you need an rf signal for tuning up the linear. Set the exciter to drive the linear as lightly as possible at first, and set the linear's output loading knob (if it has one) for minimum loading.

Note the plate-current meter reading of the linear, and slowly increase drive from the exciter until the plate current reaches about double its idling value.

Adjust the plate-tuning knob for minimum

plate current. This adjustment is easier if there is an rf-power output meter to watch, in which case the adjustment is for maximum output.

Next, tune the loading knob for maximum plate current or maximum rf output. Retune the plate-tuning knob, again for a plate-current dip or for maximum output.

Now that the linear is tuned and loaded, increase the grid drive by raising the output of the exciter. If the linear has a grid-drive meter, use it to determine proper excitation. If not, use the plate-current meter to judge drive; increase it only until plate current reaches the operating level recommended for that tube or by the manufacturer of the

meter. One model does have an rf output meter which you can use to judge the effect of its one adjustment: plate tuning. Just tune for maximum power output.

One elaborate model has grid-circuit tuning, even though the input circuits of most linear amps are rather broadband. This control is adjusted for maximum grid-current reading.

A few linear amps require neutralizing, which is done the same as with any other rf power amp. Once set, neutralization can generally be left alone. The object is essentially to stop interaction between the input and output circuits. The screen voltage can be removed, which makes the indication more

fig. 4. This stable tetrode linear amplifier has many of the distortion-reducing features described in text.

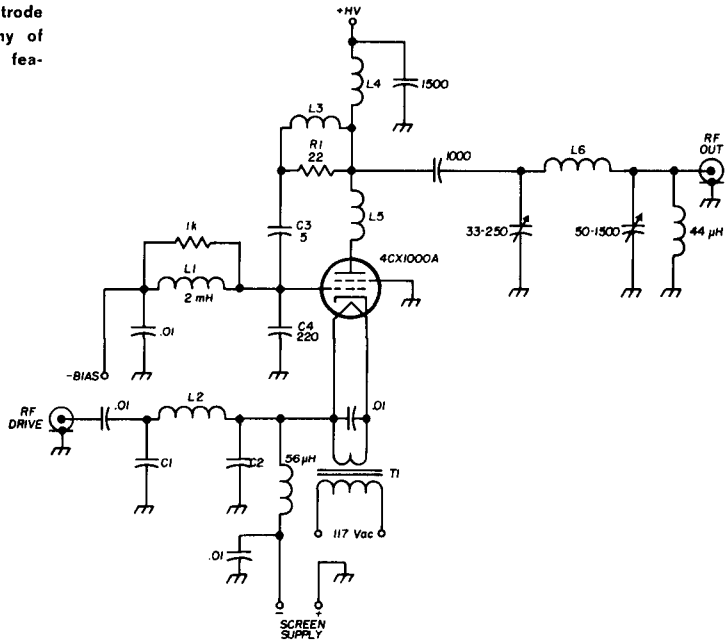

linear amplifier.

Redip the plate-tuning knob. Recheck the output loading. You may have to find a happy medium between drive and loading, since both can raise the plate current. However, there's a rule of thumb: increase the drive until increasing it doesn't raise the plate current as fast, then back it off at least 10%. Then, with the plate tuning dipped, if the current is still higher than the ratings suggest, reduce the loading.

The very simplest linear amplifiers don't have a loading adjustment, or a plate or grid

sensitive; in a triode, plate voltage should be greatly reduced.

The object of one adjustment method is to keep plate-tuning adjustments from affecting grid-current readings. Monitor the grid current while tuning the plate-tank capacitor. Keep tightening the neutralization trimmer until the effects of plate tuning can no longer be noticed on the grid-current meter. Then refine the adjustment with full plate and screen voltage.

Another neutralization method involves checking for excitation power being fed

through the output tube with all plate and screen voltage removed. A sensitive rf output meter, coupled to the output of the linear, is the monitoring device. With the transmitter all tuned up, remove plate and screen voltage, run the drive as high as it will go, and adjust the neutralization trimmer for minimum output. This method is useful if the linear is a simpler one without a grid-current meter.

protecting the equipment

Linear amplifiers need protection from two things: overloads in the circuit, and overheating. The latter is easiest: a blower in most linear amps keeps air circulating over all the components that develop much heat. If the equipment is operated within design limits, there is little fear of deterioration from too much heat.

Circuit overloads are something else. An overload or a breakdown in one spot may damage an expensive part in another. Protection is necessary. As an example, if plate voltage is lost for some reason, there should be some automatic provision to remove screen voltage; otherwise, the power tube will quickly be damaged. To prevent this, a plate-and-screen overload relay may be provided, especially in the higher-powered models.

Really, though, protection begins when an elaborate and powerful linear amplifier is first turned on. Fuses are included in each important primary circuit. Then, so no plate voltage can be applied to the power tube until its cathode is good and hot, a time-delay relay turns on at the same time as the filaments and blower. When the 3 to 5 minutes have passed, a set of contacts close, and the main dc power supplies are ready to be turned on.

The voltage must be applied to the power tube in proper sequence. In one high-power model, the grid bias is applied to the linear power tube as soon as the main power goes on. After the time delay, the "plate-on" switch can be pushed. Even then, only reduced voltage is applied to the screen and plate. The tube doesn't get full dc power until another time-delay relay has gone through its cycle.

A thermal sensor may shut down the plate and screen supplies if the power tube gets too hot. If the blower quits, the lack of cooling air triggers the sensor. If the tube exceeds its dissipating rating for any reason, the sensor removes power. Indeed, the expensive power tube in a well-designed linear is thoroughly protected.

protecting the user

Safety-consciousness is necessary around equipment with voltages as high as those used in linear amplifiers. Interlock switches on all the covers disable the power-supply primaries whenever the equipment is opened up for inspection or servicing. Never operate the unit with interlocks cheated.

The filter capacitors across the high-voltage supply can store a charge that will kill, even with the supply turned off. In a properly designed supply, the charge is drained off by bleeder resistors. Nevertheless, DO NOT trust them. Indeed, some linear amplifiers have interlock switches that discharge the capacitors just in case a bleeder hasn't done its job. One model has double interlock switching to do this job. Don't trust those, either. Always clip a set of jumper leads to ground first; then attach the other ends to each power supply point. Leave them in place until you're through inside the chassis.

Watch out for rf, too. Even though the peak envelope power of a single-sideband signal isn't as strong as a steady cw signal of the same power, that word **peak** means just that. There's a powerful lot of rf at the output and in the power stage when the linear amplifier is operating. Keep away from that rf power. Even when it isn't fatal, it can make a nasty, hard-to-heal burn.

Safety is paramount. Study the operating manual of the linear you're going to work with. No newcomer (nor anyone else) has any business on the receiving end of a nasty jolt or burn.

references

1. E. W. Pappenfus, *Single Sideband Principles and Circuits*, McGraw-Hill, New York, 1964.
2. Harry D. Hooton, W6TYH, *Single Side-Band*, Editors and Engineers, Indiana, 1967.

ham radio

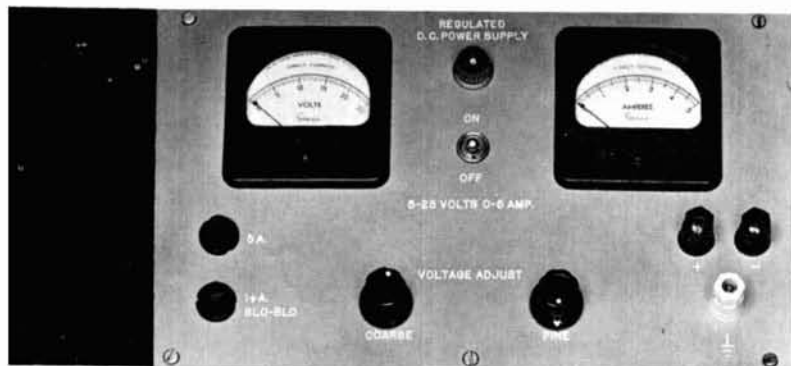

Five to twenty-five volts at 5 amps with built-in short-circuit protection.

a modern low-voltage power supply

with
**built-in
short-circuit
protection**

This variable low-voltage power supply provides up to five amps output and won't burn out if you accidentally put a short across the output

Without question, the most useful piece of equipment in my shack is the regulated low-voltage power supply. Although my wife teases me about being the only family in the neighborhood with such an elaborate battery charger, nonetheless, it is quite practical in that application. You can see that some parts of this unit are rather old, while others are very new. The explanation is simple: the control circuitry was rebuilt using silicon semiconductors. I have been using the original supply since 1959, but occasional problems prompted a change. Tests I have run on this new circuit and its components lead me to be very optimistic about their reliability.

circuitry

There is nothing new or unproven in the circuit. It was my privilege to use some new low-cost RCA plastic-encapsulated silicon power transistors which are still relatively unknown. Despite their novelty, you shouldn't have any trouble buying them. Of course, other transistors may be used, but you can't mount them on this size heat sink.

The series-regulating element consists of two RCA 2N5034 power transistors connected in parallel. The gain of this series regulator is multiplied by two Darlington-connected stages using an RCA 2N5295 and an RCA 40311. RCA has only recently announced the

Don Nelson, WB2EGZ, 9 Green Ridge Road, Ashland, New Jersey 08034

fuze zapper, look for a bad 1N747.

I wish I could use a less-expensive SCR. Unfortunately, experimental results indicate the i^2t^* surge rating of the SCR should be at least 75. It is difficult to find the exact rating to use because the i^2t surge rating usually applies to a surge of less than 8.3 milliseconds duration; in this circuit the fuse requires 80 to 600 milliseconds to blow. To compound the problem, I have had a few tenacious fuses that required noticeably longer to melt. Although I shouldn't brag, I have attained a high degree of skill in fuse blowing while perfecting this circuit.

construction

An aluminum chassis was built to fit within a Premier PAC1276 aluminum chassis box. All the large parts are mounted on this chassis. The meters mount directly to the front panel. The voltage controls, fuse holder and chassis binding post secure the chassis and

Inside the power supply. The series-regulating transistors are mounted on a Wakefield NC413K heat sink.

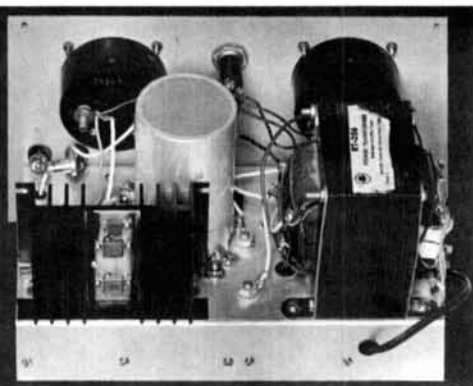

panel by mounting through both.

The main chassis acts as a heat sink for the rectifier diodes. Teflon feed-thru insulators are provided with the diodes and must be used. While the 1N2155's do a fine job, a Motorola diode assembly, MDA952-2, would be less expensive if you are buying new parts.

The power transistors are heat sunk to a Wakefield NC413K sink. Since the collectors are connected to the case and insulating

* The i^2t rating of an SCR is the rate of rise of current when the device is turned on and is measured in A^2s (amperes squared seconds).

washers were not used, the heat sink is electrically isolated from the main chassis by feed-through washers. The regulator amplifier assembly, which is on a phenolic board, is bolted to the main chassis after it is wired. Although I have no plans for heating it up, the SCR is also bolted to the main chassis with insulating hardware.

some final thoughts

Because of variations in parts, it may be necessary to adjust the values of resistors on the **coarse** control to place the regulator in the optimum range of control. The general idea of operation of the fine and coarse con-

Bottom view of the power supply. The control-amplifier board is in the upper right-hand corner.

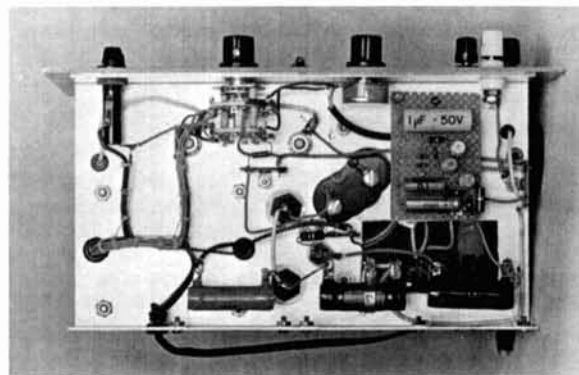

trols is to allow good regulation with a minimum voltage drop across the power transistors.

Excellent regulation and very low ripple characterize the output of this power supply. At certain voltages and high-current levels the heat-sink will get rather hot. Prolonged operation at high temperatures should be avoided. A good rule of thumb: "Keep your heat sink cool enough that you can hold your finger on it."

Much to my dismay, my low-powered transmitter blew fuses when I first hooked it up to this power supply. The problem was remedied when I found that a high value capacitor across the transmitter power input had a charging current far in excess of 5 amperes. In this case, a smaller capacitor was adequate; another application may require adjustment of the 1-ohm resistor which regulates trigger sensitivity.

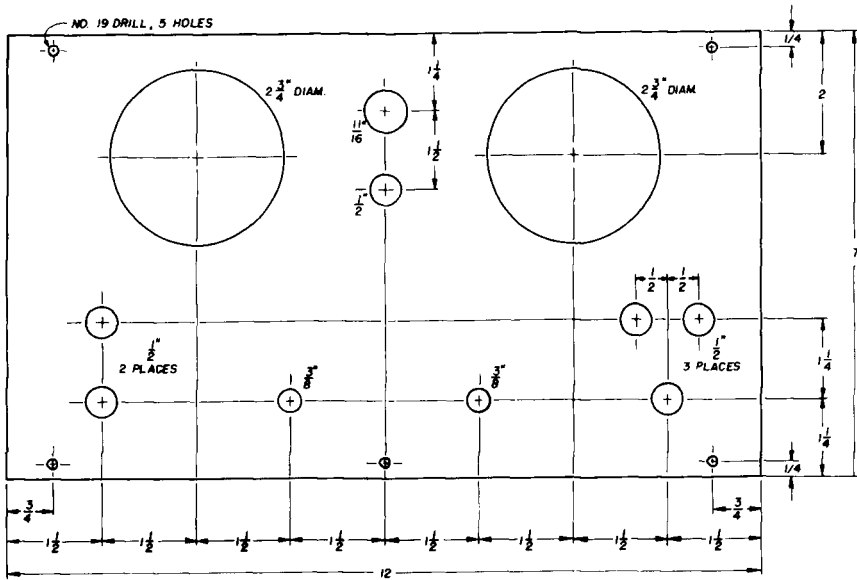

fig. 2. Panel layout for the low-voltage power supply.

You will be as enthusiastic as I am when you complete this supply. Have a good stock of fuses for demonstrating. By the way, if you run out of the 5-A variety, the crowbar will melt to 10-A fuse with only a 5-ampere load—just a little more slowly.

ham radio

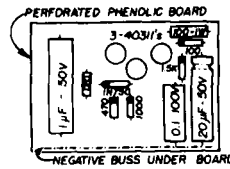
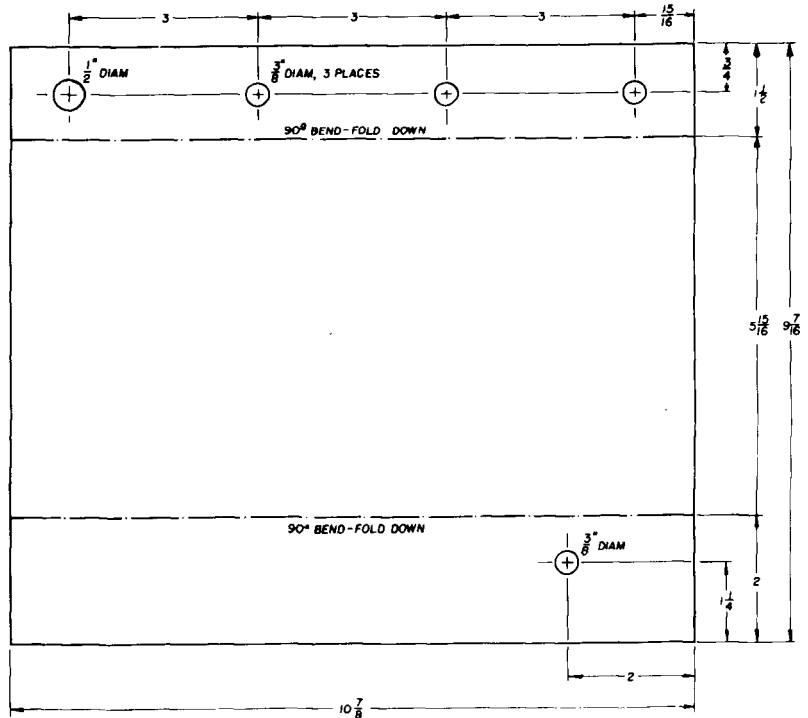

fig. 3. Layout of the control-amplifier board.

fig. 4. Power-supply chassis.





a
**grand-daddy
station-control center**

For the
discriminating ham who
wants the most in
station
control

Howard S. Pyle, W70E, 3434 74th Avenue, S. E., Mercer Island, Washington 98040

For the average ham, accumulation of various items of equipment is inevitable as he progresses up the ladder of hamdom. As time goes on, it becomes increasingly awkward to manipulate a dozen or more individual switches to turn the various gear on or off as the need warrants. All too frequently something is overlooked when you close the station after an operating session. This means that the equipment is going to sit and cook for many hours—even overnight! In addition to the wear and tear on the gear, quite often it creates a considerable fire hazard. The thinking ham then commences some thoughtful pondering: what can he do to eliminate the hazard, and, at the same time, improve his operating convenience?

The obvious solution is to take a leaf from a book of commercial or military installation practice: provide a single, foolproof central control point to insure that every item of equipment in the shack is cold and dead by simply flipping one main switch. In addition to the ac supply, you should provide individual controls for any and all accessories which are ordinarily switchable—ac power circuits, audio input and output levels, CW monitoring—in short, anything that requires frequent switch manipulation. A versatile station-control unit is the answer. I'm going to describe one here which I've been using for several years with complete satisfaction.

the control unit

I'm not going to present this in the form of an actual construction article for a very good reason. No two hams will have identical control problems. Their requirements will vary just as their station equipment does, and as we all know, no two ham shacks are alike! So, I will describe what I've been using successfully to meet my requirements. You can make modifications both in the mechanical layout and wiring to suit your station.

There is probably no other item of ham gear which offers the opportunity for individual design initiative to the extent that a control unit does. You can't buy one on the open market for the same reason I mentioned above; no two ham stations have the same requirements! But, from the photos and schematic of my unit, you can design one to meet what you think will serve your purpose.

Top view of the control center showing the digital clock and terminal strips with removable lugs.

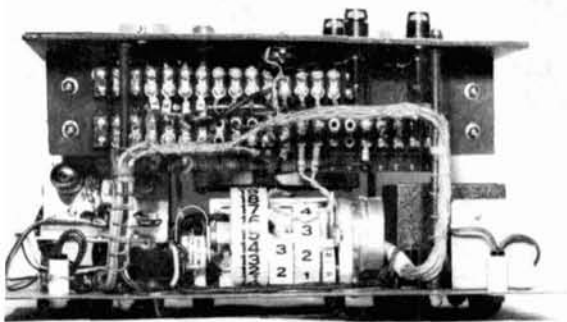

station control

First, what do you want to control from a central position in your shack? What else should you put in the unit for added operating convenience and/or safety? A third point deserves equal attention; where do you propose to locate the control center?

Suppose we take a look at this last point—location. If you want the control unit to be convenient to the operating position, it will probably be next to the actual operating area. For example, in most ham shacks, the transmitter and receiver are located on a desk along with the operating accessories—key, microphone, perhaps a few miscellaneous

switches and minor equipment items. Everything is placed so it's convenient to the operator's hand and vision. If the control center is to serve a number of functions as mine does, it must be conveniently located. If it's positioned between the transmitter and receiver, it will be within easy reach of the operating position.

Let's assume that this is where we put it. When it's within easy sight and reach, it can house the items we consider of secondary importance. For example, when the control unit is easily visible to the operator, the station clock could be included. Also, it is de-

Rear side of the front panel with the sub-panel removed.

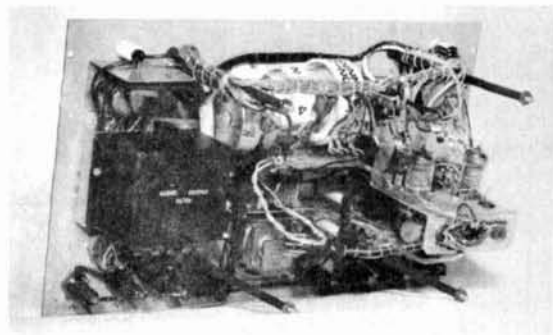

sirable to include a series of pilot lights which will serve to indicate at a glance what equipment is "on". This saves a lot of time as you don't have to look at each and every piece of equipment to see what's turned on. A monitor speaker could also be installed in the unit unless adequate speaker response is available from the speaker in your receiver.

Now, let's go back to the **primary** object of the control center; to provide **control**. By control we mean the ability to not only turn them on and off individually, but to provide additional functions such as switching receiver outputs from phones to speaker, choose the output of several receivers, switch external accessories such as notch-filters, pre-selectors, converters and similar items in or out of the system. If you use a CW keying monitor, it too can be incorporated within the control unit. Its output may be fed to a speaker or phones at will by suitable switching.

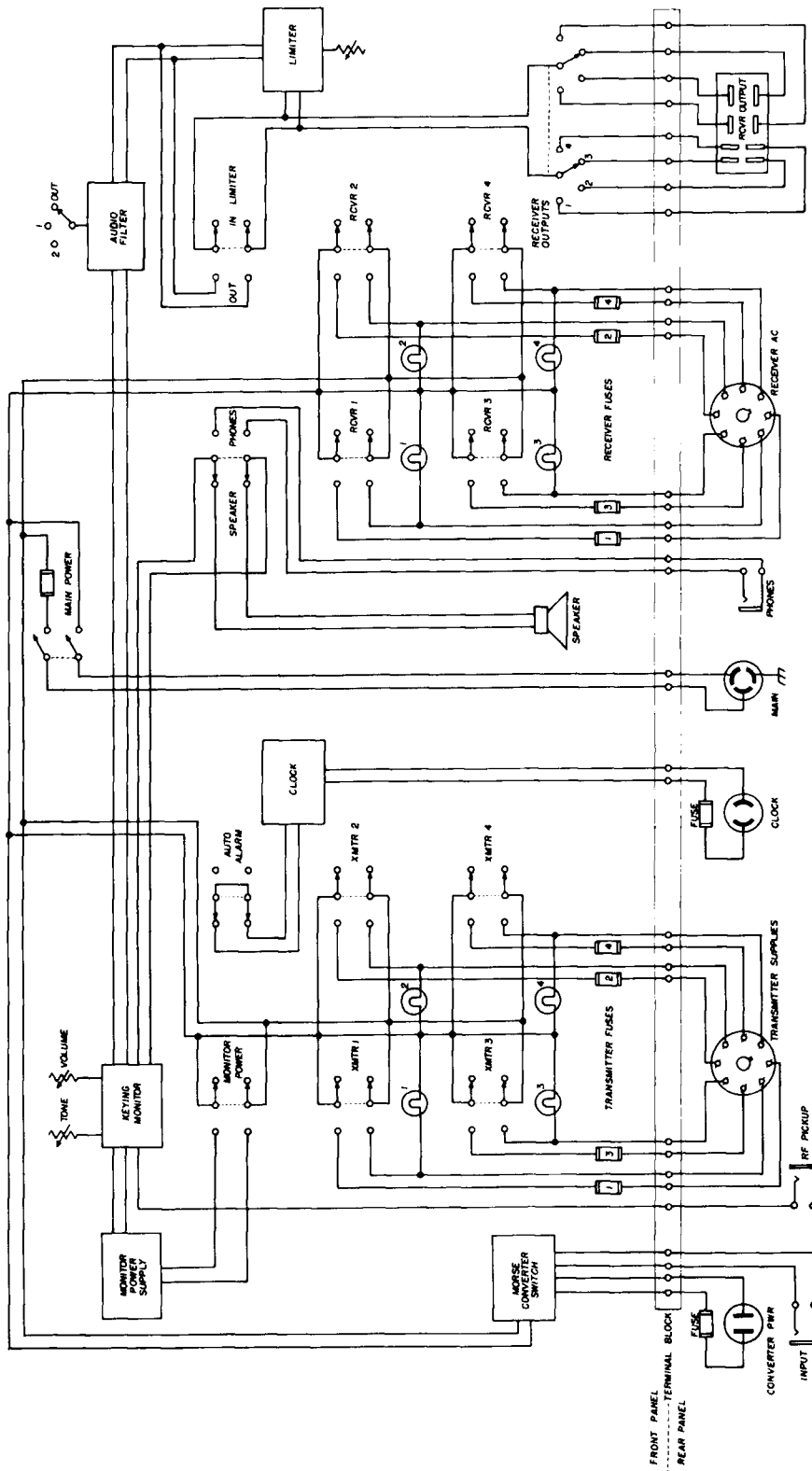

fig. 1. Subpanel and terminal block wiring diagram of the W7OE station-control center.

Turning the equipment on or off from a central point means, of course, that the ac powering the station must pass through the control center. This provides an ideal opportunity to insert a main ac switch in the circuit so that when it's off, power is removed from all equipment. Except, of course, the station clock, if it is one of the electric variety!

Appropriate fusing of all circuits should be provided, and these fuses should be in the control center, not scattered around in the equipment. Since most equipment is fused internally, an over-size fuse should be put in as a replacement with the proper size fuse in the control center. Then, in the event of a blown fuse, it will be in the control center, convenient to replace, and not buried deep in some awkward spot in the chassis!

the grand-daddy control center

Now, let's look at the control center which I have been using for several years. This has proven to be the most convenient operating aid in my station.

Suppose we start with the front panel photograph. The panel itself measures 9 x 15 inches and is part of a Bud CU882 steel utility cabinet, with removable back and front panels. These cabinets are available in either black or gray wrinkle finish; I chose black to match the other equipment in the shack.

A 24-hour digital electric clock (Call-Ident Tymeter by Penwood Numechron) takes the top center of the panel. This clock has a buzzer which will sound an alarm every ten minutes as a reminder to identify while you're in QSO. A slide switch on the panel lets you cut this feature in or out as desired. The lower center of the panel has a 2-inch hole backed with screen and grille cloth for the small 3-inch monitor speaker on the rear of the panel.

Slide switch panels (Allied #16B2197) are mounted to the extreme left and right center. Each panel provides six switching operations. The four lower switches on the left-hand panel control the ac supply to four transmitters; the lower four switches on the right-hand side supply ac to four receivers. The upper left-hand switch on the left-hand panel controls the ac supply to the CW keying mon-

itor, and the upper right-hand switch on this panel is the "on-off" switch for the clock alarm.

On the right-hand panel, the switch in the upper left selects either the internal monitor speaker or a head-phone jack on the rear subpanel. The switch on the upper right cuts a diode noise limiter in or out of the audio circuit. Just above this switch is the potentiometer for controlling the audio limiting. To the left is the 10-ampere main fuse for the control center.

To the left of the clock face is a conventional DPST toggle switch for the incoming ac mains. The knob to the left of this switch controls the volume on the CW keying monitor which feeds its output into either the monitor speaker or the headphones through the "speaker-phones" switch. Below the slide-switch panel on the left is the tone control for the CW monitor. The pointer knob to its right selects a Morse-telegraph sounder converter or the speaker or headphones. In the Morse telegraph position, this switch also turns on the ac supply to the converter.

The vertical row of red-jeweled indicator lamps to the left indicate which transmitter is in use; an identical row to the right serves the same purpose for the receivers. The row of fuse holders across the bottom of the panel at the left protect the transmitter ac supplies; a similar row at the bottom right does the same for the receivers. Just above the receiver fuses, the bar knob controls a four-position rotary switch which selects the output of any of the four receivers and feeds it to the monitor speaker (or headphones) after passing through the various audio filters. The bar knob to the right provides a choice of three values of audio filtering in the output.

rear panel

Next, let's look at the rear panel of the control center. This is not the full-sized panel supplied with the cabinet. A chassis bottom plate, 7 x 13 inches, was used here and is supported from the rear of the front panel by four 10-32 threaded rods six inches long. The threaded rods are run through metal sleeves (copper tubing) for greater rigidity and improved appearance. The rear panel is essen-

tially a subpanel and not a part of the cabinet.

Although the photograph of the subpanel should be self-explanatory, there are several points of interest. At the top is an ac socket for the separate incoming ac line feeding the clock circuit. To the right is a chassis receptacle for the rf monitor external pick-up lead. The ac circuits to all four receivers are wired to the octal socket on the left. The "audio-outputs" socket carries the outputs of all four receivers through an appropriate external terminal strip. Next in line is a receptacle to receive the ac supply plug from the Morse-telegraph converter.

The octal socket on the right carries the ac supply to all four transmitters. A jack in the lower right-hand corner takes the audio input of the selected receiver to the Morse-telegraph converter. The 3-pole polarized male plug in the lower center carries the main ac supply for the entire control unit.

internal construction

The space between the two panels accommodates all of the internal components of the center. As these will vary widely from ham to ham, the components I used can only be used as a guideline. Internal parts layout will be different of course, if you use different parts than I did. This is where ingenuity in design and layout will pay off.

The location of slide-switch panels, rotary switches, potentiometers and other panel-mounted equipment depends somewhat on the interior of the unit. No attempt was made to miniaturize any components; I used parts that I already had on hand as much as possible. Although compactness and a symmetrical panel layout were achieved, there was no overcrowding.

With all panel and subpanel equipment mounted, the remaining space must be used to best advantage to accommodate the rest of the control center package. In my unit, barrier-type terminal strips (Cinch-Jones series 140), permitted breaking all wires between the panel and subpanel. When repairs or modifications are necessary, the two panels can be completely separated by loosening the terminal strip screws on one side and lifting the spade lugs used on each wire. This arrangement also provides more elbow room

during installation and wiring of the various components. The internal arrangement I used is shown in the photographs.

wiring

Let's discuss the various parts which make up the unit. First, the main ac input. As shown on the subpanel schematic (fig. 1), a 3-pole male twist-lock connector is used for ac entrance; the third contact is grounded to the subpanel for safety. The ac line passes through the main fuse and switch on the

The grand-daddy control center. Subpanel face. The various parts as discussed in the text.

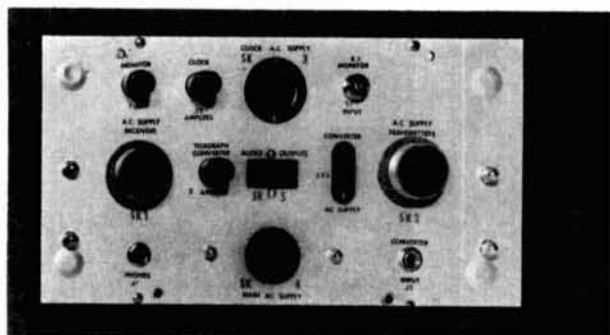

front panel; a "main power" indicator light is provided on the front panel.

The ac line between the main and subpanel is broken by terminals on the Cinch-Jones terminal strip; from there it is connected to terminals on other strips for distribution to various pieces of equipment. This includes wiring through the slide switches on the front panel to the two octal sockets on the subpanel which supply power to the transmitters and receivers.

While I use four transmitters and four receivers, the average amateur station has only one or two of each. Although you can buy slide-switch panels with fewer switches, I feel that switch panels and sockets should be provided with sufficient capacity to accommodate future additions. Play safe and provide for a minimum of four pieces of major external equipment.

Next, the eight-contact socket in the center of the subpanel. This carries the audio output circuits of all four receivers and is internally

wired to one of the terminal strips. From here, the circuitry follows through the noise limiter and audio-filter circuits, speaker-headphone switch, phone jack and the output selector switch on the front panel.

The CW keying monitor in my unit uses rf pickup to activate it. Although I use a **Johnson Signal Sentry**, any suitable keying monitor which you may happen to have may be substituted. Any of the conventional code-practice oscillator-monitors available can be adapted for this use or you can build one if you prefer. A **Cordover** solid-state CW-monitor module occupies less space and re-

The front panel to the left; the rear subpanel to the right.

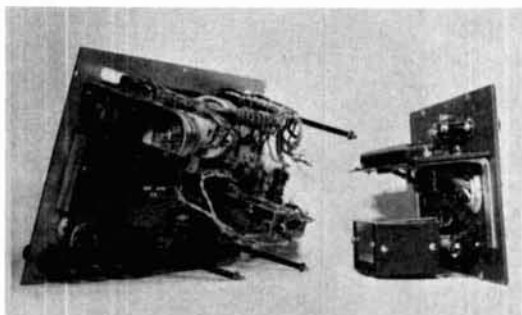

quires no external ac supply source if you'll be satisfied with an internal battery. I don't favor this approach since it's awkward to open the control-center cabinet periodically for battery replacement. Of course, a small ac supply can be substituted.

The noise limiter is a simple diode type which I built and has proven very satisfactory. The audio filter is a surplus military unit originally designed for aeronautical use. This is useful for narrowing the audio channel dur-

ing extreme interference conditions for CW reception. If you have suitable audio filtering in your receiver, either or both of these audio devices can be eliminated. Also, unless you are a Morse telegrapher, you probably won't want the controls for the telegraph converter.

summary

This pretty well covers the **grand-daddy** control center, but a few additional tips may be helpful. For instance, the switches and fuses I used may not have adequate carrying capacity if your transmitter(s) run at very high power. Check the ampere capacity of any switches you want to use and put in fuse values which agree with your current demand. Since my maximum transmitter input power is only sixty watts, the values shown here are more than adequate. I would suggest too that you use **shielded** wire for all of your audio circuitry; this will prevent hum pick-up from adjacent ac wiring in the cabinet. And, for a really professional job, lace your wiring runs into cabled harnesses.

This should give you a number of ideas for increasing the operating convenience as well as the safety of your ham shack. Carry it even further—don't stop with a nice control unit and then connect the external wiring by cords and cables straggling all over the shack. Do the **external** wiring job neatly as well: make straight wire and cable runs with rounded right angle turns. Whenever possible, use small cable clamps to strap cable runs to the wall, table or bench. You'll get a great deal of pride and operating pleasure during your on-the-air sessions and you can point to your installation with pride when visitors arrive!

ham radio

next month in ham radio magazine:

Two-Meter Swan Conversion
Electronic Bugging
Simple Transistor Checker
Dual-Channel Compressor
Mini-Monopole Antenna

How to use the Smith Chart
Two-Meter Mobile
Mini-Spotter
SSB Oscillators
Plus many more!

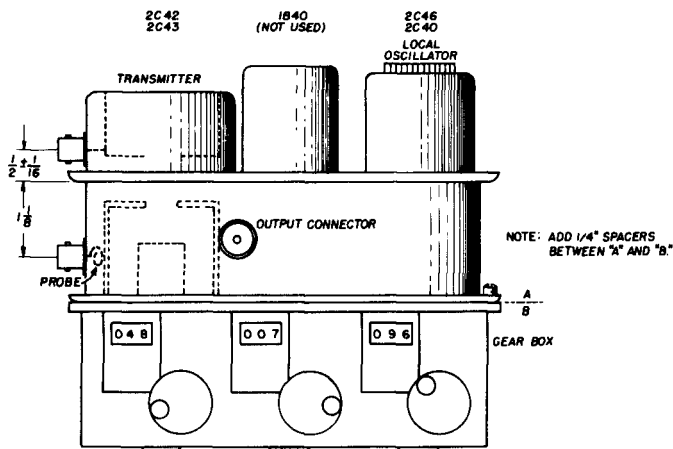

notes
on the
APX-6 transponder

The APX-6 still provides the easiest way to get on 1296 MHz. Here are some new conversion techniques, including an FET i-f preamplifier

Les Maurer, W6OSA, 209 Nob Hill Way, Los Gatos, California 95030

There have been a couple of good conversion articles on the APX-6^{1,2} and it's not my purpose to repeat all the information contained in these past articles. However, I want to amplify this information with additional knowledge that I gained the hard way—the conversion itself. The ubiquitous APX-6 is still the quickest and most inexpensive way to get on 1296; and, when you graduate to more sophisticated equipment for transmitting and receiving, you can always use it as a signal generator or grid-dip meter.³

the receiver

The receiver is the first order of business. There is nothing sacred about the 60-MHz i-f strip that comes with the transceiver. It was designed to amplify pulses—and that's what it does best. If you don't believe me, clip an antenna to the input and listen to the cars go by.

I get much better results with a 50-MHz first i-f and a 15-MHz second i-f. Probably the most important thing in my i-f amplifier is the high-gain low-noise preamp inserted between it and the APX-6 diode mixer.

I started out with a 6BQ7A cascode pre-amplifier. Later I replaced the 6BQ7A with a 6ES8. Finally, I replaced the 6ES8 with a pair of TIS-34 field-effect transistors, shown in the circuit in fig. 2. When there is no rf amplifier ahead of the mixer, the first i-f stage becomes all important. The TIS-34 FET's are about the ultimate at 50 MHz (inexpensive too).

You can use any combination of i-f frequencies from 144 MHz on down, depending on what you have on hand. However, use a cascode circuit, preferably an FET cascode, for the preamplifier. The other point to remember is that a very sharp i-f (such as the 455 kHz i-f in your low-band receiver) will not give satisfactory results with the APX-6. The 2C46 local oscillator has too much drift and frequency moding.

fig. 2. FET i-f preamplifier for use with the APX-6.

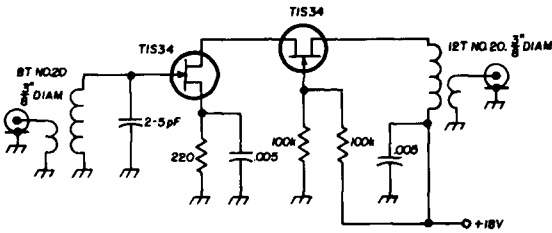

The combination of 39 and 4.7 MHz in the surplus Link receivers works out quite well. The 19- and 3.45-MHz i-f's in the guard receiver are also good. You can also use a single-frequency i-f in the 10- to 20-MHz region. The 1N25 diode goes for a pretty stiff price, even surplus. The 1N21 or 1N23 Series work equally well and are much more available.

The 2C46 in the local oscillator can be replaced with a 2C40 or a 446A. All you need to do is wind a strip of copper around the plate cap to make it as fat as the cap on the 2C46. While I'm on the subject of tubes, the 2C43 can be run at higher power than the 2C42 which was originally used in the transmitter, and it is in more plentiful supply.

All three of the APX-6 tuning pistons had to be shortened by 1/4 inch to cover the high end of the 1296 band. I used an Exacto razor saw (sold in hobby shops). As a temporary expedient, you can jack the cavity chamber up 1/4 inch above the gear chassis with wash-

ers or metal spacers and accomplish the same result (fig. 1).

No one has ever mentioned why you can't use the original 1B40 for a T/R tube instead of all that fuss with a neon bulb. The answer is that originally 450 volts or more was used on the plate of the 2C42 for pulse operation. If you only have a 300-volt power supply, as shown in both conversions, you wouldn't be able to ignite the 1B40.

the transmitter

With regard to cavity modifications, I defy anyone to use the 1/4-inch centers shown for the BNC fitting on the cathode cavity,¹ get the clamping ring under the connector and be able to plug in the male connector too! The original QST article shows 9/16 inch from the center of the BNC to the top of the cathode cavity. I recommend 1/2 inch plus or minus 1/16 from the center of the BNC connector down to the lip of the cathode cavity. Take an ordinary BNC connector and saw one

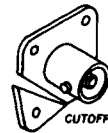

fig. 3. Modifying a BNC connector for use on the APX-6.

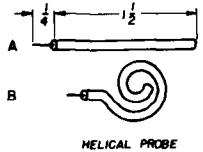

fig. 4. Improved results may be obtained by using this helical pickup probe.

corner of the flange off as shown in fig. 3; that beats grinding off the flange as one article suggested. Be sure to put the retaining ring on before soldering the BNC connector to the outside of the cathode cavity; it fits under the connector where the flange is cut away.

Here is another approach to coupling the BNC connector to the plate cavity of the transmitter. I seem to have better luck with capacitive coupling than with inductive coupling on all my UHF power sources. I tried it in this application and it worked like a charm. The design of the coupling capacitor is a W6OSA original. I don't know why it works—but it does.

Take a piece of insulated #18 or #20 wire 1-1/2-inches long and strip 1/4 inch of the insulation off one end. Solder this bare end to the tip of the inner conductor of a BNC bulkhead-type connector. Starting from the insulated end, coil one inch of the wire into a small helix as shown in **fig. 4**. The helix now becomes a capacitive probe. The insulation prevents accidental shorts to the plate line.

I use #20 stranded wire for my probes. Stranded wire is not supposed to work—but it does here! Stuff the helix through the 3/8-inch hole you drilled in the plate cavity.^{1,2} Adjust the BNC connector in and out until you get maximum output and then clamp or solder it in this position.

I used to wonder why the transmitter oscillator wasn't built like the receiver local oscillator. I tried a 2C43 and a 2C42 in the local oscillator cavity in place of the 2C46 and they oscillated very nicely. I couldn't get much power out through the regular antenna con-

fig. 5. A surplus line stretcher that I use to obtain a greater frequency range in the 1215-MHz band.

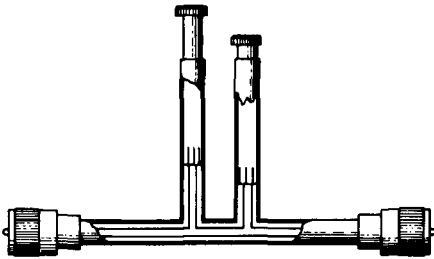

nectors, but the coupling to the local oscillator from the antenna cavity is intentionally very loose. By installing a new coupling link,¹ it should be possible to use this cavity for a transmitter. Then, if you had two sets of APX-6 cavities, you could use one for transmitting and one for receiving.

The modified transmitter with the 7.7-inch coax link will only work over a small range of frequencies. This is pretty exasperating if you are trying to hit a specific frequency such as 1296 MHz. The 7.7 inches is derived from multiplying 11-1/2 inches (3/2 wavelengths at 1220 MHz) times the velocity factor of RG-59/U coaxial cable.

However, 11-1/2 inches is 3/2 waves long at 1220 only if you add the length of the BNC's and the conductors inside the cavities.

Hence the voltage at the plate end is out of phase with the voltage at the cathode end. You could use any odd number of 1/2 waves except one one-half wave which won't reach. To increase or decrease the oscillator frequency very much, you have to change the length of the coax link.

The only way around this is to use a "line stretcher". This device (**fig. 5**) will let you move anywhere in the band and still operate at peak efficiency.

The modified transmitter cavity can also be used as a straight-through amplifier on 1296 MHz. A one-watt varactor into the APX-6 2C43 amplifier would make a good combination. Simply run 1296-MHz drive (about 1 watt) straight into the cathode cavity. The output can be taken from the original output connector, but you will get better results with the new capacitive probe.

antenna

My antenna is a 16-element expanded-extended collinear. The reflector is made of copper window screen spaced one-quarter wavelength behind the eight driven elements. The array is fed with foam-filled tubular twin lead and a Frank Jones 50 to 300-ohm balun down in the shack. The twin lead works fine except when it rains.

There are two DME (Distance Measuring Equipment) stations about 30 miles away between 1204 and 1214 MHz. I use them to check how well the complete receiving system is working before trying to make a contact on 1296 MHz. I believe that every major airport has DME equipment operating somewhere between 1150 and 1215 MHz. I hear radar stations too, but they are so loud they don't afford much of a check. Oh yes, be certain you and the other station are using the same antenna polarity (W6GHV please note). The DME's are apparently vertical.

references

1. B. Brown and A. Katz, "Putting the APX-6 on 1215 Mc," Part 1, CQ, October 1965, page 53. Part 2, CQ, November 1965, page 46.
2. E. Tilton, "Communication on 1215 Mc with the APX-6," QST, September 1960, page 31.
3. J. Fisk, "A 1296 Grid Dipper," 73, June 1967.

ham radio

Go RTTY

WITH THE AMAZING

"Beetle Box"

TELETYPE CONVERTER!

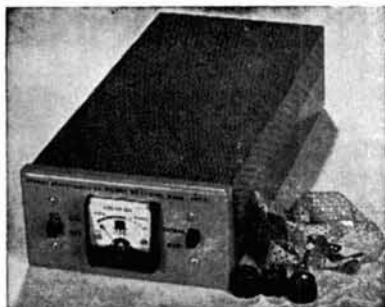

CHECK THESE FEATURES:

- ★ ALL TRANSISTORIZED, SELF POWERED.
- ★ 13 SEMICONDUCTOR CIRCUIT.
- ★ MILITARY GRADE EPOXY CIRCUIT BOARD.
- ★ RUGGED CONSTRUCTION.
- ★ REVOLUTIONARY TUNING INDICATOR, AS ACCURATE AS A SCOPE.
- ★ SINGLE CHANNEL AND NARROW SHIFT COPY.
- ★ ANTI-FADE AND DECISION CIRCUITRY.
- ★ SELECTIVE FILTERS TO MINIMIZE GARBLE DUE TO INTERFERENCE.
- ★ TWO CASCADE LIMITERS EMPLOYING DIODES AND TRANSISTORS.

RT-WIRED AND TESTED **\$99.50**

I will ship in the 48 states freight free! Write to me for top trade-in allowance!

Bill Hullquist K6LOS

MISSION HAM ELECTRONICS

3316 Main Street
Riverside 3, California 92501
Phone 683-0523 (area code 714)



Buy Yourself A New Toy

COLLINS

KWM-2 transceiver	\$1150.00
516F2 AC Pow/Sup	153.00
MP-1 DC Pow/Sup	235.00
351D-2 Mobile Mount	120.00
32S3 transmitter	795.00
75S3-B Receiver	725.00
312B-4 SWR, Patch, Spkr Watt meter	195.00
30L-1 Linear	520.00

DRAKE

TR-4 Transceiver	\$ 599.95
AC-4 AC Pow/Sup	99.95
DC-3 DC Pow/Sup	149.95
MS-4 Speaker Cabinet	19.95
MMK-3 Mobile Bracket	6.95
R4B Receiver	430.00
T4X Transmitter	399.95
L-4 Linear w/tubes & P/S	695.00
T-4 Receiver	299.95
SW-4 Short Wave Receiver	289.00
2-C Receiver	229.00
2-NT CW Transmitter	129.00
RV-4 Remote VFO	99.95

SWAN

250 6 meter Transceiver	325.00
350 5 Band Transceiver	420.00
500 5 Band Transceiver	495.00
410 VFO	95.00
406B Mobile VFO	75.00
RC-2 TRUNK Remote Control Kit	25.00
22 Dual VFO adapter	25.00
405 Mars Oscillator	45.00
117XC AC Pow/Sup	95.00
14X DC Module Supply	65.00
MARK II Linear w/tubes	630.00

MISSION HAM SUPPLIES

3316 Main Street, Riverside, Calif. 92501

- SHIP ONE "STONER" RT-I CONVERTER:
- Send spec sheet on BTI Linear.
- QUOTE Trade allowance for my
- Please send latest HAM flyer.
- Put me on your mailing list.

Name Call

(please print)

Address

City State Zip

(Calif. orders add 4% tax)

ORDER
TODAY

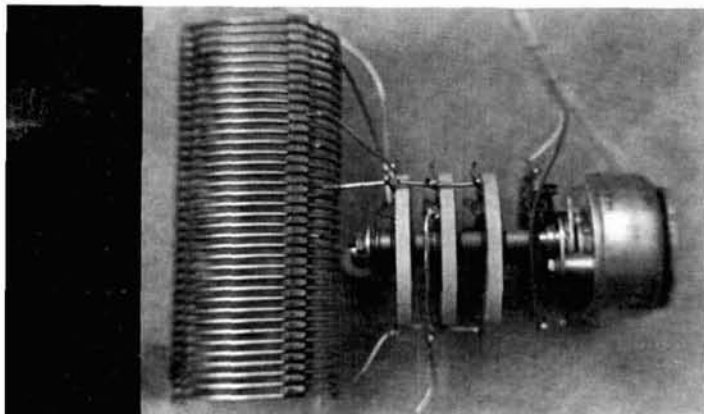

A solenoid rotary switch which is used for selecting the taps on a multiband antenna loading coil.

how to use solenoid rotary switches

If you want to remotely control antenna-loading coils or feedlines, why not try a solenoid rotary switch?

Solenoid rotary selectors can be used to simplify a multitude of remote-control functions and are often available on the surplus market. They can be used to advantage in many ham shacks; you can use them to select the proper loading inductance for a vertical antenna from inside the shack or to remotely switch one transmission line to a variety of antennas. Remotely tuning a vertical antenna only saves labor and inconvenience, but when they're used to remotely switch coaxial feedline, the savings are more tangible. This is particularly true if you use many long transmission lines at your station. In more advanced installations, it may even be desirable to remotely select antenna preamplifiers or mast-mounted converters.

Although many elaborate systems of remote switching have been developed, the easiest and most versatile method entails the use of solenoid-operated rotary-selector switches. They are simple to control, dependable, and will meet any switching function that can be accomplished with a manual rotary switch. This article describes the basic operation of the solenoid switch and some of the control circuits which may be used. I have also given some examples of how I use these devices around my shack—remotely controlling multiband antenna-loading coils and coaxial-cable switching.

John J. Schultz, W2EEY/1, 40 Rossie Street, Mystic, Connecticut 06355

basic rotary selectors

Basically, the solenoid switch is nothing more than its name implies—a solenoid-actuated rotary switch. However, a few refinements are necessary to make it operate properly. First of all, the solenoid mechanism is connected to the switch shaft through a ratchet. It's constructed so the shaft advances one position each time the solenoid is energized. The ratchet holds the switch in position when the solenoid is de-energized. You advance the switch to the desired position by simply energizing and de-energizing the solenoid.

If it's desired, a self-advancing or self-stepping action can be easily added. With this modification, the shaft rotates from position to position as long as the solenoid circuit is on. The "interrupter" which accom-

fig. 1. Basic remote-control rotary-switch circuits.

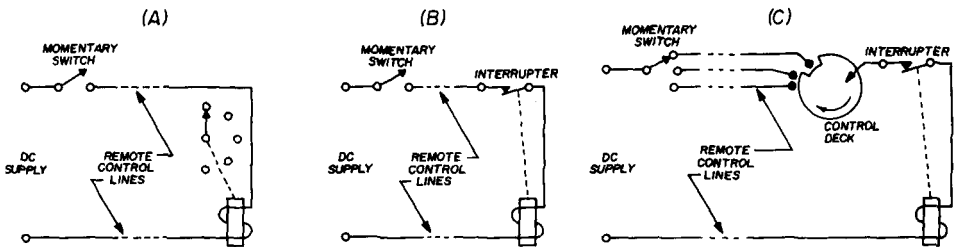

plishes this is mounted on the switch shaft. Normally it's closed. However, it opens up when the switch starts to move. When it reaches the next switch position, it's closed again. Therefore, the interrupter automatically "steps" the switch, position by position, as long as external power is applied.

The solenoid which does the work operates on direct current and is a high-torque, low duty cycle device. Most of them are designed for a 10:1 time-off to time-on operation, so for most amateur applications there is no danger of exceeding their ratings.

You can often find these switches with ten or more switching decks. In addition to the switching arrangements (number of poles and positions), you should look at the contact current rating and switch insulation. Phenolic switches are suitable for most applications including rf up to 30 MHz or so. Ceramic or epoxy-glass switches are better for VHF or

where low-level signals are being switched in high-impedance circuits.

operational circuits

Fig. 1A shows the basic method of wiring up the solenoid with a momentary-contact switch. The use of the interrupter is shown in fig. 1B. This circuit is not used in practice because the rotary switch would rotate continuously whenever power was applied. Since each step takes place in a fraction of a second, you would never know what position the switch was in. However, a "control" switch on the rotating shaft as shown in fig. 1C may be used to keep things in order.

This control deck has no electrical connection to any of the decks which you are using for remote control. If the selector switch energizes a line to the control deck, the rotary switch will advance until the notch in the control deck corresponds to the ener-

fig. 2. Modified control circuits using a reference or set position.

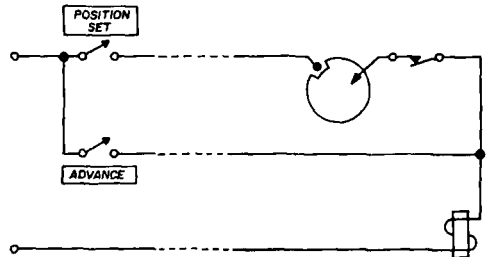

gized line. Then it will stop. With this arrangement, you can choose which position you want, and the switch automatically steps to that position. The only disadvantage is that a control line is required for each position of the switch.

As you might have guessed, various schemes have been developed to reduce the number of control lines. One arrangement is shown in fig. 2A. Here only two control lines

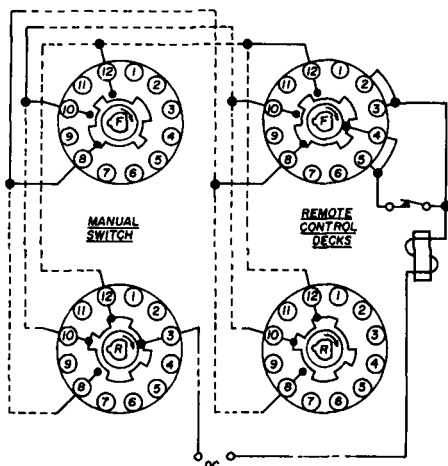
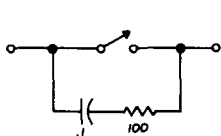
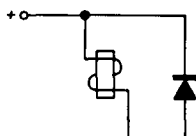

fig. 4. Methods of arc suppression which are described in the text.



(A)



(B)

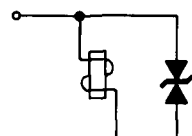

(C)

fig. 3. Modified control circuit using binary coded control.

are required for any number of rotary positions. When the "position set" switch is closed, the rotary switch will advance to the reference position and stop. It may then be manually advanced by pushing the "advance" switch. This arrangement is real handy if you lose count or don't know what position the switch is in. Just return it to its reference position and start over again.

If a binary-coded control deck is used, up to twelve positions may be controlled with only three control lines (fig. 2B). Both the remote switch and the control deck on the rotary switch have identical contact arrangements. If you trace out the circuit, you'll see that the action is the same as that shown in fig. 1C. This binary idea can be expanded to include more switch positions by changing the layout of the control decks.

arc suppression

Since the solenoid is a large inductor, when it is de-energized a high back voltage is generated. This can cause arcs which may damage the control-switch or interrupter contacts. Also, the rf interference may be very annoying if the switch is operated when your

receiver is turned on. Fortunately, these arcs can be suppressed by placing a resistor-capacitor network across the switch contacts (fig. 3A). This type of suppressor will eliminate the effect of the arc, but not its cause.

A diode or a double-anode zener may be used to eliminate the cause (fig. 3B and C). The diode is installed so that it is reverse biased when the solenoid is energized. However, the back voltage generated by the solenoid when it is de-energized is shorted to ground. Remember though, the back emf generated by the collapsing field around the solenoid can be many times greater than the applied voltage. It is standard practice in military applications to use 500-PIV, 500-mA diodes for 28-Vdc solenoids and relays.

The zener diode limits the back voltage to a preset level. If its rated voltage is about 10% higher than the applied voltage, it will not affect the applied voltage. Although the diodes tend to slow down the action of the switch, it will still be quicker than your eye.

applications

The photograph at the beginning of the article shows a remotely-controlled rotary switch which selects taps on a multiband antenna-loading coil. This is a natural for a base-loaded vertical fed with coaxial cable. The switch in the picture has three switch decks. Since only one switch was required for this job, the contacts of the other two decks were wired in parallel with those on the first deck for greater current-carrying capacity.

As shown in fig. 4A, the coaxial cable which is being switched can be used to carry the control voltage to the solenoid. Blocking capacitors and rf chokes are used to isolate the dc control circuit from the rf path. Since the solenoid is only energized momentarily, 2.5-mH, 250-mA, receiving-type rf chokes are

perfectly satisfactory. The capacitors are 0.01 μ F mica or disc ceramic.

Because of the added resistance of the rf chokes, it is sometimes necessary to use a slightly higher dc control voltage. If the coil is rated at 110 Vdc for example, 130 volts is often used. This is easily supplied by a 110 Vac isolation transformer and solid-state rectifier. No special filtering of the control-voltage supply is necessary.

In the circuit of **fig. 4A**, a momentary-contact toggle switch is used to pulse the control voltage for each step of the rotary switch.

fig. 5. Methods of controlling a single coaxial line (A), selective positive position indication (B and C) and an application to balanced transmission line (C).

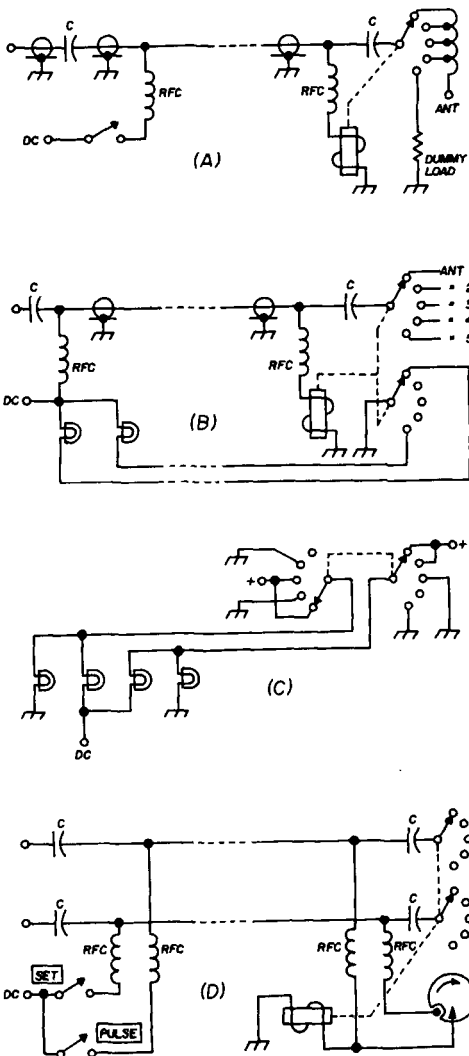

The outstanding disadvantage of this circuit is that you don't have positive control of the position the switch is in. That is, you don't always know what position the remote switch is in. The only indication you have is the way your transmitter loads. If you connect a dummy load at one of the switch positions and use an SWR meter in the circuit, this can give you a reference point, but still it isn't the best way to do it.

A better arrangement is shown in **fig. 4B**. This requires an additional two-conductor cable and use of the extra contacts on the rotary switch, but it provides a lamp indication when the switch is in the first or last position. Alternately, the extra cable can be used to wire in the control circuit of **fig. 2A** if the rotary switch is set up with a control deck.

Another interesting position indicator is shown in **fig. 4C**. If there are enough extra contacts on the rotary switch, a two-conductor cable and four indicator lamps will show the switch position. With this circuit, a unique combination of lamps will be energized for each switch position. This diagram only shows the indicator-circuit switch contacts; the rest of the circuit is the same as **fig. 4B**.

If there is a good continuous ground between the remote and control locations, the circuit of **fig. 2A** can be handled by a balanced transmission line as shown in **fig. 4D**. The "set" and "pulse" switches are momentary-contact or push-button types. For tower-mounted antennas, the continuous ground may be provided by the tower. For antennas which are mounted in the attic or near a building, the house wiring conduit may be used.

summary

There are many applications for remotely-controlled solenoid switches in the amateur station. In addition to simple antenna-switching chores, they can be used to control antenna coupler tuning or equipment switching. If you compare the prices of these switches with the cost of separate transmission lines, they often come out far ahead. This is particularly true when you can find a suitable unit on the surplus market.

ham radio

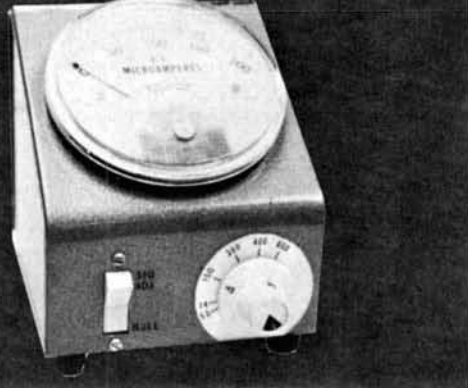

the
E-Z
impedance bridge

A handy
gadget for the active ham—
a combination antenna
impedance bridge
and
field-strength
meter

Here is a little gadget I think you will find very useful.* If you are halfway active, and like to play around with various and sundry items, such as homebrew antennas, it's just the thing for you—a simple, easy-to-build, impedance-measuring device. You can put it together with what you have around the shack in the proverbial junk-box.

construction

I'm sure almost everyone has some sort of a meter lying around that can be used. I used a 3-inch, 200 microammeter that gives plenty of sensitivity. It's easier to read a dip on a large meter than on a small one.

The case is a Bud CMA-1936 standard aluminum meter case; cost about \$1.50. You don't have to use this particular case, but I felt that it was the best solution to the problem since you don't have to cut out a hole for the meter and it will hold all of the necessary components very nicely. In addition, this chassis provides two flat sides, front and top, so you can mount the switch and dial to suit yourself.

The lettering on the impedance dial and cabinet are rub-on letters. You can get these

*Based on a design used in the *Knight-Kit Bridge* marketed several years ago.

Robert Starks, WA9QJP, 1818 Pennsylvania Street, Columbus, Ind. 47201

in sets for radio test equipment, such as hi-fi or whatever you want. They make a project look very professional. Just refer to the "dry transfer lettering" section in most electronics catalogs. After the job was finished, I sprayed the whole thing with the clear spray. This protects both the lettering and the paint job.

The dial consists of a piece of stiff, glossy, white paper. It is mounted so that the nut which holds the control also holds the dial on. Better still, use double-sided tape or rubber cement. Use your imagination. Put the calibration marks on with India ink, or use strips of the border from the rub-on letters. A piece of plexiglass about 1/16-inch thick is cut the same diameter as the dial with a 3/8-inch hole in the center and placed under the nut that retains the pot.

electrical circuit

For a meter-sensitivity control, I used a 50k pot. It gave me plenty of adjustment and at the same time had enough resistance to protect the meter when the control was wide open. The switch is a rocker-type SPDT that I picked up at the local hamfest. It looks nice, but it's more difficult to mount than a slide switch, and doesn't really work any better.

The control should be a 500-ohm linear-taper carbon pot: linear to keep the calibra-

fig. 1. Wiring diagram for the E-Z impedance bridge.

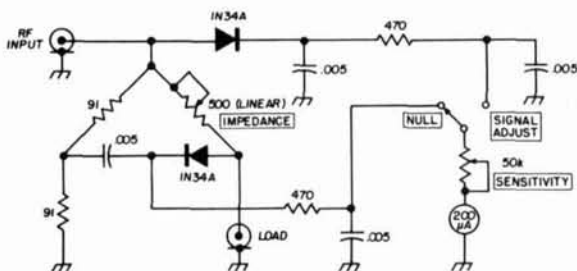

tion from bunching up on one end; carbon to minimize reactance in the circuit such as you would get with a wire-wound pot. The same thing applies to the rest of the resistors. All must be carbon. The tolerance of the components doesn't make too much difference, once you get the thing calibrated. However,

the two 91-ohm resistors in the bridge circuit (fig. 1) should be closely matched. You are depending on the accuracy of the bridge to determine the impedance of the circuit or antenna you are trying to measure.

The diodes can be almost anything you have around, such as 1N34A's. The capacitors are .005 microfarads at 600 volts. These are the disc type that you can usually scrounge out of an old chassis.

One thing you'll have to watch: build the circuit as symmetrically as possible in the chassis you decide to use. This is for electrical reasons rather than aesthetic ones. By using terminal strips, I was able to wire in most

Back view of the bridge showing the two coaxial connectors and meter-sensitivity control.

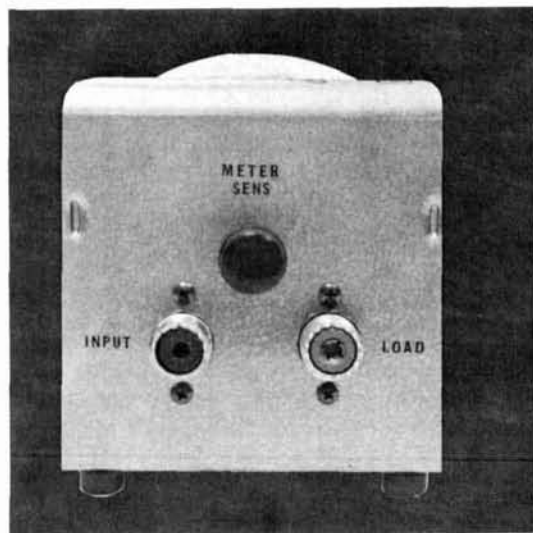

of the components point to point and still maintain a symmetrical layout. You'll probably find it necessary to extend some of the leads, so for this purpose you should use at least #16 solid buss wire. This will keep the components from bouncing around while you are trying to make a measurement. Also, try to keep the leads as far from each other as possible.

The connectors on my unit are the UHF type. While they are not required, they are fairly universal. Use what you have around, but be sure to keep them pretty close together on the rear of the cabinet. I was able to mount the meter sensitivity control just above the connectors on the rear of the cabinet, but

this will depend on the size of the control you have. It's actual placement is not critical.

calibration

The impedance dial should cover from 30 to over 600 ohms. This is enough to cover the normal range of impedances that you are likely to run across. The actual range of measurement will probably be about twice the value of the impedance pot. With a 500-ohm control, you may be able to calibrate the meter as high as 1000 ohms. In order to calibrate the meter, you'll have to come up with some close tolerance resistors. The more accurate the resistors, the more accurate the meter will be. You can buy precision resistors at various ham supply houses, or you can play it cool, and pick up some military-grade jobs at the next hamfest. At any rate, if you have 39- and 56-ohm, 5% resistors, you can pretty well decide where 50 ohms is on your dial. Just use the old noggin. I haven't met a ham yet that couldn't make anything out of almost nothing.

When you have picked up some suitable resistors, fasten one of them across the load jack, starting at the low end, so you will have enough room for all of the calibration points. Couple in a signal with a grid-dip meter or other rf source by means of link coupling and adjust the meter sensitivity control to obtain a suitable reading.

Tune the impedance control through its range until you get a dip on the meter. Mark the dial where the dip occurred and continue with the other resistors until you get the desired calibration. I used six resistors with good results to cover the range I wanted. By the way, I found that, within limits, it doesn't make much difference what frequency you use for calibration. Checks at 4 MHz and 50 MHz showed no appreciable difference.

operation

You can use a grid-dip meter, a signal generator or transmitter for a signal source. However, if you use a transmitter, you'll have to be careful to couple in only enough signal to get a dip on the meter. You should use a non-radiating load with the transmitter, and couple into the unit with a loop close to the

final. Use the lowest possible signal level where you can still get a dip.

With the unit in the "null" position and a signal coupled in, attach your antenna or coax to the load jack, and tune the control through its rotation until you get a dip on the meter. There should only be one dip. If you have wired the unit correctly, the dial should read very close to the impedance at the connector. This is the impedance your transmitter will see. For antenna measurements, the bridge should be used at the antenna itself.

To adjust an antenna to resonance, simply set the meter to the impedance you want, couple in the drive signal, and tune the antenna until you get a dip on the meter. To find the resonant frequency of an antenna at the proper impedance, set the impedance dial to the impedance of the antenna and tune the signal source through the range of the antenna until you get a dip. The more resistive the antenna is, the greater the dip will be.

If the antenna is reactive, the dip will not be nearly as pronounced; it will be much broader than it is with a carbon-resistor load. If you can't get a dip, check to see if you have reversed the connections on the rear of the cabinet or have a short or open in the setup somewhere. Also, make sure your frequency source is free of harmonics.

The other position on the switch is "signal adjust". You can use this position for field-strength measurements to peak up your transmitter.

I'm sure you will derive a lot of pleasure out of this little project. I know I did. Especially since it worked the very first time. Many thanks to K9VXL for his very able assistance.

ham radio

Motorola MPS transistors

Plastic transistors carrying MPS numbers below MPS6500 are made by Motorola, and are similar to 2N transistors carrying the same number. MPS stands for Motorola Plastic Silicon, and numbers over 6500 are special transistor types.

W2DXH

F M B U L L E T I N



**JUST
WENT THROUGH
THIS HAM MAGAZINE
FROM COVER TO COVER
AND IT IS REALLY GREAT!**

- > Repeaters
- >> Remote control
- >> Control techniques
- >> Point-to-point communications
- >> Automatic phone patches
- >> Amateur mobile telephone
- >> What's happening & where
- >> Operation (bands & areas)
- >> News - views - humor
- >> Satire - clubs - activities

SUBSCRIPTION ONLY \$2 A YEAR TO:

FM BULLETIN

2005 HOLLYWOOD AVENUE

GROSSE POINTE, MICHIGAN 48236

TRAP MASTER

Select Quality....
...Specify **Mosley**

Classic 10-15

A new beam for 10 and 15 meters. Revolutionary broad band capacitive matching.* Full power rated. Weatherproof metal encased traps. Lightweight: 27.5 lbs. assembled. May be stacked with 20 and/or 40 meter beams.

*(Pat. Pend.)

Classic 33

Hard working for extra gain on 10, 15 and 20 meters. Wider element spacing and improved clamping. Broad band capacitive match.* Full power rating. Weatherproof traps for constant frequency stability. *(Pat. Pend.)

TA-33

Excellent results for full ham bandwidth. Full power rated for 10, 15, and 20 meters. Strengthened center sections of the 28' maximum length elements. Weatherproof traps for constant frequency stability. May be converted to 40 meters.

TA-33 Jr.

A low power beam with "authority." Rated at 300 watts AM/CW, and 1000 watts P.E.P. on SSB. May be converted to MP-33 for higher power rating. Max. element length is 26' 8"

For more information on these, or any of Mosley antennas see your nearest authorized Mosley dealer, or write.

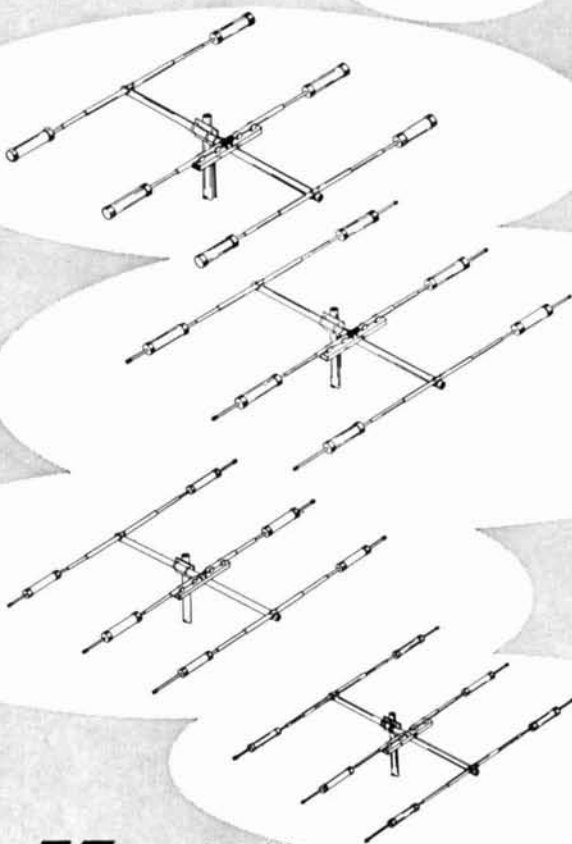

Dept. 150
Mosley Electronics, Inc. 4610 North Lindbergh Blvd. Bridgeton, Mo. 63042



When hams
discuss
**OPTIMUM
SPACING'**
in single
band beams . . .

..... *The subject turns to **Mosley***

Amateurs punch through the QRM on 20 meters with Mosley's A-203-C, an optimum spaced 20 meter antenna designed for full power. The outstanding, maximum gain performance excels most four to six element arrays. This clean-line rugged beam incorporates a special type of element design that virtually eliminates element flutter and boom vibration. Wide spaced; gamma matched for 52 ohm line with a boom length of 24 feet and elements of 37 feet. Turning radius is 22 feet. Assembled weight — 40 lbs.

20 meters

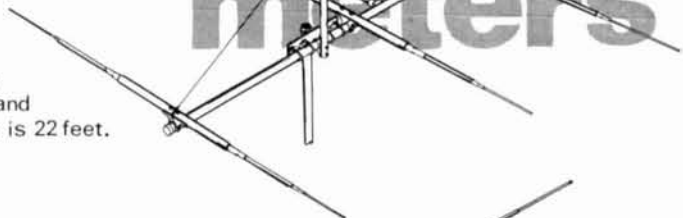

10 and 15 meters

A-310-C for 10 meters
A-315-C for 15 meters

Full sized, full power, full spaced 3-element arrays. 100% rustproof all stainless steel hardware; low SWR over entire bandwidth; Max. Gain; Gamma matched for 52 ohm line.

40 meters

S-402 for 40 meters

Top signal and unexcelled forward gain - a 2-element optimum spaced beam. 100% weatherproof. Low SWR. Heavy duty construction. Link coupling results in excellent match over full bandwidth.

For detailed specifications and performance data, write Dept 157A.

Mosley Electronics, Inc. 4610 N. Lindbergh Blvd., Bridgeton, Mo. 63042



another CW monitor and code-practice oscillator

If you ever operate CW, you know the necessity for a good CW monitor. Here is one which can be used with any transmitter that uses grid block keying. It can also be used for CW practice. Although many CW monitors have appeared in print, this one is very practical and simple.

The oscillator uses two transistors in a modified multivibrator circuit. A small 500-ohm to voice-coil transformer drives the speaker; it also cleans up the tone for easy listening. The keying is done by a 2N657

transistor in the voltage return line from your transmitter. A diode isolates the transmitter keying bias from the transistor. Although I used two 2N657's (NPN) and one 2N404 (PNP), almost any junk-box transistors will work. Just use NPN and PNP devices where I did. The transformer I used was salvaged from an old transistor radio. You can use either the receiver speaker or headphones.

Battery voltage can be anything in the range from 1.5 to 9 volts. With three D-size flashlight cells series-connected to give 4.5 volts, the volume is about right for normal conditions.

This is a pretty versatile unit; in one case it was even used to activate the VOX input for semi-break-in CW with a Gonset GSB-100 transmitter. It has also been used for code classes—for higher volume just add some more batteries.

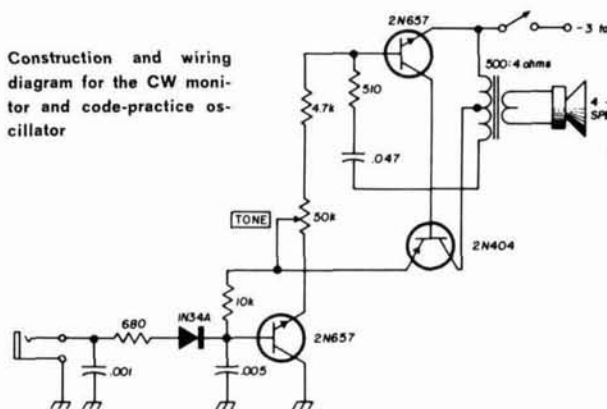
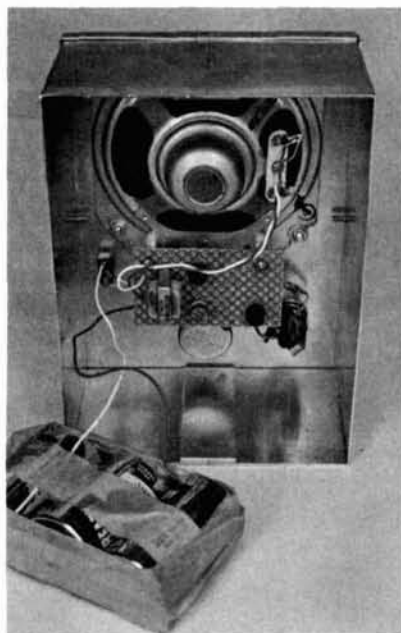

Introducing



a **new** monthly
for amateurs

that's **different** *

- the latest in technical ideas and home construction . . .
- featuring **Jim Fisk**, W1DTY, the well known amateur radio editor . . .
- and including articles by your favorite authors.

how different? — *

It looks different — it is different! It's easier to find information . . . easier to read . . . easier to understand . . . easier to build from . . . it's a magazine you'll find it easy to like.

Write for **FREE** copy . . . or

FREE copy and 4 month trial for \$1.00

FREE copy and 11 month trial for \$3.00

to Ham Radio Magazine, Greenville, New Hampshire 03048. Offer expires March 31, 1968. Be sure to include your address and Zip code.

would YOU believe ?

MORE

than you PAID

IN TRADE ?



Your clean late model SSB equipment is **actually worth more** than you paid for it in trade ON THE NEW HALLICRAFTER SR-2000 HURRICANE MAXIMUM LEGAL POWER TRANCEIVER AND P-2000 A.C. POWER SUPPLY

LOOK! AT YOUR VALUE PACKED TRADE-IN ALLOWANCE

	Original List price	Your Trade-in Allowance	SR-2000 P-2000 List Price	Your Cash Difference
SWAN 350 with 117XC AC Supply (late serial #)	\$515	\$620	\$1545	\$925
SWAN 350 with 117XC AC Supply (old serial #)	\$490	\$600	\$1545	\$945
SWAN 500 with 117XC AC Supply	\$590	\$700	\$1545	\$845
SWAN 250 with 117XC AC Supply	\$420	\$500	\$1545	\$1045
DRAKE TR4, AC4, MS-4	\$720	\$800	\$1545	\$745
DRAKE R4, T4A, AC4, MS-4	\$919	\$975	\$1545	\$570
NATIONAL NCX-5, MK-II, NCXA (old serial #)	\$795	\$800	\$1545	\$745
NATIONAL NCX-5, MK-II, NCXA (late serial #)	\$659	\$750	\$1545	\$795
COLLINS KWM-2, 516F-2 (above 9000 serial #)	\$1265	\$1300	\$1545	\$245
COLLINS KWM-2, PM-2 (above 9000 serial #)	\$1345	\$1400	\$1545	\$145
GALAXY V, AC Supply	\$500	\$600	\$1545	\$945
HALLICRAFTERS HT-46, SX-146	\$639	\$700	\$1545	\$845

YOU CAN MAKE MONEY ON YOUR PRESENT EQUIPMENT AND RUN THE LEGAL LIMIT AS YOUR BONUS!

Carefully pack and insure and ship your gear to us prepaid with check or money order for the cash difference and we will ship your fabulous HURRICANE "Living End" station via surface freight prepaid anywhere in the continental U.S.A. ACT NOW! This offer good for a limited time only.

The new HA-20 DX Adapter is now available. Remote VFO/VSWR Consol companion to the SR-2000 (gives you the most versatile station combination available) ONLY \$199.95.

Remember, your own bank financing plans ALWAYS cost you less. We feel it is to your best interest to take advantage of them.

Uncle George's Radio Ham Shack

A division of Electronic Distributors, Inc.

11324 Fern Street, Wheaton, Maryland, 20902



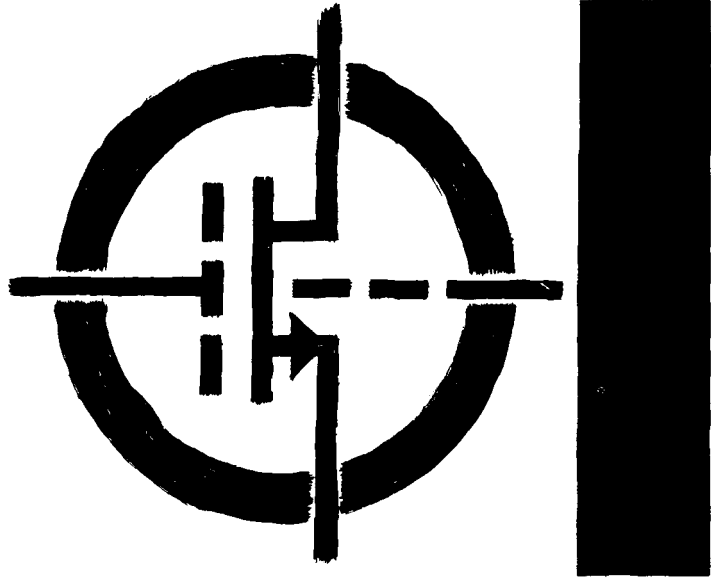

the dynistor

a
four-terminal
active
device

Hank Olson, W6GXN, 3780 Starr King Circle, Palo Alto, California 94306

In recent years the semiconductor field has been pushing the frontiers of technology ahead at an ever-increasing rate. First came the point-contact transistor; then the germanium-junction transistor, the silicon-junction transistor, the junction field-effect transistor, and the insulated-gate field-effect transistor. The monolithic and hybrid combinations of these devices have created our gigantic integrated-circuit industry—and all of this has happened in a short twenty years.

Technological progress has not always chronologically followed the theoretical physics that made semiconductor devices possible. It is well known that the field-effect transistor was completely established theoretically before the bipolar transistor. In another reverse-twist of theory and technology, the **dynistor** has been created; a device that depends on the physics of secondary emission and solid-state surfaces; an exciting active device to be used in circuit design.

the dynistor

The dynistor, shown schematically in **fig. 2**, has four electrodes: cathode, gate, dynode, and anode. The unique characteristics of the dynistor depend upon the dynode. It is **nor-**

mally operated in the depletion mode; that is, with the gate-to-cathode potential negative. However, the gate may be forward-biased slightly (a few volts) without permanent damage, if gate dissipation limits are observed. To take advantage of the "negative resistance" mode, the dynode is operated at a potential higher than the anode.

However, when the dynode is at a lower voltage than the anode, the dynamic characteristics of the dynistor are similar to those of a field effect transistor. This is shown in

resistance" mode is used, and those where the "constant current" mode is used. In the first category are the various types of oscillatory circuits. Fig. 3 shows a simple 1.8-MHz oscillator; note that no cathode-tap is needed (as in a Colpitts or Hartley circuit). It can be recognized that this oscillator is very similar to a negative-resistance oscillator using a tunnel-diode. The details of how a negative-resistance oscillator sustains oscillations is developed at some length in reference 1. Other details on practical construction are contained

fig. 1. Characteristic curves of the UY224 dynistor.

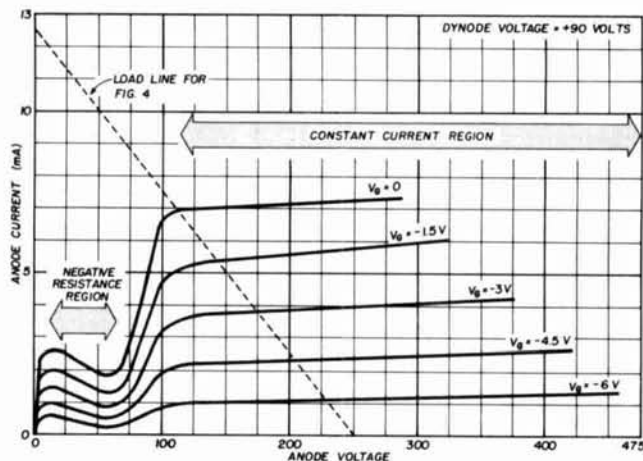

fig. 1. Note that in this "constant-current" mode, the voltages are higher than most conventional FET's.

One great advantage of the dynistor is its ruggedness. Because of the inherent internal structure of the device, local heating of any one electrode will not destroy it in a few milliseconds. This factor, coupled with the inherent high-voltage tolerance, makes it electrically very durable, unlike bipolar transistors and FET's.

applications

The applications for the dynistor fall into two categories: those where the "negative-

fig. 2. Schematic symbol for the dynistor shows its four electrodes: cathode, gate, dynode and anode.

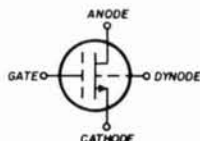

in reference 2.

If the dynistor is used in the constant-current mode, normal amplifier service is possible. Fig. 4 shows a dynistor microphone preamplifier circuit. Since the UY224 dynistor has a Y_{fs} of 1000 μ mho, the voltage gain of this circuit is 20. The high value anode load resistor allows efficient capacitive coupling of the output to the input of another dynistor amplifier stage.

While I have only shown two types of circuits here to illustrate the uses of the two operating modes, you will undoubtedly envision many more. It is hoped that a com-

HEY! HOW ABOUT THAT

S.W.R. BRIDGE

- MODEL SWB-2
- READS FORWARD AND REFLECTED POWER SIMULTANEOUSLY
- "EASY READ" METERS
- USE FOR REFERENCE POWER METER
- DUAL 100-MICROAMP METER MOVEMENTS
- LOW INSERTION LOSS
- SIZE-5"X2"X2"



\$15.95

ALLOW 5% FOR PACKING & SHIPPING CALIFORNIA RESIDENTS INCLUDE SALES TAX

THE BEST VALUE WE HAVE EVER OFFERED!

MAY BE LEFT IN LINE, UP TO 2000 WATTS.

GOOD THROUGH 2 METERS

SINCE 1933

FAST SERVICE

Phone CY 4-0464

QUEUMENT ELECTRONICS

1000 SOUTH BASCOM AVENUE

SAN JOSE, CALIFORNIA

"Northern California's Most Complete Ham Store"

95128

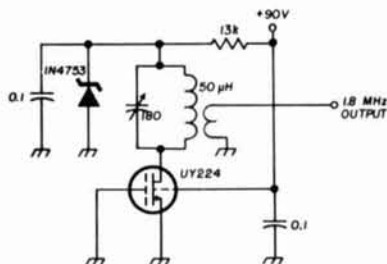

fig. 3. Simple 1.8-MHz oscillator using the dynistor. In this circuit, the dynistor operates in the negative-resistance region.

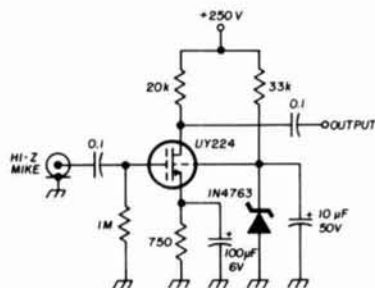

fig. 4. A microphone preamplifier using the dynistor in the constant current mode.

plete line of dynistors will eventually be developed so we have improved types for higher frequency and power.

references

1. W. Edson, "Vacuum Tube Oscillators," John Wiley & Sons, 1953, pp. 32-41.
2. A. Ghirardi, "Radio Physics Course," Radio Technical Publishing Co., 1931, pp. 904-906.
3. RCA Manual RC-15, Radio Corporation of America, 1947, p. 163.

ham radio

As a final note on the dynistor, it should be said that the device does have some mechanically weak points, as shown in the photograph on page 73. These weak points could be corrected, possibly by ceramic encapsulation.

Editor

signal tracing in ham receivers

There's probably nothing so aggravating as having your receiver go suddenly quiet in the middle of a long QSO, especially when it's the last one you need to complete your WAS or WAC. Makes you want to drop a hammer into the whole thing.

Instead, drop a probe into it—a test probe. If you've got a signal tracer on the other end of that probe, you can probably find the trouble pretty fast and maybe get back on before the band closes.

With so much ready-made and kit-form commercial equipment, the old familiarity with your home-brew stuff is largely lacking. So what you need is a way to run down faults quickly without being the guy who designed the bloody rig in the first place. Signal-tracing may be it. Once you know how to use signal-tracing, you'll probably agree it's one of the fastest and most convenient ways to track down a trouble.

simple instruments

You can signal-trace with something as uncomplicated as a plain audio amplifier. In a pinch, you could even use a channel of the stereo. One kit-form signal tracer costs less than \$25. Inside it is a quiet high-gain audio amplifier, and the probe can be switched to insert a detector diode for trouble-hunting in rf and i-f stages.

One I've used for years—and I see it's still available—is shown in **fig. 1**. This pencil-type is about the handiest thing you can have around for those sudden breakdowns. Its storage box fits easily in a desk drawer. Inside is a transistor audio amplifier, run by a pen-light cell (also inside). The clip is the power switch, and you listen through an earphone. Although you can use yourself as the ground, I generally use a jumper lead from the pocket clip to chassis. (Comes from an old habit of never putting two hands in a set at once.) The **Stethotracer*** has a thimbleful of little probes

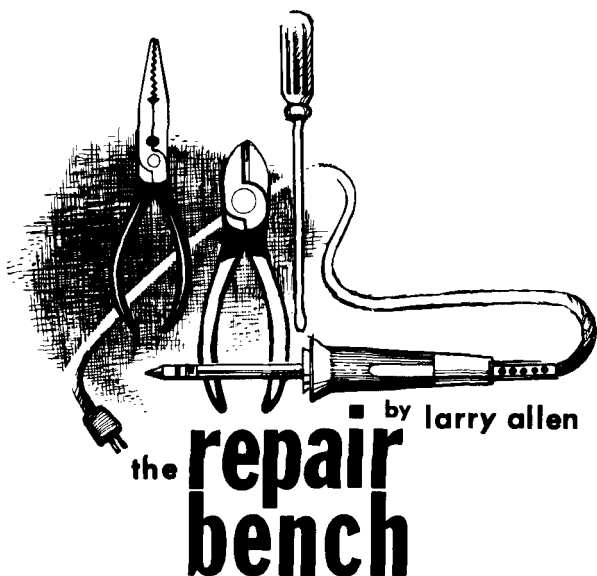

that screw on the tip; for listening in rf and i-f stages, one is a demodulator.

If you decide to use an audio amplifier you already have, it should be very quiet and hum-free. You might want to add a few extra microfarads (40 or so) of electrolytic capacitor across each power-supply filter. A dc-operated transistor amp would be even better, if the noise level is low enough. For rf and i-f tracing, you can build a little demodulator probe like **fig. 2**. Or, you can buy the kind that's used with an oscilloscope; a kit model costs under \$5 and has its housing and 3 feet of cable.

a tracer at work

Whatever kind of tracer you decide to use, you want to get the most out of it—and **speed** is what it can offer you the most of. Its **versatility** is something, too. Many who already use signal tracers think they are limited to localizing trouble to one section of a receiver. That's wrong. A signal tracer can also **pin down defective circuits and parts** in a receiver—and in some parts of a transmitter, too. All you have to do is know how to use it.

Any signal tracer needs one accessory: your brain. Fast troubleshooting with a tracer demands **logic**, and you have to supply that. I'm going to show you some trouble-hunting in a fairly elaborate double-superhet, to give

* Don Bosco Stethotracer. \$34.95 from Allied Radio, 100 N. Western Ave., Chicago, Illinois 60680.

you some idea of the tests you can make with a tracer. However, pay close attention to the **method**, the logic by which the trouble is first localized and then pinpointed. That logic is what'll get you back on the air in a hurry.

Start by looking at the schematic diagram of your receiver or transmitter. Mentally break it up into blocks representing each function or stage in the set. **Fig. 3** is the functional block diagram of the receiver I'll use as an example. As you see, it's a pretty good ham receiver: double conversion; filters for ssb, cw, or a-m; product detector for RTTY and ssb; and a dial calibrator. For the initial step, group the blocks into four sections; they're marked in **fig. 3**.

First, the rf section. In it, you have to use a demodulator probe with your tracer. What you hear is a mishmash of signals, because the rf stage in this receiver is a broadband one. Once you set the bandswitch, all the stations within shouting distance in that band will be heard if the stages are normal. The plates of the rf amp and the first mixer are the test points for this one. If you get no signal at the mixer, already you know something in the rf section is dead.

The "high" i-f section processes the output of the first mixer. It consists of a bandwidth filter, the second mixer, and the tuning oscillator. If any one of them is at fault, the i-f signal your tracer should pick up at the output (plate) of the second mixer will be missing or fouled up in some way. The normal signal at the bandwidth filter output terminal is a mishmash just as you heard at the output of the rf amplifier. All the stations that are on the air in that band will be audible through the demodulator probe. In the second mixer, however, is where an individual signal first gets picked out from among all the others. The linear master oscillator heterodynes with one frequency in the passband of the bandwidth filter and creates the "low" i-f—in this receiver, 3.395 MHz.

In the "low" i-f section, you still need the demodulator probe with your signal tracer following the selectivity filter, and for the low i-f amplifiers. The quickest test point for the whole section, though, is after either detector. You should hear a clean, clear audio signal there, without the demod probe.

Finally, the fourth section—the audio stages. The tracer can pick up whatever modulation has made its way this far through the receiver. If the whole set is okay, including the audio amp, you can hear a nice strong signal at the plate of that last stage.

Now, with this broad division of the set in mind, plan your trouble-hunting attack. Remember the secret word: **logic**.

divide and conquer

The first place to touch your tracer probe is at some point about half-way through the set. Use the demodulator probe and make your check at the output of the second mixer. By tuning the master oscillator around the band, you should be able to find a good station to zero-in on. (If you were cut off in the middle of a QSO, as in my opening example, use the net you've been on.) Remember what an ssb signal will sound like since the demod probe is an am detector. There's a chance, too, that you can tune WWV at 15 MHz, or at one of its other frequencies if you are dealing with a general-coverage receiver.

The output of the second mixer is a good starting test point for two reasons. First, it is the earliest point you can get a single-station



Kit-model signal tracer is high-gain (and quiet) audio amplifier. Probe can be used direct or with switch set for demodulation.

signal, which is easier to evaluate than the many-station mishmash earlier in the set. Second, it divides the set roughly in half, at least by function. If the signal is okay there, you've cleared the whole front half of suspicion. If it isn't, the last half is probably okay.

Suppose you get nothing there. Divide the front part of the set in half, and use the tracer again. You'll still need the demodulator probe, and the output of the first mixer is the place to connect it. Remember that there was no signal at the output of the second mixer. If the signal is okay at the new test point—the mishmash already described—the trouble must lie between the two test points; the second mixer, the master oscillator, or the bandwidth filter has trouble. If there is none, the rf amplifier, the first mixer, or the crystal oscillator must be at fault.

The back half of the receiver lends itself to similar logic. If the signal was okay at the second mixer, the next dividing point is at the am or the product detector output. Omit the demodulator probe, and check directly. A signal in the tracer means everything is okay up to there and the trouble is in the

fig. 2. Build your own demodulator probe from this circuit and you can use a plain audio amp.

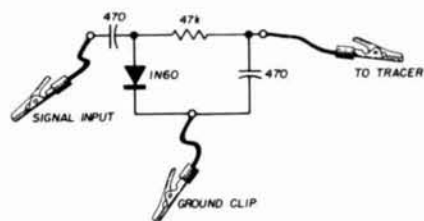

audio section. No signal means it has been blocked between the second mixer and the detector; the filter, one of the i-f amps, or one of the detectors is the offender.

getting closer

You can follow the same logic for each stage. If the signal is okay at the input of a stage and not at the output, it's obvious the trouble is between those two points. The tracer can thus put you right into the stage that's at fault.

This divide-and-conquer technique of stage

isolation works just as well for other symptoms as it does for dead sets. You can hunt noise or hum, tracking down the stage where the trouble first shows up. It also works for distortion.

There is one symptom that is probably best signal-traced in a "straight through" method: **weak signal**. If reception is weak, the fastest way to find out which amplifier isn't doing its job is to check the gain of each one by touching the probe tracer to its input and its output: if there is no increase, the amplifier

fig. 1. Servicing a small two-band portable radio with a pencil-type signal tracer.



is weak. Mixers, however, seldom show gain; there may even be a small loss. The filters introduce some loss, too, but you can judge if it's too much, after you get practice.

There are other little tricks of logic that make trouble-hunting easier at this point. As an example: you get am signals okay but can't clear up ssb. The trouble is likely in the BFO or the product detector; they are the only stages that aren't common to am too. Another example: weak signals sound okay, but strong ones distort. A good suspect is the agc stage, which may not be controlling the rf and i-f gain as it should—letting strong signals overload the receiver. This can be serious with ssb, which is especially sensitive to overloading.

Once the faulty stage has been pinned down, the usual procedure is to start measuring dc operating voltages on the tubes. There's nothing wrong with that technique, except that it's a little premature. Your signal tracer can still tell you things you can't

find out with a voltmeter. In some cases, you may have to revert to the tracer or even more elaborate equipment **after** the dc measurements. So, for speed, stick with the tracer a while longer.

And do what with it? Here are some specific things you can check inside a stage, using *only your signal tracer*. Be sure to use the demodulator probe when rf or i-f signals are involved, and tune in a signal of some sort whenever the front half of the set is working.

Fig. 4 shows a make-believe stage—a sort

fig. 3. Sectionalizing a ham-band receiver by functions. Dividing it up this way makes it easy to track down trouble by a logical method.

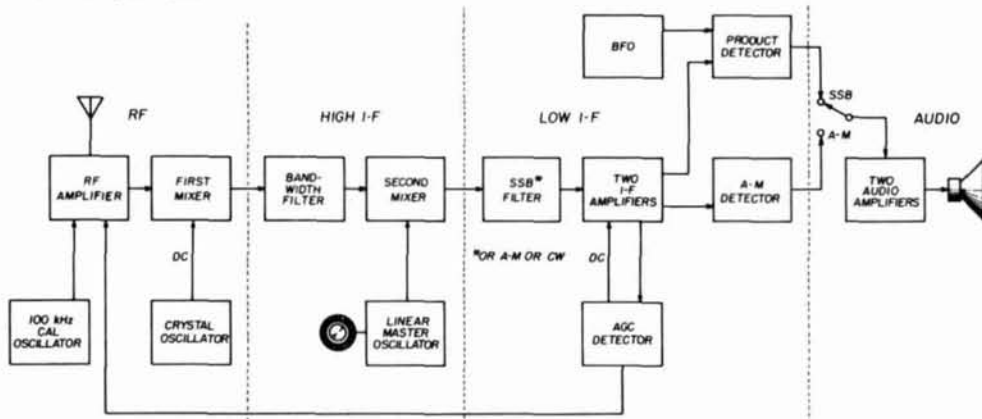

of composite to illustrate some of the parts that can be checked with a signal tracer. The different components that are highlighted can be tested right in the circuit, usually without any *unsoldering*. They are *coupling and bypass components*, which often can't be checked by voltage measurements.

Coupling capacitor C1 and interstage transformer T1 have one thing in common: they should pass the signal along with very little attenuation. Whether they are large, as in audio stages, or small, between rf or i-f amplifiers, there should be about the same amount of signal on both sides. If there is any attenuation, it should be small. To check, touch the probe to the input side of the part, and listen; then to the output side, and listen again. If the output is much weaker than the input, the part is defective.

The bypass capacitors, C2 and C3, are there to shunt the signal to ground. Their values are chosen to short out almost all signal at the

cathode (C2) and at the screen (C3). The tracer should hear very little signal at either point. If there's much, the capacitor is not doing its job. You might find a little signal at the screen of any pentode amplifier, but if it isn't a lot weaker than the input signal (at the grid) something is wrong.

Finally, notice that the B-plus connection is highlighted in fig. 4. You can check for the source of hum with your signal tracer. Just connect it directly to the various B-plus points in the receiver. Power-supply filters are just

like any other bypass capacitors; they should shunt all the signal voltages to ground and leave only dc. If one of them is at all weak, you will hear an undue amount of hum in the tracer; you may even hear something (usually a whistling or a hissing sound), that would be rf or i-f signal if you could unscramble it.

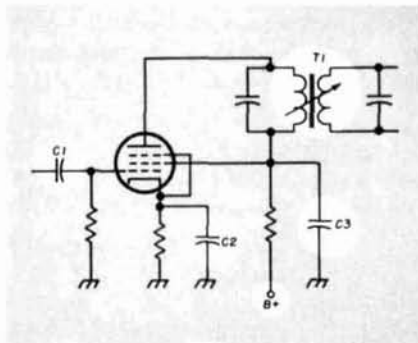

fig. 4. You can test these components with your signal tracer, without unsoldering them.

a few other tricks

Now you know how to pin down a great many faults quickly. If you haven't found the trouble by this time, you're going to miss the rest of the QSO anyway, so don't feel too bad about resorting to the dc voltmeter—that's your next step. You've gone about as far with signal tracing as you can. But you've done it with only a few minutes' work. The whole procedure just outlined takes less than 5 minutes.

There are a few other tests you can make with your tracer, and I'll throw them in for good measure. For one: the accepted way to find out for sure if an oscillator is running is by measuring its dc grid voltage. If that's missing, the oscillator is dead. You can also tell with your tracer, even though there is no modulation to be heard. Look back at **fig. 3**; you can check all those oscillators.

If other tests make you suspect the first oscillator is dead, pull the rf amplifier tube. Touch your probe (without demodulator) to the output of the am detector and listen to the hiss. Pull the first oscillator out of its socket. The hiss will diminish if that oscillator was working.

If you suspect the master oscillator, use a similar technique. Pull the first mixer (to eliminate noises from the front end). Touch the tracer to the output of the am detector. Pull the master oscillator tube while you listen to the circuit noise through the tracer. If the oscillator was working, the slight noise will stop.

The same test will work for the BFO, which is just another oscillator. Pull out the second mixer (again, to kill front-end noise). Listen with a tracer at a convenient point in the audio amps, one that lets you hear the noise in the set (not within the tracer). Switch the receiver from am to ssb or cw, which activates the BFO. You should hear more hiss in the tracer, if the beat oscillator is working. (You may be able to hear this in the speaker, without the extra amplification of the tracer.)

You don't need a trick like this to check the calibration oscillator. Make sure the rest of the receiver is working, and you can hear (or not hear) the calibration whistle readily.

next month

There you have some repair tricks that will save you time whenever your receiver kicks out. You can use the same techniques in some stages of a transmitter, but be careful—your little tracer may not be able to take those power-laden transmitter stages. Confine it mainly to speech amplifiers and low-level exciter circuits.

Though signal tracing, as you can see, is a fast way to hunt down trouble in almost any receiver, there is another method that is similar and almost as useful. Next month, in the **repair bench** I'll show you how you can do many of these same tests with this other technique—called **signal injection**. Then you can choose whichever one you prefer when you hear those signals dropping down into the silence that is so infuriating just when a new joke is coming over the net out of K6-land.

ham radio

letters

Dear Larry:

I had something interesting happen in my Collins 30S-1 linear and thought you might like to hear about it. In the middle of a sked with a K7 friend of mine, my big jewel shut down. Snooping around, I found the screen-supply fuse blown. Put in a new one, it blew again. I got out the ohmmeter and measured all the diodes. Two of them were shorted—D1 and D2 (see diagram). If one goes, the other is likely to; I replaced them both.

When I fired up, pop went the fuse. Sure enough, the same 1N1492's were shorted again. Another trip downtown, and two more diodes. This time I checked all the others again with the meter. They were all okay, but the D1 I had just put in was already leaky. I took it out, and it checked okay. You guessed it—the leakage was in the capacitor, C1. It was burning out D2, which then burned out D1. Except for my happy accident, measuring the new diodes in the circuit, no telling how many of those 1N1492's I'd have used up. Like popcorn.

Anonymous Friend
Garden City, N. Y.

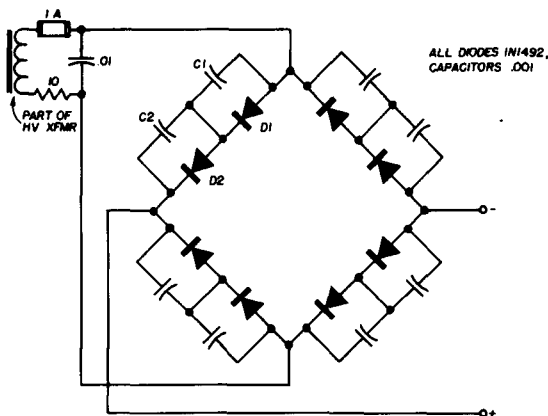

Okay, thanks, pal. You pinned it down pretty fast. Happy, maybe, but no accident. Sounds to me like you knew the score pretty well; you were in the right circuit, checking the right thing, with the right instrument. That's no accident.

Dear Larry:

My Heathkit HR-10B receiver keeps cutting out. It goes off completely, but the tubes stay lit. It does it whenever the table is jarred a little, and hitting the top makes it snap back on, sometimes. I'm not a ham yet, and don't have any idea how to fix this. I use the HR-10B for code practice and I do a lot of SWLing. I would appreciate if you can help.

Jeff Woodroot
Edison, New Jersey

Your best bet, Jeff, is to find a friendly ham in your neighborhood and see if he'll help. Of the several things that might cause the trouble, the only one you can probably do much about is this: there's an octal plug with a black cover that goes in a socket on the rear apron of the chassis. If you built the receiver, you remember that it has a jumper between pins 1 and 6. Make sure that jumper is soldered well in both pins of the plug. Also, make sure the plug isn't loose in the socket. If it is, you can tighten the socket pins with an open safety pin. Run the point down alongside each contact, between the metal and the side of the hole. Do this two or three times to bend the metal contact a little so it grips the pins of the plug better.

Dear Larry:

Maybe you can tell me what to do. I should have had it looked at long ago, but I didn't. I used a Hammarlund SPC-10 (receiver). About a year ago I noticed it getting weaker. At first it was just the sound that seemed weaker, but now I'm sure I'm not getting anybody as well as I should. A guy I know across town works 10 meters hot as a firecracker some weekends, yet I can hardly raise a signal out of the noise. I've already re-tubed it from one end to the other, but that only helped a little. The **noise** is louder, hi! Got any ideas?

David G. Montgomery
Joliet, Illinois

Sounds to me, from the few clues you give, like your SPC-10 could use an alignment job, David. I assume you've checked all the voltages in the rf and i-f stages. If you don't have the equipment or know-how to do an alignment, best take it to a qualified service shop. Your first trouble was probably a weak audio tube, which you subsequently replaced in re-tubing the set. But the long-term alignment drift is apparently still with you. (Incidentally, in a couple of months I'll be writing about alignment in this column, if you can wait that long.)

The **repair bench** is for you. Tell us about problems you have run into, keeping your rig in peak shape. Questions you ask will be answered only if accompanied by a **copy** (not returned) of the full schematic diagram and a stamped, self-addressed #10 envelope. We will print some of the most interesting case histories.

Editor

ham radio

replace one

unijunction transistor

with two transistors

Remember that circuit you recently looked at and wanted to try? You passed on, though, right? The reason was quite simple. It used a unijunction transistor (UJT). Many hams have built up a collection of miscellaneous transistors in the junk box; the right combination to make your own UJT may be there waiting.

the unijunction equivalent

The symbol for the unijunction is shown in **fig. 1A**. The two-transistor version of the UJT is shown in **fig. 1B**. The leads are labeled to correspond with **fig. 1A**. When the NPN and PNP transistors are connected as shown,

fig. 1. The schematic symbol for a UJT is shown in **A**. The equivalent two-transistor circuit is in **B**.

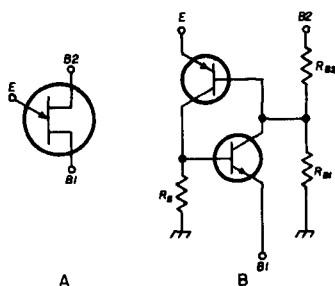

they effectively produce the equivalent internal construction of the UJT.

There is only one minor difference—it is necessary to add two resistors externally to

the circuit to produce the equivalent resistance found between each base lead and the emitter of the UJT. These two resistors are labeled R_{B1} and R_{B2} in the diagram. Resistor R_B is added for stability; a value around 10k should be sufficient.

As a general rule, the values of the two resistors R_{B1} and R_{B2} may be determined by knowing only two characteristics about the UJT you're replacing; the **intrinsic stand-off ratio** and the **interbase resistance**. These two characteristics are related by the formula:

$$\eta = \frac{R_{B1}}{R_{B1} + R_{B2}}$$

where η = intrinsic stand-off ratio
 $R_{B1} + R_{B2}$ = equivalent interbase resistance

In unijunction transistors, the interbase resistance is typically between 5k and 10k ohms. The intrinsic standoff ratio of a common general-purpose UJT runs about 0.6. Using these values in the formula, you can quickly calculate that R_{B1} would have a value around 3k and R_{B2} , about 2k, to produce the equivalent of a general-purpose UJT.

In most applications, the actual values aren't critical and equal values of resistance could be used—such as 2.2k. This would produce an intrinsic stand-off ratio of 0.5 which is fine. If lower values of resistance are used, the circuit will draw more current and vice versa.

unijunction code-practice oscillator

Now for an actual application. A code-practice oscillator using the two-transistor UJT equivalent is shown in fig. 2. Both tone and volume controls have been provided as well as a choice between speaker or ear-phones.

fig. 2. Here is a relatively simple CPO using the two-transistor equivalent UJT.

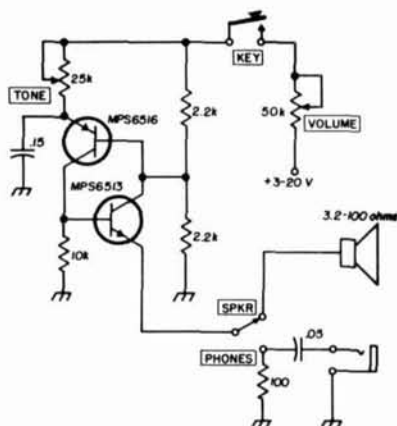

In this circuit, a 3-volt supply voltage was sufficient, but you can use as high as 20 volts. The actual voltage will depend upon your transistors and the output level you desire.

In general, a little experimenting with two transistors (one NPN and one PNP) will let you duplicate the function performed by the UJT—generally at lower cost. The transistors shown in fig. 2 are Motorola devices which are inexpensive and usable from audio through six meters: the latest price list shows the MPS 6513 at 57¢ and the MPS 6516 at 60¢. The price of these two transistors is in the ballpark of general-purpose UJT's, but with this approach, you may already have the UJT in your junk box.

Next time you start to bypass an article using a unijunction transistor, stop and think about how you could substitute two transistors and still have that same useful circuit.

reference

General Electric Transistor Manual, Seventh Edition, 1964, page 300.

ham radio

LOW PRICE, QUALITY, COAXIAL SWITCHES...



Don't pay for the 5th and 6th position. The average HAM rarely uses more than 4!

SPECIFICATIONS: Silvered Contacts. Write-on ERASABLE escutcheon plate. AVAILABLE EITHER 4 PST (COAX-4) OR LINEAR (COAX-LINEAR) IN-OUT VERSION. Handles 1000 W AM or 2000 W SSB. Insertion loss negligible to 160 Mc. VSWR: Less than 1.2 at 160 Mc. Size: 3/8" dia. x 1 1/8" overall. Single hole mount. SPECIFY MODEL. \$7.65 ea.

COAXIAL LIGHTNING ARRESTORS



Zero power loss. No increase in SWR at 150 Mc. Does not attenuate signals. Model 210 for 1000 W (AM) or 2000 W (SSB). Model 211 Electronic static arrester for 50 W (AM) or 100 W (SSB). SO-239 UHF type fittings. Other fittings available. Size approx. 3/2" x 1/4" dia. #210 \$3.15 ea. #211 \$4.65 ea. SPECIFY model #.

PRICES above are amateur net. Shipped ppd. in U.S.A. Send Check or M.O. (N.J. ADD 3% Sales Tax)

OTHER PRODUCTS: Feed thru capacitors. Tuned noise filters. Alternator, generator, low-pass and field filters. SEND FOR CATALOG.

"COMMUNICATION ENGINEERED"
By "HAMMIE" RICHARDT—W2WIY

ELECTRONIC APPLICATIONS CO.
ROUTE 46, Pine Brook, N. J. 07058

Interested in saving money?

Turn to page 47

oscillator/monitor

- a sensitive broadband RF detector gives audible tone signal in the presence of any RF field from 10mw to 1kw and 100kc to 1000mc
- a CW monitor with positive "RF" switch uses only 8" pickup antenna and NO connection to rig or key
- a code practice oscillator with adjustable tone & built in speaker
- high gain 4 transistor circuit powered by long life AA pencils
- 16 gauge aluminum cabinet in white & black epoxy finish, 3 1/2" by 2 3/8" by 1 1/4", weight 8 ounces
- 100% US made and guaranteed



1295 (batt incl)
—ppd usa & can
send cart ck or m.o.
ny res add 5% tax

the James research company
11 schermerhorn st., brooklyn n.y. 11201

a look at
the
EX crystal
and
its oscillator

A review of the new
experimenter's crystals
and oscillators
from
International
Crystal

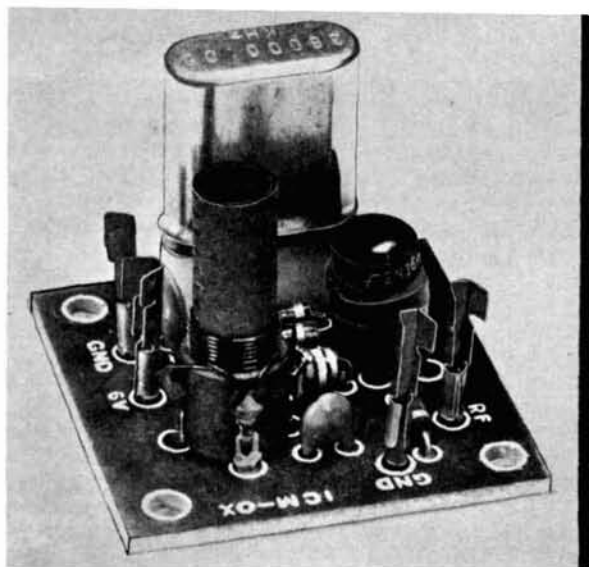

A new line of low-cost quartz crystals and crystal oscillators has been offered to amateurs by the International Crystal Manufacturing Company.* The crystals, called **EX**, have a guaranteed tolerance of .02% and are made for operation in non-critical oscillator circuits such as the International Crystal **OX** oscillator line. In fact, these crystals are only guaranteed to oscillate in that circuit.

Since I'm a gambler at heart, I purchased a 36-MHz unit at \$3.75 for use in the nuvistor oscillator circuit of the **ARRL Handbook** six-meter converter. The excellent results I obtained prompted further investigation of a second **EX** crystal and the **OX** oscillator kit.

crystal characteristics

Let's talk about crystals in general to set the stage for my findings in this investigation. The precise frequency of operation of a crystal will be modified by its loading in the oscillator circuit and also by the drive level of the crystal in that circuit. Therefore, the crystal should not be expected to have the same exact frequency from one circuit to another.

Next to frequency, the most important characteristic of a crystal is its equivalent series resistance (ESR) which is related to a crystal's activity. The ESR of a crystal is that

* International Crystal Manufacturing Company, Inc., 10 North Lee, Oklahoma City, Oklahoma 73102.

value of resistance which may be substituted for the crystal in an oscillator circuit and maintain the same frequency. Substitution of resistors is basically how the measurement is made; however, I would recommend the use of laboratory equipment over a ham-shack "kluge." In classic theory, the Q of a filter is used to describe its activity. In practice, ESR is more easily measured; and, because of its inverse relationship to Q, may be used in its place.

Using a standard crystal impedance meter in conjunction with an rf voltmeter and frequency counter to measure two 36-MHz crystals, the following results were obtained:

Frequency (MHz)	Frequency Accuracy	ESR (Ohms)
36.000582	+0.00106%	62
35.999129	-0.00240%	20

Both crystals have much better accuracy than .02%. In the OX oscillator, the crystals are pulled to a slightly higher frequency, but their accuracy was still better than .005%. The equivalent series resistance readings show the first unit to have lower activity than the second. A normal crystal of this frequency would be expected to have a maximum resistance of 40 ohms; therefore, the first crystal may have trouble oscillating in critical circuits.

What determines a critical circuit? Usually, the power level at which it drives the crystal. Bipolar transistor oscillators will generally be more demanding than FET or tube oscillators. The Pierce oscillator tends to be more critical than the OX circuit.

I was unable to find what (if any) is the limit to the ESR of an EX crystal. Upon talking to a representative of International Crystal, I was assured that the crystal blanks which are used are the same as those of the higher-priced crystals and most of the manufacturing processes are the same. Stabilization processes are omitted, which means the user may see a greater change in frequency and activity in time than he will when using a more expensive crystal. I should hasten to point out, however, that such changes will not be radical if all crystals are as good as those I tested.

The OX oscillator (fig. 1) is sold as a kit for \$2.35 which is less than the cost of the individual components. Although the oscillator is designed to work from a 6-volt source, tests were made with supply voltages ranging from 3.5 volts, where oscillation failed, to 8 volts. I see no reason why higher voltages would not be practical, but the data tabulated was made to show typical performance over a range of unregulated supplies which might be available.

Supply Voltage (Volts)	Frequency Deviation (Hz)	RF Power Output (mW to a 50-ohm load)
4.0	-144	0.29
5.0	-058	0.92
6.0	000	1.8
7.0	+051	2.9
8.0	+102	3.7

fig. 1. The basic International Crystal OX oscillator circuit.

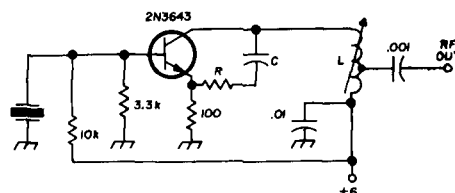

summary

The EX crystal is seen to be a good bet for most amateur work where high accuracy and long term stability are not required. I would not be scared by the conservative advertising, because these are good quality crystals. The units tested will operate in many circuits other than the OX oscillator.

Although the oscillator will operate over a wide voltage range with excellent frequency stability, the user will experience power-output variations which are quite large. This is typical of many transistor oscillators, but is emphasized here as the primary effect of supply-voltage change. In all, the EX crystals and the OX oscillators appear to be a real bargain for the experimenter, and not another low-cost disappointment.

ham radio

Quement Electronics

circular electronics slide rule

Here's an electronic
slide rule that's suitable
for amateurs,
experimenters
and
engineers

James Ashe, W2DXH, 305 Oak Avenue, Ithaca, New York 14850

Quement Electronics* has been very active in the ham supplier business. I've noticed their large ads several times, so during a recent visit to California I naturally dropped in to say hello. Had a nice talk with Pete Phelps, W6ERP, about the ham market. "Pete," I said at last, "What's new in small things that hams might find useful?" He thought for a moment, and looked up. "Jim, we've got these new electronics slide rules, just came in. I think the hams are going to like them. Interested?" I certainly was, and after a careful inspection I bought one.

The slide rule is a resilient plastic disc about 4-3/8 inches in diameter. There is a smaller rotating disc on each side, and a rotating arm that carries the hairline. It's a circular slide rule, with the circular rule's special advantages. The 14 scales are cut into the plastic, and are very sharp and clear.

I sat down with a cup of good coffee to work out the details. Fascinating. Some of the notations seem odd, but it's far better than the archaic multiple zeroes appearing on some rules. The manufacturer uses a comma to indicate a X1000 factor in some places—one or two references to **table 1** should clear things up.

The scales work from low audio to VHF and a little beyond. Two dB scales on the front provide for calculations based on power,

* Quement Electronics, 1000 South Bascom, San Jose, California 95128.

table 1.

scale symbol	quantity	exponential
P	picofarad	10^{-12}
, P	picohenry	
	nanofarad	10^{-9}
	nanoHenry	
	(thousands of picos)	
u	microfarad	10^{-6}
	microhenry	
m	millihenry	10^{-3}
	(thousands of microfarads, uncommon)	
K	Thousands (kilohms, kilocycles)	10^3
M	Millions (megohms, megacycles)	10^6
, M	Thousand-millions (gigacycles)	10^9

voltage or current measurements. A surge-impedance scale may interest engineers more than hams, but then there's not much difference these days, is there? Another scale, in red, indicates inductive reactance, and the basic L, C and F scales extend around the outside edge. Each scale carries a labeled arrow to indicate the parameter and to remind you of its direction.

On the back, a small scale relates frequency and wavelength from 30 Hz to 3,000 MHz. Note the comma used here, too, as a X1000 multiplier. The capacitive reactance scale is done in red, and the resonant frequency scale in black.

Here are a couple of hints. To become familiar with the **Electronics Slide Rule**, start with familiar L, C and F values and work gradually into new territory. The rule looks complex at first, but if you're accustomed to working out electronic calculations, it'll become familiar in minutes. If you're a beginner, choose one scale and try a few paper calculations to get oriented.

This is a good investment for any level of work. The rule ought to have a useful life of many years; it's waterproof, and seems to require no special care. It comes with a good plastic case, and a short-form instruction manual. Oh yes, I've thrown away my old paper rule—this one's much better.

ham radio

NOW!

IN THE WEST

Now... 2000 Watts P.E.P.
Full Power/Minimum Size
FOR APARTMENTS • SUBURBAN HOMES
 Marine and Portable Operation
 Packaged for APO and FPO Shipping

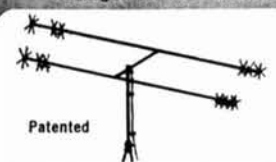

Bands	6-10-15-20 Meters
Power Rating	2000 Watts P.E.P.
El. Length	11'
Turn. Radius	7'
Total Weight	11 lbs.
Single Feed Line	52 ohm
SWR at Resonance	1.5 to 1.0 max.

6-10-15-20 METERS

The time proven B-24 4-Band antenna combines maximum efficiency and compact design to provide an excellent antenna where space is a factor. New end loading for maximum radiation efficiency. No center loading.

Model B-24
Net \$59.95

MULTIBAND COAXIAL ANTENNA for 6-10-15-20 METERS

Needs no ground plane radials. Full electrical $\frac{1}{2}$ wave on each band. Excellent quality construction. Mount with inexpensive TV hardware. Patented.

Power Rating	2000 Watts P.E.P.
Total Weight	5 lbs.
Height	11'
Single Feed Line	52 ohm
SWR at Resonance	1.5 to 1.0 max.

Model C4 Net \$34.95



Free Delivery On
"MINI BEAMS"
 From

QUEMENT ELECTRONICS

1000 SOUTH BASCOM AVE.
 SAN JOSE, CALIFORNIA
 95128
 PHONE 294-0464 SINCE 1933

the
secrets
of
long-tail biasing
in
transistor circuits

Here's a
method for biasing your
transistor circuits
that offers simplicity
with reliability—
it offers reduced
problems with
drift, transistor
replacement
and silicon-
germanium
interchangeability

James A. Ashe, W2DXH, 305 Oak Avenue, Ithaca, New York 14850

At least **one-half** of the work of designing a new circuit goes into developing appropriate biasing for its active elements. In modern gear, these are almost always transistors, usually with a simple base-bias arrangement. Base biasing is hard to compute, may require selected transistors, and is accompanied by a thermal-runaway hazard. There are other ways to achieve correct bias, and one of them is particularly well suited to amateur design and construction.

This is "long-tail" bias, an arrangement which deprives the transistor of control over its operating current. This reduces unwanted effects of transistor drift and of replacements whose characteristics are different from those of the original transistor. In fact, a long-tail bias circuit can be designed to accept silicon or germanium transistors interchangeably, with both being properly biased. If you use unlabeled surplus and computer transistors, you should find this biasing method particularly interesting.

I'll start by discussing why biasing is an important subject. Then a few words about the competition: factors that upset biasing. I'll finish with some illustrative applications and notes on finding supply-voltage sources.

dual function of biasing components

Before we discuss circuits, let's think about coins. Coins and circuits have something in common. Coins have two faces, and a coin seen **heads** may appear very different from the same coin seen **tails**. Yet we recognize coins easily, because we are familiar with them.

Circuits have a double character too, and it becomes very important when we have learned to understand it. Circuit design problems are simplified if we can limit the number of details under consideration. The two pictures of a circuit that we should learn to recognize are the signal view and the bias view.

Of course the signal view is the most interesting: that is why we are working on the circuit. Seen from this perspective, resistors and other components often appear as items that reduce the performance we might obtain without them. This is not a very flattering picture of the components we find in real circuits.

But if we check a real circuit with no applied signal, we find there is something going on anyway. Instruments show constant voltages and currents. Resistors and other components get warm. Energy is consumed, although there is no output. Here is another side to the circuit's life, a quiet and un spectacular heartbeat we may not have noticed before.

The values of these steady voltages and currents are referred to as "standing" or "static" values, to avoid any confusion with

signal voltages and currents. In particular, the collector voltage and current together identify the quiescent point, or Q point, chosen as the clearest indication of bias conditions.

We bias a transistor for two purposes. The transistor is, basically, a piece of crystal. It cannot manufacture power. It can only borrow power, and the output signal is really borrowed from the bias voltage and current. This is why supply lines must be adequately bypassed: so that power borrowed by the transistor is properly returned to the supply circuit.

The other purpose in biasing a transistor is to determine its signal characteristics. All active devices show different input, output, and gain characteristics at different Q points. We might choose an almost-off or a hard-on Q point for pulse work, or some in-between Q point for linear signal amplification.

To a large degree, the Q-point design and stability problem can be separated from the signal design problem. I have summed up the situation in fig. 1. The overall problem of designing a circuit breaks down into two simpler, somewhat independent, problems of signal design and bias design. The bias design problem, in turn, breaks down again to ques-

fig. 1. The different parts of the circuit-design problem.

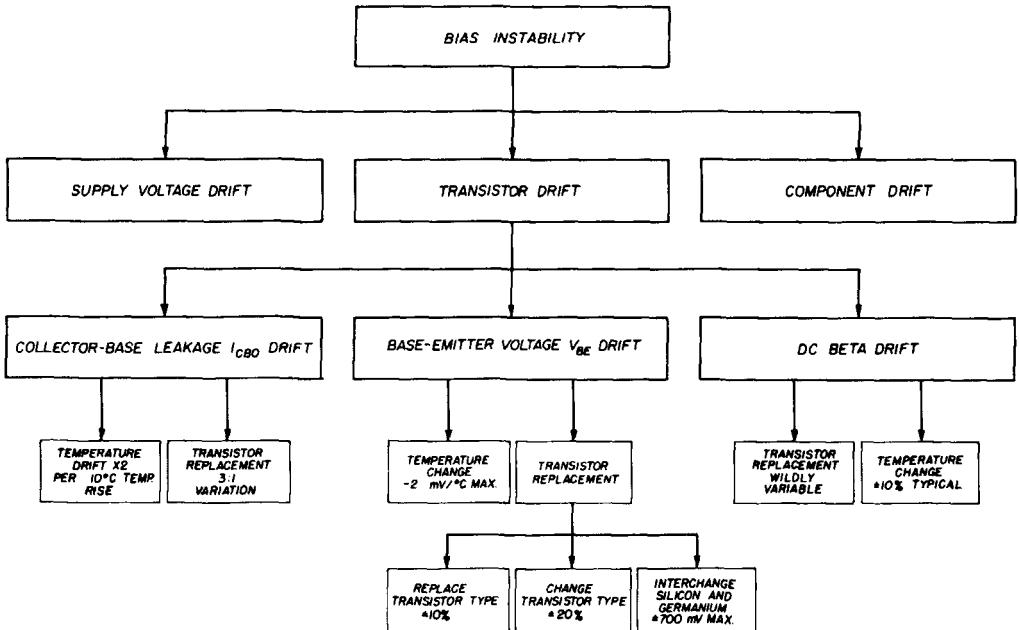

tions of choosing a good Q point, and of designing a circuit that will hold the Q point against upsetting influences. After working out the details, we put them back together again, and we have our completed design.

factors that upset biasing

Suppose you have assembled a circuit and a test shows correct standing voltages and currents. Some time later, maybe minutes later and possibly years later, you make another test and discover that although the circuit looks the same, the Q point has shifted. This is a perfectly natural event, and it will always happen in real circuits. We call it drift. There are five major causes of drift in transistor circuits, and part of the design problem is to take them into account so that drift does not seriously disturb circuit operation.

Here are the disturbing influences:

1. supply-voltage variation
2. component value drift
3. collector-base leakage, I_{CBO}
4. base-emitter voltage variation
5. beta variation

These drift components are not equally important, and their effects show differing emphasis in various circuits. I've arranged them in a convenient chart in **fig. 2**.

Because the biasing network is connected to the supply voltage source and may be seen by the transistor as a part of it, when the supply voltage drifts, the Q point moves. Very simple supplies consisting of a transformer through a diode rectifier to a capacitor filter, with no regulation, are subject to wild variations in output as load changes, or over a period of time. Plus or minus 30% seems to be in line with real experience. A simple regulating circuit or a zener diode can reduce this to the 1% ballpark and is practically always a good design provision.

Supply stability seems guaranteed when using batteries, but this is subject to hazards. As batteries age, their internal resistance rises, and this may upset a circuit much more than a mere falloff in voltage. Also, old batteries, whether sealed or not, often emit chemicals with a deadly corrosive effect upon electronic components.

As we proceed along the connections from the power source to the active devices, we come upon many resistors. A resistor is a fine, solid, stable-appearing device, but in actual experience only expensive resistors are truly reliable. The common composition resistors show noticeable drift upon exposure to heat. Soldering is likely to produce a permanent change in value. Resistors should be soldered gently, like transistors, and salvaged resistors are not to be trusted. Good design practice is to double resistor tolerances: a 10% resistor is reliable to 20%.

The other three sources of bias instability originate inside the transistor's shell. They are

fig. 2. The major factors causing Q-point drift.

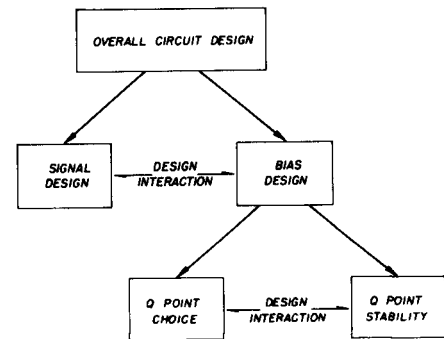

results of temperature variations, transistor aging, and transistor replacement. Amateur and experimenter circuits do not normally run very hot, but may at times be exposed to extreme temperatures. Aging is only rarely a noticeable factor. The most abrupt changes occur when a transistor is replaced. Good biasing design will result in a circuit with good tolerance for all anticipated drifts.

The most frustrating factor in base-bias designs is I_{CBO} . A transistor is basically a pair of diodes, and their close physical proximity does not upset their basic diode nature. The normal diode reverse leakage appears in the base-collector diode as I_{CBO} , which has considerable nuisance value. Typically, this leakage is in the low nanoampere* range in silicon transistors and the low microampere range in germanium transistors. It may be much larger in a poor signal transistor or a

* 1 nanoampere = 0.001 microampere = 10^{-9} ampere.

good power transistor.

I_{CBO} is annoying because its value may range over a 10:1 spectrum for different specimens of the same type transistor. In addition, it shows a very strong increase for moderate temperature rises. It roughly doubles every time the temperature goes up 10 degrees C. A germanium transistor with four microamperes leakage at 25° C (room temperature) will show about 20 microamperes leakage at 45° C, and the next transistor of the same type could have 60 microamps leakage. Small silicon transistors do not have annoying leakage except at very high temperatures.

The second transistor instability problem is rarely noticeable, requiring attention only for some precision circuits and for situations

fig. 3. A basic diode circuit illustrating the principle of long-tail biasing.

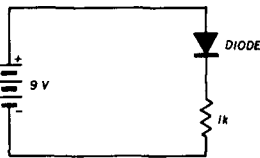

where there may be extreme temperature variations. There is normally a small forward voltage from the base to emitter of a transistor biased in its linear range. In addition to the expected small variations depending upon base current, the base-emitter voltage shows a negative temperature dependence that is typically under 2 mV per degree C. A ten degree temperature rise will reduce base-emitter voltage by roughly 20 mV in either a silicon or a germanium transistor.

Replacement of a germanium transistor with a silicon transistor has a stronger effect upon base-emitter voltage. A germanium transistor typically shows near 200 mV, a silicon transistor, near 700 mV emitter-base forward bias. This voltage variation appears in the biasing circuit, and must be considered when designing circuitry that is to accept silicon and germanium transistors interchangeably.

Finally, there is the beta problem. Transistor beta is the factor by which collector current is greater than base current. The transistor has one beta for dc biasing, and a typically lower one for signal computations. Both betas are highly variable, having been brought part-

ly under the manufacturer's control only recently.

Beta variations of 10 or 15:1 are commonly seen between transistors of the same type, and the 2:1 spread of GE's 2N3394 is a recent achievement. Transistor beta also depends weakly upon temperature and somewhat upon collector current. If the transistor is starved for current, its beta falls off.

Temperature drift effects are particularly noticeable in outdoor battery-operated gear. Only I_{CBO} drifts favorably when temperature falls; everything else goes the wrong way. Battery voltage and capacity are decreased and internal resistance increase; transistor base-emitter voltage rises, and beta is reduced. Electrolytic capacitors and other components may be affected too. These combined responses are the reason many amateur-designed circuits fail completely at or slightly below the freezing mark.

Now we see what the competition is. It is impressive. I have broken the overall picture into its component parts in fig. 2, which will help you keep the different factors organized. What circuit will maintain a Q point reliably against these influences? It must not be so stable it refuses to respond to the signal! There is one simple arrangement that belongs in the amateur literature, but somehow is not included. In a majority of cases we can delegate the entire biasing job to a single, easily-computed resistor.

long-tail bias design

This resistor is the "long tail" in long-tail biasing. Its length appears as its rather large value, and the substantial voltage that appears across it during normal operation.

To see how this works, let's start with the simple diode-resistor-battery circuit of fig. 3. Imagine that you have an unlabeled diode, but the resistor and battery are 1k ohms and 9 V respectively. We want to estimate the highest and least currents we should expect to find in the circuit. The only unknown is the diode: whether silicon or germanium. Its exact characteristics are not very important.

If we have a germanium diode, the voltage across it in forward conduction is unlikely to be less than 200 mV. Or if it is a silicon diode,

its forward voltage is unlikely to exceed 900 mV. Subtracting the diode forward voltage from the supply voltage, we find at least 8.1 volts but not over 8.8 volts across the 1k resistor. We would measure a current, if meter resistance is insignificant, of 8.1 to 8.8 mA, an 8.7% variation.

This is the key to our long-tail biasing arrangement. Most of the supply voltage appears across the stable resistor. Very little appears across the diode, which is left with little influence upon overall current. Minor changes in diode characteristics are swamped by the powerful influence of the series resistor.

Now suppose we replace the diode with a transistor, as in **fig. 4**. If S1 is open, the base-emitter junction will appear to the circuit as an ordinary diode. We can plug in germanium and silicon transistors, and the emitter current will show the variations previously observed with the real diode.

What happens when we close S1? The emitter-to-base voltage remains about the same (it will increase by maybe 10%), but the emitter current is stolen inside the transistor by the collector diode before it can get to the base terminal. Its actual value is not appreciably affected. Now the transistor is biased to the 8.1-8.8 mA we chose, less a small base control current.

Let's look that over once more. Knowing supply and base-emitter voltage, we know the voltage across the bias resistor. The effects of drift are easily reckoned by estimating the individual drifts and taking their sum. If bias stability is not good enough we must use a larger resistor and a higher voltage supply. That seems to be the complete answer . . .

But what current will we choose? A small current is economical and minimizes heating. A large current gives more power gain. In general, the small current wins, if it is not too small. See **table 1** for some notes on transistor performance. And there are usually some other factors that will help make a choice.

If we are using a germanium transistor, collector leakage current may be a factor, particularly at high temperatures. The load resistor carries the collector current we intended, and I_{CBO} too. If the leakage current

is too great a percentage of normal collector current (maximum maybe 5%), the transistor will be partly paralyzed. I_{CBO} can usually be neglected for silicon transistors.

A second practical limit relates to the size of the transistor's electrical structure. The transistor requires enough current to be well energized. If it is starved, its gain falls off. Modern transistors, particularly some epoxy-packaged ones, have tiny structures and do well at surprisingly low current levels. See the graph which compares the dc betas of a typical GE 2N3394 and an old 2N338.

At the other extreme, we must not overheat the transistor. When transistors overheat, doping atoms inside the crystal structure start jumping around, and they never end up in

fig. 4. A complete transistor bias circuit.

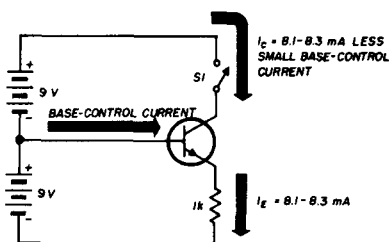

positions as good as those they left. This damage may occur in milliseconds and is permanent. If you don't have the manufacturer's specs, be careful. Also, note manufacturer's derating for high operating temperatures.

Now we can choose a collector load resistor. The collector current will be practically the same whether we use a resistor or not; maybe you will want to use an LC circuit load instead of a resistor. If so, plan to use a small resistor anyway for decoupling. But if the resistor serves as load, choose a value that leaves clearance for collector signal voltage swing. The largest signal should not carry the collector current far into the weak-transistor range or the voltage under a volt or so. A scope check will show distortion or clipping if the signal is too large for the biasing conditions you have chosen.

putting the long-tail into a circuit

To make this more real, let's imagine you're looking over my shoulder while I design a simple amplifier stage. The transistor came

out of a board; we don't know if it is silicon or germanium: a detail. An ohmmeter check shows it to be an NPN transistor, and in the next two minutes we'll design the circuit. First, we draw a schematic, See **fig. 5**.

Now, our strategy is to estimate or calculate whatever we can, and write it on the schematic. Each voltage, current, or parts value we pin down tells us something about another, and we soon find we have them all.

Starting at R2, whose lower end is at ground, we go to its base end, and let's say the base is at minus 1 volt. Transistor current is determined by R1 and we want to leave lots of supply voltage across it. Proceeding across the base-emitter diode we lose 0.2-0.7 volts depending on what kind of transistor we

Comparison of the operating characteristics of the 2N338 and 2N3394.

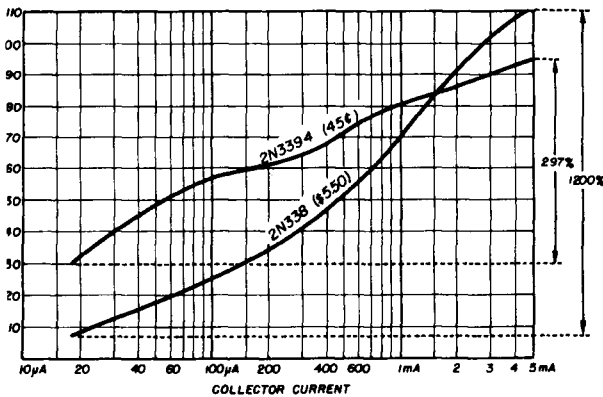

have, and that puts the emitter at minus 1.5 volts as a safe average possibility. Each of these values was written on the schematic as we arrived at it.

This unknown transistor should be good for 50 mW collector dissipation. With the base end of the base-collector diode at minus 1 volt and a supply of plus 9 volts, we have about 10 volts for collector swing; half of this reckoned from the base's minus 1 volt puts the collector at plus 4 volts. Assuming five volts available to cause collector dissipation, we wind up with 10 mA as a likely collector current. Write that beside R1 with an arrow indicating direction of conventional current.

Computing R1 from the 7.5 volts and 10 mA figure gives us a resistance we cannot find in the parts box, so we choose 820 ohms.

table 1. Characteristics of GE's 2N3394 silicon NPN epoxy-encapsulated transistor.

V_{CE0}	= 25 V maximum
I_C	= 100 mA maximum
P_C	= 200 mW maximum
I_{CBO}	= 0.1 mA max at 25° C
	10 µA max at 100° C
β	= 58 at -30° C
	100 at room temperature
	130 at +50° C
At $I_C = 2$ mA, common base emitter	
input resistance = 15 ohms typical	

Cross out the 10 mA and write 8.55 mA. Practically the same current flows in the collector circuit, giving 560 ohms for R3. Dividing the collector current by a likely transistor beta value gives an estimated base current of 120 microamps, and knowing base voltage, we find that R2 must be about 8.2 ohms. Only the capacitors remain unknown.

The transistor emitter circuit operates at a tens of ohms impedance level, so we choose 100 µF for C2 as having a comparable reactance at low audio frequencies. C1 is chosen 10 times smaller, since transistor beta is sure to be far over 10 at audio frequencies. This stage will show a low-frequency cutoff determined by C2 alone.

C3 is a little harder to determine, since the load resistance is not given. Source resistance is the transistor's output resistance in paral-

fig. 5. Low-frequency amplifier designed with the long-tail bias concept.

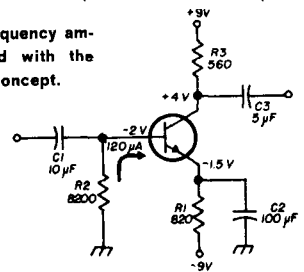

lel with R3; actually, that's another article so just take my word for it. Since C3 should be much smaller than the load resistance at low audio frequencies, a safe value might be 5 µF. A quick breadboard test will tell you if any changes are required, and if the gain is large enough for your purposes.

Hints: breadboard rf biasing circuits as audio circuits for scope checks. For small signals, use a large collector resistor for low collector voltage but improved gain.

finding bipolar voltages

There is nothing new about using bipolar voltages (two polarity) in circuit design. It is common practice in good industrial and scientific designs. The advantages are not available in any other way, and perhaps we will discover that bipolar voltages are not so hard to find after all.

The key point is, we don't really need two separate voltages. Rather, the transistor must see two voltages with respect to its base terminal. Since from a signal viewpoint we are

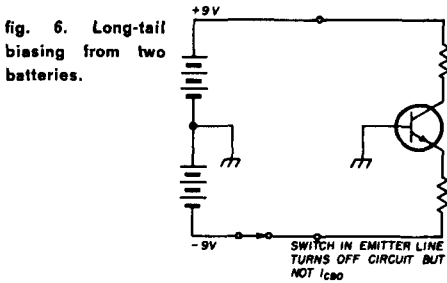

free to call any supply terminal the ground terminal, we can find several solutions to the two-voltage problem.

It is easy and convenient to call the base terminal chassis ground. If we do this, we will need a two-polarity supply: one positive and one negative with respect to ground. Nine volts is a convenient value, and we achieve the required voltages with a pair of nine-volt batteries as in fig. 6.

A second solution involves a pair of zeners across one power supply. See fig. 7. The junction between the zeners goes to chassis ground, the transistor base terminal goes to chassis ground, and the transistor sees two voltages although we have only one supply. This approach adds one zener and its shunt capacitor to the collection of components you would have used anyway.

If you are combining long-tail biased circuits with conventionally base-biased circuits, you can use a zener to obtain some intermediate base voltage as in fig. 8. The base is at signal ground but zener regulated above bias or supply ground. From the transistor's viewpoint this is the same as having the base attached to the chassis. A true bipolar arrangement is preferable at vhf.

Summing up, there are generally three points you can tie to chassis ground at your convenience. They are supply positive terminal, supply negative terminal, or something in between which is either a tap or a zener terminal. With the assistance of one or two additional zeners you should be able to work out any practical circuit problem.

applications

When you start breadboarding these circuits, you may suspect long-tail bias circuits

fig. 7. Long-tail biasing from two zeners across a single power supply.

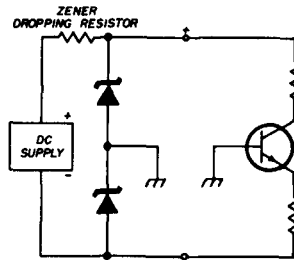

are particularly prone to oscillation. This false impression arises from the reliability of the biasing arrangement. Hit-and-miss or incompletely worked-out base-bias techniques may not bias the transistor into its really active range, so that such circuits will seem on the average to be more stable. They aren't; they are simply half-dead.

A common-base bias circuit does not compel you to use a common-base signal circuit. There are three types of signal circuit applicable to transistor use, and all of them can be fitted into a common-base bias arrangement. Some careful planning will be required, sometimes. For many useful details beyond those included here, look in the **GE Transistor Manual**, 7th Edition, Chapters 1, 2, and 4 in particular.

The most familiar arrangement is the common-emitter amplifier. Here, we have the emitter at signal ground, the input signal is applied to the base terminal, and the amplified copy appears at the collector terminal. See fig. 9.

A large capacitor is required from emitter to signal ground. This capacitor bypasses the bias circuit at signal frequencies, so that gain

is possible. Its reactance should be equal to or less than the emitter resistance, which is typically in the ohms or tens of ohms ballpark. A rough estimate is $26/I_E$ ohms for a germanium transistor or $50/I_E$ ohms for a silicon transistor where I_E is emitter current in milliamperes. The low-frequency rolloff begins where capacitive reactance equals emitter resistance. Choose the smallest capacitor that will do the job.

Base input resistance is approximately beta times emitter resistance. This puts it in the high hundreds and low thousands of ohms. Collector output resistance is typically in the 10k's to 100k's of ohms, so that stage output

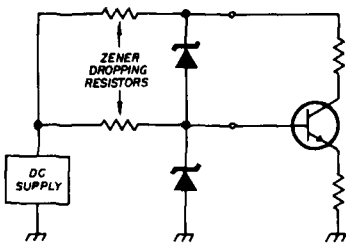

fig. 8. How to combine long-tail biased circuits with conventional base-biased circuits.

resistance is practically equal to the value of the collector resistor.

You have to get the signal in to the base by some arrangement that does not upset the low-resistance dc base-to-ground connection. One approach is link coupling, shown in fig. 9A. This is a one-stage i-f amplifier using the tiny i-f transformers available from Lafayette.* The neutralizing capacitor is required. A 470-ohm resistor and .001- μ F capacitor are included for decoupling.

If you want to make a high-gain audio amplifier, add another transistor as an emitter follower (more detail on emitter followers). See fig. 9B. The roughly 10 mA of current in the amplifier transistor is divided by the transistor beta twice, so that control current through the 100k base resistor produces insufficient voltage across it to upset the common-base biasing. Voltage and power gain are very high.

In the common-base configuration, you apply the signal to the emitter, and take its amplified copy from the collector. The base is fixed firmly at signal ground.

* Lafayette Radio Electronics, 111 Jericho Turnpike, Syosset, L.I., New York 11791.

Looking into the emitter, you see the same low resistance found in the grounded-emitter circuit, but this time transistor beta is not available as a multiplier. The signal is applied directly to the emitter resistance of a few ohms or tens of ohms. A large input capacitor is required, having a reactance at the lower rolloff frequency equal to the resistance being fed. Or you can put the signal in by a link or transformer arrangement, but the end opposite the transistor must be well bypassed to signal ground.

The common-base circuit has the highest collector resistance of any transistor configuration, and sometimes you can place it directly across an entire LC circuit. The output resistance is in the 100k's to 1 meg ballpark. Again, if you have a collector load resistor, it will set the apparent output resistance at its own value.

In fig. 10A is a very simple audio amplifier. At if you might use link coupling as shown

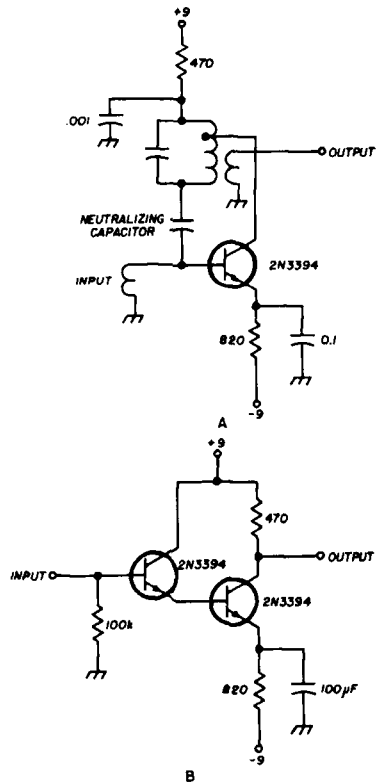

fig. 9. Common-emitter circuits.

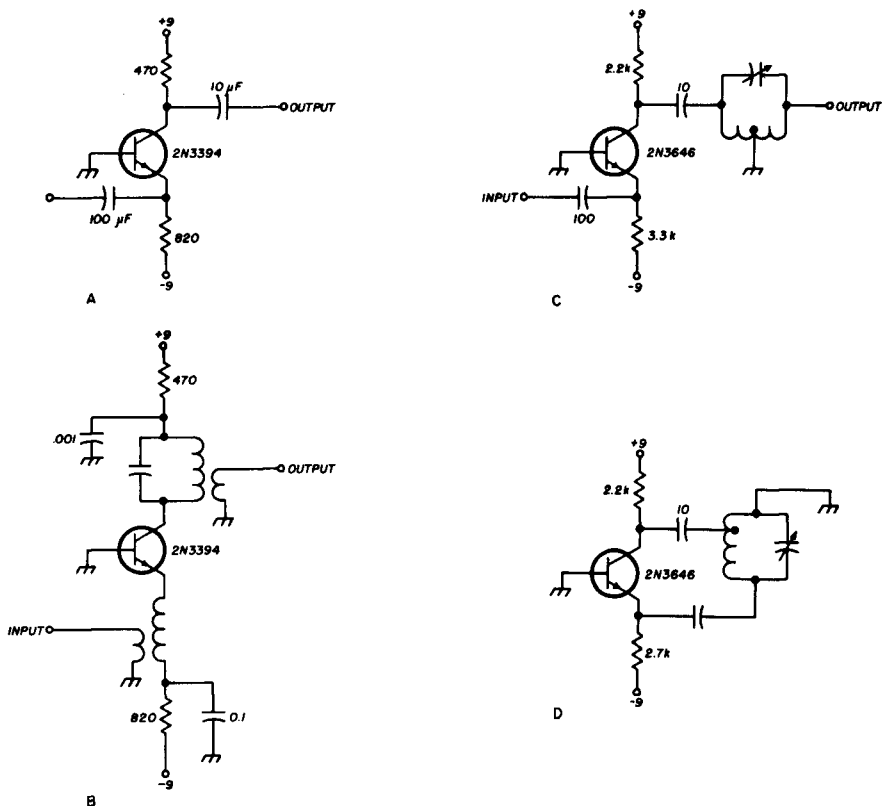

fig. 10. Common-base circuits.

in **fig. 10B**. This arrangement is prone to oscillation unless the input circuit is heavily loaded or of low reactance. The feedback is through collector-to-emitter capacitance, and cannot be eliminated.

At vhf, the common-base amplifier becomes **fig. 10C**, which is probably about the simplest vhf amplifier you can build. Heavy input circuit loading is required.

Perhaps the output circuit needs further explanation. This is simply a pi-tuner turned inside out; or you might prefer to look at it as a resonated auto-transformer. Its impedance transformation is adjusted by varying the point at which the coil is grounded. In this case you are transforming about 2k ohms to 75 ohms, so a 5:1 turns ratio is required. The emitter and collector resistors do double duty as decoupling and isolating resistors. Although very good in most respects, this circuit's one shortcoming is a tendency to instability.

If you accept the instability problem, by adding still more feedback you get an oscillator which can be remarkably stable. See **fig. 10D**. This is a breadboard VFO assembled for test purposes. It keys well at 145 MHz. The collector is tapped far down on the coil, and for vhf the emitter feedback capacitor is simply a wire close to the hot end of the coil. In some cases, a capacitor from emitter to ground will improve frequency stability.

emitter followers

Finally, there is the common-collector configuration, more generally called the emitter-follower. The signal is applied to the base circuit, and its duplicate appears at the emitter terminal. There is no voltage gain. But there is a power gain which appears as an impedance by a factor which may be as large as the transistor beta. Typical emitter resistances are the $26/I_E$ and $50/I_E$ values that are seen in the common-emitter circuit, but this time

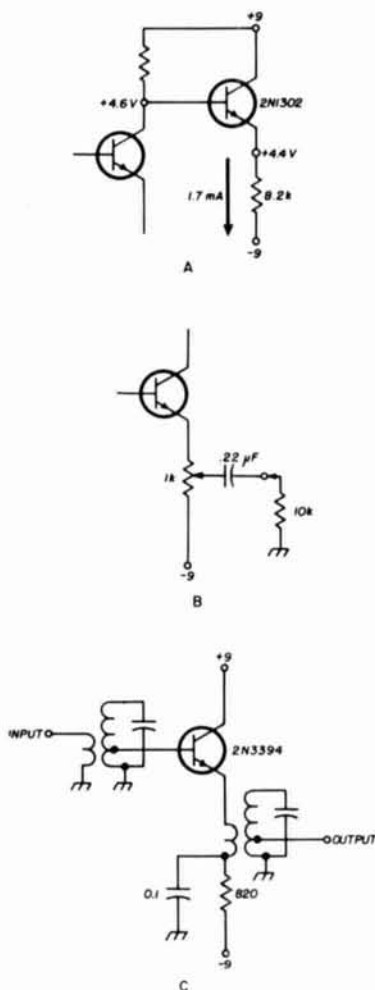

fig. 11. Common-collector circuits.

they appear as output resistances. This simple computation is no substitute for finding the manufacturer's specs if they are available. Base input resistance levels are typically beta times larger.

In fig. 11A the emitter follower is riding on the preceding transistor's collector. No coupling elements are required, but the follower's base current adds to the preceding stage collector current. Emitter voltage is the base voltage less typical base-emitter voltage, but output resistance is reduced from the thousands-of-ohms level to the tens-or-hundreds of ohms. If we replace the resistor with a potentiometer (fig. 11B), we have a

nice low-impedance level attenuator arrangement. This is good for getting adjustable level rf out of a signal generator. The capacitor shown is appropriate for audio applications into a 10k-ohm load. It would be very much smaller at rf.

We can use the emitter follower as an i-f amplifier as shown in fig. 11C. If there is no agc circuit, the number of components is reduced to an absolute minimum. If it oscillates, try a transistor with better high-frequency response. Lafayette's miniature i-f transformers are usable in this circuit.

summary

Well, there you are! The long-tail bias circuit requires an extra voltage, but it will save components over an entire project. If you've been frustrated by circuits that don't work at very low or high temperatures, now you know how to design better ones. And you can surprise your friends with good designs that take almost any old transistor and work... even silicon and germanium transistors interchangeably. But I've rather neglected the signal view: better do some breadboarding before you carry these ideas into your construction projects.

ham radio

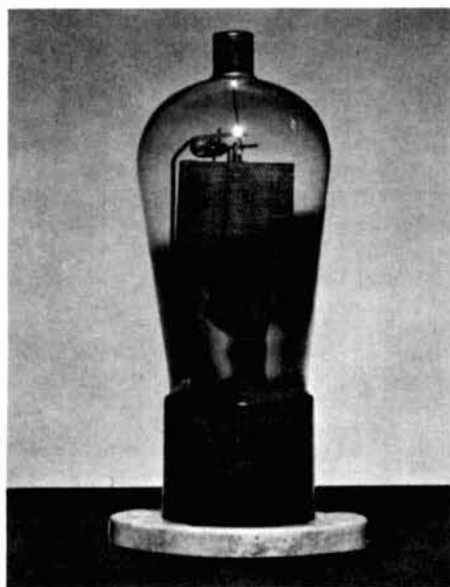

The dynistor—see page 49 for details.

an
improved
transistor voltmeter
and
its applications

A
transistor voltmeter with
excellent linearity,
low drift and high
sensitivity using
two low-cost
silicon
transistors

R. S. Maddever, Geelong Grammar School, Corio, Victoria, Australia

It is widely known that for accuracy, a voltmeter must draw a minimum of current from the circuit being tested. In recent years we have seen the widespread development of more and more sensitive multimeters at modest prices. However, in applications requiring low loading, the best meter movement is often not as sensitive as you wish. Also, as a rule, fragility, as well as cost, increases with sensitivity.

Vacuum tubes have traditionally been used as amplifiers with meter movements of ordinary sensitivity in VTVM circuits to provide low loading. With the appearance of the transistor, it seemed reasonable to assume that it could be pressed into service—to amplify current directly to a meter connected in its output. It was soon evident that this was a dream; acceptable transistor current amplifiers required elaborate modifications.

problems

The two main problems with transistorized instruments are linearity and temperature-induced drift. Linearity is the ability of the instrument to follow the signal exactly. When the input signal doubles in a perfectly linear device for example, the output signal will also exactly double. The transistor is nonlinear because its gain varies with the current flow-

ing through it. In common general-purpose transistors, the gain often falls by 20% for a 3 to 1 change in collector current. Leakage and gain also vary with temperature. Both can be reduced by the use of negative feedback. Temperature effects can be further reduced by a balanced configuration and the use of temperature compensating elements.

Most of the early articles simply ignored these problems or glossed over them with statements such as, "calibration is good" or "calibration is adequate". A few admitted that simple transistor amplifiers were not linear and needed calibration or calibration curves.²⁰ One article states simply that, "the

fig. 1. This balanced circuit minimizes the effects of h_{fe} , V_{be} and I_{cbo} .

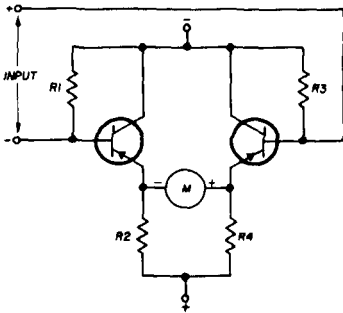

meter shown has a home-made scale which is not difficult to make".¹⁹

If you are prepared to accept the extra trouble and lower performance (as compared with a VTVM), it is possible to use inexpensive germanium transistors in a meter amplifier. A reasonably good circuit along these lines using OC71 transistors (2N3325, HEP3 or SK3004) appeared in 1958¹. Since then, many variations have appeared in print, some of which are described in the list of references at the end of this article. Two good germanium transistor circuits appear in references 2 and 6; each of these circuits has its advantages and novelties. A good silicon-transistor design based on the **GE Transistor Manual** was presented in the **Equipment Exchange Bulletin**.^{4,*}

Fortunately, it is now possible to bypass most of these elaborate methods by using a good transistor in a simple circuit. The Fair-

* This is now known as *The Australian EEB* and is a fine informal experimenters' magazine.

child 2N4250, for example, solves many of the problems with gain, noise, linearity and temperature sensitivity because of its high inherent performance. In this article I'll describe the use of this transistor in a practical voltmeter circuit. This circuit is as versatile and sensitive as the ordinary VTVM, but it is smaller, has negligible warmup time, and independent of ac power and line instabilities.

It could be argued that an FET automatically solves all semiconductor voltmeter problems, but this is not altogether true.¹³ However, it must be noted that a number of voltmeter circuits using unselected FET's have been published,¹⁴⁻¹⁸ so problems of linearity and reproducibility can be overcome. This article describes a good, but simple circuit using transistors—a circuit with minimum dependence on the characteristics of the individual transistors. Furthermore, in contrast to many FET voltmeters, it uses a low-voltage power supply (with an excellent lack of voltage dependence) and may be used with a 1-mA meter movement.

fig. 2. This circuit also minimizes the effects of h_{fe} , V_{be} and I_{cbo} , but has a lower input resistance than fig. 1.

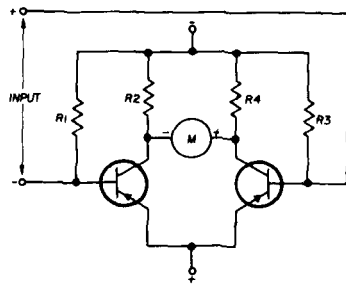

On the other hand, I can't deny that you can get higher input impedance with an FET. Although ordinary VTVM and FET voltmeters limit the input resistance to the 10- to 20-megohm range—typical transistor voltmeter performance—it is possible to increase the input resistance to several hundred megohms! In some cases this level of input resistance may introduce leakage problems. For some ohmmeter circuits, or where very high input resistances are required, an FET voltmeter is unbeatable—if the static charge problems don't plague you with other headaches.

basic design

To minimize the effects caused by variations in h_{fe} , V_{BE} and I_{CBO} , a balanced circuit may be used as shown in **fig. 1** and **2**. The circuit in **fig. 1** has a higher inherent input resistance, because of the large series resistance used to obtain low input current. Although its high input resistance is not necessarily a good reason for choosing **fig. 1**, it does have one major advantage over **fig. 2**: R2 and R4 provide negative feedback which improves the already excellent linearity of the 2N4250.

The high linearity of the 2N4250—down to collector currents as low as $1 \mu\text{A}$ —permits operation at unusually low collector currents.¹² This improves the low-noise performance of the device. Also, the leakage of the 2N4250 is only 10 nanoamperes at 40 volts, and appreciably less at normal operating voltages.

You have to make some provision for transistor gain variations and temperature effects. This is most easily accomplished by adding the potentiometer R6 shown in **fig. 3**. However, with matched transistors and slight adjustments to either R1 or R4, this potentiometer can be omitted or preset. Zeroing is then done with the meter's mechanical zero adjustment.

You can calibrate the unit for a given input current with the resistor across the meter (R5). For a $200 \mu\text{A}$ meter, the input current will be less than $1 \mu\text{A}$ for full-scale deflection. One-mil movements require from 3 to $5 \mu\text{A}$; the exact value depends on transistor gain. The capacitor across the input

fig. 3. Transistor gain variations and temperature effects are nulled out of the basic balanced circuit by resistor R6.

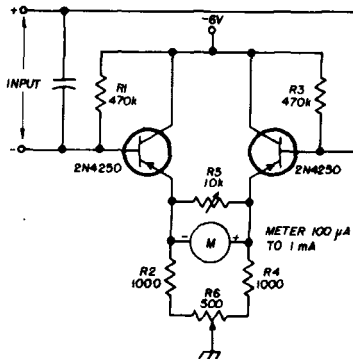

leads reduces ac pickup which could give misleading readings.

If you find that the sensitivity is too great and want to reduce it to a more convenient value, such as exactly $1 \mu\text{A}$ for $200 \mu\text{A}$ full-scale deflection, the negative feedback should be increased. This is better than reducing the value of R5 which effectively reduces meter sensitivity. The added feedback further reduces temperature drifts and improves linearity. This is done by adding R7 and R8 as shown in **fig. 4**.

If 470k-ohm resistors are used for added negative feedback, they will reduce the sen-

fig. 4. To reduce sensitivity and temperature effects negative feedback is introduced through resistor R7 and R8.

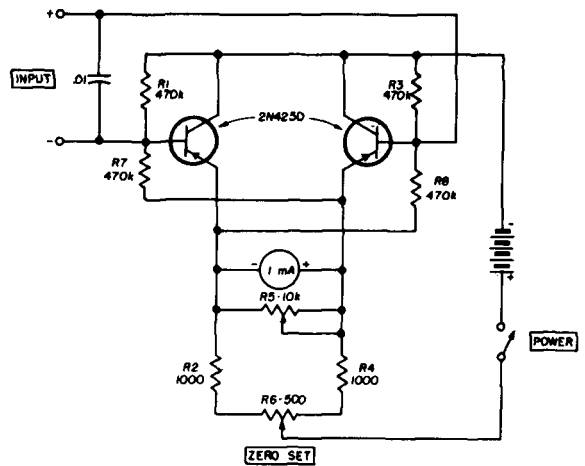

sitivity from 10 to 20 percent. Smaller values will reduce sensitivity still further, but will improve drift performance proportionally. Therefore, during initial calibration, R5 should be maximum and R7 and R8 adjusted until the overall sensitivity is nearly correct. Final adjustments are then made with R5.

With the resistor values shown in **fig. 4**, the static collector current through the transistors will be 2 to 3 mA. If you're using a $200 \mu\text{A}$ meter movement, this is needlessly high. You can gain some improvement in noise level and overload characteristics by reducing it to about 1 mA. This can be done by increasing R2 and R4 to 2.7 kilohms, and R1 and R3 to about 1.2 megohms.

To minimize the effect of any sudden temperature change, the two transistors should

be in contact—taped together or coupled with a narrow copper strip.

meter protection

In the event of a catastrophe, about 5 mA could flow through the meter in the circuit of **fig. 4**—500 μ A when the resistors have been changed to reduce the static collector current. Therefore, the meter movement should be protected with diodes, particularly if it is 100 μ A or less. This can be done most easily by putting two back-to-back silicon diodes across the meter.*

Although this protection technique is very useful, it will not permit indefinite liberties with the instrument. If an excessive input voltage is applied, it is quite likely that the transistors themselves will be damaged. The circuit could be made completely foolproof by putting several forward-biased series-connected silicon diodes across the input. Although a similar scheme has been used¹⁹, it produces slight nonlinearity and hardly seems worth the trouble.

multimeter applications

This instrument is suitable for a wide variety of measurements. As it stands, it is a very rugged and stable current meter with an input sensitivity in the microampere range and input impedance of two hundred-thousand ohms. Therefore, it is very useful for circuits using photo-electric cells at very low light levels, thermistors where small temperature changes are encountered, or as a sensitive galvanometer in bridge circuits.

You can also use this basic circuit as the basis for a very good multimeter. A few of the principles in multimeter design are discussed below, but I will leave it up to you to devise suitable switching schemes. It seems

* This will limit maximum meter current to three or four times the full-scale deflection value. An overload of this sort could bend the meter needle, and for better protection, a resistor should be included as shown here. The value of R is increased until the meter reads about 0.5% low with full-scale current. Then, with an overload,

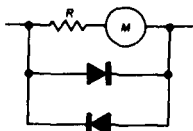

panic current will be limited to about 1-1/2 times the full-scale value, which can be comforting!

pointless to present a complete switching system for a multimeter, because individual tastes vary so much. Also, it's a lot of fun to design a system to your own requirements.

use as a voltmeter

Since the input resistance of the amplifier is about 200k ohms, we can represent the system as the "black box" in **fig. 5**. For purposes of this discussion let's assume that the amplifier has been adjusted so that exactly 5 μ A is required for full-scale deflection of the meter. The circuit's function as a volt-

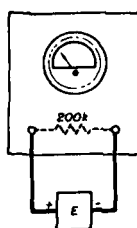
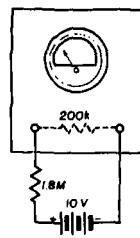

fig. 5. The transistor voltmeter may be represented by a "black box" with an internal resistance of 200 kilohms.

fig. 6. Addition of a 1.8 megohm multiplier for a full-scale reading of ten volts.



meter is easily illustrated by Ohm's law.

In this case, the circuit is 5 μ A, so for a full-scale deflection of, say, 10 volts, the required resistance is:

$$R = \frac{E}{I} = \frac{10 \text{ volts}}{5 \mu\text{A}} = 2 \text{ megohms}$$

Since the internal circuit already has 200k ohms or 0.2 megohms, we'll have to add 1.8 megohms externally as shown in **fig. 6**. If we want the meter to read 20 volts full scale, then we need a total of 4 megohms (3.8 megohms external).

The main difficulty here is to obtain the proper value of fixed resistance. Standard

values are only available in increments of 5 or 10 percent, but virtually any resistance may be obtained by various series and parallel combinations. With a variable voltage source and a reasonably accurate auxiliary voltmeter, you can quickly determine what resistances are required for full-scale deflection of your transistor voltmeter at various voltages. This is much quicker, cheaper and easier than trying to buy special resistors.

On high-voltage scales, it's possible to run into some problems. For example, 1000 V full scale would require 1000 megohms of series resistance if the input sensitivity is 1 μ A. Resistors this large are available at a reasonable price*, but can lead to difficulties with insulation leakage unless your instrument is built and kept scrupulously clean. Methods for constructing practical systems with lower input sensitivity (the 100- to 200-megohm region) are discussed in the **Equipment Exchange Bulletin**⁴. I might note that the series-parallel method will work just as well for large-value, high-stability resistors. For example, two 1000-megohm units in parallel with 125 megohms give 100 megohms, but the final result should always be compared with the performance of a known voltmeter.

Typical voltmeter ranges you might use are:

1 V Useful for emitter- or base-bias readings, though it may be necessary to take the input current into account for the latter.

5 V 1.5- and 3.5-V circuits

10 V 9-V circuits

50 V 20- to 50-V power circuits

And the usual scales for 100-, 500- and 1000-volts.

Use several resistors in a series for the 1000-V range, coming from a separate plug, not through the switch!

If you are lazy, you can manage adequately with ranges every decade—1-V, 10-V, 100-V, and 1000-V, plus the extra 5,000-V range.

* Proops Brothers, 52 Tottenham Court Road, London, W1, England. Welwyn glass-encapsulated types come in 125, 1000 and 10,000 megohms at 25c each plus postage.

When you put these resistors around the usual multipole rotary switch, you can arrange them in two ways as shown in **fig. 7**.

For the values shown in **fig. 7**, an input sensitivity of 1 μ A is assumed, using a 200- μ A meter movement. Although less sensitive meters will work well in the circuit, if you're looking for operation comparable to a VTVM, the 200- μ A meter is necessary. A 100- μ A meter would be even better. In **fig. 7** an input resistance of 200k is assumed, though this will depend on transistors, and on the feedback introduced by R6 and R7 (**fig. 4**). R5 is adjusted for 1 V full scale at the first switch position. If this cannot be achieved, reduce R_y slightly.

Note here the existence of R_x —this is an extra resistor placed directly in the probe lead to isolate the voltmeter from sensitive circuits. This considerably increases the versatility of the instrument, and allows voltage measurement on high-impedance rf circuits with low-capacitance loading. It's possible to build a small resistor into the test probe by the exercise of nominal ingenuity; it's not difficult. With the probe value shown, the actual voltage applied between points "A" and "B" is about 0.5 V.

For a given current sensitivity, the multiplying resistors can be calculated by Ohm's law, and then adjusted to give exact results by experimentally-determined series-parallel combinations.

The systems of **fig. 7** are "constant current"—the same maximum current is required from the source for full-scale deflection on any range. With 1 μ A sensitivity, a 5000-V scale would require the addition of a 4000-megohm resistor to drop another 4000 V if it were connected in series with the 1000-V position (**fig. 7B**). This could be made up of four 1000-megohm Welwyn resistors in series, but the resistors should be arranged carefully to minimize leakage paths or voltage breakdown; 5000-V is high voltage!

It must be noted that very high resistances used in the voltage-multiplying system shown in **fig. 7** will only give satisfactory service if all the relevant insulation points are perfect. This requires the use of ceramic insulation, including switches, and careful soldering to

avoid flux bridges. For ordinary construction, you may find it more suitable to add an extra gang to the rotary switch to place a shunting resistor between points A and B on the 100-, 1000-, and 5000-volt ranges to reduce sensitivity. If you used a 25k-ohm shunt, the series-multiplying resistors would be approximately 5, 50 and 250 megohms respectively on the 100-, 1000- and 5000-volt ranges.

Except for the probe resistor, the multiplying resistors should be "deposited carbon", not the "molded-in-case" type. The former are more exact, and will be considerably

with a known meter to obtain standardizing voltages.

If your requirements call for a millivoltmeter, the input voltage can be applied directly to the basic circuit. For 1- μ A sensitivity, this will provide a full-scale reading with a few hundred mV input.

The use of rectifier probes to convert the instrument to ac measurements is conventional and will not be discussed here. If you're only interested in ac measurements, it may be worthwhile to build an instrument specifically for that purpose as described in

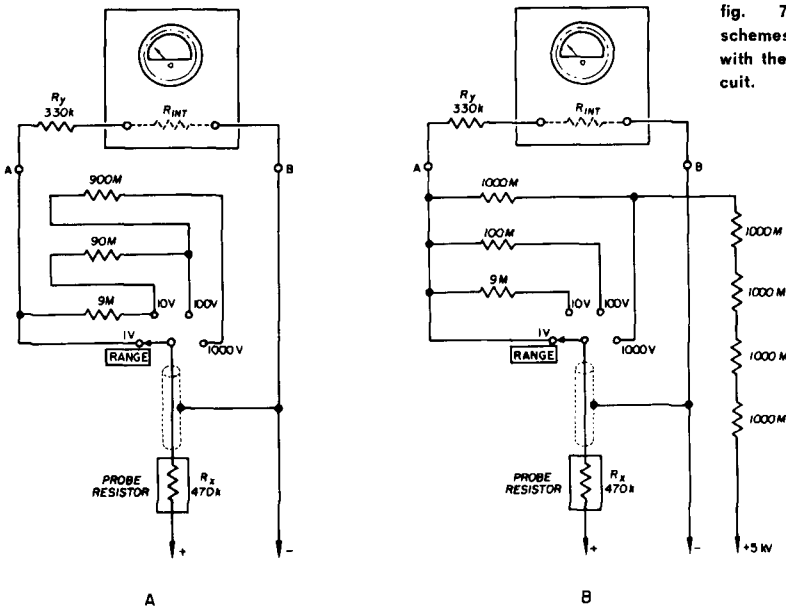

fig. 7. Two multiplier schemes which may be used with the basic voltmeter circuit.

more stable with respect to heat and aging. To reduce ac pickup with this high-impedance instrument, you should use shielded wire for the probe lead just as you would with a VTVM.

For selecting the various ranges, you can use a multi-pole switch as shown, or small plugs and sockets. For reliability and safety, the switch is better, but the plug and socket arrangement is better for maintaining low leakage with large multiplying resistors. The exact layout of the complete instrument will not be described here; it is best arranged to suit the requirements of the individual amateur. Similarly, I assume that everyone knows what a voltage divider is and how to use it

Radio-Electronics⁸. To obtain different current scales it is only necessary to put shunting resistors across the input to obtain the desired full-scale reading. For shunting circuits, it is essential that all connections are well soldered, and that switch contacts are clean and have low resistance. Also, it is impractical to use ordinary switch contacts for shunting current in excess of one ampere.

use as an ohmmeter— ordinary ranges

Standard ohmmeter circuits can be found in any reference book or from the operating manual of a good instrument, such as the Simpson 269. An interesting variation of the

usual VOM circuit is shown in **fig. 8**. In this circuit, adjustment of the "Ohms Adjust" control has negligible effect on calibration compared with circuits where the control is in series with the battery.

The higher the battery voltage, the larger the maximum resistance that can be measured, and unfortunately, the higher the external current on the low-ohms scale. A simple way to solve this is to use a larger battery voltage for the higher resistance ranges. With a 3-V battery, the lowest practical value of

fig. 8. A variation of the usual VOM ohmmeter circuit.

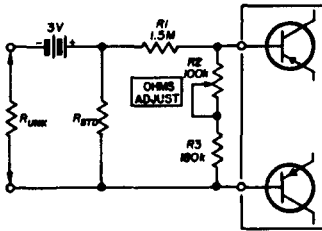

R_{std} is about 10 ohms, which allows reasonable measurement down to about 0.1 ohm*. For the highest practical value of R_{std} , the largest unknown resistance is about 100 megohms, which is not bad. Increasing the battery voltage to 45 V permits measurement up to 1000 megohms, but only if all the switching and contact terminals have very low leakage.

** Calibration of the low-ohms scale is an unavoidable burden, but it can be made easier by using the following formula:

$$R_{unk} = R_s \left(\frac{10 - V}{V} \right)$$

where:

R_{unk} = Unknown resistance

R_s = Value of R_{std} in parallel with the rest

R_s is the same as that value of R_{unk} which gives $V = 5$ when full-scale deflection is $V = 10$; in other words, half-scale deflection. V is the reading of the voltmeter for a given value of R_{unk} with the full-scale deflection taken as 10.0 when R_{unk} is shorted out.

If R_s is known accurately, you can calibrate your entire ohms scale with nothing more elaborate than a pen and a slide rule.

In general, the design center of R_2 plus R_3 should have about the same resistance as the internal resistance of the voltmeter (without R_y). This can be easily determined directly from **fig. 8**: with R_2/R_3 disconnected and the input leads shorted, adjust R_1 for full-scale deflection (R_1 should be approximately 3 megohms.) Now connect a potentiometer in place of R_2/R_3 , and reduce resistance until you get a half-scale reading. The value of this auxiliary resistor will then be equal to the internal resistance of the instrument. For a 200-k input resistance, R_2 and R_3 should have the approximate values shown in **fig. 8**, and you can proceed from there.

In **fig. 8** the actual standard resistance seen by the battery will be R_{std} in parallel with the combination of R_1 in series with R_2/R_3 paralleled with $R_{internal}$ —whooh! Thus, for R_{std} less than about 0.01 R_1 , the central-scale resistance will equal R_{std} . This is because at center scale the same voltage is developed

fig. 9. An ohmmeter circuit which is useful with high-impedance circuits such as a VTVM.

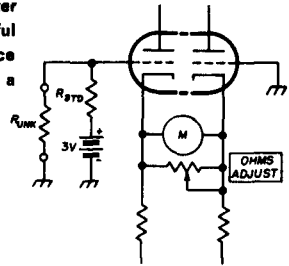

across both R_{unk} and R_{std} . When R_{std} becomes comparable to R_1 and the rest, the actual standard resistance seen by the battery will be less than R_{std} .

In practice this is nothing to be concerned about because you merely adjust R_{std} to give the high-ohms scale calibration desired when a known value of test resistance is put across the input. This assumes, of course, that you have calibrated the ohms scale with reasonable accuracy for a lower ohms range**.

The maximum ohms scale will be the one where R_{std} is infinity—absent. Since this gives an awkward scale value when compared to the lower ranges, R_{std} maximum is simply adjusted to give the highest nominal center-scale value. For the values shown in **fig. 8**, with 2.7 megohms for R_{std} , the center-scale reading is 1 megohm.

If the standard resistor is, say, 10 ohms, and the battery voltage is 3 V, there will be 300 mA flowing in the probes when they are shorted, or about 20 mA through a forward-biased diode placed across the probe. This is the reason for avoiding the lowest ohmmeter range when measuring the forward-conduction characteristics of transistors. Similarly, the use of a large battery in an ohmmeter circuit will imperil the breakdown rating of some transistors on the highest resistance scales (usually the top two). Therefore, if you must use an ohmmeter to measure the characteristics of semiconductors, be sure to choose an intermediate range.

Nearly every ohmmeter circuit works in essentially the same manner; a voltage is applied to a standard and an unknown resistance in series, and the voltage across the standard is interpreted in terms of the resistance of the unknown. This means that the center scale will read the value of the cali-

higher than the highest value of the unknown resistance to be measured. It is, therefore, only well suited for VTVM circuitry. Unfortunately, even the best transistor voltmeter draws an order-of-magnitude more input current than a VTVM grid. Maybe not for an FET, but an FET can have problems¹³ or can require elaborate circuitry for best results.

The circuit of **fig. 9** has another interesting advantage in addition to the forward reading scale: the internal resistance of the battery may be taken into account by reducing the value of R_{std} by an equivalent amount. If R_{std} has been reduced by exactly the internal resistance of the battery, this will give an accurate reading over the whole scale.

This system could be used to good advantage on the lowest ohms range if extra switching were provided, but note that the zero adjust must now be done directly at the meter. The system of **fig. 9** would be practical with the transistorized voltmeter on the low resistance ranges because of the high internal resistance of the TVM compared to R_{std} in this case. Unfortunately, it would require an extra forward-reading scale, which hardly seems worth the relatively small improvement in accuracy.

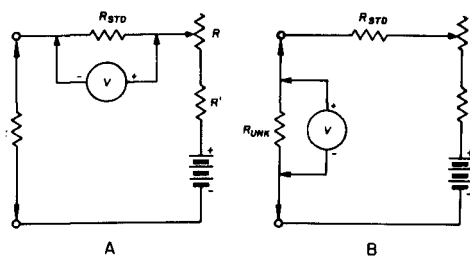

fig. 10. Proportional voltage method of measuring resistance.

brating resistance (R_{std}). Useful measurements may be made on unknowns over a factor of 100 higher or lower than this. In general, you will find it more convenient to assign the value of R_{std} to the scale (e.g. 10 ohms, 1k, 10k, 1M) than the traditional "X1, X100, X1000, etc.". If your standard resistor is 100 ohms, and you call that scale "100 ohms", you will be able to read it more rapidly than if you had to multiply the scale by some constant figure.

There is one other type of ohmmeter worthy of mention: The voltage is measured across the unknown, rather than across the standard resistance (**fig. 9**). It has the advantage that the ohms scale is forward-reading rather than the reverse. However, consistent scale calibration is only possible when the resistance of the voltmeter is appreciably

use as an ohmmeter— proportional voltage method

This method is somewhat cumbersome, but is capable of considerable accuracy down to very low values of the unknown resistance and is discussed in detail in **Radio-Electronics**.²¹ We shall assume that the internal resistance of the voltmeter, V , is much higher than that of R_{unk} or R_{std} . The voltmeter is placed across R_{std} as in **fig. 10A**, and R is adjusted for full-scale deflection. Then V is placed across R_{unk} , and resistance is read directly on the ordinary linear scale. If the unknown is, for example, 0.5 ohm, the scale with maximum reading "5" can be considered a "0.5-ohm" range, with all readings in proportion, as you would expect for an ordinary voltage reading. This is because the current through the standard and unknown is the same because they are in series; therefore, the voltage across them is proportional



PRESENTING THE ALL NEW **AMECO PT** ALL BAND TRANSCEIVER PREAMPLIFIER

- 6 THRU 160 METERS
- FEEDS 2nd RECEIVER

Model PT, with built-in power supply, transfer relay, connecting cables, wired and tested.

Amateur Net\$49.95

- A frame grid pentode provides low noise figure with ability to handle strong signals, greatly improving the sensitivity of the receiver section of a transceiver.
- A unique built-in transfer circuit enables the PT to by-pass itself while the transceiver is transmitting. The PT also feeds the antenna input of a 2nd receiver as well as muting it.

AMECO EQUIPMENT CORP.

A SUBSIDIARY OF AEROTRON, INC. ■ P. O. BOX 6527 ■ RALEIGH, N. C. 27608

to their resistances—in accordance with Ohm's law.

If the maximum full-scale deflection is 0.5 ohm, it is possible to measure down to 0.01 ohm, which is very convenient. A limitation of this method lies in the fact that the voltmeter leads must be placed directly across the standard or unknown to obtain full accuracy for low resistances. Since it is as cumbersome to build this capability into a multimeter as to do it outboard, it is advisable to set up a special breadboard with the standard resistances and leads for this purpose. Although only about half of the total range can be covered compared to the methods of **fig. 8** or **9**, accuracy is constant over the entire range, and no additional scales are required.

To keep the current through the unknown to the lowest value (and thereby reduce battery drain), it is desirable to use a voltmeter with the maximum possible sensitivity. This is best accomplished by using a given meter without any additional series-multiplying resistors. For an ordinary meter movement at V in **fig. 10**, the sensitivity will be about 100

mV full scale; for the transistor voltmeter, it will be a few hundred mV, depending on the meter used. If we assume 200 mV across a 0.5-ohm standard, the current will be 400 mA, and R plus R' will be about 7 ohms for a 3-V battery. For 200 mV across a 5-ohm standard, current will be 40 mA, with ten times R plus R' . Therefore, a 100-ohm pot at R and a fixed 5-ohm resistor at R' should suffice. If still higher ranges are to be covered, a separate R should be used for each range; this is a good idea for the outboard system in any event.

If an ordinary meter movement is used at V , the internal resistance will be several hundred ohms. This limits the maximum practical value of R_{std} to about 10 ohms if scale calibration is not to be affected appreciably. With a transistor voltmeter the internal resistance is very high and R_{std} could be used to about 5 k. For a vacuum-tube voltmeter there would be no great advantage in increasing R_{std} above 10 megohms because the circuit in **fig. 9** would cover an appreciably larger range for a given standard resistance.

\$12.95
AMAT. NET

AMERICA'S MOST ADVANCED QUALITY-CONTROLLED BALUN
W2AU BROAD BAND BALUN 2.8 TO 40 MC
WITH BUILT-IN LIGHTNING ARRESTER
HANDLES FULL LEGAL POWER LIMIT

\$12.95
AMAT. NET

4 PURPOSE BALUN

4 PURPOSE BALUN

THE BALUN THAT HAS BEEN PROVEN AND ACCEPTED. NOW BEING USED BY THE U.S. NAVY, COAST GUARD, AIR FORCE, ARMY, FCC, CIA, RCA, NBC, FAA AND CANADIAN DEFENSE DEPT. AND BY THOUSANDS OF HAMS IN THE USA AND THROUGHOUT THE WORLD.

—ANOTHER FIRST—

Our exclusive sealed type lightning arrester helps prevent lightning damage to your valuable equipment, balun and coax. Don't wait until lightning strikes. Protect your investment now. **DON'T BE MISLED!** Our one style balun is adaptable to all antennas, Yagis, quads, inverted Vees and multi-bands.



Backed by 50 years of electronic knowhow

Proven over the years.

Available at all leading dealers. If not, order direct.
IT'S WHAT'S INSIDE THAT COUNTS

UNADILLA RADIATION PRODUCTS, Mfrs. of Baluns & Quads, Unadilla, New York 13849

W2AU BALUN LETS ENTIRE ANTENNA RADIATE!

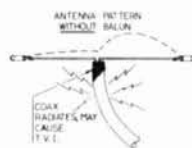
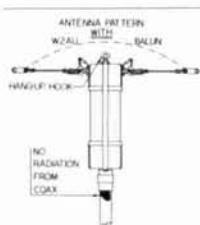

(pat. appld.)

\$ for \$

Your best balun buy.

STOP WASTING YOUR SIGNAL! REMEMBER, YOUR ANTENNA IS THE MOST IMPORTANT PIECE OF GEAR YOU OWN.

- No Radiation from Coax
- No Center Insulator Needed
- Perfect for Inverted Vees (Use Hang-up Hook)
- Built-in Lightning arrester
- Broad-Band 2.8 to 40 Mc.
- Takes Legal Power Limit
- Two Models:
 - 1:1 50 ohm coax to 50 ohm balanced
 - 4:1 75 ohm coax to 300 ohm balanced
- A must for Inverted Vees, Doublets, Quads, Yagis etc.
- Weighs 6½ oz. 5½" long

HELPS TVI PROBLEMS IMPROVES F/B RATIO

BY REDUCING LINE PICKUP

Although it is impractical to use the method of fig. 10 for more than a few ranges because of the many components required and the limited range covered by each standard, it should be kept in mind as a relatively simple circuit for obtaining high-accuracy resistance measurements—particularly at low resistances—without the extra complexity of a balanced bridge.

performance

In a unit I built from fig. 4, one transistor had a gain of 250, the other 450, but the results were very good. When a 200- μ A meter was used, the input required about 0.6 μ A for full-scale deflection before feedback was applied. After feedback and slight adjustments to R5 to give full-scale deflection for 1 μ A, the zero drift appeared to be less than 2% of full scale between zero and 30°C. The gain for a given input current changed by less than 3% from zero to 30°C and less than 8% from zero to 45°C. The long term stability

is within 2% and these variations have always been within the mechanical zero set for the meter. With the feedback resistances shown in fig. 4 linearity is excellent—better than I can discern with an ordinary meter.

Less than 1% (of full scale) zero shift is observed when the leads are shorted. Therefore, the same zero adjustment can be considered satisfactory for all resistances across the input. Increase in battery voltage has negligible effect on sensitivity and a 25% decrease reduced the sensitivity by a mere 3%. In this respect, at least, the unit appears to be far better than several differential integrated microcircuits where the gain is often very dependent on supply voltage. The inherent linearity of the 2N4250 system is also appreciably better—and the 2N4250's are cheaper!

Later units built with more closely matched transistors seem to give even better performance, and a bit of effort spent in matching transistor gains could prove rewarding. This circuit seems to be the simplest and best yet

TRAVELING HAMS!

STELLAR INDUSTRIES is now working on the solution to that age old problem of taking your hobby with you when you're on the go—by plane, car, boat, or what-have-you.

THE SUITCASE STATION

No, the idea is not a new one. *Collins* has had one for many years. Inventive hams have made their own. *But now*, we're trying to perfect it, and we need *your help!* So far, our plans call for the following equipment to be included:

Transceiver—your choice (we're using a *Swan 500* now).

Power Supply—*Linear Systems 400-12/117 Commander AC/DC*.

Fixed Antenna—*Hy-Gain 18-TD* Tape Doublet.

Mobile Antenna—*Mosley Lancer 1000* with Coil Caddy.

SWR Bridge—or your favorite tuning device—optional.

Assorted interconnecting cables as required.
Assorted tools for "on the spot" repairs and installation.

What would you like included?

All suggestions used will be rewarded with a merchandise certificate. Contact us now at:

10 Graham Road West
Ithaca, New York 14850
Dept. H



stellar industries
DIV. OF STELLAR I, Inc.
SALES AND SERVICE

for transistorized voltmeters. It owes its success to the high performance of the 2N4250 transistors.

references

1. "Transistorized Meter," *Radio, Television and Hobbies*, March 1958, p. 32. Uses two OC71 transistors in a balanced circuit with 100- μ A meter and thermistor temperature compensation. *Radio, Television and Hobbies* is now known as *Electronics Australia* and is the Australian equivalent of *Scientific American* and *Radio-Electronics*.
2. S. Schwartz, "Military Standardization Handbook: Selected Semiconductor Circuits," pp. 2-22. Balanced circuit with independent zero-set and temperature-balance adjustments; uses thermistor.
3. GE, "GE Transistor Manual," 7th Edition, Chapter 4.
4. M. Laybutt, "A Stable Transistorized Voltmeter," *Equipment Exchange Bulletin*, August 1967.
5. "A Simple Valve Voltmeter for the Diode Tester," *Equipment Exchange Bulletin*, August 1967.
6. D. M. Neale and F. Oakes, "Transistorized DC Amplifier," *Wireless World*, November 1956, p. 529. A double-stage balanced circuit using OC71 transistors with amplified negative feedback.
7. D. E. O'Neil, "Silicon Transistor Millivoltmeter," *Wireless World*, March 1966.
8. "Transistorized Audio Voltmeter," *Radio-Electronics*, March 1966.
9. "Transistorized DC Voltmeter," *Radio-Electronics*, April 1966. This circuit has an ingenious transistorized low-voltage standard reference system.
10. "Transistorized DC Voltmeter," *Radio-Electronics*, October 1966. Converts ordinary VOM to transistor voltmeter.
11. "AC Millivoltmeter," *Practical Electronics*, August 1966.
12. "Transistor DC Amplifiers," Fairchild Application Note App-60.
13. "Design Factors of an FET Voltmeter," *Electronics Australia*, July 1967, p. 36.
14. R. Palace, "Field Effect Voltmeter," 73, July 1966, p. 34.
15. J. George, "Field-Effect Transistors," *QST*, October 1966, p. 19.
16. "RCA Transistor Manual," Edition SC-12, 1966, AC Voltmeter, p. 466.
17. "Applications of the Silicon Planar II MOSFET," Fairchild Applications Note APP-109, November 1964.
18. "Build a 22 Megohm FET DC Voltmeter," *Radio-Electronics*, October 1967, p. 44.
19. J. Lee, "Test Equipment Handbook," published by 73.
20. L. Garner, "Transistor Circuit Handbook," Coyne, p. 261.
21. J. McCormick, "The Ohm Splitter," *Radio-Electronics*, September 1967, p. 261.
22. E. Sydenham, "A Transistor Multirange Test Meter," *RSCG Bulletin*, October 1967, p. 636.

ham radio

Clegg CRUISER VHF/SSB TRANSMITTING RECEIVING CONVERTERS

AT YOUR DEALERS
IN DECEMBER
WRITE OR PHONE FOR
DETAILED LITERATURE

E. T. **C**LEGG ASSOCIATES, INC.

BOX 362, MORRIS PLAINS, N. J. 07950
(201) 267-7414



**125 WATTS PEP
+ AM AND CW TOO**

Self-Contained Receiving Converter

Working 20 meter SSB? Beat the QRM and enjoy the thrill of 6 or 2 meter VHF SSB with a new Clegg Cruiser.

Already working VHF on AM or CW? Combine a Clegg Cruiser VI or II with one of the many low band, low cost exciters or transceivers available from your dealer's used equipment shelves . . . then join the SSB gang on 6 or 2 for less than half the cost of previous SSB equipment for VHF.

If you're now working 6 meter SSB, a Clegg Cruiser IIA will put you on 2 meter sideband without the expense of a complete transmitter.

THREE MODELS to Choose From:

6 METERS
The CRUISER VI
14 Mc Input

2 METERS
The CRUISER II
14 Mc Input

2 METERS
The CRUISER IIA
50 Mc Input

more 144-MHz moonbounce to Australia

Just as we were about to go to press, I received the news that the EME path to Australia had been conquered again. This time by Henry Theobalt, KØIJN, of Minneapolis. The amazing thing about this contact is that this was Henry's first moonbounce schedule, and he had heard his own echoes for the first time just fifteen minutes before schedule time.

The 160-element collinear that he had put up this winter in sub-zero temperatures was really working. In addition to working Ray Naughton, VK3ATN, he was hearing Mike, K6MYC, Bill, W6YK and Ross, WB6DEX, although he couldn't identify WB6DEX's call.

Just before schedule time, K6MYC reports

that he turned everything on, sighted the antenna on the moon and immediately heard two signals. Tuning to the strongest one, he copied KØIJN calling K6MYC—a thrill because there had been no schedule setup. After the VK3ATN schedule, Mike and Henry couldn't copy each other very well, but they were still hearing each other's echos.

After Henry's EME QSO with VK3ATN, K6MYC called Ray on ssb. Ray was experiencing difficulty with local line noise, and didn't copy. Mike was hearing his own ssb echos, but they were not readable. All in all, it sounds like a very exciting evening.

ham radio

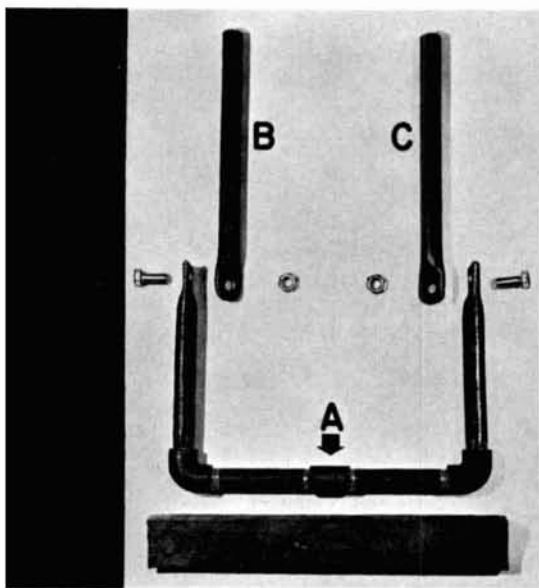

a
**low-cost
 tiltover tower
 base**

Ted Woolner WATABP, 30 Cedar Road, Shrewsbury, Massachusetts 01545.

The tiltover tower base. The U-Shaped piece is buried in cement; the two uprights, B and C, are slipped into the tower legs. The hinge is formed by the $\frac{3}{8}$ -inch bolts.

When you need a tiltover tower base, do you go out with a pocket full of loot and buy one? Most people do, and come back with a mighty thin wallet. How about using a little Yankee-Scotch ingenuity instead?

The length of the scrap piece of board shown in the photo depends upon the span of the tower legs. Hold it on the end of the tower and give it a good whack with a hammer. The marks left on the wood are used as a template by the pipe fitter when he makes up the U-shaped piece of plumbing that forms half of the hinge.

The coupling in the center of the U (A) is used to change the distance between the legs of the U to match the tower legs. The ends of the legs and the two uprights (B and C) are flattened and drilled for $\frac{3}{8}$ -inch bolts. The uprights fit into the legs of the tower and should be 11 or 12 inches long. They aren't bolted to the tower legs, just slipped in. This makes it easy to add another section of tower later on without a lot of work.

Dig a hole about two-feet deep and fill it with about sixteen inches of broken stone or gravel. Then bury the base of the hinge, the U-shaped piece, in a concrete slab six to eight inches thick. The larger the diameter of the slab, the greater stability you'll have. Don't forget the broken stone—this permits any water that collects to leach into the ground. Otherwise, water under the base may freeze and lift the concrete or crack it. To make good cement, use three shovels of sand to one of cement.

Did you ever see the wind sweep a tower off the ground from the base? I never did either, so why go halfway to china with cement? You'd be better off to put all that labor into a good deep guy anchor or dead man that holds the top.

The total cost of the whole works is low—\$1.82, state tax included. Compare that to the price of a commercially-made unit!

ham radio

**EQUIPMENT FROM THE SATELLITE
JUST ARRIVED
NEWEST MODULE PEG TYPE BOARDS**

All parts are useable as leads are wrapped around terminals. (not soldered) Therefore, no damage by heating. All parts can be removed simply by unwrapping leads from around terminal.

Boards contain:

Switching transistors, zener diodes, (signal level and power), signal level diodes, precision trim pots, resistors, adjustable pots, precision capacitors, pulse transformers.

Identification listed below:

This is a sample on various boards.
Some have as many as 25 of one type of listed below.
Number on component

LN575	6.2 Volt zener diode 400 Millowatt cap.
2N1051	NPN Transistor Hi gain 40 Volt P.I.V.
40044	NPN Silicon transistor General purpose Hi gain — small signal 50 Volt P.I.V. MAX. Power — 350 Millowatts
40045	NPN Silicon transistor Hi gain — small signal 50 Volt P.I.V. 2 amp. cont.
40056	Switching Diode P.I.V. 62 volt 400 Millowatts

Also boards are peg type construction. Terminals can be removed and placed anywhere in boards to form your own circuits.

PRICE: \$1.50 ea. or 5/\$6.00 f.o.b.

**VARIABLE VOLTAGE DUAL PLATE
POWER SUPPLY**

Input: 117V 60 cy.
Output: #1 0-600 V DC @ 0.25 amps
Output: #2 0-600 V DC @ 0.25 amps
Output: #3 12.6 V DC @ 2A fixed

These power supplies consist of two separate supplies on one 19" wide x 10 1/2" high for rack mounting. Chassis is 13" behind the panel. There are two separate variacs used for voltage control and one circuit breaker for protection. Both outputs are well filtered with a Pi section filter. Uses two type 5R4 rectifiers.

PRICE: \$49.95 f.o.b. shpt. wt. 80#

**ARC-5 TRANSMITTER
LIKE NEW 3-4 mHz.**

Complete with all tubes. One of the most versatile pieces of surplus eqpt. ever. Get yours now — not many of these left. Excellent condition.

PRICE: \$12.95 ea. f.o.b.

NEW CRYSTALS

100 crystals in a case originally for type MAR eqpt. These crystals cover the range of 4844.44 kHz to 7778.78 kHz. There are 16 units in the 40 meter amateur band, and an additional 7 units are useable in the 6 meter band. Also 17 are useable in the 10 meter band. Complete with case.

PRICE: \$12.95 or 2/\$25.00

ZERO CENTER 4" METER

1 ma. amp. movement. Calibrated 100-0-100, good for TT distortion measurements.

PRICE: \$8.50 ea.

AUDIO CHANNEL FILTERS

Centered on following freq:

595 cy.	1105 cy.	1765 cy.
765 cy.	1445 cy.	1955 cy.
935 cy.	1615 cy.	

Impedance: 600 ohms.

PRICE: \$10.00 ea. or 2/\$18.00

TT 63A/FGC

TT regenerative repeater accepts on-off signals whether tone or DC. See Feb. 1967 issue of RITTY for conversion information for frequency shift. NEW.

PRICE: \$34.95 ea. f.o.b.

FLANGELESS SILICON DIODES

All rated at 1.5 amps.

50-200 volts	6c ea.	20/\$1.00
200-400 volts	9c ea.	15/\$1.00
400-600 volts	12c ea.	10/\$1.00
600 plus	15c ea.	7/\$1.00

TRANSFORMERS

1000-0-1000 or
1200-0-1200
200 ma. CCS
110 or 220 Volts

PRICE: \$9.95 ea.

DIRECT PLUG-IN REPLACEMENTS

ratings 1 amp. 1800 P.I.V.

Replace the following tube types — #5Y3, 5U4, 5Y3G, 5Y3GT, 5V4, 5V4GT, 5AU4, 5T4, 5W4, 5Z4, 5AW4, 5V3, 5AS4, 5AX4, 5AZ4.

PRICE: \$1.95 ea.

DIRECT PLUG-IN REPLACEMENT

5R4, 5R4WGY replacement ratings 4000 P.I.V. @ 1 amp.

PRICE: \$6.00 ea.

All prices subject to change without notice.

All above merchandise subject to prior sale. All merchandise guaranteed.

All prices f.o.b. our warehouse, Philadelphia, Pa. Minimum order \$5.00

SELECTRONICS

1209 S. NAPA ST., PHILADELPHIA, PA. 19146
Phone: Area Code 215 HO 8-7891 - HO 8-4645

YOU EARN YOUR FCC FIRST CLASS LICENSE or your money back!



5 NRI COMMUNICATIONS COURSES INCLUDE FCC LICENSE TRAINING

Earning an FCC License can be quick and easy the NRI way. You can concentrate on a short FCC License course—"specialize" by training in Mobile, Aviation, or Marine Communications—or go all-out with the job-simulated NRI course in Complete Communications. It is the only home-study training plan that includes professional lab equipment specifically designed to give you on-the-job, "hands on" experience as you train.

Whichever NRI Communications course you choose, with an FCC License you're ready to operate, service and install transmitting equipment used in broadcasting stations, aviation, on board ships, and in mobile and Citizens-Band radio. And you MUST PASS your FCC exams or NRI refunds your tuition in full. Can you do it? The NRI record of success is outstanding. 87% of NRI graduates pass their FCC exams.

Get full details today about five courses that include FCC License preparation, plus seven other training plans offered by NRI, the oldest and largest school of its kind. Mail coupon. No obligation. No salesman will call. NATIONAL RADIO INSTITUTE, Electronics Div., Washington, D.C.

APPROVED UNDER GI BILL. If you served since January 31, 1955, or are in service, check GI line in coupon.

MAIL NOW for FREE CATALOG



NATIONAL RADIO INSTITUTE 46-018
Electronics Division, Washington, D.C. 20016

Please send complete data about FCC License training, other NRI courses checked below. (No salesman will call.)

- | | |
|---|--|
| <input type="checkbox"/> FCC License | <input type="checkbox"/> TV-Radio Servicing (with color) |
| <input type="checkbox"/> Complete Communications | <input type="checkbox"/> Advanced Color TV |
| <input type="checkbox"/> Aviation Communications | <input type="checkbox"/> Industrial Electronics |
| <input type="checkbox"/> Marine Communications | <input type="checkbox"/> Basic Electronics |
| <input type="checkbox"/> Mobile Communications | <input type="checkbox"/> Electronics for Automation |
| <input type="checkbox"/> Math for Electronics | <input type="checkbox"/> Electrical Appliance Repair |
| <input type="checkbox"/> CHECK FOR FACTS ON NEW GI BILL | |

Name _____ Age _____

Address _____

City _____ State _____ Zip _____

ACCREDITED MEMBER NATIONAL HOME STUDY COUNCIL

new products

Galaxy Solid-State Receiver



A solid-state general-coverage receiver of advanced professional design has been announced by Galaxy Electronics. It will cover from 0.5 to 30 MHz in 500-kHz segments and will have 1-kHz dial accuracy over this range. Among the many interesting features offered by this receiver are an adjustable noise blanker, a variable rf attenuator at the antenna input and an adjustable BFO control for RTTY. Stability is assured with the use of a phase-locked fundamental oscillator and permeability-tuned VFO. Crystal-lattice filters are used in the high-frequency i-f strip for optimum selectivity characteristics. Rear outputs are provided for the PTO, high-frequency i-f, avc, rf gain control and audio to permit dual and space diversity operation with a minimum of additional equipment.

Although this is a professional piece of equipment, its price is not out of range of other equipment offered in the amateur field.

This receiver should be available as you receive this magazine at a price in the range of \$700. For further information on the Galaxy R-530 receiver, write Galaxy Electronics, 10 South 34th Street, Council Bluff, Iowa 51501.

EACO Coaxial Switches



A new coax switch has been introduced by the Electronic Applications Company. EACO surveyed the market and found that a four-position switch would answer 90% of amateur requirements. This new switch features the concept of not paying for unused positions. In-line connectors are offered to facilitate installation behind a panel. The escutcheon features a surface suitable for writing. A separate escutcheon is also available for front-panel use when the switch is mounted behind the panel.

These switches are available in two types: the four-way switch and an in-out model for use with a linear amplifier or other accessories. The silver-plated contacts are designed to handle up to 1000 watts of a-m or 2000 watts of sideband. Negligible insertion loss is claimed up to 160 MHz with a maximum SWR of 1.2 at that frequency. Various types of connectors can be supplied. These switches are priced at \$7.65 each from Electronic Applications Company, Route 46, Pine Brook, New Jersey 07058.

electronics center, inc.
2929 N. HASKELL 214-LA6-2023 DALLAS, TEXAS 75204

here is a

**COMPLETE
ANTENNA PACKAGE
INCLUDING**

Tri-Ex

W 51

FREE STANDING TOWER

- HAM-M ROTOR
- 100 FT. CONTROL CABLE
- HY-GAIN
- TH3-MK2
- 100 FT. RG/8u BELDEN POLY FOAM CO-AX

**A REGULAR
\$635⁵⁵ VALUE**

**SPECIAL
PACKAGE
PRICE**

565⁰⁰

**SHIPPED PREPAID
TO YOUR QTH!**

We'll make you a package price on any Tri-Ex tower-antenna-rotor combo. Let us know your needs.

**"EVERYTHING
FOR THE AMATEUR"**

electronics center, inc.
2929 N. HASKELL 214-LA6-2023 DALLAS, TEXAS 75204

GET IT from GOODHEART!

EVERYTHING UNCONDITIONALLY GUARANTEED!

TEKTRONIX #531 15 mc scope w/dual-trace plug-in, w/NBS-traceable Certif., books, probes **775.00**
Other Tekt., Hewl-Pack, DuMont scopes **ASK!**

COUNT FREQ. DIGITALLY 10 cy to 220 mc with crystal accuracy, at the lowest price available anywhere; and each set has been completely checked and comes with a dated **CERTIFICATE OF CALIBRATION** (and stickers) traceable to the National Bureau of Standards. You get Hewl-Pack #524B with #525A and 525B plug-ins, and complete set of books **1275.00**

Brand new VHF rcvrs in original cartons; look exactly like the familiar **BC-453 Command Rcvr**s but are **9-tube superhet 108-135 mc AM rcvrs** and very easy to power & control without touching anything inside the unit; you can even connect an S-Meter externally. We furnish schematic and complete instructions on all pin connections and also a spline tuning knob. **A.R.C. Type No. R13B**. No tuning dial; we furnish graph of freq. vs knob turns. 2 uV sensitivity. 2 RF, 3 IF stages. Shpg wt 7 lbs fob Los Angeles **BRAND NEW \$22.50**
R32 is same but w/adjustable squelch **\$27.50**

R-23/ARC-5 Command rcvr 190-550 kc. **14.95**
A.R.C. 12 #22 Command rcvr 540-1600 kc. **17.95**
LM-14 freq. meter, .01% 125 kc-20 mc **57.50**
TS-323/UR freq. meter 20-480 mc., .001% **169.50**
BC-221's OK **\$67.50** **TS-175 OK** **127.50**
CLOSING OUT Radio Receivers 38-400 mc at **CRAZY LOW PRICES!** Ask for APR-4/Y/CV-253 sheet.

ALL-BAND SSB RCVR BARGAIN: Hallicrafters R-45/ARR-7., 550 kc to 43 mc continuous. Voice, CW, MCW, aligned, grtd, w/book; 2-RF, 2-IF's, S-meter: noise lmtr: 3 xtl, 3 non-xtl selectivity choices. Less power supply **149.50**
 60 cy power supply: \$30. SSB product detector: **\$20**

Collins R-390 Receiver, Exc. Cond w/book **750.00**
SP-600-JX Rcvr 54-54 mc, Exc. Cond., w/book **325.00**

Super. EMT 6220Y 3 ph 20 kva Line V Regulator **450.00**
Sorens. 10000S 10 kva Line V Regulator **695.00**
 And others from 250 VA up. Ask for Regulator List.
Automichron Cesium-Beam Freq. Standard **ASK!**
Regulated Power Supplies, Meter Calibrators **ASK!**
All kinds of AUDIO Test Equipment **ASK!**
Standard Signal Generators CW/AM/FM/Sweep **ASK!**
Bridges, Potentiometers, other Lab Standards **ASK!**
Electronic & Rotary Frequency Converters **ASK!**
Noise & Field Strength Meters **ASK!**

TIME PAY PLAN: Any purchase totaling \$160.00 or more, down payment only **10%**

Above is a small sampling of our terrific inventory. **We ALSO BUY!** We want Tektronix scopes, Hewlett-Packard eqpt., Aeronaut, radio-shop eqpt., etc. . . . AND Military Communications of all kinds.

R. E. GOODHEART CO. INC.

Box 1220-HR, Beverly Hills, Calif. 90213

Phones: Area 213, office 272-5705, messages 275-5342

CQ de W2KUW BEST OFFER!!

Paid for any piece of aircraft or ground radio units, also test equipment. All types of tubes. Particularly looking for 4-250 • 4-400 • 833A • 304TL • 4CX1000A • 4CX5000A et al. 17L • 51X • 390A • ARM • GRM • GRC • UPM • URM • USM units.
TED DAMES CO., 308 Hickory St., Arlington, N.J. 07032

Amphenol FET VOM



Here is a FET VOM which offers several features of interest to the amateur. The Model 870 **Millivolt Commander**, introduced by Amphenol, can measure voltages as low as 0.1 volt dc full scale or .01 volt ac full scale. These scales can be of tremendous value in servicing and debugging solid-state equipment. By comparison, a standard voltohmmeter might have a maximum sensitivity of 1.2 volt full scale. This instrument features a single probe for both ac and dc use and is rated for 2% dc accuracy full scale; 3% ac accuracy. It is battery powered, and in normal use, the shelf life of the battery will equal battery life. The unit weighs slightly over 4 pounds and is supplied with a lid for full protection when not in use. A pouch in the lid provides room for the probes.

The suggested retail price is \$99.95. Further information may be obtained by writing Amphenol Distributor Division, Amphenol Corporation, 2875 South 25th Avenue, Broadview, Illinois 60153.

1968 Radio Amateur's Handbook

In case you haven't noticed, the new edition of the **Radio Amateur's Handbook** is now available. Doug DeMaw, W1CER, the new handbook editor, has added a lot of new information in the latest volume. Obviously, you can't completely change a handbook of this magnitude in one year, but overall, the editor has done a tremendous job.

The semiconductor chapter has been en-

larged to include some typical transistor circuits plus text on FET's and integrated circuits. In addition, transistors are used in many of the construction projects in the rest of the book. There are a few projects carried over from the last edition, but there are lots of new projects, including a FET converter for 40 and 80, a 75-meter ssb transceiver, a transistor five watter for the novice, a stable FET VFO, and new amplifiers for 432 and 1296.

The VHF and UHF chapters have been completely overhauled with lots of interesting ideas for receivers, converters, transmitters and antennas. Even the appendix has been changed! Most of the low-cost transistors that are suitable for amateur work have been included in the data section. Although the list is not too long, Doug has chosen types that will satisfy most amateur requirements. This simplifies the task when you are trying to choose a transistor from the several thousand types that are currently available.

If you haven't seen this new volume yet, you owe it to yourself to take a look at it the next time you're in the local electronics emporium. A best buy at \$4 from your local distributor, or you can order directly from the American Radio Relay League, 225 Main Street, Newington, Connecticut 06111.

Lafayette 6-meter Transceiver

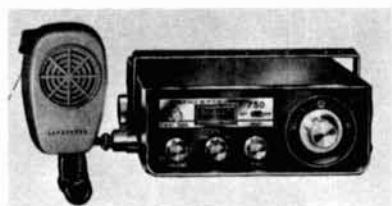

Lafayette Radio Electronics has announced a new solid-state 6-meter transceiver. This looks like a perfect low-power rig for keeping in touch with the local gang from your car or shack.

The transceiver includes a VFO and is designed to cover the busiest half of the six-

SPECIAL TV CAMERA PARTS KIT

only

\$99.95

including vidicon and lens!

To meet the many requests for a low-priced solid state TV camera kit, we have made available from our factory stock the following parts which you can assemble at very little additional expense into a superb TV camera. Included in the kit are the following:

- 1) Completely assembled and tested video amplifier plug-in circuit board with a 10-transistor 6 MHz bandwidth amplifier and keyed clamp with adjustable pedestal and sync mixer.
- 2) Completely assembled plug-in sweep circuit board with 8 transistor and 5 diode horizontal and vertical sweep generators and amplifiers featuring excellent linearity and more than enough drive for 1" vidicons.
- 3) Excellent quality deflection yoke and focus coil with beam alignment magnets and raster positioning adjustment. Also included is the vidicon tube clamp and target connector.
- 4) Camera tested vidicon excellent for amateur use and matched to the deflection assembly above.
- 5) Good quality F1.9 or better achromatic lens with matching lens mount.

Note: All items are brand new except vidicons which we guarantee will work with the parts kit supplied when assembled according to the schematic and adjusted according to normal procedure. Since step-by-step instructions are not available, we recommend this kit only to those who can follow a schematic. Due to the low price and limited quantity, we cannot sell the above components separately. When our present stock is exhausted, it will cost at least \$160.00 to repeat this offer. Order now to avoid disappointment.

VANGUARD LABS

Dept. R

196-23 Jamaica Ave., Hollis, NY 11423

IP274/ALA10, 2 Meter Panoramic Adapter

30 MC 5 MC input. 400 cycle power supply. With instructions for solid states 60 cycle supply and to 14 MC input. Internally complete, 3BP1 & 17 tubes. Excel. (45) **\$15.00**



R11A/ARC latest version of above. Has hi-Q, ceramic 85 KC IFs, (see Sept. 1963 73 "Q5-er reborn.") Very excel. used **\$11.95**

MN-26LB, BENDIX Direction Finder & Communication Receiver

3 band 200 to 410, 550 to 1200 KC & 2.9 to 6 MC. Internally complete, 12 tubes. Excel. used. (40) **\$12.95**

MN-20D, loop antenna for above. NOT ROTABLE. NEW **\$1.95**

TU-7, 4.5 to 6.2 MC

Loaded with transmitting micas, coils, 36 mmf variable, RF switches, rt angle & verniers. USED (18) **\$2.95**

LAZY MAN'S Q 5-er

1020 cycle filter, 3 position switch-RANGE passes 1020 cycle VOICE rejects 1020 cycle, BOTH no filtering. A "MUST" for CW & teletype. Lowest price. NEW (3) **\$2.25 ea**

CATHODE RAY TUBES, Mu Metal SHIELDS

902A, 2" **\$3.50**; 3AP-1 **\$2.95**;
3EP-1 **\$1.95** 5BP-1 **\$6.00**
5" for 5BP-1 **\$2.50**; 5" for 5CP-1 **\$2.50**
3" for 3BP-1 **\$2.00**; 3" * for 3JP-1 **\$1.75**

HEAT DISSIPATING TUBE SHIELDS

1 1/2, 2 or 2 1/2" for 7 pin; 1 1/2 or 2" for 9 pin. Choice **29c ea**; 4 for **\$1.10**; 25 for **\$6.25**

TUBE SOCKETS

- A) 4 pin, bayonet, for 811, 866 **69c ea**; 3/**\$1.95**
A) take outs, wired in pairs **69c pr**; 3 pr/**\$1.95**
B) 7 pin, ceramic wafer for 829B **79c**, 3/**\$2.25**
C) 7 pin ceramic wafer, for 1625 **39c**, 3/**\$1.10**
D) 4 pin, ceramic, ring & saddle **29c**, 4/**\$1.10**
D) 5 pin, ceramic, ring & saddle for 807 **29c**, 4/**\$1.10**

E) 11 pin, blk bake. EBY, for CRT **39c**, 3/**\$1.10**
All orders, except in emergency or I'm at a hamfest, shipped same day received. For free "GOODIE" sheet, send self addressed stamped envelope—PLEASE, PLEASE—include sufficient for postage & insurance. Any excess returned with order.

BC Electronics

2333 S. Michigan Ave.,
Chicago, Ill. 60616
312-CALumet 5-2235

ETCHED CIRCUIT BOARDS

Novice Trans.	2.75	Novice Recvr.	2.75
RTTY Encoder	2.50	RTTY Decoder	4.00
UHF Dippers	2.25	SWR Bridge	1.25
Lab Supply	3.50	144 Conv.	5.75
Keyer	4.95	CP Osc. Mon.	1.25

Conn. Residents add Sales Tax.
Send order or Catalog request to . . .

HARRIS CO., BOX 985,
TORRINGTON, CONN. 06790

meter band (50-52 MHz). The receiver includes one stage of rf and three stages of i-f amplification, while the seven-stage transmitter has a power input of 5 watts to the final rf stage. The transmitter can be either VFO or crystal controlled. Other features include an S-meter, spotting switch, noise limiter and a built-in speaker. It can also be used as a 2.5-watt PA system with an external speaker. The Model **HB-750** is designed for 12 volt dc (negative ground) operation and includes a power cable, mobile-mounting bracket and microphone. Both a 115-ac supply (**HB-502**) and a portable battery supply (**HB-506**) are available as accessories. The price is \$119.95 from Lafayette Radio Electronics, 111 Jericho Turnpike, Syosset, L. I., New York 11791.

Estes Noise Suppression Kits

Estes Engineering Company has announced new "bubble-pack" kits of noise suppression accessories for your mobile installation. Kits available include ignition suppression kits, alternator filtering and shielding kits, dc power-line filter kits and universal suppression kits. These packs will give you all the parts you need in one package thus simplifying the organization of your shielding problem. For further information write Estes Engineering Company, 543 West 184th Street, Gardena, California 90247.

NOISE BLANKER

Removes interference generated by auto ignitions, appliances, radars, and other sources of high energy pulse noise.



Provides the noise suppression required for reception of weak VHF DX and scatter signals. Connects between converter and receiver; for 50-93 ohm coax. Solid-state design features silicon Field Effect Transistors for reliability and minimum cross-modulation. Adjustable output coupling for optimizing system gain.

Send for technical brochure **TNB**

WESTCOM ENGINEERING COMPANY
P.O. Box 1504 San Diego, Cal 92112

WANTED: SURPLUS EQUIPMENT BUY-SELL-TRADE

WE NEED: AN/ARC-27, 34, 38, 52, 55, 73, 84; AN/ARN-14, 21C, 59; AN/APN-9, APN-70; AN/APR-13, 14, 17; AN/GRC-3 thru 46; RT-66, 67, 68, 69, 70, 77; AM-65/GR, PP-112/GR, TRC-24, TRC-75, GRC-27.

RECEIVERS: R-220/URR, R-388/URR, R-389/URR, R-390/URR, R-391/URR, R-392/URR, COLLINS 51J-3, 51J-4, URR-13, URR-27, URR-35, RAL.

TEST EQUIPMENT: SG-1A/ARN, SG-2A/GRM, SG-13/ARN, SG-12A/U, URM-25D thru F, AN/URM-26, MD-83A/ARN, UPM-98, UPM-99, SG-66A/ARM-5, ARM-8, ARM-22, ARM-25, ARM-66, ARM-68, USM-26, USM-44, TS-330, TS-510A, TS-683, TS-757, ARC H-14, H-14A, also, H.P., BOONTON, ARC, BIRD, MEASUREMENTS TEST EQUIPMENT.

COMMERCIAL AIRCRAFT EQUIPMENT: COLLINS 17L-6, 51V-3, 51Y-3, 618S, 618T, 18S-4, 621A-3, 860E-2, 618M, 618F, 479S-3, 479T-2, ARC: R-30A, R-34A, R-38A, RT-11A, R-836/ARN, BENDIX: RA-18C, TA-21A, RA-21A. TOP DOLLAR PAID PLUS SHIPPING. PAYMENT WITHIN 24 HOURS upon RECEIPT. WE TRADE OR SWAP ON NEW HAM EQUIPMENT. WRITE, WIRE, PHONE 813 (722-1843), BILL SLEP, W4FHY.

SLEP ELECTRONICS COMPANY
Highway 301

P. O. Box 178R
Ellenton, Florida 33532

one year
FREE
three-year subscription to

ham radio

only \$10.00

regular one year rate \$5.00

ham radio magazine, greenville, new hampshire 03461

MORE RANGE . . . with NO NOISE

FOR ALL
MOBILE UNITS



ELECTRO-SHIELD

CUSTOM SYSTEMS
KITS • ACCESSORIES

ELIMINATE IGNITION NOISE
ELECTRO-SHIELD[®]
YOUR ENGINE

FROM \$44.95



ESTES ENGINEERING CO.

543 W. 184th St., Gardena, Calif. 90247

VARACTOR SIMILAR TO MA4060A

Good for 40 watts at 432 MC, each tested in circuit. W/diagram for 432 MC tripler.

..... \$5.00 each

Send 25c for 1968 catalog.

MESHNA POB 62, E. Lynn Mass 01904

WE PAY CASH FOR TUBES

LEWISPAUL ELECTRONICS INC.

303 W. Crescent Avenue
Allendale, New Jersey 07401

NOVICE CRYSTALS

Fundamental frequencies in FT-243 holders. Pin size .093 in., spacing .486 in. Tolerance .03% measured in oscillator with 32 mmfd. capacity.

80 meters 3705-3745 kc.	\$1.75 ea.
40 meters 7155-7195 kc.	1.25 ea.
15 meters 7034-7082 kc.	1.25 ea.
2 meters 8056-8166 kc.	1.25 ea.

Add for postage and handling per crystal: 8c first class; 12c airmail. Specify frequency desired and nearest available will be sent. Other frequencies in stock. Send for free list. Satisfaction guaranteed.

NAT STINETTE, P.O. Drawer Q-1, Umatilla, Fla. 32784

"...IN THE DOG HOUSE?"

MOVE "IN"

WITH DESIGN INDUSTRIES WIFE
APPROVED COMMUNICATIONS DESK



. . . would You believe . . . SOME hams are permitted into the house . . . perhaps even the living room when their station includes a Design Industries Communications Desk or Console?

"Send Today For Our Special Wife Pacification Kit (Descriptive Brochure)"

DESIGN INDUSTRIES, INC.

P.O. Box 12365 Dept. H

AC 214-528-0150

Dallas, Texas 75225

ANTENNA SPACE YOUR PROBLEM?

TRY THE BARBED WIRE ANTENNA

A low-cost, easy-to-assemble application of the Fat Antenna Theory.

ADVANTAGES INCLUDE

- *1/8—Wavelength Shorter than a Conventional Half-Wave Dipole.
- *Greater Bandwidth—Less SWR Problems.
- *Easier to Match and Load.

THE BARBS IN KITS \$16.50 Prepaid.

\$2 Brings Construction Details & Picture.

CTK Enterprises—WB6ZKK

Box 444

Montebello, Calif., 90640



KEEP UP TO
DATE ON
YOUR DXING

A weekly magazine (16 to 24 pages each week).

Current DX that's on the air, and info about what's planned for the immediate future. What's being heard by the boys. Etc.

FULL DX INFO EVERY WEEK.

Per year—Surface mail (they say most 1st class mail actually goes via air) \$11.00

The DXERS Magazine, (W4BPD)
Route 1, Box 161-A,
Cordova, S.C. 29039

SOLID STATE—BROADBAND DOUBLE BALANCED MIXER

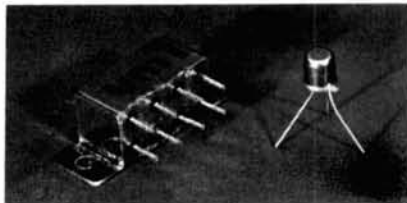

U.S.L. MODEL UM 1

Frequency Range 200 kHz to 200 MHz
When Used in a 50 ohm System
Conversion Loss 6 db Nominal; 7 db Maximum
Local Oscillator 45 db 200 kHz to 30 MHz
Rejection 35 db to 200 MHz
Replaces expensive and obsolete vacuum tube circuitry in a miniature R.F.I. package occupying less than 0.5 cubic inch.

P.C. card or chassis mount (indicate preference)

Applications Include:

- Balanced Modulator—Ideally suited for use in filter or phasing type S.S.B. generators.
- Receiver Mixer
- Product Detector
- Phase Detector
- Voltage Variable R.F. Signal Attenuator

State-of-the-Art performance and convenience offered by this broadband mixer are yours for only . . . \$15.00 (California residents add 5% Sales Tax)

SEND CHECK OR MONEY ORDER TO:

ULTRAMATIC SYSTEMS LABORATORY
Post Office Box 2143
Sunnyvale, California, 94087

LET W3KT FORWARD YOUR DX QSLs

Join the thousands of satisfied hams who have been using this service for the past seven years. During 1967 alone, over 200,000 QSLs were forwarded to DX stations. This is a DELUXE service, insuring prompt and continuous mailings, and involving a minimum of effort on your part.

Just fill in your QSLs and send them to W3KT. You don't have to address the cards, or indicate the QSL manager, or send any SASEs. Where a DX station uses a stateside QSL manager, your card will be sent to him with an SASE, and the reply will come back to W3KT, who will send it to your call area QSL bureau. Other QSLs will be sent to the proper QSL Bureau, or, if necessary, direct.

Remember, your QSL is a personal message. Therefore W3KT sends it by FIRST CLASS MAIL only.

The charge: Four cents per QSL, 30 cards per dollar. NO MEMBERSHIP FEE.

SAVE TIME! SAVE MONEY!

W3KT QSL SERVICE

RD 1, Valley Hill Road Malvern, Penna. 19355

"Your Friendly Supplier"

IN STOCK OFFERS

A COMPLETE "LINE-UP" OF ALL THE POPULAR TRANSCEIVERS

COLLINS KWM-2
GALAXY V MARK 2
DRAKE TR-2
SWAN-250
SWAN-350C
SWAN-500C
NATIONAL-200
SBE SIDEBAND ENGINEERS SB-34
Hallicrafters "Hurricane" SR-2000 SR-400

WE ALSO STOCK ACCESSORIES FOR ABOVE

For Additional Information, Write for our "Transceiver Portfolio" #73TR

Going Mobile??? Good Mobiles Go **HUSTLER**

We stock complete line of NEW-TRONICS Antennas, including the new "SUPER-HUSTLER".

We maintain the largest stock of used equipment in the Northeast—Engineering Department—Time Payment Plan available.

WRITE FOR LATEST COMPLETE LIST

Evans RADIO
P O BOX 312 CONCORD, N. H. 03301
FONE 603-225-3358

BUCK-TEN BAGS

SILICON DIODES

PIV	1 AMP	12 AMP	20 AMP	40 AMP	50 AMP	100 AMP	240 AMP
50			.25	.50	.55		1.50
100	.12	.25	.35	.75	.80		2.00
200	.15	.30	.50	1.00	1.05	1.50	2.50
400	.18	.35	.70	1.25	1.30		3.00
500	.20	.50	.90	1.50	1.60	2.00	4.00
600	.24	.65	1.00	1.75	1.90		4.40
800	.30	.75	1.30	2.00			5.00
1000	.35	.90	1.40	2.35			

2N670 Germ Audio. Gain over 100	10/\$1.10
FET's mostly C610-C615 types. w/spec sheet	3/1.10
200 miniature glass diodes, unchecked	200/1.10
2N424 MESA 80 watt	3/1.10
CK-722, a real value	6/1.10
VARACTORS experimental pack w/sheet	20/1.10
2N2875 20 Watt Planar	4/1.10
2N697 Hi freq 2 watt TO-5	15/1.10
2N696 Hi freq 2 watt TO-5	15/1.10
VARACTOR 40 Watt sim to MA-4060A w/cir.	ea. 4.00
1N251 Silicon diode, UHF mixer	20/1.10
TO-5 Sil. power mix 2N498-2N546-2N549	10/1.10
TO-3 Mix, 20-50 watt, 2N155-2N255	8/1.10
MICRO TRANSISTOR Planar Epitaxial w/sht	25/1.10
FLY SPECK transistor, micro miniature	8/1.10
MICRO DIODE silicon	20/1.10
2N706 Hi freq. 400 mc	7/1.10
BI-SWITCH make lamp dimmer etc. w/sheet	2/1.10
2N1417 Audio silicon NPN	15/1.10
2N670 Silicon audio	10/1.10
2N1059 NPN Germanium AF	10/1.10
2N613 PNP Germanium AF	8/1.10
2N404 Popular type PNP switching	6/1.10
2N414 PNP IF Germanium	6/1.10
2N990 Germ. RF factory branded	6/1.10
60 WATT silicon 2N1208-2N1209-2N1210 types	3/1.10
4 WATT silicon Mesa 2N498	4/1.10
ZENER - 6 volt .2 amp	4/1.10
GERMANIUM diodes Cleveite EM-1	20/1.10
IN82 Hi freq. mixer diode	25/1.10
TO-18 Hi-freq. switching RF transistors	25/1.10
TO-5 Hi freq. switching RF transistors	25/1.10
BI-DIRECTIONAL Silicon transistors	15/1.10
2N223 PNP germ AF, good gen. purpose	6/1.10
500 uufd Mica feed-thru button	15/1.10
IBM MEMORY CORES w/spec sheet	200/1.10
RESISTOR - MIX 100 units 1/2 watt	100/1.10
DISC CERAMIC CAPACITORS, mixed	100/1.10
2000 volt 1 amp diode	ea/ .80
3000 volt 1 amp diode	ea/1.20
REED SWITCH miniature glass	6/1.10
PHOTO-CELL resistive type	2/1.10
PHOTO-CELL, generates electricity	2/1.10
SILICON DIODES 1 1/2 amp mixed voltages	15/1.10
GEIGER COUNTER chassis, less tube	4.50
INFRA RED viewing tube, see in dark, w/specs	4.50
AIR FORCE throat mike w/strap	.60
MICROPHONE, small spy type w/experiment sht	3/1.10

All above material shipped postpaid in the U.S.

Send 25c for large catalog of many many interesting items.

Above transistors may be marked or unmarked.

**JOHN MESHNA JR 21 ALLERTON ST.
LYNN MASS. 01904**

Advertisers iNdex

AMECO Equipment Corp.	82
BC Electronics	92
Clegg Associates, E.T.	85
CTK Enterprizes	94
Dames Co., Theodore E.,	90
Design Industries, Inc.	94
Drake Co., R.L.	2
DXERS Magazine, The	95
Electronic Applications Co.	59
Electronics Center, Inc.	89
Estes Engineering Co.	94
Evans Radio	95
FM Bulletin	43
Goodheart Co., Inc., R. E.	90
Gordon Co., Herbert W.	Cover III
Ham Radio Magazine	47, 93
Harris Co., The	92
Henry Radio Stores	1
James Research Co., The	59
Lewispaull Electronics Inc.	94
Meshna, John Jr.	94, 96
Mission Ham Electronics	35
Mosley Electronics, Inc.	44, 45
National Radio Institute	88
Quement Electronics	51, 63
Selectronics	87
Slep Electronics Co.	93
Stellar Industries	84
Stinnette, Nat	94
Tri-Ex Tower Corp.	Back Cover
Ultramatic Systems Lab.	95
Unadilla Radiation Products	83
Uncle George's Radio Ham Schack ..	48
United Transformer Co.	Cover I
Vanguard Labs.	91
Waters Manufacturing Co.	6, 7
Westcom Engineering Co.	92
W3KT QSL Service	95

For Sale--More Usable Sideband Talk Power



A new design of distortion free audio clipper called the Comdel CSP 11 has been made available to the trade. Frankly, we are enthused about its performance from actual on-the-air tests. Two NCX-5's were hooked up to a SPDT coax antenna switch. One was barefoot with the processor in series with its mike. The other was using a BTI loaded to one kilowatt input and the same mike without processor. **Reports indicate almost comparable results.** I am not saying that the Comdel replaces the linear, but I do say that the greatly increased talk power is most obvious and therefore advantageous in pile ups or when the going gets rough.

The Comdel speech processor is in itself a complete miniature sideband transmitter and receiver with a common oscillator. Its circuitry includes filters and limiters designed so as to keep out the "crud" and at the same time, raise the average level of the spoken voice by a factor of 10 db. Each human voice is different. Various qualities of inflection, euphonics, and amplitude are characteristic of each of us individually. Our human voice has a notoriously low mean-to-peak signal ratio. Hence, the average signal, which determines the loudness at the receiving end, is only a small fraction of the total available peak power output. Conventionally, clippers are effective for increasing the mean-to-peak power ratio at the expense of severe and often objectionable harmonic distortion. Normally this distortion limits the usefulness of these clipping devices. In the Comdel speech processor, the objectionable harmonic distortion is absent and the intelligibility is enhanced by the unique circuit shown in the block diagram.

Conventional sideband transceivers or transmitters have power supplies which are designed for a duty cycle of about 15 to 25%. Application of the Comdel speech processor will make it necessary for the power supply to bear a substantially greater burden, since the average power is now approximately 60%. Thus, the average transceiver of and by itself

- Instantaneous limiting action
- No appreciable distortion
- Talk power gain greater than 10db
- Completely compatible with SSB
- Optimum frequency response for voice
- Installs in microphone lead
- All solid state circuitry

cannot be utilized advantageously by the Comdel. But if you have a transceiver which drives a linear with lots of room to spare, or if the linear that you have has a real bruiser of a power supply, such as may be found with the Henry II K or the BTI, or some Collins linears, or

most home-brew linears, then the Comdel will positively amaze you with its effectiveness. The unit is completely transistorized and requires but 9 volts of DC at 18 miliamperes, with the negative side grounded. This power may be supplied by dry cells or by means of a dropping resistor from a higher voltage supply. The front panel provides an in and out switch which connects the microphone straight through the equipment, or shunts the microphone around the equipment, depending upon your own wish. The volume control provides a means for setting the peak level when the device is turned on. The Comdel is priced at \$120.00, postage paid, in the continental limits of the United States. We have this very advantageous tool in stock, for immediate shipment, and we are heartily endorsing this product for use by radio amateurs or even commercial sideband stations. Literature is available for those seeking it.

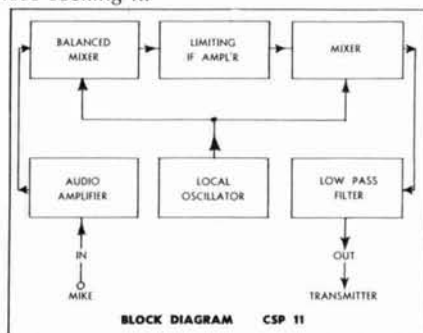

HERBERT W. GORDON COMPANY

Woodchuck Hill, Harvard, Mass., 01451

Telephone 617-456-3548



ALL NEW
THE TRI-EX
FREESTANDING
sky
needle
TM 370

*Holds 30 sq. ft. of
antenna in 60 mph wind.*

Telescopes to 70 feet up

Nested at 27-ft., it can be quickly run up to its full 70-ft. for instant use. The TM 370 Sky Needle is the only Tri-Ex telescoping tubular mast specifically designed for amateur antennas. Absolutely freestanding, the TM 370 will support a full 30^{sq.} ft. of antenna in a 60 mph wind. Only the best high-strength steel, welded by certified welders, is used in the tower's construction. Each section is fully galvanized—inside and out—after

fabrication for all-weather use. Single crank up and down operation is assured by the extra heavy-duty worm-gear, self-locking safety winch and galvanized aircraft-type cable. No special crane is needed to erect the Sky Needle because of its tilting hinged base. A ladder and work-platform is available as accessories. Tri-Ex offers immediate delivery. No shipping charges inside continental U.S.A. Write now for free brochure.



Tri-Ex TOWER CORPORATION

7182 RASMUSSEN AVE., VISALIA, CALIF. 93277