

AMATEUR TELEVISION QUARTERLY

VOLUME 6 #3
SUMMER 1993
JULY, AUG., SEPT.
ISSN 1042-198X
USPS 003-353

\$4.95

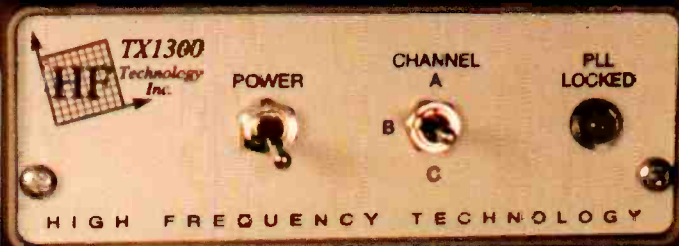
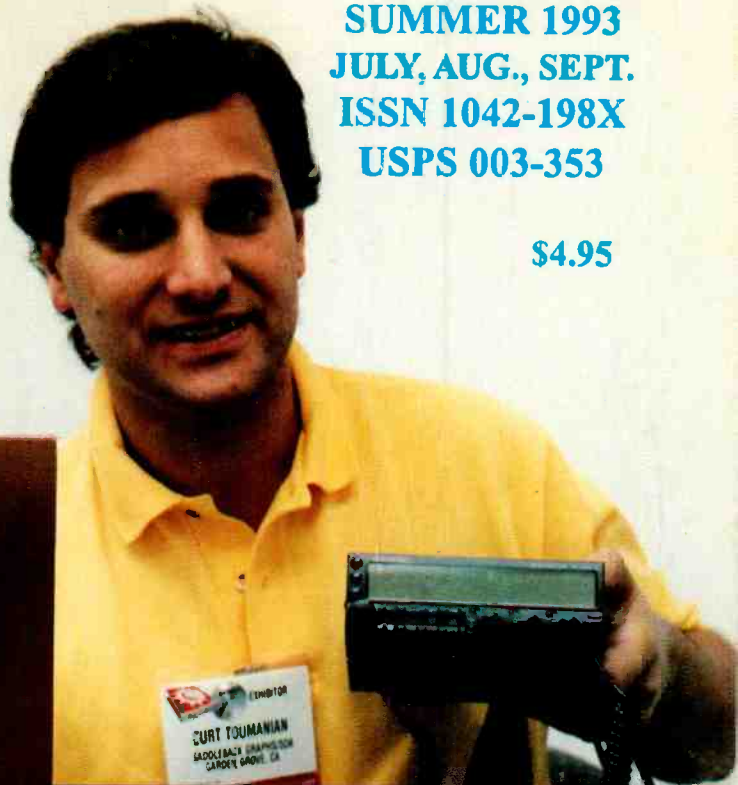

EXPIREDEXPIRES 1092 CR18
MARK R. NELSON AJ2X
17 Wentworth Rd
Natick MA 01760-1736

NEW ATV EQUIPMENT THE FM VIDEO EVOLUTION

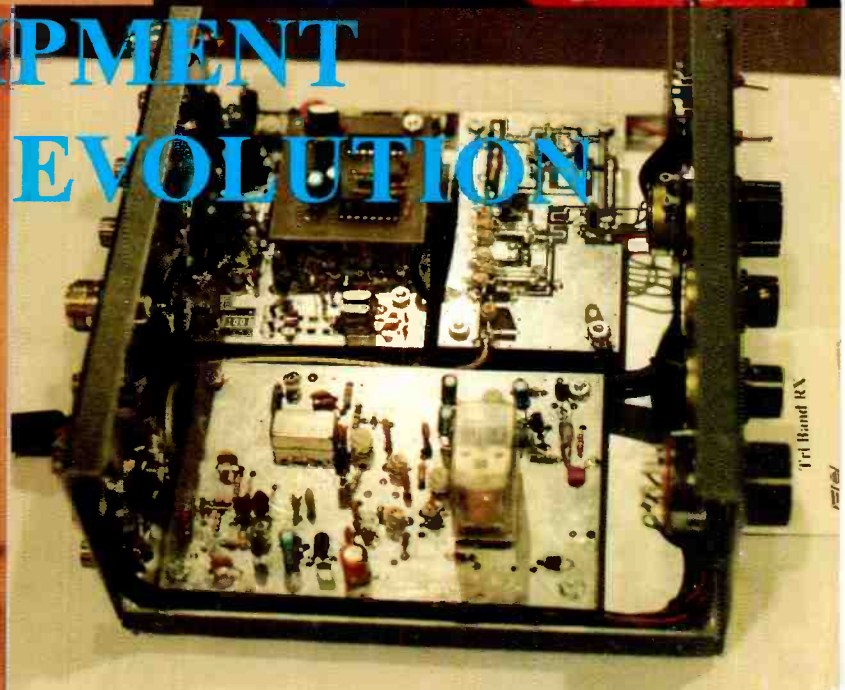



COMMERCIAL QUALITY AMATEUR TELEVISION



TX1300 \$349.00
NEW 1 WATT VERSION!

RX1300 \$219.00

IF70 \$199.00

TX1300 23 cm FM Video Transmitter
 Frequency of operation: 3 PLL synthesized user selectable channels
 1240 MHz to 1300 MHz
 Emission type: FM NTSC video with subcarrier audio (5.8 MHz)
 Deviation Video: +/- 4 MHz peak
 Audio: +/- 25 KHz peak
 Bandwidth Video: 50 Hz to 4 MHz
 CCIR pre-emphasis
 Audio: 50 Hz to 12 KHz
 75 usec pre-emphasis
 Output power: 1 W Nominal
 Power supply voltage: 11 to 15 VDC

RX1300 23 cm AM/FM Downconverter
 Tuning range: > 1240 MHz to 1300 MHz
 Noise figure: < 2 dB across band, unconditionally stable
 no internal tuning required
 Rear panel: RF input (SMA connector), IF output (F connector), connect directly to TV for AM reception or connect to IF70 for a high performance FM system
 Power supply voltage: 11 to 15 VDC

IF70 FM Video IF/Demodulator and Subcarrier Receiver
 IF input frequency: 70 MHz nominal
 IF bandwidth: 16 MHz
 IF sensitivity (20 dBQ): -70 dBm
 Input dynamic range: -80 to +3 dBm
 Subcarrier input freq: Approx. 5.8 to 6.2 MHz
 Video output: 1 V pk. to pk. for 4 MHz pk. deviation @ 1 KHz modulating freq. Follows U.S./CCIR 405-1 video de-emphasis.
 Video bandwidth: 50 Hz to 4.0 MHz
 Video capability: Broadcast standard, color and black and white
 Audio output: 0dBm nominal for 5.5 to 6.2 MHz subcarrier
 Audio bandwidth: 50 Hz to 12 KHz +/- 3 dB
 75 u sec de-emphasis
 Power supply voltage: 11 to 15 VDC
 Current consumption: 250 mA nominal (high Z speaker load)
 Operational temp: -10 to +40 C
 Rear panel: IF input (F-connector), power, video output (RCA jack) 1 V pk. to pk., audio output (RCA jack) capable of driving 8 Ohm speaker load.
 Front panel: On/Off switch, power LED, video polarity switch, volume control.

Also available...complete line of 450 MHz FMTV equipment: TX 450 FMTV transmitter @ \$ 174.00; RX 450 AM/FM ATV downconverter @ \$149.00, for use with the IF70 for FM or for AM applications. Also available soon, a complete line of FM ATV equipment for the 13 cm band. Custom versions of the above equipment can be manufactured to order. All equipment packaged similar to photographs.

For information or to place orders phone: 708 885-9021, VISA,MC accepted. To order by mail or to inquire for more information write to HFT Inc. 509 Washington Blvd. Hoffman Estates, Il. 60194. Please add \$5.00 for shipping and handling, Illinois residents add 7.5% sales tax. Some specifications may be subject to change.

HIGH FREQUENCY TECHNOLOGY INC.

Amateur Television Quarterly (ATVQ) ISSN 1042-198X is published four times a year by Amateur Television Quarterly. Subscriptions are \$18/yr. US, \$22/yr. Canada and \$29/yr. DX.

Amateur Television Quarterly USPS is mailed as Second Class Postage Paid USPS permit 003-353 at Des Plaines, IL 60018 and additional offices of entry.

Postmaster please send change of address and all other mail to: Amateur Television Quarterly, 540 Oakton St., Des Plaines, IL 60018.

Subscriptions and submissions should be sent to: Amateur Television Quarterly, 540 Oakton, Des Plaines, IL 60018. Telephone orders and inquiries may be placed using Visa or MasterCard at 708 298 2269. FAX mail, 708 803 8994. Unless instructed otherwise, subscriptions start with the current issue. Issues are also available at most ham radio stores.

Amateur Television Quarterly is copyright 1988, 1989, 1990, 1991, 1992, 1993. All rights reserved. No portion may be reproduced without written permission. Non US publications may reproduce portions provided credit is provided in the title page. Ham Clubs may obtain blanket permission by sending a request and a copy of their newsletter.

STAFF:

Publisher: Henry Ruh KB9FO
Asst. Publisher Bill Brown WB8ELK
Retail sales: Sylvia Ruh
Text Entry: Debra Gillespie
Subscription mailing: Jan Robinson
Database: Professional Services Inc.

BACK ISSUES

Amateur Television Quarterly is sold out every issue. Back issues may be obtained from EFS Copy Service, 4011 Clearview Dr., Cedar Falls, IA, 50613. 319 266 7040.

BECOME FAMOUS: SEND YOUR ARTICLES AND NEWS TO ATVQ TODAY!

Besides bragging rights, congratulatory calls from your friends, and a 6 dB improvement in your signal, your article in ATVQ will be seen by thousands of readers who will respect you for the rest of your life. Become the topic of conversation at hamfests!

WRITER'S GUIDE

If possible, text should be type written (or printed) or can be provided on disk. ATVQ can convert any DOS compatible text file. Any size disk to 1.44 Meg. Printed copy should not be dot matrix. Diagrams should be neat and drawn with the aid of rulers and drafting aids if at all possible. Label all parts and connections.

INDEX OF ARTICLES

ATV NEWS: PEOPLE AND PLACES	3
REPEATER NEWS	4
NEW PRODUCTS AND TECHNOLOGY	7
WA6SVT REVIEWS PARABOLIC FM ATV	12
THE W6ORGy NOTES: FM VIDEO PART II	16
BUILD: AN FM TV RECEIVER	20
VGA TO NTSC ELITE	30
FLEA MARKET CLASSIFIEDS	36
SUMMER CES	37
NEW AT Q	38
HAMFESTS OLD AND NEW	40
SSTV UPDATE	43
EDGE OF SPACE SYMPOSIUM	46
STACKING ANTENNAS	47
ASHLAND, KY BALLOON	49

ADVERTISER INDEX

AEA Cover IV	29	Elktronics	39
All Communications	29	HF Technology	Cover II
ATV Electronics	41	International Crystal	14, 15
ATV World	19	M ² Enterprises	5
Comet Antennas	11	Micro Computer Concepts	5
DIR Publishing	15	Micro Video Products	14
Down East Microwave	14	Olde Antenna Lab	44
Pauldon Associates	2		
P C Electronics	32, 33, 34,35		
Parabolic	10		
Pictorionics	23		
Rutland Arrays	6		
Spectrum International	13, Cover III		
Subscription forms	28		
ATVQ Book shop	25, 26, 27		

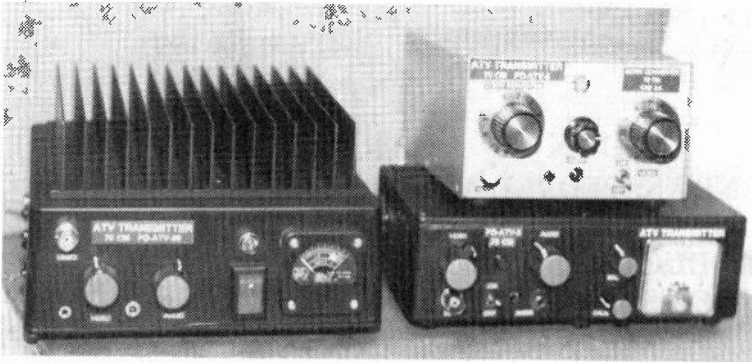

PD-ATV-50

70 CM ATV Transmitter

50 watt output

TRANSMITTER HOUSED IN A 7/8" x 7/8" DIECAST BOX
 SIZE: 6 1/2" x 7" x 1 1/4" HEAT SINK (15 FINS).
 METER INCLUDED FOR MONITORING POWER OUTPUT.
 SAMPLER (3 STAGES) OUTPUT HAS A BNC JACK FOR SCOPE AND VID.
 MONITORING
 SWITCH SELECTION OF 2 FREQUENCIES 439.25 and 434.00
 YOU CAN ORDER FREQUENCIES OTHER THAN THOSE LISTED
 HEAVY DUTY "OFF-ON" 15A SWITCH. A RED LED "TRANSMIT" LIGHT
 THERMISTOR PROTECTED
 VIDEO AND AUDIO LEVEL CONTROLS ON FRONT PANEL
 A "N" CONNECTOR FOR ANTENNA AND A BNC FOR RECEIVING OR DOWN
 CONVERTER
 SUB-CARRIER SOUND
 POWER MODULE "BRICK" (M67728) 50 WATTS OUTPUT
 AVERAGE VIDEO OUTPUT 32 WATTS
 HEAVY DUTY RELAY
 POWER VOLTAGE RED POSITIVE BINDING POST AND BLACK GROUND
 (2) CONTROLS ON BACK FOR SAMPLER OUTPUT AND VIDEO LEVEL OUTPUT
 PRICE: \$579.00

PD-ATV-5

70 CM ATV Transmitter

5 watt output

(10 W. P. E. P)

TRANSMITTER HOUSED IN A 4 1/4" x 7 1/4" DIECAST BOX
 ALUMINUM BLOCK HEAT SINK 1/4" DEEP x 4" x 2" OPTIONAL FIN TYPE.
 METERED SAMPLER FOR MONITORING POWER OUTPUT
 THE (3) STAGE SAMPLER HAS BOTH R.F. CH.3 OR CH.4 ("F" CONNECTOR) AND
 A VIDEO OUTPUT "BNC" CONNECTOR.
 SWITCH SELECTION OF (2) FREQUENCIES (439.25 OR 434.00)
 YOU MAY SELECT OTHER FREQUENCIES IF DESIRED
 TOGGLE SWITCH - 10 AMP CAPACITY
 A "RED" XMIT LIGHT WHEN TRANSMITTER IS OPERATING
 VIDEO AND AUDIO LEVEL CONTROLS ON FRONT PANEL
 BNC JACK FOR VIDEO INPUT AND 1/8" JACK FOR MICROPHONE USE
 SUB CARRIER SOUND
 POWER MODULE OUTPUT - 5 WATTS
 AVERAGE VIDEO OUTPUT 2-3 WATTS
 RED BINDING POST (+) VOLTAGE 12-13.8V
 BLACK BINDING POST (-) GROUND
 METERED 0-50 FOR POWER OUTPUT OBSERVATION
 SAMPLING POWER AND VIDEO LEVEL CONTROLS ON FRONT PANEL
 ANTENNA "N" CONNECTOR
 PRICE: \$293.00

PD-ATV-4

70 CM Transceiver

SIZE 7" x 3" x 3" HIGH (LIGHT GREY WITH BLUE TOP) TRANSMITTER OUTPUT
 IS 5 WATTS. RECEIVER IS DOWN CONVERTER - CH. 3 or 4 ("F" CONNECTOR)
 HEAVY ALUMINUM BLOCK HEAT SINK 4" x 2" x 1/4" DEEP. BRICK POWER
 MODULE. SWITCH ON BACK PANEL FOR FREQ. CHANGE.
 BI-COLOR LED (GREEN RCY - RED XMIT)
 "OFF" - "ON" SWITCH. IN DOWN POSITION RCY. GREEN (LIGHT) (UP XMIT
 RED (RIGHT) VIDEO INPUT "BNC" CONNECTOR ON FRONT PANEL
 ANTENNA "BNC" CONNECTOR ON REAR PANEL
 RELAY CONTROLLED
 AUDIO JACK 1/8" AND PTT 3/32" JACK FRONT PANEL
 SUB CARRIER AUDIO SOUND
 VIDEO AND AUDIO LEVEL CONTROLS ON FRONT PANEL
 DOWN CONVERTER RECEIVE CONTROLS ON FRONT PANEL
 PRICE: \$399.00

ATV INTERDIGITAL FILTERS



439.25\$170.00 434.00 ...\$170.00 426.25 ...\$170.00
 423.25\$170.00 & others in the 70 cm band\$170.00
 910.25 & others in the 33cm. band \$165.00

PREAMPLIFIERS

TOWER MOUNTED DIECAST 125 WATT CAPACITY
 DESIGNED FOR PACKET-FM-SSB-ATV

100 miscs. & 1/2 sec. switching
 MAGNACRAFT RELAYS & DIODE PROTECTION
 SINGLE GATE GaAs Fet, Transistor
 NF 0.6db G 16db.

PD-440TR-L 420-450mhz.\$123.00
 SAME with ISOLATOR 135.00

TOWER MOUNTED DIECAST 75 WATT CAPACITY

FAST SWITCHING
 SPECIAL RELAYS & DIODE PROTECTION
 SINGLE GATE GaAs Fet Transistor
 NF 0.6db. G 13-17db.

TPD-900-TR-L 900mhz. \$179.00
 TPD-1200-TR-L 1.2ghz.... 179.00

NON SWITCHING TYPES

PD-440S (70cm) 420-450mhz. ..\$56.00
 Diecast

TPD-900 900mhz. 82.00
 diecast

TPD-1200 1.2ghz 82.00
 diecast

YOUR CHOICE OF CONNECTORS
 PREAMPS from 2 meters -thru 2.3ghz.

WRITE OR CALL FOR CATALOGUE

POWER AMPLIFIERS				VHF - UHF	
ATV - SSB - FM - CW - PACKET - REPEATER / 2 Meters - 1.2 Ghz.				Microwave Products	
				Preamplifiers / Power Amplifiers	
				144Mhz - 2.3 Ghz.	
PD-144N	144-148 Mhz.	Preampl. Incl.	FM	4-5watts = 35W	T/R \$129.
PD-144-3	144-148 Mhz.	Preampl. Incl.	Linear	4-5watts = 35W	T/R 139.
PD-144N-2FM	144-148 Mhz.	Preampl.	Yes FM	4-5watts = 60W	T/R 175.
PD-220N	222 Mhz.	No	FM	4-5watts = 35W	T/R 119.
PD-440N	420-450 Mhz.	No	Linear	1/2 or 4-5W = 18W	T/R 119.
PD-440N-2	420-450 Mhz.	Yes	No	1/2 or 4-5W = 18W	T/R 143.
PD-440N-1	"	"	"	1/2 or 4-5W = 35W	T/R 155.
PD-440N-1	"	"	"	1/2 or 4-5W = 35W	T/R 179.
PD-440N-2	"	"	"	1/2 or 4-5W = 60W	T/R 285.
PD-440N-2R	"	"	"	3-4W = 60W	T/R 199.
PD-440N-3	"	"	"	3-4W = 60W	T/R 235.
PD-440NM	"	"	"	1/2 W = 6W	T/R 75.
PD-440NM	"	"	"	1/2 W = 10W	T/R 65.
PD-900N	902-928 Mhz.	No	FM	1/2 W = 10W	T/R 90.
PD-900N	902-928 Mhz.	No	FM	1 W = 18W	T/R 265.
PD-33LHP	902-928 Mhz.	No	Linear	1 W = 16W	T/R 299.
PD-33LP	902-928 Mhz.	No	"	1 W = 6.5W	T/R 119.
PD-33HP	"	"	"	6 W = 15W	T/R 123.
PD-33VLP-1	"	"	Hybrid	5mw = 8W	T/R 59.
PD-33VLP	"	"	Linear	1/2 W = 1.5W	T/R 65.
PD-33	Doubler 70 cm. = 33 cm.	"	"	1/2 W = 1.0W	T/R 85.
PD-33	Doubler 70 cm. = 33 cm.	"	"	1 W = 18W	T/R 149.
PD-1200N-1	1.2 Ghz.	Preampl	No	1 W = 16W	T/R 205.
PD-1200N-2	1.2 Ghz.	"	Yes	1 W = 16W	T/R 299.
PD-1200N-3	1.2 Ghz.	"	Yes	3 W = 36W	T/R 285.
PD-1200N-1	1.2 Ghz.	"	No	3 W = 36W	T/R 285.
Preamplifiers: 2 mtrs. - 2.3 Ghz. \$25.00 - 139.00					

P.A. for repeater or commercial use. Output: 1.5 watt to the 65 watt range. We will custom build if desired. Power amps. for use in the 800 mhz. region using the "HOME VIDEO" system transmitters. Ex: GEMINI VC-2000. ATV line samplers for ATV use. Power Meter included. Interdigital Filters: 70 cm. & 33 cm. Aluminum Welded 7 pole, \$170.00 and up. ANTENNA SWITCH BOXES: 20-300 watts, 2 mtrs. - 2.3 Ghz. Prices reasonable. Made in the U.S.A. All products are warranted. Call or write for catalog.

pauldon
 ASSOCIATES
 210 Ullica St., Tonawanda, NY 14150
 (716) 692-5451

DOWN CONVERTERS FOR 70 & 33 CM.
 SAMPLERS (LINE) 70-23cm RANGE.
 VARIOUS PRICES WITH OUTPUT METERS.
 BRICKS ON BOARDS: \$35.00 to \$150.00

ATV NEWS

PEOPLE AND PLACES

DARA HONORS ATV'er



PHOTO BY HARRY W0ZGL

At Dayton '93, Tom O'Hara W6ORG, received an award from the Dayton Amateur Radio Association. Presented by Bill Parker W8DMR, a 35+ year veteran of ham TV, the award is in recognition of Tom's many years of work in organizing and presenting the ATV forum. Tom is recognized the world over as THE expert on ham TV. Tom is owner (with his XYL Maryann WB6YSS) of PC Electronics that has been providing the ham community with ATV gear for nearly 30 years. Tom, holds a BS degree from Cal State, and worked for many years in the electronics industry as a design engineer for broadcast and military RF systems before "retiring" to his own business. Tom's other interests include flying, (fixed wing and rotary) marathon running and dirt biking in the desert.

Nearly all ATV manufacturers and UHF amplifier manufacturers utilize Tom's experience and expertise and have had Tom evaluate their equipment. As a result, many improvements were made because of his suggestions, thereby raising the level of quality of all ATV products. Tom has also been a long time contributor to the ARRL Handbook and advisor to the ARRL and frequency coordinators. As Tom says, "The more manufacturers in this business, the more hams will be attracted to ATV and the more fun it will be for all of us."

ARKANSAS ATV REPEATER

Folks visiting Arkansas should look towards Harrison, AR for ATV. The system is two back to back ATV repeaters, 1277 in, 1255 out and 439.250 in 421.250 out. The 1200 system uses only 1 watt, but users can control the direction of a high gain KLM beam for rx/tx using touch tones. The 450 system is less directional and with the correct code, the user can also gain access to other bands for voice. The system is at 2200' AMSL and operation to 80 miles is consistent. The owner, Elmo, also publishes a nice newsletter called Heterodyne. Send SASE for copy. Contact Elmo HC 37 Box 144, Harrison, AR 72601.

CHICAGO ATV REPEATER IS BACK

The PATC ATV repeater is back on the air. The system is operating on 439.25 lower VSB input and 421.25 upper VSB output. The system is currently using a commercial Lindsay 3 panel 14 dB gain horizontal omni antenna. The current site is for equipment tests and the system will move to a better location soon. The system uses a PC Electronics receiver, an AEA VSB-70 exciter, an AEA RLA-50 amp, and a TX-RX duplexer. Repeater call is KB9FO.

REPEATER NEWS

SAN JOSE, CA ATV NEWS

South Bay Amateur Television by Robert Reiling
W6JHJ

ATV operation is active in South Bay with many operators regularly sending pictures. This is attributed to the Palo Alto (Black Mountain) ATV repeater operation. There is excellent coverage of South Bay. It is sponsored by the Palo Alto chapter of the Red Cross.

It isn't difficult to get on our system. Input is on 434.00 or 910.25 using regular AM mode TV. The output is on 1255 MHz FM TV call sign KE6DN/ATV. Voice coordination is on 145.51 simplex. A regular net meets thursday 8:45 PM on the 145.27 FM repeater. A receiving system using a 20 inch diameter parabolic antenna, downconverter and 60 feet of coax is available for \$125.

The repeater is operational 6 PM to midnight and operation on other hours is available when a control operator is on duty.

ATCO ATV REPEATER

For those of us who have been in ATV for a while, it seems that ATV activity was started and centered in Ohio. Not true of course, but the level of activity in Ohio had always been higher than most any area except Los Angeles. Over the years the activity has fallen off a bit despite the blessings of many statewide openings which occur regularly enough to have state wide (and multi state) QSO's with ease. Repeaters finally sprung up in Dayton, Lima and Cleveland. Now Columbus, the center of the state will have an ATV repeater soon. Input will be 439.25, output 421.25. A link on 1255 MHz. Expected operation will be HORIZONTAL with 50 watts of TX power. WA8RMC and WA8RUT are the main builders and the system should be operational in June. In response to their inquiry about getting a license from a weather data service, ATVQ sent a copy of the first ever such license issued to KB9FO ATV RPT (Chicago) to assist in their efforts. A beacon is operating temporarily on 434.1 MHz and touch tone control on 147.545 (4-3-9) allows locals to find the right antenna aiming direction. TNX ATCO Newsletter.

SANTIAGO PEAK

Input 434, output 1253.25 VSB and soon 2441.5 FM Video input.

ATN reports that besides niceties like ice shields to prevent falling tower ice from crushing their cars, a four foot dish has been installed at Santiago Peak ATV repeater to link to Oat Mountain and soon another to link to Blue Ridge Mt. Nine inputs are available to select



from on the system, including Mt. Potosi, NV for the Las Vegas/Henderson area.

Jim KC6TFV converted three commercial MDS receivers for the 2 GHz links. Necessary FM IF strips and Forest Service permits were previous secured. Mike KC6CCC built a superb FM IF for the input at Santiago and the new hardware should be installed soon. Much depends on the weather at the high elevations (see cartoon). TNX ATN Newsletter.

TENTH ANNIVERSARY

Wondering what to do this summer for a little extra fun? You don't have to wait 10 years for an ATV pool party. Try this:

ATN held a 10th anniversary bash at the QTH of K6IIS, Ken Wood, of Fontana, CA. The pool party offered put luck BBQ, burgers, hot dogs and soda plus whatever side dish attendees brought. In attendance were Earl KS8J of ATV World/ATV Electronics, in Phoenix, AZ, Phil Smith WB6LQP, organizer of the annual ATV coverage of the Rose Parade, ARRL official Fred Heyn WA6WZO, and Grant Dixon G8CGK who related anecdotes of early UK ATV and is also president of the Narrowband TV Association (GB). Our reporter, John WB6ZPN reports all had a great time.

The 440-18 is a carefully computer optimized broadband yagi featuring an excellent pattern and good gain across its bandwidth. It can be mounted vertically or horizontally.

OTHER ANTENNAS OF INTEREST FOR ATV USE

420-450-11
420-5-5
432-9WL

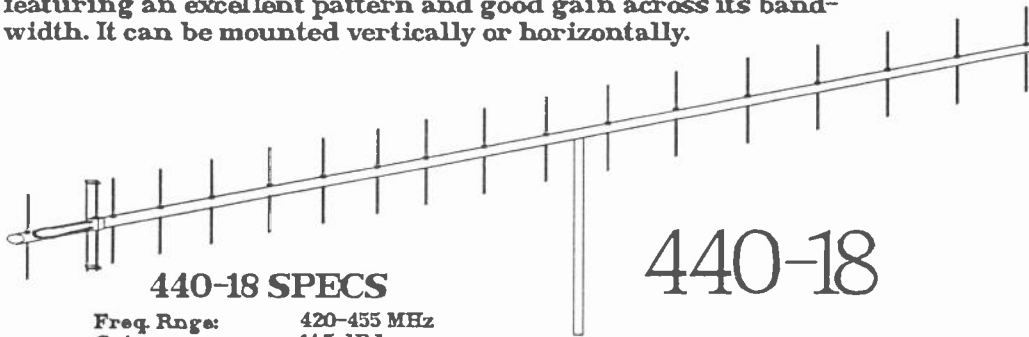

440-18 SPECS

Freq. Range: 420-455 MHz
Gain: 145 dBd
Frt to bck.: 23 dB
W. Area: .875 sq. ft.
Boom Lg: 11.33 ft.
Trn. Rad.: 6 ft.

440-18

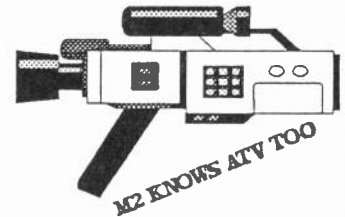

M2 KNOWS ATV TOO

ATV

Is important to us!

M² Enterprises

7560 N. Del Mar Fresno, CA 93711
(209) 432-8873 FAX (209) 432-3059

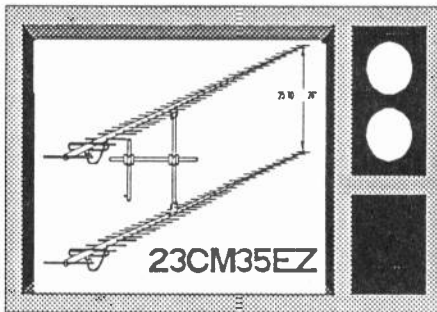

23CM35EZ SPECS

Freq. Range: 1250 to 1300
Gain: 18.4
Frt to Bck: 23 dB
W. Area: 0.6 Sq. Ft
Boom Lng: 120 in
Trn. Rad: 6 Ft.

VS-100 ATV Repeater Controller

- * Ten Video inputs and four audio inputs.
- * Three operational modes: Repeater, Scan & Manual.
- * Built in CW ID programmable with touch tone.
- * Control receiver input for touch tone control.
- * Touch tone programmable control and user codes.
- * Eight AUX TTL touch tone controlled outputs.
- * 19"w x 1.75"h x 8"d enclosure with 115 VAC power supply.
- * Video ID input with support for ELKTRONICS video ID.
- * Built in sync detector (VOR board).

Micro Computer
Concepts AMERICAN

813-376-6575

Visa, MC, MO, checks, COD

8849 Gum Tree Ave, New Port Richey, Fla 34653

REPEATER NEWS

ATV REPEATER CAN TRANSMIT MUSIC!

Well, if you are in **Great Britain** you can! The GB3ZZ newsletter, P5, reports that users should not retransmit broadcast TV as the local BBC and HTV broadcasters have hams who can easily receive the repeater, but music incidental to home movies (ie a marching band) is OK. Its nice to see some sanity in government!

So you have a hard time making it from 440 to 1252 MHz? How about 10 GHz? The Europeans have been very active on microwave, and a complete 10 GHz ATV repeater is very doable. Over here in the US it could even have practical uses for a mobile station to operate on 10 GHz FM ATV. Most radar detectors receive 10 GHz. A good high site could have coverage nearly equal to other bands provided the user station is above the trees and line-of-sight. See the article elsewhere in this issue.

ROANOKE, VA ATV RPT

The Blue Ridge Digital Society N4FHL/R ATV repeater is operating with 439.25 in and 426.25 out, horizontal polarization. Local talk audio is on 145.21 repeater (WB4QOJ/R).

DAYTONA BEACH TWIN ATV REPEATERS!

The Maley repeater on Beach Street south of Orange Avenue, input 1289.25 and 923.25 with output on 421.25 MHz. Beville Repeater on Beville Rd east of Nova Rd. Input on 434.00 and output on 1289.25 MHz. Systems have remote video cameras, video BBS, and offer shuttle operations video. Their newsletter, Daytona Beach ATV News also did a review of the ATV Electronics/ATV World (Earl Campbell KS8J and Greg Stayton NT7L) ATV-5 transmitter and rate it **two thumbs up**. Their test unit measured 9 watts out at 13 volts.

RUTLAND ARRAYS
DELIVERS
THE HIGHEST GAIN ATV ANTENNA YOU CAN BUY!
Model: **FO22-ATV**

MEASURED GAIN >15.8 dBd

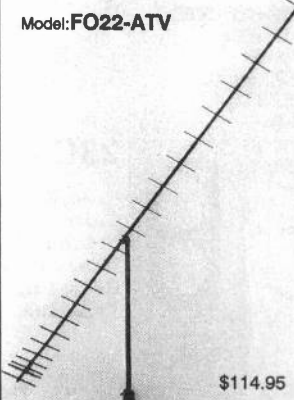

Model: **FO22-ATV**

\$114.95

ELECTRICAL SPECIFICATIONS:

Gain bandwidth 420-450 MHz
 VSWR < 1.33:1 415 to 450 MHz
 E-Plane beamwidth 23 Deg.
 H-Plane beamwidth 24 Deg.
 Sidelobe attenuation
 1st E-Plane -17.5 dB
 1st H-Plane -15.5 dB
 Maximum power 1500 Watts
 F/B ratio 22 dB
 Impedance 50 ohm

MECHANICAL SPECIFICATIONS:

Length 14 Ft.
 Boom 1" OD 6061 T-6 Al
 Elements 3/16" Al rod
 Mast up to 1.5" dia.
 Wind surface area78 Sq.Ft.
 Wind survival 90+ MPH
 All Stainless Steel Element Hardware
 Coax connector N-type
 Polarization: Horizontal or Vertical

ALSO AVAILABLE
SIX METER, TWO METER, 222 MHz, 432 MHz ANTENNAS
POWER DIVIDERS ——— STACKING FRAMES

CALL OR WRITE FOR OUR NEW CATALOG

AVAILABLE FROM

Down East Microwave
Troy, ME
Fred Gore, KA1TBS
Southwick, MA
P.C. Electronics
Arcadia, CA
Stewart Electronics
St. Charles MO.
Wyman Research
Waldron, IN

RUTLAND ARRAYS

1703 Warren St
 New Cumberland Pa 17070
 Orders 1-800-536-9266 Info. 1-717-774-9570
 7pm-10pm EST
 PA residents add 6% State Tax
 UPS S/H \$5.00

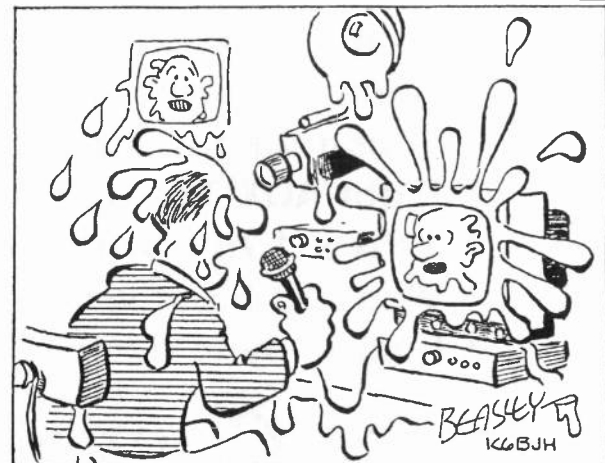

I GOT MY AUDIO SQUARED AWAY, NOW I GUESS MY VIDEO IS SPLATTERING!

6

ATVQ, SUMMER 1993

PRODUCTS AND TECHNOLOGY

T D SYSTEMS/BESTLINK CLOSES

In a phone conversation with ATVQ, Troy Jackson of Bestlink announced in mid May that the parent company has ended the Bestlink operations in Tennessee. Founded by Steve Franklin of Texas, Bestlink/TD Systems had produced excellent ATV equipment. The units were both AM and FM video the entries in FM video were pioneering for 900 and 1200 MHz ATV. T D Systems used a mast mounted RF package and a shack mounted control panel. The units were the first ATV commercial products to use surface mount technology and users reported excellent quality signals. The effort was marred by long delivery delays (reportedly up to a year and more) and by a lack of paid advertising and promotion to ATV'ers. Sales were largely due to word of mouth from early purchasers. There may be a bulk sale of parts as the plant closes.

FM ATV RECEIVERS

HF TECHNOLOGY has made improvements in their fine FM ATV receivers. The new units will have adjustable audio subcarrier to be compatible with other units. There has been no standard for FM audio on FM video and various manufacturers use among others, 6.5 Mhz, 5.5 MHz and 4.5 MHz as audio subcarrier frequencies. The new units should be available about the time this issue reaches you in the mail. The 1252 MHz FM video transmitter companion unit puts out 1 watt and Tom O'Hara W6ORG, ARRL Technical Advisor, who has tested both, says both work great. **HIF Technology** is also developing a dealer network. Time to remind readers to approach their local ham store about putting up an ATV display/demo station!

SIX METERS

No its not a new ATV band, even though Wayne Green W2NSD and Henry Ruh KB9FO years ago, independently filed with the FCC to allow ATV on this under used band. Besides DX'ing commercial TV (from Europe and Africa too) on this band, a humorous but accurate article appeared in QRP Quarterly, by ATV'er Tom W9NBG.

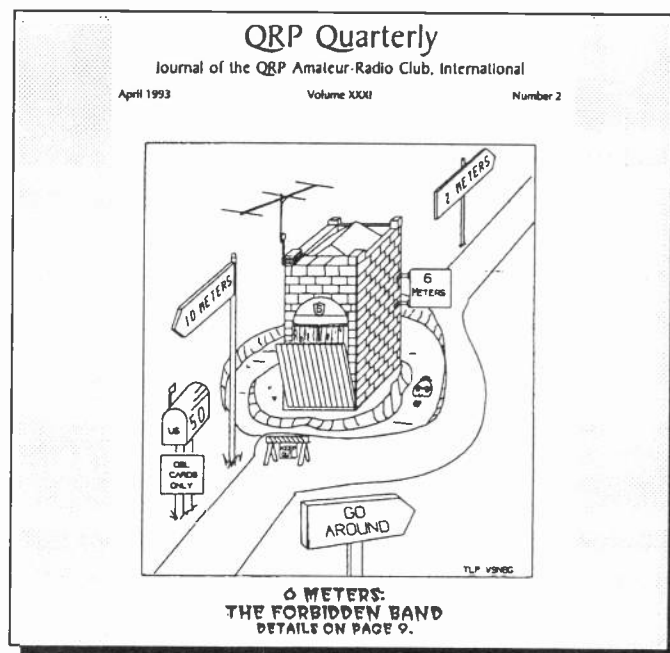

Six also makes a good QRM free talk/intercom band for ATV operations if two meters is too full in your area. The airwaves are verbally cleaner on six than two since most people get on six meters because they have a serious interest in DX, not because the local store has a sale on HT's. If you have an interest in QRP, you can subscribe from Jim Griffin W9NJP, Knight Lite USA Inc., PO Box 587, Geneva, IL 60134.

MORE ✈✈✈

ATV ANTENNA

AERO-TRAC Systems Inc, PO Box 294, West Warwick, WI 02893 is offering a UHF log periodic for 420-450 Mhz, based on the ARRL Antenna Book design. Reportedly only four feet long, the antenna has a claimed gain of 10.5 dB >15 dB F/B ratio and 2 KW power handling. The antenna weighs less than 23.5 pounds and has a wind load of 2.1 sqft. Suggested price is under \$70.

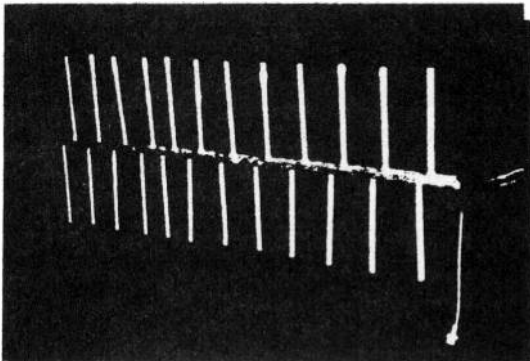

NEW POWER AMPS

Hi-Spec, a long time manufacturer of ham UHF/SHF power amps has announced a new line of power amps. The 70BS250 is for 420-450 MHz with 250 watts out for 10 watts in. The 33BA200 offers 200 watts out at 900 MHz and the 23 BA200 offers 200 watts out at 1250 MHz (all 10 watts in). The amps offer built in watt meters, plate current meter, heavy duty blower and excellent documentation. Repeater versions on standard 19" rack panel mounts are also available. Write Hi-Spec, PO Box 387, Jupiter, FL 33468

NEW ATV TRANSMITTERS offer 5 to 50 Watts output!

Pauldon Associates is offering a new line of ATV transmitters with 5 watts (10 PEP) and 50 watts (!) OUTPUT. The units have RF power output meters sampled RF video output BNC video connectors, and prices start at \$293 in a di-cast metal box.

Also available are ATV interdigital filters, mast mounted preamps and other ATV, UHF/SHF equipment. Write Pauldon, 210 Utica St., Tonowanda, NY 14150. 716 692 5451. ATVQ recently purchased a 1250 MHz mast mounted preamp (see photo) which works great with our new Yaesu 736R!

PARTS and USED EQUIPMENT:

Looking for **surplus electronics** and used ham equipment? Try these: Miley's Radio, (Jess K0TAA) 719 W 7th St., Florence, CO 81226 719 784 3040. OEM Parts 3029 N Hancock Av., Colorado, Springs, CO 80907. 719 635 0771. Colorado Springs Wintronic Co., 2838 N. Prospect St., Colorado Springs, CO 80907 719 636 1661. Centennial Electronics 2324 E Bijou, Colorado Springs, CO 80909 719 633 4666. HRO 8400 E Eliff #9, Denver, CO 80231 303 745 7373. If visiting the Denver area, visit the Tesla Museum, 2220 E Bijou, Colorado Springs, CO 80909 719 475 0918. TNX Zero Beat.

NEW TECHNOLOGY NEWSLETTER

John Hart, best known for his Amateur Radio Mail Order Catalog, is now publishing a new newsletter for those who want to keep up with the latest technology. NuTechnology Newsletter will be published every other Friday. A half year subscription can be had for 13 #10 SASE (29 cents) plus \$5 and a full year for 26 SASE's and \$20. (Now that's a novel idea!) Write to Hart Publishing 767 South Xenon Ct, Suite 117, Lakewood, CO 80228. The first issue was due out June 25, 1993. 303 987 9442.

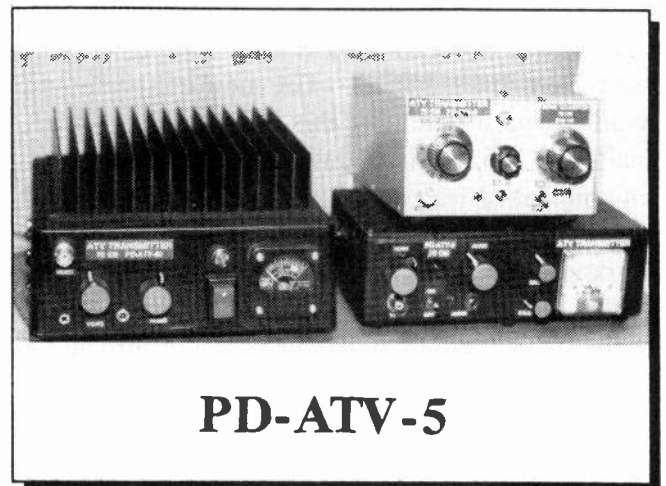

PD-ATV-5

AEA NEW GRAPHIC ANTENNA ANALYZER

Besides pioneering VSB ATV transceivers, AEA regularly introduces new products for packet, HF and station accessories. The latest product is a new graphic analyzer (see photo). The SWR-121 displays the antenna SWR as a curve over a selected frequency range. This is much easier than plotting individual readings one at a time with the old method of making forward and reverse readings, change frequency, take another set of readings, etc. The unit covers a frequency range of 1 MHz to 32 MHz and an SWR range of 1.1 to 65.1. For more information contact an AEA dealer or call 800 432 8873. List price is near \$400 and there is companion software for computer storage of the plot.

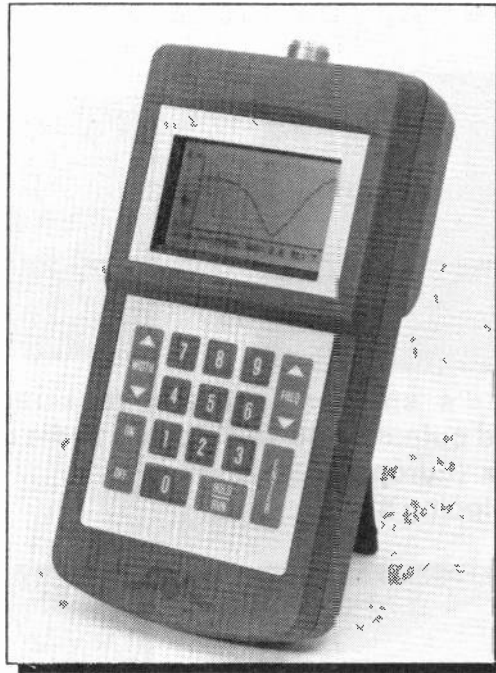

on color systems which may be available this fall. Contact them at Gene Harlan WB9MMM, 5931 Alma Dr., Rockford, IL 61108 815 398 2683.

NEW SSTV SOFTWARE

Pasokon TV has announced version 1.2 of their popular SSTV software. The new software is said to have all SSTV modes, automatic receiver mode based on VIS code, automatic AFT and more. The software also works with the popular N9AMR HiRes 32 software which allows working in graphical mode or into other programs with a single keystroke. The PC card fits in a standard PC and is the only FCC class B certified unit of its type. Contact John Langner WB2OSZ, Absolute Value System, 115 Stedman St., Chelmsford, MA 01824-1823. 508 256 6907

NEW MICRO CAMERAS

Micro Video Products, 1334 S Shawnee Dr., Santa Ana, CA 92704, 1-800-473-0538 now offers three micro video cameras for black and white and color. All are CCD type and all much smaller than a dollar bill! Prices start at \$210 which includes lens. All are DC powered. Companion micro transmitters and receivers for 400 and 900 including a part 15 license free 900 MHz system are also available. These are great for any R/C vehicle, rocket or balloon ATV application.

SOUND BLASTER SSTV

Harlan Technologies announced a new software package to copy SSTV on your home computer if you have a Sound Blaster, Pro Audio 16, Fusion 16 or other Sound Blaster compatible sound card! The system will copy 8, 12, 24, 36 second B&W and 36 or 72 sec color (in black and white) and Scotty 1 and 2 SSTV. The package called Slow Scan II will transmit and receive SSTV and pictures are saved as a .VOC file which can be played back into your radio via the mic input. Harlan Technologies is also working

WORLD'S MOST POWERFUL VHF TV TRANSMITTER

MCI Communications announced that they have installed a **1.6 Million watt** VHF TV transmitter on Failaka Island, 18 miles off shore, for Kuwait. Usually VHF TV stations operate with 100 or 300 KW ERP from 10-25 KW transmitters. This super station, the world's most powerful VHF TV station, should be great for VHF DX from the middle east as it is designed to cover a range of 500 miles down the Arabian coast. Also installed were several 5 MW UHF stations for local coverage.

MAKE SOME MONEY

Don Lancaster, ham, computer expert and author has turned out another book for those who have the desire to do more than a 9-5 job. The Incredible Secret Money Machine II, a follow-on of his first book of the same title gives sage advice and directions for those who want to start a part time business. Don also lists many pitfalls a new business is likely to encounter and thus forewarned, avoid. A must read for anyone who wants to start a new part time business. Don Lancaster, PO Box 809m Thatcher, AZ 85552

NEW GENERATION OF 24 cm FM-TV

Get linked with near broadcast quality.

65 x 35 x 160 mm

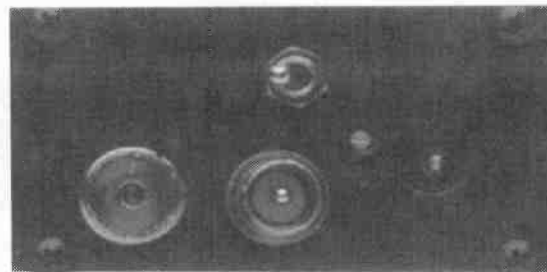
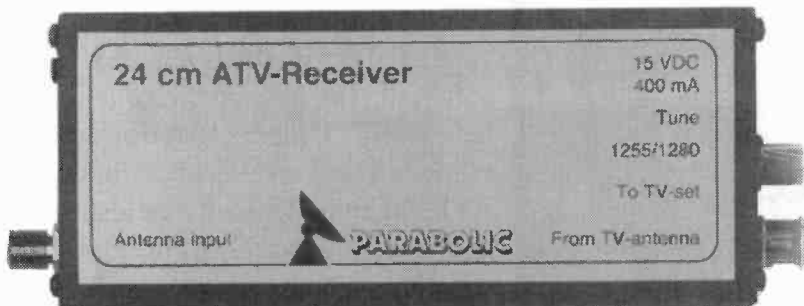

The world's smallest satellite receiver with modulated output on 48.25 MHz with audio on 53.75 MHz. (European use only).
\$179 + shipping \$12.

65 x 35 x 160 mm

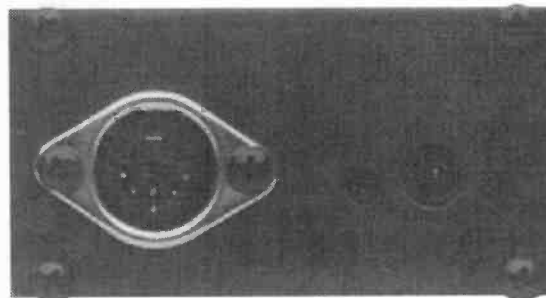
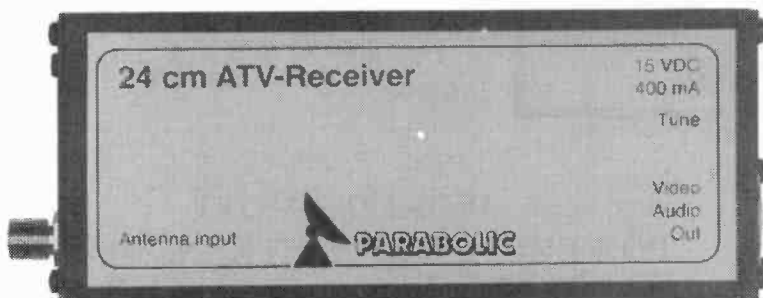

Same receiver with Video and Audio outputs.
Will tune approx. 1200 to 1500 MHz.
Both receivers deliver voltage for a preamp through the coax cable.
\$179 + shipping \$12.

65 x 35 x 160 mm

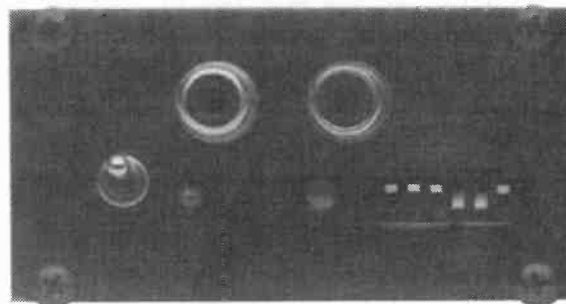

200 mW FM-transmitter that tunes between 1240 and 1279 MHz in 1 MHz steps. Will drive the M57762 to about 10W. One year guarantee.
\$249 + shipping \$12.

All modules use 15VDC max 400mA (incl. preamp) but 13.8VDC is OK. The transmitter will work as low as 10VDC. A preamp with 1,0dB NF and 40dB gain is also available at \$169.

Buy both receiver and transmitter and we ship free.



PARABOLIC
Systems AB

Fax. +46 - 300 40621

P.O. Box 10257 • S-434 23 Kungsbacka • SWEDEN

COMET

ANTENNAS FOR THE PROFESSIONAL AMATEUR

CYA-1216E

16 Element Yagi Beam 1260-1300MHz
 Gain: 16.6dBi Length: 4' 5"
 VSWR: 1.5:1 or less Weight: 7 lbs. 11 ozs.
 Impedance: 50 ohms Mounting Mast Diameter: 1 1/2"
 Max. Power: 100 watts Connector: N-Type
 Polarization: Vertical or Horizontal Construction: All Aluminum

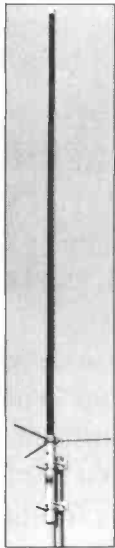
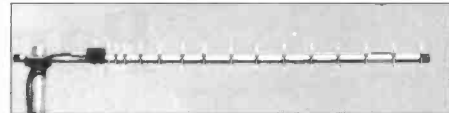

CA-1243Z

Dual Band 440-450MHz
 1250-1300MHz
 Base/Repeater Antenna
 5/8 Wave x 4 446MHz
 5/8 Wave x 9 1200MHz
 Gain: 446 9.4dB,
 1200 12.8dB
 Impedance: 50 ohms
 VSWR: 1.5:1 or less
 Max. Power: 446 150 watts,
 1200 50 watts
 Length: 7' 5"
 Weight: 2 lbs. 8 ozs.
 Connector: N-Type
 Construction: Heavy Duty
 Fiberglass

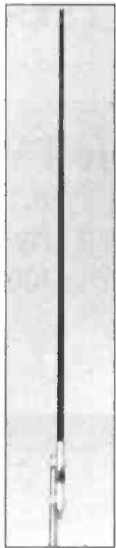

CA-1221S

Mono Band 1260-1300MHz
 Base/Repeater Antenna
 1/2 Wave 21 Step
 Collinear
 Gain: 15.5dB
 Impedance: 50 ohms
 VSWR: 1.5:1 or less
 Max. Power: 100 watts
 Length: 8' 6"
 Weight: 2 lbs. 3 ozs.
 Mounting Mast Diameter:
 1 1/4-2 1/2 inches
 Connector: N-Type

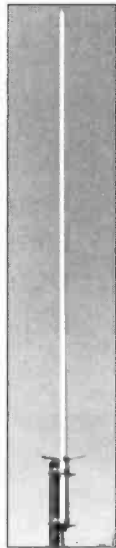

PYA-913

Base 13 Element Yagi
 904-920 MHz
 Gain: 15.8dBi F/B ratio
 over 20dB
 Max. Power: 150 watts
 VSWR: 1.5:1 or less
 Length: 4' 8"
 Connector: N-Type
 Construction: Aluminum

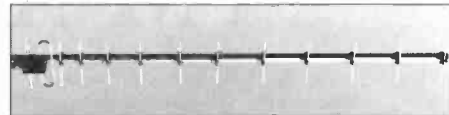

MINI SWR

		Max. Power	Insertion Loss
CM-200	140-150MHz	45 watts	0.1dB
CM-300	200-240MHz	60 watts	0.2dB
CM-400	420-460MHz	50 watts	0.2dB
CM-420	140-460MHz	50 watts	0.1-0.2dB
CM-900	840-950MHz	60 watts	0.2dB
CM-1200	1225-1325MHz	60 watts	0.25dB

Measurements: 2.25" w x 2.25" h x 1.1" d
 Weight: .25 oz.
 CM-200, 400 and 400 have SO 239 Connectors
 CM-420, 900 & 1200 have N Connectors

FP-19

Base/Repeater 905-925MHz
 Gain: 16dB
 Impedance: 50 ohms
 VSWR: 1.2:1 or less
 Max. Power: 100 watts
 Length: 7' 4"
 Connector: N-Type
 Construction: Heavy Duty
 Fiberglass

CF-4130 446/1200MHz

dB Loss: 1.3-460MHz 0.2dB,
 900-1400MHz 0.3dB
 Band Rejection: 55dB Down
 Max. Power: 146MHz 800W PEP,
 446MHz 500W PEP,
 1200MHz 200W PEP
 Connectors: N-Type



NCG CO. 1275 North Grove Street • Anaheim, CA 92806 • (714) 630-4541 • Orders (800) 962-2611

CALL FOR THE DEALER NEAREST YOU!

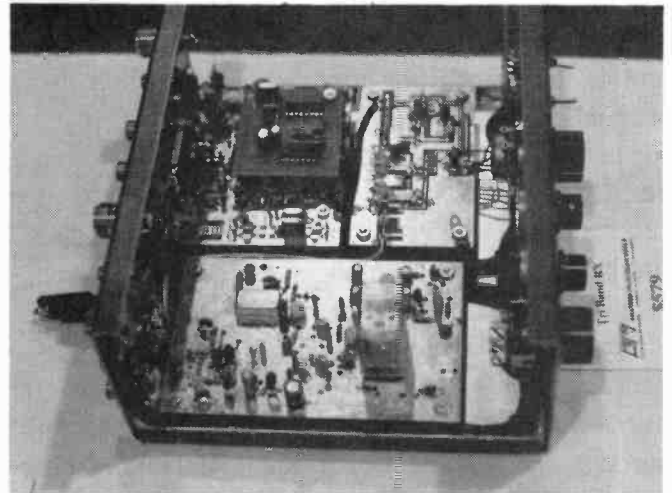
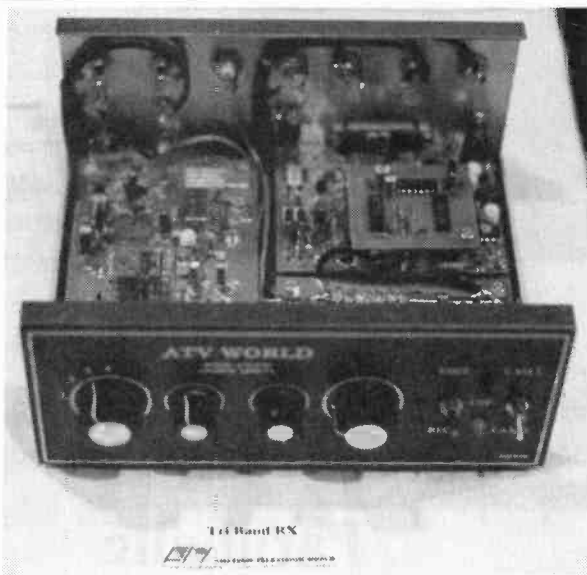

NEW ATV EQUIPMENT

On display at Dayton and at the ATVQ Friday night get together, Earl KS8J, AKA **ATV WORLD**, displayed his new equipment including this **THREE BAND** ATV receiver. ATVQ has received excellent user reports of Earl's equipment.

Dave, **OLD ANTENNA LAB**, holds his newest creation, the Turnstyle antenna. Dave is the manufacturer of all the various wheel type antennas (big, little, stacked) offering up to 6 dB omni horizontal gain.

WA6SVT Reviews the Parabolic 24 cm FM-ATV Equipment

Parabolic introduces its Swedish built 1240-1280 MHz FM ATV transmitter and receiver. Henry Ruh, KB9FO, sent me the units for evaluation. The units come in black anodized aluminum cases and look first rate. I had to open the units up to peek inside and was surprised to see that most parts are surface mounted on a computer designed PC board. Construction was professional and neat.

Next I wanted to hook up the units to see if the units would perform as well as they looked. I opened the single sheet of paper that came in the transmitter box for connection and operation only to find it only contained the dip switch code to frequency conversion (similar to the code used on P.L. encoder boards). Henry informed me that no other documentation was sent from the manufacturer. The cover on the units indicated 15 VDC was the power source as well as some of the connections on the transmitter. The manufacturer informed Henry that this is a maximum level, the normal DC power is 12-13 volts. After some circuit tracing, the rest of the connections and adjustments were found (I always liked challenges). Well, enough of this, now for the test results.

P
A
R
A
B
O
L
I
C

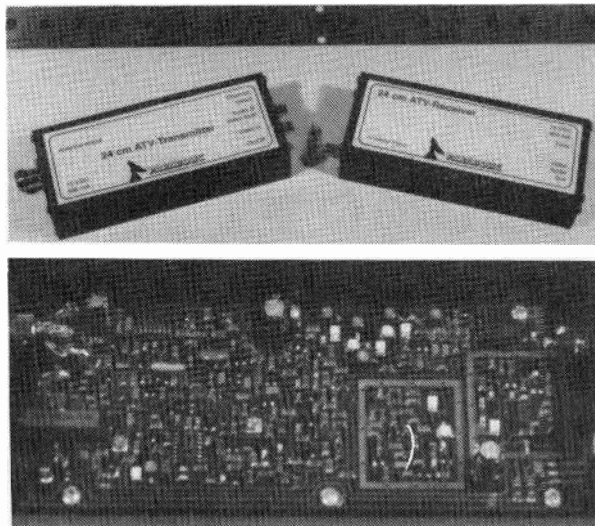

Parabolic TV403 transmitter;

FREQUENCY RANGE 1240-1279 MHz P.L.L., 1 Mhz steps
OUTPUT POWER 340 MW clean spectrum.
DC POWER 15 vdc at 400 ma although 300 MW out at 13.8V.

VIDEO LEVEL 1 V P-P, no front panel adjustment.

VIDEO BANDWIDTH 5 MHz flat differential phase and gain excellent. DEVIATION 4 MHz.

Subcarrier 6.5 MHz.
VIDEO PROTOCOL PAL, SECAM and NTSC.

AUDIO RESPONSE 10 Hz to 10 KHz within -3dB within the range. Signal to noise ratio 70dB.
Deviation 25 KHz.

AUDIO DISTORTION 1% at 25 KHz deviation.

AUDIO LEVEL -20 dBm to + 10 dBm input adjustable
ANTENNA CONNECTION type "N", audio/video connections RCA.

Parabolic

Surface mount board - looks nice.

Extruded aluminum halves 1.5x7x2.5

200 MW out tested at 1252 Mhz.

1 VP-P video in = 4 MHz dev = 21 MHz occupied bandwidth (with audio).

continued 😊👍

TV402 receiver.

FREQUENCY RANGE 1240 - 1290 MHz VCO tunable.
SENSITIVITY -72 dBm with external preamp -81 dBm
Selectivity not measured.
Video and audio same specs as transmitter.
Video output 1VP-P fixed.
Audio output -10 dBm at 25 KHz dev fixed.
Antenna connection type "F" (TV coax type).
Subcarrier 6.5 MHz.
Audio/video connections 6 pin din.
sparkle free level -72 dBm, preamp improved 8 dB.
Video and audio quality excellent.

Final Comments

The receiver seems to be designed to use an external preamp for best performance, I suggest a mast-mounted unit with at least 15 dB gain. The "F" connector allows direct connection for a radio shack power inserter to power the preamp.

The subcarrier should be changed to 4.5 MHz to fit the 10 MHz wide channel of 1252 MHz for use in the suggested US 24 cm band plan.

To change the audio subcarrier, is a matter of retuning the oscillator coils and changing the filters. One on the transmitter, the other on the receiver, need to be changed to a Murata P/N SF4.5MB, I have about 300 of them as they have to be ordered 500 quantity from Time Electronics or other stores. Contact me if you need some. I have hooked up the units as a link between my camera and ATV transmitter and ran an A/B test "A"=1265 Mhz FM ATV or direct on "B" and other ATVers could not see any difference. (transparent link)

The units are available from Parabolic, PO Box 10257, S-434 23 Kungsbacra, Sweden. Henry has sent a fax to get more information. I hope someone will be set up soon as a US vendor for this quality ATV equipment. 73's Mike, WA6SVT

1691 MHz Weather Satellite System

Spectrum International, Inc.
is pleased to announce
their appointment as
North American and International
distributor of
**Time-Step Electronic's Weather
Satellite Receiving System.**

This high quality, low cost
system consists of:

1691 MHz GaAs FET Pre-ampl. model TS-1691-P.Amp	\$450
1691 HGz Receiver model TS-1691-Recvr	\$450
Decoder Board & Software model TS VGA-SAT 4	\$399

Also available to complete
the system are:

Low Loss (microwave) Coaxial Cable (65 ft) with connectors. model 1691-coax ass'y	\$ 70
1691 MHz Loop-Yagi Antenna model 1691-LY(N)	\$ 99
1691 MHz Loop-Yagi Extension model 1691-LY-XTN	\$ 85
Demonstration Disc (IBM-PC VGA compatible) of signals recorded from WX-SAT system.	\$ 3

Shipping: FOB Concord, Mass.
Prices subject to change without notice.



SPECTRUM INTERNATIONAL, INC.
Post Office Box 1084 Dept. T
Concord, Mass. 01742, U.S.A.
Phone: (508) 263-2145
FAX: 508-263-7008

Designed specifically for amateur television in the 70cm band...

FL407 INTERDIGITAL FILTER

7-Pole Interdigital Vestigial Sideband Filter for Frequency Ranges of 420 MHz to 440 MHz

The 6 MHz nominal bandwidth and low loss design are perfect for transmitter or receiver use. Two filters can be used for repeater applications.

Heavy duty construction insures stable operation and long life.

Ordering Information: The FL407 may be ordered on any frequency between 420 and 440 MHz. Please specify video carrier frequency when ordering.

Dimensions HWD:
2 1/8" x 8 13/16" x 20 5/8"

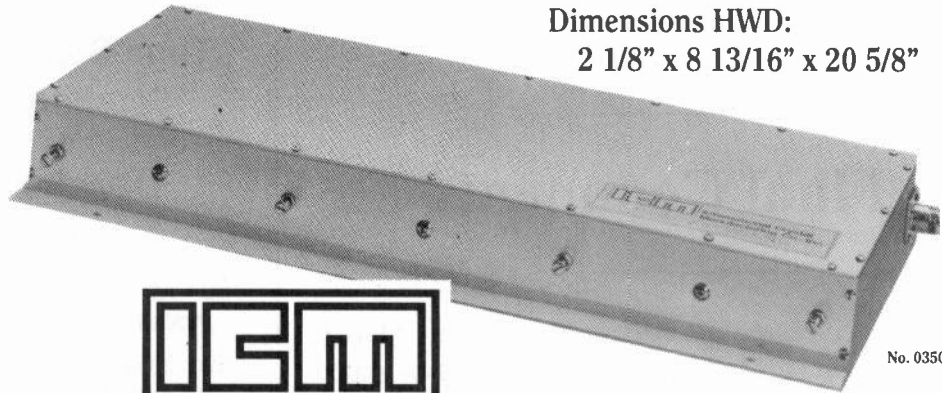

No. 035026



International Crystal Manufacturing Co., Inc.

P.O. BOX 26330 • 701 W. SHERIDAN • OKLAHOMA CITY, OK 73126-0330 • (405) 236-3741 • FAX (405) 235-1904

Micro-Video Camera SMALL SIZE 2"x3"x1"

Feather Weight 4 oz.
NTSC Output 240 TV Lines
Low Light 2 Lux 7-15 VDC/<100ma.

Typical Applications: ATV, Robotics, Computer Vision, Security, Remote Monitoring, Phone Vision

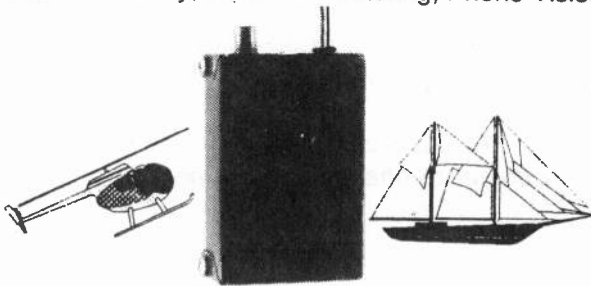

Factory New \$229.95

Add \$5.00 S/H Ca. add 6.75%

Micro Video Products

1334 So. Shawnee Dr. • Santa Ana, CA 92704
1-800-473-0538 (714) 957-9268

DOWN EAST MICROWAVE

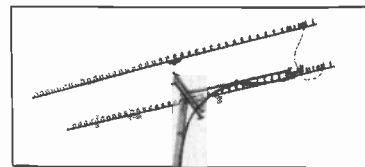

MICROWAVE ANTENNAS AND EQUIPMENT

- Loop Yagis • Power Dividers • Complete Arrays • GaAs FET Preamps
- TROPO • EME • Weak Signal • OSCAR • Microwave Transverters

902 1269 1296 1691 2304 3456 MHz

2345 LYK45el 1296 MHz 20 dBi \$89
1345 LYK45el 2304 MHz 20dBi \$75
3333 LYK33el 902 MHz 18.5dBi \$89

Above antennas kits available assembled.

Add \$8 UPS s/h

Add \$11 UPS s/h West of the Mississippi.

MICROWAVE LINEAR AMPLIFIERS SSB, ATV, REPEATER, OSCAR

2316 PA 1w in 18w out 1240-1300 MHz \$265
2335 PA 10 in 35w out 1240-1300 MHz \$315
3318 PA 1w in 20w out 900-930 MHz \$265
3335 PA 10 in 40w out 900-930 MHz \$320
23LNA preamp 0.7dB N.F. 1296 MHz \$ 90
33LNA preamp 0.9dB N.F. 902 MHz \$ 90

NEW PRODUCT ANNOUNCEMENTS

New Loop Yagi

1845 LY Loop Yagi 1691 MHz 20dBi \$99
945 LY Loop Yagi 3456 MHz 20dBi \$89
Above antennas assembled and tested

New Preamps

13LNA 0.7dB N.F. 12 dB 2.3 GHz \$140
18LNA20 0.8dB N.F. 20 dB 1.69 GHz \$140
SLNA 1.0dB N.F. 10 dB 2-2.7 GHz \$150

New Wideband Power Amplifiers

2370 PA 3w in 70w out 1240-1300 MHz \$695
2340 PA 2w in 35w out 1240-1300 MHz \$355
2318 PAM 1w in 18w out 1240-1300 MHz \$205

Rack mount Amplifiers for repeater use available.

NO TUNE MICROWAVE LINEAR TRANSVERTERS

From SHF SYSTEMS a new line of transverters designed by Rick Campbell KK7B and Jim Davey WA8NLC

Available in kit form or assembled/tested

- 903 1269 1296 2304 3456 MHz
- microstrip filters eliminate tune-up
- 2m I-F, PIN diode switched
- sequencer standard in complete unit
- low profile packaging, mast mountable

All active equipment - 13.8V

DOWN EAST MICROWAVE
BILL OLSON, W3HQT
Box 2310, RR-1 Troy, ME 04987
(207) 948-3741

CUSTOM CRYSTALS

Crystals for many applications

For over 40 years, ICM has manufactured the finest in quartz crystals for every conceivable purpose.

A wide selection of holders are available to fit most any requirement. Our computer database contains crystal parameters for thousands of equipment types.

Need crystals for communications, telemetry, industrial, or scientific applications? Let ICM's sales department assist you to determine which type of crystal is best for you.

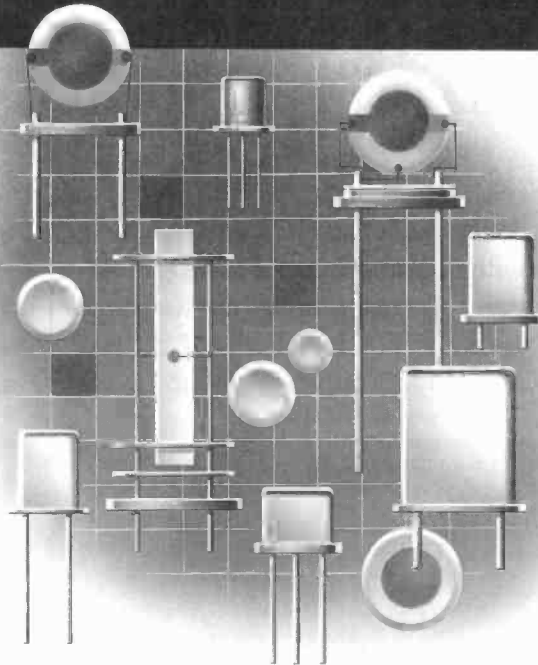

Can we solve your crystal problem?

For special purpose crystals, special holders, special sizes, call our crystal sales department. We will be pleased to provide recommended data.



International Crystal Manufacturing Co., Inc.

P.O. Box 26330, 701 W. Sheridan,
Oklahoma City, OK 73126-0330
Phone (405) 236-3741
Telex 747-147
Facsimile (405) 235-1904

**PUBLICATION DATE
11 DECEMBER 1992**

**SAVE
£5**

THE VHF/UHF DX BOOK

COVER PRICE £18.00

**order right away to receive your
copy by first-class post (in time
for Christmas) at the special
pre-publication offer price of only**

£13.00

**452
PAGES**

with 122 pages devoted to
antennas, feedlines and propagation

Direct overseas orders at pre-publication offer price are welcome, provided post-mark is 11 December or before. Price for copies ordered after 11 December is £18.00 each. For overseas credit-card orders postage will be charged at air-mail cost.

Books will be despatched as soon as stocks become available. E&OE

THE BRAND-NEW REFERENCE HANDBOOK FOR DX OPERATORS, CONSTRUCTORS & EXPERIMENTERS

WRITTEN BY LEADING VHF/UHF SPECIALISTS

- Propagation - Geoff Grayner G3NAQ
- Operating - David Butler G4ASR
- Assembling Your Station - Ian White G3SEK
- Receivers & LOs - Ian White G3SEK
- Transmitters, PAs and EMC - John Nelson GW4FRX
- Antennas & Feedlines - Günter Hoch DL6WU
- Power Supplies & Station Control - John Nelson GW4FRX
- Test Equipment & Accessories - Roger Blackwell G4PMK

PACKED WITH NEW EQUIPMENT DESIGNS

- ★ 50MHz transverter - Dave Powis G4HUP ★
- ★ 70MHz transverter - Dave Robinson G4FRE/WG31 ★
- ★ 1.44MHz transverter - Sam Jewell G4DDK ★
- ★ 432MHz transverter - John Wilkinson G4HGT ★
- ★ Power amplifiers ★
- ★ Antennas ★
- ★ Test Equipment ★

*A fresh approach
to VHF & UHF*

Please supply me with copies of **THE VHF/UHF DX BOOK**
at the pre-publication offer price of £13.00 plus £1.95 postage each

I enclose a cheque/PO Please charge to my credit card

VISA M/CARD

Expiry date _____

Signature:

Name:

Address:

.....

PostCode:

This address must match the registered credit-card holder's address. If delivery is to a different address, please enclose appropriate instructions. Freeport only applies in UK.

**POST TO: DIR PUBLISHING LTD
PO BOX 771, BUCKINGHAM, MK18 4HH, ENGLAND
TEL: (0)280 812197 FAX: (0)280 815633**

THE W6ORGy NOTES

by Tom O'Hara W6ORG

TO DEVIATE OR NOT TO DEVIATE THAT IS THE QUESTION

Part 2

Since last time I have checked out three different FM ATV receivers - Bestlink (TD Systems), Parabolic and HF Technology. All three give good video and sound and have no serious drawbacks that I could not recommend them.

According to Henry Ruh, Bestlink is not going to manufacture the TD Systems amateur gear after all. I talked with Steve at TD Systems and Troy at Bestlink about marketing some of the FM products last year once they got something going and I did get a board to test. It was more like a prototype and only came with a hand drawn rough schematic rather than a data sheet with specs and hook-up info that you would expect when ordering a regular production unit. Since they are no longer available, there is not much sense in elaborating on it here.

The other two units are both well made ready to go units with a strong metal enclosure and use a lot of surface mount parts to put a lot on a small board but make your eyes squint. A very detailed manual

comes with the HFT unit but none with the sample Parabolic. I understand that an English one is in the works. Both had P1 to P5 "FM advantage" range of about 20 dB

with the Parabolic being a little better probably due to more limiting gain in the complete receiver vs. the HFT IF/demodulator. This will be re-run with a downconverter and enough gain ahead of both to be well above the noise floor. Both will be compared to the equivalent AM system next time to show the relative signal strengths vs. P unit curves.

The Parabolic is made in Sweden so the sound subcarrier is set for a fixed 6.5 MHz which must be the standard there. Those from England or Germany are different. The frequency cannot be changed easily without changing a ceramic bandpass filter.

[Ed. Note: US standard filters are available for low cost from Mike WA6SVT]

Total xmit occupied bandwidth with this system then is about 21 MHz. This particular receiver was complete, operating on the 1200 MHz band rather than a separate down converter driving a IF input receiver. A multiturn screwdriver adjust pot is used to adjust the LO frequency. I

prefer the tuneable downconverter

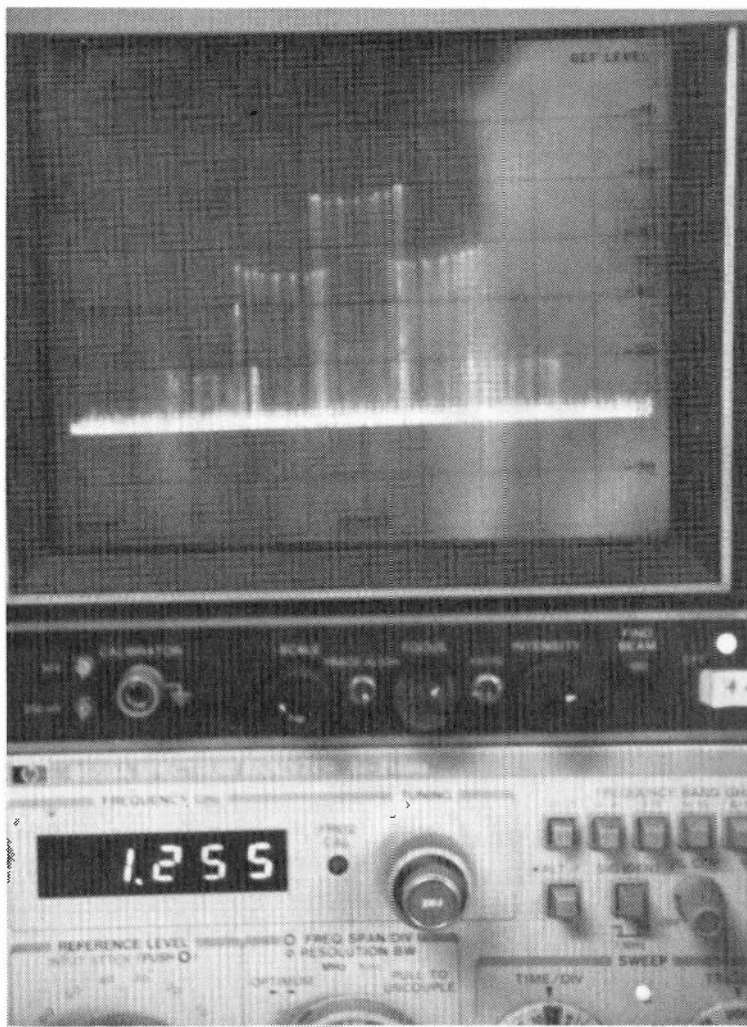

Spectrum analyzer picture of Parabolic 24 cm ATV transmitter. Horizontal scale 5 MHz/cm. Vertical 10 dB/cm. Mainpower is 1 KHz 1V p-p sine wave giving +/- 4 MHz equivalent to sync signal. Next down 10 to 12 dB is the 6.5 MHz sound subcarrier. Note the total occupied bandwidth for FM is 21 MHz as predicted by Carson's rule.

W6ORGy NOTES

to this but for a fixed link in a temperature controlled room it would be ok. The 1200 MHz antenna input is a type F connector which makes me believe that they intend the user to have an antenna mounted preamp used ahead of it. Also the fact that a preamp improved the sensitivity greatly confirms it to me. More on sensitivity next time.

[Ed. Note: the unit was designed for link service and a companion preamp is offered]

The video and audio output is through a 5 pin DIN connector. My personal preference is to have separate connectors, but no big deal. You really have to be careful if you are the typical ham who does not read the manual, assuming you get one with it, until you connect it all up and it doesn't work. The 5.0 x 2.1 mm power plug has the center as negative ground - opposite of the USA standard. No, I didn't blow it up! Only because I opened up the 1.5 x 7.25" case and used clip leads. Video output was a little hot with the full 1 v p-p taking only 3 MHz deviation. I could not see a pot inside to adjust the video gain to crank it down a little for the 4 MHz deviation USA standard. The best feature of this receiver was the capture ratio which was between -13 and -15 dBc with a little noise on the red color bar. While I can only guess by looking at the parts, I think this is due to their using a quadrature detector IC rather than a PLL. The quadrature detectors seem to react less to interfering signals.

Another interesting thing was a high side local oscillator around 1500 MHz and an IF around 246 MHz instead of the usual 70 MHz. The possibility of image or IF feedthru interference is less doing it this way. However the oscillator had spurs on each side of it that could have responded to out of pass band signals until a strong signal locked up its AFC.

HF Technology's 70 MHz IF/demodulator is made in Illinois and comes in a 1.5 x 6.5 x 4.2" enclosure. It uses a PLL detector for both the video and audio. The audio subcarrier frequency range can be set anywhere from 4.5 to 6.5

MHz to accommodate what ever is being used in your area. This particular one was set for 5.8 MHz. A 4.2 MHz video low pass filter is used to keep the sound out of the video to accommodate any sound frequency above 4.5 MHz rather than a fixed notch. The PLL detectors are very forgiving as to transmitter frequency drift and accuracy. In fact I found that the sound subcarrier could be as far as .5 MHz off and still lock on. This is an advantage since I found some of the transmitters do not use temperature stabilized sound subcarrier generators.

The disadvantage to the PLL detectors was the capture ratio is only -20 dBc to see an interfering signal in the color video. Capture ratio is only important in areas where there are other signals on in your pass band strong enough below the desired signal to put interference into the video. Also PLL's will lock up on harmonics. Since many SAW filters also pass odd harmonics, there were responses at 210 and 630 MHz. This can be fixed with an input 100 MHz low pass filter or converter filtering. The video and audio out use RCA phono jacks. The audio output is enough to drive a speaker. 4 MHz deviation produced the standard 1 v p-p. The 14 MHz SAW filter bandwidth was narrower than the occupied bandwidth given the 5.8 MHz sound subcarrier but this only made the audio drop out sooner than expected in a snowy picture.

By the time you read this, I should have some of the improved HFT IF/70's on the shelf as one of their new dealers. Delivered price will be \$199 according to their marketing people.

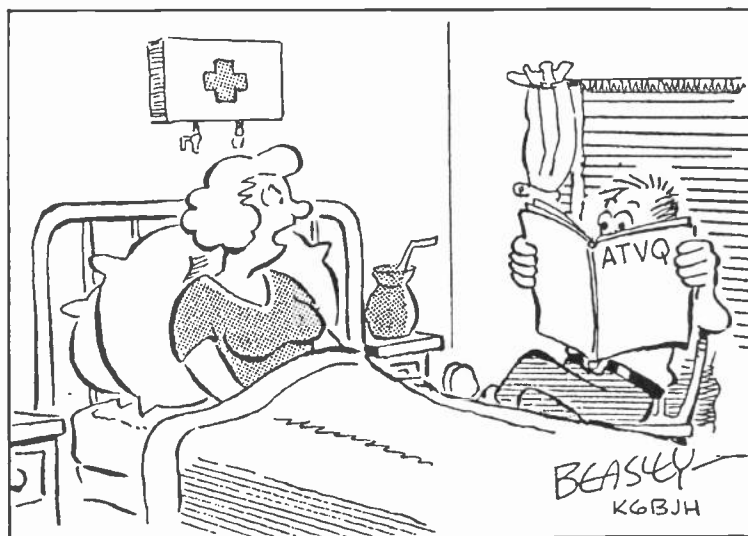

MAYBE NEXT TIME YOU COULD BRING A COPY OF LADIES HOME JOURNAL

Next time the real world definitive test - US amateur ATV FM vs. AM signal strength vs. picture to snow ratio or P unit. To do this I will put a color test pattern into a AM video RF generator and a 4 MHz deviated FM generator of equal peak power signal strengths and compare the pictures in the same TV receiver/monitor.

Tom O'Hara. W6ORG

KENWOOD ATV TRANSCEIVER

With FM operation possible on 10, 6, 2, 220, 440, 1260 bands (and receive on 900 if you know the secret) the Kenwood 741 offers 3 bands (3 1/2 if you count 900 RX) of mobile operation. Now it is possible to also operate **ATV TX and RX on any 440 or 1200** frequency and 900 RX with the same unit. All changes are internal to the unit. The crossband repeater modifications Kenwood supplies with the unit are also used in this to permit simultaneous TV/FM reception on one band while transmitting FM/TV on another band. This allows for instant crossband ATV repeater operation on ANY FREQUENCY the radio is capable of operating. No more limitations by xtals or 2 channel frequency switches. Simply dial in any frequency (ie 439.25, 439.24, etc) on one band, and then dial in a second frequency (the same band or on another band) and operate. The regular receive/transmit sections of the 741 continue to operate for FM voice (on-carrier mode) and the modifications provide video receive and transmit on the same frequencies. Reports are the receive section is equal or better than any ATV receiver currently offered since it uses the same Kenwood front end as the FM section uses.

Pictured here is Curt Toumanian N6TWB with his **Kenwood ATV transceiver**. Video in/out is provided by the existing speaker jacks which are converted as video ports. The unit has 4 audio jacks (one for each of three bands and one combined) so simply choose an unused pair for video use. The video modulator, sync stretcher and other video portions, such as an optional 4.5 MHz sound subcarrier, are all contained inside the unit, accessible by removing the front cover.

The RF output amps for 440 and 1200 can be used or the user can replace the power modules with the standard multi-mode power bricks available from RF Parts and other sources for more RF output and better linearity.

No normal 741 function is lost. Scanning, memories, PL and other functions remain unchanged. This makes the 741 the most compact ATV TX/RX multiband radio available.

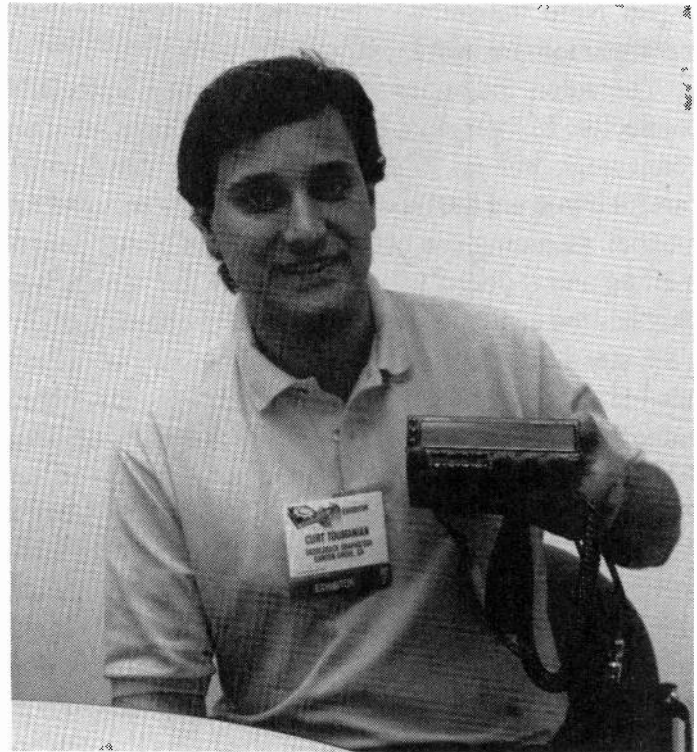

WE USE HER FOR DX --- IF THE WIND IS RIGHT,
SHE'S SOLID COPY ON THE OTHER SIDE OF THE
VALLEY!

1 - 800 - 4 - A - HAM - TV

1-800-424-2688

*** TRI BAND RX ! ***

SINGLE BAND TRANSCEIVER

\$479.95

RX 420-450 Mhz TV Ch 3/4 Output
 -- OR --
 RX on 1.2 Ghz TV Ch 7/8 Output
 -- OR --
 RX on 900 MHz TV Ch 2/3 Output
 -- AND --
 TX 420-450 Mhz 10 W. 4 Channel
 Video Monitor output on TX
 Type "N" Connectors Available

Simple Front Panel Layout
 Connectors all on Rear Panel
 May Upgrade to Dual or Tri RX
 High Grade Cabinet
 Individual RX TV Outputs
 Spare Set A/V Jacks on Rear
 Made in USA by HAMS

DUAL BAND RX TRANSCEIVER

\$569.95

TRI BAND RX TRANSCEIVER

** NEW ITEM **

\$659.95

RX on any of 2 or 3 bands AND
 TX 420-450 Mhz 10 W. 4 Channel
 Video Monitor output on TX

High Quality FR-4 Ckt Brds
 Solder Mask and Silk Screen
 Drive Amps to Full Output

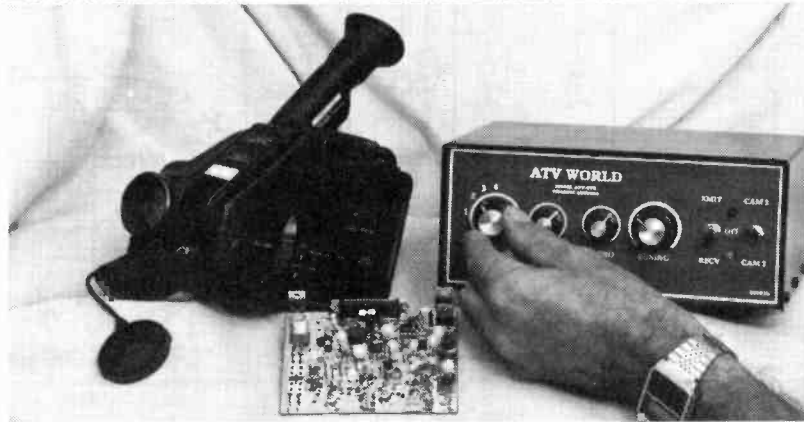

Cabinet Silk Screen NO Hardware	\$29.95
Cabinet with All Hardware	\$64.95
TX 4 Channel 10 Watt	\$199.95
TX 4.5 MHz PPL Option	\$49.95

900 MHz Loop Yagi Antenna	\$99.95
1200 MHz Loop Yagi Antenna	\$99.95
1.2 Ghz 900 MHz or 430 Mhz RX	\$99.95
RX Freq Synth Option	\$69.95



AMATEUR TELEVISION WORLD

3713 W. CHARLESTON AVE.

GLENDALE, AZ. 85308

1-800-4-A-HAM-TV

1-800-424-2688

1-602-978-4348

AN FM-TV RECEIVER

By J.Wood G3YQC

There is no doubt that frequency modulation is by far the most widely used ATV mode at present in use in the 1.3GHz band. This is probably due to the realization of the not un-considerable advantages that this mode offers over amplitude modulation. Another leading factor is that all of the proposed (GB) ATV repeaters cater for FM-TV

When presented with the choice between AM or FM the first, and most common, reaction is "...but FM is so difficult to receive as it requires a special demodulator for correct reception". True, it does need a special demodulator but it need not be very complicated or expensive to build and in this design - needs almost no test equipment to align.

There are various ways of incorporating an FM-TV receiver in the shack and these will be discussed later on.

SYSTEM REQUIREMENTS

1. An FM-TV receive system needs to have sufficient bandwidth to enable the whole of the signal to be demodulated. If the receiver bandwidth is narrower than the signal deviation, video or syncs will be lost, conversely, if the receiver bandwidth is too wide the demodulate will not produce a full amplitude video signal at its output.
2. Front-end gain should be sufficient - when used in conjunction with a domestic varicap TV tuner - to cause limiting in the PLL (IC2) at around the noise threshold, this will ensure that even a weak signal will be correctly received.
3. The system should have a low impedance input and be capable of being driven from a varicap or similar TV tuner.

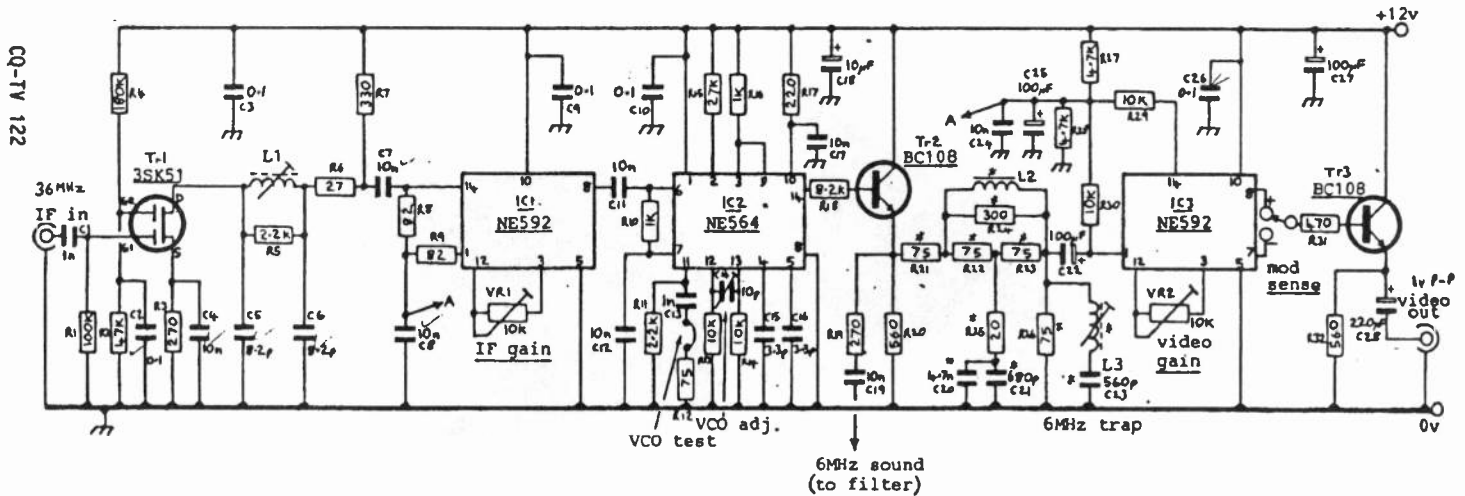

- L1 - Toko TKXCA34732 CN (36MHz)
- L2 - 33uH fixed choke 144LY-330
- L3 - Toko MKANSK1731 HM (6MHz)

Ambit International

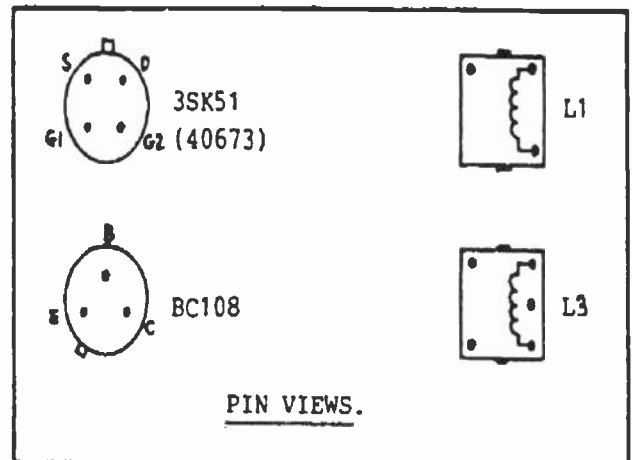

AN FM TV RECEIVER

4. The system should deliver a standard 1 volt peak-to-peak composite video output suitable for feeding a monitor or an RF modulator.
5. Variable front-end gain should be provided to cater for different input levels.
6. CCIR standard de-emphasis should be available as an option.

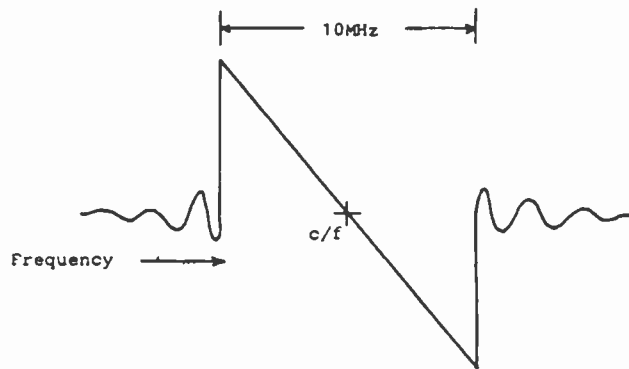
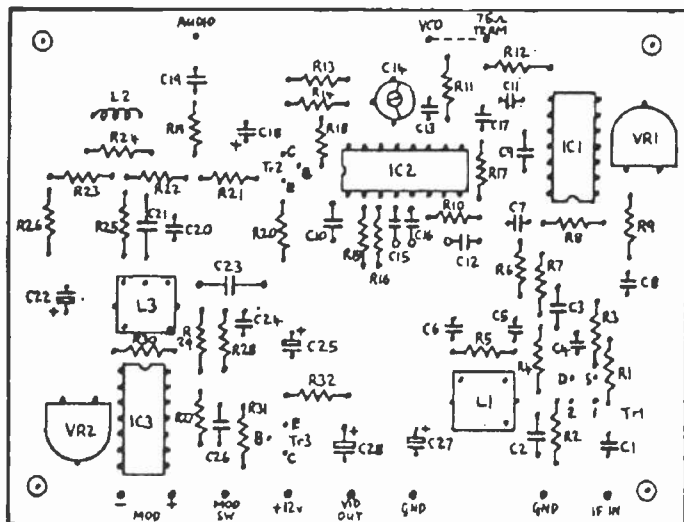

Fig.3 FM DEMODULATOR SWEPT RESPONSE



7. Provision should be made to extract an inter-carrier sound signal.
8. The unit should be powered from a single 12 volt d.c. source (excepting any tuning voltage requirements) to enable portable operation.
9. The whole should be accommodated on a single printed circuit board.

CIRCUIT DESCRIPTION

Input to the receiver is directly from a varicap tuner and is applied to gate 1 of Tr1. A MOSfet is used in order to give high amplification together with low noise performance. The tuned circuit L1 provides some selectivity which helps with the overall noise performance, R5 damps this circuit to provide sufficient bandwidth. The signal passes to an NE592 wideband amplifier i.c. operating at the IF frequency. A gain

control is provided but in this design will usually be set to maximum. The output of IC1 passes directly to the PLL demodulator IC2. This device was chosen for its superb linearity and ease of use. The circuit has been described in various forms in previous issues of CQ-TV. C14 sets the voltage controlled oscillator (VCO) which should be at the IF center frequency. A test point is provided on the board for this purpose. The demodulated video signal passes through an emitter follower (Tr2) where the sound signal is extracted. The following passive circuit is a de-emphasis network whose response is set for the CCIR standard. At present, in the U.K., no emphasis standard has been established and indeed there may not be a need to do so for amateur work. Provision is made on the board though in case de-emphasis is needed in the future or in case the receiver is used for the reception of satellite TV.

Video passes to IC3 - a second NES92 this time acting as a video-amplifier. This stage also has a gain control which sets the video output to 1 volt peak-to-peak into a 75-ohm load. There are two outputs from IC3 providing both positive and negative going video signals. Provision is made to switch between these outputs enabling both standards to be received - useful for the continentals! Tr3 is another emitter follower providing a 75-ohm video output.

COMPONENTS

Most of the components are available from AM!BIT International. The three integrated circuits are ordinary plastic dual in line packages (suffix N¹). If de-emphasis is not required the following components should be omitted: R21, 22, 23, 24, 25, 26, C20, 21, 23,

AN FM TV RECEIVER

ALIGNMENT

L2 and 3. The emitter of Tr2 should then be connected to the negative side of C22. The 6 MHz sound trap cannot remain connected in its present position if the de-emphasis components are omitted. It may be possible to connect this later in the circuit if required, perhaps in the

Alignment is very straightforward and may be carried out using no test equipment. However the following sequence should be carried out if possible: Connect +12 volts and ensure that this voltage appears

on the i.c. pins and transistor collectors. Connect a frequency counter to the VCO test point and adjust C14 for a reading equal to the IF frequency (36 MHz), C14 is usually around half mesh. Switch off and connect a link wire to terminate the test point with R12. Turn VR1 to maximum (fully clockwise) and VR2 to halfway. Connect the IF output from a varicap tuner to the input- (see figs. 4 and S) and a video monitor or oscilloscope to the output. Switch on and make sure there is plenty of white noise (snow) on the screen. Adjusting VR2 should alter the contrast. Peak L1 for best signal, its tuning will be rather flat.

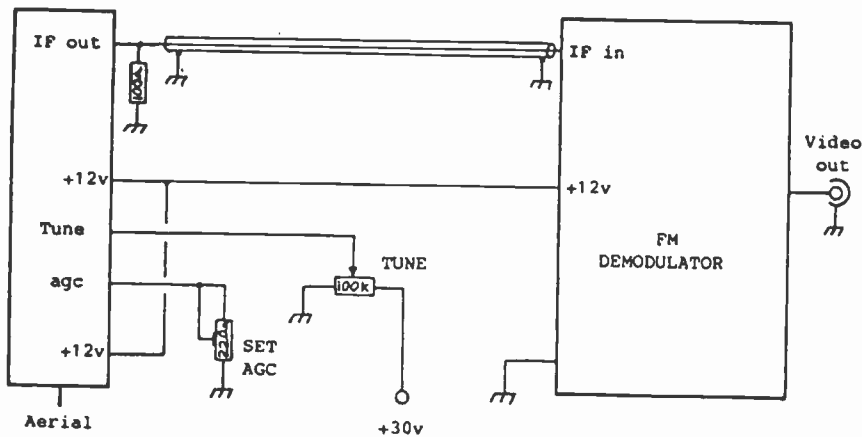

Fig. 4

USING THE U321 VARICAP TUNER

base circuit of Tr3. It is not recommended that i.c. sockets be used-especially for IC1 and IC2.

NE592 devices are unfortunately a little hard to come by (see suppliers list). A possible substitute could be the uA733. The device is pin-compatible and similar in concept but has not been tried in this design.

CONSTRUCTION

The printed circuit board is double sided, its component side being predominately a ground plane to ensure circuit stability. Components should be mounted carefully using minimum lead lengths. Where possible leads which connect to ground should be soldered on both sides of the board. Note that C12, C15 and C16 earth leads are soldered directly to the top of the board, there being no holes provided. The component side track connecting R9 and C24 should be soldered on both sides at each end. Care should be taken to insert the active devices the correct way round.

Vero wiring pins should be inserted into the holes provided round the edge of the PC board. these are used for the external connections.

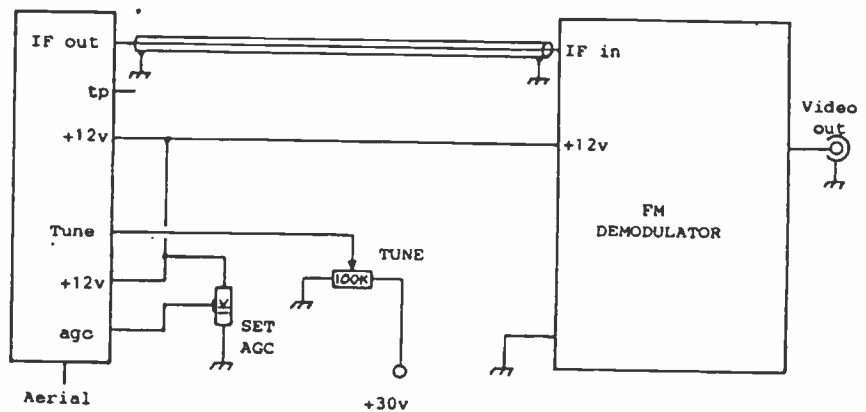

Fig. 5

USING THE ELC1043 STYLE TUNER

OPERATION

Although it is possible to receive an FM signal on an AM receiver by 'slope detecting' it is not possible to see an AM signal on a FM receiver, therefore you will need a FM-TV signal to finally check the unit. When you first tune in a picture it is tempting to tune for maximum signal (best contrast) just as you do for AM. With FM though this is not necessarily the optimum position. In practice the receiver should be tuned for the best LOCKED picture (correct 7:3 video/sync ratio if viewed on a 'scope).

EURO 600 SAT MODULE

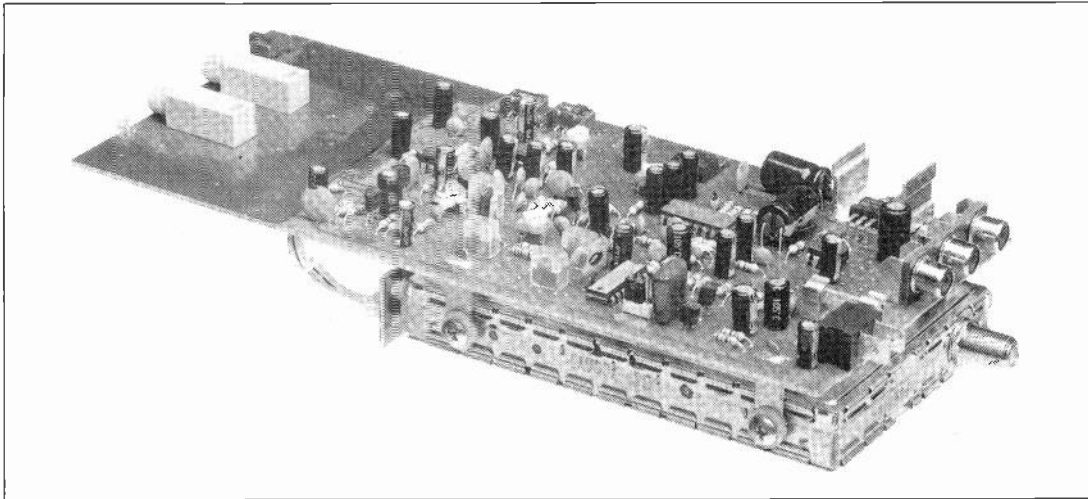

TUNING

POWER LED CHANNEL AUDIO AFC AFC

900 - 2000 MHZ 5,2 - 8,5 MHZ

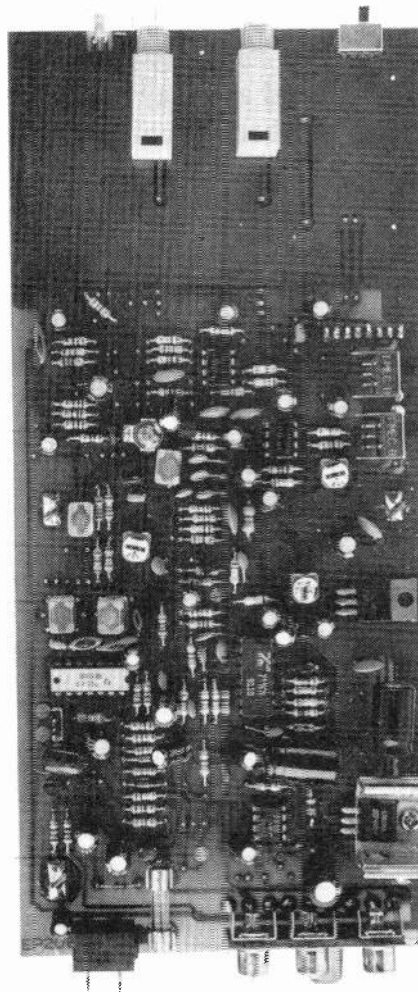

VIDEO LINEARITY

VIDEO 0,5 - 1,5 VOLTS P/P

AUDIO LEVEL

CLAMP CLAMP

16 MHZ B/W
27 MHZ

LNB POWER
LNB

AFC - CTR

AUDIO RANGE

- : + 17,5 V DC
- : 400 mA LNB
- : Type F connector
- : 950 - 2000 MHZ ADJ.
- : 5,2 - 8,3 MHZ
- : - 65 dBm
- : 6,5 dB
- : Switchable (on,off)
- : 16/27 MHZ switchable
- : 50 HZ - 5 MHZ
- : Pal/NTSC/SECAM CCIR 405-1
- : neg/pos. switchable
- : 1V P/P ADJ.
- : RCA Femelle
- : RCA Femelle
- : RCA 50 HZ - 8,5 MHZ

+ 17,5 Vdc
400 mA LNB

AUDIO VIDEO BASEBAND
50 HZ - 8,5 MHZ

PICOTRONIC
Inh. H. Boertler • Zollamtstraße 48
D-6750 Kaiserslautern • W.-Germany
Telefon 06 31/2 91 87 • Fax 49-6 31/2 95 79

AN FM ATV RECEIVER

NOTES

Several of these units have been constructed and they have worked without troubles. Please realize that tuning in an FM-TV picture is different from what you are used to so a little patience and experience may be required to realize the best from this system. It has been found that pins 3 and 9 of IC2 require between 1 and 1.5 volts on them, this may be adjusted by altering the value of resistor R17, changing this voltage will alter the demodulated bandwidth which is set here to around 10 MHz. One user has arranged to vary the main supply rail to achieve this effect, in this case the demodulator was being used to receive the Russian Gorizont TV satellite in the 4 GHz band and thus required a bandwidth of some 30 MHz! Of course the tuned circuit (L1) was removed.

It is quite possible to change the IF frequency of this unit (due to the fact that no complicated filters are used in the design) which will work quite happily at over 70 MHz. If this order of frequency is required it should only be necessary to change the frequency of L1 tuned circuit and reduce C14 from its present 10 pF to around 5 pF maximum capacity. The VCO frequency will then require setting to the new IF center frequency. The sound output is designed to connect directly to a 6 MHz ceramic filter as used in TV sound systems. In fact most ordinary TV systems are ideal for providing the sound channel.

For those interested, Fig.3 shows the demodulated waveform obtained by applying a sweep signal to the RF input. A measure of the linearity is the straightness of the line, although drawn here it is indeed very straight on an analyzer screen.

INSTALLATION

The easiest and most versatile way to construct an FM-TV receiver is to custom-build it. A demodulator can be installed into an existing TV set, especially if the set is not required for AM as well, but this may mean a fair bit of work and will restrict the units versatility. A straightforward system is to simply connect a varicap tuner to the demodulator, provide a tuning control and put it into a metal box. This could, if desired, house a sound board and loudspeaker as well. Figs 4 and 5 give details of the connections for the U321 tuner and for the popular ELC1043 range. It is useful to provide a meter on the front panel to monitor the tuning voltage, this will give some indication of where in the UHF band you are tuned and may be calibrated in frequency or channel numbers if calibration facilities are available.

All components - including the NE's are available from Ambit International, 200 North Service Road, Brentwood, Essex CM14 4SG. NE592 and NE564 devices are available from Fortop Ltd., 13 Cotehill Road, Werrington, Stoke-on-Trent, Staffs. and from Technomatic Ltd., 17 Burnley Road, London HW10 1ED or Quarndon Electronics Ltd., Slack Lane, Derby. PRINTED CIRCUIT BOARDS are available from BATC Members Services. Edited from CQ-TV 122.

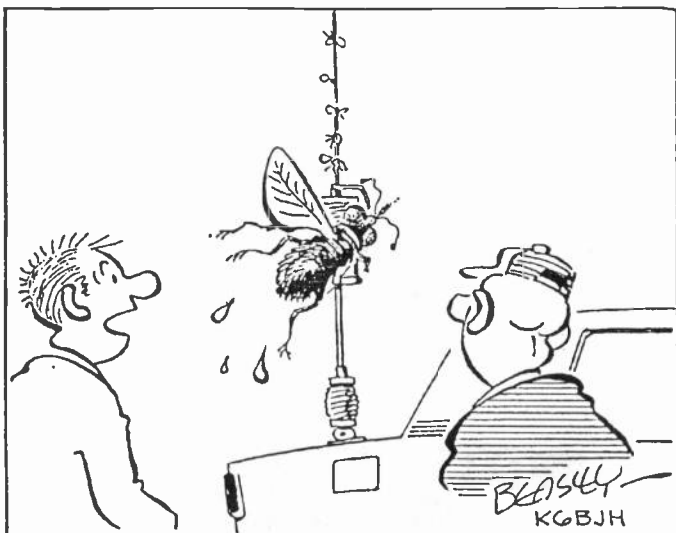

DO YOU SUPPOSE THAT'S WHY THEY CALL IT A BUGCATCHER?



WE CAN'T NAIL HIM FOR PLAYING MUSIC ON THE BAND, THAT'S NOT "MUSIC"--- HOW ABOUT "EXCESSIVE REGENERATIVE FEEDBACK?"

ATV BOOKS

THE BEST OF BOTH WORLDS

NON TECHNICAL

TECHNICAL

ATV SECRETS FOR ASPIRING ATVERS



Volume I

Everything you wanted to know about ATV but didn't know whom to ask!

FEATURING:

HAM TV ON EARTH AND IN SPACE
GET STARTED: HAM TV CHEAP AND EASY
FUN WITH HAM TV
PUBLIC SERVICE HAM TV
THE SKY WAS THE LIMIT: BALLOON, ROCKET & R/C ATV
NASA SPACE SHUTTLE ATV
INDEX TO OVER 500 ARTICLES, FEATURES, BUILD-IT PROJECTS FOR ATV

First Edition

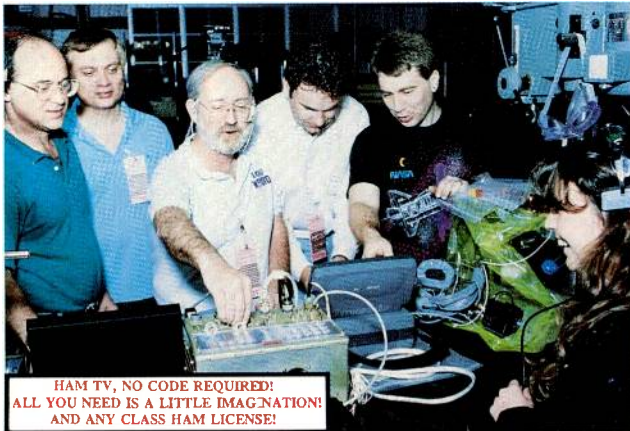

FINAL CHECKOUT OF STS 37 ATV GEAR FOR SAREX. NASA Photo.

ATV SECRETS

volume one,

FOR ASPIRING ATVERS,

AS REVIEWED IN OCTOBER 1992 ISSUE OF QST.

ATV SECRETS is a **great place to start** your ATV adventure. Its 64 pages are tightly packed with **succinct information** to cover all aspects of getting started, where to find activity, equipment, how to DX, and **answers frequently raised questions** of power, antennas, vestigial sideband operation and more. It also includes an **index to over 500 items** which have appeared in ATVQ Magazine. Everything you need to know to enjoy ATV in one place!

\$9.95 plus \$1.50 post (US), \$1.90 (Canada) \$2.90(DX)

TV SECRETS

Volume II



\$24.95 USD

International

Television Topics and Projects for Novice to Expert

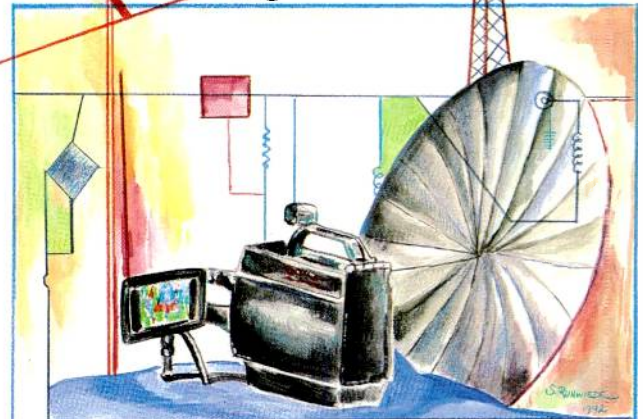

Featuring:

Best of ATVQ Magazine

Future TV: HDTV Tutorial

New Bonus Projects

TV SECRETS

volume two,

for advanced ATVERS,

As published in the October 1992 issue of QST.

A mammoth book, with **292 pages** of technical material. **Over 40 authors** present **over 90 technical projects** and theory topics to fully acquaint anyone from **novice to expert** in the how and what of TV, video and ham TV. Divided into 11 chapters, the book presents **tested projects** for all areas of interest in ham TV including antennas, amplifiers, repeaters, receivers, transmitters, video accessories and more. Suitable for all knowledge levels from novice to expert.

\$24.95 plus \$2.90 post (US) \$3.80 (Canada) \$6.50(DX).

ATV BOOKS

From the BATC available through ATVQ

ATV COMPENDIUM

104 pgs. 8.25 x 5.75 1989

A collection of **projects and useful topics** from issues of CQ-TV, compiled by Mike Wooding G6IQM. A high quality work with projects that work in both NTSC and PAL video systems. The BATC offers **circuit boards and kits** for most items they publish at reasonable cost. This book is OUT OF PRINT. A limited quantity of copies are on hand.

Available from ATVQ at \$14.95 POST PAID.

AN INTRODUCTION TO AMATEUR TELEVISION

154 pgs. 8.25 x 5.75 1992

A collection of **projects and useful topics** including 24 cm ATV and a modular remote control station. Written and compiled by Trevor Brown G8CJS and Mike Wooding G6IQM. A high quality work. **Circuit board layouts** are provided and most projects are available as **circuit boards or kits** from the BATC at reasonable cost.

Available from ATVQ for \$14.95 POST PAID

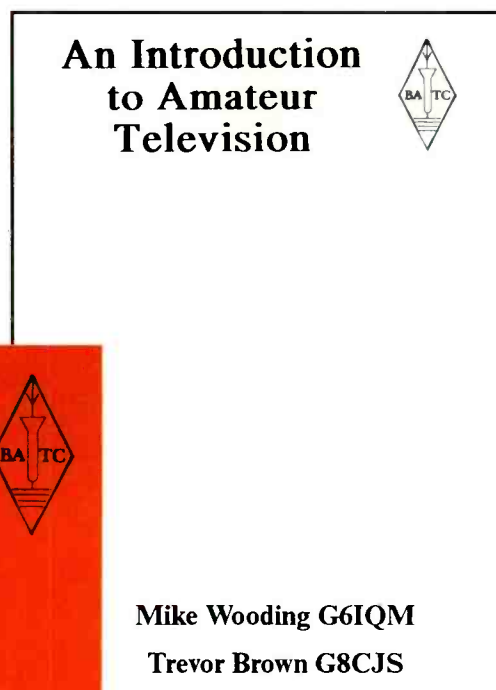
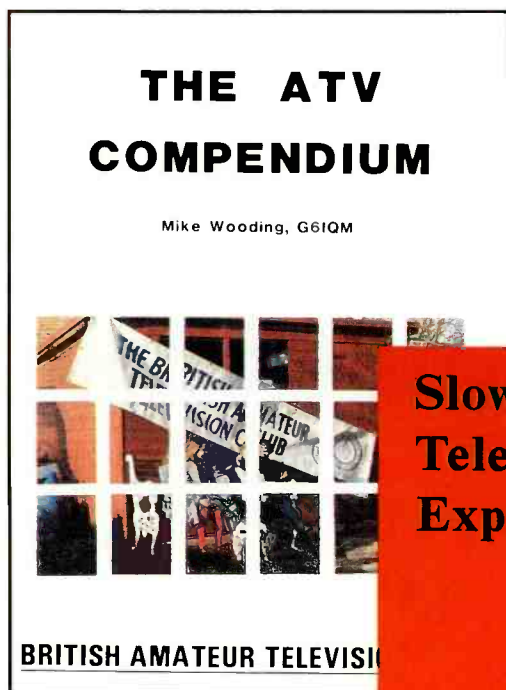

Slow Scan Television Explained



Mike Wooding G6IQM
Trevor Brown G8CJS

The latest word in SSTV!

SLOW SCAN EXPLAINED

Mike Wooding G6IQM

equipment, home studio operation and tips for good pictures, examples of various video modes and **construction projects** for a complete SSTV station.

Now you can find the latest information about SSTV in one place. The newest book from the BATC contains all the current modes including the Scotty modes. Also included are complete descriptions of popular commercial

The written explanation of how SSTV works and the various modes is the best ever written. Everything you need to know in one place to enjoy SSTV as never before. Includes color operation as well.

Available from ATVQ for only \$14.95 post paid.

ATV MAGAZINES

CQ-TV

VHF

COMMUNICATIONS

A quality quarterly publication covering mostly British ATV activity, club news and usually several **good technical projects** per issue. Typically 100+ 5.75 x 8.25 pages per issue. Most projects will also work or can be adapted to NTSC standards from PAL.

Covers video, ATV, SSTV, **ATV repeaters** with **construction projects**. Most projects also have **circuit boards and kits** available at reasonable cost from the BATC.

USA residents may subscribe via ATVQ for \$21/yr which includes all foreign funds exchange fees.

A high quality technical publication with mostly technical projects for VHF-UHF, Microwave and ATV. Projects are renowned for their quality. The publication also offers **PC Boards and kits** for projects. Probably **the best technical ham radio magazine today!** Authors are world famous hams and articles are technically sound.

USA residents may subscribe via ATVQ for \$27/yr which includes all foreign funds exchange fees.

CQ-TV

MAGAZINE
No. 140

BRITISH AMATEUR TELEVISION CLUB

NOVEMBER 1987



Repeaters list - Servicing the TVRO modules - Sound demod SCART - VSWR - Sync separ Reviews - Portable generat Building repeaters - A/V fac TV software - Contest new Time base correction

ATVQ Continuing the heritage of great US ATV publications, with topics and projects for all levels from novice to expert, plus FCC news, club and operating news, equipment reviews, build-it projects, covering all aspects of ham TV including FM-TV and HDTV.

AMATEUR TELEVISION QUARTERLY

VOLUME 6 #1
JAN., FEB., MARCH 1993
ISSN 1042-198X
USPS 003-353

AN ATV VIEW
FROM SPACE

\$100 ATV STATION
UPDATE ON HDTV
R/C ATV
ATV STUDENTS
AND SPACE

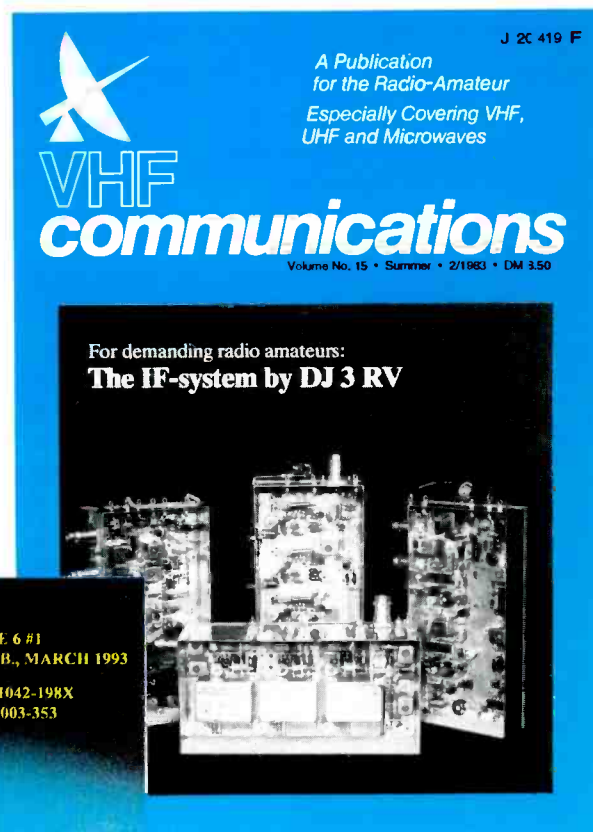

Published four times per year. a must read for any video hobbyist. Just the facts without hype. \$18/yr US, \$22 Canada, \$29 DX. multi-year discounts, see order page. ATVQ sponsors the annual friday night Dayton ATV Party featuring expert speakers, live demos, socializing and ATV fun. Published by Henry KB9FO and Bill WB8ELK.

I GOT MINE, DO YOU HAVE YOURS?

CLOSE OUT SPECIAL

The **ATVQ Indian Head Test Pattern** coffee mug. Just the thing to add class to your shack and hold your favorite beverage! **Holds 12 oz.** This fine china mug is a limited edition with the famous test pattern on one side and the famous ATVQ logo on the other. The colors are TV black for the art work and antique tan for the cup. Shipping weight is over a pound! This is a **quality product** and not available anywhere else. Show your video hobby with pride or use as **great gifts** for video friends.

Only \$5.99 plus postage (\$2.90 US, \$3.50 Canada). Satisfaction guaranteed!



ORDER FORM:

>>PUBLICATIONS<<

- > **ATV SECRETS for Aspiring ATV'ers: Vol 1.** An introduction to Amateur Television 64 pages 100 illustrations. \$11.45 post paid _____
- > **TV SECRETS, Topics and Projects for Novice to Expert: Vol 2.** 90 technical projects 292 pages none bigger, none better! \$27.75 post paid _____
- >>>SPECIAL: Both Vol 1 and Vol 2 of ATV Secrets..... \$34.95 post paid _____
- > **An Introduction to Amateur Television, BATC,** 156 pages, \$14.95 post paid _____
- > **ATV Compendium, BATC,** 104 pages..... \$14.95 post paid _____
- > **Slow Scan Explained, BATC,** 150 pages \$14.95 post paid _____
- > **Full Color test chart set,** color bars, registration, gray scale, frequency response on 4 sided heavy enamel stock \$5.00 post paid _____
- > **ATVQ Indian Head test pattern 12 oz. coffee mug.** Fine china collectors item..... \$8.69 post paid _____
- > **ATV IS FUN AND INEXPENSIVE,** 8 page handout for ATV demos, clubs, hamfests, to build interest and activity.....pkg of 25 \$5.50 post paid _____

>>VIDEOS<<

- > **An ATV Balloon Adventure.** 30 min on VHS. Watch as KB9FO in Chicago, DX's a 1 watt ATV signal launched on a balloon from Dayton Ohio. Shows how to find signal, tracking, advantage of preamp, live action with narration and intro and wrap-up. Great for ATV demos, hamfests and club meetings. NO MUSIC! \$6.49 post paid _____
US set \$59.95 post paid _____
- > **TV Bloopers.** Remastered from HI-8 and 3/4". Nearly 12 hours of US TV Bloopers (US set) and 12 nearly 12 hours of foreign TV bloopers. Rated R/X. (N,L, S, adult themes!) Varied quality due to multiple sources and vintages of material. Includes classic gags, commercials, goofs, stumble tongs, "Christmas" events and broadcast and non broadcast material. DX set \$59.95 post paid _____
BOTH (24 hrs!) \$99.95 post paid _____

>>SUBSCRIPTIONS<<

- > **CQ-TV** from BATC. 4 issues per year, subs run by calendar year. \$21/yr _____
Good technical and operational material, kits \$27/yr _____
- > **VHF Communications.** 4 issues per year, subs run by calendar year. Excellent technical material and projects, kits years _____ \$ _____
- > **ATVQ,** A must read for any ATV'er. 4 issues per year.

Factual, topical, informative, the #1 source in the western hemisphere!

RATES	US	CANADA	DX
1 yr	18	22	29
2 yr	32	39	49
3 yr	45	49	69
4 yr	59	65	89
5 yr	75	80	109
LIFE	359	399	499

TOTAL \$ _____

Send to: **ATVQ, 540 E. Oakton St.,
Des Plaines, IL 60018**
VOICE MAIL INSTANT ORDER LINE
708 298 2269 FAX 708 803 8994.
VISA/MASTERCARD ACCEPTED.

all ⁱⁿ **COMMUNICATIONS**®
THE INTERNATIONAL PRODUCT HIGHLIGHTS MAGAZINE

All in Communications
is dedicated to those people
with the knowledge and power to make informed
buying decisions within the commercial industry.

The first bilingual international product highlights magazine will be 8 1/2" X 11" standard size, printed in glossy paper. It will consist of 84 pages, out of which the first half will be in English with the other half translated into Spanish. It will serve as a technical dictionary for all those who would like to do business in a market where the only obstacle is the language barrier. With *All in Communications*, the problem is solved!

For more information about this unique bilingual publication, contact our Advertising Department.

PHONE 305 · 594 · 7735
FAX 305 · 594 · 7677

VGA TO NTSC ELITE

BY JOHN P. SPAETH KDOLO

Ever since I sold my Amiga computer I have been looking for a way to produce reasonable NTSC video from a super VGA computer. The display device used by most pc's today in the lower end graphics market is the SVGA display. It has gray level capabilities, color, and multimedia has given ATV'rs the ability to display real world images on their computers instead of simple computer generated graphics. This phenomenon is relatively new for the "PC" and the multimedia blitz which is occurring right now will continue to yield exciting new graphic "toys" for those of us who wish to integrate our computers into ATV.

Since VGA is not compatible with NTSC, and since the RGB component output from the computer is not compatible with NTSC transmission systems, a conversion has to be made.

VGA Compared To NTSC

- 1) Horizontal Frequency
VGA=31.6 KHz
NTSC=15.7 KHz
- 2) Vertical Frequency
VGA=70.0 KHz
NTSC=60.0 KHz
- 3) VGA=Non-Interlace
NTSC=Interlace

While there are several VGA to NTSC "cards" available they were all disappointing. They all had a problem of some type. While it is not within the scope of this short review to cover all the converters available, I will mention a few of the problems I encountered just in case you have occasion to purchase one of the boards, and then go on to review my personal choice of converters.

Some of the VGA video cards have feature connectors which emanate from the opposite side of the main edge connector of the video board. This Feature connector can be a small edge connector or a dual in-line header. If the video card does not have a feature connector you may run into problems later if you decide to incorporate one of the newer frame grabbers. Most of the frame grabbers require a connection to the feature connector of a VGA card. I ran into this problem with my old Ventek NTSC converter as it did not have a feature connector and I needed one when I added my MEDIA V frame grabber.

Another problem with many of the NTSC converters is that they use a TSR when operating. TSR is an acronym for "terminate and stay ready", this refers to a small program which gets loaded into your computers memory, and operates in the

background of whatever application you may be running. The TSR does require some memory to run, so you want to be sure your system resources will allow for an additional 1k to 5k of memory above and beyond that which is used by your application. One must also be sure that the NTSC converter will load its TSR into a free memory area that has not been allocated for something else by a memory manager or other application.

One method used in the NTSC conversion process is to reduce the system video to the equivalent resolution of CGA. This is roughly NTSC television size. Some of the converters actually reconfigure the computer systems video to this reduced standard for ease of conversion. This means that when you call the TSR to encode into NTSC, you might lose the picture on your SVGA monitor unless you have a multisync monitor capable of switching resolutions.

Some of the NTSC converters are internal cards that have SVGA chip sets built onto them so you won't have to use your current video card, some others are plugged into

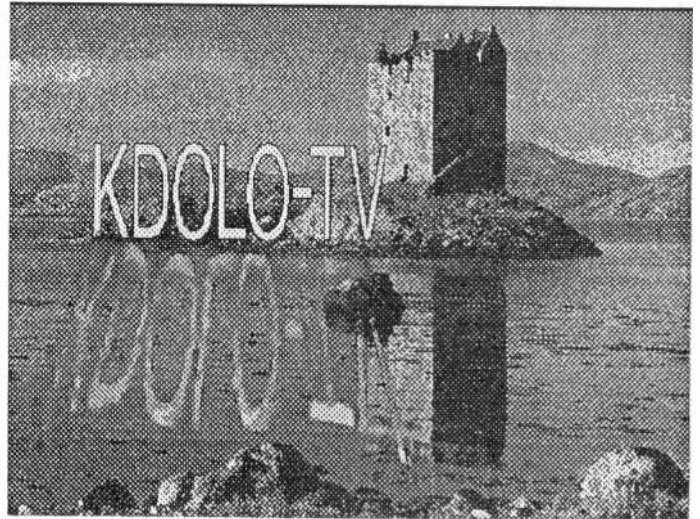

ABOVE: Photo of an actual SVGA computer graphic after conversion with the ELITE as pictured on an NTSC tv screen

the computer bus but require an external video jumper from the current VGA card to its input connector creating a pass-through situation.

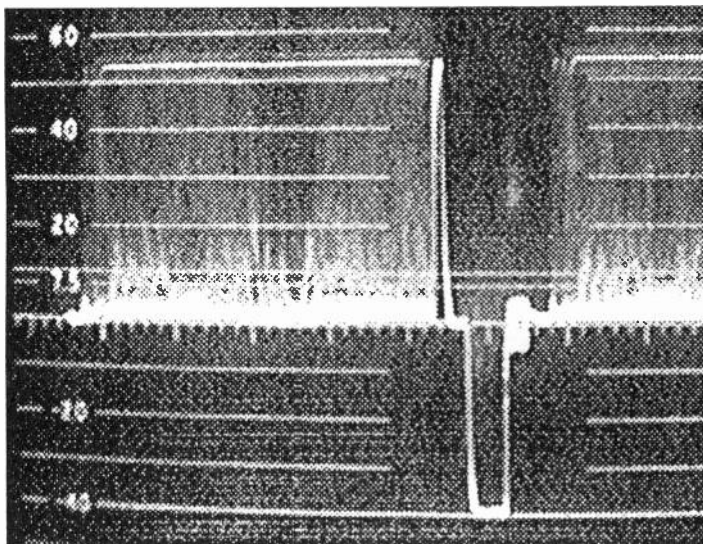

ABOVE: Photo of a video waveform from the NTSC output of the Video Elite. (note: video content is a screen from Microsoft's windows.)

Be careful of the "plug-ins" to make sure the necessary address, irq (if needed), and dma channel are compatible with other cards you are currently running. If the board has a built in SVGA chip set, check to make sure all the drivers are available for your applications (i.e. VPIC, WINDOWS, AUTOCAD, MATHCAD, etc).

There is another class of NTSC converter which does most of the conversion externally and uses very few of your computer systems resources. This is called a scan converter. It is a stand alone device which receives the SVGA video at its input, and passes it straight through to your SVGA monitor. It also samples this SVGA and rescans it into an NTSC format. So that instead of merely combining the RGB and sync and outputting composite video, it actually performs a scan conversion line by line and yields two, simultaneous, outputs one SVGA and the other NTSC in their respective formats. These scan converters require no TSR and have no system resource overhead. The catch is they are very expensive! The least expensive currently advertised being \$1600.00.

Advanced Digital Systems have developed a device which is a hybrid in terms of its function, and utilization of system resources. The unit is called VGA > TV ELITE. It does require a small TSR to operate about 2k. However it supports simultaneous viewing of VGA and NTSC on respective monitors, and is compatible with memory managers and all applications I have tried.

"...My personal pick for best converter, is the Advanced Digital Systems, VGA>TV ELITE..."

The ADS converter is an external unit which uses a SVGA loop through. It is self contained and it comes supplied with all necessary cables and power supply. The unit is small (approx 3x5x1), and in an attractive "plastic" case. The unit outputs NTSC video through an RCA connector (1 VPP), and also outputs simultaneous s-video using a standard s-video connector (cable supplied). The unit will run without the TSR installed, but the TSR eliminates the "flicker" associated with the scan conversion. The software also allows for screen alignment, and sizing which is a necessary feature.

Best of all, the unit sells for under \$300.00, and I purchased mine mailorder from Computability in Milwaukee. The unit is also available with PAL (Phase Alternating Lines) for our friends in the UK and elsewhere.

When one looks at the waveform pictured above, one can readily see that the TV ELITE is not destined for commercial broadcast use. However with 40 IRE units of sync, and an honest 1VPP output into a 75 ohm load, and good chroma characteristics, the converter is well suited for amateur use, and does a fine job transmitting through the currently available amateur television transmitters. The converter will handle all VGA resolutions up to and including 640 X 480 X 32,768 colors, and does support overscan.

Based on overall price and performance, my personal pick for best converter is the advanced digital systems VGA>TV ELITE.

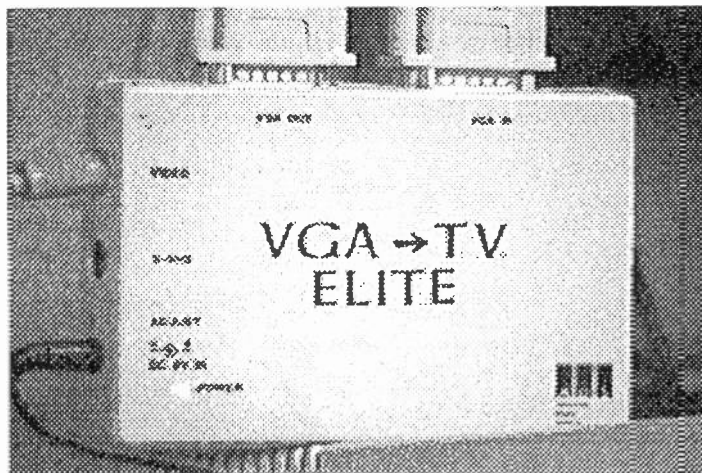

Above: VGA > TV ELITE at work on my computer



ELECTRONICS

P.C. ELECTRONICS 2522 PAXSON LANE ARCADIA CA 91007-8537 USA

TOM (W6ORG) & MARYANN (WB6YSS) O'HARA

(818) 447-4565

24 hr FAX order line (818) 447-0489



TC70-10 ATV TRANSCEIVER

All in one box



ONLY \$499 delivered

>10 Watts
p.e.p. Out
Made in USA

TC70-10 Transceiver lets you get on right away with all the power most will need in one box - *90 Miles line of sight

- Adjustable peak envelope power RF output
Typical range from 2 to 15 Watts allows proper adjustment to fully drive the RF Concepts 4-110 or Mirage D1010-ATVN to full 100 Watts output for DX, without sync or audio clipping.
- Separate mic and line audio volume controls
Lets you do voice over commenting on video tapes
- Rugged 7.5x7.5x2.7" black die cast alum. box
Stands up under rough public service applications and takes up less space on the operating table than 1 Watt plus amp.
- True Final RF detected video monitor output
lets you properly set the video gain control based on final output RF rather than low level. Camera video is at this jack during receive for focus & lighting set up before transmitting.

Front panel jacks accept composite video and line audio from your camcorder or VCR plus a low Z mic with push to look. Sensitive GaAsfet downconverter tunes whole 420-450 MHz 70cm band down to your TV channel 2, 3 or 4. Comes with one crystal you specify on 439.25, 434.0, 427.25 or 426.25. Second switch selectable crystal add \$15. Requires 13.8 Vdc @ 3 Amps.

P.C. Electronic pioneered the ATV transceiver in 1977 with the 10 Watt TC-1. While the change in 1985 to the 1.5 Watt units gives the flexibility of selecting 15, 50 or 70 Watts depending on the situation, many long time ATVer's said they missed the old 10 Watter which did just fine in most cases for local and repeater use - *90 miles snow free line of sight using 14 dBd beams. You've always been able to build your own 10 Watt system from some of the basic modules on page 2 (TVC-2G, TXA5-70, FMA5-F and PA5), but now we have a ready to go alternative in a rugged die cast aluminum box.

Transmitting equipment sold only to licensed Tech class radio amateurs, verified in the Callbook, for legal purposes. If newly licensed or upgraded, mail or fax copy of license. However, receiving downconverters available to all (pgs 4 and 5).

COMPLETE 70CM ATV STATION

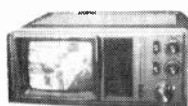

Your TV set

+



+

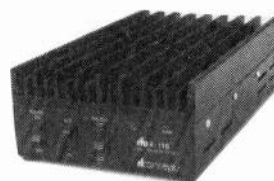

+

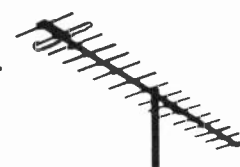

Your video camera or camcorder

TC70-10...\$499
ATV Transceiver
10 Watts p.e.p. min.
13.8 Vdc @ 3A power supply req.
specify transmit frequency(s)
Remember when comparing prices, ours include UPS

Optional 100 Watt Amplifiers
RF Concepts 4-110.....\$349
Mirage D1010-ATVN ...\$349
25 Amp pwr supply req.
surface shipping.

Antennas - see pg 5
KLM 440-16X 14dBd \$129
KLM 440-10X 11 dBd \$72
KLM 440-6X 8.9 dBd \$60
RUTLAND FO22-ATV 15.8 dBd \$115

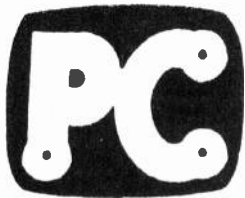

ELECTRONICS

P.C. ELECTRONICS 2522 PAXSON LANE ARCADIA CA 91007-8537 USA

TOM (W6ORG) & MARYANN (WB6YSS) O'HARA

(818)447-4565

24 hr FAX order line (818) 447-0489



NEW - THE ATV TWINS

THE LOW COST
PROGRESSIVE
ALTERNATIVE
TO A TRANSCEIVER

Made in U.S.A.



TX70-1b Transmitter only **\$279** delivered UPS TVC-4G Downconverter **\$89**

Not Sure what ATV is all about and your hobby budget's tight? Start with the tried and true TVC-4G Downconverter to see the action for just \$89. Then later, when you want to transmit, just add the TX70-1b companion Transmitter at only \$279.

TX70-1b SPECIAL FEATURES:

- * Two frequency 1.5 W p.e.p. transmitter properly matches linear amps with adjustable internal sync stretcher & blanking level on the time proven KPA5 transmitter board
- * Built-in RF T/R relay board switches antenna and applied 13.8 Vdc between transmitter and your external ATV downconverter
- * Full 25 kHz dev. broadcast standard 4.5 MHz sound subcarrier with independent mic and line audio controls allow voice over commenting while showing home video tapes. Accepts low impedance dynamic mics with "Push to Look" switch.
- * Transmit RF detected composite video outputs to monitor phono jack on back to see what you are transmitting. In receive you see your own direct camera video at this jack to enable focus and lighting set-up before flipping the switch into transmit.
- * RCA phono jack camcorder or VCR composite 75 Ohm video and line audio inputs, type N 50 Ohm antenna input, and 50 Ohm BNC output to downconverter connectors
- * Small attractive shielded cabinet - 7.3 x 4.7 x 2.1", 1lb. 11 oz.

Just plug in your camera, VCR, camcorder, etc. composite video and audio, 70cm antenna, 12 to 14 Vdc @ .5A, and you are ready to transmit live action color or black and white pictures and sound to other amateurs. Specify 439.25, 434.0, 427.25 or 426.25 MHz transmit frequency. 1 crystal included, second crystal add \$15.

*Transmitting equipment sold only to licensed Tech class or higher radio amateurs verified in the Callbook for legal purposes. If newly licensed or upgraded, mail or fax copy of license.

WHAT ELSE DOES IT TAKE TO GET ON ATV?

Any code free Tech class or higher amateur can get on 70cm ATV. Any video camera, camcorder, VCR or computer with a composite video output can be plugged into the front panel phono jacks for both audio and video.

Start by selecting a 70cm antenna and connecting a TVC-4G downconverter to your TV set to receive. Add the Transmitter along with your camcorder and 13.8 Vdc from a regulated power supply capable of .5 Amps and you are on the air.

DX with TX70-1b's and FO22-ATV antennas line of sight and snow free is over 22 miles, 7 miles with the 440-6X normally used for portable uses like parades, races, search & rescue, damage assessment, etc. For greater DX or punching thru obstacles add either of the ATV compatible 15, 50 or 70 watt amps listed below.

The TX70-1b has full bandwidth for color, sound and live action just like broadcast. You can show the shack, home video tapes, computer programs, repeat SSTV, weather radar, or even Space Shuttle video if you have a home satellite receiver. See ARRL Handbook chapt. 20 & 7 for more info & Repeater Directory for local ATV repeaters.

BUY AN AMP WITH THE TX70-1b & SAVE!
50 WATT WITH D26N-ATV...\$499
70 WATT WITH D100-ATVN..\$599

Most telephone orders shipped within 24 Hours

7/93

COMPLETE 70CM ATV STATION

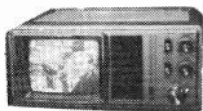

Your TV set

+



+

TX70-1b-\$279 & TVC-4G-\$89
ATV Xmit & Rec
1.5 Watts p.e.p. 13.8 Vdc
Power Supply
required

pg 3

Remember when comparing prices, ours include UPS surface shipping.



Optional Amplifiers

Mirage D15N 15 Watts RF out\$169
Mirage D26N 50 Watts RF out.....\$239
Mirage D100ATVN 70 Watts out.\$349

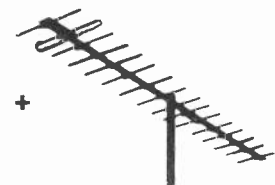

Antennas see page 5

KLM 440-16X 14dBd \$129
KLM 440-10X 11 dBd \$72
KLM 440-6X 8.9 dBd \$60
RUTLAND FO22-ATV 15.8 dBd \$115



Your video camera
or camcorder

HAMS, call 818 447-4565 for your free complete ATV catalogue now!

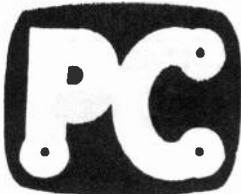

P.C. ELECTRONICS 2522 PAXSON LANE ARCADIA CA 91007-8537 USA
 TOM (W6ORG) & MARYANN (WB6YSS) O'HARA (818) 447-4565

24 hr FAX order line (818) 447-0489



ELECTRONICS

THE "KREEPIE PEEPIE" ATV TRANSMITTER

THIS IS THE ATV TRANSMITTER BOARD YOU HAVE READ ABOUT THAT HAS SURVIVED MANY BALLOON FLIGHTS TO OVER 100,000 FEET AND BACK. ALSO USED FOR R/C MODELS WHERE AN ALL IN ONE BOARD WITH SOUND IS DESIRED OR DEDICATED LINKS AND REPEATERS. JUST THE THING FOR THE BUILDER WHO WANTS TO PACKAGE AND MAKE HIS OWN PORTABLE 70 CM ATV TRANSMITTER OR HOME TRANSCEIVER WITH A WIRED AND TESTED BOARD.

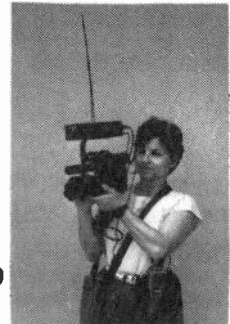
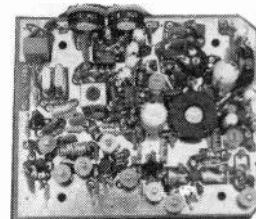
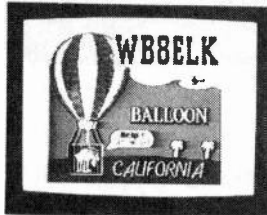
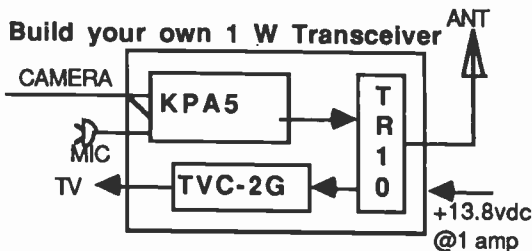

KPA5-F board only \$169

KPA5-E 70CM ATV XMTR BOARD FEATURES:

- 1.5 Watts P.E.P. typical RF output. Run barefoot for portable, but if needed for greater DX, the output properly matches the Mirage D15N 15 watt, D26N-ATV 50 Watt linear amp for full output or D100TVN to over 70 Watts with its adjustable sync stretcher.
- FULL COLOR AND SOUND on a small 3.25x4" board
- Wired and tested board runs on external 13.8 Vdc @ 300 mA. supply or 12 V battery. Weighs only 3 oz.
- Accepts composite video from cameras, camcorders, VCRs, computers, etc. 2 audio inputs, one for low Z dynamic mic, & one line level from most cameras & VCRs. Transmit monitor output enables seeing your own true RF detected video.

KPA5 APPLICATION:

PORTABLE CORDLESS TV CAMERA. Think of it as a video HT. Place the KPA5 in one of the L.M.B. Diecast aluminum boxes, AEA HR-4 half wave "hot rod" on top or at the end of 50Ω coax attached to a headset. Plug into a 12-14 v source such as a 12 Vdc battery pack. Depending on terrain & receiving antenna DX is typically over 1 mile. With KLM 440-16Xs at both ends DX is 22 miles snow-free line-of-sight.

Price only \$169 supplied with one xtal on 426.25, 434.0, 427.25 or 439.25. 2nd xtal add \$15. Specify frequency(s) when ordering, check with local ATVers, ARRL Repeater Directory or call us. Sold only to Technician class (including new code free Tech) or higher licensed radio amateurs.

ACCESSORIES:

- L.M.B. CAB247 7.3x4.7x2" roomy aluminum box.....\$20
- CAB234 4.6x3.6x2" aluminum box, smaller tighter fit.....\$13
- 100 Ohm panel pot for video gain control.....\$5
- TR-10 RF T/R relay module, mounts on chassis N conn.....\$29
- TVC-4G..\$89 or TVC-2G..\$49 Downconverter (pg 5)
- VOR-2a Video (horiz sync) operated relay board.....\$45
- MIRAGE D15N-ATV 1.5 in /15 out all mode amp.....\$169
- MIRAGE D26N-ATV 1.5 in / 50 out all mode amp.....\$239
- MIRAGE D100TVN 1.5 in/70 out all mode amp.....\$349

- AEA HR-4 "Hot Rod" half-wave portable antenna.....\$24
- 450 ISOPOLE omni 4 dBd vert. gain antenna.....\$89
- KLM 440-6X 8.9 dBd ant., 28" boom, >50 deg. BW.....\$60
- KLM 440-10X 11.2 dBd, antenna, 64" boom.....\$72
- KLM 440-16X 14 dBd antenna, 10.5 ft boom.....\$129
- UG21 type N male connector for Belden 9913 coax.....\$5
- UG58 N female flange type chassis connector.....\$2
- 800J 10 pin VHS color camera chassis connector.....\$10
- 800P 10 pin VHS color camera cable male plug.....\$15

SMALL TXA5-RC 1 WATT ATV TRANSMITTER.....\$129

Designed primarily for Radio Control models, rockets, balloons, etc. with it's small 2.25 x 4 inch size and 2 oz. weight. Adjustable power output from 1.5 p.e.p. to 100 mW. Draws 350 MA @ 13.8 Vdc and 1 Watt, 200 ma at .100 mw Has adjustable sync stretcher and provisions for sound from the FMA5-F board (pg 2) in case your application needs higher power sometimes or subcarrier sound. Comes wired and tested ready for you to mount in a shielded enclosure, connect up coax from antenna and camera and wires to power source. Plan on shielding your R/C receiver and adding the simple antenna low pass filter supplied with the application note. Receive with one of our 70 cm downconverters listed on page 5 and a TV set Specify freq., 426.25 MHz suggested for R/C, other standard ATV freq. avail.

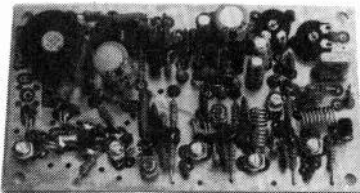

TXA5-RC

See page 8 & 10 for mini cameras

New TXA5-70a board can also be used for R/C applications where 2 frequency capability is desired. Same size as TXA5-RC but 80 mw.for .25 to 5 mile DX, or add 10 Watt PA5 amp for 3 to over 100 mile line of sight DX. See pg 2.....\$89

NEW MICROTEK ATVM-70 mini ATV transmitter board.....\$129

Only 1.0 x 1.3 inch, wired and tested board. See article in July 91 73 Magazine page 9. Nominal output 80 mw. Capable of driving the PA5 for higher power. Requires 7.0 to 10.0 Vdc maximum at <100 ma. Only 434.0 MHz is available with the SAW oscillator. Also Great for R/C models, robots, demos or short links. Snow free line of sight DX 1/4 mile dipole to dipole or up to 5 miles with KLM 440-16x's.

NEW companion MSC-2 4.5 MHz sound subcarrier board, same board size as xmtr....\$59

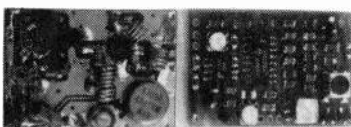

ATVM-70 Transmitter MSC-2 Sound

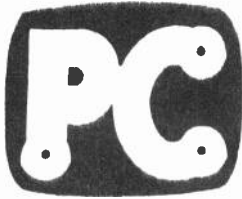

ELECTRONICS

P.C. ELECTRONICS 2522 PAXSON LANE ARCADIA CA 91007-8537 USA
TOM (W6ORG) & MARYANN (WB6YSS) O'HARA (818)447-4565

24 hr FAX order line (818) 447-0489



420-450 MHz ATV DOWNCONVERTERS

GET STARTED WITH ONE OF THESE TO SEE THE ACTION!



Space Shuttle video



TVC-4G

TVC-4G PACKAGED DOWNCONV. with AC supply.....\$89
Contains the sensitive TVC-2G board in a black die cast 4.7x3.7x2.1 inch aluminum box ready to go with 120 Vdc 60 Hz to 12Vdc 100 ma. wall plug power supply. N connector antenna input and F output to TV. Companion downconverter to our TX70-1b transmitter and other TX boards. TVC-4G is handy for ATV portable, mobile, demos, or getting a friend on. Also used in community pay TV systems outside USA.

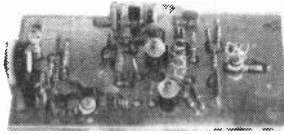

TVC-2G 2"x4"

TVC-2G GaAsFET TUNEABLE DOWNCONV. BOARD.....\$49
Wired and tested module connects between 70cm antenna and TV set tuned to channel 2, 3, or 4. Varicap tunes whole 420-450 MHz 70CM amateur band. Sensitive 1 dB NF dual gate GaAsfet used in both the preamp and mixer stages. Double tuned bandpass filter rejects strong UHF broadcast interference. 25 dB gain. Requires +11 to 18 Vdc @25 mA, shielded enclosure, knob, 10K pot, switch, fuse and connectors.

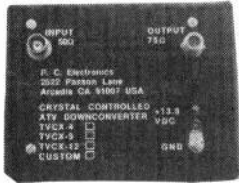

TVCX-4

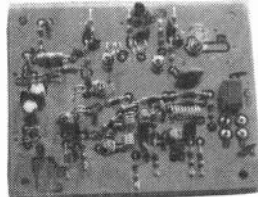

TVCX-70 3"x3.8"

TVCX-70 XTAL CONTROLLED GaAsFET DOWNCONV....\$99
Crystal controlled version of tuneable TVC-2G board used in repeaters or unattended operation with wide temperature variations or at a public service event where a tuning knob might be touched by unauthorized persons. Specify input frequency (421 to 440 MHz) and output (ch 3 or IF). +11 to 15 Vdc @ 50 mA external power, shielded enclosure and connectors required. 2 freq. add \$15. LMB CAB-234 box...\$13
TVCX-4 is the TVCX-70 board ready to go in the CAB-234 box ...\$129

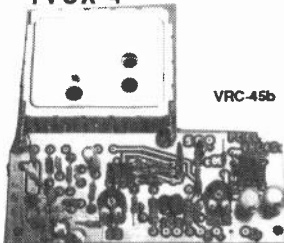

VRC-45b

VRC-45b 45.75 MHz IF/receiver module. 2 composite video outputs, squelched line & speaker audio outputs. Used with TVCX-70 in a CAB-247 box for complete receiver. 4x3.75". 12V @ .25A.....\$99



KP2

MIRAGE KP2 ANTENNA MOUNTED PREAMP.....\$159
If your coax loss is greater than 3 dB then this preamp can make a difference. Automatic T/R switching 1/4 to 150 Watts. .6 dB NF 15 to 25 dB gain. N conn. Req. 12 to 14 Vdc - included dc coupler in shack.

KLM, SWIECH & RUTLAND BROADBAND BEAMS FOR ATV

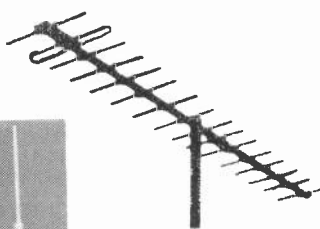

KLM 440-6X 8.9 dBd gain, 28" boom, vertical or horizontal polarization rear mount. Ideal for point to point, fixed at a repeater or small enough to be portable at public service events to minimize multipath ghosts and get some gain at the same time. Wide 60 degree beam width. All 5 include 50 Ohm balun with Type N female conn. \$60 del.

SWIECH COY4327EL 10 dBd, 4' boom, an extra dB over the 6X for 5 more bux..\$65

KLM 440-10X 11.2 dBd gain, 64" boom. Bigger version of the 6X....\$72 delivered

KLM 440-16X 14.2 dBd gain, 10.5 ft boom, center mounted. full 420-450 MHz bandwidth, and very rugged\$129 delivered

RUTLAND FO22-ATV 15.8 dBd, 420-450 MHz, 14 ft boom, center mtg...\$115 del.

The antenna, coax and tower height are the most important part of your ATV system and deserves your most care and attention. ATV antennas must have broad bandwidth in addition to high gain and low VSWR. Few other antennas work well at both 439 and 421 MHz. The three KLM, one Swiech and Rutland antennas listed here fit the requirement and have a long history of rugged operation with ATVers. The gains listed have been proven out at VHF/UHF conference antenna measuring contests, they are not marketing hype. All four beam antennas listed here take up to the maximum legal power limit. Balun or matching network with female type N connector is included. We suggest using Belden 9913 (2.6 dB/100') or better 50 Ohm low loss coax or hard line. Belden 8214 (4.2 dB/100') is more flexible and is fine for runs less than 50 feet.

AEA 450 ISOPOLE OMNI 3-4 dBd GAIN ANTENNA. 50 ohm type N, 1.25" mast mount.....\$89

DIAMOND F718 9.3 dBd OMNI 15' long, F718L=420-430, F718J=430-440 & F718A=440-450 MHz.....\$219

FOR SALE SWAP AND SHOP!

I have extra copies of the following VHF Communications issues 1975 #2, 1982 #4, 1983 #1, 1984 #3, 1985 #1 & #4, index 1970 to 1980. Sell, Trade? John Thomas, Lindsay Specialty Products, 50 Mary St., Lindsay, Ont, Canada K9V 4S7. 705 324 2196.

Complete ATV Station. TC-1 Plus (10 watt) \$250, D1010 amp (new) \$300, Astron RS35 A supply (new) \$125, Yaesu YS-500 SWR (new) \$90. Entire pkg \$700 post paid. Pastor Rick Strawcutter, WA8RJD, PO Box 892, Adrian, MI 49221. 517 263 3029.

Motorola/Eimac 300 Watt output repeater amp. RF deck and tube are new. With Motorola power supplies and unused meter panel. \$550 or BO. Contact Henry at ATVQ.

Rohn HDBX-40. Used two years. In garage now awaiting new home. Cost over \$600. Make reasonable offer. Need room for lawn mower! Contact Henry KB9FO at ATVQ.

NEW: Two, 1 watt 440 ATV Transceivers, 50 watt output amp, power supply, preamps, TTD decoder, PC Electronics various boards (VOR-2, CA-1, etc) Over \$1500 in goodies. also **D100ATV** Send SASE for list. Making room for Yaesu 736! (Will still have 4 multiband ATV stations) Contact Henry KB9FO at ATVQ.

I cleaned out the shack (wife's orders) Can now see the floor (first time in years). **Commercial TV test signal generator** (portable or rack mount, solid state) Telemet, Two **time-date generators**, one Laird one Panasonic, Two **TV Demodulators**, one all channel, one channel 5. Four, solid state **B&W 9"**

monitors. (for rack mounting, not in cases but have front panel for two) Including rack shelf. Also NEW in box, **KLM stacking kit** for four, 440 beams (any size beam) also will stack any other 440 antennas, with **power divider!** TFT digital **synthesized AM best receiver**, great for SWL or EBS, Science Workshop on carrier audio receiver, self contained. Includes books on most items. **MAKE OFFER** before trash man comes! Contact Henry KB9FO at ATVQ.

WORK HF? Heath KW Antenna tuner (metered). Tune that mattress spring or wet noodle. Get on 160 with your 2 meter whip! \$300 or best offer. Henry KB9FO.

220 MHz is calling. Now work the rare 220 stations with a **G7-220 base antenna.** 2 years old, used once. Sold the rig. U buy the antenna! In the garage taking up space. Make offer! You pick-up. I already threw out the 900 MHz F9FT's, & a new 4 element HyGain 15 mtr monobander and Heath 6/2 transceiver! Henry KB9FO.



DX COMMERCIAL TV? Collection of Jerrold **CATV UHF TV yagi antennas.** (Five at last count) Each covers about 1/3 of UHF band, cut for channels 14, 26, 32, 44, 66. About 16 dB gain each. BO Taking up garage space. Henry KB9FO

Satellite TV: Uniden C band 60 degree **commercial LNB** (900-1500 out) with Chapperal feed horn. FB condition with polarator. Use on home system! Over \$400 new. 3 years old. Make Offer! Henry KB9FO.

CHICAGO CONSUMER ELECTRONICS SHOW

The biggest attractions this year centered around **interactive (multi-player) video games** and virtual reality displays. There was, of course, no ham radio equipment on display. Some HDTV equipment was displayed but the ballyhoo of last year has abated. Large screen TV's were in abundance and one system provided goggles which was reported to give the effect of having an 8 foot high TV screen without the actual physical display.

SEGA's virtual reality display had long lines but the actual program had a lot of artifacts which were distracting and video quality was less than most regular computer games. Game fanatics could also get mini effects systems. These consisted of chairs which would tilt, vibrate, sway or turn in response to the game (ie a flying simulator) and some new games had positive feedback to the game controls, such as the steering wheel, which would simulate the drag of off-road, dirt or turning resistance.

Little was seen in the way of new micro cameras or VCR's. The palm sized units seem to have reached a plateau. New editing VCR's in all formats were on display, most

being slightly upgraded versions of last years editing systems.



Newtek displayed their new **Video Toaster 4000** which also has supporting products, the Ami-link which ties most consumer/industrial VCR's into an editing system which interacts with the Toaster. The Toaster is still Amiga based but the display floor was filled with rumors. Commodore is expected to announce a \$170 million loss and is reported

to have closed all US parts, service and sales offices as a result of the losses. The Toaster is Amiga (Commodore) based system and is dependent on the special graphics chips only available in the Commodore Amiga computers.

Sources indicated that Newtek may

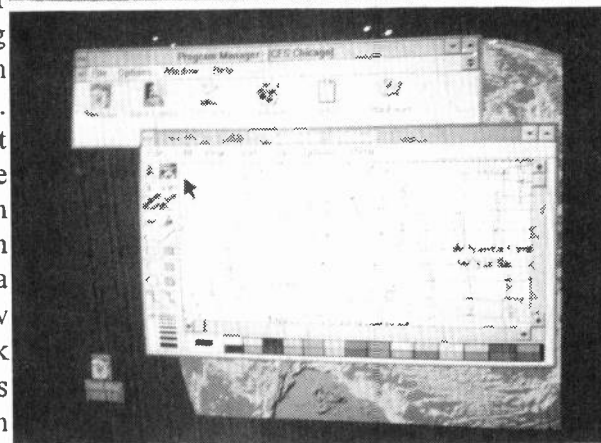

purchase Commodore in order to keep their hardware platform for the Toaster software. Newtek is also looking at interfacing their product to other computer systems to expand

their user base.

The Toaster itself has some improvements and features, some of which are excellent. The digital effects appeared a little rough, and more refinement of the video filtering seems necessary to make it truly high-end. The lack of direct access buttons and handles keeps the unit in the production arena. If there were an accessory unit which brought out the screen to buttons and level bars, which could be operated in real time, vs with a mouse, the unit would be a very powerful production tool for live operation and on-air to rival the Panasonic and Sony digital "pro-sumer" units (WJ-MX-12, WJ-MX-50, etc).

The best item I found was a pair of CD ROM disks by DeLorme which provide USA and World street maps. The USA disk is highly detailed with every street and road, the World disk only shows main highways and lacks any detail. Both have good tourist info.



NEW AT Q

SOFTWARE! %^^^&\$#&@#%

Hey, we're still learning dept.

I don't know how long it takes the average person to learn software (those expensive programs you pay hundreds of dollars for at computer stores) but there always seems to be a few items they DON't tell you. Any text used for ATVQ is usually first processed in Word Perfect 5.2 (Windows) or WP 5.1 (DOS). It is in these programs that the spelling is checked, grammar corrected, material edited to fit format and form. As we told readers in a recent issue, ATVQ also purchased the Aldus trio of Desk-top publishing programs. I even got an A for a college course this spring in Pagemaker! Well our astute readers in Zero land found a bug we failed to notice. In WordPerfect, we (the secretarial service and I) use a macro to create a zero-slash overstrike. When this was converted to Pagemaker 4.0, which imports the document and converts it to PM4 format, the macro, a control code, gets stripped out. All the Zeros were eliminated from the article from the Denver group. Is our face red! Well life goes on and we are now learning PM 5.0 upgrade which will be used for October's issue.

We get an occasional inquiry as to why the local ham store gets copies of ATVQ before subscribers. When we use UPS to deliver store copies, they go directly from the printer to the store. Subscriber copies first have to be shipped to our mailing service, which then sorts, labels and fills out the mailing forms, delivers the copies to the post office, which then sits on it for a few days before shipping the 100+ bags around the country and world. If we ship the bulk sales as part of the second class mailing, it is done on a separate form and handled as a second mailing so the 50 or so packages may still arrive faster than the 1600 individual copies. The hundreds of individual copies we send out between issue mailings are never shown on the bulk mailing forms as they go by 3rd class or 1st class mail. Second class is the least expensive but also the slowest of the mail classes.

Of course the Post Office has a special handling service for fragile items called Smash class. If you order a test pattern ATVQ cup, kindly do not use a PO Box address.

Hey, dig those new antennas! (article elsewhere)

I'll have a user report on the Yaesu FR736R in the next issue. The all mode, multi-band (up to 4) arrived and I quickly put the pieces together (the PL unit, ATV unit, 1296

MHz RF unit). 900 and 1200 MHz activity in the Chicago area is still nil. The activity is on 439.25 and 144.34. The N9AB Thursday night net seems to average a dozen stations.

AN EXPERIMENT

ATVQ has hired a telephone answering/secretarial service which takes your phone orders and inquiries with a **live person 9 AM to 5 PM local, M-F**. This replaces our answering machine (if I don't forget to turn the machine off!). They can answer most questions except subscription expirations and can take book and subscription orders. Let me know if you like this better than the answering machine. As readers know I work full time as Director of Engineering for a Chicago TV station and that leaves little time for much else.

ANOTHER EXPERIMENT

This issue of ATVQ will be mailed from a different location to see if this speeds up delivery. The mailing list has been sorted into regional areas. As this is written, the issue should leave the printer around July 26 and be in the mail around July 30 (my best guess). Last issue was given to the post office April 8th. So let us know if this is faster if the mail has been slow to get to you. ATVQ is also using Barcode labels.

ZIP PLUS FOUR.

Kindly check your address label. Ninety-four percent of ATVQ subscriptions now have ZIP +4 plus carrier route (CRRT) extensions. The other 6% fail the program. Mostly, the addresses for which we cannot find +4/CRRT extensions are RR, RT, Route/box# type addresses, or streets without a directional (N S E W). Kindly check your address label. If you are in the 6% it will help the mail get to you faster if you send us a corrected address or the +4/CRRT. Thanks!

YET ANOTHER EXPERIMENT

In this issue is a reader survey. ATVQ is trying to attract a wider advertiser base to support the Magazine and keep subscription costs down in the face of rising costs. Please take a few minutes to fill out the form and return it. The data will be compiled into a presentation form we can use to approach potential advertisers. It will serve as a profile of the "average reader" which can be compared to the profiles of other magazines.

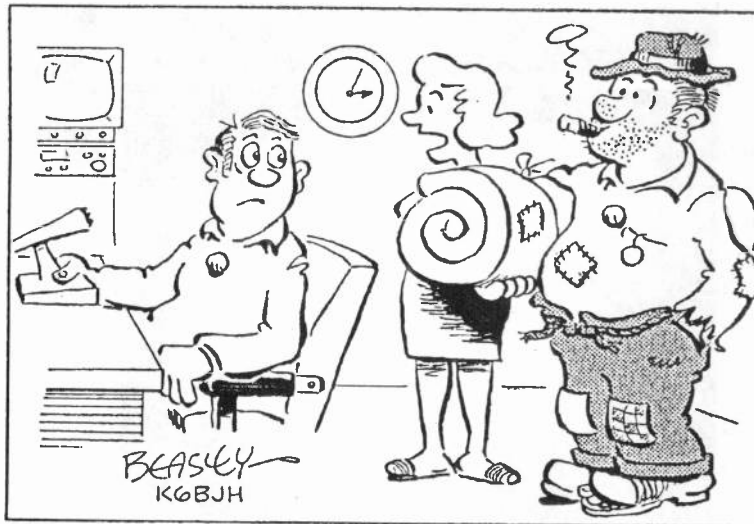

YOUR SHACK IS THE ONLY PLACE WHERE THERE'S ANY ROOM--- MY BROTHER IS GOING TO STAY IN IT FOR A WHILE



ELKTRONICS
 12536 T.R. 77
 Findlay, OH 45840
 (419) 422-8206

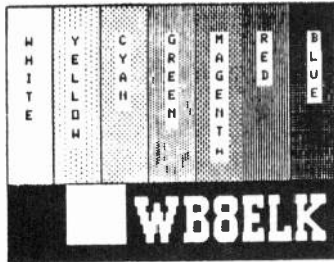

INTRODUCING THE
VDG-1



KA0JAW

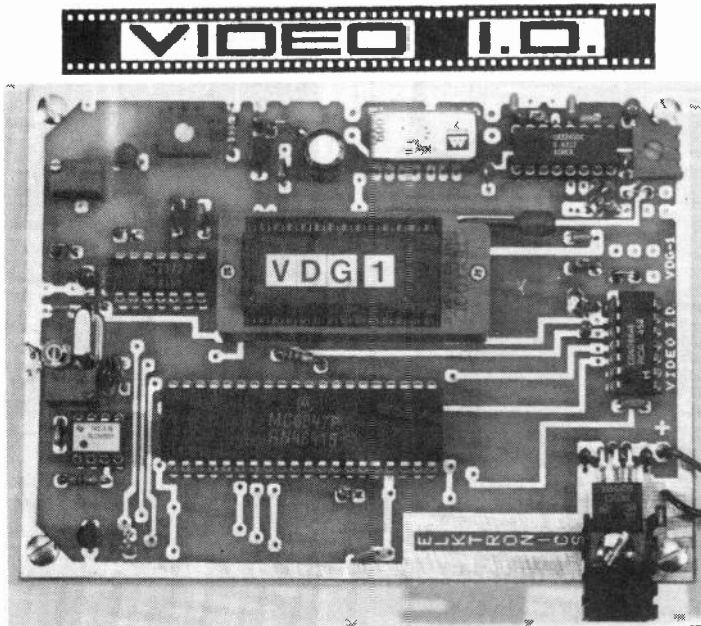
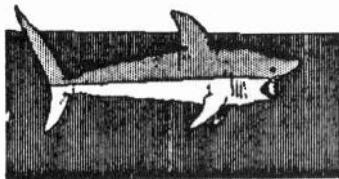

K8EEE
 Jim
 Marion Ohio

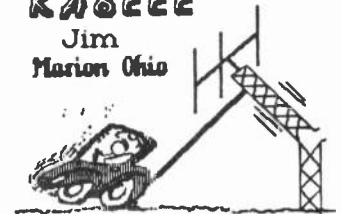

N9CAI /r



KA8ZNY
GROVEPORT



- Instant Video Source
- 4 Graphics Screens
 (2 Hi-RES / 2 Colorbar)
- 12 V D.C. Operation
- Video Relay for switching in
 live camera video
- Built-in Sequencer/Timer
 (Steps through all 4 screens)



VDG-1 with Pre-Programmed
 Custom Callsign Logo
 - \$99 ppd.

(Quick-release socket option)
 - \$10

**Call or Write for CATALOG
 of available Graphics**

Additional Programmed EPROMS
 - \$19
 Now available as a Kit
 - \$89 ppd. Blank PCB - \$19

KA8LWR

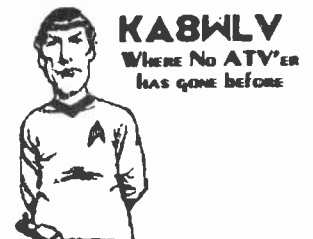
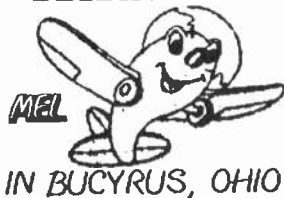



D. DARRAD

HAMFESTS OLD AND NEW

KANSAS CITY HAMFEST

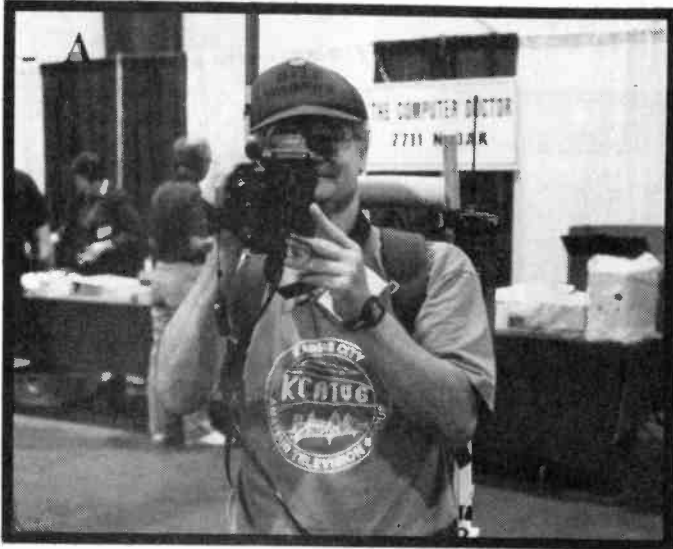

Thanks to a project cancellation, your editor/scribe was able to fly down Saturday AM to take in the KC hamfest, fly back that afternoon and still keep the wife happy by taking her to a movie that night!

Attendance was good at the hamfest and the commercial and flea market booths were active throughout. Dale Lam WA0NKE and the KCATV group had an ATV display and their weather radar video at the show. The ATV forum, hosted by Dale was well attended. While at the forum an ATV'er from Lake of the Ozarks commented he had seen my video two years ago (from Chicago!). Dale and I expressed that was worth a QSL!

A continuous ATV QSO was operated across the hamfest floor as ATVQ and KCATVG both operated portable stations and walkie-lookies! (see photos) A good amount of interest in ATV was present as were several good bargains! I managed a pile of pre-made RG214 with N connectors for \$4 each, a 10X C mount zoom lens with control and more. There were a lot of TV cameras and VCR's from \$25 up.

The local repeater group is very active and the repeater operates in-band on 440 Mhz. Our thanks to the Kansas City Hamfest for their help in securing a booth



at the last minute for atvq.

PHOTOS: A) Dale shoots the ATVQ booth and Henry KB9FO as Henry Shoots back!. B) the Kansas City ATV Group booth. C) Henry KB9FO and his microcam ATV transmitter. D) Yet another porta-lookie.

**ATV
ELECTRONICS**
16807 N. 46TH LANE
GLENDALE, AZ. 85306
PHONE: (602) 843-3585

ATV ELECTRONICS

THE ATV5 ATV TRANSMITTER FEATURES !

- O UP TO 4 CRYSTAL FREQUENCIES !
- O USE WITH 12 TO 14 VDC !
- O 300 VOLT/μSEC VIDEO !
- O ADJUSTABLE SYNC STRETCHER!
- O POWER MODULE ON THE BOARD !
- O LINEAR MODULATION WITH OP AMPI
- O ONLY 8 TUNING CAPS FOR 400 MHZ !
- O INCLUDES AUDIO SUBCARRIER GENERATOR !
- O PHASE LOCK LOOP FOR 4.5 MHZ AVAILABLE !
- O 5 WATTS AVERAGE/10 WATTS PEAK !
- O TEMPERATURE COMPENSATED 4.5 MHZ !
- O DRIVES 50W M6772B BRICK !

THIS IS THE MORE POWERFUL TRANSMITTER THAT RIVALS THE COMPETITION. IT HAS SUCCESSFULLY BEEN USED IN REPEATERS AND ATV TELEVISION STATIONS ACROSS THE COUNTRY. IT IS AN ALL IN ONE BOARD WITH SOUND FOR THE AMATEUR THAT WANTS TO PACKAGE AND MAKE HIS OWN FIXED OR PORTABLE ATV TRANSMITTER. THIS BOARD IS WIRED AND TESTED PRIOR TO DELIVERY. THE ATV5 PROVIDES AT LEAST 6 Db (ONE P UNIT) MORE POWER THAN THE ONE WATTERS. WE ALSO MANUFACTURE THE COMPANION ATV400DNC DOWNCONVERTER FOR USE WITH THIS TRANSMITTER. THE ATV400DNC PROVIDES A SIGNAL THAT CONNECTS TO YOUR REGULAR TV TUNED TO CHANNEL 3 OR 4, AND WILL TUNE THE AMATEUR TELEVISION 420 TO 450 MHZ BAND. THE ATV400DNC EVEN INCLUDES THE TRANSMIT/RECEIVE SWITCH (USUALLY COSTS EXTRA WITH OTHER DOWNCONVERTERS), AND INCLUDES A RF DETECTED VIDEO OUTPUT SO YOU CAN SEE WHAT YOU ARE ACTUALLY TRANSMITTING. ORDER THE ATVPLL4.5 AND HAVE CRYSTAL CONTROLLED 4.5 MHZ SUBCARRIER AUDIO (NEW PRODUCT).

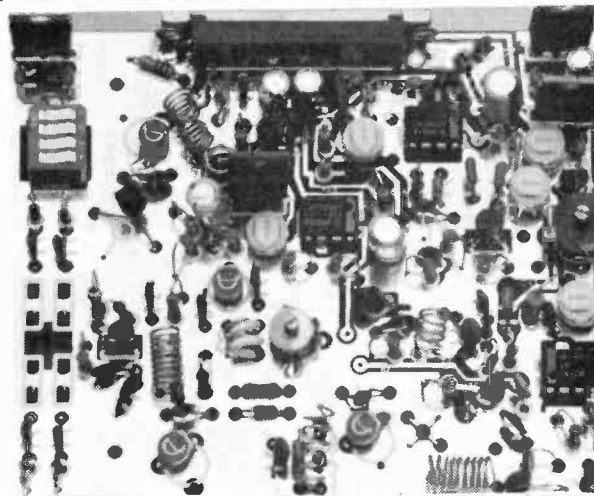
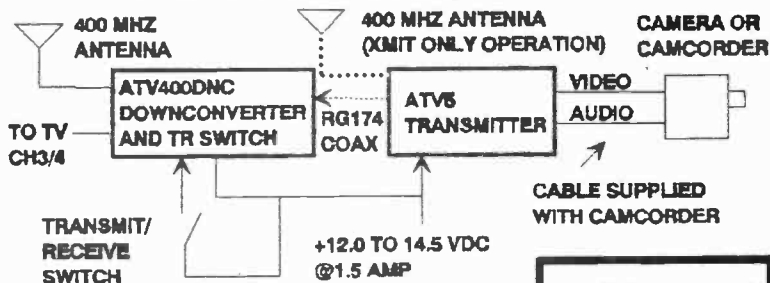

ATV5 - \$189.00
ATV400 - \$89.00
PLL4.5 - \$49.00

CALLS ACCEPTED AFTER 6PM PHOENIX TIME. SPECIFY FREQ'S 426.25, 427.25, 434.00, AND 439.00. ONE FREQ INCLUDED. EXTRA FREQ'S \$16.00 EACH. INCLUDE \$5.50 FOR SHIPPING AND HANDLING. AZ RESIDENTS ADD 6.7% SALES TAX. CHECK OR MONEY ORDER.

MARYSVILLE OHIO HAMFEST

The Union County ARC will sponsor their 17th annual Marysville Hamfest/computer show (home of the HamCam Van) at the fairgrounds in Marysville, OH. (Northwest of Columbus, OH). WALK IN LICENSE EXAMS! Overnight camping with electric and water hook-ups will be available on first come basis. 10' by 10' flea market spaces are available outside. Undercover and inside space is also available. Admission \$4 in advance, \$5 at the door. Contact Don Sabins N8MGJ, 15704 Jolly Rd., Marysville, OH 43040 513 642 0475. TNX Chuck Baldwin N8LXO. PHOTO: Gene Kirby's W8BJN HAM CAM VAN at the '93 Dayton ATVQ Friday night sumpodium.



CLUB NEEDS EQUIPMENT FOR EMERGENCY VAN

Marion ARC, 6583 S St. Meeker, Marion, OH, is building an emergency communications vehicle with the support of the local police and Red Cross. The club is looking for donations (not tax deductible) of equipment

for all modes and all bands including ATV. If you care to assist their effort, drop a note to Steve WS8S at the address above with a list of what you can spare. This includes coax, connectors, HT's etc. The club participates regularly in public service activities and has been in existence for 40 years and currently has 110 members.

MORE DAYTON



Turnout at the ATV and SSTV meetings at the Holiday Inn North, Friday night, were excellent. Both had record setting attendance. Don Miller's SSTV get together moved into more space and still had standing room only. Likewise, even the halls were full at the ATVQ meeting.

The SSTV meeting featured John Langner WB2OSZ explaining his new Pasokon software, Tom Jenkins N9AMR showed his new ri-res software. Barry Sanderson explained digital signal processing and Ralph Taggart WB8DQT's topic was a FAX add-on for PC SSTV. Below left, Martin Emmerson G3OQD .

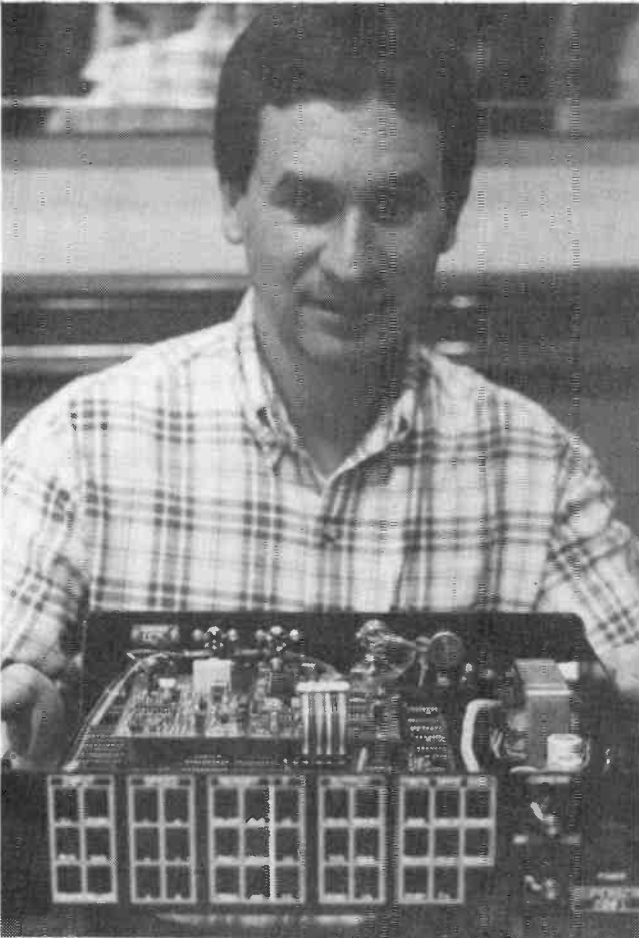

shows the Superscan 2001 SSTV scan converter kit by Jad Bashour and Martin Emmerson. Gene Harlan WB9MMM explained how to use the Soundblaster for SSTV.

The Saturday SSTV forum featured John Langer WB2OSZ, Barry Sanderson and Dr. Robert Suding W0LMD, with his presentation on virtual reality.

See the SSTV update elsewhere in this issue.

The Saturday ATV forum highlight was a presentation by Bill Parker, (who also spoke at the ATVQ party Friday night) who gave a superb talk on getting started in ATV. Bill always interjects just the right amount of humor to keep his audience's attention. His Friday night talk was "Faster than Light Communication" in which he explains the nature of waveguide propagation (velocity is frequency dependent).

1993 SSTV UPDATE

By Tom Hibben KB9MC

Much has happened in the last year and I thought it timely to report on all aspects of SSTV as it exists today. Do to space limitations the following is only a brief overview of existing, new and updated versions of SSTV related software and hardware

DEDICATED SCAN CONVERTERS:

ROBOT 1200C:

Robot Research Corporation, 5G36 Ruffin Rd. Sandiego CA 92123. Phone: 619 279 9430. Robot has ended production of the 1200C but will continue to service Ham related Robot equipment.

SERVICE REPAIR & MODIFICATIONS: Contact: Rick Hollis, 328 Whispering Leaves Lane, Sante CA 92071. Phone: 619 449 8729. All Robot Ham related equipment except 70's & 80"s. Also EPROM modifications for Robot 1200C and Clones. Flat fee of \$50.00 labor plus parts and two way shipping. 72 HR turn-around or labor free!

HANDBUCH SC-2 SSTV/FAX CONVERTER:

From Wraase Electronic, Kronsberg 10, D-2300 Altenholz/Keil, Germanay. Phone +0431-32528, FAX +0431-32579. Cost DM 2950.00 _ \$1800.00 U.S.

LM9000C Scan Converter:

Robot Clone Kit. 10 sets of boards are still available through John Wilson VK3LM, R.M.B 421A, Tallengata Valley 3701 Australia. Cost: _ \$375.00 U.S. User parts _ \$450.00

DFM 1200 USA Scan Converter:

Robot Clone Kit. Three boards, total cost of

\$98.00 U.S. plus shipping, are available from Munaki Yamafuzi JF3JOH, PO Box 670, Osaka 531, Japan. Several hard to find chips and components add about \$50.00. Cost to build including boards aproximately \$600.00. For further info contact Felipe Rojas AB4QC, 3475 Shady Woods Circle, Lawrenceville, GA 30244. PH: 404 717 0123 or Donald Lucarell, 265 Outlook, Youngstown, OH 44504. PH: 216 746 2507.

SUPERSCAN 2001:

New state of the art scan converter Kit. From Jad Bashour, 55 Brampton Road, London N15 3SX England. Phone: Jad +44 81809 3911, Martin +44 81462 4223. Kit includes 3 boards, mouse interface and special Martin Emmerson EPROM. Kit cost \$475.00 U.S. including shipping. Kit including case \$600.00. Add _ \$150.00 for hard to find components and hardware. Estiinated cost of user supplied components \$300.00.

SSTV-202 SSTV SYSTEM

A totally new system design by Mr. Nishamura JA6UHL using Digital Signal Processing for far superior

SSTV operation. Currently functions only with NEC computer and supports only Robot modes. IBM interface modification and other modes will be added soon. Cost assembled will be approximately \$550.00 U.S. plus shipping!

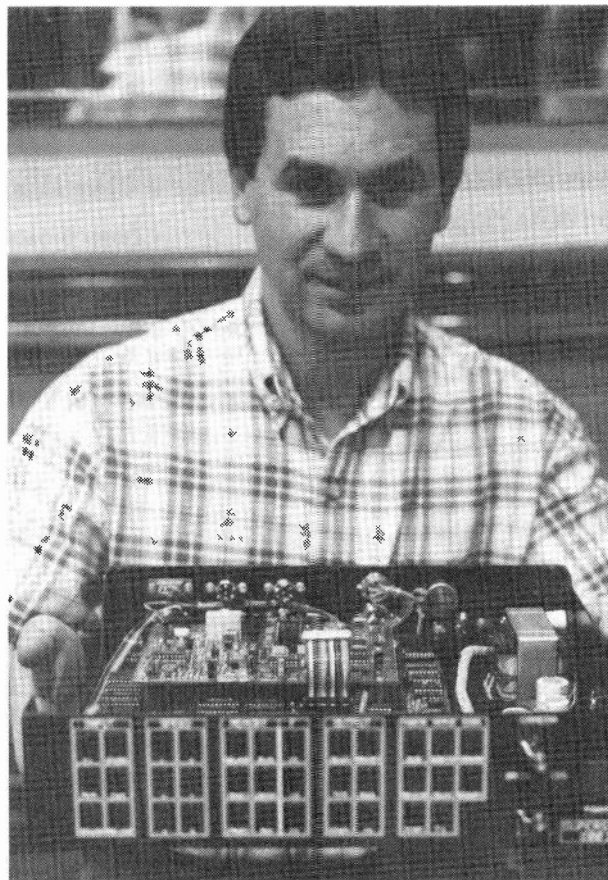

STAND ALONE COMPUTER SSTV SYSTEMS:

Amiga AVT MASTER:

For Commodore Amiga Computers. From Advanced Electronic Applications Inc. Box C12G0 Lynnwood, WA 98036. Cost \$319.00. PH. 20G 774 5554. Newest Software and updates available from Black Belt Systems, 398 Johnson Rd. RR#1 Box 4272 Glasgo, MT 59230. Additional AREXX support software is available from Michel Darneille, 16G05 SW Write St., Aloha OR 97007.

SSTe 4:

For Atari STe computer. Assembled/Tested Hardware & Software available from Bob Gendron VE2BNC, 6025 Brodeur Cr., Brossard, Quebec J4Z1Y8 Canada. Cost \$139.00 U.S. plus shipping Listen for Atari User Net on Sundays at 1G00 Z on 14.325. Net Control is Dave KD7VA.

VIEWPORT VGA COLOR SSTV:

For IBM PC/AT compatibles, 80286 or faster. External hardware interface available from A & A Engineering, 2521 W. LaPalma, Unit #K, Anaheim CA 92801. Cost Complete Kit \$169.95. Assembled & Tested Unit \$229.95. Both include ViewPort VGA software by John Montalbano, KA2PYJ, 10G46 10Gth Place, Carmel IN 4G033. For more information see Aug. '92 issue of 73. System also now includes HIGH RESOLUTION FAX capability with the addition of hardware & software by Dr Ralph Taggart. Present owners can receive hardware add-on and software at a cost of \$20.00. See the February '93 issue of QST for further details.

PASOKON TV:

For IBM PC/AT compatibles, B028G or faster. From John Langner WB20SC, 115 Stedman St. #Q, Chelmsford, MA 01824. Internal computer plug-in card plus software. Cost: Kit \$199.95 including shipping. Add \$30.00 for assembled & tested unit. Foreign orders add \$15.00 for shipping. For further details see the January '93 issue of QST.

PC SSTV:

For IBM/AT compatibles, 8038G or faster. From SSC Software Systems Consulting, G15 S. Camino Real, San Clemente, CA 92G72. Phone 714-498-5784. Cost \$149.95 plus shipping.

SLOW SCAN TV

for the SOUND BLASTER:

For IBM/AT compatibles, 8028G or faster and VGA monitor with 640 X 480 256 color display. Requires Creative Labs Inc. Sound Blaster card costing \$150.00. Software available from Harlan Technologies, Gene Harlan WB9MMM, 5931 Alma Drive, Rockford IL G1108. Ph. 815 398 2G83. Currently Black & White 8 second receive only. Cost \$20.00. Most modes and speeds and several transmit modes should be ready by Dayton. Complete Color and Transmit functions will follow by the end of the year. Also available through compuserve: GO HAMNET, Library 6, SLOWSCAN.ZIP. Also in the future: Software for fax, rtty, morse

WHEELS

(Little, Nano, Mini, Micro)

“AS USED AT THE EDGE of SPACE”

- Omni Broadband Radiators
- Horizontal Polarization
- Very Lightweight (3 oz)
- Balloons, Kites, R/C & Rockets
- Available for 70cm, 33cm, 23cm & 13cm

Reports indicate "Wheels" have been used on virtually EVERY successful ATV Balloon launch to date.

BE ONE OF THEM!

Assembled/ - \$39.95
Tested
KIT - \$34.95

Add \$3 for P & H - SPECIFY BAND
& CONNECTOR

Send postcard (QSL) for catalogue

Dave Clingerman W60AL
Olde Antenna Lab
4725 W. Quincy
DENVER, CO 80236
303-798-5926

**PC SSTV & Frame Grabber
-Software Systems Consultiny.**

For IBM/AT compatibles, PC-SSTV modem and software (Ver 5.1) real time view and serial port interface \$149. Frame Grabber 640 x 480 18 bit color 1130 second, parallel printer port interface and software (GIF, TIF & PCX) \$199. Both units bundle pkg. \$299. 615 So. El Camino Real, San Clemente, CA 92672-Phone 714 498 5784, FAX 714 498 0568.

**COMPUTER CONTROL & PROCESSING
SOFTWARE
for ROBOT 1200C:**

IMB Compatibles:

Requirements: Robot 1200C or clone with Martin EPROM and 4 memory mod, 640K RAM minimum, 80286 CPU or faster, (Math coprocessor optional but highly recommended), MSDOS 3.0 or higher (3.3 or 5.0 preferred), Microsoft mouse or fully equal, VGA color monitor, and 24 bit Address selectable I/O interface card with cable. I/O cards available from:

PIO-12 I/O Card

from Keithley MetraByte, 440 Myles Standish Blvd., Taunton, MA 02780 Phone: 508-880-3000. Cost: \$160.00.

CIO-DIO 24 (PIO-12 Clone)

from Computer Boards Inc. 44 Wood Ave. Mansfield MA 02048.

Canadian I/O Card

from Brian Summers VE3DUO, 33 Goodram Drive, Burlington Ontario L7L 2K1 Canada. Phone: 416 637 9622. Cost \$79.00 including shipping.

M. Emmerson I/O Card,

6 Mounthurst Road, Hayes, Bromley, Kent BR2 7QN, England. Cost \$120.00.

"HIGH-RES":

Latest Software Version 1.8 by Tom Jenkins N9AMR, Computer Systems Intl., 5968 S. Keystone Ave., Indianapolis IN 46227. Phone 317-784-6118. Cost \$75.00 and \$3.00 and original disk for each future upgrade. Also in development and about 90% complete is "HIGH-RES32", software to support VIEWPORT VGA and PASOKON TV as described above.

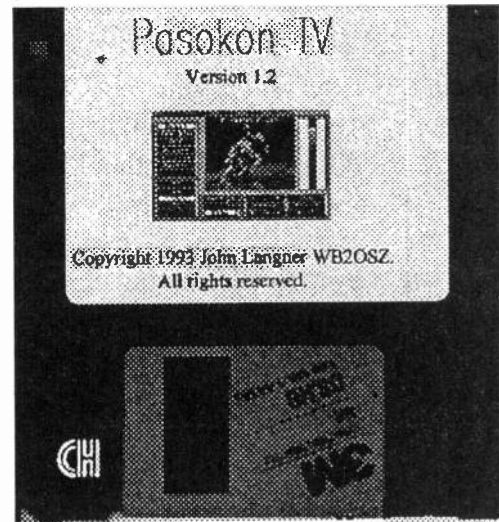

"GEST"

Latest Version available through Torontel Technology Systems Ltd. 94 Sackville Street, Suite A, Toronto, Ontario, Canada M5A 3E7 or Brian Summers, 336 Goodram Dr., Burlington Ont. L7L 2K1. Phone 416 637 9622. Cost: \$75.00. Also there may be future development of software to support the Pasokon system.

"SCAN":

Version 6.5 from Bert Beyt W5ZR, 301 Tampico St., New Iberia LA 70560. Ph. 318 365 5263

"SSTV BY KC6VC":

Final Version 3.9R available through Garnet Bebermeyer WBOUND, 15 Alameda Court, Fenton MO 63026.

"IMAGE"

Current version available from George D. (Dick) Isley WD9GIG, 746 Fellows St., St. Charles IL 60174. Phone 708-5843510. New version is under development. Some thought is being given to development of software supporting some of the new stand-alone SSTV computer systems.

"A R T Amiga Robot Terminal":

Latest Version 1.14 for the Commodore Amiga 500/2000/3000 Computer and the Robot 1200C. Available from Tom Hibben KB9MC, Box 188 Mule Hollow Road, DeSoto WI 54624. Phone 608-6482033. Cost for complete package including custom Parallel Interface Hardware, all cables and software and docs is \$190.00 including shipping.

EPROMs for the Robot 1200C:

EPROM Version 4.2A.

from Martin Emmerson, 6 Mounthurst Road, Hayes, Bromley, Kent BR2 7QN England. Phone: 01144 81462 4223. Additions include the DX Mode, new Wraase SC2 Modes, a Tuning Oscilloscope and Tone Generator for perfect frequency alignment, a much improved startup system eliminating color shifting, and finally a new Automatic Speed Selection feature eliminating the problems with lost VIS startup! Cost: Upgrade from V 4.0 = \$80.00. Upgrade from older versions V2.1, V2.2, V2.3, or V2.4 = \$120.00. New user = \$160.00. Ver. 4.2 upgrade to Ver. 4.2A \$20. Also available: Accurate (± 10 ppm) Oscillator board. Cost \$70.00.

Dual EPROM SCOTTIE GLOBEMASTER PROFESSIONAL VERSION 3.6/3.7 DX ESP

from Eddy J. Murphy GM3SBC, 65 Silver Knowes Crs., Edinburgh, Scotland EH4 5JA. Phone 01144 31312 7288. New Features: Advanced Low Signal to Noise VIS Code, DSP software control, Auto QRM Deccorrelation, Advanced Real Time Processors & QRM Post Processor, Frequency Analyzer and Alignment, and Pseudo Moving Pictures (with simultaneous sound using external filter). New system includes: Upgraded & reprogrammed V3.6 EPROM, New V3.7 EPROM, a Digital Signal Processing chip, a Small Gating IC chip, Documentation and shipping. Scottie Member Upgrade Cost: \pm \$185.00. EPROMs may be stacl-ed or installed on the SCOTTIE MULTIEPROM BOARD from John Wilson VK3LM. Cost: \$150 to \$200 with or without Mouse interface & LED display. Contact Eddie Murphy for New User Cost. 100 orders must be received world wide or all Payments will be refunded.

Edge Of Space Sciences National Balloon Symposium

August 20, 21, & 22, 1993 Denver, Colorado

EOSS

Edge Of Space Sciences is a non-profit organization committed to promoting science and education through amateur radio and high altitude balloons. EOSS members will host the first National Balloon Symposium to enable balloonist to share ideas, experiences and general wisdom. The resultant proceedings will be published and made available for wide distribution.

Location

The Symposium will be held at the Holiday Inn, Denver International Airport located at I-70 East and Chambers Road. Reservations can be made directly with the hotel at (303) 371-9494. Mention EOSS for special rates.

When

The symposium will be held August 20-22, 1993. Friday evening activities will include a hospitality event for

payload displays, launch videos and socializing. On Saturday, papers will be presented by nationally prominent balloon experimenters, educators, scientists and authors. EOSS will host a luncheon and a banquet for symposium registrants on Saturday. Sunday, weather permitting, EOSS will conduct a balloon launch and recovery of our new EOSS Balloon Shuttle.

CONTINUED PG 51

THE M² ANTENNAS

Henry KB9FO

Ever wonder if you could do better than the antenna you have now? A slight wind (96 mph) provided me with an opportunity to change from my old antennas to a new set. The array chosen is a small one to work local repeaters (350 miles) simplex (300 miles) and ATV under dead band conditions. So far only S6 from central Ohio (345 miles) on 2 FM simplex in the first few days of operating has proved the array works. A South Bend station (132 miles) had to ask where I was because I was full scale no matter where he pointed his beam.

Each day as I drive to/from work and chat on the local 145.27 repeater where the locals ask if I am ever going to put up a serious antenna. Of course some day I may put up a "Mother of all antennas" but not yet. There just isn't enough room on my half acre to erect Aricebo II. Meanwhile I must satisfy myself with a modest investment in aluminum and steel... about \$7,000.

The support system is a Rohn 4554G tilt over tower. Its 54 feet sit on a concrete base with two levels of guys. An IIX climbable mast rests on a thrust bearing and a Yaesu 2700SDX rotor. In order to not to have to observe quiet hours, I opted to not use the 200 HP Catapiller Diesel engine offered by a marine yard. This replaces a HyGain T²X which had intermittent readout over 25% of the rotation. That will go back for repair.

The IIX mast lower section is inside the tower top, which rather than getting the flat top plate which usually comes with the 4554, goes through a regular tapered/sleeve top which adds a couple of feet and I think, better support-- about 1 foot extends above the tower top. The next 6 feet have climbing pegs welded on which are very handy for getting up to the actual mast connection point. The IIX mast continues another 6 feet or so to a home made "candelabra" which holds three verticals, an Icom discone for my Icom R7000, Hustler G7-144 for 2 meters and a G6-440 for 450. I retired the G7-220 and sold the 220 rig as there is so little activity on that band in this area. Want to buy a 220 antenna?

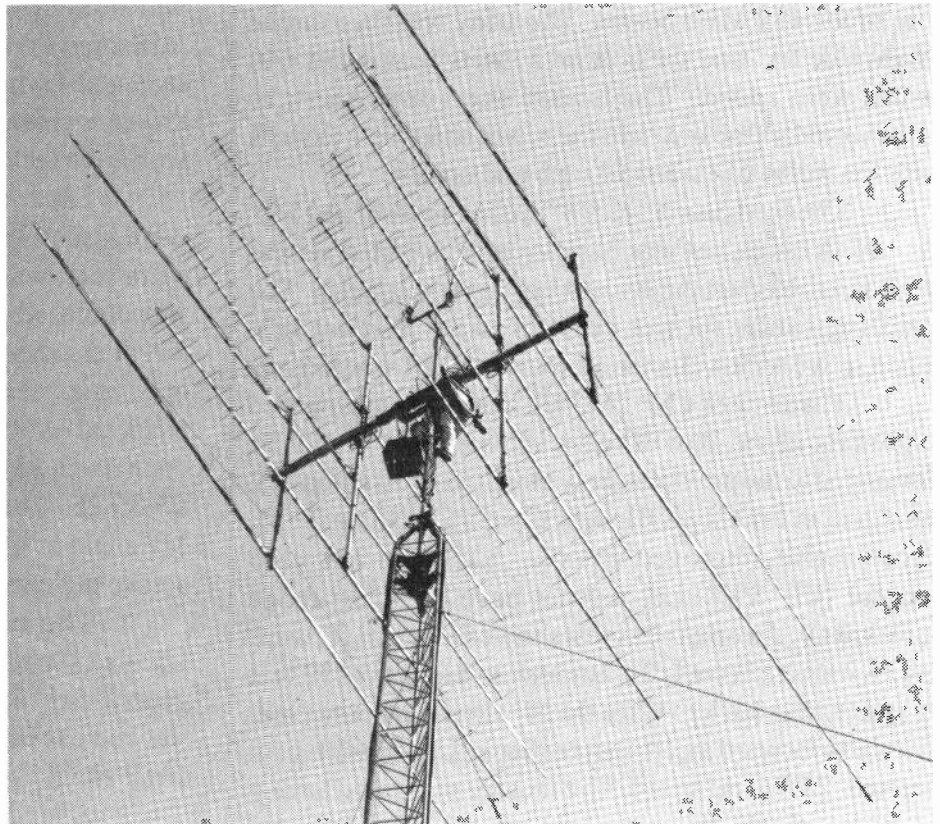

An M² model 3000 elevation rotor sits at the top of the climbable section of mast. It holds a 4" diameter cross boom which is about 12 feet long (6 feet to each side of center). The four vertical booms attach to the cross arm at proper spacing for 440 and 144 MHz. The vertical booms are 12' 6" and 15" long. These hold the first 12 yagis. The longer booms are aluminum to hold the horizontal polarized ATV antennas and the shorter booms are fiberglass to hold the vertical polarized 2 meter array.

With just the vertical and mast assemblies mounted the raising fixture of the Rohn fold over kit was near maximum load. Had I known the truth of the

A MODEST STACKED ARRAY...

minuscule load these will lift I could have saved several hundred bucks and put up a 45G or 55G tower of equal height! So if you are going to put up a simple array (under 130 pounds) the FOK will work. This array is about 250 pounds of aluminum plus supports.

A bucket truck was rented to mount each of the antennas. Help was provided by Mike WA6SVT on his stop-over before Dayton weekend. Since the array can be rotated in any direction up, down, sideways, it was an "easy" matter to mount the top two 2 meter beams (booms 33' long) as the "bottom" antennas, followed by four of the 432 MHz beams. The array was then turned "right side up" and the bottom 2 meter beams and 440 beams were added. The bucket was a little short, so Mike would climb out onto the tower and masts to work with the miles of electrical tape and coax.

The feed line is 1 & 5/8" Heliac for 440 and 7/8" for 144. A quick test was in order because the antennas were assembled on the ground but never test tuned. The matching cables (power splitters) were also not pre-tested so we took a chance all would be OK when done.

The array of 4 M² 2M5WL antennas are supposed to produce about 20.8 dB gain and have a low VSWR. Compared to the previous array of 2 CushCraft Boomers, the signal at Findlay, OH went from S1 to S6 on 2 FM. Receive also improved equally. SSB was not tried because Bill WB8ELK did not have his multi-mode radio handy. An open coax test showed 80 watts forward and 78 watts reflected (2 watts loss on a length of 90 feet up and 90 feet back). With the M² antennas connected, 130 watts forward and 0 watts reflected. Even with a 5C element, ZERO reflected. The factory suggested tuning works just fine! TV works best when VSWR is under 1.1:1 (return loss of 28 dB or better). I now run 500W.

The roughly 13' 6" x 12' 6" stacking space produces excellent side and back rejection. It was easy to separate co-channel repeaters and only the strongest locals could not be rejected fully to favor DX repeaters 150 miles away. With 33 foot booms some sag is expected! The black string provided was drawn tight and later the boom positions were altered slightly to provide straight and level booms. All were moved equally so as to not disturb the stacking distances.

The antenna assembly took about 2 hours per antenna. Work was tedious putting the insulators in the boom, sliding in the elements and then pushing on the

tinnerman style lock washers. Anyone who has used Mirage/KLM VHF antennas will recognize the system. The push tube is just short enough that you stab the outside of your palm as the rod suddenly jumps through the washer and gets you. I suggest getting a longer piece of aluminum tube to use for assembly than that provided. There was lots of hardware. No shortage of critical parts here. A blessing compared to some antennas which come routinely short washers, screws, nuts, etc.

The input is a type N connector in a pre-assembled dipole which mounts with a single screw to the boom. A Coax balun is provided with water proof seals. The driven element is a folded dipole with blocks which slide over the element ends to act as shorting bars. Hex screws hold the block in place. The factory settings were used which provided essentially no VSWR. The driven element design is the key to this antenna and it works perfectly.

Likewise the 8, 432 MHz antennas, 432-9WL, were assembled. About 2 1/2 hours each. Again, lots of extra lock washers and insulators and other hardware was enclosed. The factory settings were used and the test after assembly provided the following results. The open coax test provided 65 watts forward, 61 watts reflected on 90 feet of coax, and when the antennas were connected, 85 watts forward and a meter tickle reflected at 439.25. The same results were found at 434 and 426 MHz and at 449 MHz. The array is as flat as possible across the entire 30 MHz of the band!

The array is sharp, stacked 4 high and 2 wide. Locals (10 miles) are not visible unless I point in the general direction. Likewise the DX tests on FM repeaters showed excellent pattern and side/back rejection. The array should produce 26.3 dB gain.

Added a few weeks later was a quad array of DownEast Microwave loop Yagi's for 1296 MHz and a single DownEast yagi for 900 MHz. Polarization is VERTICAL on 2 meters and 900 MHz, and HORIZONTAL on 420-450/1252. Using a modest QRO amplifier on 2 meters will produce 300KW ERP. The "Mother of all ATV amplifiers" currently under construction will produce about 600 KW ERP on ATV. Next time I guess I'll get serious about this stuff and put up a decent array!

In summary, these are the best antennas I have ever owned. M² Enterprises is located at 7560 N. Del Mar, Fresno, CA 93711. 209432 8873. Canadian hams can purchase M² antennas from Orin Beebe, VE7BEE, Box 477, Penticon, BC, V2A 6K6. 604 493 1122.

Ashland, KY Group Launches ATV Balloon spectacular views from onboard live color TV camera

by Ron Curry WA4GSS

This balloon launch was our group's second flight. Our first payload consisted of 2m and 10m beacons and telemetry and was recovered from a coal mine in West Virginia.



The balloon is ready for liftoff as the launch crew attaches to payloads.

After our success with our first effort, we felt confident we could retrieve a more complicated (and more expensive) payload which included a live COLOR TV camera.

Our payload carried a small color TV camera (pointed at the horizon), a b/w camera looking at the balloon, timing boards to sequence between cameras, a High Technology Flight video overlay telemetry system, an ATV World 5-watt ATV transmitter (439.25 MHz), a Little Wheel (omni-horizontal) antenna, a 2m/10m telemetry beacon system (built by Bill WB8ELK) and an in-band 2m repeater (input on 146.52 and output on 144.34 MHz).

We initially wanted to fly on Saturday morning, but the weather delayed us until Sunday. Since I really wanted to see this payload again, we did a landing site prediction on the morning of the flight using the BALLTRAK program. It predicted a landing in the rugged coal mines of West Virginia once again. Since a coal miner's strike was underway and owing to the difficult recovery of our first flight from the same



Up, Up and NOT Away! After drifting across the runway after achieving only 2 feet altitude, the wayward balloon is brought back for some more helium.

region, we quickly decided to uproot from our intended launchpoint of Huntington, WV and move to another site approximately 25 miles to our northwest. Within 20 minutes, the FAA and our balloon launch commander Jim Rice KD4HPQ had permission to launch from the Minford airport in Minford, Ohio (just northeast of Portsmouth, Ohio). We loaded up balloons, helium bottles, the payload, the launch crew and all headed out for the Minford airport.

Our first attempt to launch the balloon failed to go up! The payload just would not rise as the balloon headed out across the airport just a two feet off of the ground. I did a 100-yard dash across the runway chasing out after the payload (fortunately it was only drifting along at 5 mph) and quickly grabbed the package. To ensure we took off, we pumped the rest of our helium tank into the balloon.

This time the balloon and it's payload shot right up at around 1200 ft/minute. Since we had two separate payload on the string, we had an undesirable spin for the first 10,000 feet of the flight. We had many reception reports of P5 video from some distance away. Our furthest known report was Rick Goodman WA3USG in Mechanicburg, Pennsylvania (350 miles)

with P2-P3 video.

Many hams that didn't have any ATV downconverters were actually able to receive the balloon's TV transmission by tuning into cable ready channel 60 on their VCRs or TV sets. The payload worked quite well and provided us all with spectacular

The balloon is launched from the taxiway of the Minford, Ohio airport.

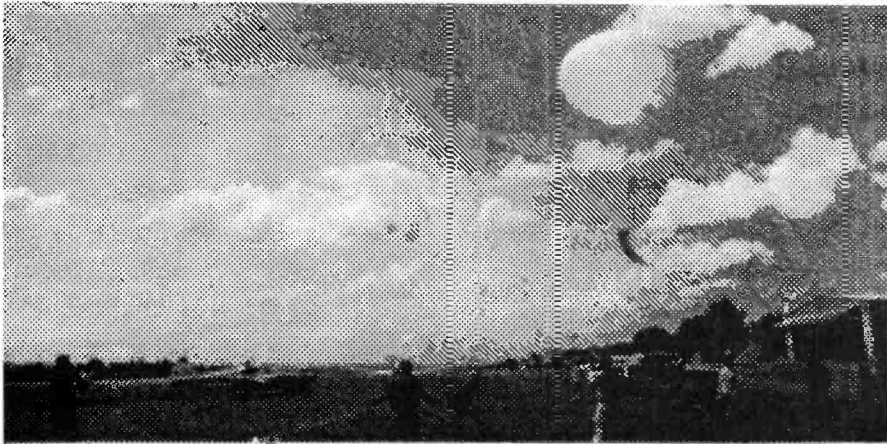

views of the blue haze of the Earth's atmosphere (as seen from the color camera pointed at the horizon) and we actually saw the balloon burst at 106,630 feet with the b/w TV camera that pointed up at the balloon. The High Technology Flight video telemetry overlay (built by Bob Rau N8IYD) worked well supplying us with real-time information right on the TV downlink. The telemetry from the ATV system compared quite well with the 2m/10m CW telemetry system.

Our two meter repeater worked great while testing on the ground, however the 147.45 MHz telemetry beacon desensed our 146.52 MHz repeater input when we attached everything to the balloon since the 2m antennas were too close (this will be fixed for our next flight). Even so, I did work Bill Parker W8DMR through the repeater while was mobile. Although a few stations did work through the repeater didn't

work as planned.

After balloon burst, the package parachuted back to the ground. I could copy the balloon video while I was mobile all the way down to 5,000 feet (from a distance of 25 miles). The payload landed near the town of Sod, West Virginia (about 67 miles away from our launch site). Two aircraft and over a dozen separate chase teams covered the mountains and hill in the landing region.

At 7:40 p.m., almost 7 hours after the payload landed, we finally spotted the package about 60 feet up in the trees. Since we were on the Hilbert Public hunting area, we decided not to cut the tree down. As darkness fell around us, we had to leave the mountain without our prize possession (the payload). It was kind of like leaving one of your children out in the woods overnight!

The next morning, Jim Rice KD4HPQ called me at 6:45 a.m. to arrange an



The payloads are recovered inside of the Hilbert Wildlife Management area near Sod, West Virginia.

expedition of a group of hams and necessary equipment for the recovery effort. I could hear the 28.8 MHz CW beacon from my house as I left. Tom Weaver K8TW brought along a 38-foot long "hot-stick" from his employer, the Kentucky Power Co. We loaded Jim Rice's extension ladder and lots of rope and headed off to the landing site. We headed up the mountain in

WEST VIRGINIA BALLOON

Jim's 4-wheel drive. It only took us about 30 minutes to bring the payload back to Earth complete with parachute! The ATV payload had quit transmitting the previous afternoon (dead batteries), but the 2m/10m beacons were still going strong.

I must admit that this balloon project has created more interest among the hams in our region than I ever could've imagined. In preparing for our first balloon launch we started Monday evening ATV balloon nets on 2 meters. We linked several high profile 2m repeaters together to cover any possible landing sites and we took check-ins and found those who could serve as good fixed stations to provide us with bearings for the plotters.

Our first balloon flight lasted 13 hours from liftoff to recovery. It was covered via several linked repeaters and allowed hundreds of hams to listen in on each part of the flight and to give us their signal reports.

In preparation for our ATV balloon, I went ATV mobile during one of our Monday night nets to allow

many hams using their TV sets to adjust and check out their equipment. I ran 100 watts with a VDG-1 video ID and a Little Wheel antenna on top of my van. I drove over 150 miles during this net.

We had a few equipment problems to iron out on the second flight, but thanks to the help of Jim Rice and Tom Weaver, we finished installing and checking out our payloads on the night before the scheduled launch.

We had over 200 check-ins on 2 meters alone during this past flight, no counting the HF net. Most stayed glued to their radio's until we called in to let everyone know we had found our package. Everyday, someone will talk to me on 2 meters and ask me when we plan to fly another ATV balloon.

Thanks to our balloon flights, many area hams seem to be looking into trying out amateur television. I can't think of a better way to create more interest in ATV.

EOSS CONTINUED...

Call For Papers

EOSS invites balloon experimenters, educators, authors and scientists involved with high altitude balloon experiments to provide papers and presentations at the National Balloon Symposium. Papers, in electronic form, should be submitted before May 8, 1993. For additional information, contact Ann Trudeau, 15487 E. Bates Ave., Aurora CO 80013, (303) 690-1669.

Call for Launches

EOSS would like to know if there is any interest for guest balloon groups to launch their balloon on Sunday. Guests would be required to provide their own tracking and recovery teams and coordinate spacecraft frequencies with EOSS launch teams. Interested groups should contact

Marty Griffin, 1647 E. Geddes Cir. N., Littleton CO 80122, (303) 794-3458.

Register NOW

Register early to receive discounted rates. Send for form and send your check to: EOSS, 376 West Caley Circle, Littleton, CO 80120. You may call (303) 794-5624 for further information.

What is the Edge Of Space Sciences

Edge of Space Sciences is a Colorado 501(c)(3) non-profit corporation that promotes science and education through amateur radio and high altitude balloons. These technology mediums provide high school and university students a unique opportunity to conduct "near space" scientific experiments at altitudes in excess of 20 miles. EOSS provides the transportation, shuttle platform, control and recovery for these worthwhile experiments.

Student Research

EOSS is proud of its affiliation with Colorado high schools and universities. To date, EOSS has conducted more than ten balloon missions, all with extensive student involvement. Each helium filled balloon and shuttle is launched to an altitude of 20 miles where student sponsored experiments can be controlled and conducted throughout the flight.

Skills Development

Participants learn important life skills in project management, tracking, geography, mission control, spacecraft integration, radio operation, spacecraft recovery, astronomy, electronics, computer programming, meteorology, applied physics and general experimental procedures.

EOSS

EOSS Shuttle

Future missions will be transported on a new "EOSS Shuttle" platform designed by the EOSS Technical Committee. The EOSS Shuttle provides a basic transportation system which includes Amateur Radio TV cameras and transmitters, control computers, beacons, sensing devices, antennas, parachutes and a balloon.

EOSS Meetings

Monthly meetings for Edge of Space Sciences are conducted at the Digital Equipment Corporation (DEC) located at 8085 S. Chester. This is located just NW of I-25 and County Line Road. Meeting days are the second Tuesday of the month, 7:30 P.M. Talk-in on 146.64 Repeater.

Information Net

An EOSS information net is held every Tuesday night, except for meeting nights, on the 147.225 Repeater, 7:00 P.M. EOSS wishes to thank the Colorado Repeater Association for use of their repeater as well as their mission support with their portable repeaters.

EOSS Phone BBS

EOSS news is now available to students and non-packet users via a telephone BBS thanks to File Bank system operators. The telephone numbers are (303) 534-4311 and 534-4646.

General

The history of high altitude ballooning and prospects for future projects.

Organizational Setting up balloon organizations, involving schools and colleges, public relations, funding, incorporation, non-profit status, liability issues.

Payloads

Power, packaging, integration, testing, telemetry, control, imaging, beacons, antennas, navigation systems.

Flight Systems

Balloon types, gas sources, inflation processes, parachutes, cut down devices, support systems, stabilization, landing survival.

Launch preparation

Site selection, site preparation, system preflight process, launch team structure, surface winds and weather, go/nogo criteria, communications.

Regulatory

FAA rules and interfaces, FCC Part 97, National Weather Service, local ordinances.

Tracking and Recovery

Flight predictions, go/nogo criteria, bearing taking, beacon requirements, field organization, communications network.

High Altitude Physics

Balloon and parachute dynamics, meteorology (winds, pressure systems, fronts), environmental (thermal, atmosphere, radiation), radio propagation.

Tales From The Highside

Gripping, bone-chilling, true life yarns about helium, balloons, Mother Nature and Murphy.



IN ASSOCIATION WITH
PRESENTS
VALLEY FORGE



HAMSHOWS 1993

INTRODUCING
AN EXCITING AMATEUR
RADIO WEEKEND OF
FUN, PRIZES, FLEA
MARKET, SEMINARS,
AND EXHIBITS.



AUGUST 21ST & 22ND

VALLEY FORGE CONVENTION CENTER, KING OF PRUSSIA, PA

ATVQ, SUMMER 1993



DAYTON BOOTHS 66, 67
SPECTRUM INTERNATIONAL, INC.

Post Office Box 1084 Dept. T
 Concord, Massachusetts-01742
 508-263-2145 — Fax #263-7008

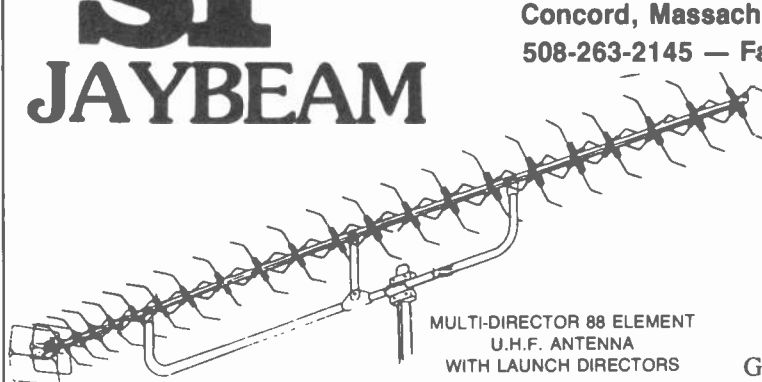

MULTI-DIRECTOR 88 ELEMENT
 U.H.F. ANTENNA
 WITH LAUNCH DIRECTORS

MBM88/70cm

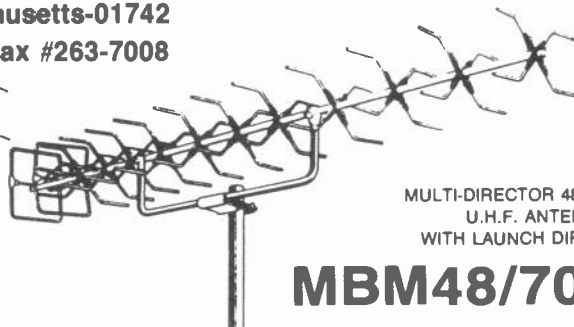

MULTI-DIRECTOR 48 ELEMENT
 U.H.F. ANTENNA
 WITH LAUNCH DIRECTORS

MBM48/70cm

General Specs:-
 Frequency Range
 Impedance
 (Built-in Balun)

420 MHz - 450 MHz
 50 Ohms

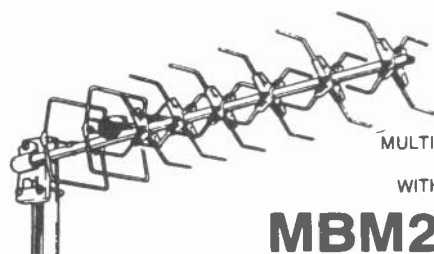

MULTI-DIRECTOR 28 ELEMENT
 U.H.F. ANTENNA
 WITH LAUNCH DIRECTORS

MBM28/70cm

	MBM48	MBM88
Gain	14.0dBd	18.5dBi
Beamwidth (E)	28 deg	23 deg
(H)	35 deg	28 deg
Boom Length	6 ft	13 ft
	\$ 115.00	\$ 160.00

VHF/UHF BANDPASS FILTERS



KNOCK OUT INTERFERING
 QRM OR SELF-DESENSE!

The PSf . . . series of Band Filters are for receiver pre-selector and transmitter use. The filters are 3 pole, 7% bandwidth, 0.1 dB ripple designs with 30 dB shape factor of 4:1.

The PSf . . . ATV series of TV Channel Filters are 5 pole, 6 MHz bandwidth designs. They are used to protect your TV receiver from inband QRM and to "strip-off" the unwanted sideband of your transmitted vestigial sideband signal.

BNC Standard
 TNC or Type 'N' optional
 (slightly higher prices)

Model	PSf144	PSf220	PSf432	PSf900	PSf1296	PSf1691
Freq (MHz)	140-150	216-228	420-450	890-940	1250-1340	1650-1750
Loss (typ)	0.1 dB	0.1 dB	0.15 dB	0.2 dB	0.25 dB	0.25 dB
	\$200.00	\$160.00	\$105.00	\$125.00	\$125.00	\$125.00

Model	PSf421-ATV	PSf426-ATV	PSf439-ATV	PSf910-ATV	PSf1253-ATV
Loss (typ)	2.0 dB	2.0 dB	2.0 dB	2.5 dB	3.0 dB
Std conns.	BNC	BNC	BNC	N	N
	\$155.00	\$155.00	\$155.00	\$180.00	\$180.00

All prices FOB Concord, Mass.

PRICES SUBJECT TO CHANGE WITHOUT PRIOR NOTICE

SPECTRUM INTERNATIONAL, INC.

Post Office Box 1084-T
 Concord, Massachusetts-01742
 508-263-2145



Don't Be An Amateur Band Hog.

If you're using a traditional double-sideband (DSB) Amateur Television transceiver, you're, in effect, hogging the band. DSB not only wastes power on the unused sideband, but uses almost twice the spectrum necessary. Not good, considering how limited the spectrum is to begin with.

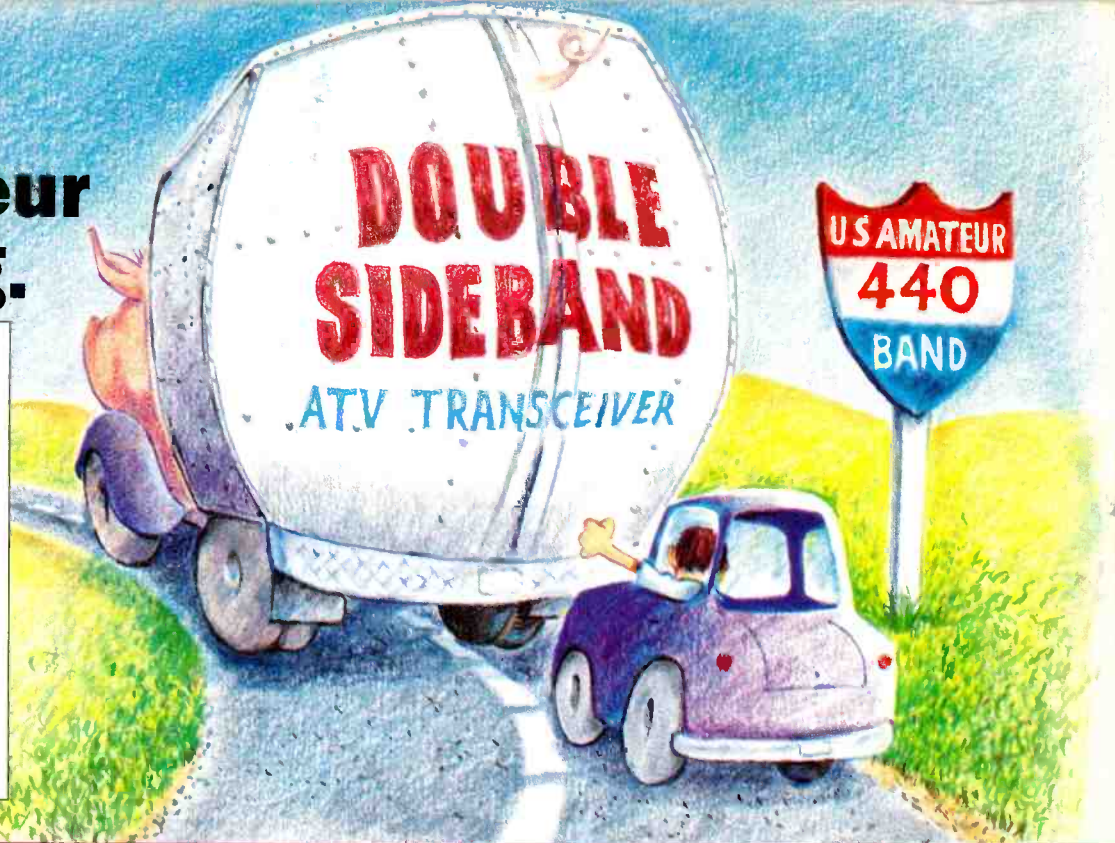

VSB-70 with Vestigial Sideband



The VSB-70 from AEA is the only amateur television transceiver that uses Vestigial Sideband (VSB), the same modulation method used by commercial TV stations. Our VSB technology reduces the unwanted sideband over 40dBc! More power where it should be and less wasted spectrum space.

Also available is the ARLA-70 mast-mount linear amplifier (with power supply), which boosts your signal while preserving the characteristics of VSB.

Be a good spectrum neighbor. Use the AEA VSB-70 ATV System.

For a complete specification sheet on the VSB-70 or any other product, call 1-800-432-8873.



Advanced Electronic Applications, Inc.

P.O. Box C2160/2006 196th St. S.W. • Lynnwood, WA 98036
Tech Support & Sales (206) 775-7373 • Office (206) 774-5554
CompuServe User ID 76703, 1012 • Brochure InfoLine (800) 432-8873

All stated specifications subject to change without notice or obligation.
© AEA, Inc. 1991. All Rights Reserved.