

FEBRUARY 2003  
ISSUE #507  
USA \$3.95  
CANADA \$4.95

# 73 Amateur Radio Today

Cheap & Easy  
HF Vertical

Troubleshooting  
Computer PS

Warblemania

Breakdown in  
Cape Town

Simple  
SMT Station

Receivers  
for Dummies

Driftmaster  
Lifeline

Radio in the  
French & Indian War

\*\*\*\*\*3-DIGIT 231  
#00000109389WR6# JUL76 227  
JACK SPEER 45  
BUCKMASTER PUBLISHING P 3

6196 JEFFERSON HIGHWAY  
MINERAL VA 23117-3425



# ALINGCO *Unleash The Power*

**New**



## DR-620T VHF/UHF

### Dual-Band Mobile/Base

**First Amateur Twin Band Mobile To Support Optional Digital Voice Communications\***

- RX-VHF 108-173.995 MHz, UHF 335-480 MHz
- TX-VHF 144-147.995 MHz, UHF 430-449.995 MHz
- Receives Airband and Wide FM
- Front control unit separation (optional EDS-9 kit required)
- Advanced 10F3 digital mode with speech compression technology (EJ-47U required)\*
- 200 memory channels
- Advanced EJ-50U TNC (optional) supports digi-peet mode
- Remote control features including parameter setting and direct frequency entry through the microphone
- Dual-Band receiver with V/U, V/V, U/U capability
- CTCSS/DCS encode/decode and European Tone-bursts
- OUTPUT: H/M/L-50/10/5 watts VHF
- OUTPUT: H/M/L-35/10/5 watts UHF



## DR-605TQ VHF/UHF

### Dual-Band Mobile/Base

**Full 2 Meter/440 Performance**

- 100 memory channels, + a "call" channel for each band
- CTCSS encoded+decoded and tone scan
- Cross-band repeat and full duplex capability
- 9600 bps packet ready with dedicated terminals
- Internal duplexer - one easy antenna connection
- RX-VHF 136-173.995 MHz, UHF 420-449.994 MHz
- TX-VHF 144-147.995 MHz, UHF 430-449.994 MHz
- MARS capability (permit required)
- OUTPUT H/L - 50/5 watts VHF, 35/5 watts UHF
- Time-out timer (ideal for repeater and packet operation)

## DJ-V5TH VHF/UHF Dual-Band FM Transceiver

**5 watts of output power, in a compact package.**

- Alphanumeric Display, up to 6 characters
- TX-VHF 144-147.995 MHz, UHF 420-449.995 MHz
- 200 memory channels plus two call channels
- Full VHF + UHF Amateur Band Coverage
- Receive Range, (76 - 999MHz) includes Wide FM capability
- Up to 5 watts output, 3 output settings
- CTCSS encode+decode DTMF squelch and European Tone bursts
- 4 scan modes, 5 programmable scan banks
- MARS capability (permit required)



Ask your dealer  
about the full line of  
Iron Horse antennas &  
accessories!



## DJ-596T VHF/UHF Dual-Band HT with Digital Voice Option\*

**Loaded with features! The breakthrough design supports optional digital voice communications and you can easily switch the unit between analog and digital modes!**

- Full 4.5 watts output VHF/4w UHF
- Powerful NiMH battery
- 100 memories in any combination of VHF or UHF channels
- Direct frequency input from keypad
- Each memory capable of "odd split" operation.
- Alphanumeric channel labels
- CTCSS/DCS encode+decode plus tone bursts
- Full 2m and 440 band coverage
- Accepts 6 to 16 VDC direct input
- Illuminated Keys and display
- Wide and narrow FM modes
- 10 autodial memories
- Theft alarm feature
- Optional EJ-40U Digital Voice Board!\*
- Programming/Clone software available



Distributed in North America by Amateur Distributing LLC • 23 S. High St., Covington, OH 45318 • (937) 473-2840  
Specifications subject to change without notice or obligation. \*Digital communications require at least two similarly equipped transceivers.  
Digital mode may not be legal in some countries. See FAQ on digital at [www.alinco.com](http://www.alinco.com). Products intended for use by properly licensed operators.  
Permits required for MARS use. Specifications subject to change without notice or obligation.

# THE TEAM

FEBRUARY 2003  
ISSUE #507

**El Supremo & Founder**  
Wayne Green W2NSD/1

**Associate Publisher**  
F. I. Marion

**Executive Editor**  
Jack Burnett

**Managing Editor**  
Joyce Sawtelle

**Technical Editor**  
Larry Antonuk WB9RRT

**Contributing Culprits**  
Mike Bryce WB8VGE  
Jim Gray II  
Jack Heller KB7NO  
Chuck Houghton WB6IGP  
Andy MacAllister W5ACM  
Joe Moell K0OV  
Steve Nowak KE8YN/0  
Dr. Rick Olsen N6NR

**Advertising Sales**  
Evelyn Garrison WS7A  
21704 S.E. 35th St.  
Issaquah WA 98029  
425-557-9611  
Fax: 425-557-9612

**Circulation**  
Frances Hyvarinen

**Data Entry & Other Stuff**  
Norman Marion

**Business Office**  
Editorial - Advertising - Circulation  
Feedback - Product Reviews  
73 Amateur Radio Today Magazine  
70 Hancock Rd.  
Peterborough NH 03458-1107  
603-924-0058  
Fax: 603-924-8613

Reprints: \$3 per article  
Back issues: \$5 each

Printed in the USA

# 73 Amateur Radio Today

## TABLE OF CONTENTS

### FEATURES

- 10 Cheap & Easy Portable HF Vertical — K8MKB**  
*Try this medium-weight, sturdy, neat, visually pleasing, fun to use ...*
- 14 Troubleshooting Computer Power Supplies — W6WTU**  
*Rule #1: Be careful.*
- 23 Build This Simple SMT Station — AA2JZ**  
*Dinner and a movie? How about pizza and a project?*
- 25 How's That Thing Really Work, Anyway? — AA2JZ**  
*Part 1: Receivers.*
- 27 Warblemania — NY9D**  
*... and other QRP afflictions.*
- 30 Breakdown in Cape Town — G3SWH**  
*The surprise activity on this little jaunt turns out to be not just on the air.*
- 33 Hamfest Survival Guide — WB9YBM**  
*So that you can live to 'fest another day.*
- 34 Radio Comm in the French and Indian War — KØRMK**  
*Anything's possible when the Military Radio Collectors Association holds its annual meet.*
- 36 CQ Sooner Spring — NB5N & Cox**  
*An emergency preparedness drill that was more than OK.*
- 39 Lifeline for Your Driftmaster — W1TLZ**  
*How to stabilize a boat anchor.*

### DEPARTMENTS

- 43 Above & Beyond — WB6IGP**  
**49 Ad Index**  
**64 Barter 'n' Buy**  
**42 Calendar Events**  
**45 The Digital Port — KB7NO**  
**48 Hamsats — W5ACM**  
**53 Homing In — K0OV**  
**4 Never Say Die — W2NSD/1**  
**47 On the Go — KE8YN/7**  
**60 Propagation — Gray**  
**1 QRX**  
**63 Radio Bookshop**

#### E-Mail

design73@aol.com

#### Web Page

www.waynegreen.com

## QRX . . .

### Here's Lookin' at Ya

Let's turn our eyes toward the planet Venus. Just our eyes. Not our telescopes. Because if we do use a telescope we might make the very same mistake made by a very famous astronomer regarding canals on that mist-shrouded planet.

Turn-of-the-(last)-century astronomer Percival Lowell is well known for promoting the incorrect notion

that water canals had been built on the surface of Mars. He also drew a map of the "canals" on Venus; the only problem was that no one else could see anything resembling canals, because Venus is always covered by clouds.

Turns out that Lowell had narrowed the aperture of his 24" telescope down to about 3" to attenuate

*Continued on page 6*

**Manuscripts:** Contributions for possible publication are most welcome. We'll do the best we can to return anything you request, but we assume no responsibility for loss or damage. Payment for submitted articles will be made after publication. Please submit both a disk and a hard copy of your article [IBM (ok) or Mac (preferred) formats], carefully checked drawings and schematics, and the clearest, best focused and lighted photos you can manage. "How to write for 73" guidelines are available on request. US citizens, please include your Social Security number with submitted manuscripts so we can submit it to you know who.

**73 Amateur Radio Today** (ISSN 1052-2522) is published monthly by **73 Magazine**, 70 Hancock Rd., Peterborough NH 03458-1107. The entire contents ©2003 by **73 Magazine**. No part of this publication may be reproduced without written permission of the publisher, which is not all that difficult to get. The subscription rate is: one year \$24.97, two years \$44.97; Canada: one year \$34.21, two years \$57.75, including postage and 7% GST. Foreign postage: \$19 surface, \$42 airmail additional per year, payable in US funds on a US bank. Second class postage is paid at Peterborough, NH, and at additional mailing offices. Canadian second class mail registration #178101. Canadian GST registration #125393314. Microfilm edition: University Microfilm, Ann Arbor MI 48106. POSTMASTER: Send address changes to **73 Amateur Radio Today**, 70 Hancock Rd., Peterborough NH 03458-1107. **73 Amateur Radio Today** is owned by Shabromat Way Ltd. of Hancock NH.



# ...POWER ON WITH ASTRON

SWITCHING POWER SUPPLIES...



MODEL SS-10TK



MODEL SS-121F

**SPECIAL FEATURES:**

- HIGH EFFICIENCY SWITCHING TECHNOLOGY SPECIFICALLY FILTERED FOR USE WITH COMMUNICATIONS EQUIPMENT, FOR ALL FREQUENCIES INCLUDING HF
- HEAVY DUTY DESIGN
- LOW PROFILE, LIGHT WEIGHT PACKAGE
- EMI FILTER
- MEETS FCC CLASS B

**PROTECTION FEATURES:**

- CURRENT LIMITING
- OVERVOLTAGE PROTECTION
- FUSE PROTECTION
- OVER TEMPERATURE SHUTDOWN

**SPECIFICATIONS:**

INPUT VOLTAGE: 115 VAC 50/60HZ  
OR 220 VAC 50/60HZ  
SWITCH SELECTABLE  
OUTPUT VOLTAGE: 13.8VDC

AVAILABLE WITH THE FOLLOWING APPROVALS: UL, CUL, CE, TUV.



MODEL SS-18

**DESKTOP SWITCHING POWER SUPPLIES**

MODEL	CONT. (Amps)	ICS	SIZE (inches)	Wt.(lbs.)
SS-10	7	10	1 1/2 x 6 x 9	3.2
SS-12	10	12	1 1/2 x 6 x 9	3.4
SS-18	15	18	1 1/2 x 6 x 9	3.6
SS-25	20	25	2 1/4 x 7 x 9 1/2	4.2
SS-30	25	30	3 1/4 x 7 x 9 1/2	5.0



MODEL SS-25M

**DESKTOP SWITCHING POWER SUPPLIES WITH VOLT AND AMP METERS**

MODEL	CONT. (Amps)	ICS	SIZE (inches)	Wt.(lbs.)
SS-25M*	20	25	2 1/4 x 7 x 9 1/2	4.2
SS-30M*	25	30	3 1/4 x 7 x 9 1/2	5.0



MODEL SRM-30

**RACKMOUNT SWITCHING POWER SUPPLIES**

MODEL	CONT. (Amps)	ICS	SIZE (inches)	Wt.(lbs.)
SRM-25	20	25	3 1/2 x 19 x 9 1/2	6.5
SRM-30	25	30	3 1/2 x 19 x 9 1/2	7.0

**WITH SEPARATE VOLT & AMP METERS**

MODEL	CONT. (Amps)	ICS	SIZE (inches)	Wt.(lbs.)
SRM-25M	20	25	3 1/2 x 19 x 9 1/2	6.5
SRM-30M	25	30	3 1/2 x 19 x 9 1/2	7.0



MODEL SRM-30M-2

**2 ea SWITCHING POWER SUPPLIES ON ONE RACK PANEL**

MODEL	CONT. (Amps)	ICS	SIZE (inches)	Wt.(lbs.)
SRM-25-2	20	25	3 1/2 x 19 x 9 1/2	10.5
SRM-30-2	25	30	3 1/2 x 19 x 9 1/2	11.0

**WITH SEPARATE VOLT & AMP METERS**

MODEL	CONT. (Amps)	ICS	SIZE (inches)	Wt.(lbs.)
SRM-25M-2	20	25	3 1/2 x 19 x 9 1/2	10.5
SRM-30M-2	25	30	3 1/2 x 19 x 9 1/2	11.0



MODEL SS-12SM/GTX



MODEL SS-10EFJ-98

**CUSTOM POWER SUPPLIES FOR RADIOS BELOW**

- EF JOHNSON AVENGER GX-MC41
- EF JOHNSON AVENGER GX-MC42
- EF JOHNSON GT-ML81
- EF JOHNSON GT-ML83
- EF JOHNSON 9800 SERIES
- GE MARC SERIES
- GE MONOGRAM SERIES & MAXON SM-4000 SERIES
- ICOM IC-F11020 & IC-F2020
- KENWOOD TK760, 762, 840, 860, 940, 941
- KENWOOD TK760H, 762H
- MOTOROLA LOW POWER SM50, SM120, & GTX
- MOTOROLA HIGH POWER SM50, SM120, & GTX
- MOTOROLA RADIUS & GM 300
- MOTOROLA RADIUS & GM 300
- MOTOROLA RADIUS & GM 300
- UNIDEN SMH1525, SMU4525
- VERTEX -- FTL-1011, FT-1011, FT-2011, FT-7011

**NEW SWITCHING MODELS**

- SS-10GX, SS-12GX
- SS-18GX
- SS-12EFJ
- SS-18EFJ
- SS-10-EFJ-98, SS-12-EFJ-98, SS-18-EFJ-98
- SS-12MC
- SS-10MG, SS-12MG
- SS-101F, SS-121F
- SS-10TK
- SS-12TK OR SS-18TK
- SS-10SM/GTX
- SS-10SM/GTX, SS-12SM/GTX, SS-18SM/GTX
- SS-10RA
- SS-12RA
- SS-18RA
- SS-10SMU, SS-12SMU, SS-18SMU
- SS-10V, SS-12V, SS-18V



**GET THE NEW CATALOG TODAY!**

*New Kits, New LPFM, New Cameras*  
**www.ramseykits.com**



**WORK THE WORLD WITH A WATT...FOR ONLY \$99!**

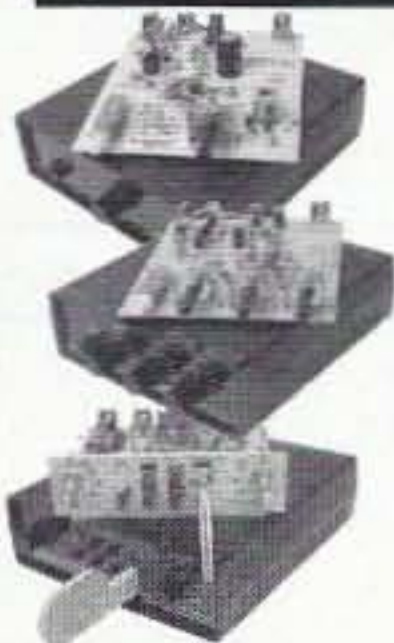

**QRP TRANSMITTER**

Available in 20, 30, or 40 Meters, these neat little transmitters put out 1 Watt!

**HR RECEIVER**

Available in 20, 30, or 40 Meters, 1.0 uV sensitivity rivals the big rigs...at a fraction of the price!

**CW700 KEYS**

With adjustable pitch & speed from 3-60 wpm, features true iambic keying and EPROM memory!

**\$99 COMPLETE!**

**\$155 Sold Separately**  
 Visit [www.ramseykits.com/qrp](http://www.ramseykits.com/qrp) to order this special deal!

*\$99 price includes QRP Transmitter kit, HR Receiver kit, and CW700 Micro-Memory Keyer kit, all the matching case & knob sets shown. Visit [www.ramseykits.com/qrp](http://www.ramseykits.com/qrp) to order this special deal!*

**35 WATT LPFM STEREO TRANSMITTER**



- ✓ 35W RF output, VSWR protected
- ✓ Automatic audio & power controls
- ✓ Digital synthesized PLL
- ✓ Full front panel control
- ✓ 110/220VAC, 12VDC operation

Whether your application is export or LPFM, the PX1 has you covered. From the over-rated continuous duty power supply & power amplifier to the 2 line vacuum fluorescent display, your station will be the easiest to setup and the most reliable for continuous operation. Full microprocessor controls provide a "virtual engineer". Check out [www.highpowerfm](http://www.highpowerfm) for full details.

PX1 35W Professional FM Stereo Transmitter \$1,795.95

**TOUCH-TONE TONE GRABBER**



- ✓ New-built-in RJ11 phone jack
  - ✓ Large memory holds over 500 numbers
  - ✓ Big bold 8 digit display, auto insertion of dashes
  - ✓ New-output latch jack
- Dialed phone numbers on the radio, repeater codes, control codes, anywhere touch-tones are used, you can read and store them! All new design for 2002. Capture those tones with the TG2!

TG2 Tone Grabber Tone Reader Kit \$59.95  
 CTG2 Matching Case & Knob Set \$14.95  
 AC125 110 VAC Power Adapter \$9.95

**ELECTROCARDIOGRAM HEART MONITOR**



- ✓ Visible and audible display of your heart rhythm
  - ✓ Re-usable sensors included; just like visiting the hospital!
  - ✓ Bright LED "beat" indicator
  - ✓ Monitor output for oscilloscope display
- Enjoy learning about the inner workings of the heart while covering the stage by stage electronic circuit theory of ECG/EKG systems. Be heart smart and learn at the same time!

ECG1 Electrocardiogram Heart Monitor Kit \$34.95  
 CECG Matching Case & Knob Set \$14.95  
 AC125 110 VAC Power Adapter \$9.95  
 ECGP10 Replacement Reusable Probe Patches (10-Pack) \$7.95

**XLR TO RCA AUDIO CONVERTER**



- ✓ Connect consumer outputs to XLR inputs
  - ✓ Left & right audio gain adjustments
- So you're trying to connect consumer audio outputs with RCA connectors (unbalanced) to XLR (balanced) inputs. Always a problem...Not anymore with the R2XL1!

R2XL1 Unbalanced to Balanced Audio Converter Kit \$49.95  
 CR2XL Matching Case & Knob Set \$14.95  
 PWR25 12VAC Power Adapter \$9.95

**GIVEAWAYS & SPECIALS EVERY MONTH!**

Register to receive our E-Mail specials and you will automatically be entered in our monthly drawing! New deals, new specials, new giveaways every month!

**Register TODAY**

[www.ramseykits.com/specials](http://www.ramseykits.com/specials)

**PROFESSIONAL FM STEREO RADIO STATION**



- ✓ Synthesized 88 to 108 MHz with no drift!
- ✓ Built-in mixer - 2 line inputs and one microphone input!
- ✓ High power module available for export use
- ✓ Low pass filter for great audio response

Our FM100 is used all over the world by serious hobbyists as well as churches, drive-in theaters, and schools. Frequency synthesized PLL assures drift-free operation with simple front panel frequency selection. Built-in audio mixer features LED bargraph meters to make setting audio a breeze. The kit includes metal case, whip antenna and built-in 110 volt AC power supply.

FM100 Super-Pro FM Stereo Radio Station Kit \$249.95  
 FM100WT 1 Watt, Wired Export Version \$399.95

**SYNTHESIZED FM STEREO TRANSMITTER**



- ✓ All new design & features for 2002!
  - ✓ Fully adjustable RF output
- Our #1 kit for years has just gotten better for 2002! Totally redesigned, the FM25B has all the features you've asked for. From variable RF output, F connector RF output jack, line input, loop output, and more.

Includes case, power supply, whip antenna, audio cables.  
 FM25B Synthesized FM Stereo Transmitter Kit \$129.95

**AUTOMATIC COLOR/BW IR CAMERA**



- ✓ Color during the day, IR B&W at night!
  - ✓ Automatically turns on IR Illumination!
  - ✓ Waterproof to IP57 standards!
  - ✓ Black anodized housing with universal mount
- Best of both worlds! This video camera is a waterproof COLOR camera during the day. When the light level drops, it automatically changes to B&W and turns on its built-in IR illumination, with 10 IR LEDs. Powered by 12VDC and terminated with a professional BNC connector. B&W only model also available if color is not needed.

Both in heavy anodized black housing.  
 CCD309 Color/B&W IR Waterproof Bullet Camera \$169.95  
 CCD308 B&W IR Waterproof Bullet Camera \$109.95  
 AC125 110 VAC Power Adapter \$9.95

**MINI B&W CAMERA WITH IR ILLUMINATION**



- ✓ Built in IR illumination!
  - ✓ Sees in total darkness!
- What a deal! This miniature B&W video camera has 6 high power IR LEDs built into it to provide illumination in total darkness! No need for external IR illuminators. Attractive black aluminum housing easily mounts at any angle with the built-in swivel bracket. Runs on 12VDC, and includes professional BNC output plug-in harness.

CCD303 Mini B&W IR Illuminated Camera \$59.95  
 AC125 110 VAC Power Adapter \$9.95

Check out all our other new cameras at [www.ramseykits.com](http://www.ramseykits.com)



**RAMSEY ELECTRONICS, INC.**  
 793 Canning Parkway  
 Victor, NY 14564  
 716-924-4560  
 sales@ramseykits.com



**Order Today! 800-446-2295**

[www.ramseykits.com](http://www.ramseykits.com)

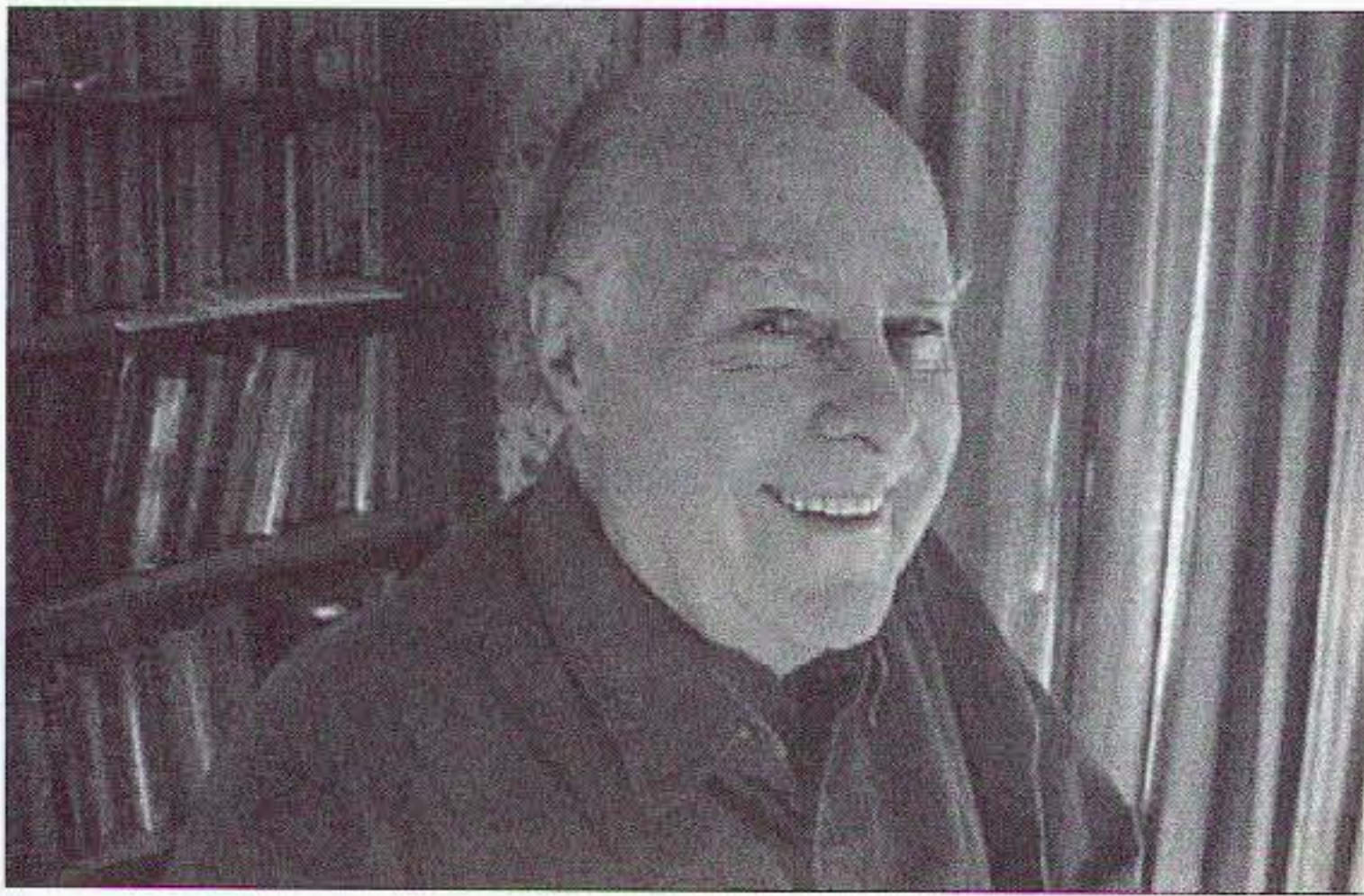

## Wise Up & Beat the Odds

### NEVER SAY DIE

Wayne Green W2NSD/1

w2nsd@aol.com

www.waynegrain.com

#### What's Going On?

Something's out of kilter. We're having more volcanoes erupting today than ever in history. We're having more earthquakes. And the Sun is having the longest and most intense sunspot period in history. Why, it's almost enough to make even a scientist think. But, not quite.

The scientific establishment in every field tends to be almost totally immune to new ideas or investigating anomalies. Always has been.

So, what's going on? The idea that Planet X will be coming along in May and destroying civilization is patently absurd. Yes, the government is still covering up Amelia Earhart's disappearance, even after 65 years. And President Roosevelt's masterminding the Pearl Harbor attack for 61 years. And the Roswell UFO crash for 55 years. And the faked Moon landings for over 30 years.

I wouldn't be such a worrywart about the whole X deal if what's happening wasn't exactly what Nancy Leider (*Zetatalk*), Mark Hazelwood (*Blindsided*), and several others predicted would be the results of Planet X nearing. Well, by next month X should be easily seen. Or totally dissed.

Hmm, got your QRP rigs tested and handy?

#### A Major Publisher

Many readers of my *Secret Guide to Health* have been pushing me to get a major book publisher to help market the book ... complete with

book tours and TV interviews. I'd sure like to help millions of people be healthy instead of only thousands, but I'm worried that the impact could cause an even worse recession than we have now.

You see, if the word ever really gets out about what I've discovered it could: Put tens of thousands of doctors out of work; close down two-thirds of our hospitals; put almost all assisted care facilities out of business; close down most nursing homes; bankrupt the pharmaceutical companies; severely impact drug stores; put most medical schools out of business; severely depress the funeral business; bankrupt the food industry giants; destroy the sugar industry; put most dentists out of business; and dental schools; bankrupt the soda pop industry; bankrupt the tobacco industry; bankrupt the beer, wine and liquor industries; put a million liquor stores out of business; wipe out cancer and other illness-related research organizations; destroy the Social Security system as we know it; wipe out HMOs; wipe out the health insurance industry; wipe out the fast food industry as we know it; put Kleenex out of business; bankrupt the TV networks.

Just think what something like this could do to the American economy. And then Europe and around the world. Icons like Coca Cola and their hundreds of thousands of workers would be history. Ditto McDonald's, Starbucks, Dunkin' Donuts, Pizza Hut, Burger King and Wendy's

(unless they bring back their salad bars).

Let's say you're a small employer like I was a while back. I had about 250 employees. Today I'd be paying about \$1 million in health benefits for them. Next year it would be \$1,125,000. Would I buy 250 copies of my health guide at \$20 a whack, a \$5,000 outlay, in the hopes of cutting my health care bills? In an instant. Further, I'd blow another \$10 for a video of Wayne Green explaining the benefits of changing one's lifestyle. I'd also get rid of the candy and coffee machines in the employees' lounge. I'd replace them with bowls of grapes, cherries, apples, etc. Oh, and water coolers with big bottles of distilled water.

A bigger company's CEO, with 10,000 employees, faced with spending \$40 million a year on health benefits (which have been lately going up at about \$500 a year per employee), might be interested in investing \$120,000 (bulk discount) in my books to help his employees be healthier. If not, his board of directors should fire his ass because the savings would go right to the bottom line, increasing the company's profits (and its stock price).

Would corner bars like Cheers and Moe's be replaced by sashimi bars? I sure hope so.

So, do you know any publisher interested in a book which could be the biggest seller yet? In 50 or so languages?

#### Treatments

The media brainwashing continues. Didja see the *Newsweek* Special Report on medicine's next frontiers? Twenty-nine pages of the issue had to do with treatments for illnesses our scientists are working on. Well, bless their hearts for their great pharmaceutical company work. But, in all that coverage I didn't see any hint about why we get sick and how, maybe, we can actually prevent it.

Yes, I know, I'm like a broken record. I keep trying to get the simple, commonsense message across that when we give our bodies the fuels they're designed to use they aren't going to get sick and need treatments. Hamburgers and fries with Diet Coke are not what our bodies are designed to cope with. Nor coffee and doughnuts. They're slow, addictive poisons.

#### The L.A. Riots

Well, it was ten years ago when the blacks rioted over the acquittal of the police who so brutally beat Rodney King. Hey, how come the jury did that? I'll bet you've never heard the real story. I know I hadn't.

The acquittal was the result of the jury seeing the entire videotape of the event, not just the little segment shown endlessly on TV. Yes, the news shows had the whole tape to work with, but showing the whole thing wouldn't have been as shocking (newsworthy).

Continued on page 8

# Big Savings on Radio Scanners

## Uniden®

## SCANNERS

## AOR



**Bearcat® 785DGV APCO P-25 Digital Ready with free deluxe scanner headset**  
**CEI on-line or phone special price \$339.95**  
**1,000 Channels • 27 bands • CTCSS/DCS • S Meter**  
**Size: 6<sup>15/16</sup>" Wide x 6<sup>9/16</sup>" Deep x 2<sup>3/8</sup>" High**

New Product. Scheduled for initial release January 10, 2003. Order now.  
**Frequency Coverage:** 25.0000-512.0000 MHz., 806.000-823.9875MHz., 849.0125-868.9875 MHz., 894.0125-956.000, 1240.000-1300.000 MHz.

When you buy your Bearcat 785D state-of-the art Digital Capable Trunktracker III package deal from Communications Electronics, you get more. The GV means "Great Value." With your BC785D scanner purchase, you also get a free deluxe scanner headset designed for home or race track use. The Bearcat 785D has 1,000 channels and the widest frequency coverage of any Bearcat scanner ever. When you order the optional BCI25D, APCO Project 25 Digital Card for \$299.95, when installed, you can monitor Public Safety Organizations who currently use conventional, trunked 3,600 baud and mixed mode APCO Project 25 systems. APCO project 25 is a modulation process where voice communications are converted into digital communications similar to digital mobile phones. You can also monitor Motorola, EDACS, EDACS SCAT, and EF Johnson systems. Many more features such as S.A.M.E. weather alert, full-frequency display and backlit controls, built-in CTCSS/DCS to assign analog and digital subaudible tone codes to a specific frequency in memory, PC Control with RS232 port, Beep Alert, Record function, VFO control, menu-driven design, total channel control and much more. Our CEI package deal includes telescopic antenna, AC adapter, cigarette lighter cord, DC cord, mobile mounting bracket with screws, owner's manual, trunking frequency guide and one-year limited Uniden factory warranty. For maximum scanning enjoyment, operate your scanner from your computer running Windows. Order Scancat Gold for Windows, part number SGFW for \$99.95 and magnetic mount antenna part number ANTMNBNC for \$29.95. Not compatible with 9,600 baud APCO digital control channel with digital voice, AGEIS, ASTRO or ESAS systems. For fastest delivery, order on-line at [www.usascan.com](http://www.usascan.com).

**Bearcat® 895XLT Trunk Tracker**  
 Manufacturer suggested list price \$499.95  
**Less -\$320 Instant Rebate / Special \$179.95**  
**300 Channels • 10 banks • Built-in CTCSS • S Meter**  
**Size: 10<sup>1/2</sup>" Wide x 7<sup>1/2</sup>" Deep x 3<sup>3/8</sup>" High**  
**Frequency Coverage:** 29.000-54.000 MHz., 108.000-174 MHz., 216.000-512.000 MHz., 806.000-823.995 MHz., 849.0125-868.995 MHz., 894.0125-956.000 MHz.

The Bearcat 895XLT is superb for intercepting trunked analog communications transmissions with features like TurboScan™ to search VHF channels at 100 steps per second. This base and mobile scanner is also ideal for intelligence professionals because it has a Signal Strength Meter, RS232C Port to allow computer-control of your scanner via optional hardware and 30 trunking channel indicator annunciators to show you real-time trunking activity for an entire trunking system. Other features include Auto Store - Automatically stores all active frequencies within the specified bank(s). Auto Recording - Lets you record channel activity from the scanner onto a tape recorder. CTCSS Tone Board (Continuous Tone Control Squelch System) allows the squelch to be broken during scanning only when a correct CTCSS tone is received. For maximum scanning pleasure, order the following optional accessories: PS001 Cigarette lighter power cord for temporary operation from your vehicle's cigarette lighter \$14.95; PS002 DC power cord - enables permanent operation from your vehicle fuse box \$14.95; MB001 Mobile mounting bracket \$14.95; EX711 External speaker with mounting bracket & 10 feet of cable with plug attached \$19.95. CAT895 Computer serial cable \$29.95. The BC895XLT comes with AC adapter, telescopic antenna, owner's manual and one year limited Uniden warranty. Not compatible with AGEIS, ASTRO, EDACS, ESAS or LTR systems.



**Bearcat® 245XLT Trunk Tracker II**

Mfg. suggested list price \$429.95/CEI price \$189.95

**300 Channels • 10 banks • Trunk Scan and Scan Lists**  
**Trunk Lockout • Trunk Delay • Cloning Capability**  
**10 Priority Channels • Programmed Service Search**  
**Size: 2<sup>1/2</sup>" Wide x 1<sup>3/4</sup>" Deep x 6" High**  
**Frequency Coverage:**

29.000-54.000 MHz., 108-174 MHz., 406-512 MHz., 806-823.995 MHz., 849.0125-868.995 MHz., 894.0125-956.000 MHz.

Our Bearcat TrunkTracker BC245XLT is the world's first scanner designed to track Motorola Type I, Type II, Hybrid, SMARTNET, PRIVACY PLUS and EDACS® analog trunking systems on any band. Now, follow UHF High Band, UHF 800/900 MHz trunked public safety and public service systems just as if conventional two-way communications were used. Our scanner offers many new benefits such as Multi-Track - Track more than one trunking system at a time and scan conventional and trunked systems at the same time. 300 Channels - Program one frequency into each channel. 12 Bands, 10 Banks - Includes 12 bands, with aircraft and 800 MHz. 10 banks with 30 channels each are useful for storing similar frequencies to maintain faster scanning cycles or for storing all the frequencies of a trunked system. Smart Scanner - Automatically program your BC245XLT with all the frequencies and trunking talk groups for your local area by accessing the Bearcat national database with your PC. If you do not have a PC simply use an external modem. Turbo Search - Increases the search speed to 300 steps per second when monitoring frequency bands with 5 KHz. steps. 10 Priority Channels - You can assign one priority channel in each bank. Assigning a priority channel allows you to keep track of activity on your most important channels while monitoring other channels for transmissions. Preprogrammed Service (SVC) Search - Allows you to toggle through preprogrammed police, fire/emergency, railroad, aircraft, marine, and weather frequencies. Unique Data Skip - Allows your scanner to skip unwanted data transmissions and reduces unwanted birdies. Memory Backup - If the battery completely discharges or if power is disconnected, the frequencies programmed in your scanner are retained in memory. Manual Channel Access - Go directly to any channel. LCD Back Light - An LCD light remains on for 15 seconds when the back light key is pressed. Autolight - Automatically turns the backlight on when your scanner stops on a transmission. Battery Save - In manual mode, the BC245XLT automatically reduces its power requirements to extend the battery's charge. Attenuator - Reduces the signal strength to help prevent signal overload. The BC245XLT also works as a conventional scanner. Now it's easy to continuously monitor many radio conversations even though the message is switching frequencies. The BC245XLT comes with AC adapter, one rechargeable long life ni-cad battery pack, belt clip, flexible rubber antenna, earphone, RS232C cable, Trunk Tracker frequency guide, owner's manual and one year limited Uniden warranty. Not compatible with AGEIS, ASTRO, ESAS or LTR systems.



Hear more action on your radio scanner today. Order on-line at [www.usascan.com](http://www.usascan.com) for quick delivery. For maximum scanning satisfaction, control your Bearcat 245XLT from your computer running Windows. Order Scancat Gold for Windows, part number SGFW for \$99.95 or the surveillance enhanced version with audio recording part number SGFWSE for \$159.95.

### More Radio Products

Save even more on radio scanners when purchased directly from CEI. Your CEI price after instant rebate is listed below:

Bearcat 895XLT 300 ch. Trunktracker I base/mobile scanner.....	\$179.95
Bearcat 785D 1,000 channel Trunktracker III base/mobile.....	\$339.95
Bearcat BCI25D APCO Project 25 digital software card.....	\$299.95
Bearcat 278CLT 100 ch. AM/FM/SAME WX alert scanner.....	\$139.95
Bearcat 250D 1,000 ch. Trunktracker III handheld scanner.....	\$339.95
Bearcat 245XLT 300 ch. Trunktracker II handheld scanner.....	\$189.95
Bearcat 248CLT 50 ch. base AM/FM/weather alert scanner.....	\$84.95
Bearcat Sportcat 200 alpha handheld sports scanner.....	\$159.95
Bearcat Sportcat 180B handheld sports scanner.....	\$139.95
Bearcat 80XLT 50 channel handheld scanner.....	\$99.95
Bearcat 60XLT 30 channel handheld scanner.....	\$74.95
Bearcat BCT7 information mobile scanner.....	\$139.95
AOR AR16BQ Wide Band scanner with quick charger.....	\$199.95
Sangean ATS909 306 memory shortwave receiver.....	\$209.95
Sangean ATS818 45 memory shortwave receiver.....	\$139.95
Uniden WX500 Weather Alert with S.A.M.E. feature.....	\$39.95

**AOR® AR8200 Mark IIB Radio Scanner**

AOR8200 Mark IIB-A wideband handheld scanner/SPECIAL \$539.95

**1,000 Channels • 20 banks • 50 Select Scan Channels**  
**PASS channels: 50 per search bank + 50 for VFO search**  
**Frequency step programmable in multiples of 50 Hz.**  
**Size: 2<sup>1/2</sup>" Wide x 1<sup>3/8</sup>" Deep x 6<sup>1/8</sup>" High**  
**Frequency Coverage:**

500 KHz to 823.995 MHz., 849.0125-868.995 MHz., 894.0125-2,040.000 MHz.  
 (Full coverage receivers available for export and FCC approved users.)

The AOR AR8200 Mark IIB is the ideal handheld radio scanner for communications professionals. It features all mode receive: WFM, NFM, SFM (Super Narrow FM), WAM, AM, NAM (wide, standard, narrow AM), USB, LSB & CW. Super narrow FM plus Wide and Narrow AM in addition to the standard modes. The AR8200 also has a versatile multifunctional band scope with save trace facility, twin frequency readout with bar signal meter, battery save feature with battery low legend, separate controls for volume and squelch, arrow four way side rocker with separate main tuning dial, user selectable keypad beep/illumination and LCD contrast, write protect and keypad lock, programmable scan and search including LINK, FREE, DELAY, AUDIO, LEVEL, MODE, computer socket fitted for control, clone and record, Flash-ROM no battery required memory, true carrier reinsertion in SSB modes, RF preselection of mid VHF bands, Detachable MW bar aerial. Tuning steps are programmable in multiples of 50 Hz in all modes, 8.33 KHz airband step correctly supported, Step-adjust, frequency offset, AFC, Noise limited & attenuator, Wide and Narrow AM in addition to the standard modes. For maximum scanning pleasure, you can add one of the following optional slot cards to this scanner: CT8200 CTCSS squelch & search decoder \$89.95; EM8200 External 4,000 channel backup memory, 160 search banks. \$69.95; RU8200 about 20 seconds chip based recording and playback \$69.95; TE8200 256 step tone eliminator \$59.95. In addition, two leads are available for use with the option socket. CC8200A personal computer control lead \$109.95; CR8200 tape recording lead \$59.95. Includes 4 1,000 mAh AA ni-cad batteries, charger, cigarette lighter adapter, whip aerial, MW bar antenna, belt hook, strap and one year limited AOR warranty. For fastest delivery, enter your order on-line at <http://www.usascan.com>.



### Buy with Confidence

**Order on-line and get big savings**

For over 33 years, millions of communications specialists and enthusiasts worldwide have trusted Communications Electronics for their mission critical communications needs. It's easy to order. For fastest delivery, order on-line at [www.usascan.com](http://www.usascan.com). Mail orders to: Communications Electronics Inc., P.O. Box 1045, Ann Arbor, Michigan 48106 USA. Add \$20.00 per radio receiver for UPS ground shipping, handling and insurance to the continental USA. Add \$15.00 shipping for all accessories and publications. For Canada, Puerto Rico, Hawaii, Alaska, Guam, P.O. Box or APO/FPO delivery, shipping charges are two times continental US rates. Michigan residents add sales tax. No COD's. Your satisfaction is guaranteed or return item in unused condition in original packaging within 61 days for refund, less shipping, handling and insurance charges. 10% surcharge for net 10 billing to qualified accounts. All sales are subject to availability, acceptance, verification and authentication. Prices, terms and specifications are subject to change without notice. We welcome your Discover, Visa, American Express, MasterCard, IMPAC and Eurocard. Call anytime 1-800-USA-SCAN or 800-872-7226 to order toll-free. Call +1-734-996-8888 if outside Canada or the USA. FAX anytime, dial +1-734-663-8888. Dealer and international inquiries invited. Order your radio products from CEI today at [www.usascan.com](http://www.usascan.com).

**For credit card orders call**  
**1-800-USA-SCAN**

e-mail: [cei@usascan.com](mailto:cei@usascan.com)

[www.usascan.com](http://www.usascan.com)

PO Box 1045, Ann Arbor, Michigan 48106-1045 USA

For information call 734-996-8888 or FAX 734-663-8888

Price schedule effective December 2, 2002 AD #120202 © 2002 Communications Electronics Inc.

**COMMUNICATIONS ELECTRONICS INC.**  
 Emergency Operations Center

**Visit [WWW.USASCAN.COM](http://WWW.USASCAN.COM) • 1-800-USA-SCAN**

continued from page 1

the bright light from Venus. That little known fact — recently publicized — caught the attention of optical experts, who realized that Lowell had unwittingly turned his telescope into a reverse ophthalmoscope, an instrument used to examine the interior of the eye. Instead of mapping the surface of Venus, Lowell was apparently mapping the shadows of blood vessels and other structures on his own retina!

*Sky & Telescope* magazine explained the situation in detail, presented Lowell's sketch of the Venusian "canals," and a photograph of retinal blood vessels. The two patterns are strikingly alike.

You can see the pictures in the on-line edition of *Sky and Telescope* magazine. Just take your Web browser over to [<http://skyandtelescope.com>].

Thanks to Q-News Australia, via Graham Kemp VK4BB, via Newline, Bill Pasternak WA6ITF, editor.

## What If?

A cell phone call from a friend. A beeper message from the boss. Justin Timberlake on the radio. 24/7 news on CNN. Each is an everyday, "wireless" event in our lives, usually unworthy of a second thought.

But what if the radio revolution had not occurred? What if Guglielmo Marconi had not lit the spark of global communication on the cold and windswept cliffs of Cape Cod a century ago? How would we communicate today? Would wires still tether us?

The National Park Service at the Cape Cod National Seashore celebrated the 100th anniversary of Marconi's first transatlantic, wireless broadcast from the U.S. on January 18th, with a daylong series of public events designed to showcase the historic and pioneering nature of the event.

"What happened January 18, 1903, at today's Marconi site in South Wellfleet changed people's lives forever," said Superintendent Maria Burks. "Its historical significance rivals the Wright Brothers' first flight."

Working with local, regional, and national celebration partners, the Seashore hosted public events that attracted visitors from all over. The events included a NASA-sponsored, family space education program; weeklong, worldwide radio communication sessions hosted by the Marconi Radio Club and other amateur radio enthusiasts; and special Marconi presentations at the Seashore's Salt Pond Visitor Center.

"There was something for everyone — from school kids to philatelists to scientists and historians," said Burks. "We told the story of one man's innovation and perseverance, his disappointments and triumph, and the lessons they hold for us today."

## The event

Using four wooden transmission towers erected on a steep cliff overlooking the rolling Atlantic, the 28-year-old Italian-born inventor set out to prove in 1903 that man could communicate across a vast distance without the wire-based technology of the 19th-century telegraph.

Michael E. Whatley recounted the momentous night in his 1987 publication, *Marconi - Wireless on Cape Cod*: "The air was literally charged with high voltage. Finally, Marconi went over to the wireless telegraph key. Within four minutes it was done. The message had been tapped out, and transatlantic radio communication between the U.S. and Europe was no longer an experiment; it was a reality."

"To His Majesty, Edward VII, London, England," read the message signed by President Theodore Roosevelt. "In taking advantage of the wonderful triumph of scientific research and ingenuity which has been achieved in perfecting a system of wireless telegraphy, I extend on behalf of the American people most cordial greetings and good wishes to you and all the people of the British Empire."

Later that night came the King's response to Roosevelt: "I thank you most sincerely for the kind message which I have just received from you, through Marconi's transatlantic wireless telegraphy."

Whatley wrote, "The triumph was Marconi's alone, and the publicity (was) astounding." The messages appeared on the front pages of *The New York Times* and *Boston Globe*, and congratulatory telegrams "kept the Cape Cod (radio) operators in turmoil."

## The legacy

In the ensuing years, as radio, TV and space communication thrived, the old Marconi station was dismantled, and the site fell into disuse. The ocean ate away at the cliffs where the towers stood. In the '60s and '70s, the National Park Service restored the venue as the Seashore's Marconi Site, salvaging remnants of a tower's base and erecting an exhibit shelter and viewing platforms.

Now the Park Service and the Seashore are able to celebrate the achievement of the man who was honored in 1909 with the Nobel Prize and who, when he died in 1937, was honored the world over by two minutes of radio silence.

Thanks to Jane and Chip Bishop of Chip Bishop Communications, West Dennis MA.

## Why Is It?

There are a lot of strange and interesting things that happen in our wonderful hobby. Working the World QRP. Making effective antennas out of practically nothing. Catching rare DX when you least expect it. Things like that. But there

are other things that can be frustrating to every ham worldwide (especially me). Things that make you go hmmm ...

One-way propagation: Why is it that at times you hear a station on the air that you would REALLY like to work, and they're practically blowing your headphones off, but they CAN'T HEAR YOU!!? It's the wonderful phenomenon known as "one-way propagation," also known as "I can hear the \*&\$@!, but he can't hear me!!" As I've found out, banging your head against the desk (nearest tree, car, cow, etc.) doesn't help to put your signal forth any stronger. Screaming into the microphone at the top of your lungs doesn't get it, either. Indulging in these activities will allow the XYL to prove once and for all that the last speed-dialer button on the phone is really for the nearest mental health response unit, and not Pizza Hut, as she has always claimed!

Birds: Why is it that when you have a nice multiband vertical looking pretty out in the yard (like mine — the vertical, not the yard!), birds always want to perch on the whip of the uppermost section, and then scream at you about the bumpy ride and suffering motion sickness? With 10 million trees around, they always seem to find antennas better landing strips. And why is it that when you're out there tuning the antenna (and possibly offering more stability to their ride), they give a personal demonstration of toilet marksmanship? Things like this that happen are frustrating. The neighbors are sure to complain that you're "out to hurt the little birdies" with that big bad slingshot, instead of just trying to get a wire antenna up into the trees (personal tip: keep the steel shot in your pocket until you're ready to use it — it's less conspicuous that way!).

Kids: Why is it that kids find coax cable so fascinating? The neighbor kids were making quite a racket in the back yard a few weeks ago. When I went out there to investigate, I found them trying to kill "the long black snake trying to eat the metal tree you have" (i.e., my poor old vertical) by snapping the coax around like a bullwhip, trying to break its neck! Thoughtful neighbors are great, but I find that it's much easier to make contacts via ham radio if the snake continues to eat the metal tree. I'm glad they didn't see where the other end of the snake went, because to see a snake pass a mobile home out of the other end probably would cause irreparable damage!

Neighbors: Neighbors can make or break a neighborhood — hence the term "neighborhood." Living in a mobile home court, neighbors frequently come and go. It is because of neighbors, however, that I found out what "front-end overload" is. This is an interesting phenomenon whereby a strong signal overwhelms reception of desired signals. It's also responsible for freaking out non-English-speaking neighbors as well. I found out from my next trailer neighbor (well, it IS a mobile home court) that my CQs on 20 meters were making the CD tray on his stereo go in and out spontaneously. I also



found out that I was the "English-speaking demon line" in their TV set! They were able to deal with this pretty well, but a visiting relative from Mexico wasn't so receptive. She wound up screaming on the way to the rear bedroom that the TV was possessed. I exorcised the demon from their home by relocating the antenna to the back yard instead of the side one. After all, if I hadn't moved it, the kids out back wouldn't have had a long black snake to kill.

Ham shacks: Why is it that we all brag about the "shack" as being a huge, well-equipped place where we have a gigawatt of power at our disposal and equipment made from the rarest, most exotic materials, and from whence we can talk to anyone in the world anytime we want to? Some of us probably can. I'm one of the more common hams: My shack is the southeast corner of my living room. I'm also a slave to propagation. Ahhh, the wonder of "sporadic E". Sporadic E is literally a cloud of highly ionized atmosphere in the E layer that allows for long skip to occur. More than once I've had the pleasure of the band dropping out (the sporadic E cloud moving on or dissipating) during a QSO, only to turn over the frequency to dead air! That's very frustrating — especially when another ham hears both sides of the conversation and then lets you know that the other party went out to lunch thinking it was all over! AARRGGGHHH! It happens.

Lingo: The "slang" of ham radio. Everything

has lingo with it, as do we. Some of the lingo can be frustrating, too. Such as "foot-warmer." To some ops, a foot-warmer is a linear amplifier. I have a foot-warmer, too. It answers to "Calico," and ruins bags of kitty litter! Lid is another one. Common term: A lid is what keeps food in a jar from spoiling. Ham lingo: A lid is someone who NEEDED a lid to keep them from spoiling everyone else's on-air time. You know what I mean. Lastly, log sheet. Why do they call it a "log sheet"? They're not nearly big enough to use as a sheet for a log unless it's really small and short. Why anybody would want to sleep on one is beyond me, anyway.

Mobile operation: Working the world while motoring down the highway is a wonderful thing. It's not a wonderful thing, though, when antenna mishaps occur. For example, I set up my trusty old Kenwood TS-180S in my Chevy Astro van as a mobile rig. A friend said that he'd had great success with Hustler resonators mounted on a mast, which is in turn mounted on a spring-loaded bumper mount. I bought all of the items necessary to share in his success. After mounting the antenna mount to the bumper (while my XYL glared at me while I made the holes), and the antenna mast and resonator, I was set to check the SWR and "go mobile." Everything looked good, so I headed out on Interstate 70 to try some 75 meter mobile phone. A slight oversight by my friend: As I achieve the 70 mph speed limit, I experience a loud "thumping" in the rear of the

van. Hmmm. I look into the side mirror to check out the noise, and discover that my awesome spring-loaded, bumper-mounted antenna is doing a live demonstration of how a sledgehammer should properly be swung! Yow! Oh the sight, friends, of seeing almost \$200 of antenna bouncing off of the highway, only to fly up and dent the back end of the van. You haven't lived until that happens. Is there ANY chance he might have forgotten to mention guying the antenna before take-off? Frustrating, you bet!

There are as many frustrating things about life in general, as there individuals to experience them. I'll bet you could think of a few things that made you want to turn a trusted HT into an automobile! Or the day when you get the coveted "Worked All Neighbors" award! Things that are unexpected, and yes, frustrating. But we all manage to deal with them in a positive manner, and often learn valuable things along the way. Be proud to be a ham. Help others with our hobby. Enrich the vocabularies of those around you when things are bad — somebody has to do it, right? After all, when the chips are down, the ham will come shining through, providing emergency communications when needed, being active in the community, helping others. It's the ham way.

Thanks to Dewey E. Boss NØZYG, 1661 W. Republic Ave. Lot #26, Salina, Kansas 67401; [dross@cox.net]; [www.geocities.com/SiliconValley/Park/3395].

73

## Smart Choice! Smartuner!

Do **YOU** want to be heard? *OF COURSE!* Then use the SGC Smartuner™ - the *Essential* link between your **HF transceiver** and **antenna**. Matching at the transceiver is good, but matching at the antenna is better. SGC Smartuners are designed to do just that. They operate completely independently to provide the best match between the feed line and the antenna, eliminating SWR problems completely.

SGC Smartuners are designed to work with *any* transceiver (including the ICOM 802) and *any* antenna. They are fully automated, intelligent enough to select the best match between feed line and antenna in seconds and remember it so it can recall that match in milliseconds. The Smartuner sets the standard. It is the original and still the best.



Illustration from the original SGC Marine SSB Facebook, 1974

*Once you've learned how the Smartuner works, you won't want anything else!*



SG-230



**No Compromise Communications**



SG-231

Visit [www.sgeworld.com](http://www.sgeworld.com) for more information on the entire line of Smartuners

SGC Inc. 13737 SE 26th St. Bellevue, WA 98005 USA Tel: 425-746-6310 Fax: 425-746-6384  
[sgc@sgeworld.com](mailto:sgc@sgeworld.com) [www.sgeworld.com](http://www.sgeworld.com)

## NEVER SAY DIE

continued from page 4

If you've watched any of the cop shows you know that suspects are often ordered to lie on the ground with their hands behind their backs. Cops have found by hard experience that this is the safest way to keep from getting shot or stabbed.

When, after a high speed chase, King was finally stopped and ordered to lie down, he refused. The other men that were in the car with him all complied and gave no trouble. When the cops tried to force King down he fought them. He was too big and strong for them, so they tried electrified darts to immobilize him. They didn't faze him. Twice he got back up and charged the cops. When they finally managed to get him down he wouldn't put his hands behind him and was still struggling to get up. It was the last few seconds of their efforts to subdue King that the media showed. And showed.

When the jury saw the whole tape they acquitted. More than 50 people lost their lives in the ensuing riots.

The media may have our attention, but it doesn't make much of an effort to be honest.

How much have you seen in the mainstream media about the reality of cold fusion, UFOs, crop patterns, and so on? I guess these things just "don't sell papers."

### College Grads

Okay, you are now "formally educated." But that doesn't mean you've learned much of practical value to your career. Or, have you really had a career in mind? Or have you just been going with the flow?

Your college teachers, with very few exceptions, are people who've never worked in the business world. They've forced you to memorize the same stuff for quizzes that they had to memorize when they went to college. Stuff out of pretty much the same textbooks.

With the job market for grads in the pits these days,

just sending out résumés, no matter how creative and exaggerated they are, isn't working.

The free ride on your parents is over. Or, worse, you've gone thousands of dollars in hock to get that degree. Either way, you're now expected to enter the job market and start making money on your own.

It's almost time to start giving some thought to building a career. So, what's it going to be? You're now facing one of the most important choices in your life. One that you postponed four years earlier when you opted for college. Now, you have to make a major choice. Will it be a job? Or back to school for an advanced degree, putting off that career decision again?

If you keep doing this you'll end up a professor with students short-term memorizing the same stuff for quizzes that you did.

### Fast Food

How come it takes me twice as long to eat as everyone else? Because I'm the only one taking the time to actually chew my food. Everyone else chews their food just long enough to be able to swallow it, and then washes it down with ice water, tea, cola, wine or a malt.

Around a hundred years ago, when Dr. Kellogg did the research, he found that a big part of the digestive system lay in the saliva action while chewing food. He recommended that every bite be chewed one hundred times before swallowing. For a while he had several million people actually chewing their food. He didn't do us any favors when he brought us corn flakes and other cold cereals.

Now, about that stuff you've been drinking while eating. That liquid goes to your stomach and dilutes the acid bath your stomach needs to dissolve the food so your intestines can get the most out of it.

Well, considering the junk people are using for food, maybe it's best that it go through the digestive system with as little absorbed as

possible. Twinkies, genetically modified potatoes deep fried in canola oil, well done beef loaded with growth hormones and antibiotics, Krispy Kremes, Oreos, etc. You get the picture.

### Raw Meeeat?

Raw meat. That's mmm-eat.

When people read my *Secret Guide to Health* and discover that cooked food is considered by our immune systems as toxic, and that this includes meat, they're ready to go vegan. Raw meat? Ugggh.

Never mind that our ancestors were hunter-gatherers who ate raw meat for thousands of generations. Or that the Eskimos, who used to be very healthy, lived totally on raw meat.

I enjoyed reading an article by a chef who explained that any customer who ordered his meat well done got the oldest and cheapest meat served to him. The finest cuts were saved for the "very rare" or "blue" customers.

Steak tartare is a favorite in France. That's raw hamburger with capers. Delicious. And with fondue bourguignonne one dips cubes of raw meat into hot oil at the table. I've always dipped mine just for a few seconds.

I'll never forget a fantastic fondue in a little cabin up on top of the mountain at Vail, where the local ham skiers were celebrating a birthday. They had cubes of steak, moose, and elk. And, at that height, the fondue oil didn't get hot enough to cook the meat much. I loved it!

The transition from 70% raw to 100% hasn't been difficult for me, though I do still cheat with liver, which I sear for about three seconds on each side. It's about 98% raw and fabulous. I like it much better than steak.

At my age, after almost 80 years of beating the hell out of my immune system, I need all the repairing ability my immune system can manage.

### Smallpox

If the recent revelations about the serious dangers of

flu shots hasn't cooled your enthusiasm to line up for a smallpox vaccination, it's time to stop believing the major media and politicians, all well under the control of the pharmaceutical industry, and do some homework. At least read Waleen James' *Immunization, The Reality Behind the Myth*. That'll slow you down. It's reviewed on page 7 of my *Wisdom Guide*.

A recent article in *Time* tells us that the smallpox vaccine "is one of medicine's most dangerous." About a third of those vaccinated get sick enough so they miss work or school. Pregnant women, small children, anyone with a suppressed immune system or eczema, are in more serious danger. Considering your diet, how strong do you think your immune system is?

Only a small percentage actually die from the vaccination ... an acceptable loss ... unless one is your child. "Gee, sorry about that."

Maybe you've heard that some Russian scientists figured out how to modify the smallpox virus so it would be able to get around any known vaccine ... and that one of them was brought to Iraq by Saddam ten years ago to help work on his germ warfare development team.

### Johnny Can't Fail

The No Child Left Behind Act has the state educational departments hustling to set their proficiency goals so low that, like Wyoming, not a single school in the state will fail. Naturally, the new law is seriously underfunded. As new tests are devised we'll see schools reacting in the time-dishonored way: teaching to the new tests.

The government mandates force all kids into fixed curriculums, allowing the kids no discretion. Is it any wonder that creativity and initiative are so thoroughly squelched in our kids?

The government wants every kid to be educated exactly the same. Cookie cutter approach. Beehive. I don't see

Continued on page 42

## LOW NOISE PREAMPS

### LNY-( ) ECONOMY PREAMP

ONLY \$29/w&t

- Miniature MOSFET Preamp.
- Low noise figure.
- Available for various bands from 28 to 450 MHz.



### LNK-( ) PREAMP

ONLY \$59/w&t

Low noise preamp in alum case w/ BNC jacks.



### LNP-( ) PRESELECTOR ONLY \$49/w&t

- Eliminate intermod!
- Sharp 3-section filter
- Low noise preamp
- Available for bands from 137 to 170 MHz.



## R121 AVIATION RECEIVER



- AM receiver for the 118-137 MHz aircraft band.
- Allows pilot control of runway lighting.
- ELT monitor to detect and locate downed aircraft.
- Used at small airports across the country.

- Dip switch frequency selection.
- Superior sensitivity and selectivity.

R121 Receiver module wired/tested .....\$209  
R121 Receiver in cabinet (see website).....\$299

## WEATHER FAX RECEIVER

Join the fun. Get striking images directly from the weather satellites!

A very sensitive wideband fm receiver optimized for NOAA APT & Russian Meteor weather fax on the 137MHz band.

Covers all 5 satellite channels. Scanner circuit & recorder control allow you to automatically capture signals as satellites pass overhead, even while away from home.

- R139 Receiver Kit less case .....\$159
- R139 Receiver Kit with case and ac power adapter .....\$189
- R139 Receiver w/t in case with ac power adapter.....\$239
- Turnstile Antenna .....\$135



## WEATHER ALERT RECEIVER



A sensitive and selective professional grade receiver to monitor critical NOAA weather broadcasts. Good reception even at distances of 70 miles or more with suitable antenna. No comparison with ordinary consumer radios!

Automatic mode provides storm watch, alerting you by unmuting receiver and providing an output to trip remote equipment when an alert tone is broadcast. Crystal controlled for accuracy; all 7 channels (162.40 to 162.55).

- RWX Rcvr kit, PCB only .....\$79
- RWX Rcvr kit with cabinet, spkr, & ac adapter .....\$109
- RWX Rcvr w/t in cabinet with spkr & adapter.....\$149

## WWV RECEIVER

Get time & frequency checks without buying multiband hf rcvr. Hear solar activity reports affecting radio propagation. Very sensitive and selective crystal controlled superhet, dedicated to listening to WWV on 10 MHz. Performance rivals the most expensive rcvrs.



- RWWV Rcvr kit, PCB only .....\$69
- RWWV Rcvr kit with cabt, spkr, & ac adapter .....\$109
- RWWV Rcvr w/t in cabt with spkr & adapter .....\$149

## HIGH PERFORMANCE VHF & UHF EXCITER & RECEIVER MODULES

### FM EXCITERS:

2W continuous duty output.

#### T301 Synthesized VHF Exciter:

for various bands 139-174 MHz, 216-226 MHz. Dip switch freq. setting. TCXO freq stability.

- Kit 2M only (TCXO option \$40).....\$109
- Wired/tested, incl TCXO .....\$189

#### T304 Synthesized UHF Exciter:

for various bands 400-470 MHz.

- Kit (440-450 ham band only) incl TCXO .....\$149
- Wired/tested .....\$189

### CRYSTAL CONTROLLED:

- TA51: for 6M, 2M, 220 MHz ..... kit \$99, w/t \$169
- TA451: for 420-475 MHz ..... kit \$99, w/t \$169
- TA901: for 902-928 MHz, (0.5W out)..... w/t \$169

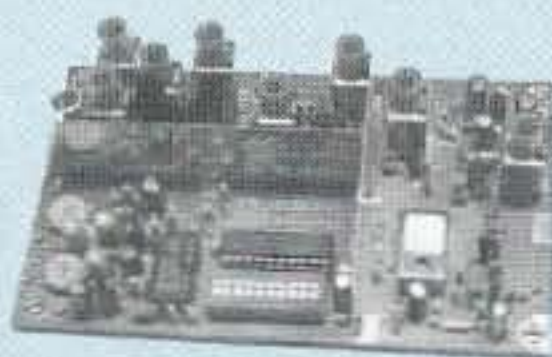

### VHF & UHF POWER AMPLIFIERS:

Output levels from 10W to 100W ..... Starting at \$99

### FM RECEIVERS:

Very sensitive, 0.2µV.

Superb selectivity, >100 dB down at ±12 kHz, best available anywhere, flutter-proof squelch.

#### R301 Synthesized VHF Receiver:

various bands 139-174MHz, 216-226 MHz. Dip switch freq. setting. TCXO freq stability.

- Kit 2m only (TCXO option \$40) ..... only \$139
- Wired/tested (incl TCXO) .....\$209

#### R304 Synthesized UHF Receiver:

various bands 400-470MHz.

- Kit 440-450 only (incl TCXO) .....\$179
- Wired/tested .....\$209

### CRYSTAL CONTROLLED:

- R100 for 46-54, 72-76, 140-175, or 216-225 MHz. .... kit \$129, w/t \$189
- R451 for 420-475 MHz ..... kit \$129, w/t \$189
- R901 for 902-928MHz ..... kit \$159, w/t \$219

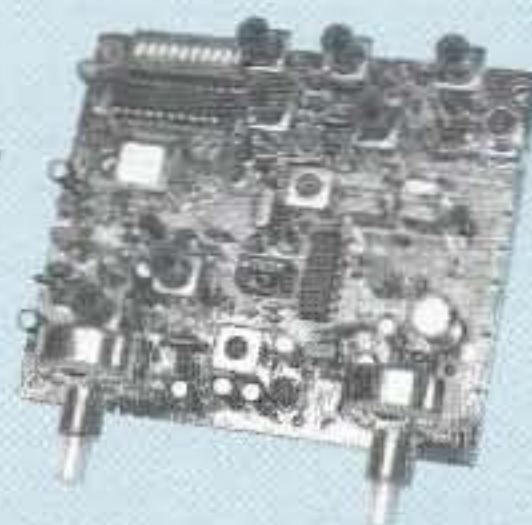

## CTCSS TONE ENCODER/DECODER



Access all your favorite repeaters!

- Encodes all standard subaudible tones with crystal accuracy and DIP switch tone selection.

• Decoder can be used to mute receive audio and is optimized for installation in repeaters to provide closed access. High pass filter gets rid of annoying rcvr buzz.

- TD-5 CTCSS Encoder/Decoder Kit .....\$39
- TD-5 CTCSS Encoder/Decoder Wired/tested .....\$59

## TRANSMITTING & RECEIVING CONVERTERS

No need to spend thousands on new transceivers for each band!

- Convert vhf and uhf signals to & from 10M.
- Receiving converters available for various segments of 2M and 432 MHz bands.
- Rcvg Conv Kits from \$49, wired/tested units only \$99.



- Transmitting converters for 2M.
- Kits only \$89. • Power amplifiers up to 50W.

## Get more features for your dollar with our REP-200 REPEATER

A microprocessor-controlled repeater with full autopatch and many versatile dtmf remote control features at less than you might pay for a bare bones repeater or controller alone!

There are more REP-200's on the air than any other repeater in the world.



- kit still only \$1095
- factory assembled still only \$1295

50-54, 143-174, 213-233, 420-475 MHz.  
( FCC type accepted for commercial service in 150 & 450 MHz bands.)

**Digital Voice Recorder Option.** Allows message up to 20 sec. to be remotely recorded off the air. Play back at user request by DTMF command, or as a periodic voice id, or both. Great for making club announcements! .....only \$100

**REP-200C Economy Repeater.** Real-voice ID, no dtmf or autopatch. .... Kit only \$795, w&t \$1195

**REP-200N Repeater.** Without controller so you can use your own. .... Kit only \$695, w&t \$995

## You'll KICK Yourself If You Build a Repeater

Without Checking Out Our Website First!

Hamtronics has the most complete line of modules for making repeaters. In addition to exciters, pa's, and receivers, we offer the following controllers.



**COR-3.** Inexpensive, flexible COR module with timers, courtesy beep, audio mixer. ....only \$49/kit, \$79 w/t

**CWID-2.** Eprom-controlled ID'er.....only \$54/kit, \$79 w/t

**DVR-1.** Record your own voice up to 20 sec. For voice id or playing club announcements. ....\$59/kit, \$99 w/t

**COR-4.** Complete COR and CWID all on one board. ID in eprom. Low power CMOS .....only \$99/kit, \$149 w/t

**COR-6.** COR with recorded-voice id. Low power CMOS, non-volatile memory. .... kit only \$99, w/t only \$149

**COR-5.** Microprocessor controller with autopatch, reverse ap, telephone remote control, lots of DTMF control functions, all on one board, as used in REP-200 Repeater. ....\$379 w/t

**AP-3.** Repeater autopatch, reverse autopatch, phone line remote control. Use with TD-2. .... kit \$89

**TD-2.** Four-digit DTMF decoder/controller. Five latching on-off functions, toll call restrictor..... kit \$79, w/t \$129

## HANDY FREQUENCY COUNTERS

Pocket sized, but lab quality! 3GHz bandwidth, 1ppm accuracy, very affordable. NiCd battery, ac adapter/charger, rugged black anodized aluminum case. Telescoping whip antenna and great sensitivity allow measurements even from a distance.

Two models with prices from \$149. Both go up to 3 GHz; one goes down to 10 Hz with noise filters and other advanced features. See our website for details.



## Hamtronics, Inc.

65 Moul Rd; Hilton NY 14468-9535

Ph: 585-392-9430; Email: sales@hamtronics.com

See special offers and view complete catalog on our web site -

**hamtronics.com**

Gerald F. Gronson K8MKB  
3529 Belinda Dr.  
Sterling Heights MI 48310  
[bassistg5693@yahoo.com]

# Cheap & Easy Portable HF Vertical

*Try this medium-weight, sturdy, neat, visually pleasing, fun to use ...*

*Antennas are the most important part of an amateur radio station. You don't believe it? Try getting on the air without one!*

Many portable antennas have been configured and described in the various amateur radio publications, throughout almost the entire history of amateur



*Photo A. The Cheap & Easy Portable HF Vertical securely mounted on a speaker stand.*

radio. This project is what I like to think of as a "better mouse trap." I've tried the various methods of winding wire on a bamboo pole (and similar wood dowel types) sitting upright in a Christmas tree stand for a base, an automobile wheel sans tire, or a patio table umbrella base. Well, they worked!

Sort of.

But, those "lash-ups" left much to be desired, in terms of being portable, sturdy, and easy to use! A "mobile whip antenna" mounted on a microphone stand, or a music stand, or a camera tripod — we've tried. All! Didn't work as well as the bamboo pole, wood dowel method, although they were a step in the right direction mechanically.

The idea to use a speaker stand came while I was browsing through a flyer I received one day from Parts Express. (They have a Web site.) Parts Express is an electronic component and parts supplier located in Springboro, Ohio (south of Dayton). At the top of the one page of the flyer was the word "SPECIAL." Below it: "TRIPOD SPEAKER STAND!!!" It didn't take long for the idea to sink in that this is what I've been searching for, searching,

every whiiiiich way! Lawd, I've been searching — just like the Northwest Mounted, you know (remember that tune??).

Hmmm ... back to the subject at hand, this impossible ideal (dream) antenna — there were times I thought of Don Quixote. Special Price! \$29.50, it said (with a carry bag, too).

Well, to make a long story short, I got one (a speaker stand that is, **Photo A**). I happen to have a Radio Shack antenna mount that I bought when I was experimenting with the different "simple antenna" projects, and with some slight modification of the antenna mount, I put together the device shown in the pictures.

The good news?. This system works, and is no biggie to put up and take down! Also, it's cheap (in the "bang-for-the buck" meaning of course)!

I assume that just about any of the mobile whip antennas out there can be used. I happened to have Valor Pro-Am types of whip antennas for 80, 40, and 20 meters. They "tuned" after adding capacitance. The need for adding capacitance, I found, was that the Valor-type antennas are tuned for the phone part of the band. That's what

they are designed for, and the addition of a capacitive "hat" (or increasing whip length) is required if operation in the CW portion of the band is desired.

I found that increasing the length of the stainless steel whip part of the antenna would work, as well as the adding of capacitance for lowering the antenna resonance point. Adding a capacitive hat has advantages over just lengthening the stainless steel whip. Hy-Gain antennas (mobile whip-type), as far as I know, can be tuned across the entire band selected for operation, by adjusting the whip length, and they would probably be the better choice.

Anyway, some tuning will be necessary if you need to work in the CW portion of a given band, no matter what brand of antenna is used. It would be good to consult an antenna book that covers mobile antenna operation, for suggestions that could be used to optimize performance. The only "serious" problem I've had so far is that the 10-meter antenna I have, a no-tune type wound on fiberglass with no whip, would not resonate at all. I even tried a straight quarter wave whip; no soap. My gut feeling is that 15 meters is about the upper usable limit of this "lash-up!"

The capacitive hat was made using

#14 copper grounding wire, available at most hardware stores; see **Photo B**. The thought has occurred to me to use an aluminum throw-away pie pan cut to the appropriate size using experimental methods, although I haven't tried it yet. The one advantage a wire hat has is that it has a smaller wind-loading co-efficient. The dimensions of the wire hat in the picture are 12" x 12" corner to corner. A disc-shaped unit would work as well, about a foot and a quarter in diameter. Increasing the number of cross members of the capacitive hat increases the capacitance in small increments, and is a good way to fine tune the system. This

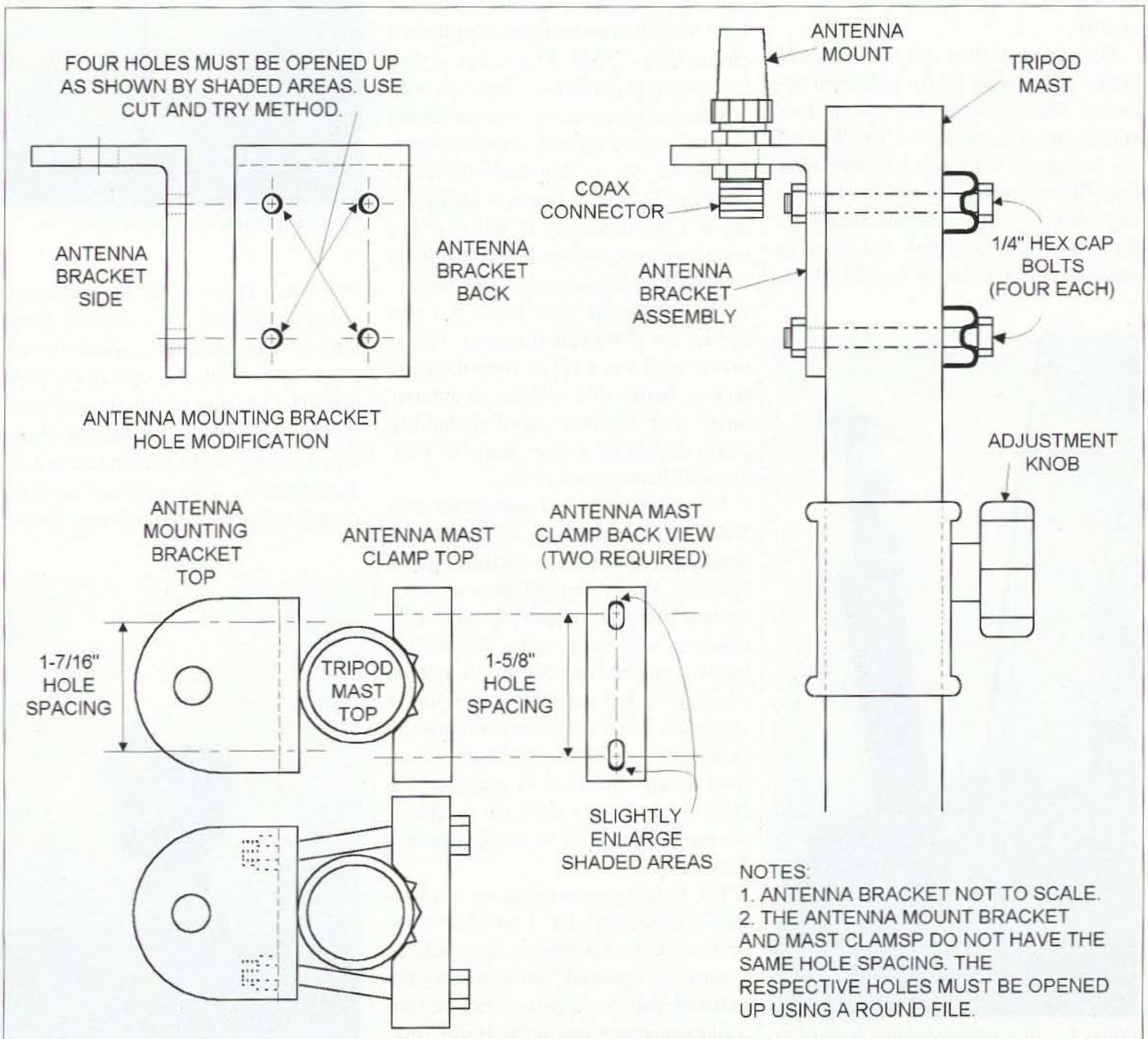
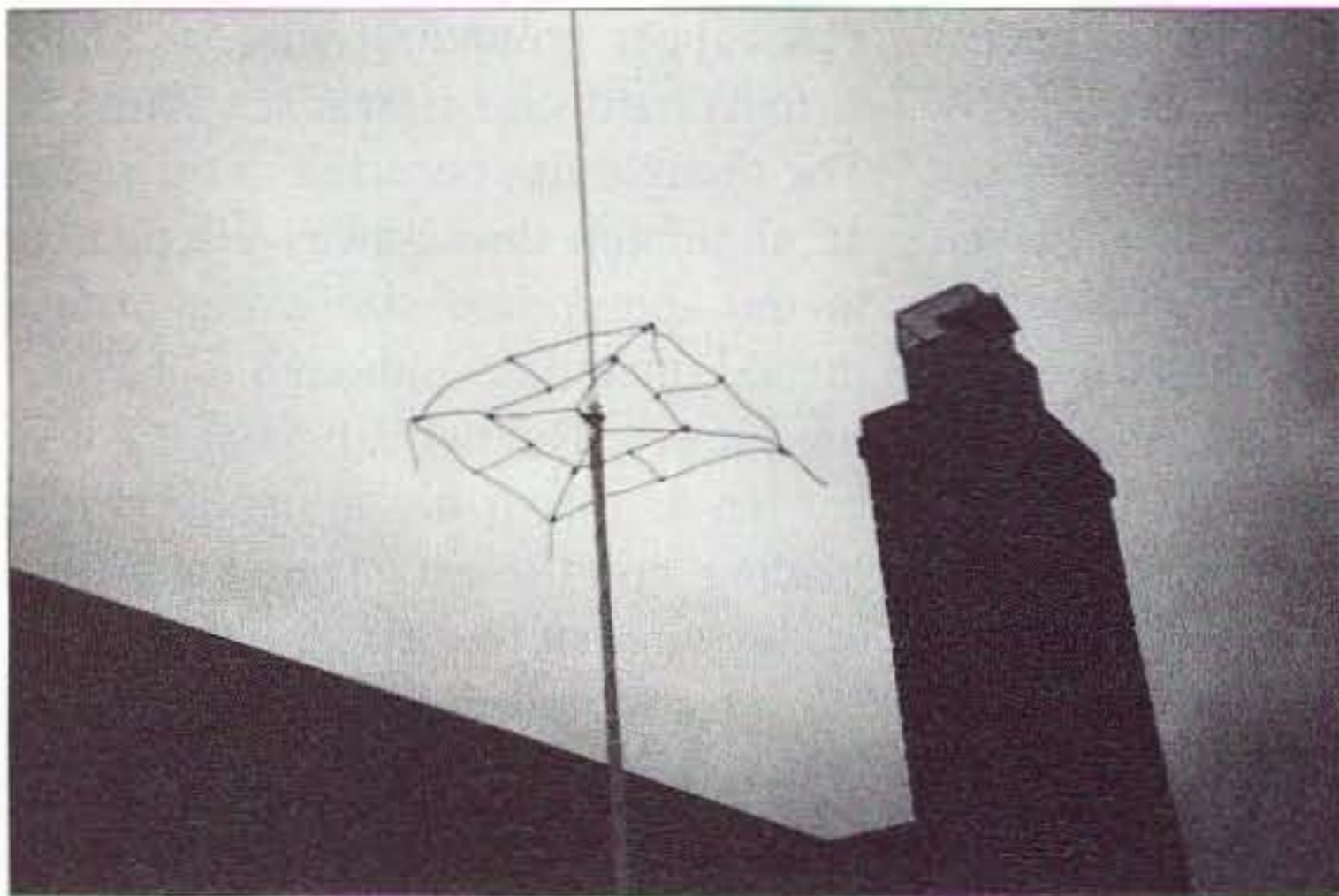

Fig. 1. Cheap & Easy details.



**Photo B.** The capacitive hat is made of #14 copper grounding wire.

system stood up to 30-mile-per-hour wind gusts, and only mildly swayed to and fro.

The tripod itself is easy to open and close, and can be easily tightened securely. The specs say that this speaker stand can safely support a 100 lb. load six feet above the floor. I should think that that's sturdy enough to handle any mobile whip antenna available. So if you're interested, the speaker stand catalog number is #245-010.



**Photo C.** This collapsed unit is easy to grab and go.

The on-special price was \$29.80, down from \$44.95; list price, \$109.95. It weighs 6-1/4 lbs., is easy to store, easy to transport (the ad says that). When collapsed it measures three feet tall — that is also the antenna operating support height (**Photo C**).

It is not necessary, nor desirable, to extend

the center support for HF band operation. The system resonates very well; a 1.2:1 VSWR was obtained as indicated on an MFJ -259B. That's not saying the system is perfect — someone with a good background in antennas could probably come up with improvements. If you do, let me know. However, it works good enough that it is worth giving it a try, especially if you live in a condo, or somewhere with smotheringly constrictive antenna covenant restrictions. You might want to keep a unit handy for portable/emergency operation as well, even if you have the good luck of being able to have an antenna farm! The speaker stand, extended, could double as a short mast for VHF and UHF antennas as well.

As of this writing, I understand that Valor Pro-Am antennas are no longer available. "Ain't that a shame?" (Fats Domino, 1955). Ummm, they were the easiest antenna to put up and take down as well as to add a "capacitive hat" to (maybe Ham Stick will pick up where they left off, just a thought). I suppose a fixture of some sort could be fashioned out of brass, which would hold a capacitive hat in place on the Ham Stick. I don't have the machines or machining skills to make a proper fixture.

The thought occurred to me, and it's only a thought so far: I wonder if two or more of the antenna set ups could be connected, "phased," so as to alter the radiation pattern. In past years I've seen a four-antenna setup at the Hazel Park, Michigan, Amateur Radio Club Field

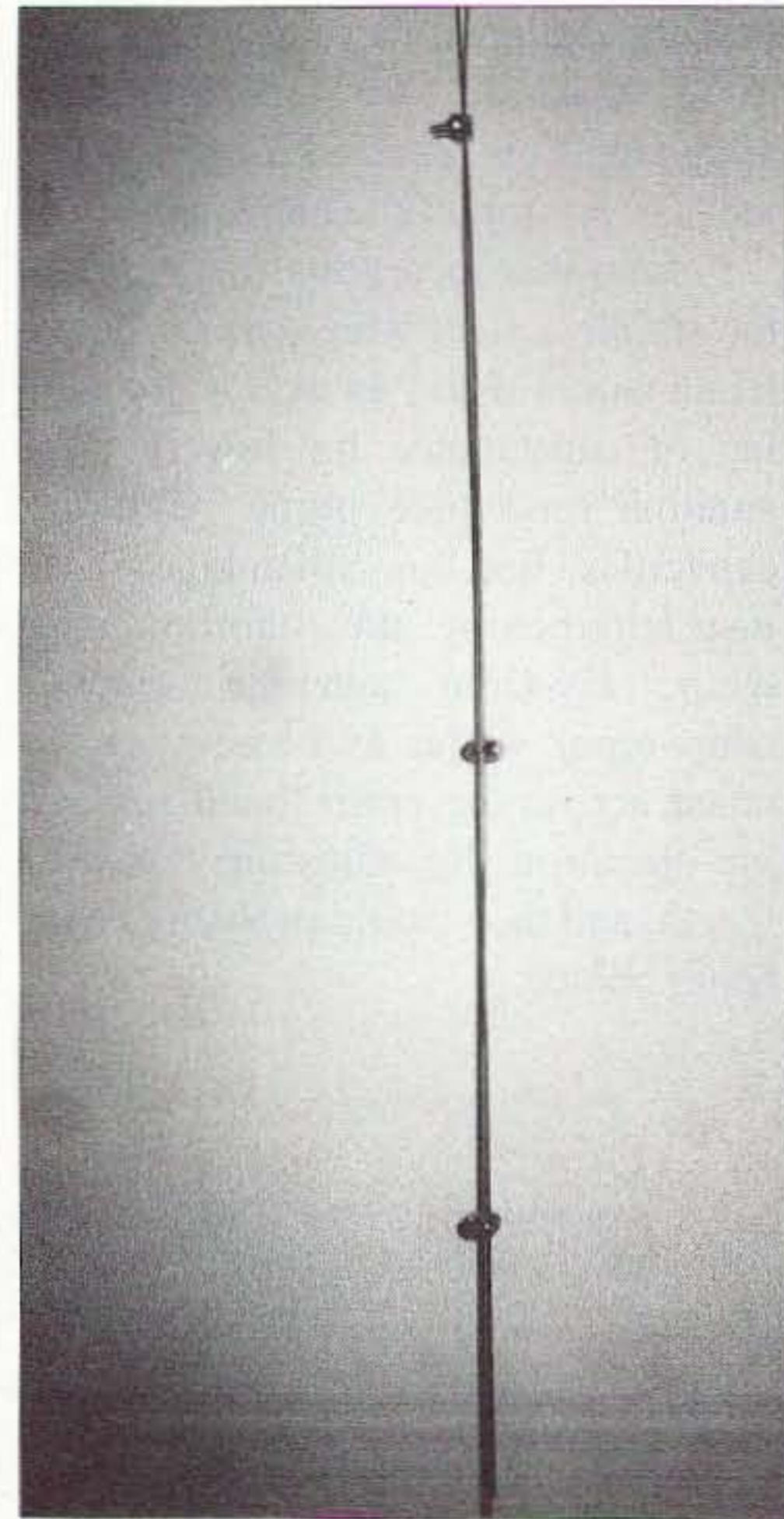

**Photo D.** Thimble clip placement.

Day site. There were four antennas ground-mounted, in a phased array, fed with a coaxial cable system, which was switched at the operator's position. The phasing of the antenna array was varied, which changed the directional pattern of the antenna array's radiated wave. This resulted in more energy being concentrated in a desired



**Photo E.** Close-up of mounting brackets.

direction during transmitting, as well as a reduction in QRM as a result of the improved antenna pattern while receiving.

In general, the mobile whip type antennas are designed to be used in the phone portion of the respective amateur bands. The problem becomes, "How do you make a stainless steel whip longer if it is too short?" The solution is simple! Another stainless steel whip! Attached to the too-short whip, with thimble clips (#4418638 1/8" Wire Rope Thimble & Clip Set by the Peerless Chain Co., Winona, MN 55987). These guys (thimble clips) look like miniature muffler clamps. See Photo D.

It takes a little "fumbling" to attach these clamps because they are small and hard to hold. You'll use three of them. When you get to working with them you will see what I mean. The antenna can be made to resonate at a lower frequency by using this method to lengthen the whip — long enough to resonate well below the phone portion of the band. I guess this is a physical realization of what in music is called theme and variation, in that a clamp-together whip is a variation on the theme of a pull-out whip. Thimble clips, a/k/a guy wire clamps, are used to fasten braided guy wires; you can get them at most hardware stores. A socket type screwdriver is the best tool to use for tightening the double-whip assembly. This idea works, both mechanically and electrically!

The capacitive hat idea goes back to WWII. Capacitive hats were first used on the whip antennas of PT boats, to increase signal range. Later, CBers used a version called a "Zing Ring." They found it boosted performance, so it's worth it if you can install one on the particular brand of antenna that you settle on. It does take some experimenting, of course.

The other parts used in this project are off-the-shelf items from Radio Shack, a #21-937 antenna mount bracket and #15-826 mast clamps. The mount bracket has to be drilled oval (Photo E) in order to accommodate the mast clamps, due to the large diameter of the speaker stand center support. I

used long shank bolts and wing nuts, in order to facilitate antenna bracket removal, without need for tools — in case I wanted to remove the whip-mount bracket, and mount a 2-meter antenna on the fully extended speaker stand. Now, how's that for an inexpensive (OK, cheap), easy-to-get-parts-for, medium-weight, sturdy, neat, fun to use, visually pleasing, professional (in an amateur sense, of course), spiffy, useful project? 73

**Scrambling News**  
915 NW First Ave., Suite 2902, Miami FL, 33136  
305-372-9427  
www.scramblingnews.com

**Pay TV and Satellite Descrambling 2002** - NEW! - satellite and cable. Includes latest information. \$19.95 plus \$1.75 shipping.  
**Hacking Digital Satellite Systems Video 2002** - New! - \$29.95 plus \$3.50 shipping.  
**Scrambling News Online** - Online service for those interested in satellite television news. \$59.95/year. \$59.95/yr.  
**Pay TV and Satellite Descrambling Series CD-Rom** - all 13 volumes over 300 pages, \$59.95 plus \$3.50 shipping.  
**Best Deal** - Everything listed above for only \$99.95 plus \$3.50 shipping.

**Amplifiers. ATU Down Converters & Hard to Find Parts**

LINEAR AMPLIFIERS		HARD TO FIND PARTS	ATU Down Converters
<b>HF Amplifiers</b> PC board and complete parts list for HF amplifiers described in the Motorola Application Notes and Engineering Bulletins: AN779H (20W) AN 758 (300W) AN779L (20W) AR313 (300W) AN 762 (140W) EB27A (300W) EB63 (140W) EB104 (600W) AR305 (300W) AR347 (1000W)		<b>2 Meter Amplifiers</b> (144-148 MHz) (Kit or Wired and Tested) 35W - Model 335A, \$79.95/\$109.95 75W - Model 875A, \$119.95/\$159.95	(Kit or Wired and Tested) Model ATV-3 (420-450) (Ga AS - FET) \$49.95/\$69.95 Model ATV-4 (902-926) (GaAS - FET) \$59.95/\$79.95
For detailed information and prices, call or write for our free catalog!		<b>RF Power Transistors</b> <b>Broadband HF Transformers</b> <b>Chip Caps - Kemet/ATC</b> <b>Metalclad Mica Caps - Unelco/Semco</b> <b>ARCO/SPRAGUE Trimmer Capacitors</b> We can get you virtually any RF transistor! Call us for "strange" hard to find parts! <b>DIGITAL FREQUENCY READOUT</b> For older analog transceivers TK-1 (Wired and Tested) \$149.95	<b>ADDITIONAL ITEMS</b> <b>Heat Sink Material</b> Model 99 Heat Sink (6.5" x 12" x 1.6"), \$24 CHS-8 Copper Spreader (8" x 6" x 3/8"), \$24 <b>Low Pass Filters (up to 300W)</b> for harmonics \$12.95 Specify 10M, 15M, 20M, 40M, 80M or 160M <b>HF Splitters and Combiners up to 2KW</b>

**CCI Communication Concepts Inc.**  
508 Millstone Drive • Beaver Creek, Ohio 45434-5840  
e-mail: cci.dayton@pobox.com  
www.communication-concepts.com

Phone (937) 426-8600  
FAX (937) 429-3811

**Subscriptions to 73 Magazine**

Only \$24.97 — 1 year  
\$44.97 — 2 years  
\$65.00 — 3 years\*

\*best buy (54% off cover price!)  
Call 800-274-7373

**WANTED**

Fun, easy-to-build projects for publication in 73.

For more info, write to:  
Joyce Sawtelle,  
73 Amateur Radio Today,  
70 Hancock Road  
Peterborough NH 03458.

<ul style="list-style-type: none"> <li>DIP switch programmable</li> <li>Miniature in size</li> <li>37 EIA tones, 27 non-standard tones from 33.0 to 254.1 Hz included</li> <li>Reverse Burst built-in</li> <li>Easy 3 wire hookup</li> </ul>		<ul style="list-style-type: none"> <li>Fully enclosed CTCSS encoder</li> <li>All 32 EIA tones from 67.0 to 203.5 Hz included</li> <li>Perfect for mobile / base applications</li> </ul>	
SS-64 CTCSS Encoder 66" x 1.08" x 21"	<b>SS-64 DIP Switch Programmable CTCSS Encoder \$28.95</b>	TE-32 5.25" x 3.3" x 1.7"	<b>TE-32 Multi-Tone CTCSS Encoder \$49.95</b>
<ul style="list-style-type: none"> <li>51 CTCSS Tones</li> <li>106 DCS Codes</li> <li>Supports 157 Repeater Subscribers</li> <li>On-Line Computer Help</li> <li>Repeater CW ID</li> <li>Air Time Loading &amp; Analysis Graphs</li> <li>Signalling Formats: CTCSS, DCS &amp; DTMF</li> </ul>		<ul style="list-style-type: none"> <li>Eight programmable, selectable messages</li> <li>Fully field programmable via included keypad</li> <li>Meets all FCC identification requirements</li> </ul>	
TP-3200 Shared Repeater Tone Panel TP-3200D Table Top Version \$269.95 each TP-3200RM-A Single Rack Mount version \$279.95 each TP-3200RM-B Triple Rack Mount version \$279.95 each *Holds up to three TP-3200s		ID-8 Automatic Morse Code Identifier 1.85" x 1.12" x .35"	<b>ID-8 Automatic Morse Station Identifier \$69.95</b>
Call or write to receive our full Product Catalog or visit our Web site for complete information at: <a href="http://www.com-spec.com">http://www.com-spec.com</a>		<b>COMMUNICATIONS SPECIALISTS, INC.</b> 426 WEST TAFT AVENUE • ORANGE, CA 92865-4296 (714) 998-3021 • FAX (714) 974-3420 Entire U.S.A. (800) 854-0547 • FAX (800) 850-0547 <a href="http://www.com-spec.com">http://www.com-spec.com</a>	

# Troubleshooting Computer Power Supplies

*Rule #1: Be careful.*

*With the increasing availability of computer power supplies, hams are the recipients of both good and bad supplies. Because of their curiosity level and association with electronics, hams are prone to remove the cover from a power supply to see what makes it tick. Although troubleshooting a computer power supply isn't very difficult, it does present a potential danger.*

**W**arning: Unless you have previous experience or are familiar with how to work with high-voltage/high-current circuits, do not remove the cover from a computer power supply. The internal voltages of a computer power supply reach 320 VDC with a current capacity up to one ampere. The energy generated within the circuit can be lethal — beware!

There is a tamperproof sticker on most computer power supplies warning of the danger of working inside of the box. Assuming that you understand the danger involved and have the background to work with high voltage circuits, I'll proceed to tell you what I know about switching power supplies and how to perform some troubleshooting techniques.

## Theory of operation

Let me point out that there are about as many different circuit designs for computer power supplies as there are designers. Each is unique in its design, but the basic operation of each follows a single pattern, the single pattern being a high power switching circuit driving an output transformer. The

technique is reminiscent of early car radios that used a vibrator to switch the DC applied to the primary of a power transformer.

The switching circuit may use one or two power transistors, depending upon the design. Because power switchers operate pretty much like a high-powered oscillator, the output voltage requires some form of voltage regulation/control. Some designs utilize an optical coupler to provide feedback from the output circuits back to the

switchers. Other designs utilize a pulse-width-modulator (PWM) IC to sense the output circuits and control the switchers. Regardless of the method used, the output voltage is controlled to maintain a voltage level at some percentage value — typically  $\pm 5\%$  of nominal.

The more you know about how a computer power supply is designed/constructed, the easier it is to troubleshoot when there is a failure. To gain familiarity with a supply, look over

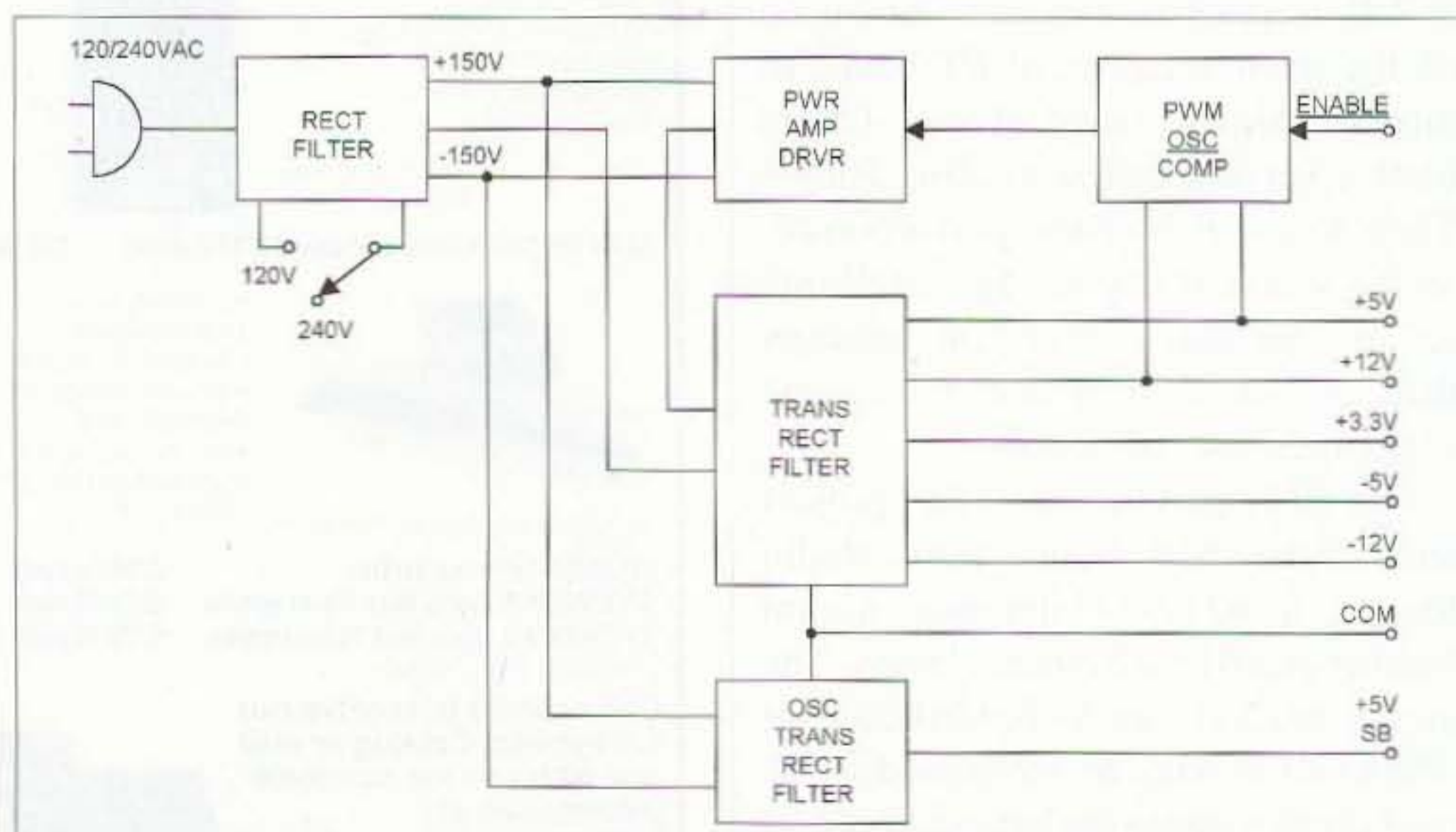

*Fig. 1. Block diagram of an ATX-version computer switching power supply.*





Arkansas's Communication Store

1710 East Parkway  
Russellville, AR 72801  
Phone 479-967-8315  
Fax 479-967-8317  
1-888-315-7388

Kenwood, Icom, Alinco, ADI,  
Police & Fire Communications Equipment,  
Surveillance Electronics (Installed).  
We sell amateur & commercial band radios.

www.rlselectronics.com

Fig. 1, which is a block diagram of a typical ATX-version switching power supply,

You'll notice that the input voltage may be either 120 VAC or 230 VAC. A switch is placed on the side of the power supply box allowing the user to select the input voltage that will be supplied. The switch changes the rectifier from a bridge (230 VAC) to a half-wave voltage doubler (120 VAC). In either case, the total voltage that is applied to the filter capacitors ends up being close to 320 VDC. The total of 320 VDC is divided equally across each filter capacitor and switching transistor. The outer +/- voltage lines are called "voltage rails."

Also connected across the 320V rails is an oscillator/driver/rectifier circuit used for developing +5 VDC at about 0.5 A. This is called standby power (SB) and is used to keep the computer "alive" even though it is intended to be asleep during periods of nonuse.

To the right of the power switching transistors is a block called the PWM. This is an IC that typically contains everything that is required to control and regulate the output voltages from the power supply during normal operation. In the case of an ATX power supply, an ENABLE line is provided to turn the PWM circuit ON or OFF as desired. Grounding the enable line will allow the PWM to come alive and drive the power switching transistors. A typical ATX power supply schematic is shown in Fig. 2.

All power supplies operating off of an AC power line require rectifiers for changing AC voltages to DC. In the case of a switching power supply, the process is done twice, with the first step rectifying the power line to produce approximately 320 VDC to

**A GREAT gift idea for yourself, your ham friend(s), or your child's school library**

is a subscription to 73 Magazine ... only \$24.97!

Call 800-274-7373 or write to 70 Hancock Rd., Peterborough NH 03458

# RIGblaster

## pro

The ultimate interface for phone and digital operating.

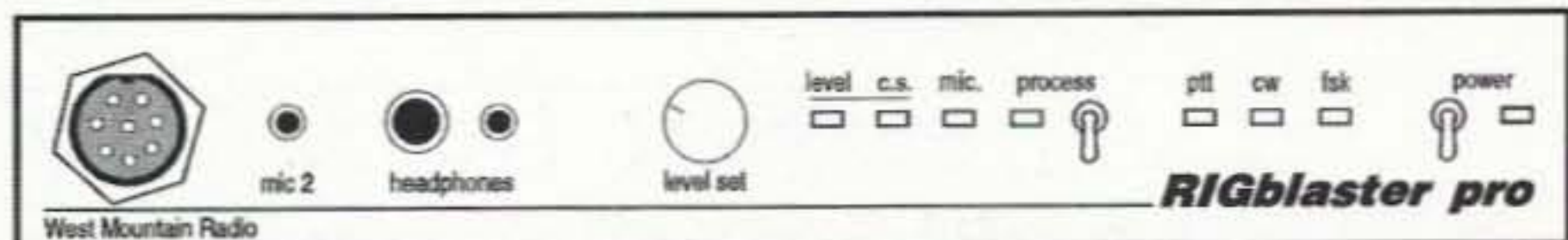

**The complete computer interface for your radio**  
Everything you can possibly do with a computer and a radio

The **pro** incorporates the time proven performance and compatibility of our **M8** and **plus** models while providing simplified operation, total versatility and functionality.

**Rig control and sound card operation with a single serial port!**  
**Transmit speech processing and voice recording on the fly!**

### THE **PRO**'s NEW FEATURES, just to mention a few.

- Easier to set up and operate than ever before.
- Built in computer rig control interface for Yaesu CAT, Icom CI-V, Ten Tec.
- Transmit speech processing: tailor your audio for DX, rag chewing or even Hi-Fi. Software off the web with an advanced ham radio application coming soon.
- LEDs show PTT, CW, FSK, audio source, processing and computer audio level.
- Record Voice-Keyer messages on the fly or record a QSO; SO2R contest operation.
- Two separate keying outputs, one for FSK and one for CW.
- Two mics: plug in automatic switchover between the main station mic. and a headset mic.
- Dual headphone outputs jacks may be used for DSP receive with or without comp. spkrs.
- Front panel sound card transmit level control, eliminates mouse sliders.
- PTT in and out jacks for a foot switch, external control or a sequencer.
- Radio speaker loop lets you easily re-connect an external radio speaker.
- Fixed-level receive direct from mic. connection for those radios that support it.
- RIGblaster standard automatic bypass, plus a power on/off switch for complete disable.

<http://www.westmountainradio.com>

**West Mountain Radio** de N1ZZ and K1UHF

18 Sheehan Avenue, Norwalk, CT 06854 (203) 853 8080



true for the model series of supplies that use a voltage boost circuit to power the PWM IC. The voltage is boosted from about 12V to 21V to power the PWM IC and the small output driver transistors. If the boost filter capacitor is dried out, the voltage is never boosted and the power supply is very reluctant to "come up" when enabled.

Normal troubleshooting techniques will fail to identify a specific problem with the circuit, yet it fails to operate. When I've encountered such a problem, I go immediately to the boost filter capacitor and change it, which usually results in a more normal operation. As a rule, if one capacitor is dried out, others are most likely dried out as well. Changing all of the capacitors may be a good idea, but probably not a very practical solution.

### Transistors

Power switching transistors rarely fail in normal power supply operation. Therefore, when a transistor fails, it is usually caused by a lack of cooling air or a shorted DC output circuit.

### Fuse

A fuse failure is somewhat obvious when the internal fuse link (element) has been vaporized. When that condition is observed, then you might conclude that something drastic created the actual failure and some extensive diagnosis may be required.

On the other hand, fuses also have their own failure mode, which isn't quite as obvious as a melted element. A fuse is typically made by attaching a fusible link between two metal end caps, and because the element is a resistor it will get warm during use. Heating and cooling of the element causes a mechanical stress on the element that will cause it to break. The break occurs more often than not near a cap rather than out in the middle, where the break might be observed through the glass tube.

### Others

Rectifiers and filter capacitors can also fail, though rarely, but when they

do fail, they place an excessive load on the switching transistors and cause them to fail. When a power transistor fails, look for additional problems that might have caused the failure.

Up to this point, we've considered the safety issues involved and have gained some insight into the basic design of a computer switching power supply with a focus on effecting a repair. Some typical problems have been identified, along with a brief discussion of typical failure modes.

### Safety tips

Personal safety is of the highest importance when working with any dangerous piece of equipment, and that includes computer power supplies. When working with an open computer power supply, it is imperative to work with only the low voltage side of the power supply when AC power is applied. There are times when some measurements must be made on the high voltage side of the supply, but when that's necessary, connections to the HV side must be done when the AC power is removed from the supply.

A meter may be attached to the HV circuit and then read after the power is applied.

To work on the underside of the power supply board, the board must be lifted and turned upside down without having to remove the wires connected to the power connectors and switch. Either a cardboard or wooden sheet is placed between

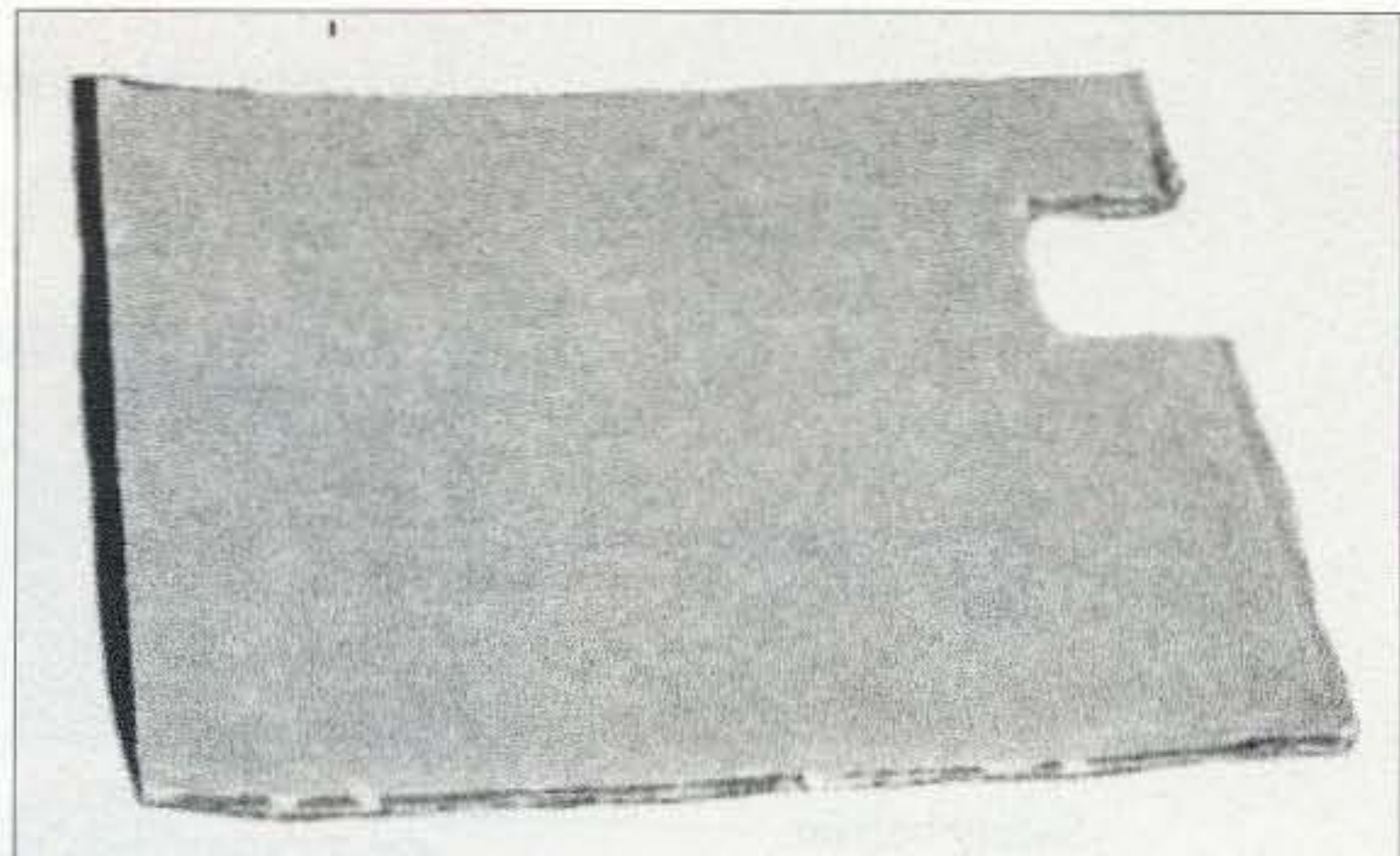
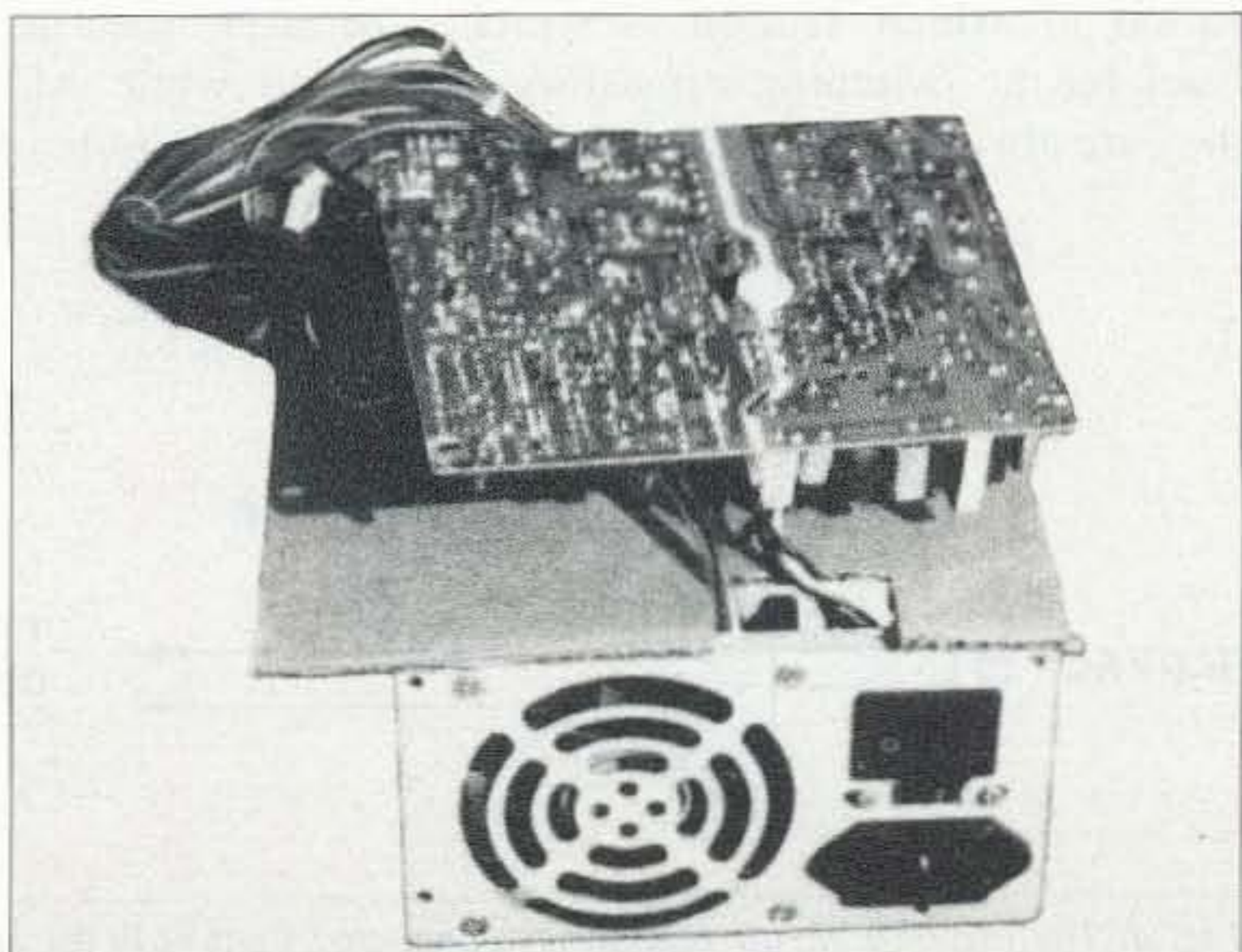

*Photo A. Heavy cardboard used as a support during troubleshooting.*

the board and the case to provide a fairly stable mount for the inverted board. **Photo A** shows a heavy cardboard sheet that I use as a support and insulator. **Photo B** shows the power supply board inverted on its case, exposing the circuitry for diagnosis.

While inverted, short solid jumper wires may be tack soldered to stand up on various pads where measurements are to be made. Meter leads can be clipped to the jumper wires so that hands may be kept away from the circuit when power is applied. Power is removed after making a measurement and before the meter leads are touched.

For safety's sake, it is important to not touch any live circuit or the HV side of the circuit board. How do you tell the LV section from the HV section? It takes a little practice, but the bottom side of the circuit board is



*Photo B. Power supply board inverted on the cardboard and ready for diagnosis.*

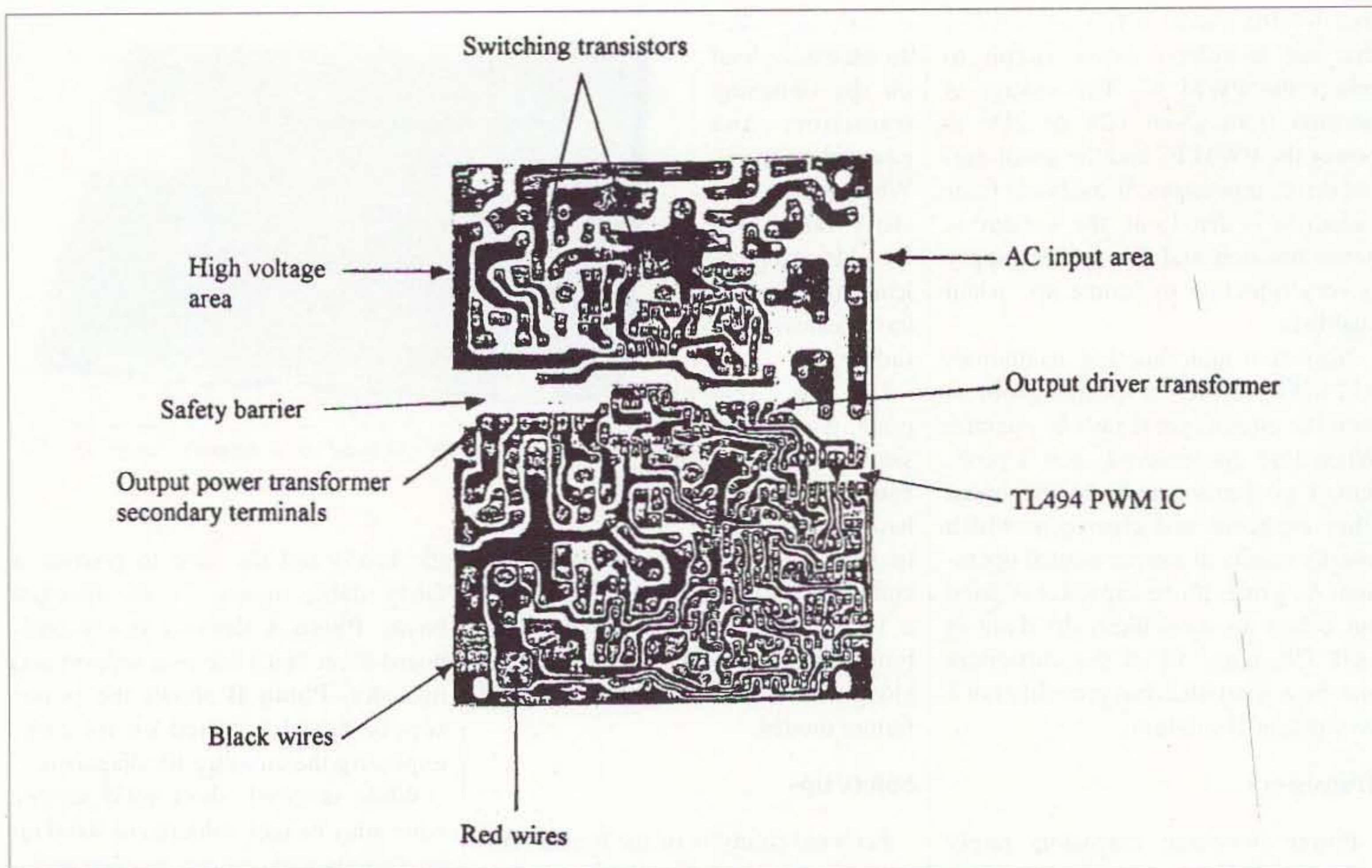

Fig. 3. Bottom side of a typical switching power supply board. Specific items are noted for identification.

divided to provide isolation between the HV and LV sections. It really pays to just study the bottom side of the board and identify as much as you can about it before ever applying power. Fig. 3 shows the bottom side of a typical switching power supply. Specific identification points are shown that will both support safety as well as assist the troubleshooting process.

The first and most prominent indication of which section is which: Look for the switching transistors, as they are always on the HV side of the

supply. In addition, the HV filter capacitors are also on the HV side. Another indicator of the LV section is the location where the heavy black, red, yellow, etc., wires are connected.

Remember, it is for your safety that you become as familiar as possible with the board layout and circuit voltages before beginning a troubleshooting process. Dangerous voltages are present on the power supply board, and care must be taken when the board is openly exposed while AC power is applied. Caution must be exercised at all times.

### Troubleshooting

Troubleshooting the circuit board starts by an attempt to identify and classify the problem symptoms that exist. In most cases, when a computer power supply fails, it is "dead" and fails to operate. That particular clue is generally not sufficient to lead you to a defective component. Because a switching power supply operates pretty much as a closed loop system, all pieces of the system must be operational before the power supply will come up and operate. Therefore, it's sometimes very frustrating to sort out what is really causing the failure. The most logical troubleshooting process is to check as much of the various parts of the circuit as possible and "clear" them of any fault. By a process of elimination, the fault will eventually surface.

Before applying power to the supply, gather all of the test gear and resistive loads that are desired. I've found the following items to be needed:

- One or two voltmeters (analog or battery-powered instruments only)

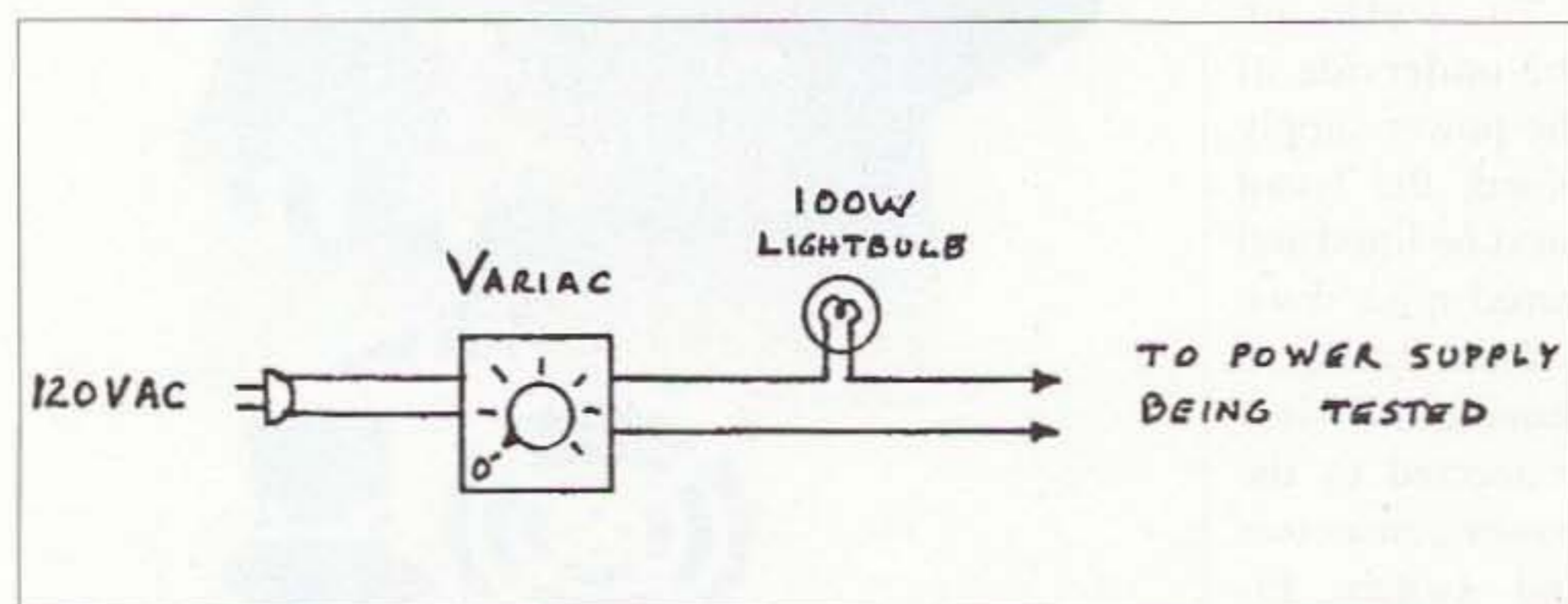

Fig. 4. The use of a Variac and series-connected light bulb for controlling line voltage and current while a power supply is undergoing diagnosis. The light bulb provides a visual indication of the amount of current being drawn.

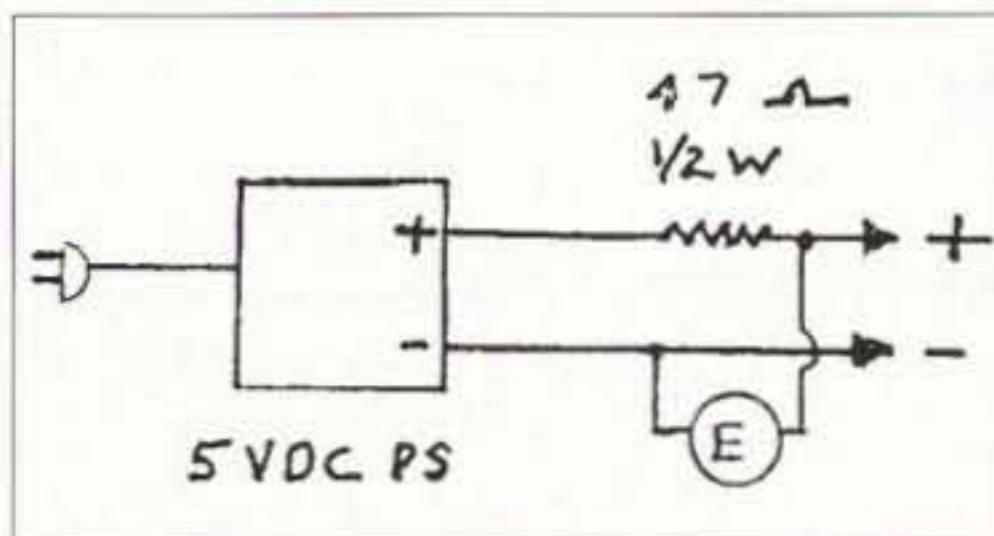

Fig. 5. A 5 VDC power supply, or a 3-6V battery, used for testing shorted components in the output circuits of a computer power supply.

- An oscilloscope
- 5 VDC power supply (or a 3-6V battery)
- 5 ohm 10 W resistor
- 10 ohm 20 W resistor
- 47 ohm 1/2 W resistor
- Selection of clip leads
- Variac
- 120V/100W light bulb in a socket with a line cord attached

#### Notes

1. As a caution, oscilloscope use

must be restricted to only the LV side of the supply.

2. The 100 W light bulb is placed in series between the Variac and the computer power supply (see Fig. 4).

3. The 5V power supply is used to test all of the low voltage output circuits for shorts. A 47 ohm resistor is connected in series with the output of the 5V supply and acts as a current limiter (see Fig. 4).

4. In the case of an ATX-type supply, the enable line must be switched to ground for the supply to be "turned on."

5. Remember that if the board fault is found and fixed while the board is inverted, there will be no heat sink cooling from the fan. Excessive testing must be avoided to prevent overheating of the switching transistors and rectifiers.

#### Test steps

CAUTION: Be sure to observe voltage polarity for all components and measurements.

DO NOT RELY ONLY ON THE POWER SWITCH TO REMOVE AC POWER; PULL THE PLUG BEFORE ATTEMPTING TO TOUCH OR WORK ON THE CIRCUIT. ALLOW A FEW MINUTES FOR THE HV FILTER CAPACITORS TO DISCHARGE — CHECK THEM WITH A VOLT-METER.

A. Clear all DC output circuits of any shorts. This process involves connecting an external 5 VDC power source through a 47 ohm resistor to each of the 5V

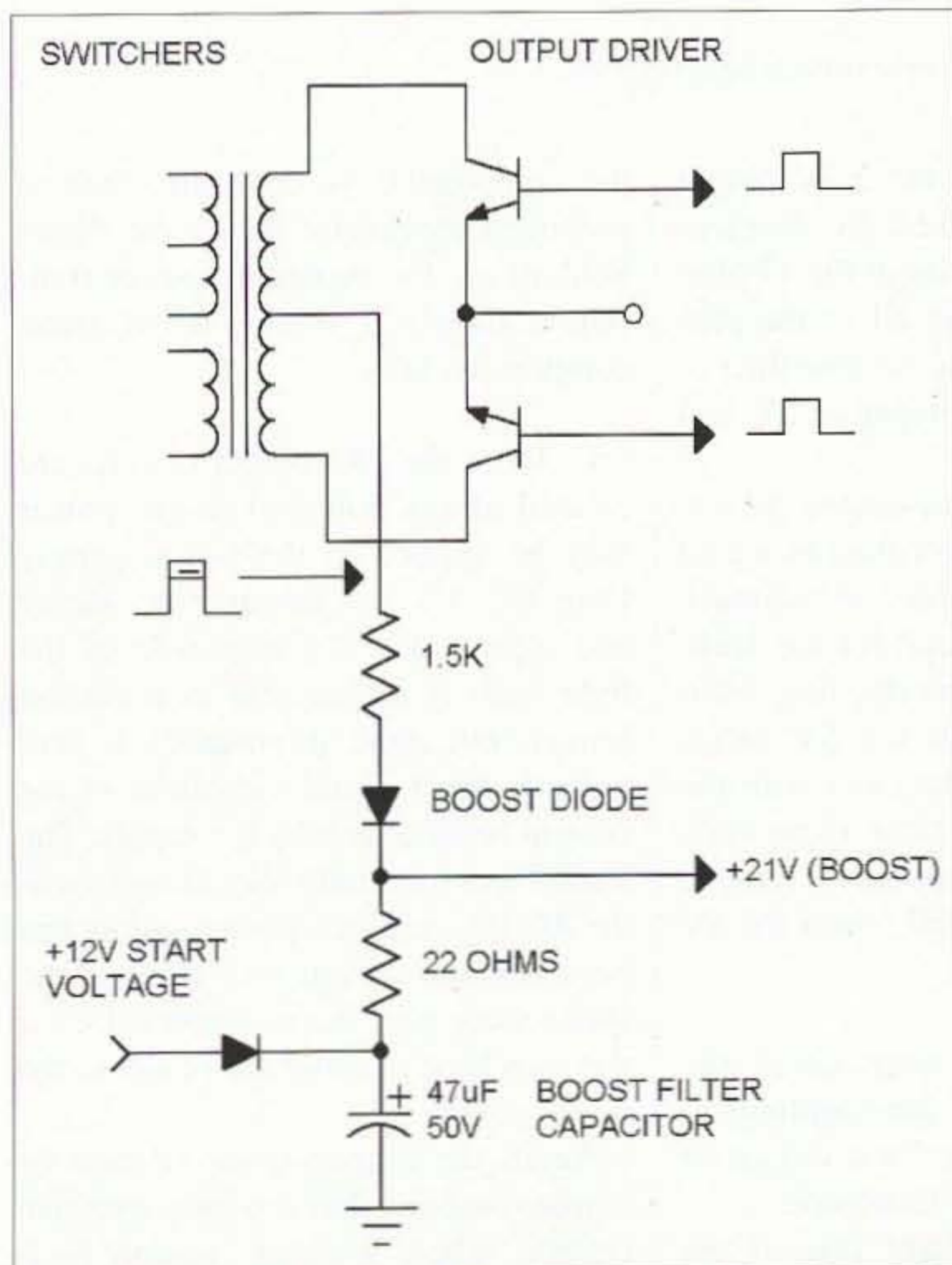

Fig. 6. Typical voltage boost circuit used in some computer power supplies. The transformer flyback pulse is rectified and filtered to create a voltage output higher than the 12V source (boost voltage).

# ALL ELECTRONICS

C O R P O R A T I O N

**Incredible Price! 12 Vdc  
120mm Cooling Fan w/ Screen**

JMC# 1225-12HBA  
120 mm (4.72")  
square x 25 mm  
(1") wide cooling fan.  
Dual ball bearing fan  
provides reliable  
output of 88 CFM @  
2600 RPM. 12 Vdc @  
0.6 Amps. 45 Dba max @ 1M. Designed for  
50,000 hours @ 25 deg. C. Thermoplastic  
housing and 7 blade impeller. Three 7" pigtail  
leads with 3-pin connector (0.1" cntrs). Third  
lead is for sensing rotation. Prepped with  
metal finger guard. UL, CSA, CUL, CE. Large  
quantity available.



CAT# CF-153  
**\$4.00**  
each

90 for \$3.00 each  
450 for \$2.25 each  
990 for \$1.50 each  
1980 for \$1.00 each

SHOP OUR ONLINE STORE  
[www.allelectronics.com](http://www.allelectronics.com)

#### 5mm Ultra-Violet LED

Emits blue 395nm UV light.  
Water-clear lens. 3.7 Vdc, 20 mA.

15 degree beam pattern. CAT# ULED-1

**\$1.75**  
each

100 for \$1.15 each  
1000 for 95¢ each

#### Tiny Vibrating Motor

Low voltage, low current miniature  
vibrating motor. Operates on 1.5 - 3 Vdc  
@ 62 mA. Tiny motor with offset  
weighted shaft is used in cell phones  
and pagers for vibrating alert signal.  
A removable black rubber boot surrounds  
the motor and provides a flat mounting sur-  
face. Without the rubber boot the motor mea-  
sures 0.24" dia. x 0.5" long. The shaft and  
weight add an extra 0.21" to the overall  
length. Prepped with 0.42" long metal tabs.

CAT # DCM-204

**\$1.75**  
each

10 for \$15.00  
100 for \$100.00

ORDER TOLL FREE  
**1-800-826-5432**  
CHARGE ORDERS to Visa, Mastercard,  
American Express or Discover

TERMS: NO MINIMUM ORDER. Shipping and handling for the  
48 continental U.S.A. \$6.00 per order. All others including AK,  
HI, PR or Canada must pay full shipping. All orders delivered  
in CALIFORNIA must include local state sales tax. Quantities  
Limited. NO COD. Prices subject  
to change without notice.

CALL, WRITE  
FAX or E-MAIL  
for our **FREE**  
**96 Page**  
**CATALOG**  
Outside the U.S.A.  
send \$3.00 postage.

MAIL ORDERS TO:  
**ALL ELECTRONICS**  
**CORPORATION**  
P.O. Box 567  
Van Nuys, CA 91408  
FAX (818)781-2653

e-mail [allcorp@allcorp.com](mailto:allcorp@allcorp.com)



applied, and then removed after the AC power has been turned off. Any AC-powered test equipment such as an oscilloscope must not be connected to the HV circuit at any time, as there is insufficient voltage isolation to protect either the operator or the equipment. Use of the oscilloscope must be restricted to only the low-voltage side of the circuit.

As a reminder, should the switching transistors be made operational during the power test phase, insufficient cooling air will be present to protect the transistors. Power-on test periods must be kept short.

Now, continuing with the test steps:

D. Setup steps in preparation for applying AC power.

Assuming that the fuse checks "good," then steps may be taken to apply AC power following these suggested steps:

1. Connect the 5 ohm resistor to the main 5V output (red) and ground.

2. Connect the 10 ohm resistor to the main 12V output (yellow) and ground.

3. Connect a voltmeter (set on the 500-600V range) to the 320V rails.

4. Using the Variac, raise the AC line voltage and observe the voltage developed across the rails. The value measured, with the switch set for 120V, should be approximately 2.8 times the AC RMS applied voltage.

5. If the light bulb glows dimly as the Variac supplied voltage is raised, then slowly increase the line voltage to 120V. Take note of the "320V" reading.

**Problem:** If the voltage fails to track at approximately 2.8 times the RMS source voltage, then remove power and troubleshoot the HV rectifiers and filter capacitors. It may be necessary to temporarily remove the switching transistors should they be suspected of being shorted.

**Note:** To remove the switching transistors, remove the whole assembly by unsoldering the transistor leads, and then remove the heatsink retainer screws. Carefully lift the assembly, making sure that the transistor leads lift out of the board.

6. If the 320 volts fails to measure

reasonably close to the 320V, then connect the voltmeter across each of the HV filter capacitors as the AC input voltage is raised.

**Problem:** If the two measured capacitor voltages are drastically different, consider that one of the power transistors or one of the capacitors may be shorted. Temporarily remove the power transistors and repeat step 6 to verify an equal voltage across each capacitor. If the voltages still fail to be close (equal) in value, check the capacitors with an ohmmeter. If the capacitors are OK, then consider the HV rectifier or the 120/230V switch as a possible problem.

E. The voltage boost circuit is always a potential problem when it is used in the power supply. Refer to the partial schematic of the boost circuit as shown in **Fig. 6**.

**Note:** Not all switching power supplies use a boost circuit.

One technique that has worked for me is to tack solder a 47  $\mu$ F/50V capacitor between pin 12 and ground of the TL494 PWM IC.

**Problem:** If the power supply comes up into operation reliably with an external capacitor in place, trace the TL494 pin 12 circuit back to a filter capacitor. The boost filter capacitor should be of a value similar to 47  $\mu$ F. After changing the boost filter capacitor, be sure to remove the tacked-in 47  $\mu$ F test capacitor.

F. Output filter capacitors do fail by drying out over time. The failure mode is typically a loss of capacitance, causing the output ripple to increase.

**Test method:** A capacitor of 100  $\mu$ F or greater having a voltage in excess of the circuit being tested may be tacked-soldered across the suspected capacitor. If the power supply operates, then replace the suspected capacitor.

Another test method is to connect the scope across the circuit in question and observe the ripple value. **Note:** There must be a resistive load on the output of the circuit being tested.

Observe any significant change in the ripple when a like capacitance value is added to the circuit. **Note:** Be

Continued on page 22

**FAIR RADIO SALES**  
ELECTRONIC MILITARY SURPLUS

**12 FOOT MAST KIT**  
12 foot Fiberglass Mast Kit 3/4"x1 3/8" Dia fiberglass mast sections, 8" top mast section for two 28 inch dipole elements and 16 feet of RG-58 coax with BNC connectors, one guy ring with ropes, three 9" stainless steel stakes, one 27" long mast base which is pushed into the ground, and O.D. green carrying bag with handle. Excellent for field day or other portable antenna use. 12 lbs sh. #MK-12, \$59.50 each; 2 for \$99.50 plus shpg.

**30 Foot Mast Kit**  
30 Foot Mast Kit. Twelve AB-35 33" aluminum mast sections, AB-154 mast base, 6/ guy ropes, 2/ guy rings, 3/ guy stakes, and a heavy duty nylon carrying bag various colors - sorry no choice. 32 lbs sh. All items listed above are in used condition except the mast sections and the bag which are unused. #ANT-KIT-30, \$145.00 plus shpg.

**WEBSITE:** fairradio.com  
E-MAIL: fairradio@fairradio.com  
PHONE: 419-227-6573 - FAX: 419-227-1313  
2395 St Johns RD - Box 1105 Lima, OH 45802  
VISA, MASTERCARD, DISCOVER accepted  
Write for latest Catalog - Address Dept. 73

Capacitors - Motors - Relays - Power Supplies - Test Equipment  
Radios - Antennas - Roller Inductors - Transformers - Wire - Tubes

**208-852-0830 • Fax: 208-852-0833**  
<http://rossdist.com>

**Over 9060 HAM Items in Stock!**

**ICOM** Under \$439.00  
**IC-2800H**

**RDC** Visit Our Site Often for Specials!  
ROSS DISTRIBUTING COMPANY All Prices Cash  
78 S. State Street, Preston, ID 83263 FOB Preston  
Hours Tue.-Fri. 9:30-12:30-5 • Mon. 9:30-12:30-3:30 Closed Sat & Sun



The impressive **IC-756 Pro II** covers HF plus 6 meters. The high resolution 5 inch TFT color display provides more operating information than ever, including a spectrum scope. The 32 bit floating point DSP provides crisp, clear reception with 41 built-in filters. The "Pro II" is the choice for serious DXers and contesters.

**IC-746 Pro** ✓ 160 to 2 Meters!



The **IC-746 Pro** covers 160-10 meters plus 6 and 2 meters with 100 watts on all bands. Call or visit our website for further details and pricing on this and other ICOM radios.

**universal radio inc.**  
6830 Americana Pkwy.  
Reynoldsburg, OH 43068  
♦ Orders: 800 431-3939  
♦ Info: 614 866-4267  
[www.universal-radio.com](http://www.universal-radio.com)

## Troubleshooting Computer Power Supplies

continued from page 21

sure to remove power before adding or removing a filter capacitor.

G. Having cleared all output circuits, the voltage boost circuit, and the power supply still fails to operate; it may be time to use an oscilloscope to check the PWM waveforms. A complete schematic of a voltage boosted power supply circuit is shown in **Fig. 7**.

Attach the oscilloscope probes only to the low-voltage side of the supply. The scope is sometimes useful for looking at the signal output from the TL494 IC. Pins 8 and 11 are the oscillator output pins and they provide a pulsed waveform that is used to drive the bases of the output driver transistors. The scope ground is attached to the black DC (ground) output lead and the probe tip is connected first to pin 8 and then to pin 11 of the TL494.

Problem: The waveform obtained from both pins 8 and 11 should be very similar in shape and amplitude. The peak amplitude of the pulse will be limited to a value approaching 2.1V. If

the waveform is missing, verify that DC voltage is applied to the PWM IC. If the DC voltage is there, consider substituting another TL494 before repeating the tests. It's also possible that the RC timing circuit connected to pins 5 and 6 of the TL494 is defective.

H. Measure the DC voltage from the driver transistor emitters to ground. Typically, two diodes are connected in series conducting from the transistor emitters to ground. The DC voltage drop across those two diodes must be in the range 1.2–1.8V when the transistors are being properly driven by the PWM.

Problem: If the voltage across the diodes is low, the driver transistors are not being turned on. Use the scope to observe the driving pulse found on the base of the driver transistors. Check twice before connecting the scope probe.

I. Assuming that TL494 pins 8 and 11 are exhibiting equal pulses, then place the scope probe onto the center tap at the driver transformer (collector/primary side). If the power supply utilizes a DC boost voltage, a series of vertical rising pulses should be observed at the center tap with an amplitude approaching 15–20V.

Problem: If the center tap voltage pulse is present, then the boost voltage should be available at approximately 20V. When the boost voltage fails to rise from 12V to 20V at startup, check the following components: boost diode, boost filter capacitor, and resistors.

Another place to check is the input to one PWM voltage comparator. One voltage comparator is used to monitor the boost voltage. Check all of the components associated with the boost sensor circuit.

### Replacement parts

At this point almost all of the obvious failure mechanisms have been checked within the power supply and hopefully the problem has been detected and perhaps corrected. Repairing a power supply requires, in most cases, a part to replace the bad one,

and there is always a quandary as to where replacement parts can be located.

One of the biggest dilemmas facing a ham these days is in locating suitable parts for projects. Because much of our electronic equipment is now built offshore, replacement parts are not readily available. One of the techniques that I use to get around the shortage is to salvage TV and VCR boards as they are scrapped.

Parts such as capacitors and resistors can always be used in ham projects so they are of great importance to me. Semiconductors from TV and VCR boards are of a lower priority unless I know the part and have a place to store it.

When it comes to parts for computer power supplies, a source for available parts is certainly lacking. NTE replacement semiconductors are perhaps the most readily available, but many types are not covered by the service. To counter the problem, I've started collecting used computer power supplies and "rob" parts from one or two as the need arises in order to repair another.

Occasionally power supply HV filter capacitors appear in the new and surplus parts catalogs so you need to keep a sharp eye peeled for the items needed.

### Conclusion

Repairing a computer power supply is quite a satisfying experience for a ham. It's also a new exposure to HV techniques and safety practices beyond what you might experience in typical solid-state circuits. Personal safety is an important issue when working with computer power supplies and caution is not to be avoided for expediency.

Hams get involved in a lot of electronic projects, and it is expected that an attempt at repairing a computer power supply will occur. The suggestions provided here on troubleshooting computer power supplies should allow a ham to be successful in the process.

Although the troubleshooting process and finding a "bad" part is fairly easy, safety is the word. Please be careful!

Ad Sales Call 800-677-8838

**HamCall™ CD-ROM**  
U.S. & International - Over 1.63 million listings



*We make a new HamCall every month! Clearly, the most current and complete CD-ROM available.*

**Latest Features**

- Choose font and color of data display.
- Displays flag and map for each country.
- Shows CQ, ITU zone, and continent.
- History list shows each callsign entered.
- Print labels in a variety of formats.
- View & search interests of 39,000 hams.
- Search for club, military, vanity, silent keys, name, address, and more.

Over 1,631,000 U.S. and International listings, 128,000 e-mail addresses, 4,000 photos and QSL cards, 37,000 vanity calls, and 20,000 references to QSL managers.

Shows path distance & bearing.  
Precise latitude/longitude for over 90% of addresses.  
HamCall is \$50.00, included is 6 months free access to our HamCall Internet Service - request when ordering.

*HamCall Mousepad, with morse code reference, 7.5" x 8", blue with yellow letters. \$5.00+\$3 shipping. \$5.00 shipping (\$8 intl) per order. Your satisfaction guaranteed!*

**BUCKMASTER**  
6196 Jefferson Highway • Mineral, VA 23117 USA  
e-mail: info@buck.com  
540-894-5777 • 800-282-5628 • 540-894-9141 (fax)





# Build This Simple SMT Station

*Dinner and a movie? How about pizza and a project?*

*SMT parts are rapidly becoming the "norm" in consumer electronics manufacturing. This "home-brew" device can make the learning and building process with SMT devices a more pleasurable event.*

**M**y initial entry into the hobby was during the generation of tube-type gear (and yes, I'm older than many and younger than a few). I then went to solid state and now have progressed to SMT (surface mount technology) devices. Not wanting to be "left behind," I've been thinking of trying a project using SMT.

SMT, as it's called, is becoming more and more the standard of the industry. That's not to say that all parts are being replaced by these miniature devices, but it sure seems to me that there are many more projects designed around them now than in the past. The manufacturers of consumer electronics can produce these parts more economically than "through-hole" items. Then there's the placement of parts on an assembly line, where robotics can handle the task effectively using the newer devices. Lately, most of the consumer products I've obtained were constructed using this technology. The "writing is on the wall," or should I say, the "chips are on the board."

That's what progress is, I suppose: adjusting your skills to coincide with technology. In April, at *Atlanticon 2002*, W2GUM sported an impressive SMT work station as an entry in the

home-brew event. His design is a square, padded work surface, with a machined-brass weighted and adjustable arm, and a padded "turntable" at the business end where construction could take place. Very neatly done and a testament to his skill as a machinist.

I was very impressed by the design and construction of his work station, but keenly aware that not all of us are machinists, capable of duplicating that device — least of all, me! I am fairly

comfortable working with common hand tools and a few "home owner" power tools, and I suspect that many of you are also. So why not make your own station, using easier to obtain materials, while using the tools that most of us either have or can borrow?!

The initial thoughts for design were centered on using a "pizza pan" as the base for the project. This proved to be a poor choice, because the structure of the pan was of such thin sheet metal

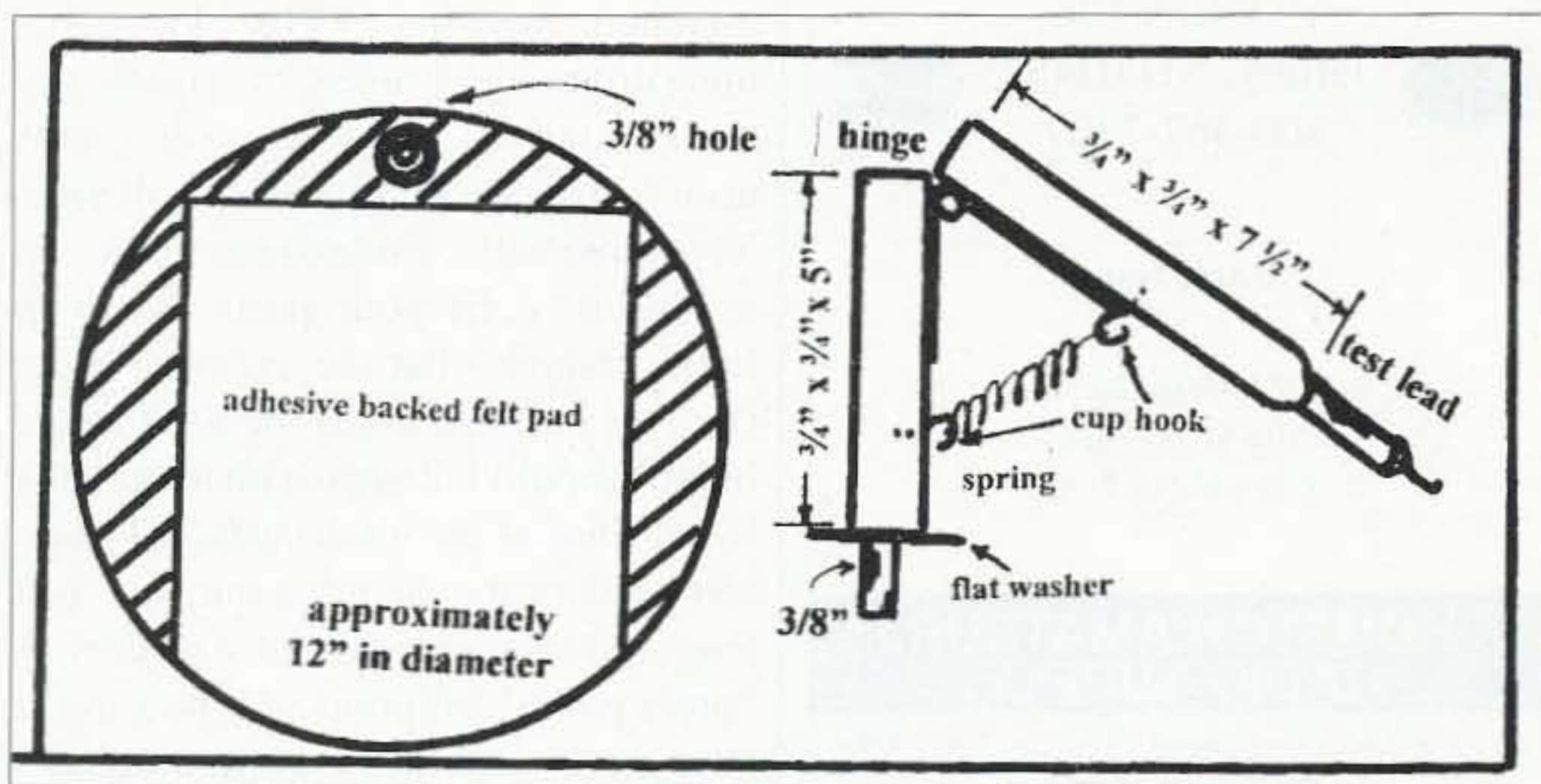

**Fig. 1.** Dimensions of the base and hold-down device are approximate. They were selected to use the wood "stock" I had on hand to match the "hobby hinge," and the base size is the remaining "stiffener" for the pizza pan. The primary requirement is, however, to have the test lead point become usable in the lower half of the working surface.



**Photo A.** The completed SMT work station, ready for operation. Not high-tech or difficult to build, it does make assembling a surface mount project much easier to do.

## The Gordon West Study Guides

Examination Test Questions & Answers for General Class and Extra Class with explanations of the answers



General Class  
\$12.95  
Plus \$3.50 S&H



Extra Class  
\$14.95  
Plus \$3.50 S&H

### Omega Sales

P.O. Box 376  
Jaffrey, NH 03452  
800-467-7237



### Back Issues

of  
73 Magazine  
Only \$5.00 Each!  
Call 800-274-7373

## HOUSTON AMATEUR RADIO SUPPLY

267 Cypresswood Drive • Spring, TX 77388  
**800-471-7373**  
Local: 281-355-7373  
email: [houstonamateurradio@prodigy.net](mailto:houstonamateurradio@prodigy.net)  
COMPLETE SALES & SERVICE  
Yaesu, Icom, ALinco, ADI, Hustler, Cushcraft

that flexing of the pan caused by the tension-producing arm would pose a problem.

Using the pan as a template, I cut the same-size disc from a composite wood material, expecting to use it as a "stiffener" under the pan. I then realized that the surface treatment on the pan was a "no-stick" material, and had the work station been completed, the circuit board would likely be sliding around uncontrollably! I wish I had realized that *before* I bought the pan! So the pan joins the pile of "good thought, bad idea" stuff.

The wooden stiffener, as a base, has proven to be the best answer. The attached drawing, (Fig. 1), gives measurements I used to create my work station. The measurements aren't critical; they "fit" my device. Your overall dimensions can be modified to fit your parts. Keep in mind, though, that the pressure point (i.e., the part that holds the SMT to the board) should fall approximately in the lower third of the work surface. I had a test lead probe in my junk box just longing to become part of a project. A "push point" ballpoint pen housing, I suppose, would have worked equally well, provided of course that the pen part was eliminated and a finishing nail of suitable size was epoxied into the housing in its place.

I filed the end of the nail to rest flat on the part being placed, having found that the point originally there marred the surface of the part. Spring tension is a matter of "guess and stretch." Don't make it so tight that the part either breaks or can't be moved. Just enough tension to hold it down firmly but allow it to still be movable. The arm assembly sizes were chosen to fit the hobby hinge (3/4" wide) and the 3/8" test point I had. You might have to adjust dimensions to fit your materials. The flat washer epoxied to the base of the shortest "arm" aids in stability by providing a larger flat surface for the arm to move on.

The felt surface applied to the wooden base serves two functions. First, it holds the project circuit board to protect it and stops it from sliding, and secondly it provides a convenient contrasting color apart from the parts being installed. Black or white parts are more visible on the green surface and therefore easier to keep track of. (See **Photo A.**)

And there you have it! An SMT work station that cost almost nothing to assemble. Construction time varies with the user's abilities and can be modified to fit your needs or available parts. It's small enough to be stored in a desk drawer when not being used, but somehow I suspect that it won't see the insides of the drawer for some time to come.

Now, when the gang shows up, I can offer them pizza. After all, I do have one very new, very unused pizza pan from the beginning of this project. **73**

12-inch diam. wooden base
8-1/2-in. by 11-in. self-adhesive felt pad
Feet, 4 each
Cup hooks
Hobby hinge (hasp and staple assembly available at Home Depot)
Test point or ballpoint pen casing
Finishing nail
Epoxy or glue
Spring
Flat washer

**Table 1.** Parts list.

# How's That Thing Really Work, Anyway?

## *Part 1: Receivers.*

*At a recently attended club meeting, a newly licensed operator confided in me; "Yes, I passed the test, but I haven't any idea how any of this stuff works! I just memorized enough to get through the test and get my license." Sound familiar to any of you out there?*

**T**he neophyte radio amateur has spent hours studying the license manual, practicing the exams, to finally complete the process and gain his or her "ticket" to proudly display on the wall. This is great! One more member enters the hobby.

But there's a problem here! Many (and some longer-licensed hams) haven't a clue as to how their gear performs the functions that it does. This article isn't intended to replace the countless tomes available that teach the engineering functions from the "ground up." It's merely an overview of the basic sections of a piece of equipment, how they interact with each other to produce the desired result after turning on the switch. Knowledge is gained one segment at a time. I hope this segment encourages you to further your knowledge in electronics. If not, you should at least have a basic understanding of how a receiver "works."

I chose to begin with receivers. No particular reason, it was the first piece of gear that came to mind. When telling you about a circuit or function, I will try to stay away from the engineering facts that all equipment are built from, and attempt to explain the

subject without a lot of technical jargon. My goal is to have you be able to *visualize* the happenings within your equipment sections, not to design the circuits. You can add all this knowledge to your "storage bank" later as you gain experience in the hobby. For now, just understanding the basic ideas of how a system works is OK.

Let's begin with a very basic **BLOCK DIAGRAM** of a receiver. Block diagrams are great because they represent circuits and paths for signal flow. The actual circuit components, their values and how they are connected are described in a **SCHEMATIC**. We won't deal with schematics here. Block diagrams show direction or the logical path we must follow to achieve results and present an "easy to understand" overview of the device being described. This process will become clear to you as we progress.

An example will help you understand how the receiver works. Let's suppose that we would like to listen to the 80-meter band, say from 3.500 MHz to 4.00 MHz. While exploring the lower end of the band, we hear AB2AF, Arthur, sending CW on 3550 MHz. We know what frequency his

transmitter is on because the frequency is marked on the front panel of our receiver or the digital readout indicates that frequency. But how does a signal being generated far above the audio spectrum become transformed to the range usable by our human hearing?

The starting point of a receiver is the **RF INPUT** circuit that is connected to the antenna. It is composed of circuits "tuned" to the desired frequency we wish to receive. By "tuned" we mean that the signals passing through a coil and capacitor network are only those between 3.5 and 4.0 MHz. There are often two or three sets of coils and capacitors "ganged" or joined together to provide the "bandpass" desired. This is accomplished by having the values of each coil/capacitor pair slightly different from each other. Other frequencies are blocked or "tuned out," and aren't allowed to pass through the network. The receive antenna is connected to the input side; the away side is attached to the **MIXER** stage.

Having a tuned input is a good thing. While antennas are designed to receive selected frequencies, they also receive a wide range of other frequencies. These additional frequencies if allowed to pass would have a negative effect on

the operation of the receiver. Thus far, the signal we desire to hear has been intercepted by the antenna and passed through a tuned circuit called the RF INPUT circuit which has been designed to pass only those frequencies between 3.5 MHz and 4.0 MHz, and is shown in Block A of Fig. 1.

The output of the RF INPUT circuit is attached to a MIXER stage, labeled Block B. Mixers are commonly identified on a block diagram by the circle with an "X" through it. The MIXER has two signals feeding it, the frequency we desire to listen to with its variations in frequency from being keyed at the transmitter, and the output from a VARIABLE FREQUENCY OSCILLATOR (Block C). The variations of the transmitted signal mathematically combine with the VFO signal. It is the mixer's function to combine these two frequencies and provide a single usable frequency as an output.

Mixers are just what the name implies. They combine frequencies to provide an output. There are four desired output possibilities from a mixer, either of the two originals, or the sum or difference of the two. For our receiver, we will use an INTERMEDIATE FREQUENCY (IF) of 10 MHz. This frequency is commonly used in QRP gear, and will be explained as we progress through the receiver's circuits.

So our signal is being received on 3.550 MHz through the RF FILTER and has arrived at the MIXER input. The MIXER must provide a 10 MHz

output to be compatible with the remainder of the receiver. Because the mixer has two input frequencies and one of them is 3.550 MHz, the second frequency to be supplied by the VFO in our example will be 6.450 MHz. This will enable the mixer to provide a 10 MHz output.

The VFO or VARIABLE FREQUENCY OSCILLATOR is a circuit designed to provide a signal to the mixer that is stable, accurate, yet variable in frequency. The range of the VFO is carefully selected to enable the mixer to use the frequency to provide an output that will be compatible with the remainder of the receiver's circuits. For this example, the range of this VFO, to be compatible with this circuit, will be from 6.000 MHz to 6.500 MHz. Using this range of frequencies from the VFO uses the "summing" principle to achieve the required 10 MHz output. By "adding" the incoming signal frequency to that of the VFO, the 10 MHz output frequency is realized. You could also use the "difference" principle, where the VFO would be designed to operate from 13.500 to 14.000 MHz. This would also result in the 10 MHz output needed. Lower-frequency VFOs are generally easier to design and operate and are therefore more commonly used.

Suppose another signal is present on 3.510 MHz, 10 MHz from the low end of the band. You would "tune" the VFO "down" 10 MHz to 6.490 MHz. The mixer circuit would combine the

incoming signal on 3.510 MHz with the VFO signal on 6.490 MHz and provide an output on 10.0 MHz. The output of this receiver's mixer will always be 10 MHz and have a bandwidth of a few kilohertz above and below the 10 MHz frequency.

The next blocks are the IF FILTER and AMPLIFIER, labeled D and E. D contains a bandpass filter designed to allow only the 10 MHz signal provided from the mixer to pass and E is an amplifier to "boost" the signal strength. Often the IF FILTER is composed of a *crystal lattice network*. This is a series of crystals (in our case 10 MHz) and capacitors designed to allow only the 10 MHz signal to pass. The crystal frequency identifies the "center frequency" of the filter, while the capacitors are selected to provide adequate bandwidth of the filter. CW filters are designed to be narrow, in the range of 750 Hz to 1,000 Hz, and SSB filters are in the 2 to 3 kHz range. While the crystals "set" the frequency allowed to pass, the filter will allow frequency slightly above and below the 10 MHz crystal frequency to pass also. These variations are Art's CW signal being passed along through the circuits.

Our signal has now passed through the IF FILTER and AMPLIFIER and is present at the input of the PRODUCT DETECTOR circuit (F). It has a different name, but it functions just like the MIXER described earlier. It has two inputs and can provide one of four outputs just like the mixer circuit. The big difference here is that the PRODUCT DETECTOR is used to mix frequency from the BEAT FREQUENCY OSCILLATOR (G) or BFO to provide a low-level audio output. The beat frequency oscillator works just like the VFO, but provides an output on only one frequency.

**Now how does that happen, do you suppose?**

The BFO circuit in our example contains an oscillator circuit using a crystal identical to those in the crystal lattice filter (10 MHz). This oscillator

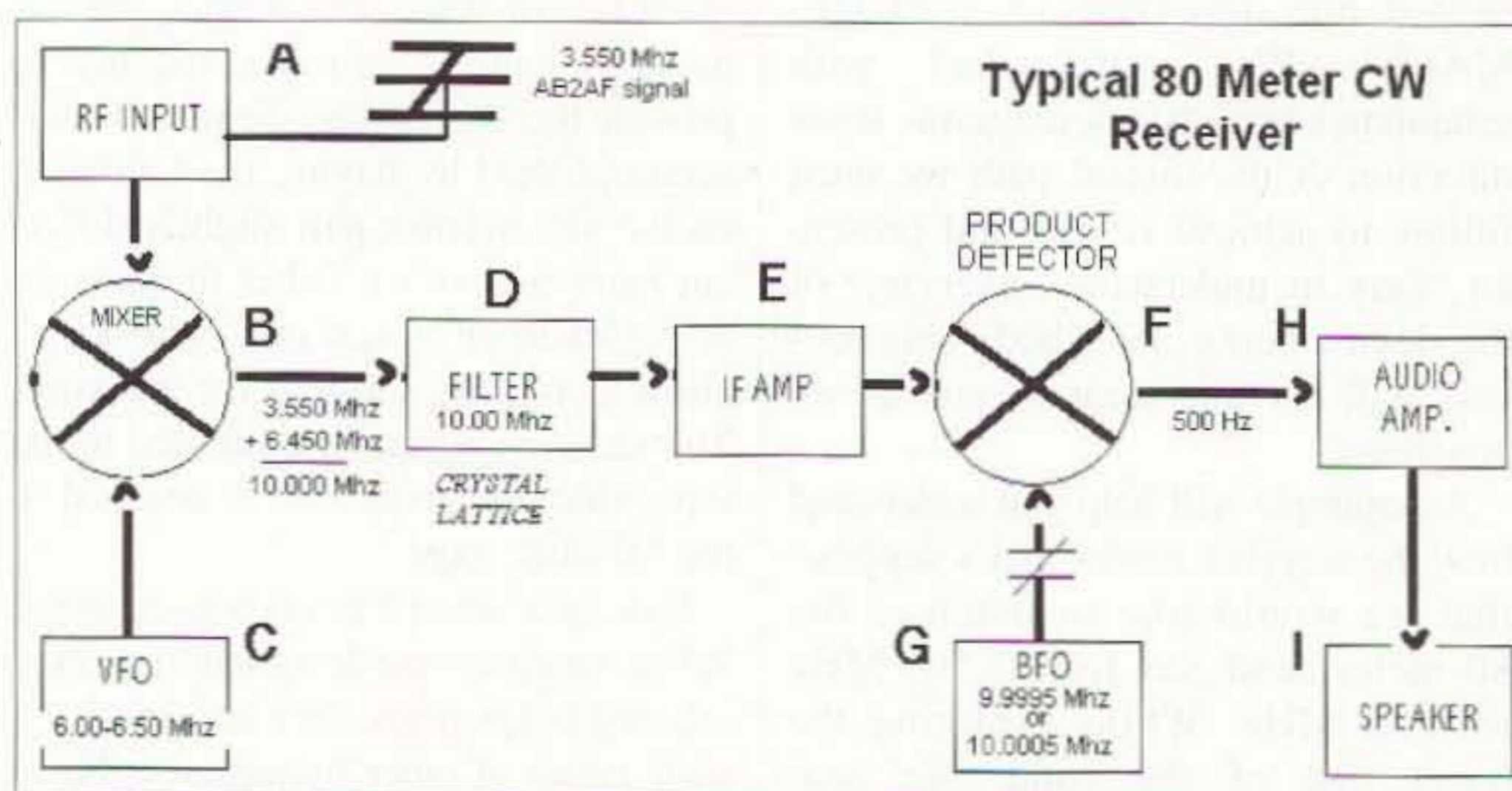

Fig. 1. Typical receiver block diagram, showing input bandwidth and signal, VFO and BFO frequencies, and audio output.

Erik Westgard NY9D  
3990 Virginia Ave.  
Shoreview MN 55126  
[ewestgard@worldnet.att.net]

# Warblemania

*... and other QRP afflictions.*

*You can't follow the work of the New Jersey QRP Club or Dave Benson K1SWL of Small Wonder Labs without seeing references to our leading edge digital mode, PSK-31, and a kit called the "PSK-80 Warbler."*

**T**he Warbler QRP transceiver is priced right (\$45) and seemed like a nice change of pace from CW kits. When mine arrived I put on some music, warmed up the soldering iron, and started jamming in parts. The transformers slowed me down a bit. These are multifilar (have more than one winding) and have to be wound exactly according to the plans.

In some of Dave's other kits he provides a nice magnet-wire ribbon cable that keeps the windings from getting fouled up. In this case you can wind one wire at a time. Each wire has to appear at the correct side of the core after each turn, and the wires should not cross inside the cores. It's hard on a black and white diagram sheet to keep track of three colors (my wife has this issue with quilt patterns) — I ended up deciding the "white" wire on the diagram was for the red wire. I just noticed there is a nice color picture of an assembled Warbler on Dave's Web site that would have been most helpful.

I breezed by the two surface mount SA612A ICs. To do these, pre-tin a pad at each corner of the mounting pad for the device. Then take a pointed tool, slide the part in place (watch the dot for pin one), and warm up the corner

pads one at a time to tack them down. If you have the part centered, you can then warm up the remaining pads and put a little solder on each. I ran into Dave Benson and asked him about this — he says he warms up an entire side of the IC pads, and blobs in solder. Then he uses desoldering braid to remove the excess. I shared with him my theory on the need to open a cold malted beverage to calm the nerves while working with surface mount parts. He said that this has some

scientific merit — it lowers the brain synapse-firing rate, so you would be less jittery while soldering.

Haste and overconfidence are not the friends of kit builders, as the little rig didn't work. I only caught myself making one assembly mistake on the 30-part board. I spent maybe an hour poking around and worrying whether I had done a good job on the transformers, or gotten a short someplace.

The cabling to the laptop was an absolute nightmare. Part of the problem

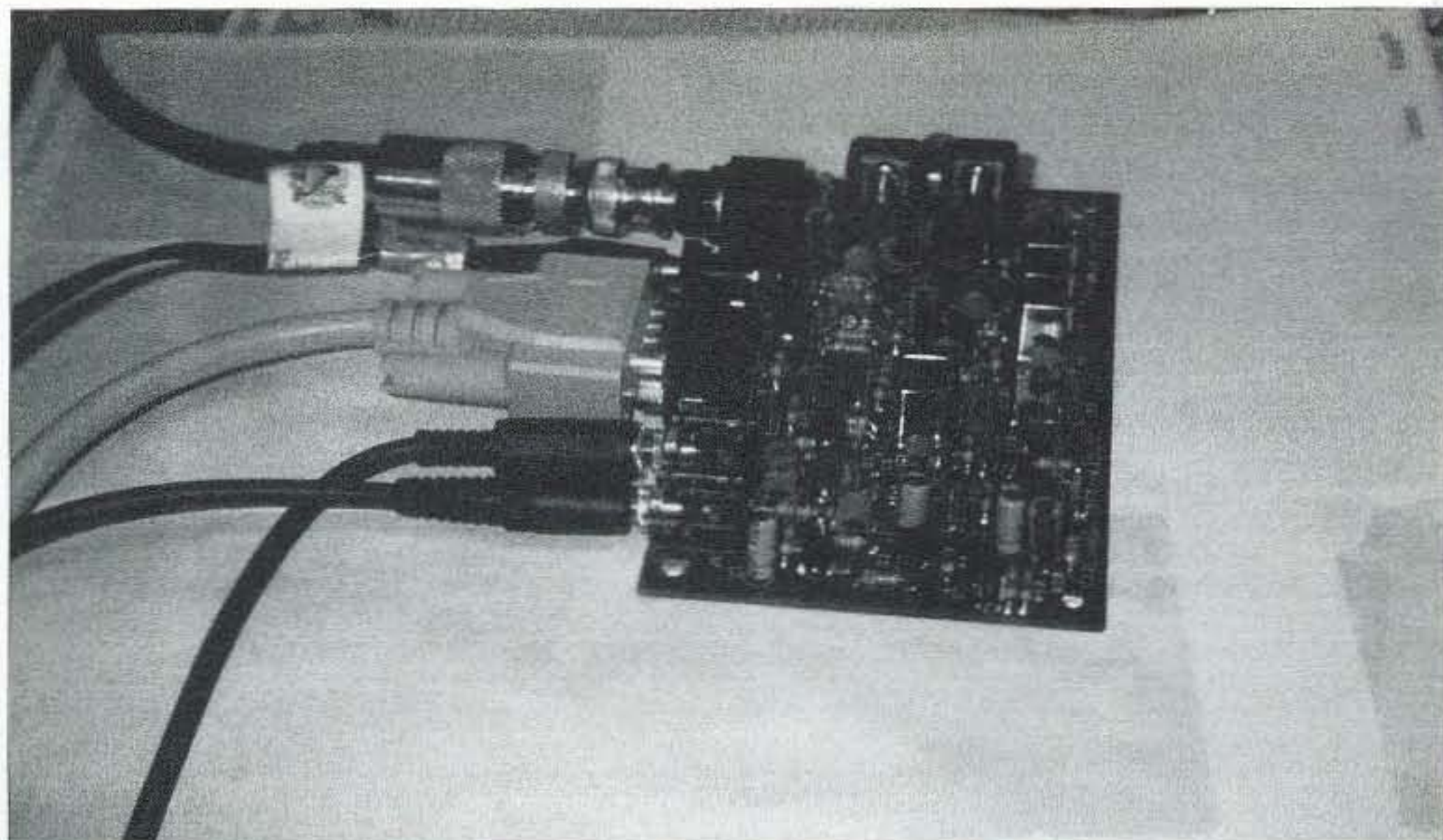

*Photo A. PSK-80 Warbler.*



Photo B. Ramsey QRP-20 Transmitter.

is left over from the audio equipment days — “output” is relative — one box’s input is another box’s output. If you decide on “line” vs. “microphone,” that is a start. There is also tendency for the audio from amateur rigs to be mono, and for the sound cards on laptops to be stereo. I ended up making two trips to Radio Shack for 1/8” jumper cables, and stereo-to-mono adapters. My final setup from the Warbler to my vintage TI laptop was as follows:

From J1 “AF Out” on the Warbler board — a mono 1/8” male-to-male jumper with a mono jack-to-stereo plug adapter on the laptop microphone end.

From J2 “AF In” — a stereo 1/8” male-to-male jumper to the laptop headphone jack.

After deciding I was getting too little AF input and too much RF output, I finally noticed that I had a pair of resistors reversed. This means I made three

wiring errors out of thirty parts — 10:1 — which is my usual ratio. There is a minor error on the 10/29/00 board layout diagram on my version of the kit. R4 (100 ohms) was not labeled. And L1 should say 68  $\mu$ H instead of 10  $\mu$ H. My wiring mistake was in swapping a 2200 ohm and a 22k resistor.

I tuned up my G5RV antenna in the tree outside and fired up the Digipan software. The software distribution site had moved since the original *QST* Warbler article, but Dave’s site had a corrected link. I found one of the railroad track patterns on the screen and clicked the mouse on it. The station I called, K2EZR, wrote back that I needed to reduce audio gain to the Warbler as I was splattering. This led to having to find the correct sound card drivers for my laptop that placed the volume control icon on the Windows® task bar. I may need to build an outboard hardware volume control to get the right level of precision, and allow the control to be set the same each time the computer is rebooted.

#### Ramsey QRP-20 20m transmitter

One of my favorite receivers is the first one I ever built from scratch, a basic 20-meter model from W1FB’s *QRP Notebook*, Fig. 3-23. I made several attempts at a scratch-built 20m companion transmitter, with no luck at all.

I was wandering the back corners at the Midwinter Madness Hamfest here, and saw one of the vendors with a display of Ramsey kits. For \$29.95 there

was a 20m transmitter kit with crystal, and they had a matching case available. I thought the kit was priced only a little bit more than the cost of the crystal alone.

If you are not in the mood to wind toroids, this kit is perfect — there are none. After a pleasant few minutes this one was together and working. I did take the time to change the RF connectors from the RCA-type phone jacks to PL-259 jacks on the back of the case. This kit has a built in transmit/receive switch which can save adding an external model, and has room for a second crystal.

#### Small Wonder Labs’ 20m PSK-31 transceiver

At the recent St. Cloud, MN, hamfest, George NØVPR had what looked like a Warbler for sale. I asked him about it — he said it was actually a 20m version. I asked why he was selling it — he said he could not get it working, and did not have enough fancy test equipment to check it out.

I said right away if he was anything like me he had a wiring mistake or two and that was it. He gave me a look of, “Well, I don’t think so, but anything is possible.” I said I’d take it home and fix it up. Back on the bench, I checked every part. No mistakes at all — the coils and soldering looked excellent, nice and neat. I took out the cables and battered laptop from my Field Day/emergency bag where my Warbler was stored and fired it up. Right away there were tracks and signals — this time from far away, like Florida and California. I sent a relieved George back his Warbler and a copy of my laptop-to-Warbler wiring instructions.

#### QRPCI-FDIM

This imposing set of acronyms is really the “Four Days in May” QRP event. It’s every year in Dayton during the Hamvention at the Ramada Inn South, near Dayton Mall. They rent out much of the hotel and hold a full-scale QRP convention. There were over 200 folks there this year, and I had a chance to meet many of the leading lights of QRP. The Rev. George Dobbs G3RJV had a witty

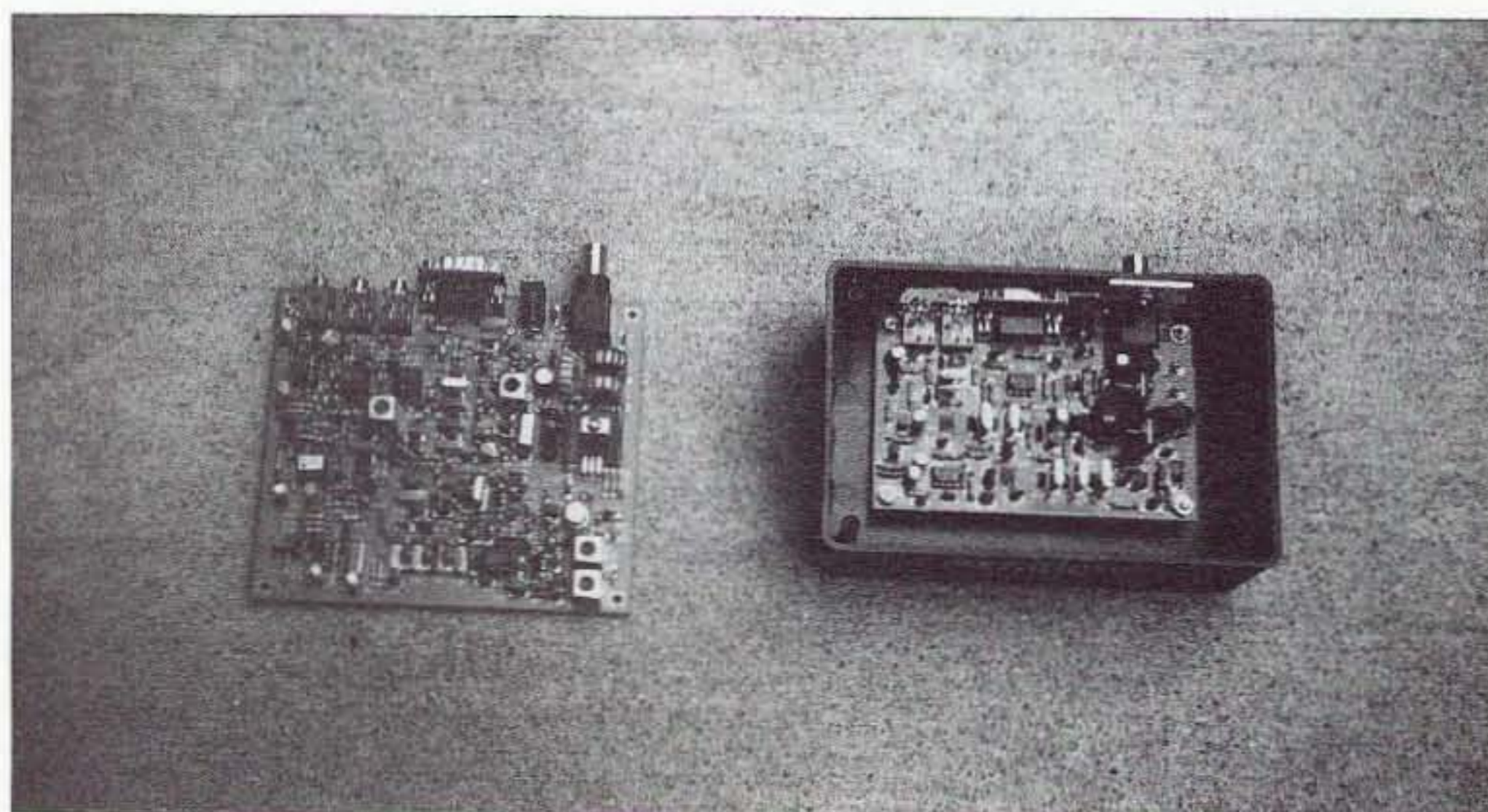

Photo C. Left: 20m Warbler; right: in box, 80m Warbler.

presentation. He is a very good speaker (years of practice on Sundays, I think) and was warning us of the danger of "pelf" — goods acquired with money one does not earn, to impress people one does not care about. I pondered this while loading up my pull cart at the big flea market, and concluded that if I spent my lunch money on something I alone wanted, I was safe from pelf.

He had a slide in his talk showing an angel figure hovering over a person soldering away at a workbench, with the caption saying you didn't need divine inspiration to get projects to work. I didn't think anything more about that until I raced up after his talk to buy a copy of his new book *Minimalist Radio*, and a copy of the complete *Sprat QRP Journal* on CD. In the book was a series of plans that might just solve a problem I have been grappling with for more than a year — building an all-Radio Shack DC receiver with no mail order or rare parts.

The QRP show has a nice awards banquet, and a QRP flea market at the hotel. This was another shocking drain on my wallet, as there were many dozens (!) of kits, books, bags of parts, and other items on offer. They have a quaint custom of taping QSL cards on the door, so you can see who your neighbors are. An added plus is that the Ramada South was the first stop on the free bus route to the Hamvention.

I had an idea for the larger DX contingents visiting Dayton from overseas, which came to me after losing out on bargains on 20' telescoping antenna masts (\$10) and 4' army-surplus antenna masting sections (\$3), neither of which would fit in my carry-on luggage for the airplane home. They should get together and rent a standard 20' shipping container — it could be filled to the brim, customs-sealed, loaded on a ship, and unpacked back home.

### The 1N914 as a varactor

It is a fact of modern life that variable tuning capacitors are getting harder and harder to find in local electronics stores. Radio Shack no longer

stocks them and they are even disappearing from the mainline mail order catalogs. The suggested replacement is in many cases the varactor diode. These are at least still being made, but require that one find an NTE dealer, or a well stocked parts store to find one locally.

In a number of the more basic QRP designs, you find some designers will use a common 1N914 diode or even a 2N3904 transistor (use the base-to-emitter junction) in place of a "real" varactor (VVC) such as the MV104. This is all well and good, but I have been trying to reverse engineer and update some of the older "all Radio Shack" designs, and have needed to find the capacitance range for the 1N914 in such an application.

In an article in one of the last issues published of *Ham Radio Magazine*, Hugh Wells has a nice table with the capacitance to voltage ranges for a number of common diodes, including the 1N4001 to 1N4007, and the 1N914. You can find the table on the *Ham Radio CD* published by the ARRL, or in your archives. I will give you a hint here — the 1N914 acting as a varactor is 0.5 to 4 pF, over an active range of 4 to 0.5 volts. So at 4 volts it's 0.5 pF, and at 0.5 volts it's 4 pF. Higher voltages did not change the capacitance. The 1N4001 had a range of 3–34 pF from 16 to 0.5 volts.

### References

Mark Milburn KQ0I, QRP ARCI, 117 E Philip St., Des Moines, IA 50315-4114.

New Jersey QRP Club (WQ2RP), [www.njqrp.org/].

QRP Amateur Radio Club International, [www.qrparci.org/].

Ramsey Electronics, 793 Canning Parkway, Victor, NY 14564, 585-924-4560, [www.ramseyelectronics.com/].

Small Wonder Labs, Dave Benson K1SWL, 80 East Robbins Ave., Newington, CT 06111, [www.smallwonderlabs.com/].

*WIFB's QRP Notebook*, Doug DeMaw, ARRL, Second Edition, 3rd Printing, 1999. ISBN 0872593657.

"Varactor Diodes from Rectifiers," Hugh Wells W6WTU, *Ham Radio*, 6/1990, pp. 40–41. 

## good deals on what you want

- Keeping the FUN in Ham Radio is what we're all about! Since 1980!
- Great prices & customer care on today's major brands, including:

MFJ QRZ	DIAMOND BATTERY TECH	MAHA Heil
GORDON WEST	ARRL	PATCOMM
PROCOMM	TRANSEL	RAMSEY
CALLBOOK	W4RT ELECT.	POWERPORT
IRON HORSE	AND MORE!	MIRACLE
LDG ELECT.		ANTENNA



Call Today

**217-352-1725**

"Our name says it all!"



**Amateur  
Accessories**

P.O. Box 7333, Champaign, IL 61826

www.amateuraccessories.com

kr4s@msn.com

## LOW PROFILE HF ANTENNAS

NO Radials • No Motors • MORE ANTENNA than just a Coil & Whip



**ISOTRON**  
BILAL COMPANY

Call for a FREE Catalog

2003  
is our  
23rd year  
in business!

**719-687-0650**

137 Manchester Dr.  
Florissant, CO  
81816



\$368.85  
80, 40, 20, 15 & 10  
60 inches tall &  
32 inches across

www.rayfield.net/isotron

EVERY ISSUE OF

**73 Amateur  
Radio Today**  
on Microfiche!

The entire run of **73** from October 1960 through last year is now available. Over 800 fiche!

You can have access to the treasures of **73** without several hundred pounds of bulky back issues. Our 24x microfiche have 98 pages each and will fit in a card file on your desk.

We offer a battery operated hand held viewer for \$150, and a desk model for \$260. Libraries have these readers.

The collection of microfiche, is available as an entire set, (no partial sets) for \$325, plus \$10 shipping (USA). Annual updates available for \$10, plus \$3 shipping/handling. Satisfaction guaranteed or money back!



**BUCKMASTER**

6196 Jefferson Highway  
Mineral, Virginia 23117 USA

540-894-5777 • 800-282-5628

Fax 540-894-9141

e-mail: info@buck.com



Phil Whitchurch G3SWH  
21 Dickensons Grove  
Congresbury  
Bristol BS49 5HQ  
UK

# Breakdown in Cape Town

*The surprise activity on this little jaunt turns out to be not just on the air.*

*When the bombshell landed that our DXpedition to the Midway Islands in April 2002 as W4M was to be canceled as a result of the hotel operator on the island ceasing their operations, Jim G3RTE and I looked around for an alternative and readily accessible destination.*

**W**e looked at the possibility of going to Grand Turk in the Turks & Caicos Islands (NA-003), which is relatively rare from the IOTA point of view, but VP5 sees a lot of holiday type activity from Providenciales (NA-002), which rather undermines interest in DXCC activity. As we were all considerably out-of-pocket following the Midway fiasco and a trip to VP5 would have been almost as expensive, we decided to put our plans for a 2002 DXpedition on hold.

Having decided to abandon a radio trip, I started to get big circular hints from Jan about going on holiday together instead. As we had already set our minds on going back to Madagascar in the autumn, we agreed it would have to be a cheap one! After much poring over brochures, we finally agreed on a very reasonably priced package of a week in Cape Town in late April, flying from London via Istanbul on Turkish Airlines.

Once the booking had been made, I sent a short E-mail to Al ZS1AAX

suggesting that we meet up for a drink and/or a meal. Al responded positively and suggested that we also involve Vidi ZS1EL and his XYL Hester ZS1ESU, N4MPQ. Several friends asked if I planned to take any radio equipment with me, but as our hotel was in central Cape Town, I decided not to. (Quite apart from the fact that I didn't think that ZS1 was rare enough to warrant the organization involved.)

We left Heathrow on the evening of Friday 19th April, arriving in Cape Town around 11 a.m. on Saturday

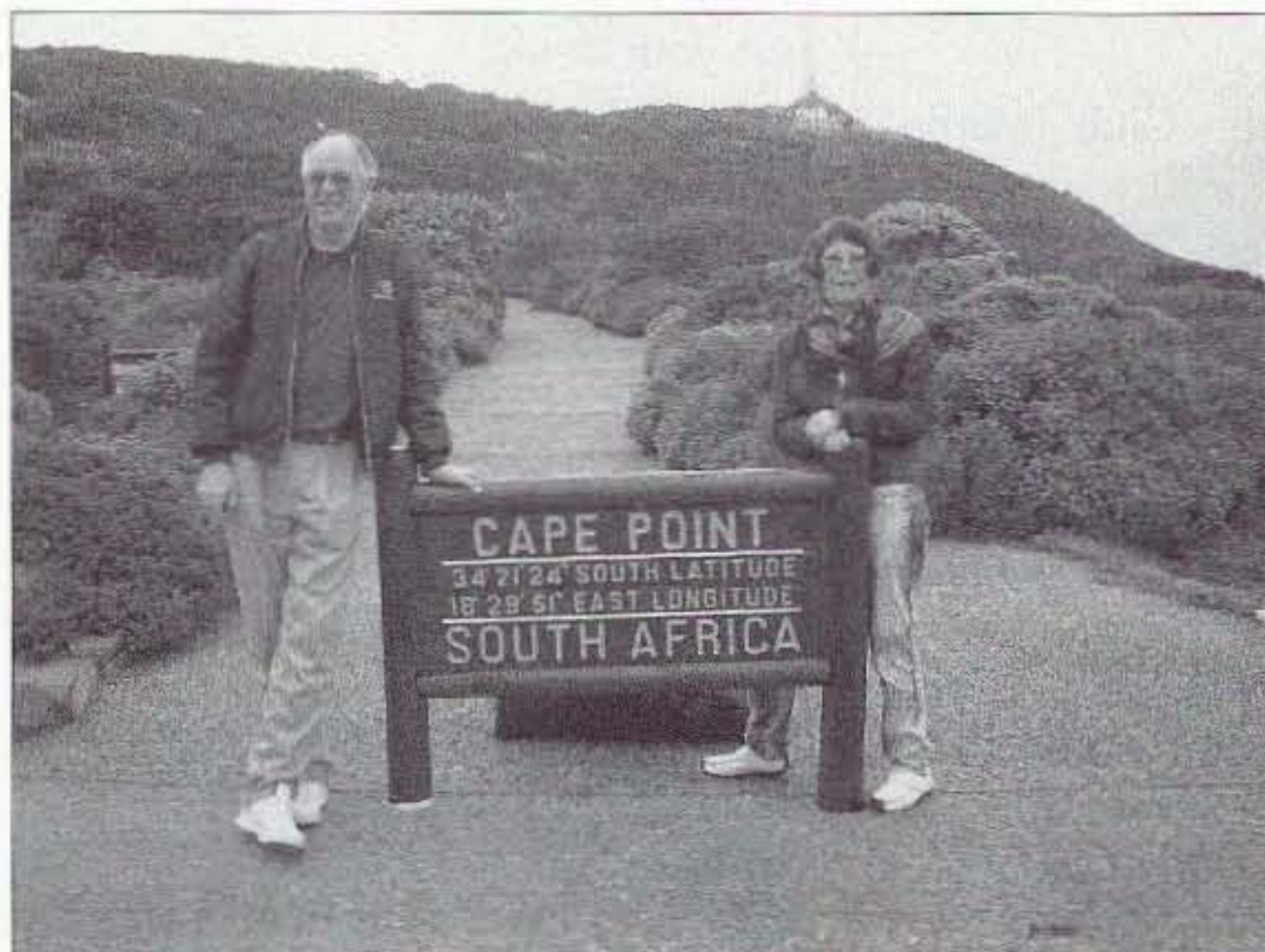

*Photo A. Jan and Phil at Cape Point.*



*Photo B. Jan, Phil, and Vidi at Sandy Bay, the famous nudist beach (it was a very cold day!).*



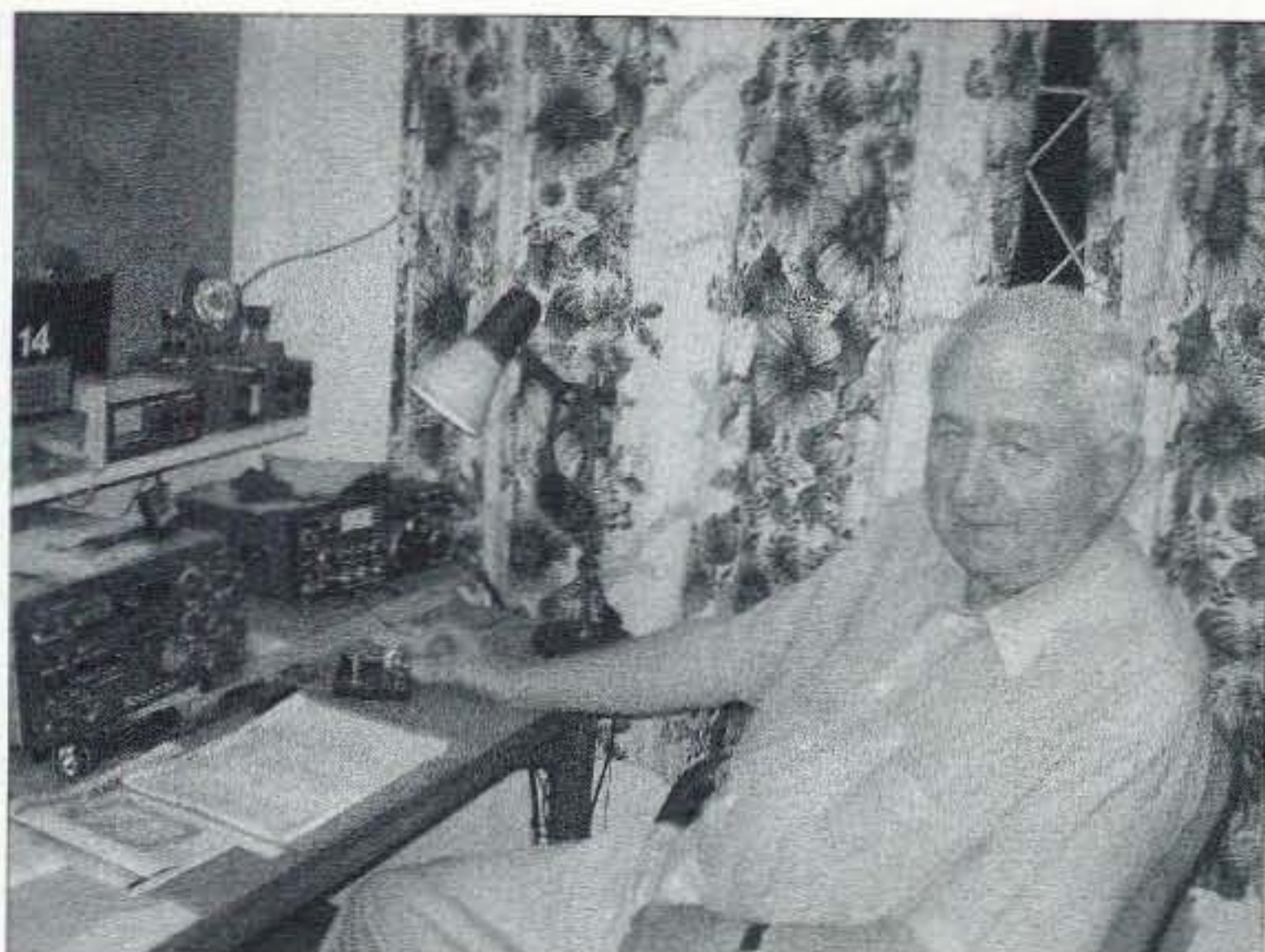

Photo C. Al ZS1AAX in his shack.



Photo D. L to R: Hester ZS1ESU, Phil G3SWH, Al ZS1AAX, and Vidi ZS1EL in Vidi and Hester's shack.

the 20th, having changed aircraft in Istanbul and touching down briefly in Johannesburg. Vidi and Hester had explained that on most Sundays they come into the city center from their home in Somerset West, to go to church and to visit the V & A Waterfront. Coincidentally, their church is quite close to our hotel and we arranged to meet at 11 a.m. in the lobby and to go to the Waterfront for lunch with Al, his XYL Kay, and his sister Stella.

The Victoria and Alfred Waterfront is still a working harbour, but much tasteful redevelopment has taken place and there are many restaurants, bars, and shops. Jan and I spent the first part of the Saturday evening exploring and having a meal — and the second part getting gloriously drunk on South African brandy in the hotel bar with another couple in our group. Heaven knows what time we went to bed, but I woke at 5 a.m. to find that all the lights in the room were still burning! After a late breakfast, Jan was still feeling hung over, but I was (surprisingly) fine.

Vidi, Hester, and Al all arrived as planned and we set off for the Den Anker, a Belgian restaurant at the Waterfront, where Kay and Stella joined us. A family of seals cavorting in the sunshine provided entertainment during the excellent lunch. Vidi asked if I wanted to play some radio during our trip, but we explained that we had a rather full schedule of sightseeing and had no time available. After lunch,

Hester proposed that we all go back to their house for coffee. Somerset West is about an hour's drive east of the city center and we were concerned about getting back to the hotel afterwards, as there appeared to be no public transport available. Al solved the problem by very kindly offering to drive out to Somerset West and then ferry us back to town in the early evening. Even so, it was a fairly devious route home for him, as he lives in Constantia in the southern suburbs of the city.

On arriving at Vidi and Hester's home, no time was lost in showing me the shack and firing up the rig. Vidi uses one of the beautiful N2DAN paddles, but I am a dyed-in-the-wool bug key user and have never got the hang of an electronic keyer. Vidi unearthed no less than three mechanical bugs from his collection and one was quickly pressed into service. A quick listen on 14 MHz at around 1400 UTC revealed a couple of W7s ragchewing on an otherwise dead band. 21 MHz made for a quick QSO with A25/DJ6SI, but 28 MHz was quite lively and a CQ call from ZS1/G3SWH was immediately answered by N2UI at 1445 UTC, followed by N4JF. After about half a dozen "normal" QSOs, a pile-up developed, mainly of Europeans, so I reached for a pair of headphones and dropped into 5NN mode. The pile-up grew and I was forced to work split at a good run rate, although I am still at a loss as to what was so interesting about a ZS station on 10 meters.

Al and Vidi were highly amused by my wrist action when using the bug, as using an N2DAN paddle is an altogether much more sedate affair. For the next couple of hours, I was plied with tea and biscuits whilst working 194 stations in 37 DXCC entities before Jan decided that I had been indulged enough and it was time for Al to drive us back to the hotel.

The rest of the holiday went as planned. Monday saw a birdwatching trip to the Paarl Mountain Reserve. On Tuesday we took a tour of the Cape Peninsula. We visited the Kirstenbosch Botanical Gardens on Wednesday in the pouring rain. Thursday was allocated to visiting the Winelands and no less than five vineyards, six if you count seeing the cheetahs at Spier. Friday dawned a beautiful day so we were up very early and took the first cable car of the day to the top of Table Mountain, which had been wearing its tablecloth (clouds) earlier in the week. That evening, we went to Al's home for dinner with his wife Kay and sister Stella, but didn't get on the air again.

Saturday, 27th April, was our last day in Cape Town and we were due to fly home late that afternoon. We decided to do little else but pack and some last minute shopping in Long Street as transport to the airport was arranged for 2:30 p.m. Jan particularly wanted to visit the Bead Shop. We didn't know until later that it was a

*Continued on page 32*



**Photo E.** Lunch at the Den Anker. L to R: Hester ZS1ESU, Vidi ZS1EL, Stella (Al's sister), Kay ZS1AAX/2, Phil G3SWH, Al ZS1AAX, and Jan G3SWH/2.



**Photo F.** Phil running a surprise pile-up as ZS1/G3SWH.

## Breakdown in Cape Town

*continued from page 31*

public holiday and most of the shops, bars and restaurants on Long Street were closed, including the Bead Shop.

Somewhat disappointed, we looked around for somewhere to have some lunch and a final beer before leaving and spotted a couple from our group on the balcony of a bar called the Purple Turtle, only a few yards from the hotel. We waved and they beckoned us to join them.

We sat at the end of the balcony with my back to the handrail. I placed my camera bag containing the passports, tickets and a not inconsiderable amount of cash on the floor on my right hand side. Whilst engaged in a pleasant conversation with our friends, I was conscious of a group of Asian people at the next table and of one of them walking several times along the balcony to look over the handrail and signal to someone below, but as the balcony was quite a busy part of the bar, I thought little or nothing of it.

When the time came for a second round of drinks, I looked down and discovered that my bag was missing. It was obvious that I had been the victim of a very slick and professionally carried out robbery by the people at the next table but who were now, of course, long gone. We rushed back to the hotel and asked them to phone the police, but as there was only about 45 minutes before we were scheduled to leave for the airport, the

local police recommended us to report the theft at the airport, which I duly did. I then reported to the Turkish Airlines desk and was informed that re-issuing the tickets would not be a problem on payment of US \$50 each but they would not let us board the aircraft without passports.

We had no option but to return to the hotel, book back in our old room and start to make phone calls home to let our family know what had happened. Needless to say, we were unable to contact the British consulate or the airline office until the Monday morning. We also phoned Vidi and Hester and arranged to meet up with them again after church on Sunday.

We spent another very pleasant day with them, including a visit to the IMAX cinema and an excellent lunch at Hout Bay.

First thing on Monday morning, I telephoned the British Consulate and spoke to a very helpful lady who explained that we needed to get some passport photos and visit the office to get Emergency Passports issued at a cost of 510 Rand each (about £34). We also visited the Turkish Airlines office, which was fortunately quite close to the Consulate. On explaining our position we were told that there were flights on Tuesdays and Saturdays only, that the following day's flight was already overbooked by 10 passengers and that there was only one seat left on the next Saturday flight. The clerk did say that he thought that he

could probably get a second seat on the Saturday flight and would call us at the hotel later in the day.

We were fairly desperate to get home as soon as possible as both Jan and I had important business commitments. Consequently, we made inquiries in a bucket shop as to the possibilities of alternative flights home and in fact took an option on a South African Airways flight on the Tuesday evening. We also managed to contact our travel insurance company in UK and were told that our policy only covered the cost of the emergency passports, ticket re-issue fees, and replacement of my camera, etc. There would be no contribution whatsoever towards our necessary living expenses whilst waiting for a flight home, nor towards the cost of an alternative flight. We have held an "annual, multitrip with independent travel" policy with the same company for several years but it's at times like these that you realize that travel insurance never covers you for real situations!

When no phone call was forthcoming from Turkish Airlines, we called them, only to be told that all their computer systems were down and to call back in the morning. Next morning, the airline's computer systems were still down and they had no idea of when they would be back on line, so we took the only decision possible — to take up our option on the SAA flight that evening.

*Continued on page 56*

# Hamfest Survival Guide

*So that you can live to 'fest another day.*

*How do you survive a hamfest? Most of us would say that the hardest part is to avoid buying items we want but probably won't need. Others might justify their purchases but worry about avoiding a divorce when their significant others see them unloading a trunk-load of what they might consider "junk." Regardless of what it is that worries you about having fun at a hamfest, here are a few pitfalls and tips on how to avoid them.*

Let's face it, there are times when the mere mention of a hamfest to our wives will elicit our looks, regardless of whether or not we're actually going to buy anything. This may be because of an established reputation of dragging home items that, regardless of their actual worth, end up cluttering the house.

While there may be no way to instantly dispel such a reputation, there are ways to lessen the impact. A trip to the hardware store for parts cabinets and a bit of time with a typewriter to type up labels for the bins on these cabinets will go a long way toward sorting out the stuff we've accumulated in the past. Convincing the folks at home that we can keep our junk organized and off the floor also will go a long way toward allowing us to be able to sneak in treasures in the future. As a side benefit, it might even extend to helping us find something when we need it for a project, instead of making us buy it brand new even though we bought the same thing at a hamfest six months ago — but can't find it in the clutter!

## Involvement

Family involvement can actually be

a benefit to surviving a hamfest. For example, even though my mom is not a ham, she's been curious enough about what I do, to learn at least a little about electronics, and ham radio. So, by telling her what the end results are that I'm aiming for — be it a search for parts for a given project, or a radio for a new mode of operation — she's gotten a lot more tolerant of the

stuff cluttering up the house if she knows that it's actually going to get used for something (instead of just taking up space).

## Do I really need it?

Before anyone gets the idea that this is a "gimme"-only type of event where

*Continued on page 57*



*Photo A. Dave N9ZAZ shows how to properly set up for selling, to make it fun and survivable.*

# Radio Comm in the French and Indian War

*Anything's possible when the Military Radio Collectors Association holds its annual meet.*

*DXpeditions in Indian country, steals and deals, and seminars on the radios that won WWII were the highlights of the Military Radio Collectors Association's annual meeting. MRCA is an offshoot of the Old Military Radio Net (0500 EST Saturdays on 3885 kHz).*

**W**ith no dues, no officers, and only one meeting each year, the 2002 meeting was held September 6–8 at the Gilbert, PA fairgrounds, in conjunction with the Red Ball Military Transport Rally — an arrangement which benefited collectors from both groups.

## **Flintlock and tomahawk vs. BC-611s**

Steve Finelli N3NNG, MRCA Events Director, created a challenging field

exercise for Friday, September 6th. Two local passes, “Big Pocono” and “Little Gap” were of crucial importance during the French and Indian War, 1754–1763. Raiding parties used these passes to punish British settlements east of the mountains. Our objective was to establish communications posts at these two locations, each just over 10 miles from the MRCA base in Gilbert. From these posts, foot patrols would fan out, giving us observational security.

The Big Pocono team was led by Dale Gagnon KW1I; the Little Gap team was led by Al Klase N3FRQ (both shown in **Photo A** conferring on the best avenues of approach for each objective). Ted Young W3PWW remained at the MRCA AN/GRC-19 base station (**Photo B**).

On Dale's team were Mark “Brown” Beezer WINZR, Brian Neri WA2CWF, Dave Kormanicki KB3ELD, and me (KØRMK). On top of Big Pocono, we put Dale's BC-474 into operation. We

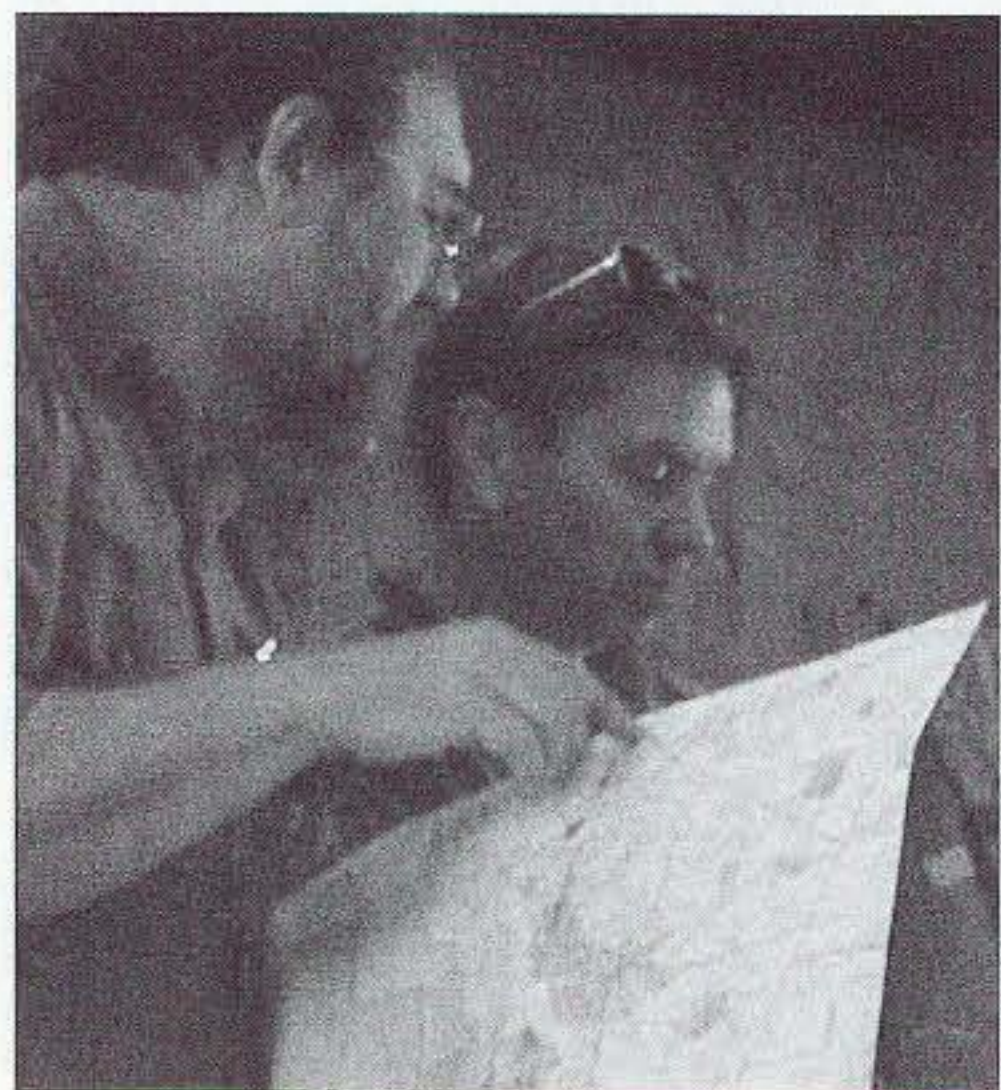

**Photo A.** Al Klase N3FRQ (at left) and Dale Gagnon KW1I plan DXpeditions.

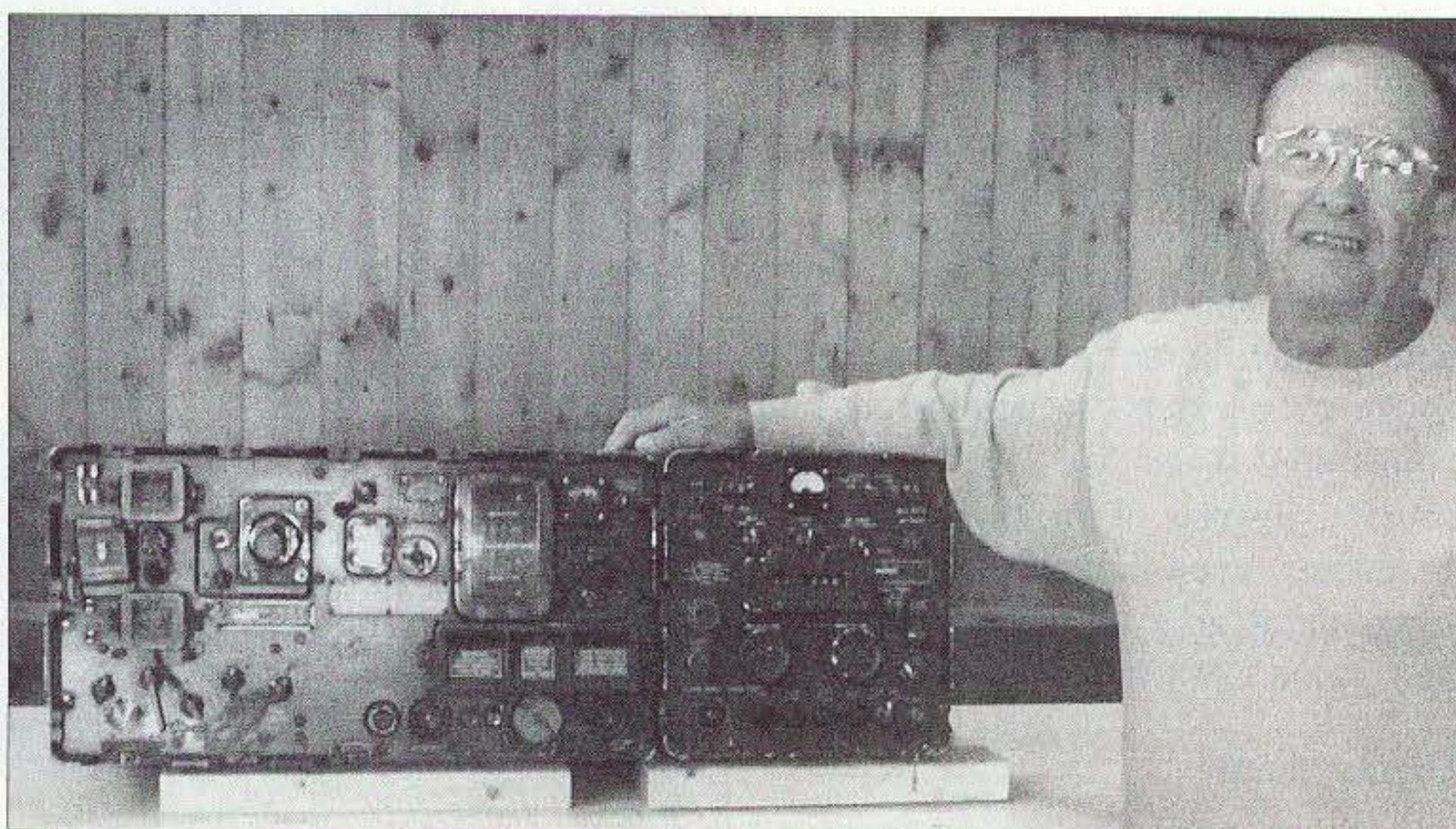

**Photo B.** Ted Young W3PWW setting up AN/GRC-19.



**Photo C.** "Big P" team from front to back: Dale KW1I, Brown WINZR, Dave KB3ELD, and Brian WA2CWF.

erected a 30-some-foot vertical antenna with a 4-wire counterpoise (two 33', two 60') laid out in the cardinal directions and connected to the vertical through a loading coil (**Photo C**). Power came from a Honda 300 watt AC generator at the other end of a very long extension cord to reduce interference. With 5 watts PEP, KW1I was able to establish contact with MRCA base using both CW and phone. With the BC-474 working, WINZR and KB3ELD patrolled as far as 600' from our post on "Big P", remaining in contact using their BC-611s.

On Al's "Little Gap" team were Pete Hamersma WB2JWU, Stew "Bud"

Beckley WA2AUI, and Breckinridge Smith K4CHE. Their GRC-9 was powered by a GN-58 with WA2AUI doing the grinding. When the GRC-9 experienced receiver failure, one of the team's BC-611s was utilized as a receiver while K4CHE took the other on foot patrol.

It is my pleasure to report that our field exercise was a success. No French or Indians infiltrated while we were on post.

### Steals and deals

The large military vehicle rally attracted quite a few dealers. Many of us were able to find bargains among what, to the undiscerning eye, appeared to be junk. KB3ELD found an M-1942 field desk in practically new condition — hard to find at any price, let alone what he paid for it (**Photo D**). Other finds included WWII headsets in original wrapping, manuals, and connectors of all kinds. Warren Harding K1BOX found a rare WWII J-47 telegraph key made by Lionel.

There were over 200 vehicle dealers and only five military boat anchor dealers, but there were some good buys on our side of the fairgrounds. While the going price was \$150 for a GRR-5, one sold for \$105 with all connectors, new original headset, new original antenna sections, and vehicle mount.



**Photo D.** Dave KB3ELD with WWII U.S. Army field desk.

### Lessons and displays

The lead lecturer was Norman Chipps N3RZU. His presentation was so interesting and humorous that 15 minutes after he started I looked at my watch and found that an hour had passed. His subject was the TBX-8 used by the Navaho Code Talkers in the Pacific Theater (**Photo E**). From interviews with surviving members of the Code Talkers he found that the TBX was preferred because of its range, and it had a portable AC generator which could be used to power a fan, very desirable in a jungle environment.

Other presentations were "Enigma Cipher Machines" by Thomas Perera W1TP, "The Enola Gay" by Mike Hanz KC4TOS, and "Command Sets" by Gordon Eliot White, a long time contributor to *CQ Magazine*.

Nearly twenty functional military boat anchors were on display inside the fairground building. William Donzelli brought his TAV1, a pre-WWII Marine Corps radio. K1BOX showed us his "Pogo Stick" radio used by the U.S. Cavalry. N3FRQ had an AN/GRC-9. My BC-654 was there with legs, thanks to N3NNG. Other static displays included a Navy Model GO-9 aircraft transmitter and an SCR 178/179.

*Continued on page 57*



**Photo E.** TBX-8 below photos of Code Talkers.

Dave Cox NB5N  
Director of Operations & Technology  
Tulsa Health Department  
5051 S. 129th E. Ave.  
Tulsa OK 74134  
[davecox@tulsa-health.org]

Gary Cox  
Director  
Tulsa Health Department

# CQ Sooner Spring

*An emergency preparedness drill that was more than OK.*

*Immediately following September 11, 2001, the Tulsa Health Department commissioned an Emergency Preparedness Committee to review the emergency response capabilities of the department, and make improvements where needed. We realized early on that we would need an Emergency Operations Command Center (EOCC) to serve as our operations nerve center.*

This article chronicles the transformation of an archived-records room into our EOCC, and our partnership with the Tulsa ARC to demonstrate the effectiveness of amateur radio during an emergency response, by staging a special event during a statewide bioterrorism drill in Oklahoma.

“CQ Sooner Spring, CQ Sooner Spring, CQ Sooner Spring.” Call for an early spring? Not really. Celebration of spring in the Sooner State (Oklahoma)? Wrong again, although not a bad idea. Then just exactly what was that determined voice on 21.320 MHz celebrating? Freedom — sort of. That voice on 15 meters on April 13 was that of Dave Cox NB5N (Photo A).



Photo A. Dave NB5N, EOCC station trustee, snags the CDC.

Dave, along with over 100 other Tulsa Health Department employees and 300 volunteers, was participating in an emergency drill code-named “Sooner Spring,” simulating a response to a biological terrorist incident — specifically a smallpox outbreak.

In addition to Dave, over two dozen members of the Tulsa Amateur Radio Club (TARC) could be found on the grounds operating six portable stations ranging in frequency from 3.5 MHz to 440 MHz, voice and data, and on 900 MHz on ATV (amateur television) (Photo B). The purpose of the portable stations, under the direction of the TARC, was to demonstrate the value of amateur radio in emergency communications. The purpose of Dave’s operating, while limited in scope to exercise-related communications, was to christen the Tulsa Health Department’s

newly constructed EOCC (Emergency Operations Command Center). Other control operators in the EOCC during the event were Cindy Kappel N5EMK and Pete Mann KF5RD (Photo C).

Until September 11, 2001, no one really thought that a release of smallpox was even a remote possibility. But, following the events of that horrific day in September, and the subsequent releases of anthrax in Florida and in the northeast, a resurgence of smallpox suddenly seems possible. And, the dedicated employees of the Tulsa



Photo B. TARC members.

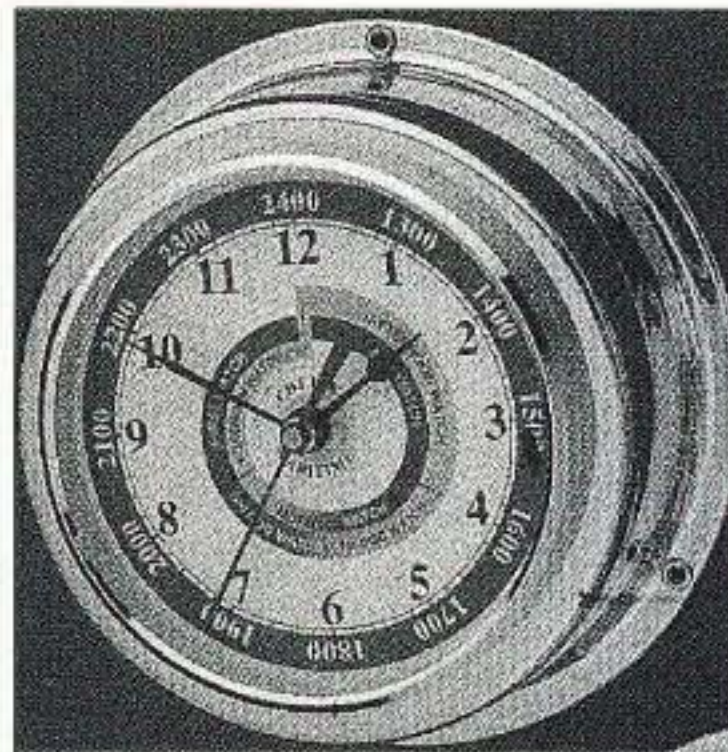

*Photo C. Cindy N5EMK and Pete KF5RD, take a breather from calling CQ.*

Health Department are actively pursuing every avenue available to make sure that they will be ready when, and if, such an incident occurs in their community — preserving our freedom, you might say.

As the lead agency in Tulsa County for response to bioterrorism, the Tulsa Health Department has significantly enhanced its emergency response capability since September 11th. A public health emergency preparedness plan has been drafted, epidemiology and environmental first-responder staff have been added, and a disease surveillance

system has been established. A critical component of their plan was the installation of their EOCC. While the EOCC is rather basic in design (Fig. 1), it is unique in character. In fact, EOCCs are virtually non-existent in local health departments. But, then again, the Tulsa Health Department is pretty unique in itself. According to Gary Cox, the director, "Tulsa's health department is considered among the top ten in the nation." And, he is quick to proclaim, "We aren't slowing down until we



Beautifully hand-polished.  
Stamped brass case and bezel.  
Curved glass crystal.  
Wall or bulkhead mounting.  
Made so well they last from generation to generation!  
Order this month and save \$20!

### Chelsea Clock

Clockmakers since 1897  
The choice of The Coast Guard Foundation.

Quartz Clock  
4" Dial

**Your price \$75**

**Omega Sales**

**P.O. Box 376**

**Jaffrey NH 03452**

**1-800-467-7237**

If you're a No-Code Tech, and you're having fun operating, tell us about it! Other No-Code Techs will enjoy reading about your adventures in ham radio—and we'll pay you for your articles. Yes, lots of nice clear photos, please. Call Joyce Sawtelle at 800-274-7373 to get a copy of "How to Write for 73 Magazine."

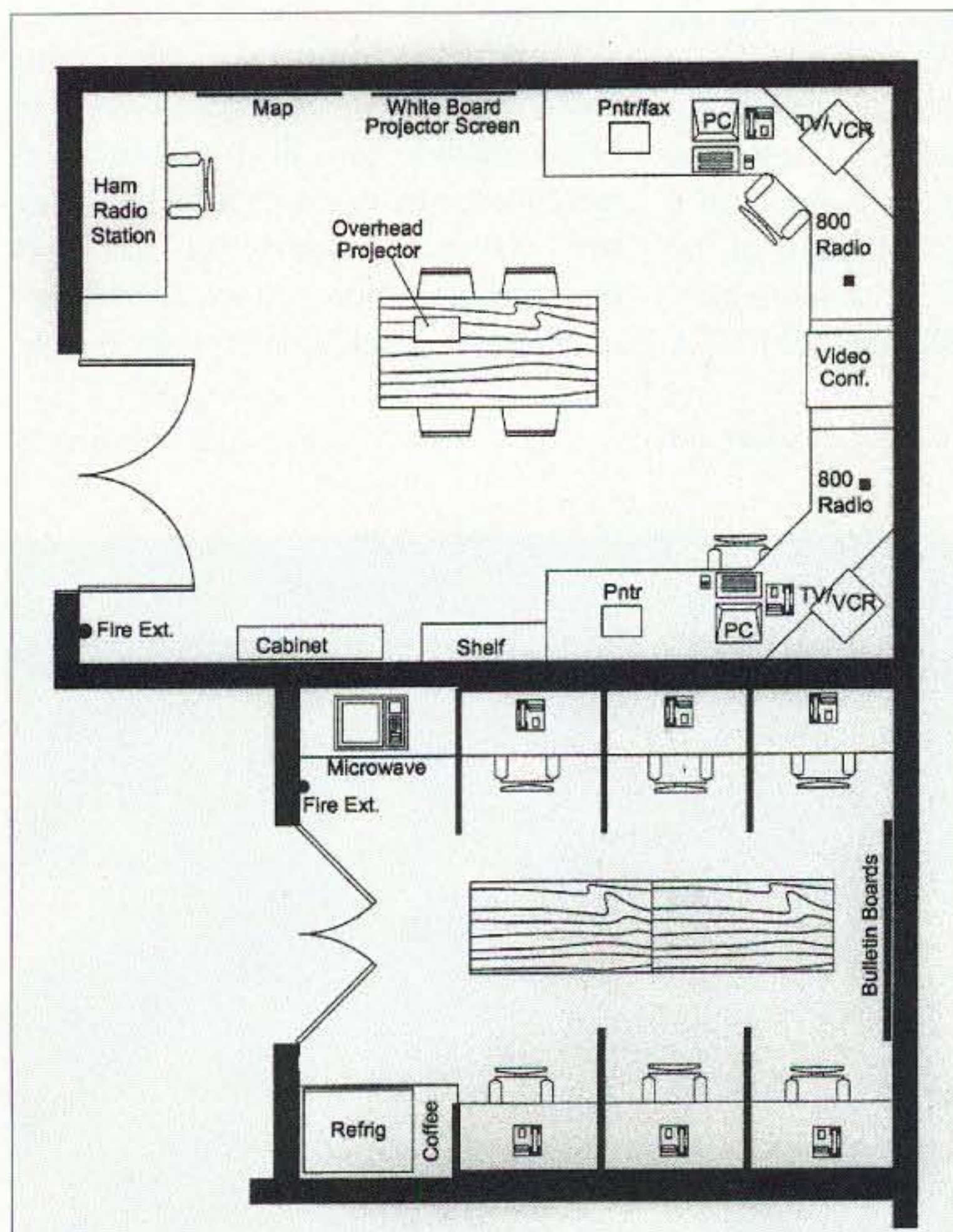

*Fig. 1. EOCC floor plan.*

## TRANSMITTER LOCATION

New fixed site direction finders provide 2 degree accuracy, and include software for triangulation from a central control site. Mobile versions also available covering 50MHz to 1 GHz

**Doppler Systems Inc.**  
PO Box 2780 Carefree, AZ 85377  
Tel: (480) 488-9755 Fax: (480) 488-1295  
[www.dopsys.com](http://www.dopsys.com)

European Marketing Director Denis Egan  
PO Box 2, Seaton, Devon EX12 2YS England  
Tel & Fax: 44 1297 62 56 90

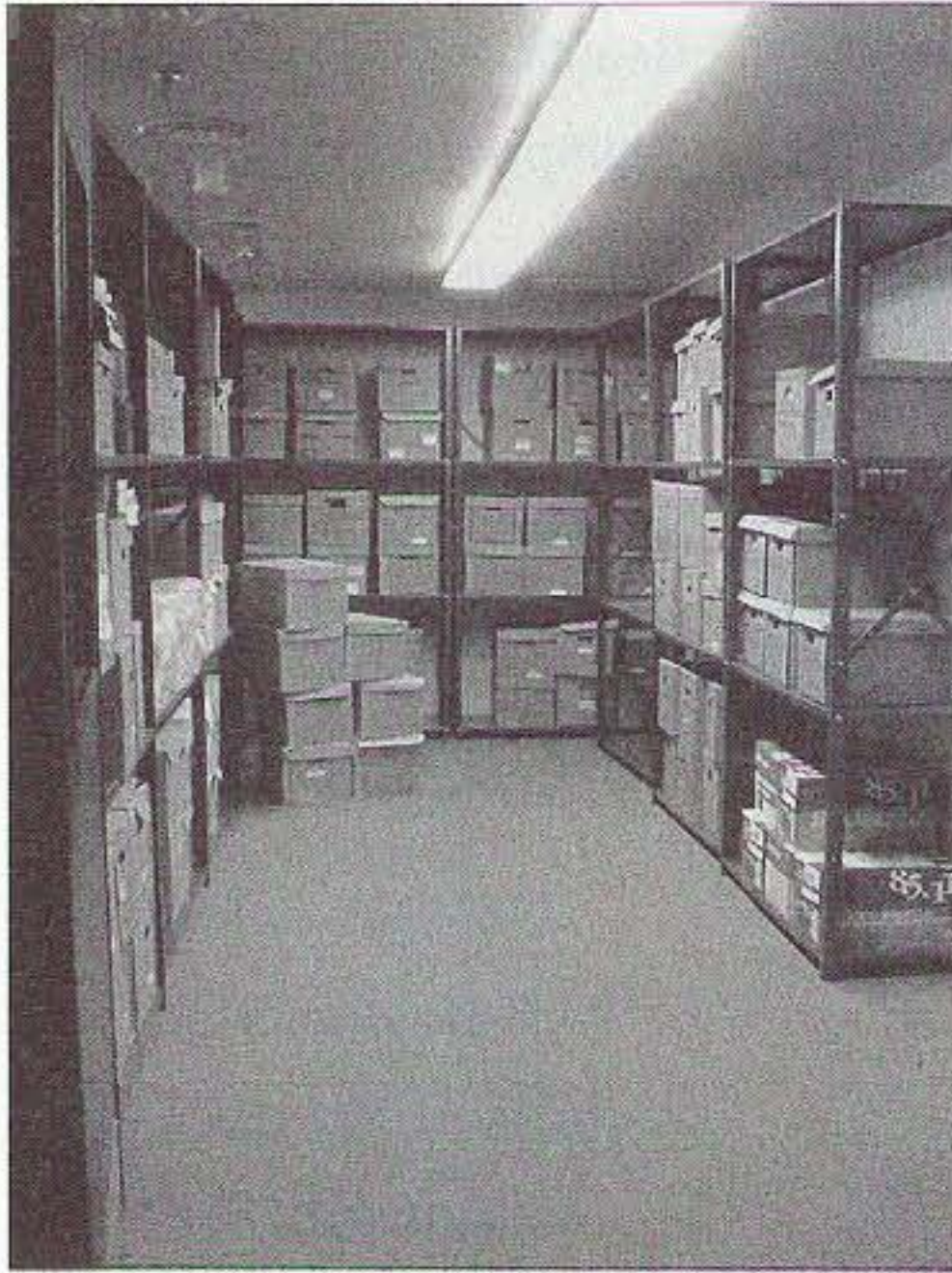

*Photo D. Records room before conversion to EOCC.*

hit number one." Clearly, their EOCC, and their partnership with the Tulsa Amateur Radio Club, will move them a step closer to their goal.

When the plan to establish an EOCC at the Tulsa Health Department was first conceived, the room where it is now located was used for storing inactive medical records (**Photo D**). Its location in the basement, adjacent to the telephone and computer network switching room, made it ideal. The elevator shaft was just a few steps away, offering an easy option for running coax to the roof three stories up. And, the roof of the elevator shaft would provide an ideal platform for mounting antennas. The bigger challenge came in outfitting the station. Weeks were spent researching equipment. Countless reviews were considered. Seasoned hams, communications specialists, and equipment manufacturers were consulted.



*Photo E. EOCC duty stations (Records Room after conversion).*

Station specifications finally fell into place a mere four weeks before Sooner Spring. Two things came out of our exhaustive research: First, every ham is of the opinion that his brand is the best; and second, virtually every major brand on the market today is excellent.

Going in, we only had three specific goals for the station:

- It had to be capable of providing the communications network that we needed — access to local emergency agencies, the Oklahoma State Department of Health 100 miles away, other local health departments throughout Oklahoma, the CDC in Atlanta, Washington, DC, and international. The Kenwood TM-V7A dual-bander (144/440 MHz) easily satisfied the local, as well as much of the state needs, especially with TARC's impressive UHF Super Links system, while the Kenwood TS-570D HF rig provided overlap for much of the state, reliable access to the CDC in Atlanta and Washington, DC, and international access for resource development and information sharing.

- The second goal was to provide equipment that would be easy to learn and easy to use, particularly in an emergency situation. We certainly didn't want an operator to be faced with the daunting task of having to learn an overly complex radio in the midst of a crisis. You have to admit, some of the rigs on the market today are incredibly complex. The TS-570D and TM-V7A fit the bill nicely.

- Finally, the station had to offer an element of intrigue. Of the 320 employees at the Department, only two were licensed amateurs. If we were to have a reliable reservoir of station operators, we would have to build internal capacity. To do that, we established the Tulsa Health Department Amateur Radio Club (K5THD), partnered with

TARC to provide license classes for all interested employees, and provided them access to the EOCC station for skills development and training. Within the first few months, nine employees had signed on. The capabilities of the Kenwood equipment, coupled with the reach of the Cushcraft A4S 4-element yagi, the Hustler 6-BTV vertical, and the Alpha Delta DX-A dipole, provided plenty of intrigue. And for good measure, and portable communication for the incident commander during an emergency, we threw in a Kenwood TH-F6A handie-talkie.

Having completed the configuration and installation of the EOCC, it was time to exercise its capability (**Photos E and F**). One of the goals that the State had set for Sooner Spring was to establish contact between Tulsa and the State Health Department, via amateur radio. Being uninitiated into amateur radio, they felt that this would be challenge enough. Our goal was a little more optimistic — to establish contact with the specific locations mentioned previously and to contact 30 states and 20 countries. This would serve as justification to the uninformed as to the capability of amateur radio.

The special event was staged from 1300Z to 2100Z on April 13th. The Department's two licensed amateurs were joined by two dozen TARC members. Over the course of the eight hours of operation, we exceeded most of our goals. In addition to contacting the

*Continued on page 57*



*Photo F. EOCC ham radio operating position.*



# Lifeline for Your Driftmaster

*How to stabilize a boat anchor.*

*Some tube-type equipment will drift to the point of distraction. When getting ready to operate, the procedure in my early days was to turn on the transmitter and receiver and then hope they would be tamed by the time I enjoyed my martini and dinner. It took a couple of hours with the station that was in the basement. My Driftmaster, in two-tone green paint, would continue to drift through the evening and the companion receiver was subject to the vagaries of room temperature and power line fluctuations. Using them on FSK, RTTY and SSB was an adventure in itself in that with tube equipment, it was always necessary to "spot" the frequency of the other station before the next transmission. I remember chasing the other station across the band most of the evening. The SSB phasing adapter was another story when three hands were useful.*

Now, with increased activity on AM, some of the old boat anchors are being resurrected and used to good advantage, to the consternation of the SSB crowd. Also, the age of tube gear does not help stability characteristics. If the equipment drift exhibited by your station is satisfactory, read no more.

A partial cure to temperature drift problems is to use a 2k, 10 watt, wirewound resistor across the power switch. This will draw current through the primary of the power transformer and yield a little less than seven watts of heat. A winterized basement may need more wattage. A disadvantage is no control of the heater and a possibility of overheating equipment in summer ambient temperatures. I suggest using the technique only if you need it.

A rough measure of temperature change in the VFO compartment can be accomplished with the circuit, in Fig. 1, using a 1N914 diode, a resistor, and a 9 volt battery. A digital voltmeter will be most accurate for measuring the voltage change across the diode. As the temperature change increases, the voltage across the diode will decrease

at a near-linear rate, when the current flow through the diode is a few microamps. The 1N914 diode can detect a temperature change of 0.1 deg. F.

A typical diode-voltage-temperature curve is shown in Fig. 2. To measure temperature change inside a compartment, solder the diode on the end of a pair of wires and connect the circuit

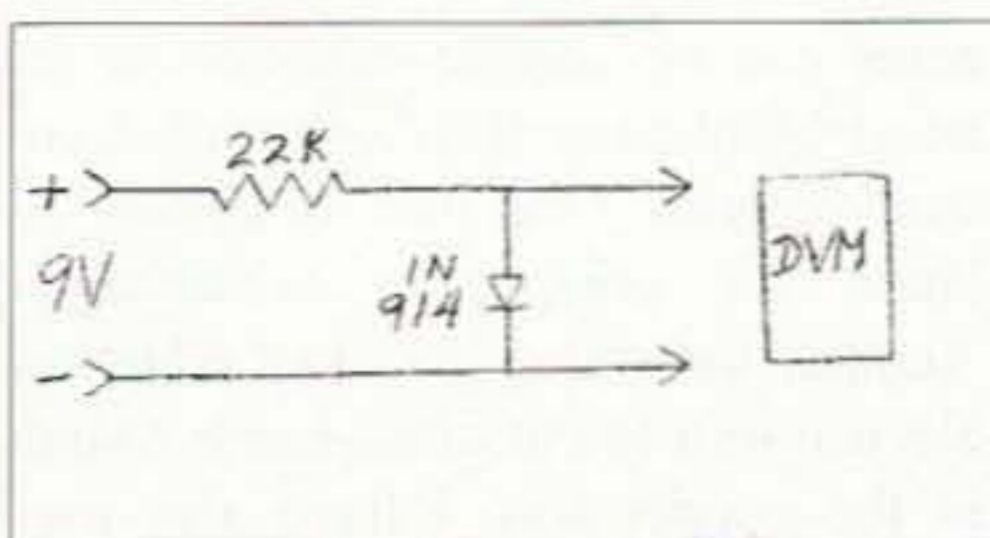

Fig. 1. Part of Fig. 2 (upper right corner) shows method of measuring temperature.

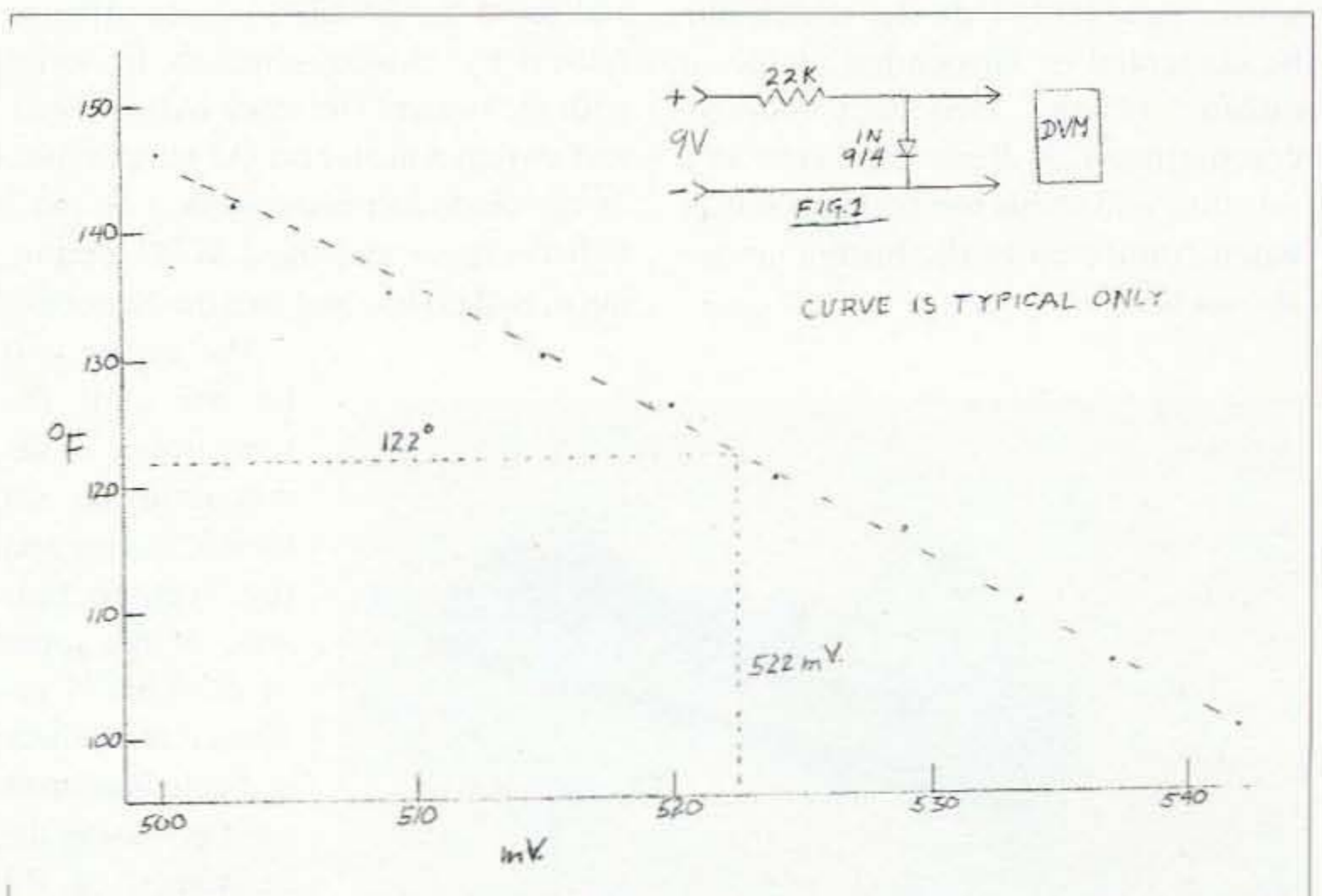

Fig. 2. A silicon diode voltage vs. temperature typical calibration, 100 to 150 deg. F. Use is to allow measurement of the equipment's internal temperature change when warming up.

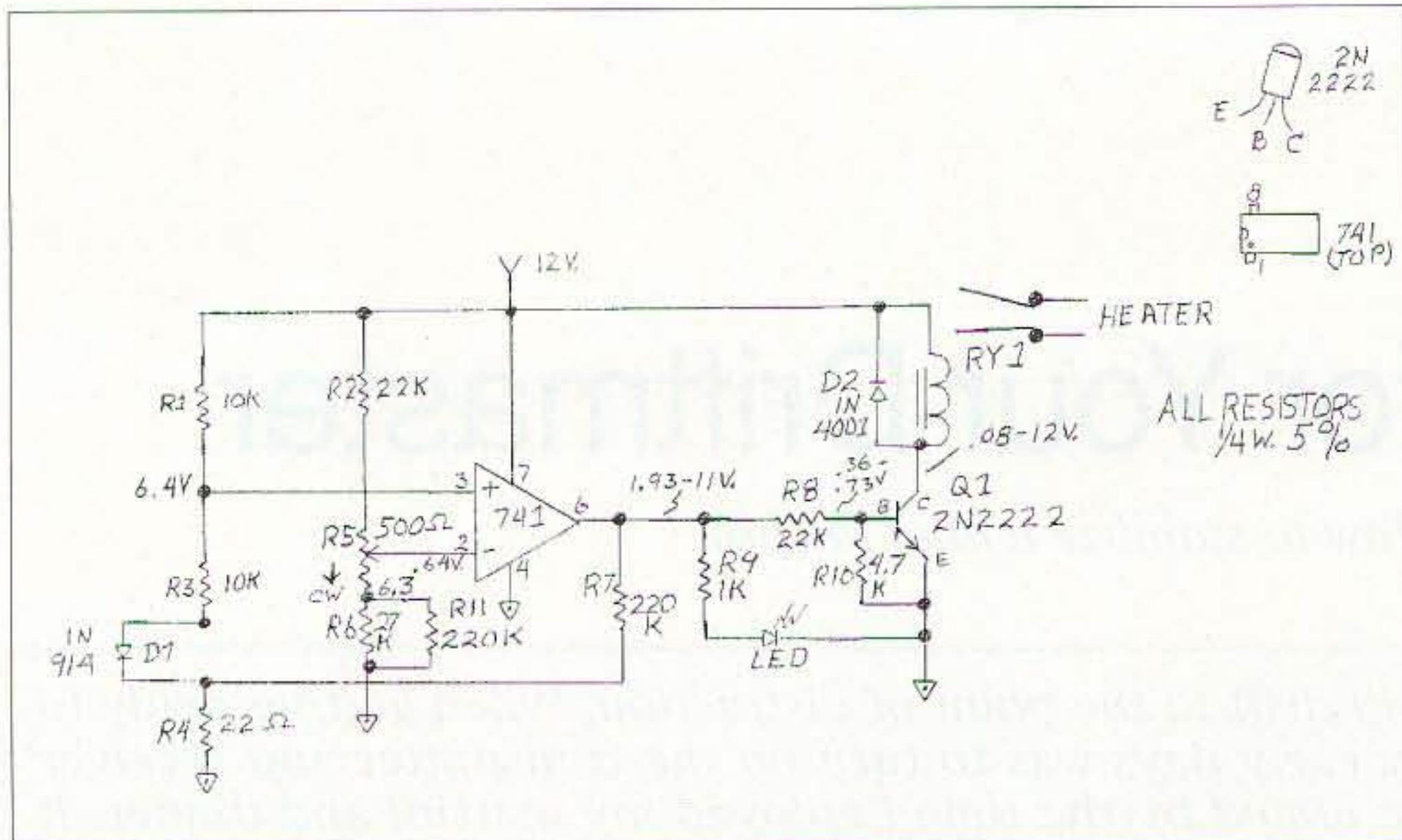

Fig. 3. Schematic of temperature control circuit for the Driftmaster system.

shown in Fig. 1. Note the ambient air temperature and the voltage across the diode.

Turn on the equipment and note the voltage change across the diode as the internal cabinet temperature increases. The diode voltage changes will indicate temperature change in the compartment. Not actual temperature, just the change. If you got this far, you really are a true experimenter.

A more scientific solution is to control VFO temperatures with a controlled heater. The schematic, Fig. 3, shows a simple circuit to control a heater placed in or near the VFO compartment. The temperature sensor is a 1N914 diode, which can be cemented or suspended inside or outside of the frequency control compartment. A diode can serve as a sensitive and stable temperature sensor when connected in the bridge circuit shown here.

### How the circuit works

Refer to Fig. 2. Resistors R-1 through R-6, with the diode, form a temperature-sensitive bridge circuit. As temperature on the diode changes, the voltage difference (pins 2 & 3) across the bridge will change. If the currents through both halves of the bridge are equal, voltage across the bridge will be equal and output of the LM741, pin 6, will be low. The LM741 op amp is used as a voltage comparator/switch.

As the temperature on the diode decreases, the voltage on pin 3 compared to pin 2 will increase and the output on pin 6 will switch to near supply voltage and drive the 2N2222 to saturation or full-on by closing contacts in series with the heater. The relay will energize and switch a heater on. As temperature on the diode increases, voltage on pin 3 will decrease and the LM741 output, pin 6, will go low and turn the heater off.

The heater will be off until the temperature in the compartment, set by R5, lowers and the voltage balance at the input of the LM741 reverses and power to the heater turns on. Decreasing the resistance of R5 (turn CW) will lower voltage at

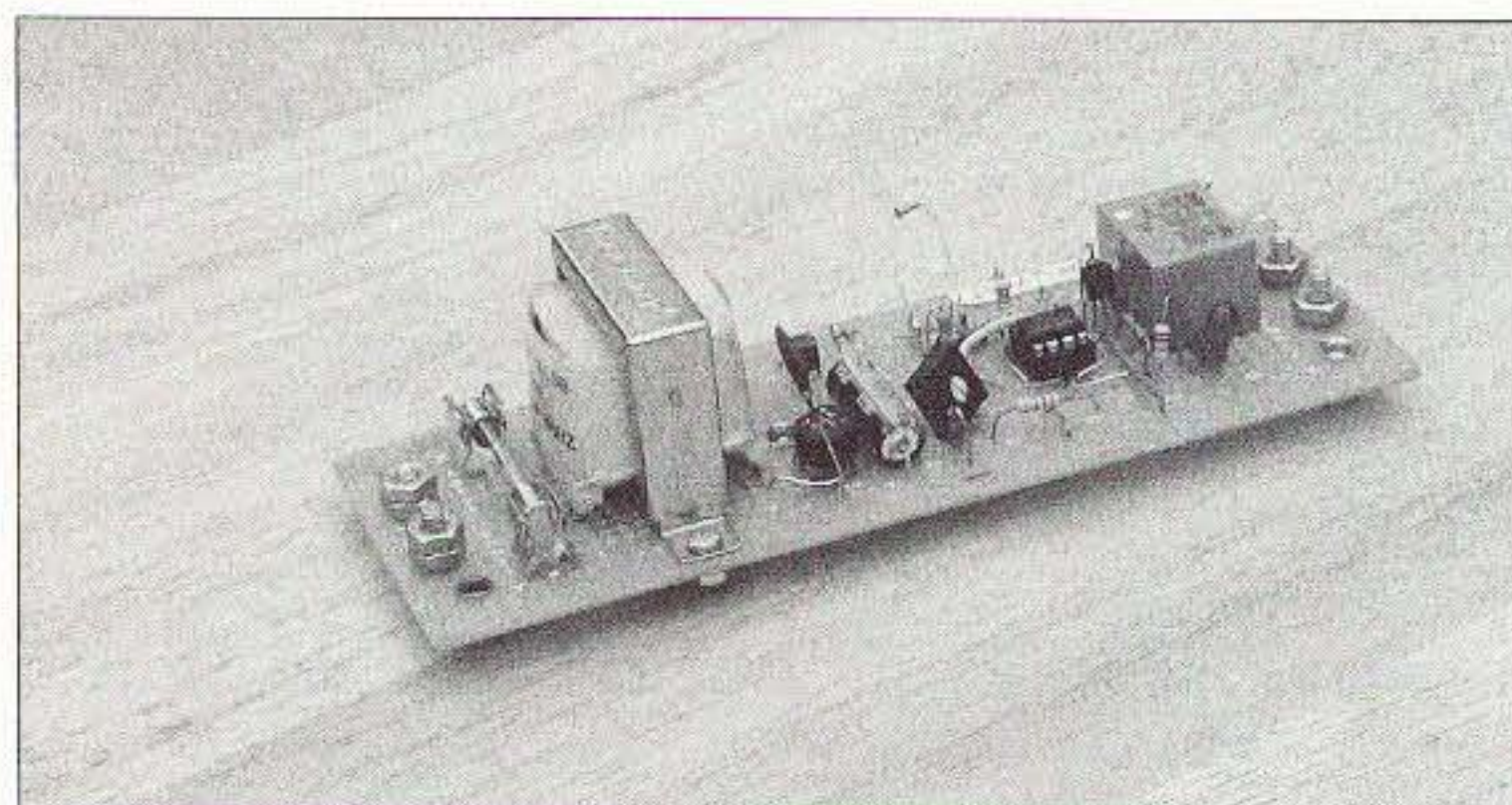

Photo A. Layout of all components on a Radio Shack 276-170 circuit board. Location of all parts is described in the text.

Part	Description (all resistors 1/4 W)	Radio Shack P/N (unless MSR, Mouser)
R1, R3	10k, 5%	271-1335
R2	22k, 5%	271-1339
R4	22Ω, 5%	271-1103
R5	500Ω trimmer	MSR 72-T20XH-500
R6	27k, 5%	RSU 11345147
R7, R11	220k, 5%	271-1350
R8	22k, 5%	271-1325
R10	4.7k, 5%	271-1330
D1	1N914	276-1620
D2	LED	276-209
U1	LM741 op amp	276-007
Q1	MPS 2N2222A transistor	276-2009
RY1	SPDT relay, 12 V coil	275-248
PCB	PCB	276-170

Table 1. Parts list, control circuitry (Fig. 3).

pin 2 (LM741) and will allow the bridge to balance at a higher temperature. Resistor R5 is used to set bias on pin 2 and control the switch-over point of the bridge circuit balance. The 220k resistor is used to introduce hysteresis and prevent chatter at the transition point of the LM741.

The sensing diode D1 and a heater element can be mounted inside or outside the VFO compartment. The diode sensor should be shaded from direct heat radiation of the heater and/or the VFO tube. Glass diodes are light sensitive and should be shielded from light for this purpose.

### Circuit board construction

Photo A shows a prototype temperature control circuit board. The components can be mounted in any favorite method. This simple circuit's components can be surface-mounted in the latest Manhattan style on printed circuit material. One pain is cutting islands for component connections. Another technique is to use a Dremel electric tool to cut cross-hatch islands in the copper foil. I have also used strips or circles cut out of electrical tape and then placed in position on the

copper side. The exposed copper can be etched away, and then the tape peeled off and parts mounted in position on the created islands. This prototype unit is on a section of Radio Shack 276-170 punched and etched circuit board. The layout is not critical, but leads associated with the 741 pins 2 & 3 should be kept short. Long op amp leads are subject to noise that could cause chatter at the transition point.

The neatest yet: The New Jersey QRP Club sells a tool they call The NJ Islander Bit. It is a hollow, diamond-tipped, 5mm end mil tool. I use it in a drill press to cut 3mm diameter islands just through the copper side of the PC material. An E-mail to the New Jersey QRP Club [www.njqrp.org] will get you information on this useful tool.

Components on the circuit board, **Photo A**, are, left to right — two #6 screws for 120 VAC connections to the transformer, 1/4 amp fuse, transformer, bridge rectifier, voltage regulator behind the disk capacitor, 220  $\mu$ F capacitor, 5k pot, and a cluster of parts associated with the LM741 op amp. The farthest end of the assembly shows the relay, 2N2222, and the LED indicator. The two #6 screws near the relay are for connections to the isolated normally open relay contacts to be in series with a heater.

### Power supply

**Fig. 4** shows the AC power supply that can be used with the Driftmaster circuit. If a 12 VDC wall transformer is used for power, all of the parts in **Fig. 4** are not necessary. However, if the 12 VDC source voltage, when unregulated, causes chattering at the transition point, add a zener or regulator IC to the circuit. The wall transformer will save space and simplify construction and mounting of the unit.

### Testing your creation (smoke test)

For a heat source, temporarily connect a small lamp in series with the relay contacts, the two screws at the right end of the circuit board. The lamp for this test should not be more than 6 to 10 watts; a Christmas tree

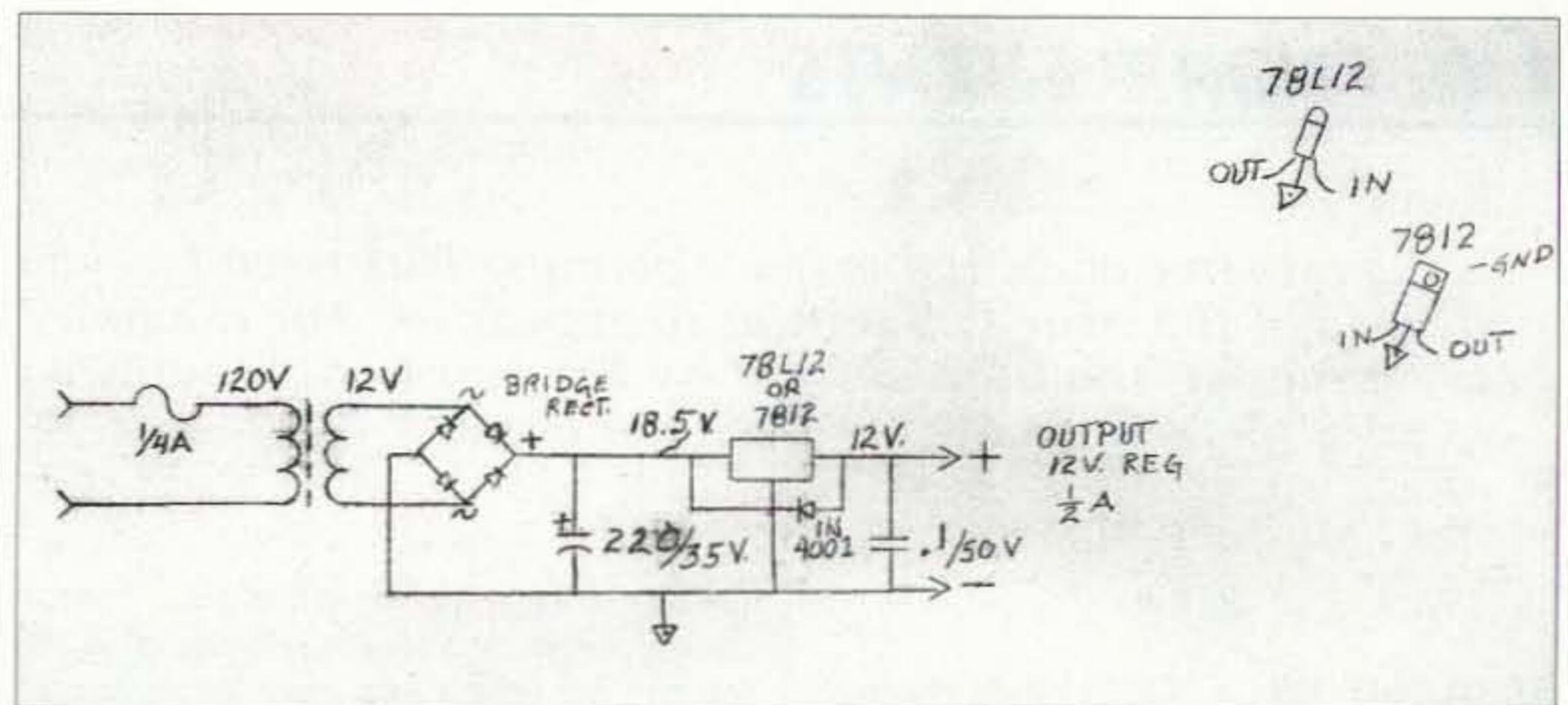

**Fig. 4.** Schematic of the power supply part of **Photo A**.

lamp for 120 volts or a small automotive lamp for 12 volts will work well. A small panel lamp would have enough heat for testing, if the room is not too cold. This will be a heater to check operation of the temperature sensing circuit. Note that the relay contacts are isolated from the rest of the circuit. As mentioned earlier, glass diodes are light-sensitive; therefore, protect the diode from direct light from any heat source with tape. For this test, the lamp should be near the diode, D1.

Connect 12 VDC to the Driftmaster circuit and turn the 500 ohm pot (R5) full clockwise and the lamp should come on. Turn the pot counterclockwise and the lamp should turn off. So far, so good? Set the pot where the LED just comes on. If you touch the diode, the heat from your finger should turn the LED off.

Place the heater (lamp) in contact with the diode and place a small cover over these two parts. Find a position of the pot (R5) where the circuit turns off and on automatically with heat from the "heater." Your control point should be above ambient room temperature. If R5 will not control the relay and LED, check the wiring, solder joints, connections, and components.

To use the Driftmaster, position the diode and heat source in or near the VFO compartment. The control circuit board can be located where convenient. Be sure wires to the heater and diode are well insulated.

This circuit has been used for temperature control of photographic baths, pool pump circulators, cooling control, and to prevent freezing.

The heater power (lamp, resistor etc.) required for your installation will depend on many factors. Equipment size, room temperature, and the heater power required to raise the internal equipment temperature to operating temperature, could vary greatly.

My thanks to W4GNC. Without his help, this document would have gross errors in spelling and punctuation. J.D. also made the photograph and you can blame me for the schematics. Trial and error, confusion, and blind faith will win out. If that prediction does not work for you, I hang around [w1tlz@arrl.net].

Part	Description	RS Part No. (unless MSR, Mouser)
C1	220 $\mu$ F, 35 V electrolytic	272-1017
C2	0.1 $\mu$ F, 50 V ceramic	272-135
F1	1/4 A 3AG fuse	270-1002
Fuse clips	Fuse clips	270-744
U2	78L12 voltage regulator — or LM7812	MSR 511-L78L12ACZ — or 276-1771
D3	1.4A bridge rectifier	276-1620
T1	120/12 VAC transformer	273-1385B

Note: If a wall transformer (wall-wart) is used, it should be rated for at least 300 mA at 12 VDC.

**Table 2.** Parts list, power supply (**Fig. 4**).

We pay \$CASH\$  
(well, check)  
for articles!  
SEND FOR "HOW TO WRITE FOR 73"

# CALENDAR EVENTS

Listings are free of charge as space permits. Please send us your Calendar Event two months in advance of the issue you want it to appear in. For example, if you want it to appear in the May issue, we should receive it by February 28. Provide a clear, concise summary of the essential details about your Calendar Event.

## FEB 8

**ST. CLOUD, MN** A "Cabin Fever Reliever Hamfest" will be held February 8th, 9 a.m. to 2 p.m. at Holy Spirit School, 1615-11 Ave. South, St. Cloud MN. The St. Cloud ARC will host this event. Set up at 8 a.m. Tickets \$5, tables \$10. VE exams 10 a.m. to 12 noon for new licenses and upgrades. Talk-in on 147.015(+), backup is 146.940(-). Contact J. Maus W0MBD, 320-685-8295, or [w0mbd@arrl.net].

## FEB 9

**MANSFIELD, OH** The Mansfield Mid\*Winter Hamfest/Computer Show will be held Sunday, February 9th, at the Richland County Fairgrounds, Mansfield OH. Plenty of prizes and an over 400-table flea market in three large modern heated buildings. Doors open to the public at 6:30 a.m. Tickets \$5 in advance and \$6 at the door. Tables \$12. Talk-in on 146.34/.94 W8WE. Advance ticket/table orders must be received and paid by February 1st. Send SASE to Dean Wrasse KB9MG, 1094 Beal Rd., Mansfield OH 44905; or call 419-522-9893 and leave a message for a return call. Info is also available at [www.MASER.org]. There will be a League Night banquet the night before the hamfest. More info on the banquet will be available on the Web site, or call Bill Martin N8TQ at 419-526-4661.

**RICHMOND, VA** The Showplace, 3000 Mechanicsville Tpke., will be the location for the "Richmond Frostfest 2003" Hamfest/ Electronics Show, and the ARRL VA Section Convention. The Richmond Amateur Radio Telecommunications Society will host this indoor event which features a flea market,

national and local vendors, major manufacturers, and forums. Admission is \$6. You can get tickets and more info online at [www.frostfest.com]. Special VIP tickets are available before Jan. 25th for early admission and special entrance. Call 804-330-3165 to make reservations. Call 804-790-0077 opt 4 for general info.

## FEB 22

**LAPORTE, IN** The LPARC Hamfest will be held February 22nd at Civic Auditorium, 1001 Ridge St., LaPorte IN, 7 a.m. to 1 p.m. Chicago time. Admission \$5, tables \$10. One admission included with each advance table reservation. Talk-in on 146.52 simplex. Contact Neil Straub WZ9N, P.O. Box 30, LaPorte IN 46352. Phone 219-324-7525. For table reservations, send E-mail to [tables@k9jsi.org]. Visit the Club Web site at [www.k9jsi.org].

**MILTON, VT** The Radio Amateurs of Northern Vermont is sponsoring the Northern Vermont Winter Hamfest and ARRL Vermont State Convention on February 22nd, 2003, from 8 a.m. until 1 p.m. at Milton High School, Route 7, in Milton, 5 miles north of I-89 exit 17. Features include a flea market, dealers, book sales, forums, demonstrations and refreshments. VE exams will be given at 9 a.m. and 1 p.m. Commercial exams at 1 p.m. Admission is \$5/\$3. Tables are free while they last. Check the Web site [http://www.ranv.org] for forum schedules and vendor setup info. Talk-in on 145.15 rptr. Bulletins on 146.67. Contact W1SJ at 802-879-6589, E-mail to [w1sj@arrl.net].

## FEB 23

**ANNANDALE, VA** The Vienna Wireless

Society's Winterfest will be held at the Northern Virginia Community College, 1 mile West on Rt. 236 of the Beltway, 8 a.m. to 3 p.m. Admission at the door is a donation of \$6. Plenty of tailgate spaces, and free general parking. Indoor tables \$20 each. Call Dave K3MV, 703-925-0584 for reservations. VE exams at 9 a.m. on Saturday, February 22nd. Walk-ins permitted. For further info check the Web page at [www.viennawireless.org].

## MAR 16

**JEFFERSON, WI** The Tri-County ARC will host "Hamfest 2003", Sunday, March 16th, at the Jefferson County Fairgrounds Activity Center, Hwy. 18 West, Jefferson WI. Open to the public from 8 a.m. until 1 p.m. VE exams start at 9 a.m. Vendors will be admitted at 7 a.m. Vendors-only parking will be provided for unloading. Food and beverages will be available. Talk-in on the 145.49 rptr. Admission \$4, 8 ft. table space @ \$6 each. Reserve your space early! Contact TCARC, 213 Frederick St., Fort Atkinson WI 53538. Call 920-563-6381 evenings. Fax 920-563-9551. E-mail [tricountyarc@globaldialog.com]. The Web site is at [www.cmdline.com/tcarc/].

## APR 13

**STOUGHTON, WI** The Madison Area Repeater Assoc. will host the Madison Swapfest on Sunday, April 13th, at Mandt Community Center, Stoughton Junior Fair Grounds, on South Fourth St. Doors open at 8 a.m. Talk-in on 147.15. For more info contact Madison Area Repeater Assoc., P.O. Box 8890, Madison WI 53708-8890. Phone 608-245-8890. For fast access to more info, check the Web site at [http://www.qsl.net/mara/].

## NEVER SAY DIE

continued from page 8

why a future physicist should have exactly the same education as an opera singer or furniture maker.

## Begging Bowl

A recent letter from the League asked me to donate money "for the defense of amateur radio frequencies." For \$30 I'd get a certificate of recognition. They

already recognize me, so I saved \$30 right there. For \$50 I'd get a lapel pin. My hamfest hat is covered with "lapel" pins that nobody notices. For \$100 I'd get a coffee mug. Wow!

Look, guys, if you're really interested in defending our frequencies, how about doing something which will get more youngsters into the hobby? And maybe find out why around 85% of the licensed hams are inactive and what it would take to get them back on the air.

If we use our bands we're not as likely to lose them, but we've been coasting along for years, using about 3% of our bands, so we're sitting ducks for any moneyed lobby.

The League's long history of maintaining the code barrier to keep people out of the hobby hasn't led to a climate of trust, so I might feel a little more generous if I thought a

Continued on page 61

## The Laser Communicator

*What is all this talk about beam expanders for lasers? Are they necessary, and why on God's green Earth would I want to expand my laser beam?*

Well, all this talk is a continuation of the laser communicator that was published (3 parts) in *73 Magazine* in June through August, 2000. The original article used an LED-based transmitter and was upgraded to include a small 650 nm red pocket laser. This provided greater output power, and while not a barnburner, was quite a simple step up in system ability performance and range. We used the laser bare-footed without any accessories when we upgraded to the laser from the LED system. The next system upgrade was to add the "beam expander." The design of this entire system and the beam expander is the effort of Kerry N6IZW. It was his vision and dedication that have brought this project forward. There may be new developments on the horizon, but for now let's describe the beam expander.

The very name "expander" seems counter to what the job of a beam expander actually is. Its job is to collimate the beam into a very condensed focused spot of near parallel light energy, minimizing the divergence or spreading out of the laser beam. For example, at the distance of, say, 10 to 15 miles, the bare laser spot size could be in the range of 200 feet in diameter. Even with shorter tests at 100 feet in distance the laser spot has grown significantly larger and is spreading out like a flashlight beam of light. With the addition of a beam expander to this very same pocket laser, the spot at the 100 foot test point is focused to one of approximately the same size remotely as it is at the objective lens. What is happening is that the focused laser light is not diverging as much and is being more parallel in nature. Comparing it at 10 to 15 miles, the beam expander is making an observed spot size something less than 10 feet in diameter.

Beam expanders and the difference in laser light between a stock laser and one with a beam expander at 100 feet is very

noticeable. The bare laser light is not focused sharply and is a very dull, spread-out dim projection, while the same laser with a beam expander is quite focused, bright, and a near duplicate to the transmitted image — sharp in detail, defined even during daylight at 100 feet. What, then, does it take to construct a beam expander? See **Fig. 1** and **Photos A** and **B** for beam expanders that Kerry constructed.

A beam expander can be constructed from two lenses spaced to focus the laser diode output. (Reference articles can be found on the Internet. I searched in Yahoo for "beam expanders" and got a wealth of information.) The laser is centered from the first lens, be it a small diameter double convex or a surplus ball lens (looks like a marble) of short focal length (approximately 8 mm), to an objective of some 30 mm diameter whose focal length is about 80 mm. The focal length of these lenses is a good match for construction of beam expander material. The ball lens is quite easy to mount, as it has a surface outside edge of about one eighth of an inch flat — allowing easy mounting in PVC pipe whose diameter is cut to fit. (Ball lens used, from Surplus Shed, part #L1729, \$4 each.)

A beam expander produces a divergence reduction to the laser beam related to the magnification factor of the system. In this case, the system magnification factor is 10 and the normal spreading out of the laser beam, when used with such a beam expander, is reduced by the factor of 10. (Magnification factor equals main objective focal length divided by first objective focal length, in this case the [ball] lens. We then have 80 mm FL divided by 8 mm FL = magnification factor of 10.)

Testing a beam expander is not difficult at all, but a test range is needed. It can be either a short range or a very long distance range. For short optical test benches within

a garage, a measurement of laser spot size at the objective is carefully measured with a caliper, and the spot dimensions should be about the same at a distant target. For approximate positioning, space your first lens and objective some 4 to 6 inches apart (by experiment) and watch the laser spot size. This simple handheld range can demonstrate the effect of the system. By varying the distance between the lenses, a very fine spot can be observed remotely. This is not a correct adjustment. Vary the distance between lenses carefully to project remotely a focused spot size near the size of the spot on the face of the objective lens.

Once you get your optics somewhat fixed in place, the experiment can take a more exact form than simple handheld optics. Adjust the objective focus (distance between first lens and objective) for same dimensions at the remote target and objective face. This is not perfect but should get you in the ballpark of ascertaining the reduction or expansion in divergence of the beam on the distant target. Observation via a spotting scope can make some further evaluation desirable. Use a test range of several hundred feet and view the target with a spotting scope for spot size evaluation.

Adjust the target spot size to the same size as at objective (focus adjustment refinement). You want the output of the beam expander to be essentially flat out of the objective lens and the same image size at the remote test target. That's close to minimum divergence for the system. The laser driving the beam expander can produce either circular or somewhat rectangular patterns of laser light output depending on optics internal to the laser pen selected. There will be differences between the large variety of pocket lasers in the market. Just purchase a few different brands inexpensively and sort out what you

*Continued on page 44*

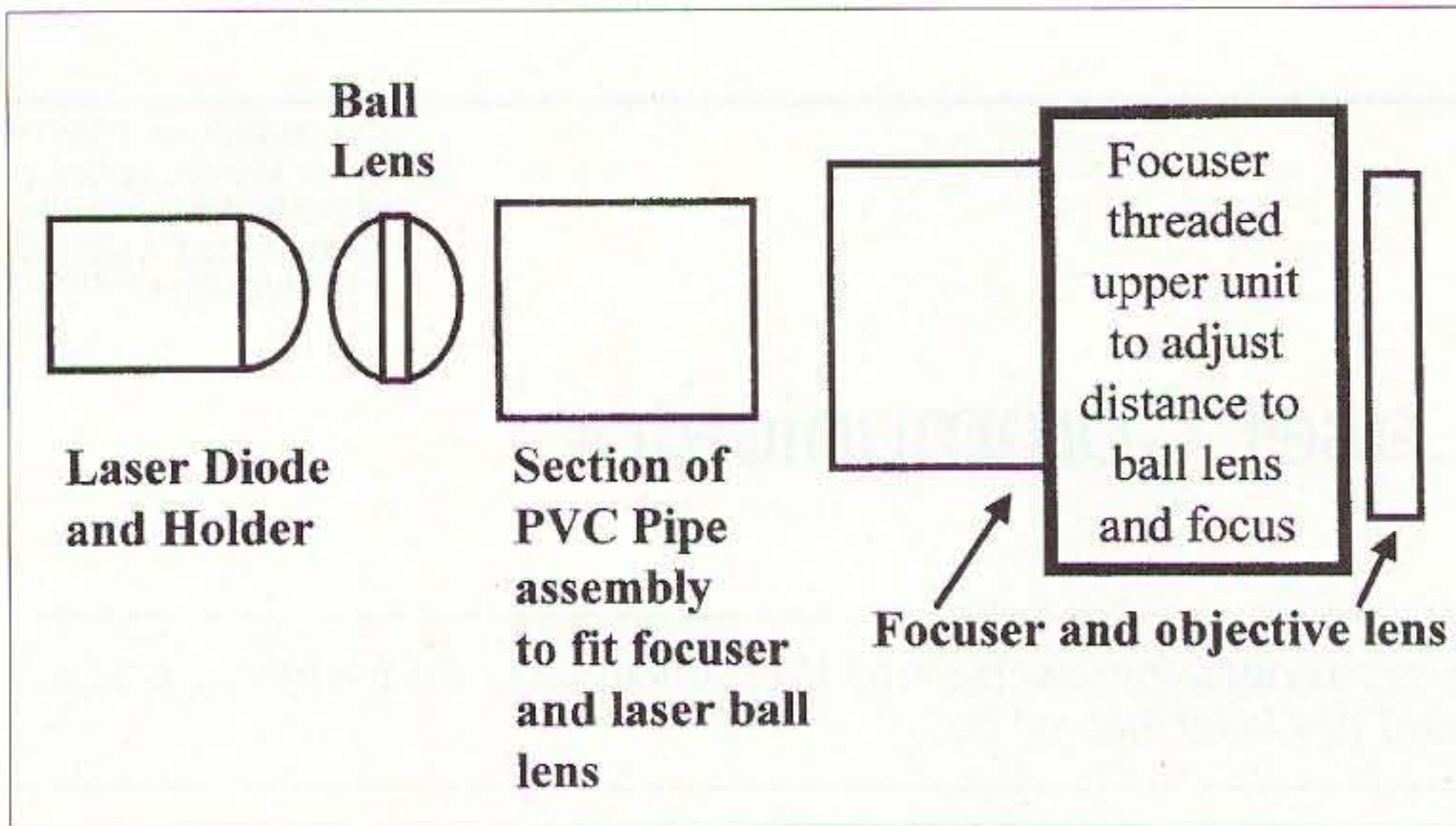

**Fig. 1.** Parts assembly diagram showing components of our laser beam expander and general idea of assembly using PVC pipe and pipe adapters to fit laser and first optical lens into focuser assembly. Adjustable side of focuser assembly holds objective lens. Layout is the same as *Photo A*.

## ABOVE & BEYOND

continued from page 43

have to something usable for modulation capabilities and ease of modification.

### Mount construction

A simple mount for a beam expander can be fabricated from PVC plastic pipe fittings and short sections of PVC plumbing pipe. The objective we used was 31.5-mm in diameter (1.240 inches) and fits into a 1-inch threaded adapter with some turning on a lathe. The ball lens used is 10.3 mm; 0.590 inch OD and PVC fittings can be machined to fit the lens and components of the focuser. Similarly the Laser Pen can be made to fit

tight into a selection of suitable PVC fittings and adapters, allowing the laser pen to be inserted at the end of these fittings. This end section will house the laser and ball lens together much like a collapsible telescope of short length. Bush out the far end and make an assembly for holding the objective lens spaced some 4 to 6 inches from the first lens, depending on optics used. For a first cut, position the objective in a simplest mount or other holder and handhold the ball lens and laser to obtain a starting separation distance between lenses.

While visiting a local surplus store, I found a mount that allowed the laser and ball lens to be held in one end of a focusing mount, and the objective in the adjustable front section. This gave us fine tuning

adjustment for proper system focus once we determined the approximate distance required between the first primary ball lens and second objective lens.

It's best to experiment first, with a simple optics test bench and some simple PVC holding mounts, to determine lens positioning dimensions. Then a final system can be assembled with only small changes needed in final focus for desired reduction in laser divergence. Once completed, it can be mounted and permanently fixed with the mounting for our telescopic sight as one unit. Allow for adjustment for vertical and horizontal positioning — to align both the rifle scope and laser together. Use the target I constructed in last month's column (Jan 2003) to accomplish this task.

A lathe could be used to great advantage to cut precise mounting insertion diameters in the soft PVC pipe and fittings for the lens elements so that they will insert tightly into each other. The lenses are then held by compression or glued in place inside the PVC elements holding them in place. Besides being inexpensive, PVC is soft and easy to cut, especially if you have access to a lathe. Then you can custom fit the plastic parts inside each other by machining them to exact tolerances.

The laser pen is modified by removing the bottom battery holder and making electrical connection to the spring and case to replace the battery connections with leads to the power supply driver. The on/off switch on the side of the laser diode assembly is jammed "ON" by a tight wrap of electrical tape. Most laser diode pointers are about

Continued on page 58

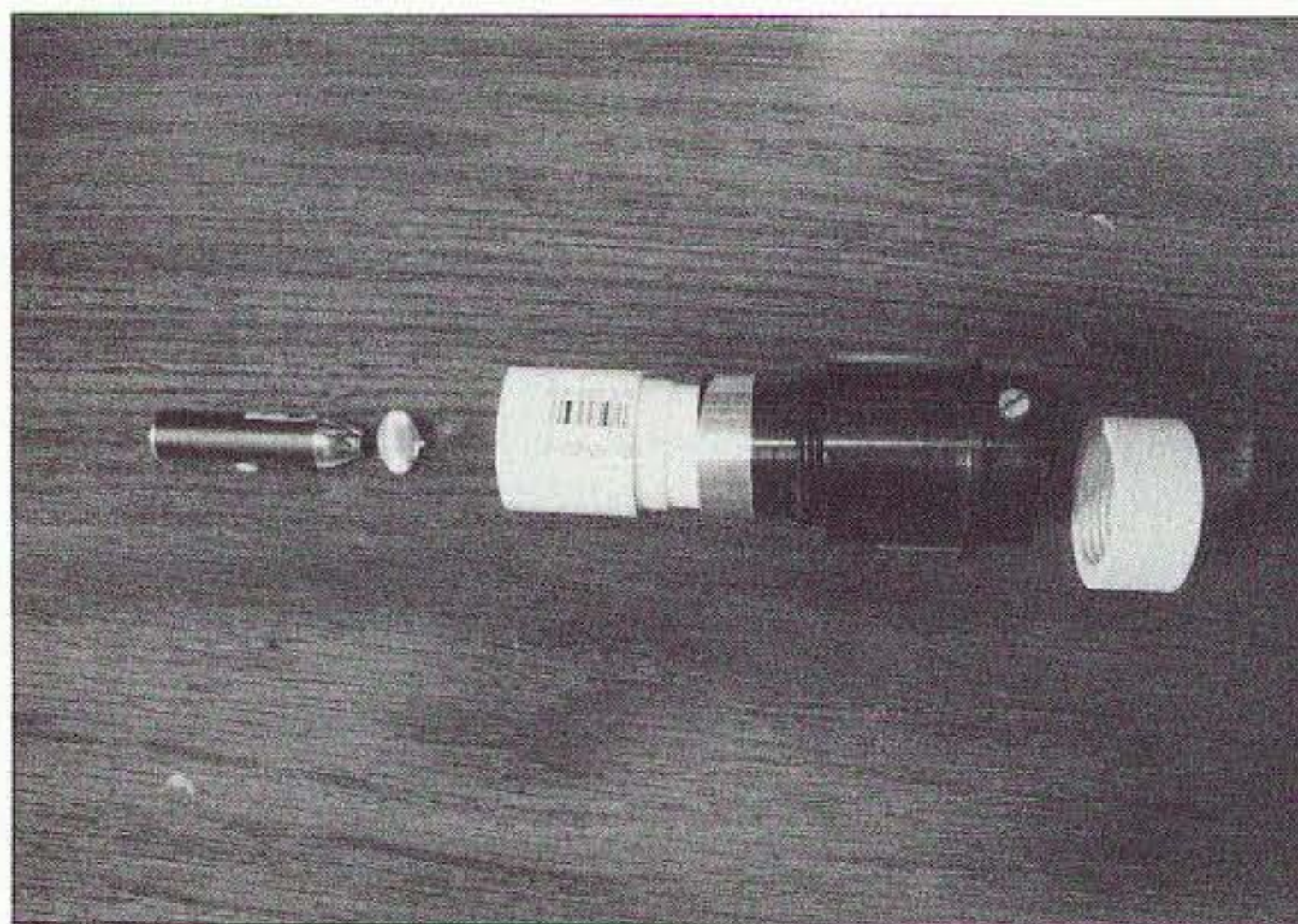

**Photo A.** Picture of components of our beam expander before assembly and fitting. Parts machined to tight fit in metal black focuser assembly we obtained surplus. Component parts laid out left to right: laser, ball lens, PVC pipe, focuser, objective in PVC bushing to fit focuser.



**Photo B.** Picture of another beam expander using old objective portion of spotting scope with the laser and first lens in PVC pipe at far left showing diversity in construction that also works well. It's the optics, not the construction methods.

## The Code Mode

*You hear a lot of talk about what programs work best for certain purposes. As one ham mentioned recently, this is akin to discussing religion. The latter is definitely a ham no-no, but the former can really bring an on-the-air discussion alive. Usually everyone leaves in a good humor, because, regardless of the opinions expressed, it is understood that they are simply opinions.*

I write some of this opening statement because I realize you readers each have your own thoughts on hamming with CW. For a long time, that was my favorite mode because I found great success with a modest station and it has always been an easy mode for me. That last part sets me apart as one of the more fortunate hams who simply did not have to struggle to pass all those code tests.

That aside, things have changed. I got into and became instantly addicted to these digital soundcard modes, and let the CW slide. Still, to me, it seemed folks should do CW *the old-fashioned way*. That is, with earphones, sharp filter, pencil, lots of paper and a manual log. I had looked at a few keyboard CW programs and was not overly impressed. The decoder between the ears always won the receive end.

### Why CW software?

Then I got to wondering why there are so many pieces of software written lately to perform this task, and suddenly it came to this old ragchewer there is another side to all this. Some hams engage in a sport called contesting and they do that on CW also! It surprises me what comes to mind when I engage the brain cells.

Well, to get into this and get it said, the CW software that seems to receive the most accolades that is strictly written to be used for CW is CwGet and CwType, available from the DXSoft Web site found via *The Chart* on the Web. These two programs work together and also with the AALog, which is found at the same Web site. You get all these, and you have about as good a setup for working modern-day, soundcard CW as can be found.

I am only displaying the receive portion

(CwGet) for the article because that, to me, is the critical part of the setup. The CwType is the transmit program, as you probably guessed, and it has the expected macros, 36 in all, and the necessary parameters to adjust the sending speed as you would expect. In fact, a screenshot of the CwType and AALog would be very reminiscent of the December shot of TrueTTY and AALog. The AALog is an excellent log program, as I mentioned in that article.

CwGet is quite a work of art in its own right. It looks simple in the screenshot. I added color to two of the backgrounds just to break up the large white area. Colors are fully selectable by the user.

The simplicity fooled me for a minute. I fired this up on a day when there was very little activity in this mode. I ran across a small DX pile-up and a few ragchew QSOs and mostly very weak signals. Even the pile-up was educational. You will see a few buttons that are labeled "GoToMax" and "AutoGTM" — very well thought out.

These two controls are very useful when trying to keep an eye on the quick interchanges. Since CW operators are not so oriented as PSK ops to being exactly on frequency, it is very handy to have the cursor leap automatically from one strong signal to the other instead of you trying to do it mechanically with the tuning knob or mouse. I noticed the change would usually take place and lose maybe two characters from the beginning of the next station's text. Score one for the software.

Most of the signals were registering about S-nothing to S-2 so I felt this was a good test day. Often, I have tried CW reception with other software and the only thing I could copy was "perfectly" sent machine code such as from W1AW. Today, I got to

observe signals that were a little "iffy" for ear detection plus I got to see what that Threshold setting was used for in the oscillograph at the bottom of the screen.

Actually, that threshold setting was my very first learning experience with the software. I tuned across a few signals that were quite well defined in my ear and saw they were not printing on the monitor. Even though I had read the rather brief instructions in the Help File, it did not matter — I still had to put the brain in gear and think about what had been said.

The screenshot has the AutoThres button activated so you cannot observe the line that was drawn in the middle of the oscillograph before that button was clicked. I experimented at first with moving this line down below the peaks of the decoded signal, and "Bingo!" — print magically appeared.

Even though the author does not claim the Auto Threshold control to be as accurate as he would like, I found it does amazingly well dividing the good stuff from the bad, as the print was doing pretty well toward the bottom of the receive pane in the screenshot. And, by the way, the signal was reading S2 on that last few lines. I believe the speed was about 22 wpm.

I also found a station sending CQ at about 15 wpm with an S0 reading and the decode on that was about 80 percent. I think some of it was timing, probably using a paddle by the sounds of it, plus there had to be some noise factor. What was happening in that case was some of the dits and dahs were being swapped to adjacent letters and confusing the issue. But, even so, this was pretty good considering the marginal conditions.

All in all, this is excellent CW receive software and it has its place for the modern-day ham who uses other such software

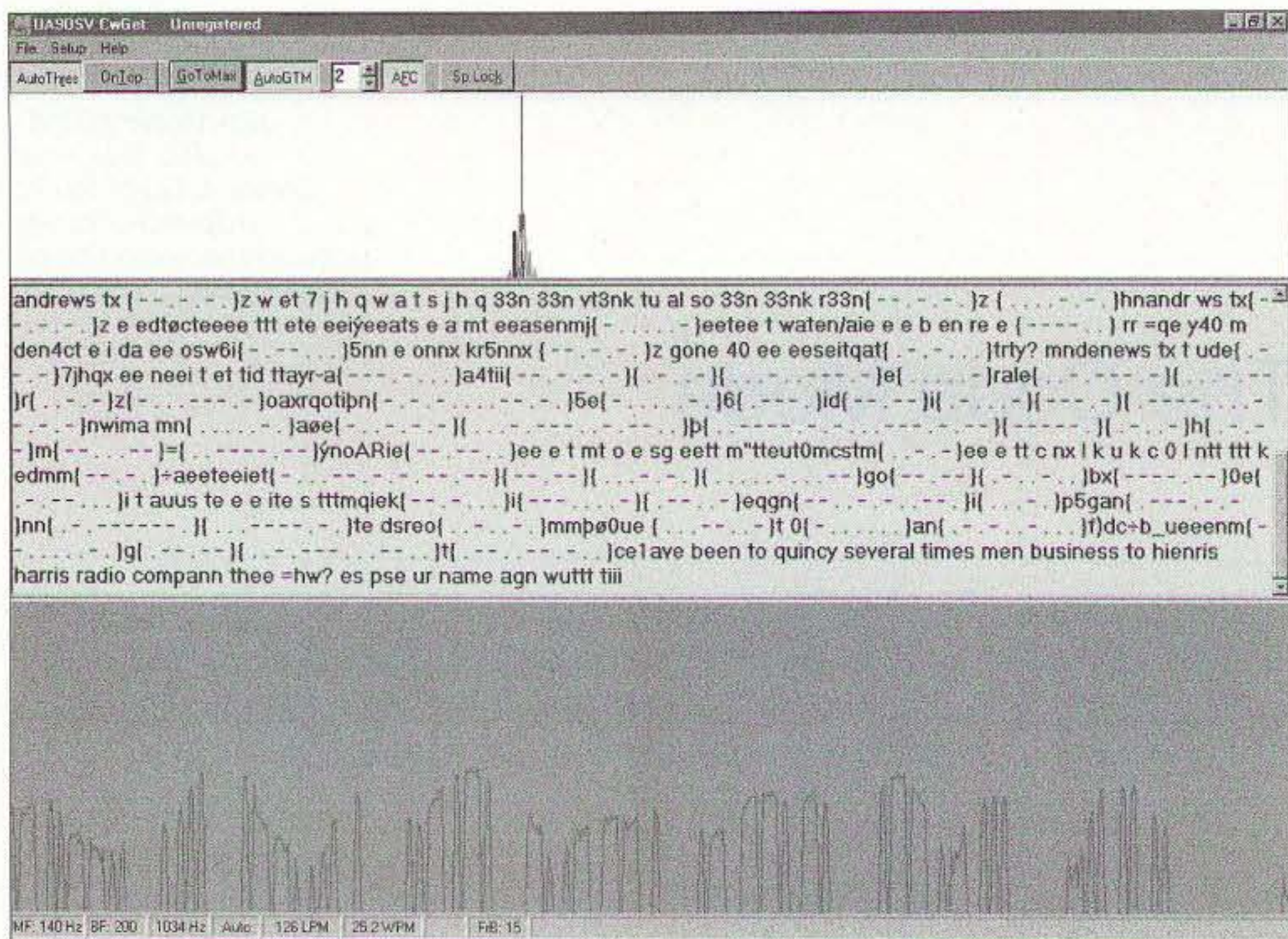

**Fig. 1. CwGet** — This is a receive-only program that integrates with CwType and AALog (see text). I feel the receive software is the most critical and this program receives the highest praise from users. It does a pretty fair job of copying CW under marginal conditions. You see readable print on the last few lines and this was about an S2 reading on the S-meter. The oscillograph at the bottom is a necessary pane. That allows a manual adjustment of the threshold (indicator does not show here because it is in auto mode). It is a lot of the secret of getting good print. The author has built in some very well-thought-out features. You will notice the “blank” spaces where the print does not exist. When unrecognizable code comes into the program, it displays the dits and dahs so you may try to make sense of it if it is critical, such as a call sign. Also the Go To Maximum Signal option is very handy (see text). You can download this software and give it a try before registering. This copy is unregistered.

and wants to get in on some of the CW action, keep a log, and do it the easiest way possible. You still need to know the Morse code, but there again, if you use this program long enough, I guarantee you will increase your skill in this area and enjoy it all the more.

Lest I forget to mention (and I was), the CwGet is shareware at \$35, but the CwType, with all its attendant bells and whistles is free for the download! The AALog: I just

checked, and it has a price posted of \$49. If you recall from the December article, I was able to get AALog up and strutting its stuff with an unregistered copy. Today's CwGet screenshot is also unregistered. This means you can give this combo a pretty fair test before you spend your hard-earned ham dollars.

### New stuff

Now that we are past the fun part, I will tell you of some of the things that are in progress and their attendant challenges. Different areas seemed to fall apart the last week or so and I have not found all the fixes for them as yet.

One silly little nagging problem started a day or so ago when, out of the blue, this computer stopped communicating with its modem. At this writing I am having to use another computer to get on-line. Sometimes that can be quite an inconvenience, but hopefully I will find a solution for this minor annoyance in the next day or so. But that is small stuff — not to sweat, as they say.

The Linux ordeal proceeds. As I mentioned

last month, I bit on one of the little cheapo computers from Wal-Mart on-line. They have (had?) a little Microtel unit loaded with the Lindows operating system for \$200 without a monitor or modem. If you buy one of these, believe me, you need the modem. It is the heart of their service (sales) platform.

Also, I found I needed a fairly late-model monitor capable of at least 800 x 640 (best with 1024 x 768) resolution. I tried two old monitors here and had to settle in with swapping the new 19" monitor back and forth with this computer. But it is working. Sometimes this ham shack resembles a used baling wire repository. If the government looked in here they might suggest this as a candidate for the nuclear waste dump. Gotta clean up my act <grin>.

The story on the modem is that there are so few modems that are Linux-compatible that it is best to order the computer with it installed to get the right one. I installed the wrong one and had to pay extra to get them to send the correct version. Later, I ran across a Linux info sheet of about five pages explaining why this was necessary. Not worth repeating here, just take their word for it.

The real thrust of Lindows appears very good on the surface for an average wannabe computer user who knows he has to have a computer “because everyone's doing it” but is not sure what to use it for once he gets it. The Lindows folk have an extensive library of “free” (well, read on) Linux software they have configured for download to their customers that includes automatic installation at the end of the download. You simply start the download and when it is done you are ready to use the software. Very slick for a Linux project.

Now the downside — it is not for hams. I downloaded a few of the Lindows packages, because you get your first ten downloads free, and was really impressed. Then I tried to install KPSK, which is not from the Lindows arsenal. The best I can see, it cannot be done. I verified this with an experienced ham Linux user when I sent him a copy of the failure execution lines.

I should mention the cost of the free Linux software from Lindows. After the first sampling of free downloads, you are invited to purchase a membership for about \$130 that includes capability to download anything in their library plus some updates and other benefits. It is a pretty good deal for those folks mentioned above, but still won't help you one bit with the ham applications.

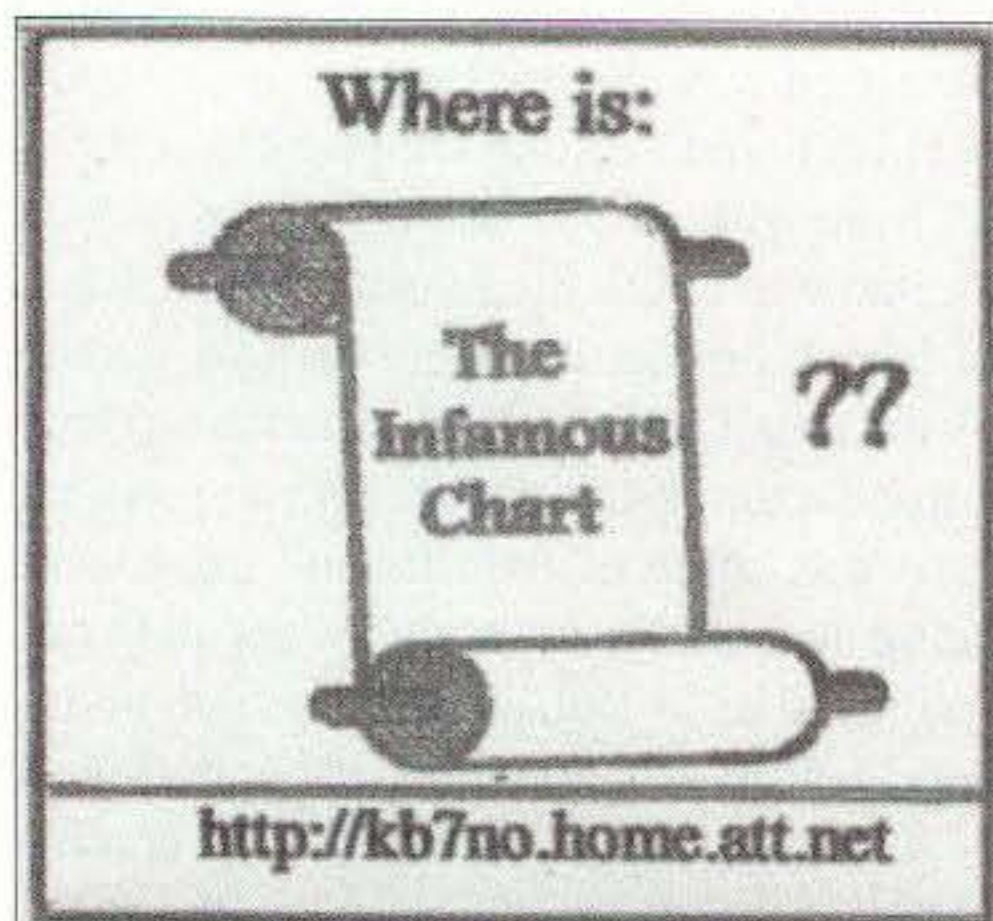

**Fig. 2.**

*Continued on page 58*



## The Ham in Winter

*Wintertime offers a few special opportunities for the radio amateur. It's too cold and gets dark too early to spend much time outside, so climbing towers and adjusting antennas is often not too practical. Likewise, for many of us, this is not the time of year to be installing a new rig in the family automobile.*

If we take those off the list, what are the opportunities for the ham in winter?

1. Spend some time with the local ham club. With the emphasis on amateur radio's support for emergency or public service communications, winter is an excellent time to have a face-to-face QSO. Get to know the people in your local club so that you can be a better asset in case amateur radio plays a part in a local event. If you've gotten out of the habit of attending meetings, you may be surprised at what the club is doing these days. There may be special support for the local Weather Service office or some other special event.

2. Be an Elmer — While the local club may run a class to help people get their licenses, many new hams may have difficulty using that license once they get it. In the event of an emergency we will need every operator to help out. Many new hams never develop the proficiency they need for everyday operations, much less to help out in an emergency. Remember suffering from a bad case of "mike fright" when you first got your license? It's as normal for new hams as it was for us. When I got my license, a couple of local hams held my hand through my first QSO. As a Novice class ham, I was limited to CW. One of the guys was at his rig across town with his two-meter at hand. Another was at my station. They used the two-meter rigs to make sure we were on the same frequency and correct any problems. The QSO went without a hitch, even from the perspective of a brand new ham. After getting past that first contact, I was much more confident and had no nervousness about getting on the air for my second time. Contact the instructor for the license classes and offer to help some of the current students or recent licensees. In some cases, this

will help a ham get active rather than just being a listener with a license. Likewise, some new hams never get past two meters because they never get a chance to see the fun of HF operations. Invite these folks over to your shack and act as control operator so they can make a DX contact and get bitten by the bug.

3. Do an equipment inventory — Go through the treasures of your ham shack and take a good hard look at what you're not using. Some hams would then sell those items no longer being used, but let's face it — the rest of us are pack rats. However, that old item may be able to get some good use in someone else's hands. Perhaps the club could act as a lending library so that new hams could borrow a piece of equipment for a few months to help them get experienced with operating. If the rig hasn't been used for a while it may need to be cleaned and adjusted. If you need to do that, why not have the intended borrower work with you so you can explain the features of that particular radio and why certain tests or procedures need to be done. If you are one of the more technically advanced club members and/or have access to a wider range of test equipment, perhaps you could be the person to coordinate this. The old-timer with an unused rig in the basement gets his radio checked out, the new ham gets some great training and the use of a rig. Besides, you'll have a much better idea as to what equipment may be available for use for a special event station or in the event of an emergency.

4. Join a net or two or three — Besides the ARES and RACES emergency nets, many repeaters host swap and shop nets, old-timer nets, weather nets, etc. If your repeater is quiet too often, why not think about starting a net that would benefit the

local community in some way. If nothing else, there should be a net to keep people familiar with net procedures. While moving to Wyoming, I had a hiatus from net procedures, particularly with regard to Navy MARS. I like to think that I'm a fairly competent operator, but I was appalled at how rusty I had gotten and how I had forgotten a lot of things. Smooth operating is like playing a musical instrument — it takes constant practice to stay at the top of your form.

5. Monitor the local emergency frequencies — There are procedures for LiTZ (long tone zero) in the repeater directory so that someone in need of assistance presses and holds the zero key on their two-meter rig for about four seconds to signal that they require assistance. This was originally set up for the simplex frequencies but now some repeaters are set up to respond to the LiTZ code. This does no good if no one is monitoring the frequency. Find out the LiTZ procedure for your area and monitor those frequencies on a regular basis so that if someone needs help, we'll be there to lend assistance.

6. Learn something new — Take a technical course at the local community college. Many adult education courses are offered as non-credit as almost a form of entertainment. More and more educational opportunities are available via the Internet as "distance learning" courses. The American Radio Relay League (ARRL) is offering continuing education courses on-line for a modest fee, starting with emergency communications [<http://www.arrl.org>]. Naturally I recommend this one, but if the last time you used Ohm's law was when you were studying for your license exam in

*Continued on page 59*

## 2002 AMSAT Space Symposium

*Every year AMSAT, the Radio Amateur Satellite Corporation, holds a symposium and annual meeting. It's an opportunity to review the events of the past year, discuss current operations, and plan for the future. This year's event was held in Fort Worth, Texas, at the Lockheed Martin Recreation Area (LMRA). AMSAT past Vice President of Operations, Keith Pugh W5IU, was the Symposium Chairman.*

Satellite enthusiasts began arriving at the Amerisuites Fort Worth Cityview Hotel early on Thursday, November 7th. No presentations were scheduled, but it was a great opportunity to register, and check out the Electronic Surplus Stores tour of the Dallas/Fort Worth Metroplex.

### Friday

The AMSAT Symposium and Annual Meeting is not a hamfest, but is similar to a gathering of professional engineers that just happen to be hams with a passion for cutting-edge, space-based communications. A few displays were in evidence just outside the main meeting room for The SETI League (Search for Extraterrestrial Intelligence) and AMSAT. Bob K5GNA had 2.4 GHz downconverter systems and components for sale. A few other electronic distributors were also in attendance with

esoteric microwave gear and hard-to-find parts.

An antenna test range was set up in a nearby softball field. Many UHF and microwave antennas were tested by Kent Britain WA5VJB. Al Ward W5LUA was inside with gear to measure preamp and downconverter noise figures and conversion gain. For those who remembered to bring their favorite homebrew or commercial antennas and electronics, it was a great opportunity to get some accurate measurements by the pros.

Robin Haighton VE3FRH provided opening remarks for the beginning of the 20th Annual AMSAT Space Symposium and General Meeting at the LMRA. Robin stressed that the future of AMSAT's projects is directly related to donations from the AMSAT membership. Robin also congratulated the designers and builders of AMSAT-

OSCAR-7. The rebirth of AO-7 was an amazing highlight of 2002. Pat Gowen G3IOR was the first to report the mysterious signals on 145.975, which were later identified as telemetry from AO-7 after over 20 years of silence.

Keith Pugh W5IU and Doug Howard KG5OA welcomed those attending to the "better half" of the Dallas/Fort Worth Metroplex and gave some symposium updates

prior to the first presentation by Anthony Monteiro AA2TX.

Tony has built some simple S-band disposable antennas for AMSAT-OSCAR-40 reception. Using such exotic materials as cardboard boxes and aluminum foil, Tony's pyramidal horn creations work well. Tools needed are as simple as the materials: single-edged razor blades, a tape measure and some marking pens. Left-over foil and cardboard, after the initial horn construction, can be used to make a disposable transmit antenna. A corner reflector and dipole for the 70-cm uplink on AO-40 takes care of any remaining material. Tony pointed out that if you have a lot of leftover materials, you can make a really big corner reflector for more gain. While the original corner reflector had about nine dB of gain, the large version had 14 dB, thus providing good-quality contacts out to apogee (60,000 km). The results have been great. Easy DX and quality contacts with nothing more than household materials for the antennas have inspired a number of curious variations.

Gould Smith WA4SXM followed Tony with an informative talk about the effects of environmental factors on AO-40 S-band reception. The bottom line was avoid buildings and trees. The attenuation caused by foliage is substantial at microwave frequencies.

Dr. Paul Shuch N6TX of The SETI League provided some thought-provoking insight into the use of small 10-foot surplus dishes to monitor 1420 MHz for the possible reception of extraterrestrial signals. Project Argus was begun in 1995 in an attempt to coordinate 5000 receive stations covering the sky. Paul's new focus on



**Photo A.** Al Ward W5LUA tests another 2.4 GHz preamp while Fred N5JXO and Andy W5ACM watch at the 2002 AMSAT Space Symposium in Fort Worth, Texas. (K5ENG photo)

*Continued on page 50*

# ADVERTISERS' INDEX

R.S.#	page	R.S.#	page	R.S.#	page	R.S.#	page	
• Alinco .....	CV2	99	Communication Concepts	13	• M <sup>2</sup> .....	58	• Radio Book Shop .....	52
• Alinco .....	CV3	•	Communications		• Michigan Radio .....	49	• Radio Book Shop .....	56
• All Electronics Corp. ....	19		Electronics, Inc. ....	5	• Omega Sales .....	24	• Radio Book Shop .....	57
• Amateur Accessories .....	29	10	Communications		• Omega Sales .....	37	• Radio Book Shop .....	63
16 Astron Corporation .....	2		Specialists, Inc. ....	13	• Omega Sales .....	58	34 Ramsey Electronics .....	3
• ATOC Amateur		13	Doppler Systems .....	37	• Radcomm Radio .....	55	• RLS .....	15
Distributing Corp. ....	CV2	•	Dudley Lab .....	58	• Radio Book Shop .....	13	254 Ross Distributing .....	21
• ATOC Amateur		•	Fair Radio Sales .....	21	• Radio Book Shop .....	15	• Scrambling News .....	13
Distributing Corp. ....	CV3	•	Hamtronics, Inc. ....	9	• Radio Book Shop .....	22	• SGC .....	7
42 Bilal Company .....	29	•	Houston Amateur		• Radio Book Shop .....	24	• Universal Radio .....	21
168 Buckmaster Publishing .....	22		Radio Supply .....	24	• Radio Book Shop .....	37	• West Mountain Radio .....	15
56 Buckmaster Publishing .....	29	42	Isotron .....	29	• Radio Book Shop .....	41	• Yaesu .....	CV4

When you buy products from these advertisers, please tell them that you saw their ads in 73.  
 Subscribe to 73 right now...call 800-274-7373 (9-5 Monday-Friday EST).

**WE SHIP WORLDWIDE**  
**Michigan Radio**  
 SALES SERVICE

Local & Tech 1-810-771-4711, Service 1-810-771-4712, Fax Service 1-810-771-6546

OPEN  
 TUES, WED, THUR 10-6  
 FRI 11-8  
 SAT 10-3  
 CLOSED SUN & MON

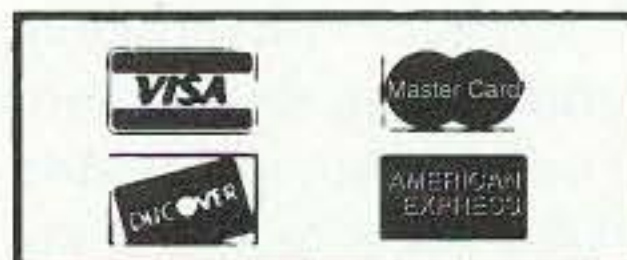

Terms do not include shipping. Price and availability subject to change without notice. Most orders shipped same day. COD's welcome (\$5.50 & shipping).

26014 Groesbeck, Warren, MI 48089  
**1-800-TRU-HAMM** (orders only)  
 (800-878-4266)

Now on the World Wide Web

<http://michiganradio.com>

E-mail [mirad@mich.com](mailto:mirad@mich.com)



TM-V7A

TM-261

TH-D7A

**KENWOOD**



TM-G707A



TS-570S

TS-870S



IC-746

**ICOM**



IC-W32A

IC-Q7A

IC-T8A



FT-2600M

FT-100



FT-847

**YAESU**



FT-8100R



VX-5R

FT-840

FT-50R

Convert Excess Equipment to CASH • We buy good, clean, used equipment • Estate Sales

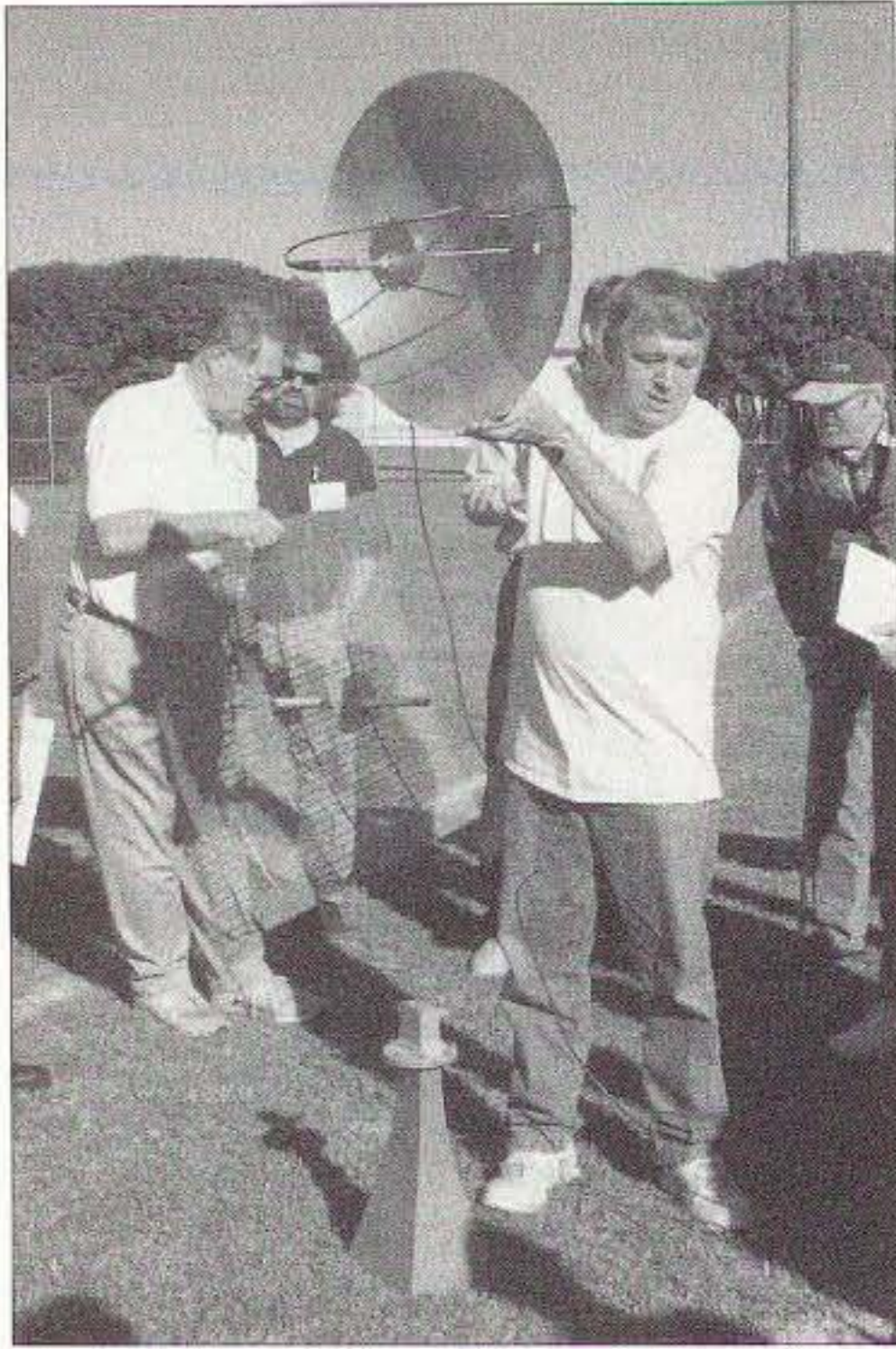

**Photo B.** Kent Britain WA5VJB checks the gain on a circular-feed dish for AO-40 reception on the antenna test range at the Lockheed Martin Recreation Area.

## HAMSATS

continued from page 48

the Very Small Array (VSA) design is a prototype system that incorporates eight 1.8-meter dishes complete with mounting hardware and other components. Paul showed photos of the installation of the dish array and discussed plans to finish the needed electronics to put the VSA into operation. More information about The SETI League and their projects can be found on the Internet at [www.setileague.org].

After lunch, Doug KG5OA introduced the AMSAT-OSCAR-7 team and paper presenter Mike Seguin N1JEZ. Mike has been

working to send control commands to AO-7 using gear that has been lying dormant for over two decades. He discussed the long history of AO-7 since launch in November, 1974. AO-7 had a design life of three years. It lasted 6.5 years in its first incarnation. Jan King W3GEY, Perry Klein W3PK, Tom Clark W3IWI, Dick Daniels W4PUJ, and Art Feller W4ART provided first-hand anecdotes and personal insights while Mike showed slides of the various components inside AO-7. This still-functioning antique hamsat is the oldest functioning satellite built with CMOS (Complementary Metal Oxide Semiconductor) integrated circuits. It is also a shining example of what can be accomplished by dedicated volunteers.

Gene Chapline K5YFL followed with his presentation on "How Kids Can Talk to Space People (Who are Aboard the International Space Station)." Gene described the process of scheduling and successfully completing school contacts with astronauts onboard the ISS. It's not a trivial process, but Gene did a great job distilling the events into a succinct description.

Kent Britain WA5VJB captivated the audience with his talk on the fads and fallacies of antennas. Metal booms and coax lines have very little effect on satellite antennas when the antenna elements are not parallel to the supporting boom. Varnished wood is better than PVC for antenna construction. Kent put an end to many pieces of antenna misinformation.

An intriguing ground station was recently constructed by Bruce Paige KK5DO and Jerry Brown K5OE for use by Ed P5/4L4FN in North Korea. Ed has been operational on the HF bands, but with the new gear, Ed would hopefully be able to provide some excellent DX for satellite enthusiasts. The station consists of a typical BBQ grill-style

antenna with downconverter for the S-band downlink and a short linear yagi for the 70cm uplink. Bruce showed photos of the system that was configured to be small enough to ship, yet still be effective for AO-40 communications. Bruce is the QSL manager for Ed while he is in North Korea. Unfortunately the North Korean government recently told Ed to pack up all of his ham gear and take it out of the country — not to return. Ed hopes to operate again on HF, and satellite, from a new rare location in the near future.

Nick Pugh K5QXJ described his experiences using sun noise to verify the performance of an S-band antenna and receiver system. Use of the sun as a signal source is easy, repeatable, allows for result comparisons, provides a way to measure incremental improvements to a system, and recognizes system degradation over time. Measurements are made with an AC voltmeter connected to the receiver's speaker output with the AGC deactivated. Using straightforward equations to compare sun to no-sun readings, the system's performance can be computed. Nick made it look easy.

Jerry Brown K5OE has done extensive testing with dual-band (23 and 13 cm) dish feed systems for AO-40 operation. Following the highly successful use of Jerry's design in front of a surplus five-foot dish on Field Day 2002, he has optimized his design for better performance. More information can be found at Jerry's Web site [http://members.aol.com/k5oe].

Jerry invited Robert Suding WØLMD to provide further information on other multi-band circular feed designs. Robert has a very interesting dish feed design that covered 70, 23, and 13 cm simultaneously. Robert encouraged those at the symposium to visit his Web site for construction details — [www.ultimatecharger.com/dish.html].

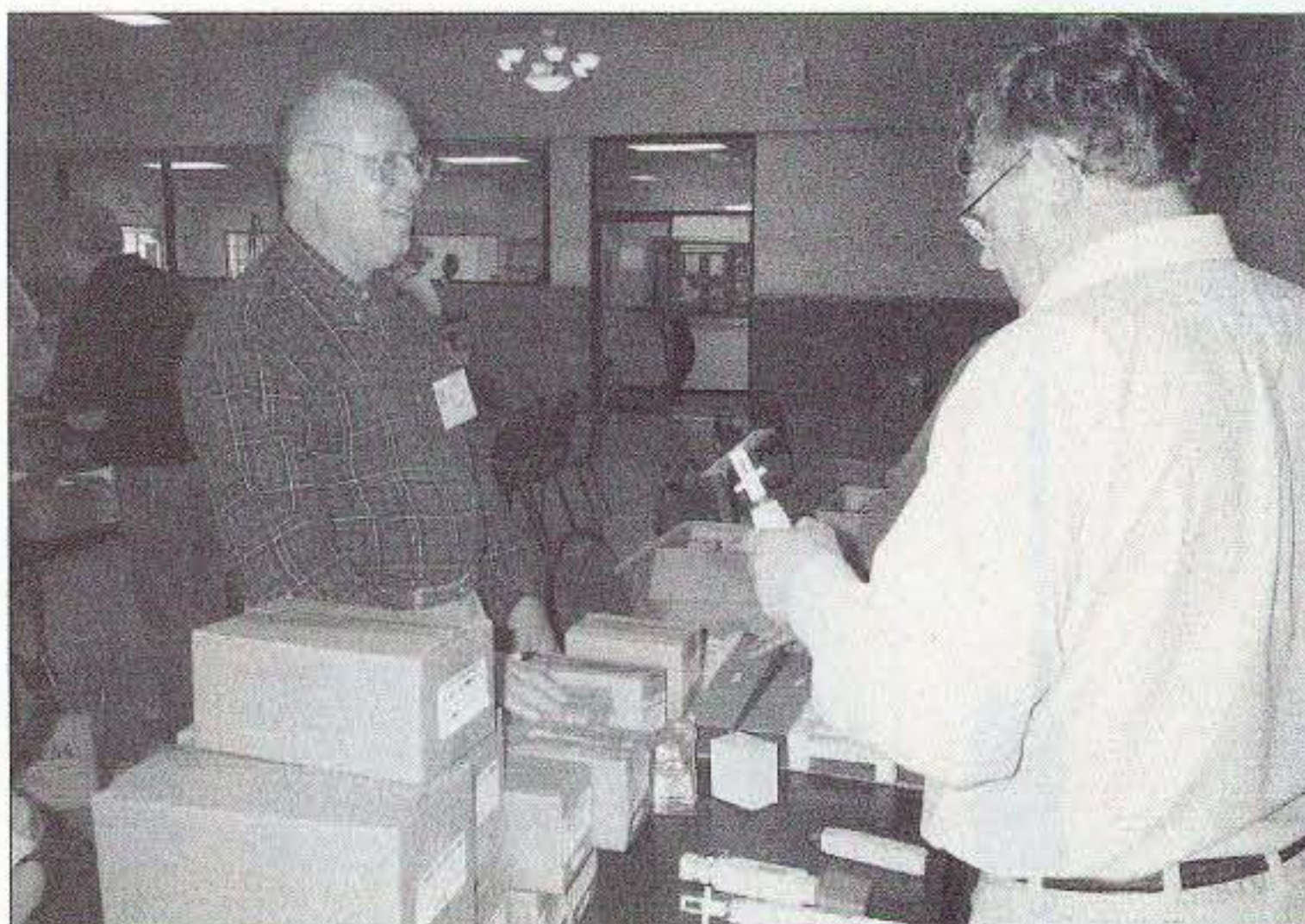

**Photo C.** Bob Seydler K5GNA brought plenty of "plug-and-play" 2.4 GHz gear for sale at the AMSAT meeting.



**Photo D.** AMSAT President Robin Haighton VE3FRH and AMSAT VP of Human Space Flight Frank Bauer KA3HDO at the AMSAT Space Symposium.

## Saturday

Robin Haighton VE3FRH got things started on Saturday morning with more welcoming remarks and a financial status report. Like many volunteer organizations, AMSAT had difficulty with donations in 2002. In order to keep both Project Echo and Eagle moving forward, Robin has initiated new programs to encourage donations for these two new satellite programs.

Richard Hambly W2GPS reminded the attendees that it has been 12 years since AMSAT-NA built the microsats. There have been versions of these small hamsats built by groups in Italy, Mexico, and elsewhere. AMSAT-OSCAR-E, or just Echo, is the next small-satellite project.

Echo will be about 10 inches on a side, weigh 22 pounds, have solar cells on all sides, and of course a number of antennas on at least two sides. Details of the satellite have been presented before [<http://www.amsat.org>], but Rick provided a review of the basic capabilities. The satellite has two 12-watt, 70-cm FM transmitters with four two-meter FM receivers. An additional receiver is multiband and multimode. The satellite can be configured for simultaneous voice and data, or any combination desired.

On the digital side, data rates up to 56 kilobaud are supported with new encoding schemes, but the satellite will also run the popular 9600-baud packet format found on current digital satellites, and supported by TNCs (Terminal Node Controllers) found in many of today's advanced radios.

On the analog side, the receivers will have two CTCSS decoders to hopefully keep out some of the noise and non-ham transmissions that have plagued other FM satellites. The multiband, multimode receiver is more like a super-high-end scanner that can be programmed from the ground for almost limitless experiments including onboard voice recording.

Echo will use six Nickel-Cadmium (NiCd) batteries with 4.4 Ah capacity for a nominal eight volts. The solar panels are high-efficiency triple-junction, Gallium-Arsenide (GaAs) units running at 27 percent efficiency. They are some of the best solar cells available. Complete copies of Rick's AMSAT symposium presentations with background information can be found at [[www.gpstime.com](http://www.gpstime.com)].

On a related topic, Rick continued with the topic "Microsat Design — What Do People Want?" There has always been a rift between the users and the builders. Users typically want things that they have had in the past while builders want to do something new. Fortunately for users, "new" can be advanced versions of previous successful and popular modes and bands, but there will always be a new mode or band that will keep everyone moving forward with technology. The 70-cm uplink on AO-7 was certainly a stretch for many hams in 1974. Now it's easy with off-the-shelf gear.

Stan Wood WA4NFY and other members of the Project Eagle staff presented updates on the systems to be included in Project Eagle. While the overall features are the same as the original proposals, detail work has been done on the power system, structure design, and the internal modules.

The final orbit for Eagle will be a modified GTO (Geostationary Transfer Orbit). An internal fuel tank and rocket motor will be used to raise the GTO perigee (low point) from 200 km to nearly 1,000 km. Remaining fuel will be available for adjusting the orbit for good satellite availability around the world, and also to deorbit the satellite at its end of life.

Frank Bauer KA3HDO finished the morning with an ARISS (Amateur Radio on the International Space Station) status report. Nine countries are now involved with ARISS. The current systems on the space station include low-power VHF and UHF voice and



*Photo E. Doug Howard KG50A models a tri-band circular feed system, built by Robert Suding WØLMD, during Jerry K5OE's talk on dual- and triple-band dish feed systems.*

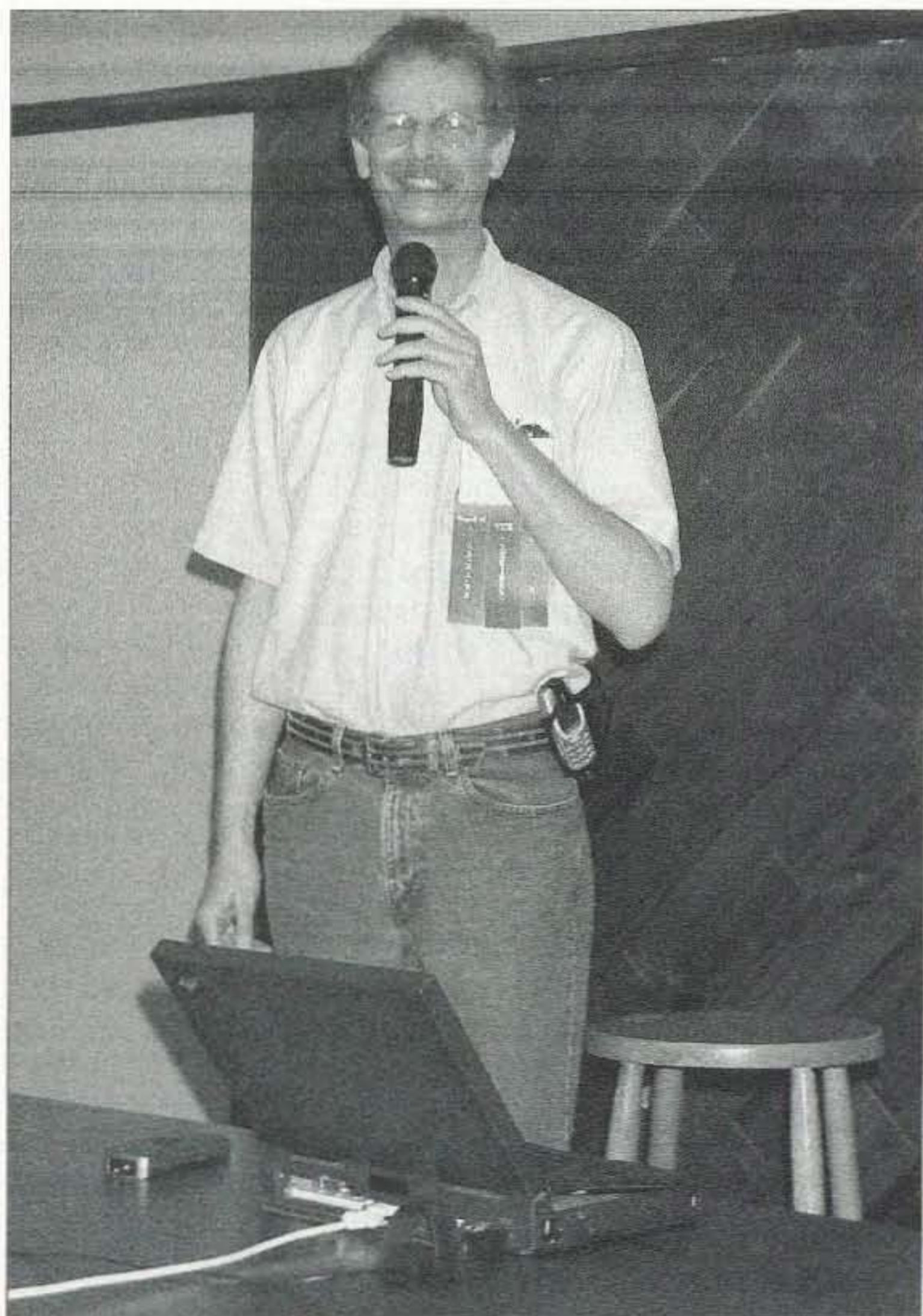

*Photo F. AMSAT VP of User Services, Bruce Paige KK5DO, describes the portable AO-40 ground station that he and Jerry K5OE built for possible use in North Korea and other remote DX locations.*



**Photo G.** Symposium Chairman and past AMSAT VP of Operations, Keith Pugh W5IU, makes a contact via AO-40 using the Lockheed Martin Amateur Radio Club station during the AMSAT Symposium.



**Photo H.** Howard G6LVB listens for AO-27 using an Arrow antenna and a small dual-band HT outside the main hotel for the 2002 AMSAT Space Symposium.

packet gear. SSTV (Slow Scan Television) is to be implemented soon as part of the second phase of the ham radio system. Other new items include higher-power VHF and UHF radios and HF operations. Future efforts will include FSTV (Fast Scan Television), more imaging options, improved packet systems, and equipment to be mounted on an Express Pallet unit.

Following yet another meal, Jim White WDØE and Bdale Garbee discussed the history of RUDAK (Regenerativer Umzetzur fur Digital Amateurfunk Kommunikation), its German roots, and the current status of this digital communications system as configured for AO-40. The first RUDAK was onboard the now silent AMSAT-OSCAR-21. AO-40's version provides a communications link to the experiments onboard AO-40 in addition to a digital store-and-forward BBS and digital repeater. A few of the experiments that operate through RUDAK include the radiation monitor CEDEX, numerous temperature sensors, a pair of NASA GPS receivers, a pair of color CCD cameras called SCOPE, and an HF scanning receiver known as MONITOR. The RUDAK system is completely operational with only a few exceptions. It takes more uplink power than expected to use RUDAK, and some experiments like MONITOR cannot be used until the satellite is reconfigured for three-axis stabilization.

Phil Karn KA9Q followed with his proposal for an FEC-coded (forward error correction) AO-40 telemetry link. The use of this transmission format would work dramatically better than the current

uncoded system during fades, and when downlink signals are weak but without fading. While the current effective telemetry data rate is 400 bps (bits per second), using Phil's proposed format will yield a slower apparent rate of 160 bps, but the effective throughput will be much more robust under difficult conditions. While the throughput will appear to be only 40 percent that of uncoded for extremely strong reception (10 dB signal-to-noise ratio), when signals fade, the coded signals will come through with much better results (2 dB signal-to-noise ratio). If Phil's system is used on AO-40, the changes to the current user telemetry software AO40RCV would be a simple update, and it would continue to work well with the user's PC soundcard. Phil recommends that the FEC-coded format be implemented on all future AMSAT spacecraft. Open-source code for Phil's system can be found at [<http://www.ka9q.net>].

Jerry Brown K5OE presented the last paper of the symposium, "A K-Band Receiver for AO-40 (For Less Than a King's Ransom)." There are two fully functional transmitters on AO-40, one on 2.4 GHz (the most popular) and one on 24 GHz. While receive gear for 2.4 GHz is easily available, it's not so easy for K-band, 24 GHz reception. Even Jerry couldn't make it look easy, but he certainly removed a lot of hurdles that most hams encounter when moving up to 24 GHz.

Saturday continued with the AMSAT General Meeting and AMSAT banquet. The keynote speaker this year was Chris Imlay W3KD, the American Radio Relay League General Counsel. Chris provided insight into the political and legal circumstances surrounding the future of many commercially desirable ham bands. The

evening concluded with awards presentations and prizes. Ranging from coffee mugs to expensive radios, the drawings were great fun. The Lockheed Martin group did a fantastic job.

### Sunday

Once again activities got off to an early start, this time with a Field Operations Breakfast hosted by the AMSAT VP of Field Operations, Barry Baines WD4ASW. This was soon followed by a tour of the Lockheed Martin Aeronautics Company. Security was tight, but any inconvenience (no cameras) was overshadowed by the insider's view of the place where F-16 fighters are born. Components for F-22s and the new Joint Strike Fighter (YF-35) will also be made at the facility.

For those that wished to stay after the tour, it was time for the AMSAT Board of Directors Meeting. With the exception of a short time of closed-session discussion, the Board meeting was open to AMSAT members, and was quite interesting as future projects were presented, finances analyzed and problems solved. The process lasted through Monday. A complete transcript is printed in the *AMSAT Journal* that is sent to all AMSAT members. Many of the papers presented at the AMSAT Space Symposium are printed in the proceedings, available for \$20 from AMSAT and the ARRL.

Start planning now to attend the 2003 AMSAT gathering in Toronto, Canada. Projects like AMSAT-NA's Echo, and AMSAT-DL's Phase 3-E should be well on the way to launch. Reports on other international and educational institution hamsat programs will be prominent. Don't miss it.

Say You Saw It in 73!

## Doppler Fun, from Austria to Your Hometown

*The Doppler Principle wasn't discovered by a ham. Its originator died two decades before Marconi was born. But when most hams think of high-tech radio direction finding (RDF), Doppler sets come to mind. This first installment of a new "Homing In" series traces the development of technologies that began with a scholar whose 200th birthday we celebrate this year.*

A great deal has been written about Christian Doppler and the effect named after him, but much of it is inaccurate. Many sources even have his given name wrong, stating it as Johann Christian, or the reverse. Dr. Alec Eden, himself a pioneer in the use of the Doppler principle for medical applications, found Doppler's baptismal records at a small church in Salzburg.<sup>1</sup> Dr. Eden discovered that the Austrian physicist/inventor's full name was Christian Andreas Doppler.

Christian Doppler was born into a family that had built a successful stonemasonry business for 125 years, but his health was always too bad for that arduous occupation. After studying mathematics and astronomy at two institutes in Vienna, he sought a career as a professor. Despite being quite ambitious and having already published four papers in mathematics, he was turned down for several positions.

To make ends meet, Doppler spent almost two years keeping the books for a cotton cloth factory, becoming more despondent as the months went by. At one point, he sold his possessions and went to Munich to arrange a permanent move to America. He ended up not going, because shortly thereafter he was offered a position at a technical school in Prague, then part of Bohemia.

Some have claimed that Doppler ascribed his principle of motion affecting perceived frequency only to sound waves, and then others extended it to electromagnetic waves. Not so. His 1842 work was titled "On the Coloured Light of the Double Stars and Certain Other Stars in the Heavens." He gave an oral presentation to the Royal Bohemian Society of Sciences at the Patriotic Hall of Carolinum on the same topic. He theorized that light from double stars (stars

mutually orbiting each other) should display differing colors. The star rotating toward Earth at a given time should appear more blue to an earthbound observer and the one rotating away should be redder.

There was no way to measure tiny shifts in apparent color from stars in those days, so Doppler couldn't directly prove his hypothesis by experiment. Most astronomers poo-hooed it. Six years later, Doppler set astronomy aside and took on a new scientific interest, studying the Earth's magnetic field as a teacher at the Academy of Mines in Slovakia. His publication topics included changes in Earth's magnetic declination, another subject of interest to hams who are mobile T-hunters.

Political unrest made him decide to return to Austria in 1850, and he soon was fortunate enough to be selected as the first director of the new Institute of Physics at the University of Vienna. But by November 1852, his health had deteriorated to the point that he sought relief by moving to sunny Venice, Italy, where he died four months thereafter.

If you read somewhere that Doppler went to great lengths to validate his principle, take it with a grain of salt. He was a visionary with a love of science and an inventor

of many novel optical instruments, but his grasp of mathematics wasn't first-rate. He insisted that light waves were longitudinal, like sound, instead of transverse as French physicist Augustin Jean Fresnel had correctly theorized in his landmark paper of 1821. But Doppler did successfully predict that his principle would someday provide an important method for determining the movements and distances of stars.

### Trumpeters on a train

It was the director of the Dutch Royal Meteorological Institute who staged the most vivid verification of Doppler's hypothesis, on June 3, 1845.<sup>2</sup> Christoph Buys-Ballot was actually a disbeliever in the principle and thought he could disprove it by using sound waves. He enlisted help from a half-dozen

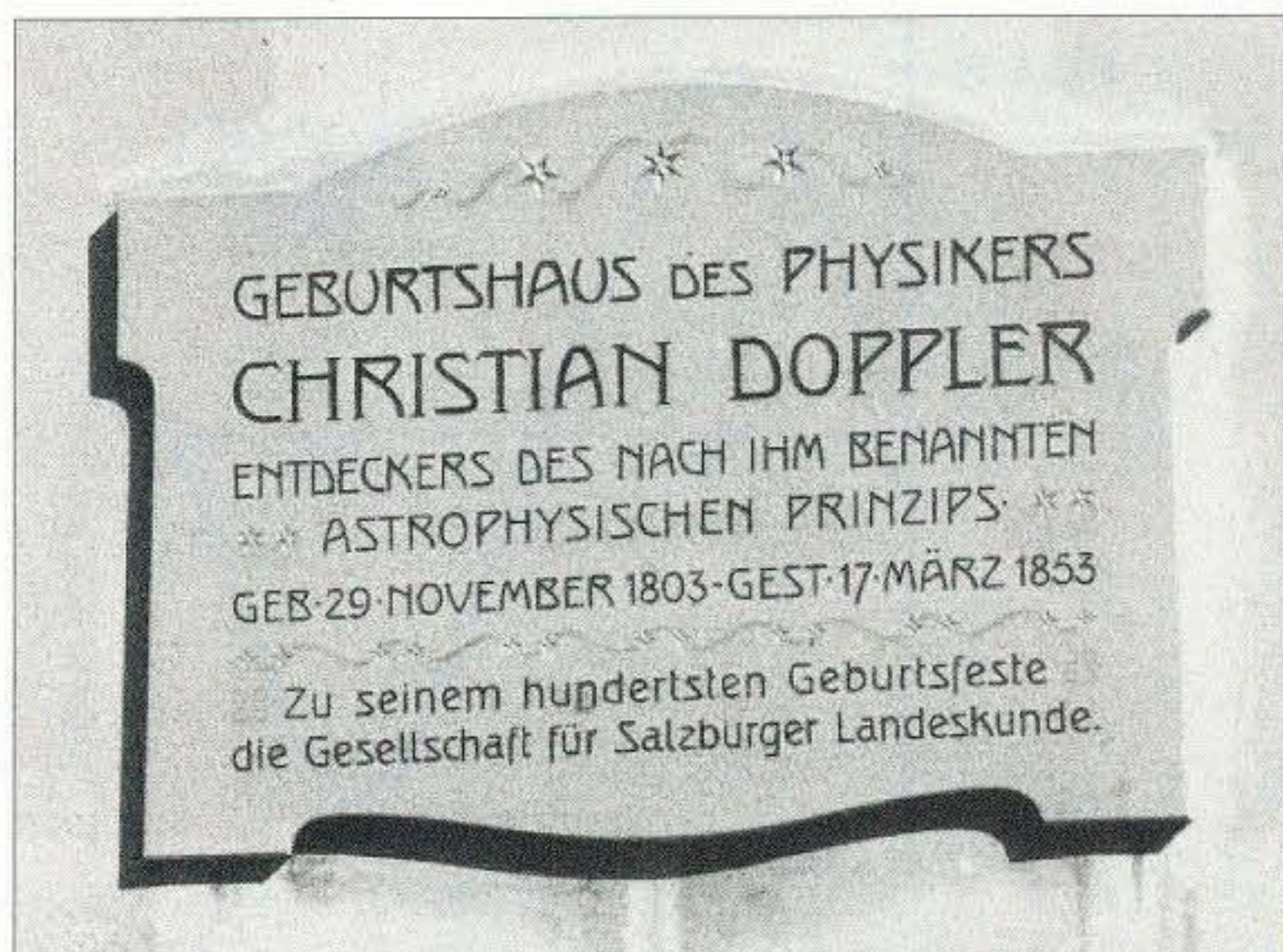

**Photo A.** Mozart wasn't the only famous person born in the "Sound of Music" city. This plaque on the house at Makartplatz 1 in Salzburg notes that Christian Doppler entered the world here on November 29, 1803, just across the river from Mozart's birthplace 47 years earlier. (Photo by Joe Moell KØOV)

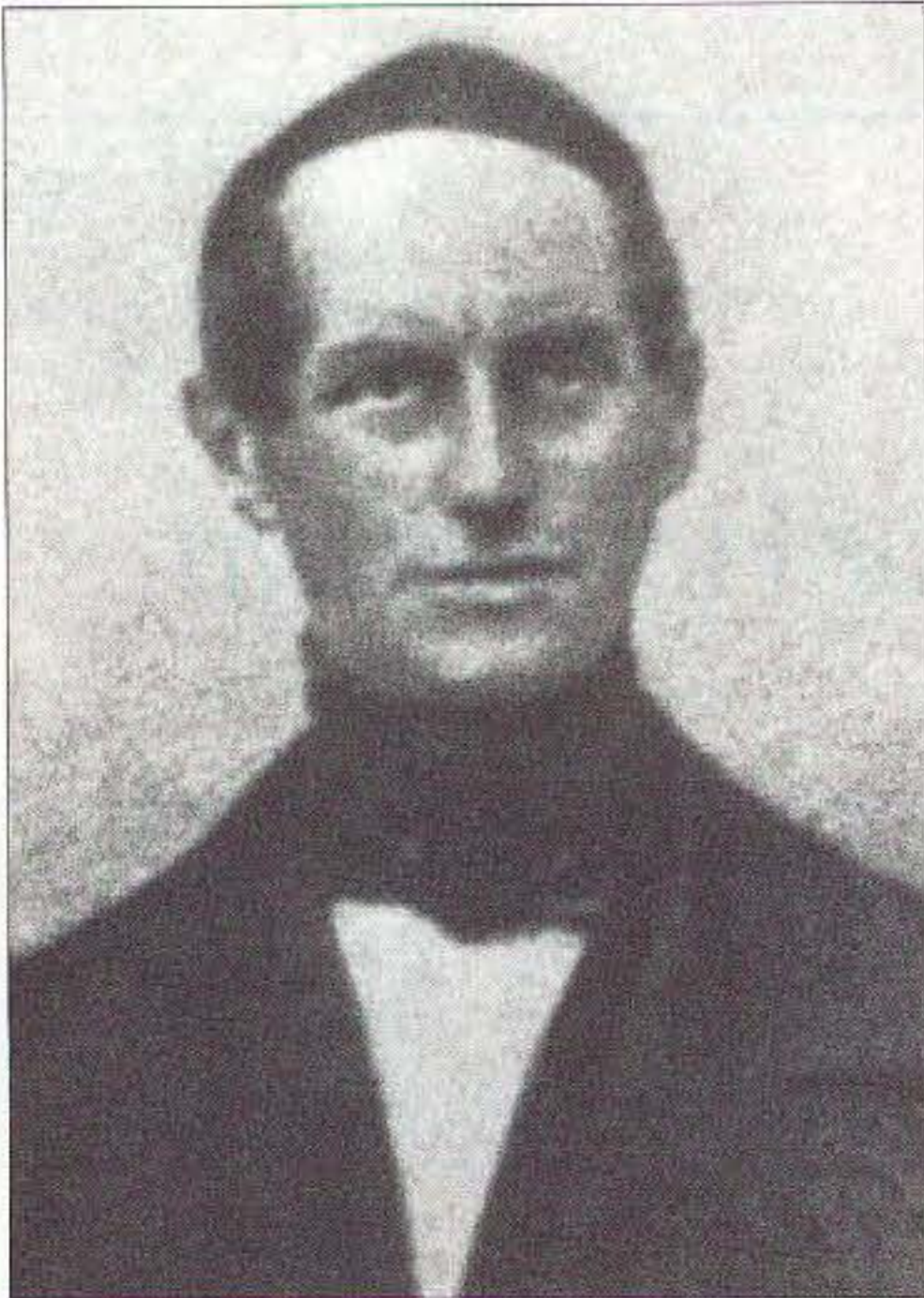

**Photo B.** This Daguerreotype of Christian Doppler is thought to have been from 1845, about six years after that silver-on-copper photographic process was invented. (Public domain image)

trumpeters with perfect pitch. Half of them rode in an open Rhine Railroad train car at high speed through Maarsen station playing a G-note, where the other half of the trumpeters stood on the platform and observed the pitch.<sup>3</sup>

The experiment was repeated on the return train trip, but this time the platform musicians played and the ones on the train listened. Buys-Ballot had calculated that if Doppler was right and if the train were moving at 46 MPH, the perceived trumpet pitch would change by a half-tone (6 per cent). Over the noise of the roaring train, the musicians agreed that it did. Despite this dramatic evidence, Buys-Ballot remained a skeptic.

Doppler published another paper further describing his principle in 1846, including movement of the observer as well as the source this time. He likened the stars' color shift to a boat heading out of port into incoming waves, making the wave impact rate appear faster than to an observer on shore. That part was right, but he didn't realize that

the relative motion of double stars is too small to create a noticeable color shift. They appear different from other stars simply because their lightwave spectrum is different.

French physicist Armand Hippolyte Louis Fizeau performed the first non-astronomical measurement of the speed of light with a rotating toothed wheel in 1849. He suggested that some amount of Doppler shift could be expected from all stars that are moving relative to the Earth. It was almost two decades later that English astronomer Sir William Huggins, the pioneer of spectroscopy, made instruments sensitive enough to show this to be true. As instruments improved, scientists measured the relative movements of stars and

galaxies to develop theories of how our solar system was formed and what its future will be.

The average non-ham citizen connects Doppler with just two things, speeding tickets and severe weather forecasts. A patrolman's radar set puts out a microwave signal and measures the frequency difference of the return signal that results from the vehicle moving toward or away from the radar. The greater the difference, the greater the speed.

Joe Citizen might not realize that ground-based radars tracking aircraft and boats make use of the principle, too. They display only the pips from Doppler-shifted moving targets and ignore all the non-moving reflections (clutter) from land objects such as buildings and hills. This Doppler-processing trick works especially well in airborne radars, which eliminate ground clutter on their displays by suppressing the echoes that appear to have exactly the same velocity as the aircraft.

Does this mean that a Doppler weather radar measures the speed of the clouds to tell which ones carry severe storms? Not exactly. Clouds usually move too slowly to create enough Doppler frequency shift, so the best way to determine cloud density and precipitation intensity is to simply measure the magnitude of the signals bounced back to the radar. That produces the multi-color "reflectivity" displays that you see on TV.

But Doppler weather radar has the additional ability to look at localized wind disturbances such as tornadoes and microbursts, by measuring the velocity of the raindrops, and even the blown-about insects! In the "radial velocity" mode, which is seldom shown on TV, a tornado produces a distinct Doppler "signature" of inbound winds next to outbound winds. Sometimes there is a pocket of no wind sandwiched between — that's the eye of the storm.<sup>4</sup>

#### RDF from orbit

The train-like situation of an object moving at a constant rate toward the observer, passing, and then moving away at the same rate is rarely found in VHF radio direction finding. The only example that comes to mind is the Search and Rescue Satellite Aided Tracking (SARSAT) system. Each of the USA's four SARSAT birds, in near-polar orbit at 528 miles altitude, passes over every point on Earth several times a day. Each one carries a Search and Rescue Repeater that receives and retransmits 121.5 MHz and 243 MHz signals to ground stations.

As a satellite passes over a squawking beacon transmitter,<sup>5</sup> its frequency appears

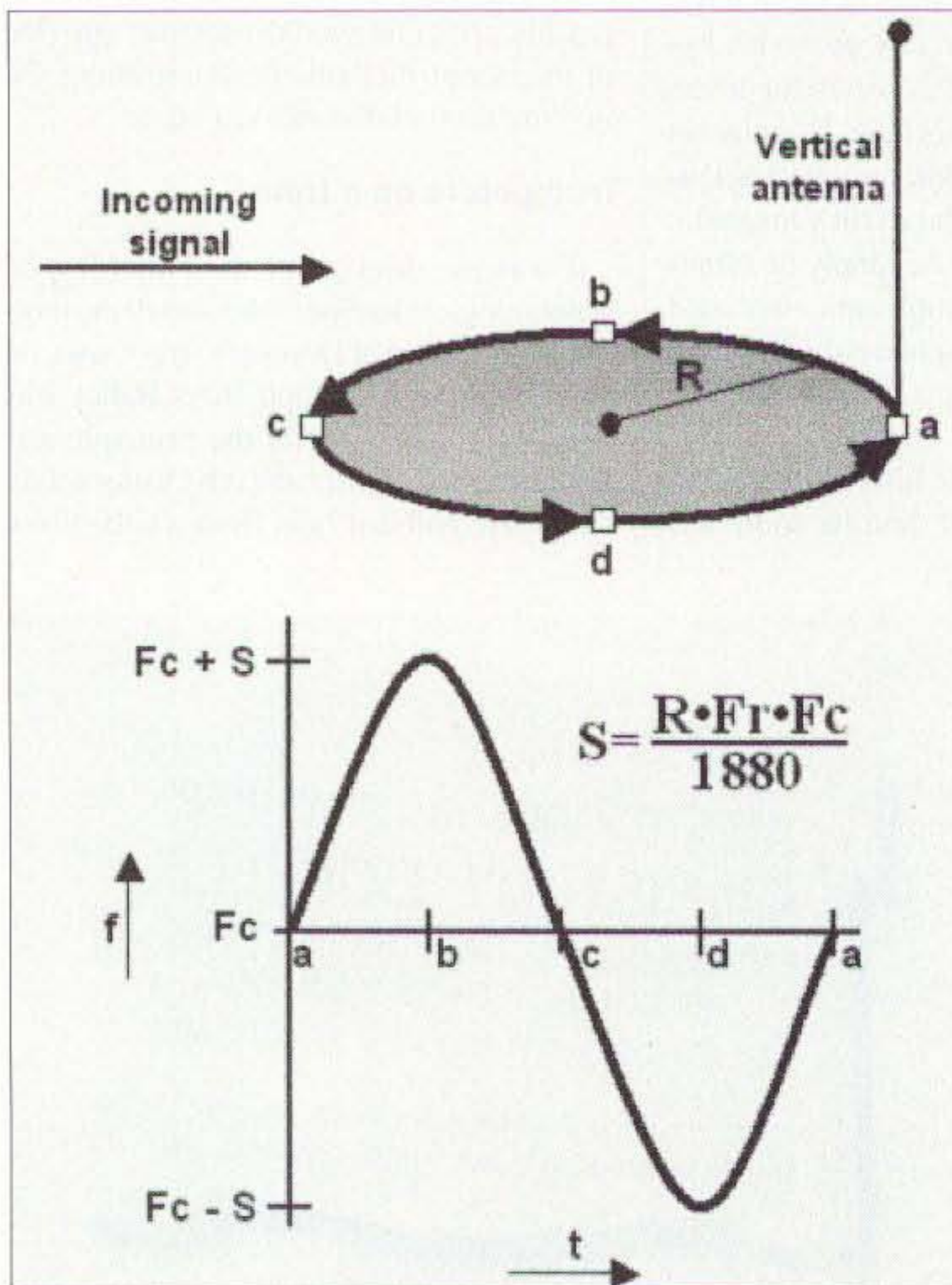

**Fig. 1.** Movement of a single vertical antenna in a circular track (top) makes received signals appear to vary sinusoidally in frequency (bottom), in accordance with the formula. This is simulated in ham Dopplers by sequentially switching three or more antennas spaced around the track, then filtering all harmonics from the stepped waveform induced in the receiver audio.





parts count from a dozen ICs down to about five. Signal processing, analog or digital, detects potentially erroneous bearings and suppresses them. Improvements are also being made to the display of bearing information. Today's Dopplers can be part of integrated mobile RDF systems that include compasses, GPS, and computer displays, as you'll learn in later parts of this series.

### How many whips?

If you go on a transmitter hunt with a bunch of Doppler fans, you'll find that most of them use four-whip antenna sets. As few as three would work, and some have as many as sixteen. No matter how many whips there are, it's important that they be placed so that they are all exactly the same distance from the center of the array circle, and they are equidistant along the circumference of that circle. Using four makes it easy to put magnetic-mount whips on a car roof, because they can be placed in a square pattern.

Is four whips the best number for a mobile setup? How is it possible to get accuracy of five degrees or better with only four whips? What does the Doppler-induced waveform from a typical 4-whip set look like, and why does it lead some hams to say that it's not a "real Doppler?" Those topics lead off the next article of this series, which delves into practical Doppler antenna sets and ways to make them work better. Meanwhile, I welcome your stories and photos of Doppler RDF installations and hunt experiences.

### End notes

1. Children were usually baptized within a few hours of their birth in the early 1800s, because so many died in infancy. Based on the date and time of the entry in the records, there is no doubt that he found the right baby Doppler.

2. He had attempted it four months earlier, but had to abandon the effort because snow was blowing into the faces of the trumpeters and the cold air was detuning their instruments.

3. The pitch of the train whistle was not pure and steady enough for the experiment.

4. For more about Doppler weather radar, go to [[http://ww2010.atmos.uiuc.edu/\(Gh\)/guides/rs/rad/home.xml](http://ww2010.atmos.uiuc.edu/(Gh)/guides/rs/rad/home.xml)].

5. There are three types of beacons, aircraft Emergency Locator Transmitters (ELTs), shipboard Emergency Position Indicating Radio Beacons (EPIRBs), and portable Personal Locator Beacons (PLBs).

For more about SARSAT, go to [[www.sarsat.noaa.gov/](http://www.sarsat.noaa.gov/)].

6. Complete plans in *Transmitter Hunting — Radio Direction Finding Simplified* by Moell and Curlee, published by TAB McGraw-Hill, ISBN 0-8306-2701-4. This book also has a comprehensive explanation of how a Doppler RDF set obtains bearings using the phase of the sinusoidal frequency modulation imposed on the incoming signal by the pseudo-rotating antenna. 73

### How's That Thing Really Work, Anyway?

*continued from page 26*

output frequency is fed to one of the two inputs of the product detector and is mixed with the incoming signal from the IF amplifier.

That's great, you say, but 10 MHz from the IF and 10 MHz from the BFO gives me the following outputs: 10 MHz, 20 MHz, and zero. Where does the audio part come from?

Easy. Let's tune the BFO slightly "off frequency" by 500 Hz, by using a "trim capacitor" in the circuit. Trimmer capacitors could be used to bring an oscillator's output exactly on frequency, or in our case we will use it to move the output frequency "away" from the 10 MHz product. Now the output from the product detector are 10 MHz, 10.0005 MHz, 9.9995 MHz, and 500 Hz. Following the previously mentioned mixer outputs, these are the two original frequencies, the sum of the two and the difference of the two. By using the "difference" of the two, a 500 Hz output is realized in the audio range, and is usable by the audio amplifier circuit which follows.

The process of adjusting stages of a receiver to meet the mathematical requirement of the section before and after it is called *alignment*. Alignment enables the sections to perform their function, while being acceptable to the remainder of the receiver.

The 500 Hz low-level audio is connected to the audio amplifier (Block H) by using a potentiometer (variable resistor) called the volume control. It is often marked "GAIN" on the front panel of the receiver. Its function is to supply an operator-controlled portion

of the low-level audio signal produced by the product detector for amplification and a comfortable listening level. The audio amplifier section increases the audio signal to a level great enough to drive the speaker or headphones, thus enabling the operator to hear the incoming signals.

Arthur's signal was processed or acted upon mathematically by the receiver's circuits. By careful manipulation of signals and amplification of the resulting products, we can convert a signal from far above the audio range to a signal reproduced at the speaker (I) which is easily understood by human hearing.

There are other circuits that can be incorporated into a receiver to increase its performance. Some of these are audio filters, notch filters, RF amplifiers, AGC (automatic gain control), "S" meters (signal strength indicator), and more. These circuits, while not described here, are used to enhance the operation of the receiver. They are sometimes referred to as the "bells and whistles" of the receiver. 73

### Breakdown in Cape Town

*continued from page 32*

The flight was uneventful and we arrived at Heathrow very early on the Wednesday morning, surrendered our temporary passports to the Immigration Officer, and caught the Rail-Air link home.

Despite the problems at the end of our trip, we had a fantastic time in Cape Town. With the exchange rate currently around 15 Rand to the £1, living is surprisingly inexpensive.

Special QSL cards have been printed and are available from my *Callbook* address or via the RSGB bureau. My particular thanks go to Vidi ZS1EL and Hester ZS1ESU, N4MPQ for the use of their station; to Al ZS1AAX and Kay for their hospitality and for ferrying us around; and to my XYL Jan for indulging me in a couple of very enjoyable and unexpected hours on the radio as ZS1/G3SWH. 73

Say You Saw It in 73!

## Hamfest Survival Guide

*continued from page 33*

only others make sacrifices to satisfy our hamfesting desires, let's have a bit of a reality check and look at ourselves as well. Often I've found myself getting hold of something at a really good price (sometimes even for free), because it was the ideal part or subassembly for a future project. Then, when "later" rolled around that perfect part or subassembly turned out to be outdated or superseded by something else entirely.

What's turned out to be a better approach for me has been to buy things on an "as needed" basis: to wait until I actually need the part and buy it when the project actually calls for it. This has the added benefit that I'm actually buying parts or subassemblies that are still being made — a great benefit when someone else wants to reproduce what I build for their own use.

Also, using current parts (instead of older ones) increases the chances that we'll be able to get spare parts for "fix-it" projects later. Concerned about saving money doing this? Don't worry: There'll always be a hamfest coming up to find bargains at. As an alternative, over a decade of home-brewing has led me to find out about several different sources for brand-new parts that are reasonably priced. If you don't have these places lined up yourself, let me know; I'll E-mail you an Excel spreadsheet of the places I've found (requests can be sent to [wb9ybm@juno.com]).

### Other reasons to hamfest

If spending money is a problem that you'd like to avoid, there are plenty of other reasons to attend a hamfest, like tracking down all those voices you keep hearing on the repeater and actually getting to see the face behind the voice. Hamfests make a great meeting point for socializing. Getting the chance to hand off an item previously only referred to in a discussion, or to pour over a project of mutual interest in a direct format, are two more reasons to meet at hamfests, and all it'll cost you is the admission fee. Pointing this out to our wives or girlfriends can make

hamfest attendance more socially acceptable to our families, as well. It might even provide distraction to our wives — they'll be so preoccupied commiserating about what awful ogres we are, they'll be too busy to notice the new toys we're stashing in the trunks of our cars! (The trick that must be observed here, though, to make this work is that the other ham you're meeting must also bring his wife.)

### Be prepared

Regardless of the reason behind attending the hamfest, there are a few things that must be observed. The seasoned hamfest veteran will already know this, but for the benefit of the newcomers, they bear repeating. During typical outings that we get dragged to, our wives or girlfriends take care of these things, because they know we forget. But, since we are the ones dragging *them* to an outing instead, it falls to us to remember these details.

For starters, I can recommend an all-weather kit. This box should contain, as a minimum, sun tan lotion, umbrella, and other such sundries to make the Great Outdoors survivable even for the meekest couch potato, under whatever weather conditions we're likely to meet during a typical hamfest. A lawn chair, thermos, and spare change for a hot dog shouldn't be missing either.

And be prepared to have some fun! 73

### Radio Comm in the French and Indian War

*continued from page 35*

The one display I will never forget was not in the building. K4CHE recreated a forward aircraft controller's base he had seen in Laos. Under a camouflage parachute, a makeshift stool sits in front of a table made from sandbags supporting a piece of steel runway lattice. Sitting on this table are an R-1004A/GRC-109 and an RT-778/PRC-71 from which you hear invisible ground controllers talking to their charges. The effect was that of ghosts from a war fought nearly forty years ago, calling to pilots who will never land.

For more information on MRCA, see their Web site [www.milradio.org]. For more pictures from the 2002 meet, I recommend [http://mywebpages.comcast.net/smithab11/], which is K4CHE's Web site. 73

### CQ Sooner Spring

*continued from page 38*

specific areas targeted, we contacted 11 countries, 43 states, and 29 Oklahoma cities and towns in 21 different counties. Other notable contacts during the event included eight other EOCs in Oklahoma and Arkansas, the Coast Guard, and the Salvation Army.

It occurred to us early into the exercise that picking DX out of our mini pile-ups would be difficult. We had to abandon our published frequencies to snag the DX. Our mission was also complicated by severe weather that moved across the state throughout the day. Oh, to be in Oklahoma. The equipment worked beautifully. It reached out nicely, yet was easy for the uninitiated to learn to operate and use effectively with little training. Cindy and Pete kept on task and worked the State Health Department, while Dave grabbed the coveted CDC amateur station, KK5UW (David Clark), and fellow operator KR4EA (Dr. Paul Halverson), a major goal of the event.

Sooner Spring proved to be an invaluable learning experience for everyone who participated. The capability of the Department to detect and respond to bioterrorism was significantly enhanced. The utility of amateur radio in emergency response was clearly demonstrated. And, the community is a safer place to live, work, and raise our children. As for the EOCC, it got a great christening. And, what started out to be just a good idea quickly evolved into a necessary component of the Health Department's public health emergency preparedness plan. 73

**Reprints**  
of  
**73 Magazine articles**  
Only \$3.00 Each!  
Call 800-274-7373

## The New Pools!

Examination Test  
Questions & Answers

The exact questions, multiple choices  
and answers for the Technician Class,  
General Class, and Extra Class  
operator's license.

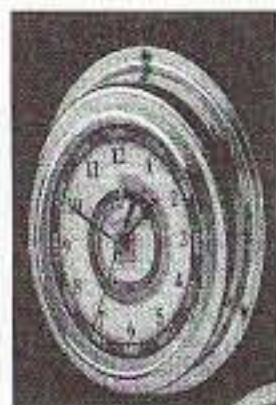

Only  
\$9.95  
Plus \$3.50 S&H

**Omega Sales**

P.O. Box 376  
Jaffrey, NH 03452  
800-467-7237



## Surplus Microwave Parts & Test Equipment

**dudlelab.com**  
Visa/MC/Discover  
732-240-6895  
Toms River, NJ 08757

# M<sup>2</sup>

## EXTRA, EXTRA! M2 BUILDS TRIBANDER

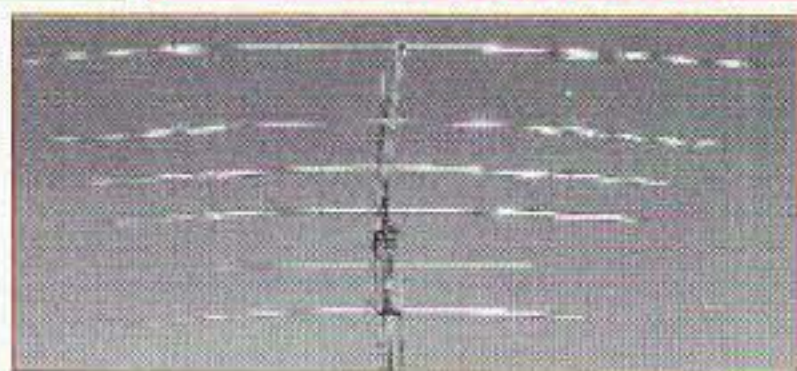

The tried and true KT34 series antennas have been made better using the latest computer modeling and mechanical design techniques to provide you with the best tribander performer available today. Just take a look!

**INCREASED FRONT TO BACK  
INCREASED GAIN  
MECHANICALLY SUPERIOR  
ELECTRICALLY SUPERIOR  
LOWER WIND LOAD THAN COMPETITORS  
LESS WEIGHT THAN COMPETITORS  
RATED AT 100 MPH WIND SURVIVAL  
AND OF COURSE, NO POP RIVETS**

Contact us for our new catalog of  
ALL the goodies!!  
Can't wait? Visit our Website  
@m2inc.com



DESIGNS  
BY K6MYC

4402 N. Selland, Fresno, CA 93722  
559-432-8873 Fax 559-432-3059  
E-Mail: wyatt@m2inc.com  
Website: www.m2inc.com



## ABOVE & BEYOND

continued from page 44

1/2 inch in diameter or slightly larger. The laser then will be inserted into the front of the PVC pipe section that it has the ball lens at the far end. The spacing between the laser diode and ball lens should be touching when the laser is inserted into the holder for lens and laser. The laser pointer is jam-fitted in the pipe or suspended in the PVC pipe by 4 each mounting screws spaced 90 degrees about the front and rear of the laser pointer. This last method will allow some adjustment for non-centered laser diode pointers much like adjustable spotting scope mounting rings. By slight loosening or tightening of each screw, the laser diode can be centered into the PVC pipe. Either way can work well — even the jam-fit laser.

The objective is mounted into a PVC threaded adapter bushing to accommodate the objective diameter and the focusing element inside diameter. A setscrew can hold the plastic bushing holding the objective lens in the focus mount front adjustable compartment. Then the job is to locate PVC plumbing pipe adapters to bush up the laser and ball lens to the size of the fixed portion of the focus adapter. If you can find a focuser it will make things easier to construct and adjust. The laser/ball lens assembly was inserted into a surplus focusing element bushed out by other short sections of PVC pipe to adapt the assembly to the adjustable section holding the main objective. If there is serious interest in construction-duplicating what we have done, I might be able to obtain a few more focusers from our local surplus store.

Some other alternate possibilities are broken or junk small spotting scopes — see **Photo B**. An excellent one can be constructed out of the tube and front objective lens. Just insert to fit the PVC housing the ball lens and laser and you're on the way to testing a beam expander. Sliding the PVC pipe holding the rear ball lens and laser forward and backward will demonstrate the beam expander quite well (even if handheld for an optics test bench). Try to piece together PVC adapters and pipe sections and even some threaded PVC sections that can be put together to do the same job of objective focus.

The inexpensive laser pocket pens used in this application should be of the type that uses a series resistor to limit current through the laser diode from the 2 small button batteries usually supplied. Other similar laser diode pointers use an internal capacitor that doesn't allow modulation to the laser and must be removed. All you want in the laser pen assembly is the laser diode and its limiting

resistor. Either laser will function as a driver for a beam expander — it's just that the one with a resistor to limit current can be modulated.

Several pocket laser pens were purchased from different vendors at swap meets and such to find out which pens had the series resistor between the battery and laser diode. Many other types used more complex power supply regulator schemes that make modulating the diode far too complex. It's much easier to buy several and determine which brand/vendor has the pocket laser pens using the series resistor current limiting scheme. The cheap ones are the most likely to be resistor-limited. These are very easy to modulate with our system described in the LED transceiver documentation. Most laser diode pens we purchased ran in the \$3 or slightly less category.

## References and tech information

Amateur laser home page of WB9AJZ: great stuff, including our original LED communicator system articles. Construction details are available on the Web at [<http://www.qsl.net/wb9ajz/laser/laser.htm>].

Surplus ball lenses and objectives can be obtained from Surplus Shed, Blandon PA 19510. Phone 877-778-7758; or on the Web at [<http://www.surplussshed.com>] for an on-line catalog. The ball lens used is part # L1729 and costs \$4. The objective used is a 31.5 mm diameter and 80 mm focal length, part # L2076, cost = \$9 each.

Edmonds Optics has a publication on beam expanders on the Web from their tech support at [<http://www.edmundoptics.com/techsupport/DisplayArticle.cfm?articleid=270>], as well as an on-line catalog available at the .com extension.

Well, that's it for this month. Not sure what topic is in store for next month's column, but I suspect it will be test equipment-orientated. As always, for any questions concerning this month's topic or other related material, please send me an E-mail at the address of [[clhough@pacbell.net](mailto:clhough@pacbell.net)], and I will answer promptly. Best 73, Chuck WB6IGP. 73

## THE DIGITAL PORT

continued from page 46

Incidentally, almost all Linux software is free for the download from other sources. The attractive part of Lindows is the automated install, and that is about the only attractive appealing part that I can see.

I should stop there, but I had some other operating system failures that resulted in

using the Lindows restore disk a few times during the first week of operation. I am currently running tests to see if there are hardware problems as well. I don't think so. It would appear the problems will sort out once I get the correct operating system installed.

Off in a corner of the shack I found my older version of Red Hat Linux and installed that on the little machine. I am finding some little problems with that but I believe a Red Hat guru could sort them out. There will be some more changes, including an anticipated (soon) arrival of Mandrake Linux which I understand is about as user-friendly as Linux gets, and boy do I need something friendly <smile>.

The little Microtel machine has an 800 MHz CPU and 128M RAM with a CD drive and a floppy I installed, plus a sound chip in the motherboard, so it should become a good ham Linux guinea pig once I get it sorted out. It looks good enough on paper that I figured the worst case scenario is to install Win98se if I can't get it to cooperate any other way. The hard drive is 10 gigabytes, which is a little skimpy for the fat programs coming out of Microsoft these days, but I don't buy those anyway.

For those who are wondering, Linux is an operating system based on Unix, both of which are used in networking. Standalone desktop operation wasn't the original intent, but a lot of software has been developed that is either freeware or very cheap that, when a user-friendly system is developed can become a real contender for the high buck software that has to be continually upgraded for the Windows platform.

I don't think at this point in time that this is causing a big disturbance at Microsoft, but it could once some folks get their act together. I felt, when I first saw it, that perhaps Lindows was going the right way. Maybe they are. We as hams may be the only folks left out of their loop.

So, hopefully by next month, I will have a Linux system up and running and can extol the virtues of a different platform for your ham radio adventure.

### Virus protection

There are times when I do things correctly. I have the Norton Anti-Virus software running in this computer, and a few months ago I started getting virus hits on my E-mail. The best reasoning I could give why this suddenly burst forth is my Web site where *The Chart* is posted. I am seeing the newer E-mail addresses on most of these fake mailings. Something to keep in the back of your mind if you have a Web site.

The next part of the story is when I discovered the problem that this computer

stopped talking to the modem, I needed to get to the E-mail by some other means. I chose to use the wife's computer, but that had not been used for incoming E-mail recently, so I installed the anti-virus software in that before checking the E-mail and, sure enough, two infected E-mails were scratching at the door. One good decision. It could have been a disaster.

### All good things run their course

I truly hope someone corrects me on this. I received an E-mail inquiring about the fate of the ChromaPIX software. It seems the Web site is not correct. It comes up but has nothing to do with one of our favorite pieces of software. I sent an E-mail to Jim N7CXI and it bounced as undeliverable. Tough to lose such a super package.

### I stand corrected

I took a little heat about a statement I made in the December column that needs explanation and an apology. I have a way of putting words on paper that say one thing to me and can be taken another way.

The statement referred to the crummy operating system, Millennium Edition (Me) from Microsoft that so many of us had problems with. What I said was many programmers were not bothering to write ham programs for that platform. I should have added the phrase, "because Me is so bad."

Having left that off, to some folks it read that the programmers could write for that platform if they wanted to, but were simply refusing to do so for some personal inadequacy. To all who were offended, please accept my apology and I will try to improve my English presentations.

### Also in the mail

I mentioned how so few receivers had a passband to take advantage of the very wide tuning pane on a program such as TrueTTY. Typically, we see about 3 kHz and that is plenty for most of us, but Jim WA9PYH dropped me a line that his Ten-Tec Jupiter will stretch out to 8 kHz. That is a bunch.

Just think how many PSK would fit, but seriously, this leads to some possibilities we don't often consider. I took a moment and brought up MixW which has a waterfall zoom and gave it a try. The maximum display width using this software is 6 kHz. With a wide passband receiver you could monitor nearly all of the popular RTTY segment continuously, kind of a fun contest option. The downside might be the need of a steady hand for tuning. But it is a thought, and here we have it available with a USA product.

That's it for this month. We'll do it again next month. 73 and keep the digital fires lit. 73

### ON THE GO

*continued from page 47*

1979, an electronics theory course might be interesting. The trick is to find one taught by someone who is excited about the material and knows how to pass that excitement along.

7. Teach something - That "someone who is excited about the material and knows how to pass that excitement along" I mentioned in the previous paragraph might be you. If you have a good theoretical background and a little time, perhaps you should teach that to others. Start with a short presentation at the local club meeting. The program chairman is always looking for an interesting presentation and will probably be thrilled to hear from you. If you do well and enjoy it, maybe help teach the license preparation class.

8. Plan something — In some areas, hamfests are being replaced by eBay and other on-line swapmeets and auctions. However, most of us have much more fun swapping equipment and stories (some of them true) in person. Besides, if I can see and touch a piece of equipment and take it home with me, it is much more satisfying. Help with the planning of your club's hamfest. What about setting up a special event station for your community's big event? When I lived in Ohio, the Doylestown club had a special event station for "Skunk Day" and it was great to operate. That was the first time I was ever on the right end of a pile-up! If you can have that much fun celebrating skunk day, you should have at least as much fun celebrating your community's special interest. Start planning for this now.

9. Reconfigure your station — Every time you operate, do you complain about how awkward you have the station arranged? Now's a great time to take a Saturday afternoon and rearrange the layout so it is more comfortable. In simpler times we were mainly interested in having the radio and telegraph key properly positioned. Now you may have an antenna tuner, external digital signal processor (DSP), a terminal node controller (TNC) for digital modes, etc. Locate the ones you need to adjust most frequently so they are the easiest to access. Play around with the locations and try out different configurations before you hook everything up.

*Continued on page 61*

## Unsettled and Unsettling

*My charts and observations indicate that the sun will be very unsettled for most of February, so the propagation outlook is quite dismal once again. However, solar activity should decrease dramatically by the end of the month and remain at low levels until mid-May. In fact, my preliminary calculations for the next twelve months indicate that this is indeed the "last hurrah" for Cycle 23 and only a few brief periods of intense activity will interrupt the steady decline toward the sunspot minimum expected in early 2007.*

As outlined in my August 2002 forecast, coronal hole effects often dominate the declining phase of a sunspot cycle. This became very evident a week before Thanksgiving when high speed solar winds from a large coronal hole buffeted the earth and caused a major geomagnetic storm that lasted several days. This occurred after a sudden decline in sunspot activity had many DXers expecting a bit more stability in worldwide propagation conditions. If currently plotted coronal holes return this month we can expect very high flux levels and geomagnetic disturbances from the 1st through 3rd, 10th through 12th, and 23rd through 25th. Since these intervals also fall on or near days of expected strong flare activity (marked as P or F-P on the calendar) then we might also anticipate several radio blackouts to occur.

Because the sun makes a full rotation approximately every 27 days, existing coronal holes reappear with the same frequency. I generally do not include them in my forecasts but these features often last for months and can have noticeable and predictable effects on propagation conditions. It may be worthwhile for you to track them if you prepare your own forecast or want to improve on the accuracy of my calendar. Since the Earth is most susceptible to high speed coronal outflows when holes are located near the center of the solar disc you can estimate the strength and timing of their influence by studying the 284 angstrom x-ray photographs taken by the Extreme ultraviolet Imaging Telescope (EIT) carried aboard the SOHO spacecraft. Go to [[http://sohowww.nascom.nasa.gov/data/realtime/realtime-eit\\_284.html](http://sohowww.nascom.nasa.gov/data/realtime/realtime-eit_284.html)] for the latest series of EIT photos. Keep in mind that high speed solar winds take 2-3 days to reach our magnetosphere after a coronal hole rotates into the central third of the sun.

73 and happy DXing!

February 2003						
SUN	MON	TUE	WED	THU	FRI	SAT
						1 P
2 P	3 F-P	4 F	5 F	6 F-P	7 P	8 F
9 F	10 F-P	11 F-P	12 P	13 F-P	14 F	15 F
16 F	17 F-P	18 F	19 F	20 F	21 F-G	22 F-G
23 P	24 P	25 F-P	26 F	27 F	28 F-G	

EASTERN UNITED STATES TO:												
GMT	00	02	04	06	08	10	12	14	16	18	20	22
Central America	15 (40)	20 (40)	20 (40)	(40)	(40)	(20-40)	(15) 20	10-20	10 (20)	10-17	10 (20)	(10) 20
South America	(15) 20	20 (40)	20 (40)	20 (40)	x	x	(15-20)	x	(10)	10 (15)	10 (20)	(10) 20
Western Europe	40	40	40	40	(40)	x	(10-20)	10 (20)	(10) 20	(15-20)	(20)	(20-40)
Southern Africa	(20-40)	(40)	x	x	x	x	x	(10-12)	10 (17)	(12) 17	(15-20)	20
Eastern Europe	(40)	(40)	x	x	(20)	x	(10-20)	(10) 20	(20)	x	x	x
Middle East	(40)	(40)	x	x	x	x	(10)	(10-15)	15 (20)	20	(20)	(20)
India/Pakistan	x	x	x	x	x	x	x	(15-20)	x	x	x	(20)
Far East/Japan	(15) 20	20	(20)	(20)	x	x	(20)	x	x	x	x	(10-20)
Southeast Asia	(15-20)	x	x	x	x	x	x	(10-20)	(10-15)	x	x	x
Australia	(10-17)	(15-20)	x	x	(20)	(30-40)	(20-40)	(10) 20	(10-20)	x	(20)	(10-15)
Alaska	15-17	20-30	x	x	x	20-30	20-30	15-17	15-17	x	x	15-17
Hawaii	(10) 15	(20)	20	(20)	20 (40)	40	(20-40)	(20)	(15-20)	x	(10)	10 (15)
Western USA	(10) 40	(15) 40	20-40	(20) 40	40	40	40	(20-40)	(10-20)	10-20	10-20	10-20
CENTRAL UNITED STATES TO:												
Central America	(15) 20	20 (40)	(20) 40	(20) 40	(20) 40	40	(40)	(10) 20	10-20	10-15	10 (20)	15-20
South America	(15) 20	20	20 (40)	20 (40)	(20)	x	x	x	(10)	10	10(20)	(10) 20
Western Europe	(40)	40	40	(40)	x	x	(20)	(15) 20	(10) 15	(15) 20	(20)	x
Southern Africa	20	(20)	x	x	x	x	x	x	(10-15)	(10) 15	15 (20)	20
Eastern Europe	x	(40)	x	x	x	x	x	(10) 20	(10-20)	x	x	x
Middle East	x	(40)	(20)	(20)	x	x	x	(10-15)	(10-15)	(20)	20	(20)
India/Pakistan	x	(15)	x	x	x	x	(20)	x	(15)	x	x	x
Far East/Japan	x	x	(20)	20	(20-40)	(40)	(20)	20	(15-20)	x	15	(15)
Southeast Asia	x	x	x	x	(20)	(20)	20	(15-20)	(15)	x	(15)	x
Australia	(10) 15	15	(15-20)	20	20 (40)	20-40	20 (40)	(20)	x	x	x	(10-15)
Alaska	15-17	15-17	x	x	x	(40)	(40)	20	20	x	x	x
Hawaii	(10) 15	(15-20)	20	20	(40)	(20-40)	20 (40)	x	(15)	(15)	(15)	(10) 15
WESTERN UNITED STATES TO:												
Central America	(20-40)	40	40	40	(40)	x	(20)	(10) 20	10 (20)	10 (20)	(10) 20	(15) 20
South America	17 (40)	(20)	x	x	x	x	x	(15)	12 (20)	10-20	10-20	12 (40)
Western Europe	x	x	(40)	(20)	(20)	x	(20)	(10-20)	(10) 20	(20)	x	x
Southern Africa	(20)	x	x	x	x	x	x	x	(10)	(15)	15 (20)	(15) 20
Eastern Europe	x	x	x	x	x	x	x	x	x	x	x	x
Middle East	(20)	(40)	(20)	20	20	(20)	x	(15)	(10) 15	(10-15)	(20)	(20)
India/Pakistan	(15-20)	x	x	x	x	x	x	(20)	x	x	x	x
Far East/Japan	(10) 20	(15-20)	x	x	(40)	40	(40)	x	x	x	(10-20)	10-20
Southeast Asia	(15)	(20)	x	x	x	x	x	(20)	(15) 20	(20)	(10-15)	10-15
Australia	(10-15)	(15-20)	x	x	x	(20-40)	(20-40)	20	(15-20)	15	(10-15)	10
Alaska	10-15	x	x	20-30	20-30	20-30	20-40	x	20	15	x	15-17
Hawaii	(15) 20	(15) 20	20	(20)	(40)	40	(20-40)	(15) 20	15 (20)	(10-15)	10 (15)	(10) 15
Eastern USA	(10) 40	(15) 40	20-40	(20) 40	40	40	(20-40)	(10-20)	10-20	10-20	10-20	10-20

**Table 1.** Band, time, country chart. Plain numerals indicate bands which should be workable on Fair to Good (F-G) and Good (G) days. Numbers in parentheses indicate bands usually workable on Good (G) days only. Dual numbers indicate that the intervening bands should also be usable. When one number appears in parentheses, that end of the range will probably be open on Good (G) days only.

## Band-by-Band Forecast

### 10-12 meters

Fair worldwide DXing can be found during daylight hours. Openings will begin to widen with the approach of Spring but windows to each region will still be limited to one or two hours. The Caribbean and Central America will provide the most reliable openings, but east-coasters should have some luck in Eastern Europe and Russia while west-coasters will do better in the Southwest Pacific. Mid-Westerners are likely to have the best luck finding "exotic" contacts in Central or West Africa. Daytime short-skip will range from 1,000 to approximately 2,000 miles.

### 15-17 meters

These bands should be excellent for worldwide DXing from sunrise through mid-evening. Operators located in the western U.S. will have trouble with Eastern Europe and the Mediterranean, but everyone else should find most of the world at their fingertips on Good (G) days. Asia and the Far East will be the most difficult to reach but gray-line propagation may provide a viable solution. Short-skip will average from 1,000 to 2,200 miles.

### 20 meters

Look for good all-night openings on "twenty" when fluxes are above 150. Peaks will also occur just after sunrise, during the late afternoon, and again in the early evening. Europe and Africa will remain open during most daylight hours while the Caribbean and the Americas should be workable at all hours except during sunrise. The South Pacific and Australia should present fairly easy pickings but Asia and the Orient are a different story. Try the hour after sunrise and the hour before sunset for weak opportunities there. Short-skip can be as little as 500 miles during the day but over 2,000 miles at night.

### 30-40 meters

Fair to good opportunities can be found on these bands but geographic opportunities will be limited. As usual, Central and South America will be the most promising areas, but paths to Europe, the Middle East, and the South Pacific are also worth checking. Skip distances will be 750 to 2,000 miles at night but under 1,000 miles during the day.

### 80-160 meters

Some worldwide DXing will be available from sunset through sunrise. Easterners can

find the best opportunities in Europe and North Africa from early evening to midnight. Midwestern operators should find the Caribbean, Central America, and South America available all night, while DXers situated west of the Rockies will find decent paths to the Americas, the South Pacific, and the Far East. Expect skip to range from 1,000 to 2,000 miles at night. 73

## ON THE GO

*continued from page 59*

10. Get on the air — Winter's longer periods of darkness mean better operating conditions for twenty meters and below. We still are enjoying good propagation, and winter keeps us relatively free of static crashes caused by lightning. Try a mode that you are set up to use but haven't operated in for a while. Have FM and an antenna that can tune ten meters? Try some quick contacts through ten-meter repeaters. When was the last time you operated CW? Why not dust off the key, give yourself a little practice and find a slow station calling CQ? Morse code was once the great stumbling block for many prospective hams. With that onus gone, let's see if we can just have some fun with it as a great mode.

Winter is truly a great time for the ham operator, with so many things to do. Before you know it, spring will raise its head and the XYL will have you out in the yard with a list of chores a mile long. While winter's here, let's take advantage of it. So finish the magazine, pour a fresh cup of coffee, and head for the shack. And for goodness' sake — have fun! 73

## NEVER SAY DIE

*continued from page 42*

donation would be put to a productive use.

The begging bowl banging this time has to do with our possible frequency losses at the upcoming International Telecommunications Union conference. This is not a new situation. Nor is the funding for the protection of our frequencies anything new. Seems to me I remember something about a League president who ran through around \$50,000 of the protection fund vacationing with a girlfriend in the Caribbean. Let's lift the carpet and see what's under it.

And what is the benefit to us members of the League flying directors over to Geneva to attend lavish parties at the

members' expense? Oh yes, and even paying for any lost salaries?

Yes, of course the League could help to protect our bands by doing some lobbying, but as far as I know, which is pretty far, they've never bothered to do that. I've been recommending this approach for the last ... um ... 43 years.

Not that this was my original idea. I went to the trouble to go to Geneva and visit the Secretary General of the ITU, who at the time was an American ham. I asked him what he thought our best bet would be to hold on to our bands. He pointed out what a bad taste several of our DXpeditions had left when they operated from the smaller countries and ignored their rules on power limitations and third party traffic. He suggested we send ham ambassadors to visit the smaller country officials to point out the benefits to their country of supporting and promoting amateur radio.

After returning home I talked with the League General Manager about this. He cursed, saying that he didn't need any fxxx-ing advice or fxxx-ing help in running amateur radio ... and hung up.

If you do decide to donate and get a pin or coffee mug, at least try to get the League to provide you with an accounting of how they've spent the Defense Fund. Heh, heh ... good luck.

The time to start defending our frequencies is right now with a team of ambassadors visiting third world government officials, rather than waiting for the delegates to the ITU conference, who will be arriving with orders in hand from their governments on how to vote.

## Poisoning Our Children

Our beloved government is at it again. Big surprise. Until I read a piece in *Forbes* I wasn't aware that the government has been providing school breakfasts for needy children.

The fuss was over the demands of do-gooders, led by Rep. Lynn Woolsey (D-Calif.), to provide all schoolchildren with breakfasts. The idea is not to make the needy children feel stigmatized. It wasn't until I went off to summer choir camp that I was exposed to food like that. My mother never fed me any cold cereal, nor any white bread, jam, or jelly. No peanut butter and jelly sandwiches. I got hot cereal, without any sugar, and eggs fixed dozens of ways. No Danish. Instead I had fresh oranges, bananas, and melons.

These days I mainly stick to fresh fruit for breakfast. I still love hot cereal, though I know that cooked food is much

*Continued on page 62*

## NEVER SAY DIE

continued from page 61

more difficult to digest and is far less nourishing than raw.

Let's see what you can do to get your Senator or Congressman to put an end to this government poisoning of kids. It's bad enough they're doing it to us with fluorides in our water and mandatory inoculations. This is supposed to be the land of the free, so how can we get those government boots off our necks?

### The First Answering Machine

John Williams W2BFD, the father of ham teletype, ran a radio repair business out of a small shop in Woodside, Queens, New York. I don't think he spent much of his time fixing radios—he was too busy inventing. He not only designed all of the first ham teletype circuits, he built one of the first ham repeaters (which I helped him set up on top of the New York Municipal Building), and he had what I'm sure was the first telephone answering machine.

It was a Rube Goldberg system, using a 78 rpm automatic record player to provide the answering message. This was in 1948, before inexpensive tape recorders. He used a Webcor wire recorder to record the incoming messages, with the whole system mounted in a six-foot 19" relay rack. Ma Bell was furious about it.

In those days Ma Bell ruled supreme and she didn't allow anyone to connect anything to one of her lines you were renting. Ma's detectives tried everything they could think of to get into John's store and confiscate the offending equipment. But John was wily. He used a carrier-current radio system to his home, a mile away, which provided him with an alarm when anyone messed with the door to the store.

At the time I was working as the chief cameraman at WPIX, the *Daily News* station. I had my 2m station set up on the top floor of the *News* skyscraper, complete with a 16-element Bill Hoisington W2BAV beam. Bill, who had his station on a fire tower up in Westchester, had a legendary 2m signal. Hmm, I'll have to write about Bill one of these days — he was another fascinating ham, and an inventor.

But what was that strange beedle-de-beedle signal up at the high end of the band? Someone said it was ham teletype and I should get in touch with W2BFD for information. Which, of course, I did.

John got so interested in ham teletype that he arranged to be an official outlet for used teletype equipment, which before that had always been destroyed when taken out of service. This was at the time that their old 1920s workhorse

Model 12 machines were being replaced by Model 19s. I got a machine from John and built a copy of his RTTY converter. This had about 20 tubes (6SN7GTs) and had control circuits so it could be turned on and off by incoming signals. This was my introduction to digital electronics and, little could I know, a major turning point in my life.

John was an electronic wizard, but he wasn't a marketer. He had little interest in promoting ham teletype; he just wanted to experiment and design new circuits. I remember one day when an FBI agent visited me, asking what I knew about John. I wasn't very helpful. Later, John said the visit probably was triggered by his building and installing a hidden microphone and transmitter in the Israeli embassy limo so Arab agents could follow the car and listen to the conversations. John wasn't politically motivated; it was fun for him to design and build the bugging system.

I tried and tried to get John to do a ham teletype newsletter, but he wasn't into writing and publishing. If he couldn't turn it out on his teletype machine, the hell with it. So, when I got a job as a TV producer-director at WXEL in Cleveland in 1951 and found they had a mimeograph machine, the first issue of a *Teletype Bulletin* went to "press." And that was my entry into the publishing world. I loved it.

John died in 1960, just as I was starting 73. Alas, he smoked (a lot), and this robbed us of around 50 years of his wizardry.

Today, thanks to the Code-A-Phone law suit against Bell, we can connect anything we want to our phone lines. We're allowed to own our own telephones. Today most of us have answering machines, but 50 years ago there was just about one of those in the world—out in Woodside, Queens.

Oh, yes. For any of you who are too young to know about Rube Goldberg, he was a famous cartoonist a generation back. Ask your grandfather about Rube's cartoons. Rube was a good friend of mine. I was the cameraman on his show and we often went out for a late dinner together after the show at the local \$1.29 steak dinner restaurant. This was back before videotape had been invented, so those programs are forever lost.

Videotape. If Gore can claim fame for inventing the Internet, I can claim without exaggerating as much for helping Ampex engineers develop their first successful videotaping system.

I got together at a television conference over coffee with the Ampex engineers who were working on the project and described the work John Williams and I had been doing with filters for ham

teletype developments as a way to get a wider band signal on their tape. Sure enough, a few months later they demonstrated a videotaping system using this approach.

### The British Are Coming!

A new tax law has been estimated by the British government to drive over 66,000 small business out of their country. The new tax rate will be 74.5%, for small companies, but not for lawyers (naturally). Many of the more enterprising Brits are understandably packing up and heading this way.

Golly, that immigration is about what we're getting every three days from Mexico, but the quality is higher. We need all the small business people we can get these days — especially in information technology, engineering, aerospace, and other high tech services.

And just to make sure that the Internet-involved leave the country, the Brits have implemented a Removal of Privacy Bill 2000 (RIP), which requires that all E-mail and Web traffic be routed to government agents for monitoring. Service providers are required to install a box on their network for this. An encrypted file can get you two to five years in prison.

This will help drive international companies out of Britain, since they sure don't want the government snooping on their E-mail with their other divisions.

Where can small businessmen go? The US provides cheaper gas, food, housing, and computer equipment. The British are coming, but this time they are refugees.

(Thanks to Jim Kocsis WA9PYH for a clipping from *Electronic Design*.)

### Reinventing Government

Communism, despite the convictions of many supposedly great minds, hasn't panned out. It's failed everywhere it's been tried. The old Soviet Union is a mess. North Korea is a mess. Cuba is a mess. And only the power of newly unleashed capitalism in China has saved that country from the same fate. It failed in every one of the Soviet-controlled Eastern European countries. I've visited China, Russia, the Ukraine, Poland, Czechoslovakia, Yugoslavia, and North Korea, so I've seen communism up close, not just from the newspapers or textbooks.

Socialism, as well, has failed in every country where it's been tried. I've been there, too.

Government control of business has been a failure. As Michael Medved said,

Continued on page 64



# Wise Up!

Here are some of my books which can change your life (if you'll let 'em). If the idea of being healthy, wealthy and wise interests you, start reading. Yes, you can be all that, but only when you know the secrets which I've spent a lifetime uncovering.

.....Wayne

**The Secret Guide to Health:** Yes, there really is a secret to regaining your health and adding 30 to 60 years of healthy living to your life. The answer is simple, but it means making some serious lifestyle changes. Will you be skiing the slopes of Aspen with me when you're 90 or doddering around a nursing home? Or pushing up daisies? No, I'm not selling any health products, but I can help you cure yourself of cancer, heart trouble, or any other illness. Get this new, 2002 expanded edition (160p). \$10 (#04)

**The Secret Guide to Wealth:** Just as with health, you'll find that you have been suckered by "the system" into a pattern of life that will keep you from ever making much money and having the freedom to travel and do what you want. I explain how anyone can get a dream job with no college, no résumé, and even without any experience. I explain how you can get someone to happily pay you to learn what you need to know to start your own business. \$5 (#03)

**The Secret Guide to Wisdom:** This is a review of around a hundred books that will boggle your mind and help you change your life. No, I don't sell these books. They're on a wide range of subjects and will help to make you a very interesting person. Wait'll you see some of the gems you've missed reading. You'll have plenty of fascinating stuff to talk about on the air. \$5 (#02)

**My WWII Submarine Adventures:** Yes, I spent from 1943-1945 on a submarine, right in the middle of the war with Japan. We almost got sunk several times, and twice I was in the right place at the right time to save the boat. What's it really like to be depth charged? And what's the daily life aboard a submarine like? How about the Amelia Earhart inside story? If you're near Mobile, please visit the Drum. \$5 (#10)

**Travel Diaries:** You can travel amazingly inexpensively – once you know the ropes. Enjoy Sherry and my budget visits to Europe, Russia, and a bunch of other interesting places. How about a first class flight to Munich, a rented Audi, driving to visit Vienna, Krakow

in Poland (and the famous salt mines), Prague, back to Munich, and the first class flight home for two, all for under \$1,000? Yes, when you know how you can travel inexpensively, and still stay in first class hotels. \$5 (#11)

**Writer's Guide:** It's easy, fun, can pad your résumé, and impress the hell out of your friends. \$0 (#78)

**Wayne's Caribbean Adventures:** My super budget travel stories – where I visit the hams and scuba dive most of the islands of the Caribbean. You'll love the special Liat fare which let me visit 11 countries in 21 days, diving all but one of the islands, Guadeloupe, where the hams kept me too busy with parties. \$5 (#12)

**Cold Fusion Overview:** This is both a brief history of cold fusion, which I predict will be one of the largest industries in the world in the 21st century, plus a simple explanation of how and why it works. This new field is going to generate a whole new bunch of billionaires, just as the personal computer industry did. \$5 (#20)

**Improving State Government:** Here are 24 ways that state governments can cut expenses enormously, while providing far better service. I explain how any government bureau or department can cut its expenses by at least 50% in three years and do it cooperatively and enthusiastically. I explain how, by applying a new technology, the state can make it possible to provide all needed services without having to levy any taxes at all! Read the book, run for your legislature, and let's get busy making this country work like its founders wanted it to. Don't leave this for "someone else" to do. \$5 (#30)

**Mankind's Extinction Predictions:** If any one of the experts who have written books predicting a soon-to-come catastrophe which will virtually wipe most of us out are right, we're in trouble. In this book I explain about the various disaster scenarios, like that of Nostradamus, who says the poles will soon shift (as they have several times in the past), wiping out 97% of mankind. Okay, so he's made a long string of past lucky guesses. The worst part of these predictions is the accuracy record of some of the experts. Will it be a pole shift, a new ice age, a massive solar flare, a comet or asteroid, a bioterrorist attack? I'm getting ready, how about you? \$5 (#31)

**Moondoggle:** After reading René's book, *NASA Mooned America*, I read everything I could find on our Moon landings. I watched the NASA videos, looked carefully at the photos, read the astronaut's biographies, and talked with some readers who worked for NASA. This book cites 45 good reasons I believe the whole Apollo program had to have been faked. \$5 (#32)

**Classical Music Guide:** A list of 100 CDs which will provide you with an outstanding collection of the finest classical music ever written. This is what you need to help you reduce stress. Classical music also raises youngsters' IQs, helps plants grow faster, and will make you healthier. Just wait'll you hear some of Gotschalk's fabulous music! \$5 (#33)

**The Radar Coverup:** Is police radar dangerous? Ross Adey K6UI, a world authority, confirms the dangers of radio and magnetic fields, including our HTs and cell phones. \$3 (#34)

**Three Gatto Talks:** A prize-winning teacher explains what's wrong with American schools and why our kids are not being educated. Why are Swedish youngsters, who start school at 7 years of age, leaving our kids in the dust? Our kids are intentionally being dumbed down by our school system – the least effective and most expensive in the world. \$5 (#35)

**Aspartame:** a.k.a. NutraSweet, the stuff in diet drinks, etc., can cause all kinds of serious health problems. Multiple sclerosis, for one. Read all about it, two pamphlets for a buck. (#38)

**\$1 Million Sales Video:** The secret of how you can generate an extra million dollars in sales just by using PR. This will be one of the best investments you or your business will ever make. \$40 (#52)

**Reprints of My Editorials from 73.** Very few things in this world are as we've been taught, and as they appear. As an iconoclast I blow the whistle on the scams around us, such as the health care, our school system, our money, the drug war, a college education, sugar, the food giants, our unhealthy food, fluorides, EMFs, NutraSweet, etc.

1996 100 Editorial Essays: \$5 (#72)

1997 157 Editorial Essays: \$8 (#74)

1998 192 Editorial Essays: \$10 (#75)

1999 165 Editorial Essays: \$8 (#76)

2000 101 Editorial Essays: \$5 (#77)

2001 104 Editorial Essays: \$5 (#78)

**Silver Wire:** With two 5-in. pieces of heavy pure silver wire + three 9V batteries you can make a thousand dollars worth of silver colloid. What do you do with it? It does what the antibiotics do, but germs can't adapt to it. Use it to get rid of germs on food, for skin fungus, warts, and even to drink. Read some books on the uses of silver colloid, it's like magic. \$15 (#80)

**Colloid Reprint.** April 97 article on a silver colloid maker, history, and how to use the stuff. \$5 (#98)

**Colloid Clips.** Three 9V battery clips, 2 alligator clips & instructions. \$5 (#99)

**AC-powered Colloid Kit:** 12V power supply, silver wires, reprint, including priority mail shipment. \$37 (#82)

**Four Small Booklets Combo:** Super Organic Food: a trillion dollar new industry; Schools in 2020: another \$ trillion industry. Anthrax, a simple cure. Dowsing: why and how it works. \$3 (#86) My 1992 **We The People Declare War! On Our Lousy Government** book—360 pages and packed with ideas that'll get you all excited. Was \$13. While they last \$10. Just a few left, found in the warehouse. Last chance for this classic. (#06)

**Stuff I didn't write, but you need:** **NASA Mooned America:** René makes an air-tight case that NASA faked the Moon landings. This book will convince even you. \$30 (#90)

**Last Skeptic of Science:** This is René's book where he debunks a bunch of accepted scientific beliefs – such as the ice ages, the Earth being a magnet, the Moon causing the tides, etc. \$30 (#91)

**Dark Moon:** 568 pages of carefully researched proof that the Apollo Moon landings were a hoax—a capping blow for René's skeptics. \$25 (#92)

**1982 General Class License Study Guides.** Teaches the fundamentals of radio & electricity. Was \$7. I found a few in the warehouse. \$3, while they last. Great book! (#83)

## Radio Bookshop

Box 416, Hancock NH 03449

Name \_\_\_\_\_ Call \_\_\_\_\_

Address \_\_\_\_\_

City-State-Zip \_\_\_\_\_

Use the numbers in the brackets or copy page and mark the books you want. Add \$3 s/h per total order in US (\$7 priority mail), \$6 Can, \$10 foreign.

Order total: US\$ \_\_\_\_\_ Phone (for CC orders) \_\_\_\_\_

MC/Visa for orders over \$10. # \_\_\_\_\_ Expire \_\_\_\_\_

www.waynecgreen.com • phone orders: 603-588-0107 • fax: 603-588-3205 • w2nsd@aol.com

Yes! Put me down for a year of 73 for only \$25 (a steal). Canada US\$32. Foreign US\$44 by sea.

I need some industrial strength stress reduction so send me your *Adventures In Music* CD catalog

Allow 4 weeks for delivery except foreign, though we try to get most orders shipped in a day or two.

Your e-mail address: \_\_\_\_\_

# Barter 'n' Buy

Turn your old ham and computer gear into cash now. Sure, you can wait for a hamfest to try and dump it, but you know you'll get a far more realistic price if you have it out where 100,000 active ham potential buyers can see it, rather than the few hundred local hams who come by a flea market table. Check your attic, garage, cellar and closet shelves and get cash for your ham and computer gear before it's too old to sell. You know you're not going to use it again, so why leave it for your widow to throw out? That stuff isn't getting any younger!

The 73 Flea Market, Barter 'n' Buy, costs you peanuts (almost) — comes to 35 cents a word for individual (noncommercial!) ads and \$1.00 a word for commercial ads. Don't plan on telling a long story. Use abbreviations, cram it in. But be honest. There are plenty of hams who love to fix things, so if it doesn't work, say so.

Make your list, count the words, including your call, address and phone number. Include a check or your credit card number and expiration. If you're placing a commercial ad, include an additional phone number, separate from your ad.

This is a monthly magazine, not a daily newspaper, so figure a couple months before the action starts; then be prepared. If you get too many calls, you priced it low. If you don't get many calls, too high.

So get busy. Blow the dust off, check everything out, make sure it still works right and maybe you can help make a ham newcomer or retired old timer happy with that rig you're not using now. Or you might get busy on your computer and put together a list of small gear/parts to send to those interested?

**Send your ads and payment to: 73 Magazine, Barter 'n' Buy, 70 Hancock Rd., Peterborough NH 03458 and get set for the phone calls.** The deadline for the April 2003 classified ad section is February 10, 2003.

**220 MHz Award;** see W9CYT on [WWW.QRZ.COM](http://WWW.QRZ.COM) for information. BNB645

**K8CX HAM GALLERY** [<http://hamgallery.com>]. BNB620

**TELEGRAPH COLLECTOR'S PRICE GUIDE:** 250 pictures/prices. \$12 postpaid. **ARTIFAX BOOKS**, Box 88, Maynard MA 01754. Telegraph Museum: [<http://wltp.com>]. BNB113

New miniature oscillator modules are now available ... all under \$20 ... plus our great reference book is still for sale. Write to **RMT Engineering**, 6863 Buffham Road, Seville OH 44273 or see our Web site at [[www.ohio.net/~rtormet/index.html](http://www.ohio.net/~rtormet/index.html)]. BNB640

**RF TRANSISTORS TUBES** 2SC2879, 2SC1971, 2SC1972, MRF247, MRF455, MB8719, 2SC1307, 2SC2029, MRF454, 2SC3133, 4CX250B, 12DQ6, 6KG6A, etc. **WESTGATE**, 1-800-213-4563. BNB6000

**METHOD TO LEARN MORSE CODE FAST AND WITHOUT HANGUPS** Johan N3RF. Send \$1.00 & SASE. SVANHOLM RESEARCH LABORATORIES, P.O. Box 81, Washington DC 20044 USA. BNB421

**Cash for Collins:** Buy any Collins Equipment. **Leo KJ6HI**. Tel./FAX (310) 670-6969. [[radioleo@earthlink.net](mailto:radioleo@earthlink.net)]. BNB425

**Browse** our Web site and check out the "Monthly Special." TDL Technology, Inc. [[www.zianet.com/tdl](http://www.zianet.com/tdl)]. BNB500

**MAHLON LOOMIS, INVENTOR OF RADIO**, by Thomas Appleby (copyright 1967). Second printing available from **JOHAN K.V. SVANHOLM N3RF**, SVANHOLM RESEARCH LABORATORIES, P.O. Box 81, Washington DC 20044. Please send \$25.00 donation with \$5.00 for S&H. BNB420

**Ham Radio Repair**, Quality workmanship. All Brands, Fast Service. **Affordable Electronics**, 7110 E. Thomas Rd., Scottsdale, AZ 85251. Call 480-970-0963, or E-mail [[HAM\\_SERVICE@AOL.COM](mailto:HAM_SERVICE@AOL.COM)]. BNB427

**SATELLITE TV** — Large selection of items at reasonable prices. We specialize in Big Dish TVRO C & Ku Band equipment. Check us out at [[www.daveswebshop.com](http://www.daveswebshop.com)]. BNB646

**HEATHKIT COMPANY** is selling photocopies of most Heathkit manuals. Only authorized source for copyright manuals. **Phone:** (616) 925-5899, 8-4 ET. BNB964

**WANTED: USED ROTORS**, controls, CD-44, Ham-M, 2, 3,4, T2X, or larger. Call C.A.T.S., 1-800-3ROTORS. BNB662

**Electricity, Magnetism, Gravity, The Big Bang.** New explanation of basic forces of nature in this 91-page book covering early scientific theories and exploring latest controversial conclusions on their relationship to a unified field theory. To order, send check or money order for \$16.95 to: American Science Innovations, P.O. Box 155, Clarington OH 43915. Web site for other products [[http://www.asi\\_2000.com](http://www.asi_2000.com)]. BNB100

**COLLOIDAL SILVER GENERATOR!** Why buy a "box of batteries" for hundreds of dollars? Current regulated, AC powered, fully assembled with #12 AWG silver electrodes, \$74.50. Same, but DC powered, \$54.50. Add \$2.50 shipping. **Thomas Miller**, 216 East 10th St., Ashland OH 44805. Web address [[www.bioelectrifier.com](http://www.bioelectrifier.com)]. BNB342

**ANTENNA SCIENCE:** Why do antennas radiate electromagnetic waves? Learn for yourself from this enlightening paper by **MAX RESEARCH**. Gain an understanding of the radiation mechanism of antennas! Written in a clear style for radio hobbyists, inquisitive amateurs and experimenters. \$4.95 ... ppd. Order from **MAX RESEARCH**, P.O. Box 1306, East Northport NY 11731. BNB426

**WANTED: ANY MODEL** Collins, working or not, including speakers, filters, options, 1-piece or collection. Bob, 651-354-5345 days: 651-345-3600 eves. E-Mail: [rkemp@mr.net](mailto:rkemp@mr.net). BNB661

**FREE!! HAM** Radio and other CD-Roms and Disk catalog. **MOM 'N' POP'S SOFTWARE**, P.O. Box 15003-TH, Springhill, FL 34604-0111, 1-352-688-9108, visit: <http://www.momnpopsware.com> BNB660

**SMART BATTERY CHARGERS** and more, [[www.a-aengineering.com](http://www.a-aengineering.com)] BNB653

**GET MORE OUT OF HAM RADIO!** Books on all topics. Up to 15% off. Quality Technical Books. [<http://qtb.com/hamradio/>]. BNB665

## NEVER SAY DIE

*continued from page 62*

"The government makes a mess of everything it does." Amen.

Our public school system is a beautiful example of a government-run mess.

Okay, Wayne, so what do you suggest? Gee, I thought you'd never ask.

With communism a failure, ditto socialism and fascism, the one shining star is capitalism. Yes, we have some problems with capitalism. It's a great system as long as businesses don't get too big. Unfortunately, as they get big they start tilting the playing field. In their direction. They tend to use their political power to eliminate competition, rather than let the marketplace make this decision. The big get bigger and bigger, gobbling up the smaller companies, such as Time-Warner and Digital Equipment.

## Government Run as a Business

Let's see how you like this concept. Let's consider setting up the federal government as a publicly owned corporation where we're both the customers and the shareholders. Like any corporation, it has a board of directors who macro-manage the business. They elect the president, CEO, CFO, and so on — and they fire poor performers. We shareholders elect the board of directors. 73

# Alinco Delivers HF Adventure!

## Alinco's HF Transceivers Deliver Incredible Performance at a Tiny Price

You're only a few hundred dollars away from a brand new Alinco HF Transceiver. That's right! Just a few hundred dollars gets you on the air with a big 100-watt signal, great audio and an easy-to-operate package that's perfect for base, portable or mobile operations. The Alinco DX-70 and DX-77 make it easy for everyone to enjoy HF with a dependable transceiver that's backed by Alinco's 1 year warranty.

**The world of HF is calling. What are you waiting for?**



### Alinco DX-70TH Base/Mobile/Portable HF + 6 Meter Transceiver

- 100 watts SSB, FM & CW, 40 watts AM
- Continuous coverage HF receiver + full 6 meter coverage
- 100 memory channels
- Speech compressor
- Great CW rig, full QSK, semi or automatic break-in
- Standard narrow filter fights QRM on SSB, CW or AM
- Two VFO's and easy "split" operation
- Removable face for remote mounting.
- RIT / TXIT, IF shift
- Multi function control for easy operation

### Alinco DX-77T Desktop HF Transceiver

- 100 watts SSB, FM & CW, 40 watts AM
- General coverage receiver 150 KHz ~ 30 MHz
- Two VFO's; easy "split" operation
- Standard speech processor
- Front panel speaker provides loud, clear audio
- Built-in electronic keyer 6 ~ 60 wpm
- Full QSK, 7-step semi break-in or auto break-in
- Enhanced Direct Digital Synthesis (DDS) eliminates need for SSB Narrow Filter
- Front panel connections for mic, key, speaker & phones



#### Options

- EDX-2 automatic wire antenna tuner
- EMS-14 desktop microphone
- DM-330 MVT switching power supply
- DM-340 MVT regulated power supply



### Iron Horse Mobile HF antennas for Alinco and other HF transceivers

*Order the Iron Horse IHF5S package from your dealer and go mobile fast!*



IHF5S Mobile HF Antennas

IHTH-1  
Optional  
Trailer Hitch Mount



You get a package of 5 rugged, easily tuned antennas for 10, 15, 20, 40 & 75 meters from Iron Horse, a name recognized for its strength and dependability. Each has 3/8 x 24 threads and is rated for 500 watts. Order the IHKD3S 5 antenna quick disconnect mounting kit to make changing bands a quick and easy operation, just push, turn & go!

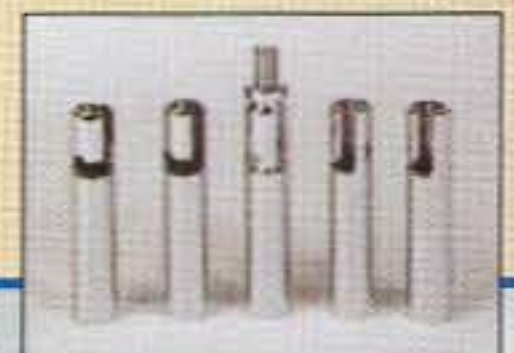

IHKD3S Quick  
Disconnect Kit



Distributed in North America by ATOC Amateur Distributing LLC • 23 S. High St., Covington, OH 45318 • (937) 473-2840  
Specifications subject to change without notice or obligation.

[www.ALINCO.com](http://www.ALINCO.com)

# ULTRA-RUGGED, SUBMERSIBLE TRI-BAND MAGNESIUM HANDIE

Own the brightest star in the Ham Radio Galaxy! The exciting new YAESU VX-7R sets new standards in ruggedness, water resistance, and versatility, and its memory capacity is unparalleled. Own the VX-7R, and you'll own the best.

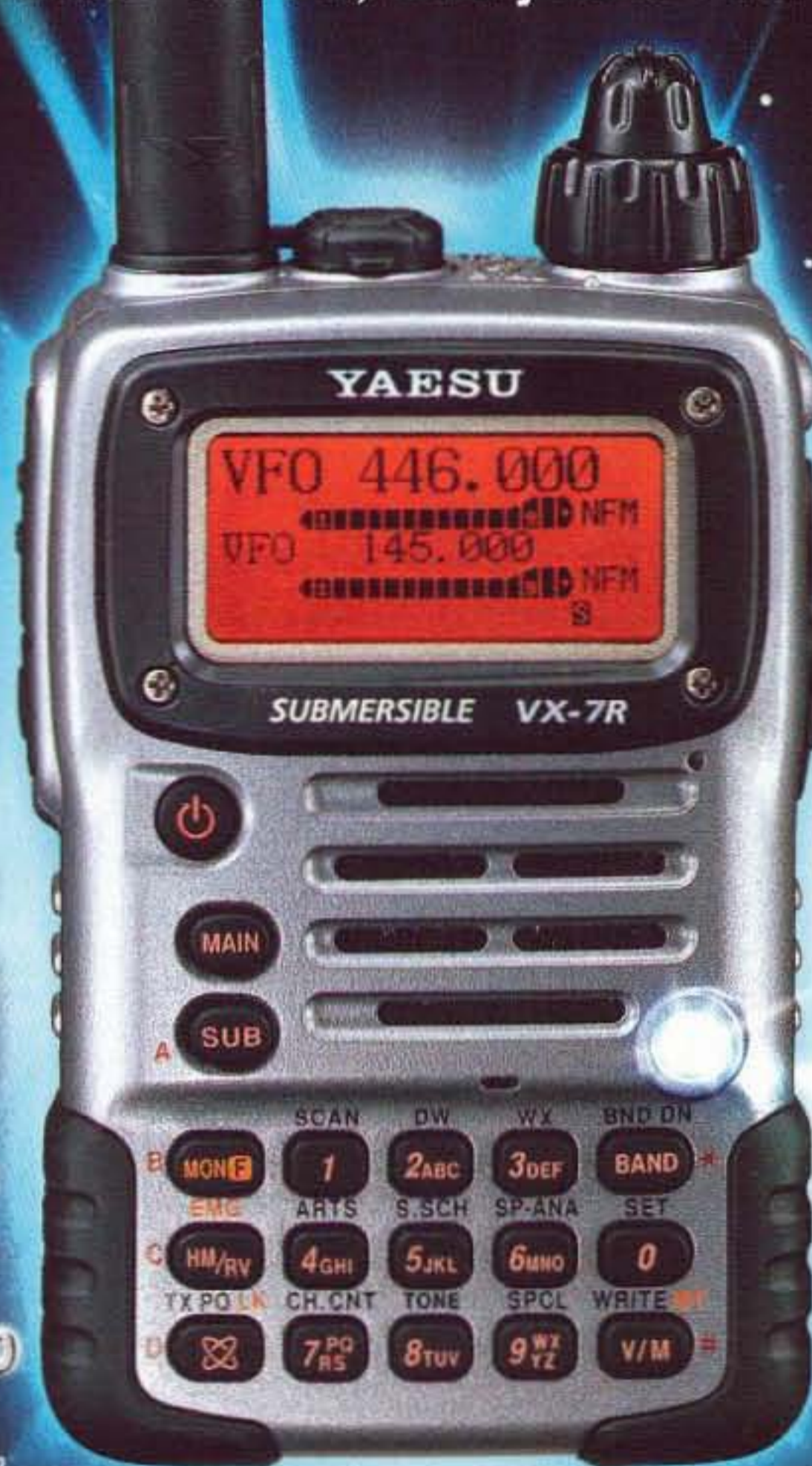

**TRUE DUAL RECEIVE**  
(V+V/U+U/V+U/HAM+GEN)

**WIDE-RANGE RECEIVER**

**MAGNESIUM CASE**

**SUBMERSIBLE**  
(3 feet for 30 minutes)

**OVER 500 MEMORY CHANNELS**

**MIXED TONE (CTCSS/DCS) CAPABILITY**

**INTERNET KEY FOR ACCESS TO**  
**WIRES**  
*Wide-Coverage Internet Repeater Enhancement System*

**SHORTWAVE BROADCAST MEMORY BANK**

**WEATHER BROADCAST MEMORY BANK WITH "SEVERE WEATHER" ALERT**

**MARINE BAND MEMORY BANK**

**MULTI-COLOR STROBE LED**

**LOW-POWER 222 MHz TX**  
(U.S. version)

**RUBBER CASE PROTECTOR**

## VX-7R

50/144/430 MHz 5W FM Transceiver

Actual Size

For the latest Yaesu news, visit us on the Internet:  
<http://www.vxstdusa.com>

Specifications subject to change without notice. Some accessories and/or options may be standard in certain areas. Frequency coverage may differ in some countries. Check with your local Yaesu Dealer for specific details.

**YAESU**  
*Choice of the World's Top DX'ers™*

Vertex Standard  
US Headquarters  
10900 Walker Street  
Cypress, CA 90630 (714)827-7600