

MAY 2002
ISSUE #498
USA \$8.95
CANADA \$4.95

73 Amateur Radio Today

Builder's Bonanza:

- High-Performance
Frequency Counter
(Amaze yourself!)
- dBm Meter
Range Extender
- Relative RF
Power Meter
- Mobile Rig
Voltage Control
- Skinflint Key

How to Build "Maui-Style"

The Maltese Welcome

"Radio Insurance" You Should Have

452
128
10
P 1

9

00174851108725111111

El Supremo & Founder
Wayne Green W2NSD/1

Associate Publisher
F. I. Marion

Executive Editor
Jack Burnett

Managing Editor
Joyce Sawtelle

Technical Editor
Larry Antonuk WB9RRT

Contributing Culprits
Mike Bryce WB8VGE
Jim Gray II
Jack Heller KB7NO
Chuck Houghton WB6IGP
Andy MacAllister W5ACM
Joe Moell KØOV
Steve Nowak KE8YN/0
Dr. Rick Olsen N6NR

Advertising Sales
Evelyn Garrison WS7A
21704 S.E. 35th St.
Issaquah WA 98029
425-557-9611
Fax: 425-557-9612

Circulation
Frances Hyvarinen

Data Entry & Other Stuff
Norman Marion

Business Office
Editorial - Advertising - Circulation
Feedback - Product Reviews
73 Amateur Radio Today Magazine
70 Hancock Rd.
Peterborough NH 03458-1107
603-924-0058
Fax: 603-924-8613

Reprints: \$3 per article
Back issues: \$5 each

Printed in the USA

73 Amateur Radio Today

TABLE OF CONTENTS

FEATURES

- 10 Build This Commercial-Quality Counter: Part 1 of 2 — K8IHQ**
Amaze your friends — and yourself!
- 14 How I Build "Modified Ugly" — AA2JZ**
Would you call this "Maui-style" construction?
- 18 Unmasking the Long Ranger — N2DCH**
Measure weak signals up to 56 MHz with this dBm meter range extender, kemosabe.
- 24 Travels with Henryk — Part 4 — SMØJHF**
All ashore at Malta.
- 27 Keying to a Different Drummer — W2GOM/7**
This CW key is simplicity for pennies.
- 29 Restoring an HQ-140-X — Part 1 — W6WTU**
This Hammarlund rig has always been a favorite.
- 34 Relative RF Power Meter — KC5MFY**
Add this handy device to your shack's arsenal.
- 37 Voltage Control for Your Mobile Rig — W4MEA**
Get turned on, and protect your rig in the process.
- 38 An Ounce Of — K7SUB**
Simple tips on upgrading your "radio insurance."

DEPARTMENTS

- 50 Above & Beyond — WB6IGP**
- 64 Barter 'n' Buy**
- 45 Calendar Events**
- 40 The Digital Port — KB7NO**
- 46 Hamsats — W5ACM**
- 53 Homing In — KØOV**
- 4 Never Say Die — W2NSD/1**
- 48 On the Go — KE8YN/Ø**
- 60 Propagation — Gray**
- 1 QRX**
- 63 Radio Bookshop**

E-Mail
design73@aol.com

Web Page
www.waynegrain.com

QRX . . .

'Til DX Do Us Part?

Get ready for a first. The first-ever wedding to be held at the Dayton Hamvention. No, we are not kidding.

For the first time in Hamvention history, wedding vows will be exchanged at the show. This, as Cyndi Krieger and Mark Elliot N8WZW will be married Saturday, May 18th at the HARA Arena during Hamvention 2002.

Mark and Cyndi met about 13 years ago through a

mutual friend. On their first date, they went out for dinner and a movie. According to Hamvention sources, they have been an "item" ever since.

Mark introduced Cyndi to amateur radio by going to a hamfest. Cyndi had no idea what a hamfest was, but it sounded interesting. It was, and she was hooked! Cyndi is now studying for her license and may test for it before Hamvention weekend.

Why get married at Hamvention? Mark and Cyndi couldn't think of a better place to share their love

Continued on page 6

Manuscripts: Contributions for possible publication are most welcome. We'll do the best we can to return anything you request, but we assume no responsibility for loss or damage. Payment for submitted articles will be made after publication. Please submit both a disk and a hard copy of your article (IBM (ok) or Mac (preferred) formats), carefully checked drawings and schematics, and the clearest, best focused and lighted photos you can manage. "How to write for 73" guidelines are available on request. US citizens, please include your Social Security number with submitted manuscripts so we can submit it to you know who.

73 Amateur Radio Today (ISSN 1052-2522) is published monthly by **73 Magazine**, 70 Hancock Rd., Peterborough NH 03458-1107. The entire contents ©2002 by **73 Magazine**. No part of this publication may be reproduced without written permission of the publisher, which is not all that difficult to get. The subscription rate is: one year \$24.97, two years \$44.97; Canada: one year \$34.21, two years \$57.75, including postage and 7% GST. Foreign postage: \$19 surface, \$42 airmail additional per year, payable in US funds on a US bank. Second class postage is paid at Peterborough, NH, and at additional mailing offices. Canadian second class mail registration #178101. Canadian GST registration #125393314. Microfilm edition: University Microfilm, Ann Arbor MI 48106. POSTMASTER: Send address changes to **73 Amateur Radio Today**, 70 Hancock Rd., Peterborough NH 03458-1107. **73 Amateur Radio Today** is owned by Shabromat Way Ltd. of Hancock NH.



...POWER ON WITH ASTRON

SWITCHING POWER SUPPLIES...



MODEL SS-10TK



MODEL SS-12IF



MODEL SS-18



MODEL SS-25M

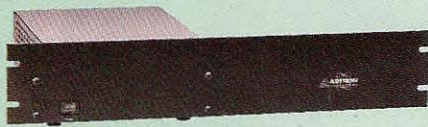

MODEL SRM-30

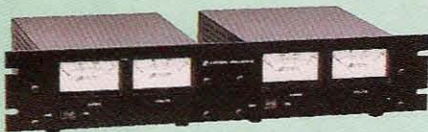

MODEL SRM-30M-2



MODEL SS-12SM/GTX



MODEL SS-10EFJ-98

SPECIAL FEATURES:

- HIGH EFFICIENCY SWITCHING TECHNOLOGY SPECIFICALLY FILTERED FOR USE WITH COMMUNICATIONS EQUIPMENT, FOR ALL FREQUENCIES INCLUDING HF
- HEAVY DUTY DESIGN
- LOW PROFILE, LIGHT WEIGHT PACKAGE
- EMI FILTER
- MEETS FCC CLASS B

PROTECTION FEATURES:

- CURRENT LIMITING
- OVERVOLTAGE PROTECTION
- FUSE PROTECTION
- OVER TEMPERATURE SHUTDOWN

SPECIFICATIONS:

INPUT VOLTAGE: 115 VAC 50/60HZ
OR 220 VAC 50/60HZ
SWITCH SELECTABLE
OUTPUT VOLTAGE: 13.8VDC

AVAILABLE WITH THE FOLLOWING APPROVALS: UL, CUL, CE, TUV.

DESKTOP SWITCHING POWER SUPPLIES

MODEL	CONT. (Amps)	ICS	SIZE (inches)	Wt.(lbs.)
SS-10	7	10	1 1/2 x 6 x 9	3.2
SS-12	10	12	1 1/2 x 6 x 9	3.4
SS-18	15	18	1 1/2 x 6 x 9	3.6
SS-25	20	25	2 1/4 x 7 x 9 1/2	4.2
SS-30	25	30	3 1/4 x 7 x 9 1/2	5.0

DESKTOP SWITCHING POWER SUPPLIES WITH VOLT AND AMP METERS

MODEL	CONT. (Amps)	ICS	SIZE (inches)	Wt.(lbs.)
SS-25M*	20	25	2 1/4 x 7 x 9 1/2	4.2
SS-30M*	25	30	3 1/4 x 7 x 9 1/2	5.0

RACKMOUNT SWITCHING POWER SUPPLIES

MODEL	CONT. (Amps)	ICS	SIZE (inches)	Wt.(lbs.)
SRM-25	20	25	3 1/2 x 19 x 9 1/2	6.5
SRM-30	25	30	3 1/2 x 19 x 9 1/2	7.0

WITH SEPARATE VOLT & AMP METERS

MODEL	CONT. (Amps)	ICS	SIZE (inches)	Wt.(lbs.)
SRM-25M	20	25	3 1/2 x 19 x 9 1/2	6.5
SRM-30M	25	30	3 1/2 x 19 x 9 1/2	7.0

2 ea SWITCHING POWER SUPPLIES ON ONE RACK PANEL

MODEL	CONT. (Amps)	ICS	SIZE (inches)	Wt.(lbs.)
SRM-25-2	20	25	3 1/2 x 19 x 9 1/2	10.5
SRM-30-2	25	30	3 1/2 x 19 x 9 1/2	11.0

WITH SEPARATE VOLT & AMP METERS

MODEL	CONT. (Amps)	ICS	SIZE (inches)	Wt.(lbs.)
SRM-25M-2	20	25	3 1/2 x 19 x 9 1/2	10.5
SRM-30M-2	25	30	3 1/2 x 19 x 9 1/2	11.0

CUSTOM POWER SUPPLIES FOR RADIOS BELOW

EF JOHNSON AVENGER GX-MC41.
EF JOHNSON AVENGER GX-MC42
EF JOHNSON GT-ML81
EF JOHNSON GT-ML83
EF JOHNSON 9800 SERIES
GE MARC SERIES
GE MONOGRAM SERIES & MAXON SM-4000 SERIES
ICOM IC-F11020 & IC-F2020
KENWOOD TK760, 762, 840, 860, 940, 941
KENWOOD TK760H, 762H
MOTOROLA LOW POWER SM50, SM120, & GTX
MOTOROLA HIGH POWER SM50, SM120, & GTX
MOTOROLA RADIUS & GM 300
MOTOROLA RADIUS & GM 300
MOTOROLA RADIUS & GM 300
UNIDEN SMH1525, SMU4525
VERTEX — FTL-1011, FT-1011, FT-2011, FT-7011

NEW SWITCHING MODELS

SS-10GX, SS-12GX
SS-18GX
SS-12EFJ
SS-18EFJ
SS-10-EFJ-98, SS-12-EFJ-98, SS-18-EFJ-98
SS-12MC
SS-10MG, SS-12MG
SS-101F, SS-121F
SS-10TK
SS-12TK OR SS-18TK
SS-10SM/GTX
SS-10SM/GTX, SS-12SM/GTX, SS-18SM/GTX
SS-10RA
SS-12RA
SS-18RA
SS-10SMU, SS-12SMU, SS-18SMU
SS-10V, SS-12V, SS-18V

RAMSEY

GET THE NEW CATALOG TODAY!

New Kits, New LPFM, New Cameras
www.ramseykits.com



WORK THE WORLD WITH A WATT...FOR ONLY \$99!

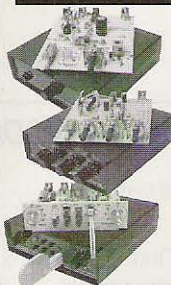

QRP TRANSMITTER

Available in 20, 30, or 40 Meters, these neat little transmitters put out 1 Watt!

HR RECEIVER

Available in 20, 30, or 40 Meters, 1.0 uV sensitivity rivals the big rigs...at a fraction of the price!

CW700 KEYER

With adjustable pitch & speed from 3-60 wpm, features true iambic keying and EPROM memory!

\$99 COMPLETE!

\$155 Sold Separately
 Visit www.ramseykits.com/qrp to order this special deal!

\$99 price includes QRP Transmitter kit, HR Receiver kit, and CW700 Micro-Memory Keyer kit, all the matching case & knob sets shown.
 Visit www.ramseykits.com/qrp to order this special deal!

35 WATT LPFM STEREO TRANSMITTER



- ✓ 35W RF output, VSWR protected
- ✓ Automatic audio & power controls
- ✓ Digital synthesized PLL
- ✓ Full front panel control
- ✓ 110/220VAC, 12VDC operation

Whether your application is export or LPFM, the PX1 has you covered. From the over-rated continuous duty power supply & power amplifier to the 2 line vacuum fluorescent display, your station will be the easiest to setup and the most reliable for continuous operation. Full microprocessor controls provide a "virtual engineer". Check out www.highpowerfm for full details.

PX1 35W Professional FM Stereo Transmitter \$1,795.95

TOUCH-TONE TONE GRABBER



- ✓ New-built-in RJ11 phone jack
- ✓ Large memory holds over 500 numbers
- ✓ Big bold 8 digit display, auto insertion of dashes
- ✓ New-output latch jack

Dialed phone numbers on the radio, repeater codes, control codes, anywhere touch-tones are used, you can read and store them! All new design for 2002. Capture those tones with the TG2!

TG2 Tone Grabber Tone Reader Kit \$59.95
 CTG2 Matching Case & Knob Set \$14.95
 AC125 110 VAC Power Adapter \$9.95

ELECTROCARDIOGRAM HEART MONITOR



- ✓ Visible and audible display of your heart rhythm
 - ✓ Re-usable sensors included; just like visiting the hospital!
 - ✓ Bright LED "beat" indicator
 - ✓ Monitor output for oscilloscope display
- Enjoy learning about the inner workings of the heart while covering the stage by stage electronic circuit theory of ECG/EKG systems. Be heart smart and learn at the same time!

ECG1 Electrocardiogram Heart Monitor Kit \$34.95
 CECG Matching Case & Knob Set \$14.95
 AC125 110 VAC Power Adapter \$9.95
 ECGP10 Replacement Reusable Probe Patches (10-Pack) \$7.95

XLR TO RCA AUDIO CONVERTER

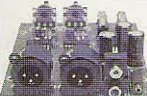

- ✓ Connect consumer outputs to XLR inputs
 - ✓ Left & right audio gain adjustments
- So you're trying to connect consumer audio outputs with RCA connectors (unbalanced) to XLR (balanced) inputs. Always a problem...Not anymore with the R2XL1!

R2XL1 Unbalanced to Balanced Audio Converter Kit \$49.95
 CR2XL Matching Case & Knob Set \$14.95
 PWR25 12VAC Power Adapter \$9.95

GIVEAWAYS & SPECIALS EVERY MONTH!

Register to receive our E-Mail specials and you will automatically be entered in our monthly drawing! New deals, new specials, new giveaways every month!

Register TODAY

www.ramseykits.com/specials

PROFESSIONAL FM STEREO RADIO STATION



- ✓ Synthesized 88 to 108 MHz with no drift!
- ✓ Built-in mixer - 2 line inputs and one microphone input!
- ✓ High power module available for export use
- ✓ Low pass filter for great audio response

Our FM100 is used all over the world by serious hobbyists as well as churches, drive-in theaters, and schools. Frequency synthesized PLL assures drift-free operation with simple front panel frequency selection. Built-in audio mixer features LED bargraph meters to make setting audio a breeze. The kit includes metal case, whip antenna and built-in 110 volt AC power supply.

FM100 Super-Pro FM Stereo Radio Station Kit \$249.95
 FM100WT 1 Watt, Wired Export Version \$399.95

SYNTHESIZED FM STEREO TRANSMITTER



- ✓ All new design & features for 2002!
 - ✓ Fully adjustable RF output
- Our #1 kit for years has just gotten better for 2002! Totally redesigned, the FM25B has all the features you've asked for. From variable RF output, F connector RF output jack, line input, loop output, and more.

Includes case, power supply, whip antenna, audio cables.
 FM25B Synthesized FM Stereo Transmitter Kit \$129.95

AUTOMATIC COLOR/BW IR CAMERA



- ✓ Color during the day, IR B&W at night!
 - ✓ Automatically turns on IR illumination!
 - ✓ Waterproof to IP57 standards!
 - ✓ Black anodized housing with universal mount
- Best of both worlds! This video camera is a waterproof COLOR camera during the day. When the light level drops, it automatically changes to B&W and turns on its built-in IR illumination, with 10 IR LEDs. Powered by 12VDC and terminated with a professional BNC connector. B&W only model also-available if color is not needed.

Both in heavy anodized black housing.
 CCD309 Color/B&W IR Waterproof Bullet Camera \$169.95
 CCD308 B&W IR Waterproof Bullet Camera \$109.95
 AC125 110 VAC Power Adapter \$9.95

MINI B&W CAMERA WITH IR ILLUMINATION



- ✓ Built in IR illumination!
 - ✓ Sees in total darkness!
- What a deal! This miniature B&W video camera has 6 high power IR LEDs built into it to provide illumination in total darkness! No need for external IR illuminators. Attractive black aluminum housing easily mounts at any angle with the built-in swivel bracket. Runs on 12VDC, and includes professional BNC output plug-in harness.

CCD303 Mini B&W IR Illuminated Camera \$59.95
 AC125 110 VAC Power Adapter \$9.95

Check out all our other new cameras at www.ramseykits.com



RAMSEY ELECTRONICS, INC.
 793 Canning Parkway
 Victor, NY 14564
 716-924-4560
sales@ramseykits.com



Order Today! 800-446-2295
www.ramseykits.com

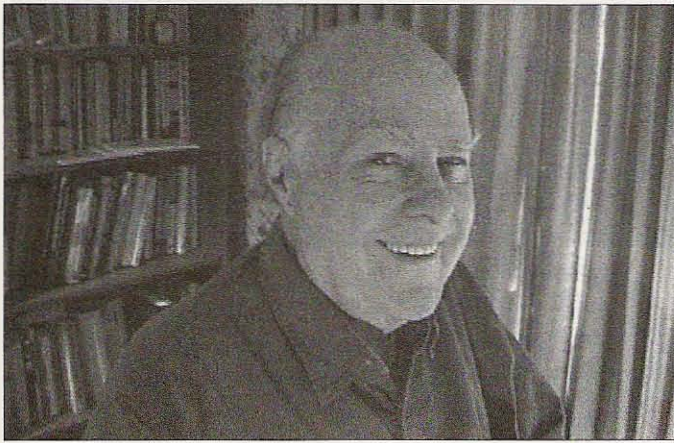

Wise Up & Beat the Odds

NEVER SAY DIE

Wayne Green W2NSD/1

w2nsd@aol.com

www.waynegr.com

Better QSOs

How often do the people you talk with on the air tell you how much they've enjoyed the contact when they're signing off?

So what's the secret?

That's easy! Just get into a conversation on the one topic your potential new friend is most interested in. What's that? Himself, of course. The more you get him to talk about himself, the more interesting the contact is going to be for him.

None of us gives a bear's butt about what make rig or antenna the other guy's using. Nor do we care much about his weather. What's he do? What're his other interests? Get him talking about his most favorite subject. Has he found any really interesting Web sites? Made any trips recently?

I've been totally failing for months to get you to tell me about the most exciting times you've had in ham radio so I can use these stories to help get youngsters interested in the hobby. Well, maybe you can ask the next few guys you work about their most exciting ham adventures. And then get them to send me the stories via w2nsd@aol.com. Subject: ham adventures.

I suspect that the main reason 80% of our licensees are burned out is the endless parade of boring contacts which eventually drove them off the air. We've got a fabulous communications medium, we just have never learned to communicate. Hello, CQ twenty ... ZZZZZ.

Dayton

Many readers asked if I was going to come to Dayton this year. Nope.

First, I didn't get invited. They stopped asking me to speak several years ago when the ARRL put on the pressure. I'm the competition, ya know.

Second, I haven't time. I've been busy every waking hour trying to keep up with the demand for my books resulting from my appearances on Art Bell's "Coast-to-Coast AM" show. Whew! And if that isn't enough, I'm also starting a new magazine which is due out starting this month. It's *NH ToDo*, and its aim is to increase New Hampshire tourism by publishing articles on how much fun the things are that we have to do.

This project has had me giving talks to New Hampshire chambers of commerce, Rotary Clubs, Lions, Elks, and veterans groups all around the state. Plus radio and TV interviews. Yes, of course I get in plugs for ham radio at every opportunity.

I've had a few ham clubs set up telephone talks for me. I'd like to have more.

I love to talk about the greatest disaster in the history of the hobby, and the day that Khrushchev saved amateur radio. I also enjoy being an iconoclast. A disestablishmentarianist. Controversial.

Heck, all I want to do is destroy the medical and pharmaceutical industries, nursing homes, assisted living services, the sugar industry, the fast food industry, the

food giants, our present lousy school system, pet food companies, the Social Security system, our prison system, our colleges, and stuff like that.

That Wretched Pole Shift

If the Earth is indeed an oblate spheroid (flat at the poles and bulging at the equator), then how would it be possible for the polar axis to shift? Clearly, there's nothing to really worry about.

Except.

Except, how else can we explain woolly mammoths being defrosted in Siberia with tropical flowers still in their mouths? Instantly deep frozen.

Except for René finding proof of the equatorial bulge more than elusive.

Except for the research of Charles Hapgood into very ancient maps.

Except for the predictions of a coming pole shift by prophets like Nostradamus and Edgar Cayce.

Except for an E-mail from Tom N8ECW: "I've dug out some books that I bought about fifteen years ago. You've talked about pole shifts in your past editorials. Gene Savoy has done a lot of exploring and studied a lot of ancient cultures. After going over the work done by him, I think that a pole shift would be more likely to occur after a sudden burst of energy from the sun. This could possibly happen during the next 11-year sunspot cycle. This peak should occur right about late 2012, the same year that the Mayan calendar expires."

Whew! That gives us another ten years respite.

With the current sunspot maximum being double-spiked and lasting longer than any other in recorded history, it's possible that the next one could be a doozie. If we weather 2003 without a major catastrophe, I'm definitely going to have an underground home done by 2012. Right now I'm too busy getting my health guide out to the few people who have not been totally brainwashed by the medical industry and starting *NH ToDo* magazine.

A recent Art bell guest made a good case for Planet X, a brown dwarf companion to our sun, coming around next year on its 3,660-year orbit. Zachariah Sitchin reported on this planet being described in ancient manuscripts and being called Nibiru. It caused huge cataclysms on its last pass. Next year it's supposed to pass between Earth and the sun, where it could easily create havoc — possibly the predicted pole shift.

I talked with prophet Gordon Scallion K1BWC, and he's all set with an underground bunker, food, and emergency power.

If any of the prophets are right, this is not a good time to be living in a city. Or even near one.

Good Fortune

My Chinese buffet lunches end up with a fortune cookie. I save the fortunes. Today's

Continued on page 8

Big Savings on Radio Scanners

Uniden® NEW!

SCANNERS

AOR



Bearcat® 780XLT Trunk Tracker III
Mfg. suggested list price \$529.95
Less -\$190 Instant Rebate / Special \$339.95
500 Channels • 10 banks • CTCSS/DCS • S Meter
Size: 7^{5/8}" Wide x 6^{15/16}" Deep x 2^{13/16}" High
Frequency Coverage: 25,000-512,000 MHz, 806,000-823,9875 MHz, 849,0125-868,9875 MHz, 894,0125-1300,000 MHz.

The Bearcat 780XLT has 500 channels and the widest frequency coverage of any Bearcat scanner ever. Packed with features such as Trunktracker III to cover EDACS, Motorola and EF Johnson systems, control channel only mode to allow you to automatically trunk certain systems by simply programming the control channel, S.A.M.E. weather alert, full-frequency display & backlight controls, built-in CTCSS/DCS to assign analog and digital subaudible tone codes to a specific frequency in memory, PC Control with RS232 port, Beep Alert, Record function, VFO control, menu-driven design, total channel control and much more. Our CEI package deal includes telescopic antenna, AC adapter, cigarette lighter cord, DC cord, mobile mounting bracket with screws, owner's manual, trunking frequency guide and one-year limited Uniden factory warranty. For maximum scanning enjoyment, order magnetic mount antenna part number ANTMNBNC for \$29.95; The BC780XLT comes with AC adapter, telescopic antenna, owner's manual and one year limited Uniden warranty. Not compatible with AGEIS, ASTRO or ESAS systems. For fastest delivery, order on-line at www.usascan.com.

Bearcat® 895XLT Trunk Tracker
Mfg. suggested list price \$499.95
Less -\$320 Instant Rebate / Special \$179.95
300 Channels • 10 banks • Built-in CTCSS • S Meter
Size: 10^{1/2}" Wide x 7^{1/2}" Deep x 3^{3/8}" High
Frequency Coverage: 29,000-54,000 MHz, 108,000-174 MHz, 216,000-512,000 MHz, 806,000-823,995 MHz, 849,0125-868,995 MHz, 894,0125-956,000 MHz.

The Bearcat 895XLT is superb for intercepting trunk communications transmissions with features like TurboScan™ to search VHF channels at 100 steps per second. This base and mobile scanner is also ideal for intelligence professionals because it has a Signal Strength Meter, RS232C Port to allow computer-control of your scanner via optional hardware and 30 trunking channel indicator annunciators to show you real-time trunking activity for an entire trunking system. Other features include Auto Store - Automatically stores all active frequencies within the specified bank(s). Auto Recording - Lets you record channel activity from the scanner onto a tape recorder. CTCSS Tone Board (Continuous Tone Control Squelch system) allows the squelch to be broken during scanning only when a correct CTCSS tone is received. For maximum scanning enjoyment, order the following optional accessories: PS001 Cigarette lighter power cord for temporary operation from your vehicle's cigarette lighter \$14.95; PS002 DC power cord - enables permanent operation from your vehicle's fuse box \$14.95; MB001 Mobile mounting bracket \$14.95; EX711 External speaker with mounting bracket & 10 feet of cable with plug attached \$19.95. The BC895XLT comes with AC adapter, telescopic antenna, owner's manual and one year limited Uniden warranty. Not compatible with AGEIS, ASTRO, EDACS, ESAS or LTR systems.



Bearcat® 245XLT Trunk Tracker II
Mfg. suggested list price \$429.95/CEI price \$189.95
300 Channels • 10 banks • Trunk Scan and Scan Lists
Trunk Lockout • Trunk Delay • Cloning Capability
10 Priority Channels • Programmed Service Search
Size: 2^{1/2}" Wide x 1^{3/4}" Deep x 6" High
Frequency Coverage:

29,000-54,000 MHz., 108-174 MHz., 406-512 MHz., 806-823,995 MHz., 849,0125-868,995 MHz., 894,0125-956,000 MHz.

Our Bearcat TrunkTracker BC245XLT, is the world's first scanner designed to track Motorola Type I, Type II, Hybrid, SMARTNET, PRIVACY PLUS and EDACS® analog trunking systems on any band. Now, follow UHF High Band, UHF 800/900 MHz trunked public safety and public service systems just as if conventional two-way communications were used. Our scanner offers many new benefits such as Multi-Track - Track more than one trunking system at a time and scan conventional and trunked systems at the same time. 300 Channels - Program one frequency into each channel. 12 Bands, 10 Banks - Includes 12 bands, with Aircraft and 800 MHz. 10 banks with 30 channels each are useful for storing similar frequencies to maintain faster scanning cycles or for storing all the frequencies of a trunked system. Smart Scanner - Automatically program your BC245XLT with all the frequencies and trunking talk groups for your local area by accessing the Bearcat national database with your PC. If you do not have a PC simply use an external modem. Turbo Search - Increases the search speed to 300 steps per second when monitoring frequency bands with 5 KHz. steps. 10 Priority Channels - You can assign one priority channel in each bank. Assigning a priority channel allows you to keep track of activity on your most important channels while monitoring other channels for transmissions. Preprogrammed Service (SVC) Search - Allows you to toggle through preprogrammed police, fire/emergency, railroad, aircraft, marine, and weather frequencies. Unique Data Skip - Allows your scanner to skip unwanted data transmissions and reduces unwanted birdies. Memory Backup - If the battery completely discharges or if power is disconnected, the frequencies programmed in your scanner are retained in memory. Manual Channel Access - Go directly to any channel. LCD Back Light - An LCD light remains on for 15 seconds when the back light key is pressed. Autolight - Automatically turns the backlight on when your scanner stops on a transmission. Battery Save - In manual mode, the BC245XLT automatically reduces its power requirements to extend the battery's charge. Attenuator - Reduces the signal strength to help prevent signal overload. The BC245XLT also works as a conventional scanner. Now it's easy to continuously monitor many radio conversations even though the message is switching frequencies. The BC245XLT comes with AC adapter, one rechargeable long life ni-cad battery pack, belt clip, flexible rubber antenna, earphone, RS232C cable, Trunk Tracker frequency guide, owner's manual and one year limited Uniden warranty. Not compatible with AGEIS, ASTRO, ESAS or LTR systems. Hear more action on your radio scanner today. Order on-line at www.usascan.com for quick delivery.

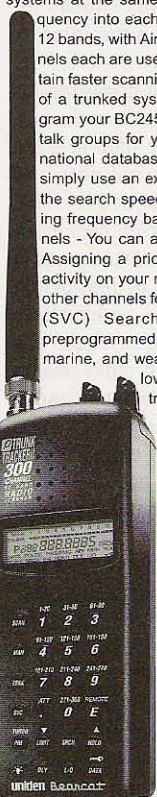

Order on-line at www.usascan.com for quick delivery.

More Radio Products

- Save even more on radio scanners when purchased directly from CEI. Your CEI price after instant rebate is listed below:
- Bearcat 895XLT 300 ch. Trunktracker I base/mobile scanner.....\$179.95
 - Bearcat 780XLT 500 ch. Trunktracker III base/mobile.....\$339.95
 - Bearcat 278CLT 100 ch. AM/FM/SAME WX alert scanner.....\$159.95
 - Bearcat 245XLT 300 ch. Trunktracker II handheld scanner.....\$189.95
 - Bearcat 248CLT 50 ch. base AM/FM/weather alert scanner.....\$89.95
 - Bearcat Sportcat 200 alpha handheld sports scanner.....\$169.95
 - Bearcat Sportcat 180B handheld sports scanner.....\$149.95
 - Bearcat 80XLT 50 channel handheld scanner.....\$99.95
 - Bearcat 60XLT 30 channel handheld scanner.....\$74.95
 - Bearcat BCT7 information mobile scanner.....\$139.95
 - AOR AR8200 Mark II Wide Band handheld scanner.....\$539.95
 - AOR AR16BQ Wide Band scanner with quick charger.....\$209.95
 - ICOM ICR8500 wideband communications receiver.....\$1469.95
 - ICOM PCR1000 computer communications receiver.....\$379.95
 - ICOM R10 handheld wideband communications receiver.....\$279.95
 - Uniden WX100 Weather Alert with S.A.M.E. feature.....\$49.95

AOR® AR8200 Mark IIB Radio Scanner

AOR8200 Mark IIB-A wideband handheld scanner/SPECIAL \$539.95
1,000 Channels • 20 banks • 50 Select Scan Channels
PASS channels: 50 per search bank + 50 for VFO search
Frequency step programmable in multiples of 50 Hz.
Size: 2^{1/2}" Wide x 1^{3/8}" Deep x 6^{1/8}" High
Frequency Coverage:

500 KHz to 823.995 MHz, 849.0125-868.995 MHz, 894.0125-2,040.000 MHz (Full coverage receivers available for export and FCC approved users.)

The AOR AR8200 Mark IIB is the ideal handheld radio scanner for communications professionals. It features all mode receive: WFM, NFM, SFM (Super Narrow FM), WAM, AM, NAM (wide, standard, narrow AM), USB, LSB & CW. Super narrow FM plus Wide and Narrow AM in addition to the standard modes. The AR8200 also has a versatile multi-function band scope with save trace facility, twin frequency readout with bar signal meter, battery save feature with battery low legend, separate controls for volume and squelch, arrow four way side rocker with separate main tuning dial, configurable keypad beep/illumination and LCD contrast, write protect and keypad lock, programmable scan and search including LINK, FREE, DELAY, AUDIO, LEVEL, MODE, computer socket fitted for control, clone and record, Flash-ROM no battery required memory, true carrier re-insertion in SSB modes, RF preselection of mid VHF bands, Detachable MW bar aerial. Tuning steps are programmable in multiples of 50 Hz in all modes, 8.33 KHz airband step correctly supported, Step-adjust, frequency offset, AFC, Noise limited & attenuator, Wide and Narrow AM in addition to the standard modes. For maximum scanning pleasure, you can add one of the following optional slot cards to this scanner: CT8200 CTCSS squelch & search decoder \$89.95; EM8200 External 4,000 channel backup memory, 160 search banks. \$69.95; RU8200 about 20 seconds chip based recording and playback \$69.95; TE8200 256 step tone eliminator \$59.95. In addition, two leads are available for use with the option socket. CC8200 PC control lead with CD Rom programming software \$109.95; CR8200 tape recording lead \$59.95. Includes 4 1,000 mAh AA ni-cad batteries, charger, cigar lead, whip aerial, MW bar antenna, belt hook, strap and one year limited AOR warranty. Enter your order now at <http://www.usascan.com>.

Buy with Confidence

Order on-line and get big savings

For over 32 years, millions of communications specialists and enthusiasts worldwide have trusted Communications Electronics for their mission critical communications needs. It's easy to order. For fastest delivery, order on-line at www.usascan.com. Mail orders to: Communications Electronics Inc., P.O. Box 1045, Ann Arbor, Michigan 48106 USA. Add \$20.00 per radio transceiver for UPS ground shipping, handling and insurance to the continental USA. Add \$13.00 shipping for all accessories and publications. For Canada, Puerto Rico, Hawaii, Alaska, Guam, P.O. Box or APO/FPO delivery, shipping charges are two times continental US rates. Michigan residents add sales tax. No COD's. Your satisfaction is guaranteed or return item in unused condition in original packaging within 61 days for refund, less shipping, handling and insurance charges. 10% surcharge for net 10 billing to qualified accounts. All sales are subject to availability, acceptance and verification. Prices, terms and specifications are subject to change without notice. We welcome your Discover, Visa, American Express, MasterCard, IMPAC or Eurocard. Call anytime 1-800-USA-SCAN or 800-872-7226 to order toll-free. Call 734-996-8888 if outside Canada or the USA. FAX anytime, dial 734-663-8888. Dealer and international inquiries invited. Order your radio scanners from Communications Electronics Inc. today at www.usascan.com.

For credit card orders call 1-800-USA-SCAN

e-mail: cei@usascan.com

www.usascan.com

PO Box 1045, Ann Arbor, Michigan 48106-1045 USA
For information call 734-996-8888 or FAX 734-663-8888
Price schedule effective March 2, 2001 AD #03020173 © 2001 Communications Electronics Inc.



Visit WWW.USASCAN.COM • 1-800-USA-SCAN

continued from page 1

for each other and for amateur radio than by getting married at the world's largest amateur radio trade show. The ceremony takes place at 3 p.m. in Forum Room 3, immediately following the Amateur Radio Newsline-produced Ham Radio Town Meeting.

Thanks to Newsline, Bill Pasternak WA6ITF, editor.

Hamvention 2002: Award Winners Named

The Dayton Hamvention has named Radio Amateur Information Network founder Alanson "Hap" Holly KC9RP as its 2002 Radio Amateur of the Year. Holly received the news of his selection on Thursday evening February 28th in a phone call from Cathi Hoskins N8ZCQ, who chairs the Hamvention Awards and Banquet Committee. KC9RP was completely taken by surprise: "I was absolutely stunned! In fact, all I could say was, 'Me?' I mean, seriously, I was just absolutely floored."

Holly, who lives in Des Plaines, Illinois, has been licensed since 1965. He began his ham radio informational programming career in 1984 on a local Chicago area repeater. This eventually led him to become founder, moderator, and guiding light of a weekly amateur radio audio feature magazine known as the *RAIN Report*.

RAIN programming is distributed to hundreds of repeaters across the country via a telephone dial-up line, via the [rainreport.com] Web site, by a subscription tape service, and broadcast over WAØRCR's weekly 160-meter informational net.

But that's is only a small part of the Hap Holly story. Originally licensed in Escondido, California, at age 14, Holly, who has been blind since age 7, served as a phone-patch station and net control for the famed WESTCARS traffic net until 1970. He then headed off to Principia College in Illinois, and, from 1970 to graduation in 1974, ran phone patches and kept radio schedules for many of his fellow students.

Holly graduated from Principia with a bachelor of arts degree in sociology, and soon found himself in the Chicago area. There, he sought out world-class jazz accordionist Leon Sash, to pursue further training in music. As a professional keyboard player, Holly's diverse repertoire of American music of the past six decades has made him a popular choice in the Chicago area.

Hap met his wife-to-be while he was teaching a class in nonvisual perception to high school students at a summer camp in Buena Vista, Colorado. The two were married in August of 1976. Stephanie, who is

sighted, received her ham ticket and KA9WKD call sign in 1986.

Over the years, Hap Holly has written articles for the *Spec-Com Journal* and *Radio Scan Magazine*, and occasionally reports for the *Amateur Radio Newsline*. Holly is also a common sight at the Dayton Hamvention, taping forums which are then incorporated throughout the year into his *RAIN Reports*. And, since 1975, KC9RP has been an honored member of the Des Plaines Lions Club. He has also been a member of the Des Plaines Toastmasters since 1976. He and Stephanie are also active with the Des Plaines, Illinois, Emergency Medical Alert system.

Named as this year's Hamvention Technical Excellence award winner is Alan Waller K3TKJ, of Laurel, Delaware. Waller was chosen for his work that led to interfacing the Internet to Amateur Radio.

First licensed in 1961, Waller combined his decades-long love for amateur radio and a burgeoning interest in the then-new Internet to design and manage the [www.qsl.net] and [www.qth.net] Web sites. That was back in 1993. Since that time, Alan Waller's Web sites have come to serve the needs of tens of thousands of ham radio operators worldwide by providing a vast technical reference platform, an electronic mail service, Web page hosting services, and links to thousands of other ham radio-related sites. And in the true spirit of amateur radio, Waller's initial work utilized leading edge experimentation to see what could be done with the technology then available. This has developed into a mature, reliable service to the worldwide ham radio community.

Rounding out this season's winners are a pair of space exploring hams who have been named as co-recipients of the 2002 Hamvention Special Achievement Award. Former astronauts Owen Garriott W5LFL and Tony England WØORE are being honored for paving the way for manned ham radio operations from the space shuttles that have made ham radio a permanent part of man's exploration of space.

Owen Garriott W5LFL was first. On November 28, 1983, Garriott was launched into space aboard the space ship *Columbia* for the STS-9 mission. It was the Spacelab 1 mission and Garriott brought along the first amateur radio station on a crew-tended space vehicle. It was a simple Motorola hand-held transceiver connected to a special antenna designed to fit in the Space Shuttle's window.

Three days later, W5LFL came on the air, and hams across the United States and around the world were witness to a historic radio transmission:

"This is W5LFL in *Columbia*. W5LFL in *Columbia* orbiting the Earth at an altitude of 135 nautical miles passing over the U.S. West Coast and calling CQ."

Among those who heard Owen Garriott's amateur radio transmissions from space was Lance Collister WA1JXN of Frenchtown, Montana.

Collister, who is now W7GJ, is credited with being the first amateur to work an astronaut in orbit.

The success of Garriott's mission led to the development of SAREX — The Shuttle Amateur Radio Experiment. And, over the years, SAREX permitted youngsters in classrooms around the world to speak directly with astronauts in space. But for this to happen, the technology of manned ham radio operations from space had to be enhanced. This aspect of the then new SAREX program fell to the next ham radio operator orbited: Tony England WØORE.

WØORE flew into space on the shuttle *Challenger* in 1985. It was Mission 51F, Spacelab 2. In addition to the 2-meter FM voice gear, Tony England also had with him the first-ever ham television station to go into space. Slow-scan, yes, but capable of sending back high resolution images which hams on the ground equipped with SSTV gear could view live or record on a simple audio cassette for later viewing and historical archiving. From space, Tony England described the station he was using:

"Essentially we've got a commercial TV camera that anyone could go out to their local radio store and buy. We feed this into a scan converter built by a commercial outfit and modified by NASA amateur radio clubs and this takes a snapshot of the scene and digitizes it and puts it in a memory.

"Then it's sent to a handie-talkie like this. From there we will send it over a wire up to the upper window upstairs and to this antenna when I get it up there in the window. Then it will be transmitted to the ground.

"When we get going, we will be able to send color TV images of what we are doing on board as a series of snapshots updated every 10 or 20 seconds. Amateurs anywhere on the ground will be able to receive them, and ones with scan converters will see the pictures."

That flight also marked another first: the first-ever two-way television — ham radio television — to and from space.

Tony England went on to flight-prove both the improved FM voice and then new SSTV systems. The SSTV was so successful that NASA gave very serious consideration to a permanent installation on all shuttles for backup communications. More important, the early on-orbit operations by Owen Garriott W5LFL and Tony England WØORE made possible the thousands of educational contacts between children in school classrooms and the crews flying in space — first on board the shuttles, and now as a permanent part of the International Space Station.

Hap Holly KC9RP, Alan Waller K3TKJ, Owen Garriott W5LFL, and Tony England WØORE will receive their honors at the Hamvention Awards Banquet slated for Saturday evening, May 18th, at the Nutter Center in Dayton, Ohio.

Thanks to Newsline, Bill Pasternak WA6ITF, editor.

Arkansas's First Full Line Amateur Radio Store

107 East Broadway
Morrilton, AR 72110
Phone 501-354-3868 (local)
Fax 501-354-3983
1-888-315-7388

RLS
ELECTRONICS

Icom, Yaesu, Kenwood, ADI, Alinco, MFJ,
Ameritron, Mirage, Vectronics, Heil, Cushcraft,
Lakeview, Maha, A.B.S., Valor, JPS, DSI Satellites,
ARRL and Gordon West Books, Iron Horse,
Ameco and Computers

www.rlselectronics.com

FCC Approves Ultra-wideband

The nation's communications regulators have approved limited use of a new technology that is actually capable of seeing through walls, finding disaster victims, and even preventing car crashes. Known as ultra-wideband, this new method of wireless transmission is being promoted as a potential solution to the squeeze on the nation's airwaves created by the explosion of mobile phone, pager, and other wireless device usage.

Ultra-wideband devices will for now operate only in 960 MHz and in the 1.99 to 10.6 GHz bands. In theory, at least, you should never even know that they are there. This is because proponents of ultra-wideband claim that interference to other spectrum users is virtually nonexistent — based on the ultra-short duration and pulsed nature of the transmissions. And the Federal Communications Commission agreed, when it voted unanimously about a week ago to allow the technology to be used on a limited unlicensed basis.

The FCC proceeded cautiously out of uncertainty whether ultra-wideband could coexist with other strategic services. In other words, it wanted to be certain that it would not cause harmful interference to military communications, cellular telephones, and the Global Positioning System. So it only provided ultra-wideband access to a small portion of RF real estate. Nonetheless, the real-life implications of the limits of the FCC decision are far-reaching.

Up to now, the military has been the only ultra-wideband user. This FCC action will allow for wireless communications and accurate readings of location and distance that have a wide range of civilian applications. For the general public this includes wireless, high-speed transmissions over short distances, possibly as a way of sending video from a camcorder to a television set or data from a personal digital assistant to a laptop computer. The technology might also include sensor systems in cars to alert a driver to movement near the vehicle. This could prevent collisions and promote smart air bag deployment.

Otherwise, the FCC has limited use of ultra-wideband technology for public safety. Only police and fire officials, scientific researchers, and mining and construction companies will be permitted the use of so-called ground-penetrating radar

Continued on page 58

A GREAT gift idea for yourself, your ham friend(s), or your child's school library

is a subscription to 73 Magazine ... only \$24.97!

Call 800-274-7373 or write to 70 Hancock Rd., Peterborough NH 03458

Two Step Tuning Step One: Pick up microphone. Step Two: Transmit.

(Please note: HF Tuning doesn't get much easier than this.)



SGC Smartuner™ HF Automatic Antenna Couplers

"For me and my radio dollar, there isn't a better coupler made!"

Jack Huebschen N9XR0

Power Input: From 1.5W - Up to 500W*
HF Frequency Range: From 1MHz - Up to 60MHz*
Up to 4,000,000 element combinations*
Five Sensor Devices *Specs differ per model

"Undoubtedly the best piece of hamgear I have ever owned."

Ronnie Kane K9MNI

**Marine, Commercial, Amateur Radio,
Aviation, Special Applications**

Starting at \$249



SGC

www.sgcworld.com

Toll Free (800) 259-7331 • Tel (425) 746-6310 • Fax (425) 746-6384 • Email: sgc@sgcworld.com

Mailing: PO Box 3526, Bellevue, WA 98009 • Shipping: 13737 SE 26th St. Bellevue, WA 98005 USA

Copyright 2001 SGC, Inc.

NEUER SAY DIE

continued from page 4

said, "A person of words and not of deeds is like a garden full of weeds."

Okay, what kind of a mark will you leave on the world to show that you were here? Have you created anything of significance? Music? A work of art? Written a book? Maybe an invention? Or perhaps you've done some research? If not, why not? It isn't as if there aren't an unlimited number of things that need to be done.

We are in desperate need of creative music and art. And there sure is a shortage of first rate books.

In the research department, as I've written endlessly over the years, all you have to do is grab an anomaly that establishment science has swept under the rug and go with it. This is what John Mack, the psychologist, did. He wanted to find out more about the contactees, so he started interviewing 'em. And that led to his discovering that these people weren't refugees from the *National Enquirer*, but had consistent stories to tell. And he wrote *Abduction*, a landmark book.

Drs. Pons and Fleischmann noticed an anomaly with palladium that had been ignored. They upset the hell out of the physics establishment, the oil, coal, natural gas, and power industries, with their discovery of the cold fusion reaction. Big money finally put them out of business, delaying the demise of OPEC and the coal companies.

Michael Cremona's *Forbidden Archeology* is a compendium of artifacts archeologists have dug up for which there is no comfortable explanation. Like a gold chain embedded in a 300 million year old lump of coal.

The history of science is a long history of the establishments of the day doing their best to keep new ideas from gaining ground. Ditto the medical field. And ditto just about any other field.

And stop complaining about greed ruining things. Greed is here to stay. It's what capitalism

is all about. The alternative is socialism, and that approach has failed every time it's been tried. Instead of fighting greed, figure out how to use it to your advantage.

Greed is everywhere. Look at any square inch of ground, on land or under water, and you'll find there is a constant battle going on for territory. Dandelions are greedy as hell. They do their best to take over your lawn. You either have to fight them constantly, or relax and admire their beauty.

Of course there's always the sheep approach, as long as you don't mind being fleeced regularly.

Will the mark you leave in the world be only a cipher?

New Energy Source!

The scientific world was rocked recently by the discovery of a new energy source ... sonoluminescence.

Sonoluminescence, wow, what a surprise! Well, a surprise only to physicists with their heads in the sand.

I've published six articles on the subject in my *Cold Fusion Journal*, with the first, a six-page article, being published eight years ago.

The article was a report on the Jim Griggs' hydrosonic steam generator in Atlanta, which my editor measured at 160% efficiency.

Jim had come up with a new way to generate steam to heat buildings using the sudden compression of water. When his customers started measuring the efficiency of their systems they were amazed to find them more than 100% efficient. I heard about it and quickly sent an editor to Atlanta to make careful measurements.

Jim got a patent on his system in 1993 and I published the first article on this amazing new energy source in 1994. Since then I've published scientific papers explaining the science involved in sonoluminescence. I published another article on using this technology to propel boats without the need of any propellers. The inventor got a patent, but never was able to

get any boat companies interested in it. Inventors just don't seem to be much good at marketing their ideas.

Jim uses a wheel with little dimples in it, running inside an outside casing which is only thousandths of an inch larger in diameter, thus suddenly compressing water sprayed onto the wheel to make steam. The compression was generating little bubbles heated to thousands of degrees, resulting in a micro hot fusion reaction.

Your Pets

Is there any real question in your mind about dogs and cats having digestive systems geared to handle raw meat? You know that's what they've been eating for a million years — up until some enterprising companies made it "easier" for us to buy cat food and dog food from supermarket shelves.

I'm a dog and cat person, but it never occurred to me that my pets should be fed raw meat. The pet food company commercials told me that their food was scientifically designed to be what was best for my pets. Duh. Wrongo, that stuff is what is best for the pet food companies.

Now I've discovered that many scientists have researched the subject and found that when you feed your pets cooked food they generally live about 65% as long and suffer from human ailments.

It was this fact which got Dr. Bruno Comby to start putting his sicker patients on raw food diets. The results were spectacular. His book, *Maximize Immunity*, is reviewed in my *Wisdom Guide*. He, like Dr. Lorraine Day and several other doctors, has been curing his patients of cancer, AIDS, and just about any other illness.

If your pets have been raised on pet food, it may take some time to get 'em used to raw meat. I suggest you invest in some beef liver, mince it, and mix it in with the stuff you've been feeding your pets. It won't take long before

they'll come running when they hear the chow call.

You can help keep them healthier by adding some silver colloid to their drinking water. They'll also have better breath as a result. They'll also stay healthier if you spray them with silver colloid every couple of days.

Keep some silver colloid in a spray bottle around for your plants. Flowers will last a week if you spray them. Spray grapes, too.

A reader says that if you spray a sore throat every ten minutes for a couple of hours, it'll go away.

When you have visitors, spray the silverware and glasses they've used to get rid of any germs.

How do you make silver colloid? Simple, you stick some pure silver in water, apply a few volts, and there it is. Since pure silver is difficult to find, I've invested in a big roll of #10 silver (99.999% pure) wire and will chop off a couple of 5-inch lengths for you for \$15, plus the usual \$3 shipping and processing. See the *Radio Bookshop* ad on page 63.

The Invasion

D'ja notice that Los Angeles now has more Latinos than whites? And it's estimated that by 2016 the same will hold for California. Mexicans are pouring into the U.S. at over a thousand a day, and most are settling in California and the southwest. Mexico is gradually reclaiming what used to be theirs.

Unlike previous immigration waves, relatively few Mexicans have shown much interest in adopting our language or being assimilated as just plain Americans after a generation or two.

Helping Africa

Any American blacks who know much about Africa must be ashamed to be called African-Americans. Africa is a basket case. The whole continent. Sick, poverty, famine, dictators ... the works.

Continued on page 59

LOW NOISE PREAMPS

LNK-() ECONOMY PREAMP ONLY \$29/w&t

- Miniature MOSFET Preamp.
- Low noise figure.
- Available for various bands from 28 to 450 MHz.

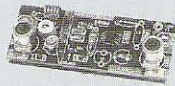

LNK-() PREAMP ONLY \$59/w&t

Low noise LNK-type preamp in alum case w/ BNC jacks.

LNP-() PRESELECTOR ONLY \$39/w&t

- Eliminate intermod!
- Sharp 3-section filter
- Low noise preamp
- Available for bands from 137 to 170 MHz.



HIGH QUALITY VHF & UHF EXCITER & RECEIVER MODULES

FM EXCITERS:

Rated for continuous duty, 2W continuous duty output.

T301 Synthesized VHF Exciter: for various bands 139-174MHz, 216-226 MHz. Dip switch freq. setting.

- Kit (ham bands only) (TCXO option \$40)..... \$109
- Wired/tested, incl TCXO..... \$189

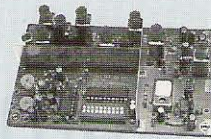

T304 Synthesized UHF Exciter: for various bands 400-470 MHz.

- Kit (440-450 ham band only) incl TCXO \$149
- Wired/tested \$189

CRYSTAL CONTROLLED:

- TA51: for 6M, 2M, 220 MHz kit \$99, w/t \$169
- TA451: for 420-475 MHz. kit \$99, w/t \$169
- TA901: for 902-928 MHz, (0.5W out)..... w/t \$169

VHF & UHF POWER AMPLIFIERS:

Output levels from 10W to 100W..... Starting at \$99

FM RECEIVERS:

Very sensitive - 0.2µV. Superb selectivity, >100 dB down at ±12 kHz, best available anywhere, flutter-proof squelch.

R301 Synthesized VHF Receiver:

various bands 139-174MHz, 216-226 MHz.

- Kit (ham bands only) (TCXO option \$40) only \$139
- Wired/tested (incl TCXO) \$209

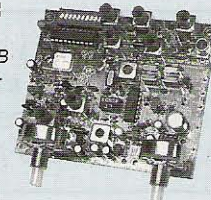

R304 Synthesized UHF Receiver:

various bands 400-470MHz.

- Kit (440-450 ham band only) (incl TCXO) \$179
- Wired/tested \$209

CRYSTAL CONTROLLED:

- R100 for 46-54, 72-76, 140-175, or 216-225 MHz. kit \$129, w/t \$189
- R144 Like R100, for 2M, with helical resonator in front end kit \$159, w/t \$219
- R451 for 420-475 MHz. kit \$129, w/t \$189
- R901 for 902-928MHz kit \$159, w/t \$219

CTCSS TONE ENCODER/DECODER

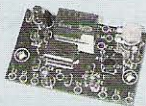

Access all your favorite closed repeaters!

- Encodes all standard subaudible tones with crystal accuracy and convenient DIP switch selection.

Decoder can be used to mute receive audio and is optimized for installation in repeaters to provide closed access. High pass filter gets rid of annoying rcvr buzz.

- TD-5 CTCSS Encoder/Decoder Kit \$39
- TD-5 CTCSS Encoder/Decoder Wired/tested \$59

TRANSMITTING & RECEIVING CONVERTERS

No need to spend thousands on new transceivers for each band!

- Convert vhf and uhf signals to & from 10M.
- Even if you don't have a 10M rig, you can pick up very good used xmtrs & rcvrs for next to nothing.
- Receiving converters (shown above) available for various segments of 6M, 2M, 220, and 432 MHz.
- Rcvr Conv Kits from \$49, wired/tested units only \$99.



- Transmitting converters for 2M
- Kits only \$89
- Power amplifiers up to 50W.

Get more features for your dollar with our REP-200 REPEATER

A microprocessor-controlled repeater with full autopatch and many versatile dtmf remote control features at less than you might pay for a bare bones repeater or controller alone!

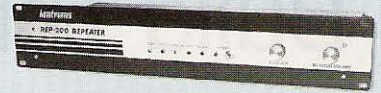

- kit still only \$1095
- factory assembled still only \$1295

50-54, 143-174, 213-233, 420-475 MHz. (FCC type accepted for commercial service in 150 & 450 MHz bands.)

Digital Voice Recorder Option. Allows message up to 20 sec. to be remotely recorded off the air. Play back at user request by DTMF command, or as a periodic voice id, or both. Great for making club announcements! only \$100

REP-200C Economy Repeater. Real-voice ID, no dtmf or autopatch. Kit only \$795, w&t \$1195

REP-200N Repeater. Without controller so you can use your own. Kit only \$695, w&t \$995

You'll KICK Yourself If You Build a Repeater Without Checking Out Our Website First!

Hamtronics has the most complete line of modules for making repeaters. In addition to exciters, pa's, and receivers, we offer the following controllers.



COR-3. Inexpensive, flexible COR module with timers, courtesy beep, audio mixer. only \$49/kit, \$79 w/t

CWID-2. Eprom-controlled ID'er. only \$54/kit, \$79 w/t

DVR-1. Record your own voice up to 20 sec. For voice id or playing club announcements. \$59/kit, \$99 w/t

COR-4. Complete COR and CWID all on one board. ID in eprom. Low power CMOS only \$99/kit, \$149 w/t

COR-6. COR with real-voice id. Low power CMOS, non-volatile memory. kit only \$99, w/t only \$149

COR-5. µP controller with autopatch, reverse ap, phone remote control, lots of DTMF control functions, all on one board, as used in REP-200 Repeater. \$379 w/t

AP-3. Repeater autopatch, reverse autopatch, phone line remote control. Use with TD-2. kit \$89

TD-2. Four-digit DTMF decoder/controller. Five latching on-off functions, toll call restrictor. kit \$79, w/t \$129

TD-4. DTMF controller as above except one on-off function and no toll call restrictor. w/t \$89

HANDY FREQUENCY COUNTERS

Pocket sized, but lab quality! 3GHz bandwidth, 1ppm accuracy, very affordable. NiCd battery, ac adapter/charger, rugged black anodized aluminum case. Telescoping whip antenna and great sensitivity allow measurements even from a distance.



Three models with prices from \$99 to \$219. All go up to 3 GHz. Some go as low as 10 Hz with noise filters and other advanced features. See our website for details.

Hamtronics, Inc.

65 Moul Rd; Hilton NY 14468-9535

Ph: 716-392-9430; Email: sales@hamtronics.com

See special offers and view or download complete catalog on our web site

hamtronics.com

R121 AVIATION RECEIVER



- Exciting new AM receiver for the 118-137 MHz aircraft band.
- Ideal for monitoring at airports.
- Allows pilot control of runway lighting.
- ELT monitor to detect and locate downed aircraft.

- Dip switch frequency selection.
- Superior sensitivity and selectivity.

R121 Receiver module wired/tested \$209

R121 Receiver in cabinet (see website)..... \$299

WEATHER FAX RECEIVER

Join the fun. Get striking images directly from the weather satellites!

A very sensitive wideband fm receiver optimized for NOAA APT & Russian Meteor weather fax on the 137MHz band.



Covers all 5 satellite channels. Scanner circuit & recorder control allow you to automatically capture signals as satellites pass overhead, even while away from home.

- R139 Receiver Kit less case \$159
- R139 Receiver Kit with case and ac power adapter. \$189
- R139 Receiver w/t in case with ac power adapter.... \$239
- Internal PC demodulator board & imaging software.. \$289
- Turnstile Antenna \$135

WEATHER ALERT RECEIVER



A sensitive and selective professional grade receiver to monitor critical NOAA weather broadcasts. Good reception even at distances of 70 miles or more with suitable antenna. No comparison with ordinary consumer radios!

Automatic mode provides storm watch, alerting you by unmuting receiver and providing an output to trip remote equipment when an alert tone is broadcast. Crystal controlled for accuracy; all 7 channels (162.40 to 162.55).

- RWX Rcvr kit, PCB only \$79
- RWX Rcvr kit with cabinet, speaker, & AC adapter \$99
- RWX Rcvr wired/tested in cabinet with speaker & adapter \$139

WWW RECEIVER

Get time & frequency checks without buying multiband hf rcvr. Hear solar activity reports affecting radio propagation.

Very sensitive and selective crystal controlled superhet, dedicated to listening to WWW on 10 MHz. Performance rivals the most expensive rcvrs.



- RWWW Rcvr kit, PCB only \$59
- RWWW Rcvr kit with cabt, spkr, & 12Vdc adapter \$89
- RWWW Rcvr w/t in cabt with spkr & adapter \$129

Build This Commercial-Quality Counter: Part 1 of 2

Amaze your friends — and yourself!

Would you be interested in a frequency counter that is immune to the effects of temperature and aging? Well, I guess we are! Do you need to take out a bank loan to pay for this little bench instrument? You bet you don't! Using all new components and printed circuit boards, it will cost you less then \$130!

The cost of the Ten-Tec® enclosure, printed circuit board(s), and displays, represents about 75% of the cost of the unit. I am a believer in making the best I know how to and then adding a nice enclosure so that it looks as good as a commercial unit. This instrument does look commercial if you use the rub-on decals and seal with polyurethane spray.

Let's outline what you are building since we know all about the specifications of

the commercial units, especially in regard to the crystal time base and displays. No attempt has been made to cheapen this unit. An absolute digital calibratable time base is used along with CMOS (silicon gate) digital devices to minimize heating effects and maintain long-term threshold stability. Both the 4000-series metal gate and the 74HC silicon gate devices are used to their characteristic advantages. The VHF/UHF prescale circuit is from the

cellular telephone industry's latest devices using surface mount (SMT) technology. These are silicon gate linear and digital devices using very low current with tremendous toggle speeds. The extremely low prices are especially attractive. A prescaler costing one-tenth the price of the old ECL device 11C90 plus using one-tenth the power is extremely nice! With a small wire as an antenna, you can measure your transmitter frequency in the 500 MHz range with no problem. The prescaler is switch-selectable from the front panel.

If there is a negative to the design, it is the cost of the displays. These are hybrid devices which have the latch, decoder (TTL) and resistor current limiting on a single DIP-14 logic chip, not to mention the dot matrix LEDs which give a very bright dot character display. The negative is that they can draw from 60 to 100 mA each. This is about 900 mA for the whole counter at 6 VDC. I used a \$4 wall converter unit which is specified at 6 VDC 800 mA regulated. This is the most inexpensive way to put power in to the unit at a low price, not to mention keep the 120 VAC line out of the enclosure.



Photo A. The K8IHQ high-performance frequency counter.

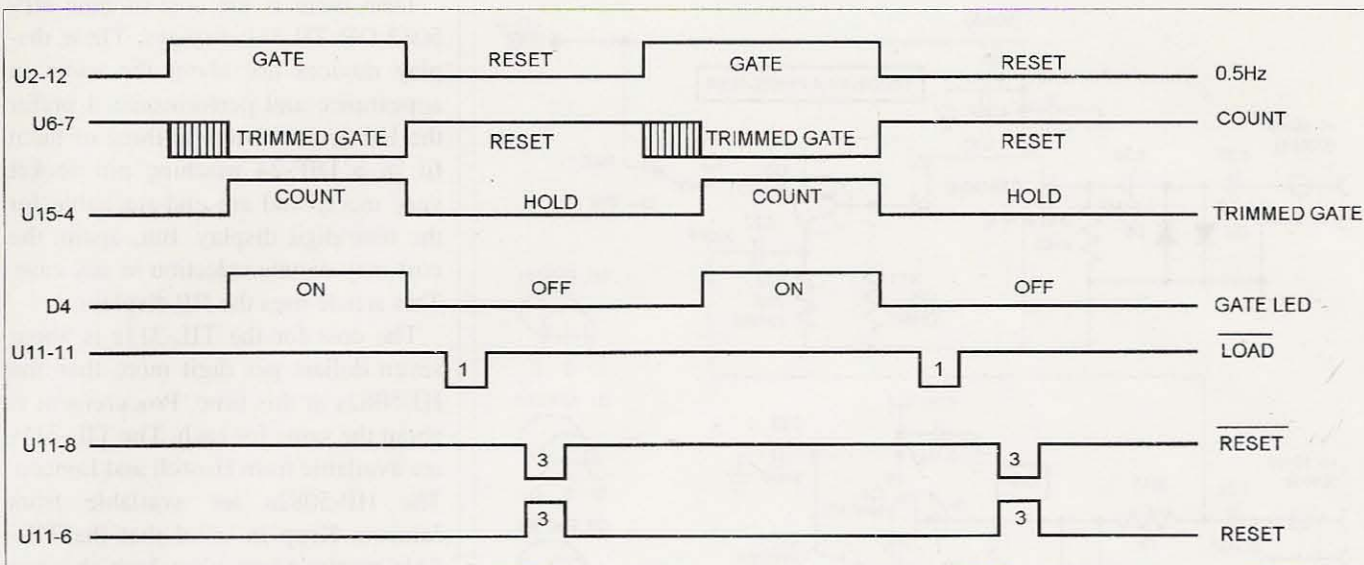

Fig. 1. Timing diagram.

There are two sources for the wall unit. I liked the wall converters so well I purchased five of them for future projects. When 825 mA was drawn,

the load of my counter, the output voltage reduced to 5.60 VDC, which is

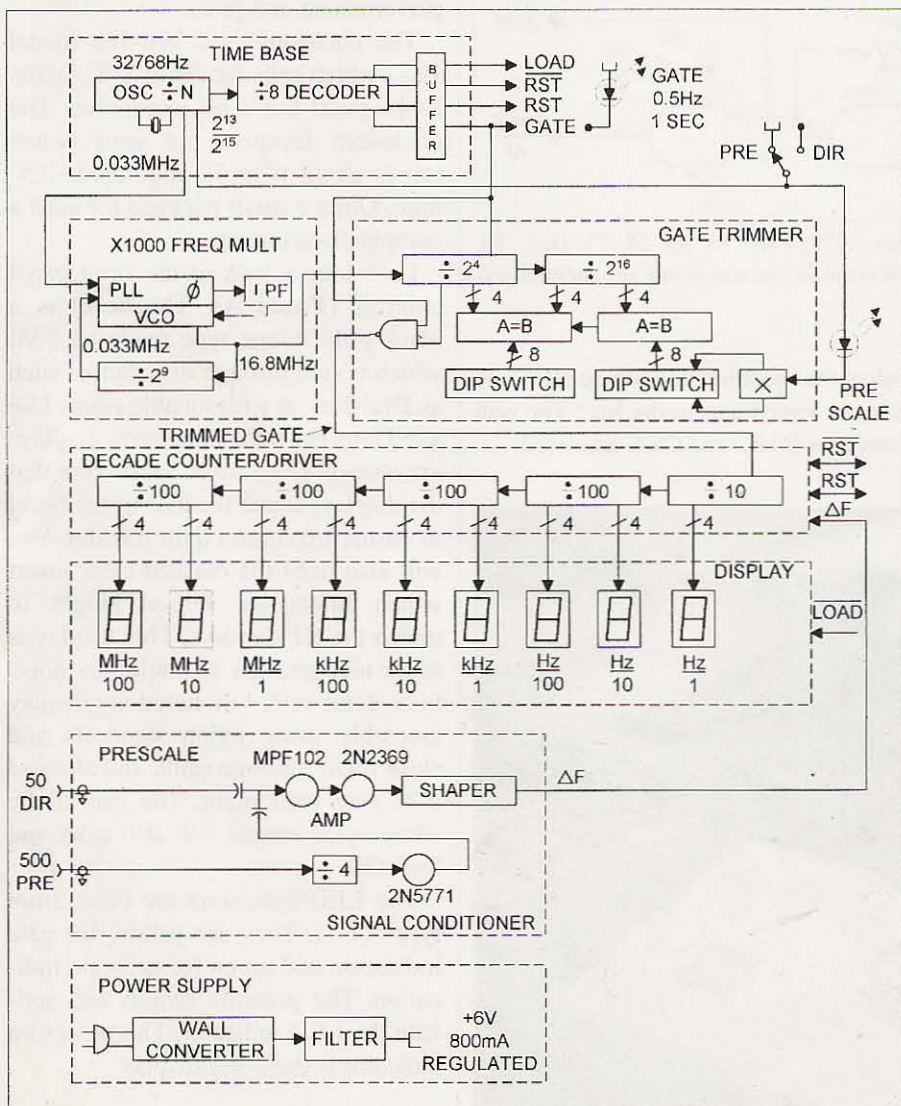

Fig. 2. Functional block diagram.

Repeaters

6 & 2 m & 440 On your frequency

\$399.95 & \$499.95

Repeater Controllers

RC-1000V \$259.95 / RC-100 \$129.95

Micro Computer Concepts

8849 Gum Tree Ave

New Port Richey, FL 34653

727-376-6575 10 AM-10 PM

e-mail n9ee@akos.net

http://mcc.stormfan.com

Smart Battery Charger

New & Improved

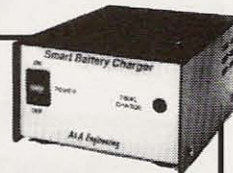

FOR GEL-CELLS or LEAD ACID BATTERIES.

Features: Precision temperature tracking voltage reference & three mode charging sequence. Standard kit is for 12V @ 1/2 or 1 Amp, user selectable. Can be connected to the battery indefinitely, will not overcharge. Weighs 2 pounds and measures 4"Wx5 1/2"Dx2 1/2"H. Finished enclosure included in kit.

Complete Kit Only \$59.95

Assembled & Tested \$79.95

CA Residents add 7.50% sales tax; S&H: \$6.50 (insured).

Foreign orders add 20%.

For more info or price list go to a-engineering.com



A&A Engineering



2521 W. La Palma #K • Anaheim, CA 92801
(714) 952-2114 • FAX: (714) 952-3280

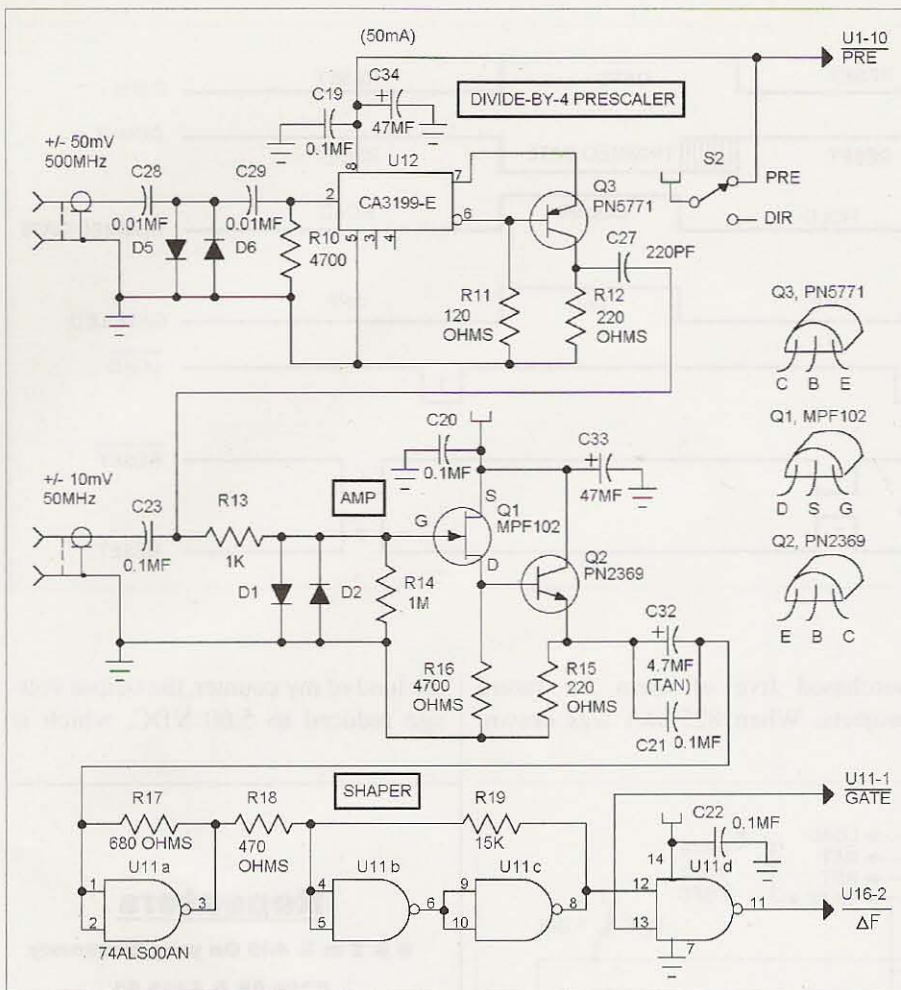

Fig. 3. Signal-conditioning schematic. References: HR, Feb. '78, pg. 28; 73, Dec. '78, pg. 107; Fairchild app. note 95H90. Note: In this article, the use of MF in schematics is meant to indicate μF .

perfect for the logic ICs. When the pre-scaler is not selected, the voltage returns to exactly 6.0 VDC, which is one volt

below the specified limit of the HC logic devices. Everything works fine! The wall converter is UL- and CSA-approved.



Photo B. The author's little helper.

Then there is the cost of nine HP-5082 OR TIL311 displays. These display devices are about the same in appearance and performance. I prefer the HP devices because three of them fit in a DIP-24 machine pin socket very nicely and are end-stackable for the nine-digit display. But, again, the cost may dictate selection in any case. This article uses the HP displays.

The cost for the TIL-311s is about seven dollars per digit more than the HJ-5082s at this time. Procurement is about the same for each. The TIL-311s are available from Hosfelt and Jameco. The HP-5082s are available from Jameco. Keep in mind that the TIL-311s require a larger bezel which is not available from PMI, the manufacturer. They also use vertically mounted DIP-14 sockets. The printed circuit board set includes PC boards for each display type. I was interested in looks and performance, not price.

The enclosure is a Ten-Tec model JW-7 which sells for about \$14. Again, looks good but a bit expensive. The enclosure footprint on your bench top is about 6" x 7" and stands 2.5" high. Quite a small package for such a complex instrument.

Let's take a look at the front panel controls (**Photo A**). The bezel is a black polystyrene type made by PMI which is sold through distributors such as Digi-Key at a reasonable price. Use a red lens since the dot matrix displays are already red-lensed. Make sure that the displays touch the lens of the bezel to ensure maximum light transfer. You will also need the masked clear insert which limits the lensed height to match the HP displays. This display is super nice and has no multiplex noise to contend with. I mounted my display assembly using nylon standoffs and clear 100% silicone caulk and allowed it to cure over night. The use of the white nylon screws will also work and look OK.

The LED indicators are clear 3mm types (T-1). They are yellow for gate indication and green for prescale indication. The prescale switch will activate the LED indicator. The power-on indicator is the 7-seg display.

Continued on page 57

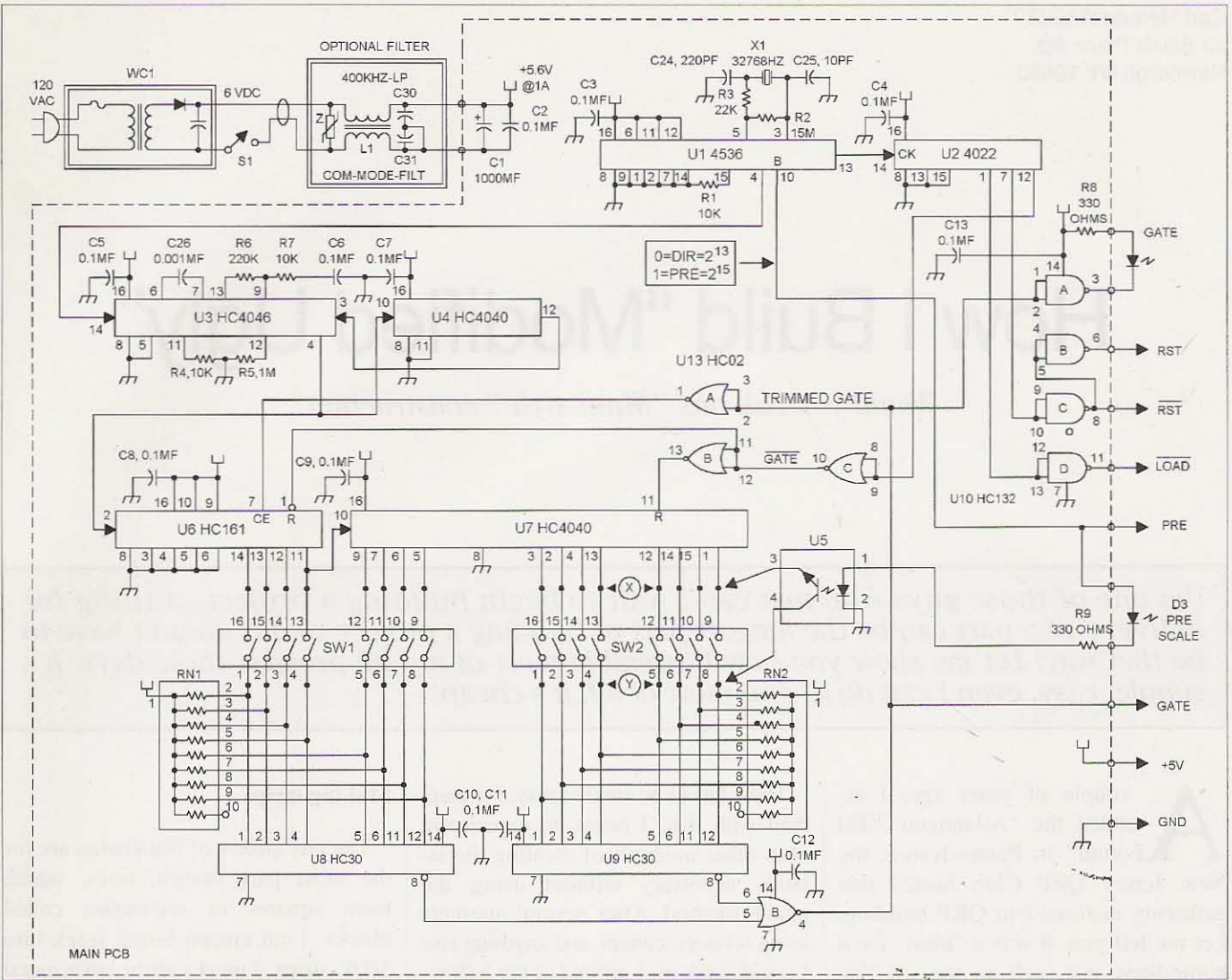

Fig. 4. Main PCB schematic. Note: After calibration of the prescaler, the switch position is used to get the same frequency reading as in the "Direct" mode. After that switch position is found to get the correct prescale number displayed, opto U-5 is used IN PLACE OF that switch position. When prescale is selected, the opto compensates for the toggle propagation delay of U-12. The fiddle factor!

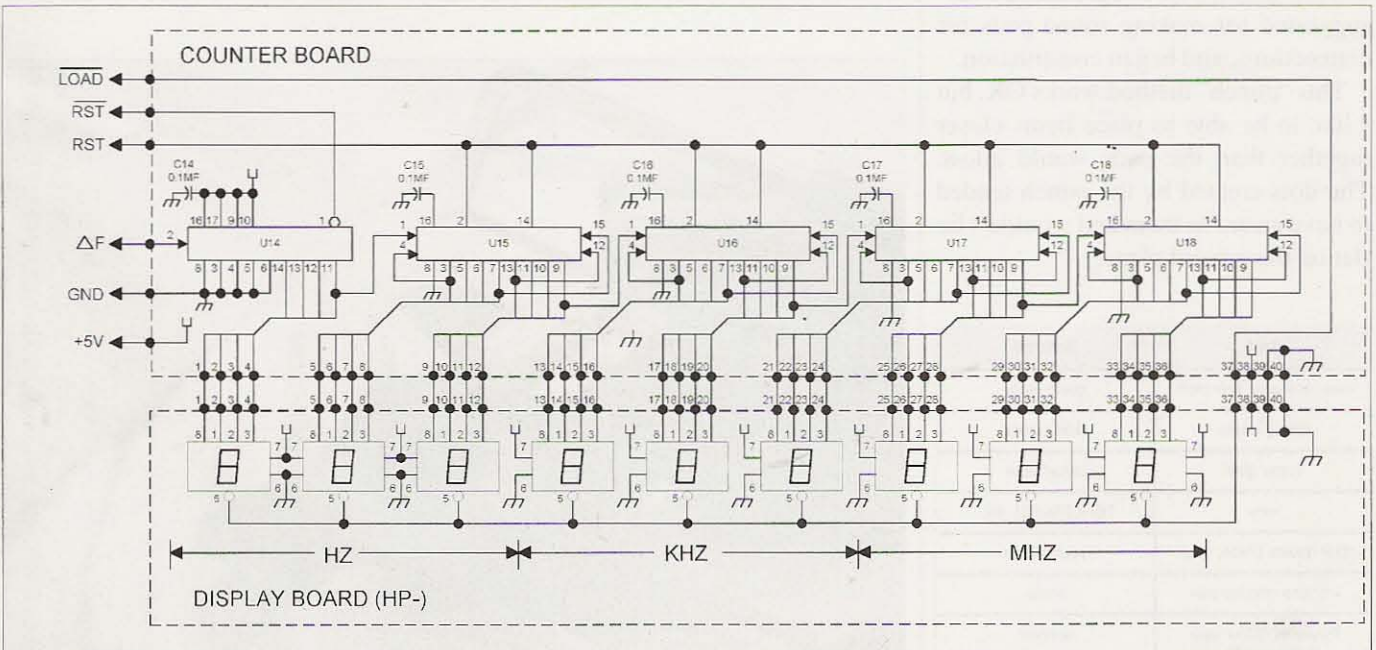

Fig. 5. Counter and display boards.

How I Build “Modified Ugly”

Would you call this “Maui-style” construction?

I’m one of those guys who just can’t wait to begin building a project. Waiting for delivery of a part can be the longest part of building a project, and it doesn’t have to be that way! Let me show you how I assemble most of my HF projects these days. It’s simple, easy, even I can do it, and most of all, it’s cheap!

A couple of years ago, I attended the “Atlanticon 2000 Forum” in Pennsylvania; the New Jersey QRP Club hosted this gathering dedicated to QRP building. Let me tell you, it was a “blast” for a home-brew nut such as me. At this event, the Manhattan style of building was introduced to many of us as a new method of assembling circuit boards. I listened attentively, bought the “punch” suggested for making round pads for connections, and began construction.

This “punch” method works OK, but I like to be able to place items closer together than the pads would allow. The dots created by the punch tended to have an arc in them and wouldn’t lie flat on the ground plane.

There has to be another way, I mused. And with that, I began to experiment with other methods of creating the islands necessary without using the punch method. After several attempts using scissors, cutters, and anything else I could think of, I arrived at the following, and have divided the process into steps.

Table 1 shows a list of the tools I use to work in this style of construction.

Making strips

The city streets of Manhattan are for the most part straight lines, which form squares or rectangles called blocks. I cut circuit board stock into 5/16" strips. I used a shear but a metal straight edge and utility knife also work well. Be careful! Red blood cells don’t improve the insulation factor of the board, and detracts from your

Part	Source
mini hack saw, fine teeth	dollar store
spring clamp	dollar store
super glue	dollar store
wire	RS # 278-501, etc.
DIP device (7404, etc.)	your choice
wooden strip for vise	scrap
Pavarotti CD or tape	optional

Table 1. Suggested toolbox contents.



Photo A. 16-pin DIP being slid along the strip.

work. It also makes holding the tools and parts while wearing a bandage very difficult at times.

After creating several strips, I placed a 1/2"-thick by 1" by 12" strip of wood in my vise, narrow side up. Be sure to leave about 1/4 inch of the wood exposed above the jaws of the vise. This is to protect the teeth of the saw from accidental contact with the vise. Choose one of the cut strips and place it on top of the wooden strip, foil side up. Using a spring clamp purchased at the local Dollar Store, anchor one end of the strip to the wood. Now, slide a 16-pin DIP under the strip, with its legs pointing straight up. DIP sockets haven't worked well here — the indent on the bottom side and the indent on the top allows the stock to slip while being cut. Slide the DIP along the strip until the flexed stock won't allow it to proceed farther. See **Photo A**.

Making solder pads

Now for the fun part! Using one hand, press the raised end of the strip

down to anchor the DIP in place. Using a mini hack saw you recently purchased from the Dollar Store, align the blade with the first pair of upright legs, from front to back of the DIP, and complete enough strokes of the blade to remove only the copper foil from the strip. Avoid excessive downward pressure — we want only to remove the copper, not sever the circuit board material.

Slide the DIP down the wood until the last slot is aligned with the last slot cut. Continue cutting until the strip is completed. You should now have a long strip, 1/4" wide, with copper foil segments evenly spaced along its length.

Check each strip to ensure that each cut completely removed the copper foil from the backing. This is especially true along the front and trailing edges. Not keeping the blade level when cutting will allow an incomplete cut on either edge. This will cause two pads to be short-circuited together. My saw blade requires five passes across

the material to remove the copper foil. Yours may require more or less — it depends on the thickness of the copper foil and the blade being used. Adjust your strokes as necessary.

Attaching parts to strips

Let's attach an 8-pin DIP to one of the strips. Using a wooden block to prevent damage to your work surface, place one strip foil side up on it. Using the last four segments, place the DIP on the strip with one leg on each segment. Solder the first leg, and check for alignment of the other three with the strip. When you're satisfied that the strip will be aligned with the DIP, solder the remaining three. **DO NOT CUT THE EXCESS STRIP MATERIAL AWAY AT THIS TIME.** Do the same with the other side. I find it much easier to handle parts while attached to the excess stock.

Now let's try transistors. New devices have nice long legs and are easy to handle. But what about those salvaged

3 DAYS!
May 17, 18, 19, 2002

May 17, 18 & 19, 2002 • Hara Arena • Dayton, Ohio

The Amateur Radio Event of the

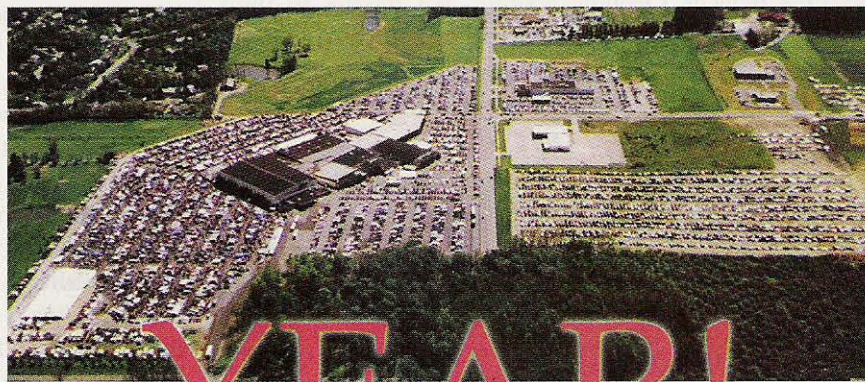

YEAR!

Over 1600 Exhibitors & Vendors.
Special emphasis on Emergency Communications.

Call Today for Ticket Information!

1-937-276-6930

www.hamvention.org • toll-free fax: 1-800-491-4267 (hams)

HAMVENTION®

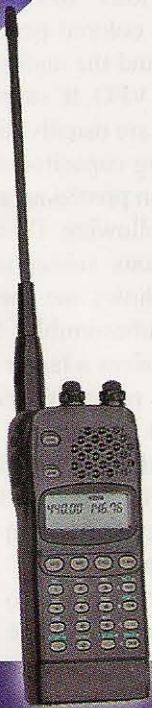

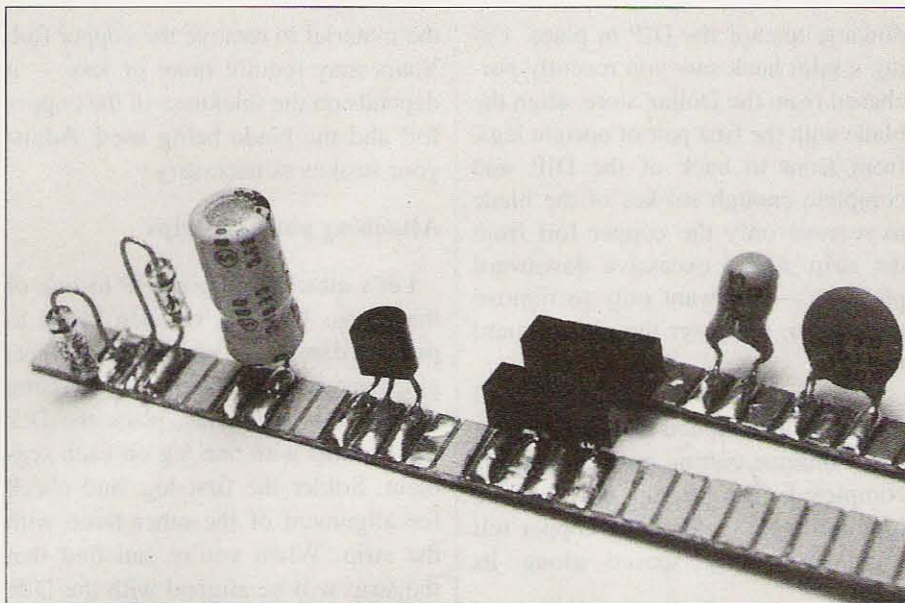

Photo B. This is how your parts will look when properly attached to the strip.

items with the trimmed legs?! They can be a problem.

However, try this. Using “duckbilled” pliers — those with a wide, flat, blunt nose — bend the legs 90 degrees. Tin one segment of the prepared strip and solder the first leg of the transistor to it. Check for alignment of the other two legs with placement on the remaining two segments and complete the soldering operation. Again, don’t cut away the excess strip just yet if you have any. Continue attaching devices on the prepared strip. Devices can be “snipped” off the strip using cutters as needed for installation on the ground

plane. Those remaining on the strip are less likely to wander off when attached to the strip. See **Photo B**.

Salvaged resistors, chokes, and diodes adapt well to this process. I always place resistors in one of two positions, either vertical with the color scheme starting at the top and working its way down, or horizontal with the color scheme beginning on the left and completing toward the right. This may sound trite, but I have found that when troubleshooting, not having to think about which end to start on saves time. It also looks darned professional!

Suppose the resistor to be used has

been trimmed and has short leads. No problem! Bend the bottom lead (the one next to the gold or silver band) to form a 90-degree angle. Solder this leg to one solder pad. Now attach a bare wire to the pad adjacent to the one just soldered. Bring the wire up parallel to the resistor, bend it neatly to intersect with the top of the resistor, and loop it once around the top resistor lead. Solder this connection and trim the excess material away. You now have a neat installation utilizing two solder pads and one used resistor. Treat chokes and diodes in a like manner.

Placing parts

Having soldered various parts on the prepared strips, it’s now time to begin placing them on the ground plane. Here’s where your imagination plays a major role. I find that it helps to imagine, or picture in your mind, what the circuit is going to look like when finished. Lacking an imagination, use layouts from various articles to see how the professionals placed the items. They have spent time aligning, making short signal paths, avoiding blockages, etc., in their product, so imitate what they have done!

I often use “islands” to form circuits. (Well, Manhattan IS an island, isn’t it!?) Divide the schematic of your project into its various “subsections.” This means take a colored pencil and draw a square around the audio stage, another around the VFO, IF strip, crystal filter, etc. They are usually discernible by the coupling capacitor used to link with the section preceding and the one immediately following. Doing this identifies the various subsections of the project, and shows me the parts needed for that subassembly. Sometimes a section requires a larger island than others. If so, place the parts on circuit board stock “dry,” and move them around to find the most effective position. Measure the length and width of the covered space and cut an island this size. See **Photo C**.

There are some advantages to building using the island idea. The entire subcircuit can be moved to a new location, while individual parts would have to be desoldered and moved. Projects

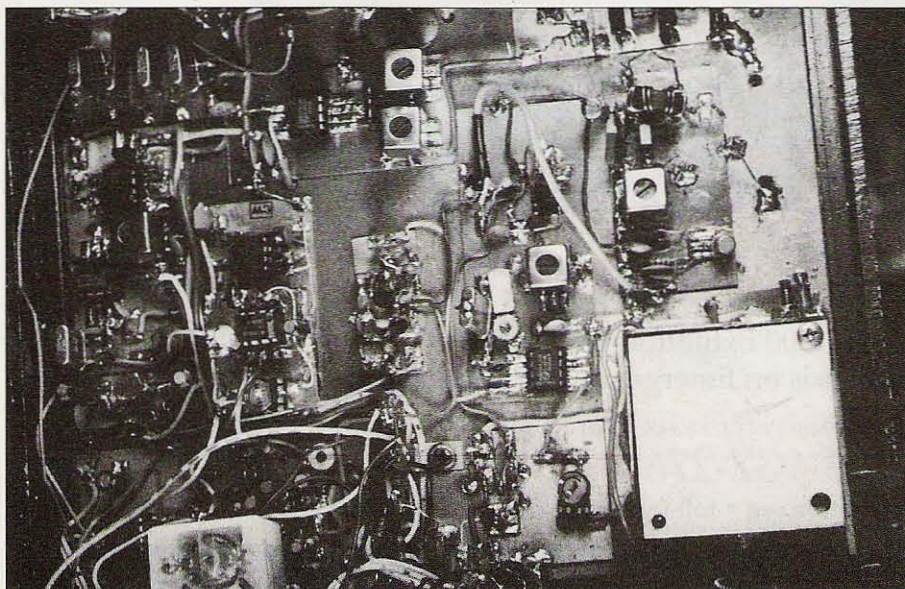

Photo C. The author used the “island” method to assemble this circuit.

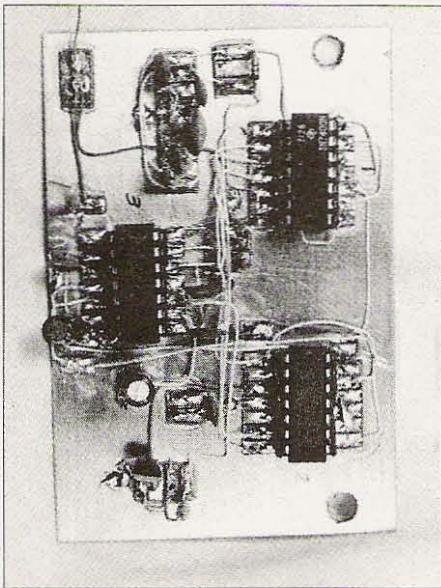

Photo D. The author's Simple Electronic Keyer circuit done Manhattan-style.

can be built in small sections, tested, and then attached to the main board. Repairs or modifications can be done on a removed subassembly, without disturbing the majority of the project. Smaller boards can be placed "on edge" on the main board to conserve space and keep the project compact, but remember to place adjusting controls in the proper perspective! It's difficult, if not impossible, to tune a transformer with the core not facing upwards. (This was learned the hard way, oops.)

Photo D shows my version of a project from *73 Amateur Radio Today*, January 2002: "Build This Simple Electronic Keyer" by Craig Sellen. Once the parts are attached to the strips, it's not difficult to adhere them to the ground plane where required. So you make an error or two. Not a problem. Using super glue to adhere the pads also makes it easy to remove them and relocate them. While the glue does provide a good bond between the two surfaces, I find that if I use the tip of a hobby razor knife, I can slide the end under the pad, twist slightly and the pad "pops" off the board. You may have to scrape excess adhesive from the bottom side of the pad before reattaching in its new location, but this is a minor chore.

Super glue is created in several formulas, from instant-acting to one

requiring time to set and cure. Use your soldering pencil to heat one of the already-soldered pads for a brief moment. The heat from the pencil and solder is transferred to the adhesive underneath, and hastens drying time. As always, beware of the fumes expelled from the rapidly curing glue. Proper ventilation to remove the solder flux fumes and the fumes from the curing adhesive is always a good practice.

Making connections

The location of the device now attached to the ground plane requires appropriate wiring. I use Radio Shack Spin Wrap wire for this. It comes in three colors (red, white, and blue), is plastic-coated, and holds its shape well. Using the tip of your soldering iron, press the end of the plastic-coated wire on a wooden block to allow the heat to melt the insulation from the end of the wire for about 1/8 of an inch. Clean the tip of the iron and solder this tip to the required solder pad. Lay the insulated wire along its required path, making neat turns, if needed, using needlenose pliers, until reaching the proper termination point. Holding the wire at the terminating pad, remove more insulation from the wire and solder it to the pad. Clip the excess wire to complete the connection.

I use the red wire for voltage connections, white for resistor and capacitor connections, and the blue for signal path. This makes checking circuits for accuracy when completed much easier. Ground connections are made with the same wire with the insulation removed.

This process may sound involved at first, but after a few connections the ease with which you can complete wiring becomes apparent. This wire lies flat against the ground plane, can be attached with double-stick tape if desired, and is easily removed and replaced if needed. I have used this heating method of stripping the end of the wire for the past few years, and haven't noticed any damage to the tip of my soldering station iron.

And there you have it! This is much easier and faster than making etched circuit boards, and it's inexpensive. 

ALL ELECTRONICS CORPORATION

SHOP OUR ONLINE STORE
www.allelectronics.com

Incredible Price! Piercing Piezo Mini-Siren

This piezo siren emits a piercing 100 db warble tone that is uncomfortable for anyone nearby. Only 2.3" long x 1.7" x 1.5," it has an adjustable metal mounting bracket and comes with 6' of wire. Operates on 9-12 Vdc. Includes a clip for operation with a 9V battery. Ideal for auto or home alarms. Large quantity available. **CAT # ES-12**



\$3.00 each
10 for \$2.50 each
100 for \$1.50 each

3 Volt Lithium Battery

Tekcell CR123A. 3 Volt lithium cell. Special quantity purchase of recent date code cells. Commonly used in photographic equipment. 1.34" long x 0.65" diameter. **CAT# LBAT-123**



\$2.85 each
100 for \$2.35 each
800 for \$1.90 each

LED Tester

Pocket-size led tester. Makes it easy to check functionality, color, brightness and uniformity. Plug any leaded LED into one of 12 positions on the socket strip to test at current ratings from 2-50ma. The seven middle positions on the strip are set at 10 mA allowing comparison of LEDs in those spaces. Requires 9 v battery (not included). **\$8.95** each
CAT# LT-100

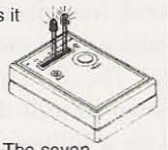

Flashing LED

SPECIAL - RED T-1 3/4 water clear
CAT# LED-84
3 for **\$1.00** each
100 for 25¢ each
1000 for 18¢ each



ORDER TOLL FREE
1-800-826-5432

CHARGE ORDERS to Visa, Mastercard,
American Express or Discover

TERMS: NO MINIMUM ORDER. Shipping and handling for the 48 continental U.S.A. \$6.00 per order. All others including AK, HI, PR or Canada must pay full shipping. All orders delivered in CALIFORNIA must include local state sales tax. Quantities Limited. NO COD. Prices subject to change without notice.

CALL, WRITE
FAX or E-MAIL
for our **FREE**
96 Page
CATALOG
Outside the U.S.A.
send \$3.00 postage.

MAIL ORDERS TO:
ALL ELECTRONICS CORPORATION
P.O. Box 567
Van Nuys, CA 91408
FAX (818)781-2653

e-mail allcorp@allcorp.com

Unmasking the Long Ranger

Measure weak signals up to 56 MHz with this dBm meter range extender, *kemosabe*.

My dBm meter from the November 1995 issue of Electronics Now has been built by many electronics experimenters and hams. It is one of the most sensitive RF meters available, far exceeding simple RF probes for voltmeters. The original instrument is rated for a 2-20 MHz range and is usable to 50 MHz with reduced sensitivity.

The actual measured sensitivity versus frequency for a -30 dBm input signal is shown in **Fig. 1**. Note that a -30 dBm signal is quite weak (one microwatt). Most RF probes cannot even measure such a weak signal. The dBm meter, however, can read down to -90 dBm, which is a signal with a millionth of the power of this one microwatt signal — a very weak signal, indeed!

Above 20 MHz, the meter's sensitivity gradually drops off so that by 30 MHz it is down by 20 dB (only 1% as sensitive), and at 50 MHz it is down by

40 dB (one ten thousandth as sensitive) but still usable. Many readers have written asking how to improve the sensitivity at 30 MHz for use with CB and 10-meter-band ham equipment or at 49-50 MHz for use with consumer 49-MHz products or with ham 6-meter-band equipment.

A simple frequency converter circuit can be used to fill in the gap for these bands. The NE602 integrated circuit designed by Robert Zavrel, coupled with some external components, is used in this project to convert these higher frequencies down to the 0-20 MHz range.

Looking at **Fig. 2**, we see a 36-MHz crystal oscillator and double-balanced mixer convert the 16-36 and 36-56 MHz ranges to 0-20 MHz, where the dBm meter is most sensitive. The crystal oscillator uses a low-cost 12 MHz "microprocessor" crystal on its 3rd overtone. Inductor L1 and variable capacitor C1 are tuned to 36 MHz to prevent operation on the fundamental or any other overtone.

The high output impedance of the NE602 converter is matched to the 50-ohm dBm meter input using a ferrite core transformer, T1. This transformer also establishes a gain of one from input to output of the converter circuit of **Fig. 2**. See **Fig. 3** for the construction details for T1. This transformer also converts the balanced output of the NE602 to an unbalanced 50-ohm load.

At the circuit output there is a 20-MHz low-pass filter with a null frequency of 36 MHz. See **Fig. 4**. This circuit prevents any 36-MHz oscillator feed-through from actuating the dBm meter. Even though the NE602 is doubly balanced, the balance provides only 40 dB of suppression of the 36-MHz oscillator, so this additional filtering is needed. It

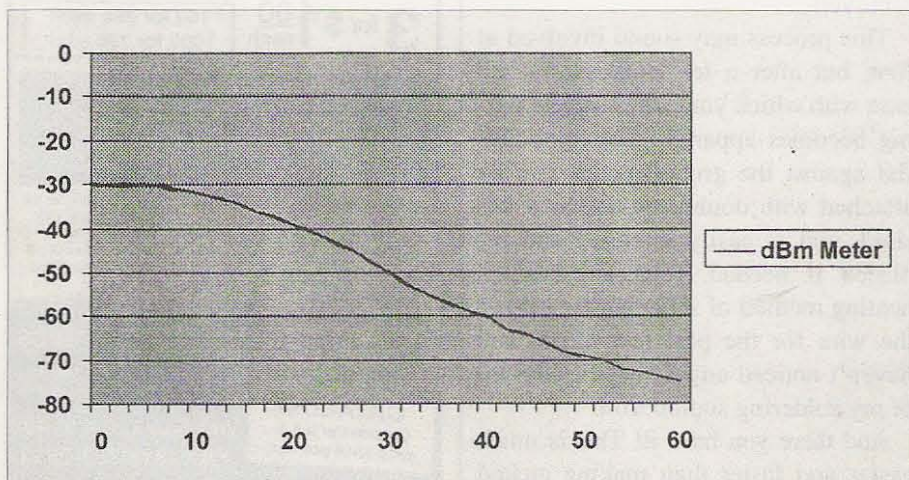

Fig. 1. Frequency response of original dBm meter (MHz vs. dB).

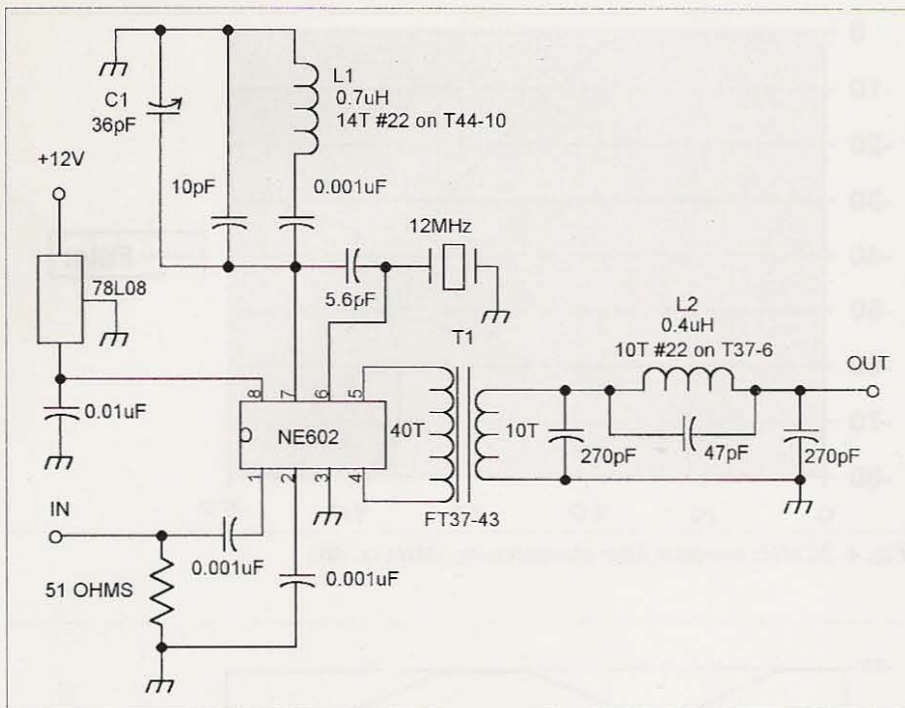

Fig. 2. Schematic of the range extender circuit.

eliminates a steady -80 dBm reading on the meter, which otherwise would prevent reading signals down to -90 dBm.

The measured frequency response of the Long Ranger range extender circuit is shown in Fig. 5. Note how the range extender neatly fills in the response for the 16-56 MHz range. Note: There will be no response within 500 kHz of either side of 36 MHz.

Building the range extender

All components for the range extender are mounted on the 2" x 2-1/2" circuit board shown in Fig. 6. Note the large amount of copper for the common ground. Positioning of the components is shown in Fig. 7. A kit of parts is available from Unicorn Electronics — see the Parts List (Table 1). The assembled circuit board is shown in Photo A. Note that a great deal of

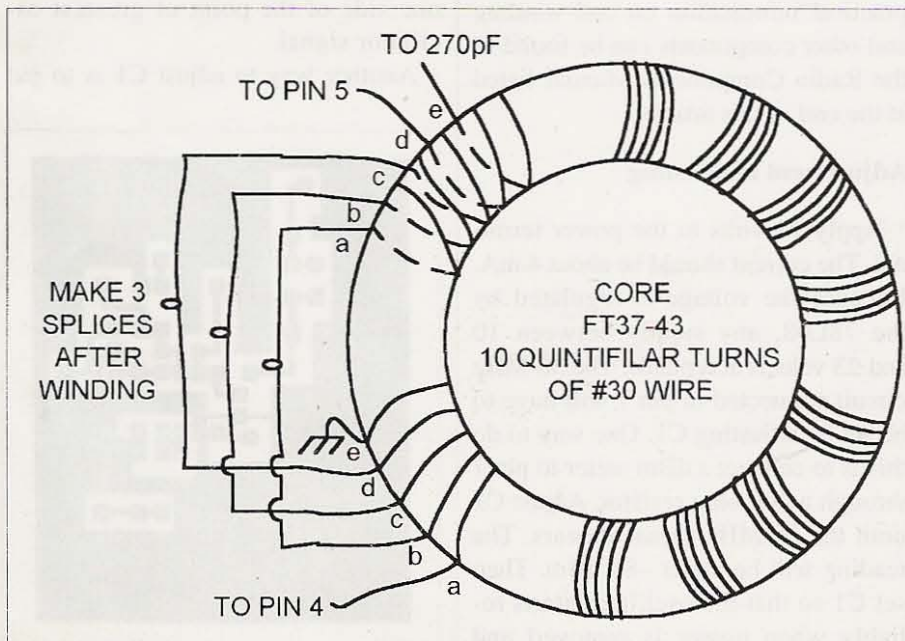

Fig. 3. Winding details for output transformer.

good deals on what you want

- Keeping the FUN in Ham Radio is what we're all about! Since 1980!
- Great prices & customer care on today's major brands, including:

MFJ	DIAMOND	MAHA
QRZ	BATTERY TECH	Heil
GORDON WEST	ARRL	PATCOMM
PROCOMM	TRANSEL	RAMSEY
CALLBOOK	W4RT ELECT.	POWERPORT
IRON HORSE	AND MORE!	MIRACLE
LDG ELECT.		ANTENNA

Call Today

217-352-1725

"Our name says it all!"

Amateur Accessories

P.O. Box 7333, Champaign, IL 61826
www.amateuraccessories.com
kr4s@msn.com

LOW PROFILE HF ANTENNAS THAT REALLY WORK!

"Work the World Without Working Up the Neighborhood"

ISOTRON

BILAL COMPANY

Call for a FREE Catalog:

719/687-0650

137 Manchester Dr.

Florissant, CO 80816

www.rayfield.net/isotron

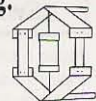

GORDON WEST HAM TEST PREP TAPES

BOOKS SOFTWARE VIDEOS

Prepare for your ham test with "Gordo" WB6NOA as your personal instructor.

- **THE NEW THEORY** on audio cassettes
No-Code Technician (4 tapes)\$19.95
General Class (4 tapes) \$19.95
Amateur Extra Class (4 tapes)\$19.95
- **THE CODE** on audio cassettes
Learning CW (0-7wpm 6 tapes)\$29.95
Speed Builder (5-16wpm 6 tapes) .. \$29.95
Speed Builder (10-28wpm 6 tapes) \$29.95
- **NEW STUDY MANUALS** by "Gordo"
No-Code Technician (Element 2) .. \$11.95
General Class (Element 3) \$12.95
Extra Class (Element 4) \$14.95
- **PC SOFTWARE** with study manuals
No Code Technician (Element 2)\$34.95
Tech/Tech+/Gen. (+ Code, Windows)\$49.95
General Class (3+Code, Windows). \$34.95
Extra Class (4 + Code, Windows).. \$34.95
Ham Operator (Tech.-Extra + Code) \$59.95
Morse Software Only\$12.95
- **VIDEO** VHS with study manual
No-Code Tech Video Course..... \$31.95

Add \$5.00 shipping 1st item, .50 each additional
Priority Mail 2-3 day service available
VISA, Mastercard, Discover, & AMEX Accepted

W5YI Group

P.O. Box 565101 • Dallas TX 75356

1-800-669-9594

www.w5yi.org

ALL ELECTRONICS

C O R P O R A T I O N

SHOP OUR ONLINE STORE
www.allelectronics.com

Flexible Thin Film Solar Panels

Very thin, extremely flexible polyester encapsulated photovoltaic modules suitable for indoor or protected outdoor use. Light-weight. Great for mounting on curved surfaces. Ideal for charging nickel cadmium and nickel metal hydride batteries or running low current applications. Can be connected in series or parallel for higher voltage or current. Modules have copper strips at each end to make solder connections.

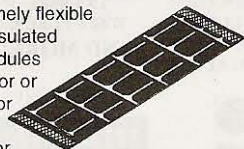

CAT # SPL-314 **\$4.50**
3 Volts @ 19 mA 4.5" x 1.44" each

CAT # SPL-328 **\$8.50**
3 Volts @ 38 mA 4.5" x 2.88" each

Great Price! 60 Watt Switching Power Supply

Autec # UPS61-1004-T
Input: 115/230 Vac
Outputs: 3.3V @ 4A, 5 V @ 2A, 12V @ 3A, 32V @ 5 mA.
New, open-frame switching supply. 5" x 3.46" x 1.68."
"Panasonic-type" two conductor receptacle for AC input, can be hardwired if desired. Fused input. 10 conductor molex-type plug output. Ferrite bead for EMI suppression on output wires. Large quantity available.

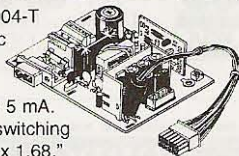

CAT # PS-70

\$4.50
each

case of 48 pieces
for \$3.50 each

Piezo Alarm

Audible piezo alarm emits a solid, high-pitched tone of low to medium loudness. Operates on 3-15 Vdc. 0.54" diameter x 0.3" PC leads on 0.3" centers.



CAT# SBZ-412

\$1.25
each

100 for 85¢ each
500 for 75¢ each

ORDER TOLL FREE

1-800-826-5432

CHARGE ORDERS to Visa, Mastercard, American Express or Discover

TERMS: NO MINIMUM ORDER. Shipping and handling for the 48 continental U.S.A. \$6.00 per order. All others including AK, HI, PR or Canada must pay full shipping. All orders delivered in CALIFORNIA must include local state sales tax. Quantities Limited. NO COD. Prices subject to change without notice.

CALL, WRITE
FAX or E-MAIL
for our **FREE**
96 Page
CATALOG
Outside the U.S.A.
send \$3.00 postage.

MAIL ORDERS TO:
ALL ELECTRONICS
CORPORATION
P.O. Box 567
Van Nuys, CA 91408
FAX (818)781-2653

e-mail allcorp@allcorp.com

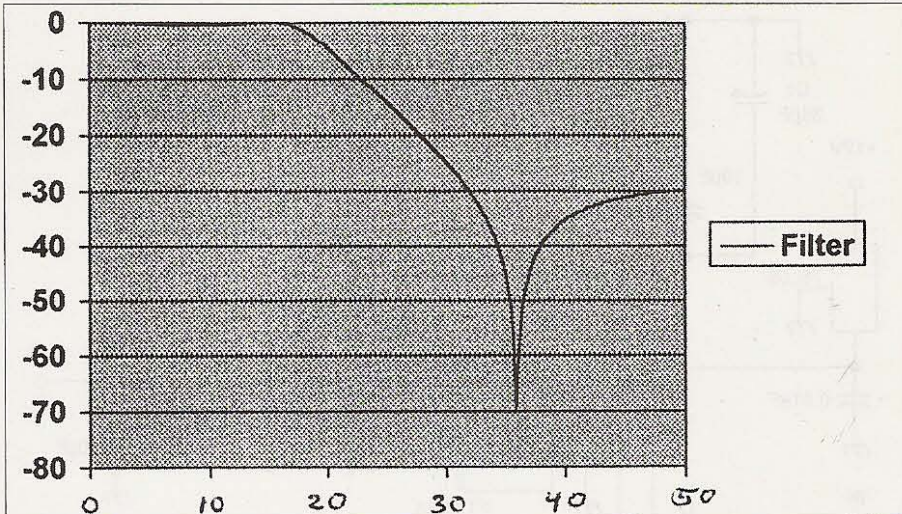

Fig. 4. 20 MHz low-pass filter characteristic (MHz vs. dB).

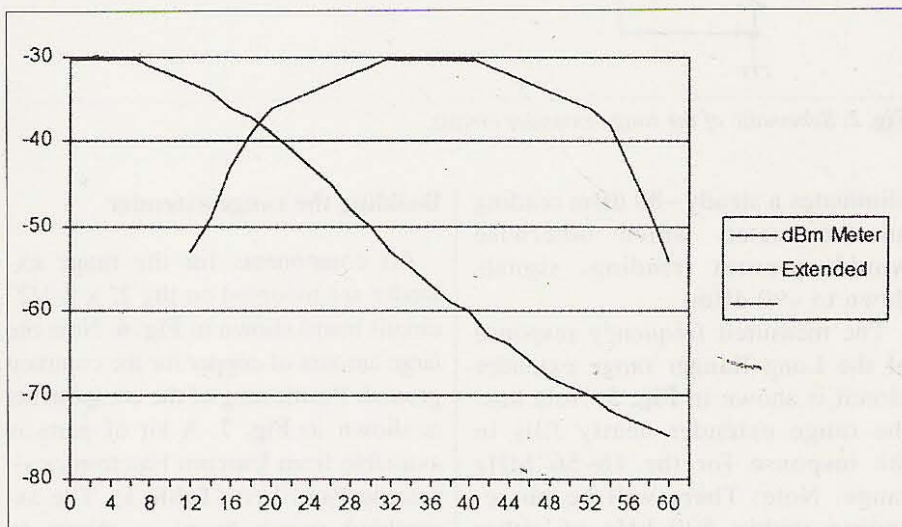

Fig. 5. Frequency response of range-extended dBm meter (MHz vs. dB).

practical information on coil-winding and other components can be found in the Radio Components Manual listed at the end of this article.

Adjustment and testing

Apply 12 volts to the power terminal. The current should be about 4 mA. Because the voltage is regulated by the 78L08, any supply between 10 and 23 volts is acceptable. The 36-MHz circuit connected to pin 7 will have to be set by adjusting C1. One way to do this is to connect a dBm meter to pin 7 through a 20k ohm resistor. Adjust C1 until the 36-MHz signal appears. The reading will be about -80 dBm. Then set C1 so that the oscillator starts reliably when power is removed and re-applied. The best setting will be to

one side of the point of greatest oscillator signal.

Another way to adjust C1 is to put

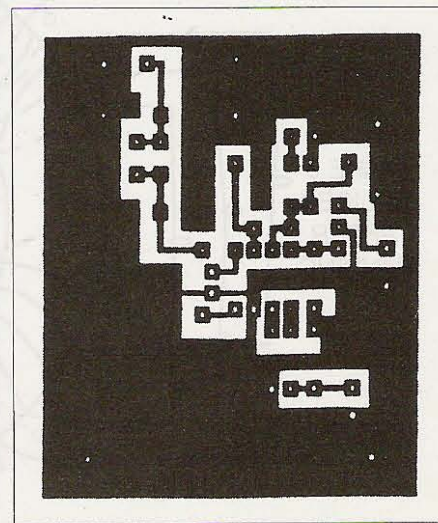

Fig. 6. Circuit board pattern, bottom view.

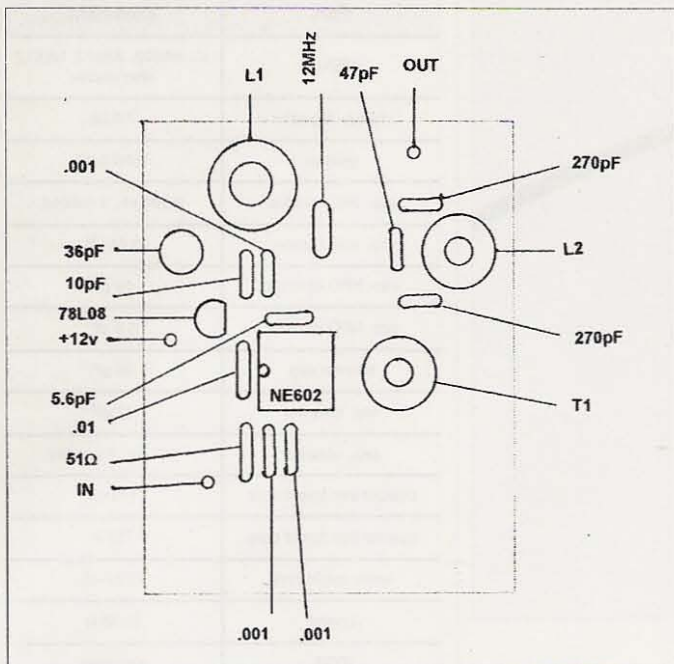

Fig. 7. Component location diagram.

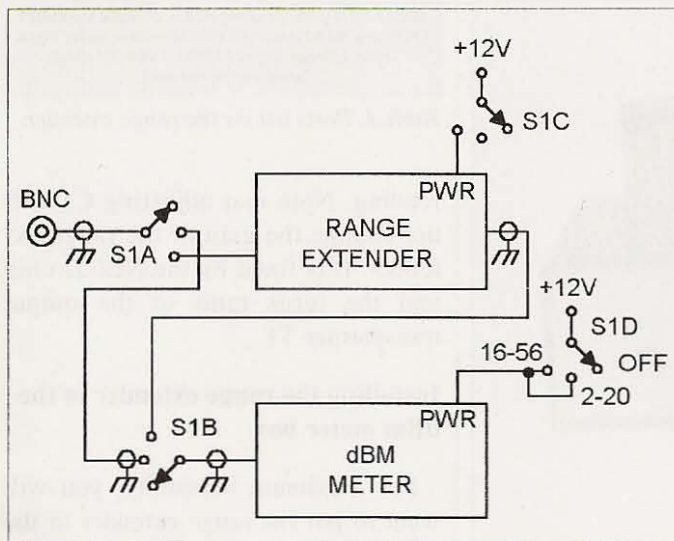

Fig. 8. Switch diagram.

together the test setup shown in **Photo B**. Set a signal generator to any frequency in the 30–50 MHz range. I used an MFJ 249B SWR Analyzer as a signal generator. A step attenuator, such as the one described in the April 1999 issue of *Electronics Now*, can be used to reduce the generator output to the weak levels covered by the dBm meter. Set the step attenuator for 33 dB of attenuation to reduce the MFJ's normal level of +3 dBm to a –30 dBm level. Feed the weak signal to the range extender input and feed its output to the dBm meter. Then adjust C1 for a reliable reading on the dBm. A 30 mV rms signal applied to the input of the range extender should read 30 mV on the dBm meter. You can check this by applying an 18 MHz signal directly to the dBm meter and measuring its level. Then supply this same signal to the range extender and read the output level on the dBm meter. It should be within 1 to 2 dB of the direct

TRANSMITTER LOCATION

New fixed site direction finders provide 2 degree accuracy, and include software for triangulation from a central control site. Mobile versions also available covering 50MHz to 1 GHz

Doppler Systems Inc.

PO Box 2780 Carefree, AZ 85377
Tel: (480) 488-9755 Fax: (480) 488-1295
www.dopsys.com

European Marketing Director Denis Egan
PO Box 2, Seaton, Devon EX12 2YS England
Tel & Fax: 44 1297 62 56 90



If you're a No-Code Tech, and you're having fun operating, tell us about it! Other No-Code Techs will enjoy reading about your adventures in ham radio—and we'll pay you for your articles. Yes, lots of nice clear photos, please. Call Joyce Sawtelle at 800-274-7373 to get a copy of "How to Write for 73 Magazine."

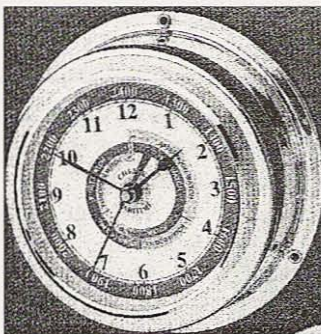

Chelsea Clock

Clockmakers since 1897
The choice of The Coast
Guard Foundation.

Quartz Clock
4" Dial

Beautifully hand-polished.
Stamped brass case and bezel.
Curved glass crystal.
Wall or bulkhead mounting.
Made so well they last from generation to generation!
Order this month and save \$20!

Your price \$75

Omega Sales

P.O. Box 376

Jaffrey NH 03452

1-800-467-7237

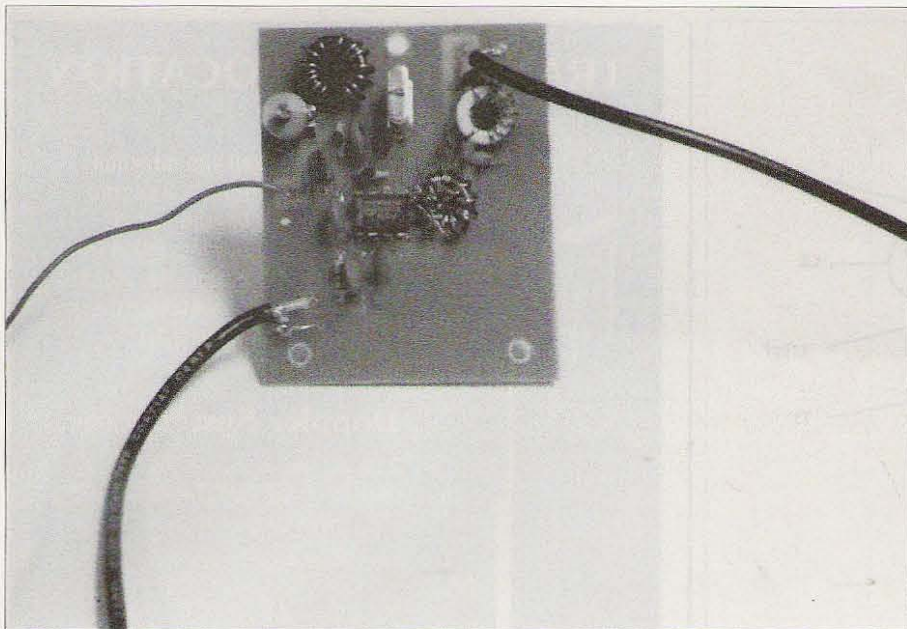

Photo A. Assembled circuit board.

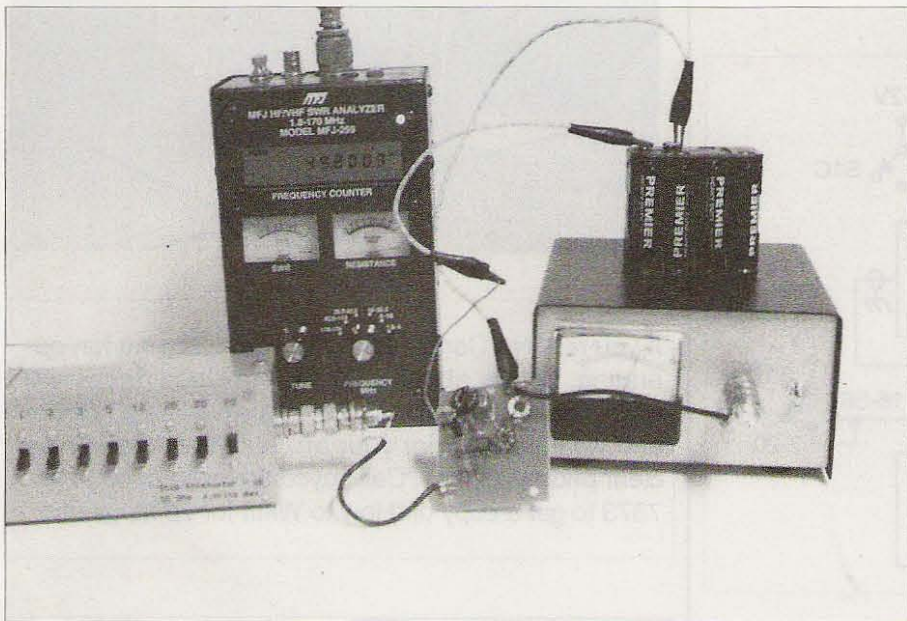

Photo B. Test setup.

Part	Comment
NE602	IC: SA602, SA612, NE612 also usable
voltage regulator	78L08
resistor	1/4W 51Ω
cap, disc ceramic	0.001 μF, 3 needed
cap, disc ceramic	0.01 μF
cap, NPO ceramic	10 pF
cap, NPO ceramic	5.6 pF
trimmer cap	36 pF
cap, ceramic	47 pF
cap, ceramic	270 pF, 2 needed
powder iron toroid core	T44-10
powder iron toroid core	T37-6
ferrite toroid core	FT37-43
crystal	12 MHz
PCB	see note
miscellaneous	#22 wire, #30 wire, RG-174/u miniature coax

Note: A kit of parts including PCB is available for \$16.95 (PCB only, \$4.00) from Unicorn Electronics, Valley Plaza Drive, Johnson City NY 13790; 1-800-321-9454; [www.unicomelex.com].

Table 1. Parts list for the range extender.

reading. Note that adjusting C1 will not change the gain of the range extender. It is fixed by the NE602 chip and the turns ratio of the output transformer T1.

Installing the range extender in the dBm meter box

For maximum versatility, you will want to put the range extender in the dBm meter case. Use a switch to select direct operation for 2–20 MHz and range extender for 16–56 MHz. A 4-pole 3-position switch can be used as shown in Fig. 8 to switch the signal connection as well as control the power applied.

The range extender circuit board will fit nicely in the case behind the meter movement. See Photo C.

Using the instrument

You now have a very sensitive meter for use up through 56 MHz. It can be used to measure signals in receivers, oscillators, and mixers. The passband of filters, including crystal filters, can be easily measured. See

LED FLASHLIGHTS (and more!)



- Lasts 4 times longer than regular flashlights
- Lifetime warranty including LED lights
- Shockproof
- Features 4 high intensity LED lights
- Powered by 3 AA alkaline batteries

After continuously being turned on for 14 days (336 hours), it was possible to read a newspaper using only the output from this amazing system. This item sold out at Dayton!

Colors: white, blue, red, and green
D & L Antenna Supply Co.

Secure Ordering On Line at
www.wavehunter.com
 1-800-965-8880
 Prices from \$4.95 to \$59.95

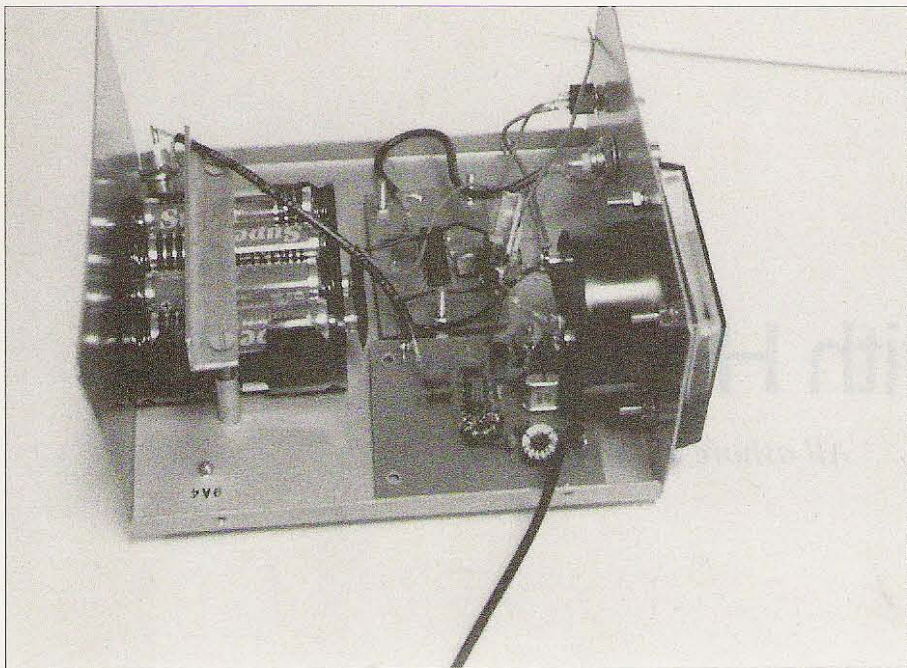

Photo C. Location of range extender in dBm meter case.

the *Ladder Crystal Filters* book listed at the end of this article for details. It can also be used to measure field strength by connection to a whip antenna.

A meter like this can be used to tune a 6-meter antenna for maximum forward gain or to measure front-to-back ratio in dB. Many other uses are possible.

The extender can also be used up through 70 MHz at reduced sensitivity. Overall, it's a very useful instrument to have available.

For further reading

1. "dBm Meter," by John Pivnichny, *Electronics Now*, Nov. 1995, pp. 112-113, 158-159.
2. *Radio Components Manual*, by Guido Silva I2EO, MFJ Enterprises, Starkville, MS, 1998.
3. "Build a Step Attenuator," by John Pivnichny, *Electronics Now*, April 1999, pp. 34-37; correction, June 1999, p. 7.
4. *Ladder Crystal Filters*, by John Pivnichny, MFJ Enterprises, Starkville MS, 1999. Available through Barnes and Noble.



Photo D. Completed unit.

PC BOARD SERVICES

Don't get bogged down with PC Board details. I have been serving Companies, Engineers and Hobbyists since 1983 with:

- PCB Design
- Fabrication
- Assembly

Midland Technologies
34374 Frontage Rd.
Bozeman, MT 59715
800-726-8871

Scrambling News

915 NW First Ave., Suite 2902, Miami FL, 33136
 305-372-9427
www.scramblingnews.com

Pay TV and Satellite Descrambling 2002 - NEW! - satellite and cable. Includes latest information. \$19.95 plus \$1.75 shipping.
Hacking Digital Satellite Systems Video 2002 - New! - \$29.95 plus \$3.50 shipping.
Scrambling News Online - Online service for those interested in satellite television news. \$59.95/year. \$59.95/yr.
Pay TV and Satellite Descrambling Series CD-Rom - all 13 volumes over 300 pages, \$59.95 plus \$3.50 shipping.
Best Deal - Everything listed above for only \$99.95 plus \$3.50 shipping.

We pay SCASHS
 (well, check)
 for articles!
 SEND FOR "HOW TO WRITE FOR 73"

The Gordon West Study Guides

Examination Test
 Questions & Answers
 for General Class and Extra Class
 with explanations of the answers



General Class
 \$12.95
 Plus \$3.50 S&H



Extra Class
 \$14.95
 Plus \$3.50 S&H

Omega Sales

P.O. Box 376
 Jaffrey, NH 03452
 800-467-7237



Travels with Henryk — Part 4

All ashore at Malta.

I have visited many islands, and one thing I've noticed is the higher-than-average interest in amateur radio on most of them. Malta is a typical example of this phenomenon.



Photo A. Quite a few people show up at MARL for the Sunday meetings.



Photo B. This room is for the multimode, multiband club station (9H1MRL).

There are almost 500 licenses issued in Malta, while the population is less than 400,000. The truth is that a large number of these license holders still enjoy CB, as in other places I have visited. The reasons are several: The CB equipment is simpler and cheaper; the number of frequencies available is smaller, so finding particular people on the radio is easier; and using a CB radio is far less demanding than using any ham transceiver.

Amateur radio activity is tremendous on the island of Malta. The local organization, Malta Amateur Radio League, occupies a whole property in the central village of Attard (**Photo C**).

A few times a week there are meetings, but Sunday usually attracts the most people (**Photo A**). One of the rooms is devoted entirely to a multimode multiband club station



Photo C. You can't miss the Malta Amateur Radio League headquarters building. It is well marked, and covered with antennas.

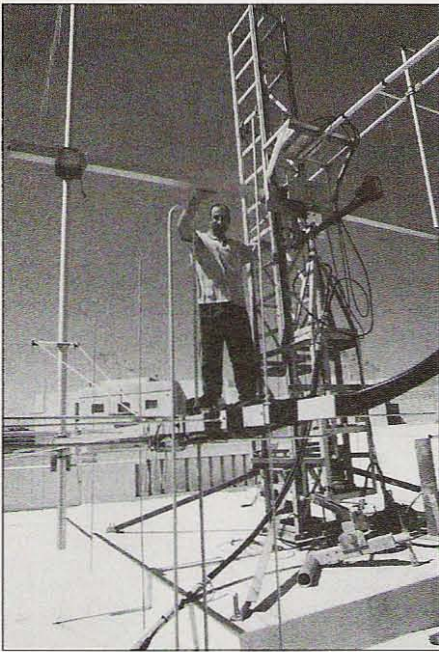

Photo D. Philip 9H1PA with part of his antenna array.

(**Photo B**). Another room is prepared for classes, as upgrading to a full privilege license is in high demand (**Photo F**), among young and older members alike. Carmelo 9H1AQ is responsible for teaching telegraphy and a lot of other things at MARL. Kudos to Carmelo!

In relation to the total number of active amateur radio operators, the number of very advanced 9H hams is



Photo E. Philip 9H1PA in his shack with his home-brewed gear.

extremely high. I had the opportunity to visit a few of them.

Philip 9H1PA is a wizard of moonbounce and has both an outstanding antenna array (**Photo D**) and a radio shack filled with professionally home-brewed gear (**Photo E**) for 144 MHz and 50 MHz.

He is not the only one with EME ambitions in Malta.

Fortunato 9H1ES is a classical

home-brewer, too (**Photo G**). His main interest is microwave, so you'll see dishes on his roof (**Photo H**).

Paul 9H1BT (**Photo L**) also has experience in moonbouncing. He is an excellent engineer and a versatile operator. He's on VHF, HF, and LF.

Mark 9H1GP is basically interested in HF and climbing his antenna pipe

Continued on page 26



Photo F. A license class in session. Carmelo 9H1AQ teaches telegraphy, among other things, at the MARL. The exams are conducted only once or twice a year at the Wireless Office.

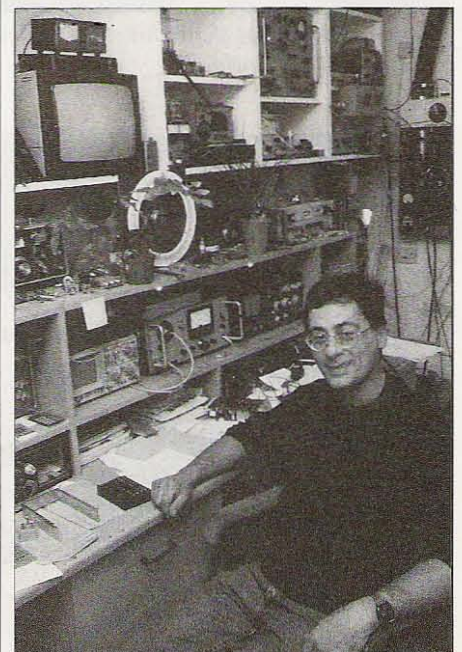

Photo G. Fortunato 9H1ES with his home-brew equipment.



Photo H. Fortunato 9H1ES on the roof with some of his antennas.

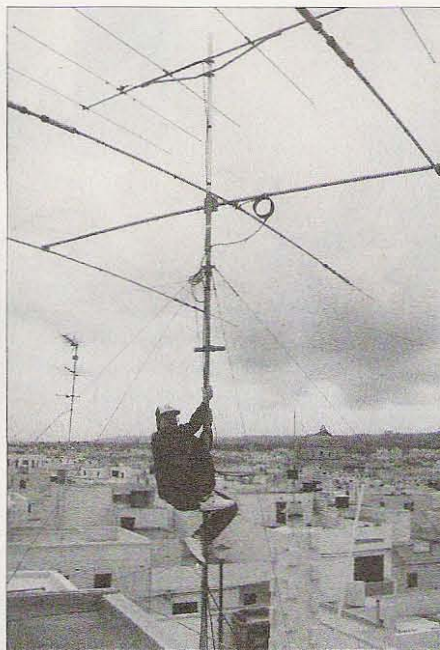

Photo I. Mark 9H1GP of Mosta shows how he climbs his pipe antenna mast.

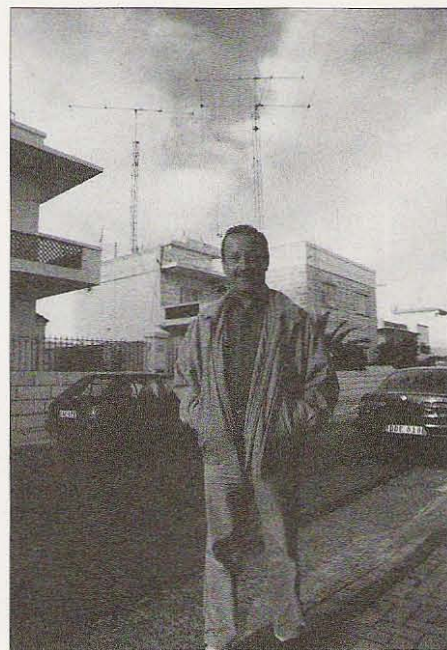

Photo J. Jeff 9H1EL, with his house and antennas in the background.

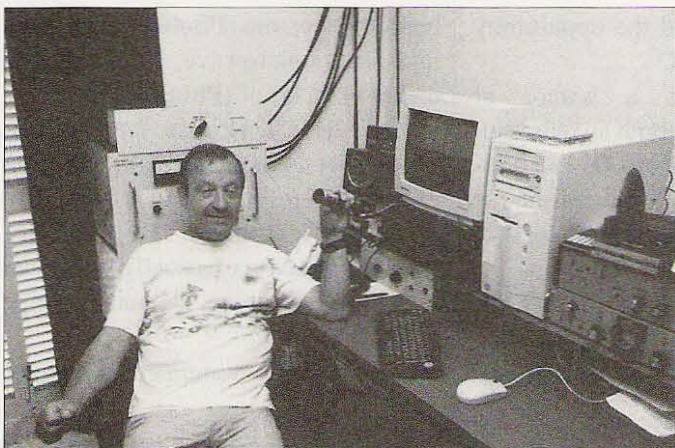

Photo K. 9H1EL has shown his shack to amateur radio operators from all over the world.

Travels With Henryk — Part 4

continued from page 25

mast (**Photo I**). ... No, no, I am kidding. I asked him to climb the mast.

The one who is responsible for most of the contest and DXpedition-style exchanges is

Jeff 9H1EL (**Photo J**), here with his house and antennas in the background. Jeff came here from England some 25 years ago, tired of dull Manchester weather. His well-equipped shack (**Photo K**) has been visited by hundreds of amateur radio operators from all over the world, including yours truly. Jeff might be more active in the future, as he has decided to retire from his oil industry work. He usually signs 9HØA in a contest, so now you know! He is a first-class operator on CW, SSB, and digital modes ... but does not care about QSL cards. If you want his card, you'll have to ask his manager in Norway, LA2TO [www.qrz.com/9h1el].

73

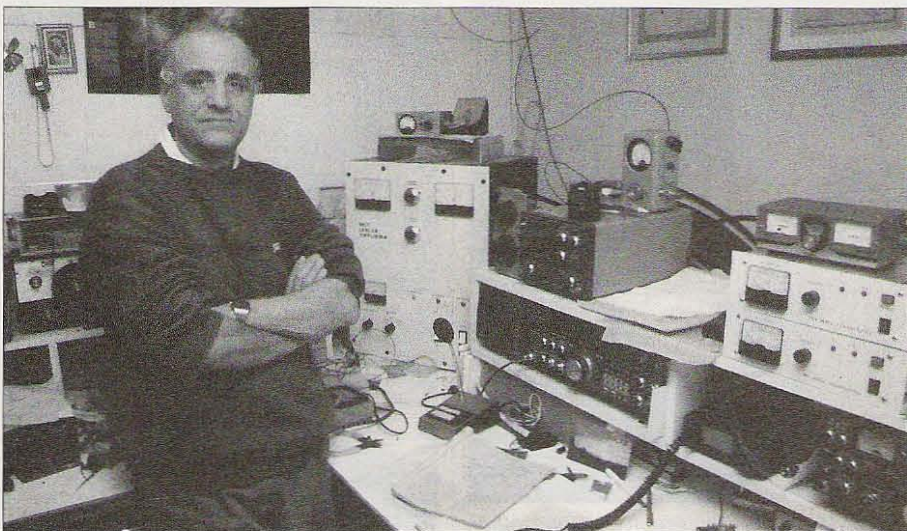

Photo L. Paul 9H1BT operates on VHF, HF, and LF, and is enjoying some time in his combined shop-shack.

Say You Saw it in 73!

Subscriptions to 73 Magazine

Only \$24.97 — 1 year
\$44.97 — 2 years
\$65.00 — 3 years*

*best buy (54% off cover price!)

Call 800-274-7373

Keying to a Different Drummer

This CW key is simplicity for pennies.

This key won't open your house, but it will open the world of basic radio communications. The simplicity of a basic CW transmitter and receiver makes for inexpensive communications. Of course, modern radio equipment and computers offer mind-boggling performance, but at a price.

You may be scared off when you see the prices of good commercial keys, but building your own is an inexpensive solution. The key described is the ultimate in simplicity and it costs pennies.

CW keys are simple devices. They are just switches that turn on the transmitter. The key described here won't key a transmitter directly — even a solid state one. It must be used with a keyer.

A keyer is basically just an electronic power switch that turns the transmitter on and off. The key controls the keyer. When the keyer is a CMOS gate or a MOSFET, the power required for control is minuscule.

Keys take two general forms: the straight key and the speed key. The straight key is a single-pole, single-throw (SPST) switch that is closed by an up and down motion. The sideswiper is the same kind of key rotated 90 degrees so that it is operated with a side-to-side motion. Both have the same limitations of keying speed: Most operators are limited to less than 25 words per minute (WPM) with straight keys.

For higher sustained speeds, a speed key like the Vibroplex "Bug," can send

more than 50 WPM — but they are still just SPST switches. With a speed key, the motion is a rolling side-to-side movement of the hand. Roll your hand to the right to make a string of dots and to the left to manually make dashes.

The function of a key is simple — just make a low resistance path to turn on the transmitter or drive the keyer. Keying the cathode of a vacuum tube requires switching a high voltage and current, so the switch must have wider contact spacing and larger contacts. With a keyer, the key only needs to control the keyer. Usually low voltage and low current.

How much spacing do you need? In a benign low voltage environment like a desktop and driving a keyer, a spacing of 0.001 inch per volt is probably sufficient. Spacing will probably be affected more by the operator's personal preferences and operating speed than by voltage breakdown considerations.

Contact resistance is another issue. Switching low voltage and low current, a dry switch, results in corrosion of the contacts of a mechanical switch and a variable high resistance contact. A CMOS or MOSFET keyer can tolerate a contact resistance of 100k, which

leads to just using the contact resistance of a finger for the switch. The hand-to-hand resistance of dry hands is in the range of 20k. The resistance across a finger is somewhat less. This resistance can switch a CMOS or MOSFET keyer.

The key described is intended to

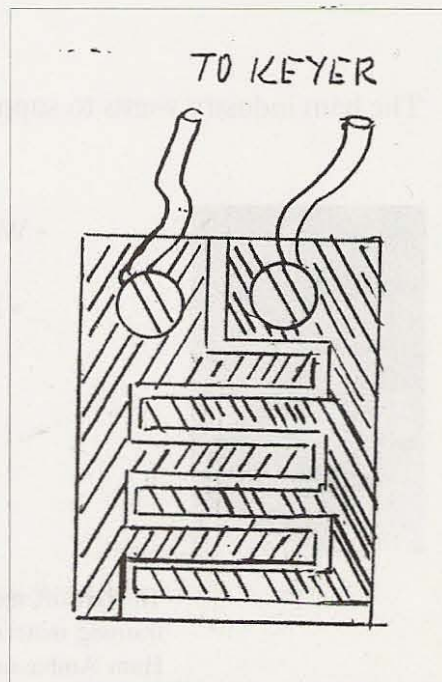

Fig. 1. The switch is made from a piece of PC board.

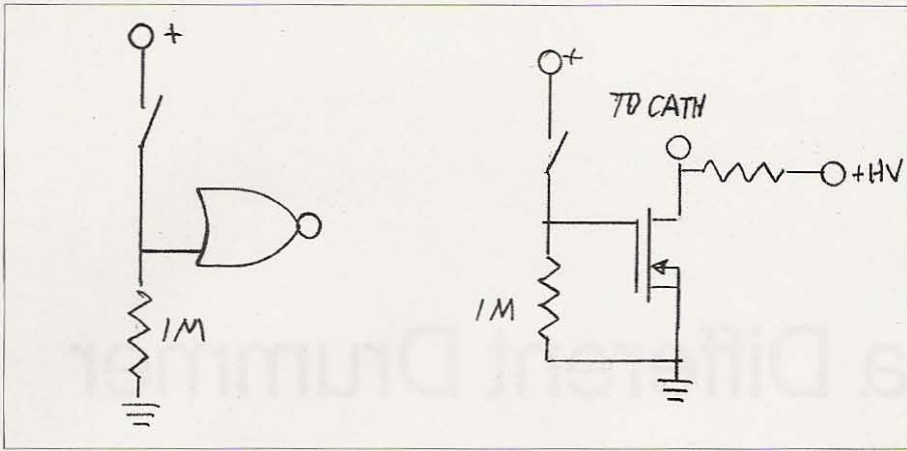

Fig. 2. The switch can drive a CMOS gate (left), or a MOSFET (right).

drive a CMOS gate or an enhancement mode MOSFET. Therefore, the current is a few micro amps and the voltage switched is probably less than 10 volts. The mechanics are the major concern, but even the mechanics become trivial when finger resistance controls the keyer.

Fig. 1 shows a keypad that uses finger resistance as a switch. The keypad is an interdigital pattern on a PC board

with the fingers of the pattern separated by a few mils. The switch is closed when the tracks are bridged by the fingers to turn on a CMOS gate or MOSFET.

Automatic keyers need a DPST (double-pole, single-throw) switch: One side to make dots and the other to make dashes. But if all you want is the equivalent of a straight key, a single enhancement mode MOSFET will do the job.

A novel arrangement I find to be comfortable to use with an automatic keyer has two PC board keypads lying flat and side-by-side and separated by half an inch. One switch is operated by touching with the thumb and the other switch is operated with the index finger. The spacing between the keypad boards is made to suit the dimensions of your hand. Operating the key is about like drumming with your fingers. For a straight key, only one keypad is needed.

The weight of the PC board is very little, and something must keep it in place. I hold mine in place with small screws into plywood and a dot of glue. The screws also provide a means of attaching the leads that connect to the keyer.

The key mates well with a keyer that uses CMOS input devices like the CD4001. CMOS can tolerate pull-down resistors of a meg or more. Since CMOS and MOSFET gates have gate

Continued on page 57

ELMERS • VE's • INSTRUCTORS • CLUB GREETERS

Become A

HAM AMBASSADOR

The ham industry wants to support your efforts for ham radio growth with free instructor materials.



- Wall Maps • Log Books • Band Plan Charts
- Frequency Charts • Grid Square Guides
- Discounts on Licensing Materials
- Equipment Discount Program
- Gift Certificates

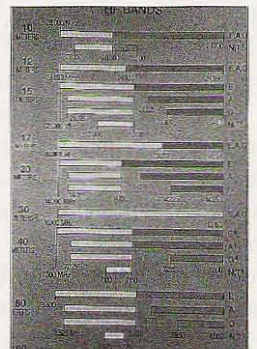

To start off the flow of materials, include \$5.95 for up to 2 pounds of training materials, and send your request to:

Ham Ambassadors, Gordon West Radio School, 2414 College Drive, Costa Mesa CA 92626.

Restoring an HQ-140-X — Part 1

This Hammarlund rig has always been a favorite.

Nostalgia! Have you really given any thought to the amount of “love” you develop for a piece of ham equipment?

After using a Hammarlund HQ-140-X for many years, it became part of my family, so to speak. It was a piece of equipment that could be counted upon to be dependable and would work any time that it was needed. I don't recall for sure when I obtained the HQ-140-X, but can tell you that once I used it, it was going to be “mine” forever — and it has remained in my possession (see **Photo A**).

My main reason for restoring the receiver, not because I needed it, was simply to see if it was still functional and to compare it to modern equipment. When I last used it, my emphasis for use was with frequency converters that took it up into the 2-meter and 450 MHz bands. I wasn't working SSB at the time, so hadn't developed a “feel” for using the receiver for SSB, though I'd tried it out upon occasion.

A few years back, I replaced the receiver with a much smaller solid-state radio, but the presence of the HQ-140-X remained in the back of my mind. Eventually I dug the receiver out of its storage location and decided to restore it — not that it ever needed very much other than AC power.

Decisions

When restoring any piece of old/antique equipment, you have to decide to what extent you will go to complete the restoration. Of concern is a trade-off of your need to have it operate versus the potential market value of the equipment. Therefore, you have to make a hard decision as to how far, or to what extent, you will go to restore the equipment. If the piece of equipment is desired for its functionality regardless of appearance, then most

anything goes to make the piece operate as desired.

If nostalgia is the motivating factor for restoration, then the effort put forth is to enhance the “original” characteristics without modification. In other words, you wouldn't change anything, including the original paint. If the original cabinet was a varnished wood, as an example, the original varnish would be left as-is, though perhaps cracked with age. Maybe a little furniture polish would be used to brighten it up without altering the original finish.

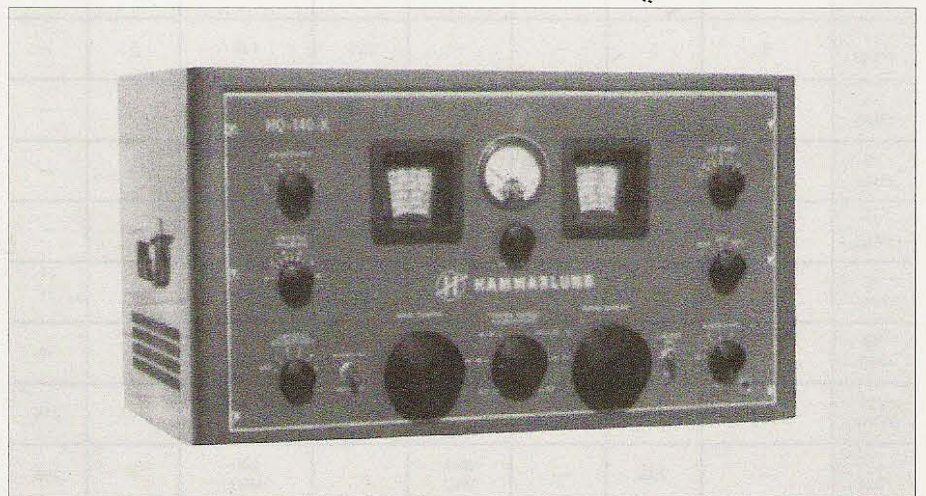

Photo A. The author's Hammarlund HQ-140-X receiver after it had been restored.

Tube	Tube Pins							
	1	2	3	4	5	6	7	8
V1 6C4	80k	—	—	—	80k	52k	0	—
V2 6BA6	> 2 megs	0	—	—	73k	78k	298	—
V3 6BE6	52k	107	—	—	74k	79k	114k	—
V4 6BA6	> 2 megs	272	—	—	74k	78k	272	—
V5 6BA6	> 2 megs	263	—	—	74k	78k	611	—
V6 6BA6	3	244	—	—	75k	107k	242	—
V7 6AL5	—	610k	—	—	0	0	275k	—
V8 12AU7	120k	90	1k	—	—	> 2 megs	35k	1.5
V9 6V6	—	—	80k	80k	243k	—	—	383
V10 VR105	80k	—	—	—	80k	—	80k	—
V11 5U4	—	> 60k	—	77	—	77	—	> 60k

Table 1. Resistance values in ohms measured from the tube socket pin to ground.

When nostalgia is the strongest driving force, it's possible that all of the electronic components "must" remain regardless of functionality. In other words, "original" means just that — no repairs that would alter the originality. The equipment becomes a prized museum piece because of its originality.

As for market value, the greatest value stems from the equipment being as close to the original stock condition as possible. Extra holes in the cabinet, modified circuits, new paint, etc., are a turn-off for a person looking for nostalgia or to have the equipment as a "collector's item."

My approach for restoring the HQ-140-X was to do the minimum amount to the receiver to restore it to operation and to maintain the original appearance as much as possible.

First steps

My first step to restoration of the HQ-140-X was to perform a diagnostic evaluation as to its performance to ascertain its health and potential problems. From the results of the evaluation, a course of action would then be planned.

One of the scary things about applying power to a piece of equipment that's been out of service for several years is, What's going to happen when power is applied? Hopefully it will operate and nothing serious will occur. Because of the possibility of an electrical problem, you have to use great caution to prevent damage.

The technique that I used on the HQ-140-X was to place a light bulb in series with the power cord that was plugged into a Variac. OK, the power line and power transformer were now protected, but what if something else happened, particularly in the HV department? How would you detect that condition early enough to prevent

Tube	Tube Pins							
	1	2	3	4	5	6	7	8
V1 6C4	96	-7	—	—	96	—	0	—
V2 6BA6	0	0	—	—	225	105	6	—
V3 6BE6	0	-7	—	—	227	96	0	—
V4 6BA6	0	5	—	—	225	105	5	—
V5 6BA6	0	2	—	—	218	103	5	—
V6 6BA6	0	3	—	—	213	118	3	—
V7 6AL5	0	0	—	—	0	—	0	—
V8 12AU7	—	—	—	—	—	—	—	—
V9 6V6	—	—	276	292	0	—	—	16
V10 VR105	232	0	107	—	107	—	107	214
V11 5U4	—	298	—	280 VAC	—	280 VAC	—	298

Table 2. Voltage values measured between the tube socket pin and ground. All voltages are DC except as noted.

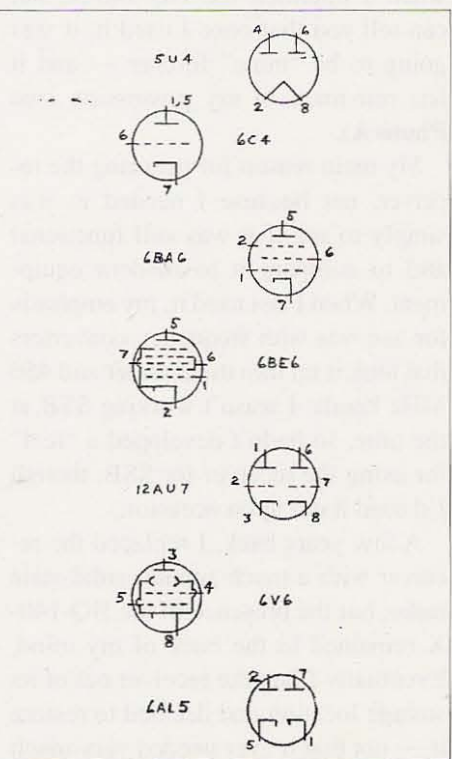

damage from occurring? One way to tell is to watch carefully the 5U4 rectifier for color. Should there be a HV short, the 5U4 will be the first to provide tell-tale signs with a purple glow inside of the plate area. In addition, if the short is allowed to remain for very long and the fuse fails to blow, the rectifier plates will begin to turn red, and then the fuse might blow. It would be desirable to detect the problem before losing a fuse.

A positive sign of proper operation is to observe the purple glow within the gas voltage regulator tube. With the regulator glow present in my HQ-140-X, I had confidence that there was no major shorting condition within the power supply. However, the first hour of operation after a long dormant period is the most critical. Electrolytic filter capacitors are subject to heating until the oxide dielectric within is reformed. Checking the filter "cans" for warmth periodically during the first hour is wise because a sign of heating is not desired. One of the ways of reducing the heating while allowing the oxide dielectric to form is to operate the line voltage at reduced levels with a periodic increase until the normal line voltage level is reached. After an hour of "no filter can" heating, the series light bulb can be removed from the input power line.

Perhaps a better approach to finding a short or potential problem in advance of applying power is to perform resistance measurements. A resistance check/measurement may be made at the socket pins for each tube. **Table 1** shows a general resistance table for most of the tubes in my HQ-140-X receiver. The values shown provide a clue as to what you should expect in a "good" receiver.

To measure the resistance at the 12AU7 tube socket, it is preferred to "pull the tube" so that resistance measurements can be made from the top side of the chassis. It's easier to pull the tube than it is to remove the shield can covering the bottom of the tube socket.

Diagnostics

My second step was to evaluate the

Ham Mall

The world's largest internet store dedicated to Ham Radio!

www.HamMall.com

This is the internet store that has it all! Open 7 days per week - 24 hours per day. Browse through our catalog viewing pictures, descriptions, accessories, and our low prices. If you are looking for a hard to find item, Email us at Bill@HamMall.com, and we will try to locate it for you.

Check out all we offer!

Call Wall QSL Manager Listing News, Announcements and Specials
Ham-to-Ham Discussion Groups Ham Shack Photos

Visa/MasterCard accepted on line. Free shipping in continental US on all orders over \$100.

When in Seattle visit us at:

Radio Depot, Suite 176, 5963 Corson Ave., So. Seattle, WA 98108

Phone (206) 763-2936 Fax (206) 763-4172

TWO YEAR WARRANTY



Starting at
\$639 VHF/\$699 UHF

Hi Pro
Repeaters



Starting at
\$1450 VHF/\$1525 UHF

Specializing in repeaters, links, crossband repeaters,
receivers and transmitters (separately or in housings)

Maggiore Electronic Lab, 600 Westtown Rd., West Chester, PA 19382
PH (610) 436-6051 FAX (610) 436-6268 <http://www.hiprorepeaters.com>

- DIP switch programmable
- Miniature in size
- 37 EIA tones, 27 non-standard tones from 33.0 to 254.1 Hz included
- Reverse Burst built-in
- Easy 3 wire hookup

SS-64 CTCSS Encoder
.66" x 1.08" x .21"

SS-64 DIP Switch Programmable CTCSS Encoder \$28.95



TP-3200 Shared Repeater Tone Panel

TP-3200D Table Top Version \$269.95 each
TP-3200RM-A Single Rack Mount version \$279.95 each
*TP-3200RM-B Triple Rack Mount version \$279.95 each
*Holds up to three TP-3200s

Call or write to receive our full Product Catalog or visit our Web site for complete information at:
<http://www.com-spec.com>

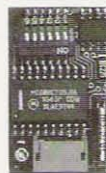

- 51 CTCSS Tones
- 106 DCS Codes
- Supports 157 Repeater Subscribers
- On-Line Computer Help
- Repeater CW ID
- Air Time Loading & Analysis Graphs
- Signalling Formats: CTCSS DCS & DTMF

- Fully enclosed CTCSS encoder
- All 32 EIA tones from 67.0 to 203.5 Hz included
- Perfect for mobile / base applications



TE-32 Multi-Tone CTCSS Encoder \$49.95
5.25" x 3.3" x 1.7"

- Eight programmable, selectable messages
- Fully field programmable via included keypad
- Meets all FCC identification requirements



ID-8 Automatic Morse Code Identifier
1.85" x 1.12" x .35"

ID-8 Automatic Morse Station Identifier \$69.95



COMMUNICATIONS SPECIALISTS, INC.
426 WEST TAFT AVENUE • ORANGE, CA 92865-4296
(714) 998-3021 • FAX (714) 974-3420
Entire U.S.A. (800) 854-0547 • FAX (800) 850-0547
<http://www.com-spec.com>

Band	Gen. Freq. (MHz)	Rcvr. Dial Freq. (MHz)	AM Min. Det. Signal (μ V)	CW Min. Det. Signal (μ V)	Notes
0.54-1.32	1.30	1.35	0.3	0.3	Bandspread inoperative
1.32-3.2	1.32	1.32	1.0	0.3	*
*	3.15	3.17	3.0	1.5	*
3.2-5.7	3.25	3.26	10	2.0	Bandspread at 100
*	5.50	5.52	1.5	0.6	*
5.7-10	5.80	5.82	0.6	0.25	*
*	9.50	9.51	0.6	0.2	*
10-18	10.50	10.52	0.7	0.2	*
*	17.50	17.52	1.0	0.6	*
18-31	18.50	18.60	1.5	1.0	*
*	30.50	30.60	0.8	0.25	*

Table 3. Table of minimum detectable signal level as related to band, frequency, and AM or CW detection mode.

functionality of the receiver in order to profile and/or identify any issues that might need to be resolved.

After power is applied, you must observe the 5U4 rectifier tube and feel the filter can for heating. **Table 2** shows the general voltage levels that I measured at the socket pins of the tubes. Because of the shield can covering the bottom of the 12AU7 tube socket, voltage values for the 12AU7 are not shown.

Although the original HQ-140-X receiver specification did not indicate a measured signal sensitivity level, most

receiver designs of the 1950s era fell into the 2 μ V sensitivity range. When measuring a receiver's sensitivity correctly, signal-to-noise ratios are the most discriminating and meaningful, but not everyone can perform the test easily. As a simple comparative test, a minimum detectable signal level can be used as a substitute. In this case, a signal-to-noise ratio sensitivity accuracy is traded for the ability to perform "a comparable measurement" using available equipment such as a calibrated output signal generator.

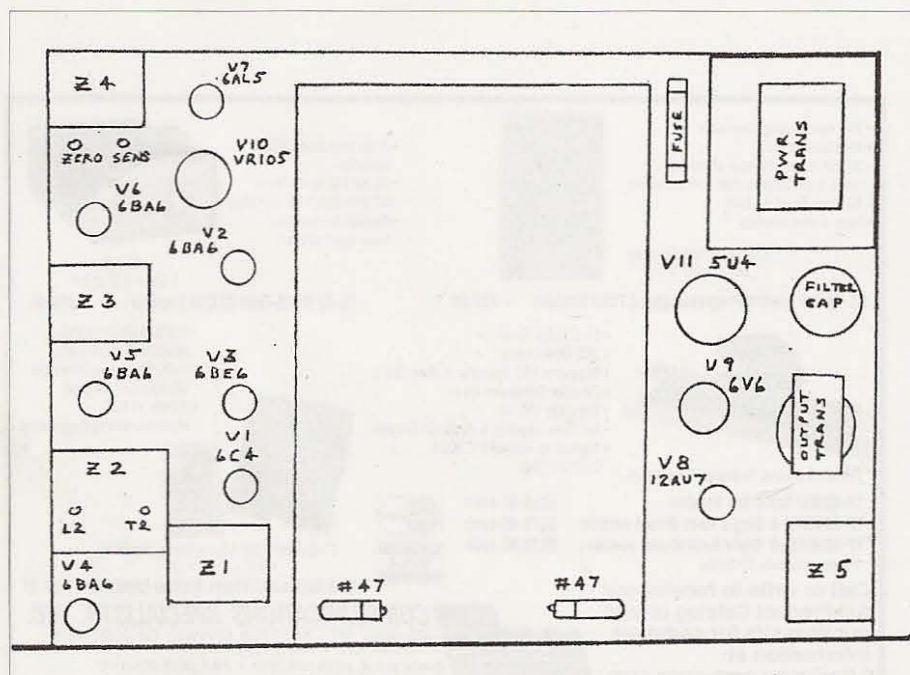

Fig. 1. Layout diagram of the HQ-140-X showing the location of the major components.

When using this technique, you have to arbitrarily establish a somewhat repeatable point for comparison as a reference for all of the measurements that follow. I chose my reference to be a minimum detectable AM signal that was being modulated at 1 kHz. I also checked the sensitivity for CW signals with the BFO turned to ON. **Table 3** shows the relative signal level measurements that I obtained for the ends of each tuning band (except the lowest band, where I could make a measurement only at the high end of the broadcast band with my equipment). In addition, **Table 3** shows the measured frequency accuracy indicated on the receiver's dial as compared to the calibrated generator. Because the slight offset in calibration was so little, a band set correction was unwarranted, though it was possible to correct.

During the diagnostic phase of my testing, several small problems were noted:

- Very dirty cabinet
- Very dirty front panel
- Dirty/noisy potentiometers
- Dirty/noisy intermittent band change switch
- Noisy tuning capacitor

Receiver design

Before starting the restoration process, I felt that it was desirable to develop some visual references for the receiver. Mapping it out would help me gain a clearer picture of the design by identifying where all of the major components were located. The first step was to develop a top view layout diagram, as shown in **Fig. 1**, that identifies tube placement and function.

The second step was to work up a form of block diagram, as shown in **Fig. 2**, of the receiver that would assist in understanding the signal flow through the receiver. With this information in hand, I was now ready to proceed with developing a plan for restoration.

Applying power and performing diagnostics on the Hammarlund was an important effort toward the restoration

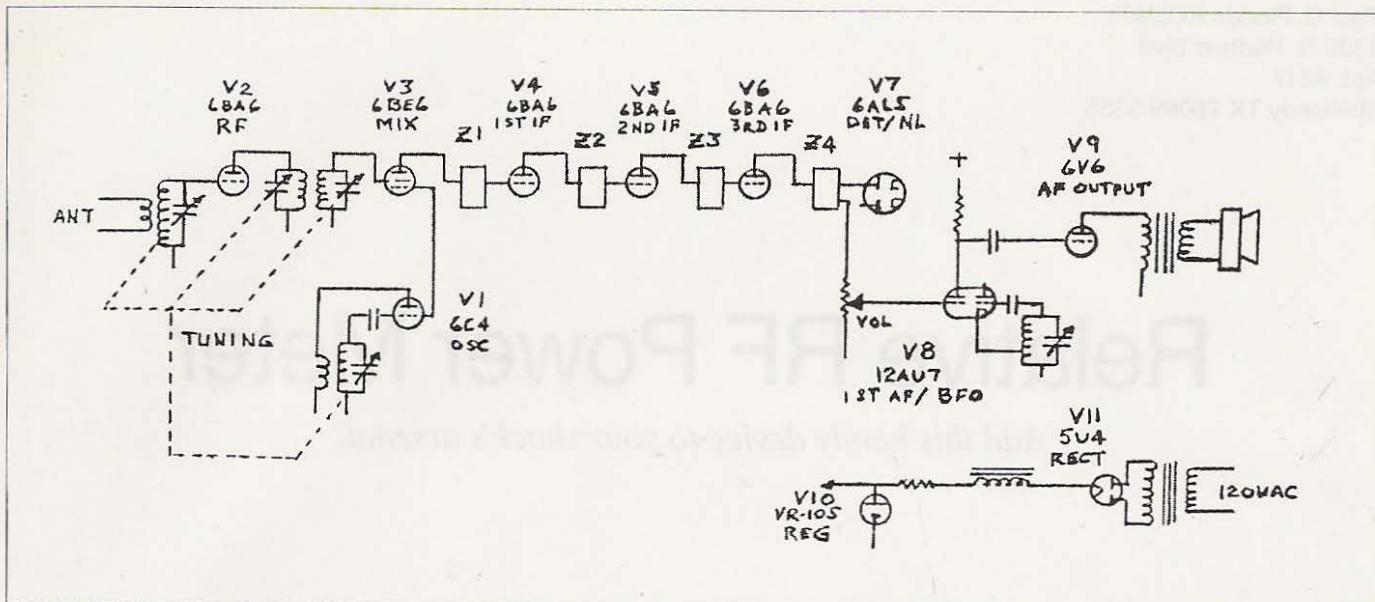

Fig. 2. Functional diagram showing the signal path through the HQ-140-X.

process. The fact that it operated without an electronic problem was of great comfort to me. Now I was ready to proceed to the next step of physical restoration.

To prepare for the physical restoration of my Hammarlund HQ-140-X, the following materials were collected.

Material listing

- Dish detergent
- Pledge, Johnson's Wax Co.
- Toothbrush, used
- Stiff bristle brush, nylon or fiber
- Paint brush with the bristles cropped short
- Automobile wax for clear coat finishes
- Paper towels
- Soft cloth
- Small cup for holding the detergent and water mixture

Summary

Part one of this series discussed the decisions you have to make before performing a restoration project, and it also discussed techniques that may be employed for applying power to the equipment with minimum risk to the equipment. With power applied, diagnostic techniques were used to evaluate the health of the receiver and to assist in establishing a

plan of action. Mapping of the major components and developing a signal path diagram assisted in understanding the receiver.

Part 2 of this series on the restoration

of my Hammarlund HQ-140-X will begin with the cleaning processes that I used and will touch on using the receiver in an SSB world. Please stay tuned, and 73.

73

Quality communications equipment since 1942.

www.RFfun.com



Universal Radio

6830 Americana Pkwy.
Reynoldsburg, OH 43068

◆ Orders: 800 431-3939

◆ Info: 614 866-4267

◆ Fax: 614 866-2339

Amplifiers, ATU Down Converters & Hard to Find Parts

LINEAR AMPLIFIERS

HF Amplifiers
PC board and complete parts list for HF amplifiers described in the Motorola Application Notes and Engineering Bulletins:

AN779H (20W)	AN 758 (300W)
AN779L (20W)	AR313 (300W)
AN 762 (140W)	EB27A (300W)
EB63 (140W)	EB104 (600W)
AR305 (300W)	AR347 (1000W)

2 Meter Amplifiers
(144-148 MHz)
(Kit or Wired and Tested)

35W - Model 335A,	
\$79.95/\$109.95	
75W - Model 875A,	
\$119.95/\$159.95	

HARD TO FIND PARTS

- RF Power Transistors
- Broadband HF Transformers
- Chip Caps - Kemet/ATC
- Metallad Mica Caps - Unelco/Semco
- ARCO/SPRAGUE Trimmer Capacitors

We can get you virtually any RF transistor!
Call us for "strange" hard to find parts!

DIGITAL FREQUENCY READOUT
For older analog transceivers
TK-1 (Wired and Tested) \$149.95

ATU Down Converters

(Kit or Wired and Tested)

Model ATV-3 (420-450)	
(Ga AS - FET) \$49.95/\$69.95	
Model ATV-4 (902-926)	
(GaAS - FET) \$59.95/\$79.95	

For detailed information and prices, call or write for our free catalog!

Phone
(937) 426-8600
FAX
(937) 429-3811

CCI Communication Concepts Inc.

508 Millstone Drive • Beavercreek, Ohio 45434-5840
e-mail: cci.dayton@pobox.com
www.communication-concepts.com

ADDITIONAL ITEMS

Heat Sink Material
Model 99 Heat Sink (6.5" x 12" x 1.6"), \$24
CHS-8 Copper Spreader (8" x 6" x 3/8"), \$24
Low Pass Filters (up to 300W)
for harmonics \$12.95
Specify 10M, 15M, 20M, 40M, 80M or 160M
HF Splitters and Combiners up to 2KW

Relative RF Power Meter

Add this handy device to your shack's arsenal.

The Relative RF Power Meter shown in **Photo A** is a piece of test equipment useful for tuning RF circuits to maximum output power. The circuit does not measure absolute power, however; it instead measures the relative output power as the RF circuit is tuned.

When the meter shows maximum deflection, the output power is peaked. The meter has been tested from 2 MHz to 1 GHz over an input power range of approximately -10 dBm (0.1 mW) to 20 dBm (100 mW).

To use this instrument, the source resistance of the circuit being measured must be 50 ohms.

Circuit description

Fig. 1 shows the schematic diagram for the Relative RF Power Meter. J1 is the RF input. J2 is the connector for the 50-ohm terminator. The RF signal enters at J1, is rectified by D3, and filtered by FB1 and FB2, and charges C1. R11, R10, and R3 form a voltage divider which determines the meter's sensitivity to input power. Overvoltage protection of U1's input is provided by

R9 and D2. The gain of U1 is set at about 200. Offset voltage is eliminated by adjusting R5. R1 and R2 form a voltage divider with the center connection used as a ground. When the meter is turned on, D1 is illuminated.

Construction

First, drill holes in the front of the case for J1, J2, R11, R10, and the LED clip. Use a nibbling tool to cut a hole



Photo A. Front panel view.

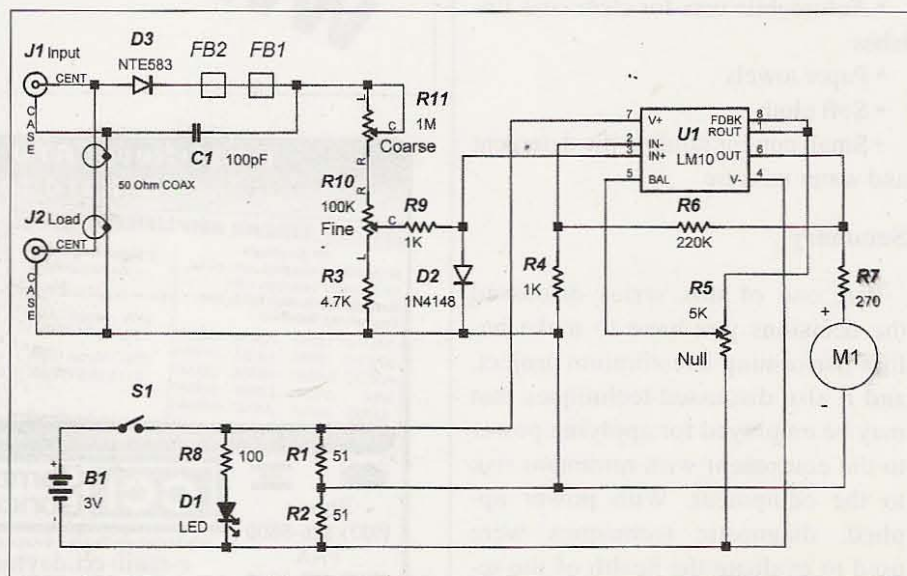

Fig. 1. Relative RF power meter schematic.

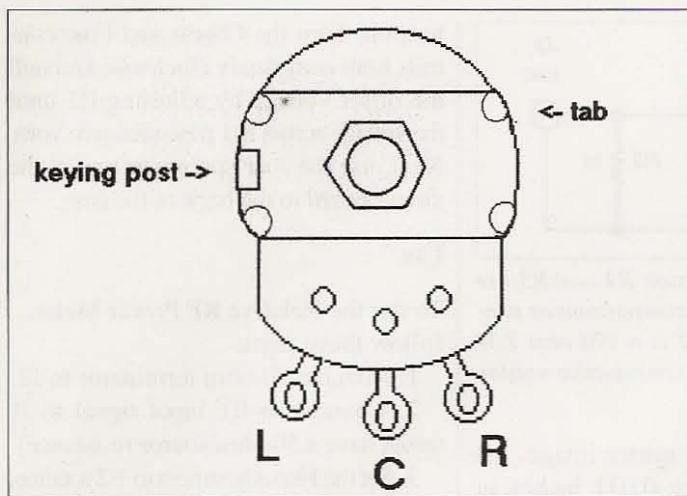

Fig. 2. Potentiometer designations.

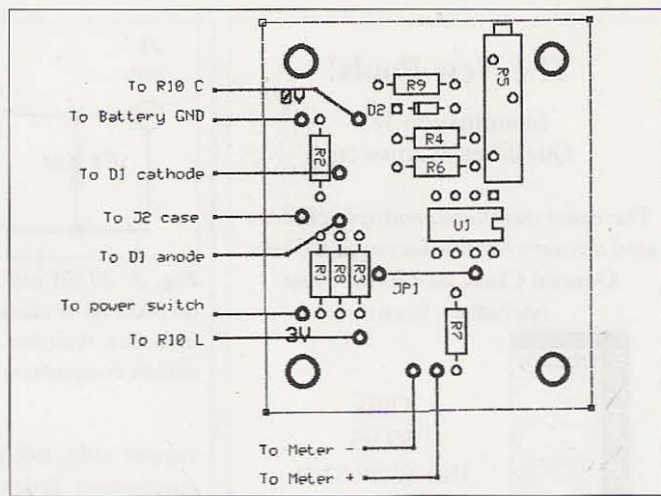

Fig. 4. Parts placement.

for the meter, and drill the holes for mounting it. Next, cut 1.25" of shaft length from R10 and R11. Break off the keying posts with pliers (refer to Fig. 2). Bend the tabs back on R11 and remove its case. Install the potentiometer switch S1 on R11. Mount the above mentioned components in the previously drilled holes.

Use two screws and nuts to secure the meter. Attach the knobs to R10 and R11. Solder J1, J2, S1, D3, C1, R10, and R11 point-to-point according to the schematic diagram shown in Fig. 1. Notice that J1 and J2 are connected with a short piece of 50-ohm coax, and the positive battery holder lead is connected to S1. When connecting D3, be sure the cathode lead passes through FB1 and FB2. Refer to Fig. 2 to determine the potentiometer mounting designations. Keep all connecting leads as short as possible.

Fig. 3 is a full-size positive artwork for making the printed circuit board. When the board is developed, the text "PCF01RFM" should appear on the

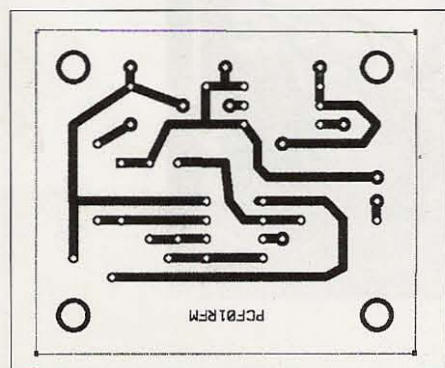

Fig. 3. Foil side of PC board.

Part	Description	RadioShack.com	Mouser
FB1, FB2	ferrite bead	900-5003	
J1, J2	BNC female		161-9323
B1	battery holder 2XAAA	910-0326	122-0421
S1	potentiometer switch	271-1740	
D1	green LED	900-6089	512-HLMP4740
D2	1N4148	900-2908	583-1N4148
D3	NTE583	901-0288	
R1, R2	51 Ω 1/4 W 5%	900-0187	291-51
R3	4.7k 1/4 W 5%	900-0234	291-4.7k
R4, R9	1k 1/4 W 5%	900-0218	291-1k
R5	5k multiturn pot		652-3006P-502
R6	220k 1/4 W 5%	900-0274	291-220k
R7	270 Ω 1/4 W 5%	900-0204	291-270
R8	100 Ω 1/4 W 5%	900-0194	291-100
R10	100k 1T pot	271-092	
R11	1 meg 1T pot	271-211	
C1	100 pF	900-2201	140-50P2-101K
U1	LM10CN or LM10CLN	900-6306	
M1	meter	910-0398	
Case	5.25 x 3 x 2.125 in.	270-238	537-TF-780
Knobs (2)	knobs for 1/4-in. shaft	900-2531	
Load	BNC 50 Ω terminator	910-0557	177-3161
Spacers (4)	nylon 1/2-in. 4-40		561-TSP3
LED clip	LED clip	900-6151	606-CMP22
8-pin socket	socket	900-5740	575-199308
Screws (10)	1/4-in. 4-40		
Nuts (2)	4-40		
50 Ω coax	3.5 in.		
#26 wire	hookup wire		
2-sided tape	adhesive tape		
AAA batteries (2)	batteries		

Table 1. Parts list.

The New Pools!

Examination Test
Questions & Answers

The exact questions, multiple choices and answers for the Technician Class, General Class, and Extra Class operator's license.



Only
\$9.95
Plus \$3.50 S&H

Omega Sales

P.O. Box 376
Jaffrey, NH 03452
800-467-7237



208-852-0830 rdc@rossdist.com
http://rossdist.com

Over 9060
HAM Items
in Stock!

TH-F6A KENWOOD



Special!
\$392.90



Check Out Our Specials! We're On The Web.
ROSS DISTRIBUTING COMPANY All Prices Cash
78 S. State Street, Preston, ID 83263 FOB Preston
Hours Tue.-Fri. 9-12/2-30-6 • 9-12/2-30-3:30 Mon. Closed Sat & Sun

EVERY ISSUE OF
73 Amateur
Radio Today
on Microfiche!

The entire run of **73** from October 1960 through last year is now available. Over 800 fiche!

You can have access to the treasures of **73** without several hundred pounds of bulky back issues. Our 24x microfiche have 98 pages each and will fit in a card file on your desk.

We offer a battery operated hand held viewer for \$150, and a desk model for \$260. Libraries have these readers.

The collection of microfiche, is available as an entire set, (no partial sets) for \$325, plus \$10 shipping (USA). Annual updates available for \$10, plus \$3 shipping/handling. Satisfaction guaranteed or money back!



BUCKMASTER



6196 Jefferson Highway
Mineral, Virginia 23117 USA
540-894-5777 • 800-282-5628
Fax 540-894-9141
e-mail: info@buck.com

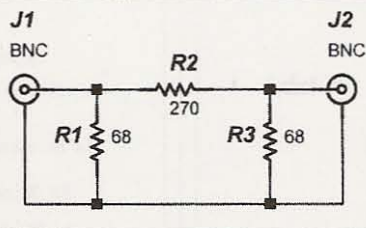

Fig. 5. 20 dB attenuator. R1 and R3 are 68 ohm 10 W carbon composition or non-inductive resistors. R2 is a 270 ohm 2 W carbon composition or noninductive resistor.

copper side, not the mirror image. All component holes are 0.031 inches in diameter. The PCB mounting holes are 1/8 inch in diameter.

Fig. 4 shows the placement of parts on the circuit board and the wiring connections from the circuit board to the front panel. Table 1 lists a description of these parts. Use a socket for U1 and don't forget to solder jumper wire JP1. Once the circuit board is assembled and the front panel connections are made, verify the correct orientation of D1, D2, D3, U1, and M1. Drill holes in the back of the case to mount the circuit board, and leave room to mount the battery holder. Attach the battery holder to the back of the case with two-sided adhesive tape. A view of the completed inside of the instrument is shown in Photo B.

Insert new batteries and turn on the power by rotating the Coarse potentiometer clockwise. The green LED should

turn on. Turn the Coarse and Fine controls both completely clockwise and null the offset voltage by adjusting R5 until the voltage across M1 measures zero volts. Next, use the four spacers to mount the circuit board to the back of the case.

Use

To use the Relative RF Power Meter, follow these steps:

1. Attach a 50-ohm terminator to J2.
2. Connect an RF input signal to J1 (must have a 50-ohm source resistance).
3. Set the Fine adjustment to 1/2 rotation.
4. Click the power on by rotating the Coarse adjustment clockwise.
5. Adjust the Coarse and Fine controls to center the meter needle. Note: If the meter shows full-scale deflection regardless of the Coarse and Fine settings, the input signal amplitude is too large to measure. If the meter reads no deflection regardless of these settings, then the input signal is too small.

6. Tune the RF circuit for a peak meter reading (if the reading is full-scale then go back to Step 5).

If the green LED does not glow at all when the unit is turned on, then the instrument needs fresh batteries. In order to measure higher input power, simply use an attenuator. Fig. 5 shows an example of a 20 dB attenuator that, when connected to the input of the Relative RF Power Meter, will allow relative power measurements to 40 dBm (10 W). 73

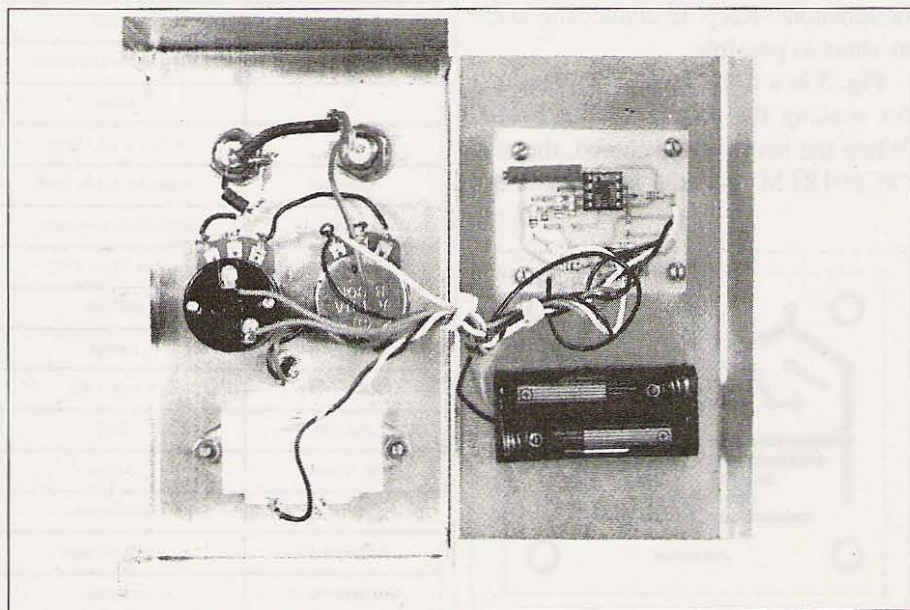

Photo B. Inside of case.

Voltage Control for Your Mobile Rig

Get turned on, and protect your rig in the process.

If you have ever left your mobile rig on all night, this article is for you.

When you pull into the drive way and turn off the ignition of your car, it would be nice if the radio turned off as well. Wiring the ham rig to the same line as the car radio is not a good idea, because the wiring and fuse are not designed to support both. The proper way to connect is to wire the rig directly to the battery with a fuse in the positive line. This means that you must remember to turn off the rig or you

could run down the battery, even if the receiver only draws a small amount of current.

This circuit does that very thing. The relay gets its power from a line that is only on when the ignition switch is on. The relay circuit draws approximately 2/10 of an ampere and should be only a very small strain on any car circuit.

When connecting to the car battery, I like to use shielded cable with the center conductor being about #10 wire. The shield can come from some RG-8 or similar coax cable. Strip off the outer jacket of the cable and then push

back the shield while pulling out the center conductor. No, you don't want

Continued on page 57

Part	Value
C1	1,000 μ F 35 V
R1	22k 1/2 W
D1	1N4001
K1	12 V 30 A relay, RS #275-226
Q1	TIP 120 transistor, RS #276-2068

Table 1. Parts list.

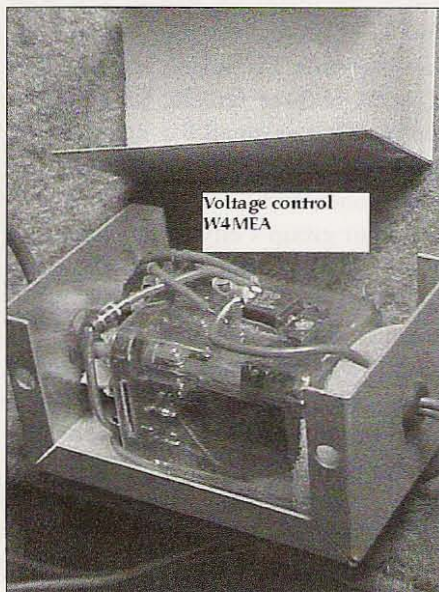

Photo A. Inside the voltage controller.

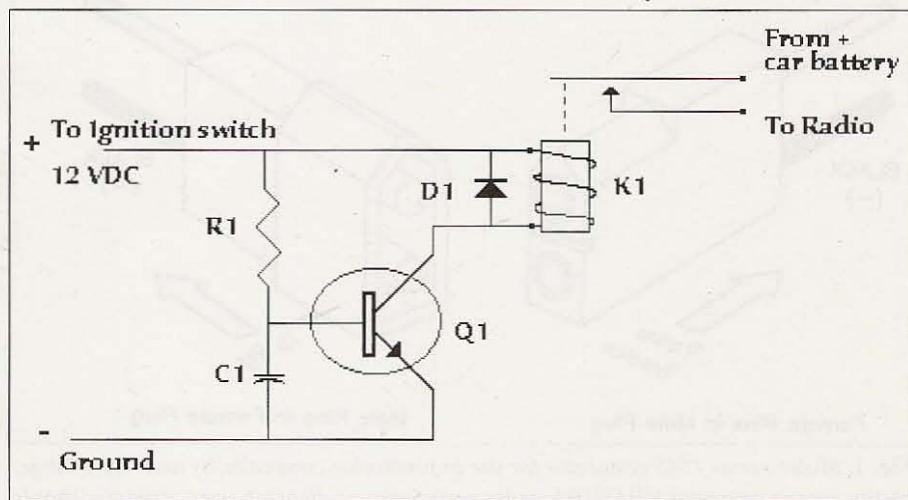

Fig. 1. Schematic.

An Ounce Of

Simple tips on upgrading your "radio insurance."

Maybe the title got your attention a little quicker than another article about emergency communications, or getting prepared. Since 9/11, there has been a lot written about emergency preparedness, which is as it should be.

This article will attempt to kill two birds with one stone: (1) standardized connectors in your neck of the woods to cover equipment swapping in an emergency, and (2) protecting ALL your equipment from the hazards encountered with different power sources, be it an emergency or not.

Power connectors

Getting your group or groups standardized on power connectors is a big

step toward making operations quicker and easier in a stress situation. Usually we have an assortment of RF adapters that can get us to an antenna eventually, but power connectors can become a real problem. The *ARES Field Manual* gives a Power Connector Recommendation on page 68 of the manual. See Fig. 1.

An identical connector is the Radio Shack RS-274-222, which costs 99 cents for a pair (male & female). Molex

rates their current-carrying capability at 12 amps, while Radio Shack rates theirs at 8 amps.

In these days of high power VHF rigs, I believe it would be more prudent to have a higher current-carrying capability as a safety margin. Radio Shack also carries a pair of slightly larger Molex-type connectors in the same configuration, which are good for 20 amps and cost 99 cents each for either a female or male connector. These are made for #14 to #10 wire and will handle most 100 watt HF mobile rigs also. The male version is RS-274-151 and the female, RS-274-154. No matter how small the Radio Shack store I've visited, they have always had these connectors.

If your group's city/county/state can agree to use one standard, there shouldn't be any interconnect problems. In the interest of universal standardization, you might want to make short cables that convert the larger connectors to the ones shown in the *ARES manual*.

Other hazards

In the stress of an emergency or even in the normal confusion of a large

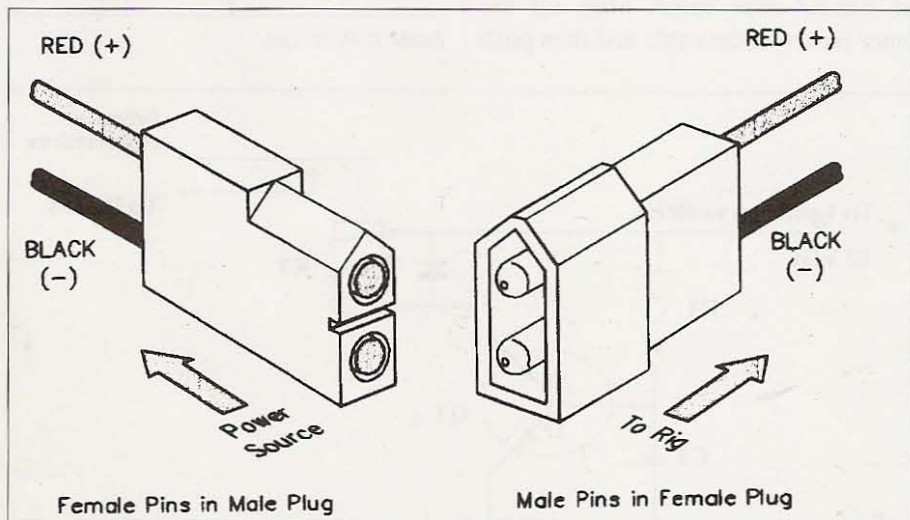

Fig. 1. Molex series 1545 connector for use in promoting compatibility and interchangeability among personal VHF/UHF radio equipment at disaster sites. Polarity should always be verified prior to connecting to radios and power supplies.

operation, things can happen and usually do. A good supply of spare fuses is ALWAYS a must! There are other ways to protect your equipment that make a lot of sense also and can save you the dollars and aggravation a cooked rig causes.

Overvoltage and spike protection is now easy and inexpensive to accomplish with the new semiconductor devices available. The Diodes Incorporated 1.5KE15A is a case in point. It will clamp 1.5 kW, which is 100 amps at its clamp voltage of 15 volts, and is about the size of a pencil eraser. It is inserted across the power input to the transceiver, AFTER the fuse and just before the rig. They are inexpensive and should be on every 12 volt rig you have. You should also have several extras. They will clip momentary spikes like starter transients without any problem, but for a longer-duration problem such as a power supply going over voltage, they will clamp and stay clamped like a dead short. They have to be replaced after such an event. I've had two such events in a short period of time. First, I had a bench supply lose its regulator and go to 26 volts; then, I had a VW alternator go crazy and run the battery to 16 volts. In both cases, the overvoltage protection saved my bacon.

A big bonus with using the 1.5KE15A is that it also provides reverse voltage protection (probably one of the most common occurrences under stress). If the input voltage is reversed, it will promptly blow the fuse (and probably survive in that circumstance). So in this one unit you have both transient and reverse voltage protection.

A good time to incorporate overvoltage and reverse voltage protection is when you are standardizing your connectors. The schematic in Fig. 2 shows the protection incorporated with the Molex connector added. You might want to fuse right off the battery or have two fuses in line — it doesn't really make any difference.

The 1.5KE15A transient diodes are available from Digi-Key [www.digikey.com] at 10 for \$5.54 plus shipping. Unfortunately, there is an additional \$5

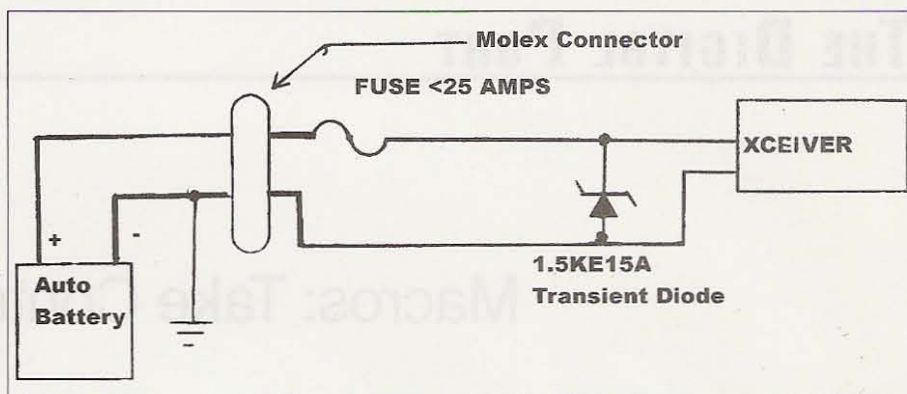

Fig. 2. This schematic shows the protection incorporated with the Molex connector added.

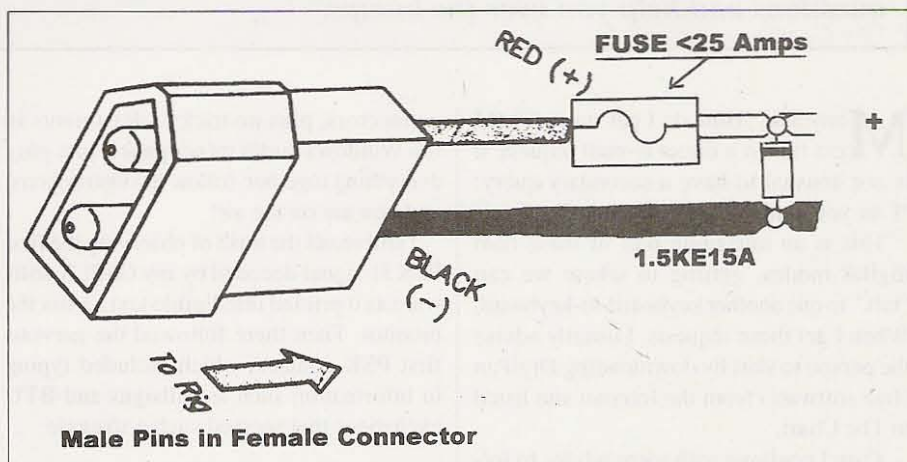

Fig. 3. The wiring pigtail from the transceiver.

handling charge for orders under \$25, so making a group order makes a lot of sense. In the worst case you should be able to get them to your door for a little over a dollar each, which is actually pretty cheap insurance. The diodes can be soldered in or put on a terminal block — whichever is easier. Just remember, you may have to replace these diodes in adverse circumstances, so make them fairly easy to get to and keep some extras with you.

Since most of the newer cars and trucks now use the blade-type fuses, I replaced the AGC-type fuse holders

with the ATC automotive blade-type fuse holders. These holders and fuses are readily available from your local automotive store, or less expensively from All Electronics [www.allelectronics.com]. The blade fuses will take more of a beating than the glass AGC-type fuses will, and are easier to carry.

Fig. 3 shows the actual wiring pigtail from the transceiver. Make sure the banded end of the diode goes to the positive lead after the fuse.

For a few dollars and a little elbow grease you can have real "radio insurance." 73

A GREAT gift idea for yourself, your ham friend(s), or your child's school library

is a subscription to 73 Magazine ... only \$24.97!

Call 800-274-7373

or write to

70 Hancock Road,

Peterborough NH 03458

Macros: Take Control!

Digital communications has experienced a virtual explosion in popularity during the past few years. This means it is still quite new to many readers. My intentions are to anticipate your questions and help you over the bumps.

Many ask, "How do I get started?" If I get this in a direct E-mail request, it is not unusual to have a secondary query: "Can you explain it step-by-step?"

This is an intriguing part of these ham digital modes, getting to where we can "talk" to one another keyboard-to-keyboard. When I get these requests, I usually advise the person to start by downloading DigiPan (free software) from the Internet site listed in The Chart.

Then I continue with some advice to follow such as clicking on the icon of the downloaded file and following the on-screen instructions to install the program. That usually gets the new digital user pretty enthused when he/she gets that far. I go on to explain to open the Help file in the program, which contains every bit of advice needed to get a successfully operating digital station on the air.

If the ham has a computer and an HF rig, about the only other necessary addition will be an interface. DigiPan comes to the rescue very nicely with suggestions. There are complete instructions for making audio cables and even a push-to-talk (PTT) circuit at very low cost. And this isn't simply a "just-to-get-you-going" setup. I am using nearly the exact cable and PTT setup that I built right from the beginning of my soundcard adventure several years ago. It is extremely workable.

There are optional methods of interface that are easy and sure-fire. They are mentioned in the Help file. A beginning digital ham can choose one of the many commercial interfaces on the market. Every ham I have conversed with who is using one of the store-bought interfaces is tickled as can be with it. The downside is cost, \$40 to \$130. The upside is they are in the plug-and-play category. No soldering of tiny DIN

connectors, plus no tricky adjustments in the Windows audio mixer panel. Just plug everything together, follow the instructions, and you are on the air!

I still recall the thrill of observing the first PSK31 signal decoded by my G3PLX software as it printed intelligible text across the monitor. Then there followed the nervous first PSK contacts which included typing in information such as call signs and BTU exchanges that seemed such a struggle.

Topic of the day

Of course, the answer was simple. Stop, pay attention, and set up the macros. And that is what I will concentrate on today. No one ever asks much about these things. Many programs, such as DigiPan, come loaded with macros all set up to do the basic interchanges of information. Others leave it entirely up to the new user of the package to set up their own macros from scratch.

Some of the programs come with macros set up by the author that, if used by the new user as-is, will send out the program author's station information. I think the advantage of the latter category is an aid to see just how macros are written in the particular program's format that affords "live" hints for ease of modification by following their pattern.

One of the confusing parts of using different programs for digital communications is that the layout of the macros often does not allow for uniformity when setting up new macros. That is, you will be used to using a certain function key to give your Name and QTH, and when you strike the same key in another program you are sending the BTU macro. And this happens more often than a casual observer would like to admit.

Here is a little blow-by-blow of how this recently struck me. I was reading some comments on the MixW reflector about rig control. In case you are unaware, a number of the programs, including HamScope, Commander, and MixW2, provide excellent software control of many popular rigs produced in the last 20 years by way of serial port interfaces.

This has become a real treat and is expected of the quality digital software being developed these days. The only problem I see with this is the knobs and buttons on the front of my rig are gathering dust since I rarely touch them during operation (no kidding).

You can now, with a number of the programs, change frequency and band as well as mode and filter settings conveniently and often more quickly by keyboard and mouse clicks than via the knobs and buttons on the rig. I read of hams who are controlling their rigs entirely from remote locations either within the house or by way of a phone line from one building to another.

For the extent of this article I will stick to having all the controls available from the operating table. It's more fun that way, at least at first. It is fun, to say the least, to be within sight of the rig and see it responding to the commands you are sending to it from the computer.

When I first delved into rig control, I felt I must be satisfied to gain the frequency input from the rig to print automatically in the log. It has come a long way since then, and this has only been a couple of years.

I mentioned earlier about using the serial port to control PTT. I still have that capability, but now it is not a necessity since the software will toggle PTT through the rig control interface. However there are other uses for that PTT circuit that we will touch on another time.

How today's subject came about is that I was observing a discussion of setting filters on the Icom 756PRO from within macros in MixW2. So, I took the time to follow through on what became a very handy set of three macros. There are three definable filter settings on the PRO, and they work very well as we focus on digital reception.

In the recent past, I found the filter was useful when a very strong signal would come up within a few hundred hertz of the signal I was copying. I could simply reach over and adjust the Pass Band Tuning (PBT) to remove that signal from the waterfall. That would include everything from that side of the signal to the edge of the waterfall display on the monitor. So I knew it worked.

Regular users of the soundcard programs are aware that the DSP filter built into the program brings out the benefits of the soundcard and are often adequate to handle many of the average interference problems without using any other filter from the rig. Experienced regular users have also encountered the problem where a particularly strong signal, even 200 Hz or more away, will reduce print seriously. So there are times when turning on a narrow filter can save the QSO.

However, using a filter has to remain an option for when it is really necessary. The disadvantage of the narrow filter is that you lose the feel of the activity across the couple of kHz in the display and you have no idea where to tune for the next contact.

So wouldn't it be nice to simply click a macro to optimize the reception of your contact when necessary? Well, you can do it. I will show you what works with the PRO with the MixW2. You will have to figure it out for other combinations. Most of the rigs with remotely accessible filters can be made to handle this idea to one degree or another.

I configured three macro keys — Control+F1; Control+F2; and Control+F3 — and labeled them as appropriately as I could so that they would make sense, at least to me.

The first or Control+F1 key macro is:

```
<ALIGN:1450>
```

```
<CATCMDHEX: FE FE 5C E0 06 01 03 FD>
```

This macro activates Filter 3 in the PRO, which I have set at 100 Hz, and at the same time centers the tuned signal in the filter's passband. See screenshot.

Incidentally, there are no letter oh's in the above — they are all zeros. Also, the spaces from FE FE 5C to the end of those

command lines are not needed but make entry simpler.

The second or Control+F2 key macro is:

```
<ALIGN: 1450>
```

```
<CATCMDHEX: FE FE 5C E0 06 01 02 FD>
```

This is the same as the first filter macro, except that it activates Filter 2, set at 400 Hz, and is meant for RTTY and MFSK.

The third or Control+F3 key macro is:

```
<CATCMDHEX: FE FE 5C E0 06 01 01 FD>
```

This activates Filter 3, which is set at 3 kHz so I can see the entire waterfall.

I found there was one default macro key that comes with MixW2 that I never use, and this became a convenient place to install a simple "fix" for a slight problem these two narrow filter designations had caused. It seems the mode settings are picking up the filter settings automatically. So in order to see all the traces in the waterfall, it became necessary to activate the wide 3k filter after changing modes. There is probably an answer for this that I will discover and that will make me able to eliminate this extra keystroke.

For now, the filtering is working just fine. You will find there is almost an endless number of macro key combinations available as you work with this program. There

Source for:	Web address (URL):
Mix W Soundcard program for PSK31, RTTY, new modes, MTTY, FSK31, more	http://tav.kiev.ua/~nick/my_ham_soft.htm http://users.nais.com/~jaffejim/mixwpage.htm
MMTTY RTTY soundcard freeware	http://www.geocities.com/mmtty_rtty/
TrueTTY — Sound card RTTY w/ PSK31	www.dxsoft.com/miltrty.htm
Pasokon SSTV programs & hardware	www.ultranet.com/~sstv/lite.html
PSK31 — Free — and much PSK info	http://aintel.bi.edu.es/psk31.html
Interface for digital - rigs to computers	www.westmountainradio.com/RIGblaster.htm
Soundcard interface info — includes Alinco	www.packetradio.com/psk31.htm
Interface info for DIY digital hams	www.qsl.net/wm2u/interface.html
WinWarbler info and free download	www.qsl.net/winwarbler/
MFSK — related tech info — how it works	www.qsl.net/z11bpu/
Throb — New — lots of info	www.lsear.freereserve.co.uk/ www.btinternet.com/~g3vfp/
Download Logger, also Zakanaka	www.geocities.com/kc4elo/
PSKGNR — Front end for PSK31	www.al-williams.com/wd5gnr/pskgnr.htm
Digipan — PSK31 — easy to use — new version 1.6	http://members.home.com/hteller/digipan/
TAPR — Lots of info	www.tapr.org
TNC to radio wiring help	http://freeweb.pdq.net/medcalf/zbx/
ChromaPIX and ChromaSound DSP software	www.silicqnpixels.com
Timewave DSP & AEA (prev.) products	www.timewave.com
Auto tuner and other kits	www.lodgeelectronics.com
XPWare — TNC software with sample DL	www.goodnet.com/~gjohnson/
RCKRtty Windows program with free DL	http://www.rckrty.de/
HF serial modem plans & RTTY & Pactor	http://home.att.net/~k7szl/
SV2AGW free Win95 programs	www.raag.org/index1.htm
Source for BayPac BP-2M & APRS	www.tigertronics.com/
Int'l Visual Communication Assn. — nonprofit org. dedicated to SSTV	www.mindspring.com/~sstv/
Hellschreiber & MT63 & MFSK16 (Stream)	http://iz8bly.sysonline.it
HamScope — multimode w/ MFSK16	http://users.mesatop.com/~ghansen/
YPLog shareware log — rig control — free demo	www.nucleus.com/~field/

Table 1. The Infamous Chart.

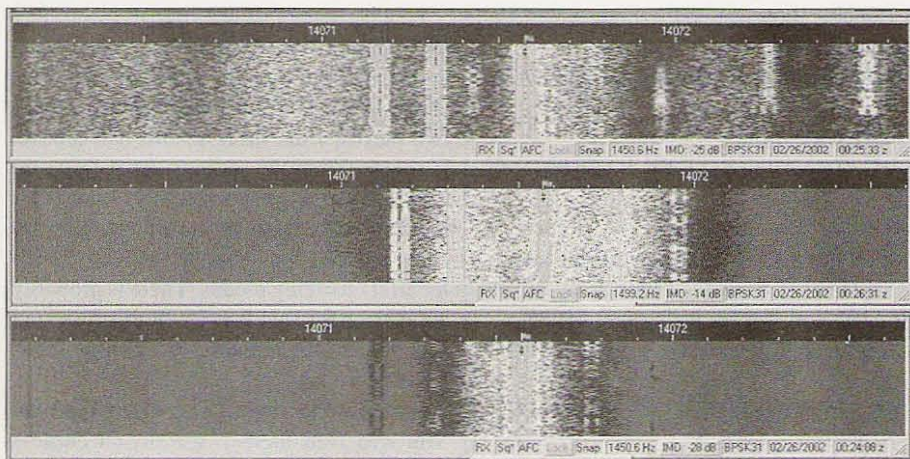

Fig. 1. Filter/waterfall screenshot — This is a composite showing the results of narrowing the rig filter on a PSK signal. The upper shot is with the filter “wide open” at 3k. The nearest trace was about 200 Hz away and not giving problems. The middle shot is using the filter set at 400 Hz width. These are not steep skirt filter configurations, so the real width for this exercise is about 700 Hz wherein signals may be copied. I put this filter in for RTTY and MFSK. The bottom shot is with the 100 Hz filter width. This is still wider than 100 Hz but extremely effective. I can get the signal trace centered and then hit the hot key for the filter and the trace is centered with maximum rig filter effect as shown. See text.

are 12 defined macros on the regular screen which can be activated by depressing the corresponding Function key. Plus you have Control+Fkey and Shift+Fkey, which makes a total of 36 individual macros. Well, not just that total, because there is also Control+Shift+Fkey. Now you are at 48, but that still isn't all!

How many macros are possible?

If you want a real experience in customizing your macros, change modes — say, to

RTTY — and right-click a macro and rename it and change the macro. (Simply renaming is the eye-opener.) You will find that the label will read whatever you typed in for the RTTY mode only. That is, go to the other modes and come back, and you will only have that label visible in the RTTY mode. The other modes will have the previous label. I didn't attempt any math on this, you can do that on your own. Reality says that there is not a need for a different set of macros entirely for each mode, but

you can see the possibilities. (See screenshot.)

There is another problem that plagues many of us, and that is the loss of the first few characters when someone does a changeover, especially when answering our return to their CQ. This is usually due to slight differences in soundcards and software settings between the two stations.

I have been trying to alleviate that problem as I start my return message to the other station by simply inserting a dozen or so spaces before hitting my Return macro that sends “hiscall de mycall.” A little help here, at least for me, is to insert the spaces in the macro itself. This doesn't solve much on my end, but perhaps it will be something that catches on. In the interim, I have learned to be ready to tweak my tuning on the other station's trace in the waterfall. MixW2 makes this fairly easy by using the Alt plus the appropriate arrow key. In using this combination, I rarely miss more than half my call before the AFC has done its job.

Mouse-wheel genius

Speaking of MixW2 tuning helps, something was introduced that I never expected, and that was tuning via the mouse wheel. I got one of these fancy new mice with the new computer six months ago and wondered whoever would need such a device. After I discovered the scrolling advantage on text it started to sink in that it is an okay thing. I had been used to clicking sidebars for so long that I still haven't learned to rely on the wheel to replace that.

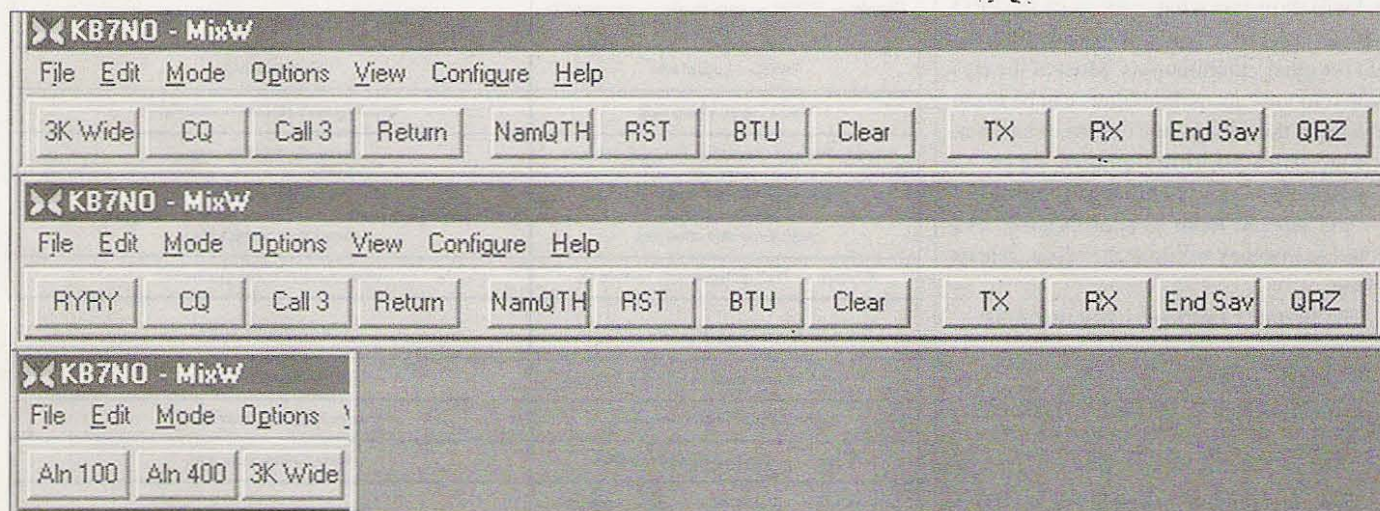

Fig. 2. Macro-key screenshot — This is a composite of three views of the visible and labeled macro keys in MixW2. The upper row of keys is what I see when working PSK31. The left button (F1) is the necessary filter de-activating macro (see text). Most of the rest are fairly self-evident. You will see that the second row of buttons differs because it is the RTTY set of macros. Only the F1 key differs in labeling. This allows many macros to replicate from mode to mode and you can retain the same labels with changes to the macros per your requirements for that mode. The third row got a little tricky to capture so it is just the first three keys displayed when I hit the Control key. These are the filter select macros (see text) and display this way regardless of mode when hitting the Control key.

But, believe me, using the wheel to quickly move from the PSK portion of the band to the MFSK and/or RTTY area is what some folks refer to as a “trick.” How it works in real life is simple. You rotate the wheel one click one way and the rig moves 500 Hz. Move it one click the other way and you are back where you started. That is a real convenience — far and away more useful to me than scrolling this text I am working on with the same wheel. Now I will never return to my favorite old trackball. I wonder if the mouse people paid Nick, the author of MixW2, to put that feature in. You never know what marketing people will come up with nowadays.

Automate reports

There were several other macros I had been bypassing in the hurry to simply use the software, and I will admit I am not one to build canned QSOs, but one that struck my fancy was the automated RST report. I didn't read how this one worked, but a little experimenting gave it away.

In this program, there is an automated report compiled that is really far more fair and accurate than you and I can guess for a signal report on PSK. If you take a look at the screenshot you will see a compiled report on a signal the rig is tuned to. I keep this little window just below the regular MixW panel for quick reference alongside the CAT bar (which I will get to in a bit).

The macro command to send the signal report in MixW2 is <RSTS>. A little experimenting taught me this is sent from the reading in the log box after I enter it. If you haven't entered it, and the macro is sent, you will see a window pop up that asks for the report and asks if 599 is OK.

I have labeled one of the function keys “RST” and the macro reads,

“... Your sig into <MYQTH> is RST <RSTS> and your IMD reading is ...”

This appears in the compose pane as,

“... Your sig into Carson City, NV is RST 599 (or what was inserted) and your IMD reading is ...”

This allows time to insert the IMD reading and if I have forgotten to place the report in the log box I can type in the info direct to the compose pane. My advantage here is that I am usually typing ahead while the other station is transmitting.

I think all communications software supports the type-ahead feature. The advantages are obvious in that you can get a message ready to transmit and the pressure is off — especially the part where the other ham is seemingly looking over your shoulder while you type. I cannot type mistake-free under

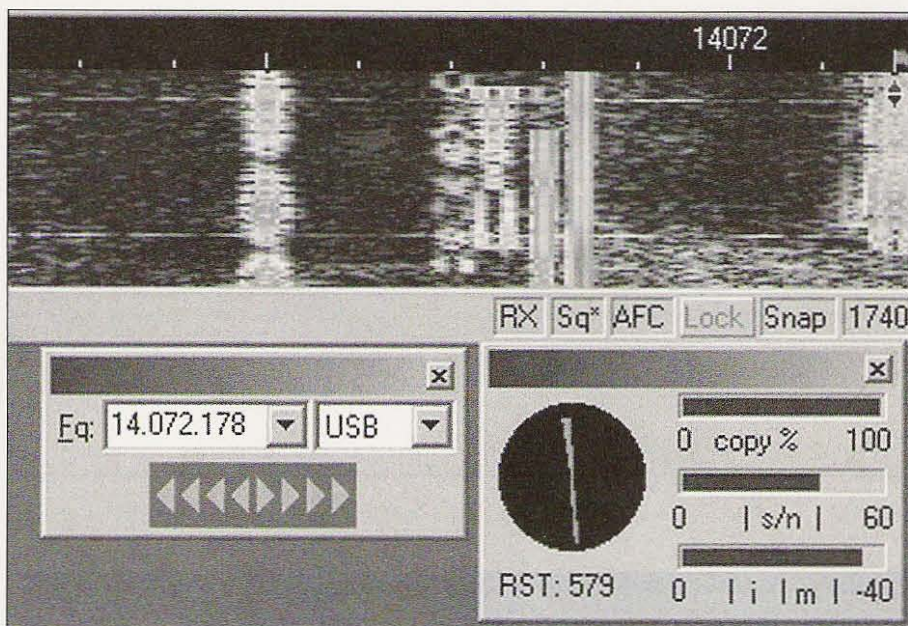

Fig. 3. Tuning indicator and CAT bar — This is not a composite! If you refer to the full screenshot of MixW2 you will see this is how I have these two pop-up screens positioned just below the regular display. The signal trace being copied is the one at the far right of the visible waterfall. If you look closely at the display that shows RST 579, you will notice the three graph bars indicating copy %, s/n ratio, and intermod. This is the basis for the RST according to the dictates of the author of MixW2. It is all calculated for you; just copy it to the log and you can write a macro to send it (see text). On the left is the CAT bar. The frequency readout is a pull-down that allows band changes. Frequency readouts are auto-calculated by the rig readout plus the scale on the waterfall. Rig modes are selectable by the pull-down next to the frequency readout.

any circumstances, but stand over my shoulder and my fingertips turn to something resembling warm putty. I never hit the correct keys.

Of course, there is a disadvantage. Once in a while, we get so caught up in the type-ahead that we forget to watch the receive screen and the other ham has asked a quick question and turned it back with a “BK” and we have blown it. But I still do it. The gaffes are much fewer and farther between and I can explain what I was doing once caught.

To get back to the RST macro, you may wish to leave out any part of this sequence since it does alter the “free life-style” we enjoy in keyboarding. However, it is workable and mimics conversational text once you get the habit in place. The habit is to copy the compiled report from the tuning indicator into the RSTsnt field while you are receiving the signal and prior to clicking the macro.

Some of the more common macros most of you have already figured out — such as what I call the Return macro, which I use to head each beginning of transmission — and you probably have a favorite BTU exchange you use. Answering a CQ is a matter of preference, as with all these macros. I make it automatic so that once I have the other

station's callsign in place, I simply hit the macro key and the TX macro toggles the rig to transmit; the other station's callsign is sent twice, after which mine is sent three times and a PSE K, then an automated return to Receive.

Then I watch the waterfall intently to see how close we are on frequency, because if we are off a bit I sometimes miss my call being sent back and do not know for sure whom he is answering. This is where the delayed transmit I was mentioning can be a real advantage. Occasionally the other station will sign on the first go-around with simply a “de W7ABC” and I have to guess he was answering me.

I think there are reasons for some of these inconsistencies. As we bask in the popularity of the newfound digital modes, there are many newbie digital operators who are only into their first few days on the modes. Learning how to build macros wasn't part of the training manual to get on the air. And we are meeting first-timers who have not yet learned how to get the “other station's call” into the little space provided in the program so that macros can work.

Nothing wrong with not knowing the basics. We all have our first-time encounters with communications software. I recall

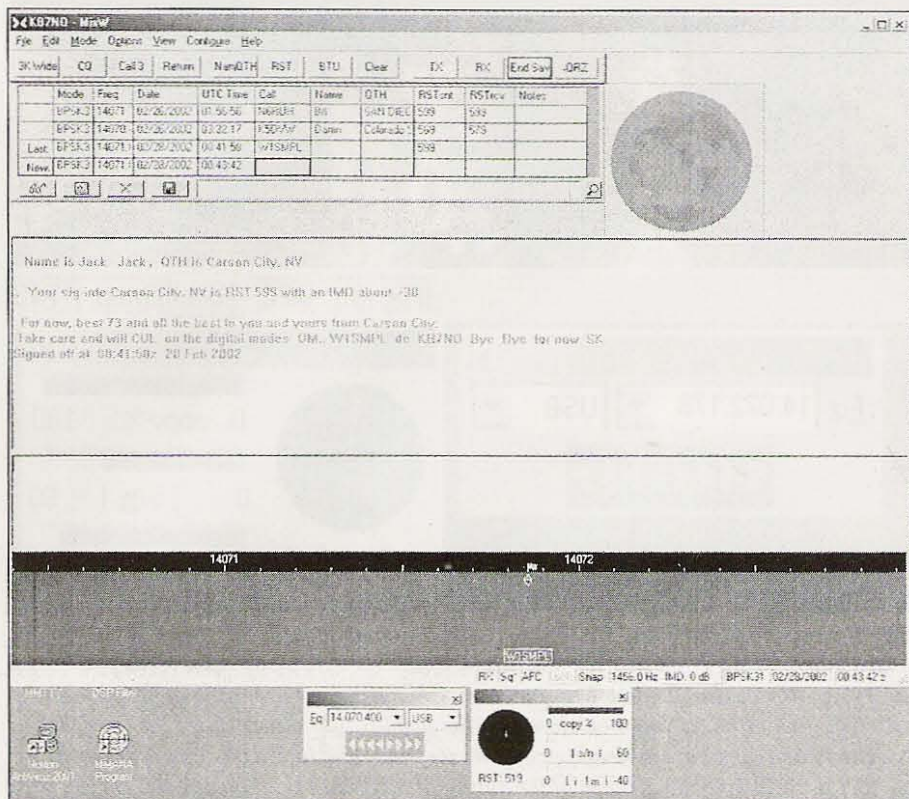

Fig. 4. Full view — To tie it all together, this shot may answer a few questions. Before this off-air shot, I executed three macros which are NameQTH, RST, and End Sav macros. The last macro saved the bogus QSO to the log, which I later removed. Since the rig was not on, the frequency readout at the bottom defaulted to the far-most left of the visible scale above the waterfall. This is what MixW2 looks like. The world map at the upper right is centered on my QTH coordinates and displays the direction to point my antenna when an entered callsign prefix is read by MixW2. The program has provision to direct a computerized rotator.

Say you saw it in 73!

HamCall™ CD-ROM
U.S. & International - Over 1.63 million listings



We make a new HamCall every month! Clearly, the most current and complete CD-ROM available.

Latest Features

- Choose font and color of data display.
- Displays flag and map for each country.
- Shows CQ, ITU zone, and continent.
- History list shows each callsign entered.
- Print labels in a variety of formats.
- View & search interests of 39,000 hams.
- Search for club, military, vanity, silent keys, name, address, and more.

Over 1,631,000 U.S. and International listings, 128,000 e-mail addresses, 4,000 photos and QSL cards, 37,000 vanity calls, and 20,000 references to QSL managers.

Shows path distance & bearing.
Precise latitude/longitude for over 90% of addresses.
HamCall is \$50.00, included is 6 months free access to our HamCall Internet Service - request when ordering.

HamCall Mousepad, with morse code reference, 7.5" x 8", blue with yellow letters. \$5.00 + \$3 shipping.
\$5.00 shipping (\$8 Intl) per order. Your satisfaction guaranteed!

BUCKMASTER
6196 Jefferson Highway • Mineral, VA 23117 USA
e-mail: info@buck.com
540-894-5777 • 800-282-5628 • 540-894-9141 (fax)

numerous sweaty-palm introductions to unfamiliar programs. Most hams demonstrate patience in this area because we have been through it ourselves. The encouragement offered to all who are joining the digital ranks is a marvel to observe. I cannot recall any digital operator dishing out a dressing-down as might be found on some of the other modes because of operator errors.

One last macro I would like to address. Many hams are using a nice "73, SK and save" macro that solves a number of problems. One is that an automated save to the log will very nearly eliminate those "lost" contacts we make. We all have them for various reasons, but if we design a Sign-off macro we will cut that problem to a minimum.

Here is one you can use to do the job:

Good luck and Good DX to you
<NAME>, 73 for now
<CALL> de <MYCALL> SK
Signed off at <TIME> <DATE>
<SAVEQSO>
<RXANDCLEAR>

I chose the MixW2 program for this demonstration because it has, as I counted the other day, over 125 macro commands that are added to regularly by the author. The macros are not only intuitive to write but also have an attendant display whenever you bring up the macro edit screen. All ham software has a method of managing and writing macros. Different commands are used. Plus, most have far fewer macros to choose from. The MixW2 is very versatile and has an excellent Help file to answer your questions.

This is not really a commercial ad

I have to apologize if this month's article sounded like a paid advertisement. I just get a little excited when I see things work this well. The truth is that this is a shareware program that costs \$50, and I paid for mine quite a long time ago before the advent of the version 2. I use the older version in my old slow laptop for portable operation still because it works well and does not require the higher horsepower machine that version 2 does. So the only thing I encourage you to do is get the free download of the full-blown program. It is small and, at this writing will fit on a floppy. Use it for the 15-day trial period and make your own decision.

I have talked to hams who said they were happier with other software, and didn't need all this complexity and wanted to hang on to their bucks. And I have to agree to at least one thing: The complexity does make the learning curve a little steep. You will spend quite a bit of time, even with the excellent Help file getting all the bells and whistles to perform. But it is worth it, especially if you appreciate rig control, antenna rotor control, TNC control, plus built-in logging, along with all the current digital modes and a few features just for the SSB operator.

Speaking of the learning curve

I have mentioned operating systems the last few months. The Win98 installation is coming together very soon. And the biggie, the Linux platform, has really presented a challenge (definition: steep learning curve).

Fortunately, some ham Linux users have come to the rescue with sources of information that had seemed to formerly be non-existent. Slowly but surely, these things will all come to fruition. There will be a way to slide the skin off these cats.

That's about all there is room for this month. If you have comments or questions about these subjects, I will be glad to help however I can. Drop me a line at [KB7NO@worldnet.att.net]. 73 for now, Jack, KB7NO.

CALENDAR EVENTS

Listings are free of charge as space permits. Please send us your Calendar Event two months in advance of the issue you want it to appear in. For example, if you want it to appear in the August issue, we should receive it by May 31. Provide a clear, concise summary of the essential details about your Calendar Event.

MAY 4

CEDARBURG, WI The Ozaukee Radio Club will sponsor its 24th Annual Swapfest, 8 a.m.–1 p.m. at the Circle-B Recreation Center, Hwy. 60 and County Hwy. I, Cedarburg. Admission is \$4 in advance and at the door. 8-ft. tables are \$10 each, limited power available on request. Food and refreshments will be available. Sellers can set up at 6:30 a.m. VE exams start at 9 a.m. Talk-in on 146.97/37 PL 127.3. For table reservations and admission tickets, send SASE to *Gene Szudrowitz KB9VJP, ORC Swapfest Chairman, W55 N865 Cedar Ridge Dr., Cedarburg WI 53012-1555*. For info and application, check the Web site at [www.qsl.net/orc], or phone 262-377-6792.

MAY 4, 5

ABILENE, TX The Key City ARC will sponsor its 17th annual Hamfest at the Abilene Civic Center from 8 a.m. to 5 p.m. Saturday, and from 9 a.m. to 2 p.m. Sunday. Free parking. VE exams. Wheelchair access. Limited RV parking for a nominal fee. Tables \$7 each. Pre-registration \$7 (must be received by April 29th), \$8 at the door. Talk-in on 146.160/760. For reservations and info, contact *Peg Richard KA4UPA, 1442 Lakeside Dr., Abilene TX 79602*, tel. 915-672-8889. E-mail [ka4upa@arrl.net].

MAY 5

HAGERSTOWN, MD The Antietam Radio Assn., Inc., of Hagerstown MD, will hold their 10th annual Greater Hagerstown Area Hamfest, and celebrate 50 years as a Club, on May 5th, from 6 a.m.–3 p.m., at the Washington County Agricultural Education Center grounds located 6.5 miles South on MD Route 65 South of Interstate I-70, Exit 29. The event will be held rain or shine, with lots of covered tailgating areas available. There will be indoor vendor and tailgating tables available, \$10 in advance or \$15 the day of the hamfest. General admission is \$5, with children 12 and under admitted free. VE exams will be held starting at 1 p.m. A limited number of walk-ins will be accepted. Please plan to arrive at 12:30 p.m. for exams. VE contact is *Joe Lockbaum WA3PTV*, E-mail [ptvjoepa.net]. Visit the hamfest Web site at [www.w3cwc.org]. Seminars, demonstrations, foxhunt, vendors. Breakfast and lunch available on grounds. Playground and picnic

areas available. Talk-in on 147.090(+) rptr. For more info or to reserve tables or tickets, contact *Carl Morris WN3DUG, ARA Hamfest Chairman, 717-267-3411*, or fax 717-261-9487. E-mail [wn3dug@arrl.net].

MAY 11

RENO, NV The Reno Area Metro Simplex ARC will sponsor the Reno Spring Ham Swap at the KNPB Television Station, 1670 N. Virginia St. (on the campus of the University of Nevada, Reno), from 7 a.m. to 1 p.m. From I-80 take the Virginia St. exit and head north one mile. Free admission to all. Vendors bring your own tables. Large indoor/outdoor swap. Plenty of free parking. Raffle, coffee, doughnuts, tours of the high definition TV station. For VE exam info contact *Don Freeman W7FD*, [dfree1@worldnet.att.net], tel. 775-851-1176. Talk-in on 147.060(+) (123). Contact *Glen Haggard KK7IH*, tel. 775-673-6401, E-mail [kk7ih@nvrms.org].

MAY 26

WEST FRIENDSHIP, MD The Maryland FM Assn. will hold the MFMA Hamfest at Howard Co. Fairgrounds, 8 a.m.–2:30 p.m. Directions: I-70 to Rte. 32, south to Rte. 144, turn right, go west on Rte. 144, approx. 1 mile to fairgrounds. Talk-in on 146.76, 224.76, and 444.00. Admission \$5. Tables are \$20 in advance or \$25 at the door. Tailgate \$5 per space. Reservations contact is *Mike W3IP*, 1294 Dorothy Rd., Crownsville MD 21032. Phone 410-923-3829.

JUNE 9

WHEATON, IL The Six Meter Club of Chicago, Inc., will present their 45th annual ham radio and electronic flea market Hamfest at the DuPage County Fairgrounds, 2015 Manchester Rd. (North of Roosevelt Rd. (Rte. 38), east of County Farm Rd.). This is an all-weather hamfest with 3 buildings and a large outdoor flea market. Features include ARRL and dealer displays, food and refreshments, free parking — no extra charge for space in the outdoor flea market, limited overnight RV parking with electrical hookup, \$15 each space — advance registration required. Advance tickets \$5, \$6 at the gate. Advance tickets available from *Six Meter Club of Chicago, 2335 South 2nd Ave., North Riverside IL 60546*, or from any club member. Payments for

registrations must be received no later than May 25th. Commercial 8-ft. tables with 110V in the air conditioned main building, \$15 each. Indoor flea market tables, 8-ft. with no electric, \$12 each. For info call the 24-hour InfoLine at 708-442-4961. General parking is at the west gate. Sellers only at the east gate. For handicap parking use the east gate. Gates open at 7 a.m. Buildings open to the public at 8 a.m. Talk-in on K9ONA 146.52, K9ONA/R 146.37/97 (107.2). VE exams 9 a.m.–11 a.m. Call the InfoLine to pre-register for exams. Please note: Absolutely no alcoholic beverages permitted. All sellers are responsible for cleanup of their spaces.

JUNE 15

DUNELLEN, NJ The Raritan Valley Radio Club's "Hamfest '99" will be held at Columbia Park, near the intersection of Routes 529 and 28. Sellers set up at 6 a.m. Buyers admitted 7 a.m.–2 p.m. Admission: Buyers \$5, sellers \$10 with \$5 for each additional space. Talk-in on 146.625 R, 447.250 R tone 141.3, 146.520 simplex. Contact *Doug Benner W2NJH*, 732-469-9009, E-mail [WB2NJH@AOL.COM]; or *Fred Werner KB2HZO*, 732-968-7789 before 8 p.m.

JUNE 30

QUEENS, NY The Hall of Science ARC Hamfest will be held at the New York Hall of Science parking lot, Flushing Meadow Corona Park, 47-01 111th St., Queens NY. Vendor setup at 7:30 a.m. Buyers admitted at 9 a.m. Free parking. Food and refreshments. VE exams at 10 a.m. Admission by donation, buyers \$5, Sellers \$10 per space. Talk-in on 444.200 R, PL 136.5, and 146.52 simplex. Web site [www.qsl.net/hosarc]. For further info, call at night only: *Stephen Greenbaum WB2KDG*, 718-898-5599, E-mail [WB2KDG@Bigfoot.com]. For info about VE exams, contact *Lenny Menna W2LJM*, 718-323-3464, or E-mail to [LMenna6568@aol.com].

Back Issues

of

73 Magazine

Only \$5.00 Each!

Call 800-274-7373

More ARISS

The ham station on the International Space Station is back in the news. In late February, Expedition 4 Commander Yury Onufrienko RK3DUO, talked with students at the Kursk Technical University club station RW3WWW south of Moscow.

This was the 47th ARISS (Amateur Radio on the International Space Station) contact since the station was commissioned in November 2000. The other two members of Expedition 4 are also hams: Carl Walz KC5TIE and Dan Bursch KD5PNU.

No more "NOCALL"

On packet radio, the transmission of "NOCALL" instead of the operator's callsign is seen as a typical newcomer's error. In the case of ARISS, it was simply the result of the demise of the memory backup battery in the packet TNC (Terminal Node Controller) and the lack of a computer for use with the packet station, which would have allowed one of the ham astronaut/cosmonauts to change the callsign.

Mr. "NOCALL" has been active from space for quite some time. Rather than turn the system off, thus denying earthbound hams the opportunity of making contacts through the digipeat function of the system, the station was left on the air with the ROM-default callsign of "NOCALL." It was strange, but users appreciated it.

One of the activities assigned to the Expedition 4 crew was to swap out the TNC with a new one with a special default ROM that identifies itself as RSØISS. If the battery goes out, the ROM takes over, but "NOCALL" will not be heard again. This same proactive action was provided with the SAREX (Shuttle Amateur Radio Experiment) ten years ago with their TASCOTNC. It held the callsign WA4SIR as the default.

The new ARISS unit is a specially modified PacComm Picopacket TNC that has been mounted inside a white metal box complete with Russian and English labels for all LEDs, connectors, and switches. The AMSAT NA logo and name are prominent on the top side. It was sent to the ISS last year. In addition to one megabyte of memory, the TNC also supports Cyrillic text for any Russian messages. This is accomplished by enabling 8-bit data.

In the early days of the new TNC's operation, the system controllers requested that hams not leave messages for the astronaut/

cosmonauts on the RSØISS-1 Personal Mailbox System (PMS) since there was no computer connected to the unit, and the crew didn't have time to install and use a laptop computer to work with the system. However, within days there were over 80 messages, some of which were likely addressed to the ISS crew. It's sometimes hard to get the word out to everyone.

A nice feature that has been incorporated into this new mailbox is a timer that will disconnect a user if no pertinent packets have been received within a one-minute period. This should help considerably. On past orbiting mailboxes, the lack of a short timeout has kept many potential users off since the TNC would not allow multiple connects while waiting for input from a previously connected station that had dropped out over the horizon.

Ground-based users have noted another feature of the new TNC. It works better. The previous TNC had what some called a "Kenwood filter." If you were running a Kenwood transceiver with built-in TNC like the TH-D7A HT or TMD-700A mobile rig,

This is the ISS PMS HELP FILE. Read it here!, not over the air from ISS

COMMAND	MEANING
K(ill)	K n [CR] deletes message number n (only to/from your callsign).
KM(ine)	KM[CR] deletes all READ messages addressed to your call sign.
L(ist)	L [CR] lists the 10 latest messages.
M(ine)	M [CR] lists the 10 latest messages to/from your callsign.
R(ead)	R n [CR] reads message number n.
S(end)	S (callsign) [CR] begins a message addressed to (callsign).
SB	Sends Bulletin
SP	Sends Personal
ST	Sends Traffic
	Subject: ending with [CR].
	Text: End each line with [CR]. End message by typing /ex [CR] or CTRL-Z [CR] at the beginning of a new line.
SR(eply)	SR n[CR] Sends a reply to message n prompting only for text. typing /ex [CR] or CTRL-Z [CR] at the beginning of a new line.
V(ersion)	V [CR] displays the software version of the PMS system.

Fig. 1. The ISS PMS Help file from WB4APR's PCSat Software.

you could easily use the "NOCALL" station in space. For others it was not so easy. The uplink signal had to be virtually perfect, and this is usually not the case with a typical transceiver-TNC lash-up. The ARISS gear seemed to have a rather narrow response. The new mix of radio and TNC is much more fault-tolerant. If you can work local stations with your two-meter packet system, you can work the new ARISS. The downlink for the 1200-baud AFSK signal is 145.800 MHz, with an uplink of 145.990 MHz. Some of the hams who were involved prepping the new TNC for launch on STS-105 included KA3HDO, K3MS, KD3VK, KA3ZYX, W5DID, KD5JSO, WA5NOM, and N8FGV.

What to do with "NOCALL"

What do you do with an old TNC? If you're on Earth, you can sell it or stuff it in the closet. If you're in space, the best solution is to reassign it. They did. The old TNC included additional circuitry to provide regulated voltage to the two-meter Ericsson transceiver from the ISS 28-volt bus. The old TNC will be used as the power supply/regulator for the new 70-cm transceiver to be installed in the Service Module. Perhaps with a new lithium coin cell battery and a little programming, it would make an excellent UHF digipeater, at least for those of us with suitable Kenwood radios.

More on ARISS

The article "All Aboard for ARISS... Amateur Radio on the International Space Station" in the November 2001 issue of 73 is still the best all-around source of information about the plans for ham activity on the ISS. The ARISS Web site at [http://ariss.gsfc.nasa.gov] provides further insight into the truly international effort of hams around the world to support this endeavor. Other sites for current news updates include [http://www.amsat.org] and [http://www.arrrl.org].

Software for ARISS and PCSAT

Looking back again to the November 2001 issue of 73, another prophetic and significant article was "The PCSat APRS Satellite — More Fun on the Horizon." PCSat (Prototype Communications Satellite) has been a surprising and delightful success after launch from Kodiak Island on October 1, 2001. In February of this year, AMSAT director Bill Tynan W3XO announced that PCSat would now be known as NAV-OS-CAR-44.

Bob Bruninga WB4APR, the driving force behind PCSat (NO-44), has recently updated his satellite command software for the user community. His DOS-based program PCSAT.EXE allows users to monitor NO-44 telemetry in real time, and to send and receive messages. The only difference between this program and the one Bob uses to command the satellite are the actual uplink commands. The program was designed to provide an instant graphic representation of the status of the satellite and to allow keyboard-to-keyboard communications through the satellite's digipeater.

PCSAT.EXE can also be used for digipeat packet operation through other satellites, but with enhancements for ARISS activity. One screen is provided to capture the directory of the ISS PMS system so the user doesn't have to log on to the PMS to see who has messages. Another screen shows a copy of the ISS Help screen — again, so the user need not log on to reference the PMS command codes. The software is free and available on-line at the TAPR (Tucson Amateur Packet Radio Society) FTP (file transfer protocol) Web site. You can get there via the PCSat site: [http://www.ew.usna.edu/pcsat].

HOUSTON AMATEUR RADIO SUPPLY

267 Cypresswood Drive • Spring, TX 77388
800-471-7373
 Local: 281-355-7373
 email: houstonamateurradio@prodigy.net
COMPLETE SALES & SERVICE
 Yaesu, Icom, ALinco, ADI, Hustler, Cushcraft

WANTED

Fun, easy to build projects for publication in 73.

For more info, write to:

Joyce Sawtelle,
 73 Amateur Radio Today,
 70 Hancock Road
 Peterborough NH 03458.

SAVE 47%!

on 12 months of 73

Only \$24.97

Call 800-274-7373

```

W5DID>LOU,RS0ISS*:
WA5NOM>GIL,RS0ISS*:
WB4APR>APRS,RS0ISS*::BLN5SYSOP:QSL: K5OE@,K9LXH,WA4SAS,KF4VAB
KD5IUG>CQ,RS0ISS*:[EM42XI] Central Mississippi
K4TOM>CQ,RS0ISS*:>73 to ALL
N8DEU-12>APK101,RS0ISS*::ALL :mobile in Huntsville
KF4AAA>CQ,RS0ISS*,EM64UP,SAM:=3439.394N/-08615.303W
W5ACM-2>ANDY, RS0ISS*:
K5OE>CQ,RS0ISS*:W5ACM Hi Andy!
K5OE>CQ,RS0ISS*:Andy W5ACM R U Live?
W5ACM-2>ANDY,RS0ISS*:yes
RS0ISS-1>N6CO:Logged on to RS0ISS's Personal Message System
RS0ISS-1>N6CO:on board the International Space Station
RS0ISS-1>N6CO:CMD(B/H/J/K/KM/L/M/R/S/SB/SP/ST/SR/V/?)>
RS0ISS-1>N6CO:International Space Station
RS0ISS>CQ:
RS0ISS>CQ:International Space Station
RS0ISS>CQ:(c) Copyright 1985-2001
RS0ISS>CQ:PacComm Packet Radio Systems, Inc.
RS0ISS>CQ:
  
```

Table 1. Sample of packets via RS0ISS, early March 2002.

Power Station 2

One of the things that you can count on in an emergency is that you won't be able to count on anything. The repeater you plan on using will be down or you won't be able to hit it with the antenna you brought. With the traffic lights out of commission, it will take forever to get to your assigned location. Then, of course, you'll only have limited choices for powering your radio. When an emergency occurs, the first rule is to be as self-sufficient as possible.

As you know, I'm a firm believer in BYOP (bring your own power). Back in the old days (a year ago or so), we used to consider it adequate to bring the handie-talkie and a couple of extra battery packs. Recent experience has demonstrated that in this day and age you need to have a higher-power rig and the battery capacity to run it for an extended period of time.

At home, a set of gel cells for the VHF rig and a deep-cycle lead acid battery for the HF rig fills the bill. With the right kind of regulated charger you can keep these batteries at peak charge so they're ready to go when needed. On the other hand, dragging a battery similar in size to what's under the hood of your car out to the Red Cross emergency shelter site is not going to be a pretty picture. One of the marvels of nature is the phenomenon that causes a battery

to increase in weight depending upon the distance it is carried.

What is needed is all the benefits of the gel cell and charger in a convenient package that is easily transported and self-contained. Fortunately, there are several offerings now available on the market that meet this need and then some. One excellent example is the Power Station product line from The Ham Contact. Recently, I had a chance to play with the Power Station 2, the latest offering for portable power for the ham.

The Power Station 2 is built around a 12 volt, 7 ampere-hour gel cell. This size of battery gives a good balance between available power and requiring an uncomfortably heavy package. The entire package weighs about 7 pounds, so it can easily be included with your "grab and go" kit. Packed in a

durable plastic case, the Power Station 2 has two cigarette lighter outlets on the face and a built-in voltage meter (see **Photo A**). The package is designed with a handle built-in, a small feature that makes such a big difference. Each outlet can be switched separately, which provides some nice flexibility. Although some may want to connect one side to the cell phone and the other to a two-meter rig, I like the prospect of using the handie-talkie on one side and an amplifier on the other. When I can operate at five watts, I leave the amplifier switched off, but when I need more power, I can adjust in a second or two. For larger loads, there are connectors on the back of the unit (see **Photo B**) that can be connected to a mobile rig. This connection can support 20 amps,

Continued on page 57



Photo A. The Power Station 2 includes a durable case, two cigarette lighter outlets, and a voltage meter. Weighing about seven pounds, it can extend your operating time.

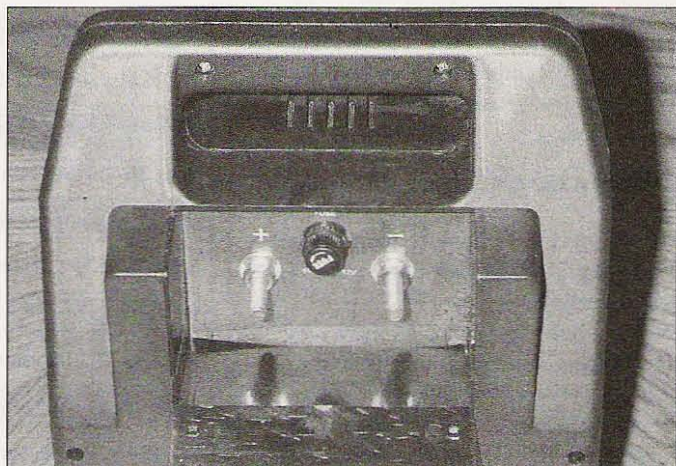

Photo B. For higher current requirements, heavy-duty connectors are located on the back. These can be used to connect to a mobile VHF or HF rig.

ADVERTISERS' INDEX

R.S.#	page	R.S.#	page	R.S.#	page	R.S.#	page
• A & A Engineering	11	• Communications		• M ²	55	• Radio Book Shop	39
• Alinco	CV2	• Electronics, Inc.	5	• Maggiore		• Radio Book Shop	45
• Alinco	CV3	10 • Communications		• Electronics Lab	31	• Radio Book Shop	47
• All Electronics Corp.	17	• Specialists, Inc.	31	• Michigan Radio	49	• Radio Book Shop	55
• Amateur Accessories	19	• D & L Antenna		160 • Micro Computer		• Radio Book Shop	61
16 • Astron Corporation	2	• Supply Co.	22	• Concepts	11	• Radio Book Shop	63
• ATOC Amateur		• Dayton Hamvention	15	• Midland Technologies	23	34 • Ramsey Electronics	3
• Distributing LLC	CV2	13 • Doppler Systems	21	193 • Morse Tutor Gold	55	• RLS	7
• ATOC Amateur		193 • GGTE	55	• Omega Sales	21	254 • Ross Distributing	36
• Distributing LLC	CV3	• Ham Ambassadors	28	• Omega Sales	23	• Scrambling News	28
42 • Bilal Company	19	• Ham Mall	31	• Omega Sales	36	• SGC	7
168 • Buckmaster Publishing	36	• Hamtronics, Inc.	9	• Radio Book Shop	21	• Universal Radio	33
56 • Buckmaster Publishing	44	• Houston Amateur Radio	47	• Radio Book Shop	23	• W5YI Group	19
99 • Communication Concepts	33	42 • Isotron	19	• Radio Book Shop	26	• Yaesu	CV4

When you buy products from these advertisers, please tell them that you saw their ads in 73.
 Subscribe to 73 right now...call 800-274-7373 (9-5 Monday-Friday EST).



Michigan Radio
SALES SERVICE

WE SHIP WORLDWIDE

OPEN
TUES, WED, THUR 10-6
FRI 11-8
SAT 10-3
CLOSED SUN & MON



Terms do not include shipping. Price and availability subject to change without notice. Most orders shipped same day. COD's welcome (\$5.50 & shipping).

26014 Groesbeck, Warren, MI 48089
1-800-TRU-HAMM (orders only)
 (800-878-4266)

Now on the World Wide Web
<http://michiganradio.com>
E-mail mirad@mich.com



KENWOOD



ICOM



YAESU

Convert Excess Equipment to CASH • We buy good, clean, used equipment • Estate Sales

Microwave Operation Tricks of the Trade

Well, tricks of the trade are not all secretive idioms, but rather they're just easy-to-use methods of procedure and equipment adjuncts to make microwave operation easier. For instance, when standing on a hilltop and trying to point your dish to a station on 10 GHz located some 50 to 100 miles from your location, where exactly do you point?

Also, how do you confirm that your station is operating on an exact frequency — let's say 10,368.1 MHz? Some preparation is needed before starting out to make hilltop contacts.

Additionally, to make remote contacts

you need a liaison frequency to first set up protocol of operation — like who is going to transmit and who is going to receive. What frequency is being used and such. Normally, most liaison communications are set up using either 2 or 3/4 meters.

Omnidirectional antennas or small beam antennas are normally used to begin setup of the communications dialogue. This is fine for setting up who and where to communicate with, but it does nothing on improving your receiver functions, frequency accuracy, and compass heading accuracy.

Where do you point your microwave dish antenna with certainty? Do you set up with a hand-held compass to align your tripod? Remember, most small microwave dish antennas have a 3-degree or less pointing angle, making pointing a dish antenna require accuracy in both vertical and horizontal angles. Larger dish antennas have smaller pointing angles of 2 degrees or less.

Well, the problem is not so difficult after all — it just requires some accessory equipment remotely located — namely a beacon transmitter to make pointing an easy function. A beacon transmitter remotely positioned in a good local spot provides a nearby signal to allow accurate pointing angles to be initially set up. Even if your location does not have a beacon transmitter, one can be set up on the way up to your hilltop spot by dropping off a portable source at a reasonable location for temporary use. Here in the San Diego area we have a local beacon set up keying CW identification followed by a solid key-down CW note for easy location and adjustment of exact heading direction. This makes a great receiver test and allows the exact positioning of a direct compass heading to be set up easily. If your beacon source is accurate in frequency, it also serves to calibrate your receiver with confidence as to frequency. If no one has confidence in frequency and they can copy the beacon, just move 100 kHz up from the beacon frequency and try this tack to make your contact. Several ways to acquire remote

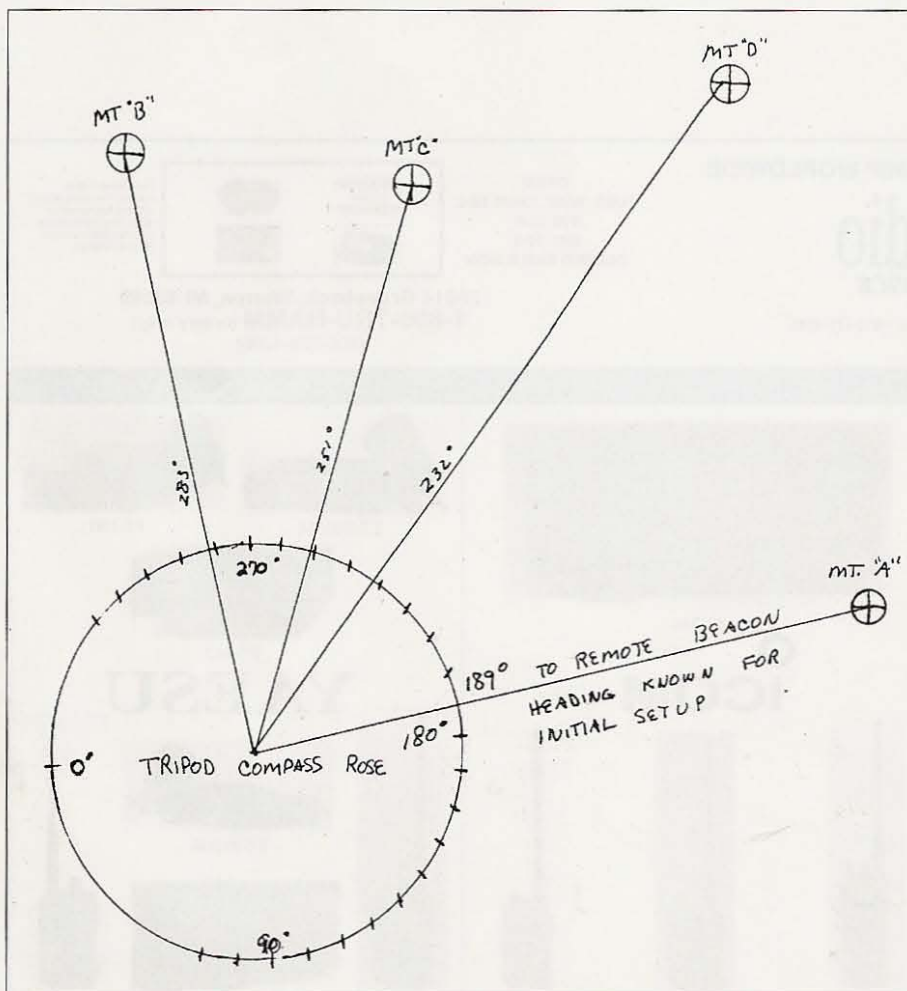

Fig. 1. Compass rose attached to tripod base enabling accurate alignment with a remote beacon, thus calibrating other microwave headings.

stations using microwave and dish antennas are possible.

Once aligned, the microwave dish antenna is properly focused on the remote beacon and the tripod and compass rose positioned to the heading in degrees from where you are to the remote beacon. All other locations are calibrated on the compass rose dial on the tripod mount. As long as the remote beacon's heading is known from your location and the compass rose is so calibrated by receiving a signal from the beacon, you then have one point calibrated. Also, all other points are calibrated by keeping the compass fixed in position and moving the tripod horizontally to the compass heading of the new direction where you wish to make test transmissions.

Knowing where you are set up and where the beacon is located removes the question as to where all other compass bearings (remote distant locations) are. These preparations can be worked out previously and logged on a simple lookup chart. Construction of the compass rose can be as simple as a paper compass on a firm backing, or even two 180-degree protractors forming calibrated 360-degree marks. In any case, whatever you use, mount this compass rose on your tripod below where the horizontal movement of the dish allows rotation of the dish antennas without movement of the compass rose.

Once you've done this simple procedure of calibrating your dish and compass heading to one distant heading, all other location headings are simple to set up. All you have to do is unlock your mount's tripod horizontal base, keeping the compass locked in direction to the beacon, and all other headings are easily aimed at by looking at the compass rose on your mount. All you have to have now is a list of possible locations remote to your location and what compass bearing they are to your location. It's just point and shoot.

Because the beacon is remote to your location — let's say a minimum of 5 miles distant — the vertical orientation will be in good agreement on stations located a hundred miles distant from your location. The difference between 5 miles and 100 miles due to Earth curvature is minimal and will be in good agreement with the beacon setup angles. Even if you want to calibrate this vertical angle it can be simply done by using an old meter movement and removing the spring on the meter vane so that the meter is free to swing like a pendulum. Mount the meter on your tripod upside down and now you have a calibrated vertical incline meter. All you have to do is reference the meter

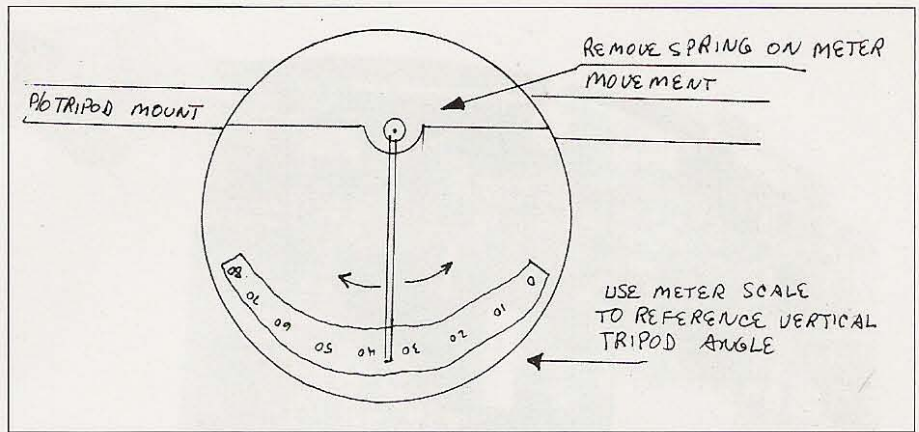

Fig. 2. Meter movement hung upside down (with meter movement spring removed). Becomes incline meter calibrating vertical dish movement.

calibration number from the meter dial (let's say 5.5 mA if it's an old current meter). This calibration is done when you are pointing and calibrated with the remote beacon. Recalibration can be determined at a glance by remembering this original calibration number (5.5 mA), which makes the operation like shooting fish in a barrel.

So much for the simple things. What if you don't have a beacon or frequency standard in your area? What can be done? Well, there are several things that can be done, none of which includes purchasing a beacon from commercial sources, as none exists at any inexpensive or modest price that I am aware of. What we can do is to construct a device home-brew fashion. There are several choices, whether a surplus low frequency brick or a synthesizer that normally operates

on a lower harmonic of the desired microwave output frequency. Finding something calibrated on the exact frequency desired would be a bonus shot if it could be located.

First, let's design a system for a frequency reference with an output of 10.368 GHz with excellent accuracy. Designing this source and constructing one from scratch would be a formidable task. Modifying one from surplus material is a far better success story. Originally, Kerry N6IZW, of the San Diego Microwave Group, constructed the first beacon here with a used Frequency West brick oscillator and a special-cut crystal in a TO-5 transistor-like case. This beacon is a great system and has operated for many years locally, providing a signal for receiver testing and antenna pointing heading alignment. While this device could be copied,

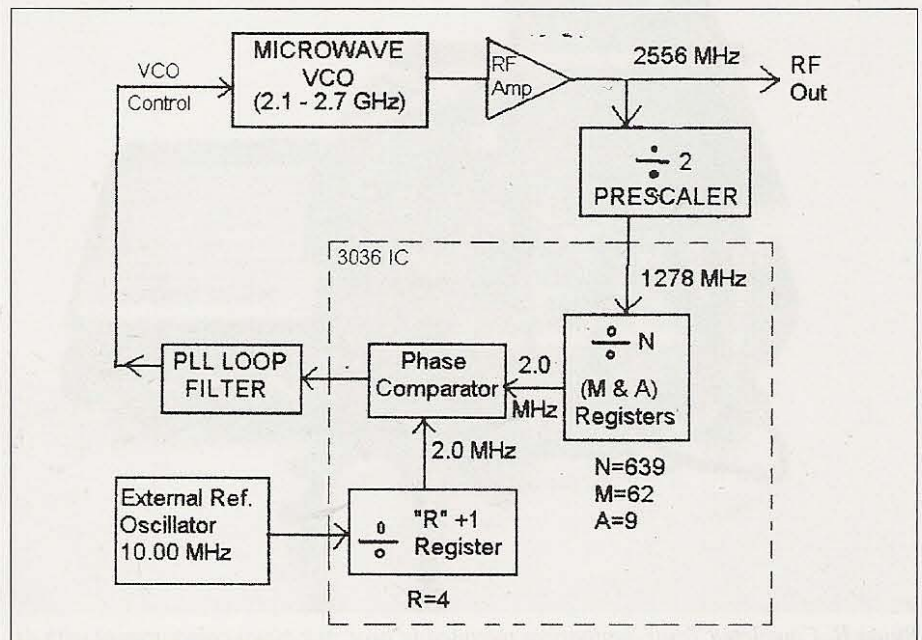

Fig. 3. Block diagram of Qualcomm synthesizer, Texas Version. Example shown for 2556 MHz and 2 MHz reference frequency. All components on PC board except 10 MHz TCXO oscillator.

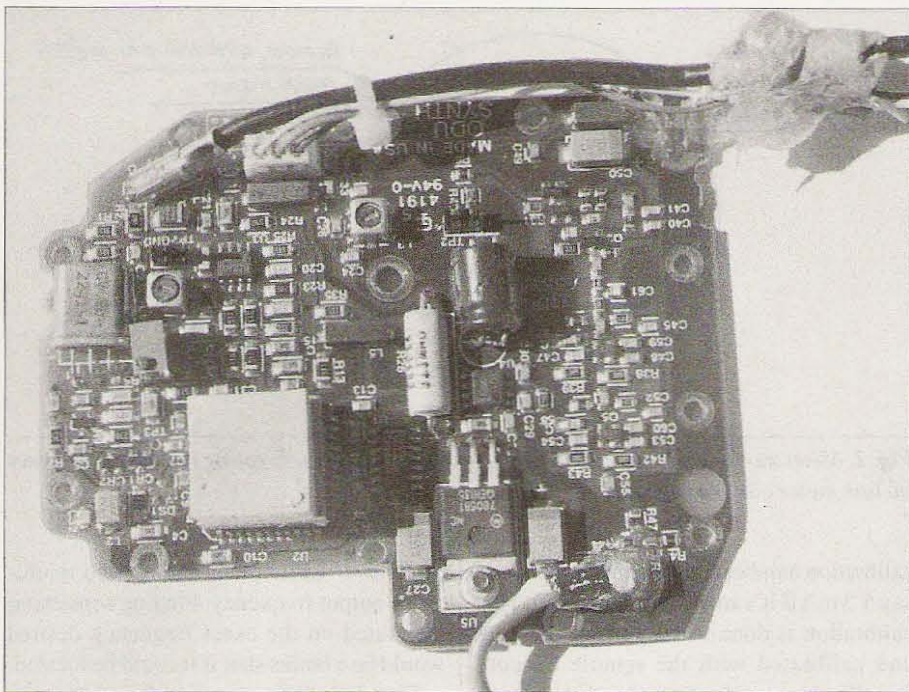

Photo A. The Texas Synthesizer. Main processor PLL chip visible as square white heat sink material. Called Texas board due to shape of unit.

there remain some material acquisition problems that the bricks of years ago present.

The problem with brick-type oscillators is the 100 MHz overtone crystal. It is getting hard to locate suppliers willing to fabricate an oven crystal at reasonable cost. It seems

the crystal required has fallen on low demand and industry wants larger-quantity orders. That makes the alternative plan to use surplus synthesizers more viable. Their attributes include being frequency-agile, small in size, and relatively inexpensive. Agility in frequency comes from the fact

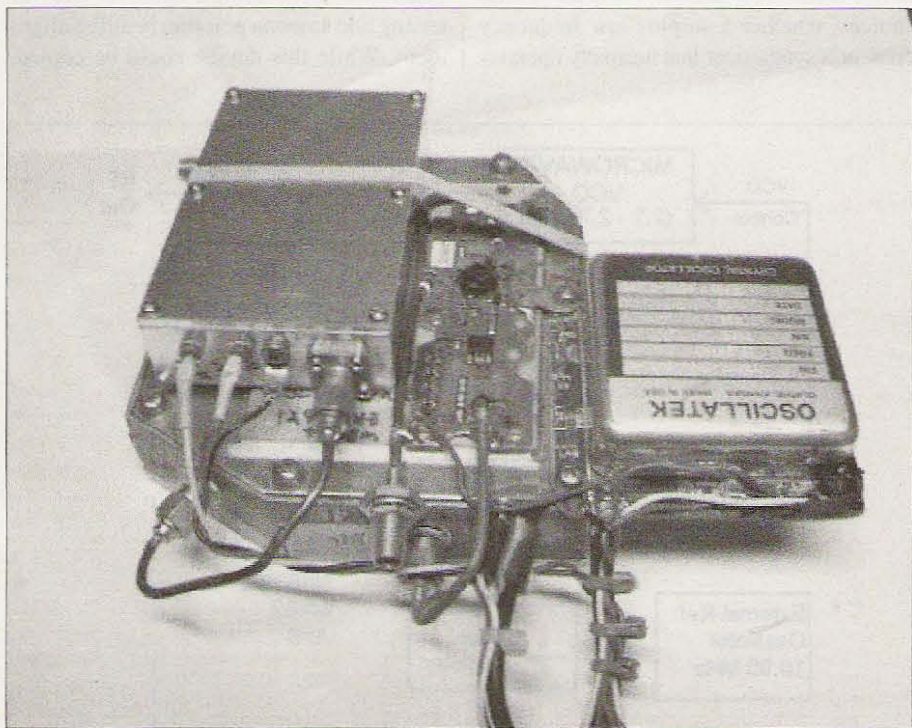

Photo B. Completed Texas Synthesizer mounted in heat sink metal compartment with 4x harmonic multiplier on top with another amplifier board for gain at divide-by-2 output. This unit can provide 1/2 LO output or 1,296 MHz, plus 2,592 MHz, multiply by 4 = 10,368 MHz. For band, very accurate band edge markers.

that they are driven by a standard frequency clock which is divided by a reference divider to a submultiple of the desired frequency. See Fig. 3. For a block diagram of a sample unit functioning at 2,556 MHz, which is the frequency for a 10,224 LO and an IF of 144 MHz = operation on 10,368 for a transverter. Another reason for using the synthesizers is that we have a modest quantity of the surplus material and will make the surplus material available.

Let's start out with the modification of a microwave synthesizer source to generate the 10,368 MHz marker signal at a subharmonic of 10,368 MHz. We have synthesizers that normally operate in the 2,300 to 2,800 MHz range in frequency steps of 2 or 5 MHz as determined in programming of the synthesizer reference divide-by counter. Dividing the 10.368 GHz operating frequency by 4 produces 2,592 MHz, which fills the bill nicely as the synthesizers run in the 2.6 GHz range normally. Modifying the original frequency from its 2,620 MHz is quite easy. It requires lifting several pins on the synthesizer chip to reprogram the divide-by counters to another value.

The synth is driven by a 10 MHz TCXO (temperature-controlled crystal oscillator) serving as master clock. For our application, the normal divide-by-2 (i.e., 5 MHz clock rate) is modified to divide by 5 to produce a 2 MHz reference frequency clock for the phase locked loop chip (PLL). This is necessary as the desired frequency in this application, 2,592 MHz, is not divisible by 5 but is divisible by 2.

The VCO (voltage-controlled oscillator) on this PLL board has a VCO oscillator that runs from about 2,300 MHz to just over 2,700 MHz normally without modification to the VCO. A divide-by-two chip interfaces the VCO and the synth chip, as the synth chip has a maximum frequency of 1.6 GHz maximum. The synthesizer we modified we call the Texas board due to its irregular shape — somewhat like the outline of Texas. These synths and clock oscillators are available from the author (see details at end of article).

To convert the Texas synth to its new frequency of operation of 2,592 MHz, lift with a sharp X-Acto knife pin #2 and short solder to pin #3 (Gnd). Lift pin #4 and leave open as it's pulled high (logic 1) by internal pull-up resistors. Lift pins 7, 8, 9, and 14, and leave high (open) logic "1". Lift pins 18, 19, and 21. Short pins 18 and 19 together to pin #20 (Gnd). Leave pin #21 open high (logic 1).

Continued on page 58

Take the Hamfest Foxhunting Challenge

If you're an active ham in the heartland of the USA, you're probably packing your bags for the annual trip to our country's biggest ham radio gathering. Maybe you're loading up a motorhome with boat anchors for the big flea market. But even if you carry only a small satchel, to simplify your encounters with airport security, consider bringing along some compact radio direction finding (RDF) gear.

Hamfests and conventions such as the one in Dayton this month are great for learning about new Amateur Radio activities such as APRS and Internet repeater linking. They are also places where many hams have their first encounter with hidden transmitter hunting, either on foot or mobile. The Foxhunt Forum has been a regular feature at the Dayton Hamvention, and this year's is shaping up nicely.

The festivities are still over two months away as I write, but Dick Arnett WB4SUV (Photo A) and the other Forum organizers are busily making arrangements. "At present we are scheduled to be in Room 4 on Saturday from 9:30 to 10:30 a.m., promoting both mobile and on-foot hunting," Dick E-mailed. "We will demonstrate hand-held 80-meter equipment and any new developments in two-meter equipment that we can uncover. Brian DeYoung KE4HOR will be showing his latest polar plotter on a Palm Pilot. We hope to have Ernie Howard W8EH tell about his external signal strength output modifications to the IC-706. I hope to have one of the new two-meter sniffers that the Australian guys have developed."

Ready for a ROCA?

WB4SUV reports that there probably won't be an official Hamvention foxhunt this year. Too bad. The one I attended in 1999 brought out hunters from as far away as Sweden for an on-foot romp.¹ Sixteen transmitters were awaiting, and hunters had to find as many as they could in exactly 90 minutes.

Everyone started and ended at the same time. The 90-minute period was just right, because it's long enough to maximize the

foxhunting fun, without being so long as to be beyond some hunters' endurance.

The hunt area, across a highway from the convention site, included the exterior of a school building, a parking lot, and a field with a baseball diamond and large water tower. Foxes could be found in any order. They were concealed inside sidewalk cracks, logs, old tire carcasses, and so forth. A small black-and-gold label with a unique 3-digit number was next to each one, to be written onto the frequency card each hunter carried.

Transmission times ranged from a few seconds each minute to continuous. Since all foxes were on separate frequencies, there was no problem of them QRMing each other.

However, hunters had to preprogram 16 frequencies into their HTs and scanners (32 if they used offset attenuation) for best efficiency on the course.

Teaming and collaboration on the course were permitted, but there could be only two hunters on each team at most. A "one RDF



Photo A. Dayton Foxhunt Forum organizers Dick Arnett WB4SUV (center) and Jim Elmore KC8FQY (right) present a new transceiver to Paul Gruettner WB9ODQ, who won second place at the 1999 Hamvention on-foot foxhunt. (Photo by Joe Moell KØOV)



Photo B. Foxhunters swarm over fortifications at old Fort MacArthur during the 1999 Hamcon foxhunt in southern California. There are two concealed microtransmitters in this view. (Photo by Joe Moell KØOV)

antenna per team" rule was also in effect. This kept team members from hunting independently and then pooling their scores. But it allowed a hunter to have extra eyes to spot the tiny tags.

Winners were determined first by number of foxes found and second by speed. To judge speed and to avoid ties, each hunter was encouraged to have his card checked regularly by course officials, who would

mark down the number of foxes found so far and the exact time. If two or more individuals/teams had the same number of foxes at the end, an earlier check time would place higher in the standings.

These walking hunts are different from standard international-rules hunts (called ARDF or radio-orienteeing) because the area is smaller and there are many more transmitters. Some hams call them ROCAs,

short for "Radio-Orienteeing in a Compact Area." ROCAs are ideal for hamfests and conventions because the emphasis is on RDF skill, not running ability.

Dayton's 1999 hunt was the inspiration for our ARRL Southwestern Division Convention (Hamcon) ROCA near Los Angeles later that year. The Fullerton Radio Club put 21 foxes on the air at Angels Gate Park in San Pedro, California.² This 130-acre site, formerly Fort MacArthur, includes everything from well-groomed picnic areas to desolate patches of barren ground, with the refurbished fort headquarters (now a museum) in the center.

Six foxes were on or within 10 kHz of the southern California coordinated T-hunt frequency (146.565 MHz). Hunters didn't know it, but they were all physically close, within about a 900-foot-diameter circle near the start/finish area in front of the fort headquarters (**Photo B**). The QRM should have made them the hardest to identify and track down. Nevertheless, most hunters spent much of the 90-minute hunt period on these six foxes.

The rest of the transmitters were each on separate frequencies throughout the two-meter band. That made RDFing for them easier, but there was plenty of legwork needed to get there. Those foxboxes were widely scattered throughout the park, including the southwest, southeast, and northeast corner areas. Just to make it more interesting, there were some decoy (nontransmitting) devices and tags out there, too.

It was easy to find dastardly hiding locations near the fort. For instance, we put a foxbox out of sight under the back seat of an old jeep that the museum volunteers were driving around the grounds. An ammunition can was already mounted in plain sight between the jeep's front seats (a poor man's glove box), but the T wasn't in there!

Perhaps the sneakiest museum fox was a microtransmitter in the rucksack on one of the young Army "soldiers" entertaining the park visitors. Only three sharp-eyed foxhunters noticed the antenna wire sticking a couple of inches out of his pack.

The mobile alternative

A convention or hamfest is an ideal time for a challenging mobile transmitter hunt. Most mobile T-hunters are used to having a set of firm rules that bound the hunt area and establish the hidden T's on/off timing. These rules usually prohibit moving or multiple transmitters, except on advanced-level hunts. At conventions and hamfests, however, there need be no hunt rules. Hiders



Photo C. Orlando HamCation staffer Dave Flagg N4BGH presents the 2002 foxhunt grand prize to Arthur Byrnes KA4WDK and Patrick Eckenrode AC4QM. Seated in front of them is Bill Thomas KE4HIX of the hiding team. (Photo by John Munsey KB3GK)

have much more latitude. A valuable prize warrants a special challenge. Some hidiers say, "If the hunters don't complain, the hunt wasn't hard enough."

John Munsey KB3GK just sent a comprehensive report of the hunt that he and Bill Thomas KE4HIX put on at the 2002 Orlando HamCation on February 9. The prize was an Icom handie-talkie, which drew hunters with a wide range of experience and skill. "This hunt is considered to be the championship hunt for Florida, if not the southeast," John wrote.

The hunters came from as far away as New Jersey, and all except their ride-alongs had lots of T-hunting experience. Two members of the winning team had been hunters for over 20 years. One hunter who didn't win said he had been doing RDF for over 50 years.

"The allotted hunt time for this three-fox hunt was two hours," John continued. "We tested the course in advance and the driving time from the start to the first was 15 minutes in normal traffic. Number two was 15 minutes from the first and number three was 15 minutes from number 2. We expected that all three could be found within an hour. They were almost 'drive-up foxes,' as no hunter would have to walk more than fifty feet after parking the car. So much for our plan.

"The first fox controller was set for one minute on and two minutes off. To get to it, hunters had only to drive east, and when they went under an overpass, make a left turn, go about a quarter-mile, turn into a parking lot, and find a J-pole next to a tree. But the signal was blocked from line-of-sight by the elevated interstate, and as hunters drove closer, it decreased. That caused them to assume that they had passed the site and were seeing a reflection from the interstate.

"Hunters spent lots of time searching the wrong side of the interstate. Then when they figured that out and got closer, there were even more problems. The lot was next to railroad tracks, a chain-link fence, tall buildings, and trees. Reflections were everywhere. After arriving at the site, most hunters took another 30 minutes to sniff out the hidden fox. The hunt started at 5 p.m., and the first team did not leave the first T until an hour later. At that point, Bill and I agreed by cell phone to reduce the hunt to two transmitters.

"The second site was almost due east of the first, with a three-element yagi pointed across a large lake. The signal was good, except when hunters drove into dips or when the signal was blocked by downtown

buildings — where it was lost completely. Only one team got close to number two, and it was after the hunt time had expired.

"When it was all over, KE4HIX and I got together with HamCation Prize Chair Dave Flagg N4BGH. We agreed that since only two teams found #1 and no team found #2 or #3, the transmitters had been too well-hidden and the award should go to the team that found #1 first. Arthur Byrnes KA4WDK and Patrick Eckenrode AC4QM were declared the winners and awarded the HT (Photo C).

"At the after-hunt dinner party, there was plenty of discussion about what went wrong, why they didn't get there, and so forth. Everyone agreed that next year they will do better."

Unofficial is OK

Even if there's no formal transmitter hunt at Dayton, perhaps there will be some unofficial opportunities to test your RDF abilities. At southern California Hamcons, it's a tradition for attendees to bring their own foxboxes, put them out on the hotel grounds, and have an informal free-for-all hunt as everyone finds each other's transmitters. There are no prizes, just lots of fun and a chance to demonstrate the sport to other hams who ask why everyone is walking around with strange antennas and listening to beeping signals (Photo D).

Will there be transmitter hunts and RDF forums at conventions and hamfests in your state this year? It's up to you to start the ball rolling. An informal spur-of-the-moment RDF "treasure hunt" at your hamfest or picnic can be great fun. It's even better to plan ahead and make a "happening" of your event.

If possible, have it be a sponsored convention activity. This will get you wider publicity, insurance coverage, and maybe enough cash to cover trophies, certificates, prizes, and refreshments. Encourage local "ham celebrities" to attend and participate in your hunt. Personally invite club presidents, repeater owners, ARRL officials, and hams in the local media. Offer to provide RDF gear to them, if you have it, to get them to go out on the course.

There is probably no perfect time period for an ARRL convention foxhunt. For instance, our Hamcons are primarily two-day events, Saturday and Sunday. Having the hunt on Saturday would eliminate the opportunity to have a full-day booth to promote the event. There are too many other competing activities on Saturday anyway, including the usual technical session on RDF. A Saturday night hunt would compete

WANT TO LEARN CODE?

Morse Tutor Gold from G.G.T.E. is the answer for beginners and experts alike.

*Get the software the ARRL sells and uses to create practice and test tapes; and **Morse Tutor Gold** is approved for VE exams at all levels.

*Since 1987, GGTE has guided nearly 25,000 hams and prospective hams around the world through proven structured lessons and a variety of character, word and conversational drills. Straight forward menus make the process simple and fun.

*This program features easy and speedy self-installation; random character drills with the characters you select; and you can create your own drills or import text files. You can type what you hear or copy by hand and see the results one line at a time. Pick the Farnsworth or the standard method; select the tone frequency most comfortable for you or select your code speed in tenths of a word per minute. For all DOS computers. You are always in command.

Certified by



Morse Tutor Gold uses your internal speaker or sound board. And, if you use a sound board **Morse Tutor Gold** supports volume control.

Sound Blaster and the Sound Blaster Compatibility Logo are trademarks of Creative Technology Ltd.



Available thru dealers, the ARRL, or send \$29.95 + \$5.00 S&H (CA residents add \$2.62 tax) to:
G.G.T.E., 2380, Cassandra Bay,
Dana Point, CA 92929

Your Ad Could Be Here!

Call

Frances

1-800-677-8838

M²

**EXTRA, EXTRA!
M2 BUILDS
TRIBANDER**

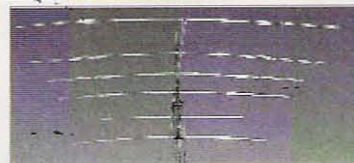

The tried and true KT34 series antennas have been made better using the latest computer modeling and mechanical design techniques to provide you with the best tribander performer available today. Just take a look!

**INCREASED FRONT TO BACK
INCREASED GAIN
MECHANICALLY SUPERIOR
ELECTRICALLY SUPERIOR
LOWER WIND LOAD THAN COMPETITORS
LESS WEIGHT THAN COMPETITORS
RATED AT 100 MPH WIND SURVIVAL
AND OF COURSE, NO POP RIVETS**

Contact us for our new catalog of ALL the goodies!!
Can't wait? Visit our Website @m2inc.com



4402 N. Selland, Fresno, CA 93722
559-432-8873 Fax 559-432-3059
E-Mail: wyatt@m2inc.com
Website: www.m2inc.com





Photo D. You never know what you'll see at a hamfest foxhunt. Here's Travis Wood KG6AUR testing his doppler hat at Hamcon01 in Riverside, CA. (Photo by Joe Moell KØOV)



Photo E. Joe Young VE7BFBK is Canada's new ARDF Coordinator. He's shown here at the 1997 Friendship Radiosport Games in Japan. (Photo by Dale Hunt WB6BYU)

with the well-attended banquet. That's why Hamcon foxhunts are traditionally on Sunday afternoon, right after the grand prize drawing. There are always a few no-shows, as people change their plans overnight and some out-of-towners decide to head for home early.

Lots of advance publicity is a must. It increases the likelihood of attracting experienced foxhunters and encourages everyone to make equipment preparations in advance. Put out the word via hamfest flyers, club newsletters, packet bulletins, and Web sites. Follow up with calls to active T-hunters to make sure they attend, and encourage them to spread the word.

If it's an on-foot hunt, remind everyone that all family members who have equipment can join in; a ham license is not required. Make a special effort to contact hams who conduct amateur radio activities with schools, Scouts, and youth groups. I'll mention it in "Homing In" if I get the information at least three months ahead of time.

New ARDF coordinator up north

Canada has a new leader for international-rules foxhunting. That announcement just came from Joe MacPherson VE1CH, First

Vice President of Radio Amateurs of Canada (RAC), which is that country's counterpart to ARRL.

The RAC Board of Directors has approved the appointment of Gordon D. "Joe" Young VE7BFBK as the new RAC national ARDF Coordinator. Young, who lives in Victoria, British Columbia, obtained his first amateur radio license in 1960. An electrical engineer by profession, he has made a 30-year career of developing instrumentation devices.

VE7BFBK first became interested in ARDF when the Victoria's chapter of the Friendship Amateur Radio Society (FARS) hosted the Third Friendship Radiosport Games in Victoria in 1993.³ He has since attended ARDF events in Russia, Japan, and USA (**Photo E**). He organized the foxhunting event when FARS-Victoria again hosted the Friendship Radiosport Games (FRG) in August 2001.

Joe Young replaces Perry Creighton VA7PC, also of Victoria, who in 1997 became the first national ARDF Coordinator to be named in North America. Under VA7PC's guidance, interest in ARDF grew in Canada as hams there put on FRG-2001 and participated in the First IARU Region 2 ARDF Championships in Portland, Oregon, during 1999.

VE7BFBK has followed the growing ARDF momentum in the USA and hopes to achieve similar growth on his side of the border. Canadian hams can E-mail him [ve7bfbk@rac.ca] to find out more about his plans and upcoming ARDF opportunities. Will Canada send a team to the ARDF World Championships for the first time this year? Maybe so — find out from him.

Similarly, I want to hear from stateside hams with foxhunting stories, photos, and ideas. My E-mail and postal addresses are at the beginning of this article. Also, it may not be too late to join ARDF Team USA for the World Championships in Slovakia, as reported here last month. Check the "Homing In" Web site for the latest team updates and contact me if you want to go.

Notes

1. Moell, Joe, "Homing In: Dayton Does DF," *73 Magazine*, September 1999.
2. Moell, Joe, "Homing In: Foxhunting at Hamcon99," *73 Magazine*, January 2000.
3. Moell, Joe, "Homing In: Foxhunt Fun at the Friendship Games," *73 Magazine*, October 1993.

Build This Commercial-Quality Counter: Part 1 of 2

continued from page 13

Now, the inputs of the counter. About five feet of RG-174/U mini coax should do the job. A connector was deemed necessary and a little expensive. I found a couple of gold-plated SMA bulkhead types at a ham flea market, so the two of them for \$1 did the job for me. If you cannot find these sub-mini coax connectors, I recommend using BNC or F types from the rear of the enclosure. Maybe two coax runs using grommets from the rear.

Frequency measurement is specified using sine waves. Digital square waves introduce some errors if a strong signal over two volts is to be measured. If a 2V signal is to be measured, use a capacitor (0.01 μ F) on the probe. Accuracy using a sine wave is ± 1 Hz up to about 130 MHz. From 130 MHz on up to over 500 MHz, the time base limits the accuracy to about ± 3 Hz. This is true nine-digit accuracy! Take a look at **Fig. 1** and check out the timing diagram and the explanation of how the accuracy is achieved.

Let's get to the details of the counter. Look at the functional block drawing for a picture of how it works. See **Figs. 2, 3, 4, and 5** for the functional block drawing and schematics.

Next time: construction and assembly. 

Voltage Control for Your Mobile Rig

continued from page 37

the center conductor, because it is too thick and not very flexible. As you pull out the center conductor, tie on a piece of #10 and pull it in. Remember, you are only going to use about 7 to 9 feet of shield, and that usually is not a big deal to pull wire into. Notice also that the shielded cable is smaller than the original coax cable.

Route the shielded wire along the fender and away from the ignition system components. Getting the wire through the firewall is a problem. Lots of luck. A few cable clamps and some plastic ties along the way, and you've got it made.

But wait, there's more.

This circuit will also delay turning on your rig by about 2 seconds. The advantage is that you will have the car started and running before the voltage is applied to the rig. It might not be a big concern, but it would be a good idea to delay the turn-on for a few seconds until everything settles down with the electrical system.

The 22k ohm resistor and 1,000 μ F capacitor give about 2.2 seconds of delay. In case you want to figure a different time, use the following formula for RC time constants:

$$T = R \times C$$

where T = time in seconds; R = resistance in ohms, and C = capacitance in farads.

I built this unit in a small aluminum box and mounted it behind the radio near the passenger side of the firewall. Protect all wires running through holes and around sharp edges with extra layers of tape.

Well, there you have it. Start the car, and 2.2 seconds later your rig springs to life. Turn off the ignition and the radio turns off.

Total cost will be less than \$10. Satisfaction from a job well done: priceless. 

Keying to a Different Drummer

continued from page 28

currents in the order of a picoamp, pull-down resistors of a meg are quite adequate. **Fig. 2(left)** shows the key driving CMOS NOR gates in an automatic keyer. **Fig. 2(right)** shows the key controlling an N-channel enhancement-mode MOSFET like Radio Shack's part number 276-2072.

The flat configuration is different and will take some getting used to. It's no deal breaker, though, if you can drum with your fingers. 

ON THE GO

continued from page 48

although the longevity of the charge will be less, of course. This will permit the use of a mobile rig with a more reliable

connection than the cigarette lighter adapter plugs.

One of the things that I particularly like about the Power Station 2 is the fact that it comes with both a wall adapter and an automobile adapter for charging. The wall adapter will be the more commonly used of the two, but there are times when the automobile charger will prove extremely valuable. While moving from location to location, just plug in the Power Station to the automobile cigarette lighter of the car to recharge the gel cell. If you've ever exhausted all your batteries during an emergency event, you know the comfort of having some way to recharge. The Power Station can operate your radio for a long time, but never as long as what you'd like to have.

Of course, 7 amp-hours should give you a pretty good base of operations. With gel cells, amp-hours are calculated over a 20-hour period, so a 20 ampere-hour rating means that you should get 1 amp for 20 hours, and not that you can operate a 20 amp load for one hour. (For some interesting facts on gel cells, check out The Ham Contact's Web page.) Based on this, you can expect to have a little over 1/3 of an amp available for 20 hours. The average ham radio consumes much less power when in receive mode, and good amateur practice dictates that during emergency operations we transmit only when necessary and as briefly as possible. Add to this that we always use the minimum power necessary, and you may find that you can operate for days with the Power Station.

Of course, any gel cell-based system needs a certain amount of basic care. The first rule is to not overdo it. Don't overcharge the battery and don't over-discharge the battery. The regulated charging circuit in this unit protects the gel cell from overcharging, but it still isn't a good idea to leave it plugged in indefinitely. Top it off once a month, and you'll always be ready to go. Likewise, when you notice that the voltage is beginning to drop, recharge it at the first practical opportunity. With a little care, you should be able to get a long life from this system.

If you get a portable backup power supply such as this, a few other suggestions are in order. First, you'll need to make sure you have power cables made up for the radios you expect to use. I like to keep an extra cigarette lighter plug with heavy wires and no connector on the other end as a "universal converter" as well as my prepared cable. You can keep all these in one bag in your grab-and-go kit.

Continued on page 58

ON THE GO

continued from page 57

Second, transmitter power is always a balance between output and longevity. Even with a good power supply, you will be well advised to optimize your effective radiated power (ERP). A better antenna or a better antenna location can give you the same "punch" as higher power input to the radio. If you can optimize output, your emergency power will last much longer.

If you want more information about the Power Station 2, here's where to look: The Ham Contact, P.O. Box 4025, Westminster CA 92684; order line: 1-800-933-4264; info: 714-901-0573; fax: 714-901-0583; [http://www.hamcontact.com].

With the frequent warnings we've seen on the television and just the current state of affairs, it pays all of us to borrow a lesson from the Boy Scouts and be prepared. Take a few minutes to go through your essential supplies and make sure they're in good order. Hamfests are coming, and you can restock or add what you may need. There are a lot of people who may need us if something else happens, so let's make sure we're ready. 73

ABOVE & BEYOND

continued from page 52

The original synthesizer ran on a 5 MHz loop filter clock frequency that was derived from a 10 MHz TCXO. Because the frequency was divisible by 5, modifications to the loop filter and chip division rate are necessary. Because the desired new frequency, 2,592 MHz, is divisible by 2, we need to convert the normal 5 MHz loop filter to 2 MHz. (See **Photo A**, The Texas Synthesizer.)

Converting to a 2 MHz clock requires retuning the original loop filter to 2 MHz. There are three chip capacitors around inductor L3, the loop filter inductor. To convert the loop filter to 2 MHz rejection requires the placing of additional three chip caps mounted on top of the existing chip cap in the circuit around inductor L3. Mount a 0.001 μ F chip cap on top of each C25 and C26. Place a 0.0033 μ F chip cap on top of C26. The filter is now converted from 5 MHz resonance to a maximum rejection at 2 MHz. The additional capacitors in the loop filter reduce spurs about the real frequency at 2,592 MHz. If the loop filter doesn't remove the reference frequency from the loop control, you will be plagued by spurious signals spaced evenly above and below the main signal at 2 MHz intervals. With a

modified loop filter it reduces their effect by some additional 20 to 30 dB rejection to clean up the 2,592 MHz main signal.

The Texas Synth requires a regulated power source of +10 volts at 1/2 amp. The chips used in this synthesizer are power-hungry, so heat sink the main synth chip to keep it reasonably cool. Unless a heat sink used for other than intermittent uses, it will destroy itself by overheating. 2 GHz power output from the board runs about +10 dBm at 2,592 MHz. Operation in an unshielded enclosure should turn a modest 10 GHz transceiver upside down co-located in the same test room. The energy at the 4th harmonic is weak but can be used as a marker at 10,368 MHz. Coupling the synthesizer to a harmonic multiplier board that was part of the original circuitry, the output at 10,368 MHz can be increased to about +7 dBm output power. Gray coax lead = RF output at 2,592 MHz, black coax = 10 MHz reference TCXO input, red lead = +10 volts DC. White and blue leads not used.

Well, then, there it is the conversion of a marker for 10,368 MHz. Test uses. Next time, I hope to cover a multiplier that will provide times-4 multiplication of the 2,592 MHz synth to 10,368 MHz at a modest power level of about +7 dBm.

This does not sound like much power output. However, as an example of power, we operate a beacon running my callsign here in the San Diego area consisting of a brick oscillator +18 dBm that is observed regularly over a hundred miles distant with quite strong signal strength. CW is created and keys DC output to turn on and off the RF output feeding a magnetic waveguide modulator, which feeds a 10 GHz omnidirectional slot antenna. The magnetic modulator attenuates on positive-going high DC pulses and minimum loss on low DC pulses, making the RF at the antenna sound like CW on a SSB receiver. This is just one method we used because it was on hand. Other methods are available and will be explored as this marker beacon project takes form.

I will be looking into pin attenuators, pin diode switches, and whatever can be implemented, using availability and least cost as a target. Waveguide slot antennas for omnidirectional use at 10 GHz are in the construction mill. We are acquiring suitable lengths of WG-16/WR-90 for their construction and looking for a machine shop to fabricate them for us. An alternate to this is to look on the Web site for details on how to construct a slot antenna. Look on the Web at [http://www.ham-radio.com/sbms/] under Technical articles/Programs for data on how to construct them and a whole series

of microwave-related projects. Looking in "Programs" on the Web site, there is a BASIC DOS Run program that will calculate custom-designed slot antennas for 10 GHz.

This synthesizer project is but just one aspect of a microwave tool that can be used for an accurate frequency marker. It can with suitable additional components be implemented into a microwave remote beacon. All it takes is time and some interesting shopping, checking surplus dealers and swap meets to find inexpensive components that can be used in part of this project. Shop your local dealers and swap meets — you might just find useful material in your own back yard. If need be, drop me a note on E-mail and I will try to answer your questions on this and other material you might have located. If you wish to copy what I have constructed so far, I will make available surplus synthesizer and multiplier boards to help bring this part of the marker/beacon project to fruition. Some material is available from me. The synthesizer is \$35 and the multiplier board is \$20. The 10 MHz TCXOs are \$15 each plus postage of \$5 for priority mail, U.S. only, or a package deal for \$70 U.S., postage paid. 73, Chuck WB6IGP. 73

QRX

continued from page 7

devices. These would only be permitted to radiate straight down, with little or no signal leakage in any other direction. The FCC notes that this system could help rescuers find victims in rubble following a disaster or locate ruptured underground pipelines without digging up entire neighborhoods.

The FCC severely limited distribution of ultra-wideband devices that can see through walls and detect motion within certain areas. Only law enforcement and firefighters will be permitted to have them. In other words, you won't soon be buying a home camcorder that can peer through your wall and into your next door neighbor's apartment. And you probably never will.

Right now, the introduction of ultra-wideband will have very little impact on ham radio due to the limited spectrum being allocated to it. But its use could be expanded in the future if it's proved not to interfere with existing military and public service communications.

If ultra-wideband is successful, it could eventually open up a whole new world of communications for ham radio. For starters, think in terms of so-called smart, software-defined radios — a radio that is so smart that you tell it whom you want to talk to and it calls you when that person is ready to hold a QSO.

Thanks to Robert Sudock WB6FDF and the FCC, via Newline, Bill Pasternak WA6ITF, editor.

Who is an American?

You probably missed it in the rush of news, but there was actually a report that someone in Pakistan had published in a newspaper an offer of a reward to anyone who killed an American, any American. So I just thought I would write to let them know what an American is, so they would know when they found one.

An American is English, or French, or Italian, Irish, German, Spanish, Polish, Russian, or Greek. An American may also be Mexican, African, Indian, Chinese, Japanese, Australian, Iranian, Asian, or Arab, or Pakistani, or Afghan. An American may also be a Cherokee, Osage, Blackfoot, Navaho, Apache, or one of the many other tribes known as native Americans.

An American is Christian, or he could be Jewish, or Buddhist, or Muslim. In fact, there are more Muslims in America than in Afghanistan. The only difference is that in America they are free to worship as each of them chooses. An American is also free to believe in no religion. For that he will answer only to God, not to the government, or to armed thugs claiming to speak for the government and for God.

An American is from the most prosperous land in the history of the world. The root of that prosperity can be found in the Declaration of Independence, which recognizes the God-given right of each man and woman to the pursuit of happiness.

An American is generous. Americans have helped out just about every other nation in the world in their time of need. When Afghanistan was overrun by the Soviet army 20 years ago, Americans came with arms and supplies to enable the people to win back their country. As of the morning of September 11, Americans had given more than any other nation to the poor in Afghanistan. The best products, the best books, the best music, the best food.

Americans welcome the best, but they also welcome the least. The national symbol of America welcomes your tired and your poor, the wretched refuse of your teeming shores, the homeless, tempest tossed. These in fact are the people who built America. Some of them were working in the Twin Towers in the morning of September 11, earning a better life for their families. [I've been told that the people in the Towers were from at least 30, and maybe many more, other countries, cultures, and first languages, including those that aided and abetted the terrorists.]

So you can try to kill an American if you must. Hitler did. So did General Tojo, and Stalin, and Mao Tse-Tung, and every bloodthirsty tyrant in the history of the world. But, in doing so you would just be killing yourself. Because Americans are not a particular people from a particular place. They are the embodiment of the human spirit of freedom. Everyone who holds to that spirit, everywhere, is an American.

So look around you. You may find more Americans in your land than you thought were there. One day they will rise up and overthrow the old, ignorant, tired tyrants that trouble too many lands. Then those lands, too, will join the community of

free and prosperous nations. And America will welcome them!

Thanks to those who forward this on the Internet, where it was first placed by a dentist from Australia, we believe.

NEVER SAY DIE

continued from page 8

Plus, the countries are \$350 billion in debt for loans made to their corrupt governments.

I thought about this while reading a *Time* cover story about Bono (U2) and his interest in helping the African people to improve their countries. He and Bill Gates want to do something about the situation.

The main thing these guys need right now is me.

Unless you've been reading my stuff, that probably sounds egotistic. If you've been reading my essays you know that AIDS, malaria, and other illnesses could be wiped out in a couple of years by getting Africans to rebuild their immune systems with a raw food diet, pure water, and a couple million inexpensive blood purifier units. These units could probably cost under \$10 with mass production, and each one could take care of a dozen or more people. I'm talking about almost zero-cost healthcare.

Then, there's poverty. So, what's the answer to poverty? Education. And in the case of Africa, not just a low-cost education, but a very-low-cost education. Okay, it's time to get Steve Jobs into the loop so his Pixar production company can start turning out DVD-based educational programs which interactively teach reading and writing, and all the other basic stuff that an educated person needs to know.

They'll need a few million DVD players. Battery-operated, rechargeable with small solar arrays, of course, since most of Africa still doesn't have electric power.

Imagine schools where no teachers are needed, there's no memorization for tests, and no grades. Schools where kids (of all ages) learn what they want, when they want, because it's fun to learn. Where they can learn about anything they're interested in.

Okay, we've tackled sickness and poverty, so what about famine? How about a way to grow healthy crops using a tenth as much water as usual? How about growing crops that are five to ten times bigger than we're growing today — and have all of the minerals that are missing from the commercially grown crops we are buying in our supermarkets?

Dictators and oppressive governments? Not when there's an educated public.

Well, not as bad as those in many African countries today, anyway.

The next need is energy. A \$10 million grant to develop a practical home cold fusion generator would provide energy at a tenth the cost of coal or oil. Power is going to be needed to build the transportation and communications infrastructure a country needs to eliminate poverty.

How You Can Help!

The problem is, how to reach billionaires like Bill Gates, Bono, and Steve Jobs. They're almost totally insulated from mail, E-mail, or visitors. Maybe you know someone who knows one of 'em and can get me an audience. Or someone who knows someone. Gates has to spend, by IRS law, \$1.2 billion a year on good works. Well, what could be better than helping to pull a whole continent out of the huge mess it's in? In quantity they should be able to get DVD players down to \$250 or less. \$250 million would buy a million of 'em. That would be a good start.

Both Jobs and Gates know me well, but even so I haven't been able to penetrate their insulation from the outside world. Have you any ideas or contacts that might help me get through? Maybe skywriting over Redmond or Cupertino?

This isn't going to be easy. I even asked the Art Bell audience to write to Bill Gates and plead with him to call me. Nothing.

National Geographic

In the Feb. 2002 issue there was a big (twelve pages) article on AIDS. Three million people died of AIDS last year. The pharmaceutical companies are doing their best to develop a cure. Etc.

But, you know, there's not one hint of the nondrug cure discovered (and quietly patented) by the researchers at the prestigious Albert Einstein College of Medicine in New York.

Gee, how could the writer for such a famous magazine miss something that important? A look through the magazine, checking out the double-page ad spreads for drugs, answered my question. M-o-n-e-y. It can buy almost anything, including the silence of the National Geographic Society.

Dreaded killer AIDS, Auto-Immune-Deficiency-Syndrome, is a disease where the name itself suggests a cure. If the immune system is failing, why not rebuild it? How? That's easy — stop doing things that harm it. Make sense?

The pioneers in this field were doctors such as Melvin Page, Weston Price, Lorraine Day, Bruno Comby, and Henry

Continued on page 61

Special DX Forecast

Overall, ionospheric conditions should improve over last month but will be counterbalanced by negative seasonal influences. At this time of year, atmospheric noise from tropical storms really begins to curtail activity on the upper bands, while decreased MUFs impinge on the lower ones.

We haven't reached the summer doldrums yet, so you can still find some good opportunities on 30, 20, and 17 meters. Look for decent openings south of the equator and on polar paths to the opposite hemisphere.

Conditions will range from good (G) to poor (P) this month, but I don't foresee any exceptionally good or bad days. The early part of our May calendar has the worst days and so will probably yield more ionospheric disturbances than the latter half of the month. Keep an eye on the 3rd-4th and 12th-13th since they are "critical," showing the highest potential for strong solar eruptions.

The technique that I use to determine these "critical" days is based on the work of John Nelson and was developed while he was employed doing propagation forecasts for RCA in the 1940s. He passed his methods on to my father, who subsequently taught them to me. His system is based on planetary motions and has been refined after years of collecting and analyzing observational data.

Over the years, many detractors have ridiculed this type of "astrology" as lacking a sound theoretical foundation and therefore have labeled it "pseudoscience" — especially after the well-publicized failure of the early-'80s predictions presented in the book *The Jupiter Effect*. However, the statistical accuracy of Nelson's method (over 80%) has continued to baffle scientists and engendered many loyal followers. Those readers interested in the work that is currently being done in this arena should investigate the following three Web sites: [http://www.allanstime.com/index.html], [http://www.tmgnow.com/repository/solar/percyseymour1.html], and [http://www.sunspotcycle.com].

Have fun, and happy DXing!

May 2002						
SUN	MON	TUE	WED	THU	FRI	SAT
			1 F-G	2 F-G	3 F-P	4 P
5 F-P	6 F	7 F	8 F-P	9 F	10 F-G	11 G
12 P	13 P	14 F	15 F-G	16 F-P	17 F	18 F-P
19 F	20 F	21 F-G	22 G	23 F	24 F-G	25 G
26 F-G	27 F	28 F-G	29 G	30 G	31 F-G	

EASTERN UNITED STATES TO:												
GMT:	00	02	04	06	08	10	12	14	16	18	20	22
Central America	15-20	(15) 30	20 (40)	(20-40)	x	(20)	20	(20)	(15)	(15)	15 (20)	(10) 17
South America	15 (20)	(15) 20	20 (40)	(20-40)	(20)	x	(15)	(15)	x	(10)	(10-20)	(10) 20
Western Europe	20	20	(20-40)	(40)	x	(20)	x	x	x	x	(20)	20
South Africa	x	(40)	x	(20)	x	x	x	x	(15)	(15)	x	x
Eastern Europe	20	20 (40)	(20)	x	x	x	(20)	x	x	(15)	(15)	(20)
Middle East	20	20 (40)	(20)	x	x	x	x	x	x	x	(20)	(15)
India/Pakistan	(15-20)	(20)	x	x	(20)	x	x	x	x	x	x	x
Far East/ Japan	(15)	x	x	x	x	x	(20)	(15-20)	(15)	x	x	(15)
Southeast Asia	(15-20)	x	x	(20)	x	x	(20)	x	x	(15)	x	x
Australia	(15)	(15)	x	x	(20-30)	(20-30)	(20)	(20)	x	x	x	x
Alaska	(15-20)	(15-20)	(15-20)	20	20 (40)	(20-40)	(20)	(20)	x	x	(15)	(15-20)
Hawaii	(15-20)	(15-20)	(15-20)	20	20 (40)	(20-40)	(20)	(20)	x	x	x	(15)
Western USA	(10) 30	(10) 30	(10) 40	(15) 40	(20) 40	(20-40)	(15) 20	(10) 20	(10-20)	(10-20)	(10) 20	(10) 20

CENTRAL UNITED STATES TO:												
Central America	South America	Western Europe	South Africa	Eastern Europe	Middle East	India/Pakistan	Far East/ Japan	Southeast Asia	Australia	Alaska	Hawaii	
(10) 20	(15) 30	20 (40)	20 (40)	(20-40)	(20)	(20)	(15) 20	(15-20)	(10-20)	(10-20)	(10) 17	
10 (20)	(10) 20	(15) 30	(15) 30	(20-40)	(20)	(20)	(15)	(15)	(10)	(10-15)	(10-20)	
(15) 20	20	(20-40)	(20-40)	x	(20)	(20)	x	x	x	x	(15-20)	
x	x	(40)	(20-40)	(20)	x	x	x	(10-15)	(10-20)	(20)	x	
(20)	(20)	(20)	(20)	x	x	(20)	(20)	x	(15)	(15-20)	(15-20)	
(15-20)	(20)	(20)	(20)	x	x	x	x	x	x	x	(20)	
(15-20)	(15-20)	(20)	x	x	x	(20)	x	x	x	x	x	
x	(15)	(15)	(15)	(20)	x	x	(20)	20	(20)	x	x	
(15)	(15)	(15-20)	(20)	x	x	(20)	(20)	(15-20)	(15)	(15)	x	
(15)	(15)	(15)	(20)	20 (40)	(20-40)	(20-40)	20	(20)	x	(15)	x	
(10) 30	(10) 30	(10) 40	(15) 40	(20) 40	(20) 40	(20-40)	(15-40)	(10) 30	(10-20)	(10-20)	(10) 20	
(15-20)	15 (20)	(15-20)	20	20	(20)	20	(20)	x	x	x	(15)	

WESTERN UNITED STATES TO:												
Central America	South America	Western Europe	South Africa	Eastern Europe	Middle East	India/Pakistan	Far East/ Japan	Southeast Asia	Australia	Alaska	Hawaii	Eastern USA
(10) 17	(15) 20	(15) 20	20	(20)	(20)	(20)	(20)	(20)	(10-20)	(10-15)	(15-20)	
(10-20)	(10) 17	15-20	(15) 20	(20)	(20)	(20)	(15)	(15)	x	(15)	(10-15)	
(15-20)	(20)	20	(20)	x	x	x	(20)	(15)	(15)	(20)	(15-20)	
x	x	x	(20)	(20)	x	x	(20)	(20)	(15)	x	x	
(20)	(15-20)	(20)	(20)	x	x	x	(20)	x	x	x	(15-20)	
(20)	(15-20)	(15-20)	(20)	x	x	x	x	x	x	x	x	
x	x	(15)	(15)	x	x	x	(20)	x	(15)	x	x	
(15)	(15)	(20)	(20)	(20)	(20-40)	(20-40)	(20)	(20)	(15-20)	(15-20)	(15)	
x	x	(15)	(15)	x	(20)	(20)	(20)	(15-20)	(15-20)	(15)	x	
(10-15)	(10-15)	15	(15-20)	20	20	20	(20)	20	(20)	x	(15)	
(10) 40	(10) 40	(10) 40	(15) 40	(20) 40	(20) 40	(20-40)	20-40	(15) 40	(10) 40	(10) 40	(10) 40	
(10-15)	(10-20)	(10-20)	(15-20)	20	20	(20-40)	20 (40)	(20-40)	x	x	(10-15)	
(10) 30	(10) 30	(10) 40	(15) 40	(20) 40	(20) 40	(20-40)	(15-20)	(10) 20	(10-20)	(10-20)	(10) 20	

Table 1. Band, time, country chart. Plain numerals indicate bands which should be workable on Fair to Good (F-G) and Good (G) days. Numbers in parentheses indicate bands usually workable on Good (G) days only. Dual numbers indicate that the intervening bands should also be usable. When one number appears in parentheses, that end of the range will probably be open on Good (G) days only.

Band-by-Band Summary

10 and 12 Meters

Daytime absorption, causing weak signals, will increase as summer approaches. As always, follow the sun by working toward the east in the morning and the west during the afternoon. Look for a midafternoon peak in the southern hemisphere on 15 meters. Short-skip should range from 1,000 to 2,000 miles.

15 and 17 Meters

These bands will also weaken as summer approaches but will still remain workable for the most part. Peak times are as follows: midmorning to the east, just before and after local noon to the south, and from late afternoon through midevening to the west. Long paths across the equator on 17 meters are always a good bet at this time of year. Short-skip will average between 1,000 miles and 2,000 miles.

20 Meters

All times of the day should have openings to somewhere in the world on all but the worst days. The strongest signals are usually heard right after sunrise and again just before sunset. A late afternoon peak to the southeast may sometimes be noticed as well. In the evening, try working over the north pole or toward the south and west Pacific. Expect a short-skip of 500 to 2,000 miles during the day and 1,000 to 2,000 miles after dark.

30 and 40 Meters

These bands can be very strong between sunset and sunrise, but atmospheric noise from tropical storms will often limit your opportunities, especially on paths across the tropics. However, the best openings should still be found in the southern hemisphere. Some weaker daytime openings also may exist, but expect skip to be very short at 500-700 miles. After dark, expect skip to vary from 750 to 2,000 miles.

80 and 160 Meters

High static and weak signals are likely to prevent decent communications on most days. Peaks usually occur near midnight and again in the predawn hours but don't happen regularly. Expect short-skip to vary from 1,000 to 2,000 miles. 73

NEVER SAY DIE

continued from page 59

Bieler. Oh, yes, and Bob Beck, who showed us how to turn the Albert Einstein breakthrough from a carefully guarded secret \$100,000 treatment into a \$150 blood-purifying do-it-yourself-at-home deal.

How come we're not seeing a hint of all this in the media? Well, I'm fast-forwarding through Nexium ads in between the car ads on just about every TV show I tape. The pharmaceutical giants are spending billions to promote their drugs. That buys a lot of silence.

Thanks, Bob!

When I was eight years old, my parents took me along to dinner with their friends Bob and Mary Sullivan. This was in 1930 and Bob had a whole bunch of records and a record player. Bob played the *William Tell Overture* by Rossini, and then some Gilbert and Sullivan. It marked me for life.

I bought my first record when I was 12 — Strauss' *Tales from the Vienna Woods* and *The Blue Danube*. I played it on my folks' old Victrola. It was a dollar, which is about like \$20 today — for ten minutes of music. Yep, I still have that record out in the barn — along with a couple thousand other mostly classical 78s.

Every time we had dinner at Bob's house, I'd sit there and play his Gilbert and Sullivan records.

Then we moved to Washington DC and Bob moved to New York. That ended my music exposure. In those days there were no classical music radio stations.

When we also moved to Brooklyn a couple years later the occasional dinners with Bob and Mary continued, though now they had a couple of small kids. The Gilbert and Sullivan continued, too. It was a three-hour round trip by subway to their place, but I went there now and then to baby-sit for them — and listen to Bob's G&S records.

Soon, I'd learned the "Nightmare" song from *Iolanthe* and songs from *HMS Pinafore* and *The Mikado*.

In high school I joined the Savoyards club and we put on *The Mikado*, with me singing Koko. Later we put on *The Pirates of Penzance*, with me singing the part of Major General Stanley.

This love of classical music got me involved with manufacturing a hi-fi speaker, and, many years later, with publishing a music magazine.

So what's the point of this glimpse into my history? I was just remembering the enormous impact that Bob Sullivan

had on my life. First, with introducing me to classical music, then Gilbert and Sullivan, then he got me my first job in television as chief cameraman at WPIX, Channel 11, in New York City. I graduated from that to TV producer and director jobs in Dallas and Cleveland.

Now, my friend, how many kids, other than your own, have you had an impact on? If you have a passion for something, be sure to share it with youngsters. If you don't have a passion, get a life. Whether it's making ship models, flying model planes, painting, playing an instrument, or ham radio, share it with some kids.

Water

The Earth is 70% water. The body is 70% water. A cell is 70% water. DNA is 70% water. A coincidence?

Virtually all of us have been short-changing our bodies when it comes to water, and this eventually leads to painful results. One of the reasons for this is that our body lies to us, sending us confusing signals when it needs more water. The signals are there, it's just that we interpret them wrong.

The most common thirst signal is one of feeling hungry. Hey, I need a snack. Maybe a piece of candy or a cookie. Wrongo, big-time — you need a glass of water. Make that pure water please, and not that toxic mix coming out of your faucet.

Another signal that your body needs water is when you feel tired during the day. You don't need a little rest, you need water.

I keep glass bottles of water handy in my office, the kitchen, and in other handy spots around the house and usually down two 48-ounce bottles a day (12 glasses). How much water should you drink? The rule is to drink one half your weight in ounces. At 170 pounds I should drink at least 85 ounces. Which I do.

If you drink coffee or a cola, these are diuretic, so you need to drink two extra glasses of water for every glass of these poisonous drinks. Dr. Batman says that colas are increasing obesity, especially among children. The diet drinks are worse because aspartame breaks down in the body into chemicals which reduce the blood sugar to our brains, making us feel hungry and storing more sugar from our blood in our fat cells.

You can get the straight dope from the leading expert in the water field, Dr. Batmanghelidj (Dr. Batman). His book, *Your Body's Many Cries for Water*, is reviewed on page 17 of my *Wisdom* book.

Continued on page 62

Ad Sales

call

800-677-8838

Fluorides

The U.S. isn't the first country to fluoridate water. The Germans and Russians added fluorides to the drinking water of concentration camp prisoners to make them more docile and apathetic. It's also added to animals' drinking water to make them more docile.

Fluoridation is illegal in every European country except Ireland. California fruits and vegetables sprayed with fluoride-based pesticides can't be legally imported into any European country.

Are you and your family drinking this stuff? In all probability you are, unless you're distilling it first.

Time Agrees!

Time magazine had a seven-page article on health. Title: "Repairing The Damage." The lead paragraph said, "Ready to turn your life around? It's simple. Eat right. Quit smoking. Get fit. Watch your weight. Drink less. And take it easy. Think it's too late to reverse a lifetime of bad habits? The latest research will surprise you."

Which is exactly what I've been prescribing.

The article says that around 70% of chronic illnesses — diabetes, high blood pressure, and even cancer — can be warded off by a lifestyle change. I think it's more like 95% to 100%.

With over 50 million Americans smoking and over 75 million obese, we have a huge educational need to get these unfortunates to change their lifestyles before they kill themselves. Say, if suicide is illegal, how about slow suicide via smoking and eating too much food?

I was delighted to see *Time* backing me up on this. You can get the gory details of my health program in my *Secret Guide to Health*.

Military Fuelishness

With the military spending about \$1 per gallon for gas, and then spending an additional \$12 a gallon to deliver it to its vehicles, their fuel bill is up into the double-digit billions. Delivery via refueling planes ups the ante to \$18.50 a gallon. Army tanks get a fifth of a mile per gallon, so a ten mile drive for a tank costs \$650 just for the gas. This low gas mileage substantially reduces their operating range.

But it isn't just the cost of the fuel — 70% of the tonnage shipped before the Persian Gulf war was fuel. The extra time it took to ship all that fuel cost us a month's delay in getting ready.

In view of all these fuel storage and handling problems, one might think that the Joint Chiefs might be interested in pursuing the possibility of developing cold fusion power units that would eliminate all of their fuel problems. One would be totally wrong, of course. The idea of spending maybe five or ten million to bring cold fusion out of the laboratory and into production with the potential of saving tens of billions of dollars has not yet occurred to them.

And this makes sense when you remember that the route to the Joint Chiefs is through the military's promotion system. This is a system which promotes officers by seniority rather than accomplishments. Anyone in the military who has creative ideas or in any other way makes waves soon gets the message that they're never going to be promoted. The system makes sure that the top brass will fight any proposals for change.

Captain Billy Mitchell tried to convince the Navy that aircraft could sink ships — and was court-martialed for his trouble. My father served with Billy when he was stationed at Langley Air Force Base in Virginia, back when I was two years old. I understand that Billy had dinner with us several times, but I don't remember it, or much else from those early days. We had a Model T Ford and I remember the runningboard coming up to my chest.

Inventor Jim Patterson, who has all of the cold fusion patents so far issued, feels that he is just a few million dollars away from developing a reliable power unit ready for mass production. What he doesn't have is the money for this final step. The oil, coal, natural gas, and power companies, with trillions to lose, have managed to bring cold fusion development to a halt. Big surprise, eh?

Those Annoying Anomalies

When someone like Uri Geller comes along, the skeptics do everything they can to discredit him. Then, when he's tested by a group of scientists and found to be legit, they try to discredit the scientists as inept and sweep the whole thing under their mental carpets. Case closed.

Well-known and thoroughly tested psychics have received the same treatment, as did Edgar Cayce. Well, it goes on like that.

The scientific establishment is just as resistant to new ideas as the medical establishment, the political, and so on.

Both J.B. Rhine fifty years ago at Duke University and the Princeton PEAR labs recently have proven that telepathy, psychokinesis, and precognition are real, yet if you ask any mainstream scientist about this, he'll snicker. Dean Radin, in

his book *The Conscious Universe* (see a review on page 41 of my *Secret Guide to Wisdom*), leaves no doubt that these abilities of some people have been proven real.

The next big step ahead for scientists is to take off their blinders and learn more about these abilities, which those who have them tell us everyone has but isn't using. We need to learn more about how to use dowsing to find things, and remote viewing to see things ... including events in the past and future.

A hundred years ago, Besant and Leadbeater pioneered meditation as a microscope to look at the structure of atoms. Their book, *Occult Chemistry*, is still a marvel to read. Wait'll you read Stephen Phillips' *Extra-Sensory Perception of Quarks*, which tells all about it (page 10, my *Wisdom* book).

How was Nostradamus 500 years ago able to do such an incredible job of predicting future events? Wait'll you read the books by Dolores Canon on her *Conversations With Nostradamus* (page 46, my *Wisdom* book)!

We don't have to spend billions on a Hubble telescope in space when we could train people to use their extrasensory abilities to do an even better job.

Hmm, speaking of telescopes: One of the things astronomers wanted to do was set up a major telescope on the back of the moon. What a fantastic platform! No interfering light from Earth, and no atmosphere to fight. Gee, I wonder why nothing ever came of that? Maybe we didn't want to mess with the aliens and their enormous spaceship that's parked there. Or something.

Writing of anomalies, how about that crop pattern that appeared in a field right next to a British radio telescope last August. The surveillance cameras at the observatory detected no lights during the night in the field. The pattern was a close replica of a broadcast made from the thousand-foot dish at Arecibo, Puerto Rico, in 1974 that included a picture of a man, the double-helix DNA molecule, and the main chemical elements of life. The crop pattern was similar except that the man figure had a much larger head, silicon was added to the life element list, and the DNA was a triple helix.

No, there was no sign of any footprints in the field, and the crops were bent over in the usual interweaved pattern of non-man-made crop patterns. Art Bell had photos of the 1974 Arecibo transmission and the 2001 crop pattern on his Web site. Did it make any of the major media? Of course not.

Continued on page 64

Wise Up!

Here are some of my books which can change your life (if you'll let 'em). If the idea of being healthy, wealthy and wise interests you, start reading. Yes, you can be all that, but only when you know the secrets which I've spent a lifetime uncovering.

.....Wayne

The Secret Guide to Health: Yes, there really is a secret to regaining your health and adding 30 to 60 years of healthy living to your life. The answer is simple, but it means making some serious lifestyle changes. Will you be skiing the slopes of Aspen with me when you're 90 or doddering around a nursing home? Or pushing up daisies? No, I'm not selling any health products, but I can help you cure yourself of cancer, heart trouble, or any other illness. Get this new, 2001 expanded edition (156p). \$10 (#05)

The Secret Guide to Wealth: Just as with health, you'll find that you have been brainwashed by "the system" into a pattern of life that will keep you from ever making much money and having the freedom to travel and do what you want. I explain how anyone can get a dream job with no college, no résumé, and even without any experience. I explain how you can get someone to happily pay you to learn what you need to know to start your own business. \$5 (#03)

The Secret Guide to Wisdom: This is a review of around a hundred books that will boggle your mind and help you change your life. No, I don't sell these books. They're on a wide range of subjects and will help to make you a very interesting person. Wait'll you see some of the gems you've missed reading. You'll have plenty of fascinating stuff to talk about on the air. \$5 (#02)

The Bioelectrifier Handbook: This explains how to build or buy (\$155) a little electrical gadget that can help clean your blood of any virus, microbe, parasite, fungus or yeast. The process was discovered by scientists at the Albert Einstein College of Medicine, quickly patented, and hushed up. It's curing AIDS, hepatitis C, and a bunch of other serious illnesses. It's working miracles! The circuit can be built for under \$20 from the instructions in the book. \$10 (#01)

My WWII Submarine Adventures: Yes, I spent from 1943-1945 on a submarine, right in the middle of the war with Japan. We almost got sunk several times, and twice I was in the right place at the right time to save the boat. What's it really like to be depth charged? And what's the daily life aboard a submarine like? How about

the Amelia Earhart inside story? If you're near Mobile, please visit the Drum. \$5 (#10)

Wayne's Caribbean Adventures: My super budget travel stories - where I visit the hams and scuba dive most of the islands of the Caribbean. You'll love the special Liat fare which let me visit 11 countries in 21 days, diving all but one of the islands, Guadeloupe, where the hams kept me too busy with parties. \$5 (#12)

Cold Fusion Overview: This is both a brief history of cold fusion, which I predict will be one of the largest industries in the world in the 21st century, plus a simple explanation of how and why it works. This new field is going to generate a whole new bunch of billionaires, just as the personal computer industry did. \$5 (#20)

Cold Fusion Journal: They laughed when I predicted the PC industry growth in 1975. PCs are now the third largest industry in the world. The cold fusion ground floor is still wide open, but then that might mean giving up watching ball games. Sample: \$10 (#22)

Julian Schwinger: A Nobel laureate's talk about cold fusion—confirming its validity. \$2 (#24)

Dowsing: Yes, dowsing really does work. I explain how and why it works, opening a huge new area for scientific research with profound effects for humanity. \$2 (#84)

Improving State Government: Here are 24 ways that state governments can cut expenses enormously, while providing far better service. I explain how any government bureau or department can be gotten to cut it's expenses by at least 50% in three years and do it cooperatively and enthusiastically. I explain how, by applying a new technology, the state can make it possible to provide all needed services without having to levy any taxes at all! Read the book, run for your legislature, and let's get busy making this country work like its founders wanted it to. Don't leave this for "someone else" to do. \$5 (#30)

Mankind's Extinction Predictions: If any one of the experts who have written books predicting a soon-to-come catastrophe which will virtually wipe most of us out are right, we're in trouble. I explain the various disaster scenarios, like Nostradamus, who says the poles will soon shift (as they have several times in the past), wiping out 97% of mankind. Okay, so he's made a long string of past lucky guesses. The worst part of these predictions is the accuracy record of some of the experts - like Hapgood, Einstein, Snow, Noone, Felix, Strieber. \$5 (#31)

Moondoggle: After reading René's book, *NASA Mooned America*, I read everything I could find on our Moon landings. I watched the NASA videos, looked carefully at the photos, read the astronaut's biographies, and talked with readers who worked for

NASA. This book cites 45 good reasons I believe the whole Apollo program had to have been faked. \$5 (#32)

Classical Music Guide: A list of 100 CDs which will provide you with an outstanding collection of the finest classical music ever written. This is what you need to help you reduce stress. Classical music also raises youngster's IQs, helps plants grow faster, and will make you healthier. Just wait'll you hear some of Gotschalk's fabulous music! \$5 (#33)

The Radar Coverup: Is police radar dangerous? Ross Adey K6UI, a world authority, confirms the dangers of radio and magnetic fields, including our HTs and cell phones. \$3 (#34)

Three Gatto Talks: A prize-winning teacher explains what's wrong with American schools and why our kids are not being educated. Why are Swedish youngsters, who start school at 7 years of age, leaving our kids in the dust? Our kids are intentionally being dumbed down by our school system - the least effective and most expensive in the world. \$5 (#35)

Aspartame: a.k.a. NutraSweet, the stuff in diet drinks, etc., can cause all kinds of serious health problems. Multiple sclerosis, for one. Read all about it, two pamphlets for a buck. (#38)

\$1 Million Sales Video: The secret of how you can generate an extra million dollars in sales just by using PR. This will be one of the best investments you or your business will ever make. \$40 (#52)

Reprints of My Editorials from 73. Very few things in this world are as we've been taught, and as they appear. I blow the whistle on the scams around us, such as the health care, our school system, our money, the drug war, a college education, sugar, the food giants, our unhealthy food, fluorides, EMFs, NutraSweet, etc.

1996 Editorials: 120 pages, 100 choice editorials. \$10 (#72)

1997 Editorials: 148 fun-packed pages, 216 editorials. \$10 (#74)

1998 Editorials: 168 pages that'll give you lots of controversial things to talk about on the air. \$10 (#75)

1999 Editorials: 132 pages of ideas, book reviews, health, education, and

anything else I think you ought to know about. \$10 (#76)

2000 Editorials: 76 pages (thinner magazine as a result of our slowly dying hobby) \$5 (#77)

Silver Wire: With two 5-in. pieces of heavy pure silver wire + three 9V batteries you can make a thousand dollars worth of silver colloid. What do you do with it? It does what the antibiotics do, but germs can't adapt to it. Use it to get rid of germs on food, for skin fungus, warts, and even to drink. Read some books on the uses of silver colloid, it's like magic. \$15 (#80)

Silver Colloid Reprint. April 97 article on a silver colloid maker, history, and how to use the stuff. \$5 (#98)

Colloid Kit. Three 9V battery clips, 2 alligator clips & instructions. \$5 (#99)

Wayne's Bell Saver Kit. The cable and instructions enabling you to inexpensively tape Art Bell W6OBB's nightly 5-hr radio talk show. \$5 (#83)

73 Writer's Guide: It's easy, fun, can pad your résumé, and impress the hell out of your friends. \$0 (#78)

Cold Fusion Six-Pack: Six Cold Fusion Journal back issues to bring you up to speed. \$20 (#19)

NASA Mooned America: René makes an air-tight case that NASA faked the Moon landings. This book will convince even you. \$30 (#90)

Last Skeptic of Science: This is René's book where he debunks a bunch of accepted scientific beliefs - such as the ice ages, the Earth being a magnet, the Moon causing the tides, etc. \$30 (#91)

Dark Moon: 568 pages of carefully researched proof that the Apollo Moon landings were a hoax—a capping blow for René's skeptics. \$35 (#92)

Dark Moon Video: 222-minute exposé nailing NASA with their own photos. If you've watched the NASA films of the astronauts walking on the Moon you wondered at their weird gait. Wait'll you see it speeded up. It looks exactly like they're running on Earth! They catch NASA in dozens of giveaways that the photos and films had to have been faked. \$46 (#93)

Radio Bookshop

Box 416, Hancock NH 03449

Name _____ Call _____

Address _____

City-State-Zip _____

Use the numbers in the brackets or copy page and mark the books you want. Add \$3 s/h per total order in US (\$5 priority mail), \$6 Can, \$10 foreign.

Order total: US\$ _____ Phone (for CC orders) _____

MC/Visa for orders over \$10. # _____ Expire _____
www.waynegrreen.com • phone orders: 603-588-0107 • fax: 603-588-3205 • w2nsd@aol.com

- Yes! Put me down for a year of 73 for only \$25 (a steal). Canada US\$32. Foreign US\$44 by sea.
- I need some industrial strength stress reduction so send me your Adventures In Music CD catalog. Allow 4 weeks for delivery except foreign, though we try to get most orders shipped in a day or two. Your e-mail address: _____

Barter 'n' Buy

Turn your old ham and computer gear into cash now. Sure, you can wait for a hamfest to try and dump it, but you know you'll get a far more realistic price if you have it out where 100,000 active ham potential buyers can see it, rather than the few hundred local hams who come by a flea market table. Check your attic, garage, cellar and closet shelves and get cash for your ham and computer gear before it's too old to sell. You know you're not going to use it again, so why leave it for your widow to throw out? That stuff isn't getting any younger!

The 73 Flea Market, Barter 'n' Buy, costs you peanuts (almost) — comes to 35 cents a word for individual (noncommercial!) ads and \$1.00 a word for commercial ads. Don't plan on telling a long story. Use abbreviations, cram it in. But be honest. There are plenty of hams who love to fix things, so if it doesn't work, say so.

Make your list, count the words, including your call, address and phone number. Include a check or your credit card number and expiration. If you're placing a commercial ad, include an additional phone number, separate from your ad.

This is a monthly magazine, not a daily newspaper, so figure a couple months before the action starts; then be prepared. If you get too many calls, you priced it low. If you don't get many calls, too high.

So get busy. Blow the dust off, check everything out, make sure it still works right and maybe you can help make a ham newcomer or retired old timer happy with that rig you're not using now. Or you might get busy on your computer and put together a list of small gear/parts to send to those interested?

Send your ads and payment to: 73 Magazine, Barter 'n' Buy, 70 Hancock Rd., Peterborough NH 03458 and get set for the phone calls. The deadline for the July 2002 classified ad section is May 10, 2002.

220 MHz Award; see W9CYT on WWW.QRZ.COM for information. BNB645

K8CX HAM GALLERY [<http://hamgallery.com>]. BNB620

TELEGRAPH COLLECTOR'S PRICE GUIDE: 250 pictures/prices. \$12 postpaid. **ARTIFAX BOOKS**, Box 88, Maynard MA 01754. Telegraph Museum: [<http://w1tp.com>]. BNB113

New miniature oscillator modules are now available ... all under \$20 ... plus our great reference book is still for sale. Write to **RMT Engineering**, 6863 Buffham Road, Seville OH 44273 or see our Web site at [www.ohio.net/~rtormet/index.html/]. BNB640

RF TRANSISTORS TUBES 2SC2879, 2SC1971, 2SC1972, MRF247, MRF455, MB8719, 2SC1307, 2SC2029, MRF454, 2SC3133, 4CX250B, 12DQ6, 6KG6A, etc. **WESTGATE**, 1-800-213-4563. BNB6000

METHOD TO LEARN MORSE CODE FAST AND WITHOUT HANGUPS Johan N3RF. Send \$1.00 & SASE. **SVANHOLM RESEARCH LABORATORIES**, P.O. Box 81, Washington DC 20044 USA. BNB421

Cash for Collins: Buy any Collins Equipment. **Leo KJ6HI**. Tel./FAX (310) 670-6969. [radioleo@earthlink.net]. BNB425

Browse our Web site and check out the "Monthly Special." TDL Technology, Inc. [www.zianet.com/tdl/]. BNB500

MAHLON LOOMIS, INVENTOR OF RADIO, by Thomas Appleby (copyright 1967). Second printing available from **JOHAN K.V. SVANHOLM N3RF**, SVANHOLM RESEARCH LABORATORIES, P.O. Box 81, Washington DC 20044. Please send \$25.00 donation with \$5.00 for S&H. BNB420

Ham Radio Repair, Quality workmanship. All Brands, Fast Service. **Affordable Electronics**, 7110 E. Thomas Rd., Scottsdale, AZ 85251. Call 480-970-0963, or E-mail [HAM_SERVICE@AOL.COM]. BNB427

SATELLITE TV — Large selection of items at reasonable prices. We specialize in Big Dish TVRO C & Ku Band equipment. Check us out at [www.daveswebshop.com]. BNB646

HEATHKIT COMPANY is selling photocopies of most Heathkit manuals. Only authorized source for copyright manuals. **Phone:** (616) 925-5899, 8-4 ET. BNB964

"MORSE CODE DECIPHERED" Simple, elegant, inexpensive, comprehensive, logical, easy! E-mail [judlind@earthlink.net]. BNB428

Electricity, Magnetism, Gravity, The Big Bang. New explanation of basic forces of nature in this 91-page book covering early scientific theories and exploring latest controversial conclusions on their relationship to a unified field theory. To order, send check or money order for \$16.95 to: American Science Innovations, P.O. Box 155, Clarington OH 43915. Web site for other products [http://www.asi_2000.com]. BNB100

COLLOIDAL SILVER GENERATOR! Why buy a "box of batteries" for hundreds of dollars? Current regulated, AC powered, fully assembled with #12 AWG silver electrodes, \$74.50. Same, but DC powered, \$54.50. Add \$2.50 shipping. **Thomas Miller**, 216 East 10th St., Ashland OH 44805. Web address [www.bioelectrifier.com]. BNB342

COLD FUSION! - FUEL CELL! - ELECTRIC BICYCLE! Each educational kit: (Basic - \$99.95, Deluxe - \$199.95, Information - \$9.95) CATALOG - \$5.00. **ELECTRIC AUTOMOBILE BOOK** - \$19.95. **KAYLOR-KIT**, POB 1550ST, Boulder Creek CA 95006-1550. (831) 338-2300. BNB128

ANTENNA SCIENCE: Why do antennas radiate electromagnetic waves? Learn for yourself from this enlightening paper by **MAX RESEARCH**. Gain an understanding of the radiation mechanism of antennas! Written in a clear style for radio hobbyists, inquisitive amateurs and experimenters. \$4.95 ... ppd. Order from **MAX RESEARCH**, P.O. Box 1306, East Northport NY 11731. BNB426

DWM COMMUNICATIONS - Neat stuff! SASE brings catalog! POB 87-BB, Hanover MI 49241. BNB641

FOR SALE — **DRAKE TR-7/R-7** 13 Extender Boards and Digital Jumper Card for servicing. See <http://users.atnet.net/~rsrolfne>. \$63.50 includes postage. **Bob W7AVK**, 2327 Malaga Road NE, Moses Lake, WA 98837, email: w7avk@arll.net. BNB647

W1TP TELEGRAPH MUSEUM AT DAYTON HAMFEST Space 2555: History, Information, Appraisals, Pretzels! Buying, Trading, Selling. <http://w1tp.com> BNB651

SMART BATTERY CHARGERS and more, [www.a-engineering.com] BNB653

NEUER SAY DIE

continued from page 62

Progress

Life in America for most people wasn't a great deal different in 1901 than it was in 1801. The industrial revolution had just begun, so around 90% were living on farms.

The average life expectancy was 47, with pneumonia and influenza the leading causes of death, followed by tuberculosis and then diarrhea.

There were only 8,000 cars and 144 miles of paved roads. Our larger cities were up to here in horse poop.

Only 14% of homes had a bathtub. The average wage was 22 cents an hour.

Well, we all know what it's like today, but we can't even begin to guess what our country will be like in 2101, any more than anyone in 1901 could have in their wildest imagination have foreseen SSTs, ICs, PCs, the Internet, nukes, faxes, cell phones, cars with global positioning maps built-in, and all the other stuff we take for granted. 73