

June 2000
Issue #475
USA \$3.95
Canada \$4.95

THE NEW! **Amateur 73 Radio Today**

Inside

**Confessions of
a Super Geek**

TV Tuner Magic

**A Ham Bench
for Dummies**

Reviews

• **Kenwood
TM-D700A**

• **Am-Com
ClearSpeech
Speaker**

On the cover: see page 53

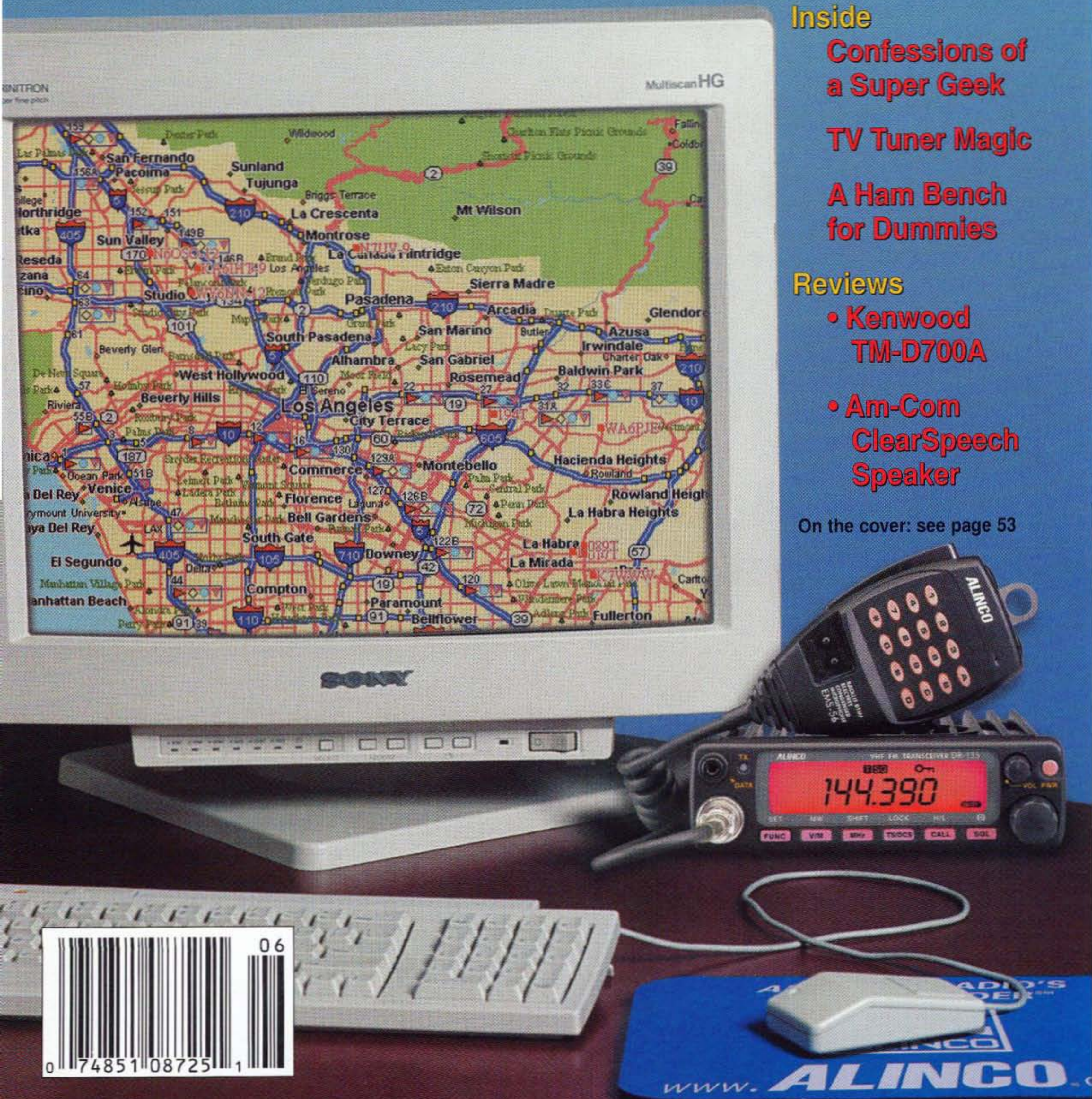

DR-135TP. Two Meters. Features Not Seen Before.

INTERNAL TNC FOR PACKET AND APRS®

actual size



- Choose black (DR-135TP) or pewter (DR-135TPG) front panel color
- DR-135T can be purchased without TNC; EJ-41U TNC board can be added later
- 50 watts, H/M/L power settings
- 100 memory channels
- TNC board operates 1200 and 9600 bps
- Front panel GPS input for APRS
- Rear panel DSUB9 computer connection
- No need to remove mic for packet operation
- Ignition key on/off feature
- CTCSS and DCS encode+decode
- Clean, clear Alinco audio
- Super-wide 7 character alphanumeric display
- Wide and narrow FM modes
- Theft alarm feature
- AM airband receive
- Backlit microphone
- Stays in mode you select (voice/packet) through power off cycles
- Ten autodial memories
- Low Alinco price

WWW.**ALINCO**.com

U.S.A. Alinco Branch: 438 Amapola Ave. • Suite 130 • Torrance, CA 90501

Product intended for properly licensed operators. Permits required for MARS/CAP use. Specifications subject to change without notice or obligation.

Performance specifications only apply to amateur bands. APRS is a registered trademark of Bob Bruninga, WB4APR.

This radio has not yet been type accepted by the FCC. It may not be offered for sale or lease until the approval of the FCC has been obtained.

THE TEAM

JUNE 2000
ISSUE #475

El Supremo & Founder
Wayne Green W2NSD/1

Associate Publisher
F. I. Marion

Executive Editor
Jack Burnett

Managing Editor
Joyce Sawtelle

Technical Editor
Larry Antonuk WB9RRT

Contributing Culprits
Mike Bryce WB8VGE
Jim Gray W1XU/7
Jack Heller KB7NO
Chuck Houghton WB6IGP
Andy MacAllister W5ACM
Joe Moell K0OV
Steve Nowak KE8YN/5
Dr. Rick Olsen N6NR

Advertising Sales
Evelyn Garrison WS7A
21704 S.E. 35th St.
Issaquah WA 98029
425-557-9611
Fax: 425-557-9612

Circulation
Frances Hyvarinen

Data Entry & Other Stuff
Norman Marion

Business Office
Editorial - Advertising - Circulation
Feedback - Product Reviews
73 Amateur Radio Today Magazine
70 Hancock Rd.
Peterborough NH 03458-1107
603-924-0058
Fax: 603-924-8613

Reprints: \$3 per article
Back issues: \$5 each

Printed in the USA

Manuscripts: Contributions for possible publication are most welcome. We'll do the best we can to return anything you request, but we assume no responsibility for loss or damage. Payment for submitted articles will be made after publication. Please submit both a disk and a hard copy of your article [IBM (ok) or Mac (preferred) formats], carefully checked drawings and schematics, and the clearest, best focused and lighted photos you can manage. "How to write for 73" guidelines are available on request. US citizens, please include your Social Security number with submitted manuscripts so we can submit it to you know who.

THE NEW!

73 Amateur Radio Today

TABLE OF CONTENTS

FEATURES

- 10 **Ah, the Technomadic Life! — N4RVE**
This special to 73 on mobiling is ... well ... special.
- 18 **Electronics Bench for Dummies — N2XS**
And it doesn't take an Einstein to know how important a good bench — like this one — really is.
- 24 **Tuner King Strikes Again — W6WTU**
Part 1: Make a basic VHF/UHF signal source from your TV/VCR tuner.
- 28 **Well, Not Exactly — K5CW**
Some of the finer points about using your o'scope.

DEPARTMENTS

- WB6IGP 54 Above & Beyond
49 Ad Index
64 Barter 'n' Buy
36 Calendar Events
KB7NO 46 The Digital Port
N6NR 42 The DX Forum
W5ACM 51 Hamsats
8 Letters
W2NSD/1 4 Never Say Die
48 New Products
53 On the Cover
KE8YN/4 57 On the Go
W1XU/7 60 Propagation
1, 6 QRX
63 Radio Bookshop

REVIEWS

- 31 **Straight Talk about ClearSpeech — AA6JR**
This Am-Com speaker gets a "B" from the reviewer — but also gets kept.
- 38 **Exploring the Kenwood TM-D700A — KE8YN/4**
Part 2: A rig for all seasons.

E-Mail

design73@aol.com

Web Page

www.waynegr.com

QRX . . .

Dayton Winners Announced

It must be getting close. Dayton Hamvention 2000 has announced their Year 2000 award winners — another great group.

Amateur of the Year has been awarded to Martti Laine OH2BH. Martti is well known in the international amateur radio community as our #1 Ambassador of Good Will. He has been responsible for promoting the activation of new DXCC countries, traveling under difficult and often dangerous conditions to promote the hobby worldwide. Additionally, Martti is the only person to be inducted into the CQ DX Hall of Fame as well as the CQ Contest Hall of Fame.

The Technical Excellence award will go to Dr. H. Paul Shuch D6TX. Paul is being honored for his pioneering work in the 1970s in VHF, UHF, and microwave receiver design; and for his recent design of amateur radio astronomy equipment for the 21-cm hydrogen line region.

Special Achievement will be recognized by Prose Walker W4BW. Prose is being honored for his early involvement in developing the concept of obtaining new amateur frequency bands. Prose first went public with this concept in a speech to the Swiss Amateur Society in Geneva, Switzerland, in 1974. Additionally, Prose was the guiding force behind the development of ACAR

Continued on page 6

73 Amateur Radio Today (ISSN 1052-2522) is published monthly by 73 Magazine, 70 N202, Peterborough NH 03458-1107. The entire contents ©2000 by 73 Magazine. No part of this publication may be reproduced without written permission of the publisher, which is not all that difficult to get. The subscription rate is: one year \$24.97, two years \$44.97; Canada: one year \$34.21, two years \$57.75, including postage and 7% GST. Foreign postage: \$19 surface, \$42 airmail additional per year, payable in US funds on a US bank. Second class postage is paid at Peterborough, NH, and at additional mailing offices. Canadian second class mail registration #178101. Canadian GST registration #125393314. Microfilm edition: University Microfilm, Ann Arbor MI 48106. POSTMASTER: Send address changes to **73 Amateur Radio Today**, 70 Hancock Rd., Peterborough NH 03458-1107. 73 Amateur Radio Today is owned by Shabromat Way Ltd. of Hancock NH.



...POWER ON WITH ASTRON

SWITCHING POWER SUPPLIES...



MODEL SS-10TK



MODEL SS-12IF

SPECIAL FEATURES:

- HIGH EFFICIENCY SWITCHING TECHNOLOGY SPECIFICALLY FILTERED FOR USE WITH COMMUNICATIONS EQUIPMENT, FOR ALL FREQUENCIES INCLUDING HF
- HEAVY DUTY DESIGN
- LOW PROFILE, LIGHT WEIGHT PACKAGE
- EMI FILTER
- MEETS FCC CLASS B

PROTECTION FEATURES:

- CURRENT LIMITING
- OVERVOLTAGE PROTECTION
- FUSE PROTECTION
- OVER TEMPERATURE SHUTDOWN

SPECIFICATIONS:

INPUT VOLTAGE: 115 VAC 50/60HZ
OR 220 VAC 50/60HZ
SWITCH SELECTABLE

OUTPUT VOLTAGE: 13.8VDC

AVAILABLE WITH THE FOLLOWING APPROVALS: UL, CUL, CE, TUV.



MODEL SS-18

DESKTOP SWITCHING POWER SUPPLIES

MODEL	CONT. (Amps)	ICS	SIZE (inches)	Wt.(lbs.)
SS-10	7	10	1 1/2 x 6 x 9	3.2
SS-12	10	12	1 1/2 x 6 x 9	3.4
SS-18	15	18	1 1/2 x 6 x 9	3.6
SS-25	20	25	2 1/4 x 7 x 9 1/2	4.2
SS-30	25	30	3 1/4 x 7 x 9 1/2	5.0



MODEL SS-25M

DESKTOP SWITCHING POWER SUPPLIES WITH VOLT AND AMP METERS

MODEL	CONT. (Amps)	ICS	SIZE (inches)	Wt.(lbs.)
SS-25M*	20	25	2 1/4 x 7 x 9 1/2	4.2
SS-30M*	25	30	3 1/4 x 7 x 9 1/2	5.0



MODEL SRM-30

RACKMOUNT SWITCHING POWER SUPPLIES

MODEL	CONT. (Amps)	ICS	SIZE (inches)	Wt.(lbs.)
SRM-25	20	25	3 1/2 x 19 x 9 1/2	6.5
SRM-30	25	30	3 1/2 x 19 x 9 1/2	7.0

WITH SEPARATE VOLT & AMP METERS

MODEL	CONT. (Amps)	ICS	SIZE (inches)	Wt.(lbs.)
SRM-25M	20	25	3 1/2 x 19 x 9 1/2	6.5
SRM-30M	25	30	3 1/2 x 19 x 9 1/2	7.0

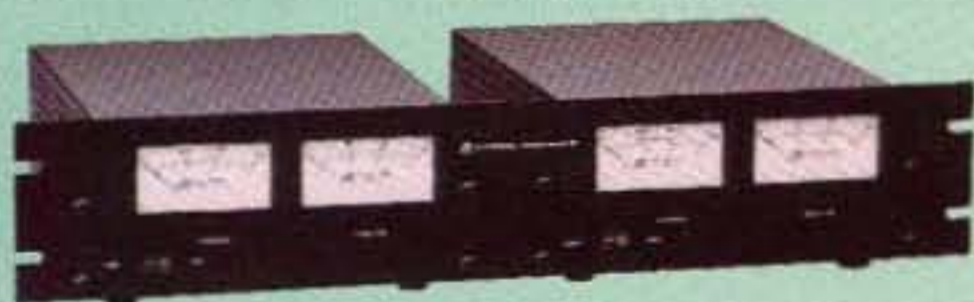

MODEL SRM-30M-2

2 ea SWITCHING POWER SUPPLIES ON ONE RACK PANEL

MODEL	CONT. (Amps)	ICS	SIZE (inches)	Wt.(lbs.)
SRM-25-2	20	25	3 1/2 x 19 x 9 1/2	10.5
SRM-30-2	25	30	3 1/2 x 19 x 9 1/2	11.0

WITH SEPARATE VOLT & AMP METERS

MODEL	CONT. (Amps)	ICS	SIZE (inches)	Wt.(lbs.)
SRM-25M-2	20	25	3 1/2 x 19 x 9 1/2	10.5
SRM-30M-2	25	30	3 1/2 x 19 x 9 1/2	11.0



MODEL SS-12SM/GTX



MODEL SS-10EFJ-98

CUSTOM POWER SUPPLIES FOR RADIOS BELOW

- EF JOHNSON AVENGER GX-MC41
- EF JOHNSON AVENGER GX-MC42
- EF JOHNSON GT-ML81
- EF JOHNSON GT-ML83
- EF JOHNSON 9800 SERIES
- GE MARC SERIES
- GE MONOGRAM SERIES & MAXON SM-4000 SERIES
- ICOM IC-F11020 & IC-F2020
- KENWOOD TK760, 762, 840, 860, 940, 941
- KENWOOD TK760H, 762H
- MOTOROLA LOW POWER SM50, SM120, & GTX
- MOTOROLA HIGH POWER SM50, SM120, & GTX
- MOTOROLA RADIUS & GM 300
- MOTOROLA RADIUS & GM 300
- MOTOROLA RADIUS & GM 300
- UNIDEN SMH1525, SMU4525
- VERTEX — FTL-1011, FT-1011, FT-2011, FT-7011

NEW SWITCHING MODELS

- SS-10GX, SS-12GX
- SS-18GX
- SS-12EFJ
- SS-18EFJ
- SS-10-EFJ-98, SS-12-EFJ-98, SS-18-EFJ-98
- SS-12MC
- SS-10MG, SS-12MG
- SS-101F, SS-121F
- SS-10TK
- SS-12TK OR SS-18TK
- SS-10SM/GTX
- SS-10SM/GTX, SS-12SM/GTX, SS-18SM/GTX
- SS-10RA
- SS-12RA
- SS-18RA
- SS-10SMU, SS-12SMU, SS-18SMU
- SS-10V, SS-12V, SS-18V



Doppler Direction Finder

Track down jammers and hidden transmitters with ease! This is the famous WA2EBY DF'er featured in April 99 QST. Shows direct bearing to transmitter on compass style LED display, easy to hook up to any FM receiver. The transmitter - the object of your DF'ing - need not be FM, it can be AM, FM or CW. Easily connects to receiver's speaker jack and antenna, unit runs on 12 VDC. We even include 4 handy home-brew "mag mount" antennas and cable for quick set up and operation! Whips can be cut and optimized for any frequency from 130-1000 MHz. Track down that jammer, win that fox hunt, zero in on that downed Cessna - this is an easy to build, reliable kit that compares most favorably to commercial units costing upwards of \$1000.00! This is a neat kit!!

DDF-1, Doppler Direction Finder Kit \$149.95

Wireless RF Data Link Modules

RF link boards are perfect for any wireless control application; alarms, data transmission, electronic monitoring...you name it. Very stable SAW resonator transmitter, crystal controlled receiver - no frequency drift! Range up to 600 feet, license free 433 MHz band. Encoder/decoder units have 12 bit Holtek HT-12 series chips allowing multiple units all individually addressable, see web site for full details. Super small size - that's a quarter in the picture! Run on 3-12 VDC. Fully wired and tested, ready to go and easy to use!

RX-433 Data Receiver..... \$16.95 TX-433 Data Transmitter..... \$14.95
RXD-433 Receiver/Decoder..... \$21.95 TXE-433 Transmitter/Encoder..... \$19.95

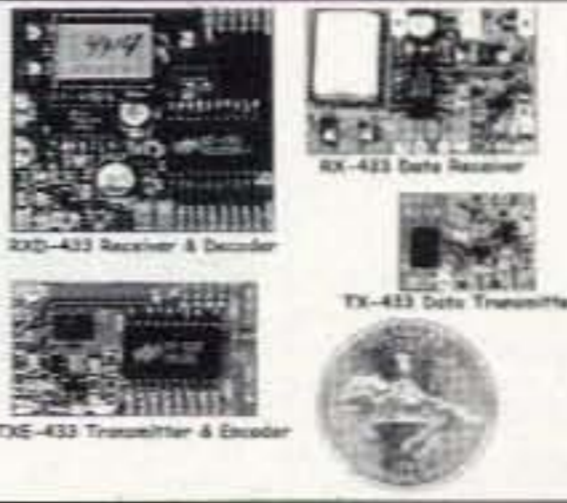

World's Smallest TV Transmitters



We call them the 'Cubes'.... Perfect video transmission from a transmitter you can hide under a quarter and only as thick as a stack of four pennies - that's a nickel in the picture! Transmits color or B&W with fantastic quality - almost like a direct wired connection to any TV tuned to cable channel 59. Crystal controlled for no frequency drift with performance that equals models that cost hundreds more! Basic 20 mW model transmits up to 300' while the high power 100 mW unit goes up to 1/4 mile. Their very light weight and size make them ideal for balloon and rocket launches, R/C models, robots - you name it! Units run on 9 volts and hook-up to most any CCD camera or standard video source. In fact, all of our cameras have been tested to mate perfectly with our Cubes and work great. Fully assembled - just hook-up power and you're on the air! One customer even put one on his dog!

C-2000, Basic Video Transmitter.....\$89.95 C-2001, High Power Video Transmitter...\$179.95

CCD Video Cameras

Top quality Japanese Class 'A' CCD array, over 440 line line resolution, not the off-spec arrays that are found on many other cameras. Don't be fooled by the cheap CMOS single chip cameras which have 1/2 the resolution, 1/4 the light sensitivity and draw over twice the current! The black & white models are also super IR (Infra-Red) sensitive. Add our invisible to the eye, IR-1 illuminator kit to see in the dark! Color camera has Auto gain, white balance, Back Light Compensation and DSP! Available with Wide-angle (80°) or super slim Pin-hole style lens. Run on 9 VDC, standard 1 volt p-p video. Use our transmitters for wireless transmission to TV set, or add our IB-1 Interface board kit for super easy direct wire hook-up to any Video monitor, VCR or TV with A/V input. Fully assembled, with pre-wired connector.

CCDWA-2, B&W CCD Camera, wide-angle lens \$69.95
CCDPH-2, B&W CCD Camera, slim fit pin-hole lens... \$69.95
CCDCC-1, Color CCD Camera, wide-angle lens \$129.95
IR-1, IR Illuminator Kit for B&W cameras \$24.95
IB-1, Interface Board Kit \$14.95

AM Radio Transmitter

Operates in standard AM broadcast band. Pro version, AM-25, is synthesized for stable, no-drift frequency and is settable for high power output where regulations allow, typical range of 1-2 miles. Entry-level AM-1 is tunable, runs FCC maximum 100 mW, range 1/4 mile. Both accept line-level inputs from tape decks, CD players or mike mixers, run on 12 volts DC. Pro AM-25 includes AC power adapter, matching case and bottom loaded wire antenna. Entry-level AM-1 has an available matching case and knob set that dresses up the unit. Great sound, easy to build - you can be on the air in an evening!

AM-25, Professional AM Transmitter Kit. . . . \$129.95
AM-1, Entry level AM Radio Transmitter Kit. . . \$29.95
CAM, Matching Case Set for AM-1..... \$14.95

Mini Radio Receivers

Imagine the fun of tuning into aircraft a hundred miles away, the local police/fire department, ham operators, or how about Radio Moscow or the BBC in London? Now imagine doing this on a little radio you built yourself - in just an evening! These popular little receivers are the nuts for catching all the action on the local ham, aircraft, standard FM broadcast radio, shortwave or WWV National Time Standard radio bands. Pick the receiver of your choice, each easy to build, sensitive receiver has plenty of crystal clear audio to drive any speaker or earphone. Easy one evening assembly, run on 9 volt battery, all have squelch except for shortwave and FM broadcast receiver which has subcarrier output for hook-up to our SCA adapter. The SCA-1 will tune in commercial-free music and other "hidden" special services when connected to FM receiver. Add our snazzy matching case and knob set for that smart finished look!

AR-1, Airband 108-136 MHz Kit..... \$29.95 FR-6, 6 Meter FM Ham Band Kit \$34.95
HFRC-1, WWV 10 MHz (crystal controlled) Kit \$34.95 FR-10, 10 Meter FM Ham Band Kit..... \$34.95
FR-1, FM Broadcast Band 88-108 MHz Kit \$24.95 FR-146, 2 Meter FM Ham Band Kit..... \$34.95
SR-1, Shortwave 4-11 MHz Band Kit \$29.95 FR-220, 220 MHz FM Ham Band Kit..... \$34.95
SCA-1 SCA Subcarrier Adapter kit for FM radio. . . \$27.95 Matching Case Set (specify for which kit) . . . \$14.95

PIC-Pro Pic Chip Programmer

Easy to use programmer for the PIC16C84, 16F84, 16F83 microcontrollers by Microchip. All software - editor, assembler, run and program - as well as free updates available on Ramsey download site! This is the popular unit designed by Michael Covington and featured in Electronics Now, September 1998. Connects to your parallel port and includes the great looking matching case, knob set and AC power supply. Start programming those really neat microcontrollers now...order your PICPRO today!

PIC-1, PICPRO PIC Chip Programmer Kit \$59.95



1 GHz RF Signal Generator



A super price on a full featured RF signal generator! Covers 100 KHz to 999.99999 MHz in 10 Hz steps. Tons of features; calibrated AM and FM modulation, 90 front panel memories, built-in RS-232 interface, +10 to -130 dBm output and more! Fast and easy to use, its

big bright vacuum fluorescent display can be read from anywhere on the bench and the handy 'smart-knob' has great analog feel and is intelligently enabled when entering or changing parameters in any field - a real time saver! All functions can be continuously varied without the need for a shift or second function key. In short, this is the generator you'll want on your bench, you won't find a harder working RF signal generator - and you'll save almost \$3,000 over competitive units!

RSG-1000B RF Signal Generator \$1995.00

Super Pro FM Stereo Transmitter



Professional synthesized FM Stereo station in easy to use, handsome cabinet. Most radio stations require a whole equipment rack to hold all the features we've packed into the FM-100. Set freq with Up/Down buttons, big LED display. Input low pass filter gives great sound (no more squeals or swishing from cheap CD inputs!) Limiters for max 'punch' in audio - without over mod. LED meters to easily set audio levels, built-in mixer with mike, line level inputs. Churches, drive-ins, schools, colleges find the FM-100 the answer to their transmitting needs, you will too. Great features, great price! Kit includes cabinet, whip antenna, 120 VAC supply. We also offer a high power export version of the FM-100 fully assembled with one watt of RF power, for miles of program coverage. The export version can only be shipped if accompanied by a signed statement that the unit will be exported.

FM-100, Pro FM Stereo Transmitter Kit \$249.95
FM-100WT, Fully Wired High Power FM-100..... \$399.95

FM Stereo Radio Transmitters



No drift, microprocessor synthesized! Great audio quality, connect to CD player, tape deck or mike mixer and you're on-the-air. Strapable for high or low power! Runs on 12 VDC or 120 VAC. Kit includes snazzy case, whip antenna, 120 VAC power adapter - easy one evening assembly.

FM-25, Synthesized Stereo Transmitter Kit \$129.95

Lower cost alternative to our high performance transmitters. Great value, easily tunable, fun to build. Manual goes into great detail about antennas, range and FCC rules. Handy for sending music thru house and yard, ideal for school projects too - you'll be amazed at the exceptional audio quality! Runs on 9V battery or 5 to 15 VDC. Add matching case and whip antenna set for nice 'pro' look.

FM-10A, Tunable FM Stereo Transmitter Kit..... \$34.95
CFM, Matching Case and Antenna Set \$14.95
FMAC, 12 Volt DC Wall Plug Adapter \$9.95

RF Power Booster



Add muscle to your signal, boost power up to 1 watt over a freq range of 100 KHz to over 1000 MHz! Use as a lab amp for signal generators, plus many foreign users employ the LPA-1 to boost the power of their FM transmitters, providing radio service through an entire town. Runs on 12 VDC. For a neat finished look, add the nice matching case set. Outdoor unit attaches right at the antenna for best signal - receiving or transmitting, weatherproof, too!

LPA-1, Power Booster Amplifier Kit \$39.95
CLPA, Matching Case Set for LPA-1 Kit \$14.95
LPA-1WT, Fully Wired LPA-1 with Case \$99.95
FMBA-1, Outdoor Mast Mount Version of LPA-1 \$59.95

FM Station Antennas

For maximum performance, a good antenna is needed. Choose our very popular dipole kit or the Comet, a factory made 5/8 wave colinear model with 3.4 dB gain. Both work great with any FM receiver or transmitter.

TM-100, FM Antenna Kit \$39.95
FMA-200, Vertical Antenna \$114.95

RAMSEY ELECTRONICS, INC.

793 Canning Parkway Victor, NY 14564

See our complete catalog and order on-line with our secure server at:

www.ramseyelectronics.com

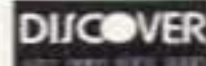
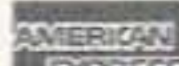
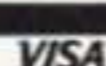

ORDERING INFO: Satisfaction Guaranteed. Examine for 10 days, if not pleased, return in original form for refund. Add \$6.95 for shipping, handling and insurance. Orders under \$20, add \$3.00. NY residents add 7% sales tax. Sorry, no CODs. Foreign orders, add 20% for surface mail or use credit card and specify shipping method.

Order Toll-free: 800-446-2295

Sorry, no tech info, or order status at 800 number

For Technical Info, Order Status
Call Factory direct: 716-924-4560

NEVER SAY DIE

Wayne Green W2NSD/1

w2nsd@aol.com
www.wayngreen.com

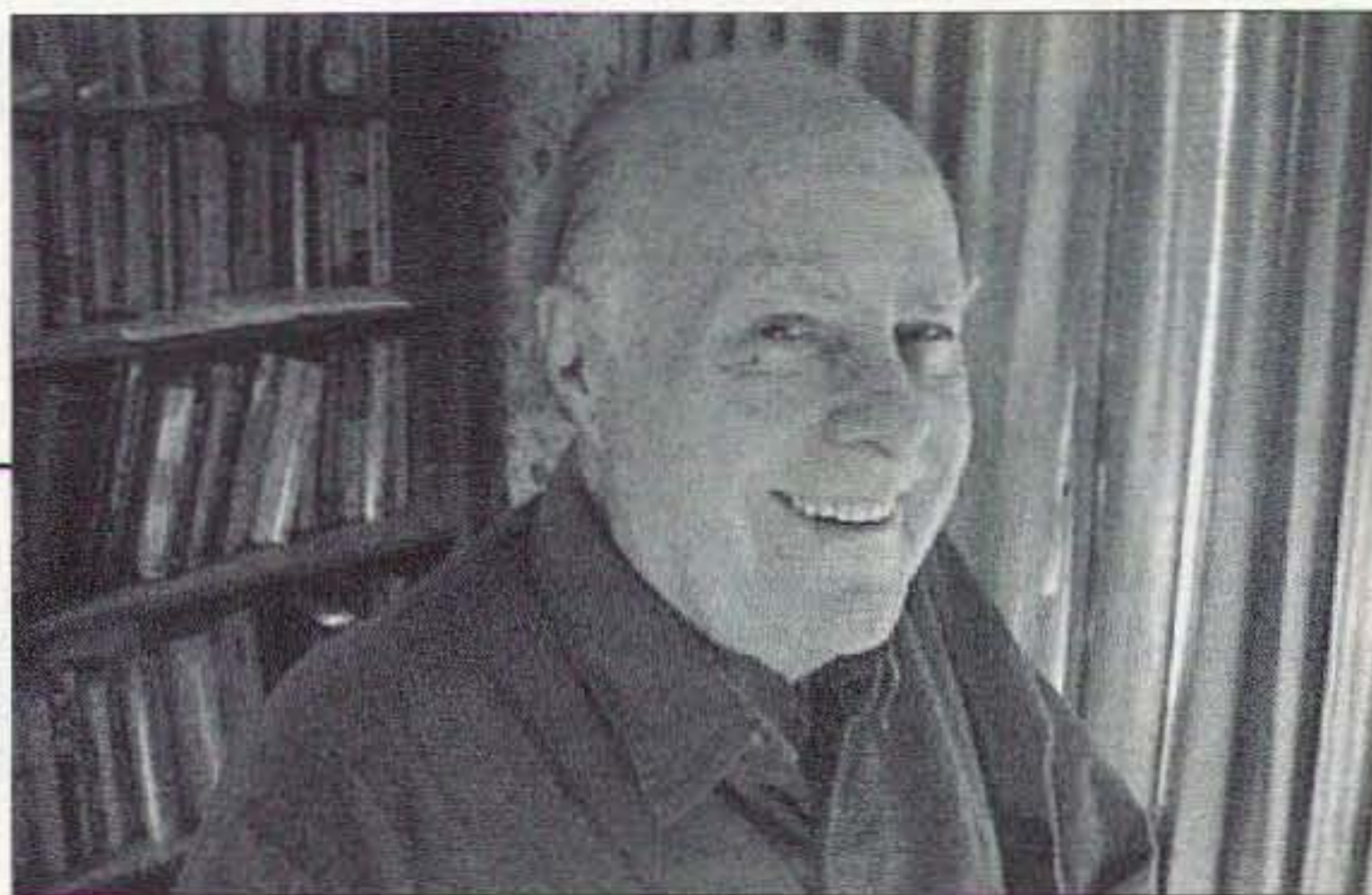

Schools Get An F

With nearly two-thirds of the 8th graders in New York City failing the recent statewide English test, and more than three-quarters failing the math test, these kids did so badly, according to the *New York Post*, that "they can barely add and subtract." Well, when I went to P.S. 199 and P.S. 99 in the New York City school system, back before teachers' unions and educational fads, the classes were large, the kids unruly, and the teachers just so-so, yet the results were far above what's being accomplished today.

This is particularly a kick in the head for disadvantaged children, who need the best help they can get to overcome their home environments.

There are complaints that it's the fault of the parents, who are not taking an interest and aren't spending time working with their kids. My parents never worked with me, nor did they show any interest in what was going on in my schools. They never even asked. Of course, I never did well in school, either. I just barely got by in most subjects, but I had plenty of time to spend down in the cellar building electronic and radio equipment. I had time to read a lot of books, to sing in the church choir, complete with rehearsals on Wednesday and Friday nights, go to a Boy Scout meeting once a week (Troop 34), sing with the school choral club and give concerts, play one of the lead parts in *The Mikado*, do endless darkroom work as a member of the camera club, and hardly ever miss seeing a new movie.

School, for me, was enormously boring, so I did just enough to get by, and spent my time on things that were more fun. In my K-12 years, I remember only one teacher who got me excited about the class, and that was Mr. Dockett, who taught art

in high school. He made it exciting and fun. I understood why my mother, who had had him as her teacher a generation before, had chosen to go on to Pratt Art Institute, where Maxfield Parrish was a classmate of hers.

There are a few outstanding schools in New York City, but the teachers' unions have been fighting hard to stop their unorthodox approaches to teaching.

Then there's the example of the Sudbury Valley School, which costs less than half as much per student to operate and whose students score through the roof on competitive exams.

Our public schools can be enormously improved if we (a) break the throttlehold the NEA has on them; (b) get the government the hell out of the school business; (c) draw on the successful examples of schools that are working.

The only area where our public school students excel is in feeling good about themselves.

The Icke Book

Dozens of readers have recommended my reading David Icke's *...and the truth shall set you free*. Okay, now I've read it. It is not a fun book to read, but I had it with me on my visit to El Salvador, so I fought my way through 520 pages of detailed proof that a small group of men are running the world. Icke explains how, with the help of ETs, they got into the position to do this. Icke names names, and cites endless references.

Running the world? To the extent of being able to select our presidents, start and end the last few wars, and stuff like that. Why would this group want to start WWI and WWII? To lend money to governments on both sides to spend on war, and also to make the arms and munitions. War can be enormously profitable if you know what you're doing,

You make tanks, planes, submarines, battleships, and guns, most of which are then blown up and destroyed or outmoded. So you lend governments more money to buy more armaments from you, collecting interest on the loans and profits on the armament sales.

What Icke doesn't do, unfortunately, is offer any practical solutions on how we can get out of this mess. My approach to problems is to try and understand them and then come up with some practical ideas on what can be done to solve the problems. But what can we do about The Fed, a group of private banks which control our money supply and are funding our government, all with interest-paying loans. What can any of us do about the small groups of enormously wealthy people who are controlling just about everything? Indeed, anyone who makes much noise about it seems to have a heart attack or die in a car accident. I'm surprised they haven't punched Icke's ticket by now.

For years I've been reading conspiracy complaints about the Illuminati, the Bilderberg Group, the Trilateral Commission, the Council on Foreign Relations, the Club of Rome, a few top Masons, and so on — well, Icke puts it all together, along with their plans for a New World Order, a one-government system for the world, run by them.

The more I've researched the situation, the more I've found we're being scammed on almost everything we've been trained (brainwashed) to believe in. Our school system is a scam. Our so-called health care system another scam. Our food supply, and all of our media, aren't what they appear.

The book is \$22 and can be

had from Truth Seeker, Box 28550, San Diego CA 92198. Yeah, it's probably better to shrug and say the whole thing is a crock. Ignorance may not be bliss, but it's safer in some cases.

The New Math

Math was not one of my favorite subjects in high school. Bluntly, I hated most of it, but it was mandatory, so I had to grind my way through it.

Now, from the perspective of having been a high-tech manufacturer and the publisher of a whole bunch of high-tech magazines and books, I can look back on those years of misery and ask, hey, how come? Yes, a few things I learned in math have been helpful. But I can't think of any time in my life in the real world that the agony of dealing with trigonometry has been justified. Nor geometry, nor solid geometry, nor calculus in college.

At the time I was suffering endless agonies over the nights I had to spend memorizing calculus equations I asked the teacher what practical use there might be for all this. I got the strong impression that this concept hadn't ever crossed his mind before. Well, gee, if you ever want to figure out how large a sphere you can put into a cone you'll need calculus. You know, in the sixty years since then, it's never come up! Nor has any other practical application for all that crapola I had to memorize — and then quickly forget. Never in all these years of business have I had to solve simultaneous equations. Take that, Binomial Theorem.

So why was I put through the years of misery? I know you, as a fellow sufferer at the hands of

Continued on page 53

Big Savings on Radio Scanners

COMMUNICATIONS ELECTRONICS INC.

Order on-line and get big savings
Take advantage of 73 Amateur Radio special savings by entering your order directly on the internet at the Communications Electronics web site. Visit CEI at <http://www.usascan.com>, click on "CEI News" and get big E-Value savings. Resellers, get special pricing when you fax your sales tax license to CEI at +1-734-663-8888.

DISTRIBUTOR'S COUPON Expires 03/31/2000 #9912M7

SAVE \$30 on one Relm MPV32

Save \$30 when you purchase your RELM MPV32 transceiver directly from Communications Electronics Inc. For fast delivery, enter your order through our web site <http://www.usascan.com> or call Communications Electronics at 1-800-USA-SCAN. TERMS: Good only in USA & Canada. Only one coupon is redeemable per purchase. Void where prohibited.

RELM® MPV32-A Transceiver

Mfg. suggested list price \$515.00/Special \$299.95

Looking for a great hand-held two-way transceiver? Amateur radio operators depend on the RELM MPV32 transceiver for direct two-way communications with their ham radio repeater, fire, police department or civil defense agency. The MPV32 is our most popular programmable frequency agile five watt, 32 channel hand-held transceiver that has built-in CTCSS. This feature may be programmed for any 39 standard EIA tones. Frequency range 136.000 to 174.000 MHz. The full function, DTMF compatible keypad also allows for DTMF Encode/Decode and programmable ANI. Weighing only 15.5 oz., it features programmable synthesized frequencies either simplex or half duplex in 2.5 KHz. increments. Other features include PC programming and cloning capabilities, scan list, priority channel, selectable scan delay, selectable 5 watt/1 watt power levels, liquid crystal display, time-out timer and much more. When you order the MPV32 from CEI, you'll get a complete package deal including antenna, 700 ma battery (add \$20.00 to substitute a 1000 ma battery), battery charger, belt clip and user operating instructions. Other useful accessories are available. A heavy duty leather carrying case with swivel belt loop part #LAMP is \$49.95; rapid charge battery charger, part #BCMP is \$69.95; speaker/microphone, part #SMMP is \$54.95; extra high capacity 1000 ma. ni-cad battery pack, part #BPMP1 is \$79.95; extra 700 ma. ni-cad battery pack, part #BPMP7 is \$59.95; cloning cable part #CCMP is \$34.95; PC programming kit, part #PCKIT030 is \$224.95. A UHF version with a frequency range of 450-480 MHz. part #MPU32 is on special for \$299.95. Your RELM radio transceiver is

ideal for many different applications since it can be programmed with just a screwdriver and programming instructions in less than 10 minutes. Programming is even faster with the optional PC kit. The programming instructions part #PIMPV is \$19.00. Call 1-800-USA-SCAN to order.

Bearcat® 895XLT-A1 Radio Scanner

Mfg. suggested list price \$729.95/Special \$194.95

300 Channels • 10 banks • Built-in CTCSS • S Meter

Size: 10-1/2" Wide x 7-1/2" Deep x 3-3/8" High

Frequency Coverage: 29.000-54.000 MHz., 108.000-174 MHz., 216.000-512.000 MHz., 806.000-823.995 MHz., 849.0125-868.995 MHz., 894.0125-956.000 MHz.

The Bearcat 895XLT is superb for intercepting trunked communications transmissions with features like TurboScan™ to search VHF channels at 100 steps per second. This base and mobile scanner is also ideal for intelligence professionals because it has a Signal Strength Meter, RS232C Port to allow computer-control of your scanner via optional hardware and 30 trunking channel indicator annunciators to show you real-time trunking activity for an entire trunking system. Other features include **Auto Store** - Automatically stores all active frequencies within the specified bank(s). **Auto Recording** - Lets you record channel activity from the scanner onto a tape recorder. **CTCSS Tone Board** (Continuous Tone Control Squelch System) allows the squelch to be broken during scanning only when a correct CTCSS tone is received. For maximum scanning enjoyment, order the following optional accessories: **PS001** Cigarette lighter power cord for temporary operation from your vehicle's cigarette lighter \$14.95; **PS002** DC power cord - enables permanent operation from your vehicle's fuse box \$14.95; **MB001** Mobile mounting bracket \$14.95; **EX711** External speaker with mounting bracket & 10 feet of cable with plug attached \$19.95. The BC895XLT comes with AC adapter, telescopic antenna, owner's manual and one year limited Uniden warranty. Not compatible with AGEIS, ASTRO, EDACS, ESAS or LTR systems.



TrunkTracking Radio

DISTRIBUTOR'S COUPON Expires 03/31/2000 #991127

SAVE \$70 on one BC245XLT

Save \$70 when you purchase your Bearcat 245XLT scanner directly from Communications Electronics Inc. For fast delivery, enter your order through our web site <http://www.usascan.com> or call Communications Electronics at 1-800-USA-SCAN. TERMS: Good only in USA & Canada. Only one coupon is redeemable per purchase. Void where prohibited.

Bearcat® 245XLT-A TrunkTracker

Mfg. suggested list price \$429.95/CEI price \$269.95

300 Channels • 10 banks • Trunk Scan and Scan Lists

Trunk Lockout • Trunk Delay • Cloning Capability

10 Priority Channels • Programmed Service Search

Size: 2-1/2" Wide x 1-3/4" Deep x 6" High

Frequency Coverage:

29.000-54.000 MHz., 108-174 MHz., 406-512 MHz., 806-823.995 MHz., 849.0125-868.995 MHz., 894.0125-956.000 MHz.

Our new Bearcat TrunkTracker BC245XLT, is the world's first scanner designed to track Motorola Type I, Type II, Hybrid, SMARTNET, PRIVACY PLUS and EDACS® analog trunking systems on any band. Now, follow UHF High Band, UHF 800/900 MHz trunked public safety and public service systems just as if conventional two-way communications were used. Our scanner offers many new benefits such as **Multi-Track** - Track more than one trunking system at a time and scan conventional and trunked systems at the same time. **300 Channels** - Program one frequency into each channel. **12 Bands, 10 Banks** - Includes 12 bands, with Aircraft and 800 MHz. 10 banks with 30 channels each are useful for storing similar frequencies to maintain faster scanning cycles or for storing all the frequencies of a trunked system. **Smart Scanner** - Automatically program your BC245XLT with all the frequencies and trunking talk groups for your local area by accessing the Bearcat national database with your PC. If you do not have a PC simply use an external modem. **Turbo Search** - Increases the search speed to 300 steps per second when monitoring frequency bands with 5 KHz. steps. **10 Priority Channels** - You can assign one priority channel in each bank. Assigning a priority channel allows you to keep track of activity on your most important channels while monitoring other channels for transmissions. **Preprogrammed Service (SVC) Search** - Allows you to toggle through preprogrammed police, fire/emergency, railroad, aircraft, marine, and weather frequencies. **Unique Data Skip** - Allows your scanner to skip unwanted data transmissions and reduces unwanted birdies. **Memory Backup** - If the battery completely discharges or if power is disconnected, the frequencies programmed in your scanner are retained in memory. **Manual Channel Access** - Go directly to any channel. **LCD Back Light** - An LCD light remains on for 15 seconds when the back light key is pressed. **Autolight** - Automatically turns the backlight on when your scanner stops on a transmission. **Battery Save** - In manual mode, the BC245XLT automatically reduces its power requirements to extend the battery's charge. **Attenuator** - Reduces the signal strength to help prevent signal overload. The BC245XLT also works as a conventional scanner. Now it's easy to continuously monitor many radio conversations even though the message is switching frequencies. The BC245XLT comes with AC adapter, one rechargeable long life ni-cad battery pack, belt clip, flexible rubber antenna, earphone, RS232C cable, Trunk Tracker frequency guide, owner's manual and one year limited Uniden warranty. Not compatible with AGEIS, ASTRO, ESAS or LTR systems. Hear more action on your radio scanner today. Order on-line at <http://www.usascan.com> for quick delivery.



VHF/GMRS/CB Radios

Have fun and use our CB, GMRS, shortwave and commercial radios to keep in touch with the world, friends and family.

Cobra 148GTL-A3 SSB CB/SPECIAL \$114.95
Maxon HCB40WX handheld CB with 10 weather ch. \$69.95
RELM RH256NB-A 25 watt VHF mobile transceiver \$284.95
RELM SMV4099W-A 40 watt VHF mobile transceiver .. \$349.95
RELM RMV60B-A 60 watt VHF mobile transceiver \$699.95
Uniden GRANTXL-A SSB CB Mobile \$124.95
Sangean ATS909-A shortwave receiver \$229.95
Sangean ATS818CS-A shortwave receiver \$199.95

Radio Scanners

Monitor fire, police, weather, marine, medical, aircraft and other transmissions with your radio scanner from CEI.

AOR8200B-A wideband handheld scanner/SPECIAL \$519.95
AOR5000+3-A desktop receiver with synch AM/AFC/NB .. \$2,399.95
AOR AR16BQ wideband handheld scan with quick charger .. \$209.95
Bearcat 9000XLT-A 500 channel base/mobile scanner \$344.95
Bearcat 895XLT-A1 300 ch.TrunkTracker base scanner \$194.95
Bearcat 278CLT-A 100 ch base AM/FM/SAME WX alert \$169.95
Bearcat 248CLT-A 50 ch.base AM/FM/weather alert scanner \$99.95
Bearcat 245XLT-A 300 channel TrunkTracker II scanner \$269.95
Bearcat Sportcat 200 alpha handheld sports scanner \$184.95
Bearcat Sportcat 180B handheld sports scanner \$149.95
Bearcat 80XLT-A2 50 channel handheld scanner \$109.95
Bearcat 60XLT1-A 30 channel handheld scanner \$79.95
Bearcat BCT12-A2 Stormtracker info mobile scanner \$144.95
Bearcat BCT7-A information mobile scanner \$149.95
ICOM ICR8500-A1 wideband communications receiver \$1,499.95
ICOM PCR1000-A1 computer communications scanner \$399.95
ICOM R10-A1 handheld wideband communications rec. \$339.95

AOR® AR8200B Radio Scanner

Mfg. suggested list price \$799.95/Special \$519.95

1,000 Channels • 20 banks • 50 Select Scan Channels

PASS channels: 50 per search bank + 50 for VFO search

Frequency step programmable in multiples of 50 Hz.

Size: 2-1/2" Wide x 1-3/8" Deep x 6-1/8" High

Frequency Coverage:

500 KHz to 823.995 MHz, 849.0125-868.995 MHz, 894.0125-2,040.000 MHz (Full coverage receivers available for export and FCC approved users.)

The AOR AR8200B is the ideal handheld radio scanner for communications professionals. It features all mode receive: WFM, NFM, SFM (Super Narrow FM), WAM, AM, NAM (wide, standard, narrow AM), USB, LSB & CW. Super narrow FM plus Wide and Narrow AM in addition to the standard modes. The AR8200 also has a versatile multi-function band scope with save trace facility, twin frequency readout with bar signal meter, battery save feature with battery low legend, separate controls for volume and squelch, arrow four way side rocker with separate main tuning dial, configurable keypad beep/illumination and LCD contrast, write protect and keypad lock, programmable scan and search including LINK, FREE, DELAY, AUDIO, LEVEL, MODE, computer socket fitted for control, clone and record, Flash-ROM no battery required memory, true carrier reinsertion in SSB modes, RF preselection of mid VHF bands, Detachable MW bar aerial. Tuning steps are programmable in multiples of 50 Hz in all modes, 8.33 KHz airband step correctly supported, Step-adjust, frequency offset, AFC, Noise limited & attenuator, Wide and Narrow AM in addition to the standard modes. For maximum scanning pleasure, you can add one of the following optional slot cards to this scanner: **CT8200** CTCSS squelch & search decoder \$89.95; **EM8200** External 4,000 channel backup memory, 160 search banks. \$69.95; **RU8200** about 20 seconds chip based recording and playback \$69.95; **TE8200** 256 step tone eliminator \$59.95. In addition, two leads are available for use with the option socket. **CC8200** PC control lead with CD Rom programming software \$109.95; **CR8200** tape recording lead \$59.95. The AR8200B comes with 4 AA ni-cad batteries, charger, cigar lead, whip aerial, MW bar antenna, belt hook, strap and one year limited AOR warranty. Enter your order now at <http://www.usascan.com>.

Buy with confidence

It's easy to order from us. For fastest delivery, enter your order on the internet. Mail orders to: Communications Electronics Inc., P.O. Box 1045, Ann Arbor, Michigan 48106 USA. Add \$19.00 per weather station or radio product for UPS ground shipping, handling and insurance to the continental USA unless otherwise stated. Add \$12.00 shipping for all accessories and publications. Add \$12.00 shipping per antenna. For Canada, Puerto Rico, Hawaii, Alaska, Guam, P.O. Box or APO/FPO delivery, shipping charges are two times continental US rates. Michigan residents add state sales tax. No COD's. Satisfaction guaranteed or return item in unused condition in original packaging within 61 days for refund, less shipping charges. 10% surcharge for net 10 billing to qualified accounts. All sales are subject to availability, acceptance and verification. Prices, terms and specifications are subject to change without notice. We welcome your Discover, Visa, American Express, MasterCard, IMPAC or Eurocard. Call anytime 1-800-USA-SCAN or 1-800-872-7226 to order toll-free. Call 734-996-8888 if outside Canada or the USA. FAX anytime, dial 734-663-8888. Dealer and international inquiries invited. Order on-line today or call today.

Price schedule effective December 1, 1999 AD #12019973 ©1999 Communications Electronics Inc.

For credit card orders call
1-800-USA-SCAN

Communications Electronics Inc.

Emergency Operations Center

e-mail: cei@usascan.com

www.usascan.com

PO Box 1045, Ann Arbor, Michigan 48106-1045 USA

For information call 734-996-8888 or FAX 734-663-8888



continued from page 1

(Advisory Committee of Amateur Radio), having established the committee and served as its first chair.

Thanks to Newsline, Bill Pasternak WA6ITF, editor.

Newsline YHOTY

The nominating period is now open for the year 2000 Newsline Young Ham of the Year Award. With corporate sponsorship from Yaesu USA and CQ Magazine, the Young Ham of the Year Award seeks to honor the amateur radio-related achievements of those hams age 18 or younger.

The Newsline Young Ham of the Year Award is your chance to bring proper tribute to the achievements of the younger members of our nationwide United States ham radio community. Prizes for this year's competition include an expense-paid week at Spacecamp in Huntsville, Alabama, courtesy of the folks at CQ Magazine.

Full rules and a nominating form are available for a self-addressed stamped envelope to the Newsline Young Ham of the Year Award, 28197 Robin Avenue, Santa Clarita CA 91350. Or, you can download the form and its instruction sheet at [www.arnesline.org].

Thanks to Newsline, Bill Pasternak WA6ITF, editor.

East Timor Calls

According to Jeremy Boot G4NJH, there's a new country to work. It's called East Timor, and its establishment is a rather complex story.

The International Telecommunications Union has communicated to the United Nations the assignment of the prefix block 4WA-4WZ for use by radio stations within the areas administered by UNTAET, the United Nations' Temporary Administration of East Timor. This prefix assignment is for the use of UNTAET as long as it exists, and will be released to the ITU at the end of its existence.

All other private and amateur radio stations in East Timor will use the prefix 4W6. Individuals who expect to be there less than one year would use a 4W6/ home call, while those who will be there in excess of one year obtain 4W6 callsigns. Permanent residents of East Timor who were previously licensed may also obtain new permanent callsigns.

Sound complex? Then follow the advice of most old-time DX operators: Work the station first and worry later, or WFWL.

Thanks to Newsline, Bill Pasternak WA6ITF, editor.

New Fuel Cells

Fresh on the heels of word from Daimler Chrysler that it was developing a new practical fuel cell for automotive and other purposes, now

comes news that Motorola researchers in Illinois and at Los Alamos are working on a new mini fuel cell battery for wireless devices.

Like the Chrysler fuel cell, this tiny version also uses methanol as a power source. It is said to have a life expectancy ten or more times that of conventional NiCd and NiMH cells in use today, and it will use transparent or translucent packaging so that users can check their fuel supply.

The research team says that it will be 2004 or 2005 before you see these mini fuel cells on store shelves — and when you do, be prepared for a little sticker shock. Word is that they will be a lot more expensive than the batteries they are designed to replace.

Thanks to Newsline, Bill Pasternak WA6ITF, editor.

Fate Twist

In a rather bizarre twist of fate, the government is seeking advice on protecting its computers from illegal infiltration with expert advice from convicted computer hacker Kevin David Mitnick, ex-N6NHG. This, only a few weeks after the government released him from a federal prison.

This spring, Mitnick appeared before a Senate panel that's looking into the hacking problem. According to news reports, members of the Senate Governmental Affairs Committee asked the former ham to explain the ways in which hackers infiltrate sensitive computer systems. They also want him to suggest solutions in dealing with hackers to lawmakers.

Mitnick is reported to have offered a half-dozen suggestions to help combat the problem. These include requiring agencies to assess what data is most valuable and training employees to recognize attacks under way. The Senate Governmental Affairs Committee is considering a wide-ranging bill to require each government agency to create an anti-hacker program.

Thanks to Newsline, Bill Pasternak WA6ITF, editor.

Things To Say When Caught Napping At Your Desk ...

15. "They told me at the blood bank that this might happen."

14. "This is just a 15 minute power-nap like they raved about in the last management course that you sent me to."

13. "Whew! Guess I left the top off the liquid paper."

12. "I wasn't sleeping! I was meditating on the mission statement and envisioning a new paradigm!"

11. "This is one of the seven habits of highly effective people!"

10. "I was testing the keyboard for drool resistance."

9. "Actually, I was doing a 'Stress Level Elimination Exercise Plan' (SLEEP) that I learned at the last mandatory seminar you made me attend."

8. "I was doing a highly specific Yoga exercise to relieve work-related stress. Are you discriminatory towards people who practice Yoga?"

7. "Dam! Why did you interrupt me? I had almost figured out a solution to our biggest problem."

6. "The coffee machine is broke ..."

5. "Someone must have put decaff in the wrong pot."

4. "Boy, that cold medicine I took last night just won't wear off!"

3. "Ah, the unique and unpredictable circadian rhythms of the workaholic!"

2. "I wasn't sleeping. I was trying to pick up my contact lens without using my hands."

And the #1 Best Thing To Say If You Get Caught Napping At Your Desk:

1. "... Amen."

Thanks to Radio Flyer, UBET (UT) ARC, September 1999.

The Old Junk Box

In days of old when hams were bold,
With materials in short supply,
They had to make do with their junk box gold,
To grab signals out of the sky.

The home-brewer's junk box was a treasure chest,
It held everything salvaged and used,
A jumbled mess in a junk box nest,
With resistors, coils, and tubes.

In those days so lean when a ham's machine
Needed this or that to run,
The old hobbyist rummaged in the box to glean
The ones that would make it hum.

As the years rolled by the junk box grew nigh,
New stock now easy to obtain,
From catalog stores with shelves stacked high,
The parts are easily gained.

And so it goes for the hams of the past,
And their junk box of traditional gore,
New hams won't remember the box that had class,
Now replaced by a Radio Shack store.

© 1998 by Bill Hendrey KC6JGS, in memory of Dan Wright K7GCJ, a ham's ham who loved to home-brew.

Ad Sales
call Evelyn Garrison
1-425-557-9611

MFJ Switching Power Supplies

Power your HF transceiver, 2 meter/440 MHz mobile/base and accessories with these new 25 or 45 Amp MFJ MightyLite™ Switching Power Supplies! **No RF hash . . . Super lightweight . . . Super small . . . Volt/Amp Meters . . .**

MFJ's new adjustable voltage switching power supplies do it all! Power your HF or 2M/440 MHz radio and accessories.

MFJ's MightyLites™ are so light and small you can carry them in the palm of your hand! Take them with you anywhere.

No more picking up and hauling around heavy, bulky supplies that can give you a painful backache, pulled muscle or hernia.

MFJ's 25 Amp MightyLite™ weighs just 3.7 lbs. -- that's 5 times lighter than an equivalent conventional power supply.

MFJ's 45 Amp is even more dramatic -- 8 times lighter and weighs just 5.5 pounds!

No RF hash!

These babies are clean . . . Your buddies won't hear any RF hash on your signal! None in your receiver either!

Some competing switching power supplies generate objectionable RF hash in your transmitted and received signal.

These super clean MFJ MightyLites™ meet all FCC Class B regulations.

Low Ripple . . . Highly Regulated

Less than 35 mV peak-to-peak ripple under 25 or 45 amp full load. Load regulation is better than 1.5% under full load.

Fully Protected

You won't burn up our power supplies!

No RF Hash!



← MFJ-4225MV
25 Amp
\$149⁹⁵
plus s&h
MFJ-4245MV →
45 Amp
\$199⁹⁵
plus s&h

No RF Hash!

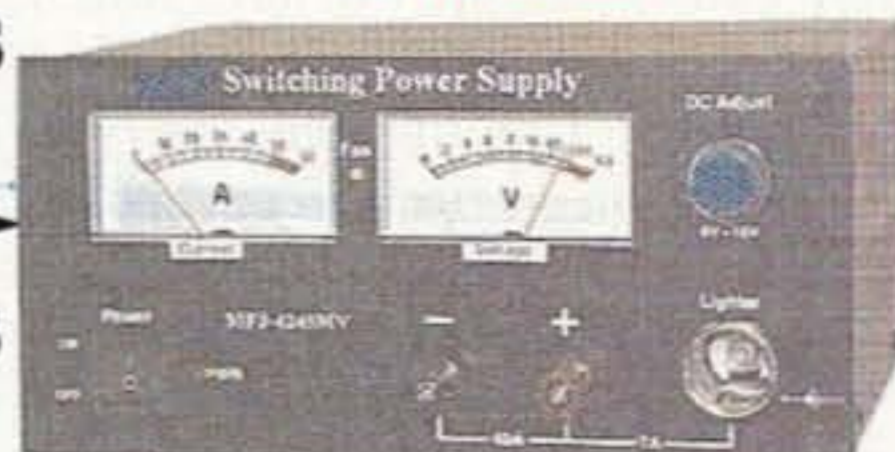

They are fully protected with Over Voltage and Over Current protection circuits.

Worldwide Versatility

MFJ MightyLites™ can be used anywhere in the world! They have switchable AC input voltage and work from 85 to 135 VAC or 170 to 260 VAC. Replaceable fuse.

MightyLites™ . . . Mighty Features

Front-panel control lets you vary output from 9 to 15 Volts DC.

Front-panel has easy access five-way binding posts for heavy duty use and cigarette lighter socket for mobile accessories. MFJ-4245MV has two sets of quick-connects on the rear for accessories.

Brightly illuminated 3 inch meters let you monitor load voltage and current.

A whisper quiet internal fan efficiently

cools your power supply for long life.

Two models to choose from . . .

MFJ-4225MV, \$149.95. 25 Amps maximum or 22 Amps continuous. Weighs 3.7 pounds. Measures 5 1/2"Wx4 1/2"Hx6D in.

MFJ-4245MV, \$199.95. 45 Amps maximum or 40 Amps continuous. Weighs 5.5 pounds. Measures 7 1/2"Wx4 3/4"Hx9D in.

NEW! 25 Amp MightyLite™

Super light, super compact switching power supply delivers 25 Amps maximum/22 Amps continuous at 13.8 Volts DC. Low ripple, highly regulated. **No RF Hash!** Five-way binding posts for high current. Quick connects for accessories. Over voltage/current protection. 110 or 220 VAC operation. Meets FCC Class B regs. 3.5 lbs. 5 1/2"Wx2 1/2"Hx10 1/4"D in.

MFJ-4125
25 Amp
\$109⁹⁵
plus s&h



MFJ 35/30 Amp Adjustable Regulated DC Power Supply

Massive 19.2 pound transformer . . . No RF hash . . . Adjustable 1 to 14 VDC . . .



MFJ-4035MV
\$149⁹⁵
plus s&h

MFJ's heavy duty conventional power supply is excellent for pow-

ering HF or 2 Meter/440 MHz transceiver/accessories.

A massive 19.2 pound transformer makes this power supply super heavy duty! It delivers 35 amps maximum and 30 amps continuous without even flexing its muscles. Plugs into any 110 VAC wall outlet.

It's highly regulated with load regulation better than 1%. Ripple voltage is less than 30 mV. **No RF hash** -- it's super clean!

Fully protected -- has over voltage protection, fold back short circuit protection and over-temperature protection.

You get front panel adjustable voltage from 1 to 14 VDC with a convenient detent set at 13.8 VDC. A pair of front-panel meters let you monitor voltage and current.

Three sets of output terminals include a pair of heavy duty five-way binding posts for HF/VHF radios, two pairs of quick-connects for accessories and a covered cigarette lighter socket for mobile accessories.

A front-panel fuse holder makes fuse replacement easy. Whisper quiet fan speed increases as load current increases -- keeps components cool. 9 1/2"Wx6Hx9 3/4"D inches.

MFJ High Current Multiple DC Power Outlets

Power two HF/VHF transceivers and six or more accessories from your 12 VDC power supply



MFJ-1118 and six or more accessories from your transceiver's main 12 VDC supply.
\$74⁹⁵
plus s&h



MFJ-1116 Two pairs of super heavy duty 30 amp 5-way binding posts connect your transceivers. Each pair is fused and RF bypassed. Handles 35 Amps total. Six pairs of heavy duty, RF bypassed 5-way binding posts let you power your accessories.
\$49⁹⁵
plus s&h



MFJ-1112 They handle 15 Amps total, are protected by a master fuse and have an ON/OFF switch with "ON" LED indicator.
\$34⁹⁵
plus s&h



New!
MFJ-1117
\$44⁹⁵
plus s&h

MFJ-1118, \$74.95. This is MFJ's most versatile and highest current Deluxe Multiple DC Power Outlet. Lets you power two HF and/or VHF transceivers

MFJ-1116, \$49.95. Similar to MFJ-1118. No 30 amp posts. Has "ON" LED and 0-25 VDC voltmeter. 15 amps total.

MFJ-1112, \$34.95. Similar to MFJ-1116. No on/off switch, LED, meter, fuse.

NEW! MFJ-1117, \$54.95. For powering four HF/VHF radios (two at 35 Amps each and two at 35 Amps combined) simultaneously. Tiny 8x2x3 inches.

Free MFJ Catalog
and Nearest Dealer . . . 800-647-1800

<http://www.mfjenterprises.com>

• 1 Year No Matter What™ warranty • 30 day money back guarantee (less s/h) on orders direct from MFJ

MFJ MFJ ENTERPRISES, INC.
Box 494, Miss. State, MS 39762
(662) 323-5869; 8-4:30 CST, Mon.-Fri.
FAX: (662) 323-6551; Add s/h
Tech Help: (662) 323-0549

Prices and specifications subject to change. (c) 2000 MFJ Enterprises, Inc.

All are protected by MFJ's famous No Matter What™ one year limited warranty.

From the Ham Shack

John Lawson W3ZC, Hatfield PA. I have been a ham for 46 years and I can assure you that I know which side of the soldering iron to pick up. I'm not a historian, but I have seen a lot of ups and downs in amateur radio. Unfortunately, lately there have been more downs than ups. With that said, here we go again. The dumbing down of the amateur radio license continues much to the delight of those who want more numbers at any cost. More licensees means more hardware and publication sales. Isn't that right, Wayne?

In the 1960s, the FCC at the behest of the ARRL, embarked on the incentive licensing program, a move that I considered imaginative and correct. It meant that in order to obtain additional privileges, you had to work and study to get or to upgrade an amateur radio license. It was an attempt to finally establish some order to the license structure and to provide a reward for working on an upward advancement. Of course, obtaining an amateur license was not made easier. I'm not sure if the sending test was eliminated at that time or at an earlier time. Nonetheless, the elimination was based on statistics that said if an applicant was capable of receiving the code, rarely if ever did that applicant fail the sending of the code. New licensees leveled off much to the consternation of manufacturers and publishers, who wanted higher numbers and sales. Well, the wailing and lamentations finally paid off for the squeaky wheel set with the dumbing-down of the VE test.

When the VE test program was started in 1984, I thought it was a move in the right direction to make testing more convenient to the hopefuls. I was certified by the ARRL and by W5YI. I participated in many, many VE sessions until the powers-that-be decided to change the nature of the written tests from "fill in the blanks" to multiple choice. This would most certainly boost the numbers. It was also a very discouraging shock, so much so that I told our VE captain that we shouldn't even worry about the testing — just present the applicants with whatever license they wanted when they entered the test site and paid their \$6+ bucks. I stopped participating not only in VE sessions, but also in amateur radio. I haven't been on the air in a year because I haven't as yet learned to say "10-4, Good Buddy."

Now, after April 15th, perhaps rather than have the applicants even show up at the testing site, we can arrange to mail them their

license. We can aptly call this new approach the "License-of-Choice Program." It certainly would be appropriate to offer discounts from the beneficiaries. I can see a reduced fee for the likes of ARRL memberships, and 73 and CQ Magazine subscriptions.

I'm sure that Wayne will have the last word in his italicized response below. He will probably say that new licensees today have to start somewhere to begin to become more proficient. So why not give them the license first and turn them loose. Can you imagine the chaos if we did that with driver's or pilot's licenses? What's wrong with learning how to swim before jumping into the pool? Go ahead, Wayne, your turn.

Unfortunately, John, you're typical of the many old-timers who have bought the ARRL line — hook and sinker included — and who haven't read my editorials. Take the "incentive licensing" program. This was, as I've reported many times, cooked up by Hudson Division Director Mort Kahn W2KR, who had, through a coup, thrown out Bud Budlong WIBUD, the ARRL's General Manager, and had quietly taken over control of the League. When the membership dropped in 1962, Mort held a secret directors meeting on his yacht to come up with something controversial which would increase interest in the League. With the help of Tom McAnn K2CMM, one of his 3999 pals, they crafted the so-called incentive licensing plan. It was, in reality, merely a return to the pre-war Class A, Class B system of licensing.

But, to a hundred thousand or so hams it meant that in order to stay on voice on the major HF bands they would have to face the FCC inspectors and take new license exams. And newcomers were facing the old two-year wait on CW before upgrading. Well, this was controversial, and it would certainly cut down on the QRM on the old Class A bands for a while. However, instead of the League selling tens of thousands of new license manuals, they found that most hams were selling their equipment for whatever they could get for it rather than have to memorize all those Q&As again. This glut of used ham gear completely stopped the sale of new equipment, forcing almost 90% of the ham dealers out of business over the next two years, and close to 100% of the ham manufacturers. That was the end of the American ham industry. Our hobby, which had been growing at 11% per year steadily

for the 17 years after WWII, suddenly was losing numbers. Around 90% of the ham clubs folded, as did most of the school radio clubs. This stopped youngsters from hearing about the hobby. Around 1960, the ARRL did a survey which showed that 80% of all new hams were teenagers, and that 80% of those went on to high-tech careers as a result. And, since it is youngsters who do most of the inventing and pioneering of new technologies, when teenage new hams dropped to around 12%, that was pretty much the end of amateur radio contributing to technology, and to our high-tech industries, most of which had to move to Japan, where they have more hams than we do, and there are radio clubs in every school. In the 35 years since "incentive licensing," our ranks have grown at around 1% per year. And yes, you bet there is strength in numbers. But I suspect, John — and you admit you're inactive — that you would like to keep amateur radio the preserve of old white men until some lobby group comes along and wants to buy our frequencies for a song. — Wayne.

Mike Leahan N9PQK. There is an even easier way to use a TV tuner to listen to UHF and above. Find an old mechanical television tuner (it should be right behind the plastic knob that you use to tune from channel 14 to old channel 83). Tear it off the television chassis. Make a piece of coaxial cable with a connector that fits the RF output jack of the tuner (probably looks like an old audio jack) and the antenna input of a low band VHF monitor (I used an old Patrolman 2B tunable monitor). Connect the tuner to the monitor. Solder a 9 V or 12 V power source to the side of the tuner (just solder the black wire to the chassis of the tuner), then solder a short piece of wire, say 8–9 cm, to the antenna lead of the tuner. Adjust the frequency of the monitor to somewhere around 47 MHz (the TV IF frequency, which is also the output of the old TV tuner) and start tuning around with the tuner up around 800 MHz, otherwise known as old TV channel 83 and below. Voilà! You have constructed a tunable frequency converter for almost nothing. 73

A fool and his money are soon partying.

Ah, the Technomadic Life!

This special to 73 on mobiling is ... well ... special.

I have to make a decision up front. This can be one of those articles that desperately struggles to cram a huge amount of technical information into a relatively tight space, which, even with the generous room allotted by 73, won't be enough. Or I can accept the futility of that approach and talk instead about what REALLY matters — the mad, obsessive technopassion that turns seemingly ordinary people into hams and hobbyists ... and what happens when you let it completely take over your life.

And I do mean *completely* ... On the surface, what we have here is a pair of high-tech adventure platforms, the result of 17 years of nonstop focus, the contributions of hundreds of sponsors, and volunteer engineering wizardry from some of the most amazing minds in industry. The level of complexity in these machines is mind-numbing, but the motives behind them are exquisitely simple: freedom, adventure, discovery, and that twisted fascination with mobile wireless connectivity that I suspect everyone reading this magazine feels in some deep, nonverbal way.

I'm going to spare you the board-by-board analysis of an infinitely reconfigurable mobile network architecture, the amusing interplay of too many closely spaced antennas with a marginal counterpoise that varies with conditions, the layering of a browser-flavored linux front end on top of a cluster of microcontrollers and sensors, and even the mad tail-chasing control theory that drives an adaptive self-optimizing solar thruster management system. We'll touch on all that, but the real subject is geek passion ... the stuff you FEEL in your core when

you stand in front of a vendor booth at a hamfest and experience heart-pounding techno-lust. I know you know what I'm talking about, or you wouldn't be here ...

(Oh, don't worry. Before this is all over, I'll point you to enough technical information to scratch the itch, and even give you a way to pitch in if you're so inclined.)

The prehistory of a nomad

It began in Kentucky in the early '60s: I was WN4KSW, a skinny, burr-headed 13-year-old prisoner of school, isolated in the cultural drought of the '50s. I was theoretically a smart little bugger, according to test scores, yet I kept hearing that I had attitude problems and wasn't working up to my potential. With the exception of science fairs, my academic career was disappointing to authority figures.

I didn't care: I had a secret life!

School received the minimum attention required, which wasn't much. My real life was far too important to dilute with homework: Since the age of 8, I had been obsessed with electronics, my lab, and the vague notion that if I prowled the magical world of electronic surplus

with enough finesse, I might even be able to cobble together a computer with a few thousand 12AU7s and an air conditioner. I amused myself with microphones in the ductwork and a phone line routed through an old black-crackle 19" rack, listening to domestic goings-on via an 8-ohm primary looped around the lab and an amplified loopstick on my headphones. I fancied a girl up the street when I was way too young to know why, and gave her a walkie-talkie so we could lie under the covers and giggle to each other and I struck an uneasy balance of power with neighborhood rednecks-in-training by countering their harassment with a high-voltage "Tickle Stick" connected to parallel squirt guns loaded with saltwater.

Empowering stuff indeed, but most seductive of all was radio ... for it connected me to the Outside.

It's like a flashback now, recalling the chirpy CW of my 50C5 crystal oscillator and the magical noises emanating from the Star Roamer ... as well as the Heaths and Hammarlunds that followed. Other people, other tongues, strange sideband squawks, blokes on marine radiotelephone saying "I bloody

miss you," political realities and cultural attitudes utterly unlike the Huntley-Brinkley Report that invariably accompanied dinner. I spent years gazing through this electronic window and building my tools; like the railroad tracks that passed near my house, radio became deeply symbolic of escape and movement. My physical adventures were confined to rural bike hikes; in my head, I could cruise the universe with a skyhook and a suitably powerful collection of instruments ablaze with Nixies, slide rule dials, dancing D'Arsonvals, and round green CRTs.

Years passed. Adventures happened; technology went deliciously berserk. I dabbled in careers, started a micro-computer consulting business called Cybertronics after firing up a homebrew 8008 system in 1974, wrote technical articles and a few books, and pulled all nighters of coffee-wired 8-bit hacking around every seductive new gizmological marvel. But through it all, one image kept coming back to me: an assemblage of communication and computing equipment symbolic of freedom ... a toolset for escape. Thus it was only natural, when at last in 1983 the first tentative network infrastructure was in place, that I would trash

my suburban lifestyle and take off across America on a recumbent bicycle dubbed the *Winnebiko* ... carrying a solar-powered computer through which I could connect to CompuServe from pay phones at an astonishing 300 baud.

I had just invented technomadics.

Winnebiko and BEHEMOTH

Life became a merger of passion and technology, art and engineering. I was fortunate enough to become a public symbol of network-enabled freedom, and sponsors began donating the equipment and workspace to create new versions of the bike. Volunteers jumped on board, the media maintained an unrelenting thirst for stories, and I even got into the once-unthinkable public speaking business. Despite chronic lifelong bad work habits, I was learning to survive on the spinoffs of play.

From 1983 through 1991, I covered 17,000 miles on three versions of the bike, actually living on the road for about 3.5 of those years and spending the rest of the time in various labs building machines, holed up writing articles, or rumbling around the US under diesel power on speaking tours. A

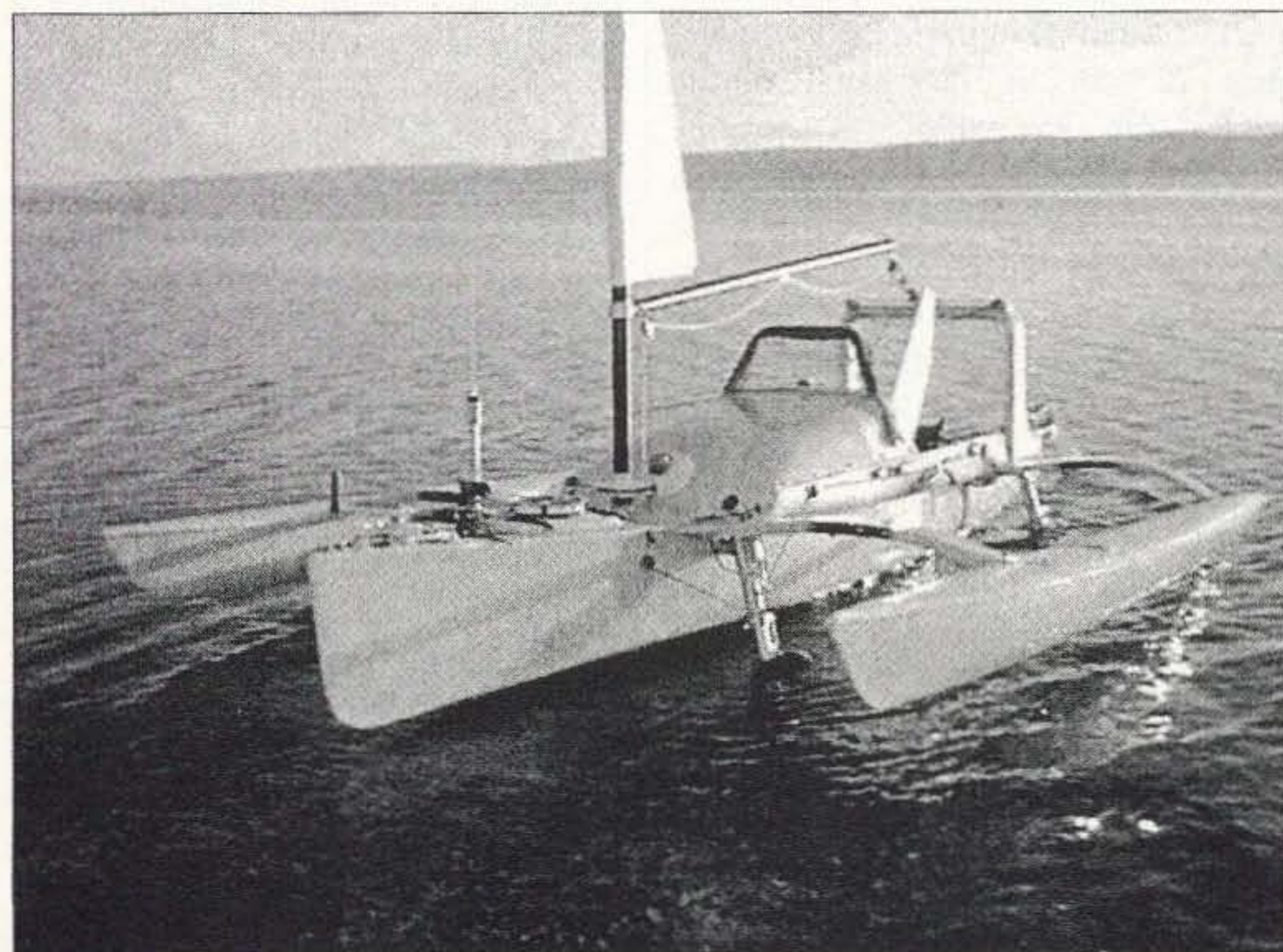

Photo A. The Microship, almost complete, missing only the fabric dodger, solar array, most of the antennas, and pressurized control console. The winch handle at the bow is for steering on land. Note, also, the drum at the base of the mast, which allows remote furling from the cockpit.

ALL ELECTRONICS CORPORATION

Laser Level



Accurate and easy to use for short and long distance leveling. Center the bubble, and anything that intersects the beam is at exactly the same height. Use it to match heights in large rooms or across buildings. Set and align electrical and plumbing fixtures, cabinets and shelves. Rugged, black anodized aluminum housing with pocket clip. Locking push button switch to prevent unintended actuation.

Includes two AAA batteries. **\$16⁹⁵ each**

CAT # LL-1

16 Character X 2 Line LCD with Backlight

Daewoo # 16216L-5-VSO
5 x 7 dot format.
2.56" x 0.54" viewing area.
3.15" x 1.41" module size.
LED backlight. Includes hook-up/spec sheet.



CAT# LCD-53 **\$7⁵⁰ each**

12 Vdc 40 mm Fan

Jamicon #JF0410S1H
1.57" x 1.57" x 0.41" thick.
12 Vdc, 0.17A. Brushless DC fan. 11 blade impeller. 10" pigtail leads. UL, CSA.



CAT # CF-70

\$1⁷⁵ each

10 for \$15.00

Blue & White Ultrabrights

BLUE / water clear 1200 mcd
45 degree viewing angle.



\$3⁷⁵ each

CAT # LED-58

10 for \$30.00

WHITE / water clear 1100 mcd

\$4⁰⁰ each

CAT # LED-48

10 for \$35.00

ORDER TOLL FREE

1-800-826-5432

CHARGE ORDERS to Visa, Mastercard, American Express or Discover

TERMS: NO MINIMUM ORDER. Shipping and handling for the 48 continental U.S.A. \$5.00 per order. All others including AK, HI, PR or Canada must pay full shipping. All orders delivered in CALIFORNIA must include local state sales tax. Quantities Limited. NO COD. Prices subject to change without notice.

CALL, WRITE
FAX or E-MAIL
for our **FREE**
96 Page
CATALOG
Outside the U.S.A.
send \$3.00 postage.

MAIL ORDERS TO:
ALL ELECTRONICS
CORPORATION
P.O. Box 567
Van Nuys, CA 91408
FAX (818)781-2653

www.allelectronics.com
e-mail allcorp@allcorp.com

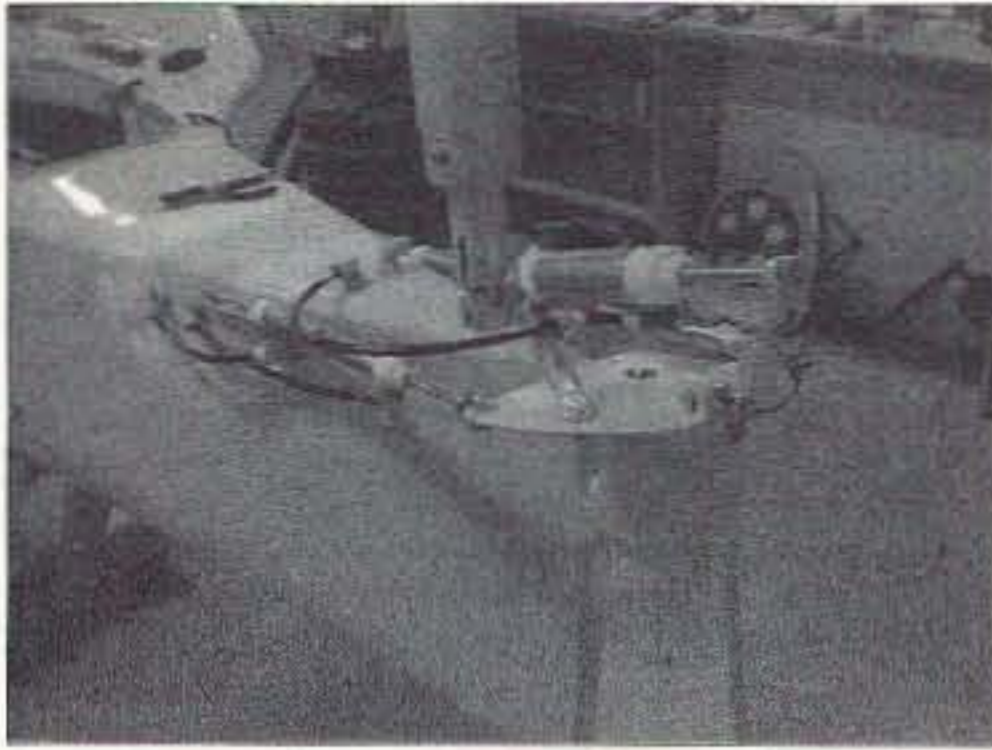

Photo B. The carbon-fiber rudder blade is steered and retracted by Clippard double-acting hydraulic cylinders.



Photo C. Hydraulic controls for landing gear steering, using a cam follower to implement the Ackerman function and a separate control arm to "pigeon toe" the front wheels for hill-holding — a sort of software brake.

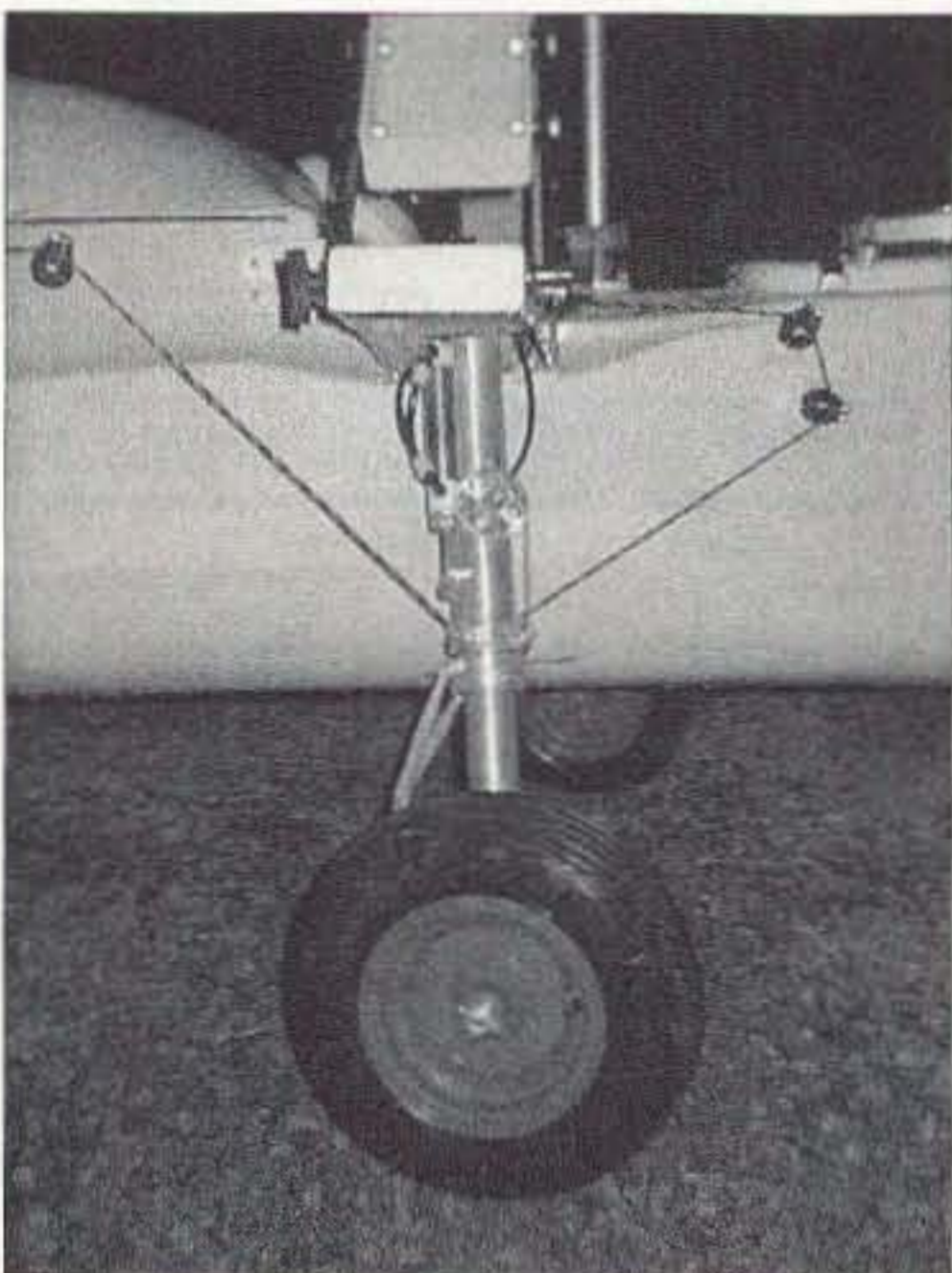

Photo D. Forward landing gear assembly before final anodizing. A hydraulic cylinder clamped to tensioned stainless cable rotates a teflon-lined collar, which couples steering inputs via the scissors assembly to the spindle bearings that carry the wheel. A column of elastomeric bumpers provides 8" of suspension travel with a 4G limit. The entire strut is retracted and extended by lines, driven by levers at the gunwales, which also add hydraulic control inputs to rotate the wheels into operating position.

long 73 column series in '88-'89 focused on the ham radio aspects of the adventure (many of those tales written on a binary handlebar keyboard while pedaling the coasts, others pounded into a laptop in the confines of my tent, consuming the day's stored solar energy).

BEHEMOTH, the final incarnation of the bike, was a 3-year Silicon Valley development project — an all-out effort to integrate every geek toy imaginable into a single system. The integration wasn't quite as complete as I had hoped and it was far too heavy, but the project did lay the groundwork for the Microship project to follow: a huge collection of diverse resources, each too dumb to be conventionally networked, all living in harmony under the umbrella of a processor and an array of crosspoint switches. The result of this approach is a coordinated toolset that feels like a single system, rendering a near infinite variety of bizarre applications trivial to implement.

Of course, *BEHEMOTH* was also a strange bicycle. At 580 pounds fully loaded (plus me), the name was apropos even without its acronymic coding: "Big Electronic Human-Energized Machine... Only Too Heavy." A 105-speed transmission helped me schlep it over mountains, pneumatically-deployed landing gear kept me upright in the granny gear, 72 watts of solar panels on the trailer ran everything except the wheels, a Qualcomm OmniTRACS terminal on the stern linked me to the Net, a heads-up display kept my right eye busy with a PC while my left gazed at the console Macintosh, ultrasonic sensors in the helmet converted head pitch and yaw into mouse movements, and binary chord keyboards in the handlebars let me yak contentedly to any of the target processors or chat live on packet while pedaling along.

The ham shack was a story in itself. Mounted behind a fold-down door in the bicycle trailer, it consisted of an Icom 725 for HF, the Yaesu 290/790 multimode pair for VHF/UHF and satellite operation, an AEA ATV rig, Bencher paddle, keyer, audio filters, antenna tuner, preamps, and so on. A folding dipole made from a pair of Outbackers on an extendible fiberglass

pole made an amazingly effective portable HF antenna, and Larsen whips took care of the rest.

All in all, *BEHEMOTH* was a fun bike ... but there was one slight problem. I had already been there! Returning to the road in 1991 was, despite some delicious mini-adventures, a let-down: After 16,000 miles on previous versions, there were few surprises lurking in the small towns and back roads of America. I started gazing at every waterway with a sense of longing ... weary of the noise and danger of asphalt.

The Microship project is born

The Microship project began with almost primal simplicity as I pedaled north along Lake Michigan in eastern Wisconsin ... if I could have wrapped a fiberglass hull around *BEHEMOTH* and pedaled 80 miles across the lake instead of huffing all the way up and around, I would have done so on the spot. But the bike was too heavy for such silly ideas, not to mention my on-board suite of nonseaworthy electronics that would, speaking optimistically, last about a day in even a freshwater nautical environment.

But shortly thereafter, while wandering the US in the Mothership on a speaking tour, a friend turned me on to sea kayaking and gave my unfocused water fantasies shape and direction. In early 1992, I announced the new project on the Net, initially naming the computerized kayak *LEVIATHAN* to echo the acronymic moniker of my bike. Over the next year, as I continued hauling *BEHEMOTH* between gigs and TV appearances (including an HF QSO from the bike on the Donahue show), my thoughts were far away ... layering communication and control systems onto a kayak ... or gee, maybe a catamaran built of two ... or gosh, possibly even a trimaran built of three! Hmmm

I had no clue at the time that I was about to undertake eight dedicated and expensive years of system design and redesign, fiberglass fabrication, hydraulics engineering, Perl coding, changes of fundamental direction, establishing a succession of labs up and down the

West Coast, developing and maintaining over 150 sponsor relationships, constant questing for volunteers, and the most expensive (and educational) project of my life. It's a good thing I didn't know this: It would have been intimidating enough to squelch the whole project.

The substrate

I'll spare you the intermediate stages; suffice it to say that the machines called Microships, now in our Camano Island lab, did not spring fully formed from the compost of my imagination. Along the way, I went through extensive nautical learning curves, in the process championing and then discarding dozens of designs ... including one based on a 30-foot cruising-scale folding tri that kept me distracted for two years. But technomadness prevailed.

The whole objective here is to build a pair of human-scale amphibian boatlets since my XYL, Natasha KF6NWO, and I would kill each other if we tried to coexist in one! Each boat (*Io* and *Europa*) needs multiple independent modes of propulsion — pedal, solar, and sail — and must accommodate pressurized control consoles to protect the gizmology that keeps us simultaneously amused and connected. The center hulls are canoes — Kevlar Wenonah Odysseys — with extensive

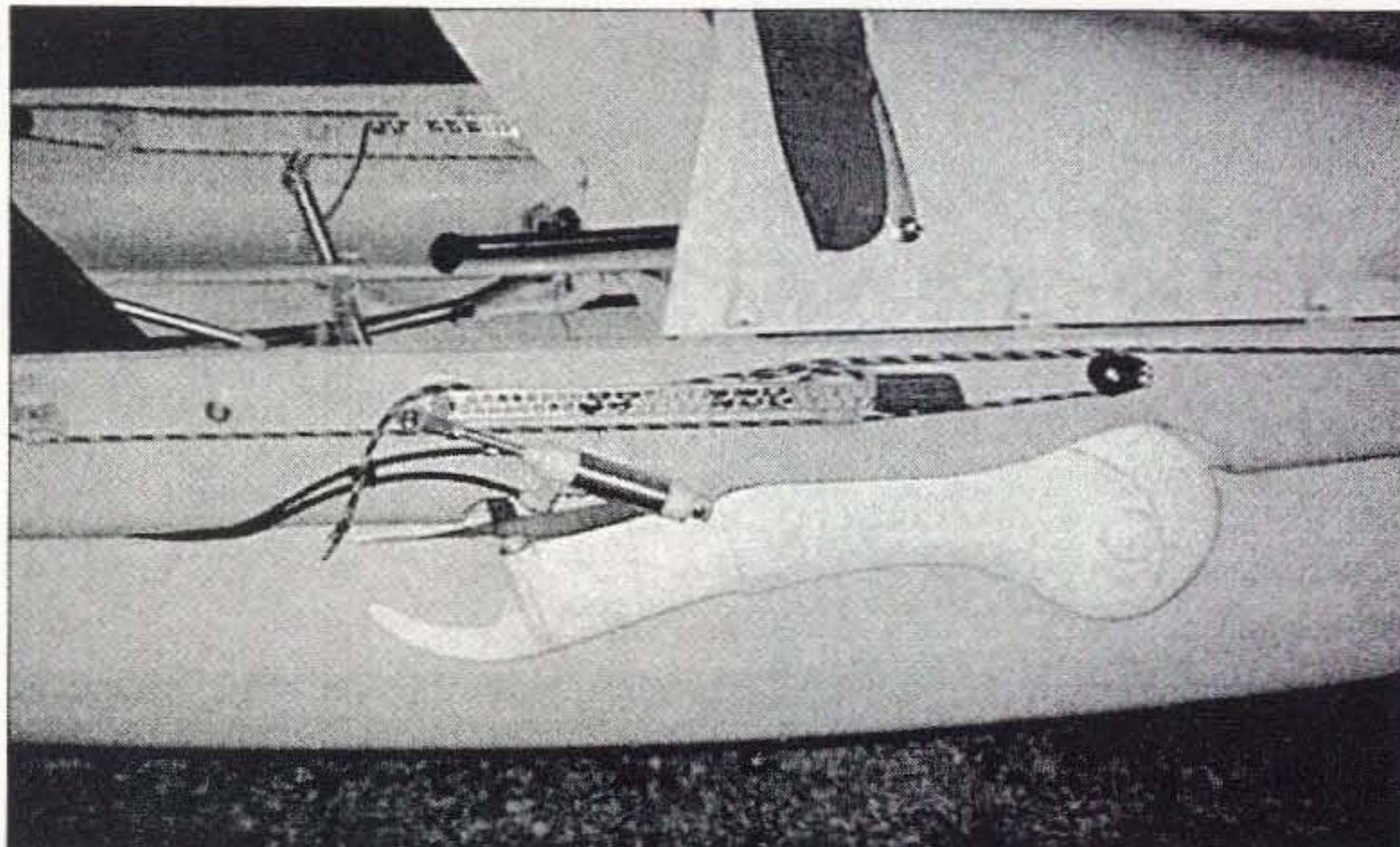

Photo E. Landing gear control levers, along with the SpinFin deployable pedal drive unit that uses a 13" model airplane prop to propel the 19' trimaran at roughly 4 knots under pizza power. The electric thruster, not shown, uses a 480-watt peak-power-tracked solar array to yield approximately 5.5 knots.

retrofitting to handle the stresses of a rotating 93 square foot sailrig and forward-angled daggerboard, with bulkheads added at the crossbeams, hatches at both ends, added arch structures, anchoring fixtures, hydraulically controlled retractable rudders, and endlessly complex deck details. A pedal drive unit allows human-powered operation at about 4 knots, and an electric thruster powered by a huge folding 480-watt foam-core solar array allows cruising on photon power.

One of the more challenging design problems was meeting the fundamental requirement for unassisted haulout and land transport ... without having some noisy truck and trailer following us around for years. Lightweight canoes and kayaks can be portaged; trailer sailors can be trailered; yachts can be used as residences. But what does a traveling couple do with a pair of 600-pound folding trimarans at the end of the day? Well, we can drop anchor and sleep aboard in the

YAESU
Performance without compromise.™

YOUR FULL LINE DEALER
FOR
ALINCO AND YAESU

ALINCO
AMATEUR RADIO'S VALUE LEADER™

See us
in Dayton!
Booths 116, 117
118 & 119

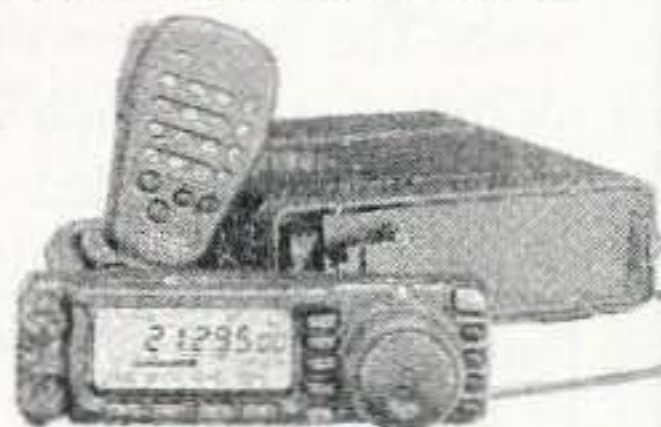

FT-100
HF/VHF/UHF

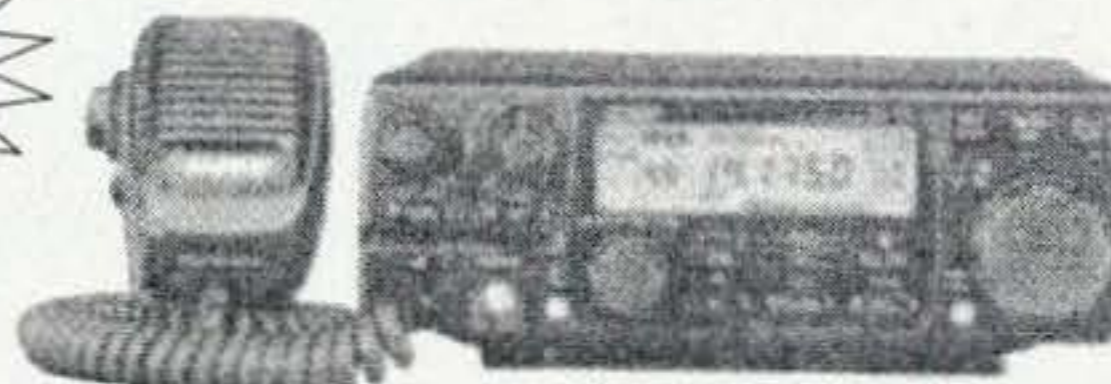

DX-70TH
\$749.00
HF and 6 Meters

Call for pricing

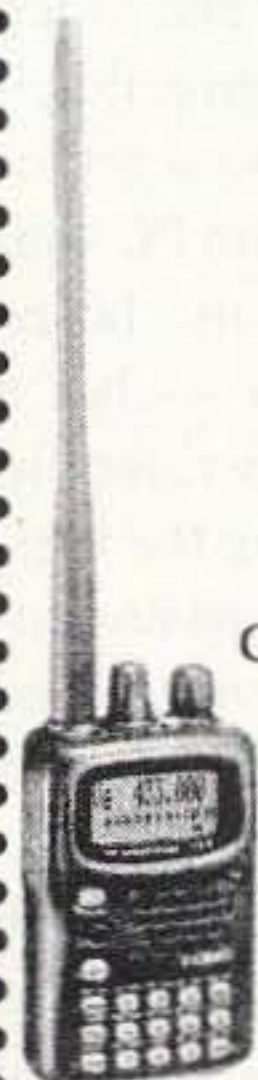

VX-5R
Tri-Band Handheld

EAST COAST
Amateur Radio Inc.

314 Schenck St., North Tonawanda, NY 14120
TEL: (716) 695-3929 • Orders: (800) 995-1787
See us on the Web! <http://www.eastcoastradio.com>
Open Mon. - Fri. 12-8 EST • MasterCard/Visa/Discover
Prices subject to change without notice



DM-330MV
\$169.00
NEW Switching
Power Supply

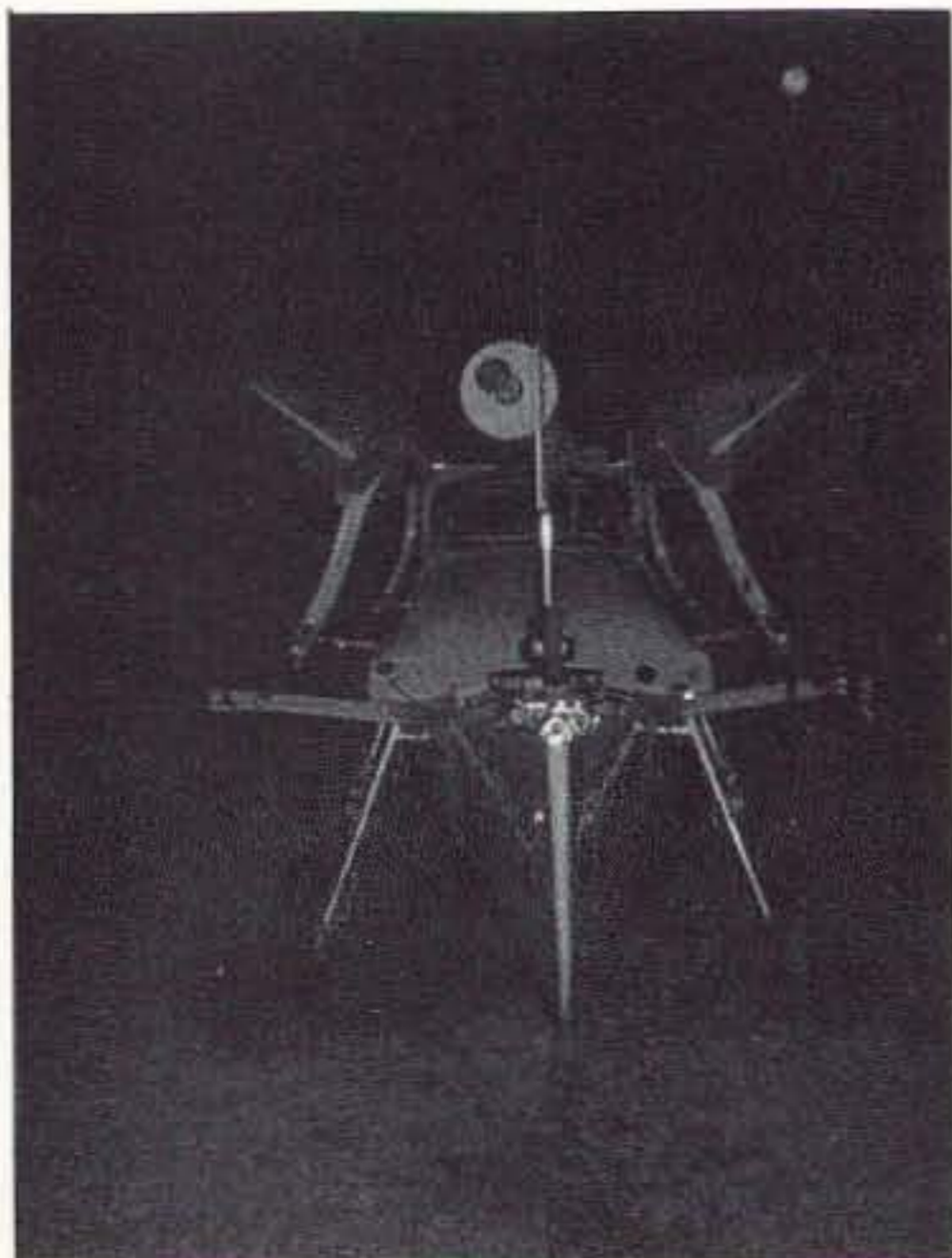

Photo F. The Microship perched on her landing gear under a full moon, looking decidedly stealthy.

coffinlike confines of the hulls, but it's a spartan existence. More often, we'll just pull a few levers, deploying our landing gear, and trundle out of the water like the strange amphibian creatures we are. The struts on my boat involved over a year of full-time development work, and include hydraulic controls, elastomeric shock absorbers that can handle 4G shock loads, Ackerman steering geometry, and tuck-away retractability from the cockpit like the landing gear of a fighter jet.

Excessive? Absurd? How many times have you let your fantasies run

away with you and imagined some mad machine, ultimate hamshack, or bizarre mobile contraption ... a creation that expresses your passion without such mundane constraints as cost or fabrication time? The beauty of turning a passion into a career is that suddenly, such mad notions become completely reasonable ... or at the very least a justifiable way to spend your life.

Under the hood

OK, so we have these retrofitted canoes that have morphed radically into amphibian folding solar trimarans with auxiliary burrito-and-wind propulsion. Now what?

Well, being geeks who thrive on ham radio, wireless data links, massive computing power, and amusing toys, the next step is obvious. A pressurized folding console (with a dedicated processor just keeping the nasties out and monitoring the internal environment) contains a tightly packed assemblage of goodies ... but immediately we run into a huge and potentially daunting design problem. How do you take a very wide range of standalone systems — ham equipment, speech and music synthesizers, cellular and satellite phones, nav and environmental sensors, dedicated controllers, marine radio, and so on — and present them as a single integrated environment that can fit on a single control console? In a lab, it would be easy to just rackmount

the whole mess ... but in a Microship, there's only about 9" of console height between pedaling legs and the pilot's line of sight across the bow!

The core of the machine has come to be known as Grand Central Station — a trio of crosspoint networks controlled by a New Micros 68HC11 board running FORTH. The first section is audio ... 32 inputs and 32 outputs, with up to 8 simultaneous connections among any combination, invoked by a simple command. A similar system handles 16 video sources and 8 video sinks ... and a third unit allows any of 32 random RS-232 serial devices to yak back and forth with any other (complete with automatic polarity detection so I never again have to swap pins 2 and 3!). In a similar vein, a bank of solid state relays allows power to be selectively applied anywhere, and a passel of digital and analog inputs cover just about any sensor need, including a huge amount of internal status monitoring and a suite of environmental water- and air-quality channels.

It may sound like overkill in a canoe, but look at what this does for us! When anything can be connected to anything under software control, every widget reduces to a set of addresses. The Icom 706? It's a serial port, a pair of audio channels, a power-control bit, and a PTT bit. Globalstar satellite phone? A couple of serial ports and more audio. Packet TNC? More of the same. Compass, wind sensor, and other environmental black boxes? Just incoming serial streams. Dedicated systems such as solar peak power trackers and video turret control? Simple bidirectional ports. The processor that sits on top of all this — an I/O-rich Octagon PC-680 industrial embedded Pentium board running Debian GNU/Linux — has a bunch of code modules (written in Perl), that take care of issuing the various connect commands, databasing incoming time- and location-stamped sensor info, sending telemetry to our public server, creating display widgets on the console ... well, you get the idea. Everything on board, thanks to Grand Central Station, has become the moral



Photo G. In "land mode," deployable landing gear allow easy portaging, though hills can be challenging. We haven't figured out what to do about gravity yet.

Continued on page 16

MFJ TUNERS

MFJ-989C Legal Limit Antenna Tuner

MFJ uses super heavy duty components to make the world's finest legal limit tuner

MFJ uses super heavy duty components -- roller inductor, variable capacitors, antenna switch and balun -- to build the world's most popular high power antenna tuner.

The rugged world famous MFJ-989C handles 3 KW PEP SSB amplifier input power (1500 Watts PEP SSB output power). Covers 1.8 to 30 MHz, including MARS and WARC bands.

MFJ's AirCore™ roller inductor, new gear-driven turns counter and weighted spinner knob gives you exact inductance control for absolute minimum SWR.

You can match dipoles, verticals, inverted vees, random wires, beams, mobile whips,



MFJ-989C

\$359⁹⁵

shortwave -- nearly any antenna. Use coax, random wire or balanced lines.

You get everything you've ever wanted in a high power, full featured antenna tuner -- widest matching range, lighted Cross-

Needle SWR/Wattmeter, massive transmitting variable capacitors, ceramic antenna switch, built-in dummy load, TrueCurrent™ Balun, scratch-proof Lexan front panel -- all in a sleek compact cabinet (10³/₄Wx4¹/₂Hx15D in).



MFJ AirCore™ Roller Inductor gives high-Q, low loss, high efficiency and high power handling.

MFJ's exclusive Self-Resonance Killer™ keeps damaging self-resonances away from your operating frequency.

Large, self-cleaning wiping contact gives good low-resistance connection. Solid 1/4 inch brass shaft, self-align bearings give smooth non-binding rotation.

MFJ No Matter What™ Warranty

MFJ will repair or replace your MFJ-989C (at our option) no matter what for one year.

More hams use MFJ tuners than all other tuners in the world!

MFJ-986 Two knob Differential-T™

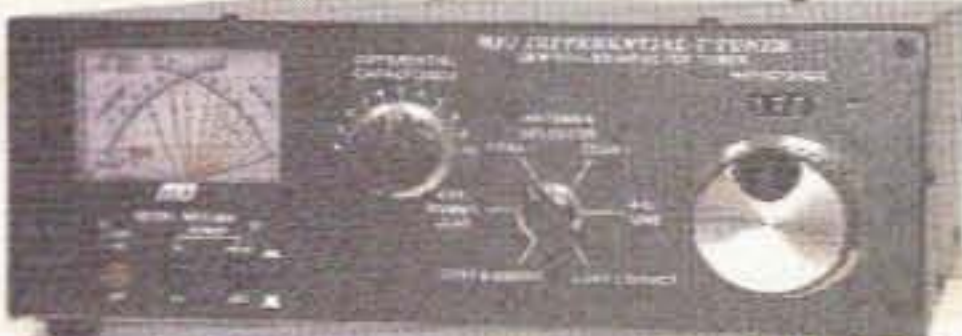

Two knob tuning (differential capacitor and AirCore™ roller inductor) makes tuning foolproof and easier than ever. Gives minimum SWR at only one setting. Handles 3 KW PEP SSB amplifier input power (1.5 KW output). Gear-driven turns counter, lighted peak/average Cross-Needle SWR/Wattmeter, antenna switch, balun. 1.8 to 30 MHz. 10³/₄Wx4¹/₂Hx15 in.

MFJ-962D compact Tuner for Amps



A few more dollars steps you up to a KW tuner for an amp later. Handles 1.5 KW PEP SSB amplifier input power (800W output). Ideal for Ameritron's AL-811H! AirCore™ roller inductor, gear-driven turns counter, pk/avg lighted Cross-Needle SWR/Wattmeter, antenna switch, balun, Lexan front, 1.8-30MHz. 10³/₄x4¹/₂x10⁷/₈ in.

MFJ-969 300W Roller Inductor Tuner



Superb AirCore™ Roller Inductor tuning. Covers 6 Meters thru 160 Meters! 300 Watts PEP SSB. Active true peak reading lighted Cross-Needle SWR Wattmeter, QRM-Free PreTune™, antenna switch, dummy load, 4:1 balun, Lexan front panel. 3¹/₂Hx10¹/₂Wx9¹/₂D inches.

MFJ-949E deluxe 300 Watt Tuner

More hams use MFJ-949s than any other antenna tuner in the world! Handles 300 Watts. Full 1.8 to 30 MHz coverage, 48 position Precision48™ inductor, 1000 Volt tuning capacitors, full size peak/average lighted Cross-Needle SWR/Wattmeter, 8 position antenna switch, dummy load, QRM-Free PreTune™, scratch proof Lexan front panel. 3¹/₂Hx10⁵/₈Wx7D inches.

MFJ-948, \$129.95. Economy version of MFJ-949E, less dummy load, Lexan front panel.

MFJ-941E super value Tuner

The most for your money! Handles 300 Watts PEP, covers 1.8-30 MHz, lighted Cross-Needle SWR/Wattmeter, 8 position antenna switch, 4:1 balun, 1000 volt capacitors, Lexan front panel. Sleek 10¹/₂Wx2¹/₂Hx7D in.

MFJ-941E \$119⁹⁵

MFJ-945E HF+6 Meter mobile Tuner

Extends your mobile antenna bandwidth so you don't have to stop, go outside and adjust your antenna. Tiny 8x2x6 in. Lighted Cross-Needle SWR/Wattmeter. Lamp and bypass switches. Covers 1.8-30 MHz and 6 Meters. 300 Watts PEP. MFJ-20, \$4.95, mobile mount.

MFJ-971 portable/QRP Tuner

Tunes coax, balanced lines, random wire 1.8-30 MHz. Cross-Needle Meter. SWR, 30/300 or 6 Watt QRP ranges. Matches popular MFJ transceivers. Tiny 6x6¹/₂x2¹/₂ inches.

MFJ-901B smallest Versa Tuner

MFJ's smallest (5x2x6 in.) and most affordable wide range 200 Watt PEP Versa tuner. Covers 1.8 to 30 MHz. Great for matching solid state rigs to linear amps.

MFJ-16010 random wire Tuner

Operate all bands anywhere with MFJ's reversible L-network. Turns random wire into powerful transmitting antenna. 1.8-30 MHz. 200 Watts PEP. Tiny 2x3x4 in.

MFJ-906/903 6 Meter Tuners

MFJ-906 has lighted Cross-Needle SWR/Wattmeter, bypass switch. Handles 100 W FM, 200W SSB. MFJ-903, \$49.95, Like MFJ-906, less SWR/Wattmeter, bypass switch.

MFJ-921/924 VHF/UHF Tuners

MFJ-921 covers 2 Meters/220 MHz. MFJ-924 covers 440 MHz. SWR/Wattmeter. 8x2¹/₂x3 inches. Simple 2-knob tuning for mobile or base.

MFJ-922 144/440 MHz Tuner

Ultra tiny 4x2¹/₂x1¹/₄ inch tuner covers VHF 136-175 MHz and UHF 420-460 MHz. SWR/Wattmeter reads 60/150 Watts.

MFJ-931 artificial RF Ground

Creates artificial RF ground. Also electrically places a far away RF ground directly at your rig by tuning out reactance of connecting wire. Eliminates RF hot spots, RF feedback, TVI/RFI, weak signals caused by poor RF grounding. MFJ-934, \$169.95, Artificial ground/300 Watt Tuner/Cross-Needle SWR/Wattmeter.

Free MFJ Catalog

and Nearest Dealer . . . 800-647-1800

<http://www.mfjenterprises.com>

1 Year No Matter What™ warranty 30 day money back guarantee (less s/h) on orders from MFJ

MFJ ENTERPRISES, INC.
Box 494, Miss. State, MS 39762
(601) 323-5869; 8-4:30 CST, Mon.-Fri.
FAX: (601) 323-6551; Add s/h
Tech Help: (601) 323-0549

Prices and specifications subject to change. (c) 1998 MFJ Enterprises, Inc.



Photo H. Steve Roberts N4RVE, hauling the folded trimaran down to Saratoga Passage on the west side of Camano Island for a test sail.

Ah, the Technomadic Life!

continued from page 15

equivalent of code, and the front end looks just like a Web site.

On the water, Microship mobile ...

The net effect of all this is a sort of *Star Trek* gestalt: complete integration of all communication, control, and

sensor tools with access from any of the four browser environments (two boats and two backpack laptops, all linked via high-speed wireless network). Random interconnects are trivial to implement, so it's no big deal, for example, to speak a verbal command like "Where is Natasha?" via dual-band HT and have the Microship system respond over the air with a synthesized voice, giving me range and bearing based on the latest APRS

data from both of our packs. Or to have the security system respond to unauthorized midnight hatch opening by rotating the steerable camera platform to face the intruder, flooding him with IR, and routing video to the serial-controlled VCR while simultaneously paging me and calling the police. And streaming 50+ sensor channels to console Java strip chart emulators, live

instrument displays, and outgoing satellite/packet telemetry to our public breadcrumb-trail server is a piece o' cake

Of course, the real point here is taking all those geek delights and integrating them into an adventure ... and my XYL and I are leaving our island lab in the Spring of 2001 to begin a 15,000+ mile mobile field day: a circumnavigation of the eastern US beginning down the road at the mouth of the Columbia River (inside the bar!). From there, it's a 465-mile slog upriver to Lewiston, Idaho, where we'll load the boatlets into a truck and haul them over the Rockies to the headwaters of the Missouri River at Three Forks, Montana.

There begins the downhill run, though from what I've read of the upper Missouri that's a bit of an oversimplification. We'll traipse 2,546 miles across the northern plains and down between Nebraska and Iowa ... cutting east to join the Mississippi River just above St. Louis. A short float downriver brings us to the mouth of the Ohio ... then upriver slightly to the Tennessee, whereupon we turn south and continue along the Tenn-Tom Waterway and down the Tombigbee River to Mobile, Alabama (the more obvious parallel path down the lower Mississippi is relatively hostile to small boats). At the Gulf, we turn left on the



Photo I. Arrhh! Fresh from a successful nonelectronic test sail, N4RVE is about to start hauling her out of the water.



Photo J. N4RVE, Steven Roberts, at the BEHEMOTH hamshack, somewhere in Wisconsin.

Intracoastal Waterway and meander all the way around Florida (through the Everglades and the Keys) and north along the Atlantic Coast. The ICW will carry us past Boston, with no shortage of interesting explorations en route.

At this point, unless forced by seasons or sanity to shortcut up the Hudson, we encounter open coast for a while as we traverse the exquisitely convoluted Maine shoreline — then into the Bay of Fundy, followed by a short portage across New Brunswick at Moncton (to skip the suicidal outside coast of Nova Scotia). After darting around the Gaspé Peninsula during a favorable weather window, we'll head up the St. Lawrence, turn left at Montreal to sail down Lake Champlain, pop over to the Erie Canal, travel back in time across New York, emerge into Lake Erie, cruise up Lake Huron and down Lake Michigan, cut through Chicago to the Illinois, float down Old Muddy, then finally struggle up the Ohio River to Louisville, my boyhood QTH, where we'll stop at my father's house and truck the tattered and filthy Microships back to our Camano Island lab to fix things and address the long list of essential changes that should have been obvious at the beginning. And then? Who knows?

QRZ

Here's where you come in. Human-scale technomadic adventure puts us out there far from the gentle isolation of the lab, where "surfing" implies a succession of HTTP protocol transfers instead of careening headlong toward the rocks on the back of a rogue ferry wake. We'll be on the edge constantly, living in wild and unpredictable ways, always welcoming the warm QSOs, shared QTHs, and technical participation of the amateur community.

If you'd like to keep an eye on us, read archived and current road stories, get detailed technical information about the Microships, watch live telemetry, peer over our shoulders via the labcam, help with fabrication, or get on the mailing list for monthly updates, please visit our Web site at [http://www.microship.com]!

In the space of an article, I can

barely begin to describe the details of this system ... but as I stated at the outset, that wasn't my intent. The thing I'd like most to leave with you is much

more important than that: It's a sense of passion ... the wide-eyed delight

Continued on page 58

NEW



IC-756 PRO
32 Bit Floating Point DSP
HF thru 6M

ICOM



IC-746
HF/6M/2M/100 Watts

New Pricing



IC-706 MKIIG
HF + 6M + 2M +
440MHz

Call For Alinco Specials



DX-70TH Compact, 100W, HF

ALINCO



DR-610T
2M/440MHz Mobile/Base

Hi, To All The Folks At SEAPAC



DJ-V5TH
V/UHF, FM
Handheld

RADCOMM RADIO

3300 82nd St. #E, Lubbock, TX 79423
1-800-588-2426
 806-792-3669 FAX 806-785-3699
www.rad-comm.com



WWW.HAMCONTACT.COM

Serving the LORD since 1987



\$49.95!
Buy the second for only **\$39.95!**



THE POWER STATION

The POWER STATION is a 12v 7Amp/Hr gel-cell battery. It comes complete with a built in voltmeter, a wall charger and a cord for charging via automobiles. It powers most hand held radios at 5 watts for 2-4 weeks (depending upon how long winded one is). It will also run a VHF, UHF, QRP or HF mobile radio, such as the Icom 706 at 100 watts. There are no hidden costs. All that is required is a mobile power cord or a HT cigarette lighter adapter.

The POWER STATION provides 12V from a cigarette lighter outlet and has two recessed terminals for hardwiring. A mini-phone jack with 3V, 6V, or 9V output can be used separately for CD player, Walkman, etc. The POWER STATION can be charged in an automobile in only 3 hours, or in the home in 8 hours. The charger will automatically shut off when the battery is completely charged. Therefore, The POWER STATION may be charged even when it has only been slightly discharged (unlike Ni-Cads that have memory). The charging circuit uses voltage sensing circuitry. Other brands are timed chargers, which always charge a battery a full cycle. If all that is needed is a partial charge, this damages a battery and shortens the life. The POWER STATION has a voltmeter that indicates the state of charge of the battery, not worthless idiot lights that declare "YOUR BATTERY IS NOW DEAD". The voltmeter can even be used to measure voltages of other sources.

Dealer Inquiries Invited

Send Check or M/O for Model 752 for \$49.95 + \$10.50 s/h. Include UPS-able address and tel. no. to:

THE HAM CONTACT, P.O. BOX 4025, DEPT. 73
Westminster, CA 92684



CA residents Add 7 3/4% Sales Tax. Canadian Residents Please Send U.S. Money Order & \$26.00 Shipping. If you wish for more information please send a SASE with 3 stamps to the above address. E-mail: 73@hamcontact.com
 INFO LINE: (714) 901-0573 FAX: (714) 901-0583, ORDERS ONLY (800) 933-HAM4.

Electronics Bench for Dummies

And it doesn't take an Einstein to know how important a good bench — like this one — really is.

The first principle of engineering is that if you are going to build something, you must have something to put it on. So this is it: an article on what goes under the rig, the bench.

Benches for ham rigs are a problem. The stores have computer benches that could be used. They look really stylish and might look good in a living room. But when you look closer you see it is usually cheap particleboard with a veneer over it. As for comfort, they look like they were designed by a guy who specializes in medieval torture equipment. They are perfectly suitable for a guy who weighs under 90 pounds and doesn't intend to move a muscle. On the other hand, the benches offered for

shops are good for carpenters to assemble furniture on, but they are murder for a ham rig. Too high, too narrow, and never fit into the place you want.

Benches don't have to be elaborate — merely a good strong table that is the correct distance above the floor and at least six feet long will do. The six feet comes from the fact that most people sit in the center and do not want to reach any farther than three feet. If it is less than six feet, then you are not making use of the space you have around you.

For your ham rig, you want a place where you can sprawl around and put your feet up on the bench without knocking the whole thing over or having it cave in. A leg rest under it is also nice, so you can change the position of your feet a little from time to time and avoid stiff legs. It is also nice to have the rig back far enough so that you have room in front for the log and keys without cramping. If the commercial bench is of the right width, it never is the correct length — and if it is the correct length, it is the wrong width.



Photo A. Set the 4-ft. by 8-ft. piece of 3/4-inch plywood on sawhorses.



Photo B. You can use a nail tightly set in your drill chuck to make nail holes ...

Making your own has the additional advantage of allowing you to exactly fit it into the space you have and make it fit you besides. Also, when you only pay for the lumber and not the work, you get a lot more bench for your money. It is nice to have a bench designed for you first and not for the maximum profit of the manufacturer first.

A similar bench for a computer lets you have a place for a desktop computer so that you can change disks and CDs fast without fishing under the bench — which you have to do with a minitower. In addition, it would also allow the installation of new boards without getting yourself killed in positions that are taken only by a guy installing a new radio in an old car. You can put the printer on top of the desktop, so that putting the desktop on the desktop takes up no additional room. This arrangement also gives you lots more leg room.

I also want the computer monitor in a position such that I do not have to look up at it and far enough back (2 feet) so that I don't become nearsighted. The best is to have the monitor on the same table surface as the keyboard. If you have the monitor on top of the computer, eye strain develops.

I also wanted nothing that would require a cabinetmaker's tools, and I want to be able to put it together with a circular saw, drill, hammer, and wrench, the tools I have. I decided on a bench merely made of 2-by-4s and some ordinary 3/4-inch plywood, since I wanted it cheap, strong, and big. I decided to make a table 30-3/4 inches

above the floor, six feet long and 32 inches wide. This height makes it possible to store an office chair under the table with its arms clearing, as well as have enough room to put a standard two-drawer file cabinet (28 inches tall) under it. [Before deciding on the height of any desk or bench these days, it would probably be a good idea to research information on the optimum height(s) for avoiding metacarpal tunnel syndrome. — ed.] The width makes it possible to have your ham rig or computer CRT back 24 inches from the front edge of the table, which is a sightsaving feature.

So I went to the old discount lumber yard and bought:

1. One 3/4-in. plywood panel, 4 by 8 feet, good one side, indoor type.
2. Five 14-foot-long 2-by-4s (or any combination that makes up about 70 feet of it). (For you guys who aren't carpenters, a board that is 1-1/2 inches by 3-1/2 inches in cross-section is called a "two-by-four". That's because they are allowed a plus or minus 1/2-inch in lumber dimensions, and they always make it minus.) I checked them by eyeball to make sure they had no bad warps. At the prices I pay, you don't expect 2-by-4s to look like veneer ... and they sure didn't. Some still had some bark on them, but they were mostly pretty good.

I paid about \$50 for the whole lot.

In addition, what is needed is:

3. Eight 5/16 cartridge bolts, 3-1/2 inches long. Also 6 nuts and 6 washers that fit on them.
4. One box 8d finishing nails. They

The New Pools!

Examination Test
Questions & Answers

The exact questions, multiple choices and answers for the Technician Class, General Class, and Extra Class operator's license.

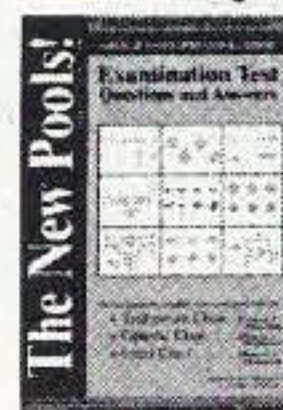

Only
\$9.95
Plus \$3.50 S&H

Omega Sales

P.O. Box 376

Jaffrey, NH 03452

800-467-7237



HamCall™ CD-ROM
U.S. & International - Over 1.5 million listings



We make a new HamCall every month! Clearly, the most comprehensive and current CD-ROM available.

Latest Features

Choose font and color of data display.
Displays flag and map for each country.
Shows CQ, ITU zone, and continent.
History list shows each callsign entered.

View & search interests of 26,000 hams.
Search for club, military, RACES, vanity, silent keys, name, address, and more.
Over 1,566,000 U.S. and International listings, 104,000 e-mail addresses, 4,000 photos and QSL cards, 30,000 vanity calls; and 12,000 references to QSL managers.

Shows short & long path distance & bearing.
Precise latitude/longitude for over 90% of addresses.
HamCall is \$50.00, included is 6 months free access to our Internet Search Service - request when ordering.

HamCall Mousepad, with morse code reference, 7.5" x 8", blue with yellow letters. \$5.00+\$3 shipping.

\$5.00 shipping per order. Your satisfaction guaranteed!
Free 800 technical support - we won't let you fail.



BUCKMASTER

6196 Jefferson Highway • Mineral, VA 23117 USA
e-mail: info@buck.com www.buck.com
540:894-5777 • 800:282-5628 • 540:894-9141 (fax)



Photo C. Turn the plywood top over so that the good side is down.

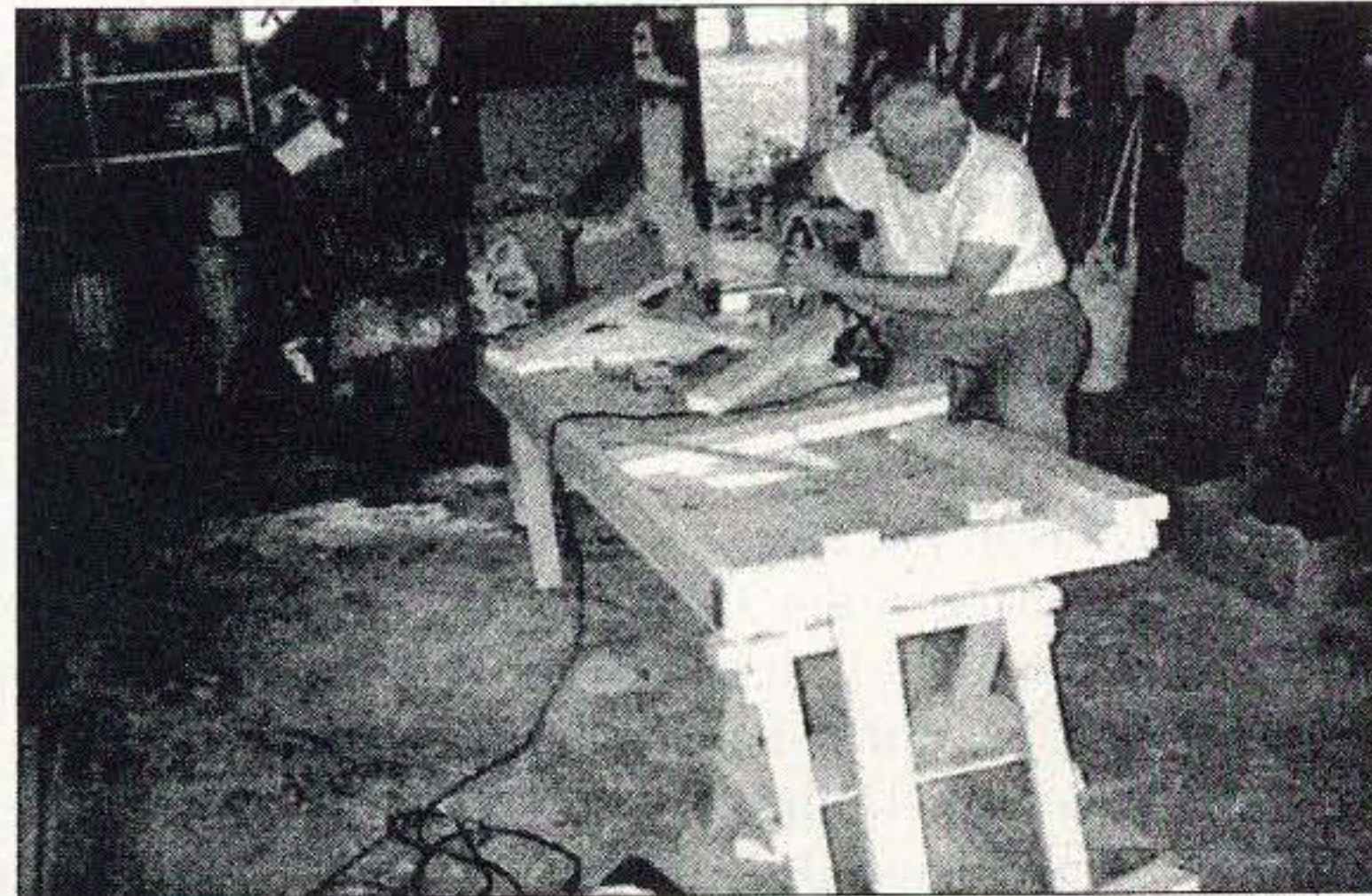

Photo D. Cut four pieces of 2-by-4 30 inches long ...



Photo E. Place the two "H" pieces in position as the legs, and clamp them in place.



Photo F. Take a 2-by-4 and line it up with the gap between the H's crosspiece and the tabletop 2-by-4 ...

are 2-1/2 inches long. Since 2-by-4s are 1-1/2 inches thick, an 8d nail lets you nail two together without the nail going through.

5. One small bottle of white wood glue.

6. One circular sandpaper disk, medium, fits in drill (optional).

7. Two sheets coarse sandpaper, 2 sheets medium sandpaper.

8. A small amount of paint thinner. A pint is fine.

9. One quart of indoor latex paint, you pick the color. I picked green so that it would look something like a gambling table. It made me feel more at home.

10. About 4 hours of time, including a break, to complete unfinished. Finishing is longer, since you have to wait for the paint to dry.

The tools I used were:

1. A 7-1/4-in. circular saw with a combination blade.

2. A hammer.

3. An electric drill and 5/16-inch bit.

4. A small block plane.

5. A 5/16-inch wrench.

6. Two 8-inch or larger clamps.

7. A yardstick or roll ruler and pencil.

8. A tri-square; 8-inch is OK.

9. Two sawhorses.

10. Two-inch paintbrush.

The idea was to put 2-by-4s around the edge of a piece of the 3/4-in. plywood, with the 3-1/2-inch side vertical. But across the front where you sit, the 2-by-4 has the 1-1/2-inch side vertical to give you more leg room. To make up for the difference in strength,

two 2-by-4s were run across the front. These two-by-fours were glued into place so that there are no nail holes through the plywood in front of the operator.

So, for those people who are not master carpenters, here's how to build it:

Photo A: Set the 4-by-8-foot piece of 3/4-inch plywood on sawhorses, good side up. Look for the best corner (usually, by the time you get plywood home at least one corner is chipped). Draw a rectangle from there for the size of the top you want to cut. This was, for me, 72 by 32 inches.

Also observe the safety precautions: wear some kind of eye protectors, make sure the wood being cut is solidly mounted, and, if necessary, use a clamp to the sawhorses. To keep metal clamps from marring the plywood, put a small piece of wood or heavy cardboard between the clamp and the plywood. Use a GFI electrical socket if outdoors or in a basement or garage.

Take up your circular saw, and make sure the sawhorses are not under the line you will be cutting. Remember, with a circular saw, **WHEN THE LINE YOU DRAW IS IN ITS SIGHTS, THE PIECE TO THE LEFT WILL BE THE CORRECT DIMENSION.** Cut. It should cut easily. If you have trouble cutting, you are using the wrong blade in your circular saw. Do not use a "plywood blade": That kind of blade is only for thin plywood veneer, not for 3/4-inch.

Photo B: Lay a 2-by-4 across the width of the plywood top and make a

mark on the 2-by-4, then use a tri-square to draw a line across the 2-by-4. It should be nearly 32 inches long. Always measure a single piece and draw a line. Never mark two lines at a time and cut twice, since the accuracy is not good enough to make the pieces fit well. Clamp the unmarked side of the 2-by-4 and then saw on the cut, using the line to guide your circular saw across. Use the sights on the saw, and keep the marked piece to the left. Sometimes, as you come to the end of the cut you may have to slightly rotate the 2-by-4 away from you to enlarge the opening of the cut to keep from jamming the blade. Usually this does not have to be done. Finish the cut even though you have passed the guideline you have drawn. By this time, the blade will be guided by the cut. There may be bad sections on some of the 2-by-4s. Just don't use them — except for firewood.

Then cut a piece of 2-by-4 69 inches long (the 72 inches of the width of the bench minus two 1-1/2-inch widths of the 2-by-4s).

With the plywood on the sawhorses, good side up, arrange the three pieces under the edges of the plywood top with the short side of the 2-by-4 against the plywood.

Place a nail in the drill chuck and push all the way in, close the chuck, but not tight. Pull the nail outward until the head just touches the teeth of the chuck, and push back slightly. Then tighten using the key in **ALL THREE HOLES** to keep it from slipping. Use

this to drill the nail holes here and anywhere you ever need it in the following. The drilling of nail holes using a nail as a drill saves a lot of time, bent nails, and bruised fingers.

Drill a hole and drive an 8d nail through the plywood into the 2-by-4 about every 8 inches, but do not join the 2-by-4s with nails yet. Use finishing nails 2-1/2 inches long.

Photo C: Turn over the plywood top so the good side is down on the sawhorses.

Drive three nails in each of the two corners to hold the 2-by-4s together. It is best to drill a hole for the nail beforehand whenever nailing.

Line up a 2-by-4 to fit the front edge between the two side pieces, draw a mark, use the trisquare to draw a line, and cut. Put a wiggly stripe of wood glue on the total length of one of the wide sides of this piece. If the piece has a bend, put it so that the center is high, not the ends. Press this side into place along the remaining edge of the top. Use wood clamps to hold in place until dry (usually overnight). If the wood clamps are metal, place pieces of scrap wood or cardboard between the clamp and the good side of the plywood to prevent marring from the clamp. If you do not have wood clamps, fill a bucket with water and use it as a weight to hold it in place. Drill and drive in three nails at the ends to hold the 2-by-4's together, but don't knock over the bucket of water.

Photo D: Cut four pieces of 2-by-4's 30 inches long (height of legs). Remember to measure, cut, measure, cut, etc. Again, never draw two or more lines then cut them.

Cut two pieces of 2-by-4 27 inches long.

Set the two 30-inch-long pieces down. Place a 27-inch piece to make an "H" with the bottom of the 27-inch piece 9 inches from the ends of the two 30-inch pieces. Drill holes for the nails, putting one nail in each joint. Use a trisquare to make the pieces at right angles, then drill and drive in three more nails in each joint, making roughly a square pattern. When making this kind of joint, it is usually better that the nails be driven in at very slightly

If you must choose between two evils, pick the one you've never tried before.

Ham Mall

The world's largest internet store dedicated to Ham Radio!

www.HamMall.com

This is the internet store that has it all! Open 7 days per week - 24 hours per day. Browse through our catalog viewing pictures, descriptions, accessories, and our low prices. If you are looking for a hard to find item, Email us at Bill@HamMall.com, and we will try to locate it for you.

Check out all we offer!

Call Wall QSL Manager Listing News, Announcements and Specials
Ham-to-Ham Discussion Groups Ham Shack Photos

Visa/MasterCard accepted on line. Free shipping in continental US on all orders over \$100.

When in Seattle visit us at:

Radio Depot, Suite 176, 5963 Corson Ave., So. Seattle, WA 98108
Phone (206) 763-2936 Fax (206) 763-4172



Only From LDG Electronics!
Assembled and Tested: \$129
\$99 with purchase of any
assembled Automatic Antenna
Tuner (phone orders only)

DWM-4 Wattmeter includes 2 Sensors | Shipping Additional

Digital Accuracy

- Microprocessor Controlled
- Monitor 4 Radios With 1 Meter
- Accurate Measurement for:
QRP/HF/VHF/UHF
- Programmable Alarms
- Programmable Callsign Display
- 11 to 14 VDC Operation

1445 Parran Rd.
St Leonard, MD 20685
Toll Free Sales 877-890-3003
Info: 410-586-2177 Fax: 410-586-8475
Web Site: www.ldgelectronics.com
E-mail: sales@ldgelectronics.com



- DIP switch programmable
- Miniature in size
- 37 EIA tones, 27 non-standard tones from 33.0 to 254.1 Hz included
- Reverse Burst built-in
- Easy 3 wire hookup

SS-64 CTCSS Encoder
.66" x 1.08" x .21"

SS-64 DIP Switch Programmable CTCSS Encoder \$28.95

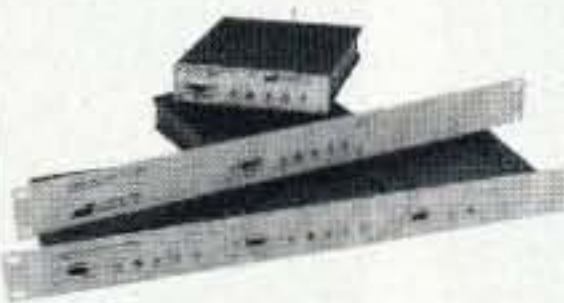

TP-3200 Shared Repeater Tone Panel

TP-3200D Table Top Version \$269.95 each
TP-3200RM-A Single Rack Mount version \$279.95 each
*TP-3200RM-B Triple Rack Mount version \$279.95 each
*Holds up to three TP-3200s

Call or write to receive our full Product Catalog or visit our Web site for complete information at:
<http://www.com-spec.com>



- 51 CTCSS Tones
- 106 DCS Codes
- Supports 157 Repeater Subscribers
- On-Line Computer Help
- Repeater CW ID
- Air Time Loading & Analysis Graphs
- Signalling Formats: CTCSS, DCS & DTMF

- Fully enclosed CTCSS encoder
- All 32 EIA tones from 67.0 to 203.5 Hz included
- Perfect for mobile / base applications

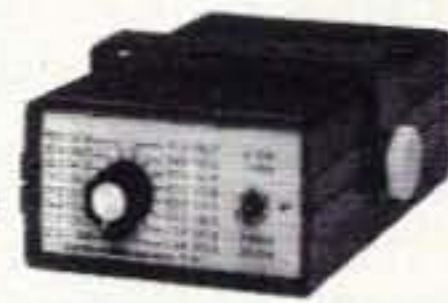

TE-32
5.25" x 3.3" x 1.7"

TE-32 Multi-Tone CTCSS Encoder \$49.95

- Eight programmable, selectable messages
- Fully field programmable via included keypad
- Meets all FCC identification requirements



ID-8 Automatic Morse Code Identifier
1.85" x 1.12" x .35"

ID-8 Automatic Morse Station Identifier \$69.95



COMMUNICATIONS SPECIALISTS, INC.
426 WEST TAFT AVENUE • ORANGE, CA 92665-4296
(714) 998-3021 • FAX (714) 974-3420
Entire U.S.A. (800) 854-0547 • FAX (800) 850-0547
<http://www.com-spec.com>

CIRCLE 10 ON READER SERVICE CARD



Photo G. Cut two pieces equal to the overall length of the table ...



Photo H. Cut the end of a 2-by-4 off to form a 45 degree angle. Place in position as a support, as shown, and mark and cut.

different angles to make them hold better. Repeat this, making a second "H."

Photo E: Place the two "H" pieces in position as the legs, and clamp in place.

Make sure the legs are firmly against the plywood top, and then drill a 5/16-inch hole through the tabletop's 2-by-4s into the legs. Put a cartridge bolt into each joint, a washer, and a nut. Tighten so that the legs do not move — firmly, but not hard. The final tightening will be done later.

Photo F: Take a 2-by-4 and line it up with the gap between the "H" crosspiece and the tabletop 2-by-4. Mark and draw a line. Tap it into position as shown. Drill three nail holes in each piece and drive in three nails spaced along its length, holding the piece with your other hand. Repeat for the other legs.

Photo G: Cut two pieces equal to the overall length of the table, about 72 inches long. Place one as shown across

the legs: the other is a foot rest and will be put in later. Drill and nail in position as in photo.

Cut a piece of 2-by-4 equal in length to the piece previously glued along the front edge. Place it against the plywood next to the front 2-by-4 legs. Glue in place and clamp by putting small pieces of 2-by-4 across both this and the edge piece. Drill and drive in three nails in each end. Let glue dry. These 2-by-4s can support a standard 15"W by 12"D drawer [obtainable from Kitchen & Home, stock #615647, tel. 1 (800) 414-5544].

Photo H: Cut the end of a 2-by-4 off to form a 45 degree angle. Place in position as a support, as shown, and mark and cut. Place the piece as shown. Clamp them in place and drill two 5/16-inch holes in each as shown. Place a cartridge bolt in each hole and tighten firmly, but not all the way. Repeat for the second support.

Photo I: Flip the table off the saw-

horse and onto its legs. Make sure the table is on a flat surface, and tighten all the bolts. If the table wobbles, loosen the bolts and place a scrap of 2-by-4 under one of the diagonal legs that does not leave the floor and press down suddenly over the legs on the opposite diagonal. This may have to be done several times. When any wobble is gone, tighten all the bolts.

Put the remaining 72-inch 2-by-4 as a footrest, as shown, on the horizontal crosspieces, drill, and nail in place.

Cut off the front lower corners of the 2-by-4s at the front of the table as shown in the photo. This prevents hitting your knees on the protruding corners. Use a sanding disk in your drill to round off the edges.

At this point the construction is ended and the finishing starts.

Take a piece of coarse sandpaper and run it over all the 2-by-4s to get rid of the splinters and rough stuff. You should be able to run your hand over



Photo I. Flip the table off the sawhorse and onto its legs.



Photo J. Finished bench.

the wood and it should feel smooth. This should not take more than 10 or 15 minutes.

Slightly round the edges of the tabletop to about a 1/4 in. radius, using a block plane. Set the plane to a small gap and run it around the edge, making a 45 degree flattening. Then go around to smooth the ridges at about 22-1/2 degrees, then at 67-1/2 degrees, and then run over it with hand-held coarse sandpaper. This only requires a few minutes, but you will be glad this edge is rounded when you use your rig or computer. Be sure it's well sanded, so your arms are not against a sharp edge when sitting at the table.

Cut two pieces of 2-by-4 to 5 inches long. Drill and nail them to the back edge of the table, at the sides, to hold the table away from the wall to make a space for cables and line cords. These are shown in **Photo I**.

Sand the desktop by wrapping a sheet of coarse sandpaper around a piece of scrap 2-by-4 that is longer than the sandpaper. Run over the top with a circular motion. This should only take about 5 minutes.

Take the other piece of coarse sandpaper and use it, by hand, to smooth off the 2-by-4s and the edge of the top. All wood surfaces should feel smooth to your hand. Fill in any holes with wood putty.

Use the paintbrush and dust off all sawdust off of the table and the legs. Soak a rag in paint thinner and run it over all the wood, but use rubber gloves — or wrap tin foil around the rag to keep it from contacting your skin. This removes all sawdust clinging to the wood. Do not skip this. Do not use water or let water contact the surface of the plywood before it is painted, since it will cause it to become rough.

Put the table back on the sawhorses, tabletop down. Paint it. (After each painting, hose the brush, and use a little detergent until the water runs clear, and you will have a usable brush after you finish.) When dry, go over the bench with medium sandpaper to make it smooth to the touch. Be careful you do not miss any rough spots. This should only take a few minutes.

Add the drawer if you want. Give it a second coat, but only paint the front of the drawer, not the rails.

Flip the table onto its legs. Wipe off the top with paint thinner as described and paint it. Go over again with medium sandpaper to make it smooth to the touch. After it has dried, give it a second coat. A third coat can be given to the top if you have any paint left.

Let the paint dry a day or more. Latex paint requires about a week to cure. During this time, the table *should not be wiped with wet cloths*. Some heavy objects, such as the computer monitor may stick a little to the top for the first two weeks. Place wax paper under the monitor during the curing time if this is a problem.

To complete the installation, you need an office desk chair. Get one at an office furniture store. Make sure it can be adjusted in height so that it can be set to just the right position. The table is built so that it is easy to trim a little off of the legs with a circular saw should the desk be too high. Save the scrap wood for a shelf.

Well, that's it. The table serves well, and I am hardly aware that it is there as I work, since there are no irritations coming from the table design. It may not look right in your living room, but people who see it are surprised that it is made from rough-in lumber and say it wouldn't look bad in a living room. Latex paint and a little sanding can cover up an awful lot of blemishes.

If you like it, you can build another for your computer or electronics workbench. Mine is shown in **Photo J**. I did not actually write about the bench shown with the ham rig on it, because that was my first one and had a number of mistakes that were corrected in the described design. I now have three of these benches in use. 73

WANTED

Fun, easy to build projects for publication in 73.

For more info, write to:

Joyce Sawtelle,
73 *Amateur Radio Today*,
70 Hancock Road
Peterborough NH 03458.

FREE! NEW CATALOG

CALL TOLL FREE: 1-800-JAN-XTAL

Quality Crystals
and Oscillators for:

AMATEUR BANDS • CB • MARINE VHF
SCANNERS • MICROPROCESSORS • PAGERS

P.O. Box 60017 • Fort Myers, Florida 33906



(941) 936-2397



JAN Crystals

CIRCLE 242 ON READER SERVICE CARD

LOW PROFILE HF ANTENNAS THAT REALLY WORK!

"Work the World Without Working Up the Neighborhood"

ISOTRON

BILAL COMPANY

Call for a FREE Catalog:

719/687-0650

137 Manchester Dr.
Florissant, CO 80816

www.rayfield.net/isotron



CIRCLE 42 ON READER SERVICE CARD

Shortwave Receivers Past & Present

Communications Receivers 1942-1997

RECEIVERS PAST & PRESENT

Communications
Receivers
1942-1997

Third Edition Fred Osterman

Third Edition Fred Osterman

- New 3rd Ed.
- 108 Chapters
- 472 Pages
- 840 Photos
- Printed 03/98
- Covers 1942 to 1997.
- 770 Receivers
- 660 Variants
- Includes 98 U.S. and Intl. manufacturers
- Only \$24.95

This huge 472 page Third Edition includes over 770 shortwave and amateur communications receivers made from 1942 to 1997. Here is everything you need to know as a radio collector or informed receiver buyer. Entry information includes: receiver type, date sold, photograph, size & weight, features, reviews, specifications, new & used values, variants, value rating and availability. Ninety eight worldwide manufacturers are represented. 840 Photos. Become an instant receiver expert!

universal
radio inc.

Universal Radio

6830 Americana Pkwy.

Reynoldsburg, OH 43068

◆ Orders: 800 431-3939

◆ Info: 614 866-4267

www.universal-radio.com

Tuner King Strikes Again

Part 1: Make a basic VHF/UHF signal source from your TV/VCR tuner.

Since my first TV/VCR Tuner Applications articles were published in 73 Amateur Radio Today (April, May, and June 1997), there has been a lot of interest expressed in using TV/VCR tuners as a signal source. Because TV/VCR tuners vary so much in design, examination and experimentation was deemed necessary to work out the minimum details required to create a signal generator from the more commonly available tuners. Three major concerns were expressed, involving frequency coverage, which tuners work best, and the available signal amplitude available.

Perhaps the easiest question to answer is which tuners work best. I've only been partially successful, at this point, in using the later model tuners that are digitally controlled. A digital tuner requires that a computer

"word" generated by a microprocessor or data transmitter be clocked serially into the internal register and frequency synthesizer. An enable signal then sets the band for the tuner and the frequency for the phase-locked loop (PLL) circuit.

So far, relative to digital tuners, I've managed to circumvent the PLL on one tuner and operated it in an analog mode. I can't really call that a success, but I did learn a lot from the experience. I'm currently experimenting with a serial data transmitter that is capable of generating the desired computer word for the tuner.

Digital tuners appear to be an interesting challenge for those hams who are computer- and digitally inclined. The advantage, of course, is that a phase-locked oscillator increases the oscillator's stability — particularly when used as a signal generator. With the synthesizer controlling the frequency, every incremental or step frequency within the tuning band should be available.

All of the older-style analog TV/VCR tuners lend themselves very well for use as a signal generator, with some types working better than others. There are four basic types that I will discuss individually, with the modifications required for each.

Frequency range

Because TV and VCR tuners are designed to cover TV channels from 2

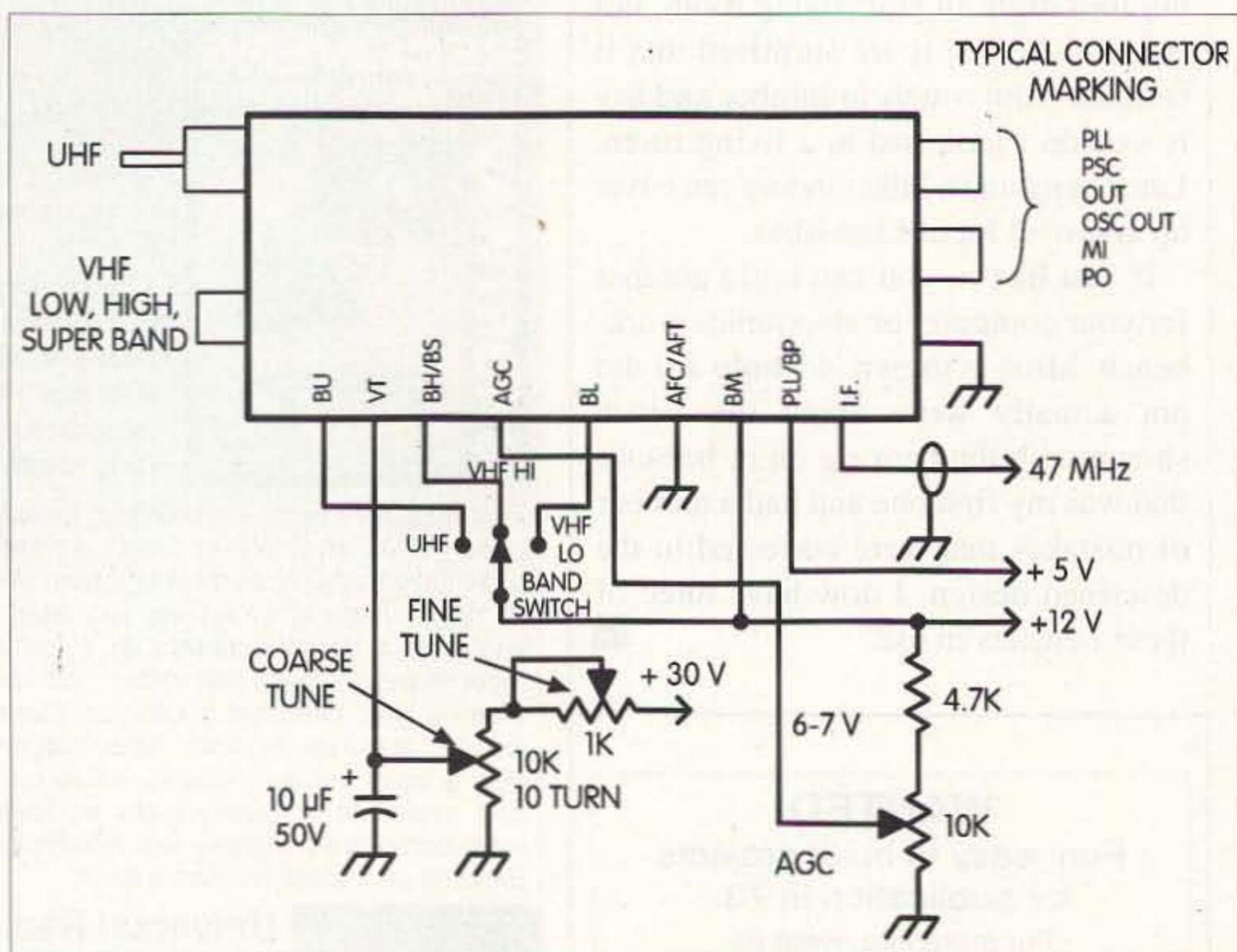

Fig. 1. Typical TV/VCR tuner connections with voltage applied to all functions. Fine tuning may be done by controlling the 30 V source (shown) or by controlling a 1–2 volt source applied to the AFC/AFT terminal.

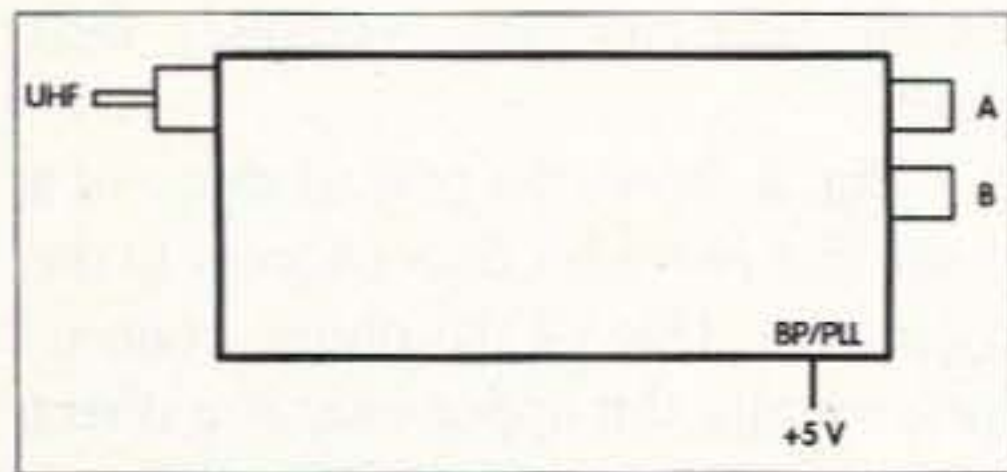

Fig. 2. A tuner having direct access to both local oscillators. Terminal "A" is usually connected to the UHF oscillator and terminal "B" is connected to the VHF oscillator. The output port is enabled when +5 volts is applied to the BP/PLL terminal.

to 69 (83 for older tuners), the frequency range is nearly the same for each. However, some tuners are capable of tuning a wider range than others, depending upon age and being "cable ready." Those tuners that are "cable ready" have the greatest frequency range when channel 83 has been included. Therefore, it is desirable to collect and test several tuners to find those having a preferred frequency range.

The typical tuner uses high side injection that places the internal oscillator approximately 47 MHz above the received signal. Table 1 shows the typical oscillator tuning frequency ranges vs. tuning voltage. Four typical tuners are shown with their respective oscillator frequency charts. The frequency range covers generally 90-900 MHz, with a few holes between tuner bands.

Tuner connections

Connections made to analog TV/VCR tuners are nearly the same regardless of tuner design. But due to the manufacturing differences, terminal identification must be worked out for

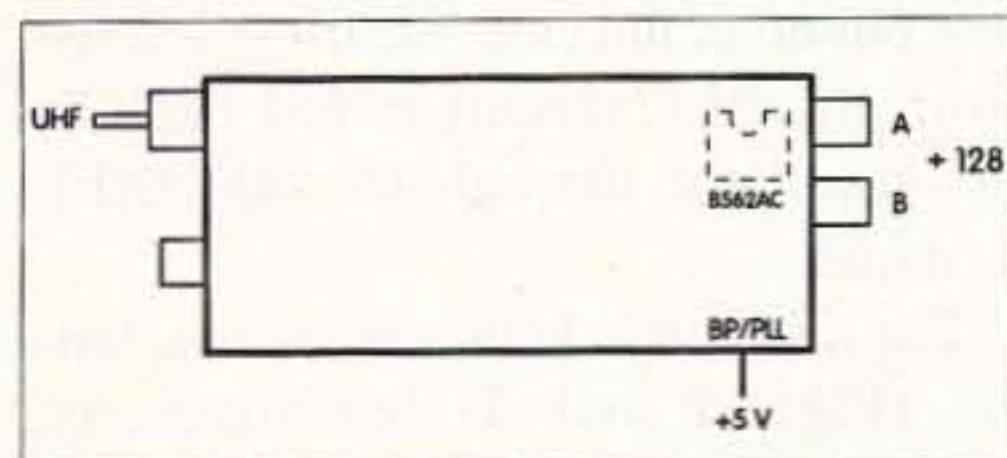

Fig. 3. The combined output from the local oscillator is divided by 128 before being made available at the connector. If the oscillator outputs are separated, "A" is usually the UHF output and "B" is the VHF output.

each tuner. I recommend that any terminal labeling indicated on the printed circuit board be transferred to the tuner's case. Fig. 1 shows the typical terminal connection scheme used for operating the tuner as a receiver's front end. Three frequency bands are shown and used by most tuners, with the "BS" and "BH" bands combined and enabled as "BH". Some tuners have four bands, with the "BH" and "BS" bands separated.

When used as a signal generator, I've found that 12 volts needs to be applied only to the respective band control terminal to enable the appropriate oscillator. A tuning voltage of 0-30 volts must be made available to the tuning voltage terminal for frequency control. When used as a basic tuner or when the tuner is used as a signal generator, the AFC terminal must be grounded. However, if used for fine tuning, a low value potentiometer-controlled voltage (typically 2 volts maximum) may be applied to the AFC terminal. Because of the wide frequency range of each band, tuning is very fast and creates a need for a fine tuning control. Voltage sources for the tuner should be regulated to reduce drifting problems.

Of course, the antenna connections are not used unless the tuner will double as a tuner and a signal generator. And if that's the case, then respective voltages must be applied to the AGC and mixer terminals when used as a receiver front end. A 47 MHz receiver would be connected to the IF terminal when the tuner is used in the receiver mode.

Basic tuner types

Even though all TV/VCR tuners

WANT TO LEARN CODE?

Morse Tutor Gold from G.G.T.E. is the answer for beginners and experts alike.

*Get the software the ARRL sells and uses to create practice and test tapes; and Morse Tutor Gold is approved for VE exams at all levels.

*Since 1987, GGTE has guided nearly 20,000 hams and prospective hams around the world through proven structured lessons and a variety of character, word and conversation drills. Straight forward menus make the process simple and fun.

*This program features easy and speedy self installation; random character drills with the characters you select; and you can create your own drills or import text files. You can type what you hear or copy by hand and see the results one line at a time. Pick the Farnsworth or the standard method; select the tone frequency most comfortable for you or select your code speed in tenths of a word per minute. For all DOS computers. You are always in command.

Certified by



Morse Tutor Gold uses your internal speaker or sound board. And, if you use a sound board Morse Tutor Gold supports volume control.

Sound Blaster and the Sound Blaster Compatibility Logo are trademarks of Creative Technology Ltd.



Available thru dealers, the ARRL, or send \$29.95 + \$4 S&H (CA residents add \$2.32 tax) to: GGTE, P.O. Box 3405, Dept. MS, Newport Beach, CA 92659 Specify 5 1/4 or 3 1/2 inch disk.

CIRCLE 193 ON READER SERVICE CARD

IN STOCK ...
at your **FAVORITE Amateur Radio Dealer**



A new Dual Element Studio Microphone with full range, smooth, articulate response. Great for broadcast quality SSB, AM or FM. Wide 60 to 16kHz response with a +4dB peak at 2kHz - so important for well balanced articulation while at the same time producing a robust 'big bottom' low end.



5/8-27
thread
mic. clip
supplied

Hi-Fi SSB!
FULL Range Dual Element
GOLDLINE
Studio Microphone

The **GOLDLINE** is equipped with the new full range studio cartridge element plus your choice of the HC-4 DX DREAM MACHINE or the HC-5 Mid-Range element - switch selectable for tough or normal band conditions. Features a new 'soft touch' PTT microswitch for smooth and reliable operation.

HEIL Model
GM-4 with Full Range/HC4..... \$139⁹⁵
GM-5 with Full Range/HC5..... \$139⁹⁵
GM-V 'VINTAGE GOLDLINE' w/built-in matching transformer for use with those older hi-Z 'boatanchor' inputs..... \$159⁹⁵
CC-1 Connecting Cable for Icom, Kenwood, Yaesu or TenTec radios..... \$29⁹⁵

HEIL SOUND

5800 N. Illinois
Fairview Heights, IL
618-257-3000

www.heilsound.com

HEIL SOUND

Defining the Standard for Amateur Radio Communications

have a built-in local oscillator, the problem is, how do you gain access to it? Although there may be better and alternate methods, I'll discuss the methods that have worked for me.

There are four basic types of tuners that are available to hams (although they do not necessarily cover all of the variants). Each of the four will be discussed separately, three here and the

fourth (mechanically variable) next time.

I. Fig. 2 shows the typical shape of a tuner that provides direct access to the oscillators. One of the phono connectors, usually the upper one, is a direct output port from the UHF oscillator, and the lower phono connector may be a direct output from the VHF oscillator. When one or two phono connectors are used on the tuner, it is necessary to examine the output from each to determine its purpose.

In TV/VCR use, the direct output was connected to a phase-locked loop (PLL) circuit that divided the signal frequency of the oscillator and applied it to a frequency comparator. At the comparator, a reference signal was compared to the divided oscillator signal and that produced an error voltage. The error voltage was fed back into the tuner through the AFC/AFT terminal, where it would steer the oscillator to hold it onto a specific frequency TV channel.

For our purpose in using the local oscillator as a signal source, the output from the phono connector is used directly. If a "PLL" or "BP" terminal exists, then +5 V must be applied to that terminal to enable the output port circuit.

RG-174 is a suitable coax for transferring the signal from the phono connector to the outside front panel level control and panel connector. A potentiometer may be used as an output level control.

II. Another basic tuner type has an external appearance similar to the one above, and is shown in Fig. 3. This type of a tuner may also have a single "PLL" output phono connector instead of two as shown. The outputs of both oscillators are combined and ported to one phono connector. Steering voltage from the PLL circuit is fed back to the oscillator through the AFC/AFT terminal.

The difference between the two tuners (Figs. 2 and 3) lies internally, where a divide-by-128 IC is used to process the oscillator signal before it exits the tuner. Fig. 4 shows a typical internal mixing port for combining the VHF and UHF oscillator signals into a single output that is divided. The

SHARP VTSA7				MITSUMI UVE30			
Frequency in MHz				Frequency in MHz			
Vt	BL	BH	BU	Vt	BL	BH	BU
0	86	138	478	0	90	139	476
2	96	164	541	2	97	165	536
4	104	183	582	4	106	184	582
6	109	200	625	6	113	201	621
8	116	218	661	8	120	219	661
10	123	239	703	10	127	240	707
12	131	261	748	12	134	262	757
14	138	282	773	14	140	283	806
16	144	299	831	16	144	302	848
18	148	313	861	18	147	316	883
20	151	322	886	20	150	326	911
22	154	330	907	22	151	333	934
24	156	336	923	24	152	338	948
26	157	340	934	26	153	341	956
28	158	342	941	28	153	343	960
30	158	344	945	30	153	344	962
HITACHI ET-341				SANYO T2529AA			
Frequency in MHz				Frequency in MHz			
Vt	BL	BH	BU	Vt	BL	BH	BU
0	81	166	473	0	90	173	450
2	91	188	535	2	101	197	517
4	97	202	583	4	107	210	568
6	101	214	625	6	111	220	614
8	107	227	669	8	115	228	660
10	113	243	727	10	119	236	711
12	120	262	784	12	122	244	763
14	124	272	829	14	125	249	810
16	126	278	863	16	127	253	849
18	128	281	889	18	128	256	880
20	128	283	910	20	129	259	906
22	129	285	924	22	130	260	925
24	130	286	932	24	130	261	938
26	130	287	936	26	131	262	945
28	-	287	939	28	131	262	948
30	-	-	941	30	-	-	950

Table 1. Oscillator frequency vs. tuning voltage for four typical TV/VCR tuners.

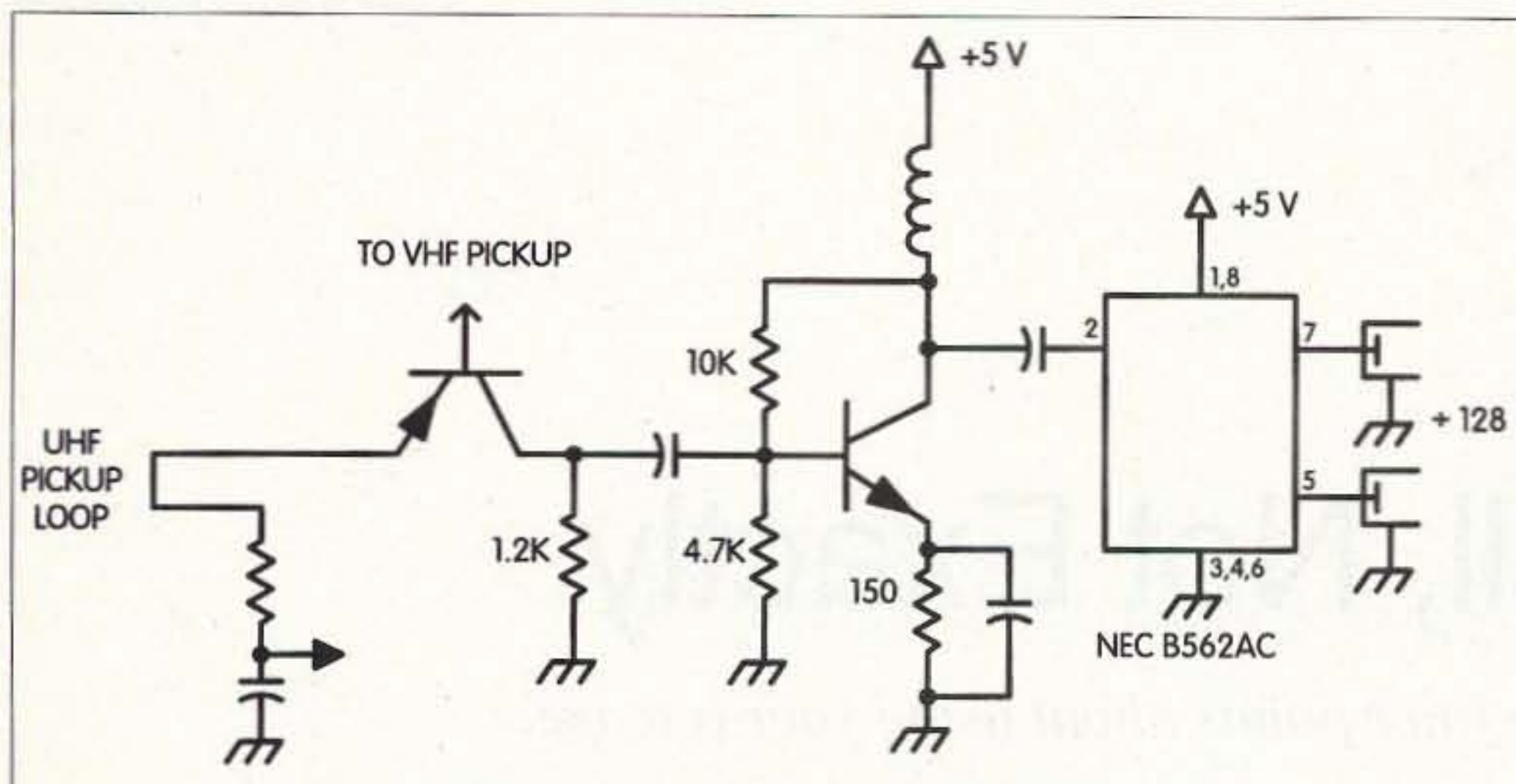

Fig. 4. Combined VHF and UHF oscillator output port with the divider circuit. (The circuit has been simplified for clarity.)

typical divider (128:1) IC used is an NEC B562AC, although other IC types have been used. Some provide a different divide ratio for VHF and UHF outputs.

Some tuners will divide the UHF output at the upper connector by 128.

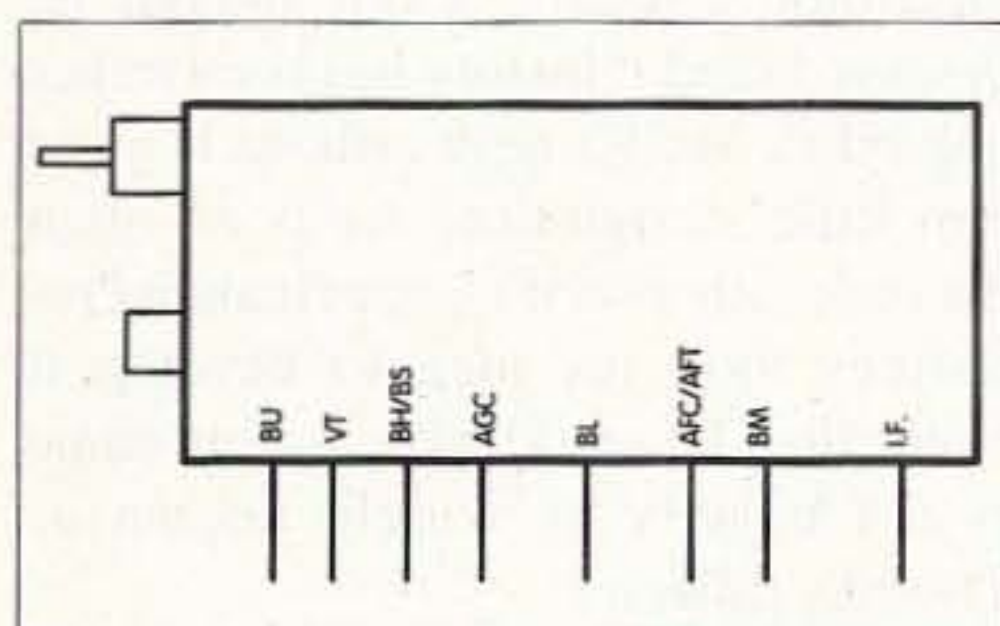

Fig. 5. The most common tuner configuration. There is no direct access to the internal oscillators.

The lower connector may be a direct output from one or both oscillators.

To obtain a direct oscillator output when one is not available at either connector, two techniques have been tried with success. The first technique was

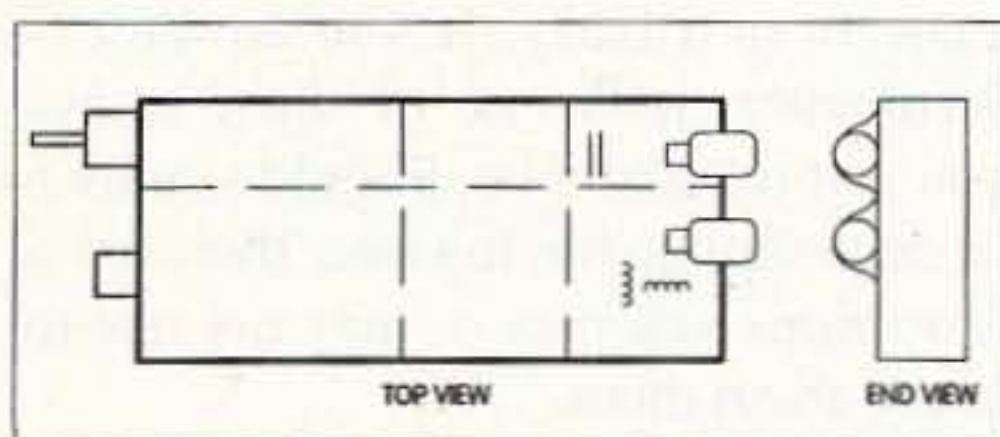

Fig. 6(a). Soldering two phono connectors to the top edge of the tuner's case. The end view shows jumper wires soldered over the connector's mounting to increase the mechanical support.

to remove the B562AC and place a jumper between pins 2 and 7. A second technique that requires less modification is to remove the wire from the phono connector. Then, an insulated wire is connected from the connector to pin 2 of the B562AC. Plus-5 volts must still be applied to the "BP/PLL" terminal to enable the mixer port. The signal out of the tuner is transferred as described for the tuner as in #1 above.

III. Fig. 5 shows the most common type of TV/VCR tuner. In the absence of an internal port connection to each of the local oscillators, external pickup loops must be placed into the oscillator circuits for direct access. It will be necessary to remove the metal shield cover over the tuner to expose the oscillator's resonators, of which there are two. The oscillator pickup loop may be mechanically stabilized by soldering a phono connector to the top edge of the tuner's case as shown in Fig. 6(a). Fig. 6(b) shows the general shape of the pickup loops that I've used successfully for optimum coupling. With the loops in place, each provides an individual signal output from an oscillator.

If some signal leakage can be tolerated in the final application, a switch may be used to toggle between the two output connectors. Short lengths of RC-174 coax are run between the pickup loop connectors to the switch, and then on to the output level potentiometer.

Placing the loop into the correct position requires a little experimentation. The objective is to couple tightly in

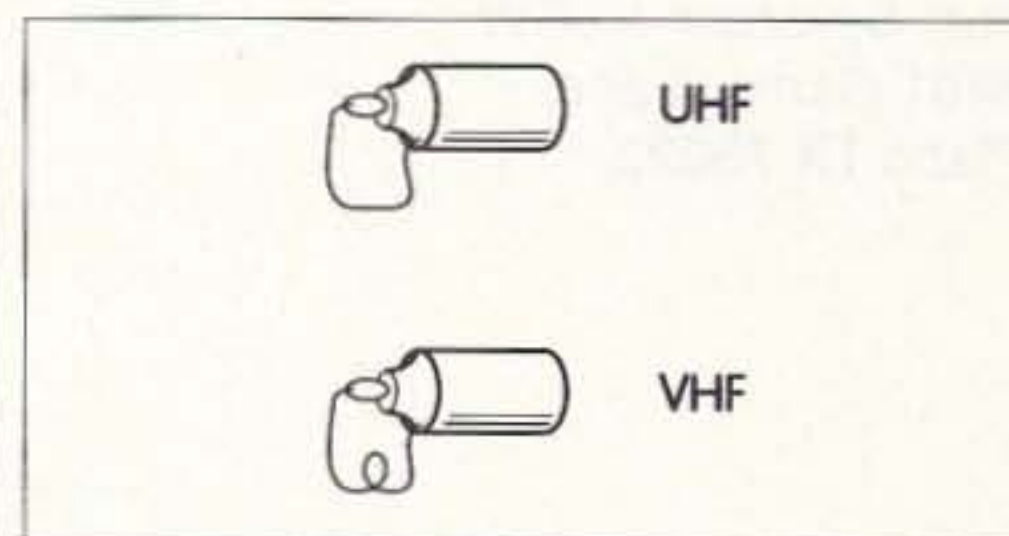

Fig. 6(b). Typical pickup loop configurations for the VHF and UHF oscillators.

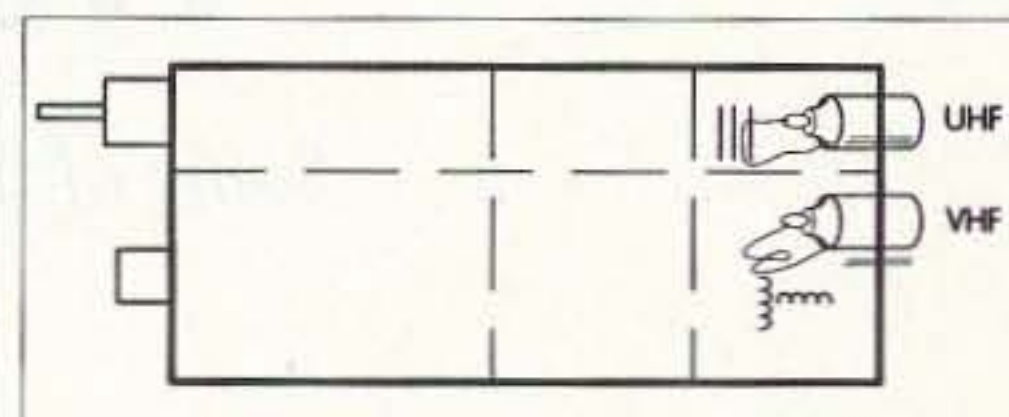

Fig. 7. Typical pickup loop placement in both the UHF and VHF oscillator circuits.

order to achieve maximum output from each oscillator.

Fig. 7 shows the placement positions that have worked for me. When in use as a signal generator there is no signal buffer in place (unless an amplifier is used) to prevent external loading changes from affecting the oscillator's frequency.

Part 2 of using a TV/VCR tuner as a signal source will continue with a discussion of basic tuners (including type IV), adjustments, calibration, and output amplitude. While waiting for Part 2, start collecting tuners and prepare to build your project!

ELECTRONIC MILITARY SURPLUS
FAIR RADIO SALES
30 FT MAST KIT
 AB-1244/GRC MAST KIT, twelve aluminum alloy on steel sections form sturdy, yet lightweight 30 foot 1.7" dia mast. Kit includes five each lower and upper sections, one ea lower and upper adapter sections, gin pole swivel base, four ea 36 and 42 ft guy ropes, four guy stakes, two guy rings plus 2.5 pound sledge hammer. Part of OE-254/ GRC antenna set; 30 lb sh. NEW, \$139.50
 NYLON BAG for above. New, \$39.50; See Web.
Electron Tubes, JAN-BOXED unused:
 4CX300A Eimac, \$45.00 1625 Nat. Union, \$4.50
 4CX5000J imac, \$650 5998A Sylvania, \$9.95
 4D32 Raytheon, \$28.00 6336B Cetron, \$30
 6AJ5 Tung-sol, \$3.50 6922 ECG, \$3.50
 811A Cetron, \$25.00 7308 Amperex, \$3.50
 955 Hytron, \$3.50 7360 ECG, \$15.00
 Allow money for shipping on merchandise.
WEBSITE: fairradio.com
 E-MAIL: fairradio@wcoil.com
 PHONE: 419-227-6573 - FAX: 419-227-1313
 1016 E. Eureka - Box 1105 Lima, OH 45802
 VISA, MASTERCARD, DISCOVER accepted
 Write for latest Catalog - Address Dept. 73

Well, Not Exactly

Some of the finer points about using your o'scope.

As we enter a new century, we hear the question asked, "What was the greatest invention of the last one?" Many answers are given, but no one mentions the cathode ray tube. This is very understandable, as it is taken for granted that the tube has always been here. Besides, there are not very many of us around anymore who remember what it was like to be an experimenter in the 1930s, before its existence.

Test equipment was a luxury back then, and most experimenters considered themselves lucky if they owned a 1,000 ohms/volt multimeter. Troubleshooting circuits was a real challenge, as measurements were restricted to DC and low frequency AC voltages. When it came to troubleshooting radio frequency circuits, the meter was of little use. This consisted of either applying what was then known about theory, component substitution, or plain guess work. It was a flying-blind experience.

At that time, an inventor named

Philo Farnsworth was working on an electronic display for television to replace the mechanical scanning disk that was then state-of-the-art. Nobody could have foreseen the impact that his brainchild, the cathode ray tube, would have on so many things throughout the remainder of the century. Besides being a display device for many things, such as used in television, radar, computers, and many other applications, in the form of the oscilloscope it is a most powerful diagnostic and developmental tool that makes it possible for us to peer into the invisible world of

electronic circuitry. Even though he deserved credit, history has been rather unkind to Mr. Farnsworth, as it gives him little recognition. As is so often the case, others with large financial resources took his idea to develop it faster than he could have, so his name is not exactly as widely known as Thomas Edison's.

The oscilloscope's development has come a long way since we amateurs first used a motor-driven mirror and gas-filled tube to observe the trapezoidal modulation pattern produced by our AM transmitters. Modern oscilloscopes have the capability to display complex wave shapes all the way up into the gigahertz range. When we are working on electronic circuitry and ask ourselves what is happening or why doesn't this work, it can give us answers in a hurry. If you are an experimenter, it is one of those things you just have to own. Should you own or contemplate buying one, there are a few things you may or may not like to know about them.

We all like to own the very best, but usually are forced to be practical where money is concerned. We settle for something at the right price that will just meet our needs.

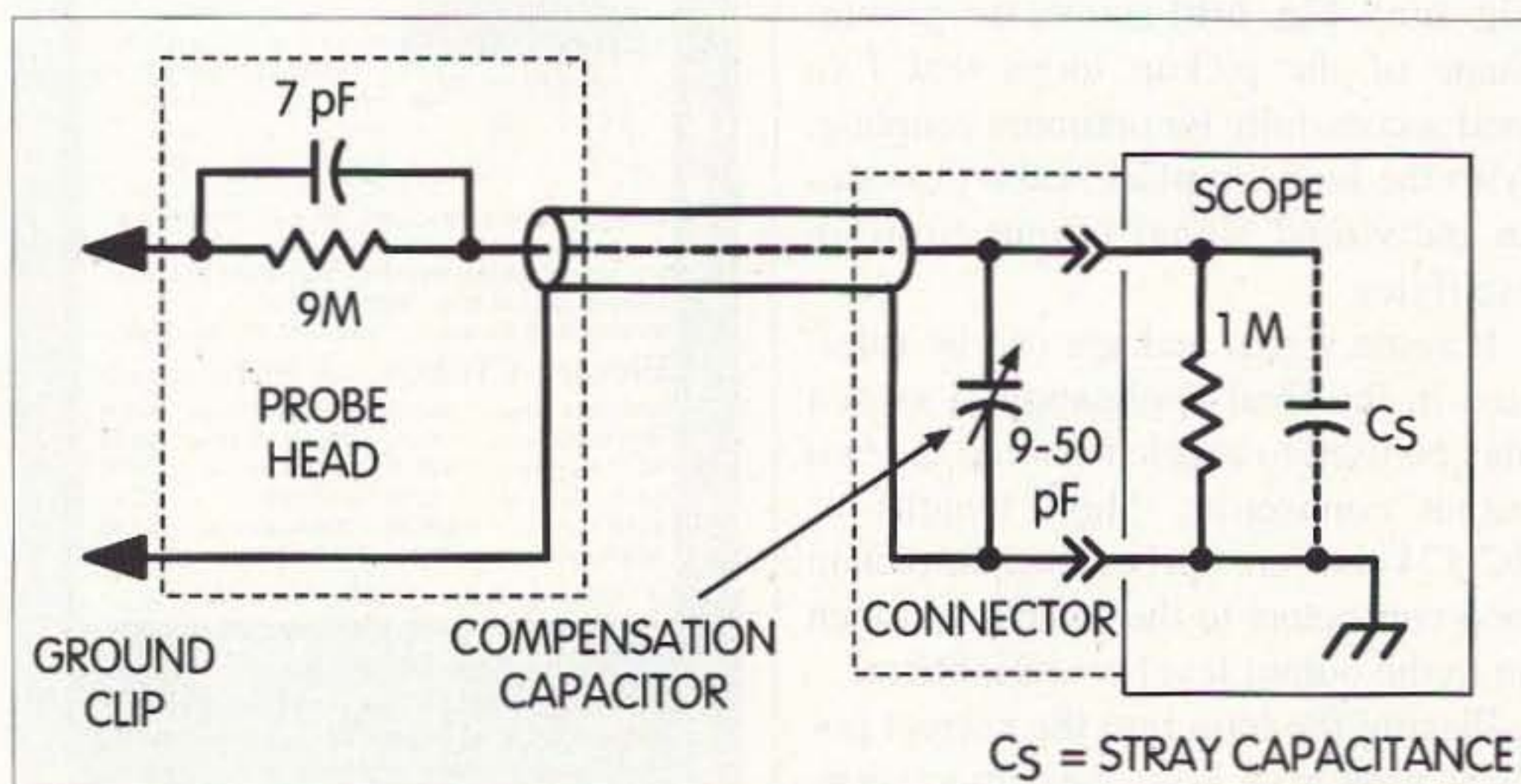

Fig. 1. 10:1-type probe.

Striking a compromise between the specifications of the instrument we would like to buy and what our pocket-book will tolerate can be an agonizing decision. The price of oscilloscopes seems to rise directly proportional to their vertical amplifier bandpass width. Most of us feel that one good up to 40 megahertz is adequate to meet our needs, and assume that signals in this range will be accurately displayed. For the instrument itself, this is very true. What the vertical input sees, is what it displays.

Being a pessimist (not liking unpleasant surprises), I am often heard saying, "If you do not expect anything, you are not disappointed." Working with oscilloscopes over the years has had something to do with it. When the pattern on the screen is not what it should be, it is one of those unpleasant surprises. Why does this happen, other than when a mistake was made?

The method used to transport the signal from the unit under test (UUT) to the input has much to do with what is displayed. If the question were posed, "Is the signal the scope input sees identical to that being fed into the test probe?", wouldn't you guess that almost everyone (not knowing much about test probes) would assume that the answer is "yes"? To the contrary, it could be, "Well, not exactly."

Most people who use oscilloscopes believe that the test probes they use are perfect in every way, and seldom consider them as a possible source of trouble. Having had a career in the electronics industry, I was amazed to learn just how few engineers and technicians knew the reason why they used the particular type of scope probe they did. Probes play an important role in what an oscilloscope displays, and their characteristics should be of interest to those who use them. Let's take a look at a few things about scope probes.

Reactances, be they inductive, capacitive, or resistive, in the signal path from the source to the scope input can spell trouble, and, like death and taxes, they are things we cannot avoid. We do our best to contend with them. Every shielded cable exhibits capacitance.

The 1:1 probe is the most basic. It consists of a length of shielded cable with a test pick and ground clip on one end and a connector on the other end for the scope input. Usually, the lowest capacity cable available exhibits about 10 or more picofarads of capacity per foot. The capacity of a 3-foot probe cable, plus the scope input capacity, can add up to around 40 picofarads. A scope probe with this much capacitive loading will upset many circuits operating above the audio range. Just how badly this will degrade a signal is largely determined by its source impedance and frequency. Because of this, the use of a 1:1 probe is generally restricted to relatively low frequency use.

The most commonly used probe is the 10:1 type. In using it, you need your head screwed on right to avoid making mistakes because the input attenuator settings are now multiplied by a factor of 10. Its advantage is that it presents very light loading to the circuit it is connected to. Typically, this probe presents less than 10 picofarads of capacitance shunting 10 megohms of resistive loading. It functions as a simple 10:1 resistive and capacitive voltage divider (shown in **Fig. 1**). The small input capacitor (shunting the 9 meg input resistor) and that of the combined compensating capacitor, cable capacitance, and scope input capacitance form a 10:1 AC voltage divider, as do the resistive components for DC.

A 1 volt peak-to-peak, 1 kilohertz square wave test signal source is usually provided on the front panel of the instrument for the purpose of adjusting the probe compensating capacitor. Theory tells us that a square wave contains the fundamental frequency plus an infinite number of its harmonics. Therefore, if we use this signal to adjust the compensating capacitor to display the square wave without any overshoot or undershoot, can it be assumed that the frequency response is uniform throughout the probe's useful spectrum?

Well, not exactly. In practice, the presence of harmonics up to the tenth one will produce a reasonable reproduction

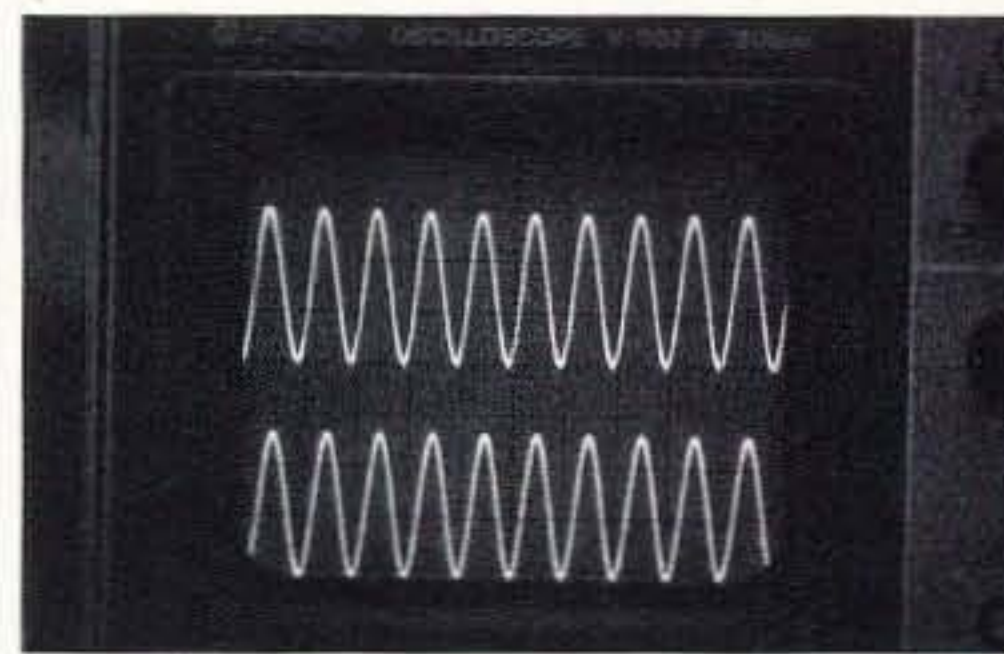

Photo A. A 5 kHz sine wave. Article photography by Peg Syverson.

of the square wave, and up to the twentieth harmonic, slightly better. The amplitude of those above the twentieth harmonic are considerably lower, and their presence or absence is relatively undetectable. The 1 kilohertz square wave test signal can really only give us assurance up to about 20 kilohertz, which is an exceedingly small percentage of the total bandpass (about .05% of a 40 MHz scope's band pass). **Photos A and B** show the amplitude and phase changes one might expect using a low-priced 10:1 test probe to exhibit. **Photo A** is that of a 5 kHz sine wave. The upper trace is the input to the probe, and the lower trace is the output. Amplitudewise, they are the same, but the lower trace is shifted by approximately 10 degrees. **Photo B** is that of the same probe at 30 MHz. The output is now down about 15% and the phase shift is nearing 180 degrees. This may or may not be of any consequence. It all depends upon what we are trying to measure. Higher-priced scope probes may contain some form of frequency compensation to level off the response curve.

We know that an unloaded conductor or unterminated transmission line (which the 1:1 and 10:1 scope cables are), when shocked by a steep rise or fall time signal, will produce a train of

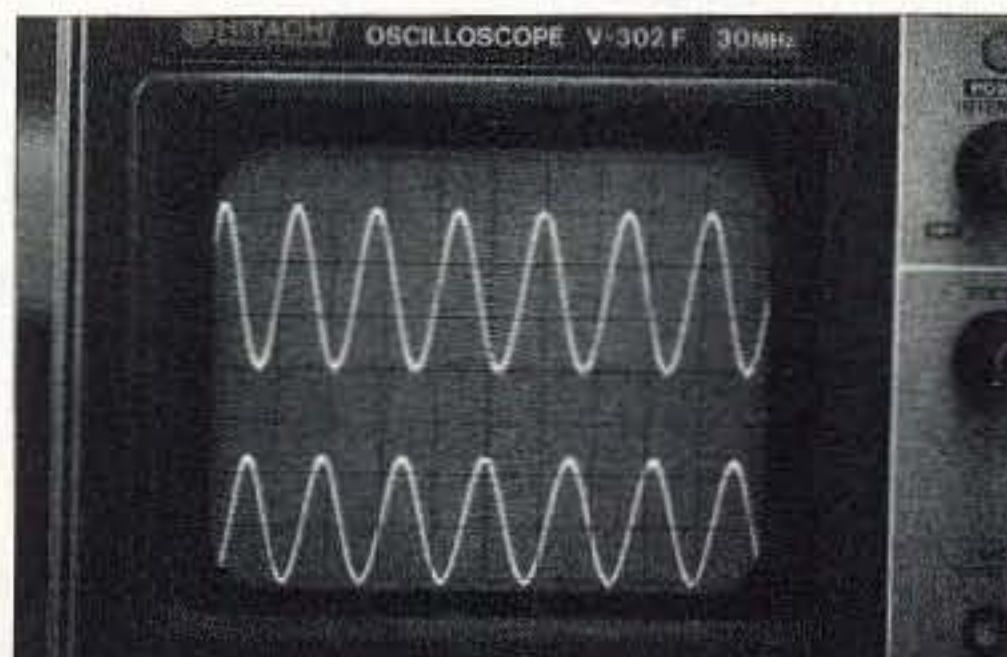

Photo B. The same probe at 30 MHz.

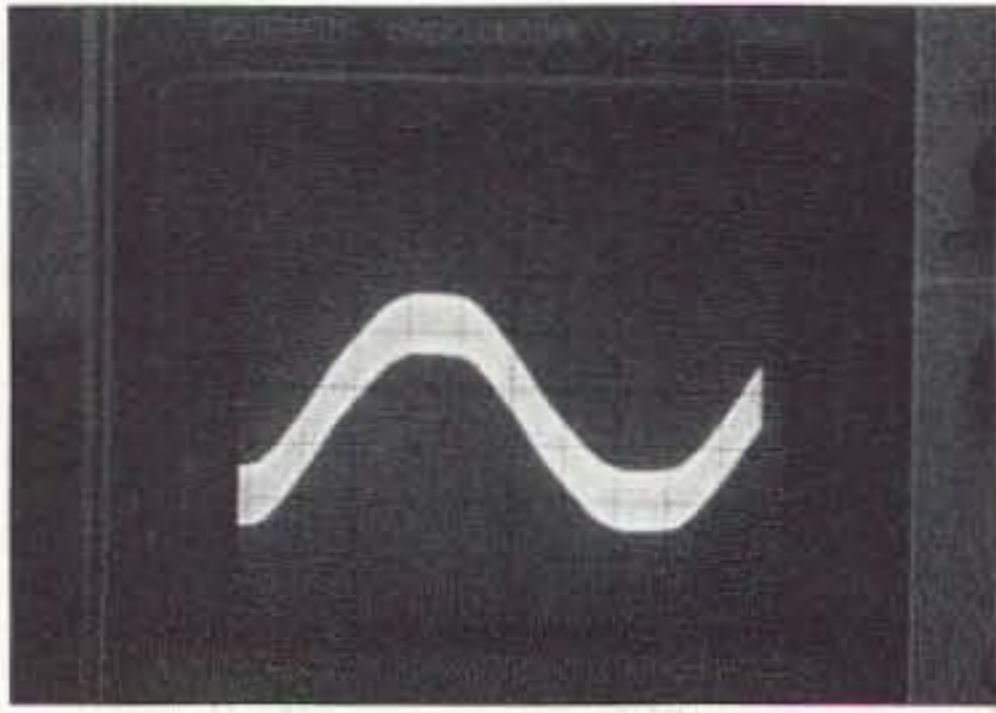

Photo C. Sine wave of a big, bad 60 Hz signal.

damped oscillations at its resonant frequency (ringing). With the scope input capacitance, that of the compensating capacitor and that of the circuit being tested can resonate at some frequency to set the stage for ringing to appear on the trace. When unexplained ringing appears on a trace, it is not necessarily coming from the circuit under test.

Using a terminated coaxial line to transport the signal to the scope input gets around the frequency response and ringing problems of the aforementioned probes nicely. The only problem is that the source must be able to deliver power into a very low resistance load (50 ohms typically). This pretty much limits its use to low impedance power sources. However, it is used in the VHF range where the generally used probes tend to be less useful frequency-wise and the input and output impedances are generally 50 ohms.

There is one type of probe that combines the high input impedance characteristics of the 10:1 type probe with that of terminated line. It is the active probe. Basically, it is a wideband unity

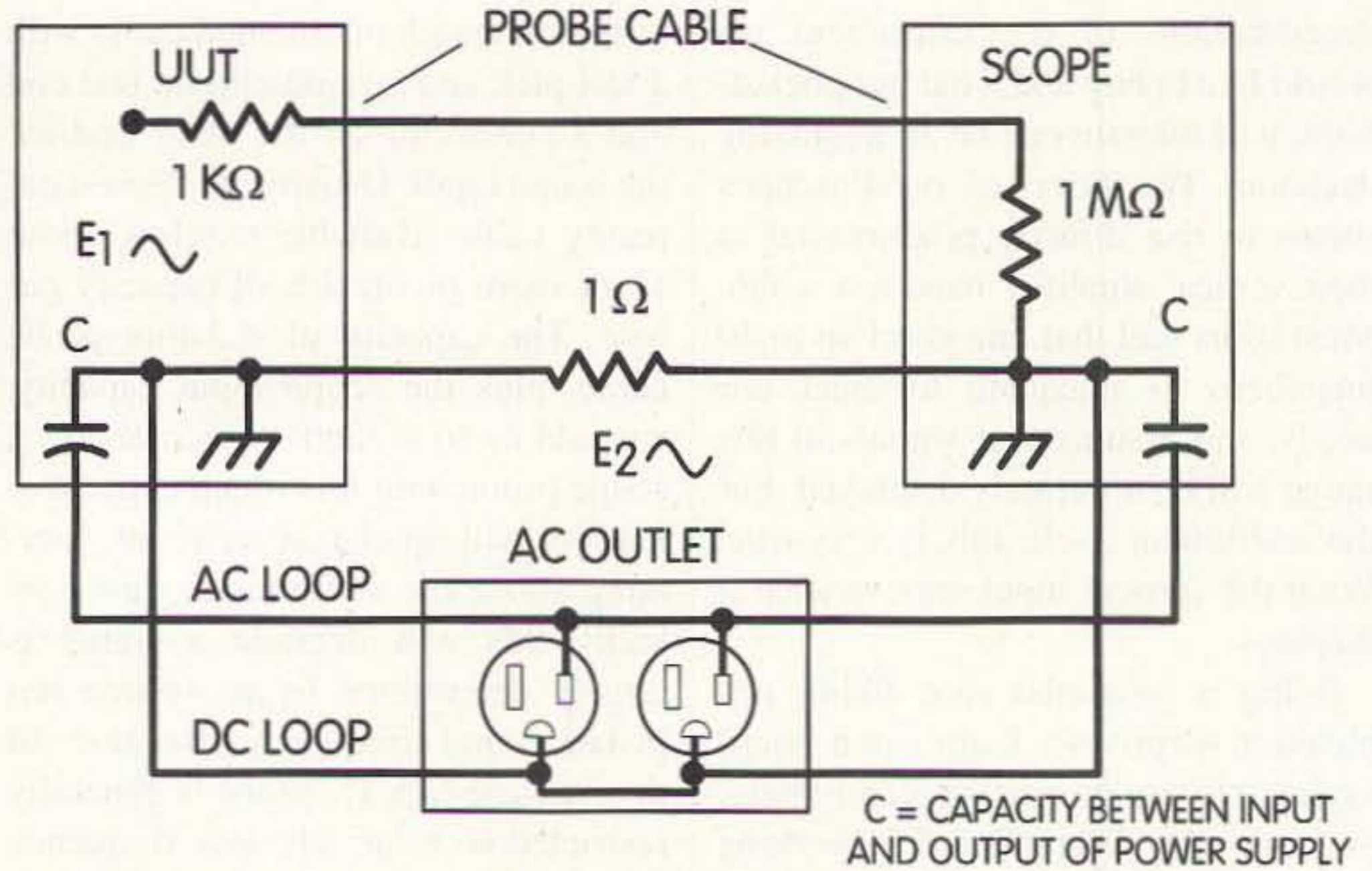

Fig. 2(b). Problems arise when unwanted currents flow through the probe cable shield impedance. This illustrates one way that this can happen.

gain amplifier located in the head of the probe. It has very high input and very low output impedance intended to drive its terminated coaxial cable. The amplifier has a very high current gain (well over 1,000). At 1 volt, a few nanoamperes of input current will cause 20 milliamperes of current to flow in a 50 ohm cable termination. While looking ideal, it isn't exactly. Operating potentials for the amplifier must be supplied to the probe head. The peak-to-peak input signal level cannot exceed the supply voltage values unless a suitable frequency-compensated attenuator is provided ahead of the amplifier input. Thus, to increase the useful input voltage range could mean another control to set, and tend to

make the probe head bulkier and not suitable for getting into tight places. Even though it has a wide bandwidth, these may be the reasons for it not being widely used.

Every so often, we have the need to view a signal down in the millivolt range. Frequently, the scope display we want to view is riding on top of a big old (usually 60 hertz) signal that the scope prefers to trigger on (as shown in Photo C), much to our dismay. It is wanted about as much as the ham with the kilowatt rig that covers up a weak DX signal you are trying to copy. Where does it come from?

For convenience, probe cables need to be flexible. Also, the resistance of the cable is of little consequence, as the normal signal currents normally produce far less than 1 microvolt of voltage drop, which is insignificant. Fig. 2(a) is a simplified schematic of the resistance path encountered by the source voltage (E1) of a unit under test through a 1:1 test probe to the 1 megohm input resistance of the scope. The 1 ohm resistor is the value of what the cable shield impedance might be. The probe cable impedance plus the source impedance (1 k ohm) being very small in comparison to the scope 1 megohm input impedance, practically all of voltage E1 appears across it.

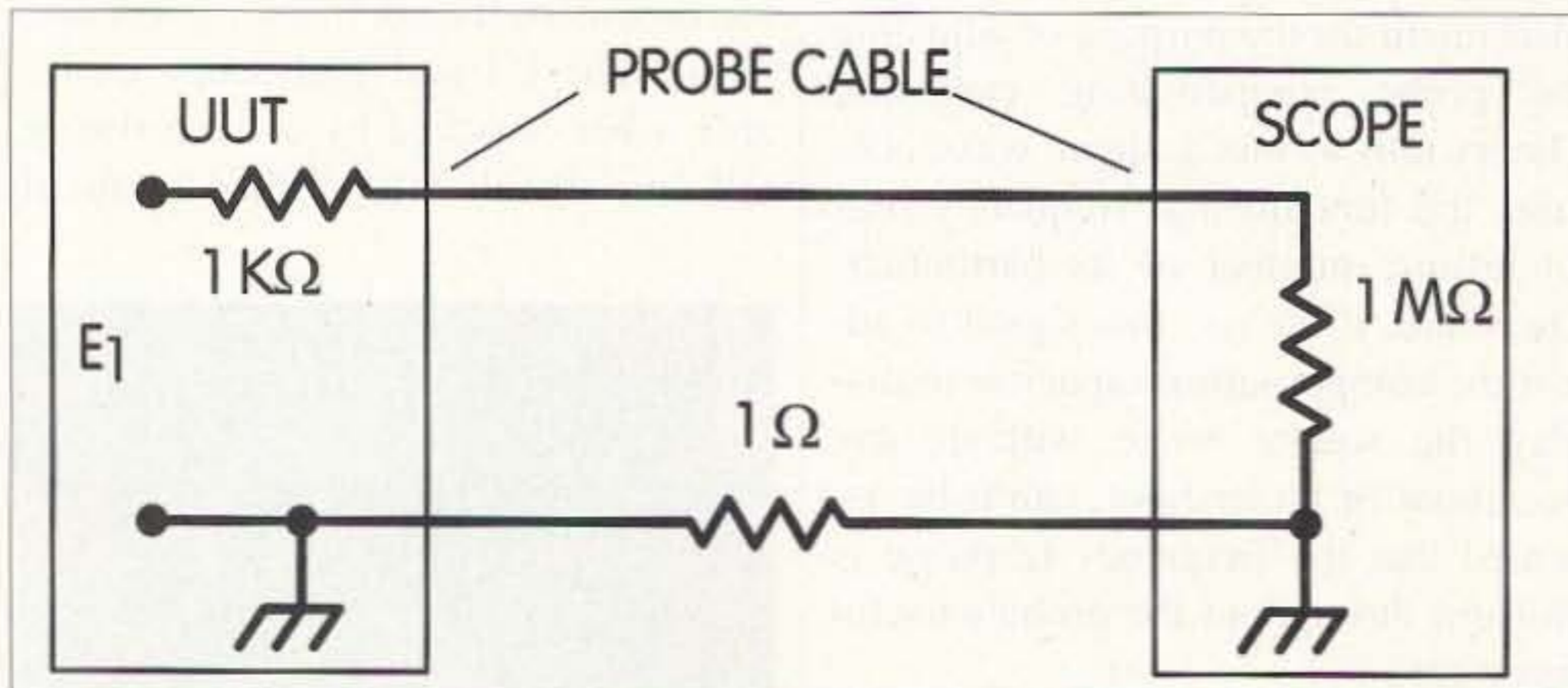

Fig. 2(a). A simplified schematic of the resistance path encountered by the source voltage (E1) of a unit under test through a 1:1 test probe to the 1 megohm input resistance of the scope.

Continued on page 58

Straight Talk about ClearSpeech

This Am-Com speaker gets a "B" from the reviewer — but also gets kept.

Looking for a way to hear more audio and less noise? The ClearSpeech speaker may do the job, in spite of a few quirks!

For several months, I contemplated the advertisements for the Am-Com ClearSpeech speaker. After seeing some favorable comments posted on a ham radio special interest group, I decided to buy it and give it a try.

The Application — mobile HF

The ClearSpeech unit promises to filter background noise, static, and other interference. These qualities looked appealing for my mobile HF operations. I have an Alinco DX-70TH permanently mounted in my car, a Mercury Grand Marquis. When parked, with the engine off, the installation does very well. With the engine running, it's a different story. In spite of numerous grounding straps, heavy power leads connected to the battery, and a fuel pump noise filter installed by my dealer, the Mercury generates substantial noise that interferes with the pleasures of HF mobile operation. Could the ClearSpeech improve my situation?

When I called Am-Com, the speaker was on back order, but well inside the promised delivery period, my unit arrived. The speaker comes nicely packaged, with a well-written instruction

manual. It appears well-made and comes with a mounting bracket for mobile or base installation.

Due to the complex mobile installation in my vehicle, this was not going to be a simple "plug and play" situation. The transceiver is in the trunk and the control head under the dash, and the speaker is mounted on the "B" pillar near the roof. (Note: I do not recommend this mounting location for

The ClearSpeech unit certainly seems to fulfill the claims in its magazine ads and on its Web site.

your installation. Be sure any accessories you mount are in a safe location away from passengers and clear of possible air bag deployment!) Being a powered unit, the speaker requires a connection to +12 volts DC and to ground, in addition to an audio connection to the radio. The power lead is fused, and the supplied audio connector is a standard mono 1/8" mini plug. It was interesting to note that there was a toroid on the power leads close to the

speaker but outside its case and only on the power leads. This posed a bit of a problem when mounting the speaker. Finally, the rear of the unit has a jack for (are you ready?) an external speaker. I can't think of too many situations where an external speaker needs an external speaker. ClearSpeech, in its manual, tells us not to connect headphones to this jack, as it could result in hearing damage because of high audio levels. The thought would never occur to me.

Initial test

After a few hours of disassembling the car and routing wires, it was time for the big test.

First discovery: The ClearSpeech unit requires 12 VDC to operate even when its signal processing is not active. More on that in a bit. Power up the radio with the car's engine off and the speaker's processor out of the circuit, and a moderate noise level was present. Activate the processor, and much of the noise disappeared. So far, so good! Start the car with the processor off, significant electrical noise. Activate

Continued on page 34

Providing Battery & Charging Solutions



MH-C777 SMART UNIVERSAL CHARGER & CONDITIONER

- Rapid charge and rejuvenate almost any NiCD/NiMH battery packs for your two-way radio, camcorder, cellular, and notebook computer battery packs.
- Conditioning feature may rejuvenate dead battery packs!
- Microprocessor driven -deltaV and temperature sensor allow accurate charges.
- Car kit included.
- Support 4.8V to 12V battery packs. Automatic polarity protection.



MH-C888 FLEX SMART UNIVERSAL DROP-IN CHARGER & CONDITIONER

- Convenient universal drop-in design. Rapid charge and rejuvenate NiCD/NiMH battery packs for your two-way radio battery packs.
- Special FLEX Negative Pulse feature prevents crystallization of your battery pack, and extends battery life by keeping it at cooler temperature during the charge.
- Deep-conditioning battery care feature allows 3 consecutive charge and discharge.
- Informative digital LCD display that indicates charging progress.
- Bank up to 12 chargers on a single power source, hassle-free.
- Built-in switching power supply, for home, office, and 12V portable use.



NiMH Battery Packs ULTRA HIGH CAPACITY FOR TWO-WAY RADIOS

- Ultra high capacity Nickel Metal Hydride rechargeable battery packs.
- Memory-free operation. Can be charged any time without been fully drained.
- Recharge up to 500 times.
- Environment friendly.
- A diverse selection of battery packs for different two-way radios, backed by Maha's One-Year Limited Warranty. Visit our website for complete selection.



MAHA CELL **NEW** AA CONSUMER BATTERY & CHARGERS

AA NiMH Battery Cells

- Ultra high capacity at 1550mAh.
- Can be used in your handheld battery case, FRS, GPS, and scanners.
- Recharge up to 500 times.
- Also available in AAA, C, D, and 9V sizes.

MH-C204F Intelligent Rapid Charger & Conditioners

- Rapid charge 2 or 4 AA / AAA NiCD / NiMH batteries.
- Rejuvenate and restore dead batteries.
- Can be used on a 12V power supply and in a car with the optional car kit.

MAHA

"Your Supplier, Your Partner,
Your Friend!"

Maha Communications, Inc. Amateur Radio Division
545-C W. Lambert Rd., Brea, CA 92821
Tel: 714-990-4557 or 800-376-9992 Fax: 714-990-1325

<http://www.maha-comm.com/>

COMET™

COMET has an extensive line of Mono-Band, Dual-Band, Tri-Band Antennas for Base Station and Repeater use.

Featuring the COMET Exclusive SLC System:

- Linear Coil for Maximum Gain
- Soldered Element Joints
- ABS Radome Joints: Weather Proof/Invisible to RF for the Finest Radiation Pattern



GP-15 • Tri-band 52/146/446MHz Base Repeater Antenna
Gain & Wave: 52MHz 3.0dBi 5/8 wave • 146MHz 6.2dBi 5/8 wave x 2 • 446MHz 8.6dBi 5/8 wave x 4 • Max Pwr: 150W • Length: 7'11" • Weight: 3lbs. 1oz. • Conn: Gold-plated SO-239 • 2MHz band-width after tuning (6M) • Construction: Single-piece fiberglass

CX-333 • Tri-band 146/220/446MHz Base Repeater Antenna
Gain & Wave: 146MHz 6.5dBi 5/8 wave x 2 • 220MHz 7.8dBi 5/8 wave x 3 • 446MHz 9.0dBi 5/8 wave x 5 • Max Pwr: 120W • Length: 10'2" • Weight: 3lbs. 1oz. • Conn: Gold-plated SO-239 • Construction: Fiberglass, 2 Sections

GP-3 • Dual-band 146/446MHz Base Repeater Antenna
Gain & Wave: 146MHz 4.5dBi 6/8 wave • 446MHz 7.2dBi 5/8 wave x 3 • Max Pwr: 200W • Length: 5'11" • Weight: 2lbs. 9ozs. • Conn: Gold-plated SO-239 • Construction: Single-piece fiberglass

GP-6 • Dual-band 146/446MHz Base Repeater Antenna
Gain & Wave: 146MHz 6.5dBi 5/8 wave x 2 • 446MHz 9.0dBi 5/8 wave x 5 • Max Pwr: 200W • Length: 10'2" • Weight: 3lbs. 8ozs. • Conn: Gold-plated SO-239 • Construction: Fiberglass, 2 Sections

GP-9 GP-9N • Dual-band 146/446MHz Base Repeater Antenna • BEST SELLER!
Gain & Wave: 146MHz 8.5dBi 5/8 wave x 3 • 446MHz 11.9dBi 5/8 wave x 8 • Max Pwr: 200W • Length: 17'8" • Weight: 5lbs. 11ozs. • Conn: GP-9 Gold-plated SO-239 • **GP-9N** Gold-plated N-type female • Construction: Fiberglass, 3 Sections

For a complete catalog of **COMET** Antenna products call or visit your local dealer. Or, contact **NCG Company** at **800/962-2611**. Use **NCG/COMET** products, and enjoy amateur radio to it's fullest!



COMET™

CYA-240 • Dual-band 146/446MHz Yagi Cable and Divider included • Gain VHF 9.5dBi 3 Elements • UHF 11.6dBi 5 Elements • Max Pwr: 150 FM/300W SSB • Boom Length: 5'3" • Weight: 4lbs. 7ozs. • Conn: SO-239 • Construction: Aluminum
NEW 240KIT • Stacking Kit for the CYA-240.

1275 N. Grove Street • Anaheim • California 92806
(714) 630-4541 • (800) 962-2611 • Fax: (714) 630-7024 • www.cometantenna.com

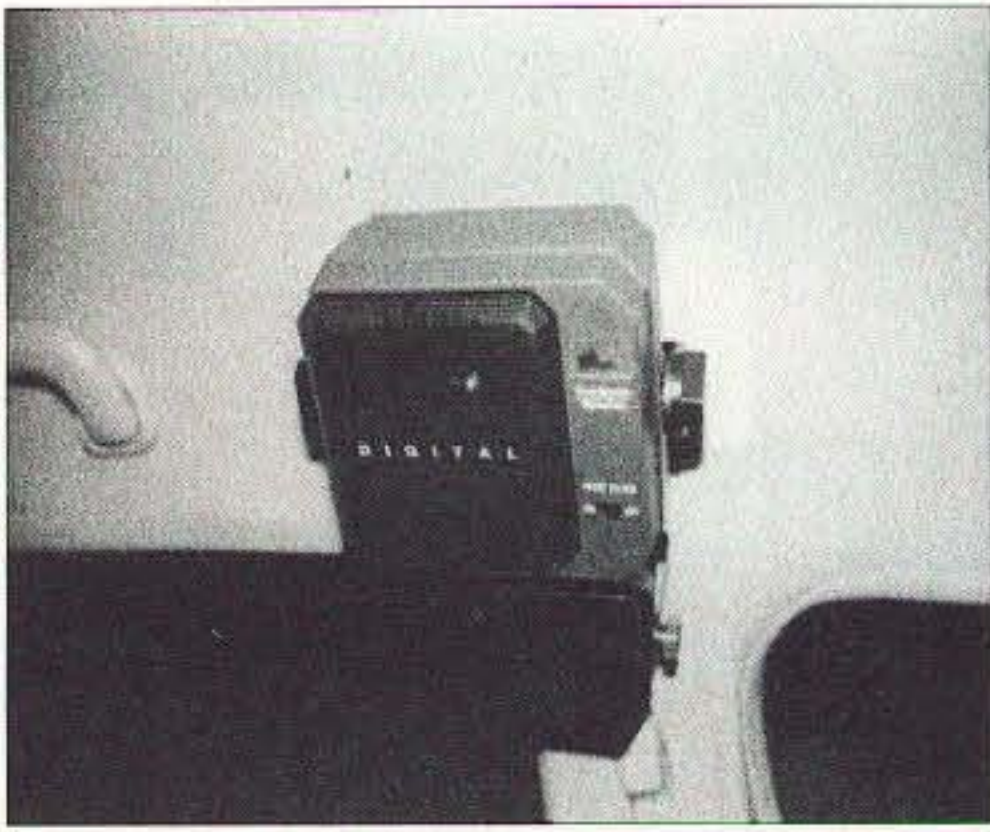

Photo A. ClearSpeech speaker mounted in author's vehicle. Note how it dwarfs the speaker used for VHF/UHF communications (below it).

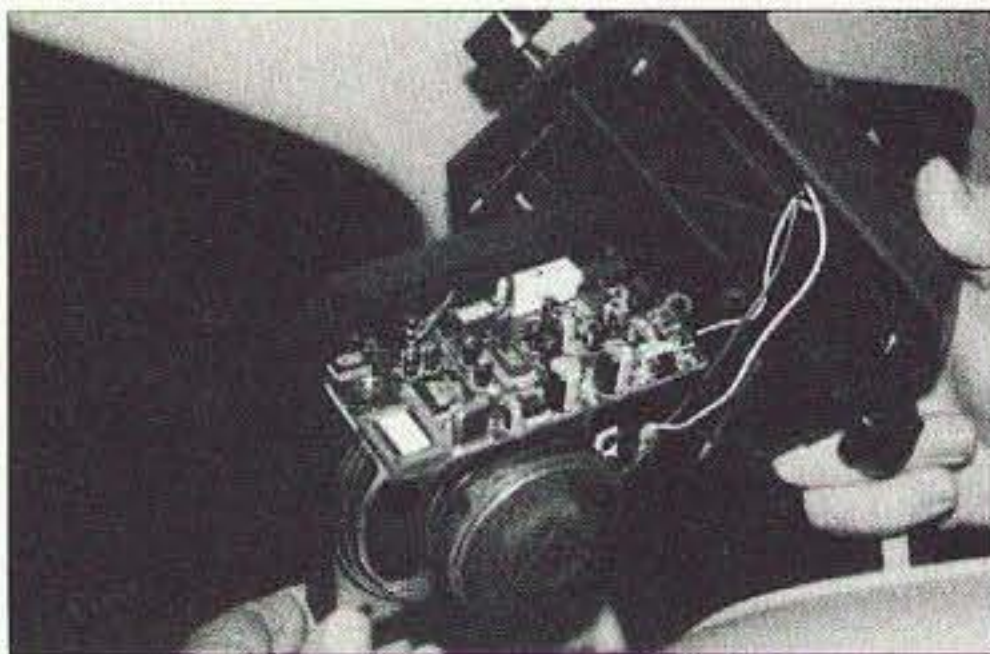

Photo B. Circuit board and speaker are accessible by removing four screws.



Photo C. Audio and power leads to ClearSpeech are mounted low on its case. Toroid is mounted on power leads outside case and is depicted as shipped from the factory. Note "Auxiliary Speaker" jack at top of ClearSpeech case.



Photo D. Large speaker moves a lot of air but adds to the heft of the ClearSpeech unit.

Straight Talk about ClearSpeech

continued from page 31

the processor, much of it goes away. Great! Some driving around listening to HF stations on various bands and switching the unit on and off revealed significant improvement in the ability to copy weak signals. In certain instances, it made the difference between being able to copy or not hear the station at all!

Another benefit was the apparent reduction of noise from nearby electrical lines; the unit seems to attenuate annoying heterodynes to a significant extent. The ClearSpeech unit certainly seems to fulfill the claims in its magazine ads and on its Web site [www.amateurcommunications.com].

Some concerns

Tempted to make a contact with a fairly weak station, I picked up the microphone and put out a call on 20 meters. Uh-oh! RF feedback came through the speaker. I finished my transmission, and when I released the transmit control, I noted what seems to be the automatic gain control of the speaker's amplifier, surging forth, then cutting back on its audio output. Not a debilitating problem, but one that can cause a request for information to be repeated if the person you're communicating with is quick on the comeback.

With the radio turned off, and the speaker in the "on" position, a swirling sound can be heard through the speaker. Even with the speaker's switch in the "off" position, a slight hiss can be heard. In fairness, remember that my speaker is mounted on the pillar, next to the driver's head. If the speaker is mounted below the dash or on the rear window shelf, the sounds described would be less noticeable.

It was surprising to me, that even with its processor turned off, the ClearSpeech speaker requires power to pass audio. It also consumes power with the radio off and its processor in the off position. This situation will require one of the following when the unit is installed:

You may want to power the speaker from a circuit controlled by the ignition switch of your car.

You may want to install an on/off switch or relay on the power lead to the speaker.

You might leave the speaker powered all the time, but you run the risk of a dead battery if your car is not started for a considerable period of time. The ClearSpeech manual advises disconnecting all power sources from the unit if it is not to be used for a long time.

It would appear to this non-engineer reviewer that it would have been relatively easy for the designers to incorporate a power on/off function integral with the speaker, either using the space occupied by the existing slide switch or by adding another switch to the unit.

Another preference would have been for the speaker to operate in a "pass through" mode when there is no power to it. Again, a simple circuit or multipole mechanical switch arrangement would seem to be a relatively easy design to incorporate. There are times, when band noise conditions are low or when the car is stopped, when "pass through" operation is desired. Operating without any of the circuitry of the ClearSpeech speaker being active is not a choice.

The ClearSpeech speaker provides PLENTY of audio. A relatively large speaker moves a lot of air and it seems to have a pretty good range. When driven at levels slightly above normal, mine will occasionally buzz as though something in the cabinet is vibrating or the speaker itself may have a defect.

ClearSpeech Responds

I took some of these concerns to ClearSpeech via E-mail. Their responses

Positives:

- Good noise reduction, aggressive DSP
- Large speaker moves plenty of air
- Good factory support

Negatives:

- Unit must be powered to work
- "Afterthought" external toroid TX/RX recovery time

to my comments were prompt and well-composed.

On the subject of power being necessary at all times, I was told that the DSP and internal amplifier circuit require 12 VDC to operate. No power, no audio.

I was also told that the slight hiss when the radio is off is normal and that the manual recommends a switched DC power source, which would (of course) eliminate the noise.

My big concern was with the RF feedback. Prior to installing the ClearSpeech unit, I had a non-amplified speaker located in the same position in the car the ClearSpeech unit now occupies. I never had an RF problem with that speaker. The ClearSpeech response to my concern was that there should be no RF feedback to the speaker. They claim to know of some truckers who run over 1 kW with the antenna mounted on the speaker brackets only a few feet from the speaker. The respondent to my note also said he runs 700 watts of RF from his motor home with no RF feedback problem. It was stated that taking power directly from the battery is an important consideration, which I admit, I did not. I tapped a circuit switched by the vehicle ignition/

accessory circuit in an effort to work around the lack of a power switch on the unit.

Since my communication with ClearSpeech, I have spoken to another ham who reported RF feedback with his ClearSpeech unit. The RF choke on the power leads to the unit indicates to me that they are an add-on (not built into the original design), suggesting I am not the only person to experience the problem. It must be noted that every vehicle installation is unique, and there are properties to each situation that can cause results to vary widely.

It should be added that ClearSpeech comes with a limited satisfaction guarantee. If you're not pleased, it can be returned (in its original condition and packing materials) for a refund. This would seem to be good insulation from risk if you want to try to evaluate the product as applied to your situation.

My concern about the recovery time of the unit after transmission was addressed, too. The responder said yes, there is a momentary "rush" after transmission. It takes a little more than a half-second for the processor to lock on to new noise and cancel it, according to ClearSpeech.

I also asked about the occasional buzzing from the speaker, and was told that reducing the volume could help, but if the speaker had a problem such as a broken or cracked cone, the unit would be repaired under the terms of the warranty.

Not just mobile

It is possible the ClearSpeech can be used in a number of other installation scenarios. It may be a valuable accessory if your home station is plagued by electrical noise from power lines or other sources. Another operator I know wants to try it in an aircraft installation. (He's FAA certified. Don't mess around with aircraft wiring if you're not!)

Summary

Overall, I give the ClearSpeech unit a "B" grade. It certainly does what it claims to do in terms of reducing noise, reducing listener fatigue, and adapting to changing noise situations.

It's easier to operate than a freestanding DSP unit, particularly in a mobile scenario.

I believe a little more thought in the design phase would have helped the speaker immensely. Pass through audio, a power switch and moving the power line toroids inside the case would be definite improvements. Perhaps there will be a revised version or upgraded model sometime in the future. Is the unit susceptible to RF? There are too many variables in mobile installations to come to a definitive conclusion. I think the company's responses to the problem are reasonable, and its generous return policy provides the opportunity for a prospective buyer to make an informed purchase decision.

After using the unit for a period of time, I decided to keep it because of the strong job it does in reducing noise and elevating the enjoyment of HF mobile operation. That's what it's all about. 73

Power supply voltage	12.0 VDC
Max current	500 mA
Output audio power	2 watts
Input impedance	8 ohms
Max input power	2 watts
Speaker bandwidth	300 ~ 3400 Hz
Background noise reduction	> 12 dB
Tone reduction	> 50 dB
Mass	1.34 lbs (0.61 kg)
Dimensions	5.5 x 4.3 x 2.5 in. (140 x 109 x 64 mm)
Manufacturer/distributor: NCT Group, Inc., 1025 West Nursery Rd., Linthicum MD 21090; tel. (410) 636-8700	

Table 1. Technical specifications.

From MILLIWATTS to KILOWATTS™



RF PARTS HAS IT!

Complete inventory for servicing Amateur, Marine, and Commercial Communications Equipment.

- Transmitting Tubes & Sockets
- RF Power Transistors
- VHF/UHF RF Power Modules
- Low Noise RF FET's
- Bird Electronics Wattmeters
- Doorknob Capacitors
- Chokes • Broadband Transformers

Se Habla Español • We Export

Visit our Web Site for latest Catalog pricing and Specials:
<http://www.rfparts.com>

ORDERS ONLY
1-800-RF-PARTS • 1-800-737-2787

ORDER LINE • TECH HELP • DELIVERY INFO.
760-744-0700

FAX 760-744-1943 TOLL-FREE FAX 888-744-1943

E-MAIL: rfp@rfparts.com



RF PARTS
435 SOUTH PACIFIC STREET
SAN MARCOS, CA 92069

Listings are free of charge as space permits. Please send us your Calendar Event two months in advance of the issue you want it to appear in. For example, if you want it to appear in the September issue, we should receive it by June 30. Provide a clear, concise summary of the essential details about your Calendar Event.

JUN 2-3

MARIETTA, GA The Atlanta Radio Club Hamfest will be held at Jim Miller Park in Marietta GA. From I-75 at Windy Hill Rd., go west for approx. 5 miles to Austell Rd. Take a left, go 1/4 mile to Callaway Rd., take a right on to Callaway Rd. Go 3/4 mile. The hamfest is on the right. Talk-in on 146.820(-). Setup Friday June 2nd, 9 a.m.-3 p.m.; Saturday June 3rd, 6:30 a.m.-8:30 a.m. Open to the public Friday 3 p.m.-7 p.m., and Saturday 8:30 a.m.-3 p.m. Admission \$5 at the gate. Children, under 12 years, free with an adult. 8 ft. tables \$25 inside A or B buildings. Outside space (10 ft. x 10 ft.) \$10. Outside covered space (10 ft. x 10 ft.) \$15. Camping: RV full hookups \$10. Free parking. VE exams at the First United Methodist Church, Marietta GA, starting at 9 a.m., Saturday, June 3rd. Contact *Charles Golsen N4TZM, 5580 Lake Forrest Dr., Atlanta GA 30342; tel. (404) 252-3303; E-mail [cgolsen@atlanta.com]; or Ben Dasher KE4YZX, 1560 Cave Rd., Atlanta GA 30327. Tel. (404) 869-6959, E-mail [bendasher@mindspring.com].* Please, no phone calls after 9 p.m. Eastern time.

JUN 3

GRAND RAPIDS, MI The annual IRA Hamfestival, West Michigan's largest hamfest, will be held at the Hudsonville Fairgrounds near Grand Rapids. Talk-in on 147.16 link rptr. system. Doors open at 8 a.m. for general admission. Free parking. Dealers can setup on the 2nd after 7 p.m., or after 6 a.m. on the 3rd. Bring your ham equipment, coax, computer equipment, software, books, wire, jewelry, sweat-shirts etc. to sell. Hams, bring your used equipment to trade or sell. Computer hobbyists, bring your excess hardware, software, books, etc. to trade or sell. Overnight camping is available, \$10. VE exams at 10:30 a.m. Indoor table space, 8 ft. tables \$8 each. 10 ft. trunk sales spaces, \$6. Contact *Kathy at (616) 698-6627 from 4 p.m. to 7 p.m. EST.* Visit the Web at [<http://www.iserv.net/~w8hvg>].

SPRINGFIELD, IL A Hamfest will be held June 3rd at Illinois State Fairgrounds. Enter Gate 11. This event is being co-sponsored by Sangamon Valley Radio Club & Shooting Stars 4-H Club. Talk-in on 146.685(-). Flea market opens at 6 a.m.; building opens at 8 a.m. Tables \$5 in advance. Admission tickets \$5 each. No extra charge for covered flea market

spaces. ARRL VE exams. For more details contact *Ed Gaffney KA9ETP, 13977 Frazee Rd., Box 14A, Divernon IL 62530. Tel. (217) 628-3697; or E-mail to [egaffney@family-net.net].*

JUNE 4

MANASSAS, VA The Ole Virginia Hams ARC, Inc., will hold Virginia's Olde Fashioned Manassas Hamfest at Prince William County Fairgrounds, 1/2 mile south of Manassas VA on Route 234. Talk-in on 146.97(-), 224.660(-), and 442.200(+). Indoor exhibitor space, 8 ft. tables \$30 each, with chairs and electricity. Setup 2 p.m.-10 p.m. Saturday. General admission is \$5 per person at the gate. No advance sale. Gates open at 7 a.m. Free parking. Tailgating \$5 per space (plus admission). Gates open at 6 a.m. Setup 2 p.m.-10 p.m. Saturday. Find directions, details, and hotel info at the Web site [<http://www.qsl.net/olevahams>]. Dealers, contact *Jack N4YIC, (703) 335-9139; Fax: (703) 330-7987; E-mail [N4YIC@arrl.net] or [patnjack@erols.com].* For general info, contact *Mary Lu KB4EFP, tel. (703) 369-2877; E-mail [mblasd1638@aol.com].*

NEWINGTON, CT The Newington Amateur Radio League Hamfest will be held Sunday, June 4th, 9 a.m.-1 p.m., with setup at 8 a.m., at Newington High School, 605 Willard Ave. (Rte. 173). Talk-in on 145.45, 146.52, 224.84 and 443.05. Flea market, tailgating (\$10, two parking spots on a first-come, first-served basis), VE exams (12 noon, walk-ins welcome; pre-register with special needs). Contact *Dan Miller K3UFG, (860) 206-3379 or [k3ufg@arrl.net].* Admission \$5 (indoor and outdoor). Tables \$15 in advance, \$20 at the door. Make check payable to NARL and send with an SASE to *John DiSarro KA1HQK, 134 Winslow Dr., Newington CT 06111.* For more info contact *Tom Ponte WB1CZX, 99 Jeffrey Lane, Newington CT 06111; tel. (860) 666-4539. E-mail [wb1czx@arrl.net].*

QUEENS, NY The Hall of Science ARC Hamfest will be held at the New York Hall of Science parking lot, Flushing Meadow Corona Park, 47-01 111th St., Queens NY. Doors open for vendors to setup at 7:30 a.m. Buyers admitted at 9 a.m. Free parking. VE exams at 10 a.m. Admission by donation, buyers \$5. Sellers \$10 per space. Talk-in on 444.200 rptr, PL 136.5; 146.52 simplex. Contact (eves. only)

Stephen Greenbaum WB2KDG, (718) 898-5599. E-mail WB2KDG@Bigfoot.com] or Andy Borrok N2TZX, (718) 291-2561; E-mail [N2TZX@webspan.net]. For info about the VE exams, contact *Lenny Menna W2LJM, tel. (718) 323-3464, or E-mail [LMenna6568@aol.com].*

JUNE 11

BETHPAGE, NY The Long Island Hamfair and Electronics Flea Market will be held, rain or shine, by LIMARC, 8:30 a.m.-2 p.m. at Briarcliffe College, 1055 Stewart Ave., Bethpage, Long Island NY. Amateur radio equip., shortwave radios, scanners, CB equip., power supplies, accessories, ARRL info, and the all new 50/50. Tailgate spaces \$15. General admission \$6. Children under 12 admitted free. For more info call the 24-hour LIMARC info line at (516) 520-9311; or on the Internet at [www.limarc.org]. Talk-in on the 146.850 (PL-136.5) rptr.

NEAR SUFFIELD, OH The Goodyear ARC will hold their 33rd Annual Hamfest and Family Picnic Sunday, June 11th, 8 a.m.-1:30 p.m., at the Goodyear Wingfoot Lake Park near Suffield OH, 10 miles east of Akron. Talk-in on 146.985(-) or 146.520. Admission \$4 in advance or \$5 the day of the event. One ticket admits ham, spouse, and children. Vendors (pavilion) \$10 per table, \$8 in advance plus admission ticket. VE exams available. For additional info contact *Don Longshore N8QCA at (330) 733-7989; or Fred Mealy KC8BQX at (330) 665-4563.*

WHEATON, IL The Six Meter Club of Chicago, Inc., will hold its 43rd Annual ARRL sponsored Hamfest, Sunday, June 11th, at the Dupage County Fairgrounds, 2015 Manchester Rd. (north of Roosevelt Rd. Rte. 38), East of County Farm Rd., Wheaton IL. Free parking. No extra charge for space in outdoor flea market. General parking at the West Gate. Sellers only at the East Gate. Handicap parking at East Gate. Gates open at 7 a.m.; buildings open to the public at 8 a.m. Talk-in on K9ONA 146.52; K9ONA/R 146.37/.97 (107.2). VE exams 9 a.m.-11 a.m. Call the 24-hour InfoLine, (708) 442-4961, to preregister for testing, or for more info. Absolutely no alcoholic beverages permitted. Limited overnight RV parking with electrical hookup \$10, advance registration required. Advance tickets \$5, \$6 at the gate. Advance tickets are

available from *Joseph Gutwein WA9RIJ, 7109 Blackburn Ave., Downers Grove IL 60516*. 8 ft. commercial tables w/110V in the air conditioned main building, are \$15 each. Indoor 8 ft. flea market tables, no electrical hookup, \$12 each. Make check payable to *Six Meter Club of Chicago*, and mail with an SASE to *Six Meter Club of Chicago, 7109 Blackburn Ave., Downers Grove IL 60516*, no later than May 25th.

JUNE 17

DUNELLEN, NJ W2QW, the Raritan Valley Radio Club "Hamfest 99" will be held at Columbia Park, near the intersection of Routes 529 and 28, 7 a.m.-2 p.m. Setup at 6 a.m. Admission: buyers \$5, sellers \$10 (\$5 each additional space). Talk-in on 146.625(r), 447.250(r) tone 141.3, and 146.520(s). Contact *Doug Benner W2NJH, (732) 469-9009*, E-mail [WB2NJH@AOL.COM]; or *Fred Werner KB2HZO (732) 968-7789*, before 8 p.m.

JUNE 18

MACEDONIA, OH The Cuyahoga ARS will hold their 9th annual Father's Day Hamfest and Computer Show/Fleamarket, 8 a.m.-1 p.m. at Nordonia High School, 8006 South Bedford Rd., Macedonia OH. Setup is at 6 a.m. For reservations, call or fax *Rich James N8FIL, (330) 468-6021*; or *CARS, P.O. Box 133, 526 W. Aurora Rd., Sagamore Hills OH 44067*; E-mail [Hamfest@cars.org]. The Web page is [http://www.cars.org]. Admission \$5. Indoor tables \$11 for the first table (includes admission), \$8 for each additional table. Talk-in on 146.82(-).

MONROE, MI The Monroe County Radio Com. Assn. will hold its annual "Monroe Hamfest" 7:30 a.m.-1 p.m., at the Monroe County Fairgrounds, 2 miles west of Monroe on M-50. Indoor tables \$15 for the first 8 ft. table and 1 ticket, \$10 each additional table. Trunk sales \$6 per 8 ft. space. Overnight camping \$15. Free parking. Talk-in on 146.72. Admission \$6 in advance, includes two stubs for the drawing; \$6 at the door with one stub. Contact *Fred VanDaele KA8EBI, 4 Carl Dr., Monroe MI 48162*; tel. (734) 242-9487 after 5 p.m.; or E-mail [ka8ebi@arrl.net].

JULY 8

PETOSKEY, MI The Straits Area ARC's 25th Annual Swap & Shop will be held Saturday, July 8th, 8 a.m.-12 p.m., at Emmet County Fairgrounds, Petoskey MI. US 31, 2 blocks west of 131. Tickets \$4, tables \$5 (splits OK). VE exams 1 p.m. at the American Red Cross Bldg. For testing info contact *Floyd KG8CS, (231) 526-5503*. For general info contact *Tom W8IZS, (231) 539-8459*; or *Dirk KG8JK, (231) 348-5043*, E-mail [kg8jk@qsl.net].

SALISBURY, NC The Rowan ARS will sponsor the Salisbury Firecracker Hamfest,

Saturday, July 8th. From I-85, take exit 76B to Salisbury. Turn right at the ramp intersection with E. Innes St. Turn left on S. Boundary St. (Captain D's/McDonald's intersection). Go two blocks to find the Salisbury Civic Center — hamfest site on your left. Doors open at 8 a.m. Admission \$4 in advance, \$5 at the door. Indoor tables \$5 each as long as they last. Talk-in on 146.73 (W4EXU) tone 94.8; back up on 146.52 simplex. Walk-in VE exams. For more info call *Jim Morris KA4MPP, (704) 278-4960*; or *Carol Maher W4CLM, (704) 633-6603*. Send mail to *Rowan Amateur Radio Society, P.O. Box 593, Salisbury NC 28145*. E-mail [rbrown@salisbury.net].

JULY 9

PITTSBURGH, PA The North Hills Amateur Radio Club's 15th Annual Hamfest will be held July 9th, 8 a.m.-3 p.m., at the Northland Public Library, 300 Cumberland Rd. Pittsburgh PA; approx. 10 miles north of Pittsburgh on McKnight Rd. (Truck Route 19). At the 3rd traffic light after Northway Mall, turn left onto Cumberland Rd. Northland is on the left at the top of the second hill. From points north, take Route 19 south toward Pittsburgh. Follow signs for McKnight Rd., and at 4th traffic light turn right onto Cumberland Rd. If on Perry Hwy., turn left onto Cum-

berland Rd. at the Sunoco. Talk-in and check-ins will be on 149.09 W3EXW North Hills Club rpt. Free admission and free parking. Paved tailgating, 1st space free; additional \$5 each. Handicapped accessible. For more info contact *Keith Ostrom KB3ANK, 205 Poplar Dr., Pittsburgh PA 15209*, tel. (412) 821-4135; *Bob Ferrey, Jr. N3DOK, tel. (412) 367-2393*, E-mail [n3dok@pgh.net]; or see the club's Web site at [www.nharc.pgh.pa.us].

JULY 28-30

FLAGSTAFF, AZ The 49th Arizona State Convention and Hamfest, sponsored by the Amateur Radio Council of Arizona, will be held at Ft. Tuthill in Flagstaff AZ. Some of the features will be manufacturers, dealers, exhibits,

seminars, VE exams, a huge swap, camping, and more. Gordon West WB6NOA will present two of his famous seminars, and (TBA) will be the guest speaker at the Sat. night BBQ. Other speakers, seminars and forums include Dan Miller from ARRL headquarters, Bill Pasternak from *Newsline*, AMSAT, APRS, Ten-Ten, Ladies programs, QRP, and an ARRL Forum. For more info contact *Amateur Radio Council of Arizona, PO Box 312, 16845 N. 29th Ave., Ste. 1, Phoenix AZ 85053-3041*. E-mail [arcathill@aol.com]. Voice mail (602) 779-2722. Visit the Web site at [http://www.Hamsrus.com].

73

73 Ad Sales
call Evelyn Garrison
1-425-557-9611

SAVE 47%!
on 12 months of **73**
Only \$24.97
Call 800-274-7373

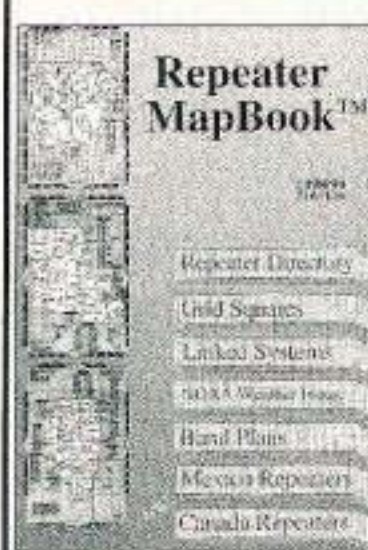

A perfect travelling companion. The Mapbook contains locations of hundreds upon hundreds of open repeaters throughout the U.S., Canada and Mexico. These detailed maps show all highways and major cities in each state. If you travel anywhere in the United States, this Mapbook will be the best investment you ever made!

\$9.95

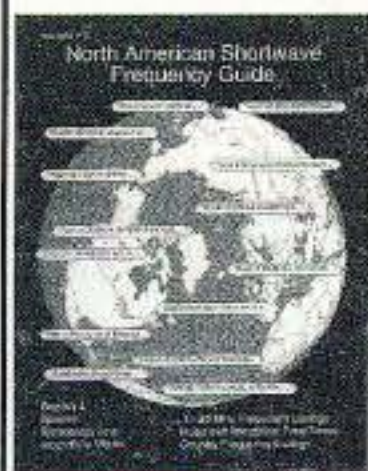

New in this third edition book are world frequency maps to help you tune into a specific country, anywhere in the world. The new quick country guide will help you tune in almost any time of the day or night.

\$19.95

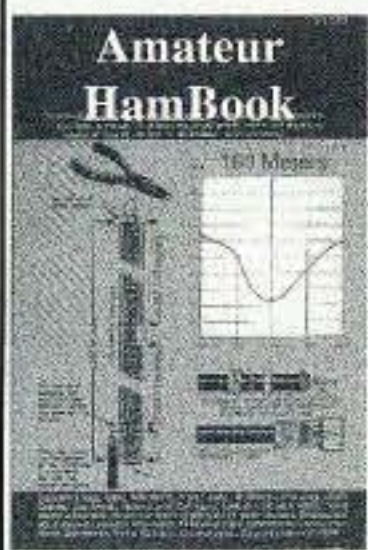

A true cornucopia of technical information for ham radio. Not only will you find the theoretical aspects, you will find real practical information presented in a no nonsense form. Equipment & Log Sheets, Charts, Tables showing: worldwide callsigns, world times, shortwave listening frequencies, coax losses, CTCSS details, conversions, construction plans, emergency information, etc.

133 pages. \$14.95

Send check or money order plus \$3.50 shipping & handling to:

Omega Sales
P.O. Box 376
Jaffrey, NH 03452
1-800-467-7237

Exploring the Kenwood TM-D700A

Part 2: A rig for all seasons.

Last month, I wrote about the many features of the Kenwood TM-D700 as a high-quality dual-band mobile transceiver. As impressive as it is, it is not its capability as a multi-function FM transceiver that sets the TM-D700A apart from the pack. What makes this rig really exciting is the fact that it is a very powerful hybrid of a radio and a computer. This radio can function as a repeater, a packet radio system, a slow scan TV station, or a complete APRS operation. The more I play with this radio, the more I find that it can do and the more fun I have with it.

The radio can function as a dual-band repeater that may prove extremely useful in some situations. I like to use a very small (and therefore low power) handheld around the house. I can hit my favorite repeaters with this, but for some nets I need a more powerful signal. By setting the TM-D700A up as a repeater, I can use the handheld set to transmit on a UHF frequency and have the TM-D700A retransmit

my signal to the 2-meter repeater. While this is certainly convenient, the real benefit would be in a disaster or emergency situation where no repeater is available to a disaster relief group. A mobile-mounted rig could be parked as close (or as high) as possible to expand coverage. Having just one more repeater available in such a relief effort can make the difference between being able to provide communications and not.

Many of the advanced functions revolve around the TM-D700A's built-in terminal node controller (TNC). TNCs were developed over ten years ago to permit radios to communicate digital information in packets. The TNC became the link between a computer and a radio in the same way that a modem is the link between a computer and a telephone line. Packet radio caught on, big, with much of the excitement being the ability to establish and maintain packet bulletin boards. The level of interest dropped off as the Internet and World Wide Web caught on, since they provided faster access to similar bulletin boards. At that time, TNCs were capable of 1200 baud, while modems jumped from 2400 baud to nearly 56 kilobaud. Needless to say, bandwidth is a powerful attraction. While there are still many packet bulletin boards around today, they tend to be more specialized. Packet clusters are bulletin boards that meet the information needs of a specialized group of hams. DX packet clusters, for example, allow DX chasers to keep up on the latest activities of rare stations while trying to work the stations on HF. Another interesting application of packet is through

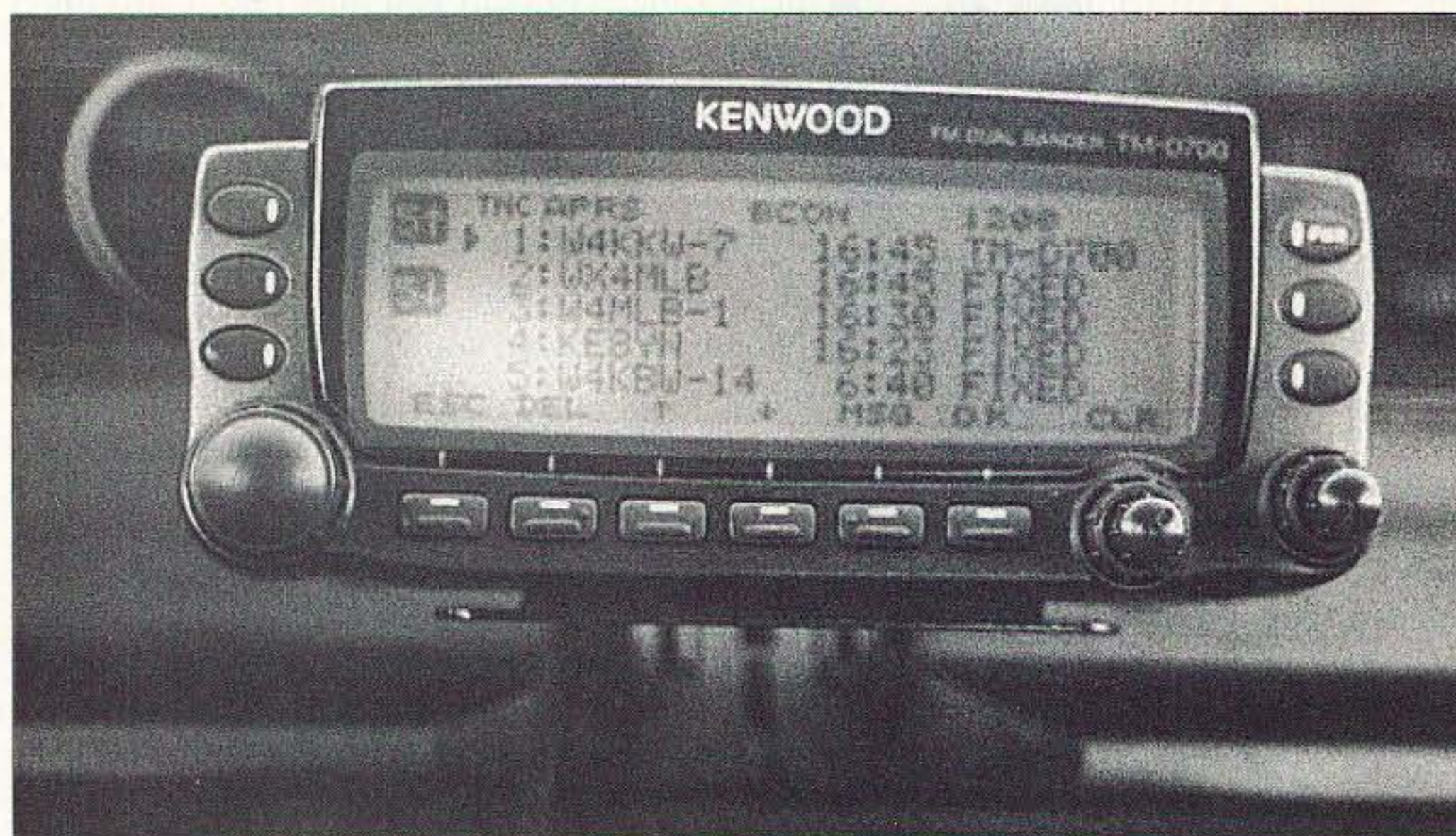

Photo A. In APRS mode, the control panel can display a list of stations recently heard. By moving the cursor to a particular station, you can recall details or send a message to that station.

TM-D700A Panels

The Kenwood TM-D700A utilizes a separate main unit and control panel. The control panel is mounted in a convenient location where it can be readily seen and the controls reached. The main unit can be securely mounted under a seat or even in the trunk. Since the control panel is easily removable from its bracket and cable, this reduces the chance of theft, especially since Kenwood has announced that it is not intending to sell replacement control panels.

The main unit has connections located on both the front and rear. On the front (Fig. 1) there is a DB-9 connector (1) used to connect to the serial port of a computer. The computer can be used to load or store frequencies to be memorized, as a terminal for packet radio operations, and to perform other control functions.

A GPS jack (2) permits the connection of a standard GPS receiver so that the TM-D700A can report its position as determined by GPS. The data connector (3) uses a DIN socket and can be used for connection to Kenwood's VC-H1 video input or for connection to an external TNC.

There are two modular connections. The first is used with the cable to connect to the control panel (4). The second is used for the microphone (5). The connectors are all different, so there is no chance of plugging the wrong item into the wrong port.

The last item on the front of the main unit is a reset button (6). As with all good computers, this is the "when all else fails" button. Don't try to plug in the GPS by feel alone, or you may inadvertently try to plug it into the reset (Oops!).

The rear of the main unit (Fig. 2) has an SO-239 connector (1) for the antenna. There is a cooling fan in the

middle. The power cable (2) comes complete with cables with fuses to be located near the connection to the power supply or battery. There are two speaker jacks (3) and, by using the software control, you can route the A and B bands to a particular external speaker or the internal speaker. Several combinations are possible.

The front control panel (Fig. 3)

includes a dozen buttons and three knobs. All but the power button are programmable and change with the radio's function. The large knob is used primarily for tuning although it also performs other functions. The two small knobs control the A and B band volume and squelch. Pressing one of them determines which band is the active band.

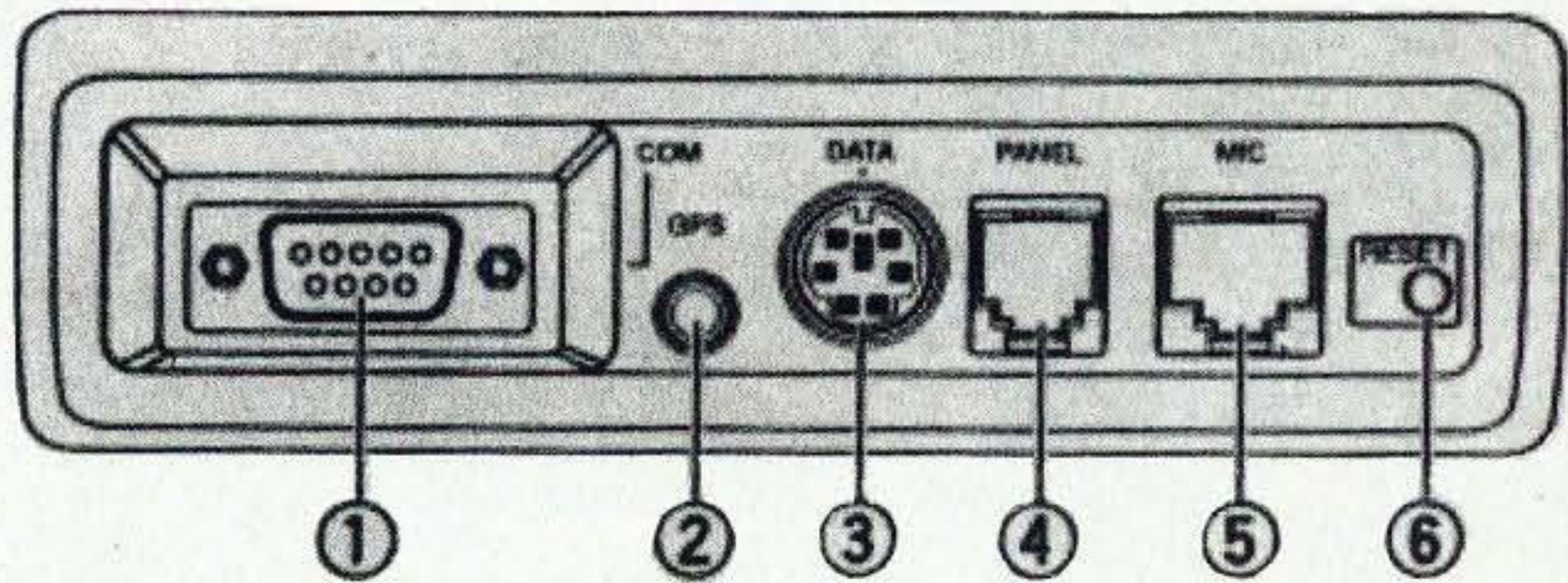

Fig. 1. Main unit front panel.

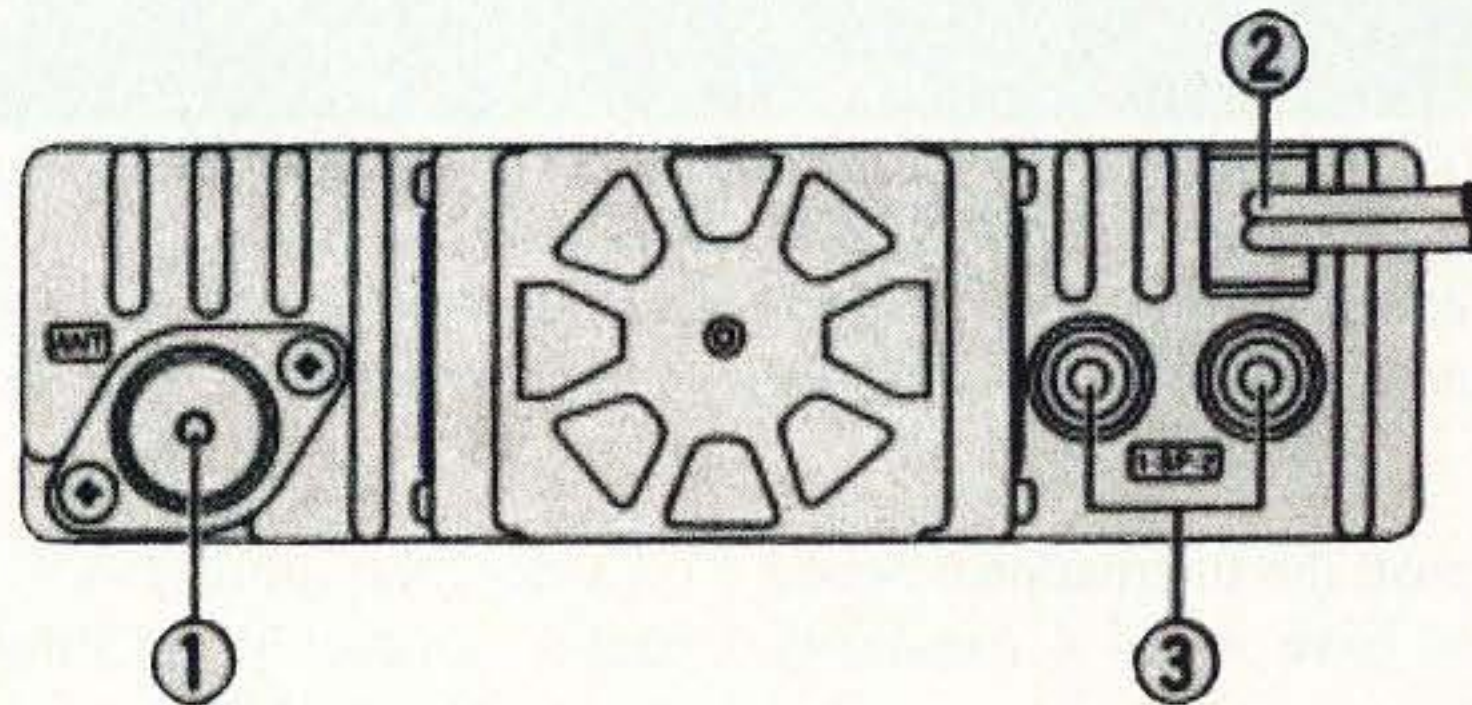

Fig. 2. Main unit rear panel.

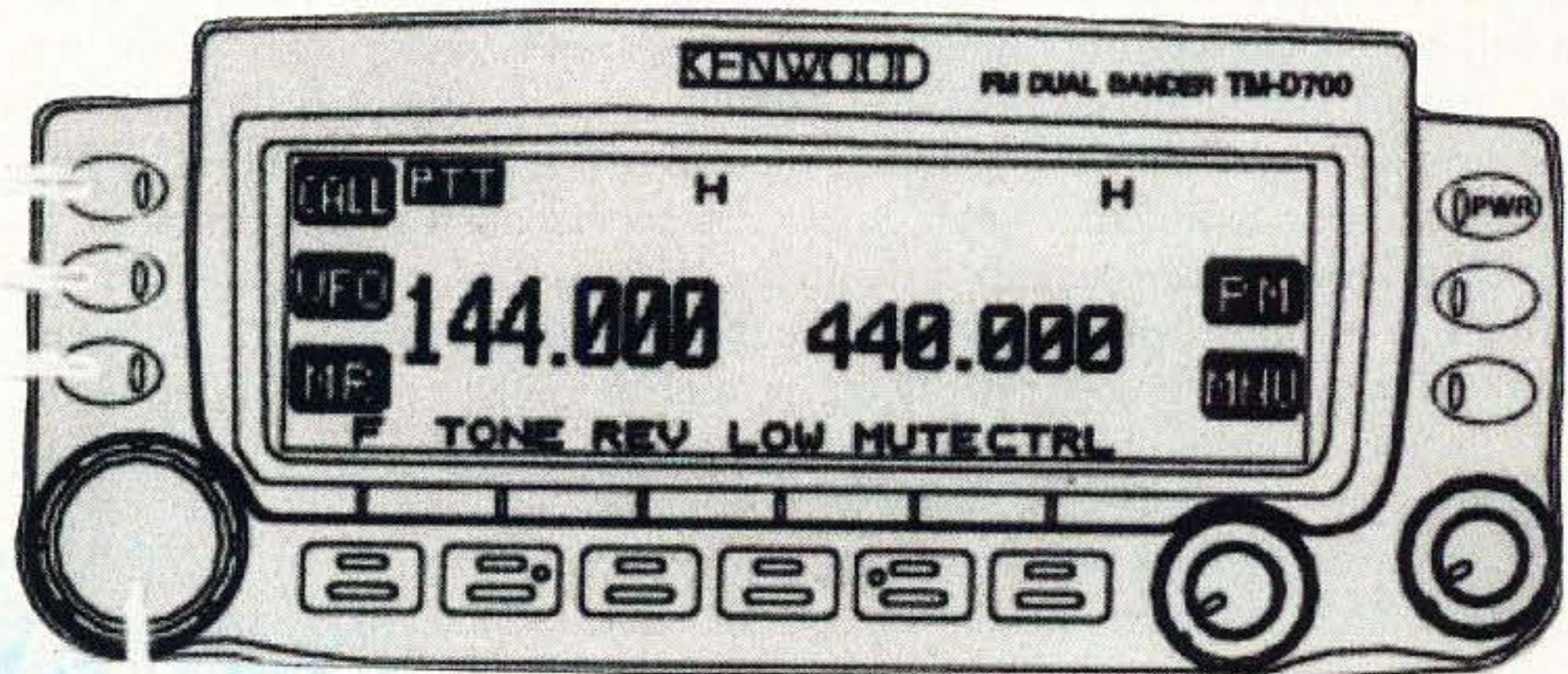

Fig. 3. Control panel.

satellite or space station operation. A message is sent by packet to the orbiting bulletin board on one orbit and the station responds the next time it's "in the neighborhood" on its next orbit.

Since some packet stations are geared for satellite contacts, you can connect to the space station through one of these specialized stations and not have to worry about having your own alti-

tude/azimuth circularly polarized antennas and other satellite equipment. As I write this, a crew is being sent back to the *Mir* space station, which has operated such a space-based packet

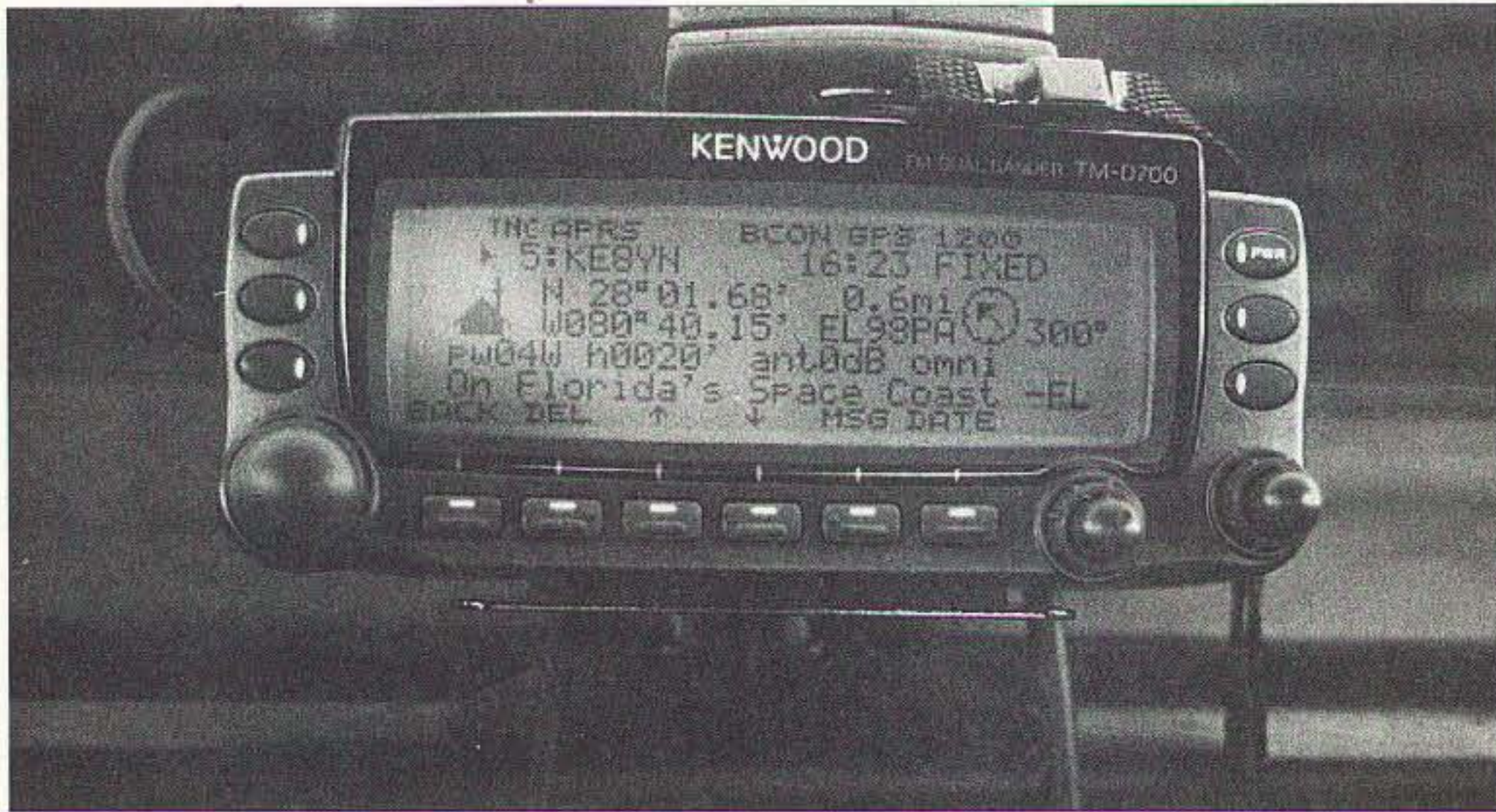

Photo B. This is the type of detail you can display about a station. In this case, the screen in my car indicates the transmitted information about my home station, including its location as latitude and longitude. Since my mobile station includes a GPS receiver, the screen also indicates the direction and distance from my mobile to my home station.

BBS in the past; the International Space Station may have such a capability once occupied.

The TM-D700A provides the radio and the TNC, so all you need to add is a computer in order to operate packet. You will need some type of program to allow you to communicate with the TNC through the keyboard. You can use either a basic terminal program to control the TNC or one specially written for such purpose which may provide a split screen. The top half often shows the incoming information while the bottom shows the outgoing data as you type it in. Packet is usually run from a fixed location, but this rig

provides the ability to run mobile packet. I prefer to think of it as relocatable packet, since the idea of operating with one hand on the wheel, one on the keyboard and eyes darting between the windshield and the computer screen is pretty scary. If the operator is a passenger, then mobile operations may work, but safety always supersedes operating a radio. In any case, a laptop computer can be connected to the main unit for portable operation. Since the TNC performs most of the work, a very modest laptop will suffice because it needs only to function as a terminal. A basic black and white model may have lower



Photo C. If you have a GPS receiver hooked to your Kenwood TM-D700A, the control panel can show key data including speed, heading, latitude and longitude, and even the current grid square.

power requirements, providing longer operating time. Don't forget that LCD displays may be difficult to see in bright sunlight, so a sunshield or even a shade made of cardboard might be necessary. A cable with DB-9 connectors can be fitted between the main unit of the TM-D700A and the serial port of the computer. As long as you've got the computer hooked to the system, you might as well try some of the other state-of-the-art capabilities of this unit.

Kenwood's Web page has a downloadable program that can be used to arrange, store, and upload frequencies, offsets, subaudible tones, etc. While this can be entered from the front panel, there's a high tech solution that's more fun. You can arrange data according to location, type of operation or other preference and maintain multiple files that can be easily and quickly uploaded from the computer to the radio. Some TM-D700A owners have begun to write their own programs to control even more features through their computer rather than the front panel. While we hams once experimented with a soldering iron and a junk box full of parts, today we experiment with a keyboard and a computer language.

One of the interesting capabilities of this unit is the Kenwood Sky Command system. Sky Command permits you to use the TM-D700A in conjunction with another data radio and a high frequency rig to operate remotely. Want to work that rare DXpedition on FlySpot Island in the South Pacific from your handheld dual-bander? No problem! Basically the Sky Command system uses a transceiver such as the TM-D700A or the TH-7 at each end. If the TM-D700A is connected to a Kenwood state-of-the-art HF rig, the UHF transceiver can be used for control functions while the 2-meter transceiver can be used for voice transmissions. The voice transmissions on 2 meters are being handled as third party traffic as it passes from one band to another.

You may have read that there have been some questions raised about this system. Actually, this is not at all surprising nor unexpected since any new

and innovative approach, by definition, raises questions. You just can't make progress and maintain the status quo at the same time. In the meantime, you have to admit that this is an interesting and innovative capability.

The TM-D700A also is geared to slow scan TV. Slow scan has been a tried and true mode in the ham bands for many years, although most of us tend to think of SSTV as an activity that shows up on 20 meters around 14.230 MHz. Kenwood has been encouraging portable operations in the VHF band (don't forget that you have to move up to UHF before you can operate fast scan TV). You can use Kenwood's VC-H1 which includes a CCD camera, LCD monitor, and a slow scan converter. I expect that slow scan TV will begin to catch on in these bands in the near future. Imagine the benefit this would provide during disaster support by allowing the sending of a digital snapshot of the scene back to the command post. Then, of course, there is slow scan from a balloon or other experimental platform.

Finally, there is my absolute favorite: the Automatic Packet/Position Reporting System APRS. Even with everything else that this rig offers, nothing compares with the capability this brings to this new and extremely exciting mode. For APRS, all you have to add is — NOTHING. It's got it all. You can send and receive APRS packets automatically and continue to rag-chew through the local repeater on the other. You can program in key information about your station including callsign, an icon that will show on other people's maps, and a status message. You can set it up to beacon periodically with your message being relayed through APRS stations that allow digipeating. Yes, the TM-D700A can act as a digipeater, too. You can enter location coordinates in latitude and longitude into memory; if you enter your home and work locations and key landmarks in between, you can transmit these locations as you hit them. In this way, you can indicate your progress.

However, for even more fun, you can attach a Global Positioning Satellite (GPS) receiver to the radio. GPS

receivers tune to the signals from satellites and are able to determine location by mathematically comparing the signals from multiple satellites. The receiver can determine your current location, speed, direction, elevation, and distance from "way points" or other

Continued on page 58

SAVE 47%!
on 12 months of **73**
Only \$24.97
Call 800-274-7373

Amplifiers, ATU Down Converters & Hard to Find Parts

LINEAR AMPLIFIERS

HF Amplifiers
PC board and complete parts list for HF amplifiers described in the Motorola Application Notes and Engineering Bulletins:

AN779H (20W)	AN 758 (300W)
AN779L (20W)	AR313 (300W)
AN 762 (140W)	EB27A (300W)
EB63 (140W)	EB104 (600W)
AR305 (300W)	AR347 (1000W)

2 Meter Amplifiers (144-148 MHz)

(Kit or Wired and Tested)

35W - Model 335A, \$79.95/\$109.95
75W - Model 875A, \$119.95/\$159.95

HARD TO FIND PARTS

- RF Power Transistors
- Broadband HF Transformers
- Chip Caps - Kemet/ATC
- Metalclad Mica Caps - Unelco/Semco
- ARCO/SPRAGUE Trimmer Capacitors

We can get you virtually any RF transistor! Call us for "strange" hard to find parts!

DIGITAL FREQUENCY READOUT

For older analog transceivers
TK-1 (Wired and Tested) \$149.95

ATU Down Converters

(Kit or Wired and Tested)

Model ATV-3 (420-450) (Ga AS - FET) \$49.95/\$69.95
Model ATV-4 (902-926) (GaAS - FET) \$59.95/\$79.95

ADDITIONAL ITEMS

Heat Sink Material
Model 99 Heat Sink (6.5" x 12" x 1.6"), \$24
CHS-8 Copper Spreader (8" x 6" x 3/8"), \$24
Low Pass Filters (up to 300W) for harmonics \$12.95
Specify 10M, 15M, 20M, 40M, 80M or 160M
HF Splitters and Combiners up to 2KW

For detailed information and prices, write for our free catalog!

CCI Communication Concepts Inc.

508 Millstone Drive • Beavercreek, Ohio 45434-5840
e-mail: cci.dayton@pobox.com
www.communication-concepts.com

Phone (937) 426-8600
FAX (937) 429-3811

THE POCKET GENERATOR

5 Amp-Hr, Portable Gel-Cell and 110 VAC Inverter..... \$59.95 + \$10.50s&h
ONLY 3" x 3.5" x 4" & Very Light Weight (3.5 Lb.) Perfect for Laptops, Chargers, Boom Boxes, Cameras, etc.

- AC Wall Charger
- 50 Watt Continuous/80 Watt Peak DC to AC Inverter Measures Only 1.25" x 2.5" x 3.25"
- 110 VAC Outlet Modified Sine Wave
- Shoulder Strap and Soft Carrying Case
- 12 VDC Cigarette Lighter Outlet
- DC Charging Cord

THE POCKET STATION

Same as THE POCKET GENERATOR, But a Smaller, Lighter 3 OR 7 Amp-Hr Gel-Cell, Without the Inverter..... \$34.95 or \$44.95 +9.50s&h.

12 VDC to 110VAC INVERTERS

- Modified Sine Wave
- Great w / The POWER STATION or MEGA STATION
- Overload, Thermal, & Undervoltage Protection

Model	Cont. Pwr	Peak Pwr	Price
PC140	140 Watts	250 Watts	\$34.95*
PC300	300 Watts	500 Watts	\$49.95*
PP600	600 Watts	800 Watts	\$99.95*
PP1000	1000 Watts	2000 Watts	\$219.95**
PP1500	1500 Watts	3000 Watts	\$324.95**
PP2500	2500 Watts	4000 Watts	\$549.95***
* \$10.50s&h ** \$12.50s&h *** \$14.50s&h			

CHARGE CONTROLLERS

- Flexcharge 12V x 7 Amp Controller.....\$59.95+\$8.50s&h
- Flexcharge 12V x 25 Amp Charge.....\$119.95+\$8.50s&h
- Charge Controllers for Multiple Battery Banks Also!

For Literature on Antennas, HT & Gel Batteries, Inverters Power Supplies, Etc., Send a large SASE w/3 stamps

POWER STATION

- 12 Volt x 7 Amp/Hr Gel Cell Battery
 - 12 Volt Cigarette Lighter Outlet
 - 3, 6, & 9 Volt Output Jack
 - Car & Wall Charger w/Auto Shutoff, Built-in Voltmeter
 - 2 Hidden Terminals For Hardwiring Provide Up To 90 Amps (Short Circuit)
-
- \$49.95+
\$10.50s&h

MEGA STATION

- 17 Amp/Hr Gel Cell w/Heavy Duty Jumper Cables Provide up to 300 Amps Short Circuit
 - Cigarette Lighter Output
 - Charge Indicator Meter
 - Car & Wall Charger
-
- \$69.95+
\$10.50s&h

SOLAR CELLS

- All Wattage's & Sizes**
- Rigid - 5, 11, 22, 32, 42, And 64 Watt Panels
 - 5 Watt: \$105* 11 Watt: \$179**
 - 22 Watt: \$219**
 - 32 Watt: \$269*** 42 Watt: \$329****
 - 64 Watt: 449****
 - Flexible 5, 11 & 32 Watt Panels
 - 5 Watt Flex: \$115* 11 Watt Flex: \$189** 32 Watt Flex: \$399***
 - Reverse Blocking & By-Pass Diodes
 - Silicon Alloy Deposited on Stainless Steel. No Glass to Break
 - Triple Junction Silicon Cells
 - *\$10.50s&h **\$12.50s&h ***\$16.50s&h ****\$18.00s&h
-

WWW.HAMCONTACT.COM

P.O. Box 4025
Westminster, CA 92684, Dept. 73
INFO 714-901-0573
FAX 714-901-0583
ORDERS 800-933-4264
E-MAIL: 73@HAMCONTACT.COM

Serving the LORD since 1987

Dr. Rick Olsen N6NR
Western Washington DX Club
PO Box 538
Issaquah WA 98027-0538
[n6nr@arrl.net]

Chesterfield, the Holy Land, and More

By now, just about everyone has heard about the tremendous success of the Chesterfield Island DXpedition. I had a blast working this new one from home, and I hope you did, too. I was quite impressed with the operating skills and the dedication of the operators on this one.

The statistics from this group are awesome. Here is TX0DX bulletin number 15 from Tom N4GN, dated March 21, 2000:

Chesterfield operators safely back in New Caledonia

The TX DX operation went QRT on Wednesday, 29 March, shortly after 0000 UTC. In six days of operating, they completed 72,654 QSOs. The majority of QSOs were on 21 MHz SSB and CW, as per the original strategy to provide the maximum number of DXers their first-ever Chesterfield contact. However, other complementary bands and modes were activated sporadically, including 50 MHz with more than 2,500 QSOs and RTTY with some 800 stations in the log.

All the Yaesu radio equipment and Suzuki generators performed well under very severe weather conditions. The daily temperature

regularly exceeded 38°C (100°F) and heavy rain was experienced often. The five FinnFet beam antennas were all at heights of 25 feet. The CW site was placed at the south end of the island, while SSB sites were located at the north end, providing 300 meters of physical separation. The Comtek 20-meter four-square performed exceptionally well.

On the way to the Chesterfields, the TX DX group made a slight detour to the area where intervening reefs are indicated on some older maps. The team was able to confirm the French Navy's documentation that the claimed islands simply do not exist. Thus, the 350-kilometer open water separation between New Caledonia and the Chesterfields is assured, and the concerns expressed by some in the DX community can be put to rest. With the recent decision to admit ARANC — New Caledonia's amateur radio society — to the IARU, the way

is now cleared for the Chesterfield Islands to be added to the official DXCC List, and no further complications are expected in this process.

The TX DX log search will be operational in approximately one week, since some of the QSOs were logged on paper as the result of two computers succumbing to the elements. No QSO data was lost; every made QSO is safely in the hands of the group.

The TX DX operating team of FK8GM, FK8HC, JA1BK, N5KO, N7NG, OH1RY, OH2BC, OH2BH, and OH2RF are pleased to be safely back in Noumea, New Caledonia, and they wish to thank the following organizations and individuals for supporting this undertaking: Yaesu Musen Co., Suzuki Co., FinnFet, Comtek, INDEXA, GDXF, F6AJA, FK8CR, JH1KRC, JK1KRS, N4GN, OH2BN, K6GNX, W5IZ, W6OTC, VK3EW, and all their family members back home.

Tom's bulletin mentions a log search routine that was pending. In case you haven't gotten the details yet, it has been available since early in April. You can obtain a listing of your entries in the TX0DX log by sending an E-mail to [tx0dx-log@n4gn.com], with your callsign at the beginning of the subject line. You do not need to enter anything in the body of the E-mail. You will receive something that looks like this:

"The TX0DX Chesterfield Islands DXpedition was made possible by the generous support of Yaesu Musen Co. Ltd., the International DX Association (INDEXA), and the German DX Foundation (GDXF).

"Based on the SUBJECT line of your E-mail request, the TX0DX 2000 DXpedition HF log book was searched for the callsign 'N6NR' and the following QSOs were found (call, band, mode):

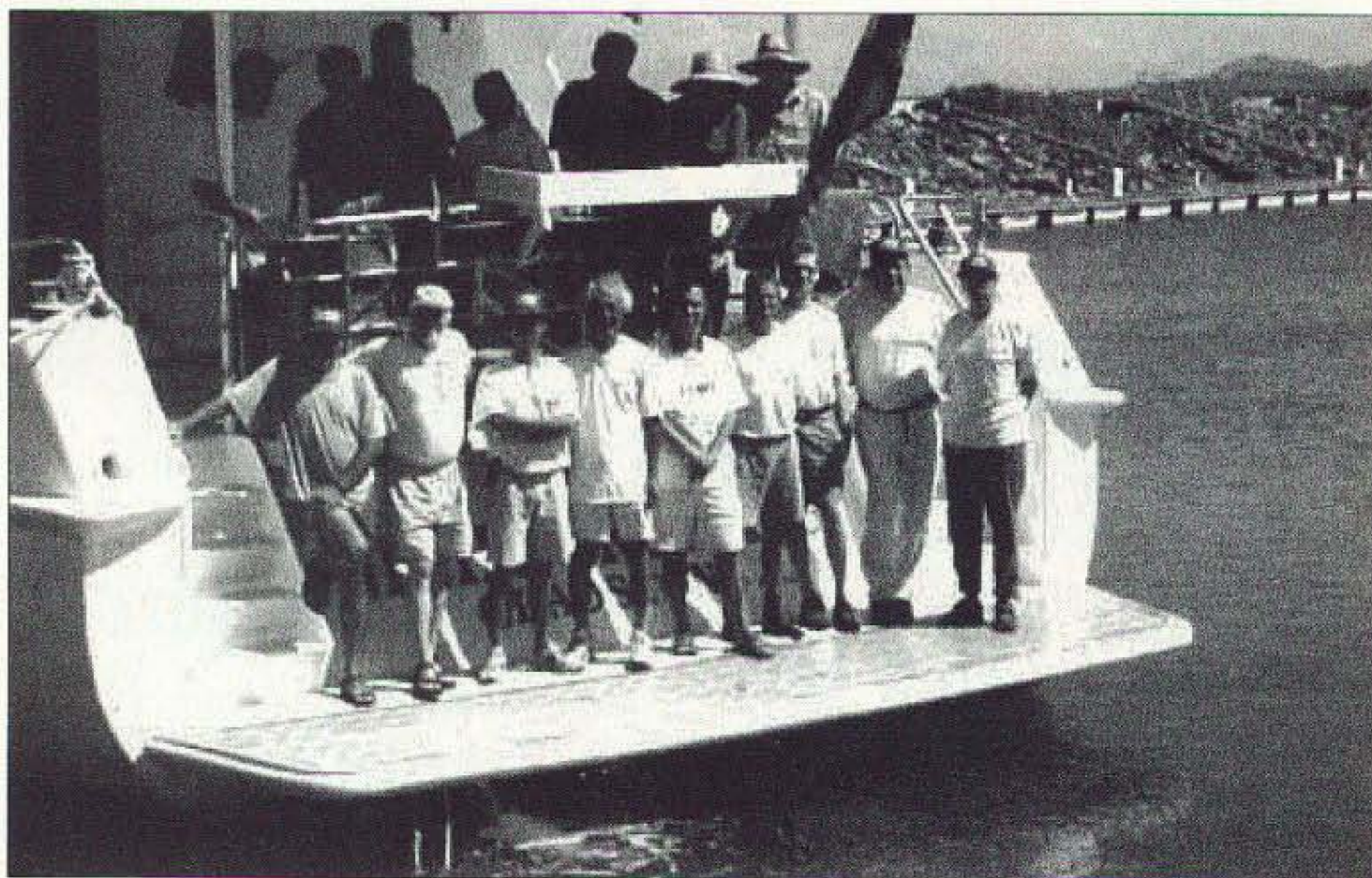

Photo A. Martti and gang put a new one in the water!! Photo courtesy [<http://www.n4gn.com/tx0dx>].

Top of Form

Enter Callsign:

N6NR

Search Log

Clear Callsign

Bottom of Form

4W/W3UR QSL manager is Jarmo, OH2BN.

Jarmo's address is:

Jarmo J. Jaakola

Kiilletie 5-C-30

00710 Helsinki

FINLAND

QSOs with N6NR

Band Mode

15m SSB

A total of 1 QSO was found

This log contains 9,191 QSOs
from 26-Mar-2000 1437Z through 2-Apr-2000 2302Z

Photo B. This is what you will see on the 4W/W3UR log server Web page. As you can see, I just barely made it.

N6NR 20S [20 SSB]

N6NR 15C [15 CW]

N6NR 12S [12 SSB]

N6NR 10C [10 CW]

Total number of N6NR QSOs found in TX0DX log: 4

... The TX0DX E-mail log search was developed by Tim N4GN [n4gn@n4gn.com].

Copyright (c) 2000 Tim Totten N4GN. All rights reserved."

So now you know how many times I worked them, eh?

Once again congratulations, and a hearty THANK YOU to the team. Stay tuned for some more details and photos next month.

The Daily DX heads to Timor Timur

Having lived in Indonesia for a time myself, I was excited about the news of several hams heading off to East Timor to put this new one on the air. Among several hams who went was The ARRL's own Bernie

McClenney W3UR, of The Daily DX and How's DX? fame. Bernie was originally scheduled to operate with the call 4W6DX, but his operational authorization was later modified to include the call 4W/W3UR. His trip to East Timor was not without hardship. I have made that trip myself, and it's no picnic. I am looking forward to including some of his narrative in next month's column for those of you who are devoted readers of 73.

In the meantime, I want to make sure that all of you who collect QSLs have

AC6V's

Amateur Radio and DX Reference Guide

Photo C. AC6V sports an excellent Web page at [http://www.ac6v.com/pagedx.html].

EVERY ISSUE OF

73 Amateur Radio Today on Microfiche!

The entire run of **73** from October 1960 through last year is now available. Over 800 fiche!

You can have access to the treasures of **73** without several hundred pounds of bulky back issues. Our 24x microfiche have 98 pages each and will fit in a card file on your desk.

We offer a battery operated hand held viewer for \$150, and a desk model for \$260. Libraries have these readers.

The collection of microfiche, is available as an entire set, (no partial sets) for \$325, plus \$10 shipping (USA). Annual updates available for \$10, plus \$3 shipping/handling. Satisfaction guaranteed or money back!

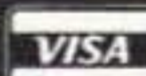

BUCKMASTER

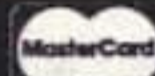

6196 Jefferson Highway
Mineral, Virginia 23117 USA
540:894-5777 • 800:282-5628
Fax 540:894-9141
e-mail: info@buck.com

CIRCLE 168 ON READER SERVICE CARD

E Z HANG

Hang your next wire antenna the EZ way.

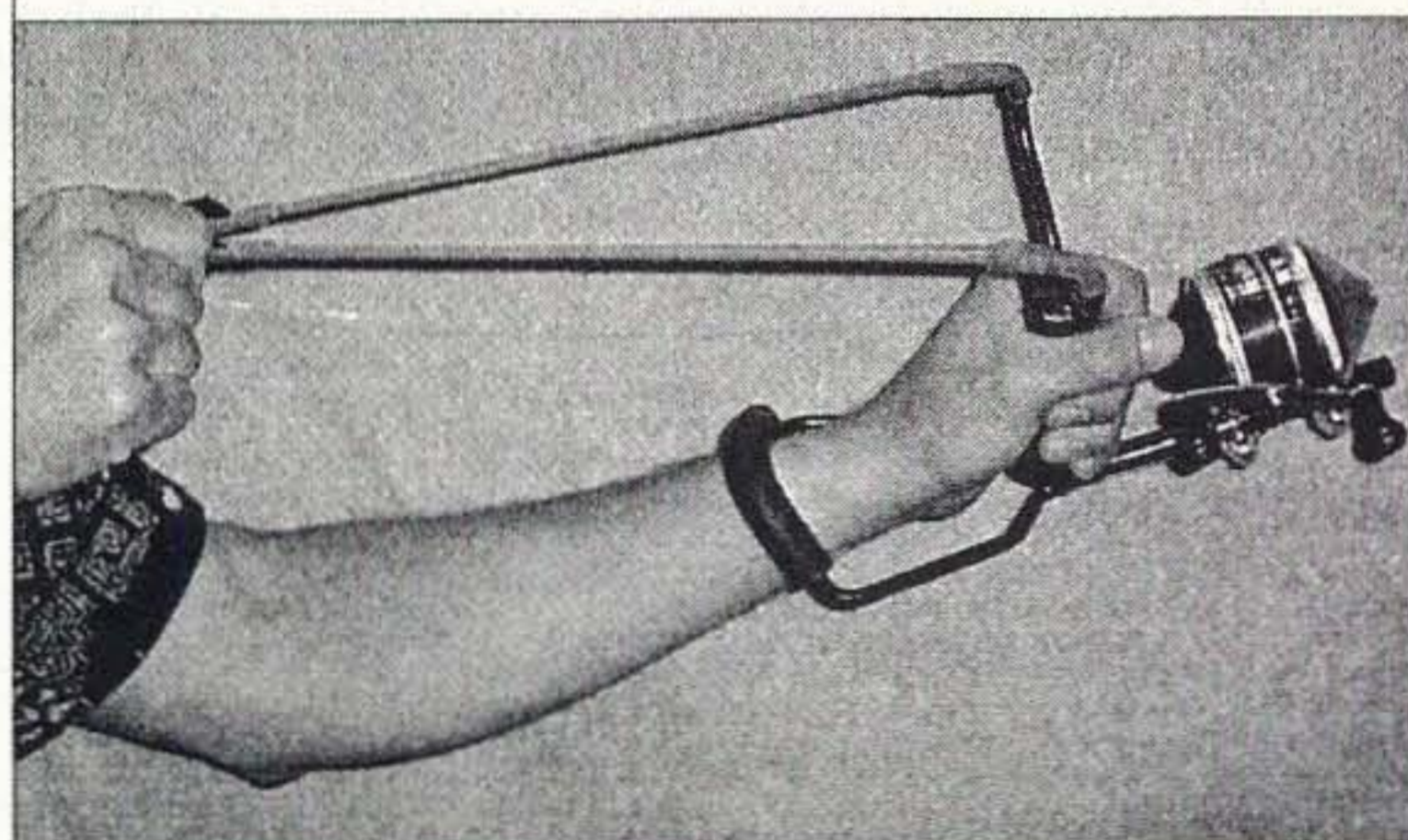

No climbing trees or ladders — No tangled string — No dangerous bow-and-arrow. This is the perfect tool if you want to put up a wire antenna easily and quickly.

EZ Hang will clear a 100 ft. tree.

Only \$49.95 plus \$5.95 shipping & handling

Send check or money order to:

EZ Hang, Inc.

8645 Tower Dr.

Laurel MD 20723

Phone: 540-286-0176

Web: http://www.ezhang.com



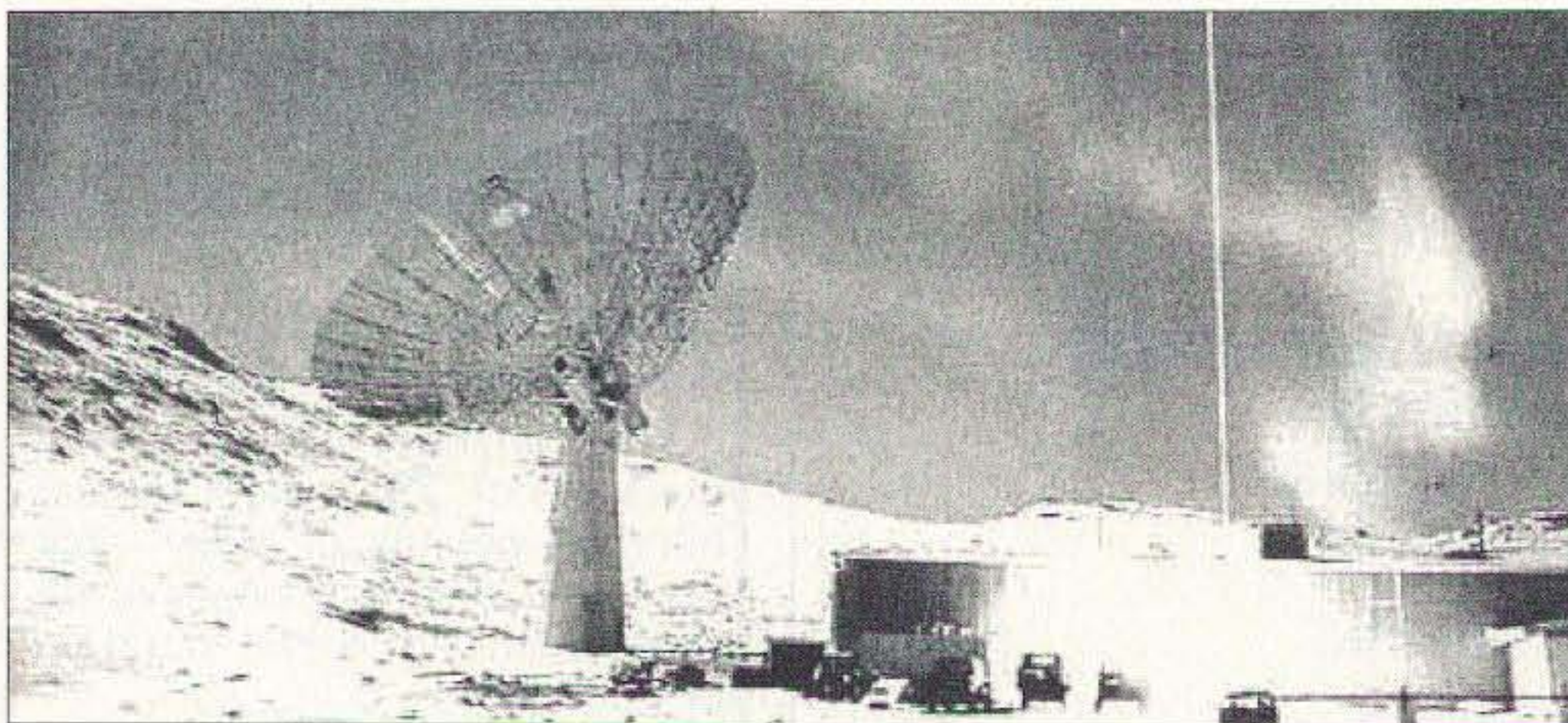

Photo D. Here is the 32-meter dish that will be used from OX2K.

the opportunity to first confirm the fact that you are in the log. The URL is: [<http://www.dailydx.com/4W6DXlog.html>].

Bernie's QSL manager is Jarmo J. Jaakola OH2BN. His mailing address is Kiilietie 5-C-30, 00710 Helsinki, Finland. Bernie made over 9,000 Qs in his short stay on the island. I hope you're in the log!

On the horizon ... upcoming DXpeditions

Here are some noteworthy DXpeditions that have come to us from AC6V's Web page at [<http://www.ac6v.com/pagedx.html>]. The first announcement is that of an Earth-Moon-Earth (EME) DXpedition to Greenland. This is a big deal for the moonbouncers among us. The period of operation is May 29 to June 5, 2000; using the callsign OX2K, for "Greenland 2000."

Skywave communication is planned to be on 160-6M. EME communication will be via a previously installed 32-meter dish that will have feeds for 2M, 432, and 1296. Here is some of the information on the event from Bo OZ1DJJ/OX3LX, which can also be found at the following URL: [<http://www.qsl.net/ox2k/>].

History

In 1988, Claus OZ1FDH and I, OZ1DJJ/OX3LX, made the first contact from Greenland via the moon (Earth Moon Earth). The idea of making a bigger VHF DXpedition was born after contacts with W5UN and KB8RQ. After visiting the 32 meter dish in Sondrestrom, the idea of an EME DXpedition seemed very possible. After talking to Holger OX3HI, who lives near the dish in Sondrestrom, it was evident

to us that we could use the dish in some way but not on all-band. After Michael OZ2ELA/OX3LG, a well-known HF/VHF/UHF/SHF DXer in 1998, began working at TELE Greenland, the idea of an EME DXpedition took a very fast turn. I will like to give credit to Michael for his enthusiasm in this project. Without him, I do not think we would have seen an EME DXpedition in this scale. Thanks, Michael, and also special thanks to Holger for making it possible for us to come to Sondrestrom.

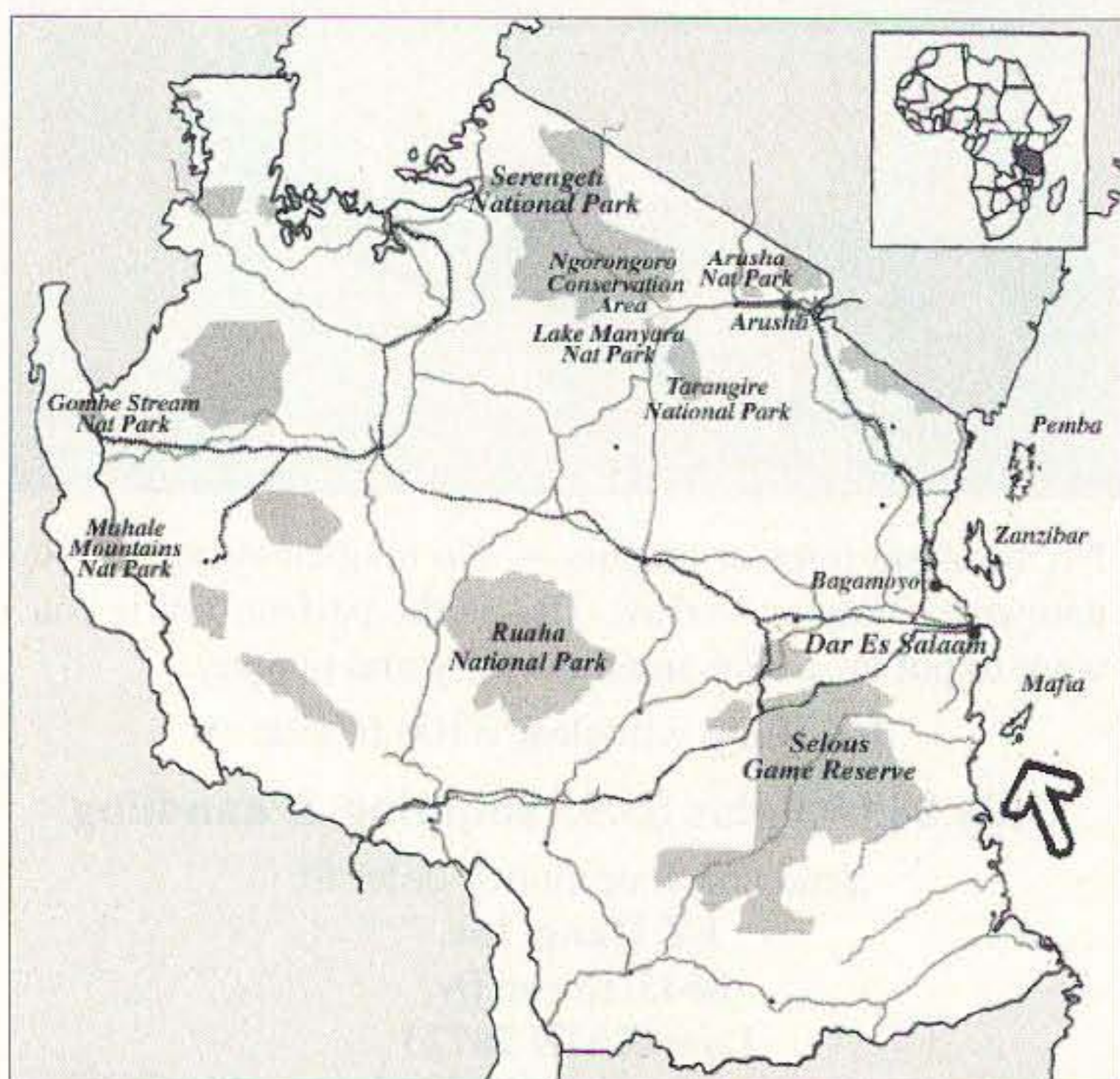

Photo E. Mafia and Pemba straddle the well-known island of Zanzibar on the east coast of Tanzania.

Objectives

The objective of this EME DXpedition is to make as many contacts via moon on 2 m, 70 cm and 23 cm as possible. We will also be active round the clock on 6 m and short-wave. Also, the intention is to put Greenland radio amateurs on the world map and show how friendly and beautiful this country is. We hope one day other radio amateur or other travelers can share what we will experience. Another goal is to try to make it easy for other radio amateurs to go on DXpedition to Sondrestrom in Greenland. We will have six different stations, so we are able to be on the air at the same time on all bands. The crew is about 25 operators.

Operating skeds

Bo OZ1DJJ/OX3LX, is the Sked Manager for the DXpedition. He can be reached at his E-mail only. When requesting a sked or just wanting to notify the team that you will be looking for us, please specify your station, e.g., antenna, power, etc. Please also write how, when, and where you can be active so we can get in contact with you, through E-mail(s), phone numbers, and short messages. It may be that we can only operate random on 23 cm — thus instant skeds may also happen.

Mafia and Pemba Islands

In June Bert PA3GIO will be traveling to Mafia (AF054) and Pemba (AF063) Islands off the east coast of Tanzania. This will be a "double-header" of sorts for a couple of reasons. First, there are a whole bunch of folks who are in need of these IOTAs. Second, Bert's DXpedition will involve some island hopping. He will be on Mafia Island from the 18th to the 24th. He will then travel to Pemba Island from May 25th to June 1st. Operation is planned on 80-10 (SSB only), with the exception of 30 meters. You can learn more about this trip at: [<http://www.qsl.net/pa3gio/5H3/>].

Lesotho

In July a team of German hams will be heading to Lesotho, and will be using the call 7P8AA. They are scheduled to depart on my birthday, July 2nd, and will stay until July 22nd. The team is comprised of Jeorg DF6VI, Dieter DJ9ON, Markus DL1AN, Hans (aka Jack) DL1YFF, Tom DL1QW, and Tom DL4OCM. Some of these names should be familiar to you. They will run three stations — SSB, CW, and RTTY, and will cover 160 through 6 (including WARC).

QSLs should go to Fritz Bergner DL7VRO, Sterndamm 199, D-12487 Berlin, Germany. For more information point your browser to: [http://www.qsl.net/7p8dpxpedition2000/]. My thanks go out to AC6V for compiling this information.

4X2K: Israel's 2000 years of history in the Holy Land award

My good friend Moni 4X6ZK just reminded me of a new award that is being offered to amateurs of the world by the Israel Amateur Radio Club. This is the 4X2K award, and is specifically intended for the promotion of awareness of historical sites in Israel that are related to the beginning of Christianity in the Holy Land. Detailed information about this award may be found on the Hagal Web site [http://hamgate.netvision.net.il/hagal/], which, if my memory serves me correctly, is maintained by 4X6LM, who lives close to Moni in Holon. He lists the following as the primary purposes for this award:

Purpose and goals

1. To enhance and develop historical sites in the Holy Land.
2. To help reforesting and development of nature and recreational areas around the historical sites.
3. To promote historical awareness of the region.
4. To encourage portable and mobile HF operations.
5. To establish contacts with amateurs from all over the world.
6. To encourage foreign amateurs to come and operate from these historical sites.

This award applies to QSOs with stations in Israel made between January 1st and December 31st, 2000. To qualify for the award, you must contact at least five of seven historical regions defined by the

award committee, and accumulate a total of 300 contact points. The points are accumulated according to the following criteria:

Credits and points

1. A QSO with a station operating from a major historical site gives 5 points.
2. A QSO with a Holy Land station located outside the major historical area gives 1 point.
3. The special event station 4X2K will operate throughout the year. A QSO with this station gives 20 points; for example, if 4X2K/3 operates from Jerusalem, a QSO with this station gives 20 points, and a credit of area 3 for Jerusalem. Each area may count only once for the award.
4. All QSOs made during the Holy Land contest will count double points.

Major historical sites

7 major historical sites related to the life of Jesus were selected. Each is marked with a number:

- 1 Bethlehem
- 2 Nazareth
- 3 Jerusalem
- 4 Tiberias and the Sea of Galilee
- 5 Galilee (excluding Tiberias and the Sea of Galilee)
- 6 Samaria
- 7 Judea

Stations may be worked only once for each region, which implies that they may be worked again whenever they move to another region. A QSO is considered valid when there is a successful exchange of



Photo G. Here is a photo I took as I traveled the Via Dolorosa (Avenue of Misery) in Jerusalem — just one of the sites featured in the 4X2K award celebration.

callsign, and the major historical area number, signal report of the 4X station. Stations located outside the major historical areas need only send their callsign and signal report.

The fee for this award is nominal, only \$10, or 12 IRCs. However, the benefit goes well beyond that. Included in the fee is the cost associated with the planting of one tree by the Forestry Department in one of the

Continued on page 59

7P8 Lesotho DXpedition 2000

Photo F. In July, a team of German hams will be heading to Lesotho and using the call 7P8AA. They are scheduled to depart on my birthday, July 2nd, and will stay until July 22nd. The team is composed of Jeorg DF6VI, Dieter DJ9ON, Markus DLIAN, Hans (aka Jack) DLIYFF, Tom DLIQW, and Tom DLAOCM. Some of these names should be familiar to you. They will run three stations — SSB, CW, and RTTY — and will cover 160–6 (including WARC). QSLs should go to Fritz Bergner KL7VRO, Sterndamm 199, D-12487 Berlin, Germany. For more information, point your browser to: [http://www.qsl.net/7p8dpxpedition2000/]. My thanks go out to AC6V for compiling this information.

 <p>TRANS-MITTING TUBE Eimac #3CX10000A7 power output tube used in radio transmitters, RF heating equipment, sputtering and diffusion equipment. 20A001 \$1495.00</p>  <p>Computer Beige DESK WART Input: 115 VAC. Output: +5 VDC @ 3.0 A, +12 VDC @ 2.0 A, -12 VDC @ 0.35 A. With pinout docs. 98E015 \$7.95</p> <p><small>40 CHARACTERS X 2 LINES DOT MATRIX RESOLVE</small></p>	 <p>NEW CATALOG! 108 pages of bargains that you can download from our web site, or send US\$3.00 (\$4.50 foreign) for a printed copy.</p>  <p>TVRO PARTS BOARD These are motherboards from block-conversion-type satellite TV receivers. The tuners and PROMs have been removed, but there are hundreds of useful RF and digital parts left, including the 70MHz IF strip. 94V005 \$7.95</p> <p>Check the list of vacuum tubes on our website!</p>	 <p>TV IF MODULE Zenith part 9-1320 has AGC and video pots and audio, AFC and osc coils. 99V012 \$6.95</p>  <p>HELPING HANDS MAGNIFIER Heavy cast iron base. 2X 2.2" magnifying glass. Locks at any angle. 93U002 \$5.95</p>  <p>NEC PASSIVE SPEAKERS Excellent sound quality. Will handle up to 30 Watts. Woofer, midrange and tweeter in case. 20V004 \$8.95/pair</p>
<p>2x40 CHARACTER LCD DISPLAY Has 14-pin interface with documentation to help you interface to your microcontroller projects. 94L005 \$14.95</p>	<p>FERRITE ROD 1KHz-1MHz frequency range. Material 33. 5.875"L x 0.5"D. Docs included. 98P005 \$4.95</p>	<p>ALLTRONICS Download Our Catalog: http://www.alltronics.com Open 9-6 M-F and 10-3 Sat. Visa, M/C and AmEx accepted. 2300-D Zanker Road - San Jose, CA 95131-1114 Voice (408-943-9773 - Fax (408) 943-9776</p>

0004

Jack Heller KB7NO
P.O. Box 1792
Carson City NV 89702-1792
[jheller@sierra.net]

Timewave's DSP-599zx

I was reading the short description of one of the new Icom rigs and thinking how nice that would be for the PSK31 reception where there are some very strong adjacent signals. The new 756PRO claims over 40 programmable IF filters, which makes it my kind of radio except for one small problem: It doesn't fit the budget. So, I thought it was time to experiment with one of the magic boxes sitting here that I just hadn't given a chance on the PSK31 mode. This would be the Timewave DSP-599zx. One ham had mentioned he uses his with remarkable results, but it took a while for me to make the effort.

In this case, the effort was practically all done except for plugging in some already made-up cables that I have ready for SSTV. It was even easier, as I ran the 599zx from the speaker jack on the radio, figuring to adjust the volume control appropriately at the radio to avoid overloading the sound card. It worked first time, just like plug 'n' play.

It was only necessary to adjust the volume and to adjust the 599zx in the CW mode to get the correct audio center frequency and experiment with width. The center frequency seemed to need to be changed from time to time as I experimented. At the end of an hour or so, I discovered the reason. The frequency of the sound card had shifted over 150 Hz, probably due to my tinkering with the 599zx.

That shift would never be noticed during normal operation, except that it is necessary to keep the waterfall display centered on the signal to keep from clipping one side of the

signal when the width is tightened down to 35 Hz. This, you will find, is easily adjusted by changing the center frequency on the 599zx. The starting point is about 1040 Hz, and after a while it becomes as much as 1,100 Hz. Not a problem, as long as you watch for it.

The first contact was on 10 meters. There wasn't any real noise problem, but that was the band where the radio was last used, and there was a QSO in progress. I gave Dick N1RCT a call as he signed with the other station, and we discussed this hookup. It seems Dick had already given this a try, and was currently using one of the other popular DSP units.

There are pros and cons to be heard from users, but it is generally agreed there are definite advantages. It was easy to see the effects of the unit, while using the Logger program, which has both a waterfall and a spectral display in the tuning indicator. The waterfall, as I mentioned, is useful for setting the center frequency. (See Figs. 1 and 2.)

The spectral display tells many additional stories. And some of the stories are nearly unbelievable; you have to see for yourself. Just for openers, once a signal is tuned and the filter is set properly, the only thing in the spectral display will be the signal that is being printed on the screen. All the noise and any adjacent PSK31 signal is out of sight.

Fortunately, as any good filter must allow, the 599zx can be disabled with the toggle of a push-button and the rest of the spectrum can be observed. I was listening to a 20 meter QSO when a PACTOR signal started up and was centered precisely on their operating frequency. Interestingly, neither station was severely affected by the intrusion with the regular PSK31 software they were using, but I had 100% copy of both signals as long as the filter was in place. Both of the stations complained of losing a certain percentage of the other's transmission. So, I thought, this really works.

To continue, this seemed to be a day when the activity was a little light, so I tuned carefully with the filter in and out of the process for comparison. If you have ever gone exploring with a really narrow filter you already know it is very difficult to not pass over signals, so you learn quickly to disable (by-pass) the filter for casual tuning.

The problem, this day, was that most of the signals that were on the air were down in the mud. They didn't even show in the spectral display, much less in the waterfall. This soon became a very good test.

The next move was to adjust the filter width to about 100 Hz and tune very carefully (that means excruciatingly slowly). As you may have noticed, one of the telltale

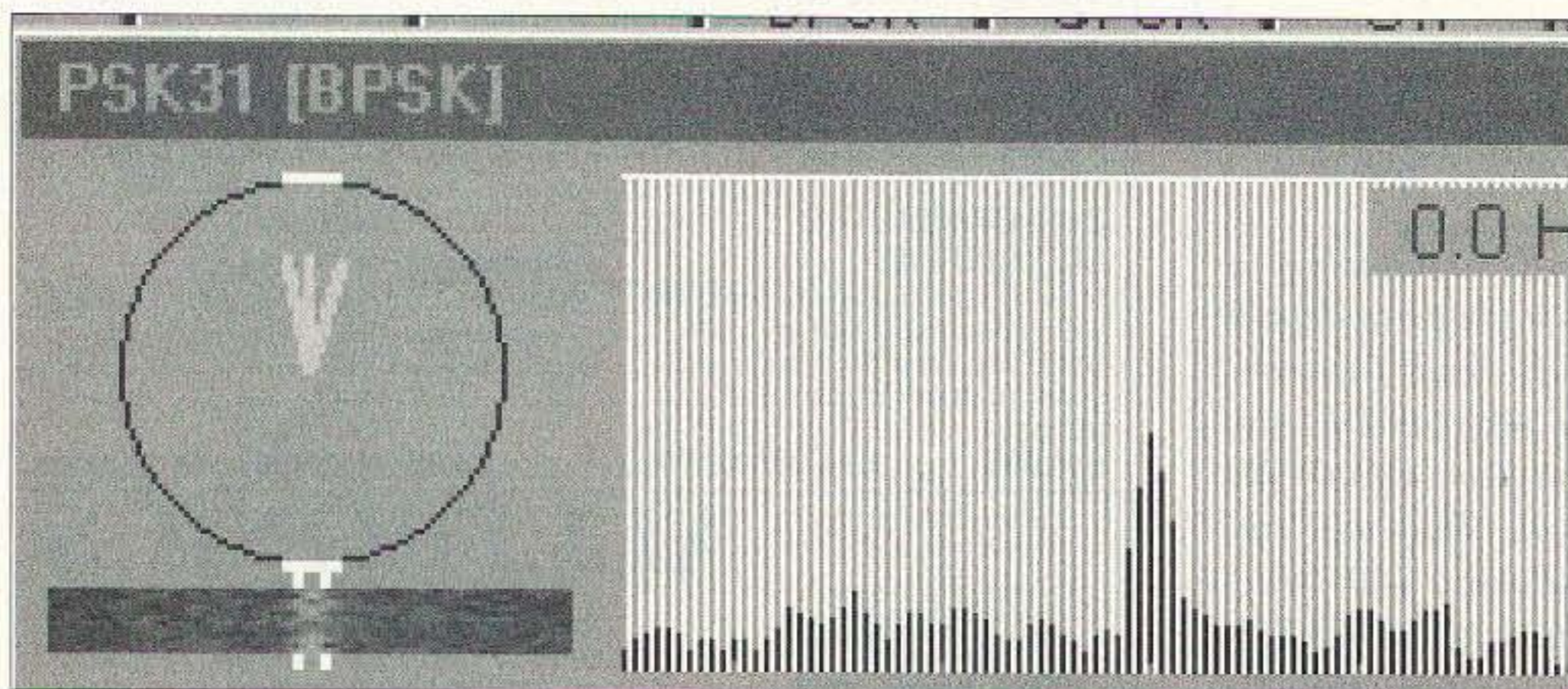

Fig. 1. Here you see the spectral display and waterfall from the Logger tuning indicator with the 599zx in by-pass mode.

signs of a signal is a change in indicator color from red to yellow, but that usually takes a second or two after you have "found" the signal. This translates to passing right over a weak signal if you do not exercise extreme patience.

Normally, signals that difficult to tune are not readable. This was the dawning of a new day. I was finding signals that did not register on the waterfall, nor did they display recognizable peaks on the spectral display. Simply said, the slow tuning was paying off, because when there was a change of color, I could stop and examine the peaks in the spectral display and tune either on a peak or between two of them and a signal would magically materialize. It would not be audible from the speakers nor would it display in either tuning indicator, but it would be causing legible print. This happened several times across a "dead" band.

This may sound as if I found the answer to all interference with the additional hardware, but there are a few things it doesn't cure. Number one is that the loud adjacent signal which blanks the band, usually PACTOR, will still do just that. It doesn't happen too often, but I used the 599zx long enough to confirm that the problem did not go away.

There is one other problem I became aware of that relates back to the frequency shift caused by the software. When conditions get far enough "out of shape," it becomes very difficult to quickly tweak the 599zx back to 100% print. I found that this happened with a perfectly good signal when some adjacent QRM came on the scene, and the best thing to do at the time was to resort to the ever-faithful PBT with the 599zx out of the loop.

Some education came to me also as I was running this experiment. I saw something happen I had heard about a few times in the past. As you recall, I was using the speaker output to the 599zx direct. This worked okay, as I could control the level with the audio control on the rig. What I saw was the waterfall occasionally turn red when the level was too high. This is a sign of overdrive I had never experienced with the constant audio level from the jack on the back of the rig. Sometimes the PACTOR signals would come up and cause red lines in the waterfall. Now I have an answer to a question from experience that I never would have had.

So, was I impressed? Absolutely. There is definitely room for better filtering. All things being equal, with no super strong interference, the outrigger audio DSP units can give you a lift. This one did. The best is still going to be IF filtering. It can be done.

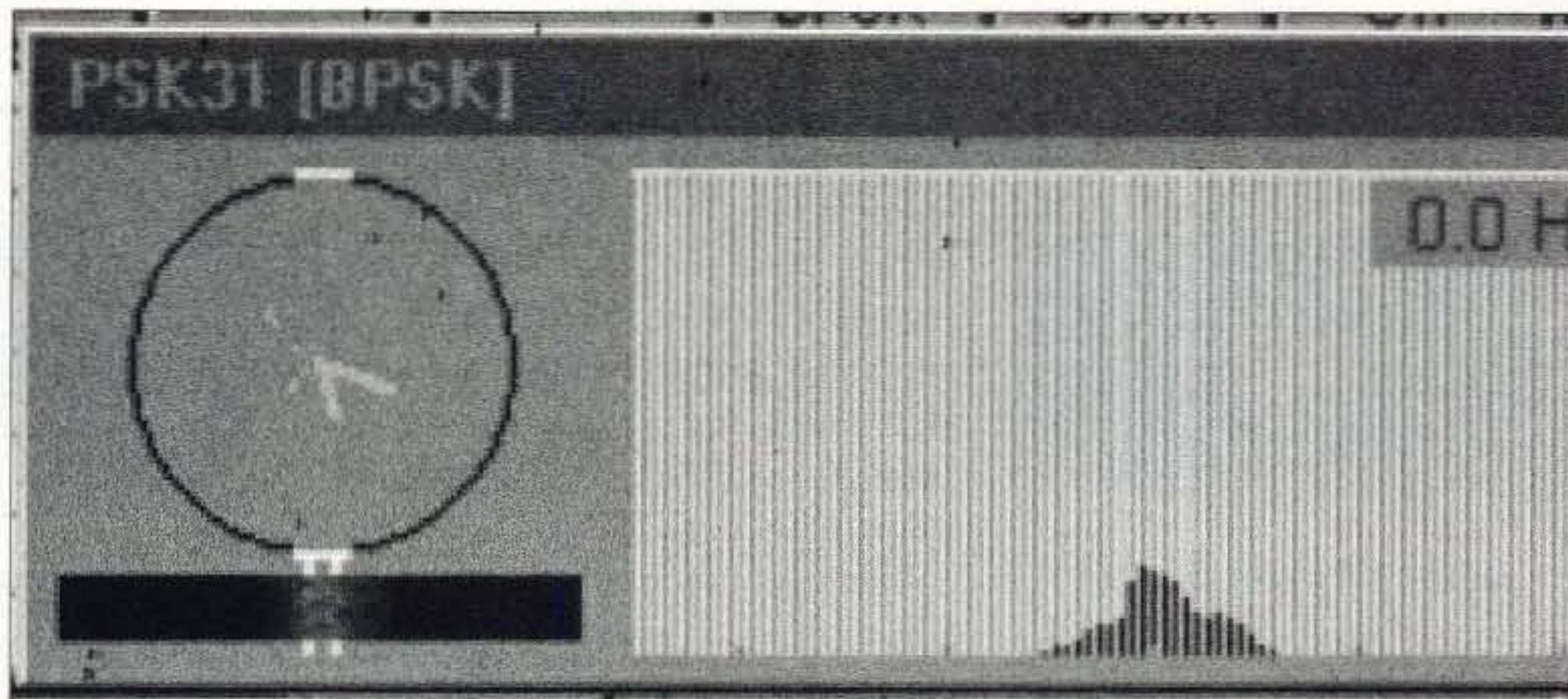

Fig. 2. This is a shot with the 599zx set at 35 Hz width. Note the absence of adjacent signals or noise in the spectral display. Also note that the waterfall is clean and centered. One drawback to this is you must concentrate on visual tuning. Anywhere you move the receiver dial, the sound from the speaker will cause you to believe you are hearing a PSK31 signal. Initial tuning is much easier with the 599zx in bypass mode. See text.

Perhaps by the time next month rolls around, I will have found the answer.

I should put it this way. The Timewave unit is a good piece of equipment and is easily adapted to this mode. If you have one or have access to it, give it a try. If you like RTTY or any of the "normal" modes, it makes them come alive. I don't think I

would purchase the unit simply for the use I put it to today on PSK31, but I find it nearly indispensable for other modes such as RTTY.

I was thinking that there is another trick piece of software that could possibly work here, but I don't think so. The folks at ChromaPIX who developed the ChromaSound program came to mind. The problem here is that program would have a real conflict with the PSK31 sound card program, because they can't both use the same sound card at the same time. However, if someone would like to install a second sound card — Well, let me know how it turns out.

I have talked to some folks with

Kenwood rigs who make a provision to use a narrow IF (CW) filter for receive mode only. I am not sure about Yaesu. I have run across a fairly complex piece of software that is supposed to make that possible for the Icom rig I am using.

Continued on page 50

The NiCd Lady Company

**Individual Cells - Replacement Packs - Lead Acids
Rebuilding Service - O.E.M. Assembly**

for

***Handheld Radios *Laptops *Cellular Phones
*Camcorders*Portable Scanners*Test
Equipment*Power tools**

**Check into our rebuilding service - Substantial Savings
over NEW!**

**Convert your pack to NiMH! Same size pack -
HIGHER capacity!**

Call for a price list or visit our website:
www.nicdlady.com

20585 Camino Del Sol, Riverside, CA 92508

(909) 653-8868

email: nicdlady@nicdlady.com

FAX: (909)653-5189



CIRCLE 141 ON READER SERVICE CARD



Alinco Power Supply

Alinco USA has announced the DM-330MV, a new communications-grade power supply. The DM-330V is compact (only 2.6 inches high, less than 7 inches wide and deep) and lightweight (less than 5 pounds), yet provides up to 30 amps continuous (32 amps peak) at 5 to 15 volts variable output.

In what is believed to be an industry first, there is a

user-selectable "memory" preset voltage, along with a lighted meter that displays volts or current and a triple internal protection system against short circuits, overload, and over-temperature conditions.

Other features include: noise offset circuit; ripple less than 15 mV p-p; rear panel binding posts (32 A); two sets of snap-in terminals (5 A each); front panel cigar outlet (10 A); memory, power, and protection indicators; and quiet fan on rear panel.

For further information, contact Alinco USA, 438 Amapola Ave., Suite 130, Torrance CA 90501; tel. (310) 618-8616; fax (310) 618-8758.



Finger Tappers™ Keys

Morse Express has announced the availability of a new single lever paddle and straight key made in California by Jim Richards KD6VDH.

The straight key is a medium-size key machined from solid brass stock and mounted on a polished hardwood base with rubber pad underneath. The knob is very unusual, with a brass cap and wooden base, and is surprisingly comfortable

during extended sending sessions. The trunnion is mounted in full race bearings with adjusting screws.

The Finger Tappers single lever paddle is a classic machined-brass-on-wood design, and a lot of fun to use. Contact spacing can be precisely adjusted for a very light touch, and it can easily be configured as a "cootie key."

Each of these Finger Tappers is \$99.95. For further information or to order, contact Morse Express, 2460 S. Moline Way, Aurora CO 80014-3155; tel. (800) 238-8205 to order, (303) 752-3382 for info; [mailto:n1fn@MorseX.com]; [www.MorseX.com].



New Bird Power Meter

Bird Electronic Corporation has announced the Model 5000 THRULINE digital power meter, the industry's first handheld directional RF power meter combining a digital display

with the ability to accurately measure power in both analog and digital RF systems. The Model 5000's compact 8- x 4-5/8- x 1-3/4-inch size, rugged construction, and rechargeable NiMH battery make it ideal for use in the field. It provides average, true average, or peak measurements of 0.1 to 10,000 watts with $\pm 5\%$ accuracy, and automatically calculates VSWR, return loss, and match efficiency.

For further information, contact Ms. Lisa Weist, CSR, Bird Electronic Corporation, 30303 Aurora Rd., Cleveland OH 44139; tel. (440) 248-1200, ext. 2226; fax: (440) 248-5426.

Marine Radio Control

Creative Services Software has now introduced radio control software for the Icom M700PRO and M710PRO/R. This 32-bit software, for the mariner and ham running Windows 95/98/NT/2000 and an Icom marine radio, also includes an NMEA interface cable (clone port).

Features include: remote frequency control via virtual knob or arrow keys; remote antenna tuning; remote mode changes; real-time meter signal display; and free version 1.x upgrades. \$49.95.

Contact CSS at 503 West State Street, Suite 4, Muscle Shoals AL 35661; tel. (256) 381-6100; fax (256) 381-6121; site: [www.cssincorp.com].

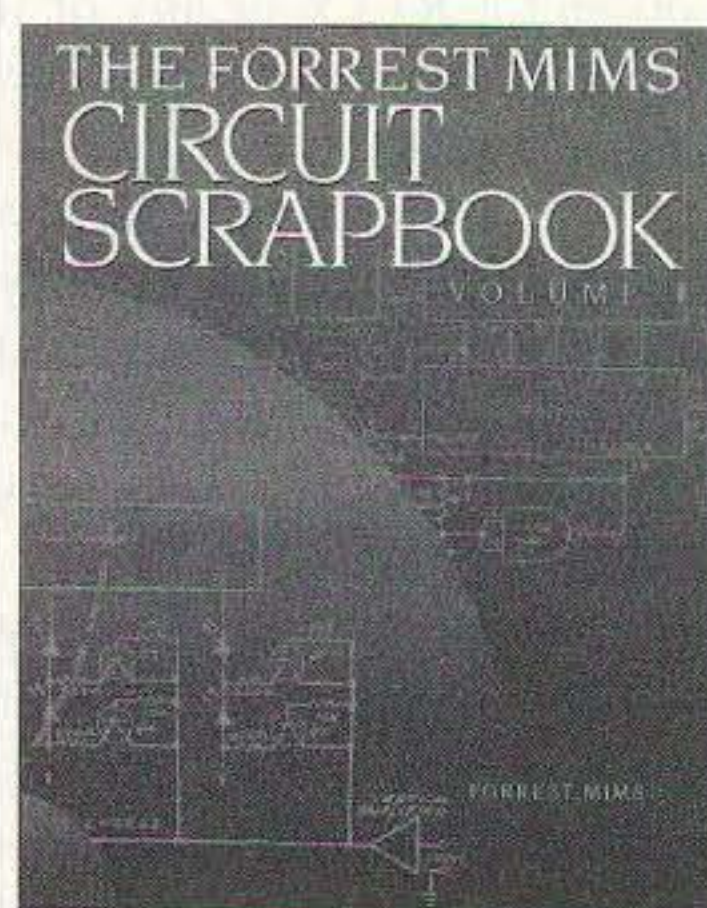

Circuit Scrapbook Volume I

This book by famous author Forrest Mims III offers a wealth of information and ideas, all originally published in *Popular Electronics*. In this volume (there is also a second),

he deals with analog computers; color organs; digital PLLs; frequency-to-voltage and voltage-to-frequency converters; interval timers; LED oscilloscopes; light wave communicators; magnetic field sensors; optoelectronics; pseudorandom number generators; tone sequencers; and much more.

Each circuit contains schematic, theory, construction hints, and other useful information. 8-1/2" x 11", 156pp., \$19.95.

For further information, contact LLH Technology Publishing, 3578 Old Rail Road, Eagle Rock VA 24085; tel. (540) 567-2000; fax (540) 567-2539; E-mail: carol@LLH-Publishing.com.

Your New Product announcement could be here. For details contact Joyce at 800-274-7373.

If you're a No-Code Tech, and you're having fun operating, tell us about it! Other No-Code Techs will enjoy reading about your adventures in ham radio—and we'll pay you for your articles. Yes, lots of nice clear photos; please. Call Joyce Sawtelle at 800-274-7373 to get a copy of "How to Write for 73 Magazine."

ADVERTISERS' INDEX

R.S.#	page	R.S.#	page	R.S.#	page	R.S.#	page
• Alinco	CV2	13	Doppler Systems	52	• Maha	• Radio Book Shop	55
• All Electronics Corp.	11	• East Coast		• Communications, Inc.	32	• Radio Book Shop	62
• Alltronics	45	• Amateur Radio	13	86 MFJ Enterprises	7	• Radio Book Shop	63
16 Astron Corporation	2	• E-Z Hang	43	86 MFJ Enterprises	15	• Radio Book Shop	64
42 Bilal Company	23	• Fair Radio Sales	27	• Michigan Radio	49	34 Ramsey Electronics	3
56 Buckmaster Publishing	19	193 GGTE	25	160 Micro Computer Concepts	55	• RF Parts	35
168 Buckmaster Publishing	43	• Ham Mall	21	193 Morse Tutor Gold	25	254 Ross Distributing	55
• COMET	33	• Hamtronics, Inc.	9	• Omega Sales	19	• Scrambling News	55
99 Communication		• Heil Sound	25	• Omega Sales	37	167 Sescom, Inc.	55
• Concepts, Inc.	41	42 Isotron	23	• Omega Sales	52	• The Ham Contact	17
• Communications		242 Jan Crystals	23	• Radcomm Radio	17	• The Ham Contact	41
• Electronics, Inc.	5	• Kenwood		• Radio Book Shop	6	• The Nicad Lady	47
10 Communications		• Communications	CV4	• Radio Book Shop	23	• Universal Radio	23
• Specialists, Inc.	21	• LDG Electronics	21	• Radio Book Shop	41	• Yaesu	CV3

When you buy products from these advertisers, please tell them that you saw their ads in 73.

Subscribe to 73 right now...call 800-274-7373 (9-5 Monday-Friday EST).

WE SHIP WORLDWIDE
Michigan Radio
SALES SERVICE

Local & Tech 1-810-771-4711, Service 1-810-771-4712, Fax Service 1-810-771-6546

OPEN
 TUES, WED, THUR 10-6
 FRI 11-8
 SAT 10-3
 CLOSED SUN & MON



Terms do not include shipping. Price and availability subject to change without notice. Most orders shipped same day. COD's welcome (\$5.50 & shipping).

26014 Groesbeck, Warren, MI 48089
1-800-TRU-HAMM (orders only)
 (800-878-4266)

Now on the World Wide Web

<http://michiganradio.com>

E-mail mirad@mich.com



KENWOOD



TM-G707A

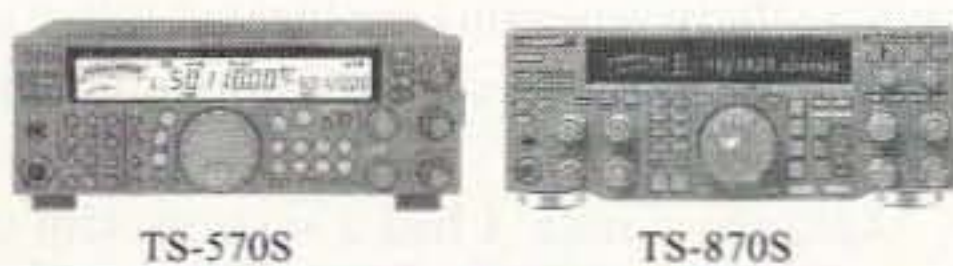

TS-570S

TS-870S



IC-746

ICOM

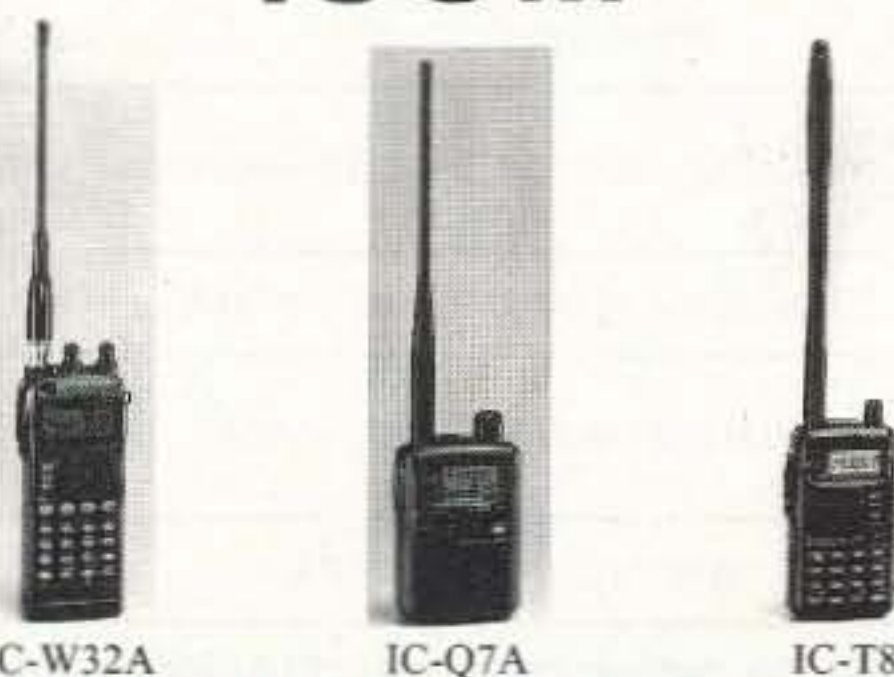

IC-W32A

IC-Q7A

IC-T8A



FT-2600M

FT-100



FT-847

YAESU



FT-8100R



VX-5R

FT-840

FT-50R

Convert Excess Equipment to CASH • We buy good, clean, used equipment • Estate Sales

THE DIGITAL PORT

continued from page 47

I made another attempt at this very promising piece of software intended to take advantage of the narrow CW filter when receiving PSK31. It will take more time. I will not elaborate; I have sent a query to the author. It appears I have a conflict with other configurations between the computer and the Icom 735. However, if I can make this work, it may well take care of the very strong signals that occasionally blank the PSK31 portion of the band. I will let you know.

The PSK31 community is certainly livening up. I hear more activity all the time. At the time of this writing, it is a fairly normal event to turn on the rig and hear Europe on 28.120 PSK31 in the mornings from this western end of the States. And it is not unusual to work them. That propagation will likely subside by summer, but it gives an idea what to expect.

Another day, I got a chance just before noon to listen on ten meters. I copied a few European signals and contacted an Italian station. Then a Spanish station gave a call. I was sure I was onto something, but ten

meters simply has ten meter propagation and it went dead by noon, almost on the dot. Fun times though.

While I was experimenting with the 599zx today, I copied an HA9 from Hungary, though not well enough to work. This was on 20 meters. He was one of the stations way down in the mud. At the appropriate time, I am sure he would have made my day.

A recent E-mail from Les WA7HAM reminded me of another fine rig that also has an abundance of IF filtering combinations. Les has been using the Ten-Tec Pegasus with good results. He has been using Logger and had a complaint about having to click back and forth between screens to take advantage of all the features.

After reading my April review of DigiPan, he jumped on the bandwagon, got his own copy, and found a new ease to operating PSK31 with his fancy digital rig. The real advantage is the simplified tuning process with the wide spectrum display of the program. He simply moves between displayed signals by clicking with the mouse, and keeps the DigiPan screen up all the time. He likes that.

That reminded me of an old note I had from a ham who had found he could work with the Pegasus software and his favorite PSK31 software more simply yet. He found that his larger monitor (I don't recall the size) would allow the placement of all the software screens so that he could avoid minimizing and maximizing continuously. Of course, those large monitors carry a hefty price tag, but you simply tell the XYL, "Everyone's doing it."

Speaking of XYL approval, I came close to convincing the wife of what a great need I had for the new Icom radio mentioned earlier. Well, at the time of this writing, I found most vendors do not have the rig listed as available. Saved her day!

But, you know what? I can still have almost as much fun with the little radio I have working. That is part of the secret to success in this hobby. If we can simply be satisfied for a time with that which works, we still meet each other at about the same rate each day, and, conditions permitting, exchange ideas and enjoy good company.

I goofed. A while back, I reviewed DigiPan and Bob Furzer's scope program. Following that, I received requests for URLs where these programs are located. They are now dutifully added to the Chart. Thanks for your patience.

One short note. I had a session with the

Source for:	Web address (URL):
TrueTTY — Sound card RTTY w/ PSK31	www.dxsoft.com/mitrtty.htm
Pasokon SSTV programs & hardware	www.ultranet.com/~sstv/lite.html
PSK31 — Free — orig. PSK31 — also Logger	http://aintel.bi.ehu.es/psk31.html
Site with links to PSK31 and Logger 6.12	www.mysite.com/k5fq
PSKGNR — Front end for PSK31	www.al-williams.com/wd5gnr/pskgnr.htm
Digipan— PSK31 — easy to use	http://members.home.com/hteller/digipan/
Scope program by Bob Furzer	www.chroniclenetworks.com/~dwm/Logger.htm
TAPR — Lots of info	www.tapr.org
TNC to radio wiring help	http://freeweb.pdq.net/medcalf/ztx/
ChromaPIX and ChromaSound DSP software	www.siliconpixels.com
Timewave DSP & AEA products	www.timewave.com
Auto tuner and other kits	www.ldgelectronics.com
XPWare — TNC software with sample DL	www.goodnet.com/~gjohnson/
RCKRtty Windows program with free DL	http://home.t-online.de/home/dl4rck/ [use lowercase DL4RCK]
HF serial modem plans & RTTY & Pactor	http://home.att.net/~k7szl/
SV2AGW free Win95 programs	www.forthnet.gr/sv2agw/
Source for BayPac BP-2M & APRS	www.tigertronics.com/
BayCom — German site	www.baycom.de/
BayCom 1.5 and Manual.zip in English	www.cs.wvu.edu/~acm/gopher/Software/baycom/
N1RCT site — excellent RTTY ref.	http://www.megalink.net/~n1rct/
Int'l Visual Communication Assn. — nonprofit org. dedicated to SSTV	www.mindspring.com/~sstv/
Creative Services Software	www.cssincorp.com
Hellschreiber & MT63	www.freeweb.org/varie/ninopo/iz8bly/index.htm

Table 1. The chart from Hell(er) — your guide to good things on the Web.

Field Day 2000

In the last column, we investigated the basics of a functional home station for OSCAR operation. OSCAR is an acronym for Orbiting Satellite Carrying Amateur Radio. Now it's time to put all of the information and skills together for a successful outing during this year's Field Day exercise.

The American Radio Relay League Field Day is always scheduled for the fourth weekend in June. This year that occurs on June 24th and 25th. We have a few new low-earth-orbit satellites for extra points in the ARRL competition, or for the AMSAT (Radio Amateur Satellite Corporation) activity. The AMSAT rules last year worked well, and will show little if any change for 2000. The first-place emergency power/portable station will receive a plaque at the AMSAT General Meeting and Space Symposium in Portland, Maine, in October. Certificates will be awarded this year for second and third place portable/emergency operation in addition to a certificate for the first-place home station running on emergency power. Stations submitting high, award-winning scores will be requested to send in dupe sheets for analog contacts and message listings for digital downloads. Check the AMSAT Web page at the URL [<http://www.amsat.org>] for details. The Field Day information is down a few levels under the "activities/amsatfd" subdirectories. The rules will also be published in the *AMSAT Journal*, or can be obtained for a self-addressed stamped envelope from me, W5ACM.

There are some good reasons to check out the AMSAT rules if you are serious about chasing satellites on Field Day. The ARRL sees satellite contacts lumped together as a single band, even though there are many satellites to work. The AMSAT rules recognize the individual hamsats as separate bands, thus promoting the pursuit of all of the "birds" for the duration of the event. AMSAT also awards points for digital satellite activity. Special Field Day messages are sent to the "digisats" for download points by anyone who can receive them.

Making choices

It would be nice to try to work every active hamsat in the sky on Field Day, but it's just not possible without a lot of gear and a lot of club members or active participants in the satellite chase. The best thing to do is to pick satellites that have transponders, either analog (voice and CW) or digital (1200 or 9600 baud), for which you have equipment.

If you are considering only the FM voice satellites like UoSat-OSCAR-14, AMRAD-OSCAR-27, or SUNSAT-OSCAR-35, don't, unless you are simply hoping to make one contact for the ARRL rules bonus points. The FM voice satellites turn into a solid FM-repeater pileup during Field Day. Typically, one or two stations will dominate the majority of a pass. They will have a few successful contacts, while most hopefuls can only listen. The low-power, portable stations we have described in recent months just won't cut it in the face of this type of congestion. It's fun listening, but that's not what Field Day is all about.

If you have worked the satellites on Field Day in recent years, you may have noticed that a lot of good contacts can be made on some of the less-populated, low-earth-orbit hamsats like Fuji-OSCAR-20, Fuji-OSCAR-29, and RS-13. During a typical work-week, contacts are few and far between, but during Field Day the transponders come alive like 20 meters on a weekend. The good news is that the transponders on these satellites will support multiple simultaneous contacts. The bad news is that you can't use FM — just low duty-cycle modes like SSB and CW. AMSAT-OSCAR-10 can also be a lot of fun on Field Day if the solar panels are properly illuminated and it is in a good position in the sky for Field Day. Plot some orbits and check it out.

Equipment

The best radios for Field Day are the ones you use at home, unless, of course, they are heavy antiques. My previous satellite radios included two HF transceivers, an integrated transverter system, and multiple external power amplifiers. The radios didn't transport well, and there always seemed to be at least one cable that got left behind.

If you have one of the newer, all-in-one, do-it-all HF/VHF/UHF transceivers, take it with you. If you don't have one, find someone who does and borrow it. Make sure that you practice prior to the event. There's nothing worse than trying to figure out a strange radio while you are hunting for a satellite, keeping tabs on uplink and downlink frequencies, and adjusting for Doppler, all at the same time.

Be prepared to at least work SSB and CW on Mode A (two meters up and 10 meters down) via RS-13 and Mode J (two meters up and 70 cm down) via the Fujis. If you have a good 10-meter antenna, RS-15 Mode A can net some contacts. With a nice set of two-meter and 70-cm directional antennas, AO-10 can be a lot of fun on a good day.

Unless you have experience with low-power satellite work, don't try satellite "QRP" on Field Day. It's really hard even for the best satellite operators, and can be quite difficult and disappointing to demonstrate to potential newcomers. There are too many inexperienced satellite operators on the air during Field Day, and many are trying to deal with noisy generators, bugs, and unfamiliar radios. Listening for weak stations is too much to ask of them.

Have at least 50 watts available for your transmitter uplink for all modes. A backup rig or two may save your outing from disaster. Bring at least one extra system

along. Even if you never have to unpack it, the insurance is worth it.

Antennas

A simple system for RS-13 Mode A can

get by with a dipole in the trees for 10 meters and a ground plane in the clear on two meters. Most serious satellite operators will have an antenna system that will rival many home stations', with large circularly-

polarized yagis positioned by azimuth and elevation rotors. Something in between these extremes should suffice.

Some innovative omnidirectional antennas like "egg beaters" can be effective for VHF and UHF work on good passes. Check out some of the designs and ideas proposed by Jerry K5OE, Lee KØLEE, and John KD6PAG on their Web sites: [<http://members.aol.com/k5oejerry/>], [<http://members.aol.com/lee810/ham.html>], [<http://www.qsl.net/kd6pag/>]

Predictions

Don't assume that you can take a laptop computer to Field Day and do your predictions after you get there. Plot all of your potential satellite passes in advance for every satellite you intend to pursue. Check the results. Look for timing conflicts. Make sure that the coordinates of the Field Day site and recent satellite element sets have been entered into the software. Don't forget to take along some satellite frequency guides unless you are one of the few who has memorized all the uplink and downlink bands for all of the hamsats in orbit.

Power and interference

There is nothing worse than having all the gear, antennas, predictions, and accessories ready to go, and then discovering that you can't hear anything but noise on the downlink frequencies. It happens a lot. Noisy power sources are the #1 culprit. If you can operate with batteries, do it. Satellite chasing is considered weak-signal work. Most of our hamsats only have a few watts output to simple antennas. They can be hard to hear. A typical consumer-grade gasoline generator can produce a lot of noise in the RF spectrum. Be sure to test your generator prior to Field Day. Check it with your satellite rig for a few passes. If it is noisy, either cure the problem or get another generator or power source.

Don't forget about "the other guy." Most Field Day operations include multiple stations for HF, VHF, and satellite work. The folks in the tent next door on 10 meters can ruin your best attempts to make Mode-A contacts. Coordinate with them so that they can go to another band or take a break during those short intervals when the RS hamsats come by.

If your group operation has any terrestrial VHF stations or two-meter packet systems, they can destroy any chances you might have had hearing AO-10 on Mode B (70 cm up and two meters down). As with the HF folks, make your intentions known and arrange for an operating schedule in advance. Even with all these precautions, it is always a good idea to isolate the satellite station from the others. A high-power 20-meter SSB rig will almost always mess with a 10-meter receiver just a few feet away.

Have fun!

You may ask, "How can he say 'have fun' after all of those warnings?" I have to admit that I have been chasing satellites on Field Day for 20 years, and I am really looking forward to doing it again in 2000. We have had multiple rig failures, antenna failures, computer glitches, generator disasters, tropical storms, and even satellite problems, but it has always been fun. Every year, we learn something new. We try different gear. We demonstrate satellite operations to hams who didn't even know that the hamsats existed. We learn more about emergency, portable operation. We test our equipment. And, finally, we have fun doing it!

I'll see you on Field Day!

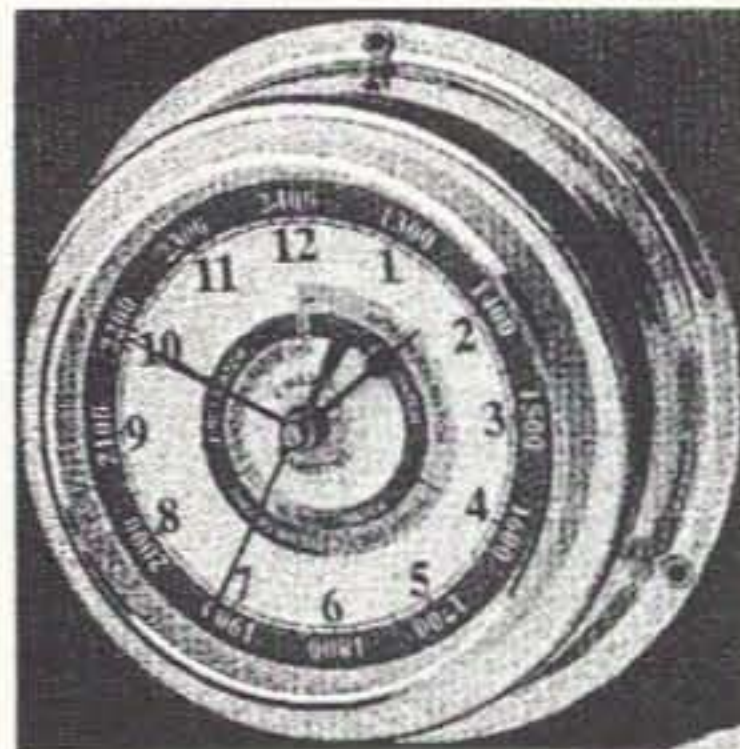

Chelsea Clock

Clockmakers since 1897
The choice of The Coast
Guard Foundation.

Quartz Clock
4" Dial

Beautifully hand-polished.
Stamped brass case and
bezel.

Curved glass crystal.

Wall or bulkhead mounting.

Made so well they last from
generation to generation!

Order this month and save
\$20!

Your price \$75

Omega Sales

P.O. Box 376

Jaffrey NH 03452

1-800-467-7237

TRANSMITTER LOCATION

New fixed site direction
finders provide 2 degree
accuracy, and include
software for triangulation from
a central control site. Mobile
versions also available covering
50MHz to 1 GHz

Doppler Systems Inc.

PO Box 2780 Carefree, AZ 85377
Tel: (480) 488-9755 Fax: (480) 488-1295
www.dopsys.com

European Marketing Director Denis Egan
PO Box 2, Seaton, Devon EX12 2YS England
Tel & Fax: 44 1297 62 56 90



CIRCLE 13 ON READER SERVICE CARD

On the cover this month, the screen shows busy APRS activity in Southern California captured by the new Alinco DR-135TPG and APRS Plus software developed by Brent Hildebrand KH2Z for use with the DeLorme Street Atlas program.

The new 2-meter mobile features an internal TNC for packet and APRS; operates at 1200 or 9600 bps; and has a rear-panel DSUB9 computer connector, 100 memories, a large 7-digit alphanumeric display, GPS input port, ignition key on/off, theft alarm, CTCSS and DCS encode/decode, 50/10/5 watts output, wide and narrow FM modes, autodial memories, and more.

It can also be ordered without the TNC, which can be added later.

APRS is a trademark of Bob Bruninga WB4APR, creator of the popular geolocating program.

For specs on the radio, see [www.alinco.com]; for APRS info and downloads, visit [www.tapr.org].



NEVER SAY DIE

continued from page 4

the so-called educational establishment, aren't going to want to believe this. Frankly, until I read about it in Iserbyt's *the deliberate dumbing down of america*, it just never occurred to me. And that's the beauty of this subversive system — none of us thinks about it. We just accept it as the way things are.

We know that our educators must have chosen the things we're going to be taught in school for some very good reasons, which may not be evident to us at the time.

Well, Iserbyt has done the research and she quotes the educators, who established our school system. It turns out that there's a whole lot more to this New World Order baloney than I suspected. I'm so damned sick of the conspiracy fanatics who are blaming things on the New World Order, the Council of Foreign Relations, and so on, but never provide any proof to back up their rantings. Iserbyt has the proof! I hate it when fanatics turn out to be right.

In the case of math, they aimed to teach "... a math that the pupils cannot apply to life situations when they get out of school." Well, they sure did that to me! And millions of other suckers. And it's all mandatory wasted time and effort. And the worst part of it is that our schools are still doing this to our children.

Flu Shots

For those of you who still believe in doctors and dutifully go to get your flu shots, I'm sure you haven't read what Dr. Hugh Fudenberg, the world's leading immunologist (850 papers published in peer-reviewed journals), has said about them. He's found that anyone who had five flu shots between 1970 and 1980 had a ten times higher chance of Alzheimer's than if they had one or none. How come? He attributes it to the mercury and aluminum that's in every flu shot, which quickly migrates to the brain.

This, of course, suggests that the use of amalgam fillings in teeth as a possible leading contributor to Alzheimer's. Mercury is severely toxic, and it's gradually released from your teeth into your body. Visit a nursing home some time and see what it's like for old people to turn to veggies, tied to their chairs. My mother went that route, so I know the full horror. Well, she had no way of knowing this could happen, since that was before I started researching the situation.

Dr. Page

An ex-employee of mine, who died last year of fatness, swiped my treasured 1949 copy of Dr. Page's *Degeneration*—>*Regeneration*, so I was delighted to come across his

Your Body Is Your Best Doctor. This 1991 reprint of Page's 1972 book [Keats Publishing, Box 876, New Canaan CT 06840 (0-87983-540-0)] runs 236 pages, and costs only \$6. Get it. Page, a dentist, noticed that one of the early signs of degeneration of our bodies was dental cavities. That's a sure sign that you're eating wrong—wrong as far as your body is concerned, though probably "right" as far as the food experts on TV, radio, and in magazines are concerned. Plus around 95% of the stuff in our supermarkets. We're digging our early graves with our teeth — at least until we lose them. Page echoes with his research what Dr. Henry Bieler (*Food Is Your Best Medicine*) discovered. And Dr. Weston Price (*Nutrition and Physical Degeneration*). If you can read the Page, Bieler, and Price books and not make a major change in your diet, you are either monumentally stupid (like smokers), or seriously addicted to sugar. These all confirm what I've been preaching in my editorials and are the basis for my *Secret Guide to Health*. Through over 99% of our development over the last 3 to 4 million years, humans ate raw food. Our systems haven't yet adapted to cooked food, refined sugar and flour, hydrogenated fats, and so on. These things are slowly killing us.

Continued on page 61

A Safe LED Optical Transceiver System

What? An LED in a transceiver system? LEDs are used in many different devices for lots of communications uses, right on down to our couch potatoes' TV remote controls. While we cannot see the IR light from LED-type remotes, it is there nonetheless, communicating with our TV set to effect changes for us.

Many at this point would wonder why we would use a visible red LED (660 Nm) for a transmitter light source when much higher power lasers are available, and are much more concentrated in their beamwidth, making long communications paths possible. I do not disagree with this point, that lasers are much better at making a long range system possible. However, there are many other considerations that need to be addressed to properly evaluate the merits of each system.

One very important consideration, when using high power lasers, is to be very careful not to point them at anyone, as this could

cause eye damage. In many communities, there are laws on the books to bring legal action where lasers have been pointed at aircraft, presenting great harm to the pilot. Be it a rotary-winged (helo) or conventional aircraft, a laser can momentarily blind a pilot. Extend this scenario to homeowners, as most of us use hilltops to make microwave and light system communications possible. Take, for instance, the prealignment of a laser system — you could just drop the laser beam into someone's home while trying to align on a remote hilltop.

The problem with lasers is they concentrate a great deal of light energy into a very

small beam, and as such have quite a small spot emanating from the laser. In most cases, this angular beamwidth of light is on the order of a couple of milliradians. That's the equivalent to a spot of 5 feet at 2 miles distance for the laser beam. In other words, a fly speck as compared to a compass degree. A laser's light beam is a very concentrated and high intensity point of light. LEDs, on the other hand, for comparison, have quite a wide beamwidth of quite a few degrees, say, 10 to 15 degrees.

The safety angle here is that lasers could work against you, as their very tight beamwidth makes them harder to aim than a microwave dish. If you inadvertently hit something and cause damage, you could have a problem with the law. With the aiming difficulty and safety issues paramount in our minds, Kerry N6IZW came up with the idea of the LED transceiver system, for several reasons in addition to the safety issues above.

Lasers are difficult to aim and require a mount much more sturdy than conventional microwave tripods. If you have such a mount for laser use, it probably has micro positioners or axis positioners like micrometer heads to provide fractional degree changes in the aiming of the laser beam. Mounts suitable for laser use would weigh in at many times the weight of a conventional microwave tripod system. And don't forget to add in the additional support equipment, like the high voltage power supply for the laser, making the system package large and cumbersome.

Does an LED system work? You bet it does! We tried out the system full duplex over a 2.2-mile path, and had 14 dB of signal margin on the 2.2-mile path, according to calculations. Did I get your attention (duplex!)?

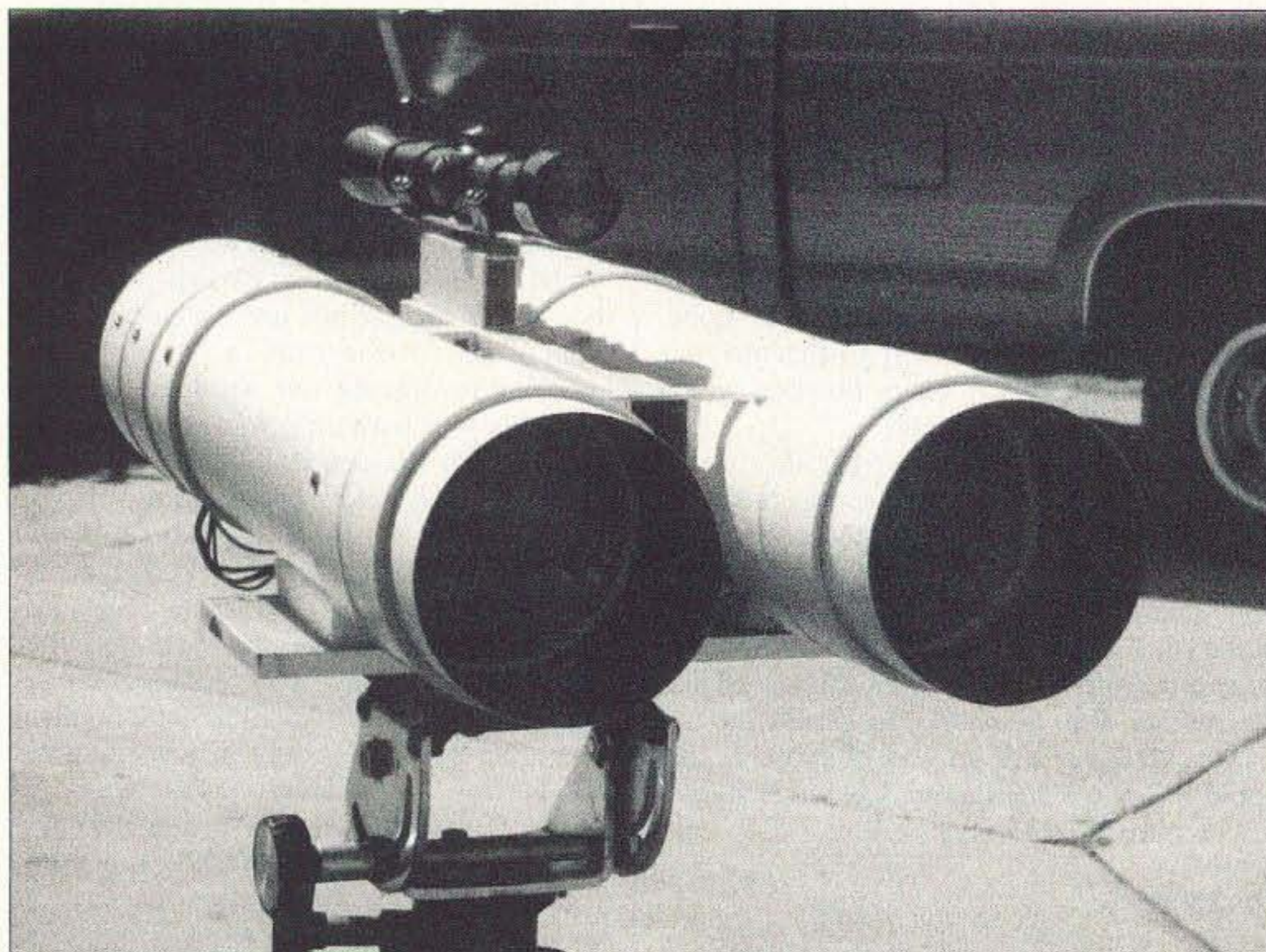

Photo A. Front photo of LED transceiver system showing both receiver and transmitter lens systems on 4-inch PVC pipe, using end caps and a splice union for 4-inch pipe to hold lens in place.

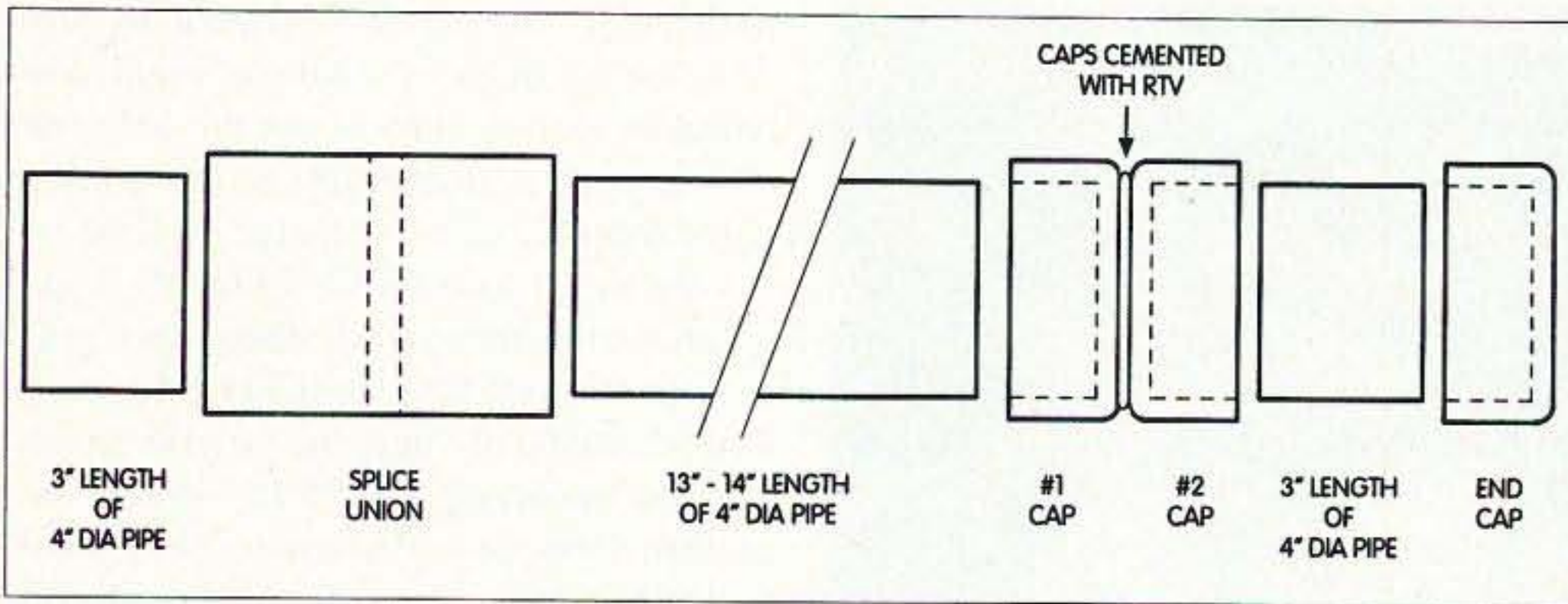

Fig. 1. Diagram of plastic pipe construction using splice unions and end caps and the method of assembling them into an optical receiver and transmitter. The 3-inch sections of pipe at the front and rear are used to fix a rear cover cap to protect the electronics, and for a dust cap to keep the lens clean when the system is in storage. Cap #1 holds LED or photo detector centered in Cap aligned with Fresnel lens. Cap #2 hold electronics for either receiver or transmitter circuitry.

Yes, I meant full communications duplex (sort of) using two similar transceivers that consist of, for each system, a single LED for the transmitting light source and a large aperture (1/4-inch) surplus photo diode for the light receiver.

Fresnel lenses focus the transmit light and received light from and to the optical devices. As for safety concerns, while the LED is a high intensity bright light, it is not anything like the intensity of a laser. However, I find looking at my 3-cell mag flashlight more uncomfortable than the LED. I don't recommend looking at any high intensity light source but if it hits you directly, it is not lethal. Had it been a laser, the story would have been different. The LED system, even if pointed accidentally at a remote object that views it from quite a distance, looks much like a large red stop light, be it a few hundred feet or 2 miles.

Amplification and large aperture optical lenses go hand-in-hand, and were used here. The Fresnel lens in question was obtained at a stationery store for \$3, and is called a sheet magnifier. These sheet-sized acrylic

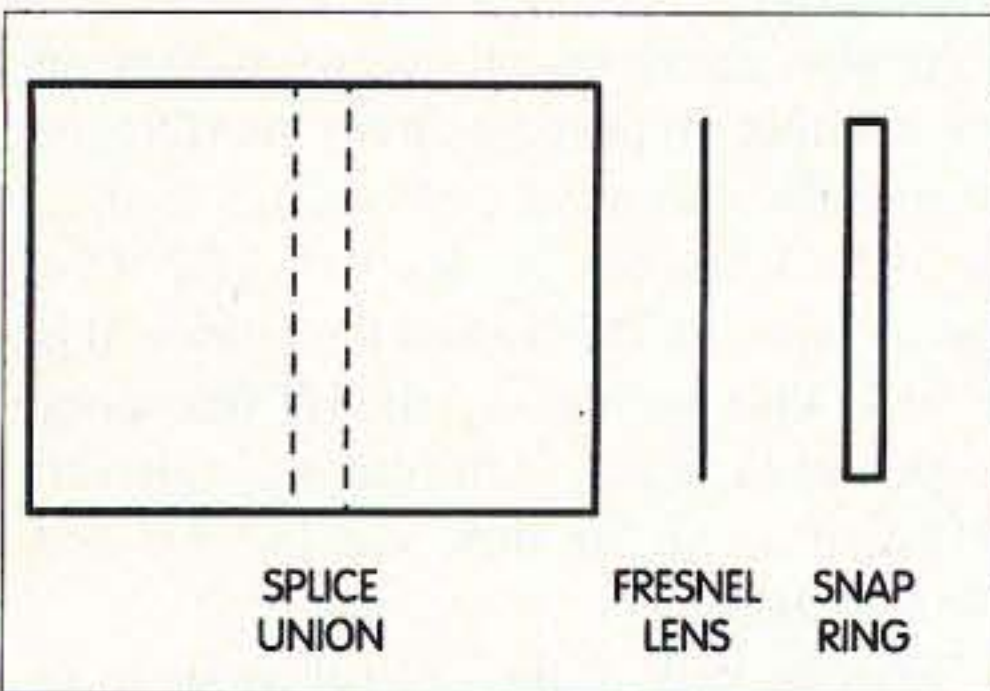

Fig. 2. Method of holding lens in rear section of splice union, using a 1/4-inch short section of 4-inch pipe as a "snap ring" to hold the rear of the Fresnel lens in place firmly against the center rib inside the splice union.

Fresnel lenses are used to magnify book or newspaper pages for reading aids. They come in a variety of sizes, with the most common being 8-1/2 by 10 inches. The focal lengths of the Fresnel lenses tried were very close to 12 inches. You can test them with a point light source and focus for best sharpness of the magnified image on a piece of paper, and then measure the separation from the lens to paper for focal length determination.

Now comes another beautiful part of this project: What to mount the LED and detector and lens into to make a hardened package easy to set up and transport. We wanted something inexpensive, and 4-inch plastic drainpipe looked just right. The pipe came with a black plastic interior and white outer covering of plastic. Just right for light reflections, with the black nearly eliminating reflections inside the pipe.

Accessory fittings made for the drainpipe made life quite easy. To make one system, eight pipe caps and two 4-inch splice unions are required, in addition, of course, to a length of 4-inch PVC plastic pipe. We obtained ours at our local Home Depot hardware store.

Let's get into the system description of the electronics side of things that control and receive the light from the LED transmitter. Development of this was the idea of Kerry N6IZW. The LED used is a common high intensity red visible LED obtained from Radio Shack for about \$2. The control circuit consists of a common CMOS 4046 PLL chip, using only the VCO portion of the chip. What makes this circuit unique is the modulation technique used. It's a single-stage electret mic amplifier using an LM-324 op amp and coupling audio through a 0.1 coupling capacitor and series 10 k resistor to the VCO control pin #9 on the 4046 PLL chip.

The output of the VCO is set at 35 kHz

Back Issues Only \$5.00
Call
1-800-274-7373

Pay TV and Satellite Descrambling
New ... Year 2000 Edition ... New

Pay TV and Satellite Descrambling 2000 has latest cable and satellite fixes, schematics, bullet blockers, cubes, etc. Pay TV Series Vol. 1-10 (300 pages) \$59.95. Hacking Satellite TV Video \$29.95. Monthly Newsletter Subscription with web access, \$34.95. Everything listed above \$99.95 (choose hard copy or CD-ROM). Find Anyone Anywhere: Using the Internet. Search public and private databases to get information on anyone. \$59.95. Catalog \$1.00.

Scrambling News
4798 S. Florida Ave., PMB #108
Lakeland, FL 33813-2181
941-646-2564. COD's are OK. Add \$6.

CIRCLE 36 ON READER SERVICE CARD

ORDER TODAY!

www.sescom.com

Rack Chassis					
MODEL	W x D x H in.	PRICE	MODEL	W x D x H in.	PRICE
1RU5	19 x 5 x 1.75	38.50	2RU17	19 x 17 x 3.5	70.00
1RU7	19 x 7 x 1.75	41.50	3RU5	19 x 5 x 5.25	52.25
1RU10	19 x 10 x 1.75	44.00	3RU7	19 x 7 x 5.25	57.25
1RU12	19 x 12 x 1.75	57.00	3RU10	19 x 10 x 5.25	65.00
1RU15	19 x 15 x 1.75	62.00	3RU12	19 x 12 x 5.25	70.00
1RU17	19 x 17 x 1.75	67.00	3RU15	19 x 15 x 5.25	76.00
2RU5	19 x 5 x 3.5	41.50	3RU17	19 x 17 x 5.25	80.00
2RU7	19 x 7 x 3.5	44.00	XTRA PANELS F & R		15.00
2RU10	19 x 10 x 3.5	46.75	ADD \$8 FOR BLACK PLUS ADDITIONAL \$5.00 (AT TIME OF ORDER)		
2RU12	19 x 12 x 3.5	60.00			
2RU15	19 x 15 x 3.5	65.00			

\$30.00 MINIMUM ORDER INCLUDES FREE SURFACE SHIPPING (US, CANADA & MEXICO)
FREE CATALOG OF ALUMINUM ENCLOSURES

SESCO, INC.
2100 WARD DR., HENDERSON, NV 89015 USA
ORDERS ONLY 800-634-3457
Tech Line 702-565-3993 (weekdays 8 am - 4 pm PST)
Office 702-565-3400 Fax 702-565-4828
FAX TOLL-FREE U.S. and Canada (Mexico dial 95 first) 800-551-2749
SESCO, INC. is not responsible for inadvertent typographical errors; prices and specifications subject to change without notice.

CIRCLE 167 ON READER SERVICE CARD

208-852-0830
<http://www.rossdist.com>

In Stock!

KENWOOD
TM-G707A
Under
\$330.00

RDC Check Out Our Specials! We're On The Web.
Over 9010 HAM Items in Stock. All Prices Cash FOB Preston
ROSS DISTRIBUTING, 78 South State Street, Preston, ID 83263
Hours Tue.-Fri. 9-12 / 2:30-6 • Mondays 9-2. Closed Saturday & Sunday

Repeaters

On your freq tuned, plug & play
6m, 2m & 440.. \$399.95 & \$499.95

Repeater Controllers
RC-1000V\$259.95

Micro Computer Concepts
8849 Gum Tree Ave
New Port Richey, FL 34653
727-376-6575 10 AM - 10 PM
e-mail: n9ee@akos.net
<http://home1.gte.net/k4lk/mcc>

CIRCLE 160 ON READER SERVICE CARD



Photo B. Rear photo of LED transceiver with pipe caps in place on rear of system. More detail of aluminum rectangular tubing and "U" brackets to side of main support for "U" bracket holding 4-inch pipes in place. Additional rectangular aluminum tube attaches rifle scope on top of main support aluminum. All mounted on heavy plate for tripod mounting.

and drives an IRFZ44 power FET used as a switch to turn on and off the LED at the 35 kHz rate. Superimposed on the 35 kHz carrier is the audio FM modulating the VCO control voltage. This produces great-sounding FM audio of about 5 kHz deviation impressed on the LED, light modulation with such a simple scheme.

The detector is also quite simple. It consists of a surplus photo diode and amplifier stage that came from an IR light detector. This photo diode came as a complete assembly with a 4-stage transistor amplifier. In the surplus bin, we found several modules that use large aperture (1/4-inch) photo diodes with clear molded optics over the active area of the photo diode. Several others were dark red and only functioned with IR light sources. This IR detector can be removed and replaced with a non-IR photo diode. In both cases, the IR unit and the visible photo device conversions to the circuitry had to be made. They needed to be converted on the transistor output stage from digital output to linear, by adding one resistor and a .001 μ F capacitor.

This detector is just a large aperture (surface diode detection area for light) of about 1/4 inch of active surface. The photo diodes amplifier (4-stage transistor amplifier) is used to drive the RF port of an SBL-1 diode mixer. (Remember, the transmitter LED is being modulated at a 35 or 45 kHz frequency rate, turning on and off the LED controlled via an IRFZ44 FET.)

The 35 kHz received carrier and FM modulation is applied to the RF port of the mixer, and a local oscillator is used to convert to a convenient frequency for reception of the FM modulation. The decision here was not to build a 35 kHz receiver; instead, we opted for a simpler approach. We used 145 MHz for the local oscillator injection to the mixer. The LO we used was a synthesizer, as surplus material was on hand to convert to a frequency to mix the 35 kHz to our 2 meter HT.

We set the synthesizer up for an LO of 145 MHz, allowing a 2 meter HT to be set to 145.035 MHz for the receiver portion of the system. We are looking at replacing this synthesizer with a simpler LO using a TTL crystal oscillator at 78 MHz (because it was in the junk box). The thought is that the mixer driven by 78 MHz hard will produce harmonics of 78 MHz, and using the second harmonic 156 MHz as the LO frequency will allow using a wide coverage receiver at 156.035 MHz, replacing the 2 meter HT.

We think this is a viable alternative and are experimenting with it at present. Besides, we have lots of TTL oscillators at 78 MHz and can supply them for postage costs if you don't have an alternative frequency oscillator. The exact frequency of this LO is not critical. Any frequency is usable as long as it hits an FM frequency that you and your partner agree upon. If you have an FM receiver of narrow band (5 kHz) bandwidth

in the VHF range, it will function by juggling the LO frequency that you might have on hand. Our solution is not the only one — many others are possible — this is just a guide from the parts we had at the time.

Why use 35 kHz for the LED? Well, experimentation using workbench signal generators showed that the LED efficiency dropped markedly near the 60 kHz operation test frequency. The 35 and 45 kHz operation frequencies seem to be a good tradeoff for best efficiency and operation in general along with the superimposed mic audio, 5 kHz deviation FM modulation.

We went overboard and used a 145 MHz synthesizer, because we had a few on hand, and we were able to convert them to a desired frequency on the 2 meter ham band for use with our 2 meter HTs. These synths were from surplus material and in low quantity, making other arrangements necessary such as the TTL 78 MHz system. At worst, we will need to build an MMIC amplifier doubler to 156 MHz and then use this signal to inject into the mixer LO port. In our system with the synthesizer, the 145 MHz oscillator provided our LO input to the mixer port. The IF port was tied directly to a 2 meter HT tuned to the LO plus our transmitting light frequency of 35 kHz or 145.035 MHz to receive the narrowband FM-modulated LED (35 kHz).

Why reinvent the wheel, when the HT can be used, making circuitry less complex in the construction and application of this LED transceiver. Besides, using the 2 meter HT eliminates audio amplification RF receivers and S-meter construction, as it is all incorporated in a finished, packaged 2 meter HT. (Just don't push the PTT switch on the HT — it's not needed!) That's another good point for off-ham-band frequencies such as 156 MHz, as the newer radios will receive this frequency on full coverage receivers, but will not transmit, so some protection is built in here for accidentally keying the transmitter.

Another catch concerning two stations so constructed: To prevent direct interference when both stations are closed for testing, the PLL frequency is offset 10 kHz. One station is set to 35 kHz and the other end is set to 45 kHz. In that way, the HT frequency needed at each end of the circuit is also 10 kHz apart, being in this case 145.035 and 145.045 MHz.

You can look at the optical scenario as one LED transmitter pointing at the remote receiver as path one, and the remote transmitter pointing at the other receiver. That's why it's not full duplex operation, as the

Continued on page 59

Welcome to APRS

With all the buzz about license restructuring, one of the hot topics for discussion has been the change in the Morse Code requirements. While ham radio was once totally dependent upon Morse code, today there are dozens of ways by which we can communicate with one another. Even more important is the fact that new modes and modalities appear on a regular basis. One of the most exciting of these is the Automatic Packet/Position Reporting System (APRS). Imagine sitting in front of your computer and seeing displayed on a map where every ham station you receive is located. And the good news is that you may already have almost everything needed to put an APRS station on the air!

APRS was originally developed in 1992 by Bob Bruninga WB4APR. With a background as a naval officer with expertise in tactical planning and execution, Bob realized that knowing where a particular station or event was located was just as important as the information it was sending. APRS incorporates the location of any station into its message format. In fact, most APRS stations periodically report their position even when no other message is to be transmitted. As hams, we always have placed a high priority on location, whether it was DX chasing or county hunting. We usually exchange information on our city, and may even include map coordinates in the form of grid squares.

APRS stations are far more precise, and indicate their location in terms of latitude and longitude, which only needs to be entered once for a fixed station. On the other hand, a mobile APRS station can utilize the Global Positioning Satellite (GPS) system to determine precise location coordinates and then update its location to other stations each time it transmits. This means that you can watch the track of a mobile station on the map display as the station travels. Cars, trucks, boats, planes, balloons, and even satellites are common APRS objects.

APRS stations may be connected to sensing devices so that weather data can be displayed, which may include temperature, barometric pressure, rainfall, and wind speed and direction. There is even the ability to display objects on the APRS display that are not stations. The current location of a hurricane or wildfire may be very significant during disaster communications. On

the other hand, when hams are assisting in a public service event, displaying the location of a visiting dignitary or the lead runner in a marathon provides better information than periodically getting verbal updates.

Like packet, most of the activity takes place on two meters, although, also like packet, there are HF operations as well. The main difference between packet and APRS is the software that you'll be running to operate the station and the manner in which you communicate. While packet was generally text-driven and seemed to revolve around packet bulletin boards, APRS is far more graphical in nature. The most popular APRS software is available for download on the Web for DOS, Windows, Macintosh, LINUX, and various hand-held systems such as the Palm Pilot.

So, what does it take to get into APRS? If you are a fan of recycling, APRS provides an excellent opportunity. Not only can you use that old TNC gathering dust in the closet, but this may provide a new life for your old brick-sized 2 meter HT you stopped using 3 years ago. Have your kids taken over your Pentium III computer for playing games? You can just drag in that old 386 computer from the garage — it will work fine for APRS. Congratulations! You now have the hardware you need to get started! Don't have Windows 95 or 98 on the old computer? The DOS version of APRS will surprise you with its capabilities. The 2-meter rig you are planning on using is only a watt and a half? APRS uses a relay system in which this should work just fine.

Connecting everything together is relatively easy. Obviously the radio needs to be connected to a power supply and an antenna. If you are using an old handie-talkie, the drop-in charger and rubber duck may be all you need. If you opt for an external antenna, a simple (and inexpensive) quarter wave will be all that you need unless you are located in some very remote and isolated area. The computer will be connected to the TNC through a serial cable. These are frequently DB-9 connections, so the cable is available at any computer store and most electronics stores, such as Radio Shack.

The cable that connects the TNC to the radio may require a little assembly. Usually you can find the requirements in the manual for the TNC, but essentially they will include the following. A cable from the external speaker or earphone jack on the radio to the data in connector on the TNC. A connection from the data out on the TNC to the microphone socket on the radio, and finally a cable to activate the push-to-talk on the radio. My MFJ TNC uses a DIN-type plug, so I found a cable originally intended for a game controller, cut the one end off, and added the connectors for the radio to that end. This cable should provide no major challenges, but if it does, odds are that you can find a fellow ham in the area who can provide some advice. You can also check out a Web site such as the one operated by the Tucson Amateur Packet Radio (TAPR) group [<http://www.tapr.org>]. There are discussion groups and even lists of hams who

Continued on page 58

ON THE GO

continued from page 57

are willing to be a resource for new entrants into the APRS arena.

Speaking of the TAPR Web site, you'll be stopping there anyway to download the software that will make everything work. Choose the APRS section, then find the operating system your computer uses. There are zip files that contain the entire program as well as updates from one version to newer versions. The file names are usually pretty self-explanatory. If there are numbers in the file name, they often refer to the version number, so between the number in the title and the date listed next to it, you should be able to determine which is the most recent offering. If it is a zip file, you will need to expand the program to its regular size by using a program such as WinZIP. This is a shareware program that can also be obtained on the Web. Once expanded, the program will have all the necessary directories, folders, and files, including a selection of maps.

A word about shareware. Shareware is a means for distributing software to make it easily accessible. Why drive to the computer store when you can purchase a program online? With shareware, you have the opportunity to obtain the software and try it out, with the expectation that if you continue to use it, you will send the author payment and register your copy. Usually the price is very reasonable, and happy authors tend to write more and better software!

The shareware versions of most of the APRS programs allow you to use all the functions of the program, but do not save the settings from one session to the next. Until you register the program, you'll have to enter your call-sign, location, and all your preferences (one of the practical good reasons to register your software). You can determine your location in one of several ways. Obviously, a detailed map with latitude and longitude is helpful, but most versions of the APRS programs allow you to determine map coordinates by using the mouse to point to your location on the map. You can also check various Web sites such as [<http://www.QRZ.com>], enter your own callsign, and then ask for more details. You will see information that includes your address, grid square, and latitude and longitude.

Tune your radio to the APRS frequency (144.390 MHz simplex for 2 meters). You should soon see stations begin to appear on your map. You'll be amazed at all the features the software offers, but fortunately it is very intuitive and fun to explore. Give it a try, and let me know what you think! See you on APRS! 73

Ah, the Technomadic Life!

continued from page 17

that first sparked your interest in electronics, radio, and computers. I see it slipping away all around me, as incredible technology becomes taken for granted and relegated to the dusty corners of a busy life. Embrace it. Take it to extremes. Imagine the wildest application possible for your gadgets of choice and then make it happen! It's astonishing what you can accomplish if you just start dreaming and building ... one step at a time.

73 from the Microship ... see you out there! 73

Well, Not Exactly

continued from page 30

Problems arise when unwanted currents flow through the probe cable shield impedance. **Fig. 2(b)** illustrates one way that this can happen. Typically, the scope and power supply of the unit under test are connected to the same "U" grounding 115 VAC outlet. The safety ground leads now form a loop with the probe cable resistance in series. This loop (let's call this the DC loop), being in the presence of magnetic fields, causes current through the cable shield resistance and results in voltage drop E_2 . This, being in series with source voltage E_1 , is presented to the scope input. This results in the condition shown in **Photo C**. The 60 hertz wave shown is caused by 84 milliamperes AC rms flowing in the probe cable shield. Another parallel loop exists (call this the AC loop), in which the cable shield is also a common impedance. It is formed by the 115 VAC power leads supplying the scope and UUT. It differs slightly from the DC loop in that there is no DC path inside the scope and UUT. However, considerable capacity exists between the input and output of their respective power supplies, which completes the AC loop.

Trying to rid yourself of an unwanted signal may or may not be easy. Here are some suggestions. For 60 hertz signals, providing another low impedance ground path between the scope and

UUT chassis may help. Breaking the DC loop will work, but may compromise the safety ground feature and this is not recommended. Higher frequency unwanted signals (transients, such as generated by a switching-type power supply) getting into the AC loop are considerably harder to eliminate. A low resistance additional ground path between units may still exhibit considerable RF reactance and not be effective. Placing ferrite cores (of the type used for TVI reduction) on the power cords of both units may help. If the scope has dual inputs, it may be possible to cancel out a large portion of the unwanted signal by using the B input. Connect the B probe ground clip and tip to the same point as the A probe ground clip. Set the scope control to subtract trace B from trace A, and adjust the attenuator of trace B for best cancellation.

Perhaps the low-priced scope we own may not exactly be perfection, but it is quite capable of providing much information and can be very useful if we keep in mind what may be happening. I hope this article will be of some use to you. Take it from me — even the poorest scope beats a 1,000 ohms/volt multimeter for troubleshooting. 73

Exploring the Kenwood TM-D700A

continued from page 41

locations you've identified to the system. Most GPS receivers use a standard four-pin connector that has a lead for power, ground, and data in as well as data out. The Kenwood TM-D700A comes with a cable that allows the signal to be accessed by the radio. Add the proper connector for the GPS receiver and plug it in. When the radio detects that it has received a valid GPS position, it can broadcast a beacon announcing your position. Don't want everybody to know exactly where you are? You can introduce a variance which will still provide a relative position but at less than pinpoint accuracy.

As you receive other stations, the TM-D700A will display the station ID. If it is a new station it will also display its status text. You can toggle the

screen so that it will list the last 50 stations you have received. If you wish to send a message to one of the stations, you can select it from the list and enter a message from the control panel. You can select upper and lower case, as well as numerals and various characters by using the tuning knob and two of the buttons. You can also use the keypad to directly enter text. Since the keypad buttons are programmable, you have additional flexibility in setting it up the way in which it feels most comfortable to you. These two methods may not be the same as touch typing, but they are more than adequate for short communications without having to add/plug-in/switch on any other equipment.

While receiving other stations, you can display the details of that station, which usually include city, state, transmitter power, antenna height, and location. If the TM-D700A knows your current location, it will display the direction and distance from your current location to that particular station. I have mine set so that it shares the location information on other stations with my GPS in both directions. This means that the GPS unit then gives me a map of the area showing where the other APRS stations are located. While this is a lot of fun, needless to say it could be of great benefit when supporting a special event or emergency. Want to find KE8YN? He's 3.2 miles on a heading of 231 degrees from your current location. Are the roads inaccessible? Don't worry. If you have to go off the beaten path, the GPS will turn you back to the correct direction.

I have mine set so that it automatically answers for any message sent to me. The automatic response requests that they indicate a frequency for voice communications if the other station wishes to have a QSO. I get a beep when I receive a message and a quick glance at the screen will tell me what frequency they wish to use. The TM-D700A allows me to talk on 2 meters (or 440 MHz) while the APRS continues to operate on the other band. Of course if you notice me on your display from a greater distance you can enter a 20-meter frequency as well. With the

relay capability of APRS, it is very possible to have a station display that is not in the immediate area, so HF might be the band of choice.

So there you have it. A rig for all seasons and with capabilities that you will grow into, not out of. Would I recommend this rig to a friend? Absolutely, and without a moment's hesitation! If I were buying a new rig, this would definitely be the one I'd get. I guess that says it all. 73

THE DX FORUM

continued from page 45

major historical areas. In exchange, a certificate will be issued in the name of the amateur that contributed the fee. Special certificates are also available for 10 trees or more.

As for log submission, all logs must include callsign, RST reports, date, time (UTC), and major historical area. Also all calculations for credit must be clearly specified. The operator's callsign, name, country/state, address/mail address and zip code must be clear on the log form. No QSLs are required (yippee!). All logs must be submitted before March 3, 2001, and may be sent to the award manager either via bureau or via home address: Yoram Gottesman 4Z1GY, 1 Kehilat Jitomir St., Neot Afeka, Tel Aviv 69410, Israel, or to: [high_test@ibm.net].

Pulling the big switch

So much for this month's offering. I look forward to hearing from all of you very soon, so ...

73 and good DX!! 73

THE DIGITAL PORT

continued from page 50

doctors this last month. I had quintuple heart bypass surgery. That seems to put me right in the mainstream of "must-do" events. Since this was the same description given to David Letterman's bout with the medical folks, I asked, "Is this going to make me rich and famous?" There wasn't even a hint of encouragement there. Doctors are sometimes overly serious about their work.

They seem to have done a good job. I don't see any complications. It did cut back on some of my experimenting time, but I got a bit of operating time in instead. I will

try to be more enlightening for you when next month rolls around.

If you have questions or comments about this column, E-mail me at [jheller@sierra.net]. I will gladly share what I know or find a resource for you. For now, 73, Jack KB7NO. 73

ABOVE AND BEYOND

continued from page 56

frequency is split, but as far as I look at it this is a full duplex system. In operation, full duplex audio is present to the listener at either end of the path. In the 2.2 mile contact Kerry N6IZW and I made, communication was as good as AFC locked 10 GHz Macom Gunnplexers.

The optical path has some parallax which can be minimized with little effort. The real path is like looking at both ends of the circuit as being binoculars looking at each other. One side of the binocular is the transmitter and the other is the receiver. Maximum light detection system amplification is aided by the 4-inch diameter Fresnel lens over the Tx LED and Rx photo diode.

Getting to the optics and plastic pipe construction is not difficult at all. Sections of 4-inch pipe are cut to a length of between 13 and 14 inches to allow movement for final focus of the electronics and lens positioning. Plastic pipe caps are used to hold a small PC board with slots cut for mounting 6/32 nuts and bolts. This allows the electronics to be centered in the pipe cap. Final positioning of the LED and photo diode will be centered in the Fresnel lens pipe system. Three pipe caps form the rear housing, with two caps RTV-cemented back to back. One cap slides over the 4-inch tube at the rear of the device, holding either the LED or photo diode. The remainder of the electronics are contained in the second rear-facing pipe cap. This allows simple servicing without disturbing the position of the optical components once aligned.

To close off this opening after installation and check it out, a 3-inch section of 4-inch plastic pipe is inserted in the rear pipe cap and another pipe cap is pushed over the protruding short section of pipe. This closes off the container at the rear and provides protection for the electronics. A hole is drilled in the pipe cap for DC power and IF coax to leave the assembly. A notch is cut in the 3-inch pipe section to allow for the pipe to slide over the cable exit hole.

Continued on page 61

Jim Gray W1XU/7
210 E Chateau
Payson AZ 85541
[jimpeg@cybertrails.com]

Ionization and You

You can see from the calendar that the days June 1-8 and 23-27 are expected to provide seasonably good DX signal propagation above 20 meters, but not be as good as HF propagation in March and April.

The days from June 9-13, 18-20, and on the 30th, are expected to exhibit ionosphere disturbances — some severe — accompanied by Poor and Very Poor propagation on 30, 40, and 80 meters, due to excessive signal absorption and noise from an upset-to-active magnetic field.

Contrarily and occasionally surprisingly, propagation on the 20 through 10 meter bands could be quite good during this disturbed period, particularly on paths across

the equator. Polar paths, however, are likely to exhibit auroral echo on most signals. Frequently, some of the best times for excellent DX propagation occur on the days following recovery of the ionosphere from disturbances (P-F and F on the calendar).

VHF and UHF openings may often occur during ionospheric disturbances which result from Earth's upset to active magnetic field.

Please note that the Band-Time-Country chart shows the MUF (maximum usable)

absorption rather than refraction/reflection, but when the sunlight grazes the upper atmosphere at shallower (less than direct) angles during morning and afternoon hours, there is a time when ionization is at its most effective level for refracting HF signals.

You may have noticed that above 30 meters, the best DX occurs during early morning and late afternoon hours, and on bands below 30 meters, daytime ionization is usually too intense, and signal absorption is too great, for effective propagation. However, these lower frequency bands begin to recover after sunset and usually provide their best DX propagation during night-time hours.

Gray-line propagation occurs along a sunset/sunrise path about an hour before dark, and after sunrise, and offers excellent propagation to many parts of the world at these times.

Band-by-band summary

10 and 12 meters

Good daytime DX on transequatorial paths to North and South America, Africa, and the Pacific, is expected on (G)ood days, with signals peaking in strength during the local afternoon. Plenty of short skip to 1500 miles or more should occur on (G)ood days.

15 and 17 meters

Good daytime DX to many parts of the world, with maximum signal strength occurring during the late afternoon hours. These bands usually close after dark. Daytime short skip is expected to 2,300 miles and beyond on (G)ood days.

20 meters

Good DX conditions both day and night, with best signal strengths occurring after sunrise and again in the late afternoon and

EASTERN UNITED STATES TO:												
GMT:	00	02	04	06	08	10	12	14	16	18	20	22
ALASKA							17/20	15/17	15/17			
AUSTRALIA	12/15	12/15			12/15	20/40	12/15	20				
CENTRAL AM.	15/17	15/17	15/17	40	40		20	20			10/12	10/12
EUROPE		30/40	30/40					12/15	12/15	20/15	12/15	12/15
FAR EAST						20	15/17	20				
HAWAII	12/15	12/15	20/17	20/17	20/17		20					
INDIA	20				20	20						15/20
MID-EAST	20	20/40	20/40							12/15	12/15	12/15
RUSSIA/C.I.S.	17/20	17/20	17/20									17/20
S.E. ASIA	15/17	17/20										
SOUTH AFRICA		40/30		17/20				12/15	12/15			
SOUTH AM.	15	15	20	20							10/12	10/12
WEST COAST	15/17	20	20	30/40	30/40	30/40	30/40		10/12	10/12		15/17
CENTRAL UNITED STATES TO:												
ALASKA	15/17	17/20	17/20			30/40	17/20	17/20				
AUSTRALIA	15/17	15/17	17/20	17/20	20		20	20				
CENTRAL AM.	15/17	17/20	17/20	17/20	17/20		17/20	17/20	15/17	10/12	10/12	10/12
EUROPE	17/20	17/20	17/20									17/20
FAR EAST	15/17	17/20	17/20			30/40	17/20	17/20				
HAWAII	15/17	15/17	15/17	20	20/30	30/40		17/20				
INDIA	15/17	20					20					15/17
MID-EAST	17/20	17/20	20									
RUSSIA/C.I.S.	17/20	17/20	17/20	17/20						12/15	12/15	
S.E. ASIA	15/17		20	20				20				15/17
SOUTH AFRICA				20					15/17	20	20	
SOUTH AM.	10/12	15/17	30/40	30/40							10/12	10/12
WESTERN UNITED STATES TO:												
ALASKA	10/12	15/17		20	20	30/40		20				15/17
AUSTRALIA	10/12	15/17	15/17	20	20	20/30	30/40					
CENTRAL AM.	15/17	15/17	20/30	20/30	20/30	30/40				10/12	15/17	10/12
EUROPE	20						20		15/17	15/17	20	20
FAR EAST	10/12	15/17		20	20	30/40		20				15/17
HAWAII	10/12	17/20	20	30/40	30/40	30/40	20	20		15/17	15/17	15/17
INDIA	15/17							20	15/17			
MID-EAST	20	20							15/17		20	
RUSSIA/C.I.S.	20	20	20	20								20
S.E. ASIA	10/12							20	15/17	15/17		
SOUTH AFRICA			20	20					15/17			
SOUTH AM.	15/17	15/17	15/17	20	20	20/30						10/12
EAST COAST	10/12	10/12	15/17	20/30	30/40			20	10/12	10/12	20	20

June 2000						
SUN	MON	TUE	WED	THU	FRI	SAT
				1 G	2 G	3 G
4 G	5 G	6 G	7 G	8 G-F	9 F-P	10 P
11 P	12 P-VP	13 VP-P	14 P-F	15 F-P	16 P-F	17 F-P
18 P-VP	19 VP-P	20 P	21 P-F	22 F-G	23 G	24 G
25 G	26 G	27 G	28 G-F	29 F-P	30 P	

evening hours. You can also expect to hear strong signals in the west, northwest, and Pacific areas during hours of darkness. Daytime short skip beyond 2,000 miles is anticipated on most days.

30 and 40 meters

Good DX to most parts of the world from our location is likely during night-time

hours, beginning at sunset and extending after sunrise. High static levels due to occasional thunderstorms along the path of propagation may be expected. Short skip between 500 and 1,000 miles can be expected on most days.

80 and 160 meters

Some weak DX openings may occur during darkness hours and around sunrise, but will often be masked by high noise levels due to thunderstorm static. Night-time skip between 200 and 2,000 miles may be expected, but daytime skip will be limited to about 200 miles. 73, W1XU/7. 73

ABOVE AND BEYOND

continued from page 59

The front lens, for both transmitter and receiver, is made by carefully cutting out an exact-diameter lens centered on the circular pattern of the Fresnel lens material, cut to the same diameter as the outside of your 4-inch pipe. Be careful here, as the inner dimension of the pipe is 4 inches, the outside is slightly larger. You want the lens to be the exact size as the outer pipe dimension, as a 1/4-section (snap ring) of pipe will hold the lens in this splice union assembly for the soft acrylic lens.

A pipe union or splice for 4-inch pipe has a rib of plastic about 1/8-inch square centered inside the length of the splice union. This centrally located rib is used to hold the front of the lens internally in this union. A section of 4-inch pipe about 1/4-inch wide is then inserted into the splice union and pushed up to hold the rear of the lens firmly in place against the centrally located rib section. Essentially, the lens and 1/4-inch retaining ring holds and compresses the edge of the lens against the fixed rib, making a near perfect lens mount easy to construct.

After final focus with the LED transmitter and receiver optics, the outer part of the 4-inch pipe is marked where the caps and splice union should be positioned on the 4-inch main tube. Drill to hold this marked position on both the splice union and rear pipe caps and tap for 6/32 or a convenient short screw to hold these parts together firmly. Don't drill too deep and run the drill into the electronics inside the pipe caps.

Well, that's it for this month. Next time, I will get into the construction of the transmitter circuitry and details of the mount for both receiver and transmitter. See you next month, Chuck WB6IGP. 73

NEVER SAY DIE

continued from page 53

Dr. Bieler

Walter Chamberlin, an old buddy from my 1950 ham teletype days, stopped by with his wife Sally. Naturally our conversation got to health. I was surprised to find that Sally's father was Dr. Henry Bieler, who wrote *Food Is Your Best Medicine* back in 1965. The good doctor had discovered what I've discovered in my research — that all degenerative diseases are the result of poor nutrition. And that includes dental problems as well as arthritis, cancer, heart disease, Alzheimer's, Parkinson's, diabetes, and so on. The book, published by Ballantine Books, ISBN 0-345-35183-5, is \$6, 236 pages, 1992. So, if you won't take my word for the only way you are going to repair the years of damage you've done to your body through ignorance, and "doing what everyone else does," read Dr. Bieler's book and get busy rebuilding your body. Walt was kind enough to send me a copy of another Bieler book, one which is not currently in print, *The Incurables*. In it, he goes into detail on his treatment of youngsters with leukemia, kids the hospitals and other doctors had given up as incurable and would soon die. Step one was to stop all milk and milk products. Step two was to feed the kids pureed vegetables and either pureed raw

liver or liver juice (for babies). The results were spectacular! As I've mentioned, I happen to love raw liver. Mmm, it's good! Well, as I've explained, I do cheat just a little by searing the outside of the slab of liver for about five seconds per side. However, you are probably so conditioned that you won't even be able to try it. The ugggh factor.

Hmm, how strong is your ugh factor? Would you rather die than even try liver my way? Probably. Anyway, get the book and see if you can help some friends to stop poisoning themselves, even if you are unable. Go thou and heal!

Rich Dad

Spend the sixteen bucks for *Rich Dad, Poor Dad*, by Robert Kiyosaki, Tech Press, 6611 N. 64th Place, Paradise Valley AZ 85253. The better book stores should have it. ISBN 096438561-9. I love it when a book comes along that backs up my attempts to deprogram your total trust in jobs — in working for a company for a living. The author of the book has a poor dad, who is a college professor and thus never has much money. His best friend's dad, the rich dad, skipped college and has his own successful business.

The book pushes investing as a way to accumulate money. I've never had much of an interest in money, so I've never paid much attention to investing. I've invested, in my own way, by starting new magazines or other projects when I had any extra money. I've invested in growth, rather than cash or stocks.

But, no matter what you do with the money you make, this book makes it very clear that the normally accepted career path via college so you can become a working stiff is a crock. That's the poor dad approach.

For instance, Lesson Six says: Work to learn, don't work for money. If you read my *Secret Guide to Wealth*, this is exactly what I preach. Yet, this is a totally alien concept to 99.9% of the public. I've had over a thousand employees and I can't think of more than one or two who ever made any detectable effort to use their job as a way to learn. Almost all put in the minimum hours they could get away with and spent as little effort possible.

Just as reading a health book won't get most people to change their destructive eating habits, reading this book (and mine) won't change the belief in the need for a college "education." Such religious beliefs are deeply ingrained.

Pure Water

Considering all of the toxic waste in our drinking water, plus the importance of drinking at least eight glasses a day (remember, we're about 70% water, so we need a lot of water to keep our cells healthy — indeed, one of the moves Dr. Lorraine Day made when she found she had terminal breast cancer was to drink 20 glasses of pure water a day, plus lots of carrot juice and an all-raw

Continued on page 62

NEVER SAY DIE

continued from page 61

food diet), we need to invest around \$200 in either a reverse osmosis filter or a small still.

Well, there's a third, less expensive alternative. What you do is fill a jug with your tap water, then freeze it in your freezer for 18 hours, pour off the remaining liquid, and melt the ice. If you want to be sure to have ultra pure water, do this twice.

This is a process that can be used to desalinate sea water. Water freezes far before the impurities in it, so they stay at the bottom.

If you have fluorides or chlorine in your water you and your family are at risk. Why introduce these toxic chemicals into your body? Fluorine is one of the most corrosive elements known, just what you and your kids need to drink. It mottles the teeth and there isn't one honest study that has shown fluorides in the water to reduce tooth decay. If you think I'm wrong please read at least one of the books on the subject which I've reviewed in my *Secret Guide to Wisdom*.

Isolationist Hooey

Someone was nice enough to send me a video of John Coleman ranting about the loss of American jobs due to more and more of the stuff we used to make now being made in other countries. I remember Ross Perot telling us about the great sucking sound of American jobs moving to Mexico as a result of NAFTA.

Well, all these isolationists *are* right — millions of American jobs *have* been moving to lower wage countries. Gee, that's awful, isn't it? Here in New Hampshire hundreds, maybe thousands, of women who used to work on production lines in our shoe factories lost their jobs when the factories moved to China, and so on.

So, if it's so awful, how come our national unemployment is at record lows? Is everybody working for peanuts at McDonald's and Burger King? Worse, how about the millions of aliens who have come here, legally or illegally, taking away jobs from hard-working Americans? Okay, so where are the unemployment lines?

I was looking over my shirts. I have several that are so old they say "Made in USA." But my newer shirts were made in Malaysia, Indonesia, Mauritius, Pakistan, China, United Arab Emirates, Dominican Republic, Bangladesh, Taiwan, Hong Kong, South Africa, Korea, El Salvador, England, Ireland, and Japan.

With machine wash and wear winter flannel shirts (Malaysia) selling for \$10 from Haband (800-742-2263), and their "fit-for-ever" expandable jeans, which seem to also wear forever, at \$17.50 (United Arab Emirates), well-made clothes have never been cheaper.

Also, Americans have never been living better. Most families these days have all the usual appliances: color TVs (often in several rooms), VCR, microwave, food processor,

dishwasher, clothes washer and dryer, a personal computer or two, and so on.

When I was a kid, we had wash tubs in the basement, my mother used a washboard, and hung the clothes on the line in the back of the house. It had pulley wheels on each end so it could be loaded from the back porch. The ice man came a couple times a week. He knew how much ice to put in our ice box from the sign in the front window. The milk was delivered early every morning to the back porch. The Bohack boy delivered groceries on his bicycle which we ordered by phone. Our macaw would yell out "Bohack" when the boy appeared at the door. We washed the dishes in the kitchen sink and the dryer was one of the more modern conveniences, a wooden rack hung on the wall. There was a butter and egg man who delivered door to door, as well as a bakery man.

In the summer, a fellow came around with a horse-drawn wagon selling Italian ices. 2¢ and 3¢ cups. Delicious. The scissors and knife grinder man also had a horse-drawn wagon. The man buying used clothes was on foot. He walked down the middle of the street yelling, "Cash clothes." There weren't many cars in those days, so he didn't worry about getting run over. In fact, there were so few cars that we played marbles in the gutter. With cars parked solidly on every street kids can't do that any more. We also had Italians with hurdy-gurdies and a monkey to go after the pennies from his audiences down at the corner by the Chinese laundry.

Instead of making shoes and coats in New Hampshire we've got mail order companies such as Brookstone, Eastern Mountain Sports, and New England Business Services (NEBS). There's New Hampshire Ball Bearing, which makes miniature ball bearings for your disk drives, and hundreds of software companies. We've turned the old mill buildings into groups of boutiques and restaurants. PC/Mac Connection moved from an old farmhouse in Marlow NH, rebuilding a shopping mall in Amherst, where their hundreds of cars are parked seven days a week. New Hampshire has gone high-tech and, according to every national survey, has the highest quality of life of all 50 states. The air is clean. We're about 75% forested. We have no state income or sales taxes, so prices are bargains. Our White Mountains are beautiful and we have the largest citizen legislature in the country. Yet it's a state small enough so that I've known and worked with the last six governors personally.

Culture? There's a blues club a mile and a half from where I live. We've a nearby restaurant that specializes in folk and bluegrass entertainment. There are three Chinese restaurants and four supermarkets within a ten minute drive.

With today's cell phones, e-mail, voice mail, the Internet, and faxes, communications anywhere in the world has never been easier or cheaper. The personal computer has revolutionized everything, eliminating millions of semi-skilled jobs. Between jumbo jets and container ships, shipping has never been faster or cheaper.

Many worriers are bent out of shape over the idea of a world government. Well, a couple hundred years ago, 13 states got together and started the United States, and that has worked out pretty well. It's grown to 50 and if we'd relax a bit we'd see a bunch more countries delighted to join us.

Yes, I agree, we've got a lot of serious problems. It's just that, as bad as they are, the other countries are in worse shape. If we'd implement my proposals for solving the control big business and the banks have over Congress, my solution to the drug war, to our far-too-expensive health care system, to our worst-in-the-developed-world public school system, and so on, we'd be able to interest a hundred countries in joining us.

What drawback would there be if Canada added 13 more states? We might have more of a problem adjusting to 24 Mexican states. Well, at least we'd only have one Canadian state that wasn't English-speaking.

At any rate, the cry for isolationism should be ignored. It's all a bunch of hooey. Pee-rot, you're full of it.

Coffee

In my health guide, I list caffeine as an addictive poison which anyone interested in health should avoid. Sure, we're able to last 60 or 70 years, even when we poison our bodies with caffeine, nicotine, alcohol, sugar, cooked food, and so on. But the resulting quality of life sure sucks. I challenge you to find a nursing home anywhere that's feeding it's prisoners healthy food. That's as unlikely as finding any other kind of prison providing healthy food.

Coffee is so toxic that it does chromosomal damage, causing mutations. Just what parents want to do to their children, right? It has also been linked to an increased risk of stomach and bladder cancer. It contributes to diabetes. The rush of white cells to fight the caffeine depresses your immune system, making you more likely to get anything that's going around.

In animal tests those who were given coffee drank two to four times more alcohol. Yep, that morning cup of coffee you use to wake you up can help make you an alcoholic.

One of the most brilliant electronic engineers I've known was addicted to coffee. He got diabetes and it eventually killed him in his 60s.

Coffee reduces bone density for women. It reduces fertility, and it's responsible for a higher rate of miscarriages.

Oh yes, many sodas have caffeine in 'em, too.

Are you addicted? It's easy to find out. Just stop drinking coffee or caffeinated drinks like Coke — if you can. Good luck!

Reprints

of 73 Magazine articles

Only \$3.00 Each!

Call 800-274-7373

Wise Up!

Here are some of my books which can change your life (if you'll let 'em). If the idea of being healthy, wealthy and wise interests you, start reading. Yes, you can be all that, but only when you know the secrets which I've spent a lifetime uncovering.

.....Wayne

The Bioelectrifier Handbook: This explains how to build or buy (\$155) a little electrical gadget that can help clean the blood of any virus, microbe, parasite, fungus or yeast. The process was discovered by scientists at the Albert Einstein College of Medicine, quickly patented, and hushed up. It's curing AIDS, hepatitis C, and a bunch of other serious illnesses. The circuit can be built for under \$20 from the instructions in the book. \$10 (#01)

The Secret Guide to Wisdom: This is a review of around a hundred books that will help you change your life. No, I don't sell these books. They're on a wide range of subjects and will help to make you a very interesting person. Wait'll you see some of the gems you've missed reading. \$5 (#02)

The Secret Guide to Wealth: Just as with health, you'll find that you have been brainwashed by "the system" into a pattern of life that will keep you from ever making much money and having the freedom to travel and do what you want. I explain how anyone can get a dream job with no college, no résumé, and even without any experience. I explain how you can get someone to happily pay you to learn what you need to know to start your own business. \$5 (#03)

The Secret Guide to Health: Yes, there really is a secret to regaining your health and adding 30 to 60 years of healthy living to your life. The answer is simple, but it means making some difficult lifestyle changes. Will you be skiing the slopes of Aspen with me when you're 90 or doddering around a nursing home? Or pushing up daisies? No, I'm not selling any health products. \$5 (#04)

My WWII Submarine Adventures: Yes, I spent from 1943-1945 on a submarine, right in the middle of the war with Japan. We almost got sunk several times, and twice I was in the right place at the right time to save the boat. What's it really like to be depth charged? And what's the daily life aboard a submarine like? How about the Amelia Earhart inside story? If you're near Mobile, please visit the Drum. \$5 (#10)

Wayne's Caribbean Adventures: My super budget travel stories - where I

visit the hams and scuba dive most of the islands of the Caribbean. You'll love the special Liat fare which let me visit 11 countries in 21 days, diving all but one of the islands, Guadeloupe, where the hams kept me too busy with parties. \$5 (#12)

Cold Fusion Overview: This is both a brief history of cold fusion, which I predict will be one of the largest industries in the world in the 21st century, plus a simple explanation of how and why it works. This new field is going to generate a whole new bunch of billionaires, just as the personal computer industry did. \$5 (#20)

Cold Fusion Journal: They laughed when I predicted the PC industry growth in 1975. PCs are now the third largest industry in the world. The cold fusion ground floor is still wide open, but then that might mean giving up watching ball games. Sample: \$10 (#22).

Julian Schwinger: A Nobel laureate's talk about cold fusion—confirming its validity. \$2 (#24)

Improving State Government: Here are 24 ways that state governments can cut expenses enormously, while providing far better service. I explain how any government bureau or department can be gotten to cut its expenses by at least 50% in three years and do it cooperatively and enthusiastically. I explain how, by applying a new technology, the state can make it possible to provide all needed services without having to levy any taxes at all! Read the book, run for your legislature, and let's get busy making this country work like its founders wanted it to. Don't leave this for "someone else" to do. \$5 (#30)

Mankind's Extinction Predictions: If any one of the experts who have written books predicting a soon-to-come catastrophe which will virtually wipe most of us out are right, we're in trouble. In this book I explain about the various disaster scenarios, like Nostradamus, who says the poles will soon shift (as they have several times in the past), wiping out 97% of mankind. Okay, so he's made a long string of past lucky guesses. The worst part of these predictions is the accuracy record of some of the experts. Will it be a pole shift, a new ice age, a massive solar flare, a comet or asteroid, a bioterrorist attack? I'm getting ready, how about you? \$5 (#31)

Moondoggle: After reading René's book, *NASA Mooned America*, I read everything I could find on our Moon landings. I watched the videos, looked carefully at the photos, read the astronaut's biographies, and talked with some of my readers who worked for NASA. This book cites 25 good reasons I believe the whole Apollo program had to have been faked. \$5 (#32)

Classical Music Guide: A list of 100 CDs which will provide you with an outstanding collection of the finest classical music ever written. This is

what you need to help you reduce stress. Classical music also raises youngster's IQs, helps plants grow faster, and will make you healthier. Just wait'll you hear some of Gotschalk's fabulous music! \$5 (#33)

The Radar Coverup: Is police radar dangerous? Ross Adey K6UI, a world authority, confirms the dangers of radio and magnetic fields. \$3 (#34)

Three Gatto Talks: A prize-winning teacher explains what's wrong with American schools and why our kids are not being educated. Why are Swedish youngsters, who start school at 7 years of age, leaving our kids in the dust? Our kids are intentionally being dumbed down by our school system — the least effective and most expensive in the world. \$5 (#35)

Aspartame: a.k.a. NutraSweet, the stuff in diet drinks, etc., can cause all kinds of serious health problems. Multiple sclerosis, for one. Read all about it, two pamphlets for a buck. (#38)

One Hour CW: Using this sneaky booklet even you can learn the Morse Code in one hour and pass that dumb 5wpm HF entry test. \$5 (#40)

Code Tape (T5): This tape will teach you the letters, numbers and punctuation you need to know if you are going on to learn the code at 13 or 20 wpm. \$5 (#41)

Code Tape (T13): Once you know the code for the letters (#41) you can go immediately to copying 13 wpm (using my system). This should only take a couple of days. \$5 (#42)

Code Tape (T20): Or, you can start right out at 20 wpm and master it in a weekend. \$5 (#43)

Wayne Un-Dayton Talk: This is a 90-minute tape of the talk I'd have given at the Dayton, if invited. \$5 (#50)

Wayne Tampa Talk: This is the talk I gave at the Tampa Global Sciences conference—where I cover amateur radio, cold fusion, health, books you should read, and so on. \$5 (#51)

\$1 Million Sales Video: The secret of how you can generate an extra million dollars in sales just by using PR. This will be one of the best investments you or your business will ever make. \$40 (#52)

Reprints of My Editorials from 73. Very few things in this world are as we've been taught, and as they appear. I blow the whistle on the scams around us, such as the health care, our school system, our money, the drug war, a college education, sugar, the food giants, our unhealthy food, fluorides, EMFs, NutraSweet, etc.

1996 Editorials: 120 pages, 100 choice editorials. \$10 (#72)

1997 Editorials: 148 fun-packed pages. 216 editorials. \$10 (#74)

1998 Editorials: 168 pages that'll give you lots of controversial things to talk about on the air. \$10 (#75)

1999 Editorials: 132 pages of ideas, book reviews, health, education, and anything else I think you ought to know about. \$10 (#76)

2000 Editorials: In the works.

Silver Wire: With two 3" pieces of heavy pure silver wire + three 9V batteries you can make a thousand dollars worth of silver colloid. What do you do with it? It does what the antibiotics do, but germs can't adapt to it. Use it to get rid of germs on food, for skin fungus, warts, and even to drink. Read some books on the uses of silver colloid, it's like magic. \$15 (#80)

Wayne's Bell Saver Kit. The cable and instructions enabling you to inexpensively tape Art Bell W6OBB's nightly 5-hr radio talk show. \$5 (#83)

NH Reform Party Keynote Speech. It wow'd 'em when I laid out plans for NH in 2020, with much better, yet lower cost schools, zero state taxes, far better health care, a more responsive state government, etc. \$1 (#85)

Stuff I didn't write, but you need:

NASA Mooned America: René makes an air-tight case that NASA faked the Moon landings. This book will convince even you. \$25 (#90)

Last Skeptic of Science: This is René's book where he debunks a bunch of accepted scientific beliefs - such as the ice ages, the Earth being a magnet, the Moon causing the tides, and etc. \$25 (#91)

Dark Moon: 568 pages of carefully researched proof that the Apollo Moon landings were a hoax—a capping blow for René's skeptics. \$35 (#92)

Radio Bookshop

Box 416, Hancock NH 03449

Name _____ Call _____

Address _____

City-State-Zip _____

Use the numbers in the brackets or copy page and mark the books you want. Add \$3 s/h per total order in US (\$5 priority mail), \$6Can, \$10 foreign.

Order total: US\$ _____ Phone (for CC orders) _____

MC/Visa for orders over \$10. # _____ Expire _____

www.waynegr.com • phone orders: 603-525-4747 • fax: 603-588-3205 • w2nsd@aol.com

Yes! Put me down for a year of 73 for only \$25 (a steal). Canada US\$32. Foreign US\$44 by sea.

I'd like to get more romance into my dreary life so send me your How-To-Dance Videos catalog.

I need some industrial strength stress reduction so send me your Adventures In Music CD catalog

Allow 4 weeks for delivery except foreign, though we try to get most orders shipped in a day or two.

Turn your old ham and computer gear into cash now. Sure, you can wait for a hamfest to try and dump it, but you know you'll get a far more realistic price if you have it out where 100,000 active ham potential buyers can see it, rather than the few hundred local hams who come by a flea market table. Check your attic, garage, cellar and closet shelves and get cash for your ham and computer gear before it's too old to sell. You know you're not going to use it again, so why leave it for your widow to throw out? That stuff isn't getting any younger!

The 73 Flea Market, Barter 'n' Buy, costs you peanuts (almost)—comes to 35 cents a word for individual (noncommercial!) ads and \$1.00 a word for commercial ads. Don't plan on telling a long story. Use abbreviations, cram it in. But be honest. There are plenty of hams who love to fix things, so if it doesn't work, say so.

Make your list, count the words, including your call, address and phone number. Include a check or your credit card number and expiration. If you're placing a commercial ad, include an additional phone number, separate from your ad.

This is a monthly magazine, not a daily newspaper, so figure a couple months before the action starts; then be prepared. If you get too many calls, you priced it low. If you don't get many calls, too high.

So get busy. Blow the dust off, check everything out, make sure it still works right and maybe you can help make a ham newcomer or retired old timer happy with that rig you're not using now. Or you might get busy on your computer and put together a list of small gear/parts to send to those interested?

Send your ads and payment to: 73 Magazine, Barter 'n' Buy, 70 Hancock Rd., Peterborough NH 03458 and get set for the phone calls. The deadline for the September 2000 classified ad section is July 10, 2000.

President Clinton probably doesn't have a copy of *Tormet's Electronics Bench Reference* but you should. Check it out at [www.ohio.net/~rtormet/index.htm]
—over 100 pages of circuits, tables, RF design information, sources, etc. BNB530

TELEGRAPH COLLECTOR'S PRICE GUIDE: 250 pictures/prices. \$12 postpaid. **ARTIFAX BOOKS**, Box 88, Maynard MA 01754. Telegraph Museum: [<http://wltp.com>]. BNB113

Great New Reference Manual with over 100 pgs of P/S, transistor, radio, op-amp, antenna designs, coil winding tables, etc. See details at [www.ohio.net/~rtormet/index.htm] or send check or M.O. for \$19.95 + \$2.00 P&H to RMT Engineering, 6863 Buffham Rd., Seville OH 44273. BNB202

RF TRANSISTORS TUBES 2SC2879, 2SC1971, 2SC1972, MRF247, MRF455, MB8719, 2SC1307, 2SC2029, MRF454, 2SC3133, 4CX250B, 12DQ6, 6KG6A, etc. **WESTGATE**, 1-800-213-4563. BNB6000

QSL CARDS. Basic Styles; Black and White and Color Picture Cards; Custom Printed. Send 2 stamps for samples and literature. **RAUM'S**, 8617 Orchard Rd., Coopersburg PA 18036. Phone or FAX (215) 679-7238. BNB519

Cash for Collins: Buy any Collins Equipment. **Leo KJ6HI**. Tel./FAX (310) 670-6969. [radioleo@earthlink.net]. BNB425

Browse our web site and check out the "Monthly Special." TDL Technology, Inc. www.zianet.com/tdl. BNB500

MAHLON LOOMIS, INVENTOR OF RADIO, by Thomas Appleby (copyright 1967). Second printing available from **JOHAN K.V. SVANHOLM N3RF**, SVANHOLM RESEARCH LABORATORIES, P.O. Box 81, Washington DC 20044. Please send \$25.00 donation with \$5.00 for S&H. BNB420

Ham Radio Repair, Quality workmanship. All Brands, Fast Service. **Affordable Electronics**, 7110 E. Thomas Rd., Scottsdale, AZ 85251. Call 480-970-0963, or E-mail HAM_SERVICE@AOL.COM. BNB427

METHOD TO LEARN MORSE CODE FAST AND WITHOUT HANGUPS **Johan N3RF**. Send \$1.00 & SASE. SVANHOLM RESEARCH LABORATORIES, P.O. Box 81, Washington DC 20044 USA. BNB421

ASTRON power supply, brand-new w/warranty, RS20M \$99, RS35M \$145, RS50M \$209, RS70M \$249. **Web:** [www.aventrade.com]. Call for other models. (626) 286-0118. BNB411

HEATHKIT COMPANY is selling photocopies of most Heathkit manuals. Only authorized source for copyright manuals. **Phone:** (616) 925-5899, 8-4 ET. BNB964

"MORSE CODE DECIPHERED" Simple, elegant, inexpensive, comprehensive, logical, easy! E-mail [judlind@earthlink.net]. BNB428

Electricity, Magnetism, Gravity, The Big Bang. New explanation of basic forces of nature in this 91-page book covering early scientific theories and exploring latest controversial conclusions on their relationship to a unified field theory. To order, send check or money order for \$16.95 to: American Science Innovations, PO Box 155, Clarington OH 43915. Web site for other products [http://www.asi_2000.com]. BNB100

COLLOIDAL SILVER GENERATOR! Why buy a "box of batteries" for hundreds of dollars? Current regulated, AC powered, fully assembled with #12 AWG silver electrodes, \$74.50. Same, but DC powered, \$54.50. Add \$2.50 shipping. **Thomas Miller**, 962 Myers Parkway, Ashland OH 44805. BNB342

COLD FUSION! - FUEL CELL! - ELECTRIC BI-CYCLE! Each educational kit: (Basic - \$99.95, Deluxe - \$199.95, Information - \$9.95.) CATALOG - \$5.00. **ELECTRIC AUTOMOBILE BOOK** - \$19.95. **KAYLOR-KIT**, POB 1550ST, Boulder Creek CA 95006-1550. (831) 338-2300. BNB128

TELEGRAPH KEYS AT DAYTON HAMFEST: 500+ Civil War - Present. Bring Yours! History, Information, Appraisals, pretzels! Buying, Trading, Selling. **SPACE 2555**. <http://w1tp.com>. BNB705

ROHN TOWERS HUGE DISCOUNTS CHECK PRICES AT HILLRADIO.NET BNB600

Wanted COLLINS S-LINE Pristine (RE) 32S3-A, 75S3-C, 516F2, 312B4, 30L1, or 30S1 and SM-3. Willing to pay top dollar for the station I have wanted since age 13. 1-512-925-3907 (cell), 1-888-917-9077(home), toll free residential, willbryant@aol.com WA5JUL Bill Bryant. **THIS STATION IS FOR PERSONAL USE, NOT FOR RESALE!** BNB700

Silver, Gold, Calcium, Zinc. Health promoting minerals in pure water form. New technology = new products! Free Info: Health c/o Minerals, P.O. Box 23, Grantsburg, WI 54840. BNB701

ARIZONA STATE CONVENTION AND HAMFEST. Largest **FREE ADMISSION** Hamfest in the Southwest. July 28, 29, and 30, 2000. I-17 exit 337 (Ft. Tuthill), Flagstaff, AZ. Our 49th consecutive year. Manufacturers, Dealers, Exhibits, Seminars, VE Testing. Huge Swap. Camping and more. Gordon West, WB6NOA, will present two of his famous seminars and will be the (TBA) guest speaker at the Sat. night BBQ. Other speakers, seminars and forums include Dan Miller from ARRL Headquarters, and Bill Pasternak from Newsline. AMSAT, APRS, Ten-Tec, International, WRP, Ladies programs, and ARRL Forum. For more information, contact Amateur Radio Council of Arizona, POB 312, 16845 N 29th Avenue, Suite 1, Phoenix, AZ. 85080-2003 or Email: arcathill@aol.com. Voice mail 1-602-779-2722. Web site: <http://www.Hamsrus.com>. Enjoy cool weather and the pines. An ARRL-sanctioned event. BNB702

SAVE 47%!

on 12 months of **73**

Only \$24.97

Call 800-274-7373



FT-1000MP
The radio of choice for world-class contest operators, the FT-1000MP provides 100 Watts of power, Enhanced DSP,™ Dual In-band Receive, Cascaded IF filters, General Coverage RX, and 160-10 M TX. (DC-only version also available.)



FT-920
The FT-920 HF/6M Transceiver is designed for today's active Ham. It features high-speed DSP in all modes, 127 memory channels, AFSK or FSK Digital operation, new-technology MOSFET PA finals, high-speed Automatic Antenna Tuner, and high-resolution LCD display.



FT-1000D
Truly an elite-class HF masterpiece, the 200 Watt FT-1000D provides Dual Receive (in-band or cross-band), Cascaded IF Filters, extraordinary Dynamic Range, DDS, high-speed Automatic Antenna Tuner, and 100 memory channels.



FT-100
This ultra-compact HF/VHF/UHF 100 Watt Transceiver provides SSB, CW, AM, FM and AFSK coverage of the HF, 6M, 2M and 70 CM bands. Features include 300 memory channels, built-in Electronic Memory Keyer, DSP, IF Shift, IF Noise Blanker, and CTCSS/DCS.



FT-840
Affordable yet feature filled, the FT-840 is an ideal traveling companion. It offers 160-10M TX with general coverage RX, 100 memory channels, DDS, CTCSS, Twin Band Stacking VFOs, and excellent receiver dynamic range.



FT-600
This compact 100 Watt HF Transceiver offers the utmost in operating simplicity. The MIL-STD rated FT-600 covers the 160-10M Amateur bands with General Coverage Receive, 100 memory channels, Direct Keypad Frequency Entry, and a front-mounted speaker.

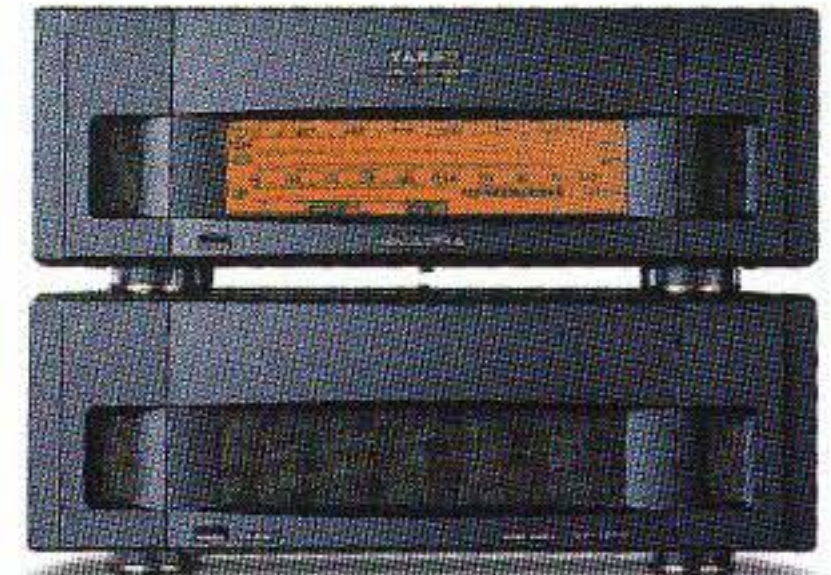

VL-1000/VP-1000
The VL-1000 Quadra System is a Solid-State Linear Amplifier featuring four twin-MOSFET PA modules to produce 1000 Watts of clean power output on 160-15 Meters (500 Watts on 6M, modifiable for 12/10 meters). Included are an Automatic Antenna tuner, 2 Input and 4 Output Antenna Jacks, and extensive status displays on the multi-function LCD.

FT-847

The introduction of the FT-847 completely redefines base station operation by offering three radios in one—HF, VHF/UHF and Satellite. A full power multi-mode transceiver, the appropriately named Earth Station covers the HF, 50 MHz, 144 MHz and 430 MHz bands, and it includes crossband Full Duplex operating capability for satellite work. Its exceptional receiver performance is ready for all aspects of DX work thanks to the DSP filtering. And for local FM work both CTCSS and DCS encode/decode are built in. The FT-847 is an engineering breakthrough offering you the earth, the sky, and the moon in one compact package.

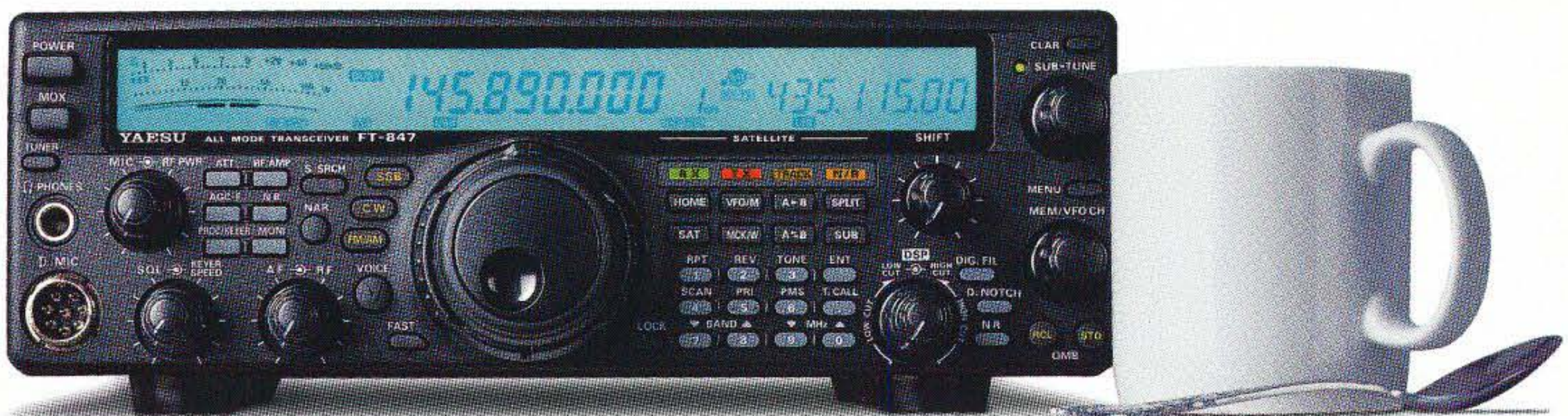

THE TASK MASTERS.

They're out there. Those elusive DX signals that can't poke through the QRM regardless of the late-night hours you put in trying to find them. But when a Yaesu HF enters the picture, weak signals suddenly jump into your headphones. Yaesu's High Frequency transceiver technology uniquely combines years of RF and AF design know-how with cutting edge advancements in IF filtering, noise reduction, and dynamic range. Whether you're on high bands or low, at home or away, the high frequency technology of Yaesu's task masters quickly fills up your log with contacts. Learn more about Yaesu products on the web at www.yaesu.com

YAESU Choice of the world's top DX'ers.

©1999 Yaesu USA, 17210 Edwards Road, Cerritos, CA 90703, (562) 404-2700. Specifications subject to change without notice. Specifications guaranteed only within amateur bands. Some accessories and/or options are standard in certain areas. Check with your local Yaesu dealer for specific details.

Dollar for Dollar... Best Value & Performance in HF Radio

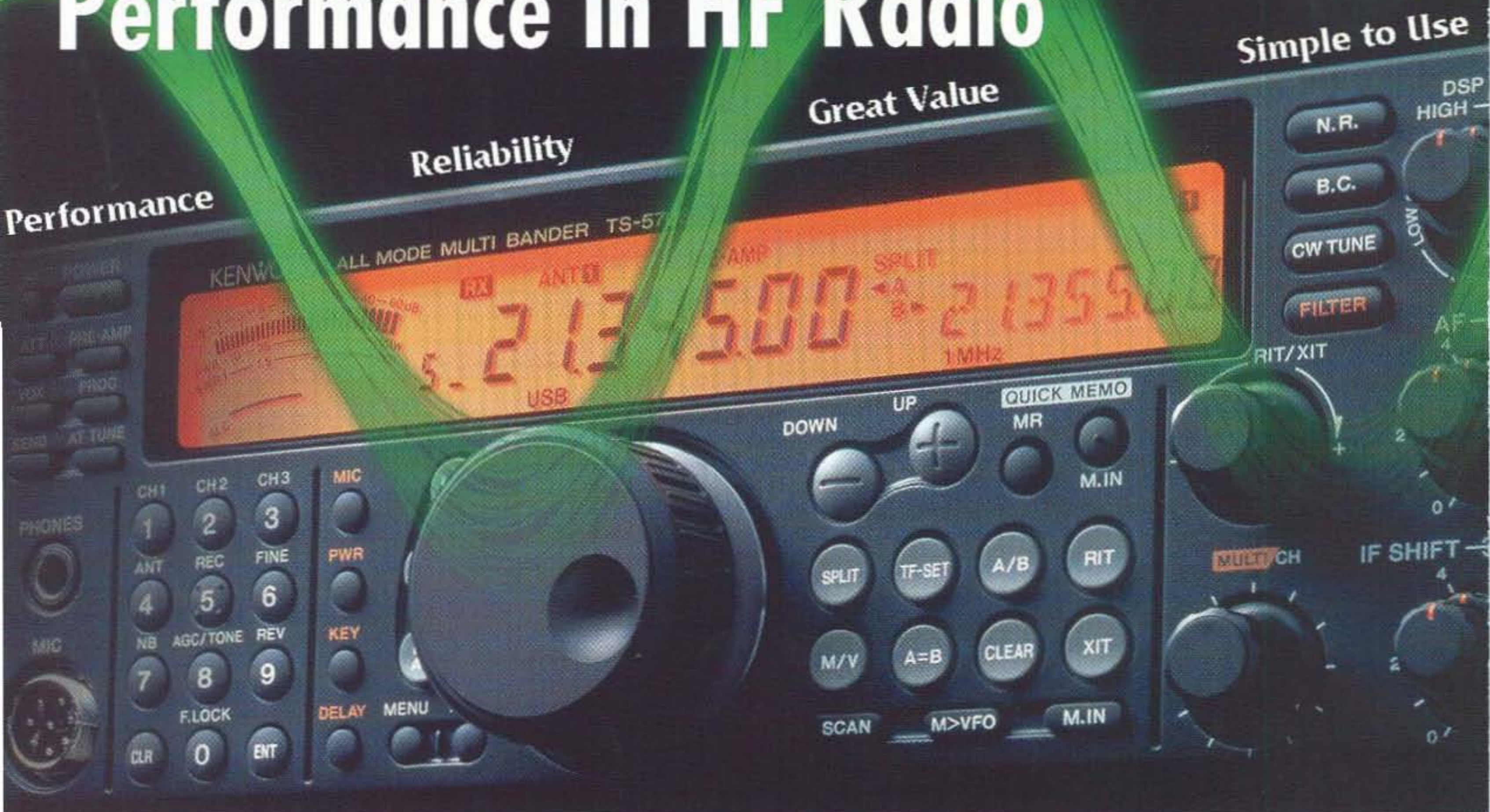

TS-570D(G) HF TRANSCEIVER/TS-570S(G) HF + 6M TRANSCEIVER

Kenwood has not been standing still since the introduction of the TS-570D/S HF Transceiver last year. Now you can command even more of Kenwood's advanced DSP technology with the G model.

The DSP filters and extracts signals with digital technology that is unmatched with standard analog circuits. It provides **CD-class transmit and receive audio quality** that can be shaped to your needs, and two powerful noise reduction systems: **Line Enhancer Method** for SSB/AM modes, and **Speech Processing by Auto Correlation (SPAC)** for CW mode. DSP also enables the **CW-Auto Tune** feature that automatically zero-beats CW signals.

The **Extensive Memory Functions** provide a bank of 100 memory positions split into 90 standard channels for general operation and 10 for programmable VFO, programmable scan and long-term memory. Memory contents can be scrolled, copied or locked out. In addition there are **5 quick memories** for storing frequencies and modes on the fly, perfect for the busy DX contester.

The powerful **Menu System** incorporates **46 menu features** and an **on-line guide** for instant reference. The **large amber backlit LCD display** provides 4 light levels for clear readability under any lighting conditions.

The TS-570D/S has no shortcomings in the construction and performance area. The **continuous-duty 100 watt transmitter** incorporates a large

heavy-duty heat sink with integrated cooling fan for non-stop operation even under extreme environmental conditions. The **wide-band receiver** is rock-stable from 500 kHz through 30 MHz with **dual pre-amps** and **dual bandpass filters** for exceptional selectivity and sensitivity.

With the features and performance of a high-end radio integrated into an affordable mobile-size package, the TS-570D/S is the perfect choice for the field or to build a full station around at home.

- ▶ **FREE operating manual via FTP site**
<ftp://ftp.kenwood.net>
- ▶ Beat cancel
- ▶ 2 position antenna switch
- ▶ CW auto tune adjust (a world's first)
- ▶ Channel scan, program band scan, memory scan with channel lock-out and group channel scan, all with TO (time operated) or CO (carrier operated) resume modes
- ▶ Compact 10-5/8 inch by 3-3/4 inch front panel size for any travel or installation requirement
- ▶ Preset auto antenna tuner with 18 sub-bands
- ▶ Variable electronic keyer (0 and 100 wpm)
- ▶ Packet and FSK features
- ▶ RCP-2 software for PC-based display and memory configurations available via the Internet
- ▶ Full functionality on 6M (TS-570S) including DSP, 100 watts output and preset Auto Antenna Tuner

TS-570D/S (G) new features

- TX sound quality monitor with 9-step monitor volume for absolute control over voice quality
- NR1 (SSB) is operator controllable in 9-step increments, or automatically tracks input signal strength
- New CW DSP Filters (80 Hz, 150 Hz and 500 Hz) give you a total of 11 user-selectable filters
- NR1 and NR2 settings can now re-configure automatically when changing mode groups (SSB/AM/FM to CW/FSK)
- Manual weight feature (with built-in electronic keyer) for adjusting the relative length of dots and dashes in 16 steps between 1:2.5 and 1:4.0
- Equalize receive signals, and use different settings for both TX and RX
- "One-touch" DSP filter wide mode allows 'resurfacing' to check the band conditions when operating in narrow mode
- Dual selectable Beat Cancel (BC) works against intermittent beat interference (except in CW mode)
- CW auto tune mode links only with the RIT frequency without changing the transmit frequency.

Advance Technology Upgrade is available in new production models and for pre-existing TS-570D/S; contact your dealer for details.



ISO 9001
JQA-1205

Communications Equipment Division
Kenwood Corporation
ISO9001 certification

KENWOOD
Amateur Radio Products Group

KENWOOD COMMUNICATIONS CORPORATION
AMATEUR RADIO PRODUCTS GROUP
P.O. Box 22745, 2201 E. Dominguez St., Long Beach, CA 90801-5745, U.S.A.
Customer Support/Brochures (310) 639-5300 Y2ARD-1993/#031700

INTERNET

Kenwood News & Products
<http://www.kenwood.net>