

Including Ham Radio Fun!

73[®] Amateur Radio Today

JULY 1998
ISSUE #454
USA \$3.95
CANADA \$4.95

International Edition



Darko Rusman T95A

Build a CW ID

80m RASER Beam

Timeout Battery Saver

Build an RF Ammeter

Vintage Ham Gear Prices

Review:

Pasokon's SSTV System



Get more features for your dollar with our REP-200 REPEATER

A microprocessor-controlled repeater with full auto-patch and many versatile dtmf remote control features at less than you might pay for a bare bones repeater or controller alone!

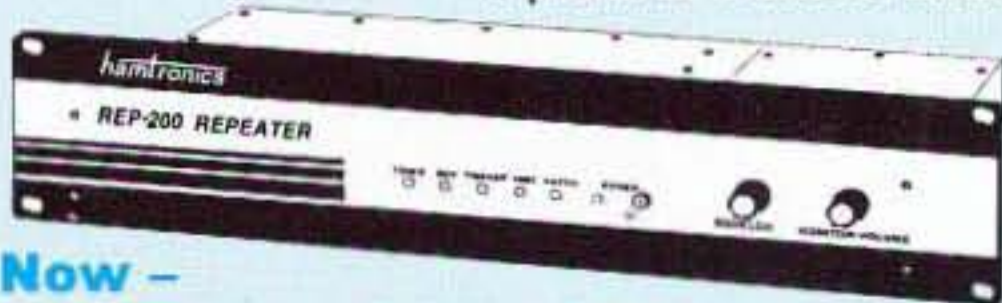

Now –
**2 meter machines in
stock for next day shipment!**

- kit still only \$1095
- factory assembled still only \$1295

50-54, 143-174, 213-233, 420-475 MHz. (902-928 MHz slightly higher.)
FCC type accepted for commercial service in 150 & 450 MHz bands.

Digital Voice Recorder Option. Allows message up to 20 sec. to be remotely recorded off the air. Play back at user request by DTMF command, or as a periodical voice id, or both. Great for making club announcements!only \$100.

REP-200C Economy Repeater. Real-voice ID, no dtmf or autopatch. Kit only \$795, w&t \$1195.

REP-200N Repeater. Without controller so you can use your own. Kit only \$695, w&t \$995.

You'll KICK Yourself If You Build a Repeater

Without Checking Out Our Catalog First!

Hamtronics has the world's most complete line of modules for making repeaters. In addition to exciters, pa's, and receivers, we offer the following controllers.

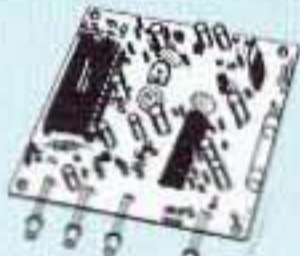

COR-3. Inexpensive, flexible COR module with timers, courtesy beep, audio mixer. only \$49/kit, \$79 w/t.

CWID. Traditional diode matrix ID'er. kit only \$59.

CWID-2. Eprom-controlled ID'er. only \$54/kit, \$79 w/t.

DVR-1. Record your own voice up to 20 sec. For voice id or playing club announcements. \$59/kit, \$99 w/t.

COR-4. Complete COR and CWID all on one board. ID in eprom. Low power CMOS. only \$99/kit, \$149 w/t.

COR-6. COR with real-voice id. Low power CMOS, non-volatile memory. kit only \$99, w/t only \$149.

COR-5. μ P controller with autopatch, reverse ap, phone remote control, lots of DTMF control functions, all on one board, as used in REP-200 Repeater. \$379 w/t.

AP-3. Repeater autopatch, reverse autopatch, phone line remote control. Use with TD-2. kit \$89.

TD-2. Four-digit DTMF decoder/controller. Five latching on-off functions, toll call restrictor. kit \$79.

TD-4. DTMF controller as above except one on-off function and no toll call restrictor. Can also use for selective calling; mute speaker until someone pages you. kit \$49.

SUBAUDIBLE TONE ENCODER/DECODER



Access all your favorite
closed repeaters!

- Encodes all standard CTCSS tones with crystal accuracy and convenient DIP switch selection.

- Comprehensive manual also shows how you can set up a front panel switch to select tones for several repeaters.
- Decoder can be used to mute receive audio and is optimized for installation in repeaters to provide closed access. High pass filter gets rid of annoying buzz in receiver. New low prices!

- TD-5 CTCSS Encoder/Decoder Kitnow only \$29
- TD-5 CTCSS Encoder/Decoder Wired/tested \$49

CRYSTAL CONTROLLED VHF & UHF FM EXCITERS & RECEIVERS

FM EXCITERS: 2W output, continuous duty.

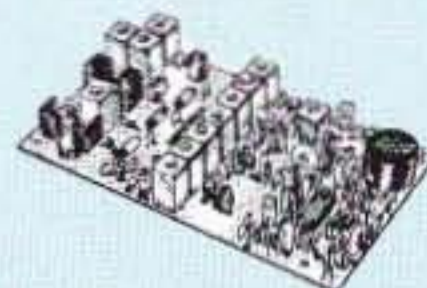

- TA51: for 6M, 2M, 220 MHz kit \$99, w/t \$169.
- TA451: for 420-475 MHz. kit \$99, w/t \$169.
- TA901: for 902-928 MHz, (0.5W out)w/t \$169.

VHF & UHF POWER AMPLIFIERS.

Output levels from 10W to 100W Starting at \$99.

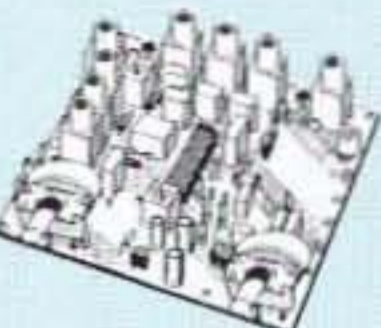

FM RECEIVERS:

- R100 VHF FM RCVR. Very sensitive – 0.15 μ V. Superb selectivity, >100 dB down at ± 12 kHz, best available anywhere, flutter-proof squelch. For 46-54, 72-76,

140-175, or 216-225 MHz. kit \$129, w/t \$189.

- R144 RCVR. Like R100, for 2M, with helical resonator in front end. kit \$159, w/t \$219.

- R451 FM RCVR, for 420-475 MHz. Similar to R100 above. kit \$129, w/t \$189.

- R901 FM RCVR, 902-928MHz \$159, w/t \$219.

WEATHER ALERT RECEIVER

A sensitive and selective professional grade receiver to monitor critical NOAA weather broadcasts. Good reception



even at distances of 70 miles or more with suitable antenna. No comparison with ordinary consumer radios!

Automatic mode provides storm watch, alerting you by unmuting receiver and providing an output to trip remote equipment when an alert tone is broadcast. Crystal controlled for accuracy; all 7 channels (162.40 to 162.55).

Buy just the receiver pcb module in kit form or buy the kit with an attractive metal cabinet, AC power adapter, and built-in speaker. Also available factory wired and tested.

RWX Rcvr kit, PCB only \$79

RWX Rcvr kit with cabinet, speaker, & AC adapter \$99

RWX Rcvr wired/tested in cabinet with speaker & adapter \$139

WEATHER FAX RECEIVER

Join the fun. Get striking images directly from the weather satellites!



A very sensitive wideband fm receiver optimized for NOAA APT & Russian Meteor weather fax on the 137MHz band.

Designed from the start for optimum satellite reception; not just an off-the-shelf scanner with a shorted-out IF filter!

Covers all 5 satellite channels. Scanner circuit & recorder control allow you to automatically capture signals as satellites pass overhead, even while away from home.

- R139 Receiver Kit less case \$159

- R139 Receiver Kit with case and AC power adapter \$189

- R139 Receiver w/t in case with AC power adapter ... \$239

- Internal PC Demodulator Board & Imaging Software \$289

- Turnstile Antenna \$119

- Weather Satellite Handbook \$20

WWV RECEIVER

Get time & frequency checks without buying multiband hf rcvr. Hear solar activity reports affecting radio propagation. Very sensitive and selective crystal controlled superhet, dedicated to listening to WWV on 10 MHz. Performance rivals the most expensive receivers.



- RWWV Rcvr kit, PCB only \$59

- RWWV Rcvr kit with cabt, spkr, & 12Vdc adapter \$89

- RWWV Rcvr w/t in cabt with spkr & adapter \$129

SYNTHESIZED VHF FM EXCITER & RECEIVER MODULES

No more waiting for crystals!



Hamtronics is pleased to announce a new line of its vhf fm transmitters and receivers, popular for repeaters, voice & data links, control, telemetry, and other demanding applications.

T301 Exciter and R301 Receiver provide high quality nbfm and fsk operation on 144-148 MHz and 220-225 MHz (also 139-174 MHz and 216-226 MHz for export and gov't services). Features include:

- Dip switch frequency selection.
- Exceptional modulation for voice and ctcss.
- Very low noise synthesizer for repeater service.
- Direct fm for data up to 9600 baud.
- Commercial grade tcxo for tight frequency accuracy in wide range of environmental conditions.
- In stock for same day shipping.

T301 EXCITER

Rated for continuous duty, 2-3W output.

- Kit (ham band only) ...\$109
- TCXO option ...\$40
- Wired/tested ...\$189 (includes TCXO)



R301 RECEIVER

- Kit (ham band only) ...only \$139
- TCXO option ...\$40
- Wired/tested ...\$209 (includes TCXO)

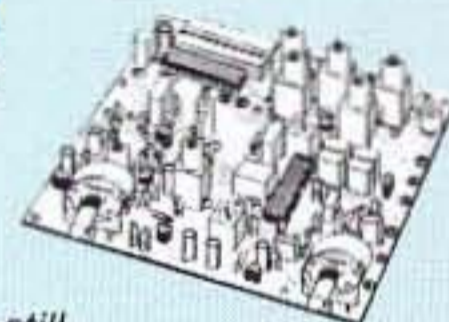

Traditional crystal-controlled receivers & exciters are still available for all vhf and uhf bands.

LOW NOISE RECEIVER PREAMPS

LNG-() GaAs FET PREAMP
STILL ONLY \$59, wired/tested

- Make your friends sick with envy! Work stations they don't even know are there.
- Install one at the antenna and overcome coax losses.
- Available for 28-30, 46-56, 137-152, 152-172, 210-230, 400-470, and 800-960 MHz bands.

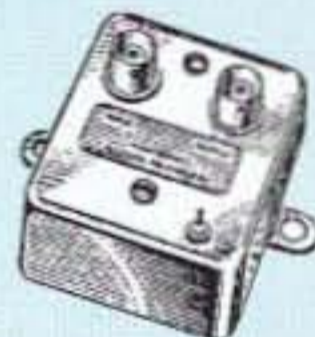

LNW-() ECONOMY PREAMP
NOW ONLY \$24/kit, \$44/w&t

- Miniature MOSFET Preamp
- Solder terminals allow easy connection inside radios.
- Available for 25-35, 35-55, 55-90, 90-120, 120-150, 150-200, 200-270, and 400-500 MHz bands.

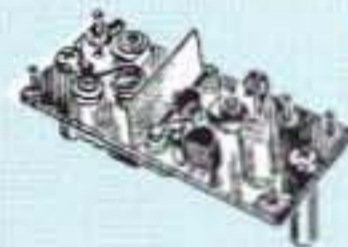

TRANSMITTING & RECEIVING CONVERTERS

No need to spend thousands on new transceivers for each band!



- Convert vhf and uhf signals to & from 10M.
- Even if you don't have a 10M rig, you can pick up very good used xmtrs & rcvrs for next to nothing.
- Receiving converters (shown above) available for various segments of 6M, 2M, 220, and 432 MHz.
- Rcvg Conv Kits from \$49, wired/tested units only \$99.
- Transmitting converters for 2M, 432 MHz.
- Kits only \$89 vhf or \$99 uhf.
- Power amplifiers up to 50W output.

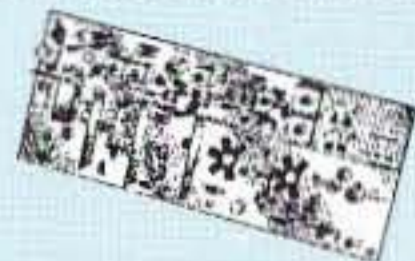

Buy at low, factory-direct net prices and save!
For complete info, call or write for complete catalog.
Order by mail, fax, email, or phone (9-12, 1-5 eastern time).
Min. \$6 S&H charge for 1st lb. plus add'l weight & insurance.
Use Visa, MC, Discover, check, or UPS C.O.D.



See SPECIAL OFFERS and view complete catalog on our web site:
www.hamtronics.com
email: jv@hamtronics.com

Our 36th Year
hamtronics, inc.
65-D Moul Rd; Hilton NY 14468-9535
Phone 716-392-9430 (fax -9420)

SWITCHING POWER SUPPLIES

	CONT.	ICS	WT.(LBS)
SS-10	7	10	3.2
SS-12	10	12	3.4
SS-18	15	18	3.6
SS-25	20	25	4.2
SS-30	25	30	5.0



SS-25M With volt & amp meters
SS-30M With volt & amp meters

ASTRON POWER SUPPLIES

• HEAVY DUTY • HIGH QUALITY • RUGGED • RELIABLE •

SPECIAL FEATURES

- SOLID STATE ELECTRONICALLY REGULATED
- FOLD-BACK CURRENT LIMITING Protects Power Supply from excessive current & continuous shorted output
- CROWBAR OVER VOLTAGE PROTECTION on all Models except RS-3A, RS-4A, RS-5A, RS-4L, RS-5L
- MAINTAIN REGULATION & LOW RIPPLE at low line input Voltage
- HEAVY DUTY HEAT SINK • CHASSIS MOUNT FUSE
- THREE CONDUCTOR POWER CORD except for RS-3A
- ONE YEAR WARRANTY • MADE IN U.S.A.

PERFORMANCE SPECIFICATIONS

- INPUT VOLTAGE: 105-125 VAC
- OUTPUT VOLTAGE: 13.8 VDC ± 0.05 volts (Internally Adjustable: 11-15 VDC)
- RIPPLE Less than 5mv peak to peak (full load & low line)
- All units available in 220 VAC input voltage (except for SL-11A)

SL SERIES



• LOW PROFILE POWER SUPPLY

MODEL	Colors		Continuous Duty (Amps)	ICS* (Amps)	Size (IN) H x W x D	Shipping Wt. (lbs.)
	Gray	Black				
SL-11A	•	•	7	11	2 5/8 x 7 5/8 x 9 3/4	12
SL-11R	•	•	7	11	2 5/8 x 7 x 9 3/4	12
SL-11S	•	•	7	11	2 5/8 x 7 5/8 x 9 3/4	12
SL-11R-RA	•	•	7	11	4 3/4 x 7 x 9 3/4	13

RS-L SERIES



• POWER SUPPLIES WITH BUILT IN CIGARETTE LIGHTER RECEPTACLE

MODEL	Continuous Duty (Amps)	ICS* (Amps)	Size (IN) H x W x D	Shipping Wt. (lbs.)
RS-4L	3	4	3 1/2 x 6 1/8 x 7 1/4	6
RS-5L	4	5	3 1/2 x 6 1/8 x 7 1/4	7

RM SERIES



MODEL RM-35M

• 19" RACK MOUNT POWER SUPPLIES

MODEL	Continuous Duty (Amps)	ICS* (Amps)	Size (IN) H x W x D	Shipping Wt. (lbs.)
RM-35A	25	35	5 1/4 x 19 x 12 1/2	38
RM-50A	37	50	5 1/4 x 19 x 12 1/2	50
RM-60A	50	55	7 x 19 x 12 1/2	60
• Separate Volt and Amp Meters				
RM-12M	9	12	5 1/4 x 19 x 8 1/4	16
RM-35M	25	35	5 1/4 x 19 x 12 1/2	38
RM-50M	37	50	5 1/4 x 19 x 12 1/2	50
RM-60M	50	55	7 x 19 x 12 1/2	60

RS-A SERIES



MODEL RS-7A

MODEL	Colors		Continuous Duty (Amps)	ICS* (Amps)	Size (IN) H x W x D	Shipping Wt. (lbs.)
	Gray	Black				
RS-3A	•	•	2.5	3	3 x 4 3/4 x 5 3/4	4
RS-4A	•	•	3	4	3 3/4 x 6 1/2 x 9	5
RS-5A	•	•	4	5	3 1/2 x 6 1/8 x 7 1/4	7
RS-7A	•	•	5	7	3 3/4 x 6 1/2 x 9	9
RS-10A	•	•	7.5	10	4 x 7 1/2 x 10 3/4	11
RS-12A	•	•	9	12	4 1/2 x 8 x 9	13
RS-12B	•	•	9	12	4 x 7 1/2 x 10 3/4	13
RS-20A	•	•	16	20	5 x 9 x 10 1/2	18
RS-35A	•	•	25	35	5 x 11 x 11	27
RS-50A	•	•	37	50	6 x 13 3/4 x 11	46
RS-70A	•	•	57	70	6 x 13 3/4 x 12 1/8	48

RS-M SERIES



MODEL RS-35M

MODEL	Continuous Duty (Amps)	ICS* (Amps)	Size (IN) H x W x D	Shipping Wt. (lbs.)
• Switchable volt and Amp meter				
RS-12M	9	12	4 1/2 x 8 x 9	13
• Separate volt and Amp meters				
RS-20M	16	20	5 x 9 x 10 1/2	18
RS-35M	25	35	5 x 11 x 11	27
RS-50M	37	50	6 x 13 3/4 x 11	46
RS-70M	57	70	6 x 13 3/4 x 12 1/8	48

VS-M AND VRM-M SERIES



MODEL VS-35M

• Separate Volt and Amp Meters • Output Voltage adjustable from 2-15 volts • Current limit adjustable from 1.5 amps to Full Load

MODEL	Continuous Duty (Amps)			ICS* (Amps)	Size (IN) H x W x D	Shipping Wt. (lbs.)
	@13.8VDC	@10VDC	@5VDC			
VS-12M	9	5	2	12	4 1/2 x 8 x 9	13
VS-20M	16	9	4	20	5 x 9 x 10 1/2	20
VS-35M	25	15	7	35	5 x 11 x 11	29
VS-50M	37	22	10	50	6 x 13 3/4 x 11	46
VS-70M	67	34	16	70	6 x 13 3/4 x 12 1/8	48
• Variable rack mount power supplies						
VRM-35M	25	15	7	35	5 1/4 x 19 x 12 1/2	38
VRM-50M	37	22	10	50	5 1/4 x 19 x 12 1/2	50

RS-S SERIES



MODEL RS-12S

• Built in speaker

MODEL	Colors		Continuous Duty (Amps)	ICS* Amps	Size (IN) H x W x D	Shipping Wt. (lbs.)
	Gray	Black				
RS-7S	•	•	5	7	4 x 7 1/2 x 10 3/4	10
RS-10S	•	•	7.5	10	4 x 7 1/2 x 10 3/4	12
RS-12S	•	•	9	12	4 1/2 x 8 x 9	13
RS-20S	•	•	16	20	5 x 9 x 10 1/2	18
SL-11S	•	•	7	11	2 3/4 x 7 5/8 x 9 3/4	12

Synthesized FM Stereo Transmitter



Microprocessor controlled for easy frequency programming using DIP switches, no drift, your signal is rock solid all the time - just like the commercial stations. Audio quality is excellent, connect to the line output of any CD player, tape deck or mike mixer and you're on-the-air. Foreign buyers will appreciate the high power output capability of the FM-25; many Caribbean folks use a single FM-25 to cover the whole island! New, improved, clean and hum-free runs on either 12 VDC or 120 VAC. Kit comes complete with case set, whip antenna, 120 VAC power adapter - easy one evening assembly.

FM-25, Synthesized FM Stereo Transmitter Kit.....\$129.95



Tunable FM Stereo Transmitter

A lower cost alternative to our high performance transmitters. Offers great value, tunable over the 88-108 MHz FM broadcast band, plenty of power and our manual goes into great detail outlining aspects of antennas, transmitting range and the FCC rules and regulations. Connects to any cassette deck, CD player or mixer and you're on-the-air, you'll be amazed at the exceptional audio quality! Runs on internal 9V battery or external power from 5 to 15 VDC, or optional 120 VAC adapter. Add our matching case and whip antenna set for a nice finished look.

FM-10A, Tunable FM Stereo Transmitter Kit.....\$34.95
CFM, Matching Case and Antenna Set.....\$14.95

RF Power Booster Amplifier



Add some serious muscle to your signal, boost power up to 1 watt over a frequency range of 100 KHz to over 1000 MHz! Use as a lab amp for signal generators, plus many foreign users employ the LPA-1 to boost the power of their FM Stereo transmitters, providing radio service through an entire town. Power required: 12 to 15 volts DC at 250mA, gain of 38dB at 10 MHz, 10 dB at 1000 MHz. For a neat, professionally finished look, add the optional matching case set.

LPA-1, Power Booster Amplifier Kit.....\$39.95
CLPA, Matching Case Set for LPA-1 Kit.....\$14.95
LPA-1WT, Fully Wired LPA-1 with Case.....\$99.95

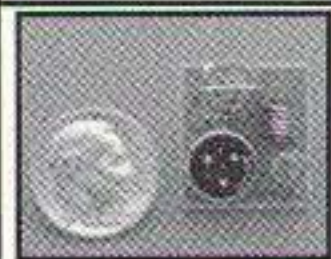

Micro FM Wireless Mike

World's smallest FM transmitter. Size of a sugar cube! Uses SMT (Surface Mount Technology) devices and mini electret condenser microphone, even the battery is included. We give you two complete sets of SMT parts to allow for any errors or mishaps-build it carefully and you've got extra SMT parts to build another! Audio quality and pick-up is unbelievable, transmission range up to 300 feet, tunable to anywhere in standard FM band 88 to 108 MHz. 7/8" w x 3/8" h x 3/4" h.

FM-5 Micro FM Wireless Mike Kit.....\$19.95

Crystal Controlled Wireless Mike



Super stable, drift free, not affected by temperature, metal or your body! Frequency is set by a crystal in the 2 meter Ham band of 146.535 MHz, easily picked up on any scanner radio or 2 meter rig. Changing the crystal to put frequency anywhere in the 140 to 160 MHz range-crystals cost only five or six dollars. Sensitive electret condenser mike picks up whispers anywhere in a room and transmit up to 1/4 mile. Powered by 3 volt Lithium or pair of watch batteries which are included. Uses the latest in SMT surface mount parts and we even include a few extras in case you sneeze and lose a part!

FM-6, Crystal Controlled FM Wireless Mike Kit.....\$39.95
FM-6WT Fully Wired FM-6.....\$69.95

RAMSEY

Super Pro FM Stereo Radio Transmitter

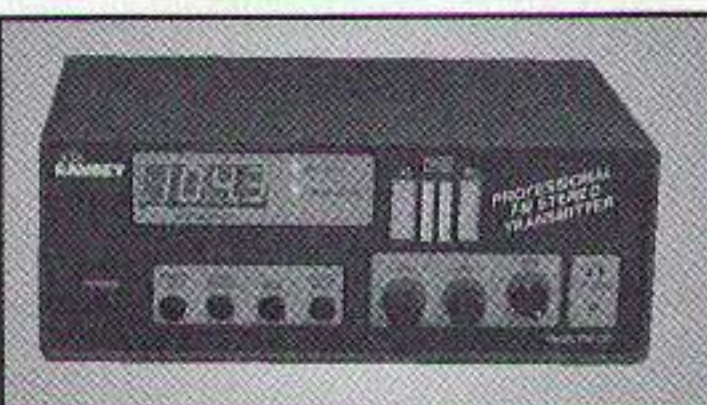

A truly professional frequency synthesized FM Stereo transmitter station in one easy to use, handsome cabinet. Most radio stations require a whole equipment rack to hold all the features

we've packed into the FM-100. Set frequency easily with the Up/Down freq buttons and the big LED digital display. Plus there's input low pass filtering that gives great sound no matter what the source (no more squeals or swishing sounds from cheap CD player inputs!) Peak limiters for maximum 'punch' in your audio - without over modulation, LED bargraph meters for easy setting of audio levels and a built-in mixer with mike and line level inputs. Churches, drive-ins, schools and colleges find the FM-100 to be the answer to their transmitting needs, you will too. No one offers all these features at this price! Kit includes cabinet, whip antenna and 120 VAC supply. We also offer a high power export version of the FM-100 that's fully assembled with one watt of RF power, for miles of program coverage. *The export version can only be shipped outside the USA, or within the US if accompanied by a signed statement that the unit will be exported.*

FM-100, Professional FM Stereo Transmitter Kit.....\$299.95
FM-100WT, Fully Wired High Power FM-100.....\$429.95

AM Band Radio Transmitter



Ramsey AM radio transmitters operate in the standard AM broadcast band and are easily set to any clear channel in your area. Our AM-25, 'pro' version, fully synthesized transmitter features easy frequency setting DIP switches for stable, no-drift frequency control, while being jumper settable for higher power output where regulations allow. The entry-level AM-1 uses a tunable transmit oscillator and runs the maximum 100 milliwatts of power. No FCC license is required, expected range is up to 1/4 mile depending upon antenna and conditions. Transmitters accept standard line-level inputs from tape decks, CD players or mike mixers, and run on 12 volts DC. The Pro AM-25 comes complete with AC power adapter, matching case set and bottom loaded wire antenna. Our entry-level AM-1 has an available matching case and knob set for a finished, professional look.

AM-25 Professional AM Transmitter Kit.....\$129.95
AM-1 Entry level AM Radio Transmitter Kit.....\$29.95
Cam Matching Case Set for AM-1.....\$14.95

Tone-Grabber Touch Tone Decoder / Reader



Dialed phone numbers, repeater codes, control codes, anywhere touch-

tones are used, your TG-1 will decode and store any number it hears. A simple hook-up to any radio speaker or phone line is all that is required, and since the TG-1 uses a central office quality decoder and microprocessor, it will decode digits at virtually any speed! A 256 digit non-volatile memory stores numbers for 100 years - even with the power turned off, and an 8 digit LED display allows you to scroll through anywhere in memory. To make it easy to pick out numbers and codes, a dash is inserted between any group or set of numbers that were decoded more than 2 seconds apart. The TG-1 runs from any 7 to 15 volt DC power source and is both voltage regulated and crystal controlled for the ultimate in stability. For stand-alone use add our matching case set for a clean, professionally finished project. We have a TG-1 connected up here at the Ramsey factory on the FM radio. It's fun to see the phone numbers that are dialed on the morning radio show! Although the TG-1 requires less than an evening to assemble (and is fun to build, too!), we offer the TG-1 fully wired and tested in matching case for a special price.

TG-1, Tone Grabber Kit.....\$99.95
CTG, Matching Case Set for TG-1 Kit.....\$14.95
TG-1WT, Fully Wired Tone Grabber with Case.....\$149.95
AC12-5, 12 Volt DC Wall Plug Adapter.....\$9.95



The Cube World's Smallest TV Transmitter

Perfect video transmission from a transmitter you can hide under a quarter and only as thick as a stack of four pennies - that's a nickel in the picture! Transmits color or B&W up to 150' to any TV tuned to cable channel 59 with a solid 20 mW of power. Crystal controlled for no frequency drift with performance that equals law enforcement models that cost hundreds more! Deluxe model includes sound using a sensitive built-in mike that will hear a whisper 15 feet away! Units run on 9 volts and hook-up to most any CCD camera. Our cameras shown below have been tested to mate perfectly with The Cube and work great. Fully assembled.



C-2000 Video Transmitter Cube.....\$89.95
C-3000 Video and Audio Transmitter Cube.....\$149.95



CCD Camera Interface Board

Here's a nifty little kit that eases hook-up of your CCD camera module to any video monitor, VCR or video input TV set. The board provides a voltage regulated and filtered source to power the camera (CCD Cameras require a stable source of power for best operation), sensitive electret condenser mike for great sound pick-up and RCA Phono jacks for both audio and video outputs. Runs on 11 - 20 VDC

IB-1 Interface Board Kit.....\$14.95

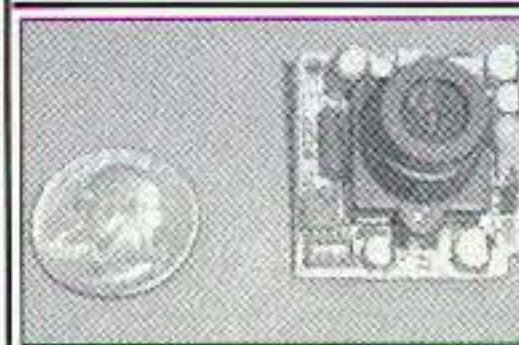

CCD Video Cameras

If you're looking for a good quality CCD board camera, stop right here! Our cameras use top quality Japanese Class 'A' CCD arrays, not the off-spec arrays that are found on many other cameras. You see, the Japanese suppliers grade the CCDs at manufacture and some manufacturers end up with the off-grade chips due to either cost constraints or lack of buying 'clout'. These cameras have nice clean fields and excellent light sensitivity, you'll really see the difference, and if you want to see in the dark, these are super IR (Infra-Red) sensitive! Available with Wide-angle (80°) or super slim Pin-hole style lens. Both run on 9 VDC and produce standard 1 volt p-p video. Add one of our transmitter units for wireless transmission to any TV set, or add our Interface board (below) for Audio sound pick-up and direct wire connection to any Video monitor or TV video/audio input jacks. Fully assembled.

CCDWA-2 CCD Camera, wide-angle lens.....\$99.95
CCDPH-2 CCD Camera, slim fit pin-hole lens.....\$99.95
IR-1 IR Illuminator Kit.....\$24.95

Call for our Free Catalog !

RAMSEY ELECTRONICS, INC.
793 Canning Parkway
Victor, NY 14564

Order Toll-free: 1-800-446-2295

Sorry, no tech info or order status at this number

Technical Info, Order Status
Call Factory direct: (716) 924-4560

www.ramseyelectronics.com



ORDERING INFO: Satisfaction Guaranteed. Examine for 10 days, if not pleased, return in original form for refund. Add \$6.95 for shipping, handling and insurance. Orders under \$20, add \$3.00. NY residents add 7% sales tax. Sorry, no CODs. Foreign orders, add 20% for surface mail or use credit card and specify shipping method.

THE TEAM

El Supremo & Founder
Wayne Green W2NSD/1

Associate Publisher
F. I. Marion

Associate Technical Editor
Larry Antonuk WB9RRT

Nitty Gritty Stuff
J. Clayton Burnett
Priscilla Gauvin
Joyce Sawtelle

Contributing Culprits

Bill Brown WB8ELK
Mike Bryce WB8VGE
Joseph E. Carr K4IPV
Michael Geier KB1UM
Jim Gray W1XU/7
Jack Heller KB7NO
Chuck Houghton WB6IGP
Dr. Marc Leavey WA3AJR
Andy MacAllister W5ACM
Dave Miller NZ9E
Joe Moell K0OV
Steve Nowak KE8YN/5
Carole Perry WB2MGP

Advertising Sales

Frances Hyvarinen
Roger Smith
603-924-0058
800-274-7373
Fax: 603-924-8613

Circulation

Linda Coughlan

Data Entry & Other Stuff

Christine Aubert
Norman Marion

Business Office

Editorial - Advertising - Circulation
Feedback - Product Reviews
73 Amateur Radio Today Magazine
70 Route 202N
Peterborough NH 03458-1107
603-924-0058
Fax: 603-924-8613

Reprints: \$3 per article
Back issues: \$5 each

Printed in the USA

Manuscripts: Contributions for possible publication are most welcome. We'll do the best we can to return anything you request, but we assume no responsibility for loss or damage. Payment for submitted articles will be made after publication. Please submit both a disk and a hard copy of your article (IBM (ok) or Mac (preferred) formats), carefully checked drawings and schematics, and the clearest, best focused and lighted photos you can manage. "How to write for 73" guidelines are available on request. US citizens, please include your Social Security number with submitted manuscripts so we can submit it to you know who.

JULY 1998
ISSUE #454

73[®] Amateur Radio Today

Including Ham Radio Fun!

TABLE OF CONTENTS

FEATURES

- 10 **Raising the RASER to New Heights — W2OZH**
A two-element beam for 80 meters.
- 15 **Build This Simple CW Identifier — KA2CWL, K2MQJ**
You, too, can program EPROMs.
- 21 **FM Revisited — W6WTU**
Secrets of stuff you thought you knew.
- 25 **Vintage Values — W2BLC**
Heading for a hamfest? Tempted by the timeless?
- 29 **Home-Brew RF Ammeter for the Shack — W4LJD**
Another fun project from W4LJD.
- 34 **Take the Jekyll and Hyde Test — W2CQM**
Which shack is yours?
- 42 **Mega-Mini Micropower Timeout Switch — N4UAU**
Here's a great excuse to play with SMT.

DEPARTMENTS

WB6IGP	50	Above & Beyond
	73	Ad Index
	88	Barter 'n' Buy
K4IPV	74	Carr's Corner
N0UJR	88	Cartoon
KB7NO	52	The Digital Port
WB2MGP	57	Hams With Class
NZ9E	54	Ham to Ham
K0OV	60	Homing In
	6	Letters
W2NSD/1	4	Never Say Die
	72, 86	New Products
KE8YN/4	62	On the Go
W1XU/7	87	Propagation
WB8VGE	58	QRP
	8	QRX
	48, 56, 58, 76,	
	80, 82, 83, 84,	
	85, 88	Radio Bookshop
WA3AJR	63	RTTY Loop
	38	Special Events
	87	Updates

REVIEW

- 31 **A Look At Pasokon's 3.1 SSTV System — K1BUM**
Today's slow-scan gets better and easier.

HAM RADIO FUN SECTION

KA4J	64	The Shelby Hamfest <i>What are you doing the weekend before Labor Day?</i>
WB2AQC	65	Roamin' Romania <i>Part 2: Amateurs of the Jiu Valley.</i>

On the cover: Darko Rusman T95A lives and works in Bosnia, 14th rarest DX country in the world. He is a radio operator working with the United Nations High Commission for Refugees in Tuzla, and one of Bosnia's most active hams. On good weekends he works as many as 500 stations around the world, concentrating on the United States. Photo submitted by Jeffrey L. Baker T98WKU & WK3U.

Feedback: Any circuit works better with feedback, so please take the time to report on how much you like, hate, or don't care one way or the other about the articles and columns in this issue. G = great!, O = okay, and U = ugh. The G's and O's will be continued. Enough U's and it's Silent Keysville. Hey, this is *your* communications medium, so don't just sit there scratching your...er...head. FYI: Feedback "number" is usually the page number on which the article or column starts.

73 Amateur Radio Today (ISSN 1052-2522) is published monthly by 73 Magazine, 70 N202, Peterborough NH 03458-1107. The entire contents ©1998 by 73 Magazine. No part of this publication may be reproduced without written permission of the publisher, which is not all that difficult to get. The subscription rate is: one year \$24.97, two years \$44.97; Canada: one year \$34.21, two years \$57.75, including postage and 7% GST. Foreign postage: \$19 surface, \$42 airmail additional per year, payable in US funds on a US bank. Second class postage is paid at Peterborough, NH, and at additional mailing offices. Canadian second class mail registration #178101. Canadian GST registration #125393314. Microfilm edition: University Microfilm, Ann Arbor MI 48106. POSTMASTER: Send address changes to 73 Amateur Radio Today, 70 N202, Peterborough NH 03458-1107. 73 Amateur Radio Today is owned by Shabromat Way Ltd. of Hancock NH.

Contract: By being so nosey as to read this fine print, you have just entered into a binding agreement with 73 Amateur Radio Today. You are hereby obligated to do something nice for a ham friend—buy him a subscription to 73. What? All of your ham friends are already subscribers? Donate a subscription to your local school library!

NEVER SAY DIE

Wayne Green W2NSD/1



Rx Laughter

Laughing is good for you, so stay the heck away from 14.313. Laughing helps block pain, relaxes your muscles, fights infection, and reduces emotional stress. Certainly, by now, you must have read or heard about Norman Cousins' laughing his way out of ankylosing spondylitis, a debilitating arthritis-like illness.

This Rx came to mind when I was reading the cover features about the *South Park* TV series on the Comedy Central channel in both *Newsweek* and *Time*. And in *TV Guide* too. Most of the episodes break me up, but the Christmas one about Mr. Hanky had me laughing until I was gasping for breath. They keep repeating the older episodes, so keep your VCR handy and save 'em all for when you need a pick-me-up.

If you've heard me being interviewed on the Art Bell (W6OBB) radio talk show or attended any of my talks at hamfests you know I love to laugh. I don't take very many things seriously. Heck, if I did I'd have been dead a long time ago.

So I buy the *Dilbert* books and get big loud laughs as I read 'em, over and over. And I get some great laughs from *The Simpsons* and *Roseanne* reruns.

Say, if you know of any books or other stuff that might get me laughing, drop me a note. If you're too cheap to spend the 32¢, then send it via [design73@aol.com]. I read my snail stuff every day and my E-mail once a week (or so).

In my *Guide to Books* I list several books that always make me laugh. Have you ever read any of H. Allen Smith's books? Or the old Alexander Botts stories by Upson? Then there's Thurber, Benchley, and Potter. Don't forget O'Rourke!

Staples vs. Paper Clips

Staple users tend to be uptight and impatient. Bam, and they're done with it. Paper clip users understand that nothing is permanent, so they like to make it easy to change things. I've noticed that paper clip people tend to be more creative, open to new ideas and developments, while the staplers tend to be firmly stuck in their ingrained working, living, and thinking habit patterns. Worse, many staplers tend to be seriously disorganized, so I suspect that staples give them a false sense of organization. Let me know if you see any correlation between staple users and people who are self-abusers — like smokers, coffee drinkers, or alcoholics.

I don't have a stapler anywhere near my working areas, but I do keep a staple-puller at hand when I'm opening the mail so I can deal with the seldom-worth-reading stuff from staplers.

Energy Sources

To get an idea of what the cold fusion crowd (can such a small group be called a crowd?) is up against, consider the size of the industries that could be decimated by this new technology. Now, if you were an executive drawing

down six or seven figures in one of the companies presently supplying energy, what would be your reaction to a new energy source which threatened to supply energy at one-tenth of the cost of your product?

Today 40% of our energy comes from oil, 25% from natural gas, 23% from coal, and 12% from hydro, wind, solar, and nuclear. These giants aren't going to be blown away without a fight. A very big fight.

Right now their influence can be felt with the disinformation campaign to discredit cold fusion: the Department of Energy's head calling cold fusion a hoax, and the Patent Office refusing even to consider any cold fusion patent applications.

Alas, there's nothing new about this situation. Every new technology has faced similar battles.

You've probably read about the court-martial of Billy Mitchell, who claimed that airplanes could sink a battleship. By a coincidence, my father was there at Langley Field at the time as a pilot, working with and a good friend of Mitchell. I was there, too, but I was a little too young to remember the celebrated case. I do remember my dad taking me up in their Martin bombers. Heck, he first took me up when I was two months old, so I've been flying since 1922.

Ooops, I'm off on a tangent. Golly, that's never happened before!

The biggest use for oil (1998 figures) is for personal vehicles (34%), then for truck-

ing (20%), industrial fuel (8.3%), air transport (7.6%), heat and power (7.3%), water transport (2.7%), and other misc. (8%). Thus the biggest change is going to come about when cold fusion generators are adapted to vehicles, thus eliminating half the need for oil, refineries, tankers, and corner gas stations. Gee, we'll sure miss all those gas stations that uglify our towns, right?

It seems downright greedy and shortsighted to me to totally use up the whole world's supply of fossil fuels before we make a serious effort to develop alternatives — particularly much less expensive alternatives. There seems to be this mindset that we are the only generation of people on the Earth that's important — let our grandchildren take care of themselves, as long as we have jobs and make money today.

There's nothing new about this. We've forced extinction on many species in the past and we're doing well toward extinguishing most of the African wildlife. England at one time teemed with elephants, tigers, hippos, and dense forests. So did the rest of Europe.

Thus we can expect self-interest in the energy companies to do its best to stop the development of cold fusion, and since they are working with hundreds of billions of dollars, their influence will be felt via all levels of government, federal and state, through our universities, and the financial markets.

This presents both one whale of a problem, and an opportunity.

As I've pointed out before, it was the stubbornness of the established computer industry that allowed the personal computer to come along and blindsided it, giving us Bill Gates and a few other new billionaires (mostly college dropouts, by the way). Can some enterprising newcomers blindsided the oil and power companies? I believe they can.

Fortunately there are very few people who have somehow escaped or avoided the establishment way of living,

so this new technology presents a great opportunity for these winners. Most people are totally buried in working at jobs and being entertained the rest of the time. Ball games, sitcoms, TV talk shows, 100 channels of garbage, rock 'n' roll, fast food, coffee and Danish, Coke™, and so on. Almost everyone you know is buried in this crap and unable to be motivated to change. Well, these are *not* likely to be the entrepreneurs who are going to be our new billionaires. The PC has generated new billionaires such as Gates, Allen, Jobs, McGovern, and Ziff, so let's see who the new cold fusion billionaires will be. I don't need a new career, but how about you?

Mooned!

My wife, Sherry, enrolled in a video production course at a local college. One part of the course called for the students to do a short documentary on some subject. So she decided to do hers on René's book, *NASA Mooned America*. She read the book again, then read Kaysing's *We Never Went To The Moon*, and Brian's *Moongate*. She then got all of the videos and books she could locate on the Apollo missions and went through everything carefully.

Did the data presented in the books by René, Kaysing, and Brian hold up? Sherry was amazed to find that though the Apollo astronauts supposedly took thousands of photographs, that there were only a dozen or so which were available, and that these same few photos were used in all of the books.

Then she watched the videos and was amazed. In several instances, where both of the astronauts were supposedly walking on the moon, the camera somehow managed to pan all by itself, following their action. Say, who was operating the camera? Then, when the LEM was taking off, the camera panned upward, following it. How'd they do that? Radio control from Earth? Not likely, considering the several-second

delay for radio transmissions.

Oh yes, that radio delay. In several instances in the videos they had the astronauts on the moon talking with Houston, and there was no delay as they talked back and forth! That's not only impossible, but represents very shoddy technical directing.

None of the moon videos or photographs show any stars, yet that's the first thing our early astronauts in space commented on. They were amazed at how incredibly bright the stars were.

I suspect that the difficulties of showing the stars in their right places and with their correct brightness from the vantage of the moon's surface was beyond their technical ability in the 1960s, so they just had to leave them out and use plain black backdrops.

I did enjoy one short scene where we could see a reflection in the face plate of an astronaut supposedly on the moon which showed what sure looked like someone sitting at a video console in the background. I suspect Sherry will be using that in her documentary.

Many of the video scenes showed moon dust being kicked up and footprints in the dust. Yet scientific experiments at North American Aviation have proven that it takes an atmosphere to have dust blow around. When you remove the air from dust it becomes like brick and you can bounce a steel ball off it.

There was one other scene in the moon video that got Sherry laughing. The two astronauts were showing how high they could jump in the one-sixth-Earth's gravity. The funny part was that they did this from behind something which obscured them both from the waist down so that you couldn't see the trampoline which must have been hidden there. Even so, they weren't able to jump any higher than we would expect on Earth.

I suspect that the other students in the class, who are doing documentaries on things like how they wash their socks, will be surprised when they see Sherry's video.

Why did NASA fake the Apollo missions? 1. President Kennedy, with the assurance of NASA, said we'd put a man on the moon before the end of the 1960s. 2. Congress budgeted \$40 billion for it. Then, when it became clear that doing it was beyond their ability for several reasons, NASA had to decide whether to lose the \$40 billion or fake it. Well, that's my scenario, so let's see what happens next.

The next big problem for NASA was that damned face on Mars we've all seen ballyhooed in the tabloids. If it turns out to be clear evidence that it is not a natural phenomenon, then the pressure will be on for sending men to Mars to take a closer look — which NASA *still* can't do. The only practical alternative for the NASA top people has

been to prevent more photos of the face being taken.

Remember that Mars observer NASA sent a couple of years ago. Golly, it sort of disappeared, according to the NASA (Never A Straight Answer) releases. But several NASA engineers have reported that the satellite is there and working just fine, according to Richard Hoagland. The recent NASA release saying that the new Mars Observer satellite won't be able to photograph the Sidonia region, where the face is, was not a surprise.

Hoagland then went on the Art Bell talk show and got thousands of Art's listeners to FAX Golden, the NASA head, pushing for the photos to be taken and released. So we'll see what happens. Maybe.

If this whole subject is of any more than casual disinterest to you, you could do worse than read Jim Marrs' book, *The Alien Agenda*. It seems that a surprising number

Continued on page 78



QRP VFO!

High power key pad controlled direct digital synthesis VFO for low power enthusiasts

Get base station performance from your QRP rig with keypad controlled VFO featuring:

- ✓ Keypad entry of frequency
- ✓ 10 Hz to 40 MHz frequency range
- ✓ Digital VFO with 10 Hz resolution & display
- ✓ Variable rate incremental keypad or rotary tuning
- ✓ Dual VFOs (A&B) allows cross band selection
- ✓ 100 memories for VFO A&B
- ✓ Keypad selection of bands
- ✓ RIT (+/- 9.99kHz)
- ✓ Size: L-4" X H-2.5" X D-0.9"

Special limited time introductory price: \$149 (U.S.) plus \$10 shipping

Order now and also receive the RS-232 option to control VFO operation via your PC. Orders: 1-800-923-3423.
Info: (Tel.) 905-470-2900 (Fax) 905-470-6742.

Menu Plus

Menu Plus Inc.
1271 Denison St., Units 56-57
Markham, Ontario, Canada L3R 4B5

NEW!

CIRCLE 335 ON READER SERVICE CARD

LETTERS

From the Ham Shack

David Black KB4KCH supplied 73 readers with a copy of the following letter he sent to ARRL President Stafford, via *QST*.

To Mr. Rod Stafford W6ROD, ARRL President: As I write this, residents of central Alabama continue to dig out from the Oak Grove tornado, the worst such storm to strike the state in more than half a century. The April 8th tornado, packing winds estimated at more than 260 miles an hour (making it a Category 5), ripped a 30-mile path of destruction through residential areas near Birmingham around 8 p.m. More than 30 people died.

Several officials described the destruction as the worst they had ever seen. Federal disaster declarations followed quickly. Vice President Gore, along with James Lee Witt, Director of FEMA, toured the area, and President Clinton is scheduled to arrive in less than 24 hours to visit the disaster scene (at this writing).

We note with great pride the major role Alabama radio amateurs took before, during and for several days following the tornado's violent attack. Before the storm hit, amateurs across north and central Alabama (who regularly take part in the local Skywarn network) had already been on the air nearly nine hours, relaying important storm-related messages to assist the National Weather Service in Birmingham. The NWS later said of the amateurs, "We couldn't have done it without them." As the tornado hit, more frequencies were pressed into service for disaster relief and additional storm spotting needs. At one point, more than half a dozen VHF and UHF repeaters in the Birmingham metro area were used in some capacity either for the weather emergency itself, EMA operations or for storm

report relays. Valuable reports were also received via an Internet/packet radio gateway developed by hams. In the third phase, still more radio amateurs remained on the air in the disaster zone for several days, assisting with relief communications to assist the hundreds of people displaced from their homes. Members of a federal disaster survey team sent to Birmingham were reported to be planning to interview local radio amateurs who provided Skywarn communications services during the crisis. In short, central Alabama was rocked by a disaster of a magnitude rarely experienced. Birmingham was the subject of extensive coverage, much of it live, by the nation's broadcast networks and other news media. Amateur radio operators were among those receiving prominent and very favorable coverage for their efforts. It is important to point out that the radio amateurs participating in the many aspects of this emergency did not come from any one group. Some are individuals. Many are members of various amateur radio emergency communications groups and some radio clubs all across the state. Within these groups, many individuals hold League affiliation. While the hams responding to this disaster came from diverse groups and backgrounds, they held in common a commitment to pull and work together, using their communications skills to help a community shattered by tragedy try to get on its feet. While many of the amateur operations were conducted in an ARES mode, none of the hams working the disaster cared for a second what group other hams were affiliated with. If they were on the air helping, they were simply part of a team effort. This philosophy is not unique to the April

8th tornado. Rather, it has become commonplace as emergency communications groups all across Alabama have been actively working more and more closely with each other during the recent past to achieve common goals.

Today, on this, the sixth day since the storm hit, we note—with astonishment—the League's failure to utter so much as a word in any bulletin or advisory to its members about any of the efforts of Alabama radio amateurs in the disaster. This blatant inaction comes despite submission of reports on the hams' activities to the League by four individuals (including myself). Some of the information was sent to Newington within a few hours of the tornado's touchdown. Though my submission was never acknowledged, I know for a fact it was received. Fortunately, arrival of the Internet means that hams no longer have to rely on the League to disseminate important information to the amateur community. Our amateur radio group's interactive Web site (<http://bandmaster.com/alert>) has been a source of extensive news coverage involving the tornado and the role hams played. We gratefully acknowledge other amateur radio news media that aired news of the disaster within a day of its occurrence. I am reminded of your August, 1996 *QST* editorial in which you praised the merits of being involved in public service communications. There is a place for everyone, you told readers, adding, "Naturally, we want you to participate in ARRL-sponsored programs such as ARES and NTS, but this is subsidiary to the main point: Participate in any way that's right for you." It is no secret that more and more radio amateurs today feel an increasing distance between their interests and concerns as hams and those held by the League and its hierarchy of Directors who dictate so much policy. This latest incident does nothing whatsoever to improve that image. I have a more than

10-year history as a League member, including serving as a Public Information Officer and Public Information Coordinator. In 1997, I was honored to be recognized as Ham of the Year by ARRL Alabama for my work in the Skywarn program. In the past, I have defended the ARRL on more than one occasion, saying, in effect, "Newington really does care." The League's pathetic lack of acknowledgment of Alabama radio amateurs for almost one week now strongly suggests that I was wrong and reeks of politics. This is no accident. The League's leadership has chosen not to acknowledge the valiant efforts of so many, apparently because the entire operation did not fall under the ARRL "umbrella" of dominance. League members are the ones who suffer from being denied access to information as a result of this blatant arrogance. When the day comes that the League's Directors as a whole acknowledge that the ARRL does not, and cannot, speak for every amateur when acting in such an elitist way, the ARRL will be at the starting point of regaining some of the credibility it so badly needs among the growing number of active hams who choose not to be League members.

I am very proud to be affiliated with the Alabama amateur radio operators who responded to the April 8th disaster even if the ARRL couldn't care less. And I don't care what group they were members of. The League's refusal to even merely acknowledge what these people did during the first few days is incredible, regrettable and is a slap in the face to every one of them. In short, every League official with any role in the decision not to recognize hams during the Oak Grove tornado should be ashamed. Sincerely, David Black KB4KCH, President, Alabama Emergency Response Team (ALERT).

As a 60-year ARRL member I've probably been making a nuisance of myself over the

ARRL's ancient Board's management of the organization, making the League seem to the majority of ham newcomers as irrelevant to both them and the 1990s. Hey, up there in your moat-protected ego-built castle, wake up! We hams are hams because we're different from everyone else. We don't like to be treated like sheep and we won't stand for it. If the ARRL Board wants the League to represent us amateurs, then they'd better stop being all mouth and no ears ... Wayne.

Kenneth E. Stone W7GFH. Thanks for running my letter and circuit schematic for my bioenergizer (see April 1998 "Letters"). I notice that the correction I sent didn't make it to the circuit. The timing capacitor and resistor connections should have the common terminal as 3 instead of 1 and the capacitor is connected to pin 1 instead of 3.

I have made a further improvement (Fig. 1) on the circuit I use at home. I removed the 100 k current adjust pot and added a solid state current limiter circuit in one of the output leads. The limiter uses four switching diodes, such as 1N914, in a bridge rectifier configuration and an LM334 current limiter with a fixed 270-ohm resistor and a 5 k pot in series to adjust the limiter current. By using a true RMS DMM the limiter potentiometer can be calibrated to provide an actual known output current, assuming you use low resistance

electrodes. With the 270-ohm fixed resistor the maximum output will be about 250 μ A. Using this addition allows you to know the actual current—which I find mentally satisfying, even if not really needed.

Jack Burton WA6TDU. Hi, Wayne, I have been following your editorials in 73, particularly subjects concerning health (I'm a 22-year Navy retiree and a 32-year aerospace electronics retiree).

Somehow I missed the first of the Bioelectrifier articles, but last year I built the one designed by Tom Miller in the May 1996 73. It works very well but I believe that I have simplified it further with some of the suggestions in that article. See Fig. 2 and Photo A of my simplified version. Note that the oscillator is a three-volt version, which is adequate to switch the 4N37s. Kudos to Mr. Beck and Mr. Miller, and keep up the hassling!

Chris White KD3SR, Charleston SC. I am writing in response to Jim Kocsis' article "Noise Surgery 101." Jim has a few good ideas about reducing RF noise from your PC, but there are a couple of things I would like to add to his article.

First, while Jim does mention taking care while removing cables from the motherboard, he really should stress this point more. Many cheaper motherboards—the ones most likely to be noisy in the first place—are fairly thin and fragile. Repeated stress on any motherboard

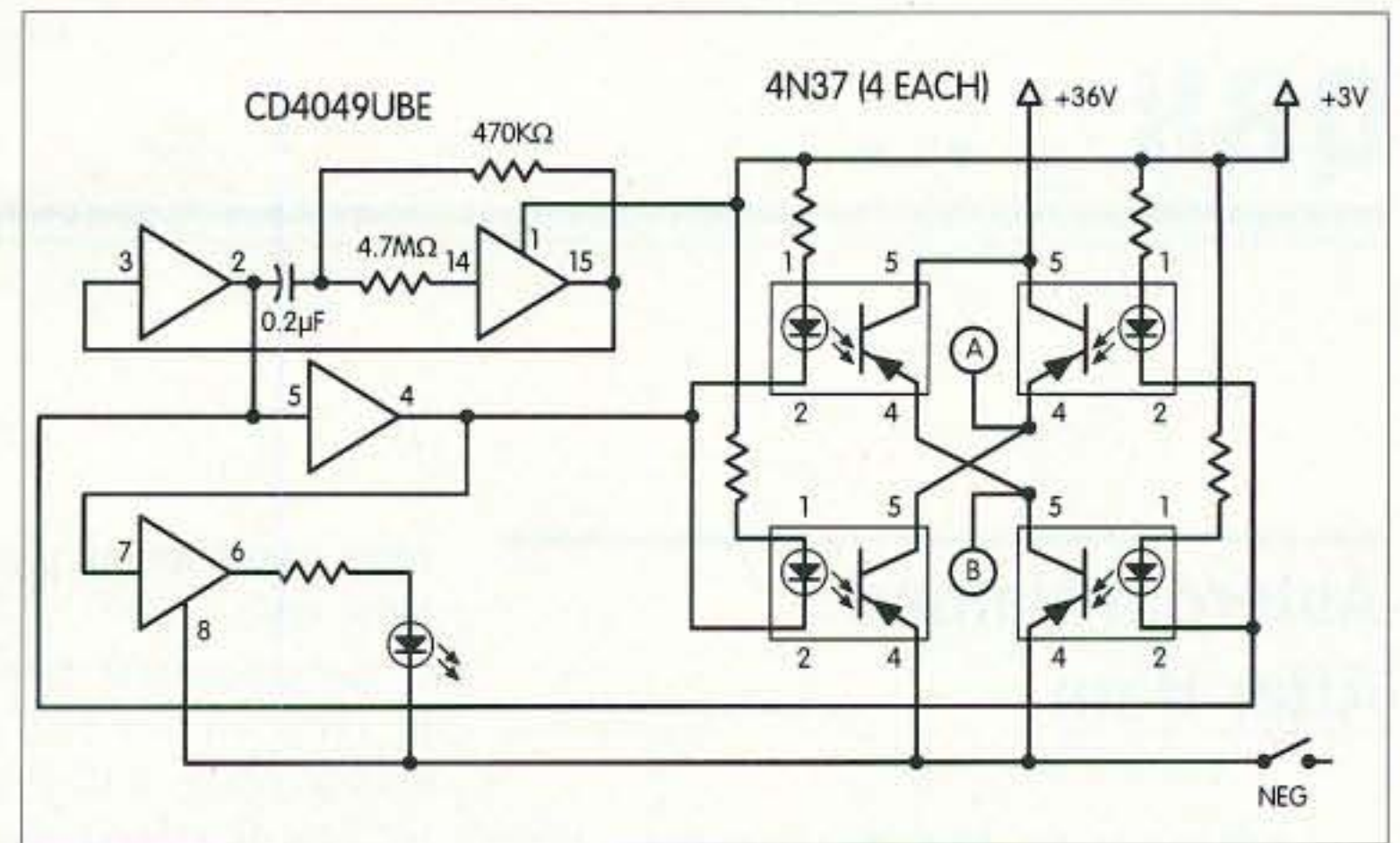

Fig. 2. Yet another "improvement" of the Bioelectrifier.

connector can cause board traces to crack, resulting in a useless computer.

Next, since some motherboards are so fragile, care must be taken when removing them. Bending and dropping are obvious no-nos, as is lack of a wrist strap to prevent static discharge from your hands from damaging the board. But just as important is where you store the motherboard when you are making your modifications. It needs to be in a clean, dry place, where it won't get kicked off the kitchen table or stepped on by the family pet. Static charge on the surface you store it on can also harm the motherboard, so an anti-static mat, conductive foam, or anti-static bag are best for storing your motherboard if you can find them.

One thing Jim didn't mention is metal shavings. Your case modifications will make a lot of them. Any left behind in the case

could cause your motherboard to short out. Then you would have proof of the smoke theory of electron movement! Clean these out of the case as best you can before re-installing any components.

An alternative to the wire-brushing is to use star washers. Cinch them down until just snug, then another quarter turn. Now twist them back and forth a few times, until you can see bare metal through the tines of the washer. Remove the washer and clean the paint from its tines. When you reinstall it, you should have good contact to the chassis of the computer.

When re-installing the motherboard, it is important to ensure you *do not* overtighten the screws.

The metal screen Jim suggests for use over the fan outlet can be improved some. The

Continued on page 78

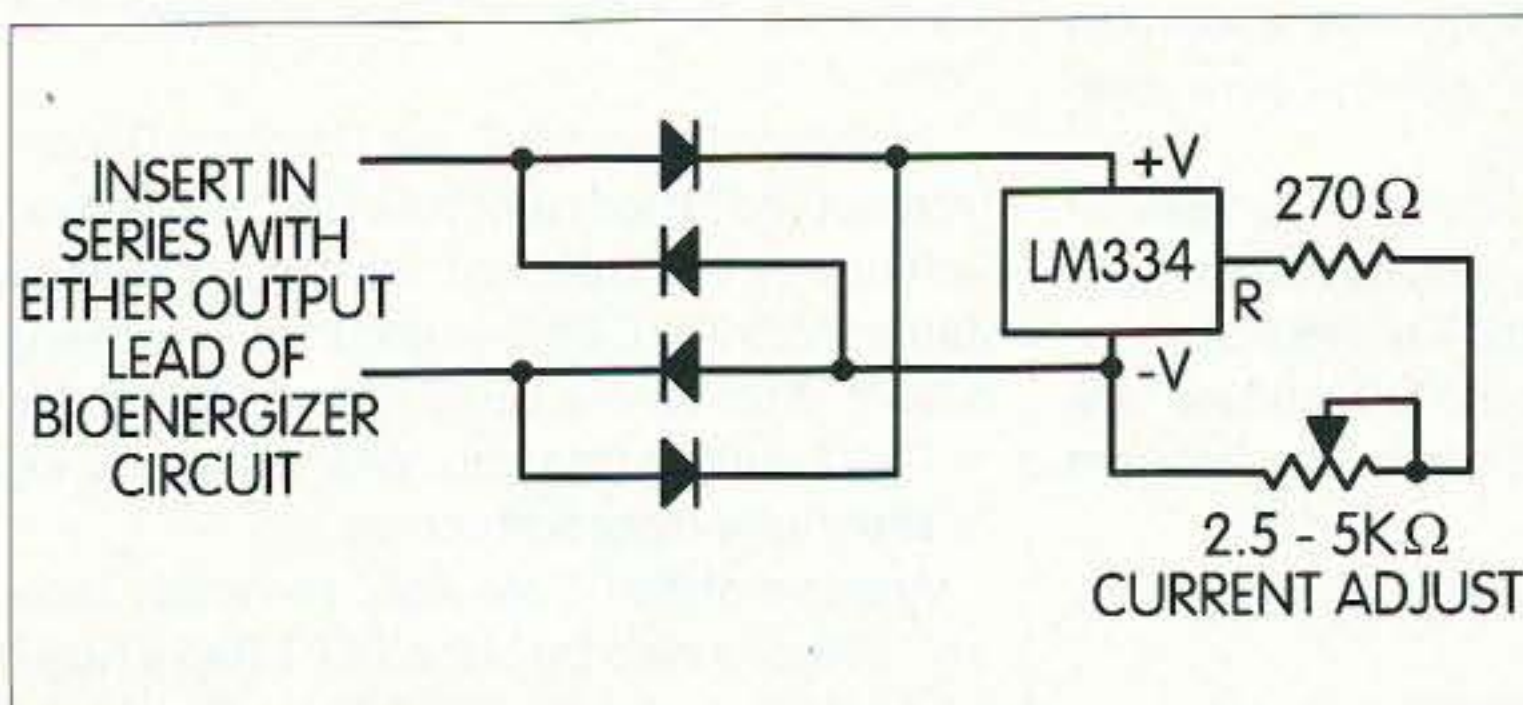

Fig. 1. Another "improvement" for Tom Miller WA8YKN's Bioelectrifier™.

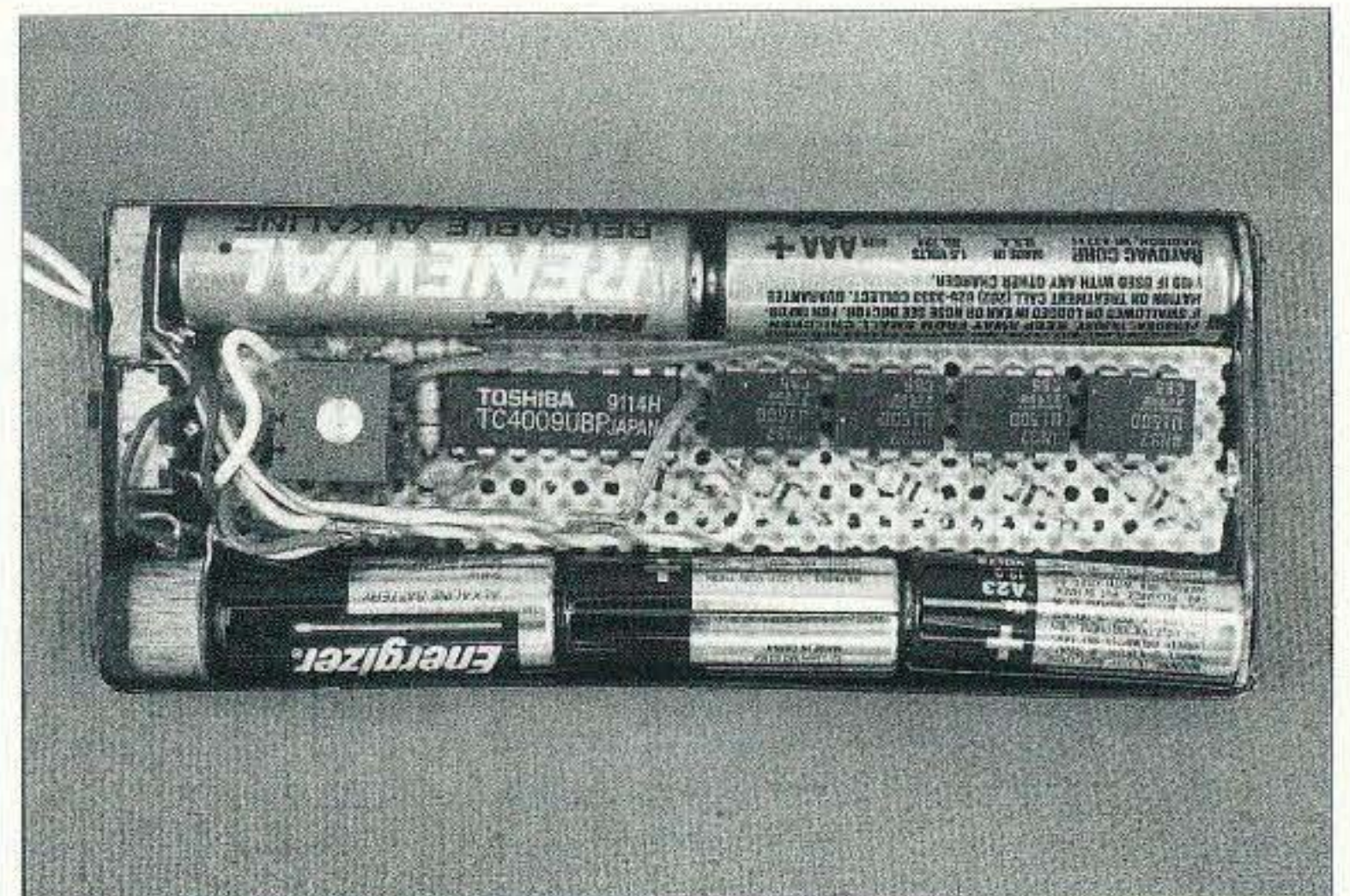

Photo A. WA6TDU's simplified version.

QRX . . .

Asteroid Named After Ham

In addition to his interest in ham radio, Warren Offutt AF9Q, of Cloudcroft, New Mexico, has a deep interest in astronomy and gained considerable renown as an amateur stargazer. His name is now up in lights—in a manner of speaking—in the form of an asteroid some 350 million miles from Earth.

Offutt said he learned just a few days before his 70th birthday that the International Astronomical Union was naming a minor planet in honor of his scientific contributions. The asteroid will be known formally as Minor Planet (7639) Offutt. Estimated to be several miles in diameter, it orbits the sun in the asteroid belt between Mars and Jupiter.

Over the past year, Offutt has helped in three major discoveries from his home observatory. He reports that his and his wife's confirming observations of one of the newly discovered moons of Uranus appeared in the British journal *Nature*.

Offutt, an ARRL member licensed in 1943, says his 55 years of hamming have been a wonderful experience: "I still get a thrill out of each new contact."

The Offutts have 10 children, three of whom are hams.

From *The Modulator*, newsletter of the Fort Myers ARC, March 1998, Earl Spencer K4FQU, editor.

Hams Off the Great Circus Train

A Wisconsin ham radio tradition of more than 30 years has come to an end. Ham radio has been bumped from the annual run of the Great Circus Train. The train runs each summer between Baraboo—where the Ringling Brothers Circus got its start in 1884—and Milwaukee, the site of the annual Great Circus Parade. ARES members rode the rails to help handle communication along the route and, once in Milwaukee, at the show grounds and for the parade itself.

In a letter to Bob Goldstein K9KJT, of the Milwaukee ARES group, the train's sponsors, the Circus World Museum, cited "severe space limitations" on the coaches for their decision to drop ham radio in favor of an offer of free commercial digital and analog service from PrimeCo. "We are attempting to eliminate as much clutter from the train coaches as possible this year and open up

more space for our passengers," the museum's letter read.

Ham radio first came aboard the circus train in 1965 when ARES member Don Evenson K9JYX set up a VHF station that relayed to an HF mobile station chasing the train. In 1994, onboard HF operation was added. Wisconsin ARRL PIC Jim Romelfanger K9ZZ—an indefatigable circus train booster—reports that over the past two years, hams aboard the circus train worked an average of 225 stations during the run, and fielded some questions about the circus at the same time. He said that without ham radio, the circus events and the museum would lose a tremendous public relations benefit that cost nothing. Romelfanger says he met a lot of the state's shakers and movers over the years through his association with the train. One time, he said, Ted Mack (of radio and television's "Amateur Hour" fame) rode the train and was interviewed by Evenson.

This year, the National Governors' Conference is in Milwaukee in late July. The train runs the last Monday and Tuesday in July, and the parade is August 3, Romelfanger said.

He added that the museum's decision surprised and puzzled him, and he expressed disappointment that the circus train would not carry amateur radio this year, when Wisconsin marks its sesquicentennial. "It was a privilege to work for the museum, the train, and the parade," he said.

From the ARRL, via *Tuned Circuit*, May 1998, Dave Herrington N8NLK, editor.

Field Day Lessons Learned

- Have comfortable operating chairs. Lawn chairs just don't hack it.
- Phone bands should have full headsets with boom mike and a footswitch.
- Digital voice keyers (DVKs) are a real plus when the bands are not so active. Check them out *before* Field Day begins.
- If you have an automatic antenna tuner in your rig, use it even if you already have a good SWR. It will cut down on the interference.
- Get a clear frequency, call CQ, and run 'em. Tuning around and pouncing is *not* the preferred method.
- Computers must have a 3-1/2-inch floppy drive.
- Set computer clock to UTC, and make sure band is correct.
- Save log periodically (at least every two hours).

- Check out antennas beforehand, and make contacts before Field Day starts.
- Set up your station on Friday afternoon.
- Band captains should plan to have backup ops scheduled to operate even during off-hours of propagation.
- Be prepared for scorching heat, numbing cold, torrential rains, and full sunshine.

Yes, you've heard it all before—but it's still good advice!

From *Wireloose*, May 1998, newsletter of WWI, Woodbridge, Virginia.

More on Morse

The Radio Society of Great Britain says that it no longer supports mandatory Morse code testing for access to the amateur bands below 30 MHz, according to several sources in the UK. The national society will lobby the IARU to try to get a rules change passed at the 2001 World Radio Conference to support the abandonment of the international statutory requirement for Morse testing.

The change in policy by the RSGB comes only 18 months after its December 1996 announcement of the results of a survey on the future of amateur radio in that nation. At that time, 30% of the society's members responded. Two thirds said that Morse code should remain as an international licensing requirement.

The same sources say that the RSGB will propose to the nation's radiocommunications agency that a new class of ham license be introduced in the United Kingdom, one that will give all amateurs access to the HF bands below 30 MHz by passing a very simple slow-speed CW test—possibly as slow as 5 wpm.

Via *Newsline*, Bill Pasternak WA6ITF, editor.

Reciprocity Approaches

US amateurs soon will not need to apply for reciprocal licenses in order to operate during short visits to most European countries. Although at this writing an official announcement had not been made, the US request to participate in the European guest license arrangement has been approved; similarly, most European hams visiting the US no longer will have to submit FCC Form 610A.

In September of 1997, the US State Department applied for US participation in the European Conference of Postal and Telecommunications Administrations (CEPT) amateur radio licensing system. A holder of a CEPT license can operate in CEPT-participating countries without having to apply for a reciprocal license.

Approval of the US request came in late January 1998, at a meeting of the CEPT Radio Regulatory Working Group (WGRR), in Groningen,

Continued on page 49

MFJ 300 Watt Roller Inductor Tuner

World's only 300 watt AirCore™ Roller Inductor Antenna Tuner gives you absolute minimum SWR... Covers 6 Meters thru 160 Meters... lighted Cross-Needle meter... tunes any antenna... 8 position antenna switch... dummy load... balun... 1 year No Matter What™ warranty

Covers 6 Meters thru 160 Meters!

MFJ-969

\$189⁹⁵

Call your dealer for your best price!



NEW MFJ-969 gives you MFJ's superb AirCore™ Roller Inductor and full 6 Meter thru 160 Meter coverage!

You get everything you've ever wanted including... 300 Watts PEP SSB full featured antenna tuner, widest matching range, lighted Cross-Needle SWR/Wattmeter reads true peak forward power, QRM-Free PreTune™, 8 position antenna switch, built-in 50-Ohm dummy load and heavy duty 4:1 balun -- all in a tough, scratch-proof cabinet.

AirCore™ Roller Inductor



MFJ-969's AirCore™ Roller Inductor, three-digit turns counter and spinner knob gives you exact inductance control for absolute minimum SWR.

MFJ's exclusive AirCore™ Roller Inductor has an air core that can't burn up! You get ultra high-Q, the lowest loss, highest efficiency and highest power handling of any roller inductor in ham radio.

MFJ's exclusive Self-Resonance Killer™

MFJ-989C world famous 3 KW Antenna Tuner



MFJ-989C **\$359⁹⁵** More hams use MFJ-989s than any other 3 KW antenna tuner in the world!

The rugged MFJ-989C handles 3 KW PEP SSB and covers 1.8 to 30 MHz including all MARS and WARC bands.

Match dipoles, verticals, inverted vees, random wires, beams, mobile whips, shortwave -- nearly any antenna. Use coax or balanced lines.

MFJ's new AirCore™ Roller Inductor, three-digit turns counter and spinner knob gives you exact inductance control for absolute minimum SWR. It has an air core that can't burn up! An exclusive Self-Resonance Killer™ removes damaging self resonances.

keeps potentially damaging self-resonances away from your operating frequency.

Large self-cleaning wiping contact gives you excellent low-resistance connection without contact arcing or burning.

Solid 1/4 inch brass shaft has self-align bearings for smooth non-binding operation.

Covers 6 Meters thru 160 Meters

The MFJ-969 covers all frequencies from 6 Meters through 160 Meters, including the "magic band" -- the widest matching range of any full featured antenna tuner.

Match any Antenna

You can match dipoles, verticals, inverted vees, random wires, beams, mobile whips, shortwave receiving antennas -- nearly any antenna. You can use coax cable or balanced feedlines. Has heavy duty 4:1 balun.

Lighted Cross-Needle Meter

MFJ's lighted Cross-Needle Meter shows you SWR, forward and reflected power simultaneously. It reads true peak forward power and average power on 300 watt or 30 watt ranges.

Meter light has ON/OFF switch and requires 12 VDC or 110 VAC with optional MFJ-1312B, \$12.95.

8 Position Antenna Switch

MFJ's 8 position antenna switch lets you

select two coax fed antennas, random wire/balanced line or built-in dummy load for use through your MFJ-969 or direct to your rig.

QRM-Free PreTune™

MFJ's QRM-Free PreTune™ lets you pre-tune your MFJ-969 off-the-air into a built-in dummy load without causing QRM.

Pre-tuning into a dummy load makes tuning your actual antenna faster and easier.

Full Size Dummy Load

The MFJ-969 has a full size non-inductive 50 Ohm dummy load.

You'll find it handy for tuning, testing and repairing your rig, setting power level, adjusting your mic gain and more.

Superior Cabinet

Each MFJ-969 cabinet has a new tough scratch-proof vinyl cladding. You won't find a tougher, longer lasting finish anywhere. Measures 3 1/2 x 10 1/2 x 9 1/2 inches.

No Matter What™ Warranty

Every MFJ-969 is backed by MFJ's famous one year No Matter What™ unconditional warranty. That means we will repair or replace your MFJ-969 (at our option) no matter what for a full year.

Call your dealer for your best price!

MFJ versatile 1.5 KW Tuner



MFJ-962D **\$269⁹⁵** Use your barefoot rig now and have capacity to add a linear amplifier later! Great for Ameritron's AL-811H! Lighted cross-needle SWR/Wattmeter 6 pos. antenna switch, Teflon® wound balun, ceramic feedthru insulators-balanced lines. 1.8-30 MHz. 10 3/4 x 4 1/2 x 14 7/8 in.

Free MFJ Catalog

Nearest dealer/Free Catalog... 800-647-1800

<http://www.mfjenterprises.com> FAX: (601) 323-6551
•1 year unconditional warranty •30 day money back guarantee (less s/h) on orders from MFJ •Add s/h

Our 25th Year!

MFJ MFJ ENTERPRISES, INC.
P.O. Box 494, Miss. State, MS 39762
(601) 323-5869; 8-4:30 CST, Mon-Fri
Technical Help: (601) 323-0549
E-Mail: mfj@mfjenterprises.com

Prices and specifications subject to change. ©1997 MFJ Enterprises, Inc.

MFJ... the world's most trusted name in antenna tuners

Raising the RASER to New Heights

A two-element beam for 80 meters.

James E. Taylor W2OZH
1257 Wild Flower Drive
Webster NY 14580

Because of the unique effectiveness of this antenna system, a number of the hams I have talked with have asked me to put the construction details into an article. This article, therefore, is directed to those who wish to duplicate the system without complicated formulas or computations. This is offered as a fun project which teaches some advanced understanding of antenna theory as well as some practical assembly experience.

In the past, I have successfully used conventional two-element phased-array beams on the 80-meter band. These were composed of two parallel resonant dipoles, spaced one quarter-wavelength apart, horizontally, and fed at their centers by coaxial cable. The pattern direction was reversed by throwing a switch. This changed the length of the feedlines, initially equal, so that one feedline was one quarter-wavelength longer than the other. The phase shift introduced by this "quadrature" delay results in reinforcement of the radiated signal in this direction with a corresponding cancellation or null in the opposite direction. Thus, we have a beam antenna with the ability to switch directivity, for example, from east to west! The phased array featured

in this article has still greater gain, accomplished by replacing the dipoles in the former design with longer dipoles called RASERs.

I first wrote "The RASER," published in 73, September 1992, and "The RASER Revisited," 73, October 1993 (both of those articles can be viewed on the Internet at [<http://home.att.net/~JETAYL/w2ozh.html>], along with additional comments). As I described in those previous articles, the development of the RASER gain dipole was derived from prior work by Harry Mills W4FD.

(Note: I have chosen the term "RASER" for the novel structure, due to its remote similarity to the LASER—both use coherent radiation to obtain gain. Also, in the past, the acronym CCD for Controlled Current Distribution has been used. Because that term is now almost universally accepted by engineers to mean Charge Coupled Device, I will be using what I hope is a less confusing term, DCR—for Divided Current Radiator.)

The RASER approach

Let's go back to general principles: If we consider a short length of wire

carrying RF current, it has an inductance which can be readily calculated; see **Table 1**. If the current is to be essentially constant along the wire in each DCR, its length must be a small fraction of a wavelength—for example, 1/50th.

RASER Parameters	
Assumed Frequency	3.953 MHz
Initial Terminator Length	59 feet, 2-1/4 inches
Wavelength	249 feet
1/50th Wavelength	~5 feet
Calculated Self-Inductance of DCRs	2.15 μ H
Capacitance for Resonance	~750 μ F
Empirically Determined Optimum Values	
DCR Length	57 inches per section
Reduction of Terminator per DCR Section	~2.21 feet

Table 1. RASER parameters—calculated and empirical.

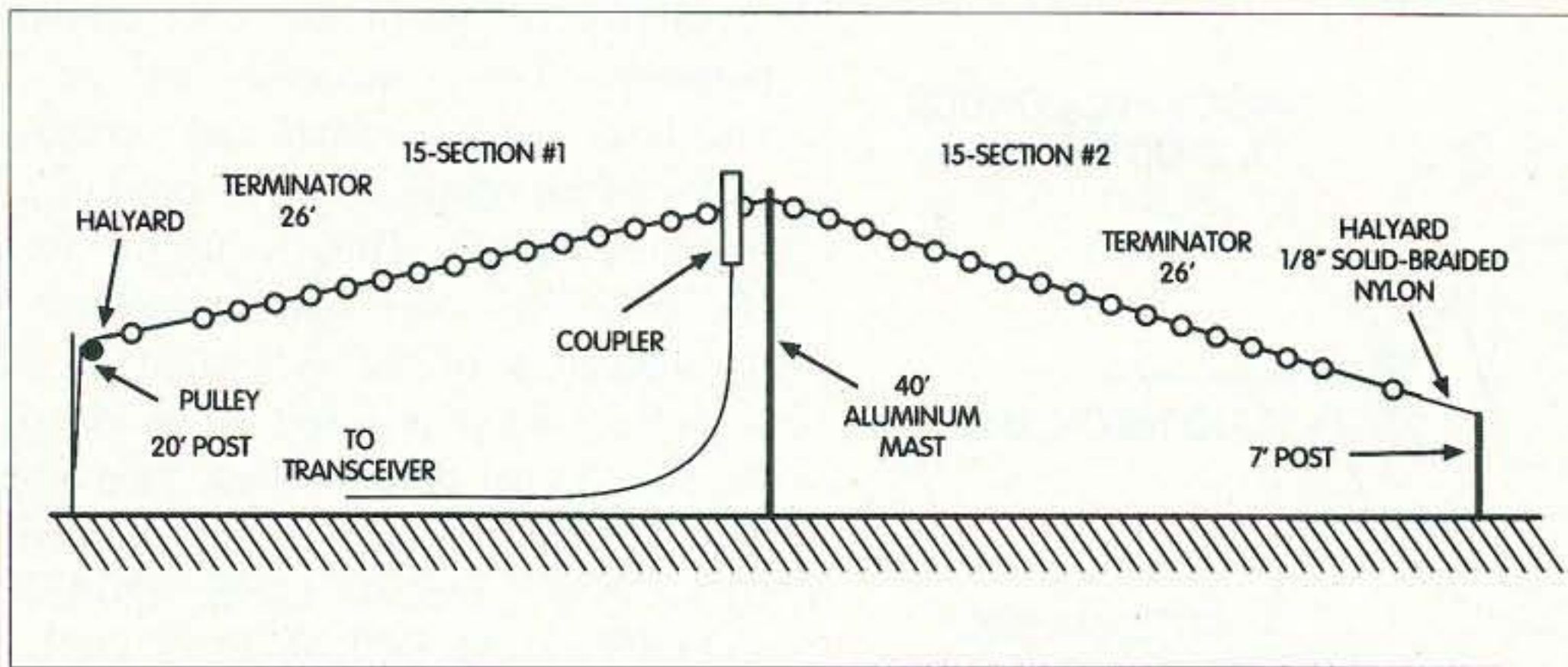

Fig. 1. Balanced 30-section RASER (centerfed).

This length could be increased with a corresponding decrease in the number of DCRs required. For a chosen frequency, the value of series capacitance required for resonance can then be calculated. At this frequency the tuned circuit is, of course, nonreactive; that is, it acts like an element of radiation resistance with only the mutual inductance between DCRs remaining. If we place several of these tuned DCR sections in series, as in Fig. 1, their currents will be in phase and the resulting radiation will be coherent, i.e., mutually reinforcing. The result is a stretched resonant radiator. Let us now place a number of these DCR elements at either side of the center of a dipole, and trim the structure of resonance by adjusting the lengths of the capacitive terminating wires at its ends. This RASER concept offers gain over a half-wave dipole antenna due to the increased aperture and the coherent radiation from the resonant DCRs.

Construction

Let me review, briefly, the construction of RASER gain-dipoles for the 80-meter band, and also the extension of the idea to a two-element phased array with switchable directivity. A tabulation of values for other amateur bands is included. Also, please note that the quarter-wave delay line has been replaced by a simple pi-section phase-shifting circuit. The centerfed configuration will be emphasized here, although the endfed RFD arrangement has proven to be equally effective (see "RFD: Resonant Feedline Dipoles," *QST*, August 1991).

The RASER dipoles

The installation at my QTH has a single RASER dipole as shown in Fig. 1. Each RASER is composed of 30 DCR sections (see Fig. 2), with 26-foot wire terminating stubs at each end. Each RASER is fed with 52-ohm coaxial cable through a coupler unit placed at its center (see Fig. 3). The coupler unit is a bifilar-wound, toroidal impedance-matching transformer tapped at 26 turns and enclosed in a plastic box.

The RASERs are tuned to resonance at the desired frequency by pruning the lengths of the terminators symmetrically. The desired 1:1 SWR was obtained by changing the tap position on the transformer. An antenna impedance bridge is useful in this adjustment—I used a Palomar noise bridge. The overall length of each RASER radiator, some 200 feet, was determined solely by my site restrictions, as was the height above ground. The geometry can be changed to match other site dimensions by changing the number of DCRs, the lengths of the terminators, and the position of the tap on the matching transformer. Greater lengths of the RASER will increase gain up to the point where cumulative phasing errors diminish coherence of the radiation from the DCR sections. The height should be as great as possible for best efficiency of radiation.

Configuration of the RASER phased array

As shown in Fig. 4, I fabricated and installed two identical RASERs, horizontally spaced approximately one

ALL ELECTRONICS

C O R P O R A T I O N

3 INCH 15 WATT Full Range Speaker

AuraSound # AS3-75-8FR

For its size this is a good full range speaker. 8 ohm impedance, 15 Watt max. power rating. The 3" cone has a soft foam surround for improved bass response, and a whizzer cone to accentuate the high range. It has a shielded magnet assembly so it is ideal for home theater and multi-media applications.



3.15" square mounting frame. 1.9" depth.

\$3⁷⁵ each

CAT # SK-36

120 VAC SOLENOID

Dormeyer Industries # 3000-M-1

Heavy-duty, pull-type solenoid.

120 Vac, 6.2 ohm coil,

continuous duty cycle.

3" x 2.36" mounting

base. 2.95" high.

16 lbs pull force

at 1". Max. stroke, 1.25".

CAT # SOL-51

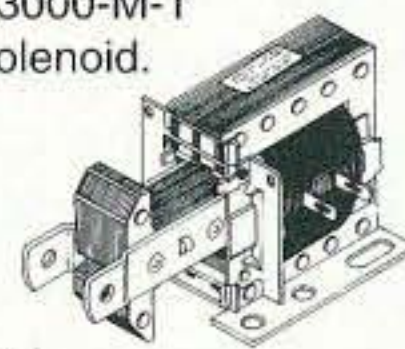

\$9⁰⁰ each



FLASHER LED

T 1 3/4 (5mm) HIGH BRIGHTNESS

RED LED with built-in

flasher unit. 3-5 Vdc operation

CAT # LED-4 **2 for 90¢**

100 for \$40.00 • 1000 for \$300.00

EQUIPMENT KNOB

Alcoknob # PKG90B1/4

0.86" dia. X 0.56" black molded

phenolic knob with brushed aluminum

face. Ribbed body with indicator line.

Brass insert with two set screws.

Fits 1/4" full round shaft.

CAT# KNB-74 **75¢** each



25 for \$16.25 • 100 for \$50.00

ORDER TOLL FREE

1-800-826-5432

CHARGE ORDERS to Visa, Mastercard,
American Express or Discover

TERMS: NO MINIMUM ORDER. Shipping and handling for the 48 continental U.S.A. \$5.00 per order. All orders including AK, HI, PR or Canada must pay full shipping. All orders delivered in CALIFORNIA must include local state sales tax. Quantities Limited. NO COD. Prices subject to change without notice.

CALL, WRITE
FAX or E-MAIL
for our **FREE**

96 Page
CATALOG

Outside the U.S.A.
send \$3.00 postage.

MAIL ORDERS TO:
ALL ELECTRONICS
CORPORATION
P.O. Box 567

Van Nuys, CA 91408
FAX (818)781-2653

e-mail allcorp@allcorp.com
internet - <http://www.allcorp.com/>

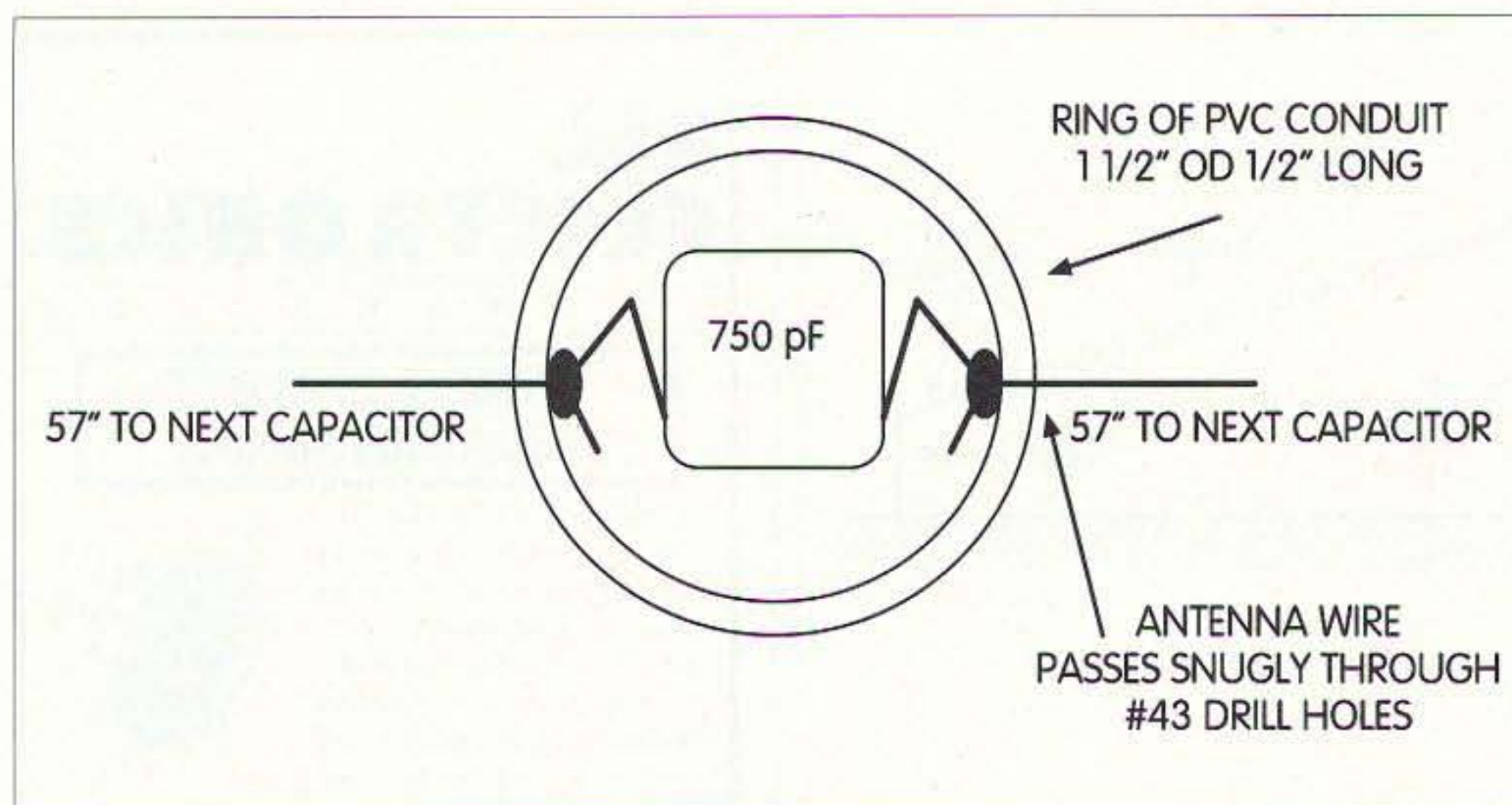

Fig. 2. Capacitor assemblies in the DCR.

quarter-wavelength, or about 60 feet, along the perpendicular horizontal line through their centers. The initial feedline lengths are made equal. These lengths can be randomly chosen, although it is useful to use an integral multiple of a half-wave (*in the coax*) in each to minimize reactance effect. I found it convenient to use two lines, each of which is one wavelength long, or about 180 feet. The switching of direction of radiation is accomplished by the use of a multisection, wafer-type selector switch. An impedance matching transformer is required to correct for mismatch at the input to the feedlines. See Fig. 5, T1. As mentioned, instead of using the quarter-wavelength delay line to provide the required quadrature delay, I found it expedient to use a simple pi-section phase-shift network as shown in Fig. 5 (L1, C1, and C2).

The operation of the system is more readily understood by referring to the schematic diagram, Fig. 5. If the selector

switch is thrown to the dial position marked BEAM EAST, power from the transceiver is switched to the input of the impedance-matching transformer T1 through capacitor C3. This provides the small capacitive reactance necessary to compensate for the inductance of the transformer winding. The output from this transformer, at lowered impedance level, is fed into the pi-section phase-shift network, L1, C1, and C2. The unmodified signal at the input to the network is switched to the WEST RASER. The quadrature shifted output is switched to the EAST RASER. As mentioned earlier, this phase shift produces an antenna pattern with gain in the east direction and with cancellation in the west direction. Following the diagram, conversely, when the switch dial points to BEAM WEST, the pattern will be directed to the west.

Additional switch positions have been provided so that we can select either of the two RASERs separately. This

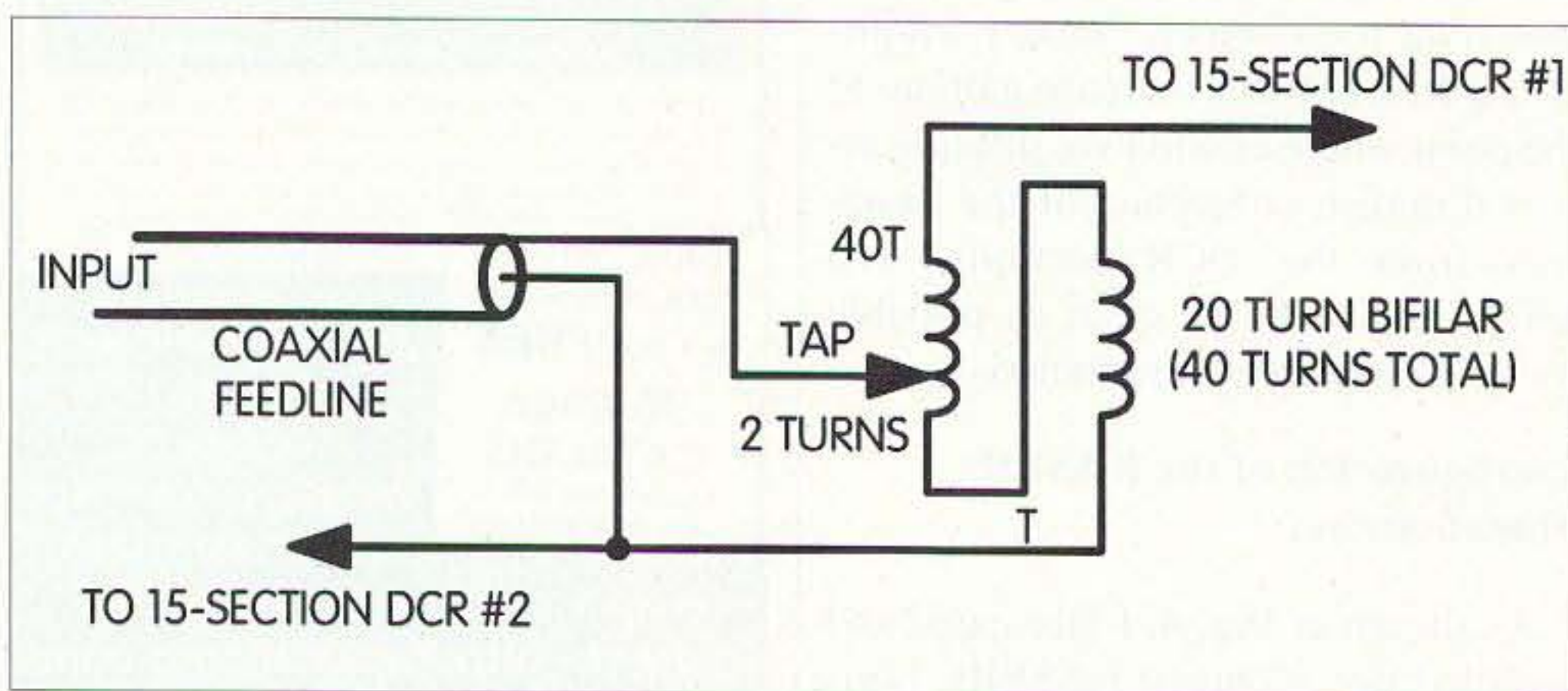

Fig. 3. Coupler unit schematic (centerfed).

capability is useful for comparison purposes. Two connectors are provided for the horizontal and vertical plates of an oscilloscope to present a lissajous figure. This is useful for checking phase shift and for monitoring operation of the system. Also, a separate switch position is provided for an external dummy load. Two coaxial connectors are provided (marked OPTIONAL DELAY-LINE INPUT and OPTIONAL DELAY-LINE OUTPUT) for use if an external quarter-wave delay line is desired instead of the internal phase-shift circuitry. To achieve this, the circuit is broken at the three points marked X, effectively eliminating the components L1, C1, and C2.

Please refer to the schematic diagram, Fig. 5, and to its notes, Table 2. The switch, the toroidal matching transformer, the phase-shift circuitry, and the sockets required for all of the coaxial cable connections are housed in a metal chassis box. I used a three-by-five-by-seven-inch aluminum box, although any one sufficiently large to accommodate the parts will be satisfactory. As any experimenter will agree, you are wise to install extra coaxial connectors for possible future experiments. Table 3 is a simplified parts list for the system.

Adjustment of the system

The two RASER gain-dipoles in the beam are separately adjusted for resonance using the noise bridge. For these resonance adjustments, the selector switch is alternately in the EAST RASER position, then the WEST RASER position. During these measurements, the feedline of the unused RASER is disconnected at the switch-box and terminated at its input with a noninductive 52-ohm carbon resistor. This is used to simulate the cross-coupling between the two RASERs during operation. After the separate radiators have been adjusted to resonance by trimming the lengths of the terminator wires, and the match has been set by adjusting each coupling unit, the beam is ready for on-the-air use. If the option of using a quarter-wavelength of coax is chosen, no further adjustment is needed.

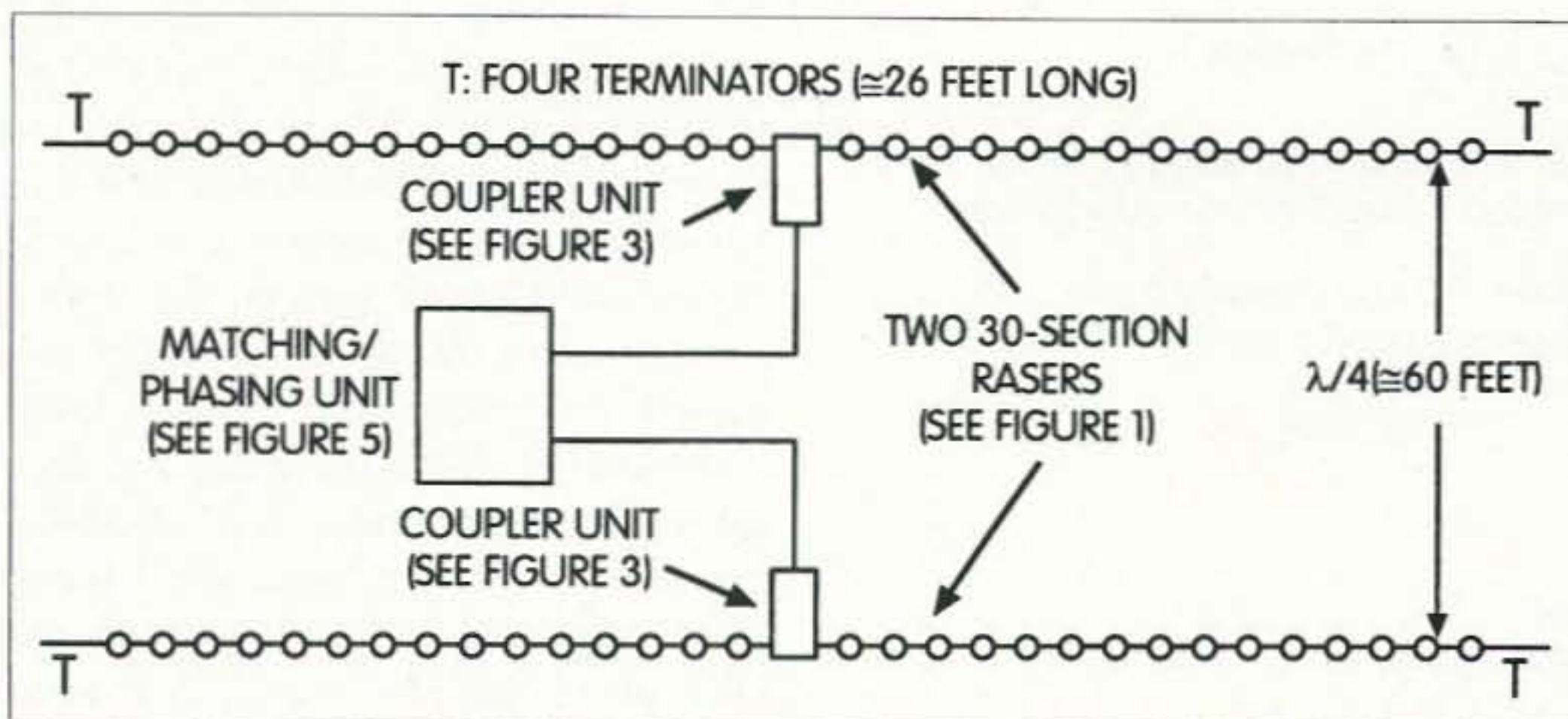

Fig. 4. RASER phased array (viewed from above).

However, if the pi-section phase-shift network has been chosen instead of the coaxial delay line, it will be necessary to optimize the values of the inductor L1 and the capacitors C1 and C2 for optimum phase-shift between the two RASER radiators. If the inductor has been fabricated as described, probably no readjustment of this component will be required. The values of C1 and C2 can be readily adjusted by use of a split-stator air capacitor, since these are nominally equal capacitors. The adjustment is made by viewing the lissajous pattern, or by measuring received signal strengths. The capacitors are then adjusted for the most symmetrical elliptical scope pattern or for optimum signal strength and front-

to-back ratio when the direction of the antenna pattern is switched from EAST to WEST. Ideally the patterns would be perfect circles, but actually this is seldom achieved because of cumulative differences in the parameters of the antennas. These may be due, in part, to site variations and differences of component values. Bill Shanney W6QR has modeled the RASER beam using the EZMEC 1.0 program. The resulting charts strongly reinforce my experimental results. Contact Bill by E-mail at [wshanney@earthlink.com] for more information.

Extensions to other bands

As pointed out, the lengths and other parameters mentioned above were

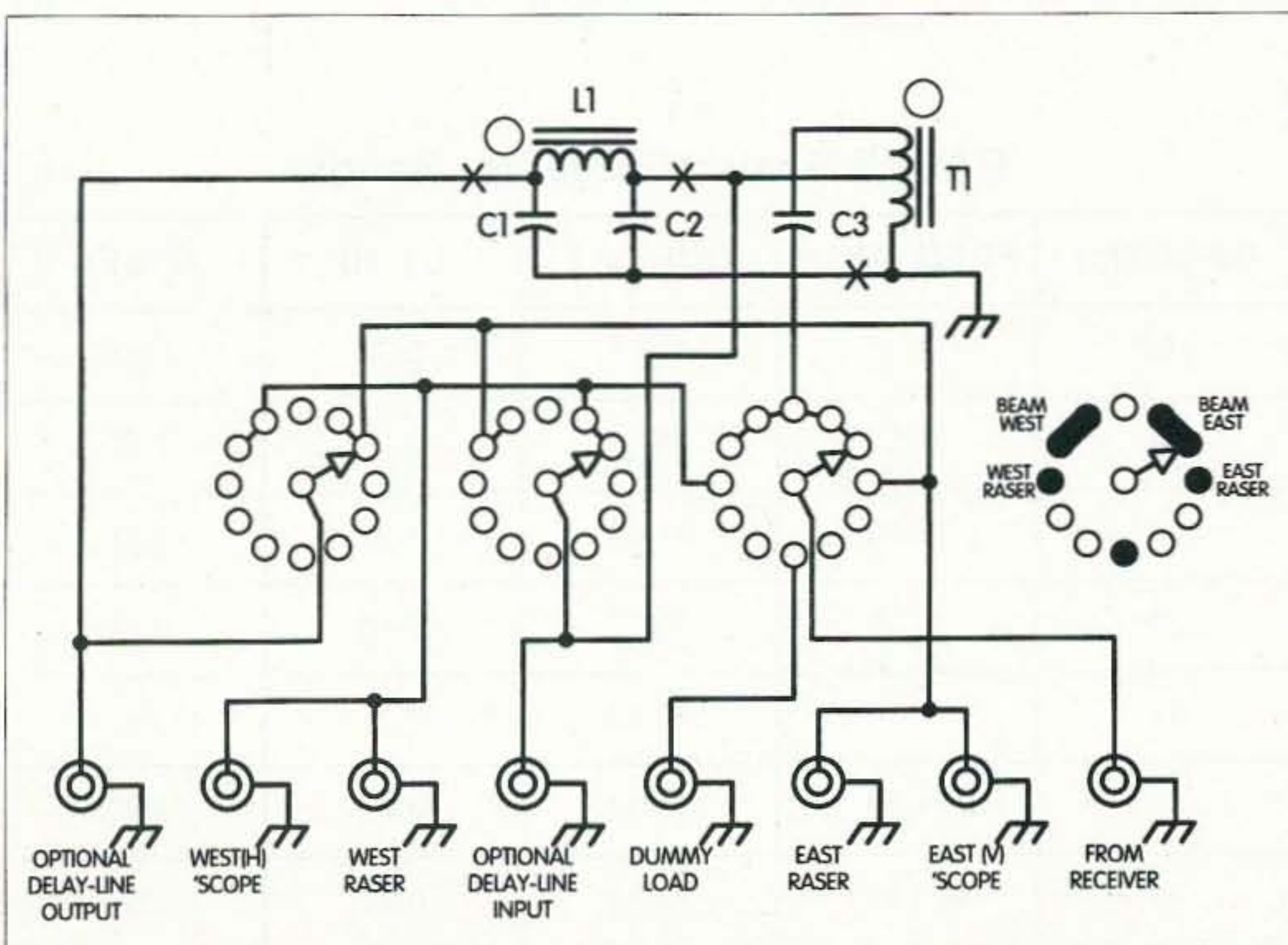

Fig. 5. Two-RASER phased array switching/phasing unit.

Mr. NiCd **THE BEST BATTERIES IN AMERICA!**

July '98 Specials

Packs & Charger for YAESU FT-50R / 40R / 10R:

FNB-40xh	Slim-NiMH	7.2v	650mAh	\$41.95
FNB-47xh	(NiMH)	7.2v	1800mAh	\$49.95
FNB-41xh	(5w NiMH)	9.6v	1000mAh	\$49.95
BC-601c	Rapid/Trickle Charger			\$54.95

For YAESU FT-51R / 41R / 11R:

FNB-31	pack	4.8v	700mAh	\$31.95
FNB-38	pk. (5W)	9.6v	700mAh	\$39.95
BC-601b	Rapid/Trickle Charger			\$54.95

For YAESU FT-530 / 416 / 816 / 76 / 26:

FNB-26	pack	7.2v	1200mAh	\$29.95
FNB-27s	pk. (5w)	12.0v	800mAh	\$35.95
BC-601a	Rapid/Trickle Charger			\$54.95

For YAESU FT-411 / 470 / 73 / 33 / 23:

FNB-10	pack	7.2v	600mAh	\$20.95
FNB-11	pk. (5w)	12.0v	600mAh	\$24.95
FBA-10	6-Cell AA case			\$14.95
BC-601a	Rapid/Trickle Charger			\$54.95

Packs for ALINCO DJ-580 / 582 / 180 radios:

EBP-20ns	pack	7.2v	1500mAh	\$29.95
EBP-22nh	pk. (5w)	12.0v	1000mAh	\$36.95
EDH-11	6-Cell AA case			\$14.95

For ICOM IC-Z1A / T22-42A / W32A / T7A:

BP-180xh	pk. NiMH	7.2v	1000mAh	\$39.95
BP-173	pk. (5w)	9.6v	700mAh	\$49.95
BC-601d	Rapid/Trickle Charger			\$54.95

For ICOM IC-W21A / 2GXAT / V21AT: (Black or Gray)

BP-131xh	(NiMH)	7.2v	1500mAh	\$39.95
BP-132s	(5w)	12.0v	850mAh	\$39.95
BC-601e	Rapid/Trickle Charger			\$54.95

For ICOM IC-2SAT / W2A / 3SAT / 4SAT etc.:

BP-83	pack	7.2v	600mAh	\$23.95
BP-84	pack	7.2v	1200mAh	\$34.95
BP-83xh	pk. (NiMH)	7.2v	1500mAh	\$39.95
BP-90	6-Cell AA case			\$15.95
BC-79A	Rapid/Trickle Charger			\$52.95

For ICOM 02AT etc & Radio Shack HTX-202 / 404:

BP-8h	pack	8.4v	1400mAh	\$32.95
BP-202s	pk.	7.2v	1400mAh	\$29.95
IC-8	8-Cell AA NiCd/Alkaline Case			\$15.95
BC-350	Rapid Charger			\$52.95

For KENWOOD TH-79A / 42A / 22A:

PB-32xh	pk. (NiMH)	6.0v	1000mAh	\$29.95
PB-34xh	pack (5w)	9.6v	1000mAh	\$39.95
KSC-14	Dual Rapid/Trickle Charger			\$62.95

For KENWOOD TH-78 / 48 / 28 / 27:

PB-13	(original size!)	7.2v	700mAh	\$26.95
PB-13xh	pk. (NiMH)	7.2v	1500mAh	\$39.95
BC-15A	Rapid/Trickle Charger			\$54.95

For KENWOOD TH-77, 75, 55, 46, 45, 26, 25:

PB-6	pk. (w/chg plug!)	7.2v	600mAh	\$27.95
PB-8sh	pack (5w)	12.0v	1000mAh	\$39.95
KSC-14	Dual Rapid/Trickle Charger			\$62.95

For STANDARD C-628A / C558A / 528A / 228A:

CNB-153xh	pack	7.2v	1500mAh	\$32.95
CNB-152	pk. (5w)	12.0v	800mAh	\$32.95
CSA-181	Rapid/Trickle Charger			\$54.95

For MOTOROLA GP-300 radios:

HNN-9628	pack	7.2v	1200mAh	\$39.95
----------	------	------	---------	---------

Mr. NiCd also supplies batteries for your
LAPTOP COMPUTERS / CELLPHONES
CAMCORDERS / NiCd & NiMH INSERTS
We can rebuild your Computer pack! Call!
 Mail, Phone, & Fax orders welcome! Pay with
MC / VISA / DISCOVER / AMEX

CALL OR WRITE FOR OUR FREE CATALOG!

Mr. NiCd - E.H. Yost & Company
 2211-D Parview Rd., Middleton, WI 53562
Phone: (608) 831-3443
Fax: (608) 831-1082
E-mail: ehyst@midplains.net

Notes for Schematic, Fig. 5 (parts details)

L1	10 turns #12 enameled copper wire wound on approximately 1/4 of the circumference of an Amidon T-200-2 powdered iron core
T1	8 turns, bifilar, wound on Amidon T-200-2 powdered iron core, tapped 4 turns down from the ungrounded end (8 + 4 turns up from the grounded end)
C1, C2, C3	Silver Mica, or equivalent C1 = 857 pF C2 = 848 pF C3 = 953 pF (for resistor loads) C3 = 803 pF (for 30-section RASERs)
Switch	3-gang, multipole selector switch: I used a Centralab Type 2017 with contacts paralleled

Coaxial sockets shown are SO-239 (8)

Table 2. Notes for Fig. 5.

chosen for the band of principal interest, 80 meters. However, in response to a number of requests, I have calculated approximate values of DCR lengths and capacitances for the HF bands as shown in Table 4 (the lengths of terminators and tap position on the transformer are best determined through experimenting after a rough estimate by scaling to the frequency).

Parts List

Qty.	Description
425 ft.	7X #22 stranded copper-clad antenna wire
400 ft.	RG/8 coaxial cable
2	4" x 2-7/16" x 1-1/16" plastic boxes
1	3" x 5" x 7" aluminum chassis box
1	2017 3-gang multipole switch
Assorted	Silver mica caps, 50 pF to 1000 pF
60	Silver mica caps, 750 pF, or equivalent
2	T-200-2 powdered iron toroid cores
8	SO-239 Coaxial sockets
10 ft.	2 x #20 Parallel bell wire
	Foam epoxy potting compound

Table 3. Parts list.

The gain of each RASER is directly dependent upon the number of DCR sections used, so the more sections the better! The 30 elements in my two-element array work just fine!

Results

The two-element RASER phased array has been in operation at W2OZH for several years now with outstanding results. I have consistently received reports of superior signal strength from both east and west directions, as expected. I call many CQs using a single gain-dipole and have had almost no answers from

the more distant northerly and southerly locations. This is to be expected if the pattern is mainly east and west as designed. As might be expected for the variations of propagation conditions encountered on 80 meters, the front-to-back ratios, measured on either received or transmitted signals, vary considerably with time of day and distance. However, a ratio of 25 decibels is commonly experienced and I have frequently measured a front-to-back ratio of 35 decibels—equivalent to a power ratio of some 3000 to one! This ratio is even more impressive when we realize that the signal strength of a station running the legal limit of power to the rear of the beam is reduced to sound like a half-watter!

One dramatic dividend from the use of a beam on the lower frequency bands is the obvious reduction of QRM, especially during the crowded evening hours. For example, if I have the pattern pointed to the east, I can readily work stations in that direction without either hearing or interfering with same-frequency stations to the west.

I wish to acknowledge the encouragement and assistance of many hams who have shown interest and who have patiently given signal strength comparisons for the numerous experimental arrangements which led to this final design.

73

RASER Scaled For Other Bands

BAND (m)	FREQ (MHz)	DCR (in.)	L (μ H)	C (pF)
160	1.9	118.6	5.33	1250
80	3.954	57	2.15	750
40	7.263	31.03	1.10	430
20	14.29	15.77	0.40	310
17	18.14	12.42	0.31	250
15	21.38	10.54	0.29	185
10	28.65	7.866	0.21	150

Table 4. RASER scaled for other bands.

Build This Simple CW Identifier

You, too, can program EPROMs.

Rudolf F. Graf KA2CWL
111 Van Etten Blvd.
New Rochelle NY 10804-2321

William Sheets K2MQJ
P.O. Box 200
Hartford NY 12838

The CW identifier (ID) has a number of uses, from automatic identification of repeaters, transmitters, and beacons, to performing repetitive CW chores such as calling CQ. An identifier is a device that generates a preprogrammed message of some kind, generally a callsign and possibly additional data such as the geographical location or status of the transmitter with which it is used.

An identifier can be set up to generate a message either on command or continuously, depending on application. There are several approaches to the circuitry, and these may involve anything from simple mechanical keyers, a tape-recorded audio tone driving a keying relay, or a purely digital approach that generates the required keying waveform from a programmed memory of some sort. A microprocessor can be programmed to generate the desired message, but if no other control, monitoring, or data transmission features are needed, it is easier to simply read out a message stored in a memory such as an EPROM.

We had a requirement for a simple ID circuit for an experimental beacon transmitter system currently under construction. We needed to generate a keying waveform that would include callsign and grid square, together with a short carrier for tuning purposes, that would be continuously running. In addition, simplicity and low cost were desired. A circuit evolved using a 555 timer running at the baud rate and feeding a counter that addresses a CMOS EPROM.

The message can be programmed into the EPROM with an EPROM programmer. Our programmer runs off the lab PC; its DOS-based software makes the programming a breeze. It connects to a second parallel port (LPT2). If you do not have a programmer and/or a PC, the EPROM can be manually programmed via a simple circuit consisting of a pulse generator and a few SPDT switches. See the EPROM manufacturer's data sheets for the exact procedure. In many cases, these can be found on the Internet and downloaded free of charge.

EPROMs have become cheap and easily available. Even a long-winded ID sequence will fit into the smallest of them. The smallest commonly available EPROM today is the 2716, which is a 16 K-bit unit. The memory is arranged in bytes, so there are 2048 bytes (eight bits). However, there seems to be no correlation between price and size. The 2764 is usually cheaper, as it is common in surplus; we used the CMOS version, the 27C64, which is also fairly common.

If you use a surplus part, make sure it is erased clean (all bits logic one) before using it. You can use an EPROM eraser or a strong UV lamp to do this, or else try leaving the EPROM with its window uncovered in strong sunlight for a few days (not very practical here in the northeastern US!). Otherwise, use a new part.

The desired code is programmed into the EPROM one byte (eight bits) at a time. We used a logic high (again: an erased, "clean" EPROM has all bits at logic high) as a space and a logic low as a mark.

Memory Location (Hex)	Data Bits							
	0 ₇	0 ₆	0 ₅	0 ₄	0 ₃	0 ₂	0 ₁	0 ₀
0019								
0018								
0017								
0016								
0015								Counter Reset
0014								Space
0013								
0012								
0011								"B"
0010								
000F								
000E								
000D								
000C								
000B								
000A								
0009								
0008								Space
0007								
0006								
0005								"A"
0004								
0003								
0002								
0001								
0000								Space

Table 1. EPROM programming scheme. Only 04 and 00 are used. Space (white) = logic 1. Mark (black) = logic 0. Gray = don't care (logic 1 or 0). An erased EPROM has logic 1s at all locations. Memory map shows message AB programmed into locations 04 and 00. Counter reset requires 04 to be space, 00 to be mark. Leave first location as space to avoid longer cycle that occurs on first oscillator cycle after powering up.

However, a little thought can save some circuitry and programming effort. Normally, each bit is addressed sequentially. This will require circuitry at the EPROM output (which is eight lines per address) to select each bit, zero through seven, in sequence. But we have 8192 addresses, so why not

use only one bit per byte and ignore the rest? This saves circuitry and will simplify programming. One other bit can be used to signify the end of the message and to reset the counter once the last needed address is reached.

Wasteful, yes, in terms of memory utilization, but we have far more than

we will ever need anyway. We used the bit four as the programmed output and bit zero as a control bit. When bit zero—normally the same as bit four—is different from it, this condition can be employed as an end-of-message marker and used to reset the counter back to zero, starting the cycle over. Of course, any other two bits can be used as well.

Morse characters are formed from dots and dashes. Generally, a dot is considered as a unit length. Then a dash is three (but may be up to five) dots in length, and dots and dashes are separated by the length of a dot. Letters are spaced generally at three to five dots, or the length of a dash. Words are spaced somewhat further, five dots or so. These are a matter of individual preference, but longer dashes are somewhat easier to read at very slow (less than five wpm) CW speeds, as the dots may be made shorter for a given speed. This is also somewhat more "comfortable" to read and avoids the dots being at first mistaken for dashes.

Wider spacing between individual letters with correspondingly faster transmission speeds for individual letters is sometimes used. This makes for better copy by CW operators who are used to faster speeds. (When you are used to normal 18–25 wpm QSOs, five wpm can be a bit tedious to copy.)

We found that a ratio of three to one sounded best at the 10 wpm speed intended, and adopted a spacing of one dot between dots and dashes, and three dots (one dash) between letters. However, this is a matter of individual preference.

The EPROM is programmed sequentially depending on the desired message. A given address location is programmed all ones (FFh), where the quantity in the brackets is the hexadecimal number programmed at that address, or all zeroes (00h). For those having to rig up a simple EPROM programming circuit, this makes life easier as all locations are the same logic level, reducing chances of error.

If you have ever manually programmed an EPROM, you will appreciate this fact. A single mistake in programming usually means erasure of

all data and the need to start all over. In accordance with Murphy's Law, this generally seems to happen when you are three-quarters done or more, or have manually entered a few hundred data bytes. We strongly suggest using an EPROM programmer that operates with a PC, if at all possible, if you are going to program a long message.

However, for a short ID such as your call letters, you can get by with a manual programmer. The only location where there is any difference is the last one, used to signify end of message. In this location, an F0h is programmed. This condition is sensed by the logic and used to reset the counter that addresses the EPROM. A diagram showing the programming scheme is shown in Table 1.

Circuit operation

Referring to Fig. 1, IC1 is configured as a free-running oscillator with a frequency range of 4.5 to 13 Hz. The period of this waveform, which is determined by the total resistance of R2 plus the resistance of speed control pot R1, and capacitor C1, determines the CW speed. Assuming that an average Morse letter plus the space between

letters has ten dot periods, this means 27 to 81 letters per minute, or roughly five to 16 words per minute, assuming an average of five letters per word.

This can be changed by changing the value of C1. R3 determines the discharge time of C1 and hence the width of the negative pulses appearing at pin 3 of IC1. This is not critical. R4 is used as a pull-up resistor for the output of the timer IC connected to IC5. A section of IC5, a quad NAND, is used as an inverter to derive the positive-going CMOS-level pulses to drive counter IC2.

Counter IC2 has 12 output lines and thus has 4096 states, and can address 4096 addresses (0000h to 0FFFh) of the EPROM IC3. Note that the counter drives address lines A0 through A11 of IC3.

The A12 line (pin 2 of IC3) is connected to ground. By the way, a switch or a jumper could be arranged to tie pin 2 of IC3 alternatively high. This will result in the addressing of locations 4096 to 8191 (1000h to 1FFFh) of IC3 and a second message could indeed be programmed in this memory space. We did not bother with this as it was not needed, but it should be mentioned in passing.

R15 and C3 provide power and bypassing to the V_{dd} , pin 16 of IC2. R15 actually is probably unnecessary and was used as a jumper to avoid the necessity of a double-sided PC board layout. C4 and C5 provide bypassing for the five-volt DC supply line. The data programmed into the EPROM appears at the 8 outputs O0 through O7 of the EPROM, but we only need O4 and O0. The other output pins can be disregarded.

During the message, the outputs of O4 and O0 are identical. Typically, only the first 50 to 150 addresses will be used, depending on message length, but all 4096 can be used if needed. At the average speed of one Morse letter per second, this allows up to around a six- to seven-minute, 350-420-letter (80-word) message to be programmed.

Output from the EPROM is fed to Q1 via resistors R5 and R6. When the desired output is a space (key up), the EPROM is programmed with an FFh (all ones) and O4 and O0 are high. This biases on Q1 and the collector of Q1 is driven low, causing bias current from collector load R7 to flow to ground. This removes bias fed via R8 and R9 to Q2, cutting Q2 off, and the

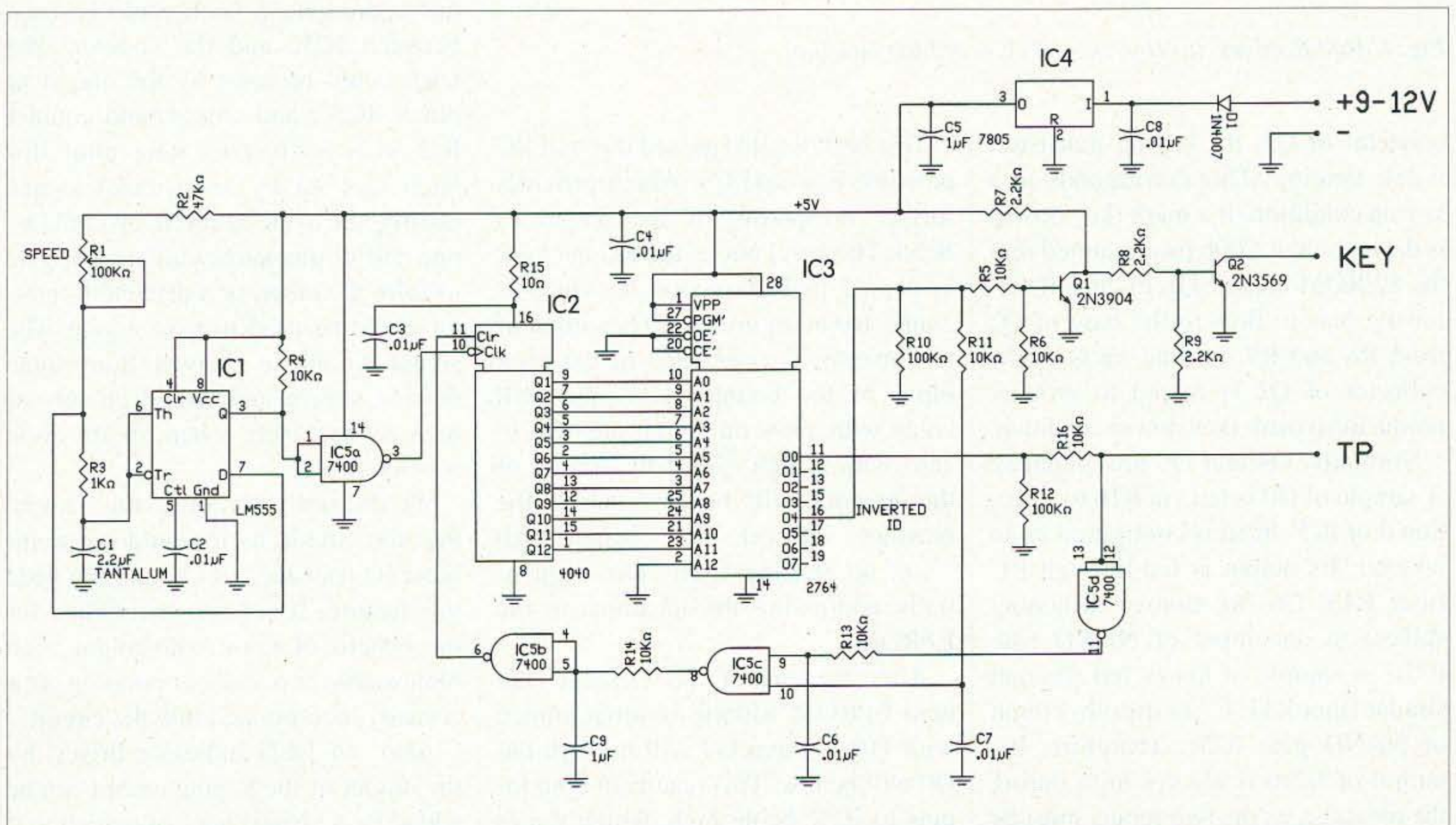

Fig. 1. Schematic. EPROM: FF = space, 00 = mark, F0 = reset counter. TP = test point. Unit shown with TTL-type ICs.

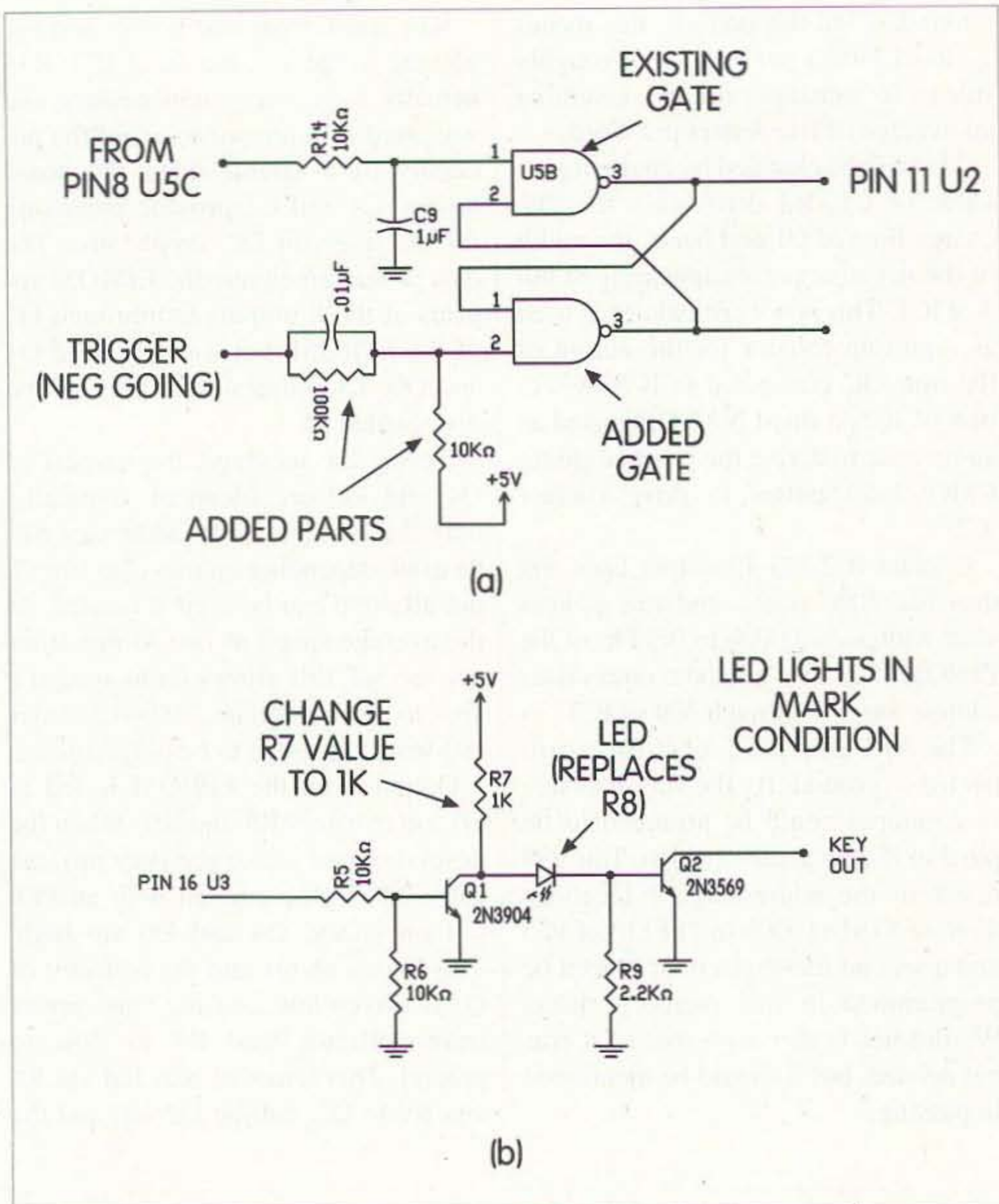

Fig. 2. Modifications. (a) One-shot. (b) Use of LED indicator.

collector of Q2, the keying transistor, is left floating. This corresponds to a key up condition. If a mark (key down) is desired, then a 00h programmed into the EPROM causes Q1 to cut off, allowing bias to flow to the base of Q2 from R8 and R9, turning on Q2. The collector of Q2 is forced to ground, producing a mark (key down) condition.

Normally, O4 and O0 are identical. A sample of O0 is fed via R16 to a section d of IC5. IC5d is configured as an inverter. Its output is fed through RC filter R13, C6 (to remove switching spikes) to one input of NAND gate IC5c. A sample of O4 is fed through similar filter R11, C7 to the other input of NAND gate IC5c. Therefore, the output of IC5c is always high during the message, as the two inputs must be both high for the output to go low.

This high level is passed through RC network R14 and C9, which provides further de-spiking of the output of IC5d. The level out of the RC network is passed to IC5 section b, which is connected as an inverter. The output of the inverter is connected to the reset input of the counter IC2. IC2 will count with a low on pin 11 and reset to zero with a high. Since the output of the inverter will be low during the message interval, the counter will count up starting from zero, sequentially addressing the locations in the EPROM.

After the end of the message, the next EPROM address is programmed with F0h, so that O4 will be high but O0 will be low. This results in both inputs to IC5c being high, which forces its output (pin 8) low. This causes C9

to discharge through R14, eventually driving the input of IC5b low.

Then, the output of IC5b goes high, producing a high level at the pin 11 (clear) input of counter IC1, resetting it to zero. This starts the message cycle over. In addition, C9 holds the voltage at pins 4 and 5 of IC5b momentarily at ground on power-up, providing a reset to counter IC2 and initializing it to zero. This ensures that the message starts at the beginning on power-up. Also, if the counter were not initialized to zero, it might initialize at a count beyond the end of the message. It would have to then count up to 4095 and roll over before the message started again. This could take several minutes and would be very undesirable.

IC4, an LM7805, provides regulated +5 V to the circuit and will work with any input voltage of +8 up to +35 V. It is not necessary to use such a large regulator, but plenty were on hand. A smaller 78L05 will do fine if the supply voltage is kept below about 18 V. D1 provides polarity protection and "Murphy's Law insurance." C5 and C8 ensure regulator stability. Current drain is about 7 mA to 9 mA.

If monostable operation is desired (one ID cycle only rather than continuous operation), a latch could be used between IC5c and the counter. The latch could be reset by the output of pin 8, IC5c, and would hold counter IC2 in a set-to-zero state until this latch was set by an external signal, starting the cycle again. IC5b could be one half of this latch with another gate to form the other, or a discrete transistor could be used to save a gate. The signal would be derived from some outside source and would go low or high as necessary when an ID cycle was required.

We did not incorporate this feature into the circuit, as it would mean another IC package, and we did not need this feature. It is being mentioned for the benefit of those who might need monostable or one-shot operation, as it is easily incorporated into the circuit.

Also, an LED indicator driven by the output of the keying circuit can be added for a visual check of operation if desired. You can substitute an LED for

R8 if you like. R7 could be changed to 1 kΩ to increase LED brightness. Nothing is very critical here. Speed is not important, and we just need to ensure adequate drive to the keying transistor Q2 so as to handle about 50 mA load current. Make sure to observe LED polarity. See Fig. 2 for these modifications.

Other applications of this circuit are possible. The use of this circuit as a timer with up to 4096 possible on/off segments is certainly feasible. The timing components in the 7555 circuit (R1, R2, R3, and C1) can be made large enough (resistors of around 20 megs and tantalum caps of 10 μF or

Continued on page 20

- DIP switch programmable
- Miniature in size
- 37 EIA tones, 27 non-standard tones from 33.0 to 254.1 Hz included
- Reverse Burst built-in
- Easy 3 wire hookup

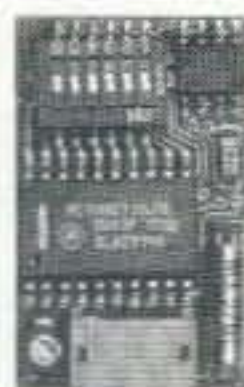

SS-64 CTCSS Encoder
.66" x 1.08" x .21"

SS-64 DIP Switch Programmable CTCSS Encoder \$28.95

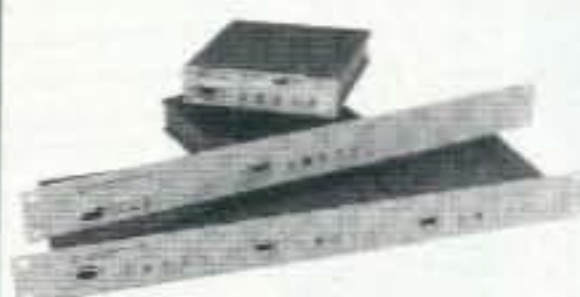

TP-3200 Shared Repeater Tone Panel

TP-3200D Table Top Version \$269.95 each
TP-3200RM-A Single Rack Mount version \$279.95 each
*TP-3200RM-B Triple Rack Mount version \$279.95 each
*Holds up to three TP-3200s

Call or write to receive our full Product Catalog or visit our Web site for complete information at:
<http://www.com-spec.com>

- Fully enclosed CTCSS encoder
- All 32 EIA tones from 67.0 to 203.5 Hz included
- Perfect for mobile / base applications



TE-32
5.25" x 3.3" x 1.7"

TE-32 Multi-Tone CTCSS Encoder \$49.95

- 51 CTCSS Tones
- 106 DCS Codes
- Supports 157 Repeater Subscribers
- On-Line Computer Help
- Repeater CW ID
- Air Time Loading & Analysis Graphs
- Signalling Formats: CTCSS, DCS & DTMF



ID-8 Automatic Morse Code Identifier
1.85" x 1.12" x .35"

ID-8 Automatic Morse Station Identifier \$69.95

COMMUNICATIONS SPECIALISTS, INC.
426 WEST TAFT AVENUE • ORANGE, CA 92665-4296
(714) 998-3021 • FAX (714) 974-3420
Entire U.S.A. (800) 854-0547 • FAX (800) 850-0547
<http://www.com-spec.com>

CIRCLE 10 ON READER SERVICE CARD

Parts List

R1	100 k pot
R2	47 k
R3	1 k
R4, R5, R6, R11, R13, R14, R16	10 k
R7, R8, R9	2.2 k
R10, R12	100 k
R15	10
C1	2.2 μF 35 V tantalum
C2, C3, C4, C6, C7, C8	.01 disc GMV
C5, C9	1 μF 35 V electrolytic
D1	1N4007
Q1	2N3904
Q2	2N3569
IC1	ICM7555 CMOS timer
IC2	CD4040 counter
IC3	27C64 CMOS EPROM
IC4	LM7805 5 V regulator
IC5	74C00N quad NAND

Misc.: PC board; 4-40 BHMS; 4-40 lockwasher; 4-40 hex nut

Table 2. All resistors are 1/4 W 5%; IC sockets, CMOS or TTL versions of the chips may be used if desired.

CALL TOLL FREE
(800) 292-7711 orders only
Se Habla Español

YOUR ONE STOP SOURCE
FOR ALL YOUR TEST
EQUIPMENT NEEDS

CALL OR WRITE FOR OUR
NEW FREE 64 PAGE
CATALOG!
(800) 445-3201

NEW XK-700 Digital / Analog Trainer
Especially designed for school projects. It is built on a single PC board for maximum reliability. It includes 3 built-in power supplies, a function generator w/ continuously sine, triangular and square waveforms, 1,000 Hz port (breadboard area). Tools and meter shown optional. (Mounted in a professional tool case made of reinforced metal).

XK-700
Assembled and Tested \$189.95

XK-700-SEMI Kit
Assembled and Tested \$174.95

XK-700K - Kit
\$159.95

Made in U.S.A.

Elenco Scopes
Free Dust Cover & Probes

S-1325 25MHz	Delayed Sweep	\$325
S-1330 25MHz		\$439
S-1340 40MHz		\$475
S-1345 40MHz	Delayed Sweep	\$559
S-1360 60MHz	Delayed Sweep	\$749
S-1390 100MHz	Delayed Sweep	\$895

DIGITAL SCOPE SUPER SPECIALS

DS-203 20MHz/10Ms/s Analog/Digital	\$695
DS-303 40MHz/20Ms/s Analog/Digital	\$895
DS-603 60MHz/20Ms/s Analog/Digital	\$995

4 Functions in One
MX-9300
\$459.95

Features

- One instrument w/ four test leads and measuring systems.
- 1.5GHz Frequency Counter
- 2MHz Sweep Function Generator
- Digital Multimeter
- Digital Triple Power Supply

• 0-30V @ 3A, 15V @ 1A, 5V @ 2A

NEW Tektronix DMMs

- 40,000 Count
- High Accuracy
- Tektronix Quality
- 3 Year Warranty

DMM 912	\$199	\$179
DMM 914	\$249	\$229
DMM 916	\$299	\$275

20MHz Sweep/Function Generator
with Frequency Counter
Model 4040

- 0.2Hz to 20MHz
- AM & FM Modulation
- Burst Operation
- External Frequency Counter to 30kHz
- Linear and Log Sweep

10MHz - Model 4017	\$309
5MHz - Model 4011	\$239

\$399

Fluke Scopemeters

123	\$950
92B	\$1445
96B	\$1695
97	\$1895
99B	\$2095
105B	\$2495

ALL FLUKE PRODUCTS ON SALE!!

Technician Tool Kit
TK-1500

28 tools plus a DMM contained in a large flexible tool case with a handle ideal for everyone on the go!

\$49.95

Fluke Multimeters

Model 26II	\$63	Model 12	\$84
Model 70III	\$85	Model 83	\$235
Model 73III	\$115	Model 85	\$209
Model 75III	\$139	Model 87III	\$209
Model 77III	\$154	Model 863E	\$475
Model 79III	\$175	Model 867BE	\$650

DIGITAL LCR METER
Model LCR-1810

- Capacitance 0.1pF to 20MF
- Inductance 1nH to 20H
- Resistance .01W to 2000MW
- Temperature -20°C to 750°C
- DC Volts 0-20V
- Frequency up to 15MHz
- Diode/Audible Continuity Test
- Signal Output Function
- 3 1/2 Digit Display

\$99.95

B&K High Current DC Power Supply

- Variable 3-14VDC
- Thermal Function
- Current Limiting

Model 1686 12A	\$159
Model 1686 28A	\$239

B&K 13.8V Fixed DC Power Supplies

Model 1680 6A	\$39
Model 1682 15A	\$75

Quad Power Supply
Model XP-581

Four Fully Regulated DC Power Supplies in One Unit

4 DC Voltages: 3 Fixed, 1 Variable

- -2V @ 3A
- +12V @ 1A
- +12V @ 1A
- 1 Variable 2.5 - 20V @ 2A

\$89.95

Digital Multimeter
Model M-1740

\$39.95

Free Holster

11 functions including freq to 20MHz, cap to 20nF. Meets UL-1244 safety specs.

10% OFF ON ALL STANDARD AMATEUR RADIO PRODUCTS
Including Accessories

Elenco LCR & DMM
Model LCM-1950

\$69

12 Functions
Freq to 4MHz
Inductance
Capacitance

Handheld Universal Counter
F-2800

1MHz - 2.8GHz

Features:

- 16 segment RF signal strength bargraph 100Hz - 2.8GHz
- 16 segment RF signal strength bargraph
- 6 hour NiCd battery operation
- High speed 250MHz direct count for high resolution

NEW \$99

Kit Corner over 100 kits available

Model AR-2N6K
2 Meter / 6 Meter
Amateur Radio Kit

\$34.95

Model AM/FM-108K
Transistor Radio Kit

\$29.95

35mm Camera Kit
Model AK-540
Learn all about photography

\$14.95

No Soldering Required

Radio Control Car Kit
Model AK-870

- 7 Functions
- Radio Control Included

\$24.95

No Soldering Required

Repair System Soldering and Desoldering Station Model SL-916

Top-of-the-line repair system will handle desoldering. Temperature controlled soldering from 300°F to 700°F (150°C to 425°C), desoldering temperature range 410°F to 900°F (210°C to 480°C). The system is based on principle of vacuum absorption of the solder from the PC board.

SL-916 Desoldering System with Digital Display also available \$325.00

\$425.00

Guaranteed Lowest Prices

UPS SHIPPING: 48 STATES 5%
OTHERS CALL FOR DETAILS
IL Residents add 8.25% Sales Tax

C&S SALES, INC.
150 W. CARPENTER AVENUE
WHEELING, IL 60090
(847) 541-0710 • FAX: (847) 541-9904
http://www.elenco.com/cs_sales

15 DAY MONEY BACK GUARANTEE
FULL FACTORY WARRANTY
PRICES SUBJECT TO CHANGE WITHOUT NOTICE

CIRCLE 184 ON READER SERVICE CARD

more) to produce clock speeds of as low as one cycle per several minutes. Do not use aluminum electrolytic capacitors, as their leakage will be too high for this application and circuit operation will be erratic and unreliable.

Large values permit a 4096 state cycle that may easily exceed one week. Almost any conceivable timing pattern within this time interval can be programmed, with 4096 segments possible. If no reset is used, the counter will simply roll over to zero when a count of 4096 is reached, and then repeat the cycle. An optoisolator and triac arrangement could be used to control large AC loads at 120 V or 240 V line voltages. Similarly, the counter can be speeded up and used to generate serial digital waveforms for experiments or as an arbitrary waveform source.

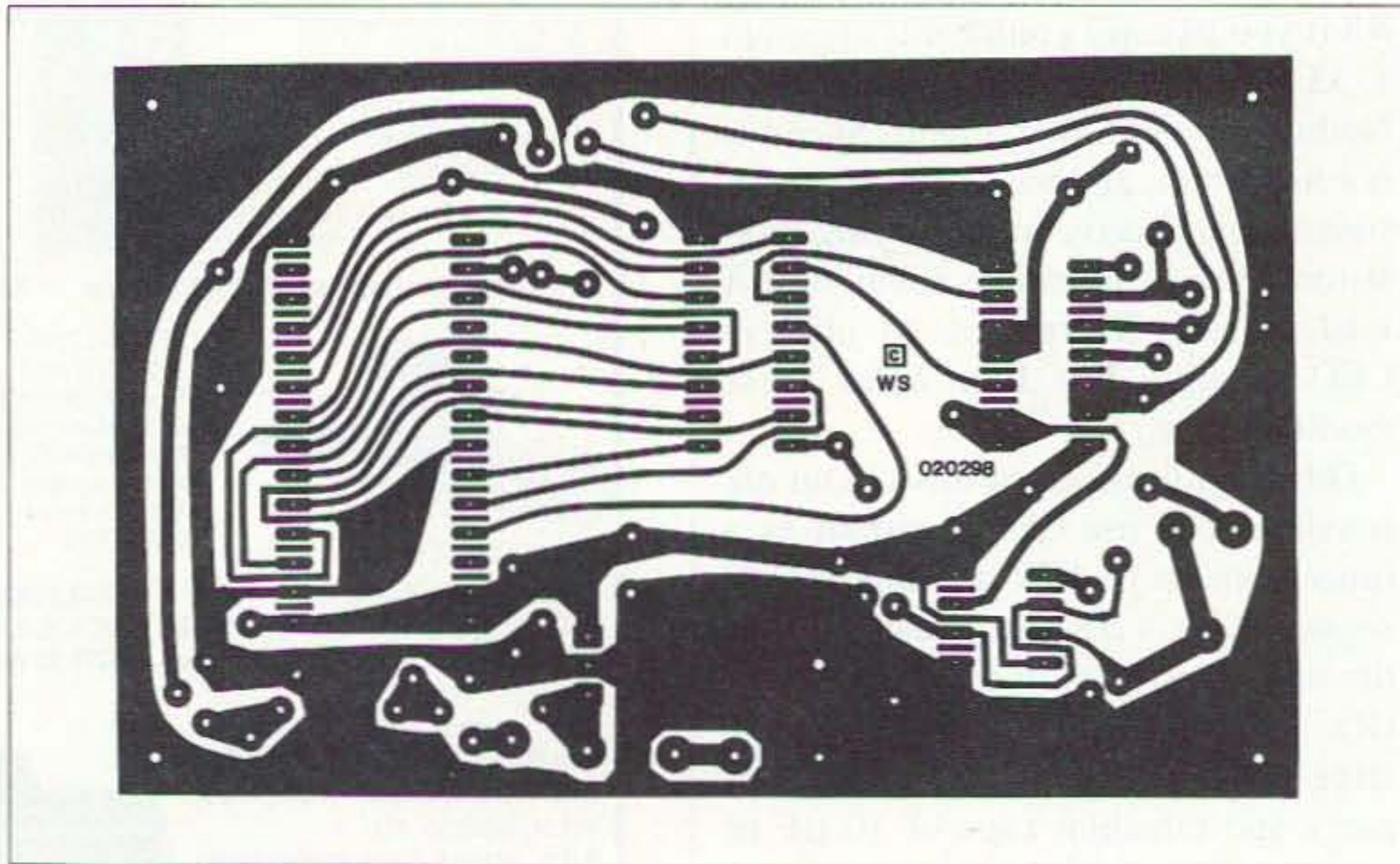

Fig. 3. Foil side of PC board (actual size).

Construction can be from the PC layout in Figs. 3 and 4. You could also use Vectorboard® and hardwire the connections, or use "ugly bug" or wire-wrap techniques. The highest frequencies present are in the low audio range, so almost any reasonable layout can be used.

A drilled and etched circuit board for constructing the CW identifier is available for \$20 (US), including shipping and handling, from:

North Country Radio
P.O. Box 53
Wykagyl Station
New Rochelle NY 10804-0053

E-mail: [NCRadio200@aol.com]; Web site: [http://www.northcountryradio.com]. Please note that New York residents must add \$1.50 sales tax.

A catalog of kits for amateur radio projects, ATV transmitters, downconverters, receiver and video accessory kits, and video and surveillance cameras and lenses is posted at our Web site. In addition, technical articles and construction details on several projects will also be found there. A printed catalog (included free with PCB order) is available for \$2 plus SASE with 78¢ return postage from the above address. **73**

BIOELECTRIFIER

PLANT GROWTH STIMULATOR

- COMPACT SIZE, 4.5" X 2.25" X 1"
- ADJUSTABLE OUTPUT UP TO 25 VOLTS
- STAINLESS STEEL ELECTRODES
- WIRED AND TESTED

FOR MORE INFORMATION

SEND SASE TO:

SEAGON COMPANY
5541 OAKVILLE CENTER
SUITE 215
ST. LOUIS, MO 63129

CIRCLE 241 ON READER SERVICE CARD

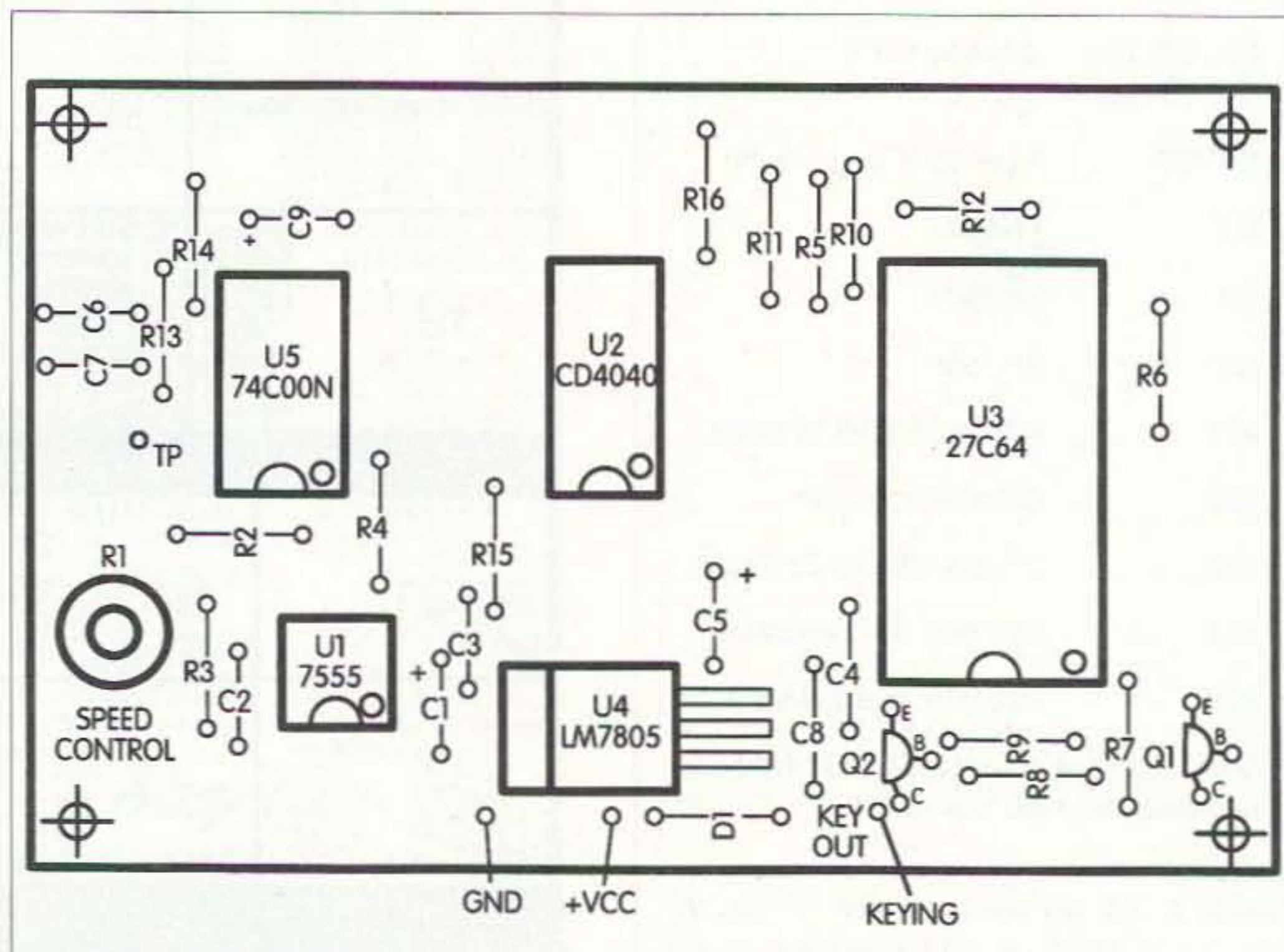

Fig. 4. Parts layout.

FM Revisited

Secrets of stuff you thought you knew.

Hugh Wells W6WTU
1411 18th Street
Manhattan Beach CA 90266-4025

Over the years, there have been many schemes developed for modulating a transmitter. The purpose of each was to provide a method for communicating intelligence via radio from one location to another. Of the many schemes or techniques used, amplitude modulation (AM) and frequency modulation (FM) have formed the basis for the majority of techniques.

With both techniques, the intelligence being communicated is carried in sideband energy produced by the transmitter during the modulation process. Although amplitude modulation is still used in AM broadcasting, TV video, and aircraft communications, its form has been modified to single sideband (SSB) for the remaining AM applications.

Frequency modulation (FM) appears to be the most predominant technique used by both hams and commercial interests for communicating on frequencies above 100 MHz. Because the communication of intelligence is carried in sideband energy produced by a transmitter, let's review AM sidebands to set a foundation before proceeding with FM.

Amplitude modulation

In AM, the audio signal is added to (mixed with) the carrier forming a pair (or set) of identical sidebands which straddle the carrier. These sidebands represent the audio component referred to as modulation and all of the intelligence is carried in these sidebands. A fully modulated signal (100% modulation) has an amount of total sideband power equal to the unmodulated carrier power; when fully modulated, the amount of power in the transmitted signal will be doubled.

The carrier itself contains no modulation, but goes along for the ride when transmitted to assist in demodulating the sidebands at the receiver. Because a pair of identical sidebands are produced containing the same intelligence, either sideband may be eliminated without loss of intelligence. As most hams realize, SSB (single sideband) is a process where the carrier and one sideband are suppressed at the transmitter, permitting only one sideband to be transmitted. However, upon receiving the SSB signal, a carrier must be reinserted at the receiver as a replacement for the one removed prior to transmission.

As a final observation regarding AM, the transmitted power in AM sidebands varies as a function of the audio amplitude, and the frequencies of the sidebands are a function of the audio frequencies as they are mixed with the carrier. It is important to note that the carrier frequency remains stationary, but the sidebands come and go in accordance with the audio.

Frequency modulation

Like AM, FM also generates sidebands during the modulation process. But unlike AM, the carrier changes frequency and the composite signal (carrier and sidebands) remain at a constant amplitude. An FM transmitted signal can be obtained by either of two basic modulation methods. One is direct, sometimes referred to as true FM, and the other is an indirect method called phase modulation (PM). In the direct method, the audio signal is introduced directly into the carrier oscillator, causing it to shift frequency in direct correspondence to the audio amplitude. With PM (phase modulation), the audio signal is introduced into a phase modulator stage which follows the oscillator. The oscillator

frequency remains constant at all times with PM, but the combining of the oscillator signal and audio create a new signal which is phase-shifted from the oscillator. The phase angle of this new signal varies as a function of the audio voltage amplitude.

In an FM transmitter, the amount of frequency or phase shift that occurs is small at the point of modulation. To obtain the amount of desired shift (deviation) at the transmitted carrier frequency, it is necessary to multiply the shift through the various frequency multiplier stages of the transmitter. As an example, if the oscillator is operating at approximately 6 MHz and the transmitted output is 146 MHz, the amount of multiplication is 24. It follows, then, that if the transmitted frequency shift (deviation) is 5 kHz, the amount of shift at the oscillator/phase modulator will be 1/24th of 5 kHz, or 208.33 Hz.

There is a significant difference between direct FM and phase-modulated FM that needs to be discussed. In the generation of a phase-modulated signal, the phase modulator causes the signal phase angle shift, as a function of the audio frequency, to be pre-emphasized at 6 dB/octave. As the audio frequency increases, say from 1 kHz to 2 kHz (one octave), the carrier is shifted by a factor of 6 dB. Direct FM, on the other hand, has essentially a flat

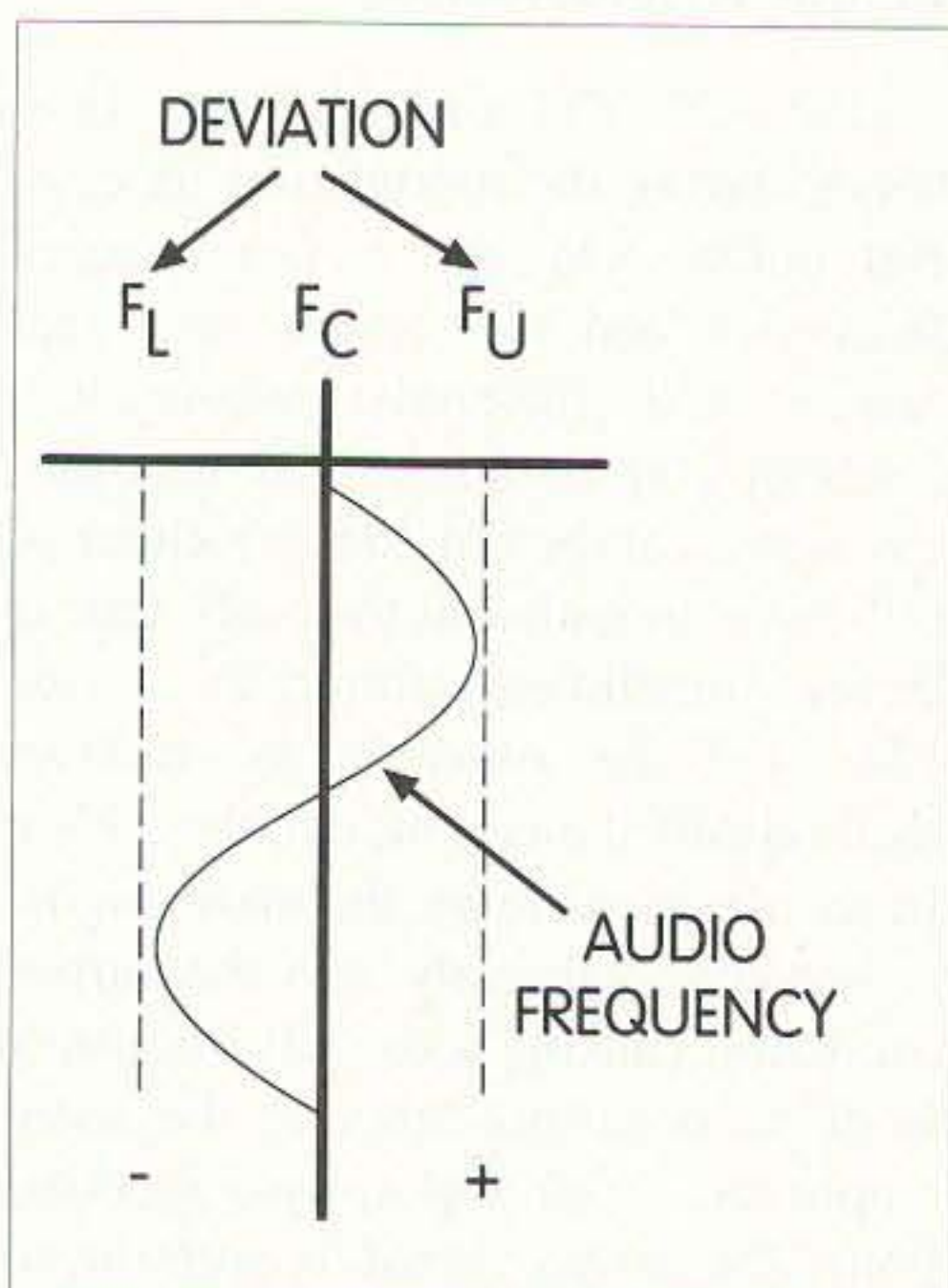

Fig. 1. Relationship of deviation to the audio voltage.

response to a change in audio frequency. This response difference matters when the transmitted signal is received. To demonstrate the difference, it would be necessary to set up two transmitters operating without pre-emphasis compensation, one using direct modulation and the other using PM. A noticeable audio response difference would be observed when receiving the two signals alternately by a receiver. With the 6 dB pre-emphasis, the PM signal would sound more "brilliant," with its higher audio frequencies emphasized, as compared to the "flat" response of the direct method.

To go one step further, if the receiver was de-emphasized at 6 dB/octave to accommodate PM, the direct method would sound bassy because the higher frequencies have been rolled off. However, both direct and PM modulation methods may be used by different transmitters in the same communications service. To create the same recovered audio response at the receiver, it is necessary only to adjust the pre-emphasis network in the transmitter to produce the desired response at the receiver.

Terms

To gain a better perspective of FM, it is necessary to define several terms that describe the modulation process and resulting sidebands. The terms relating to FM probably describe FM better than any word description or example that can be cited. In short, understanding the terms provides a concise capsule of FM.

Deviation

Deviation is the amount of instantaneous carrier shift from its resting point (center frequency of the carrier without modulation). The shift may be measured in either the plus or minus direction from the carrier. Deviation is a direct function of the audio signal amplitude. In other words, the audio amplitude controls the amount of deviation as shown in Fig. 1. Observe the carrier shift from F_C toward F_U as the audio sinewave increases in a positive direction. A matching shift from F_C to

F_L will occur as the sinewave increases in a negative direction. This example assumes that the modulator, whether direct or PM, will produce an equal shift in both directions (symmetrical shift).

Rate of deviation

The rate of deviation is the speed with which the carrier moves while deviating and is a function of the audio frequency. Simply, the frequency of the audio controls the rate of deviation. This relationship can be imagined in Fig. 1 by observing the increasing sweep rate from F_U to F_L and back as the audio frequency is increased.

Modulation index (M)

Modulation index is a term which describes the complex sideband structure created by the FM process, and is related to the combining of frequency deviation and the audio frequency. Values of modulation index provide, in capsule form, a total description of FM sidebands. In essence, modulation index describes the transmitted signal bandwidth as a function of significant sidebands produced during modulation. A sideband is considered significant when it has a power value equal to, or greater than, 1% of the unmodulated carrier. For a graphical view of FM, a Bessel Function chart shows the complex sideband structure produced by FM and the following equation shows the ratio of the factors involved.

$$M = \frac{\text{Max deviation allowed}}{\text{Highest actual audio freq}}$$

Table 1 shows a partial listing of sideband quantities as a function of M values. Values indicated in the table were obtained from a Bessel Function chart by counting the number of sidebands having a power amplitude greater than 1% of the resting carrier power.

Deviation ratio (DR)

Deviation ratio is a specialized form of modulation index where the two factors are the maximum values allowed. As a comparison, the modulation index utilizes the maximum deviation allowed with an actual audio

Modulation Index (M)	Number of Sidebands
1.0	3
1.5	4
1.67	4
2.0	4
3.0	6
4.0	7
5.0	8
6.0	9

Table 1. A sampling of the number of significant sidebands as a function of modulation index (M).

frequency. The following equation shows how DR can be determined.

$$DR = \frac{\text{Max deviation allowed}}{\text{Max audio freq allowed}}$$

Bandwidth (BW)

The term bandwidth describes the amount of frequency spectrum occupied by the transmitted signal. Bandwidth is a function of the number and spacing of sidebands, and is controlled by the highest modulating audio frequency. The following equation shows how the bandwidth can be determined when the number of significant sidebands and highest audio frequency are known. The number of sidebands as a function of M values may be obtained from **Table 1** or by examining a Bessel Function chart. It is necessary to double the number of sidebands, as the data obtained from the chart and table represent only the number of sidebands on one side of center frequency.

$$BW = 2(\# SB) \times (\text{audio freq})$$

Bessel Function chart

Perhaps the best way of describing sidebands as generated by an FM transmitter is to examine a Bessel Function chart adapted to values of M (modulation index) as shown in **Fig. 2**. Although Bessel Functions may be carried out to infinity, it is rarely necessary to

Continued on page 24

INDIANAPOLIS HAMFEST
 HOST TO THE
ARRL CENTRAL DIVISION CONVENTION
SATURDAY, JULY 11, 1998
 INDIANA'S HAM RADIO, COMPUTER AND ELECTRONICS SHOW
SETUP Friday 4PM - 9PM **HAMFEST** Saturday 6AM - 7PM
 MARION COUNTY FAIRGROUNDS AS BEFORE
 COMMERCIAL EXHIBITS — INDOOR AND OUTDOOR FLEA MARKETS
 FORUMS — OFF SITE TESTING
 Write or call: Indianapolis Hamfest Association Dept DS
 P.O. Box 88677, Indianapolis IN 46208
 (317) 251-4407 <http://www.indyhamfest.com> E-mail: ogarr@in.net

The NicD Lady - N6WPA
Individual Cells - Replacement Packs - Lead Acids
Rebuilding Service - O.E.M. Assembly
 for
***Handheld Radios *Laptops *Cellular Phones *Camcorders**
***Portable Scanners *Test Equipment *Power Tools**
 Check into our rebuilding service - Substantial Savings over NEW!
 Convert your pack to NiMH! Same size pack - **HIGHER** capacity!
 Call for a price list or visit our website: www.nicdlady.com 
 17052 Alameda Drive Gavilan Hills, CA 92570-8846
(909) 789-0830 email: nicdlady@deltanet.com FAX: (909)789-4895

CIRCLE 141 ON READER SERVICE CARD

<p>THE ORIGINAL WD4BUM HAM STICK™ ANTENNAS for HF MOBILE OPERATION \$19⁹⁵ each</p> <p>The only lightweight HF mobile antenna recommended by noted author Gordon West W3GNOA</p> <ul style="list-style-type: none"> • Monobanders for 75 to 6 meters. • Very rugged fiberglass & stainless steel. • Telescopes for easy adjustment. • 3/8 x 24 TPI base fits most mounts. • Low profile & low wind load. • Needs no springs or guys. • Complete tuning & matching instructions included. • Approximately 7 ft. tall. • 600 watts. <table border="1"> <thead> <tr> <th>Cat.#</th> <th>Band</th> <th>Cat.#</th> <th>Band</th> </tr> </thead> <tbody> <tr> <td>9175</td> <td>75 meters</td> <td>9115</td> <td>15 meters</td> </tr> <tr> <td>9140</td> <td>40 meters</td> <td>9112</td> <td>12 meters</td> </tr> <tr> <td>9130</td> <td>30 meters</td> <td>9110</td> <td>10 meters</td> </tr> <tr> <td>9120</td> <td>20 meters</td> <td>9106</td> <td>6 meters</td> </tr> <tr> <td>9117</td> <td>17 meters</td> <td></td> <td></td> </tr> </tbody> </table>	Cat.#	Band	Cat.#	Band	9175	75 meters	9115	15 meters	9140	40 meters	9112	12 meters	9130	30 meters	9110	10 meters	9120	20 meters	9106	6 meters	9117	17 meters			<p>NEW !! AT LAST!! NEW 2 METER ANTENNA NO GROUND REQUIRED</p> <ul style="list-style-type: none"> • Boats • R.V.s • Fiberglass roof vans • Plastic cars • Bicycles • Motorcycles • Can be used with ground plane <ul style="list-style-type: none"> • 3 Db Gain • Power rated at 100 watts • NMO base mount • Only 40" tall • 17-7 ph stainless steel whip • Adapter and fully adjustable marine mount available. • Patent Pending <p>CAT. # HW-1 \$44⁹⁵</p>	<p>NEW LICENSE PLATE MOUNT NEW</p> <ul style="list-style-type: none"> • Mounts behind license plate • Mount is constructed of type 304 Stainless Steel • Complete with S/S hardware • For Antenna's with 3/8" x 24 Thread • Accepts PL-259 Direct • Ground strap included • Complete mounting instructions included <p>100% MADE IN USA \$44⁹⁵ CAT. #TM-1</p>
Cat.#	Band	Cat.#	Band																							
9175	75 meters	9115	15 meters																							
9140	40 meters	9112	12 meters																							
9130	30 meters	9110	10 meters																							
9120	20 meters	9106	6 meters																							
9117	17 meters																									
<p style="text-align: center;">Lakeview Company, Inc. 3620-9A Whitehall Rd., Anderson, SC 29626 • 864-226-6990 FAX: 864-225-4565 • E Mail: hamstick@hamstick.com • www.hamstick.com</p> <p>  ALL 100% MADE IN USA Add \$7 per order for S/H</p>																										

CIRCLE 275 ON READER SERVICE CARD

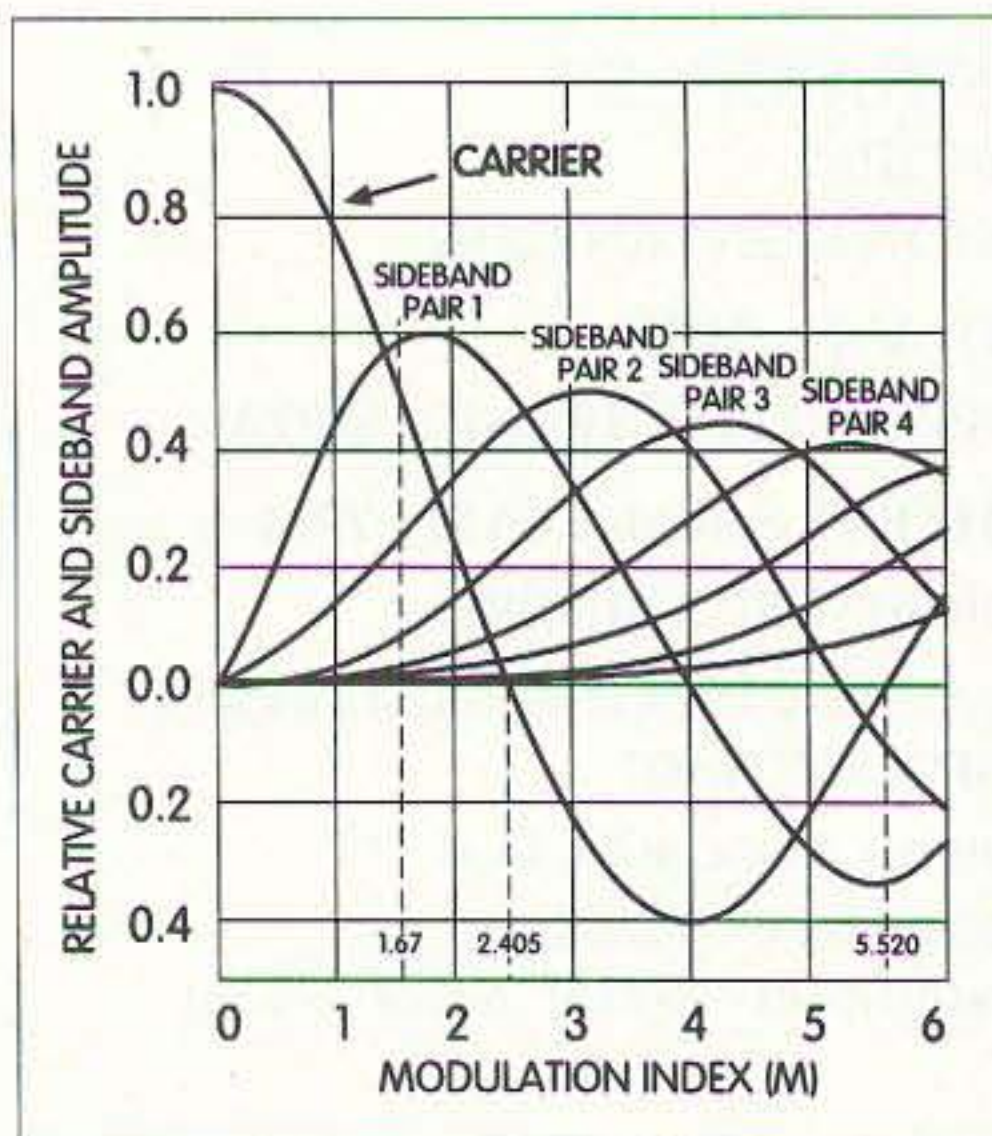

Fig. 2. Bessel Function chart used to show signal amplitude versus modulation index.

FM Revisited

continued from page 23

chart the functions beyond a modulation index of five. For ham use, a modulation index of 1.67 is sufficient, where the chart is concerned with determining the number of sidebands produced as a function of deviation. Another important feature of the chart is the indication of when the FM carrier passes through a null point. This indication is needed for an accurate measurement of deviation and is used for calibration purposes.

The chart provides insight through graphical presentation of the complex carrier and sideband structure created by the FM process. But the chart shows only one-half of the total sideband structure. The other half is a direct mirror image of that shown. Therefore, examining one side is sufficient for obtaining all of the information needed for understanding the structure.

Examining the chart reveals its structure and layout. The bottom horizontal line is marked off in units of M from zero to six. The vertical axis indicates signal amplitude from zero to 1.0 (100% of carrier power) in the positive direction. For most ham applications, only the amplitude, not polarity, is of interest. Observe, also, that the majority of significant sidebands are predominantly positive for values of M below five.

At $M = 0$, observe that the carrier amplitude is at 1.0 (100%), indicating there is no audio signal present. At this point, all sidebands are equal to zero. Following only the carrier curve, observe that it begins to decrease in amplitude as the modulation index increases. This is an indication that the audio signal amplitude is increasing.

Note that the carrier amplitude passes through zero when $M = 2.405$. At this null point all of the modulation intelligence is contained in the sidebands. With continued increases in deviation, the carrier will pass through additional null points at modulation index values of 5.52, 8.654, 11.792, 14.931, 18.071, etc. Each numerical point is separated by approximately the value of pi (3.14).

Determining the number of sidebands from the chart is simply a matter of counting the number of sideband lines crossing the vertical M value line. At $M = 5$, there are eight sideband lines and at $M = 1.5$ (also 1.67), there are four. The carrier is not counted, as it is not a sideband.

Once the number of sidebands at a given M value has been determined, then the frequency occupancy of the transmitted signal can be calculated. As an example, to find the bandwidth of a VHF ham-transmitted signal having 5 kHz deviation at an audio

frequency of 3 kHz, it is necessary to determine the value of M and the number of significant sidebands. An M value of 1.67 is found by dividing 5 kHz deviation by 3 kHz audio. For 1.67, the Bessel Function chart reveals that four significant sidebands exist per side for a total of eight sidebands. Therefore, the bandwidth occupancy of the ham transmitted signal is 24 kHz (8 SB x 3 kHz).

Summary

FM has become a very popular means for communicating intelligence from one place to another. With the multitude of transmitters operating on the bands, bandwidth occupancy becomes an important factor, and can be controlled by the amount of deviation and the highest transmitted audio frequency. Studying the terms and tools associated with FM will provide the insight needed to understand the technical characteristics of FM. Terms such as deviation, bandwidth, and modulation index describe the very heart of FM, with tables, equations, and a Bessel Function chart serving as tools for examining the characteristics in detail.

For more in-depth study of FM, here's a list of suggested reading:

The ARRL 1985 Handbook. Newington, Connecticut. Pg. 18-21.

Elements of Electronic Communications, Joseph J. Carr. Reston: Reston Publishing Co., Inc. 1978. Pg. 363.

Frequency Modulation Receivers, A.B. Cook and A.A. Liff. Englewood Cliffs: Prentice-Hall, Inc. 1968. Pg. 27.

Reference Data For Engineers: Radio, Electronics, Computer, and Communications, Edward C. Jordan (ed.). 7th edition. Indianapolis: Howard W. Sams & Co., Inc. Pgs. 24-8, 46-38, 47-9.

Radio Handbook, William I. Orr. 21st edition. Indianapolis: Editors and Engineers. Chapter 13.

Handbook of Electronic Instruments and Measurement Techniques, Harry E. Thomas and Carole A. Clarke. Englewood Cliffs: Prentice-Hall, Inc. 1967. Pg. 275.

Electronic Communications Systems, Wayne Tomasi. Englewood Cliffs: Prentice-Hall, Inc. 1988. Chapter 7. 73

CODEMASTER V

0-20WPM in 90 Days
Guaranteed!

Codemaster V is the *only* computer-based Morse code training system that **guarantees RESULTS!** Whether you're a beginner or want to break the 30wpm barrier, it will take you as far as you want to go, and it's fun!

Only
\$29.95

Codemaster V has a wide variety of training and practice routines, trial exams, interactive arcade game, and much more. CM5 can use multiple Morse alphabets including foreign characters, and it's endorsed for military training! For any IBM compatible PC. S/H \$5.00 (in US). Credit card orders toll free!

Milestone Technologies, Inc.
3140 S Peoria Unit K-156 Aurora, CO 80014
(303)752-3382 sales@mtechnologies.com
www.mtechnologies.com/mthome

800-238-8205

CIRCLE 136 on READER SERVICE CARD

Vintage Values

Heading for a hamfest? Tempted by the timeless?

Bill Clarke W2BLC
764 Alta-Voor Road
Altamont NY 12009

Thinking about buying an older rig? One of those operable vintage rigs? Want to put an old-timer on the air? Perhaps an old Collins KWM-2 or a Drake TR-4C is of interest to you ... or a Hallicrafters, National, or other make or model of vintage ham equipment.

Vintage ham equipment, mostly built during the '50s, '60s, and '70s, consists of tube-based rigs that glow in the dark and can effectively warm your shack on a cold winter's night. Of course, *some* will say vintage rigs are merely cranky rigs that require manual retuning every time you QSY, that they constantly drift up and down the band, and that they always need tinkering to keep them on the air. In general, vintage equipment is fondly (sometimes less so) referred to as "boat anchors."

There is a following for vintage AM equipment, such as Johnson and many Hallicrafters rigs. AM is alive and well on 75 meters in the evenings, and in New England there is a nice group heard in the middle of every morning. Vintage CW equipment is less costly to purchase and maintain than either SSB or AM rigs. There are some very fine vintage CW stations on the air.

However, the big interest appears to be for vintage SSB equipment.

For the most part, the classic rigs were made famous when the great names of Fort Orange Radio, Evans Radio, Walter Ashe Radio, Uncle George's Radio Ham Shack, and a few others ruled the ham marketplace.

There has been a real resurgence of interest in vintage rigs over the past few years. I have followed with great interest the prices some of these vintage rigs sell for—or perhaps I should say the value some owners place on their boat anchors.

Retail when new

Table 1 is a list of popular US-built vintage SSB ham equipment listed by make, model, type, year of production, and retail price (at that time). Not every piece of equipment available is listed; however, the more common and well known are shown. A very few are in a category all by themselves, that of the vintage solid state rig. Even a few linear amplifiers fit into the vintage era.

Vintage values

It's interesting to note that particular pieces of vintage equipment bring high

prices—high, that is, in comparison to similar equipment of other manufacturers, built at about the same time. Of course, the justification is usually based upon the quality of original manufacture, a factor that may be based more in the mists of time and lust than on fact.

Support for equipment maintenance must be taken into consideration when talking values. For example, Collins appears to have good parts support and lots of advice for keeping the equipment operating—due, no doubt, to the large numbers of the various Collins rigs still in existence. There seem to be no terrible parts shortages—if you're willing to pay the price. This will, in time, change, as the junk rigs get stripped of parts. Support and advice is available from the Collins Collectors Association, P.O. Box 840924, Pembroke Pines FL 33084.

Drake still offers factory support for their equipment. The work isn't cheap; however, it is very good. Send a rig to Drake for service and it will return looking great and working like new. Contact R.L. Drake at (513) 746-6990; by FAX (513) 743-4576; or by E-mail at [bill_frost@rldrake.com] for additional

Make	Model	Type	19__	\$	Make	Model	Type	19__	\$	Make	Model	Type	19__	\$
Atlas	180	1	73	479	Galaxy	V Mark 2	1	67	420	Heath	HW-100	1	69	250
	210	1	75	599		V Mark 3	1	68	420		SB-220	7	69	350
Collins	32S-1	2	58	590		AC-400	4	68	90	Henry	2K-3	7	64	745
	75S-1	3	58	495		2000B	7	68	495		2KD-3	7	64	745
	516F-2	4	58	105		GT-550	1	69	475		2K-Ultra	7	70	845
	312B-3	5	58	28		SC-550	6	69	25		2K-4	7	70	795
	312B-4	6	58	185	Hcrfrts	SR-150	1	62	350		2KD-4	7	70	795
	30S-1	7	58	1560		SX-117	3	62	380		Tmpo 1	1	71	298
	30L-1	7	58	520		PS-150	4	62	100		AC/One	4	71	99
	KWM-2	1	60	1150		SX-122	3	63	295	Johnsn	Valiant	2	56	440
	312B-5	8	60	350		HT-44	2	63	380		Rnger II	2	61	360
	32S-3	2	62	750		HT-45	7	63	500	Nationl	NCX3	1	63	369
	75S-3	3	62	680		SR-160	1	63	395		NCXA	4,5	63	120
Dentrn	MLA2500	7	77	800		SX-146	3	65	250		HRO500	3	65	1295
	Clip'on-L	7	78	600		HT-46	2	65	295		NCX5	1	67	549
	GLA1000	7	78	379		SR-400	1	65	800		NCX500	1	69	425
Drake	TR-3	1	63	550		PS-500A	4	65	120		AC-500	4	69	99
	AC-3	4	63	80		SR-2000	1	65	1095	SBand Engnrs	SBE-33	1	63	390
	RV-3	8,5	63	80		PS-2000	4	65	450		SBE-34	1	65	395
	R-4	3	65	380		HA-20	9	65	200		SBE-36	1	72	895
	T-4X	2	65	400		FPM-300	1	72	595	Signl 1	CX7A	1	71	2195
	AC-4	4	65	100		FPM-300/II	1	74	625	Swan	SW-120	1	61	275
	MS-4	5	65	20	H-lund	HQ-110	3	57	239		SW-240	1	63	320
	L-4	7	67	825		HQ-180	3	60	429		SW-117	4	63	95
	R-4B	3	68	430		S-200	5	60	20		350	1	64	395
	T-4XB	2	68	449		HX-500	2	60	695		117XC	4,5	65	95
	L-4B	7	68	825		HQ-145X	3	61	269		Mark II	7	67	630
	TR-4C	1	72	600		HX-50	2	61	400		500-C	1	68	520
	R-4C	3	73	500	Heath	HX-20	2	62	200		270-B Cygnet	1	70	499
	T-4XC	2	73	530		HR-20	3	62	135		500-CX	1	70	565
ETO	Alpha 77	7	72	1795		SB-200	7	64	220		700-CX	1	73	570
	Alpha 78	7	78	2400		HW-12A	1	66	100		350-A	1	77	600
Galaxy	300	1	63	300		HP-23A	4	67	54	WRL	Duo- Bander	1	65	160
	G300D	4	63	120		SB-101	1	67	360		AC384A	4	65	90
	III	1	64	350		SB-600	5	67	18		Duo- Bndr II	1	69	170

Table 1. US-built vintage SSB ham equipment. Type codes: 1—xcvr, 2—xmtr, 3—rcvr, 4—AC PS, 5—spkr, 6—spkr/console, 7—linear amp, 8—VFO, 9—VFO/SWR meter.

information. Drake, however, cautions that some parts are getting very scarce.

It may be less difficult to “make a rig operate properly” than it is to “restore to

like-new.” The latter can enhance the value of a rig to a collector. National,

Year	Conversion Factor	Year	Conversion Factor
1950	0.163	1974	0.322
1951	0.176	1975	0.349
1952	0.179	1976	0.368
1953	0.180	1977	0.392
1954	0.181	1978	0.419
1955	0.181	1979	0.459
1956	0.184	1980	0.511
1957	0.189	1981	0.559
1958	0.195	1982	0.593
1959	0.196	1983	0.618
1960	0.200	1984	0.645
1961	0.202	1985	0.667
1962	0.203	1986	0.680
1963	0.207	1987	0.705
1964	0.209	1988	0.734
1965	0.212	1989	0.769
1966	0.218	1990	0.811
1967	0.225	1991	0.845
1968	0.234	1992	0.870
1969	0.244	1993	0.896
1970	0.256	1994	0.919
1971	0.267	1995	0.945
1972	0.275	1996	0.973
1973	0.293	1997	1.000

Table 2. Consumer Price Index (CPI) conversion factor chart 1950 through 1997. To convert from a prior year, divide dollar amount by conversion factor; e.g., 1950 price of \$425 is divided by conversion factor of 0.163 to get 1997 dollar value of \$2607. To convert from the present, multiply dollar amount by conversion factor; e.g., present price of \$1995 is multiplied by conversion factor of 0.225 to get 1967 dollar value of \$449.

Hallicrafters, Galaxy, and the others all suffer from a lack of parts and no strong support organization. Heathkit suffers all the more, as there is no real measure of assembly quality. The rigs were all kits at one time or another and assembled by a widely spread group—some with good construction and soldering skills and others without.

Value examples

What can you expect to pay for a vintage piece of ham equipment? Well,

it will depend upon the make, model, and condition of the individual unit. There are no accurate price guides, as the market is too small—with too few examples being bought and sold. In general, Collins equipment will be at the top of the price heap, with Drake next. The others will follow depending upon the specific model.

Old value

The original selling price for new equipment is generally an indicator of

BIOELECTRIFIER™
 EXPERIMENTAL MICRO-CURRENT SUPPLY
 Now FULLY ASSEMBLED with batteries and FINE SILVER (not stainless steel) electrodes
\$89.50 + \$2.50 S&H
Beware of IMITATIONS!
 ALSO...
COLLOIDAL SILVER GENERATORS
 ZAPPERS, SILVER ELECTRODES, SEMI-KITS, etc.
 send SASE for information
 On the WEB: www.infocom.com/~thomil/
 To order, send CHECK or MONEY ORDER to:
THOMAS MILLER, W8YKN
 314 South 9th Street
 Richmond, IN 47374
 Voice/FAX (765) 962-3509 thomil@infocom.com

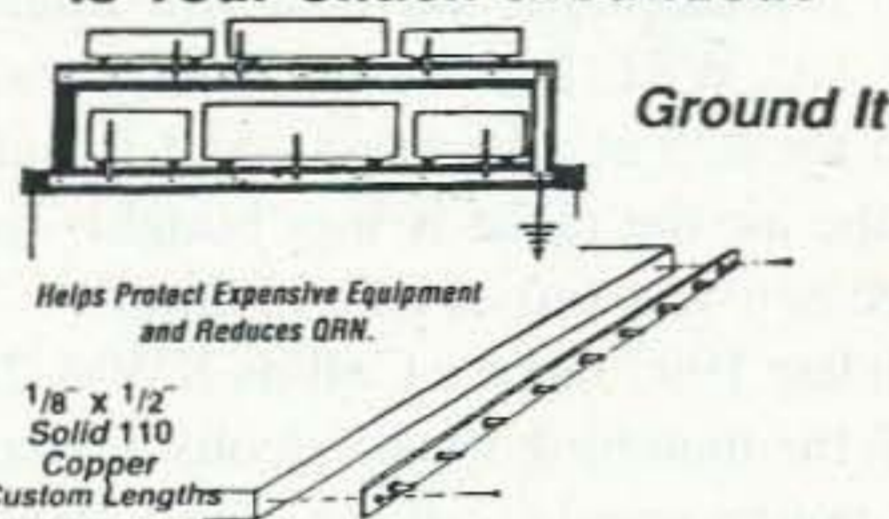
Is Your Shack Grounded?

Ground It
 Helps Protect Expensive Equipment and Reduces QRM.
 1/8" x 1/2" Solid 110 Copper Custom Lengths
 Solid Copper Buss - Stainless Steel Hardware - Grounding Stud Every 6 Inches - Ground all of your equipment chassis's to a single earth ground in one easy installation.
 2 ft. \$24.95 3 ft. \$29.95 4 ft. \$35.95
 \$5.00 S&H + \$2.00 Per Each Additional Buss
 Flexible Rope Wire Straps w/Terminal Ends, All Solid Copper \$2.50 per ft. \$5.00 S&H
 Custom Lengths Available
 Price Includes CT & NY Sales Tax
 money back guarantee
J. Martin Systems
 35 Hilltop Ave. Dept. 7, Stamford, CT USA 06907
 (24 hr voice mail) or FAX: 203-461-8768
<http://www.websiteint.com/199515>
 CALL, WRITE for International S & H

GET THE ATV BUG!
 Any Tech or higher ham can transmit live action color and sound video from their camcorder, just like broadcast, to other hams. It's fun, low cost, and easy! Uses any TV set to receive, add our TC70-10 ten watt 420-450 MHz Transceiver, and antenna - no other radios. See ARRL Handbook page 12.46.
HAMS: Ask for our free 10 pg ATV Catalog!
 We have it all, downconverters, transmitters, antennas, amps, etc. for the 70, 33, 23 and 3cm ATV ham bands.

P. C. Electronics
 2522 PAXSON Ln, ARCADIA, CA 91007
 CALL (626) 447-4565 or FAX 626-447-0489
 WEB: WWW.HAMTV.COM - Email: TOM@HAMTV.COM

Amplifiers, ATV Down Converters & Hard to Find Parts

LINEAR AMPLIFIERS

HF Amplifiers

PC board and complete parts list for HF amplifiers described in the Motorola Application Notes and Engineering Bulletins:

AN779H (20W)	2 Meter Amplifiers (144-148 MHz)
AN779L (20W)	(Kit or Wired and Tested)
AN 762 (140W)	35W - Model 335A, \$79.95/\$109.95
EB63 (140W)	75W - Model 875A, \$119.95/\$159.95
AR305 (300W)	
AN 758 (300W)	440-450 MHz Amplifiers
AR313 (300W)	(SSB-FM-ATV)
EB27A (300W)	100W - Model KEB 67, \$159.95
EB104 (600W)	
AR347 (1000W)	



HARD TO FIND PARTS

- RF Power Transistors
- Broadband HF Transformers
- Chip Caps - Kemet/ATC
- Metallized Mica Caps - Unelco/Semco
- ARCO/SPRAGUE Trimmer Capacitors

We can get you virtually any RF transistor!
Call us for "strange" hard to find parts!

ATV Down Converters

(Kit or Wired and Tested)

Model ATV-3 (420-450)
(Ga AS - FET)
\$49.95/\$69.95

Model ATV-4 (902-926)
(GaAS - FET)
\$59.95/\$79.95

DIGITAL FREQUENCY READOUT

For older analog transceivers
TK-1 (Wired and Tested)\$149.95

For detailed information and prices, call or write for a our free catalog!

ADDITIONAL ITEMS

Heat Sink Material

Model 99 Heat Sink (6.5" x 12" x 1.6"), \$24.00
CHS-8 Copper Spreader (8" x 6" x 3/8"), \$24.00
Low Pass Filters (up to 300W) for harmonics
Specify 10M, 15M, 20M, 40M, 80M or 160M
HF Splitters and Combiners up to 2KW



Add \$4.50 for shipping and handling

CCI Communication Concepts Inc.

508 Milstone Drive • Beavercreek, Ohio 45434-5840
Phone: (937)426-8600 • Fax (937)429-3811
E-Mail: cci.dayton@pobox.com

CIRCLE 99 ON READER SERVICE CARD

its value today. Collins equipment sold for the most money then, and it still does today. WRL (World Radio Labs) sold for the least and also still does. The last WRL DuoBander I saw was sold for \$75 at a hamfest—and it was on the air the night it was bought. Its price *new* was only \$160. Hmmm!

In late 1997 I saw a Collins KWM-2, with the matching speaker/console and AC power supply, sell for over \$2500. The equipment was described as being in perfect condition. The original cost of this combination was \$1140. That's nearly \$1400 more than it sold for new, right? Wrong! To look at true values we must compare dollars today with the dollars from years past.

Consumer Price Index

The Consumer Price Index (Table 2) is the official means of comparing what the current dollar buys, with the dollars of past years. For example, today's (1997) \$1000 has the same purchasing strength as did \$163 in 1950. To place this into perspective, a really good job of the same year paid about \$5000 annually. See the table for the factors to be used when converting 1997 dollars to other years from 1950 to present.

Now let's look again at that Collins station. It cost \$1440 new in 1960 and sold for \$2500 in 1997. Using the CPI chart, we find that in 1960 dollars this used rig is worth \$500; it retained about 33% of its original value. How did the WRL DuoBander fare? Well, its selling price of \$75 was the same as

\$16 in 1965. It retained about 10% of its value.

A Drake TR-3 with matching speaker, remote VFO/speaker, and power supply, listed in like-new condition, sold for \$285. Its cost new in 1963 was \$710. In 1963 dollars, the TR-3's used value is \$59. It retained *less* than 10 percent of its original value.

There are loads of examples of rigs and prices to compare. Some, such as the Collins S-line and KWM-2 series were in production for many years. Values vary widely over the entire production run. Other rigs, such as the National NCX-3 and Heathkit HW-100 transceivers, will never bring top dollar. They do, however, offer an inexpensive entry into the world of boat anchors. I often see these low-end boat anchors selling for under \$100, in near- or fully-operable condition.

Setting a fair price

There is a formula for setting a fair value on a piece of vintage ham equipment, which goes something like this: The selling price is the amount of money the seller of the fine top-quality vintage rig agrees to accept from the purchaser of the same broken-down worn-out radio.

Are vintage rigs a good deal?

The Yaesu 1000MP lists for about \$3000 and is considered by many to be a good example of state-of-the-art equipment. The 1000MP includes a power supply, automatic antenna tuner, DSP, extra filters, memories,

digital accuracy, etc. If it had been available in 1960, the 1000MP would have cost \$600, considerably less than the Collins example shown earlier in this article. You get a lot of radio for the money today, when you compare the capabilities of today's equipment to what you got for the same value back in the vintage days. However, this statement is in no way meant to take away from the pleasure of owning and using vintage equipment.

Where to find vintage equipment

Vintage ham gear can be found at most hamfests, listed in the famous "yellow sheets," heard about on swap nets, and listed in a dozen locations on the Internet. Generally, you will find prices to be the lowest when dealing directly with an owner, locally—where no shipping is involved. Equipment from dealers will be the most expensive. However, the rigs are usually checked out prior to sale and repairs made where necessary. The following commercial/semi-commercial sources can be contacted by mail or telephone, or found on the Internet:

Chris Seig Surplus

P.O. Box 123

Hillsboro NH 03244

(603) 464-5625

[www.conknet.com/piexx/piexx/piexx.htm]

Joel Thurtell

The Radio Finder

975 Arthur

Plymouth MI 48170

(313) 454-4666

[www.radiofinder.com]

Radio Recyclers

7730 W. National Avenue

West Allis WI 53214

(414) 771-7121

[www.execpc.com/~radiorec/]

Note: This list is not meant to be exhaustive in nature. If you know of suitable additions, contact me at: [W2BLC@bigfoot.com] or mail me a letter. Are you interested in these older rigs and want more information? Watch for more articles about individual rigs coming in the future.

Home-Brew RF Ammeter for the Shack

Another fun project from W4LJD.

J. Frank Brumbaugh W4LJD
c/o Defendini
P.O. Box 30
Salinas PR 00751-0030

Now you can simplify tuning up, save the cost of an SWR meter, and still be assured of sending maximum possible RF to your antenna—and know that your SWR is as low as possible. Three facts prove this statement:

- When maximum forward RF current is delivered to your antenna, this is the most your rig will put out.
- When maximum forward power is delivered to your antenna, reflected power and SWR are at the minimum possible.
- The above two facts are reciprocals of each other. As forward power increases, reflected power decreases simultaneously.

A little history

Forty and more years ago, before the SWR meter was invented at Collins Radio, hams used RF ammeters in their feeders to indicate maximum current, and therefore maximum power, to their antennas. These meters were installed between the transmitter output and the feeders in the shack. Many

hams used two ammeters, one in each wire of their 600 Ω open wire feeders (there wasn't any coax in those days, either). No separate antenna tuners were used because transmitters used either an adjustable link output or, more recently, a pi network between the final tube(s) and the feeders. This essentially accomplished the purpose for which we use antenna tuners today, because the output stage of our transceivers is broadbanded and not tunable. Rigs were tuned for maximum RF current in the feeders, and we worked the world.

The SWR meter

The SWR meter is a wonderful device in these days of solid state 50 Ω output transceivers. Used between the transceiver and the antenna tuner, it allows monitoring forward and reflected power while adjusting the antenna tuner for a conjugate match and the lowest SWR presented to the transceiver, on either a single switched meter, or two separate meters. A cross-needle meter is two meters combined in the same case.

Many hams build their own SWR meters because commercial units are rather expensive. However, the builder needs to take great care to assure symmetry and short leads—and the layout must be precise, too. At least one meter is required, and meters today can be very expensive.

My solution

A properly-used RF ammeter can easily substitute for an SWR meter, but they are extremely rare and very expensive, even in the surplus market. Additionally, RF ammeters are intended for use in low impedance lines, such as 50 Ω coax. However, an RF ammeter placed between the transceiver and antenna tuner, where the SWR meter is normally installed, does *not* provide accurate information! Tuners can do all kinds of weird things to indications on RF ammeters in this location, none of which bear any resemblance to what is going on in the real world. No, the only correct place for an RF ammeter to indicate accurate power is at the *output* of the antenna

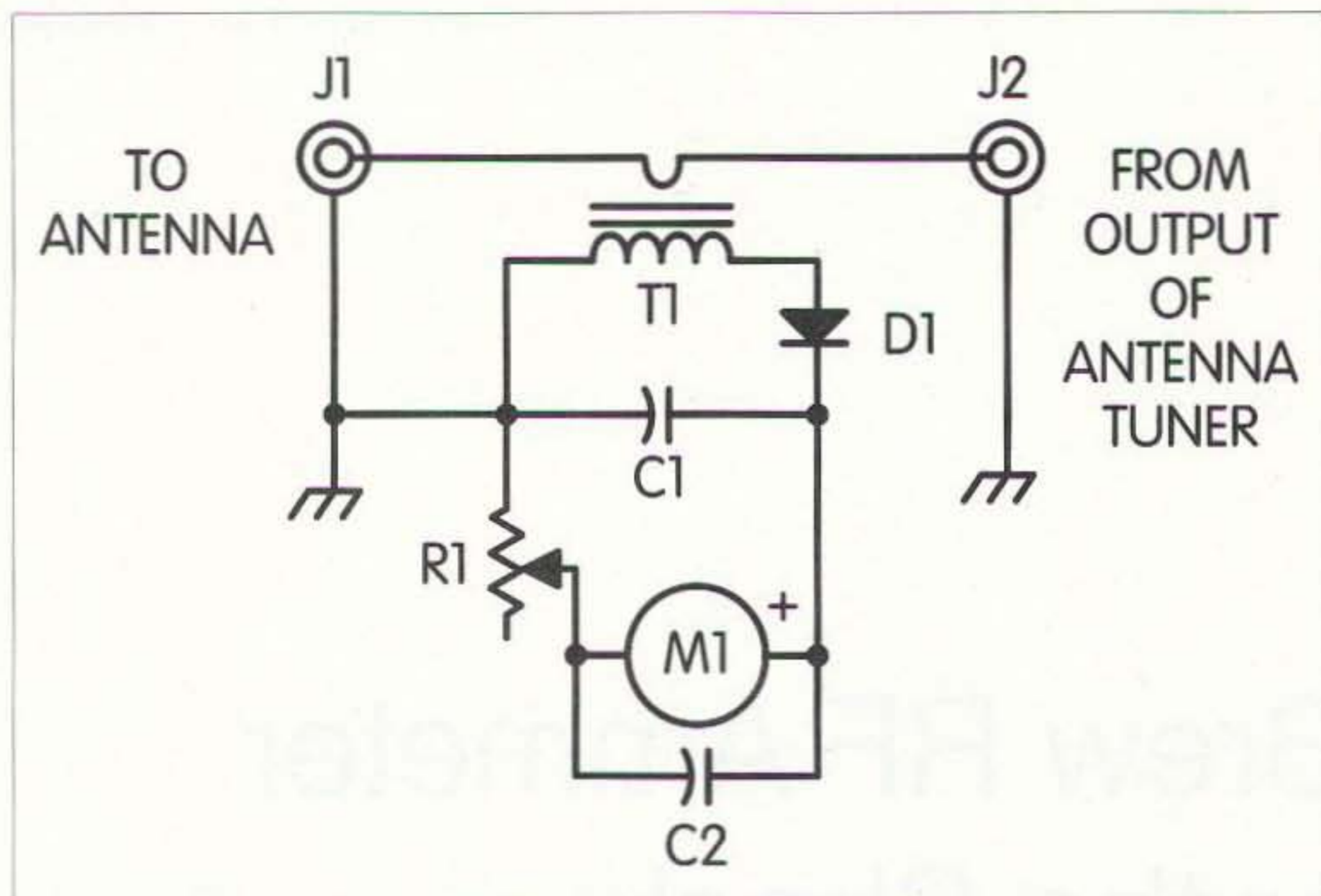

Fig. 1. Schematic for the home-brew RF ammeter.

tuner. Therefore, what is needed is an analog of an RF wattmeter which is not restricted by the impedance in its measurement location.

The accurate home-brew RF ammeter

The circuit of this unit is illustrated in Fig. 1. It is far simpler than the most bare-bones SWR meter yet it delivers accurate results, and is much less expensive and easier to construct than an SWR meter.

Toroid transformer T1 consists of 40 turns on a T37-6 toroid, with the primary "winding" a single pass through the core. RF current flowing through the single wire primary of T1 feeds directly through the feeders to the antenna. This current flow induces a voltage in the secondary winding of T1, which is rectified by D1, filtered by C1, and applied across the meter M1 and sensitivity control R1. R1 is required to keep the meter needle on scale at various power levels and on different bands. The higher the current in the feeders and the primary of T1, the greater the voltage across the secondary winding. When peak current is indicated—when no more power can be gotten from the transceiver—when the needle won't go any higher at your current power level, the antenna tuner is properly adjusted and the SWR is at its minimum. (Refer to the three facts quoted in the first paragraph.)

Some comments

There is nothing sacred about the values of the parts given in Table 1. This is primarily a junk box project, and the values shown are those I used from my junk box. Different toroids could be used, and the number of turns in the secondary of T1 can differ, depending upon whether you operate QRP, as I do, or have a monster amplifier in your attic. The meter, also, can be anything from 50 μ A to a few milliamps, depending upon your RF power level. High-power stations should use either a 1N270 or 1N4148 for D1, and really high-power stations may want to use two diodes in series, as well a larger toroid.

There is nothing special about the circuit, and it is not original with me. In fact, it is about the same as the forward power portion of many SWR meters. All I did was to put it in the proper place so it could do what I intended it to do—replace SWR meters. Because of where it is located, and the reciprocity of forward vs. reflected power, it is no longer necessary to measure the latter. SWR will always be minimum when the meter indicates the highest forward current peak and is delivering the highest power to the antenna.

Any questions?

Q. Why do I need this when I already have an SWR meter?

A. You don't. But it's easier to watch one meter than two, or to have to switch one meter back and forth. See also: Final thought.

Q. Will it work between my 100 W transceiver and my amplifier?

A. I don't know. But you really want to know the maximum power to your antenna, not the drive to the grids or cathodes of your amplifier. Think about it.

Q. Can this meter be calibrated to indicate output power?

A. Yes, over the range of power you normally use, but not if you operate at 100 mW one day and 1500 W the next. Be reasonable. Set R6 with the needle at peak at the maximum power you want to indicate with the needle slightly less than full scale, and mark this power. Reduce power until the needle at peak at the lowest power you want to indicate is a bit above zero.

Then calibrate the meter at whatever intermediate levels you wish, always tuning for the peak on the meter at each power level.

Q. I usually operate at less than one watt output. Will this unit work at milliwatt levels?

A. Yes. Depending upon how low in power you go, you may need to increase the number of turns on T1 secondary, or make the primary one or

Continued on page 49

Parts List

C1, C2	0.01 μ F ceramic disc
D1	Germanium diode, 1N34, 1N60, 1N270, etc.
J1, J2	Coax connectors, builder's choice
M1	590 μ A surplus 3-1/2" meter
R1	50 k Ω potentiometer
T1	40 turns AWG-28 magnet wire on T37-6 toroid (yellow)

Table 1. All parts are from author's junk box. See text for discussion on choice of parts values.

A Look At Pasokon's 3.1 SSTV System

Today's slow-scan gets better and easier.

Michael J. Geier K1BUM
c/o 73 Magazine
70 Route 202 North
Peterborough NH 03458

SSTV (slow-scan television) has become increasingly popular on the HF bands in the past few years, due to a couple of factors: the personal computer, and the advent of affordable hardware and software to turn it to SSTV use. Also, the graphical nature of the Internet has piqued interest in image transmission, and what could be more fun than doing it over the air?

A major pioneer in this field has been John Langner WB2OSZ, inventor of the popular Pasokon computer-based SSTV system, and proprietor of Absolute Value Systems. There are lots of Pasokon stations on the air, and there are sure to be plenty more of them, especially since the release of the latest generation of Pasokon software, with its powerful new features and low-cost interface options.

The Pasokon setup is one of the most complete available. Unlike some others, this one covers virtually all of the SSTV modes, and there are quite a few! To his credit, John has been incorporating new ones as they've come along. In addition, the Pasokon software has enjoyed periodic upgrades, with new capabilities. The newest version, 3.1, is quite a leap forward.

For starters, this new version does away with what was perhaps the only annoying feature of the old one. Previously, you had to press a "full screen" button in order to see an image in full-screen mode. Once you did that, you lost access to the buttons controlling

the program until you went back to "normal" mode, in which the image showed up postcard-sized.

In all fairness, this wasn't the Pasokon's fault. The display standard at the time was VGA, which left no room for anything on the screen when

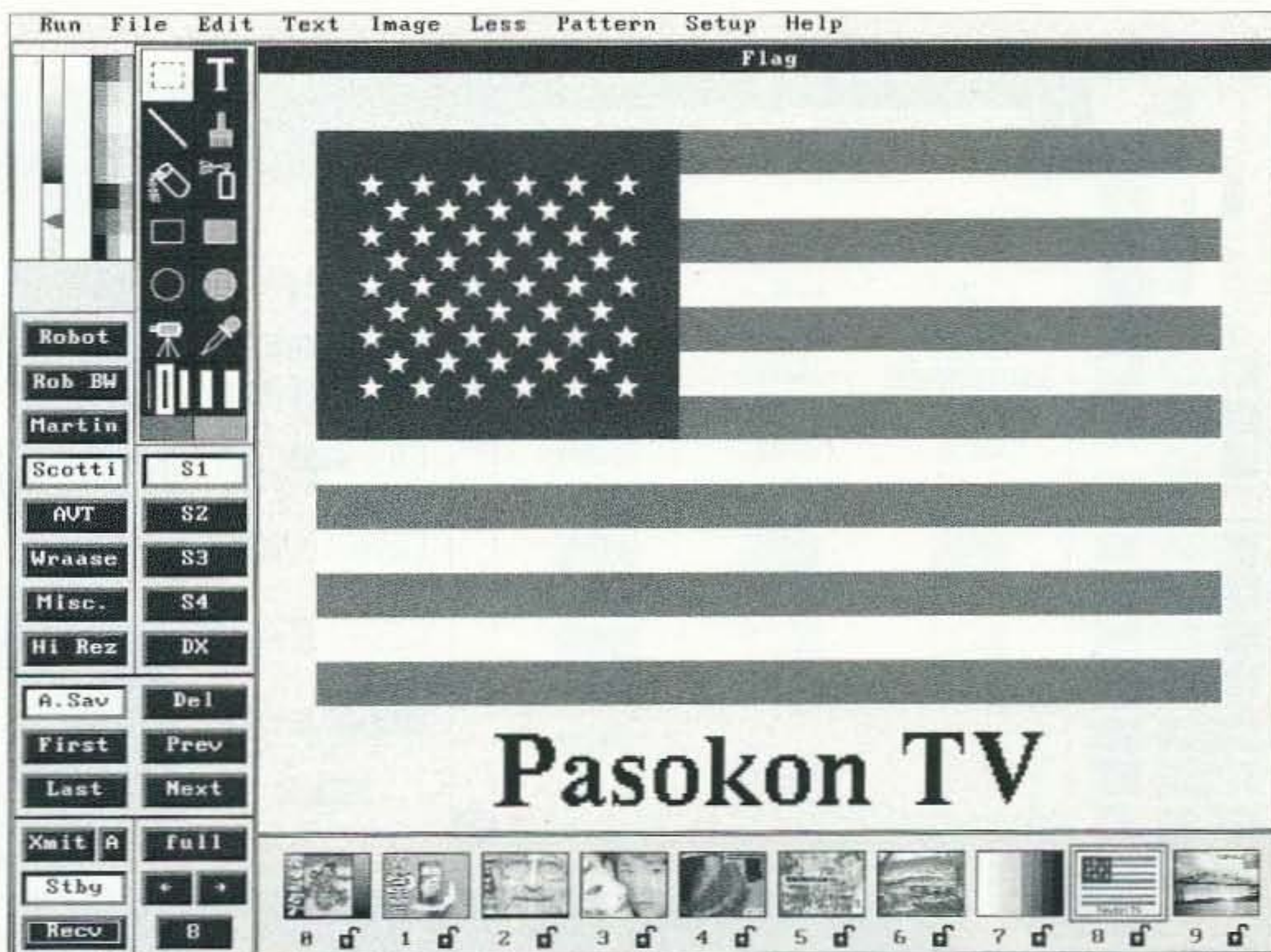

Photo A. One of the built-in test patterns. Screen captures courtesy of John Langner WB2OSZ.



Photo B. Typical SSTV image received.



Photo C. Another typical SSTV image.

a full-sized image was shown. On today's computers, it's now possible to see an entire 640 x 480 image and still have room for buttons and controls, thanks to the availability of 800 x 600 resolution. It's a pleasure not to have to switch back and forth between modes. If you have only a 640 x 480 screen, though, the old way can still be used.

There are numerous additions to 3.1, so let's take a look at a few of the more important ones:

- Higher image resolution. Images are now saved as 640 x 480, rather than 320 x 240. That's four times the image detail! In the old version, even full-screen images were really 320 x 240.

- More color depth. The old 32,768 colors have given way to 16 million. Of course, as with the 800 x 600 screen resolution, what you'll actually

get will depend a great deal on your video card.

- Built-in paint program. Yup, you can paint on images without even leaving the Pasokon program! That can be a lot of fun when relaying pictures back and forth; you can add your own comments, your call, or some drawing to what's already there.

- Support for more file types. Images can be saved and loaded in just about all of the common file formats, including JPEG.

- Thumbnail images. When you go to open an image file, you get a nice little postage-stamp-size picture next to the name. Especially given the eight-character name limitation in DOS, that's very handy when you have lots of pictures and aren't sure what each file contains.

- Contest assist. There's a nifty contest logger here, optimized for SSTV contesting. This one puts the sender's call, your call, and a serial number right on the image! Clever.

- SSTV repeater. This option lets you use your station as a repeater for pictures, so two stations who can't hear each other can still communicate. I haven't actually tried it, but it seems like a good idea, as long as you have a pretty heavy-duty transmitter and power supply (which I don't).

- Automatic image save and load. This one lets you assign certain images to be automatically saved when you quit the program, and automatically loaded back up the next time you restart. It's very handy for pictures you use all the time, such as your CQ shot, shack shot, etc.

- New modes. There are some new ones out there, such as Wraase 120 and 180, Scottie DX, and 480-line, hi-res mode. Version 3.1 covers 'em all.

- Color printer support. With the increasing popularity of color inkjet printers, the ability to print out some of your SSTV images is very appealing. You should have no trouble doing so. In fact, even the gamma (intensity curve) is adjustable, so you can fine-tune things until your printouts match your screen.

- Full 32-bit. The old versions were 16-bit applications. What does that mean? Well, they'd run on 286 machines, but they were less powerful and slower than they would have been if they were full 32-bit apps. The new one uses the full 32 bits of the 386-and-up architecture. The only tradeoff is that it won't run on a 286. Given the antique status of that processor these days, it's not much of a loss.

- On-line help. This program has a very complete on-line help system. Not sure what a button does, or even how to set up your hardware interrupts? The answers are just a click away. I was impressed at the ease with which I found answers to my questions. I've seen plenty of software from big companies which didn't come close in this department.

- Menu options. In the old versions, various setup parameters could be

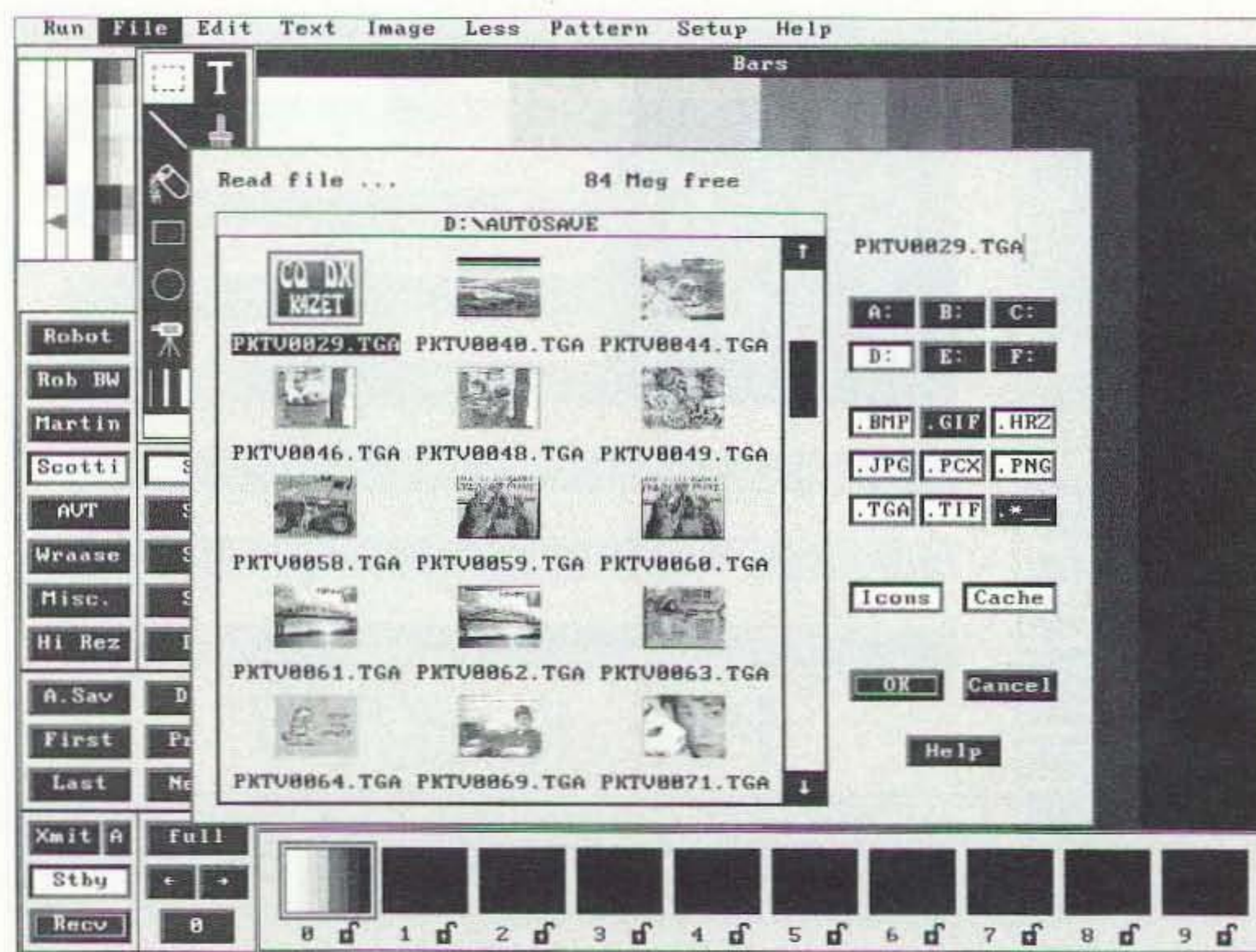

Photo D. Thumbnail images in file selector.

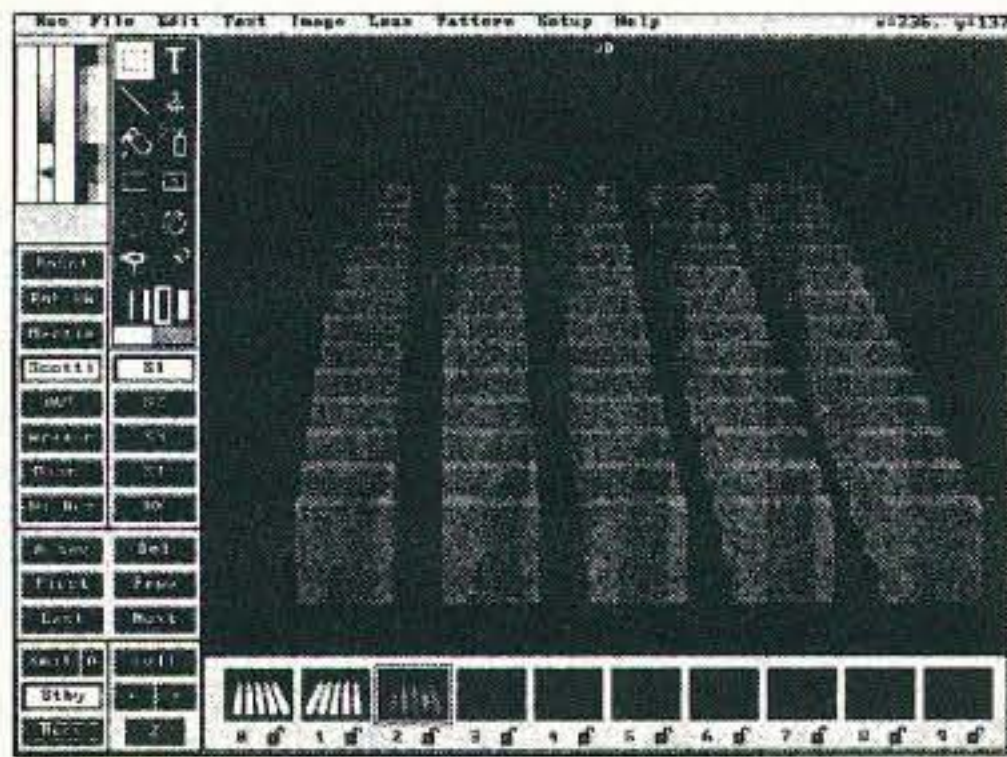

Photo E. 3D picture for viewing with red/blue glasses.

adjusted only by editing the configuration file with a text editor. It was powerful, but it sure wasn't friendly. Especially to beginners, the whole process could be intimidating. Version 3.1 puts most of this stuff into simple menu options that should be easy for everyone.

Three ways to go

There are three variations on the Pasokon theme. The first, Pasokon Classic, uses the standard Pasokon interface board. This board costs \$200 and fits in an ISA slot. While the most expensive route, it's also the highest-quality option. The board has an audio filter for digging out the weak ones. It also offers the most accurate demodulation, for the best pictures. Its onboard crystal oscillator offers precise timing, and it has a relay for PTT and transmit audio switching. It's the classy way to go.

Recognizing that there are some very low-cost SSTV systems out there, AVS has wisely chosen to offer its own version. Pasokon Lite costs only \$30, and it works with many of the low-cost, serial-port interfaces available from other manufacturers, such as EZ SSTV Vsn 2, GSH-PC, JV Fax, PC SSTV, and others. While AVS doesn't offer its own interface, the new software does come with an on-line schematic for making your own! (See, I told you that the on-line help was complete!) It only takes a few parts, and even the Radio Shack catalog numbers are included. Plus, there are hard copies of two more simple interfaces you can put together.

So, what do you give up by using Lite instead of Classic? The simple

interface doesn't offer the image quality of the fancier unit, but it's not bad! You lose the audio filter, of course, and the crystal oscillator. Still, the price is right, and you can use it with computers that don't have an ISA slot, such as laptops. Naturally, it does tie up a serial port. Just think, though ... you're in the woods with a mini-rig, your laptop, and Pasokon TV Lite, and you have a camp-site SSTV station! Sounds like fun to me!

EZ SSTV is a stripped-down demo version of Pasokon TV Lite, and it uses the same type of interface. Many of the modes are removed, and file-saving options are limited. Here's the good part, though: it's free, and you can download it off the Internet at [http://www.ultranet.com/~sstv/ezsstv.html]. How can you beat that? Once you know you like it, you can move up to Lite and not have to rewire anything!

Please note: In all versions, there is no digitizer. Getting pictures into your computer is still up to you, as it is with most computer-based systems. These days, though, good digitizers are getting pretty inexpensive, making computer SSTV more and more attractive. And, Pasokon TV 3.1 includes a button for activating a digitizer, so you don't even have to quit the program to snap a picture. Of course, if you have a digital camera, you don't need a digitizer at all! Just transfer the picture files onto your hard drive, and they should load right up, thanks to the Pasokon's support of the common file formats.

Also, SSTV is very sensitive to timing, so it can't be run under Windows. You must have DOS to use the Pasokon TV.

Conclusion

This new edition of the Pasokon TV software is quite an achievement. There's really nothing to complain about. It's very full-featured, it's easy to set up and use, and it works great! SSTVers are quite active on 14.230 and 14.233, just about any time the propagation is running. Check out the action on Saturday afternoons.

Absolute Value Systems offers top-notch SSTV systems at very reasonable prices. If you like SSTV or ever wanted to see what it was all about,

you'll find the Pasokon TV a worthwhile purchase, no matter which version you choose. I love my Pasokon TV Classic. Now, if they only had a Mac version ...

For further information, contact Absolute Value Systems, 115 Stedman St. #E, Chelmsford MA 01824-1823; telephone (508) 250-0611. 73

Pay TV and Satellite Descrambling 1999 Edition

Pay TV and Satellite Descrambling 1999 has latest cable, wireless and satellite fixes for most systems. Includes schematics, bullet blockers, cubes, etc. Only \$16.95. Complete Pay TV and Satellite Descrambling series Vol. 1-9, Only \$39.95. Hacking satellite TV video (VHS), Only \$39.95. Subscription to Scrambling News with web, Only \$34.95. Our Best Deal is everything here for only \$99.95. Shipping included. Free catalog.

Scrambling News

4798 S. Florida Ave., #108

Lakeland, FL 33813

941-646-2564. www.scramblingnews.com

CIRCLE 36 ON READER SERVICE CARD

NEW for ham radio operators!

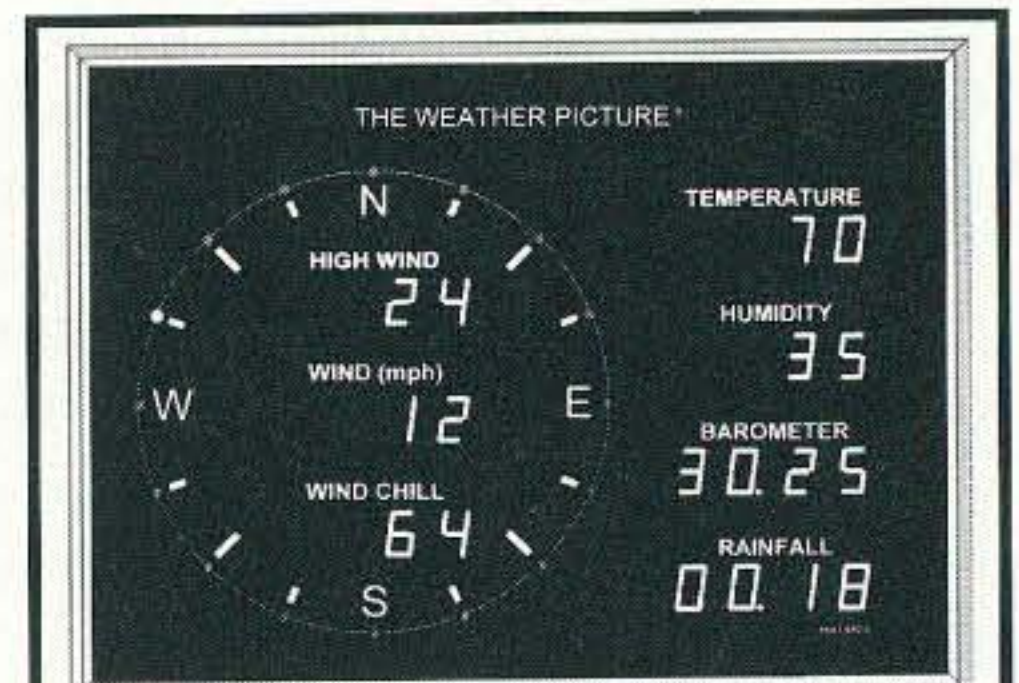

Size shown: 15 1/4" x 11 1/4"

Put the weather on your wall

The Weather Picture™ is an eye-popping new wall unit that continuously displays all the vital weather data you have selected, without having to press a single button. Big red numerals are easy to read from across the room, day or night. Available in two sizes, in brushed aluminum or elegant solid teak frame. The separate control unit provides detailed data—more than enough to satisfy even the most dedicated weather buff.

Purchase the Weather Picture together with the incomparable ULTIMETER® Weather Station, starting at under \$400. Or add it to your existing ULTIMETER System for less than \$170. It's easy to add programmable display modules to The Weather Picture now or later as needed.

For complete details, call toll-free, fax, or write us. Or visit our Web Site to see and try our ULTIMETER Systems. "The best!" says *WeatherWatch* magazine (5/96).

1-800-USA-PEET

or 732-531-4615 FAX: 732-517-0669

www.peetbros.com

©PEET BROS COMPANY

1308-8077 Doris Ave., Ocean, NJ 07712



Take the Jekyll and Hyde Test

Which shack is yours?

Ronald Lumachi W2CQM
73 Bay 26th Street
Brooklyn NY 11214-3905
[W2CQM@juno.com]

A first-time visitor to the home of a radio amateur most assuredly would be overwhelmed by the array of equipment and the layout complexity of the ham shack shown in **Photo A**. When that visitor invariably raises questions about the theory of its operation, the principles of construction, and how all that he sees actually came about, the inevitable response from the amateur is that it had very *humble* beginnings.

During the discussion, the amateur may describe how, in some mystical, helter-skelter, topsy-turvy manner, the shack evolved into his private retreat, filled to overflowing with radio gear. However, the ham is quick to defend his creation, and boasts that he is proud to have a comfortable place of his own and a personalized space for a hook to hang his headphones on. He describes it as a home away from home—a very private enclave.

On the other extreme, his better half laments the choice of this hobby because it keeps him from the timely completion of his chores and at the same time encourages what appears to be just mindless chatter. From the amateur's point of view, though, both

he and the station perform a vital function that is generally not fully understood. They participate in emergency communications exercises and generate awards and QSLs that emblazon the walls. This is all the result of his commitment to the hobby and to the quality of the big-gun signal he consistently radiates.

Unfortunately, in most instances the differences of opinion between the spouses usually remain irreconcilable unless the non-ham can be convinced to get a ticket. But of course that results in other problems (two objects cannot occupy the same space ...). Needless to say, that's a story well beyond the scope of this discussion.

Fortunately, the visitor, after some persuasive arm twisting, may reluctantly concede that there is perhaps some logic to the scene and that the space offers some degree of comfort and utility. Yet, even to his untutored eye, and the fact that he's still not 100% convinced, the shack remains the classic example of organized chaos!

In all fairness to the amateur radio community, this is admittedly an example of radio shack design in the

extreme. For balance in this presentation, I hasten to mention that there are many radio shacks (see **Photo B**) that, in addition to being state-of-the-art equipped, are thoughtfully planned, artfully constructed, tastefully furnished, and fastidiously maintained. They combine those appealing attributes in a dignified, quiet and reserved manner that showcases every aspect of the hobby.

For example, components are selected for their compactness and power, i.e., small size, big signal. Equipment is purchased in matched sets and grouped on the desktop for eye appeal and ease of operation. There is a conscientious effort to keep the station area clutter-free and functional. This effort incorporates both form and function in a homogeneous composite of strategies to create the ultimate radio room. With all that work, skill, and effort utilized to create this space, the term *radio shack* in this instance just does not seem an appropriate descriptive term for so elegant an entity.

In either of these two extreme examples of the radio amateur's inner sanctum, the experience will have an

equal and lasting impact on any visitor who happens along. The recollections of the visit will be both a vivid and awe-inspiring experience. However, no self-respecting ham will say with any degree of conviction that the neater shack will produce better on-the-air results.

It doesn't necessarily follow that simply because it's more aesthetically pleasing it will do a better job on the air. As a matter of fact, there are stories about super big gun signals that emanate from stations that indeed resemble the classic movie laboratory of Dr. Frankenstein. Whatever the case, it's safe to assume that there will always be examples of Jekyll-and-Hyde radio shacks just as long as there are radio amateurs.

Where does the story begin?

In point of fact, many amateurs often begin their radio careers on a small table in an obscure corner of a room or attic. Others are relegated to the basement area, where more often than not it is dark and drafty. An extension cord, a length of plywood (or old door) fitted across a couple of milk crates, and a battered folding chair combine to form the embryo of the wannabe ham shack.

Within a short time, some basic pieces of test gear, a hand key, a small transceiver, several editions of reference/study material, and a rat's nest of wire begin to crowd the work area. An extension to the table is added to make some room. A fluorescent fixture dangling by a length of chain is installed and an electrical outlet is spliced into an existing line and brought over to the area. In most cases it is tapped off a circuit from some other part of the house. You'll find out soon enough when half the lights and the TV go dead (and the screaming starts) as a result of one of your projects short-circuiting.

But life goes on! The room continues its erratic growth pattern as skill, experience, and equipment accumulate. As junk box inventory expands, space is utilized by piling boxes against the walls and under tables. Equipment on tables and in boxes juts out in all directions and begins to resemble the board game Scrabble® in a well-advanced stage of serious play.

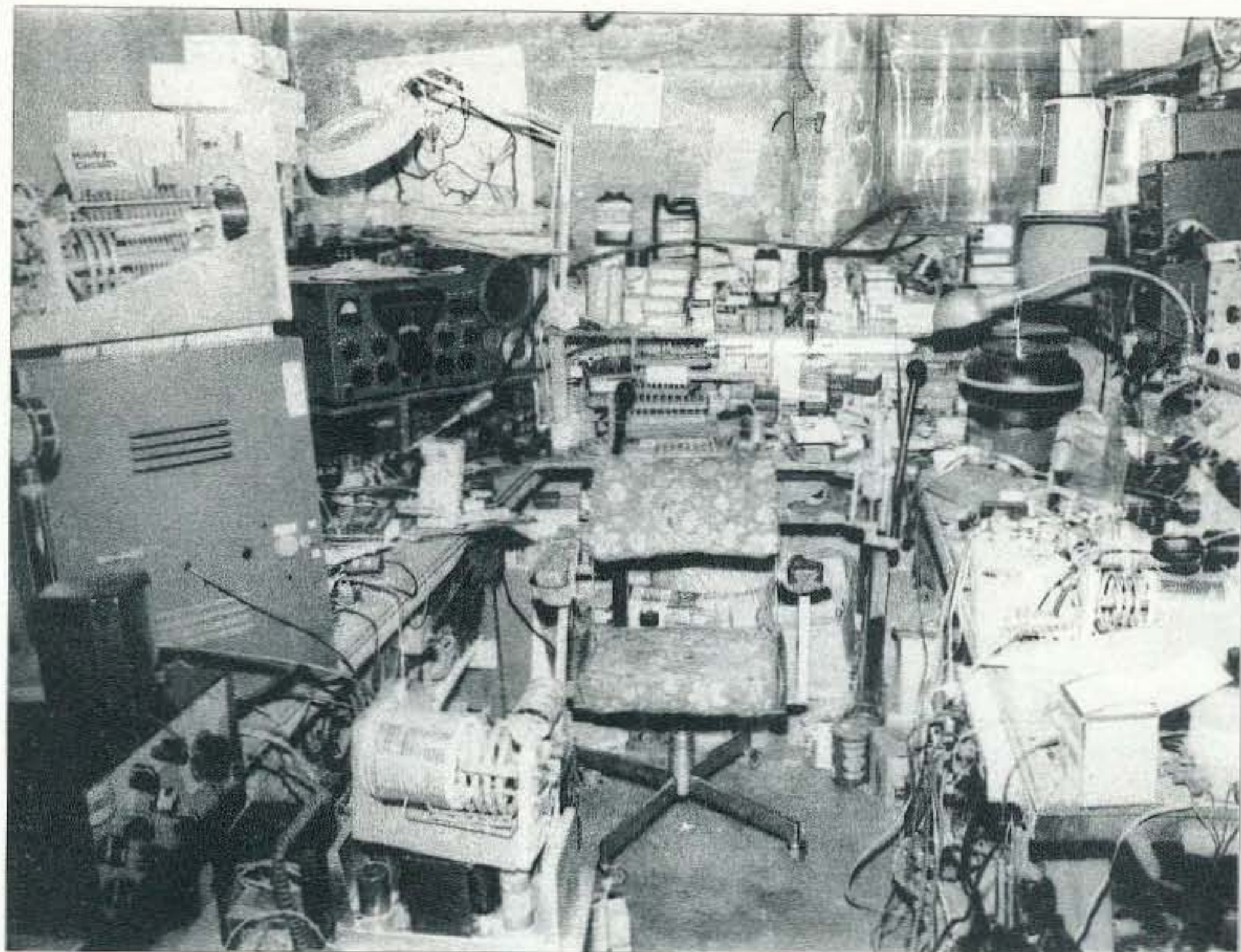

Photo A. An overview of the Mr. Hyde station. Note the jumble of coax cables leaving the shack via drilled holes in the window jamb. Sitting behind the Drake TR-4 (lower left) is a monster circa-1962 power supply for the 813 amplifier (three-tube) resting with no cover on top of the supply. A mint 75A4 and an FT-1000D are nested one above the other in the left-hand corner of the room. On the bench to the right is a 4-1000A deck being reworked for 160 m. The B&W 850A tank circuit can be seen amongst the junk pile. A modified 10-160 m B&W is visible in the foreground awaiting installation in an RF deck equipped with a pair of 8877s. The Drake AC-4 power supply (center front) has the top cover removed and is awaiting the arrival of replacement filter capacitors for the HV doubler circuit.

Only when good sense prevails will a contract go out to an electrician for a 220 VAC line. That move would be motivated by the completion of a newly home-brewed linear. The building of that piece of equipment is a story in itself.

Parts for that project were gathered piecemeal from a number of hamfest visits.

Others were acquired by some serious on-the-air and Internet horsetrading. The pole pig transformer, for example (which oozed transformer oil for years), was too large for any enclosure and relegated to a spot under the table.

It was connected to the primary via a length of three-conductor wire salvaged from an electric clothes dryer ready for the junk heap.

Connections to the power supply rectifiers were made using high-voltage wire strung out to the power supply chassis sitting on the shelf above. It was decided to use four 3B28s in a full-wave bridge because the tubes and

the three filament transformers were purchased from a tailgater dirt cheap.

Two junker 50¢ bargain chassis, twice as large as needed, were used to mount the power supply and RF deck components. That tailgater was elated to see those clunkers go. Time passed, and after a series of mishaps, including poor solder joints, reversed diode polarity, and an endless number of adjustments, the legal limit station finally got on the air—with no pipsqueak signal. The project looked like hell and components and wires were everywhere, but no DX station cared. It was the signal that mattered and the QSOs netted in the pileups.

The bottom line was that no one could see it except the family members and they, for the most part, refused to go into that part of the house primarily because it insulted their sensibilities. So, depending on the eye of the beholder, this was the classic paradox: Is it beauty or the beast? Remember, ugly or not, the signal was up there with

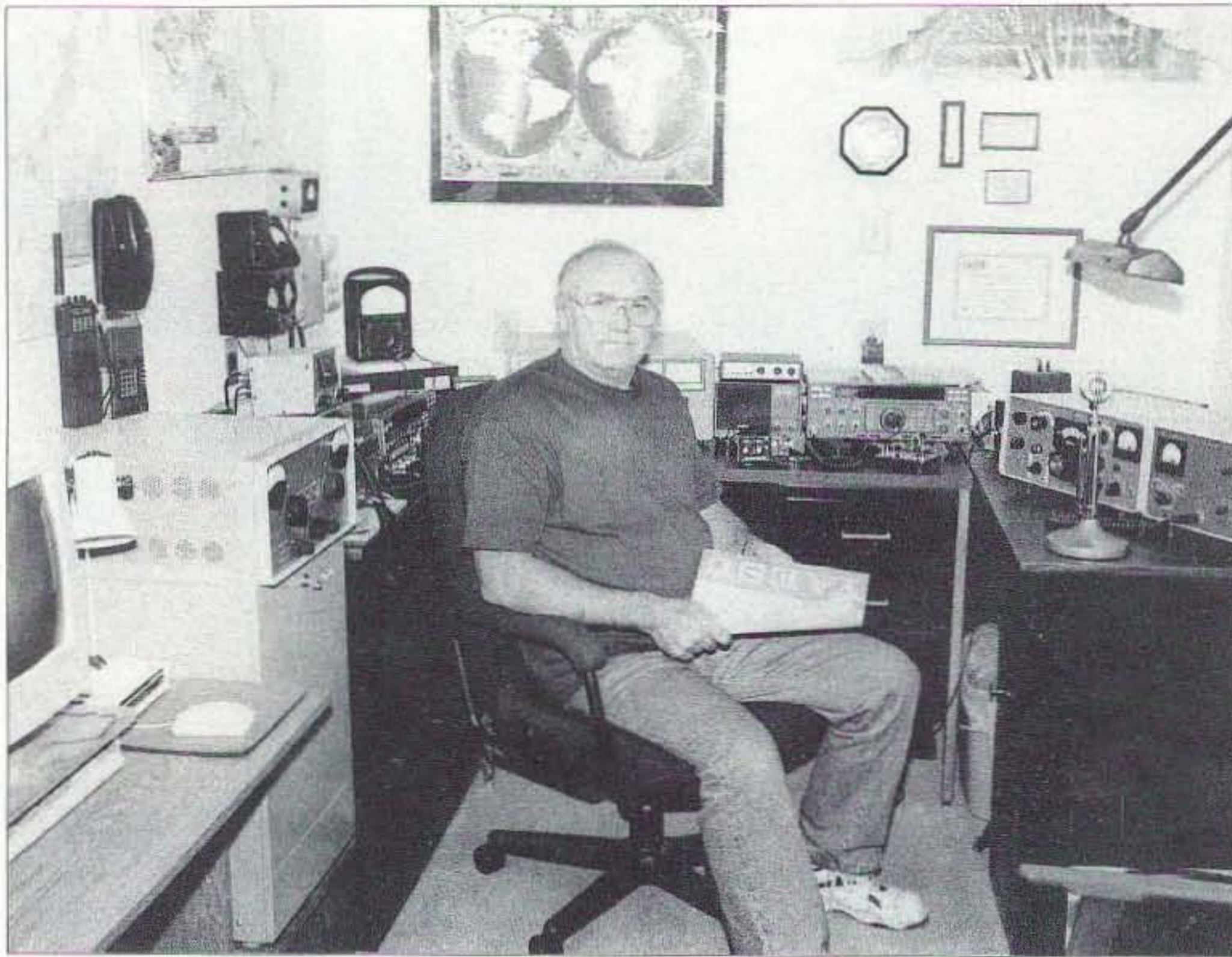

Photo B. Apologies for not wearing a jacket and tie in the Dr. Jekyll station. It's obvious that order and neatness prevail. The absolutely necessary computer is sitting beside a newly restored Henry 2K-3. Barely visible behind the Henry is a Yaesu FT-840 and an FT-736. To the left of the Triplet meter is the master disconnect assembly. The meters in the black cases monitor both household current and voltage. Immediately behind me is a Command Technologies 2500 amplifier, an SP6, an FT-990DC and a Collins (round emblem) KWM2A.

the big boys and that's the ultimate reward.

In that light, it's perfectly OK to be considered Mr. Hyde's home away from home!

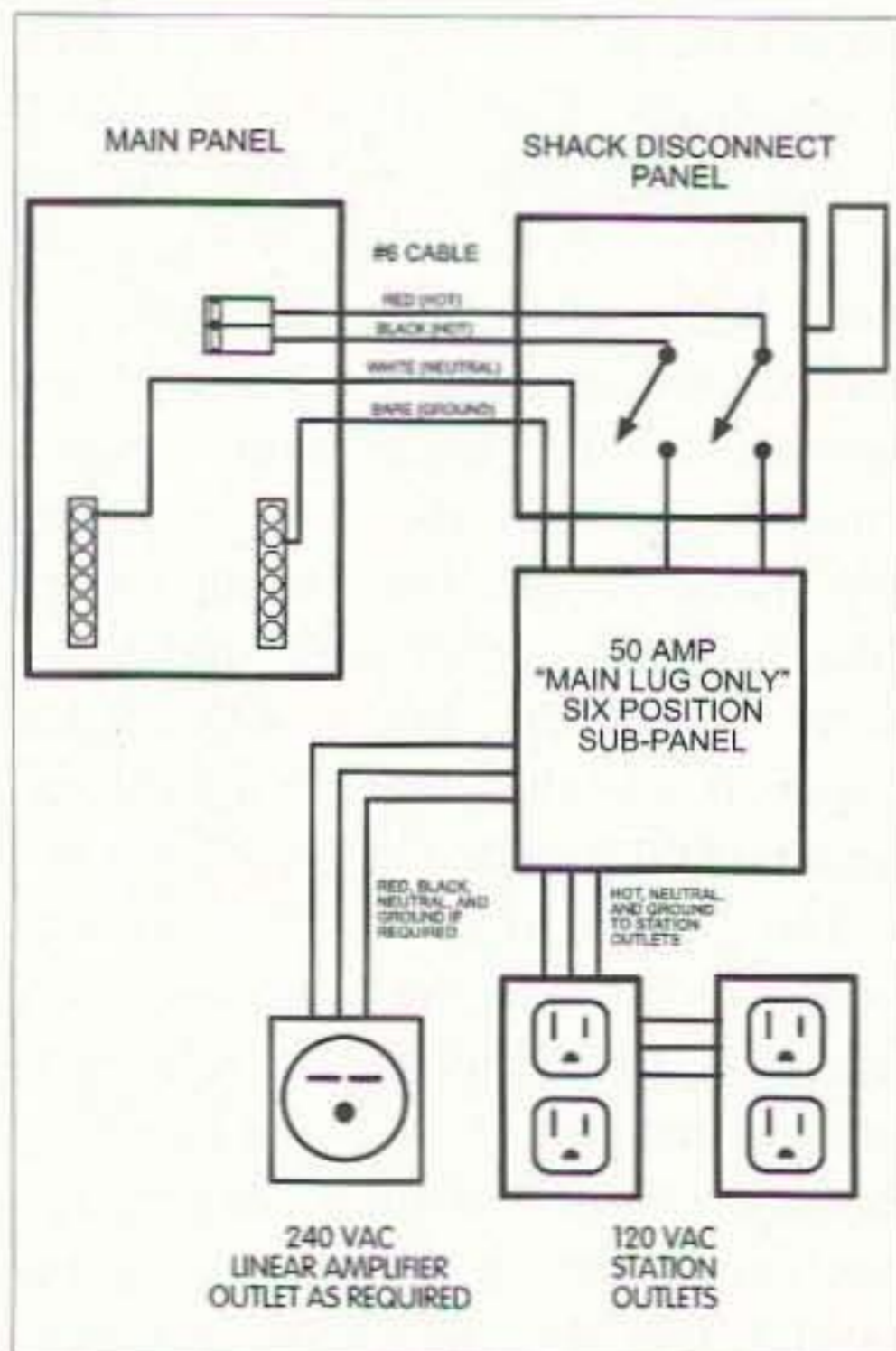

Fig. 1. Block diagram of shack disconnect system. See sidebar for details.

People say that neatness counts!

For a variety of reasons, some lucky amateurs get a chance to build a second shack. (Others get it right the first time.) Some get married, some change jobs and move, others divorce, or some on occasion acquire a second home (and a need for a second station). There's also a group that simply feels it's time for a change.

For whatever reason, a substantial percentage of them elect to follow a different construction format, making certain that all the mistakes previously made were cast out and only the best ideas incorporated into the new plan. The motivation to undertake this monumental task might have even come from a disgruntled spouse who, because of a bellyful of dust, disorder, and disarray, simply laid down the law.

The message was simple—*Clean up your act, or else!* So if you're starting out with a clean slate in a new location, and not tearing down what's already in existence, it's not terribly difficult to create your own private Utopia. Keep in mind that new construction is always easier than renovation.

Begin by setting up a proposed space that's not overly large. Remember—junk will expand to fit the area, so restrict yourself from the outset. Think carefully about the placement of furniture so that the space is best utilized. Generally a "U"-shaped area works well.

Visit the home improvement center and determine what's offered in assemble-it-yourself furniture. There's a whole array of knockdown computer- and office-type furniture that looks good and is relatively inexpensive. Plan the size of the room in order to accommodate your choices.

Once this is done, it's time to think seriously about your electrical power. Bring in a dedicated 220 VAC (#6 AWG) and a 110 VAC line (#12 AWG). Plan for a master disconnect box within the shack. (See the sidebar for a discussion of this aspect of the project.)

Don't forget to consider a source of heat to ensure your comfort during the winter months. A baseboard electric heater works well. If possible, an air conditioner helps get you through the dog days of summer. When the walls are open, it's a snap to install additional electrical outlets. A duplex box costs about 60¢, and a receptacle adds an additional 40. There's no excuse not to have them every couple of feet. It's far better than a twisted network of wires and extension cords.

Before the walls are closed up, bring in the telephone lines with four-conductor cable. Make certain to include an additional tap for the computer modem. The second twisted pair will accommodate a dedicated telephone if you eventually go the Internet route. While you're at it, include a couple of lengths of two-inch PVC to be used as behind-the-wall conduits in order to route the coaxial cable to the outside. Use PVC elbows to make the turn both at the inside floor level and out through the foundation. There's nothing more offensive to look at than four or five lengths of 8U cable and a hunk of ground cable strung across the wall, leaving the shack for the outside antennas through a couple of holes drilled through the window jamb.

Do It Right the First Time!

It makes good sense to plan from the outset for an adequate supply of electrical power to the ham shack. It's an equally good idea to do it right the first time and save the inconvenience and added expense down the line if you find you've outgrown the electrical capacity of the setup ... it happens all the time as newly purchased equipment is added to your inventory. Whether you're planning on undertaking the project yourself (to save some bucks) or hiring the job out, make certain it complies with the local electrical codes. Many localities allow the homeowner to undertake an electrical upgrade provided a permit is obtained and the job passes an electrical inspection. Check out the deal in your community. Keep in mind that any ham familiar with wiring up the simplest circuit can complete this job in a snap. Electricity should not frighten anyone, provided care is taken to prevent injury.

You'll have to start the project at the main panel. (See **Fig. 1.**) Use a 20 A SPST breaker and a length of #12 cable (two-conductor black/white + a bare ground) in this portion of the circuit to power the overhead lights, clock, handheld charger, electric pencil sharpener, etc. Run a second #6 (three-conductor red, black, white + bare ground) from a newly installed DPST 50 A 240 VAC breaker on the main panel to your shack location. Terminate this line in a DPST master disconnect switch box with an external shut-off handle. Keep in mind that only the "hot" black and red wires will be switched in and out of the circuit by the shut-off. The neutral and ground are always through-connected to the termination outlets and are never broken. To the master disconnect panel, close-couple a "main lug only" 50 A sub-panel. All the shack's outlets will be connected from this fused panel. I'd suggest that this box have provisions for at least six circuit breakers. For your 240 VAC linear amplifier electrical needs, install a DPST 240 VAC breaker. The breaker amperage is determined by the electrical needs of your particular amplifier; however, it's safe to assume that in the majority of installations 20 amps on each pole is sufficient. Needless to say, all bets are off if you're running a bunch of 4-1000As. You may have to wire up directly to the power company generators. When hooking up the 240 VAC outlet, make certain to include the neutral leg since many amps use 120 VAC (half the circuit voltage) to run fans, filament transformers, etc. For the other 120 VAC outlets that you want switched off at the end of the day, use a 20 A SPST breaker. Remember to wire them up to equalize the current draw on both sides of the neutral bar. You don't want to overload one leg of the circuit running back to the main panel.

Keep in mind that 240 VAC plugs and receptacles are configured to prevent either under- or overloading a circuit. You'll realize this if you ever tried to plug a table lamp into an air conditioner receptacle. If your 240 VAC linear does not have a factory-installed plug for you to match to a socket, determine the current rating from the manufacturer's specification sheet and purchase the appropriate plug and connector. In a nutshell, you'll not want to use a plug/socket combination from your electric clothes dryer on a solid state 600-watt amplifier. It's both impractical and expensive and could place your equipment at risk. The typical 120 VAC ham shack appliance generally offers no problems. Purchase the 20 amp duplex outlets. Plug your computer, transceiver power supply, and other gear into these switched receptacles. When you're ready to call it a day, one disconnect will remove all the expensive gear out of harm's way in the event there's a possibility of damage due to lightning storm activity.

A reminder!

You'll need to be reminded (visually) to shut off the main breaker when leaving the shack. To accomplish this quickly and easily, pick up a 120 VAC neon night light from your local department store. Leave this indicator permanently installed in one of the switched outlets. When the neon isn't glowing, you'll know that the expensive gear is out of the circuit. It's easy to see in the darkness when you shut off the light and nothing is glowing. This safety feature will save you a midnight, toe-banging, expletives-deleted, panic run to the shack to pull plugs when you're jolted out of a deep sleep by a severe electrical storm.

Give it a whirl. It's a great time- and equipment-saver and is probably the cheapest insurance you can buy to prevent electrical damage.

Consider a set of wires for an intercom so you can communicate with the rest of the house without having them bang on the ceiling to get your attention. After the drywalling, taping, and painting, lay down some inexpensive carpeting. It lends that touch of class, and more importantly keeps your legs from freezing in the winter.

Pick out your most prestigious awards and rarest QSLs and tastefully position them on the walls. They make a statement of accomplishment that's hard to beat. Purchase some inexpensive dimestore picture frames (black with gold leafing works particularly well) and matting to give the wall decorations addi-

tional ambiance. That's the way Dr. Jekyll would handle it.

Make certain that you have a comfortable (cushioned) high-back chair that is height-adjustable (especially if you're a dedicated brasspounder). It's nice if it swivels and allows for some

Continued on page 49

SPECIAL EVENTS

Listings are free of charge as space permits. Please send us your Special Event two months in advance of the issue you want it to appear in. For example, if you want it to appear in the October issue, we should receive it by July 31. Provide a clear, concise summary of the essential details about your Special Event.

JULY 4

DILLSBURG, PA The 1998 July 4th Firecracker Hamfest will be held by the Harrisburg Radio Amateur's Club at Monaghan Fire Hall, 245 W. Siddonsburg Rd., Dillsburg PA (near Harrisburg). Traveling north on US-15: Pass traffic light and Chevrolet dealer on right in Dillsburg. Continue 1/2 mile past Harr's Drive-In. Turn right onto Siddonsburg Rd. Continue to the hamfest. Traveling south on US-15: Pass PA Turnpike entrance and Country Market to PA-114, Bowmansdale exit. Turn left at the stop sign onto PA-114. Continue 3 miles and turn right onto Siddonsburg Rd. Continue to the hamfest. Indoor air-conditioned table space. Tables, \$15 each. General admission \$4, XYLs and harmonics free. Tailgating, \$3 first space, additional spaces \$5 each. Dealer setup Friday night 6 p.m.-9 p.m., Saturday at 6 a.m. Doors open to the general public at 8 a.m. VE exams at 9 a.m. For further info, contact the HRAC AnswerLine at (717) 232-6087; E-mail [fabinfo@fabral.com]. To reserve tables, contact N3NJB, 2501 S. 2nd Street, Steelton PA 17113-3009; or E-mail [N3NJB@AOL.COM]. Talk-in on W3UU 146.16/.76 MHz.

JULY 10-12

DUNSEITH, ND The 1998 35th Annual International Hamfest will be held July 10th-12th at the International Peace Garden, between Bissevain MB and Dunseith ND. Camping on-site, forums, large flea market, transmitter hunts, mobile judging contest, dancing and socializing. The International Peace Garden Hamfest Committee is handling the arrangements. For more info, contact Dave Snyder VE4XN, 25 Queens Crescent, Brandon,

Manitoba, Canada R7B 1G1, (204) 728-2463; or Lynn Nelson W0CQ, 2700 23rd Street SW, Minot ND 58701, USA. Tel. (701) 839-8200.

JULY 11

MILTON, ONTARIO, CANADA

The 24th annual "Ontario Hamfest," which is being sponsored by the Burlington ARC, will be held at Milton Fairgrounds, Milton, Ontario. Open to commercial vendors at 7 a.m. (Robert St. gate only); tailgaters at 8 a.m. (Robert St. gate only); and the public at 9 a.m. (Thomas St. gate only). The C.L.A.R.A. Annual Picnic Meeting will begin at 11:30 a.m. Large indoor/outdoor flea market. For further info, contact Burlington ARC, P.O. Box 85037, Burlington, Ontario L7R 4K3, Canada. Take a look at the Web site, at [www.bigwave.ca/~ve3coj/barc/]. You can also contact Lorne VA3LOR at (905) 336-2999; E-mail [ve3coj@bigwave.ca]. Talk-in on VE3RSB 147.21 and simplex 146.52.

OAK CREEK, WI The South Milwaukee ARC will hold its 29th annual "Swapfest" at the American Legion Post #434 grounds at 9327 S. Shepard Ave., from 7 a.m. until at least 2 p.m. CDT. VE exams are pending. Free parking, picnic area, overnight camping. Admission \$5 per person, which includes "Happy Time" with free refreshments. Talk-in will be on WA9TXE 146.52 simplex, as well as on many of the local repeaters. Get a free flyer by writing to: The South Milwaukee Amateur Radio Club, Inc., P.O. Box 102, South Milwaukee WI 53172-0102. Tel. (414) 762-3235.

PETOSKEY, MI The Straits Area ARC will host its 23rd Annual Swap & Shop on July 11th, 8 a.m.-1 p.m., at Emmet County

Fairgrounds in Petoskey MI, US 31, 2 blocks west of 131. Admission \$3 at the door, tables \$5 (splits OK). VE exams at 1 p.m. in the American Red Cross Bldg. For VE exam info call Floyd KG8CS, (616) 526-5503. For more details, contact Harry N8OIV at (616) 347-7771. Talk-in on 146.68 and 146.52.

SALISBURY, NC

The North Carolina Alligators Group will hold their Firecracker Hamfest July 11th, 8 a.m.-1 p.m. at the Salisbury Civic Center. From Interstate #85, West/East Innes St., turn left on South Boundary St. and the 'fest is on the left. Advance admission is \$3 with an SASE, or \$4 at the door. Always free to XYLs. The price of admission allows you to set up outside for the flea market. Tables in the air-conditioned center are \$5. Dealers can set up on Friday from 3 p.m.-9 p.m. and check into the center at 7 a.m. on Saturday. There will be an auction of goods at 1 p.m. VE exams by TEARC/VEC on site at 10 a.m., walk-in only, no pre-registration. Applicants must bring original license, photocopy of present license, any CSCEs, and a photo ID to the exam session. For further details, contact Rae Everhart K4SWN, P.O. Box 41, Lexington NC 27293-0041. E-mail [RAEF@infoave.net]. Talk-in on 146.520 simplex. For hamfest info, contact Walter (Alligator) Bastow N4KVF, 3045 High Rock Rd., Gold Hill NC 28071. Tel. (704) 279-3391.

TOMPKINSVILLE, KY The Monroe County ARC Hamfest will be held at the National Guard Armory Highway 163. Setup at 6:30 a.m.; doors open to the public at 8 a.m. Admission \$5. Tables \$7. VE Exams, walk-ins are accepted. Talk-in will be on the 146.775 rptr. For table info call J. Bunch at (502) 678-5784; or E-mail David Welch K4PL at [dwelch@glasgow-ky.com].

JULY 12

AUGUSTA, NJ The Sussex County ARC will hold its 20th annual Hamfest at the Sussex County Fairgrounds, Plains Road, Augusta NJ, on Sunday, July 12th. Doors will open at 8 a.m. Registration is \$5 per person (YLs and harmonics are free). Indoor

table space, which is limited, will be available at \$13 per table; outdoor selling space will be available at \$10 per space. Talk-in will be found on 147.300 and 224.50 rptrs., and on 146.52 simplex. Contact Daniel Carter N2ERH, 8 Carter Lane, Branchville NJ 07826. Tel. (973) 948-6999.

BRUNSWICK, MD

"SweatFest 98," sponsored by the Mid-Atlantic DX and Repeater Assn., will be held 7 a.m.-3 p.m. This year's event includes a tailgater area for ham radio, RC aircraft, RC cars, and model railroad hobbyists. ARRL VE exam session, ATV demonstration, and an RC aircraft demo will be featured. For more info, contact MADRA SweatFest 98, (301) 473-4151; or E-mail to [madra@qsl.net]. Take a look at the Web page at [www.qsl.net/madra].

KIMBERTON, PA

The Kimberton Fire Company Fair Grounds, Rte. 113, south of intersection with Rte. 23, will be the location for a hamfest being sponsored by the Mid-Atlantic ARC. Indoor-outdoor space: tables 1-4 \$10 each, 5 or more \$8 each, not including admission. Indoor tables have electricity. Tailgating \$5, no reserved tailgate space. Admission \$5. Talk-in on 146.835(-) and 443.80(+) CTCSS 131.8. Contact MARC, P.O. Box 352, Villanova PA 19085; or call Bob Haase W3SA at (610) 293-1919; or E-mail [wb3joe@voicenet.com].

PITTSBURGH, PA

The North Hills ARC will hold its 13th annual Hamfest on July 12th, 8 a.m. to 3 p.m. at the Northland Public Library, 300 Cumberland Road, Pittsburgh PA. The hamfest is approximately 10 miles north of Pittsburgh on McKnight Road (Truck Route 19). At the 3rd traffic light after Northway Mall, turn left onto Cumberland Road. Northland is on the left at the top of the second hill. From points north, take Route 19 south toward Pittsburgh. Follow signs for McKnight Road, and at the 4th traffic light turn right onto Cumberland Road. If on Perry Highway, turn left onto Cumberland Road at the Sunoco. Talk-in and check-ins will be on 149.09 W3EXW, the North Hills Amateur Radio Club rptr. Free admission,

free parking. One free automobile-sized space per tailgater; each additional space \$5. Handicap/wheelchair accessible. Contact **Bob Ferrey, Jr. N3DOK** at (412) 367-2393, or via E-mail at [n3dok@pgh.net] or through the North Hills ARC Web site at [http://nharc.pgh.pa.us].

JULY 18

NEWPORT, NH The Sugar River Amateur Radio Festival, sponsored by Shklar & Lader L.L.P., Attorneys at Law, will be held on the Newport Town Common, 8 a.m.-3 p.m. Amateur radio, computers, and electronics will be featured. There will also be Packet Radio and Internet demos. All Scouts are invited for a Scout Ham-Boree. A Special Event Station will be on the air. VE exams will be given in the Sugar River Bank Community Room (rear lower parking lot entrance). Register for testing by 8:45 a.m. Food and refreshments will be provided by Newport Boy Scout Troop 316. Talk-in on 146.76 rptr., and 146.52 simplex. For further info, contact **Rob Boyd N1CIR**, #648, Rt. 103, Sunapee NH 03782-3719. Tel./FAX (603) 863-5383; packet [N1CIR@WA1WOK.NH]. Repeater: 146.76, Ascutney. Directions: From I-91 in Vermont—exit 8, 12 miles east on Rte. 11/103. From I-89 North in New Hampshire—exit 12, 8 miles west on Rte. 11. From I-89 South in New Hampshire—exit 13, 10 miles south on Rte. 10.

JULY 19

CAMBRIDGE, MA Tailgate electronics, computer and amateur radio Flea Market Sunday, July 19th, 9 a.m.-2 p.m., Albany and Main Sts., Cambridge MA. Admission \$4. Free off-street parking for 1000 buyers. Fully handicapped accessible. Tailgate room for 600 sellers, sellers \$10 per space at the gate, \$9 in advance—includes one admission. Setup at 7 a.m. For space reservations or further info call (617) 253-3776. Mail advance reservations before July 5th to **W1GSL**, P.O. Box 397082 MIT BR., Cambridge MA 02139-7082. This event will be held rain or shine! Talk-in on 146.52 and 449.725/444.725 pl 2A W1XM rptr. Sponsored by the MIT Radio

Society and the Harvard Wireless Club.

SUGAR GROVE, IL The Fox River Radio League will hold their annual Hamfest at Waubensee Community College, Rte. 47 at Harter Rd., Sugar Grove IL (5 miles NW of Aurora). Doors open Sunday at 8 a.m. Setup Saturday at 7 p.m., Sunday 6 a.m.-8 a.m. VE exams 10 a.m.; bring original license, copy of license and photo ID. Talk-in on 147.210(+) (pl 103.5/107.2). Contact **James Von Olnhausen N9UZZ**, c/o FRRL, P.O. Box 673, Batavia IL 60510. Tel. (630) 879-3042 or E-mail to [n9uzc@amsat.org].

VAN WERT, OH The Van Wert ARC will hold their 11th annual Hamfest July 19th at the Van Wert County Fairgrounds, US 127 South. Open 8 a.m.-3 p.m. Admission \$5, parking free. Overnight \$10. Some may set up Saturday evening after 7 p.m. if there is not a conflict with another activity on the Fairgrounds. Talk-in on 146.850/.250. VE exams given, with pre-registration by July 12th. Send SASE or call **Bob High K8BIAF**, 12838 Tomlinson Rd., Rockford OH 45882. Tel. (419) 795-5763. To reserve tables, send an SASE with your name and address to **VWARC**, P.O. Box 602, Van Wert OH 45891-0602. 8' tables \$10, includes one free ticket. Extra tickets \$5. Vendor

setup is on Sunday at 6 a.m. Telephone **Bob WD9LPY** at (419) 238-1877 after 5 p.m. After July 6th, call (419) 795-5763.

WASHINGTON, MO The 36th annual Zero Beaters ARC Hamfest will be held Sunday, July 19th, 6 a.m.-2 p.m. at Bernie E. Hillerman Park. Commercial vendors, handmade quilts, computer and radio flea market, and more. Free parking. Free admission. Talk-in on 147.24(+) rptr. Watch for green-on-white hamfest signs. VE exam registration starts at 9 a.m. Walk-ins welcome: Limit 60. Bring original license and a photocopy. For more info, SASE to **ZBARC VE Exam**, P.O. Box 24, Dutzow MO 63342. For hamfest info, write to same address or call **Keith Wilson K0ZH**, (314) 629-2264; FAX (314) 629-1196. E-mail: [n0mfd@amsat.org]. Web site at [http://zbarc.usmo.com].

JULY 24-26

FLAGSTAFF, AZ The ARCA Fort Tuthill Hamfest, sponsored by the Amateur Radio Council of Arizona, will be held at Coconino County Fairgrounds in Flagstaff. Contact the ARCA at (602) 779-2722, or E-mail [arcathill@aol.com], for reservation info. Hamfest hours will be Friday and Saturday, dawn to dusk, and Sunday, dawn to 2 p.m. Admission is free. Tailgating spaces \$15 before June 1st, \$20

after June 1st. Nighttime camping \$8. Dinner \$15. Seminars, an ARRL forum, a ladies' program, Sunday Junque sale, and more, will be featured. VE exams Saturday, July 25th, registration is 8:30 a.m. to 10:30 a.m. You must have the original and one copy of your license and/or any applicable CSCE. Photo ID required. Walk-ins only. For exam info call (602) 779-2722. Talk-in on 146.980 requires 100 Hz pl.

JULY 25

WAYNESVILLE, NC The Western Carolina ARS of Asheville NC will host their 23rd annual Hamfest on July 25th at the Haywood County Fairgrounds in Waynesville (approx. 25 miles west of Asheville). Take exit 24 off I-40 then south on Hwy. 209 3 miles, or take exit 104 off US 19-23 then north on Hwy. 209 1 mile. Tickets are \$4 in advance, or \$5 at the gate. Commercial dealers, covered flea market, tailgating. VE exams. Free parking. The Haywood County Shriners will serve food and refreshments, with proceeds going to Shriners Children's Hospitals. For dealer and flea market info, contact **Chet Allen KE4VXC**, (828) 258-3954. E-mail [KE4VXC@Juno.Com]. For ticket reservations contact **Bob Helton KS4FX**, P.O. Box 1488, Asheville NC 28802; E-mail [BHelton@interpath.com]. For general info

WE SHIP WORLDWIDE Local & Tech 1-810-771-4711, Service 1-810-771-4712, Fax Service 1-810-771-4545

Michigan Radio

SALES SERVICE



OPEN
MON-FRI 10-6
SAT 10-4
SUN CLOSED

23040 Schoenherr, Warren, MI 48089
1-800-TRU-HAMM (orders only)
(500-878-4266)

Now on the World Wide Web <http://michiganradio.com> E-Mail at mirad@mich.com



TH-79A(D)



TMV7A



TM-261A

KENWOOD



TS-50/60



TS-570



TM-742



TS-950SDX



FT-8500



FT-900AT

YAESU



FT-50R



FT-2500M



VX-1R

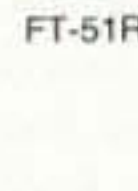

FT-51R



FT-920



FT-1000MP



FT-8100R



FT-1000

Convert Excess Equipment to CASH We buy good clean, used equipment Estate Sales

contact *Tommy Queen K4BNP*, (828) 258-2639; E-mail [*K4BNP@aol.com*] or [*K4BNP@Juno.Com*]. Talk-in on 146.76/.91.

JULY 24-25

OKLAHOMA CITY, OK The Central Oklahoma Radio Amateurs will sponsor their 25th annual "Ham Holiday '98/ARRL State Convention" at the Oklahoma State Fair Park (Hobbies, Arts & Crafts Building), northeast of the I-40 and I-44 intersection. Doors open 5 p.m.-8 p.m. Friday, July 24th, and 8 a.m.-5 p.m. Saturday, July 25th. Technical and non-technical programs, foxhunt, WAS card check, VE exams, flea market. Pre-registration \$7, \$9 at the door. Flea market tables \$10 in advance, \$15 each at the door (if available). Electrical hookup \$5. Talk-in on 146.82. Wouff Hong, midnight Friday. Additional info and registration forms are available on the CORA Web site [*www.geocities.com/heartland/7332*]. Address other inquiries to *Ham Holiday '98/ARRL State Convention, P.O. Box 850003, Oklahoma City OK 73085*; or E-mail [*n1lpn@swbell.net*].

JULY 26

HONOLULU, HI In celebration of their third wedding anniversary, a grand Ham-Boree is being planned by Gordon Crowhurst G4ZPY and Brenda in the form of a big get-together of hams and their partners for an evening meal in Honolulu. They would like to put a face to a callsign, a face to a name, of their many friends and acquaintances all over the world. For those who are interested, there are a lot of nearby mountains for DXing on the Pacific Rim. For more info contact *G4ZPY Paddle Keys International, 41 Mill Dam Lane, Burscough, Ormskirk, L40 7TG England. Tel./FAX (44) (0)1704-894299* anytime until 2300, but not between the hours of 1600-1830 local time. Everyone must make their own holiday arrangements themselves and pay for their evening meal. Please R.S.V.P. so that a suitable location may be arranged for the get-together.

TIMONIUM, MD The Baltimore Radio ATV Society will hold its annual Maryland Hamfest and Computer Fest Sunday, July 26th,

at the Timonium Fairgrounds on York Road off I-695, I-83. Free VE exams will be given at 9 a.m. only; check-in is at 8:30. Preregistration is required. To pre-register, call *John Creel WB3GXW* after 6 p.m. at (301) 572-5124. Vendors can set up beginning at 2 p.m. on Saturday. Tailgating area opens at 6 a.m. Sunday, indoor vendors open at 8 a.m. The event will be held rain or shine, and the fairgrounds is accessible to the handicapped. Admission is \$5 per adult, children under 12 admitted free. Tailgating spaces are \$10 each on a first-come, first-served basis with no advance reservations. Talk-in will be available on the 147.03(+), 224.96, and 448.325 MHz rpters. See the BRATS Web site at [*http://www.smart.net/~brats*]. You can contact them by E-mail at [*brats@smart.net*]; or write to *BRATS Hamfest, P.O. Box 5915, Baltimore MD 21282-5915*.

AUG 1-2

JACKSONVILLE, FL The 25th annual Greater Jacksonville Amateur Radio & Computer Show will be held August 1st and 2nd at the Osborn Convention Center in downtown Jacksonville. The site is conveniently located one mile north of the I-95/I-10 junction. Take the Forsyth St. exit off I-95. Activities include forums and group meetings, a huge indoor swap area, and commercial exhibitor booths. Testing for all grades of ham license will be at 9 a.m. Sunday in the lobby area. Walk-ins are welcome. Hours are 9 a.m.-5 p.m. Saturday, and 9 a.m.-3 p.m. on Sunday. Exhibitor and swap area setup is Friday July 31st, 1 p.m.-6 p.m., with drive-in access for easy unloading. Admission is \$8 at the door. Swap tables are \$25 each for the weekend. Tables may be ordered from *Karl Hassler N4DHG, 2767 Scott Circle, Jacksonville FL 32223. Tel. (904) 268-2302*. Commercial booths are available via *Menard Norton KE4IOR* at (904) 384-6750 or E-mail via [*ke4ior@juno.com*]. Headquarters hotel is the Jacksonville Omni with a special rate of \$69 to those mentioning the hamfest. Phone (904) 355-6664 or 1-800-843-6664 for reservations. Free parking is available in the main convention center parking lot and the entire hamfest is air-conditioned. Many alter-

native activities are available in the area. Talk-in is on the 146.76 rpt, or for more details, check the Web site at [*http://www.pobox.com/~w4ue/hamfest.html*]; or write *Greater Jacksonville Hamfest, P.O. Box 27033, Jacksonville FL 32207*. The 1997 Greater Jacksonville Hamfest was designated the ARRL National Convention and the eight participating clubs plan an even bigger show this year. All proceeds go to upgrading amateur radio projects and activities in northeast Florida.

AUG 2

BERRYVILLE, VA The Shenandoah Valley ARC, of Winchester VA, will present the 48th Berryville VA Hamfest at Clarke County Ruritan Fairgrounds, 6 a.m.-3 p.m. Talk-in 146.830. Admission \$5. Tailgaters \$7 (indoor spaces available by reservation). VE exams by the Mountain ARC Teams. Contact *Tom Martin KF4TNX, (540) 323-0074. E-mail [hamfest@Vvalley.com]*, or write to *Shenandoah Valley Amateur Radio Club, P.O. Box 139, Winchester VA 22604*.

ANGOLA, IN Land of Lakes ARC will sponsor a Hamfest Sunday, August 2nd, 7 a.m.-2 p.m. at Steuben County 4-H Fairgrounds, corner of 200 W. and 200 N., Exit 150 off of 69. Free parking, camping, chicken BBQ, swimming, amusement park and outlet shopping nearby. Indoor tables \$8, trunk sales \$2. Vendors setup Saturday, August 1st, 3 p.m.-10 p.m., Sunday, August 2nd, 4 a.m.-7 a.m. Not responsible for theft or accidents. Advance tickets \$3, gate tickets \$4. Advance sales end July 22nd. For more info, contact *Theresa J. Limestahl KB9NNR, P.O. Box 346, Fremont IN 46737. Tel. (219) 495-5403; FAX (219) 495-1675. Packet [KB9NNR@N9LCF]*. Talk-in on 147.180 pl 131.8, 444.350, packet 145.510.

MARSHFIELD, WI The Marshfield Area ARS will hold their 7th annual "Hamnic" (a potluck dinner/swapfest) on Sunday, August 2nd, at Wildwood Park Shelter in Marshfield WI. Gather around 11 a.m. Talk-in on 147.180 or contact *Guy Boucher KF9XX, 107 West Third Street, Marshfield WI 54449. Tel. (715) 384-4323. E-mail [guyboucher@tznet.com]*.

Packet [KF9XXX@W9IHW.E5.AI.WI.USA.NA]. All are welcome!

RANDOLPH, OH The Portage ARC "Hamfair '98 For Radio Amateurs and Computer Enthusiasts" will be presented at Portage County Fairgrounds in Randolph (between Akron and Youngstown, on St. Rt. 44, 4 miles south of I-76). The event will take place from 8 a.m. to 4 p.m. Unlimited free parking. There will be indoor vendors and a huge flea market. Setup begins at 6 a.m. An on-grounds restaurant will serve breakfast and lunch. Advance tickets (available until July 15th) are \$4; \$5 at the gate. Other features include Worked-All-States card checking and ARRL officials to answer your questions and bring you up-to-date with what is happening. Indoor tables with electricity are \$10 each. Flea market spaces \$3 each. For reservations or info and tickets, contact *Joanne Solak KJ3O* at (330) 274-8240. Mail registration with a check/m.o. for the total amount, payable to *Portage Amateur Radio Club, 9971 Diagonal Rd., Mantua OH 44255*. Talk-in on 145.39 (-600 MHz). Get a look at the Web site at [*http://parc.portage.oh.us*].

AUG 8

HUNTINGTON, WV The Tri-State Amateur Radio Assn. (TARA) will hold their hamfest at the Huntington Memorial Fieldhouse at 2590 5th Ave. For more information call *Bernie Mays* at (304) 743-5459, or E-mail to [*wb8zer@juno.com*].

OSCODA, MI The 1998 I.C.A.R.E. Hamfest will be held at Oscoda Airport in the Yankee Air Force Museum, Oscoda MI, 8 a.m.-2 p.m. Setup at 6 a.m. \$3 trunk sales, tickets \$4 in advance, \$5 at the door. Tables \$7 each. Free overnight RV parking available. VE exams with 9 a.m. check-in. Mail ticket orders with an SASE and payable to *I.C.A.R.E., P.O. Box 271, Oscoda MI 48750*. For more info, call (517) 739-2896, or (517) 739-3129. E-mail [*ka8aip@centuryinter.net*].

AUG 9

ST. CLOUD, MN The St. Cloud Radio Club will hold its 50th annual Hamfest on August 9th at

Whitney Senior Center, St. Cloud MN. VE exams begin at noon. Talk-in on 146.94 and 147.015. For info and tickets contact W0SV, 401 Great Northern Dr., Waite Park MN 56387. Tel. (320) 255-1410. E-mail [jmaus@cloudnet.com]. Check the Web site at [WWW.W0SV.ORG].

AUG 18

ANGELS CAMP, CA The Calaveras ARS will hold an Amateur Radio Flea Market Saturday, July 18th, 7 a.m.-2 p.m. at Utica Park in Angels Camp. Buyers free! Sellers \$5. Talk-in on 145.170(-) pl 100. For more details call Steve at (209) 878-3829 or Susan at (209) 795-0618.

AUG 29-30

BOXBOROUGH, MA The 1998 New England ARRL Convention at Boxborough MA will be held at the Holiday Inn Boxborough Woods Hotel and Conference Center, Route I-495. For information regarding exhibits, contact day or evening, Anthony Penta W1ABC, General Chairman, 88 Hill St., Topsfield MA 01983. Tel./FAX (978) 887-8887. E-mail [tony@shore.net]. For room reservations, contact Mel Cole WZ1Q, Reservations Chairman, P.O. Box 8, Prides Crossing MA 01965. Tel. (978) 927-1953. E-mail [mel@shore.net]. For exhibit and advertising info, contact Richard Cosma KD1BF, Exhibits Chairman, 95 Higgins Road, Framingham MA 01701-4311. Tel. (508) 877-8241; FAX (617) 248-6939; or E-mail [kd1bf@amsat.org].

SPECIAL EVENT STATIONS

JULY 1-5

OSHKOSH, WI Radio Amateurs of Wisconsin, in conjunction with the Wisconsin Sesquicentennial celebration and the 27th annual Sawdust Days Festival, will operate W9W 1700-0200 UTC, in the General portions of 10, 15, 20, and 40 meters, SSB and CW. Send a 9 x 12 SASE for the certificate to Mark Miller N9WT, 336 W. 8th Ave., Oshkosh WI 54901-5928 USA.

JULY 4

DELTAVILLE, VA The Middlesex Amateur Radio Group (M.A.R.G.)

will operate Station KB4NGO, from 1300 hours to 1900 hours on Saturday, July 4th, commemorating the annual Deltaville Heritage Day Celebration. Operation will be on the lower General 80-10 meter phone and CW. For a certificate, send a 9 x 12 SASE to Fay Smith, P.O. Box 88, Hardyville VA 23070 USA.

PLYMOUTH, MI The Stu Rockafellow ARS will operate station W8NJH for their 2nd annual "Salute to America's Small Towns," on July 4th. SSB target frequencies will be 7.270 MHz and 14.270 MHz. Hours of operation will be 1200 UTC-2000 UTC. For a certificate, please QSL with a 9 x 12 SASE to Dave Langston KB8RAP, 1000 Town Center, Suite 1200, Southfield MI 48075 USA.

JULY 11

BETHEL, CT Rare VHF grid square FN40 will be activated to coincide with the July 1998 CQ VHF contest weekend. The Candlewood ARA in Danbury CT will set sail for grid FN40, located just off the eastern tip of Long Island NY, on July 11th, 1998. Operation will begin before the contest period at 1300 UTC, and conclude at 2359 UTC, Saturday only. Contest class will be multi-operator class 2. Packet cluster spots will be through YCCC and Tri-State networks. The club call, W1QI, will operate simultaneously on the 50, 144, 220, and 432 MHz bands, using SSB primarily, with some CW and FM. Output will range from 50 to 150 watts to single yagis mounted on one or two small boats (sorry ... the cruise ships were all booked!). Plans and operating details will be posted as they develop on the CARA Web page at [http://www.danbury.org/org/cara/].

JULY 11-12

KALAMAZOO, MI The Southwest Michigan Amateur Radio Team (SMART) will sponsor a special event station starting July 11th at 1800Z-0200Z July 12th. The station will be located in Kalamazoo MI and will operate under the new club call K8KZO. All contacts will be in the phone bands on or around 3.904, 7.2704, 14.304, 28.304, and 147.04. This

event is to celebrate the 40th anniversary of SMART. To obtain a certificate confirming the contact, send a QSL and a 9 x 12 SASE to SMART, P.O. Box 3175, Kalamazoo MI 49003-3175 USA.

JULY 19

STRATFORD, NY The Fulton County Dr. Mahlon Loomis Committee will operate Station W2ZZJ on July 19th to commemorate the 172nd Anniversary of the birth of Dr. Loomis, the American radio pioneer who was born at Oppenheim NY on July 21st, 1826. Operation will be from 1300-2000 UTC on the General class phone portion of 75, 40, and 20 meters; and on the Novice 10 meter phone band. Also, on area 2-meter FM repeaters. For a parchment certificate and extensive literature, send QSL, contact number, and a #10 SASE (55¢ postage) to: George P. Sadlon W2ZZJ, 5738 St. Hwy. 29A, Stratford NY 13470 USA.

JULY 26-AUG 8

KINCARDINE, ONT., CANADA The Kincardine DX Group will operate XK3K to celebrate the 150th Anniversary of the Town of Kincardine. This special call sign will be used between 0000 UTC July 26th and 2359 UTC August 8th. Operations will be on all bands 80-10 meters, SSB and CW. Please send an SASE for QSL to Bill Hardie VE3EFX, 755 Johnston Crescent, Kincardine Ontario N2Z 1S5, Canada.

JULY 31-AUG 2

OSHKOSH, WI The Fox Cities ARC of Appleton WI will operate W9ZL from the Experimental Aircraft Assn. Fly-In and Convention (EAA AirVenture '98) at Wittman Regional Airport in Oshkosh. SSB-HF operation will begin on Friday, July 31st and continue through Sunday, August 2nd, in the General portions of the phone bands. RTTY operation

Continued on page 78

Motron 310 Garfield St Suite 4
PO Box 2748 Eugene, Oregon 97402
ELECTRONICS **Only \$99.00**
<http://www.motron.com>

Control your home from your radio!

The AUTO-Kall® AK-16 DTMF Controller Board features 16 relay driver outputs and DTMF to X-10 house control capability! Using your radio keypad, you can control either the relay outputs, X-10 modules, or both! X-10 operation requires the PL-513 Power Line Interface (\$20). The AK-16 mates readily with our **RB-8/1** (\$99) or **RB-16/1** (\$149) relay boards. The 0-12 digit security code is user programable using your DTMF keypad. Additional features include reprogramable CW ID and several modes of operation, including two with CW response tones. Printed circuit board, assembled and tested. VISA, MASTERCARD, AMERICAN EXPRESS, DISCOVER CARD COD ON CASH OR MONEY ORDER basis only S/H: \$8 USA; \$11 CANADA; \$16 FOREIGN. COD: \$5

Price and Specifications are subject to change without notice
Se Habla Español. Pida por Don Moser.

Orders: (800) 338-9058
Info: (541) 687-2118 Fax: (541) 687-2492



CIRCLE 248 ON READER SERVICE CARD

Mega-Mini Micropower Timeout Switch

Here's a great excuse to play with SMT.

Sam Ulbing N4UAW
5200 NW 43rd Street
Suite 102-177
Gainesville FL 32606
[n4uau@afn.org]

What's one-sixth the size of a postage stamp, draws about 10 microamps and gives delays from seconds to hours?

This timeout circuit!

\$2.50. That's how much it cost every time I had to replace the nine-volt battery in my DMM (digital multimeter), and I was getting tired of replacing it every month or so. Of course, the battery should last a lot longer, but I have a bad habit of forgetting to turn off the meter when I am done with it. In a few days, the battery is pretty well run down. My inexpensive calculator has an automatic shutdown, so why not make one for my DMM? Then, if I leave it on by mistake, it will shut itself off after a few minutes.

I envisioned a circuit small enough to put in the battery compartment of the DMM and of low enough power to not run down the nine-volt battery. It took some time and a bit of experimenting to find the proper parts to build a circuit that would meet these criteria, but I now have a neat automatic shutdown switch. As an unexpected bonus, I also have a "soft" On/

Off switch that is much easier to work than the rotary function switch on the meter. The project seemed simple enough, but it turned out to be a lot more sophisticated than I thought it would be. In the process of building it I learned a lot about ultra-low current ICs, which will be useful as more new low power ICs are introduced.

Early attempts were unsuccessful

My first thought was to use an LM555 timer in a one-shot (monostable) configuration as shown in **Fig. 1**. This is a common application of the 555, but for me it had two drawbacks. First, the timing graph showed that I would need a 10-megohm resistor and a 50- μ F capacitor to get a shutdown delay of seven minutes. Such a physically large capacitor would not fit in my battery compartment. Worse, the chip drew 5 mA (more than the meter itself) and since it would be connected to the battery all the time, I'd run my battery down in only four days.

I considered an LMC555, the CMOS version, which uses only 0.25 mA

maximum, but it would still run the battery down in about two months.

I thought about using the ICL7660 and four AA batteries to power the setup as I had for the digital ammeter on my boat (see "Penny Pincher's Digital Ammeter," 73, May 1998). That approach would not power the meter down, but four AA batteries would have more capacity or I could use rechargeable batteries. That would work, but the arrangement would be bulky and I would have to strap the batteries to the back of the meter. Not a very neat or easily portable solution.

Another solution I thought of was to use a small microcomputer chip as a timer, but this seemed to be overkill for what should be a simple job. Besides, it would probably use too much current and be too big to fit inside my meter.

My battery-saver project went on hold for a couple of years until I discovered the LMC7221. As a National Semiconductor ad says, "With the right parts, you can do anything." And this was the right part for my project. It is one of a family of micropower op

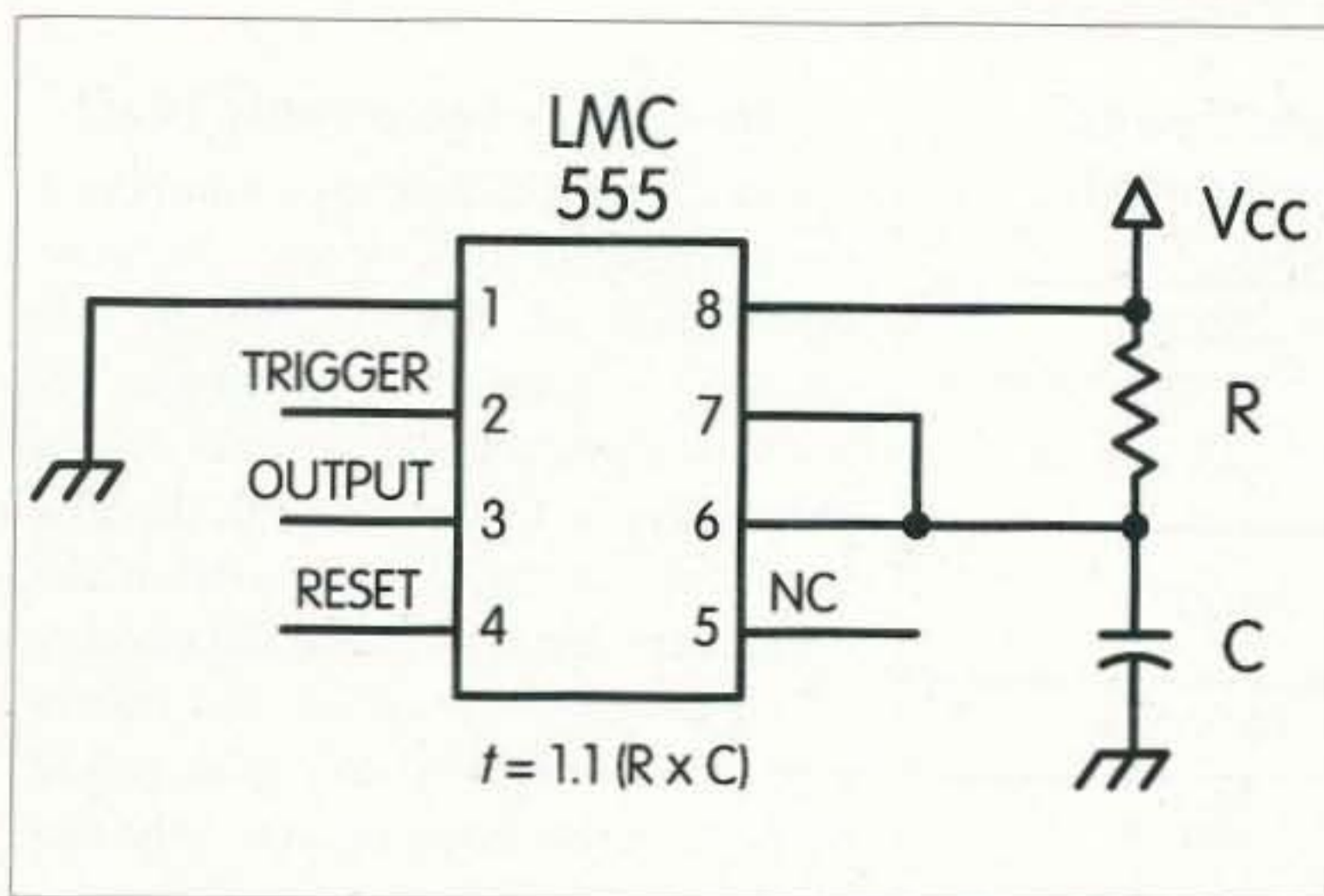

Fig. 1. Typical timeout circuit using LMC555.

amps and comparators for applications in "mobile phones, pagers, notebook computers, Personal Digital Assistants, and PCMCIA cards."

The LMC7221 is a comparator with an open drain output (there is also a 7211 with a push-pull output) that can operate with voltage sources from 2.7 to 15 volts. It has a maximum supply current of 18 microamps, so it can run for at least 24,000 hours, or nearly three years, before it drains a nine-volt battery. The chip is available in DIP, SO-8, and SOT23-5 packages. Since I had a sample of the SOT23-5 chip, I decided to use it. The entire circuit fits on a PC board one-sixth the size of a postage stamp (see **Photo A**).

The circuit

Fig. 2 shows my auto shutdown circuit. U1 is the comparator with an open drain output. The output is low when the inverting (-) input is greater than the noninverting (+) input. When the inverting input is less than the noninverting one, the output goes into a high impedance state. The circuit uses the chip as a low side switch. Timing is set by an RC circuit (R3 and C1). The timer is started by pushing PB1, which charges C1. R3 then discharges C1 until its voltage is less than that set by the voltage divider, R1 and R2, at which point the switch turns off. Pushing PB2 will manually shut down the circuit by discharging C1.

Easy, isn't it? Yes and no. Recall that when I thought about using the LM555, a delay of seven minutes required a

50- μ F capacitor and 10-meg resistor. This same RC "time constant" also applied to my circuit, and if I had to use such a large capacitor, I would not be able to make the circuit small enough. (Recall that one time constant = RC, which equals the time needed for a charged capacitor C to discharge to 37% of its initial voltage through a resistor R, where R is in ohms, C is in farads, and T is in seconds.)

Fortunately, the LMC7221 characteristics allow the use of a much smaller capacitor. The LMC7221 data-sheet shows that the current at the + and - input pins is typically 40 femtoamps. That's 40 quadrillionths in layman's terms, or 40×10^{-15} amps, or .00000004 of a microamp. The input uses so little current that you can almost count the electrons as they go by (see sidebar, "How Many Electrons Is That?"). Since $R = V/I$, the input

resistance (at nine volts) is more than 0.225×10^{15} or 225 million megohms. That is a *lot* of resistance and it allows some interesting possibilities. Compare that to using a chip like the LMC555, which has a maximum leakage current at pins 6 and 7 of about 100 nanoamps (10^{-7}). That is "only" 90 megohms at nine volts. This "low" resistance sets an upper limit on the value of the timing resistor in the RC circuit. A 10-megohm resistor is about 10% of the leakage resistance. Using the same upper limits with the LMC7221 circuit allows the use of a two-million-megohm resistor (2×10^{12}). This is half a million times as large, and hence for an identical time constant we could use a capacitor half a

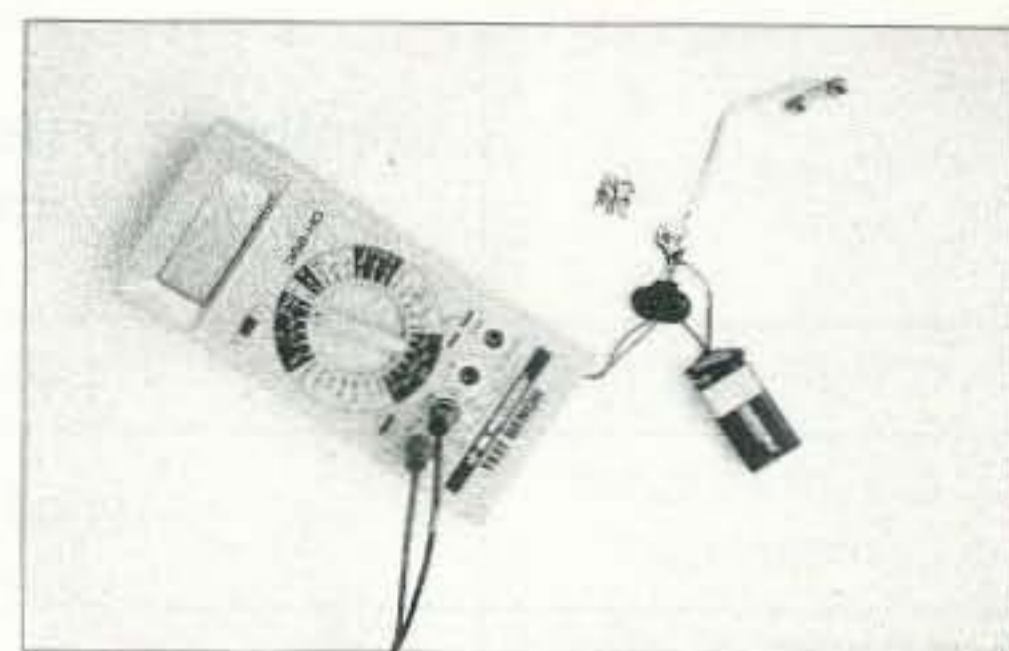

Photo A. A postage stamp is about six times larger than the completed circuit to its right.

resistance (at nine volts) is more than 0.225×10^{15} or 225 million megohms. That is a *lot* of resistance and it allows some interesting possibilities.

Compare that to using a chip like the LMC555, which has a maximum leakage current at pins 6 and 7 of about 100 nanoamps (10^{-7}). That is "only" 90 megohms at nine volts. This "low" resistance sets an upper limit on the value of the timing resistor in the RC circuit. A 10-megohm resistor is about 10% of the leakage resistance. Using the same upper limits with the LMC7221 circuit allows the use of a two-million-megohm resistor (2×10^{12}). This is half a million times as large, and hence for an identical time constant we could use a capacitor half a

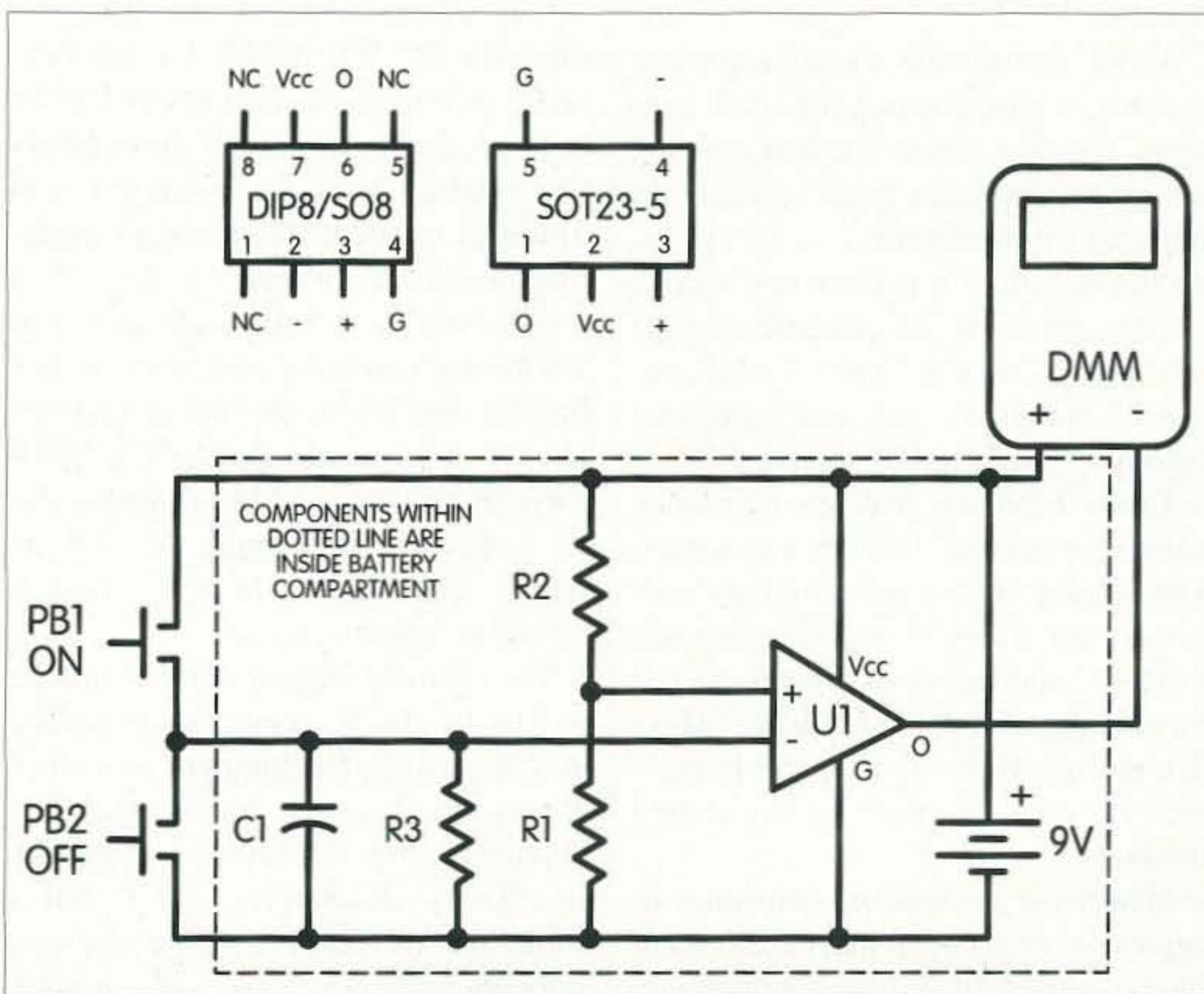

Fig. 2. Schematic of automatic shutdown switch.

Capacitor	Minimum R per Catalog (megohms)	Test Results (megohms)
0.1 μ F ceramic	2000	2600
0.1 μ F ceramic monolithic	2000	50,000
0.22 μ F ceramic SMT	2000	30,000
1.5 μ F tantalum	800	16,000
1 μ F electrolytic	2.2	55

Table 1. Capacitor test results.

million times smaller (about 100 picofarads)!

Selecting the components

I did not use those values, however, not only because I could not find a two-million-megohm resistor but also because at such large values leakage current becomes a significant consideration. PC board insulation resistance typically ranges from 10^7 to 10^{16} ohms (from *Low Level Measurements*, 4th edition, Keithly Instruments, Inc., p. 4-22). Nearly everything in the environment will have a significant impact on the number of electrons leaking out of the capacitor and thus cause unpredictable behavior.

An RC circuit with a small capacitor and large resistor uses very small currents. For this reason, the leakage current of the capacitor itself becomes an important consideration. A leaky capacitor acts like a perfect one with a resistor across it. Electrolytic capacitors are notoriously "leaky," while ceramic, tantalum, and polypropylene capacitors are generally better.

Table 1 shows leakage resistance values for several different capacitors. The catalog data gave minimum values. To get a feel for actual resistance, I ran an experiment on several capacitors I had on hand. (The sidebar "More Technical Information for the Experimenter" contains more on my testing methods.)

Measuring the leakage resistance of capacitors is not a job that can be accurately done with ordinary equipment, due to the very large values involved,

and there are many factors which make accurate measurements difficult even with expensive equipment. Nevertheless, I found it was possible to get a rough feel for the relative resistances and this was all I needed to build my switch.

The biggest surprise was that a ceramic capacitor I had from a surplus place "leaked like a sieve" but the SMT (surface mount technology) ceramic and the monolithic ceramic capacitors had very high leakage resistance. The electrolytic capacitors were the worst, as expected. I decided to try both the tantalum and one of the better ceramic capacitors.

Four components set the shutdown time: R1, R2, R3, and C1. I wanted the meter to shut down after about 5 to 10 minutes. Using an Excel® spreadsheet (see sidebar "More Technical etc." and Table 2) to solve the discharge equation for an RC circuit, $V = E * e^{-t/RC}$, I found that a 1.5- μ F capacitor and 2,600-meg resistor would work by setting R1 and R2 so that C1 discharged to 91% of its initial voltage. Or, a 2,600-megohm resistor would work with a .22- μ F capacitor discharging to half its initial value. But where to find a 2,600-megohm resistor?

The ultimate large resistor would be to just let the IC input pin resistance and the capacitor internal resistance act as R3. It seemed that the leaky 0.1- μ F ceramic capacitor should work by slowly discharging itself, but I found that the shutdown time was very unpredictable. The values for the tantalum and other 0.1 capacitors were

How Many Electrons Is That?

Working with such large numbers, I wondered just how many electrons were involved. This is not an idle question, since one of the major efforts in computer electronic design these days is to reduce both the distance of electrical paths (to make computers run faster) and the number of electrons involved (to help them run cooler). Ideally, the goal would be to have no distance and only one electron to represent a "one" and no electrons to represent a "zero."

A search on the Internet revealed that one coulomb = 6.25×10^{18} electrons. I already knew that one amp equals one coulomb per second. So 40 femtoamps is 6.25×10^{18} times 40×10^{-15} , which equals a mere 250,000 electrons per second. That's the maximum amount of electrons that will leak out through the input pin.

A quarter of a million may still seem large, but compare that with the number of electrons for one microamp, which is normally considered a very small current with 6,250,000,000,000 electrons per second. In perspective, 250,000 is getting very close to that single electron.

I also wondered how many electrons were in a capacitor when it was charged to nine volts.

The equation for that is:

Coulombs = Capacitance x Voltage

For our 1.5- μ F capacitor, there are 13.5×10^{-6} coulombs, or $84.3 \times 10^{12} = 84,300,000,000,000$ electrons.

Using the just the LMC7221 input pin, and with no other leakage effects, it would take about 10 years for the 1.5- μ F capacitor to discharge.

While I was working on my switch, I happened to note in *Electronic Engineering Times*, Jan. 5, 1998, that in a recent breakthrough researchers have fabricated a single-electron transistor. One of the researchers commented that "the single-electron effect is going to dominate transistor design regardless of whether we like it or not. The question is how do we take advantage of it." I think this project is just such a step!

Shut-off voltage (at non-inverting pin) for different values of R1 and R2 (Vcc = 9)			Voltage on C1 for different % of the time constant		Time to reach t/RC for different R and C values				
					R3 = 2600		R3 = 2600		R3 = 10
					C1 = 1.5		C1 = 0.22		C1 = 1.0
					R3C1 = 3900.0		R3C1 = 572.0		R3C1 = 10.0
					Time		Time		Time
R2	R1	Shut-off voltage	t/R3C1 (%)	C1 voltage	Sec.	Min.	Sec.	Min.	Sec.
1	10	8.2	0	9.0	0	0.0	0	0.0	0.0
2	10	7.5	1	8.9	39	0.7	6	0.1	0.1
3	10	6.9	2	8.8	78	1.3	11	0.2	0.2
4	10	6.4	3	8.7	117	2.0	17	0.3	0.3
5	10	6.0	4	8.6	156	2.6	23	0.4	0.4
6	10	5.6	5	8.6	195	3.3	29	0.5	0.5
7	10	5.3	6	8.5	234	3.9	34	0.6	0.6
8	10	5.0	7	8.4	273	4.6	40	0.7	0.7
9	10	4.7	8	8.3	312	5.2	46	0.8	0.8
10	10	4.5	9	8.2	351	5.9	51	0.9	0.9
10	9	4.3	10	8.1	390	6.5	57	1.0	1.0
10	8	4.0	20	7.4	780	13.0	114	1.9	2.0
10	7	3.7	30	6.7	1170	19.5	172	2.9	3.0
10	6	3.4	40	6.0	1560	26.0	229	3.8	4.0
10	5	3.0	50	5.5	1950	32.5	286	4.8	5.0
10	4	2.6	60	4.9	2340	39.0	343	5.7	6.0
10	3	2.1	70	4.5	2730	45.5	400	6.7	7.0
10	2	1.5	80	4.0	3120	52.0	458	7.6	8.0
10	1	0.8	90	3.7	3510	58.5	515	8.6	9.0
			100	3.3	3900	65.0	572	9.5	10.0
			110	3.0	4290	71.5	629	10.5	11.0
			200	1.2	7800	130.0	1144	19.1	20.0
			250	0.7	9750	162.5	1430	23.8	25.0
			300	0.4	11700	195.0	1716	28.6	30.0
			400	0.2	15600	260.0	2288	38.1	40.0
			500	0.1	19500	325.0	2860	47.7	50.0
			600	0.0	23400	390.0	3432	57.2	60.0
			700	0.0	27300	455.0	4004	66.7	70.0

Table 2. Spreadsheet for determining components for desired shutoff times.

much too large, and tests showed that the circuit stayed on for very long times.

As I was pondering this dilemma, I recalled that the small 1N4148 diode passes a very low current when reverse

biased. Datasheets showed a maximum reverse current of 25 nanoamps at 25° C and a typical current of six nanoamps. That seemed like a large variation and I knew that the current was quite temperature-dependent, so I

decided to measure a few of the ones I had.

The results are in Table 3. These values were near the values I needed, but

Continued on page 46

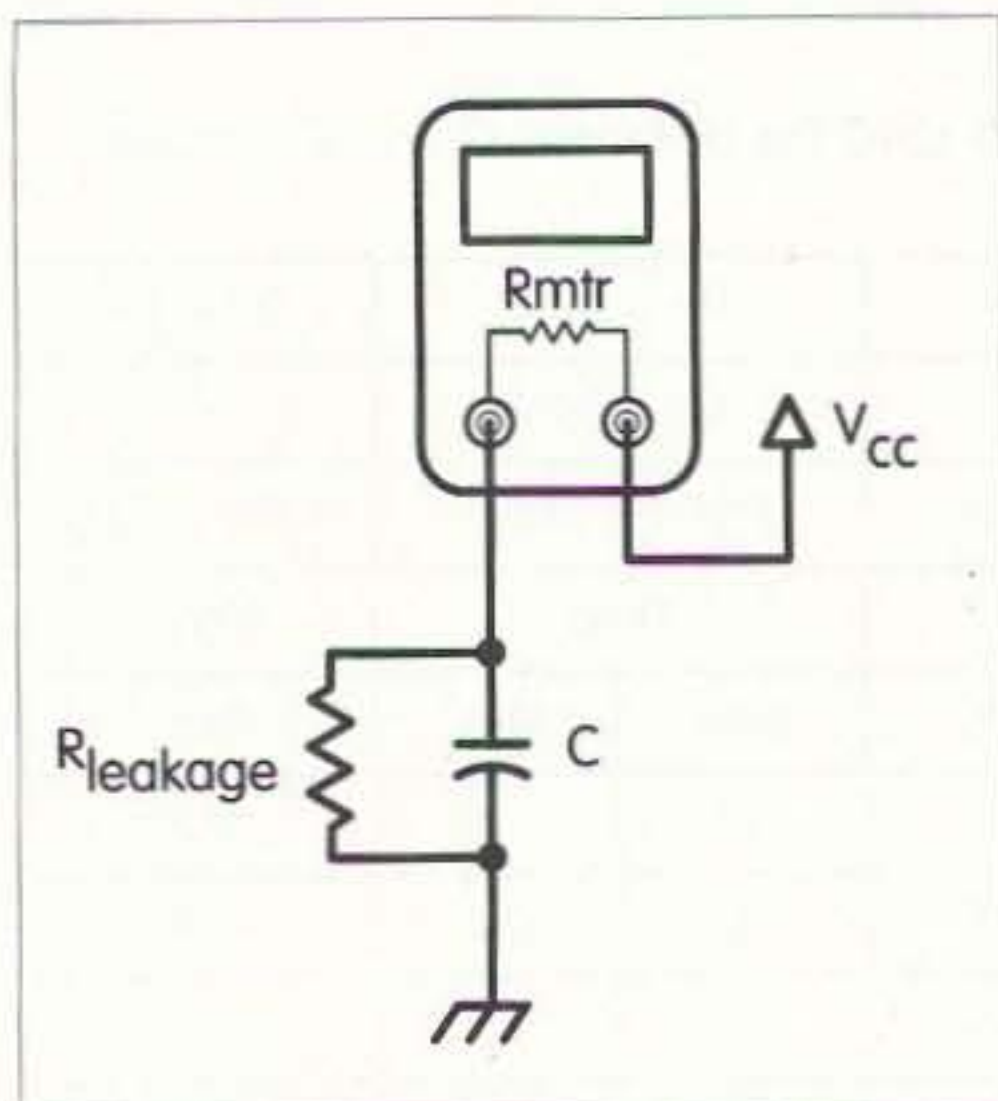

Fig. 3. Using a 10-megohm DMM to measure very high leakage resistances.

Mega-Mini Micropower Timeout Switch

continued from page 45

with such a large range of values I would have to select the specific diode to use.

Prototyping and the final circuit

I made several prototypes. For the first one, I set R1 at 10 megs since it was the largest value resistor I could find in the catalogs. By using this value, I would limit the current flow through R1 and R2 to 1 μ A. I set R2 at 1 meg because I had a small SMT resistor of this value. Combined with the 1.5- μ F tantalum capacitor, the circuit worked well. It was small and drew only 9.4 μ A, but after I built it, I wondered if I could improve it. I made a version using a 0.22- μ F SMT capacitor and two 10-meg resistors that also worked well. It was a bit smaller and drew only 9.1 μ A.

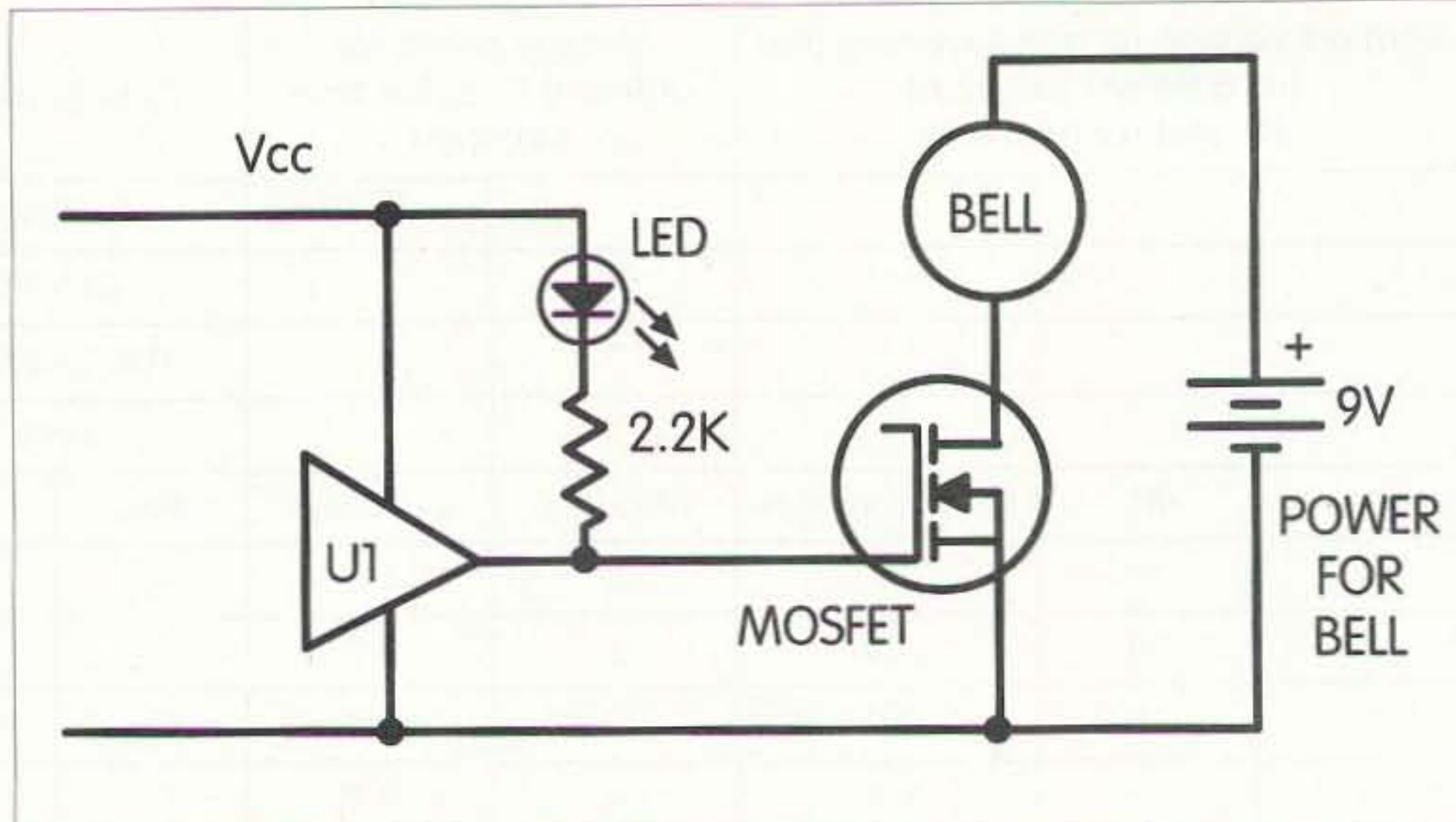

Fig. 4. Test setup for breadboard timing tests.

It's funny how the mind gets stuck in a rut. I suddenly realized that I was trying to minimize current through the R1-R2 branch but was limiting my thinking to "standard" resistors. I had just learned that a reverse diode would work as a resistor, so why not make R1 and R2 with reverse diodes which are cheap, small, and have a lot more resistance than my standard resistors? In order to do this, it was necessary to measure a bunch of diodes and select two that had about the same reverse resistance (for a 50% voltage divider). I did this, and found that the circuit worked fine—and drew only 8.7 μ A.

Since accurate measurements were not possible, I used the "try it and see" method with the DIP version of the IC to select the actual components for my final version. I breadboarded the different circuits and ran timing tests. Each circuit had a slightly different shutdown time and none was "clock-like" in accuracy, but all three were

within the five-to-10-minute range I wanted and none varied more than about a minute. This timer would not be suitable as a mass-produced circuit, but as a custom one with selected parts it works very well.

I made my "final" version on a single-sided piece of PC board measuring 9 mm by 10 mm—only slightly larger than a DIP IC! I used two 1/8-watt resistors, an SMT capacitor, and a 1N4148. My technique for making an SMT PC board is described in "A Pentium-Style Positive and Negative Power Supply," 73, June 1998. I was delighted to find that using the SOT23-5 version of the chip was not much harder than building with the larger SO-8 since there are only two

Diode	Current (nanoamps) 9 V & Room Temp.	Resistance (megohms)
#1	3.8	2300
#2	2.6	3300
#3	1.2	7100
#4	2.8	3000
#5	1.4	6000
#6	0.8	10,900

Table 3. Diode test results.

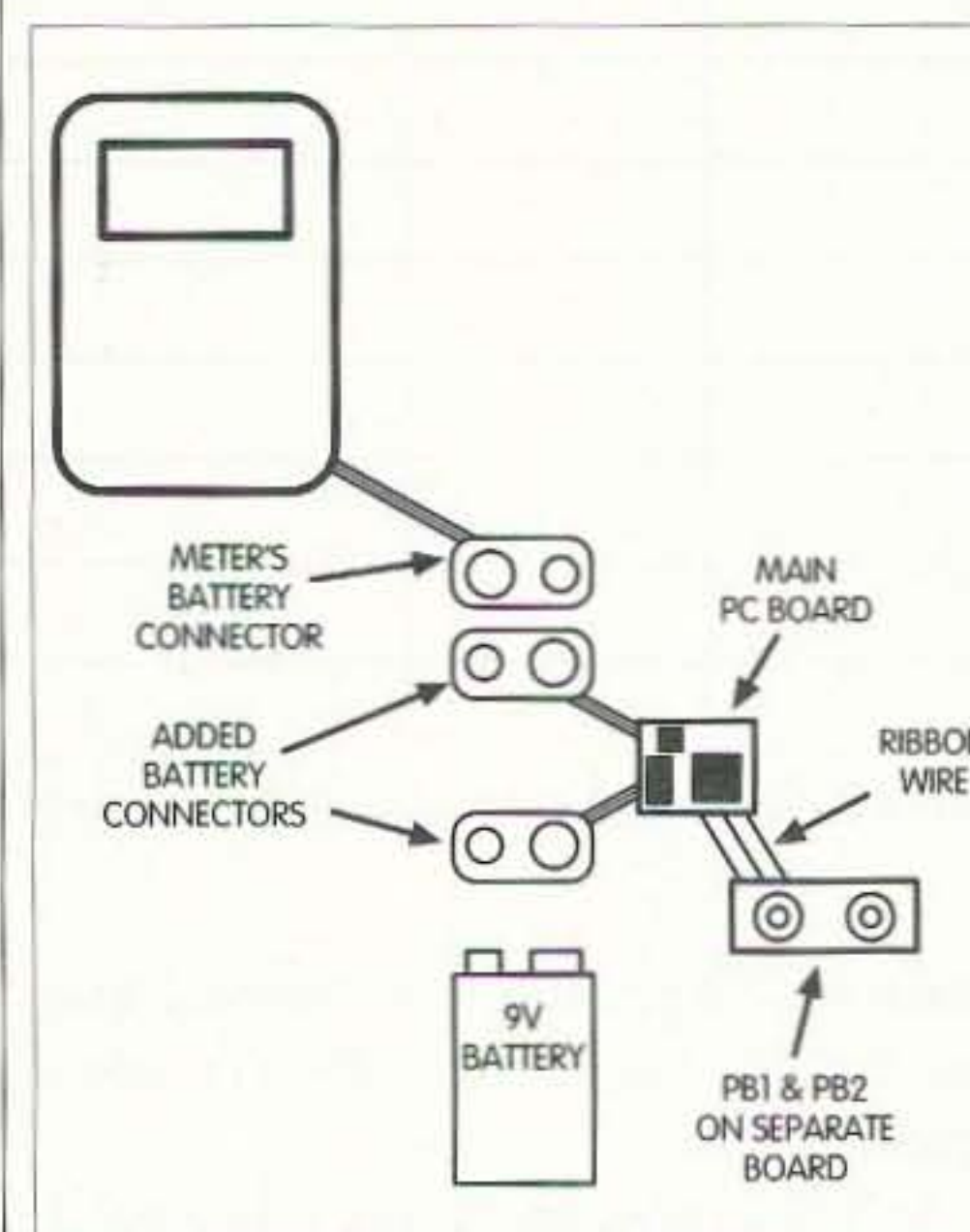

Fig. 5. The completed circuit is easy to connect.

More Technical Information for the Experimenter

Measuring and using very large resistances

With a meter that only measures to 2000 megs, I needed a different way to measure the resistances involved. The method I used is similar to the one I use for very low resistances. I measured the voltage across a resistor in series with the one I wanted to determine. I then calculated the current through that resistor and with that I was able to calculate the unknown resistance. The resistance I used was the DMM internal resistance measured as 9.9 megs. Putting the meter in line as shown in **Fig. 3** is like placing a 9.9-meg in series. I determined the meter resistance by using a 1-meg 1% resistor in series with it.

The equations are:

$$I = V_{\text{measured}} / R_{\text{meter}}$$

And the unknown resistance is

$$R = (V_{\text{cc}} - V_{\text{measured}}) / I.$$

With the 1.5- μF tantalum capacitor, I measured 5.45 mV, giving a current of 5.45×10^{-10} amps. With only 5.45 mV across the meter, essentially the entire source voltage (8.47 volts) was across the capacitor. Thus the resistance of the capacitor was $8.47 / (5.45 \times 10^{-10}) = 1.554 \times 10^{10}$, or about 16,000 megs.

Due to capacitance and dielectric effects, it takes some time for the current to charge the capacitor and reach its leakage value. For a 1% accuracy, you need to wait at least five time constants, which for a 10-meg resistor and a 1.5- μF capacitor is about two minutes (with no absorption). Notice that you cannot use a DMM to measure the voltage across the capacitor directly since the meter resistance is much less than that of the capacitor. The high resistances of a couple of the capacitors I measured caused readings so small (1 mV or less) that noise and meter error prevented really good readings—but at least I knew these capacitors had a very large resistance.

High-value resistors require careful handling. Surface films from moisture or careless handling can reduce the resistance by increasing surface current flow. I tried some SMT diodes and found the shutdown time was less than expected. Since the solder contacts are next to the surface, I suspect that surface currents were present.

Using a standard IN4148 diode as a resistor has worked well for my meter. For other applications, it is important to recognize that the resistance of a diode varies with temperature. According to National Semiconductor, a rule of thumb is that the reverse current through it will double with every 10°C increase.

Dielectric absorption

Low Level Measurements (see text) notes the following: Dielectric absorption occurs when randomly-oriented permanent dipoles of molecules within a capacitor dielectric are aligned by an applied electric field. For timing this can seriously degrade the accuracy of the circuit. This absorption must be known and compensated for if you want an accurate circuit. Dielectric absorption is not normally specified by a manufacturer. A test for dielectric absorption is to charge a capacitor through a resistor for one or two minutes and then discharge the capacitor through a resistor for a short period. Then let it sit for a couple of minutes and measure the voltage. This voltage is a measure of the dielectric absorption.

To measure the voltage on a capacitor, however, it is necessary to have a very high impedance meter—a common DMM will not work. I made a “jury-rigged” high impedance buffer using one of National’s high impedance op amps, LMC6082, and was able to get a feel for dielectric absorption. I found that some of the larger tantalum capacitors had a large dielectric absorption, their shutdown times in my timing tests differing significantly from what was predicted.

Using an Excel spreadsheet to determine components

Table 2 shows the spreadsheet I used to select the values for my circuit. The left-hand side gives the voltage at the noninverting input for various R1, R2 combinations with $V_{\text{cc}} = 9$ volts. With $R_2 = 1$ meg and $R_1 = 10$ megs, the voltage is 8.2 volts. The next two columns show the results of the capacitor charging equation: the voltage on C1 for different percentages of an RC time constant. Note that C1 reaches 8.2 volts after 9% of a time constant. The next columns solve for the time in seconds and minutes for certain R and C combinations. For $R_3 = 2,600$ megs and $C_1 = 1.5 \mu\text{F}$, 9% of a time constant is 351 seconds (six minutes), which is what I wanted. Using $R_3 = 2,600$ megs and $C_1 = 0.22 \mu\text{F}$, six minutes was 60% to 70% of a time constant. C1 will be at 4.5 volts and setting $R_1 = R_2 = 10$ megs gives 4.5 volts.

Note also that after five time constants (500%), the capacitor is nearly fully discharged.

It is easy to make a spreadsheet like I did since the function for e^x is part of the function library of Excel. If you don’t have Excel, you can use the last column and ratio the results for $R = 10$ and $C = 1$ for other values.

Using a DIP chip

I breadboarded my test versions on a regular breadboard using a DIP chip. This is certainly not the best way to get a repeatable results, however, and it is likely to be a major cause of my variable results. If you decide that you want to make a circuit with the DIP package, keep in mind a technique suggested in one of the National Semiconductor datasheets. They suggest bending the input pins and using what hams call “ugly construction,” with the components connected directly to the pin. As they note, air is an excellent dielectric.

An alarm

I used an LED and resistor for the output load during breadboard tests. Sitting around waiting for the LED to turn off was boring, to say the least. I devised an alarm by connecting a MOSFET to the output of the comparator. When the LED went off, the bell turned on (**Fig. 4**).

PC HF Facsimile 8.0



For Windows™ \$179.95

SSC is proud to announce PC HF Fax 8.0 for Windows. Now you can receive weather Fax, FEC, RTTY, Morse Code, Navtex, Amtor and Sitor while working with other software. The package comes with our new Windows FSK demodulator, software, manual and database. Just plug it in, connect your receiver, and you are copying the world! Call or write for our FREE Products Catalog.

Visa and MasterCard Welcome

Software Systems Consulting



615 S. Elcamino Real
San Clemente, CA 92672
Tel: 714/498-5784
Fax: 714/498-0568
<http://www.sscorp.com>

CIRCLE 250 ON READER SERVICE CARD

Shortwave Receivers Past & Present

Communications Receivers 1942-1997



- New 3rd Ed.
- 108 Chapters
- 472 Pages
- 840 Photos
- Printed 03/98
- Covers 1942 to 1997.
- 770 Receivers
- 660 Variants
- Includes 98 U.S. and Intl. manufacturers
- \$24.95 (+\$2 ship)

This huge 472 page Third Edition includes over 770 shortwave and amateur communications receivers made from 1942 to 1997. Here is everything you need to know as a radio collector or informed receiver buyer. Entry information includes: receiver type, date sold, photograph, size & weight, features, reviews, specifications, new & used values, variants, value rating and availability. Ninety eight worldwide manufacturers are represented. 840 Photos. Become an instant receiver expert!



Universal Radio

6830 Americana Pkwy.
Reynoldsburg, OH 43068

- ◆ Orders: 800 431-3939
- ◆ Info: 614 866-4267
- ◆ FAX: 614 866-2339

Radio Bookshop

Phone 800-274-7373 or 603-924-0058, FAX 603-924-8613, or see order form on page 88 for ordering information.

A book of TITANIC import!

EARLY RADIO

In Marconi's Footsteps, 1894 to 1920

by Peter R. Jensen VK2AQJ/G4GZT

This handsome volume is a must for hams everywhere. It's the fascinating story of how Marconi's technology was first put to use, based on written records of the time and absolutely packed with historic photos, drawings, and documents (many of which have never been published before).

As the saying goes, "truth is stranger than fiction," and this book from Australia is very, very hard to put down. One page after another is filled with anecdote after anecdote about life with ether in the early days. Among the most captivating chapters is a nine-page account of the *Titanic* disaster; also, in the Appendixes is the Press Report of the Surviving Wireless Officer.

We highly recommend the technical adventure that reading this book will be for you. And when you're done, don't put it on the bookshelf—you'll want to show it off on the coffee table.

And with the holidays coming up once again, here's a good chance to give yourself a great present. Just circle this ad and leave it where you-know-who can find it!

[Kangaroo Press, 1994, 8 x 11 inches, hardbound with dustcover, 176 pp., profusely illustrated]

Available today for ONLY \$40.00

Radio Bookshop

Phone 800-274-7373 or 603-924-0058, FAX 603-924-8613, or see order form on page 88 for ordering information.

Rene's Books

NASA Mooned America. René makes an airtight case that NASA never landed anyone on the moon. Ridiculous, of course, so maybe you can be the first to find fault with René's 30 "gotchas." He sure convinced Wayne. \$28.

The Last Skeptic of Science. René blows holes in one cherished scientific dogma after another. Do you believe there have been ice ages? That the moon causes the tides? That the iron core of earth causes its magnetic field? That the transmutation of elements is difficult? Another \$28 well spent.

critical cuts to make. Perhaps this is also because I have now done three projects with SMT parts. My first one, an audio amplifier ("SMALL—a Surface Mount Amplifier that is Little and Loud," *QST*, June 1996) was on a 21 mm by 26 mm PC board. At the time I thought it was as small as I could go, yet this one is only one-sixth that size. Practice must help!

Exact PC board layout depends on what components you use. I put the On/Off switches on a separate piece of PC board and connected them with a three-wire ribbon cable so that I could mount the switches on the front of the meter. While a power supply bypass capacitor is generally used with comparators, I did not use one and have seen no problems—perhaps because the circuit is so close to the battery.

Other uses

I am already thinking of other uses for this nifty chip. I could use it (with other parts) to have an AC lamp shut itself off. Power MOSFETs come in very small packages now, so an ultra-small high current switch is also possible. I could build an intruder alarm and have it shut down after a few minutes.

Another intriguing possibility is for very long time delays that are not feasible with lower-resistance ICs. By making $C1 = 3.3 \mu F$ and $R1 = R2 = 10$ megs, I made a 90-minute timer. It should be possible to extend that time to five hours by making $R1 = 1$ meg and $R2 = 10$ megs. The chip will operate on voltages as low as 2.7 volts, and I breadboarded a switch powered from a single tiny lithium battery cell which worked. The battery should last several years. All of these options will take a bit of experimenting to get the best circuit, but then, isn't that what ham radio is about? I would like to hear from anyone who experiments with this chip. I wonder if there are better small capacitors available and if there is a better way to make high value resistors.

I have been using my new switch for about six months now. I find that with the "soft" On/Off push-button switches, I tend to turn off the meter more often because it is so easy. When I forget, though, the circuit reliably shuts down my meter—just as planned.

Home-Brew RF Ammeter for the Shack

continued from page 30

two turns instead of the wire straight through the core.

Q. I use open wire feeders. Do I have to build two of these units?

A. Actually, this is "builder's choice," but not necessarily. You can duplicate the rest of the circuit and use a dual pot, switching the single meter from one side to the other, but (although I haven't tried it; I use coax) probably one in either side of your feeder pair would serve as well.

Q. How do I know this simple unit will work? How did you test it?

A. My antenna, about 10 feet high and which runs through an avocado tree and resonates at about 12 MHz, fed by my QRP++ through my home-brew low pass antenna tuner, which also includes a cross-needle meter, was used to check operation of this RF ammeter on all bands 40 through 10 meters, the only bands I operate. There is no reason it should not function as well on 160 and 80 meters.

Final thought: Build one (or two) RF ammeters, and then sell your SWR meters to hams who didn't read this article. 73

Take the Jekyll and Hyde Test

continued from page 37

reclining. These executive chairs can be expensive, so check discount office suppliers for a good deal. Whatever the cost, it's worth the added expense.

So what's the bottom line?

It is difficult to present a convincing argument for either the Jekyll or Hyde ham shack designs by stating unequivocally that one is better than the other. There are probably just as many amateurs who will make a case for either extreme, so the safest bet is to adjust your sights for a compromise plan but make certain to include all the safety and as many of the comfort features as

you can. Think about your current space requirements and make certain to allow for some room to expand if you decide down the road to become involved in a new dimension of the hobby.

Remember: If that occurs, you're off again with a component here and a piece of gear there, and before you know what's happening, Mr. Hyde is rearing his ugly head! 73

QRX

continued from page 8

The Netherlands. The European Radiocommunications Office (ERO) has been instructed to officially notify the FCC of the decision approving US participation.

The State Department's action came at the urging of the ARRL that the US take advantage of the CEPT Recommendation T/R 61-01 arrangements and issue a license that would be recognized by CEPT-participating administrations and would be valid for brief visits.

Also, last fall the FCC proposed amending the amateur radio rules to make it easier for hams holding a CEPT license or an International Amateur Radio Permit (IARP) to operate during short visits to the US.

Under the arrangement, a US Technician license would be recognized as a CEPT Class 2 (VHF only) license, with full privileges above 30 MHz. Holders of Tech Plus through Extra tickets would be given a CEPT Class 1 license, with full privileges on HF and VHF. Novice licensees would not be eligible for a CEPT equivalent license since most CEPT countries don't offer a license of this type.

Once the ERO formally advises the FCC of the decision, the FCC must complete the steps to implement the participation before CEPT licensing can become effective.

Space Station Launch Delayed Again

Space agency officials from around the world met in May at Cape Canaveral, Florida, to discuss a new launch timetable for the International Space Station. The launch of the ISS has been delayed once again, this time due to space hardware production problems in Russia. While the first modules of the ISS are still slated to be launched later this year, Russia admits that it is far behind schedule in finishing its main contribution to the station. A top Russian space official has told the press corps that the launch of the new station's first module will have to be pushed back into late autumn of 1998, because his nation had

Continued on page 77



All Aluminum

Chassis Kits	Rack Shelves
Cabinet Kits	Rack Equipment
Assembled Cabinets	Antenna Grounding Kits
Slope Box Kits	Tower Mounted Box Kits
UHF & VHF Antenna	Dipole Hangers
Power Divider Kits	Other Enclosures

Small sheets Aluminum and Brass
UHF / VHF Antenna Parts

Byers Chassis Kits

Charles Byers K3IWK
5120 Harmony Grove Road • Dover, PA 17315
Phone 717-292-4901
Between 6PM and 9:30 PM EST. Eves.
E-mail k3iwk@juno.com

CIRCLE 222 ON READER SERVICE CARD

See the FUN you've been missing!



Every day more and more hams are enhancing their enjoyment of ham radio by adding images to their conversations. Join the fun!

new Pasokon TV Lite \$30 + \$3 shipping.
Pasokon TV Classic \$200 + \$5 shipping.

Absolute Value Systems
115 Stedman St. #7
Chelmsford, MA 01824-1823
(508) 250 0611

<http://www.ultranet.com/~sstv>

CIRCLE 351 ON READER SERVICE CARD

INSURANCE

for

AMATEURS

Insure all your radio and computer equipment (except towers and antenna).

HAMSURE

E-Mail: hamsure@ameritech.net
www.ameritech.net/users/hamsure/hamsure.html
800-988-7702

Available only in 48 contiguous US states
Special Club Rates

CIRCLE 78 ON READER SERVICE CARD

VHF and Above Operation

C. L. Houghton WB6IGP
San Diego Microwave Group
6345 Badger Lake Ave.
San Diego CA 92119
[clhough@pacbell.net]

Making antenna measurements

This month I want to describe some experiments with microwave and VHF test equipment and antennas that were covered at one of our San Diego Microwave Group meetings at Kerry N6IZW's home. These experiments covered some of the most basic of all antenna principles, demonstrating them on small models. The ability to see on a small-scale equivalent proved invaluable; it clarified our understanding of antennas and effects that demonstrate antenna principles.

We all are aware of these basic principles, like put the antenna in the clear at least one-quarter wavelength above ground, place it away from obstructions in the transmission path, and on and on. I, too, have been pretty much aware of what I have read, but due to the sheer size of antennas and their supporting structures, I don't have the space/time/inclination to test these principles. I just put up the best antenna and structure that I can

manage and let it go at that point.

The antenna test range

A short antenna demonstration range was set up on a tabletop showing how RF propagation is affected, and some principles applied to its path losses from source (transmitter) to destination (receiver). 10 GHz microwave frequencies were used in this demonstration, which allowed a tabletop to function as the test range. The table, being about five feet long, provided a test range nearly 70 wavelengths long, making a good evaluation on a simple basis. 300 million divided by a frequency of 10250 MHz equals .29 meters or 3 cm (1.14 inches) for a wavelength at 10250 MHz. See Fig. 1.

Does this make any sense when you think about a 10 GHz waveguide (wavelength being one inch and waveguide for 10 GHz being one-half by one inch in physical size)? With a wavelength being about an inch and the table being five feet long,

each inch of that separation is equivalent to a full wavelength of RF radiation between antennas. Try that at 40 meters—if you do, you'll need the entire farm and *that* might not be enough.

The tabletop test

The tabletop antenna test range was set up to have a microwave power meter connected to a coaxial waveguide transition and a small horn antenna at the head end of the table. (The transition used was very similar to the transition described in last month's column.) At the opposite end of the table was a Gunn diode oscillator, equipped with similar horn antennas as the power meter end of the path being tested.

The power meter (destination) and the transmitter (source) were tested to each other (without a table in the path); there was little difference noted in the power meter reading as the transmitter source was raised to a higher position of alignment than each horn antenna. Originally the horn antennas were pointing at each other at similar heights. Well, you say, what does this test show? This test proves that for two antennas aimed at each other, with the transmit antenna at varied heights, there will be no change in the receive antenna signal strength. If the path changes with height you have secondary path interference.

If there was a secondary reflection path it would arrive with phase difference, in reference to the main signal path. I refer to either the addition of energy or the subtraction of energy, due to the signals being in or out of phase with each other. A simple test to set up is to place something under the antennas that would reflect energy. This test simulates the earth and possibly a body of water or structures in the path between antennas.

With the table back in place, space the antennas about a foot above the table surface (exactly the same position as the

previous test, without table). Place a piece of tin foil covering the length of the table between the antennas and repeat the same test as before. The tin foil will simulate the earth, structures and bodies of water. Slowly increase or decrease the vertical position of the transmit antenna and source, while watching the power meter for any change in dB level. Note as you change vertical height there is quite a change in power meter reading. There will be a point where you can reach minimum and maximum meter indications.

This change that you now see is directly affected by the tin foil reflecting part of the microwave signal into the detector with the main path signal. This is ground reflection, or multipath, affecting the total path performance of the microwave signal. It's kind of a slick trick to see a complete antenna test range on top of a table. I find it very interesting to demonstrate in miniature the test range and see firsthand things we have read about antenna structures, but because of the lower frequencies involved, we were not able to create these types of effects. You can read about them but the demonstration brings the message home much better.

Polarization tests

Another experiment can be one test of polarization, that is, where both antennas are vertical or horizontal. Is there a penalty in the transmission and reception if one antenna is vertical and the other horizontal in polarization? This test can be made with the test range from the last experiment—just remove the tin foil from the test setup and note the power meter reading. Let's say it was reading +5 dBm for a point of reference. The number is not important: Just record what you are reading, for reference in dB power.

We're assuming that the transmitter is mounted on a small camera tripod for these

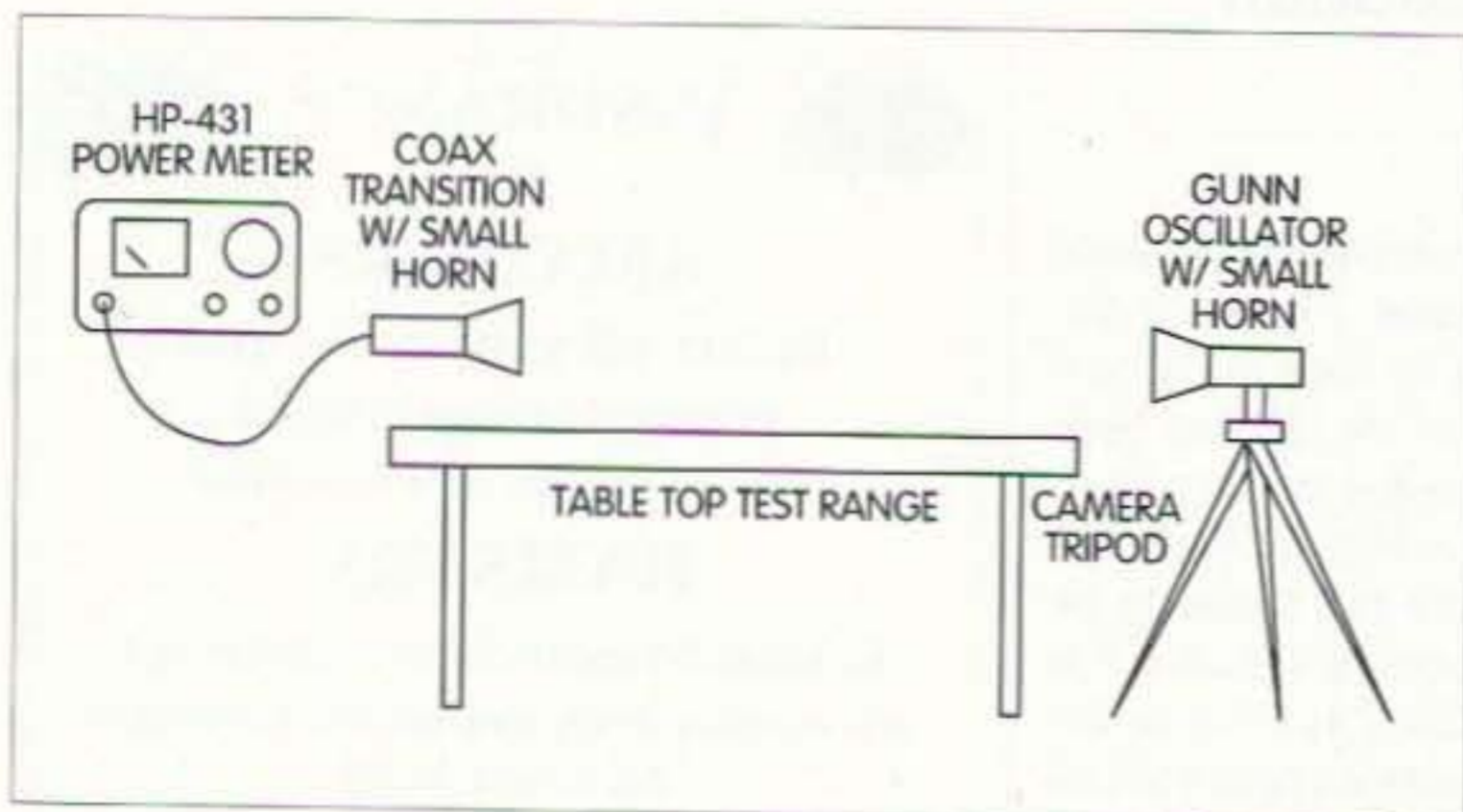

Fig. 1. Antenna test range constructed on a tabletop. The microwave power meter is located on one end and the test transmitter (10 GHz Gunn oscillator located on small camera tripod) is on the other end of the test range.

tests. Unlock the swivel mount of the camera tripod, and while noting the power meter reading, slowly rotate the mount into a vertical position. Notice the power meter as you rotate the antenna from one polarization to another. If things are proper you should see something near 30 dB, all things being equal. We saw a dB change on our test range of 26 dB, as read on the power meter. This was attributed to our test fixture and influence from reflections in the garage. For demonstration purposes it worked well.

Circular polarization

What other tests can you perform in such an antenna test range? Let's try circular polarization. This is neither vertical nor horizontal but can be described as using a spiral type of antenna when incoming signals are of various polarizations. You are familiar with crossed polarization antennas that are used for satellite communications. They differ from circular antennas in that they can be switched to either vertical or horizontal by a relay at the antenna.

As the name implies they are cross-polarized, in that two single-beam antennas are combined on one boom to support both polarizations, vertical and horizontal. Usually for gain purposes two sets of such antennas are mounted horizontally in reference to the antenna tower or mast.

The circular antenna can take several forms, one being constructed like a coil of wire as it is taken off a spool and allowed to drop to the ground in coils much like a stretched Slinky™ toy. This type of antenna is frequency-dependent on a center design frequency. It is not sharp, but rather broadbanded in nature. See Fig. 2 for circular antenna details.

Another form of spiral, or helix, antenna can take the shape of a modified coil, or helix, in that the coils start at the feed with a very tight coil and as the length of the antenna increases

so does the spiral increase. It's much like winding a spaced coil of wire on a pointy ice cream cone.

Still another version, used for condensed space, is a small flat circular spiral etched on a piece of PC board. The spiral is very tightly wound of really closely-spaced printed lines etched on the circuit board. This antenna is broadband in frequency range from several GHz to about 12 GHz. This type of antenna is primarily for radar threat reception and similar uses.

These antennas are usually found in surplus, looking much like a can of tuna with a coax connector on one side, and a plastic or epoxy lens on the front side. Some show a spiral pattern on the plastic side through the plastic cover. Other forms could be of similar diameter but only a quarter of an inch deep, with a coax connector, again, on the back side of the antenna.

In any case, replace the horn antennas on both ends of the tabletop test range with the spiral circularly polarized test antennas. Repeat the previous test as to vertical/horizontal movement of the test antenna. Note the power meter reading this time, when the test antenna is rotated between vertical and horizontal patterns. Did the meter change in level from the test rotation?

Repeat the test on multipath with the spiral feeds. Replace the tin foil on top of the table before running this test. We did not have time to finish this test at our monthly microwave meeting. Give both these tests a try. Just had to leave you with something to ponder and speculate on when the spiral is varied in height above the tabletop. I will answer that question next month.

If you want to work out a pattern of the antenna you have under test there is a simple platform to construct that will manually let you test an antenna, be it a horn spiral or other 10 GHz antenna on this test range.

What you need to do to evaluate the antenna pattern is to place the transmitter with its antenna to be tested on a calibrated turntable. What you should do is to scribe 360-degree compass calibration marks on the turntable from an old record player turntable and rotate the entire antenna and turntable while taking readings.

If you're diligent enough, you can make checks every degree or so, to evaluate what the power meter sees from the test antenna, as you rotate the test structure turntable and antenna about the compass headings. The best way to do this test is to take the test antenna range out of the garage and out into the open to avoid reflections of nearby objects interfering with the transmission of energy between the two antennas.

Commercial manufacturers have automatic equipment to perform tests and create examples, but we can do similar,

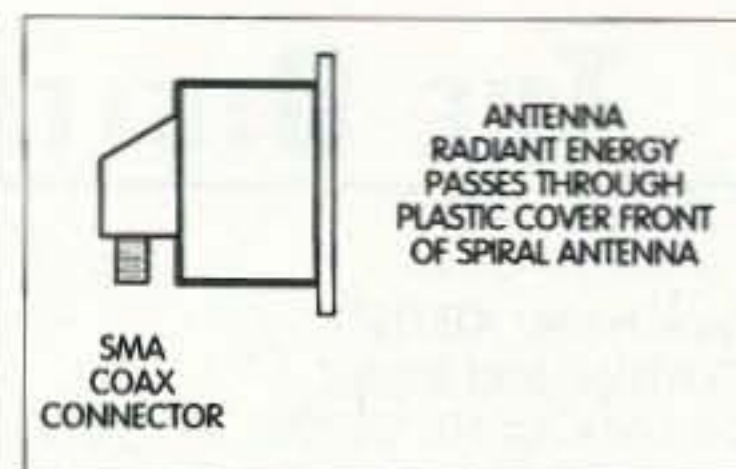

Fig. 2. Several types of circularly polarized microwave broadband antennas are similar; shown is an example of a typical military surplus model.

if less high-tech, testing. Sure, it takes time to make a lot of readings, but when you plot them out on a piece of graph paper you will have a picture of what your antenna's beam pattern looks like from this simple antenna test range.

I cannot state this more strongly: Recording many readings like this gives a true picture of just what an antenna is doing—be it at 10 GHz, or at lower frequencies where you cannot repeat the test, because

TRANSMITTER LOCATION

New fixed site direction finders provide 2 degree accuracy, and include software for triangulation from a central control site. Mobile versions also available covering 50MHz to 1 GHz

Doppler Systems Inc.
 PO Box 2780 Carefree, AZ 85377
 Tel: (602) 488-9755 Fax: (602) 488-1295
www.dopsys.com

European Marketing Director Denis Egan
 PO Box 2, Seaton, Devon EX12 2YS England
 Tel & Fax: 44 1297 62 56 90

CIRCLE 13 ON READER SERVICE CARD

THE DIGITAL PORT

Jack Heller KB7NO
712 Highland Street
Carson City NV 89703
[jheller@sierra.net]

You can still build your own packet modem, and this may be a fascinating project for your club. In past columns I have covered the ease of building a serial modem for the HF digital modes and lamented on the lack of the all-important TCM 3105 to build a VHF packet modem. Through the thoughtfulness of Dave WA4GVT, I found LDG Electronics still has a supply of ready-to-go kits to build your own low-cost 1200b packet modem.

I don't know if there will be more kits after these are gone, but there are probably enough for those who wish to take advantage of a most reasonable entry into packet radio. The price tag, at \$30, should be enough incentive to grab the interest of even the most frugal prospective packeteer.

The cost will cover all you need except for connectors, cables and an enclosure. You will find instructions to build your own cables are included, so you can save a little there. And it will perform, of course, without the enclosure. There is a terminal software package included, plus there are a lot of programs available elsewhere to

make this project successful and fun to experiment with.

The disk in the kit contains, along with the program, a comprehensive educational manual that explains packet operation, plus explicit instructions for assembly. The printed circuit board is plainly marked, and by following the step-by-step instruction sheet, the assembly is simple and straightforward. All in all, it's an enjoyable experience.

You will also find a parts list that gives Radio Shack™ numbers for connectors, cable parts and a suggested enclosure. I found the box was no longer available and substituted a part # 270-1802. This worked well, though it was necessary to elongate the mounting holes on the PCB slightly to fit the bosses in the box.

Also, you will want to avoid one of my forays into near futility. Since I wanted to use the same 25-pin cable to this modem as I use on the HF modem and the BayCom™, as well as the PK232, I installed a connector on the end of the box that just does *not* belong. It will survive and doesn't look really awful, but only after drilling and tapping, epoxy, plus modifying

the scale of materials is too large. That's the beauty of using microwave as a modeling structure, to help explain what is happening and how the antenna is performing.

The tests you make and the data you obtain will be usable not just at 10 GHz, but will also be applicable to other frequencies. It's like working with a model train set on the living

room carpet. While we know it's just a scaled-down version of a real train, its operation is just the same, be it 100 tons, or just a pound or two. The difference here is size, and with the antenna test range, it's still size—and scaling down to test for similar features and effects. Modeling allows you to demonstrate antenna performance on top of a table. 73

the connector. A nine-pin connector is the best advice. Of course, a plastic shoe box would offer more leeway for the untamed builder.

It works great

After completing the hardware and cabling stage, I brought up my copy of BayCom 1.4 software. It has been the most reliable of all I have tried for use with the serial modem, so I like to rule out failure at first, then advance into unknown waters later. The Basic Packet Modem is a sparkling success. It connects to the local PBBS with speed rivaling the PK232.

I found the previous source of this version of BayCom software is no longer at the Web site where I first discovered it. After running an Internet search, I could only find Version 1.5 (I've listed the address in **Table 1**). It is a DOS program and the documentation that comes in the separate "Manual.zip" will lead you through the setup and operation.

As with any terminal program, the configuration must be correct. So ... print the manual, read it and follow the instructions. It is an education in itself.

As I read and listen to others, I hear similar praises for this program. I did find Version 1.4 in other than English versions, but even those locations are getting sparse. Version 1.6 is out and not a freebie. I have not had my hands on it, but presumably the commercial version is a tad more user friendly. Take this as your clue that the freeware version takes a little getting used to.

The often mentioned freeware from George SV2AGW is listed in **Table 1**. George is continuously upgrading his programs and they work very well. I found, in this instance, that my local node was not responding as well to the commands from this software as I would have liked. You will find performance varies from node to node, so experimentation is a key here.

Incidentally, George tells me he has been working a gateway

onto the Internet in Europe with an interface he wrote and surfing the World Wide Web with Netscape™ and similar browsers. There is a glaring difference between the possibilities as we see them in the States and European packet radio where they are running at 9600 baud. I hear numerous complaints that we need to upgrade from the snail-like 1200b. ... Someday.

Speaking of other software, I received a few messages from hams that made me rethink my position on PCFlexnet. Don WL7NF sent me info via packet that there is a driver on the PCFlexnet Web site that will work with the SoundBlaster™ cards. I had stated previously there was no such module. Just to be sure, I received word from Jim AB8AB that he had the system up and working with just a little tweaking left. So ... it can be done. Just leave it to the persistent ham to prove it.

A recent visit from Hal KC7STU made me painfully aware of trends in ham radio, and that some of this digital technology that we either ignore or take as a matter of course holds a large degree of the answer to breathe new life into this hobby. Hal is a software engineer and the things he saw that day obviously impressed him.

Some of this is not exactly new technology. Audio Frequency Shift Keying (AFSK) technology has been around for a few decades. Many of us ignored it, preferring the "real modes" of phone and CW. Besides, the cost of using digital modes was once prohibitive. You could scrimp and save to buy a radio that got you on the air. Why double the cost for something that tied you to a keyboard?

It has all changed

Hal could see there is something more to ham radio than a two-meter handheld and repeaters—and this was something he could afford and for which he could perhaps write some software to satisfy his needs. After

all, if someone with a limited understanding of computers (such as his friend Jack) could assemble these gadgets, make them work and have all this fun, Hal could surely have twice the thrills. And again, the cost is attractive.

Hal saw not only packet messages on the local ham PBBS, but the fact that, through the local node, there is a gateway to other packet nodes around the world. Plus, it is possible to access Internet gateways and enter another realm of communication. Additionally, he got a quick tour of what is being done with HF digital communications.

The excitement

When he saw the RTTY being decoded on the screen, he was glued to it. When I showed him the spectrum analyzer built into the HamComm software his eyes sparkled. Then, even though we picked a time when there wasn't much SSTV activity, there was just enough to make him nearly salivate. Oh, the things he could do!

The most important aspect of all this is that we have, within this digital communication framework, the means to retain the attention of the current crop

of new inductees. I could detect the quickening of the senses when Hal reflected on the fact that these communications were being accomplished without relying on the telephone. This comparison relates to so much that is currently done with modems over landline.

What I am saying is simply this: If we are to hold the interest of the new ham generation, we must let them know these modes are available, affordable, and expanding. They can be part of a technology they can contribute to, plus have a lot of fun doing it.

If you are thinking of getting on board the digital trend, this will be a good project to do and share with a ham of your acquaintance. It could be a catalyst not only for your friend, but you may revive something fascinating in yourself by putting together a neat little project that provides communication through the airwaves.

Packet communication is usually done through bulletin boards, but it can be keyboard to keyboard. That is another facet that will stir your imagination when you connect to a friend across town. It is similar to AMTOR or PACTOR in that you make a link in the connection



Photo A. Packet on wheels—Since the LDG Basic Packet Modem draws its power from the serial port of the computer, it is possible to run the entire packet station from batteries. Here, the battery providing power is the auxiliary battery of the RV. The modem is located just to the right of the ICOM W2A HT that is running without its battery attached. This makes the modem approximately the same dimensions as the radio. Two simple cable connections and your station is on the air. It was up and working at the time of the photo. The camera flash killed the screen display.

and the packets are self-correcting so the received message is identical to that which was transmitted.

When you want to try this keyboard stuff over long distances, RTTY is a nice step and the cost is, again, nominal, with the use of a serial modem and a piece of low cost shareware. You can talk to the world with equipment you made yourself and find many others following

the same path. Check out the Web site listed in **Table 1** for HF serial modems and my column in the February 1998 edition of 73.

With the addition of the LDG Electronics Basic Packet Modem, I now have a modem for VHF packet and, in a matching box, an HF serial modem for RTTY, AMTOR and SSTV.

Continued on page 54

Current Web Addresses

Source for:	Web address (URL)
HF serial modem plans + software	http://www.accessone.com/~tmayhan/index.htm
PCFlexnet communications free programs	http://d10td.afthd.th-darmstadt.de/~flexnet/index.html
Tom Sailer's info on PCFlexnet	http://www.ife.ee.ethz.ch/~sailer/pcf/
SV2AGW free Win95 programs	http://www.forthnet.gr/sv2agw/
BayCom - German site	http://www.baycom.de/
Pasokon SSTV programs & hardware	http://www.ultranet.com/~sstv/lite.html
Winpack shareware for Windows	http://www.duckles.demon.co.uk/ham/wp.htm
Baycom 1.5 and Manual.zip in English	http://www.cs.wvu.edu/~acm/gopher/Software/baycom/
Tucson Amateur Packet Radio—where packet started—new modes on the way	http://www.tapr.org
VHF packet serial modem kit	http://www.ldgelectronics.com

Table 1. All of the above were cut and pasted directly from the Web page to avoid the inevitable errors when copying. If you encounter a problem with a European address, the network is often at fault. Try again later.

HAM TO HAM

Your Input Welcome Here

Dave Miller NZ9E
7462 Lawler Avenue
Niles IL 60714-3108
[dmiller14@juno.com]

Your input is always welcome!

Roger and Ron Block of PolyPhaser Corporation have put together a well-written series of tips and suggestions on how we can effectively protect our ham radio stations from the effects of a lightning strike. The series began in the January 1998 "Ham To Ham" Column and Part 6 of that series appeared last month. Part 7 follows:

Lightning protection—what your mother never told you, part 7

Last month, we talked about the special considerations needed for high-rise building antenna installations, but even so-called ground-mounted vertical antennas require the same type of earthing as do other antenna structures for lightning protection. If operating on 160 or 80 meters, the lightning ground should also make a great counterpoise for your quarter-wave ground-mounted vertical! Remember, a vertical's impedance is half that of a dipole's (about 35 ohms for a full-sized quarter wave). This means that the better the ground plane, the worse the VSWR match will appear to

a standard 50-ohm coax cable. As a result, a vertical with a poor ground plane may actually give a better match, and as the ground plane is improved, the match will worsen. But don't be fooled. A good ground plane is critical. The better the ground plane for RF, the better the earthing for lightning as well (assuming that the RF ground plane is actually *in* the ground). You're far better off with a good low-inductance underground earthing system than with a slightly better VSWR reading. Correct any slight mismatch with an appropriate tuning unit instead. Consider running two 75-ohm coax feedlines in parallel; this can often be the best match for a ground-mounted vertical (75 divided by 2 = 37.5 ohms).

In terms of antenna supports, avoid using trees or wooden poles to support wire antennas. If one of these supports is already in place, then install two parallel vertical copper straps from the top of the support to ground. The straps will ground a VHF/UHF antenna and divide the strike currents with the coax cable. By using two straps, the inductance in such a ground run is minimized. Also, place the

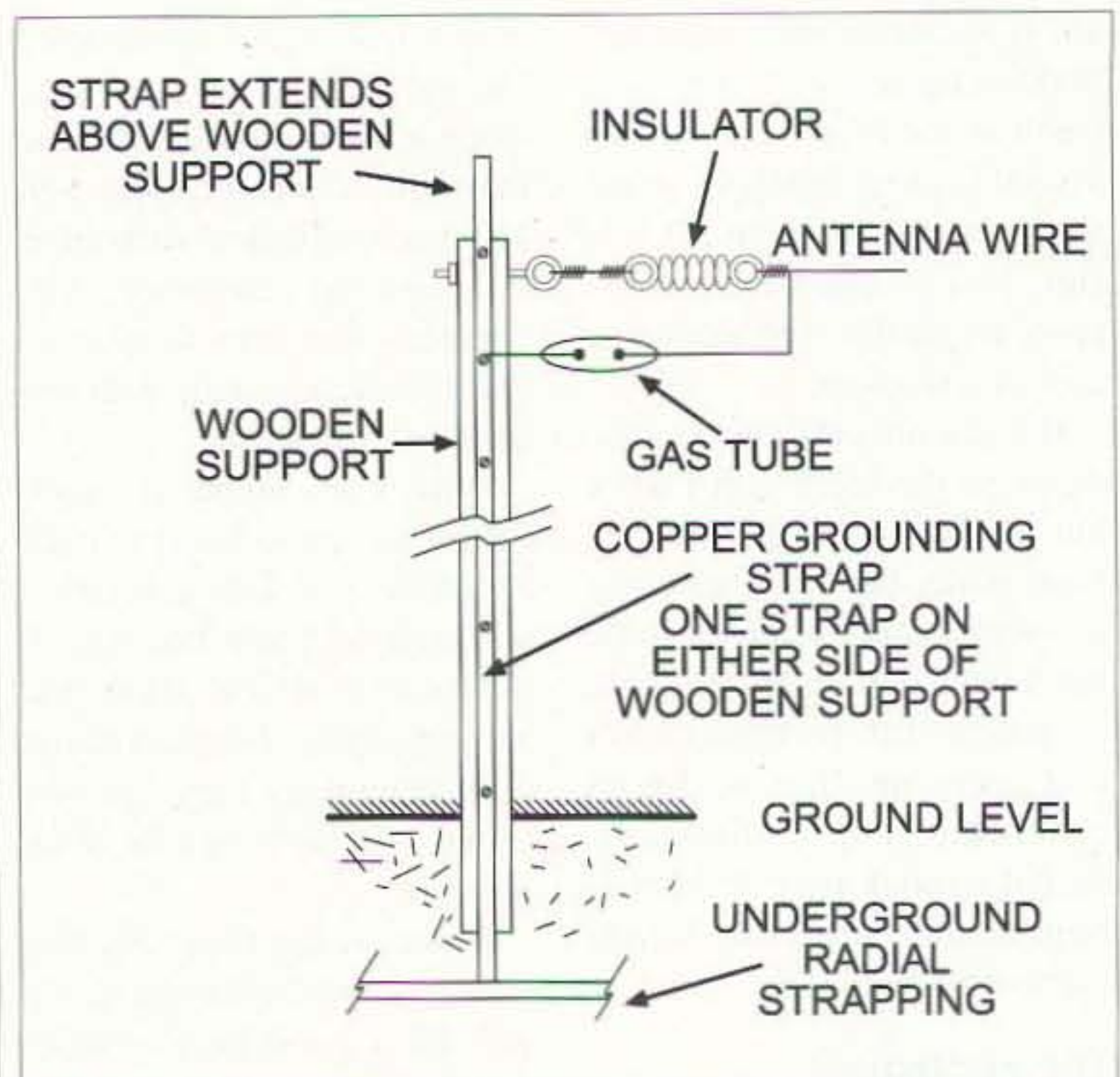

Fig. 1. One method of providing grounding protection for a wooden wire antenna supporting structure.

straps on opposite sides of the pole to reduce mutual inductance. The coax line should run down between (and well clear of) the straps.

If a longwire (fed by a transmatch) and a wooden pole (as a support for the antenna wire) are being used, the grounded straps should extend higher than the pole to intercept a strike or to divert energy to ground if the wire is struck (see Fig. 1). Additionally, place a high-voltage gas tube between the long wire and the ground straps or make a mechanical air gap between the wire and the ground straps. A gas tube is not adversely affected by temperature, humidity, pollution, wind or other environmental forces, while a mechanical air gap is greatly affected. It may be difficult to calculate the voltages present at the gas tube or air gap point, because they will change as bands are changed. As a rule of thumb, however, at about 7 kV an air gap would be 0.175 inch at sea level with 50% humidity. The break-over voltage goes up with higher elevation and/or increased humidity (surprisingly, humid air is actually less dense than dryer air). Gas tubes can also be connected in series for a

higher turn-on voltage; however, the turn-on times are also additive. Another gas tube assembly may be added closer to the match box for additional safety.

For dipole antennas using baluns, use one gas tube across the balun (one lead of the gas tube to each of the dipole wires) and one tube from each side of the balun (where it connects to the dipole's wires) to its ground straps. This will help to protect the balun from a strike to the dipole wires and greater strike energy will be diverted to the ground before reaching the equipment.

Power/telco entrance

The story of complete protection for a ham shack covers not only strikes to the tower but also high voltages on the utility lines coming into your shack. By using single-point grounding, ham equipment will survive a hit to its tower. If the outside (tower/perimeter) ground system has a low impedance, most of the strike energy will be dispersed into the ground and little energy will enter the shack. If the ground conductivity has deteriorated over time, the ground system

THE DIGITAL PORT

continued from page 53

Both of these are low-cost projects you can do yourself. Now, I need to add an HF antenna to the RV and I can play just about anywhere. Ah, the things a ham can do with his toys!

To contact LDG Electronics by phone, call (410) 586-8475.

Their mail address is 1445 Parran Road, St. Leonard MD 20685. A really good look at their wares can be found on their Web site as listed in Table 1. Their real claim to fame is in other areas of ham radio—especially impressive is their automatic antenna tuner kit. You will be impressed when you see their full product line.

73

can only absorb a limited amount of energy before becoming saturated. In 90% of all earthbound lightning strikes, a traffic jam of electrons will be forced into the tower. If the electrons cannot disperse in a reasonable time frame, the back-up pressure (voltage) will find or create another path. The ground system, if too small in area, will cause more energy to traverse the cables and other lines into the shack. These last two sentences are very important: Please read them once more. The I/O protectors can keep the voltage levels between the single point ground and the signal line(s) at survivable limits, but the energy is only diverted elsewhere. This "elsewhere" might be onto the house telephone and power lines, leaving other appliances at risk. When the ground system is saturated, the energy can even actually come up from the (utility) ground system (and go through a television receiver for example), in an effort to leave the area by way of the cable television drop. Similar problems can also exist with satellite dish installations.

The best way to protect the rest of your house from these occurrences is to provide protection at the power and telephone service entrance(s). The utility ground rod is used by both the power neutral and the telephone protector installed by the phone company. By placing a power mains protector and a secondary telephone line protector at this location, the entire house will be protected. The cable television or outside antenna coax should be redirected, and a coaxial protector installed at this same point. The cable company-installed protector is usually just a grounding block that will earth only the outside shield of their coax; it does nothing for the center conductor energy, which can carry as much of the surge as the outside shield. Install your own protector to eliminate the problem.

That's Roger and Ron's presentation for this month. If you'd like to see the original unabridged version of this series, you can contact PolyPhaser Corporation, Customer Service Department, 2225 Park Place, P.O. Box 9000, Minden NV 89423-9000 and ask for their Special Bulletin, "Protection to Keep You Communicating" (©1995). You can also pay a visit to PolyPhaser's home pages on the World Wide Web at: [http://www.polyphaser.com/]. PolyPhaser's Web site also supports text downloads of the original material that's going to be condensed here, plus other related texts on the subject. The PolyPhaser Tech Line telephone BBS at (702) 782-6728 is also available to interested readers. The communications parameters are: Data bits—8, Parity—None, Stop bits—1, Baud rate—300 to 14400. If you are dialing in for the first time, the Tech Line requests your name, address and telephone number. You will also need to create a password. Once you've logged on, just follow the menus to navigate around the Bulletin Board. The "Ham To Ham" column will continue this series on protecting your ham station from the destructive effects of a lightning strike, with part 8 coming up next month.

Follow the pattern!

Here are some interesting notes from Dick Warren W7TIO, regarding the addition of radials to a half-wave amateur VHF (or UHF) transmitting/receiving antenna as described in "Ham To Ham," November 1997. In that column, M. Marcel Chapleau VE2GMZ of Quebec, Canada, described a VHF/UHF J-pole antenna to which he added two-meter and 70-cm radials to achieve better results. In the moderator's notes, I commented that the use of radials wasn't normally called for with half-wave antenna designs, since a half-wave antenna is a complete minimum antenna unto itself (no phantom ground

plane was needed). In the following text, however, Dick brings up some interesting points gleaned from his years of experience in the commercial two-way radio installation and maintenance field ... points well worth remembering.

From Dick Warren W7TIO: "Over the years, I've worked on many commercial 'base station' installations, and while many hams feel that a half-wave vertical doesn't need a set of radials because it's a 'complete' antenna in itself, it is commercial practice to put ground radials on every vertical collinear gain antenna installation (of those not made up of folded dipoles as explained more fully below).

"Most hams know that the horizontal ground radials under a quarter-wave vertical are needed to provide a 'mirror' or 'image' antenna, thus making a 'complete' half-wave radiator, as well as to support the driven element itself. The down side is that these horizontal radials also put the radiation angle way above 45 degrees (referenced to the horizon). An antenna used for HF skip work may benefit from this high angle of radiation, but at VHF/UHF frequencies, it wastes a goodly part of the RF into the atmosphere, by not putting it at the horizon where it's needed. Drooping radials, however, provide the same 'image' antenna, and also lower the radiation angle nearer to 45 degrees. The drooping radials will raise the 50-ohm feedpoint impedance to nearer the 72-ohm expected half-wave feed impedance.

"Sometimes you'll see a repeater/base station antenna mounted upside down, on a very high point such as a mountain top. Mounting it upside down inverts the high angle of radiation and puts the energy down into the desired coverage area in the valley below.

"In the case of the ever-popular five-eighths-wave vertical, the five-eighths-long radiator brings the energy back down

nearer the horizon, and additionally narrows the beamwidth. This concentrates the signal and produces the typical gain figures attributed to five-eighths-wave radiators. The coil provides impedance matching to the 52 ohm feedpoint, by presenting a simulated three-quarter-wave feed, and does not affect the radiation angle. This antenna still needs ground radials, however, and is used in some commercial 450 MHz limited-range installations.

"Other commercial installations use vertically-stacked, vertically-polarized 'folded dipole' type antennas ... and these configurations need no radials. However, those commercial antennas that look like a stretched-out ground plane, some 20 feet long at 150 MHz and perhaps six feet long at 450 MHz, do have radials, under what is a multi-half-wave collinear gain antenna ... ground radials are always put under this variety. An antenna of this type can produce omnidirectional gains of 10 dB, almost like having a 10-element beam in all directions!

"The next time that you pass a professional communications installation, be it a commercial or governmental facility, stop and study some of the antenna design options used in this service. See if you can pinpoint the designs I've referred to here; it's likely that you'll see these techniques put into practice. They work well, since these installations are engineered for the coverage needed as well as for dependability. People's lives often depend upon them!"

Go figure!

From Doug McKibben KB9IMG: Here's a tip for determining how to easily and quickly get the sloping elements of an HF inverted vee antenna at a true 45-degree angle for optimum performance. "It's been known for years that the optimum angle for the elements of an inverted vee should be 45 degrees from vertical, but most antenna books don't explain

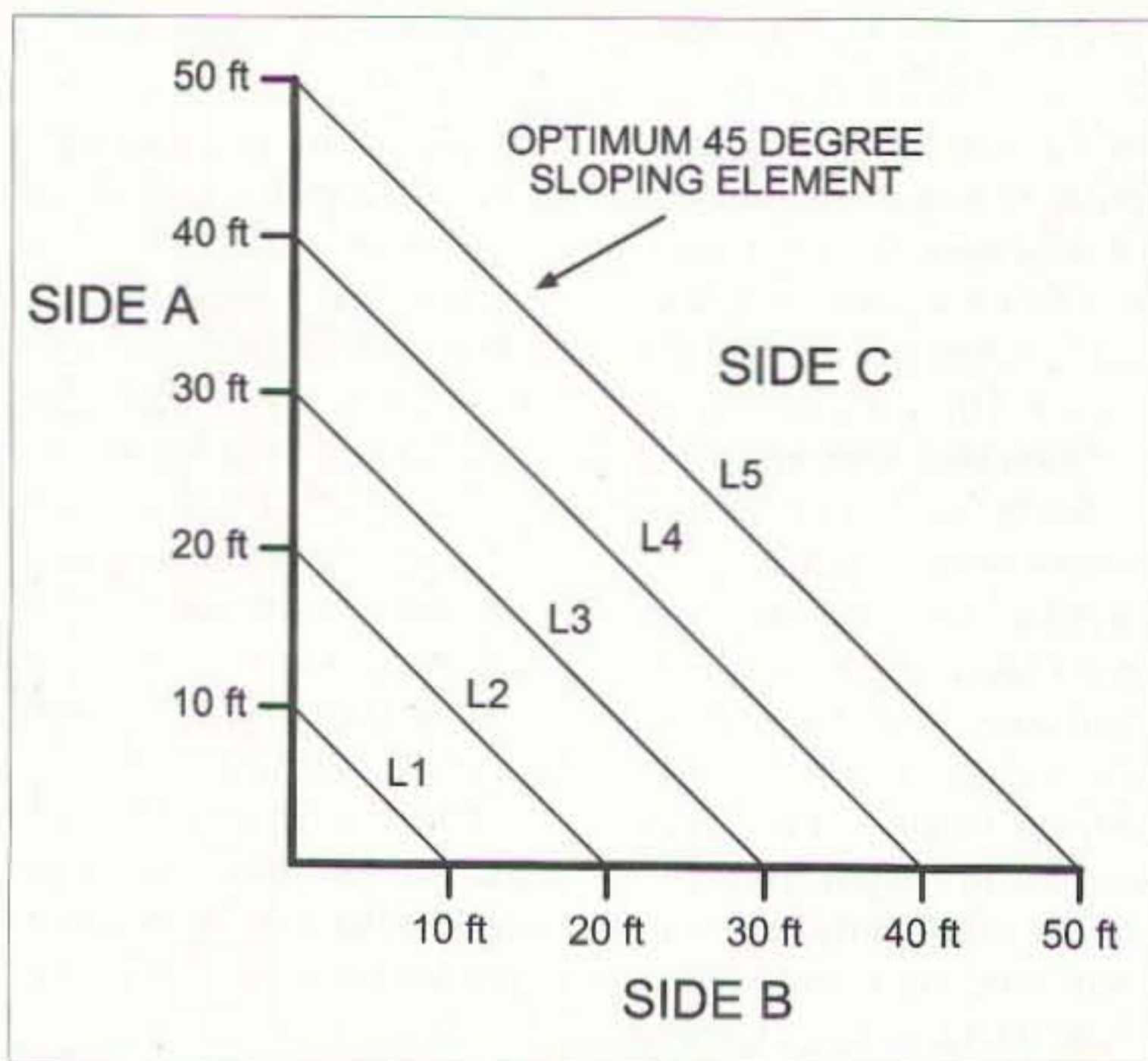

Fig. 2. Relative lengths of the 45-degree sloping elements of an HF inverted vee antenna for various mast heights and at various distances from the mast's base. See text for details on how to determine length of Side C.

how you can easily determine when you've achieved that 45-degree angle. The answer can be found by using basic geometry, but in case you've forgotten (or would rather forget) that high school experience, I've laid out the basics here, limiting the explanation to only what's needed for the job at hand.

"Since most of us find ourselves limited to fairly low mast heights (because of landlord or neighborhood constraints), I'll start with an example of a 30-foot mast for a 40-meter inverted vee. Looking at **Fig. 2**, the vertical mast is depicted as Side A of the right triangle that will represent one half of our 40-meter inverted vee. Side B of **Fig. 2** is the straight-line distance from the mast to the first ground anchor for one of the antenna's elements. Use Pythagoras' theory: $A^2 + B^2 = C^2$.

"So to find out what the total value (element length plus extension rope) of Side C will be, simply add the square of 30 (900) plus the square of 30 (900) which gives us 1800. On your calculator, enter 1800 and press the square root button. The answer is 42.43 feet. Since one element of our 40-meter antenna

is 33 feet, nine and a half feet is left over to reach the ground stake, so the rope extension and egg insulator will be nine and a half feet long (plus whatever you feel you'll need to make the knots at each end of the rope. Remember, this is only half of the inverted vee; the other side will be identical with the feedpoint at the top of the mast.

"If you can only manage 25 feet of mast height, the value of Side C of the right triangle in **Fig. 2** comes out to be 35.35 feet. This puts the sloping wire end of a 40-meter inverted vee (again, 33 feet) only a couple of feet above the ground, but the antenna will still work well.

"Now try calculating what the length of Side C would be for a 15-meter inverted vee with a mast of 20 feet high yourself. Don't peek! You should have calculated 20 squared (400) plus 20 squared (400). The square root of 800 is 28.28 (feet) and a single element at 15 meters is about 11 feet, so the amount left over for the egg insulator and rope would be about 17-1/2 feet.

"While you have this method well in mind, why not come up with a chart showing the element lengths and insulator-rope

extensions for all of your favorite bands or band segments? Just to complete **Fig. 2** for you, however, the various overall lengths of Side C for the 10, 20, 30, 40 and 50 foot marks from the base are:

Side C

- L1 = 14.14 feet
- L2 = 28.28 feet
- L3 = 42.43 feet
- L4 = 56.57 feet
- L5 = 70.71 feet

"Just keep in mind that in order to have a true right triangle, with a 45-degree slope on Side C, the lengths of Side A and Side B must be equal. Then, squaring Side A and Side B, adding them together, and taking the square root of that total, will give you the length of Side C, which is the antenna element's wire plus any needed insulating extension. The length of the actual wire element is given by the antenna book formula: $468/\text{Frequency in MHz}$ (divided by two for just one of the elements)."

Moderator's note: You can use Doug McKibben's right triangle hint to find the exact 45-degree angle for the radials mentioned by Dick Warren in the piece above here as well. Simply reverse the formula, squaring the length of the VHF antenna's radial, dividing by two, taking the square root of that figure, and measuring out from the antenna's mast by that amount. The drooping radial should end up at that point for a 45-degree angle.

Murphy's Corollary: Once you open a can of worms, the only way to get them back in is by using a much bigger can!

Many thanks, as always, to our loyal contributors. Remember, I'm always looking for interesting and innovative tips, ideas, suggestions and shortcuts to include on the pages of **73**

Magazine within this column. Just jot down your thoughts and send them to the address at the beginning of the column. Those who accepted the offer this month are:

O. Dick Warren W7TIO
 Certified Electronics Technician
 P.O. Box 973
 Pleasant Grove UT 84062-0973

Douglas R. McKibben KB9IMG
 2112 Marion Avenue
 Mattoon IL 61938

If you're missing any past columns, you can probably find them at **73's** "Ham To Ham" column home page (with special thanks to Mark Bohnhoff WB9UOM), on the World Wide Web, at: [<http://www.rrsta.com/hth>].

Note: The ideas and suggestions contributed to this column by its readers have not necessarily been tested by the column's moderator nor by the staff of **73 Magazine**, and thus no guarantee of operational success is implied. Always use your own best judgment before modifying any electronic item from the original equipment manufacturer's specifications. No responsibility is implied by the moderator or **73 Magazine** for any equipment damage or malfunction resulting from information supplied in this column.

Please send any ideas that you would like to see included in this column to **73 Magazine's** "Ham To Ham" column, c/o Dave Miller NZ9E, 7462 Lawler Avenue, Niles IL 60714-3108, USA. We will make every attempt to respond to all legitimate ideas in a timely manner, but please send any specific questions on any particular tip to the originator of the idea, not to this column's moderator nor to **73 Magazine**. **73**

Back Issues

of
73 Magazine
 Only \$5.00 Each!
 Call 800-274-7373

HAMS WITH CLASS

Carole Perry WB2MGP
Media Mentors Inc.
P.O. Box 131646
Staten Island NY 10313-0006

NASA resources

Those of you who follow my column know that I always incorporate a unit on space travel and communications in my ham radio classes. For the past 20 years I've been teaching "Introduction to Amateur Radio" to 6th, 7th, and 8th graders at Intermediate School 72 in Staten Island, New York. Through the years, the teaching techniques and motivational devices have had to change due to the constant changes in population in a culturally diverse school.

The area of instruction that continues to spark the children's imaginations and stimulate them is the unit about astronauts, space shuttles, and radio communications. Many of the great lesson ideas come from the NASA resource guides. The *Educational Horizons* newsletter, which was a tremendous source of information, has been discontinued due to budget constraints. I have, however, put together a list of other NASA resources that will be valuable for teachers to make use of in the classroom.

Educators can utilize Spacelink, which provides electronic access to NASA educational materials, news, and reference data as well as educational products, images, and computer software that can be useful to educators, students, and the general public. Spacelink also provides a powerful search feature and links to other NASA educational sites throughout the Internet.

NASA Quest is an electronic resource specializing in providing programs, materials, and

opportunities for educators and students to use NASA resources as learning tools to explore the Internet.

NASA Television (NTV) is the agency's distribution system for live and taped programs. It offers educators and students a front-row seat for launches and missions, as well as informative and educational programming, historical documentaries, and updates on the latest developments in NASA research.

NASA On-Line Resources for Educators provides current educational information and instructional resource materials to teachers, faculty, and students. A wide range of information is available, including science, mathematics, engineering, and technology education lesson plans, historical information related to the aeronautics and space program, current status reports on NASA projects, news releases, information on NASA educational programs, and useful software and graphic files. Educators and students can also use NASA resources as learning tools to explore the Internet, access information about educational grants, interact with other schools that are already on line, participate in on-line interactive projects, and communicate with NASA scientists, engineers, and other team members to experience the excitement of real NASA projects. The address is: [<http://www.hq.nasa.gov/education>].

NASA Spacelink is one of NASA's electronic resources specifically developed for use by the educational community. This comprehensive electronic library contains current and his-



Photo A. There are many projects and ideas you can get from NASA resources.

torical information related to NASA's aeronautics and space research. Teachers, faculty, and students will find that Spacelink offers not only information about NASA programs and projects, but also teacher guides with activities, images, and computer software that can en-

hance classroom instruction. Spacelink also provides links to other NASA resources on the Internet. Educators can access materials chosen specifically for their educational value and relevance, including science, mathematics, engineering, and technology education lesson plans,

MultiMode



BayPac™



SITOR A/B
ARQ/FEC
BAUDOT
PACKET
NAVTEX
FAX 480
AMTOR
WEFAX
SYNOPSIS
ASCII
RTTY
SSTV
CW
More...

BP-2 Packet Only \$49.95
BP-2M MultiMode \$69.95
+ \$5 Shipping & Handling

The best little packet modem just got better! Building on the tradition of the BP-1 Packet Modem, we are very proud to announce the BP-2 and BP-2M. The BP-2 is a new and improved version of our famous BP-1, while the BP-2M expands your horizons even further with MultiMode operation! So, whether you have been waiting to automate your CW, checkout AMTOR or just copy Weather Fax - Now is the time for you to jump in and join in all the fun!

Tigertronics
INCORPORATED

Call Today! 1-800-8BAYPAC
800-822-9722 (541) 474-6700 Fax 474-6703
World Wide Web: <http://www.tigertronics.com>



Tigertronics, Inc. 400 Daily Ln. P.O. Box 5210 Grants Pass, OR 97527

CIRCLE 269 ON READER SERVICE CARD

Radio Bookshop

Phone 800-274-7373 or 603-924-0058, FAX 603-924-8613, or see order form on page 88 for ordering information.

Wayne's Five Buck Books:

98 Books You're Crazy if You Don't Read. Brief reviews of books that will help make you healthy, wealthy, and wise. If you are sick you did it to yourself through messing up your body. This is probably the single most important five bucks you'll ever spend.

How to Make Money, A Beginner's Guide. Commuting to work is stupid. You can't get fired, laid off, downsized or outsourced if you own your own business. This is an instruction book on how to get others to pay you to learn what you need to know to be independently wealthy, have a ball doing it, and have that ham shack you've dreamed of.

Grist I. Fifty of Wayne's recent non-ham oriented editorials. They're about almost anything and guaranteed to almost make you think. You'll sure have things to talk about on the air other than your antenna and the weather.

Grist II. Fifty more non-ham editorials. Even more fascinating stuff to think and talk about.

information on NASA educational programs and services, current status reports on agency projects and events, news releases, and television broadcast schedules for NASA Television. Spacelink may be accessed at the following address: [<http://spacelink.nasa.gov>]. For additional information, E-mail a message to: [comments@spacelink.msfc.nasa.gov].

Quest is the home of NASA's K-12 Internet Initiative, one of the electronic resources that the agency has developed for the educational community. The project specializes in providing programs, materials, and opportunities for teachers and students to use NASA resources as learning tools to explore the Internet along with some of their projects designed for this specific purpose.

One of Quest's most unique endeavors is the "Sharing NASA" on-line interactive project. Students and educators are given the opportunity to communicate with NASA scientists and researchers to experience the excitement of real science in real time. In addition to these programs, the project also houses information about materials that accompany the K-12 Internet Initiative videos. These videos promote the Internet in school and assist educators in acquiring and integrating the Internet into the classroom. For information about the videotapes, send

an E-mail message to: [video-info@quest.arc.nasa.gov].

NASA Television (NTV) features space shuttle mission coverage, live special events, interactive education video conferences, electronic field trips, aviation and space news, and historical NASA footage. Programming has a three-hour block—Video (News) File, NASA Gallery, and Education File—beginning at noon Eastern and repeated, with the last block beginning at midnight Eastern.

The Education File features programming for teachers and students on science, mathematics, and technology. You and your class can investigate exciting NASA research endeavors in aeronautics, microgravity, planetary sciences, human exploration of space, Earth systems, robotics, and more. Educators are welcome to videotape from NTV. Check the Internet for program listings at: [<http://spacelink.nasa.gov/NASA.News/>]. Check the NTV Home Page, select "Today at NASA," "What's New on NASA TV?" and "TV Schedules."

I know you will find these on-line resources to be informative and helpful. Combining these interactive lessons with ham radio curriculum can only add a whole new excitement and stimulation to your classroom. Have fun and write to me about your experiences with the NASA resources. 73

QRP

Low Power Operation

Michael Bryce WB8VGE
SunLight Energy Systems
955 Manchester Ave. SW
North Lawrence OH 44666
[prosolar@ssnet.com]

If you build most of your equipment, then there's a good chance that you're a QRP operator. As a group, we sure seem to go through a lot of solder in the course of a year.

This month we'll look at some tools of the trade to make building our gear faster and easier. Now, it may seem a no-brainer to most of us that you must use hand tools to assemble electronic projects. How many of us have a soldering iron, screwdrivers and a hammer or two? But, to really make your life easier, there are some tools you've just got to have in your toolbox.

The basics

I'll start with one of the most basic tools used by all QRP operators—the soldering iron. If you only have one soldering iron, you're really missing some labor-saving tools. A well-equipped QRP workbench should have at least three different types of soldering equipment. You'll need one soldering iron for soldering parts on PC boards. This soldering iron should be between 15 and 25 watts. A 25-watt iron is really pushing your luck if you are planning on using that much heat on a PC board! Of course, you'll also need a small 1/8-inch conical tip to prevent solder bridges on the PC board.

With a 15-watt iron, you'll have a time removing a part from a double-sided PC board with desoldering wick. So, you need more oomph to remove parts from a PC board. I recommend at least a 35-watt iron with a wide spade tip. An iron that

generates 35+ watts must be used carefully when desoldering PC boards. Too much heat and you'll lift traces off the board.

The third soldering iron you'll need is a whopping 50-watt. This guy is a must for soldering PL-259 connectors or large terminal strips to PC boards. It works great for just about any antenna project, too. I use an American Beauty 60-watt for just such chores. Although you don't come across them too often in this day and age, if you work on old boat anchors, a high-wattage soldering iron is a must.

Plan on keeping at least three different wattage soldering irons on your workbench. Not only will they reduce your work load, but they will make your life easier, too. Trying to solder a PL-259 with a small-wattage soldering iron will more than likely damage the coax before the solder melts.

Also, keep a good selection of soldering iron tips on hand. This is one case in which one size does *not* fit all. Change the tips to match the job being done. Don't wait until the tip is trashed to replace it. Get iron-plated tips; they'll last much longer than the plain old copper ones will.

Keep your soldering iron tips in good shape with a damp sponge. Most newer soldering iron stations have a sponge built-in. When the sponge becomes damaged, replace it with a new one.

Several companies also market special chemical pads to help re-wet the tips. If you do a lot of soldering, these are a good investment.

Screwdrivers and nutdrivers

I'm frequently surprised at how many hams lack a good set of common screwdrivers on the workbench. Since we are working with small parts, we need small screwdrivers.

Radio Shack™ sells a compact set of jewelers' screwdrivers for under \$11. Sears™ also carries a set of precision drivers for delicate work. I prefer the Wiha™ precision screwdrivers myself. They're available from FAI Electronics™. It's not a bad idea to have a set of precision slotted, cross point and Torx® screwdrivers.

You should also have a set of standard-size (for working on the lawn mower) screwdrivers as well. Check the ones that you are using. Are the tips in good condition? If not, they can be ground back to their proper size and shape with a power grinder. Most of the time, screwdrivers are used for just about everything—except for driving screws. Making sure the screwdrivers are in excellent condition will make your job easier.

A set of nutdrivers should also be included in your toolbox. I prefer hollow shaft drivers. The hollow shafts allow you to tighten the nuts on volume controls by allowing the shaft to fit inside the nutdriver. Check before you buy, as some hollow nutdrivers won't fit over the 1/4-inch shafts. If you've ever scratched the front panel of your latest creation, you'll see that a set of nutdrivers is worth its weight in gold.

The next item I myself had done without, only to have things bite me in the butt time and time again. Late last year, I sprang for the money and purchased a set of alignment tools.

There are so many different types of coils and slug tuned inductors in today's rigs, you really need a selection of alignment tools. This is another case where one does not fit all. If you use the wrong size tool, you'll crack the slug in a form. Try

using an alignment tool that's too small for the slot in an inductor, and you'll chip the top right off. Of course, the odds of this occurring on a Saturday night are unbelievably low!

I have several "kits" from various companies. I know that somewhere in those kits, I'll find the proper alignment tool. Hosfelt™, FAI™ and Mouser™ all sell alignment tools in kits or by the piece.

As with anything, you get what you pay for. If you pay for cheap alignment tools, you'll get cheap tools. To avoid breaking coil slugs, then you must have the right alignment tools.

Wire cutters and nippers

Stuffing a PC board with resistors, diodes, and other through-hole parts is the most popular activity with homebrewers. Have you ever taken a second to check the wire cutters you've been using to trim resistor leads? I'll bet the farm that you're using wire cutters designed to cut *wire*, not component leads. There are zillions of different types of wire cutters on the market. We have the shear cutter, flush cutter, and diagonal cutters to name some of the more popular types. If you have ever looked through the pages of a Jensen Tools™ catalog you know what I mean. Prices range from about two dollars to over 90 bucks a pop!

In my shack, I use several types of cutters. All of them are under five bucks, and for me they're disposable. When first purchased, they're really sharp, and I use them for cutting resistor leads, diode leads, and other pieces parts on PC boards. After they start to get a little dull, they're used for cutting wire and nipping off larger component leads such as AMP pin terminals. When they're all nicked up, the last place you'll find them on my bench is for cutting thick wire (12 gauge), terminal blocks, and small bolts. When the cutter is completely worn out, it's on its way to the recycling center.

I have three favorite cutters. The first one is an easy-to-obtain cutter from Radio Shack. Called the "Nippy Cutter," this guy goes for about \$4. The cutting edge is very sharp, but I've found the ends are rather brittle. They'll break if you try to cut too much at one time.

The next two I get from Hosfelt Electronics, Inc. Their number 170M is a micro series shear cutter. It's about \$5, and has a very nice cushioned hand grip.

The other cutter from Hosfelt is the model 175M. This guy is \$6 and has an internal safety clip. This safety clip helps hold the lead as it is being cut, preventing the lead from flying into your eyes.

The key to the above cutters is knowing when to toss them out. Although in the long run it may be cheaper to get some of the very expensive cutters,

I find the disposable route is the best for me. I assemble a lot of PC boards here because of SunLight Energy Systems. I go through about four pairs of cutters per month. On the other hand, I assemble hundreds and hundreds of PC boards per month as well.

PC board holders

Speaking of PC boards, unless you put one kit together per year, you really should have a PC board holder of some kind.

Here in my shack, I use four different types. For working with one PC board at a time, the best thing going is the Panavise circuit board holder #315. Of course you'll also need at least one of the Panavise base mounts to hold the circuit board holder. Both the Panavise mount and

Continued on page 60

WE DON'T BUILD THE MOST, WE JUST BUILD THE BEST!

- Our LM-470D is now redesigned to hold 15 ft. of antennae at 70 mph!
- Tri-Ex builds the finest in crank-up, free-standing or guyed towers.
- All towers are complete with rigid concrete base mount.

CALL
OR WRITE
FOR A FREE
CATALOGUE!



Iri-Ex[®]
TOWER CORPORATION

7182 Rasmussen Ave. • Visalia, CA 93291

Where engineering and quality come first!

TO ORDER CALL
800-328-2393

FAX
209-651-5157

CIRCLE 22 ON READER SERVICE CARD

HOMING IN

Radio Direction Finding

Joe Moell P.E. K0OV
P. O. Box 2508
Fullerton CA 92837
[Homingin@aol.com]
[http://members.aol.com/
homingin/]

Receiver hunting

Whenever I make a presentation on hidden transmitter hunting to a radio club or convention, one of my main points is that radio direction finding (RDF) skills have many other uses besides radio sports. There will surely be occasions in your life as a ham when these techniques can help you, even if you never go on a hidden transmitter hunt or track down a malicious interferer.

Is that loud buzz on 10 meters coming from a power pole on

your block? Where is the cable TV system leak that wipes out the 145.25 MHz repeater? Which of the dozens of radio sites in your city is the source of the intermodulation product hanging up your repeater? Radio direction finding can help answer all these questions.

RDF could even save you some money, as it did for Rick Choy N3HXT of Winchester, Virginia. Rick hones his RDF skills as a trustee of the Shenandoah Valley Amateur Radio Club, where he and others keep the repeater free of jammers

QRP

continued from page 59

circuit board holder are available from Hosfelt Electronics.

I also use the Weller #ESF120 circuit board holder. This guy will allow you to rotate the board around its axis. There's also a movable arm that's used to hold a part on the board while it's being soldered. This holder is great for troubleshooting a PC board. The Weller holder is \$63 and it's available from FAI Electronics.

The third PC board holder I used won't find its way to your shack. This holder is designed to hold several dozen PC boards at a time. Depending on the size of the PC board, I've been able to stuff 36 boards at a pop. Here's how it works.

The boards are held in tracks. These tracks are adjustable and are easily moved up and down. Each track has a groove cut into it so a PC board will slide in. By adjusting the tracks, you can place as many boards as you can fit on the frame.

Then the fun begins! You stuff a single part into each board. You repeat this step until the entire rack is full of stuffed boards. A foam-lined cover is snapped over the stuffed boards. The foam holds the parts down onto the boards. You then flip the entire rack over and solder the exposed leads.

Finish up by trimming back the leads and the boards are ready for testing and calibration. I purchased this PC rack from a company specializing in PC board assembly. The rack is about \$400 with two extra tracks.

Sources used in this month's column:

FAI Electronics
(800) 655-0006
41 Main Street
Bolton MA 01740

Hosfelt Electronics
(800) 524-6464
2700 Sunset Blvd.
Steubenville OH 43952

73

and stuck mikes. "We are usually successful at tracking and finding a fox in around an hour within a 15-mile radius," Rick writes. "We use yagis, loops, TDOAs, Doppler units, and highly sensitive field-strength meters. Many of the circuits came from the book *Transmitter Hunting—Radio Direction Finding Simplified*." (It's available from 73's Radio Bookshop.)

When Rick lost his pager recently, it led him on a different kind of RDF effort. Instead of a transmitter hunt, he went on a receiver hunt. But before I tell the story, did you know that most receivers are also mini-transmitters?

Receivers transmit, too

As you may remember from your ham license studies, all superheterodyne receivers include at least one RF oscillator. For instance, when you tune a typical FM broadcast set from one band edge to the other, you are adjusting the frequency of its local oscillator (LO) stage from 98.7 to 118.7 MHz. This oscillator and its associated mixer stage convert the desired 88–108 MHz signal to the 10.7 MHz intermediate frequency (IF) by subtraction. The remainder of the radio's circuits amplify, limit, detect, and process the 10.7 MHz stereo signal.

Few receiver cases provide perfect shielding, so the LO signal doesn't stay confined. The FCC insists that its radiation be kept within limits, because signals in the 118 MHz range could interfere with aircraft communications. Your FM broadcast sets, scanners, and other receivers have a notice, either on the set itself or in the instructions, stating that they comply with Part 15 regulations. For VHF sets, this means that LO signals must be below 150 microvolts/meter field strength, as measured three meters away. That is far above the level of a squelch-breaking signal at that distance.

Most receivers radiate much less than that, of course, but the LO is usually detectable. For

instance, when I set my scanner next to my two-meter handie-talkie, its LO puts a rhythmic ticking sound in the HT's audio. No wonder flight attendants insist that you turn off your Walkman™ during takeoff and landing.

Now back to the tale of Rick's pager, which receives on 158.7 MHz.

"I wear it on my belt, but sometimes it has a tendency to fly off when snagged by something," N3HXT continues. "Usually the clip snaps loud enough that I am alerted to what has happened. Once, while walking through the woods, a small branch grabbed it and when I turned around, it was hanging eight feet in the air!"

"One day, I was down at my pond clearing some shrubs, scrub growth, and small trees. I also worked in the garden, cutting and burning some of last year's planting, and I used a backhoe to move a few large piles of dirt around. I covered quite a bit of territory on my 12-acre tract that day.

"When I got back to the house, I noticed that the pager wasn't on my belt. It took me some time to figure out that I didn't just take it off or leave it in my car. I knew I had lost it somewhere outside and I didn't have much time to find it because of threatening rain that would ruin it. What worried me more was that I could have buried it by accident in one of my dirt piles.

"I live in a rural area in a fringe of the pager's range. Sometimes it works and sometimes not. I tried dialing the number from my cellular phone while walking the property in hopes that I might hear it, but to no avail. I worried that I could have left it in silent 'vibrate' mode and would thus never hear it.

"About three years ago, I did a demonstration of my Avcom spectrum analyzer at a club meeting. Using a length of RG-58 with about a half inch of center lead sticking out, I could sniff out a 'bug' or other weak

signal without masking by a lot of other ambient signals. I demonstrated that my pager had LO radiation strong enough to be sensed by the analyzer when I held the sensing lead against the pager, enough to put a blip on the screen 20 dB above the noise floor.

"From that, I knew that the LO frequency of the pager was 20 MHz below the receive frequency, making it 136.7 MHz. I took my Alinco DJ580 and tuned it there. I guessed that a quarter-wavelength whip antenna would give me the least loss, so I used it instead of the 'rubber ducky.'

"Most pagers have a 'sleep' mode to conserve battery power. They wake up once a second to see if a carrier is present and if the header information is valid. If not, the pager sleeps again. So I had only one short pulse per second to sense. How close did I need to get in order to hear it? Using a borrowed pager with another phone number, I determined that I could detect a distinctive carrier blip within 15 feet.

"I went throughout my house, car, and workplace with the Alinco, just to make sure I didn't leave the pager under a pile of books or under a sofa. No luck! I went around my property to see if it might have just fallen off. Still nothing.

"To see if I could detect it under soil, I put the other pager in a plastic bag and buried it about six inches. It was still detectable, but somewhat weaker. Soil density, moisture, and depth affected the amount of signal that would pass through. So if it were buried in the soil, I would have to get a whole lot closer.

"I went back to my shop and got a four-foot aluminum rod and taped it to a broomstick. I ran a piece of coax from my HT to the rod. Back to the pond I went with this contraption and a shovel. I started prodding the dirt piles with the rod. 'Blip! Blip! Blip!' A little careful digging and I uncovered my pager!"

If you think you might need to go on a pager hunt some day, Rick has some advice for planning ahead. "Find your LO frequency, write it down, and put it in a safe place," he recommends. "See if you can pick it up on your scanner or HT. Practice by having someone hide it around the house for you to look for. It's a neat way to get family members interested in transmitter hunting."

As for the hunt procedure, N3HXT suggests, "Once you get a strong signal with the telescoping antenna extended, retract it some and zero in on the pager. Soon you should be able to remove the antenna and sniff with just the BNC connector as a feedhorn. Remember, if your receiver has a 'sleep' feature, deactivate it. It may awaken the receiver when the pager is asleep, and vice versa. If so, you may never hear it."

Rick was lucky that his pager's LO was within the tuning range of his handie-talkie. More and more pager systems are using UHF. For instance, my pager (**Photo A**) receives near 930 MHz.

Your car's radio tells all

As in the case of N3HXT's pager, knowledge of the IF and LO frequencies is enough to determine the receive frequency. A company is using this fact to provide an important service to broadcast stations by placing sensitive roadside receivers throughout the market to be surveyed. They detect emissions from the LOs of passing car radios. The LO frequencies, and thus the receiver frequencies, are rapidly determined using digital signal processing and compiled. In just a few minutes, listenership data can be obtained from hundreds or thousands of vehicles.

Besides being unobtrusive, this technique of listener research has many advantages over traditional methods such as telephone surveys and handwritten diaries. It doesn't rely on memory. ("Let's see, what station did I

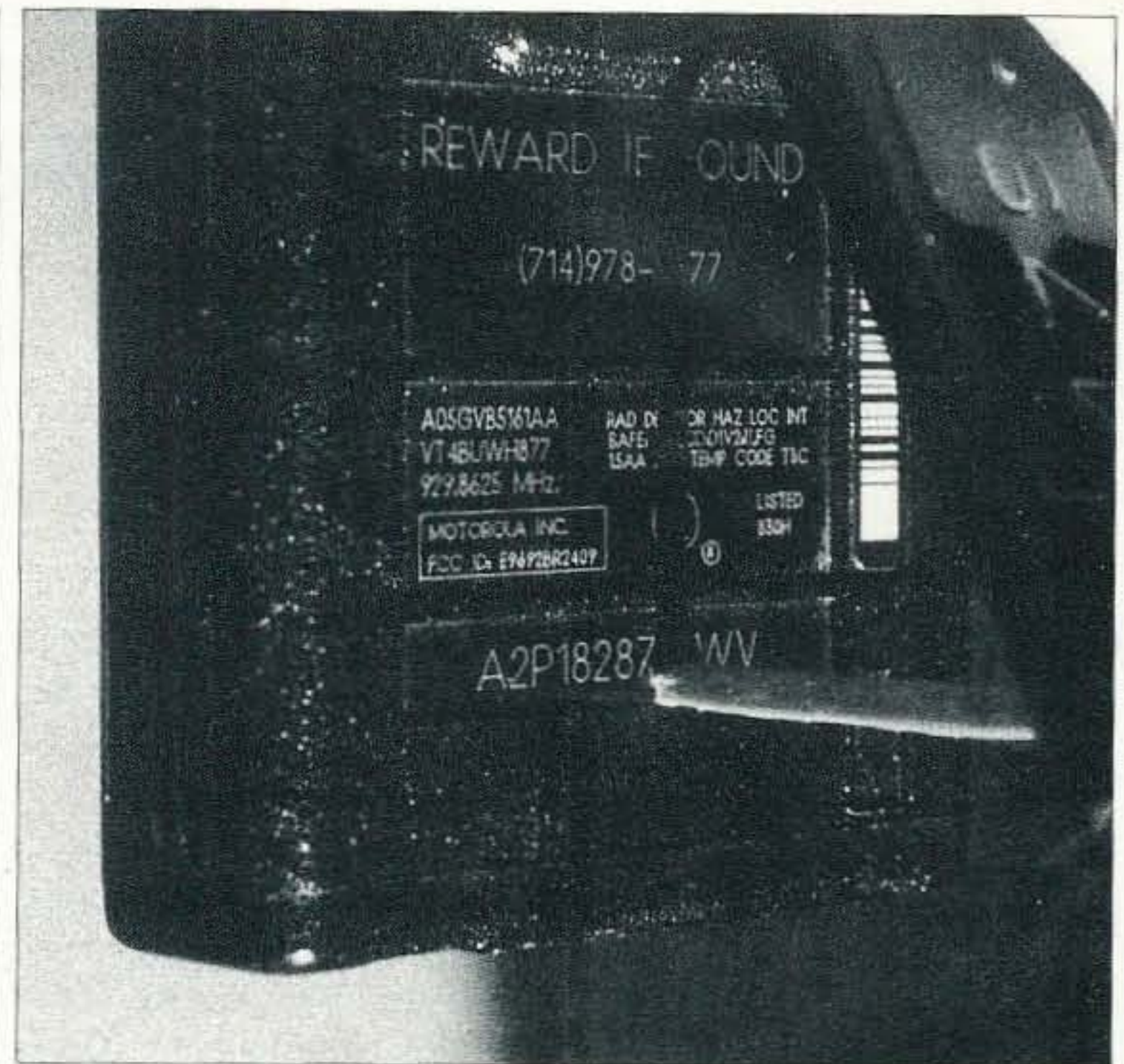

Photo A. The label on this pager gives the receive frequency and FCC identification number, showing that it complies with Part 15 of the regulations.

punch up at 7 a.m. today?") It is so fast that it can determine radio ratings on a minute-to-minute basis, revealing which program elements and commercials are being heard and which are tuned out. I can envision someday having this data displayed in real time at the subscribing stations. (Program director to DJ: "Don't play that Waylon Jennings song any more, it made us lose 35% of our audience.")

An invasion of listener privacy? Of course not, because no attempt is made to link specific listeners with stations, as in "Red-haired Buick drivers prefer K-BLAH." And stations will no longer feel compelled to prompt the holders of Arbitron™ diaries. I will be very happy if it means that I never again have to hear an unctuous announcer say something like, "If anyone asks, remember that you listened to the Frank Flapjaw Show today."

US takes on the world

Last month I invited international-style foxhunting enthusiasts in the US and Canada to consider attending the 1998

ARDF World Championships in Hungary during the first week of September. The best radio-orientees of over 20 nations are expected at this gathering, which will be in Nyiregyhaza, 150 miles east of Budapest.

Contrary to my understanding last month, no independent individual competitors are allowed at World Championships. Each entrant must be part of a national team. The good news this month is that our national team is forming and its application for places at the starting line has been sent to the organizers.

At present, Team USA has three members. International Amateur Radio Union (IARU) rules permit each country to have a maximum of three competitors, in each of five age and gender divisions, for the 80-meter and the two-meter event. These categories are: Women, for females with any date of birth (DOB); Seniors, males with any DOB; Juniors, males with DOB after 1/1/79; Old-Timers, males with DOB before 1/1/58; and Veterans, males with DOB before 1/1/43.

This means that plenty of positions are still available. Because the sport is so new in this

ON THE GO

Mobile, Portable and Emergency Operation

Steve Nowak KE8YN/4
1011 Peacock Ave. NE
Palm Bay FL 32907-1371
[pangen@compuserve.com]

OOPS!—over ...

As a people, Americans tend to be doers. In most cases we prefer to take action—even when taking action may not be the most appropriate course. To what am I specifically referring? That ever-present and tempting push-to-talk button on the microphone. We have learned to avoid salt, cholesterol, excessive alcohol and extramarital affairs. Unfortunately for some, it is still impossible to avoid the temptation to grab the mike and press that button even when we have absolutely nothing to say. It would seem that we view the PTT as an exercise machine to develop a firm and tenacious grip. Perhaps we need to press that button because, like Mount Everest, "it is there."

It's easy to see examples of this on the local two-meter repeater where the duty cycle of the transmitter seems to approach 110%. I expect to see a headline in the supermarket tabloids that scientists have determined that the absolutely smallest unit of temporal measurement is the delay between

one ham finishing a transmission and the next ham keying his microphone. This may eventually be measured as a pico-micro-milli-nanosecond, or faster.

Of course, it's not only the interval between transmissions that is a problem, but the duration of the transmissions. Once many of us begin a transmission, we take serious pleasure in transmitting. After all, this is what makes us hams—the ability to transmit, and we may enjoy it so much that we may be reluctant to share the frequency with others. When on the UHF or VHF bands, most repeaters incorporate a timer to limit transmissions, yet we all have overstayed our welcome and timed out the repeater. A friend of mine took it one step further. He installed a toggle switch in his two-meter mobile rig and suspended a microphone from his sun visor. In this way he no longer needed to keep the PTT pressed. The rest of us were treated to his running commentary on his driving experience followed by those witty repeater timeout messages. When he

hemisphere, you will not have to win a qualifying match to earn a place on the American team. However, you should be in good health and have some experience in the sport. You should also be prepared to fund your own travel and other expenses for the trip. Even though Team USA members will compete under the ARRL banner (because ARRL is the US's national IARU society), no League or commercial financial support

has been promised as of this writing.

Team makeup and financial conditions may have changed by the time this gets into print, so check the "Homing In" Web site for the latest information. Contact me by electronic or postal mail if you are interested in going to Hungary and/or holding ARDF events in your own area. The URL and mail addresses are at the beginning of this month's column, as usual. 

unkeyed and heard the timer reset, he'd immediately hit the switch again and repeat whichever parts of the soliloquy he thought we might have missed.

As we all know, these practices are impolite, and might even be dangerous. During the time when most folks are driving to or from work the repeater may be so completely tied up that someone needing to make an emergency call cannot access the repeater. During disaster operations it may even be worse.

Now, what, you may ask, caused me to drag out my soap box and begin to lecture on this subject? In the April 13, 1998, issue of *Navy Times* I read an article about efforts to convert the communications with the Soviet *Mir* space station to E-mail. Why take *Mir* (and maybe the shuttle or the new International Space Station) off the ham bands? Because we hams are not being seen in the best of lights. As you may be aware, the ham stations in space are used frequently to communicate with students at their schools. The idea is to generate interest among students in the sciences, and maybe even an interest in amateur radio. Unfortunately, as the article points out, while the astronauts or cosmonauts are trying to maintain a contact with a particular school, many hams jump on the frequency and interfere with the contact. This is met with the same reaction that we have toward malicious interference or jammers. Normally I love to read about amateur radio in the paper, but not when we are portrayed as discourteous (to say the least), or when our bad habits are paraded for all to see. Some of us are old enough to remember Walt Kelly's *Pogo* comic strip wherein the expression "We have met the enemy and he is us" was coined.

The Amateur Radio Service is just that—a service. We have an obligation to serve the general public, whether it is technical education of high school students through communications with space stations or an alternate

source of communications when the phone lines are down. During an emergency, disaster or public service communications, it is critical to limit transmissions to those pieces of information which must be passed along. Net control or the liaison to the command center have their hands full handling critical and relevant traffic. They do not need extraneous transmissions. There are other considerations, as well. Until we develop new technology, a given frequency will only be able to be used by one station at a time. When operating under emergency conditions, needless transmissions drain the batteries in your handie-talkie, not to mention the repeater, if it is using backup power.

In any case, here is a message that could help us get on track. Maybe we should remember what our Elmers taught us when we were younger and more idealistic and working toward our ham licenses. These good practices are important during routine hobby operations but are absolutely critical during emergency or disaster efforts.

- Listen first. Make certain the frequency is clear, or the person operating would wish to speak to you. If it is a directed net, the only person to speak with is net control, unless you get permission to go direct with another station. A ham does not interrupt a conversation in progress on the air any more than he would one in person. If your two best friends are talking, naturally, you'd join in, but it would be rare to interrupt two strangers without a compelling reason.

- Think about what you want to say before starting to transmit. Politics, sex, religion and fair weather reports during a SkyWarn session are best avoided.

- Before pressing the PTT, pause so someone who needs to break in can do so. This is especially important during rush hour when many accidents or traffic hazards can create significant problems.

RTTY LOOP

Amateur Radio Teletype

Marc I. Leavey, M.D., WA3AJR
P. O. Box 473
Stevenson MD 21153
[ajr@ari.net]

A tradition has arisen with this column. It is July, and it is another anniversary. This month begins the 22nd year of "RTTY Loop." Twenty-two years—can you believe it? When this column started, my son was not yet born; now he is battling his way through higher education. When this column was starting, a popular question concerned some of the basics of radio-teletype, like which tube circuit to use as a demodulator. And now?

Michele Del Pup I3MDU, is looking for a simple but effective demodulator circuit for demodulating radioteletype.

While demodulating a radio-teletype signal has a striking resemblance to computer modem tones, using a conventional computer modem just does not work for most functions, as some others of you have asked. One circuit that has remained popular is a simple one based on the XR-2211 phase-locked loop demodulator. At one time, this chip was available in every small Radio Shack™ store. Now, you may have better luck in some of the parts purveyors that advertise within the pages of *73 Magazine*.

All other components in this project are common parts, which can be purchased at Radio Shack or other parts houses. I recommend building it on a small piece of perfboard, with point-to-point wiring. Clubs may wish to etch a circuit board; this could be a useful introductory project.

Now, to the matter at hand. **Fig. 1** is a schematic diagram of the demodulator. The audio output of your receiver, either HF or VHF, is coupled to the demodulator through a 0.1 μ F capacitor to pin 2 of the XR-2211. With no input filtering on this device, it is important to present a clean signal, so either a good VHF RTTY signal or a strong, interference free HF signal, is desirable.

A phase-locked loop demodulator is normally tuned for the frequency and bandwidth desired. Here, the 0.022 μ F capacitor from pin 13 to pin 14 of the integrated circuit and the 20 k resistor (an 18 k fixed and 5 k variable) on pin 12 set the center frequency to about 2125 Hz, midway between a 2025 Hz mark and 2225 Hz space frequency.

Bandwidth needed to allow 300-baud transmission is set by

• Remember that, besides the station you are working, there are other hams, shortwave listeners and scanner fans listening as well. What would your mother say if she heard you talking like that?

Amateur radio includes some of the finest people it has been my pleasure to encounter. We have the opportunity to be the last refuge for common courtesy, even when the rest of so-

ciety seems to have no interest in being polite. On the HF bands, we realize that we are goodwill ambassadors to our contacts in other countries, but hams throughout the globe give each other the benefit of the doubt. Now that our contacts are no longer limited to the planet Earth, and more people are listening to us, we really need to present ourselves as competent and courteous. 73

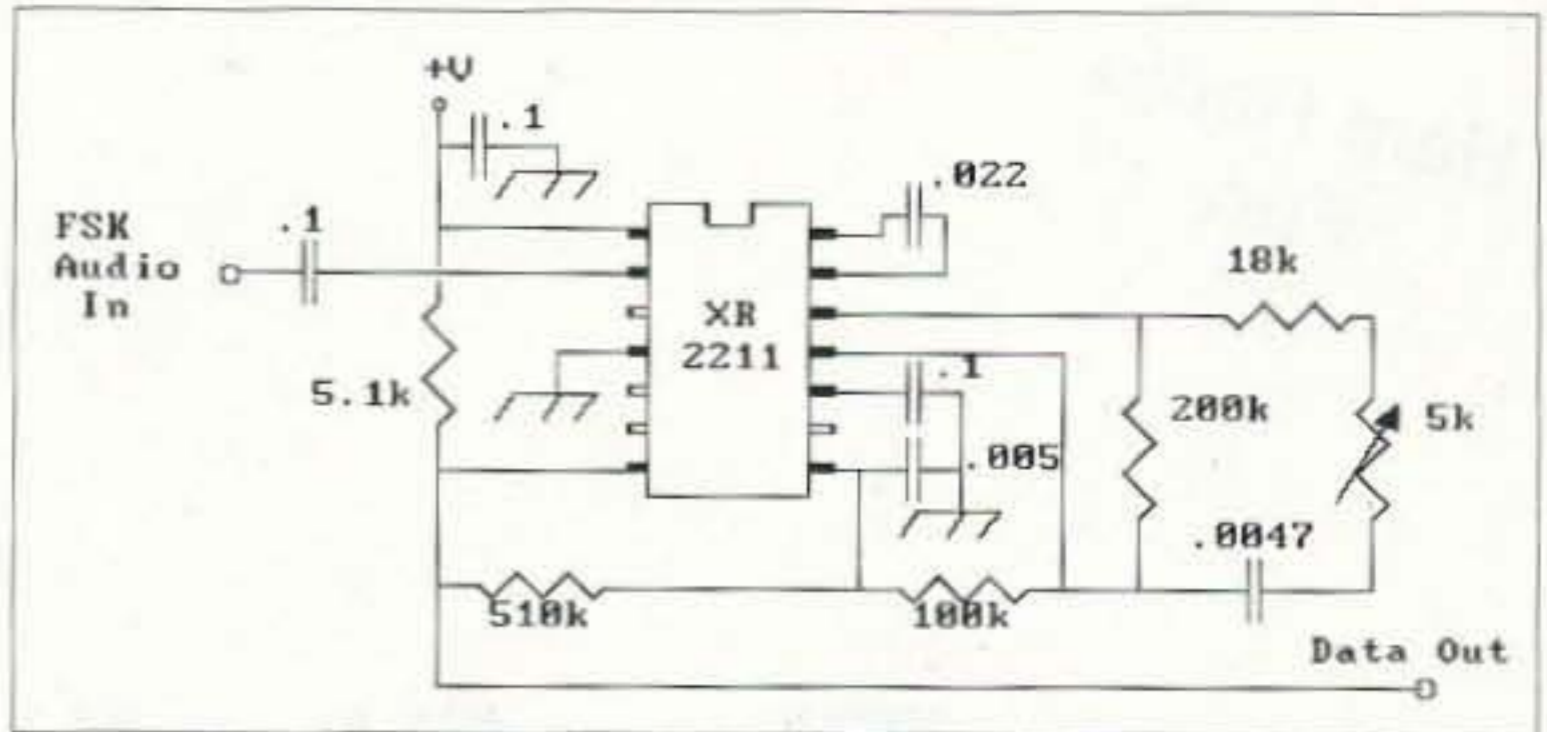

Fig. 1. XR-2211 RTTY demodulator.

the 200 k resistor between pins 11 and 12, with additional trimming provided by the filter of the 0.005 μ F capacitor and 100 k resistor coming from pin 8.

Naturally, with a circuit operating at TTL levels, the output from this one-chip wonder is at TTL levels. So don't try to drive a Model 15 with it—at least not directly. To interface the demodulator with the RTTY loop, we use one of my all-time favorite devices, an optoisolator, to convert either a TTL level or RS-232 level to the more common, for TTY, that is, current loop.

Before we get too deeply into the circuit, though, perhaps a word or two about the optoisolator may be in order. You might think that converting the high-level loop current to the low-level RS-232 or TTL current might be accomplished with some resistors, or a transformer, or some such device. Well, while you might be able to effect some information transfer that way, there is an inherent danger. If the transfer circuit were to fail, high-level current might be allowed into the TTL device. At a minimum this would fry some components. Maximally it could be quite dangerous.

For this reason, various schemes have been introduced to isolate the loop from a driving circuit. While a relay might seem obvious, conventional relays are too slow to keep up with the keying pulses of RTTY.

One version of relay that can be used is the reed relay. This little beauty consists of two thin reeds of magnetically active

metal sealed in a glass tube. Either a permanent magnet or electromagnet will cause the reeds to react, making or breaking the circuit. Thus, driving the magnet from the loop can allow the reeds to key a low-voltage device. This may be ideal for a keying circuit, but the reeds cannot handle the current to key the loop itself.

Continued on page 74

For XR-2211 RTTY Demodulator:

IC: XR-2211

Resistors (1/4 or 1/2 watt; Radio Shack parts are nearest whole values): 5.1 k Ω , 18 k Ω , 100 k Ω , 200 k Ω , 510 k Ω

Potentiometer (miniature PC mount): 5 k Ω

Capacitors (precision disk): 0.022 μ F, 0.005 μ F, 0.0047 μ F, 0.1 μ F x 3

Perfboard: 0.1" grid

For RS-232 to TTY Converter:

Optoisolator: 4N33

Resistors (1/4 or 1/2 watt; Radio Shack parts are nearest whole values): 220 Ω , 4700 Ω , 10 k Ω

Diode: 1N4004

Transistors: 2N2222, MJE3055

Perfboard: 0.1" grid

Table 1. Parts list.

The Shelby Hamfest

What are you doing the weekend before Labor Day?

Larry G. Ledford KA4J
553-4th Street S.E.
Cleveland TN 37311
[ka4j@juno.com]

One of the fastest-growing hamfests in the South is held in Shelby, North Carolina.

While it is smaller than the Dayton hamvention®, it bears many similarities. Both are held in smaller communities in their respective areas and attract larger crowds than their larger-neighbor hamfests.

I had the pleasure of attending the 1997 hamfest, which was the 41st year it had been held. Shelby's been called the "Grand-Daddy of them all," and between 12 and 15 thousand visitors were expected. From the looks of the parking lots, attendance was close to that. As with all good hamfests, there was a good mix of used ham gear in the flea market area, new gear inside the buildings and some computer stuff and those odd related items that defy description in both. Very enjoyable.



Photo A. Hams from all over, ready to tackle the sea of tents in the distance.

Where is Shelby?

It's just off Interstate 85, but still slightly off the beaten track. It's about 40 miles from Charlotte and 75 miles from Asheville. Granted, it is a bit hard to get to, particularly from my QTH in southeastern Tennessee, but well worth the trip. I would have had an easier route but Interstate 40 was closed at the Tennessee/North Carolina state line due to a massive rockslide that took months to clean up. The shortest (but not the quickest) route for us was through the mountains of Tennessee, Georgia, South Carolina and North Carolina. This takes you through the areas of two wild rivers: the Ocoee, in Tennessee, and the Nantahala, in North Carolina. Both are very scenic and canoes, kayaks and rafts are everywhere. While we set no speed records, we saw some very beautiful rivers and mountains.



Photo B. Judging from the intent looks on these faces, bargains abound.

The hamfest is held at the Cleveland County Fairgrounds on US 74 Business Loop at NC 180, about three and a half miles from Shelby. It was a bit dusty due to the dry weather but that made for easier walking. A regular participant said that it had rained the last four years at the hamfest. It is scheduled for the weekend preceding Labor Day each year.

The hamfest has two firm rules: No "adult" videos or discs are allowed to be sold or displayed, and no firearms are allowed on the premises. This promotes more of a family-type event, one that will bring more people. It would be nice if *all* hamfests adopted these rules.

What did I find? An Alinco DJ-11, the new shirt pocket-sized HT and an older Drake TR-3 sideband transceiver (I collect low band rigs). On Sunday I found two bargains: a WRL Galaxy 300 for \$6 and a 486 motherboard running at 33 MHz with 16 Meg of RAM and a video board for \$25.

There are several very good restaurants in the area and one is an outstanding steak house. It's called Kelly's, and is about 15 miles away, over in South Carolina. That meal was to repay my wife for carrying the stuff to the car (you married men will understand).

Why not plan to attend in 1998? For specific information you may contact the Shelby Hamfest Web site at [<http://www.shelby.net/n4fan/>].

Roamin' Romania

Part 2: Amateurs of the Jiu Valley.

George Pataki WB2AQC
84-47 Kendrick Place
Jamaica NY 11432

In the fall of 1997, while visiting my home town of Timisoara, Romania (see Part 1, June), I took a side trip to see the radio amateurs in Hunedoara County. The area known as the Jiu Valley is a mining region. The visits were organized by George YO2BBB, the chief of the radio club of Hunedoara County, located in Deva. During this trip I saw radio amateurs in Deva, Orastie, Beriu, Calan, Hateg, and Petrosani, and one on Parang Mountain.

Deva

From Timisoara I took a train. After about three and a half hours I was met by George YO2BBB at the Deva railway station. I had my tag with my name and call pinned to my jacket, so I was easily identified.

Deva, with about 80,000 inhabitants, is a university center. The Deva Fortress, built in 1241 on the top of a nearby hill at 1225 feet, is on the site of a Roman *castrum*. These days it is in ruins. The reason is that during World War I, while it was an ammunition depot, it blew up. They don't build fortresses like they used to, I guess—this one did not even last 700 years.

George YO2BBB took me to his house where I stayed while in Deva, which is also the county seat. This city, and the entire county, is rich in amateur radio activities, due in large

part to the work and skills of George, who has been employed full-time by the radio club for more than 30 years. One can say that George is a professional amateur.

First, George took me to the county radio club, which has several rooms. One is for the station YO2KAR, sometimes using the YO2KHE call; others are used for meetings, workshops, QSL bureau, etc. There I met Felicia YO2LIP, licensed in 1996, the club's secretary and trainer for direction-finding competitions. She has the prestigious title of Master of Sport, and happens to be

George's daughter-in-law. Her husband Marius is YO2CWR, George's wife Doina is YO2CGV, and George and Doina's daughter Georgeta is married to Artur YO2COC.

You might say that George YO2BBB is the undisputed head of a reigning amateur radio dynasty. Everybody in this family is involved, in one way or another, with ham radio. Most of them are direction-finding (foxhunt) champions several times over.

The club station has a factory-made transceiver and a homemade linear with the final tubes installed temporarily



Photo A. Maria YO2LHW, a secretary, shares the shack with radio technician and husband Adrian YO2BPZ. (Reportedly, their favorite and most read ham magazine—ahem—was too dog-eared to be put on display.)

outside the cabinet, there being no room inside. In this case, "temporary" lasts a very long time. The antenna is a wire dipole.

At the radio club I met many local hams. Dem YO2CMH, licensed in 1980 and a chemical lab technician in the mining industry, is a builder and experimenter. Sorin YO2DNY, licensed in 1985 and an electronics engineer, likes two-meter contests. Marin YO2LMS, licensed in 1995 and an auto mechanic, is a builder and a two-meter contester. Ioan YO2LCV, licensed in 1988 and a lathe operator, is a builder and contester.

George YO2BJS, licensed in 1975 and a retired electronic technician, is a builder who works mostly on SSB. Adrian YO2BPZ, licensed in 1976, handles radio communications for the civil defense. Cori YO2LAG, licensed in 1986, is a retired policeman. Marcel YO2BJZ, licensed in 1975, is an electronics technician and master builder.

Gratian, operator at the YO2KAR club station, is a military firefighter and builder who operates mostly on two meters. Bela YO2LOH, licensed in 1997 and a retired electrician, works only on two meters. Vasile YO2LEG, licensed in 1990 and an electrician, is a builder. Liviu YO2CC, licensed in 1960 and a retired electrical engineer, is also a builder. Most of these hams built their own stations from scratch; very few have access to factory-made equipment. All claimed to have QSL cards. A favorite local joke goes: A child asked his father, a ham operator, "Dad, does every fairy tale start with 'Once upon a time'?" "No, son. Some of them start with 'QSL is no problem, I'll mail it tomorrow.'"

I photographed many hams at the radio club and some of them at their personal stations. Adrian YO2BPZ is an active fellow; with the help of his wife Maria YO2LHW (Photo A), he is publishing a quite interesting four-page monthly bulletin, the *YO/HD Antena*. They have also edited and published a service manual for the A-412 Romanian transceiver, as well as an amateur radio glossary in 45 languages. Maria YO2LHW, licensed in 1993 and a secretary in a trading company, works on two and 80 meters SSB.



Photo B. Ioan YO2LHZ is a mechanic in "real life."

Celino YO2BMI, an electromechanical engineer, is a typical success story of the new freedom in enterprising, and the free market system which started in the recent years in the Eastern Europe. He owns eight furniture stores in various cities of this county. Celino, licensed in 1971, is the president of the local amateur radio association. He uses a Yaesu FT-840; a 14AVQ antenna; a dipole for 17 meters; a five-element rotatable yagi for two meters; and a vertical for 70 cm. YO2BMI has a computer with Windows 95® and a CD-ROM with the *Callbook*, and does computer logging.

He is a reliable QSLer, has a nice card, and has over 150 countries towards his DXCC.

Cori YO2LAG, the retired policeman, has a very small homemade transceiver, works on two meters and on 80 meters SSB, and has QSL cards.

Orastie

Celino loaned us a company car to take George YO2BBB and me to Orastie, 17 miles east of Deva. This municipality, located at 760 feet, is a very old cultural center, mentioned by document in 1224. There we met Ioan YO2LHZ, licensed in 1994, a mechanic

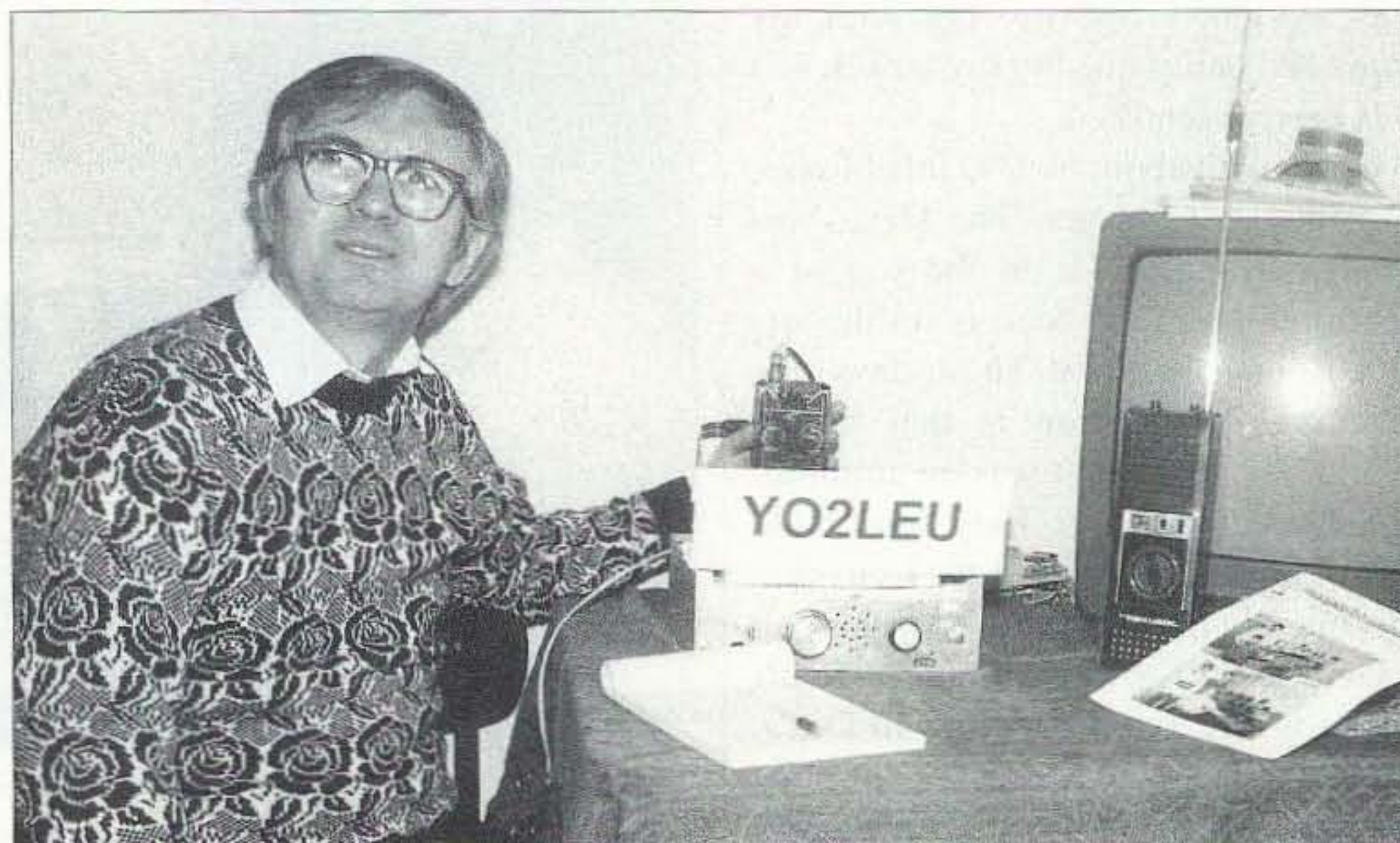

Photo C. Liviu YO2LEU is a retired telephone operator active on two meters.



Photo D. Retired mechanic Mike YO2QY has over 290 countries confirmed.

(Photo B); Liviu YO2LEU, licensed in 1990, a retired telephone operator, very active on two meters (Photo C); Miron YO2LHY, licensed in 1994, a retired mechanic for farm machinery; Theo YO2CKO, licensed in 1979, an auto mechanic, builder and operator on 80 meters SSB; and Ioan, a short-wave listener waiting to take the license examination.

We visited the personal station of Liviu YO2LEU, who is visually handicapped and seems always to be on two meters. Wherever I went in various cities of this county, when I listened on the two-meter band, Liviu was there.

Beriu

From Orastie I went to the nearby small village of Beriu to see the station of Ioan YO2LHZ. Ioan uses a combination of old military surplus equipment and homemade accessories. He works on the two- and 80-meter bands.

I observed that there is a lot of traffic on these two bands, especially in the afternoon and evening hours. After Beriu I returned to Orastie.

Then, in Celino's company car, George YO2BBB and I went through Simeria to Calan.

Continued on page 68



Photo E. Nicu YO2CBK is the radio teacher at YO2KBY in Hateg.

CAPTURE IMAGES LIKE THIS DIRECTLY FROM SPACE ON YOUR PC!



- Internal Systems and Portable, External (Parallel Port) Systems Available for IBM Compatibles.
- Capture Full Satellite Resolution (2-3 Miles with NOAA Satellites) with Either System.
- Professional Software with "Point and Click" User Interface, Mouse Support, Satellite Tracking, Zoom, GIF and Binary Output, False Colorization, Printer Support, Grid-ding, IR Temperature Calibration, Animation, Much More...
- PLL Circuitry Automatically Provides Ruler Straight Images. No Complicated Timing Settings Required.
- Simple Antenna Used for NOAA and Meteor Satellites. NO Dish Required.
- SVGA to 1024x768x256.
- Receive High Resolution Images from NOAA, Meteor (Russia), GOES, and Meteor-sat Satellites, and HF Fax.
- Receivers, Antennas, Downconverters, and Feed-horns also Available Separately or in Complete Systems.
- Internal Demodulator with Software only \$289. Multi-FAX Programmable Satellite Receiver. Just \$249!
- Call, Write, or Fax for Complete Information. Download the above and dozens of other images (as well as software and current orbital elements) from our home page at <http://www.frontier.net/~multifax/>

MultiFAX® 30 Steele Road
Victor, NY 14564

Voice: 716-425-8759(BBS after 5PM) Fax: 716-223-6198

The Original

"Chassis Handler"

A patented adjustable support stand for antique radio, ham, and hi fi repairs. Maneuverable on casters, it features adjustable work height, chassis width (to 28"), and chassis inversion. Large enough to handle Scott radio or Fender amp Chassis. 35 lb sh.

\$175.00 plus UPS

The Tech Shack-- 1645 W 5th Street
Washington, NC 27889

Ph (919) 975-2677 or (919) 943-5253
Mastercard, Visa, COD, Check

CIRCLE 146 ON READER SERVICE CARD

208-852-0830
<http://www.rossdist.com>

SPECIAL!
Under \$140.00



KENWOOD
TH-235A
2 Meter Handheld



Check Out Our Specials! We're On The Web.
Over 9010 HAM Items in Stock. All Prices Cash FOB Preston
ROSS DISTRIBUTING, 78 S. State Street, Preston, ID 83263
Hours Tue.-Fri. 9-6 • 9-2 Mondays, Closed Saturday & Sunday

Roamin' Romania

continued from page 67

Calan

The town of Calan used to be an important metallurgical center; nowadays, many of its facilities are closed down. Here I had the pleasure to visit Mike YO2QY, with whom I had QSO'd and exchanged cards (**Photo D**). His card is on the wall of my radio room. Mike, licensed in 1963, is a retired chief mechanic and skillful builder, as well as a contester and DXer with over 290 countries confirmed. YO2QY is a passionate ham operator, but his license was suspended from 1983 to 1990, when he was investigated and harassed by the *Securitate*—the secret police of the former dictatorial regime. The reason? His amateur radio contacts. It was a difficult period for him, as it was for his entire family. Mike uses a Swan 350, a 14AVQ, and an inverted V for the 80-meter band. He has over 300 awards and a nice photo QSL card, and is a reliable QSLer.

We also went to see Feri YO2ARV. Licensed in 1968, Feri is a chief electrician. He is using an FT-DX505 with a separate VFO, a homemade linear amplifier, an electronic keyer, and other gadgets made by him. He has a 12AVQ and a Windom antenna for 40 and 80 meters. YO2ARV has worked over 300 countries for his DXCC and has over 450 awards. He is a builder, experimenter, and contester, and has two types of QSL cards.

After Calan, we returned to Deva. The next morning, George YO2BBB and I went 35 miles south to Hateg.

Hateg and Petrosani

Hateg is another small but very old town, first referred to in 1247. Here we went to the Children's Club, established in 1984 and home of radio station YO2KBY. Nicu YO2CBK is the teacher and chief operator (**Photo E**). Licensed in 1978, he is a builder, experimenter, and contester, and operates both CW and SSB. The children learn the Morse code, build simple electronic projects, and operate the club



Photo F. Marius YO2LNL (age 11), Alin YO2LHK (12), and Flaviu YO2LHM (10) find the propagation good for smiles.

station on 80-meter SSB. From his personal station, Nicu operates SSB on the 10-40-80 meter bands with a sloper, and on two meters with a rotatable nine-element yagi.

The club station is homemade. The antennas are a delta loop for 40 and 80 meters, and a ground plane for 10 meters. At the club I met several children, some already with their own callsigns: Marius YO2LNL, age 11;

Alin YO2LHK, age 12; and Flaviu YO2LHM, age 10 (**Photo F**).

We saw Marcu YO2BVH, licensed in 1960, a retired radio technician at the post office. Marcu, now 77, used to be active on CW and SSB with a homemade five-watt station and a wire dipole. His table is full of equipment, absolutely everything made by himself.

We also met Tony YO2LMA, licensed in 1996, a mechanical engineer



Photo G. Maria YO2BJX is an electronics engineer and world-famous (as of now) high-speed chauffeur.



Photo H. High school students Robi YO2LMT, George YO2LLV, and Bianca (SWL) show off the Petrosani Sports School's shack.

working for the bus company. Tony is a builder. He has worked over 100 countries on 80 meters, CW and SSB, with his homemade 50-watt transmitter and a multiband wire dipole. His station is strictly one-man: one chair, no table, built in a closet. He has a picture QSL card showing sights from Hunedoara county.

From Hateg, Maria YO2BJX, a pretty and very active lady (**Photo G**),

drove us southeast about 28 miles to Petrosani, elevation 2,000 feet, the center of the region's coal fields. The ride was scary; Maria drove fast on narrow, winding, mountain roads. Slow-moving carts, pulled by horses, without the required lamps, often showed up unexpectedly in the dark. I prayed not to become a news item in

Continued on page 70



Photo I. Feri YO2LAH uses a 10-element yagi for two meters.

EVERY ISSUE OF
73 Amateur
Radio Today
on Microfiche!

The entire run of **73** from October 1960 through last year is now available. Over 800 fiche!

You can have access to the treasures of **73** without several hundred pounds of bulky back issues. Our 24x fiche have 98 pages each and will fit in a card file on your desk.

We offer a battery operated hand held viewer for \$150, and a desk model for \$260. Libraries have these readers.

The collection of microfiche, is available as an entire set, (no partial sets) for \$325, plus \$10 shipping (USA). Annual updates available for \$10, plus \$3 shipping/handling. Satisfaction guaranteed or money back!

VISA **BUCKMASTER** **MasterCard**
6196 Jefferson Highway
Mineral, Virginia 23117 USA
540:894-5777 • 800:282-5628
Fax 540:894-9141
e-mail: info@buck.com

CIRCLE 168 ON READER SERVICE CARD

REPEATER HEADQUARTERS

Make "Commercial Quality" repeaters from GE and Motorola Mobiles

- 45 Watt VHF Micor from \$99
- 40 Watt UHF Master II from \$199

Conversion Information Available!
<http://www.versatel.com>

VersaTel Orders: 800 456 5548
COMMUNICATIONS Info: 307 266 1700
FAX: 307 266 3010

CIRCLE 259 ON READER SERVICE CARD

HamCall™ CD-ROM
U.S. & International - Over 1,490,000 listings

The HamCall™ CD-ROM allows you to look up over 1,490,000 callsigns from all over the world, including over 300 call areas. Over 108,000 new and updated International listings on the April, 1998 edition!

The same CD works in DOS, Windows 3.1, and Windows 95. Look up hams by call, name, address, city, state, postal code, county, and country. View photographs (list included), edit records (now including fax number), and calculate beam heading and distance.

- Data displayed: callsign, class, name, address, license issue date, expiration date, birth date (over 678,000 U.S. birthdates still in database), previous call(s), previous class, latitude, longitude, grid square, county, time zone, e-mail address, QSL manager, and WWW URL.
- Displays precise latitude, longitude, and grid square for almost every U.S. and DX call.
- Calculates beam heading and distance from your station.
- Enhanced label printing for Windows. Select printer, font and print any size label. Label size, margins, columns, and rows are fully configurable. Supports copy & paste.

Also on HamCall™ are over 144,000 cross references from old to new calls, over 60,000 e-mail addresses, over 3,500 photos, 19,000 vanity calls and much more.

HamCall™ is still just \$50.00 plus \$5.00 shipping U.S., \$8.00 international.

BUCKMASTER
6196 Jefferson Highway
Mineral, VA 23117 USA
e-mail: info@buck.com
540:894-5777 • 800:282-5628 • 540:894-9141 (fax)

CIRCLE 56 ON READER SERVICE CARD



Photo J. Sever YO2BUJ is a retired mining engineer and devoted builder.

Roamin' Romania

continued from page 69

the next morning's paper; I am a modest man and shun publicity.

We arrived at Petrosani in the evening and went directly to the High School for Sports. There the principal is Eugen YO2QC, and the professor at the radio club is Bela YO2LEP. We met a bunch of local hams, made the schedule for the next day, and went to sleep in the house of Paul YO2CXJ. About the schedule: After long discussions, three different plans were made—

one after another—but the next day we followed none of them.

At the school there is a radio room where the children study Morse code and can build some gadgets.

There is also radio station YO2KBE, where several licensed young operators were on hand: Robi YO2LMT, age 15; George YO2LLV, age 14; and Andrei YO2LNW, age 16; as well as Bianca, Dan, and Raul, shortwave listeners and club operators without personal callsigns (**Photo H**). The station is home-brewed and they have a computer.

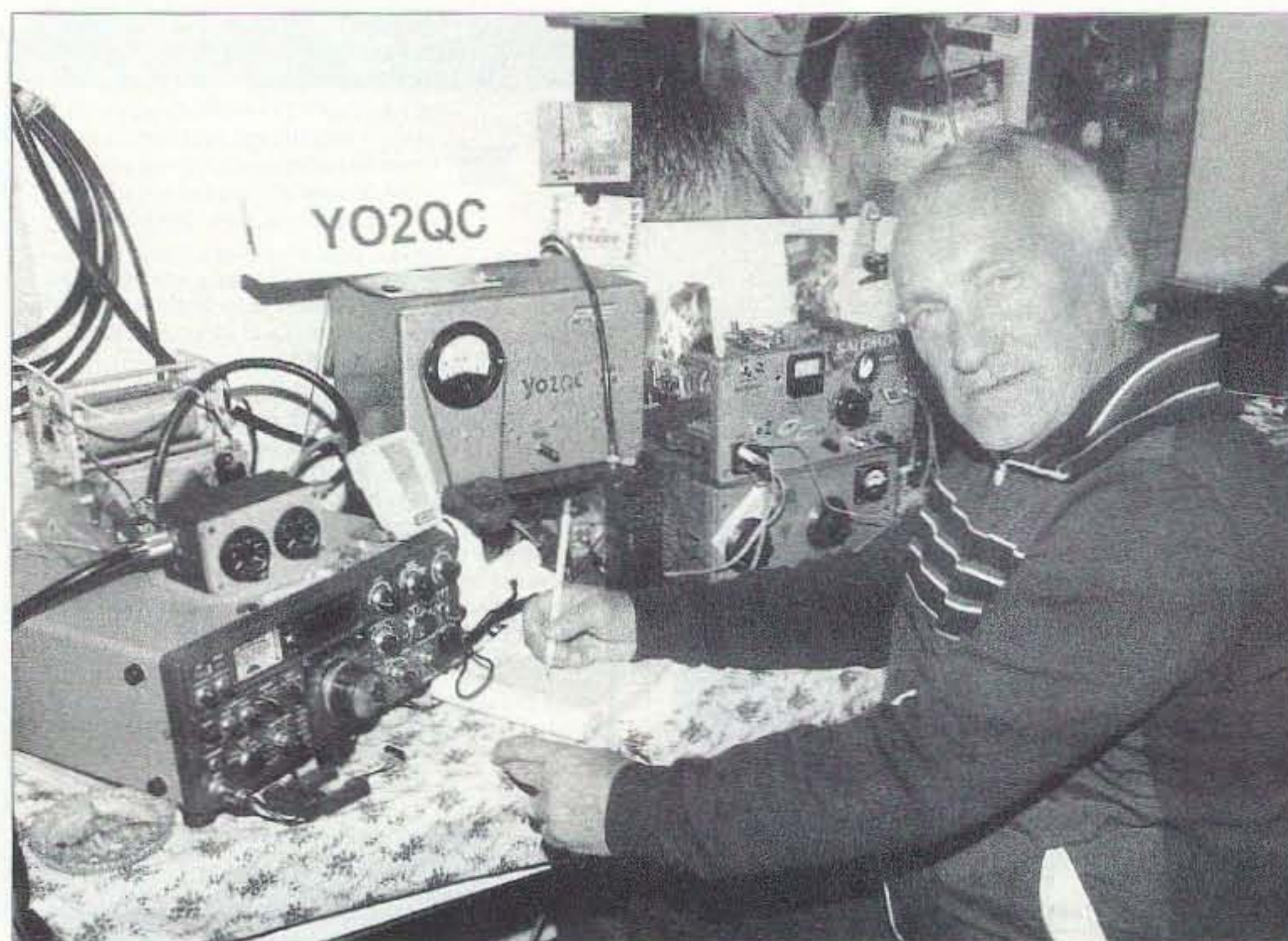

Photo K. Eugen YO2QC holds the title of Master of Radio Sport.

I also visited a couple of personal stations. Zoli YO2CPV, licensed in 1980 and an electrical engineer, is a master builder operating CW and SSB with a homemade station and a multi-band dipole. His shack is in a narrow, built-in storage compartment—he barely fits in. Zoli has QSL cards.

Iosif YO2CJ, licensed in 1952 and a retired mining engineer, showed us his dashing black miner's uniform. Iosif is a tinkerer and experimenter, a specialist in antennas, a contester, a DXer with over 220 countries. He is using the Drake line, some homemade accessories and a computer. YO2CJ is also the author of three popular books: two about HF antennas, and one about VHF and UHF antennas.

He wanted to give me a miner's lamp as a souvenir, but I had to turn him down. The gift was too bulky and heavy to carry, and I don't have any mines where I can use it.

Paul YO2CXJ, licensed in 1980, is the president of the Jiu Valley Amateur Radio Association. He is a geology engineer teaching at the local university. Paul is a master builder, a contester, and a DXer with over 180 countries worked for his DXCC. He has a neat station with an FT-DX500 and a bunch of homemade equipment; his antenna is multiband wire dipole. His 15-year-old son, Victor YO2LLU, was licensed in 1996 and is a high school student. He operates SSB on 80 meters and so far has worked 50 different countries. Paul's wife Tania, a certified translator for three or four languages, is a short-wave listener.

Feri YO2LAH, licensed in 1985, is an electronics technician (**Photo I**). He is using an SB-102 with dipoles for 20 and 80 meters, and a longwire for 10 and 15 meters. For two meters, he has a 10-element yagi. YO2LAH is a builder, a contester, and a DXer with over 220 countries worked for his DXCC. Feri has QSL cards.

Sever YO2BUJ, licensed in 1974 and a retired mining engineer, is a builder (**Photo J**). With his 40-watt homemade transceiver, a wire dipole for 10-40-80 meters, and a nine-element yagi for two meters, Sever has worked mostly Europeans. He is constantly

changing, improving his gadgets, and nothing stays the same for a long time. Sever also has QSL cards.

Andy YO2AXY, licensed in 1970, is an electrical engineer. He is a tinkerer, building transceivers and various accessories. His FT-757GX is now pushing 100 watts into a horizontal delta loop. YO2AXY has worked over 200 countries and has QSL cards. His son Claudiu is waiting for his license.

Last but not least, I visited the personal station of a family of radio amateurs: Bela YO2LEP, the radio teacher from the sport school; his wife Maria YO2BJX, an electronics engineer involved in various businesses; and their son Andrei YO2LNW, a high school student. Andrei has computer-generated QSL cards.

Maria was the one who drove us from Hateg to Petrosani and made me see my whole life flashing before my eyes, with several fast reruns. Later she took us from Petrosani back to Deva, another unforgettable experience.

Parang Mountain

Eugen YO2QC was licensed in 1962 and is the principal of the High School for Sports (Photo K). A former gymnast on the Romanian national team, he holds the prestigious title of Master of Radio Sport, and several times was national champion on two meters. He has two stations: one in Petrosani, and the other at the ski center of the sport school, on Parang Mountain, with an elevation of over 5,900 feet.

There he is using a TS-830S with a longwire for 10 to 80 meters; a ground plane for 10 meters; a two-element quad for six meters; a nine-element yagi for two meters; and two connected nine-element yagis for 70 cm. At that elevation, he can work DX even when loading a proverbial wet noodle. I worked YO2QC and promptly received his QSL.

Also in Eugen's care is a two-meter repeater installed on a tower right near his little homemade chalet.

To reach the ski center, Maria YO2BJX drove us from Petrosani to the site of a ski lift. There we had to jump on a moving chair hung on a steel cable, going in about 25 minutes

from elevation 3,630 feet to elevation 5,940 feet. The system has 130 double chairs, moving sometimes at a height of 160 feet above ground. A cold wind was blowing, George YO2BBB was wiggling around near me on his chair, and I was scared; I think I had every right to be.

Bela YO2LEP and some of the young amateurs also came up: Laura YO2LNU, Constantina YO2LLW, George YO2LLV, and Cosmin, a shortwave listener.

All's well that ...

Yes, it ended well. I got off the mountain—frozen, but in a single piece. With George YO2BBB I returned to Deva, spent the last night there, and then in the morning I took the three-and-a-half-hour train ride back to my home town of Timisoara.

After a couple of days, I went to the airport and passed through the annoying Romanian customs. Why was it annoying?

Well, because the customs officer looking at my luggage through his X-ray machine saw something that he was not supposed to see, and asked me to open the suitcase. I had two identical suitcases, so I opened the other one. An honest mistake—it could happen to anyone. But there was nothing in that suitcase, just a bunch of books and QSL cards. I passed that test with flying colors—and after about nine hours in the air I was safe and sound in New York City. 73

ISOTRON
ANTENNAS FROM 160-10 METERS

NO TUNERS
NO RADIALS
NO COMPROMISE
PRICES START AT \$49.95

SEVEN EXCELLENT REVIEWS
JUST DON'T HAPPEN BY CHANCE
CALL US FOR A FREE CATALOGUE

See review in 73, Oct. 1984; 73, Sept. 1985; 73, March 1986
CQ, Dec. 1988; W.R., Mar. 1991; 73, Nov. 1994; 73, Apr. 1996

ASK ABOUT OUR NEW ISOTRON 160C!



BILAL COMPANY
137 MANCHESTER DRIVE
FLORISSANT, COLORADO 80816
(719) 687-0650



CIRCLE 42 ON READER SERVICE CARD

Weather Satellite Imagery



PCMCIA Convertible Capture Board

- Low power - PCMCIA type II
- Use on your Laptop and Desktop
- HF Marine, NOAA polar satellites, GOES satellites
- Perfect for boat, vehicle, plane, or home

Full Function Software

- DOS and Windows
- Sea surface temperatures
- Coastline and Lat/Lon grids
- GOES animation
- Decodes WEFAX headers

The Best in PC based Weather Satellite Imagery



OFS WeatherFAX, Phone/Fax: (919) 847-4545
6404 Lakerest Court, Raleigh, NC 27612 E-Mail: jdahl@worldnet.att.net

MOTOROLA RADIO SYSTEMS BUY DIRECT AND SAVE 1-800-990-2929

"WE SHIP WORLDWIDE"

SPECIAL PRICING FOR DEALERS AND EXPORTERS



VX-1R

BUSINESS • HAM • GOVERNMENT • MARINE • AVIATION • SHORTWAVE
CB • CELLULAR • PAGERS • SCANNERS • UHF • VHF • TRUNKING

MOTOROLA

ICOM • KENWOOD

SONY • STANDARD

FT-920

MAXON
YAESU/VERTEX
WE REPAIR RADIOS

"OUR 46th YEAR"

BARRY ELECTRONICS CORP.
540 BROADWAY, NEW YORK, NY 10012

1-800-990-2929



TEL 212-925-7000
FAX 212-925-7001

CIRCLE 41 ON READER SERVICE CARD

NEW PRODUCTS



MAKE YOUR YAESU HT EVEN HANDIER!

Got a Yaesu FT-10R, FT-40R, FT-50R, or VX-1R? The new MFJ-295Y YAESU Mini-SpeakerMic™ is made to give your Yaesu handheld superb

crystal-clear audio. It's incredibly lightweight, made of high-impact water-resistant plastic, and uses a one-quarter-inch speaker to produce 83 dB of brilliantly clear audio. It's got an eight-position swivel lapel clip and three and a half-foot stretchable cord for hands-free, move-as-you-like use, and a built-in earphone jack for private listening. MFJ has priced all these features and more at \$15.95, and of course it comes with MFJ's *No Matter What™* one-year limited warranty.

To order or for information about your nearest dealer, call (800) 647-1800; FAX (601) 323-6551; E-mail [mfj@mjenterprises.com]; or check out the Web site at [http://www.mjenterprises.com].



DOES THE WORK OF SIX — AND NOW IT DOES WINDOWS!

Allison Technology Corporation has released the O-Scope II for Windows™. Now the O-Scope II digital storage oscilloscope module has both DOS and Windows™ operating programs. The O-Scope II, which as everyone knows, does the work of six other instruments (dual-trace storage oscilloscope, digital voltmeter, frequency counter, frequency spectrum analyzer, data logger, and X-Y display mode), con-

verts a PC into an advanced digital storage oscilloscope and data logger. Data may be captured to disk or transferred to other Windows™ programs. Display screen data may be captured graphically for print-outs or may be converted to graphic images. The modules are small, low-cost, and lightweight, making them suitable for portable operation as well as for the crowded workbench. The O-Scope II works with standard scope probes and is powered from 12 VDC. ATC offers a variety of probes for the unit, including standard attenuating probes, high-voltage probe, differential probes, and automotive ignition probes. The O-Scope II sells for \$349 including the module, manuals, AC power adapter, cable and both the Windows™ and DOS software packages.

To order or for more information, contact Allison Technology Corporation, 8343 Carvel, Houston TX 77036-6301; call them toll-free at (800) 980-9806.

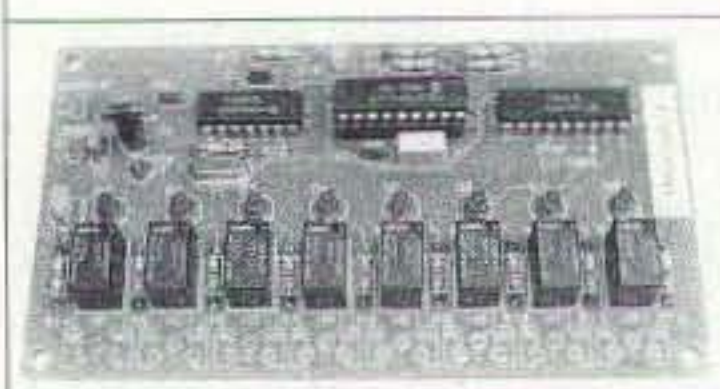

INTUITIVE CIRCUITS' VERY FIRST!

Here's the very first product from Intuitive Circuits, LLC: the DTMF-8 decoder board. It's great for remote control of most equipment (like repeaters) via radio—or any other audio source, with its eight relay out-

puts. Relay contacts are rated at 1 A and can be programmed for momentary, latching (or combination), or mutually exclusive one of eight. Password programming adds security and allows multiple DTMF-8 boards attached to the same audio source to control even *more* equipment—and it's only \$119! For more information, contact Intuitive Circuits, LLC, 2275 Brinston Ave., Troy MI 48083, or check out their Web site at [http://www.icircuits.com].

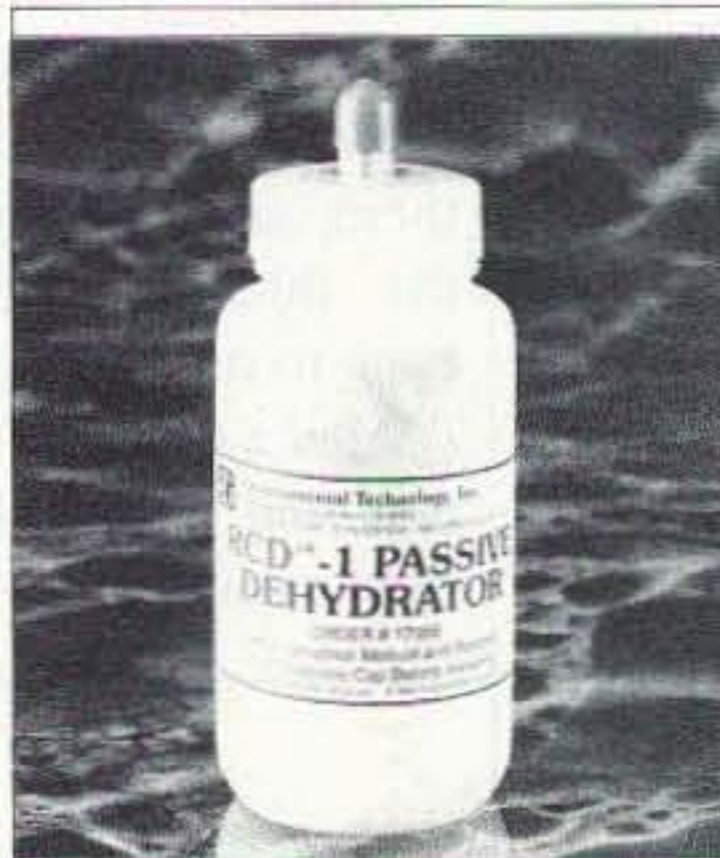

DRIER IS BETTER

Environmental Technology, Inc., introduces the new RCD™-1 and RCD™-2 Passive Dehydrators. They're super-inexpensive, require no electric power, and will protect microwave and satellite earth station waveguide, coax and other RF compo-

nents from moisture condensation and performance-robbing corrosion.

Both the RCD™-1 and the RCD™-2 are ideally suited to fixed, portable, and mobile station applications having limited or no power availability, including general-purpose dehydration and equipment protection during shipping and storage, or to back up mechanical dehydrators in emergencies. They use an inert desiccant blend that changes color to let you know when it needs replacement or regeneration—usually around every 18 months.

For more information contact Environmental Technologies, Inc., 1302 High Street, South Bend IN 46601. Call (800) 234-4239 (US and Canada) or (219) 233-1202 (elsewhere).

SAFETY BOOK

Concerned about RF exposure safety? *RF Exposure and You*, newly published by the ARRL, will explain the new FCC rules designed to ensure that you, your family, neighbors, and anybody else at risk, are exposed only to low levels of radio frequency energy. Worksheets allow you to determine whether or not your station is in compliance, and if not, there are comprehensive, plain-English instructions on what to do about it. Included are reprints of the FCC documents, a review of basic electromagnetic theory, and tables to simplify determining compliance with the new rules. You'll also find a list of additional resources and FCC information sources, primarily on the Internet.

RF Exposure and You (ARRL order #6621) is available from amateur radio dealers for \$15.00 retail, or you can order from ARRL. Call (888) 277-5289; FAX (860) 594-0303; or send check or money order for \$15.00 plus \$4.00 s/h to ARRL Publication Sales, 225 Main St., Newington CT 06111-1494.

ADVERTISERS' INDEX

R.S.#	page	R.S.#	page	R.S.#	page	R.S.#	page
351	Absolute Value Systems ... 49	78	Hamsure 49	248	Motron Electronics 73	34	Ramsey Electronics 2
68	Advanced Battery Systems 80	•	Hamtronics, Inc. CV2	114	Mr. Nicd 13	254	Ross Distributing 67
•	All Electronics Corp. 11	•	Indianapolis Hamfest 23	•	MultiFAX 67	36	Scrambling News 33
297	Antique Electronic Supply . 73	42	Isotron 71	•	OFS WeatherFAX 71	241	Seagon Company 20
16	Astron Corporation 1	•	J. Martin Systems 27	•	P.C. Electronics 27	167	Sescom, Inc. 81
41	Barry Electronics Corp 71	158	Japan Radio Co. CV4	•	Peet Bros. 33	188	SGC, Inc. 81
42	Bilal Company 71	•	Kachina	68	Periphex 80	250	Software Systems
168	Buckmaster Publishing 69		Communications, Inc. CV3	•	Radio Book Shop 48		Consulting 48
56	Buckmaster Publishing 69	275	Lakeview Company, Inc. ... 23	•	Radio Book Shop 56	69	Spectrum Electronics 81
222	Byers Chassis Kits 49	335	Menu Plus 5	•	Radio Book Shop 58	141	The Nicad Lady 23
184	C & S Sales, Inc. 19	86	MFJ Enterprises 9	•	Radio Book Shop 76	146	The Tech Shack 67
99	Communication Concepts 28	•	Michigan Radio 39	•	Radio Book Shop 80	•	Thomas Miller 27
10	Communications	160	Micro Computer	•	Radio Book Shop 82	269	Tigertronics 57
	Specialists, Inc. 19		Concepts 77	•	Radio Book Shop 83	22	Tri-Ex Tower
13	Doppler Systems 51	136	Milestone Technologies 24	•	Radio Book Shop 84		Corporation 59
114	E. H. Yost 13	193	Morse Tutor Gold 80	•	Radio Book Shop 85	•	Universal Radio 48
193	GGTE 80	248	Motron Electronics 41	•	Radio Book Shop 88	259	Versatel Communications . 69

When you buy products from these advertisers, please tell them that you saw their ads in 73.

Subscribe to 73 right now...call 800-274-7373 (9-5 Monday-Friday EST).

Motron 310 Garfield St Suite 4
 PO Box 2748
ELECTRONICS Eugene, Oregon 97402
<http://www.motron.com>

New DTMF Decoder

\$59.00
 plus shipping

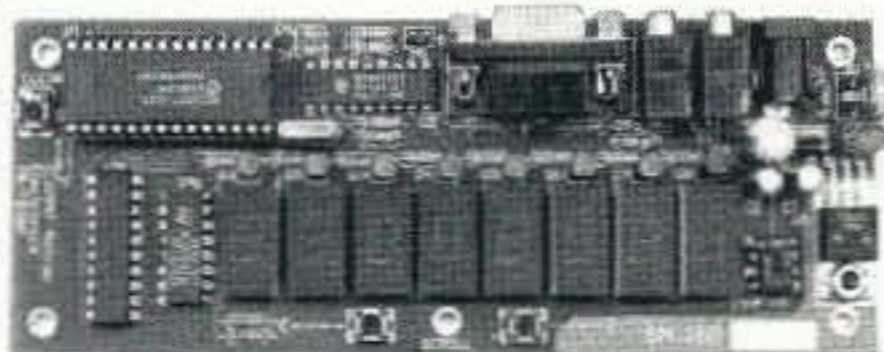

The **ToneLogger™**

DTMF Decoder Display Board with ASCII Serial Output decodes all 16 DTMF digits and features a large 8-digit LED display, an amplified audio output, jumper selectable Normal and High-speed decoding, and an ASCII serial output at 9600 baud. The 56 character memory is viewed, without loss of data, by scrolling either left or right. Although a computer is not required, the serial ASCII output allows for automatic logging of decoded number groups. Logging software for both DOS and Windows environments is included with each **ToneLogger™** purchase. The **NEW ToneLogger™** is 2-1/4" x 6" and requires 9 VDC at a minimum of 150 ma current.

ToneLogger™ Assembled & Tested PCB **\$59.00**
CAB-3 Audio & Computer Cables **20.00**
PMK-1 Plastic Mounting Kit **15.00**
PS-9/2 9 VDC @ 200 ma AC Adaptor **10.00**

Visa, MasterCard, American Express, and Discover/Novus accepted.
 COD \$5 (Cash or Money Order only) S/H: \$8 USA; \$11 Canada; \$16 Foreign

Orders: (800) 338-9058

Info: (541) 687-2118 Fax: (541) 687-2492

CIRCLE 248 ON READER SERVICE CARD

TUBES-PARTS-BOOKS-SUPPLIES

(602) 820.5411 FAX (800) 706.6789

FIND EVERYTHING YOU NEED
 WITHOUT A LOT OF DOUBLE TALK

I wonder where can I find a 2A3 audio tube?

With 50,000 watts we can broadcast for bla bla bla bla bla

Call or fax today for our new 60 page FREE catalog of vintage tubes, hard to find parts, books and supplies. We have everything you need to build new or repair classic audio equipment at prices you haven't seen in decades.

ANTIQUE ELECTRONIC SUPPLY

6221 SOUTH MAPLE AVENUE
 TEMPE, AZ U.S.A. 85283
 VISIT OUR WEBSITE AT WWW.TUBESANDMORE.COM

CIRCLE 297 ON READER SERVICE CARD

CARR'S CORNER

Joseph J. Carr K4IPV
P.O. Box 1099
Falls Church VA 22041-0099
[carrjj@aol.com]

Radio way-backs

One of the things that has interested me over the years is to look back over radio history. When I was a pre-teen, the late Hal Wilcox W4OP invited me and a couple of other boys to go with him to a ceremony one Saturday morning. Most of us were pre-hams as well as pre-teens, but were hanging around the now defunct Falls Church Radio Club in Virginia while trying to qualify for our Novice, Technician and/or General Class licenses. The local radio clubs were invited to the decommissioning of the Navy's first radio station, NAA, in Arlington, Virginia (the callsign has since been reassigned to the VLF station at Cutler, Maine), and Hal

thought it would interest us young 'uns.

The station was put into commission in 1913, and had a trio of high towers (Photo A). In 1940 those towers were removed because they were only two miles from the end of the runway of Washington National Airport (now Ronald Reagan Washington National Airport), which was then being built. Can't have aircraft flying into those towers, after all. The towers were reassembled near Annapolis, Maryland. The site (701 South Court House Road, Arlington VA 22204) is still in use. For a long time it was occupied by the Defense Communications Agency (DCA), and shows up under that name on a lot of

local maps. But the current user is actually the Defense Information Systems Agency (DISA), which absorbed DCA some years ago.

The old NAA used a number of transmitters (Photos B and C), including powerful spark gaps and Alexanderson alternators. One source book, published by Naval Research Laboratory (which operated NAA at one time) claimed that the station operated on 113 kHz with a power of 100 kW.

CW is gone? More or less

The US Coast Guard (USCG) is the federal government agency primarily responsible for carrying out the United States' obligations (under the Safety of Life at Sea Treaty) for the protection of life and property at sea. While its law enforcement duties tend to grab the headlines more often today, especially in the war on drugs, the USCG has been in the forefront of protecting those at sea for as long as anyone can remember.

Indeed, the Coast Guard has maintained a manned radio

watch on 500 kHz and other international radiotelegraph (CW) hailing frequencies for all but a few years of this present century ... nearly 100 years. Coast Guard radiomen spent endless shifts listening for the staccato SOS that indicated a ship or smaller vessel in distress on the high seas.

I can recall that one of my ham radio mentors (from the 1950s), another member of the old Falls Church Radio Club, was a captain in the USCG. He spun tales of rescues at sea that would chill the spine—men battling 40-foot seas in 12-man whaleboats to rescue the crews of ships breaking apart in storms.

He told me that, when he was a newly-minted ensign, his skipper put him in charge of a two-boat party to effect a rescue in somewhat less vicious seas, and gave him the choice of using motorized boats or the 12-rower whaleboats. He thought for a moment, and selected the whaleboats. It turned out to be the right choice: 12 men, rowing for their lives, can keep the oars in the water, while the propeller of a

RTTY Loop

continued from page 63

Here we must bow to another form of subterfuge, the optoisolator. Most of us are familiar with photocells, those little wonders that change resistance based on the amount of light falling upon their faces. When I

was in school, we marveled at how a transistor, with the top cut off the case, makes an excellent photocell. Of course, you can buy transistors prepared this way (phototransistors, naturally).

Anyway, you are also aware, no doubt, of the illuminating wonders known as Light Emitting Diodes, or LEDs. Able to

produce light from relatively low energy sources, these darlings find their way into almost every electronic device imaginable. Now, if you take an LED and pot it so that it shines directly onto a phototransistor, you have an optoisolator. The output is directly controlled by the input, but there is no electrical connection, the transfer being accomplished over a beam of light.

Admittedly still at low level, now you can use the output of the optoisolator to key a transistor, and that transistor to key another, power, transistor, and that transistor to key a loop. Simple, huh? Well, Fig. 2 shows the results.

Although the diagram shows the input as "RS-232 Levels," TTL levels should work nicely, as well. The key purpose is to light up the LED in the optoisolator.

The rest of the circuit is fairly conventional, and may be built on perfboard, with point-to-point wiring, or on a printed circuit board.

The power supply requires a 12 volt supply for the transistors, and a more typical loop supply for the TTY machine. Be careful around those loop supplies, folks. They can deliver quite a kick if you lay your hand across the terminals.

See what happens when you ask a question? All kinds of information can flow your way. Check out the "RTTY Loop" Web site at [http://www2.ari.net/ajr/rtty/] for more goodies in and about the column; and send me your comments, questions, and suggestions at the above E-mail or snail-mail address. See you next month, on the RTTY Loop.

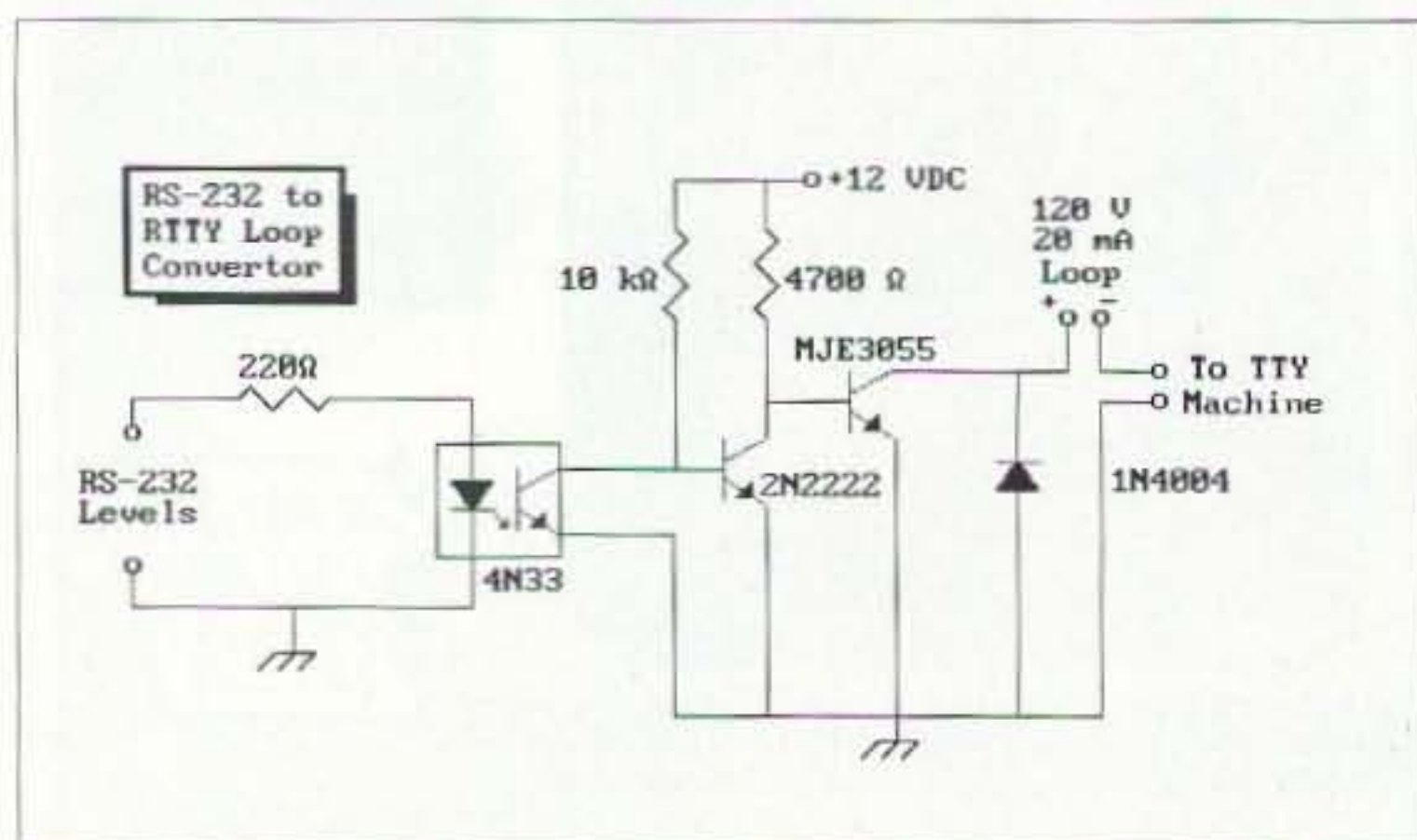

Fig. 2. RS-232 to TTY converter.

motorboat is out of the water much of the time in heavy seas. A motorboat will only give you the maximum that the engine can produce, while men seem to be able to exert superhuman effort when called on to do so.

He also told me that the skipper of his Coast Guard cutter told him in no uncertain terms that, even though he was the officer, that on this, his first rescue, the chief petty officer who was commanding the other boat party was the "real boss" and was to be obeyed.

If you want to read something about the Coast Guard today, then I highly recommend *The Perfect Storm*, which was until recently on the bestseller list. This book details the storm that combined a nor'easter, Hurricane Gloria and a third storm out of Canada over the Grand Banks. It produced waves over 100 feet high, with average wave heights on the order of 50 or 60 feet. In order to rescue first the crew of a sailing yacht, and then the crew of a small boat sent to rescue the yachtsmen, a "coastie" rescue swimmer went into those 60-foot waves not once but three times. When I finished reading that passage I had to ask,

"Where the hell do we get such men?"

The US Coast Guard has ended its manned radio watch on 500 kHz—the last CW frequency. Automatic signaling alarms have replaced the "fist" of the Morse code radio operator. Satellites and automatic navigation beacons have long since replaced the Morse code as the primary means of communications, and now, the only means of communications: Morse is essentially gone for emergency purposes (tuning between 400 and 510 kHz will still show some CW communications activity, however).

On April 1, 1995, with a number of local radiomen gathered for the end event at the Coast Guard radio station at Chesapeake, Virginia, the "big switch" was thrown for the last time at 7:19 p.m. EST with the end of the last Morse message transmission. Similar shut-offs occurred at Coast Guard radio stations at Boston, Miami, New Orleans, San Francisco, Honolulu, and Kodiak (Alaska). As recently as five years ago, Morse code messages flowed into the Chesapeake station at rates of up to 10,000 per month,

but in the last year of operation the total dwindled to a mere 500 a month. Only two SOS calls were received in all of 1994, and none occurred in 1995, according to a story in *The Washington Post*.

Some CW lore

A certain lore is found among CW operators. The "fist" (how one sends dots and dashes) is very personal, and many operators could identify friends simply by their fist. Indeed, the original definition of a "lid" (bad operator) was someone whose fist was unreadable.

One could also tell the fist difference between "straight key" operators, who used the traditional telegraph key, and "bug" operators who used a semiautomatic "speed key." The latter were operated using a

side-swiping motion, with the dash manually formed by pushing the paddle to the left, and the dots were formed by pushing the paddle to the right. The dots were "semiautomatic" because they were formed by a vibrating action of the extended arm repeatedly striking a second set of contacts together. In latter years, automatic electronic keyers became popular. Those instruments automatically formed dots and dashes of the correct lengths, and kind of destroyed the notion of a "personal fist" (but made the CW bands a heckuva lot more readable—there were lots of lids on the CW ham bands, and not all of them went to SSB!).

By the way, the world's record for CW reception is 73.5 words per minute (wpm). The record has not been beaten since it was set in 1939 by Chief Petty

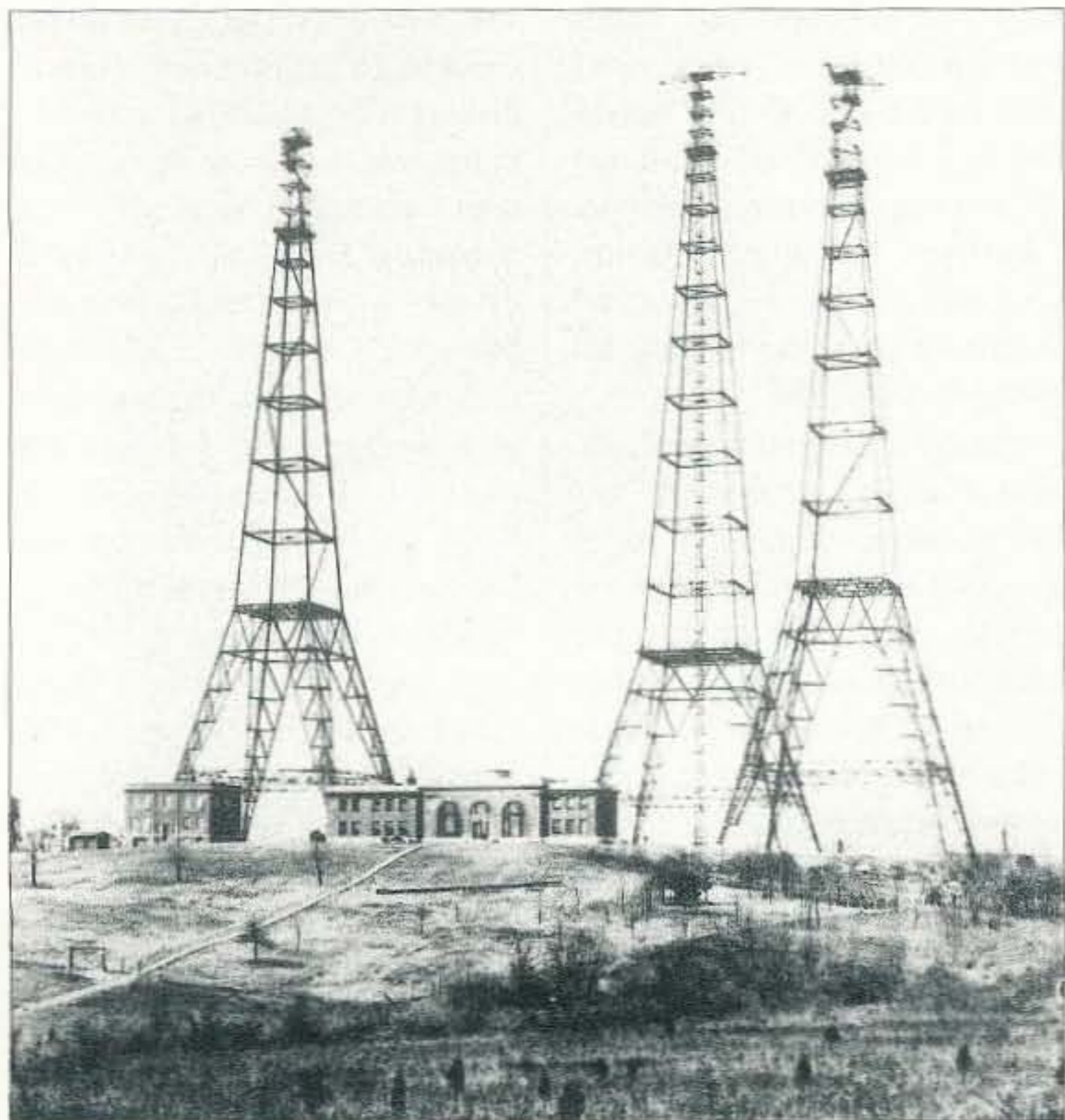

Photo A. The triple towers of the US Navy's first radio station.

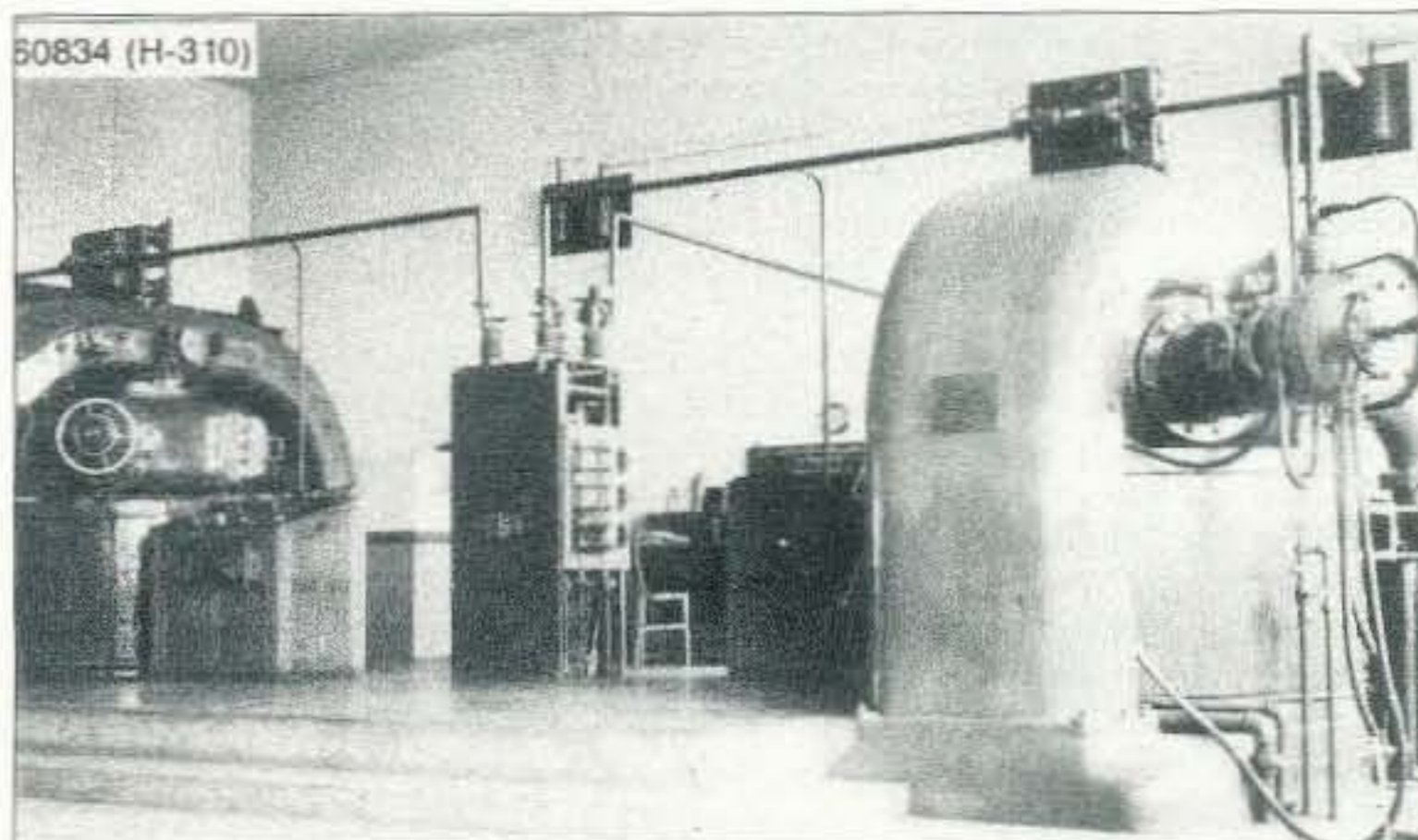
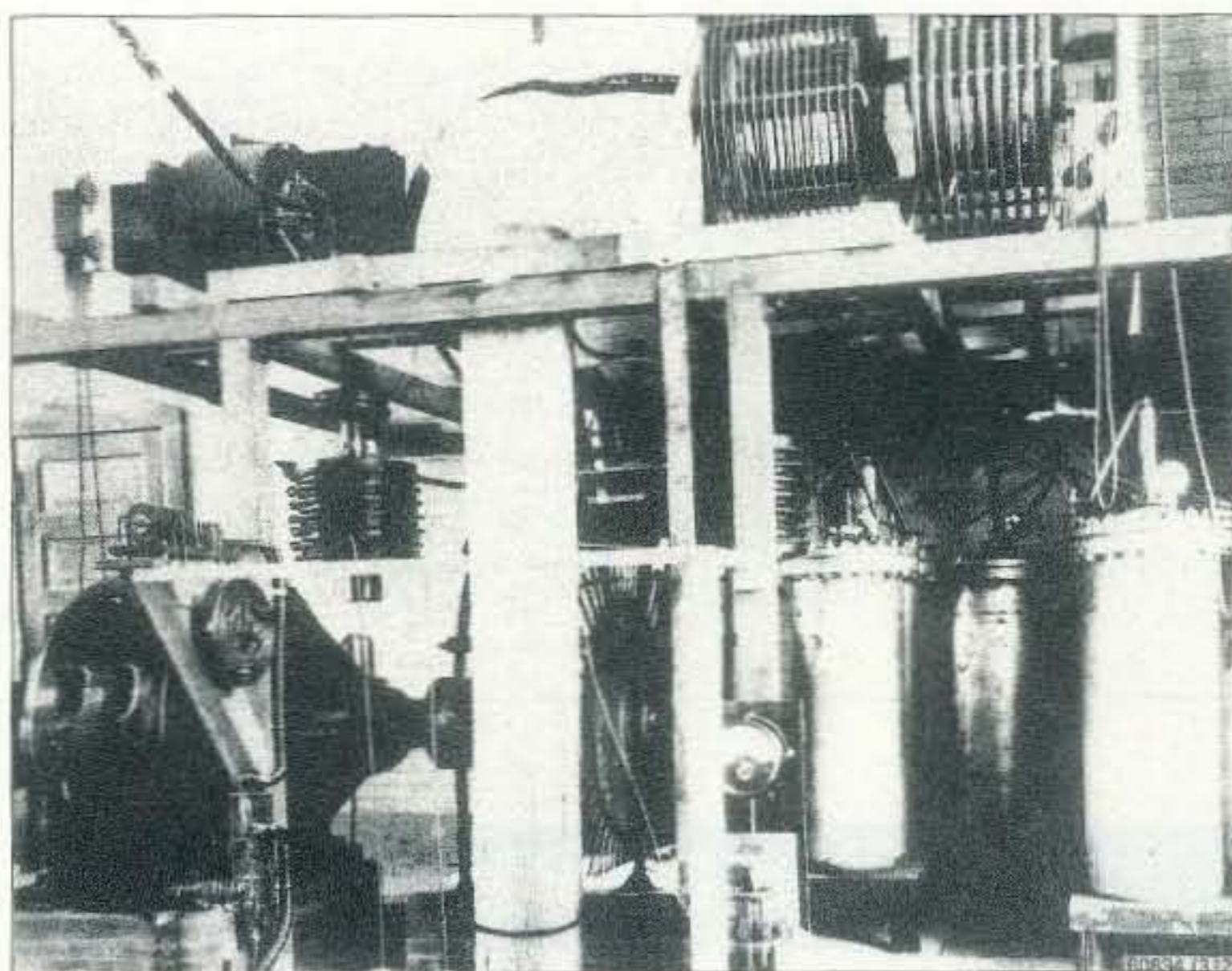

Photo B, Photo C. The NAA transmitters. All photos provided by Naval Research Laboratory.

Officer Ted McElroy, at a contest held at Louisville, KY.

Having grown up around CW operators, and using mostly CW myself even today, I heard a lot of stories about different types of operators. The maritime operators on the high seas were the largest class, but the maritime operators on the Great Lakes had a special "fist" style that marked them apart from the ocean-going operators: the Great Lakes Swing. They sent dashes at the correct length for the speed involved, but dots were sent at a length appropriate for speeds three times faster; hence, the "swing" aspect.

Another distinct class were the aviation CW operators. When radios were first placed in aircraft, the longest range system was CW, rather than voice. The practice of carrying a radio operator aboard aircraft persisted into the late 1940s. World War II movies of American bombers often show the radio operators aboard B-17s with their radio sets. Although equipped with an amplitude modulator for voice, the main mode was CW. As a young ham in the 1950s, we could still buy ARC-5 receivers and transmitters, as well as ART-13 transmitters from World War II military aircraft.

Civilian airline operators developed fists that came to be called the "airline bee-bop." I don't know the details, but would love to hear from some former airline operator who does.

Other operators used a constant dot-dash length "fist" (called the Farnsworth system). They sent out the dots and dashes that make up the individual letters at a speed of, say, 25 words per minute, even if the speed of the message was slower. The space between characters was varied to account for the speed differences.

The golden era

The "golden era" of radio, before World War II, was a time of immense progress in radio design. And the shortwaves, which we use today with ease, were a deep mystery. Radio traffic was carried out on frequencies whose wavelengths were 200 meters or longer (which correspond to the top end of the AM broadcast band and lower). In 1919, the cynical commercial interests convinced the Commerce Department (before the FCC was created) to put ham operators on "200 meters and below" (the shortwaves), because "They'll never get out of their backyards with that ..."

Little did they know—ionospheric propagation had not been discovered by that time!

I can recall an older ham (Charlie) who came to our radio club and told of his experiences on the bands in 1921. He lived in central Virginia, and attended engineering school at the University of Virginia. When he left home for his freshman year, he had a three-wire "flattop array" that ran several hundred feet across his father's farm. When he came home for Thanksgiving, the antenna had been replaced by a 40-meter dipole. Not wanting to confront his younger brother in front of the family, he waited until after dinner. "We're using 40 meters, now," was the excuse offered by his brother. Warming up the transmitter and receiver, he tapped out a "CQ, CQ, CQ" only to be answered by a ham with a callsign "8XX." In those days, there were no national callsign indicators (like the "K" in my callsign, K4IPV), but they did have call districts. The "8" indicated West Virginia or possibly Ohio, especially given my friend's location in Virginia. He asked 8XX to relay a message to his college roommate, who lived near Dayton, Ohio. The other ham replied, "Sure, OM, but you're probably in a better position than I am ... because I am FRENCH 8XX." Charlie darn near croaked: He'd just discovered ionospheric propagation.

Perhaps in the near future we'll discuss the vagaries and benefits of ionospheric propagation in this column.

Perhaps the crowning achievement of radio's golden era was the invention of radar ("radio detection and ranging") by the British, just in time for the Battle of Britain at the very beginning of World War II. Radar had a rough beginning because many prominent radio scientists of that day didn't believe that enough backscatter signal would be reflected from aircraft to be received with the equipment of that day. But Sir Watson-Watt and his engineers persisted, and created the Chain Home radar

system just in time to see German bombers coming over the horizon. The system operated in the HF shortwave bands, rather than in the radar bands.

The first combat use of the radar was not exactly an auspicious occasion. According to a story told in a history of radar (*Race on the Edge of Time*) and other sources, the first use was called the "Battle of Barking Creek." It seems that a French flier escaped from his German-occupied country in a small plane. It was picked up on the Chain Home radar, so a flight of Hurricane fighters was scrambled to intercept the incoming "German." Unfortunately, the first antennas used were dipoles, which are bidirectional. The radar scope, however, was a primitive "A-scan" type that showed signal amplitude versus time. When the Hurricanes lifted off, they were behind the coastal radar in England. They showed up on the A-scan scope as a series of blips behind the "German's" leading blip. To the operators, it looked like the standard *Luftwaffe* formation of a pathfinder out front and a squadron of bombers following. So the Royal Air Force scrambled a flight of Spitfires to intercept what they thought were Germans. The Chain Home radar had a height-finding capability (using sea bounce multipath) with an accuracy of 600 feet. The Spitfires climbed above the Hurricanes, and then dived on them, machine-guns blazing. They never saw the red, white, and blue roundels on the wings, but did note the squared-off canopies (which were similar to those on the Messerschmitts). When cooler heads analyzed the incident, they noted some strange coincidences, and investigated: The Hurricanes were shot down by the Spitfires! That's when the engineers decided to add reflectors behind the dipoles, making a two-element directional beam antenna that wouldn't see land-side aircraft as if they were out over the English Channel! Sighhhhhhhhh. 73

Radio Bookshop

Phone 800-274-7373 or 603-924-0058, FAX 603-924-8613, or see order form on page 88 for ordering information.

Wayne's Five Buck Books & Stuff:

Boilerplate. 45 of Wayne's ham oriented editorials. Great material for club newsletter editors who are always short of interesting items for filler.

Submarine Adventures. Wayne's WWII adventures on the USS Drum SS-228, now on display in Mobile, Alabama.

Wayne's Caribbean Adventures. Scuba diving and hamming all through the Caribbean. 11 islands in 21 days on one trip? You bet, and you can't beat the price either.

Wayne & Sherry's Travel Diaries. Cheapskate traveling to Russia, Europe, and so on. Now, how did Wayne and Sherry fly first class to Munich, drive to Vienna, Krakow, Prague, and back to Munich, staying at excellent hotels and eating up a storm, all for under \$1,000?

Cold Fusion Journal - Issue #20. Read the latest scoop on cold fusion in this whopping 92-page sample issue. Cold fusion dead? No way!

One-Hour CW Course. How anyone can pass the 5 wpm code test with less than one hour of study. This also explains the simplest system for learning the code at 13- and 20-per ever discovered. Or, do it the old fashioned (ARRL) hard way and suffer. Your choice.

Other, Slightly More Expensive Stuff:

Pure Silver Wire for making those miracle silver colloids. Two 3" lengths of #10 99.999 pure silver wire \$15. Should last for years.

Bioelectrifier Handbook. Background, circuits, uses, etc. \$10.

QRX

continued from page 49

not finished construction of the service module where astronauts will live.

The launch was already eight months behind schedule before the latest unexpected change, meaning that the first crew would not arrive until late spring or early summer of 1999. Ham radio is still slated to be an integral part of the station as soon as the first astronauts arrive.

With ISS being delayed again, and few shuttle flights scheduled to carry SAREX gear, don't look for a lot of live ham radio from space except for operations from the aging *Mir* spacecraft.

Meanwhile, NASA has two new astro-hams. They are astronauts Winston Scott and Daniel Tani. Scott is KD5DXD, and Tani is KD5DXE.

Via ARRL, NASA, and *Newsline*, Bill Pasternak WA6ITF, editor.

Got a New Callsign?

Changing your callsign entails a bit of house-keeping. For instance, if you have a new vanity callsign and are active on packet, you should alert the sysop of your packet BBS of your new on-air identity. You'll also need to change the callsign in your packet TNC firmware and in your ham radio software (communication and logging software, for example). If your callsign is also part of your E-mail address, you'll want to update that with your Internet service provider, as well. ARRL field appointees should alert section managers, too. A new callsign also can mean a new club or ARRL field appointment badge, new QSL cards, new business cards (if they carry your callsign or packet or E-mail address) and maybe a new license plate for the car.

The list goes on and on. One thing you *won't* have to do is alert ARRL HQ. ARRL members' callsigns are automatically changed as the FCC database is updated.

From March 1998's *Modulator*, newsletter of the Ft. Myers ARC, Earl Spencer K4FQU, editor.

Are You Burnt Out?

Sure, amateur radio is a great hobby, and the public service that we provide is invaluable. But at the same time, it's possible to get too involved and burn out or overstress yourself. As an aid to determining whether you are a candidate for burnout, rate yourself on a 0-5 scale on the following questions (0 = never, 5 = always), then add up your score and see where you stand at the end of the test.

1. Do you tire more easily? Feel fatigued rather than energetic?

2. Are other club members annoying you by telling you, "You don't look so good lately?"

3. Does sex seem like more trouble than it's worth?

4. Are you increasingly forgetting net schedules, autopatch codes, and newsletter deadlines?

5. Is your Morse code proficiency dropping?

6. Is joy elusive?

7. Do you find that you use the 2 m repeater less these days because you have very little to say to people?

8. Have you held the same office in your radio club for more than two years?

9. Are you afraid to speak up at club meetings?

10. When you do speak up, are you increasingly irritable? More short-tempered? More disappointed in other people?

11. Are you seeing close friends and family members less frequently?

12. Have you stopped looking forward to Field Days?

13. Are you using E-mail rather than packet to get messages to other club members?

14. Are you often invaded by a sadness you can't explain?

15. Have you lost the desire to attend every hamfest within a 150-mile radius?

16. Has each of your last three Sweepstakes scores been lower than the previous year's score?

17. Are you increasingly disenchanted and cynical? (This question does not apply if you are a repeater trustee—that's a requirement for the job.)

18. Do you find yourself stopping at Taco Bell® more often than at Radio Shack®?

19. Do you have an unsatisfactory relationship with other club members?

20. Do you experience feelings that the FCC is actually doing an excellent job?

Now add up your scores and see what you should do about your total:

0-20: You don't have a problem. Run for club president. Convince your spouse to become licensed. Convert your dining room into a ham shack. Plan a DXpedition.

21-40: You show a little stress but this is normal. Are you participating in enough club activities? Make sure all your vehicles have HF capability. Add 40 feet to your tower's height.

41-60: You are a candidate for stress burnout. If a club officer, don't run for reelection. If a newsletter editor, look for a replacement. Join a health club. Stop trying to increase your Morse code speed.

61-80: You are significantly overstressed. Skip the next three club meetings. Take your spouse to a romantic B&B and leave the HT at home. Do not renew your ARRL membership. Sell 50% of your equipment.

81-100: I'm surprised that you can even hold a pencil with your stress level. Resign your club membership. Charter a flight to the Bahamas. Buy a CB radio. Take up bridge and bicycling as hobbies.

TNX to the May 1998 *Q-Fiver*, official newsletter of OH-KY-IN ARS, Susie Scott N8CGM, editor.

Brand New Old Ham

My wife and our kids try hard not to remind me

The days of my lean, trim physique are behind me.

Not "over the hill" but fast reaching the summit, My hairline recedes while I watch my waist plummet.

I've bags underneath each dimmed eye— My teeth aren't all there (but then neither am I!).

Cholesterol rises, but arches are falling— My "get up and go" is, well, constantly stalling. I'm not an "antique"—please, just call me a "classic"—

(Tho' I've heard some remark, "Why, he's almost Jurassic!")

So why's my face beaming as bright as it can? My very first contact just called me "Old Man"!

—Jim Knoop KB8SFL; lifted from *The Q-Fiver*, September 1997. They got it from *Worldradio* 12.94.

A Tale of Christmas Passed

An item from January 2nd's *The Sun*, a London newspaper, relates the tale of the lost cellular phone: Rachel Murray planned to surprise her roommate with a gift of a cell phone. She left the gift under the Christmas tree. Later she found only a pile of torn paper. She immediately suspected that friend Tony Dangerfield's bloodhound, Charlie, was the culprit.

Murray started a frantic search of the apartment. She found nothing, but figured that if the phone were turned on, she could dial the number and hope to hear it ringing. So Ms. Murray dialed, and heard muffled ringing coming from ... the sleeping dog's stomach.

At first she thought Charlie was lying on the phone, but then realized where it actually was. The dog was rushed to a veterinarian for treatment. The vet told Murray and Dangerfield to let nature take its course. Twenty-four hours later, Charlie was just fine. If you're wondering about the phone, it works just fine, too!

Continued on page 85

REPEATERS

6 m, 2 m & 440
ON YOUR FREQUENCY
tuned ready to go.
\$349.95 to \$609.90
depending on controller.

Controls: basic to autopatch/voice

Micro Computer Concepts

8849 Gum Tree Ave

New Port Richey, FL 34653

813-376-6575

<http://home1.gte.net/k4lk/mcc>

VISA, MC, Cks, CODs, PO

CIRCLE 160 ON READER SERVICE CARD

LETTERS

continued from page 7

screen will collect dust (you probably won't believe how much), and you'll want to remove it to clean it. Not cleaning it could lead to overheating your computer. Disassembling your computer several times a year is not good for it, or you. An externally mounted screen would be better, perhaps fastened into a frame with a hinge and thumbscrew for easy removal and cleaning.

Lastly, soldering capacitors across the input power leads is probably unnecessary. Most power supplies these days have RF suppression circuitry built right into the power cord connector socket. Computer switching power supplies would give off a lot of RF noise without them, and would never pass

FCC Class B ratings. Save this step for absolute last, if you have done everything else and still can't get the interference to go away.

Another thing Jim doesn't mention is the video cable. Most modern monitors have hefty ferrite chokes on the cables already, but it can't hurt to check. If there is a large plastic mass on your video cable, either molded in or snapped around it, that is the ferrite core.

If not, you may want to pick one up at Radio Shack™, or from your favorite electronic supplier.

Jim Kocsis WA9PYH, South Bend IN: Chris, I agree with you on each point. However, I think the wrist strap and motherboard connector issues were covered adequately. You brought up some very good

points that I did *not* cover—so, readers, please observe his additional precautions.

You apparently have had more experience with PC servicing than I. I'm going to observe these additional precautions next time I get my hands in a PC. Thanks for your additional suggestions, Chris!

Robert Beasley K6BJH. Regarding the item titled "The Old 73," in the QRX feature (April 73), Paul Valley has his facts somewhat askew. The name "Peacemaker" was not given to the Colt .44 single-action revolver. That appellation was accorded to the Colt single-action .45, also known as the 1873 army model. The .45 was designed specifically as the US Army official service revolver, but found great favor in

the civilian market, especially among lawmen and cattle drovers in the Old West.

There was, however, one problem. The aforementioned also carried the Winchester 73 rifle or saddle carbine chambered for the .44-40 cartridge. This meant that two different types of ammunition had to be carried, which was a little unhandy on the trail or in a mounted posse. While the two cartridges were very similar, they were not interchangeable. At the behest of those carrying the two different types of weapons, Colt introduced in 1878 the single-action revolver chambered to accept the .44-40 cartridge for the civilian market, and it was given the name "Frontier Model." Now the cowpunchers and lawmen could carry one cartridge for both their carbines and handguns. 73

SPECIAL EVENTS

continued from page 41

will be mostly on 7085 and 14085. Operators of the club will man the station from 8 a.m.—4 p.m. daily. A special 8 x 10 certificate is offered for contacts with proper QSLs. QSL to Wayne Pennings WD9FLJ, 913 N. Mason, Appleton WI 54914 USA.

AUG 15-17

ENGLEWOOD, NJ The Englewood ARA, Inc. invites all amateurs the world over to take part in the 39th Annual New Jersey QSO Party. For further details, contact as soon as possible, Englewood Amateur Radio Association, Inc., P.O. Box 528, Englewood NJ 07631-0528 USA. Send a #10 size SASE for a reply.

The contest will be held from 2000 UTC Saturday, August 15th to 0700 UTC Sunday, August 16th, and from 1300 UTC Sunday, August 16th to 0200 UTC Monday, August 17th. Phone and CW are considered the same contest. General call is "CQ New Jersey" or "CQ NJ." New Jersey stations identify themselves by signing "DE NJ" on CW, and "New Jersey calling" on phone. Frequencies:

1810, 3535, 3950, 7035, 7135, 7235, 14035, 14285, 21100, 21355, 28100, 28400, 50-50.5, and 144-146. The Englewood ARA suggests phone activity on the even hours; 15/10 meters on the odd hours (1500-2100 UTC); and 160 meters at 0500 UTC. Logs must show the UTC date and time, QSO exchange, band and emission, and be received not later than Sept. 12th, 1998. 73

NEVER SAY DIE

continued from page 5

of abductees who have been hypnotically debriefed tell stories of Martians coming to Earth about 65 million years ago when a planet, which comes through our solar system every 65 million years, wiped out Mars' atmosphere and did enough damage to Earth to extinct the dinosaurs. The ETs tell a story of what's left of the Martians living underground or in domed cities. Their ships (UFOs) bring needed supplies from Earth. Since they're millions of years ahead of us in technology their presence here is only detectable to us when they want it to be.

Where does truth lie? Time may tell, but in the interim there is a lot of data to support Jim Marrs' conclusions. He ties in the crop circles, cattle mutilations, and other such anomalies. If you've read much about those you know that we have no way to duplicate them with our current technology. And the more facts you get, the stranger these things are.

Dried Brains

You probably missed the PBS show on the brain. I taped it and watched it at my convenience while eating breakfast. One thing they mentioned

was that our brains tend to shrink as we get older. They didn't know why. Bet I do.

The rest of you are a lot like me in that you've been dehydrating your body for umpteen years. Sure, you've heard about the body being 90% water and you may even have heard that the brain is more like 95% water, but that hasn't made any dent in your inability to put two and two together. If your body is 90% water, shouldn't you be putting in nine times more water than food? Which may tie in loosely with the news flash from scientists that our bodies need at least eight glasses of water a day. That's a gallon.

So we go on for years gradually dehydrating our bodies. And brains. Our cells gradually shrink, which in no way is healthy for them. Ditto the cells in our brains.

The moral is: drink more like 12 glasses of water a day so your cells can gradually rehydrate themselves. They'll work better. Also, your immune system will tend not to be so depressed and it'll be able to fight off the stuff that's "going around."

One more thing. Please distill your water so your body won't have to deal with chlorine, fluorides, lead, dioxin, and the other great stuff our city or town water supplies

provide along with the water. At 50¢ a gallon for distilled water, maybe it's time to buy a still.

Sure, your body can limp along with you dehydrating it — with you dumping poisons into it — and malnourishing it — but eventually you're going to croak, probably after a long, expensive, painful illness. It's your choice.

Another Drug Scam

If you are careless enough in maintaining your body to get sick, the drug industry is waiting for you in ever more lucrative ways. Not only do they essentially control the AMA and our doctors, our hospitals, the FDA, WHO, NIH, and on through the alphabet; now they've got a new wrinkle to get your bucks.

The insurance companies own the HMOs, which work in hand with the drug companies. Pharmaceutical Benefit Management (PBM) companies were set up to control the cost of prescription drugs for HMOs. The drug companies quickly figured out that if they bought the PBMs they could dictate that doctors prescribe *their* drugs instead of those of their competitors, all under the pretense of cost management.

Eli Lilly, Merck, and Smith-Kline Beecham, three of the largest drug companies in the world, have bought the three largest PBM companies for \$10 billion, creating a monopoly.

The PBMs have been crossing out the drugs prescribed by doctors and substituting completely different drugs, and all this without the knowledge of the doctors. Pharmacists are awarded up to \$12 for every prescription the druggist "persuades" a doctor to change to that of the controlling drug company.

Make sure that if your doctor prescribes a certain drug, that that's what you get from the druggist.

Better yet, change your destructive behavior so you won't need to get involved with this whole crooked mess.

Mother Instinct

An experiment a few years ago with monkeys made it

clear how important close contact between a mother and her baby are for at least the first year. In the experiment baby monkeys were separated from their mothers a few hours after birth and surrogate mothers were provided — made of heavy wire or wood, covered with soft terry cloth, with a nipple for feeding.

Later in life these monkeys clutched themselves and rocked constantly back and forth and were unable to participate in sex. The females, when they did have babies, either ignored them or abused and often killed them.

This is something mothers who want to continue going to work as soon as possible after giving birth should consider. There seems to be a very good possibility that being separated from the baby, while it is difficult for the mother, can have irreparable consequences for the baby. There's much to be said for mothers having a home business, at least for the first year, so they can be with their babies full-time.

Social Security Solution

One of the recent guests on the Art Bell show was Dolores Cannon, who claimed to have been in contact with Nostradamus. That reminded me of the *National Enquirer*. Sure.

But Dolores' story made some sense, so I called and talked with her, and she sent me copies of her first two books of the interpretations of Nostradamus' famous quatrains, as explained to her by the man himself. But let me start more at the beginning.

Dolores was regressing people to past lives, mostly as a way to help them resolve present life problems. I could understand that since that's what I found I had to do when I was doing my psychological counseling a few years back. Often, when I'd be asking the patient to go to the first time some situation had occurred they would flip into a past life experience. At first I didn't know how real these memories were, but my aim was to

resolve their problems so they could live happier and more healthy lives by deconditioning the traumas, either in their present lives, or in past lives, which were affecting them in this life.

Of course my curiosity pushed me to find out more about all this, so I began to explore these past lives. I found them easily available from every patient, and available in full living color and sound. I wish now that I'd taken more time to research past lives.

Dolores one day had a person exploring a past life in which she was Dyonisis, a student of Nostradamus. Naturally she asked Dyonisis to tell her about the great man, who lived in the 1500s. After a couple of sessions gathering data on Nostradamus, he suddenly broke in to say that he was aware that Dolores was asking questions about him. After some discussion, Nostradamus said that he would like to explain each of his nearly 1000 quatrains.

The end result is a four-volume series of books, going into each of the quatrains in detail, and explaining how those referring to past history have come to pass as he predicted. But for me, his predictions of events soon to come were even more interesting.

Nostradamus had to hide his predictions in his four-line poems so as not to get burnt at the stake for witchcraft, which was the preferred treatment at the time for anyone doing any serious seering. Sear the seers. The result has been a series of translations from the old French (and Latin and Greek), all giving different interpretations of his predictions. His calling Hitler "Hister" was pretty close, considering he was looking ahead from 400 years ago. In retrospect, his predictions have been incredibly on target.

Okay, you want to know what the old guy saw for our future, right? Well, it isn't encouraging.

Like Noone in his *5/5/2000*, Nostradamus is predicting a pole shift, but in 2028. And, like Noone, he says that

it will be the crust of the Earth which will shift, not the whole Earth, as René predicts in his *Last Skeptic* book. The result of this will be all sorts of tectonic plate shifting and grinding, with earthquakes, volcanoes erupting, and the polar ice quickly melting. This will bring us tsunamis and unimaginable winds.

All of our port cities around the world will be destroyed and submerged. He estimated that only about 120 million people would survive, and that the shift would wipe out about 97.6% of us.

Nostradamus produced for Dolores' contacting person a map of what the world would look like after the shift. She drew a copy of the map, as well as she could remember it. But in order to get a better-detailed map Dolores got a new person to remote-view the future under hypnosis and draw what he saw there. His map and Nostradamus' map were almost identical.

If you're experienced in hypnosis you might try getting some people to remote-view 2028 and 2029 and find out what they see coming.

Nostradamus explained that all of the world's governments would fall. Our continents would be islands, with each being a separate duchy. The US map shows that about 75% of the country will be under water, with islands in northern New England, Pennsylvania/West Virginia/Ohio, eastern Washington/Oregon, some in Wisconsin and Minnesota, a big island covering parts of Nebraska/Iowa/Missouri/Oklahoma/Kansas; another covers parts of Colorado/New Mexico/Wyoming/Arizona.

This is even worse than Scallion's (K1BWC) map of the US in 2012, which is bad enough. But at least Nostradamus puts the catastrophe 30 years away. Whew!

With all phone lines and cables kaput, we hams, if we're still around, will be the main communications source. That's unless most of our global communications shift to

Continued on page 80

SAVE 47%!

on 12 months of 73

Only \$24.97

Call 800-274-7373

WANT TO LEARN CODE?

Morse Tutor Gold from G.G.T.E. is the answer for beginners and experts alike.

*Get the software the ARRL sells and uses to create practice and test tapes; and Morse Tutor Gold is approved for VE exams at all levels.

*Since 1987, GGTE has guided nearly 20,000 hams and prospective hams around the world through proven structured lessons and a variety of character, word and conversation drills. Straight forward menus make the process simple and fun.

*This program features easy and speedy self installation; random character drills with the characters you select; and you can create your own drills or import text files. You can type what you hear or copy by hand and see the results one line at a time. Pick the Farnsworth or the standard method; select the tone frequency most comfortable for you or select your code speed in tenths of a word per minute. For all DOS computers. You are always in command.

Certified by



Morse Tutor Gold uses your internal speaker or sound board. And, if you use a sound board Morse Tutor Gold supports volume control.

Sound Blaster and the Sound Blaster Compatibility Logo are trademarks of Creative Technology Ltd.



Available thru dealers, the ARRL, or send \$29.95 + \$4 S&H (CA residents add \$2.32 tax) to: GGTE, P.O. Box 3405, Dept. MS, Newport Beach, CA 92659 Specify 5 1/4 or 3 1/2 inch disk.

CIRCLE 193 ON READER SERVICE CARD

NEVER SAY DIE

continued from page 79

satellites, in which case we probably won't be needed.

If I'm still around, I'll be 106 at the time, so please don't figure on depending on me for much, even though my New Hampshire farm might just be in a survival area.

Look on the bright side: In 30 years we may finally get rid of our government, which seems to be doing us a lot more harm than good these days. No more IRS, FBI, CIA, FDA, NIH, DIA, ONI, and all the other alphabetical agencies that are costing us billions and doing very little, if any, good.

In a hundred years or so new polar ice caps will lower the oceans, giving us continents instead of islands. The new poles, according to Nostradamus, will be where Russia and South America are now. That'll put South Carolina on the new equator.

Nostradamus seems to suggest that the recent French atomic testing in the Pacific has unsettled the Pacific tectonic plate, causing more and more volcanoes under the ocean to erupt. This is warming the ocean, bringing us *El Niño* and

rain which is building the polar ice caps. These are off-center enough to eventually shift the poles.

The other continents apparently won't do much better — except Australia.

On the other hand, in *Mass Dreams of the Future* the catastrophe is pegged for July 1998. Happy Fourth of July!

Electrolytes

I love it when I find a book that tells me a bunch of things I'm already convinced are true. Get Gillian Martlew's *Electrolytes, the Spark of Life* for \$12 and you'll see much of what I've been writing about confirmed. Keep a highlighter handy. ISBN 0-9640539-0-x; Nature's Publishing, Box 380361, Murdock FL 33938, 941-426-1929, 1994, 95p.

If you have any reservations at all about how important trace minerals are to your health, and how badly they are missing from our food supply, this book will dispel them. It explains how we've poisoned our meat with hormones, our fruit and vegetables with pesticides, and our water with chlorine, fluorides and aluminum. We eat from aluminum pots, wrap our food in aluminum foil, rub on aluminum deodorants, drink from aluminum cans, and in general do everything we can to make sure a growing percentage of us turn into memoryless veggies in a nursing home by the time we're ready to collect our Social Security checks. Aluminum is also responsible for many cases of hyperactive children.

Senate document #264 in 1936 says, "Sick soils mean sick plants, sick animals and sick people." 60 years later the situation is far worse. The US now ranks at the same level as Third World countries with respect to health. And the \$1.5 trillion we spend annually has not prevented us from ranking 17th in the world in longevity, 19th in general health, and 23rd in infant survival, according to WHO figures.

We complain about kids killing kids, yet this is largely the result of really lousy nutrition, not a national moral problem. If you feed kids sugar and white flour you're going to get the same thing we see with rats fed the same diet: aggression, killing, and diminished brain development.

The University of Hawaii fed 80 pigs the standard high-sugar American diet and 68 developed heart disease.

The book is a great read; please do yourself (if not me) a favor and spring for the \$12. The bottom line is that you'll see that what I've discovered in my research and have been fruitlessly preaching is valid. No, no matter how serious the consequences for you and

LOOK! PERIPHEx®

High Capacity **BATTERIES** Memory Free
(800) 634-8132 NiMH!

SUPPLYING AMERICA'S BATTERIES FOR OVER 15 YEARS!

BUY DIRECT!!

\$38 SPECIAL! :

- BP-113 7.2v@1200mAh for ICOM
- PB-13S 7.2v@1200mAh for KENWOOD
- EBP-24S 7.2v@1200mAh for ALINCO
- EBP-34 4.8v@1200mAh for ALINCO

over here... →

Offer expires September 30, 1998.

Above are 1 year warranty NiCd batteries

Charge NiMH & NiCd!!



CALL NOW!!!

Universal Battery Charger!
NOW ONLY \$49.95 !!

+ FREE GIFT!
Policies & prices subject to change without notice

home.navisoft.com/periphex

E-Mail: periphex@aol.com

Amateur Radio * Cellular * Laptop Computer * Alarms

Advanced Battery Systems, Inc. * 300 Centre Street * Holbrook, MA 02343
(781) 767-5516 * Fax (781) 767-4599

CIRCLE 68 ON READER SERVICE CARD

your family, I don't have any delusions about you stopping smoking, stopping drinking beer and coffee, cutting out sugar and white flour (which have zero nutrition, but make up for it by lousing up everything else in your system), or your eating fresh vegetables and fruits.

We're At War!

The worst part is that each of us is so isolated from reality by our educational system and media that we don't even know it. With whom are we unknowingly at war? Most of the world, but in particular, the Asian countries.

There goes Wayne exaggerating again, right? You wish.

One of the fundamental differences between American (and European) educational systems and Asian is their concentration on studying the art of war. Chinese texts on this art (*Bing-Fa*) go back beyond 1200 BC. Have you invested in (and read) Lao Tsu's *The Art of War*? The lessons his book teaches are still basic, and are being applied every day by Asians in the current war: business. "*Shang chang ru zhan chang*." That translates to "The marketplace is the battlefield."

It is no accident that America is flooded with Toyota, Honda, Mazda, Nissan, Isuzu, Mitsubishi, Yamaha, Suzuki, Sony, Toshiba, Matsushita, etc., products. It is no accident that the pants I'm wearing, my shoes, socks and shirts say "Made in China." The Mac monitor I'm using to write this says NEC (Nippon Electric Company). My Mac was made in the USA, but the engine in my laser printer was made by Canon. My FAX machine and photo copier say "Canon." My telephone says "Made in China."

What's happened?

Part of the answer is attributable to lower wages in other countries, part to the lowered cost of transportation and communications, but a large part of our failure to compete with Japan and China (and Taiwan, Singapore and Hong Kong) lies in our school system, which fares badly in comparison with virtually every other developed country in the world. Even Albania!

Not only are our college graduates unable to compete with foreign graduates in the sciences and technology, but our graduates have almost zero understanding of business, and in particular the fierce competitiveness of businesses. Knowing how a Chinese general defeated a much larger army 2500 years ago can directly affect the success of a business today. Our military, our government, and our big businesses tend to try to win by might rather than by guile, and they're losing. When I suggested we

24 DIFFERENT PANELS
PRE-PUNCHED FOR POP-
ULAR CONNECTORS

MAKE TEST
FIXTURES QUICKLY!
PANELS ARE 0.040" RAW ALUMINUM

MODEL	W x D x H in.	PRICE
LAB-1	1.5 x 2.0 x 0.75	3.75
LAB-2	1.5 x 4.0 x 0.75	4.50
LAB-3	1.5 x 6.0 x 0.75	5.25
LAB-4	2.0 x 2.0 x 1.0	4.00
LAB-5	2.0 x 4.0 x 1.0	4.75
LAB-6	2.0 x 6.0 x 1.0	5.50
LAB-7	2.0 x 2.0 x 1.5	4.10
LAB-8	2.0 x 4.0 x 1.5	5.00
LAB-9	2.0 x 6.0 x 1.5	6.00

www.sescom.com

\$30.00 MINIMUM ORDER INCLUDES FREE SURFACE SHIPPING
(U.S., CANADA & MEXICO)

FREE ENCLOSURES CATALOG

SESCOM, INC. sescom@sescom.com
2100 WARD DR., HENDERSON, NV 89015 USA
ORDERS ONLY 800-634-3457
Tech Line 702-565-3993 (weekdays 8 am - 4 pm PST)
Office 702-565-3400 Fax 702-565-4828
FAX TOLL-FREE U.S. and Canada (Mexico dial 95 first) 800-551-2749
SESCOM, INC. is not responsible for inadvertent typographical errors; prices and specifications subject to change without notice.

CIRCLE 167 ON READER SERVICE CARD



Handheld Repeater Controller

Spectrum Electronic Products 10 introduces the world's first Control and programming, handheld repeater controller. hang and time-out timers, Digital Voice Operated held radios, the HRC-10 con- Digital Voice Operated Squelch (DVOS™), telemetry verts a single or dual-band tones, and private voice mail radio into a full featured slot. **\$299**

plex or duplex repeater system. Key features of the HRC- <http://www.spectrum-usa.com>
800-565-2788 - fax 408-335-9461

CIRCLE 69 ON READER SERVICE CARD

HF TO GO

The World's Smallest Full-Featured HF-SSB Radio



The SG-2020 is the perfect choice for base, backpacks or business trips.

- Weighing in at just 4.5 pounds, the SG-2020 features fully adjustable output power from 0 to 20 watts PEP.
- Low current requirements in receive mode allow practical battery pack operation.
- A bullet-proof front end provides third order intercept at better than +18dB, virtually eliminating adjacent channel interference.
- Designed with the portable user in mind, it comes complete with built-in, fully adjustable mode 'B' lambdaic keyer, VOGAD baseband speech processing and RF clipping.
- All this plus legendary SGC quality and reliability at an incredibly low price.

SG-2020

For complete details on the SG-2020, see your SGC dealer, or check out our website.

SGC

1-800-259-7331
www.sgcworld.com



P.O. Box 3526 Bellevue, WA 98009 USA
Phone: (425) 746-6310 Fax: (425) 746-6384 Email: sgc@sgcworld.com

CIRCLE 188 ON READER SERVICE CARD

Radio Bookshop

Phone 800-274-7373 or 603-924-0058. FAX 603-924-8613, or see order form on page 88 for ordering information.

1998 Collected Works

And work it was! The Never Say Die editorials for the first four months of 1998 have been reprinted in larger, more easily readable type for you doddering old-timers. 82 editorial segments, without the usual gerrymandering through the magazine, and complete with an index. 1998 Volume 1 of the Secret Guide to being Healthy, Happy, Wealthy, and Wise runs 92 pages and is available for a measly five Federal Reserve Notes, which are worth every bit of the paper they're printed on.

Gluttons for mental exercise can invest \$15 in the 1997 Collected Never Say Die Works, which runs to 240 pages. Just call Chris at 603-924-0058 with your Visa or MasterCard.

Say, while you're at it, have you started on the educational program your college should have provided, but didn't, by getting Wayne's Guide to Books You're Crazy if You Don't Read? It's only \$5 more. Wayne's sorted through thousands of books and reviewed the ones which will give you the best in straight dope on a wide variety of subjects. No, he/we don't sell the reviewed books. This is a reading guide, not a catalog.

There's a \$3 s/h charge on any total order, so the more books you buy at one time, the better you do. Maybe it's time to get the \$10 Bioelectrifier Handbook?

Wanted

Fun, easy-to-build projects for publication in 73.

For more info,
write to:

Joyce Sawtelle
73 Amateur Radio Today,
70 Route 202 North,
Peterborough NH 03458

try guile instead of brute force to win the war in Viet Nam, I couldn't get one member of Congress to pay any attention.

What I proposed was simple enough. Instead of spending \$650,000 for every one of the enemy we were killing (which we did), why not bribe them? Bribery is an age-old accepted business stratagem in Asia, so why not use it? I proposed issuing the enemy soldiers coming down the Ho Chi Minh Trail a booklet which would guarantee a plot of ground for them and their family, a small hut with electricity, food to last them until their crops made them self-sufficient, and a TV set. The cost of this bribery would be minuscule compared to what we were spending to kill them, and we wouldn't have lost 58,000 Americans in the fruitless war. How much were *they* worth?

I saw in New Caledonia how the French ended centuries of tribal warfare among the natives by putting in TV stations. The natives had to stop fighting and make enough money to buy a TV set. Then, their families, goaded by ads on TV, kept them busy working so they could buy the advertised products.

In Yugoslavia I saw that people would work for years to get enough to buy a car. So why not set up a factory in Viet Nam to manufacture the most basic of cars? Like the old French Deux Cheveaux or even a go-kart.

Singapore was rescued from terrible poverty by a UN team which did a study of the raw materials and markets within easy shipping distance. They then went to Europe and got investors to build the factories and high-rise apartments for the workers to make the products. A similar study of the Viet Nam resources and nearby markets could have jump-started their economy, too.

But dissuading our military or our government from using brute force was impossible. Wrong mindset — the result of lousy educations.

Even our business schools are not teaching students what they're going to need to know to be successful in business. As an overseer of the Rensselaer School of Management I studied the curriculum carefully and found it, as a businessman and entrepreneur, pathetic. I tried to get the dean of the school to offer some of the courses I felt were badly needed by the students, but bringing about changes in the minds of a college faculty has defeated better people than I. I failed. I hired some of the school's graduates, but I found them both ill-equipped for working in a small business and unwilling to even learn. I failed there, too.

Until we make some major changes in our school system I believe that America is going to continue to lose in business. The car market is dominated by the

Japanese. The music market is dominated by foreign-owned companies. Over 95% of all music sales in the world come from six companies, five of which are foreign-owned. Now the movie industry is being gradually taken over, and so it goes.

Business is war. The Japanese lost World War II, but they're making one heck of a comeback in the global business war. And we're sitting here, fat, dumb and moderately happy, while Japan and now China are eating our lunch, and looking forward to a big dinner.

That's the problem. What's the solution? I propose that some business colleges smarten up and start teaching the art of war — as well as courses which are of practical use to their graduates. I've proposed two ways of making sure that the courses are relevant — one by polling graduates as to the value of the courses they've taken and the other by having students work half time at local high-tech businesses while they are in school.

Psi-Fi

The Skeptical Enquirer has zero credibility with me (and many others) due to their pathological skepticism. Telepathy doesn't exist, nor clairvoyance, precognition, and so on, for them. And this despite endless scientific studies which have confirmed the existence of these abilities.

For instance, in the field of precognition, 309 studies reported in articles over a 50-year period were examined and the odds that the results did not show precognition came out to be one in ten million, billion, billion. That sort of ruled out chance as an explanation for the study results. But what about failed or other unpublished studies? There would have had to have been over 14,000 such studies to even the odds.

That's almost enough to get us seriously wondering about time. How can almost everyone see ahead in time if encouraged to do so? And some people with amazing accuracy?

How about our ability to influence matter? Psychokinesis? A review of 832 studies gave odds of over one trillion to one that people were able to influence the throwing of dice. And it didn't seem to matter how far they were away, or even if separated in time. Hey, what's going on here?

The only convincing explanation for a disbelief in psi is ignorance.

Serendipity

Blame reader Stowe for this. He asked me about how American Mensa got started. Well, I was there, and if you doubt it, the next time you're going to Vienna I'll put you in touch with the

chap who triggered the whole thing. He, too, has dropped out of Mensa. Well, I got bored with the New Hampshire Mensa group doing nothing. They don't even have monthly meetings with interesting speakers.

Anyway, one day, back in 1960, I read an article in *The Village Voice* about this high-IQ club in England. In college they tested what was left of my brain after my four years in the Navy and said I have a high IQ. Well, I knew *something* was wrong, and that explained it. So when I read about Mensa I sent away for a membership application. They sent that and a quiz. Soon I had a membership card. Wow!

Then, a couple months later, I got a phone call from Peter Sturgeon, asking if I'd be interested in helping him get an American Mensa group started. I was familiar with his brother Ted, a writer who'd done a book (*I Libertine*) with my friend Jean Shepherd K2ORS. I taught Jean how to water ski with my Chris Craft out on Jamaica Bay, where we used to go on picnics.

Four of us showed up for the first meeting at Peter's apartment in downtown Brooklyn. Since I had duplicating and addressing machines, I was elected as the first secretary of American Mensa. The next two meetings were at my house in Brooklyn. I served coffee and doughnuts. Well, I didn't know any better, probably like you.

I carried on as secretary until I moved to New Hampshire in 1962 and became W2NSD/1. I was the Local Secretary for NH Mensa for the next 10 years or so.

I kept all the old newsletters and meeting notices I wrote and sent out for a few years. I contacted the Mensa historian, but he wasn't interested, so I finally threw all that stuff out around 1975, when I was starting *Byte* and needed more space for people to work.

It seemed to me that Mensa offered an opportunity for high-IQ people not to just get together and revel in their fabulous intelligence, all try-

ing to one-up the other, but to pool their mighty brains and help businesses and our government to solve problems.

Alas, with so few exceptions that I'm not aware of them, the Mensa members I've met, and I've met a lot of them, have turned out to be losers. Few have much money. Few have accomplished anything notable in life. Few have made any effort to provide their brains with information. You know, like reading something more than a few novels. It's like having a whiz of a computer and then not giving it any data with which to work. Phooey.

Success in life, I've found, has little to do with IQ, or even education. It has everything to do with motivation and the ability to stick to something. That's the secret that Ray Kroc (McDonald's®) explained in his book. And Napoleon Hill in his.

You know people who never get around to finishing anything. They leave piles of unfinished projects in their wake. In the end they have little or less to show for their having been here on Earth.

Children's Suicide

I see where they are fussing about kids committing suicide. If "they" would do some homework instead of hand-wringing, they'd know why this activity has been growing.

A couple of years ago the University of New Hampshire did a survey which showed the close correlation between childhood spanking and later suicide. That didn't surprise me. My father started early with the razor strop or the hair brush. I remember when I was about three and ate some of the doughnuts he'd made without asking. After that we never really had a father-son relationship. I knew that if I made him angry I could get hurt. Really hurt! What I didn't know was what would trigger his anger. Of course he was an alcoholic, and that helped make it a hair-trigger anger.

So I spent my teens being depressed and thinking of

Radio Bookshop

Phone 800-274-7373 or 603-924-0058, FAX 603-924-8613, or see order form on page 88 for ordering information.

Code Tapes

73T05 **Genesis 5 wpm code tape** This beginning tape takes you through the 26 letters, 10 numbers and necessary punctuation complete with practice every step of the way. \$7.00
73T06 **The Stickler 6 wpm code tape** This is the practice tape for those who survived the 5 wpm tape and it is also the tape for the Novice and Technician licenses. It is comprised of one solid hour of code. Characters are sent at 13 wpm and spaced at 5 wpm \$7.00
73T13 **Back Breaker 13 wpm code tape** Code groups again at a brisk 13+ wpm so you'll be really at ease when you sit down in front of a steely-eyed volunteer examiner who starts sending you plain language code at only 13 per. \$7.00
73T20 **Courageous 20+ wpm code tape** Go for the Extra class license. \$5.95
73T25 **Mind Boggler 25+ wpm code tape** \$7.00

suicide. I know how it feels to be so depressed that you don't care if it ever gets better. The break came for me when a new kind of mental repair system came along when I was 28, one which did in minutes what psychiatry did in weeks and psychoanalysis did in years. I quit a very promising radio broadcasting job in Florida and went to a New Jersey research institute to learn more about this amazing system. We students worked on each other and in a few weeks the painful memories of my many childhood beatings had been removed and, for the first time in years, I was completely free from depression. For the first time I became aware of myself as me. I found that I'd taken refuge in being my mother as much as I could. For the first time I understood what people mean when they say that they feel a oneness with the whole world.

I could understand about plants communicating with people, and how our cells can stay in communication with each other, no matter how far separated.

A recent *Newsweek* report said that 70% of Americans

believe that spanking children is okay. Well, it is if you aren't going to mind them killing themselves later on. And I'll bet you can exacerbate the problem by giving them a high-sugar diet. You know, cold cereal, boxed orange juice, coffee, Danish or toast and jam for breakfast. Burger and fries for lunch, and so on. Maybe peanut butter and jelly sandwiches in the afternoon.

If my mother had fed me that stuff I doubt I would have made it out of my teens. My best friend in high school stuck a gun in his mouth and blew his brains out. His parents believed in punishment.

I don't think you'll find any animal trainers any more who use pain or punishment in their work. They use love and positive reinforcement. Maybe you saw the PBS show about the "horse whisperer" who is able to train a wild horse to a saddle in minutes just by understanding the horse. No threats. No pain. Only positive reinforcement. The old days of Clyde Beatty, the lion and tiger "trainer" with the whip and the chair, have been replaced by Siegfried and Roy,

A GREAT gift idea for yourself, your ham friend(s), or your child's school library

is a subscription to 73 Magazine ... only \$24.97!
Call 800-274-7373 or write to 70 Route 202 North,
Peterborough NH 03458

If you're a No-Code Tech, and you're having fun operating, tell us about it! Other No-Code Techs will enjoy reading about your adventures in ham radio—and we'll pay you for your articles. Yes, lots of nice clear photos, please. Call Joyce Sawtelle at 800-274-7373 to get a copy of "How to Write for 73 Magazine."

who sleep with their tigers. How can we go about getting this message through to the 70% of Americans who are still taking out their anger and frustration on their children by punishing them?

El Niño II

If you haven't been listening to the Art Bell show (W6OBB) you missed his recent interview with Sam Dale, a chap down in Australia who called the last *El Niño* months before any of the weather people. He called it and predicted what the results would be: heavy rains on our West Coast and tornadoes in the South and East.

Sam looks over the ocean temperatures and sees how their changing patterns have changed the worldwide weather.

Now, the really bad news. Sam says that our last *El Niño* was a baby compared with the one that's now brewing. He predicts that things will be much, much worse this next time around. For us hams this means that our emergency communications are going to be needed even more. So get your emergency gear into top working order. Get your emergency nets organized. Have your repeaters set up with emergency power. Be prepared to coordinate with your local police, fire, and other emergency services.

The rains have flooded the western states and made the Nevada desert bloom for the first time in years. The record tornadoes in the South have proven the need for amateur radio as phone systems have been wiped out and cellular phone systems too jammed to use.

Is there any connection between this warming of the Pacific Ocean and the reported calving of 75 miles of the Ross Ice Shelf in Antarctica? Well, if you take a good look at your world globe you'll see that the Ross Shelf is right next to the Pacific Ocean. That's hardly just a coincidence.

The ice shelf breaking off and melting won't raise the ocean levels because it was floating anyway, but once it's gone we could start seeing the flow of the Antarctic glaciers into the warm Pacific Ocean and that *will* raise the sea level. Oops, there goes New York, London, Tokyo, and a bunch of other ocean port cities. Hey, I'm going to be able to charge a premium for survival lots on my farm, which is at 1000 feet, for refugee New Yorkers and Bostonians.

So, mind the Boy Scouts' motto, and start making plans, at least for the soon-coming weather changes.

Antarctic Rocks

René mentioned in his book that the 800 pounds of rocks supposedly brought back from the moon were actually from Antarctica. Thus I was interested when I got a letter from a reader who said he'd shipped 800 pounds of Antarctic rocks back to NASA at about that time.

On the Art Bell radio show a few nights ago I was discussing my disbelief that our astronauts actually went to the moon and I mentioned the rock coincidence. Art couldn't believe that there could possibly be a coverup of that magnitude. Just not possible. They couldn't lie to us about something as big as that! He asked if I'd put him in touch with the guy who'd sent the rocks back. I said sure, but won-

dered if I could find the letter. No, I'm not perfectly organized.

A little later a chap called into the show and said that he was the one who had shipped the rocks from Antarctica to NASA! I love serendipity like that.

The last time I was on Art's show I mentioned that the mercury from amalgam fillings was poisonous and accounted for a high percentage of multiple sclerosis victims. Art wouldn't believe me. His dentist had assured him that amalgam fillings are perfectly safe.

Soon after, two different dentists called in and backed me up! Art sure has a huge listener group.

I really enjoy getting on with Art (W6OBB) and talking ham radio. Plus I naturally discuss cold fusion, health, the moon hoax, how anyone can make all the money they want, and a bunch of the other things I write about in my editorials.

Checking the Mail

Another interview on the Art Bell (W6OBB) show in late April showered me with thousands of letters — a surprising number of them with ham calls. So *that's* where the 20m crowd is sitting out the sunspot situation.

For instance, a nice letter from Henry W3RRF mentioned meeting me at a Virginia Beach hamfest. I don't get invited to that one any more. Henry says he hasn't been active lately — not much interested in idle conversation. That's probably what's kept my hand off the power switch too.

Of course, I have a more serious problem. I really enjoy doing new things, but have little interest in doing things a second time. I had a fantastic time helping to pioneer ham RTTY back in the 1950s, and then I walked away from it. Ditto slow scan in 1960s and repeaters in the 70s. I worked over 350 countries and got DXing out of my system. I've operated from around 60 countries and find

BE THE FIRST
to call Norman at
800-677-8838
AND BENEFIT
from this
1/4 page ad space
next month
FOR ONLY \$214.

That's
50% OFF
the regular rate!

Call today!!
Call **NOW!!!**

800-677-8838

From *Amateur Radio Newslines*, via *The LCARA Patch*, February 1998, Tim Culek KQ8TC, editor.

Youngest Hams in the US?

While older hams bemoan the dearth of youthful licensees in the hobby's ranks, along come Samuel Lewis KB9RYP and Sarah Bruno KB9SEG, both of Gary, Indiana, and both just four years old. Samuel, who turned five on June 1, upgraded last spring to Tech Plus; Sarah, turning five on September 8, got her Novice ticket February 25.

Both are members of families in which both parents and all but the infant members are licensed amateurs. Sarah's parents are the Reverend Ronald Bruno Jr. KG9LY, and Pam Bruno KB9RVX. Her siblings include Ronald III KG9MH, age 15, 10-year-old Jeffrey KB9RHO, and five-year-old Joshua KB9RER, who upgraded to General in December (he said the written test was hard). Their grandfather is the Reverend Ronald Bruno Sr. KB9NWM, and their grandmother is Judith Bruno KB9QZK.

Samuel's parents are the Reverend Daryl Lewis KB9RRG, and LaDonna Lewis KB9RRK, plus siblings nine-year-old Gabriel KB9REP, who just got his General ticket, and John KB9RRF, age seven. Samuel studied several months for his ticket and said passing the code test to upgrade was difficult.

All of the youngsters attend the senior Rev. Bruno's Grace and Truth Baptist Academy in Gary, where ham radio has been a regular part of the curriculum for about a year now. The school has a ham station on site and classes run 52 weeks a year. KB9NWM says it's not uncommon for kids approaching age four to be able to read pretty well. He says the two families and other members of the church community use ham radio to stay in touch and for potential use during an emergency.

The eldest Bruno says he started out with his Tech license a couple of years ago, but decided he'd like to try HF and began learning the code. While he says the youngsters in his school readily

grasp Morse code, he concedes the code was "a killer" for him. He now has his Advanced ticket.

The younger Rev. Bruno soon will depart for the Philippines as a missionary and plans to take ham radio along with him.

From an article by Bill Peterson N9LL in April 1998's *PARKing Ticket*, newsletter of the Plano (TX) AR Klub, James Benningfield WB5RZJ, editor.

The Dark Sucker

For many years, it has been believed that electric bulbs emit light. However, recent information has proven otherwise. Electric bulbs do not emit light; they suck up darkness. Thus, we call these bulbs "dark suckers." The Dark Sucker Theory (that electric bulbs suck up darkness) and the proven existence of dark suckers postulates that darkness has mass and is heavier than light. To prove the theory to yourself, take an energized dark sucker device (light bulb) into any dark room. Notice that there is much less darkness right next to it than there is anywhere else in the room—and the larger the dark sucker device, the greater its capacity to suck up darkness. Note that dark suckers placed in a parking lot have a much greater capacity to suck up darkness than the ones in this room. But, as it is with many great things, dark suckers don't last forever. Once they are completely filled with darkness, they lose their ability to suck in more. This is easily proved by the dark spot on a full dark sucker device.

A candle is a primitive form of dark sucker. Note that a brand new candle has a white wick, but after the first use, the wick turns black, representing the darkness it has sucked into it. If you put a pencil next to the wick of an operating candle, it will turn black. This is because it got in the path of the darkness flowing into the candle.

Portable dark suckers have also come into common usage. With these, the bulbs (being much smaller) can't handle all the darkness by themselves and must be aided by a darkness storage unit. When the darkness storage unit is full, it must be either replaced or emptied before the portable dark sucker will operate again.

Darkness has mass. When darkness goes into a dark sucker, friction from the mass generates heat. Thus, it is not wise to touch an operating dark sucker. Candles present a special problem. Since

Radio Bookshop

Phone 800-274-7373 or 603-924-0058, FAX 603-924-8613, or see order form on page 88 for ordering information.

Crystal Set Projects

This 160-page book has 15 projects you (or your junior op) can build. It doesn't take a well-stocked junk box to build these crystal radios. You can build 'em into match boxes, cigar boxes, or anything else that's handy. Some even tune the short wave bands! Published by The Xtal Set Society. Start having some fun! \$15.

Crystal Set Building

This book is packed with 168 pages of easy home crystal radio projects. Your batteries will never wear out with these radios. They might even make a great science fair project. These projects are reprinted from Volumes 6 and 7 of The Xtal Set Society Newsletter. They do have some tube sets and TRF's too. Great weekend projects. \$16.

the mass must travel into a solid wick instead of through clear glass, a great amount of heat is generated. Thus, it is also not wise to touch an operating candle.

A fact not readily apparent is that darkness is heavier than light. If you were to swim just below the surface of a lake, you would see a lot of light. Now if you were to slowly swim deeper and deeper, you would notice it getting darker and darker. If you were to swim really deep, you would be in total darkness. This is because the heavier dark sinks to the bottom of the lake and the lighter light floats at the top. After all, that's why it's called "light."

Finally, we must prove that dark travels faster than light. If you were to stand in a lighted room, in front of a closed, dark closet and slowly open the closet door, what would you see? As we all have observed, you would see the light slowly enter the closet. However, since darkness travels so fast, you would be unable to see the dark leave the closet.

Now, having been properly educated, the next time you wish to refer to an electric bulb, please use its technically correct term: a dark sucker.

By Amor N2FY, from April 1998's *Harmonics*, newsletter of South Jersey RA, John Buzby W2BU, editor. 73

that doesn't seem to get me excited any more. Been there, done that. I had a wonderful time with Oscar VII, even managing to work Moscow one day. Done that. I was on packet early on. Done that. I had great fun working seven states on 10 GHz. I rag chewed on 75m for a year or so with W1MLX, W1KPL, and W1IF in 1946-7. W1FZJ and I used to have fun DXing

on 75m. Two-meter aurora was exciting. For a while. Working 2m from a mountain top with a kilowatt and a 336-element beam was a blast for two or three years, but I don't want to do it again. I spent years at the workbench building ham gear — and loving every frustrating minute of it. So I'm sort of waiting for some new ham bug to bite. In the

meanwhile I'm doing my best to get as many of you as I can to share in the fun I've had doing all of the things I've done. There isn't one of those adventures that I regret.

Arnold KH6COY enjoyed my poke at the QCWA, the society of pre-dead hams, in my April editorial. Their stance supporting the code qualifies them as one of the leading

groups facing squarely backward, tenaciously holding on to the past — apparently blind to both the future and the present. How buried under the Tech pileup do we have to get before an alarm bell goes off in calcified heads?

Well, I've endeared myself to the ARRL, QCWA and the FCC — what other group can I offend? Any suggestions? 73

NEW PRODUCTS



MINIMIZE INVENTORY WITH FME UNIVERSAL CONNECTORS

MAXRAD's most popular mobile antenna mounts are now available with FME universal connectors. Faster installation results because the diameter of an FME connector is only slightly greater than that of the cable it's attached to. The installer can easily pull the antenna mount's cable and factory-installed connector through a vehicle. When the cable reaches the radio or phone, the installer simply attaches the appropriate threaded adapter, which connects with the radio's antenna port, to the threaded FME universal connector.

Mini-UHF, PL-259, TNC and N-type adapters that mate with the FME universal connector are available from MAXRAD. A dealer or installation shop can minimize inventory by stocking a few antenna mounts with FME universal connectors and a variety of inexpensive adapters that fit virtually any radio or phone. Plus, when a vehicle is equipped using a MAXRAD antenna system with FME universal connector, just a new adapter is needed if the user later decides to change the brand or model of radio.

For more information, call toll-free (800) 323-9122 or write MAXRAD, 4350 Chandler Drive, Hanover Park IL 60103; check out their Web site at [<http://www.maxrad.com>].

SAY YOU SAW IT IN 73!



FANTASY TIME

Novatech Instruments, Inc., announces three new versions of its popular 2950AR Rubidium Frequency Standard. Dubbed the 2950AR/01, /02 and /03, these versions provide additional output frequency combinations while maintaining the $\pm 5 \times 10^{-11}$ monthly stability of the 2950AR. The 2950AR/01 provides three 10

MHz outputs; the 2950AR/02 provides 10 MHz, 5 MHz and 100 kHz; while the 2950AR/03 provides three outputs of any customer-specified combination of 10 MHz, 5 MHz, 1 MHz, and 100 kHz.

The 2950AR/01 is \$4145; 2950AR/02 is \$4245 and the 2950AR/03 is \$4495. Delivery may be up to eight weeks, which might give you time to explain to the XYL why your credit card balance doubled.

Check Novatech's Web site at [<http://www.eskimo.com/~ntsales>]. It'll give you all the data on this series, or just send money to Novatech, 17962 Midvale Avenue North, Suite 219, Seattle WA 98133.



IS "MALE UNIVERSAL" THE SAME AS "MR. UNIVERSE"?

OK, maybe not. But RF Connectors has announced the availability of a newly designed

N male plug which accommodates a broad range of the most popular coaxial communications cables. That's right—the RFN-1001-S N Male Universal Plug is made for 35+ different cables!

Simply insert the stripped cable into the connector body and solder the center conductor to the center contact. Screw this body/cable assembly into the N male interface housing and your job is complete!

For additional information, see your RF Connectors distributor or call (800) 233-1728.

Catalog 981 \$3

Jim@RadioWorks.com
RadioWorks.com

The RADIO WORKS
Where Ham Radio Is a Contact Sport!

1-800-280-8327
757-484-0140
757-483-1873

GET YOUR JUICES RUNNING

For \$3 you can get a 78-page catalog of antennas, baluns, antenna accessories, wire, coax, and connectors. This'll get you going, trying to choose among a variety of windows and loop antennas, for HF and VHF—but this is lots more than just a catalog. Check it out. The Radio Works, Box 6159, Portsmouth VA 23703.



ROLLIN' AND RAG-CHEWIN'

Your HT and rubber ducky radiate poorly inside your car—it's a fact of life; your car roof is a shield. Clip the MFJ-310 to your window, however, and the QSO range is dramatically extended. The MFJ-310 HT window mount clip with

BNC connector holds your antenna securely on the outside of the car window, where it can radiate freely. It comes with 10 feet of flexible mini-coax that can be pushed out of sight into tiny crevices in the upholstery or whatnot, and it unclips as easily as it clips on. Just put it in the glove compartment when you're done. Talk farther, longer, clearer with MFJ's new HT window mount clip for mobile operation—only \$14.95—and of course it comes with MFJ's famous *No Matter What*™ one-year limited warranty.

To order or for the name of your nearest dealer, call (800) 647-1800; FAX (601) 323-6551; E-mail [mfj@mfjenterprises.com]; or check out the Web site at [<http://www.mfjenterprises.com>].

PROPAGATION

Jim Gray W1XU/7
210 E Chateau Circle
Payson AZ 85541
[jimpeg@netzone.com]

As you can see from the calendar, we have what might be called a "mixed bag" of conditions this month. Your *best* opportunities for DX are likely to be the 14th-19th and again the 26th-28th. The *worst* days are likely to be the 5th, 21st, 24th, 25th, and 30th. The remaining days will probably be Fair or trending, and it's on these days that your operating skills and sharp ears will pay off in DX dividends.

The month of July is notoriously poor for HF operation due to high signal absorption levels, summer thunderstorms (QRN), and the fact that we're just now beginning to notice an increase in solar flux levels.

For VHF operators, however, July could very well be an excellent month for openings on the six and two-meter bands ... and particularly near those days that are the worst for HF operation. Keep tuned for possible auroral propagation during those days.

10, 12, and 15 meter bands

Sporadic E propagation on many (G) or (F) days, with good signal strengths of short duration and quick fading. The ionized

clouds drift with the high-altitude winds. Expect skip to 1,500 miles or so, and beam across the equator for possible contacts in the opposite hemisphere. These bands will close at sunset.

17 and 20 meter bands

Twenty will be the best, and sometimes 17 will be almost as good, but not as heavily occupied. If open, the higher-frequency band will provide the longest skip. Twenty will remain open after sunset and sometimes late into the evening. Seventeen will close at dark or shortly after. Possible gray-line DX along the terminator is a bonus.

30 and 40 meter bands

Excellent nighttime possibilities on evenings when QRN is low and conditions are Good. Thunderstorms between you and your target can make copy difficult if not impossible. Daytime short skip out to 1,000 miles is frequent, and nighttime skip to 2,000 miles or more will occur less regularly. Thirty meters will behave more like 20, and 40 meters will behave more like 80 on many occasions, due to the height of the reflecting layer at that time. Always check

July 1998

SUN	MON	TUE	WED	THU	FRI	SAT
			1 F	2 F	3 F	4 F-P
5 P	6 P-F	7 F	8 F	9 F	10 F-G	11 G-F
12 F	13 F	14 F-G	15 G	16 G	17 G	18 G
19 G-F	20 F-P	21 P	22 P-F	23 F	24 F-P	25 P-F
26 F	27 F-G	28 G-F	29 F-P	30 P	31 P-F	

the next-higher and next-lower bands.

80 and 160 meter bands

Expect lots of QRN. You'll hear very few signals on 80 during the day, and none on 160. These bands are the nighttime bands in summer, and it pays you to keep a sharp ear open after sundown. On particularly

good nights with low noise, you will find both long skip and DX on both bands. Avid DXers must be patient, however, because in summer there's almost always noise present. I'd recommend that you use the long summer days and evenings for building up better antennas for these bands, and wait until fall for conditions to improve. W1XU/7. 73

EASTERN UNITED STATES TO:

GMT:	00	02	04	06	08	10	12	14	16	18	20	22
ALASKA						20	20					
ARGENTINA	20	20	20	40			20	20	15	15	15	15
AUSTRALIA		20	20	20	40	40	20					
CANAL ZONE	15	40	40	40	40	40		15	15	15	10	10
ENGLAND			40	40			20	20	20	20	20	20
HAWAII			20		40		20					
INDIA												
JAPAN						20	20					
MEXICO	15	40	40	40	40	40		15	15	15	10	10
PHILIPPINES							20					
PUERTO RICO	15	40	40	40	40	40		15	15	15	10	10
RUSSIA (C.I.S.)							20	20		20		
SOUTH AFRICA			40	40		20	20				20	
WEST COAST	20	40	40	40	40	40						20

CENTRAL UNITED STATES TO:

ALASKA		20	20					20	20			
ARGENTINA	15	20	20	40			20	20		15	15	15
AUSTRALIA	15	20	20	20	40	40		20			20	
CANAL ZONE	15	20	20	20	40	40	20	20	15	15	15	10
ENGLAND	20	40					20	20		20	20	20
HAWAII	15	15	20	20	20	40	20	20				
INDIA												
JAPAN		20	20					20	20			
MEXICO	15	20	20	20	40	40	20	20	15	15	15	10
PHILIPPINES		20	20				20	20				
PUERTO RICO	15	20	20	20	40	40	20	20	15	15	15	10
RUSSIA (C.I.S.)								20			20	
SOUTH AFRICA							20				20	20

WESTERN UNITED STATES TO:

ALASKA		20	20						20			
ARGENTINA	15	20	20	40	40			20	20		15	15
AUSTRALIA		20	20	20	20	40	40		20		15	15
CANAL ZONE	15	15	20	20	40	40		20	20	15	15	15
ENGLAND	20							20	20			20
HAWAII	20	15	15	20	20	20	40	40	20		20	20
INDIA				20					20			
JAPAN		20	20						20			
MEXICO	15	15	20	20	40	40		20	20	15	15	15
PHILIPPINES				20					20			
PUERTO RICO	15	15	20	20	40	40		20	20	15	15	15
RUSSIA (C.I.S.)									20			
SOUTH AFRICA			40						20			
EAST COAST	20	40	40	40	40	40						20

Number 87 on your Feedback card

UPDATES

"Limited Space Antenna"

We received a note from Francis Y. Kelson HL9BK/K2KSY, regarding his article published in December 1997's 73:

... "Sincerest apology for an oversight that has deluged my E-mail with queries in regard to the construction of the coil L1.

"On page 28, under 'Coil Construction,' the fourth line indicates that the coil has a diameter of 11/16 inches. This is wrong; it should be 7/8 inch.

"In the 'Parts List' it indicates that the coil should have a diameter of 1-1/16 inch where in fact it should be 7/8 inches in diameter. All else is correct." 73

Barter 'n' Buy

Turn your old ham and computer gear into cash now. Sure, you can wait for a hamfest to try and dump it, but you know you'll get a far more realistic price if you have it out where 100,000 active ham potential buyers can see it, rather than the few hundred local hams who come by a flea market table. Check your attic, garage, cellar and closet shelves and get cash for your ham and computer gear before it's too old to sell. You know you're not going to use it again, so why leave it for your widow to throw out? That stuff isn't getting any younger! The 73 Flea Market, Barter 'n' Buy, costs you peanuts (almost)—comes to 35 cents a word for individual (noncommercial!) ads and \$1.00 a word for commercial ads. Don't plan on telling a long story. Use abbreviations, cram it in. But be honest. There are plenty of hams who love to fix things, so if it doesn't work, say so.

Make your list, count the words, including your call, address and phone number. Include a check or your credit card number and expiration. If you're placing a commercial ad, include an additional phone number, separate from your ad.

This is a monthly magazine, not a daily newspaper, so figure a couple months before the action starts; then be prepared. If you get too many calls, you priced it low. If you don't get many calls, too high.

So get busy. Blow the dust off, check everything out, make sure it still works right and maybe you can help make a ham newcomer or retired old timer happy with that rig you're not using now. Or you might get busy on your computer and put together a list of small gear/parts to send to those interested?

Send your ads and payment to: 73 Magazine, Barter 'n' Buy, 70 Rt. 202N, Peterborough NH 03458 and get set for the phone calls. The deadline for the October 1998 classified ad section is Aug. 10, 1998.

TOWER for sale. 100' MILITARY AB-105C. Heavy duty galvanizing. Dismantled, includes guy wire, screw anchors, new bolts, excellent condition. **Jim W9GLR**, 5165 Island View Circle South, Polk City FL. [jimw9glr@juno.com]. (941) 984-1317. BNB56

BIOELECTRIFIER™ 5 Hz micro current supply for plant and animal research. Semi-Kit \$38.00. Assembled complete with batteries and silver electrodes \$89.50. Add \$2.50 postage. **Thomas Miller**, 314 South 9th Street, Richmond IN 47374. BNB343

MAHLON LOOMIS, INVENTOR OF RADIO, by Thomas Appleby (copyright 1967). Second printing available from **JOHAN K.V. SVANHOLM N3RF**, SVANHOLM RESEARCH LABORATORIES, P.O. Box 81, Washington DC 20044. Please send \$25.00 donation with \$5.00 for S&H. BNB420

TIRED OF IRONING? PCB service. No \$ setup, free scanning available. **FIRST PROTO**, 4201 University Drive, #102, Durham NC 27707. (919) 403-8243. BNB5005

HEATH COMPANY is selling photocopies of most Heathkit manuals. Only authorized source for copyright manuals. **Phone:** (616) 925-5899, 8-4 ET. BNB964

FREE: Scanner collector's methods and secrets. Learn how to buy, sell, trade and USE scanners in the most efficient manner. Enclose \$2.00 for postage and handling to: P.O. Box 402, Decatur TX 76234. BNB523

RF TRANSISTORS TUBES 2SC2879, 2SC1971, 2SC1972, MRF247, MRF455, MB8719, 2SC1307, 2SC2029, MRF454, 2SC3133, 4CX250B, 12DQ6, 6KG6A, etc. **WESTGATE**, 1-800-213-4563. BNB6000

COLLOIDAL SILVER GENERATOR! Why buy a "box of batteries" for hundreds of dollars? Current regulated, AC powered, fully assembled with #12 AWG silver electrodes, \$74.50. Same, but DC powered, \$54.50. Add \$2.50 shipping. **Thomas Miller**, 314 South 9th Street, Richmond IN 47374. BNB342

Cash for Collins: Buy any Collins Equipment. **Leo KJ6HI**, Tel./FAX (310) 670-6969, [radioleo@earthlink.net]. BNB425

ASTRON power supply, brand-new w/ warranty, RS20M \$99, RS35M \$145, RS50M \$209, RS70M \$249, **AVT**. Call for other models. (626) 286-0118. BNB411

METHOD TO LEARN MORSE CODE FAST AND WITHOUT HANGUPS **Johan N3RF**. Send \$1.00 & SASE. SVANHOLM RESEARCH LABORATORIES, P.O. Box 81, Washington DC 20044 USA. BNB421

QSL CARDS. Basic Styles; Black and White and Color Picture Cards; Custom Printed. Send 2 stamps for samples and literature. **RAUM'S**, 8617 Orchard Rd., Coopersburg PA 18036. Phone or FAX (215) 679-7238. BNB519

Radio Bookshop ORDER FORM

You may order by mail, telephone, or fax. All payments are to be in US funds. Allow 4 weeks for delivery. (Prices subject to change without notice if suppliers increase prices or new editions cost us more.)

ITEM	TITLE	QTY	PRICE	TOTAL

Shipping: All orders add \$5.00 handling *plus there is an additional at cost shipping charge added to all foreign orders. We ship UPS where possible, please give us street address.

S&H* TOTAL \$

Make checks payable to "Radio Bookshop."

Foreign Orders: Choose one surface shipping air shipping (Surface delivery may take 2-3 months.)

*Note: The actual foreign shipping costs will be additional to the regular shipping and handling fees.

Name _____ Phone _____

Address _____

City _____ State _____ Zip _____ Country _____

\$10 minimum for credit card orders

Total Paid \$ Check/Money Order AMEX MC VISA

Card # _____ Expires _____

Signature _____ Date _____

Telephone: 603-924-0058, 800-274-7373, FAX 603-924-8613

Mail: Radio Bookshop, Dept. 798, 70 Route 202 N, Peterborough NH 03458

YES, Send me 12 issues of 73 at the low rate of \$24.97 (save 47% over the cover price). Canada add \$7 plus \$1.40 GST; Foreign add \$19 surface; \$42 airmail.

Copyright © 1997 by Greg Trook



X-ray November Alpha ... location somewhere near point 26 ... reporting sudden low visibility ...

The New Approach to HF Radio!

The Kachina 505DSP Computer Controlled Transceiver

Features:

- Works with any Computer Running Windows 3.1, 95 or NT
- Covers all Amateur HF Bands plus General Coverage Receiver
- IF Stage 16/24 Bit Digital Signal Processing (DSP)
- II DSP Bandpass Filter Widths from 100 Hz to 3.5 kHz (6 kHz in AM Mode)
- Band Activity Display with "Point and Click" Frequency Tuning
- On-screen Antenna "Smith" Chart, Logging Software and Help Menus
- Automatic Frequency Calibration from WWV or Other External Standard
- "Snapshot" Keys for Instant Recall of Frequencies and Settings
- Optional Internal Antenna Tuner

PC not included

The Kachina 505DSP Computer Controlled HF Transceiver After twenty years of building commercial transceivers in Arizona, Kachina has decided the time is right for a new approach to amateur radio. The Kachina 505DSP is nothing short of a revolution in HF transceivers.

Why Use Knobs if You Have Windows? The old-fashioned front panel has become too cluttered to be useful. Too many knobs, too many buttons. Kachina's 505DSP transceiver connects to your computer's serial port and is completely controlled under Windows™. With optional cables, the radio may be remotely located up to 75 feet away from your computer. Imagine combining a state-of-

the-art DSP transceiver with the processing power and graphics capabilities of your PC and you'll soon wonder why all radios aren't designed this way. Why settle for a tiny LCD display when your computer monitor can simultaneously show band activity, antenna impedance, heat sink temperature, SWR, forward and/or reflected power and a host of other information?

16/24 Bit DSP/DDS Performance In addition to 100% computer control, the Kachina 505DSP offers exceptional 16/24 bit DSP/DDS performance. IF stage DSP, "brick-wall" digital filtering, adaptive notch filters and digital noise reduction, combined with low in-band IMD and high signal-to-noise ratio, produce an

excellent sounding receiver. Sophisticated DSP technology achieves performance levels unimaginable in the analog world. The transmitter also benefits from precise 16/24 bit processing. Excellent carrier and opposite-sideband suppression is obtained using superior phasing-method algorithms. The RF compressor will add *lots* of punch to your transmitted signal without adding lots of bandwidth, and the TX equalizer will allow you to tailor your transmitted audio for more highs or lows.

Seeing is Believing

American-made and designed, and able to stand on its own against the world's best, the 505DSP is bound to set the standard for all that follow. But don't take our word for it. Visit our website at <http://www.kachina-az.com> for detailed specifications, to download a demo version of our control software, or to see a current list of Kachina dealers displaying demonstration models in their showrooms.

KACHINA 
COMMUNICATIONS, INC.

P.O. Box 1949, Cottonwood, Arizona 86326, U.S.A.
Fax: (520) 634-8053, Tel: (520) 634-7828
E-Mail: sales@kachina-az.com

Windows is a trademark of Microsoft Corp.
Specifications and features subject to change without notice.



JST-245

160-10 Meters PLUS 6 Meter Transceiver



Fifteen reasons why your next HF transceiver should be a JST-245...

- 1** All-Mode Operation (SSB, CW, AM, AFSK, FM) on all HF amateur bands and 6 meters. JST-145, same as JST-245 but without 6 meters and built-in antenna tuner.
★ JST-145 COMING SOON ★
- 2** MOSFET POWER AMPLIFIER • Final PA utilizes RF MOSFETs to achieve low distortion and high durability. Rated output is 10 to 150 watts on all bands including 6 meters.
- 3** AUTOMATIC ANTENNA TUNER • Auto tuner included as standard equipment. Tuner settings are automatically stored in memory for fast QSY.
- 4** MULTIPLE ANTENNA SELECTION • Three antenna connections are user selectable from front panel. Antenna selection can be stored in memory.
- 5** GENERAL COVERAGE RECEIVER • 100 kHz-30 MHz, plus 48-54 MHz receiver. Electronically tuned front-end filtering, quad-FET mixer and quadruple conversion system (triple conversion for FM) results in excellent dynamic range (>100dB) and 3rd order ICP of +20dBm.
- 6** IF BANDWIDTH FLEXIBILITY • Standard 2.4 kHz filter can be narrowed continuously to 800 Hz with variable Bandwidth Control (BWC). Narrow SSB and CW filters for 2nd and 3rd IF optional.
- 7** QRM SUPPRESSION • Other interference rejection features include Passband Shift (PBS), dual noise blanker, 3-step RF attenuation, IF notch filter, selectable AGC and all-mode squelch.
- 8** NOTCH TRACKING • Once tuned, the IF notch filter will track the offending heterodyne (± 10 KHz) if the VFO frequency is changed.
- 9** DDS PHASE LOCK LOOP SYSTEM • A single-crystal Direct Digital Synthesis system is utilized for very low phase noise.
- 10** CW FEATURES • Full break-in operation, variable CW pitch, built in electronic keyer up to 60 wpm.
- 11** DUAL VFOs • Two separate VFOs for split-frequency operation. Memory registers store most recent VFO frequency, mode, bandwidth and other important parameters for each band.
- 12** 200 MEMORIES • Memory capacity of 200 channels, each of which store frequency, mode, AGC and bandwidth.
- 13** COMPUTER INTERFACE • Built-in RS-232C interface for advanced computer applications.
- 14** ERGONOMIC LAYOUT • Front panel features easy to read color LCD display and thoughtful placement of controls for ease of operation.
- 15** HEAVY-DUTY POWER SUPPLY • Built-in switching power supply with "silent" cooling system designed for continuous transmission at maximum output.



Japan Radio Co., Ltd.

430 Park Ave., 2nd Floor New York, NY 10022 Phone: (212) 355-1180 Fax: (212) 319-5227

CIRCLE 159 ON READER SERVICE CARD