

Including Ham Radio Fun!

JULY 1996

ISSUE #430

USA \$3.95

CANADA \$4.95

73[®] Amateur

International Edition

Radio Today

Does HAARP =
Armageddon?

Yes, ATV Websites too!
Garbage Can Filter
The Magic of DSP
The Basic Stamp-
(a fabulous new toy!)

Launch of live camera ATV system





JST-245

160-10 Meters PLUS 6 Meter Transceiver



Fifteen reasons why your next HF transceiver should be a JST-245...

- 1** All-Mode Operation (SSB, CW, AM, AFSK, FM) on all HF amateur bands and 6 meters. JST-145, same as JST-245 but without 6 meters and built-in antenna tuner.
★ JST-145 COMING SOON ★
- 2** MOSFET POWER AMPLIFIER • Final PA utilizes RF MOSFETs to achieve low distortion and high durability. Rated output is 10 to 150 watts on all bands including 6 meters.
- 3** AUTOMATIC ANTENNA TUNER • Auto tuner included as standard equipment. Tuner settings are automatically stored in memory for fast QSY.
- 4** MULTIPLE ANTENNA SELECTION • Three antenna connections are user selectable from front panel. Antenna selection can be stored in memory.
- 5** GENERAL COVERAGE RECEIVER • 100 kHz-30 MHz, plus 48-54 MHz receiver. Electronically tuned front-end filtering, quad-FET mixer and quadruple conversion system (triple conversion for FM) results in excellent dynamic range (>100dB) and 3rd order ICP of +20dBm.
- 6** IF BANDWIDTH FLEXIBILITY • Standard 2.4 kHz filter can be narrowed continuously to 800 Hz with variable Bandwidth Control (BWC). Narrow SSB and CW filters for 2nd and 3rd IF optional.
- 7** QRM SUPPRESSION • Other interference rejection features include Passband Shift (PBS), dual noise blanker, 3-step RF attenuation, IF notch filter, selectable AGC and all-mode squelch.
- 8** NOTCH TRACKING • Once tuned, the IF notch filter will track the offending heterodyne (± 10 KHz) if the VFO frequency is changed.
- 9** DDS PHASE LOCK LOOP SYSTEM • A single-crystal Direct Digital Synthesis system is utilized for very low phase noise.
- 10** CW FEATURES • Full break-in operation, variable CW pitch. built in electronic keyer up to 60 wpm.
- 11** DUAL VFOs • Two separate VFOs for split-frequency operation. Memory registers store most recent VFO frequency, mode, bandwidth and other important parameters for each band.
- 12** 200 MEMORIES • Memory capacity of 200 channels, each of which store frequency, mode, AGC and bandwidth.
- 13** COMPUTER INTERFACE • Built-in RS-232C interface for advanced computer applications.
- 14** ERGONOMIC LAYOUT • Front panel features easy to read color LCD display and thoughtful placement of controls for ease of operation.
- 15** HEAVY-DUTY POWER SUPPLY • Built-in switching power supply with "silent" cooling system designed for continuous transmission at maximum output.



Japan Radio Co., Ltd.

430 Park Ave., 2nd Floor New York, NY 10022 Phone: (212) 355-1180 Fax: (212) 319-5227

CIRCLE 159 ON READER SERVICE CARD

Corner Beam?

**Big Forward Gain
Wide Backward Rejection
Exceptional Bandwidth
Compact Size**

Your antenna makes all the difference at VHF and UHF—It determines transmitting range. It sets the limit for weak signal reception. And it decides what interference you'll hear & create.

An omnidirectional antenna radiates uniformly in all direction, and it also hears noise and interference from every direction.

A directional antenna not only sends your signal where you want, it hears the signal it's pointed at, rejecting others.

Gain really counts when you have to reach out across large distances to make contact. It also lets you operate with minimal power and cuts the interference you inflict on other stations.

Directionality is desirable in high activity locations. A clean sharp pattern without sidelobes or spikes reaches past the noise and interference to get the message through. Wide rear rejection lets you null out strong nearby signals to reduce interference.

CornerBeam vs. Yagi

When you want to control your signal, think CornerBeam, not yagi. Take a look at what CornerBeam will do:

- 10 dB gain vs. dipole
- 40 dB Front-to-Back
- 60 degree Half-power Beamwidth



- SWR <1.1:1 across the band
- No dimension over 4 ft
- Mounts directly to mast or tower
- No need for offset or side mount for vertical polarization
- Vertical or horizontal polarization
- weighs only 10 pounds

Make the comparison with a yagi. A yagi with the same gain would have a boom 10 feet long. And yagi bandwidth would be less than half. Unlike a yagi, CornerBeam's pattern has no unwanted spikes or bustles to the side or behind.

Symmetrical Pattern

CornerBeam's gamma match is engineered to be in-line rather than displaced from the element axis. The result is a distortion-free measured pattern that is precisely equal on each side of the antenna center line.

Bandwidth Counts

With its exceptional bandwidth, your CornerBeam can be put to work right out of the box without special tweaking. It can serve you now when you're working repeaters with an FM handheld, and later when you go after small signal DX at 144.05 or set out to work satellites.

CornerBeam can still be your beam when you join MARS at 143/148 MHz, team up with the Civil Air Patrol to locate downed aircraft at 154 MHz.

Scanning Too?

CornerBeam's directionality and gain extend your monitoring range on public service, marine, and aircraft frequencies.

CornerBeam for Repeaters

If your repeater shares a frequency with another, the deep wide null toward the rear could keep your signal out of the neighboring repeater's receiver and turn a

deaf ear to its signal. A pair of CornerBeams can be combined to provide special radiation footprints. A CornerBeam aimed at an area your repeater hears poorly could improve service where incoming signals from HTs are presently too weak. CornerBeam makes it possible to increase repeater density while reducing interference. ■

Corner Beam Models

Band	Max Dim	WindLd	Price
2 meters	4 ft	<2 sqft	\$145
220 MHz	4 ft	<1 sqft	\$145
70 cm	3 ft	<1 sqft	\$115
Dual 146/435	4 ft	<3 sqft	\$165

Construction: Aircraft aluminum.

Booms are square. Elements are solid rod. Stainless hardware included for tower and mast mounting accepts up to 1.5" dia. mast and may be rotated for vertical or horizontal polarization. Connector is SO-239 for VHF, N female for UHF. Dual-Band antenna has separate driven elements, both with N connector.

Dimensions given in table are for reflector booms and reflector elements.

Options: Commercial Frequency \$45.

Duplexer: Add \$80 for VHF/UHF

Duplexer and cabling for single coax feed of Dualband 146/435 Corner.

Shipping: UPS ground to continental USA (\$11 S&H). Air Parcel Post to HI, AK, & Possessions (\$14 P&H). Canada (\$16 P&H).

Allow 2 weeks for delivery.

Can You Find the Tiger's Tail?



If your eyes are sharp you can spot the TigerTail™ in the photo above. It puts extra growl into the signal from the Hand Transceiver it's attached to.

TigerTail™ improves SWR, lowers radiation angle, and extends range. You can use low power and save your battery pack, but still have a big signal.

Better than an amplifier, it improves reception too. TigerTail™ does all this by simply slipping under your flex antenna and just hanging down. It doesn't stick up or out or get in the way. It's the simplest way to boost your signal.

Yes, I want Performance in My Corner!

Send my CornerBeam: __2m, __220MHz, __70 cm, __Dual 146/435.

Options: __DualBand Duplexer, __Commercial/Marine Frequency: _____

Send my TigerTail. (1 for \$7.95, 2 for \$15, 3 for \$21. Specify band.)

Yes, I circled the TigerTail! Knock \$5 off my order.

Name _____ Amt. Enclosed _____

Call _____ Phone _____

Street _____ Unit _____

City _____ State _____ Zip _____

Antennas West

Box 50062-S Provo UT 84605

InfoPak
\$1

Order
Hotline

800 926 7373

WWV RECEIVER

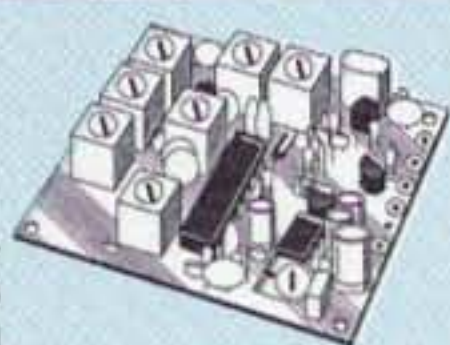

Get time & frequency checks without buying multiband hf rcvr. Very sensitive and selective xtal controlled superhet, dedicated to listening to WWV on 10,000 MHz. Performance rivals the most expensive receivers. only \$59 kit, \$99 w/t.

LOW NOISE RECEIVER PREAMPS

LNG-(*)

still only \$59
wired&tested



FEATURES:

- Very low noise: 0.7dB nf vhf, 0.8dB uhf
- High gain: 13-20dB (depends on freq)
- Wide dynamic range - resist overload
- Stable: dual-gate GAS FET

*Specify tuning range: 26-30, 46-56, 137-139, 139-152, 152-172, 210-230, 400-470, 800-960 MHz.



LNW-(*) MINIATURE PREAMP

still only \$29 kit, \$44 wired&tested

- Low-cost MOSFET preamp.
- Small size. Only 5/8"W x 1-5/8"L x 3/4"H.
- Nf 1.2dB vhf, 1.5dB uhf.

*Specify tuning range: 25-35, 35-55, 55-90, 90-120, 120-150, 150-200, 200-270, 400-500 MHz.

HELICAL RESONATORS



Helical resonator filters may reduce your intermod & cross-band interference.

MODEL HRF-(*), \$59 vhf, \$99 uhf.

*Specify tuning range: 136-140, 142-150, 150-162, 162-174, 213-233, 420-470.

RECEIVING CONVERTERS

Low noise converters to receive vhf & uhf bands on a 10M receiver.



- Input ranges avail: 50-52, 136-138, 144-146, 145-147, 146-148, 220-222, 222-224 MHz, 432-434, 435-437, 435.5-437.5, and 439.25 (atv conv. to chan 3).
- Kit less case \$49, kit w/case & BNC jacks \$79, w&t in case \$99.

TRANSMITTING CONVERTERS

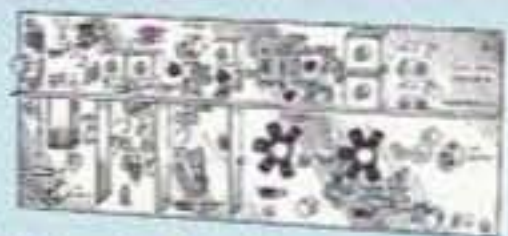

XV2 for vhf and XV4 for uhf. Models to convert 10M ssb, cw, fm, etc. to 2M, 432, 435, and atv. 1W output. Kit only \$89 (vhf), \$99 (uhf). PA's up to 45W available.

REPEATER CONTROLLERS



CWID-2. Eprom-controlled, miniature, easy to build, low power CMOS.

(specify call) only \$54 kit, \$79 w/t

COR-6. COR & Real Voice ID

on one board. Digital ic records up to 20 seconds of your voice. Can record multiple id messages. Tail and time-out timers, courtesy beep, solid-state relay to key transmitter.

..... kit \$99, w&t \$149

COR-3. COR, timers, court.beep kit \$49

CWID. Diode programmable kit \$59

COR-4. Complete COR and CWID all on one board. CMOS logic for low power consumption. EPROM programmed; (specify call) kit \$99, w&t \$149

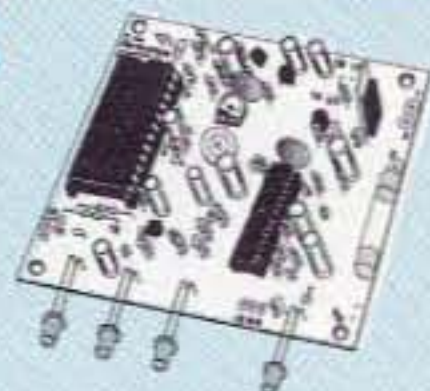

ACCESSORIES

DVR-1 DIGITAL VOICE RECORDER. Records up to 20 sec. of your voice with built-in mic. or external mic. Terrific as voice ID'er for repeaters or fox hunt xmt, contest caller, radio notepad, etc. Extensive manual tells how to use multiple messages adapt to many applications. kit \$59, w&t \$99



TD-4 SELECTIVE CALLING MODULE. Versatile dtmf controller with 1 latching output. Mutes speaker until someone calls by sending your 4-digit tt code. Or use it with a long tt zero digit to alert anyone in club for emergencies. Also may be used to control autopatch or other device, like TD-2 except only one output. kit \$49, w&t \$79

TD-4 SELECTIVE CALLING MODULE.

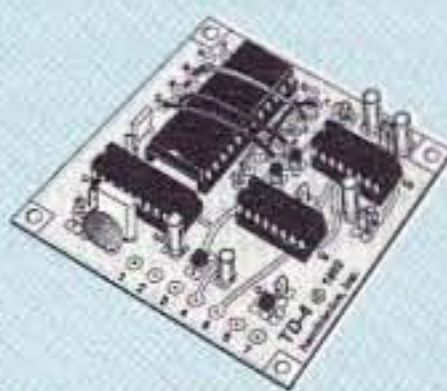

TD-3 CTCSS DECODER/ENCODER. Prevents access to repeater or receiver unless proper tone is present. Tone output for transmitters, too. kit \$29, w/t \$59

TD-2 DTMF DECODER/CONTROLLER. 16 digits, jumper-programmable, toll-call restrictor. Can turn 5 functions on/off. kit \$79, wired & tested \$129

TD-1 DIGITAL VOICE RECORDER. Records up to 20 sec. of your voice with built-in mic. or external mic. Terrific as voice ID'er for repeaters or fox hunt xmt, contest caller, radio notepad, etc. Extensive manual tells how to use multiple messages adapt to many applications. kit \$59, w&t \$99

AUTOPATCHES

AP-3 REPEATER AUTOPATCH. Reverse patch and phone line remote control. kit \$89, wired & tested \$139

AP-2 SIMPLEX AUTOPATCH Timing Board. Use with above for simplex operation using a transceiver. kit \$39

TD-2 DTMF DECODER/CONTROLLER. 16 digits, jumper-programmable, toll-call restrictor. Can turn 5 functions on/off. kit \$79, wired & tested \$129

DATA MODEMS

MO-202 FSK DATA MODULATOR & DE-202 DEMODULATOR. Run up to 1200 baud digital signals through any fm transmitter & receiver kits \$49, w&t \$79

9600 BAUD DIGITAL RF LINKS. Call for info on low-cost packet networking system: MO-96 Modem and special versions of our 144, 220, or 450 MHz fm xmtrs and rcvrs. Use directly with most TNC's. Fast, diode-switched PA's output 15 or 50W.

You get more features for your dollar with our

REP-200 REPEATER

A fully microprocessor-controlled repeater with autopatch and many versatile dtmf control features at less than you might pay for a bare-bones repeater or controller alone!

Kit still only \$1095
w&t still only \$1295

50 & 900 MHz bands slightly higher

• Available for the 50-54, 143-174, 213-233, 420-475, 902-928 MHz bands.

• FCC type accepted for commercial service in 150 & 450 bands. (Request catalog for details.)



REP-200T Voice Message Repeater. As above, except includes Digital Voice Recorder. Allows message up to 20 sec. to be remotely recorded off the air. Play back at user request by DTMF command, or as a periodical voice id, or both. Great for making club announcements! adds only \$100!

REP-200C Economy Repeater. Uses COR-6 Controller (no DTMF control or autopatch). Features real-voice ID. Kit only \$795, w&t \$1195

REP-200N Repeater. Want to use your own controller? No problem! We'll make you a repeater with rf modules only. Kit only \$695, w&t \$995

XMTRS & RCVRS FOR REPEATERS, AUDIO & DIGITAL LINKS, TELEMETRY, ETC.

Also available in rf-tight enclosures, and with data modems.

FM EXCITERS: 2W continuous duty. FCC type accepted for com'l bands.

• TA51: 50-54, 143-174, or 213-233MHz.

• TA451: 420-475 MHz. *New low price!*

Either model: kit \$99, w/t \$169.

• TA901: 902-928 MHz, (0.5W out);

New low price! w/t \$199.

VHF & UHF AMPLIFIERS.

For fm, ssb, atv. Output levels from 10W to 100W. Models starting at \$99.

FM RECEIVERS:

R100 FM RECEIVERS for 46-54, 72-76, 140-175, or 216-225 MHz.

Very sensitive - 0.15uV, exceptional selectivity - both crystal & ceramic if filters for >100dB at ±12kHz (best available anywhere), flutter-proof squelch.

..... *New low price!* kit \$129, w/t \$189.

• R451 FM RCVR, for 420-475 MHz. Similar to above. *New low price!* kit \$129, w/t \$189.

• R901 FM RCVR, for 902-928MHz. Triple-conversion. *New low price!* \$159, w/t \$219.

R150 MONITOR RCVR for 143-164 or 216-225 MHz. 4-channels.

Great for monitoring repeaters, amateur calling frequencies, packet radio, commercial two-way radio, police/fire frequencies, or weather forecasts. Good starter kit, easy to assemble and align kit only \$99, w/t \$189.

• **R120 AIRCRAFT RCVR** for 110-136 MHz kit only \$99, w/t \$219.

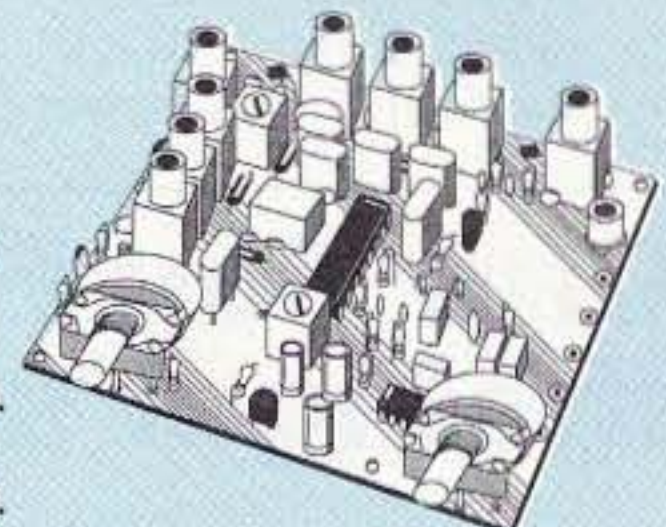
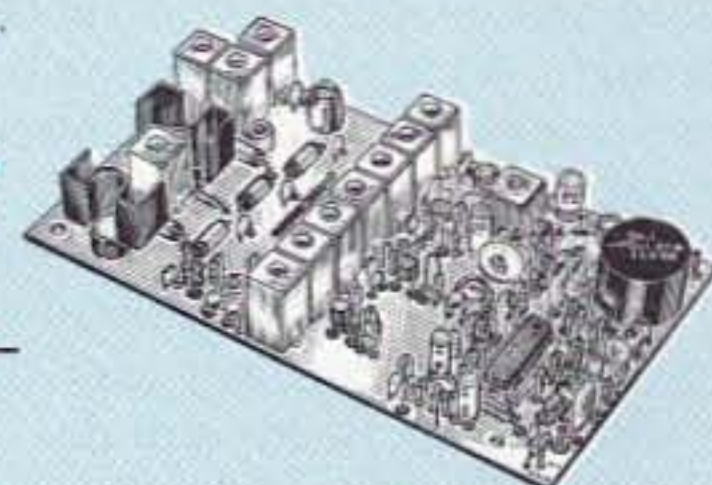

WEATHER SATELLITE RECEIVER

R139 Is The Affordable WeSat Rcvr!



Join the growing ranks of amateurs who get striking images directly from the weather satellites! We



used our 30+ years of experience in designing high-quality vhf receivers to bring you a new enhanced version of our long-popular WeSat receivers. The new R139 is a very sensitive wideband fm receiver optimized for amateur reception of NOAA APT and Russian Meteor weather facsimile images on the 137 MHz band. Use with any popular demodulator and software. Covers all five popular satellite channels. Scanner circuit and recorder control allow you to automatically search for and tape signals as satellites pass overhead, even while away from home.

• R139 Receiver Kit less case \$159

• R139 Receiver Kit with case and 12Vdc power adapter \$189

• R139 Receiver Wired/tested in case with 12Vdc power adapter \$239

- Buy at low, factory-direct net prices and save!
- For complete info, call or write for free catalog. (Send \$2 for overseas air mail.)
- Order by mail, fax, or phone (9-12 AM, 1-5 PM eastern time).
- Min. \$5 S&H charge for first pound plus add'l weight & insurance.
- Use VISA, Mastercard, Discover, check, or UPS C.O.D.

Our 33rd Year!
hamtronics, inc.

65-D Moul Rd; Hilton NY 14468-9535
Phone 716-392-9430 (fax 9420)

THE TEAM

El Supremo & Founder
Wayne Green W2NSD/1

Associate Publisher
F. I. Marion

Associate Technical Editor
Larry Antonuk WB9RRT

Nitty Gritty Stuff
Priscilla Gauvin
Joyce Sawtelle
David Underwood

Contributing Culprits
Bill Brown WB8ELK
Mike Bryce WB8VGE
Joseph E. Carr K4IPV
Michael Geier KB1UM
Jim Gray W1XU/7
Chuck Houghton WB6IGP
Dr. Marc Leavey WA3AJR
Andy MacAllister WA5ZIB
Dave Miller NZ9E
Joe Moell K0OV
Carole Perry WB2MGP
Jeffrey Sloman N1EWO

Advertising Sales
Frances Hyvarinen
Roger Smith
603-924-0058
800-274-7373
Fax: 603-924-8613

Circulation
Linda Coughlan
Helen Senechal

Data Entry & Other Stuff
Christine Aubert
Norman Marion

Business Office
Editorial - Advertising - Circulation -
Feedback - Product Reviews
73 Amateur Radio Today Magazine
70 Route 202N
Peterborough NH 03458-1107
603-924-0058
Fax: 603-924-8613

Reprints: \$3 per article
Back issues: \$5 each

Printed in the USA by
Quad Graphics

Manuscripts: Contributions for possible publication are most welcome. We'll do the best we can to return anything you request, but we assume no responsibility for loss or damage. Payment for submitted articles will be made upon publication. Please submit both a disk and a hard copy of your article (IBM or Mac formats), carefully checked drawings and schematics, and the clearest, best focused and lighted photos you can manage. "How to write for 73" guidelines are available on request. US citizens must include their Social Security number with submitted manuscripts so we can submit it to you know who.

73 Amateur Radio Today

JULY 1996
ISSUE #430

TABLE OF CONTENTS

FEATURES

- 10 **Ham Shack Test Equipment - KB4ZGC**
What you really need, based on the author's 47 years of experience
- 12 **Garbage In-No Garbage Out - AA6NG**
Turn hardware store purchases into a cavity filter for satellite and 2m reception
- 16 **A Funny Thing Happened On The Way To The Shack - W3UWH**
Strange stories from the world of hamdom!
- 17 **Receiver Preamplifiers - K41PV**
The pros and cons of these little signal boosters
- 18 **Weather Control and Mind Control - W1XU**
Science fiction? Well, it's science but not fiction!
- 21 **Persistence Wins - KK5LU**
Nothing ventured, etc.
- 30 **How Much Are Those Decibels Worth? - WA4BLC**
A survey of amplifier costs and the resulting S-units
- 31 **The JB Keyer - KU8K**
A low-tech solution to good keying
- 38 **Lubricating a Transceiver's Fan Motor - NZ9E**
Cut down on background noise and prolong the motor's life
- 44 **The 2m Quad Project - W7KZE**
Here's a great antenna project for your club

DEPARTMENTS

- WB6IGP 69 Above & Beyond
- 73 Ad Index
- KB1UM 54 Ask Kaboom
- WB8ELK 58 ATV
- 76 Barter 'n' Buy
- K4IPV 60 Carr's Corner
- NZ9E 50 Ham to Ham
- WB2MGP 49 Hams With Class
- K0OV 55 Homing In
- 6 Letters
- W2NSD/1 4 Never Say Die
- 72 New Products
- W1XU 87 Propagation
- WB8VGE 48 QRP
- 8 QRX
- 33, 48, 57, 61, 79, 83, 86, 88 Radio Book Shop
- WA3AJR 62 RTTY Loop
- 84 Special Events
- 77, 88 Updates

REVIEWS

- 22 **JPS Communications NIR-12 - WB2QLL**
DSP? Yes, you need it!
- 26 **The MFJ 20 Meter SSB Rig - AC4HF**
More fun in the sun
- 28 **The BASIC Stamp - WB2SRF**
Wait 'til you read about this fabulous new toy!
- 80 **CMOS Super Keyer 3 - AA0X/VK5FN**
"State-of-the-art keyer kit is a bargain!"

HAM RADIO FUN SECTION

- KB4ZGC 34 Home-Brew Whip Antennas
- W5UOJ 40 Just Who Did Invent Radio?
- W5UOJ 42 Repeater Coordination
- VE3WMF 46 Life After Your No-Code Tech License and Handheld Communications
- K2OAW 64 Simplified Part 7
- White 74 Where Am I?

On the cover: Peter Sias WBØDRL of Salina, Kansas, launches a balloon that carried a live camera ATV system to cover over 100,000 feet. Photo taken by Bill Brown WB8ELK. We would also like to thank Bill for the picture of Wayne in this month's issue.

Feedback: Any circuit works better with feedback, so please take the time to report on how much you like, hate, or don't care one way or the other about the articles and columns in this issue. G = great!, O = okay, and U = ugh. The G's and O's will be continued. Enough U's and it's Silent Keysville. Hey, this is *your* communications medium, so don't just sit there scratching your...er...head. FYI: Feedback "number" is usually the page number on which the article or column starts.

73 Amateur Radio Today (ISSN 1052-2522) is published monthly by 73 Magazine, 70 N202, Peterborough NH 03458-1107. The entire contents ©1996 by 73 Magazine. No part of this publication may be reproduced without written permission of the publisher, which is not all that difficult to get. The subscription rate is: one year \$24.97, two years \$44.97; Canada: one year \$34.21, two years \$57.75, including postage and 7% GST. Foreign postage: \$19 surface, \$42 airmail additional per year, payable in US funds on a US bank. Second class postage is paid at Peterborough, NH, and at additional mailing offices. Canadian second class mail registration #178101. Canadian GST registration #125393314. Microfilm edition: University Microfilm, Ann Arbor MI 48106. POSTMASTER: Send address changes to 73 Amateur Radio Today, 70 N202, Peterborough NH 03458-1107. 73 Amateur Radio Today is owned by Shabromat Way Ltd. of Hancock NH.

Contract: Even the most cursory glance at this text is sufficient to bind you, morally and legally, to take a kid (or kids) along on Field Day, get 'em fired up on amateur radio, and then help 'em get started toward a license. You'll feel good about yourself and our legal counsel won't have to hassle you.

NEVER SAY DIE

Wayne Green W2NSD/1



ARRL Attacks FCC

Surely Wayne is exaggerating. Even the ARRL, which has pulled some corkers in the past, wouldn't be dumb enough to give the Big Kahuna a hot foot. Basically the League has the same complaint I've been expressing for many years: It's too bloody difficult to shut down hams who are causing trouble. There's a serious need for a shortcut to lifting the tickets of our more egregious offenders.

The result of all this is that the FCC has routinely been ignoring complaints from amateurs, no matter how well documented. And, of course, the bad guys know that they can get away with murder, even ignore fines, and nothing will happen.

So there's the League with a bunch of Official Observers who have zero clout. The League complained, "The League has had an Official Observer program in place, with dedicated volunteers, but its work product, once submitted, has been ignored and implicitly rejected by the Commission as a basis for any enforcement action, and the program is essentially non-functional as a result. The work of radio amateurs who volunteer thousands of hours monitoring these violations, conduct sophisticated direction-finding to identify the rule violators, and prepare transcripts for the FCC, has all gone for naught, and the volunteers are understandably and justifiably demoralized."

This lack of enforcement is well known and has contributed significantly to the growth of bad language, poor operating, creeping commercialism, malicious interference, and lawlessness on our bands.

The League is also on the FCC's case about interference to consumer electronic equipment such as TV, hi-fi, and so on. Consumers have every right to expect their TV sets to operate without getting interference from nearby transmitters. The manufacturers save a few pennies by leaving out the necessary filter. Oh, the FCC has told them tut tut, but it hasn't ever said dammit, put 'em in. The result is one heck of a mess, with consumers automatically blaming us for the interference. The FCC has the authority to fix the problem, but they've done nothing.

The question is, will the FCC see the error of its ways and reform? Or will it take aim at the messenger, shooting all of us down in the process? Well, that'll sure stop the complaints.

Yes, the League complaints are right. But I think they picked a really dumb way to tackle the problem. The FCC can be made to effect enormous changes if you go about it the right way. I was able to get the full cooperation of the FCC to make the biggest bunch of rule changes in history a little over 20 years ago, so I know it can be done, and how to do it. And it isn't by getting them mad at you.

Thanks K6YGK!

George Uminski K6YGK sent me a note with some stuff that might interest you. There was a column by Bob Pease from *Electronic Design* pointing out that people who use their minds a lot seem to be able to stave off memory loss and even Alzheimer's. Maybe I'm not completely wasting the time I spend compulsively doing crossword puzzles. He also passed along the address of Mead

Killion, 61 Martin Lane, Elk Grove IL 60007, for anyone who thinks that hearing aids have to be lousy. He also included a review of *Reunions: Visionary Encounters with Departed Loved Ones*, by Dr. Raymond Moody. If I haven't reviewed this book for you yet, I should. I found it fascinating and convincing. It explains how anyone can set up a large mirror in a darkened room with only a 15W light and sit and talk with the "spirits" of those on the next astral plane. That's presuming there's anyone who's passed on that you'd like to talk with. Maybe 20m DX has more of an attraction than a parent or grandparent. I've been intending to find someplace around the house to set up a "psychomanteum" so I could thank whatever spirit keeps helping me at cribbage with "24" hands. And the angel who steps in to save me when people I've trusted take advantage of that trust.

More Ham Politics

When I got frantic calls from several of the repeater frequency coordinating groups asking if I would come to the ARRL-called coordinator's meeting in Missouri last October to help them deal with the ARRL, I begged off. I could see why the League called the meeting, but I didn't think that a fight on their turf, with them holding all the cards, was smart. Further, one of the League officials involved was a chap I'd trusted and then, I felt, had screwed me out of several thousand dollars a few years ago, so I thought that might interfere with my impartiality.

My advice to the coordinating groups attending the conference was to accept whatever benefits

the ARRL was offering, but to form their own national coordinating council and cede no control. I suggested they look for a retired ham to run the council and cover his basic expenses with a small fee collected from each repeater they coordinate.

They were all adamant that they didn't want to turn coordination over to the ARRL, which was understandable.

I could understand, too, why the FCC would be enthusiastic about there being a Single Point of Contact (SPOC) for them to pass along repeater problems, thus saving them a ton of aggravation (and expense). I could also understand a certain reluctance of the ARRL, no matter their compulsive need to control every aspect of amateur radio so as to prevent any competing organizations from getting started, to put themselves into the position of being a deep-pockets target for lawsuits from every ham failing to get a coordination for his repeater. And we seem to be heading in the direction of there being one repeater for every licensed ham. Fine, we'll have 600,000 unused repeaters instead of a few hundred active and merely thousands of almost unused repeaters.

I probably shouldn't write about this at all, since every time I mention anything the ARRL is doing I get accused of being anti-ARRL. Go soak your head, if you think that. I'll be getting my 60-year plaque in a couple of years; how about you, buster? I joined in 1938. I would have joined a couple years earlier if WICUN hadn't given me his 1936-37 *QSTs* Alas, when Cowan, the publisher of *CQ*, fired me as editor in 1960, he kept my 24-year collection of *QST*, my beloved SX-28A, my Navassa KC4AF DXpedition slides, and a bunch of other treasures. But since getting fired forced me to start 73, that was a huge favor for me. That changed my life, making it possible for me to start *Byte*, *80 Micro*, *InCider*, etc.

I started building receivers and SWLing in 1936, graduating to bootlegging by 1937. Ask Walt WA6BMG about my early days on 160m in Brooklyn when he was W2LBF, just four short blocks from me.

Anyway, by forming a National Frequency Coordinating Council (NFCC), incorporating

Continued on page 7

ORDER NOW 1-800 4 HOBBY KITS

AIRCRAFT RECEIVER

Hear exciting air-craft communications—pick up planes up to 100 miles away! Receives 110-136

MHz AM air band, smooth varactor tuning superhet with AGC, ceramic filter, adjustable squelch, excellent sensitivity and lots of speaker volume. Runs on 9V battery. Great for air shows or just hanging around the airport! New 30-page manual details pilot talk, too. Add case set for "pro" look.

AR-1 kit.....\$29.95 Matching case set, CAR...\$14.95

SYNTHESIZED AUDIO GENERATOR

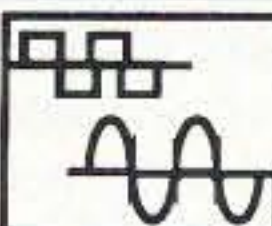

DDS (Direct Digital Synthesis) technology brings you a terrific audio generator at a fantastic price! Generates from 0.01 Hz to 50 KHz with five digit LED display of frequency. Sine and square wave output adjustable 0-5 volt p-p. Frequency selected by direct keyboard entry and with handy continuous tune tuning knob. Crystal controlled accuracy of 10 ppm and two memories for rapid frequency changes. Retire that jury-rigged old generator and treat yourself to the pleasure of using a new state-of-the-art SG-550!

SG-550 Kit ..\$199.95 SG-550WT assembled\$269.95

SHORTWAVE RECEIVER

Fantastic receiver that captures the world with just a 12" antenna! Can receive any 2 MHz portion from 4-11 MHz. True superhet, has smooth varactor tuning, AGC, RF gain control, plenty of speaker volume and runs on a 9V battery. Fascinating Scout, school or club project, provides hours of fun for even the most serious DXer. For the car, consider our shortwave converter. Two switchable bands (in 3-22 MHz range), each 1 MHz wide—tunable on your car radio dial. Add some interest to your drive home!



Shortwave receiver kit, SR1.....\$29.95
Shortwave converter kit, SC1.....\$27.95
Matching case set for SR1, CSR.....\$14.95
Matching case set for SCI, CSC.....\$14.95

AM TRANSMITTER

High quality, true AM broadcast band transmitter is designed exactly like the big commercial rigs. Power of 100 mW, legal range of up to 1/4 mile. Accepts line level inputs from tape and CD players and mike mixers, tunable 550-1750 KHz. Complete manual explains circuitry, help with FCC regs and even antenna ideas. Be your own Rush Limbaugh or Rick Dees with the AM-1! Add our case set for a true station look.

AM-1 Transmitter kit.....\$29.95
CAM Matching case set.....\$14.95

SCANNER CONVERTER

Tune in on the 800-950 MHz action using your existing scanner. Frequencies are converted with crystal referenced stability to the 400-550 MHz range. Instructions are even included on building high performance 900 MHz antennas. Well designed circuit features extensive filtering and convenient on-off/bypass switch. Easy one hour assembly or available fully assembled. Add our matching case set for a professional look.



SCN-1 Scanner converter kit.....\$49.95
SCN Matching case set.....\$14.95
SCN-1WT Assembled SCN-1 and case.....\$89.95

SURROUND-SOUND/REVERB

Add concert hall realism to your stereo, TV or even 2-way radio! Easily synthesize a stereo effect from mono sources or richly enliven regular music. Add a big-voice reverb to your radio voice that others will envy! Our reverb/surround sound kit uses a Bucket Brigade IC Device for reliable solid-state performance. Adjustable reverb, delay and mix controls to customize your sound. Easily connected to radios, stereos, CB's and TV's. Plenty of audio to drive a small speaker for stand-alone operation too. Experience the fun and realism that surround sound provides - without spending hundreds! Add our case set for a neat, pro look.

RV-1 Surround Sound/Reverb kit.....\$59.95 CRV Matching case set.....\$14.95
RV-1WT Assembled RV-1 and case.....\$89.95

TOUCH-TONE REMOTE CONTROL

Control virtually anything by Touch-Tone remote control. The URC-1 has 16 switched outputs, 4 adjustable voltage outputs (20 mV steps 0 to 5 VDC), two 10K digital pots (for volume, squelch, etc.) and 3 timers adjustable from 10 ms to 40 hours! Two level password control allows secure control and multi-level access. Six digit LED display shows currently entered codes and a crystal controlled touch-tone decoder provides reliable operation. There's nothing else like this unit, be in complete control of remote radios, thermostats, hi-fi's, homes or even factories with the URC-1. Add our matching case set for a handsome finish.

URC-1 Remote control kit.....\$129.95 CURC Matching case set.....\$14.95
URC-1WT Fully assembled URC-1 and case.....\$189.95

FM SUBCARRIER DECODER

Tap into the world of commercial-free music and data that is carried over many standard FM broadcast radio stations. Decoder hooks to the demodulator of FM radio and tunes the 50-100 KHz SCA subcarrier band. Many radios have a demod output, but if your radio doesn't, it's easy to locate, or use our FR-1 FM receiver kit which is a complete FM radio with a demod jack built-in. These "hidden" subcarriers carry lots of neat programming - from stock quotes to news to music, from rock to easy listening - all commercial free. Hear what you've been missing with the SCA-1.

SCA-1 Decoder kit.....\$27.95 CSCA Matching case set.....\$14.95
FR-1 FM receiver kit.....\$24.95 CFR Matching case for FR-1.....\$14.95

L-C METER

Measure inductors from 10 uH-10mH and capacitors from 2 pF-2uF with high accuracy by connecting the LC-1 to any digital multimeter. Two pushbutton ranges for high resolution readings and we even give you calibration components to assure proper accuracy of your kit! Active filters and switching supplies require critical values, no one should be without an accurate LC meter. For a pro look, add our matching case set.

LC-1 LC meter kit.....\$34.95 CLC case set.....\$14.95

MOTOR CONTROLLER

Control the speed and direction of any motor. Use our SMD-1 for those nice steppers you see surplus, and our MSC-1 for DC motors. The stepper driver features variable speed, half step rotation, direction and power down mode, can drive most any stepper motor. Our DC driver features pulse width modulation control allowing full motor torque even at low speeds and can drive motors up to 50 VDC @ 10 Amps! Add our case set for a professional assembly.

SMD-1 Stepper kit.....\$24.95 MSC-1 DC motor kit.....\$24.95
CSMD SMD-1 case.....\$14.95 CMSC MSC-1 case.....\$14.95

STEREO FM TRANSMITTER

Run your own Stereo FM radio station! Transmits a stable signal in the 88-108 MHz FM broadcast band up to 1 mile. Detailed manual provides helpful info on FCC regs, antenna ideas and range to expect. Latest design features adjustable line level inputs, pre-emphasis and crystal controlled subcarrier. Connects to any CD or tape player, mike mixer or radio. Includes free tuning tool too! For a pro look add our matching case set with on-board whip antenna



FM-10A Stereo transmitter kit.....\$34.95
CFM Case, whip ant set.....\$14.95

DR. NI-CAD CONDITIONER/FAST CHARGER

Quit spending big bucks for replacement battery packs, rejuvenate and condition your batteries for peak capacity. Advanced circuitry has optimized discharge before charge to eliminate memory effect and to condition batteries that have been poorly cared for in the past. Quick charge rapidly brings battery to full charge in less than an hour—just 15 minutes for some types! And "top-off" charge mode squeezes every last bit of energy into each cell for the absolute most capacity. Switch-mode regulator controls constant current charge while being monitored by a negative delta-V system that cuts off the fast charge at the exact point of full charge—batteries are charged, not cooked! Charges NiCads or NiMH packs from 2 to 10 cells (easily expanded) and current capacities up to 10 Amp-hours. Runs on 12 to 15 VDC. Quit cooking your batteries, buying new packs, waiting hours for recharge, get a Dr. Ni-Cad today! Available in money saving kit form or wired and tested with case at a special price. Kit builders: add our matching case set for a snazzy finish.

DN-1 Dr. Ni-Cad conditioner/fast charger kit.....\$49.95
CDN Matching case set.....\$14.95
DN-1WT Fully assembled Dr. Ni-Cad with case.....\$89.95

SPEED RADAR

New low-cost microwave Doppler radar kit "clocks" cars, planes, boats, horses, bikes or any large moving object. Operates at 2.6 GHz with up to 1/4 mile range. LED digital readout displays speed in miles per hour, kilometers per hour or feet per second! Earphone output allows for listening to actual Doppler shift. Uses two 1-lb coffee cans for antenna (not included) and runs on 12 VDC. Easy to build—all microwave circuitry is PC stripline. ABS plastic case with speedy graphics for a professional look. A very useful and full-of-fun kit.



SG-7 Complete kit.....\$99.95

STEREO PEAK HOLD BARGRAPH

Finally a dual LED bar graph with a peak hold display! Bar graph displays are neat and eye catching but their speed is their downfall - they just can't capture the peaks. Our kit is like two units in one, a fast display to show the signal and a long persistence display to capture peaks, similar units go for hundreds of bucks! We offer 3 models: Linear for general use, Semi-Log for audio VU meters, and Log for power displays. Dual - for stereo! - 10 segment multi-colored LED display for snazzy, eye grabbing display and easily set ranges for virtually any signals, from voltmeters to audio VU meters to audio power amps to SWR meters. Complete instructions for easy hook-up to most any device. Add our matching case set for a sharp looking unit.

PH-14 Dual Linear bargraph kit.....\$39.95 PH-15 Dual Log bargraph kit.....\$39.95
PH-16 Dual Semi-Log bargraph kit.....\$39.95 CPH Matching case set.....\$14.95

SPEECH SCRAMBLER

Descramble most scramble systems heard on your scanner radio or set up your own scrambled communication system over the phone or radio. Latest 3rd generation IC is used for fantastic audio quality - equivalent to over 30 op-amps and mixers! Crystal controlled for crystal clear sound with a built-in 2 watt audio amp for direct radio hook-up. For scramble systems, each user has a unit for full duplex operation. Communicate in privacy with the SS-70. Add our case set for a fine professional finish.

SS-70 Scrambler/descrambler kit.....\$39.95
CSSD matching case set.....\$14.95
SS-70WT Assembled
SS-70 and case set.....\$79.95

CRYSTAL RADIO

Relive the radio past with a crystal set like your grandfather built. Uses genuine Galena crystal and catwhisker. Several different types of radios are built, including standard AM broadcast, shortwave and even WW II foxhole style. To compare modern semiconductor detectors, we include a diode for comparison. No soldering required and we even give antenna ideas. Radio for free, get it now before Clinton taxes it!

CS-1 Crystal set kit.....\$19.95

TOUCH-TONE DECODER

Grab Touch-Tone numbers right off the air, phone or tape. A simple hook-up to any radio speaker or phone line is all that is required to instantly decipher touch-tone phone numbers or codes. A 256 digit memory stores decoded numbers and keeps its memory even in the event of power loss. An 8 digit LED display allows you to scroll through the memory bank to examine numbers. To make it easy to pick out number groups or codes, a "dash" is inserted between sets of digits that were decoded more than 2 seconds apart. A "central-office" quality crystal controlled decoder is used allowing rapid and reliable detection of numbers at up to 20 digits per second! For a professionally finished look, add our matching case set. Start cracking those secret codes tomorrow with the Tone Grabber!

TG-1 Tone Grabber kit.....\$99.95 CTG Matching case set.....\$14.95
TG-1WT Fully assembled TG-1 and case.....\$149.95

DIGITAL VOICE RECORDER

Chatterbox digital voice storage unit will record your message of up to 20 seconds. Time is split up into four 5 second blocks which can be played separately or cascaded for longer messages. An LED display shows message location and current mode for easy operation. Nifty built-in interfaces allow simple connection to transmitters for automatic keying when the PTT is initially closed or after it is released. You can even loop your rig's mike through the Chatterbox. For contest or fun use, the CB-1 can drive an external speaker. Includes a built-in electret mike. For that finishing touch, add our matching case set.

CB-1 Voice recorder kit.....\$59.95 CCB Matching case set.....\$14.95

ORDERS CALL 1-800-4 HOBBY KITS (446-2295) ORDERS ONLY
TECH/ORDER/INFO (716)924-4560 FAX (716)924-4555

TERMS: Satisfaction guaranteed. Examine for 10 days. If not pleased return in original form for refund. Add \$4.95 for shipping, handling and insurance. For foreign orders add 20% for surface mail. COD (U.S. only) add \$5.00. Orders under \$20 add \$3.00 NY residents add 7% sales tax. 90-day parts warranty on kit parts. 1-year parts & labor warranty on wired units.



RAMSEY ELECTRONICS, INC 793 CANNING PARKWAY VICTOR NY 14564

CIRCLE 34 ON READER SERVICE CARD

LETTERS

From the Ham Shack

Bill Haddad WD9HXH. Talk about pissing contests! I'd like to do just that to many of your letter writers. What's this crap about agreeing with you 95% of the time, then proceeding to make feeble attempts at refuting your statements? Also, some of your readers (AB6QR is a good example) have a habit of misconstruing what they have read. They miss the point completely, then ridicule and display their ignorance attempting to disprove plain ordinary facts. I have reference to my letter in the August 1994 issue and a really dumb rebuttal in your November 1994 issue.

Bill included a column by Charlie Reese lauding the Duesberg book, Inventing the AIDS Virus for which, thanks. I caught the same column in Conservative Chronicles, which has some great columns by Thomas Sowell, Paul Harvey, etc. The Duesberg book seems in agreement with Dr. Douglass in his marvelous Second Opinion newsletter on the AIDS deal. Well, whatever the truth, the Beck gadget seems to be helping to solve the problem, as are the Dr. Comby and some other approaches, much to the consternation of the AMA, FDA, NIH, WHO, and AIDS activists, all of whom have a bunch to lose if a simple cure is found. Money talks ... Wayne

Jim Hynde KA8DDZ. Sheesh! I can't help wondering if we are ever going to stop worrying about our hobby falling apart. Why are some folks so hung up over our hobby remaining on the leading edge of technology, and promoting it to thousands of new hams each year? I got into this hobby because I was interested in short-wave radio and communications, not because someone sold me on the hobby. I enjoy it and recently joined the Northern California QRP club. What a great club! No meetings, no minutes, no one asking me if I am going to help with the parade or some other event. A radio club that makes kits for the

members to build. Doers! I have had a ball showing my QRP rigs to friends and generating a lot of interest in the hobby, by the way. Meet another member on the air and you have got yourself a QSO!

No, I do not have to sell my hobby to anyone. They are either interested or not. If no one else ever wants to learn CW or pass an electronics test to get a license that's OK with me. If the hobby must die, let it die gracefully. I fail to see how you can artificially keep a hobby alive by stuffing it down the throats of our youth. In the March issue of 73, a reader wrote "Dynamic young (-minded) people need to join the stagnant clubs and get involved." Ha! What on earth makes you think they would want to join such a club? Let's see now, how could we pitch it? "Hey there young high school kid, I want to introduce you to a club of old white cholesterol-laden ham radio operators who have been in the hobby for 30 years and don't want to do anything. Wanna join up?" You must be joking. If we're not attractive to the youth of today then think about how you can change your club to make it attractive! Don't ask our youth to join to add "new blood," make the hobby appealing and they will come. Wish I had a nickel for every enthusiastic kid who got into radio but was turned off by the incessant babble on 2m. Two options: learn to talk like the rest of the goons or be an outsider. It's disgusting.

I laugh every time I hear about a club doing a presentation at a school and getting no interest. I bet those kids are saying, "Gee, if this hobby is so great and wonderful why are these guys here trying to sell it to us?" I do it by showing the QRP rigs I've built and showing how much fun it is to send Morse code on a telegraph key. I get much more attention with that than trying to show the "high-tech" aspect of the hobby. Try and convince someone on the Internet who communicates in the "chat mode" with friends in

Europe to get involved in packet radio, heh heh. Or show my friends who carry cell phones how neat a 2m phone patch is, har har.

So, enough about staying on the leading edge of technology. Why not just have some fun on the air? Build a radio! The new ideas and technologies will be born from the spirit of radio. I may be wrong, but I can't imagine that the forefathers of our hobby became hams because they wanted to develop a new mode called SSB or FM. I think they just wanted to have fun.

Fun is the key, of course. Repeaters are fun, at least at first. Some people have fun doing the same thing every day for years, others need new adventures to maintain their interest. We offer both. I'm a "been-there, done-that" kind of person, so I need adventure to keep my excitement going. Thus I keep getting involved with new technologies. For the unadventurous we have repeaters and 75m nets. But recruiting is important if we're going to hold billions of dollars worth of public property for our exclusive use. Congress isn't spending much of the taxpayers' money on maintaining horse trails. If we don't provide some sort of public service, we're goners, and all those wonderful excuses we had for the amateur "service" back 50 years ago have just about dried up and blown away. Like just about everything else, we're in a "grow or die" situation, so I suggest we sell QRP, DXing, satellites, packet, and so on. And sell hard ... Wayne

Paul W. Minor AAØXG. Sometimes it seems like all you get from the media is news about crime and evildoers. But there is a large group of people in this world who are quietly active in making the world a better place. These people become known only to the extent that they can do their function, otherwise they want to stay in the background, but let's resist that.

"Elmer" is an old term used in amateur radio to describe a person who helps new amateurs to get licensed and off to a good start in the hobby. We need to encourage and recognize these great

people, so I propose we establish an "Elmer of the Year" award.

I have a candidate to propose for this award and hope that others will submit Elmers they have known so we can give them the recognition that they deserve.

My candidate is Ace Hudson AAØVM. He is a good example of what makes ham radio and the people in it fun. Ace is a real ham radio salesman. He talks to just about everybody he comes in contact with about it in barbershops, restaurants, stores—anyplace he can bring up the subject.

Ace has a regular parade of people coming to his house with old radios or questions about tests, antennas, etc., and they usually leave with study guides, handbooks, repaired equipment, and well fed. He keeps a library of study guides, code tapes and reference books to loan. Sadly, many of these loaners are not returned, so Ace replaces what he can with his limited income.

Ace is neurologically handicapped as a result of an auto accident and has a small disability income. Nevertheless, he has gotten his Extra Class license and is a volunteer examiner in charge of the local radio club's monthly exams.

Everybody in our club looks forward to Field Day, where Ace cooks a wonderful variety of gourmet foods for us. People like this enrich our hobby and make it what it is. Let's hear from others out there about their Elmers.

If someone will design a nice certificate, we can have an Elmer of the Month ... Wayne

Michael Farrar VE3WME. You and many others complain that No-Code Techs do not "upgrade," but it is only upgrading in your terms. No-Code Techs see it differently. We see the CW requirement not as an upgrade, but as a backward step into yesterday with a bunch of old-timers who are forcing us to live with them in the past. You say that we can't win this by hassling the Techs. Ridicule won't work either. But you use the ultimate ham radio insult by referring to Techs as ex-CBers (most are not and those that are wanted to get out of that ugly

Continued on page 35

NEVER SAY DIE

Continued from page 4

it, and then keeping it poor, potential lawsuits can be avoided. The NFCC would be valuable as a resort for those unhappy over some coordinating practices. While most groups are honest and fair, there are a few whose scrupulousness could stand some investigation. Some people just can't handle power honestly.

The main benefit to the ARRL of providing assistance would be an inside track on repeater frequencies for their *Repeater Directory*, which might help the publication be more accurate and up-to-date.

Adventure I

In my talks at educational and science conferences I stress the importance of amateur radio as a hobby entry into the high-tech world. I point out that ham radio offers plenty of adventure, as well as a sugar-coated learning experience.

When the Mohawk Amateur Radio Club newsletter published a list of famous radio amateurs (reprinted from *The Canadian Amateur*), naturally I couldn't help but go down the list and see how many I knew personally, or at least had met. And that got me to thinking about the adventure side of amateur radio, for it was through amateur radio that I got to know 20 of these famous hams.

Father Moran 9N1MM led the list. I first met him when I visited Nepal in 1966, where he put me up at his boys' school, and gave me a wonderful tour of the Katmandu area. We kept in touch after that. A few years ago, we met again in Singapore, and then again in Bangkok, where I gave a talk at the Seanet conference.

Next on the list was His Majesty King Hussein JY1, whom I visited and spent two weeks operating JY1 from the Royal Palace. Talk about an adventure! I had dinner with him and his family, and helped introduce amateur radio into Jordanian schools.

Then came Jean Shepherd K2ORS, the famous talk show humorist and later writer and film writer. Jean and I were good friends. I even taught him to water-ski on Jamaica Bay with my Chris Craft Express Cruiser.

I won't go down the whole list. That would expand this into another of my booklets. My trip around the world with Bill Leonard W2SKE could fill a hundred pages alone. My point is that all of these adventures came as a result of my interest in amateur radio, and I haven't done one single thing that any other ham couldn't have done. Or that any newcomer can't do.

It does mean my being adventurous rather than spending all my ham days making rubber-stamp contacts or checking in with the same small group every night for the rest of my life. Perhaps it's this same spirit that has triggered my entrepreneurial adventures.

My visit with Father Moran came about through my talking with Robbie 5Z4ERR in Nairobi many times on 20m. He talked me into coming over to visit. So I read a book on

how to go on an African hunting safari for \$690 by George Christian Herter and talked two other hams into going on the trip with me. Well, as long as I was going that far, I found that it didn't cost much more to keep on going around the world, so my safari stretched on to my visiting hams in around 23 more countries: Nepal, Burma, Ethiopia, Syria, Iraq, Iran (where I operated from the American Embassy), and so on.

Imagine the excitement of working your home station from Damascus (YK1AA), Nepal, Afghanistan (YA1NSD), and even on 75m from VK3ATN! Doing the kava ceremony with a village chief in a native hut on Fiji (VR2FD), zipping around American Samoa on a scooter, and flying all around New Caledonia with another ham in his plane.

Closer to home, I've had a ball mountain-topping on 2m from the highest mountains in Massachusetts, New Hampshire, and Vermont, working amazing distances from airplanes on 2m, and dawking a 10 GHz transceiver and dish to the top of Mt. Monadnock to work seven states on that band.

How about working moonbounce hams all around the world from the big dish at Arecibo?

If you haven't been having adventures in amateur radio, that's 100% your doing. Or, lack of doing. The adventure is there, just waiting for you. The opportunities are there at every turn, pounding away at the door. Take out your earplugs and have some fun that you'll never forget. I still talk about the 75m round table I tried to break into from Western Samoa (5W1AZ), but they said my signal wasn't strong enough so not to bother them. And my slow-scan operation from JY8AA and KC4DX (Navassa).

Have some adventure via amateur radio and then talk it up at your local schools. Get kids interested. Elmer. And I want to see some hint in the club newsletters that someone is making an effort to attract youngsters.

Also, newsletter editors, how about getting your fellow club members to write about their adventures in amateur radio? Thousands of hams have had wonderful adventures. Like when I went to Yugoslavia to help a fellow ham and his wife emigrate to America. Or when I "smuggled" hundreds of the latest transistors into Austria, Hungary, and some other European countries so the hams could build things. Or when I brought treasured American toilet paper to Bill Orr W6SAI, who was summering near Monaco on the Riviera.

There are plenty of fascinating and famous people to meet through the hobby, but you have to make an effort.

Now, what's the most exciting ham adventure you've had so far?

Adventure II

We have three main sales points when it comes to selling our hobby to youngsters. I do hope you aren't in disagreement with me about our needing to recruit youngsters. In the late 1940s and 1950s 80% of our new

Continued on page 39

ALL ELECTRONICS CORPORATION

SPECIAL SALE! METAL OXIDE VARISTOR SURGE SUPPRESSOR

Harris / GE # V130LA20B or equivalent
130 Vac nom. 70 Joules.
Peak pulse current: 6,500 amps.

\$1.00 each
CAT# MOV-130-20
100 for \$75.00



MAGNETIC CARD READER

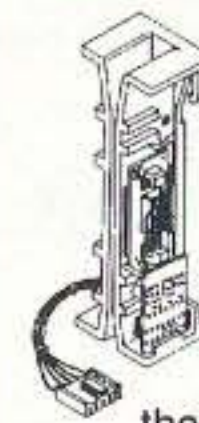

Magtek# 21045002
Credit card or ID card magnetic strip reader consists of break-resistant plastic card guide with decoder pc board and head. Head is mounted on spring steel strip which keeps it pressed against the card surface. Terminated with a socket connector at the end of 5 color-coded leads.

3.57" X 0.9" X 0.95"
CAT# MCR-2 **\$6.00** each

ULTRA-BRIGHT LED

Rohm # SLA-580MT-E49 T-1 3/4
GREEN, water clear in off state. 500+
mcd @ 2.1 v, 16ma.

CAT# LED-33 **2 for \$1.00**

100 for \$40.00 • 1000 for \$300.00



FLASH ASSEMBLY

Great source of parts. This camera circuitry includes a flash assembly with a 410uf, 300 volt photoflash capacitor, flash tube and trigger transformer. Hook-up information is no available.

4.5" X 2.7" X 0.8" h.
\$2.00 each
CAT# FSH-4
10 for \$15.00

ORDER TOLL FREE
1-800-826-5432
CHARGE ORDERS to Visa, Mastercard,
American Express or Discover

TERMS: NO MINIMUM ORDER. Shipping and handling for the 48 continental U.S.A. \$5.00 per order. All others including AK, HI, PR or Canada must pay full shipping. All orders delivered in CALIFORNIA must include local state sales tax. Quantities Limited. NO COD. Prices subject to change without notice.

CALL, WRITE
FAX or E-MAIL
for our FREE
64 Page
CATALOG
Outside the U.S.A.
send \$2.00 postage.

MAIL ORDERS TO:
ALL ELECTRONICS
CORPORATION
P.O. Box 567
Van Nuys, CA 91408
FAX (818)781-2653

E-Mail allcorp@allcorp.com
WWW <http://www.allcorp.com/>

CIRCLE 194 ON READER SERVICE CARD

DXer of the Year Nominations

The New Orleans International DX Convention is soliciting nominations for the DXer of the year award, to be presented at the 1996 convention Aug. 30-31. The recipient last year was Vince Thompson K5VT. All nominations received will be confidential and will be given equal treatment by the review committee. Send a letter describing your candidate and your reasons for the nomination to Michael Mayer W5ZPA, 5836 Marcia Ave., New Orleans LA 70124; FAX 504-524-2129. From *The DX Bulletin*.

FCC Commissioner Quello Issues Statement on Band Allocation

Introduction

1. By this action, the Commission addresses the Petition for Reconsideration (Petition) of the Report and Order in this proceeding filed by Fred Daniel d/b/a Orion Telecom (Orion). Specifically, we affirm our allocation of the 219-220 MHz band to the Amateur Radio Service on a secondary basis. We also maintain our regulations concerning the notification distance between Automated Maritime Telecommunications Systems (AMTS) and amateur radio operations, the exclusion distance between AMTS and amateur operations, and the type of equipment permitted in this band. However, we are amending our amateur rules to reflect the frequency upon which the AMTS stations operate. Finally, we are also taking this opportunity to update and correct the Table of Frequency Allocations as a purely ministerial matter.

Background

2. The 216-218 MHz and 219-220 MHz frequency bands are currently allocated on a primary basis to the Maritime Mobile Service for AMTS. In the Report and Order, we allocated the 219-220 MHz band on a secondary basis to the Amateur Radio Service for the provision of point-to-point fixed digital message forwarding systems, including intercity packet backbone networks. We found that this allocation will serve the public interest by: 1) relieving congestion that exists in the 222-225 MHz band in certain geographic areas; 2) encouraging the development and implementation of regional and/or nationwide digital message forwarding system networks that can be used for emergency and national defense communications purposes; 3) facilitating connection of local packet nodes to form such regional and nationwide networks; and 4) providing spectrum for exploration of new technology related to these purposes.

Submitted by Klaus Spies from PACKET.

Spread Spectrum Comment

The Tucson Amateur Packet Radio Corporation ("TAPR") submits the following reply comments regarding the Petition for Rulemaking (the "Petition") filed by the American Radio Relay League ("ARRL"), which proposed certain changes in the rules governing spread spectrum operation in the Amateur Radio Service ("ARS").

I. Permitting more widespread spread spectrum operation in the ARS would serve the public interest.

A number of the comments recognized the benefits that could be provided by more widespread use of spread spectrum technologies in the ARS. In addition to those that would accrue to ARS operators, as described in the Petition, increased use of spread spectrum in the ARS would contribute to the overall development of spread spectrum communications and, as a result, would provide benefits indirectly to commercial users as well.

Expanded use of spread spectrum in the ARS also would further the Commission's objective of promoting efficient spectrum use. At the FCC's March 5, 1996 *en banc* hearing on spectrum policy, Paul Barens, the "father" of one of the technologies that forms the basis of the Internet, made the following statement:

"What do we see today if we tune a spectrum analyzer or a radio receiver across most of the scarce spectrum bands? Mostly nothing. Dead air. This strongly suggests that most of our limited spectrum space is not being fully utilized and is going to waste. Specifically, with digital technology, spectrum bands can be more efficiently packed without interfering with existing services."

By increasing the ability of ARS operators to use spread spectrum technologies, the Commission would enhance their ability to use digital technologies to enhance spectrum efficiency, as recommended in the above passage. In turn, the Commission also would make it possible for the ARS to better accommodate the many new users seeking to use ARS bands, which are already congested due to the widespread use of non-digital equipment.

Although spread spectrum is not a panacea, it offers the promise of increased spectrum efficiency, reduced interference, and improved communication performance without adversely affecting other spectrum users. As a result, the Commission's rules governing spread spectrum operation should be modified to enable these technologies to flourish within the amateur service community.

II. Expanded spread spectrum operations will not adversely affect other ARS operations.

Several repeater coordinating organizations, who are responsible for the coordination of

repeater operations in their regional areas of activity, filed comments opposing the Petition. These entities generally alleged that adoption of ARRL's proposals would cause widespread interference to, and disruption of, existing operations.

The fears and concerns expressed in these comments defy the proven ability of properly designed and implemented spread spectrum systems to operate in harmony with other spectrum users, are based upon "worst-case" scenarios, and reflect a desire to maintain the status quo even at the cost of stifling new technologies and services. As a result, they should not be permitted to prevent the development of spread spectrum in the ARS.

First, as discussed by Robert Buaas, claims that spread spectrum operation will raise the noise floor ignore the fact that few real systems operate near it, and those that do would profit from applying spread spectrum technology.

Second, in the ten years since the Commission first allowed limited spread spectrum operation in the ARS, a great deal of work has been done to address concerns that more flexible spread spectrum operation would adversely affect other types of ARS operations. In particular, the 1991 Buaas spread spectrum STA has made it possible for experimenters to engage in widespread use of spread spectrum technologies in the amateur band allocations below 450 MHz. Notably, operation under the existing spread spectrum rules and experimentation under the spread spectrum STA have not generated substantiated claims of objectionable interference.

Finally, the successful operation of Part 15 spread spectrum systems provide substantial evidence of the ability of these devices to coexist with other users. Today, millions of spread spectrum devices operating under Section 15.247 of the Commission's rules are being used to support end-user solutions in areas such as cordless phones, location monitoring devices, and local and metropolitan-area networking. These devices have been deployed across the United States without any local coordination and without any licensing by the Commission. Yet despite this flexibility and extensive use, spread spectrum Part 15 devices have almost universally operated without causing objectionable interference to other Part 15 devices or to others operating in shared spectrum. This success story provides ample proof that when spread spectrum devices are properly designed, manufactured, and deployed, they can coexist successfully with many diverse applications and, in addition, can facilitate frequency reuse.

In light of this history of successful, non-interfering operation, the Commission should not permit unsubstantiated claims of potential interference to thwart the introduction and use of new spread spectrum technologies in the ARS.

III. Section 97.119(B)(5) of the rules should be deleted, as suggested by NCS.

TAPR supports the suggestion made by the Manager of the National Communications System ("NCS") to delete Part 97.119 (b)(5), which

deals with the requirement for CW identification. TAPR agrees that no currently available commercial equipment implements such a function, and that deletion of this requirement will act to speed the rapid adoption of this equipment into use in the ARS.

Conclusion:

TAPR congratulates the ARRL for its forward-looking proposal to liberalize the spread spectrum rules in the ARS. ARRL's proposal, if adopted, could provide a variety of benefits to both members of the amateur service community and to the wider public.

Proposals to modify the status quo often generate opposition by those who are adequately served by it. Like the turmoil that occurred in the ARS during the transition from AM to SSB, the growing use of spread spectrum in the service will not be without incidents of disagreement and misunderstanding. For this reason, TAPR intends to use its resources during the rule making process to educate the ARS community on the theory, application, and practice of spread spectrum technology.

Yet, while fear and opposition are understandable, they should not be permitted to stifle new developments. In light of spread spectrum's strong track record and proven benefits, unsubstantiated claims of potential interference should be discounted and the Commission should act promptly to issue a Notice of Proposed Rulemaking proposing to implement the changes sought by ARRL, modified as discussed in TAPR's earlier comments.

TAPR believes that a program of continuing education of the ARS community on the merits and benefits of spread spectrum technology coupled with a wider use and deployment of equipment by amateurs in various applications, will go a long way towards resolving the concerns of many of those who have filed in opposition. TAPR intends to use its resources to perform this function and service for the amateur radio community in much the same fashion that it helped start the packet radio revolution in the ARS during the mid-1980s.

Respectfully submitted, the Tucson Amateur Packet Radio Corporation.

Touring and Tuning

From December 1995 to February 1996, my wife and I toured the southwestern United States. Our RV has a little 50-watt ham rig with a whip antenna on the rear bumper. During that trip, I tuned each of the HF bands at various times of the day to see just what activity was there.

I was amazed at how much was going on as I tuned from 160-10 meters. In almost every band and in almost every check there were more QSOs on CW than any other mode. The second highest usage was SSB, then various forms of digital communication, and last was AM voice. In that, the 10 meter band was most times dead. I did not hear any FM stations and only a very few 160 meters stations.

Who uses the HF bands? I found a good cross-section of ham radio. Daytime operation

during weekdays was mostly older operators—mostly men of 60 and over. However, in this group, I found a number of lady hams operating CW, and a few on voice modes.

About sundown, the bands make a shift to the younger working people who now have a chance to enjoy our fine hobby. As we went into early nighttime, more and more younger operators filled the bands on all modes. Higher bands faded out many nights and the "good" bands became more active. The CW bands became very crowded at night.

On many weekends, the bands were filled with contest operators, with the CW bands being most active (CW takes the prize for the most activity per kHz of space during a contest while late nights and early morning are the prime time for the DXers).

What do hams talk about? Those of my age talk about health problems, economic stress among the elderly, children, grandchildren, radio in the old days, and conditions of community and government. Younger hams talk about computers, new radio gear, their antennas, and operating power. The youth of our ham community are not frequently heard on the HF bands except is for the Novice-Technician CW band.

I found message nets on many of the HF bands. The CW nets pass messages rather quickly. This appears to be the result of experienced operators and many coded messages. Voice messages often have reception problems, with phonetics slowing down the process.

DX pileups try the patience of most operators and lead to ugly remarks by a few, bringing shame to our hobby. This was the case on 75 meters, and to a lesser extent on 40 and 20 meters. Clean speech and courtesy are generally found throughout the CW bands, with few exceptions.

I did not have equipment to copy the digital signals. They were a small portion of the stations heard at any point in time. A very few digital stations were heard out of the generally accepted band plan. Likewise some CW stations were found outside of the band plan. However, in each case these things were not a serious problem.

What conclusion did I draw? Thousands of hams are busy expanding our hobby and our technology. Just a few darken our colors. Let's all work to enjoy, extend, and cleanse our wonderful hobby...de "Old Huck" Huckabee AA5BU. (Lifted from AARC/Over- Austin Amateur Radio Clubs Bulletin.)

Badger State Hams Pitch In

The north-central Wisconsin village of Weyauwega got an early and most unwelcome wake-up call on March 4, 1996 when, at about 5:45 AM, a Wisconsin Central Ltd. freight train en route to Neenah from Stevens Point derailed on the north edge of the village. Thirty-four cars left the tracks, 14 or 15 of which were pressurized tank cars filled with liquid propane. Six of those cars began burning.

Emergency officials decided to take no chances; all 1,700+ residents were evacuated
Continued to page 33

Pocket Morse Code Trainer

Learn Code Faster & Easier
Better than code tapes
Take it anywhere to practice
Light weight & compact

The Deluxe Pocket Morse Code Trainer

- *Selectable code rates from 3 wpm to 33 wpm
- *Plays standard or Farnsworth
- *Size 1" x 3.8" x 2.4"
- *Runs 40 hrs on one 9 v battery



- 1) Plays continuous fresh random code (Selectable letter groups, ie A-Z, 0-9, & more)
- 2) Preprogramed random character playing
- 3) Interactive training (Excellent for beginners)
- 4) Continuous newly generated QSO (1 million different QSO like the General exam)
- 5) Preprogramed QSO to check accuracy
- 6) Continuous random words Playing

The Ultimate Pocket Morse Code Trainer

It has all the above features plus

- 1) A 16 character LCD display which allows you to check yourself during or after a QSO
- 2) Internal amplified speaker.
- 3) Selectable random character playing. (Select which character or numbers to practice)

Call 214-350-0888 Price \$99.00

Add 2.50 for a mono ear piece & 3.50 for a stereo head set
Visa/MC accepted Add \$6.00 S/H + 8.25% Tx
Computer Aided Technology, 4088 Lindberg Dr, Dallas, Tx 75244

CIRCLE 276 ON READER SERVICE CARD

World's best ham weather station

— only \$379

Others from \$179

New Model 2000:

Helps you alert others to weather extremes via A.P.R.S. or on SKYWARN and A.R.E.S. networks. Features accurate:

- barometric pressure • 3-hr. pressure change • indoor/outdoor humidity* • dew point* • wind speed/direction • indoor and outdoor temperature • wind chill temperature • rainfall*.



Actual size: 6 3/4" x 1 1/4"

Instant access to: • current values • today's highs and lows • yesterday's highs and lows • long term highs and lows • time/date for all highs/lows • rain totals* for today, yesterday and long term • alarms • 4-mode serial port, and more.

Patented design makes this complete weather monitoring system easy to install and simple to use. Informative, educational, and fun. The ULTIMETER 2000 is a great value, too—only \$379 + shipping. (*Optional sensors add'l.)

Call or write for free brochures.

1-800-USA-PEET

or 908-531-4615 FAX: 908-517-0669

PEET BROS COMPANY

1308-6077 Doris Ave., Ocean, NJ 07712

Our 20th Year

© 1996 Peet Bros. Co.

Ham Shack Test Equipment

What you really need, based on the author's 47 years of experience.

J. Frank Brumbaugh KB4ZGC
P.O. Box 30, c/o Defendini
Salinas PR 00751-0030

Every ham shack, no matter how simple and inexpensive, or complex and costly, needs a certain amount of test equipment. Measurements must be made from time to time. Additionally, sometimes signals and voltages need to be generated.

The average ham does not have an unlimited budget, so he or she cannot load up on commercial test gear, most of which is rather expensive. However, some commercial test equipment along with some simple home brew gear, in the proper mix, will be cost effective and make every necessary job possible and easy to accomplish.

Digital multimeter

The digital multimeter (DMM) is probably the most-used item of test equipment in the shack. Although a few are available in kit form, they do not have all the usual capabilities of a full-featured DMM, nor are they very easy to construct unless you have lots of experience in close soldering on printed circuit boards. Therefore, I recommend purchasing a commercial meter.

Although prices range from about \$20 to several hundred dollars, it is possible to purchase a full-function DMM for about \$60-\$80. By "full-function" I mean that the meter has the ability to measure (full-scale) AC and DC volts from 200 mV to 750 or 1,000 V, and AC and DC current from 20 mA to 10 or, preferably, 20 amperes. Resistance should cover 200 ohms to 20 megohms or more. The DMM should measure capacitance from 2 nF (0.002 μ F) to 100 μ F or more. Transistor DC beta (h_{FE}) should also be included. Most full-function DMMs measure from 0 to 1,000.

Some DMMs costing less than \$100 will also measure frequency, usually to 20 kHz, and some as high as a few hundred kHz or even 1 or 2 MHz. However, they usually require a relatively high signal level, and with

the usual 3 1/2-digit readout it is impossible to pinpoint a frequency higher than 9.999 kHz.

A few DMMs in the under-\$100 price range will also measure inductance. However, the lowest range is usually about 2 mH full scale. Hams usually need to measure much smaller inductances in the μ H range, so this capability will be of limited, if any, value to most, especially if this feature increases the price of the meter.

Almost all DMMs have a switch position for continuity, with an audible "beep" indication. Personally, I use the lowest ohms scale and glance at the readout.

All DMMs include a switch position to check diodes. Some work; some don't. Those that do work provide merely a go/no go indication. They will differentiate between open and short diodes, and functioning ones, but will not provide any indication of forward and reverse resistance, important characteristics of all diodes in many circuits. Attempting to measure diode resistances on the ohms ranges does not work. The voltage available at the test prods, usually less than 1 volt, is insufficient to bias the diode into conduction.

Analog multimeter (VOM)

A small pocket-sized analog multimeter which measures AC and DC volts, DC current, and ohms will be necessary when measuring forward and reverse resistance of diodes in order to match them. It will also be needed for monitoring voltage or current for a dip or a peak while adjusting other equipment, such as aligning or peaking tuned circuits in a receiver or transmitter, etc.

This type of meter does not have to have a high input impedance nor be particularly accurate—most such meters have an accuracy of only 2% or 3% of full scale. A multimeter with 1,000 or 2,000 ohms per volt sensitivity will be satisfactory. It will also be inexpensive. Buy one.

Dummy load

Although 50 ohm dummy loads for low power levels can be home-brewed using an appropriate number and values of 2 watt carbon composition or film (non-inductive) resistors (this is recommended if you operate only low power because it is cheap), many different manufacturers offer accurate non-inductive dummy loads capable of handling different power levels up to the legal maximum and higher. Prices vary from about \$30 (MFJ-260B, 50 watts for three minutes, 300 watts for 30 seconds) to much more expensive load resistors mounted in gallon paint buckets full of oil. Choose one which will handle the power you are using, or plan to use once you get that amplifier you have your eye on.

Cross-needle SWR power meter

An accurate cross-needle SWR power meter rated for your output power or somewhat higher, connected between your rig and antenna tuner, will enable tuning for maximum power output simultaneous with lowest SWR. These meters are available from MFJ, Daiwa and other sources, in various power and frequency ratings. Some cover just HF through 30 MHz, while other HF meters include coverage of the 6 meter band. Others are available for VHF and UHF. Prices start at about \$40 (MFJ-860, 30 and 300 watt ranges, 160 through 6 meters) and increase from there.

You can also home-brew SWR and power meters for HF, though you must use two separate meters, or switch a single meter between forward and reflected power. There are some excellent designs in W1FB's *Design Notebook* and other publications. Also check the back issues of the various ham magazines.

Continued on page 82

MFJ-989C 3 KW Antenna Tuner

More hams use MFJ-989s than any other 3KW tuner in the world! Why? . . . Because MFJ uses super heavy duty components to make the world's finest 3 KW antenna tuner . . .

In Stock at ham dealers everywhere!

Call your dealer for your best price

\$349⁹⁵

MFJ-989C

- New for 1996 -- MFJ AirCore™ Roller Inductor
- Super Heavy Duty Components • Made in U.S.A.
- Handles 3000W PEP SSB
- peak/average Cross-Needle SWR/Wattmeter
- Antenna Selector • Balun • Built-in Dummy Load



More hams use MFJ-989s than any other 3 KW tuner!

MFJ uses super heavy duty roller inductor, variable capacitors, antenna switch and balun to build the world's most popular 3 KW antenna tuner.

The rugged MFJ-989C handles 3 KW PEP SSB and covers 1.8 to 30 MHz, including all MARS and WARC bands.

MFJ's new 1996 AirCore™ Roller Inductor, three-digit turns counter and spinner knob gives you exact inductance control for absolute minimum SWR.

You can match dipoles, verticals, inverted vees, random wires, beams, mobile whips, shortwave -- nearly any antenna. Use coax or balanced lines.

You get everything you've ever wanted in a high power, full featured, antenna tuner -- widest matching range, lighted Cross-Needle SWR/Wattmeter, antenna switch, built-in dummy load, balun, convenient flip-stand -- all in a sleek, compact cabinet.

MFJ builds the world's most popular 3 KW antenna tuner using these super heavy duty components . . .

MFJ AirCore™ Roller Inductor

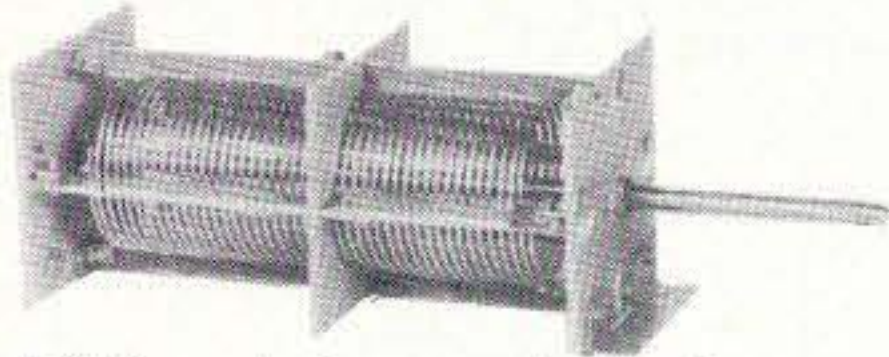

MFJ's exclusive super heavy duty AirCore™ Roller Inductor has an air core that can't burn up! You get ultra high-Q, the lowest loss, highest efficiency and highest power handling of any roller inductor in ham radio.

MFJ's exclusive Self-Resonance Killer™ keeps potentially damaging self-resonances away from your operating frequency.

Large, self-cleaning wiping contact gives excellent low-resistance connection without arcing or contact burning.

A solid 1/4 inch brass shaft with self-align bearings gives smooth non-binding rotation.

Some competing "legal limit" tuners use a lossy, low Q, solid core with erratic electrical contacts and have potentially damaging self-resonant frequencies. This can cause excessive heating and can destroy the core.

Massive Transmitting Capacitors

Look inside . . . you'll see two super heavy duty transmitting variable capacitors that can handle 6000 volts. Extra wide (0.27 inch) stator plate spacing gives you arc-free operation.

Specially shaped plates give low minimum capacitance when unmeshed. This and a hefty 250 pf maximum give you an extremely wide matching range -- even on 160 and 10 Meters.

The nearest competing "legal limit" tuner has variable capacitors physically much smaller than the MFJ-989C's. Theirs is rated at 4500 volts -- a full 25% less than the MFJ-989C. Theirs is more likely to arc -- not what you want in a "legal limit" tuner!

Super Antenna Switch

The MFJ-989C super heavy duty antenna switch is made of two individual ceramic wafers wired in parallel. Extra wide spaced, heavy duty contacts handle extreme voltages and currents. We've never burned one up!

You can select two coax antennas (directly or through tuner), balanced line/random wire, or built-in dummy load.

3 KW Current Balun

MFJ's super heavy duty 3 KW current balun for balanced lines uses two giant 2 1/2 inch toroid cores. It's wound with Teflon® wire connected to high voltage glazed ceramic feedthrough insulators.

The MFJ-989C lets you safely operate high power into balanced feedlines without core saturation or voltage breakdown.

Some "legal limit" tuners have inferior voltage baluns with smaller diameter toroid cores and use soft plastic feedthrough insulators that can arc and melt.

More reasons why the MFJ-989C is the world's finest 3 KW tuner . . .

Built-in Dummy Load

A full-size 300 watt non-inductive 50 ohm dummy load is built into the MFJ-989C.

You'll find it handy for transmitter tuning, testing and repairing your rig, setting power level, adjusting your mic gain and more.

Some "legal limit" tuners don't have a built-in dummy load. They want you to pay for an external dummy load that just gets in your way.

Lighted Cross-Needle Meter

MFJ's lighted Cross-Needle SWR/Wattmeter lets you monitor SWR, forward and reflected power simultaneously. Read both peak and average power in two power ranges.

Sleek and Compact

The compact MFJ-989C slides right into your operating position -- you'll hardly know it's there. It's just 10 3/4 x 4 1/2 x 15 inches. Do you really want a bulky "legal limit" tuner that's bigger than your amplifier?

Superior Cabinet

The MFJ-989C's premium, low-profile all-aluminum cabinet has a sub-chassis that adds strength and RFI protection.

Every cabinet is chemically treated and has a tough, scratch-proof vinyl cladding -- not paint that can scratch or chip off. You won't find a tougher, longer-lasting finish anywhere.

Detailed logging scales and legends are permanently silk screened on real aluminum front and back panels -- they aren't decals or glued-on paper strips that can peel off.

Superior Construction

Every MFJ-989C uses PEM nuts (not self-tapping screws), wing-nut for ground post (not a cheap nut), fire-retardant epoxy glass PC board (not canvas based), heavy gauge wire throughout (not small gauge), locking compound on nuts/bolts (not loose hardware).

No Matter What™ Warranty

Every MFJ-989C is protected by MFJ's famous one year No Matter What™ unconditional warranty. We will repair or replace your MFJ-989C (at our option) no matter what for a full year.

Others may give you a limited warranty on defects in material and workmanship.

But what do you do if your "legal limit" tuner burns up and they say, "Sorry, your limited warranty does not cover that?"

Outstanding Customer Service

We're here to help keep your MFJ-989C performing flawlessly -- no matter how long you own it -- just call 800-647-TECH(8324).

Call your dealer for your best price

In stock at ham dealers everywhere!

Order today or pick one up at your favorite dealer or hamfest -- no shipping, no waiting.

Free MFJ Catalog

Nearest dealer/Orders: 800-647-1800

76206.1763@compuserve.com FAX: (601) 323-6551

•1 year unconditional warranty •30 day money back guarantee(less s/h) on orders from MFJ •Add s/h

MFJ MFJ ENTERPRISES, INC.
Box 494, Miss State, MS 39762
(601) 323-5869; 8-4:30 CST Mon-Fri.
Prices/Specs subject to change. ©1996 MFJ, Inc.

MFJ . . . the world's most trusted name in antenna tuners!

Garbage In—No Garbage Out

Turn hardware store purchases into a cavity filter for satellite and 2m reception.

John Portune AA6NG
724 Celestial Lane
Foster City CA 94404

Do you capture pictures from Automatic Picture Transmission (APT) weather satellites on 137 MHz? If so, you probably are plagued by aircraft interference. The APT satellite frequencies are uncomfortably close to the aviation band used by every

There is something fascinating about building an RF device from hardware store parts, especially a 20-gallon garbage can. Getting good results from such "garden" variety materials is very satisfying. By the way, you 2 meter types can effectively modify this cavity for use at

"I not only eliminated the interference from planes and the airport's tower, but I can now copy the WX satellites several degrees lower in the sky."

airplane and airport in the world. I live right under the glide path of San Francisco International Airport and, to make matters worse, I run a high-gain receiver and a wideband GaAsFET preamp so that I can copy the satellites down near the horizon. I was a prime target for the endless flow of planes that passed over my house, resulting in innumerable glitched and noisy weather satellite images.

The bandpass cavity shown here was like pennies from heaven. Aircraft interference is gone, and I get noise-free pictures. But let me offer you some advice: Don't test the cavity like I did — in the middle of my home office where my computer and WX receiver are. The QRM from the XYL was far worse than that from the aircraft.

144-148 MHz by merely taking an inch off the center pipe.

Why you need a cavity

Many hams do not know that modern superhet receivers develop selectivity late in their circuitry. **Fig. 1** shows a simple block diagram of a typical modern receiver. The front end, including the RF amplifier, must be extremely broad. Its job is to span a broad range of frequencies. The 2 meter band, for example, is 4 MHz wide. The receiver's front end, by design, cannot exhibit high selectivity. Even receivers with helical resonator front ends are several MHz wide. Many of the commercially available receivers used by hams for the weather satellite band, like my Hamtronics R-138, are even broader.

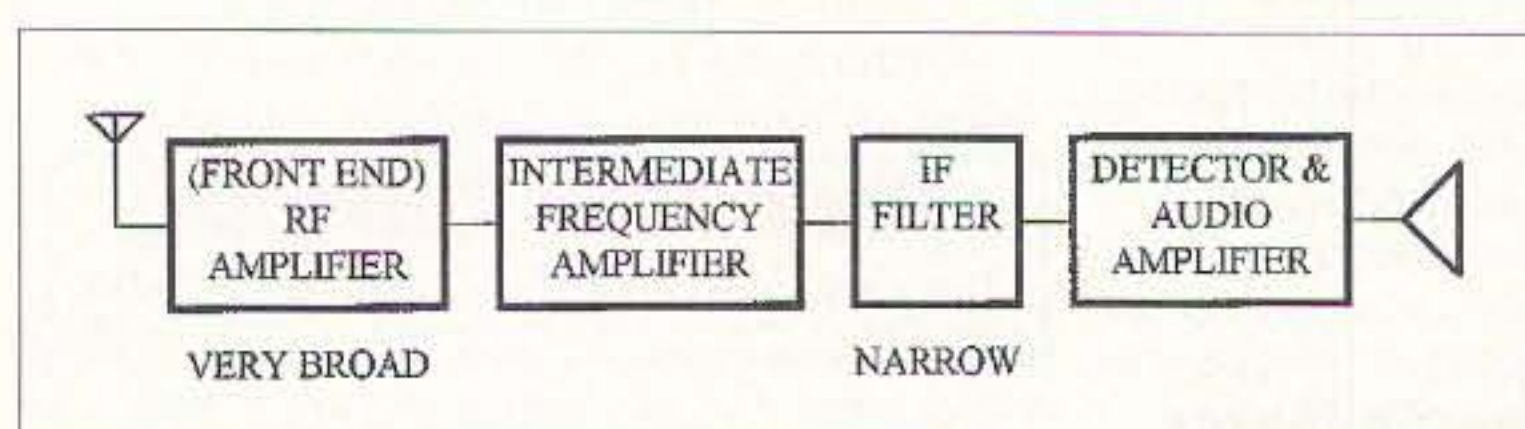

Fig. 1. Block diagram of a typical superheterodyne receiver. Selectivity is developed late in the circuit, in the IF filter. The earlier stages, especially the RF front end, are wide open to overload by strong adjacent signals and other noise.

A broad, unprotected front end like this can easily be overloaded (desensed) by signals several MHz off frequency. True, the IF filter in your receiver may stop you from hearing

these signals, but such signals destroy the working sensitivity of your receiver whether you hear them or not. Even the normal noise in the passband of the front end of your receiver degrades the sensitivity. A receiver may show spectacular sensitivity when connected to a signal generator, but when it's connected to an antenna in a noisy environment, the working sensitivity of the receiver may be terrible. This is something many ham repeater owners often fail to consider.

By adding a passive filter ahead of your receiver and preamp, you will eliminate the aircraft interference the correct way and the effective sensitivity of your receiver will be greatly increased. I not only eliminated the interference from planes and the airport's tower, but I can now copy the WX satellites several degrees lower in the sky. Amazing, all of this from a garbage can, a piece of stovepipe, two connectors, and some 14 AWG wire!

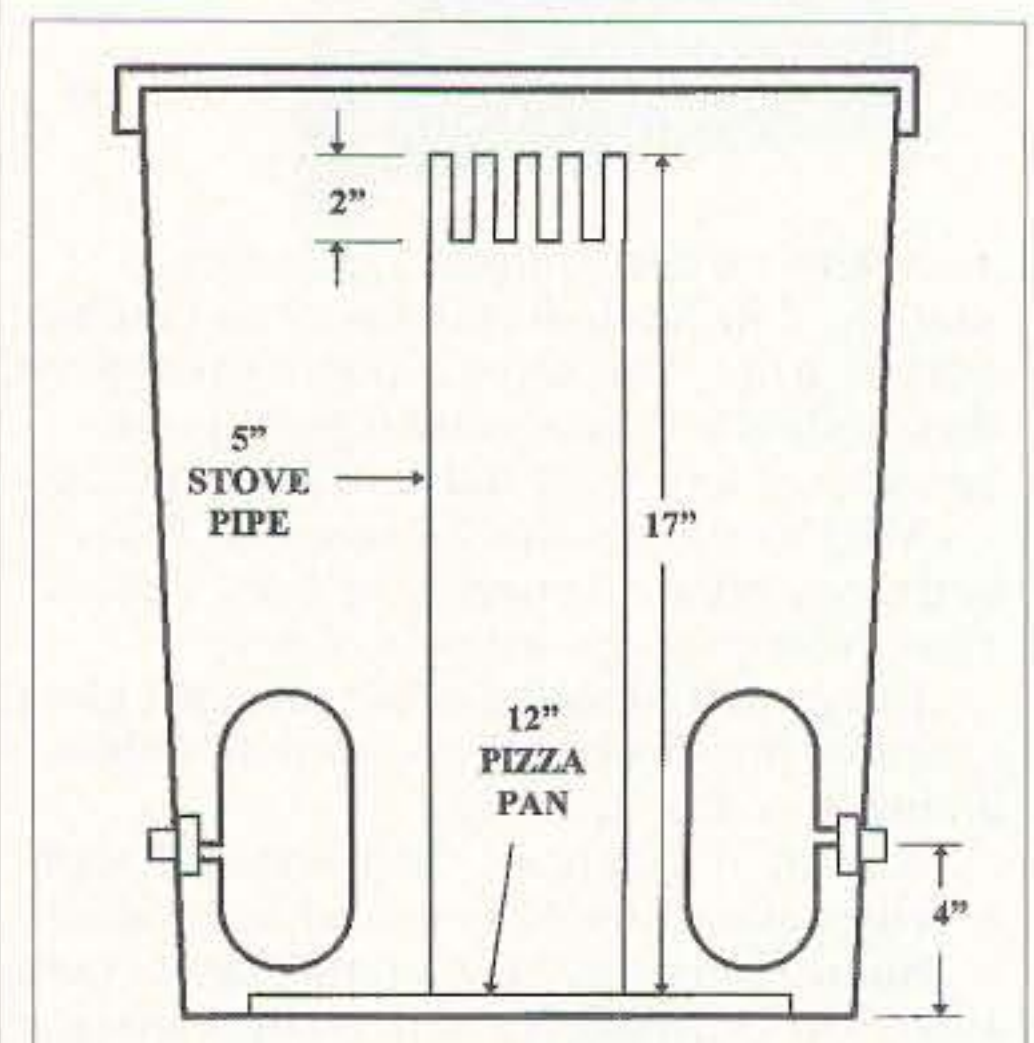

Fig. 2. Cross section of cavity, showing dimensions of inner conductor and placement of coupling loops.

Cavity basics

Like most of the cavities used in duplexers, this one is a 1/4-wavelength section of large diameter coaxial transmission line. It is open at one end and shorted at the other. The lid, as long as it is not too close to the open end, acts mostly as an RF-tight cover (see **Fig. 2**).

In designing any resonant cavity, theory specifies three things required for achieving efficiency: large volume, a 3.6:1 outer-to-inner conductor ratio, and low resistivity. Let's examine each briefly.

"There is something fascinating about building an RF device from hardware store parts, especially a 20-gallon garbage can."

Volume

Quite simply, the bigger the cavity, the better. Anything up to roughly 1/3 wavelength in diameter (21 inches at 137 MHz) will work. Above 1/3 wavelength, a cavity breaks into alternate modes of oscillation which have too much loss for filter service. Selectivity, the cavity's Q factor, improves in direct proportion to diameter. Since I was already constrained to make my cavity roughly 20 inches tall (1/4 wavelength on 137 MHz), when I visited my local hardware store in search of cylindrical metal containers with lids, metal garbage cans immediately caught my eye. They commonly come in two sizes: 20-gallon and 33-gallon. The smaller size is 17 inches in diameter and 22 inches tall. It was just what I needed, though the larger size would have worked well too.

Outer-to-inner ratio

A little-known fact about coaxial transmission line is that loss is minimum

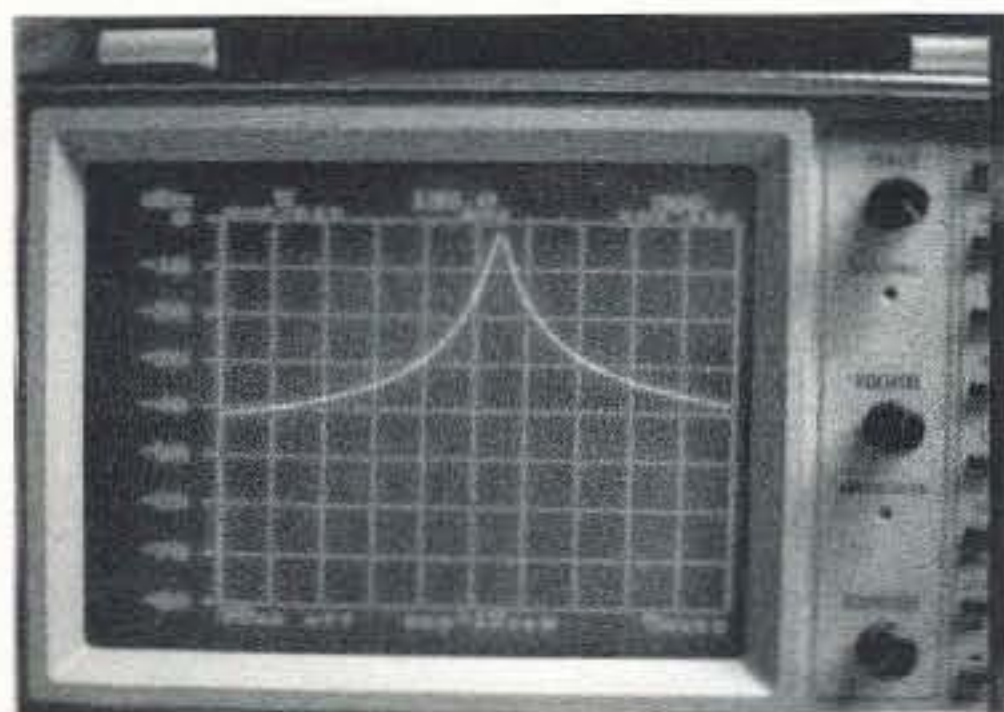

Photo A. Spectrum analyzer display of the filter's frequency response.

at a characteristic impedance of roughly 77 ohms. This is why we use 75-ohm cable where minimum signal loss is important, such as for TV receiver cables. We use 50-ohm cable for power applications because at 50 ohms impedance the cable will carry maximum power without breakdown.

The characteristic impedance of air line is determined mostly by the ratio of the diameter of the outer conductor to the inner conductor. For those of you who like mathematics, the formula for air-insulated coaxial line is:

$$Z_0 = 138 \log(D_o/D_i)$$

D_o = Diameter of outer conductor (the garbage can)

D_i = Diameter of inner conductor (both in the same units)

Since we want Z_0 to be 77 Ω , we simply substitute in the above equation and find that D_o/D_i must equal 3.6.

In other words, the ratio between the garbage can diameter and the inner conductor needs to be 3.6:1 for low loss. Using a tape measure while still in the hardware store, I discovered that ordinary 5-inch galvanized sheet metal stove pipe is very close to the ideal size needed when used with a 17-inch diameter garbage can. Modest variations in this ratio are not critical, however.

Low resistivity

The biggest source of loss in cavities is ohmic loss in the metal. It might not seem that something this large could have much resistance, but don't forget skin effect. RF current, even at low frequencies, flows in a thin film on the inner surface of a conductor, so even a large cavity can have significant ohmic losses. The galvanized surface of the garbage can is not a particularly good conductor. Aluminum or copper would be much better, but at this size and at 137 MHz the losses are modest. This is, after all, a receiving application where a few dBs are not critical. For transmitting purposes or duplexer use, you should go to the trouble of lining the inner surfaces

of the cavity with copper or aluminum foil, particularly at the bottom and on the inner conductor.

The loops

Hams tend to consider cavity design a "black art," but it's not. Coupling loops seem especially mysterious, but are actually fairly straightforward. They simply need to be equal in size and shape, oriented perpendicular to the magnetic field, and placed near the shorted end of the cavity. The exact location, wire size and loop shape have very little effect on performance once they are optimized.

I simply kept changing the area of both loops, by altering the amount of wire or by bending the loops, until I obtained critical coupling. Critical coupling is the condition in which, as the loops get larger in area, losses have just begun to reach a minimum and selectivity is just beginning to fall off. This point is easy to find using a spectrum analyzer with a tracking signal generator (see **Photo A**). For this project, merely duplicate my dimensions and you'll be very close.

Construction

Dimensions and parts placement are shown in **Fig. 2**. Construct the center conductor by cutting a length of 5" stove pipe 18" in length (17" for 2 meters). At the bottom end, make axial cuts, 1" long and 1" apart, around the end to form bend tabs. Do the same at the top end, but make the tabs 2" long and 1/2" apart (see **Photo B**). At the bottom end, bend the tabs outward perpendicularly. At the top, break off every other tab, leaving the remaining ones straight. You will later bend these slightly to tune the cavity.

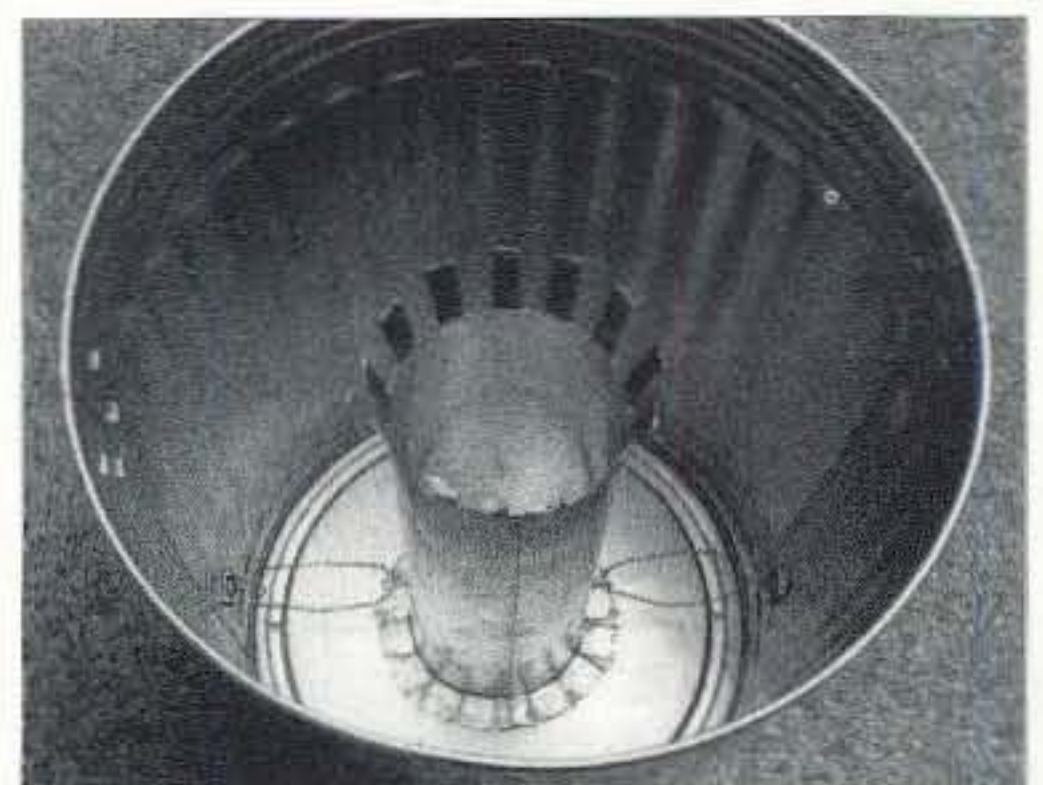

Photo B. Interior of completed filter showing center conductor soldered to pizza pan (in place) and coupling loops.

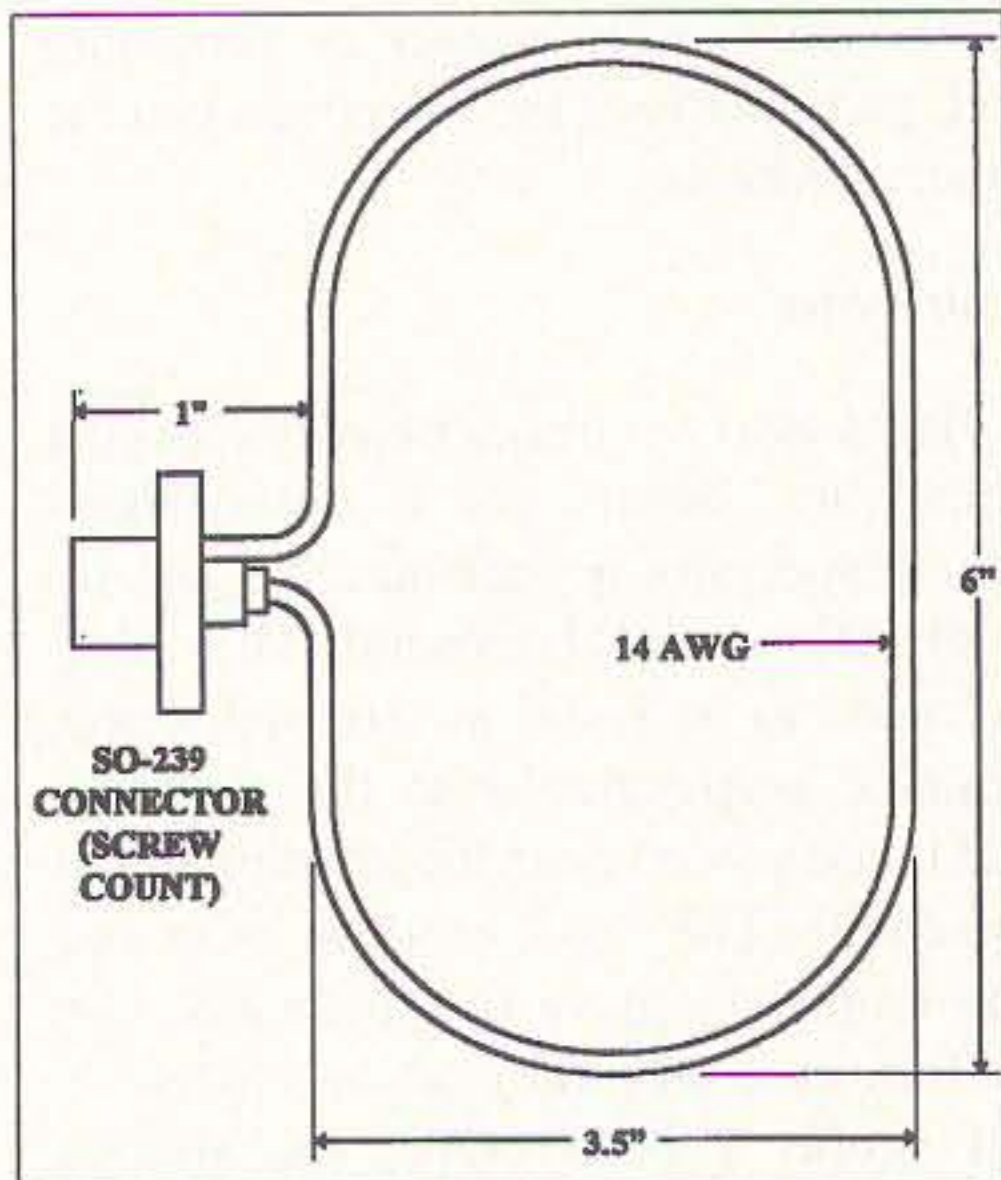

Fig. 3. Detail of coupling loops. Mount in the position shown.

Solder the bottom of the center conductor to the center of an inverted 12" common pizza pan (use a large, high wattage soldering iron). Use a pan that is not plastic-coated, or scrape off the plastic and tin the surface before soldering. Do not use excessive solder; it's required only for mechanical support. Capacity and skin effect make the necessary RF connection. Finally, secure the center conductor, on its pizza pan, into the bottom of the garbage can with a couple of screws.

Make the loops as shown in Fig. 3 and Photo C. Attach the loop to its

connector prior to installation. Install the connector and loop from the inside, rather than the outside. This makes the loops easier to remove. Use the kind of SO-239 connector that installs with four 4-40 screws, as opposed to the type that uses a large locking nut. Once the loops are installed, carefully bend the wire until both loops are the same shape and in the same position. The loops should be extended sideways so that they come within about 1/2" of the center conductor. Install them so that the end of the loop connected to the center pin is downward toward the bottom of the cavity. If you intend to install the cavity out of doors, be sure to seal the connectors from the weather. The lid need not be secured, but some wide plastic tape to hold it on would be a good idea.

Tuning the cavity

Be sure that the lid is on whenever you measure the resonant frequency. Without the lid, the resonant frequency will be quite a lot higher. The ideal test equipment to tune the filter is a spectrum analyzer with a tracking signal generator. With it you can display the shape of the bandpass curve, and set the coupling of the loops and the resonant frequency.

A less elegant way to tune the filter is with a dip oscillator. To do this, solder a small test loop of wire, roughly one inch in diameter, onto a PL-259 connector. Connect it to one connector on the cavity and connect a non-inductive 50-ohm terminating resistor on the other. You will then be able to "dip" the cavity at the small test loop.

Another possible method is to use an RF signal generator to inject a signal into one side and an oscilloscope on the other side of the cavity as a detector. Again, be sure that the cavity has a 50-ohm terminator installed on the output. The oscilloscope will have to be able to display a signal at 137 MHz.

If you lack the above equipment, you can also tune the cavity with just a signal generator and a receiver. Reduce the generator output until the received signal is near the quieting point of the receiver, and adjust the loops for best quieting. If you can't get your hands on a signal generator you can loosely couple some signal from a distant transmitter (yours or the satellite's) into the input of the cavity. Use a step attenuator

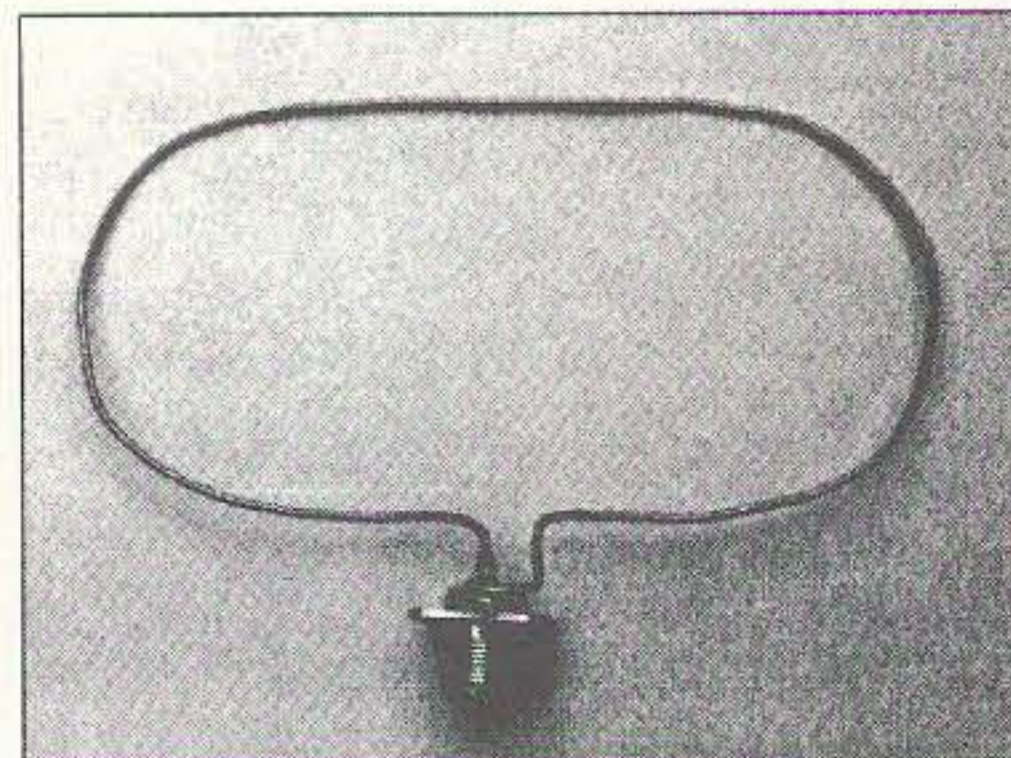

Photo C. Detail of a coupling loop.

on the output, and connect it to your receiver. Once again, adjust the attenuator to get the received signal down near the quieting point of the receiver, and make your adjustments.

Tuning is a simple matter. As you bend the tabs outward at the top end of the center conductor, the resonant frequency of the cavity will decrease. Effectively, you are adding capacitance. Such a cavity is electrically a parallel tuned circuit. Altering the capacitance in this way will not decrease the Q of the cavity to any degree. Q is determined almost entirely by cavity volume and metal resistivity. Tune the cavity for the center of the WX satellite band, or about 137.6 MHz. Changing the length of the inner conductor will also change the frequency. For 2 meters, for example, the center conductor will need to be roughly one inch shorter.

After building this cavity, I have to admit that it qualifies for an honored place in the long-standing ham practice of making do with very little. It also fits nicely into the grand ham tradition of tuna fish can, filing cabinet and lunch box radios. So if you are being plagued by pesky aviators or mountain-top intermod, give this project a try. You'll find it a winner, if you can get it by the XYL. 73

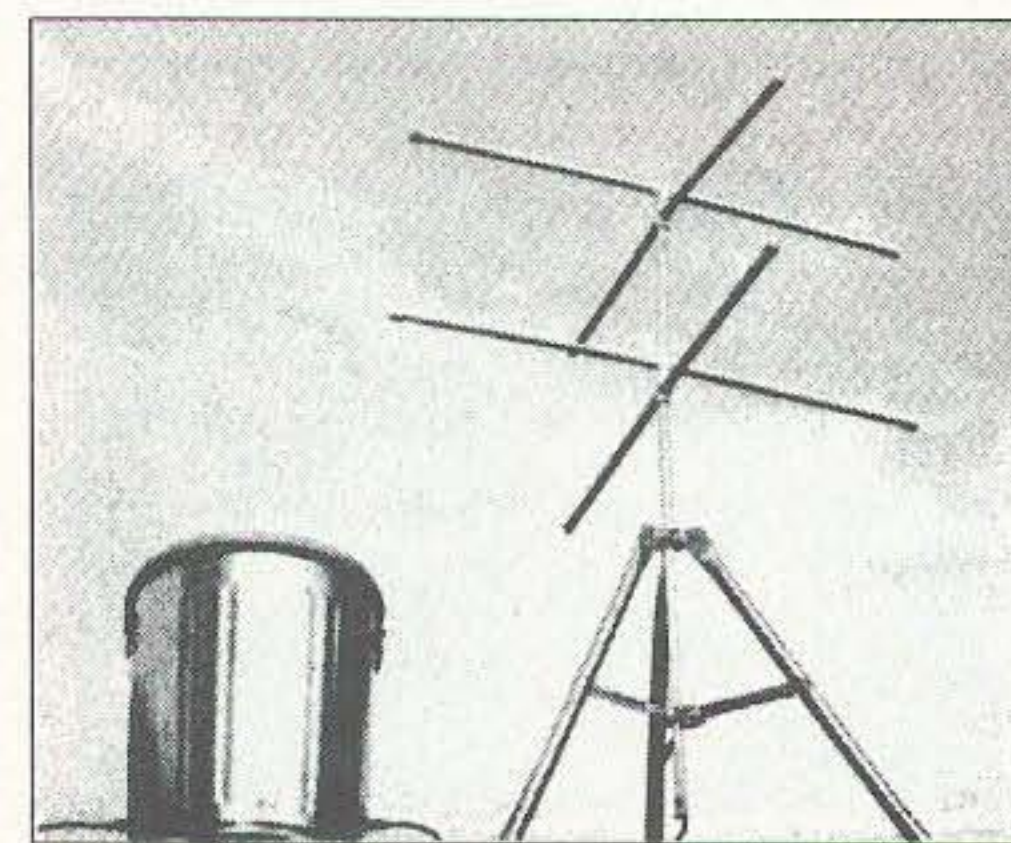

Photo D. Author's turnstile weather satellite antenna and cavity filter on the roof of his house.



CENTAUR ELECTRONICS
SPECIALIZING IN CUSTOM ELECTRONIC PRODUCTS

NEW!

Station Tuning Instrument
(Save station wear & tear)

New Centaur "Cricket" Pulser
\$67.00

- **CRICKETPULSER:** User-Controlled, Variable Duty Cycle Station Tuning Instrument. Positive and Negative Keying Circuit. Compatibility: 200V max, 750MA max. Adjustable duty cycle; 0.5% to 95% 9 volt battery operation. BNC output; custom cable supplied. Dual controls-Pulse and Key Down.
- **1:1 Dipoles and YAGI mounts:** Very broadband - 5 to 50 MHz - 3 kW SSB, stainless hardware, Teflon SO239A connectors.
- **4:1 High Performance Ladder Line and YAGI Baluns,** 0.5 to 50 MHz, 3 kW SSB - \$64.95
- **"Big Bertha" Series** - 10 KW AEGIS class coaxial choke baluns, "N" Conn. High Power apps.

ANTENNA SYSTEMS (includes Balun, Wire, Insulators, Wire Terminations)

- **1:1 Dipole Balun:** 160 or 80/40 or 30/17/12 or 20/15/10(m) - \$79.95
- **Coaxial Center Supports:** high power applications, stainless hardware, SO239A Teflon connectors, custom connectors available - \$19.95

Systems with Coaxial Center Support: 160 or 80/40 or 30/17/12 or 20/15/10(m) - \$49.95

HIGH QUALITY WIRE PRODUCTS (Competitive Prices. Call for Quote)

- Mil-C-17 coax, ratings to 10 kW • Pre-fab wire/connector combinations • General and specialty coax • Ladder line • special orders • Heavy duty rotor cable, (B conductor).

LIFETIME WARRANTIES

24 hour a day order line

CENTAUR ELECTRONICS
3720 S. PARK AVE., #604
TUCSON, AZ 85713
(520) 622-6672 • FAX (520) 622-1341

Circle 78 on reader service card.

ASTRON POWER SUPPLIES

• HEAVY DUTY • HIGH QUALITY • RUGGED • RELIABLE •



MODEL VS-50M

SPECIAL FEATURES

- SOLID STATE ELECTRONICALLY REGULATED
- FOLD-BACK CURRENT LIMITING Protects Power Supply from excessive current & continuous shorted output
- CROWBAR OVER VOLTAGE PROTECTION on all Models except RS-3A, RS-4A, RS-5A, RS-4L, RS-5L
- MAINTAIN REGULATION & LOW RIPPLE at low line input Voltage
- HEAVY DUTY HEAT SINK • CHASSIS MOUNT FUSE
- THREE CONDUCTOR POWER CORD except for RS-3A
- ONE YEAR WARRANTY • MADE IN U.S.A.

PERFORMANCE SPECIFICATIONS

- INPUT VOLTAGE: 105-125 VAC
- OUTPUT VOLTAGE: 13.8 VDC ± 0.05 volts (Internally Adjustable: 11-15 VDC)
- RIPPLE Less than 5mv peak to peak (full load & low line)
- All units available in 220 VAC input voltage (except for SL-11A)

SL SERIES



• LOW PROFILE POWER SUPPLY

MODEL	Colors		Continuous Duty (Amps)	ICS* (Amps)	Size (IN) H x W x D	Shipping Wt. (lbs.)
	Gray	Black				
SL-11A	•	•	7	11	2 5/8 x 7 5/8 x 9 3/4	12
SL-11R	•	•	7	11	2 5/8 x 7 x 9 3/4	12
SL-11S	•	•	7	11	2 5/8 x 7 5/8 x 9 3/4	12
SL-11R-RA	•	•	7	11	4 3/4 x 7 x 9 3/4	13

RS-L SERIES



• POWER SUPPLIES WITH BUILT IN CIGARETTE LIGHTER RECEPTACLE

MODEL	Continuous Duty (Amps)	ICS* (Amps)	Size (IN) H x W x D	Shipping Wt. (lbs.)
RS-4L	3	4	3 1/2 x 6 1/8 x 7 1/4	6
RS-5L	4	5	3 1/2 x 6 1/8 x 7 1/4	7

RM SERIES



MODEL RM-35M

• 19" RACK MOUNT POWER SUPPLIES

MODEL	Continuous Duty (Amps)	ICS* (Amps)	Size (IN) H x W x D	Shipping Wt. (lbs.)
RM-12A	9	12	5 1/4 x 19 x 8 1/4	16
RM-35A	25	35	5 1/4 x 19 x 12 1/2	38
RM-50A	37	50	5 1/4 x 19 x 12 1/2	50
RM-60A	50	55	7 x 19 x 12 1/2	60
• Separate Volt and Amp Meters				
RM-12M	9	12	5 1/4 x 19 x 8 1/4	16
RM-35M	25	35	5 1/4 x 19 x 12 1/2	38
RM-50M	37	50	5 1/4 x 19 x 12 1/2	50
RM-60M	50	55	7 x 19 x 12 1/2	60

RS-A SERIES



MODEL RS-7A

MODEL	Colors		Continuous Duty (Amps)	ICS* (Amps)	Size (IN) H x W x D	Shipping Wt. (lbs.)
	Gray	Black				
RS-3A	•	•	2.5	3	3 x 4 3/4 x 5 3/4	4
RS-4A	•	•	3	4	3 3/4 x 6 1/2 x 9	5
RS-5A	•	•	4	5	3 1/2 x 6 1/8 x 7 1/4	7
RS-7A	•	•	5	7	3 3/4 x 6 1/2 x 9	9
RS-7B	•	•	5	7	4 x 7 1/2 x 10 3/4	10
RS-10A	•	•	7.5	10	4 x 7 1/2 x 10 3/4	11
RS-12A	•	•	9	12	4 1/2 x 8 x 9	13
RS-12B	•	•	9	12	4 x 7 1/2 x 10 3/4	13
RS-20A	•	•	16	20	5 x 9 x 10 1/2	18
RS-35A	•	•	25	35	5 x 11 x 11	27
RS-50A	•	•	37	50	6 x 13 3/4 x 11	46
RS-70A	•	•	57	70	6 x 13 3/4 x 12 1/8	48

RS-M SERIES



MODEL RS-35M

MODEL	Continuous Duty (Amps)	ICS* (Amps)	Size (IN) H x W x D	Shipping Wt. (lbs.)
• Switchable volt and Amp meter				
RS-12M	9	12	4 1/2 x 8 x 9	13
• Separate volt and Amp meters				
RS-20M	16	20	5 x 9 x 10 1/2	18
RS-35M	25	35	5 x 11 x 11	27
RS-50M	37	50	6 x 13 3/4 x 11	46
RS-70M	57	70	6 x 13 3/4 x 12 1/8	48

VS-M AND VRM-M SERIES

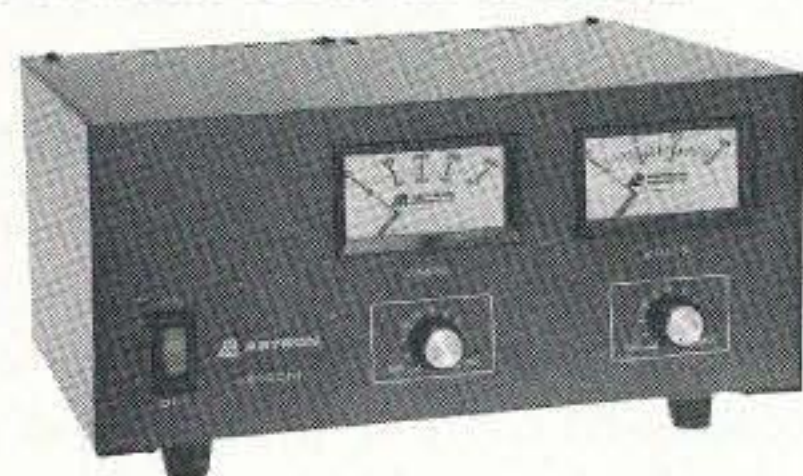

MODEL VS-35M

• Separate Volt and Amp Meters • Output Voltage adjustable from 2-15 volts • Current limit adjustable from 1.5 amps to Full Load

MODEL	Continuous Duty (Amps)			ICS* (Amps) @13.8V	Size (IN) H x W x D	Shipping Wt. (lbs.)
	@13.8VDC	@10VDC	@5VDC			
VS-12M	9	5	2	12	4 1/2 x 8 x 9	13
VS-20M	16	9	4	20	5 x 9 x 10 1/2	20
VS-35M	25	15	7	35	5 x 11 x 11	29
VS-50M	37	22	10	50	6 x 13 3/4 x 11	46
VS-70M	67	34	16	70	6 x 13 3/4 x 12 1/8	48
• Variable rack mount power supplies						
VRM-35M	25	15	7	35	5 1/4 x 19 x 12 1/2	38
VRM-50M	37	22	10	50	5 1/4 x 19 x 12 1/2	50

RS-S SERIES



MODEL RS-12S

• Built in speaker

MODEL	Colors		Continuous Duty (Amps)	ICS* Amps	Size (IN) H x W x D	Shipping Wt. (lbs.)
	Gray	Black				
RS-7S	•	•	5	7	4 x 7 1/2 x 10 3/4	10
RS-10S	•	•	7.5	10	4 x 7 1/2 x 10 3/4	12
RS-12S	•	•	9	12	4 1/2 x 8 x 9	13
RS-20S	•	•	16	20	5 x 9 x 10 1/2	18
SL-11S	•	•	7	11	2 3/4 x 7 5/8 x 9 3/4	12

A Funny Thing Happened On The Way To The Shack

Strange stories from the world of hamdom!

Hal Goodman W3UWH
7 Perkins Road
Eastport ME 04631

Back in the days just after the FCC took 11 meters away from hams to create the Citizens Band, most of us still had equipment capable of operating on 11 meters. At that time I was living in a house on the top of a hill, an excellent location for transmitting. It seems there was this enterprising Citizens Band operator who would park his car right next to my house and spend several hours a day operating. There was nothing wrong with this, except he kept splattering all over my 10 meter receiver.

And that's just what I did. I zero-beated his frequency, turned the Variac all the way up, pointed my three-element beam right at him and waited. As soon as he stopped talking and switched to receive I threw the switch and silently counted to five. Letting go of the switch, I walked to the window and looked out. What I saw was a large cloud of black smoke billowing out of his car. Some of you more technically inclined might be able to figure out just how many volts at what amperage I sent down his antenna. All I know is that it was enough. He never came back.

shack with his earphones on, enjoying a DX with a ham Down Under, oblivious to all outside sounds. Finally, in desperation, she went next door and tried calling him on the phone. Same result. Luckily, the neighbor was also a ham operator, and was able to make contact with the station talking to the husband. Imagine his surprise when a voice with an Australian accent said, "I say, old chap, you'd better bloody well go down and let your wife in—it's bloody cold out there!"

Then there was the case of the haunted bedroom. It seems that several times a week, late at night, the lights in the upstairs spare bedroom would start to blink on and off, accompanied by a faint hissing sound. Thinking that there might be something wrong with the electrical system, the new home owner removed the fuse. When this didn't stop the light show, he called the previous owner for help. The previous owner told him that the blinking lights had been going on for as long as he could remember and that he didn't know what caused it either, but not to worry since it never hurt anybody.

Being somewhat less easygoing, the new owner decided to prevail on the local priest to come spend the night just to be certain the house was not haunted and in need of an exorcism. The priest, who was a ham, quickly realized that this was Morse code and recognized the call of a local ham. The next morning the priest explained that the exorcism could best be performed by an electrician—the length of the wiring in the bedroom was resonant on 20 meters.

"The priest, who was a ham, quickly realized that this was Morse code. The exorcism could best be performed by an electrician."

On several occasions I asked him politely to not park so close to my house, explaining that he was interfering with my 10 meter receiver. His response was that it was a free country and that this was a public street and I could investigate where the sun don't shine with my receiver. Well, I'm as patient as the next guy, but this was getting out of hand.

A little more information is necessary at this point in order to get the full import of what happened next. My equipment was Naval surplus out of an old battleship. You know the kind: solid silver coils, Faraday shields (also solid silver), etc., etc. It was built like the battleship it had come from, using the spare-no-expense government construction. When the Variac was cranked all the way up this baby could deliver a cool 5 kW without any strain.

There is a tale of a young ham back in the days when everybody operated AM. As the story goes, his neighbor, a middle-aged lady, filled her big old cast iron bath tub that had just had new copper pipes installed by her plumber. As she stepped into the tub, raising the water level just slightly, there suddenly came a voice speaking to her from the tub. Several Hail Marys later she once again she set foot into the tub and just as suddenly as before, a voice said unto her, "Five nine with QRM and a dipole."

Then there is this story about a lady who, on a dark, cold night, somewhere in the Midwest, dressed only in a robe and slippers, took the trash out. As you might expect, the door slammed closed behind her. She kept banging on the door and ringing the doorbell but it seems her husband, a ham operator, was in his

Continued on page 20

Receiver Preamplifiers

The pros and cons of these little signal boosters.

Joseph J. Carr K4IP
P.O. Box 1099
Falls Church VA 22041

Preamplifiers and preselectors are popular antenna accessories, and are used ahead of receivers. If you use a separate receiver, or have one of those transceivers that permits a separate receive antenna, then you might be a candidate for a receiver preamplifier to improve performance. Chances are, however, that you're not such a good candidate. The preamplifier is one area where the actual performance is a bit counterintuitive. The "first blush" an-

"What do you mean, I've got mushy ghosts?"

swer would seem to say that anything that boosts weak signals will help the reception of those signals, right? Nope! Not always.

The issue on receivers is the signal-to-noise ratio (SNR). If the signal level is above the noise level a certain amount, then you will receive it effortlessly. Some published sources say a signal must be 1 dB above the noise to be detected by ear, and 3 dB for reasonable copy by a skilled operator; effortless, comfortable copy is said to require about 10 dB SNR, which is how many rigs quote their own SNR.

The problem is that the preamplifier adds noise of its own, plus it amplifies the noise that's "out there" in the atmosphere. Thus, the preamplifier might impair performance, rather than boosting it. The correct solution is to buy a preamplifier that has a noise figure that's a lot better than the noise figure of the receiver front-end. A little bit of math called the Friis equation tells us that the major portion of the receiver's noise performance is set by the noise figure of the first amplifier in the chain. Thus, adding a noisy preamplifier ahead of a good receiver is dumb, but if the preamplifier is a lot better than the receiver, the overall performance is improved.

Maybe. There are other issues besides noise. You really don't want to have too much gain in a preamplifier ahead of a marginal receiver, or at all if the preamplifier is a little mushy. What does "mushy" mean? A proper preamplifier must have a high dynamic range,

produce little intermodulation and have a high third order intercept specification. Otherwise, strong local signals in the same band with the desired weak signals may produce all manner of problems—like desensitization and ghost signals where none really exist.

Continued on page 20

WE SHIP WORLDWIDE

Barry Electronics Corp.

WORLD WIDE AMATEUR RADIO SINCE 1950
Your one source for all Radio Equipment!

KITTY SAYS: WE ARE OPEN 7 DAYS A WEEK
*Sat. 10-5 *Sun. 11:30-5 *M-F 9-6 *Come to Barry's for the best buys in town.*

WHEREVER I GO, I TAKE MY RADIO.
SPECIALIST IN RADIOS:
•BUSINESS •MARINE
•AVIATION •HAM RADIOS
•SCANNERS

KENWOOD
A-S, AES, Cushcraft, Hy-Gain, Hustler, KLM, METZ, Urban, MOUDBLOX, TONNA, Butternut, Multi-Band

MARINE RADIOS
ICOM M7, M11, M56, M700TY, M800, AVIATION PORTABLE ICOM A22, MOTOROLA, TRITON MARINE

Surveillance Devices Available

Shortwave Receivers
Drake • Grundig • JRC • Sony • Yaesu • ICOM
Call 212-925-7000
Satellite telephone in suitcase for worldwide use

CB Radios Stocked
148GTL, Washington, Ranger 2950-70, Antennas: Wilson, Antron, etc.
Power mikes w/beeps - ECHO - SilverEagle etc.

ALINCO DJ-580T, DJ-582T, etc.

Privacy scramblers for radios and phones. CALL

ANTENNAS:
AEA, AlphaDelta, ANLI, Antenna Specialist, Barker & Williamson, Comet, Cushcraft, Diamond, GAP, Hy-Gain, Hustler, Larsen, Etc. Watt Meters Stocked.

GARMIN GPS RECEIVERS

MOTOROLA
We serve: Governments • Consulates • Embassies • Overseas and • Domestic orders.

Yaesu Vertex Portables
FT-2070 dual band VHF/UHF 5 watts VX500, FT-2200R/7000VTR VR-2500, 5000 repeater.

CONTACT US FOR THE LATEST IN BUSINESS AND HAM RADIOS, SHORTWAVE RECEIVERS & SCANNERS.
MOTOROLA, YAESU, ICOM, KENWOOD, KANCO, STANDARD, MAXON, RELM, etc. KING, SONY, GRUNDIG
BRAND NEW Long Range Repeater service for business

"YAESU HAM & VERTEX BUSINESS RADIOS" FT51-R, FT-8500, FT-10, FT-11, FT-2500, FT-3000, FRG-100B, FT-1000D, FT-50R, FT-5200, FT-840, FT-900AT, FRG-100, VXR-5000 repeater 25 watts, VHF or UHF. Marine Mobile VXM-100.

NEW — 220 MHz BUSINESS RADIOS WITH REPEATERS

MOTOROLA RADIOS EXPORT & DOMESTIC CALL FOR PRICES

Business Radios:
Motorola, ICOM, Maxon, Yaesu, FTH 200B/700B, etc. Uniden, Regency, Reim
Marine ICOM: M10A, mli, etc.
Aviation ICOM: A22, A200

TH-79A(D) Kenwood **FT-51R Yaesu**

Wide selection of SW & Amateur Publications

Antenna Tuners:
MFJ, AEA AT-300, ICOM, KENWOOD, YAESU, VERTEX

COMMERCIAL & HAM REPEATERS STOCKED. WRITE FOR QUOTES

KANTRONICS KAM PLUS Etc.

MOTOROLA AUTHORIZED DEALER
KACHINA COMMUNICATIONS DEALER
AUTHORIZED DEALER
SONY
Shortwave Radios Stocked
DIGITAL FREQUENCY COUNTERS
OPTOELECTRONICS model 1300 H/A, 0-1300MHz
2300, 2210 H, 0-2200 MHz, 2600H, UTC-3000, 2610

Long-range Wireless telephone for overseas. **CALL**

BENCHER PADDLES
BALUNS, LOW PASS FILTERS IN STOCK

MIRAGE/RFC Amplifiers
ASTRON POWER SUPPLIES
Belden Wire & Cable, Int'l Wire
OPTOELECTRONICS STOCKED

AMPLIFIERS STOCKED:
RF Concepts
Mirage
TE Systems

Shortwave Radios
Drake, JRC, Lowe, ICOM, Kenwood, Yaesu, Sony, Grundig & Sangean.
Write or Call for Prices

Hy-Gain Towers will be shipped direct to you **FREE** of shipping cost.

Amplifiers, HF/VHF/UHF AMERITRON, etc.

FM & AM BROADCAST TRANSMITTERS STOCKED

SATELLITE PHONES & BROADCAST EQUIPMENT

Save money on batteries. Call for Special Prices.

Barry's supplies all MFJ products Call us direct.

SHORTWAVE RECEIVERS STOCKED

Radios for Business, Government
Stocked & Serviced
Call or FAX for Great Prices!

Telephone Autopatch
Patches telephone calls from your radio to phone line. Great for making and receiving phone calls where there are no phone lines. Simple to use. Write or fax for inquiries.

Electron Tubes
3-500Z, 572B, 6JS6C, 12 BY7A, & 6146B

BIRD Wattmeters & Elements in Stock

Computer Interfaces
Stocked: MFJ-1270B, MFJ-1274, MFJ-1224, AEA PK-88, MFJ-127BT, PK-900, PK-232 MBX W/FAX, DRSI PRODUCTS DSP 2232

Domestic & Special Prices for Export
GP300, GM300, P110, FP50, etc.

Linear Amplifier
Amerrtron, Icom, Kenwood, Yaesu

Antennas
A-S, AES, Cushcraft, Hy-Gain, Hustler, KLM, METZ, Urban, MOUDBLOX, TONNA, Butternut, Multi-Band

Scanners Our Specialty
Bearcat • ICOM • AOR • etc.
Huge Stock Call

WE NOW STOCK COMMERCIAL COMMUNICATIONS SYSTEMS
DEALER INQUIRIES INVITED PHONE IN ORDER & BE REIMBURSED
COMMERCIAL RADIOS STOCKED & SERVICE ON PREMISES.
EXPORT orders shipped immediately. **CALL**

COMMERCIAL RADIOS STOCKED:
•MOTOROLA •ICOM
•MAXON •STANDARD,
•YAESU •RELM etc.
We serve municipalities, businesses, Civil Defense, etc. Portables, mobiles, bases, repeaters...

Monday-Friday 9 AM to 6 PM
Saturday 10-5 PM / Sunday 11:30-5 PM

Subways: #6 Spring St. stop, N. or R. train to Prince St. stop
F train to Houston St. stop
Bus: Broadway bus to Prince St. stop, Path train to 9th St./6th Ave.

SALES FINAL **Technical help offered upon purchase** **FAX: 212-925-7001**

CIRCLE 41 ON READER SERVICE CARD

Weather Control and Mind Control

Science fiction? Well, it's science but not fiction!

Jim Gray W1XU
210 E. Chateau Circle
Payson AZ 85541

This saga began with Nicola Tesla, was developed by the Soviet Union and the United States (Star Wars technology), and has been used on and off since the 1960s for both defense and offense. HAARP is being further developed for operation in Alaska at gigawatt levels. Look out, world!

HAARP stands for "High-frequency Active Auroral Research Project" and is a project that uses megawatts of VHF/UHF

This new technology creates extremely high-energy particles which can be guided along magnetic field lines to locations at various selected altitudes above the Earth. These areas of super-high energy can be made self-sustaining for specified periods of time, meaning that their effects upon the Earth (and us) can be designed and maintained at will...and within a few minutes of turning on the generators.

The complex waveforms were generated, focused, and directionally guided by three Siberia-based transmitters to any point on Earth in a manner similar, but in reverse, to the way receiving antennas can locate the source of a received signal by triangulation. The transmitted signals are thus combined at the selected point by radio interferometry to produce various concentrated effects.

The frequency-agile Woodpecker signals were transmitted in the HF bands and exhibited waveforms containing unusual pulse and pulse combinations between about 10 and 20 Hz. Ten Hz pulses resonate at the approximate frequency of the space between the surface of the Earth and the ionosphere, producing what is known as Schumann resonance.

The human brain produces electrical waves whose frequencies are between about 0.5 and 25 Hz, and can be affected by concentrated pulse energy at these frequencies. These so-called Alpha, Beta, Delta, and Theta frequencies are each related to various "states" of consciousness. Therefore, interference with any or all of these frequencies by external means can effectively change human behavior.

Note 1. Alpha frequencies are about 7-13 Hz, Beta about 13-25 Hz, Delta about 0.5-3.5 Hz, and Theta about 3.5-7 Hz. The Alpha state is a relaxed and receptive state of consciousness where a question put to an individual in it may produce a response in the form of a

"Great areas of Earth can literally be 'frozen' or 'fried' at will by controlling the movement of air masses, particularly near the poles, where most of the Earth's weather originates in the form of high- or low-pressure air masses."

energy focused along Earth's magnetic field lines by multiple arrays of phased, circularly-polarized antennas. The purpose? To "heat" the plasma contained in the Earth's ionosphere and magnetosphere by adding energy in the form of atomic particles (electrons) which then produce patches, areas, and even "shells" of enhanced plasma extending around the Earth at the heights of the ionosphere and magnetosphere. These are designed to:

- Disrupt radio communication.
- Disrupt electronic navigation and guidance systems.
- Destroy satellites, directly or indirectly.
- Destroy ICBM missiles and/or warheads.
- Control the weather.
- Provide a new means of communication.

Frequencies and energy levels can be chosen to deplete specific areas of the atmosphere of nitrogen, oxygen, carbon dioxide, and other gases...or, conversely, enrich or enhance other areas with the same gases. Great areas of Earth can literally be "frozen" or "fried" at will by controlling the movement of air masses, particularly near the poles, where most of the Earth's weather originates in the form of high- or low-pressure air masses. These can be "artificially" moved and their pressure changed.

What about the "Woodpecker"? It was a Soviet system consisting of three plasma heaters: giant megawatt transmitters which were *not* over-the-horizon radar, as claimed by our government, although they could be used for that purpose. The main purpose, however, was for weather and mind control...yes, *mind* control.

Theta burst in the Alpha wave known as the "K" or potassium spike.

Just suppose the Woodpecker actually interfered with brain waves in a single individual or a mass of individuals.

energetic particles to "supercharge" the ionosphere and magnetosphere. In fact, Tesla predicted that someday artificial auroras would be produced to flood the world's cities with a soft illumination

Satellites were also used to "seed" the ionosphere with radioactive particles and thereby enhance the plasma by alternate means. Another experiment sowed millions of tiny copper needles around the earth at an altitude of several hundred miles. It worked...but only marginally...as signals were temporarily intensified (not blacked out), but soon lapsed back to normal. Not everyone was enthralled with the idea of an artificial shell of copper encircling the earth.

"Are there any radio amateurs out there who listened (one couldn't avoid it) to the Soviet 'Woodpecker' and experienced changed states of consciousness or aberrant behavior?"

What were the consequences? Are there any radio amateurs out there who listened (one couldn't avoid it) to the Woodpecker and experienced changed states of consciousness or aberrant behavior?

The required power level for effective alteration of plasma to create such effects is in the gigawatt range, but producible by magneto-hydrodynamic devices using power fueled by natural gas, oil, or coal deposits and/or hydroelectric generators.

Alaska's natural resources of gas, coal, and oil are ideally suited for production of power of the magnitude required for plasma-heating transmitters. Of particular interest is the fact that great sources of natural gas and oil on Alaska's north slope are ideally located where polar magnetic field lines are concentrated. You may correctly assume the HAARP transmitters are located there.

The Earth can be considered somewhat like a bar magnet in which magnetic field lines originate at the ends and diverge at the center. Most of us remember science classes in which the teacher laid a paper or card on top of the magnet and sprinkled iron filings on the paper to make the field lines visible. The Earth's magnetic field lines of force originate at the poles and diverge over the equator. Launching electrons along these field lines is a simple exercise in electro-technology.

Nicola Tesla developed his "magnifying transmitter" based on the Tesla coil and resonance effects to generate power (not just "signals") and transmit it wirelessly over substantial distances. He succeeded in doing so in Colorado before the turn of the 20th century. Tesla coil research and practice has been carried on ever since by numerous companies and countries. The military interest is, of course, power and control. "Magnifying" transmitters based on the Tesla principle are capable of producing

after dark. How else than by plasma stimulation and enhancement?

In the late 1950s and early 1960s, atomic and hydrogen bombs (euphemistically called "devices" by the military) were detonated in the ionosphere and magnetosphere to supply vast excesses of high-energy particles and create a radio "blackout" and disrupt radio communication. It worked! I happened to be on the air during one such test in 1958, and totally lost receiver signals for over an hour...on all bands. Everything "went dead" and I thought my receiver had died. Not so, as I later discovered when I talked to many hams who suffered a similar mysterious signal blackout at the same time. It was only years later that the truth was made public.

HAARP transmitters ordinarily employ electrons whose masses are more easily raised to the point of cyclotron resonance, but particles of greater mass can be accelerated to produce "beams" of heavy-element ions, for example...and these can do great damage to distant objects (targets). We used to call them "atom smashers" in the old days, but technology has advanced as far beyond that simple phrase as electricity has advanced beyond fire.

Given the ability to raise the energy levels of plasma electrons and ions to sufficiently high levels, dispersion becomes a problem. That is, for maximum concentration of energy on a small area,



CABLE X-PERTS, INC.

COAX (50 OHM "LOW LOSS" GROUP)			ROTOR & CONTROL CABLES		
ITEM		100ft/up ... 500ft	ITEM		100ft/up ... 500ft
"FLEXIBLE" 9913 FOIL +95% BRAID 2.7 dB @ 400 MHz		58ft ... 58ft	5971 8/Cond. (2/18 6/22) BLK UV RES JKT. Rec. up to 125 ft.		20ft ... 18ft
9913 EQUAL FOIL +95% BRAID 2.7 dB @ 400 MHz		42ft ... 40ft	4090 8/Cond. (2/16 6/22) BLK UV RES JKT. Rec. up to 200 ft.		35ft ... 34ft
LMR 240 DBL SHLD (8X SIZE) IIIA JACKET 1.7 dB @ 50 MHz		41ft ... 39ft	1418 8/Cond. (2/14 6/18) BLK UV RES JKT. Rec. up to 300 ft.		47ft ... 45ft
LMR 400 DBL SHLD IIIA JACKET 2.7 dB @ 450MHz		53ft ... 51ft	1216 8/Cond. (2/12 6/16) BLK UV RES JKT. Rec. up to 500 ft.		78ft ... 74ft
LMR 400 ULTRAFLEX DBL SHLD "TPE" JKT. 3.1dB @ 450 MHz		75ft ... 72ft	18 Ga. Strd 4/Cond. PVC JACKET		20ft ... 18ft
LMR 600 DBL SHLD IIIA JACKET 1.72dB @ 450MHz		1.25ft ... 1.20ft	18 Ga. Strd 5/Cond. PVC JACKET		22ft ... 20ft
LDF4-50A 1/2" ANDREWS HELIX 1.5 dB @ 450 MHz (25 ft. & up)		2.10ft	18 Ga. Strd 6/Cond. PVC JACKET		23ft ... 21ft
FSJ -50 1/4" ANDREWS SUPERFLEX 2.23 dB @ 150MHz (25 ft. & up)		1.50ft	18 Ga. Strd 7/Cond. PVC JACKET		25ft ... 23ft
COAX (50 OHM "HF" GROUP)			COAX W/SILVER TEFLON PL259's EA END (soldered & tested)		
ITEM		100ft/up ... 500ft			PRICE
RG213/U MIL-SPEC DIRECT BURIAL JKT. 5dB @ 50MHz/36/FT		34ft ... 32ft	100ft "FLEXIBLE" 9913 FOIL +95% BRAID 2.7dB @ 400MHz		\$65.00/each
RG8/U FOAM 95% BRD UV RESISTANT JKT 1.2dB @ 50MHz		32ft ... 30ft	50ft "FLEXIBLE" 9913 FOIL +95% BRAID 2.7dB @ 400MHz		\$35.00/each
RG6Mini(X) 95% BRD BLK UV RES JKT (GRY, CLR, or WHT JKT TOO)		15ft ... 13ft	100ft RG213/U MIL-SPEC DIRECT BURIAL JKT. 1.5dB @ 50MHz		\$45.00/each
RG58/U SOLID CENTER COND 95% BRAID		15ft ... 13ft	50ft RG213/U MIL-SPEC DIRECT BURIAL JKT. 1.5dB @ 50MHz		\$25.00/each
RG58AU SOLID CENTER COND 95% TC BRAID		17ft ... 15ft	100ft RG8/U FOAM 95% BRD UV RES JKT. 1.2dB @ 50MHz		\$40.00/each
450 Ohm SOLID 18Ga. CW LADDER LINE		12ft ... 10ft	50ft RG8/U FOAM 95% BRD UV RES JKT. 1.2dB @ 50MHz		\$22.50/each
450 Ohm STRD16Ga CW LADDER LINE		18ft ... 17ft	100ft RG6Mini (X) 95% BRD UV RES JKT. 1.2.5dB @ 50MHz		\$21.00/each
24Ga. SOLID 4/PWR UNSHLD LAN CABLE 1 LEVEL 5" PVC JKT		16ft ... 14ft			
RG214/U DBL SILVER SHLD MIL-SPEC (25 Ft. & Up)		1.75ft			
RG142/U DBL SILVER SHLD MIL-SPEC "TEFLON" (25 Ft. & Up)		1.25ft			
ANTENNA WIRE (BARE COPPER)			FLEXIBLE 2/COND RED/BLK DC POWER "ZIP" CORD		
ITEM		100ft/up ... 500ft			
14Ga. 168 STRD "SUPERFLEX" (Quads, Port set-ups etc.)		12ft ... 10ft	10Ga. (rated: 30 amps)		25ft \$10.50 ... 50ft \$19.00 ... 100ft \$36.00
14Ga. 7 STRD "HARD DRAWN" (permanent Dipoles, etc.)		.08ft07ft	12Ga. (rated: 20 amps)		25ft \$8.00 ... 50ft \$14.00 ... 100ft \$26.00
14Ga. SOLID "COPPERWELD" (very long spans, etc.)		.08ft07ft	14Ga. (rated: 15 amps)		25ft \$6.00 ... 50ft \$10.00 ... 100ft \$18.00
14Ga. SOLID "SOFT DRAWN" (ground radials, etc.)		.08ft07ft			
3/16" DBL BRD "DACRON" ROPE 770# TEST, WEATHERPROOF		.12ft09ft			
			TINNED COPPER "FLAT" GROUNDING BRAID		
			1 INCH WIDE (equivalent to 7Ga.)		25ft \$22.00 ... 50ft \$43.00 ... 100ft \$85.00
			1/2 INCH WIDE (equivalent to 10Ga.)		25ft \$12.50 ... 50ft \$24.00 ... 100ft \$48.00
			CONNECTORS		
			PL259 SILVER/TEFLON/GOLD TIP 10pc \$11.00 25pc \$25.00 50pc \$47.50 100pc \$90.		
			N-2PC SILVER/TEFLON/GOLD TIP 10pc \$32.50 25pc \$75.00 50pc \$143.75 100pc \$275.		

ORDERS ONLY: 800-828-3340

TECH INFO: 847-520-3003 FAX: 847-520-3444

416 Diens Dr., Wheeling, IL 60090
e-mail: cxp@ix.netcom.com

FOR COMPLETE LITERATURE SEND \$10 S.A.S.E.

CABLE & WIRE CUT TO YOUR SPECIFIC LENGTH! CUSTOM CONNECTOR WORK, TOO.

Given the ability to raise the energy levels of plasma electrons and ions to sufficiently high levels, dispersion becomes a problem. That is, for maximum concentration of energy on a small area, the particle "beam" must be very narrow. Lasers maintain collimation and in-step light waves more easily than devices that use heavier particles.

Ions of "heavy" elements (elements having greater atomic weight) are focused magnetically by cryogenically-cooled toroidal electromagnets placed along the beam path. A similar principle is used in your TV set, which deflects ions away from the electron beam and "traps" them to avoid destroying the screen of its cathode ray tube. A device that "shoots" and focuses electrons is called an electron gun, and a device that "shoots" ions is therefore an ion gun. The greater the atomic weight of a chosen "ammunition" element, the greater the power of the ion gun must be for particle acceleration, containment, and focus.

The Eastland patents

There are three basic patents relating to the production, use, and effects of enhanced plasma: U.S. Patent 4,686,605, issued August 11, 1987, to Bernard J. Eastland of Spring, Texas, and assigned to APTI, Inc. of Los Angeles, California, titled "Method and Apparatus for Altering a Region in the Earth's Atmosphere, Ionosphere, and/or Magnetosphere"; U.S. Patent 4,712,155, issued December 8, 1987, to the same inventor and to Simon Ramo, Beverly Hills, California, assigned to the same assignee, titled "Method and Apparatus for Creating an Artificial Electron Cyclotron Heating Region of Plasma"; and U.S. Patent 5,038,664, issued August 13, 1991, to (not available to this author), assigned to (also not available to this author), titled "Method for Producing a Shell of Relativistic Particles at an Altitude Above the Earth's Surface."

There are alleged to be at least 12 more related patents issued to Eastland et al. which describe in detail the "Treator," "MHD Generator," "Transmitter," and "Antennae," plus a wealth of ancillary devices, methods and uses. As in the three basic patents, all of the information contained in the earlier patents is incorporated in the later patents by reference.

Note 2. The following references are of particular interest: "Ionospheric Modification Theory," G. Maltz and

F.W. Perkins; "The Platteville High Power Facility," Carrol et al.; "Arecibo Heating Experiments," W.E. Gordon and H.E. Carlson, Jr.; "Ionospheric Heating by Powerful Radio Waves," *Radio Science*, Vol. 9, No. 11, November 1974, pages 885-888, 889-894, 1041-1047, and 1049-1063, respectively. "The MST Radar at Poker Flat, Alaska," *Radio Science*, Vol. 15, No. 2, March-April 1980, pages 213-223. *Controlled Thermonuclear Reactions*, Glasstone and Lovberg, D. Van Nostrand Co., Inc., Princeton, NJ, 1960. *The Radiation Belt and Magnetosphere*, Hess, Blaisdell Publishing Company, 1968.

Note 3. Frequencies used by HAARP are 1.45 MHz, 1.8 MHz, and 7-20 MHz. "A Theoretical Study of Electron-Cyclotron Absorption in Elmo Bumpy Torus," Batchelor and Goldfinger, *Nuclear Fusion*, Vol. 20, No. 4 (1980), pages 403-418, describes one type of controlled nuclear fusion device in which heating is provided by microwaves at the electron-cyclotron resonance interaction.

Further information about HAARP and other fascinating subjects which may be of critical importance to our future may be obtained from the International Tesla Society, Inc., P.O. Box 5636, Colorado Springs, CO 80931; telephone (719) 475-0918; or FAX (719) 475-0582. Ask for their catalog of handbooks, guides, manuals, and summaries.

Much of the information for this article was taken from the *1995 HAARP Resource Guide*, available as #290004, and priced at \$19.95 plus shipping and handling.

[A note from El Supremo: Can our beloved government really be planning to experiment on us on such a large scale? You can order Nick Begich's book, Angels Don't Play This Haarp, from the Tesla Society book store (233p., ISBN 0-9648812-0-9, \$15, 1995) and get the straight dope. More and more Alaskans are learning about this massive government project and there's a move in the Alaskan legislature to stop this nonsense before it gets operational. Well, exposés have shown us that they've done this sort of thing before with radiation and many drug tests on unsuspecting people. Meanwhile, the construction of this secret multi-billion dollar project is moving ahead in Alaska, with the whole world as guinea pigs... Wayne]

A Funny Thing Happened On

Continued from page 16

And then there was the time I was "reading the mail," listening to a local station talking to KC4USN, the Naval Antarctic station. In the middle of his transmission he suddenly said, "Stand by, must QRT for a minute." When he came back on he apologized for the interruption, explaining that someone must have left a door ajar and he'd had to shoo out a penguin that had wandered into the shack. Life is too short for QRP (QRPenguin, that is).

These are just a few of the funny and unusual incidents involving ham radio that I have accumulated over the years. I'd be interested in hearing about other incidents you may have experienced or heard about. 73 Hal.

Receiver Preamplifiers

Continued from page 17

The ghost signals problem was driven home to me by a fellow who proudly boasted that he had two, count 'em—two, 20 dB preamplifiers ahead of his 2-meter band receiver. Oddly, he thought, there's a problem with the receiver because other hams' signals appear at two or three spots on the dial. No kidding. That receiver was experiencing front-end overload, and it's not necessarily clear whether the overload was in the receiver itself or one of the those preamplifiers. Disconnecting one of the preamplifiers gave him plenty of weak signal performance, but reduced the overload problem to negligible levels. Too much of a good thing isn't a good thing.

At the end of the day, if you want to improve your receiver's weak signal performance, put the first dollars into the antenna system (besides, it helps on transmitting as well). A good beam antenna is not too awfully costly at VHF/UHF frequencies, and some other forms (e.g. vertical collinear array) are positively cheap.

One thing that many people don't realize is that a lot of the wire array antennas found in textbooks (like my own *Practical Antenna Handbook* or *Receiving Antenna Handbook*—see Radio Bookshop) are practical at VHF/UHF even when they take too much space at HF frequencies.

Persistence Wins

Nothing ventured, etc.

King Waters KK5LU
4003 Grennoch
Houston TX 77025-2301

I took my test for Advanced the other day. It was a step far removed from my mind that day two years ago when I sat for Novice.

All this wasn't really my fault. I have wanted to be a ham since I was 11; radio fascinates me. I am told that at the age of three I disassembled an old black Philco AM broadcast receiver, while it was still plugged in. I must have done a good job; the repairman said he couldn't fix it.

But that was the tenor of my radio experience—fascination, interest, destruction. I learned Morse code as a Boy Scout, but radio theory was never a strong point. One of my best friends understood it backwards, but his interest was hi-fi, not ham.

"I was stunned. They had to tell me twice."

I would read up on the hobby occasionally. I bought ARRL books from Radio Shack™ right after I got married in 1972, but they were written by engineers, and I was a journalist. I still have the books. There are ads in the back for crystal-controlled ICOM 2 meter mobile rigs, and Heath kits, but my attention wandered.

Law school, a litigation practice, and four sons intervened. Then two things happened independently: I accidentally bought a copy of 73, and I copied some CW. That's what started me off to that VE session the other day.

In 1992, I had a case involving a fatal accident on a microwave tower. The case centered on a claim of defective climbing belts. At a bookstore one day I saw a copy of 73, and thought it might have some information on safety around towers. It did, although that's another story, but the important thing for me was that it also said there were study courses for licensing now, and that testing was by

VEs, not the FCC. I thought I might look into it when I had the time.

Then I went flying that summer with a friend. We were navigating from Mobile to New Orleans when he asked me to tune in a directional beacon. The beacon would have a Morse identifier, he said,

so the dots and dashes were printed on the air chart. I tuned to the frequency, but I recognized the code without the chart. He was surprised. So was I.

I went to Radio Shack and bought the Novice course. The code work went
Continued on page 25

CALL TOLL FREE
(800) 292-7711
Se Habla Español

C&S SALES
EXCELLENCE IN SERVICE

**WRITE FOR A
FREE 60 PAGE
CATALOG!**

**AFFORDABLE, HIGH QUALITY ELENCO OSCILLOSCOPES
2 YEAR WARRANTY**



STANDARD SERIES
S-1325 25MHz \$335
S-1340 40MHz \$489

Features:

- TV Sync
- 1mV Sensitivity
- X - Y Operation
- High Luminance 6" CRT
- Complete Schematic
- Plus much, much more!!



DELUXE SERIES
S-1330 25MHz \$439
S-1345 40MHz \$569
S-1360 60MHz \$759

Features:

- Delayed Sweep
- Automatic Beam Finder
- Z Axis Modulation
- Built-in Component Test
- Plus all of the features of the "affordable" series!!
- Dual time base
- Illuminated internal gradicule

2 FREE probes included with each scope!!

MX-9300

Four Functions in One Instrument

Features:

- One instrument with four test and measuring systems:
- 1.3GHz Frequency Counter
- 2MHz Sweep Function Generator
- Digital Multimeter
- Digital Triple Power Supply
- 0-30V @ 3A, 15V @ 1A, 5V @ 2A



\$479.95

B&K 2MHz Function Generator Model 4010



\$195.95

- 0.2Hz to 2MHz
- Sine, Square, Triangle, Pulse and ramp output
- Variable duty cycle
- Variable DC offset

Model XP-581

4 Fully Regulated Power Supplies in One Unit

4 DC voltages: 3 fixed - +5V @ 3A, +12V @ 1A, -12V @ 1A • 1 Variable - 2.5 - 20V @ 2A

Ideal for laboratories, service shops and hobbyists.



\$85

Fluke Multimeters

70 Series

Model 70II	\$69.95
Model 73II	\$97.50
Model 75II	\$135.00
Model 77II	\$154.95
Model 79II	\$175.00

80 Series

Model 83	\$235.00
Model 85	\$269.00
Model 87	\$289.00

Model M-6000

Features Computer interface and Software



\$99.95

- Frequency to 4MHz
- Capacitance to 40nF
- Large 3 3/4 LCD Display
- Temperature to 199°F
- TTL logic
- Data/Peak Hold
- Audible continuity
- Auto power off
- Unit indicator
- Diode test
- w/ RS232 Cable

B&K Model 1688

High Current (25 amp) Power Supply
Variable 3-14VDC



\$249.95

M-1700

Digital Multimeter

11 functions including freq to 20MHz, cap to 20µF. Meets UL-1244 safety specs.



\$42.95

Kit Corner over 100 kits available

Model AR-2N6K

2 meter / 6 meter Amateur Radio Kit



\$34.95

Model AM/FM-108K

AM/FM Transistor Radio Kit



\$29.95

M-2665K

Digital Multimeter Kit



\$54.95

Full 34 Ranges w/ cap & trans tests

TT-400K Telephone Analyzer Kit



\$19.95

1.3GHz Universal Counter Model F-1300

- Period
- Frequency
- & 8 other functions



\$225

XK-550 Digital / Analog Trainer

Elenco's advanced designed Digital / Analog Trainer is specially designed for school projects. It is built on a single PC board for maximum reliability. It includes 5 built-in power supplies, a function generator with continuously sine, triangular and square wave forms. 1560 tie point breadboard area.



\$169.95

XK-550K - Kit
\$139.95

Tools and meter shown optional

15 DAY MONEY BACK GUARANTEE

FULL FACTORY WARRANTY

PRICES SUBJECT TO CHANGE WITHOUT NOTICE

WE WILL NOT BE UNDERSOLD

UPS SHIPPING: 48 STATES 5%
OTHERS CALL (\$5 min. / \$15 max.)
IL RES. 8% TAX

C&S SALES, INC.

150 W. CARPENTER AVENUE
WHEELING, IL 60090
FAX: (847) 541-9904 (847) 541-0710

73 Review

JPS Communications NIR-12

DSP? Yes, you need it!

Pete Ferrand WB2QLL
65 Atherton Avenue
Nashua NH 03060-1904

The endless struggle to hear signals with a minimum of noise has given rise to many little boxes with knobs over the years. However, I believe the best solution to date is digital signal

"Now you can have a 50 Hz bandwidth if you want it."

processing (DSP). Let's face it, a computer can analyze a signal a lot better than a pair of diodes clipped across a

speaker line. If that means nothing to you, it might be fun to take a nostalgic trip through the magazines and handbooks of 30 or more years ago to see just what our now old-timers were up against.

About five years ago I asked 73 if I could do a review of the JPS NIR-10. After using professional noise reduction gear, I was eager to see what a more reasonably priced ham version could do. The result was not only a positive review, but a unit that got used almost every day until last month, when I upgraded to the new NIR-12. The bottom line is that I'm



Photo A. The NIR-12 noise and interference reducer.

now using the NIR-12 every day. This clever device gives me an array of weapons to fight interference in just about all modes: voice, CW, the digital modes, and TV.

Noise reduction systems

A DSP unit first digitizes the signal in a way similar to the process used to create sound from a computer or audio compact disc. The unit then analyzes the signal, tries to find what it's looking for, and subtracts the remainder. To the degree that the noise doesn't sound like what you're looking for, the NIR-12 can reduce it.

Any noise reduction device works best with a strong signal and little noise. Big deal, right? One good way to reduce receiver noise is to turn down the RF gain control, with either a knob or a front-end attenuator. I like to demonstrate this to any newcomers who, for some reason, have never learned to use those controls on a rig. As long as there is a reasonable difference between the signal level and the noise level this method is very effective.

The difference in noise reduction systems is most evident when there's about zero difference, or 0 dB, between the noise and the signal. It's also much harder for electronics (or our ears) to figure out the difference between noise and signal with something as complex as the relatively wideband human voice. It can do much better with a data mode, which is narrowband and usually synchronous (PACTOR, Clover, etc.), where the demodulator knows when to expect the signal and what it looks like, and can ignore what's left.

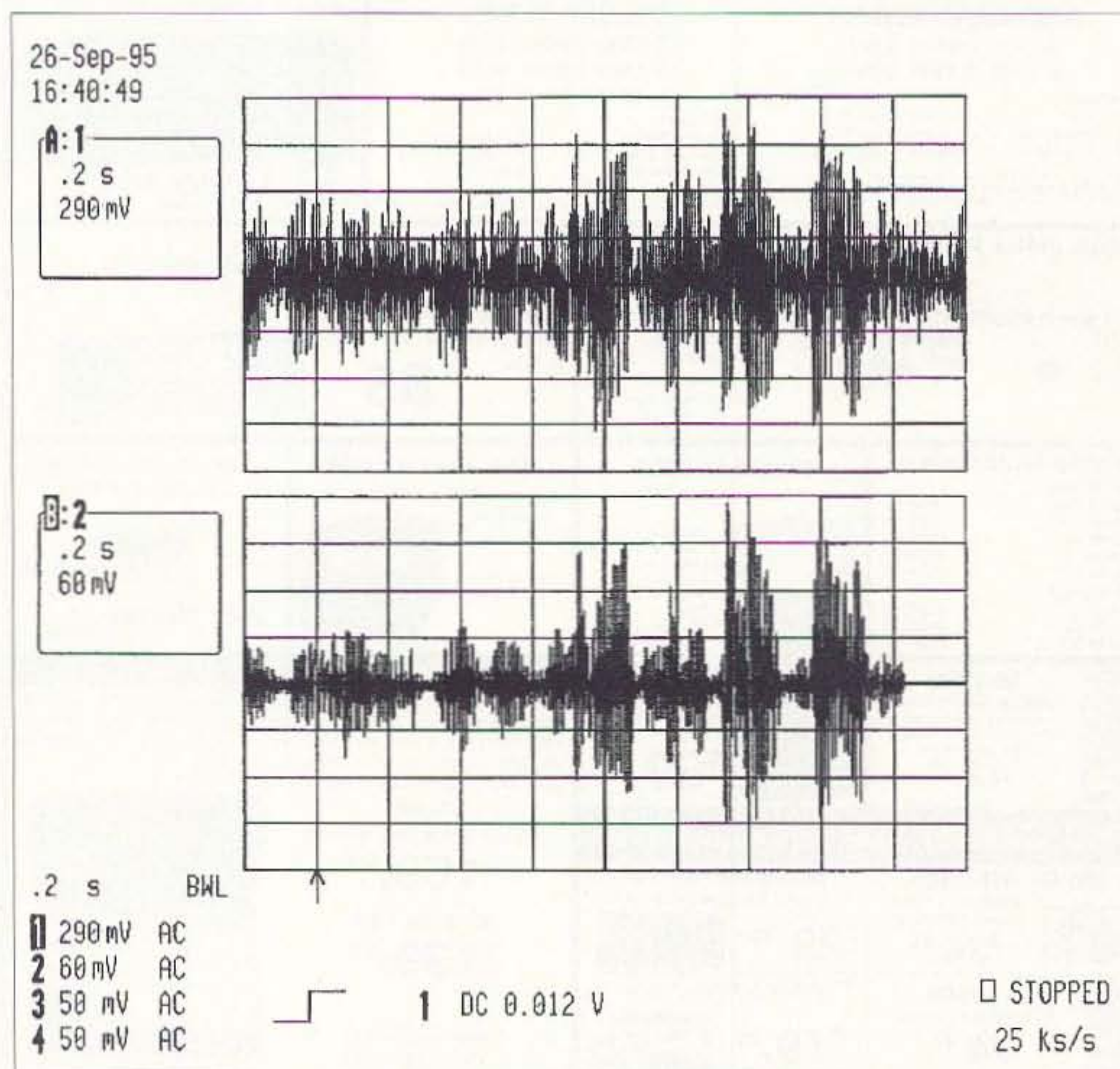

Fig. 1. The upper trace shows the unprocessed audio of a phone station in the noise. The lower trace shows the effect of the NIR-12, NIR mode only, NIR control set to 10 o'clock. The pattern displays amplitude on the vertical axis, time on the horizontal. The timing has been adjusting to compensate for the NIR-12's delay.

While we're waiting for some mode that digitizes our voices, we'll have to contend with pulling voices through an array of noise and interference. It's just getting worse with more electronics in our midst.

I work as a radio talk show host, and one of my major radio pursuits is listening to my competitors on other stations to make sure I'm being consistently original (yeah, right...). Living in a city and trying to listen to AM stations is about the toughest challenge for noise reduction.

The NIR-12 does the best job of any similar unit I've seen. It's also better in every respect than the previous JPS unit, the NIR-10.

One question that arises is why anyone would buy a DSP accessory when many transceivers now have them built in. The argument for the built-in unit is convenience and simplicity. Buying something like the JPS means you have the flexibility of using DSP with a variety of radios, especially mobile ones, or you can even clean up a noisy cassette tape. Then, when the technology is improved, you can get a newer DSP unit without having to upgrade your transceiver.

The NIR-12's features

Now, let's take a look at the NIR-12. It's built in a heavy steel box which provides magnetic shielding and keeps it from moving around when operated. The hookup is simple – you feed audio from the speaker output into the NIR-

NIR mode

The NIR mode (for Noise and Interference Reducer) tries to recognize human speech and pass it, while reducing everything else. Most CW and data modes sound close enough to speech to pass as well. By adjusting the front

“The NIR-12 works well, and JPS's reliability and customer support are superb.”

12's input, and connect the speaker to the NIR-12's output. It needs 11 to 16 volts DC, which you can get from the rig or wall transformer. Then all you do is adjust the receiver's volume control until the “signal” LED flashes on signal peaks, and control the speaker audio to your liking with the NIR-12's volume control.

You have four modes of operation, plus a pass-through mode where no noise reduction is performed. The modes are: NIR mode for spectral noise subtraction, dynamic peaking mode, bandwidth control, and a notch filter.

panel NIR control, you can change the amount of noise reduction. This is the mode that works best on general electrical noise, static, and auto electrical system interference.

Five years ago I thought it would be helpful to put the noise reduction to a test, so I asked my friend John Seney WD1V, the area sales engineer for LeCroy, to come by with one of his fancy digital scopes to get a print-out of what the difference is with and without the unit.

Well, now it's 1996, John's still my friend, and he's still selling for LeCroy, so once again he stopped by and took some scope printouts of 40 meters in the

See why the RLC-CLUB knocks the competition's socks off!

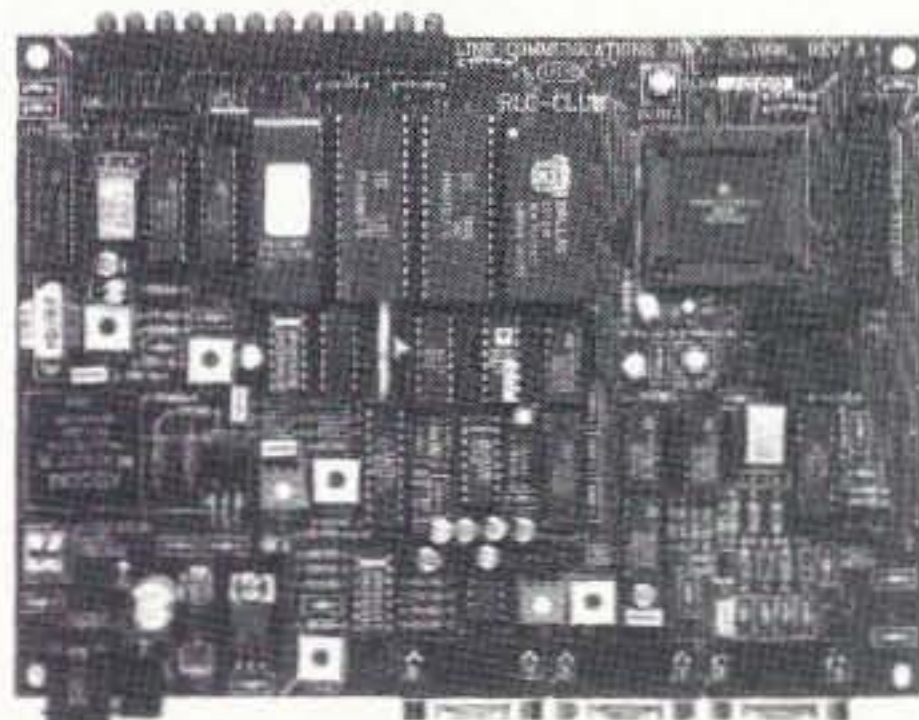

\$500.00 RLC-CLUB

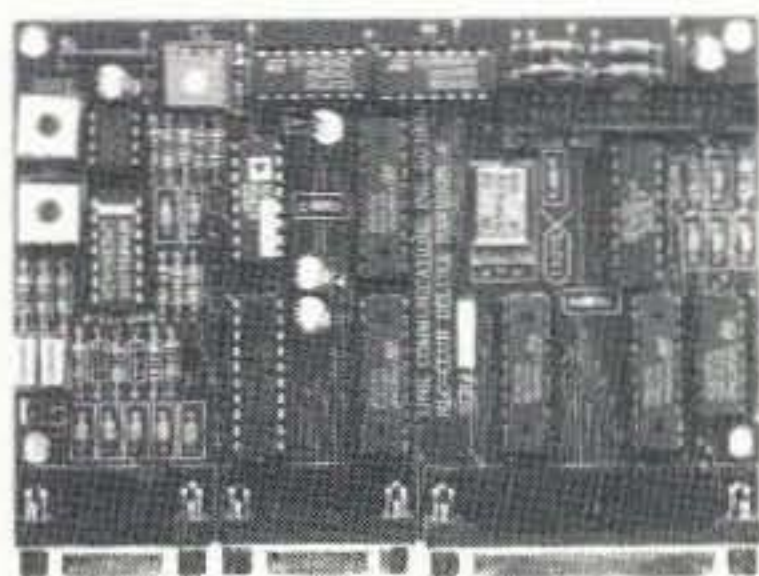

\$175.00 DELUXE MODULE

Remote base support for Icom CI-V, Kenwood serial and Yaesu CAT HF/VHF radios. Other remote bases supported include the RLC-ICM IC-900 band module controller and the Doug Hall RBI-1 interface.

Only the RLC-CLUB controller system gives you Windows™ programming software that allows timers, messages, users and most functions to be set-up with the ease of a computer; very powerful autopatch features, and multiple repeater control at such a low price! And with the addition of the RLC-Deluxe module an additional radio port, increased output controls and support for our large voice mail based Digital Voice Recorder is provided.

RLC-CLUB Controller

Dual Port Repeater and Remote Base Controller

- Individual full duplex repeater, link or remote base port with second additional radio port expansion using the Deluxe option module.
- Built in Autopatch with 500 number autodialer, 500 call sign slots, 500 user autopatch code and 500 number long distance dialing table.
- 100 time-of-day scheduler slots with grandfather clock function.
- TI voice synthesizer with 685 word male, female and special effects library
- Internal 16 second Digital Voice Recorder allows custom voice message.
- 2 analog temperature inputs, signal strength input and door alarm input standard.
- 8 output function control lines using the Deluxe option module.
- Built-in front panel 12-LED display. Shows COR, PL, PTT and DTMF valid.
- 19" Rack Mount Enclosure available for \$50.00.
- FCC part 68 patch with fuse and surge protection, FCC part 15 class A typed.
- Free Windows™ programming software included with easy on-line help menus.



Link Communications, Inc.

115 2nd Ave. NE • P.O. Box 1071 • Sidney, MT 59270-1071

World Wide Web Access: <http://www.link-comm.com/linkcomm> • Voice: (406) 482-7515 • Fax: (406) 482-7547 • Sales: 1-800-610-4085

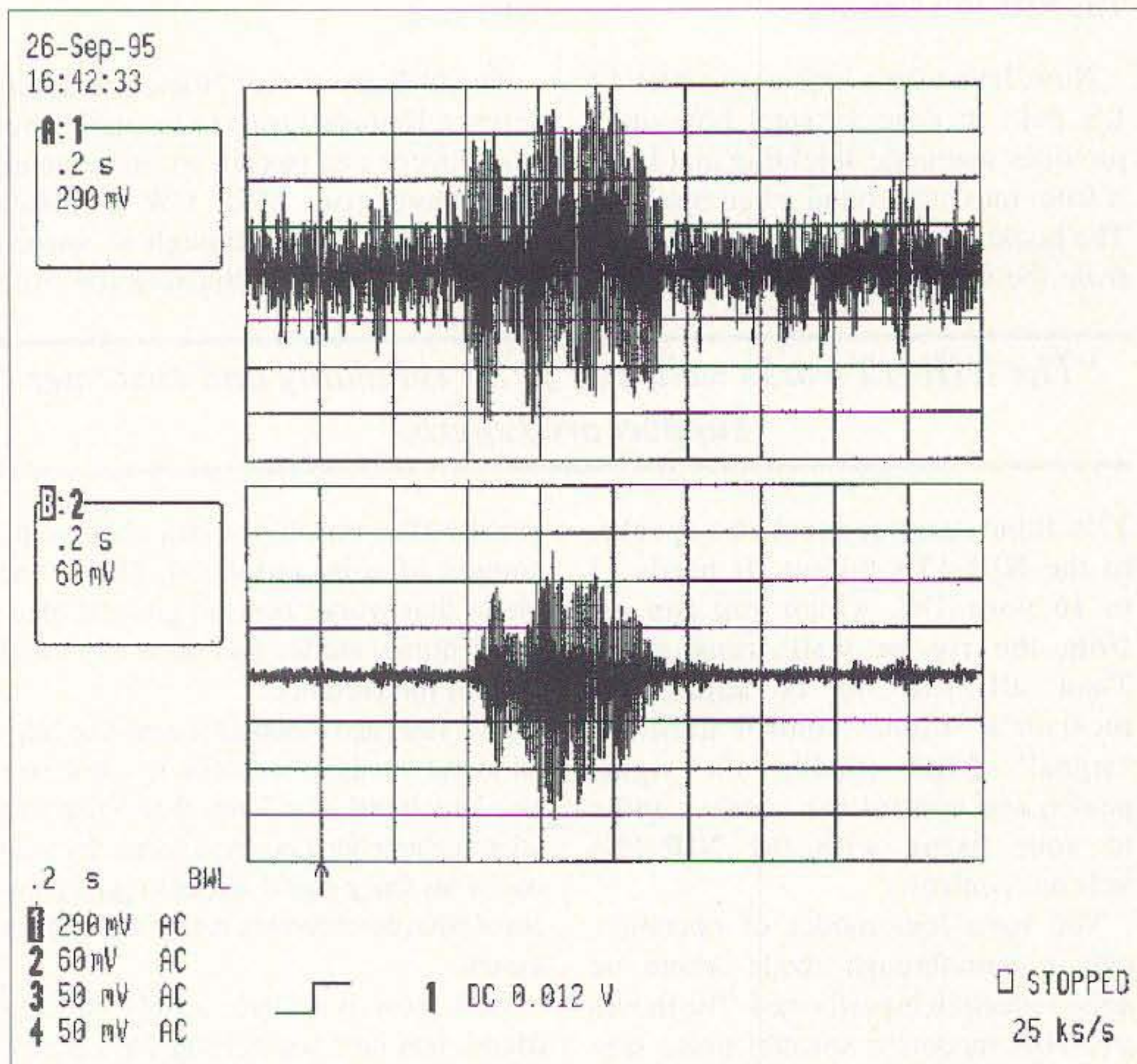

Fig. 2. The top trace shows unprocessed audio; the bottom one shows dynamic peaking mode. The data for the traces in both figures was captured at a sample rate of 25,000 samples per second. Each trace is two seconds long, so you're looking at 50,000 samples for each trace.

afternoon. I was using the same receiver, but yes, it's a much better scope!

The NIR mode graphs are shown in **Fig. 1**; the difference between the top and bottom traces is quite evident. I adjusted the NIR level for what sounded best to me, not the highest noise reduction, which JPS specifies as 0 dB.

The NIR-12 has an automatic mode that engages when the control is turned fully clockwise and provides a setting based on signal-to-noise ratio, and for some types of noise it's pretty close to optimum.

The problem with this subtractive type of noise elimination is that de-randomizing the noise leaves odd artifacts in the remaining signal. It seems much improved over the NIR-10, probably through an improved algorithm, or perhaps I've just become used to it. After all, I must have been used to listening to plain old radio noise, though I really can't remember that far back.

Dynamic peaking mode

The dynamic peaking mode looks for coherent information in the received

audio, be it voice, CW, or data. It then forms a peaking filter around the coherent information. By "peaking" we're talking about a filter passing a bandwidth that's only as wide as the coherent signal. This mode is activated with a front panel push-button, and its aggressiveness is controlled with a three-position slide switch on the rear panel.

Dynamic peaking works best on general atmospheric noises. You lose just about all naturalness of voice, but sometimes it lets you copy an otherwise impossible signal. I'd have preferred that this mode be less aggressive. A knob for continuous control might have worked better than the three-position switch. Interfering voice signals are just as coherent as the one you want, so, by itself, dynamic peaking doesn't help, but you can use the bandpass controls to reduce nearby signals and the two work well together.

The artifact that dynamic peaking produces is, in JPS's terms, a "surging" quality which is hard to describe. I've discovered that by using an audio equalizer between the NIR-12 and the radio I'm able to improve the voice quality. A

boost in the speech range of the voice being listened to can sometimes make the sound more palatable.

You won't see the artifacts, but you'll see the dramatic noise removal between the top and bottom traces in **Fig. 2**. As before, this is 40 meters at mid-afternoon.

Notch filter

The notch filter is much simpler to understand. It hears a tone and, if the "Notch" button is depressed, in five milliseconds 50 dB of the tone is eliminated. It will attenuate a whole bunch of tones, although there's less attenuation for more than four of them.

The notch mode is useful in getting rid of heterodynes, some data transmissions, noise from a nearby computer, and even people whistling to tune up. It isn't useful on CW or data modes, since it interprets those as tones as well. It's very impressive to visitors when they press a button and the tones just go away. This feature is very good about not removing any more of the audio than is necessary.

Bandwidth control

The audio bandpass filter provides a continuously variable passband of 50 to 3400 Hz. The center frequency of the filter can be varied from 200 to 3400 Hz. If you think for a moment, you'll see that this amounts to a low-pass filter with the center frequency at 200 Hz, and a high-pass filter if you set the center frequency at 3400 Hz.

As is typical of digital filters, the "skirts" are extremely steep; that refers to the graphical representation of bandwidth along a horizontal axis and amplitude along the vertical. It basically means that anything outside the bandwidth you have set is attenuated by more than 60 dB.

The most obvious use is with a receiver that has low quality filters, such as inexpensive shortwave portables. The other use is for modes that you don't have crystal filters for. Now you can have a 50 Hz bandwidth if you want it.

Most operators aren't aware that you can understand a voice signal with only a 1000 Hz bandwidth. That's because you can adjust the center frequency to anything you want, so you may find you

Continued on page 32

Persistence Wins

Continued from page 21

easily. My trouble was, and remains, theory. When I got to where I could copy 5 words a minute 100 percent, and my study program said I was consistently 85 percent accurate, I called around for test sites. Several were available, but I decided to go to the one in downtown Houston put on by the Echo Society.

The session started at 8:30 AM. I was there a few minutes early, nervous, like the rest of the 20 or so people in the room, a cold basement in the City of Houston's Emergency Operations Center.

The VEs called for Extra Class code takers. Three people stood up and walked out of the room, trooping upstairs to the test facility and the rest of us sat back. Gene Whitehurst WA5GZX looked at the group and said all of us should have gone upstairs to take the 20 wpm test. It wouldn't cost any more, it would be good practice, and so what if you didn't pass it—what if you *did*?

I was not persuaded, but when they called for the General code test, I decided what the heck and went along. There were seven of us. The test was in a long, narrow room, tables stretching its length, with cubicle desks along one side. The test was over a speaker—scratchy and loud.

I knew I could only copy 8 words a minute max. I knew it was a waste of time, and I knew the callsigns, being important, would be repeated at the end. When the tape started, I tried my best but it was hopeless. I thought I had the callsigns, but the rest was a hodge-podge. It looked like random practice, but the test was multiple choice and I found the first callsign on my sheet. Then I froze. The next callsign on my page was

incomplete, since every answer listed had a virgule—the stroke sign—and two digits after it, showing mobile operation.

I checked both ends of the message but I had missed it both times. It was a toss-up, since two choices had different answers for the same callsign so I guessed and went on.

There was a question on weather. I saw a "C" on my page and a "Y" nearby. I guessed "cloudy" and went on.

The rig being used was the next question. I had a "Y" on the page and a neighboring "U" so I guessed "Yaesu" and moved on.

In all, I made such "informed" guesses on five questions. You need seven right. I guessed on five others. On one, I might have actually remembered hearing the answer without writing down the characters, but who knows? I turned in the answer sheet and my note paper. I grinned when the VEs said they would check to see if there was one minute perfect copy. I hadn't made 20 seconds.

I went downstairs as they graded. It would be a few minutes before they set up the Novice test, one I could at least copy. The VE was using 2 meters simplex to talk room to room. They called down to say only two had passed the General code test. One of them was me.

I was stunned. They had to tell me twice—I didn't believe them. The odds were all wrong. There were so many blanks on the page, although I do well at crossword puzzles. The remainder of the testees went upstairs to take the Novice test. I panicked, thinking I would miss this chance and they would re-grade the General and flunk me. They didn't.

Continued on page 29

TRANSMITTER LOCATION

Direction Finding System Tracks Down

- Stuck Microphones
- Cable TV Leaks
- Jammed Repeaters & Cell Sites

Models available with computer interface, synthesized speech, for fixed or mobile use, covering 50 MHz to 1 GHz. Call or fax for details

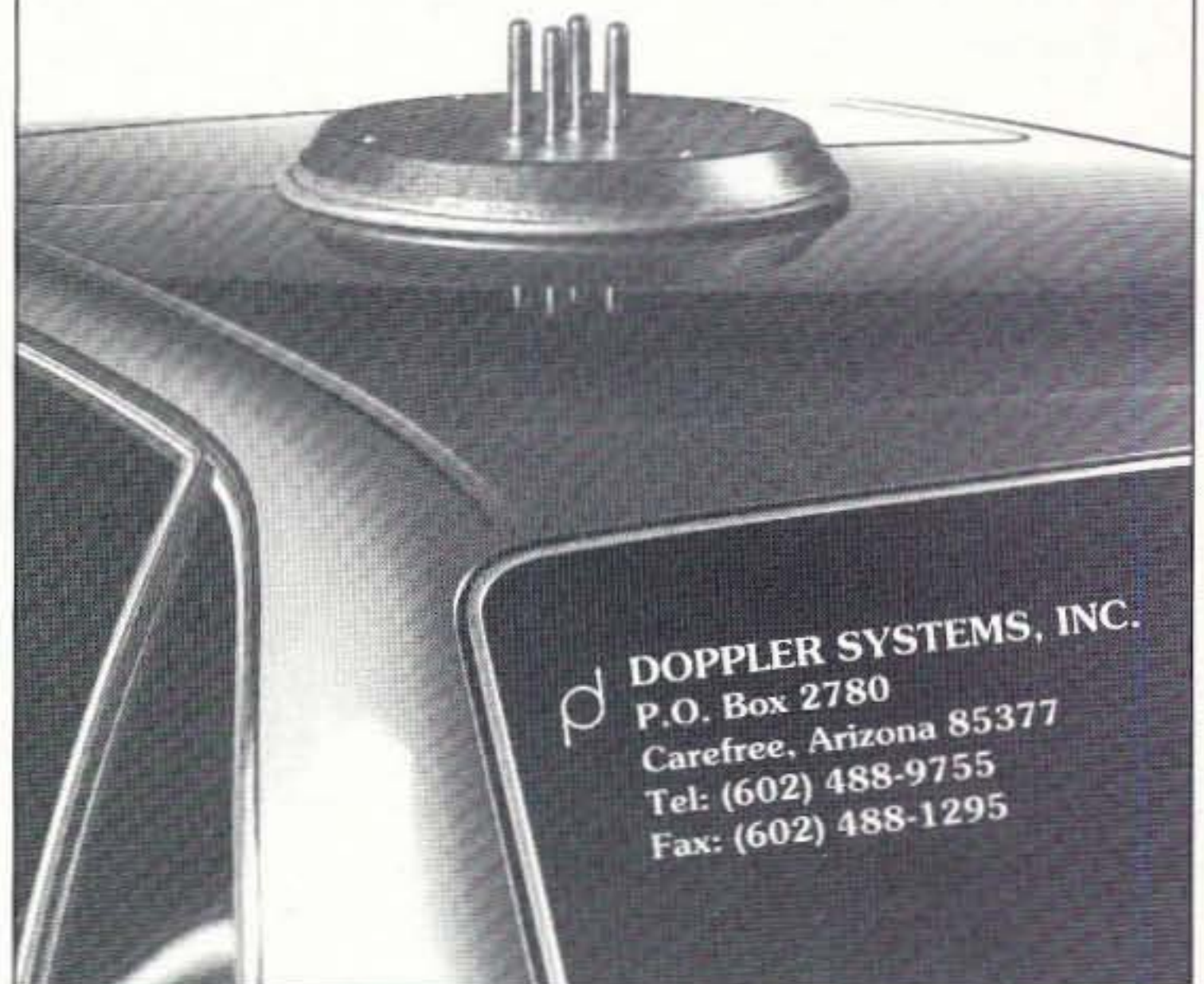

CIRCLE 13 ON READER SERVICE CARD

AMATEUR TELEVISION



SEE THE SPACE SHUTTLE VIDEO AND GET THE ATV BUG

Many ATV repeaters and individuals are retransmitting Space Shuttle Video & Audio from their TVRO's tuned to Spacenet 2 transponder 9 or weather radar during significant storms, as well as home camcorder video from other hams. If it's being done in your area on 420 - check page 538 in the 95-96 ARRL Repeater Directory or call us, ATV repeaters are springing up all over - all you need is one of the TVC-4G ATV 420-450 MHz downconverters, add any TV set to ch 2, 3 or 4 and a 70 CM antenna (you can use your 435 Oscar antenna). You don't need computers or other radios, it's that easy. We also have ATV downconverters, antennas, transmitters and amplifiers for the 400, 900 and 1200 MHz bands. In fact we are your one stop for all your ATV needs and info. We ship most items within 24 hours after you call.

Hams, call for our complete 10 page ATV catalogue.

(818) 447-4565 M-Th 8am-5:30pm

P.C. ELECTRONICS

2522 Paxson Ln, Arcadia CA 91007

Visa, MC, UPS COD

Email: tomsmb@aol.com

24 Hr. FAX (818) 447-0489

73 Review

The MFJ 20 Meter SSB Rig

More fun in the sun.

Jeff Gold AC4HF
1751 Dry Creek Road
Cookeville TN 38501

I love to operate 20 meter QRP. I got my start in the QRP mode with one of the original MFJ 20m CW rigs and a dipole. I had a blast working all over the world while I was portable and using battery power.

When MFJ came out with the 20m SSB travel rig, I just had to have it so I bought one and had a great time. We used it during a University Club QRP/ expedition, an event which really gave students a reason to want to upgrade. They had a great time operating outdoors with wires strung in the trees

said they didn't; they'd all been sold. But, after some waving of arms, I got her to go look and she found one out back, still on clearance for \$50.

I drilled a hole in the back of the MFJ for an audio signal out jack and spliced in the speaker. When I tried it, I smelled smoke. Oops, I had to insulate it from ground.

The Radio Shack DSP really works great with the MFJ. In the CW mode, it's like a whole new radio. There are three bandwidth settings; I have found the middle position best for most of my operating, and when there is a contest I use the narrower position. I hadn't really noticed a need for additional filtering

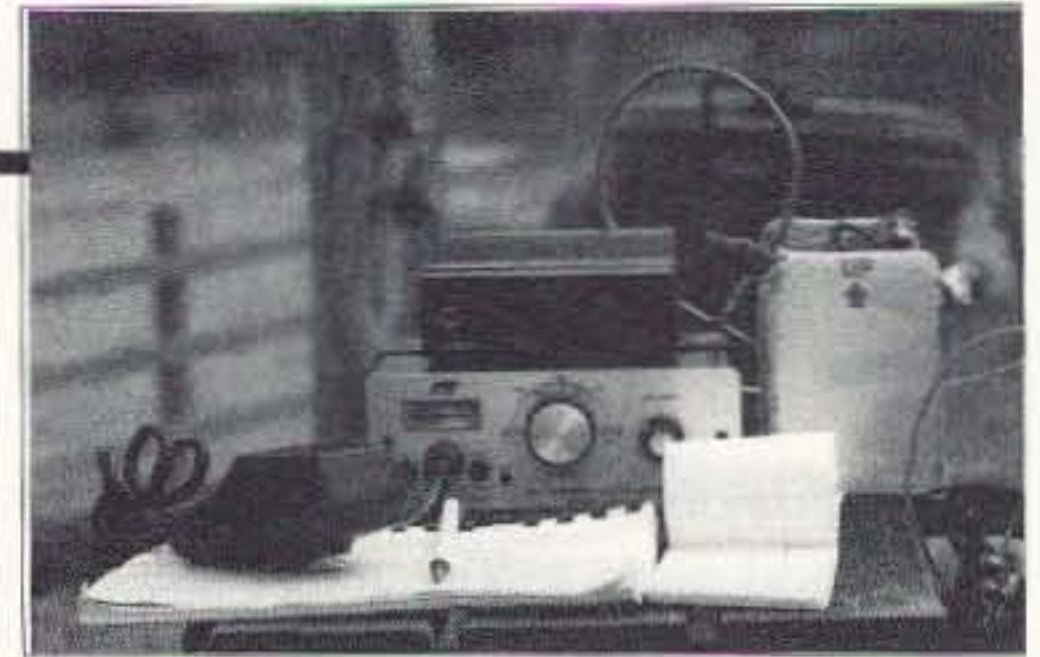

Photo A. AC4HF's portable setup, using the MFJ-9420 and a Radio Shack DSP unit. (Photo by AC4HF.)

like you are swallowing your mike. Back away and don't shout." When I did, he said, "Good quality audio and a nice signal." The transmitter draws about 2.2 amps peak at 13.8 volts. The rig I tested put out 12 watts on audio peaks. The rig will tolerate VSWRs up to 3:1.

The VFO has a 8:1 reduction-drive with ball bearings so I had no problem tuning in stations, even under crowded conditions. There's a lighted analog meter which acts as an S-meter on receive. I checked it against my commercial rig and found the readings to be comparable. In the transmit position the meter monitors the processor. It is a good idea to keep an eye on this until you get used to the rig and you'll get the same glowing audio reports I get. There's a push-button on/off switch; a push-button tune switch; which is useful with an antenna tuner; and both power and transmit lights as well as a volume control. The mike jack is a five-pin DIN for connection with a dynamic microphone. The jack accepts a standard Radio Shack 274-003 plug.

The rear panel has a standard SO-239 antenna connector. The power jack is a 5.5mm OD, 2.1 mm ID which accepts standard plugs that can be purchased at Radio Shack. There is also a mike gain adjustment. The manual explains that you may have to turn down the mike gain if you are operating under noisy conditions. There are two additional holes for the plug-in CW adapter. One of them is for the push-

"This rig and accessories can easily be packed into a small airplane carry-on bag."

during the weekend. The rig did tend to drift and had a loud relay, but these weren't serious problems. The newer MFJ units are much more stable and work first-rate. The club used the little rig on Field Day and in some big DX competitions with great success.

Unfortunately, I ran short a while back and sold my original MFJ 20, so when I recently came across the newer MFJ 20 meter SSB in a local flea market, I traded immediately.

It took me a couple of days to track down a CW adapter. I installed it, re-aligned the VFO, and set up all the little adjustments on the adapter board (pretty easy). It worked well, but there was no filtering so I found it hard to operate when there a crowd on the band.

I considered building a small audio filter and putting it in the cabinet with a selection switch on the back of the rig. Then I just happened to pass a Radio Shack™ and somehow my van just pulled right into the parking lot. I asked if they had any DSP units left. The young lady, who I had dealt with before,

while on SSB, but, since the filter was already attached, I started to experiment with the different DSP SSB options. The noise reduction feature seems to do a nice job and the narrower filtering sometimes comes in handy. The DSP now lives securely attached to the top of the MFJ. The whole thing, with my mini dipole and gel cell, is now ready for hiking trips.

The MFJ-9420 SSB travel radio

The manual says, "Your MFJ-9420 features a very potent speech processor. Please resist the natural temptation to shout or close-talk the microphone in order to be heard! Instead, hold the mike about two inches away and speak normally." On my first contact, looking at the small rig on top of a number of much larger rigs, I found myself with the microphone up close and talking louder than normal so that my small signal would become bigger. The ham on the other end said, "You're plenty strong, but it sounds

button switch and the other for the key. This module wasn't available at the time I tested the rig, but I am looking forward to testing it. I like 20 meters a lot and having both CW and SSB capabilities in a small portable rig is a big plus to me.

The rig is the same size as their CW QRP rigs and operates easily off a gel cell. I've used a 4 Ah gel cell for a long period of time without any difficulty. If you are planning on operating from hotel rooms or other places where power is available, there is an optional AC portable power supply available. This rig and accessories can easily be packed into a small airplane carry-on bag. I'll be packing the rig, a small gel cell, battery charger, and a 20 meter dipole for a trip to Arizona this summer. Be listening for me.

I don't think I ever had as much fun testing a new piece of equipment as I did this rig. It doesn't have a lot of bells and whistles, such as memories, but this makes it the easiest-to-use SSB rig I have come across. My first contact was with Frank W6AIY. He reported that the audio was solid and very good quality. Mike KD1QR said, "I read about that rig and I'm more impressed now that I hear the audio."

I started to get excited about what the rig could do. I made up a cigarette-lighter power cable and stuck my 20 meter Ham Stick on the back of my convertible. I heard someone calling CQ, Lou KC2LL. He told me that the rig had great audio and a good solid signal and stated, "Can't believe how well you are doing with low power and a Ham Stick antenna."

Next was to see if anyone could hear me during the CQ WPX contest. Contests are a tough test for any rig, but I managed to make quite a few contacts using the home station five-band quad. At one point I heard a big pileup on TM1C. I gave him a call. We exchanged contest information and I snuck in the comment that I was working low power on a new MFJ rig. He came back and asked me if I really said I was using low power. When I affirmed that I was he said, "Unbelievable, you are stronger than the rest."

Amplifiers, ATV Down Converters & Hard to Find Parts

LINEAR AMPLIFIERS

HF Amplifiers

PC board and complete parts list for HF amplifiers described in the Motorola Application Notes and Engineering Bulletins:

AN779H	(20W)	2 Meter Amplifiers (144-148 MHz) (Kit or Wired and Tested)
AN779L	(20W)	
AN 762	(140W)	35W - Model 335A, \$79.95/\$109.95 75W - Model 875A, \$119.95/\$159.95
EB63	(140W)	
AR305	(300W)	440-450 MHz Amplifiers (SSB-FM-ATV)
AN 758	(300W)	
AR313	(300W)	
EB27A	(300W)	
EB104	(600W)	100W - Model KEB 67, \$159.95
AR347	(1000W)	



ATV Down Converters (Kit or Wired and Tested)

Model ATV-3 (420-450)
(Ga AS - FET)
\$49.95/\$69.95
Model ATV-4 (902-926)
(GaAS - FET)
\$59.95/\$79.95

HARD TO FIND PARTS

- RF Power Transistors
- Broadband HF Transformers
- Chip Caps - Kemet/ATC
- Metallized Mica Caps - Unelco/Semco
- ARCO/SPRAGUE Trimmer Capacitors

We can get you virtually any RF transistor!
Call us for "strange" hard to find parts!

DIGITAL FREQUENCY READOUT
For older analog transceivers
TK-1 (Wired and Tested)\$149.95

For detailed information and prices, call or write for our free catalog!

ADDITIONAL ITEMS

Heat Sink Material
Model 99 Heat Sink (6.5" x 12" x 1.6"), \$24.00
CHS-8 Copper Spreader (8" x 6" x 3/8"), \$24.00
Low Pass Filters (up to 300W) for harmonics
Specify 10M, 15M, 20M, 40M, 80M or 160M
HF Splitters and Combiners up to 2KW

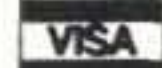

Add \$4.50 for shipping and handling

CCI Communication Concepts Inc.

508 Millstone Drive • Beaver Creek, Ohio 45434-5840
Phone:(513) 426-8600 • FAX (513) 429-3811

CIRCLE 99 ON READER SERVICE CARD

MAGGIORE ELECTRONIC LAB.

Hi Pro Repeater

Maggiore Electronic Lab.

Model R1

INTRODUCES THE NEW Hi Pro "R1" REPEATER

HERE IS A COMPLETE LOW COST VHF REPEATER, LESS CONTROLLER, PRICE \$589.00

A 35 WATT VHF REPEATER WITH VOICE, AUTO PATCH, AUTO DIALERS ETC. \$1145.00

THIS IS NOT A KIT BUT A COMPLETE REPEATER WITH A 2 YEAR WARRANTY

AVAILABLE IN BOTH VHF OR UHF. FOR MORE INFORMATION CALL OR WRITE,

MAGGIORE ELECTRONIC LAB., 600 WESTTOWN ROAD, WEST CHESTER, PA., 19382, Ph: 610-436-6051 Fax: 610-436-6268

The transceiver was designed as a small, portable travel rig that is rugged enough to take on camping trips. The rig was not meant to be a replacement for your main station rig. It doesn't have RIT and there is no jack for headphones, but it does do a great job at what it was designed to do. It lists for \$219.95 without the microphone and \$229.95 with the mike—buy the mike. The AC portable power supply lists for \$39.95.

The Radio Shack DSP noise reduction system

The unit is very small and light. It can operate off a standard AC outlet if you purchase the optional adapter. It comes with a power cord to operate from 12V DC. The unit is a computer controlled digital signal processor with a built-in audio amplifier and speaker. It was designed for communication receivers and its purpose is to reduce heterodynes, to reduce back-

ground noise and separate it from the desired signal.

The audio amplifier puts out 5 watts, which is more than adequate. There is an external speaker jack that lets you connect a speaker using a 1/8" plug. There are filters for CW that allow you to select one of three bandwidths. In the SSB mode you can either choose the bandwidth mode (works same as CW) or the Noise Reduction Mode (NR). The NR mode really gets out the heterodynes well for such an inexpensive unit. It has an on/off control that also controls the volume, and a power-on indicator. It comes with a mobile mounting bracket which slips on the DSP end, and hardware is provided for the car installation end. A phone jack is also included on the front panel. It is a very simple and straightforward unit to connect (the cable to connect to the rig is included) and to operate. I didn't even have to read the manual.

73

73 Review

The BASIC Stamp

Wait 'til you read about this fabulous new toy!

Bob Johansen WB2SRF
61 Burnside Ave.
Staten Island NY 10302

The adage "Good things come in small packages" needs to be changed to "Great things" for Parallax's BASIC Stamp. It's a stamp-sized computer that runs BASIC. How 'bout them apples?

Currently there are three versions of the BASIC Stamp: (1) The original version, now several years old, which used two socketed DIP-ICs mounted on a small (1-1/2" x 2-1/2") PCB. It has eight I/O ports, program storage of 80 BASIC instructions, and 4 MHz operation. A small prototyping area on the board is reserved for your use. (2) The surface-mount module version of the BASIC Stamp, which is called the BS1-IC,

reserved for your prototyping. It is wise to buy at least one carrier board for whichever version of the stamp you intend to use so that you can program it. Afterwards, you can place the BASIC Stamp module into a socket on your own PCB to work with your own projects.

These products have come to revolutionize the way your projects can be controlled, keeping your time spent on development to a minimum. For example, BASIC Stamps are being used by model railroaders to control their train layouts. Robotics hobbyists use them to make "brains" to control their pet robots. Ham operators use them to build ID units, repeater remote controllers, etc. There are also endless industrial applications for this device.

"Its real beauty is its ability to change time durations or circuit paths quickly and easily."

and has 14 pin (SIP) single in-line pins. The size is about 1-3/8" x 3/8" x 1/8" thick and it has the same electrical specifications as the original version. (3) The new BASIC Stamp II (BS2-IC), which is also a surface-mounted module, has 24 (DIP) dual in-line pins. This one is just slightly longer than a postage stamp. It is only about 3/16" thick and fits into a standard 0.6" wide DIP-IC socket. It has 16 I/O ports and program storage of 600 BASIC instructions. It includes many new functions and performs much faster with 20 MHz operation.

Note: The BS1-IC and the BASIC Stamp II modules require a separate carrier board to provide power and programming connections, while a small blank area of the board is

Any application which previously required devices such as the venerable Signetics NE555 timer, various logic gate ICs, etc., wired together to serve a function, can be better implemented by use of the BASIC Stamp. Its real beauty is its ability to change time durations or circuit paths quickly and easily—you just change a few keystrokes during programming, instead of having to bother with the selection of resistor or capacitor values and/or hacking away with hard-wired circuitry to obtain the desired function.

Once the desired program is developed, loaded and debugged in your system, you disconnect your PC from the Stamp and it will continue to function on its own. The program is held in EEPROM (electrically

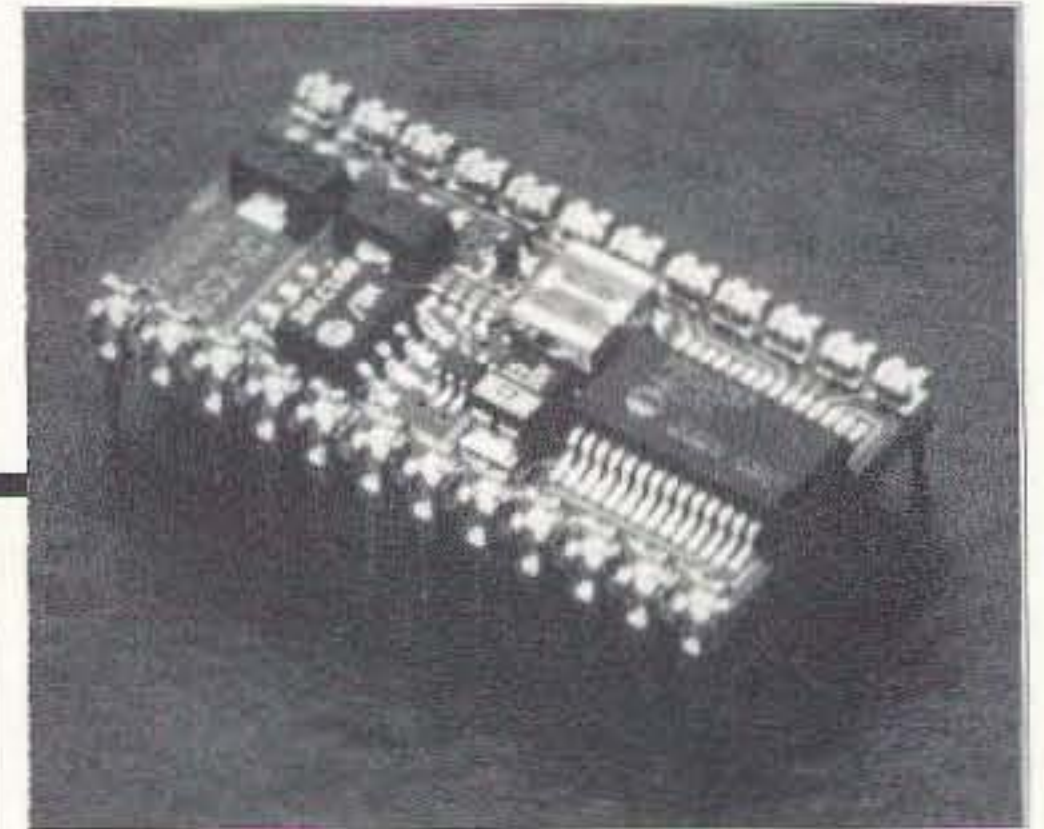

erasable programmable read only memory) so that no battery backup is required for it to hold your program (for over 10 years) and it can be reprogrammed hundreds of thousands of times for different functions. They are based on Microchip Inc.'s PIC 16C56 and 16C57 RISC (reduced instruction set) based microcontrollers to which Parallax has added its proprietary P-BASIC interpreter, permanently burned into the chip's memory.

How to get started

The BASIC Stamp is programmed by using a special programming package that sells for about \$100, a one-time investment for programming many BASIC Stamps. The IC module and the matching carrier boards are sold separately, and are not included with the programming package. The BS2-IC with the carrier board sells for about \$70 and the BS1-IC with the carrier board sells for about \$50. The BASIC Stamp alone sells for about \$40.

The programming package includes an excellent instruction book with 20 different application notes, shown in detail, with both program listings and schematics, for interfacing with the BASIC Stamp. Some examples of these applications are interfacing to an LCD panel, keypad, A/D converter, servo, a stepper motor, sensing temperature and humidity, sending Morse code, infrared control, sonar range finding, and solar power.

The BASIC Stamp II, which is Parallax's new product, has

additional capabilities so they now include an additional booklet with the programming package. Besides the increased I/O lines and speed, the two most outstanding new features are XOUT X-10 (power line remote control code transmission) and DTMFOUT (DTMF tone generation).

You'll need a PC with at least 128K RAM running MS-DOS 2.0 or greater. One 3.5" HD disk is provided with the programming package. The BASIC Stamp uses the Parallel printer port with three wires to the DB-25 plug interface hookup. The cable is provided with the programming package. The BASIC Stamp II uses the computer's serial port; a DB-9 cable is provided with the programming package.

The Stamps are powered most conveniently, using a standard alkaline 9V transistor radio type battery which snaps directly onto the carrier board.

I can recall my first experience programming my first BASIC Stamp. Within five minutes, I loaded in a short program, which made an LED that I'd connected to one of the I/O lines blink. I was very excited about being able to control a device through my PC keyboard. The next thing I did was hardwire a DTMF decoder IC onto the prototyping area and develop a program to decode touch-tone commands. I made several remote control devices with the BASIC Stamp to use with a pair of HTs.

Now I'm hooked not only on soldering components together, but also on sketching flow charts and developing programs to try out with the new stamp in my collection, the BASIC Stamp II. Try one—you'll like it!

For more information contact: Parallax, Inc., 3805 Atherton Road #102, Rocklin CA 95765. (916) 624-8333. 

Persistence Wins

Continued from page 25

I was still in shock when I went upstairs to take my Novice written and I thought I did okay. I was sitting down when I heard over the simplex, "Tell Mr. Waters he will have to take another test." I thought this meant I had failed the written. I thanked the test staff and left to join my sons on a Scout trip, thinking I could always take the Novice written again.

I started studying again that night, and I wondered how I had failed when I did so well on the computer.

On Tuesday night, I got a letter from Gene Whitehurst asking me why I had left without taking the Technician written, since there would have been no additional charge. He enclosed the CSCE—for 13 wpm and Element 2. I would be receiving

my license in six weeks. I went to work that night on Technician study, thinking I had only a year to pass General written. By June, though, I had done it. I got my General license in August.

I thought there I would stay, never hoping to get to 20 wpm and Advanced was a 500-question pool, but a fellow lawyer called up—Madison Jones, then KB5ZMH. He wanted to say hello. We became friends. Then the so-and-so upgraded to Extra (AB5TV) and started talking about less crowding for QRP contacts.

I bought the Advanced study materials, which is all regulations, procedure, theory, and antennas, my favorite, and took the test on a Saturday. I wasn't ready. The computer

Continued on page 32

WE DON'T BUILD THE MOST, WE JUST BUILD THE BEST!

- Our LM-470D is now redesigned to hold 15 ft. of antennae at 70 mph!
- Tri-Ex builds the finest in crank-up, free-standing or guyed towers.
- All towers are complete with rigid concrete base mount.

CALL
OR WRITE
FOR A FREE
CATALOGUE!



Tri-Ex[®]
TOWER CORPORATION

7182 Rasmussen Ave. • Visalia, CA 93291

Where engineering and quality come first!

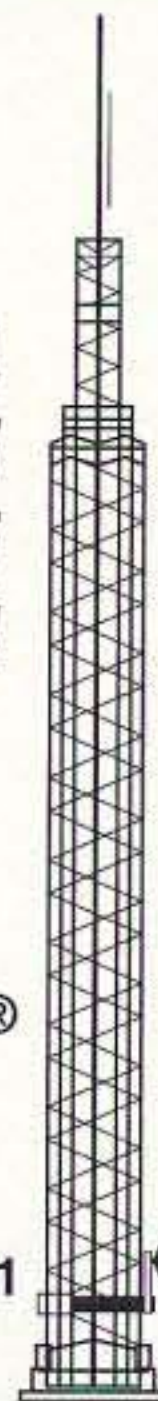

TO ORDER CALL
800-328-2393

FAX
209-651-5157

TECH SUPPORT
209-651-7859

CIRCLE 22 ON READER SERVICE CARD

Motron 310 Garfield St Suite 4
PO Box 2748
Eugene, Oregon 97402
<http://www.motron.com>

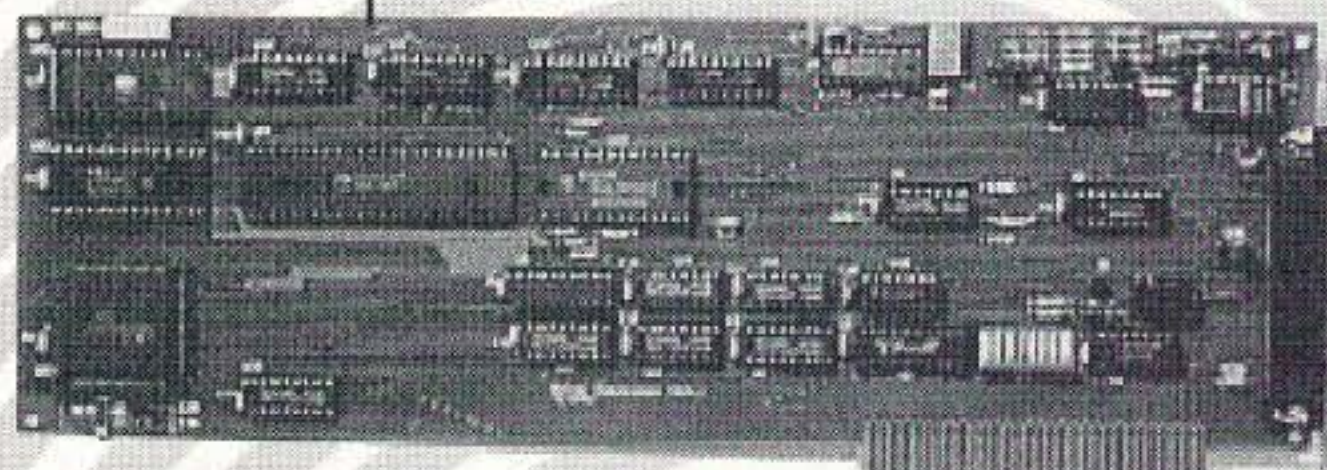

TxID-1

TRANSMITTER FINGERPRINTING SYSTEM

TxID™ Software and IBM/Compatible circuit card.

Now Shipping VERSION 2 SOFTWARE
WITH AUTOMATIC MATCH AND COMPARE!

TxID™ TxPorter™

EXTERNAL ADAPTER FOR MOBILE OPERATION.
CONNECTS THE TxID TO YOUR LAPTOP COMPUTER!

TxID-1 FINGERPRINTING SYSTEM WITH SOFTWARE **\$699.00** Plus
TxPorter™ MOBILE OPERATION ADAPTER **\$249.00** S/H

Call for more information.
Info: (541) 687-2118 Fax: (541) 687-2492

CIRCLE 248 ON READER SERVICE CARD

How Much Are Those Decibels Worth?

A survey of amplifier costs and the resulting S-units.

Bill Clarke WA4BLC
764 Alta-Voor Road
Altamont NY 12009

Thinking of purchasing an HF amplifier? What output do you want: kilowatt, legal limit, or California kilowatt? Perhaps you're happy to operate with only 100 watts, which is the typical output of today's transceivers. So what is the *real* difference in signals at the receiving end, as compared to the output signal at the transmitting end? And what are the dollar costs for these S-meter differences?

First, a basic: Each time the final RF output power is doubled, there is a power increase of 3 dB. A gain of 3 dB on HF is generally considered to be the least discernible change at the receiving station. An increase of 6 dB is one S-unit and can be considered a worthwhile gain (Note: S-units vary between receivers, though they shouldn't). The following dB gain figures are based upon an initial RF output power of 100 watts:

Small amplifiers

A power gain of 6 dB can be achieved with a small amplifier which usually uses four sweep tubes. These amplifiers offer an economical entry to moderate RF power gains; however, they must be handled carefully since the tubes won't stand prolonged tune-ups. Such amplifiers were plentiful a few years ago; however, I am unaware of any being made now. There are several different models available used, generally selling for \$150-\$250.

Kilowatt amplifiers

The next step is the kilowatt. Used kilowatt amplifiers generally use four 811A tubes, two 572B tubes, or a single 3-500 tube. New kilowatts use either the single 3-500 tube or four 811A tubes. Output levels are around

800-1,000 watts, for a 9 dB or 10 dB increase above our 100 watt input level. New kilowatt amplifiers cost from \$1,100 to about \$1,500. Used kilowatts start at about \$300 (more if

"You don't need an amplifier to make contacts, but it sure can make life easier."

you want 160 meter and WARC band coverage). One exception to these prices is the Ameritron amplifiers using the 811A tube. The three-tube unit (AL811) is rated at 600W output and sells for under \$600. The AL811H uses four tubes at 800W and sells for a little over \$700. It's a new amplifier at a used amplifier price, and the difference in dB between 600W and 800W isn't really significant. In between the kilowatt and the small sweep tube amplifier lies an area of 500W and 600W solid-state amplifiers. Generally, these are easy to operate, requiring no tune-up. Some models interconnect with the transceiver and track band changes and/or make antenna selections. Prices vary from \$1,100 for the Ameritron ALS600 (with a built-in power supply) to nearly \$3,000 for a full-featured ICOM IC-2KL. Solid-state amplifiers require no tuning and produce no filament heat. They are, however, expensive for the amount of power gained!

Amplifier Gain	Power Output
6 dB	400W
9 dB	800W
10 dB	1000W
12 dB	1600W
15 dB	3200W

QRO

The last legal step is the full-power amplifier, capable of developing the amateur limit of 1,500W PEP output. Amplifiers in this power class typically use two 3-500 tubes, a single 3CX-1200A7, an 8877 tube, or a 4CX-1600U. Many of these amplifiers are capable of producing slightly more output than that legally allowed.

More than the law allows? Let's look at the 3 dB rule again. In order to make a discernible difference at the receiving end, your output must increase by 3 dB. That means you'd have to increase your 1500W legal limit to 3,000W to make a difference on the other end. The difference between running your amp at 1,500W and at 2,000W will not be noticed. It is, however, illegal!

New amplifiers in the legal limit class generally sell in the area of \$1,800 to \$2,300. However, top-of-the-line units such as the Alpha series sell for up to \$6,000. Used 1,500W amplifiers start at about \$800 (more for 160 meters and WARC bands).

The cost of decibels

Here is the lowest cost you'll probably find for each power increase:

Amplifier Gain	Power Out	New Cost	Used Cost	\$/dB
6 dB	400W	N/A	\$150	\$25
9 dB	800W	\$700	\$300	\$78
10 dB	1000W	\$1000	\$500	\$100
12 dB	1500W	\$1800	\$800	\$150

Notice the difference in dollars/dB between an 800W amp (\$78/dB) and one that puts out the full legal limit (\$150/dB). If you invest \$1,100 more to get from 800W to 1,500W, the S-meter on the receiving end will go up about *half* of an S-unit. Is it worth it? Only you can decide. The cost-per-dB ratio gets even higher as you consider better equipment. A full-featured kilowatt output solid-state amplifier, such as the ICOM IC-4KL, lists for nearly \$9,000, or \$900/dB.

Used amplifiers

Older amplifiers, such as the Heathkit SB-200, using two 572Bs, or the Collins 30L1, using four 811As, make excellent general-use kilowatt amplifiers. You may need to use a relay box on the keying line to protect some solid-state transceivers from high switching voltages. Many older amplifiers sell on the used market for \$300 to \$600, depending upon their appearance and tube condition. Be aware that 160 meter and WARC band coverage does not exist on most older amps, whether kilowatt or legal limit versions.

Tubes

Tube costs are a factor when buying any amplifier, since at some point in time you will be faced with buying a replacement. The tubes in used amplifiers are always an unknown factor and replacement costs should be considered prior to making a purchase.

Sweep tubes sometimes sell for less than \$10 each, but can go higher than \$20. For other amplifiers, the Russian-made Svetlana 811A tubes sell for under \$20 each, 572B pairs sell for about \$95, and 3-500s start at about \$110. When you get to the more exotic tetrode tubes, the prices go up quickly:

3CX800A7 at about \$300, 3CX1200A7 at just over \$400, and 8877s at better than \$600 each.

Remember, a kilowatt will sound the same regardless of what tubes are producing it.

When a kilowatt is not 1,000 watts

Watch out for those advertised power claims; they can be devious and misleading

due to confusion between input and output power. Generally, a good amplifier will be about 65% efficient. This means that a manufacturer may refer to an amplifier with one thousand watts input as a kilowatt; however, that amplifier would only provide 650 watts output. The examples used in this article are based upon output power.

Amplifier observations

You don't need an amplifier to make contacts, including DX and contesting. There are thousands of hams using 100 watt transmitters and wire antennas, all enjoying their share of DX and contests. It is the antenna first, then the power level, that counts, and somewhere between the two is the operator whose skills bring about many more contacts than brute force alone.

Seldom do local contacts (75 meter nets, for example) require the use of an amplifier. After all, we are supposed to use only the power necessary to maintain communications. Unnecessary amplifier use serves to clog up the bands with QRM and make the electric power companies richer.

Too often an amplifier is used as the means to attain a good signal report, when the same good report could have been had if the antenna system was improved (at much less cash outlay than the cost of an amplifier). This statement is very often the case on 160 and 75 meters and, to a lesser degree, applies to other bands as well.

A directional antenna such as a three-element yagi or a two-element quad will concentrate your signal and give about 7 dB gain in a single direction (using a 100W transceiver, this is the equivalent of 500W into a dipole). A tower and yagi/quad can be expensive; however, there are many wire antenna configurations that are equally effective, costing only a few dollars and requiring only a little time to put up.

Some bands, such as 15, 12, and 10 meters, do not play the amplifier game well. Propagation-wise, these bands are either open or they are closed. No amount of power will routinely support communications at a level any greater than 100W will do.

A place for amplifiers

It is not uncommon for an amplifier to make the difference between getting through and getting that QSL. As an added feature, amplifiers are nice in the winter. The ones with real tubes provide a warm glow in the shack and help heat it as well!

From
Micro
Computer
Concepts

RC-1000 REPEATER CONTROLLER

- Autopatch • Reverse Autopatch
- User Programmable CW ID,
Control & User Codes & Timeouts

Manual with schematics • 90-Day Warranty
Wired & Tested w/ manual **\$239.95**



Micro Computer Concepts
8849 Gum Tree Ave.
New Port Richey, FL 34653

813-376-6575

CIRCLE 160 ON READER SERVICE CARD

Field Day Antenna Installation System

One person
installs
in minutes

Info
\$1.00

Re-usable
Ready for Action
Fast & Easy to Use
Eliminates Climbing

**ANTENNA
LAUNCHING
MADE EASY**

\$29.95
add
\$5 Air
Ship

1-801-373-8425
AntennasWest
Box 50062-S, Provo, UT 84605

CIRCLE 304 ON READER SERVICE CARD

JPS Communications NIR-12

Continued from page 24

can pull out a certain voice with a center frequency of 1100 Hz and a 1000 Hz bandwidth, copying voice frequencies between 600 and 1600 Hz. It's like the IF pass control on some receivers.

Those are the four modes available with this filter. A significant advantage of the NIR-12 is the ability to use them all at the same time, including cutting the bandwidth when using the NIR mode, as I mentioned.

Some of the artifacts created by the NIR mode can be reduced by using the dynamic peak mode, and, many times, both can be adjusted for best overall noise reduction. Of course the notch filter is always useful with voice modes.

Additional features

You can also use an NIR-12 for transmit audio processing. This is most useful if your microphone is picking up a lot of ambient noise. You'll have to provide your own switching and preamplification if you want to use the same unit for transmitting and receiving, but there's no provision for resetting the controls for different transmit and receive settings, so you're better off using the unit on either TX or RX — but not both.

The NIR-12 provides a line level output that's not controlled by the volume control for things like TNCs, RTTY demodulators, or

Persistence Wins

Continued from page 29

said I was only averaging 32 to 36 right, and you need 37 out of 50.

I had bought Gordon West's tapes, Jerry Ziliak's tapes, and Radio Shack's book (also by Gordon). I finally committed two formulas to memory. The test was at a library. The answer sheet had two rows of blanks. You go down the sheet, filling in the blanks, then start out at the top of the other half of the page. I finished and turned it in.

One of the VEs started grading. He ended the first row of 25 questions with only three marked wrong. He looked up and said, "So far, so good." I missed five on the other side.

"Take the Extra," the VEs said.

"I'm not ready," I said.

"If you haven't studied, you won't pass it, but take it anyway," they said. "It will be good practice and you never

know." Where had I heard that before? I took it, and, as I was turning it in, I saw a ham I knew, Maurice, sitting at the VE table, turning in his 5 wpm test for the Plus upgrade.

"I think I could have passed it if you'd have let me write down the dots and dashes," Maurice said. "Then I could have gone back and transcribed."

"Ha! The Wayne Green Novice Code strategy," I, a 73 subscriber, thought.

The VE leader said, "I never said you couldn't do that," and the room fell silent. Maurice looked at him for a full 10 seconds.

"I'd like to take another code test, please," he said. I turned in my Extra written. It wound up with a lot of red on it—my first ham test failure.

"You didn't do so well that time," the VE said, handing me a CSCE for Advanced. Even so, I was higher than a Gigahertz (Maurice got his upgrade, too). Today I bought the Extra book, and the 20 wpm tapes. Nothing ventured... 73

modems. A headphone jack for both stereo and mono headphones is also on the rear panel. A "bypass" position lets you switch the unit into bypass mode through your transmit/receive relay so you can monitor your transmitted signal (especially CW) without going through the NIR-12's delay.

The instruction manual is comprehensive and clear. It has sections providing a brief description, and instructions for quick operation, controls, and operation. The result is that a cover-to-cover reading of the manual reveals the same information in varying detail three or four times. This may lead to some head-shaking, but you *will* know how to use it by the time you're done.

You also get a schematic; it's barely readable, but JPS is to be commended for putting one in at all. There's a programming interface available if you want to develop your own filter algorithms, and there's a section on the limitations of the NIR-12. The reality is that there are still some signals that are so far down in the noise you can't hear them, even with 1996 technology. Obviously noise algorithms and more powerful processors are needed and will continue to evolve.

Since the DSP chips need time to do their thing, there is a measurable delay through the unit, especially in NIR mode, where the delay of 130 milliseconds renders the TOR modes unusable in normal

ham operations. For all the other modes, the delay is specified as less than 19 milliseconds, which allows normal TOR operations.

The NIR-12 is better than the NIR-10 in every way, but we still have a way to go before I will stop complaining about computer noises! The emitted RFI from the NIR-12 is far less than that of the previous model, but there's still a little and for some reason it still carries the less restrictive FCC Class A rating. Equipment that's well-shielded for home use normally carries a Class B rating.

The other noise is what comes out of the audio output. Again, it's better than the NIR-10 and better than some competing units, but I still hear its microprocessor running in the background through the speaker. JPS rates the output at 2 watts with 10% distortion. I'd prefer less, and DSP units that are 10 times the price achieve that.

For my money, I haven't yet found anything better than the NIR-12; it works well, and JPS's reliability and customer support are superb. They have regularly come out with customer-installable firmware updates for their units. I continue to use the unit for ham radio and broadcast monitoring, where I can set up the unit and know that the tape I'm recording won't be ruined when I turn on a computer. While it isn't the only noise reduction I have, it is the most generally effective. 73

from the village, many with only the clothing they were wearing. Most evacuees were taken to nearby Waupaca.

Amateur Radio Emergency Service (ARES) personnel contacted State Director of Emergency Government, Al Shanks, later that morning, who instructed ARES to activate communications and set up a command post at the Red Cross Center in Waupaca. At DEG's direction, amateurs also provided communications for the incident command post at Weyauwega, at the Fremont WI Fire Station (where all the Weyauwega fire department's equipment was taken to be housed and maintained), and at a road block check point at State Highways 10 and 49.

Communications were provided for Red Cross shelters in Waupaca. Circuits were also active from Waupaca to the State Emergency Operations Center of the DEG in Madison, where RACES station WC9AAG was in operation 24 hours a day for nearly two weeks. Two meter repeaters, the 3993.5 kHz RACES frequency, and some packet radio nodes were used for the long-haul path to Madison.

Ham Radio Operator Lauded for Helping Save Sinking Yacht

Los Angeles: As an amateur radio operator, Bob Karon has frequent conversations with people from around the world, swapping stories about family, sports, or new radio equipment with other enthusiasts.

But a recent transmission, heard as he was testing a new amplifier, sent the 46-year-old ham operator from Los Angeles leaping to his feet; a frantic voice was calling, "Mayday! Mayday!"

Within seconds, he had begun a search by radio and telephone that, with the assistance of the U.S. Coast Guard, ended in the rescue of four people aboard a yacht sinking in the Caribbean Sea at night with a storm moving in.

"This all came out of the blue," he said after receiving a letter of commendation from the Coast Guard. "I wasn't expecting an emergency call."

The night of March 18, he was speaking with another ham operator in Naples, FL. when he heard the mayday call on the same frequency.

In the first few minutes of talking to the sinking craft, Karon found out that it was a 44-foot Canadian yacht named the Cambria, carrying owner, Kenneth Cunningham, his wife, and another couple.

The yacht had been grounded on a reef about 150 miles southwest of Jamaica, Cunningham indicated in static-interrupted transmissions.

The yacht had a hole in it, water was coming in fast, and a storm was approaching. Cunningham said that the waves were growing and the boat would go under within the hour.

"They sounded terrified," Karon said. "It sounded like they had very little time."

Karon first telephoned the Coast Guard in Los Angeles, and was transferred to the Miami

station. With the phone to his ear and microphone in hand, Karon was the only link between Cunningham and the potential rescuers.

"I had to make sure (the Coast Guard and the sailors) got absolutely correct information about the yacht and its location," Karon said. That turned out to be very difficult.

The grounding left the vessel on its side on the reef and jolted the communications system out of place, including the radio antenna, which was almost touching the water, Cunningham told Karon.

"The signal was weak and full of static," Karon said. "A lot of times I would say something and the response would come back, 'Negative,'" Karon said, meaning Cunningham was trying to correct him.

The Coast Guard determined that its closest rescue team was 2 1/2 hours away, but the Nord-Jahre-President, a freighter, was about 25 miles away and could reach the Cambria in an hour and a half. It might be too late, Cunningham told Karon, but it was their best chance.

Karon was connected by the Coast Guard to the Nord-Jahre, which accepted the mission, changed course toward the Cambria, and took over for Karon, who learned the rest of the story when he got the letter from the Coast Guard.

"Your professional and humanitarian actions are heartily commended and demonstrate the finest traditions of assisting mariners in distress," said Coast Guard Capt. Robert Gravino in his letter to Karon.

"This is the first time that I know of that someone picked up the call before the Coast Guard," added Petty Officer Scott Carr, who aided in the rescue from the Miami station. by Jose Cardenas, *Los Angeles Times*. Reprinted from *Sarasota Herald-Tribune* / Sunday, April 7, 1996. 73

Radio Bookshop

Phone 800-274-7373 or 603-924-0058, FAX 603-924-8613, or see order form on page 88 for ordering information.

Books and Tapes for Beginners

TAB4354 **Beginner's Handbook of Amateur Radio** by Clay Laster W5ZPV. 395 pages. Wonderful book for newcomers. It is basic and well illustrated. Even if you have all the other ham handbooks, you'll still find this one useful. \$22.00

W5GWNV **No-Code Video, Manual, Part 97 Rules** by Gordon West Learn how to be a ham radio operator \$29.95

W5GWNC **Technician Class License Manual: New No-Code** by Gordon West This book covers everything you need to become a Technician Class Ham. Every question and answer on the examination is found in this one book. FCC Form 610 application. \$9.95

XTAL-1 **The Crystal Set Handbook** by Phil Anderson WØXI Want to give a kid an exciting present? Or maybe yourself? Crystal sets are alive and fun. Here's a whole book packed with crystal set circuits that anyone can build. Now start saving those oatmeal boxes, okay? 133 pages. \$10.95

Code Tapes

73T05 **Genesis 5 wpm code tape** This beginning tape takes you through the 26 letters, 10 numbers and necessary punctuation complete with practice every step of the way. \$5.95

73T06 **The Stickler 6 wpm code tape** This is the practice tape for those who survived the 5 wpm tape and it is also the tape for the Novice and Technician licenses. It is comprised of one solid hour of code. Characters are sent at 13 wpm and spaced at 5 wpm \$5.95

73T13 **Back Breaker 13 wpm code tape** Code groups again at a brisk 13+ wpm so you'll be really at ease when you sit down in front of a steely-eyed volunteer examiner who starts sending you plain language code at only 13 per. \$5.95

73T20 **Courageous 20+ wpm code tape** Go for the extra class license. \$5.95

73T25 **Mind Boggler 25+ wpm code tape.** \$5.95

Get The Picture!



VHF Wx Satellite Decoding
Call or write for our free catalog

Software Systems Consulting

615 S. El Camino Real
San Clemente, CA 92672
Tel (714)498-5784 Fax (714) 498-0568

CIRCLE 250 ON READER SERVICE CARD

UHF VIDEO TRANSMITTER

Miniature 200 Mw p.e.p. Video Transmitter Built tough. Housed in a black anodized milled aluminum case with stainless steel SMA antenna connectors & screws.

Available either at 434 mhz or 423.25 mhz Using SAW Resonator technology



\$279 plus s/h \$5
Check, Money Order, Visa or Mastercard
CA Res. add 8.25% tax

TECHNICAL

Modulation Type: AM
Voltage: 12 vdc - 100 ma
RF Output: 200 mw PEP
Frequencies: 434 Mhz, 423.25 Mhz
Specify when ordering
Dimensions: 17/8" L x 1-3/8" W x 5/8" H
47mm L x 34.5 mm W x 15 mm H

A.I.G., INC.

P.O. Box 642057
Los Angeles, CA
90064-2057

TEL: 310 821-6770

FAX: 310 821-6690

THE ISOTRON
COMPACT ANTENNAS FROM 160-10 METERS

NO TUNERS
NO RADIALS
NO RESISTORS
NO COMPROMISE

SIX EXCELLENT REVIEWS JUST
DON'T HAPPEN BY CHANCE
CALL US FOR A FREE CATALOG.

*See review in Oct. 73, 1984 *Sept. 73, 1985 March 73, 1986
CQ, Dec. 1988 Mar. W.R. 91 NOV. 72, 1994



BILAL COMPANY
137 Manchester Drive
Florissant, Colorado 80816
(719) 687-0650

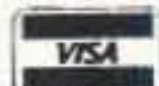

CIRCLE 42 ON READER SERVICE CARD

Home-Brew Whip Antennas

Make field-strength whips from your basement junk pile.

J. Frank Brumbaugh KB4ZGC
PO Box 30 C/O Defendini
Salinas PR 00751

Many hams would like to have a cheap and simple way to make collapsible whip antennas that would mate with field-strength meters and other test equipment. Others would like to replace the rubber ducks on their handhelds with quarter-wave whips. A whip which would collapse to about six inches and extend to about 19 inches could be used on the 2 meter, 1-1/4 meter and 70 cm bands, and would be ideal for a dual-band transceiver.

Many mail order dealers offer small collapsible whip antennas that vary in length, diameter, and number of sections. However, usable whips can be salvaged from old TV rabbit ears and small AM-FM radio receivers.

Depending upon the outside diameter of the base of the whip chosen, it can be mounted in a UHF or BNC connector so it will mate with similar connectors on your ham equipment. A BNC to UHF adapter will enable a single whip to be mated with either connector on equipment. The exploded views in **Fig. 1** illustrate clearly how to mate a whip to a male connector, both UHF and BNC.

Solder a short length of bare wire to the base of the whip. It may be necessary to file through the shiny coating on the

whip to allow the solder to adhere adequately. Use of a solder gun is recommended because of the thermal mass of the whip.

UHF

Insert the wire from the base of the whip through the center contact in the plug body. Making certain the wire and

BNC

The wire soldered to the whip must be thin enough to fit into the hole in the end of the contact pin. Cut this wire to a length that, when inserted into the contact pin, which is then inserted fully into the plug body, ensures that the base of the whip is within the plug body and that no short to the body exists. This may

“Usable whips can be salvaged from old TV rabbit ears and small AM-FM radio receivers.”

whip base do not touch the body of the connector, solder the wire into the center contact. While holding the whip centered in the plug body, inject hot glue or epoxy cement into the space between the whip and the plug body. More hot glue or epoxy can be injected through the solder holes in the plug body; this will strengthen the bond. When the glue has cooled or the epoxy has set, slide the sleeve of the PL-259 over the whip and screw it into place on the plug body. Use an ohmmeter to make sure that there is no short between the whip and the plug body, and that the whip and center contact are continuous.

require some cut-and-try. When it's at the proper length, solder the wire into the contact pin and remove any excess solder from the outer surface of the pin.

Note: Discard the nut, washer, gasket and clamp from the BNC; these will not be used.

Insert the contact pin into the plug body and make sure it is firmly seated. The base of the whip must be partly inside the plug body, but not shorted to it. Inject hot glue or epoxy into the plug body between it and the base of the whip. Hold the assembly until the glue or epoxy is set, making sure the whip is not shorted to the plug body.

Additional hot glue or epoxy can be mounded into a fillet around the whip and plug body of the BNC connector, or the PL-259 if this is used. This will add strength and provide a neater appearance. Use a wet finger to mold the fillet into a neat appearance. Always check with an ohmmeter for continuity between contact pin and whip, and for no short between whip and plug body. 

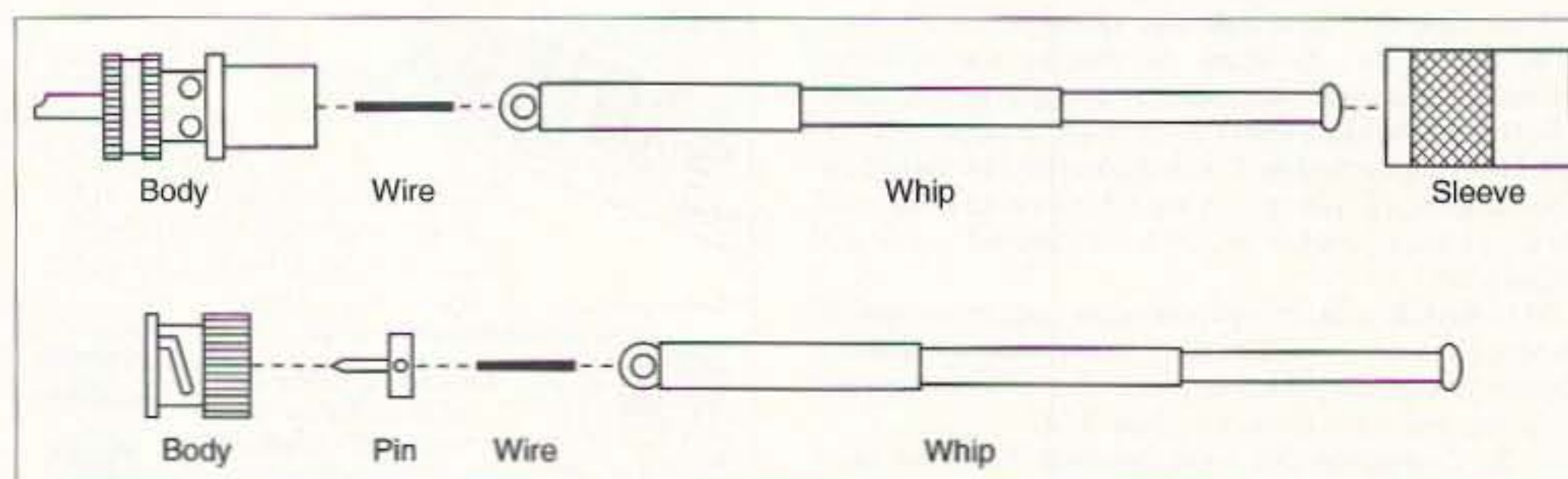

Fig. 1. Whip antennas, exploded views.

LETTERS

Continued from page 6

scene). It is little wonder that many drop out after a year. Shame on you, Wayne, you should know better, but I do understand your frustration. I am one of those who has upgraded. I'm into weak signal VHF SSB, Mode A satellite, packet (home-built BayCom), and Ham-Com CW, RTTY, etc., decoder to decode VHF beacons. Yes, amateur radio is dying, but more accurately is committing suicide. Sure, there has been a dramatic increase in No-Code Techs. It will be interesting to see what percentage of these will renew over the next 10 years. I'll bet it'll be less than 25%. Combine that with the age of the higher class license holders and the future doesn't look good. Perhaps we should replace the CW requirement with tougher exams, including up-to-date technologies.

Mike, I've operated CB in dozens of cities and never had a bad experience, so I feel no shame about CB. I've had some wonderful contacts with interesting people and found most of 'em very helpful to visitors. Yes, the code is perceived as an ogre all out of proportion to the actual difficulty it presents, but we have to deal with this religious belief, not reality. Many of us spend lifetimes not taking a relative few minutes to do things that would make our lives much more fun. Like dieting, for instance. Or eating more healthily. Or improving our educations. As the sunspots heat up our lower bands are going to get hot too, and those poor suckers trapped on 2m are going to miss out on an incredible amount of fun. So, let's try to break the ARRL's insistence on the code test, but let's also make sure those marooned in the ham attic on 2m know what fun they're missing downstairs ... Wayne

Edward Slabe N8TQP. On the very last page of the May issue, in the "Updates" column, you ask for input by anyone who has purchased and built the Super CW Station which 73 featured in the June 1995 issue. Well, let me tell you about my experience with Sam Ulbing and

his incredible CW-keyer-reader-tutor-clock.

The assembly was very straightforward and the well-written assembly guide made building the SCS (as Sam calls it) a lot of fun. During assembly I had a few questions on the SCS and was impressed by how quickly Sam answered my questions when I E-mailed them to him.

I've never had so much fun working on Morse code as I have had with this unit. Why? Because this keyer also shows you how well you are sending as your copy scrolls across the screen. I'm sending good copy because I can see how it sounds to those listening. When I send a "C" it won't sound like "N N." And sending is only part of the fun. The other night I was listening to a QSO between two stations who were using keyboard keyers. So what's the big deal? They were sending to each other at 40 words a minute. I followed the entire QSO without missing a single word. Now I am really impressed with my SCS unit. It really held on to the signal with only very slight adjustments of the RIT control over a period of 20 minutes without losing a word as the signal dropped down to an S-2. The tight bandpass of the code reader ignored the noise.

The best part is that I can use the SCS anywhere. It is not tied to a computer. This is great; now I can sit out in the back yard under a nice shade tree with a QRP rig and my SCS. This is the way to enjoy having a relaxed conversation on CW. And if you have a keyer built into your rig, just use it and the SCS will display your copy using the sidetone from your rig.

This unit far exceeded my expectations. I not only have a ball honing my CW skills, I also have a great keyer, and as I grow tired and start missing some of the conversation I can look at the LCD and check my copy.

If anyone is thinking about a keyer, a CW tutor, or a CW reader, you should contact Sam Ulbing and check out his Super CW Station. It is to CW and ham radio what Superman was to crime fighting. The fun is only

Continued on page 62

MultiMode



BayPac™

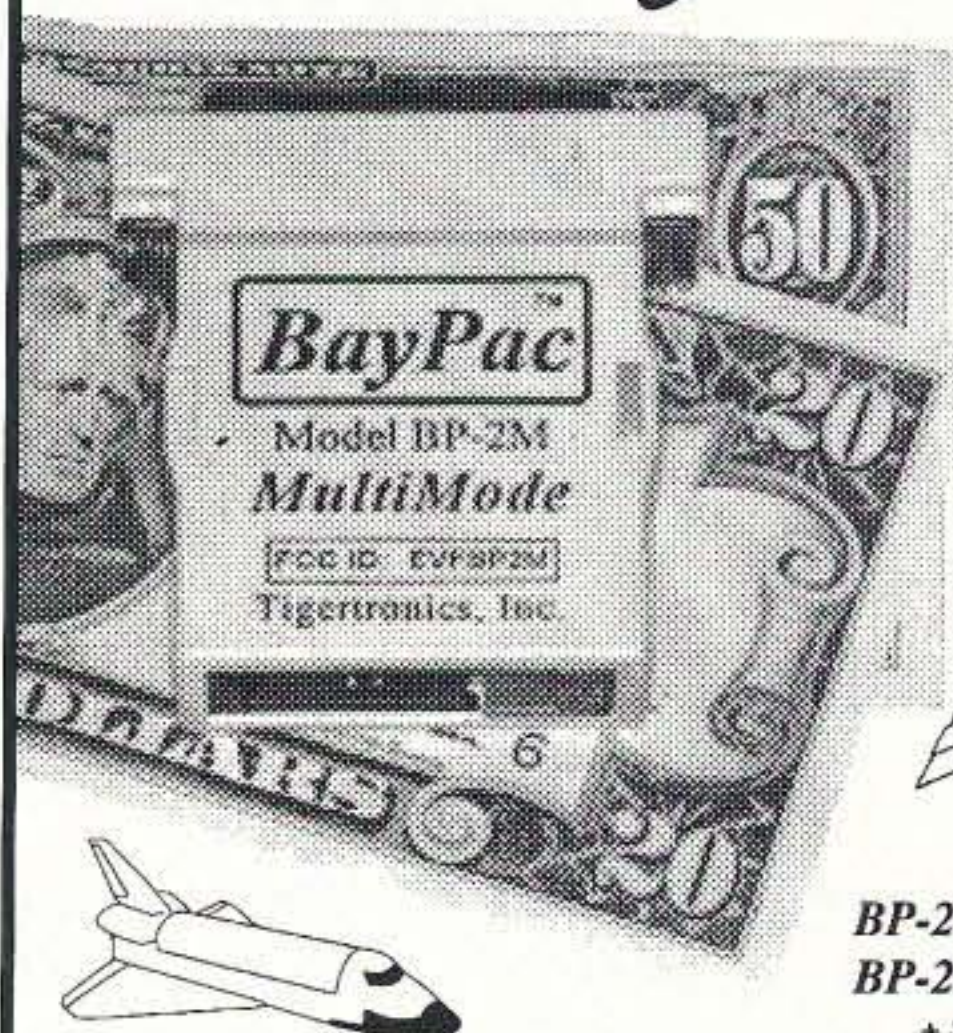

SITOR A/B
ARQ/FEC
BAUDOT
PACKET
NAVTEX
FAX 480
AMTOR
WEFAX
SYNOPSIS
ASCII
RTTY
SSTV
CW
More...

BP-2 Packet Only \$49.95
BP-2M MultiMode \$69.95
+ \$5 Shipping & Handling

The best little packet modem just got better! Building on the tradition of the BP-1 Packet Modem, we are very proud to announce the BP-2 and BP-2M. The BP-2 is a new and improved version of our famous BP-1, while the BP-2M expands your horizons even further with MultiMode operation! So, whether you have been waiting to automate your CW, checkout AMTOR or just copy Weather Fax - Now is the time for you to jump in and join in all the fun!



Call Today! 1-800-8BAYPAC
800-822-9722 (541) 474-6700 Fax 474-6703
World Wide Web: <http://www.tigertronics.com>



Tigertronics, Inc. 400 Daily Ln. P.O. Box 5210 Grants Pass, OR 97527

CIRCLE 269 ON READER SERVICE CARD

CAT-300 Repeater Controller

Attention Repeater Owners

Finally a repeater controller with a TI voice synthesizer and full feature autopatch incredibly priced at \$299.00.

Features Include:

- ✓ Voice Synthesizer
- ✓ (412) Word Vocabulary
- ✓ Twelve Voice Messages
- ✓ Two Voice Identifiers
- ✓ CW Identifier
- ✓ Full Feature Autopatch
- ✓ User Speed Dials
- ✓ Emergency Speed Dials
- ✓ Reverse Autopatch
- ✓ DTMF Key Pad Test
- ✓ DTMF Repeater Access
- ✓ DTMF Repeater Muting
- ✓ (56) Control Functions
- ✓ Remote Control Switches
- ✓ Hardware Logic Inputs
- ✓ DVR Controller Ready
- ✓ Female Voice & Sound Effects
- ✓ Programmable Courtesy Tones
- ✓ Programmable Codes and Timers

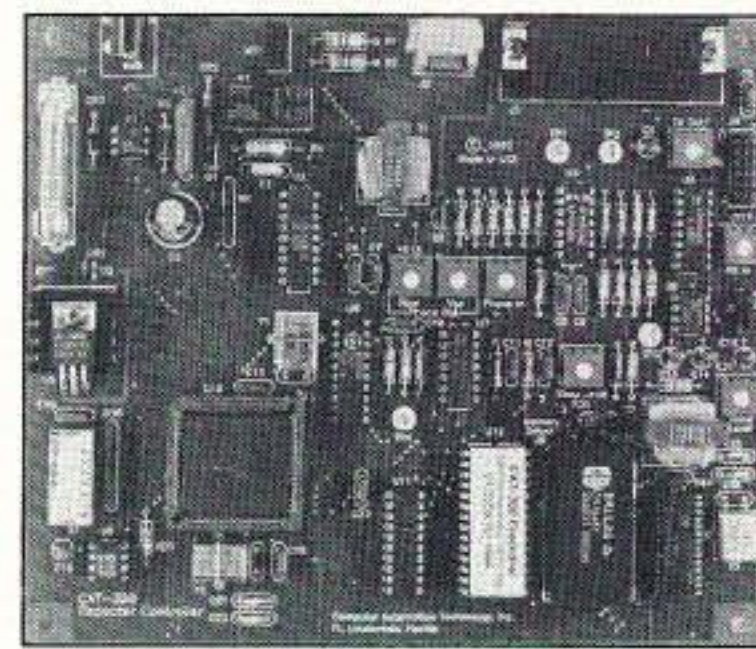

Write or Call for a brochure describing the CAT-300 Controller, including schematic, voice word list, and control functions.

CAT-300 Controller Board \$299.00 Wired and Tested

Computer Automation Technology Inc.

4631 N.W. 31st Avenue, Suite 142

Fort Lauderdale, Florida 33309

Phone (305) 978-6171- Fax (407) 488-2894

<http://www.catauto.com>

CIRCLE 268 ON READER SERVICE CARD

The JB Keyer

A low-tech solution to good keying.

Richard Koelker KU8K
550 Stanley Road
Akron OH 44312

What has no tubes, no transistors, no ICs, no keyboard, yet can make machine-like Morse code? The JB Keyer.

The JB Keyer makes self-completing dots and dashes. When idling, it takes zero standby current. It's not very sensi-

The schematic for the JB Keyer is shown in **Fig. 1**. Several of these keyers have been built using relays and capacitors removed from old circuit boards. All provided acceptable performance without careful parts selection. It should be noted, however, that electrolytic capaci-

How it works

The JB Keyer makes use of the difference between the "pull-in" and "drop-out" voltages of the relays used, in combination with RC time constants that change when these voltages are reached. Refer to the schematic diagram in **Fig. 1**. Relay K1 and the components on the left side of the schematic dictate the "on time" or "mark" of the keyer; relay K2 and the right hand components determine the timing of the "off time" or "space." When the key lever is pressed to the DOT side, capacitor C1 is charged rapidly through the normally closed contacts of K2, in series with resistor R1. R1 is chosen to be large enough to limit the peak current through the key con-

"The JB Keyer can be cheap, depending on your junk box, and it need not be much, if any, larger than a keyer using ICs."

tive to power supply voltage and takes about 25 mA from a 12 VDC source when generating characters. It can be cheap, depending on your junk box. It need not be much, if any, larger than a keyer built using ICs.

tors are generally wide tolerance parts (+80% to -20%, for example), and in some cases parts may need to be hand-picked. The pull-in and drop-out characteristics of the relays used also affect the speed and mark/space ratio.

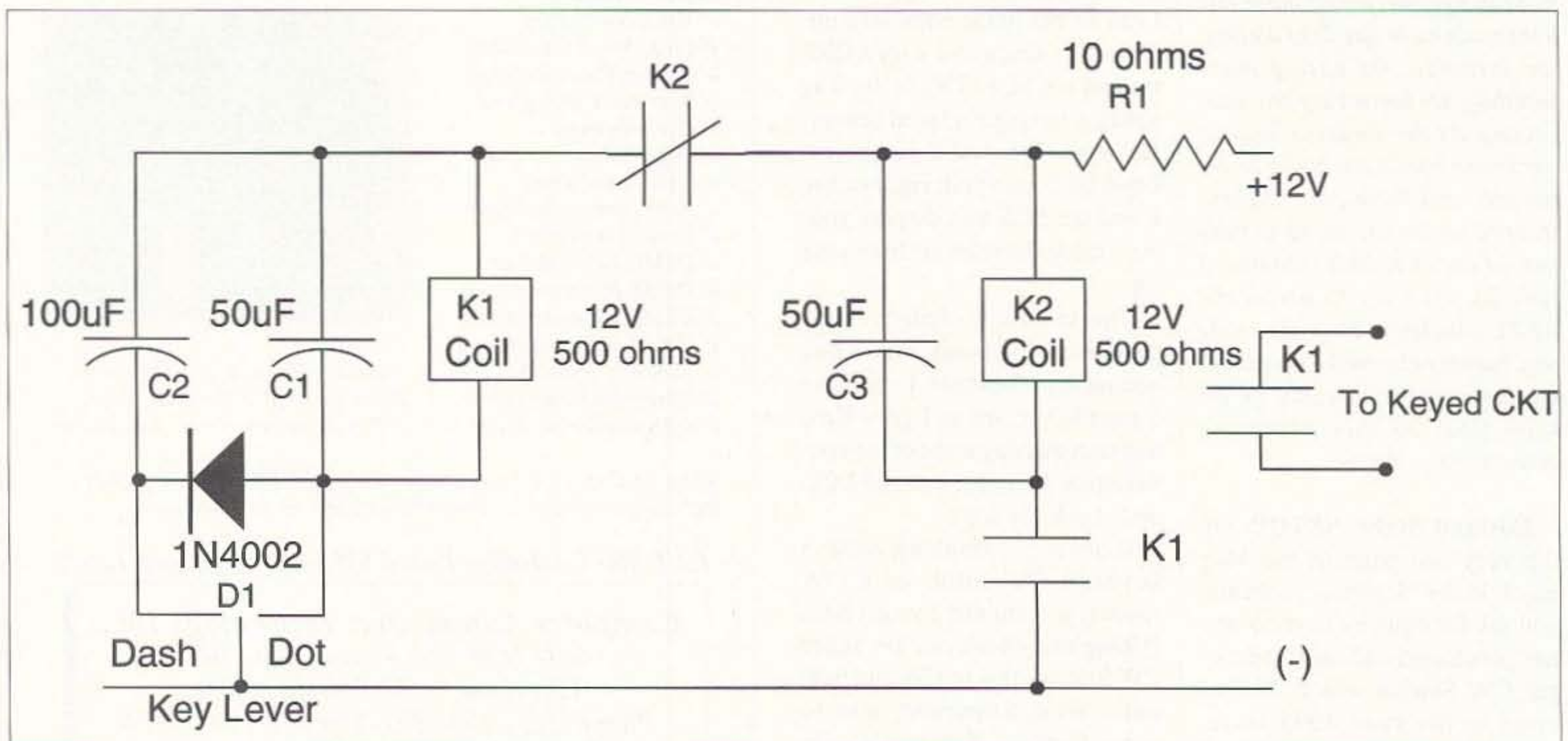

Fig. 1. Schematic for the JB Keyer.

tacts, but small enough to allow C1 to charge rapidly (before the key contact is opened). As C1 charges it will pass the pull-in voltage of K1, causing it to operate. When K1 operates, it closes its normally open contacts, completing the circuit for C3 and R1. When C3 reaches the pull-in voltage of K2 the relay throws, opening the current path to C1 and K1. Even if the DOT contact is still closed, K1 will be unable to pull in again until C3 discharges through K2. If the DOT contact is held closed, the K1-C1 time constant will determine the "dot" timing, and the K2-C2 time constant will determine the spacing between dots—which should be equal to the length of the dot itself. A second set of relay contacts of K1 keys the transmitter, ideally with a 50% duty cycle if both the left and right time constants are equal.

By definition, a dash is the length of three dots. If the DASH contact is closed, C1 and C2 appear to be in parallel (through D1) and their values add. The dash time constant therefore consists of C1 + C2 combined with K1, and will be three times as long as the C1-K1 combination. The dash will be self-completing as before, and the space following it will be the length of one dash, as expected.

Choice of relays

The coils of the relays used in my versions of the JB Keyer are rated at 12 VDC and have 500 ohms of resistance. These relays will pull in at less than 12 volts and, once energized, will stay thrown when the voltage across the coil drops well below the pull-in voltage. These relays, therefore, have a type of "hysteresis," which is essential to the operation of the JB Keyer. Although they will not pull in at the lower voltage, they do not drop out, once energized, until the voltage across the coil falls to the lower value as the capacitor across it discharges. Virtually all relays have some amount of hysteresis, so it's worth experimenting with whatever you have in your junk box.

Capacitors

Because of the high capacitance values required, the only practical types to use are electrolytic types. These capaci-

tors are polarized and can be installed correctly in only one way. Polarity markings must be observed! These capacitors are generally wide tolerance components. If marked 100 μ F, the actual value of an aluminum foil electrolytic capacitor may be as little as 80 or as much as 180 μ F. On the other hand, another type of electrolytic capacitor, the tantalum electrolytic type, can be obtained in closer tolerance values, but they are more expensive.

In addition, as electrolytic capacitors age, their capacitance value decreases. Many radio and television problems are due to dried-out electrolytic capacitors. The humming often associated with old tube-type radios is usually an indication that dried-out electrolytics need to be replaced. The only sure way to know the condition of an electrolytic capacitor is to test it with a capacitance tester or substitute a known new one.

In other words, if you use salvaged capacitors you may have to experiment. On the other hand, *all* of my parts were salvaged and performed acceptably. While new capacitors will probably be higher than their marked value, used ones may be off considerably from their nominal value in either direction, but probably on the low side.

Speed control

The capacitance values for the original model of the JB Keyer were chosen to provide a comfortable speed for mobile operation. In the interest of small size, no speed control was provided. A hi/lo speed operation can be obtained by switching in fixed resistors across both relay coils. 1,000 Ω is a suitable value. A two-gang variable resistor in series with these added resistors would give continuously variable speed.

Construction

The relays specified have their contacts arranged on a 0.1-inch grid. The keyer was constructed using point-to-point wiring on a 1 x 2-inch piece of scrap perf board. The small size of the JB Keyer allows you to tuck it away inside the transmitter, if you want.

In case you wondered, the "JB" in JB Keyer refers to the origin of the parts used in the circuit—my Junk Box. 73

Comm-Pute, Inc.

Kenwood, Yaesu, Icom, Cushcraft, AEA, Kantronics, Bencher, Diamond, Astron, MFJ, Hustler, Ameritron, Larsen, ARRL, and more...

(800) 942-8873

Authorized Service For All Major Brands
HF, VHF, UHF And Accessories

Local or FAX (801) 567-9494

7946 South State Street Midvale, UT 84047
Closed Mondays

CIRCLE 156 ON READER SERVICE CARD

Next Day

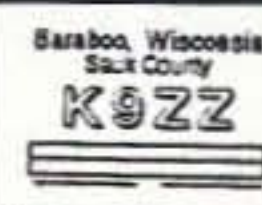

Baraboo, Wisconsin
Salt County
Info 51
Antennas West
(801) 373-8425

Call Today & We Ship	Next Day	2nd Day	ASAP
100	\$29.95	\$24.95	\$19.95
200	\$39.95	\$34.95	\$29.95
400	\$49.95	\$44.95	\$39.95
500	\$54.95	\$49.95	\$44.95
1000	\$99.95	\$89.95	\$79.95

All orders pld 2nd day airt priority mail.
For overnight air delivery add \$10.
Box 50062-S, Provo, UT 84605

QSLs Two-Color Rainbow Assortment

CIRCLE 5 ON READER SERVICE CARD

REPEATER HEADQUARTERS

Make "Commercial Quality" repeaters from GE and Motorola Mobiles

- 45 Watt VHF Micor from \$99
- 40 Watt UHF Master II from \$199

Conversion Information Available!
<http://www.versatel.com>

VersaTel Orders: 800 456 5548
COMMUNICATIONS Info: 307 266 1700
FAX: 307 266 3010

CIRCLE 259 ON READER SERVICE CARD

CUBEX QUAD ANTENNA CO.

40 YEARS OF QUALITY ANTENNAS
SKYMASTER H.F. KITS FROM \$275.95
PRE-TUNED H. F. QUADS FROM \$379.95
Quad Antennas From 2 Through 40 Meters
2 METER 4 EL. PRE-TUNED \$44.95 + \$7.00 S&H
6 METER 2 EL. PRE-TUNED \$69.95 + \$15.00 S&H
BEST PRICES ON DOUBLE BRAIDED "DACRON" ANTENNA ROPE
visit our new web site <http://www.cubex.com>
Write Or Call For Free Catalog
2761 SATURN ST. "E" BREA CA 92621
(714) 577-9009 FAX (714) 577-9124



Handheld Repeater Controller

Spectrum Electronic Products 10 include voice IDer, DTMF introduces the world's first Control and programming, handheld repeater controller. hang and time-out timers, No larger than most hand- Digital Voice Operated held radios, the HRC-10 con- Squelch (DVOSTM), telemetry verts a single or dual-band tones, and private voice mail radio into a full featured sim- slot. \$299
plex or duplex repeater sys- <http://www.spectrum-usa.com>
tem. Key features of the HRC- 800-566-2788 - fax 408-336-9461

CIRCLE 69 ON READER SERVICE CARD

Lubricating a Transceiver's Fan Motor

Cut down on background noise and prolong the motor's life.

Dave Miller NZ9E
7462 Lawler Ave.
Niles IL 60714-3108

The fan motors in most amateur 100 watt HF transceivers should be lubricated every now and then, particularly if their sound changes noticeably. These fans are absolutely essential for keeping free air moving in and around the transceiver final

will likely do as much harm as good, since the oil needs to be only in the bearing surfaces themselves. First, remove the white plastic fan blades, loosening the tiny straight-blade set screw in the mounting collar. Unfortunately, the motor that Kenwood uses can't be "cleanly"

"Resist the temptation to simply 'shot-gun' spray the little guy; it will likely do as much harm as good."

amplifier's heat sink, even more so when using the rig on AM, FM, or any of the data modes. The fan motors in my two Kenwood TS-430S HF transceivers became noisy recently, so I was more or less forced to remove and lubricate them. What follows is a detailed explanation of the procedure that I used in the TS-430S, but it will apply in part to other transceivers in the same class.

Getting inside

The motor in the TS-430S is easily accessed by removing the four Phillips-head screws around the plastic "fan guard" that faces rearward on the transceiver. Then there are three more, recessed and smaller, Phillips-head screws to be removed in order to free the fan motor from its mounting configuration on the transceiver. Mark the terminals "+" and "-" and unsolder the shielded coaxial-type cable that feeds 12 VDC to the motor. Now it's completely free. The bracket with the three mounting "ears" can be left on the motor's housing for the rest of the operation.

Now for the fun part! The motor bearings are not accessible from the outside; the motor's housing has to be disassembled to gain access to these bearings, where the oil must go. Resist the temptation to "shotgun" spray the little guy; it

disassembled by unscrewing nice little screws. There are two small bent-in tabs holding it together instead! The only way to get it apart is to bend those two little tabs up and slip the rear white plastic end-bearing housing away from the main steel motor housing section. This means you can't take it apart too many times before the tabs break off, so try to do a good job the first time around. I used a small jeweler's screwdriver to start the bend in those tabs, finishing with a small pair of long-nosed pliers.

In my own motors, the inside was clean, but without any noticeable lubrication. I used a Teflon®-based lubricant (Radio Shack™ # 64-2301A) myself, but any of the modern, long-lasting lubricants intended for high speed should work well. You'll want to apply just a small amount—a couple of drops—on both the front and rear bearing surfaces (where the motor's shaft touches the motor housing bearing surface). To get to the front bearing surface, you'll have to pull out the rotor section, overcoming the resistance of the magnets around it, and apply the oil to the shaft surface just forward of the windings themselves. The rear bearing is a bit easier, since there's a small "cup" and plastic washer at that point. A "pinpoint" lubricator, like the one mentioned above, is almost a must.

There should be no need to remove the rotor winding assembly from the commutator's bushes, but if it happens accidentally while working on the inside of the motor, the rear shaft of the rotor can be reinserted into the rear bearing cup, with the plastic washer in place (its shoulder pointed toward the commutator segments) and the brushes very carefully spread and placed once again against the commutator. The brushes are very delicate but do have a fair amount of spring in them, so take your time and you should have no trouble with the task.

Now carefully slide the assembly back together and bend the two locking tabs back down far enough to hold the housing securely in place. Run the motor for a few minutes on your workbench, using a small 12 VDC power supply, or even a 9 volt battery. If everything seems well, solder the cable back on and reinstall the fan motor package. In both cases, with my units, it made a tremendous difference in the amount of noise generated by the fan motor during operation, which was almost unnoticeable after a good lubrication.

There's a good chance that the small motors used in other ham transceivers for cooling the final amplifier's heat sink are constructed in a similar manner, though some may be more easily disassembled because they have small screws instead of a locking-tab construction. So don't be afraid to give it a try, regardless of the particular transceiver you might own. Just do it carefully, when you're not rushed, and document your steps as you go, noting the correct placement of any small parts within the motor's innards. You'll prolong the life of the motor significantly, as well as cut down on the background noise in a positive way. 

NEVER SAY DIE
Continued from page 7

hams were teen-agers. Today it's around 12%, tops. That's not the key to keeping the hobby alive.

Sales point #1 is fun. It's fun to make friends over the air. It's fun to work DX. Amateur radio is a whole bunch of fun hobbies, which I try and cover with articles and columns in 73.

Sales point #2 is the fantastic career path that an interest in amateur radio provides. I hope there's no argument that the world is going to need millions of technically literate workers in the 21st century. The electronics, communication, and computer industries are going to need people to develop, build, sell, operate, and maintain the electronic systems of the future.

Sales point #3 is adventure, and amateur radio has plenty of that if you have the guts (aka initiative) to take advantage of the opportunities. My life has been filled with adventure as a result of my interest in amateur radio.

I was having a ball experimenting with 2-1/2 meters back before World War II. Heck, 10m was still mostly an experimenter's band in those days. I built my first 2-1/2m walkie-talkie in 1939 and wrote about it in the school literary magazine. When my ticket arrived, I made my first contact with it, working Dexter Miller W2MSV, as I was walking along the street. Today I'd use an HT that fits into my shirt pocket, but then my walkie talkie was in a Bud box about 10" x 10" x 10".

Came WW II and my first really big adventure. I joined the Navy in 1942 as a radio technician and went to their electronics schools. That led to my being assigned as an Electronics Technician to the *USS Drum* in 1943. After five exciting war patrols, I was transferred to the Submarine Base in New London (CT) to teach electronics in 1945. You can read about my submarine days in my *Submarines in WWII* book (\$8). I got discharged in 1946 and, not knowing any better, went back to college.

Then there was my adventure as KC4AF on a DXpedition to Navassa Island in 1958. Now, that was exciting, complete with riding out a hurricane, and almost getting killed a couple of times. And my being appointed to the US team to represent amateur radio at the ITU in Geneva in 1959. And how about Operation World-Wide, where I operated from an Air Force C-54 as we flew around the world, visiting 23 countries?

Less epic, but still exciting, were my many mountaintop VHF expeditions. How about working seven states on 10 GHz? Adventure is there if you keep your eyes and ears open.

Like operating from Swaziland and Lesotho. Or even a few days operating from St. Pierre Island, just a short flight from Halifax. Or cranking the generator for Field Day on a bicycle (last year at Boulder).

Every now and then I get a letter from Ken Miller K6IR from some weird place or

visiting with someone famous, all as the result of amateur radio. Ken and I had a great time visiting Asia together. Several times. I used to escort groups of up to 250 hams and electronics people on tours of the Asian electronics shows every October, attending shows in Tokyo or Osaka, Taipei, Seoul, and Hong Kong. Every trip was an adventure. I can't wait to set up a web site and put about 10,000 color slides of my trips on it. Plus pictures of hundreds of well-known hams.

I've been asking you about your ham adventures, so how about it? Well, when talking with the kids, you can point to what's possible in the way of adventure.

Now let's get those kids excited and licensed.

Meihem

When a manuscript came in from Ray Eisner proposing an updating of English spelling which might be launched via amateur radio, I remembered a wonderful story in *Astounding Science Fiction* 50 years ago, back when I still had a full head of hair. There was a story, "Meihem in Ce Klasrum," by Dolton Edwards, which made a lot of sense. Well, Ray has picked up the ball for us.

How come English has so many letters that aren't pronounced, but have managed to stay in the dictionary, much to the frustration of children and foreigners trying to learn our crazy-quilt language? A couple hundred years ago they were pronounced. It's just that we've had several generations of lazy talkers since then, so today we pronounce tough as tuf and might is mite, don't you k-no-w?

The main problem I found with Ray's well-thought-out article was that it was 16 pages long! Yoiks. Also, there was just the tiniest question in my mind as to whether 100% of the readers would be as excited about the whole idea as I. People will go to extremes not to change habits and here was an idea for updating our language which meant making a big change. If Ray had proposed just one little change it might have a chance, but instead he's rebuilt the English language in a very practical form.

Ray's system gets rid of letters with two sounds, letters which aren't needed, double letters, silent E's, and so on. Sure, it makes sense and would make it infinitely easier to learn to spell.

Continued on page 68

160-10 G5RV QuicKits™
created by AntennasWest Box 50062-S, Provo, UT 84605

• Double Size G5RV 204 ft. 160-10 Dipole	\$39.95
• Full Size G5RV 102 ft. 80-10 Dipole	\$39.95
• Half Size G5RV 51 ft. 40-10 Dipole	\$29.95
• Quarter Size G5RV 26 ft. 20-10 Dipole	\$24.95
• Ready-Made 102 ft. G5RV	\$50.00
• Ready-Made 51 ft. G5RV/2	\$40.00
• 200' Dacron 250# line	\$11.95

Fast & Easy to Build
• Fail-Safe visual instructions
• No measuring or cutting
• Everything included
• Finish antenna in minutes

Quality Components
• Presoldered Silver Fittings
• Kinkproof QuietFlex wire
• Fully insulated, wx sealed, no-corrode, low noise design

Tune All Bands Incl WARC

Want Plans, Patterns, Data? Order TechNote #124-D \$6.95 ppd USA

Order Hot-Line: Add \$5 P&H
1-800-926-7373

CIRCLE 116 ON READER SERVICE CARD

Desert Storm Solar
10 watt DesertStorm panel is size of open 73 magazine, weighs 1lb, and delivers 600mA for 12v charging or direct operation. Tough, Solid, with no glass to break. So rugged Uncle Sam used this for spotter communications and portable repeaters in Desert Storm. Ready to use. \$169. Add \$5 S&H. Info \$1.



AntennasWest Box 50062 Provo UT 84605 Order HotLine 801 373 8425

CIRCLE 340 ON READER SERVICE CARD

GRUNDIG YB-400



"The compact model most preferred by our panelists for listening to major worldband stations... audio quality is tops within its size class."
Passport to Worldband Radio

Here's everything you want at a price you can afford. The Grundig YB-400 covers LW, MW, FM and all of SW. An illuminated LCD reads to 1 kHz on SW. Enjoy smooth SSB with fine tuning knob. Tune your favorite stations instantly with keypad entry or 40 memories. Other features include: dual digital clock-timer with snooze and dial lock. Switches for: Wide-Narrow, Local-DX and Hi-Low Tone. Supplied with six AA cells, carry case, wind-up antenna, manual and Grundig Wave Guide. #0040 \$199.95 (+\$6)

Universal has a limited number of like-new **Factory Reconditioned YB-400s**. All accessories and same one year limited warranty. #1704 \$149.95 (+\$6)

For a limited time, we will include a **FREE radio stand** with your YB-400 purchase. An \$8.95 value!

universal radio inc.
6830 Americana Pkwy.
Reynoldsburg, OH 43068
♦ Orders: 800 431-3939
♦ Info: 614 866-4267
♦ FAX: 614 866-2339
http://www.universal-radio.com
Quality Communications Equipment Since 1942

QUICK, AND SIMPLE!!!
Flash cards NOVICE thru EXTRA theory. Key-words underlined. COMPACT - EASY Over 9000 sets used. A card for each question!

NOVICE	\$11.95
TECHNICIAN	\$10.95
GENERAL	\$9.95
ADVANCED	\$19.95
EXTRA	\$14.45

Shipping 1 - \$4.00
2 or more - \$5.00

Call Today! 1-800-OKK-HAMS

VIS STUDY GUIDES
P.O. BOX 17377
HATTIESBURG, MS 39404

CIRCLE 104 ON READER SERVICE CARD

ULTIMATE MODIFICATION BIBLE VOL. V
NEWEST AND MOST COMPLETE!!!

OVER 1000 MIKE WIRING CODES FOR CB AND HAM RADIOS
OVER 500 CB POWER/MODULATION BOOST INSTRUCTIONS
OVER 200 MODIFICATIONS FOR CB PLL'S
OVER 125 MODIFICATIONS FOR HAM RADIOS
OVER 50 COMPLETE SYNTHESIZED CRYSTAL CHARTS WITH INSTRUCTIONS
OVER 20 PRECALCULATED MODIFICATION CRYSTAL CHARTS
OVER 30 SCANNER MODIFICATIONS AND TEN METER RADIO MODIFICATIONS

LINEAR SCHEMATICS AND ANTENNA/COAX db GAIN/LOSS CHARTS \$29.95

KDC SOUND ORDERS ONLY; 1-800-256-9805 MONEY ORDER, CDEX 475, P.O. BOX 8632 ALL OTHER CALLS; 409-231-3753 MCDISC/VISA OR CK. GRANGERLAND, TX 77382

CIRCLE 151 ON READER SERVICE CARD

Just Who *Did* Invent Radio?

If you're sure you know, the answer may surprise you.

Glen E. Zook W5UOJ
410 Lawndale Drive
Richardson TX 75080

There's a lot of interesting history in the realm of radio and its child, television. The players include inventors, businessmen, performers, and lots of other people. Unfortunately, the vast majority of this information has not been made available to the masses!

Marconi

First of all, ask the average American, "Who invented radio?" If they know at

about 1920, this company dominated the radio scene worldwide.

Lodge and Fessenden

However, several years before Marconi even started experimenting, as early as 1888, Oliver Lodge (later Sir Oliver), a professor at Liverpool University, was conducting experiments in wireless telegraphy. Lodge was granted a patent on his system (which, by the way, was the source of the receiving

operating in the United States because of his patent for a wireless telegraphy system (which, by the way, was virtually identical to the system used by Marconi)! Later, the Dolbear patent was purchased by the Marconi Company, thus allowing them to use wireless in the United States.

Loomis

Dolbear was also late on the scene, for, as early as August 15, 1858, an American dentist named Mahlon Loomis was beginning a series of experiments in wireless telegraphy within the state of Ohio! With the interruption of the American Civil War, Loomis continued his work. In October of 1866 he sent signals between two mountaintops, about 15 miles apart, in the Blue Ridge Mountains. Senator Samuel Pomeroy of Kansas and Representative John Bingham of Ohio were present at this demonstration. Both men later gave much support on Loomis' behalf in the U.S. Congress.

In January of 1869, Senator Charles Sumner of Massachusetts introduced a bill into Congress to appropriate \$50,000 (well over a million dollars in present-day purchasing power) for development of Loomis' system. This bill languished in committee for two years, at which time Rep. Bingham introduced a bill to incorporate the Loomis Aerial Telegraph Company, giving it the right to issue up to two million dollars worth of stock. This bill stated that no money was to come from the U.S. Government (one of the reasons the original bill was stalled in committee).

In early 1873, President Grant signed the bill into law, and a few months later, on July 20, 1873, Loomis was granted U.S. patent #129,971 for the invention

"By the mid-1890s Fessenden was transmitting voice and music from the shore to people aboard pleasure boats on the St. Lawrence River."

all, the reply will usually be "Marconi." For most of my life, and that of my parents and grandparents, *the* inventor of radio has been, according to all the history books, Guglielmo Marconi, born in Bologna, Italy, on April 25, 1874. Marconi was the son of a very successful Italian businessman with extensive business ties to Great Britain.

Marconi was interested in wireless telegraphy (radio) from an early age, and conducted experiments on his father's estate starting in June of 1895. Later that year he was able to send messages up to one-and-a-half miles.

Seeing the commercial potential of communications with ships, the 22-year-old Marconi went to England where, in 1896, he was granted his first patent on radio communications. Later, with the help of his father, Marconi contacted a number of influential British businessmen, and the Marconi Company was formed to develop wireless communications. Until

detector used by Marconi—the coherer) in May 1897. This patent was purchased by Marconi in 1911.

At the same time, a Canadian university professor (Western University) named Reginald Fessenden was experimenting not only with wireless telegraphy, but with voice and music transmission as well. Also, he was interested in the radio control of boats. By the mid-1890s Fessenden was transmitting voice and music from the shore to people aboard pleasure boats on the St. Lawrence River.

Dolbear

As you can easily see, both Lodge and Fessenden predate the experiments of Marconi but they were late-comers, for, in 1886, the United States patent 350,299 had been issued to Amos Dolbear, a physics teacher at Tufts College. In fact, for a time, Dolbear was able to keep the Marconi Company from

EVERY ISSUE OF 73 Amateur Radio Today on Microfiche!

The entire run of 73 from October 1960 through last year is available.

You can have access to the treasures of 73 without several hundred pounds of bulky back issues. Our 24x microfiche have 98 pages each and will fit in a card file on your desk.



We offer a battery operated hand held viewer for \$75, and a desk model for \$260. Libraries have these readers.

The collection of over 600 microfiche, is available as an entire set, (no partial sets) for \$285 plus \$5 shipping (USA). Annual updates available for \$10.

Satisfaction guaranteed or money back!

BUCKMASTER

6196 Jefferson Highway
Mineral, Virginia 23117
540:894-5777-800:282-5628
Internet: info@buck.com

 Fax 540:894-9141 

CIRCLE 168 ON READER SERVICE CARD

Mini Project Boxes

MODEL	W x D x H (IN)	PRICE \$
MPB-1	1 1/2 x 2 1/2 x 1 1/2	1.45
MPB-2	1 1/2 x 2 1/2 x 1 1/2	1.45
MPB-3	1 1/2 x 2 1/2 x 1 1/2	1.45
MPB-4	1 1/2 x 2 1/2 x 1 1/2	1.45
MPB-5	1 1/2 x 2 1/2 x 1 1/2	1.45
MPB-6	1 1/2 x 2 1/2 x 1 1/2	1.45
MPB-7	1 1/2 x 2 1/2 x 1 1/2	1.45
MPB-8	1 1/2 x 2 1/2 x 1 1/2	1.45
MPB-9	1 1/2 x 2 1/2 x 1 1/2	1.45
MPB-10	1 1/2 x 2 1/2 x 1 1/2	1.45
MPB-11	1 1/2 x 2 1/2 x 1 1/2	1.45
MPB-12	1 1/2 x 2 1/2 x 1 1/2	1.45
MPB-13	1 1/2 x 2 1/2 x 1 1/2	1.45
MPB-14	1 1/2 x 2 1/2 x 1 1/2	1.45
MPB-15	1 1/2 x 2 1/2 x 1 1/2	1.45
MPB-16	1 1/2 x 2 1/2 x 1 1/2	1.45
MPB-17	1 1/2 x 2 1/2 x 1 1/2	1.45
MPB-18	1 1/2 x 2 1/2 x 1 1/2	1.45
MPB-19	1 1/2 x 2 1/2 x 1 1/2	1.45
MPB-20	1 1/2 x 2 1/2 x 1 1/2	1.45
MPB-21	1 1/2 x 2 1/2 x 1 1/2	1.45
MPB-22	1 1/2 x 2 1/2 x 1 1/2	1.45
MPB-23	1 1/2 x 2 1/2 x 1 1/2	1.45
MPB-24	1 1/2 x 2 1/2 x 1 1/2	1.45

PERFORATED OR PLEXIGLASS PANELS ALSO AVAILABLE

GREAT LITTLE BOXES
FOR LOW COST CONSTRUCTION
DESIGNED TO GET THE JOB
DONE WITHOUT THE FRILLS!

0.040" BARE
ALUMINUM PANELS

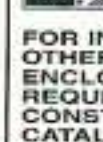

NEW

FOR INFO ON
OTHER
ENCLOSURES
REQUEST FREE
CONSTRUCTOR'S
CATALOG

**MENTION AD
AND TAKE 5% OFF
FIRST ORDER!**

ORDER TODAY! (\$30.00 MINIMUM ORDER)
ALL PRICES INCLUDE WORLDWIDE SHIPPING!
A IS USA, CANADA & MEXICO; B IS REST OF WORLD

ORDER (800) 634-3457 ■ FAX (800) 551-2749
(702) 565-3400 ■ FAX (702) 565-4828
SESCOM, INC. 2100 WARD DR., HENDERSON, NV 89015
SESCOM, INC. is not responsible for inadvertent typographical errors
and prices and specifications are subject to change without notice.

CIRCLE 167 ON READER SERVICE CARD

INSURANCE Computer & Radio Equipment

HAMSURE coverage follows your equipment wherever you take it. Theft from vehicles, earthquake, water damage and all other hazards including surges. Insure all your equipment and accessories (except towers and antennas but including rotors), media and purchased software.

Low Premium Low Deductible

HAMSURE

7901 Laguna Lane
Orland Park, IL 60462
800-988-7702 Anytime
E mail: hamsure@aol.com

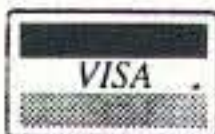

Available only in the
48 continuous states



CIRCLE 78 ON READER SERVICE CARD

Slow Scan TV

doesn't have to be expensive anymore!



Every day more hams are enhancing their communication by using images. Join the fun and see what you've been missing.

Quality Color SSTV is easy and affordable with **Pasokon TV**. \$239.95

Requires IBM PC-compatible, '386 or better CPU, 1 Megabyte of memory, color VGA display, MS-DOS. Shipping: \$5 to U.S.A. and Canada, \$15 for others. Write or call for complete details.

Absolute Value Systems
115 Stedman St. # 7
Chelmsford, MA 01824-1823
(508) 256 6907
e-mail: johnl@world.std.com

CIRCLE 351 ON READER SERVICE CARD

Where's the Beam?

Unobtrusive DX Gain Antennas for 80 thru 10
• Easily hidden • Install Fast • Fixed or Portable •

There's a 20 meter antenna with real DX Punch hidden in this picture. You can't see it, and your neighbors can't either. But it works DX barefoot anyway. How about a low profile 80/40/30 tri-band? Or a 2 element monobander for the attic? All easily fit the pocketbook—Priced \$29 to \$99.

Work DX without telling the neighbors

Infopack \$1 **AntennasWest**
Box 50062-R, Provo, UT 84605 (801) 373-8425

CIRCLE 332 ON READER SERVICE CARD

of his system. Unfortunately, Loomis' company had gone bankrupt during the stock market "panic" of 1869, and he was never able to garner enough financial support to put the system into operation.

Although Loomis died in 1886, he left his mark in other areas. He was not only an inventor in the area of radio, but he also held a number of patents in the field of dentistry, including methods of making false teeth and specialized filling materials and methods. Some of his ideas are still being used today!

Patent disputes

There are certain things to be noted about these early inventors. The first is that during this time period, patent offices would issue patents on working items only, either full-sized or models. Thus, Loomis, Dolbear, and the others had to actually demonstrate that their equipment worked! There was no patenting of ideas at that time.

Next, although most of the people involved were university types, they did not publish papers to the extent that

papers are published today. Also, there was a lot of nationalism involved with something of such possible importance as communicating without wires.

Marconi had established a consortium of powerful British investors. Several of these were members of Parliament, and the rest were in a position to command the ear of that governing body. Because of this, both Lodge and Fessenden (Canada being a member of the British Commonwealth) were effectively silenced by governmental actions. The Marconi Company soon dominated the wireless (radio) scene.

From about 1900 until 1943, there were a large number of patent rights battles in the courts of the United States and Great Britain. Little by little, Marconi's patent empire was voided until, just before his death in 1943, his last patent was vacated in favor of Nikola Tesla.

In fact, Marconi's list of patent fights included almost all of the inventors and pioneers of radio communications. People like deForest, Fleming, and others were in an almost constant fight with Marconi and his company. Because of

these lengthy patent battles, the British Government did not wish to aid those fighting against the British-based Marconi Company. Therefore, they insisted that Marconi was the inventor of radio. It is unfortunate that this misconception is still being taught today.

Marconi, through the efforts of his British company, did more than anyone else to commercialize radio. However, he really did nothing himself in the actual invention of the systems. Everything he used was invented by someone else, and was actually used in two-way radio communications before Marconi. In Loomis' case, the patent was issued before Marconi was even born!

Because the history books of the early 20th Century taught that Marconi was the inventor of radio, it is still being taught today. This is unfortunate, for there were, in reality, several true inventors (each with a different system type) who were communicating before him. But such is the world of the history text writer.

There are other such tales about grossly wrong history texts, but those can wait for another time!

73

Repeater Coordination

Boom or bust?

Glen E. Zook W5UOJ
410 Lawndale Drive
Richardson TX 75080

97.205(c) *Where the transmissions of a repeater cause harmful interference to another repeater, the two station licensees are equally and fully responsible for resolving the interference unless the operation of one station is recommended by a frequency coordinator and the operation of the other station is not. In that case, the licensee of the non-coordinated repeater has primary responsibility to resolve the interference.*

In my copy of Part 47 of the Code of Federal Regulations, that part of federal law which pertains to the Federal Communications Commission (FCC), this is the *only* reference to coordination of

repeater operators, there were a few hardheads who absolutely refused to cooperate with anyone. Various attempts were made to bring these operators into the fold, including (I am told) nighttime sorties to repeater sites, pins through the coax, and all sorts of damage done to the equipment.

Of course, such activities are illegal under both civil and criminal law, but such were the activities of a few renegades during the battles of the 1960s. Then, when vigilante justice was abandoned, various organizations of amateur radio repeater operation arose. At the time, there were at least three items on their agenda. The first was to serve as a

on the same frequency, turf wars were inevitable. However, as the coordination bodies came into being, many existing repeaters, and virtually all new repeaters, were moved to other, approved, frequencies.

Today's problems

In general, for many years, the frequency coordination bodies have done an excellent job of preventing repeater wars. However, a significant number of these bodies have lapsed into a police state mentality when dealing with repeater coordination. They have forgotten that they have no basis in law for their existence. They threaten, they tell lies, and sometimes they give preferential treatment to certain individuals.

In many areas, frequency coordinators will tell an amateur that no frequency pairs are available in certain bands (primarily the 144 MHz and 440 MHz bands), but when one tries to bring up a repeater, nothing happens. Then it's back to the coordinator who then tells the applicant that these are *private* repeaters, and that the frequencies are not available for use by the general amateur public.

Well, I seem to remember that within the regulations of the FCC that no one owns a frequency. All frequencies available to an amateur, within his license class limitations, can be used. The only restriction is not to interfere with an *on-going* communication. If no one else is using the frequency, then it is perfectly OK to use that frequency. Period! But, when a frequency coordination body gives coordination to an amateur for the purpose of placing a private (or closed) repeater in operation, that body is, in

“When a frequency coordination body gives coordination to an amateur for the purpose of placing a private (or closed) repeater in operation, that body is, in effect, giving ownership of that frequency to a particular amateur, which is in direct violation of federal regulations.”

amateur repeaters except for the definition of frequency coordinator in Part 97.3 (20). Unless I have overlooked some other reference, and I have read and re-read the regulations many times looking for such, this is the basis on which all frequency coordination bodies within the areas served by the FCC exist.

The unfortunate history

When FM and repeaters first came into vogue in the late 1960s, unfortunately, in some areas, there did exist groups of amateur radio guerrillas who waged “wars” over specific frequencies on which they operated their repeaters. Although most repeater operators tried to cooperate with other

clearing house for technical data. The second was to influence the FCC during times when the actual existence of repeaters was in doubt. The third item was to serve as a coordination body to help alleviate repeater interference on the very few frequencies then being used.

In most areas, the repeater pair was 146.340 MHz input and 146.940 output. In a few areas, 146.940 MHz was reserved for simplex operation, so 146.340 MHz was paired with 146.760 MHz as an output. But, within a very few years the standard frequency splits came into being. There are explanations why the upper 1 MHz of 2 meters has an inverted split, but that will be reserved for another time. With almost every repeater

effect, giving ownership of that frequency to a particular amateur. This is a direct violation of federal regulations.

For example, in California, according to a fairly recent edition of the *ARRL Repeater Directory*, there are 426 repeater stations in the 440 MHz band located in the northern portion of the state. Of these, 170 are open, and the remaining 256 are closed. This makes a total of almost exactly 60% of the repeaters in the northern portions of California closed. In the southern half of the state there are 452 repeaters listed, of which 38 are open. That makes a whopping 84% of

now allotted. But, when an amateur, or group of amateurs, wants to install an open repeater, the frequency coordination would automatically be revoked and be transferred to the open repeater. In areas in which there are frequencies available, it may take years until the frequency coordination of a closed repeater is revoked. On the other hand, in areas where no frequencies are available, then frequency coordinations might start to be revoked immediately. However, a repeater open to *all* amateur operators should take priority over one with restricted usage.

"A repeater open to all amateur operators should take priority over one with restricted usage."

the 440 MHz repeaters in southern California *closed!* Yet, each and every one of these repeaters is presently protected from interference from normal amateur operation.

Is this fair? In my opinion, no way! Is this trend all over the country? You bet your sweet bippy! Is this legal? *No way!* But such are the activities of the majority of frequency coordination bodies in the United States.

Now, I have no problem with closed or private repeaters. The FCC has issued opinions that a repeater operator can restrict the users of his/her repeater. Often, these repeaters are just an excuse for a private phone patch (autopatch) for use by a single, or at most a few, amateurs. Legal? As long as the conversations fall within FCC guidelines; but should the amateur community in general suffer the loss of the vast majority of frequency spectrum to support the whims of a very few amateurs? I think not!

Possible solutions

I propose two possible solutions. The first is to designate a few frequency pairs for use by private or closed repeaters. Since each probably has only a few users, there will be little chance for interference. Often, and I have monitored some of the closed repeater frequencies for quite a while, there is no activity for days, even weeks! Yet the frequency pair is coordinated and thus unavailable to the general amateur public.

The other solution is to continue to coordinate private repeaters and/or allow them to operate on the frequency pairs

Amateurs who are now operating closed or private repeaters will not like giving up their exclusive rights to a frequency. But, since this ownership of the frequency is illegal under present regulations, they have no right to this de facto ownership. I cannot blame someone for wanting to have his/her private frequency, but such activities are prohibited by law. Thus, much of the blame must go to the coordination bodies who have allowed and even encouraged this practice for so many years.

Of course, there are amateurs who have gotten frequency coordination for a repeater and who have never placed a machine on the air. Definite time limits should be set (say three months) for a repeater to be placed in operation. If there are very extenuating circumstances, a one-time extension of another three months could be given. Then, no matter what, the frequency goes back into the coordination pool if no repeater is in operation.

Many amateurs are intimidated by frequency coordinators. Unfortunately, some of these people have declared themselves to be demigods, and refuse to face the reality of amateur operations today. It is possible to force the frequency coordinators back into the real world—it just takes a concerted effort on the part of the majority of amateurs.

Anyway, in the urban areas of the country there are just not enough frequency pairs to go around if we continue to allow all the private and closed repeaters to operate with no restrictions. According to FCC regulations, no

HamCall™ US & International CD-ROM- Over 1,250,000 Listings

ICALL for DOS and Windows now allows EDITING! Data displayed for U.S. hams: call sign, class, name, address, issue date, expiration date, birth date, license class, county, lat/long, area code, time zone, grid square, previous call and class, hours past GMT.

New editing feature allows you to add new records, change addresses, add e-mail address, or add phone numbers. View photos/QSLs of many hams.

• Menu-driven • Print Labels • Latest public domain PC software • Unzip to hard/disk or floppy • Lookup TSR runs from text window • Updated at the end April & October • Windows 95 compatible • Dealer discount on 25 or more • MAC users can retrieve by call, name and zip.

Price remains \$50.00 plus shipping; \$5.00 U.S., \$8.00 International.

Electronics Software Compendium™

The Electronics Software Compendium™ is a collection of shareware programs and data files that pertain to electronics, broadcasting, amateur radio and SWL activity.

Over 25,000 files in total. The disc is updated and issued annually in April. Over 300 megabytes of PC and 50 MB for MAC. Send for your new edition today! The price is still only \$25.00 plus shipping; \$5.00 U.S., \$8.00 International.

Try our call sign server www.buck.com

BUCKMASTER
6196 Jefferson Highway
Mineral, VA 23117
540-894-5777 • 800-282-5628
540-894-9141 (FAX)
Internet: info@buck.com

CIRCLE 56 ON READER SERVICE CARD

RDC THIS MONTH'S HAND HELD SPECIAL
KENWOOD TH-22AT
Under \$265.00

Similar savings on Standard, ICOM, Heath Kit, Yaesu, Alinco, Etc. All L.T.O.

KENWOOD TH-79AD	UNDER \$460.00
KENWOOD TH-27A	UNDER \$280.00

Over 8800 Ham Items in Stock, all Prices, cash FOB Preston.
More specials in QST Ham Ads • Less any applicable coupons - All limited time offer

Call Today (208) 852-0830
ROSS DISTRIBUTING COMPANY
78 S. State Street, Preston, Id. 83263
Hours Tue.-Fri. 9-6 • 9-2 Mondays. Closed some Saturdays (call for appointment)

CIRCLE 254 ON READER SERVICE CARD

Pico-J rolls up and hides in his 4-ounce pocket-sized holder, waiting like the Genie in a bottle till you need full-quieting signal pouch.

Call him forth and his glistening black weather sealed lines reveal a sleek end-fed halfwave antenna ready to hang anywhere. Suspend in the apartment closet or patio doorway. Attach Pico-J to window glass or curtain rod. He needs no radials for broadband low-angle omni halfwave gain.

Carry Pico-J with you for emergencies. Hang in the motel when on the road. He improves range, boosts reception, saves batteries.

Pico-J comes ready for work with 72" isolated coaxial feedline and gold pin BNC. Typical edge-to-edge SWR under 1.2:1. Hand-crafted in the U.S.A.

Info \$1
Box 50062-D
Provo, UT
84605

Models	Antennas West
2 Meters	Order Hotline
440MHz	801-373-8425
Dual Band add \$6	

19.95

CIRCLE 89 ON READER SERVICE CARD

person can own a frequency. Thus, the practice of allotting our scarce frequency spectrum to a very small number of amateur radio operators must not continue. However, unless a cry is heard from the majority of operators, this will continue to happen, as it does now.

Cry out! Let the ARRL, your state repeater organization, your local frequency coordinator, the editors of any club newsletters you know, and anyone else who can help know of your displeasure with this practice of coordinating closed repeaters to the detriment of normal amateur operation. Yes, there is a place for closed repeaters, but not at the expense of general amateur operations. Think about it, then act. 73

The 2m Quad Project

Here's a great antenna project for your club!

Larry R. Luchi W7KZE
P.O. Box 1612
Mukilteo WA 98275

As the rainy season blew into Puget Sound, I was giving thought to the second semester of our electronics technology program at Sno-Isle Skills Center. During this semester I teach amateur radio to my junior and senior high school students ... a daily block of three hours of classroom lecture and lab. Each of my students builds an AM/FM superheterodyne receiver to give further understanding to my lectures on electronics theory. This gives these teenage intellects a break from the 30 minutes of dits and dahs of Mr. Morse's code.

December brought rain, rain and, when the sun was about to appear, more rain. January was just a little bit more of December: rain, rain and wind. What does this have to do with young high school students and amateur radio? A reason to demonstrate antenna theory in the classroom, and hope for sun in February—to be exact,

“The rationale for using oxyacetylene welding wire for the elements was to keep the cost of our quad to \$0, and also to improve the students' soldering skills.”

on Groundhog Day. On February 2nd the sun did peek out to greet my birthday. Having spent over nine-tenths of my life as a ham radio operator, I felt that this was an appropriate time to take the class outside to test the antennas we'd made in the classroom.

We'd made a half-wave dipole for 2 meters, 146.58 MHz, using the formula $468 \text{ divided by the frequency in}$



Photo A. Devin Corbett KB7NKT and Matt Chapsin checking the SWR.

MHz for a length of 38.5 inches. Devin Corbett KB7NKT cut the number 12 wire and installed a PIN diode and a Fluke 87 Digital Multimeter in series with the antenna to measure the current. Two meters gave us the compact size and also allowed me to demonstrate vertical and horizontal polarization.

As I explained the half-wave dipole antenna to my students, their eyes began to glaze: “Like how can this work?” With our demonstration, some of these bright young minds opened up and started to ask questions: “How can a full wave fit into a half-wave length of wire?” My excitement increased with each question. I found *The ARRL Antenna Book* and started to look for a 2 meter quad antenna that we could make with little cost to the students.

Sno-Isle Skills Center is a vocational high school with 22 programs of

instruction, from automotive technology to welding. The resources of the faculty and supplies are a ham's dream come true.

During the last week of January, it rained some more. This was an opportune time to build a single-element quad at home to illustrate a full-wave antenna to the students. The third quarter of instruction is communication electronics and the goal of each student is to pass the Technician Plus exam. The half-wave dipole and quad are both antennas that are covered in the exams. In my lectures on antennas the students calculated the length of each type of antenna needed to pass the exams. For quads, the length of the full-wave loop can be calculated by $1005 \text{ divided by the frequency in MHz}$. If multiple elements are used, the reflector should be five percent

longer and the director(s) five percent shorter.

With my *Antenna Book* in hand, I went to the faculty lounge to discuss my quad antenna project with some of the staff. I showed Dan Minzel, our welding instructor, the drawings of a portable 144 MHz four-element quad. He had a large quantity of 1/8-inch diameter oxyacetylene

center, 13 inches from the driven element. Finally, the first director measured 13 inches from the second, then all of the PVC tees were glued into place.

Construction of our first four-element quad began with 1/2-inch PVC spreaders. These elements were first assembled with the holes drilled for the 1/8-inch brazing rods. The reflector spreader

A 12-inch x 2-inch Plexiglas™ plate was used to support the feed point hardware and the feedline. The feed point support was epoxied to the boom. Using a heat gun, we bent the Plexiglas to meet the driven element. The ends of the brazing rods were 3/4 inch apart where they mounted on the Plexiglas plate. We left enough excess rod to bend a small loop for attachment to the coaxial feedline with stainless steel hardware.

For vertical polarization, we located the feed point in the center of one side of the driven element. In tests, we found that there was a 10 dB loss in the horizontal polarization when we tested with a local repeater.

We connected the coax to the bolts connected on the driven element support plate, and ran the RG-8 along the Plexiglas to the boom. From there the cable was routed directly to the mast and down. The antenna provided very good performance, with a reasonable SWR over the entire 144 MHz band. We used a Bird wattmeter to measure the reflected power and found that with 100 watts out, less than 1/2 watt was reflected.

The kids now know what a full-wave antenna is, compared to a half-wave antenna. Our next classroom project is to build a PVC 10 meter quad. We'll be looking for you on 10 meters. 73

“The resources of the faculty and supplies at Sno-Isle Skills Center, a vocational high school, are a ham’s dream come true.”

welding wire that we could use for the loops. Al Urness N7QDC, our plastics instructor, had the PVC support (spreaders) and a Fiberglas™ boom. The machine trades instructor, Tom Clemans, suggested he have his students drill all of the holes needed in the PVC (spreaders) supports and boom. It’s as exciting to have cooperative working groups on the staff as it is to teach in the classroom. It was a good beginning to the second semester.

The element spacing for quad antennas found in literature ranges from 0.14 to 0.25. Factors such as the number of elements in the array and the parameters to be optimized (F/B ratio, forward gain bandwidth, etc.) determine the optimum element spacing within this range. The four-element quad we constructed in class was cut for 146.58 kHz. We decided on a reflector length of 86 inches, with the driven element 81 inches and the directors 77 inches long.

Construction

We began with the 10 feet of 1/2-inch PVC for the booms that was provided by Al. It was cut to 42 inches in length, with allowances given for the two PVC tees, one for the reflector and one for the first director.

The reflector tee was glued to one end of the boom, 16 inches from the center of the driven element tee. This was the work of another classroom team led by Matt Watson. Matt made sure that the distance from the center of the reflector tee was 16 inches to the center of the driven element tee, and the second director tee was on

was 22-1/2 inches long, with 1/8-inch holes drilled 10-3/4 inches from the center of the boom. The driven spreader was 21-1/4 inches long, with holes drilled 10-1/8 inches from the center of the boom, and the directors were 20-1/4 inches, with holes drilled 9-5/8 inches from the center of the boom.

We used 1/2-inch PVC for the boom with PVC tees to install the spreaders; each spreader was cut in half, i.e. the reflector was cut at 11-1/4 inches, then each end was glued to the tee and in turn to the boom.

The rationale for using oxyacetylene welding wire for the elements was to keep the cost of our quad to \$0, and also to improve the students’ soldering skills. No. 8 aluminum ground wire will work just as well. The brazing rods cost around \$2.26.



Photo B. Devin Corbett KB7NKT measuring the spacing for the feedline.

Life After Your No-Code Tech License and Handheld

Without having to know CW.

Michael Farrar VE3WMF
12-125 Weldrick Rd W.
Richmond Hill ON L4C 3V2
farrarmi@epo.gov.on.ca

Now that you have your No-Code Technician's license, you've bought a 2m handheld, mounted it in your car for mobile use, even put up a good vertical antenna on your chimney, and bought or built a 13.8V power supply to get the handie's "full gallon" out ... *great, welcome to the hobby!* Now where do you go from here? There are several modes, other than FM repeaters, that will let you talk to a wider world.

With repeaters, you can get out a reasonable distance, but with a better antenna and more power (30-150+ watts) you can do even better on the FM

"Welcome to the hobby! Now where do you go from here?"

simplex frequencies. Add a linear amplifier (with a receive preamp) to your handheld and a modest beam antenna mounted 10 feet or more above your roof line, and you are in business. Contacts up to 100 miles are routine (including distant repeaters), but when the band opens up, look out! Contacts of up to 500 miles are common. All of this assumes you do not live in a hole; if you live in a valley with a 100-foot+ ridge within a quarter mile, you should consider moving, learning CW and going HF, or going to satellite operation.

Vertically polarized FM signals do not travel as well as horizontally polarized SSB signals. This world requires multimode transceivers, which are more expensive because they do everything your handheld will do, but add SSB and CW modes, more power, and more features. There is a lot of activity in both modes on the 2 and 6 meter bands, with a bit less on 70 cm. Let's stick with 2 meters for now

because you will likely want to use FM to check into nets and use repeaters—so keep your vertical antenna.

Transceivers

What is available? Unfortunately, not much on the used market. Rigs occasionally become available, but sell quickly. Most older rigs seem to have been good, but avoid radios that are more than eight years old if you want to work satellite (they aren't designed for the required talking and tuning). In the current market, the basic multimode is the Yaesu FT-290R11. It puts out 25 watts, is small, and can be used as a base, mobile or fat handheld. The new Kenwood TM-255 can be either a mobile or base, puts out 40 watts, has many more features, and costs more—but it's worth the extra money. Both these rigs can be enhanced with a linear amplifier that will boost the output to 150-170 watts. It is best to get one with a GaAsFET receive preamp for weaker signals. They cost about \$280 and require a minimum of a 35 amp power supply. Next, there is the ICOM IC-275H base station running 100 watts. It requires a 12V, 20A power supply. The IC-275H costs more than the Yaesu and Kenwood models, but it is required if you want to drive a full-legal-limit linear. Finally, there are multiband base stations that start at \$1,700 and go up as you add bands and options. The extra investment may be worth it if you want to work 2 meters and 70 cm or 1.2G (one radio will do four bands) and all satellite modes.

Towers, antennas, and feedlines

It helps to have a good antenna, but it helps even more to get it up as high as

you can and feed it with the best coax you can afford. Since VHF antennas are small and light, TV towers or mounts are more than adequate. Used TV towers are relatively cheap and easy to install. If you live in a two- or three-story house with a high-pitched roof on high ground, then a rooftop tripod mount will do just as well.

Use RG-8 or better coax for runs up to 50 feet, and RG-9913 or 9914 for longer runs. Hard-line or heliax is ideal if you can get it cheaply, but be careful to examine used hard-line very carefully for any previous kinks or water penetration.

You will need a rotor and, again, a TV rotor is all you need. Used ones are all right but I prefer new ones with good seals to prevent freeze-up if you experience that type of weather.

If you enjoy building things, then it is easy to build your own antenna. The simplest antenna is a cubical quad, but feed the coax at the bottom for SSB and at the side for FM. This antenna can be made from common building materials such as wood, ABS, PVC, CPVC, aluminum wire, copper wire, or brazing rod. Plans are readily available and easily adaptable to the materials you are comfortable working with. Just be sure you build it well; most plans I've seen are rather flimsy designs that are not suited to Canadian or Minnesota winters. If you got a used TV antenna with your used tower, or you otherwise find used TV/FM antennas, they are an excellent source of material for a yagi antenna (73, September 1993). To improve gain, stack two yagi antennas for an extra 3 dB. To achieve the same increase in gain you have to double the boom length, which creates major mechanical and wind load

problems. A VHF SWR meter (MFJ-812B or equivalent costs about \$30) is a must-have to tune your antenna.

the 144 and 430 MHz bands. Because of their higher orbits they have much better coverage (sometimes halfway around the

become marginal unless they are well guyed. Likewise, TV rotors are not adequate for larger (four- to six-element) boom antennas; medium duty rotors are recommended, or required if you add your 2 meter beam to the mast.

“If you have a big back yard, very understanding neighbors, very deep pockets, and considerable technical skills, then bouncing signals off the moon can be a real challenge.”

If you are not a builder, an eight- to 13-element commercial yagi will work just as well. Get one that is optimized for the 144-146 MHz part of the band (that's where the SSB/CW activity is).

RS-10 and RS-15

These are Russian amateur satellites that are relatively easy to use because they are in low circular orbits. If you started as an SWL and have a good tabletop communications receiver that handles SSB, then you are in business. You will also need a computer and some tracking software to tell you when the satellites are overhead. These satellites receive SSB or CW on 2 meters, then return the signals on the 10 meter band; look at them as a fast-moving repeater in the sky, with a big offset. You should listen to them on 29.352-29.405 MHz USB first because you may be in a high-noise area and because they are low power; local noise levels may overpower their signal.

A homemade quarter-wave vertical or turnstile 2 meter antenna (25-100W) and a 10 meter inverted Vee antenna with a 10 meter preamp both work great. With the satellite in the right position you can talk to all four coasts. The newer RS-15 satellite is in a higher orbit with even better coverage (into western Europe and north-west Africa from eastern N.A. and Central/South America). If you do not have a good SW receiver, used Radio Shack™ HTX-100 10 meter transceivers sell for \$100-125 (or less if it has a blown transmitter). For an additional investment of \$30-200 you can cover three continents and Hawaii.

Other birds

There are a number of other amateur satellites available that are in higher elliptical orbits. They also have a different set of transponders, operating in

world). To work them requires a dual-band multimode transceiver and a special antenna and rotor system for tracking.

6 meters

Depending on conditions, this band can be either a VHF band or an HF band without much of the noise associated with HF. Contacts of 250 miles are routine, but when this band opens up it is spectacular. Contacts into Central and South America, and occasionally Europe, are possible. Since 6 meter antennas are larger, TV towers

Moonbounce

If you have a big back yard, understanding neighbors, very deep pockets, and considerable technical skills, then bouncing signals off the moon can be a real challenge. Eight 17-element yagis, a precise two-axis rotor system, a computer to control it, a full-legal-limit linear, a super-low-noise preamp, and a good transceiver are all you need. It would also help to be single or have a wife who is a ham and shares this interest. With this mode, I have violated the subtitle of this article—moonbounce activity is almost entirely CW, but 5 wpm is enough. 75

Survey of VHF/UHF Radios

The following list is by no means comprehensive but is intended as a beginner's guide to the marketplace. Detailed specifications can be obtained from the manufacturers or your favorite ham radio emporium. Prices quoted are from my favorite U.S. discount chain. Your dealer may sell for less but ask them why if they do not.

Single-Band Multimode Radios:

- Yaesu FT-290R II 2 meter mobile—\$630; 25W. Basic FM radio with SSB/CW added, few features and not suited for satellite or CW operation.
- Kenwood TM-255 2 meter base/mobile—\$900; 40W. Full-featured “state-of-the-art” FM/SSB/CW transceiver.
- ICOM IC-275H 2 meter base—\$1,700; 100W. Full-featured FM/SSB/CW transceiver, recently reduced in price.
- Kenwood TS-60S 6 meter base/mobile—\$990; 90W. If you want to go 6 meters, this is the radio.
- MFJ-9406X 6M SSB/CW base—\$260; 10W. Excellent starter radio; add a linear as budget allows.

Used 2 Meter Radios:

- Kenwood TR-751A—A not-so-old

goodie. They sell quickly; be first in line at the hamfests. \$400-600.

- Kenwood TR-9000—An oldie, but perhaps not so good any more, 10W (or 30W on TR-9130). Unsuitable for satellite operation. Good starter radio for about \$200, or \$250 for the 9130.

Multiband (2 Meter and 70 cm) Radios:

- ICOM IC-820H—ICOM's newest, but 2 meter and 70 cm only. \$1,700; 30W-45W. Full-featured for terrestrial and satellite.
- ICOM IC-970H—ICOM's best. \$3,900; 30W-45W; 1.2 GHz optional. Overpriced compared to others.
- Kenwood TS-790A—\$1,770, 30-45W; 1.2 GHz optional.
- Yaesu FT-736R—\$1,830; 25W. Can add two more bands from 50 MHz to 1.2 GHz for great flexibility.

Amplifiers:

Any radio with less than 50W should have a matching linear amplifier. Manufacturers are: Henry or Command Technologies for kilowatt units, and Mirage, RF Concepts, RF Technologies and TE Systems for 100W-300W units.

Michael Bryce WB8VGE
2225 Mayflower NW
Massillon OH 44646

Operating QRP usually means you're going to be using CW. Building a transmitter for CW is a lot easier than hacking one out for SSB. So, it's easy to see why there are many add-on devices to improve the sending of CW, but there's very little on the market

Low Power Operation

The circuit board is fitted to go inside an edge-card connector, or to be plugged into the PC board with the supplied dual-pin header.

A closer look

The VM-1110A contains everything you need to record and play back audio. All you need to

"Voice memory keyers have been expensive for the once-in-awhile QRP phone operator—until now."

for the phone operator. Voice memory keyers have been expensive for the once-in-awhile QRP phone operator—until now.

The ChipCorder

Killing some time at a local Radio Shack™ store, I came upon a small blister package containing the VM-1110A voice record and playback module. The VM-1110A is a self-contained solid-state voice module that will hold up to 10 seconds of audio. The entire VM-1110A is housed on a preassembled PC board about the size of a postage stamp (see Photo A). There are about a dozen surface mount components on the board, while the actual ChipCorder is just a blob of epoxy on the circuit board.

add are some switches and an electret microphone. The VM-1110A has a built-in audio preamplifier, automatic gain control, and an anti-aliasing filter on board. There's even an audio power amplifier on the board that will drive a speaker directly. But perhaps the best part of the VM-1110A is the price—it's only \$15! The Radio Shack stock number is 276-1324.

Another feature of the VM-1110A is the automatic power-down mode to drop current to .5 μ A. It will operate on a single +5 volt supply, and the message storage retention uses zero power. After I've been laid out on that cold marble slab, the VM-1110A will still keep my "CQ CQ QRP..." in memory for at least 100 years!

Making the VM-1110A talk

You'll need a +5 volt supply at 35 mA to run the VM-1110A. A 78L05 will work, just be sure you bypass the input and output leads of this regulator with some .1 capacitors.

You can also use a set of four AA batteries with an 1N4002 diode in series to drop the voltage down to .5 volts. If you use the batteries, there is no need to use the regulator. Be careful to put the correct polarity to the VM-1110A as it will most certainly be damaged by reverse voltage polarity.

You'll also need an electret microphone; Radio Shack #270-

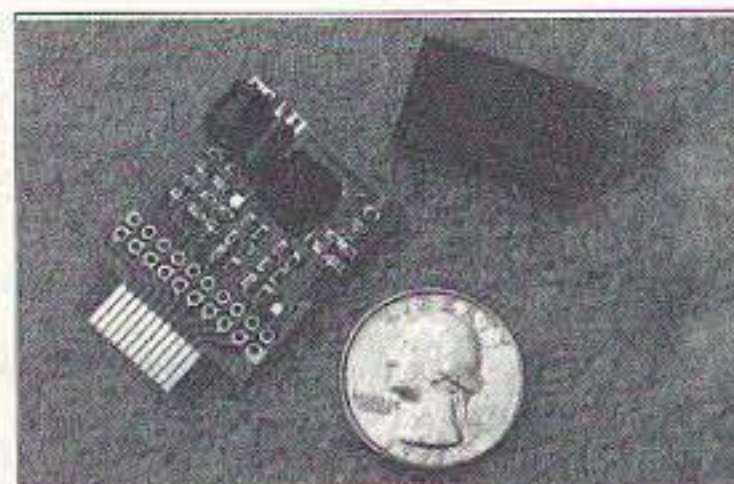

Photo A. The entire VM-1110A is housed on a preassembled PC board about the size of a postage stamp.

090 is the one of choice. Also, a couple of push-button switches will be required for the start/record and playback function.

There's not much to do—you hook up the switches to the correct pins and connect the microphone, apply power, then begin recording. You can make up to a single 10-second recording. At first that does not sound like a lot of run time, but in real life, 10 seconds is rather long! Most dyed-in-the-wool DXers can work six contacts within a 10-second period.

Recording

To record a message, a low-going transition on the REC line initiates a new record operation from the beginning of the memory, or at a selected location, regardless of any current operation in progress. You do not

when the end of message marker is encountered. Playback then ceases and the device goes to sleep.

Interfacing the VM-1110A into the rig

I coupled some of the audio output from the VM-1110A directly into the microphone jack of my Argonaut II. It seemed to work just fine after I played with the gain and drive controls.

A much better approach would be to use an op amp as a simple microphone mixer and adjust the mixer to match the audio level of the external microphone. This way, the audio level from either the VM-1110A or the microphone would be the same.

Odds and ends

I guess it would be possible to use one of the level active pins and link two or more VM-1110A modules together to provide longer record and playback times. Any one want to give that a try?

As a club project, a single circuit board could be assembled to hold a VM-1110A and the required switches and power supply. You could record and then

"For the ultimate bell and whistle, how about a programmed VM-1110A triggered by an SWR sensor to alert you to a problem with your antenna system?"

need to fill the entire memory. Releasing the REC signal HIGH before filling the message spaces causes the recording to stop and an "end of message marker" to be placed. The device then powers down and goes to sleep.

You can place an LED on the RECLE output pin to provide an active low signal which can be used to drive the LED as a "record in progress" indicator. The module has a 1k current-limiting resistor already on the board to limit current to the LED.

Playback

Pulling PLAYE or PLAYL signal LOW initiates a playback cycle. This cycle is then completed

remove the VM-1110A to use at a remote location.

The VM-1110A is cheap enough to allow you to record one module with a CQ and then a second or third module to hold reports or "QRZs..."

And for the ultimate bell and whistle, how about a programmed VM-1110A triggered by an SWR sensor to alert you to a problem with your antenna system?

All in all, the VM-1110A is a whale of a lot of fun. There's not much in life that's this much fun (legally, anyway) for under twenty bucks. Pick up one of the VM-1110As from Radio Shack and shoot a Saturday evening.

Radio Bookshop

Phone 800-274-7373 or 603-924-0058, FAX 603-924-8613, or see order form on page 88 for ordering information.

Wayne's Book!

WG1 We The People Declare War On Our Lousy Government by Wayne Green W2NSD/1 360p soft cover. This is Wayne's report explaining what the major problems are facing both New Hampshire and the country, and proposing simple, inexpensive solutions: a simple way to have government departments happily cut their expenses by 50% within three years; how to cut the cost of incarcerating prisoners by over 90%; how to end welfare; how to reduce the deficit; how to cut medical costs and improve health care; how to cut school costs and improve schools. An absolute steal at \$13

HAMS WITH CLASS

Number 49 on your Feedback card

Carole Perry WB2MGP
Media Mentors Inc.
P.O. Box 131646
Staten Island NY 10313-0006

He rides the airwaves

Now that I'm in the process of packing away many of my wall displays of QSL cards and trying to fit the school term's collection of papers and books into cartons for the summer, I promise myself to throw away outdated materials that I can no longer use. Being a collector by nature, this is no easy task. I subscribe to the philosophy of "sooner or later every scrap will have some use."

Since I am rapidly growing out of classroom space and storage area, I must start separating my materials before I pack them away. One textbook that definitely goes into the "to save" pile is *Ride The Airwaves With Alpha & Zulu*, written by John Abbott K6YB. If you're looking for a new resource to put into your classroom or clubhouse library, you should consider this book.

John Abbott K6YB

First, let me tell you a little about John. His class and mine made several really terrific radio contacts a few years ago. He has been teaching ham radio class, a requirement for gifted students at Los Feliz Elementary School in Hollywood, California, since January 1990. Then a communications engineer for the Los Angeles City Department of Water and Power, he had joined a DWP program in which engineers did volunteer work with students one day a week. He chose Los Feliz Elementary at the suggestion of his wife, Teri, who teaches third and fourth grades there.

He retired in 1992 and now holds classes twice a week. "My wife told me the kids needed something like this as an outlet," says John, a ham radio devotee since he was 13. "Most of the kids live in little apartments. This lets them know there's another side of life out there."

According to a newspaper article John sent me, his students have spoken with people in

Mexico, Central and South America, and as far away as New Zealand and Japan. They communicated with the space shuttle in 1993 and received printouts from NASA's MARS observation satellite observing Mars.

School principal Betty Castaneda estimates that John's contributions would cost the Los Angeles Unified School District about \$30,000 a year if he were paid. That's not even mentioning

"School principal Betty Castaneda estimates that John's contributions would cost the Los Angeles Unified School District about \$30,000 a year if he were paid, and that doesn't even include the equipment he's donated—about \$5,000 worth."

the equipment he's donated—about \$5,000 worth. She says, "There are four or five other schools in our district that have a ham radio class, but they don't have a real engineer to teach them, and they're not as diversified.

"The most important thing John does is provide a role model," she says. "He's comfortable around the technology, so the

kids are too. Also, more than half the kids do not have fathers—they come from single-parent homes—so he's a father role model as well."

As for the kids: "It's fun," says 10-year-old Gerardo Arturo Estrada. "You get to meet a lot of people and make friends."

John sees another appeal, the one that hooked him as a teenager: "Here you are in your little world, and all of a sudden you can get on the air and talk to anybody in the world," he says. "It's that feeling that you're riding the airwaves. You're bouncing around

the world; your voice is going through space and time forever."

The newest *Ride The Airwaves*

The 1996 edition of *Ride The Airwaves With Alpha & Zulu* is an improvement over the 1993 version. There are now 59 characters instead of 16—all 43 characters required by the

Element IA code test, plus 16 binary characters. In addition, a "space" theme has been incorporated. This delightful soft-cover book uses comic book characters, The "Phoneticos," to prepare students to take two different amateur radio exams, the Novice and the No-Code Tech. If you look closely at the Phoneticos characters you will notice that each of their bodies is made up of the Morse code "Dits" and "Dahs" that form the correct symbol for that character's letter.

After each cartoon page there is a testing page. The answers to the quiz are found on the bottom of the following page. There are crossword puzzles and games throughout the book. The children in my sixth-, seventh-, and eighth-grade ham radio classes always enjoy the lessons I do based on material from John Abbott's book. For more information or to purchase a copy of the book (single copy: \$14.95), contact John at ABTRONIX, P.O. Box 220066, Newhall CA 91322, (805) 222-7384.

Well, there's no need to continue the throwing out process today. I'll pick up where I left off tomorrow. Of course, if I keep on discovering books like John's that I enjoy so much, not too many items will be thrown away. What I really need is a suite of rooms, not just a classroom, for all my wonderful ham radio materials. Have a great summer! 73



Photo A. John Abbott K6YB (rear) with Joyin and Jimmy (back row), and Gerry and Suzan (front row). Joyin is from Korea, Jimmy and Suzan are from Thailand and Gerry is from Mexico.

HAM TO HAM

Your Input Welcome Here

Dave Miller NZ9E
7462 Lawler Avenue
Niles IL 60714-3108

This month's column contains quite a bit of good information, so let's get right to it. Suffice it to say that I'm always interested in any ideas from readers, such as the ones below, that have practical amateur radio applications. So get out your pens, word processors or parchment and quills, and keep them coming this way. My address is at the top of this page. All contributions will be promptly acknowledged; I'm also usually able to give you a rough idea of when your tip will appear if it's accepted.

On the "light"er side

In last month's column, I suggested using one of the new "laser pointers," for "seeing-through" a printed circuit board so that a component located on the top side of the board could be easily identified for unsoldering on the bottom side.

In addition to the laser pointer, a small Mini-Mag® light, one with a beam that's able to be focused down to a small "spot,"

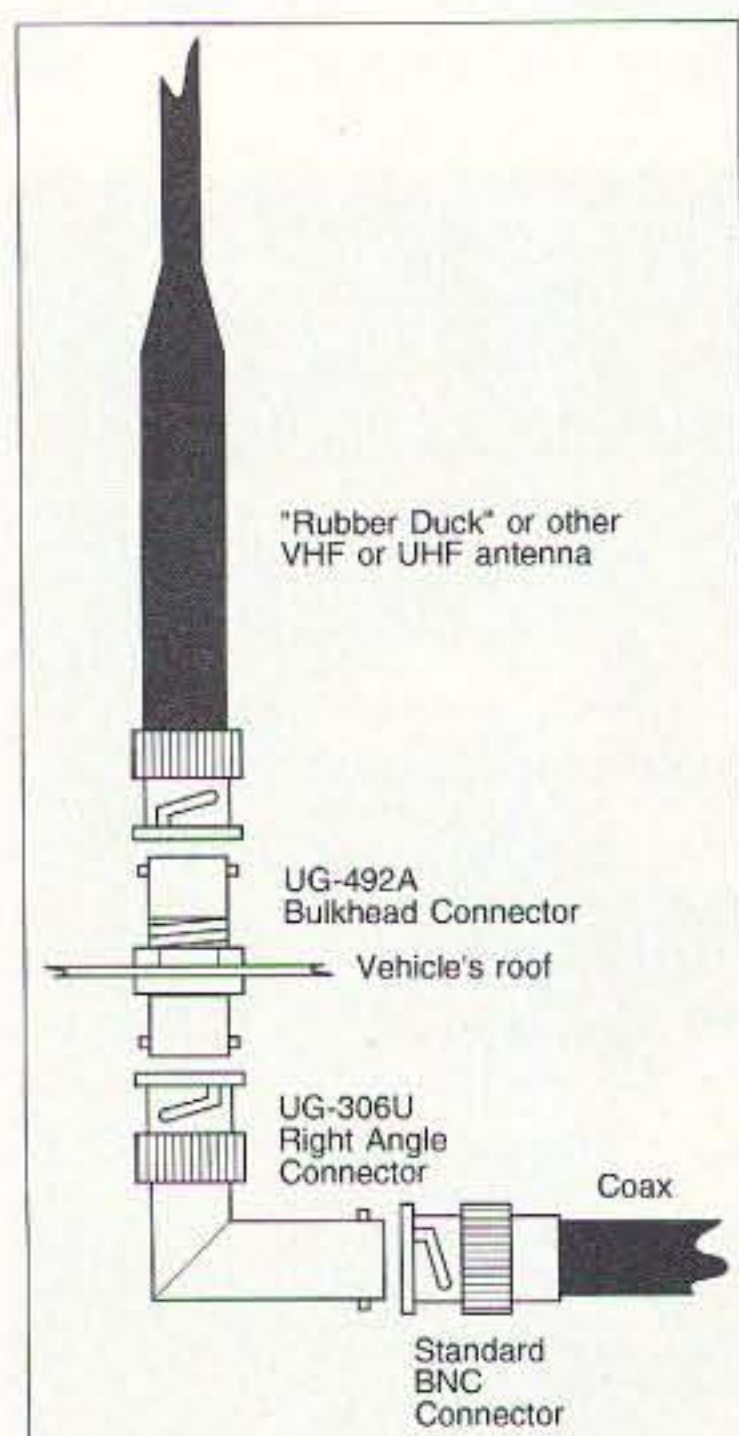

Fig. 1. NZ9E's tip for inexpensively mounting a VHF or UHF mobile antenna on a vehicle's roof.

can be used to highlight the area of interest. It's not as dead-on-accurate as a laser pointer, and it only works on PC boards that are translucent—the room must be fairly dark—but it does work nicely on most phenolic boards encountered in ham radio equipment. Sometimes you can even see the silk-screened printing from the other side coming through, though of course it's reversed.

So if a laser pointer is still not on your workbench (they're down to less than \$30 now), a small mag flashlight should be, and it can be used in a similar way. Now all you need do is to hunt down the component that needs replacing! Some of the other tips we have this month may help in that area.

Put the heat on 'em!

To make the removal of self-adhesive labels or escutcheon plates on equipment much easier, try using a heat gun to pre-soften the sticky adhesive backing first. I recently wanted to repaint the top and bottom covers of a used ham transceiver I'd bought. Using a shrink-tubing heat gun to soften the backing on the covers' labels allowed me to neatly remove them without a trace of damage, something that would not have been the case had I tried to remove them "cold." The heat supplied by the shrink-tubing heat gun (or perhaps a directable hair blow dryer) was just enough to loosen the backing so I could slip a single-edge razor blade under the escutcheon label and pry it up. (To reinstall the escutcheon labels after painting the covers, I used Scotch™ #136 Double Stick Tape; it's available at stationery supply stores.) Just be very careful about how much heat is applied to plastic or other surfaces that may be damaged by too much of a good thing. Generally, if the right amount of heat is used, self-adhesive labels will release easily, and can be removed without leaving a gummy residue behind—or at least leave only a minimal amount. Give it a try.

Goo Gone

If my tip on softening labels with a heat gun (above) comes too late, the goo left behind by unsuccessful prior removal can often be cleaned up with a product called Goo Gone®! Really, that's its name! Actually, I have to respect products that state what they do right up front. Goo Gone is made by Magic American Corp. of Cleveland, Ohio 44122. Its maker claims that it's effective in removing residue left behind by tape and other adhesives, as well as oil, gum, tar, scuff marks, polish, wax, grease and many other remnants. It has a pleasant citrus smell and comes as a thin, gold-colored liquid in several container sizes. It can usually be found in hardware stores and home centers. I bought mine at a railroad hobby show, since it's also popular for cleaning model railroad engines and track.

As with any cleaning product, always test a small spot first to check for any adverse chemical reactions, especially on painted surfaces and plastics. There are so many chemical formulations today that it's virtually impossible to make an effective cleaner totally compatible with all of the possible synthetic combinations.

Easy does it!

Here's an idea that I've used several times to give me an inexpensive, option-filled mounting scheme for mobile antennas on my own cars (see Fig. 1). It lets me swap antennas at will, as well as remove the radiating element very quickly for automatic car washes, etc., replacing it with a BNC dummy plug instead.

The idea requires drilling a single hole, large enough to pass the mounting threads of the UG-492A bulkhead connector, so if drilling a hole in your car's roof or trunk lid is completely out of the question, read no further. Personally, I'm not averse to the idea since it provides a low-profile mounting arrangement, with a good connection to the surrounding ground plane (the car's metal roof).

The quick exchange of antennas is also very nice, allowing me to use anything from a 2

meter rubber ducky to a 19" whip mounted in a BNC connector, to a 5/8-wave-gain whip antenna...all with a twist of the wrist! Though I've only used this combination on 2 meters, it should work equally well on 1-1/4 meters and 70 cm. It's as strong as the roof of your car, so even a fairly robust 2 meter gain antenna is usable with it. If, however, too much roof flexing occurs, a steel backup plate with a clearance hole drilled in its center should solve the problem easily. When it comes time to sell the car, you can simply leave the BNC bulkhead connector jutting out, or use a small hole-plug to make it even less objectionable...but that's probably the least of the items that the buyer will be concerned about when it comes to your car's value.

Be sure that whatever brand of rubber ducky you use will handle the power output of your mobile radio. Some of these flexible rubber-coated antennas are only rated for a few watts and will become noticeably warm to the touch when any more power than that is applied to them. It's easy enough to test—just place your palm around the antenna's body after 30 seconds or so of FM transmit time; if it feels too warm, use lower power or a different antenna.

Color-wise

From William Thim, Jr. N1QVQ: If anyone is planning on home-brewing an outdoor antenna, and those plans include the use of PVC non-conductive pipe, here's a caveat. Although you may feel that white PVC piping may be better for aesthetic reasons, white may not be the best choice for longevity. White PVC out-of-doors will yellow, lose its plasticizer, become brittle and eventually crack upon prolonged exposure to the elements and ultraviolet rays. So for most amateur antenna work, black is probably the better choice.

Black PVC pipe is embedded with carbon and holds up outside considerably better than its white counterpart. There is also a clear PVC pipe not generally available

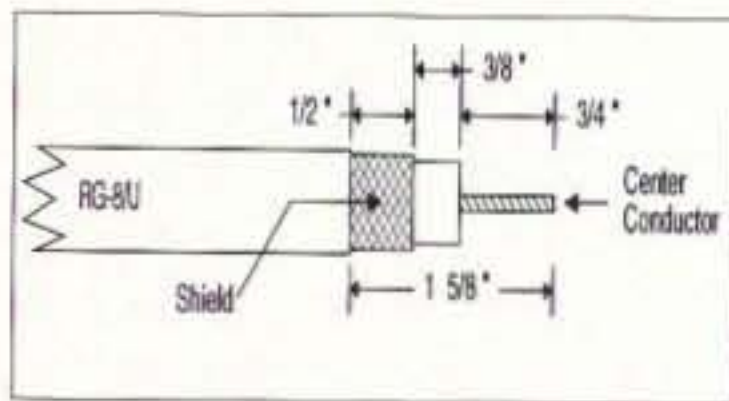

Fig. 2. Stripping dimensions for an RG-8/U cable, using the method of attachment described in WB9YBM's text.

to the public, but it's impossible to guess how the clear variety will weather until it's been in general use for a while. Perhaps other readers may be able to offer more input.

I've used a couple of sections of the white variety of PVC pipe outside on my own antennas, though I don't have any long-term experience with its durability. Bill's point is a good one, and I did paint the pieces I'm using, for the very reason he gave: ultraviolet exposure protection. Painting should help. The black PVC pipe Bill mentioned doesn't seem to be found as easily in home centers in this area of the country, so my use of painted white was pretty much forced upon me. Lacquer spray and oil-based paints seem to hold a bit better to the non-porous PVC surface. Latex appears to be the worst for good adhesion properties on this material, although it does "give" more with any pipe flexing.

Neatness counts

From Klaus Wolter N8NXF: Teflon™-insulated wire is great for repairing damaged foil traces on the bottoms of printed circuit boards, as well as for point-to-point bus wiring, due to its non-melting characteristics, even when subjected to direct contact with a hot soldering iron. Unfortunately, it's not at all easy to strip, especially in cramped quarters! As a result, I've been making my own Teflon bus wires using #24 tinned solid copper wire and hollow Teflon tubing.

I cut off a piece of bus wire a little longer than I think I'll be needing, then stretch it to get it nice and straight by pulling it through my fingers a couple of times. After straightening it, I slip on a length of Teflon tubing—also a bit longer than I

think I'll need—and solder one end of the wire to the first connection point. Now, laying out the wire/tubing combination along the path I want the bus wire to take, I slip the tubing right up to the soldered connection point and grip it firmly with diagonal cutters at the other end, where it will end. I then slide the tubing back out past the end of the wire a bit and clip it off. When it's pushed back on again, it will be a perfect fit and the free wire end can now be cut and soldered in place. No tugging, no stripping woes, and it's immune to any molten solder drops and hot irons.

Here's another quick tip you might try if you don't have any lacing cord or cable ties handy: Waxed dental floss makes a tough, space-saving lacing twine substitute to hold groupings of wires together in today's compact radios. You do have dental floss, don't you?

Clamp down on PL-259s

From Klaus Spies WB9YBM: Adapters are readily available for attaching RG-58 and RG-59 diameters of coaxial cabling to a PL-259 connector, but there is nothing similar for attaching the thicker RG-8 diameter cables to that fitting.

Most references suggest that you solder the shield of the RG-8/U coax to the body of the PL-259 (through those little holes on the connector's body, just past the outer shell mating threads), but that requires a great deal of heat and carries with it the possibility of damaging the insulation because of that excessive heating. Well, here's a way to attach RG-8 diameter cables to a PL-259 securely without having to apply any heat at all to the coax's shield conductor, and it makes a reliable,

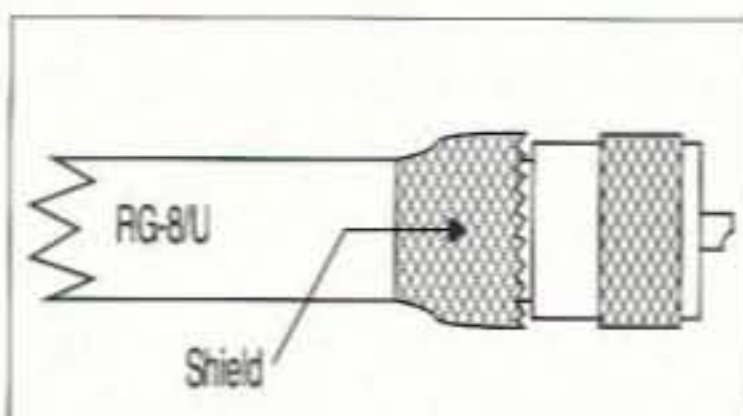

Fig. 3. The shield of the RG-8/U cable is shown fanned in place over the connector's rear sleeve area. See text for complete details.

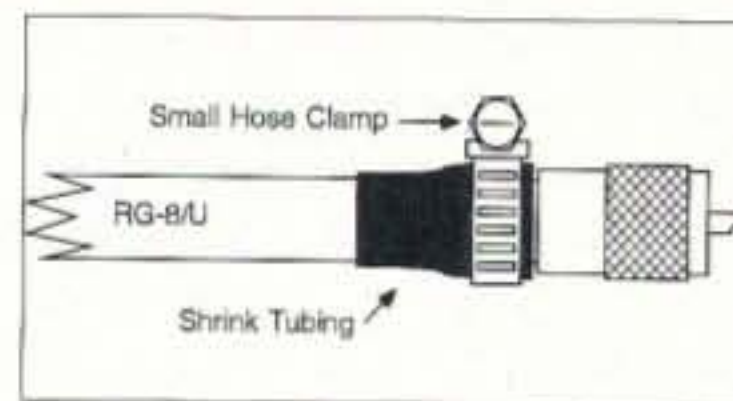

Fig. 4. WB9YBM's completed termination, shown with the stainless steel hose clamp in place over the connector's rear sleeve area.

weather resistant connection in the process.

Fig. 2 shows the stripping dimensions to prepare the RG-8 cable for attachment. Prior to stripping the cable, slip a piece of 5/8" inside diameter heat-shrink tubing and a small stainless steel hose clamp onto the cable's end. Tin the center conductor, screw the outer shell and body of the connector together, slip it onto the cable, then solder the inner conductor securely. Next, fan the shield forward over the rear sleeve area of the body, as shown in **Fig. 3**. Now slip the shrink tubing forward over the fanned-out shield wires, and shrink it down nice and tightly using a hot air gun. The process is completed by sliding the stainless steel hose clamp up and over the tubing and the rear sleeve area of the connector and tightening it down securely, as depicted in **Fig. 4**. I've used a Tridon™ 300-SS clamp successfully, which is about 5/8" inside diameter when fully loosened (but not quite parted). These and other brands of clamps are readily available at automotive supply or general hardware stores. Bring a PL-259 connector along with you if you're not sure of the exact size needed.

That's it; you're done. You now have a mechanically tight, electrically sound PL-259 on a length of RG-8/U or similar diameter cable. For use outdoors, you must still waterproof the entire fitting using layered electrical tape, self-bonding tape, coax cable sealant putty, or whatever method of total sealing you prefer. Water should never be allowed to enter into the coax cable's shielding; this method of attachment helps to assure that this won't happen because of the shrink tubing addition.

Should you ever want to salvage the connector in the future, the fact that the shield and surrounding insulation isn't "melted" into the inside of the PL-259 body will make reuse a snap. As far as the soundness of the shield's contact with the connector's body is concerned, I've not had one of these fail me—inside or outside—in a number of years of use. After all, the shield isn't soldered to the mating SO-239 connector either, but, obviously, mechanical tightness is important for long-term trouble-free service.

Dirt cheap test gear

From Michael Fratus: A working, inexpensive, portable AM/FM broadcast band radio can often be used as a substitute for more costly test gear when building, testing, or repairing ham equipment. Used with its internal 9 volt battery, the portable BC band radio can prove to be the safest and most versatile choice at times.

The AM band oscillator, for example, can be utilized as a signal source for a 1 MHz to 2 MHz CW signal when troubleshooting or signal injecting. This signal can be tapped from the AM tuning capacitor, via a 100 pF disc capacitor, and brought out for injection into the ham receiver under test. The AM oscillator can be modified to generate a slightly different range by adjusting or removing the coil's tuning slug, or by varying the number of turns on the coil itself through experimentation.

The 455 kHz AM band IF circuit can be coupled, via a 100 pF disc cap, to the ham receiver under test for checking either the 455 kHz conversion circuitry (by feeding the ham receiver's signal into the AM portable's known-to-be-good IF chain) or for injection into the ham receiver (by feeding the AM IF signal into the ham receiver's IF chain).

The FM portion of the portable receiver can offer the same options—checking the 10.7 MHz conversion stage or for feeding a 10.7 MHz known IF signal back into the ham receiver via a 10 pF disc cap. The FM oscillator can also be used as a signal source, from 98 MHz to 118 MHz, coupled via a 10 pF or so disc cap,

and the basic oscillator frequency range can be easily changed by spreading or compressing turns on the oscillator coil itself or by winding a completely new coil.

The audio section of the portable can be tapped, via a .1 μ F or higher non-polarized coupling cap, to the center lug on the volume control. Again, audio can either be fed into the portable or injected from the portable into the ham band receiver. Higher level audio, of course, is available at the above-ground speaker terminal.

I usually start by finding all of these points on the portable's circuit board, attach the appropriate capacitor, then bring the cap's lead out via a small hole drilled in the plastic case. A loop on the outside end of the capacitor's lead makes a nice point for gripping with an alligator clip. Don't forget to bring out an insulated wire from the circuit board's ground and to mark all of the "tap" points for easy identification later on.

Excessive voltages can sometimes destroy one of these small portable radios, but even if you do damage it at some point, you can replace it for a couple of dollars at the next hamfest!

Switch to manual(s)

From Peter Albright AA2AD: Servicing, at almost any level, is made much easier by having the published service data for the specific piece of gear in question at your fingertips. While many problems can be located and rectified without the service literature, just having the schematic diagram can provide a quantum leap in servicing efficiency. Perhaps because of ham radio's more technical nature, ham equipment manufacturers have traditionally been more likely to include at least some service information (albeit, perhaps just a schematic diagram) along with their operating manual, but some are no longer doing even that.

Full-blown service manuals are available from the manufacturer for most ham transceivers, and they are a good investment if you intend to do any repair work yourself. The service manual often contains an informative "how-it-works" section, in addition to the

schematics, PC board layouts, parts listings and setup, and adjustment procedures. Even if you never use the service manual yourself, you can often recoup its investment when you later sell the rig! Many "ham friend" service techs won't go very deeply into your radio without the aid of a service manual (equipment today is just too complicated to risk it) so servicing information will often be required by independent technicians. It's a good idea to procure a service manual for your new transceiver as soon as you can, since as time goes on they often become harder to find.

One source for older service manuals (if the manufacturer tells you that he no longer stocks it) may be Howard W. Sams Company in Indianapolis (Tel: 215-725-6722). Though often associated more with consumer electronic servicing information, Sams does have a photocopy service information index that lists many ham radio transceivers and accessories, so they're worth checking with before you give up completely.

Some ham equipment dealers also stock service manuals and a few quick calls to them can be rewarding. The ham VHF/UHF packet network is also a possibility. If you don't have packet access yourself, a ham friend who does can put out a "WANT @ ALLUSA" bulletin for the manual you're looking for (we see them every day). Don't forget to mention that you're more than willing to pay all associated

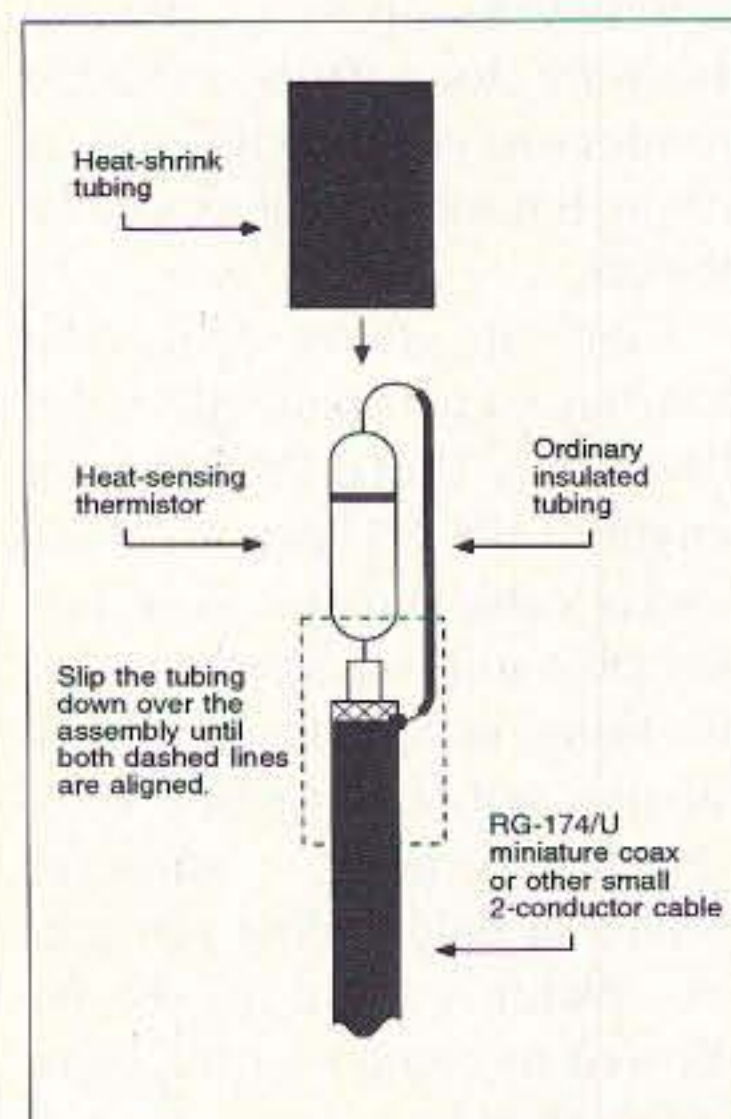

Fig. 5. AA5YA's heat-sensing thermistor's wiring details. See text for complete description.

expenses for obtaining the copy that you need, and provide your home phone number for the quickest response. Some voice repeater nets have a "Swap & Shop" segment in their net-night gatherings, and putting out a "wanted" request there might be worthwhile at times. 73 also has a want-to-find public service column called "Ham Help" that can be effective after you've exhausted the other avenues.

Servicing information is worth its weight in gold when you need it, so play it smart and don't put it off until the last minute, when your station is down because of an inoperative key piece of gear.

Free mountings

From Joel Masur AA5YA: If you need to mount a thermistor on a chassis or heat sink to signal a cooling fan or other circuit when to turn on, try this inexpensive method.

If you know someone who works with the power company, or you can make friends with one of their linemen, the blown "in-line disconnect switch" fuses that they use can be disassembled and the threaded end-cap recycled as a rugged mounting for an in-line, pigtail thermistor mount. These "in-line disconnect switches" have a door that's spring-loaded and drops down whenever the pole service fuse blows (it sounds like an M-80 firecracker going off!). The parts I'll describe are the throw-away end caps. They're already threaded for 1/4-28 MS, so only a 1/4" hole needs to be drilled into the body of the cap. Then, using a glass-encapsulated thermistor (about the size of a 1/8 watt resistor) such as the Digi-Key #KC009G 10k ohm NTC unit, bend one of the leads so that both are parallel to the thermistor's body. Now, carefully solder the correct length of RG-174/U miniature coax cable to the staggered leads (see Fig. 5). Insert the wired thermistor into the end-cap body (leaving it about 1/4" from the top of the fitting) and cement it in place—at the entrance only—using clear silicone adhesive. The thermistor itself should be in contact with the free air inside the fitting, or white

silicone heat-sink grease can be used to transfer the heat picked up by the fitting's body over to the thermistor. You'll now have a neat, protected, metal-encased thermistor package that can be bulkhead-mounted wherever you need to sense a thermal rise.

Another item that can be used for the same purpose can often be found at hamfests or swap meets. Look for an older Ohmite No. Q120 Model E wire-wound porcelain rheostat. When you disassemble it you'll end up with a threaded brass barrel with a shoulder on it, and a nice brass nut to match. The wired thermistor (as above) can be cemented inside, again providing a nice-looking, protective mounting arrangement. By the way, if you're able to acquire the blown power line cartridge fuses mentioned first, the tails on these fuses are made of heavy-gauge, stranded, tinned copper wire and are great for short high-current bonding straps or for connecting stud-mounted power rectifier diodes together. A two-for-one bonus!

The thermistor that Joel refers to in his tip can be obtained from Digi-Key, 701 Brooks Avenue South, Thief River Falls, MN 56701-0677 (Tel: 1-800-344-4539).

Cool it!

From Ken Guge K9KPM: If left idling too long, the copper-clad tip on a small soldering iron can become too hot and begin to build up oxidation. It's a problem that's easily overcome, however, by simply installing an on/off switch in the AC line cord to the iron. Use the larger type of in-line switch (the type that uses screw connection terminals on the inside) and cut just one of the iron's AC wires at the point where the switch will be easy to access. Now connect one end of each half of the cut wire to each of the switch's terminals. Don't stop there, though; also place a small silicon diode across the switch terminals. Something like a 1N4005 will do nicely (the diode's polarity isn't important in this application). Now the diode is in parallel with the switch, so the iron isn't off completely when the switch is open; that's because

the diode keeps it running at about half voltage (only the positive or negative halves of the AC sine wave get through to the iron, it doesn't matter which). When you want the iron to "idle down," simply throw the switch to "off" and it will drop to half power. When you begin soldering again, throw the switch to "on" (shorting out the diode) and the iron will come back up to full soldering temperature quickly. Most importantly, it keeps the tip from oxidizing as badly and prolongs its life significantly.

If you'd like to go one step further, mount a wall dimmer into a 4" x 4" electrical box, along with a duplex outlet. Then connect an AC line cord of convenient length to the dimmer (following the dimmer's instructions), but instead of the dimmer's output going to a ceiling lamp, it will go to the duplex outlet instead. Now when you plug your soldering iron into that duplex outlet you'll have continuously variable heat control for any size job,

plus half-level for idling via the in-line switch from above. A small "night light" plugged into the remaining outlet on the duplex pair will visually show you roughly where the dimmer—and your iron—are set.

Ken's idea concludes another "Ham To Ham" column, our 10th. Thanks to all who've taken the time to write and offer their favorite suggestions so that the rest of us can benefit from their knowledge and experience. I hope you feel as I do, that this is in the very best of traditions of our hobby—one ham helping another...Ham To Ham. Let's see your ideas in print here.

This Month's Contributors

William Thim, Jr. N1QVQ
50 Miller Road
Broad Brook CT 06016-9676

Klaus Wolter N8NXF
910 Pinetree Drive
Ann Arbor MI 48103

Klaus Spies WB9YBM
8502 N. Oketo Avenue
Niles IL 60714-2006

Michael Fratus
Dept. of Criminal Justice
Inmate #650394
Jester - 3
Richmond TX 77469

Peter Albright AA2AD
28 E. Summit Street
Lakewood NY 14750

Joel F. Masur AA5YA
1465 Chris Avenue
DeLand FL 32724-6187

Ken Guge K9KPM
1107 E. Woodrow Avenue
Lombard IL 60148

Note: The ideas and suggestions contributed to this column by its readers have not necessarily been tested by the column's moderator nor by the staff of 73, and thus no guarantee of

operational success is implied. Always use your own best judgment before modifying any electronic item from the original equipment manufacturer's specifications. No responsibility is implied by the moderator or 73 for any equipment damage or malfunction resulting from information supplied in this column.

Please send all correspondence relating to this column to 73's "Ham To Ham" column, c/o Dave Miller NZ9E, 7462 Lawler Avenue, Niles, IL 60714-3108, USA. All contributions used in this column will be reimbursed by a contributor's fee of \$10, which includes its exclusive use by 73. We will attempt to respond to all legitimate contributors' ideas in a timely manner, but be sure to send all specific questions on any particular tip to the originator of the idea, not to this column's moderator nor to 73. 73

Hear The Difference Dual DSPs Make...

The NIR-12 is the most advanced DSP noise reduction unit available. Unparalleled performance, super-selective FIR filters, fully adjustable center frequency and bandwidth, **both Dynamic Peaking and Spectral Subtraction Noise Reduction**, spectral multi-tone NOTCH filter. All NIR-12 modes are usable simultaneously. Use on all operating modes including AMTOR and PACTOR. Installed between the receiver audio and external speaker. **\$349.95**

ANC-4 Antenna Noise Canceller (not shown)

Eliminates power line noise before it enters the receiver to let you hear signals you did not know were there. Reduces any locally-generated noise typically 50dB. Useable between 100kHz and 80MHz. Noisewhip and wire antenna supplied with each unit. Auto xmit switchover up to 200W. Installed between the antenna and receiver. **\$175.00**

Contact JPS for a dealer near you.



NIR-12 Dual DSP Noise Reduction Unit

JPS Communications Inc.

P.O. Box 97757 • Raleigh NC 27624-7757 • USA
Tech Line: 919.790.1048 • Fax: 919.790.1456 • Email: jps@nando.net

ORDER LINE: 800.533.3819

<http://emporium.turnpike.net/J/JPS/jps.html>

Ask for a catalog of JPS' complete line of noise reduction products..

ASK KABOOM

Your Tech Answer Man

Michael J. Geier KB1UM
c/o 73 Magazine
70 Route 202 North
Peterborough NH 03458

Fixing oscilloscopes

In a previous series of articles, we explored the use of the mighty oscilloscope. Fact is, you just can't do much serious electronics work without one. Once you get used to having a scope on your bench, you'll find yourself depending on it for so many tasks that you'll wonder how you ever got along without one. So, it can be quite a problem when "old faithful" breaks down. After all, how are you going to fix your scope without a scope??

If you can, borrow one! If you can't do that, you will have to try and repair the thing with lesser instruments, like your DVM and frequency counter. Either way, fixing a scope can be a challenge. Like all repair jobs, though, sometimes it's a bear and sometimes it's a piece of cake. (Hmmm, wonder if bears like cake?)

Been there, done that?

In some ways, an oscilloscope is like a TV set, particularly because both have CRTs. That means they both use very high voltages to create and manipulate the beam that hits the screen and forms the image, and they both have circuits relating to horizontal and vertical movement of the beam.

That's where the similarities end, though. Unlike computer monitors, which are very like TV sets, scopes use some fundamentally different techniques to operate the CRT, causing them to have very different circuits and overall structure. Let's take a look, but, before we do, here comes the safety lecture again:

Like TV sets, scopes use thousands of volts to operate their RTs. Unlike TVs, though, most scopes connect the highest voltage (for the CRT anode) right at the back of the tube, on one of the regular socket pins. Compared to the nice,

insulated anode cap on the side of a TV CRT, the high voltage in a scope can be much more exposed. *So be careful!* All the TV servicing rules apply, such as using only one hand when exploring or adjusting a powered unit, and discharging the power supply caps and CRT anode before messing with them.

Vive la difference!

So what makes a scope so different from a TV set? Primarily, the dissimilarities result from the scope's requirement of widely variable scan rates. A TV always scans its CRT at the same rate, which is about 15.735 kHz horizontal and 60 Hz vertical. A scope, though, can scan its tube at any rate you choose, allowing the viewing of all kinds of different signals with all manner of time periods. Without the variable scan rate, scopes would be fairly useless.

Gimme a ring

In a TV set, the beam is swept across the face of the tube by a magnetic field, which is generated by a set of coils placed around the neck of the tube. Current through the coils creates the field, sweeping the beam. Unfortunately, it's difficult to use magnetic deflection of the beam unless the scan rate is constant, because those coils have plenty of inductance (which is what makes them work, of course) and must be used in a fairly resonant condition. Essentially, it's the same situation as with SWR on your antenna: If you try and pump nonresonant energy into the deflection coil, some of it will come back at you and cause distortion of the original current waveform, or even heating and destruction of the coils, the driving amplifier, or both. That's one reason some computer monitors can be damaged if you try to run them at the wrong scan rate, and also why multiscan monitors cost more; they need special circuits to

handle the different rates. Even with the multiscan units, the range of scan rates is fairly limited, varying by perhaps a few hundred Hz for the vertical, and a few tens of kHz for the horizontal.

On a scope, you might want to change the scan rate from 0.2 seconds to 0.2 *microseconds* as you examine a waveform. So, you can see why magnetic deflection just isn't practical; you're dealing with scan rate ratios of over a million to one! The way around it is to use another form of deflection: electrostatic. That's just a fancy way of saying that the presence of one electrical field can alter another. Just as the anode voltage on a CRT's face will attract the cathode's electrons to it (which is the same effect as the plate

monitoring, where one signal moves the beam up and down and another one moves it left and right.)

The other elements of a scope are somewhat different, too. On a TV, the beam is scanned in a raster pattern, and the only modulation of that beam is of its intensity. On a scope, intensity is usually constant, and the modulation is of the *direction* of the beam! That means the scanning circuitry has to have amplifiers as well as oscillators. A typical scope has two amplifiers for the vertical direction, allowing the viewing of two simultaneous waveforms. The horizontal section does have an oscillator, but it often also has an amplifier, letting you use an external signal to drive the beam

"A scope can scan its tube at any rate you choose, allowing the viewing of all kinds of different signals with all manner of time periods"

voltage on any tube, for that matter) so will another strong, positive voltage pull those electrons toward it when it's placed on the *side* of the tube. So, a scope tube has four electrode plates in its neck, one for each of the required directions of pull.

High voltage

In a TV set, the high voltage is nearly always generated by the horizontal circuitry, using a "flyback" transformer. Like the deflection yoke (set of coils), the flyback is resonant at the horizontal scan rate, and can't be used over a wide frequency range. Trying to do so can overheat the flyback and, eventually, destroy it. Even more than the yoke's, the flyback's resonance requirement limits the range of available scan rates.

Thus, in a scope, the scanning and high voltage circuits must be kept separate, so while a TV can't make anything at all on the screen unless the horizontal circuits are running, the same is not true on a scope. (In fact, there are occasions when you may want to turn the horizontal scan of your scope off, such as for X-Y signal

horizontally, for display of X-Y signal patterns.

Just as a TV has sync circuitry to keep the position of the beam lined up with the original picture, a scope has a trigger circuit to synchronize the horizontal scan with some repetitive point on the incoming signal. This is a crucial function; without it you can't see anything more than a blur on the screen.

Finally, a scope depends on a power supply, just as does any other circuit. Most scope power supplies provide several different voltages, the loss of any of which will severely disturb the scope's operation.

Where to start?

Well, what's wrong with your scope? If it died altogether, the power supply is the first place to look, of course. If the power light doesn't come on, check the fuse, and then start troubleshooting the low-voltage supply, using standard repair techniques. Many scopes use simple, linear supplies, although some use switchers. If yours is a switcher, be awfully careful when servicing it. If you don't know how to

HOMING IN

Joe Moell P.E. K0OV
PO Box 2508
Fullerton, CA 92633

Testing the Vector-Finder

As I pulled into the starting area of one of my first 2 meter hidden transmitter hunt at a hamfest in San Diego about 20 years ago, I thought I couldn't be better prepared. I had my four-element radio direction finding (RDF) quad on a mast going out of the passenger-side window, a big external S-meter on the dash, and an RF attenuator to knock the signal down into S-meter range as I closed in. The back seat was full of maps and on-foot "sniffing" gear. I was confident that I would soon bag the hidden T and have a prize in my hands.

Then the signal came on the air. What's this? It was on for a half second, then off for a half second, like the tick of a clock. And every time it came on, my meter reading was different! Sure enough, the hider had programmed his rig to change output power each time it made a half-second transmission. My big S-meter bounced around wildly as I turned the quad. Spinning it rapidly didn't help me get a bearing, because the transmissions were too short. Turning it really slowly wasn't any better, due to flutter on the signal as I began to move.

I eventually found the hidden transmitter, which was near a rutty gravel road in the mountains. All along the way, I resolved that in future I would carry some RDF equipment that is immune to changes in the amplitude of the signal.

TDOA points the way

The time-difference-of-arrival (TDOA) technique fills the need for a non-amplitude-based RDF system by picking up the target signal on two or more antennas. The relative times at which the signal wavefront strikes each antenna give clues about its incoming direction. Some sophisticated military RDF systems use this principle at fixed-site installations

Radio Direction Finding

to get highly accurate bearings on shortwave signals. Both the incoming azimuth and elevation angles can be determined, so the distance to skip-propagated stations can be calculated. But resolving ambiguities, determining elevation, and achieving high accuracy in a non-rotating TDOA system requires at least three antennas and a very large, fast computer for signal processing. We're talking megabucks, so that's not practical for ham radio, at least not yet.

"The VF-142Q is as close as you can get to plug-and-play RDF."

Fortunately, there is a much easier way to use the TDOA principle. **Fig. 1** shows a simple array that will give sharp bearings with your VHF-FM receiver or handie-talkie. Two vertical dipoles are at the ends of a horizontal bar, supported by a short mast. It is called a "narrow aperture TDOA" because the dipoles must be a half wavelength or less apart for proper operation. A diode network switches the receiver RF input electronically from one dipole to the other very rapidly; say, 500 times per second.

The signal from Transmitter #1 arrives at Antenna A before it arrives at Antenna B. Conversely, the signal from Transmitter #3 arrives at Antenna B before Antenna A. Because the wavefronts from these two transmitters don't arrive at both antennas simultaneously, there is an abrupt phase change of the receiver input signal during the switching when receiving either one. This phase jump is detected by the receiver's FM discriminator and sent to the speaker. It sounds like an audio tone superimposed on the received audio. The tone frequency is constant at the switching rate, but its amplitude increases with increasing phase difference between the signals arriving at the two antennas.

The signal from Transmitter #2 arrives at both antennas

simultaneously. Thus, there is no phase jump during switching and the tone is minimized or disappears entirely. When you have rotated the mast of a TDOA antenna set to null the tone on an incoming signal, you know that it is along the line of bearing of Transmitter #2.

No receiver S-meter is needed to get bearings with a TDOA set. Your ear easily detects the tone null. The bearing indication is very sharp, compared to the broad forward lobe of a yagi or quad. There are no strong-signal overload problems because the process uses phase, not amplitude.

The first TDOA RDF project for hams was by David Geiser WA2ANU in *QST*, July 1981. His

Double Ducky Direction Finder had two vertical "rubber duckies" mounted about a foot apart on a grounded screen. This simple no-indicator TDOA implementation is still popular as a "starter" RDF system for fledgling T-hunters. You may have seen kits for similar versions, with duckies or "batwing" antennas, selling for less than \$30 at a hamfest or swap meet in your area.

The packaging and antenna systems in most of these rudimentary sets leave a lot to be desired. Their biggest flaw is that they have a "figure-8" directional pattern with no built-in method for resolving the ambiguity. That's right, they give you two possible directions to the hidden



Photo A. Typical of all Q-suffix Vector-Finder RDF sets, the VF-142Q has dual dipole antennas and left-right LED indicators. The on-off push-button is mounted on the handle, like a trigger.

work on switchers, find somebody who does, because they can be dangerous. In any event, simple power supply problems are likely to be caused by failed diodes, transistors and voltage regulators, or perhaps a shorted electrolytic cap.

If the outputs from the low voltage power supply are working, take a look at the back of the CRT. Its filament should glow, although the glow can be pretty dim. If you see nothing at all, follow the leads back to the board and see where the voltage disappears. It's possible for the filament to be driven from a part of the high-voltage supply, and the drive may be pulsed, so you might not be able to read it on a voltmeter. That's where another scope really comes in handy. By the way, although the filament could be open, I've never run into that problem.

Various other voltages are required on the tube in order to make a trace, and many are generated from "boost" voltages, which are intermediate voltages created by the high-voltage supply, just like in a TV set. With a TV, you can usually tell if there's high voltage getting to the tube by touching the face of the screen and feeling the crackle—not so with a scope! The voltages are lower (although they're still in the thousands), and I've never been able to feel a crackle on a scope. So, if there's no trace, it may not be obvious whether there's high voltage or not. Assume there is, as far as safety is concerned; there may still be enough voltage to kill you. To be sure, you'll have to measure it, and that requires a special probe. High-voltage failure is nowhere near as common on a scope as it is with TV sets, due to the lower voltages required, I guess. I did have one old scope that died of high-voltage failure, but it was pretty obvious, as the trace went out of focus and bloomed, a sure indicator of dying high voltage.

Well, we've barely scratched the surface of scope repair. Next time, we'll dig into it quite a bit more. Until then, 73 de KB1UM. 73

Got any ham related photos suitable for a 73 cover-pix???
Call Frances 800-274-7373.



Photo B. The 2-1/2" x 6" x 6-1/4" Vector-Finder control box includes a tone pitch control, speaker, and oil-filled magnetic compass.

transmitter, not one. When you turn the antenna and get a sharp null that indicates the signal source lies directly in front of you, it could just as easily be directly behind you! No serious T-hunter wants that.

WA2ANU realized that polarity of the phase jumps at the receiver discriminator output can be used to resolve the ambiguity. He explained the principle in his original article and in a follow-up article in the May 1982 issue of *QST*. Included was an improved Double Ducky design featuring a left-right meter indicator. With it, the TDOA technique was truly useful. Since then, several home-brew TDOA projects have been published and commercial versions have come to market. Some give left-right indications on a zero-center panel meter, while others use a pair of light-emitting diodes (LEDs).

The VF-142Q

This month, "Homing In" looks at the Vector-Finder VF-142Q, manufactured by Radio Engineers. Bob Decesari WA9GDZ formed this company in 1979 as a part-time business, and went full-time three years later. His company brought out its first TDOA RDF set for boaters in the 1980s, but I paid little attention to it because it had bidirectional ambiguity. Now Radio Engineers has added the Q-suffix series of Vector-Finders with left-right indicators to its product lineup.

The VF-142Q (Photo A) is as close as you can get to plug-and-

play RDF. Just unfold the antenna arms, extend the whips, attach a 9-volt battery, then connect the cable to your receiver's antenna connector (BNC type supplied) and extension speaker jack. The unit comes completely assembled and tested. It is not available in kit form.

WA9GDZ put careful thought into the mechanical design of the Vector-Finder series. Antenna supports are hinged to swing out for use and to fold against the control box for storage and transport. When fully extended, the VF-142Q dipoles are 38-1/2" long, just right for 2 meters. The 17" spacing between dipoles permits operation up to 300 MHz. An oil-filled magnetic compass atop the control box makes it easy to read bearings while on foot in the field. A speaker with volume control is included, so you can hear the receiver with the audio pick-off plug inserted (Photo B).

A good report card

The unit I tested had good electrical balance in the antenna system and produced very sharp tone nulls on both the 2 and 1-1/4 meter bands. The left-right indicators tended to flicker on and off as turned in a full circle, which led me at first to think that they were not working properly. But with a little practice, I came to realize that the LEDs are quite accurate and steady within ± 20 degrees of the line of bearing, where it matters the most.

I discovered that the best technique for taking a bearing with the VF-142Q is to turn slowly in a circle while listening carefully for the two nulls in the DF tone, ignoring the LED indicators for the moment. If your surroundings are noisy, it may help to plug an earphone into the front panel jack to better detect the tone nulls. When you have found the nulls, face one, watch the LEDs, and rock the unit slightly to the left and right of the bearing line. If you are facing the signal source, the "go right" LED will come on as you rotate to the left. Conversely, the "go left" indicator will light as you rotate to the right. If the opposite happens, you are facing away from the incoming signal. By walking, turning, and

following the null and lights, you will approach the hidden transmitter more or less directly.

An important test of a dual-antenna TDOA RDF set is how it performs when there is high audio deviation on the signal, as often happens when hidden T's have "foxbox" tone generators. A few TDOA circuits I have evaluated in the past got good bearings on dead carriers, but the indicators were unusable when there was voice, tones, or noise on the signal. The VF-142Q processor did a good job of rejecting modulation. In the ± 20 degree range around the null, voice and tones had little or no effect on the left-right indicators. If a particular modulating tone caused blinking, it could be minimized by changing the antenna switching rate with the front panel pitch control.

Another problem with some TDOA sets is unreliable operation as battery voltage sags. Duracell specifies that a standard 9-volt alkaline battery reaches end of life at 4.8 volts. The VF-142Q produced reliable bearings all the way down to that voltage, though the LEDs became very dim. Still, this was much better than another brand I have tested, which stopped working at 7.8 volts.

I had only a few minor complaints about the VF-142Q. Light from the miniature green indicators is nearly washed out by sunlight. A hood or larger LEDs might be an improvement. The antenna switching action produces some RF hash, which closes the receiver squelch on weak signals. To counter this, I opened the squelch control completely when taking bearings on a distant T. Since the dipoles are electrically disconnected from the receiver when the trigger is not being depressed, weak signals must be monitored with the DF buzz in the background. It would be nice to have a "zero frequency" position on the pitch control so the dipoles could be used to listen to weak signals, or for transmitting.

There is no bracing to hold the four pivoting collapsible whips in place, so the dipoles can easily get knocked out of position when you are crashing through the brush on foot. The antenna arms are not

detachable from the control box, so the unit cannot be easily mounted on a vehicle for mobile T-hunting. Last but not least, the bolt holding the antenna supports protrudes 3/4" from the back case, making it awkward to lay the unit on its back when you pause during the hunt.

Keep in mind that there are certain RDF situations where all TDOA models are at a disadvantage. Horizontally-polarized signals are much more difficult to track than vertical, because signal reflections are enhanced relative to the direct signal when received by the vertical dipoles. Very weak signals may be masked by noise from antenna switching. A properly polarized beam or quad works better for RDF in these special situations.

Tracking in the presence of many signal reflections (inside a building, for instance) is difficult with a TDOA. The multiple paths may make it impossible to get a good null, or the null may be off the correct line of bearing. The best way to combat this problem is to keep moving in the general direction of the signal source and take frequent bearings as you walk along.

Since amplitude of the incoming signal is ignored when your TDOA set takes bearings, you must remember to pay attention to signal level as you hunt. I have seen T-hunters following a TDOA's line-of-bearing null walk right over a buried hidden transmitter. They didn't realize that the signal had gotten super-strong and then diminished. Consider carrying along a field strength meter in addition to your TDOA set so you can tell when you are very close to the hidden T. If you can't do that, check for "You are here!" signal strength by disconnecting the receiver antenna or listening on the third harmonic frequency with your dual-bander. Take bearings continuously and verify your left-right indications to be sure you have not gone too far.

Where to get one

The VF-142Q RDF is available for \$239.95, plus tax and shipping, directly from Radio Engineers, 7969 Engineer Road, Suite

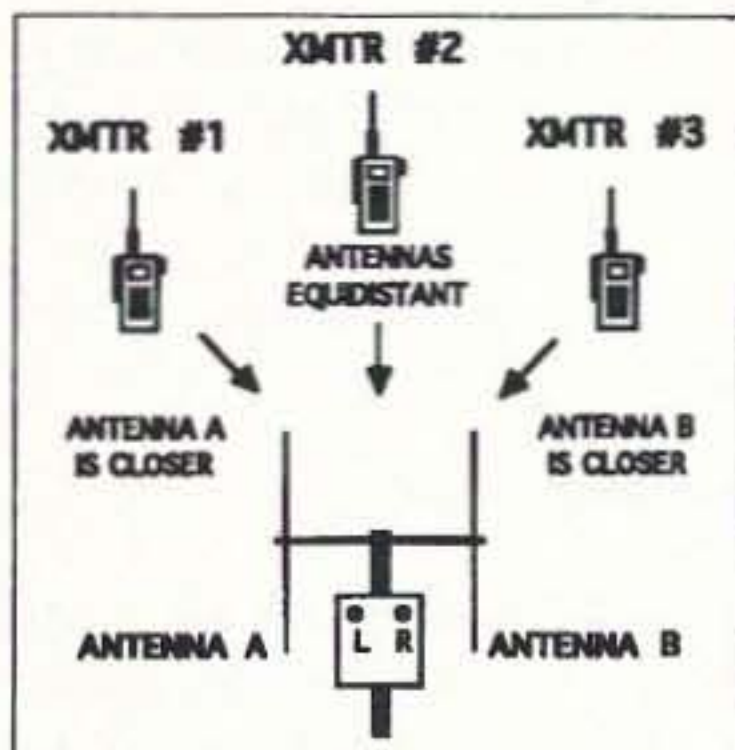

Fig. 1. TDOA RDF sets such as the VF-142Q get bearings by determining which of its two vertical antennas is closest to the transmitter. Differences in arrival time produce differences in the phase of the signals from each antenna. Accordingly, some hams prefer to call these units "phase front detectors."

102, San Diego, CA 92111, phone (619) 565-1319. In addition, Radio Engineers makes the VF-142QM, which has a slightly different configuration of the antenna support arms. This allows them to be positioned closer together, so the unit can be operated up to 500 MHz when used with a suitable receiver. It sells for \$289.95. Be sure to order a model with the Q suffix so your unit will have left-right indicators.

The TDOA method of RDF is favored by some search and rescue volunteers for tracking aircraft Emergency Locator Transmitters (ELTs). These beacons are AM signals in the AM-only aircraft band, but the TDOA RDF method requires an FM

receiver. For tracking ELTs, Radio Engineers makes two Vector-Finder models called "ELT Stalkers." They include an up-converter to shift incoming 121.5 MHz signals to 146.52 MHz, where they can be received and tracked with a 2 meter FM receiver. Converters to 2 meters for 243 and 406 MHz ELT frequencies are not provided. The VF-121Q ELT Stalker (up to 300 MHz) sells for \$379.95, and the VF-121QM (up to 500 MHz) sells for \$409.95.

A TDOA RDF sniffer is an important addition to your T-hunting bag of tricks. When signals are strong, vertical, and in the clear, it will give sharper bearings than a beam. Bearings will be

easy to take, even if the fox transmitter is changing power. Its inherently broadband antenna system will give you RDF capability over a wide frequency range.

Do you know of a new or novel RDF product? Tell me about it, so it can be considered for a "Homing In" review. Write to the address atop this article or send e-mail to me at Homingin@aol.com or 75236.2165@compuserve.com. **75**

Radio Bookshop

Phone 800-274-7373 or 603-924-0058, FAX 603-924-8613, or see order form on page 88 for ordering information.

Wayne's Book!

WGI We The People Declare War On Our Lousy Government by Wayne Green W2NSD/1 360p soft cover. How to end welfare; how to reduce the deficit; how to cut medical costs and improve health care. \$13

WANT TO LEARN CODE?

Morse Tutor Gold from G.G.T.E. is the answer for beginners and experts alike.

*Get the software the ARRL sells and uses to create practice and test tapes; and Morse Tutor Gold is approved for VE exams at all levels.

*Since 1987, GGTE has guided nearly 20,000 hams and prospective hams around the world through proven structured lessons and a variety of character, word and conversation drills. Straight forward menus make the process simple and fun.

*This program features easy and speedy self installation; random character drills with the characters you select; and you can create your own drills or import text files. You can type what you hear or copy by hand and see the results one line at a time. Pick the Farnsworth or the standard method; select the tone frequency most comfortable for you or select your code speed in tenths of a word per minute. For all DOS computers. You are always in command.

Certified by



Morse Tutor Gold uses your internal speaker or sound board. And, if you use a sound board Morse Tutor Gold supports volume control.

Sound Blaster and the Sound Blaster Compatibility Logo are trademarks of Creative Technology Ltd.

Available thru dealers, the ARRL, or send \$29.95 + \$4 S&H (CA residents add \$2.32 tax) to: GGTE, P.O. Box 3405, Dept. MS, Newport Beach, CA 92659 Specify 5 1/4 or 3 1/2 inch disk.

CIRCLE 193 ON READER SERVICE CARD

Walking-Stick Beam?

Hold it in your hand—it's a walking stick made of aluminum with rubber ends. But inside are all the elements of a 4 element yagi that goes together in 2 minutes. Ready for the T-Hunt. Ready to get your signal out of a hole into the repeater. No little bits to drop and get lost. Everything fits clean and tight and tough. 2meters \$79, 70 cm \$49. Weighs only 1 lb. Add \$6 Shipping & Handling. Info \$1.

AntennasWest
Box 50062-S Provo UT 84605

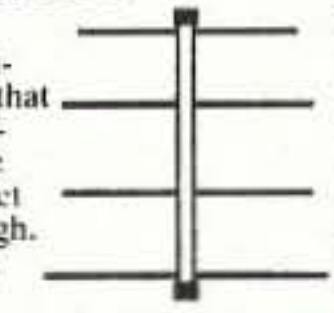

Order HotLine
801 373 8425

CIRCLE 324 ON READER SERVICE CARD

"ONLINE" U.S. & INTERNATIONAL CALL DIRECTORY

Hamcall's "Online Service" gives you access to over a million hams via your computer & modem. The latest data, updated every month! *Only* \$29.95 per year. Unlimited use—24 hours a day—you pay for the phone call. Call today 800:282-5628!

BUCKMASTER

540:894-5777 • 800282-5628 • FAX 540:894-9141
6196 Jefferson Highway - Mineral, Virginia 23117
Internet: info@buck.com

CIRCLE 7 ON READER SERVICE CARD

DIRECTION FINDERS



VECTOR-FINDER

HAND-HELD PHASE SENSE ANTENNAS FOR VHF DIRECTION FINDING. USES ANY FM RCVR. ARMS FOLD FOR STORAGE.

TYPE VF-142 144-220 MHZ \$139.95
TYPE VF-142Q LEFT-RIGHT LEDS & AUDIO, 144-220 MHZ \$239.95
TYPE VF-142QM SAME AS Q MODEL EXCEPT FREQ. 144-500 MHZ \$289.95
TYPE VF-121Q SAME AS VF-142Q PLUS 121.5 MHZ ELT FREQ \$379.95
CALL ABOUT HF DF, ADD \$4.50 S/H ATTENUATORS CA ADD TAX

RADIO ENGINEERS

7969 ENGINEER RD, #102
SAN DIEGO, CA 92111
619-565-1319 FAX 619-571-5909

CIRCLE 58 ON READER SERVICE CARD

\$40 Special To Charge You Up...

Periphex Power Packs for Longer QSO Time



replacements for	regular price
FNB-12 YAESU 600ma	\$ 54.50
BP-84S ICOM 1400ma	\$ 63.00
PB-13S KENWOOD 1200ma	\$ 49.75
EBP-24S ALINCO 1500ma	\$ 62.00

Now Only \$40 Each

- One Year Warranty
- Matched cell construction
- Case re-build service
- Long life, extended operating time

We also offer: Camcorder Batteries Accessories Cordless Phone Batteries • Custom Battery Packs • NiCad Cells • Lithium Cells
Add \$4.00 Shipping & Handling for first battery. \$1.00 for each add'l battery - U.S. only
Massachusetts residents add 5% tax

Available from your dealer...

PERIPHEX inc.

the only thing low about our charge is the cost...

Special Expires August 31, 1996 **1-800-634-8132**

300 Centre Street • Holbrook, MA 02343 • (617)767-5516 • FAX (617)767-4599

<http://home.navisoft.com/periphex>

CIRCLE 68 ON READER SERVICE CARD

Bill Brown WB8ELK
139 Angela Dr. Apt. B
Madison AL 35758
bbrown@hiwaay.net

For those of you who enjoy surfing the Internet, you'll find lots of ATV information online. A number of ATV groups and individuals have taken advantage of the capabilities of the World Wide Web to provide net surfers with a wide variety of entertaining web pages. You'll find basic

Ham Television

each group usually will have links set up to other ATV pages. The Arizona Amateurs on ATV page, the ATN group of Southern California, and the German group appear to have the most extensive list of links that I have found. Once you have found the link page, you can cruise to all of the other groups easily with just one mouse click. It's a good idea to bookmark each group's

"A couple of groups actually offer live digitized still-frame images of their ATV repeater so you can check in remotely from anywhere in the world."

information about getting started in ATV, pictures of local ATVs, circuit diagrams, construction articles, product reviews and recommendations, event schedules and announcements, as well as operating hints. A couple of groups actually offer live digitized still-frame images of their ATV repeater so you can check in remotely from anywhere in the world. WA6ZJG in Alameda, California, even has a live tower camera that updates every three minutes that you can rotate by clicking your mouse!

The real power of these Internet web sites is the linking capabilities to other pages anywhere in the world. You might be cruising through the Arizona site and with one mouse click you are instantly transported to the German ATV. I've found that as you cruise through each group's pages you'll find all kinds of interesting links to related information about television, video digitizers, R/C aircraft, kites, and balloons. Just be sure that you have a lot of time set aside before you begin browsing since, once you've started cruising these ATV sites, it'll be difficult to stop.

ATV web sites

The URL address given for the following groups should be entered into your web browser to access each site; you'll find that

page so you can return easily without having to type in the address.

Alabama

The Tennessee Valley ATV group has a web page giving a description of their repeater system on top of Monte Sano mountain in Huntsville, as well as operating news and net times. <http://fly.hiwaay.net/~bbrown/tvatv.htm>

Arizona

The Arizona Amateurs on Television home page shows club members' photos, ATV pictures from events, an ATV manufacturers' list, a club calendar and links to other sites. <http://www.hayden.edu/guests/aatv/>

California

Southern California. The Amateur Television Network (ATN) of Southern California has several pages devoted to their extensive system of linked ATV repeaters, club newsletters, and digitized photos of their members. <http://www.ladas.com/ATN/>

San Francisco Bay Area. This intriguing site operated by WA6ZJG of Alameda offers live video images taken from the W6CX ATV repeater as well as a remotely controlled (via the Internet) tower camera with up-

dates every three minutes. <http://citynight.com/atv> and <http://citynight.com/camera>

Visalia. Operated by KC6YRU, this site offers practical information for the beginning ATV operator. <http://www.valleynet.com/~jreeves/atv.html>

Florida

The LISATS group (Launch Information Service and Amateur Television System) provides information about their repeater system in Cocoa, Florida, complete with a list of touch-tone commands. <http://calvin.ksc.nasa.gov:1080/lisats.html>

Georgia

The Atlanta area ATV page has descriptions of both the N4NEQ and W4ZTL ATV repeater systems. Construction diagrams for their popular Hawg Fence and Hawg Amp circuits are available, as well as members' photos. <http://www.mindspring.com/~rwf/aatn1.html>

Germany

This site describes the PI6ANH ATV repeater system in Arnhem, The Netherlands, and is a cooperation of German and Dutch amateurs. It contains an excellent description of their repeater and has a lot of useful construction projects online. <http://www.regio.rhein-ruhr.de/hamradio/atv/>

Maryland

The BRATS page (Baltimore Radio Amateur Television Society) lists upcoming activities and events, net times and information about their W3WCQ ATV repeater. <http://www.smart.net/~brats/>

New Jersey

The Brookdale Amateur Television Repeater System page offers block diagrams of their repeater, some product reviews and modifications, and photos of their repeater system. <http://www.njin.net/~magliaco/atv.html>

Ohio

The ATCO page (Amateur Television in Central Ohio) has

online versions of their very popular newsletters, net information, and a map of active ATVs in the state. <http://psycho.psy.ohio-state.edu:80/atco/>

Pennsylvania

The Carnegie Tech Radio Club W3VC shows some intriguing ways that ATV has been used in their annual "buggy" competition. <http://www.contrib.andrew.cmu.edu/org/ar99/w3vc.html>

Tennessee

The East Tennessee ATV group has information about their repeater on top of Buffalo Mountain. Check out the "old page" for a neat special effects photo of their repeater. <http://www.geocities.com/SiliconValley/1242/>

Texas

Houston. The Houston Area Television Society (HATS) has a listing of their club meetings and location, a description of their ATV transmitter kit, and some useful test screens in GIF format. <http://www.stevens.com/hats/home.html>

United Kingdom

This page provides a description of the Solent Club for Amateur Radio & Television (SCART). <http://www.inside-info.co.uk/scart.htm>

Utah

The Utah ATV home page is managed by Clint KA7OEI and describes the WB7FID and KA7OEI ATV repeaters. They offer links to a variety of ATV related activities (balloons, mountaintopping, R/C planes, and astronomy experiments). http://uugate.aim.utah.edu/utah_atv/root.html

SSTV

This multimedia page has loads of information about Slow-Scan TV. A must-see page for anyone with an interest in this popular mode. <http://www.ultranet.com/~sstv/>

R/C Aircraft ATV

Carl Berry K5MWN has put together a very detailed and informative site that describes how to build a remotely-powered vehicle with an R/C plane, and a converted arcade game that actually puts you in the pilot's seat via ATV and

find telemetry information, launch and recovery photos as well as several incredible photos taken from the edge of space.

There is a Amateur Radio Balloon Symposium in Iowa this July; check out the detailed information about the symposium in the "News from other Balloon Groups" section.

"As you cruise through each group's pages you'll find all kinds of interesting links to related information about television, video digitizers, R/C aircraft, kites, and balloons."

telemetry. His system is called the Cyclops. Included are links to other R/C sites on the web. <http://198.83.140.5/~cyclops/cyclops.html>

High altitude balloons

For those of you with interests in flying ATV onboard high altitude weather balloons, or those who would like to know when a flight is scheduled, there are several sites that have popped up from the more active balloon groups across the country. These sites can all be accessed via the EOSS (Edge of Space Sciences) home page at <http://www.usa.net/~rickvg/eoss.htm>; links to the other balloon groups can be found in their "Information about other Balloon Groups" section. You'll

Kites

This page had some intriguing info about using telemetry in their altitude record attempts for kiting. Fun reading. <http://www.magic.ca/~kite>

Internet live cameras

Check out Leonard's Cam World page for links to numerous live camera sites accessible via the Internet. <http://jax.jaxnet.com/~len/camera.html>

Netcruising

I hope you enjoy your cruise down the information highway. If your group is online and not listed here, please feel free to E-mail me at bbrown@hiwaay.net and I'll update the information in a future column. 73

AMATEUR TELEVISION

GET THE ATV BUG

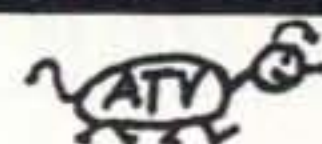

≥10 Watt pep

Transceiver
Only \$499

Made in USA

Full Color
and sound



Snow free line of sight DX is 90 miles - assuming 14 dBd antennas at both ends. 10 Watts in this one box may be all you need for local simplex or repeater ATV. Use any home TV camera or camcorder by plugging the composite video and audio into the front phono jacks. Add 70cm antenna, coax, 13.8 Vdc @ 3 Amps, TV set and you're on the air - no computer or other radios necessary, it's that easy!

TC70-10 has adjustable RF out (1 to ≥10w p.e.p.) and sync stretcher to properly match RF Concepts 4-110 or Mirage D1010N-ATV amps for 100 Watts p.e.p. Specify 439.25, 434.0, 427.25 or 426.25 MHz, 2nd xtal add \$20. Hot GaAsfet downconverter varicap tunes whole 420-450 MHz band to your TV ch3. Transmit and camera video monitor output. 7.5x7.5x2.7".

Transmitters sold only to licensed amateurs, for legal purposes, verified in the latest Callbook or send copy of new license.

Hams, call for our complete 10 pg. ATV catalog
Everything you need for 400, 900 or 1200 MHz ATV.

(818) 447-4565 M-Th 8am-5:30pm pst Visa, MC, UPS COD

P.C. ELECTRONICS

Email: tomsmb@aol.com

24 Hr. FAX (818) 447-0489

2522 Paxson Lane Arcadia CA 91007

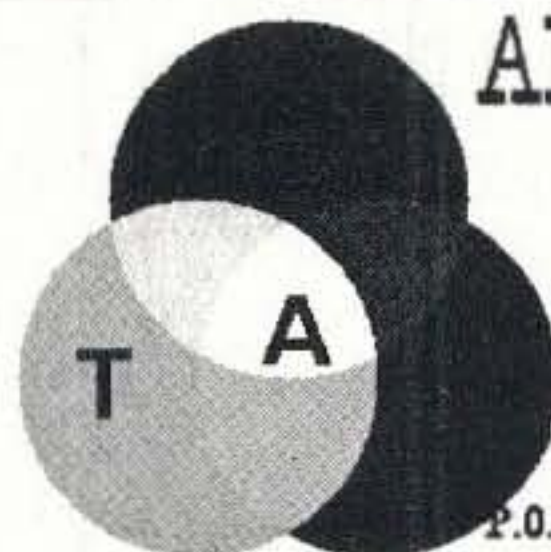

**ARIZONA AMATEURS
ON TELEVISION
HOME PAGE**

P.O. BOX 64051 PHOENIX, ARIZONA 85082-4051

TIRED OF GETTING YOUR TAIL KICKED IN THE PILEUPS?

Then put up a Raibeam and kick some back!

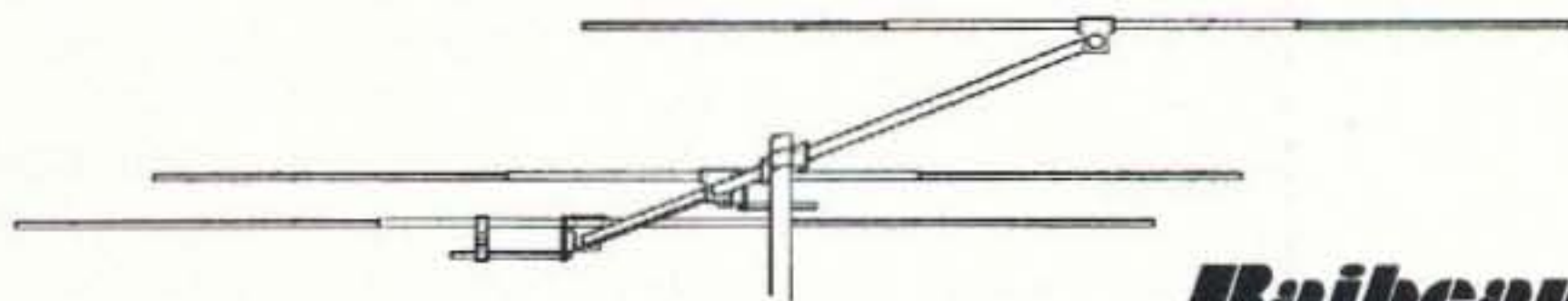

Raibeam™
It's not just another yagi.

High performance monoband beams with WA7RAI's phenomenal bi-periodic dual drive system Get the DX edge with higher gain - lower radiation angles - high F/B ratio - lower noise, plus a 100% performance guarantee. Designed to the highest standards and manufactured of high quality aluminum with stainless steel hardware, all of our antennas are built to survive and are rated to 2000 watts PEP.

Model	Type	Boom Len. (ft)	Wgt. (lbs)	Turn radi. (ft)	Wind load (sq ft)	Price*
RB-206	2 el 6m	2.1	3.25	5	.9	\$129.95
RB-406	4 el 6m	14.0	11.5	9.7	4.2	\$249.95
RB-210	2 el 10m	3.60	6	8.6	1.7	\$199.95
RB-310	3 el 10m	12.9	15	10	3.75	\$299.95
RB-410	4 el 10m	24	25	14.75	5.5	\$349.95
RB-212	2 el 12m	4.15	7.5	10	1.9	\$209.95
RB-215	2 el 15m	5.0	11	12.25	2.25	\$229.95
RB-217	2 el 17m	5.7	13	14.5	3.0	\$249.95
RB-220	2 el 20m	7.125	16	17.5	3.3	\$299.95
RB-320	3 el 20m	25.75	38	21.0	8.0	\$549.95



* Orders for US must include \$30.00 for shipping & handling (\$50.00 for RB-320). Call or write for OS s&h Info.

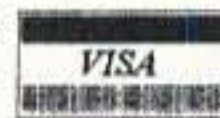

RAIBEAM ANTENNAS INTERNATIONAL
5638 West Alice Ave., Glendale, AZ 85302

Sales & information:
(602) 931-9135

9 am-5 pm MST
Monday - Friday

E-mail: RAIbeam@aol.com

CARR'S CORNER

Joseph J. Carr K4IPV
P.O. Box 1099
Falls Church VA 22041

Radials For Your Antenna

Radials are quarter-wavelength (usually) pieces of wire connected to the ground side of the transmission line to an antenna. These radials can be on the surface of the Earth, under the surface, or elevated, depending on the particular antenna. The radials are used to form a counterpoise ground, i.e. an artificial ground plane. It is seen by the antenna as essentially the same as the ground.

90° from the radiator element (i.e. horizontal to the ground).

The version shown in Fig. 2 is used with ground-mounted verticals (the base insulator is not shown here). A ground rod is recommended, and it should be a long one. The television type (typically three or four feet long) is not sufficient. Use an eight-foot copper or copper-clad steel ground rod for the best results. The shield of the coaxial cable is connected to the ground rod. The radials are fanned out from the top of the ground rod and extended as far as necessary.

"Whatever type of antenna you put up, make sure that it is in a location where it cannot possibly fall over and hit a power line."

Ground level configurations should be buried, rather than on the surface, to prevent injury to people passing by, either from RF burns or stumbling over the fool wire. But what do you do in a limited space situation?

Figs. 1 and 2 show the most common forms of radial installation. In Fig. 1 we see the radials connected to a vertical antenna that is mounted above the ground (usually quarter-wavelength or some convenient height). The radials are connected to the shield of the coaxial cable. They may be at a drooping angle (as shown) or

The radials in this illustration are buried several inches below the surface in order to prevent anyone from tripping on them; some nasty injuries can result from such a fall. Also, wires buried underground tend to come to the surface from time to time, so either bury them deep (like below the frost line, which is 28 inches in my neighborhood) or perform regular inspections to ensure that they are still where they are supposed to be—underground.

The radials should be made of AWG 14 or thicker wire, and the wire can be either insulated or bare. Even underground it

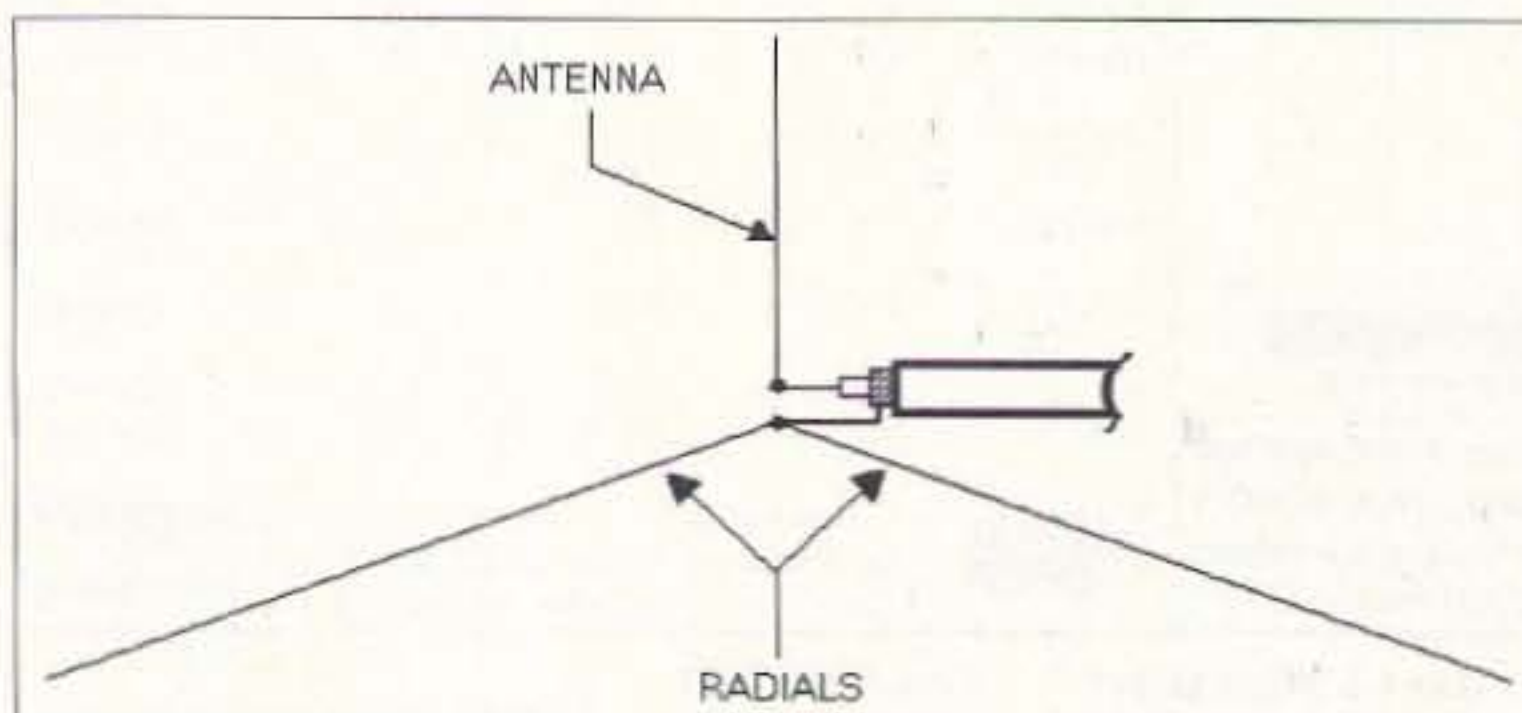

Fig. 1. Radials connected to a vertical antenna that is mounted above the ground. The radials are connected to the shield of the coaxial cable.

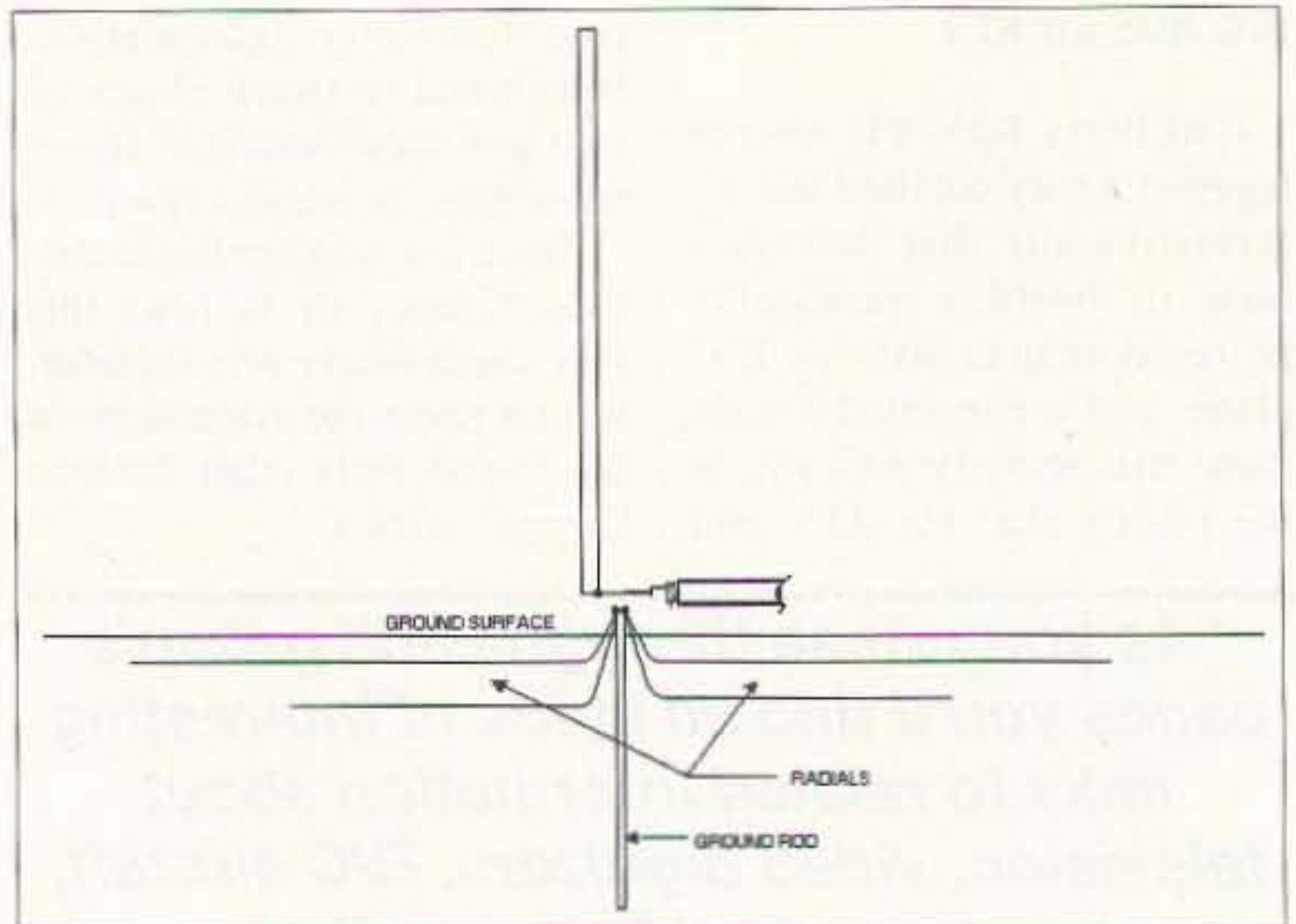

Fig. 2. Radial installation used with ground-mounted verticals (base insulator not shown).

matters little which is used. A lot of people use the same type of wire that is used for antennas in their radials, AWG 14 copper-clad steel wire.

Fig. 3 shows the method for connecting the radials to the ground rod. There is almost always some sort of wire collar on commercially produced ground rods. If not, then get a wire clamp from the electrical section of a do-it-yourself hardware store (some of which also sell ground rods of suitable length). A relatively healthy number of radials can be accommodated under the clamp. Make sure that the clamp is tight, and that the screw or hex nut holding the wires is well set. The wire to the shield side of the coaxial cable is also connected at this point.

How many radials?

Boy! Am I gonna get hollered at! Every time I write about radials the number of radials goes up. And it seems that there is a lot more heat than light out there in Readerland over this matter. But cool off, and I'll share my opinion with you... and it's an opinion that is backed up by both practical experience and the antenna engineering literature.

The minimum number of radials is one. But a one-radial antenna system isn't going to work very well. I've done it, but only as a get-on-the-air-as-fast-as-possible temporary measure. One time, right after we moved into our first house, I mounted

a 20 meter Hustler mobile antenna to an upstairs windowsill, and ran a 16-foot radial out to a nearby tree. It worked, and worked pretty well considering what it was—and didn't even burn up my aging Heathkit HW-101 transceiver. But it didn't work nearly as well as the half-wavelength dipole and commercial trap vertical that went up two weeks later. As a practical minimum, you need at least two radials for each band of operation, and four radials per band is better. The radials should be spread out symmetrically around the antenna.

Now that we've established a practical minimum, what does the antenna engineering literature say? The charts and graphs show that up to 120 radials per band are useful. Commercial radio stations operating in the medium waveband, AM BCB and under, tend to use that many radials. But if you look at the charts, you see a distinct knee between 14 and 18 radials where there is a downward trend in the effectiveness of each additional radial. In other words, it's a point of diminishing returns. One of the most vicious reader letters I've ever received flamed me for recommending no more than 16 radials, and held fast to the 120 radial scheme. It didn't make any difference that sources such as Bill Orr's *Radio Handbook*, *The ARRL Antenna Book* and other well respected sources—including two of the principal college-

level antenna textbooks—confirmed the 16-radial-per-band practical limit. Oh well, that same idiot also flamed me for claiming that the maximum feed point impedance of the usual

the sail area of the antenna makes it a lot heavier (or so it seems). Always use a buddy system when erecting antennas. I have a bad back caused by *not* following my own advice.

“Wires buried underground tend to come to the surface from time to time, so either bury them deep or perform regular inspections to ensure that they are still where they are supposed to be—underground.”

quarter-wavelength vertical is 37 ohms ... with four pages of calculus he proved conclusively that the real value is 36.6 ohms (sighhh).

Limited space radial layout

If you live on a small lot, then the radials problem is a little more daunting, but it's not insurmountable. A representative solution is shown in Fig. 4. The radials shown in textbooks are straight, and that is the preferred configuration. But if you don't have the space, then you need to use some variant of the two paths shown in Fig. 4. The radial can either go around the perimeter of the property, or zig-zag back and forth in either a triangle or rectangle pattern (the latter is shown here). I've even tacked radials to the baseboard of a student boardinghouse room (not recommended over a few watts QRP power levels).

Antenna safety

Every time I write about antenna construction I like to talk a little bit about safety. The issue never seems too old or too stale, because a lot of people out there never seem to get the word. Antenna erection does not have to be dangerous, but if you do it wrong it can be very dangerous. Antennas are deceptive because they are usually quite lightweight, and can easily be lifted. I have no trouble lifting my trap vertical and holding it aloft ... on a windless day. But if even a little wind is blowing (and it almost always is), then

Another issue is electrical safety. Don't ever, ever, ever toss an antenna wire over the power lines. *Ever*. Period. Also, whatever type of antenna you put up, make sure that it is in a location where it cannot possibly fall over and hit the power line.

The last issue is to be careful when digging to lay down radials. You really don't want to hit water lines, sewer lines, buried electrical service lines, or gas lines. Heck, I know one property where a long distance oil pipeline runs beneath the surface. If you don't know where these lines are, try to guess by looking at the locations of the meters at the street, and the service entrance at the house. Hint: Most surveyors' plats (you know, those map-like papers you get at settlement) show the locations of the buried services. They should also be on maps at the local government offices (although you might have to go to two or three departments!). The utility companies can also help.

Be safe, be happy or, as Mr. Spock put it, "Live long and prosper."

Connections

I can be reached at P.O. Box 1099, Falls Church VA 22041, or via E-mail at CARRJJ@AOL.COM. I welcome your correspondence. One thing does tend to annoy me, though. Please don't call me on the telephone. A number of readers have done that recently. In the past, I didn't mind so much because only a few people every

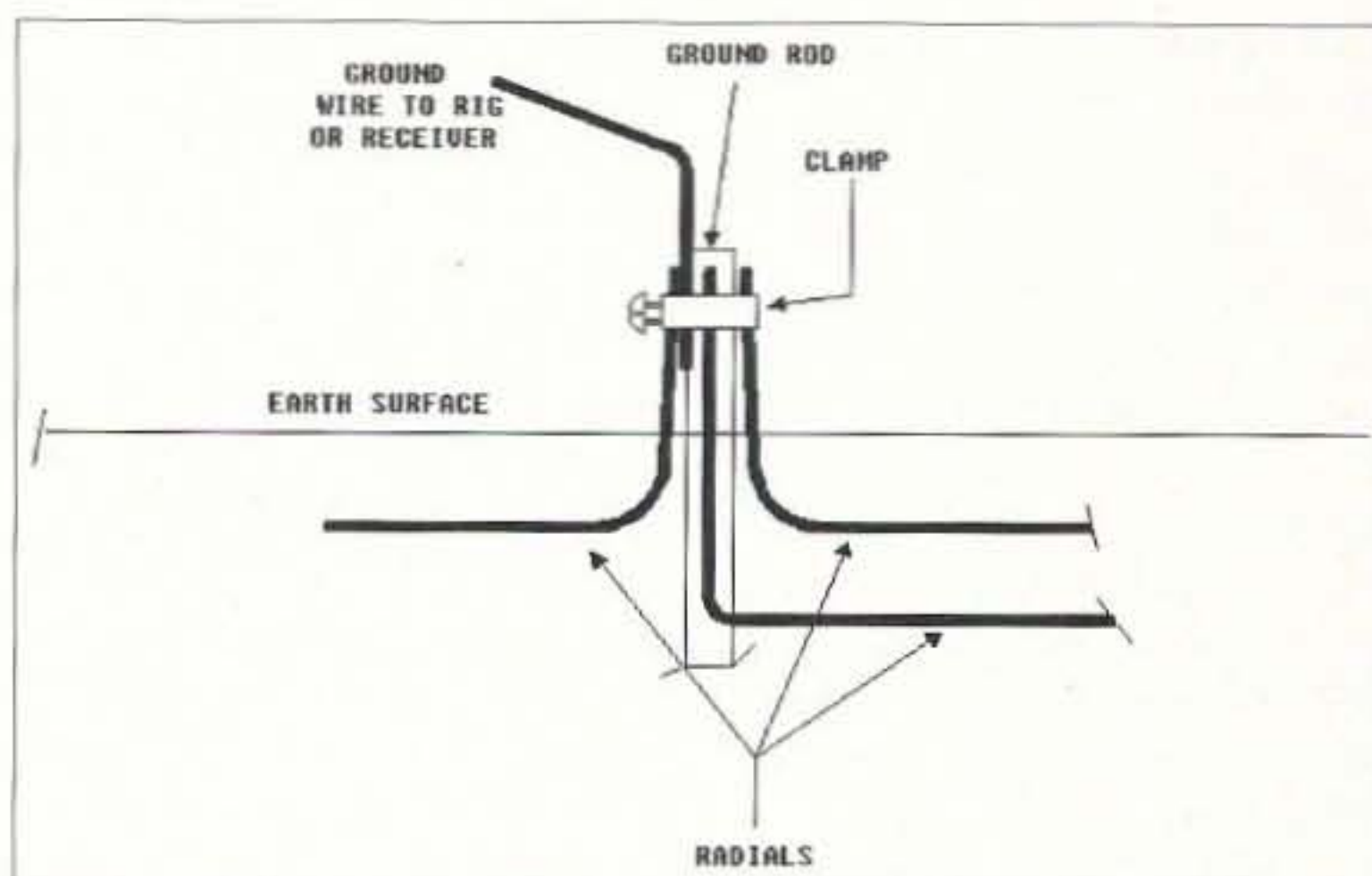

Fig. 3. Method for connecting the radials to the ground rod.

year called, but the traffic has increased quite a bit. Although I try to be polite and helpful, it almost always interferes with some activity. I arise every morning in time to arrive at my office at 7 a.m., and that means I go to bed early. And while the

caller almost always thinks he has kept to the polite "before 10 p.m." rule, the call nonetheless wakes me up. I make it a point to answer all E-mail and try to answer as much snail mail as I have time for, so please don't call.

73

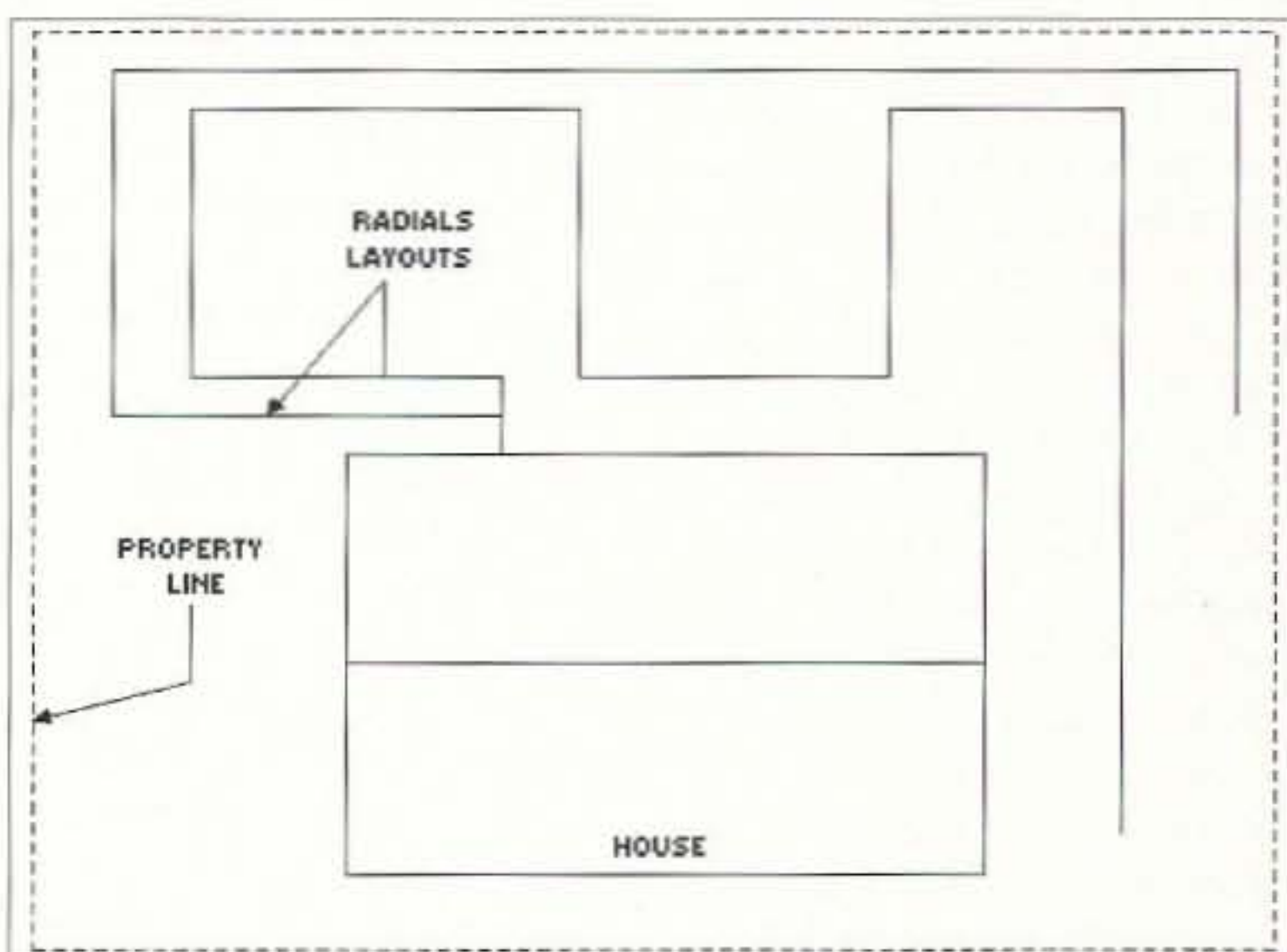

Fig. 4. A straight radial configuration is preferable, but if you live on a small lot and don't have the space, use some variant of the two paths shown above.

Radio Bookshop

Phone 800-274-7373 or 603-924-0058, FAX 603-924-8613, or see order form on page 88 for ordering information.

Wayne Writes!

WG5 **Submarine Life In World War II** by Wayne Green W2NSD/1 60p. Wayne's stories of his adventures on the USS Drum SS-228 on five war patrols in the Pacific in 1943-1945. What's it really like on a submarine when you are being depth charged? And what's the day to day life on a submarine like? \$7.50

WG6 **Uncle Wayne's Caribbean Adventures** 96 pages. Wayne's adventures scuba diving all around the Caribbean, visiting ham operators, and sight seeing. If you are interested in how to travel economically, you'll get some great ideas from this. He starts out with his "Diving, the Wimp Sport." You'll love the visit to eleven islands in 21 days trip. A measly \$7.50

WG7 **Uncle Wayne's Travels**—52 p. Wayne travels to Russia, London, Aspen, and St. Pierre, Munich, Vienna, Krakow, and Prague without it costing nearly as much as you might think. Cheap for you too, at \$5.00

WG9 **Wayne Talks: 'Dayton' 1995**. -90 minute tape—What he would have said if he'd been asked to speak. \$5.00

WG4 **20/20 Foresight**—Twenty 16 updates on the **Declare War** book - 320p. Further proposals for solving critical American problems, such as a new approach to financing small businesses, how to finance Russia and other countries and make a profit doing it, the real dope on bioelectromagnetics, a new kind of polytechnical university, a new electronic technology, why Africa is in such a mess, why Perot bombed, how to have tuition free universities, a plan for making Congress turn honest, etc. Plenty more. Ridiculously priced at \$10.00

LETTERS*Continued from page 35*

beginning—this from someone who has been fighting an uphill battle learning the code. I really enjoy sitting down practicing code with my SCS. I now have the way to not only learn the code for the test, but to enjoy using the code. Thanks, Wayne, for featuring this great unit in your magazine. Keep up the great work in bringing some really exciting things to us as you have with this unit. And thanks to Sam Ulbing N4UAU for inventing the Super CW Station.

*Now don't you wish you'd saved your June '95 issue?...
Wayne*

Jim Thompson KC7APO. This letter is in response to "Dots and Dashes" by Hal Goodman W3UWH in the March issue. I've been a ham for just over two years. Like Mr. Goodman, my first few CW contacts were unforgettable. The day my license came in the mail it was hard to decide whether to fire up the Ramsey kit I had built or the Collins KWM2A I had picked up along the way. The coin came up tails so I turned on the Ramsey and it barely worked; just a problem with microphone mismatch, but the group on the 2 meter repeater helped me figure that out. After meeting several people and having a great time, I cleared and turned on the big radio. It took me a while to find a clear frequency and tune up for the first time (lucky I did not fry the finals!). I sent CQ on the 80 meter Novice band with a very shaky fist. After the second attempt, I began to wonder if I was getting out with only 100 watts. The third time, I got an answer from a fellow in Northern California. The QSO was brief, but it was my first CW contact and that does not happen very often (actually just once).

I was soon to meet many "Old-Timers" like Hal, who were very supportive and helpful. Much of what I know I learned from them and I am grateful. If I've ever said "thank you" to those guys, I probably can't say it strongly enough.

I quickly found out that learning the code was just the

beginning. There are abbreviations, standard procedures, and phrases to learn that are barely covered in the books. That's fine; there's nothing wrong with the books. Just realize that, in many ways, the first ham ticket is just a "license to learn."

Much of my early copy looked like Hal's copy from Bill and, at first, I assumed that it was my faulty ears. I heard lots of characters that I couldn't identify or that never formed recognizable words. There was one time I thought I heard my name as "Wim." I listened carefully the next time and convinced myself that that was what he was actually sending. So I corrected him and he replied, "QSL Wim, got ya." I was learning.

Another time I turned it over and the fellow replied, "S" "O" then a pause and I thought, "Aha, a word." So I wrote down "so" and listened for the next. Then came "L, I, D" and I thought, "Aha, another word." So I wrote it down. Two words in a row! But then I began to wonder, "Wait a minute, is this guy calling me names? I'm new to this, but am I that bad?" The next word was of course, "COPY," but after that my self-confidence was so badly shaken that I copied little of what followed. Finally I realized that the guy was still sending and that I'd better get my pencil going. It ended up that he was really a friendly chap after all and the mistake was all mine. I copied all the characters just fine but of course there is more to it than that.

I listened carefully to the good counsel of these "Old-Timers" and learned lessons like: Don't send faster than you want to receive and don't be afraid to send PSE QRS. I also learned from the mistakes of others and strove to develop a good fist and operating habits. I started with a straight key, picked up paddles and found it all too easy to send those extra dits and dahs. I finally got a bug, learned to use it, and liked it. With the bug, I made far fewer mistakes than with paddles and was more relaxed than I was with a straight key.

The first step to good keying is to hear the sound of the character

Continued on page 86

RTTY LOOP

Marc I. Leavey, M.D., WA3AJR
P. O. Box 473
Stevenson MD 21153

This column marks the beginning of the 20th year of *RTTY Loop*. Twenty years is quite a milestone. Just look at what postage and interest rates have done over that time. Just look at interest in ham radio over that time! Overall, though, we're still doing OK. Because of the personal computer revolution, interest in digital communication has never been higher. Your letters and E-mail have shown me that. I am also aware, however, that any number of you feel that the old-timers are ignoring the fundamentals and basics when speaking to newbies. In this month's column, and the next several, I'll address that need.

We throw around terms and concepts as if they were common knowledge, forgetting that even the most seasoned among us once regarded the acronym AFSK as newspeak gobbledygook. My intent has always been to address the wide spectrum of amateurs interested in digital communications and computers. Having dealt with lots of cutting-edge questions of late, let's define some terms.

This month, I present a glossary for radioteletype and digital communication. Because there are those of us who are still using old paper printers, and those who are using fancy computer interfaces, this list will attempt to encompass terms used in both camps, with some others thrown in. If you have any additional vocabulary words you think should be included in the list, feel free to send them along. I'll keep an updated copy of this list on the RTTY Loop Home Page, for reference.

AFSK: Stands for Audio Frequency Shift Keying and is a means of encoding the digital information by changing the frequency of an audio tone.

AMTOR: Derived from a commercial mode, SITOR, Amateur Teletype Over Radio allows the receiving station to dynamically respond to errors from the sender.

Amateur Radio Teletype

ASCII: The American Standard Code for Information Interchange, this seven-bit scheme for encoding alphanumeric is the standard computer code used.

Baudot: A five-bit code which is used to encode the alphabet and numerics, through use of a shift

"Many of you feel that old-timers are ignoring the fundamentals and basics when speaking to newbies."

into an alternate character set, this is the original Teletype code. Also called the Murray code.

Bias: With conventional digital signals, the state of the signal alternates between **MARK** and **SPACE**, with the length of pulses in either state the same. If the relative length of the pulses is unequal, the system is said to exhibit various kinds of bias.

Chad: When you punch a hole in a piece of paper, the plug that comes out is called a "chad." Paper tape, punched with many holes to serve as a memory device, generates tons of these chads.

Chadless: Obviously, without chads. If you want to type on the tape with the holes in it, the absence of paper where the holes are makes it difficult. Chadless tape leaves the plugs attached by little lips, to permit such typing.

CPU: Central Processing Unit, the brain of a computer. Common CPUs in home computers are Intel series 80386 and 80486, part of the x86 line, and Pentiums, as well as the Motorola 68000 series in the Macintosh computers.

Demod: Short for Demodulator, this is the electronic marvel that converts the warbling tones of radioteletype from a receiver into pulsed DC that a Teletype machine can interpret.

Fox Tape (or Key): There is a marvelous sentence that contains all the letters of the alphabet: **THE**

QUICK BROWN FOX JUMPS OVER THE LAZY YELLOW DOG. People frequently have a tape to send this for test purposes. Digital or computer setups may have this sentence reprogrammed at the touch of a key.

FSK: Stands for Frequency Shift Keying. Similar to AFSK, the frequency of a radio carrier is shifted to encode the digital information.

Governor: Not the person in your state capitol. Mechanical teleprinters are run by motors, and it is important for the motor to be turning at a precise speed. Older machines, or those intended for AC/DC work, used a governor on the motor to set the speed. A special tuning fork is used to set the motor speed.

Local Loop: If you hook all your equipment together so that anything you type on the keyboard prints on the printer, kind of like a big electric typewriter, that's a local loop—essential for testing.

MARK: Spelled differently than my first name, this is the state when everything is running quietly, and loop current is present. Could call it "1" if you're into logic.

Model 12, 14, 15, 28, 32, 33, 35, etc.: These are different series and styles of teleprinters and tape machines produced by the Teletype Corporation. The Model 15 is the classic keyboard and page printer on a table, seen so often in police and science fiction movies of the 1950s and 1960s. The Model 19 is the Model 15 with built-in Model 14 tape

equipment. In general, the higher the number, the more recent the equipment manufacture.

Modem: A combination Modulator, for sending digital data, and Demodulator, for receiving. May be used for radio or telephone, for a variety of modes.

Packet: A scheme for sending digital data in discrete packets, which are acknowledged by the receiver after sending. Each packet can be addressed to a specific receiver or for wider distribution, making transmission more reliable.

Page Printer: If the teleprinter prints on a roll of paper which, when you tear it off, looks like a page, then it's a page printer.

Patch Panel: One of those can't-do-without things. Usually a jack strip which allows anything to be connected to anything (anything?).

Perforator: A keyboard connected to an electromagnetic device which punches tape as you type is a perforator. This cannot punch tape from an incoming signal.

Polar Relay: Normal spring-return relays take more energy to make than to hold. This would cause distortion in a digital signal, called bias. A polar relay uses two magnets, one to make and one to break, to overcome this problem. A bias (no relation) supply is needed for one of those windings.

RAM: The read-write memory populating home computers is commonly referred to as Random Access Memory, even though most memory boards, whether

read-write or read-only, are random access.

Reperforator: A tape punch which decodes incoming signals and punches them into tape is a reperforator. Some versions type on the tape at the same time, and are called Typing Reperfs, of course, and are chadless.

RTTY: The ham's abbreviation for radioteletype.

RY: These two letters contain all the bits in the commonly used five-bit Baudot code. Therefore, repeating the letters, as RYRYRY, makes a good test signal.

SPACE: See also **MARK**. This is the state without loop current. Machines in such a state just shuttle back and forth making noise, called running open. This is the logical state "0."

Strip Printer: No, not what you're thinking; this is a printer which, unlike the page printer, prints its data on a narrow strip of paper, like a stock ticker.

Synch Motor: Since the motor for a teleprinter has to be a precise speed, it is nice to synchronize it to the 60 Hz line frequency. It takes the place of a governor motor.

TD: Stands for Transmitting Distributor, which is quite a mouthful, making the abbreviation convenient. This is a tape reader—so why couldn't they just say that?

TNC: Terminal Node Controller—the interface box used between the radio and terminal for packet mode communication.

TT, TTY: More abbreviations for Teletype.

Teletype: The whole ball of wax we are talking about. This is a trademark, however, of the Teletype Corporation, and should always be capitalized.

TU: Stands for Terminal Unit, and is the same thing as a Demodulator.

Once again, I welcome input to this list, both additions and corrections to my definitions. Send them to me via any of the means at the end of the column, and watch for updates on the RTTY Loop Home Page, at <http://www2.ari.net/ajr/rtty>. Also up there is the latest version of the RTTY Loop Software Collection, featuring over a dozen disks of data, along with old columns and links.

Several of you have been looking for the latest addition to Gary Johnson's XCOM software; check out the XCOM page at <http://www.indirect.com/user/gjohnson> for the latest and greatest, direct from the author.

As for me, reach me on the page, through the E-mail link, or at ajr@ari.net, or on America Online as MarcWA3AJR, or on CompuServe as 75036,2501. Or, if you have no other way, at the post office box above. Use that address, as well, for materials for the Software Collection.

I plan to continue the beginners' introduction next month, with a look at just why, and how, the alphabet can be encoded over a single wire circuit. Please feel free to send along comments, questions, or suggestions. I look forward to them! 73

All Aluminum

Chassis Kits	Rack Shelves
Cabinet Kits	Rack Equipment
Assembled Cabinets	Antenna Grounding Kits
Slope Box Kits	Tower Mounted Box Kits
UHF & VHF Antenna	Dipole Hangers
Power Divider Kits	Other Enclosures

Small sheets Aluminum and Brass
UHF / VHF Antenna Parts

Byers Chassis Kits
Charles Byers K3IWK
5120 Harmony Grove Road • Dover, PA 17315
Phone 717 - 292-4901
Between 6PM and 9:30PM EST. Eves.

CIRCLE 222 ON READER SERVICE CARD

YOUR SOURCE
FOR

BATTERIES!

- * AMATEUR RADIO BATTERY PACKS
- * REPLACEMENT RECHARGEABLE INSERTS
- * LAPTOP COMPUTER BATTERIES
- * CAMCORDER BATTERY PACKS
- * CELLULAR PHONE BATTERY PACKS
- * SEALED LEAD-ACID BATTERIES
- * O.E.M. & CUSTOM ASSEMBLY PACKS
- * AUTHORIZED SANYO NiCd DISTRIBUTOR

Call or write for our free catalog!

Mr. NiCd -E.H. Yost & Co.
2211-D Parview Rd., Middleton, WI 53562
Phone (608) 831-3443 / Fax (608) 831-1082
DEALER INQUIRIES INVITED

CIRCLE 114 ON READER SERVICE CARD

Antenna-Stealth or Not

If you need *multi-band* antennas, *hidden or not*, for *fixed, portable or mobile*. This antenna and feedline kit, with construction manual, shows you how to make antennas and feedlines on the ceiling, wall, roof, car, etc. Use high-tech copper foil tape to construct yagis, verticals dipoles, loops, feedlines, coils, traps and much more!

TapeTenna™

*It's paintable!
Stick It On And
Color It Gone!*

108' self adhesive super conductive copper tape, 65 page antenna construction manual & connectors. Hamco, A3, 3333 W. Wagon Trail Dr. Englewood, Co. 80110- Info 303-795-9466
Check or M.O. for \$34 ppd- Tape Refill for \$24 ppd
Save Money! Kit + Tape Refill Only \$54 ppd

CIRCLE 165 ON READER SERVICE CARD

Communications Simplified, Part 7

AM sidebands.

Peter A. Stark K2OAW
PO Box 209
Mt. Kisco NY 10549

Let's review a little. Awhile back, we learned that a square wave consists of a fundamental frequency and some harmonics. We made a rather sweeping statement that any repetitive waveform can be broken down into a fundamental and/or some harmonics.

Let's start this segment off by putting down a general rule, and then we will explain it: *When a carrier with frequency C is modulated by an audio (or other) signal having frequency A, we get two sidebands, whose frequencies are C+A and C-A. Moreover, at 100% modulation, the two sidebands are exactly one-half the size of the carrier.*

Let's consider an example. Suppose an AM radio station at 880 kHz transmits a carrier whose amplitude is 100 volts when there is no modulation (that is, when there is no sound being transmitted). If you looked at this signal with a spectrum analyzer, you'd see just a carrier, as shown in **Fig. 1**.

Now suppose the announcer steps up to the mike and whistles a 1 kHz note into it, loud enough to produce exactly 100% modulation. If you looked at the transmitter output with an oscilloscope, you would see a 880 kHz carrier, whose envelope goes up and down at a 1 kHz rate, but if you looked at that same signal with a spectrum analyzer, you'd see

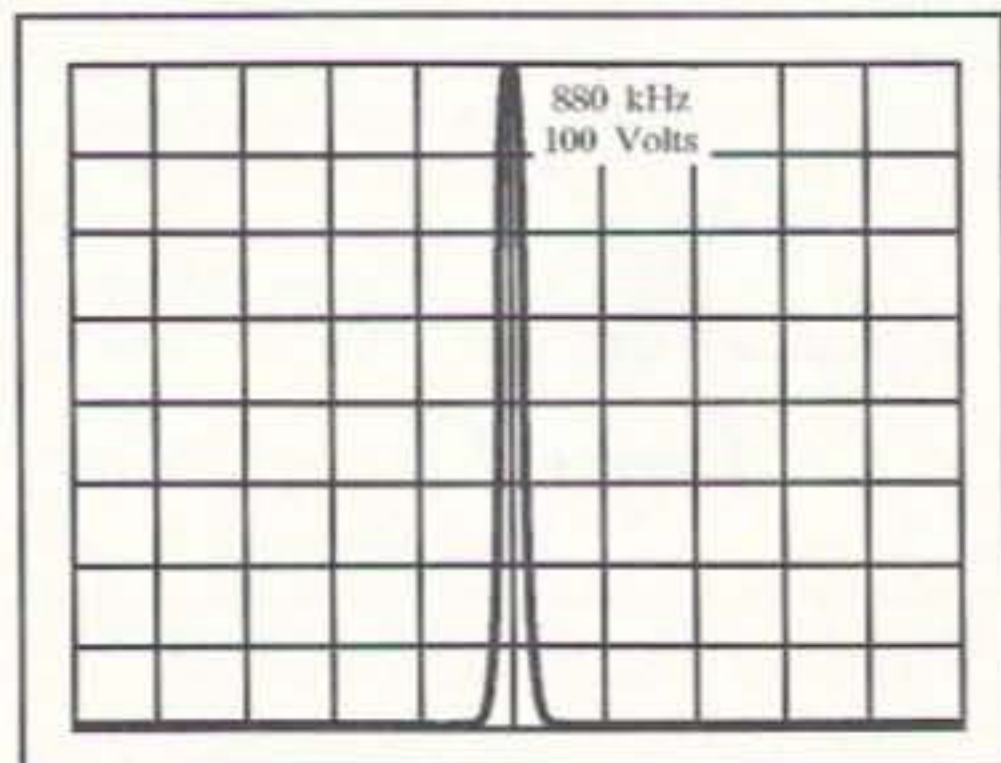

Fig. 1. An unmodulated carrier at 880 kHz.

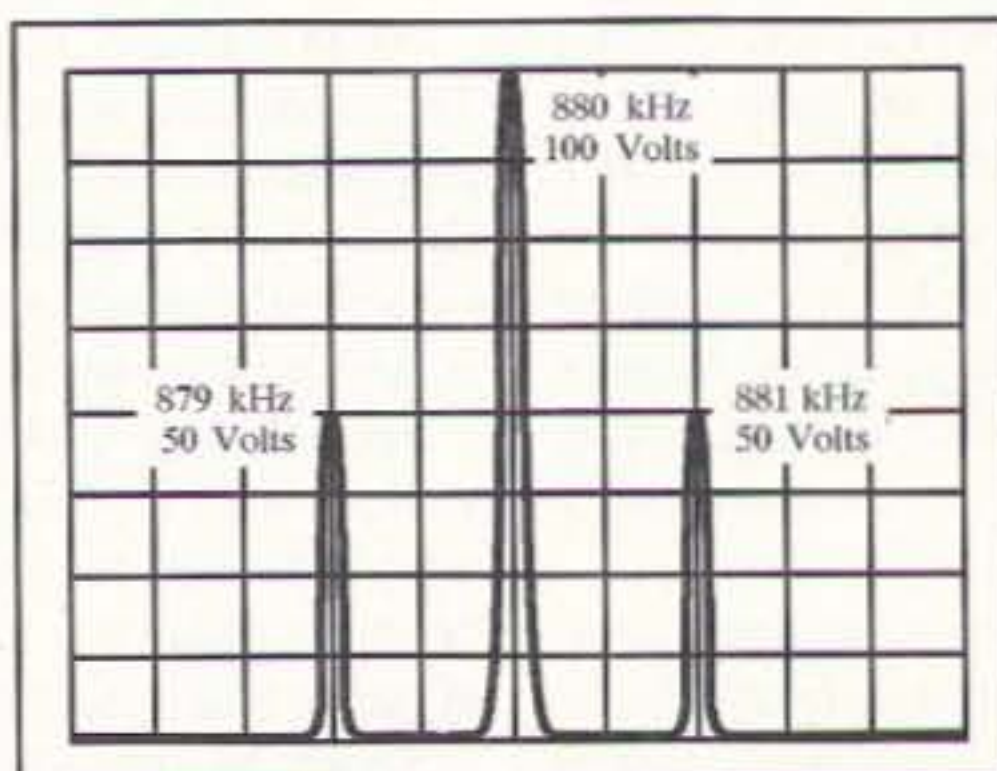

Fig. 2. 880 kHz carrier modulated 100% by 1 kHz.

the picture shown in **Fig. 2**. You would still see the same 100 volt carrier at 880 kHz (which never changed amplitude), plus a 50 volt signal (called an *upper sideband*) at 881 kHz (881 is 880 plus 1 kHz), and another 50 volt signal (called a *lower sideband*) at 879 kHz.

So what's really happening is that the radio station is generating a 880 kHz carrier, and then AM modulating it (changing its amplitude) at a 1 kHz rate. On the air, we actually have an 880 kHz carrier which has a constant amplitude, plus two extra signals called sidebands. These sidebands also have a constant amplitude, but when we see the combined signal on an oscilloscope, all three of these interact together to make it look as though the carrier is changing height.

Fig. 3 shows how this is possible. This is a computer-generated graph, which shows three sine waves at the top, and their sum on the bottom. The bottom waveform is simply the point-by-point sum of the top three waves. At the far left and far right, the three top waves are pretty much in phase, and so they add up to a big result. In the middle, however, the two sidebands are out of phase with the unmodulated carrier, and so they cancel it out to produce a very small result.

DETOUR

Here's the BASIC program which draws the same waveforms as in **Fig. 3**:

```

10 'Generate AM from sidebands
20 SCREEN 2
30 FOR X=0 TO 639
40 CARRIER=SIN(X/10.185616#)
50 UPPER=.5*SIN(X/10.185616#*1.1)
60 LOWER=.5*SIN(X/10.185616#*.9)
70 AM=CARRIER+UPPER+LOWER
80 PSET(X,20-20*CARRIER)
90 PSET(X,60-20*UPPER)
100 PSET(X,90-20*LOWER)
110 PSET(X,150-20*AM)
120 NEXT X
130 IF INKEY$="" THEN 130
140 SCREEN 0
    
```

END OF DETOUR

Look at **Fig. 3** some more. Suppose this graph covers exactly one second of time. Since the unmodulated carrier on top has exactly 10 cycles, its frequency is exactly 10 cycles per second, or 10 Hz. It's a little harder to count the cycles of the AM signal on the bottom, but it too has exactly 10 cycles, and therefore is also exactly 10 Hz. Now look at the envelope of the AM signal; draw it in, if that will help. The envelope starts big, goes to small in the middle, and then becomes big again, so it has exactly one cycle during that second, and is therefore at 1 Hz. So we have a 10 Hz carrier, modulated by 1 Hz. (These frequencies are not exactly practical for real radio, but they are nice simple numbers, and easy to visualize.) According to our

previous discussion, the two sidebands should therefore have frequencies of 11 and 9 Hz (which is 10+1 and 10-1).

Sure enough, if you count the cycles of the two sidebands, you can see that the upper sideband has 11 cycles, while the lower sideband has only nine cycles. Their frequencies are therefore 11 Hz and 9 Hz, respectively.

Note also that the AM signal is modulated to 100%—you can see that its amplitude goes all the way to zero. You can also see that the two sidebands are each exactly one half the size of the unmodulated carrier.

Let's go back to the 880 kHz transmitter example (refer to Part 6, in the June 1996 issue of 73, if necessary). The carrier voltage V_c is 100 volts. When the two 50 volt sidebands are in phase with the carrier, all the voltages will add up to a V_{max} of 100 + 50 + 50, or 200 volts. On the other hand, when the two sidebands are out of phase with the carrier (look at the center portion of Fig. 3 to see how this happens), they all subtract to give us a V_{min} of 100 - 50 - 50, or 0 volts.

So we now have two ways of determining the percentage of modulation of an AM station: Look at it on the oscilloscope, or look at it on the spectrum analyzer. For example, what is the modulation percentage for the signal in Fig. 4?

Let's see, the carrier has a height of about 6.4 divisions. Since we can't see the knobs on the analyzer, we don't know how many volts that is, but that doesn't matter; 6.4 divisions is good enough for us. If that signal were 100% modulated, then the sidebands should be half of 6.4, or 3.2 divisions, but they are only about 1.7 divisions high. So the modulation is only 1.7/3.2 of its maximum. That works out to:

$$\frac{1.7}{3.2} \times 100\% = 53\%$$

So far, so good. Now that we've gotten so good at this, let's look at a *real* AM broadcast station on the analyzer and try to figure out what their percentage of modulation is. It's actually quite easy; we just have to throw some wire out the window and connect it to the analyzer's input, and we get Fig. 5. We still see a nice carrier, but on each side we now see just plain fuzz, rather than a neat sideband. What's going on?

The difference is that the real station isn't broadcasting just plain tones—their audio consists of music and speech. This includes many different frequencies, all at different amplitudes but at the same time. Every single frequency in the audio generates its own pair of sidebands. So we have many sidebands, all occurring at the same time, and all constantly changing as the music or voice changes. The result? A fuzz that actually extends past the edges of the analyzer picture.

To avoid confusion, some people use the term *side frequency* when they describe the sideband from a single tone, as in Fig. 4. They would then say that all of these different side frequencies combine to make the two sidebands in Fig. 5, a lower sideband to the left of the carrier, and an upper sideband to the right.

Bandwidth

Our simple example with the announcer whistling at 1,000 Hz showed that the radio signal would consist not just of the carrier at 880 kHz, but also of sidebands (side frequencies) at 879 and 881 kHz, 1 kHz away from the carrier on each side. AM broadcast stations normally transmit voice or speech with a frequency range of about 50 to about 10,000 Hz—not quite hi-fi, but still higher than just 1 kHz, and since the side frequencies lie at the carrier frequency plus and minus the audio frequency, we will now have side frequencies that lie anywhere from 50 Hz to 10,000 Hz away from the 880 kHz carrier. In other words, the sidebands will extend 10 kHz out from the carrier in both directions, down to 870 kHz on the left, and up to 890 kHz on the right.

The complete radio signal will, therefore, take up 20 kHz of space on the band (from 870 to 890 kHz), and so we say that the bandwidth of the AM signal is 20 kHz. We can summarize it this way: *The bandwidth of an AM signal is twice the highest audio frequency being transmitted.*

The bandwidth is related to how close stations can be placed to each other on the dial; the wider the bandwidth, the farther apart they have to be. To limit the bandwidth of commercial broadcast stations, the FCC limits their audio frequency range to a maximum of 10 kHz, which sets the maximum bandwidth at 20 kHz. Actually, though, AM broadcast stations are placed farther apart than their bandwidth would indicate, because the tuned circuits in most radios are not good enough to separate stations that are too close together. For example, in the New York City metropolitan area, stations are typically 50 or 60 kHz apart.

Sideband power

When a transmitter sends out sidebands, it needs power to do that. Let's consider a commercial AM broadcast station which sends out a 5 kW carrier. If the cable leading from the transmitter to the antenna has an impedance of 50 ohms, then we can find the output voltage by solving the power equation $P = V^2/R$ backward for the voltage:

$$V = \sqrt{P \times R} = \sqrt{5000 \text{ watts} \times 50 \text{ ohms}} = 500 \text{ volts}$$

When the station modulates that carrier at 100%, it still sends out a 5 kW (500 volt) carrier, but now it also sends out two 250 volt sidebands.

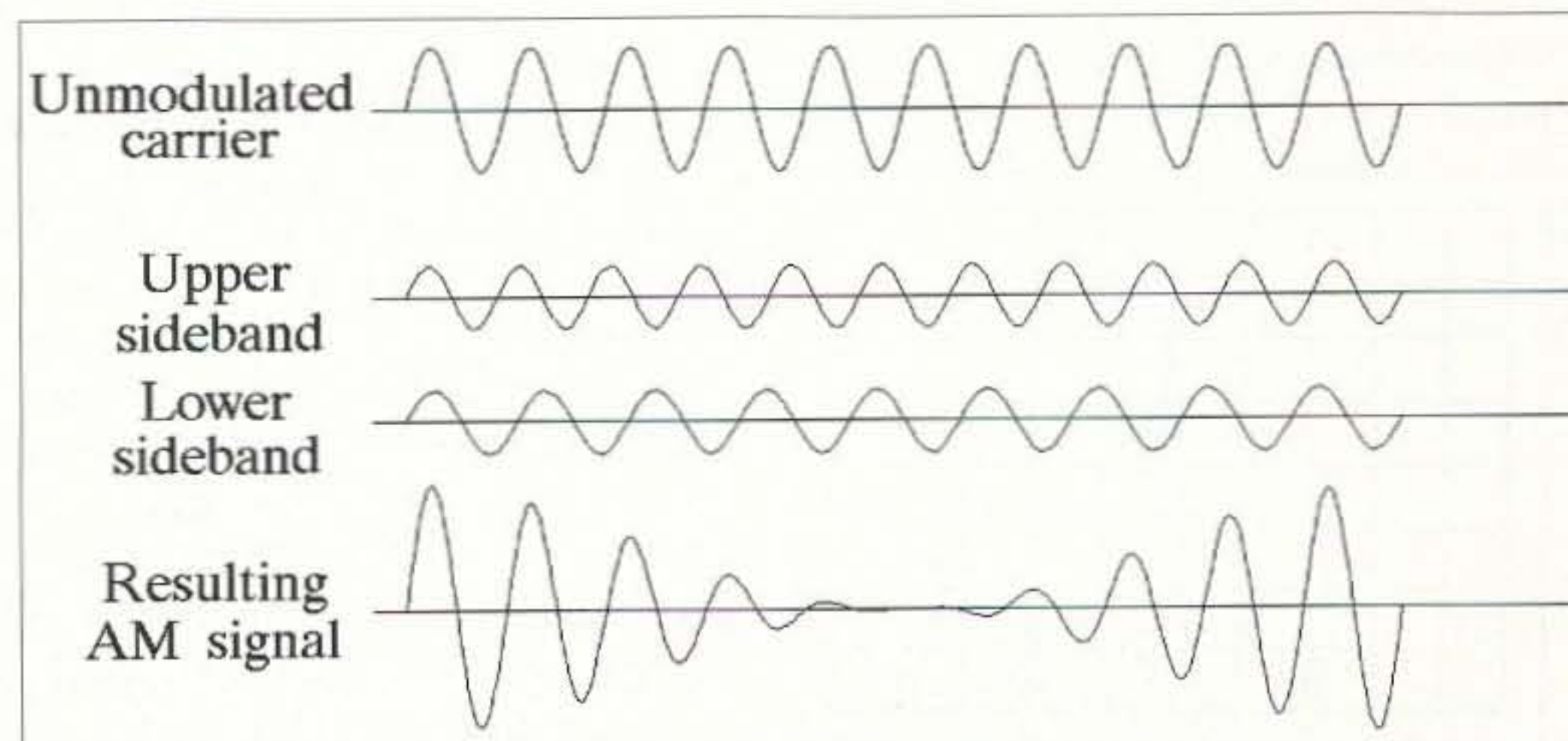

Fig. 3. The carrier and its sidebands.

Each of those also goes into the 50 ohm cable, so the power in each sideband is

$$P = \frac{V^2}{R} = \frac{250^2}{50} = 1,250 \text{ watts}$$

The transmitter is now putting out 5,000 watts into the carrier, plus another 2,500 watts into the two sidebands, for a total of 7,500 watts.

Efficiency

The amount of sideband power depends, of course, on the modulation percentage. From the $P = V^2/R$ equation, we see that the power is proportional to the square of the voltage. Thus, cutting the modulation down to 50%, for example, drops the sideband voltage to 1/2 of the 100% value, and so drops the sideband power to 1/4. Cutting the modulation percentage to 10% would drop the sideband voltage to 1/10, and the sideband power to 1/100. So in normal speech or classical music, where the volume is seldom at its maximum, the modulation percentage and sideband power tend to be much smaller than the carrier power. On the other hand, in modern popular music, where it seems like everybody is constantly yelling and screaming (to my jaded ears, anyway), the average modulation percentage would be higher, and the sideband power also.

In any case, we now know that the carrier in an AM signal never changes; only the sidebands change, depending on the signal being sent. We also know that the carrier contains most of the power of the AM signal. But is it really needed?

If the carrier never changes, then it doesn't carry any information to the receiver. By the time it gets to the receiver, it is just a weak sine wave. In fact, if the transmitter somehow turned the carrier off (sending only the sidebands), and the receiver had a circuit which generated a

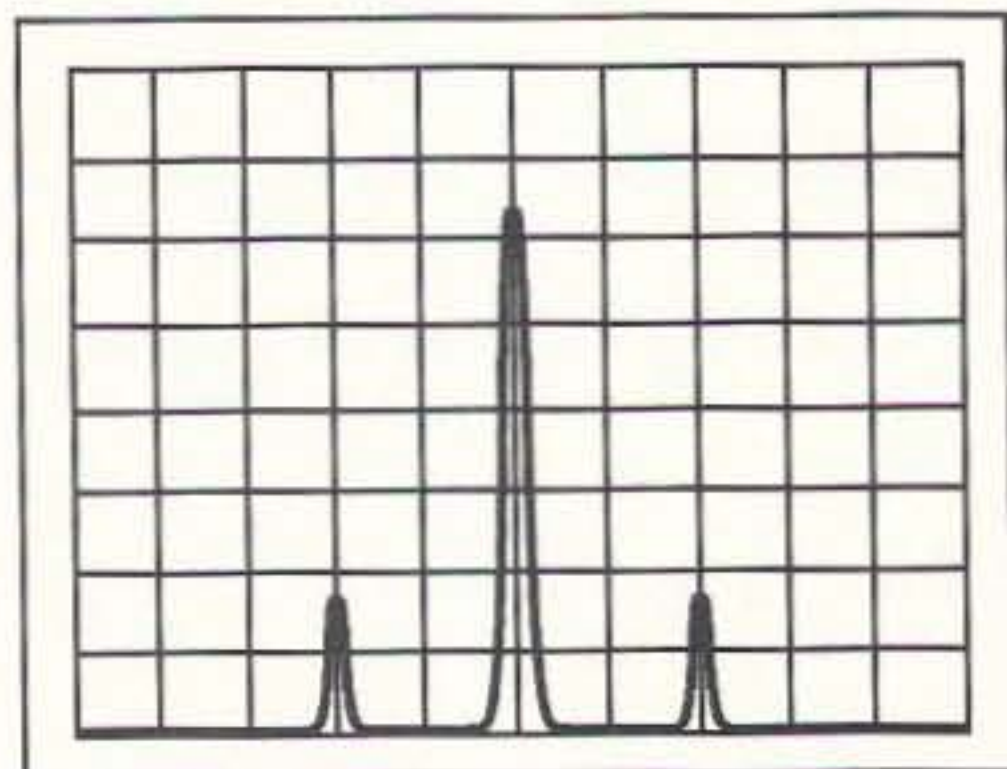

Fig. 4. What is the modulation percentage?

substitute sine wave of the right frequency, amplitude, and phase, it would never know the difference. But generating a weak sine wave at the receiver is a lot cheaper than generating a high power carrier at the transmitter.

This is the basic idea behind several variations on AM; changes which make both the transmitter and receiver somewhat more complex, but which greatly increase the efficiency of the system by reducing the transmitter power. These two major methods are called double sideband (DSB) and single sideband (SSB).

Double sideband

DSB is also sometimes called DSSC, which stands for double sideband suppressed carrier, a name that describes it well. In DSB, the transmitter sends out only the two sidebands and eliminates the carrier, which is then reinserted by the receiver.

Although the transmitter could produce regular AM and then filter out the carrier, this approach would waste power. A better approach is to use a *balanced mixer* to produce the DSB directly. In the balanced mixer, two AM signals are produced at low power, and then combined in such a way that the carrier gets canceled out.

The major advantage of DSB is efficiency. Consider, for instance, the 5,000 watt AM transmitter we discussed a moment ago. At 100% modulation, the transmitter would have to add 2,500 more watts for the two sidebands, for a total power output of 7,500 watts. On the average, considering typical voice or music, the sidebands might only contain a total of 1,000 watts or so, but the transmitter must still output the carrier. So its average output power might be closer to 6,000 watts. If it could eliminate the carrier, then it would need only to output an average 1,000 watts or so for the same sideband strength, and the resulting signal would travel just as far.

Alternatively, if you didn't mind spending the money, you could put all 6,000 watts into the sidebands, and get the same punch as if you had an AM transmitter of perhaps 20,000 watts or more. There would be still another advantage, too: When two signals are close together in frequency, they interfere with each other and it turns out that most of

the interference is between the carriers, not between the sidebands, so eliminating the carriers would eliminate much of the interference. In fact, during silent passages there is no interference at all since the sidebands are only there when there is something being transmitted.

By now you're asking, "If DSB is so wonderful, why doesn't everyone use it?" There are two answers to that: (1) It has some disadvantages, and (2) there's something even better.

One disadvantage is that it makes the receiver more complicated. In commercial broadcasting, the philosophy has always been to make the receivers as cheap as possible so everyone can afford one, even if that makes things more expensive for the broadcasters. DSB doesn't fit into that pattern.

A second problem is that inserting a fake carrier in the receiver is not that difficult, but making sure that it is just the right frequency and amplitude is tricky. Putting it at the wrong frequency is the same as putting the sidebands in the wrong place; if the frequency difference between the carrier and the sidebands is wrong, the frequency of the audio will be wrong too. Even a slight difference, on the order of a small fraction of a percent, can make voices sound funny, and make music inaudible.

So DSB would be okay for voice communications, but not really for music. (There are some places where it is used for music, as in stereo FM, but that's a special case, because some extra circuitry is used there to help the receiver put the carrier in the right place). For strictly voice communications, there is something even better: SSB.

Single sideband

If you look at any of the spectrum analyzer pictures of AM (Figs. 2 or 5), you will note that the lower sideband is

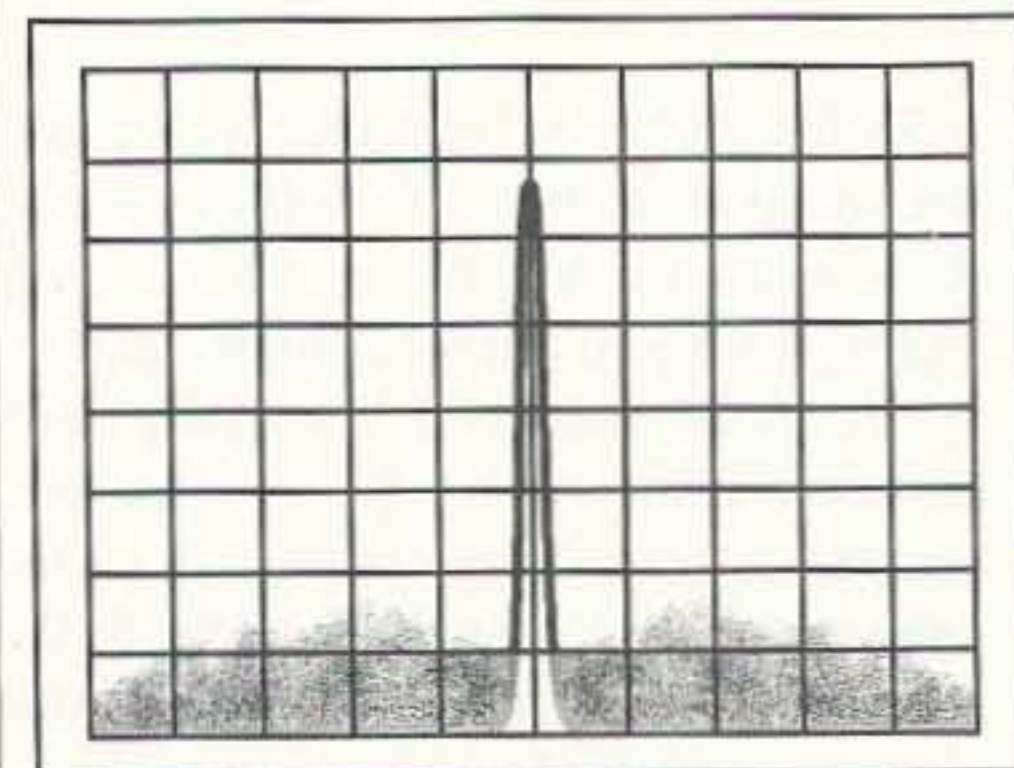

Fig. 5. An actual broadcast station.

always the mirror image of the upper sideband. For every side frequency component in the lower sideband, there is also a matching side frequency component in the upper sideband. So why does the receiver need both sidebands? It doesn't.

As long as the receiver gets one sideband, it gets all the information there is. It's sort of like you mailing a letter to a friend, but putting a second copy of the letter into the same envelope just in case. That second copy doesn't really tell your friend anything new. Unless the first copy gets damaged, of course, but in that case the second copy probably will too.

That is the idea behind SSB. With it, the transmitter sends only one sideband—no carrier, no second sideband. There are two ways to do that. One way is to generate a DSB signal, but then filter out one of the sidebands; the other is to generate two DSB signals in such a way that adding them cancels out one of the sidebands because it is out of phase in the two signals.

Let's look at the advantages of SSB:

1. It's much more efficient than plain AM, and even twice as efficient as DSB. No output power at all when there is no audio.

2. It causes even less interference to other stations than DSB, which also has no carrier.

3. It's half the bandwidth of AM or DSB. Remember that the bandwidth of an AM signal is twice the highest frequency being sent. For example, a telephone-quality signal with audio from 300 to 3,000 Hz would have an AM or DSB bandwidth of 6,000 Hz. With SSB, on the other hand, the bandwidth is only 2,700 Hz (since that is the frequency difference between the side frequency caused by a 300 Hz signal and the side frequency caused by a 3,000 Hz signal).

The bandwidth is important for several reasons. First, it means that twice as many stations can be crammed into the same band as AM or DSB (actually, more than twice, because there is so much less interference between them). Equally important is the fact that the receiver can now have tighter filters, which can do a better job rejecting other noise. The noise power picked up by a receiver is proportional to the bandwidth; cutting the bandwidth in half cuts the noise power in half too.

What about the disadvantages? The major one is that it is even more difficult for the receiver to decide where to put its

fake carrier. With DSB, at least the receiver can simply put the carrier exactly midway between the sidebands. With SSB, there is no midpoint. In fact, unless the user knows whether the transmitter is sending the upper sideband or the lower sideband, the receiver may not even know which side of the sideband to put the carrier on.

Tuning in an SSB signal is difficult. Even very expensive receivers require the user to adjust the tuning until "it sounds right." That may be close enough for voice, but useless for music. Hence, SSB is used only for radio voice communications, never for music (although SSB is used for certain wire-line communications with better results, but there again there are special tricks used to give the receiver additional information to help it generate the right carrier).

Vestigial sideband

As we mentioned in an earlier installment, the bandwidth of the composite video signal in a TV is approximately 4 MHz. Since AM is used for transmitting the picture in commercial TV, modulating this composite video signal onto a carrier would normally result in an 8 MHz bandwidth (twice the highest frequency in the picture), but TV stations are only allowed 6 MHz bandwidth (and some of that has to be used for the sound carrier).

The solution used for TV is *vestigial sideband*. The word vestige means leftover or remainder. TV transmitters transmit the entire upper sideband, but only a part (the "vestige") of the lower sideband.

For example, TV's channel 2 occupies frequencies from 54 to 60 MHz. The picture carrier is at 55.25 MHz; the upper sideband goes from 55.25 to 59.25 MHz, the full 4 MHz, while the lower sideband goes from 55.25 MHz down to 54 MHz, just 1.25 MHz. Even though most of the lower sideband is missing, the upper sideband contains all the information

that the TV needs to properly receive the picture. We should mention that the top part of the 6 MHz channel is used for the sound signal, which has a carrier at 59.75 MHz, but this part is sent as FM (or frequency modulation), so we will leave that discussion for later. For now,

DETOUR

Here's an interesting calculation you can do yourself.

We've already said that, when an AM carrier is modulated 100%, each sideband is 1/4 the power of the carrier. With two sidebands, that increases the power by 1/2. Here is how to check that.

Fig. 6 shows 10 cycles (20 half-cycles) of a 1 volt unmodulated carrier on the left, followed by 10 cycles (20 half-cycles) of a carrier modulated 100% on the right. Since the formula for power is $P = V^2/R$, the power is proportional to the square of the voltage. So let's square the voltage of each half-cycle of the unmodulated carrier on the left, and add up all the squares to get some idea of the relative power (ignore the units). Each half-cycle is 1 volt, whose square is also 1. For 20 identical half-cycles, the sum is 20.

Now repeat the same for each half-cycle of the modulated carrier. For example, the shaded half-cycle has a height of about 1.2 volts, so its square is about 1.44. Repeat that calculation for each of the 20 half-cycles (some are so tiny they are hard to see) and add up. You should get a sum of about 30, which is 1/2 more than 20.

This calculation shows that the total power of an AM signal increases by 50% when it is fully modulated. As we explained before, this extra power all goes into the two sidebands.

END OF DETOUR

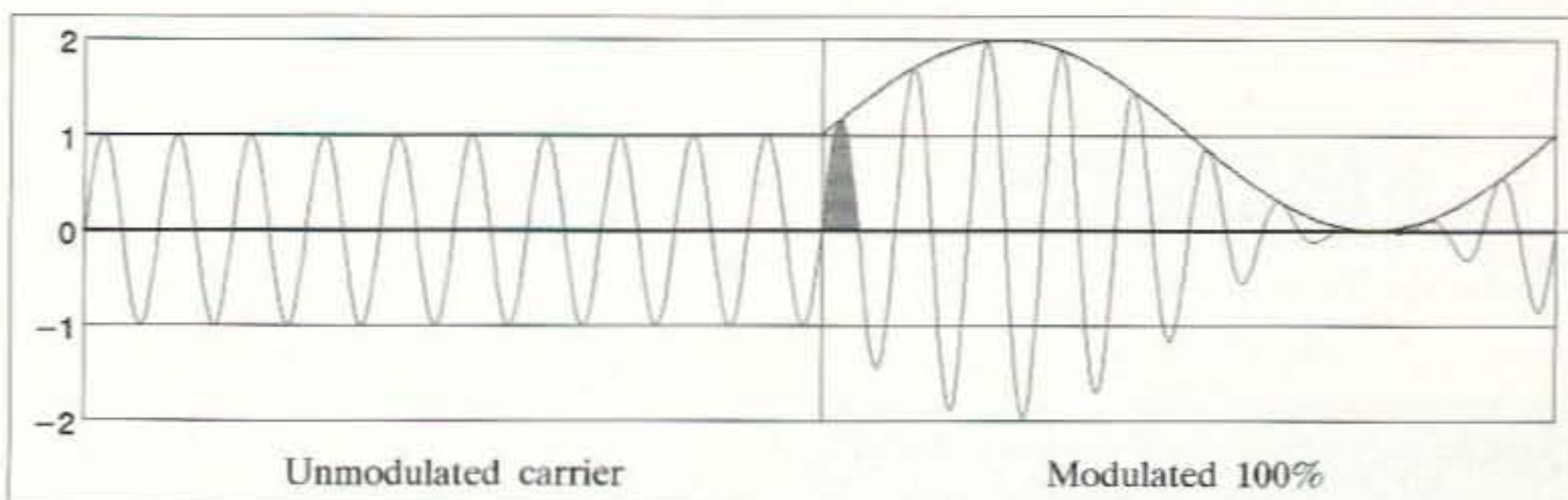

Fig. 6. Calculating the power of a 100% modulated carrier.

it's just important to mention that the TV picture and sound carriers are purposely different so that they cause as little interference with each other as possible.

Conclusion

Amplitude modulation is used in a number

of important places. Commercial AM broadcasting uses it, of course, but so does TV (although with a vestigial sideband). It's also used in the aircraft band, and by international broadcasters on the shortwave bands.

In amateur radio and other point-to-point communications, however, AM has been replaced by other modulation methods. SSB is important, but so is FM and various digital pulse methods (both will be discussed in future installments of this series). 73

NEVER SAY DIE

Continued from page 39

Imagine, convincing people to spell the words the way they sound! Impossible, of course. Yet, anyone who's done much CW work is used to abbreviated spelling, so this just might present some fertile ground to start the change. Fb om es cul, right?

The booklet is available from Radio Bookshop for \$5 postpaid in the US and Canada. For foreign mailing please add \$1.

If you know people who teach school you might get them to try Ray's ideas out on their kids and see what they think. Lemeno.

Math Problem

A fax arrived from Irwin Math WA2NDM, who writes a column for *CQ*. He was worried that some careless souls might hop into the Happy Hunting Ground via the Bioelectrifier described in the May 73 via passing the current through their hearts. In my AIDS booklet I do stress the importance of *not* passing the 50 μ A from arm to arm. Yes, I know, a lot of experimenters have done it and none have, as far as I know, done themselves in. But why take chances?

The article says to pass the current from one ankle artery to the other. Bob Beck called to say *not* to use any metal around the ankles, as the author did. That can give burns. He says to use an inch or so of solid bare wire wrapped in flannel and tied in place with a silk thread. Then soak it in a saltwater solution.

On the other hand, since any experimenting on live people must be done by a doctor, presumably the doctor will know better than to zap the heart. But then they have a license to kill, so one never knows.

I wanted to reassure Math that the base was covered, but he forgot to put an address or fax number on his fax, so I looked into *CQ* for his address. None given there either. But while I was looking for his column, which was indexed to be on page 86 (I finally found it on page 40), I couldn't help but notice that most of the magazine was devoted to columns. I counted 9-2/3 pages of

feature articles and reviews, and the rest of the 134-page magazine was devoted to columns and ads. From page 34 onward it was all columns! Only one of the articles was construction oriented—a simple antenna switch. Say, I wonder when editor K2EEK is going to get his General ticket and join us on the low bands?

One of the reasons I got fired as the editor of *CQ* after five years at the helm was my insistence on publishing construction projects. Speaking of which, I counted 26 pages of feature articles and reviews in *our* May issue.

Getting back to the Bioelectrifier, getting viruses and other crud out of the blood is beneficial, but with HIV you also have to chase it out of the lymph glands, where it can hide for years. Beck has a simple system for doing this. He wound a small coil, about 150 turns on an old VCR spool, and put it in series with a flash-gun bulb. This provides a short blast of about 20,000 gauss, which Beck says knocks the virus out of the lymph gland and into the blood stream, where a Bioelectrifier can keep it from attaching to the white cells.

At the Tampa Global Sciences Congress, Beck also reported that he'd been using the coil-flash unit on his head and, as a result, was sporting a new head of hair. Beck, by the way, has the original patents on flash guns. Let's see, I wonder how much an old flash gun is going for at flea markets now?

If that also counts as a medical procedure, then it should be done under a doctor's care. I dunno, I'm just reporting what I've seen and heard. But if you have a heart pacer, I hope you won't be dumb enough to jump-stop it with the coil.

If you'd like to hear Beck's fascinating one-hour talk for yourself, it's available for \$10 from Radio Bookshop as item BB-1.

The Numbers

The latest FCC count from Gettysburg tells the story. Let's compare the number of General, Advanced, and Extra Class licenses between 1982 and 1996; 14 years. $320,249 - 242,583 = 77,666$ gain. That's a 2.3% gain per year in 14 years. Less than a three percent growth for 14 years! Heck, we're probably dying faster than that! Those figures count nine years of dead hams, plus nine years of who knows how many drop-outs who won't bother to renew.

Yes, the Novice and Techs have grown from 164,866 to 393,322 in the last 10 years, for an average growth of 13.9% per year! And almost all of 'em are still up there on 2m. Maybe you can figure some way to get

'em Generalized and down on our HF bands. I tried hard with *Radio Fun* and I failed to make a dent. Since the written exams are so easy to memorize, it has to be the dreaded code that's gradually killing our hobby.

Are the Techs coming to your club meetings? If not, why not?

You're probably right. I should shut up about this and let what's going to happen, happen. Heck, I don't even know how to motivate people to stop killing themselves and their families with poisons and poor nutrition.

HAARP News

Unless you've been living in a cave somewhere, you're at least somewhat aware of all the fuss over the government's multi-megawatt plans to blow holes in the ionosphere with an Alaskan research project called HAARP. Nick Begich, whom I met at the Tampa Global Sciences conference in January, is the author of *Angels Don't Play This HAARP: Advances In Tesla Technology*.

A letter from author Fred Jueneman (I reviewed his *Raptures of the Deep* for you) had an interesting comment on the project. "If HAARP, in its wildest dreams, does succeed in short-circuiting the ionosphere to the surface of the Earth, or by some extension of the same principle, short-circuit the Van Allen Belt with its four million ampere current, this might momentarily negate the Earth's magnetic field, resulting in an effect known as the Giauque-Debye adiabatic demagnetization—a technical mouthful meaning that with the precipitous loss of a magnetic field an extreme cooling results. If HAARP somehow manages to short-circuit the Van Allen Belt, this effect is what I anticipate would occur. The results are so much more devastating in magnitude that they would make any thoughts of the destruction of the ozone layer pale in comparison.

"I'd expect that such a massive electrical discharge would make the ionosphere flare up like a multi-colored fluorescent display, sending spectacular streamers throughout the upper atmosphere. What could happen next with the almost instantaneous cooling of the polar air is the precipitation of the atmosphere itself like snowflakes in a blizzard over a rather sizable area. This adiabatic effect could create an equally sizable vacuum that would be filled by onrushing atmospheric air from the more temperate regions of the Earth's surface, generating winds of tornadic force which would level everything in their paths.

Continued on page 77

QUADS

5 Band 2 Element Quad **\$289 Complete**

Many other models available

Call for brochure today.

UPS Shippable

Lightning Bolt Antennas

RD #2, RT 19, Volant PA 16156

412-530-7396 FAX 412-530-6796

ABOVE & BEYOND

VHF and Above Operation

C. L. Houghton WB6IGP
San Diego Microwave Group
6345 Badger Lake Ave
San Diego CA 92119
Internet: clhough@aol.com

The wideband FM Gunn transceiver

Gunn oscillators and wideband FM for communications were covered in detail in the April 1990 issue of this column in 73. I have received many requests for information on how to set up a simple Gunn system, so I will cover part of that information again.

Why use a simple Gunn diode oscillator for microwave communications? Well, what the Gunn diode oscillator system has going for it is that it's a low cost method of getting into microwave operations. I'm happy to comply with readers' requests—for those interested in microwave operation, 10 GHz FM provides the easiest minimal cost system to put together. The equipment that will be described here functions very well and is capable of commercial-sounding full-duplex audio. I have to apologize for skipping this simple mode of operation as I have moved on to more costly and complex SSB communications schemes. Let's go back to my roots on 10 GHz.



Photo A. Cavity wave meters (frequency meters) suitable for measurement at 10 GHz. The devices in the front row are slide-screw tuners, detector mounts and a sliding short for waveguide analysis.

Scrounge yourself a simple transceiver

In the beginning, all microwave components were not created equal, and their prices were high, keeping many amateurs from obtaining them. That prevented many amateurs from investigating operation on our microwave bands. Amateurs being what they are, avid scroungers soon broke the price barrier (\$10 to \$15 each), noting that a simple Gunn oscillator from a burglar alarm unit could function in a 10 GHz WBFM communications system.

This unit is a simple form of the very popular Gunnplexer™ from Microwave Associates, the premiere WBFM transceiver. Most of the component parts for this simple version can be scrounged, and it can be assembled at home. (Of course, if you want the best and easiest WBFM operation, purchase a Gunnplexer from M/A; these units are costly, but they function perfectly.)

Bits and pieces can be obtained through diligence and the constant combing of local resources. (Caveat: This information might not be as timely as it was several years ago when material was more plentiful.) Where do you find transceivers? Look in your

own back yard: in the burglar alarm, garage door opener, and shopping center supermarket door opener industries. A lot of these devices are microwave, operating at 10525 MHz in the common use frequency band. This frequency is just above our 10 GHz amateur band and these devices can be adjusted down into our band very easily. Just increase (in most cases) the penetration of the frequency tuning screw into the cavity to lower frequency to WBFM frequencies of approximately 10250 MHz.

adjust pot, it's just a slow frequency change that might be plus or minus 3 to 5 MHz or so. This is the fine frequency control for the simple Gunn oscillator. The M/A Gunnplexer uses a varactor frequency control, making for far superior control and frequency adjustment.

FM modulation is the very rapid changes (AC audio impressed on the adjust terminal) causing the audio voltage changes to frequency modulate the voltage regulator voltage setting, and, thereby, the carrier frequency. The

"For those interested in microwave operation, 10 GHz provides the easiest minimum-cost system to put together."

If you go to suppliers or alarm companies, tell them you are looking for the metallic microwave units and are not interested in reusing them for alarm purposes. If they still have some of these units in their junk rooms, this strategy will usually work. If not, units can still be purchased from various sources and swap meets for a reasonable cost (not over \$20 for a working cavity). New cavities from alarm company suppliers might go up to the \$35 or so price range.

Most of these cavities employ a Gunn diode and a detector diode within the same cavity arrangement. Usually the Gunn diode is isolated in the rear and the detector diode is forward-mounted in the open end of the waveguide. The Gunn diode is fed from a power supply modulator circuit which reduces a 12- to 14-volt source to a regulated (variable) output voltage of 7 to 10 volts. The "adjust" terminal of the power supply regulator is modulated with a small AC voltage from an audio amplifier which is microphone-driven.

The mike amplifier is capacitively coupled to the adjust terminal of the regulator (an LM-317 variable voltage regulator). This regulator is preset to a voltage between 7 and 10 volts for proper Gunn operation. When you vary the voltage regulator's adjust pot, the Gunn's voltage will vary and so, slightly, will the frequency of the Gunn oscillator. With the

audio changes are transparent to the adjust terminals fine control. It's like two signals riding the same control, one fast (modulation) and one slow (fine frequency adjust of the DC voltage output).

The minute audio voltage changes control the FM deviation of your oscillator. These millivolt changes (AC) cause the voltage regulator's output voltage to vary accordingly, slightly up or down. This depends on the waveform being positive or negative at a particular instant. Positive adds to, and negative subtracts from, the overall output voltage. Its effect is to reproduce your speech (voltage changes) on the Gunn diode, producing frequency modulation. The exact level of the audio driving the regulator sets the deviation and is somewhere around 50 to 100 kHz wide bandwidth, producing commercial sounding audio. That's why it is called WBFM, wideband FM.

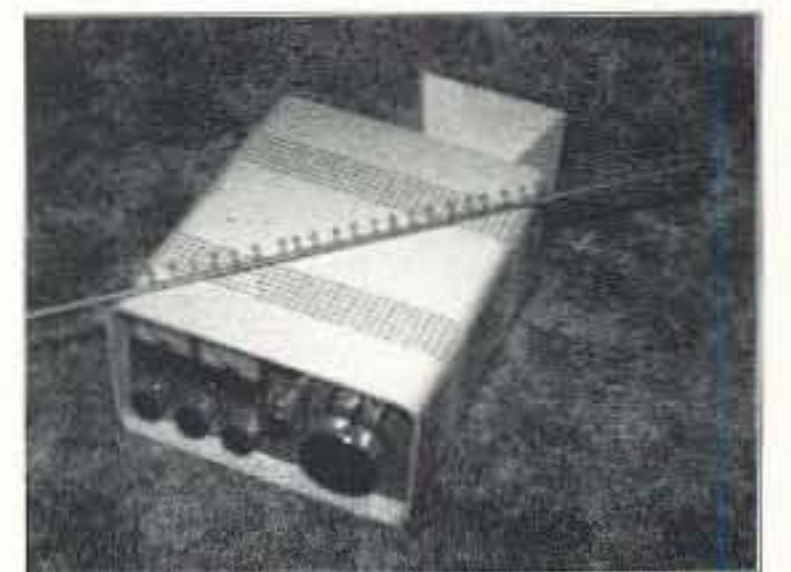

Photo B. The antenna on top of the rig is a 40-element loop yagi for 10 GHz. It measured 15.5 dBi at the Central States VHF Antenna Contest. (Photo courtesy of Kent WA5VJB.)

Not too bad, considering the minimum parts count to produce a microwave transmitter circuit with voice modulation. You have only used a Gunn diode in a cavity, an op amp and one voltage regulator. For now it's sufficient to say that the Gunn diode is oscillating on some frequency in the 10 GHz range. To set the frequency, a waveguide frequency meter is perfectly suited as its accuracy (plus or minus a few MHz) is sufficient for WBFM operation. (Note: A wavemeter is not suitable for narrowband SSB or narrowband FM operation. Narrowband FM is what is generated by a VHF HT.)

A frequency counter is required for SSB/FM narrowband operation due to the more exacting frequency requirements imposed on narrowband operation. In trying to contrast these two modes of operation, I like to envision WBFM looking for a detectable signal in 250 kHz or 1/4 MHz

“Our Microwave Group in San Diego was founded on the use of WBFM and simple Gunn transceivers; the cost was minimal, and it got about 20 to 25 people on the air.”

bites as opposed to looking for a similar narrowband FM or SSB signal in 2 kHz bites, which is some 100-200 times more critical in terms of frequency bandwidth.

The receiver circuit

The receiver circuit is not quite as simple as the transmitter described above. The receiver consists of a detector diode in the front end of the Gunn diode cavity structure, normally coupled to a 30 MHz RF preamplifier to amplify the small signal recovered from the detector diode (mixer) and pass it on to the main IF amplifier/audio amplifier circuit. The IF amplifier that I used is a complete FM radio receiver (IF amplifier in this case) on a single 16-pin chip (Signetics TDA-7000). It is capable of operation up to 120 MHz. We have determined that an IF of 30 MHz is quite satisfactory and is becoming a standard for WBFM operation on the microwave bands.

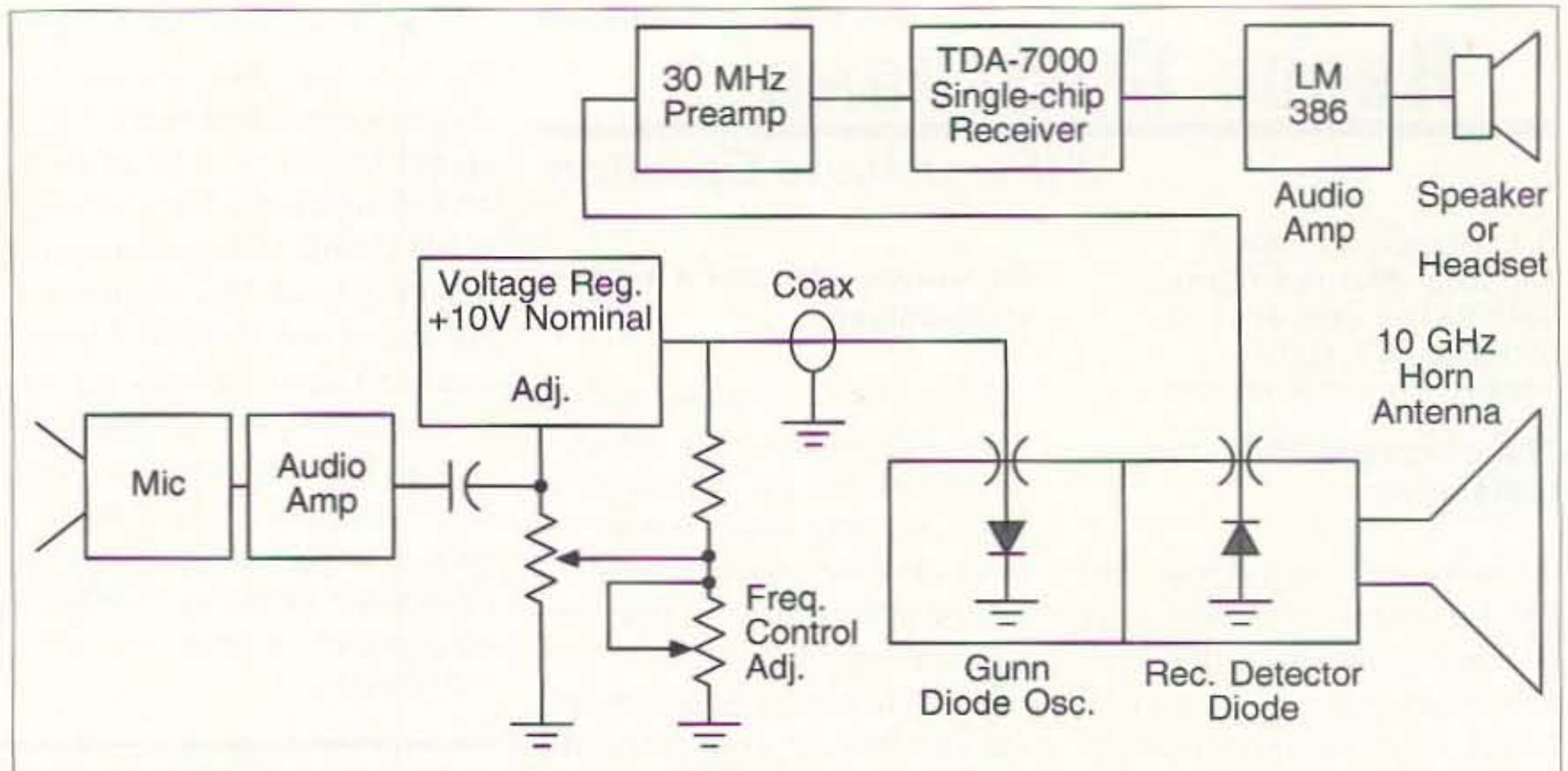

Fig. 1. Block diagram for a 10 GHz wideband FM Gunn transceiver.

The TDA-7000 chip IF amplifier that I used is capable of detecting a signal of 10 microvolts and producing a full quieting audio output. Coupling it with a simple single-stage RF amplifier, such as a 40673 MOSFET or a U-310 JFET amplifier, will

improve sensitivity to a fat tenths-of-a-microvolt or so. The complete schematic of the circuit (Fig. 1) shows how simple it is. Basically, the circuit is a free-running L/C-controlled oscillator operating on a low frequency of 70 kHz (internal to the TDA-7000 chip). The coil and capacitor that determine frequency are set to resonate at 30 MHz. I used a 1.8-inch shielded miniature slug-tuned core to wind 12 to 13 turns or #20 gauge enameled wire for the main oscillator coil. Add capacitance to tune to 30 MHz with the core adjustment and capacitor value. The exact capacitor value will vary due to coil "Q" and exact size and construction techniques. This is not exact, so a fudge factor is appropriate here.

We use 30 MHz as our IF frequency, which is produced by mixing two different signals—the same as in any receiver. However, when you look at Fig. 1, you'll notice that there isn't a separate local oscillator to mix with the

incoming received signal, as you might expect. In this receiver the local oscillator signal is actually provided by the transmitter itself. As long as the two transmitters are offset by 30 MHz each transmitter can also act as the receiver's local oscillator, producing a 30 MHz IF signal to feed to the TDA-7000. Here's how it works. Unit #1 sets his transmit frequency to 10250 MHz, and Unit #2 sets his transmitter 30 MHz to either side of Unit #1's—let's say 10280 MHz. Back at Unit #1, the 10280 MHz signal from Unit #2 is being received in the horn antenna. This signal mixes with some of the 10250 MHz being transmitted out of the Unit #1 dish, and produces a 30 MHz difference frequency. (The receiver detector diode is actually acting as a mixer.) This difference frequency is processed by the TDA-7000 as an IF frequency and demodulated. On the other side of the link, Unit #2 is still transmitting on 10280 MHz. He receives the 10250 MHz signal from Unit #1, which mixes with his transmitter frequency. This produces a 30 MHz difference frequency in his feedhorn, which gets passed to his receiver circuit. As long as the two stations are offset by 30 MHz—one high, and one low—full-duplex conversations can take place.

Now, don't be gullible—this is not all rosy. The operation is true and works, but there are some small hitches to this mode of operation.

First, you have to have some test equipment to set frequency,

even though the frequency is a very wideband FM mode of operation. It will be somewhat frustrating trying to keep a free-running Gunn oscillator near the 100 kHz or so band widths of simple burglar alarm type cavities that exhibit limited electrical frequency tuning. More expensive cavities solve this deficiency by placing a varactor to adjust the cavity frequency about 60 to 80 MHz, making frequency adjustment a very simple manner. But,



Photo C. Jack N6XQ on Mt. Soledad assembling his WBFM M/A rig on his 30-inch dish. This is a popular spot in San Diego for contacts to Mexico, Los Angeles and beyond as it's an almost all over-the-water shot. I have observed microwave ducting from this location many times.

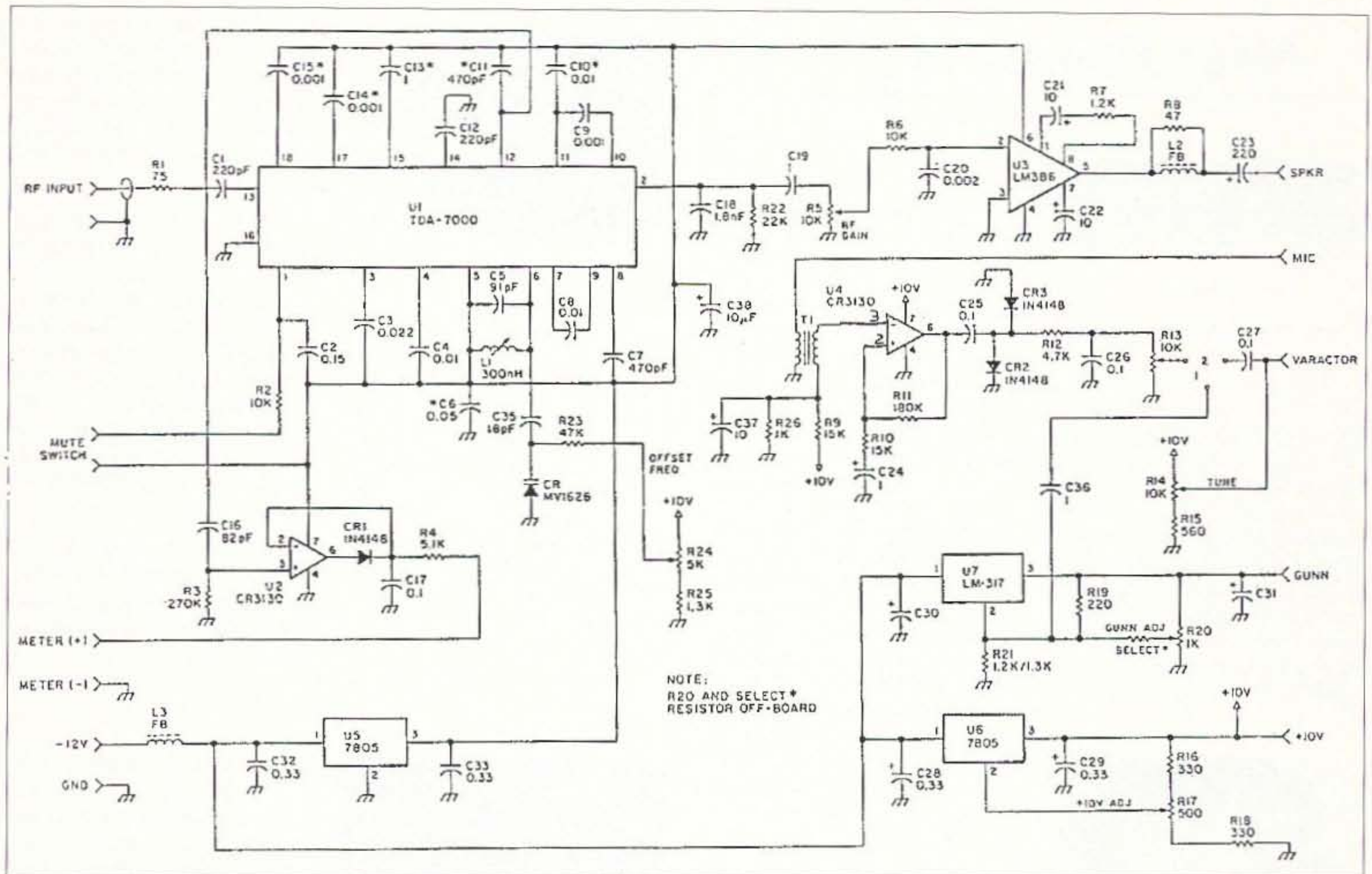

Fig. 2. Schematic for a 30 MHz IF power supply and transmit modulator control circuitry for a complete 10 GHz communications system.

as in the difference between a Chevy and a Caddy, price looms as the great separator.

If you are asking yourself what basic system you want to play with for microwave, I suggest you get the Chevy. For all its faults, it will not bankrupt you and, for a limited output of cash, it will let you test the microwave waters. This column is intended to provide you with a guide to a circuit that works. It is by no means the last word, but rather a starting place for inexpensive experimentation.

Sure, there are much better modes of operation, and far more sophisticated circuitry will blow the doors off this project, but then there goes the Caddy vs. Chevy talk. That discussion can go on to time's end. The real end to the discussion is what you want to accomplish. If you want to get your feet wet and test the waters, try this approach. If it doesn't meet your needs, go on to another fishing hole or try another microwave frequency band.

Our Microwave Group in San Diego was founded on the use

of WBFM and simple Gunn transceivers; the cost was minimal, and it got about 20 to 25 people on the air. Our use of WBFM lasted for several years and produced some very amazing contacts. We became quite proficient in operation and new improved methods. Simple things like "Where is north?" and "I mean *that-a-way*" are not accurate enough for pointing a dish antenna at microwave frequencies. Accurate pointing has to be dealt with when you want to remove pointing errors and make microwave contacts.

PC board available

There are several things that need to be addressed in this arena and will be dealt with in next month's column. Let's wrap up the receiver construction and get this project on the road. I am told that I can replenish my stock of TDA-7000 chips if I order 100 devices. I am placing an order as this is being typed and will have PC boards and data with the TDA-7000 chips available for \$12.50 postpaid to US

destinations. I will toss in some capacitors (tantalum) and a few other parts that I have on hand to assist you in the parts count (this is a freebie on my part because I have extra components on hand). I am hoping the chips arrive from the factory in a timely manner; I am quoted eight to 10 weeks' delivery time. I also have a quantity of new 30 MHz TTL clock oscillators for use as test generators. If you want the TTL 30 MHz oscillator add \$2. I know you will want one as we will build test equipment with it next month.

Board test

As with any construction project, check it out with an ohmmeter. Check out the voltage regulator circuit with a resistance load, not with the Gunn diode. Make sure everything works as expected before you try the circuit and the Gunn detector diode as a complete package. As you test the variable voltage regulator circuit, check out the 30 MHz preamp. Inject a signal with a signal generator and see if the circuit is functioning at some

specific frequency. Frequency prior to adjustment could be anywhere from 20 MHz to 70 MHz, depending on the components and values used.

I connect a signal generator and tune for the frequency of operation. When you find out where the circuit is receiving, you can trim the coil slug or add capacitance to bring the circuit to resonance near 30 MHz. The signal generator method works for a first cut as it tells you what the sensitivity and approximate frequency of operation are. When completed, both units should be set to exactly 30 MHz; or, if in doubt, set them to the same frequency (you can use the TTL 30 MHz oscillator for alignment). If other units are to be used they also should be set to the same standard: either exactly 30 MHz or all the same frequency.

Now, the other alternative to building the PC board 30 MHz IF amplifier: Use an inexpensive 88 to 108 MHz FM portable radio along with the modulator voltage regulator circuit. It's the same thing, except there's one provision: The stations you wish to

Continued on page 79

NEW PRODUCTS

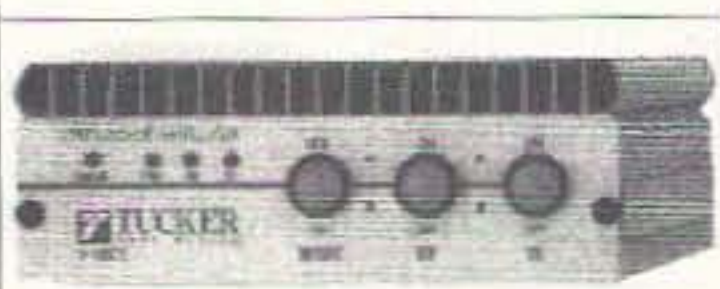

V-100W

Two 2m Amps from Tucker

The new V-35W 2m VHF amplifier from Tucker Electronics features a built-in 15 dB preamp and a unique DC Monitor Meter that provides the operator with a constant reading of DC input voltage. The V-35W will accept 0.5-8W input power and produces up to 35W of output power. It operates on both FM and SSB/CW and is equipped with a built-in RF power meter.

Tucker has also introduced the V-100W, which will accept 0.5-8W input power and produces up to 100W of output power. An input power signal of only 0.5W is required to produce 50W of output power, and 3-8W will drive the V-100W to full power output of 100W. Like the V-35W, it features a built-in 15 dB preamp and a built-in RF power meter.

Both amplifiers are designed to be used with 2m HTs and low-wattage 2m desktop transceivers, and both are covered by Tucker Electronics' one-year warranty and 30-day "Satisfaction Plus" no-questions-asked return policy. For more information, contact Tucker Electronics at 1717 Reserve Street, Garland TX 75042; phone (800) 559-7388 or FAX (214) 340-5460.



V-35W

Manufacturers: if you would like to have your products reviewed here, please call Fran at 603 924 0058.

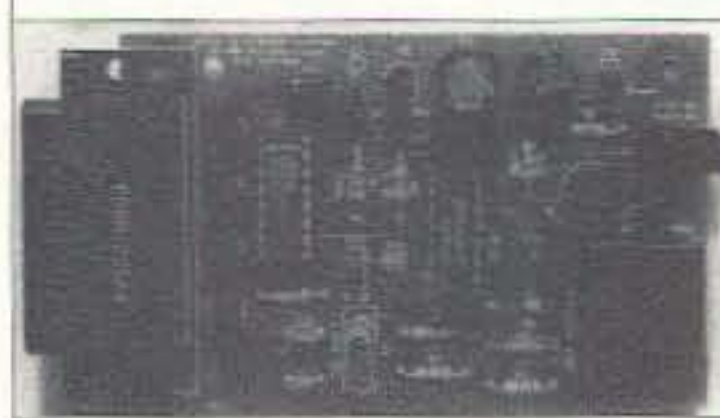

ID to Interface Kit

Compared to high-priced modems and units costing five to 10 times as much, ITU Technologies' new Caller ID to PC

Interface Kit is a price and performance breakthrough. It measures only 2.25 by 3 inches and can be plugged directly into any spare PC serial port. Software is included with the kit, for DOS and Windows-based programs. The ITU Caller ID to PC Interface Kit is a bargain at \$39, plus \$5 shipping and handling, from ITU Technologies, 3477 Westport Ct., Cincinnati OH 45248-3026. Call (513) 574-7523 or FAX (513) 574-4245.



Stop drifting!

B+K Precision has just introduced four new spectrum analyzer models that are guaranteed to drift less than 0.150 MHz per hour, and this guarantee is good for a full year after purchase. All four models have stability and dynamic range equal to that of spectrum analyzers costing thousands of dollars more.

Two optional accessories are available: a battery pack to make the analyzers truly portable, and a 75Ω to 50Ω impedance matching adapter, to extend the analyzer's usefulness to 75Ω applications.

Models 2615 and 2620 are ideal for applications of up to 500 MHz. They include scanwidth selectors and an LED readout. Model 2620 also includes a tracking generator, a frequency synchronous signal source. Models 2625 and 2630 have AM and FM audio modulation to allow the user to listen to and identify RF signals. Model 2630 also includes a tracking generator.

For more information or the name of the nearest B+K distributor, call 1-800-462-9832 or write B+K Precision, 6470 W. Cortland St., Chicago IL 60188.

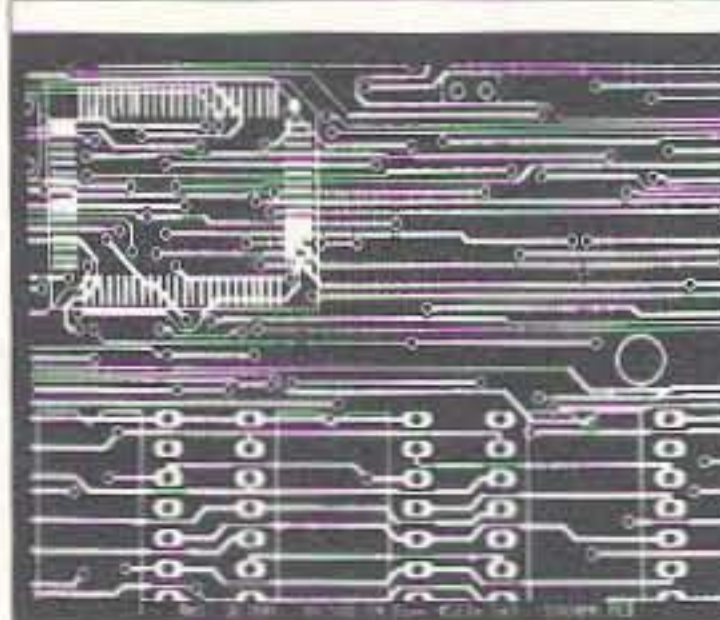

Produce perfect double-sided layouts in record time!

Number One Systems, in Cambridgeshire, England, is justly proud of the new, fast, powerful MultiRouter. Designing an autorouter to handle today's complex and dense layouts is no easy task, but the latest autorouting technology gets your routes through where other routers fail.

MultiRouter is a 32-bit multi-pass, shape-based autorouter. It uses proven push-and-shove and rip-up-and-retry techniques to achieve 100% completion on

most layouts, and MultiRouter is so fast and easy to use, you could be looking at your first fully routed layout within an hour of installing the software. Surface-mount components? Memory Planes? No problem for MultiRouter!

MultiRouter works with Number One Systems' well-known PCB layout tool Easy-PC Professional XM. Together they form one of the fastest and most effective PCB design systems available for the PC and, priced at only £295 and £245 respectively, they are accessible to all PCB designers. US prices (including airmail) are \$575 for MultiRouter; \$475 for Easy-PC Professional XM. For further information contact Roger Wareham, Number One Systems, Harding Way, ST IVES, Huntingdon, Cambridgeshire PE17 4WR, Great Britain. Telephone +44 1480 461778; FAX +44 1480 494042. E-mail: rmw@numberone.com.



1996 Sescom catalog

If you're into building, you can't do without this catalog. If you're not into building, you're missing a heck of a lot of fun. Building stuff is like going on a DXpedition; you never forget anything you've built—never. Old Uncle Wayne still remembers the very first radio he ever built, back 60 years

ago. Not having a Sescom enclosure, he built it into a cigar box. And it worked! Now send for the catalog from Sescom, 2100 Ward Drive, Henderson NV 89015-4249; (800) 634-3457, FAX (800) 551-2749. Then let's see what you can build with the Sescom tools and enclosures.

**Wanted
ham-related
articles to publish
in 73.
Contact Frances at
603-924-0058 for
details.**

ADVERTISERS' INDEX

R.S.#	page	R.S.#	page	R.S.#	page	R.S.#	page
351	Absolute Value Systems ... 41	184	C & S Sales, Inc. 21	151	KDC Sound 39		
	• Advanced Info Group 33		• Cable X-Perts, Inc. 19		• Lightning Bolt 68		• Radio Book Store 83
194	All Electronics Corporation 7	178	Centaur Electronics 14		• Link-Com 23		• Radio Book Store 86
57	Antennas West 1	156	Commpute Corporation ... 37		• Maggiore Electronics Lab . 27	58	Radio Engineers 57
116	Antennas West 39	99	Communication Concepts 27	86	MFJ Enterprises 11		• RAI Enterprises 59
340	Antennas West 39	276	Computer Aided Technology ... 9	160	Micro Computer Concepts 32	34	Ramsey Electronics 5
332	Antennas West 41	268	Computer Automation Technology 35	193	Morse Tutor Gold 57	254	Ross Distributing 43
304	Antennas West 32		• Cubex 37	248	Motron Electronics 29	167	Sescom, Inc. 41
5	Antennas West 37	13	Doppler Systems 25	114	Mr. Nicd 63	188	SGC, Inc. 88
324	Antennas West 57	114	E. H. Yost 63		• Patcomm CV3		• Sirio Antenna CV4
89	Antennas West 43	193	GGTE 57		• P.C. Electronics 25	250	Software Systems 33
16	Astron Corporation 15	165	Hamco 63		• P.C. Electronics 59	69	Spectrum Electronics 37
41	Barry Electronics Corp 17	78	Hamsure 41		• Peet Bros. 9	269	Tigertronics 35
42	Bilal Company 33		• Hamtronics, Inc. 2	68	Periphex 57	22	Tri-Ex 29
168	Buckmaster Publishing 41	42	Isotron 33		• Radio Book Store 33		• Universal Radio 39
56	Buckmaster Publishing 43	159	Japan Radio Co. CV2		• Radio Book Store 57	259	Versatel Communications . 37
7	Buckmaster Publishing 57		• JPS Communications 53		• Radio Book Store 61	104	Vis Study Guides, Inc. 39
222	Byers Chassis 63				• Radio Book Store 79	191	W & W Associates 73

When you buy products from these advertisers, please tell them that you saw their ads in 73.

Subscribe to 73 right now...call 800-274-7373 (9-5 Monday-Friday EST).

BATTERIES

BUY DIRECT FROM US, THE MANUFACTURER!



YAESU

FNB-2	10.8v @	600 MAH
FNB-4	12v @	750 MAH
FNB-4A	12v @	1000 MAH
* FNB-10(S)	7.2v @	1200 MAH
FNB-12(S)	12v @	600 MAH
FNB-17	7.2v @	600 MAH
FNB-25	7.2v @	600 MAH
FNB-26	7.2v @	1200 MAH
**FNB-26(S)	7.2v @	1500 MAH
FNB-27	12v @	600 MAH
**FNB-27(S)	12v @	800 MAH
**1/4" longer than FNB-27		
FNB-31	4.8v @	600 MAH
FNB-33(S)	4.8v @	1500 MAH
FNB-35(S)	7.2v @	600 MAH
* FNB-35(S)(S)	7.2v @	1500 MAH
FNB-38	9.6v @	600 MAH

*1 1/3" longer than FNB-38 case
BATTERY ELIMINATORS AVAILABLE

Special
FOR THE
MONTH OF JULY
10% OFF
on ALL
Camcorder
Replacement Batteries

Look for August's
Special of the Month
MONTHLY DISCOUNTS
APPLICABLE TO END-USERS ONLY

Powerpac⁺

6 V for Camcorders & 12 V for 2-way



Prices and specifications subject to change without notice

W & W ASSOCIATES

800 South Broadway, Hicksville, NY 11801

WORLD WIDE DISTRIBUTORSHIPS AVAILABLE. PLEASE INQUIRE

In U.S.A. and Canada Call Toll Free:(800) 221-0732 • In NY State Call:(516) 942-0011 • Fax:(516) 942-1944

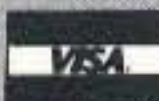

NYS residents add 8 1/2% sales tax. Add \$4.00 for postage and handling

MADE IN THE U.S.A.
SEND FOR FREE CATALOG AND PRICE LIST

CIRCLE 191 ON READER SERVICE CARD

Where Am I?

Here's how to find your grid square.

Arthur C. White
Route 2 Box 5600
Talihina OK 74571

Do you know the grid square of your location? If not, do you know how to find it? It's something that should be on your QSL card because, more and more, it is of interest to a lot of your fellow hams. This article offers a step-by-step procedure for finding your grid square.

The present system of grid squares was adopted at a conference held in Maidenhead, England (and is commonly called the Maidenhead system). By the mid-1980s it had become a worldwide standard. In this system, the entire world has been divided into (1) fields, (2) squares, and (3) subsquares. A particular location may be known as EM 24 KR—field, square, and subsquare, respectively. We'll get to each of them in turn.

Fields

These cover the entire world. Each field is 20° wide in longitude (or east-west) and 10° in latitude (north-south). Starting at 180° longitude (the international date line) and proceeding eastward, each 20° field is designated alphabetically all around the globe until arriving back at the date line again (Fig. 1).

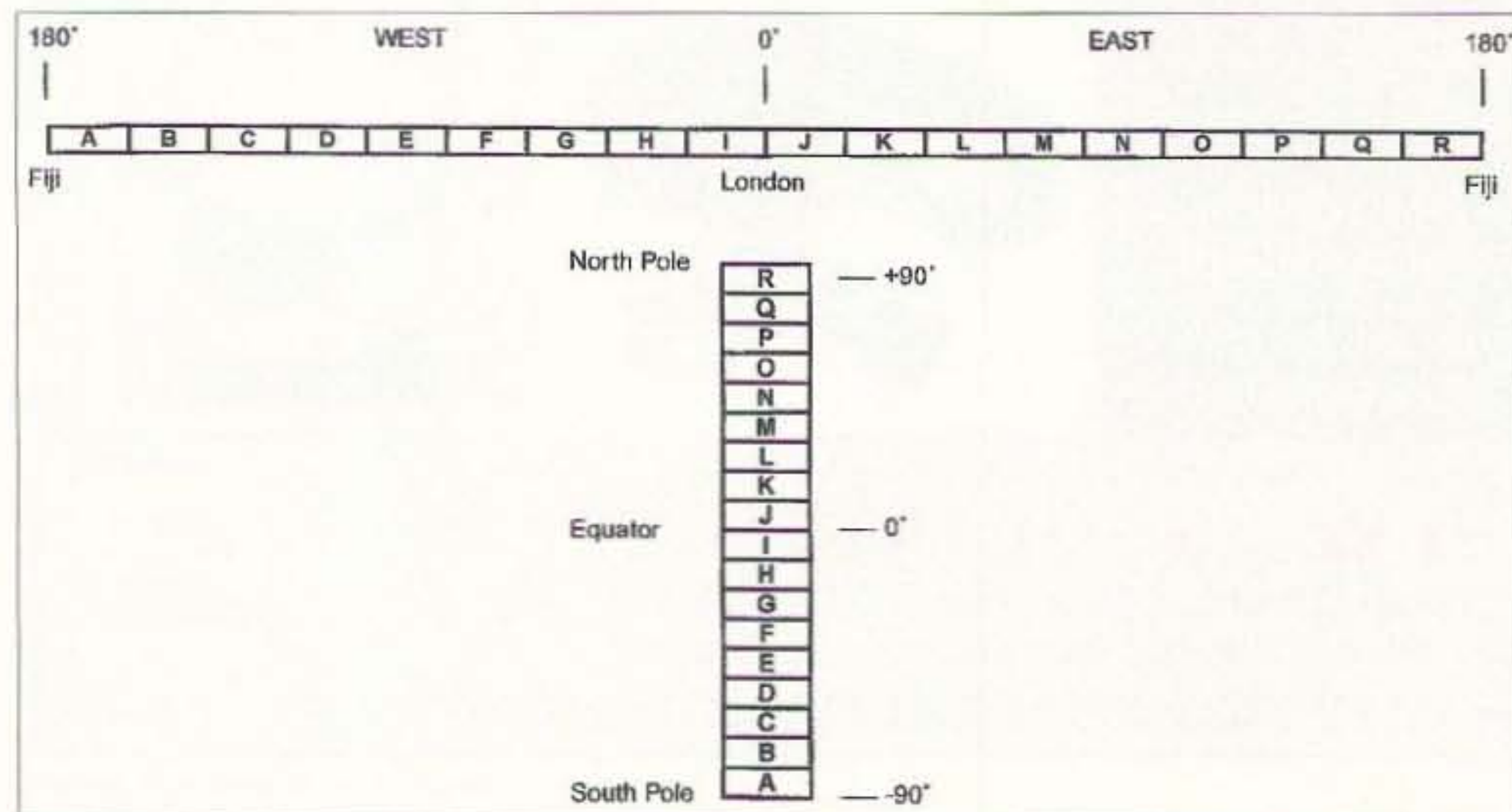

Fig. 1. East-west fields of 20° designate the distance from the international date line, while 10° north-south fields designate the location relative to the equator.

AR	BR	CR	DR	OR	PR	QR	RR
AQ	BQ	CQ	PQ	QQ	RQ	...
AP	BP	QP	RP	...
AO	RO	...
...
AD	RD	...
AC	BC	QC	RC	...
AB	BB	CB	PB	QB	RB
AA	BA	CA	DA	OA	PA	QA	RA

Fig. 2. North-south and east-west field designators are combined to create a two-letter designator for each 10° x 20° block on the face of the earth.

Since there are 360° in a circle, and since each field is 20° wide, there are 18 (360 ÷ 20 = 18) fields horizontally. Fields are designated with the 18 letters from A to R.

“Given a longitude and a latitude, you can find your grid square location yourself.”

Similarly, starting at the South Pole and proceeding to the North Pole (a span of 180°), with each field occupying 10°, there are also 18 fields vertically (180 ÷ 10 = 18). These are also designated A to R (see Fig. 1).

So there are 324 (18 x 18) fields worldwide. All field designations start at the left and proceed to the right and then up. The longitude letter comes first, followed by the latitude, so that each field is specifically identified with a unique two-letter label. Your longitude and latitude at any place on earth determine the field you're in (see Fig. 2).

Of course, since the earth is round and the longitude lines converge at the poles, none of the fields is really square. They are wider on the side nearest the equator and narrower on the side nearer the pole.

Squares

Each field is divided into squares. A square is 2° in longitude and 1° in latitude. Hence, each field contains 10 squares (20 ÷ 2) in longitude and 10 (10 ÷ 1) in latitude, making 100 squares in all. Starting at the lower left corner, they are numbered from 0 to 9 towards the right, and 0 to 9 from south to north, again with longitude first (see Fig. 3).

Subsquares

Subsquares provide icing on the cake. To provide a higher degree of resolution, each square is divided into subsquares. Each longitude and latitude dimension is divided by 24, making 576 (24 x 24) subsquares. Since each square is 2° wide, 24 subsquares must each be 5' in

69	79	89	99
...	78	88	98
	...	87	97
		...	96
			95
			94
		...	93
	...	82	92
...	71	81	91
60	70	80	90

Fig. 3. Each field is divided into 100 squares, numbered from 00 in the southwest corner to 99 in the northeast corner.

longitude. Likewise, the 1° north-south distance of a square divided by 24 equals 2.5' in latitude. The subsquares are designated by letter, again starting at the lower left and proceeding to the right, and then from south to north, with longitude first. Hence, a location such as EM 24 KR designates a location on the surface of the earth within a 5' by 2.5' boundary. Fig. 4 shows the western section of a square and the subsquare lettering system.

How to determine your location from scratch

The first thing is to know your longitude and latitude. Your library or a local surveyor may be a convenient source for this information. Say you're at 95°, 08', 55" west longitude and 34°, 43', 05" north latitude. We can simplify this to 95°, 08.9' west and 34°, 43.1' north (convert minutes and seconds to decimal minutes by dividing the seconds by 60 and rounding to the nearest tenth).

Let's begin by considering our longitude designators. We'll work eastward from the date line. First, determine how many fields you are removed from the date line. In this case, we are 180° - 95°, 08.9', or 84° 51.1' away (see Fig. 5, top).

AX	BX	CX	DX	...
AW	BW	CW	...	
AX	BV	...		
AU	...			
...				
AD	...			
AC	BC	...		
AB	BB	CB	...	
AA	BA	CA	DA	...

Fig. 4. Each square is divided into 576 subsquares, designated AA in the lower left to XX in the upper right.

Note that if we were located in the Eastern Hemisphere, we would simply add 180° to our longitude to find our longitude distance from the date line. We have now established the first letter of our location: E. Since each field is 20° wide, 84° 51.1' puts us just past the fourth field (80°) and into the fifth.

Now, how far inside E are we? $84^\circ 51.1' - 80^\circ = 4^\circ 51.1'$ so we are 4° 51.1' past the fourth field. Squares are 20° wide, so $4^\circ 51.1' \div 2^\circ = 2$ with 51.1' remaining, so we are in the third

Now for the latitude indicators. Our latitude is 34°, 43.1' north. Starting from the South Pole, with a letter assigned to each 10°, we find we are in field M (Fig. 6, left). We are 4°, 43.1' north of 30° which places us in square 4 (Fig. 6, middle). And we are 43.1' north of 34° with $43.1' \div 2.5'$ being 17.24, so we are in the 18th subsquare above 34° which is R (see Fig 6, right). Combining our three latitude indicators with the previous longitude indicators (keeping the longitude first in each case)

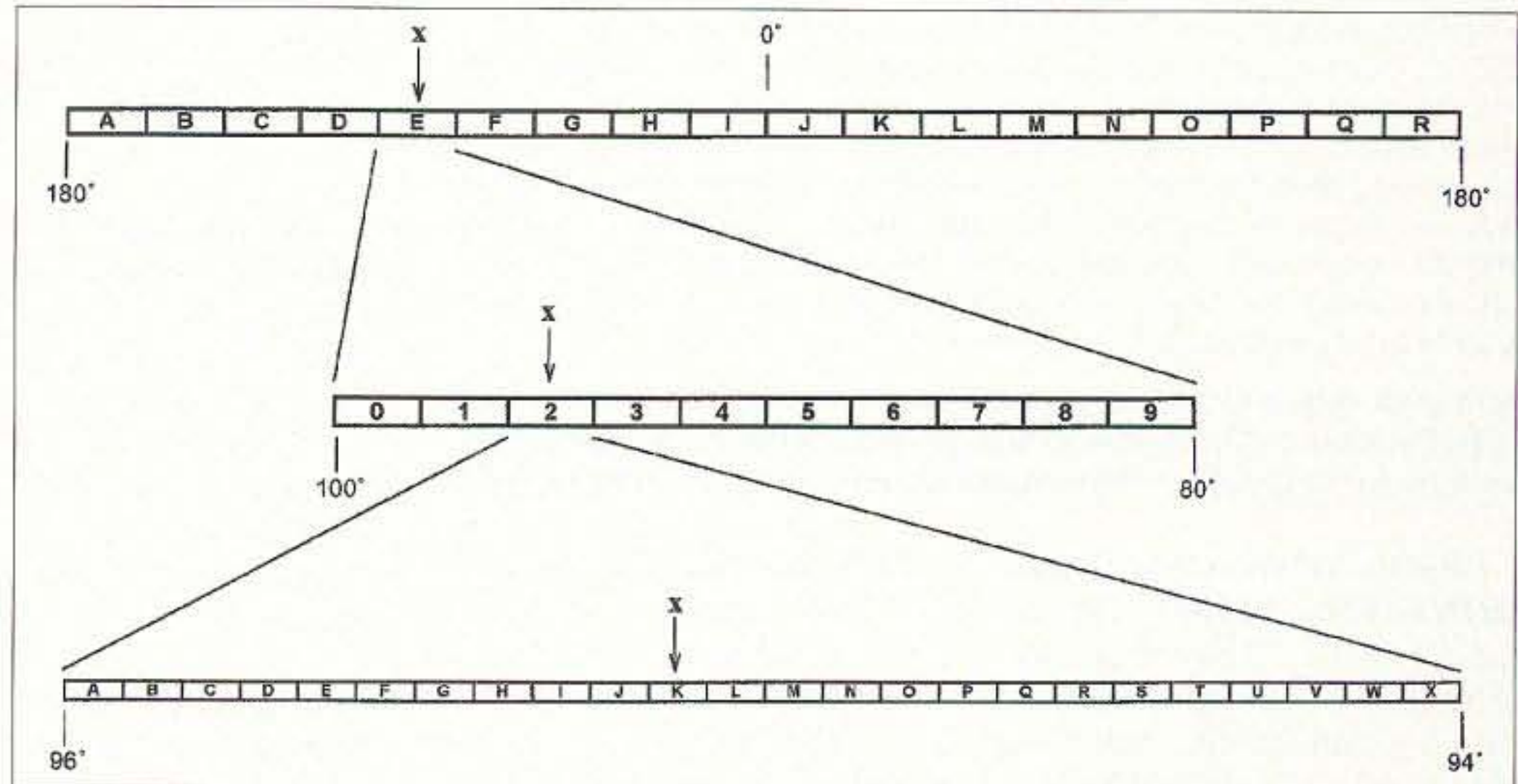

Fig. 5. The longitude portion of the grid square designator is found by locating the proper fields, square, and subsquare (top to bottom).

square, which gives us the first digit in our square designator: 2 (see Fig. 5, middle).

Now we are 51.1' within square 2. Since the square is divided into 24 sections of 5' each, then $51.1' \div 5' = 10 + 1.1$, so we are in the 11th sector. Our designator for the 11th subsquare, therefore, is K (Fig. 5, bottom).

gives us the complete grid locator: EM 24 KR.

That's all there is to it. Given a longitude and latitude, you can "do it yourself." Try it. 73

Reference: The ARRL World Grid Locator Atlas.

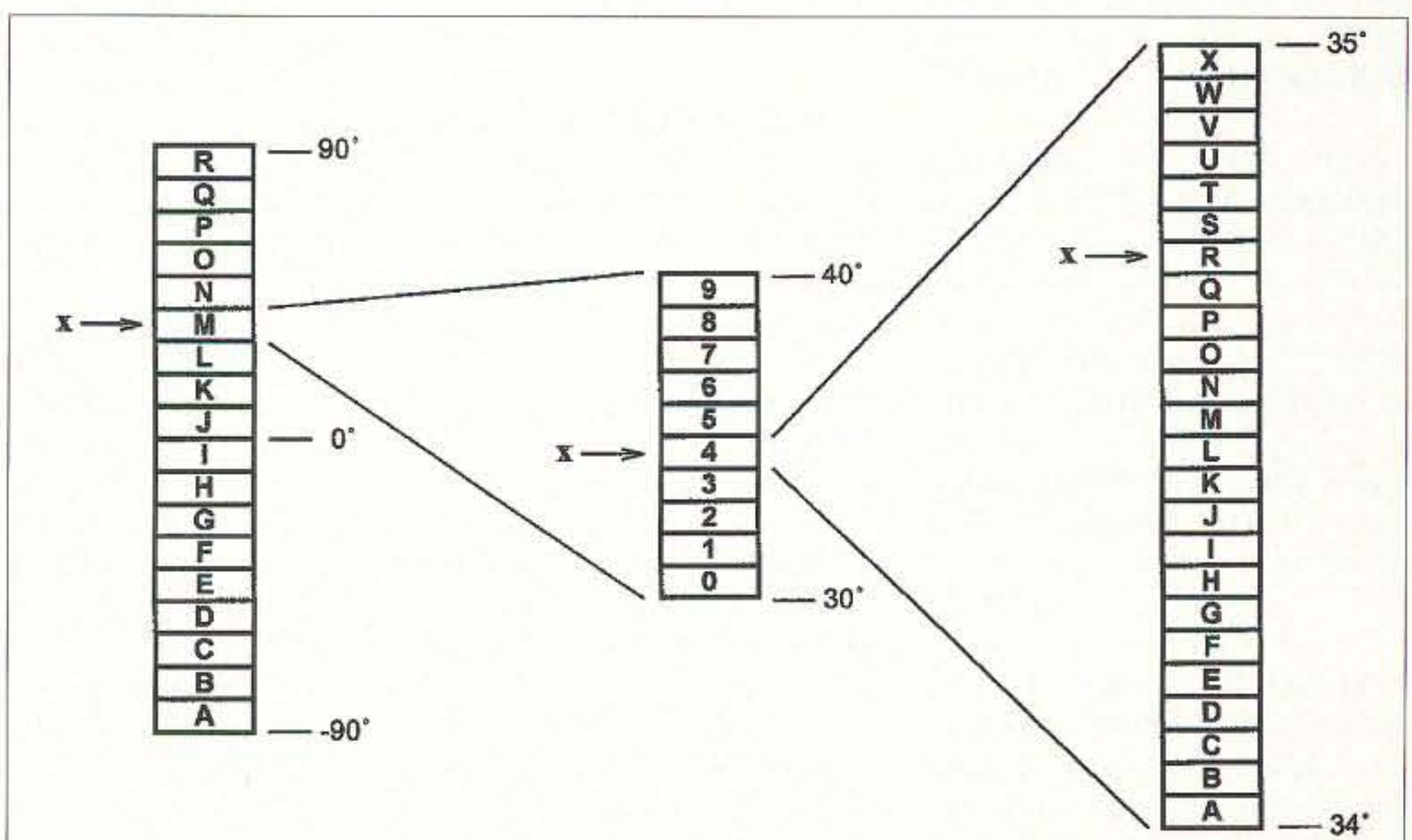

Fig. 6. The latitude portion of the grid square designator is found by locating the proper field, square, and subsquare (left to right).

BARTER 'N' BUY

Turn your old ham and computer gear into cash now. Sure, you can wait for a hamfest to try and dump it, but you know you'll get a far more realistic price if you have it out where 100,000 active ham potential buyers can see it than the few hundred local hams who come by a flea market table. Check your attic, garage, cellar and closet shelves and get cash for your ham and computer gear before it's too old to sell. You know you're not going to use it again, so why leave it for your widow to throw out? That stuff isn't getting any younger!

The 73 Flea Market, Barter 'n' Buy, costs you peanuts (almost)--comes to 35 cents a word for individual (noncommercial) ads and \$1.00 a word for commercial ads. Don't plan on telling a long story. Use abbreviations, cram it in. But be honest. There are plenty of hams who love to fix things, so if it doesn't work, say so.

Make your list, count the words, including your call, address and phone number. Include a check or your credit card number and expiration. If you're placing a commercial ad, include an additional phone number, separate from your ad. This is a monthly magazine, not a daily newspaper, so figure a couple months before the action starts; then be prepared. If you get too many calls, you priced it low. If you don't get many calls, too high.

So get busy. Blow the dust off, check everything out, make sure it still works right and maybe you can help make a ham sure it still works right and maybe you can help make a ham newcomer or retired old timer happy with that rig you're not using now. Or you might get busy on your computer and put together a list of small gear/parts to send to those interested?

Send your ads and payment to: **73 Magazine, Barter 'n' Buy, 70 Rt. 202N, Peterborough NH 03458** and get set for the phone calls. The deadline for the August 1996 classified ad section is **June 12, 1996**.

EPSON WIDE-CARRIAGE PRINTERS: \$65.00 (Refurbished) With 30-day warranty. Technical Equipment Services, Inc., 23 Stevens St., Littleton, MA 01460-4352, Tel. (508) 486-0600 or FAX (508) 486-4925.

BNB4012

CYBER II, measurement, control, robotics unit. Connects com port, your Personal Computer. Includes program. Information: Tesco Automation, Box 6216-T, Lubbock TX 79493.

BNB4019

ASTRON power supply, brand-new w/warranty, RS20M \$99, RS35M \$145, RS50M \$209. Call for other models, (818) 286-0118.

BNB411

NOW ON 40 METERS! NEW, KNOB-TUNED w/DIGITAL DISPLAY, SYNTHESIZED QRP transceiver. Complete kit only \$199.95. S&H \$7.50 (continental US). GUARANTEED TO WORK. For info send SASE: Call/write to order: **S & S ENGINEERING**, 14102 Brown Road, Smithsburg MD 21783; (301) 416-0661.

BNB334

NI-CD BATTERY analyzer cyclers. PC controlled. DOS software. \$289. P.O. Box 672, London, Ontario Canada N6A 4Y4 **Lamantia Products** (519) 472-5566 Fax (519) 472-1702.

BNB385

IT'S BACK! The return of the HW-8 Handbook! Second printing. Modifications for the Heath QRP rigs. First class mail \$11. DX add \$4 for air mail shipping. **Mike Bryce, WB8VGE**, 2225 Mayflower NW, Massillon OH 44647.

BNB404

MAHLON LOOMIS, INVENTOR OF RADIO; by Thomas Appleby, (Copyright 1967). Second printing available from **JOHAN K.V. SVANHOLM, N3RF, SVANHOLM RESEARCH LABORATORIES**, P.O. Box 81, Washington DC 20044. Please send \$25.00 donation with \$5.00 for S&H.

BNB420

HEATH COMPANY is selling photocopies of most Heathkit manuals. Only authorized source for copyright manuals. **Phone** (616) 925-5899, 8-4 ET.

BNB964

HAMCATION: 27 & 28 July 1996, Bahia Shrine Temple, Orlando, FL. Table for Vendors, Individuals and Info. Booths. **ARRL VE EXAMS**. Further info. Contact Cecil F. Morehouse K4KEN, (407) 281-9169.

BNB3001

WANTED: Western Electric Audio Equipment. Amplifiers, pre-amps, tubes, speakers, parts, mixing boards, etc. 1-800-251-5454.

BNB1050

Morse Code Computer Interfaces \$49.95, with CW Filter \$79.95, Free IBM Shareware and Ham Catalog. Dynamic Electronics, Box 896, Hartselle AL 35640, (205) 773-2758, FAX-773-7295, dei@whnt19.com. BNB1034

ATLANTIC TRACKER for **WINDOWS** Fastest HURRICANE Tracking Program for Windows 3.1 & Win. 95. 15 separate maps for pseudo-zoom. MultiTrac and QuadPane viewing. Storms thru 1995 included. \$31.95 ea. S&H incl. (FLA residents add 7% tax). **WEBBS SOFTWARE**, Box 30102, Pensacola FL 32503-1102.

BNB4029

BREAK THE CODE BARRIER: Psychologist & Extra Class operator has developed an amazing hypnosis tape that allows you to master any code speed easily and quickly. To order send \$14.95 + \$3.00 S&H to Dr. Hal Goodman, P.O. Box 184, Eastport ME 04631. For more info. send SASE. BNB2031

WANTED: HAM EQUIPMENT AND RELATED ITEMS. Donate your excess gear, new-old-in-any-condition to the **Radio Club of Junior High School 22**, the Nation's only full-time nonprofit organization working to get Ham Radio into schools around the country as a teaching tool using our EDUCOM - Education Thru Communication - program. Send your radio to school. Your donated material will be picked up ANYWHERE or shipping arranged, and this means a tax deduction to the full extent of the law for you as we are an IRS 501(c)(3) charity in our 16th year of service. It is always easier to donate and usually more financially rewarding, BUT MOST IMPORTANT your gift will mean a whole new world of educational opportunity for children nationwide. Radio's you can write off, kids you can't. Make 1996 the year to help a child and yourself. **Write, phone or Fax the WB2JKJ "22 Crew" today: The RC of JHS 22**, POB 1052, New York NY 10002. 24 hours call (516) 674-4072 or Fax (516) 674-9600.

Join us on the **WB2JKJ CLASSROOM NET**, 7.238 MHz 1100-1230 UTC daily and 21.395 MHz from 1300 to 1900 UTC. Meet us this month at the Fort Tuthill Hamfest. BNB762

COMMODORE 64 HAM PROGRAMS- 8 disk sides over 200 Ham programs \$16.95. 32 cents stamp gets unusual software catalog of Utilities, Game and British Disks. **HOME-SPUN SOFTWARE**, Box 1064-BB, Estero FL 33928.

BNB1052

SUPERFAST MORSE CODE SUPEREASY. Subliminal cassette. \$12. **LEARN MORSE CODE IN 1 HOUR.** Amazing super easy technique \$12. Both \$20. Money back guarantee. Free catalog: SASE. **Bahr-T3**, 150 Greenfield, Bloomingdale IL 60108.

BNB1025

Surplus electronic test equipment for sale at deep discounts. Write, phone, or fax to request the current list. **Jim Stevenson**, 3401 Sunny Slope Road, Bridgewater NJ 08807. Phone: (908) 722-6157, Fax: (908) 722-6391.

BNB2084

HOME AUTOMATION. Become a dealer in this fast-growing field, 800-838-4051.

BNB2032

QSL CARDS Many Styles. Top quality. Order Risk Free. Plastic cardholders, T-Shirts, Personalized caps, mugs, shirts. Other ham shack extras. Information and samples. **Rusprint**, 1-800-962-5783.

BNB1021

"QSL VIA USBURO" Info send SASE, USA QSL BUREAU, Dept. A, Box 814, Brewer ME 04412.

BNB2082

Test Equipment: Tektronix 7403N Oscilloscope Mainframe \$150; Millivac MV-828A Millivoltmeter \$75; PRD 7828 80 MHz Frequency Synthesizer \$200; HP 3320A Frequency Synthesizer \$150; HP 3466A Multimeter \$125; Fluke A90 Current Shunt \$150; Ballantine 323 RMS Voltmeter \$60; Fluke 893A Differential Voltmeter \$50; HP 3300A/3302A Function Generator \$75; HP 5328A Counter \$150; Request long list of other equipment. Phone: (908) 722-6157 Fax: (908) 722-6391.

BNB2084

"HACKERS CATALOG". 40 Pages and over 100 Books, Videos, Software Packages and Test Chips for Hackers, Crackers, Phreakers, and Experimenters. It's FREE! 1-520-726-2833.

BNB1024

UPDATES

PACKET RADIO AND MORE! Join TAPR, connect with the largest packet/digital group in the U.S. Creators of the TNC-2 standard. Currently focused on Spread Spectrum. Benefits: newsletter, software, discount on kits and publications. \$15/year US, \$18 Can/Mex, \$25 elsewhere. Visa/MC. When joining, mention 73, receive TAPR's Packet Radio: What? Why? How? (\$12 value) FREE! Internet: tapr@tapr.org Web: http://www.tapr.org (817) 383-0000 Mail: 8987-309 E Tanque Verde Rd #337, Tucson AZ 85749-9399. BNB4000

Wanted QSL Information from Phila Holmesburg Amateur Radio Club. Also wanted is information on the 15m Planetarium CW Net and for the following call signs: KA3IZF, AA3AW, SSV, KT4K, N2SFT, KW1C, PC5PKHT, KA1TQK, NA1TQK, K4CRF, KC4QMX, K4IVK, AA9JM, K4FLA, K8MTH, KC8BTE, KC5IWN, WYFR31M, K3EQ, AC4TYA, WA2PJF, K5TF, K4DX, WB4FFJ, K6CR, VE1TRH, CO3JY, W1CW, WZNUV, W8US, W9FF, W8AW/HCB, W4AX, VCS, WCC, KA3LVN. Phone (215) 877-2665. BNB4002

NEVER SAY DIE

Continued from page 68

"If winds of tornado strength poured into the void left by the precipitating atmosphere, Coriolis forces would cause them to spiral about the pole in a counter-clockwise direction—the same as the Earth's rotation—carrying considerable oceanic waters along the way. Further, the cumulative energy of the massed atmosphere would cause it to pile up at the pole and subsequently helically spiral upward into space.

"Does HAARP have the potential to generate such an electrical discharge? We don't know. But, if the means were at hand to make the sun go nova, there would be those who would be eager to make the attempt. This would automatically terminate the experiment, but this would be beside the point."

Maybe you can understand why the Alaskan legislature is beginning to get worried about the rapidly being built HAARP project in their back yard. I'm not worried. Amateur radio has provided me with a wonderful lifetime of adventure, so if some government-funded scientists blow the world to smithereens instead of investing the money in developing cold fusion as a low-cost source of pollution-free energy, big deal.

But maybe, if you tend to be a worry-wart, you'll want to read Begich's book and get a better handle on what's going on up there in Alaska. Or maybe you are comfortable, confident that the government knows what it is doing.

I Beg To Differ

Maybe you've noticed that we come in all sizes, shapes, colors, and temperaments. It's

a problem for the clothing industry, which they haven't managed to cope with all that well. It's been less of a problem for our school system, which does its best to force all children, no matter their IQ or other characteristics, into a one-size-fits-all educational system. The fast get slowed. The slow get run over.

Our medical industry uses the same one-size-fits-all approach. For instance, there's one RDA, the recommended daily average dose of vitamins and minerals for people, no matter their size or shape, or any genetic differences in their body chemistry. Ditto immunization shots, and so on. Sumo wrestler or 97-pound weakling, everyone gets the same shots.

The fact that our genetic makeups are all different is one we can plainly see, with variations in skin color, height, body build, and so on. Does it make sense that we might just all be somewhat different chemically too? We know that we're all allergic to different things, right? Thus, maybe it stands to reason that our bodies are going to have somewhat different needs when it comes to vitamins and minerals and resistance to poisons. So should it be surprising when some people have violent reactions to some medications and shots? Some even die, but the number is acceptable to the medical profession. And the government.

Some people are more easily addicted to nicotine, alcohol, caffeine, and other drugs than others. And a few of our soldiers got sick (some died) from the barrage of immunization shots they got on their way to the Gulf War. Acceptable losses, no doubt. And the fluoride put in

our drinking water kills a few people. Tough. Our water supplies are 60% fluoridated. Those in Europe are under 2%. Obviously they're a backward people. I'm sure it's a coincidence that fluoride is used on animals to make them more docile and we're seeing similar side effects with our people in cities with fluoridated water.

But books have already been written on these subjects, complete with references to research reports. So read the books first and then argue with the authors. I don't want to turn my editorial into an in-depth report on things that books cover much more thoroughly. I just want to wave the red flag and point you toward learning more and not docilely accepting what our caring government, and the big money industries which guide and drive it, do to you.

Crankcase Sanding

Mother Nature (aka God) spent several million years developing our mind/bodies into an incredibly intricate system. It has evolved perfectly adapted to the environment, designed to perform optimally on the food, water, air, and sunlight that was available during this development period. Does that make sense?

The more I read and listen to people who've spent years studying health and longevity, the more convinced I am that if we were to provide our bodies with the same food and water it was designed to handle, it would last at least double the mileage we're getting out of it now. We're putting sand in our crankcase, sugar in our gas tank, sludge in the radiator, and throwing garbage in the back seat of the fantastic limo we were issued at birth.

Let me put this another way. How much would you be willing to pay right now to get one more week of life 20 years from now? A buck? A hundred? A thousand? Okay, what would you pay to put off dying today until a week from today? Every nickel you have or could borrow, right? You might want to sit back and think about that. Put it into perspective. How important is next week for you? Next year? Ten years from now?

Does the prospect of being able to live healthily until you are 150 seem at all attractive?

Which switch is which?

In the May issue, '96, we mislabeled a switch in each of J. Frank Brumbaugh's schematics. First, in "Simple Multi-use Amplified Speaker," on page 41, the switch that's connected to BT1 should be labeled S1. Then, in "Antenna Noise Bridge Detector," on page 78, the switch that is labeled S1 and connected to BT1 in the upper right of the schematic should be S2.

It's alive!

In May's 73, "How to Make an Old HW-8 Come Alive" appeared on page 42; author Gerald Gronson K8MKB has alerted us to a few changes that should have been made.

Resistors Rb and Rc: 33,000Ω, Ra: 1Meg. R27 is between 3.3 Meg and 2.2 Meg. Try 3.3 Meg; if, with the volume control wide open, the receiver breaks into oscillation, replace it with the next-lower 5% value (a larger R27 resistor makes for higher gain in the IC2C stage, however). R205 can be 1.5k (whatever is on hand).

In Fig. 2, the capacitor labeled "C" can be anywhere from 1μF to 5μF tantalum or electrolytic, 15V unit (μF value not critical). C38's only change is to 4.7μF (or 5μF—it doesn't matter; whatever capacitors are on hand—all 4.7μF or 5μF are OK). C31 should read .1μF to .05μF.

Yes, there are men over a hundred who are still fathering children and who are probably a whole lot healthier than you are right now.

Is this important enough for you to make an effort to learn more about your health and what you're doing every day to ruin the fine machine you were issued at birth?

Tomorrow

Tomorrow I'll start eating healthier food. Tomorrow I'll start taking those walks. Tomorrow I'll get some sun. Tomorrow I'll read that book Wayne recommended. Next week I'll start that small business I've been thinking about. Next week I'll get started toward upgrading my

ticket. Next month I'll buy that new rig. Next year I'll go on that DXpedition.

Blue collar jobs are moving to lower wage, higher automated countries. White collar jobs are being replaced by computers and better communications systems. Upper management jobs are being downsized. Pensions are an endangered species, except for government workers.

A generation or so ago you used to be able to pretty much count on retiring at 65 with a gold watch and a nice pension. Then the big corporations figured out that it was a whole lot cheaper to get rid of upper management people by bumping them out before the generous pensions kicked in. That cut down on their long-term liabilities, making their stock more desirable.

Now, many of us are forced to face that tomorrow when, in our 50s, suddenly we may be laid off. Fired. Canned. Talk about a mid-life crisis! You're too old to be of any real interest to another large company. You never put much aside, preferring to enjoy a nice home, an expensive car, and lots of toys to planning about tomorrow, so even if you had a small business in mind to start, you haven't the savings cushion to do it. So what do you do?

Our Blind Media

Thanks Mike Browsher K8HQQ for a clipping from *Media Bypass Magazine* on the decision "not to run" by 45 members of Congress. Other than an "oh my" or two, I haven't seen much in the media about this wholesale evacuation of DC.

The article asks why all these politicians are willingly giving up their seats of power and endless money. Their answer is that a small group of computer hackers (called the Fifth Column), formerly with US intelligence agencies, have been tracing the secret foreign bank accounts of our politicians and in many cases repatriating billions of their dollars to the Treasury. Each of the "not running" or "retiring" officials has, according to the article, been handed a detailed report of their Swiss bank transactions. The options: retire immediately or face widespread distribution of the information, including the IRS.

There are a thousand ways for officials to sidetrack re-election

funds, honorarium, bribes, lobbyist donations, and so on. Politics can be a ver-r-ry lucrative career path. A threat to investigate the liquor industry brings in massive bribes to stop that nonsense. Ditto every other controlled industry. And most of our larger industries are controlled by a small group of men. I remember when Senator Dodd of Connecticut got caught pulling this extortion.

When I got involved with the music industry I found it totally controlled, from performers to record stores, by seven mega-corporations, six foreign-owned. They controlled record store distribution, radio airplay, juke boxes, and so on. Fewer than 5% of their performers ever made a nickel in royalties due to book-keeping practices similar to those in the movie industry. And so it went.

The magazine distribution industry is even worse. Ditto the medical industry, the education industry, and so on.

If you think I am exaggerating and have any facts to support it, please let me know. I've done my homework on this pretty carefully. More likely, you'll tell me about the corruption in the industry you're involved with.

Doctors

Like you, I was brought up to look on doctors as experts I should turn to when I get sick. It's been difficult for me to get over that early programming. And probably, despite my editorial educational efforts, I've failed to shake your belief in their expertise. The sad fact is that doctors are in a fix. It costs a fortune and years to get the license to kill, and they have to go through the warping experience of medical school, where the curriculum is controlled by earlier experts. And this whole works is solidly in the hands of the pharmaceutical industry, supported by the FDA, NIH, and WHO. And they're kept in control via Congress and millions of dollars from lobbyists.

So we have spectacles like the continuing resistance to the low-cost cure for ulcers. And all this AIDS nonsense, which is a billion-dollar industry. Duesbery has a new book, *Inventing the AIDS Virus*, which I haven't read yet. I did read his earlier book on the subject, and this one further confirms his claims that the HIV

virus is not the cause of AIDS. I've recommended the similar book by Dr. William Douglass of *Second Opinion*, which claims that AIDS was developed and spread on purpose by the World Health Organization.

AIDS is a billion-dollar industry, so the worst fear of those in the business is a cheap, simple cure. This is why the Beck approach has been resisted so strongly by the AMA, FDA, and AIDS researchers and workers, despite the credentials of the Albert Einstein College of Medicine and 15 patents for the process being issued to hospitals.

Have you read *Racketeering In Medicine* by Dr. Carter, which is on my list of books you're crazy if you don't read (my list is \$5 from Radio Bookshop)? I've added *Dirty Medicine* by Martin Walker, a 733-page thoroughly documented indictment of the medical industry, to my list on the latest update. Sling-shot Publications (London), ISBN 0-9519646-0-7 (\$24).

The sorry fact is that if you have any interest in living long enough to get your Social Security taxes back, and living it in good health, you've got to do your homework, because the doctors you've been trusting haven't. They're generally busy dealing out prescriptions for drugs and operating to repair the mischief they and you've done to your body through negligence. Like lousy food, polluted water and air, a lack of needed minerals, immunization shots, and so on.

Yeah, I suppose I may come across as a health nut. Well, there are a lot of 'em out there who've been caught up in vegetarianism, macrobiotic diets, fasting, popping handfuls of vitamins, and so on. I like to see ideas supported by common sense and by a number of different researchers so I don't buy into some kind of nincompoopery. And, since I'm almost to the age when half of my compatriots are already dead, it's probably about time that I started paying more attention to the maintenance of my body.

Of course, if you don't mind annoyances like cataracts, Alzheimer's, allergies, arthritis, diabetes, herpes, osteoporosis, heart attacks, high blood pressure, and so on, hey, it's your body, and from what I've been reading in books recommended by your fellow readers, none of this is necessary or unavoidable.

It's not God or chance that's rolling the dice, it's you.

Mamiya RB-67 Wanted!

The best equipment photo camera I ever had was the old Mamiya RB-67. Then my staff photographer swiped it when she quit. Ouch! But how do I prove it? I've been making do with my 35 mm Nikon, but I'd like to replace my old RB-67, which has a 6 cm x 7 cm negative, and therefore makes the sharper pictures needed for magazine use. The problem is that I'm thrifty (NSD = never spend a dollar), so I'd like to hear from any reader in the camera business who might be able to find an old used RB-67 for me at the wholesale price. Camera, back, and a 127mm or so lens. Maybe a macro lens?

Really Bugged

I've been living in NH for 34 years now and I've never seen anything like the ladybug infestation we had this spring. I was amazed last fall when I was out in the yard pulling dandelions one day and I was almost covered by ladybugs. Then, all through March and April, the windows on the west side of the house were crawling with them in the afternoons.

Everyone knows that ladybugs are good, so I was surprised to find that they bite. Ouch! Hmm, so I started collecting them as they managed to somehow crawl inside my windows and take them downstairs to our dining room mini-rain forest. Well, big deal, eh? Hey, I'm talking 100-500 bugs some days! Inside. Never in all the years I've lived here can I recall seeing even one ladybug coming inside like that.

I visited a chap who lives about 20 miles from here and one of his windows was swarming with ladybugs too. What's going on?

The X Files

While I enjoy the Fox™ program of the same name, in this case it has to do with transmutation. X, as in x-former or x-mit. Well, we use "x" for xtal...meaning crys, perhaps short for cross. With the cold fusion research going more and more into the transmutation of elements as an explanation for the excess heat being developed, I've been keeping my eyes open for anything relevant. I've written about

this recently, so I won't go over it again.

Anyway, when I read about a transmutation experience in René's *The Last Skeptic of Science* book, I quickly rattled René's cage for more details. The experiment described in the book was his and Pete Ross's effort to whip up some small diamonds out of carbon.

Back in 1977 they made a furnace out of a 25-gallon steel drum, which was split in half lengthwise and laid on its side. They lined it with lime as a refractory material. They set up two long 3" diameter carbon rods for the arc and powered them with a large electric arc welding machine. They loaded the arc area with calcium carbide and turned on the power.

Once the arc got going, the rods were pulled back and the arc was able to continue, but it was only drawing 260 watts, while the heat being generated was more in the thousands of watts range. The following day, the pot started growing into a baby volcano, percolating up hot viscous material, much like a volcano's lava. Concerned, Pete lowered the power to slow the growth. It didn't slow, so he poked the bubbling mound with a half-inch steel rod. It instantly vaporized at least a half inch of the rod, shooting a blue-white light beam toward the roof of the old warehouse where they were working. Pete quickly shut off all power, yet the volcano continued to grow.

To stop the runaway volcano Pete broke open its walls and poured in more calcium carbide. This stopped the reaction.

The bad news was that when

they sorted through the remains, the few tiny diamonds they found were of a poor quality and worth less than the current consumed making them. The good news (for scientists willing to pay attention) was the anomaly of finding higher atomic weight elements. Nothing with an atomic weight over 20 went into the mix, and elements up to 83 (bismuth, which is heavier than lead, and is as high as you can go without getting into the radioactive elements) resulted. They found a lot of iron ($_{26}\text{Fe}$), which could be calcium ($_{20}\text{Ca}$) plus carbon ($_6\text{C}$).

They tried for several years to get universities to redo the experiment and confirm the transmutation products. But since the transmutation of elements is "impossible," they could find none that would even try. I asked René what happened to Pete and he said that Pete had gotten interested in computers, had hacked his way into the CIA computers, and shortly after suddenly disappeared one day and nobody, including his family, has ever seen or heard from him since.

If you decide to try this, be sure to have plenty of room around for accidents. René says to have the electrodes spring-loaded so they can be pulled apart quickly when things start to take off by themselves. And remember that virtually all of the major breakthroughs in science have been made by amateurs who didn't know that it couldn't be done. Remember, too, that few of the beliefs in physics 50 years ago are still believed today. I'll bet the same will be said 50 years from now.

René's *Last Skeptic* book is available exclusively from Radio Bookshop. It's \$25 + \$5 s/h. It will keep you armed with interesting things to talk about for weeks.

A Little Late

Vern Hargreaves K4HMY just sent me a QSL, for which my thanks. It was for a 1948 2m contact. I hope Vern isn't as far behind with everyone else. Vern is not only still active, he's also a subscriber and contributor to my *Cold Fusion* magazine, plus an early experimenter with the Beck blood purifier circuit.

That reminded me that the 50th anniversary of our return to the air after WWII went by without any special notice. Since I was teaching radio at the New London (CT) Submarine Base at the time, I was able to get on the air the day they opened 2-1/2 meters with a radio in my lab. That weekend I brought my pre-war walkie-talkie up from Brooklyn. It had a 1G4GT oscillator with a 1Q5GT modulator and superregen receiver. I made contacts from a hill on the sub base evenings. Then they opened 10m, and I got on there the first day the band opened. One of my first contacts on 10m was Ed Ricca W2OCL (now K4PT).

Thanks Vern, for the QSL.

McDonald's

A reader sent me a McDonald's place mat extolling the importance of immunization and giving the ages at which children should be given shots, citing the National Medical Association and the National Council of La Raza, whatever they are. Are they fronts funded by

the pharmaceutical companies? I sure hope you do your homework on this one and at least read *Immunization, The Reality Behind the Myth*, by Walene James. It's on my \$5 list of "Books You're Crazy if You Don't Read." If this book doesn't turn you into a religious fanatic opposed to immunization, let me know.

We spend 30-40% more on "health care" than any other country in the world, yet we have 40 million people with arthritis (a nutritional disease), 15 million with asthma, and over a million new cancer cases annually, of which half will be fatal. And the situation is getting worse, not better! Heck, according to a Nader report, over 300,000 people die a year just due to mistakes in hospitals.

Until mass immunization of our kids came along, autism was virtually unknown, as were dyslexia, learning disabilities, and hyperactivity. Now we have millions of hyperactive kids, so we drug them with tranquilizers, frying their brains, and wonder why the SAT scores have been plummeting. No problem, they just lowered the scale.

What can you do about it? Well, if one 13-year-old kid can make a worldwide fuss over child labor, complete with an interview on *60 Minutes*, you too can move mountains. Arm yourself with the facts and then get busy. One way to have a good chance at being able to change things is to run for your state legislature. That will give you access to the media, and an opportunity to make a difference.

Or have your brains been fried too? 73

ABOVE & BEYOND

Continued from page 71

communicate with must also use the same frequency range (IF) to receive on. It doesn't matter what frequency you select—just tune the FM radio to a quiet place on

the dial, say the lowest frequency, 88 MHz. The modulator must still be used as is. Of course, the frequencies on 10 GHz will now be 88 MHz apart instead of 30 MHz, as with the PC board unit. Now this is a simple project; I hope you

enjoy simple microwave operation.

Well, that's it for this month. Next month I will cover some additional test circuits to add pleasure, smooth methods, and test procedures for microwave operation. One of them is the

microwave reflection antenna using the 30 MHz TTL oscillator. For questions, drop me a line on the Internet at clhough@aol.com, or send an SASE to the address at the beginning of this column. 73

Phone 800-274-7373 or 603-924-0058, FAX 603-924-8613, or see order form on page 88 for ordering information.

Radio Bookshop

New Book!

Simplified English - By Ray Eisner. Isn't it about time that English was spelled the way it sounds? Well, Ray has done it! He's restructured English so it's spelled just as it sounds. He's gotten rid of double

letters, letters that sound the same, silent letters, and so on. We're still spelling our words the way they were pronounced back when the first dictionaries were written, but our spelling has never caught up. This 16-page booklet by Eisner was too long to print in 73, so now we're making it

available for anyone interested. It's \$5 postpaid in the US and Canada, \$6 elsewhere. The resulting English will be simple to learn, even for kids and foreigners. Where better to initiate such a badly needed language change than via amateur radio? *Ok, fb es cul om.*

More stuff

Books You're Crazy If You Don't Read... 28 pages. \$5 ppd.

How To Make Money - A Beginner's Guide... 24 pages. \$5 ppd.

73 Review

CMOS Super Keyer 3

"State-of-the-Art Keyer Kit is a Bargain!"

Marshall G. Emm AAØXI/VK5FN
2460 S. Moline Way
Aurora CO 80014

It's probably a sign of the times, but when it comes to Morse keyers and keyer kits, there isn't a whole lot to choose from. There are lots of "basic" iambic keyers based on the Curtis 8044ABM chip or an imitator, starting

All settings and the contents of the memories are stored in NV RAM, which is permanent and does not require a battery or power connection.

Power consumption is extremely low, typically 20 mA key-down and 10 μ A when idle, so it is perfect for battery operation in emergency conditions.

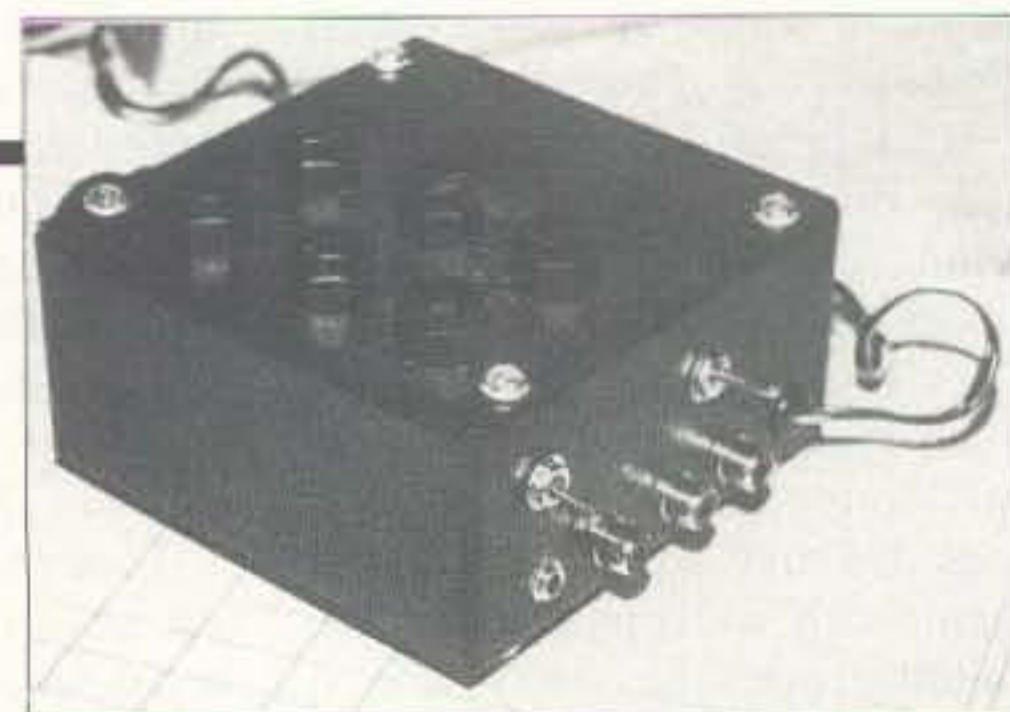

labeled as a product announcement and not a project, but that is, of course, a criticism of *QST*, not the keyer.

The "kit" from Idiom does not include any construction information or instructions. There is an oblique reference to a "construction article" which turns out to be the article in the ARRL Handbook (in accordance with Murphy, I have the '91 and '96 Handbooks). In subsequent correspondence, Idiom has promised to include at least minimal construction information.

Construction

Building the CMOS 3 is relatively straightforward—it's a matter of populating the circuit board and making the connections. Without any instructions, you will need to consult the circuit diagram (in the center of the manual) to identify component values. There are only two issues which may require clarification. You can probably deduce both of them, but I have found that it is generally not advisable to make any assumptions when building a complex kit!

1. The orientation of the resonator Y1 doesn't matter; it can go in either way.

2. Some external wiring uses a shared ground return connection (e.g. the switches), while other components have labeled connections for both wires.

You will need to be very careful with the soldering. The CPU chip socket has 38 pins, and the tracks on one side of it are the closest I have ever seen. You will need a very light soldering iron with a fine tip. I soldered under a large magnifying glass, pausing frequently to check my work with a 10x loupe.

"It's probably fair to say that the CMOS Super Keyer 3 is the most feature-rich and flexible keyer on the market."

at around the \$20 mark. Then there are the all-the-bells-and-whistles memory keyers, which start at around \$100 and go well above that figure. So it was a pleasant surprise to find a memory keyer available as a board kit for a mere \$58 postpaid.

The CMOS Super Keyer 3, available as a board kit from Idiom Press, is a full-featured keyer, with a substantial amount of memory (1530 characters) configured as either 6 or 18 separate messages, and enough functions and features to fill a couple of books; for example, the tutorial and operating guide that comes with the kit. It does just about everything you can think of, and the price is substantially below that of any other memory keyer or kit presently available.

The features of this keyer are too numerous to describe individually. There are twenty listed features on the first page of the manual, which include burst sending to 990 wpm, contest serial numbering, and full beacon capability. There are 19 function commands, 18 inquiry functions, 11 programming functions which can be embedded in stored message text, and 7 two-button direct commands.

Some features that I found to be of particular interest:

You use Morse to communicate with the keyer. Commands are sent from the paddle, and the keyer responds, in Morse, via the speaker!

You can select any of ten different keyer emulations so the CMOS 3 will work just like the keyer you are used to.

It's probably fair to say that the CMOS Super Keyer 3 is the most feature-rich and flexible keyer on the market, but there is a catch, or two....

First, when Idiom says "board kit" they mean exactly that. You get the circuit board, the board-mounted components, and the tutorial/operating book. That's it. Figure another \$20 or so for hardware: a box, six push button switches, a pot for speed selection, speaker, and jacks for paddle and key line. I added a straight key jack, and a second keyed line with a switch so that I can key rig a, rig b, or both. I also added an LED, a type 7805 voltage regulator (RS276-1770), and a manual tune switch.

Second, although the CMOS 3's antecedents have been around a long time (the CMOS II was described as a project in the ARRL Handbook from 1992-1995), it's not like buying an ordinary kit, exactly. Version 3 was announced and described in the August issue of *QST*, and shown on the magazine's cover as a "weekend project," but you couldn't build it from the article; there is only one supplier of the board and the programmed chip. So in this reviewer's opinion, the article should have been

Since both ICs (the CPU and memory) are CMOS devices, they are extremely sensitive to static electricity. Handle them no more than absolutely necessary, and it is a good idea to ground yourself whenever you are working with them. A ground wire with an alligator clip attached to your metal watch band or a finger ring is fine. Before you insert the chips in their sockets, connect the negative power supply lead first and ground it.

RFI Problem

The CMOS 3's CPU is a computer, and, like all such devices, it generates RF hash which is audible across the HF spectrum. Without shielding, the level is high enough to cause problems with reception, and makes QSK (break-in) operation impossible. Note that the hash is generated only when the processor is working, i.e. when you key it, send a command or inquiry, or send from memory. If you use the beacon mode to send CQ, the hash will be generated during the pause between calls, so you should do everything possible to minimize it.

You can add bypass capacitors to all external connections, and, as suggested in the *QST* article, you will want to install the keyer in a metal box. Indeed, one of the authors made the illustrated box from copper-clad PC board material. Finally, use shielded (e.g. audio) cable to connect your paddle and your rig.

I did all of the above (using a steel box in place of a copper one), and still have a problem. Next step will be to "deconstruct" the keyer and place ferrite beads on all wires connected to the circuit board. As it stands, the level of RFI is just a nuisance and not a critical problem.

Operation

The CMOS Super Keyer 3 is a joy to operate. There are a lot of functions and commands, but they are generally mnemonic and therefore easier to use than the digital codes common on "keypad" keyers. For example, you put the keyer into inquiry mode and send "S" to have it report the currently selected sending speed.

The keyer has three operating modes:

Direct Sending mode. Whatever you send with the paddle is processed and used to key the transmitter directly.

Command mode. Pressing one or more buttons causes the keyer to send from memory or carry out programmed

is clumsy and requires a second command in order to make any speed change later (the speed pot is "disengaged").

"You can build the CMOS Super Keyer 3 in about three hours."

or keyed instructions. For example, pressing button 1 causes the keyer to send the contents of memory register one. Simultaneously pressing buttons one and two puts the keyer into keyed-command mode, and you use your paddle to send the relevant function command.

Inquiry mode. Simultaneously pressing buttons five and six puts the keyer into inquiry mode. Paddle an inquiry command and the keyer will respond by "sending" the current setting.

In both command and inquiry modes you will receive feedback in Morse from the speaker, and you can set a different speed for this type of communication than the sending speed. Communication between the user and the keyer is handled "off-line," without keying the rig.

The designers, KCØQ and NØII, are amenable to suggestions; indeed the *QST* article says that Version 3 arose largely from user feedback. There are some things I'd like to see in a software upgrade, and in the context of a review it should be noted that these are things that are missing in Version 3:

A function to set an absolute speed in wpm. As currently programmed, you can achieve the same effect by specifying a range with the same figure entered for both upper and lower limits, but this

Have a paddle-touch terminate memory sending without keying the paddled element. Some keyers work one way, some the other, so perhaps this could be a user-selectable option.

Offer "bug mode" as one of the emulations, i.e. have the dit paddle send dits, but the dash paddle in "straight key" mode.

A function to copy the contents of one memory location into another. This would allow for easier building of complex messages with repetitive text.

An ability to edit a message from the first word, and/or an ability to insert text into an existing message.

Conclusion

If you have good soldering skills, you can build the CMOS Super Keyer 3 in about three hours, depending on how you handle the hardware options. The result will be a keyer that is every bit as good as any keyer you can buy, with the advantage of relatively low cost.

Availability

The CMOS Super Keyer 3 kit, comprising circuit board and all board-mounted components, is available by mail order only from Idiom Press, P.O. Box 1025, Geyserville CA 95441 (916) 857-3524. 73

QSL Contest

Did you buy your QSL off a rack, or did you put some thought and creativity into it? If you think you have a winner, send it in and let us have a look at it. Who knows, it might make the cover. Well, maybe page 85 or so. Or maybe Wayne's wastebasket. If it's declared a winner, you'll get a CD of your choice of any of 26 kinds of music, as listed in Wayne's November editorial. You'll also see it in 73!

Send it to:

QSLContest,
73 Magazine,
70 N202,
Peterborough NH 03458-1107
Bribery? You Bet!

Ham Shack Test Equipment

Continued from page 10

SWR analyzer

This commercial instrument is invaluable for measuring antennas, as well as at the end of the feeders in the shack. It also enables you to determine antenna tuner control settings without putting the transmitter on the air and generating QRM.

Several manufacturers offer different models, for HF as well as VHF and UHF. Many include an LCD readout of the frequency of the internal oscillator, and can be pressed into service as frequency counters over their ranges, although most require a fairly substantial input signal. Some also measure radiation resistance at the feed point.

Some, possibly all, can be used as a dip oscillator to check the resonant frequency of tuned circuits, and the value of either L or C if one or the other's value is known accurately. MFJ offers an adapter, primarily a coil of wire wound on a form, for several models of their analyzers, allowing them to be used as accurate dip oscillators.

Although the tuned oscillator in these analyzers is not especially stable, it can be used as a signal generator. The output of most analyzers is relatively high; the RF voltage approaches 1 volt RMS no load at 160 meters, and a bit less as the frequency is increased. You should use an attenuator if you're feeding the antenna input of a receiver directly, or stick a wire in the central output terminal and radiate a signal to the receiver.

In general, prices begin just under \$100 and go up. Look at what is available, considering the bands you normally work or plan to work, and choose the best analyzer you can afford. An SWR analyzer is strongly recommended as an invaluable addition to your shack.

Field strength meter

A small field strength meter sitting at your operating position will continuously monitor the power radiated from your antenna, when it isn't being used to check the radiation pattern, front-to-back ratio, and major lobe width of your beam. The ham literature is filled with many different designs for various types of field strength meters, and home-brewing is the cheapest way to go.

A short vertical whip or piece of stiff wire feeding a voltage doubler, consisting

of a pair of germanium diodes bypassed by a 0.01 μ F disc capacitor, into a 10k ohm pot with a microammeter from wiper to ground will be adequate for most ham stations.

Should you require accuracy instead of relative measurements, the *ARRL Handbook* has had a suitable design for several years. Commercial (and extremely expensive) accurate instruments with digital readout are available from several manufacturers who advertise in ham magazines.

Frequency

Accurate frequency measurement is necessary when aligning receivers, checking band edges, calibrating analog dials on home-brew receivers, VFOs and some test equipment, and in many other situations.

The simplest and cheapest way is to build a secondary frequency standard (crystal marker generator). A unit based on a digital oscillator using a 74LS00 and a 10 MHz surplus microprocessor crystal, followed by a few 74LS90 decade dividers and a 74LS74 dual flip-flop, will produce known, stable frequencies of 1 MHz, 100 kHz, 50 kHz, 25 kHz and 10 kHz, with harmonics well into the VHF range. The 10 MHz oscillator must be set on frequency either with a frequency counter or by zero beating against WWV during the seven-second period every minute when the carrier is not tone modulated. The cost of the marker generator should not exceed \$10, though it can be zero if you have a well-filled junk box or know someone who does.

A much handier (and highly recommended) step up is to purchase a commercial frequency counter. A great many are available, covering different frequency ranges and having differing sensitivities at various prices, some of which are rather high.

If you are interested in microwaves, you will want a counter capable of making measurements in the gigahertz range. If you usually operate HF, VHF, or UHF through the 70 cm band (this includes the majority of hams), my personal recommendation is the Ramsey CT-90 frequency counter. It covers 10 Hz to 600 MHz with a nine-digit LED readout and three gate periods: 0.1, 1, and 10 seconds. Sensitivity is less than 10 mV from 10 Hz to 150 MHz, and less than 150 mV up to 600 MHz. Constructed in the standard small Ramsey cabinet, about 5" x 5" x 1-1/2"

high, it can be powered by 12 volts AC or DC, or by four AA NiCd internal batteries which are kept charged whenever the supplied wall transformer is in use. Ramsey offers two probes, one for 10 Hz to 20 kHz and the other from there to 600 MHz, but you can easily build your own for a very few dollars. The advertised price for the CT-90 is \$169.95. (Ramsey Electronics Inc., 793 Canning Parkway, Victor NY 11454; (716) 924-4560).

Although I use the Ramsey and recommend it highly (I operate only 40 through 10 meters), there are a number of manufacturers offering frequency counters and you should investigate them all, depending upon your own special needs. Compare specifications and prices, and then choose the best instrument for the money.

Inductance

The chances are that unless you do a lot of experimenting and building VFOs, receivers, etc., you won't need to measure many small inductances. However, for home-brewers and QRP enthusiasts who do need to know the value of small coils (20 μ H or less), there are several choices.

Commercial LCR meters, which look much like DMMs, are widely available from many manufacturers at fairly high prices. Buying one if you already have a full-function DMM is overkill. Other much more expensive inductance bridges are available commercially, but most hams can't afford them and don't need them. Occasionally a "boat anchor" such as the superb Boonton Q-Meter becomes available on the surplus market, but at a fairly high price.

Another choice is to build your own. The 1995 *ARRL Handbook* describes a multi-range inductance bridge. Several ranges are beyond those of interest to most home-brewers, but they might come in handy someday.

My personal recommendation is one that I designed and used (see "The Handy Inductance Bridge," *73 Amateur Radio Today*, May 1991, page 11). I have since modified the RF generator, eliminating the two transistors and substituting a 74LS00 crystal oscillator.

For a simpler, cheaper inductance meter, please see: "A Simple Inductance Meter," *73 Amateur Radio Today*, June 1996. This is not a bridge and uses an entirely different means of measuring inductance, eliminating the need for a zero-center meter which the instrument in the 1991 reference requires.

Capacitance

In case your DMM does not measure capacitance, you can construct a simple, accurate instrument for less than \$5.00. Please see "A Simple Capacity Meter," 73 *Amateur Radio Today*, March 1996, page 71.

Audio frequency generator

A stable, known frequency source of clean audio between 300 and 3,000 Hz is necessary when checking audio circuits, and is invaluable when designing and building active and passive audio filters, and when setting the center frequency of SCAF filters. The frequency must be variable, and so must its level; this eliminates small, fixed-frequency oscillators. Commercial audio generators covering several wide frequency ranges are available. Not only are they large and costly, but they also have much broader capabilities than the 300-3,000 Hz most hams need. A much cheaper and far more stable and accurate option is to build your own (see "Crystal-Controlled Audio Generator," 73 *Amateur Radio Today*, November 1995, page 28. Note: There is an error in the schematic; C11 should connect between the Q3 emitter and the Q2 emitter.) This simple instrument covers the 300-3,000 Hz range when calibrated. The parts cost should not exceed \$10. The stability and accuracy will be that of the crystals used.

Multiple voltage module

It is true that "you can't have too many power supplies." However, power supplies are bulky, costly, hot and, unless needed most of the time, represent a waste of dollars. However, it is often necessary to provide a fixed voltage to a circuit being designed or a piece of equipment being tested or serviced. Most of the time the needed voltage will be other than that supplied by the station power supply. A common example is the +5 volts required by TTL digital circuits, or the 6 or 9 volts needed to power a portable radio you're working on.

The home-brew answer is cheap and simple. Mount 7805, 7806, 7808 and 7809 regulators in a small aluminum box (which also serves as a heat sink for the regulators). Mount at least two RCA jacks for each voltage output. Feed the box with 13.8 VDC from your station supply. Bypass the DC line where it enters the box with both a 0.001 μ F and a 0.1 μ F

capacitor. Use the same values of capacitance to bypass each pair of voltage output jacks.

To make this unit even more versatile, connect a 317T variable regulator and a 5k pot and another RCA output jack (remember to bypass it) and you'll also have an ampere at about 2 to 12 volts DC. Don't forget to insulate the tab of the 317T from the case.

Oscilloscope

Of all the items of test equipment helpful to hams, the 'scope is the most useful and versatile. However, they are large, generally heavy, and always expensive; not every ham can afford one. But, if your budget will stretch that far, a good wideband oscilloscope will be most useful.

For the ham who operates primarily in the HF bands, a 'scope with a 50 MHz bandwidth will do a fine job, although a 100 MHz bandwidth would be even better. It should be a dual-trace 'scope. Occasionally such a

'scope appears on the surplus market, at a price starting around \$350. Such 'scopes were built by companies like Hewlett-Packard, Tektronix, etc., for the military. All of these are solid state (except for the CRT) and dual-trace. Most have a 100 MHz frame, but many will have 50 MHz

Those built for the Navy cost the taxpayers \$3,300 each, and they are "built like a battleship" and almost as heavy. If you can afford \$350-\$400 or so and can find one, grab it!

Some rather large and heavy vacuum tube-type Tektronix 'scopes in their 500 series are usually available from outlets such as Fair Radio Sales, Inc. in Lima, Ohio, but I do not recommend

buying even a bargain 'scope which is from the vacuum tube era. Tubes have become scarce and expensive. This supplier, as well as Tucker, often have other suitable surplus 'scopes. Get their catalogs and keep checking ads. To my knowledge, for you microwave buffs, oscilloscopes with a bandwidth of 3,000 MHz are available but their cost is prohibitive.

About the only other option is to locate a good, recent Heathkit® 'scope with a 5 or 10 MHz or more bandwidth at a hamfest, and if it works and the price is right, buy it. Then build the HF adapter described in the *ARRL Handbook*, adjusting its oscillator frequency as required. This will allow you to see a high frequency signal on a low frequency 'scope, and the overall cost will be much less.

A personal note

I own and use everything I have discussed here-except an oscilloscope. Would anyone like to donate one to me (ha!)?

73

Radio Bookshop

Phone 800-274-7373 or 603-924-0058, FAX 603-924-8613, or see order form on page 88 for ordering information.

Great ARRL Books!

AR1996 **The ARRL 1996 Handbook** includes the latest innovations in ham radio, plus all the fundamental data. \$38.00
AR1086-4 **ARRL Operating Manual** Information on how to make the best use of your station, including interfacing with home computers, OSCAR, UHF-VHF. \$18.00
AR4173 **Now You're Talking! All You Need To Get Your First Ham Radio License**-A complete study guide for the Technician and Novice written exam. Practical information every beginner needs is written clearly and simply and in small doses. \$19.00
AR4734 **ARRL Antenna Book**. Best and most highly regarded info on antenna fundamentals, transmission lines, design, and construction of wire antennas. \$30.00
AR3177 **ARRL Spread Spectrum Source Book** From a deceptively simple beginning, a group of experimenters set out to develop first theoretical and later practical systems for spread spectrum communications. This book consists of articles, papers and government reports that document the process whereby amateur spread spectrum progressed from the drawing board to the airwaves. \$20.00
AR3851 **Hints and Kinks** Ideas for setting up your gear for comfortable efficient operation. \$10.00
AR4653 **Companion Software for Weather Satellite Handbook** 5-1/4" MS-DOS floppy \$10.00

ARRL License Manuals:
AR4181 **Technician Class** \$6.00
AR4688 **General Class** \$12.00
AR3274 **Advanced Class** \$8.00
AR3272 **Extra Class** \$8.00
AR3185 **The Satellite Experimenter's Handbook** by Martin Davidoff K2UBC Expanded and revised. Focusing on satellites built by and for the international radio amateur community \$20.00
AR4645 **Satellite Anthology** The latest information on OSCARx 9 thru 13 as well as the RS satellites, the use of digital modes, tracking antennas, RUDAK, microcomputer, and more! \$10.00
AR2973 **Complete DX'er** by Bob Locker W9KI Learn how to hunt DX and obtain hart-to-get QSL cards. \$12.00
AR0402 **Solid State Design** Good basic information, circuit designs and applications; descriptions of receivers, transmitters, power supplies, and test equipment \$15.00
AR4971 **ARRL Repeater Directory 1995-1996** Over 19,000 listings with digipeaters, bandplans, CTCSS (PL(TM)) tone chart, frequency coordinators, ARRL special service clubs, and beacon listings from 14MHz to 24GHz. \$7.00
AR4661 **ARRL's Antennas & Techniques for Low-Band DXing** can be your ticket to low-band success. \$20.00
AR4483 **Weather Satellite Handbook** by Dr. Ralph Taggart WA8DQT. Expanded and revised to reflect today's weather-fax satellite technology. \$20.00

SPECIAL EVENTS

Listings are free of charge as space permits. Please send us your Special Event two months in advance of the issue you want it to appear in. For example, if you want it to appear in the April issue, we should receive it by January 31. Provide a clear, concise summary of the essential details about your Special Event.

JUL 5-6

PASCAGOULA, MS The Jackson County ARC will hold its 2nd annual Hamfest in the Pascagoula MS Civic Center, located on the Jackson County Fairgrounds. Talk-in will be on the W5WA Rptr. 1700-2100 hrs July 5th, and 0800-1500 hrs July 6th; 145.110(-); alternate 146.880. Nearby hotels and motels at reasonable prices. For tables and flea market reservations, contact "Kim" Kimmerly N5XGI, Hamfest Chairman, 19000 Busby Rd., Vancleave MS 39565. Tel. (601) 826-5811. For VE Exams, starting at 0900 Sat., July 6th, contact Bob Pierson N7NE, 1216 Hickory Hill Dr., Gautier MS 39553. Tel. (601) 497-3096.

JUL 6

MILTON, ONTARIO, CANADA The 22nd annual Ontario Hamfest, sponsored by the Burlington ARC, will be held at Milton Fairgrounds starting at 9 AM (Thomas St. gate only). Tailgaters at 8 AM (Robert St. gate only). Set up at 7 AM for commercial vendors (Robert St. gate only). C.L.A.R.A. annual Picnic Meeting at 11:30 AM. For more details, contact Burlington ARC, P.O. Box 85037, Burlington Ont. L7R 4K3, Canada; or contact Norm VE3CZI at (905) 335-8962; or Packet: VE3CZI@VE3DTV.

PETOSKEY, MI A Hamfest and Swap/Shop will be sponsored by Straits Area ARC, 8 AM-1 PM at the 4-H Building, US-31, 2 blocks west of US-131 intersection. Talk-in on 146.68/.52. Commercial displays will also be featured. Contact Harry N8OIV, (616) 347-7771.

SALISBURY, NC The North Carolina Alligators Group "Firecracker Hamfest" will be held at Salisbury Civic Center, 8 AM-1 PM. An Auction will be held at 1 PM. Setup Fri. 3 PM-9 PM; or Sat. at 7 AM. Contact Walter Bastow N4KVF, 3045 High Rock Rd., Gold Hill NC 28071. Tel. (704) 279-3391 until June 28, then (803) 266-7900. Talk-in on 146.730.

JUL 7

LISBON, OH The Triangle ARC will sponsor a Hamfest at Columbiana County Fairgrounds 8 AM-3 PM. Talk-in on 146.70/.805. Contact Dick Sisley K8JKB, 1218 Northside Ave., East Liverpool OH 43920. Tel. (330) 385-1245.

JUL 12-14

DUNSEITH, ND The Internat'l Peace Garden Hamfest Committee will host a Hamfest at Internat'l Peace Gardens, North of Dunseith. Transmitter Hunts, Mobile Judging, Camping. Talk-in on 146.85/.52. Contact Dave Snyder, 25 Queens Crescent, Brandon MB, Canada R7B 1G1; or John Engel WAØLPV; 616 8th St. SE, East Grand Forks MN 56721.

JUL 13

OAK CREEK, WI The South Milwaukee ARC Inc. will hold its 27th annual "Swapfest" at the American Legion Post #434 grounds at 9327 S. Shepard Ave., 7 AM until at least 2 PM CDT. For a free flyer, write to The South Milwaukee ARC Inc., P.O. Box 102, South Milwaukee WI 53172-0102. Talk-in will be on 146.52 simplex, and local Rptrs.

JUL 13-14

INDIANAPOLIS, IN The Indianapolis Hamfest, host to the ARRL Central Div. Convention, will be held at the Marion County Fair Grounds. Commercial Exhibits, Indoor/Outdoor Flea Market, Forums, Banquet, T-Hunts, Homebrew Contest. Write or call Indianapolis Hamfest Assn., P.O. Box 88677, Indianapolis IN 46208. Tel. (317) 251-4407.

JUL 14

PITTSBURGH, PA The North Hills ARC will hold its 11th annual Hamfest 8 AM-3 PM at the Northland Public Library, 300 Cumberland Rd. Talk-in and Check-ins will be on 149.69/.09, the North Hills ARC Rptr. Handicap/

wheelchair accessible. Contact John Sibenac KE3PI, 216 Kinvara Dr., Pittsburgh PA 15237. Tel. (412) 487-2740.

SUGAR GROVE, IL The Fox River Radio League will hold their annual Hamfest at Waubensee Community College, Rte 47 at Harter Rd. Set up Sat. 7 PM; Sun. 6 AM-8 AM. Doors open Sun. at 8 AM. VE Exams at 10 AM. Bring original license, copy of license and photo ID. Talk-in on 147.210(+) PL 103.5/107.2. Contact Diana Skube WD9API, c/o FRRL, P.O. Box 673, Batavia IL 60510. Tel. (708) 293-7485.

JUL 19-21

GLACIER PARK, MT The 62nd annual Glacier Waterton Internat'l Hamfest will be held at the Three Forks Campground between Essex and East Glacier MT. Contact Bill Vodall WA7NWP, Box 75, Kevin MT 59454. E-mail: hamfest@tlatech.com. Internet: http://thor.tlatech.com/hamfest. Talk-in on 146.520 MHz. For Campground reg., contact Three Forks Campground, P.O. Box 124, East Glacier MT 59434. Tel. (406) 226-4479.

PHOENIX, AZ The ARCA Fort Tuthill Hamfest will be held at Coconino County Fairgrounds in Flagstaff AZ. Times: Fri. & Sat., Dawn to Dusk; Sun., Dawn to 2 PM. VE Exams July 20; reg. 8:30 AM-10:30 AM. You must have original and one copy of your license and/or any applicable C.S.C.E. Photo ID required. Walk-ins only. For exam info call (602) 440-2039. No-Code Tech Class: contact Morgan Riley N7DLW, (602) 938-4356.

JUL 20

WELLINGTON, OH The Northern Ohio ARS will host "Noarsfest 96," 8 AM-3 PM at the Lorain County Fairgrounds on Rt. 18. Vendor set up at 7 AM. Flea Market. Talk-in on 146.10/.70. Walk-in VE Exams at 9 AM; reg. 8 AM-9 AM. For tables, tickets, hotel list, maps, contact Stan Zupan AA8IN, 32549 Walker Rd., Avon Lake OH 44012-2228 (SASE required). Tel. (216) 933-4261 before 9:30 PM; or E-mail: 75131.3561@compuserve.com.

JUL 21

FARMINGVILLE, NY The Radio Central ARC will host "Summerfest 96" at Bald Hill Cultural Center beginning at 9 AM. Swapmeet,

Tailgating. Talk-in on 145.510 (CTCSS 136.5 Hz), and 449.525 (CTCSS 114.8 Hz). Contact Scott Johnson N2ZKB, (516) 395-2263; Emil Tilolona KD1F, (516) 696-0610, or John Mark KB2QQ, (516) 689-6343.

INDIANA, PA The Indiana County ARC's 4th annual Summerfest Computer and Ham Radio Fair will be held at the Red Barn Sportsman Club near Homer City PA, 8 AM-3 PM. Contact Bill McMillen KE3QM, RD 2, Box 157AB, Marion Center PA 15759; Tel. (412) 397-2702, or Tom Ringler WA3W at (412) 349-8847. Talk-in on 146.910(-).

VAN WERT, OH A Hamfest and Computer Show will be presented by the Van Wert ARC at Van Wert County Fairgrounds, US 127 South, 8 AM-3 PM. Talk-in on 146.850. Scanners, electronics, software, computers, used gear, hobby/craft items, more. VE Exams, pre-reg. by July 11th. Send SASE or call Bob High KA8IAF, 12838 Tomlinson Rd.; Rockford OH 45882. Tel. (419) 795-5763, before 5 PM. Or call Bob WD8LPY, (419) 238-1877 after 5 PM.

JUL 26-27

OKLAHOMA CITY, OK The Central Oklahoma Radio Amateurs will sponsor their 23rd annual "Ham Holidays 96" at the Oklahoma State Fair Park (Hobbies, Arts & Crafts Bldg.), northeast of the I-40 and I-44 intersection. Doors open Fri., July 26th, 5 PM-8 PM; July 27th, 8 AM-5 PM. Technical and non-technical programs. Fox Hunt, Flea Market, VE Exams. Talk-in on 146.82. Address all inquiries to Ham Holidays '96, P.O. Box 95942, Oklahoma City OK 73143; or E-mail: n1lpn@aol.com.

JUL 27

MIDLAND, MI The Midland ARC will host their 21st annual Hamfest at the Midland Community Center, 8 AM-1 PM. Talk-in on 147.00(+), Midland. To reserve tables, send an SASE to MARC Hamfest, P.O. Box 1049, Midland MI 48641. For info, call Swap Manager Bill N8LTR at (517) 832-3053 eves. and weekends.

NEWPORT, NH Grace's Radio Shack™ will sponsor a Hamfest 8 AM-3 PM. Tailgaters Flea Market, Family Crafts Show, R.C. Model Airplane Flying Show, VE Exams, SE Station and more. Overnight camping in nearby Camp Grounds

Fri. night. Talk-in on 146.76 Rptr. For info, contact *Rob Boyd N1CIR*, #648, Route 103, Newport NH 03773. Tel. (603) 863-5383. Voice contact 146.76 Rptr. Packet: N1CIR @ WA1WOK.NH

TAMPA, FL The Univ. of South Florida Radio and Electronics Club will hold its 5th annual "Last Minute" Hamfest, 9 AM-3 PM, indoors, at the U.S.F. Tampa Campus. Enter campus on North Palm Dr. VE Exams at 11 AM. Talk-in on 146.940 (-), 442.275(+), and 147.240(+) MHz. Contact *USF Radio and Electronics Club*, 4202 E Fowler Ave., CTR 2416, Tampa FL 33620. Tel. (813) 979-0033, or E-mail: *douglass@suntan.eng.usf.edu*.

JUL 27-28

ORLANDO, FL The Bahia Shrine AR Unit will host "Hamcation" at Bahia Shrine Temple, 2300 Penbrook Dr., Sat. and Sun. 9 AM-4 PM. ARRL VE EXAMS: Novice thru Extra Class, July 27th, 9 AM at "Hamcation". Call *AIWB4DRF*, (407) 671-1056. For general info, contact *Cecil F. Morehouse K4KEN*, 150 Willow Dr., Orlando FL 32807-3222. Tel. (407) 281-9169.

AUG 3

CLAYTON, NY The Jefferson County RAC will sponsor the 1000 Islands Internat'l Hamfest, 8 AM-3 PM at the Clayton Rec. Park Arena, corner NYS RT 12 and CO RT 3. Talk-in on 146.700/.100 Rptr. Vendors must have an admission ticket. VE Exams at 9 AM (NR2S); walk-ins accepted. Contact *Janet Long N2ZMS*, P.O. Box 523, Brownville, NY 13615. Tel. (315) 788-8543.

ESCANABA, MI The Delta County ARS will host the Upper Peninsula Hamfest at the U.P. State Fairgrounds. Set up Fri. night, and 6 AM Sat. Doors open to the public at 8 AM, EST. Contact *Jim Bauer N8XAJ*, (906) 786-1580; E-mail: *JBAN8XAJ@AOL.COM*; or *John Anderson WD8RTH*, (906) 789-9148, E-Mail: *ANDEROJ@BAYDENO.CC.MI.US*.

AUG 4

FOWLerville, MI The Livingston ARK will hold the Livingston County HamFair at Fowlerville Fair Grounds, Grand River Rd. (M43); 1 mi. west of Fowlerville. VE Exams. Ham/Computer/Electronic equip., new and used. Covered trunk sales. Flea Market. Setup starts at 6 AM. Open to the public 8 AM-2 PM.

SASE to *LARK*, P.O. Box 283, Howell MI 48843; or call *Ray* at (517) 546-9209. Talk-in on 146.680(-).

MARSHFIELD, WI Marshfield Area ARS will hold their 5th annual Picnic/Potluck/Swapfest in Wildwood Park starting around 11 AM. Talk-in on 147.180. All are welcome. Contact *Guy A. Boucher KF9XX*, 107 West Third St., Marshfield WI 54449. Tel. (715) 384-4323. Packet: *KF9XX @ W9IHW.WI.USA.NA*.

MATAMORAS, PA The Tri-State ARA will hold their 3rd annual Hamfest at Matamoras Airport Park, off Exit 11, I-84. Sellers 6 AM, Buyers 8 AM. Talk-in on 146.16/.76 PL 100, or 144.75/145.350 PL 100. Contact *Paul KD3L*, (717) 491-4808; *Ray WY2D*, (914) 856-1733; or *Ray AA2WC*, (914) 856-0426.

PEOTONE, IL The Hamfesters RC will hold its annual Hamfest at the Will County Fairgrounds on I-57 Exit 328 East. Open 6 AM-3 PM. Flea Market. Exhibits. Talk-In on 146.52, 146.64(-107.2), 146.94(-). Contact *John Dvorak W9ZUV*, 5750 S. Newcastle Ave., Chicago IL 60638. Tel. (312) 586-0128.

OCT 27

NEWTOWN, PA The Penn Wireless Assn. will sponsor "Tradefest '96," 8 AM-3 PM. Setup at 6 AM. The event will be held at Bucks County Community College, Swamp Rd. Talk-in on 145.25(-) PL 131.8. VE Exams. Contact *Steve* (215) 752-1202.

SPECIAL EVENT STATIONS

JUN 28-30

WATERTOWN, SD The Lake Area Radio Klub of Watertown SD, and the Huron ARC of Huron SD will operate *KB0TAH* at DeSmet SD from 1700 UTC-0200 UTC daily. Phone freq. will be 3.870, 7.265, 14.265, 21.340, and 28.340 MHz. CW operation will be 40 kHz up from the bottom of each band, 80-10 meters. For a certificate, send SASE to *Lake Area Radio Klub*, P.O. Box 642, Watertown SD 57021-0642. To obtain an unfolded certificate, supply a 9" x 12" envelope with two units of postage.

JUL 4-7

SAINT LOUIS, MO The Suburban Radio Club will operate *W0DCW* CW and phone, on the lower 25 kc of the General portion of the

amateur bands, 10 AM-5 PM CDT. For a certificate, contact *Bill Coby KB0MWG*, 4946 Pernod, St. Louis MO 63139-1252.

JUL 6

DELTAVILLE, VA The Middlesex AR Group will operate Station *AD4VI* 1300 hrs-1900 hrs to commemorate the annual Deltaville Heritage Day. Freq.: lower General 80m-15m phone and CW, and Novice 10m phone. For a certificate, send a 9" x 12" SASE to *Peter Wright AD4VI*, P.O. Box 1025, Deltaville VA 23043.

JUL 8-9

BARABOO-MILWAUKEE, WI *K9KYX/Circus Train Mobile* will operate 1400 UTC-2030 UTC both days, from the Great Circus Train as it travels from Wisconsin's Circus World Museum to Milwaukee. The train will pull 20 double-length flat cars carrying more than 60 priceless, fully restored circus wagons for the Great Circus Parade which will occur the following Sunday. Operation will be on 20 or 40 meters, whichever band is in the best condition, around 7.240 or 14.240. There may be extended hours July 8th. For a certificate, send a 9" x 12" SASE with three units of first-class postage. SASE to *Don Evenson K9JYX*, 401 11th St., Baraboo WI 53913.

JUL 8-14

AUSTIN, TX Amateur Radio Operators affiliated with the American Assn. for Nude Recreation, the Naturist Soc., and the Federation of Canadian Naturists will observe the 21st annual N.A. Nude Awareness Celebration by operating Special Event Stations from naturist resorts, on the following freq.: 7.265, 14.265, 21.365, and 28.465 +/- QRM. For a personalized certificate, send QSL and 9" x 12" SASE to *Bob Redoutey KF5KF*, P.O. Box 200812, Austin TX 78720-0812.

JUL 13-14

SAN PEDRO, CA The United RAC and the Ft. MacArthur Military Museum Assn. will operate *K6AA* at the Ft. MacArthur Military Museum, 3601 South Gaffey St., 0800-2000 PDT July 13th, and 0800-1600 PDT, July 14th. Freq.: SSB-7.260, 14.280, 50.150, and 144.250 MHz. FM Voice-51.060 and 145.520 MHz. For a commemorative QSL card, send QSL and a 9" x 12" SASE

to *United Radio Amateur Club*, Los Angeles Maritime Museum, Berth 84-Foot of Sixth St., San Pedro CA 90731.

JUL 17-22 & JUL 25-AUG 1

CAPE BRETON, NOVA SCOTIA, CANADA The West Island ARC of Montreal will operate from two locations on a DXpedition to Atlantic Canada. From 17-22 July a DXpedition to the Marconi Nat'l Historic Site in Cape Breton Nova Scotia will concentrate on 2-meter contacts with Europe. A CW beacon-type CQ will be transmitted on 144.020 MHz, with a reply sought on the same frequency. European hams are requested *NOT* to transmit on this frequency *UNLESS* the CQ is heard. From 25 July-1 Aug., a DXpedition to Seal Island off the southern tip of Nova Scotia will focus on a 2-meter Trans-Atlantic contact as described above, but using two separate systems, on 144.020 and 144.030 MHz. Operation will be on all bands from 160m to 70 cm (excluding 220 MHz), including the RS-10/11, RS-12/13, RS-15, AO-10 and AO-13 satellites. Special emphasis will be placed on participation in the worldwide IOTA (Islands On The Air) contest from 1200 UTX 27 July-1200 UTC 28 July. The callsign will include the suffix "CWI." For further info, contact *Fred Archibald VE2SEI* at (514) 694-3441, Fax: (514) 630-4134; or E-mail: *ARCHIBALD@NASH.PUBNIX.NET.CA*; or contact *Al Penney VO1NO* at (902) 427-0550 Ext 3701; or (902) 876-2779. QSL cards may be sent to *VE2CWI*.

JUL 20

CHAMBERSBURG, PA The Cumberland Valley ARC will operate *W3ACH* to commemorate the 132nd Anniversary of the Burning of Chambersburg PA by Confederate forces on July 30, 1864. Operation will be 1200Z-2100Z. Freq.: 3.870, 7.240, 14.250, and 147.12. For a certificate, send QSL and 9" x 12" SASE to *CVARC*, P.O. Box 172, Chambersburg PA 17201.

JUL 20-21

STRATFORD, NY The Fulton County Dr. Mahlon Loomis Committee will operate *W2ZZJ* to commemorate the 170th Anniversary of the birth of Dr. Mahlon Loomis, the American radio pioneer. Operation will be from 1300Z-2000Z on the General class phone portion of 75, 40, 20, and 15 meters, and on the Novice 10 meter phone band. Also on area 2-meter

FM Rptrs. For a parchment certificate and extensive literature, send QSL, contact number, and a #10 SASE (55¢) to W2ZZJ, 5738 STHWY 29A, Stratford NY 13470.

JUL 24-28

NANAIMO, BRITISH COLUMBIA, CANADA The Nanaimo ARS will operate CY7TUB 0001 UTC-2359 UTC, to celebrate the 30th Anniversary of the world famous

Nanaimo to Vancouver Bathtub Race. Primary modes on HF (-160) will be SSB and CW. More info will be posted on the DX Packet Cluster. Send QSL cards and an SASE to VE7NA.

JULY 27-28

GREENVILLE, OH Station W8UMD will be sponsored by the Treaty City ARA in celebration of the Annie Oakley Parade/Festival.

Operation will be July 27-28, 1300Z-2300Z, CW and phone, on General portions of the hamband. For a Certificate, QSL to W8UMD, T.C.A.R.A., P.O. Box 91, Greenville OH 45331.

JULY 27-29

OSHKOSH, WI Members of the Fox Cities ARC (Appleton WI) will operate W9ZL from the Experimental Aircraft Assn. Fly-In

and Convention. Operation will be from "Pioneer Airport" adjacent to the EAA Aviation Museum. Listen on the General phone portions of the HF bands, as well as RTTY and CW, as conditions and operators permit. The club will also be giving "on grounds" convention info (no QSLs please) on 146.520 simplex. For an 8" x 10" picture certificate, send a proper QSL and SASE to Wayne Pennings WD9FLJ, 913 N. Mason, Appleton WI 54914. 73

LETTERS

Continued from page 62

in your head before you send. Say it aloud if you have to—sing it! Then use your hand key to make the sound you heard. If the rhythm or spacing is not quite right, try again until you are sending what you are hearing. Realize that, if not carefully sent, many characters can sound alike—"C" and "Y" for example. To make it clear, I tend to hold the final dah in the "Y" a little longer. It takes practice, like playing scales on the piano. Sit down with the latest copy of 73 and send Wayne's column on your practice oscillator. Don't try for speed, that will come. In fact, with consistent slow practice

speed will creep up on you before you know it. Just keep a nice steady pace with clear characters and good spacing between. A little silence between characters and even more between words is no waste of time. It gives the other guy a chance to catch up and makes for greater accuracy with fewer repeats—nothing wastes more time than repeats.

The code was easy for me. I've a musical background—never met an instrument I couldn't play. The code is just a style of music (reminds me of the blues) and the hand key is just another instrument. This may be why I enjoy it so much. On the other hand, I know a fellow who is a fine RF engineer who could not carry a

tune and cannot learn the code. He wanted to be a radio operator in the Army, but washed out and ended up being a technician.

The question I have is: Why should musical talent make me a superior radio operator? Why am I better qualified to operate the HF bands than a respected engineer with a tin ear? In the early days, when CW was the only game in town, the code requirements made sense. There is the myth that CW will get through when other methods fail. My experience has shown this to be baloney. Compared to AM, sure, but if it's hard to copy on SSB, then it's going to be tough on CW too.

I do CW for fun, but never would I want to impose my idea

of fun on anyone else. Some will never learn code, others learn 13 wpm, pick up a mike and throw away the key. A few nut cases (like me) really like it.

I'd like to encourage all newcomers to give CW a try, but do it for yourself and not to be politically correct on the air. I hear many no-coders on the air say things like, "I'll start learning code as soon as the basketball season is over." This is a free country and there's no need to feel guilty about not wanting to learn code. If you learn it, learn it well and you'll find it can bring just a little bit of magic to ham radio.

Let's see, where did I put that key? ... Wayne 73

Radio Bookshop

Phone 800-274-7373 or 603-924-0058, FAX 603-924-8613, or see order form on page 88 for ordering information.

UE220 **The Easy Wire Antenna Handbook** by Dave Ingram K4TWJ. All of the needed dimensions for a full range of easy to build and erect "sky wires." \$9.95
WGP87034 **All About Cubical Quad Antennas** by William Orr and Stuart Cowan "The Classic" on Quad design, theory, construction, operation. New feed and matching systems. New data. \$11.95

TAB 3270P **Practical Antenna Handbook—2nd edition** by Jos. Carr. This 560-page book is a treasure. Starts with fundamentals, explains propagation of all kinds, and provides a ton of easy antenna projects. \$26.95

AR4734 **ARRL Antenna Book**. Best and most highly regarded info on antenna fundamentals, transmission lines, design, and construction of wire antennas. \$30.00

WGP87107 **All About Vertical Antennas** by William Orr. Comprehensive coverage of amateur communications. \$11.95

WGP87042 **Beam Antenna Handbook** by William Orr and Stuart Cowan. Everything you need to know about beam design, construction, and operation. \$11.95

WGP87077 **Simple, Low-Cost Wire Antennas For Radio Amateurs** by William Orr and Stuart Cowan. Low-cost, multi-band antennas; inexpensive beams, "invisible" antennas for hams in "tough" locations. \$11.95

AR4661 **ARRL's Antennas & Techniques for Low-Band DXing** can be your ticket to low-band success. \$20.00

ARRL Extra Class License Manual

The sixth edition of *The ARRL Extra Class License Manual* has been completely revised and updated to match the newest Amateur Extra Class (Element 4B) question pool, released by the Volunteer-Examiner Coordinators' Question Pool Committee in December 1995. The new questions will be used on Extra Class license exams starting July 1, 1996, and are expected to be used until the year 2000.

The ARRL Extra Class License Manual includes study material for every question in the question pool, and will help you pass the written exam required for the Extra license. It also provides operating hints to help you get on the air and enjoy some of the more "exotic" operating modes, such as Earth-Moon-Earth (EME), satellites, and amateur TV. *The ARRL Extra Class License Manual* is \$12.00.

1996-1997 Repeater Directory

The American Radio Relay League has released the 25th Anniversary Edition of the *ARRL Repeater Directory*, a completely updated, pocket-sized collector's edition. Besides expanded listings for U.S. and foreign repeaters, you'll find greatly expanded propagation beacon listings, information on repeater operation, interference tracking, and use of the LiTZ system, among other things. Also included are names and addresses of ARRL officers, committee members, frequency coordinators, and a complete listing of ARRL Special Service Clubs, with meeting times and locations. All this and lots more in the *1996-1997 ARRL Repeater Directory* is \$8.00 and is available from Radio Bookshop. (See page 88 for order form and S&H fees.)

PROPAGATION

Jim Gray W1XU
210 Chateau Circle
Payson AZ 85541

HF band conditions are likely to be in the doldrums with the usual QRN and seasonal slump in DX activity; however, the HF bands will be open long after dark, and there will be lots of vacation-time mobile and portable activity, so all is not lost.

The Earth's magnetic field—hence ionosphere—is expected to be active between July 3rd and July 7th, and again on the 31st, with possible violent storms and even earthquakes and volcanic activity during these days.

The monthly chart anticipates the 10th, 17th, and 23rd to 25th to be Good days, but

JULY 1996						
SUN	MON	TUE	WED	THU	FRI	SAT
	1 G-F	2 F-P	3 P	4 P-VP	5 VP	6 VP-P
7 P-F	8 F	9 F-G	10 G	11 G-F	12 F	13 F
14 F	15 F	16 F-G	17 G-F	18 F-P	19 P-F	20 F
21 F	22 F-G	23 G	24 G	25 G	26 G-F	27 F
28 F-G	29 G-F	30 F-P	31 P			

EASTERN UNITED STATES TO:

GMT:	00	02	04	06	08	10	12	14	16	18	20	22
ALASKA						20	20					
ARGENTINA	20	20	20	40			20	20	15	15	15	15
AUSTRALIA		20	20	20	40	40	20					
CANAL ZONE	15	40	40	40	40	40		15	15	15	10	10
ENGLAND			40	40			20	20	20	20	20	20
HAWAII			20		40		20					
INDIA												
JAPAN						20	20					
MEXICO	15	40	40	40	40	40		15	15	15	10	10
PHILIPPINES							20					
PUERTO RICO	15	40	40	40	40	40		15	15	15	10	10
SOUTH AFRICA			40	40		20	20				20	
U.S.S.R.						20	20		20			
WEST COAST	20	40	40	40	40	40						20

CENTRAL UNITED STATES TO:

ALASKA		20	20					20	20			
ARGENTINA	15	20	20	40			20	20		15	15	15
AUSTRALIA	15	20	20	20	40	40		20			20	
CANAL ZONE	15	20	20	20	40	40	20	20	15	15	15	10
ENGLAND	20	40					20	20		20	20	20
HAWAII	15	15	20	20	20	40	20	20				
INDIA												
JAPAN		20	20					20	20			
MEXICO	15	20	20	20	40	40	20	20	15	15	15	10
PHILIPPINES		20	20				20	20				
PUERTO RICO	15	20	20	20	40	40	20	20	15	15	15	10
SOUTH AFRICA							20				20	20
U.S.S.R.								20			20	

WESTERN UNITED STATES TO:

ALASKA		20	20						20			
ARGENTINA	15	20	20	40	40			20	20		15	15
AUSTRALIA		20	20	20	20	40	40		20		15	15
CANAL ZONE	15	15	20	20	40	40		20	20	15	15	15
ENGLAND	20							20	20			20
HAWAII	20	15	15	20	20	20	40	40	20		20	20
INDIA				20						20		
JAPAN		20	20							20		
MEXICO	15	15	20	20	40	40		20	20	15	15	15
PHILIPPINES				20						20		
PUERTO RICO	15	15	20	20	40	40		20	20	15	15	15
SOUTH AFRICA			40							20		
U.S.S.R.										20		
EAST COAST	20	40	40	40	40	40						20

Where 10m is shown, also check 12m. Where 15m is shown, check 17m too. Where 20m is shown, be sure to look at 17 as well. Always check the bands above and below the indicated bands for possible openings to the areas shown. Remember that DX is where you find it, and not always where it is predicted to be.

the remainder of the month shows trending conditions. Possible bright spots are potential VHF opportunities during the disturbed period mentioned earlier, supplemented by meteor-burst propagation from the Delta Aquarid meteor shower which begins on the 29th and lasts about 10 days.

10-12 meters

This is a daylight-only band this month, but may present openings to tropical areas as well as short-skip openings on the best days (G). During intense, sporadic E conditions (rare this month) bursts of strong signals can come and go unexpectedly. Stay alert.

15-17 meters

These bands could stay open into early evening hours with possibilities of transequatorial DX on Good (G) days and evenings. Signals seem to peak toward the west during afternoon and evening hours. Short-skip to 1,000 miles or so should be available on many days.

20 meters

This should be your main choice for DX-chasing. Because some areas of the world are dark and others are in daylight at the same time, you can expect dawn-to-dusk, and even later, DX opportunities on Good (G) days/nights.

Short-skip will prevail to about 2,000 miles during the day, and further at night.

30-40 meters

You may find these bands quite noisy (QRN) during the daytime, due to the onset of thunderstorms this month, but they will be quieter during the nighttime hours. DX to your east will be the best before midnight, and best to your west before dawn. Choose Good (G) days for best chances of scoring a new country. Short-skip of 100-1,000 miles during the day, and 500-2,000 miles or so at night will prevail.

80 meters

You may find that 80 meters will provide DX on Good (G) nights, limited by thunderstorm activity. It may also provide short-skip openings of 200 miles or so during the day and 2,000 miles or more after dark.

160 meters

There will be no daytime openings here, due to a high absorption of signals, but it ought to provide skip to 1,000 miles or so after dark. Only rarely will you find DX, and only on Good (G) nights with low or no thunderstorm activity. Low-frequency static bursts, hundreds of miles in length, limit your summer operations.

MORE UPDATES

Poor Man's incorrect call sign

Sam Guccione wrote an article for us back in November of 1995 titled "Poor Man's Doppler." If you have been trying to reach him on the air, we're sorry that you haven't. His correct call sign is K3BY, not K3BYCC and the photographs used in his article were courtesy of N3JCP, not N3JGP.

change "C13" to "C3". Column 3, last paragraph, lines 8 and 9, "constant frequency" should be straight line frequency, and in the same paragraph, lines 3 and 4, "constant capacity" wants to be "straight line capacity." One more thing; in the schematic, C11 should go from Q3 emitter to Q2 emitter.

440 Super-J Pole

In an effort to prevent confusion about the "440 Super J-Pole Antenna" article published in April's 73, we offer this advice from author Marty Gammel KAØNAN: "Please connect the feedpoint as shown in the photo, not as the text described it. The center conductor *does* clamp to the short vertical element." 73

Crystal-Controlled update

The November 1995 issue featured Mr. Frank Brumbaugh's article "Crystal-Controlled Audio Generator" for which we have a few corrections. Look to page 32 for these: column one, paragraph one, lines one and eight; please

POWERTALK™

Stunning HF-SSB Receive Clarity With SGC DSP.



With SGC's new PowerTalk™, you'll intercept weak HF signals, increase signal clarity and eliminate unwanted noise. You'll hear SSB signals clearer and easier than ever before. PowerTalk™ combines the advanced receiver technology of SGC's exclusive ADSP™ (Adaptive Digital Signal Processing) and SNS™ (Signal Noise Subtraction). Fast audio *and* visual tuning—a DSP command center with a high performance spinner knob and bright LED indicators. Plus all the outstanding features of the popular SG-2000: 644 ITU and ham frequencies, programmable memory, large LCD display and 150 watts of power out. PowerTalk™ is a true HF-SSB Power Tool. We have all the details. Call us *and hear more.*



SG-2000. Standard marine SSB head. 644 ITU and ham frequencies, emergency alarm and backlit keypads - a world proven HF transceiver.

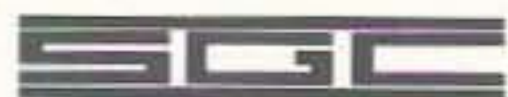

1-800-259-7331

The SGC Building Box 3526 Bellevue, WA 98009 USA
(206) 746-6310 Fax: (206) 746-6384



Radio Bookshop ORDER FORM

You may order by mail, telephone, or fax. All payments are to be in US funds. Allow 4 weeks for delivery. (Prices subject to change without notice if suppliers increase prices or new editions cost us more.)

ITEM	TITLE	QTY	PRICE	TOTAL

Shipping: All orders add \$5.00 handling *plus there is an additional at cost shipping charge added to all foreign orders. We ship UPS where possible, please give us street address. **S&H* TOTAL \$**

Make checks payable to "Radio Bookshop."

Foreign Orders: Chose one surface shipping air shipping (Surface delivery may take 2-3 months.)

*Note: The actual foreign shipping costs will be additional to the regular shipping and handling fees.

Name _____ Phone _____

Address _____

City _____ State _____ Zip _____ Country _____

\$10 minimum for credit card orders

Total Paid \$ _____ Check/Money Order AMEX MC VISA
Card # _____ Expires _____

Signature _____ Date _____

Telephone: 603-924-0058, 800-274-7373, FAX 603-924-8613

Mail: Radio Bookshop, Dept. 396, 70 Route 202 N, Peterborough NH 03458

YES, Send me 12 issues of 73 at the low rate of \$24.97 (save 47% over the cover price). Canada add \$7 plus \$1.40 GST; Foreign add \$19 surface; \$42 airmail.

See Advertisers' Index for location of various Radio Bookshop ads.

Patcomm introduces the PC-16000 HF Transceiver for \$1395⁰⁰

Featuring Built-In Keyboard/Digital Mode Interface & Digital Signal Processor

Patcomm Corporation™ introduces the PC-16000™, a full featured HF Transceiver with a built-in keyboard interface. Plug a standard IBM-AT* compatible keyboard into a PC-16000™ and instantly enjoy keyboard CW, RTTY (BAUDOT) and ASCII data communications. Incoming morse and RTTY data is decoded and displayed on the built-in LCD display. Data is also sent to an RS-232 serial port for display on a "dumb terminal" or equivalent.

The PC-16000™ offers the following features:

- Built-in AT keyboard interface (keyboard optional)
- General coverage receiver (1.5–29.9 MHz)
- Dual up conversion design
- USB/LSB/CW/FSK/AM & optional FM modes
- 160 thru 10m ham band coverage on transmit (CAP & MARS available)
- 100W output power
- DDS driven PLL synthesizer—1 Hz minimum step size
- Selectable variable speed/fixed 10Hz step VFO tuning

- Basic display lets you know exactly where you are.

```
14.03510-T  0930
14.03510-R  1000
```

- Standard Display shows RX/TX VFO freq's, time and current memory

- Send & Receive in:
CW / RTTY(BAUDOT) / ASCII

```
TNX FER QSO, 73
```

- ← Incoming data
- ← Outgoing data appears here

Digital Signal Processing Filtering System

- 2.4KHz, 1.8KHz, 500Hz, 250Hz & RTTY "Brick Wall" filters
- Auto notch filter removes multiple hetrodynes on SSB signals automatically
- De-noiser reduces background noise

- Manual notch for CW operation
- Built-in digital power/SWR meter
- 24 hour clock

- Built-in 5–75 WPM IAMBIC keyer

- Select 1 of 3 antennas from the front panel
- Slow/fast AGC
- IF shift

Specifications are subject to change without notice.

* IBM AT is a registered trademark of the IBM Corporation.

**ALL THIS
FOR ONLY
\$1,395⁰⁰**

Patent Pending

(Keyboard Optional)

patcomm
corporation

**Call or Write for a Detailed Brochure
Major Credit Cards Accepted**

Designed and manufactured in the U.S.A.
Phone: (516) 862-6512 ■ Fax: (516) 862-6529
7 Flowerfield M100, St. James NY 11780

Connect to the world !!

A full range of cellular antennas is available: hole mount, magnetic mount, on-glass and base station.



SKA 900 1/4



SKA 901 1/4



SKA 901 C



MICROCELL MAG



SKA 900 C



SGM 900

SIRIO
antenne

46049 VOLTA MANTOVANA - MN - ITALY - Tel. (39) 376/801515 - Fax (39) 376/801254
NORTH AMERICA OFFICE: TORONTO - CANADA - TEL. (519) 650 9277 - Fax (519) 650 1779