

73 AMATEUR RADIO

AUGUST 1989

ISSUE #347

USA \$2.95

CAN \$3.95

International Edition

A WGE Publication

Home-Brew Bonanza!

- Add FM to Older Rig
- PL Tones for Pennies
- IF Shift Add-On
- 80m Phased Antenna Array

REVIEWS

- Kantronics' KAM Data Controller
- Ramsey's Service Monitor

ALSO

- Rapid Hamsat Signal Finding
- Ham-ed, the Swiss Way



ICOM

IC-4KL



GIVE YOUR SIGNAL A BOOST!!!

ICOM's all new IC-4KL solid state HF linear amplifier represents a hefty step forward in modern electronic technology and futuristic station design.

It installs in a limited space, interconnects in a breeze and delivers band-commanding performance in the most reliable top-of-the-line fashion. Give your signal a power boost with ICOM's IC-4KL!

GLOBE SPANNING POWER.

The rugged IC-4KL delivers 1000 watts output with full 100 percent duty cycle.

Covers 160-15 meters. A power boost that will be heard around the world!

ALL SOLID STATE AND FULLY AUTOMATIC.

No lethal high voltages required. No warm-up, no tune-up, no fumbles. Fully automatic and overload-protected. Just switch on and operate. Follows band selections on your ICOM transceiver. Add ICOM's optional EX-627 and setup even selects the proper antenna. The ultimate HF amplifier!

AUTOMATIC ANTENNA TUNER BUILT-IN.

Advanced design and wide impedance matching range. Internal CPU stores previous settings on each band for rapid single-button operation. Automatically seeks for and memorizes new settings if SWR changes or antennas are swapped.

FULL CW BREAK-IN.

The IC-4KL uses extremely quiet and high speed relays. A DX'er's winning edge and a Packeteer's delight!

UNIQUE MODERN DESIGN.

Husky RF/PS unit rolls conveniently under desk or into nearby corner. All you see is a small remote control featuring dual multi-functioned meters for SWR and output watts.

The IC-4KL comes complete with a remote control unit, RF/PS deck and nine feet of interconnecting cable for easy installation. The IC-4KL... Big Signal Performance backed by a one-year warranty at any one of ICOM's four North American Service Centers.

ICOM America, Inc., 2380-116th Ave. N.E., Bellevue, WA 98004
 Customer Service Hotline (206) 454-7619
 3150 Premier Drive, Suite 126, Irving, TX 75063 1777 Phoenix Parkway, Suite 201, Atlanta, GA 30349 ICOM CANADA, A Division of ICOM America, Inc., 3071 - #5 Road, Unit 9, Richmond, B.C. V6X 2T4 Canada
 All stated specifications are subject to change without notice or obligation. All ICOM radios significantly exceed FCC regulations limiting spurious emissions. 4KL689

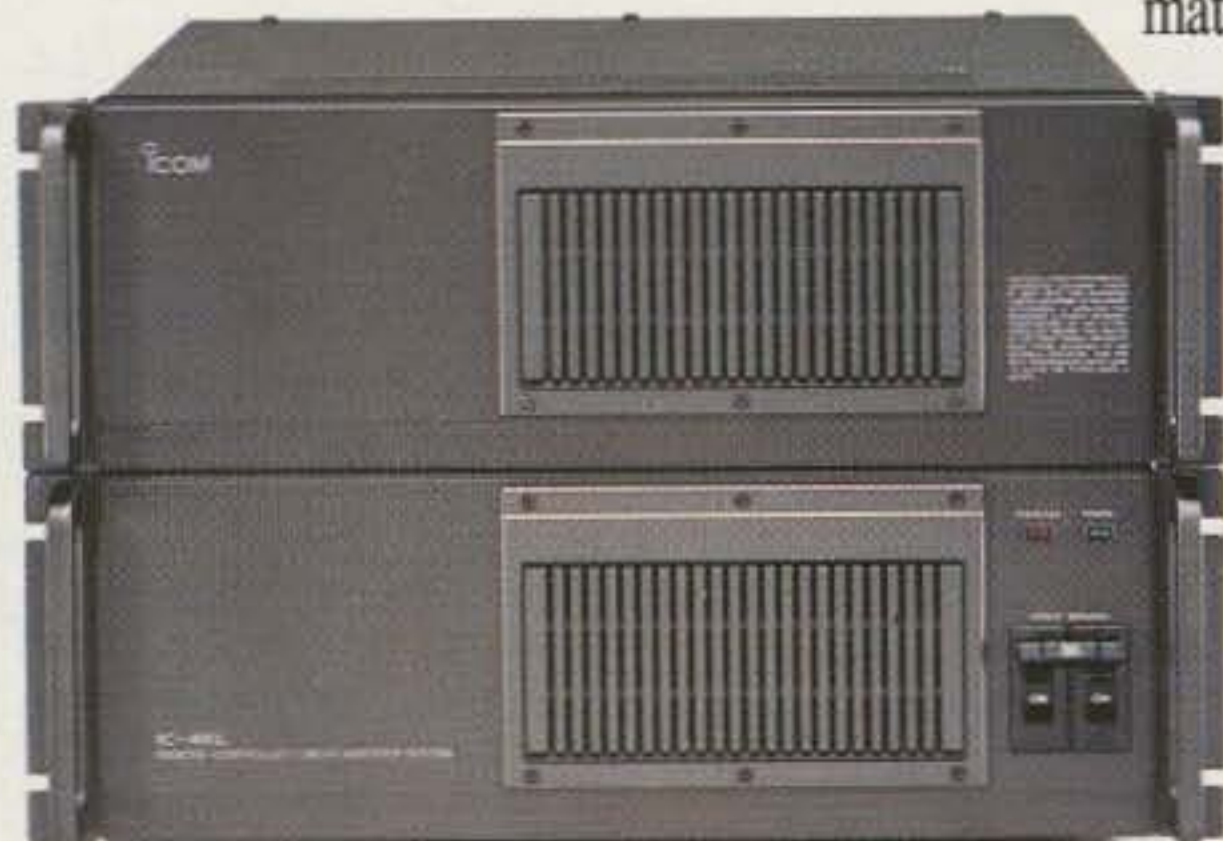

ICOM
 First in Communications

NO OTHER FULL DUPLEX PATCH OR REPEATER CONTROLLER GIVES YOU SO MUCH FOR SO LITTLE

FULL DUPLEX AUTOPATCH USING DUAL BAND RADIOS...

Most people are within radio range of their base station 90% of the time. Why not install an 8200 and enjoy your own private full duplex mobile telephone system? Only 3 connections are required. The 8200 provides both full duplex and half duplex operation.

(Inquire about Private Patch V for simplex operation. Operates in enhanced sampling or VOX modes...user selectable.)

ADVANCED AUTOPATCH FEATURES...

The 8200 incorporates many features which are simply not available in any other product. For example...

90 Phone Number Auto Dialer: The 8200 will store (in non-volatile memory) 90 phone numbers which can be dialed with abbreviated two digit key codes. The auto dialer is programmable over the air or with the built-in keyboard.

Last Number Redial: Redialing the last number called is reduced to a single digit (plus access code).

Hookflash: Operates call waiting etc. Simply press * three times. Only CSI has it.

Call Progress Tone Detection: Busy signals and second dial tones are detected and cause automatic disconnect. Ample time is allowed for dialing second dial tones when required.

Powerful Toll Protection: One to four digit sequences can be restricted. For example, you could lock out 0, 1, 976 and 911. Additionally, digit counting will prevent dialing more than 10 digits. A separate 2 to 6 digit toll override code allows making toll calls when desired. Re-arm is automatic.

Dial Access Remote Base: The 8200 can be accessed and controlled from any telephone. Call up and drop into the system from your desk phone at lunch hour!

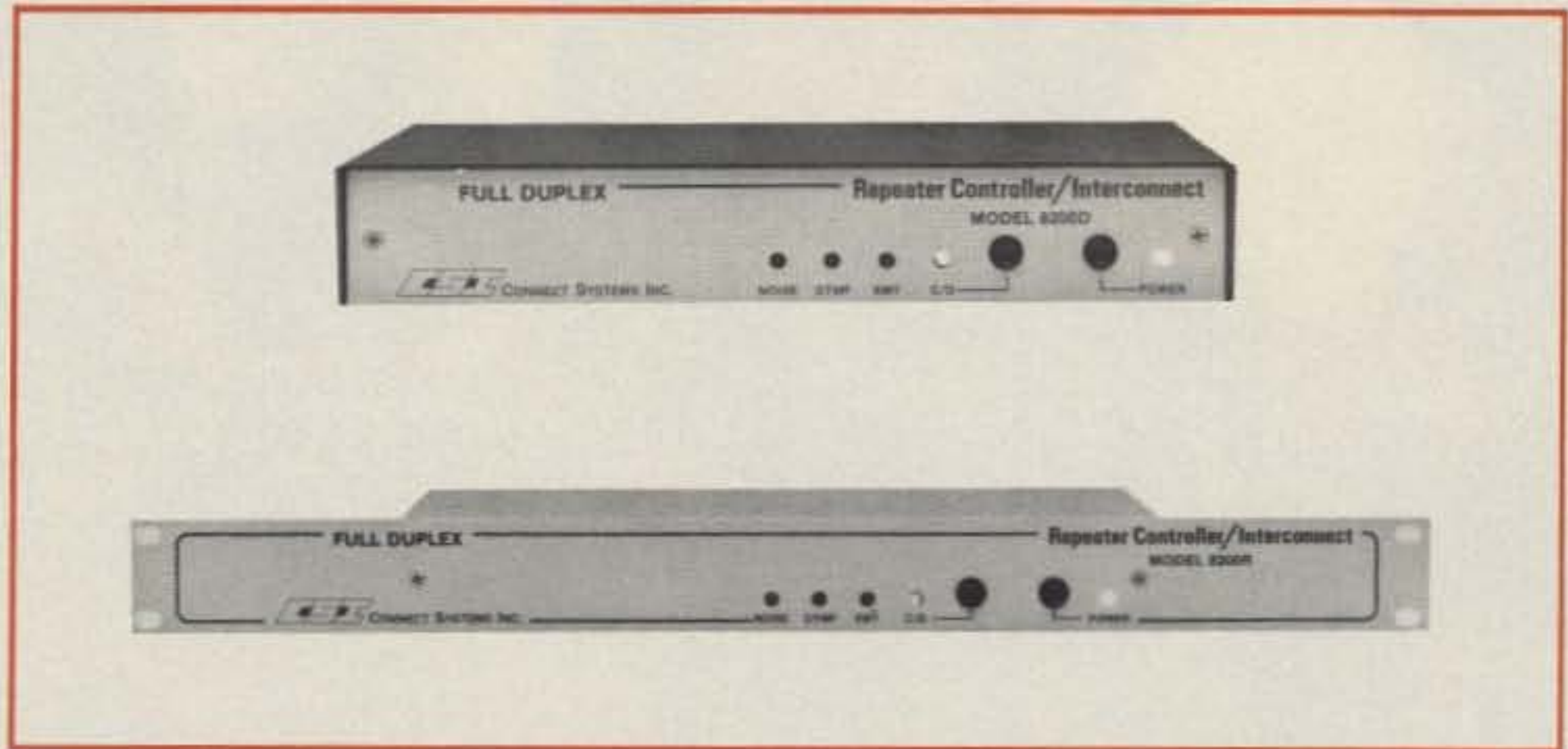

Ringout Selective Calling: Ordinary calls can be received using ringout (reverse patch) and mobiles can be selectively called using regenerated DTMF.

Optional ANI access codes: This option will allow up to 50 separate (remotely programmable) 1 to 6 digit access codes. A call can only be disconnected with the code that initiated the call. Thus eliminating sabotage disconnects.

AN ADVANCED REPEATER CONTROLLER...

The 8200 is a powerful repeater building block and is perfect for all private and club systems.

The 8200 contains everything necessary to convert any receiver and transmitter into a powerful repeater. Only one connection to the receiver and two to the transmitter are required.

Menu style programming is accomplished with the built in keyboard and display. The user can select a 3 digit repeater up/down code, CW ID message, CW ID interval, hang time, activity timer time, and you can even select any Morse character as a courtesy beep!!

An optional plug-in CTCSS board converts the 8200 to private use. The incoming CTCSS is filtered out and replaced with fully regenerated tone. 32 tones are dip switch selectable.

STANDARD FEATURES...

- Line in use detection
 - 90 number auto dialer
 - Redial
 - Hookflash
 - User programmable CW ID
 - Regenerated tone/pulse dialing
 - Selectable activity, timeout and hang time timers
 - 3 digit repeater on/off code
 - Two remotely programmable 1-6 digit autopatch connect codes. (Regular and Toll Override)
 - Powerful toll protection
 - Remotely controllable relay (relay optional)
 - Ringout (reverse patch)
 - Busy channel ringout inhibit
 - Ring counting
 - Auto answer
 - Telephone remote base
 - DTMF-DTMF selective calling
 - Courtesy beep (any Morse character)
 - Automatic busy signal and dial tone disconnect
 - MOV lightning protectors
 - Non-volatile memory
- And MUCH more!



CONNECT SYSTEMS INC.

2064 Eastman Ave. #113

Ventura, CA 93003

Phone (805) 642-7184

FAX (805) 642-7271

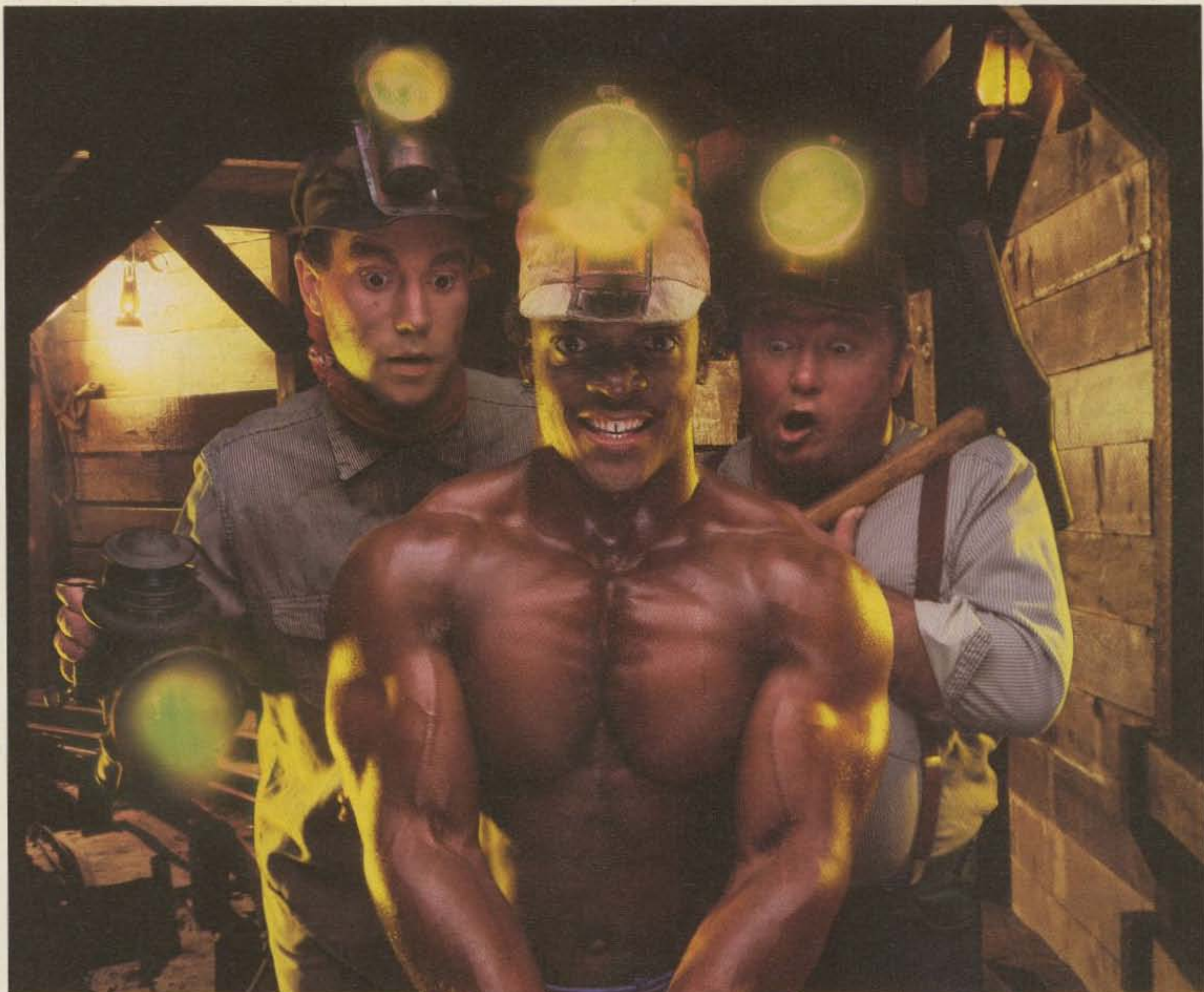

Dynamite Discovery

Communications Specialists' latest excavation brings to light yet another dynamite discovery—our new dip switch programmable SD-1000. No need to tunnel your way through Two-Tone Sequential decoding anymore. We've mined this amazing unit! Now, for the first time, you can stock one unit that will decode all calls in a 1000-call paging system with $\pm .2\text{Hz}$ crystal accuracy. The EEPROM on-board memory can even be programmed for custom tones, and every unit includes group call. Universal switched outputs control your call light, squelch gate and horn. The SD-1000 can

also generate CTCSS and decode Two-Tone Sequential. Its miniature size of 2.0" x 1.25" x .4" is no minor fact either, as it's a flawless companion for our PE-1000 Paging Encoder. We ensure one-day delivery and our one-year standard warranty. Tap the rich vein of Communications Specialists and unearth the SD-1000 or other fine gems.

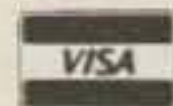

COMMUNICATIONS SPECIALISTS, INC.
 426 West Taft Avenue • Orange, CA 92665-4296
 Local (714) 998-3021 • FAX (714) 974-3420
 Entire U.S.A. 1-800-854-0547

CIRCLE 10 ON READER SERVICE CARD

QRM

Editorial Offices
WGE Center
Hancock NH 03449
phone: 603-525-4201

Advertising Offices
WGE Center
Hancock NH 03449
phone: 800-225-5083

Circulation Offices
WGE Center
Hancock NH 03449
phone: 603-525-4201

Manuscripts

Contributions in the form of manuscripts with drawings and/or photographs are welcome and will be considered for possible publication. We can assume no responsibility for loss or damage to any material. Please enclose a stamped, self-addressed envelope with each submission. Payment for the use of any unsolicited material will be made upon publication. A premium will be paid for accepted articles that have been submitted electronically (CompuServe ppn 70310,775 or MCI Mail "WGE PUB" or GENIE address "73MAG") or on disk as an IBM-compatible ASCII file. You can also contact us at the 73 BBS at (603) 525-4438, 300 or 1200 baud, 8 data bits, no parity, one stop bit. All contributions should be directed to the 73 editorial offices. "How to Write for 73" guidelines are available upon request. US citizens must include their social security number with submitted manuscripts.

73 Amateur Radio (ISSN 0889-5309) is published monthly by WGE Publishing, Inc., WGE Center, Forest Road, Hancock, New Hampshire 03449. Entire contents © 1989 by WGE Publishing, Inc. No part of this publication may be reproduced without written permission from the publisher. For Subscription Services write 73 Amateur Radio, PO Box 58866, Boulder, CO 80322-8866, or call 1-800-289-0388. In CO call 1-303-447-9330. The subscription rate is: one year \$24.97; two years \$39.97. Additional postage for Canada is \$7.00 and for other foreign countries, \$19.00 surface and \$37.00 airmail per year. All foreign orders must be accompanied by payment in US funds. Second class postage paid at Hancock, New Hampshire and at additional mailing offices. Canadian second class mail registration number 9566. Microfilm Edition—University Microfilm, Ann Arbor, MI 48106. Postmaster: send address changes to 73 Amateur Radio, PO Box 58866, Boulder, CO 80322-8866.

Contract:

Reading this binds all you electronics out there in Hamdom to perform the following:

- 1) Send for our Writer's Guide.
- 2) Following instructions therein, apply at least one of your brainchilds to film, paper, and/or diskette.
- 3) Send it to us in article form so that we may print it for everyone's benefit.

No cavilling now—if you can design and/or build it, you can write about it! You'll feel better and you even get paid.

FEEDBACK... FEEDBACK!

It's like being there—right here in our offices! How? Just take advantage of our FEEDBACK card on page 17. You'll notice a feedback number at the beginning of each article and column. We'd like you to rate what you read so that we can print what types of things you like best. And then we will draw one Feedback card each month for a free subscription to 73.

73 AMATEUR RADIO

AUGUST 1989

Issue # 347

TABLE OF CONTENTS

FEATURES

- 44 Find Your Signal the First Time!
How to quickly deal with Doppler shift on the hamsats. AA6CQ/VE6
- 46 JEZ—Jugendelektronizentrum
First-class ham education program. HB9DU

HOME-BREW

- 13 CTCSS, Fast and Cheap
Simple PL tone board project. N6UE
- 24 COCOA—A COLLinear COaxial Array
Deluxe 80m wire antenna. W2OZH
- 34 Control Your Rig from a PC
This project lets your rig and home computer talk to each other. N7IPY
- 42 Full-Wave VHF Vertical Antenna
Easy-to-build, good gain antenna. AF8B
- 48 Need FM?
Add this mode to your rig at little cost. KB2BQK
- 49 10 GHz RF Preamp
Get started on putting together your 3cm system! WB6IGP
- 53 IF Shift, Cheap
Quick 'n' easy QRM-buster for your older rig. W0WUZ

REVIEWS

- 18 Kantronics KAM
Multi-mode controller with packet gateway function, PBBS, and much more! WB6RQN
- 28 Ameritron AL-80A Linear Amp
This reliable 1kW amp won't drive you to the poorhouse. W1FYR
- 32 Ramsey COM-3
Quality service monitor at less than one-third the cost of its peers. WB9RRT
- 38 Ramsey SR-1 Receiver Kit
SW listening and home-brewing fun for only \$25. WA9PYH

BOOK REVIEWS

- 31 Uno, Dos, Cuatro
Introduction to the "numbers" stations. W3LOY

DEPARTMENTS

- | | |
|---------------------|---------------------|
| 80 Ad Index | 81 Letters |
| 76 Above and Beyond | 66 Looking West |
| 55 Aerial View | 8 Never Say Die |
| 65 Ask Kaboom | 70 New Products |
| 94 Barter 'N' Buy | 95 Propagation |
| 58 Circuits | 72 QRP |
| 92 Dealer Directory | 10 QRX |
| 17 Feedback Index | 60 RTTY Loop |
| 90 Ham Help | 84 73 International |
| 17 Ham Profiles | 74 Special Events |
| 64 Hamsats | 82 Tech Tips |
| 62 Homing In | 90 Updates |
| 93 Index: 8/89 | 6 Welcome Newcomers |

Cover of Ramsey COM-3 service monitor by Marilyn Moran



See our new department "Ham Profiles" for more on Diane KG5CS

WANTED

\$100.⁰⁰ REWARD



\$50.⁰⁰ REWARD



For a limited time Alinco Electronics will give a \$100.00 "Reward" for your working, 2 meter or 70 centimeter Mobile Transceiver, or \$50.00 for your working 2 meter or 70 centimeter Hand-Held Transceiver.

The way it works is really quite simple. Just take or send your old, but working, transceiver to your favorite dealer for **TRADE-IN**. Whatever the dealer offers for Trade-in allowance, Alinco will increase the amount by either \$50.00 or \$100.00, depending on whether it's a Hand-Held or Mobile, **ON THE SPOT!** There are only two requirements:

- 1) The Trade-In "Reward" can only be used towards an Alinco DR-510T Dual Band Mobile or an Alinco DJ-500T Dual Band Hand-Held, on a Mobile for Mobile and Hand-Held for Hand-Held basis.
- 2) The Trade-In unit must be in good working order and salable.

Remember, the company that already gives you the best value for your dollar, and a two year factory warranty, now gives you something else that no other company does—A substantial Trade-In "Reward" for using our products! *****OFFER GOOD AT TIME OF SALE ONLY. OFFER EXPIRES AUGUST 31, 1989*****

ALINCO ELECTRONICS INC.

CIRCLE 67 ON READER SERVICE CARD



ALINCO ELECTRONICS INC.

20705 S. Western Ave., Suite 104, Torrance, CA 90501 • (213) 618-8616 • FAX (213) 618-8758

BIG POWER IN A SMALL PACKAGE

DR-510T DUAL BANDER



The Tiny, Tough and Terrific Alinco DR-510T, 2m/70 cm FM Dual Band Mobile Transceiver has been specially designed to condense maximum performance and operating convenience into an ultra compact package. An impressive array of features give maximum flexibility in mobile installations.

- ▶ 144.00 Mhz-147.995 Mhz & 440-450 Mhz*
- ▶ CROSS BAND REPEATER FUNCTION
- ▶ BUILT-IN DUPLEXER
- ▶ CROSS BAND-FULL DUPLEX
- ▶ ENCODE/DECODE SUBAUDIBLE TONES
- ▶ COMPACT SIZE: 5 1/2" (W) x 2" (H) x 8 1/16" (D)
- ▶ HIGH OUTPUT POWER : High: 45 Watts VHF, 35 Watts UHF, Low: 5 Watts both Bands.
- 14 Multi Function Memory Channels
- 6 Channel Spacing Steps
- 4 Scanning Modes
- 16 Button DTMF Microphone
- Multi Color LCD
- 3 Mode Priority Scan
- 1 Call Channel
- All Function Keys Illuminated

* CAP and MARS Frequency Modifiable (Permit required)

2-Year Limited Factory Warranty



- DR-110T**
2m FM Mobile Transceiver
- 144.00 - 147.995 Mhz*
 - 5 1/2" (W) x 1 5/8" (H) x 6 1/2" (D)
 - 45 Watts Hi / 5 Watts Low

* CAP and MARS Frequency Modifiable (Certificate required)

- DR-410T Coming Soon**
- 70cm FM Mobile Transceiver
 - 440-450 Mhz
 - 35 Watts Hi / 5 Watts Low

Welcome, Newcomers!

The Universe Electric

In 640 B.C., Thales, a Greek philosopher, theorized that electricity was the soul in matter. Today we describe electricity as the flow of electrons. The **electric charge** is inherent in all matter, and when the positive-negative balance is disturbed, a net charge is created. Like charges repel each other and unlike charges attract each other. You can see the effects of electrostatic repulsion in clean, newly combed hair.

Displays of electrical activity, such as lightning, have always fascinated philosophers, scientists, and children. Do you remember, as a child, rubbing your blanket in the dark to see the sparks fly, or making a balloon stick to the wall? Warnings to stay away from the AC outlet? Did that peak your curiosity? Something really amazing must be inside there for Mom to get so excited when you try to explore it with a fork.

Phosphenes, those bright spots which appear before your eyes whenever there is a lack of external stimuli, can be induced by an electrostatic generator. In the 18th century, phosphene parties were popular, and Benjamin Franklin, kite-flyer and statesman, took part in at least one. People would sit in a circle and hold hands, letting themselves be shocked by an electrostatic generator. Each time the circle (circuit?) was opened or closed, they would see phosphenes. (Scientists still do not know exactly what phosphenes are, or how electrical stimulation or lack of stimulation produces them.)

Measuring Electricity

In 1751 Benjamin Franklin published *Experiments and Observations on Electricity*, which became the standard for electrical research for more than a generation. Since he left school at age 10, the work was entirely nonmathematical, but it inspired a French engineer, Charles Coulomb, to perfect a contraption called the "torsion balance." Experimenting with it, in 1789 he discovered the law of electrical force and proved that electricity obeys an inverse square law.

The inverse square law describes a relationship in which, under certain conditions, the intensity of a spherical wave varies inversely with the square of its distance from the source. Now measurable, electricity could be studied scientifically.

Named after the man, one **coulomb** is equal to the charge on 6,280,000,000,000,000 electrons, or in scientific notation, 6.28×10^{18} . When one coulomb of electrons moves past a fixed point in one second, we say the current is 1 **ampere**. The ampere, or **amp**, named after André Marie Ampère, is the unit we use to describe the amount of current. In 73 features, you'll see these abbreviations: **A** or **amp**, for ampere; **mA**, milliampere (0.001 of an ampere); and **mAh**, milliamp hour(s). The last unit describes the amount of current flowing past a point for a given amount of time.

In mathematical expressions, the current is represented by the letter **I**, for **intensity**. This is the first of the three most important electrical

quantities all hams should be familiar with.

Although very old devices which may have been voltage cells have been found in unlikely places, we credit Count Volta, an Italian, with making the first battery in 1796. He was the first to describe **voltage**, or electrical potential. Voltage is the amount of work done in moving a unit charge from one point to another against the electric field. Often compared to the water pressure in a pipe, it's the electric potential difference between two points; there is an excess of electrons at one point, and a deficiency of electrons at the other point. The universe being the way it is, the free electrons will rush in to fill in the gaps.

Mathematically, voltage is represented by the letter **E**, for **electromotive force** or **EMF**, or by the letter **V** for volts, the units of voltage. One volt across 1Ω of resistance causes a current flow of 1 ampere. Voltage is another of the three important electrical quantities.

The third electrical quantity, the unit of the measurement of resistance, is the **ohm**, symbolized by the Greek letter Ω . Mathematically, it's represented by the letter **R**. One ohm is the amount of resistance which will limit the current to one ampere when one volt is applied across the circuit.

In the early 19th century in Germany, Georg Ohm discovered that a current in a circuit is directly proportional to the electric pressure and inversely to the resistance of the conductors. We call this **Ohm's Law**. Mathematically, it's expressed as $E=IR$. If you know any two of these quantities, it's easy to find the third. You can transpose the terms to solve for either current or resistance: $I=E/R$ and $R=E/I$. The **watt**, product of the voltage and the current (IV or IE), is the unit of electrical power. In formulas, it's represented by the letter **W**. Fractions of the watt, such as **mW** (milliwatt, or 0.001 watts) and μW (microwatt, or 0.000001 watts) express low power. For larger power levels, we have **kW** (kilowatt, or 1000 watts) and **MW** (megawatt, or 1,000,000 watts). You will also see **Wh** (watt hour) and **kWh** (kilowatt hour). These last two represent the amount of power expended continuously for a given amount of time (one hour).

Electron Matters

Electricity is a highly versatile form of energy in both its **static** and **dynamic** forms. Materials such as copper, gold, silver, lead, and many other metals, which are composed of atoms which have less than four electrons in their outer shells, tend to be **conductors** because they are electrically unstable. They lose electrons easily, and these free electrons make the electric current possible.

In an electric current, a free electron doesn't travel from one end of the circuit to the other. Each electron only travels a short distance before colliding with another atom, knocking off more electrons, which in turn collide with other atoms.

Materials composed of atoms which have

more than four outer shell, or valence, electrons tend to be **insulators**, or poor conductors, because they are electrically stabler. They hold onto their electrons and grab free electrons to fill in their outer rings (eight valence electrons, a full shell, gives complete electrical stability). Some insulators are wood, plastic, and glass.

An element with four valence electrons in its atoms, such as germanium and silicon, are generally **semiconductors**. They are neither good conductors nor good insulators.

An atom which has the same number of orbiting electrons as it has protons in the nucleus, is electrically balanced or neutral. A **negative ion** has a surfeit of electrons; it is negatively charged. An atom which has lost electrons is called a **positive ion**, or cation; it is charged positively. Positively charged particles, such as *holes* in solid state electronics, can also produce an electric current.

DC and AC

DC (direct current) is a constant-value electrical current that flows in only one direction. The **amplitude**, or strength, remains at a constant level.

AC (alternating current) is a flow of electricity that constantly changes in **magnitude** and **polarity**. Magnitude refers to *how much* current is flowing, and polarity to the *direction* of the flow, positive or negative, through the circuit. An AC wave rises from zero to maximum voltage in one direction, decreases to zero, reverses itself and reaches the maximum in the opposite direction, and decreases to zero again. This is one **cycle** of an AC wave. A basic AC wave is called a sine wave; it moves sinuously, like a snake.

The number of cycles per second, or **cps**, is the **frequency** of the current. One cycle per second is one **Hertz**, or **Hz**, named after Heinrich R. Hertz, who showed that electromagnetic waves propagate in the same way as light waves.

Radio frequency waves, which are AC waves, begin at 20,000 Hz (20 kHz), and go above 300 billion Hz (300 GHz). Since this range is vast, for convenience we use the standard metric prefixes with Hertz: kilo (1,000), mega (1,000,000), and giga (1,000,000,000). Thirty kilohertz, for example, is 30,000 Hertz. Combined with Hertz, these are abbreviated **kHz**, **MHz**, and **GHz**. Frequencies below 20 kHz are called audio frequencies.

Harnessing Electricity

Electricity is not a solid, a liquid, or a gas. Is it the soul in matter, the flow of charged particles, or both? How will we describe electricity fifty years from now?

When you turn on your **transceiver** (transmitter/receiver), you're harnessing one of the basic energies of the universe. By understanding the properties of electricity, developing a system to measure it, and providing the hardware to channel it, you can use it to communicate with people all over the world. And that's no small accomplishment. . . . de Linda Reneau 73

While others offer you some digital modes using 3 year old technology, *only* MFJ gives you *all 9* digital modes and *keeps on* bringing you state-of-the-art advances

MFJ-1278
\$279⁹⁵

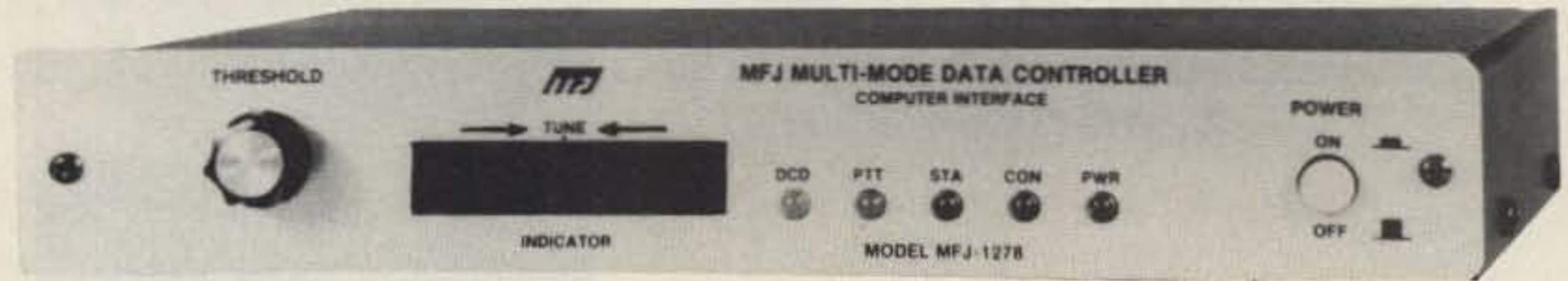

No three year old technology at MFJ!
Using the latest advances, MFJ brings you 9 exciting digital modes and keeps on bringing you state-of-the-art advances.

You get tons of features other multi-modes just don't have.

Only MFJ gives you all 9 modes

Count 'em -- you get 9 fun modes -- Packet, AMTOR, RTTY, ASCII, CW, WeFAX, SSTV, Navtex and full featured Contest Memory Keyer.

You can't get all 9 modes in any other multi-mode at any price. And nobody gives you modes the MFJ-1278 doesn't have.

The best modem you can get

Extensive tests in *Packet Radio Magazine* prove the MFJ-1278 modems gives better copy with proper DCD operation than all other modems tested.

New Easy Mail™ Personal Mailbox

You get MFJ's new Easy Mail™ Personal Mailbox with soft-partitioned memory so you and your ham buddies can leave messages for each other 24 hours a day.

20 LED Precision Tuning Indicator

MFJ's unequalled tuning indicator makes it really easy to work HF packet stations.

And unlike others, you use it *exactly the same way for all modes* -- not differently for each mode.

Just tune your radio to center a single LED and you're *precisely tuned in to within*

10 Hz - and it shows you which way to tune!

New MFJ technology prevents collisions: gets packets through faster

MFJ's new Anti-Collision technology gets packets through faster, more reliably.

How? Automatic random transmit delays prevent packet collisions.

An MFJ exclusive: MFJ-1278 is the only multi-mode to have this *new* technology.

Multi-Gray Level FAX/SSTV Modem

You'll enjoy natural looking pictures that only multiple gray levels can give you.

MFJ's exclusive new built-in modem lets you transmit and receive up to 16 gray levels.

Only MFJ can transmit FAX

Most packet stations can receive FAX.

But *only* the MFJ-1278 lets you transmit FAX without internal modifications that disable other modes.

So now you can send your own high resolution pictures, maps and diagrams by FAX to stations throughout the world.

Too bad they can't send theirs to you... unless they have the MFJ-1278.

One FREE Upgrade!

When you buy your MFJ-1278 today, you don't have to worry about missing new modes and features that come out tomorrow.

Why? Because your MFJ-1278 comes with a coupon good for one *free* eprom upgrade exchange that'll add new features.

Plus more...

Plus you get... 32K RAM, free AC power supply, KISS, true DCD, random code generator, independent printer port, lithium battery backup, RS-232 and TTL serial ports, standard 850 Hz RTTY shift, socketed ICs, tune up command, automatic serial numbering, programmable message memories, software selectable dual radio ports and tons more -- all in a sleek 9 1/2 x 9 1/2 x 1 1/2 inch cabinet.

Get on the air instantly Just plug it all in

All you need is an MFJ-1278, your rig, any computer and a terminal program.

With an MFJ Starter Pack, \$24.95, you just plug it all in, wire up your mic connector and you're on the air.

Order MFJ-1282 (disk)/MFJ-1283 (tape) for C-64/128/VIC-20; MFJ-1284 for IBM compatibles; MFJ-1287 for Macintosh.

Unconditional Guarantee

You get the best guarantee in ham radio -- a full one year unconditional guarantee.

That means we will repair or replace your MFJ multi-mode (at our option) no matter what for a full year.

Get 9 new ways of having fun

Don't settle for 3 year old technology. Choose the only multi-mode that gives you the latest advances and *all 9* modes.

Get 9 new ways of having fun -- get yours today!

MFJ Packet Radio



MFJ-1274
\$159⁹⁵
MFJ-1270B
\$139⁹⁵

MFJ-1270B super clone of TAPR's TNC-2 gives you more features than any other packet controller -- for \$139.95.

You can double your fun by operating VHF and HF packet because you get **high performance** switchable VHF/HF modems.

You get the Easy Mail™ Personal Mailbox with soft-partitioned memory so you and your ham buddies can leave messages for each other 24 hours a day.

In MFJ's new WeFAX mode you can print full fledged weather maps to screen or printer and save to disk using an IBM compatible or Macintosh computer with an MFJ Starter Pack.

A new KISS interface lets you run TCP/IP. They also come NET ROM compatible -- *no modification needed!*

You also get 32K RAM, one year unconditional guarantee and a free 110 VAC power supply (or use 12 VDC).

For dependable HF packet tuning, the

MFJ Video Digitizer

Here's an actual print-out of Aimee from the MFJ Order Desk. She was digitized with the MFJ-1292 and the result was printed on a 9-pin Epson compatible printer. We reduced the size to fit the ad.



Create fascinating digitized snapshots you can transmit with your MFJ-1278 of anything you can point your camcorder at!

The MFJ-1292 "Picture Perfect" Video Digitizer connects your video camera to your IBM compatible computer so you can capture digitized video snapshots on disks.

Your MFJ-1292 package includes a plug-in card for your computer, software and complete instructions for... \$199.95.

As an added bonus you get a handy Contrast and Brightness Control unit that you can conveniently place near your keyboard for fine tuning your pictures.

MFJ-1274 gives you a high resolution tuning indicator that's accurate to within 10 Hz -- and it's only \$20.00 more.

Packet Pictures

Transmit and receive high resolution VGA, EGA and CGA color pictures via packet with MFJ picture passing software.

Beautiful color pictures are automatically received, saved to disk and "painted" to screen.

Pictures are compressed as they are transmitted - so you get true high speed picture passing.

You can save to disk any CGA picture you can see on your screen.

You can set up your own picture bulletin board and exchange pictures with others - even if you're not there.

Let's help spread picture passing throughout the world and create a new world standard. Get this powerful new software for only... \$9.95.

MFJ-1288 works with virtually any packet radio controller and IBM compatible computer. It's included free in the MFJ-1284 IBM Starter Pack.

MFJ

MFJ ENTERPRISES, INC.
P.O. Box 494, Mississippi State MS 39762
601-323-5869; TELEX: 534590 MFJSTKV
Nearest Dealer/Orders: 800-647-1800
Include shipping and handling

MFJ... making quality affordable

CIRCLE 258 ON READER SERVICE CARD

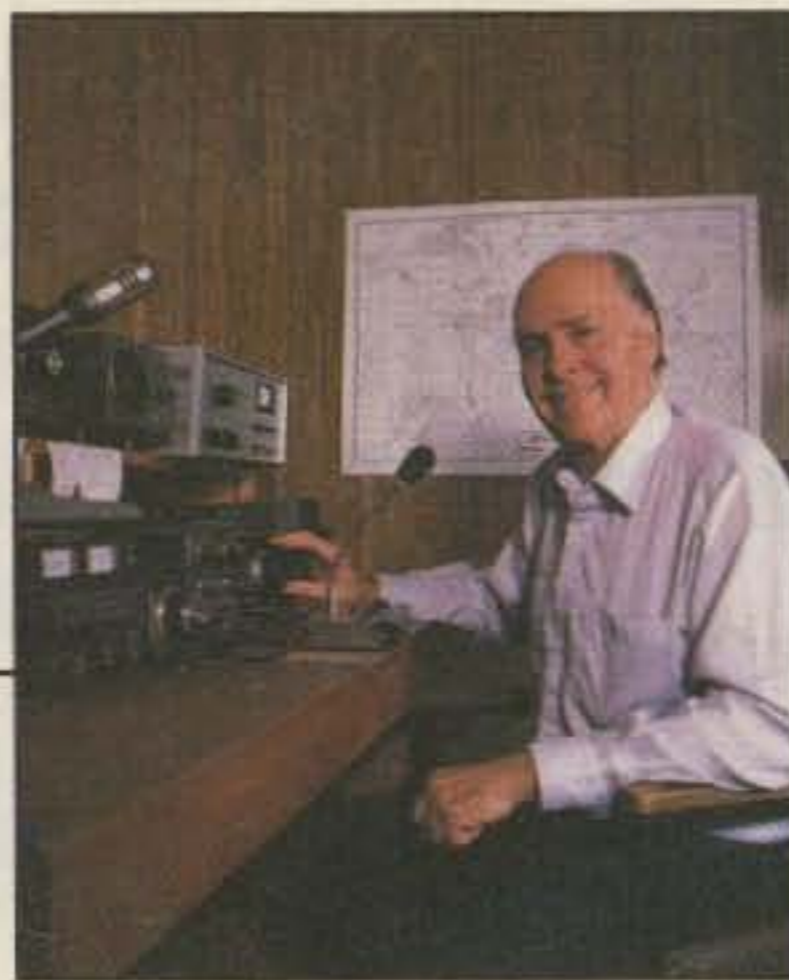

NEVER SAY DIE

Wayne Green W2NSD/1

Are You Fighting Change?

Whenever I run into a staunch Morse Code supporter, I can't help but marvel at how out of touch many hams are with the changes technology has made, not just in amateur radio, but the whole world. Indeed, it is this inability to cope with changes which is helping to sink our country economically. This isn't a vague philosophical problem, it's one which is having a major impact right now on your ability to make a living and is going, even more, to change things enormously for your children and grandchildren.

Just a generation ago we imported only a small percentage of the things we buy. Indeed, the term "imported" was quite a cachet which meant "unusual." Today it's getting so almost everything is imported. How'd that come about and what's it mean?

Technology is what happened. Today's low-cost transportation and communications has made it possible for the steel worker in Korea to be in direct competition with the steel worker in Pittsburgh—for the car assembler in Japan to be in direct competition with the worker in Detroit. A generation ago the costs of transportation and communications added so much to prices that direct foreign competition was difficult and imports tended to be specialty items.

Farm and Factory

Look at the changes technology has made in farming. When I was young, half of the American people were farmers. Then came improved transportation, such as railroad refrigerated cars and trucks, making it possible to sell farm products anywhere in the entire country instead of just locally. This inevitably brought on farm automation and truck farms. Now we call it agribusiness—and we see small farmers fighting a losing battle. Today, under 2% of our population are farmers.

Unless our unions recognize what's happened and make it possible for our factories to compete on a more equitable basis with foreign producers, we're going to keep losing jobs. The last I heard, our car unions had, with the backing of the government, forced car makers to pay roughly double the average American wage to their members—and they've lost over 200,000 jobs in recent years. Is it any wonder America has been losing more and more business to imports? Even if their cars were made as carelessly as ours, they'd still be able to undersell us.

What about automation, you ask? Fine, that cuts assembly costs, but we have to go some way to out-automate our foreign competitors. Korea may have low wages compared to us, but some of their electronic factories I've

visited are way ahead of anything I've seen in the US in automation—and I get around.

Prohibitions and Restrictions Don't Work

This is a very basic problem—one which trying to set up import restrictions isn't going to solve—indeed, will only make worse. Trying to get us to "Buy American" isn't going to work, either. Few Americans are going to put up with poor quality and higher prices. That'll just build a black market. Name one product people really want which laws have been able to keep out.

They tried it with liquor and the black market that developed laid the foundations for today's tax-free organized crime industry. They tried it with drugs, only to make crime an even bigger business. Recently they tried it with IC chips, which quickly began pouring in via Canada to fill the need.

If we can no longer compete with countries who have lower wages on mass produced products, how are we going to stay in business? America's industrial strength was built on blue-collar mass production and now we're losing that edge—permanently. We can't uninvent jumbo jets, containerized shipping, and the whole trucking industry.

The weakening of our large firms can be seen in their gradual shrinking—the layoffs at the automobile firms, layoffs at steel firms (half the workers have been laid off so far). The only growth in jobs we've had in the last few years has been in small business. Perhaps it's time to start investing more in this growth market.

Investing in Small Business

Japan, Inc., may be able to raise Cain with our car market, and the Philippines with our shoes, but when it comes to short-run special products, they can't compete with our thousands of small companies. Unfortunately there seems to be virtually no recognition of this major change in the economy, so our tax laws still are forcing as much production overseas as possible. Indeed, if we had as a basic government policy the destruction of our small manufacturing businesses we could hardly be more effective.

Continued on page 88

STAFF

PUBLISHER/EDITOR
Wayne Green W2NSD/1

EDITOR IN CHIEF
Bryan Hastings NS1B

MANAGING EDITOR
Hope Currier

SENIOR EDITOR
Linda Reneau

INTERNATIONAL EDITOR
Richard Phenix

EDITORIAL ASSISTANT
Joyce Sawtelle

ART DIRECTOR
Marilyn Moran

JAPANESE TRANSLATOR
David Cowhig WA1LBP

ASSOCIATES/TECH ADVISORY COMMITTEE

Mike Bryce WB8VGE
Michael Geier KB1UM
Jim Gray W1XU
Chuck Houghton WB6IGP
Dr. Marc Leavey WA3AJR
Andy MacAllister WA5ZIB
Joe Moell K0OV
Bill Pasternak WA6ITF
Mike Stone WB0QCD
Arliss Thompson W7XU

ADVERTISING
1-603-525-4201
1-800-225-5083

SALES MANAGER
Ed Verbin

ADVERTISING SALES
Jim Bail KA1TGA

ADVERTISING SALES COORDINATOR
Lisa Niemela

MARKETING ASSISTANT
Donna DiRusso

WGE PUBLISHING, INC.

CHIEF FINANCIAL OFFICER
Tim Pelkey

CIRCULATION DIRECTOR
Rodney Bell

TYPESETTING/PAGINATION
Susan Allen, Linda Drew,
Ruth Benedict

GRAPHICS SERVICES
Dale Williams, Peri Adams

GRAPHICS PHOTOGRAPHER
Dan Croteau

Editorial Offices
WGE Center

Peterborough, NH 03458-1194
603-525-4201

Subscription Customer Service
1-800-525-0643

Colorado/Foreign Subscribers
call 1-303-447-9330

Wayne Green Enterprises is a division of International Data Group.

Reprints: The first copy of an article—\$3.00 (each additional copy—\$1.50). Write to 73 Amateur Radio Magazine, WGE Center, Forest Road, Hancock, NH 03449.



QSL OF THE MONTH

To enter your QSL, mail it in an envelope to 73, WGE Center, Forest Road, Hancock, NH 03449, Attn: QSL of the Month. Winners receive a one-year subscription (or extension) to 73. Entries not in envelopes cannot be accepted.

KENWOOD

...pacesetter in Amateur Radio

DX-cellence!

#1 Rated HF!

TS-940S Competition class HF transceiver

TS-940S—the standard of performance by which all other transceivers are judged. Pushing the state-of-the-art in HF transceiver design and construction, no one has been able to match the TS-940S in performance, value and reliability. The product reviews glow with superlatives, and the field-proven performance shows that the TS-940S is "The Number One Rated HF Transceiver!"

- **100% duty cycle transmitter.** Kenwood specifies transmit duty cycle **time**. The TS-940S is guaranteed to operate at full power output for periods **exceeding one hour**. (14.250 MHz, CW, 110 watts.) Perfect for RTTY, SSTV, and other long-duration modes.
- **First with a full one-year limited warranty.**
- **Extremely stable phase locked loop (PLL) VFO.** Reference frequency accuracy is measured in **parts per million!**

Optional accessories:

- AT-940 full range (160-10m) automatic antenna tuner
- SP-940 external speaker with audio filtering
- YG-455C-1 (500 Hz), YG-455CN-1 (250 Hz), YK-88C-1 (500 Hz) CW filters; YK-88A-1 (6 kHz) AM filter
- VS-1 voice synthesizer
- SO-1 temperature compensated

- crystal oscillator
- MC-43S UP/DOWN hand mic.
- MC-60A, MC-80, MC-85 deluxe base station mics.
- PC-1A phone patch
- TL-922A linear amplifier
- SM-220 station monitor
- BS-8 pan display
- IF-232C/IF-10B computer interface.

Complete service manuals are available for all Kenwood transceivers and most accessories. Specifications, features, and prices are subject to change without notice or obligation.

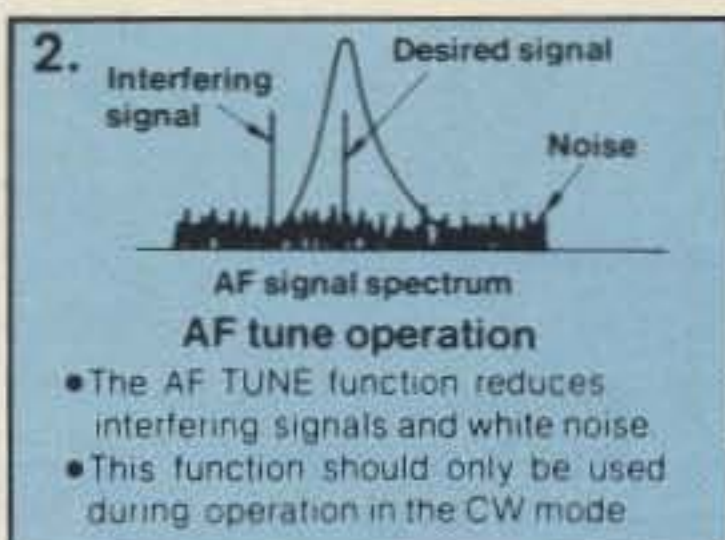
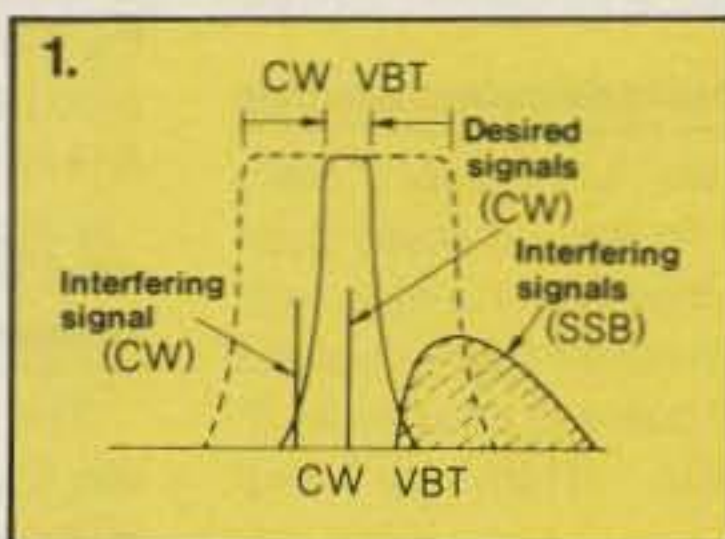

1) CW Variable Bandwidth Tuning. Vary the passband width continuously in the CW, FSK, and AM modes, without affecting the center frequency. This effectively minimizes QRM from nearby SSB and CW signals.

2) AF Tune. Enabled with the push of a button, this CW interference fighter inserts a tunable, three pole active filter between the SSB/CW demodulator and the audio amplifier. During CW QSOs, this control can be used to reduce interfering signals and noise, and peaks audio frequency response for optimum CW performance.

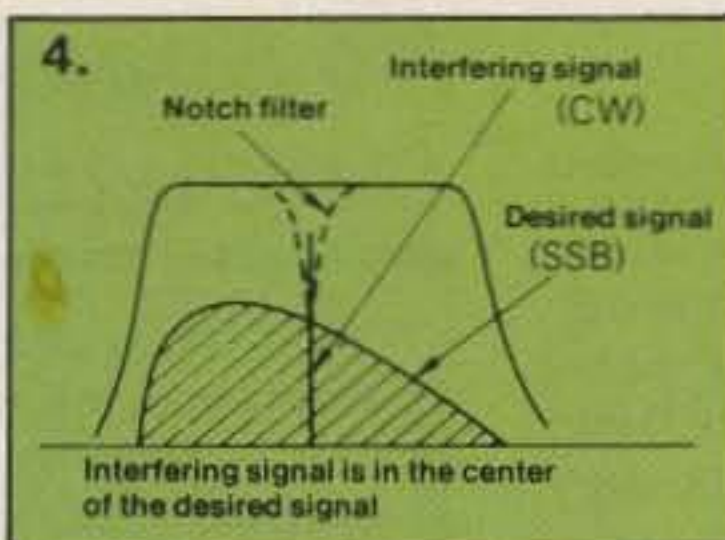
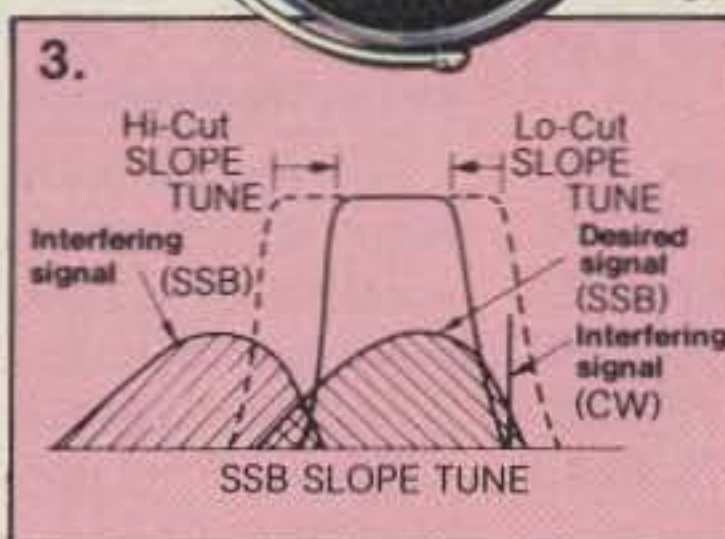

3) SSB Slope Tuning. Operating in the LSB and USB modes, this front panel control allows independent, continuously variable adjustment of the high or low frequency slopes of the IF passband. The LCD sub display illustrates the filtering position.

4) IF Notch Filter. The tunable notch filter sharply attenuates interfering signals by as much as 40 dB. As shown here, the interfering signal is reduced, while the desired signal remains unaffected. The notch filter works in all modes except FM.

- **Complete all band, all mode transceiver with general coverage receiver.** Receiver covers 150 kHz-30 MHz. All modes built-in: AM, FM, CW, FSK, LSB, USB.
- **Superb, human engineered front panel layout for the DX-minded or contesting ham.** Large fluorescent tube main display with dimmer; direct keyboard input of frequency; flywheel type main tuning knob with optical encoder mechanism all combine to make the TS-940S a joy to operate.
- **One-touch frequency check (T-F SET) during split operations.**
- **Unique LCD sub display indicates VFO, graphic indication of VBT and SSB Slope tuning, and time.**
- **Simple one step mode changing with CW announcement.**
- **Other vital operating functions.** Selectable semi or full break-in CW (QSK), RIT/XIT, all mode squelch, RF attenuator, filter select switch, selectable AGC, CW variable pitch control, speech processor, and RF power output control, programmable band scan or 40 channel memory scan.

KENWOOD

KENWOOD U.S.A. CORPORATION
2201 E. Dominguez St., Long Beach, CA 90810
P.O. Box 22745, Long Beach, CA 90801-5745

WB6NOA Industry Service Report

Ever wanted to throw a bouquet or a brickbat at a service department of an amateur radio equipment manufacturer? Now's your chance!

Gordon West WB6NOA, noted ham educator and prolific author of a wide range of amateur radio related articles, has embarked on an industry service study, to appear in print in the first half of 1990. As part of his study, West will visit the US divisions of major amateur radio equipment manufacturers, and interview the heads of the service departments at each company. West will also outline in his report what hams can do on their part to achieve smoother and more efficient service.

The most important part of his report, however, will be YOUR input. Send a self-addressed envelope to Gordon West to obtain the service survey. He wants to hear from anyone who feels they have something important to say about their dealings with these service departments. Was customer support prompt and courteous? Were equipment repairs turned around quickly? Which companies have given you good service? Bad service?

Please send your SAE, dated no later than November 30, 1989, to: Gordon West WB6NOA, 2414 College Rd., Costa Mesa, CA 92626. ATTN: Service Survey. You may also download the survey form from the 73 BBS (see connect info below, in "Thanks"), from the /73mag SIG.

"I Hear You"

Our apologies to Debra Davis N7IHY, the operator of the ATV mobile station on the cover of the July Microwave/Video issue. The cover credit incorrectly listed her call as KA7FPL.

Deb has been in the amateur radio industry for almost a decade, including a lengthy period with ICOM, America. She currently serves as Marketing Manager for Advanced Electronic Applications (AEA) of Lynnwood, Washington.

Trade Sanction

The price of amateur gear that operates above 400 MHz could double as the result of a proposed 100% U.S. Import Tariff on such gear.

The *Federal Register* of 8 May carries notice of a hearing by the United States Trade Representative, to review telecommunications trade with Japan on 24 May. The hearing is being held pursuant to Section 1377 of the Omnibus Trade and Competitiveness Act of 1988, and, among other matters, will bring up

the possible imposition of a 100% trade tariff on all radio gear from Japan capable of transmitting and receiving signals on frequencies at and above 400 MHz.

The proposed tax is a response to certain Japanese restrictions on telecommunications trade, primarily in dealing with the use in Japan of US-made third party radio and cellular telephone products. The Japanese Ministry of Post and Telecommunications has kept a cellular system that uses American-built gear from operating in several cities, even though spectrum is available for such services.

New Part 97 Released

Amateur radio has a new Part 97 regulatory base to guide it into the 21st century. This revised base was approved by all current Commissioners by unanimous vote on 31 May. See details on this revision in this month's "Looking West."

Ham Help, Tech Tips

For the moment, we have few "Ham Help" or "Tech Tip" items, so these submissions stand a good chance of running very soon. Send them to us in hard-copy, or upload them to the 73BBS (see connect info below, in "Thanks"), to the SIGs "/Hamhelp" and "/Techtips."

No Special Callsigns

The FCC dropped plans to permit special amateur callsigns assigned by an entity or entities in the private sector. After reading all comments and proposals on PRB-3, the Commission said it recognized that, while the amateur community wanted this service, there was no way to implement it without diverting funds from the current licensing system. Amateurs will have to continue to make do with callsigns assigned at random by the FCC computerized licensing system.

Commissioner Bias?

Mimi Dawson, former FCC Commissioner, joined the law firm of Wiley, Rein, and Fielding. This is the same group of lawyers that is handling UPS's lobbying effort for spectrum for their digital voice national dispatch system in the reallocated 220-222 MHz amateur band.

President Bush is now considering, among others, Sherrie Marshall to replace Ms. Daw-

son. Interestingly, Ms. Marshall is currently an attorney of the above-mentioned law firm!

If Ms. Marshall is nominated and confirmed by the Senate, it would likely be a blow to the amateur community in the matters of retention of current spectrum allocations and in issues such as the fight to reverse the reallocation of the lower 40% of 1-1/4 meters to Land Mobile. Further, it would make it difficult if not impossible for a three-member Commission to effectively and impartially deal with the 87-14 reallocation, possibly forcing the FCC to go to a four member or full five member level to function on this issue.

Armenia Follow-up

Vern Riportella WA2LQQ, former AMSAT president, visited and interviewed Leonid Labutin UA3CR in Moscow, and learned from him that the six packet stations sent from the US to assist communications for the Armenian earthquake will now be used in Project Search, a network to help reunite families separated by the quake disaster.

The complete interview between UA3CR and WA2LQQ covers just about every aspect of amateur radio and amateur space activity in the Soviet Union. This interview was scheduled begin running in serial form in the *Westlink Report* newsletter in late June.

ANARC BBS

The Association of North American Radio Clubs Computer Bulletin Board System will have moved back to Kansas City by 1 July. The new BBS phone number is (913) 345-1978, and the new mailing address is PO Box 11201, Shawnee Mission, Kansas, 66207-0201. Use the same number and address to reach the Association of Clandestine Enthusiasts (ACE) radio monitoring organization.

Feedback Winner

Congratulations to Ralph Tafel WA8RLV, this month's feedback card draw winner! Winners receive a free 1-year subscription to *73 Magazine*. Future feedback winners will be listed in "Feedback."

Thanks!

...to all those folks who contributed to this month's QRX. They are *Westlink Report*, *220 Notes*, N6AHU, and W5KNE. Keep those ham radio related news reports and photos rolling in to *73 Magazine*, WGE Center, Forest Rd., Hancock NH 03449, ATTN: QRX. You may also submit news items to the 73 BBS at 603-525-4438, 300/1200 baud, 8 data bits, no parity, and one stop bit. Upload items to the /QRX SIG. 

KENWOOD

...pacesetter in Amateur Radio

All New
Dual Bander!

Two in the Hand!

TH-75A

2m/70cm Dual Band HT

The new TH-75A Dual Band HT from Kenwood is here now! Many of the award-winning features in our dual band mobile transceivers are designed into one hand-held package.

- **Dual Watch** function allows you to monitor both bands at the same time.
- **1.5 watts on 2 meters and 70cm: 5 watts when operated on 12 VDC (or PB-8 battery pack).**
- **Large dual multi-function LCD display.**
- **10 memory channels** for each band stores frequency, CTCSS, repeater offset, frequency step information, and reverse. A lithium battery backs up memories. Two memories for "odd split" operation.
- **Selectable full duplex operation.**
- **Extended receiver range:** 141-163.995 and 438-449.995 MHz; transmit on Amateur band only. (Modifiable for MARS and CAP. Permits required. Specifications guaranteed on Amateur bands only.)
- **Uses the same accessories as the TH-25AT (except soft cases).**
- **Volume and balance controls, plus separate squelch controls on top panel.**
- **Super easy-to-use!** For example, to recall memory channel, just push the channel number!
- **CTCSS encode/decode built-in!**
- **Automatic Band Change (ABC).** Automatically switches between main and sub band when signal is present.
- **Automatic offset selection on 2 meters.**
- **Tone alert system for quiet monitoring.** When CTCSS decode is on, the tone alert will function only when a signal with the proper tone is received.
- **Four ways to scan,** including **dual memory scan**, with time operated or carrier operated scan stop modes, and priority alert.
- **Automatic battery saver circuit extends battery life.**



• **Supplied accessories:** Dual band rubber-flex antenna, PB-6 battery pack, wall charger, belt hook, wrist strap, water resistant dust caps.

Optional Accessories

- **PB-5** 7.2 V, 200 mAh NiCd pack for 1.5 W output
- **PB-6** 7.2 V, 600 mAh NiCd pack
- **PB-7** 7.2 V, 1100 mAh NiCd pack
- **PB-8** 12 V, 600 mAh NiCd for 5 W output
- **PB-9** 7.2 V, 600 mAh NiCd with built-in charger
- **BC-10** Compact charger
- **BC-11** Rapid charger

- **BT-6** 6-cell AA battery case
- **DC-1/PG-2V** DC adapter
- **HMC-2** Headset with VOX and PTT
- **SC-22 and SC-23** Soft case
- **SMC-30/31** Speaker mics.
- **WR-1** Water resistant bag.

KENWOOD

KENWOOD U.S.A. CORPORATION
COMMUNICATIONS & TEST EQUIPMENT GROUP
P.O. BOX 22745, 2201 E. Dominguez Street
Long Beach, CA 90801-5745
KENWOOD ELECTRONICS CANADA INC.
P.O. BOX 1075, 959 Gana Court
Mississauga, Ontario, Canada L4T 4C2

KENWOOD

...pacesetter in Amateur Radio

All-mode
tri-bander!

Warp Drive!



TS-790A Satellite Transceiver

The new Kenwood TS-790A VHF/UHF all-mode tri-band transceiver is designed for the VHF/UHF and satellite "power user." The new TS-790A is an all-mode 144/450/1200 MHz transceiver with many special enhancements such as automatic uplink/downlink tracking. Other features include dual receive, automatic mode selection, automatic repeater offset selection for FM repeater use, VFO or quick step channel tuning, direct keyboard frequency entry, 59 memory channels (10 channels for separate receive and transmit frequency storage), multiple scanning and multiple scan stop modes. The Automatic Lock Tuning (ALT) on 1200 MHz eliminates frequency drift. Power output is 45 watts on 144 MHz, 40 watts on 450 MHz, and 10 watts on 1200 MHz. (The 1200 MHz section is an optional module.)

- **High stability VFO.** The dual digital VFOs feature rock-stable TCXO (temperature compensated crystal oscillator) circuitry, with frequency stability of ± 3 ppm.
- **Operates on 13.8 VDC.** Perfect for mountain-top DXpeditions!
- **The mode switches confirm USB, LSB, CW, or FM selection with Morse Code.**
- **Dual Watch allows reception of two bands at the same time.**
- **Automatic mode and automatic repeater offset selection.**
- **Direct keyboard frequency entry.**
- **59 multi-function memory channels.** Store frequency, mode, tone information, offset, and quick step function. Ten memory channels for "odd split."
- **CTCSS encoder built-in.** Optional TSU-5 enables sub-tone decode.
- **Memory scroll function.** This feature allows you to check memory contents without changing the VFO frequency.

- **Multiple scanning functions.** Memory channel lock-out is also provided.
- **ALT—Automatic Lock Tuning—on 1200 MHz eliminates drift!**
- **500 Hz CW filter built-in.**
- **Packet radio connector.**
- **Interference reduction controls:** 10 dB RF attenuator on 2m, noise blanker, IF shift, selectable AGC, all mode squelch.
- **Other useful controls:** RF power output control, speech processor, dual muting, frequency lock switch, RIT.
- **Voice synthesizer option.**
- **Computer control option.**

Optional Accessories:

- **PS-31** Power supply • **SP-31** External speaker
- **UT-10** 1200 MHz module • **VS-2** Voice synthesizer unit
- **TSU-5** Programmable CTCSS decoder
- **IF-232C** Computer interface • **MC-60A/MC-80/MC-85** Desk mics • **HS-5/HS-6** Headphones
- **MC-43S** Hand mic • **PG-2S** Extra DC cable

KENWOOD

KENWOOD U.S.A. CORPORATION
COMMUNICATIONS & TEST EQUIPMENT GROUP
P.O. BOX 22745, 2201 E. Dominguez Street
Long Beach, CA 90801-5745

KENWOOD ELECTRONICS CANADA INC.
P.O. BOX 1075, 959 Gana Court
Mississauga, Ontario, Canada L4T 4C2



Complete service manuals are available for all Kenwood transceivers and most accessories. Specifications, features, and prices are subject to change without notice or obligation.

CTCSS, Fast and Cheap

Low-cost PL tone generator.

by Ray Isenson N6UE

So you've got a problem! Last night the repeater group voted to put your favorite machine on PL, and you don't have a single rig with CTCSS capability. Worse, half of your rigs are so old you couldn't buy a modification kit even if you had the money. The XYL (XYM) hasn't cooled down since you bought that new packet TNC, so there's no way you could come up with the money for a tone board for the fancy all-mode that Santa brought last Christmas!

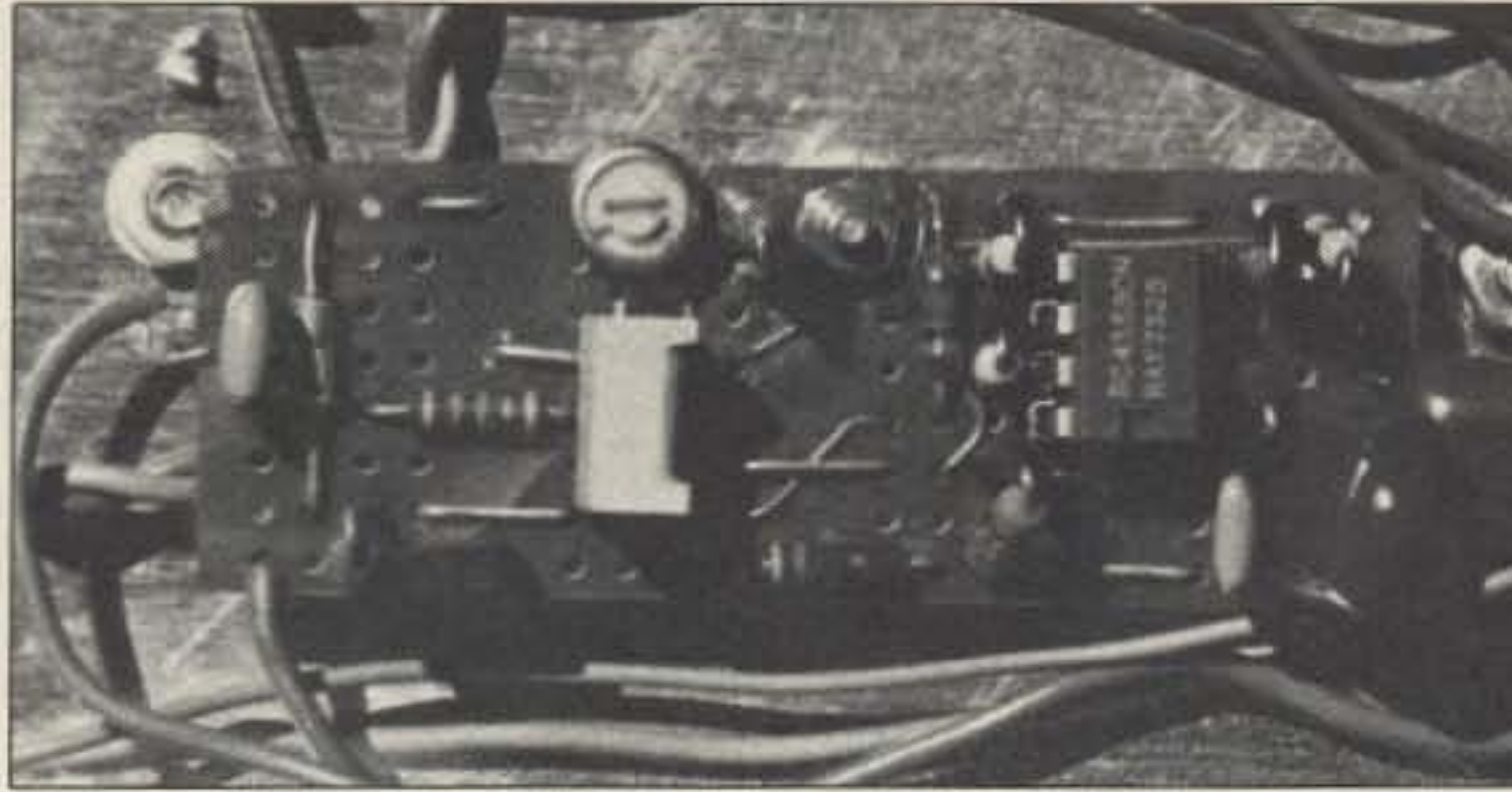

Photo A. The completed PL board.

out dissenters. Unfortunately, its early use by amateurs was intended to deny repeater access to non-members. Many of us, including myself, believed strongly that this was contrary to the open spirit of amateur radio, and we refused to have anything to do with it. More recently, we've had to reconsider our position, as more amateur and commercial repeaters have taken over the hilltops. Using PL helps combat intermodulation and other interference problems.

Uncle Elmer to the Rescue

Actually, if you can squeeze about seven dollars out of the kid's piggy bank; if there's a Radio Shack or its ilk around; if you have a soldering iron; and if you're not above a small challenge, your old Uncle Elmer may have just the solution for you. It should make a good one-evening project.

What is PL?

Some years ago Motorola introduced "private listening (PL)" to the commercial radio community. In one implementation, a tone, generally a subaudible frequency (67-210 Hz), is impressed on the transmitter's carrier along with the audio intelligence. A companion, single-frequency demodulator at the re-

ceiver enables the audio circuits only in the presence of this tone. The result is a form of selective calling.

Picture a master station with the ability to switch in any one of a number of different "calling" tones. If there is also a remote receiver for each of these tones, remote stations will hear only those transmissions addressed to each of them. The master station can talk with any secondary station without bothering operators at the other receivers. Additional circuitry maintains the privacy of the return link.

Some members of the amateur community adapted the concept to VHF and UHF radio when repeaters became popular, but not with-

How PL Works

In the normal scheme of things, the repeater receives an FM signal and the detected carrier switches in the transmitter through COR, or Carrier Operated Relay. The typical PL operating repeater uses the detected sub-audible frequency tone, as opposed to the detected carrier frequency, to pull in the transmit relay. In some cases the operation requires a continuous subaudible tone to maintain contact. In others the tone serves only to pull in the relay; the carrier or some other signal holds it in. In the latter case the system generally will function even if the tone is continuous. To work through the protected machine, we only need to provide a tone at the right frequency and amplitude to

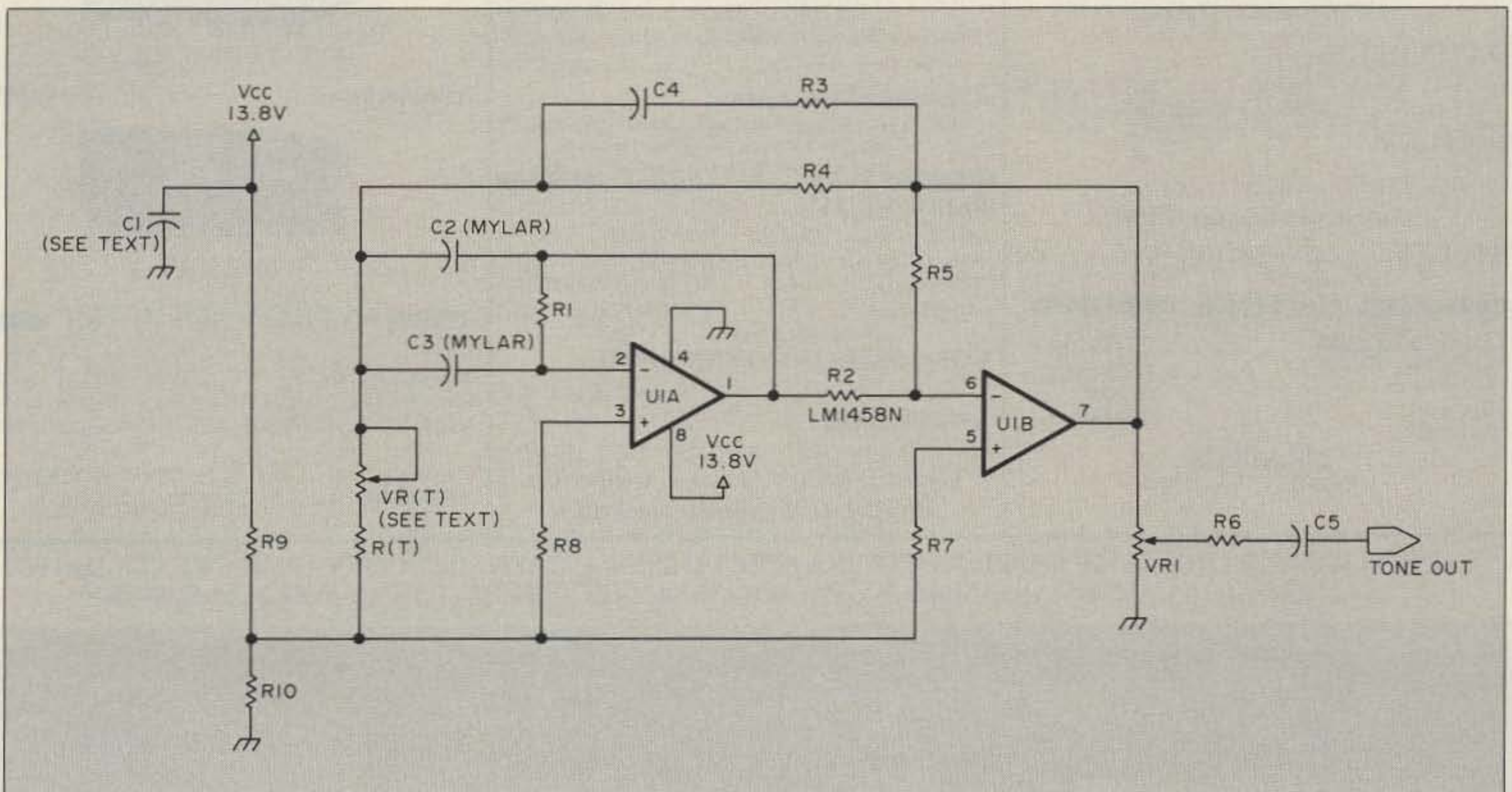

Figure 1. The PL Tone Generator Circuit.

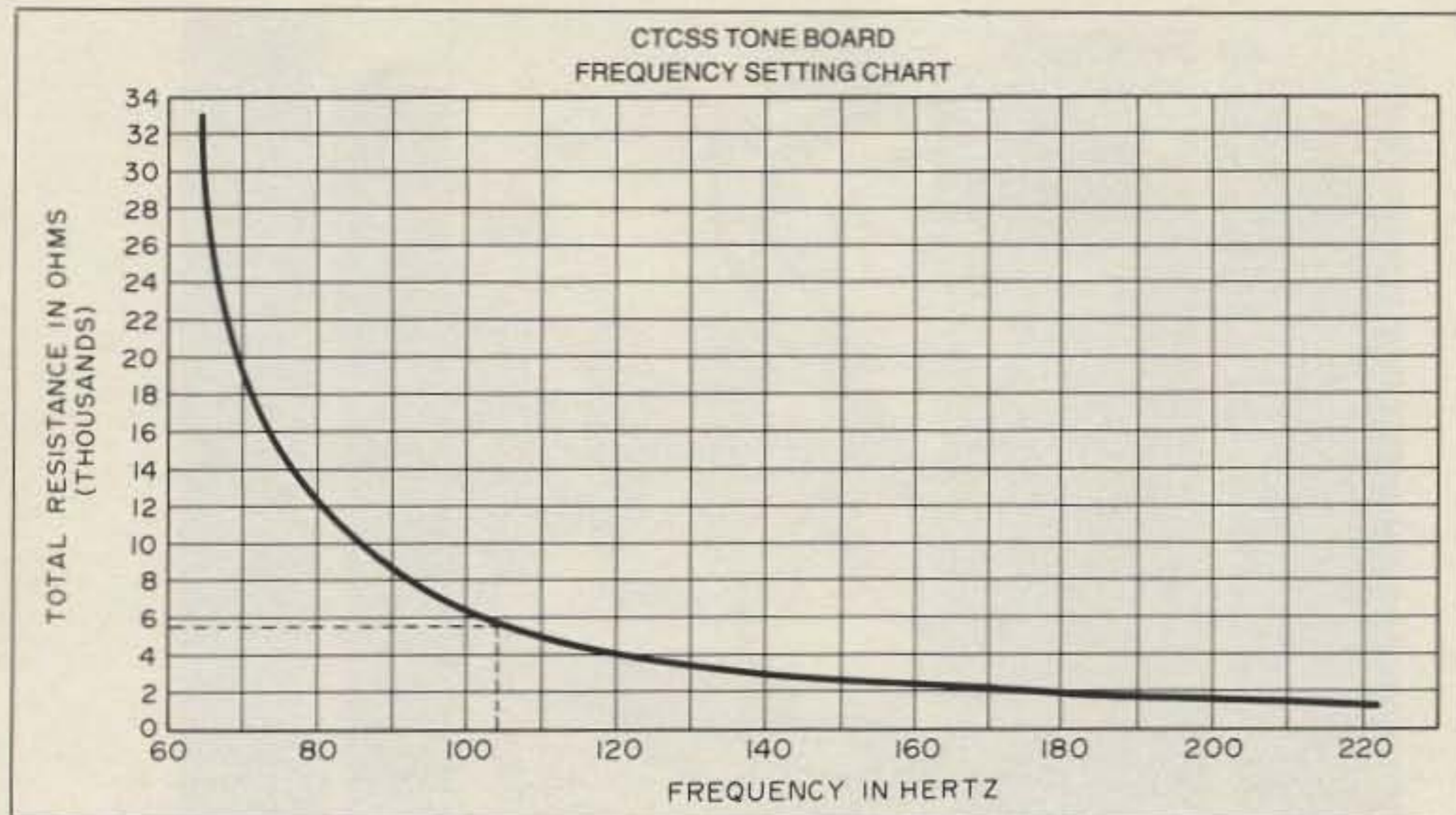

Figure 2. Graph showing tone frequency vs. tuning resistance, to help you choose the right resistance combination for a desired subaudible tone.

satisfy the repeater. Figure 1 is a schematic of a very simple circuit designed to do just that.

Uses Common Parts

There are no high cost or hard-to-find parts in the circuit. Your local electronic parts store is a good source. The total cost for the unit, assuming that you have none of the parts on hand, is less than \$7. The only critical parts are C2 and C3, two 0.1 μF Mylar™ capacitors. These must be Mylar, polystyrene, or a similar material, to minimize temperature sensitivity and assure frequency stability. The common RF bypass type disc cap will not work. They are too temperature-sensitive! Although a well-equipped hobbyist could make a custom PC board for the project, the predrilled Multipurpose Board (RS 276-150) for 99¢ is not only adequate, it's probably preferable.

The R(T) and VR(T) resistors connected in series, and the previously noted 0.1 μF capacitors, let you tune to the desired PL frequency. The commonly accepted range of subaudible frequencies extends from 67 Hz to 210 Hz. The unit that you assemble will not be able to tune in this entire range, but it won't need to. The computer or electronics technician will have picked the frequency for your machine. Your board will have to be able to set that frequency to within a Hertz. This circuit offers this capability.

Setting the Right Tone

Examining the circuit diagram, you will notice a resistor identified as R(T); a variable resistor, VR(T); and a 47k Ω resistor between pins 1 and 2 of the dual operational amplifier. The three resistors and the 0.1 μF capacitors are the basic frequency-determining components of the circuit.

To give you the freedom to pick among a wide range of frequencies, and set your machine precisely, the circuit uses the two resistors in series. Your task is to select a fixed resistor of a value yielding a tone in the desired range. The variable resistor is used for fine-tuning.

Figure 2 shows total resistance versus

frequency in Hz. The curve was experimentally determined with 1% components as the critical frequency determining elements. Use it to make the initial selection of the fixed resistor, R(T), as you design your CTCSS board.

Why the initial setting? As previously noted, the curve was generated with 1% tolerance components for the 0.1 μF capacitors and the timing resistors; a most unlikely thing to realize. Expect values more like $\pm 5\%$ resistors and capacitors. So we'll select a resistor that is somewhat smaller than the curve calls for, and use the variable resistor, VR(T), to make up the difference and allow for some tuning flexibility. The value of the variable resistor should be slightly greater than the difference between the value of the fixed resistor and the value of the next larger one.

Why not just use a potentiometer in the first place? The smaller the total value of variable resistor, the more precise the setting you can make. The variance in resistance per degree of rotation of the potentiometer is less! Now, if you find that your initial choice won't let you tune down to the desired frequency, you can replace the fixed resistor with the next higher value.

With curve-fitting

analysis, we find that the Resistance/Frequency curve can be closely approximated by the equation:

$$\text{Frequency} = 3896 \times ((R \times 47000) / (R + 47000))^{-0.4222}$$

where R is the sum of the fixed and variable tuning resistors. I note this equation to emphasize that if you replace the feedback resistor across the first part of the dual operational amplifier with something other than the 5%, 47,000 Ω device specified, you may not be able to use the curve in Figure 2 to select your tuning resistor. In other words, change that resistor and you're on your own!

Choosing the Resistor Combo

This project was originally undertaken to build PL tone generating boards for members of a 2 meter repeater group in the California Central Coast area. Their repeater was subjected to some intermodulation from two commercial paging service machines situated on the same hilltop. The offending RF frequencies, unfortunately, were exactly 600 kHz apart! These two frequencies, beating with the repeater transmitter output, resulted in an annoying "grunch" at the repeater's input frequency. The trustee demonstrated that the PL technique circumvented the problem, and he opted to put his machine on PL.

He selected a frequency of 103.5 Hz for the PL tone. Using that frequency as an example, and referring to the curve in Figure 2, the vertical dashed line that intersects the abscissa at 103.5 Hz represents the selected design

With the videOsmith Spectrum Probe™ Convert your oscilloscope into a SPECTRUM ANALYZER... AFFORDABLY!

SPECIFICATIONS:

Frequency Range: less than 1 MHz to more than 100 MHz
Dynamic Range: 50 dB min
Vertical Logarithmic Linearity: +3dB
Sensitivity: 100 μV ± 3 dB @ 50 MHz
flatness ± 2 dB @ 5-100 MHz
LF generation 1 MHz down approx 8 dB
IF Bandwidth: 180 kHz @ -3 dB
All with the isolation of a low capacity probe.



Introductory offer \$349.00

The Spectrum Probe™ opens up a whole new world you've never seen before... The Spectrum Probe™ is ideal for Hams and other techs who want to check for harmonics and other spurious emissions. With the Probe, you can perform oscillator alignment, check switching power supply functions and many other applications previously limited to \$8,000 and up spectrum analyzers. An excellent educational tool!

AVAILABLE THROUGH: rf enterprises

HCR Box 43, Merrifield, MN 56465

ORDERS: 1-800-233-2482 INFO: 1-218-765-3254



line. A horizontal line drawn from the intersection of the vertical line and the curve to an intersection with the vertical scale, suggests the need for total timing resistance of approximately 5.5kΩ.

The closest 5%, ¼-watt resistor offered by Radio Shack is 4700Ω. The next higher value of ¼-watt resistor is 10k. The closest variable to the 5.3k unit we need to get the tunability (10–4.7) is Radio Shack's 5k PC board potentiometer. This combination worked well.

If you have access to a more complete selection of electronic components, a 1 or 2k potentiometer and a 5100Ω fixed resistor might be even better for increasing the setting sensitivity. If, because most of your component tolerances stack up on the high side, the highest achievable frequency is just slightly low, shunt the fixed resistor with a large value (perhaps one of the 47k resistors still in the bubble pack). If that doesn't work, you'll have to go to a higher value resistor, but we have not encountered this problem.

From an examination of the curve in Figure 2, it is clear that a significant change in the tuning resistor is needed for a given change in frequency at the lower frequency end of the curve, and a very slight change at the higher frequency end. Because of this, I would be leery of using the circuit for tones above 120 Hz. At that end, even slight temperature variations could throw the circuit outside of the 0.3 to 1.0 Hz tolerance that most PL systems accommodate. The answer is to use a PL tone in the lower end of the band, if possible. In regions subject to wide temperature variations, it would be wise to stay with tones under 100 Hz if you are selecting the PL frequency. The unit in my car operates from the low 30s to slightly over 100 degrees Fahrenheit. It has never failed to access the repeater. Ambient temperature may never be a problem for you.

In Praise of Predrilled Boards

If this is your first experience with a predrilled board, you're in for a pleasant surprise. Except for the fact that you have to be very careful to avoid solder bridges,

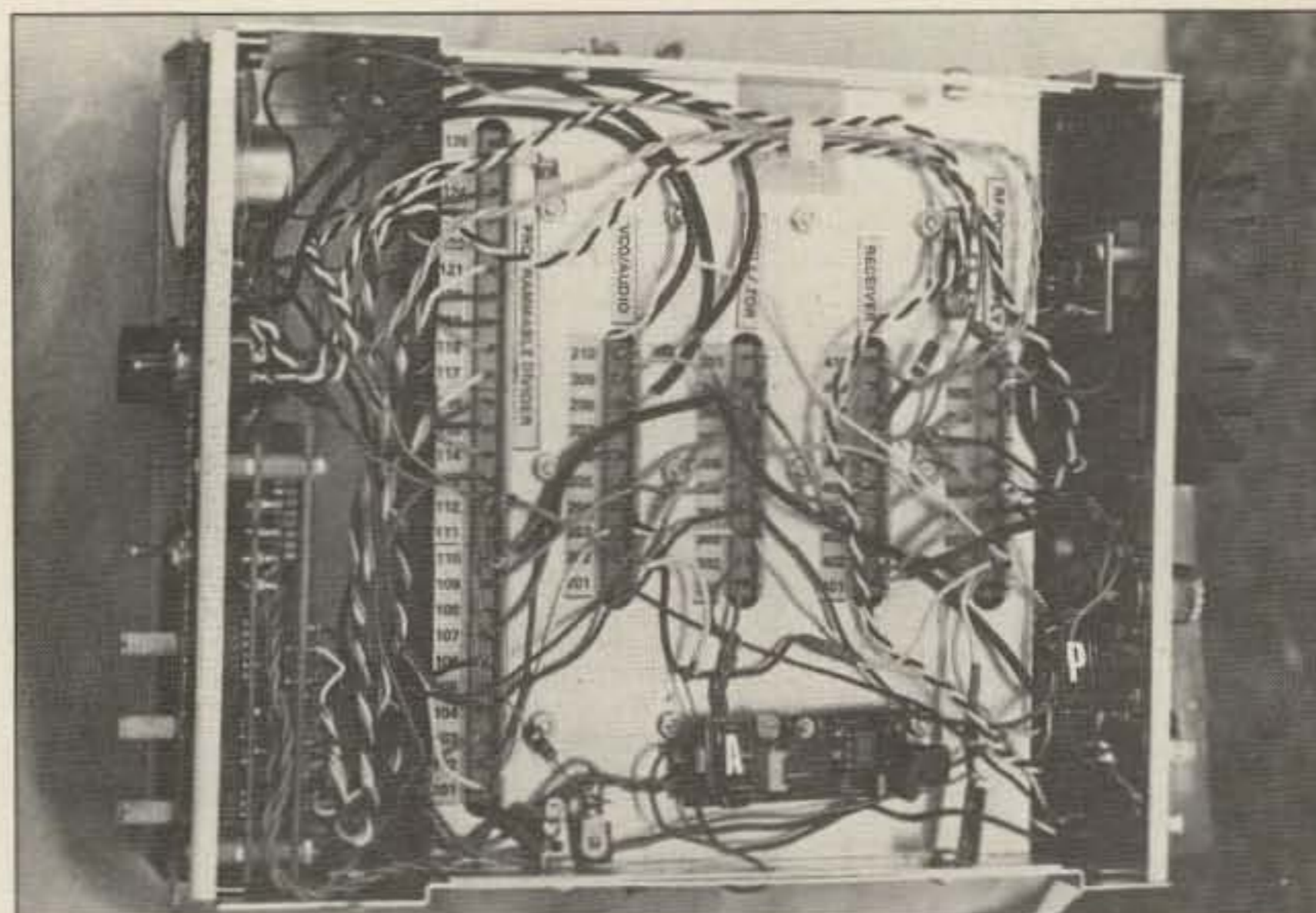

Photo B. The PL board installed in the Conarc 452 2m rig.

predrilled boards simplify small project assembly. Radio Shack offers several variations of these boards. You could use either the RS 276-149 or 276-150 board to make two of these CTCSS tone boards. I prefer the 150 board because it has strings of connected pads to simplify construction. You may prefer the flexibility of the other. For group projects, it'll be cheaper to cut up one of the larger boards into suitably sized pieces.

Make the board as small as possible, to fit inside the transceiver. The largest components are the potentiometers and the Mylar capacitors. You can get it as small as 0.8 x 1.5 inches. Photo A shows the completed board. You'll find space to mount the unit inside most mobile 2 meter transceivers, but for an HT, you will probably have to resort to external mounting. This has been done without trouble as long as the 0.001 μF RF bypass capacitor was used on the power lead, as shown on the circuit diagram, and all leads were kept short.

Once all of the components are in hand, it's a good idea to make a sketch showing the physical layout. If you use a board with con-

nected pads, such as the RS 276-150, make sure that all items entering or leaving each "node" are connected—even if you have to jumper strips together to do it. If you use the separate pads, as on the RS 276-149, remember that you'll have to "wire" the pads together after soldering the components to the predrilled board. Show these wires on your sketch. (Note: I use very fine wire to connect the pads and create "solder bridges" between those pads that I want to connect.)

Check to make sure that you make all of the connections called for in the schematic. If the circuit doesn't oscillate at the desired frequency, you can bet that the diagram didn't support the circuit. It is a good idea to try a few different layouts to find the one that fits your transceiver the best; it's better to do it at this time than after the board is all made up! Cardboard cutouts are useful for sizing.

As of this writing, the circuit has been used in more than twenty transceivers of many different types. These include the Conarc 452, the Azden PCS 4000, the Kenwood TR-7850, the Heath HW-2036, other Kenwoods, both newer and older than the 2850, several different Midlands, an ICOM 22A, a more recent ICOM, and a few different models made by Yaesu. Other than the difficulty of squeezing the board into a clear place in the cabinet, the only problem we encountered was finding a suitable point to insert the signal.

Having the Right Connections

DO NOT—REPEAT—DO NOT try to insert the tone into the microphone circuit. Signal shaping in that area is almost guaranteed to attenuate and distort the tone to oblivion. User manuals for many fairly new 2 meter rigs suggest a connection point for the PL tone generator. Read your manual before taking someone else's advice!

If the manufacturer didn't offer a solution, use the schematic to locate the deviation adjust potentiometer. Tone input at the tip end (preferably), or center tap of that potentiome-

Parts List for the CTCSS Tone Board

Component	Type	Cost
Fixed Resistors ¼-Watt, 5%	R9, R10 1000Ω (Pkg. of 5)	\$.39
	R2, R3	33kΩ@ .39
	R1, R4, R5, R6, R7, R8	47kΩ@ .78
	R(T)	See article@ .39
Mylar Capacitors, 50 WVDC	C2, C3	0.1 μF (Pkg. of 2)@ .79
Capacitors, RF bypass	C1	0.001 μF@ .49
Potentiometers, ¼-Watt	VR1	25Ω@ .59
	VR(T)	See article@ .59
Integrated Circuits	U1	LM1458@ .99
Project Board		See article@ .99
TOTAL COST		\$6.39

Table 1.

Continued on page 40

HAM PROFILES

There are no "average" hams!



Photo A. Diane Magen KG5CS, age fifteen, Hot Springs, Arkansas. Her career plans include aviation, engineering, and mathematics.

Friends the World Over

Diane R. Magen KG5CS is a fifteen-year-old high school sophomore in Hot Springs, Arkansas. In addition to the time she puts in to maintain her "A" average in school, Diane manages to find time to study in ground school for her private pilot's license.

Diane participates in YL contests and enjoys the security of a 2 meter rig in the family car. Other interests include baton twirling, needlepoint, and traveling.

Writes Diane, "No matter where you travel, you always have friends. Amateur radio is a wonderful fraternity!" She had a wonderful opportunity last summer to meet face to face some distant acquaintances made over the air. She and her mother (also a ham) travelled aboard the *Ocean Pearl*, which sailed to Singapore, Borobudur and Bali, Indonesia, Manila, and Canton. During this trip, they met with Roger DU1KT, Phil VS6CT, and Ian G4LJF. By the time you read this, Diane KG5CS will have explored Monaco, Florence, Rome, Venice, the Lipari Islands, Corfu Island, Dubrovnik, Yugoslavia, and Paris. She will also have visited Vince Sullivan N2UN at the United Nations.

This coming school year, Diane KG5CS hopes to work as a page in the House of Representatives.

Meet Another Southern Belle!

Be sure also to get in touch with Dorothy Livsay KC4IQP when you're travelling through eastern North Carolina. This thirteen-year-old spends a lot of time working CW on



Photo B. Dorothy Clark KC4IQP, thirteen years old, is an active 220 MHz FMer.

two 220 repeaters, NF4C and WA4DAN. She is a very active and enthusiastic ham.

Dorothy KC4IQP and her father studied amateur radio together and became licensed at the same time. This month, they plan to upgrade to General. Their Elmer, who sent us Dorothy's photo, prefers to remain anonymous, but has been a ham for fifty-five years.

In addition to amateur radio, Dorothy KC4IQP enjoys music and softball. Her current ambition is to attend the Coast Guard Academy. **73**

To obtain guidelines for submitting Ham Profiles, write or call Joyce at 603-525-4201 Ex. 551, or download them from the 73 BBS/73mag SIG. (PH: 603-525-4438, 8 data bits, no parity, one stop bit).

FEEDBACK

In our continuing effort to present the best in amateur radio features and columns, we recognize the need to go directly to the source—you, the reader. Articles and columns are assigned feedback numbers, which appear on each article/column and are also listed here. These numbers correspond to those on the feedback card opposite this page. On the card, please check the box which honestly represents your opinion of each article or column.

Do we really read the feedback cards? You bet! The results are tabulated each month, and the editors take a good, hard look at what you do and don't like. To show our appreciation, we draw one feedback card each month and award the lucky winner a free one-year subscription (or extension) to 73.

To save on postage, why not fill out the Product Report card and the Feedback card and put them in an envelope? Toss in a damning or praising letter to the editor while you're at it. You can also enter your QSL in our QSL of the Month contest. All for the low, low price of 25 cents!

Feedback# Title

- 1 Welcome Newcomers
- 2 Never Say Die
- 3 QRX
- 4 Home-Brew: CTCSS, Fast and Cheap
- 5 Ham Profiles
- 6 Feedback Index
- 7 Review: Kantronics KAM
- 8 Home-Brew: COCOA—A Collinear COaxial Array
- 9 Review: Ameritron AL-80A
- 10 Book Review: Uno, Dos, Cuatro
- 11 Review: Ramsey COM-3
- 12 Home-Brew: Control Your Rig from a PC
- 13 Review: Ramsey SR-1 Receiver
- 15 Home-Brew: Full-Wave VHF Vertical Antenna
- 16 Find Your Signal the First Time
- 17 JEZ—Jugendelektronizentrum
- 18 Home-Brew: Need FM?
- 19 Home-Brew: 10 GHz RF Preamp

Feedback# Title

- 20 Home-Brew: IF Shift, Cheap
- 21 Aerial View
- 22 Circuits
- 23 RTTY Loop
- 24 Homing In
- 25 Hamsats
- 26 Ask Kaboom
- 27 Looking West
- 28 New Products
- 29 QRP
- 30 Special Events
- 31 Above and Beyond
- 32 Ad Index
- 33 Letters
- 34 Tech Tips
- 35 73 International
- 36 Ham Help
- 38 Dealer Directory
- 39 Index 8/89
- 40 Barter 'n' Buy
- 41 Propagation

73 Review

by Brian Lloyd WB6RQN

Kantronics KAM

Versatile multi-mode data controller.

Kantronics, Inc.
1202 E. 23rd Street
Lawrence KS 66046
(913) 842-7745
Price Class: \$320

The Kantronics KAM is an all-mode computerized interface that will send and receive CW, packet, RTTY, ASCII, and AMTOR. The KAM can be used with a personal computer to receive weather facsimile (WEFAX) broadcasts.

The Hardware

The KAM is a modem-sized box, 22.5 x 14.7 x 4.7 cm. The front panel has two push-button controls, one for power and one to select the FM or AM (limiter-less) operation of the HF modem. The rest of the front-panel controls are all LED status indicators, plus an easy-to-read green bar graph tuning indicator. The back panel has two radio connectors, a connector for the computer or terminal, and a connector for power.

The KAM operates at 12VDC at 260mA. The power connector is standard coaxial, like that found with most small radios and accessories today. Kantronics provides a small 12VDC at 300mA power cube with the KAM. The low-power 12 volt operation makes the KAM a natural for portable or mobile operation. You have the options of providing operating power on one of the pins of the computer interface connector, or on the VHF radio connector, to reduce the number of cables.

The unit connects to your computer or terminal with a standard RS-232 DB-25 connector. This connector is factory configured for a standard RS-232 DCE (modem) connection. This means that you can probably unplug the modem from your computer and plug the KAM in its place with no other wiring changes. The KAM computer interface supports all the standard modem signals, so your terminal program may be used without modification. Alternatively, you may choose to use Kantronics' terminal program called "Kanterm" (I did—more on this later).

If your computer does not support RS-232 signals (the Commodore 64 and VIC-20 immediately come to mind) you will want to open the KAM and change jumper K7. This changes the controller output to the computer to TTL.

A word of warning: Pin 25 of the computer connector is "hot" with 12VDC. Make sure that pin 25 of the computer interface is not inadvertently grounded through the computer. Damage to the KAM and/or the computer could result. Play it safe and use an RS-232 cable that does not provide a connection to pin 25.

There are two radio connectors: one for HF and one for VHF packet. The HF port is an 8-pin female DIN jack. CW, RTTY, AMTOR, and low-speed (300 baud) packet are supported from this connector. The VHF port is a DB-9 female connector identical to the radio ports



Photo A. The Kantronics KAM—a multi-mode data controller.

on the KPC-2, the KPC-4, and the KPC-2400. If you have one of these other Kantronics products you can use the radio cable interchangeably with the KAM. The VHF connector on the KAM supports 1200 baud VHF packet only.

The Manual

With a device this complex (the KAM can do a great deal) the manual is VERY important. Almost nothing about the KAM is intuitive (although it will be very familiar to anyone who has used TNCs before). The manual is complete, albeit somewhat terse. Everything you need to know is in there, but you might miss it if you do not read carefully. I strongly recommend that you read the manual, especially the part about interfacing the radios and the computer, from beginning to end before you attempt to connect and use the KAM.

There are MANY commands for controlling the KAM (I counted 165). The manual does a reasonably good job of covering the most important commands and walking you through getting the KAM operating. I read the section describing all the commands before I tried operating because there are some differences between the KAM command set and the common TNC command set.

The only section of the manual I found at all difficult to understand was the section on multiple connections (being connected to more than one other station concurrently). I cannot really blame Kantronics for the confusion. Kantronics chose to be compatible with the multiple connect format used in the TAPR TNC. I find this format is awkward to use. The KAM manual does as good a job of explaining the convolutions of multiple connections as I have seen anywhere. (This is one of the reasons that I have personally switched to using the KA9Q TCP/IP packet program for my packet operations. With KA9Q TCP the computer does all the work keeping the sessions separate, and I don't have to worry about it.)

Connecting the Computer

The first step in getting the KAM to operate was to establish communications between it and the computer or terminal. I started out using both my standard terminal program and the Kantronics-provided Kanterm program. I

finally settled on Kanterm since I liked the split screen display with separate windows for data received on the HF port, data received on the VHF port, and keyboard data. Kanterm does a good job of formatting the screen and keeping things visually separate without hiding the actual exchange of commands.

My only complaint about Kanterm is that it erases the content of the windows if you change the window format (if you change from horizontal to vertical windows, from one to two windows, etc.). The information that was contained in the windows however, is not lost. It can be retrieved with the scrollbar function.

I did have one technical problem with Kanterm (the PC version). Kanterm did not work with either of my computers the first time, although my terminal programs, Bitcom and Procomm, worked just fine. The problem turned out to be the cable between the KAM and the computer. It seems that some of the RS-232 control signals are not asserted by the KAM, and Kanterm can't or won't initialize the RS-232 port. The fix was to use the "three-wire" RS-232 cable described in the KAM manual, and to add the jumpers on the computer side of the cable (connect pin 4 to pin 5 and connect together pins 6, 8, and 20). This solved the problem and allowed Kanterm to run normally.

I spent plenty of time properly interfacing the radios to the KAM. A quick and dirty interfacing job is liable to lead to poor performance because neither the radio nor the KAM are likely to see the proper signal levels.

VHF Port Connections

This is straightforward, since there are only four signals you need to worry about: audio out (to the mike input on the radio), audio in (from the speaker), push-to-talk, and ground. There is an optional external carrier detect signal, but that is very rarely used. Since I already have a KPC-2 connected to my 2m rig (an ICOM IC-245) I used its cable to connect the KAM.

It's very important to set the signal level from the KAM to provide 3 kHz deviation of the VHF FM transmitter. There is a problem doing this because the KAM provides only three jumper-selected choices for output level: low, high, and much too high. I had to change the value of one of the resistors on the circuit board (R-12) to get the proper level for my transceiver. Fortunately, the manual clearly describes the procedure. This was not a problem for me because I am comfortable using a soldering iron to make changes to a circuit board. Still, it would have been much nicer if Kantronics had provided a pot for output level adjustment.

B & W PRESENTS A WINNING COMBINATION



1500W.

MODEL PT2500A LINEAR AMPLIFIER

The Barker & Williamson PT2500A Linear Amplifier is a completely self-contained table-top unit designed for continuous SSB, CW, RTTY, AM or ATV operation. Intended for coverage of all amateur bands between 1.8 MHz and 21 MHz. Two type 3-500z glass envelope triodes provide reliability and rapid turn-on time.

FEATURES INCLUDE:

- Full 1500 watt output
- Pi-network input for maximum drive
- Pressurized plenum cooling system
- DC antenna relay for hum-free operation
- Illuminated SWR and power meters
- Vernier tuning for accurate settings
- Pi-L output for greater harmonic attenuation

Ruggedly constructed of proven design, this amplifier reflects the manufacturer's critical attention to details—such as the silver-plated tank coil for maximum efficiency. Cathode zener fuse and internal/external cooling are among the protective and safety devices employed. Input and output impedances are 50 ohms.

Dimensions: 17" wide x 19" deep x 8 1/2" high
Weight: 80 lbs. (shipped in 3 cartons to meet UPS requirements)

Price: **\$2175.00** FOB Factory.
Price includes one year limited warranty.

Call or write factory for complete specifications.



1500W.

MODEL VS1500A ANTENNA COUPLER

The Barker & Williamson VS1500A antenna coupler is designed to match virtually any receiver, transmitter or transceiver in the 160 to 10 meter range (1.8 to 30 MHz) with up to 1500 watts RF power to almost any antenna, including dipoles, inverted vees, verticals, mobile whips, beams, random wire and others, fed by coax cable, balanced lines or a single wire. A 1:4 balun is built in for connection to balanced lines.

FEATURES INCLUDE:

- Series parallel capacitor connection for greater harmonic attenuation.
- In-circuit wattmeter for continuous monitoring.
- Vernier tuning for easy adjustment.

Front panel switching allows rapid selection of antennas, or to an external dummy load, or permits bypassing the tuner.

Dimension (Approx.): 11" wide x 13" deep x 6" high

Weight: 6 1/2 lbs.

Price: **\$499.00** FOB Factory.
Fully warranted for one year.

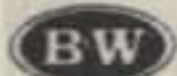

ALL OUR PRODUCTS MADE IN USA
BARKER & WILLIAMSON

Quality Communication Products Since 1932
At your Distributors Write or Call
10 Canal Street, Bristol, PA 19007
(215) 788-5581

CIRCLE 53 ON READER SERVICE CARD

"GUARANTEED TO OUTPERFORM"
THEOR YOUR MONEY BACK!

HAM 10™ TEN METER HAM ANTENNA



CUT-AWAY VIEW OF THE HAM 10

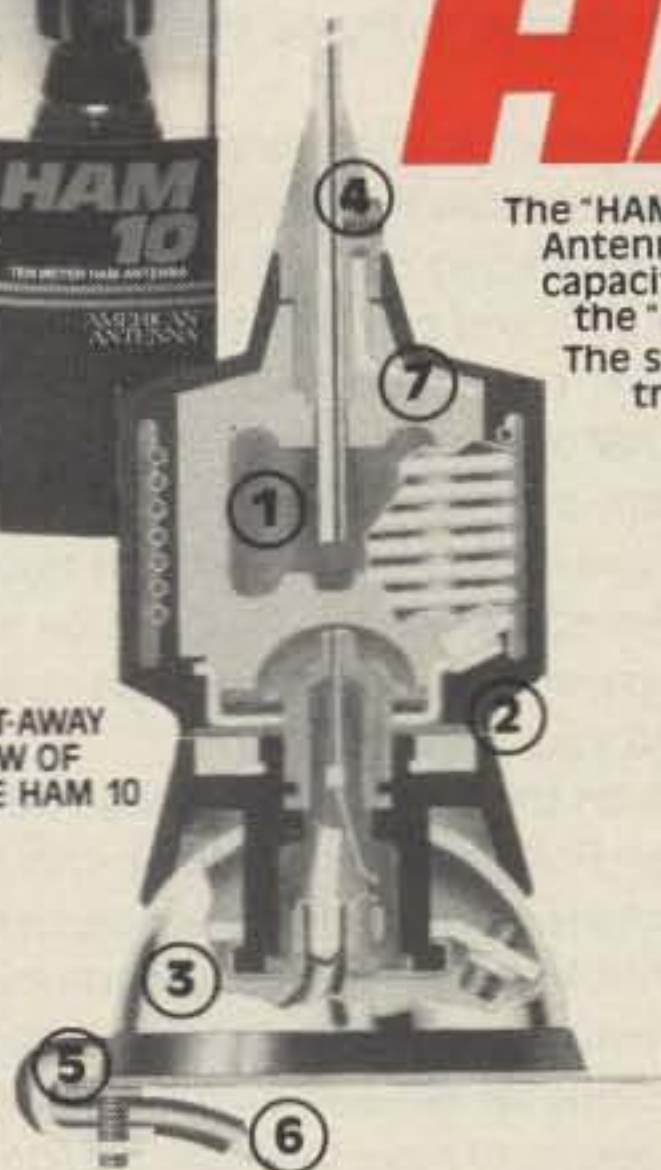

The "HAM 10" ten meter antenna is designed and manufactured by American Antenna, makers of the world famous K40 Antenna. With a power handling capacity of 1500 watts and a band width of 1.5 mhz between 2:1 SWR points the "HAM 10" is the perfect compliment to all single-band ten meter rigs. The stainless steel base of the "HAM 10" is supplied with an adjustable trunk lip mount. Also available is an optional adaptable heavy duty magnamount. For a free brochure, call 1-800-323-6768 in Illinois 1-800-942-8175.

EXCLUSIVE FEATURES:

- ① HANDLES UP TO 1500 WATTS!
- ② METALPLAS CONSTRUCTION.
- ③ 30° ROTATION OF BASE.
- ④ STAINLESS STEEL WHIP AND BASE.
- ⑤ MOUNTS ANYWHERE ON ANY VEHICLE!
- ⑥ FULLY ASSEMBLED WITH 18' OF RG-58 COAX.
- ⑦ COMPUTER DESIGNED ISOLATION CHAMBER.

For A Free Brochure, Call:
1 800-323-6768 IN IL. 1 800-942-8175
TLX# 6871370 K40INTL
....(Or Write) AMERICAN ANTENNA
1500 EXECUTIVE DR. ELGIN, IL. 60123

THEY'LL THINK THEY'RE JUST HAVING FUN



YOU'LL KNOW THEY'RE LEARNING

Carole Perry's (Dayton 1987 Ham of The Year) "Introduction To Amateur Radio" package allows children of all abilities to achieve success.

Ready-to-teach package contains: Teacher's Manual with 26 lesson plans, Code Practice Oscillator for Morse Code practice, Spacecode audiocassette which follows lesson plans. **\$99.95**

•FREE Video Tape Showing Classroom Use

- Any motivated teacher can teach the program.
- Ham Radio program is used as a motivational tool to teach skills in other subject areas.
- 24 hour Hotline is available for help and questions.

High motivational activities, homeworks, fund raisers, quizzes, & reproducibles included.

Media Mentors inc.

P.O. Box 131646
STATEN ISLAND
N.Y. 10313-0006
718-983-1416

CIRCLE 241 ON READER SERVICE CARD

New from
AOR

2000 Channels
5MHz to 1500MHz

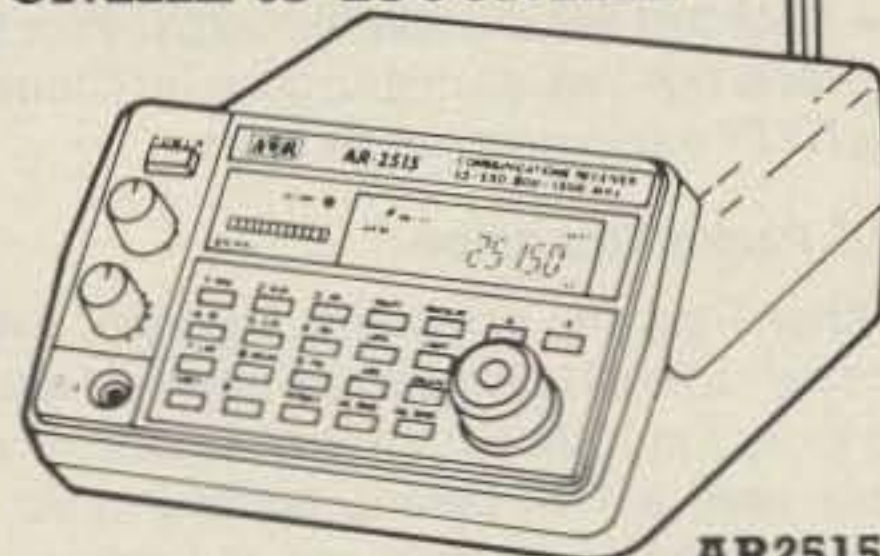

AR2515

- Covers 5MHz to 1500MHz in AM/FM/Wide FM modes. Continuous coverage
- 2000 Channel Memory 1984 Scan Frequencies & 16 Search Groups
- Scan/Search speeds up to 36 channels or increments per second.
- Built in RS 232 computer interface.
- 25 Day Satisfaction Guarantee. Full Refund if not Satisfied.
- Size: 3 1/4" H x 5 1/4" W x 7 1/4" D. Wt.: 2 lb. 10 oz.
- Supplied with AC & DC power cords. Telescopic antenna.

Total Price, Freight Prepaid (Express Shipping Optional)
*Upgrades of AR2002's to AR2515 specs Available:

\$695.00

ACE
COMMUNICATIONS

10707 E. 106th St. Indpls., IN 46256

Toll Free 800-445-7717

Visa and MasterCard (OOD slightly higher)

In Indiana 317-849-2570 Collect FAX (317) 849-8794

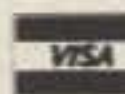

CIRCLE 355 ON READER SERVICE CARD

The manual indicates that the VHF modem is sensitive to input level. Kantronics suggests a maximum input of 50 mV to the KAM. The easy way to set this is to hook the KAM's VHF audio input to the speaker of the transceiver and then adjust the volume control for 50 mV while receiving packets.

A nice feature of the KAM is that it allows the user to select from three different receive equalization settings (jumper K-1). With my configuration, the TNC and/or KAM connected to the discriminator through a buffer, I found that the position that disabled equalization provided the best results. Connecting the KAM to the speaker jack would probably have required partial or full equalization. The KAM is shipped with jumper K-1 set to the full EQ position.

HF Port Connections

For this, you have to build your own cable. The HF connector on the KAM supports the following signals: audio in (from the speaker or phone patch output of the rig), audio out (to the mike or aux audio input of the rig), key out (to the CW key jack on the rig), FSK out (to the FSK input on the rig), PTT out (the PTT line on the rig), external carrier detect (from the squelch on the rig), and ground. I tested the KAM with a Kenwood TS-940S transceiver and most of the connections went to the accessory jack on the back of the transceiver. The two exceptions were the key and the FSK signals. I had to run those signals to separate plugs.

Setting the level for AFSK operation was much easier. Most HF rigs allow you to set transmit levels from the front panel, usually with the mike gain control. Use jumper K-5 (HF AFSK output) to select the lowest output from the KAM that will provide full output from the rig. Most rigs include instructions for connecting RTTY equipment; follow them.

VHF Packet Operation

After I got my computer, Kanterm, KAM, and my radio all talking to one another I decided to try the KAM out on VHF packet. If you have used a TNC before, nothing could be simpler. The commands are all familiar and work in a similar manner. The KAM performs as well as any other TNC I have used on VHF packet.

Kantronics has added a few commands that have the potential to make packet operation more effective. In addition to the DWAIT command (used to prevent collisions between packets from end-user stations and digipeaters), Kantronics added the PERSIST and SLOTTIME commands. These two commands implement something called p-persistent CSMA which promotes better channel sharing amongst the users. Users in your area will notice an improvement in throughput and a reduction in retransmissions as more stations begin using p-persistent CSMA.

After I used the KAM to check into the bulletin board and have a QSO or two, I tried it out with TCP/IP, my usual packet operating mode. The KISS mode worked just fine. I transferred a couple of files and several mail mes-

sages, and had a QSO, all at the same time.

HF Operations

The KAM is as good on VHF as any TNC, but the reason to buy it is to get the HF packet, RTTY, AMTOR, and CW capability. Any discussion of these modes requires a discussion of the design features that make them possible.

One of the keys to the flexibility of the KAM is the programmable HF modem. The modem can be programmed for just about any baud rate (up to 500) and any two tones. When you select RTTY, HF packet, ASCII, AMTOR, or CW, the KAM automatically chooses the standard modem settings used with that mode. If you wish, you may change the baud rate, the mark, or the space tones. This can be a real boon to experimenters. You can also optimize the tones to your particular rig.

A switch on the front panel of the KAM selects either FM (limiter) or AM (limiter-less) operation of the demodulator. I noticed a small but discernible performance difference between the two modes. The AM mode seems to have the edge on weaker signals, while the FM mode seems to have the edge on stronger signals when QRM is present. It is nice to be able to choose between the two.

Tuning Indicator

This is part of the HF modem and is used as an aid to tuning RTTY, ASCII, AMTOR, Packet, WEFAX, and CW. The green bar graph display is labeled with mark and space at opposite ends. If you have selected the proper shift and tuned the signal properly, the bar extends fully from the center to both ends.

The tuning indication on CW is slightly different. When no signal is present the bar graph segment nearest the left (mark) will be lit. When the other station is key down, the segment nearest the right (space) should be lit. Tune slowly until this occurs.

CW Operation

The first HF mode I tried was CW operation. Here, the KAM allows you to independently select filter bandwidth (the standard is 200 Hz, but it may vary from 50 to 1000 Hz), and the filter center frequency. The KAM keys the transmitter using a reed relay so it can work with relatively high voltage grid-block keying circuits. Using a relay also ensures that polarity is not a problem.

The manual claims that the KAM can automatically track CW sent at speeds up to 20 WPM different from the value set with the CW or CWSPEED commands. This means that you can set it for 20 WPM and the KAM will lock and track just about anything between 0 and 40 WPM. From what I could tell it did. Although the KAM will track any speed, the KAM sends CW at the speed set by the CW or CWSPEED commands. This means that you have to guess how fast the other guy is sending and set the KAM appropriately.

The KAM did a good job of copying a good fist or machine-sent code. It pretty much falls apart trying to copy a poor fist. The KAM is also picky about inter-character spacing. If the sender sends the characters at a faster rate

but then inserts more time between characters the KAM will display the characters separated by spaces (as if each character is a separate word). It is readable but annoying. If you are copying someone with a keyboard or using a keyer, the copy is flawless. I found it great fun to copy the high-speed maritime CW transmissions.

Once you have selected the CW mode the KAM tries to copy everything. Pressing "control-C" followed by "T" (^CT) enables the keyboard, and everything you type will be sent. Pressing "control-C" followed by "R" (^CR) returns the KAM to the receive mode.

Several keyboard keys are mapped to produce special Morse symbols such as AR, BT, AS, KA, SK, KN, AA, and SN. It takes a little getting used to. I solved the problem by making small adhesive labels and attaching them to the computer's keyboard.

RTTY and ASCII

RTTY and ASCII are both character asynchronous data transmission. Their sole difference is that RTTY uses the 5-bit Baudot code and ASCII uses the 7-bit ASCII code. I didn't test sending and receiving ASCII because I never found anyone else using ASCII. Since there is no other difference between RTTY and ASCII operation, I expect that my comments about RTTY will apply to ASCII as well.

Receiving RTTY is simple. Just select the shift and the baud rate, then tune the receiver for the proper indication on the bar graph tuning indicator. The tuning indicator also makes it obvious if you select the wrong shift. On the ham bands I found 45 baud (60 WPM) with 170 Hz shift to be the rule. Tuning was simple and I could copy almost anything.

How you choose to send RTTY depends on your rig. Most SSB rigs do not have a special RTTY mode so you must use AFSK. The tones from the KAM are fed into the transmitter and the transmitter is operated on lower sideband. If your rig supports direct FSK (the TS-940S does) you can use that mode, but you lose the ability to select transmit shift from the computer. I tried both methods and they worked equally well.

One activity I particularly enjoyed was trying to copy commercial and private RTTY transmissions. In this game you tune in a transmission and try to decode it. It's easy to change shift, baud rate, and inversion "on the fly." This activity is more difficult now because few of the commercial transmissions use character asynchronous clear-text transmission; most now use some transmission mode that is indecipherable by the KAM.

AMTOR

After becoming comfortable with RTTY operation I decided to try my hand at AMTOR, a mode I have never used before. Before I could operate AMTOR I needed to understand some concepts.

AMTOR is like a cross between RTTY and packet radio operation. Data is transmitted in three character "packets," using an error detection code. In this way, AMTOR is like packet radio. On the other hand, AMTOR is like RTTY because it uses the similar speeds and

THE MOST AFFORDABLE REPEATER

ALSO HAS THE MOST IMPRESSIVE PERFORMANCE FEATURES
(AND GIVES THEM TO YOU AS STANDARD EQUIPMENT!)

KIT, ONLY \$675
WIRED \$975
VHF OR UHF



FEATURES:

- **SENSITIVITY SECOND TO NONE!** GaAsFET front end on vhf models gives 12dB SINAD of 0.12uV (vhf), 0.15uV (220). UHF model 0.25uV std, 0.1uV with optional helical resonator preamp.
- **SELECTIVITY THAT CAN'T BE BEAT!** Both 8-pole xtal filter & ceramic filter for > 100dB at only ±12kHz. Helical resonator front end to combat desense & intermod.
- **CLEAN, STABLE TRANSMITTER**, up to 18W output standard; 50W with accessory power amplifier.
- **FCC TYPE ACCEPTED** for commercial high band and uhf.
- **Courtesy beep**, field-programmable CWID, flutter-proof squelch, automatic frequency control to compensate for off-frequency transmitters (all standard features).
- **Full range of options** available, such as autopatch, phone line or radio remote control, sub-audible tones, duplexers.

HIGH PERFORMANCE TRANSMITTERS & RECEIVERS FOR REPEATERS AUDIO & DIGITAL LINKS, TELEMETRY, ETC.

FM EXCITERS:

Kits \$99, w/t \$179. 2W continuous duty. TCXO & xtal oven options available.

- **TA51 for 10M, 6M, 2M, 150-174, 220 MHz.**
- **TA451 for uhf.**

FCC type accepted for commercial bands.

- Call for latest information on 900 MHz transmitters.
- **VHF & UHF AMPLIFIERS.** For FM, SSB, ATV. Output from 10 to 50 Watts. Several models, kits starting at \$79.

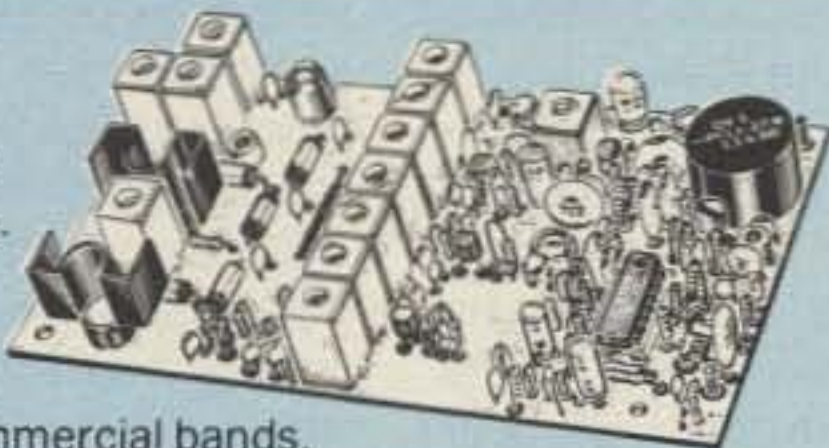

- **R144/R220 FM RECEIVERS** for 2M, 150-174, or 220 MHz. GaAs FET front end, 0.12uV sensitivity!

Both crystal & ceramic filters plus helical resonator front end for exceptional selectivity: > 100dB at ±12kHz (best available anywhere)! Flutter-proof squelch. AFC tracks drifting transmitters. Kit \$149, w/t \$229.

- **R451 UHF FM RCVR.** Similar to above. Tuned line front end, 0.25uV sens. (0.1uV with optional hel. res. preamp). Kit \$149, w/t \$229.

- **R901 FM RCVR FOR 900 MHZ.** Triple-conversion, GaAs FET front end, 0.2uV sens. Kit \$169, w/t \$259.

- **R76 ECONOMY VHF FM RCVR** for 10M, 6M, 2M, 220. Without hel res or afc. Kits only \$129.

- **Weather satellite & AM Aircraft receivers also avail.**

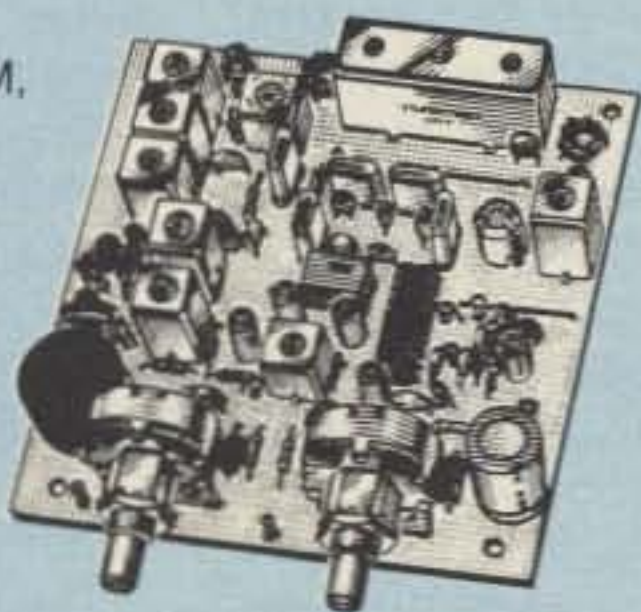

GaAs FET PREAMPS at a fraction of the cost of comparable units!

LNG -(*)

GaAs FET PREAMP

ONLY \$59!
Wired/tested



FEATURES:

- **Very Low Noise:** 0.7dB VHF, 0.8dB UHF
- **High Gain:** 13-20dB, depending on frequency
- **Wide Dynamic Range:** to resist overload
- **Stable:** new-type dual-gate GaAs FET

* Specify tuning range desired: 26-30, 46-56, 137-150, 150-172, 210-230, 400-470, or 800-960 MHz.

LNW -(*)

MINIATURE GaAs FET PREAMP

ONLY \$24/kit,
\$39 Wired/tested



GaAs FET Preamp

similar to LNG, except designed for **low cost & small size.** Only 5/8"W x 1-5/8"L x 3/4"H. Easily mounts in many radios.

* Specify tuning range desired: 25-35, 35-55, 55-90, 90-120, 120-150, 150-200, 200-270, or 400-500 MHz.

LNS-(*)

IN-LINE PREAMP

ONLY \$79/kit,
\$99 Wired/tested



GaAs FET Preamp with features similar to LNG series, except **automatically switches out of line during transmit.** Use with base or mobile transceivers up to 25W.

* Specify tuning range desired: 120-175, 200-240, or 400-500 MHz.

HELICAL RESONATOR PREAMPS

Low-noise preamps with helical resonators **reduce intermod & cross-band** interference in critical applications.

MODEL HRA-(*), \$49 vhf, \$84 uhf.

* Specify tuning range desired: 142-150, 150-162, 162-174, 213-233, 410-454, or 454-475.

ACCESSORIES

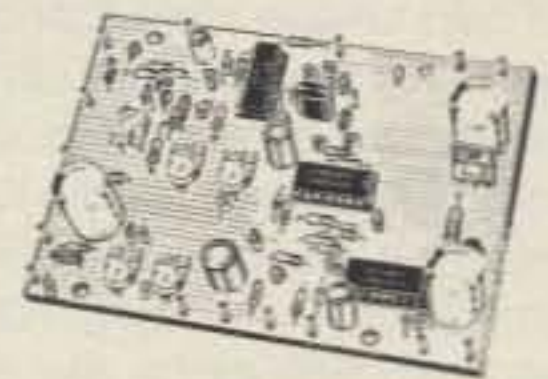

COR-3 REPEATER CONTROLLER kit. Features adjustable tail & time-out timers, solid-state relay, courtesy beep, and local speaker amplifier.\$49

CWID kit. Diode programmed, adjustable tone, speed, and timer, to go with COR-3.\$59

NEW COR-4 kit. Complete COR and CWID all on one board for easy construction. CMOS logic for low power consumption. Many new features. EPROM programmed; specify call letters..\$99

NEW TD-3 SUBAUDIBLE TONE DECODER/ENCODER kit.\$24

TD-2 DTMF DECODER/CONTROLLER kit. Full 16 digits, with toll-call restrictor, programmable. Can turn 5 functions on/off. Great for selective calling, too!\$79

AP-3 AUTOPATCH kit. Use with above for repeater autopatch. Reverse patch and phone line remote control are std.\$79

AP-2 SIMPLEX AUTOPATCH Timing Board kit. Use with above for simplex operation.\$39

MO-202 FSK DATA MODULATOR kit. Run up to 1200 baud digital signals through any fm transmitter with full handshakes. Radio link computers, telemetry gear, etc.\$39

DE-202 FSK DEMODULATOR kit. For receive end of link.\$39

9600 BAUD DIGITAL RF LINKS. Low-cost packet networking system, consisting of new MO-96 Modem and special versions of our 220 or 450 MHz FM Transmitters and Receivers. Interface directly with most TNC's. Fast, diode-switched PA's output 15 or 50W. Call for info on the right system for your application!

RECEIVING CONVERTERS



	Antenna Input Range	Receiver Output
	28-32	144-148
	50-52	28-30
	50-54	144-148
VHF	136-138	28-30
	144-146	28-30
MODELS	145-147	28-30
Kit with Case	\$59	146-148
Kit less Case	\$39	220-222
Wired w/case	\$89	220-224
		222-224
UHF MODELS	432-434	28-30
Kit with Case	\$69	435-437
Kit less Case	\$49	432-436
Wired w/case	\$99	439-25
		902-928
		902-922
		430-450

See catalog for full line of 2w transmitting converters for vhf & uhf. Kits only \$79. Linear Amplifiers avail. up to 50 w.

FCC TYPE-ACCEPTED TRANSMITTERS & RECEIVERS AVAILABLE FOR HIGH-BAND AND UHF. CALL FOR DETAILS.

- Send \$1 for 36 page catalog by return mail. (Send \$2.00 or 4 IRC's for overseas mailing)
- Order by phone or mail • Min \$3 S & H per order
- Use Visa, Mastercard, Check, or UPS COD.

Our 26th Year
hamtronics, inc.
65-J MOUL ROAD • HILTON NY 14468-9535
Phone: 716-392-9430 Hamtronics® is a registered trademark

shifts, and only one pair of stations at a time can use a given frequency.

Each AMTOR station on a frequency must have its own unique identification (SELCAL). The SELCAL is a 4-character identifier used to call and establish communications with another station. To save you time the KAM automatically creates a SELCAL entry from your call-sign. In my case my call, WB6RQN, was permuted into WRQN for the SELCAL. The KAM provides the option to manually enter the SELCAL of your own choice.

To get started with AMTOR I used the LAMTOR (Listen AMTOR) command to "eavesdrop" on other AMTOR and commercial SITOR transmissions. This gave me practice in recognizing and tuning AMTOR signals. The KAM copied these signals well, with only an occasional lost or duplicated "packet" (duplicated when the receiving station requested retransmission of a packet). Copy of transmissions using the Forward Error Correction (FEC) mode B was almost always 100%.

Active contacts require a special protocol because AMTOR is designed as a reliable station-to-station mode of operation. Most AMTOR QSOs use the Automatic Request for Retransmission (ARQ), Mode A. This requires that the two stations "handshake" (the receiving station must "ACK" each transmitted packet). This makes calling CQ an interesting prospect.

To call CQ with the KAM, you enter AMTOR mode with the AMTOR command and do not specify a SELCAL. This places the KAM in standby mode (ready to receive). Key the transmitter with the control-C T (^CT) command (same as with CW and RTTY) and type a standard 3 x 3 call making sure to include your SELCAL. End the CQ with the control-C R command (^CR). If someone else wants to respond they will zero-beat your CQ and then call you using your SELCAL. The KAM recognizes your SELCAL and begins the handshaking process with the other station.

The link is turned around with the character combination "+?". This tells both the KAM and the other station that you want to turn the link around so the other station can send (this is equivalent to the word "over" in voice communications). When you are done with a QSO and wish to break the link you enter the sequence control-C X (^CX). You have the option of "breaking" the other station when he/she is sending by entering the ^CT command. This forces link turnaround immediately.

I had absolutely no problem getting the KAM's AMTOR to work with the TS-940S. If you have problems getting AMTOR to work I would suspect the rig before I would suspect the KAM. AMTOR places significant stress on the rig because it is constantly switching from receive to transmit and back again several times a second. Some rigs just can't switch fast enough. A good thing to look for in a rig for AMTOR is full QSK capability in CW. That indicates that the rig is designed to switch rapidly from receive to transmit and back again. The TXDAMTOR (transmit delay AMTOR) command allows some adjustment for rigs that are slow to switch.

One other significant point in AMTOR's favor is that it does not require massive amounts of power to be successful. For this reason I imagine that most stations run barefoot. An amplifier just adds to the transmit delay and may even make it impossible to establish an AMTOR connection. Even with significant amounts of QRM or QRN, the KAM seems to be able to slip the data through.

HF Packet

The big feature of the KAM for me is its HF packet radio capability. After trying out RTTY and AMTOR, I felt very comfortable with the computer/rig/KAM combination.

The default values for packet operation work pretty well with one exception; Kantronics selected the default value for MAXFRAME to be 128 octets (bytes or characters). This is much too long for HF packet. I shortened it to 32 octets and operated that way.

I had absolutely no problem running HF packet. The KAM automatically selected 200 Hz shift (1600/1800 Hz tones) and 300 baud. I used lower sideband and AFSK operation without any problems. Setting the receiver's bandpass to 500 Hz seemed just about optimum. In sum: It works well and was easy to set up.

WEFAX

The last mode offered by the KAM is the ability to receive weather facsimile (WEFAX) broadcasts. For this mode the KAM operates strictly as a WEFAX modem. The actual processing of WEFAX pictures takes place within the computer.

There is a surprise in store for you when you try to use the KAM to receive WEFAX: The signal must be connected to the VHF port! You may wonder about this after you took all the trouble to hook your HF receiver to the HF port, but that's the way it is. Perhaps a switch-box to allow switching the receiver to either the HF or the VHF port is in order.

Kantronics supplies two WEFAX programs for use with the KAM and a PC: MaxFAX and SuperFAX. I started out using the MaxFAX program, but wasn't pleased with its performance. On my computer with a CGA graphics adaptor the FAX pictures were jumbled on the CRT display but printed properly on the printer. My other complaint was that MaxFAX lacks any onscreen key labeling or help.

The SuperFAX program is MUCH better. I found it to be much more "friendly." SuperFAX also properly displayed the pictures on the CRT display. SuperFAX is larger and slower than MaxFAX, but that is a very small price to pay for the much improved performance.

There is another feature of SuperFAX that I like very much; it comes with the source code to the program (it is written in BASIC). This should make it possible to make changes or to move the program to another computer without too much difficulty. I would like to see more vendors do this.

Special Packet Features

The KAM comes equipped with two special packet features not found in most other TNCs or multi-modes: a gateway function and a per-

sonal packet mailbox. The gateway function permits the KAM to act as a crossband digipeater when both the HF and VHF ports are enabled. This means that packets may be picked up from the HF channel and digipeated on the VHF channel, and vice versa.

To make the gateway work you must enter a different ID for the gateway. My ID (call) is WB6RQN-0 for local HF and VHF operations, and WB6RQN-1 for the gateway. Packets that arrive on VHF to be digipeated by WB6RQN-0 are retransmitted on the VHF channel. Packets that arrive on the VHF channel to be digipeated by WB6RQN-1 are retransmitted on the HF channel. Likewise, packets that arrive on the HF channel to be digipeated by WB6RQN-1 are retransmitted on the VHF channel.

I think that the gateway feature is a big plus. I expect it to be a very useful feature if and when we are granted permission by the FCC for unattended operation of HF packet stations. Presently, you must be in the shack whenever the gateway is enabled.

The second function is the personal packet mailbox (PPM). This permits people or BBS stations to connect to the KAM and leave or retrieve messages. In essence the KAM becomes a small BBS with messages stored in the KAM's memory rather than on a disk.

I do not expect the PPM to replace any BBSs but I do think that it can become a big part of the local BBS operation. One of my big complaints with BBSs is that you have to periodically check into them to see if you have received any messages. If there are many BBS users in your area this can become a painful process with several people trying to access the BBS and/or keeping it tied up for long periods of time. PPM can help alleviate this problem by allowing the BBS to automatically forward your mail to the KAM-running PPM. All you need to do then is to check the KAM for your mail. Sending mail works the same way: You prepare the mail in the KAM and let PPM automatically forward your mail to the BBS.

The concept is very good. PPM performs as advertised. The only problem is that the KAM's memory is limited so you can not have many large messages stored. PPM, however, has the potential to significantly reduce BBS overload if people make use of it.

Final Impressions

The KAM has performed flawlessly for me for the six months or so that I have used it. After this much use I can safely say that the KAM is a very impressive product. It does everything that it is advertised to do, and does it well. For relatively little money Kantronics has provided a great deal of functionality in a very small package. From this point of view the KAM may be the ultimate station accessory.

If you are looking for a small, low-power, lightweight, all-purpose terminal unit to use with your personal computer, the KAM may be the answer. Ditto, if you are tired of just rag-chewing on HF and want to do something really different. I recommend the KAM without any reservation. 73

For the Latest in Repeater Technology Go with the Leader—

SPECTRUM

NEW!

SCR7000X



Now there's no need for a separate, complicated outboard controller! With the New 7000X Repeater, an Advanced, State of the Art Controller is "built-in".

For that new Machine—Spectrum now makes 3 lines of Repeaters—the world famous Deluxe SCR1000A, the Low Cost line of SCR77s, and the New State of the Art SCR7000X with 'built-in' Microprocessor Controller.

Here are just a few of the Standard Features of the SCR7000X:

- Fully User Programmable
- Digital Readout of many important operating parameters
- Voice or CW Readout of Meter Functions, ID, Tail Message
- Many "built in" Control Functions
- 12 Auxiliary Functions
- Autopatch/Reverse Patch, 200 Autodial Numbers.
- Courtesy Tone & Anti-'Kerchunk'
- All Functions Remotely or Locally Controllable via DTMF or a Computer/Terminal
- Computer may be interfaced via the RS-232 jack, or via your Packet TNC.
- Control via Repeater Receiver, Link Receiver or Phone Line.
- Finest RF Performance in the industry!
- 30-75 Watt Transmitters

All Spectrum Repeaters are available with Sharp RF Filters or Preselectors, CTCSS, 100-150W Power Amps, Duplexers, Cabinets, etc.



Shown in optional cabinet.

Call or write today for details and prices!

Get your order in A.S.A.P.!

Sold Factory Direct or through Export Sales Reps. only.

INQUIRE ABOUT—

- Our Drawing for a FREE SCR77 Repeater*, for all customers who order a SCR7000X before 9/29/89! (*Or equivalent value of other Spectrum equipment.)
- Special Trade-in Offer for owners of existing (operating) Spectrum Repeaters or RF Sub-Assemblies—toward a new SCR7000X.



SPECTRUM COMMUNICATIONS CORP.

1055 W. Germantown Pk, S8 • Norristown, PA 19403 • (215) 631-1710 • TELEX: 846-211

FAX: (215) 631-5017

CIRCLE 51 ON READER SERVICE CARD

COCOA—A Collinear COaxial Array

Make COCOA your cup of tea.

by James E. Taylor W2OZH

Since 1970, I have used a straightforward, phased array for 75m. This array is composed of two parallel dipoles a quarter-wavelength apart, with a ganged switch to control directivity by changing the lengths of the coaxial feedlines to the separate dipoles.^{1,2}

A Few Improvement Ideas

Although I've had great results from this system, old-fashioned ham curiosity led to several improvement attempts. I first looked at two-phased verticals.³ These vertical radiators were a quarter-wavelength high and apart, and ultimately, each included 73 quarter-wave radials. Although electrically excellent, they never showed a consistent advantage over the horizontal system over several years of use, in spite of published material to the contrary. It's likely the far-field ground losses at my location cancelled the vaunted low-angle advantages.

I then looked at using three half-wavelengths of coaxial cable, with inner and outer conductors interchanged, to provide a collinear in-phase array. Balsley and Ecklund used such a scheme for a radar system at 49.8 MHz.⁴ However, space and height limitations made this system impractical on 75 meters. What to do?

Build On the Original

Challenged by the above experiences, and by an ignorance of limiting factors such as ground losses, I went back to my 2-element array to try to build on that.

Recall that this system comprises two parallel half-wave elements positioned one quarter-wavelength apart. The center feedpoint of each element is supported a quarter-wavelength above the ground. One way to improve this system would be to add a half-wavelength element, collinearly, to each end of the two radiators, yielding a total of six half-wave elements! Such prospects led to a summer of exciting experimentation. This article describes the results of my summer fun!

This article is in two parts. First, I describe the 3-element in-phase radiator (COCOA-3) and its extension to a 6-element phased array (COCOA-6). I then cover the

shortened, more limited configuration I used for experimentation.

The Collinear-Coaxial Concept

Antenna handbooks commonly show a collinear antenna comprising three half-waves in phase. They usually show a centered flat-top, three half-waves long. In the standard configuration (Figure 1), phase reversing stubs, added at the ends of a centered dipole, put the instantaneous RF current in the end elements in phase with that in the center element. You can make these phase reversing stubs from open wire line or coaxial cable. Normally, a shorted quarter-wave stub is used, but an open-ended half-wave stub would work just as well. The problem here, though, is that the dangling stubs are unwieldy at the lower frequencies.

COCOA-3

We can replace the dangling stubs with something sturdier and more compact. See the basic shorted quarter-wavelength of coaxial cable, shown in Figure 2. When you apply an RF voltage of phase angle P' to the center conductor A at the open end, the stub causes a voltage phase lag of $P' - 180^\circ$ at the adjacent coax shield. Why this happens is easy to see.

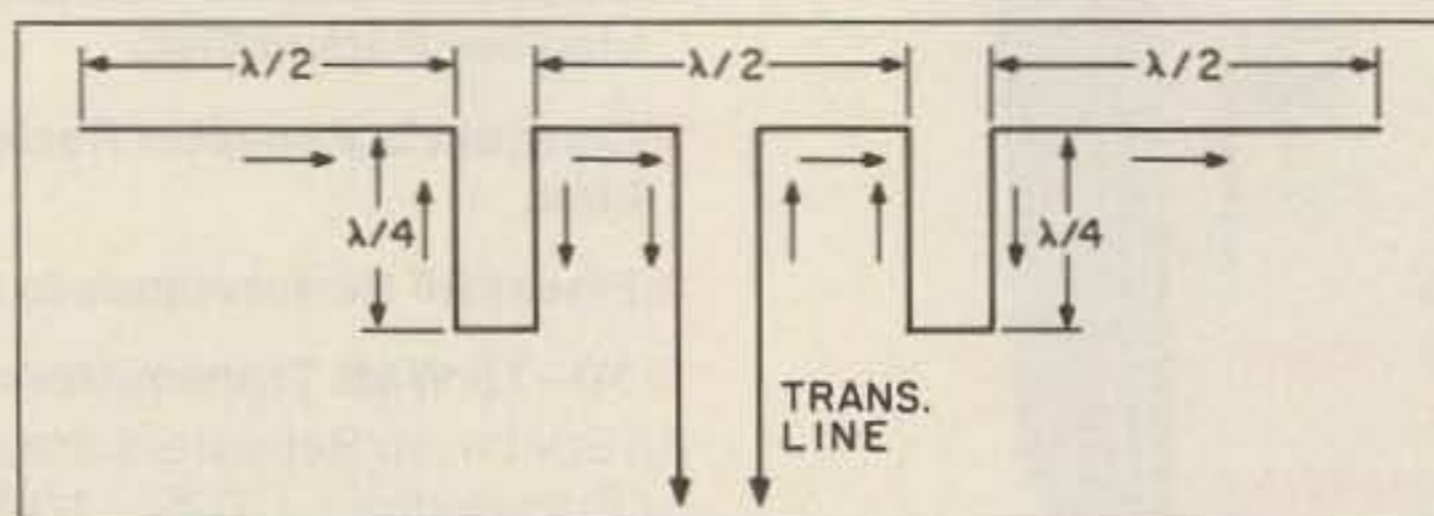

Figure 1. Three half-wave sections phased using "dangling stubs."

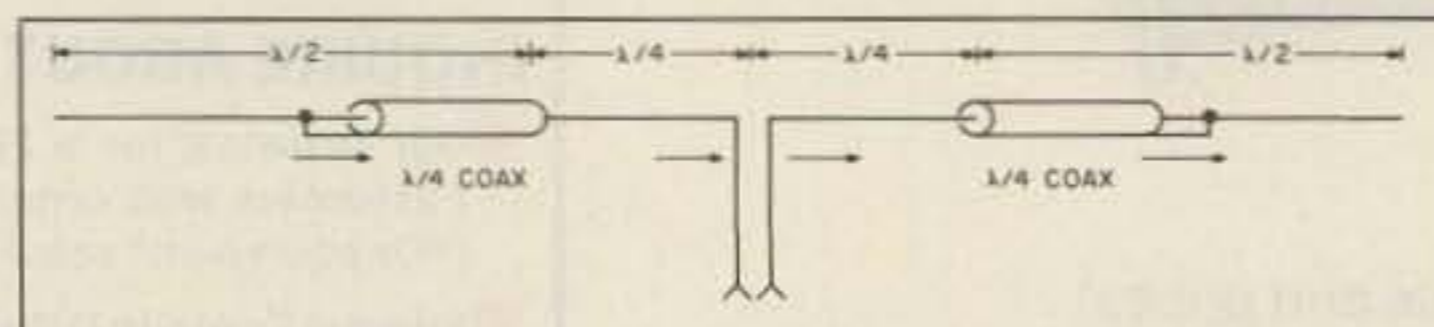

Figure 2. Horizontal quarter-wave stub. It replaces the dangling stub and is less unwieldy and sturdier.

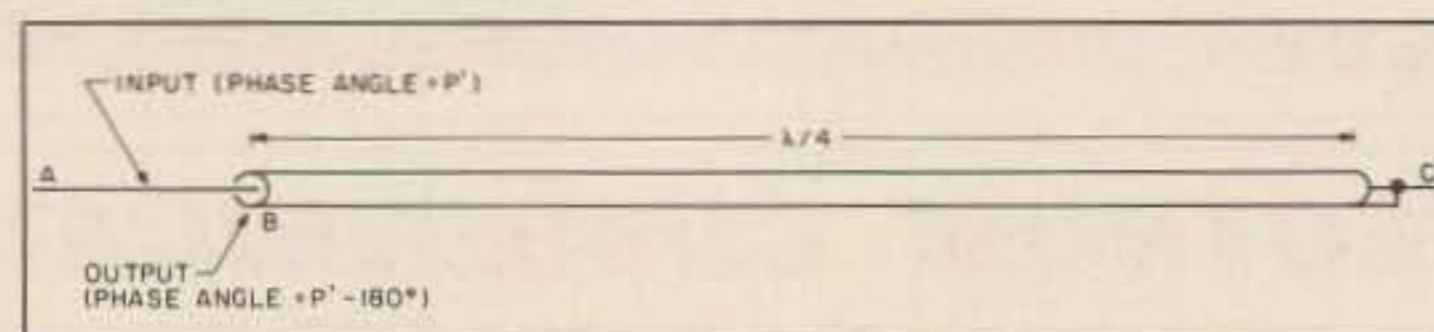

Figure 3. COCOA-3, a 3-element in-phase radiator.

The RF is delayed by one quarter-cycle as it passes from left to right, from A , inside the coax, to the shorted end. There's another quarter-cycle delay as the wave passes back from right to left inside the coax and emerges on the shield at B . Add up the delays and you get a total time delay of one-half cycle, or 180° .

RF energy can also readily turn corners if a lower impedance beckons. Thus, we further expect the RF wave to continue travelling to the right, along the outside of the coaxial shield, arriving at C . The setup shown in Figure 3 replaces that in Figure 1. In Figure 3, the stubs are horizontal. They perform the desired phase reversal while providing part of the added half-wave radiators with the outsides of their shields. You need only add enough wire at the ends to complete the COCOA-3 radiators. (See construction details below.)

Six-Element Phased Array (COCOA-6)

For a given power level, the current at the feedpoint of the COCOA-3 radiator is lower than that for the simple dipole radiator, so the input resistance in this case is higher. Add a toroidal transformer at the COCOA-3 input to decrease this value to 50Ω . If possible, put the matching transformer at the top of the mast that supports the radiator center.

Once the impedance is matched to 50Ω , you can excite the two COCOA-3 radiators. The phasing can be controlled by a switching network, as in the 2-element phased array. Figure 4 shows the COCOA-6 arrangement with nominal lengths for 3.955 MHz. I measured these lengths electrically, using a noise bridge to assure precise matching.

Keep'em High

Each COCOA-3 radiator is approximately 354 feet long (noise-bridge measurements determine the exact dimensions). For lower frequency bands, it's very important to place all radiating elements as high as possible above ground, since ground penetration greatly reduces radiation efficiency. If possible, support all three COCOA-3 elements no less than 40

SUPER PERFORMANCE BATTERIES

SUPER ICOM

SUPER ICOM BP-7S, 13.2 volts, 900ma, double the capacity of the Icom BP-7, 5w output.

SUPER ICOM BP-8S, 9.6 volts, 1200ma, 50% more capacity than the Icom BP-8.

Both are rapid base charge only, or slide in wall charger, 4 inches high. BP-7S or BP-8S. \$69.00.

SUPER KENWOOD

SUPER KENWOOD PB-25S/PB-26S. 8.4 volts, 900 ma, double the capacity of the PB-25/PB-26 for the 2500/2600/3500/3600. Charge with either the standard wall charger or drop in charger. 3 inches high. \$65.00.



Exact replacement FNB-2 Nicad pack for Yaesu FT-404R/207R/208R/708R \$27.00.

SUPER YAESU

SUPER YAESU FNB-4SH, 12 volts, 1000ma, double the capacity of the Yaesu FNB-4, 5 watt output. Rapid charge only. \$71.00

SUPER YAESU FNB-3S, 9.6 volts, 1200ma, triple the capacity of the Yaesu FNB-3, 3.5 watt output. Rapid or wall charge. \$60.00

Both are perfect for the 03, 09 and 727 series radios and are 4 inches high.

Inserts for:

Kenwood PB-25, 25H, 26	\$29.00
Icom BP-3	\$22.00
Icom BP-5 (500ma)	\$30.00
Icom BP-7 (500ma)	\$35.00
Icom BP-8	\$34.00

Add \$4.00 shipping & handling for first pack. CT residents add 7 1/2 % tax.

Complete line of NICAD packs for Icom, Kenwood, Yaesu, Tempo, Santec, Azden, Cordless Telephones, Alkaline, Nicad, and Gell-Cells. All NICAD packs include a 1 year guarantee. Commercial Radio Packs also available.

For all your battery needs, write or call today for a complete catalog. Dealer inquiries invited.

Made by Hams for Hams

PERIPHEx inc.

149 Palmer Road • Southbury, CT 06488

(800) 634-8132 In CT (203) 264-3985



CIRCLE 68 ON READER SERVICE CARD



Drive A Winner

The performance of your system depends upon the antenna it drives.

Drive A Winner - Hustler.



Yes, please send information on your line of amateur antennas to:

NAME _____

ADDRESS _____

CITY _____ STATE _____ ZIP _____



One Newtronics Place
Mineral Wells, Texas 76067
(817) 325-1386

CIRCLE 269 ON READER SERVICE CARD

VHF COMMUNICATIONS

280 Tiffany Ave.
Jamestown, New York 14701

Western New York's finest amateur radio dealer.

PH. (716)664-6345

FEATURING W2DRZ 902 MHz TRANSVERTER. NOW ONLY \$299
140 MHz 3W ATTENUATOR \$49
DEALER INQUIRIES INVITED
ICOM, AEA, LARSEN, VAN GORDEN, VIBROPLEX, NYE-VIKING, FALCON COMM, LEADING EDGE, ARRL PUBLICATIONS, KAGLO, HAMTRONICS, SINCLAIR ANTENNA, AMP SUPPLY

ATV CONVERTERS • HF LINEAR AMPLIFIERS

DISCOVER THE WORLD OF FAST SCAN TELEVISION



AMATEUR TELEVISION CONVERTERS
ATV2 420-450 \$44.95 Kit
ATV3 420-450 (GaAs-FET) \$49.95 Kit
ATV4 902-928 (GaAs-FET) \$59.95 Kit

AUDIO SQUELCH CONTROL for ATV
SIL \$39.95 Kit

2 METER VHF AMPLIFIERS
35 Watt Model 335A \$79.95 Kit
75 Watt Model 875A \$119.95 Kit
Available in kit or wired and tested

HF AMPLIFIERS per MOTOROLA BULLETINS

Complete Parts List for HF Amplifiers Described in the MOTOROLA Bulletins.
AN758 300W \$160.70 EB63 140W \$88.65
AN762 140W \$93.25 EB27A 300W \$139.20
AN779 20W \$83.79 EB104 600W \$448.15

NEW!! 300 WATT 10-150 MHz Amplifier

POWER SPLITTERS and COMBINERS (2-30MHz)
600 Watt 2-Port \$89.95
1200 Watt 4-Port \$79.95

100W 420-450 MHz PUSH-PULL LINEAR AMPLIFIER - SSB-FM-ATV

KEB67-PK (Kit) \$129.95
KEB67-PCB (PC Board) \$18.00
KEB67-I (Manual) \$5.00

For detailed information and prices, call or write for our free catalog.

FERROXCUBE DEVICES

VK200-20/4B RF Choke \$1.20
56-590-65-3B Ferrite Bead \$.20

HEAT SINK MATERIAL

Model 99 Heat Sink (6.5x12x1.6) \$22.00
CHS-6 Copper Spreader (6x6x1/4) \$18.00
Add \$2.00 additional shipping.

We also stock Hard-to-Find parts

CHIP CAPACITORS
METALCLAD MICA CAPACITORS
RF POWER TRANSISTORS
MRF141G \$209.20
MRF151G \$186.80
MINI-CIRCUIT MIXERS
SBL-1 \$6.50
SBL-1X \$7.95
ARCO TRIMMER CAPACITORS

Add \$2.00 for shipping and handling.

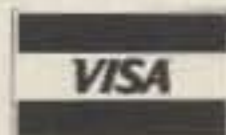

CCI Communication Concepts Inc.

121 Brown Street • Dayton, Ohio 45402 • (513) 426-8600
FAX (513) 429-3811

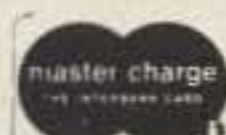

CIRCLE 99 ON READER SERVICE CARD

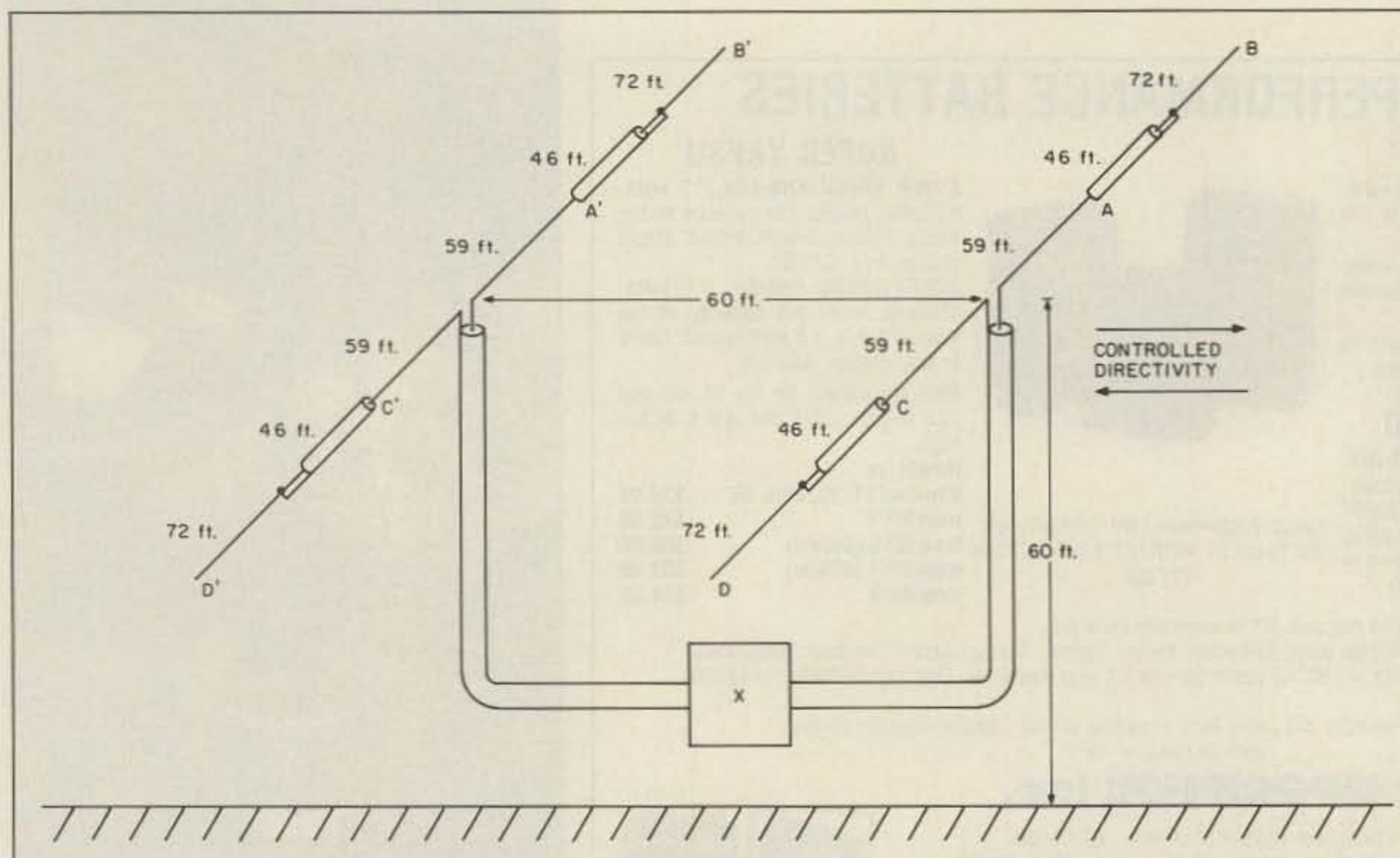

Figure 4. The COCOA-6, a 6-element phased array. "X" is the direction-switching manifold. Lengths shown are nominal values for 3.955 MHz.

feet above ground. They work best at one quarter-wavelength (about 60 feet) above ground.

The center masts at W2OZH proved practical over the years. I briefly describe their arrangement here. (See Reference 1 for more details.) Each mast is made from three 20-foot lengths of 2-inch outer diameter (o.d.) aluminum irrigation pipe, spliced end-to-end. Place the bottom half of each mast coaxially inside a 30-foot length of 3-inch o.d. pipe for added strength. Use quarter-inch crossed bolts to complete the mast assembly. Pivot the assembly on a 1-foot high, 2-inch diameter post, anchored in concrete in the ground.

The aluminum's light weight and the stiffening effect of the double pipe make for easy erection. After erection, bolt the masts to the roof structure at about 18 feet above the ground, and guy wire them in four directions at about 40 feet, as well as at the top. The center radiator wires guy the mast at the top in two of the four directions.

Pass the coaxial feedline (RG-213/U) up through the masts to the top insulator assembly. This assembly is a 6-inch length of capped PVC pipe, 2-inch i.d., that contains a balun transformer. Firmly anchor the feedline here, and pot the assembly in automotive grade epoxy.

Phase Reversing Stubs

The center radiators extend about 59 feet to either side of the center masts. Use seven strands of #22 copper-clad wire. After final measurements, paint them with polyurethane varnish to resist rust. Type RG-8 Mini-Foam coax works well here because it's light and convenient to handle. Make sure the coax terminals are mechanically secure, and that you've put a good moisture seal on them.

Figure 5 shows this in detail. Seal both ends of the coax after trimming it to precisely one quarter-wavelength. The spade lugs are convenient for disconnecting the end sections of the COCOA-3 during resonance measurements.

Measurements and Adjustments—COCO A-6

You need to adjust the electrical length of each phase reversing stub on the ground, before assembly, using a noise bridge. The impedance-transforming properties of a quarter-wavelength of coax are such that, if the far end is an open circuit, the impedance at the near end is essentially zero. Connect the noise bridge with short leads to one end of a 47-foot length of RG-8 Mini-Foam coax, and trim the other end until the null corresponds precisely to the desired frequency. In this article, I use 3.955 MHz. Then assemble and seal both ends, as Figure 5 shows.

Let's assume we are adjusting the full 6-element array (The procedure for adjusting a single, 3-element array is identical, except you don't have to consider the second feed radiator.) You adjust the three elements of the COCOA-3 sequentially by noise bridge measurement, beginning with the center element. Before measuring the antennas, trim the two feedlines so that the electrical length of each is an integral multiple of one half-wavelength (in the coax) for the frequency used. This assures that the impedance of the antenna feedpoint is measured accurately by the noise bridge. In my case, each feedline is two half-wavelengths long at 3.955 MHz, measured and trimmed in a like way as for the phase reversing stubs.

Again refer to Figure 4. To adjust the antennas, open the spade lugs (which connect the end elements to the center elements of

both COCOA-3s) at A, A', C, and C', and pull the antennas up to their final positions. To allow for the mutual impedance effect between the two antennas, terminate the feedpoint of the non-adjusted "antenna" with a 50Ω, 1 Watt carbon resistor. The noise bridge null now measures the input resistance as approximately 50Ω at the resonant frequency of this dipole antenna. Adjust the lengths of the wires equally, at points A and C until you reach the desired frequency. Then shift the resistor to the newly-adjusted antenna and trim the second dipole to resonance in the same manner. These two dipoles now make up a 2-element phased array. The

gain, compared to a dipole, is approximately 4 dB. The front-to-back ratio varies, typically from 3 dB to as much as 30 dB, depending upon propagation conditions.

End Element Radiator Adjustment

You can still terminate the feedline of the antenna you are not adjusting with a 50Ω resistor, even though the feedpoint resistance is now somewhat higher. Connect the spade lug at A on the side which goes to the feedline's center conductor. Point C, on the side going to the shield, remains open during the resonating of the opposite end element. Connect the noise bridge at the input end of the feedline to see the resonance of the 2-element (COCO A-2) antenna—two half-waves in phase. Trim the element at B until you get the desired resonant frequency. The measured input resistance will be somewhat higher than for the dipole, about 60-70Ω. Next, shift the resistive termination to the feedline of the COCO A-2 just adjusted, and adjust the resonance of the other antenna in a similar manner by trimming at B'. Check and readjust, if necessary, the first antenna.

The two antennas just adjusted make up a 4-element phased array, the COCO A-4. There's a slight mismatch because the input resistances are no longer 50Ω. This results in a small phasing error, but you can compensate for this by using two toroidal matching transformers (see below and Figure 9).

Adjust the remaining two elements, C-D and C'-D', in the same fashion. The spade lugs at A and A' remain connected, and those at C and C' will now be connected. Trim the ends at D and D' to resonate the two COCO A-3 radiators, just as the COCO A-2 antennas were adjusted. Here, the input resistance will be from 100-120Ω, so the

continued on p. 54

INTRODUCING...



Special Introductory Offer
 Just **\$19.95** Per Library
 (Reg. Retail Value \$24.95)
PLUS FREE BONUS
 (See Details)

THE NEW AZIMUTH AWARDS QSL LIBRARY

New Handsome Custom Albums To Collect, Protect & Organize Your Hard-Earned QSL Cards... Plus Special Albums for DXCC, WAS/WAC, & WAZ Radio Awards

Throw out the shoe boxes. Get your QSLs organized with the new Azimuth Awards QSL Library. The perfect way to display the cards for your prestigious awards—for easy viewing. Each padded vinyl album comes complete with 20 heavy duty crystal-clear, slip-in pocketed vinyl pages (each holds 6 cards).

Now available for the most prestigious awards in amateur radio... order all and organize your cards for each award.
 • DX Century Club • Worked All Zones • Worked All States & Continents • & a general QSL Album for any purpose!
 Looks great in your shack! Need more pages? Order extra pages (20/pack).
 Satisfaction Guaranteed! If not completely delighted return your purchase in 10 days for a money-back refund.

Call or Send For Your Azimuth QSL Award Library Today!



SEND TO: Azimuth Awards Library, Dept. A77
 11845 W. Olympic Bl., Suite 1100, Los Angeles, CA 90064
 1-213-473-1332 for information

FREE BONUS WITH TWO OR MORE ALBUMS!

Get The New Azimuth Awards Base Tracking Software for the IBM-PC (\$24.95 value) **Free!** Exclusive new program helps you stay on top of contacts by band, cards sent and received and much, much more to monitor your radio award progress.



Azimuth QSL Awards Library—Each just \$19.95 plus \$2.50 shipping & handling.
 Specify: 1) DXCC 2) WAZ 3) WAS/WAC 4) Standard Album
 Extra 20 Page Packs Just \$12.95 (\$2.50 S&H)
 Enclose check or money order. (Cal. Res. add 6.5% tax.)
VISA or MasterCard. (Foreign orders triple S&H)

Credit Card Orders Call Today Toll Free

Nationwide **1-800-882-7388**
 (9AM to 6PM PST) Made in USA

Allow 4 to 6 Weeks Delivery
 © MCMLXXXIX Azimuth Communications Corporation
CIRCLE 158 ON READER SERVICE CARD



SAVE TIME and MONEY with THE HAZER

Bring things down for safety and convenience.

Never climb your tower again with this elevator system. Antennas and rotator mount on HAZER, complete system trams tower in vertical upright position. Safety lock system operates while raising or lowering. Never can fall.

Complete kit includes winch, 100 ft. of cable, hardware and instructions. For Rohn 20 and 25 G Towers.

Hazer 2— Heavy duty alum. 12 sq. ft. load **\$311.95 ppd.**
 Hazer 3— Standard alum. 8 sq. ft. load **\$223.95 ppd.**
 Hazer 4— Heavy galv. steel 16 sq. ft. load **\$291.95 ppd.**

NEW for ROHN 45 and 55 Towers

Hazer 8— Heavy duty galv. steel 16 sq. ft. load **CALL**
 Ball Thrust Bearing TB-25 for any of above **\$64.50 ppd.**

Send for free details of aluminum towers specifically engineered for use with the Hazer. Two sizes; M-13 (13" wide) and M-18 (18" wide). All bolted construction, no welds. Easy to install hinge base, walk up erection. Complete tower UPS or air freight shippable. Pre-assembled or kit form.

Satisfaction guaranteed. Call today and charge to Visa, MasterCard or mail check or money order.

GLEN MARTIN ENGINEERING INC.

Rte 3, Box 322
 Boonville, MO 65233
 (816) 882-2734 FAX 816-882-7200

CIRCLE 72 ON READER SERVICE CARD

BATTERIES "R" US...

You've bought our replacement batteries before...
NOW YOU CAN BUY DIRECT FROM US, THE MANUFACTURER!



ICOM
CM2, PB2 7.2v @ 500MAH
CM5, PB5 10.8v @ 500MAH
SUPER 7S & 8S
 13.2v @ 1100MAH
 9.6v @ 1200MAH
 (base charge only - 1" longer)
Introductory Offer!
SUPER 7S & 8S - \$64.95 each

AUGUST SPECIAL
Kenwood PB-1 and
KNB-4 Replacement
Batteries
 An additional 10% OFF
 orders received in the
 month of August.
 Look for next month's
SEPTEMBER special!



YAESU/MAXON
 * **FNB-10** 7.2v @ 600MAH
 * **FNB-12** 12v @ 500MAH
 * **FNB-10(S)** 7.2v @ 1000MAH
 * same size case as FNB-12
Introductory Offer!
P4W 11v @ 500MAH - **\$22.63**
FNB-2 11v @ 500MAH - **\$22.63**



CUSTOM MADE BATTERY
PACK & INSERTS
 Made to your specifications.
KENWOOD INSERTS
PB-21—\$13.75, PB-25—\$20.00
PB-28—\$20.00
ICOM INSERTS
BP-5—\$23.00, BP-3—\$18.95,
BP-7, BP-8

Prices subject to change without notice.



MasterCard and Visa cards accepted. NYS residents add 8 1/4% sales tax. Add \$3.50 for postage and handling.



SOURCE FOR ALL YOUR COMMUNICATION BATTERY REPLACEMENT NEEDS.

W & W ASSOCIATES

29-11 Parsons Boulevard, Flushing, N.Y. 11354

WORLD WIDE DISTRIBUTORSHIPS AVAILABLE. PLEASE INQUIRE.

MADE IN THE U.S.A.

SEND FOR FREE CATALOG AND PRICE LIST

In U.S. & Canada Call Toll Free (800) 221-0732 • IN NYS (718) 961-2103 • Telex: 51060 16795 • FAX: (718) 461-1978

CIRCLE 191 ON READER SERVICE CARD

73 Review *by Alan C. Merrill W1FYR*

Ameritron AL-80A Linear Amp

A reliable 1kW amp at a bargain price.

Ameritron, Inc.
2375 Dorr Street
Toledo OH 43607
Phone: (601) 323-9715
Technical Inquiries: (419) 531-3024
Price Class: \$995

Ever tried to work a rare DX station, and have him tell you that he just couldn't pull you out of the mud? Then the big guns opened up, and you were gone.

Ever tried to get a piece of priority traffic through when the receiving station couldn't pull you out of the slop, and there was no one around to relay?

Ever try to call the net up when only half the members could hear you?

Ever get on a frequency during a contest and after a few nice contacts, have another station "steal" your spot because he didn't even know you were there?

Ever get on 75 after a solar flare and try to keep your schedule with the gang, only to realize that you are just barely hearing them, but not vice-versa?

If so, sounds like you need an amp! Many times, in a marginal copy situation, the extra 10 dB of a linear amplifier will make all the difference in the world. My hat is off to the QRP gang. I greatly admire those devotees, but there are times when an amp may well be the answer to a ham's prayers. To be legal as well as courteous, I always try to make it with the exciter alone. But it is also nice to be able to hit a switch and add another 10 dB to your signal. So often in handling traffic I have been told, "Sorry, Alan, you are not strong enough for me to copy traffic." After hitting the switch, it changes to "Loud and clear—send your traffic." It certainly beats QSP.

Desirable Features in an Amplifier

There are a number of nice HF linear amplifiers available today, both in kit form and fully built, and they range in price from a low of \$600 to a high of better than \$4000.

I was looking for an amp that had a respectable output, not necessarily the legal limit; would cover all bands including WARC; was well-constructed; used a tried and true relatively inexpensive tube or tubes; had a relatively small footprint; had a provision for QSK (full break-in) that would work on



Photo A. The front panel of the AL-80A, showing controls, illuminated multimeter, and grid meter.



Photo B. Rear panel, showing the SO-239 connectors, phono plug connectors for RELAY, ALC OUT, and 12 VOLTS. Also visible are the ALC adjustment pot and dual fuses on the AC line.

AMTOR; used a time-proven design; and lastly, would not cost me the proverbial arm and a leg.

The more I looked, the better I liked what I saw in the Ameritron AL-80A. It met all my criteria, and then some. Although the AL-80A is not a QSK machine in its basic form, Ameritron makes a Pin 5 board you can add in the field. It switches fast enough for AMTOR. It all looked good, so I counted out a bit of the coin of the realm, and bought one. It was a good choice!

AL-80A Specifications

The AL-80A is the second step up, power-wise, in the Ameritron series of amps. The smallest one, the AL-84, is a 400 Watt CW, 600 Watt PEP SSB unit.

The AL-80A is a nicely designed amplifier, using a tried and true single 3-500Z high mu triode, running in class AB2 grounded grid. The 3-500Z is not a cheap tube, but on the other hand, if you ever have to replace one, it will not break the bank. Ameritron claims an RF output of 1000 Watts PEP SSB and 850 Watts CW. My experience with the amp showed that both output figures were easily reached, with Bird and Heath wattmeters to tell the story. I run a lot of RTTY, with key down for 5 to 10 minutes at a time. I found that if I kept the output to about 500 Watts in this mode, the amplifier showed no signs of overheating.

The claimed driving power is typically 85 Watts. Both my rigs (with outputs of about 100 Watts) drove the AL-80A to full power on all bands.

You can configure the amp for 120 or 240 volts AC by using jumpers on a terminal strip. An optional multi-voltage transformer is available, allowing for oddball voltages, such as 110, 115, 230, or 235. The filament supply has inrush current limiting to insure maximum tube life. A very efficient, quiet cooling system keeps the tube cool even during continuous operation.

The amp is shipped with the tube in a separate container, as it should be. In opening things up to insert the tube and

to check for the proper voltage setting, I was impressed again with the good construction, steel chassis, clean layout, and the obvious high quality of the parts. Everything is well-shielded and bypassed to help with RFI and TVI problems. The power transformer, with a core of hypersil steel laminations, weighs about 22 pounds. The complete unit weighs about 50 pounds, with shipping weight a few more pounds. Its footprint is 8¾ inches high, 14¾ inches wide, and 15 inches deep.

Frequency coverage is 160 through 10,

AMERITRON

SYMBOL OF ENGINEERING INTEGRITY. . .QUALITY
WORKMANSHIP. . .RELIABLE LONG-LIFE PERFORMANCE

AL-80A LINEAR AMPLIFIER

The AL-80A will provide a signal output that is within 1/2 "S" unit of the signal output of the most expensive amplifier on the market—and at much lower cost.

The Ameritron AL-80A combines the economical 3-500Z with a heavy duty tank circuit to achieve nearly 70% efficiency from 160 to 15 meters. It has wide frequency coverage for MARS and other authorized services. Typical drive is 85 watts to give over 1000 watts PEP SSB and 850 watts CW RF output. A new Pi-L output circuit for 80 and 160 gives full band coverage and exceptionally smooth tuning.

Size: 15 1/2"D. x 14"W. x 8"H. Wgt. 52 lbs.



AL-1200 LINEAR AMPLIFIER 3CX1200 TUBE

Full legal output with 100 watts drive.

AL-1500 LINEAR AMPLIFIER 8877 TUBE

Full legal output with 65 watts drive.

The cooling system in both amplifiers keeps the tube safely below the manufacturers ratings even when operating at 1500 watts output with a steady carrier. The filament supply has inrush current limiting to insure maximum tube life.

Size: 18 1/2"D. x 17"W. x 10"H. Wgt. 77 lbs.



AL-84 LINEAR AMPLIFIER

The Ameritron AL-84 is an economical amplifier using four 6MJ6 tubes to develop 400 watts output on CW and 600 watts PEP on SSB from 160 through 15 meters. Drive required is 70 w typical, 100 w max. The passive input network presents a low SWR input to the exciter. Power input is 900 watts. The AL-84 is an excellent back-up, portable or beginner's amplifier.

Size: 11 1/2"W. x 6"H. x 12 1/2"D. Wgt. 24 lbs.

ATR-15 TUNER

The Ameritron ATR-15 is a 1500 watt "T" network tuner that covers 1.8 through 30 MHz in 10 dedicated bands. Handles full legal power on all amateur bands above 1.8 MHz.

Five outputs are selected from a heavy duty antenna switch allowing the rapid choice of three coaxial lines, one single terminal feed or a balanced output. An internal balun provides 1:1 or 4:1 ratios (user selectable) on the balanced output terminals.

A peak reading wattmeter and SWR bridge is standard in the ATR-15. It accurately reads envelope powers up to 2KW.

Size: 6"H. x 13 1/4"W. x 16"D. Wgt. 14 lbs.



RCS-4 FOR CONVENIENT INSTALLATION

No control cable required.
Selects one of four antennas.
VSWR: under 1.1 to 1 from 1.8 to 30 MHz.
Impedance: 50 ohms.
Power capability: 1500 watts average, 2500 watts PEP maximum.

Remote COAX Switches

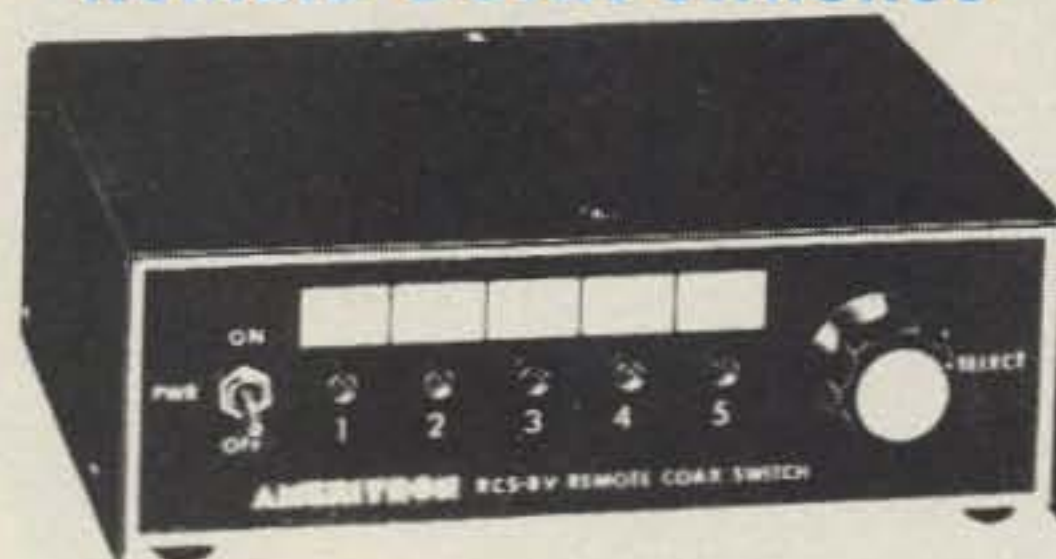

RCS-8V FOR SPECIAL APPLICATIONS

Selects up to five antennas.
Loss at 150 MHz: less than .1 dB.
VSWR: under 1.2 to 1 DC to 250 MHz.
Impedance: 50 ohms.
Power capability: 5 kW below 30 MHz, 1 kW at 150 MHz.

Available at your dealer. Send for a catalog of the complete AMERITRON line.

AMERITRON

2375 Dorr Street • Toledo, OH 43607

For more information: (601) 323-9715 • Technical inquiries: (419) 531-3024

including the WARC bands and most MARS frequencies. To enable the 10 and 12 meter bands, you have to make a very simple modification. All the parts are there; you just have to enable them. To obtain the information, write a note to the factory with a copy of your license, or talk to someone else who owns one.

The tuned input circuit (a necessity with most solid state exciters) is an adjustable Pi-network, and the output circuit is a Pi-L network, with harmonic suppression.

The claimed efficiency on CW/SSB is better than 66%. Spot checks on CW gave me between 67% and 70%.

Front Panel

The AL-80A has two illuminated meters, the left-hand meter being a multimeter which shows high voltage, plate current, RF output and ALC voltage, depending upon the switch position. The right-hand meter is only for grid current, and allows you to monitor this important parameter continuously.

Two rocker switches control POWER/OFF and OPERATE/STANDBY. In the standby position, the amp is out of line, and the exciter is operating straight through. Incidentally, the 3-500Z tube is an "instant heating" type, so there is no long wait for the tube to come up to operating temperature. (I hate to do that to a tube, though!)

The band switch has 160, 80, 40, 20, and 15 meter positions. The unmarked position to the right of 15 is the 10 meter position. It will work if you have enabled the 10 meter band, as discussed previously. Go to the nearest listed band on the band switch to reach the WARC bands.

Both the LOAD and PLATE controls have reduction gears, and provide very smooth tuning. There is a small red pilot light to indicate when the unit is in transmit. The controls are nicely laid out and easy to operate, even with my fat fingers and big hands.

Rear Panel

On the rear panel, towards the top, are two SO-239 connectors for the RF in and RF out. The remaining connectors are phono jacks. The next one down is for the relay, and goes to a normally open contact in your exciter. Unlike some of the older amplifiers with 100 volts DC, this amp only uses 12 volts at 100 mA to switch to transmit. All solid state rigs that I know of will handle that voltage nicely.

Next is the ALC jack, to supply ALC voltage back to the exciter. Below that is the ALC pot for controlling the ALC voltage. Below that, and at the bottom, is yet another jack that supplies 12 volts DC at 100 mA for any use you may have. There is a good heavy lug with a wing nut for the earth ground, and of course two fuses and the AC line cord.

Hookup and Operation

To configure the jumper block for

either voltage setting, you need to take the case off. While the case is off, place the tube in its socket. There is an interlock switch for protection from high voltage if the cover is off and the amp gets plugged in and turned on. Voltages in there are high enough to be FATAL—don't bypass the interlock!

"I was able to use the WARC bands with just about full power by using the closest 'old' band position."

Be sure to have a good earth ground. Also, install a good heavy wire or braid connection between the exciter, the antenna tuner (if you use one), and the amplifier. I hooked up everything with 1/2-inch copper braid, and kept the ALC lead and the relay lead as short as possible. I used shielded wire, as the instruction book suggested, for the two leads.

The instruction book gives you a very brief outline of tune-up procedures. Tune up for the

80A is typical—you start with low drive and keep adjusting the plate and load controls for resonance at the operating frequency as you increase the drive. Keep the grid meter below 200 mA during operation. I made some notes as I went along, and marked the plate dial to make it easier to relocate the spot again. I tuned the unit up into a dummy antenna first before putting it on the air. With the availability of inexpensive dummy antennas, there is absolutely no need to do any of your preliminary testing on the air.

In order to get full output I needed to adjust the ALC pot on the rear of the amplifier. I used my station monitor, which happens to be one of the Heath SB series, to look at the RF envelope and to check for clipping as I set the ALC control. The instruction manual does not give you much information on this procedure, but most of the recent amateur handbooks have a detailed section on amplifier tune-up. After I finished the preliminary tests on the dummy load, I tried a couple of critical on the air checks, with a few of my hypercritical friends. All the reports were gratifying! I suspect most of the 100 Watt exciters probably will not give you much problem with clipping when used to drive the AL-80A, assuming everything is correctly tuned.

The band switch only covers the six "old" bands. I was able to use the WARC bands with just about full power by using the closest "old" band position. For example, the 12 meter band will work in the 10 meter position, and the 17 meter band will work in the 15 meter position.

Final Comments

I wish the instruction manual were more detailed. The basics are all there, with parts list and schematics, but there could be more detail in, for example, the tuning procedures and ALC adjustment. Perhaps I am just spoiled with the Heath type manual! And speaking of Heath, their SB-1000 HF linear amplifier, available in kit form, looks suspiciously like the AL-80A! Who knows?

One other minor problem was the position on the multimeter. It is supposed to show peak power out in Watts. Like many built-in power meters, it only shows a rough approximation of power which does not correlate well with an external meter known to be accurate. As long as the reading is not taken as gospel, you can use it as a relative indicator.

Having used the amp for several months now, I can report that it performs very well, with very nice reports. There has been no hint of instability even when the SWR was a bit higher than it should have been. It is quiet, reliable, and easy to tune. I obtained a Pin 5 QSK board for the unit, which I will try it out for a few months before reporting on it. All in all, the AL-80A was just what I was looking for, and I am certainly pleased with it. **73**

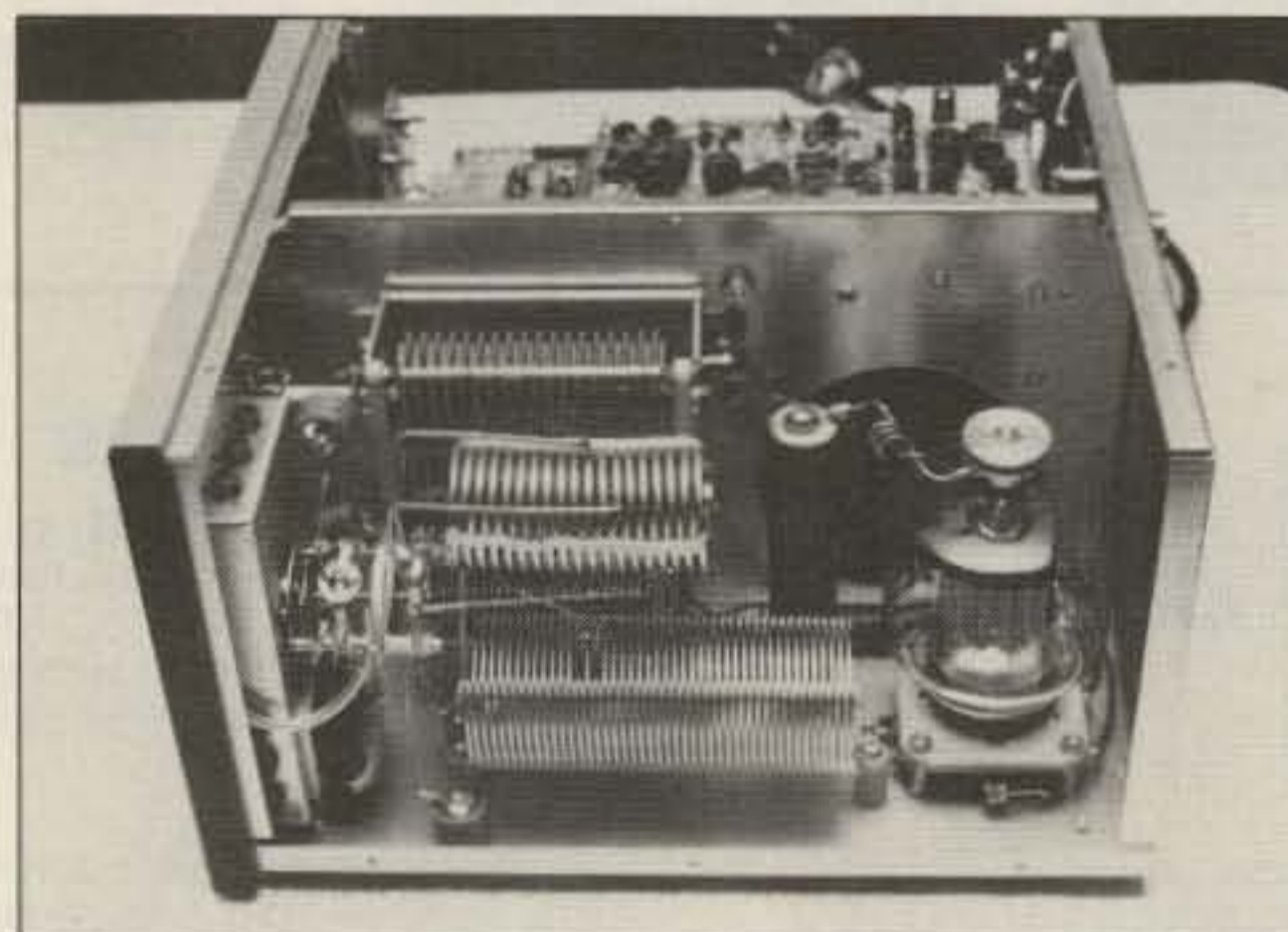

Photo C. The RF compartment, showing the Pi-L Network, the 3-500Z with fan just behind it, and the tuned input circuit which is just behind the front panel. The layout is clean.

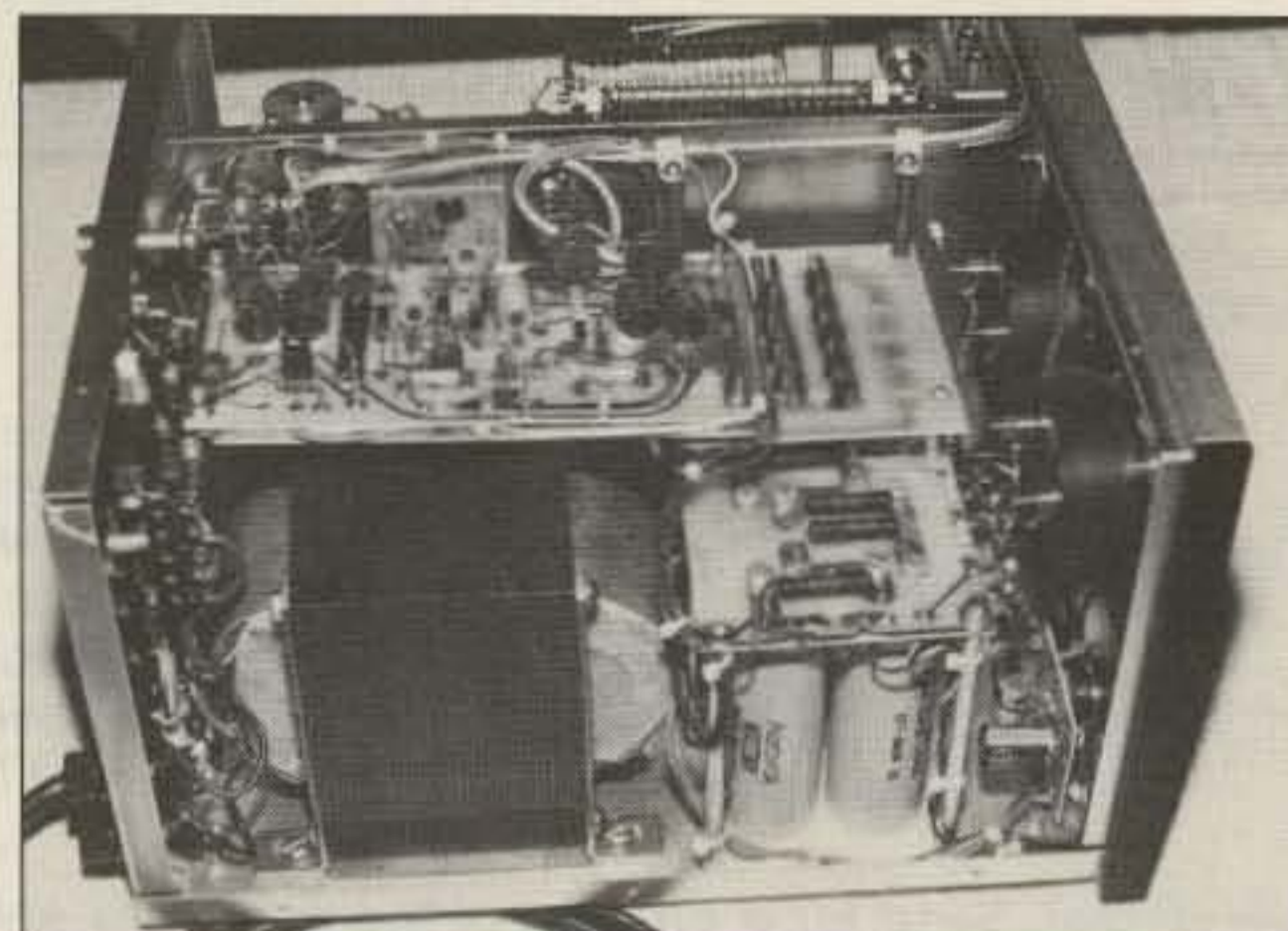

Photo D. The power supply compartment. Note the hypersil transformer, filter caps, and diodes. The horizontal circuit board above the transformer is the optional Pin 5 QSK board.

73 Review by Ed Clegg W3LOY

Uno, Dos, Cuatro

Introduction to the Numbers Stations

Tiare Publishing
Lake Geneva, WI 53147, (414) 248-4845
Price Class: \$15

Has there ever been a ham who didn't experience a surge of excitement upon hearing a mysterious signal that sounded like a clandestine message? Don't we all have a little "Mission Impossible" or "007" in our blood?

With the advent of ham transceivers that include continuous receiving coverage from VLF to 30 MHz, some of us have become shortwave listeners as a hobby within our hobby. More hams are into SWLing than will admit it.

Shrouded in Mystery

According to the Publisher's note, "Uno, Dos, Cuatro" was written by an ex-member of the intelligence community. Though the book offers only obscure info on him, the Preface states that "Havana Moon" has appeared in print elsewhere for several years. The note that he was quoted frequently in the Newark (NJ) news Radio Club testifies to his tenure since that periodical ceased to exist quite a few years ago.

Real Page-Turner

My curiosity was instantly piqued; midway

through the first chapter I started tuning my TS-930 to frequencies where it had never been to before looking and listening for signals of the nature described by Señor Moon.

What is the nature of Moon's mysterious signals? Simply, groups of four or five digit numbers transmitted in a well-organized manner, and in various languages. He reports that many are delivered in English spoken with various alien accents, while some are in Spanish spoken with English or German accents. The author does not hint to the location of these signal sources in most cases, but there are notable exceptions, including within the US. Such US QTHs include Vent Hill, Virginia, a publicly known monitoring post for the government, and Tequesta, Florida, a unique government outpost which includes a LORAN station and missile tracking system. Moon also suggests that some numbers stations have questionable allegiance to the US, alluding to such transmissions from Cuba. Don't count on those transmissions coming from Guantanamo Bay!

The subject matter was so fascinating that I could endure the disorganized presentation. Some chap-

ters consist principally of lists of frequencies where one has a good chance of hearing these mysterious transmissions. In later chapters, however, Moon tells us that previously listed frequencies may not be currently active. There is little or no indication in the text that some of the "high probability of intercept frequencies" are daytime or nighttime predictions, except for the one I experienced and was able to confirm on two separate instances! In this case, the author accurately forecasted not only the day of the week and the time of the day, but also the apparent source in Florida. I discovered that the time, frequency, and apparent source were all accurate! That experience alone was enough to justify the purchase and get me hooked.

The book is a paperback in large sheet format with 90 pages including about a dozen pages that were either afterthoughts or later edition supplements. These include a listing of other related publications by the publisher and excerpts from *Monitoring Times* as well as *Popular Communications*.

Fire Up The SW Receiver

Give a listen sometime to 11,565 kHz at 2000Z on Saturdays, and you may well be in for a pleasant surprise. Now I'm in the market for a multi-frequency, multi-channel, long-long-long playing tape recorder so that I don't miss out on any of these mysterious signals.

This book has certainly whetted my appetite. I look forward to seeing a guide to possible meanings of these codes! Anyone interested in forming a numbers stations monitoring net? **73**

ASSOCIATED RADIO

8012 CONSER BOX 4327
OVERLAND PARK, KANSAS 66204

EVERY DAY A HAMFEST
BUY—SELL—TRADE
ALL BRANDS NEW AND RECONDITIONED



WE'LL BUY YOUR EXTRA RIG

STATIONS-ESTATES ETC. Call 913/381-5900 FAX 913 648 3020

SEND \$2 FOR CATALOG AND WHOLESALE LIST

73 Reviewby *Larry R. Antonuk WB9RRT*

Ramsey COM-3

The most features for the money in communications service monitors.

Ramsey Electronics, Inc.
2575 Baird Road
Penfield, NY 14526
Tel: (716) 586-3950
Price Class: \$2500

“I just bought a \$2500 service monitor!” Drop that statement into polite ham conversation, and you’re guaranteed one of two responses:

- A. “Wow!”
B. “What’s a service monitor??”

From Many Boxes to One

First, the answer to “B.” A communications service monitor is a tool used by anyone in the two-way radio business, or anywhere that precise measurement of radio parameters is needed. In the days before synthesizers, phase-locked loops, and memory scan, back when they even used tubes, technicians needed to carry several pieces of equipment.

First, he needed a wattmeter for indicating forward and reflected power. Next, he needed a frequency meter to give him an idea of whether or not this power was on the correct frequency. Once he was assured of that, he could pull out his modulation meter to check his transmitter’s deviation. If the deviation is within the specifications, he loads all of the equipment into the van and hauls out the signal generator to measure the receiver’s sensitivity. He could then modulate the signal generator with an audio tone generator to check the audio circuits. A CTCSS generator would let him check the private line (PL) operation. All in all, a well-equipped technician could easily have half a dozen boxes with him at all times. Imagine having to hike up a mountain while trying to decide which equipment to haul along!

A few years back, technology advanced to the point where it became feasible to roll all of these pieces of equipment into one box. These units were called system analyzers, communications monitors, etc., but the term “service monitor,” or simply “monitor,” stuck. Today’s service monitors combine all of the above features, with the more advanced units performing spectrum analysis, tone decoding, and many specialized functions. The only problem with service monitors is the price.

Obviously, a unit that can take the place of six pieces of test equipment has to cost seven times as much as the most expensive piece! Indeed, the price of the average service monitor is around eight thousand dollars, with some deluxe models clearing the twenty thousand mark.

Now microprocessor technology has developed to the point where Ramsey Electronics



The Ramsey COM-3 Service Monitor packs a lot of tools into a single unit.

can offer a full-featured communications service monitor for \$2495. The Ramsey COM-3 measures frequency, modulation, and receiver sensitivity—all the normal service monitor functions. In addition, the unit offers several features not found on units costing three times as much: a ten channel memory, repeater offset buttons, audio frequency counter, RF frequency counter, CTCSS tone generator, and built-in battery pack.

Now for the Wow

The COM-3 package measured 12" x 5.5" x 14" and weighed a mere 13 pounds. The controls on the front panel are the on-off/volume, squelch, and RF level controls. You access all other operating functions, such as generator attenuation, in addition to basic numeric input, with the membrane keypad, which covers the entire face of the unit.

As far as basic service monitor functions, the COM-3 has the same capabilities most monitors have. You can generate or monitor frequencies from 100 kHz to 999.9999 MHz. The generator has a range of 0.1 μ V to 10,000 μ V, and can be modulated by an internal test tone or CTCSS tone.

The unit measures modulation in two ranges, 1.5 and 7.0 kHz, on a 20-segment LED bargraph. In addition to these functions, however, the COM-3 performs quite a few tricks of its own.

Once you get used to the keypad frequency entry system, you’ll want to store often-used frequencies in one of the ten memory positions. Rather than simply storing frequencies, these positions store complete operating modes. For instance, memory one could generate 147.375, modulated with 1 kHz tone and 123.0 Hz PL tone. Hit memory two, and you’re monitoring 448.600 MHz, AM mode, counting PL tone. All at the push of two buttons. If you

don’t know the frequency, simply use the built-in frequency counter. Once you count the frequency, put that freq in the monitor and enter the Audio Freq Count mode to decode any CTCSS tones.

Service techs will especially appreciate the programmable plus or minus offset buttons, and an up/down 5 kHz at-a-time function. The first feature makes it easy to switch back and forth between a transmit frequency and the associated receiver frequency of a repeater pair, and the second feature acts like a VFO, letting the operator “tune around” to check the bandpass of a receiver, etc.

The COM-3 cannot measure RF power, but it can protect itself from it. Once the unit senses input power of more than 500 mW, it switches the input to a BNC connector on the back panel. (You previously attached a dummy load to this port, of course, anticipating that you were going to goof and key a radio into your brand new monitor.)

Drawbacks

The COM-3 has very little in the way of RF shielding. Once the cover is removed from the unit, the large main board sits relatively unprotected on the bottom of the case. It doesn’t have the heavy shielding, bypassing, and fingerstock seen on some monitors. While this might present a problem at a commercial broadcast station or a crowded repeater site, most hams and radio technicians will find the RF immunity of the monitor more than adequate.

Speaking of broadcast stations, the FM monitor mode is designed only for 5 kHz systems—75 kHz commercial systems can’t be measured. One final point concerns the lack of an “image” switch to identify “birdies.” Like all monitors, the COM-3 produces birdies (as do all monitors), but we have no way to distinguish birdies and image frequencies from the real thing.

Conclusions

All in all, the Ramsey COM-3 is an exceptional instrument. Whether purchased for a two-way shop, ham club, or for a ham making the transition to a service business, the COM-3 represents a lot of equipment for the dollar. With the addition of the optional case (\$90) and the carrying handle/front cover (\$30), the unit becomes a go-anywhere service tool. There’s really only one word for it: “Wow!” 

Uniden®

\$12,000,000 Scanner Sale

Uniden Corporation of America has purchased the consumer products line of Regency Electronics Inc. for \$12,000,000. To celebrate this purchase, we're having our largest scanner sale in history! Use the coupon in this ad for big savings. Hurry...offer ends September 30, 1989.

★★★ MONEY SAVING COUPON ★★★

Get special savings on the scanners listed in this coupon. This coupon must be included with your prepaid order. Credit cards, personal checks and quantity discounts are excluded from this offer. Offer valid only on prepaid orders mailed directly to Communications Electronics Inc., P.O. Box 1045 - Dept. UNI6, Ann Arbor, Michigan 48106-1045 U.S.A. Coupon expires September 30, 1989. Coupon may not be used in conjunction with any other offer from CEI. Coupon may be photocopied. Add \$11.00 for shipping in the continental U.S.A.

COUPON

COUPON

COUPON

COUPON

Regency TS2-T \$259.95
 Regency INF5-T \$79.95
 Regency R2060-T1 \$114.95
 Regency UC102-T \$109.95
 Regency RH606B-T \$419.95
 Regency RH256B-T \$294.95
 Bearcat 200XLT-T \$249.95
 Bearcat 100XLT-T \$184.95
 Bearcat 800XLT-T \$249.95
 Uniden HR2510-T \$229.95
 Uniden PRO500D-T1 \$32.95

★★★★ VALUABLE COUPON ★★★★★

Bearcat® 760XLT-T

List price \$499.95/CE price \$244.95/SPECIAL 12-Band, 100 Channel • Crystalless • AC/DC Frequency range: 29-54, 118-174, 406-512, 806-956 MHz. Excludes 823.9875-849.0125 and 868.9875-894.0125 MHz. The Bearcat 760XLT has 100 programmable channels organized as five channel banks for easy use, and 12 bands of coverage including the 800 MHz. band. The Bearcat 760XLT mounts neatly under the dash and connects directly to fuse block or battery. The unit also has an AC adaptor, flip down stand and telescopic antenna for desk top use. 6-5/16" W x 1 1/2" H x 7 3/4" D. Model BC 590XLT-T is a similar version without the 800 MHz. band for only \$194.95. Order your scanner from CEI today.

NEW! Regency® Products

R4030-T Regency 200 ch. handheld scanner \$254.95
 R4020-T Regency 100 ch. handheld scanner \$189.95
 R4010-T Regency 10 channel handheld scanner \$114.95
 R1600-T Regency 100 channel mobile scanner \$244.95
 P200-T Regency 40 channel CB Mobile \$38.95
 P210-T Regency 40 channel CB Mobile \$56.95
 P220-T Regency 40 channel CB Mobile \$79.95
 P300-T Regency 40 channel SSB CB Mobile \$137.95
 P400-T Regency 40 channel SSB CB Base \$174.95
 PR100-T Regency visor mount radar detector \$54.95
 PR110-T Regency "Passport" size radar detector \$114.95
 PR120-T Regency "micro" size radar detector \$144.95
 MP5100XL-T Regency 40 Ch. marine transceiver \$139.95
 MP5510XL-T Regency 60 Ch. marine transceiver \$159.95
 MP6000XL-T Regency 60 Ch. marine transceiver \$209.95
 MP2000XL-T Regency handheld marine trans. \$189.95

Regency® RH256B-T

List price \$799.95/CE price \$299.95/SPECIAL 16 Channel • 25 Watt Transceiver • Priority The Regency RH256B is a sixteen-channel VHF land mobile transceiver designed to cover any frequency between 150 to 162 MHz. Since this radio is synthesized, no expensive crystals are needed to store up to 16 frequencies without battery backup. All radios come with CTCSS tone and scanning capabilities. A monitor and night/day switch is also standard. This transceiver even has a priority function. The RH256 makes an ideal radio for any police or fire department volunteer because of its low cost and high performance. A 60 Watt VHF 150-162 MHz. version called the RH606B-T is available for \$429.95. A UHF 15 watt, 16 channel version of this radio called the RU156B-T is also available and covers 450-482 MHz. but the cost is \$454.95.

★★★ Uniden CB Radios ★★★

The Uniden line of Citizens Band Radio transceivers is styled to compliment other mobile audio equipment. Uniden CB radios are so reliable that they have a two year limited warranty. From the feature packed PRO 810E to the 310E handheld, there is no better Citizens Band radio on the market today.

PRO310E-T Uniden 40 Ch. Portable/Mobile CB... \$83.95
 PRO330E-T Uniden 40 Ch. Remote mount CB... \$104.95
 PRO500D-T Uniden 40 Channel CB Mobile \$38.95
 KARATE-T Uniden 40 channel rescue radio \$53.95
 GRANT-T Uniden 40 channel SSB CB mobile \$166.95
 MADISON-T Uniden 40 channel SSB CB base \$244.95
 PC122-T Uniden 40 channel SSB CB mobile \$119.95
 PRO510XL-T Uniden 40 channel CB Mobile \$38.95
 PRO520XL-T Uniden 40 channel CB Mobile \$56.95
 PRO530XL-T Uniden 40 channel CB Mobile \$79.95
 PRO540E-T Uniden 40 channel CB Mobile \$97.95
 PRO640E-T Uniden 40 channel SSB CB Mobile \$137.95
 PRO710E-T Uniden 40 channel CB Base \$119.95
 PRO810E-T Uniden 40 channel SSB CB Base \$174.95

★★★ Uniden Radar Detectors ★★★

Buy the finest Uniden radar detectors from CEI today. TALKER-T Uniden talking radar detector \$184.95
 RD7-T Uniden visor mount radar detector \$99.95
 RD9-T Uniden "Passport" size radar detector \$114.95
 RD9XL-T Uniden "micro" size radar detector \$144.95
 RD25-T Uniden visor mount radar detector \$54.95
 RD500-T Uniden visor mount radar detector \$74.95

Bearcat® 200XLT-T

List price \$509.95/CE price \$254.95/SPECIAL 12-Band, 200 Channel • 800 MHz. Handheld Search • Limit • Hold • Priority • Lockout Frequency range: 29-54, 118-174, 406-512, 806-956 MHz. Excludes 823.9875-849.0125 and 868.9875-894.0125 MHz. The Bearcat 200XLT sets a new standard for handheld scanners in performance and dependability. This full featured unit has 200 programmable channels with 10 scanning banks and 12 band coverage. If you want a very similar model without the 800 MHz. band and 100 channels, order the BC 100XLT-T for only \$189.95. Includes antenna, carrying case with belt loop, ni-cad battery pack, AC adapter and earphone. Order your scanner now.

Bearcat® 800XLT-T

List price \$549.95/CE price \$259.95/SPECIAL 12-Band, 40 Channel • No-crystal scanner Priority control • Search/Scan • AC/DC Bands: 29-54, 118-174, 406-512, 806-912 MHz. The Uniden 800XLT receives 40 channels in two banks. Scans 15 channels per second. Size 9 1/4" x 4 1/2" x 1 1/2". If you do not need the 800 MHz. band, a similar model called the BC 210XLT-T is available for \$178.95.

Bearcat® 145XL-T

List price \$189.95/CE price \$94.95/SPECIAL 10-Band, 16 Channel • No-crystal scanner Priority control • Weather search • AC/DC Bands: 29-54, 136-174, 406-512 MHz. The Bearcat 145XL is a 16 channel, programmable scanner covering ten frequency bands. The unit features a built-in delay function that adds a three second delay on all channels to prevent missed transmissions. A mobile version called the BC560XLT-T featuring priority, weather search, channel lockout and more is available for \$94.95. CEI's package price includes mobile mounting bracket and mobile power cord.

President® HR2510-T

List price \$499.95/CE price \$239.95/SPECIAL 10 Meter Mobile Transceiver • Digital VFO Full Band Coverage • All-Mode Operation Backlit liquid crystal display • Auto Squelch RIT • Preprogrammed 10 KHz. Channels Frequency Coverage: 28.0000 MHz. to 29.6999 MHz. The President HR2510 Mobile 10 Meter Transceiver made by Uniden, has everything you need for amateur radio communications. Up to 25 Watt PEP USB/LSB and 25 Watt CW mode. Noise Blanker. PA mode. Digital VFO. Built-in S/RF/MOD/SWR meter. Channel switch on the microphone, and much more! The HR2510 lets you operate AM, FM, USB, LSB or CW. The digitally synthesized frequency control gives you maximum stability and you may choose either pre-programmed 10 KHz. channel steps, or use the built-in VFO for steps down to 100 Hz. There's also RIT (Receiver Incremental Tuning) to give you perfectly tuned signals. With receive scanning, you can scan 50 channels in any one of four band segments to find out where the action is. Order your HR2510 from CEI today.

NEW! President® HR2600-T

List price \$599.95/CE price \$299.95/SPECIAL 10 Meter Mobile Transceiver • New Features Delivery for this new product is scheduled for June, 1989. The new President HR2600 Mobile 10 Meter Transceiver is similar to the Uniden HR2510 but now has repeater offsets (100 KHz.) and CTCSS encode.



BC760XLT
800 MHz.
mobile scanner
SPECIAL!

★★★ Facsimile Machines & Phones ★★★

FAX3300-T Pactel Fax machine with phone \$1,099.95
 XE750-T Uniden Cordless Phone with speaker \$99.95
 XE550-T Uniden Cordless Phone \$79.95
 XE300-T Uniden Cordless Phone \$69.95

★★★ Extended Service Contract ★★★

If you purchase a scanner, CB, radar detector or cordless phone from any store in the U.S. or Canada within the last 30 days, you can get up to three years of extended service contract from Warrantech. This service extension plan begins after the manufacturer's warranty expires. Warrantech will perform all necessary labor and will not charge for return shipping. Extended service contracts are not refundable and apply only to the original purchaser. A two year extended contract on a mobile or base scanner is \$29.99 and three years is \$39.99. For handheld scanners, 2 years is \$59.99 and 3 years is \$79.99. For radar detectors, two years is \$29.99. For CB radios, 2 years is \$39.99. For cordless phones, 3 years is \$34.99. Order your extended service contract today.

OTHER RADIOS AND ACCESSORIES

BC55XLT-T Bearcat 10 channel scanner \$114.95
 BC70XLT-T Bearcat 20 channel scanner \$159.95
 BC175XLT-T Bearcat 16 channel scanner \$156.95
 R2060-T Regency 60 channel scanner \$149.95
 TS2-T Regency 75 channel scanner \$269.95
 UC102-T Regency VHF 2 ch. 1 Watt transceiver \$114.95
 BPS5-T Regency 16 amp reg. power supply \$179.95
 BP205-T Ni-Cad batt. pack for BC200/BC100XLT \$49.95
 B8-T 1.2 V AA Ni-Cad batteries (set of eight) \$17.95
 FBE-T Frequency Directory for Eastern U.S.A. \$14.95
 FBW-T Frequency Directory for Western U.S.A. \$14.95
 RFD1-T Great Lakes Frequency Directory \$14.95
 RFD2-T New England Frequency Directory \$14.95
 RFD3-T Mid Atlantic Frequency Directory \$14.95
 RFD4-T Southeast Frequency Directory \$14.95
 RFD5-T N.W. & Northern Plains Frequency Dir. \$14.95
 ASD-T Airplane Scanner Directory \$14.95
 SRF-T Survival Radio Frequency Directory \$14.95
 TSG-T "Top Secret" Registry of U.S. Govt. Freq. \$14.95
 TTC-T Tune in on telephone calls \$14.95
 CBH-T Big CB Handbook/AM/FM/Freeband \$14.95
 TIC-T Techniques for Intercepting Communications ... \$14.95
 RRF-T Railroad frequency directory \$14.95
 EEC-T Embassy & Espionage Communications \$14.95
 CIE-T Covert Intelligence, Elect. Eavesdropping ... \$14.95
 MFF-T Midwest Federal Frequency directory \$14.95
 A60-T Magnet mount mobile scanner antenna \$35.95
 A70-T Base station scanner antenna \$35.95
 A1300-T 25 MHz.-1.3 GHz Discone antenna \$109.95
 USAMM-T Mag mount VHF ant. w/ 12' cable \$39.95
 USAK-T 3/4" hole mount VHF ant. w/ 17' cable \$35.95
 Add \$4.00 shipping for all accessories ordered at the same time. Add \$11.00 shipping per radio and \$4.00 per antenna.

BUY WITH CONFIDENCE

To get the fastest delivery from CEI of any scanner, send or phone your order directly to our Scanner Distribution Center. Michigan residents please add 4% sales tax or supply your tax I.D. number. Written purchase orders are accepted from approved government agencies and most well rated firms at a 10% surcharge for net 10 billing. All sales are subject to availability, acceptance and verification. All sales on accessories are final. Prices, terms and specifications are subject to change without notice. All prices are in U.S. dollars. Out of stock items will be placed on backorder automatically unless CEI is instructed differently. A \$5.00 additional handling fee will be charged for all orders with a merchandise total under \$50.00. Shipments are F.O.B. CEI warehouse in Ann Arbor, Michigan. No COD's. Most items listed have a manufacturer's warranty. Free copies of warranties on these products are available by writing to CEI. Non-certified checks require bank clearance. Not responsible for typographical errors.

Mail orders to: Communications Electronics, Box 1045, Ann Arbor, Michigan 48106 U.S.A. Add \$11.00 per scanner for U.P.S. ground shipping and handling in the continental U.S.A. For Canada, Puerto Rico, Hawaii, Alaska, or APO/FPO delivery, shipping charges are three times continental U.S. rates. If you have a Discover, Visa, American Express or Master Card, you may call and place a credit card order. 5% surcharge for billing to American Express. Order toll-free in the U.S. Dial 800-USA-SCAN. In Canada, dial 800-221-3475. FAX anytime, dial 313-971-6000. If you are outside the U.S. or in Michigan dial 313-973-8888. Order today. Scanner Distribution Center™ and CEI logos are trademarks of Communications Electronics Inc. Sale dates 3/8/89 - 9/30/89 AD #030889-T Copyright © 1989 Communications Electronics Inc.

For credit card orders call
1-800-USA-SCAN

COMMUNICATIONS ELECTRONICS INC.

Consumer Products Division
 P.O. Box 1045 □ Ann Arbor, Michigan 48106-1045 U.S.A.
 For orders call 313-973-8888 or FAX 313-971-6000

Control Your Rig from a PC

Simple interface for an IBM-PC or clone and many new synthesized HF rigs.

by William Waters N7IPY

Today's new, full-functioned solid-state radios have many powerful features that, with a little time and creativity, you can control from your computer keyboard. Many radios have a serial data computer interface, composed of hardware and software, that allows you to change functions, such as the VFOs, RIT, and memory channels from your keyboard.

Why would you want to do this? To save time and effort while setting and changing memory channel information. The Kenwood TS-440S, for example, has 100 memory channels, each holding the frequency and mode of operation. Adding or changing channel data is time-consuming; this program and interface makes it much less so.

The Hardware Interface

I discuss Kenwood radios here, but ICOM and Yaesu radios have similar interfacing capabilities.

On the back of the Kenwood TS-440S, R-5000, and TS-940S (added to the TS-711S/811S with the Kenwood interface kit), there

is a connector labeled ACC1. This is the serial I/O port of the radio. The signal level is 5 volt TTL (Transistor-Transistor Logic). This signal level is not acceptable for most computers, which require RS-232 voltage levels; i.e., +12, -12. Directly connecting the radio to the computer could damage the radio's control electronics. The first part of the hardware interface is the TTL to RS-232 level translator, with the proper interface cables and power supply voltages. See Figure 1.

The basic translator or interface consists of three ICs. One IC is a 1488 quad line driver that converts the TTL signal levels to RS-232 signal levels. The second IC, a 1489, converts the logic level in the opposite direction (from RS-232 to TTL). The third IC, a 74LS04 hex-inverter, inverts the radio's RXD and TXD signals. The interface electronics require three separate voltages: +5, +12, and -12, all at a very low current.

Kenwood radios have five interface signals on the 6-pin DIN connector, ACC1, for serial data communications. Figure 2 shows the signals and their pin numbers. Only TXD

(transmit data), RXD (receive data), and GND (ground) signals are needed to communicate to the computer, but it is a good idea to include the CTS and RTS lines in the interface design.

For the computer, I used an IBM clone

with a multi-function board that supports two RS-232 serial data ports. Both ports are brought out to the back of the computer via two standard DB-25 connectors called COM1 and COM2. By connecting (through the interface) the radio's TXD to the computer's RXD, and the computer's TXD to the radio's RXD, you achieve full communications between the radio and the computer.

A Few Chips for the Rig

For the Kenwood radios that support the serial interface, you need an accessory to enable this function. In the TS-440S and R-5000, you must install two ICs into the control unit: an 8251A (a UART, or Universal Asynchronous Receiver Transmitter), to convert serial data to parallel data and vice versa; and a CMOS CD4040 12-stage binary counter to support the UART. Refer to the Kenwood instruction manual for details on the installation of these two ICs.

This Kenwood accessory is called the "IC-10 Kit" for the TS-440S and R-5000. It contains the two ICs and the instruction manual with all the information on the commands. If you plan to buy a ready-made program, you do not need the IC-10 Kit. You won't need the kit's software manual, and you can buy the two ICs from many electronics parts mail order companies, for a fraction of the cost of the Kenwood kit. On the TS-940S/711S/811S, the interface kit consists of an additional circuit board, a new EPROM (Erasable Programmable Read-Only Memory), and instruction manual. You will find

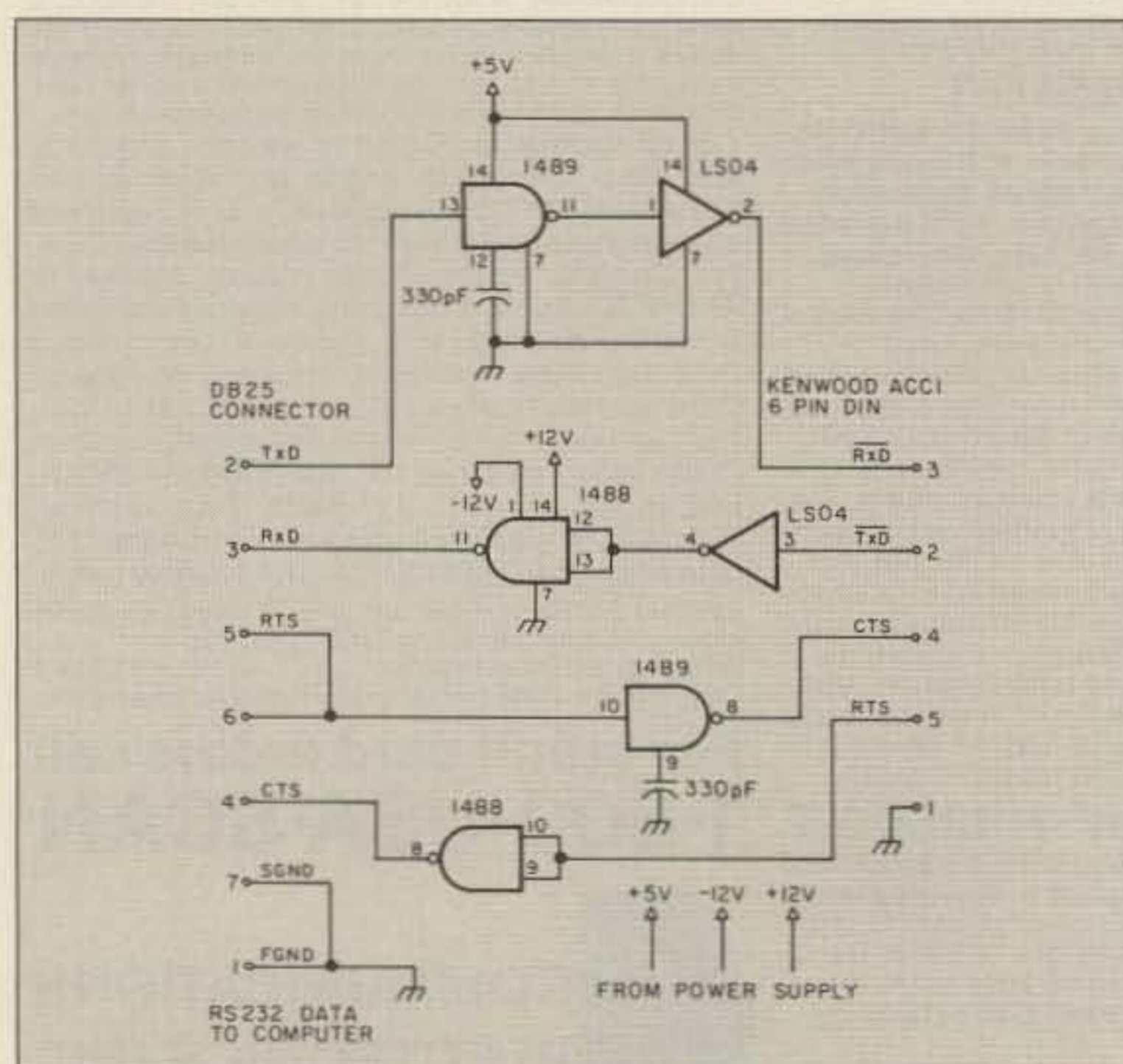

Figure 1. The computer RS-232 to Kenwood 5-volt TTL interface schematic.

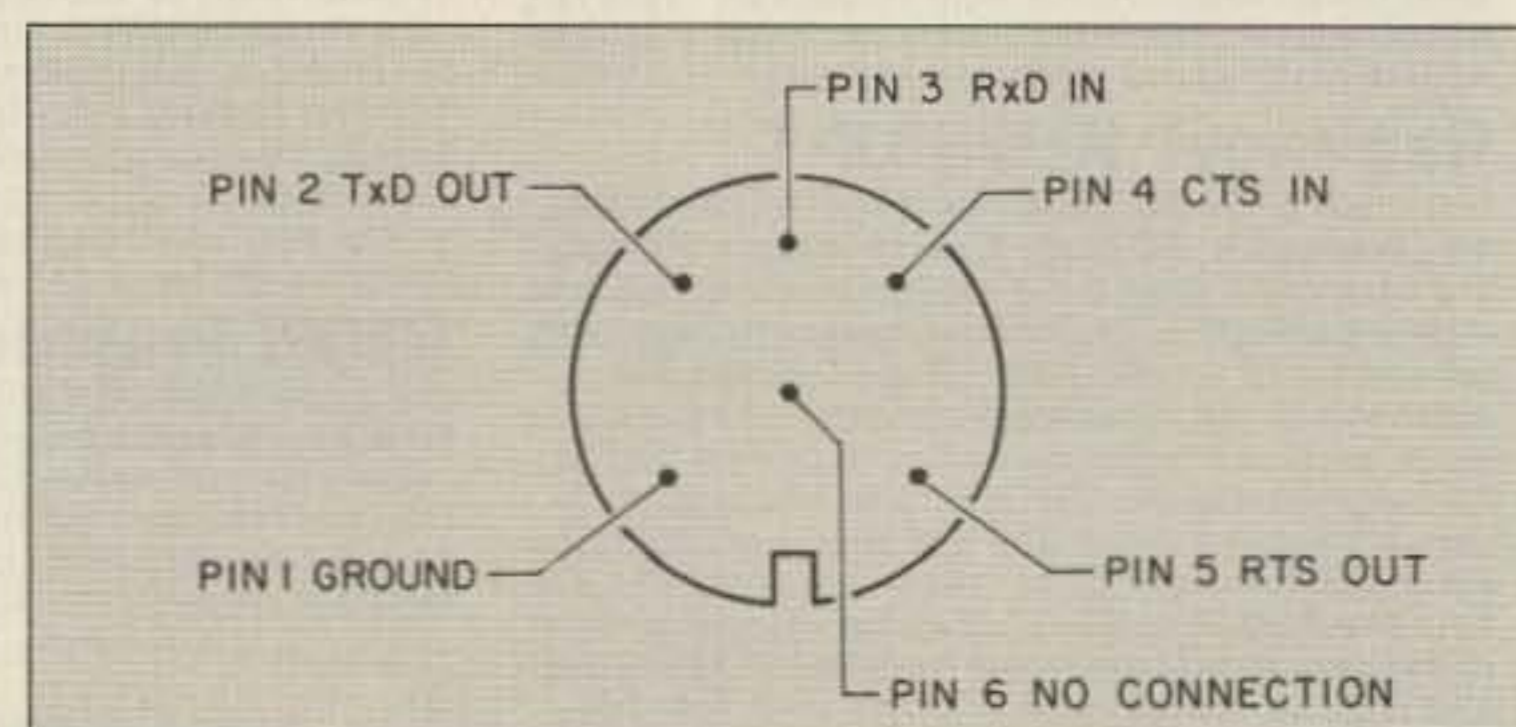

Figure 2. ACC1 DIN connector on the Kenwood rig.

HF Equipment Regular SALE
 IC-765 Xcvt/ps/keyer/auto tuner 3149.00 2789
 IC-781 Xcvt/Rcvt/ps/tuner/scope ... 6149.00 Call



IC-761 Xcvt/Rcvt/ps/tuner 2699.00 2369
 HM-36 Scanning hand microphone 47.00
 SP-20 Ext. speaker w/audio filter .. 149.00 139⁹⁵
 FL-101 250 Hz 1st IF CW filter 73.50
 FL-53A 250 Hz 2nd IF CW filter 115.00 109⁹⁵
 FL-102 6 kHz AM filter 59.00
 EX-310 Voice synthesizer..... 59.00



IC-751A 9-band xcvt/.1-30 MHz rcvt 1699.00 1469
 PS-35 Internal power supply 219.00 199⁹⁵
 FL-63A 250 Hz CW filter (1st IF).... 59.00
 FL-52A 500 Hz CW filter (2nd IF) ... 115.00 109⁹⁵
 FL-53A 250 Hz CW filter (2nd IF) ... 115.00 109⁹⁵
 FL-33 AM filter 49.00
 FL-70 2.8 kHz wide SSB filter 59.00
 RC-10 External frequency controller 49.00

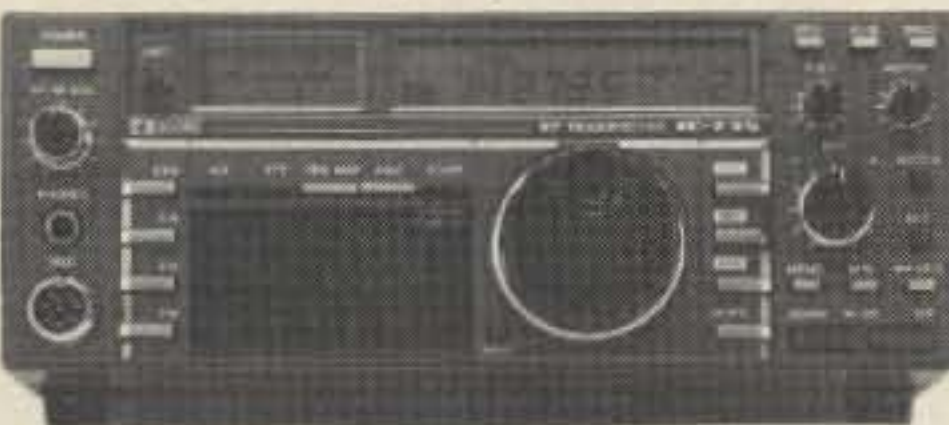

IC-735 HF transceiver/SW rcvt/mic 1149.00 989⁹⁵
 PS-55 External power supply 219.00 199⁹⁵
 AT-150 Automatic antenna tuner ... 445.00 369⁹⁵
 FL-32A 500 Hz CW filter 69.00
 EX-243 Electronic keyer unit 64.50
 UT-30 Tone encoder 18.50
 IC-725 Ultra compact HF xcvt/SW rcvt 949.00 849⁹⁵

Other Accessories Regular SALE
 IC-2KL 160-15m solid state amp w/ps 1999.00 1699
 EX-627 HF automatic antenna selector 315.00 279⁹⁵
 PS-15 20A external power supply 175.00 159⁹⁵
 PS-30 Systems p/s w/cord, 6-pin plug 349.00 319⁹⁵
 MB Mobile mount, 735/751A/761A... 25.99
 SP-3 External speaker 65.00
 SP-7 Small external speaker 51.99
 CR-64 High stab. ref. xtal for 751A... 79.00
 PP-1 Speaker/patch..... 179.00 164⁹⁵
 SM-6 Desk microphone 47.95
 SM-8 Desk mic - two cables, Scan.... 89.00
 SM-10 Compressor/graph EQ, 8 pin mic 149.00 139⁹⁵
 AT-100 100W 8-band auto. ant. tuner... 445.00 389⁹⁵
 AT-500 500W 9-band auto. ant. tuner... 589.00 519⁹⁵
 AH-2 8-band tuner w/mount & whip.... 758.00 689⁹⁵
 AH-2A Antenna tuner system, only 559.00 499⁹⁵
 GC-5 World clock..... 91.95 79⁹⁵

ICOM

★ Large Stocks
 ★ Fast Service
 ★ Top Trades
 at **AES**[®]

VHF/UHF base multi-modes Regular SALE
 IC-275A 25W 2m FM/SSB/CW w/ps 1299.00 1099
 IC-275H 100W 2m FM/SSB/CW 1399.00 1199
 IC-375A 25W 220 FM/SSB/CW (Close) 1399.00 799⁹⁵
 IC-475A 25W 440 FM/SSB/CW w/ps 1399.00 1199
 IC-475H 75W 440 FM/SSB/CW..... 1599.00 1369
 IC-575A 25W 6/10m xcvt w/ps 1399.00 1129
 IC-575H 100W 6/10m xcvt..... 1699.00 1499

VHF/UHF/1.2 GHz Mobiles Regular SALE
 IC-47A 25W 440 FM/TTP mic (Closeout) 549.00 369⁹⁵
 PS-45 Compact 8A power supply ... 145.00 134⁹⁵
 UT-16/EX-388 Voice synthesizer ... 34.99
 SP-10 Slim-line external speaker ... 35.99

IC-28A 25W 2m FM, TTP mic (Special) 469.00 379⁹⁵
 IC-28H 45W 2m FM, TTP mic 499.00 439⁹⁵
 IC-38A 25W 220 FM, TTP mic 489.00 349⁹⁵
 IC-48A 25W 440-450 FM, TTP mic.... 509.00 449⁹⁵
 HM-14 Extra TTP microphone 59.00
 UT-28 Digital code squelch 39.50
 UT-29 Tone squelch decoder 46.00
 HM-16 Speaker/microphone 34.00

IC-228A 25W 2m FM/TTP mic (Special) 509.00 429⁹⁵
 IC-228H 45W 2m FM/TTP scan mic... 539.00 479⁹⁵
 IC-448A 25W 440 FM/TTP mic 509.00 449⁹⁵
 UT-40 Pocket beep function..... 45.00
 IC-900A Transceiver controller..... 639.00 569⁹⁵

★ Package Special ...

IC-900A Transceiver controller with UX-29H
 2m/45W and UX-39A 220/25W band units.
\$969⁹⁵

UX-19A 10m 10W band unit 299.00 269⁹⁵
 UX-29A 2m 25W band unit..... 299.00 269⁹⁵
 UX-29H 2m 45W band unit..... 349.00 319⁹⁵
 UX-39A 220MHz 25W band unit.... 349.00 299⁹⁵
 UX-49A 440MHz 25W band unit.... 349.00 319⁹⁵
 UX-59A 6m 10W unit 349.00 319⁹⁵
 UX-129A 1.2GHz 10W band unit ... 549.00 499⁹⁵

IC-1200A 10W 1.2GHz FM mobile.... 699.00 599⁹⁵
 IC-2500A 440/1200MHz FM mobile 999.00 899⁹⁵
 IC-3210A 25w 2m/440 FM/TTP 739.00 649⁹⁵
 AH-32 2m/440 Dual Band antenna ... 39.00
 AHB-32 Trunk-lip mount 35.00
 Larsen PO-K Roof mount 20.00
 Larsen PO-TLM Trunk-lip mount.... 22.00
 Larsen PO-MM Magnetic mount 22.00
 RP-1210 1.2GHz 10W 99 ch FM xcvt 1529.00 1349
 RP-2210 220MHz 25W repeater 1649.00 1399

Due to the size of the ICOM product line, some accessory items are not listed. If you have a question, please call. All prices shown are subject to change without notice.

Top Trades ! • We'll take your Clean Late Model gear in trade towards New ICOM Equipment.
 Write or Call for our Quote Today!
AES[®] ★ Over 30 Years in Amateur Radio



Hand-helds Regular SALE
 IC-2A 2-meters..... 289.00 259⁹⁵
 IC-2AT with TTP..... 319.00 279⁹⁵
 IC-02AT/High Power 409.00 349⁹⁵
 IC-04AT for 440 MHz 449.00 389⁹⁵
 IC-u2AT for 2m w/TTP 329.00 279⁹⁵
 IC-u4AT 440 MHz, TTP 369.00 289⁹⁵

FREE Battery! . . .

BP-23 600ma/8.4V • No Charge with purchase of IC-u2AT or IC-u4AT

IC-2GAT for 2m, TTP 429.00 379⁹⁵
 IC-4GAT 440MHz, TTP 449.00 399⁹⁵
 IC-32AT 2m/440MHz 629.00 559⁹⁵

Aircraft band handhelds Regular SALE
 IC-12AT 1W 1.2GHz FM HT/batt/cgr/TTP 473.00 369⁹⁵
 IC-12GAT 1W 1.2GHz HT/batt/cgr/TTP 529.00 469⁹⁵
 A-2 5W PEP synth. aircraft HT..... 525.00 479⁹⁵
 A-20 Synth. aircraft HT w/VOR..... 625.00 569⁹⁵

Accessories for all except micros Regular
 BP-7 425mah/13.2V Nicad Pak - use BC-35 79.00
 BP-8 800mah/8.4V Nicad Pak - use BC-35 ... 79.00
 BC-35 Drop in desk charger for all batteries 79.00
 BC-16U Wall charger for BP7/BP8..... 21.25
 LC-11 Vinyl case for Dlx using BP-3 20.50
 LC-14 Vinyl case for Dlx using BP-7/8 20.50
 LC-02AT Leather case for Dlx models w/BP-7/8 54.50

Accessories for IC and IC-O series Regular
 BP-2 425mah/7.2V Nicad Pak - use BC35.... 49.00
 BP-3 Extra Std. 250 mah/8.4V Nicad Pak 39.50
 BP-4 Alkaline battery case 16.00
 BP-5 425mah/10.8V Nicad Pak - use BC35 65.00
 CA-5 5/8-wave telescoping 2m antenna 19.95
 CP-1 Cig. lighter plug/cord for BP3 or Dlx 13.65
 CP-10 Battery separation cable w/clip..... 22.50
 DC-1 DC operation pak for standard models 24.50
 MB-16D Mobile mtg. bkt for all HTs..... 25.99
 LC-2AT Leather case for standard models.... 54.50
 RB-1 Vinyl waterproof radio bag..... 35.95
 HM-9 Speaker microphone..... 47.00
 HS-10 Boom microphone/headset..... 24.50
 HS-10SA Vox unit for HS-10 & Deluxe only 24.50
 HS-10SB PTT unit for HS-10..... 24.50
 SS-32SMP Commspec 32-tone encoder 27.95

For other HT Accessories not listed please CALL

Receivers Regular SALE
 R-71A 100kHz to 30MHz receiver..... \$999.00 869⁹⁵
 RC-11 Infrared remote controller.... 70.99
 FL-32A 500 Hz CW filter 69.00
 FL-63A 250 Hz CW filter (1st IF) 59.00
 FL-44A SSB filter (2nd IF)..... 178.00 159⁹⁵
 EX-257 FM unit..... 49.00
 EX-310 Voice synthesizer 59.00
 CR-64 High stability oscillator xtal 79.00
 SP-3 External speaker..... 65.00
 CK-70 (EX-299) 12V DC option..... 12.99
 MB-12 Mobile mount 25.99
 R-7000 25MHz to 2GHz scan rcvt 1199.00 1029
 RC-12 Infrared remote controller.... 70.99
 EX-310 Voice synthesizer 59.00
 TV-R7000 ATV unit..... 139.00 129⁹⁵
 AH-7000 Radiating antenna 99.00
 R-9000 100kHz-2GHz all-mode rcvt... 5459.00 4899

HOURS • Mon. thru Fri. 9-5:30; Sat. 9-3
 WATS lines are for Quotes & Ordering only, use Regular line for other Info & Service dept.

Order Toll Free: 1-800-558-0411 In Wisconsin (outside Milwaukee Metro Area) 1-800-242-5195

AMATEUR ELECTRONIC SUPPLY[®] Inc.

4828 W. Fond du Lac Avenue; Milwaukee, WI 53216 • Phone (414) 442-4200

AES[®] BRANCH STORES

Associate Store

WICKLIFFE, Ohio 44092
 28940 Euclid Avenue
 Phone (216) 585-7388
 Ohio WATS 1-800-362-0290
 Outside Ohio 1-800-321-3594

ORLANDO, Fla. 32803
 621 Commonwealth Ave.
 Phone (407) 894-3238
 Fla. WATS 1-800-432-9424
 Outside Florida 1-800-327-1917

CLEARWATER, Fla. 34625
 1898 Drew Street
 Phone (813) 461-4267
 No In-State WATS
 No Nationwide WATS

LAS VEGAS, Nev. 89106
 1072 N. Rancho Drive
 Phone (702) 647-3114
 No In-State WATS
 Outside Nevada 1-800-634-6227

CHICAGO, Illinois 60630
 ERICKSON COMMUNICATIONS
 5456 N. Milwaukee Avenue
 Phone (312) 631-5181
 Outside Illinois 1-800-621-5802

this kit at a Kenwood dealership. The interface kit for the TS-711S/811S is called the "IF-10A" and the interface kit for the TS-940S is called the "IF-10B." Both come with instruction manuals.

The Software Interface

After the hardware is ready, the software must be developed. The Kenwood radios have an interface language consisting of 17 commands for the R-5000, 19 commands for the TS-440S, 20 for the TS-711S/811S, and 22 commands for the TS-940S. These commands allow the control of functions like:

- Programming and recall of VFO A and VFO B frequencies
- Memory Input and Memory Recall
- Memory Channel Selection
- Mode Selection
- Control of RIT/XIT and frequencies
- Complete status updates of the radio operations

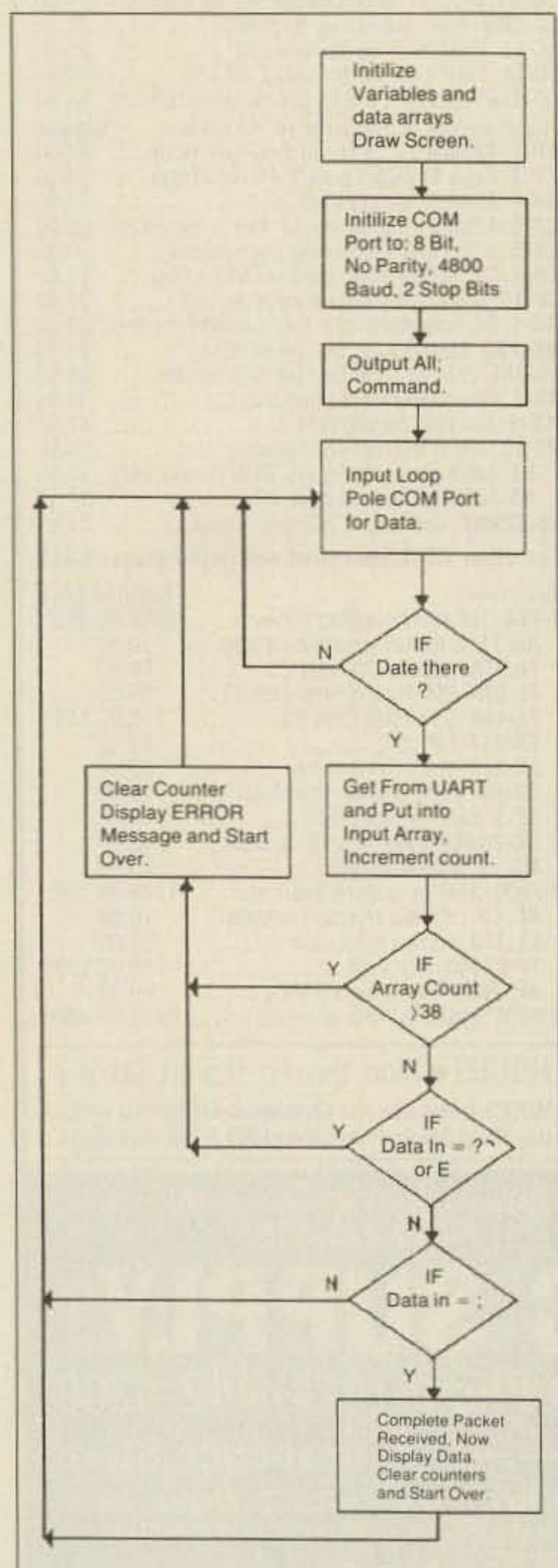

Figure 3. Flow chart for the radio status monitoring program.

Along with the basic commands, there is a well-defined protocol for controlling communications between the two pieces of equipment. After every command from the computer or response from the radio, a semicolon ";" is sent at the end of the data or command packet to tell the other end that the transmission is complete. The radio can tell the computer that it could not understand a command. If the computer sends data too fast, the radio will reply with an "E;" which signals an overrun or framing error in the transmission. If the command syntax is incorrect, or the radio cannot execute a command, it replies with a "?;" which informs the computer of a problem.

I prefer the programming language "C," but you can use BASIC, FORTRAN, PASCAL, or another language. The most important considerations are the language's speed and its ability to send and receive data from the communications port. Below is an example of how I communicate to the UART using "C":

```
ch_in = inportb(io_adr);
```

Where:

ch_in = the data from the UART

io_adr = the hardware port address.

inportb() = the input function.

```
outportb(io_adr, ch_out);
```

Where:

ch_out = the data to be sent.

io_adr = the hardware port address.

outportb() = the output function.

At first, I used the language's high level interface to handle the UART, but that was not fast enough, so I had to go to a direct I/O method. These commands would be very similar in most languages. The main thing is to get data to and from the UART as fast as possible.

Three of the common commands the radios support are:

ID; Identification of radio type. Reply as follows:

ID001; - for the TS-711S.

ID002; - for the TS-811S.

ID003; - for the TS-940S.

ID004; - for the TS-440S.

ID005; - for the R5000.

AIx; Turn ON or OFF the Automatic Information transfer from the radio. Here, x = 1 for ON and x = 0 for OFF. The reply data format is the same as the IF; command.

IF; This command asks for the radio's current condition. The reply data packet is 38 bytes long, and structured as follows:

Bytes	Description
1 and 2	IF. Command name.
3 to 13	Selected VFO frequency in Hz.

Figure 4. BASIC program for testing the computer/rig interface.

Note that the first three bytes are not used.

- | | |
|----------|---|
| 14 to 18 | Step frequency in Hz for TS-940S, TS-711/811. |
| 19 to 23 | RIT frequency. (E.g. +0100 or -1250.) |
| 24 | RIT On/Off. 1=On, and 0=Off. |
| 25 | XIT On/Off. 1=On, and 0=Off. |
| 26 | Memory Bank. TS-940S only. |
| 27 to 28 | Memory channel. |
| 29 | TX/RX. 0=RX, and 1=TX. |
| 30 | Mode. 1=LSB, 2=USB, 3=CW, 4=FM, 5=AM, and 6=FSK. AM, FSK. TS-440S/R5000/TS-940S only. |
| 31 | Function. 0=VFO A, 1=VFO B, 2=MEMORY. |
| 32 | Scan On or Off. |
| 33 | Split On or Off. |
| 34 | Tone On or Off. TS-811A, B, E/711A, E only. |
| 35 to 36 | Tone Frequency, TS-811A, B/711E only. |
| 37 | Offset. 0=Simplex, 1=+, 2=-. TS-711/811 only. |
| 38 | Terminator character. This is ";". |

The IF; command need not be sent for constant updating of the data array, because the radio will automatically send the data packet every time one of its settings or conditions change, provided the AI1; (AI on) command has been sent.

Testing The Hardware

After the hardware is assembled, connect the IBM PC or clone to the radio via the interface unit. A test program, IOTEST.BAS, is given in Listing 1. It is written in GWBASIC, but other versions of BASIC will work with little or no changes to the code.

The program initializes the computer's COM2 port, sends a request to the radio for information, and then waits for data from the keyboard or serial port. If data from the radio is sent, the computer will display it on the screen. If you press a key, it will display that character and then send it to the radio. If your serial port is COM1, change line 15 accordingly. This simple test program does not do any error checking and is intended only to test the hardware function.

Enter the program and run it. If you rotate the VFO knob, you should see a block of 38 bytes displayed on the screen. If so, your interface electronics are working properly. If not, go back and check your work. You will notice that the radio sends the data only when a condition has changed in its operations or settings, and then only after one to two seconds after the change occurred. This is a feature of the radio's control microprocessor. It doesn't send serial data when it is busy doing other operations, such as dealing with the VFO tuning knob as it is rotated. This ensures that all changes are completed before the radio sends out new data.

A Simple Program Example

Because a full-functioned control program

is too complex for an article, I give here only a simple and understandable example. The flow chart shown in Figure 3 will help those programming in different high level languages.

Initialization

This is where the program starts. Define any variables, if the language needs them. I recommend using a 38 byte array for storing the radio information as it is received. Initialize the serial data port for 4800 baud, eight data bits, two stop bits, and no parity. You can also paint the display screen at this point.

Input Loop

The input loop should be as fast as possible with minimum steps, thereby allowing polling of the input port. If done correctly, you will be able to run the program on the slower 4.77 MHz IBM PC. When a character is ready, read it into the input array and increment the array pointer, making the UART ready for the next character.

After reading a character from the UART, three conditions must be tested: 1) whether or not the input array is full, indicating a communications problem; 2) whether or not the last received character was a "?" or an "E," indicating a communications problem; and 3) whether or not the character was a ";" indicating the end of the data packet from the radio. If the data was received and terminated properly, you will want to display it on the screen, overwriting the old screen data. If any of the error conditions exist, you will want to display a small error message, reset the array pointer to 0, and get ready for the next packet of information.

Where To Get Parts

All of the parts in the basic interface unit are available at Radio Shack. The Radio Shack part numbers are listed below. The interface kits IF-10, IF-10A, and IF-10B are available from any Kenwood dealer. You can also get a full-featured program for the Kenwood from Rad-Com, PO Box 1166, Pleasanton CA 94566; 408-443-4633.

Conclusion

From this basic understanding, you could design a very comprehensive program to control the functions of the radio in a real-time operating mode. Along with the novel process of controlling the radio from the computer, you accomplish a much more important function—full memory channel management through your computer, which saves you time and makes the radio easier to use. **73**

Parts List for Simple Interface Unit

1 MC1488 Line Driver	RS# 276-2520
1 MC1489 Line Receiver	RS# 276-2521
1 7404 Hex Inverter	RS# 276-1802
3 14 Pin Sockets	RS# 276-1999
1 6 pin DIN Plug	RS# 274-020
1 Small PC Board	RS# 276-158
Misc.: Small enclosure, cable, low current +5, +12, and -12 volt power supply.	

IRON SLEEVE Only \$19.95

Place a hot soldering iron in your toolkit without having to wait for it to cool! Saves wasted time!

Insulated carrier protects while it absorbs the iron's heat. Fits most popular soldering irons. 11" long tube 1.5" in diameter.



WINDOW COUPLER

Run your coax from inside to outside through the glass! No Holes! No Pinched Coax! No Drafts! 2MTR & 440 1.5:1 SWR with less than 2db loss. 10MHz bandwidth and rated for 25 watts. Boxes mount to window with tape. Specify BNC or UHF/50239 cons. WPO-VHF (140-160MHz) \$59.95 WPO-UHF (440-460MHz) \$59.95 SCANNER/TV version 60-800MHz RX only, 8db loss, "F" connectors. WPO-TV \$49.95

NEW PRODUCTS!!

VAK-TENNA

IDEAL FOR APARTMENTS!

For 2mtr & 220 or Scanners. Mounts to glass with suction cups. Collapsible dipole extends to 79". With 15' coax and choice of BNC, PL259 and other connectors. \$29.95 MORE MODELS AVAILABLE!



SIGNAL INTENSIFIER Receiver Preamplifiers

Assure the best reception. MANY MODELS AVAILABLE, including the following:

RFP-40 1-1300MHz 15db gain 2.9db nf. 115VAC powered (DC avail +\$4) receive use only \$69.95 (BNC/50239)

RFTR-SSB 10mtr & CB 13db gain. 12VDC powered (AC avail) for use with transceivers under 50 watts \$64.95

RFTR-M for VHF MARINE \$69.95



TAPE SAVER

Scanner Recording Interface

switches your remote controlled

cassette recorder on and

off to record during ac-

tivity only \$49.95



ELECTRON PROCESSING, INC
P.O. BOX 708
MEDFORD, NY 11763
(516) 764-9798

When Ordering please add \$4 continental US,

\$7 AK, HI, PR, Canada Shipping/Handling.

NYS address add sales tax.

SATISFACTION GUARANTEED! SEND FOR MORE DETAILS!

CIRCLE 291 ON READER SERVICE CARD

"The '850 Found a New Friend"



The industry standard RC-850 Repeater Controller can now talk with your computer.

And there's so much for them to say!

The '850 computer interface improves the management of your voice repeater system. It allows you to command and program interactively from your terminal or personal computer using a MODEM or packet TNC. Even preview and edit repeater messages by typing words from the controller's vocabulary directly into message slots.

Retrieve and catalog data relating to your site measurements, equipment status, and repeater and command activity. Download

and print out the information programmed into your controller. And view your system "front panel" on your computer screen.

You'll find the RC-850 controller on the leading voice repeaters around the world. ACC pioneered remote programming of repeaters - and continues to pioneer with remote computer access. While the rest of the world just talks about catching up, ACC continues to lead the way in advanced repeater technology.

Now, with its computer interface, the '850 can be best friends with your computer.

ACC

advanced
computer
controls, inc.

2356 Walsh Avenue, Santa Clara, CA 95051 (408) 727-3330

CIRCLE 1 ON READER SERVICE CARD

73 Review by Jim Kocsis WA9PYH

Ramsey Electronics
2575 Baird Rd.
Penfield NY 14256
(716) 586-3950
Price Class: \$25

Ramsey SR-1 Receiver

A lot of listening fun at an affordable price.

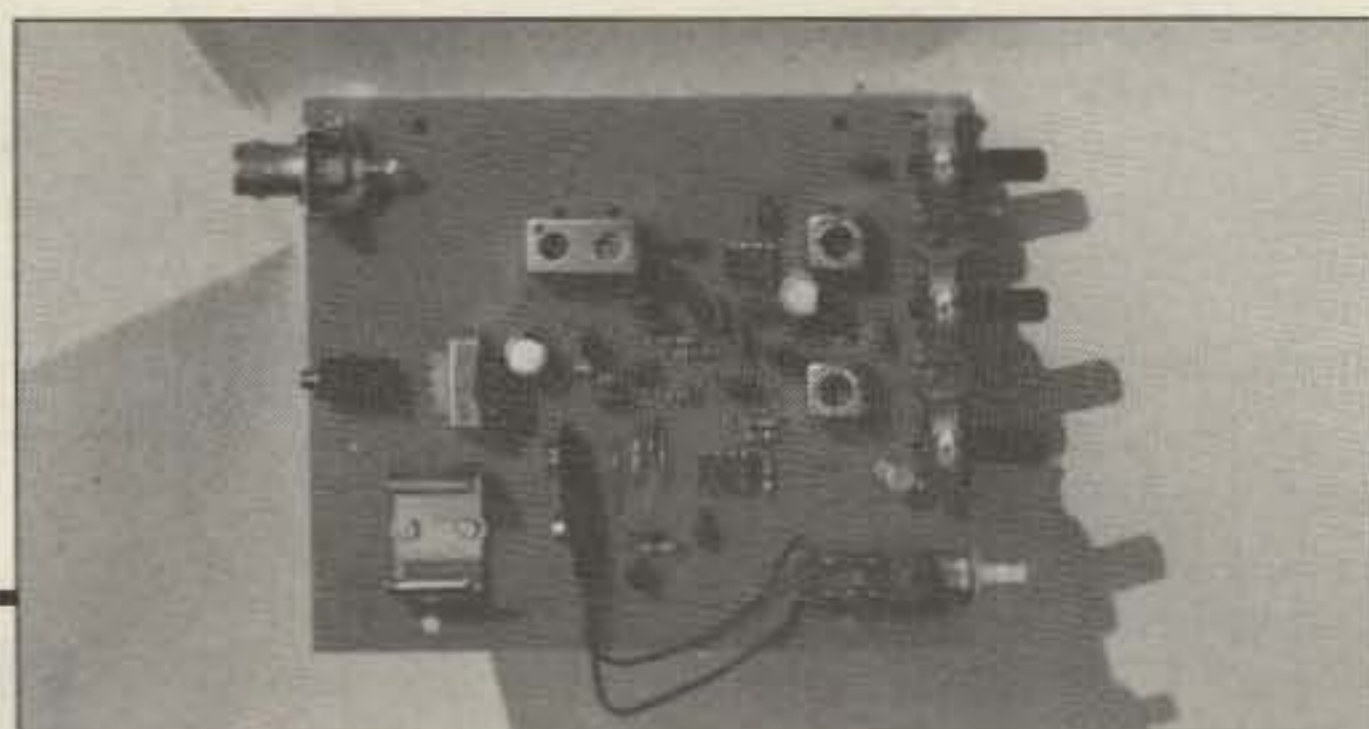

Photo A. Top view of the assembled Ramsey SR-1 receiver. (Photo courtesy of Bob W8MDV.)

Ramsey Electronics offers inexpensive kits ranging from frequency counters to LED blinkers and small receivers. This simple, inexpensive AM-only shortwave receiver is a great starter project for budding hams.

Assembly

The parts come in a plastic bag with a single-sided phenolic PC board that has a solder mask but no component markings. The absence of a component layout on the board isn't a problem because the page that accompanies the kit shows the location of all the parts. I strongly recommend placing all large components first (transformers, pots, antenna connector, etc.). Next, mount all the resistors and capacitors. Add the transistors, diodes, and ICs last. Don't "jump the gun" like me and forget the jumpers. (I was anxious to see how this little receiver worked.)

This unit is easy to assemble. For an experienced kit builder, the assembly time is 1 to 2 hours. All but one part fit perfectly; there was not enough room for the large 220 μ F capacitor at pin 8 of the NE602 IC. I managed to make it fit on top, but you could also mount it beneath the board. The disc capacitors are not all marked as described, but by the process of elimination you can figure out that the 100 pF capacitors are marked 100k, not 101, and the 0.01 μ F capacitors are marked 0.01, not 103. I would guess that Ramsey switched sources for their parts so the instructions are not quite correct. The mismarked components are really a very small point, since overall the assembly was very easy and straightforward.

Two of the transformers need to be modified by breaking out a small internal capacitor. Otherwise, all parts can be used as supplied. There were no extra holes in the board and no extra components. (The appearance of mysterious extra holes or parts can be confusing to the beginner. Ramsey did really well in this area.)

Tuneup and Operation

I applied power (a 9 volt battery), added a 10 foot piece of wire for an antenna and an ear-

phone, and immediately began tuning in LOTS of shortwave stations. Actual tuneup consists of peaking a single 262 kHz IF transformer and presetting the local oscillator and antenna coils for the desired 2.5 MHz segment of the receiver's 4-10.5 MHz coverage. In a few minutes of listening I heard the BBC, CBC, and many Spanish-, German-, and French-speaking stations.

The three controls—RF gain, AF gain, and tune—are potentiometers. Use the RF gain if there's so much signal coming in that the simple AGC circuit can't handle it. The audio output is more than enough for an earplug, but there isn't sufficient audio for even a small speaker.

*“. . . assembly time
(for the SR-1) is 1 to
2 hours.”*

Technical Information

This receiver uses the Signetics NE602 for the mixer/local oscillator; a two-transistor IF amplifier with a doubly-tuned transformer comes next. The IF amps are followed by 2 op amps used as an audio preamp, and an AGC amplifier. A single transistor forms the audio output stage. Current draw at 9 volts is 45 mA, so the battery should provide many hours of listening.

Plusses: The receiver is really hot, mostly due to the NE602. The chip is just coasting in this frequency range—it can actually operate up to 500 MHz RF input with its own local oscillator running at 200 MHz. The assembly, tune-up, and operation are all very straightforward. No special tools or equipment are required.

Minuses: The overriding problem with the receiver is: "What is the frequency?" There is no frequency indication—all tuning is done with a pot-tuned varicap (voltage variable ca-

pacitor) and the oscillator coil. There are also a few heterodynes as the receiver is tuned throughout the selected range. This is an indication of inadequate front-end selectivity. Another problem area involves the RF and oscillator coils. Tuning these coils requires a very small screwdriver-type alignment tool. I've seen these types crack after several adjustments. Adjust them sparingly or consider installing another type of coil.

Modifications

As an option, you can supply an external oscillator signal to the NE602. It should be at least 200 mV peak-to-peak. Ramsey doesn't provide this option or describe it. Consult the Signetics Linear Data Manual, Volume 1 for more information on this IC.

For the experienced builder, I would recommend adding a BFO or product detector for CW/SSB reception, an LM386 audio stage for speaker operation, and more tuned RF stages to improve the image rejection. Some type of frequency synthesizer in place of the local oscillator would also be useful. (Signetics and other companies make several synthesizer chips that might be used here.)

Another option for frequency read-out is the addition of a simple buffer and frequency counter. This could involve a lot of work and extra parts, and would detract from the simplicity of this receiver.

An Overall Good Deal

Am I glad I bought this receiver? You bet! I plan on putting it in my car and listening to SW instead of the local AM-FM broadcast "chatter," or when 2 meter FM is inactive. Ramsey did a fine job on this receiver. The price is reasonable, and all parts are high quality. (Ramsey uses the same NE602 chip in their 80/40 meter hamband receiver, in a 2 meter receiver and in an aircraft receiver—all reasonably priced.) You can also buy an optional plastic receiver case for \$12.95.

Do you remember your first kit or project? I've been building kits and home-brewing since 1962. I can honestly say that this one was nearly as much fun as the first! **73**

RAMSEY ELECTRONICS

Quality Test Gear & Electronic Kits for Professionals and Hobbyists

COM-3

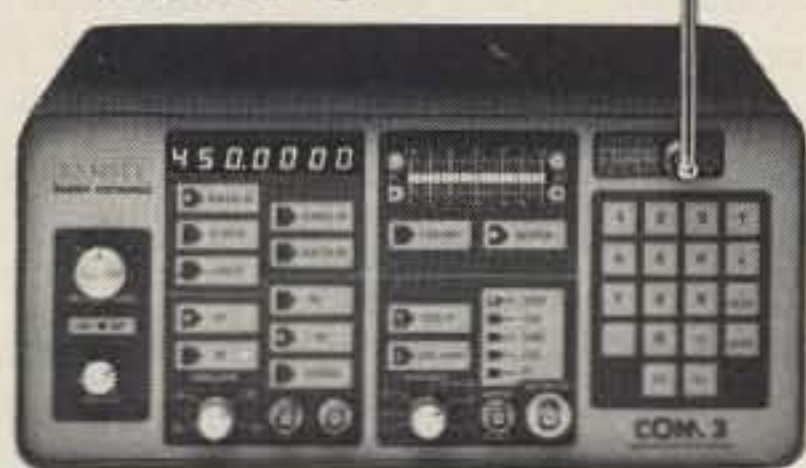

\$2495.00

THE COMMUNICATIONS SERVICE MONITOR THAT WORKS HARDER FOR LESS.

Introducing COM-3... the new service monitor designed by service technicians for service technicians. It works harder for less... giving you advanced testing capabilities at a very affordable price. **FEATURES** • Direct entry keyboard with programmable memory • Audio & transmitter frequency counter • LED bar graph frequency/error deviation display • 0.1-10,000 μ V output levels • High receive sensitivity, less than 5 μ V • 100 KHz to 999.9995 MHz Continuous frequency coverage • Transmit protection, up to 100 watts • CTS tone encoder, 1 KHz and external modulation



PR-2 COUNTER PREAMP

\$49.95

wired includes AC adapter
PR-2 kit **\$39.95**

The PR-2 is ideal for measuring weak signals from 10 to 1,000 MHz • flat 25 db gain • BNC connectors • great for sniffing RF • ideal receiver/TV preamp • 3 db NF



PS-2 AUDIO MULTIPLIER

\$69.95

wired PS-2 kit **\$49.95**

The PS-2 is handy for high resolution audio resolution measurements. multiplies up in frequency • great for PL tone measurements • multiplies by 10 or 100 • 0.01 Hz resolution & built-in signal preamp/conditioner



PS-10B 1.5 GHz PRESCALER

\$89.95

wired includes AC adapter

Extends the range of your present counter to 1.5 GHz • 2 stage preamp • divide by 1000 circuitry • super sensitive (50 mV typical) • BNC connectors • 1.5 GHz in, 1.5 MHz out • drives any counter.

CT-70 7 DIGIT 525 MHz



\$139.95

WIRED INCLUDES AC ADAPTER

CT-90 9 DIGIT 600 MHz



\$169.95

WIRED INCLUDES AC ADAPTER

CT-50 8 DIGIT 600 MHz



\$189.95

WIRED INCLUDES AC ADAPTER

CT-125 9 DIGIT 1.2 GHz



\$189.95

WIRED INCLUDES AC ADAPTER

FREQUENCY COUNTERS

Ramsey Electronics has been manufacturing electronic test gear for over 10 years and is recognized for its lab quality products at break-through prices. All of our counters carry a full one year warranty on parts and labor. We take great pride in being the largest manufacturer of low cost counters in the entire USA. Compare specifications. Our counters are full featured, from audio to UHF, with FET high impedance input, proper wave shaping circuitry and durable high quality epoxy glass, plated-thru PC Board construction. All units are 100% manufactured in the USA.

ACCESSORIES FOR COUNTERS

Telescopic whip antenna—BNC plug	\$ 8.95
High impedance probe, light loading	16.95
Low pass probe, audio use	16.95
Direct probe, general purpose use	13.95
Tilt bail for CT-70, 90 & 125	3.95
Nicad pack for CT-70, 90 & 125	8.95

MODEL	FREQ RANGE	SENSITIVITY	ACCURACY	DIGITS	RESOLUTION	PRICE
CT-70	20 Hz-550 MHz	< 50 mv To 150 MHz	1 PPM	7	1 Hz, 10Hz, 100Hz	139.95
CT-90	10 Hz-600 MHz	< 10mv To 150 MHz < 150mv To 600 MHz	1 PPM	9	0.1Hz, 10Hz, 100 Hz	169.95
CT-50	5 Hz-600 MHz	LESS THAN 25 mv	1 PPM	8	1Hz, 10Hz	189.95
CT-125	10 Hz-1.25 GHz	< 25mv @ 50 MHz < 15mv @ 500 MHz < 100mv @ 800 MHz	1 PPM	9	0.1Hz, 1Hz, 10Hz	189.95
CT-90 WITH OV-1 OPTION	10 Hz-600 MHz	< 10mv To 150 MHz < 150mv To 600 MHz	0.1 PPM	9	0.1Hz, 1Hz, 10Hz	229.90

MINI KITS—EASY TO ASSEMBLE—FUN TO USE

TONE DECODER

A complete tone decoder on a single PC board. Features: 400-5000 Hz adjustable range via 20 turn pot, voltage regulation, 567 IC. Useful for touch-tone burst detection, FSK, etc. Can also be used as a stable tone encoder. Runs on 5 to 12 volts.

Complete kit, TD-1 **\$5.95**

COLOR ORGAN

See music come alive! 3 different lights flicker with music. One light each for high, mid-range and lows. Each individually adjustable and drives up to 300 W runs on 110VAC.

ML-1 Kit, **\$8.95**

VOICE ACTIVATED SWITCH

Voice activated switch kit provides switched output with current capability up to 100 mA. Can drive relays, lights, LED or even a tape recorder motor. Runs on 9 VDC.

VS-1 KIT **\$6.95**

VIDEO MODULATOR

Converts any TV to video monitor. Super stable, tunable over ch 4-6. Runs on 5-15V accepts std. video signal. Best unit on the market! Complete kit, VD-1

\$7.95

LED BLINKY KIT

Alternately flashes 2 jumbo LEDs. Use for name badges, buttons, warning panel lights. Runs on 3 to 15 volts.

BL-1 Kit, **\$2.95**

UNIVERSAL TIMER

Provides the basic parts and PC board required to provide a source of precision timing and pulse generation. Uses 555 timer IC and includes a range of parts for most timing needs.

UT-5 Kit **\$5.95**

MAD BLASTER

Produces LOUD ear shattering and attention getting siren like sound. Can supply up to 15 watts of obnoxious audio. Runs on 6-15 VDC.

MB-1 Kit **\$4.95**

WHISPER LIGHT

An interesting kit, small mike picks up sounds and converts them to light. The louder the sound, the brighter the light. Includes mike, controls up to 300 W, runs on 110 VAC.

WL-1 Kit **\$6.95**

FM WIRELESS MIKE

Transmits up to 300' to any FM broadcast radio, uses any type of mike. Runs on 3 to 9V. Type FM-2 has added sensitive mike preamp stage.

FM-1 Kit **\$3.95**

FM-2 Kit **\$4.95**

SIREN

Produces upward and downward wail. 5 W peak audio output, runs on 3-15 volts, uses 3-45 ohm speaker.

Complete kit, SM-3 **\$2.95**

SUPER SLEUTH

A super sensitive amplifier which will pick up a pin drop at 15 feet! Great for monitoring baby's room or as general purpose amplifier. Full 2W rms output, runs on 6 to 15 volts, uses 8-45 ohm speaker.

BN-9 Kit **\$5.95**

TELEPHONE TRANSMITTER

Low cost with professional performance. Features include: self phone line powered, tunable from 76 to 100 MHz, polarity insensitive, compact size (1" x 1"), easily installs anywhere on the phone line or inside the instrument itself.

PB-1 KIT **\$14.95**

FM RECEIVER

For built-in applications, or hobby experimentation. Full fledged super-heterodyne receiver, microvolt sensitivity, 10.7 MHz IF, integrated circuit detector, 50 mw audio amplifier, 9V external power source, operation on standard FM broadcast band as well as large portions on each side, compact (6" square), for bug detection or reception.

FR-1 KIT **\$14.95**

FM MINI MIKE

A super high performance, FM wireless mike kit! Transmits a stable signal up to 300 yards with exceptional audio quality by means of its built in electret mike. Kit includes case, mike, on-off switch, antenna, battery and super instructions. This is the finest unit available.

FM-3 Kit **\$14.95**

FM-3 Wired and Tested **19.95**

NEW

NEW

MICROWAVE INTRUSION ALARM

A real microwave doppler sensor that will detect a human as far as 10 feet away. Operates on 1.3 GHz and is not affected by heat, light or vibrations. Drives up to 100 ma output, normally open or closed, runs on 12 VDC.

Complete Kit, MD-3 **\$16.95**

Case kit, CSS-7 **12.95**

SPEECH SCRAMBLER

Communicate in total privacy over your telephone or radio. This scrambler kit features full duplex operation using frequency inversion. Runs on a 9 volt battery. Both mike and line or speaker output/inputs. Easy to connect to any radio—telephone use requires no direct connection! Easy to build, uses IC DBM circuitry. Can also be used to descramble most com. scramblers.

Complete kit, SS-7 **\$29.95**

Case kit, CSS-7 **12.95**

ALL NEW KITS



Complete kit, SG-7

\$89.95

PERSONAL SPEED RADAR

New low cost microwave doppler radar kit "clocks" cars, planes, boats, horses, bikes, baseballs, models, runners or virtually anything that moves. Operates at 2.6 GHz with over 1/4 mile range. LED digital readout displays speeds in miles per hour, kilometers per hour or feet per second! Earphone output permits listening to actual doppler shift. Uses two 1 lb coffee cans for antenna (not included) and runs on 12 VDC. Easy to build—all microwave circuitry is PC stripline. Kit includes deluxe ABS plastic case with speedy graphics for a professional look. A very useful and full-of-fun kit.



RADIOS

40 & 80 METERS HAM RECEIVERS

Sensitive all mode, AM, CW, SSB receivers for 3.5-4.0 or 7.0-7.5 MHz. Direct conversion design using NE602 IC as featured in QST and ARRL handbooks. Less than 1 μ V sensitivity, varactor diode tuned, 50 mw audio output. Runs on 9VDC, has RF gain control. This kit is very easy to build, lots of fun and educational—ideal for the beginner or the old pro. The optional matching case kit features a rugged ABS plastic case with screened graphics. Included are machined aluminum knobs for a well-finished professional look.

40 Meter receiver kit, HR-4 **\$24.95** 80 Meter receiver kit, HR-8 **\$24.95** Receiver case kit, CHR **\$12.95**

QRP TRANSMITTER KITS, 40 & 80 METERS

Operate a mini ham shack. These little CW rigs are ideal mates to our 40 and 80 meter receivers. Features include smooth variable tuning, one watt output and excellent keying characteristics. Runs on 12 VDC and is VSWR protected. See how far you can stretch your signal with one of these mini rigs. Optional ABS cases are available.

40 meters QRP rig, QRP-40 **\$24.95** 80 meters QRP rig, QRP-80 **\$24.95** Case kit, CORP **\$12.95**

AIRCRAFT RECEIVER KIT

Hear exciting aircraft communications—picks up planes up to 100 miles away. Receives 110-136 MHz AM air band, varactor tuned superhet design with AGC, ceramic filter and adjustable squelch. Runs on 9V battery, 50 mw audio output, 1 μ V sensitivity. Optional matching ABS plastic case lets you take it anywhere. Features screened graphics and machined aluminum knobs for a real professional look. Compact—great for airshows or for just plain hanging around the airport.

Complete kit, AR-1 **\$24.95** Receiver case kit, CAR-1 **\$12.95**



SHORTWAVE RECEIVER KIT

A fantastic receiver that captures the world with just a 12" antenna! Receives 4-11 MHz in 2 MHz bands, varactor tuned, superhet design with AGC, RF gain control, and 50 mw audio output. Uses new Signetics mixer chip for less than a microvolt sensitivity, runs on 9V battery. This is a fascinating scout, school or club project, and will provide hours of fun even to the most serious DX'er. Add the optional case kit and you have a real nice looking shortwave set.

Complete kit, SR-1 **\$24.95** Receiver case kit, CSR-1 **\$12.95**

PACKET RADIO

Commodore C64/128 packet radio interface. Uses famous German Digicom software. Features EXAR IC chip set for reliable operation—runs HF or VHF tones. Includes FREE disk software, PC board, all necessary parts and full documentation.

Complete kit, PC-1 **\$49.95**

FM COMMUNICATIONS/2 METER RECEIVER

Sensitive superhet FM receiver tunes any 5 MHz segment from 135-175 MHz. Listen to 2 mtr ham operations, high band police calls, weather or mobile phone calls! Easy to build receiver features varactor tuning, IC mixer stage, ceramic IF filters and dual conversion design with adjustable squelch. Less than 1 μ V sensitivity, runs on 9 V battery, with 50 mw audio output. Optional ABS case with screened graphics and machined aluminum knobs provide a nice professional look.

Complete kit, FR-7 **\$29.95** Receiver case kit, CFR-7 **\$12.95**

NEW MINIKITS—NEW MINIKITS

BROADBAND PREAMP

A sensitive all purpose preamp, ideal for scanners, TV sets, VHF, UHF rigs, counters, etc. Features low noise, 4 db NF, 20 db gain, 100 KHz-1 GHz operation. Runs on 9-12 VDC, 50 ohms input.

Complete kit, SA-7 **\$12.95**

LIGHT BEAM COMMUNICATORS

Transmits modulated infrared light up to 30 feet without lenses, up to 1/4 mile using lenses. Uses 30 KHz carrier for hum-free operation, transmits thru windows, etc. Ideal for "bugs" or listening to IR remote controls. Transmitter has sensitive mike input, receiver uses PIN detector and drives speaker output. Units operates on 9-12 VDC.

Transmitter kit, LB-6 **\$8.95**

Receiver kit, LB-5 **\$9.95**

HIGH POWER 1 M WIRELESS MIKE

A high power unit that will transmit up to 1/2 mile to any FM broadcast radio. Sensitive input accepts any type of mike, will pick up normal voices 10 feet away using the available mini-electric mike cartridge. Operates on 9-12 VDC.

FM-4 kit **\$9.95**

Sensitive microphone cartridge **\$2.95**

2 MTR & 220 BOOSTER AMP



Here's a great booster for any 2 meter or 220 MHz hand-held unit. These power boosters deliver over 30 watts of output allowing you to hit the repeaters full quieting while the low noise preamp remarkably improves receptions. Ramsey Electronics has sold thousands of 2 mtr amp kits but now, we offer completely wired and tested 2 mtr as well 220 MHz units. Both have all the features of the high priced boosters at a fraction of the cost.

PA-10 2 MTR POWER BOOSTER (10 X power gain) Fully wired & tested **\$59.95**

PA-20 220 MHz POWER BOOSTER (8 X power gain) Fully wired & tested **\$59.95**

- 30 WATTS OUTPUT
- LOW NOISE PREAMP
- LOW COST
- RUGGED CAST ALUMINUM CASE
- ONE YEAR WARRANTY

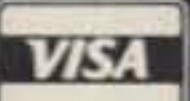
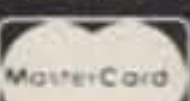

TERMS: • satisfaction guaranteed • examine for 10 days; if not pleased, return in original form for refund • add 6% for shipping and insurance to a maximum of \$10.00 • foreign add 15% for surface mail • COD add \$2.50 (COD in USA only) • orders under \$20.00 add \$1.50 • NY residents add 7% sales tax • 90 days parts warranty on all kits • 1 year parts & labor warranty on all wired units.

PHONE ORDERS CALL **716-586-3950**

FAX 716-586-4754

RAMSEY ELECTRONICS, INC., 2575 Baird Rd., Penfield, N.Y. 14526

CTCSS

Continued from page 16

ter, will generally be satisfactory. In one or two cases, with older synthesized transceivers using the Motorola MC4044 Phase/Frequency Detector in a phase-locked loop circuit, we obtained the best results when we coupled the output of the PL board directly to the varactor diode. If you do this, make sure that the 0.47 (or 0.50) μF capacitor is not a tantalitic.

Just as some manufacturers provide a connecting point for a PL signal, some also offer a front panel switch-controlled power source. Such was the case with the Kenwood and the Azden models. If so, by all means take advantage of it. Even though this CTCSS board uses very little current, it's preferable to take it from the transmitter source.

The circuit diagram of Figure 1 suggests a Vcc of 13.8 volts, but any voltage from 6 to 13.8 works, as long as that is the voltage applied when tuning the oscillator. The current requirement varies from about a low of 7.4 mA at 8 volts to about 9.5 mA at 12 volts. It should not pose a problem for even a small battery.

If you use a mechanical relay to switch power to the transmitter finals, you can usually find a switched positive 8-12 volt source at one of the relay terminals. To get the tone when you want it, put a wire from that point to a mechanical switch at some accessible place on the cabinet, and from there to the CTCSS supply terminal. The switch lets you disable the tone when you don't want it.

When you use a transistor switch, rather

than a relay, to key on the transmitter finals, you have a couple of choices. If you're sure about what you're doing, pick up the 8-12 volts your rig uses at the same point that the transmitter final uses it. Bring the ground wire of the CTCSS board to the collector (or the emitter, as the case may be) of the transistor that actually keys on the power transistors. If you're not comfortable doing that, go to the same source point, but take the ground wire from the CTCSS board to the open side of the PTT (Push-to-Talk) switch in the microphone circuit. You will probably still want to use a mechanical switch to disable the CTCSS board when you're not operating PL.

If you're not using a voltage source provided by the manufacturer, it's a good idea to protect the CTCSS circuit—and your audio signal—against unwanted RF. Use the 0.001 μF bypass capacitor as shown on the schematic.

Various Installations I Have Done

Photo B shows the underside of a Conarc 452 2-meter transceiver. The CTCSS board seen at "A" was the prototype installation. You can get a feeling for the size from the small dual-operation amplifier IC just left of center, and the $\frac{1}{4}$ -watt resistors.

At the left of the chassis, just inside of the SO-239 connector, is a large relay for power and antenna switching. An accessible terminal that goes to 13.8 volts when the transmitter is keyed on, provides the voltage source. A toggle switch, barely visible near "P," interrupts the current supply when you don't

want PL operation. Because of the length of wire needed to get from the relay, to the switch, to the tone board, an RF bypass capacitor (see Figure 1) was used. The CTCSS tone is injected at the varactor diode used for modulation. There are two small potentiometers on the right end of the board: one for frequency control, and the other for signal amplitude. Unfortunately, the devices available from Radio Shack are not as tiny as the junk box specials seen here.

In the Azden PCS 4000, the manufacturer provides both a connection point for the tone signal and a switched voltage source for the board. The signal-in point is shown on the transceiver's schematic as the inverting input on an operational amplifier; the microphone input is the noninverting input of the same device. I mounted the board at the front end of the component side of the Azden's main board, in the left corner, when facing the front panel.

This installation furnished an interesting problem. The circuit diagram that came with the Azden is wrong. It shows a terminal, J406, and identifies this pin as the tone input; supposedly the input to the op amp noted above. Actually, it is the terminal which provides 8 volts when the tone switch on the rig's front panel is engaged and the PTT squeezed. To get to the op amp (at "B"), you must connect the wire from the CTCSS board to a lead of resistor R464. Otherwise there was no difficulty. Even the best of us make mistakes!

Installing the board in the Kenwood TR-7850 was straightforward. The manufacturer provided junction points (see the manual) for the tone signal, Vcc, and signal ground. We built the board to be as narrow as possible, and longer, so that it could be positioned on edge behind the front panel.

Because of the high risk of shorting against other devices, a piece of cardboard, cut to fit and taped to the bottom, exposes only the tuning potentiometers. Again, because the hook-up wires stretch quite a ways across the transceiver chassis, recourse was made to the bypass capacitor. It is mounted on the underside of the CTCSS board.

Conclusion

With these examples and your imagination, you should have very little trouble adapting the circuit to your rig. Although the design is for a single tone, you can readily modify it to offer two tones by adding another tuning potentiometer, a fixed resistor, and if necessary, a switch. If you have to use an external power switch, as we did for the Conarc 452, you could make it a double-pole-double-throw-center-off switch to do double duty for ON/OFF and frequency select.

Think Big

This easy, one- or two-evening project is full of possibilities. Since it's at audio frequency, layout is not at all critical. Admittedly, you will need a good low frequency counter to adjust the tone, but if a repeater is near, that shouldn't be a problem. Just contact the trustee. With any luck, you'll find one close at hand, and you'll have the pleasure of home-brewing as it used to be—at minimum cost! **73**

108-1000 MHz RADIO DIRECTION FINDING



- ★ Interference Location
- ★ Stuck Microphones
- ★ Cable TV Leaks
- ★ ELT Search & Rescue

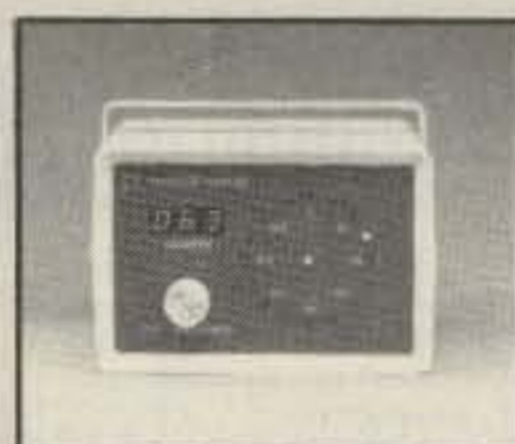

New Technology (patented) converts any VHF or UHF FM receiver into a sensitive Doppler shift radio direction finder. Simply plug into receiver's antenna and external speaker jacks. Models available with computer interface, synthesized speech, fixed site or mobile - 108 MHz to 1 GHz. Call or write for details.

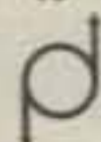

DOPPLER SYSTEMS, INC.

P.O. Box 31819

(602) 488-9755

Phoenix, AZ 85046 FAX (602) 488-1295

CIRCLE 15 ON READER SERVICE CARD

GOES 1691 MHz RECEPTION

S-BAND CONVERTER FOR YOUR 137 MHz RECEIVER

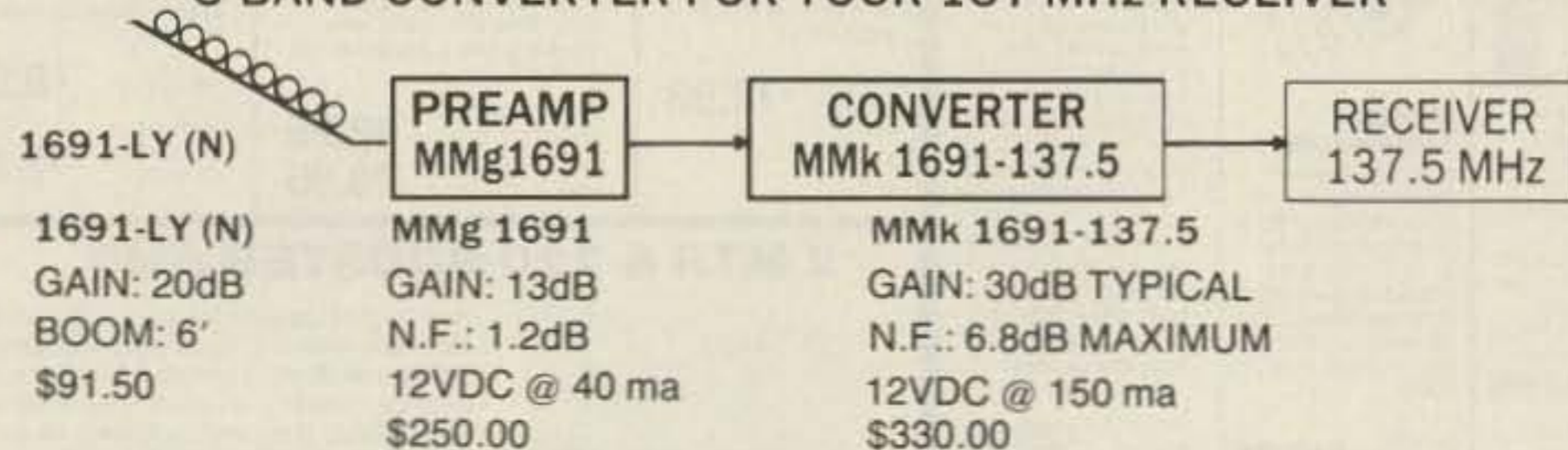

Send 75c (3 stamps) for detailed specs on all VHF & UHF products. Shipping FOB Concord, MA

PRICES SUBJECT TO CHANGE WITHOUT PRIOR NOTICE



SPECTRUM INTERNATIONAL INC.

(508) 263-2145

P.O. Box 1084S, Concord, MA 01742, USA

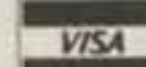
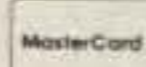

CIRCLE 183 ON READER SERVICE CARD

WE SHIP WORLDWIDE

Barry Electronics Corp.

WORLD WIDE AMATEUR RADIO SINCE 1950

Your one source for all Radio Equipment!

For the best buys in town call:
212-925-7000
Los Precios Mas Bajos en Nueva York
WE SHIP WORLDWIDE!



MAY We Help You With the Best in Commercial and Amateur Radios?
Kitty WA 2BAP

KITTY SAYS: WE ARE NOW OPEN 7 DAYS A WEEK.
Saturday & Sunday 10 to 5 P.M.

Monday-Friday 9 to 6:30 PM Thurs. to 8 PM
Come to Barry's for the best buys in town.



ONV Safety belts-in stock

YAESU

FT-767GX, FT-757GXII, FT-747GX,
FRG-8800, FT-736R, FRG-9600,
FT-4700RH, FT-212/712RH, FT-470

YAESU
FT-23/73/33/727R
FT411-811
FT-1903/1123
FTH-2005/7005

ICOM
IC2AT/12AT
IC02AT/32AT
IC2/4GAT
IC-A2/U16

Landmobile HT's
ICOM: U16, H16, V100, U400
MAXON, MOTOROLA,
YAESU: FTH 2005/2007
UNIDEN, REGENCY, KING,
MARINE ICOM: M5, M55, M700
AVIATION ICOM: A20, TAD

AMPLIFIERS
STOCKED:
RF Concepts
Mirage
TE Systems



IC-32AT



Motorola
Radius P-100



TH-75AT



FT-470

ALINCO
DJ-500T, DR-110T



Computer Interfaces
Stocked: MFJ-1270B,
MFJ-1274, MFJ-1224, AEA
PK-88, MFJ-1278, PK-232
W/FAX

FREQUENCY
COUNTERS:
1MHz-1.3GHz

COMMERCIAL
& HAM
REPEATERS
STOCKED.
WRITE FOR
QUOTES



Kantronics
UTU, KAM, KPC II,
KPC 2400, KPC IV,
KAM



MFJ-989C

Covercraft, Coaxseal Stocked

SHORTWAVE RECEIVERS
STOCKED



Ten-Tec
Tuner 238

MOTOROLA AUTHORIZED DEALER
KACHINA COMMUNICATIONS DEALER

AUTHORIZED
SONY
DEALER

DIGITAL FREQUENCY COUNTERS
Opto Electronics model 1300H, 0-1300MHz
Long-range Wireless
Telephone for export in stock

BENCHER PADDLES,
BALUNS, LOW PASS FILTERS
IN STOCK

MIRAGE AMPLIFIERS
ASTRON POWER SUPPLIES
Saxton Wire & Cable, Int'l Wire
OPTO KEYERS STOCKED

Radios for Business,
Gov't, 2-way, etc.
Stocked & serviced,
call for great prices!

COMET ANTENNAS
STOCKED

HEIL
EQUIPMENT
IN STOCK

SANGEAN Portable Shortwave Radios



New TEN-TEC
Corsair II, PARAGON,
OMNI V

IX Towers, Antennas,
Mobile Radio mounts
stocked. Call.

AMERITRON AUTHORIZED DEALER

KENWOOD



ANTENNAS
A-S, AES, Cushcraft, Hy-Gain,
Hustler, KLM, METZ,
MODUBLOX, TONNA,
Butternut, Multi-Band

TS440S/AT, R-5000, R-2000, TS-940 S/AT, TM
231A/431A, TM-2570A/50A/30A, TR-751A, Ken-
wood Service Repair, TM-721A, TS-711/811A,
TM3530A, TH205AT, TH215A, TM-621A, TM-
321A, TS140S, TS680S, RZ-1, TS-790A.

Budwig ANT. Products
NEL-TECH DVK-100 Digital Voice Keyer
FLUKE 77, 83, 85, 87 Multimeters

Media Mentors—
Amateur Radio Course

VoCom/Mirage/Alinco
Tokyo Hy-Power/TE SYSTEMS
Amplifiers &
5/8λ HT Gain
Antennas IN STOCK

MICROLOG-ART 1, Air Disk,
SWL, Morse Coach

Professional
Soldering
Station
48 Watts
\$79

METRON
KW HF Mobile
Amplifier
Stocked

AR 900 Hand Held Scanner 100
ch. Covers 27-54, 108-174,
406-512, 800-950 MHz

Alpha Delta
Products
Stocked



EIMAC
3-500Z
572B, 6JS6C
12BY7A &
6146B

AEA 144 MHz
AEA 220 MHz
AEA 440 MHz
ANTENNAS

BIRD
Wattmeters &
Elements
In Stock

MAIL ALL ORDERS TO: BARRY ELECTRONICS CORP., 512 BROADWAY, NEW YORK CITY, NY 10012 (FOUR BLOCKS NORTH OF CANAL ST.)

New York City's LARGEST STOCKING HAM DEALER
COMPLETE REPAIR LAB ON PREMISES

"Aqui Se Habla Espanol"

BARRY INTERNATIONAL TELEX 12-7670
MERCHANDISE TAKEN ON CONSIGNMENT
FOR TOP PRICES

Monday-Friday 9 A.M. to 6:30 P.M. Thursday to 8 P.M.
Saturday & Sunday 10 A.M. to 5 P.M. (Free Parking)

IRT/LEX-"Spring St. Station". Subways: BMT-
"Prince St. Station". IND-"F" Train-Bwy Station"
Bus: Broadway #6 to Spring St. Path-9th St./6th Ave.
Station.

COMMERCIAL RADIOS
STOCKED: ICOM, Motoro-
la, MAXON, Standard,
Yaesu. We serve municipa-
lities, businesses, Civil
Defense, etc. Portables,
mobiles, bases, re-
peaters...

ALL
SALES
FINAL

We Stock: AEA, ARRL, Alinco, Ameco, Ameritron, Antenna Specialists,
Astatic, Astron, B&K, B&W, Bencher, Bird, Butternut, CDE, CES, Cushcraft,
Daiwa, Eimac, Henry, Heil, Hustler, Hy-Gain, Icom, KLM, Kantronics, Larsen,
MJF, J.W. Miller, Mirage, Nye, Palomar, RF Products, Saxton, Shure,
Tempo, Ten-Tec, TUBES, Yaesu, Vibroplex, Duplexers, Repeaters, Scan-
ners, Radio Publications, Uniden, Kenwood, Maxon, RFC.

WE NOW STOCK COMMERCIAL COMMUNICATIONS SYSTEMS
HAM DEALER INQUIRES INVITED PHONE IN YOUR ORDER & BE REIMBURSED
COMMERCIAL RADIOS stocked & serviced on premises.
Amateur Radio Courses Given On Our Premises, Call
Export Orders Shipped Immediately. TELEX 12-7670

FAX: 212-925-7001

Full-Wave VHF Vertical Antenna

Easy-to-build, good gain antenna.

by Don Norman AF8B

This full-wave vertical antenna grew out of a series of experiments with the vertical J antenna. The result is a full-wave antenna easily built by the average amateur. The final version of the antenna is matched by a form of gamma match, and features full RF decoupling from the feedline.

The antenna can be grounded and in fact may be a continuation of the supporting mast. The 52Ω coaxial feedline runs up inside (MUST be inside) the antenna. It emerges through a 3/8" diameter hole next to the feedpoint on the matching stub. The diameter of the radiator does not seem to be critical, as working models have been built with radiator diameters ranging from 5/8" to 1 1/4".

Antenna dimensions for 145 MHz (packet) are given in Figure 1. You can easily build the antenna from a 10-foot length of 1/2" electrical conduit. The insulators are fabricated by cutting a plastic pipe tee in half. This plastic pipe tee, used mostly with semi-flexible plastic pipe joined with molded fittings and hose

clamps, is common in hardware stores. A single 1" tee cut along the line shown in Figure 2 will yield two insulators that will fit over the 1/2" EMT tubing.

Cut the matching rod from #10 copper wire, 3/32" brass brazing rod, or 1/8" copper tubing. Cut the radials from brazing rod or

hard aluminum wire, and attach them to the radiator with self-tapping sheet metal screws.

The first step in building the antenna is drilling holes in the metal tubing for the coax and radial attachment. Mark one end of the tubing "Top." Drill a 3/8" hole through one side of the tubing 40 1/2" from the top. Drill

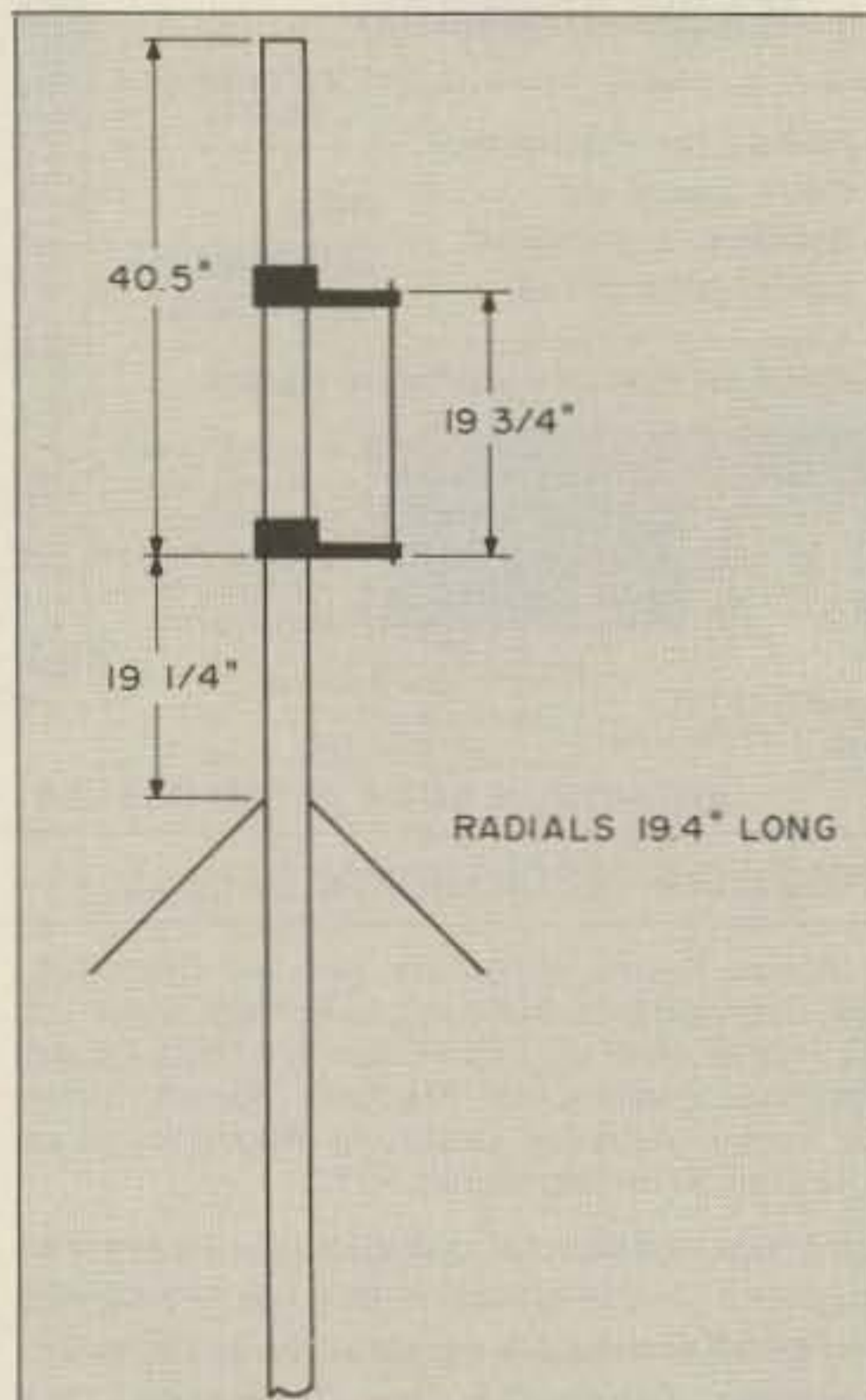

Figure 1. Full-wave vertical dimensions for 145 MHz.

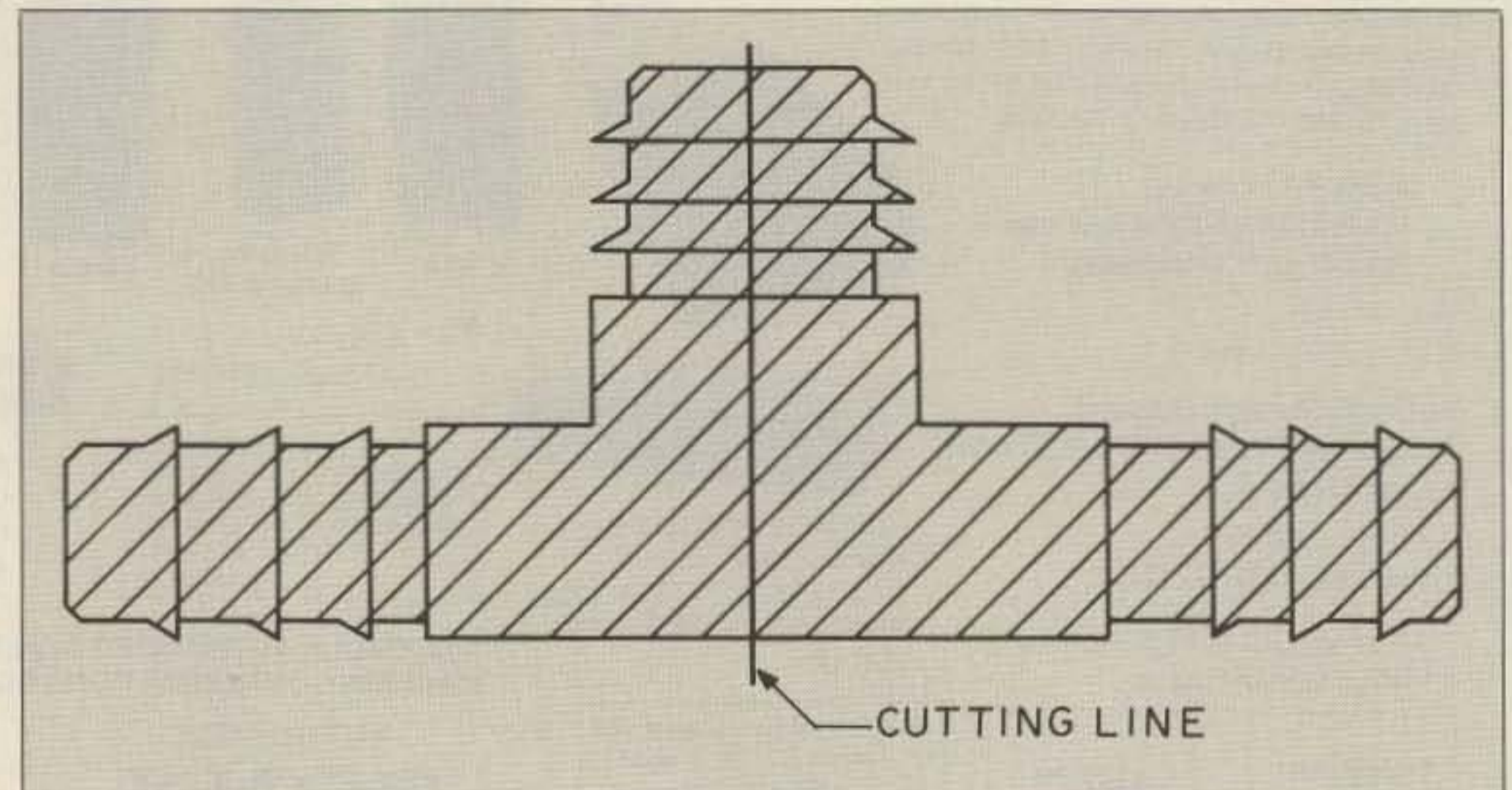

Figure 2. Make the insulators by cutting a plastic pipe tee in half.

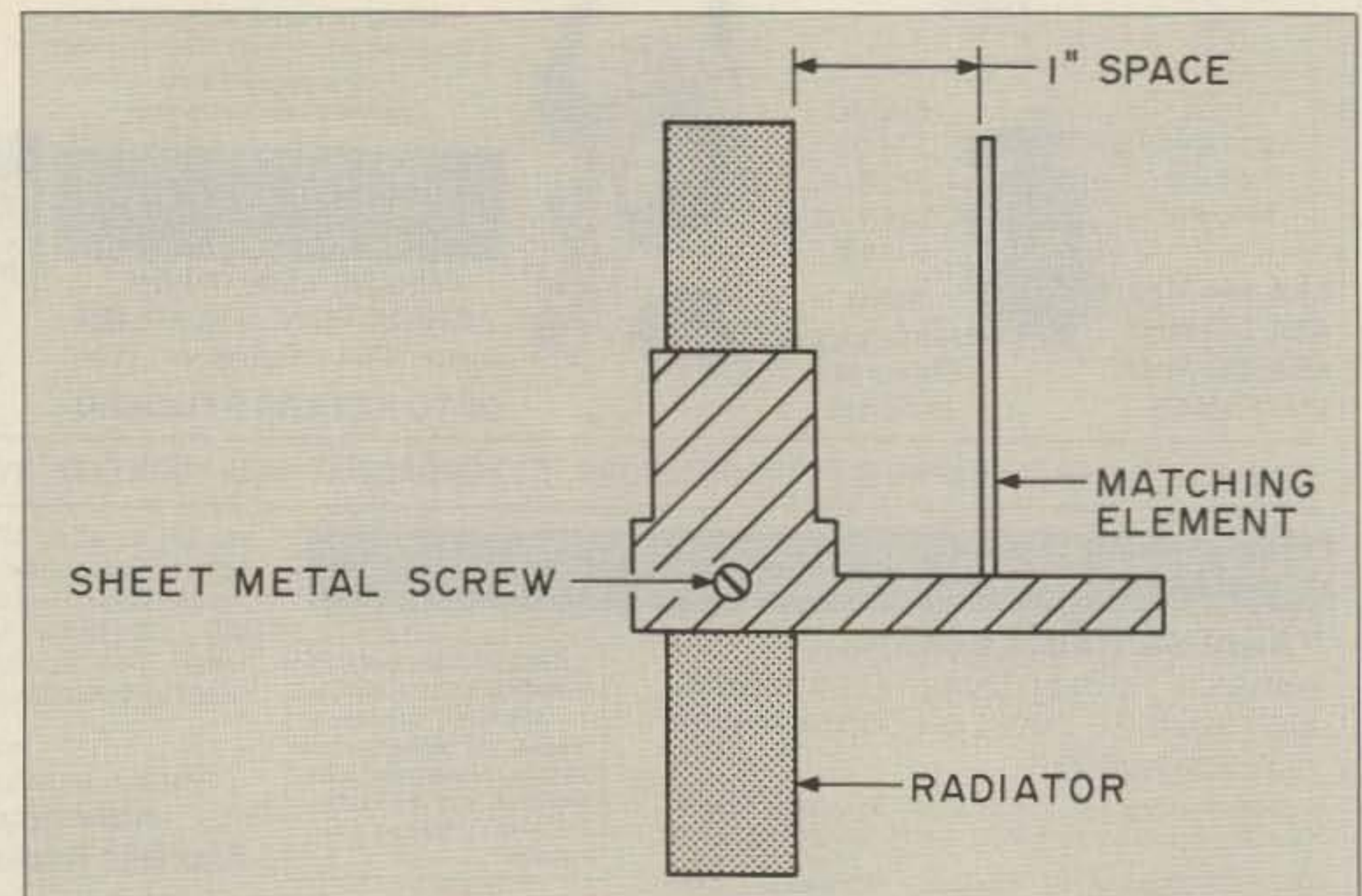

Figure 3. Matching element and bottom insulator attachment to vertical element.

three or four 1/8" holes for sheet metal screws 59/32" from the top. Use a round file to remove burrs and snags from the inside of the 3/8" hole. Fish the coax cable up through the tubing past the small holes and out through the 3/8" hole. Figure 3 shows the matching element and bottom insulator.

Cut the insulators. Measure and cut the gamma matching rod. Slip the insulators over the tubing and measure 1" from the main tubing, then drill small holes through the projecting part of the insulators large enough to accept the matching rod. The distance between the radiator and the matching rod is critical. Use your best concentration, and make the spacing as near to 1" as possible. Refer to Figures 3 and 4 for proper bottom insulator placement.

Install the radials. Cut the radials 1" longer than the correct dimension. Bend one end in a small circle and attach the radials to the radiator with sheet metal screws. CAUTION! Don't pinch the coax with the screws! The radials are clipped to the correct dimension after they are installed. The radials, an essential part of the antenna, decouple the RF from the support and feedline. Their dimensions are as critical as the rest of the antenna.

Performance

Checking the antenna with an absorption wavemeter indicates the presence of RF from the tips of the radials upward in the classic patterns depicted in the various antenna manuals.

On-the-air tests indicate it is equal to or better than a commercial 5/8-wave vertical.

Choose Your Resonant Frequency

Dimensions for frequencies other than 145 MHz may be calculated as follows: Radiator above the feedpoint, 5872/Frequency (MHz). Feedpoint to radial attachment point, 2790/Frequency (MHz). Matching rod length, 2865/Frequency (MHz). Radial length, 2810/Frequency (MHz). Matching rod spacing, 146/Frequency (MHz). The spacing of the matching from the radiator is the most critical measurement. A quarter-inch more or less makes a great difference in the performance of the antenna. Radial length and placement are somewhat critical and should be within a half inch of calculated dimensions.

That's all there is to it. Enjoy solid signals with this easy-build vertical! **73**

"... the antenna is matched by a form of gamma match, and features full RF decoupling from the feedline."

Slip the bottom insulator over the radiator, place it as shown in Figure 4, and drill a small hole through the insulator and the radiator. Lock the insulator in place with a self-tapping sheet metal screw. Attach the shield of the coax under this screw. Cut a 3" piece of small bare wire. Wrap one end around the gamma rod an inch from the end and solder. Slip the second insulator over the radiator. Slip the matching rod through the holes in the insulators. Solder the center conductor of the coax to the end of the matching rod. Move the top insulator upward against the 3" wire soldered to the matching rod. Bend the wire around the insulator and wrap around the matching rod. Lock the insulator in place with a sheet metal screw.

Figure 4 shows the bottom insulator rotated 90 degrees from Figure 3. Notice that the coax end is protected by the semi-circular bottom of the insulator.

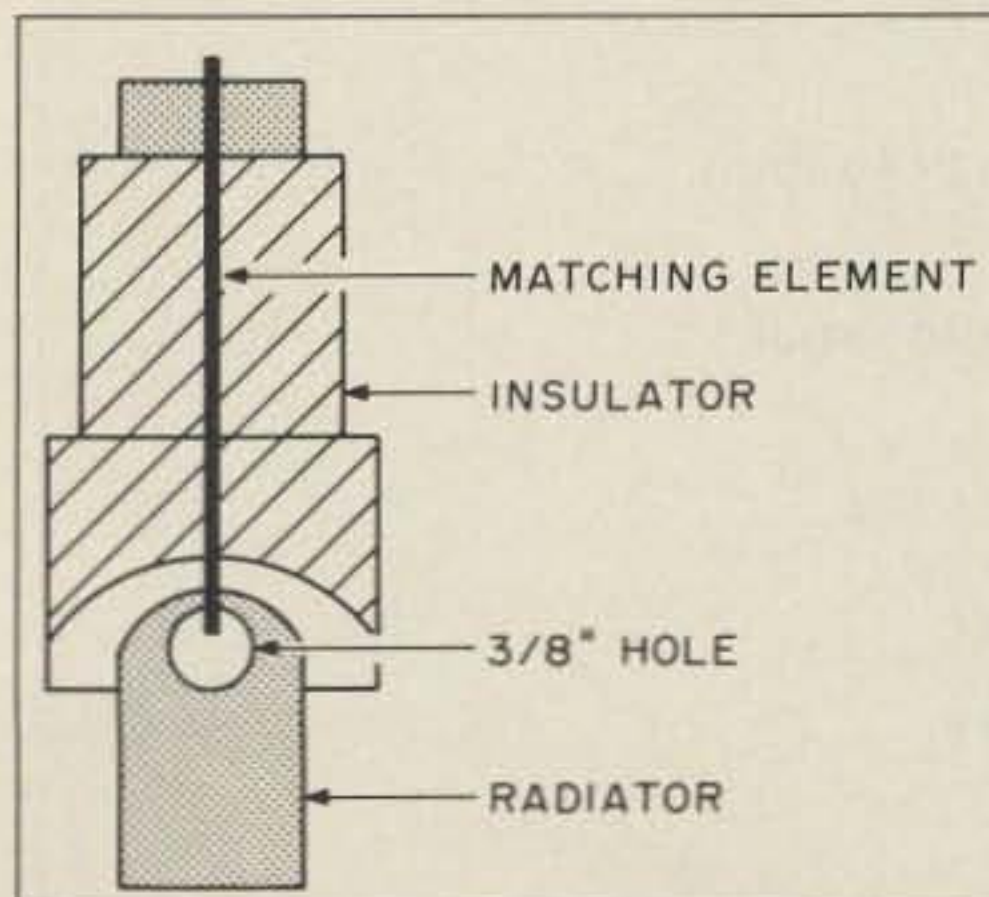

Figure 4. Bottom insulator placement. The coax end is protected by the semi-circular bottom of the insulator.

HITACHI SCOPES AT DISCOUNT PRICES

 V-212 \$419 List \$560 Save \$141 20MHz Dual Trace Oscilloscope All Hitachi scopes include probes, schematics and Hitachi's 3 year warranty on parts and labor. Many accessories available for all scopes.	 V-425 List \$995 \$835 • DC to 40MHz • Dual Channel • CRT Readout • Cursor Meas • DC Offset • Alt Magnifier • Compact Size	 V-1060 List \$1595 \$1,325 • DC to 100MHz • Dual Channel • Delayed Sweep • CRT Readout • Sweep Time • Autoranging • Trigger Lock • 2mV Sensitivity
V-223 20MHz D.T., 1mV sens, Delayed Sweep, DC Offset, Vert Mode Trigger V-422 40MHz D.T., 1mV sens, DC Offset Vert Mode Trigger, Alt Mag V-423 40MHz D.T., 1mV sens, Delayed Sweep, DC Offset, Alt Mag V-660 60MHz D.T., 2mV sens, Delayed Sweep, CRT Readout V-1065 100MHz D.T., 2mV sens, Delayed Sweep, CRT Readout, Cursor Meas V-1100A 100MHz D.T., 1mV sens, Delayed Sweep, CRT Readout, DVM, Counter V-1150 150MHz Q.T., 1mV sens, Delayed Sweep, Cursor Meas, DVM, Counter	LIST PRICE SAVE \$770 \$695 \$75 \$875 \$725 \$150 \$955 \$825 \$130 \$1,190 \$1,025 \$170 \$1,895 \$1,670 \$225 \$2,295 \$2,045 \$250 \$3,100 \$2,565 \$535	

ELENCO PRODUCTS AT DISCOUNT PRICES

20MHz Dual Trace Oscilloscope  \$359 MO-1251 • 6" CRT • Built in component tester • TV Sync • X-Y Operation	See Us At Dayton! SCOPE PROBES P-1 65MHz, 1x, 10x \$19.95 P-2 100MHz, 1x, 10x \$23.95 Fits all scopes with BNC connector	35MHz Dual Trace Good to 50MHz  \$495 MO-1252 • High luminance 6" CRT • 1mV Sensitivity • 6KV Acceleration Voltage • 10ns Rise Time • X-Y Operation • Z Axis • Delayed Triggering Sweep		
Top quality scopes at a very reasonable price. Contains all desired features. Two 1x, 10x probes, diagrams and manual. Two year guarantee.				
Autoranging DMM M-5000 \$45 9 Functions Memory and Data hold 1/2% basic acc 3 1/2 digit LCD	True RMS 4 1/2 Digit Multimeter M-7000 \$135 .05% DC Accuracy .1% Resistance with Freq. Counter and deluxe case	Multimeter with Capacitance and Transistor Tester CM-1500 \$55 Reads Volts, Ohms, Current, Capacitors, Transistors and Diodes with case	Digital Capacitance Meter CM-1550 \$58.95 9 Ranges .1pf-20,000ufd .5% basic acc Zero control with case	Digital LCR Meter LC-1801 \$125 Measures Coils 1uH-200H Caps .1pf-200uf Res .01-20M
AC Clamp-On Current Adapter ST-265 \$22 0-1000A AC Works with most DMM	Bench DMMS M-3500 3 1/2 digit .1% accy M-4500 4 1/2 digit .05% accy \$125 \$175	SOLDERING STATION TEMPERATURE CONTROLLED SL-30 \$135 Digital display Temp range: 300F-900F Grounded tip Overheat prot	Solderless Breadboards 9430 1,100 pins \$15 9434 2,170 pins \$25 9436 2,850 pins \$35 All have color coded posts.	Low Cost Multimeter M-1500 \$25 3 1/2 digit LCD 1% DC Accy 10A Scale Auto zero/polarity
Wide Band Signal Generators SG-9000 \$129 RF Freq 100K-450MHz AM Modulation of 1KHz Variable RF output SG-9500 with Digital Display and 150MHz built-in Freq Ctr \$249	3 1/2 Digit Probe Type DMM M-1900 \$39 Convenient one hand operation Measures DCV, ACV, Ohms Audible continuity check, Data hold with batteries and case	Function Generator Blox #9600 \$28.95 Provides sine, tri, squ wave From 1Hz to 1MHz AM or FM capability	Decade Blox 9610 or 9620 \$18.95 #9610 Resistor Blox 47 ohm to 1M & 100K pot #9620 Capacitor Blox 47pf to 10MFD	
Digital Triple Power Supply XP-765 \$249 0-20V at 1A 0-20V at 1A 5V at 5A Fully Regulated, Short circuit protected with 2 Limit Cont., 3 Separate supplies. XP-660 with Analog Meters \$175	Quad Power Supply XP-580 \$59.95 2-20V at 2A 12V at 1A 5V at 3A -5V at 5A Fully regulated and short circuit protected XP-575 without meters \$39.95	10MHz XT 100% IBM® Compatible 5 Year Warranty \$595 MODEL PC-1000 • 510MHz Motherboard • 8 Expansion Slots • Math Compressor Slots • 360K Floppy Drive • AT Style Keyboard • 150W Power Supply • 256K RAM • Expandable to 540K • Monochrome Monitor • Monographic Video Card • Parallel Printer Port FREE spreadsheet and word processor 3.3MS DOS and GW Basic add \$75		

WE WILL NOT BE UNDERSOLD!
 UPS Shipping: US 5%
 (\$10 Max) IL Res., 7% Tax

C & S SALES INC.
 1245 Rosewood, Deerfield, IL 60015
 (800) 292-7711 (312) 541-0710

15 Day Money Back Guarantee
2 Year Warranty
WRITE FOR FREE CATALOG

CIRCLE 356 ON READER SERVICE CARD

Find Your Signal the First Time!

Getting the shift of it.

by David G. Hart AA6CQ/VE6

So where is your signal on the bird? You've got your new Mode B equipment and you continue having trouble locating your downlink frequency. The most likely problem is the Doppler shift. Once you have the translation frequency figured out, you still have to account for the dreaded Doppler shift. This shift not only makes it difficult to locate your own signal and start a QSO, but you may also inadvertently transmit right over someone else. This is especially critical when the bird is crowded.

In this article I will explain a little about the Doppler shift equation (unfortunately, yes), the Doppler shift effects, and illustrate some simple methods to find your signal the first time, and I will let you in on some simple rules. Included is a simple BASIC computer program to help you along.

The Doppler Shift

Everyone has experienced the Doppler shift, first described by Christian J. Doppler in 1830. When a speeding train is approaching you and blowing its whistle, the whistle's pitch becomes higher and higher until it passes you, then it becomes lower and lower in pitch as the train recedes from you. The same thing happens to your radio transmission to the satellite. Complicating this is that you are both transmitting TO the satellite and receiving FROM the satellite at the same time. You have to account for Doppler shift on both the uplink and downlink channels.

The Doppler shift equation is:

$$f^* = f_o \pm Vr/c(f_o)$$

where f_o is the transmitter frequency measured at the transmitter and f^* is the received frequency. The \pm means that the received signal can be either higher or lower than the transmitted frequency, depending on whether the satellite is moving towards you or away from you. Vr is the relative velocity of the satellite, and c is the speed of light.

If the satellite is moving towards you, the signal received will be higher than the actual signal the satellite is transmitting. Vr is positive. Also, the frequency the satellite receives will be higher than your actual transmitted signal. The difference in frequency is due solely to the magnitude of the relative velocity, Vr .

Typical maximum relative velocities are around 4 km/s (14,400 km/h!). Fortunately, these occur generally at or near perigee, where you won't be operating much.

In general, the magnitude of the relative velocity is the key to knowing the proper

uplink frequency. Here I will calculate the Vr from actual satellite transmissions. You can calculate Vr directly from orbital data or slant range (the distance from you to the satellite), but it is tedious by hand. Many programs are available to do the calculations. ORBIT-II is an MS-DOS program available from AMSAT which also calculates Doppler shift.

Calculating the Shift

All major satellites have beacons. Since these beacons are on a fixed known frequency, it is very easy to use the Doppler equation to calculate the relative velocity, and then go on to calculate other Doppler shifts.

For example, the beacon frequencies on OSCAR 13 are 145.985 and 145.812 MHz on

Mode B; 436.677 and 436.651 MHz on Mode JL; and 2400.664 MHz on Mode S. Simply listen for any of the beacons and note the frequency that you hear them on. They will be different from the actual transmitted frequency. If you hear the Mode B engineering beacon at 145.813500, the Doppler shift is 1500 Hz. To calculate the relative velocity, insert these numbers into the Doppler shift equation and solve for Vr :

$$145,813,500 = 145,812,000 + Vr(145,812,000/300,000)$$

$$Vr \text{ is equal to } 3.09 \text{ km/s}$$

Note that the apparent shift of 1500 Hz does not mean that your uplink frequency is

```

10 ModeBB# = 145.812
20 ModeBT# = 581.398
30 ModeLB# = 435.651
40 ModeLT# = 1705.356
50 ModeSB# = 2400.664
60 ModeST# = 1965.11
70 CLS:Print "Copyright 1989 by David G. Hart, AA6CQ/VE6"
80 Print "OSCAR-13 Doppler Shift Calculator"
90 Print "Select Mode (B,L,S) ";
100 Mode$ = Input$(1):Print Mode$
110 Print "Enter Received Beacon Frequency (MHz) ";
120 Input RXBF#
130 Print "Enter Received Station Frequency (MHz) "
140 Print "To exit enter a number less than 14"
150 Input RxSF#
160 If RxSF# < 14.0 then GOTO 410
170 IF Mode$ = "S" or Mode$ = "s" then goto 230
180 IF Mode$ = "L" or Mode$ = "l" then goto 270
190 RV# = ((RXBF#-ModeBB#)/ModeBB#)*300000.0
200 SatTxF# = (RxSF#/(1+RV#/300000.0))
210 SatRxF# = ModeBT# - SatTxF#
220 GOTO 300
230 RV# = ((RXBF#-ModeSB#)/ModeSB#)*300000
240 SatTxF# = (RxSF#/(1+RV/300000))
250 SatRxF# = SatTxF - ModeST
260 Goto 300
270 RV# = ((RXBF#-ModeLB#)/ModeLB#)*300000
280 SatTxF# = (RxSF#/(1+RV/300000))
290 SatRxF# = ModeLT - SatTxF
300 Uplink# = (SatRxF#/(1+RV#/300000.0))
310 CLS
320 Print "YOUR UPLINK FREQ = ";
330 Print Using "#####.#####";Uplink#
340 Print "Your Receive Freq = ";
350 Print Using "#####.#####";RxSF#
360 Print "Relative velocity =";
370 Print Using "+#####.##" ;RV#;
380 Print " km/s"
390 Print
400 GOTO 130
410 CLS:Print "Goodbye":END

```

BASIC program for calculating Doppler shift for the six different modes.

shifted by 1500 Hz. In fact, your Mode B uplink frequency will be shifted by 4500 Hz. For example, if you hear a station on 145.905 MHz, the satellite is actually transmitting 1500 Hz LOWER at 145.9035 MHz. As OSCAR-13 Mode B is an inverting repeater with a translation frequency of 581.398 MHz, the satellite must receive a frequency of 435.4945 MHz to transmit at 145.9035 MHz. At any point, the sum of the satellite's received frequency and the satellite's transmitted frequency is always 581.398 MHz.

Uplink Shift

Since the satellite must receive a frequency of 435.4945, we must transmit a signal that allows for the Doppler shift. To calculate the ground transmit frequency (f_g), place the satellite receive frequency and the V_r into the Doppler shift equation and solve for f_g :

$$435,494,500 = f_g + 3.09 (f_g/300,000)$$

$$f_g = 435,490,000$$

Thus to receive on 145.905 MHz, you would transmit on 435.490 MHz. The uplink Doppler shift is 4,500 Hz down while the downlink shift is 1500 Hz up, for a net shift of 3,000 Hz down.

You might notice that the total shift is twice the apparent shift of the beacon in the opposite direction. You can follow this rule for all OSCAR-13 Mode B operations: *The total shift is equal to twice the opposite beacon shift.* If the beacon frequency is shifted by

1000 Hz down, raise your transmit frequency by 2000 Hz.

If you wanted to put your receive signal on 145.8 MHz, without Doppler shift you would transmit on 435.598 MHz. However, if the beacon is shifted 2000 Hz UP, the transmit frequency would be shifted 4000 Hz DOWN, to 435.594 MHz.

Mode L and Mode S Rules

Using the Doppler formula, you can also work out the rules for Mode L and Mode S. Mode L is also an inverting repeater (with a translation frequency of 1705.356 MHz) with a rule similar to Mode B: the total shift is equal to 1.9 times the opposite beacon frequency shift. If the beacon shift is 3000 Hz UP, you must shift the actual transmit frequency 5700 Hz DOWN. This rule is not exact, but it is close enough for government work.

Mode S is a non-inverting repeater (with a translation frequency of 1965.11 MHz) so the rule here is a little different: The total shift is equal to 1.2 times the beacon frequency shift. If the beacon is shifted 10,000 Hz UP, you must shift the actual transmit frequency 12,000 Hz UP.

The rules are a result of translation frequencies, repeater types, and uplink/downlink frequencies, and not just whether the mode is inverting or not.

Let The Computer Do It

Because Mode L and Mode S rules are not

exact, I have included a simple BASIC program to aid in exact shift calculations. The program is also for those of us who can't do simple math. The program assumes you are using OSCAR-13.

To use the program, either run the compiled version or load the code into your BASIC interpreter. The program will ask you for your operating mode (B,L,S) and the measured beacon frequency. The program will then ask for the received frequency that you want to wind up on. Your transmit frequency will then be displayed along with the relative velocity, V_r .

The program should run on most computers having BASIC. The source code and compiled version is available on CompuServe (in the Hamnet conference) or from the author (in MS-DOS format on 5 1/4" or 3 1/2" diskette) for US \$5.00. If you get the program from the author, a more sophisticated version will be included with the simple version. Contact AMSAT for information on commercial software or join the Hamnet conference on CompuServe.

OSCAR-13 really adds an exciting new mode of communications to the amateur world. By monitoring the beacon frequencies on the satellite, you can use these simple rules to find your signal the first time, every time. This is especially easy using Mode B since your transmit frequency shift is just twice the opposite of the beacon shift. So have fun and happy satelliting! **73**



Hi Pro Repeater
ELCO

MAGGIORE ELECTRONIC LAB.

Manufacturers of Quality Communications Equipment

- Repeaters
- Links
- Remote Base
- VHF,UHF
- Receivers
- Transmitters
- Antennas



- Standard and Computerized Controllers
- Standard and Computerized Auto Patches
- Duplexers

Hi Pro 'E'

EXPANDABLE REPEATER SYSTEM

- A NEW CONCEPT IN REPEATER DESIGN, THE Hi Pro "E" IS AN EXPANDABLE REPEATER WITH THE FOLLOWING FEATURES: A BASIC REPEATER WHICH WOULD INCLUDE A COMPLETE RECEIVER, TRANSMITTER, COR, FRONT PANEL CONTROLS AND INDICATORS, LOCAL SPEAKER AND MIC JACK AND CAPABLE OF FUTURE EXPANSION. ALL HOUSED IN AN EXTREMELY RUGGED, ENCLOSED, 19-INCH RACK MOUNTABLE CABINET.
- THIS SYSTEM CAN BE EXPANDED AT TIME OF PURCHASE OR CAN BE AN AFTER-PURCHASE ADD ON. THE ADD ONS ARE—HIGHER POWER, 110/220 VAC POWER SUPPLY, IDENTIFIER, AUTO PATCH, OR COMPUTER CONTROLLERS. IN ADDITION TO THESE ADD ONS AN ADDITIONAL RECEIVER AND TRANSMITTER CAN BE MOUNTED INTERNALLY FOR USE AS CONTROL LINKS, REMOTE BASE OR DUAL BAND OPERATION, ETC.
- AN EXTENSION PANEL IS AVAILABLE FOR LOCAL MONITORING OF THE REPEATER AND CONTAINS ALL NECESSARY METERING, STATUS LIGHTS AND INDICATORS. ALL ADD ONS ARE AVAILABLE FROM THE COMPANY AND ARE COMPLETE INCLUDING INSTRUCTIONS.

MAGGIORE ELECTRONIC LAB.

600 Westtown Rd. West Chester, PA 19382

Phone (215) 436-6051

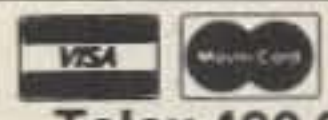

Telex 499 0741 MELCO

WRITE OR CALL FOR OUR COMPLETE CATALOG

JEZ— Jugendelektroniczentrum

How one Swiss group supports the education of young hams.

by Ruedi Mangold HB9DU

I have been a ham since 1930. At first, I did shortwave listening, but in 1938 I got my amateur license. Then, during WW II, I was in the Swiss Army Signal Corps, repairing equipment. After that I taught physics at the Basel technical college.

But we always come back! Recently, I began teaching amateur radio, 30 adults at a time, using my excellent physics equipment and the college physics auditorium. Candidates for licenses were tested by our experts from the PTT (like the American FCC) from Berne, and they got the highest percentage of passing grades in Switzerland—86% of them correctly answered the required 70% or more of all the questions!

This was, we here all agree, because the course included lectures, films, experiments, what you call "hands-on" training, and visits to Swiss transmitting stations. It was a real triumph for them, for our PTT is a hard taskmaster in every respect.

PTT Rules and Regulations

Some who have worked HB stations have perhaps thought Swiss hams curt and impolitely short. Please do not think so. It is because a ham is likely to be punished should he talk more than, say, ten words about the weather. The PTT listening, or control, stations are severe supervisors. You are allowed only conversations about technical topics and "information of negligible value, for which the use of the telephone is not justified." Third party information "is strictly forbidden."

Furthermore, there is no protest allowed against any PTT verdict. In the Swiss Constitution, the PTT is given absolute monopoly over all communications. And since there is no exact definition of forbidden conversations, the Swiss ham, as we say, "always has one of his legs in the law courts!"

The first license in Switzerland was issued to H. Degler in 1926. His call was H9XA.



Photo A. From left to right: Ruedi Mangold HB9DU, founder and spiritus rector of JEZ; Christine Wirz-v. Planta, president of the supporting club; and Christoph Biel HB9DKQ, technical chief of JEZ. (Copyrighted photo by Andre Muelhaupt, Basel. Published in Basler Zeitung: 17.3.1988.)

When the Union of Swiss Shortwave Amateurs, the USKA (our version of the American ARRL) was formed in 1929, there were 35 amateurs. Today we have over 3,500.

Testing Requirements

They all passed the tests. For the "small license," meaning you can send on 144 MHz and up (200 W PEP for the first three years, then 1,000 W PEP), the tests are:

- (1) 20 multiple-choice questions—most about complicated algebraic problems in general electronics, and on receiving and transmitting techniques—to be answered within 60 minutes.
- (2) 20 questions on international regulations, codes, and security regulations.
- (3) 10 questions on antenna-building regulations. (Switzerland is a highly electrified country with a rather dense telephone network, and severe laws about the protection of landscapes.)

For the "big license," allowing use of the short waves, you also must pass the Morse exam. For a five-minute period you must work at 60 characters-per-minute (12 wpm), transmitting and receiving in mixed languages with no more than three errors.

Exam questions change with every test, and there is no book of past questions you can study. Candidates *must* have a thorough understanding of electronics. This is why we have courses which run for three semesters, two hours per week.

Now you see why my candidates were so proud of themselves!

Formation of JEZ

I was able later to have classes for youngsters, ages 14 to 18, using my college facilities, but having the Basel Education Department pay all of their expenses. There were nine courses, three of them for kids, by the time I retired in my sixties. And then, having seen the very big need

to help introduce youngsters to the world of electronics and amateur radio, in 1974 I founded JEZ—the Jugendelektroniczentrum.

Within months it was clear that leisure-time courses would not be enough and community involvement was called for. The local radio club, the Funkamateurlub of Basel (FACB), pitched in. An unused kindergarten building was obtained; it was located on the second highest point in Basel, surrounded by meadows where antennas could be erected. Ten FACB members put in 1600 hours of volunteer time and installed electricity and plumbing. The town's chemical companies donated furniture, a chain-store company (the Migros) donated tools, and factories gave dozens of measuring instruments, including multimeters, spectrum analyzers, a sheet metal bending machine, and lathe and turning tools. The library stocks 10 different European and US electronic journals, and there are drawers that contain over 8,000 different components. In this self-service system, students pay for what they use when they leave the workshop.

By the mid-1980s we were offering courses (much less expensive than the usual \$230 for school boys to learn about ham radio) in a



Photo B. JEZ antennas: twenty meter mast with beams for 2 meters and 70 cm; satellite antennas and a Windom above for 40/80 meters; Versatower with DJ2UT beam in foreground. Not visible: Meteosat and ATV receiving and transmitting antennas.

variety of subjects in the field of electronics. As of 1988, some 40 youngsters were taking courses weekly. About 20% of them will become interested in ham radio and the others will get very good jobs in the electronics industry. We don't just make amateurs, we make motivated youngsters for high tech fields.

Because the response to our center was so great, and the task too much for volunteers from the 80 member FACB, we had to organize more formally. We now function with the government giving us rent-free space and an annual contribution of 55,000 Swiss francs (about \$39,000), and we have a supporting club, the "Trägerverein JEZ," presided over by a prominent Basel Member of Parliament, Mrs. Christine Wirz-v. Planta. We have private donations which also amount to 55,000 SFr, and a working crew which includes six instructors, and other volunteers who help keep the center tidy and the equipment working. Christoph Biel HB9DKQ is the JEZ chief instructor now, and I am a helping hand for him. (I sometimes say that HB9DKQ is now the conductor,



Photo C. At left are resistors and condensers; window shelves hold spectrum analyzer. Also shown are frequency generator (10 Hz to 12.6 GHz), frequency counters, and oscilloscopes.

and I am only the semiconductor!)

In A Word: Meaningful

We have now a serious learning center with a friendly atmosphere. The youngsters cannot just come and go as they wish. We have a nice cafeteria and a well-stocked library, and the best of equipment and the best sponsors. The electronics industry has been saying to me that we provide them with the best technicians.

I am afraid nobody often hears the HB9DU call any more; I am too busy. But in my choice between being an Elmer for 40-50 youngsters and a DX chaser, I have taken the route that is eminently more satisfying. . . 73

ART-1

ART-1: A complete interface system for send and receive on CW, RTTY (Baudot & ASCII) and AMTOR, for use with the Commodore 64/128 computer. Operating program on disk included. **\$199.00**

AIR-1: A complete interface system for send and receive on CW, RTTY (Baudot & ASCII) and AMTOR, for use with Commodore VIC-20. Operating program in ROM.

\$99.95

AIR-1

SWL

SWL: A receive only cartridge for CW, RTTY (Baudot & ASCII) for use with Commodore 64/128. Operating program in ROM. **\$64.00**

AIRDISK: An AIR-1 type operating program for use with your interface hardware. Both VIC-20 and C64/128 programs on one disk. **\$39.95**

AIR-ROM: Cartridge version of AIRDISK for C64/128 only. **\$59.95**

AIRDISK

MORSE COACH

MORSE COACH: A complete teaching and testing program for learning the Morse code in a cartridge.

For C64 or C128.

\$49.95

VEC SPECIAL

\$39.95

G AND G ELECTRONICS
OF MARYLAND

8524 DAKOTA DRIVE, GAITHERSBURG, MD 20877
(301) 258-7373

CIRCLE 372 ON READER SERVICE CARD

AMATEUR TELEVISION

SMILE! YOU'RE ON TV



Only
\$329

Designed and built in the USA
Value + Quality
from over 25 years
in ATV...W6ORG

With our all in one box TC70-1 70cm ATV Transceiver you can easily transmit and receive live action color and sound video just like broadcast TV. Use any home TV camera or VCR by plugging the composite video and audio into the front VHS 10 pin or rear phono jacks. Add 70cm antenna, coax, 13.8 Vdc and TV set and you are on the air...it's that easy!

TC70-1 has >1 watt p.e.p. with one xtal on 439.25, 434.0 or 426.25 MHz, runs on 12-14 Vdc @ .5A, and hot GaAsfet downconverter tunes whole 420-450 MHz band down to ch3. Shielded cabinet only 7x7x2.5". Transmitters sold only to licensed amateurs, for legal purposes, verified in the latest Callbook or with copy of license sent with order.

Call or write now for our complete ATV catalog including downconverters, transceivers, linear amps, and antennas for the 70, 33, & 23cm bands.

(818) 447-4565 m-f 8am-5:30pm pst.

Visa, MC, COD

P.C. ELECTRONICS

2522 Paxson Ln Arcadia CA 91006

Tom (W6ORG)

Maryann (WB6YSS)

Need FM?

FM demodulation circuit for older receivers.

by Walter Symczyk KB2BQK

Phase-locked loop (PLL) integrated circuits can enhance the capabilities of older equipment. With the recent increase in FM activity on the 6 and 10 meter bands, I began looking for a way to monitor this activity. My station did not support either band. I monitored the 6 and 10 meter bands with my Hammarlund HQ-170-A, but this receiver didn't demodulate FM.

The Mod

I decided to use a PLL IC to demodulate FM signals from the IF strip of the Hammarlund. The IF frequency of the Hammarlund HQ-170-A is 455 kHz. A phono plug on the rear of the receiver allows access to the IF strip. The IC chosen for this task was a NE-565-N which has a frequency range from 0.001 Hz to 500 kHz.

This IC, readily available for less than five dollars, consists of a phase detector, VCO, and amplifier. For projects with receivers of different IF frequencies, you may need a different IC. For example, the NE-560-B has a frequency range of 1 Hz to 15 MHz. (Please note that the internal configurations and pinouts differ on these ICs, but you can otherwise apply the concepts in this article.)

How Demodulation Occurs

The operation of this IC is controlled by the following external components: C1 and R1 control the free running frequency of the VCO, and C2 controls the capture range (the range over which the PLL acquires phase lock). To demodulate FM, set the free running frequency of the VCO to the frequency of the receiver IF, and set the capture range to approximately the width of the signal you wish to demodulate.

Connect the VCO to the phase detector through pins 4 and 5. Connect the input signal at pin 2. The demodulated output is presented at pin 7; it is the correction voltage which keeps the VCO locked on the input signal. In other words, the phase detector compares the input signal with the signal generated by the VCO and generates a correction voltage for the VCO. This correction signal is amplified internally and fed back to the VCO to maintain the lock. It is this correction signal which provides the demodulated output.

The design formulae used with the 565 are:

$$\text{Free-running frequency of VCO: } f_0 = 1.2/4(R1)(C1)$$

$$\text{lock range } f_L = \pm 8f_0/V_{CC}$$

$$\text{capture range } f_C = \pm \frac{1}{2\pi} \sqrt{\frac{2\pi f_L}{r}}$$

$$\text{where } r = (3.6 \times 10^3)(C2)$$

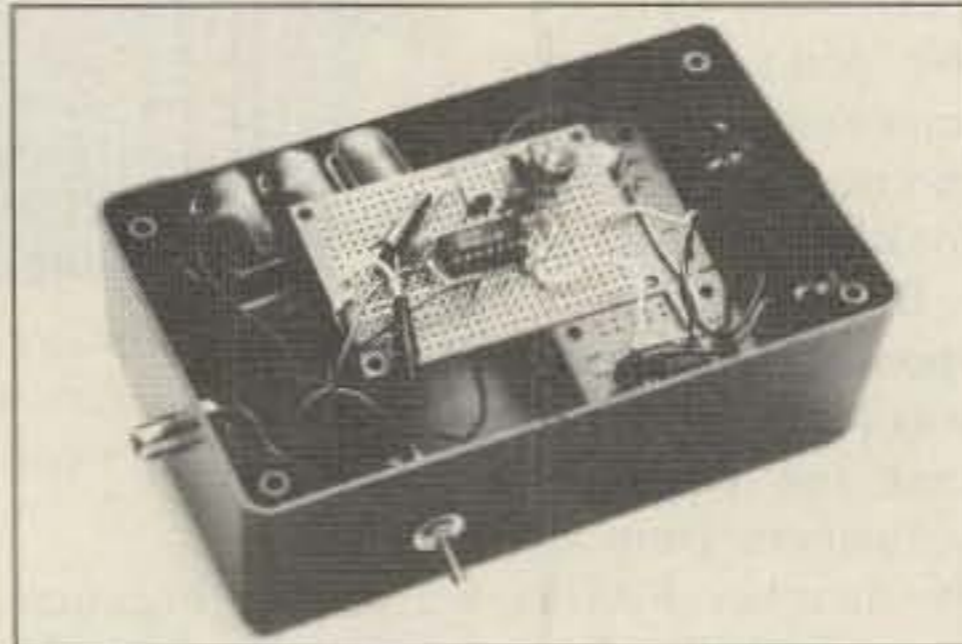

Photo A. Assembled FM demodulator.

Parts List

U1	NE 565 N	
C2	0.1 μ F ceramic	
C1A	100 pF ceramic	C1A & C1B used in parallel to obtain 127 pF
C1B	27 pF ceramic	
C3	0.001 μ F ceramic	
R1	10k variable	
R2	5230 Ω	

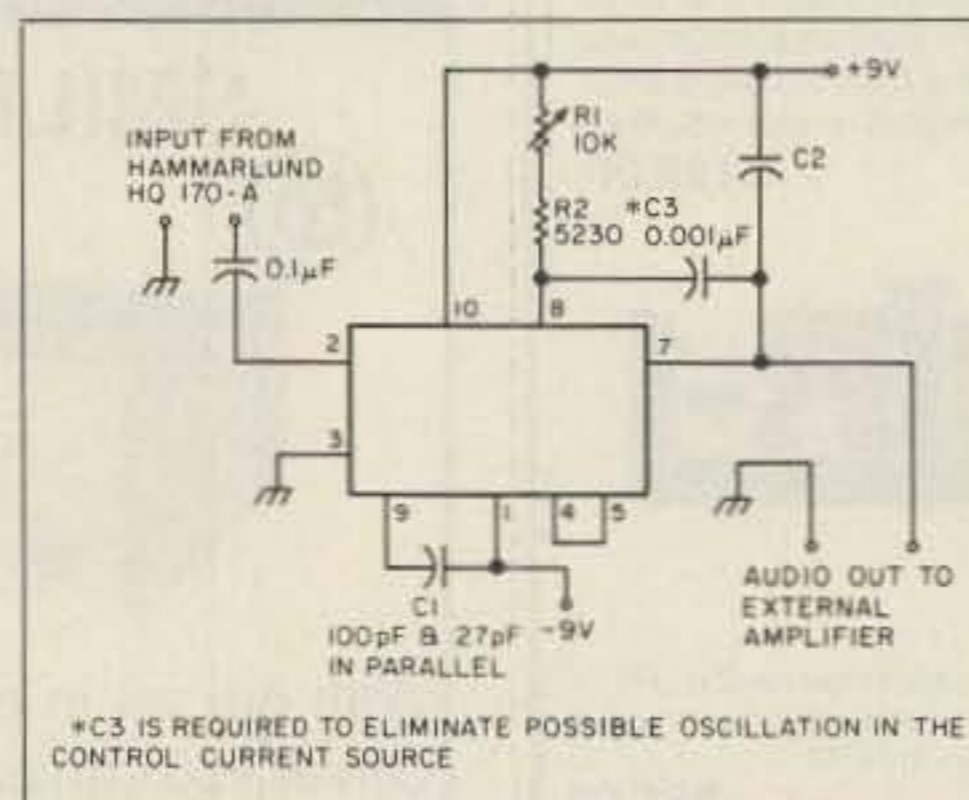

Figure 1. Schematic of the FM demodulator.

served all the inputs and outputs until I was comfortable with the operation of the 565 IC. What I learned at this stage was invaluable for later debugging. I highly recommend that anyone doing a project of this nature go through this exercise.

Figure 1 is the circuit I came up with, and which I am currently using. The component selections were all compromises based upon what was in my junk box. Therefore, in many areas there is room for optimization. I constructed and tested the circuit on a breadboard. When I finished playing with it, I moved it to a PC board using ugly construction.

Solving the Problems

The first problem I encountered was insufficient signal strength at the phone plug IF tap of the HQ-170-A. To solve this problem, I changed the tap point further down the IF strip where a stronger signal was available.

The second problem was tuning the circuit. I accomplished this by setting the 565 VCO free running frequency with a frequency counter to 455 kHz, adjusting R1. To do this, remove the jumper between pins 4 and 5, and ground the input pin 2. I also used a filter capacitor which allowed a capture range of ± 13 kHz. I connected everything up to the Hammarlund. When I was satisfied that the circuit was locking on signals (this required some fiddling with R1), I replaced the filter capacitor with one which provided for a capture range of ± 4.2 kHz.

After everything was running, the audio required external audio amplification. In regards to performance of this circuit I observed that signals received with a strength of S-5, as indicated by the Hammarlund's S-meter, are full quieting. I believe that the circuit could also be improved by a better choice of components and the addition of an external amplifier stage prior to the PLL.

If you have an older receiver and you can spare the cost of the IC, I think you'll find this an educational, entertaining, and rewarding project. **73**

Bibliography

- Berlin, H.M., *Design of Phase-Locked Loop Circuits with Experiments*, Howard W. Sams & Company, Indianapolis, 1988.
- The ARRL Handbook for the Radio Amateur*, American Radio Relay League, Newington, 1985.

10 GHz RF Preamp

A building block toward a complete 10 GHz transceiver system.

by C.L. Houghton WB6IGP

Construct an amplifier for the 10 GHz microwave band? How about 18 dB gain and 3 dB noise figure at 10 GHz? Does it sound impossible? Well, it isn't! San Diego Microwave Group members have constructed several of these amplifiers and all have worked quite well. Thanks to Clark Bishop WB4PQD, who designed this stable, high performance, dual-mode amplifier for 10.12 GHz, and who is allowing us to publish the design for amateur use.

Preamp Construction

The amplifier described here has been used as a receiving preamplifier and as a transmit amplifier, with appropriate RF relay switching. Construction of this amp is somewhat delicate due to its small printed circuit board and components. The finished PC board is 1½" by 1" (see Photo A).

Mitsubishi's low-cost (about \$15 each) Gallium Arsenide Field Effect Transistor (GaAsFET) MGF-1402 is central to the pre-amplifier's design. It has gold metalization strapping over the ceramic case, connecting the two strip line opposed source leads. Most importantly, this metalization reduces the total inductance of the source leads necessary for good operation at 10 GHz. When ordering, be sure to specify the full gold metalization over the case connecting the source leads together.

In other designs, the emitter or source leads are bent down and over to connect to the rear ground foil. At lower frequencies, this works well, but at frequencies above 5 GHz, a very small inductance in the leads will give low gain and

the amplifier may become useless. Lead length is critical for proper operation. See Figure 1 for the schematic and parts placement.

The Teflon™ PC board is 0.031" thick, with a dielectric constant of 2.5. You will need Teflon stock because other materials will not perform at microwave frequencies. If you can not find any Teflon, or just don't wish to make our own, I will provide the etched PC boards and/or a minikit of parts.

The amplifier is a two-stage device requiring a small power supply with negative bias and positive drain. Current demands are light. The external power supply that I built furnishes a bias of -1 volt DC and drain voltage of +4.5 volts. You could use an AA battery for bias and an adjustable regulator for the drain voltage (see Figure 2).

Building the Power Supply

I decided to build a power supply that provided sequencing protection, as Ray W6AMD suggested. By putting a series pass transistor in the positive input circuit, the positive voltage will not activate until the bias supply is operating at full potential (see Figure 3). I have used this protected power supply for months, and it has proven reliable. It runs from a 12 volt supply. The negative power supply is enclosed in a small 24-pin DIP package and looks much like a large EPROM. The transformer-isolated power supply is regulated to -9 volts with 40 mA of current available.

We only need a few mA, so the power supply loafs in this application. Part of the negative supply is voltage divided to the -1.2 volts to feed the gate bias circuitry. This requires very little current. The main -9 volt output is fed to a series current limiting resistor in series with a 6 volt zener diode, which in turn feeds the emitter of a 2N2222 NPN transistor.

Tie the collector of the 2N2222 to the base of the 5 Watt dissipation PNP pass transistor which controls the input of the LM-317 positive adjustable regulator. When you apply +12 volts to the power module, the negative power supply turns

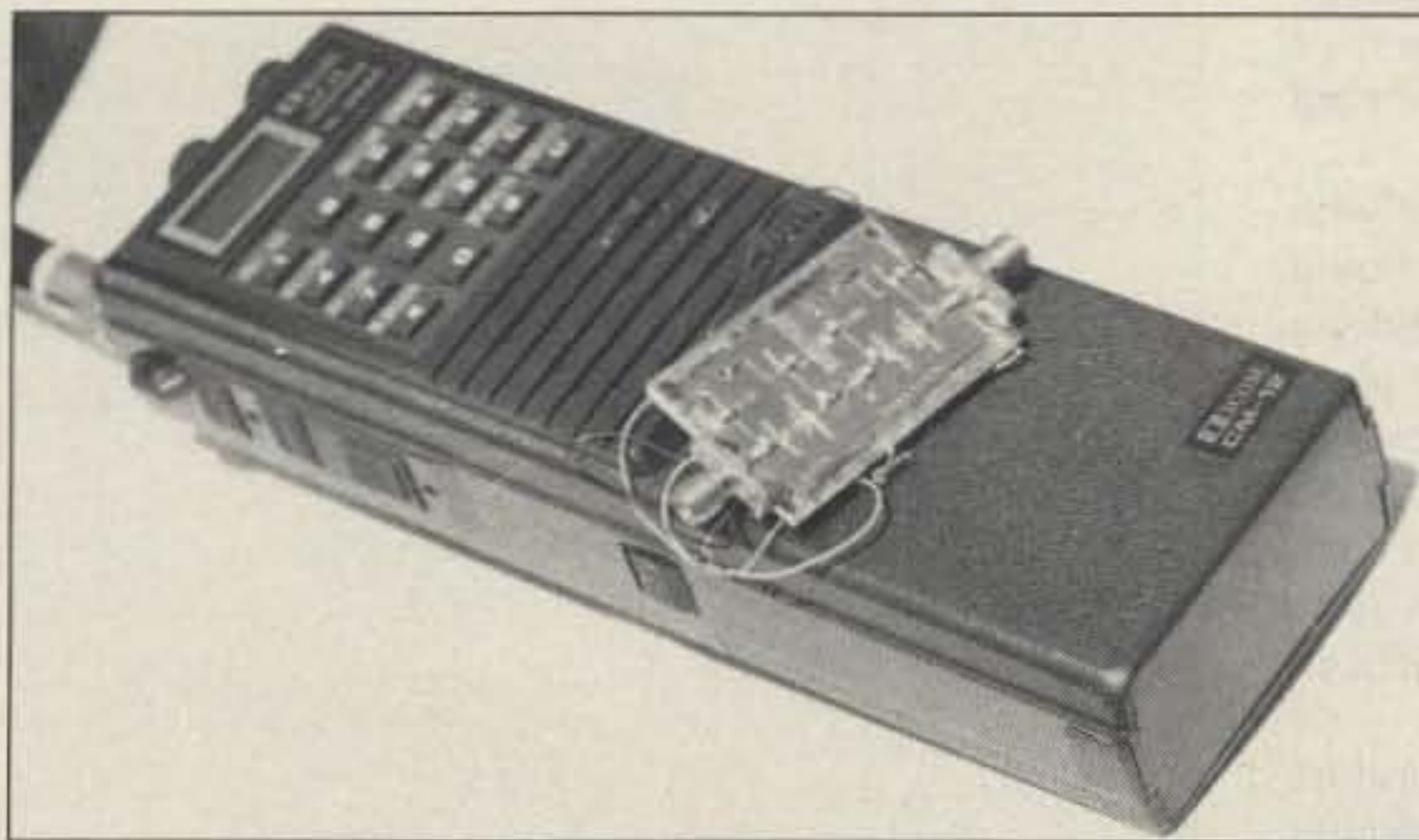

Photo A. Close-up showing the 10 GHz preamp on top of an IC-02 battery box for size comparison. The amplifier uses two MGF-1402s and boasts only 3 dB noise figure and 18 dB gain.

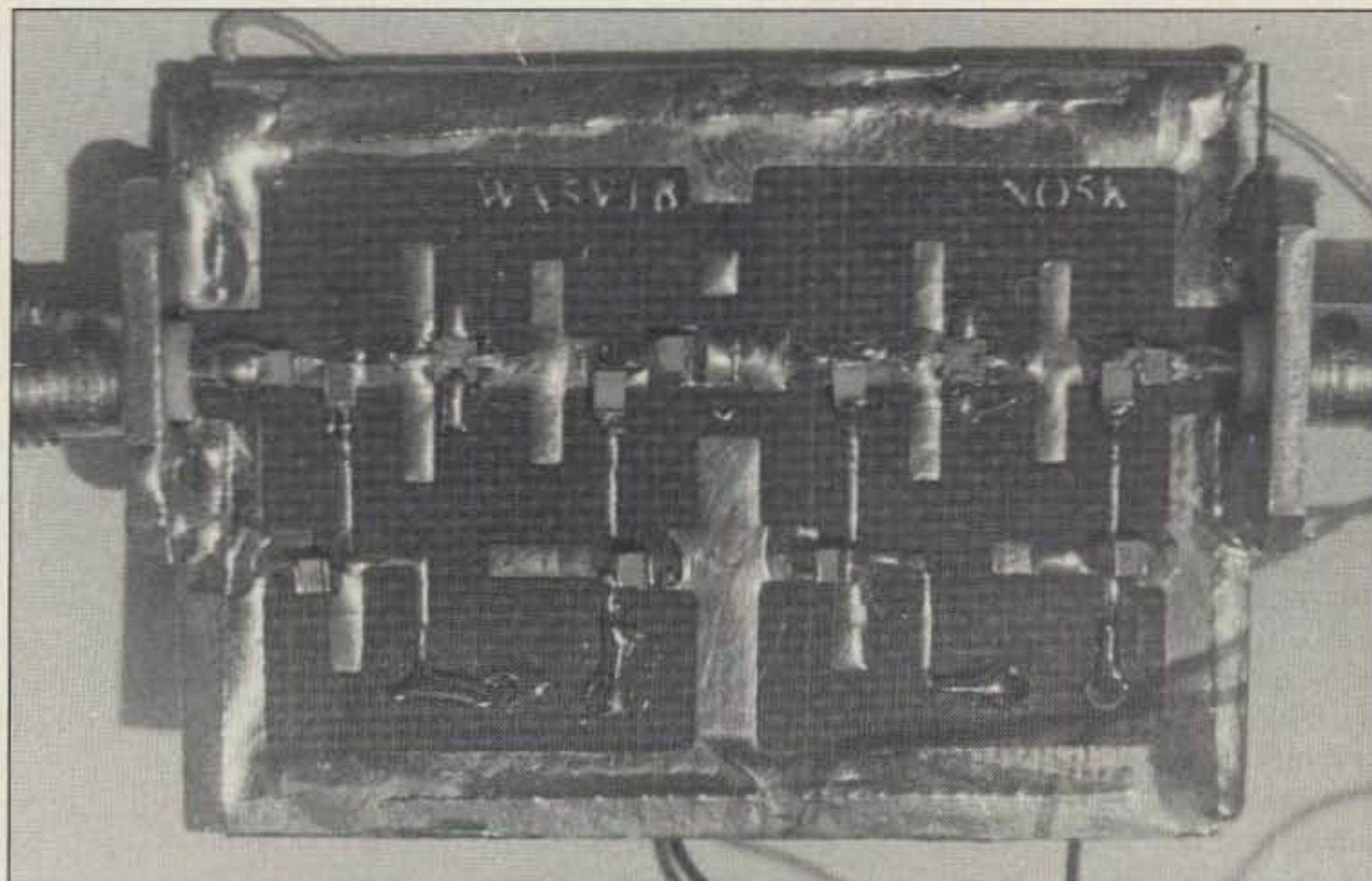

Photo B. N6IZW's 10 GHz pre-amp. GaAsFETs are mounted upside down, under the "W" and "N" in the callsigns. Coax connectors are SMA.

on, producing -9 volts output. This negative voltage passes through the 2N2222 switching transistor, and turns on the base of the pass transistor, a 2N5322. If for some reason the negative voltage isn't high enough to overcome the series resistor and zener, or if it fails to come on at all, the positive supply will not come on, either. This prevents the positive supply from applying voltage with zero bias on the FETs. There are 100Ω in the drain leads to further protect the FETs, so this is just additional protection. More than 6 volts can destroy FETs, so this rating should never be exceeded. I placed 5.6 volt zeners in both the negative and positive power supply outputs to prevent any possible problem. I modified the PC board to accept 5 Watt zeners, which should fold down the power supply in case of over-voltage.

Mounting the Components

The components to be mounted on the amplifier board are all chip type resistors and capacitors. The chip resistors, of which you need four, are 100Ω. Three 1 pF ATC-100 type chip capacitors are used to connect the input, output and interstage coupling. We have used values up to 2 pF with little change in performance. The bypass capacitors, of any value from 100 pF to 1000 pF, are chip type.

Prepare the PC board by cleaning it with fine steel wool. Apply a small dab of liquid rosin to the spot where you want to solder a chip component. This will hold it in place while you solder. You can use a toothpick to position the chip resistor or capacitor and to hold it down so you can solder only one end of the device. Then you can solder the other end. A chip soldered on both ends is difficult to reposition.

By the way, I recommend a temperature controlled, low voltage iron, such as a Weller WTCPS soldering station. They're grounded, a requirement for working with the static-sensitive GaAsFETs. If you don't have one, unplug your soldering pencil and ground it when soldering GaAsFET devices.

Position and solder all chip capacitors and resistors on the front face of the PC board. Solder a grounding foil around the outside of the PC board edges. Cut out the top foil where the SMA coaxial connectors will be mounted, to give clearance to the center conductor of each SMA connector. Solder the ground foil and the ground part of each SMA connector together, on top of the board. This makes a short ground connection to the outer perimeter of the top of the PC board, and a solid connection to the rear ground foil surface.

Now, make the cutouts for the FETs in the circuit board and rear ground foil, clearing a hole about 0.100" square to fit the FET. The case size of the FET is specified at 0.071". The hole should allow easy entry of the FET on the PC board when you're ready to solder the device. The FET is mounted upside down on the PC board (see Photo B), allowing the top of the FET (part of the strip line source connections common to the FET) to be

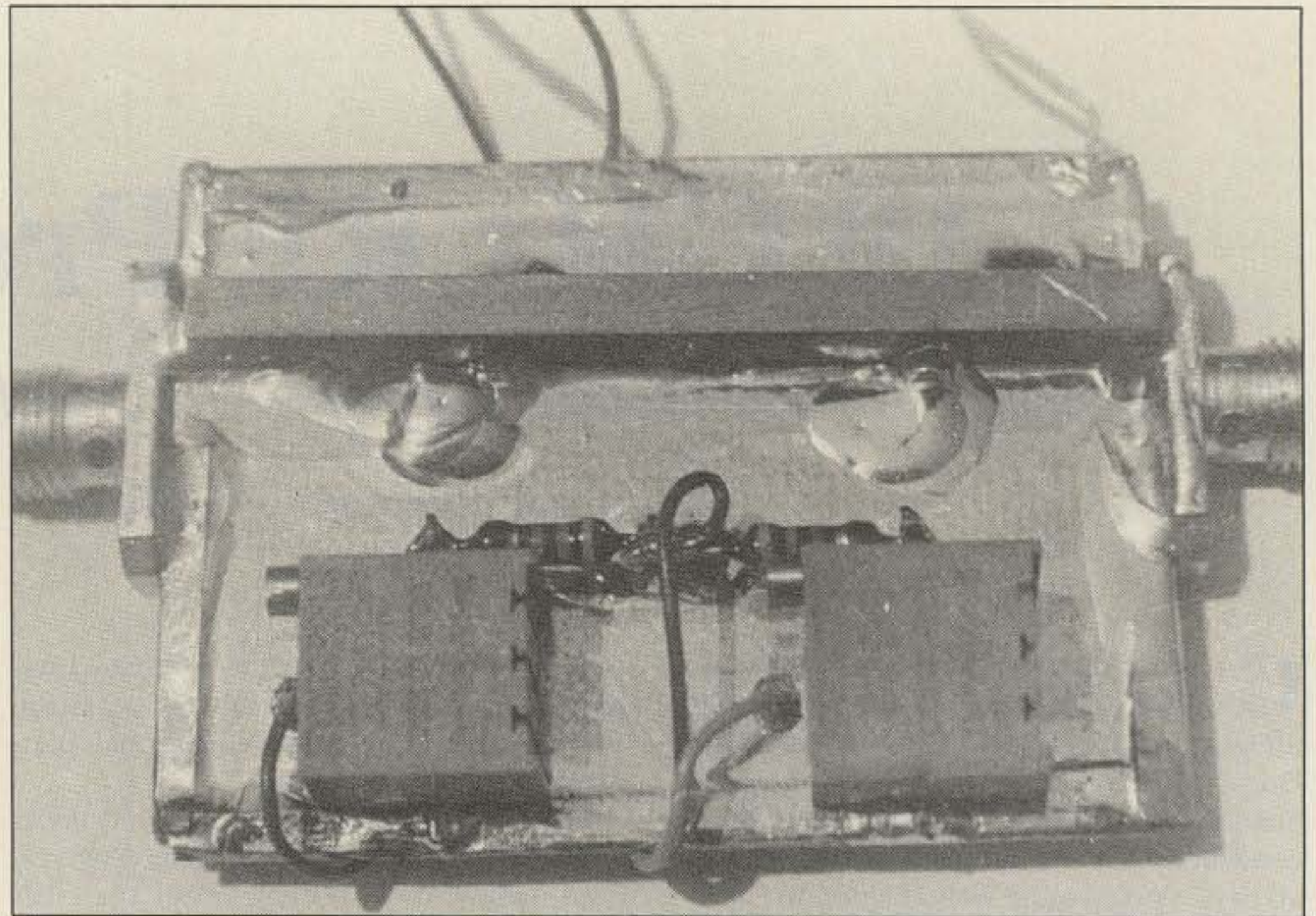

Photo C. Rear view of the 10 GHz preamp, showing the mounting arrangement of bias adjustment pots, and the brass bar which strengthens the soft Teflon PC board.

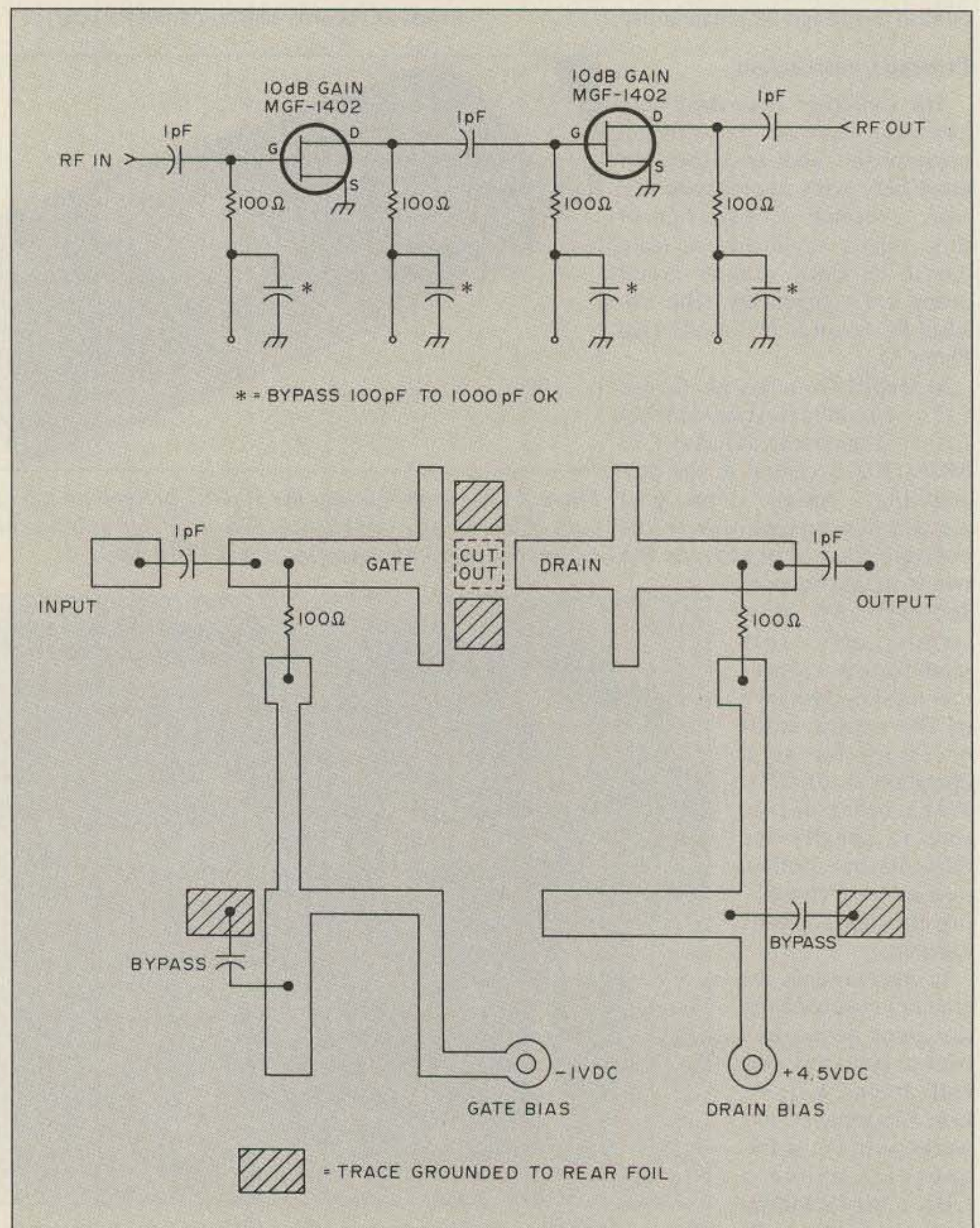

Figure 1. 10 GHz preamp schematic and parts placement diagram.

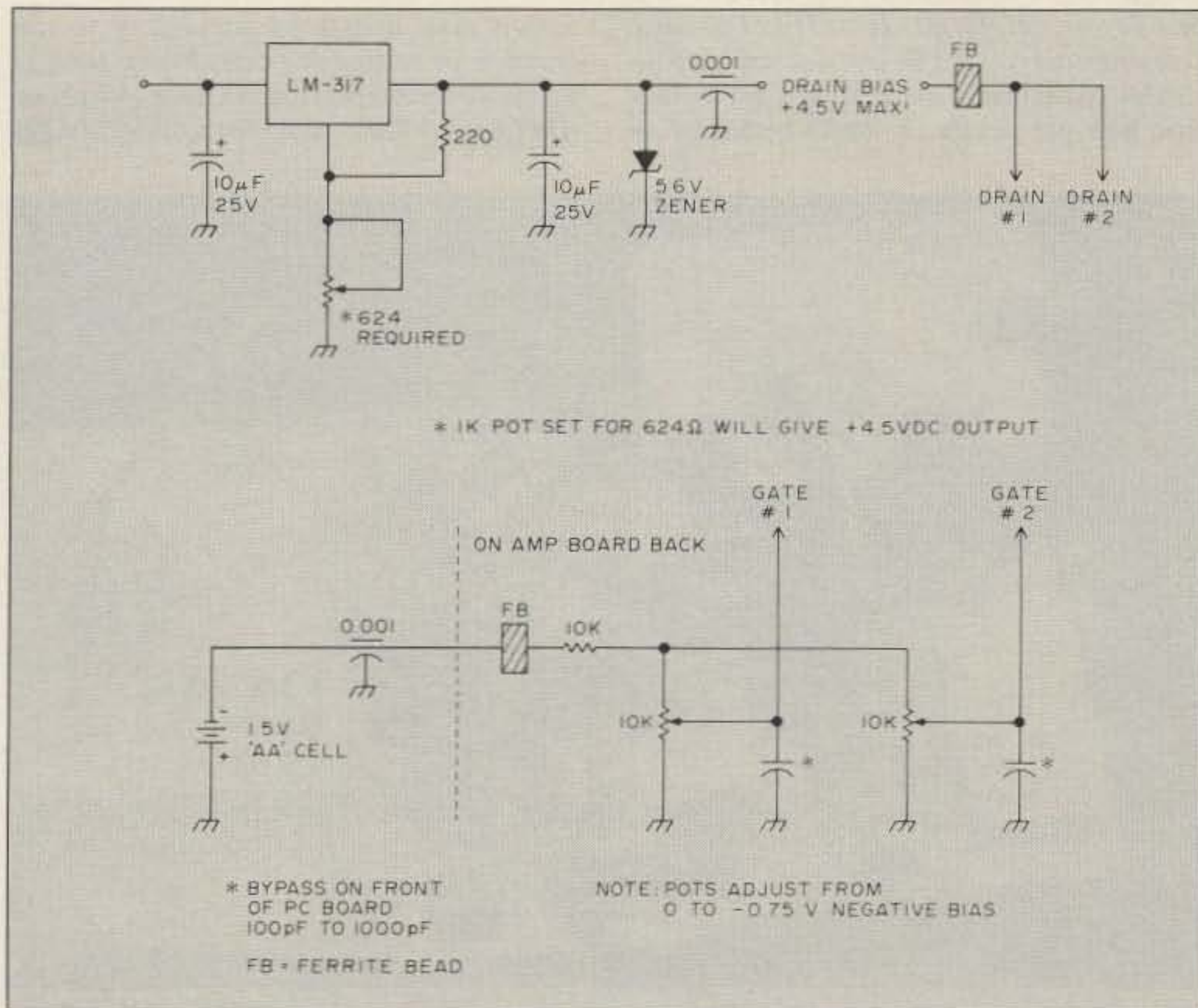

Figure 2. Power supply with battery for the 10 GHz preamp.

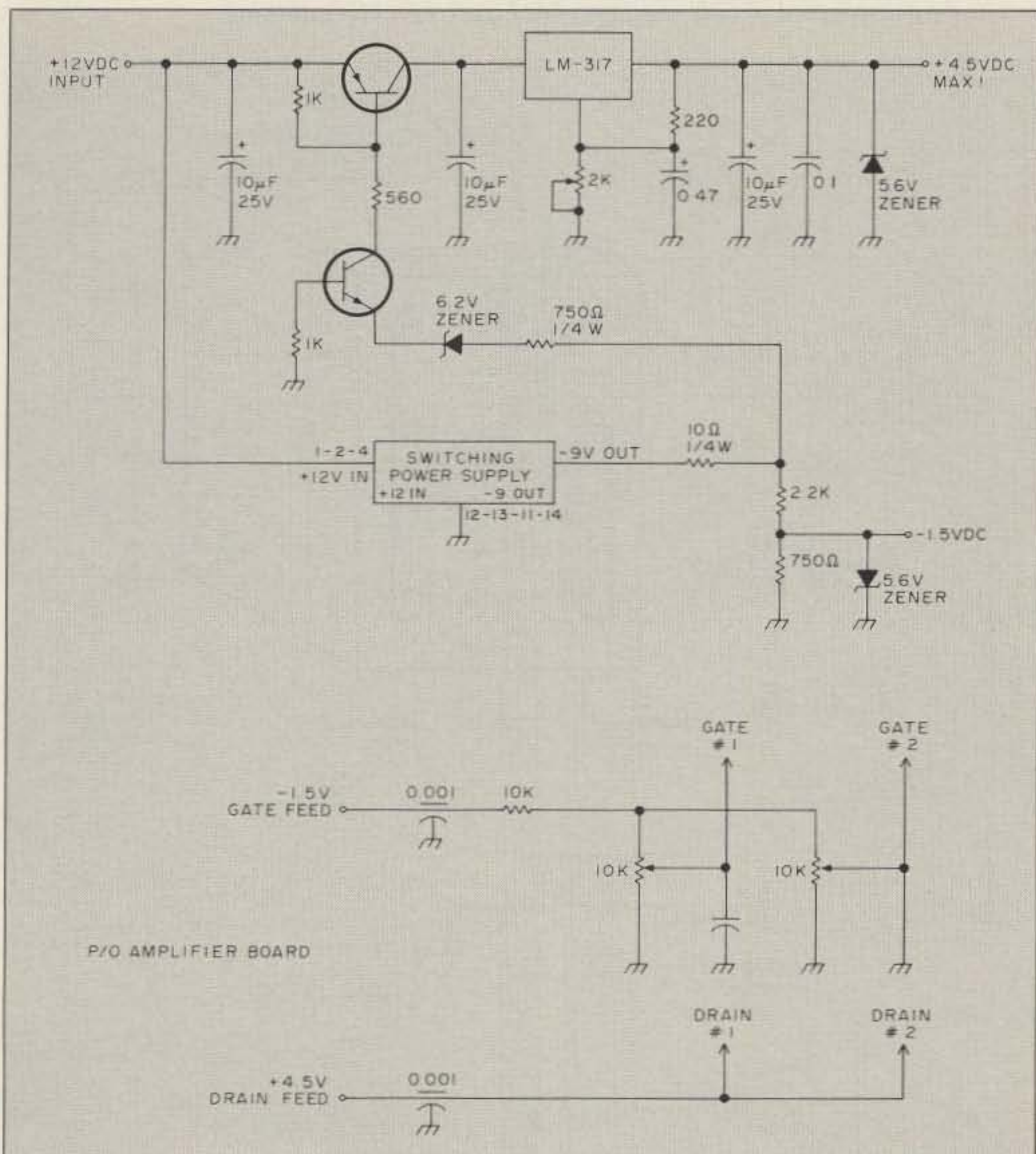

Figure 3. Power supply for preamp. Supply provides sequencing protection. The schematic below the power supply schematic shows where the power supply leads attach to the amp board.

soldered to the rear ground foil. This makes the short source leads required for this frequency. Do not mount the FETs now.

Next, mount the bias adjust circuitry, two 10kΩ pots, on the back of the board. Pass the wiper of each pot through a small hole in the ground plane so that it contacts the bias feedpoint for FET#1 and #2. The opposite end of the adjustable potentiometer is grounded, and the high end is tied common to each other with a 10k ¼ Watt resistor in series with the bias supply. Place a small insulator under the pots to prevent the top negative supply point from possibly touching ground with any downward pressure on the pot. Tie the two drain lines common, on the back of the board.

When all components are mounted and the FET cutouts made, check the board carefully, then insert the GaAsFETs, one at a time, into the board. Use a grounded soldering station, and don't forget to ground yourself to the work piece. A wrist strap of high resistance, but sufficient to discharge any static from yourself, is available from many dealers. This is necessary to prevent damage to the sensitive FETs. If you take these precautions you should not have any trouble. Just work slowly and carefully, and keep all components grounded.

Final Check

In this last stage, pre-set the bias pots to maximum resistance, or maximum negative bias, to limit the FETs' drain current. Apply negative bias to both FETs, and while watching the first stage with a current meter (I used a 0 to 100 mA meter), adjust the associated bias pot to a drain current reading of 10 mA. (For the preliminary check, you might want to start with a positive DC voltage somewhat less than 4 volts.)

The first stage current of 10 mA is consistent with minimum noise figure according to the gain versus noise figure curves. Stage two is adjusted in the same way, except that you should adjust for a current reading of 20 mA. Higher current is not necessary, as the device is operating at optimum performance at this current level. For fine tuning anomalies, you may affix small pieces of copper to a toothpick and move around the traces of the PC board. We did not perform this step because we were satisfied with the gain we obtained. It was stable and very near optimum.

When you are satisfied with the operation, you can adjust the bias to minimum current and re-set the positive DC supply to 4.5 volts. Go through the same procedure to set current levels. Do not apply DC voltage, negative or positive, above 5 volts because 6 volts will destroy the device. Go slowly, don't rush, and think your operations through. You can measure three times, but you can cut only once.

After the final checkout, put a short piece of scrap brass on the back of the PC board, over the soldered connection for the FET source case lead (see Photo C). Mount the brass to clear the other parts, and solder it between the two SMA flanges and the ground

foil. This will reinforce the Teflon PC board. House the amplifier in a suitable, shielded container along with the power supply (see Photo D).

Performance

From use, we know the amplifier is quite stable, with a good performance record. Most of the units we built varied due to different construction techniques, but they all gave close to 18 dB gain. The amplifier as both a receiving and transmit amplifier gave very good results. In transmit, the maximum output we obtained was +8 dBm as read on my HP-431 power meter. Kerry N6IZW and I feel that this is due partially to the fact that the 100Ω drain resistor on the output stage limits the device. We plan to try changes by setting bias and replacing the 100Ω resistor with a RFC. This will require further experimentation.

We made the relay switching scheme with four relays which happened to be the only microwave relays in our junk box. You can use other types, but check their loss, as the ones we used were less than 0.1 dB connection loss per contact. Cross isolation was excellent; loss from coupling from one operated side to the non-operated side was in excess of 50 dB. All interconnections were made with 0.141 coaxial hardline and SMA coaxial connectors.

The outline in Figure 4 shows our complete SSB system for 10 GHz. Other major parts of the system are the mixer and phase locked microwave oscillator. We obtained the latter from surplus. You can buy or build the the mixer. In another article, I will cover these items in detail.

Conclusion

Construction of this amplifier will give you a very good preamplifier and versatile device for 10 GHz microwave band operation. We have also used this device on our spectrum analyzer to improve system sensitivity.

PC boards for the 10 GHz amplifier are available etched and ready for mounting parts, with the ground foil, for \$10 each postpaid. A kit with the chip resistors and capacitors, SMA connectors (2), ground foil and PC board, is \$20 postpaid. The switch mode power supply module is \$5. Specify 5 volts or 12 volts input. The MGF-1402 GaAsFET is available from *Microwave Components of Michigan, 11216 Cape Cod*

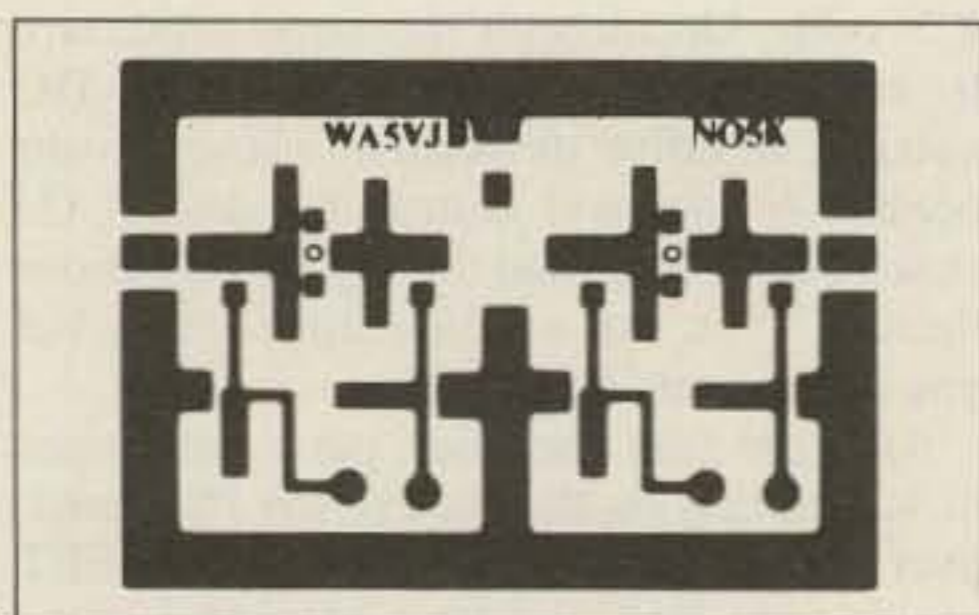

Figure 5. PCB foil diagram for 10 GHz preamp.

St., Taylor, MI 48180. Tel. (313) 941-8469 (evenings only). Or call any distributor who carries Mitsubishi GaAsFETs. Cost is less than \$15 per device. I would be happy to

answer any questions pertaining to microwave or related subjects. Please send an SASE for a prompt reply to *Chuck Houghton, 6345 Badger Lake, San Diego CA 92119.* 73

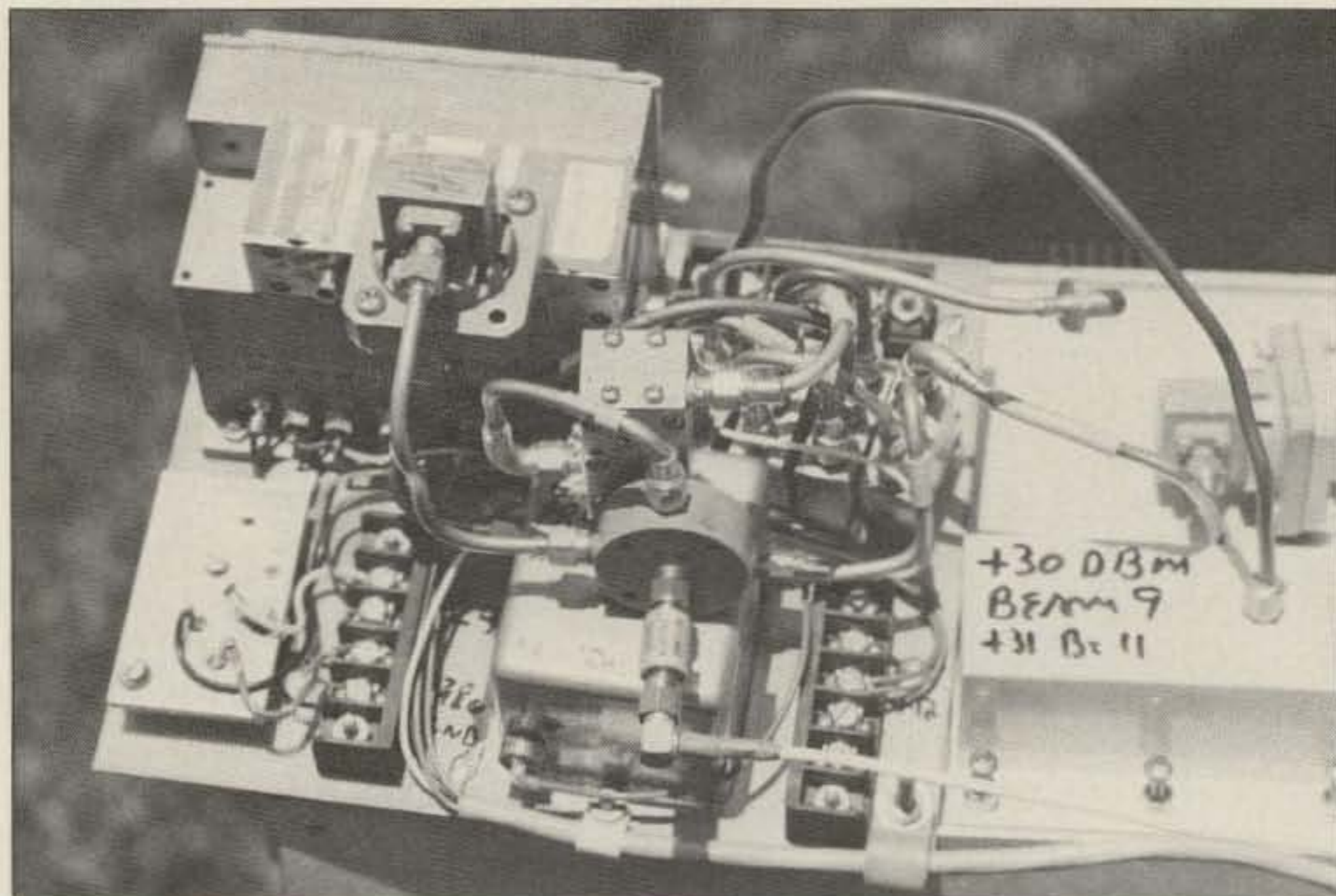

Photo D. 10 GHz SSB station WB6IGP uses 24 SMA connectors and 4 SMA SPDT 18 GHz relays. Preamp is inside the small bathtub-capacitor-looking shielded box. The large unit in the rear is the phase locked 10 GHz oscillator. See Figure 4 for block drawing.

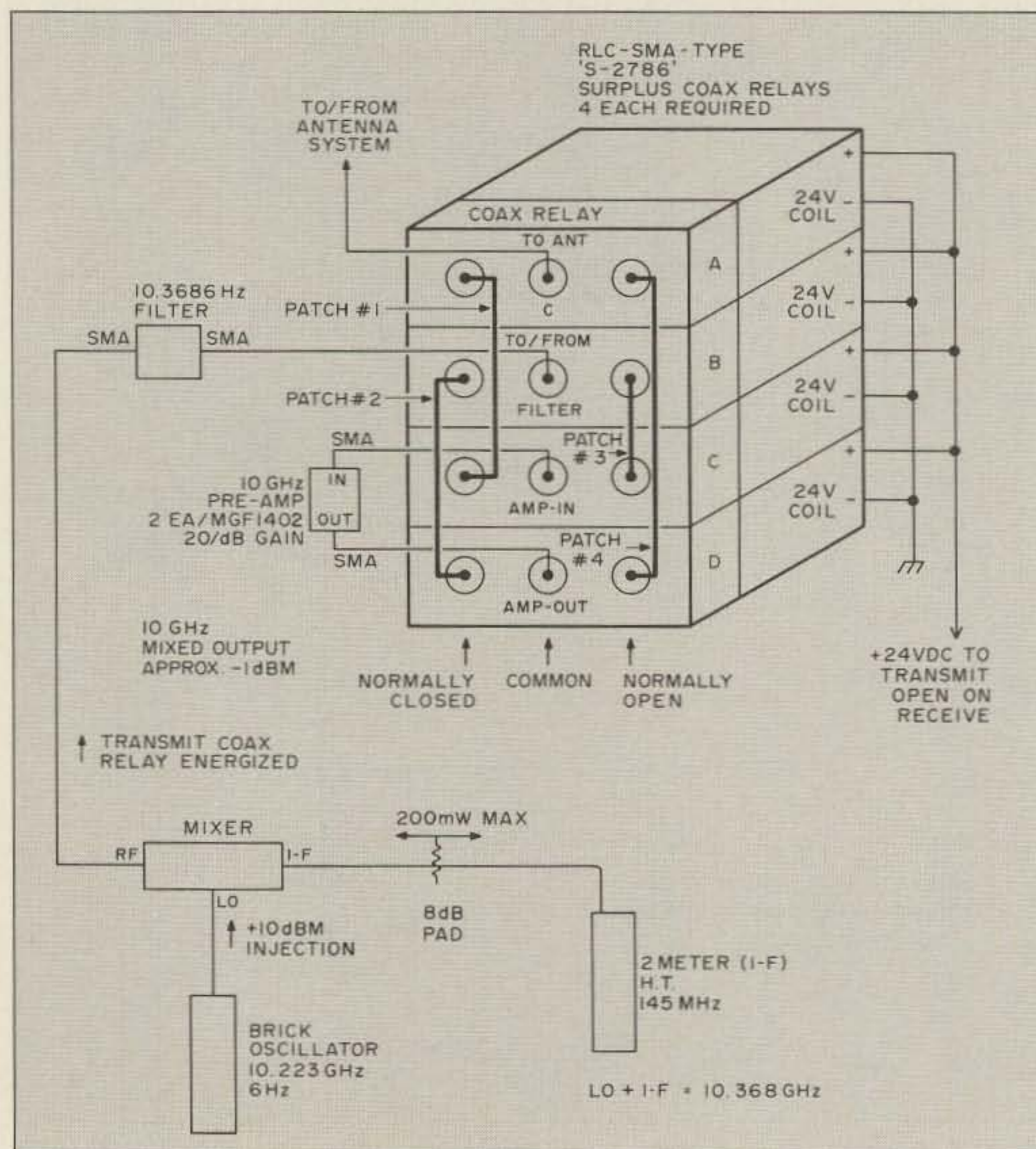

Figure 4. 10 GHz switching, for receive and transmit.

IF Shift, Cheap

Easy IF shift add-on to your older rig.

by Terry F. Staudt, LPE, W0WUZ

About 1980, passband tuning, or IF shift, was one of the first goodies to upgrade the transceivers of the late '70s in the A, S, or MK II versions. Most people with the earlier sets just figured it was another of life's insoluble problems, and let it go at that. After looking at several schematics, I came up with a coup. Not only is it possible to insert IF shift in these sets, it's easy and costs less than five bucks!

I'm going to show you how terribly simple it is to do. The only odd part is an outer tuning ring, which you can get from your manufacturer for a little over a dollar, if you want everything to match. Otherwise, anything will do.

IF Shift—What It Is

IF shift is simply a tuned circuit that uses a varactor diode, such as the Motorola MV 1872, or a general AFC unit made for FM home receivers. The circuit is in the secondary of (usually) the first IF transformer, the original components being re-connected to the far side of the added trimmer capacitor.

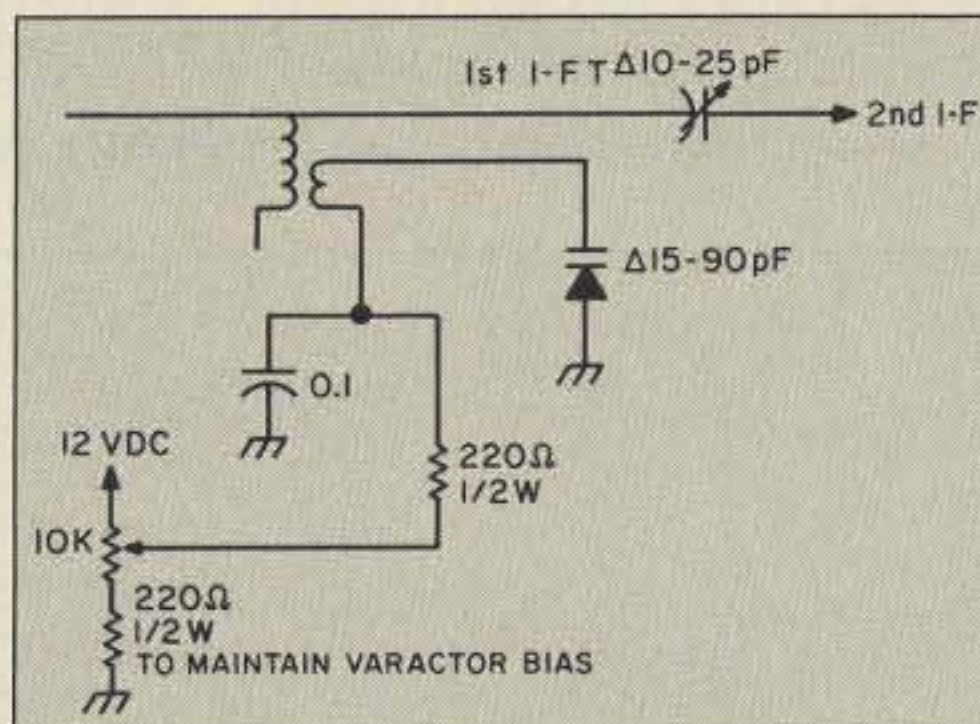

Figure 1. Schematic for the IF shift circuit.

The two 220Ω resistors are there to prevent failure from a bad varactor or the 10k linear pot parked at the far end.

I'm using a 25-year-old Galaxy 5 MK II, and the circuit works wonders. I got a "finger ring," as used on the RF gain at a hamfest, for a perfect match.

Recipe for a Tuned Circuit

Choose which control would be suitable,

get the value from the schematic or measurement, and go to a parts house. Have them make you up a dual-ganged pot with the original value as the center control, and a 10k linear pot as the outer ring. Pick up the varactor, trimmer cap, and two 200Ω resistors.

Assembly and Adjustment

The schematic in Figure 1 is generally satisfactory for universal application. After installation, when you have taken an S-meter reading on 10 meters, you must make two adjustments. You also need to establish a 12 volt DC "pick-up" point.

First, with the new pot at 50/50, adjust the IF transformer for the highest reading. Second, adjust the trimmer cap for the same S-meter reading as before. Resist the temptation to go for more, as it would degrade the selectivity. Make these adjustments and the "benchmark" reading with the unit's calibrator signal. I chose 10 meters to avoid fooling around with a 20 dB over 9 reading.

So simple and yet so useful—don't know why I haven't yet seen it in print! **73**

SAVE TIME & POSTAGE!

Circle advertiser's numbers on our handy reader service card to send for valuable information from advertisers in this issue. Use our Ad Index to locate advertiser's Reader Service numbers even faster!

G5RV All-Band QuickKits™

Fast & Easy to Build

- Failsafe visual instructions
- No measuring or cutting
- Everything included
- Finish antenna in minutes

Quality Components

- Presoldered Coax Fittings
- Kinkproof QuietFlex wire
- Fully insulated, wax sealed, no-corrode, low noise design

Fastest Antennas in the West

• Double Size G5RV	\$59.95
• 204 ft 160-10 Dipole	
• Full Size G5RV	\$34.95
• 102 ft 80-10 Dipole	
• Half Size G5RV	\$24.95
• 51 ft 40-10 Dipole	
• Quarter Size G5RV	\$19.95
• 26 ft 20-10 Dipole	
• Marconi Adapter kit	\$ 4.95
• Converts any dipole to Marconi	
• 200' Dacron 250# line	\$11.95
• Add \$5 Post & Handling	Info \$1

Antennas West
 (801) 373-8425 Box 50062-S, Provo, UT 84605

CIRCLE 107 ON READER SERVICE CARD

*** OMAR ELECTRONICS ***
 FOR ALL YOUR AMATEUR NEEDS
SPECIAL PRICES on all
MFJ PRODUCTS * A.R.R.L. PUBLICATIONS
 and other Ham Radio equipment!

404-760-8846
OMAR ELECTRONICS • Omar Pupo WA8FON
 3650 HWY 138 NE Suite C • Loganville, Ga 30249

THE RF CONNECTION

"SPECIALIST IN RF CONNECTORS AND COAX"

Part No.	Description	Price
PL-259/USA	UHF Male Phenolic, USA made	\$.70
83-1SP-1050	PL-259 Phenolic, Amphenol	.89
83-822	PL-259 Teflon, Amphenol	1.75
PL-259/ST	UHF Male Silver Teflon, USA	1.50
UG-175	Reducer for RG-58	.20
UG-176	Reducer for RG-59 & MINI 8	.20
UG-21D/U	N Male RG-8, 213, 214, Delta	3.25
UG-21B/U	N Male RG-8, 213, 214, Kings	5.00
9913/PIN	N Male Pin for 9913, 9086, 8214	
	fits UG-21D/U & UG-21B/U N's	1.50
UG-21D/9913	N Male for RG-8 with 9913 Pin	3.95
UG-21B/9913	N Male for RG-8 with 9913 Pin	5.75
UG-146A/U	N Male to SO-239, Teflon USA	6.00
UG-83B/U	N Female to PL-259, Teflon USA	6.00

"THIS LIST REPRESENTS ONLY A FRACTION OF OUR HUGE INVENTORY"

THE R.F. CONNECTION
 213 North Frederick Ave. #11
 Gaithersburg, MD 20877
 (301) 840-5477

PRICES DO NOT INCLUDE SHIPPING
 PRICES SUBJECT TO CHANGE
 VISA, MASTERCARD, ADD 4%
 UPS C.O.D. ADD \$3.00 PER ORDER

CIRCLE 115 ON READER SERVICE CARD

MISSION CONSULTING, INC. MISSION COMMUNICATIONS

11903 Alief-Clodine Suite 500
 HOUSTON, TEXAS 77082

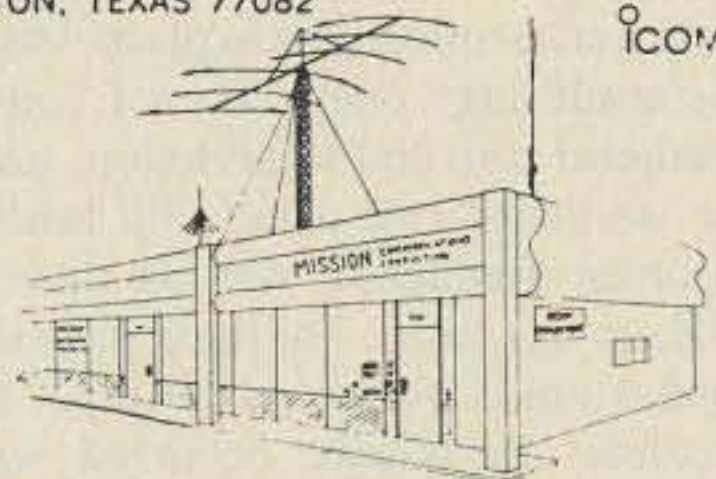

WE HAVE EXPANDED AND NOW STOCK MANY NEW PRODUCTS. WE CARRY:

AEA, ALINCO, AMECO, AMP SUPPLY, APHA DELTA, ANTECO, ARRL, B&B INSTRUMENTS, BARKER & WILLIAMSON, BENCHER, BOMAR, BUTTERNUT, BEE, CUSHCRAFT, COMMUNICATION SPECIALISTS, CRB RESEARCH, DAIWA, DIAMOND, HENRY, HUSTLER, HAM RADIO, INTL. CRYSTAL, INTL. WIRING & CABLE, KANTRONICS, KACHINA, KENPRO, KDK, KLM/MIRAGE, LUNAR, LARSON, MOBILE MARK, MFJ, NEUTECH, NCG, NYE, PERIPHAX, QST, RF INDUSTRIES, RADIO PUBLICATIONS, RADIO AM. CALLBOOK, SAMSON, SPI-RO, SMILEY ANTENNA, SANTEC, SYN. TEXTILES, 73MAG, STANDARD, TAD, TEN-TEC, VALOR, VECTOR, GORDON WEST, WELZ, YAESU, AND ICOM. (713) 879-7764
 In house service available. Telex 166872 MCON UT
 Just write, or give us a call! FAX (713) 879-9341

CIRCLE 187 ON READER SERVICE CARD

Discover CAROLINA WINDOM

80-10M Use transmatch 132' overall Matching XFMR Line Isolator Vert Radiator Coax fed Assembled \$69.95

High performance Proven Results \$70 Beam?

Your Passport To a world Of new ideas and exceptional HF wire antennas

Rugged new baluns Full range of HF, VHF mobile antennas, ducks, wire, coax, parts, line, accessories.

SEE WHAT WE'RE DOING NOW!
 Contact Jim, W4THU—free discount catalog
 Send \$1 for catalog by 1st Class mail.
 Box 6159, Portsmouth, VA 23703
 (Dealer Inquiries Welcome)

804-484-0140

CAROLINA WINDOM
 SEE THE REVIEW IN DECEMBER '88 73MAGAZINE
 Enthusiastic users say it's the best wire antenna. Outperforms wire antennas previously used. Knock-you-socks-off performance on 80-10. A \$70 beam?
 If you hear one, you'll want one.
 Made with pride by the RADIO WORKS in VA/USA

CIRCLE 150 ON READER SERVICE CARD

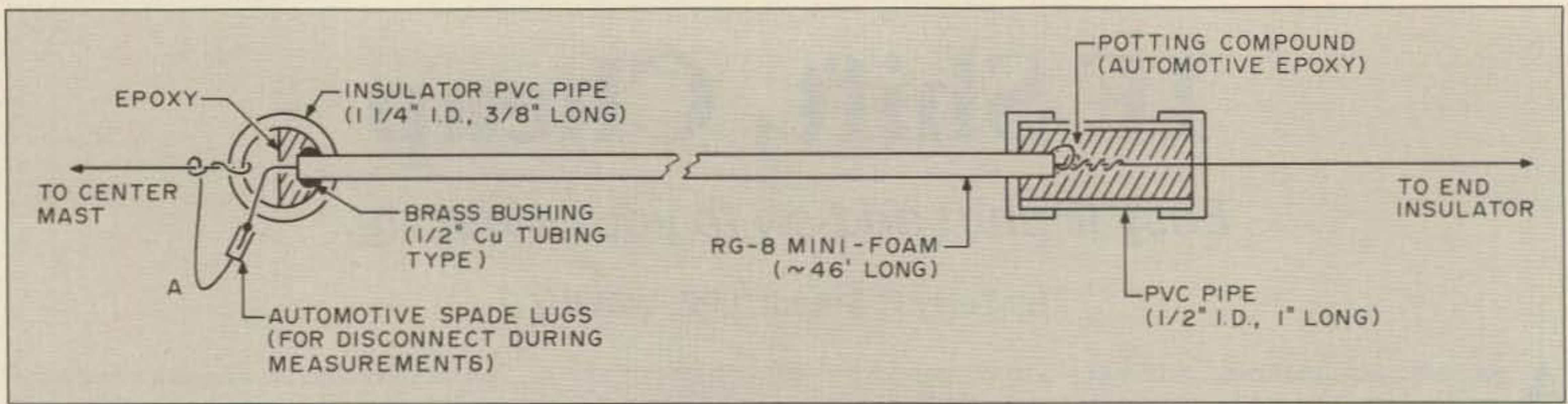

Figure 5. Quarter-wave phasing stub construction details.

continued from p. 26

terminating resistor should be changed from 50Ω to about 100Ω.

Because of the higher input resistance, wind a toroidal matching transformer to match the 50Ω value at the transceiver. If possible, place these transformers at the tops of the masts at the feedpoints. If this is impractical, place the transformers at the feedline inputs with tolerable standing waves in the lines. Again, losses are low at these frequencies.

Physical Layout

Suburban plot limitations (about two-thirds of an acre) demand dimensional compromises. Figure 6 shows the original 2-element phased array for each dipole. The mast is assembled from aluminum irrigation tubing as described above, and the support posts are 2½" (i.d.) galvanized steam pipe.

The radiation capture area may greatly increase if the halyards, which are almost a quarter-wavelength long, could support radiator extensions. For example, if each halyard supported a half-wave element fed in-phase from the end of the corresponding radiator, we would have three half-waves in phase, instead of a half-wave basic radiator. Two of these makes up the 6-element phased array.

For this, I put together the quarter-wave phase reversing stubs, and connected them as shown in Figure 4. Since I had limited space, however, I couldn't extend the end sections the full 72 feet. I foreshortened these sections by adding inductive loading coils beyond the ends of the quarter-wave stubs. To reduce inductive loading and decrease ground losses due to penetration by the high E-fields at the ends of the radiators, I turned these extensions upwards to form vertical terminations above the support posts. I achieved this by clamping 10-foot lengths of 2"-PVC (i.d.) pipe against the support posts.

The coils were commercial units, 2½" in diameter. They slipped over and were supported by these pipes above the support post tops. 8½-foot long CB whips mounted on caps at the tops of the pipes terminated these extensions. See Figures 7 and 8 for details.

Again, the four quarter-wave phase reversing stubs were made from RG/8M Mini-Foam coaxial cable. I adjusted the lengths to resonance with a noise bridge. Due to the slight variations in dielectric constant, these

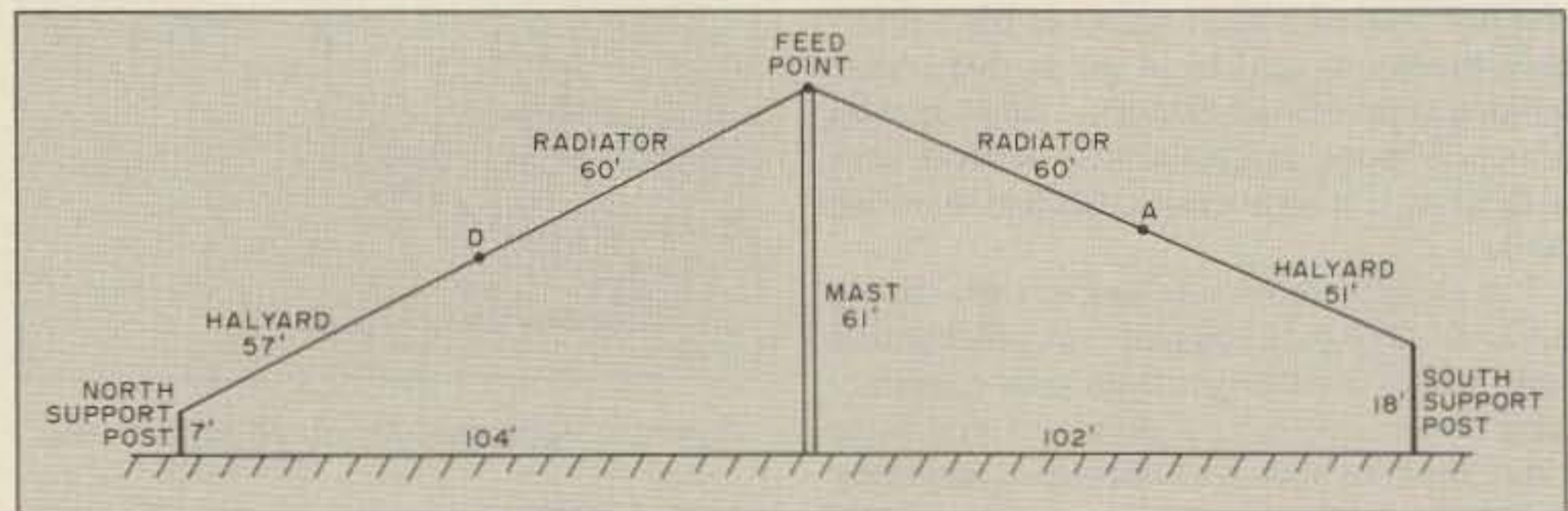

Figure 6. Original two-element phased array.

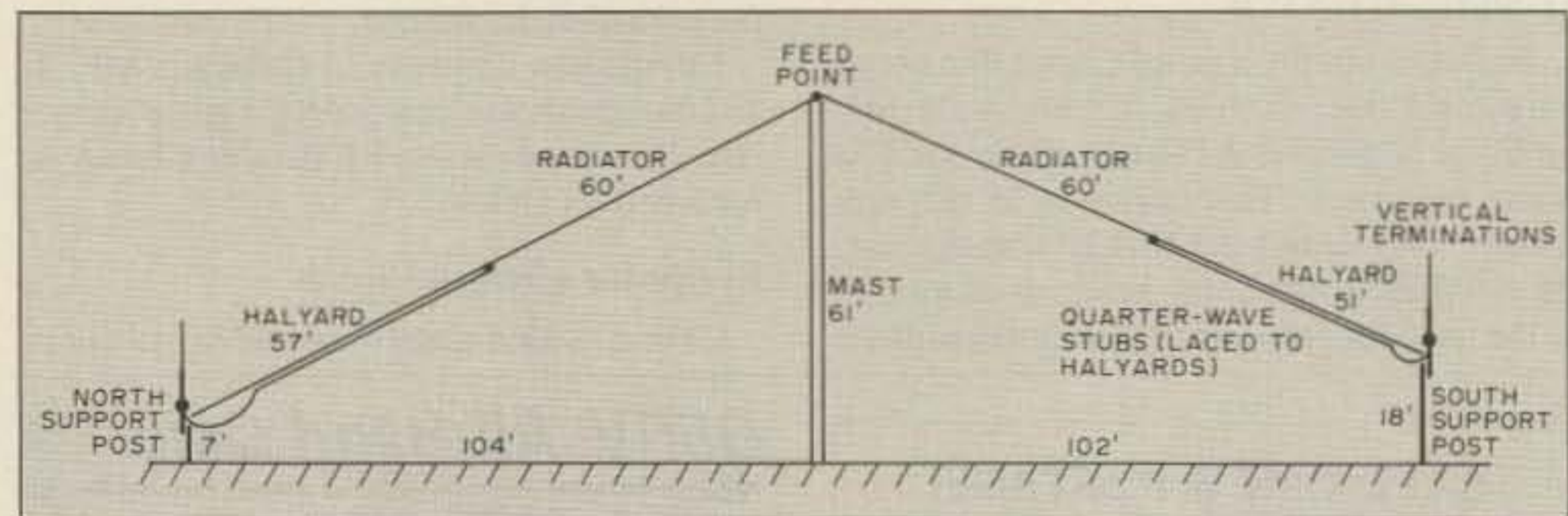

Figure 7. Modified array using inductive coils and vertical elements at the terminations.

lengths varied from 45 feet, 10 inches to 46 feet, 2 inches. The feedline polarity was such that, in this installation, the center conductors fed the south sections of the radiators, and the shields fed the north sections.

Setting the Coils

First, I checked the east and west dipoles for proper resonant frequency with the stubs and terminations in place, but with all of the spade lugs open. Then I connected the southeast stub and termination, and adjusted the southeast coil using clip leads until the resonant frequency was as desired (3.955 MHz in this case). For these measurements, I used a noise bridge at the input end of the feedline. Resonance occurred with 27 ¼-turns on the coil. The corresponding input resistance measured about 60Ω.

Next, I connected the northeast stub and termination and adjusted the northeast coil until I again reached the desired resonant frequency. This occurred with a northeast coil of 22 ¼-turns. The input resistance measured 110Ω.

I adjusted the west radiator system in the same way to yield the COCOA-3 arrangement. The measured resonance values were similar, with slight variation in coil turns and

resistance, probably due to local near-field obstructions.

Toroidal transformers were wound as shown in Figure 9 to correct for mismatches in impedance and phase between the two radiators, and between source and radiator. The positions of the tap, X, and the preliminary value of the capacitor, C, which compensate for the inductive reactance of the transformer windings, were determined by noise bridge measurement using a load resistor of 110Ω. I completed the final trimming adjustment of C using the antennas as loads.

Results

After completing the resonating adjustments, I measured the SWR for each of the combinations corresponding to the seven positions of the phase controlling switch. The reflected indication was less than five percent of full scale for each of the combinations. This is far below 1.5:1 SWR for all settings. For the two separate COCOA-3 radiators, the indication was less than two percent of full scale.

The performance of the array with foreshortened radiators was evaluated in some detail using a receiver equipped with an accu-

continued on p. 78

AERIAL VIEW

Antenna News

Arliss Thompson W7XU
Route 1, Box 52
Colton SD 57018

Testing Coax

One of the most commonly used, and sometimes abused, items around a ham shack is coax. While open-wire lines certainly have their place, most of us use coaxial cable in one form or another to feed our antennas. Although it's relatively expensive, coax often doesn't receive much respect or attention once it has been installed. If your antenna doesn't seem to be performing the way it used to, perhaps the problem lies with the feedline and not with the antenna itself. Is your coax as good now as the day you bought it? How do you know?

None 100% Efficient

They're all losers. Regardless

of price, no coax is perfect. They all have losses that arise from a number of sources. Two causes are the resistance of the wires making up the cable, and the effects of the dielectric material. These losses increase with the logarithm of the cable length and are expressed in decibels of attenuation per hundred feet of transmission line.

For any given coaxial line, the losses increase with frequency and SWR. Figure 1 shows typical frequency-dependent losses for a variety of common lines; Figure 2 shows increased losses due to standing wave ratios greater than 1:1. The losses caused by elevated SWR arise from increased losses in the conductors and in the dielectric. Conductor losses increase because currents are higher in lines with high SWR. Such lines also have increased

voltages, thereby increasing dielectric losses. This situation may be expressed mathematically or, as in Figure 2, in graphical form.

Coaxial cable losses tend to increase with the age of the cable, particularly when the cable is used outdoors or is somehow abused. Cables equipped with PL-259 (UHF) connectors are particularly susceptible to water damage since that style of connector is not waterproof. Other environmental contaminants can affect coax by entering through the cable's outer covering. This is especially likely if the cable has a polyvinyl chloride outer jacket that is not noncontaminating. Try to use a noncontaminating jacket if you're going to bury the transmission line.

Measuring Losses

Ideally, check for coaxial cable losses when you first buy it, then recheck it at intervals thereafter. Rechecking every two years should be sufficient unless there is an obvious decrease in trans-

mission line performance.

Testing new coax is relatively simple. All you need is a source of RF (your transmitter), a dummy load whose impedance is equal to the characteristic impedance of the line, and a wattmeter. With the wattmeter at the transmitter end of the line and the dummy load attached at the far end, apply power and take a wattmeter reading (P1). Remove the power, move the wattmeter to the dummy load end of the cable, and then, without making any changes at the transmitter, reapply power and note the new wattmeter reading (P2). You can determine the line loss from the equation: $\text{dB} = 10\log(P1/P2)$.

For example, assume you have 200 feet of RG-8 and you set up the test as described above. Let's say you apply RF to the coax and measure 10 watts of power at the output of the transmitter. You then move the wattmeter to the dummy load end of the line and reapply power. Now the wattmeter reads 8.3 watts. Using the equation above, $\text{dB loss} = 10\log(10/8.3) = 0.8\text{ dB}$ for 200 feet of cable. The

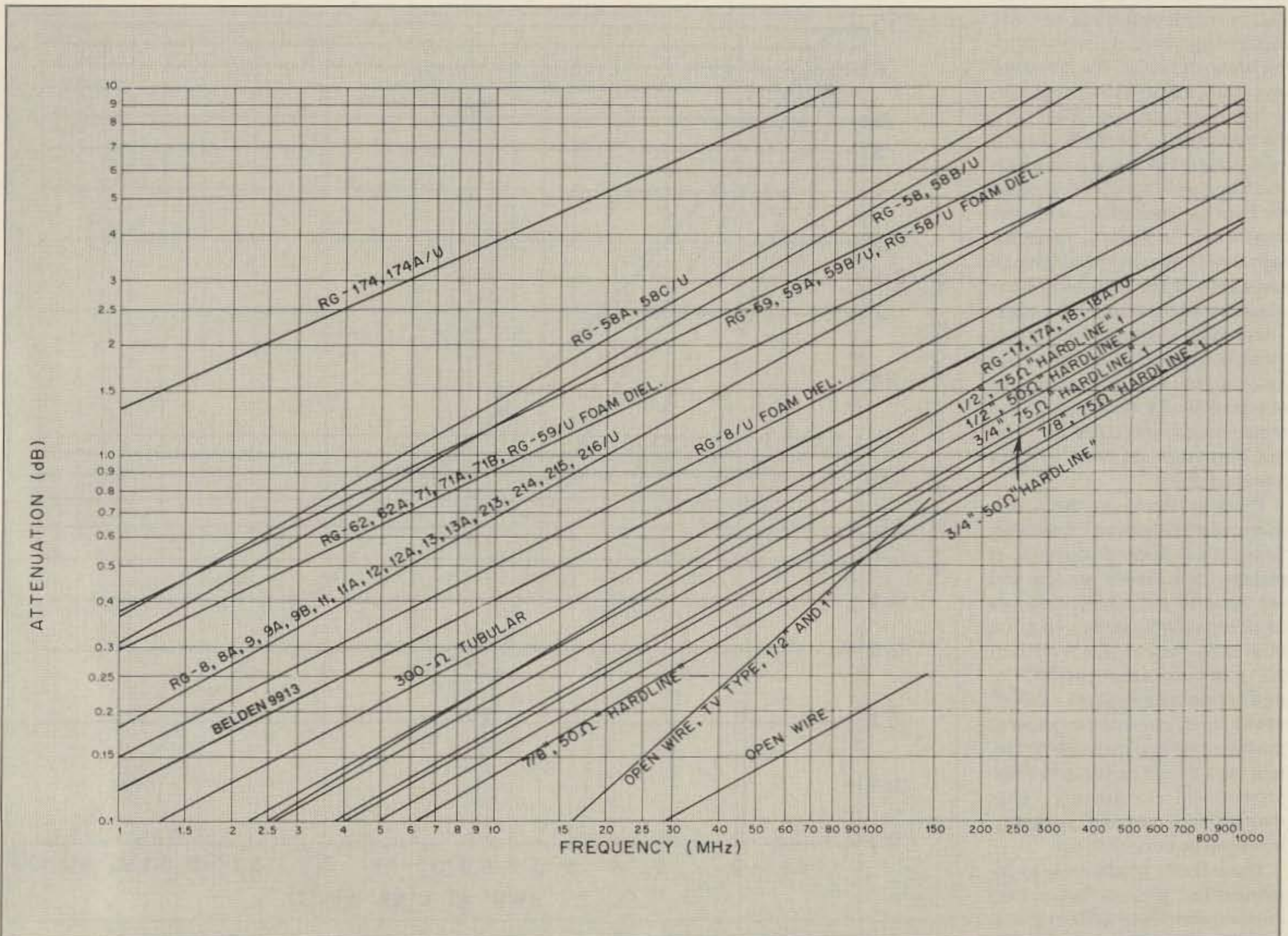

Figure 1. Attenuation in decibels per 100 feet for various common transmission lines (from the ARRL Antenna Book).

loss for 100 feet will be half of that, or 0.4 dB. Referring to Figure 1, you can see that the attenuation equals the specified value at 4 MHz.

Now let's assume that you have installed your coax, some time has passed, and you wish to confirm that the cable is still working as well as it should. You could bring the coax back into the house and retest it using the method described above, but that would not be very convenient if the feedline is securely fastened to the side of your tower. Another possibility would be to carry a dummy load and a wattmeter to the end of your feedline and go through the above procedure. Neither method is particularly convenient. Are there any alternative methods of measuring feedline losses? The answer is yes.

Other Ways to Measure Loss

One method that has appeared in the *ARRL Antenna Book* in past years is to create an infinite SWR at the far end of the transmission line and then measure the standing wave ratio at the input end. You can produce this infinite SWR by shorting the coax, or by creating an open circuit. If a line were very lossy, it would at least partially "hide" the very high SWR from the transmitter. The SWR as measured at the input would be much less than infinite. On the other hand, better lines (those with less loss) would indicate a relatively high SWR under those conditions since less of the reflected power would be attenuated by the coax. Thus, if you knew the SWR under those conditions and had the appropriate graph (such as curve E of Figure 3) or worked through the mathematics, you could arrive at the matched-line loss without heroic efforts.

There are some problems with this second method, however. See curve E on Figure 3. If matched line losses are low you will need to accurately measure some high SWR values. "High" in this case may mean SWRs of 20:1, 30:1, or even greater. For most of us those values of SWR are all tightly crammed together at the full-scale end of our SWR meters, and it isn't possible to measure them accurately. This method sounds good in theory, but it can be difficult to use.

There is still another way to determine line losses. Rather than creating an infinite SWR at the far end of the transmission line, place a load there that creates a finite

SWR and then measure the SWR at the input. The load may be any non-inductive resistor; suitable values for 50Ω coax would be in the 150 to 500Ω, or the 17 to 5Ω ranges (to produce SWRs between 3 and 10 to 1). With this load at the far end of the transmission line, you can take an SWR reading at the input end and determine the matched line losses from a graph, or mathematically. Figure 3 shows matched-line attenuation versus measured SWR for standing wave ratios of 2:1 (curve A), 3:1 (curve B), 5:1 (curve C), 10:1 (curve D) and, as mentioned previously, infinite (curve E).

Here is an example. Consider the previous case of RG-8 coax. Suppose you used 100 feet of that line to feed a 75 meter inverted "V" supported near the top of your tower. You tested the coax before you installed it so you know that it originally showed 0.4 dB of loss per 100 feet at the high end of the 75 meter band. A few years have passed since then and you are curious to see if the line still works as well as it once did. The

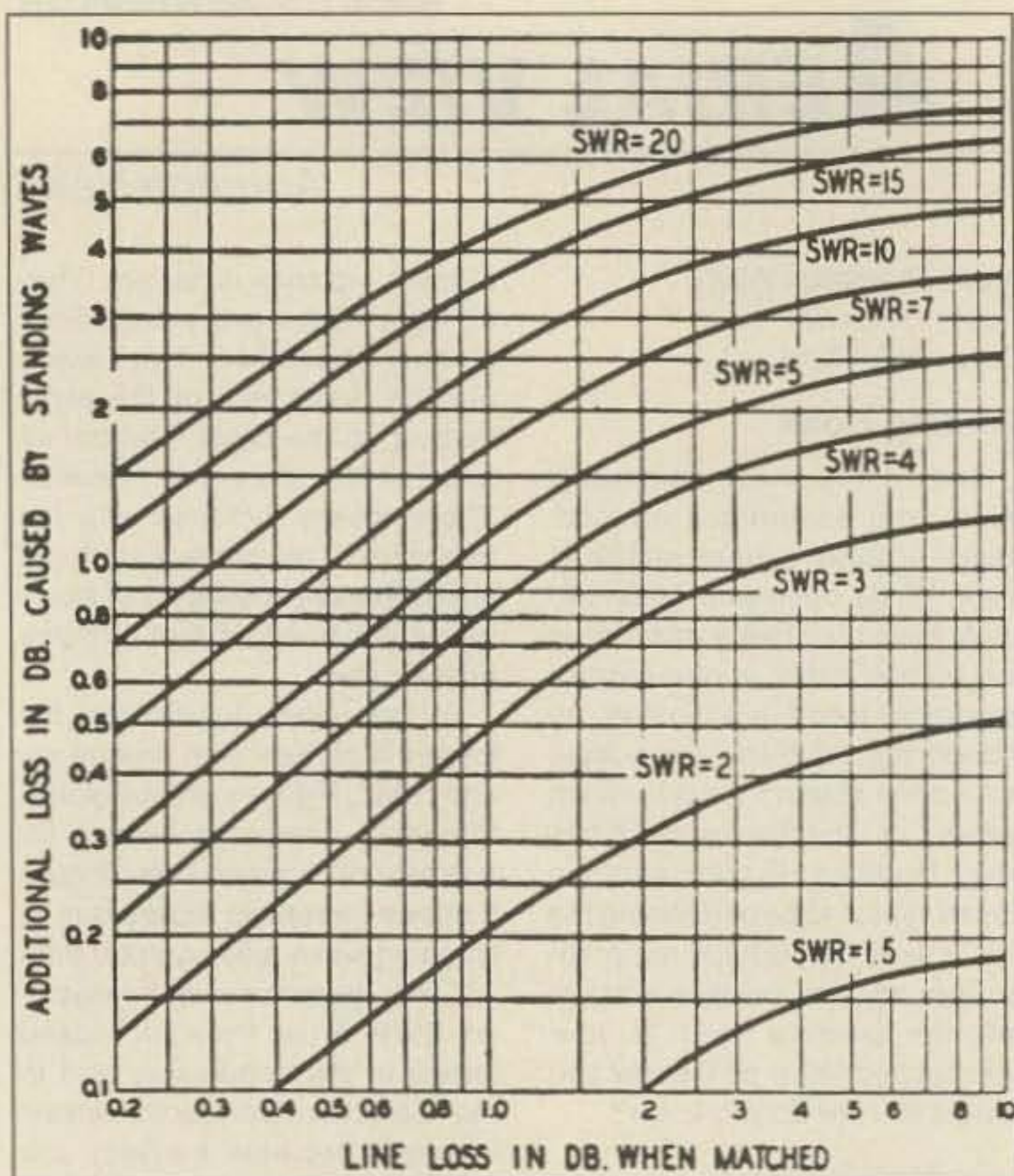

Figure 2. Additional line losses due to SWR greater than 1:1 (from the *ARRL Antenna Book*).

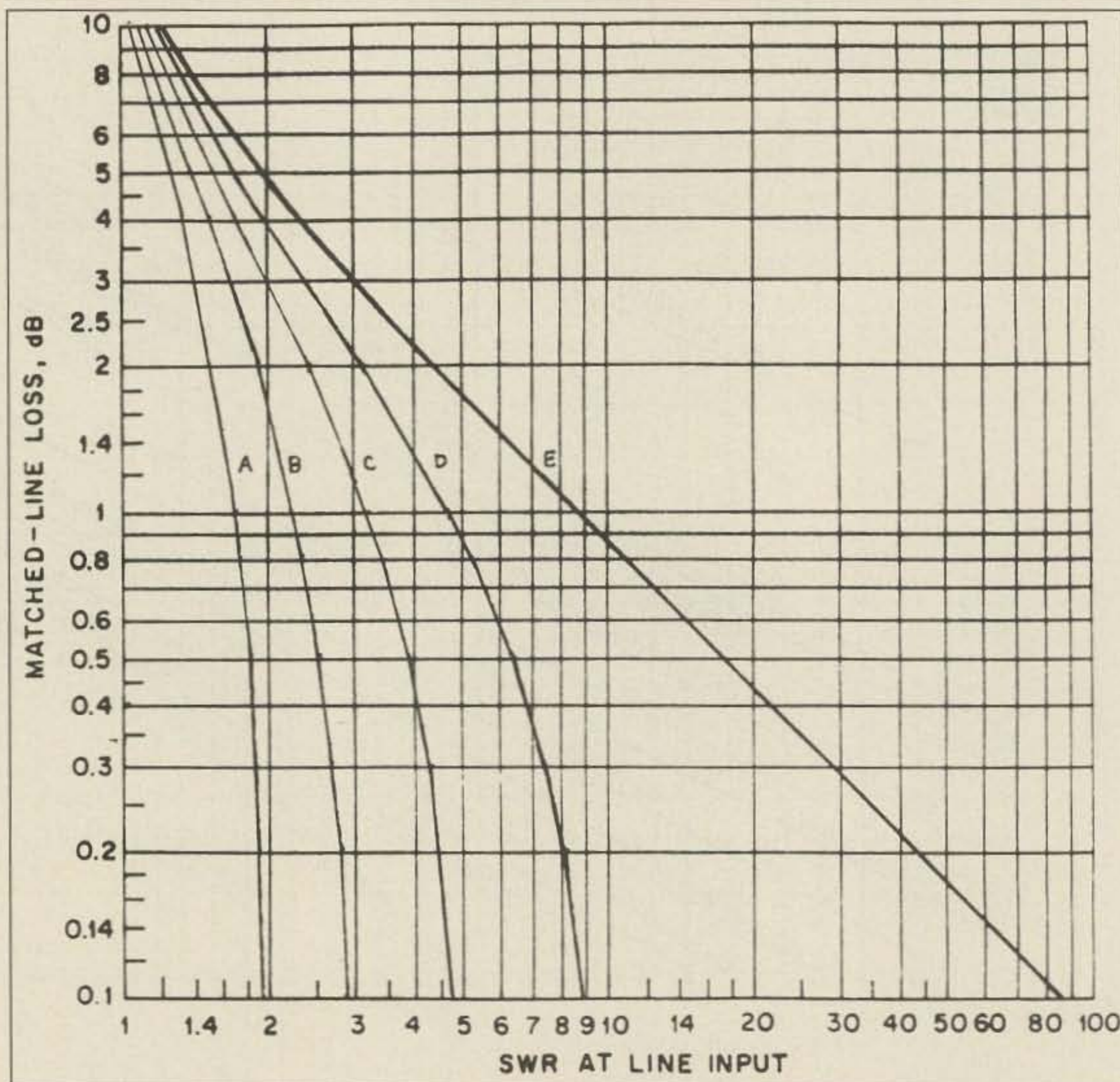

Figure 3. Matched-line loss versus SWR at the input (transmitter) end when the SWR at the load (antenna) end is (A) 2:1, (B) 3:1, (C) 5:1, (D) 10:1, and (E) infinite.

coax is buried between your house and the tower, then taped in multiple locations as it runs up the side of the tower. Bringing it inside for testing is out of the question.

After a bit of consideration you climb the tower to your antenna and disconnect the feedline, leaving the connector at that end dangling in midair. Returning to your shack, you apply just enough RF to operate your wattmeter and measure the SWR. The needle comes to rest somewhere between 5:1 and infinity, but with the meter scale the way it is you can't be much more exact than that. Referring to Figure 3, curve E, you see that the worst the matched-line loss can be under this set of circumstances is about 1.7 dB. That's not a major loss, but it is a significant change from the value you measured when the cable was new. Some authorities recommend that you should replace a line if there is an increase of more than 1 dB in the rated loss per 100 feet. At this point you need to more accurately determine the matched-line loss before you can make a decision about replacing the line.

There are two ways to proceed

at this point. One way would be to leave the transmission line as is but repeat the SWR readings at a higher frequency. From Figure 1 you can see that the rated attenuation for new RG-8 at 144 MHz is slightly greater than 3 dB per 100 feet. When you check the SWR on this open-circuited line at 144 MHz you read a value of 2.5:1.

will continue to use the line for the time being. However, you make a mental note to test the line more frequently in the future.

Another possible solution to this problem would have been to place a noninductive resistor across the far end of the feedline. Let's say a 250Ω resistor was available, creating an SWR of about 5:1 when

scribed conditions the matched-line loss must be slightly greater than 1 dB, or approximately 0.7 dB per 100 feet worse than it was when the coax was new. Again, the coax is showing signs of aging but it will still work in this application. A similar increase in feedline losses to an EME array, on the other hand, would be a more serious problem.

Figure 3 will probably be adequate for most readers, but for those of you who may wish to do some experimenting, here are the general formulas for calculating the expected input SWR given the matched line loss and the SWR present at the load. It is a simple matter to incorporate these formulas into a BASIC computer program and arrive at answers tailored to your particular set of circumstances:

$$A = 10^{(L/10)}$$

$$B = (SWRL - 1)/(SWRL + 1)$$

$$SWRI = (A + B)/(A - B)$$

where L is the matched-line loss, SWRL is the SWR at the load and SWRI is the SWR at the input. More information on this topic can be found in the 15th edition of the *ARRL Antenna Book*. **73**

"For any given coaxial line, the losses increase with frequency and SWR."

Again referring to Figure 3, curve E, you see that the matched-line loss is in the neighborhood of 0.7 dB greater than it should be at that frequency. You decide that although the losses in the cable have increased with age, the actual attenuation on 75 meters (presumably slightly over 1 dB per 100 feet) is still low enough that you

installed as indicated. Back in the shack you measure an SWR of 3.1:1 at a frequency of 3.99 MHz. Had the line been perfect (none are) you would have seen an SWR of 5:1. Had you done this test when the line was new you could have expected an SWR reading of 4:1. Reading from curve C of Figure 3 you find that under the de-

JANUARY 4, 1983

A CURE WAS FOUND FOR THESE DISEASES :

1. REFLECTED POWER-ITCH
2. KNOB-ITUS
3. QRM-DEAFNESS
4. BUTTON-PHOBIA
5. SWITCH-CANKER
6. SUPER TUNER-BLUES
7. CROSS NEEDLE-EYES



THE CURE IS:

MAXCOM



AUTOMATIC ANTENNA MATCHER
FOR ALL S.S.B. RADIOS

*** ONE SHOT GUARANTEED TO LAST AT LEAST FIVE YEARS!**

**MAXCOM, INC. BOX 502, FT. LAUD., FL. 33302
305-523-6369**

* MAXCOM is a registered trademark and is owned by Maxcom Electronics, Inc.

THE BOTTOM LINE: "MAXCOM WORKS"

CIRCLE 101 ON READER SERVICE CARD

DOCKING BOOSTER

Converts Your HT to a Powerful Mobile Unit



- 30 watts output
- GaAs FET pre-amp
- Fits on car door
- 2 Meters or 70 cm
- Icom
- Kenwood
- Yaesu

**NEW!
DUAL BANDER
FOR FT727**

NAVAL ELECTRONICS, INC.
5417 Jetview Circle • Tampa, FL 33614
Phone: 813-885-6091 • Telex: 289-237 (NAVL UR)

CIRCLE 151 ON READER SERVICE CARD

CIRCUITS

Great Ideas From Our Readers

Have a quick'n'easy circuit idea? Share it and get a one year subscription or extension to 73! Clearly mark all entries as submissions for Circuits to distinguish them from manuscripts. Send your entries to Circuits, 73 Magazine, Peterborough, NH 03458.

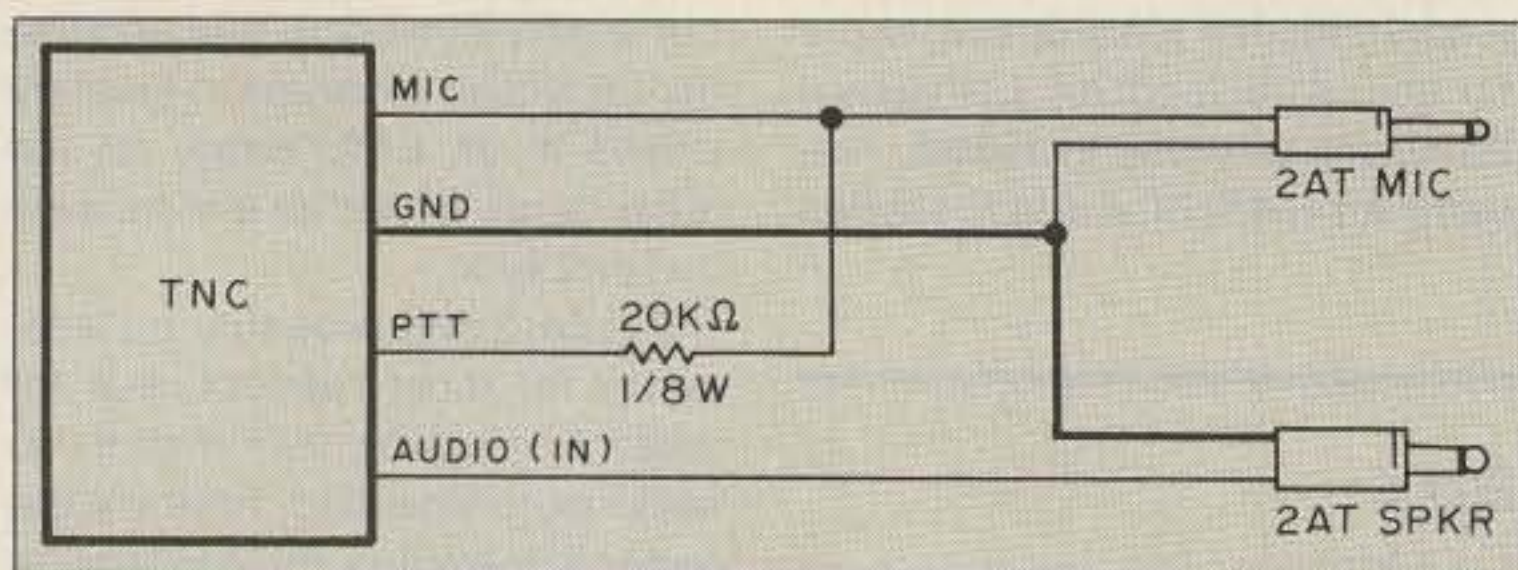

Figure 1.

Coupling Audio and PTT DC Circuits

The August 1987 issue of 73 contains an article by WB5WSV describing a way to interface the IC-2AT with the MFJ-1270 TNC-2 Terminal Node Controller. Normally, a microphone jack in a transceiver provides 3-wire operation of PTT and microphone audio where the circuits are kept separate. In the ICOM IC-2AT, however, the circuits are combined and operated through a 2-wire mike input jack (center pin and ground). The circuit described in the 73 article exactly duplicates the microphone circuit. The relay does the PTT switch closure, and the 50k potentiometer replaces the microphone element resistance. However, the circuit is too complex, relay-closure time delay is intro-

duced, and the cost of the relay is an unnecessary expense. Also, there is the problem of providing +12V DC to operate the relay.

For the last 15 months, I have been interfacing an MFJ-1270 with an IC-2AT by using a simple one-resistor circuit. I do not use the loudspeaker circuit.

The reduced schematic, which is supplied in the 2AT User's Manual, shows the PTT circuit as DC-coupled to the jack, and the microphone input as AC-coupled. Figure 1 in WB5WSV's article shows the circuit of the hand-held 2AT microphone. Notice that the microphone element and PTT switch are in series; closing the PTT switch provides a DC path through the microphone element. In voice operation, the audio signal current is superimposed on

the DC PTT current. When interconnecting to the TNC, the necessary DC path is not provided through the audio (out) terminal; relay closure in the audio path does not make PTT current flow. R1 (50k pot) is connected in parallel, from the audio (out) terminal to ground, to provide the DC path. WB5WSV suggests 30k of parallel resistance for the DC path. I have used 20k and have had excellent results.

Instead of having the series path for PTT and audio current run as shown in the hand-held microphone, combine the circuits in parallel. (See Figure 1.) The TNC provides a ground path via the PTT terminal through the 20k parallel resistor, and this resistor en-

ergizes the 2AT PTT circuit. Because the MIC audio is AC coupled, there is no interference with PTT operation. The audio generated in the TNC for transmission by the 2AT sees a parallel load of 2000Ω (audio circuit in the 2AT), 20k (parallel resistor), and 47k (PTT circuit in the 2AT) with equivalent resistance of 1750Ω. The TNC provides sufficient audio drive to handle this load.

Connect receive audio in the normal manner. I would suggest a level control if you want to monitor the buzz. After an evening of packet QSOs, you will probably want to turn off the sound and monitor with the blinking yellow light.

Ian Kushner AF6K
San Jose CA

Packet/Voice Switch Box

Have you joined the Packeteers? If you don't have a 2 meter transceiver dedicated to packet, would you still like to avoid the inconvenience of disconnecting the input to the TNC and reconnecting the microphone before you can use the transceiver for voice?

A simple switch box lets you enjoy the benefits of both packet and voice communications without the need to change connections.

Figure 3 is a wiring diagram of the switch box. The connector for the microphone needs to be the same as on the 2 meter transceiver. I was able to find a cable with a plug on one end that matched the microphone connector on my 2 meter transceiver. The connector for the cable to the 2 meter transceiver can be any suitable connector such as a DIN type. I used a D sub male connector (Radio Shack 276-1537) for the output to the TNC. The switch is a 3-pole 2 position, either a rotary or push-push type. The audio input on this transceiver is from the external speaker plug. I used a phono jack (Radio Shack 274-346) for this.

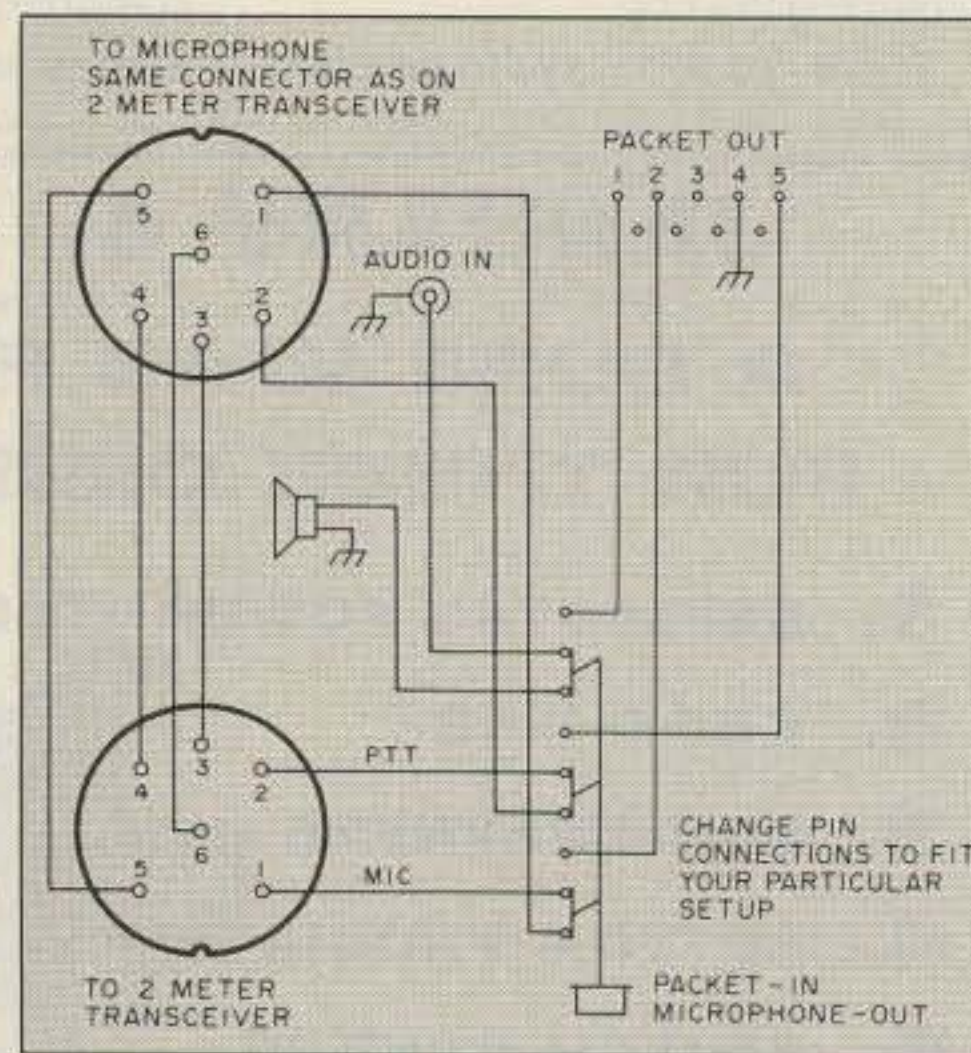

Figure 3.

I built my switch box with a flange on one side and mounted it on the side of the TNC with one of the screws holding the cover on the TNC. The box doesn't shift or move when I change positions of the switch.

Most of the newer high frequency transceivers have an output on the rear for PTT, AFSK, and Audio, but this box is useful for HF transceivers that don't have such an output and with which you have to use the microphone connector for the input to the TNC.

No more inconvenient connection changes!

Robert L. Dingle KA4LAU
Dayton Ohio

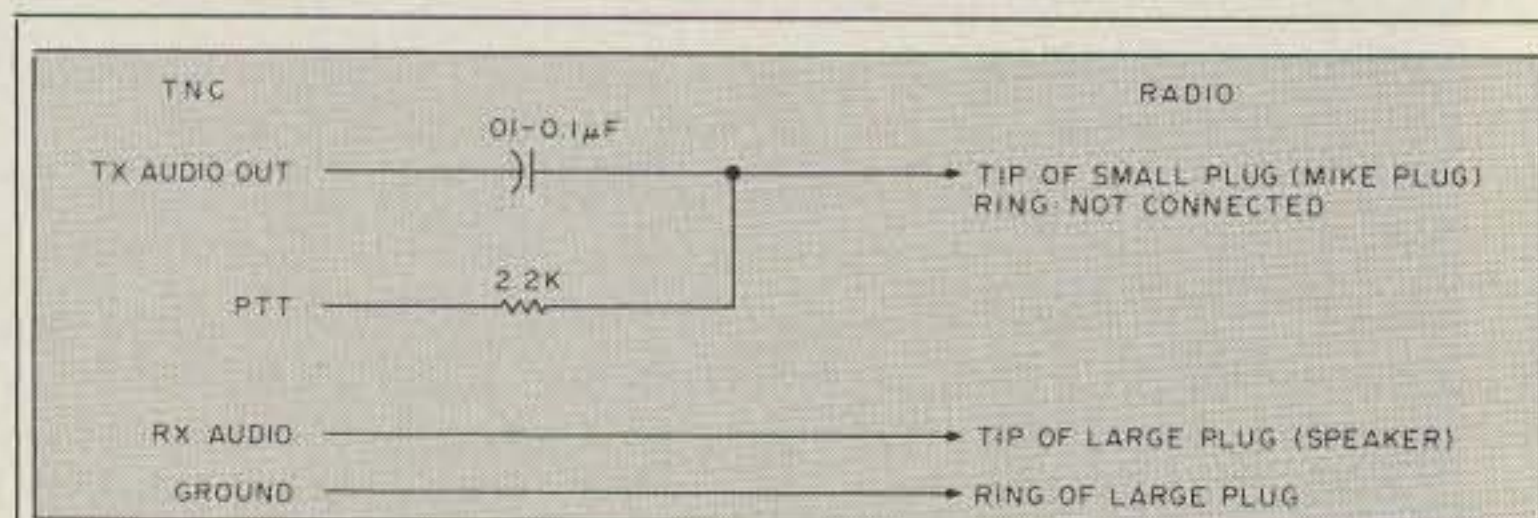

Figure 2.

FT-727R/Data Controller Hook-up

I recently bought an MFJ-1278 controller to use with my Yaesu FT-727R HT. The MFJ-1278 manual gives a method for connecting an IC-02AT using a small (1:1) audio transformer, where the TNC RX audio and HT speaker are connected directly to each other.

While this technique should work, it presents a problem from a convenience standpoint, since you need a separate box or enclosure for the audio transformer and leads.

I called Yaesu tech support at

(213) 404-4884 and got the following alternate hookup info for the FT-727R which avoids the use of a transformer. This should work for most other Yaesu HTs, and for many ICOM HTs which use a similar mike/PTT setup. (See Figure 2.)

The cap can be anything in the range of 0.01-0.1μF. The resistor should be 1/2-1/4 watt.

The cap and resistor can be wired up, then covered with heat sink material for a neat appearance. I've tried this on my setup and it works great!

Dale Gaudier N4REE
Atlanta GA

Field Day Solar Power

The \$289.95 Bullet-Tested QRV Solar Power Supply keeps your repeater on the air 'round the clock or powers your 100w HF station 60 hrs a month. Control circuit speeds charge, protects gel cells & sealed batteries. Fully assembled, QRV, portable. Easily expanded.
Add \$10 S&H Info \$1
AntennasWest
Box 50062-S Provo UT 84605
(801)373-8425

CIRCLE 236 ON READER SERVICE CARD

SYNTHESIZED SIGNAL GENERATOR

MADE IN USA



MODEL SG-100F
\$429.95 delivered

• Covers 100 MHz to 199.999 MHz in 1 kHz steps with thumbwheel dial • Accuracy +/- 1 part per 10 million at all frequencies • Internal FM adjustable from 0 to 100 kHz at a 1 kHz rate • External FM input accepts tones or voice • Spurs and noise at least 60 dB below carrier • Output adjustable from 5-500 mV at 50 Ohms • Operates on 12 Vdc @ 1/2 Amp • Available for immediate delivery • \$429.95 delivered • Add-on accessories available to extend freq range, add infinite resolution, AM, and a precision 120 dB attenuator • Call or write for details • Phone in your order as fast COD shipment.

VANGUARD LABS

196-23 Jamaica Ave., Hollis, NY 11423
Phone: (718) 468-2720 Mon.-Thurs.

CIRCLE 79 ON READER SERVICE CARD

POSTCARD COLLECTOR

The Hobby's Leading Monthly Magazine Packed With Tips From Experts on How to Buy, Sell, Display, Preserve and Enjoy your Postcards.

Get 12 big issues for only \$15.95!

1 yr. (12 issues) \$15.95
2 yrs. (24 issues) \$29.95
3 yrs. (36 issues) \$42.00

Clip this coupon and mail with payment to:
Postcard Collector
Dept. A
P.O. Box 337
Iola, WI 54945

N6KW QSL Cards

The finest QSL Cards at reasonable prices. Basic Cards, map cards, cartoon cards, photo cards and more. Your idea converted to ink or use standard designs. 747 ink colors, any card stock. Photos b/w or beautiful color. Have cards that fit your style. FREE SAMPLES - postage appreciated.

KW Litho - Dept. 73 P.O. Box 17390
(817)332-3658 Ft. Worth, TX 76102

KENWOOD ICOM YAESU

We want to be Your Radio Store

Full Line of Amateur Radio and Computer Interfacing & Accessories. - Tim W7IQY or Preben K7KMZ



1-800-942-8873
(801) 467-8873

1057 E. 2100 So. Salt Lake City, Utah 84106

CIRCLE 343 ON READER SERVICE CARD

5-1000 MHz PREAMPLIFIERS

	NF	G	P(1 dB)	\$
WLA20M*	2dB	15dB	0dBm	73
WLA21M	3	13	8	57
WLA22M	4	11	12	61
WLA23M	4	22	12	87
WLA24M	3	23	18	109
WLA25M	5	11	20	82
WLA26M	6	21	24	199

Add \$4 for S&H; *BW 1-500 MHz



WILAM TECHNOLOGY, Div. of

WI-COMM ELECTRONICS INC.

P.O. Box 5174, MASSENA, N.Y. 13662
(315) 769-8334

Short Broadband Dipoles & Slopers

Trapless 3-conductor legs create short antenna with broad 2- & 3-band resonance.
FB Dipoles
FB 80/40/15 62' \$79.95
(• CW • Center • LSSB • HSSB)
FB 40/20 31' \$69.95
FB 20/10 16' \$59.95
When ordering add \$5 P&H Infopack S1
Box 50062-S, Provo, UT 84605 (801) 373-8425

Trapless 2 & 3 band Tower-Mount
FB HalfSlopers
FB 160/80/30 CW 70'
FB 160/75 SSB 62' \$69.95
• 2KW • Efficient • Coax Fed • Ready to Use • No Caps or Coils • Fully wx sealed & insulated
AntennasWest
Box 50062-S, Provo, UT 84605 (801) 373-8425

CIRCLE 303 ON READER SERVICE CARD

Subscription Problems? Change of Address?

Our new toll-free number is:

1-800-525-0643

Colorado/Foreign Subscribers:

1-303-447-9330

*****PRESENTING*****

CABLE TV DESCRAMBLERS

*****STARRING*****

JERROLD, HAMLIN, OAK
AND OTHER FAMOUS MANUFACTURERS

- FINEST WARRANTY PROGRAM AVAILABLE
- LOWEST RETAIL/WHOLESALE PRICES IN U.S.
- ORDERS SHIPPED FROM STOCK WITHIN 24 HOURS

FOR FREE CATALOG ONLY 1-800-345-8927
FOR ALL INFORMATION 1-818-716-5914



PACIFIC CABLE CO. INC.
7325 1/2 RESEDA BLVD., DEPT. 1830
RESEDA, CA 91335



CIRCLE 178 ON READER SERVICE CARD

CB-TO-10 METERS

We specialize in CB radio modification plans and hardware. Frequency and FM conversion kits, repair books, plans, high-performance accessories. Thousands of satisfied customer since 1976! Catalog \$2.

CBC INTERNATIONAL

LOU FRANKLIN/K6NH - Owner
P.O. BOX 31500X, PHOENIX, AZ 85046

Littlite

Gooseneck Lamps and Accessories



- Quartz Halogen Bulb
- Dimmer Controlled
- 12" and 18" Lengths
- Slot for Color Filter
- 12 Volt Operation, AC or DC
- Mounting Accessory Options

Performs with consistent reliability providing dimmer controlled illumination for late night DX'ing.

\$49⁹⁵

Includes shipping & handling

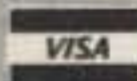

Credit card customers can order by phone. Call: (313) 231-9373

Send To:
Littlite/CAE Inc.
P.O. Box 430
Hamburg, MI 48139

My check or money order is enclosed.

Charge: VISA MasterCard

Acct No. _____ Exp. ____/____

PLEASE PRINT CLEARLY

Name _____

Address _____

City _____

State _____ Zip _____

Phone () _____

Sign Here _____

CIRCLE 278 ON READER SERVICE CARD

RTTY LOOP

Amateur Radio Teletype

Marc I. Leavey, M.D. WA3AJR
6 Jenny Lane
Baltimore MD 21208

One-Chip AFSK Generator

You all are certainly a vocal crew. It may take me until Labor Day to sift through all the responses to the First Annual Decade survey published here. But, try I must, and I promise to let you all know the sense of the readership... just as soon as I figure out what it is!

In the meantime, here is the second in the series of one-evening kitchen table projects that you are all asking for. This month, I have a one-chip AFSK generator. With its reasonable purity of emission, it should be useful for putting many of you onto RTTY.

It's based on a versatile chip billed as a "function generator." I picked up my last few on the bargain clearance table at my local Radio Shack. While the XR-2206 may not be in the latest Radio Shack catalog, it certainly remains available from them on order, or on the Jim Paks wall of many distributors, for about six bucks, list price.

Figure 1 shows the schematic of the AFSK generator, which is easily assembled on a perf board just by following the diagram. Take special note of the chip's +Vcc—it is +10 volts DC, rather than the +5 volts DC common to other TTL chips.

The RTTY keying input is basically TTL level voltage, with a swing from less than one volt to more than two volts for the mark/space transition. Most keying cir-

cuits should supply this level without much trouble. If you would like to key this circuit off of a 60 mA teleprinter loop, you will need some form of isolation, such as an optoisolator or reed relay.

Meanwhile, the output frequency of this device is as stable as the frequency determining components used, particularly the capacitor connected between pins 5 and 6. Nominally a 0.01 μ F capacitor, this should be a high quality, stable capacitor, rather than the common disc variety. The latter has too wide a manufacturing tolerance, and too much drift in value, to be used in this critical area.

A high level signal on pin 9 generates an output frequency determined by the combination of the capacitor between pins 5 and 6, and the resistor going to ground from pin 7. A low level signal on pin 9 similarly generates a signal dependent on the resistance of the potentiometer on pin 8. The formula is:

$$\text{freq} = \frac{1}{R \times C}$$

where *freq* is the output frequency, *R* is the resistance presented to either pin 7 or 8 to ground in ohms, and *C* is the capacitance in farads between pins 5 and 6.

With a 0.01 μ F (0.00000001 F) capacitor and a 45k Ω (45000 Ω) resistor, a frequency of about 2222 Hz would be generated. This is well within the common AFSK range. Therefore, the use of a 50k potentiometer allows frequencies as low as 2000 Hz to be generated, with no real upper limit. If you like, for finer control, a 30k resistor in series with a 20k potentiometer would allow coverage of the 2000 Hz to 3000 Hz range,

with much better accuracy.

The perceptive among you may have noticed that I have not really labeled one or the other signals "mark" or "space." That is because such labels are, after all, relative. If you are keying this circuit with a positive voltage for mark, and a zero or negative voltage for space, then the mark frequency will be determined by the resistor on pin 7, and the space frequency on pin 8.

However, if you are using a computer to key this circuit, and you are using the common RS-232 standard interface, then you may have a surprise coming. Mark voltage in the RS-232 standard is a negative voltage; space is positive. This is just the reverse of what we were talking about. But, no problem. Just use the potentiometer on pin 8 to set up the mark frequency, and pin 7 for the space.

You could put in a reversing switch if it were important to you to swap mark and space frequencies.

Now, for those of you who are VHF bound, the standard mark frequency is 2125 Hz. There are two standard shifts in use, the old 850 Hz, so-called "wide shift," and the newer 170 Hz, or "narrow shift." To save you trouble with higher math, that yields a space frequency of 2975 Hz (2125 + 850) for wide shift, and 2290 Hz (2125 + 170) for narrow shift.

VHF and SSB

But these are for VHF AFSK, you see. If you will be feeding this AFSK into a single sideband transmitter to produce FSK, you don't need those frequencies at all. Most transmitters will not pass a signal upwards of 2000 Hz that well, as the audio stage is peaked for voice transmissions. Therefore, feel free to use a lower set of frequencies. There are two pre-

cautions you should take, though.

First, choose a pair of frequencies, not harmonically related, that fits in the passband of your transmitter. If you are using wide shift, for example, *don't* choose 850 Hz and 1700 Hz. I know that they are 850 Hz apart, and reasonably low, but the higher is the first harmonic of the lower. Bad news! Better to choose 1000 Hz and 1850 Hz, or a similar combination for a 170 Hz shift.

Second, remember that FSK convention places the space on the lower frequency. That is, the frequency shifts downward from the mark frequency. When transmitting on lower sideband, the audio tone used for space is the higher frequency, reversed from FSK convention. This goes along with AFSK practice, though, so there is some consistency. Once again, generate an AFSK pair with a low mark and high space, and use lower sideband to convert this into an FSK signal with high mark and low space.

Transmitting

Now that you've selected your transmit frequencies, you will want to couple the signal to your transmitter. The potentiometer on pin 3 controls the amplitude of the output signal. According to the specs of the chip, about 60 mV of signal are available per kilohm of resistance, so a 50k resistance should generate about 3 volts peak to peak.

The adventurous among you might chose to combine the previous demodulator project and this month's modulator into a box, with a common power supply, and make a small RTTY modem. Keep all that data flowing this way, to the above address, or electronically. Either CompuServe (ppn 75036,2501) or Delphi (username: MARCWA3AJR) are fine. Let's hear from you! 

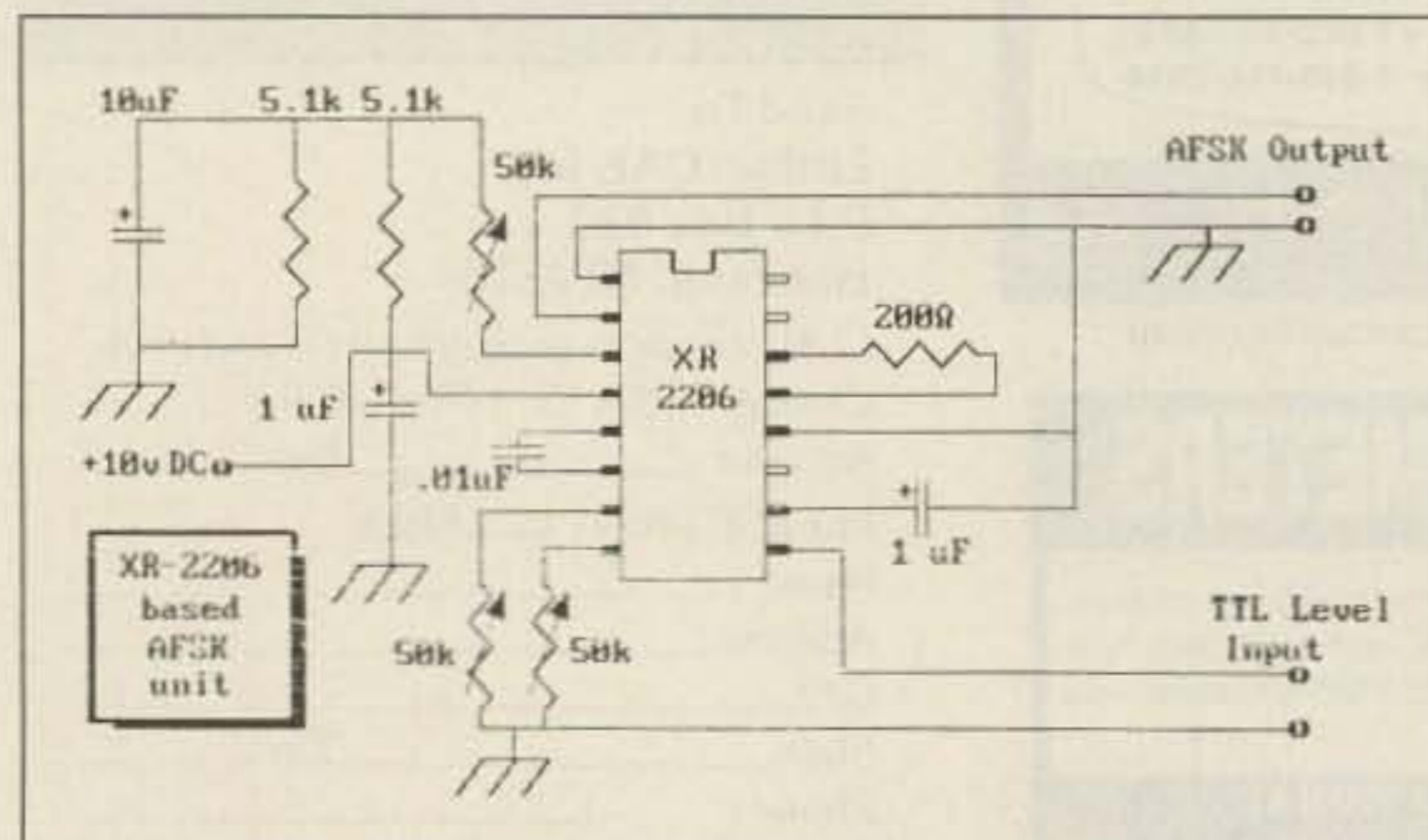

Figure 1. Simple one-chip AFSK generator.

AFSK Generator Parts List

Integrated Circuit	XR-2206	Jim-Paks or mail order
Resistors	5100 Ω	RS 271-13305* \$0.39
	(1/4 or 1/2 W)	RS 271-13135 \$0.39
Potentiometer	50000 Ω	RS 271-219 \$0.69
	Miniature PC mount	
Capacitors	0.01 μ F	RS 272-10652 \$0.59
	1.0 μ F	RS 272-1434 \$0.59
	10.0 μ F	RS 272-1436 \$0.79
Perf board	0.1 inch grid	RS 276-1394 \$1.99

*Radio Shack parts are nearest whole values. Resistor values are nominally within 10%. For all practical purposes, the available Radio Shack values are close enough for this project to the specified values. If you can get exact values, fine. If not, don't lose any sleep over it.

Field Day AntennaPacks

EmergencyPacks contain QRV All Band kink-proof wx-sealed multi-band Dipole-V-Sloper antenna, 70' coax feedline, Quick Launch system, rotproof dacron support braid, 40 p Tech Manual. Complete. Ready for Action. One person installs in 15 minutes. Infopack \$1

Fastest Antennas in the West

Box 50062-S, Provo, UT 84605

EmergencyPack
80-10 \$99.95
102' long
40-10 \$89.95
51' long
Add \$10 S & H.

AntennasWest
(801) 373-8425

CIRCLE 90 ON READER SERVICE CARD

NEW ONLINE CALL DIRECTORY

Our new **HAMCALL** service gives you 494,114+ Hams, via your computer. \$29.95 per year — unlimited use!

BUCKMASTER PUBLISHING

Mineral, Virginia 23117

703: 894-5777 800: 282-5628

CIRCLE 156 ON READER SERVICE CARD

Where's the Beam?

Unobtrusive DX Gain Antennas for 80 thru 10
• Easily hidden • Install Fast • Fixed or Portable •



There's a 20 meter antenna with real DX Punch hidden in this picture. You can't see it, and your neighbors can't either. But it works DX barefoot anyway. How about a low profile 80-40-30 tri-band? Or a 2 element monobander for the attic? All easily fit the pocketbook—Priced \$29 to \$99.

Work DX without telling the neighbors

Infopack \$1

Box 50062-R, Provo, UT 84605

AntennasWest

(801) 373-8425

CIRCLE 5 ON READER SERVICE CARD



IF YOU BUY, SELL OR COLLECT OLD RADIOS, YOU NEED...

ANTIQUE RADIO CLASSIFIED

Antique Radio's Largest-Circulation Monthly Magazine

Articles - Classifieds - Ads for Parts & Services

Also: Early TV, Ham Equip., Books, Telegraph, 40's & 50's Radios & more...

Free 20-word ad each month. Don't miss out!

Free Sample. 6-Month Trial - \$11.

1-Year: \$19 (\$28 by 1st Class). Foreign - Write.

A.R.C., P.O. Box 2-E4, Carlisle, MA 01741

CIRCLE 271 ON READER SERVICE CARD

RAISED PRINT QSL CARDS

From Dennis, WA5QMM

Offset Printed - High Quality

Nothing like it anywhere! You can actually FEEL the type! 17 beautiful designs including a Full-Color Eagle.

For Free samples & Info. call

(318) 443-7261

Network QSL's - P.O.B. 13200 - Alexandria, LA 71315-3200

CIRCLE 114 ON READER SERVICE CARD

A X M Incorporated
Serving the radio amateur who needs more than an amateur radio.

11791 Loara Street, Suite B
Garden Grove, California 92640
Tel (714) 638-8807
FAX (714) 638-9556

Larsen Antennas
Repro
RITRON
Standard Communications
MOBILE MARK
TRILETRIC
uniden
TAD

ASTRON CORPORATION
CES Communications Electronics Specialists, Inc.
COMMUNICATIONS SPECIALISTS, INC.
JOB-COM
COMUMON

CIRCLE 243 ON READER SERVICE CARD

Look at our MOBILE MARK "ON WINDOW" Line

PATENTED

VHF (140-175)

- No Hole
- Easy to Mount
- Rugged
- Superior Performance
- Radiator Snaps On and Off
- Competitively Priced



UHF (420-520)

- 3 db gain
- No Hole
- Easy to Mount
- Rugged
- Superior Performance
- Radiator Snaps On and Off
- Competitively Priced

Cellular/Trunking (800-895 MHz)

- 3db Gain
- No Hole
- Easy to Mount
- Rugged - Goes through Car Wash Without Removal
- Superior Performance
- Broad Bandwidth
- Small Size
- Competitively Priced

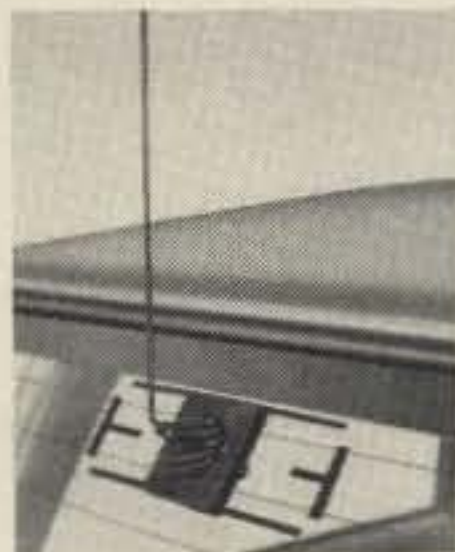

MOBILE MARK, INC.
COMMUNICATIONS ANTENNAS

3900-B River Road
Schiller Park, IL 60176
312-671-6690

brings imagination and innovation to antennas and has been since 1948!!

CIRCLE 163 ON READER SERVICE CARD

Engineering Consulting's computer controlled Ham Shack See system variables, control & reprogram all via packet! Ultra Comshack 64 Repeater Controller HF & VHF Remote Base*Autopatch*CW Practice*Rotor Control*Voice Meters*Paging*Logging*Polite ID's*Packet Voice B.B.S.

Model CS64S \$359.95
Includes: Interface, disk, cables, Manual
Ultra Options

NEW! Add Duplex Remote Base operation & monitor mode from any telephoneTLCN.....\$159.95
External relays; 3 DPDT relays +5 Open Col. Trans. Sw....CS 8...\$89.95
*Rotor control D.C. to digital display & Voice; for all rotors....HM1...\$59.95
*Packet & BBS; Voice Meters & Alarm Inputs; 8 On/Off. PK8.\$159.95
*Slave Packet interface & cable Links PK8 to 2nd C64....PK1...\$89.95
*EPROM Autopatch CART, custom with your system.....CART...\$109.95
*C64 & 1541 12V. Switching supply crystal controlled ...DCPS...\$129.95
*Manual(REFUNDED) MN1...\$20.00

Controller Features
*Change variables remotely from touchtones or Packet
*Unlimited voice vocabulary!
*Alarm Clock, auto execute
*Individual 4 digit user codes
*Disk & Printer logging of users, tel #'s, lapsed time
*18 Rotating Polite ID's
*16 External relay controls
*2-tone & sub tone Paging
*CW Practice with voice
*Security mode, T.tone mute
*Voice announces each user call sign when logging on

Autopatch & Reverse
*1000 (18 digit) tel #'s stored
*Quick dial & quick answer
*Directed, general page
*Selected restricted patch
*Telephone control input
Dual Combined Remotes
*18 Macro/Scan memories
*Scan up/down; 100Hz steps
*Monitor & lock modes
*Operate splits, combine HF & VHF radios as Dual VFO's
*Automatic mode selection
*Talking S Meter; Voltmeter
*Voice Beacon rotating msg

Computer Control YAESU FT-727R
C64 OR IBM Mini Cat
Allows H.T. to scan 100 Channels & programs
H.T. for field use! Digital "S" Meter; comment fields; auto resume & delay; Scan Lock-outs; Loads FT727 in 15 sec. Hardware, cables, & disk included for C64 or IBM
Model 727 \$49.95

Touchtone Decoder
4 digit sequence; & QUAD expansion 4 relay option
2"x3" TSDQ QUAD
8/20 V & audio in; Field Program 50,000 Codes; Mom. & Latching; DPDT Relay; Wrong digit reset; LED for digit valid & latch; inc. 24 Pin connector
QUAD option adds: four 2 Amp. relays; 5 digit master on/off control for each relay.
TSDQ \$89.95 QUAD \$99.95

Decode-A-Pad
Touchtone to RS232 300 Baud Interface
Use with all computers
Decodes 16 touchtones
Includes Basic program
DAP \$99.95

12 Volt C64 SWITCHER
Crystal 60Hz 9VAC 5V. 2A. C64 & 1541
DCPS \$129.95

AUDIO BLASTER IC02;04;2AT;FT-727R 411;209;470;73;23;U16
AB1S ←-Miniature Audio Amp.
Module installs inside all H.T.'s; 1 watt audio amp! When it needs to be loud! Installs in 15 Min. Used by police, fire!
Model AB1S \$24.95

New C64 "Packet Talker"
PKTA
TNC COMMODORE 64 TX/RX
disk PACKET TO VOICE
Stores messages on disk for up to 300 users; touchtone commands recall & speak your stored messages on repeater or packet freq. Works with all Packet TNC's; Converts all packet messages to VOICE!
Inc. disk & Interface **PKTA \$189.95**

ENGINEERING CONSULTING
583 CANDLEWOOD ST.
BREA, CA. 92621
TELEPHONE: 714-671-2009
FAX: 714-255-9984

We accept: C.O.D.'s
MasterCard, VISA, Disc
American Express
*add \$3.00 S/H U.S.A.
+ Ca. residents add 6%

HOMING IN

Joe Moell PE K00V
PO Box 2508
Fullerton CA 92633

S-Meters

How well does your two meter FM transmitter hunting setup work when the signal is really weak? Getting an accurate bearing with a beam or quad is tricky when the signal just barely breaks the squelch. Such situations are common at the beginning of hunts, particularly after you leave the high elevation of the starting point.

Today's VHF and UHF rigs are very sensitive, but their S-meters are not. The S-meter takeoff point must be at an early stage in the IF chain to minimize saturation effects and give maximum dynamic range (which is none too high anyway). So the typical S-meter doesn't start upscale until the signal is about 10 dB above the threshold of detection.

There have been a lot of hunts where I've gone well over halfway to the hidden T before getting S-meter readings good enough to use for bearings. Without meter indications, the only way most hunters can get a bearing is to find the squelch break points and average between them. This method is often inaccurate due to flutter and local noise conditions.

The better equipped you are to get bearings on weak carriers, the better your chance of winning the hunt. Wouldn't it be great if there were a way to indicate the strength of signals that are too puny to move typical S-meters? There is!

Squelch Secrets

Ever notice that the squelch on your VHF-FM rig opens properly on stations that are too weak to read on the S-meter? That's because the squelch senses the signal level in the IF differently from the way that the S-meter does this. If the squelch worked like the S-meter, it would be very insensitive and unreliable. Instead, the squelch uses the "quieting" effect that occurs on even the weakest FM or CW signals.

Because of the very high gain of the IF stages in an FM receiver, the FM detector stage (the discriminator) outputs a high level of random noise when it's not re-

ceiving a signal, sometimes as great or greater than the peak audio level of typical signals. Most of the noise is at high audio frequencies, well above the pass-band of the speaker amplifier. When any carrier-type signal (such as FM) comes in, even if it is very weak, this noise is quieted. The stronger the signal, the greater the quieting.

Figure 1 shows the output stages of a typical FM receiver. Signal pickup for the squelch comes directly from the discriminator and passes through an audio high-pass filter. The system senses the supersonic noise components instead of the voice range audio, then amplifies and rectifies the noise. Next, a logic circuit decides if there is enough quieting to represent a signal. If so, the squelch gate connects the discriminator audio through a low-pass filter (the de-emphasis network) to the speaker amplifier. In many radios, the squelch control varies the gain of the noise amplifier, as in Figure 1. In other sets, such as the Kenwood TR-7950, the squelch pot is part of the logic.

WA6DLQ's Noise Meter

Why not meter the squelch detector? Great idea! The rectified noise is a very sensitive indicator

of the relative strength of feeble signals.

There are two methods for metering noise on ham VHF-FM transceivers. The easiest way is to find a takeoff point in the receiver where there is a DC voltage proportional to the noise, then amplify that voltage to drive a meter. That's what Vince Stagnaro WA6DLQ did with his TR-7950 two meter rig. It's practical for other rigs, too.

WA6DLQ's meter box features a switch, S2 (see Figure 2) to make the unit either a noise meter or an external S-meter that tracks the one in the TR-7950. With this system, you hunt weak signals using the noise meter then, when the signal gets to near full quieting, switch to the S-meter position and use your dashboard meter instead of the small one on the transceiver.

The collector of transistor Q12 in the TR-7950 is an ideal noise meter pickoff point. With no sig-

nal, rectified noise turns Q12 on hard, resulting in Q12 collector voltage near zero. As the signal level rises toward full quieting, the drive to Q12 decreases until it is at cutoff, and the collector voltage rises to about +7.3 volts. The S-meter tapoff for the TR-7950 comes from TP3, which varies from 0 volts with no signal to +1.6 volts at full scale.

The meter amplifier unit is basically a straightforward DC gain stage using the National LM324 quad op amp, U2. (See Figure 2.) This chip is ideal because it works when input voltage is near zero, with no need for a negative supply voltage. Be sure to strap and ground the unused sections, as shown.

Easy-To-Find Parts

Most parts for this project are carried at Radio Shack. L1-L2 and C1-C4 are filters to keep RF out of the radio and meter circuitry, and can be omitted if there

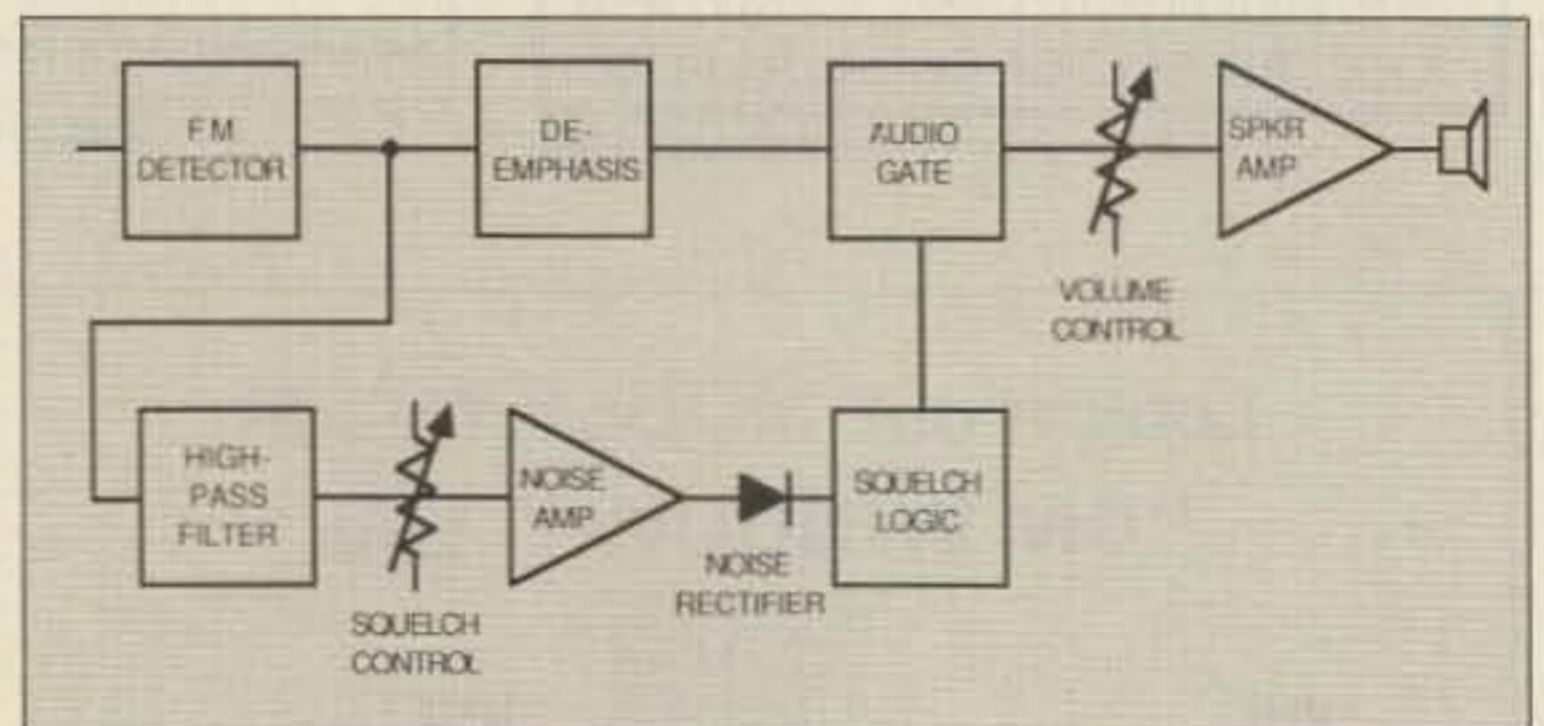

Figure 1. Block diagram of a portion of a typical VHF-FM receiver, showing the discriminator, audio, and squelch.

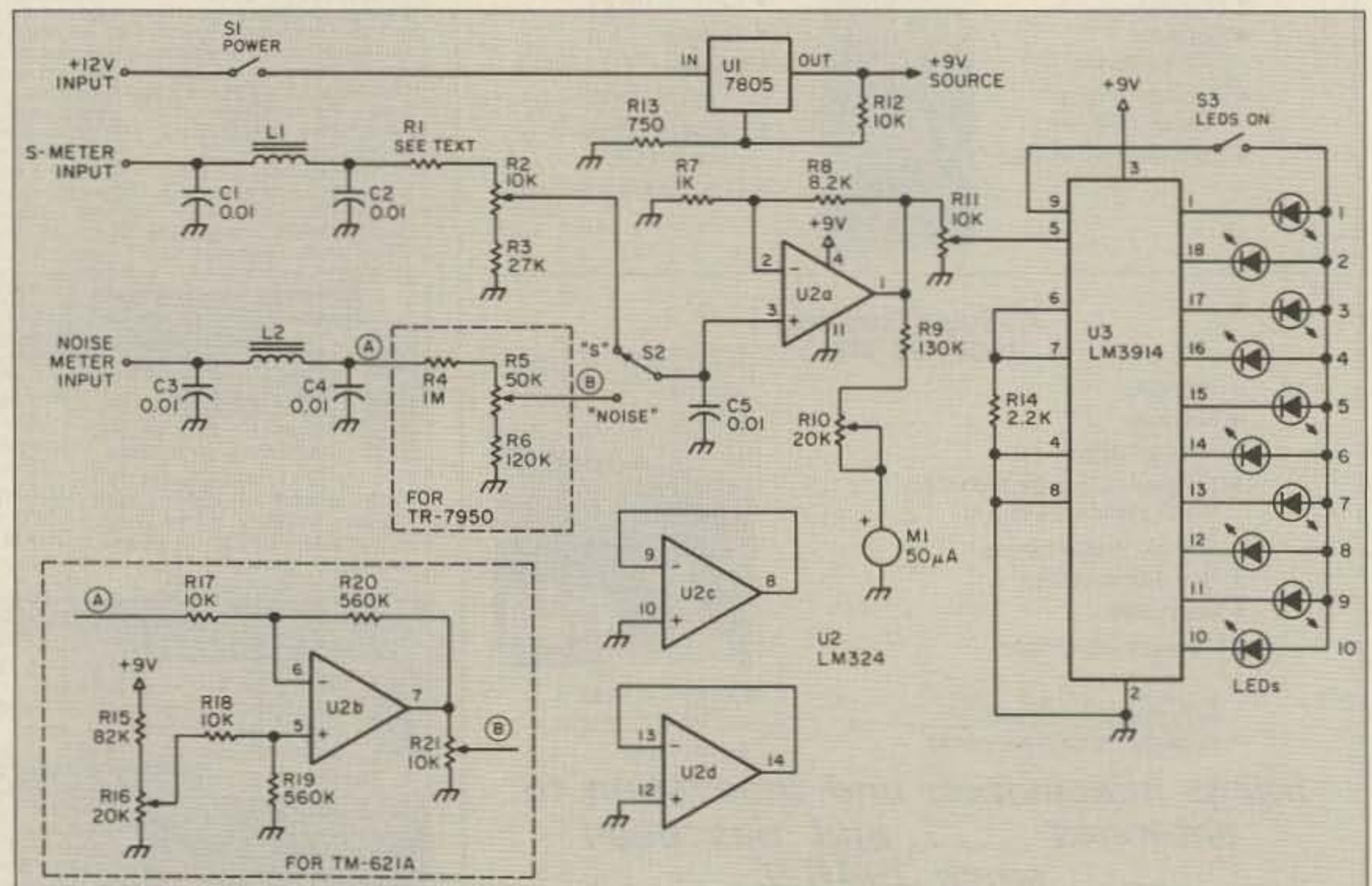

Figure 2. Schematic diagram of WA6DLQ's noise meter and external S-meter circuit for use with the Kenwood TR-7950 and TM-621A transceivers.

PC HF FACSIMILE 4.0 \$99



A complete facsimile reception system for the IBM PC or Compatible. Receives up to 16 intensity levels.

Includes:

Demodulator Software 80 Page Manual
Frequency List Interpretation Guide

Features:

Print on Epson, or HP Laser Jet
Disk Save, Zooming, Image processing
Unattended Image Capture and much more

Software Systems Consulting
1303 S. Ola Vista, San Clemente, CA. 92672
(714)-498-5784

CIRCLE 250 ON READER SERVICE CARD

SRC-10 REPEATER/LINK CONTROLLER

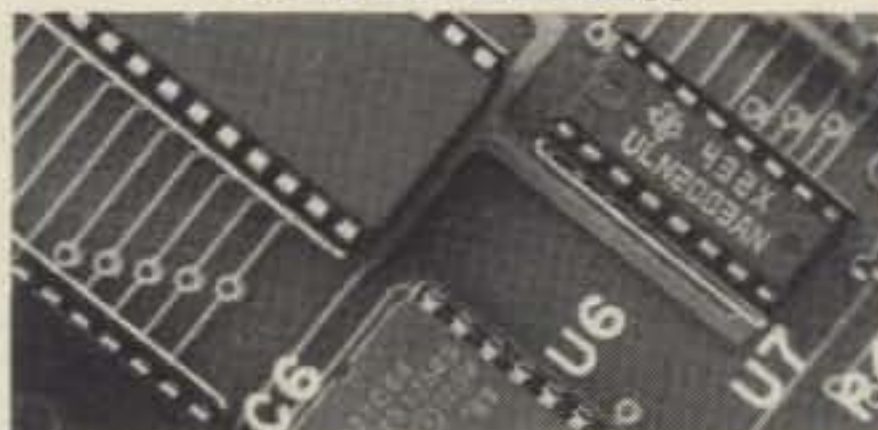

DTMF muting
Intelligent ID'er
Auxiliary outputs
Easy to interface
Alarm monitor input
Telemetry response tones
Low power CMOS, 22ma @ 12v
Detailed application manual
Programmable COS polarities
Repeater & link courtesy tones
Synthesized link/remote base capability

\$149.00 Assembled & Tested

CREATIVE CONTROL PRODUCTS

3185 Bunting Avenue
Grand Junction, CO 81504
(303) 434-9405



CIRCLE 306 ON READER SERVICE CARD

THE BIG SIGNAL DANDY DIPOLE™ ANTENNA KIT



Dandy Dipole™ Kit With Insulator Includes:

1—Dandy Dipole™ Book of Instructions
1—Pair Endsulators
135 ft.—#14.7 Strand Copper Wire
1—W2AU Center Insulator
TOTAL COST: \$26.00 plus \$3.50 UPS

Dandy Dipole™ Kit With W2AU 1:1 Balun

1—Dandy Dipole™ Book of Instructions
1—Pair Endsulators
135 ft.—#14.7 Strand Copper Wire
1—W2AU 1:1 Balun
TOTAL COST: \$38.00 plus \$3.50 UPS

M/C VISA M/O NO C.O.D. Please
At Your Local Dealer Soon.
In Hurry? Order Direct for Immediate Delivery

Unadilla Antenna Manufacturing Co.
P.O. Box 4215 BV • Andover, MA 01810
(508) 475-7831

CIRCLE 136 ON READER SERVICE CARD

FREE CATALOG!

Features Precision Tools,
Tool Kits, Test Equipment



Jensen's new catalog features hard-to-find precision tools, tool kits, tool cases, test equipment and computer accessories used by sophisticated hobbyists, scientists, engineers, laboratories and government agencies. Call or write for your free copy today.



JENSEN TOOLS INC.

Dept. 158, 7815 S. 46th St.
Phoenix, AZ 85044-5399 (602) 968-6231

CIRCLE 245 ON READER SERVICE CARD

PowerPole® Connectors

Tired of looking for power connectors for all those rigs?
The PowerPole® system is for you!
Shack to mobile just Plug & Go!

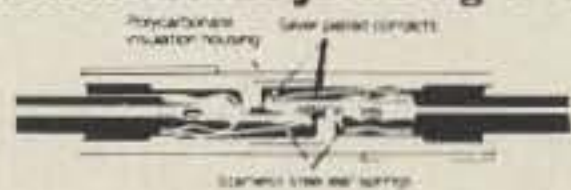

- 15 - 30 - 60 amp @600 volt AC/DC ratings
- Genderless! All connectors mate.
- Polarity is determined when multiple poles are assembled.
- Cannot be mated incorrectly!
- Silver plated contacts mean low resistance(600 micro ohms/PP30)
- Easy to assemble, crimp and/or solder.
- Dovetail assembly allows "stacking" multiple poles as needed.

Powerpak 15 - 4 or 30 - 4 with 2 red & 2 black poles **Just \$1.99**

(*2.99 shipping and handling up to 50 pks. \$10 min. order)

Distributed By: **Reighcon Systems**
626 S. Blue Sky Dr., Cedar City, UT 84720
Dealer Inquiries Welcome (801) 586-2302

CIRCLE 347 ON READER SERVICE CARD

SPECIALISTS IN FAST TURN P.C. BOARDS

PROTO TYPE P.C. BOARDS AS LOW AS \$25.00

- SINGLE & DOUBLE SIDED
- PLATE THROUGH HOLES
- TEFLON AVAILABLE
- P.C. DESIGN SERVICES

FOR MORE INFORMATION _____

Midland Technologies

34374 EAST FRONTAGE ROAD
BOZEMAN, MT 59715 (406) 586-1190

CIRCLE 252 ON READER SERVICE CARD

DIAMOND ANTENNA

KNOWN WORLD-WIDE FOR PREMIUM QUALITY ANTENNAS AND METERS

POWER/SWR METERS



- Forward & Reflected Power & SWR
- Selectable RMS or PEP switch
- 3 Power Ranges:
5/20/200 Watts
30/300/3KW (SX-100 only)
- Power Meas. Accuracy 5% (typ.)
- Insertion Loss: 0.2 dB Max.
- Wideband Performance

FOUR MODELS TO CHOOSE FROM

SX-100	1.6-60 MHz	\$109.95
SX-200	1.8-200 MHz	\$89.95
SX-400	140-525 MHz	\$99.95
SX-600	Dual-Band 1.8-200 MHz 140-525 MHz	\$139.95

DUAL-BAND ANTENNAS

We believe that DIAMOND Dual-Band Antennas are the best antennas on the market today!

BASE	2m	70cm	Net
DX-50	2.8dB	5.8dB	\$94.95
DX-200	5.5dB	8.0dB	\$139.95
MOBILE	2m	70 cm	Net
NR-770S	unity	3.0dB	\$34.95
NR-770R	3.0dB	5.5dB	\$47.95

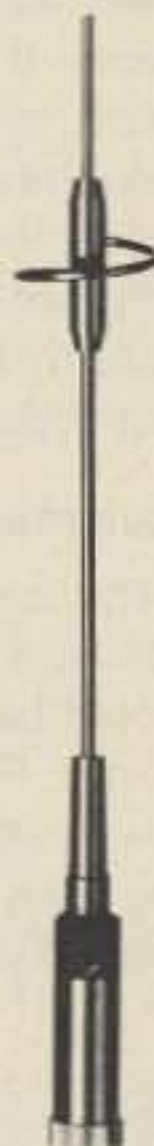

*We guarantee each DIAMOND antenna and wattmeter sold by us to meet your satisfaction or return it to us within ten days for a full refund!

Orders received by 1 PM PST shipped UPS same day.
Next day UPS delivery available

PARTS ORDERS ONLY — NO TECHNICAL
(800) 854-1927

ORDER LINE and/or TECH HELP
(619) 744-0728

FAX 619-744-1943

"QUALITY NEED NOT BE EXPENSIVE"



RF PARTS COMPANY
1320 Grand San Marcos
California 92069

Amateur Radio Via Satellite

Andy MacAllister WA5ZIB
14714 Knightsway Drive
Houston TX 77083

HAMSATS AWAY FROM HOME

Satellite mobile operations do well with low-orbit, amateur radio satellites like RS-10/11 and Fuji-OSCAR-12. The October and November 1987 columns discussed mobile activity in detail. But what about portable setups?

With gain antennas, the high-orbit birds, like AMSAT-OSCAR-10 and 13, can yield many enjoyable contacts while you're on vacation or at a weekend campout at the beach. Today many radios operate from 12 volts DC, and gain antennas don't need rotators; pointing adjustments are made only every 20 to 40 minutes during a typical satellite pass.

Many VHF and UHF satellite-chasing antennas can be broken down into easily transportable pieces. If installed at a remote location, a pole just tall enough to keep the antennas above ground and aimed at the sky provides a sufficient mast. To rotate your antenna by hand, lash it to a six-foot stepladder for easy access.

Equipment Choices

Your antennas for A-O-13 Mode B (70 cm up and 2 meters down) should be the best you can take along. For most stations the Cushcraft AOP-1 package will suffice. Both the 20-element, 2 meter crossed yagi, and the 16-element,

70 cm antenna should be set for right-hand circular polarization (RHCP). The 70 cm, crossed yagi construction project, featured in the May 1989 special satellite issue, would also do well. Keith WB5ZDP has been able to put these antennas together in only a few hours.

Other antennas, like those shown in the photos from N6JJI, may draw both curious looks and great results. Alex uses a corner reflector fed with full-wave loops for 2 meters and 70 cm. The reflector is made from two sheets of aluminum diamond screen 48 inches by 20.5 inches, supported by a wooden frame. It uses PVC plumbing with a bearing to accommodate any polarization.

The 70 cm loop is tuned to 435.5 MHz, and spaced 8.75 inches from the 90-degree corner; the 2 meter loop is spaced 18.25 inches from the corner. The assembly is placed on a surveyor's tripod and aimed manually at the satellite. Preamps for 2 meters and 70 cm are located at the loop feedpoints. Alex reports excellent contacts with Europeans while operating from his Long Beach, California, QTH.

Field Day Operations

During Field Day this year, our group in south Texas was active via Mode L (23 cm up and 70 cm down). We used an ICOM 1271A all-mode 1.2 GHz transceiver with a Down East Microwave 35 watt, solid state amplifier for the uplink. The antenna was a four-foot dish

with the coffee-can feed system shown in *The ARRL Handbook*. The system, rotated by hand, was propped in place with a four-foot pipe in the ground and steadied by elastic cords. The winds occasionally get brisk on the beach at Galveston, so a few stakes and some rope helped. If you are considering a portable Mode-L station, check WB5ZDP's dish article in the May issue of 73. This five-foot parabolic reflector provides excellent gain for good contacts with only 10 watts of 1.2 GHz energy.

Our Field Day Mode L downlink system incorporated a Cushcraft 416T mounted near the dish. An Advanced Receiver Research GaAsFET preamp in front of a Yaesu FT780R mobile all-mode 70 cm transceiver completed the operating position. All of the radios ran from a group of batteries charged by solar panels.

On your next portable outing you can discover the satisfaction of real VHF/UHF DX via satellite. With terrestrial line-of-sight operation, you have to climb a mountain just to get marginal copy from a nearby county or state. Give portable satellite activity a try!

New Publications

AMSAT North America has announced a new magazine and a completely updated beginner's guide with comprehensive details on A-O-13 operation from the ground up.

The new quarterly magazine, the *AMSAT-NA Journal*, has Joe Kasser G3ZCZ/W3 at the helm. Joe was editor of the popular magazine *Orbit* in the early 80s, and in charge of the *AMSAT Newsletter* during the late 70s. The new publication is available

only to AMSAT members. They will continue between issues of the new journal, with timely amateur-satellite news items and orbit data. If you would like to join, dues are \$30 per year. Write AMSAT, PO Box 27, Washington DC 20044, or call the main office at (301) 589-6062.

Keith Berglund WB5ZDP recently compiled a new Beginner's Guide to A-O-13 operation via Modes B and J. Keith WB5ZDP compiled this fifty-page manual. The cost is \$7. For new members, it is \$3, just enough to cover printing and postage.

The guide contains comparison charts for commercial satellite antennas, 2 meter and 70 cm multi-mode rigs, receive converters, and preamps. Also included are discussions and explanations of computer tracking programs and printouts, instructions for the proper use of N connectors, data on coaxial cable attenuation, diagrams of typical earth-station interconnections, and satellite transponder configurations and antennas. A complete uplink/downlink frequency chart of A-O-13 explains its orbital characteristics and gives the beacon telemetry output schedule. The text, full of computer graphics, was produced on a laser printer.

The *Amateur Satellite Report* will certainly be an excellent reference for all current and future satellite chasers. For the new enthusiast, it contains a list of AMSAT Area Coordinators with addresses and phone numbers to provide local contacts for individual help. Copies are available at AMSAT booths during most ham conventions and directly from the AMSAT office. Get a copy. You'll be glad you did. **73**

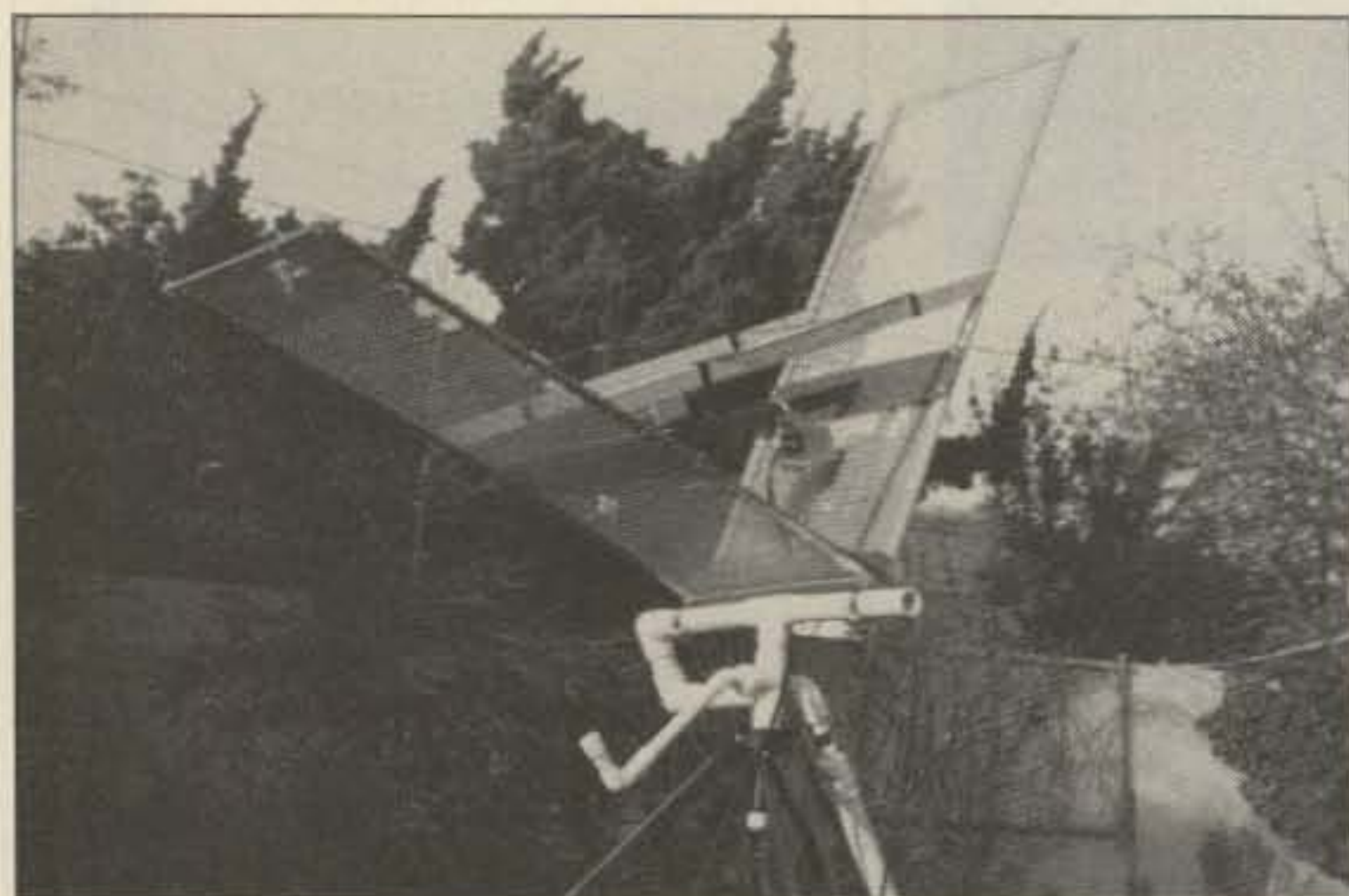

Photo A. N6JJI's corner reflector with full-wave loops for 2 meter and 70 cm. Built with a wood frame and mounted on a surveyor's transit, this simple satellite antenna has logged many DX contacts via A-O-13.

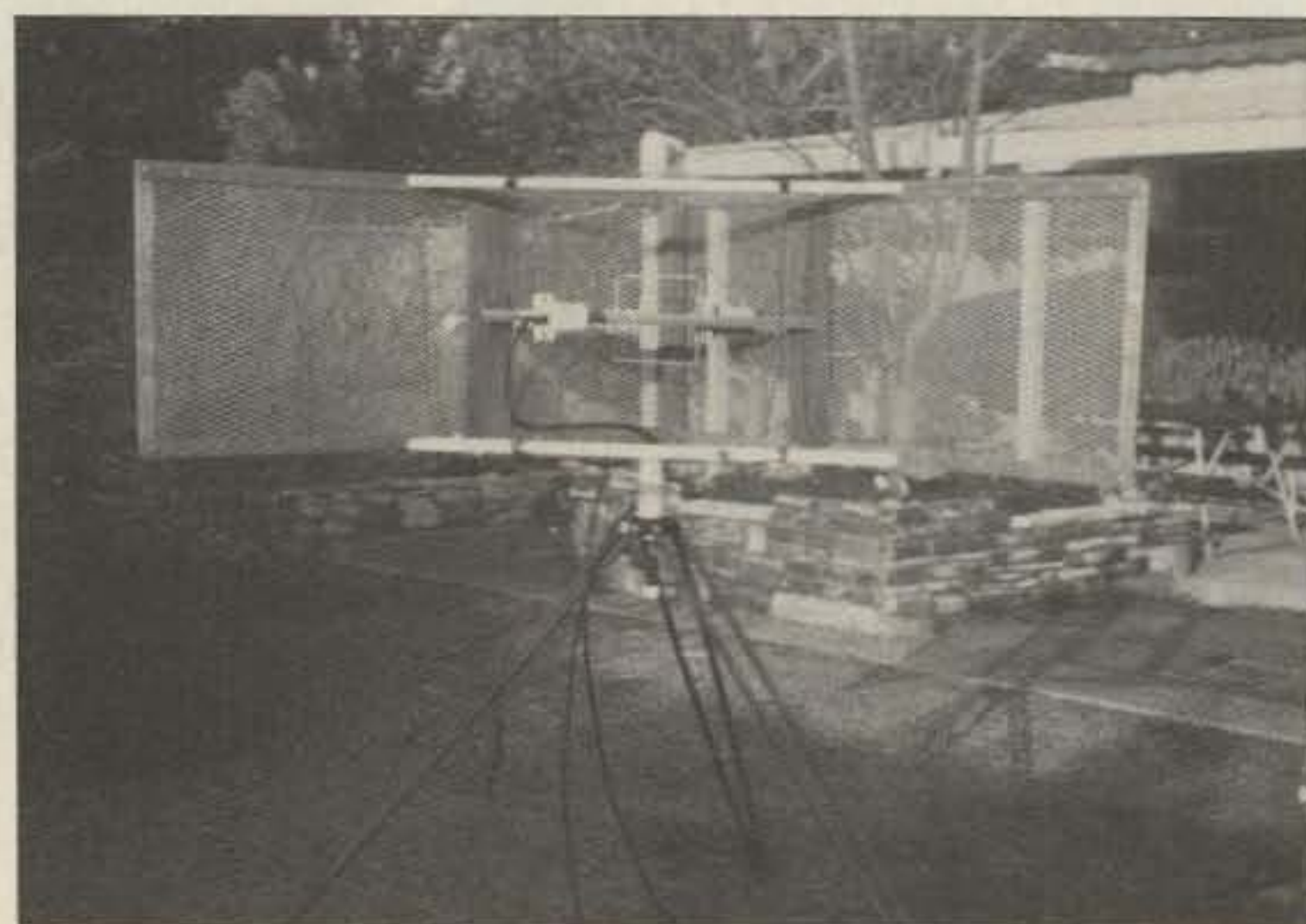

Photo B. Front view of N6JJI's corner reflector antenna. The antenna is tiltable for any polarization.

ASK KABOOM

The Tech Answer Man

Michael Geier KB1UM
7 Simpson Court
S. Burlington VT 05403

"Schematic" Defined

Most folks I've met who claim to be diagram-literate point with pride to various components, thinking that the ability to recognize them constitutes "reading" the schematic. That's like saying that recognizing the letters of the alphabet is the same as reading a novel!

The root of the word "schematic" is "scheme," and that is the diagram's purpose: to impart the scheme, or path of signal flow, of the circuit.

Think of the components as the characters, the overall function (such as "transmitter") as the theme, and the signal flow through individual circuit stages as the plot winding its way through the various chapters. Like a book, a given circuit and its diagram can involve many subplots and themes before arriving at its conclusion, typically the antenna or speaker of your radio.

Good vs. Evil

Also, like a book, there are good and bad circuits, and good and bad diagrams. Generally, late-model Japanese gear comes with good diagrams. Older stuff can be questionable. A truly great diagram will show voltages, and sometimes even oscilloscope waveforms for the inputs and outputs of each stage. It may also illustrate signal flow with emphasized or color-coded lines. Having this information makes troubleshooting a breeze, because you know what should be happening when the thing works. The service manuals for most VCRs have this kind of data, but it seems to be coming into use only recently for ham gear.

A normal "good" diagram will at least be logically laid out, with circuit stages arranged so that most signal flow occurs from left to right, and with clearly marked terminals, transistors, and ICs. (Some use actual part numbers, such as "2N2222A," while others may use a "callout" such as "Q11," referring you to a separate parts list. Part numbers complicate things less.) If you know

how to read it, it should quickly give you a sense of how the circuit is meant to work, hopefully triggering ideas regarding where to look for trouble.

A really rotten schematic may have sparse, or even no, component markings. It may be illegible, show layout of stages in a jumbled manner, omit parts, or even have errors. Fortunately, erroneous schematics are very much the exception.

Learning to Read

Ok, you've got a repair job, and the schematic looks decent. Where to begin? In past columns, I've mentioned the idea that electronic circuits are made up of bite-sized stages. If, for example, you examine the diagrams for various receivers, you'll see that, while the actual circuitry can differ greatly, the basic scheme is the same. There's an input stage to couple the signals from the antenna, perhaps an RF amp, one or more local oscillators, some IF stages (easily identified by the transformers between each one), a detector, and an audio amp.

Generally, at the center of each stage is an active device. Active devices are those which require power input from the power supply, and modulate that power to achieve switching, amplification, or oscillation. They define the stage's purpose, and are often the cause of its failure. These devices include tubes, transistors, ICs (linear and digital), SCRs, and most other semiconductors.

Passive devices, such as resistors, capacitors, and coils, can be thought of as support systems for the active devices. The passives are the lungs and kidneys providing the active brains with what they require to function, and most active devices are surrounded by them.

Focus on the active device at the center of each stage, and the organization of the stages should become clear. To do this, you MUST have at least some idea how the active device works. If you don't know that current between the base and emitter of a transistor makes the collector-emitter path conduct, then you can't hope to understand the stage's function. There are many good books covering the common

active devices, and I hope to explore semiconductors in more detail in future columns. Let me emphasize that you don't have to be an engineer, or need to understand complex formulas, in order to master this. If you comprehend Ohm's law, and have some basic knowledge of the active devices, you can learn to see the signal flow through nearly any circuit.

Identity Crisis

Probably the biggest hurdle for beginners is the identification of stages. Which one is the power supply and which one is the audio amp? As a rule, look for a part you know, and see where it's connected. For example, once you find the speaker, you can't help but find the audio amp! Here's a guide to identifying common stages:

AC Power Supplies nearly always have a transformer with the primary winding typically shown to the left, and one or more secondaries to the right. Hanging off the secondaries will be rectifiers (diodes) followed by big capacitors. The capacitors will be marked for polarity (+ or -, usually + on the diagram, and - on the part itself). Sometimes, coils, transistors, and even ICs may be included. But the transformer is a dead giveaway.

Audio Amps can be made of transistors or on a chip. Look for the speaker and earphone jack. Discrete (non-chip) amps are usually push-pull, which means they feed the speaker with two transistors working together, one for each half-cycle of the audio waveform. The transistors are usually shown one above the other, with either the speaker or a capacitor leading to it, connected where the transistors meet. Once you've successfully recognized this type of stage, it'll stand out in your mind any time you see it again.

RF "Front Ends" are the input stages coupling the antenna to the first mixer. They may be passive or may contain an RF amp. Look for the antenna. In a transceiver, it may be coupled to both the transmitter's output stage and the front end at the same time. If the feed to the first active device is to its base or gate, then you've found the receiver. If it's to an emitter or collector, that's most likely the transmitter final. There are some front ends using what is known as a "common base" amplifier, in which the base is grounded and the emitter or collector serves as the input, but it isn't common.

Oscillator failure is a common cause of dead receivers and transmitters. In a transceiver, failure of both together warrants a look at the oscillators. Look for crystals, variable capacitors, and coils. Generally, fixed-frequency and manually-tuned oscillators have connections for power, ground, and output, with no other inputs. Variable oscillators used in synthesizers have an input to control the frequency with a voltage. In these, look for varactor diodes, which look like a combination diode and capacitor on the diagram.

Mixers and Product Detectors mix the incoming signal with an oscillator to heterodyne to a new frequency, or for audio detection. They can be active or passive. Passive ones look like the bridge rectifiers (four diodes in a diamond configuration) in power supplies. Active ones can be made from transistors or chips. Look for two inputs, one from the preceding signal stage, and one from an oscillator.

IF (Intermediate Frequency) Amps amplify and filter the heterodyned signals resulting from the action of the mixer. They always have tuned circuits between them, usually using transformers, and there will be several in a row. In receivers, they are followed by detectors. In transmitters, you can follow them by driver amplifiers leading to the RF final. Either way, the succession of stages with their transformers (or sometimes ceramic resonators, which are drawn somewhat like crystals) between them, makes them easy to spot.

RF Final Amps build up the power and pump it to the antenna. In CW and FM rigs, they can be very simple, consisting of little more than a transistor with input and output transformers. In SSB rigs, they are somewhat more complicated, and can look similar to push-pull audio amps, except that they have transformers at their outputs. In any event, their signals will lead to a coil/capacitor filter and then to the antenna or antenna relay.

Digital Controls are made up mostly of chips, which are drawn as boxes with lots of leads. They have many interconnections, and can be quite hard to follow. Usually, your focus will be on their outputs to the rest of the radio. The rows of chips are unmistakable.

Next month—more letters. Til then, grab some schematics and start reading! 

LOOKING WEST

Bill Pasternak WA6ITF
28197 Robin Avenue
Saugus CA 91350

Notable Ham-Com Event

At last!—the FCC released the newly reorganized Part 97 Amateur Service Rules on Saturday, June 3, at the ARRL Diamond Jubilee National Convention in Arlington, Texas. Robert McNamara, Chief of the Special Services Division, and John B. Johnston W3BE, Chief of the Personal Radio Branch, brought the regulatory revision to the Arlington convention, and presented them before a standing room only crowd.

Part 97 Past

Prior to this action, Part 97 had not undergone a major restructuring since 1951 when most communications systems in the Service were using HF hand-keyed telegraphy and AM telephony. Since then, a number of emerging technologies, such as SSB, FM telephony, VHF and UHF repeaters, radio-teleprinting, satellite transponders, digital communications, television, and other modes have become popular. And, while rules have been modified or added to accommodate these technologies, the result has been a patchwork quilt of rules surrounding an antiquated and often confusing structure.

The New Part 97

In a prepared press release, the Commission recognized that current amateur radio rules don't easily apply to modern amateur radio communications, such as packet radio. Thus, the FCC reorganized Part 97 of its rules to create a regulatory environment designed to encourage modern techniques and modern technology in the Amateur Radio Service. They also made the rules easier to understand, and deleted any unnecessary, obsolete, and redundant provisions.

The essential tenets for the Service, however, remain the same. "The Amateur Radio Services consist of the Amateur, Amateur Satellite, and Radio Amateur Civil Emergency Service (RACES)" noted the FCC, continuing: "The

amateur service exists for the purpose of self training, intercommunication, and technical investigation carried out by duly authorized persons interested in amateur radio techniques solely for their personal purpose and without any pecuniary interest."

Part 97 has now been restructured into a format of six subparts and two appendices. These are:

- Subpart A: General Provisions, which contains those rules concerned with license and station location requirements.
- Subpart B: Station Operating Standards, which comprises those standards that apply to all types of amateur station operation.
- Subpart C: Special Operations, which contains the requirements that apply to non-standard operations such as repeaters, beacons, and the Amateur Satellite Service.
- Subpart D: Technical Standards for all operations.
- Subpart E: Emergency Communications, which contains all rules applicable to operating in distress and disaster situations along with the rules governing RACES.
- Subpart F: Qualifying Examination Systems, which is self-explanatory.
- Appendix I lists the geographic area of the world where the FCC holds jurisdiction of the amateur service.
- Appendix II lists Volunteer Examiner Coordinator regions.

More Liberal

The new rules combine those regulations that pertain to an amateur station providing emergency communications with those that govern RACES stations. They do not, however, change the basic principles or purpose of the Amateur Service in the United States. Also unchanged is the "Quiet Hours Rule" that can be used to impose restrictions as necessary on the operation of amateur service stations to eliminate interference to home entertainment equipment. The proposed change to delegate blanket authority to impose quiet hours was a major source of irritation to the amateur community, which feared that FCC engineers might abuse such a power. In the final version of the revised Part 97, the authority to

impose Quiet Hours will remain as it has been.

The general prohibitions against amateur stations transmitting communications as an alternative to other authorized radio services, such as commercial radio services, has been clarified. They now allow any required emergency communications. The new rules also permit the use of amateur radio stations to provide communications that relate to the public's safe observation and participation in parades, marathons, and similar public events so long as the principal beneficiary of the communications is the public, and any benefit to the event sponsor is incidental.

Communications relating to the buying and selling of amateur station apparatus—such as ham-radio swap-nets—will also be permitted as an exception to the prohibition against business communications. However, the new rules expressly forbid any communications by persons seeking to profit from such sales or purchases on a regular basis, e.g. on-the-air dealers.

Another exception in this area is business communications that assists journalists in filing stories. Such reports, however, must not detract from the efforts of other stations that are actually engaged in providing emergency communications. Just about every mass media outlet in the nation, including ABC, NBC, CBS, and CNN, lobbied hard for this exemption.

With respect to operator license examinations, the FCC codified the policy that a telegraphy receiving test alone is adequate proof of both sending and receiving ability. The exam test message must be sent for at least five minutes and contain all letters, numbers, and prosigns. Also specified is the exact number of questions that must be answered correctly for each exam element to replace the previous method dealing with percentage of correct answers. The new rules also give administering Volunteer Examiners the authority to require expert verification that an examinee with a physical disability requires a reader or transcriber other than the one administering the exam element. In another rule change, the concept of the Regional VEC was deleted and all VECs are now National and permitted to service tests wherever they desire.

The new rules retain the "definitions" sections, and some terms used in the Amateur Service

Rules have been shortened and/or simplified. By way of example, the terms "beacon," "repeater," "earth station," and "space station" are now defined. The Commission also included an exception to the prohibition on international third party communications that states the prohibition does not apply to any third party who is eligible to be control operator of the station.

An exception to the time limitation for a RACES Drill has been incorporated where an Emergency Planning Official has approved the drill or test. Also, the "Good Amateur Practice" requirement has been combined with the rules governing frequency selection, frequency sharing, and malicious interference. Also under the new rules, a representative of a foreign government is not barred from holding a reciprocal permit.

With respect to repeaters and allied relay operations, the revised rules delete the antiquated requirement that relay operations be discontinued within five seconds after cessation of the relayed radio communication by the user stations. The restriction that a repeater cannot transmit on more than one channel from the same location was also deleted.

In addition, the FCC also clarified the permissible emission types to be used by amateur stations, and codified or clarified many other policies concerning amateurs that have evolved over the years as interpretations of existing rules. Also codified is the existing FCC policy concerning state and local regulations governing the height and placement of amateur station antenna structures. The new Part 97 also includes the essential holding of the Commission's PRB-1 limited preemption ruling that local regulation of an amateur service antenna structure must not preclude amateur service communications.

The Future

The new Part 97 is definitely a step forward in modernization of the United States Amateur Service. Thanks to the work of Personal Radio Branch Chief John B. Johnston W3BE and his staff, our service has a new lease on life—one to carry it forth into the 21st century and maybe, hopefully, beyond. **73**

(Adapted from *FCC News Release*—May 30 1989 with special thanks to Joe Schroeder W9JUV and Fred Maia W5YI.)

antenneX[®]

"The Magazine About Antennas"

IF YOU -

- Have a lousy mobile signal on all bands?
- Need an inexpensive beam for 10 meters?
- Unsure about using vert vs horiz antenna?
- Need a low noise antenna for 160 meters?
- Want to design an antenna just for you?
- Need a program for design and plotting?
- Need to solve a unique problem?
- Know the best antenna for hamsats, etc.?
- Need a disguised mobile antenna?
- Want a cheap automatic coupler system?
- Just want to learn more about antennas?

THEN SUBSCRIBE TO - antenneX

12 MONTHLY ISSUES - only \$15.97 for USA and possessions. \$19.97 Foreign.

antenneX

P.O. Box 8995 Dept. 19
Corpus Christi, TX 78411

CIRCLE 82 ON READER SERVICE CARD

NEW!

MORSE TUTOR

Made Easy & Fun

Introducing the most Comprehensive and Easy-to-Use code course available today!
—MORSE TUTOR is available for IBM PC, XT, AT, PS/2 and compatibles.

FEATURING!

- ★ 1-100 word/minute code speeds
- ★ Standard or Farnsworth modes
- ★ Adjustable code frequency
- ★ Over 1 Billion possible random QSOs
- ★ Letter, number, and punct. mark coverage
- ★ Self calibrating/menu driven design
- ★ Display text—while listening or after copying

To Upgrade or learn CW, Send check or M.O. for \$19.95 + \$2 S&H to:

"Morse Tutor is, quite simply, a superb value!"
Bryan Hastings, KA1HY
July, 1988, 73 Magazine

997E

REFER TO QST
JULY '88 P. 49

21881 Summer Circle, Dept. MTS
Huntington Beach, CA. 92646

CA. Residents add \$1.20 sales tax

NOW AVAILABLE THRU UNCLE WAYNE'S BOOKSHELF,
THE ARRL & FINE DEALERS EVERYWHERE

CIRCLE 339 ON READER SERVICE CARD



FREE IBM - PC SOFTWARE CATALOG

- For Hams, Electrical Engineers and Finicky PC Users.
- Hundreds of programs tested to IDS's rigid standards.
- IDS's president is a HAM and hard to please. Only 30% of the programs submitted for testing make it to the catalog.
- He's also a Cheapskate!

Programs Include:

CW CODE PRACTICE • CONTEST LOG • accurate BEAM HEADINGS • GRAPHIC on-screen-plotting CALCULATORS • CIRCUIT DESIGN AIDS • super-tested PROPAGATION FORECASTING • TERMINAL EMULATION

NONE OF OUR DISKS COST OVER \$4.95

Please send your Name and Address (we would be grateful for \$.65 cash or stamps for postage, but not required) to:

INTERCON Data Systems
Dept. 7, P.O. Box 696
Gambrills, MD 21054-0696

The HF5B "Butterfly"[™]

A Compact 2 Element Beam
for 20-15-12-10 Meters
Operate As A Di-Pole on 17 Meters

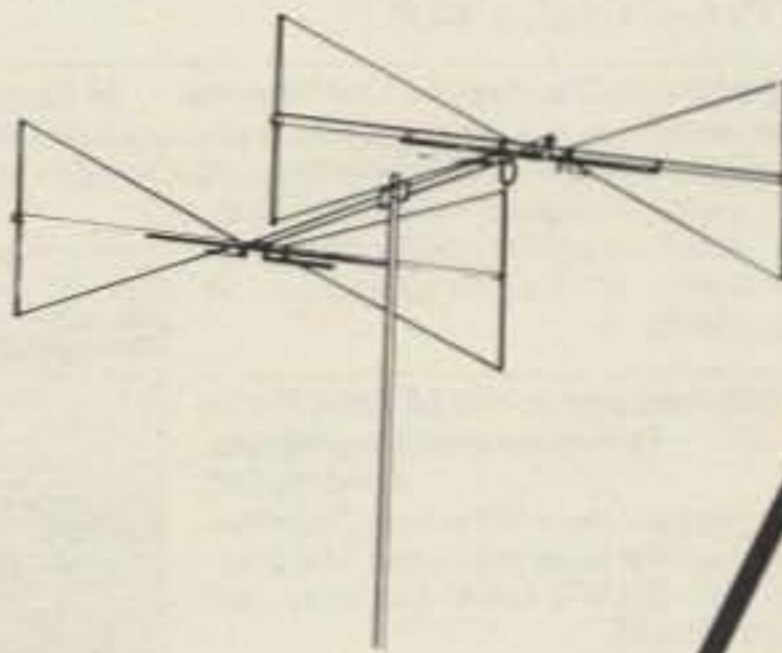

- Unique design reduces size but **not** performance.
- No lossy traps; full element radiates on all bands.
- Turns with TV rotor
- 19 lbs.

HF ANTENNAS FROM BUTTERNUT

Butternut Verticals

Butternut's HF verticals use highest-Q tuning circuits (not lossy traps!) to outperform all multiband designs of comparable size!

Model HF6V

- 80, 40, 30, 20, 15 and 10 meters automatic bandswitching.
- Add-on kit for 17 and 12 meters available now.
- 26 ft. tall

Model HF2V

- Designed for the low-band DXer
- Automatic bandswitching on 80 and 40 meters
- Add-on units for 160 and 30 or 20 meters
- 32 feet tall - may be top loaded for additional bandwidth.

For more information see your dealer or write for a free brochure

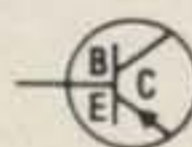

BUTTERNUT ELECTRONICS CO.
405 East Market, Lockhart, TX 78644



PacComm

- Advanced Technology
- Enduring Value

New! PC-320 / TNC-320 PACKET CONTROLLERS

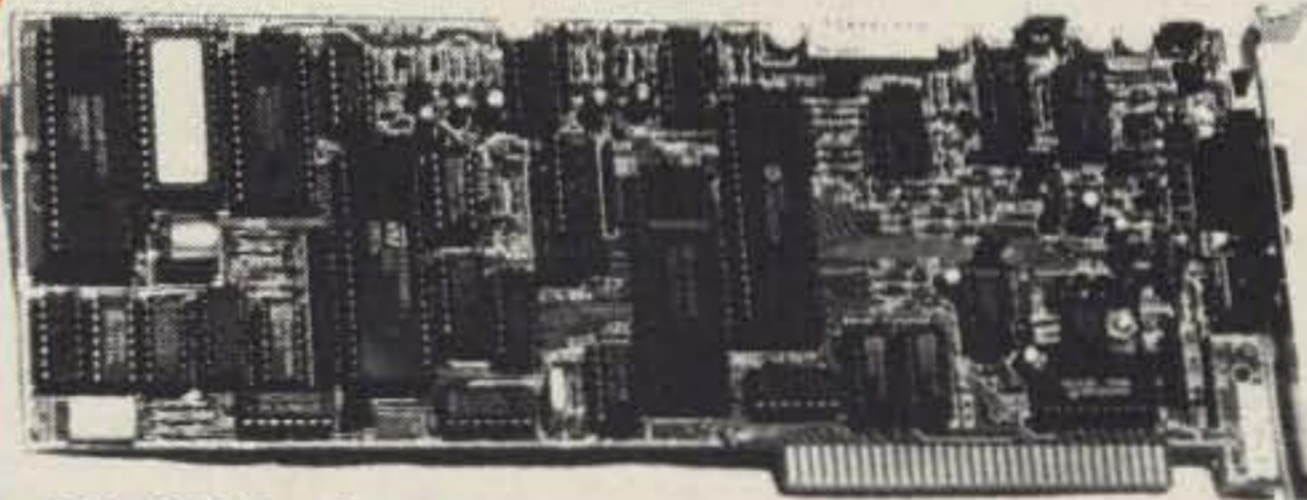

Announcing the next generation of packet controllers for the serious operator!

The new inboard PC-320 (shown), is designed to work with all PC/XT, PC/AT, and Tandy 1000 series computers. The TNC-320 outboard controller offers many of the same high quality features!

PC-320

\$209⁹⁵

TNC-320... **\$194.95**

(Wired & Tested / 1 Year Warranty)

For complete info & specifications
Call (813) 874-2980 / To Order, Call
Toll Free: 1-800-223-3511
Major Credit Cards Accepted!

PC-320 features . . .

- Dual modems for optimal VHF and HF operation.
- Appears as regular PC serial port (COM 1-4) - operates with any terminal program just like an external TNC.
- Dual Powered - operates from PC or external power. Continues complete operation even when the PC is turned off!
- Personal Message System - the most advanced personal mailbox available... included at no extra charge.
- Displays on-screen HF tuning indicator and simulated 'LEDs'.

PacComm • 3652 West Cypress Street • Tampa, Florida 33607

Please send PC-320 TNC-320 More Information FREE Catalog

Name _____ Call _____

Address _____

State _____ Zip _____ Card# _____ Exp. Date _____

MONEY BACK GUARANTEE! Add \$4.00 shipping/handling per order. FL residents add 6% sales tax.
Major Credit Card give number, expiration and signature. FAX: 813-872-8696

CIRCLE 152 ON READER SERVICE CARD

UNCLE WAYNE'S BOOKSHELF

Aw right, a'ready! NOW, the popular electronics and amateur radio books you've been hounding poor old Uncle Wayne for are here! Now you can build up your hamshack library with these soft-cover favorites...

•The Packet Radio Handbook
by Jonathan L. Mayo KR3T
"...an excellent piece of work. Well worth reading for both the experienced and the new packeteer... the definitive guide to amateur packet operation."
—Gwyn Reedy WIBEL Only \$14.95



•The Beginner's Handbook of Amateur Radio—2nd Edition
by Clay Laster
Combines theory and practice in an easy-to-understand format, and provides information for choosing and installing radio receivers and transmitters, antennas, transmission lines, and test equipment. 400 pages, 291 illustrations \$16.95

•DX Power: Effective Techniques for Radio Amateurs
by Eugene B. Tilton KSRSG
256 pages, 10 illustrations \$10.00

•The World Ham Net Directory
by Mike Witkowski
New—second edition now over 600 net listings. This book introduces the special interest ham radio networks and shows you when and where you can tune them in. \$9.95



•Transmitter Hunting: Radio Direction Finding Simplified
by Joseph D. Moell K0OV and Thomas N. Curlee WB6UZZ
336 pages, 248 illustrations \$17.95

•The Digital Novice
by Jim Grubbs K9EI
Your guide to the fascinating worlds of communication that have just opened for thousands of amateur radio operators. Now you can learn about everything from Morse code to the latest in packet radio technology. \$8.95



•RTTY Today
by Dave Ingram K4TWJ
The new and only up-to-date RTTY book in existence. Covers all facets of RTTY—RTTY and Home Computers—most comprehensive RTTY guide ever published. Fully illustrated. A must for RTTY fans. 112 pages. \$8.95

•Shortwave Clandestine Confidential
by Gerry L. Dexter
Fascinating reading—new book covers all clandestine broadcasting, country by country—tells frequencies, other unpublished information—spy—insurgents—freedom fighters—rebel—anarchist radio—secret radio—covers all. Current publication. 84 pages \$8.95



•1989 Passport to World Band Radio
by International Broadcasting Services, Ltd.
You can have the world at your fingertips. You'll get the latest station and time grids, the 1989 Buyer's Guide and more. 416 pages. \$14.95

•Shortwave Directory
by Frank Baylin
A complete directory listing all domestic and foreign station frequencies data from 1.6 MHz to 30 MHz. Over 6,000 listings of Air Forces, Navies, Army, energy, emergency, spy, smugglers, pirate/ clandestines, aero federal space, interpol and many more services. Covers all types of transmission modes. SSB, RTTY, FAX, CW and AM. \$17.95

•The Hidden Signals on Satellite TV
by Thomas P. Harrington and Bob Cooper Jr.
New book shows and tells how to tune in the many thousands of Telephone, Data, Telex, Teletype, Facsimile Signals on most of the TV Satellites, covers equipment, hook-ups, where to tune. Only book covering these secret signals on the satellites, plus all subcarriers. 234 pages. \$19.95

•GGTE Morse Tutor
Floppy disk for IBM PC, XT, AT and compatibles. Learn the International Morse code or improve your capabilities. One diskette will take you from beginner through extra class in easy self-paced lessons. Standard or Farnsworth mode. Code speeds from 1 to over 100 words per minute. \$20.00

•The Commodore Ham's Companion
by Jim Grubbs K9EI
160 pages of useful information on selecting a Commodore computer for the ham shack, where to find specialized programs, the Commodore-packet connection, and more! \$9.95

•Master Handbook of 1001 Circuits—Solid-State Edition
by Kendall Webster Sessions
With this outstanding reference in hand, electronics hobbyists and professionals will never have to search for schematics again. Completely updated, the book is thoroughly indexed and all 1001 circuits are clearly illustrated. 420 pages. \$19.95 soft cover

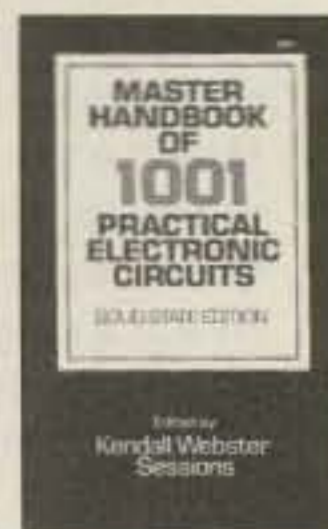

•World Press Services Frequencies (RTTY)
by Thomas Harrington WSOMV
A comprehensive manual covering Radioteletype news monitoring—contains all information—antenna, receivers, terminal units, plus three extensive frequency lists. Covers 65 World Press Services broadcasting in English. "The Original Press Book." 84 pages. \$8.95

•Radio Handbook, 23rd Edition
William I. Orr W6SAI
(Hard cover only) This book is filled with 840 pages of everything you wanted to know about radio communication. You will get an in depth study of AC/DC fundamentals, SSB, antennas, amplifiers, power supplies and more. \$29.95

•Basic AC Circuits
by Stanley R. Fulton/John Rawlins
A step by step approach for the beginning student technician or engineer. Covers concepts, terms and mathematics required to understand AC circuit problems in an easy to read format. \$24.95

•Easy-up Antennas for Radio Listeners and Hams
by Edward M. Noll
Would you like to learn how to construct low-cost, easy-to-erect antennas? Easy-Up Antennas will help you do just that. \$16.95

•Forrest Mimms' Circuit Scrapbook II
by Forrest M. Mimms, III
From the articles in this book you will learn how-to information that will enable you to experiment with MOSFET, analog and digital circuits, laser diodes and opto electronics! \$19.95

Additions from the ARRL Library of Fine Books

•FCC Rule Book
The FCC Rule Book is invaluable as a study guide for the regulatory material found on the exams and as a handy reference. \$5.00

•ARRL Data Book
This handy reference is a valuable aid to the RF design engineer, technician, radio amateur, and experimenter. Commonly used tables, charts, and those hard-to-remember formulas are found in this one source. \$12.00

•Interference Handbook
This 250-page book is written from an RFI sleuth's perspective and is a diary of his experiences in solving interference problems. \$12.00

•ARRL 1989 Handbook
The 1200-page sixty-sixth edition contains over 2,100 tables, figures and charts. The Handbook is packed with component data and construction articles. \$21.00

•Solid State Design
Solid State Design is chock full of good, basic information—circuit designs and their applications, and descriptions of receivers, transmitters, power supplies and test equipment. \$12.00

•ARRL Antenna Book
The ARRL Antenna Book represents the best and most highly regarded information on antenna fundamentals transmission lines, design and construction of wire antennas. \$18.00

•ARRL Operating Manual
The ARRL Operating Manual is packed with information on how to make the best use of your station, including: Interfacing home computers, OSCAR, VHF-UHF, contesting. \$15.00

•Technician/General Class License Manual \$5.00
•Advanced Class License Manual \$8.00
•Extra Class License Manual \$8.00

Beginning with Tune in the World with Ham radio for the Novice and progressing through the critically acclaimed ARRL License Manual series for the Technician through Extra Class; you will find passing each exam element a snap! There are accurate text explanations of the material covered along with FCC question pools and answer keys.

•Yagi Antenna Design
Ham Radio published a series of articles on Yagis. The material from these articles that is presented here was polished and expanded by Dr. Lawson. \$15.00

•Novice Antenna Notebook
Novices will learn, among other things, how antennas operate, and what governs their effectiveness for short- and long-distance communication. \$8.00

•ARRL Repeater Directory 1989-1990
This edition is 14% larger and includes over 475 beacons covering frequencies from 14 MHz to 24 GHz. You'll also find over 13,300 regular repeater listings and over 2,200 digipeaters. \$5.00

•Satellite Anthology
You'll find the latest information on OSCARs 9 thru 13 as well as the RS satellites. Information on the use of digital modes, tracking, antennas, RUDAK, microcomputer and more! \$5.00

•Low Band DXing
This book shows you how to meet the challenges of the different forms of 160, 80 and 40 meter propagation with effective antennas, equipment and operating strategies. \$10.00

•Satellite Experimenters Handbook
Under one cover is what the Amateur Radio Operator needs to know in order to communicate through the OSCAR satellites. \$10.00

•Your Gateway to Packet Radio
Filled with information for all amateurs, this book tells everything you need to know about this popular new mode: how to get started, equipment you need and more. \$10.00

•Tune in the World with Ham radio Kit
Tune in the World with Ham radio has put the fun back into learning what Amateur Radio is all about. Also included is two C-90 tape cassettes. One tape teaches the code, the other provides practice. \$15.00

Tune in the World—Book only \$12.00

UNCLE WAYNE'S CODE TAPES

This course makes the code so incredibly simple to learn that only the total ignorance of it is driving the no-code fanatics. Almost anyone can pass the Novice code test with less than three hours of practice. If you start right you'll zip through your General test in just a few hours. Genesis starts you right, at 13-per for each character, so you only have to learn the code once. This is the fastest code system known to man. Or woman.

"Genesis" \$5.95

5 wpm—This is the beginning tape, taking you through the 26 letters, 10 numbers and necessary punctuation, complete with practice every step of the way. The ease of learning gives confidence even to the faint of heart.

"The Stickler" \$5.95

6 + wpm—This is the practice tape for those who survived the 5 wpm tape, and it's also the tape for the Novice and Technician licenses. It is comprised of one solid hour of code. Characters are sent at 13 wpm and spaced at 5 wpm. Code groups are entirely random characters sent in groups of five—definitely not memorizable!

"Back Breaker" \$5.95

13 + wpm—Code groups again, at a brisk 13+ wpm so you'll be really at ease when you sit down in front of a steely-eyed volunteer examiner who starts sending you plain language at only 13 per. You'll need this extra margin to overcome the sheer panic universal in most test situations. You've come this far, so don't get code shy now!

"Courageous" \$5.95

20 + wpm—Congratulations! Okay, the challenge of code is what's gotten you this far, so don't quit now. Go for the Extra class license. We send the code faster than 20 per. It's like wearing lead weights on your feet when you run; you'll wonder why the examiner is sending so slowly!

UNCLE WAYNE'S BOOKSHELF

•**First Book of Modern Electronics Fun Projects**
Edited by Art Salsberg
 Looking for a way to have fun, increase your technical expertise, and save money—all at the same time? This unique compendium chock-full of projects will show you how. \$19.95

•**Commodore 64 Troubleshooting & Repair Guide**
by Robert C. Brenner
 This book will guide you step by step through the complexities of making simple repairs to your Commodore 64. \$19.95

•**C64/128 Programs for Amateur Radio & Electronics**
by Joseph J. Carr
 The electronics hobbyist, programmer, engineer and technician will enjoy the task-oriented programs for amateur radio and electronics in this book. \$14.95

•**Fun Way Into Electronics**
by Dick Smith
 This 3 volume series features introductory projects for beginning electronics enthusiasts. \$9.95 ea.

•**Vol 1** includes 20 projects on basic materials and tools, component descriptions and a guide to successful projects.

•**Vol 2** gives 20 projects covering topics such as soldering onto circuit boards, using multimeters and reading circuit diagrams.

•**Vol 3** covers advanced projects investigating integrated circuits, constructing PC boards and building a mini synthesizer.

•**Basic Electricity/Electronics**
by Robert R. Manville
 In this basic electricity/electronics series of textbooks a modern programmed format is used to present the material in a logical and easy-to-understand way. \$11.95 ea

•**Vol 1** introduces the student to the basic concepts of circuit fundamentals.

•**Vol 2** (How AC/DC Circuits Work) This volume builds on the basics. It gives detailed information on series and parallel circuits; effects on inductance, capacitance and transformer action.

•**Solid-State Projects You Can Build**
by Rudolf F. Graf/George J. Whalen
 Have you searched for challenging innovative projects, imaginatively designed and skillfully debugged to stimulate your own creative thinking? If so, this book was written for you! \$10.95

•**The 555 Timer Applications Sourcebook with Experiments**
by Howard M. Berlin
 This book is about the 555 timer. It will show you how to use it by itself and with other solid state devices. \$9.95

•**Weather Satellite Handbook**
by Dr. Ralph E. Taggart
 Dr. Taggart has written this book to serve both experienced amateur satellite enthusiast and the new comer. Amateur weather satellite activity represents a unique blend of interests encompassing electronics, meteorology and astronautics. \$16.95

•**One Evening Electronics Projects**
by Calvin R. Graf and Richard S. Goss
 16 projects that can be assembled in a simple home workshop, a voltage detector, solid-state telephone bell, a transistor audio amplifier, and 13 others. This is an easy to understand, enjoyable guide to completing basic electronics projects - with just one evening's work. \$8.75

•**The Basic Guide to VHF/UHF Ham Radio**
by Edward M. Noll
 This book provides a first rate introduction to life on the 2.6 and 1.25 meter bands as well as 23, 33, and 70CM. \$6.95

•**Crash Course in Electronics Technology**
by Louis E. Frenzel, Jr.
 With a proven format of programmed instruction, this book teaches you the basics of electricity and electronics in a step-by-step, easy-to-understand fashion. \$21.95

•**Shortwave Radio Listening with the Experts**
by Gerry L. Dexter
 Do you sit for long hours in front of a radio receiver listening to faint sounds and noises? Then you're a SWL'er or DX'er, and you can probably use some help. \$22.95

•**Mastering Packet Radio: The Hands-on Guide**
by Dave Ingram K4TWJ
 Packet radio is the hottest, most rapidly expanding area of amateur communications. Written for the amateur enthusiast, mastering Packet Radio will put you on the cutting edge of this digital communications revolution \$12.95

•**ABC's of Electronics**
by Earl Jacob Waters
 Written for anyone wanting to learn the basics of electronics, this is a comprehensive, well illustrated look at the fundamentals of electronics and electronic applications. \$12.95

•**All About Cubical Quad Antennas**
by William Orr W6SAI/Stuart Cowan W2LX
 The "Classic" on Quad design, theory, construction, operation. New feed and matching systems. New data. \$9.95

•**Beam Antenna Handbook**
by William Orr W6SAI/Stuart Cowan W2LX
 Yagi beam theory, construction, operation. Wire beams. SWR curves. Matching systems. A "must" for serious DXers. \$11.95

•**The Radio Amateur Antenna Handbook**
by William Orr W6SAI/Stuart Cowan W2LX
 Clear, complete! All about wire antennas, beams, tuners, baluns, coax, radials, SWR and towers. Best locations, antenna height. \$11.95

•**Simple, Low-cost Wire Antennas for Radio Amateurs**
by William Orr W6SAI/Stuart Cowan W2LX
 All New! Low-cost, multi-band antennas; inexpensive beams. "Invisible" antennas for hams in "tough" locations! New data. \$11.95

•**All About Vertical Antennas**
by William Orr W6SAI/Stuart Cowan W2LX
 Effective, low-cost verticals 10-160 m. -DX, multiband; compact verticals for small spaces; ground; test equip.; lightning. \$10.95

•**All About VHF Amateur Radio**
by William Orr W6SAI
 DX propagation, VHF Yagi and Quad beams, repeaters and how they work, OSCAR satellites and how to use them. \$11.95

THE WORLD \$4.00



Yes, places you've never even heard of! Nearly 400 DX countries gleaned from the Awards List of dozens of IARU members—more countries than any other map available anywhere! ARRL's DXCC map doesn't even come close!

Uncle Wayne's Bookshelf Order Form

- | | |
|---|---|
| <input type="checkbox"/> The Packet Radio Handbook \$14.95 | <input type="checkbox"/> Stickler Code Tape \$ 5.95 |
| <input type="checkbox"/> The Beginner's Handbook \$16.95 | <input type="checkbox"/> Back Breaker Code Tape \$ 5.95 |
| <input type="checkbox"/> DX Power: Effective Techniques \$10.00 | <input type="checkbox"/> Courageous Code Tape \$ 5.95 |
| <input type="checkbox"/> Transmitter Hunting: Radio Direction . . \$17.95 | <input type="checkbox"/> DX World Map \$ 4.00 |
| <input type="checkbox"/> The Digital Novice \$ 9.95 | <input type="checkbox"/> Weather Satellite Handbook \$16.95 |
| <input type="checkbox"/> The Commodore Ham's Companion \$ 9.95 | <input type="checkbox"/> One Evening Electronics Projects \$ 8.75 |
| <input type="checkbox"/> Master Handbook of 1001 Circuits \$19.95 | <input type="checkbox"/> The Basic Guide to VHF/UHF \$ 6.95 |
| <input type="checkbox"/> World Press Services \$ 8.95 | <input type="checkbox"/> World Ham Net Dir. \$ 9.95 |
| <input type="checkbox"/> RTTY Today \$ 8.95 | <input type="checkbox"/> FCC Rule Book \$ 5.00 |
| <input type="checkbox"/> Shortwave Clandestine Confidential \$ 8.95 | <input type="checkbox"/> ARRL Data Book \$12.00 |
| <input type="checkbox"/> Shortwave Directory \$17.95 | <input type="checkbox"/> Interference Handbook \$12.00 |
| <input type="checkbox"/> The Hidden Signals on Satellite TV \$19.95 | <input type="checkbox"/> ARRL 1989 Handbook \$21.00 |
| <input type="checkbox"/> GGTE Morse Tutor floppy disk \$20.00 | <input type="checkbox"/> Solid State Design \$12.00 |
| <input type="checkbox"/> Radio Handbook \$29.95 | <input type="checkbox"/> ARRL Antenna Book \$18.00 |
| <input type="checkbox"/> Basic AC Circuits \$24.95 | <input type="checkbox"/> ARRL Operating Manual \$15.00 |
| <input type="checkbox"/> Easy-Up Antennas \$16.95 | <input type="checkbox"/> Technician/General Class \$ 5.00 |
| <input type="checkbox"/> First Book of Modern Electronics \$12.95 | <input type="checkbox"/> Advance Class \$ 5.00 |
| <input type="checkbox"/> Commodore 64 Troubleshooting \$19.95 | <input type="checkbox"/> Extra Class \$ 8.00 |
| <input type="checkbox"/> C64/128 Programs For Amateur Radio . . \$14.95 | <input type="checkbox"/> Yagi Antenna Design \$15.00 |
| <input type="checkbox"/> Fun Way Into Electronics Vol. 1 \$ 9.95 | <input type="checkbox"/> Novice Antenna Notebook \$ 8.00 |
| <input type="checkbox"/> Fun Way Into Electronics Vol. 3 \$ 9.95 | <input type="checkbox"/> ARRL Repeater Directory \$ 5.00 |
| <input type="checkbox"/> Basic Electricity & Electronics - Vol. 1 . . \$11.95 | <input type="checkbox"/> Satellite Anthology \$ 5.00 |
| <input type="checkbox"/> Basic Electricity & Electronics - Vol. 2 . . \$11.95 | <input type="checkbox"/> Low Band DXing \$10.00 |
| <input type="checkbox"/> Solid State Projects You Can Build \$10.95 | <input type="checkbox"/> Satellite Experimenters \$10.00 |
| <input type="checkbox"/> 555 Timer Applications Sourcebook \$ 9.95 | <input type="checkbox"/> Gateway to Packet Radio \$10.00 |
| <input type="checkbox"/> Forest Mims' Circuit Scrapbook II \$19.95 | <input type="checkbox"/> Tune in the World Kit \$15.00 |
| <input type="checkbox"/> Crash Course in Electronics \$21.95 | <input type="checkbox"/> Tune in (book only) \$12.00 |
| <input type="checkbox"/> Shortwave Radio Listening with \$22.95 | <input type="checkbox"/> Cubical Quad Antenna \$ 9.95 |
| <input type="checkbox"/> Mastering Packet Radio \$12.95 | <input type="checkbox"/> Beam Antenna Handbook \$11.95 |
| <input type="checkbox"/> ABC's of Electronics \$12.95 | <input type="checkbox"/> Radio Amateur Antenna \$11.95 |
| <input type="checkbox"/> Magic of Ham Radio \$ 3.95 | <input type="checkbox"/> Low-cost Wire Antenna \$11.95 |
| <input type="checkbox"/> 1989 Passport to World Band \$14.95 | <input type="checkbox"/> Vertical Antennas \$10.95 |
| <input type="checkbox"/> Genesis Code Tape \$ 5.95 | <input type="checkbox"/> VHF Amateur Radio \$11.95 |

You may order by mail, telephone, fax or our Bulletin Board. All payments are to be in US funds. Please add \$2.50 for shipping and handling for all orders. Allow 3 weeks for delivery.

Name _____

Street _____

City _____ State _____ Zip _____

TOTAL \$ _____ AE MC VISA Check/Money Order

Card # _____ Expiration Date _____

Telephone: (603) 525-4201, FAX: (603) 525-4423, Bulletin Board (603) 525-4438

Mail: 73 Magazine, Attn. Uncle Wayne, Forest Road, Hancock, NH 03449



ATTN: Uncle Wayne
 Forest Road
 Hancock, NH 03449

NEW PRODUCTS

Compiled by Linda Reneau



PRODUCT OF THE MONTH

AZIMUTH COMMUNICATIONS CORPORATION THE AZIMUTH AWARDS QSL LIBRARY

Azimuth announces its Awards QSL Library albums for organizing and protecting your QSL cards. You can select an album for each kind of award—DX Century Club, Worked All Zones, Worked All States, and Worked All Continents, with beautiful graphics for each award. Or you can order an album for all your QSLs in general.

Each album is made of durable, quality vinyl, its 20 scratch-resistant pages holding 120 cards. Each pocket-page holds six 4 x 6 cards.

The introductory price is \$20; extra 20-page packs are \$13. Add \$2.50 for shipping and handling per album and page pack (foreign orders, add \$7.50 US). California residents please add sales tax.

If you order now, Azimuth will send you FREE their AWARDS-BASE Log & Tracking Program for IBM-PCs and clones. Retail, this program costs \$25. For VISA and MC orders, call (800) 882-7388, or write *Azimuth Awards QSL Library, Dept. E73, 11845 W. Olympic Bl., Suite 1100, Los Angeles CA 90064*. Or circle Reader Service Number 201.



ADVANCED ELECTRONICS APPLICATIONS, INC.

Advanced Electronics has a new antenna tuner. The AT-300 features a low-pass design to reduce or eliminate TVI; coverage of 3.5–30 MHz; 300 watts continuous power; a dual-needle wattmeter; and two 18-tap inductors for tuning accuracy. The meter range selects 300 watts and 30 watts to ease tuning.

Front panel controls include impedance adjustment, and switching for power, antenna, and meter lamp.

Rear panel connections include

a coax connector for input, two coax connectors to antennas, one coax connector to a dummy load, two ceramic feed-through connectors to balanced feedlines, one for single-wire antennas, and a DC power connector to the meter lamp. Price, \$250. *Advanced Electronic Applications, Inc., PO Box C2160, Bldg. O & P, 2006-196th SW, Lynnwood WA 98036-0918. (206) 775-7373. Telex: 6972496 AEA INTL UW. FAX: (206) 775-2340*. Or circle Reader Service Number 202.



KENWOOD USA CORPORATION

Kenwood's new dual-band TH-75A has many of the features of the dual-band mobile transceiver, and uses the same accessories as the TH-25AT (except for the soft cases).

The dual watch function allows you to monitor both bands at the

same time. For readability, it has a large multi-function LCD display. Ten memory channels for each band store frequencies, CTCSS, repeater offset, step information, and selectable full duplex operation. Two memories are for odd split operation.

The CTCSS encode/decode is built-in, and the automatic band change switches between main and subband when a signal is present. The TH-75A also has auto offset selection on 2 meters, four-way scan, tone alert system, and battery-saver circuit.

Extended receiver range covers 140–163.995 and 438–449.995 MHz; transmit on amateur band only. The TH-75A is modifiable for MARS and CAP, with permits.

The TH-75A operates on 1.5 watts on 2 meters and 70 cm, and 5 watts when it operates on 12 volts DC (or PB-8 battery pack). A lithium battery backs up memories.

Suggested retail price, \$550. Soft case optional. *Kenwood USA Corporation, Communications & Test Equipment Group, 2201 E. Dominguez Street, Long Beach CA 90810. (213) 639-4200*.

DOPPLER SYSTEMS, INC.

Doppler Systems has expanded its RDF systems to cover frequencies up to 1 GHz. The 5000 series, using a remote RF summing circuit, is accurate ± 5 degrees. Doppler offers a wide range of antennas to cover frequencies between 108 and 1000 MHz.

With a narrowband FM receiver, the system works in a quasi-Doppler mode. Using a patented technique, four antennas arranged in a square pattern simulate a single, rotating antenna. As it moves toward the RF source, the apparent frequency increases, and as it moves away, the apparent frequency decreases. A narrowband FM receiver detects this Doppler shift and sounds a 300 Hz tone. The RDF system measures the phase angle and displays the bearing. Quasi-Doppler mode is good for tracking unmodulated carriers and standard NBFM signals. In amplitude mode with an AM re-

ceiver, it's good for tracking aircraft band amplitude modulated signals, including ELTs.

A typical installation consists of a processor/display unit, an RF summer unit, and one or more antennas. A receiver is required. You may use a good quality scanner, but if you use transceivers, service monitors, or spectrum analyzers, take care not to transmit through the direction finder.

The price of an RDF Doppler System ranges from \$955 to \$1850, depending on the type of installation—mobile or fixed—and antenna requirements for your operating frequencies. *Doppler Systems, Inc., PO Box 31819, Phoenix AZ 85046*. Or circle Reader Service Number 206.



ELECTRONIC SPECIALISTS, INC.

Electronic Specialists has expanded their patented isolator line to include remote power switching, power fail interrupt, and 20 amp options. Suppressor performance of all units has been expanded to 39,000 Surge Amps for added equipment protection. Isolators, with wide band-high attenuation channel filters, are widely used in industrial and laboratory computer or sensitive equipment applications to provide smooth AC power conditioning.

Available in Commercial, Indus-



trial, and Laboratory Grades. Prices start at \$100. *Electronic Specialists, Inc., 171 South Main Street, Natick MA 01760. (800) 225-4876. Or circle Reader Service Number 203.*



THE RADIO WORKS

The CAROLINA WINDOM/2© is a half-size 40-10 meter version of the CAROLINA WINDOM© with performance equal to the latter. It covers seven HF bands, including all WARC bands. A transmatch is required on all bands. It is fed with 50Ω coax.

It has a 10-foot vertical radiator section which works with the 66-foot long horizontal radiator to produce complex radiation patterns. Simultaneously, the horizontal radiator acts as a counter-

poise for the vertical radiator. Radiation takes place high in the air for high efficiency, since ground losses are avoided.

Each antenna comes assembled, complete with matching unit, vertical radiator section, highpower transmission Line Isolator©, #14 stranded antenna wire, glass-filled insulators, CoaxSeal® and illustrated manual. Price, \$70. *The Radio Works, Box 6159, Portsmouth VA 23703. (804) 484-0140. Or circle Reader Service Number 204.*

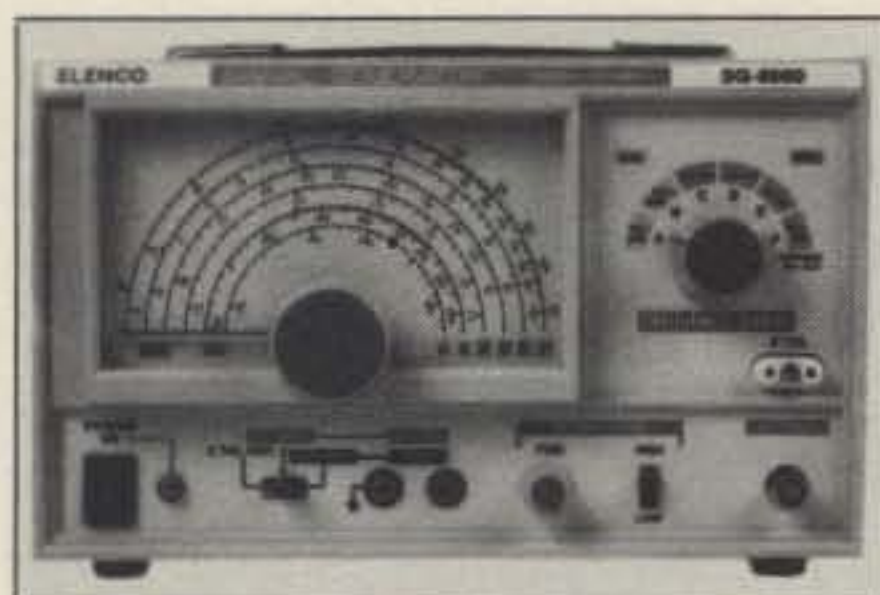

ELENCO ELECTRONICS, INC.

The Elenco SG-9000 is a high frequency signal generator capable of AM modulation. It incorporates a stable RF oscillator with frequency range of 100 kHz to 150 MHz. It has an easy-to-read dial. Frequencies of 455 kHz, 4.5 MHz, and 10.7 MHz are specially

noted for easy setting.

An internal audio frequency of 1 kHz is available for AM or external use. External crystals may be used to lock the oscillator to, say, a frequency between 1-15 MHz. The RF output voltage is variable and has a 20 dB attenuator switch. The SG-9000 comes with instruction manual with circuit description, block diagram, and schematic. Cost, \$196. *Elenco Electronics, 150 W. Carpenter Avenue, Wheeling IL 60090. (312) 541-3800. FAX: (312) 520-0085. Telex: 706061 ELENCO UD. Or circle Reader Service Number 207.*

HEIL SOUND

The HM-10 microphone is at the center of Heil Sound's Concept 2000. Unlike other amateur radio microphones, the HM-10 uses professional cannon-type 3-pin connectors. You can buy the HM-10 by itself, or with the Heil HC-4 "DX Dream Machine" or the Heil HC-5 full range element.

Interface the HM-10 to your transmitter input connector by specifying the cable with the right color: red, Kenwood; yellow, Yaesu; blue, ICOM; and black, special. Operate PTT or VOX, hand-held or desk mounted. Adjustable booms and goose-neck mounts available.

The HM-10, built for durability, is heavy and rugged. Wired, with plugs, carrying case, stand adapter, colored cable, and foam



windscreen, the price is \$80. *Heil Sound, PO Box 26, Marissa IL 62257. (618) 295-3000. Contact: Bob Heil. Or circle Reader Service Number 205.*



HUSTLER, INC.

Hustler announces a new HF mobile mast for their line of mobile resonators and accessories. Model MO-4, a 22" all-stainless steel mast, creates many mounting options previously unavailable to the

mobile HF operator. It's ideally suited for RVs, trucks, vans, and cars with plastic bumpers. You can mount it on trunk lips, mirrors, roof racks, and ladders. In conjunction with standard Hustler resonators, you can install the MO-4 on a high quality magnetic mount.

You can make a shortened dipole with two MO-4 masts and a matching pair of resonators. You can assemble a tri-band dipole, good for apartments and areas of restricted space, by adding two Hustler VP-1 tri-band adapters and two resonators.

The MO-4 comes with three 30" tip rods for 10, 15, and 20 meter resonators. No tip rods are necessary on 40, 75, or 80 meters. Suggested retail price, \$20. *Hustler, Inc., One Newtronics Place, Mineral Wells TX 76067. (817) 325-1386. Or circle Reader Service Number 209.*

MFJ ENTERPRISES, INC.

Dave Ingram K4TWJ shows you how to collect, restore, and operate classic ham gear in his book, *Golden Classics of Yesteryear*, published by MFJ Enterprises, Inc. Remember the 6L6 rigs, Heathkit DX-100, Collins KWM-1, WRL Globe Scout, Hallicrafters, RME, Hammulard, National HROs, Eimac tubes, Vibroplex, Speed-X, Dow KEY, McElroy...?

The book is packed with real-life tales and easy-to-build weekend projects from the 20s, 30s, and 50s. K4TWJ shows you how to build a "Tailender"—an early DX memory keyer that requires no power supply or electronic parts, but works "like a champ." He includes fa-



vorite circuits, telegraph keys and bugs, and other ham topics.

Dave has authored over 300 articles and 12 books. He writes the "World of Ideas" column in *CQ*. Order his latest book for \$10 from *MFJ Enterprises, Inc., PO Box 494, Mississippi State MS 39762. Telephone: (601) 323-5869 or (800) 647-1800. FAX: (601) 323-6551. Telex: 53 4590 MFJ STKV. Or circle Reader Service Number 210.*

Low Power Operation

Mike Bryce WB8VGE
2225 Mayflower NW
Massillon OH 44646

Portable Operation

Operating portable requires very little—one portable radio and a source of power to operate it from. I've always been inclined to operate portable with solar panels, but sometimes they're just too much trouble to set up. Likewise for conventional 110 volt power supplies. Ruins all the fun if you have to dig up a hundred-foot extension cord. Operating portable from the deck of the house just isn't the same as doing the same in a field or in the woods.

Because of the small current drain of most QRP rigs, battery power is quite attractive. A small Gel/Cell™ will operate my Argonaut for many a weekend. But

what do you do when that battery needs charging? I just connect it up to the solar panels and let the home-brew control circuit do its thing. What's this? You don't have solar panels for battery recharging? Well, that's what we're going to build this month: a 110 volt battery charger, but with a twist—actually, a pulse or two. This unit will charge all kinds of batteries, from Gel/Cells to sealed lead-acid batteries, vented lead-acid batteries, and good 'ol NiCds.

I've tried to do something a bit different this month. With a few exceptions, you can get all the parts from the local Radio Shack store. I built my version from both the junk box and Radio Shack. But before we get too carried away, let's look at how this critter works.



Photo A. The complete charger. Note the 0-500 mA panel for current adjust.

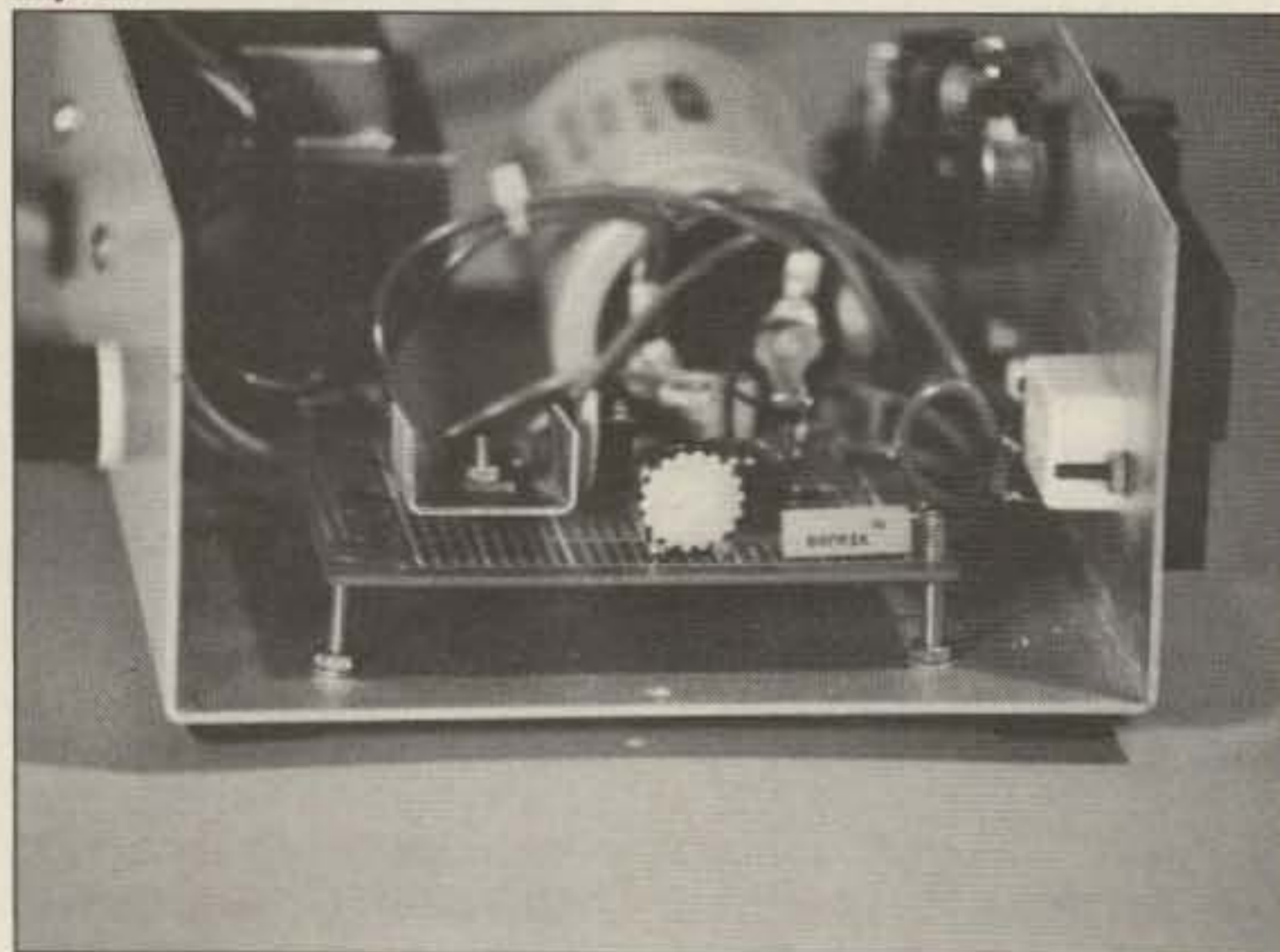

Photo B. Inside view of the charger. Most parts mount on the perfboard.

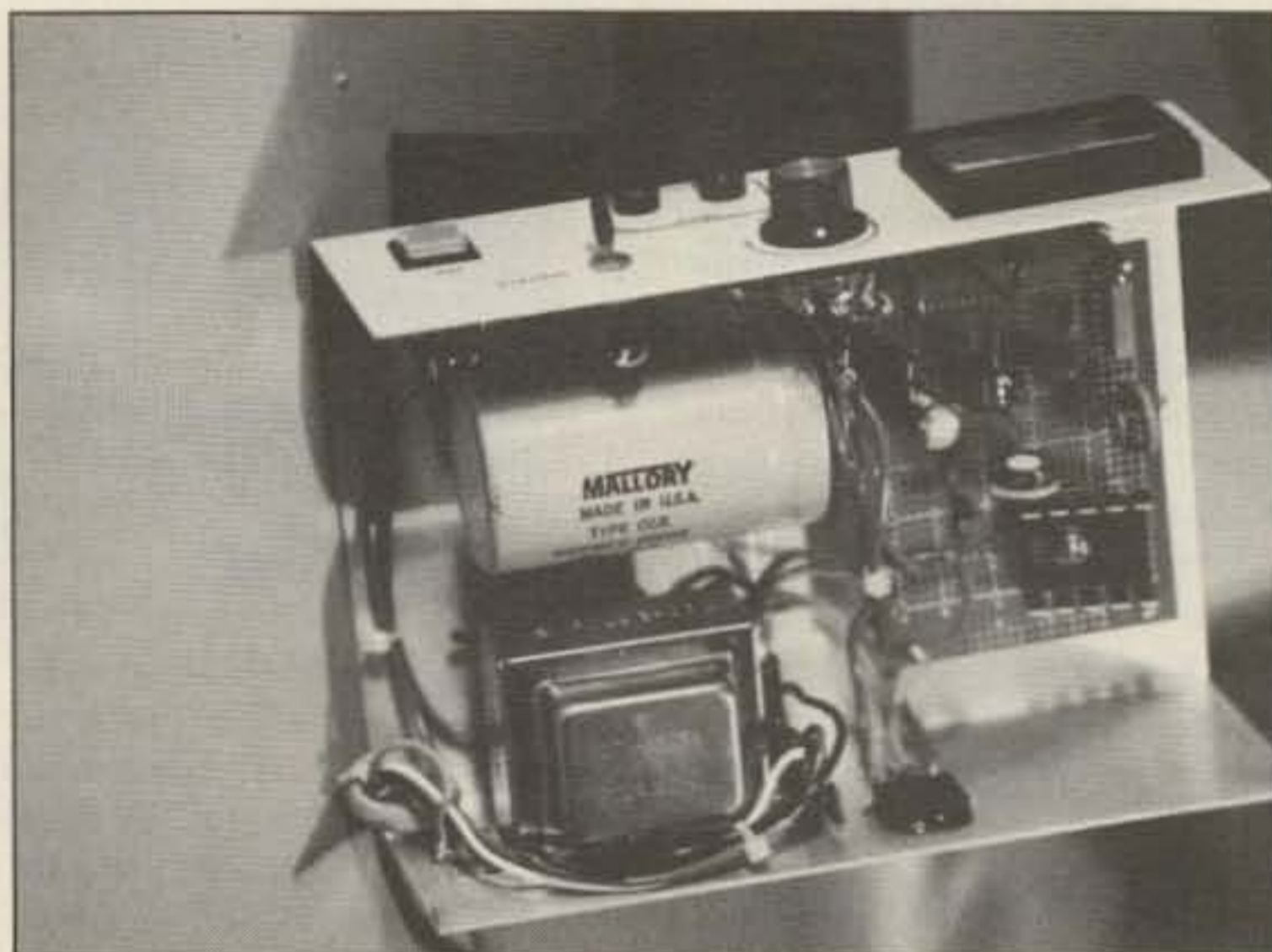

Photo C. Large capacitor IF filter for the 110 volt supply.

Battery Charging Methods

You can charge batteries by several means. Two of the most popular are voltage limiting and current limiting. Current limiting, as the name implies, limits the current going into the battery. The voltage is allowed to move about, but within limits. As the battery becomes charged, the current drops and the voltage comes to rest at the full charge voltage of the battery.

In voltage limiting, the voltage is preset at the full charge setting, and the current is allowed to move about. If a really discharged battery is connected to a constant voltage charger, heavy current will flow into the battery and possibly damage it.

As with all battery chargers and the batteries being charged, the manufacturer has the final say as to how much current and at what voltage the battery will be considered "charged." I've been using Yuasa sealed lead-acid batteries for portable use. They are rated at

20 hours at 60 mA to 10.5 volts (1.2 amp/hour). Great for running HW-8s in the woods. Yuasa recommends, for cycle use, a charge voltage of 14.4 to 15 volts, with the current at 250 mA.

Universal Battery Charger

So, enter the universal battery charger. It's nothing special; in fact, you've probably seen some of the circuitry before. Most of it is tried and true, sure-to-work stuff. Now, that's what we both like to hear, right?

A lot of battery chargers use the LM317 to control the charge voltage. Since I'm not one to re-invent the wheel, I'm going to use it, too. The LM317 comes in many case styles. Radio Shack sells the LM317 in the popular TO-220 case. If you have one in the TO-3 case, so much the better. The TO-3 case seems to dissipate heat better. A trimmer in the adjust lead of the LM317 sets the output voltage. Notice there are two different trimmers. I added a switch to select between two

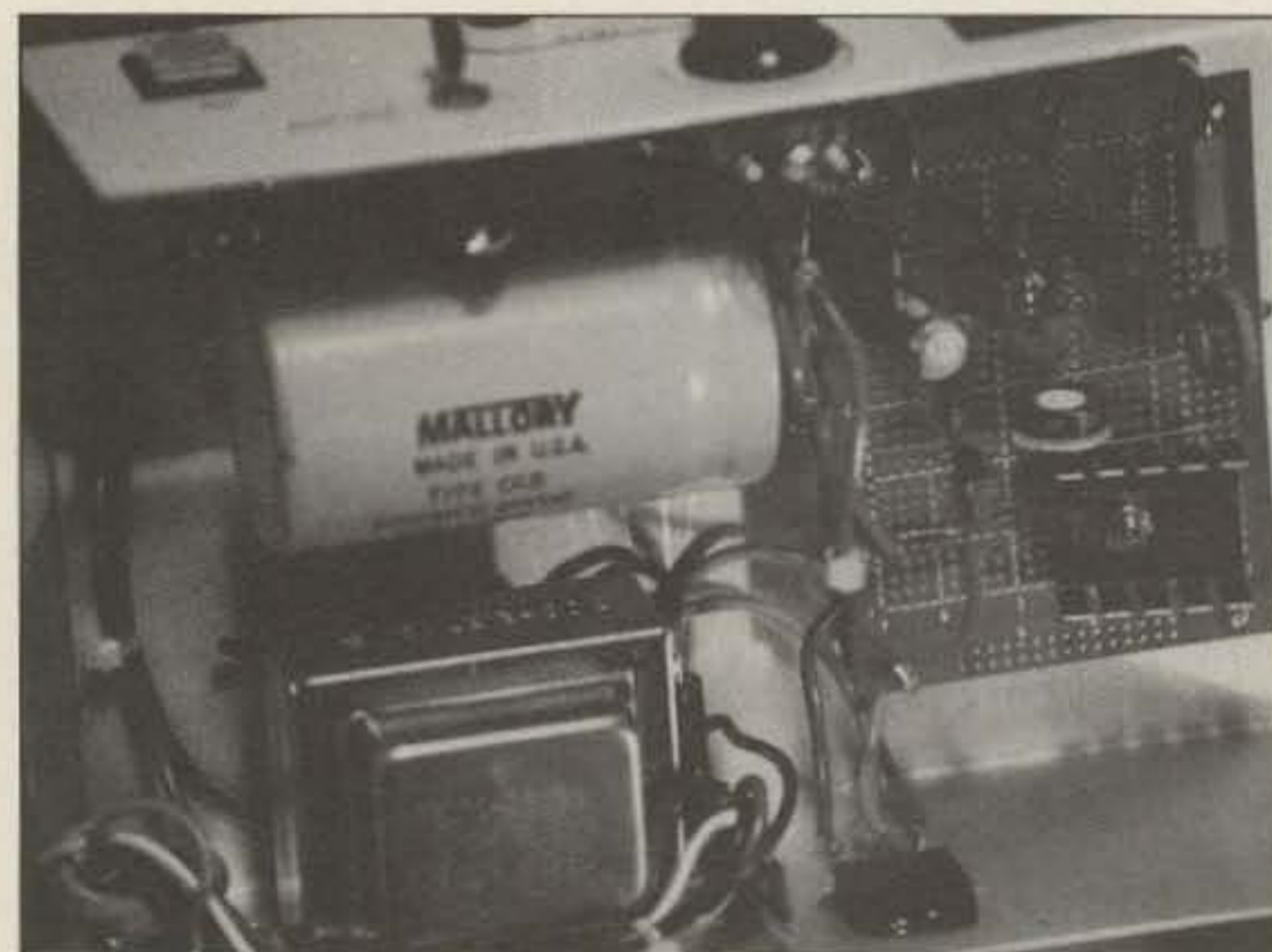

Photo D. Heat sink on LM317. Bridge rectifier is glued to the back panel.

different set points, one for 12 volt charging and the other for 6 volt charging. Now for the added goodies that make this charger a bit different.

Notice that a 2N2222 transistor's collector is connected to the common of the selector switch. When the transistor is off, the regulator operates normally. When the transistor is on, it pulls the ADJ line to ground, through the 220Ω resistor. This turns the LM317 off. Now you're asking, "What turns the transistor on?" Good question. Simple answer. A 555 timer chip, that's what. The 'ol come-to-the-rescue 555 is wired for stable operation. With the components shown, we can adjust the duty cycle of the 555. The more OFF the transistor is, the more current will flow into the battery via the LM317. Less duty cycle, less current.

Advantages of Pulse Charging

In other words, we charge the battery by using high current pulses, rather than a constant current. Those 7.2 volt RC batteries are charged just like this. That's why you can recharge one 7.2 volt battery from a car battery in less than 15 minutes. Charge currents can approach seven amps or more, but the duty cycle is low enough to avoid damage to the cells.

By using pulse charging, we can charge the battery without overheating it. The parts passing the current to the battery will also operate cooler. All and all, it's a slick way of charging a battery.

Let's look a bit closer. The timing components adjust the duty cycle of the 555. I've panel-mounted the adjustable control so that I can adjust the current to suit different capacity batteries, with the same voltage. The output of the 555 is a square wave. The more on, the higher the duty cycle. You can look at the output with a scope or a VOM. However, you'll only see a voltage move about (as you adjust the duty control) on the VOM due to the meter averaging out the result. The scope will reveal a square wave. Not the best looking waves you've ever seen, but square waves nonetheless, which will turn on the transistor switch.

Time to heat up the soldering iron!

Construction Details

As noted earlier, you can buy most of the parts at Radio Shack. The meter I used in my charger, which has a range of 0-500 mA, came from my junk box. I found it the most useful when setting the charge rate for the batteries.

Most of the circuit is like a circuit for a conventional power supply. T1 supplies 18 volts AC at 2 amps. A bridge rectifier, rated at 4 amps, supplies DC to the filter capacitor. I used a small glob of epoxy to mount the bridge rectifier to the back case panel. The filter capacitor, a computer grade unit, smooths out the DC. Don't worry too much if you can't get the same amount of capacitance I used, just try to get it as large as possible.

A 7812 regulator supplies 12 volts to the 555 timer, since the direct output of the filter capacitor is a bit high for the timer.

The LM317 requires a heat sink. I use a small screw-on unit. If you wish, use the inside back case to heat-sink the regulator. If you do, be sure to insulate the device from the metal chassis.

I mounted the parts, including the trimmer pots, on a Radio Shack copper-plated perfboard. A socket for the 555 makes troubleshooting easier. In point-to-point wiring, keep the heavy current leads short and direct. Attach wire to the battery with five-way binding posts. If you follow the schematic, you'll have no trouble building the charger.

Check over your wiring, especially the 110 volt wiring, for errors. You might want to divide the charger into smaller modules for building and testing. Good idea. Start with the 110 volt side. You should see about 20 volts on the filter capacitor.

With the 555 timer out of its socket, turn on the supply and check for 12 volts on the output of the 7812. While the 555 is still out of the socket, switch the voltage selector switch to either 6 or 12 volts. Adjust the proper trimmer to the finish charge voltage. Switch to the second trimmer and adjust it also. Again, I set mine for 7.2 volts for 6 volt batteries and 14.4

volts for 12 volt batteries.

Turn off the unit and install the 555 timer into the socket. With a battery connected to the output, and the voltage switch set for the proper voltage, adjusting the duty control should make the current meter go up and down. Of course, if the battery is fully charged to begin with, you won't see much current flowing. Because of the blocking diode in series with the output, you can leave the battery connected to the charger and not worry about the battery discharging if the charger is turned off.

That's about all there is to it.

One final point. This unit is only for charging batteries. DON'T try running anything from it. You'll get all kinds of strange results.

With a few changes, you can have a really versatile unit. By using an LM350, output currents of 5 amps are possible. If you build the charger as I did, you can charge up to 1.5 amps. I don't recommend this charger to charge large lead-acid batteries, 105 amp hours or more.

Next time you get the urge to operate out in the field, you won't have to worry about dead batteries! **73**

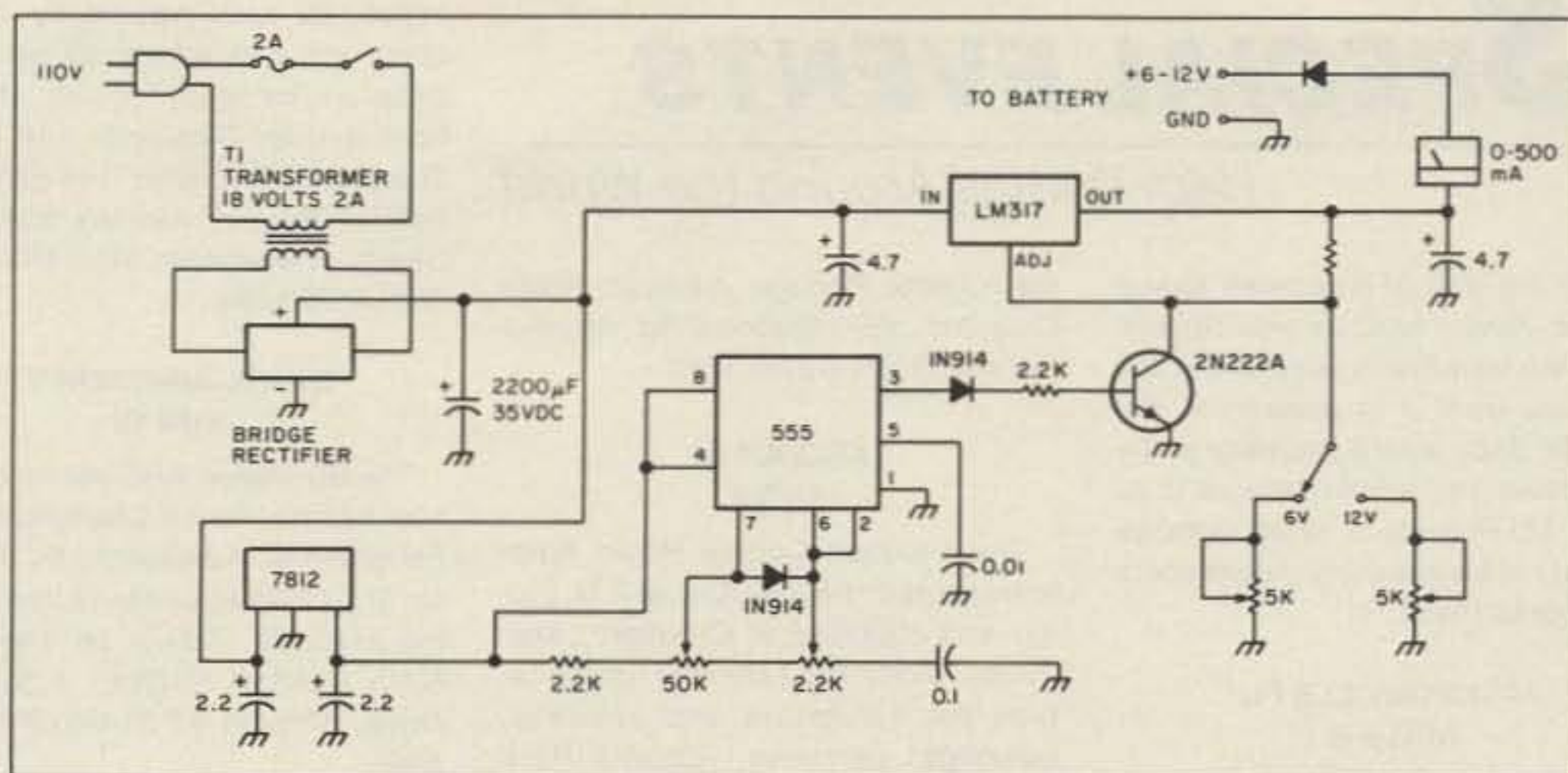

Schematic for the universal battery charger.

AMATEUR TELEVISION

SURVIVES 100,000 FT. FALL

KPA5 1 WATT ATV XMTR ON 434 MHZ WORKED PERFECTLY IN WB8ELK LIVE CAMERA BALLOON THROUGH 100,000 FT AND BACK TO CONTINUE RUNNING EVEN AFTER FREE FALL IMPACT IN THE MOJAVE DESERT! VIDEO SEEN FOR 300 MILES.

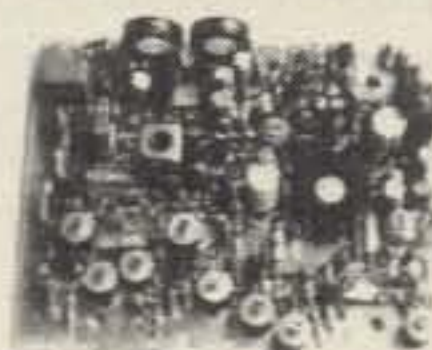

KPA5-E board \$169

Shouldn't your ATV transmitter be as reliable? Weather you want to put one in a balloon, R/C model, Robot, use as portable ATV xmtr, or get one in our ready to go TX70-1 for the shack, with P.C. Electronics you see the best! Companion receiving downconverter board TVC-2G \$49, or ready to go in a cabinet - TVC-4G \$89.

TX70-1 XMTR \$259



TVC-4G RECV CONV. \$89

THE ATV TWINS

Hams, Call or Write for our latest catalog of ATV gear! Transmitters sold only to Tech or higher licensed amateurs varified in latest Callbook or copy of new license. 5/89

(818) 447-4565 m-f 8am-5:30pm pst.
P.C. ELECTRONICS
2522 Paxson Ln Arcadia CA 91006

Visa, MasterCard
Tom (W6ORG)
Maryann (WB6YSS)

SPECIAL EVENTS

Number 30 on your Feedback card

Ham Doings Around the World

Listings are free of charge as space permits. Please send us your Special Event two months in advance of the issue you want it to appear in. For example, if you want it to appear in the June issue, we should receive it by March 31. Provide a clear, concise summary of the essential details about your Special Event.

JACKSONVILLE FL AUG 5-6

The 1989 Greater Jacksonville Amateur Radio & Computer Show will be downtown at the Prime Osborn Convention Center. Huge air-conditioned indoor swap area, exhibitor's section, forums, programs, FCC exams, prizes, boat-anchor auction. Registration, \$5. Swap area tables, \$15 for the weekend, \$12 Saturday only, \$6 Sunday only. Exhibitors contact *Billy Williams N4UF* at (904) 765-3230 or (904) 766-2410. PO Box 9673, Jacksonville FL 32208. For tables, registration, information, (include SASE), contact *Greater Jacksonville Hamfest Association*, PO Box 10623, Jacksonville FL 32207. (904) 350-9193.

MILDORD CT AUG 5-6

The Greater Bridgeport Amateur Radio Club will hold its special event from Booth Memorial Park at the City-wide Picnic on the 5th, and from the Shakespeare Theater grounds on the 6th. There will be dancing, actors, singers, bands. Club call WA1RJI on 20 meters. Contact *Millie*, 11 Pearl Hill St., Milford CT 06460. (203) 874-8740.

CEDAR RAPIDS IA AUG 5-6

The Cedar Valley Amateur Radio Club, Inc., is sponsoring their "Summerfest 89" at the air-conditioned Teamsters Hall. There will be amateur radio seminars, FCC exams, a large variety of commercial vendors, a large flea market, and free outside tailgating. One hotel, several motels, and mall nearby. Talk-in on 16/76 and 52. 8-foot tables, \$8. Commercial, \$15 first table, \$10 each thereafter. Admission, \$4; age 12 and under, free. *Summerfest 89*, *Cliff Goldsberry*, 2926 Shaffer Drive SW, Cedar Rapids IA 52404. (319) 356-8849.

RANDOLPH OH AUG 6

The Portage Amateur Radio Club, Inc., ARRL affiliated, will sponsor its 4th annual Hamfair at the County Fairgrounds. Tickets, \$3 in advance, \$4 at gate. Children under 12 free. Indoor tables, \$8 each. Flea market spaces, \$3 each. Activities include forums and nonham activities. Computer hobbyists welcome. Mobile check-in on 145.390 (negative offset). *Joanne So-*

lak KJ30/8, Portage Amateur Radio Club, Inc., 9971 Diagonal Rd., Mantua OH 44255. (216) 274-8240.

ANGOLA IN AUG 6

The Steuben County Radio Amateurs present the 29th Annual F.M. Picnic and Hamfest at Crooked Lake. Prizes, picnic BBQ chicken, inside tables for exhibitors and vendors, overnight camping. (County Park charges fee.) Communications on 146.52 and 147.81/.21. Admission, \$3. *Donn W. Laird WB9YIT*, Steuben County Radio Amateurs, %Lakeland Electronic Supply, 202 W. Pleasant St., Box 330, Angola IN 46703.

LANCASTER PA AUG 6

The Red Rose Repeater Association is sponsoring its Computer-Fest at the McCaskey High School. Features: Computer hardware/software, tailgating, prizes. Inside, air-conditioned. Talk-in on 147.015/.615. Admission, \$4. Children under 14 free with paying adult. *Computer Fest Committee*, PO Box 5092, Lancaster PA 17601. Vendors contact *Jim Linville*, PO Box 5029, Lancaster PA 17601 or *Fred Hammer-sand* Tel. (717) 569-1471.

BERRYVILLE VA AUG 6

The 39th Annual Winchester Hamfest, sponsored by the Shenandoah Valley ARC, will be at the Clarke County Ruritan Fairgrounds. Admission \$5, before July 15, \$4. Children under 12 and nonham spouses free. Tailgaters and limited tables, \$7. Commercial exhibitors. Donations from major manufacturers. VE exams. Talk-in on 146.22/.82 and 146.52 simplex. *Joanne Blaker WB2CMV*, (703) 869-4878. Or, *SVARC*, PO Box 139, Winchester VA 22601.

GREENFIELD IN AUG 6

The Greenfield Amateur Repeater Association Hamfest will be at the 4H Fairgrounds. Admission, \$5; children under 12 free. Flea market. 8-foot table, \$5. Commercial Bldg. \$7. Tailgate, \$2. Talk-in frequencies 147.000+ or 444.725+. *Keith Dalrymple N9GWK*, 2210 Wayne Dr., Greenfield IN 46140.

RHINELANDER WI AUG 12

The 10th annual Rhinelander Swapfest, sponsored by the Rhinelander Repeater Association, the Northerwoods ARC, and the Tomahawk Repeater Association, will be at the Ice Arena. VEC testing, free parking, dealers welcome. Admission, \$1;

tables, \$5 each prepaid by July 31; bring your own tables, \$3 per space; outside tailgating, no charge. Rhinelander Repeater 146.34/.94. Tomahawk Repeater 144.83/145.43. *Leonard Bauman K9RMN*, 804 Lincoln Street, Rhinelander WI 54501. (715) 369-3296/5564.

ESSEX JUNCTION VT AUG 12

The Burlington ARC will hold its annual hamfest at the Champlain Valley Fairgrounds. Admission, \$4 (Canadian, \$5). Children under 12 free. Camping available. Talk-in on 146.34/.94. *Barb Kimball N1DLE*, 1 Sundown Drive, Williston VT 05495. (802) 878-5555.

FAIRMOUNT IN AUG 13

The Grant County ARC will hold its annual swapfest at the Fairmount Play Acres Park. No ticket, no charge, bring lunch, table, chairs. Talk-in on 146.19/.79. *Dennis Clevenger KA9JUB*, 516 S. Walnut, Fairmount IN 46928. (317) 948-9351.

WARRINGTON PA AUG 13

The Mid-Atlantic ARC hamfest will be at the Bucks County Route 611 Drive-In Theatre. Tailgating spaces, \$2 each. Admission, \$3. Talk-in on 147.06/R and 146.52/S. *Al Maslin W3DZI*, (215) 446-4936. Or write *MARC*, PO Box 352, Villanova PA 19085.

ST. CLOUD MN AUG 13

The St. Cloud Amateur Radio Club Hamfest will be held at Whitney Senior Center. Tickets, \$3; additional tickets, \$2. Prizes, talk-in on 34/94 primary, 615/015 secondary. *Scarc*, Box 141, St. Cloud MN 56302.

GEORGETOWN KY AUG 13

The Central Kentucky ARRL Hamfest, sponsored by the Bluegrass Amateur Radio Society, Inc., will be at the Scott County High School. Technical forums, license examinations, awards, and commercial exhibits in air-conditioned facilities. Outside flea market space free with admission. Tickets \$5 in advance, \$6 at gate. Talk-in on 146.16/.76 repeater. *Bill DeVore N4DIT*, 112 Brigadoon Parkway, Lexington KY 40503.

VALPARAISO, IN AUG 13

The Porter County Amateur Radio Club presents the Annual Northwest Indiana Hamfest and Computer Fair at the County Fairgrounds and Expo Center. Features: Walk-in VE testing, large flea market, and many commercial vendors. Talk-in on 146.775/.175 or 146.52. Admission, \$4 at the gate, \$3.50 in advance. Kids under 12 free. *Hamfest Committee*, PCARC, PO Box 1782, Valparaiso IN 46384.

BRIDGEWATER NJ AUG 16-18

The Somerset County Office of Emergency Management will operate WC2ADK from 1400-0100Z each day. R.A.C.E.S. and Public Service at the annual 4-H Fair. Suggested frequencies: lower 25 kHz of General 80-10 meters and 10 meter Novice; visitors on 145.320 simplex. Send QSL and SASE to *Somerset County OEM/4H*, PO Box 3000, Somerville NJ 08876.

SCARBOROUGH ONTARIO AUG 16-SEP 4

One of Canada's most ambitious amateur radio exhibits will again be part of the Canadian National Exhibition. The VE3CNE Exhibit will be in the Arts & Crafts Building. Take time to operate the station. Listen for VE3CNE on all the HF bands, apply for a colorful QSL card. *VE3CNE Executive Committee*, 44 Innisdale Road, Scarborough, Ontario CANADA M1R 1C3.

POMONA CA AUG 19

The Tri-County Amateur Radio Association is sponsoring its Hamfest '89 at the Palomares Park Recreation Hall at Orange Grove. Indoors, free parking, prizes, ARRL booth, VEC exams, admission, \$3. \$3 per table, \$5 non-members. No personal tables. For pre-registration and table reservations, contact *WB6UFX*. For exams, send SASE, 610, original license and copy of current license, photo I.D., \$4 to *TCARA*, %*Joe Lyddon WB6UFX*, 6879 Sard St., Alta Loma CA 91701. (714) 980-4563.

OAKLAND NJ AUG 19

The 13th annual Ramapo Mountain Amateur Radio Club Hamfest & Computer Flea Market will be at the American Legion Hall and Grounds. Indoor and tailgate vendors, VE exams, prizes. Talk-in WA2SNA/R, 146.49/147.49, 146.52/.55 simplex. Details on WA2SNA-1 PBBS. *Marc WA2S @WA2SNA packet* or (201) 652-1318/8493.

ITHACA NY AUG 19

The Fingers Lakes hamfest, sponsored by the Tompkins County Amateur Radio Club, will be at the 4H-Acres. Admission, \$3. Under 18, free. Tailgaters, \$1. Indoor tables, \$5 each. Overnight camping, vendors. handicapped parking. Talk-in on 37/97. *Bob KD2IM AT*, (607) 347-4444.

VICTORIA TX AUG 19

The Victoria and Port Lavaca Amateur Radio Clubs are sponsoring their annual swapfest at the Knights of Columbus Hall. Raffle chance included with admission ticket. Prizes, barbecue, VEC exams, displays, and programs for hams and nonhams. Talk-in on 145.19 (Victoria) and 147.02 (Port

Lavaca). Gary Garnett AA5JT, PO Box 7025, Victoria TX 77905; or Lynn Hewitt K8KKD, PO Box 330, Port Lavaca TX 77979.

TACOMA WA AUG 19-20

The Northwestern Division Convention and Tacoma Hamfair, sponsored by the Radio Club of Tacoma, will be at Pacific Lutheran University. Admission, \$5 till Aug. 6, \$7 at door. \$1 for nonhams; 12 and under, free. Flea market, tables \$18 (includes registration), commercial exhibits, exams. RV parking (no hookups), \$2.50 each night; dormitory rooms (no reservations required), \$15 single, \$22 double. Entertainment, banquet program, activities, displays, technical seminars. Pacific Rim Disaster Team presentation, "Radio Communications for the Armenia Earthquake." Radio Club of Tacoma, PO Box 11188, Tacoma WA 98411. (206) 759-2040 or Bill Morgan W7GPR, (206) 531-3821.

HUNTSVILLE AL AUG 19-20

The Huntsville Hamfest 1989 will be at the Von Braun Civic Center, the site of the 1989 ARRL Southeastern Division Convention. Free public admission; free electricity in each booth; free coffee and doughnuts each morning; and free catered lunch both days. There is no charge for attending any part of the Huntsville Hamfest. There is a charge for booths. Send for informa-

tion packet. Art Davis WB4KKA, Dealer Show Chairman, (205) 883-0477. John Morris K4XH, Assistant Chairman, (205) 859-3994. Huntsville Hamfest, Inc., 2804 S. Memorial Parkway, Huntsville AL 35801.

W. LAFAYETTE IN AUG 20

The Tippecanoe Amateur Radio Association will hold its 18th Annual Hamfest at the Tippecanoe Fairgrounds. Tickets, \$3. A large flea market, dealers, and forums will be featured. Talk-in on 13/73. D.C. Roberts, 5124 Jackson Highway, West Lafayette IN 47906.

TOKYO, JAPAN AUG 25-27

The Japan Amateur Radio League will hold their HAM FAIR '89 at the New Hall (Shinkan) of the Tokyo International Trade Center in Harumi, Tokyo. The two principle themes of the event are: enjoy Cycle 22 more fully by operating new bands and support the success of new Amateur Satellite JAS-1b. 90 manufacturers and dealers, outdoor flea market, display of vintage transmitters, CW contests, technical forums, do-it-yourself workroom, best home-brew contest, display and sales of ARRL publications. Tickets, good for all three days, are 900 yen for adults, 400 yen for children under 15, and will be sold at the gate. JARL 14-2, Sugamo 1-chome, Toshima-ku, Tokyo 170, JAPAN; PO Box 377, Tokyo Central

Post Office 100-91, JAPAN. Tel. 81-3-947-8221. FAX: 81-3-943-8282. Telex: j23868 JAPRETAR.

DAYTON OH AUG 26-27

The Dayton Microcomputer Association, Inc., presents Computerfest™ '89, the 14th annual Computer and Electronic Convention and Flea Market indoors at the Hara Conference & Exhibition Center. Dealers, speakers and seminars, demonstrations, user group and club displays, prizes, free parking. Admission, \$3 each day. Children under 12 free. Special offer for groups. (513) 263-FEST (general and vendor information). Mark Hanslip, 143 Schloss Lane, Dayton OH 45418 (vendor information). BBS, (513) 293-1754; parameters 300/1200/2400, 8, 1, none. For placing an ad, contact by July 31, Dave Taylor, 3030 Viola Drive, Beavercreek OH 45385. (513) 426-7650.

MARYSVILLE OH AUG 27

The Union County Amateur Radio Club announces its 14th annual "Marysville Hamfest" at the fairground. Free overnight camping, entertainment by the "Ham Band," admission \$3 in advance, \$4 at the gate. Indoor and outdoor flea market space available. The Union County Amateur Radio Club, 13613 US 36, Marysville OH 43040. (513) 644-0468, W8BJN.

DANVILLE IL AUG 27

The 21st annual Danville Area Hamfest will be at the UAW #579 Civic Center. Tickets, \$2; or three for \$5. Talk-in on 146.82. Cookout. FCC VE testing, walk-ins welcome. Bring ID, \$4.75; if upgrading, bring your original license and a copy to send with the 610. Overnight OK, but no hookups. Prizes. John Cunningham WA9WJG, 1703 E. English, Danville IL 61832. (217) 443-0100.

LEBANON TN AUG 27

The Lebanon Hamfest, sponsored by the Short Mountain Repeater Club, will be at the Cedars of Lebanon State Park. Outdoor facilities only, exhibitors bring your own tables. Talk-in on 146.31/.91. Mary Alice Fanning KA4GSB, 4936 Danby Drive, Nashville TN 37211. (615) 832-3215.

ST CHARLES MO AUG 27

The St. Charles ARC will sponsor HAMFEST89 at Blanchette Park. Forums and license exams, free admission and parking. Handicapped parking available. \$2 per space for tailgate flea market. Dealers welcome in air-conditioned halls. Talk-in on 146.07/.67, 444.65/449.65 repeaters and 146.52 simplex. Mike Nolan KA0UXQ, 16 Gateswood Drive, St. Peters MO 63376.

SUPERFEST '89

September 16 and 17, 1989

Exposition Gardens, Peoria, Illinois

- Featured speaker, Gordon West, WB6NOA
- Commercial and manufacturer exhibits
- Acres of flea market
- Home and professional computers

Tickets: \$4 through Aug. 31; \$5 Sept. 1 through show

Write: Superfest '89, P.O. Box 3461 Peoria, Ill. 61614

Call: 309-674-5656 (24-hour answering machine)

HIGH POWER RF SWITCHED PREAMPS



Model 146 160W 2 Meters 19db Gain .75db Nf
Model 146OS 160W 2 Meters 19db Gain .75db Nf
Model 440 70cm 100W 16db Gain .75db Nf

All preamps have helical filters to prevent out of band intermodulation in the receiver. Model 146 covers the entire 2 meter band. Model 146OS is of very narrow bandwidth and would be suitable for SSB, Packet, or Satellite. Model 440 is factory tunable from 430-440 MHz or 440-450 MHz per customer request. All models are powered with 13 to 20 VDC and are mounted at the antenna.

AMPIRE, INC.
10240 NATHAN LANE
MAPLE GROVE, MINN
55369
612-425-7709

Model 146 \$179
Model 146OS \$179
Model 440 \$189

EVERY ISSUE of 73 on microfiche!

The entire run of 73 from October, 1960 through last year is available.

You can have access to the treasures of 73 without several hundred pounds of bulky back issues. Our 24x microfiche have 98 pages each and will fit in a card file on your desk.

We offer a battery operated hand held viewer for \$75, and a desk model for \$200. Libraries have these readers.

The collection of over 600 microfiche, is available as an entire set, (no partial sets) for \$180 plus \$5 for shipping (USA). Annual updates available for \$10.

Your full satisfaction is guaranteed or your money back. Visa/MC accepted.

BUCKMASTER PUBLISHING

"Whitehall"
Route 3, Route 56
Mineral, Virginia 23117

703-894-5777
800-282-5628

CIRCLE 365 ON READER SERVICE CARD

ABOVE AND BEYOND

VHF and Above Operation

C.L. Houghton WB6IGP
San Diego Microwave Group
6345 Badger Lake
San Diego CA 92119

24 GHz Operation

Equipment for 24 GHz seems to be very scarce. Recently, I heard a new word to describe it—"unobtainium." Well, there is good news which I hope will put you at ease: you can obtain materials inexpensively. You may have to dig a little to locate surplus materials, but not for long. Several commercial systems are being constructed which will contribute to the surplus market in a few years.

I know of two units you can use on our 24 GHz band. They are available from Microwave Associates and California Eastern Labs. Microwave Associates makes the familiar Gunnplexer units for 10 GHz, and a similar unit for 24 GHz which costs about \$350. According to MA/COM, the unit's features are similar to the 10 GHz unit. It has a circulator/detector in the output, and varactor tuning of the Gunn source. These features are essential for a high performance unit.

The 24 GHz Gunn oscillator/detector device, the NEC ND-610AAM, is available from California Eastern Labs. It is a basic setup intended for alarm applications, without the added features of the MA/COM device. This inexpensive unit has a waveguide detector and an approx. 10 mW Gunn source (no varactor tuning). You can adjust the unit mechanically as well as by Gunn voltage tuning.

One word of caution to users of 10 GHz systems: You need to modify the Gunn DC voltage supply to connect the 24 GHz unit to your 10 GHz wideband FM system. The 10 GHz system Gunn runs on a 10 volt supply, while the 24 GHz Gunn device requires 7 volts maximum. Accidentally connecting the 10 volt supply to the 24 GHz device would destroy it. Be careful—one mistake is COSTLY.

Preliminary tests on one of the NEC ND610AAM Gunn oscillators prove it to be a fast way to get on 24 GHz with minimum cost (\$50). It's available from California Eastern Labs 3260 Jay Street, Santa Clara CA 95954. Tel. (408)

988-3500. Quite a bargain.

Test Equipment Limits

My only trouble working at this frequency was finding test equipment. In the surplus market, test equipment usually stops at 18 GHz. Most pieces of equipment on my test bench are older Hewlett Packard units, like the 5245 frequency counters, which go to only 18 GHz. My power meters are rated to 12.4 GHz. With an external detector, my spectrum analyzer can go above 12.4 GHz. This was the only tool I had for setting frequency. Kent Brittan WA5VJB found a wavemeter that covers the 24 GHz band, and I plan to keep a lookout for one for my shack.

Unit operation was little unstable without a circulator. Waving my hand in front of the antenna caused the oscillator to shift frequency quite a bit. This occurs on 10 GHz in simple wideband units, but it was more pronounced on the 24 GHz oscillator.

Commercial equipment for this band is being made for short distance point-to-point-to-point telephone communications by some companies, such as Raycon and MA/COM. The Raycon system, for short range communications (15 miles), usually involves multiplexed (many) telephone circuits on one microwave frequency. Their brochure states that they

METER	GHz (1000 MHz)	METER	GHz (1000 MHz)
33cm	0.902 - 0.928	12mm	24.0 - 24.25
23cm	1.240 - 1.300	6.4mm	47.0 - 47.4
13cm	2.300 - 2.310	4.0mm	75.5 - 81.0
9cm	3.300 - 3.500	2.5mm	119.98 - 120.02
6cm	5.650 - 5.925	2.1mm	142 - 149
3cm	10.0 - 10.50	1.2mm	241 - 250

use wideband FM, and have the capability of 192 channels available for two-way voice communications on one 24 GHz microwave system.

The limitations on these systems and on amateur applications are the same, however. Narrowband systems, which are becoming more popular in amateur applications, give a greater range than their commercial counterparts. Narrowband signals better tolerate a noisy path.

However, all is not rosy. Transmission through a normal atmosphere shows an average loss of 0.02 dB per mile at 10 GHz, and a loss of 0.2 dB per mile at 24 GHz. When it rains, these losses almost double the loss over those on a dry day (see Figure 1). Additionally, the loss figure suddenly peaks at the 24 GHz range due to the absorption of water vapor in the atmosphere. Some people suggest we were given this band because of the high loss due to water vapor absorption, but other bands have this problem. The first oxygen absorption band is 65 GHz.

Field Tests

Several local amateurs bought equipment from California East-

ern Labs and conducted tests between San Diego and Los Angeles. Experimenting with mobile operation on 24 GHz from the Los Angeles area produced successful results. Jack N6XQ (mobile in Los Angeles) made many contacts with Alan Packer WA6CPL, who was operating from his home QTH. N6XQ made several successful contacts, from stops along the highway on his return trip to San Diego, to further test 24 GHz operation. The last 24 GHz contact on his return trip was from a spot near the Camp Pendleton USMC base, about 50 miles south of Los Angeles. Signal strength was still good, and he made the contact with little difficulty.

We made the next contact from San Diego from N6XQ's home location, a spot on Point Loma which has yielded good 10 GHz contacts to Los Angeles before. However, several tries from Jack's QTH in San Diego on 24 GHz to Los Angeles proved futile. The path is over water to Los Angeles for about 100 miles. We made 10 GHz wideband contacts easily, with approximately the same power output levels. Finally, after many attempts over several weeks, we made a two-way con-

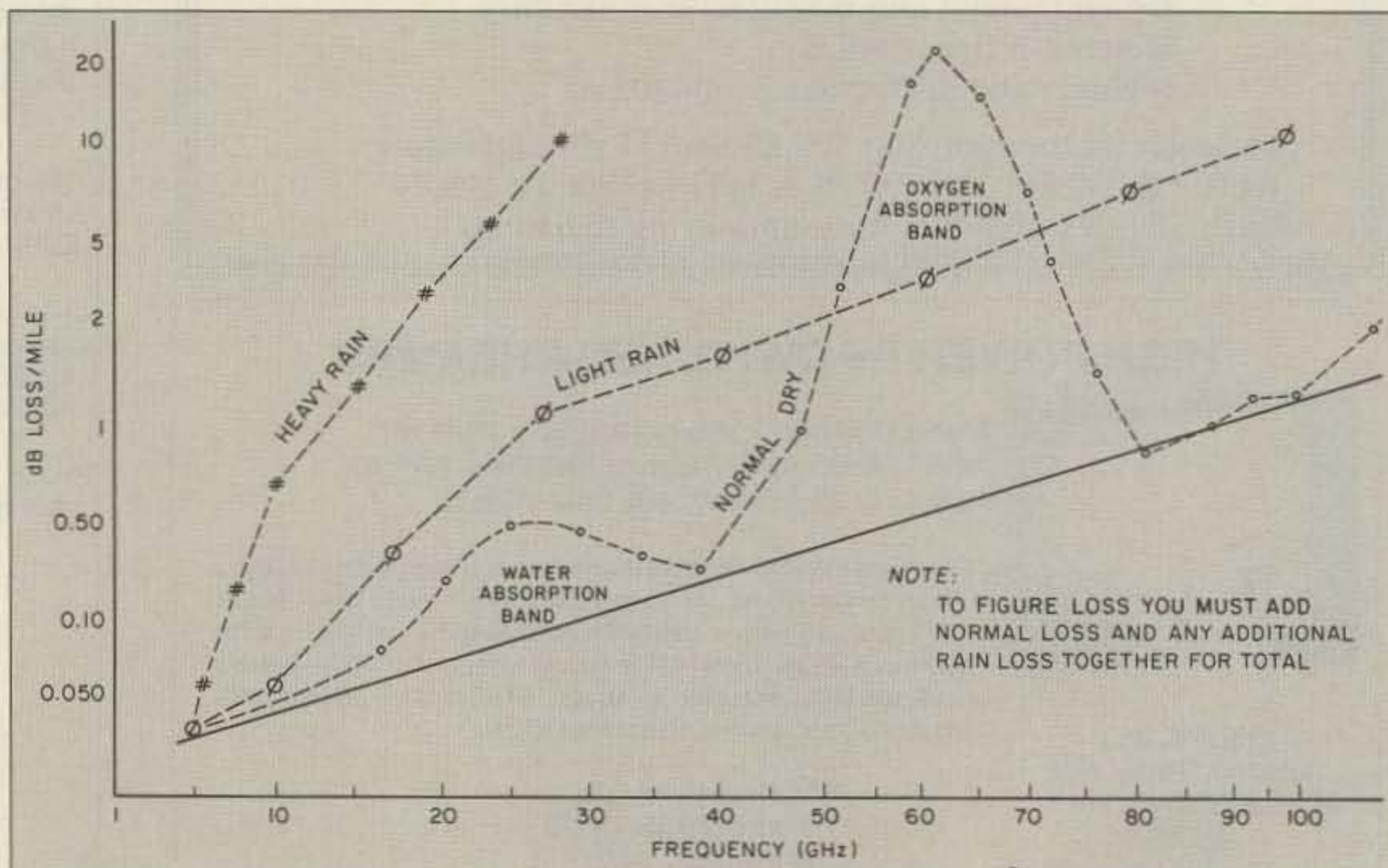

Figure 1.

HIGH PERFORMANCE PRESELECTOR-PREAMP

The solution to most interference, intermod, and desense problems in **AMATEUR** and **COMMERCIAL** systems.



- 40 to 1000 Mhz - tuned to your frequency
- 5 large helical resonators
- Low noise - High overload resistance
- 8 dB gain - ultimate rejection > 80 dB
- 10 to 15 volts DC operation
- Size - 1.6 x 2.6 x 4.75" exc. connectors
- **FANTASTIC REJECTION!**

Typical rejection:

- ±600 KHz@144 Mhz: -28dB
- ±1.6 Mhz@220 Mhz: -40dB
- ±5 Mhz@450 Mhz: -50dB

Price - CALL bipolar w/RCA jacks
Connector options: BCN \$5, UHF \$6,
N \$10

SUPER HOT! GaAs Fet option \$20

AUTOMATIC IDENTIFIERS

ID-1

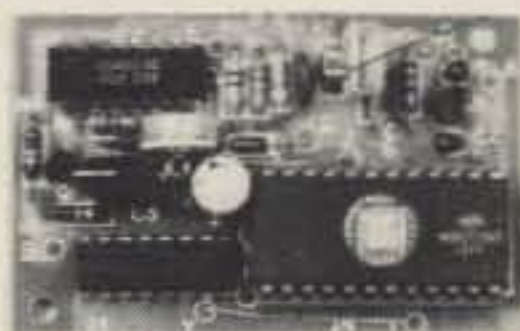

ID-2



- For transceivers and repeaters - **AMATEUR** and **COMMERCIAL**
- Automatic operation - adjustable speed and amplitude
- Small size - easy installation - 7 to 15 volts DC
- 8 selectable, reprogrammable messages - each up to 2 min. long
- Wired, tested, and programmed with your message(s)

Model ID-1 - \$54.95 Model ID-2 w/2 to 10 minute timer - \$79.95

We offer a complete line of transmitter and receiver strips and synthesizers for amateur and commercial use.

Request our free catalog.

Mastercard and VISA welcome

GLB ELECTRONICS, INC.

151 Commerce Pkwy., Buffalo, NY 14224
716-675-6740 9 to 4

CIRCLE 17 ON READER SERVICE CARD

Kenwood TH-75A



The **Kenwood TH-75A** dual band HT features 2 m and 70 cm in one compact package. Dual LCD display, full duplex operation, tone alert, ten multifunction memories, multi mode scanning plus many more features. Comes with antenna, PB-6 nicad and charger.

Only \$469.99 (+\$5 UPS)

Order #73-2179

➔ **EXTRA PB-6 Battery only \$19.99**
with purchase of TH-75A.

Limit one per purchase while supply lasts.

Informative Catalogs

AMATEUR CATALOG

This 48 page catalog covers all major lines of ham gear including Kenwood, Icom, Yaesu, AEA, Kantronics, and Hustler. With prices!
Only \$1 Postpaid

SHORTWAVE CATALOG

52 pages of everything that is new for the SWL, including receivers, portables, antennas, RTTY & FAX decoders, books and accessories.
Only \$1 Postpaid

Universal Radio

1280 Aida Drive Dept. 73
Reynoldsburg, OH 43068
Toll Free: 800 431-3939
In Ohio: 614 866-4267

Universal has been serving the ham community since 1942. We are an authorized dealer and service center for Kenwood, Icom and Yaesu.

THIS MONTH'S GOODIE FROM THE CANDY STORE



NYE-VIKING MB-V-A
\$554.90

(AUGUST ONLY)

SIMILAR SAVINGS ON KENWOOD, ICOM, YAESU, HY-GAIN, ETC. ALL L.T.O.
KENWOOD TH-315A \$259.90

OVER 8788 HAM RELATED ITEMS IN STOCK. ALL PRICES CASH FOB PRESTON

More specials in HAM-ADS.

LOOKING FOR SOMETHING NOT LISTED? CALL, WRITE, or FAX

ROSS DISTRIBUTING COMPANY (P.O. Box 234)

78 South State Street, Preston, Idaho 83263

Telephone (208) 852-0830 FAX (208) 852-0833

HOURS: Tuesday-Friday 9:00 to 6:00, 9:00 to 2:00 Mondays, Closed Sat. & Sun.

CIRCLE 254 ON READER SERVICE CARD

HI-PERFORMANCE DIPOLES

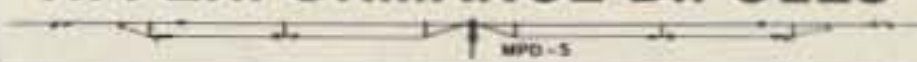

Antennas that work! Custom assembled to your center freq. ea. band - advise ht. of center and each end - hang as inverted "V" - horizontal, vert dipole, sloping dipole - commercial quality - stainless hardware - legal power - no-trap, high-efficiency design. Personal check, MO or C.O.D. (\$3)

MPD-5*	80-40-20-15-10M max-performance dipole 87' long	\$105ppd
MPD-2	80-40M max-performance dipole, 85' long	\$62
HPD-3*	160-80-40M hi-performance dipole 113' long	\$79 ppd
SSD-6*	160-80-40-20-15-10M space saver dipole 71' long	\$125 ppd
SSD-5*	80-40-20-15-10M space-saver dipole-specify L. 42'-\$105 52'-\$108 ppd	
SSD-4*	80-40-20-15M space-saver dipole-specify L. 46'-\$93 60'-\$ 96 ppd	

*9-bands with wide-matching-range tuner.

BASE for catalogue of 30 dipoles, slopers, and space-saving, unique antennas

312-394-3414 BOX 393 W9INN ANTENNAS MT. PROSPECT, IL 60056

CIRCLE 38 ON READER SERVICE CARD

Field Day Antenna Installation System

One Person installs in minutes
ANTENNA LAUNCHING MADE EASY
\$29.95 add \$6 Air Ship
Info \$1.00
Re-usable Ready for Action Fast & Easy to Use Eliminates Climbing
1-801-373-8425
AntennasWest
Box 50062 S. Provo, UT 84605

CIRCLE 304 ON READER SERVICE CARD



Wideband Preamp 10-1000 Mhz

Dual GasFet low noise preamplifier for HF, UHF or VHF systems. Just perfect for the R-7000. Excellent for Spec Analyzers, Scanners, etc. Gain 20 Db +/- 1 DB, -3 Db at 2 & 1100 Mhz. 1 Db compression of >10 Dbm. Intercept points >45 Dbm. New shipped price of only \$124.95. Pa. residents please add 6% state tax.

GTI Electronics

RD 1 BOX 272
Leighton, Pa. 18235
717-386-4032

CIRCLE 326 ON READER SERVICE CARD

PC Slow Scan \$149.95

A complete slow scan television station for your IBM PC or compatible. Send and receive images in up to 10 shades of gray depending upon your graphics card and printer.

Includes:

Demodulator Modulator 75 Page Manual
Software Tutorial Cassette

Requires:

Ham transceiver PC with 640K Parallel Port
Graphics Card Tape Recorder Serial port

Slow Scan Formats: 8,12,17,23,34,36,48,72 sec.



Software Systems Consulting
1303 S. Ola Vista
San Clemente, CA 92672
(714) 498-5784

CIRCLE 244 ON READER SERVICE CARD

RC-1000 REPEATER CONTROLLER

From Micro Computer Concepts

- Complete RX-TX-Phone Line Interface
- Repeater Control
- CW ID
- Remote Base/Tape
- Reverse Patch
- Pulse/Tone Dialing
- Autopatch
- Tailbeeps
- 12 V AC/DC Oper.
- DTMF Decoder
- 90 Day Warranty

Wired & Tested w/manual ...\$219.95

Distributed by:

R & L Electronics

575 Main St. / Hamilton, OH 45013

1-800-221-7735



in Ohio
513-868-6399

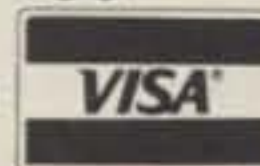

CIRCLE 348 ON READER SERVICE CARD

continued from p. 54

can assume identical results for the transmitted signal.

Symmetry Comparisons

With a symmetrical, dual-radiator antenna system, you can compare the two individual radiators. You can run listening tests by switching from one radiator to the other and often detect any defects from the outset. I compared each of the three radiator types—the dipole, COCOA-2, and COCOA-3—with its counterpart before progressing to the next, more complex configuration. In each case, listening tests showed the two radiators identical, within the 1–2 dB accuracy of the measurement method.

Front-to-Back Measurements

After finishing the tests above, I ran extensive listening tests, using the foreshortened model, to determine the overall feasibility of these configurations. Front-to-back ratios for each of the radiator combinations averaged 10–15 dB. Principal directivities in this installation are in the east-west direction (elements run north and south). However, with the two radiators connected *in-phase*, both the COCOA-6 arrangements gave an F-to-B of up to 30 dB and signal strengths approxi-

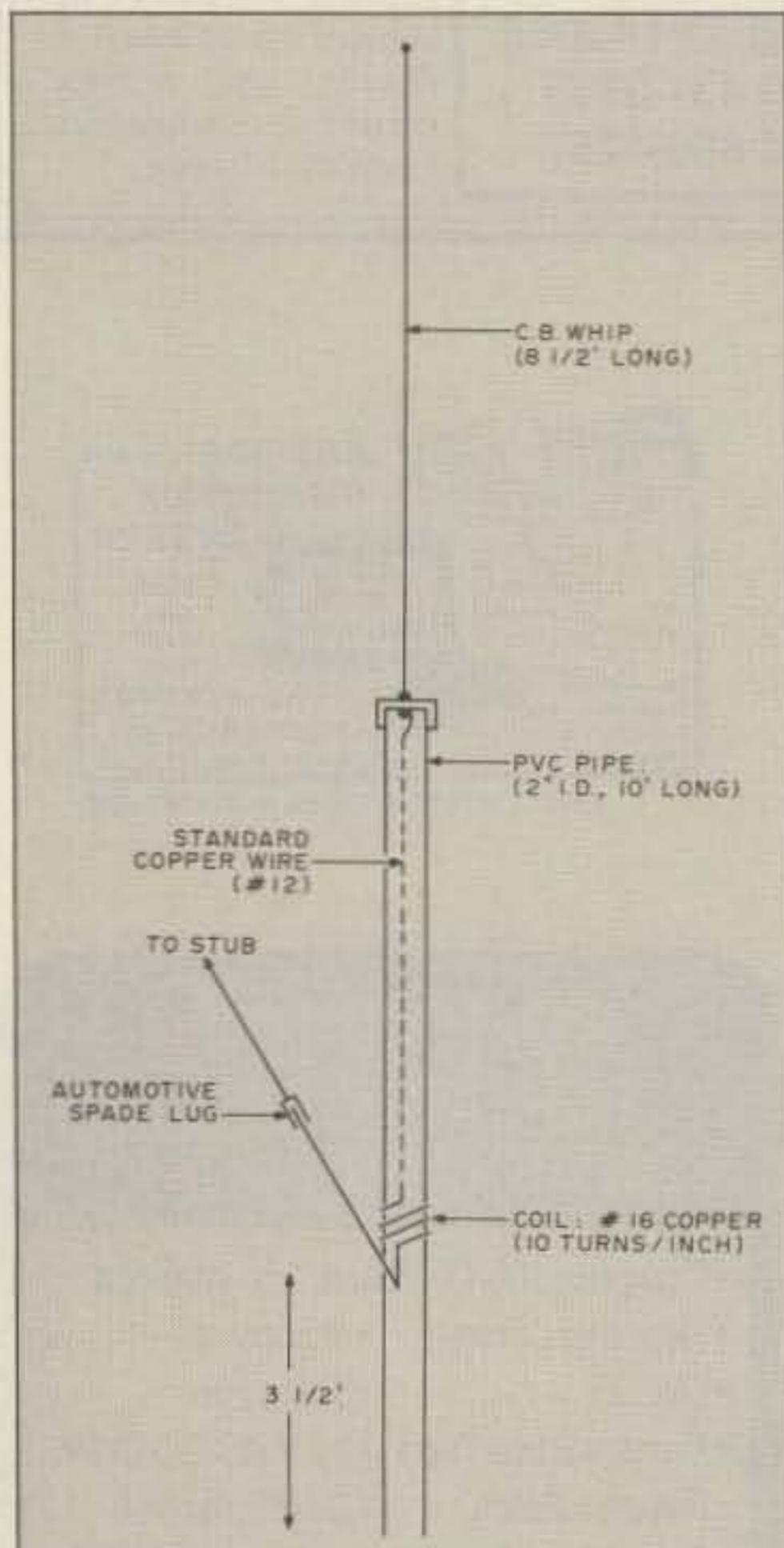

Figure 8. Detail of vertical terminations.

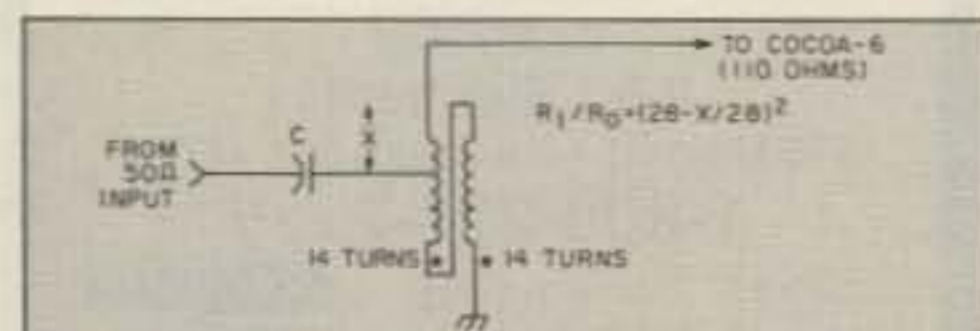

Figure 9. Diagram of toroidal matching transformer.

mately 4 dB stronger for stations to the south, compared to the single radiator of the same type. Repeating this comparison for the dipole radiators yielded only a 2 dB change.

Gain Considerations

I found a loss of 10 dB for a dipole at a height of 12 feet, compared to an identical dipole at a height of 61 feet. This is about equivalent to the gain of a typical linear amplifier! Keep this in mind when evaluating data for the foreshortened COCOA-3 radiators.

Figure 7 shows that the two foreshortened radiators, with the high induction fields of their loading coils on either end of the high dipoles, are close enough to the ground to have appreciable comparative ground losses, perhaps in excess of 10 dB. See Figures 10a and 10b. Using the high dipole mentioned above for comparison, we see that, for a level COCOA-3 radiator, the effective radiation from the three dipoles located collinearly is $3 \times P/3$, or P . That is, nearly all of the power is effectively radiated. However, referring to Figure 10b, if we assume that the two low dipoles are each down by 10 dB in effective radiated power (equivalent to the 12-foot-high case), the resulting effective power from the three dipoles is only $0.4P$. In other words, expect the output to be down approximately 4 dB from the high dipole.

Signal Strength Comparisons

I made extensive dB comparisons, using the receiver mentioned above. The east and the west COCOA-2 and COCOA-3 were compared with the opposite standard dipole using signals at various distances and times of day.

The signal strengths from both of the compound radiators showed losses compared to the reference dipole. Specifically, the COCOA-2 measured about 3 dB down and the COCOA-3 measured about 6 dB down, compared to the dipole. Recall though, that for the uncompromised antenna shown in Figure 4, if all four terminations are located at the highest practical height (60 ft.), the gain would be 8 dB over a dipole—the kind of gain one would expect in a 4-element rotary beam!

Conclusion

This article described a practical design of a 6-element, direction-switching phased array antenna system for 75 meters. This system features two coaxial, collinear radiators, each comprising three half-waves in phase. You can control directivity and angle of radiation by switching delay lines in the coaxial feed system. A version of this system, using inductively foreshortened elements close to the ground, has been constructed and used to evaluate gain and front-to-back ratios. Height above ground is all-important! 

References

- 1 "A Balanced Dipole Antenna," by J.E. Taylor, *73 Magazine*, October 1973, page 57.
- 2 "A Low Frequency Phased Array," by J.E. Taylor, *73 Magazine*, July 1974, page 49. Also, "An 80 Meter Phased Array," by J.E. Taylor, *73 Magazine*, March 1975, page 52.
- 3 "The 80 Meter Pile Crusher," by J.E. Taylor, *73 Magazine*, June 1978, page 76.
- 4 "A Portable Coaxial Collinear Antenna," by B.B. Balsley and Warner Ecklund, *IEEE Transactions on Antennas and Propagation*, July 1972, pages 513–16. See also *Radio Communication*, September 1972, page 597.

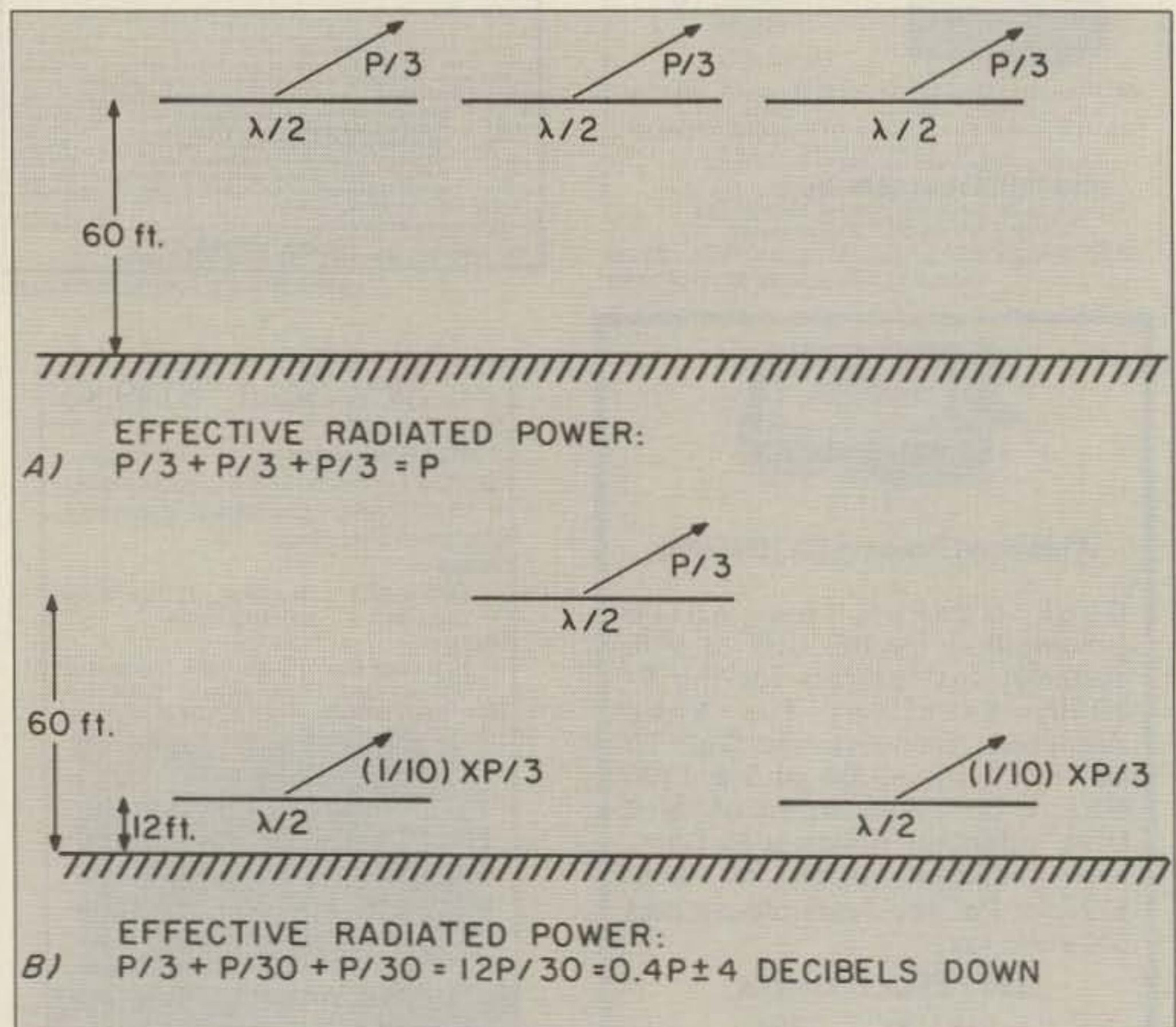

Figure 10. Calculated gain difference between a) an antenna whose three half-wave elements are all up at 60 ft, and b) an antenna whose two outside half-wave elements terminate at only 12 feet above the ground. Ground absorption at low frequencies greatly reduces antenna gain.

LINK COMM REPEATER LINK SYSTEMS

RLC - 5
 - DIRECT CONNECTION TO THE 8-COM 5K REPEATER CONTROLLER
 - ADAPTABLE TO ANY REPEATER CONTROLLER
 - TWO MODES OF LINKING:
 - CENTRAL HUB LINKING
 - CROSS SYSTEM CHAIN LINKING
 - LED DISPLAY PANEL
 - LOW POWER CMOS DESIGN
-AFFORDABLE- ONLY \$99.95 + \$5.00 S&H

AVAILABLE FROM: LINK COMM, 306 So 20th, BOZEMAN MT, 59715
 PC BOARD AND SCHEMATIC LAYOUT SERVICE AVAILABLE, CONTACT LINK COMM FOR ADDITIONAL INFORMATION.

REPEATER LINK CONTROLLER

CIRCLE 47 ON READER SERVICE CARD

NEW ETCHED COFFEE CUPS !!

\$7.95 Each BLACK or BLUE
 A.R.R.L. LOGO Add \$1.00
 13 OZ. GLASS MUG AVAILABLE

Checks Payable To: TODD SKOGEN, P.O. Box 3025, Fox Valley Station, Aurora, IL 60504, (312) 805-5972
 Company LOGO's and Custom Orders Welcome. Write or Call for Quote. Add \$2.50 Ship. & Hand. IL RES. ADD 6.75% TAX. Allow 1-2 Weeks Delivery.

CIRCLE 268 ON READER SERVICE CARD

1989 CALL DIRECTORY
 (On microfiche)
 Call Directory \$8
 Name Index 8
 Geographic Index 8
 All three — \$20
 Shipping per order \$3
BUCKMASTER PUBLISHING
 Mineral, Virginia 23117
 703: 894-5777 800: 282-5628

CIRCLE 7 ON READER SERVICE CARD

NextDay QSLs
 Two-Color Rainbow Assortment

Call Today & We Ship NextDay 2nd Day ASAP

Baraboo, Wisconsin Sauk County	100	\$29.95	\$24.95	\$19.95
K9ZZ	200	\$39.95	\$34.95	\$29.95
	400	\$49.95	\$44.95	\$39.95
	500	\$54.95	\$49.95	\$44.95
Info \$1	1000	\$99.95	\$89.95	\$79.95

AntennasWest (801) 373-8425
 All orders ppd 2nd day air / priority mail. For overnight air delivery add \$10. Box 50062-S, Provo UT 84605

CIRCLE 89 ON READER SERVICE CARD

THE ISOTRON
 COMPACT ANTENNAS FROM 160-10 METERS

NO TUNERS!
 NO RADIALS!
 NO RESISTORS!
 NO COMPROMISE!

FOUR EXCELLENT REVIEWS JUST DON'T HAPPEN BY CHANCE
 CALL US FOR A FREE CATALOGUE.

*See review in Oct. 73, 1984 *Sept. 73, 1985 March 73, 1986 CQ, Dec. 1988

BILAL COMPANY
 137 Manchester Drive
 Florissant, Colorado 80816
 (719) 687-0650

CIRCLE 42 ON READER SERVICE CARD

GET A BIRD'S EYE VIEW
 From GrafTrak II™ and your IBM® PC

SUGARLAND AO-13 1989 FEB 19 06:55:14

LAT 2.2° N ECHO 250 ms ELEU 15.3°
 LON 32.4° W FRQ 145.81271 RZIM 102.0°
 HGT 33296 km DOP -294 Hz SQUINT 18.6°
 RNG 37512 km DRF 4 HzM

GrafTrak II™ provides real-time graphic display of a flat projection map that moves under selected satellite/Sun/Moon/star coverage circle and updates once per second.

The Silicon Ephemeris™ gives tabular data output to the screen, printer or disk file. Editing, data base update and rotator/receiver control programs also included.

Requires an IBM PC, PC/XT, PC/AT, or true compatible, an IBM Color/Graphics Monitor Adaptor or true compatible, optional but recommended 80x87 math coprocessor, minimum 512K RAM, DOS 2.0 or later, and either two 360K floppy drives or one 360K floppy and one hard drive; the programs are not copy protected.

SEE DETAILED PRODUCT REVIEW IN THE APRIL '89 ISSUE OF 73.

COMPLETE PACKAGE \$395 LIST.

CALL FOR QUOTATION
 (713) 777-3057

Silicon Solutions, Inc.
 P.O. Box 742546
 Houston, TX 77274-2546

IBM is a registered trademark of IBM Corporation. GrafTrak II and Silicon Ephemeris are trademarks of Silicon Solutions, Inc.

Make the DEPENDABLE CONNECTION

Morcom International Inc.
 distributor of:

- **HELIOPOWER**—Photovoltaic Panels 49w, 40w, 30w, 9w, 4.5w, 1.3w
- **CES**—Phone Patches, DTMF Microphones, DTMF keyboards
- **KANTRONICS**—Packet Radio, and Software
- **CAPRICORN II**—Digital weather console, measures and displays wind speed and direction, temperature, pressure (computer compatible), Programmable alarms.
- **MIRAGE/KLM**—Amplifiers, Antennas.

Most models in stock. Call for prices. Looking for International distributors.

MORCOM INTERNATIONAL INC.

Phone: # (703) 750-3414
 5130 Duke St. Suite #6
 Alexandria, VA 22304, U.S.A.
 Fax #: (703) 354-8843 Telex: 854081

CIRCLE 375 ON READER SERVICE CARD

PERFORMANCE AND VALUE WITHOUT COMPROMISE

KRP-5000 REPEATER

2 METERS-220-440

Word is spreading fast- "Nothing matches the KRP-5000 for total performance and value. Not GE, not even Motorola."

RF performance really counts in tough repeater environments, so the KRP-5000 receiver gives you 7 helical resonators, 12-poles of IF filtering, and a precise Schmitt trigger squelch with automatic threshold switching. The transmitter gives you clean TMOS FET power.

Enjoy high performance operation with remote programmability, sequential tone paging, autopatch, reverse autopatch, 200-number autodial, remote squelch setting, status inputs, control outputs, and field-programmable Morse messages.

Call or write for the full performance story... and the super value price!

KRP-5000 Repeater shown with PA-100 Amplifier

Micro Control Specialties
 23 Elm Park, Groveland, MA 01834
 (508) 372-3442
 TELEX: #4932256 KENDECOM
 FAX: #5083737304

The first choice in Transmitters - Receivers Repeaters Repeater Controllers Power Amplifiers Voice Mail Systems

CIRCLE 295 ON READER SERVICE CARD

R.S.#	page	R.S.#	page	R.S.#	page	R.S.#	page
355 Ace Communications	19	• Butternut Electronics	67	245 Jensen Tools & Alloys	63	31 Radio Amateur Callbook	63
1 Advanced Computer Control	37	356 C & S Sales Inc.	43	272 Jun's Electronics	89	34 Ramsey Electronics	39*
65 Advanced Electronic Applications	96*	• CB City International	59	• K-40	19	• Reighcon Systems	63
67 Alinco Electronics	4,5*	157 Cleveland Inst. of Electronics	87	• Kenwood U.S.A. Corporation	CV4,9,11,12*	142 RF Enterprises	14,15
• Amateur Electronics Supply	35*	343 Commpute Corp.	61	99 Communication Concepts, Inc.	25	254 Ross Distributing	77
314 Ameritron	29	121 Communications Electelectronics	33	47 Link-Com	79	73	
• Ampire, Inc.	75	10 Communications Specialists	2*	278 Littlite/CAE Inc.	59	Cummilative Index	90
5 Antennas West	61	12 Connect Systems	1	• Maggiore Electronics Lab	45	Dealers Ad	
89 Antennas West	79	306 Creative Control Products	63	101 Maxcom Inc.	57*	Subscription Problems?	
303 Antennas West	59	15 Doppler Systems	40*	241 Media Mentors	19*	Uncle Wayne's Bookshelf	68,69
90 Antennas West	61	112 E. H. Yost	61	241 Media Mentors	90*	• Silicon Solutions	79
107 Antennas West	53	291 Electron Processing	37*	114 Metro Printing	59	244 Software Systems	77
236 Antennas West	59	• Engineering Consulting	61	258 MFJ Enterprises	7	102 Sparrow Hawk Communications	59
304 Antennas West	77	268 Etched Call Sign Cups	79	348 Micro Computer Concepts	77	51 Spectrum Communications	23
302 Antennas West	90	372 G & G Electronics	47	295 Micro Cont. Specialities	79	183 Spectrum International	40
82 Antennex	67	157 Gap Antenna Products	83	252 Midland Technologies	63	• Summitek	90
271 Antique Radio Classified	61	153 Gap Antenna Products	83	187 Mission Communication & Consultant	53	150 The Radio Works	53
• ARRL	87	339 GGTE	67*	163 Mobile Mark	61	115 The RF Connection	53
• Associated Radio	31	17 GLB Electronics	77	375 Morcom International	79	136 Unadilla/Antennas Mfg. Co.	63
243 AXM Inc.	61	72 Glen Martin Engineering	27	• N6KW QSL Cards	59	• Universal Amateur Radio	77*
360 AXM Inc.	87	346 Great Circle Maps	87	151 Naval Electronics	57	79 Vanguard Labs	59
158 Azimuth Communications	27	326 GTI Electronics	77	• Omar Electronics	53	• VHF Communications	25
• B & K Computer	87	• Hamtronics, Inc.	21	• P.C. Electronics	47,73*	191 W & W Associates	27
53 Barker & Williamson	19	• Heath Co.	90,91	152 Pac-Comm	67	38 W9INN Antennas	77
41 Barry Electronics Corp.	41	269 Hustler, Inc.	25*	178 Pacific Cable Co. Inc	59	• Wi-Comm Electronics	59
42 Bilal Company	61	354 ICOM America	CV2*	• Peoria Amateur Radio Club	75	• Yaesu Electronics Corporation	CV3
156 Buckmaster Publishing	61,75,79*	• Intercon Data Systems	67	68 Periphex	25		
• Burghardt Amateur Radio	93			378 Protel Technologies	83		
				145 QSO Software	83		

*Advertisers who have contributed to the National Industry Advisory Committee(NIAC).

continued from p. 62

are no such RFI problems in your setup. You can make L1 and L2 by winding 50 turns of #26 wire on an Amidon T-37-2 (red) toroidal core. M1 is a 50 microampere lighted meter for nighttime use. R1 is 18k for the TR-7950.

An optional LED bar graph indicator (U3 and associated components) tracks the 50 microamp meter movement. The LEDs are handy for checking noise or signal level out of the corner of your eye on night hunts. Use a variety of colors to aid visibility if you wish.

Vince built his meter amplifier on a predrilled grid board, Radio Shack part number 276-158. There's plenty of room to add other goodies, such as the internal attenuator from the March 1989 "Homing In" column. Use sockets on the ICs for ease of setup and troubleshooting. Make the three connections from the radio to the box (S-meter, noise meter, and ground) with ribbon or other multiconductor cable.

Metering a Dual-Bander

Hunts on 220 MHz are gaining in popularity, as are dual-band rigs such as the Kenwood

TM-621A. WA6DLQ recently got one and modified his noise meter box for use with it. The TM-621A is a very compact unit with surface-mount components. I suggest you get the service manual for it, or any other rig you wish to modify, to aid in locating tap-off points.

Noise meter input on the TM-621A comes from signal SQ-1 at the connector on the main board. With no signal, there are 0.6 volts present at SQ-1, dropping to 0.55 volts with the squelch open. This shift is much smaller and of opposite polarity to the shift in the TR-7950, so an amplifier/inverter stage is used. U2b and associated components in the inset box in Figure 2 replace R4-R6, connecting at points A and B.

Tap off signal SQ-1 without disturbing the delicate surface mount PC boards by removing the proper pin from that connector, soldering the added wire to the pin, and then reinstalling the pin into the connector and plugging it back in. S-meter pickoff for the TM-621A is at test point TP-1, which has +4.85 volts at full scale. TP-1 sticks out of the two meter board in the TM-621A. R1 in the meter amp is changed to

120k because of the higher signal level.

Checkout and Operation

For initial checkout, leave U1 and U2 out of the sockets. Apply +12 volts input, close S1, and measure the voltage at the output of regulator U3. If it's not close to +9 volts, change R13 as necessary. For the TM-621A, adjust R16 for 0.6 volts at the tap of the pot. Connect +9 volts to U2-1 with a clip lead and adjust R10 for exactly full scale on M1.

Now, turn off the power, remove the clip lead, and install U1 and U2. Set S2 to the "S" position, and apply a strong on-frequency signal to the receiver. Adjust R2 for exactly full scale on M1. Adjust R11 until all except the last LED comes on, then slowly increase R11 until that last LED just comes on.

Set S2 to the NOISE position and adjust R5 or R21 for exactly full scale on M1, with the strong signal still applied. For the TM-621A, remove the signal and adjust R16 to zero the meter. Repeat the adjustments of R21 and R16 if necessary.

For hunting, adjust the squelch control in the rig to get a near zero

reading on the noise meter when there's no signal coming in. Weak signals will then move the noise meter upscale. You'll be amazed how easy it is to get bearings on them! Switch to the S-meter position as signals become stronger and the noise meter tops out.

Remember: I said that there are two methods for noise metering. If you can't find a good DC take-off point in the squelch circuit of your particular VHF-FM receiver model, you can use the second method. Tap off the noise at the discriminator and build an external high-pass filter, noise amplifier, rectifier, and meter amplifier. It's easier than it sounds. A schematic and full details are in the T-hunt book. (Moell and Curlee, *Transmitter Hunting—Radio Direction Finding Simplified*, TAB Books #2701, p. 156. Available from Uncle Wayne's Bookshelf.)

How do you hunt when the hider is varying the transmitter power, making both the S-meter and noise meter bounce around like crazy? You'll want RDF equipment that does not depend on signal amplitude to obtain bearings. We'll discuss such units in the next column. **73**

LETTERS

From the Hamshack

Hypocrites?

First you guys complain that code is an unworthy item which should be eliminated, then you'll have some article on how easy it is to learn 5 wpm. I really don't get it, such hypocrisy! I think your goal is to sell more magazines to the new hams.

**Robert Wright, Radio Officer
US Merchant Marine
Lt jg USNR**

Code is still required for the ham ticket, and as long as it is, we will run articles on how to study it. Furthermore, since some people actually enjoy learning and using code, we will run the occasional code study article, even when a no-code license comes about.

The code controversy is widespread, and we try to present as many thoughtfully conceived opinions as possible, pro and con (see "Letters" in the June issue). Many of us believe there should be some type of license which does not require code, but that does require stiffer testing in theory and practice.

You are right about selling more magazines to new hams. In fact, we believe every ham should read 73—there is something in it every month for everyone. . .

Linda Reneau, Senior Editor

Alternatives to the CW Exam

There are many possible alternatives to the CW exam which would enrich, rather than cheapen, the ranks of operators. For example, why not a stringent exam on emergency operating procedures? How many hams today could, in a true emergency, function immediately as competent, professional conduits of information between agencies and people? Alternative licensing modules to the CW exam could be much harder than CW, and yet make our hobby more accessible to many people.

We can no longer continue to see ham radio shrink, and console ourselves with the thought that at least we kept out the CBers—because we are also keeping out the people we need to attract the most! If ham radio doesn't expand and attract more of the best and the brightest in electronics, our children may never have a chance.

I have been a licensed ham for thirty years. Recently I attended an ARRL forum to come to some understanding of why the ARRL seems so dead-set against any attempts to replace the CW requirement. I was very personally disappointed in the ARRL representative, as he repeatedly confused a no-code license with a no-work-to-get license.

It's time all hams rallied around some plan to strengthen our hobby and bring it into the twenty-first century. I think the first step on such a plan must mean that we have to make one thing very clear: that a no-code license should be, could be, and would be, a license that a person would have to work very hard for, in a dedicated and professional manner.

**Neil Shapiro WB2KQI
Bethpage NY**

Hear, hear, Neill!

CW—Not Just A Filter

It seems most people believe that the CW requirement is a way of weeding out riff-raff from our valued ham bands. Some argue that CW is out-moded and useless compared to the new digital modes.

RTTY, AMTOR, and packet, can be fast and accurate, but there's one very important fact: CW works during propagation conditions where the digital modes—even voice modes—fall down. How much more reason do you need to keep the requirement?

**Ronald Scott Gray N7CTF
Glasgow MT**

Another Success Story

About three years ago, my school received a grant of \$8,000 for a program called "the communications option." This meant constructing a radio station to train our students with the techniques of a disk jockey and commercial radio station management. After spending half the money, the school administration asked me to think of a way to spend the other half, and I said I would begin a program on amateur radio, about which I knew practically nothing at the time.

I received lots of material and help from the ARRL and designed a course to prepare 17 stu-

dents for the Novice exam. I bought a Kenwood 940 S/AT and accessories. I also purchased a tower, rotor, A-4 beam, and other things.

We all studied code and theory from *Tune in the World with Ham Radio*, then called two amateur operators from Queens College to examine us. We all passed, had a big party, and assembled a station.

Every one of those kids got on the air, made CW contacts, exchanged QSL cards, and had a lot of fun. The following year, they all went off to college and took with them something besides a high school diploma. Since that first group, we have continued the program and we have just licensed another 14 students.

Well, Wayne, this letter is to tell you that ham radio is not dead in some schools. There is also a loose knit group of amateur radio operators led by Marty Smith in the New York City School System. They are completing an amateur radio curriculum for students in the elementary through secondary grades.

**Bob Weinstein KE2FE
Richmond Hill NY**

What Cheek!

You're really asking for it. What an idea, that we should allow gay amateurs to use the airwaves and advertise in 73. Nonetheless, I think the idea is a good one. Would you allow your advertising staff to refuse an advertisement from a group of YL hams? No? Then how about German-speaking hams? Or maybe even Asian or Jewish hams?

The fact is pretty well proven that gay folks have no more choice about who and what they are than a Jew or Arab has. They have every right to live with as much freedom as everyone else, as long as they harm no one. That includes the right to get a license, to use the airwaves in accordance with regulations, and, yes, to organize and meet with others of similar background and experience. For 73 to print an advertisement from a group of gay hams (assuming the ad itself is not offensive) does not constitute an endorsement of anything other than the right of these people to exist. You do believe in that right, I hope. Allowing them to advertise in 73 would seem consistent with your history of backing progressive ideas. Frankly, I was surprised and disturbed that there should be any question at all over

this issue. By all means, print the ad, and continue to print it. Set an example for those people who insist on being blinded by their own prejudice.

**Gary Lee Phillips KA9NZI
Chicago IL 60640**

If we can't be blinded by our own prejudices, whose prejudices can we be blinded by? Gary, you're a trouble-maker. . . Wayne

Lambda ARC

In his "Never Say Die" column in May, Wayne Green asks for input from the readers as to whether or not 73 should run a classified ad from our gay and lesbian ham radio club. The readers might find the following information about our club useful in considering the question.

The purpose of Lambda Amateur Radio Club is to provide its members with opportunities for friendship, promote good fellowship, provide support and technical assistance, and facilitate enjoyment of the hobby. We are also dedicated to providing public service and promoting the amateur radio service.

Our club has assisted individuals in obtaining their tickets and helped inactive hams rekindle their interest. Our club is international, with 112 members in the US, Canada, and the United Kingdom. We publish a monthly newsletter containing technical and human interest articles, and we maintain a lending library of study materials for those wishing to obtain an amateur radio license or upgrade. We sponsor member nets which encourage members to operate in a variety of modes, and we sponsor an awards program with certificates for proficiency.

We wish to advertise in 73 simply to reach other individuals who might be interested in our club. Our club shares at least two important goals in common with all concerned amateurs: adding as many new hams as possible, and strengthening the amateur radio service. Last year, we increased our club membership by 60 percent, in spite of the fact that we have not been permitted to publicize our existence in mainstream amateur radio publications. We are confident that we can do our part to turn around the decline in our hobby if we're given a chance.

**Jim Kelly KK3K, President
Lambda Amateur Radio Club
Philadelphia PA 19130**

TECH TIPS

Pearls of Tech Wisdom

TVI Snake in the Grass

My friend's older tube final rig was driving him nuts, even though it seemed like he had checked out all the suspect circuitry.

He consistently overlooked, however, the plate chokes (56Ω, 1 watt resistors with four turns of wire). I snipped the resistor choke wires and found one resistor reading 7Ω and the other about 12Ω.

These things are sort of a shock absorber in that they pass everything under 30 MHz and inductively stop and resistively dissipate those components higher in frequency. The problem is that the wattage is too low, and the "Q" of the surrounding wire-wound coils is willy-nilly.

My solution: I replaced them with 2 watt units, wound with four turns of "solder wick," and added a ferrite bead at the plate cap ends of the unit. I obtained the ferrite beads from a Radio Shack ferrite pack. Any bead that will slip over the end of a 2 watt resistor lead will do nicely.

Now he's on the air, and the neighbors are off his case.

Terry F. Staudt W0WUZ L.P.E.
Loveland CO 80537

TS-930 AMTOR Keying Mod

(Reprinted from January '89 *NCARC Communicator*) First, go to the signal board and locate C500. C500 is a 4.7 μF electrolytic near the center of the board (if viewed with radio upside down, with the front facing you) near connector 30. Remove this capacitor by twisting it with a pair of needle nose pliers. This capacitor cannot be removed any other way without complete disassembly of the radio. Its function is to debounce the PTT switch and is a big reason why the 930 will not work satisfactorily in AMTOR mode.

The next step is to ground one leg of R476. This resistor is on the same board just above the large CW filter. The lead of R476 that is exposed is on the side of the resistor that needs to be grounded. An easy and foolproof way to do this

is to locate R474, right next to R476, and scrape some of the insulation from both of the exposed leads and solder a bridge between them. Note: The leads that are not easy to get to are not the ones to worry about.

These modifications are recommended by Kenwood and will prove to be very satisfactory.

W5AU

Removable Weatherproofing for Connectors

Every time I work on my outdoor antenna system, I find that I need to weatherproof a few coax connectors. After all, coax is expensive and I don't want moisture to get inside of it and spoil it.

Over the years I have used silicon glues, butyl caulk, plastic electrical tape, and recently a shoe repair glue. All provided protection, at least initially. Although the shoe glue and the butyl caulks lasted very well, they were murder to remove from the connectors when I wanted to open them.

I recently came across a new product that weatherproofs very well, but allows me to open the coax connectors when necessary. Star Brite® Liquid Electrical Tape, available in several colors,

is a liquid vinyl which seals out moisture and prevents corrosion in wires, terminals, and connectors. It dries to a flexible coating.

Star Brite comes in a can with a brush applicator attached to the screw-on cap. Just brush the liquid onto the exterior surface of your coax connectors, being sure to coat all joints and an inch or more of the coax sheath. Allow it to dry for five minutes.

This product was tested by UL (Underwriters Laboratory) and found to offer better dielectric properties than plastic electrical tape.

I found that it was no problem to remove the coating of Star Brite on coax connectors with my pliers and a pocket knife. Porous surfaces were another story. The coating does not come off of them very well.

Star Brite Liquid Electrical Tape is available in 4 fl. oz. cans for \$5, and in 2 lb. cans for \$25. The manufacturer states it is available at True Value Hardware stores or direct from *Star Brite, 4041 S.W. 47th Ave., Ft. Lauderdale FL 33314. (800) 327-8583.*

Bill Clarke WA4BLC
Falls Church VA 22042

continued from p. 76

tact on a cold day, with low humidity, a condition here in California that we call an on-shore flow. The relatively dry air from the land mass flows out to sea.

The 24 GHz contact made over this 100 mile path was poor quality, and we didn't make a full exchange. We plan additional tests, and we'll continue until we make contact. We used the simpler but very efficient NEC 24 GHz units. We consider the NEC 24 GHz unit to pack quite a punch, considering its low cost.

24 GHz Waveguide Transition

Kent WA5VJB has come up with the construction of a 24 GHz WR-24 waveguide transition (see Figure 2). Kent is constructing a 24 GHz SSB system using a 10 GHz IF and a 13 GHz injection frequency to a mixer for generating SSB on 24 GHz. I will provide the construction details in a future column. Thanks to Kent and the North Texas Microwave Society. Be sure to check out their bi-monthly newsletter *The Feedpoint* (contact Wes Atchison, Rt. 4,

Box 565, Sanger TX 76266).

General VHF/UHF News

News from the *Midwest VHF Report* is that several stations took advantage of the aurora during the VHF Sweepstakes. WA9O worked 10 states on 2 meter SSB. N/0LL added 20k contest points to

his score by making 39 contacts on 220 MHz and 1296 MHz. Rich K9DZE had a SUPER Aurora Saturday and Sunday. He picked up 10 new grids on 2 meters and 12 on 6 meters.

In Michigan, Bruce Rittenhouse N8IRW and Ken Hendrickson N8DGN have formed the West Michigan Microwave Group. They're out to shatter some myths about microwave operation:

MYTH #1 *It's only good for line-of-sight operation.* Not true! The same tropospheric scattering that makes QSOs of up to 500 kilome-

ters possible on 2 meters (on a dead band), is also present on 10 GHz. Band openings occur on microwave frequencies, too. From the *RSGB VHF/UHF Manual*, 4th Edition: "There was a famous occasion in 1798 when the whole of the French coast from Calais to Dieppe became visible one afternoon from the cliffs near Hastings. Effects such as these are even more pronounced at radio frequencies."

MYTH #2 *It's expensive.* N8IRW and N8DGN are busy showing their home-brew trans-

ceiver, which cost about \$50 to build and works very well, at swap meets and clubs.

MYTH #3 *You have to be a Ph.D. to work microwave.* You don't have to be an RF expert to build a microwave station. There are several active amateurs in this country on various microwave bands who are not even technicians or engineers.

I will be happy to answer any questions related to microwave operation. For a prompt reply, send an SASE to the above address. Best 73s. **73**

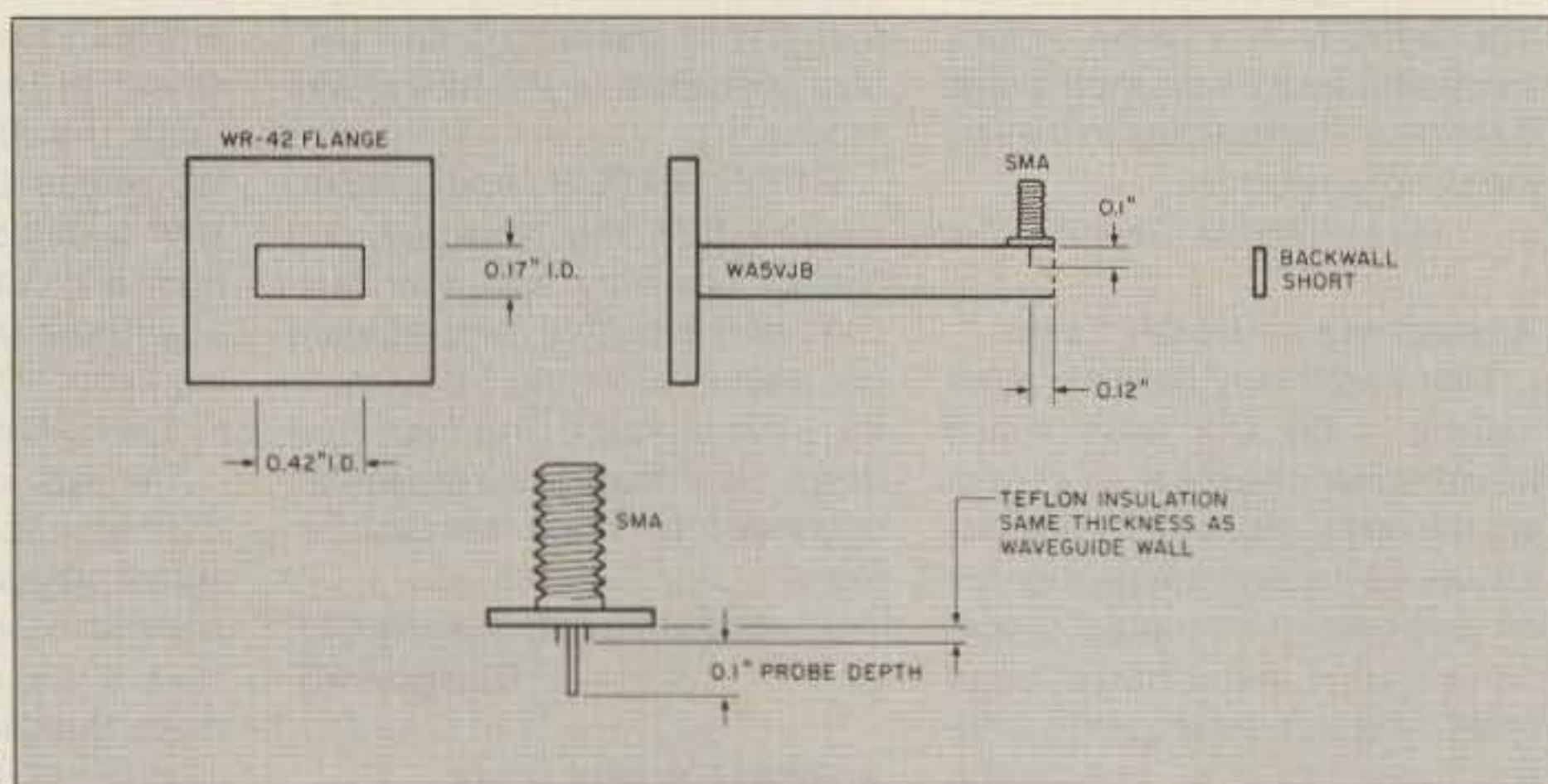
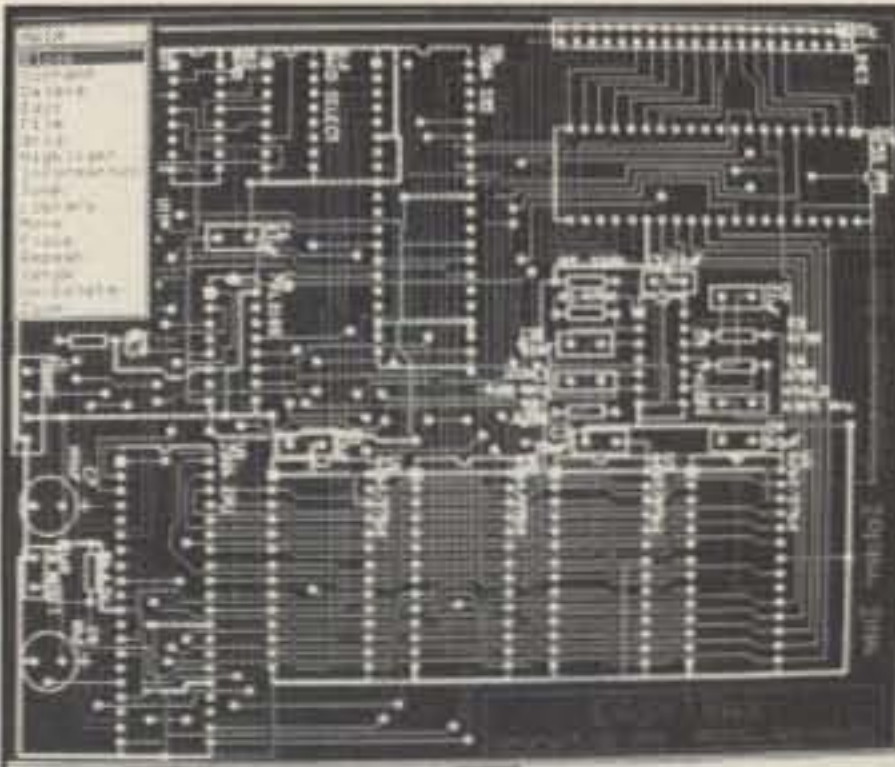

Figure 2.



EASY LOW- COST PCB DESIGN

PROTEL-EASYTRAX ~~\$495~~ **INTRO PRICE \$395**

Easy to learn, easy to use manual PCB design package. Capable of producing professional artwork for multi-layer, through-hole boards to 32 x 32 inches. Host of powerful editing features make efficient PCB lay-out a breeze. Gerber and NC Drill output.

Protel offers other fine programs: PROTEL-SCHEMATIC, the easy to use schematic capture program, and PROTEL-AUTOTRAX, the full-featured PCB layout program.

HARDWARE: IBM PC/AT/XT/PS2 or compatibles..... 640K RAM..... 2 floppies or a hard disk..... PC or MS-DOS greater than version 2.0

ORDER TOLL FREE, CALL: (800) 544-4186

If you are in CA, HI, AK, or Canada, call: (408) 437-7771

PROTEL TECHNOLOGY INC.

A Member Company of Critec Corporation

50 Airport Parkway
San Jose, CA 95110

(408) 437-7771
fax (408) 437-4913



CIRCLE 378 ON READER SERVICE CARD

Orbit the World With The **DISCOVERY DX-II**

The First 10/11 Meter Beam to Launch Your Signal with **G.A.P.** Technology, the **DISCOVERY DX-II** is Pretuned and has No Matching Networks!

The **DISCOVERY DX-II**, the Beam of the 21st Century:

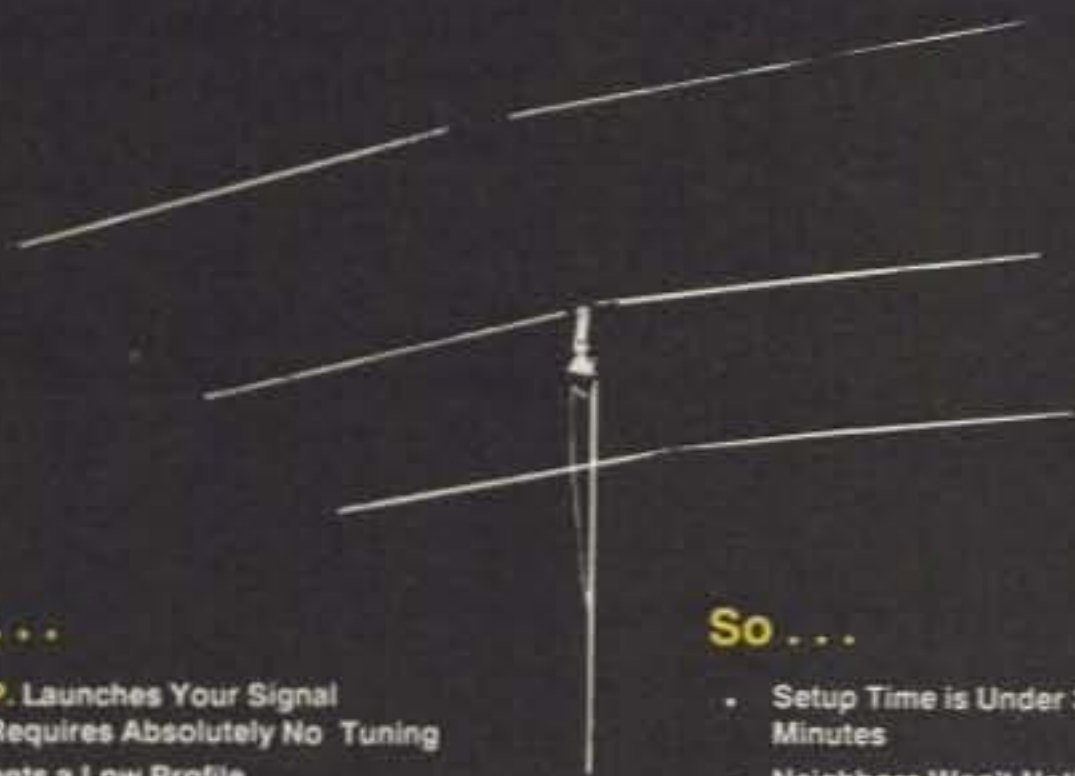

That . . .

- **G.A.P.** Launches Your Signal and Requires Absolutely No Tuning
- Presents a Low Profile
- Weighs only 8 Pounds
- Wind Loads 1.2 sq. ft.
- Is Constructed of Stainless Steel & Aluminum
- Fully Sleeves Together
- Has Excellent F/B and Gain

So . . .

- Setup Time is Under 30 Minutes
- Neighbors Won't Notice
- It is Readily Mast Supported
- A TV Rotor Can Easily Turn It
- It Will Withstand the Elements
- Hose Clamps are Not Necessary
- You Can Orbit the World !!!

To Order Call—(407) 388-2905

119.00 plus shipping & handling
Florida residents add 6% tax



G.A.P.
ANTENNA PRODUCTS
6010-Bldg J
N. Old Dixie Highway
Vero Beach, FL 32967

CIRCLE 157 ON READER SERVICE CARD

Round-trip to Europe* on **G.A.P.** Airwaves for only \$169.00

Introducing

THE CHALLENGER DX-V

A Unique Multiband Antenna that Utilizes the Patented **G.A.P.** Center Launch Technology

The Revolution in Antenna Design

That . . .

- Operates all five bands 80'-40-20-15-10m
- Launches RF from an elevated **G.A.P.**
- Provides 1500 W peak operation
- Assembles in less than 30 minutes
- Comes pre-tuned. No adjustments are necessary
- Has short Radials 3' or 25"
- Is self-standing with a drop in Ground Mount
- Is only 31 Feet High
- Has a wide bandwidth (less 2:1)

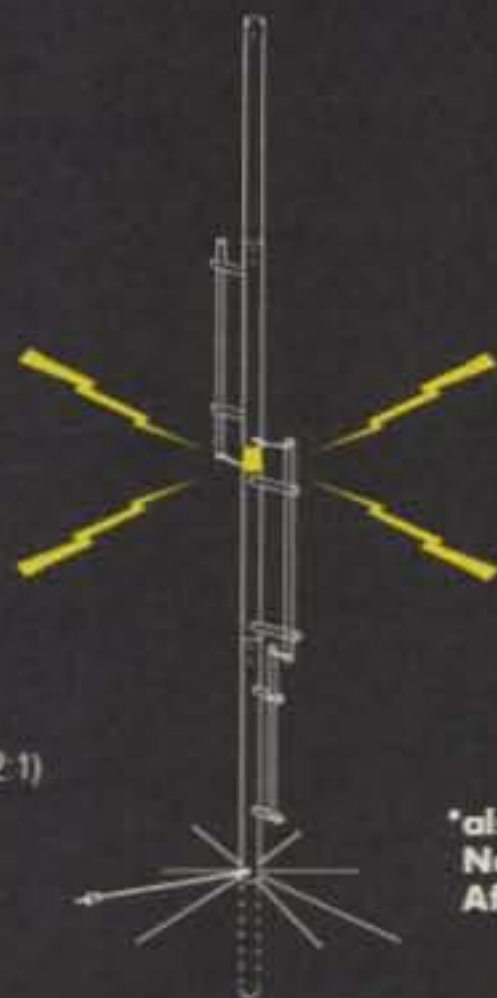

but has **NO!!!**

- Traps
- Coils
- Transformers
- Baluns
- Resistors
- or Base Insulators

*also Asia, South America, North America, Australia, Africa and Antarctica.

Best of all the **ENTIRE** antenna is always active!!

To Order Call—(407) 388-2905

169.00 plus shipping & handling
Florida residents add 6% tax



G.A.P.
ANTENNA PRODUCTS
6010-Bldg J
N. Old Dixie Highway
Vero Beach, FL 32967

CIRCLE 373 ON READER SERVICE CARD

Ver 3.7

QSO Tutor

Copyright © 1988 - 1989 by N4CST



PC Study Aid for the Amateur Radio Exams

Study for your Novice license or upgrade to a higher class the easy way, with individually tailored studying that analyzes your performance and concentrates where you need it.

Program Features:

- Runs on IBM Personal Computers and compatibles with minimum 256K RAM and graphics capability.
- Contains entire question pool for each license class.
- Work with the entire pool, selected areas, or automatic selection of questions in your weak areas.
- Includes full screen graphics and explanations on appropriate questions and a pop up calculator.
- Logs multiple study sessions and allows resuming at a later time, returns to review missed questions if desired.
- Creates randomly generated or custom sample tests and analyzes results showing areas for additional study.
- Will print random written tests and answers with Epson/IBM compatible printers.

Public Domain disk also available contains excellent Morse code tutor as well as contest logger, propagation predictors, beam plotter and others. Cost is \$3 to cover materials and handling, \$2 if shipped with QSO TUTOR.

Call or write to order:

QSO Software
208 Partridge Way
Kennett Square, PA 19348
215-347-2109

\$29.95 per Class

VISA & M.C. accepted

- PA residents add 6%
Price includes shipping

"Using QSO Tutor made studying for the exam enjoyable and interesting. thanks to your program I passed the technician test with a perfect score."
N3GME

"Thanks for thinking of us hams. Your program has eliminated the worry of the Theory part of the test for me."
KA3RHW

"As a computer professional, I can recognize a quality piece of software. As a student I can help me gain the confidence I need to pass the amateur exams. By the way, I passed with 100% of the questions answered correctly."
Dan Dereence Jr.

CIRCLE 145 ON READER SERVICE CARD

73 INTERNATIONAL

edited by C.C.C.

Notes from FN42

Amateur Radio has always been international in the sense that political boundaries, obviously, have never been able to stop radio waves in midair. Today, however, international broadcasting (governmental, commercial, and also private—amateur) is purposeful to a degree not ever known before; and the worldwide communications of "tomorrow," meaning in immediate future months and then all future years, is going to boggle our minds.

Just as an example: As Wayne W2NSD/1 said in an interview for an article a few months back, "...in 10 or 15 years we'll [be using] a little laptop keyboard for writing messages and [having] them delivered anywhere in the world in seconds, for pennies."

It is May 17, 1989, as we write these words for the August "73 International," and they are to remind you that on this date the 166 member nations of the ITU (the International Telecommunications Union) celebrated the 21st World Telecommunications Day. A year from this date they will be celebrating the 22nd World Telecommunications Day.

We think it would be a great idea if Amateur Radio clubs around the world scheduled some events in honor of internationalism, little events or big ones, on or around May 17, 1990—and let us know about them! If you have

sent us your plans (and pictures, if you can) before the end of February, 1990, we will be able to make the May 1990 issue internationally special! See the feature item of this month's column, below, "Communications At The Crossroads."

Roundup

**Albania. EXCLUSIVE! A DX-
pedition to ZA—the rarest of the rare!** Not since the 1971 trip by Martti Laine OH2BH has an Albanian trip been in the news. This one, proposed for September of this year by Peter Vekinis EI4GV (19 rue Le Titien, 1040 Brussels, Belgium; Tel: 02/ 736-3690; Fax 03/ 271-1715; The Source ID: IP2006), is still being worked on—contact him for details and watch for more information.

Austria/China.[•] (Roundup items marked [•] are from Sweden Calling DX-ers, the publication of Radio Sweden.) A delegation from Radio Austria International went to China on the invitation of Radio Beijing and the Chinese government to discuss a possible exchange of broadcasting hours and relay cooperation.

Australia.[•] We may get more details from VK3AJU, but a flash for now: The new Radio Australia transmitter at Brandon, Queensland, had two days of use before along came Tropical Cyclone Aivu and its 200-kilometer winds and put it out of business. The storm equalled the ferocity of 1974's Cyclone Tracy which wiped out

Darwin, and reportedly killed 4 and injured many.

Costa Rica.[•] For the third year in a row, the Swedish DX Federation has named Radio Impacto of Costa Rica "QSL Station of the Year." This shortwave station has answered reception reports even though it has not intentionally been broadcasting for listeners abroad. Its programming has been political and aimed at neighboring Nicaragua.

Switzerland. The First World Book and Audiovisual Fair on Telecommunications and Electronic Media will take place in Geneva between October 3 and 8. It will be associated with ITU-COM 89, the first World Electronic Media Symposium and Exhibition. Further information from: *Book Fair '89 Secretariat, ITU, PR Division, Place des Nations, CH-1211 Geneve 20, Switzerland.*



CANARY ISLANDS (Spain)

Woodson Gannaway N5KVB/EA
Apartado 11
35450 Santa Maria de Guia
(Las Palmas de Gran Canaria)
Islas Canarias
Spain

It feels time to send in something from the Canaries again. Today is El Dia de los Trabajadores (Labor Day, I think, or May Day, as it is now called in China, France, Germany, and the USSR) and so nobody is working.

We live in a small town on the NW side of the island of Grand Canary; the town is Santa Maria de Guia. It's famous for its cheese and as a long time supplier of the best of Canary knives. The acknowledged best of the few men still forging blades for these distinctive knives is in his sixties, and I work in his shop every morning to learn. In the afternoons and evenings, I teach my English classes.

I get on the radio whenever I can; up to now, usually CW above 21.100 on 15 meters, but I'm starting to branch out a little more. The old Drake covers 80-10 and I've dipoles for 40-20-15 so far. For the present I have to stay on my long, narrow balcony, so I'm somewhat limited. Still, I get over to the US now and then with a 559 signal (the balcony is open to the E, not to the W). Although no trou-



Woodson Gannaway N5KVB/EA,
Canary Islands, Spain.

ble to boom into Yugoslavia, it's a challenge to go elsewhere.

Radio Club Cultural Gran Canaria (EA8RCT) in Las Palmas is proceeding with remodeling its meeting room and adding additional space outside. The two areas will be joined by large sliding doors to allow use of both areas together during the marvelous summer evenings when a lot of hams gather there.

(A friend there also asked me to mention their continued wholehearted participation in all contests, with all QSL cards replied to.)

The Club de los Radioaficionados del Noroeste (Amateur Radio Club of the Northwest) came up with and executed an idea a few years back—around 1982, perhaps. Maybe somebody can send me a photocopy of the QSL card? I wanted to find a photo of this so bad, but just haven't been able to turn one up! Drat! [Do keep trying—we'll publish it!—CCC]

Members of the club, based in Guia and Galdar, spawned and brought to fruition the idea to make a walk around the perimeter of this island with radio equipment—the radios to be carried by a burro. They fashioned a rack to balance the radios and batteries, with an extension out over the burro's tail to carry the antenna.

They secured the special call-sign EA8VIB (EA8 Vuelta de la Isla con Burro—Trip Around the Island With a Burro—although in English VIB could also be "Very Important Burro") and operated on five bands.

So, for five days they walked around this scenic island with the burro carrying the gear and batteries and acting as a station platform. A doctor went with

Calendar for August

- 1—Army Day, China; National Holiday, Switzerland (2nd for El Salvador, 9th for Singapore)
- 3—Memorial Day, Cyprus; Independence Day, Niger (6th for Bolivia, 10th for Ecuador, 11th for Chad, 14th for Pakistan, 15th for India, 17th for Indonesia, 19th for Afghanistan, 25th for Uruguay)
- 4—Freedom Day, Guyana; National Day, Jamaica and Burkina Faso (15th for Congo and Korea, 20th for Morocco, 31st for Malaysia and the Republic of Trinidad and Tobago)
- 7—Battle of Boyaca, Colombia; Bank Holiday, Ireland
- 12—Queen's Birthday, Thailand
- 13—Women's Day, Tunisia
- 16—Restoration Day, Dominican Republic
- 20—Constitution Day, Hungary
- 23—Liberation Day, Romania (27th for Hong Kong)
- 24—National Flag Day, Liberia
- 28—Summer Bank Holiday, Great Britain
- 29—Heroes Day, Philippines
- 30—Victory Day, Turkey

them—a good thing because there were numerous foot problems (for the people, not the burro). They camped out at night and recharged the batteries.

When they completed the circuit and were walking back into Guia, it was a festival day, so they got a rousing welcome with lots of people cheering and church bells ringing!



GREAT BRITAIN

Jeff Maynard G4EJA
32 Waldorf Heights
Hawley Hill
Camberley GU17-9JQ
England

Regular readers of this column will know that the 50-metre band became available to UK amateurs only quite recently. So major openings still capture the attention of us all; indeed, the events of the last weekend of February have been described as the biggest 50-metre event since the band became available.

Things began to look promising on the Wednesday when LU5EZT maritime mobile was worked 5 and 3 each way from G0DAZ in Worcester (pronounced *Wustah* for intending tourists!). By Saturday, things really began to hot up with the VS6SIX beacon being heard just before 0900; this was quickly followed by what is believed to be the first G to VS6 QSO on 50 MHz, when G4UPS worked VS6UP with strong signals and full readability in both directions. G stations on the South Coast are also believed to have worked VS6TC, WA, and GU.

Barely was the excitement of VS6 contacts in control when a number of Japanese stations were heard 5 x 9 at about 0915. Indeed, JA4MBM was still being heard 5 x 9 at 1100. Unfortunately, despite the strength of the JA signals, there are no reports of two-way contacts with G stations on this day, although G3XBY is reported to have worked "several" Japanese stations.

Back to Saturday when, at the time the JA stations were first being heard, ZS6BMS was worked 599 both ways by G0DAZ, who also is believed to have worked T77C (San Marino) for another probable first.

Perhaps the biggest pileup oc-



Eddie V. Manalo DU1UJ, founder of the AsiaNet Group, and presently QRV on 14.111 MHz, operating DU1BBS packet bulletin board mailbox.



Art Lising DU1AUL, QRV on packet VHF, 144.090 MHz.

curred when J52US in Guinea-Bissau was working G stations with good reports both ways. Other exotic DX was heard in the shape of TR8CA (Gabon), ZS4TA, and numerous VS6s added to the pileup. Less exotic, but nevertheless welcome, DX was apparent from North America when the opening swung in that direction by Monday. Amongst those stations heard were K2QIE, VE1YX, and K2GAC.

Other examples of this opening included the 10-metre beacon, VK2RSY, being heard 5 and 5 and a whole clutch of exotica heard (but not worked) including stations from DU1, Z23, CT1, 9HI, HC5, and HC1. The world's QSL managers will no doubt be busy in the next few months!

If the 50 MHz opening was not enough, there was a major auroral event beginning on Monday, March 13th and opening up the whole of Europe to 144 MHz stations. Indeed, so strong was the aurora in Scotland that stations were reporting 5 and 9 signals from Sweden regardless of the direction in which they pointed their beams.

Stations as far north as the Midlands (say, between Birmingham and Manchester) reported good contacts with the Channel Islands, Germany (East and West), Scandinavia, Yugoslavia, Czechoslovakia, Austria, Poland, Hungary, and Italy. Stations in the east of England had numerous

contacts with Russian stations, including those in UQ2, UC2, UR2, and UB5.

The same event giving all this lovely DX was responsible for a blackout denying communications to the base camp of the ill-fated attempt by Sir Ranulph Fiennes to walk to the North Pole. Ten-metre contact was eventually established with the base camp by the London Control Centre. Despite the temperature of minus 40 degrees Celsius (!) the base camp reported everyone to be in good spirits.



PHILIPPINES

Lynn V. Manalo DU1AUJ
AsiaNet Packet Network
Box 68, U P Diliman
Quezon City 3004
Republic of the Philippines

[We were happy to receive this report from DU1AUJ; in fact, we are always happy to receive reports from citizens of all countries outside the USA, particularly when there has been a long silence from a Hambassador. Lynn is thought to be the first Asian woman to go on HF packet and is the only XYL station on AMTOR and RTTY. She is active on 20 and 15 meters, and is active daily beginning around 1300 UTC;



Lynn V. Manalo DU1AUJ, founder of the Asian YL-Net, on HF RTTY, ARQ, packet and SSB.



David Tan 9M2DT, on 14.111 MHz, operating 9M2BBS packet mailbox.

presently she handles the Asia YL-Net on 21.188 every Sunday at 0700 UTC.—CCC]

The Republic of the Philippines has been a center for world news since the days of what they called "The Peaceful Revolution." With all the changes in the government, the progress of amateur radio was not hampered. Activities, particularly in packet related matters, grew, and success followed success.

On July 1, 1986, Eddie DU1UJ with Kohjin JR1EDE founded the AsiaNet Packet Network. For several months they were the only stations handling traffic all throughout Asia, but later were joined by AX4BBS (Brian VK4AHD) and Gil VK6AGC. This expanded the operations quite a bit, as did the next additions, 9M2BBS (David 9M2DT) and YB1BBS-Kinta. With all this cooperation, they later decided to move to 14.111 MHz from 14.107 MHz to have a good link with the USA. This made it possible to hook into SkipNet. And with the efforts that these fellow amateurs are making, the world is helped to meet one common objective: to promote friendship and brotherhood.

Locally, on VHF, there are many packet bulletin board systems operating. In the Metropolitan Manila area there is DU1BBS operated by Eddie DU1UJ, Art DU1AUL, Glenn DU1CUP, Mon

MEMBER

ZS6ET
 S42ET
 DF4YE

PETER STRAUSS
P.O. BOX 35461
NORTHCLIFF 2115
REP. OF SOUTH AFRICA

Promote a common world wide
radio amateur licence!

SOUTH AFRICA

CARAVEL
BARTOLOMEU DIAS

TO RADIO					
DATE	UTC	FREQ	RST	MODE	QSL
					TNX PSE

BEST 73 GOOD DX

DU1BJD, Paul DU1POL, Eddie DU1EAG, and Pete DU1PJS. In the south of the Philippines there is Den DU9EW, and in the north, Mo DU3MF.

With all these BBSs in town, DU1UJ decided to put up a digipeater in Tagaytay, utilizing a KPC-4 and ICOM 28H and 48A. The vast activities of this digipeater is proven effective, for it covers most of the Luzon area—the biggest of the three main Philippines islands.

In the Mindanao area, DU1POL and DU9BC have established a digipeater at Mt. Kitanlad which is supposed to cover the island of Mindanao; and right now these fellow hams are negotiating for the establishment of a third digipeater, in the Visayas region—the island between Luzon and Mindanao.

With these and continuing efforts, it won't be long, we hope, before all of the 7,100 islands which make up the Philippines are linked together into one, through the wonders of amateur radio.



SOUTH AFRICA

Peter Strauss ZS6ET
PO Box 35461
Northcliff, ZA-2115
Republic of South Africa

News Items

The South African license authority will consider applications for short-term permits from amateurs from any country holding CEPT Class I- or II-compatible licenses—except Novice, since there is no compatible license grade here.

The South Africa administration has concluded bilateral agreements with 15 countries (see box).

The rare DX country, Marion Island, is on the air again, with Peter Sykora ZS6PT using the call ZS8MI. Amateur Radio Spectrum on RSA—the Voice of South Africa—will regularly give news of this operation, weekly, as follows (times approximate): **SATURDAYS—1345 UTC** to India, the Far East—21590 and 17755 kHz; Southern Africa—9585 kHz; **1445 UTC** to Middle East, Eastern Europe—25790 and 17755 kHz; Southern Africa—11925 kHz; UK and Europe—21590 kHz; USA and Canada—21670 kHz; **1845 UTC** to UK and Europe—21535 and 17795 kHz; **1945 UTC** to West Africa—21590 kHz; to Southern Africa—7295 kHz; to East Africa and Middle East—17795 kHz; **SUNDAYS 0245 UTC** to USA and Canada—9815, 9580, and 11730 kHz.

Peter will often be heard around 1830 UTC on 14145 kHz—a good time to learn of the next few days' activities. Please do not break in until he has finished his traffic with his QSL manager. QSL address: ZS6PT, PO Box 1387, Vanderbijlpark 1800, South Africa (or through the bureau). If you expect a QSL direct, include suitable postage in US\$ or IRCs. **73**

BILATERAL AGREEMENTS, SOUTH AFRICA AND:

Bophuthatswana
Botswana
Chile
Ciskei
W. Germany (Incl. W. Berlin)
Great Britain
Israel
Portugal
SW Africa/Namibia
Swaziland
Switzerland
Transkei
Venda
USA
Zimbabwe

COMMUNICATIONS AT THE CROSSROADS

When Prince Henry of Prussia tried to telegraph a thank-you message to President Theodore Roosevelt at the turn of the century, it was refused because his ship's equipment was incompatible with that of the coastal receiving station. And when the *Titanic* was sinking, radio distress signals to a passing ship went unheeded as its radio operator slept through the night.

This would not happen today. International standards ensure world linkages of compatible and interference-free networks which allow an unfettered flow of signals across national borders.

International cooperation was not always necessary. When Samuel Morse sent the first public telegraph message in 1844, no one dreamed the breakthrough would actually alter life as it was then. Early telegrams went from city to city, always within national boundaries. But as communications spread from country to country, the need for global international legislation prompted 20 countries to meet in 1865. They drew up the first International Telegraph Convention, the precursor of today's equivalent of a charter for the ITU, the International Telecommunication Union.

The 20 founding States of the ITU in 1865 were: The Austro-Hungarian Empire, the Grand Duchy of Baden, the French Empire, the Free City of Hamburg, the Empire of all the Russias, the Swiss Confederation, the Ottoman Empire, and the Kingdoms of Bavaria, Belgium, Denmark, Spain, the Hellenes, Hanover, Italy, the Netherlands, Portugal and the Algarve, Prussia, Saxony, Sweden and Norway, and Wurttemberg.

Today, the Union's 166 members meet regularly, countries talk to each other instantaneously, and airwaves circle the globe, but there are new challenges as the 21st century approaches. The speed and complexity with which people now communicate requires unprecedented cooperation and international agreements involving rules for sharing costs when calls transmit through more than one country, harmonized switching and transmission principles to interconnect a variety of national networks, and regulation of frequencies to allow for satellite systems and broadcasting and mobile services for maritime, aeronautical, and land communications to function throughout the world.

"The telecommunications industry has changed drastically. There are more players now, with traditional users and providers constantly exchanging places as they mix and match equipment, networks, services, and information to provide each other with new services and business opportunities. . . The success of world finance and global trading depends not just on a few rules, but on the movement of goods, on financial services, and especially on telecommunications to support all this activity."

Richard E. Butler, ITU Secretary-General

Last May, the 13th Plenipotentiary Conference in Nice, France, examined a series of crucial issues with respect to future challenges. Economic zones will have to be considered, such as the European Community in 1992, and new cooperative relationships within North America and Asia. The committee called for more results, more quickly. As one example, it called for a new policy to cut paper flow. In 1988 60 kilopages of documents were produced for activities of the International T & T Consultative Committee (CCITT) alone! And more pages pertained to others of the 438 experts (from a roster of 2,500) who undertook 591 field missions in 1988. Last year US\$31 million was spent on projects in developing countries, financed mostly by the United Nations Development Programme and Funds-in-Trust.

CIE Cleveland Institute of Electronics

Accredited Member National Home Study Council

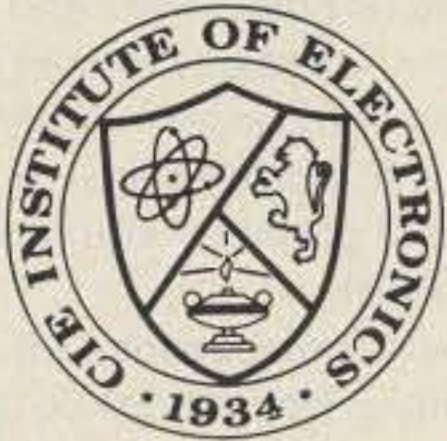

CIE is the world's largest independent study electronics school. We offer ten courses covering basic electronics to advanced digital and microprocessor technology. An Associate in Applied Science in Electronics Engineering Technology is also offered.

Study at home — no classes. Programs accredited and eligible for VA benefits.

CIE Cleveland Institute of Electronics
1776 East 17th St., Cleveland, Ohio 44114
YES! I want to get started. Send me my CIE school catalog including details about the Associate Degree program.

Print Name _____
Address _____ Apt. _____
City _____ State _____ Zip _____
Age _____ Area Code/Phone No. _____
Check box for G.I. Bulletin on Educational Benefits
 Veteran Active Duty **MAIL TODAY!**

AAR104

CIRCLE 157 ON READER SERVICE CARD

AMATEUR SOFTWARE FOR YOUR IBM PC/XT/AT/PS2 AND COMPATIBLES.

Bill Kantz WD2AEV
B & K Computer
1863 Cambridge Dr.
Wall, NJ 07719

SATRACK—A very simple to use satellite tracker. Will display AZ-EL for up to 10 satellites in tabular format. Also includes variable time window & time step.

COMPULOG—Sophisticated computer logging for the DX'er or contester. Search QSO's by call, prefix, name, time & date. Produces QSL report for cards to be sent and QSL's to be received.

System Requirements: 256K Memory; 1 Disk Drive; Color or Monochrome System.
Programs are \$19.95 each or \$34.95 for both, plus \$2.00 S/H.

VISA TO ORDER CALL 1-800-842-9127 MC

WHEN DOES ONE EQUAL TWO? WHEN IT'S A TAD M8 FM TRANSCEIVER COMMERCIAL & AMATEUR BANDS IN ONE UNIT



- Ideal for MARS, Vol. Fire, EMT, B'cast RPU, Police, etc.
- Fully Field Programmable
- 99 Channels
- True 40 Watt Power
- Extremely Rugged
- Multi Function LCD display
- Frequency Range 138-174 or 430-480 mHz
- FCC & DOC type accept.
- Low Cost DTMF mike avail.
- Overnight Shipping Available
- Shipped Complete w/Mike, Mobile Slide Mount & Power Cable
- Base Station P.S.; mobile Antennas etc. in Stock

AXM Incorporated
11791 Loara St.

Garden Grove, CA 92640-2321

Write or Call 714-638-8807 for immediate information



CIRCLE 360 ON READER SERVICE CARD



JOIN ARRL

BENEFITS FOR YOU

QST, QSL Bureau, Awards, Low Cost Insurance, Operating Aids, Government Liaison and More—Much More!

MEMBERSHIP APPLICATION

Name _____ Call _____

Street _____

City _____ Prov./State _____ PC/ZIP _____

\$25 in U.S. \$36 elsewhere (U.S. funds) Licensed amateurs, or age 65 or over, upon submitting proof of age, may request the special dues rate of \$20 in the U.S. \$28 elsewhere, in (U.S. funds) Persons age 17 and younger may qualify for special rates, write for application.

For postal purposes, fifty percent of dues is allocated to QST, the balance for membership.

Charge to VISA Mastercard AMEX Discover Expires _____

Card Number _____ Signature _____

The American Radio Relay League

225 Main St. Newington, CT. 06111 USA

73

GET YOUR BEARINGS STRAIGHT



At last! A map dedicated to the radio amateur. Announcing the **Azimuth-Equidistant** wall map from the Great Circle Map Co.

An azimuth map provides information about heading and range to any place on Earth. No longer will you have to guess at which way to aim your beam antenna for that rare DX.

Each map is specially drawn with your station at the exact center. The rest of the world is spread out around you. To use the map, simply find the target station and read the compass heading from the border of the map. To find the range, count the number of rings from the center. Each ring is spaced 1000 miles apart. Voila! You now know the true heading and range to the target station.

The maps are custom drawn with computer accuracy for your location and are personalized with your station's call sign at the lower right. Each map measures 35"x23", is brightly colored, and is printed on high quality poster stock making it suitable for framing.

To order, send \$59 check or money order and your station's call sign and location (if you live in a large city, state which side of town) to:

Great Circle Map Co.

P.O. Box 691401 • San Antonio, TX 78269

DEALER INQUIRIES INVITED

CIRCLE 346 ON READER SERVICE CARD

NEVER SAY DIE

Continued from page 8

To be honest about it, what we have is a government policy of screwing small business. Think about it. Both the administration and Congress are like willows, bending whatever way lobbyists blow. And lobbyists are paid by big business, not by small. Thus small business has little control over the government—little say—little power. The government moves the way money pushes it, and big business has the millions to be heard—clearly—wiping out the faint background noise from small business which has only thousands to spend.

Myopia—Doing Away with Tomorrow

Worse, and you've been reading a lot about this lately (if you've been reading), big business is totally in the grip of the quarterly report, so its goals are invariably short-range. There's no planting of seeds possible, just reaping as if there is no tomorrow, which takes care of eliminating tomorrow just fine. So we've avoided automation and updating our old factories; avoided technology's benefits.

How far are you willing to let all this go? When are you going to lift your head and take a look at what's going on? Are you going to let America sink into a miasma like the horrible mess Britain is in? It wasn't very long ago it used to be called *Great Britain*.

Britain got into deep trouble earlier than we because the lowered transportation and communications costs hit them sooner, being so close to the Continent. Their unions, abetted by labor governments, refused to face the reality of global competition. Now they have millions of people who are out of work and may never work again. They have a new generation which has never worked and may never work—no jobs because the unions forced their industries to lose money until they closed. They fought automation and lost jobs.

If I'm right, what can we do to cope with the changes? Can we hold back the ocean by stubbornly refusing to come to grips with the ways technology has changed the world? We see just that mentality at work with Morse Code in amateur radio. We see it in unions which fight reality. We see it in weak government officials who blow with the winds from union PAC funds and lobbyist money from big corporations. We see it in a Congress whose priorities are (1) getting re-elected, (2) getting the money needed to buy re-election, and (8,275) doing what's best for the country.

The Strength of Our Country

Once we recognize that small business is the real strength of our country—and I mean small manufacturing businesses much more than service businesses—we can start working to build this strength. But won't the economies of scale always allow big business to produce lower cost products than a small business? Only in a few industries where tooling costs are enormous. Oddly enough, the bureaucracy which inevitably builds up in a big business, keeps it from being able to compete head-to-head with the almost always more efficiently run small businesses. So big business has to pull every dirty trick it can to wipe out pesky small businesses.

If we're going to have strong small businesses, we have to have people to run them and work for them. This comes down to education. Again, unless you're just off the turnip truck, you know that

every recent study has rubbed our nose in how poor our education is compared to many other countries—in how much it has gone down in quality in the last fifty years. We're not going to be able to compete with Korea, Singapore, Japan, Taiwan and Europe unless our educational system is at least as good as theirs.

The worst part of this is that we've been protected against much of the potential competition the world could offer. The beyond-description poor management of African countries has kept them from being players so far. The same in India, Malaysia and Indonesia have also protected us. Imagine what could happen if China and Russia ever notice that communism has never worked anywhere in the world it's been tried, and stop hobbling their industries with government planning!

Using Technology in Education

We do have the potential to come out on top of all this in the long run. We have the potential to turn things around and stop going the British route. That opportunity lies in being the first country in the world to modernize our education—to come to grips with technology and use it for our benefit, instead of fighting it.

Our teachers brag about how they have defeated every high-tech teaching aid which has been offered them. They brag about killing off the use of audio cassettes, film strips, films, video and now, computers. They're not going to lose their jobs just because there are some more efficient ways of teaching.

Did you see the recent articles in news magazines about how our kids are learning less and less? We amateurs are so used to talking with the world that we know pretty much where things are, but in a recent test 14% of the kids couldn't name the country just to the north of us—and 37% didn't know what country was to the south.

I was amazed a few years ago when I was driving a high school senior babysitter home. I mentioned that I'd just had a contact with King Hussein on my radio. She'd never heard of him. Hmm, he's the king of Jordan. Nope, never heard of Jordan. It's right next to Israel. Never heard of Israel, either. That's a senior here in Peterborough.

No wonder we're having trouble getting kids interested in talking with other countries—they don't even know they're there. That isn't the fault of the kids, it's OUR fault for being so lazy about our schools and letting them fail so miserably in their responsibilities. We permit less than 25% of our kids to get any science education in high school.

Our Novice exam calls for no more electronic knowledge than the average high school student should have learned. Instead, the exam is almost an insurmountable obstacle for many kids. If you don't think all this comes right down to you, just look at what's been happening with the Asian students in our schools. They're running away with all the honors and getting first crack at our better colleges just because their parents insist on their working hard.

Your grandparents or great-grandparents, when they came here, worked their asses off to make things better for their kids. And they really pushed their kids to work hard. Then something went wrong at home. Can we honestly blame it on television or Dr. Spock? The blame is irrelevant, the question is, what can we do about all this?

Training Kids and Dogs

If you, as a parent or grandparent, make it your

business to see that kids are pressured to learn—to excel—this will, in turn, put pressure on the teachers and schools to do better. We can force them to turn to technology to help them teach, to be more productive. And that's what technology does, it makes for more productivity. Getting kids interested in learning isn't easy. You won't get far with punishment, so you have to outsmart them, if possible. You have to make it worthwhile to excel.

I've a couple of greyhounds. Training them is much like training kids, they'll do anything you want as long as you convince them it's what they want to do. If you try to force a greyhound to do something, it'll just put on a martyred look and lie down. Punishment is completely useless. Only guile will win. Same with kids.

But amateur radio today is even more relevant than it's ever been. It's a key to helping youngsters have a major advantage in life over those without this boost. The future is technology, so the more our kids can learn about communications, electronics and computers, the better it's going to be for them and for our country. Learning geography won't hurt either.

Here we are with electronic and communications technology growing almost faster than we can follow it. We have the potential to use amateur radio as a way to invent and pioneer new communications systems and to inspire kids to go for high tech careers. It was our amateur radio repeaters which spawned cellular radio. Now we have everything we need in technology to develop a high speed automated message-handling system using HF, UHF, microwaves and satellites which could allow any of us to reach any other licensed amateur in the world in seconds. Or are we going to continue to try to jam our 1930s code requirement down unwilling young throats, alienating the kids we need so desperately to get our hobby going again?

Recognizing and Keeping Up with Changes

In the '20s we heard the cries of "Spark Forever." In the '50s it was "AM Forever." Now it's "CW Forever." Will someone lift a few rocks and let some light in? I got a good laugh at a recent talk I gave. I asked how many in my audience were still using CW. A bunch of hands went up. Hmmm. Then I asked how many were using computers to copy it—same hands. Give me a break!

The fact is my four-pound \$399 Model 100 computer can copy code faster and better than the world's best Morse op. You say my batteries may fail? Nope, they're rechargeable. You say the nuclear winter may make it so dark I can't see the LCDs? Gee, that's a big problem—maybe I'd better brush up on my code so I'll be able to help handle the hundreds of millions of messages a few hundred hams will be called upon to pass.

I've had a good deal of success in life by keeping track of the changes technology is making for us, and pushing in the direction of the change instead of fighting it. But, you know, I can't think of any time I haven't had an "old guard" fighting both me and the changes.

I read about sideband in the '50s, tried it, and believed it was our future for voice communications. So as editor of *CQ* and then *73* I pushed hard—was fought tooth and nail by AMers. In the '60s I saw solid state as the future—again was fought angrily by tubes-forever hams. Was it as recently as 1969 that the technical editor of *QST* wrote an editorial saying hams would always be

tube people—that transistors would never be of much value to hams?

In the early '70s I saw FM and repeaters as a big future for us—and was fought every inch of the way by old guard hams, with no help from any other ham magazine.

In the mid '70s I saw the just-invented micro-computer as the future. Indeed, I wrote at the time that I believed the microcomputer would eventually spawn an industry as large as the automobile industry—to guffaws and letters beefing about my publishing articles on computers in 73. So I started Byte and a few other computer magazines. Did well.

When I read about compact discs, I again saw the future . . . and started *Digital Audio* magazine. It's done well, too. I turned out to be right again. It's the fastest growing consumer electronic industry in history.

So here I am, keeping track of change—looking to see how it's affecting our future . . . and I'm worried. The lack of young hams is hurting amateur radio as a hobby—and it's helping bring about a serious drop in the number of American engineers, technicians and scientists.

NO, a resurgence of young hams alone isn't going to save America. But without 'em we're going to have a lot harder time with the other problems...like our decayed educational system, the high cost of college, and a tax system which is helping to drive manufacturing overseas. I need your help with the ham end. I'm working on RPI to provide a proven way to get college costs cut in less than half—and Jordan to develop a new and much more productive educational system for kids.

Updating Ham Radio

Changing the ham requirements from a demonstrated Morse Code skill to a tougher technical entrance exam is just one step I believe we need to take to keep up with technology. I don't expect that's going to uncork any large scale youngster interest in hamming by itself—it'll just help us make more sense to them once we get their interest. We still need radio clubs in schools and a campaign to get kids interested in the excitement hamming has to offer.

Yes, I know all about kids not being excited about hamming because they see international television programs every day. Baloney! The fun of personally talking with people anywhere in the world—or anywhere around town—beats the hell out of CB, CompuServe, Playnet and TV. It does for you, doesn't it? So why do you think you are so different?

How have you been handling change? Fighting it or embracing it?

The Time Warp

I've some letters from old-time hams who are furious that a copy of 73 now costs \$2.95 and a subscription \$20. Good grief, they say, it used to be 37¢ and \$3 a year! And it used to be a lot fatter. Come on here, what are you doing to us?

Apparently the Carter years' trauma has wiped out all recall of a most memorable inflation, leaving no lasting impression on these OTs. Look, we've had almost thirty years of inflation since I started 73 back in 1960, and we haven't had any deflation. Haven't you codgers noticed that *everything* costs more?

Eisenhower said it clearly when he promised the government would tax us in dollars for social security and pay us back with dollarettes. So today we're spending Monopoly money when we

go to the store. A nickel subway ride is a buck. A nickel cone is over a buck. That 37¢ copy of 73 should cost at least \$7.50 a copy today.

Well, what looked like a fat magazine at 128 pages in 1960 now looks like a pamphlet because scientists have invented new, lighter, and much thinner paper. Maybe you haven't noticed the way magazine pages stick together now. They're down to about one RCH in thickness.

Ham Day

Ham Radio Day—the first Saturday in December—is alive and growing. How about your club mounting a major PR offensive next December. You've got lots of time to plan for it, unless you do as usual and put it off until late November.

The idea is to set up a ham station in a public area—like a mall—and do two things. First you want to be able to hook into the national traffic network to deliver worthless messages—probably using packet, which seems the way the NTS is going these days. Second, and much more important, you want to have an exhibit which will show people who never heard of amateur radio some of the things we do which are fun—so you can interest passer's by in the hobby. Let's see if we can drum up some interest, particularly with kids. This means the exhibit (s) have to be fun oriented and not the usual eclectic snob stuff which tells people this is too complicated for them to ever understand and also too expensive.

The Evolution of 73

In 1960 we used 60-pound per ream of a standard paper size, the most popular magazine stock. As paper prices went through the roof, the paper companies had to make lighter and lighter paper, from 50-pound to 48, down to 45, 42 and now most magazines use 40-pound! This makes the same number of pages much thinner and lighter, and keeps the cost of both paper and postage down.

Old-timers probably haven't noticed that the magazine size has increased by 73%, from the old 6" x 9" size to 8.5" x 11". That's 1.73 times as much page space. That makes a 116-page issue today equivalent to a 200-pager in the old size.

That's not all. Again, in order to keep the cover and subscription prices low, all magazines have had to increase the percentage of advertising pages per issue. In the early days of 73 we ran around 35% ads. Today a magazine is in trouble if it runs much less than 50% advertising.

So, if you don't mind paying \$7.50 per copy or \$60 a year for a subscription, adjusted for inflation, we can go back to the small, heavier-weight magazines with fewer ads. Please let me know.

Amateur radio is a whole bunch of hobbies, so I try to cover as many of them as I can in 73. Construction projects (more than the other three magazines combined), technical articles to keep you up with the state of the art, antennas, DXing (our DX Dynasty Award is the most difficult there is), packet, RTTY, SSTV, weather satellites, OSCAR, repeaters, UHF, contests and certificates, FCC actions, club activities, and ham politics. In my editorials I tell it as I see it, even when this means attacking some deeply held ham religious beliefs, such as the sanctity of the Morse Code test.

Anyway, I think we've done well to keep the 73 price as low as we have. The equivalent price today is more like a 15¢ cover price in 1960. Hey, if you would like to pay 37¢ again, adjusted for inflation, I can give you a 200 page magazine every month. I love the idea, but do you really like the idea well enough to pay \$60 a year for a subscription? **73**

800-882-1343



ICOM

	List	JUN's
IC-781 New Deluxe HF Rig	\$6149	Call \$
IC-765 Gen. Cvg Xcvr	3149.95	Call \$
IC-735 Gen. Cvg Xcvr	1149	Call \$
IC-751A Gen. Cvg Xcvr	1699	Call \$
IC-R7000 25-1300 MHz Rcvr	1199	Call \$
IC-R71A 100 kHz-30 MHz Rcvr	999	Call \$
IC-228A/H FM Mobile 25w/45w	509/539	Call \$
IC-28A/H FM Mobile 25w/45w	469/499	Call \$
IC-2GAT 2m 7w HT	429.95	Call \$
IC-900 Six Band Mobile	639	Call \$
IC-3S AT	220	Call \$
IC-2S AT 2M		TBA
IC-48A FM Mobile 25w	509	Call \$
IC-4GAT New 6w HT	449.95	Call \$
IC-38A 25w FM Xcvr	489	Call \$
IC-32AT 2m/70cm HT	629.95	Call \$

SPECIAL	LIST	SALE
IC-12AT 1.2 GHz FM, HT	\$473.95	\$333.95
IC-47A 25W 440 Mobile	\$549.00	\$269.95

KENWOOD

RZ-1 Wideband Rcvr	599.95	Call \$
TS-940S/AT Gen. Cvg Xcvr	2449.95	Call \$
TS-440S/AT Gen. Cvg Xcvr	1449.95	Call \$
TS-140S Gen. Cvg Xcvr	949.95	Call \$
TM-55AT 2m-70cm 1.2 GHz	469.95	Call \$
TS-790A 2m-70cm 1.2 GHz	1999.95	Call \$
TS-711A All Mode Base 25w	1059.95	Call \$
TR-751A All Mode Mobile 25w	699.95	Call \$
TM-231A 2m 45w	459.95	Call \$
TH-215A 2m HT Has It All	399.95	Call \$
TH-25AT 5w Pocket HT NEW	369.95	Call \$
TM-721A 2m/70cm FM Mobile	729.95	Call \$
TM-701A 2m/70cm Mobile	599.95	Call \$
TH-75A 2m/70cm HT	TBA	Call \$
TM-431A Compact FM 35w	699.95	Call \$
TH-45AT 5w Pocket HT 220 MHz	389.95	Call \$

SPECIAL

TM-3530A FM 220 MHz 25w	519.95	Call \$
TM-321A Compact 25w Mobile	469.95	Call \$
TH-315A Full Featured 2.5w HT	419.95	Call \$

YAESU

FT-767 GX Gen. Cvg Xcvr	1929.00	Call \$
FT-757 GX II Gen. Cvg Xcvr	1129.95	Call \$
FT-747 GX Gen. Cvg Xcvr	889.95	Call \$
FL-7000 15m-160m AMP	1995.00	Call \$
FT-212RH NEW 2m 45w	459.95	Call \$
FT-712RH 70cm 35w	499.95	Call \$
FT-290R All Mode Portable	599.95	Call \$
FT-23 R/TT Mini HT	344.95	Call \$
FT-736R, All Mode	1749.95	Call \$
FT-470 2m/70cm HT	559.95	Call \$

SPECIAL

FT-311 RM 220 FM Mobile	\$439.95	\$259.95
-------------------------	----------	----------



3919 Sepulveda Blvd.
Culver City, CA 90230
213-390-8003

CIRCLE 272 ON READER SERVICE CARD

HAM HELP

Your Bulletin Board

We are happy to provide Ham Help listings free, on a space available basis. Please type or neatly print your request on a full-size sheet of paper. Use upper and lower case letters—not all capitals. Be sure to print numbers carefully. A "1" and "I"; "7" and "T" or "I" and other numbers and letters can be easily misread when they are not printed clearly. "U" and "V" can also be confused. Thank you for your cooperation.

I need an operating manual and/or schematic for a Heathkit HR-10. I will pay all associated costs for a copy, or I will copy and return the original. Thank you.

Warnant Patrick
736 Raymond
St. Jean, Quebec
CANADA J3B 4Y6

I need instruction manual and schematic for Southcom SC-102 Thunderbird transceiver. Also need 12 volt P/S for same. Will pay.

Dick Beckham W7FVM
1989 Hibiscus Circle
St. George UT 84770

I need a copy of the July 1988 article in *Hands On Electronics* magazine about the "mini-receiver" using the Radio Shack TDA7000 IC. Will pay postage and copying costs. Thanks.

Scott A. Littfin NØEDV
921 Raton Court
Manitowoc WI 54220

UPDATES

AMPIRE and PROCOMM/DIGITREX

The May 1989 review of the Ampire 146-OS did not include a phone number. It is (612) 425-7709.

Please correct the phone number in the April 1989 review of the Wideband Supercone antenna. It is (805) 497-2397.

Uniden Mod

Refer to the Uniden mod correction in June "QRX." Change the referenced resistor R39 to R93.

Double Oops

We finally have it right this time—Al Misunas' call is WA2RLO, not WB2RLO as listed in the March 1989 QRX column, page 14, or the May 1989 QRX column under "Errata," page 10.

Siliconix Makes Power FETs

Refer to the sidebar "What Is MOS-Power?" in the article "220 MHz Amp" in the June '89 issue, on page 40. Ed Oxner KB6QF from Siliconix wrote to correct us. Although Siliconix sold the RF power MOSFET product line to M/A-COM PHI, Inc., in 1983, they still produce a large range of power FETs, as outlined in their MOSPOWER catalog. **73**

BATTERIES

Nickel-Cadmium, Alkaline, Lithium, Etc.
INDUSTRIAL QUALITY

**YOU NEED BATTERIES?
WE'VE GOT BATTERIES!**

CALL US FOR FREE CATALOG



E.H. YOST & CO.
EVERETT H. YOST KB9X1
7344 TETIVA RD.
SAUK CITY, WI 53583
ASK FOR FREE CATALOG
(608) 643-3194

CIRCLE 112 ON READER SERVICE CARD

MAKE LEARNING FUN with the CODEKEY 1000 Code Practice Oscillator



- Compact and Easy to carry
- Operates on 9V battery included
- Adjustable Volume
- Durable Metal Case
- Variable Sidetone

\$19.⁹⁵ TO ORDER
—CALL—
(718) 983-1416



P.O. Box 131646
STATEN ISLAND
N.Y. 10313-0006

CIRCLE 241 ON READER SERVICE CARD

PORTA-BEAM Model DL-146

At last! A completely portable 2 meter three element Delta loop beam. Easy to set up with no small parts to lose. Low VSWR over entire 2 meter band. Gain equivalent to a 4-element Yagi. All elements and feed line with BNC connector store inside a 3 ft boom. An ideal emergency antenna, backpackable (18 oz.), general field use with accessory mast. Money back if not fully satisfied.

P.O. Box 520011-S
Salt Lake City, UT 84152

SUMMITEK
AM (801) 277-4205

\$84.95
(Free shipping)

Field Day All-Band Antenna

- | | |
|-----------------|------------------|
| Ready to Use | Full Legal Power |
| Fastest Install | No Lossy Traps |
| Coax Feed | Low Noise |
| 3000 V Insul | Never Corrodes |
| Tough | |
| Flexible | |
| Kink-Proof | |

ORV- \$49.95 80-10 51 ft. long
Includes 40-page Tech Manual
Infopack \$1

ORV- \$59.95 160-10 102 ft. long
Add \$5 Post & Handling

AntennasWest
Box 50062-S, Provo, UT 84605
(801) 373-8425

CIRCLE 302 ON READER SERVICE CARD

73 in 1988

How often have you asked yourself, "Where did I see an article/review on that rig?" Or wanted to locate a fabulous article but could remember only the name of the author and/or callsign?

Now you have an excellent resource—73's compiled Index for 1988. This is a complete listing of all of our reviews, features, and columns, and a complete keyword listing for every issue from January through December 1988.

The index is available in a printed format, on an MS-DOS 5 1/4" floppy disk (ASCII format), or by direct upload (have your credit card number ready). The hard-copy is two dollars, and the floppy costs five. Uploading costs five dollars at 1200 baud, and \$7.50 at 300 baud. Send your check or money order, along with your name and address, to:

1988 Index
73 Magazine
Forest Road
Hancock, NH 03449

Now receive or leave messages with other local hams using the 16K Bulletin Board featured on the smallest TNC available—the Heath® HK-21 Pocket Packet.

The BBS operates under your call with simple commands like Send or Write a message, Kill a message and read the File messages currently on the system. And the HK-21 Pocket Packet is fully TNC-2 compatible.

Hookup is easy.
Plug in supplied cables instantly to most

HT's, or wire a separate cable into your mobile or base VHF or UHF rig. Connect your

computer via RS-232 and you're ready to call a fast-growing number of packet hams.

The HK-21 Pocket Packet requires only a single 12 VDC@40mA power source or as little as 29mA from an optional HKA-21-1, internally mounted 4.8 volt, 120 mAh, NICAD battery.

The Heath® HK-21 Pocket Packet — \$219.95 (Amateur net price)
To order, call 1-800-253-0570

For information on Heath's complete line of amateur radio products call 1-800-44-HEATH for your FREE Heathkit® catalog.

Best to start with.
Best to stay with.

Heath Company
Benton Harbor, MI 49022

Get your message across... even when no one is listening.



A subsidiary of Zenith Electronics Corporation.
©1989, Heath Company

D

X-ing, contests, pile-ups, traffic handling.

When you need to command attention, you will with the SB-1000 Linear Amplifier from Heath. And you'll do it for a cost that no one else can match.

From our recent DX-pedition to Taiwan, operators easily controlled pileups with the SB-1000 and nothing more than a dipole antenna. This means that when conditions are tough, you know you can depend on your SB-1000 to lift your signal above the rest. Whether you're using a dipole or stacked monoband beams.

Proven output power

We don't play games by using old rating methods to make you pay for input power you don't get at the antenna. What you do get is 1000 watt output of peak

envelope power on SSB and 850 watts on CW. Even 500 watt output on RTTY.

On the chance that someone might doubt our claims, at hamfests we demonstrate that with only 80 to 100 watts of drive, our SB-1000 develops more output than even the world-famous Heath SB-220!

Designed for today, the SB-1000 offers quiet, compact tabletop operation at rated output. That's only 1.7dB (or about 1/3 of an S-unit) below

the maximum legal power limit.

"I built it myself!"

Because you build the Heathkit SB-1000 Linear Amplifier yourself, you not only enjoy cost savings, you have the unique opportunity of knowing your equipment inside and out.

A top quality amplifier, cost savings, bragging rights, plus industry-recognized Heathkit manuals and technical assistance from our licensed ham consultants, should you ever need it. An offer that's hard to pass up.

See the SB-1000 and our complete line of amateur radio products in the Spring Heathkit Catalog. Call today for your free copy.

1-800-44-HEATH
(1-800-444-3284)

Best to start with.
Best to stay with.

Heath Company

Benton Harbor, Michigan 49022

©1989, Heath Company.
Heathkit is a registered trademark of Heath Company.
A subsidiary of Zenith Electronics Corporation.

Top performance for less than 80 cents a watt



DEALER DIRECTORY

CALIFORNIA

Burbank

Free QSL Cards on orders over \$100!! Discount prices on all amateur products. Open 7 days a week. Call our Bulletin Board. **A-TECH ELECTRONICS, 1033 Hollywood Way, Burbank CA 91505; (818) 845-9203, (818) 846-2298 FAX, (818) 846-6746 Modem/BBS.**

San Diego

Hard to find parts, surplus electronics, standard line items. Hams, hobbyists, industrial professionals—from nuts & bolts to laser diodes...Electronically speaking, Gateway's got it! M-F 9-5:30 Sat. 9-5. **GATEWAY ELECTRONICS, 9222 Chesapeake Drive, San Diego CA 92123; (619) 279-6802.**

COLORADO

Denver

Hard to find parts, surplus electronics, standard line items. Hams, hobbyists, industrial professionals—from nuts & bolts to laser diodes...Electronically speaking, Gateway's got it! M-F 9-5:30 Sat. 9-5. **GATEWAY ELECTRONICS, 5115 N. Federal Blvd. #32, Denver CO 80221; (303) 458-5444.**

DELAWARE

New Castle

Factory authorized dealer! Yaesu, ICOM, Ten-Tec, KDK, Kenwood, AEA, Kantronics, Santec. Full line of accessories. No sales tax in Delaware. One mile off I-95. **DELAWARE AMATEUR SUPPLY, 71 Meadow Road, New Castle DE 19720; (302) 328-7728.**

IDAHO

Preston

Ross WB7BYZ has the largest stock of amateur gear in the Intermountain West and the best prices. Call me for all your ham needs. **ROSS DISTRIBUTING, 78 S. State, Preston ID 83263; (208) 852-0830.**

KANSAS

Wellington

We have it! ASTRON, BUTTERNUT, ENCOMM, HEATHKIT, GORDON WEST, KANTRONICS, LASER COMPUTERS, MFJ, RADIO SHACK, TEN-TEC, VALOR ANTENNAS & more. Small town service with discount prices. **DANDYS, 120 N. Washington, Wellington, KS. 67152, (316) 326-6314. Circle Reader Service 263 for more information.**

MISSOURI

St. Louis

Hard to find parts, surplus electronics, standard line items. Hams, hobbyists, industrial professionals—from nuts & bolts to laser diodes...Electronically speaking, Gateway's got it! M-F 9-5:30 Sat. 9-5. **GATEWAY ELECTRONICS, 8123 Page Blvd., St. Louis MO 63130; (314) 427-6116.**

NEW HAMPSHIRE

Derry

Serving the ham community with new and used equipment. We stock and service most major lines: AEA, Astron, B&W, Cushcraft, Encomm, Hy-Gain, Hustler, ICOM, Kenwood, KLM, Larsen, Mirage, Mosley; books, rotors, cable and connectors. Business hours Mon.-Sat. 10-5, Thursday 10-7. Closed Sun./Holidays. **RIVENDELL ELECTRONICS, 8 Londonderry Road, Derry NH 03038; (603)434-5371.**

NEW JERSEY

Lyndhurst

A full service Ham Radio Store! Discount sales and service on most major brands. Monday to Friday 12:00am to 7:00pm, Saturday 10:00am to 4:00pm ¼ mile south of Rt.3. **ABARIS SYSTEMS, 227 Stuyvesant Avenue, Lyndhurst NJ 07071; (201) 391-7887.**

NEW YORK

Jamestown

Western New York's finest amateur radio dealer featuring ICOM-Larsen-AEA-Hamtronics-Astron. New and used gear. 8 am to 5:30, Sat. and Sun. by appointment. **VHF COMMUNICATIONS, 280 Tiffany Ave., Jamestown NY 14701, (716) 664-6345. Circle Reader Service number 129 for more information.**

Manhattan

Manhattan's largest and only ham and two-way Radio Store. Featuring MOTOROLA, ICOM, KENWOOD, YAESU, AEA, SONY, UNIDEN, etc. Full stock of radios and accessories. Open 7 days M-F, 9-6:30 pm; Sat & Sun, 10-5 pm. We ship worldwide. **BARRY ELECTRONICS, 512 Broadway, New York NY 10012; (212) 925-7000. FAX (212) 925-7001.**

NORTH CAROLINA

Greensboro

9a.m. to 7p.m. Closed Monday. ICOM our specialty-Sales & Service. **F&M ELECTRONICS, 3520 Rockingham Road, Greensboro NC 27407; (919) 299-3437.**

OHIO

Columbus

Central Ohio's full-line authorized dealer for Kenwood, ICOM, Yaesu, Ten-Tec, Info-Tech, Japan Radio, AEA, Cushcraft, Hustler, and Butternut. New and used equipment on display and operational in our 4000 sq.ft. store. Large SWL department, too. **UNIVERSAL AMATEUR RADIO, 1280 Aida Drive, Reynoldsburg (Columbus) OH 43068; (614) 866-4267.**

PENNSYLVANIA

Trevese

Authorized factory sales and service. **KENWOOD, ICOM, YAESU, featuring AMERITRON, B&W, MFJ, HYGAIN, KLM, CUSHCRAFT, HUSTLER, KANTRONICS, AEA, VIBROPLEX, HEIL, CALLBOOK, ARRL Publications, and much more. HAMTRONICS, INC., 4033 Brownsville Road, Trevese PA 19047; (215) 357-1400. FAX (215) 355-8958. Sales Order 1-800-426-2820.**

TEXAS

Dallas

In Dallas since 1960. We feature Kenwood, ICOM, Yaesu, AEA, Butternut, Rohn, amateur publications, and a full line of accessories. Factory authorized Kenwood Service Center. **ELECTRONIC CENTER, INC., 2809 Ross Ave., Dallas TX 75201; (214) 969-1936.**

Houston

Hard to find parts, surplus electronics, standard line items. Hams, hobbyists, industrial professionals—from nuts & bolts to laser diodes...Electronically speaking, Gateway's got it! M-F 9-5:30 Sat. 9-5. **GATEWAY ELECTRONICS, 9890 Westpark Drive, Houston TX 77063; (713) 978-6575.**

Southwest Houston

Full line of Equipment and Accessories, in-house service, Texas #1 Ten Tec Dealer! **MISSION COMMUNICATIONS, 11903 Alief-Clodine, Suite 500, Houston TX 77082; (713) 879-7764.**

DEALERS

Your company name and message can contain up to 25 words for as little as \$300 yearly (prepaid), or \$175 for six months (prepaid). No mention of mail-order business permitted. Directory text and payment must reach us 60 days in advance of publication. For example, advertising for the April '89 issue must be in our hands by February 1st. Mail to *73 Amateur Radio*, Donna DiRusso, Box 278, Forest Road, Hancock, NH 03449.

KEYWORD INDEX

Issue #347

10 GHz	49-52	DB-25 connector	18	Microwave Components	52	Switzerland	46-47
24 GHz	76	dipoles	24	microwave equip	76	SWR	55-57
555 timer	73	Doppler shift problems	44	microwave op	49-52, 76, 82	Tiare Publishing	31
1488 quad line driver IC	34	education, teaching AR	46-47	Mitsubishi	49	TO-220	72
1489 quad line driver IC	34	electricity	6	mobile/portable operation	64, 72-73	TS-930 key mod	82
3-500Z	28	FM demod circuit	48	Motorola MV 1872	53	TS-940S	20
2N2222	49, 50, 73	GaAsFET	49-52, 64	N6UE, Ray Isenson	13	TVI solution	82
74LS04 hex-inverter	34	Galaxy 5 MK II	53	N7IHY, Debra Davis	10	UA3CR, Leonid Labutin	10
AA6CQ/VE6, David G. Hart	44	Gel/Cell	72	N7IPY, William Waters	34	Uniden mod	90
AF8B, Don Norman	42	Havana Moon	31	packet/voice switch	58	voltage/current limiting	72-73
AFC unit	53	HB9DU, Ruedi Mangold	46	Part 97 revision	10, 66	W0WUZ, Terry F. Staudt, LPE	53
AFSK generator	60	HW-8	72	PL tone generator	13-16, 40	W1FYR, Alan C. Merrill	28
AL-80A	28	IC-02AT/MFJ 1278 hookup	58	PL-259 connectors	55	W2OZH, James E. Taylor	24
Ameritron, Inc.	28	IC-2AT/MFJ-1270 interface	58	PROCOMM/DIGITREX	90	W3LOY, Ed Clegg	31
AMPIRE	90	IF shift mod	53	propagation	95	W7XU, Arliss Thompson	55
AMSAT	64	interface, computer/radio	34-37	Rad-Com	37	WA2LQQ, Vern Riportella	10
AMTOR	20, 22	K0OV, Joe Moell PE	62	Ramsey COM-3	32	WA2RLO, Al Misunas	90
antenna, vertical	42-43	Kantronics, Inc.	18	Ramsey SR-1	38	WA3AJR, Marc I. Leavey, M.D.	60
Argonaut	72	KAM	18-22	Ramsey Electronics	32, 38	WA4BLC, Bill Clarke	82
Armenia	10	KB1UM, Michael Geier	65	RS-232	18, 34	WA5ZIB, Andy MacAllister	64
battery charging	72-73	KB2BQK, Walter Symczyk	48	RTTY	20, 22	WB6IGP, C.L. Houghton	49, 76
California Eastern Labs	76	KC4IQP, Dorothy Livsay	17	satellite newsletters	64	WB6RQN, Brian Lloyd	18
coaxial cable	55-57	KG5CS, Diane Magen	17	schematic reading, how-to	65	WB6NOA, Gordon West	10
collinear antenna	24	linear amp	28	service monitor	32	WB8VGE, Mike Bryce	72
Commodore 24/VIC 20	18	LM317	49, 72-73	Signetics NE602	38	WB9RRT, Larry R. Antonuk	32
connector weatherproofing	82	LM350	73	Siliconix	90	weak signal detection	62, 80
COR	13	LM386	38	SMA connectors	50, 52	WEFAX	18
Cushcraft 416T	64	LM386	38	SO-239 connector	30, 40	Yaesu FT780R	64
Cushcraft AOP-1	64	MGF-1402	49	solar power	72	yagi	64
data controller	18	Microwave Associates	76				



NEWS BULLETIN

CALL US NOW!

In 1937, Stan Burghardt (WØIT), because of his intense interest in amateur radio, began selling and servicing amateur radio equipment in conjunction with his radio parts business. We stand proud of this long-lasting tradition of *Honest Dealing, Quality Products and Dependable "S-E-R-V-I-C-E"!*

Above all, we fully intend to carry on this proud tradition with even more new product lines plus the same "fair" treatment you've come to rely on. Our reconditioned equipment is of the finest quality with **30, 60** and even **90-day** parts and labor warranties on selected pieces. *And always remember:*

— WE SERVICE WHAT WE SELL —

- | | | | |
|---------------------|-----------|------------|----------------|
| AEA | B & W | Daiwa | Palomar |
| Alinco | Belden | Hustler | Radio Callbook |
| Ameritron | Bencher | Kantronics | Ritron |
| Amphenol | Bird | Kenwood | Rohn |
| Ampire | Butternut | Larsen | Telex/Hygain |
| Antenna Specialists | Centurion | MFJ | Ten-Tec |
| Astron | CES | Mirage/KLM | Unadilla/Reyco |
| | Cushcraft | Mosley | Yaesu |

Write today for our latest Bulletin/Used Equipment List.

YOUR HAM DOLLAR GOES FURTHER AT...

CALL OR WRITE FOR SPECIAL QUOTE

When it comes to **FAST DELIVERY, HONEST DEALING** and **PROMPT/DEPENDABLE S-E-R-V-I-C-E** back-up. We don't just advertise it — **WE GIVE IT!**

we'll treat you

SELECTION
SERVICE
and
SATISFACTION!

STORE HOURS:
9-5 P.M. (CST)
MONDAY thru FRIDAY
OPEN SATURDAYS
from 9-1 P.M. (CST)
CLOSED
SUNDAYS/HOLIDAYS

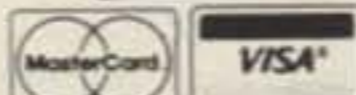

182 N. Maple
P.O. Box 73
Watertown, SD 57201



"AMERICA'S MOST RELIABLE AMATEUR RADIO DEALER"

SELL-TRADE

New & Reconditioned
HAM EQUIPMENT

Call or Write Us Today For a Quote!
You'll Find Us to be Courteous, Knowledgeable and Honest

PHONE **(605) 886-7314**

FAX **(605) 886-3444**



Get the most of HF Mobiling

Yaesu FT-747GX

SPECIAL OFFER!

CALL TODAY FOR SPECIAL QUOTE

BARTER 'N' BUY

QSLs TO ORDER. Variety of styles, colors, card stock. W4BPD QSLs, PO Drawer DX, Cordova SC 29039. BNB260

THE DX'ERS MAGAZINE Up-to-date, informative, interesting. Compiled and edited by Gus Browning W4BPD, DX-CC Honor Roll Certificate 2-4. Send for free sample and subscription information today. PO Drawer DX, Cordova SC 29039. BNB261

QSL CARDS—Look good with top quality printing. Choose standard designs or fully customized cards. Better cards mean more returns to you. Free brochure, samples. Stamps appreciated. Chester QSLs, Dept A, 310 Commercial, Emporia KS 66801. BNB434

SUPERFAST MORSE CODE SUPEREASY. Subliminal cassette. \$10. LEARN MORSE CODE IN 1 HOUR. Amazing new supereasy technique. \$10. Both \$17. Moneyback guarantee. Free catalog: SASE. Bahr, Dept 73-8, 1196 Citrus, Palmbay FL 32905. BNB531

ELECTRONIC KITS & ASSEMBLIES. For our latest catalog, SASE (45c) to: A&A Engineering, 2521 W. LaPalma, #K, Anaheim CA 92801. BNB624

HT-CLONE BATTERIES: ICOM: BP-3S Double BP3 "Wall Chargeable" \$43.95, BP5 \$42.95, YAESU: FNB2 \$21.95, SANTEC: 142/442/1200 (3 Pin) \$22.95. "REBUILDING: SEND-UR-PACK" Icom BP3 \$20, BP5 \$28, BP7/8 \$34, BP70 \$30, Yaesu FNB4/4A \$37, Kenwood PB21 \$18, PB25/H/26 \$28, T-T 2991 \$28. "U-DO-IT REPAIR INSERTS" ICOM: BP2 \$18.95, BP3 \$16.95, BP5 \$22.95, BP7/BP8 \$28.95, KENWOOD: PB21 \$12.95, PB24/25/

26 \$19.95, AZDEN 300 \$19.95, YAESU: FNB4/4A \$32.95, TEMPO: S1,2,4,5,15/450 \$22.95, 12V/5Ahr PORTA-PAC W/CHGR \$49.95, "ANTENNAS" 2MTR 5/8-Tel/BNC \$18.95. "TELEPHONE / PAGER & COMMERCIAL PACKS" "FREE CATALOG." \$3 Shipping/order. PA +6%, Visa-M/C +\$2. (814) 623-7000. CUNARD ASSOCIATES, Dept. 7, R.D. 6 Box 104, Bedford PA 15522. BNB628

ROSS' \$\$\$\$ NEW August SPECIALS: KENWOOD TS-140S \$784.90, TW-4100A \$459.90, TM-2530A \$405.90, TM-3530A \$344.90, TM-401B \$334.90; H A L PCI-2000 \$429.90, CT-2100 \$499.90, DRAKE 7000E \$369.90, ROBOT 800H \$299.90, 800 \$299.90, 1200C \$1235.90, ICOM IC-38AW/TTM \$338.99, IC-45A \$289.90, IC-32AT \$539.90, IC-725 \$809.90, YAESU FT-711RH \$369.90, FT-411 \$336.90, FT-109RH \$276.99, FT-209RH \$276.99, FT-73RTT \$289.90, FT-33RTT \$299.90, CUSHCRAFT 124WB \$41.50, 230WB \$234.90, A4S \$353.90. ALL L.T.O. (LIMITED TIME OFFER) LOOKING FOR SOMETHING NOT LISTED?? CALL OR WRITE. Over 8780 ham-related items in stock for immediate shipment. Mention ad. Prices cash, F.O.B. PRESTON. HOURS TUESDAY-FRIDAY 9:00 TO 6:00, 9:00-2:00 P.M. MONDAYS. CLOSED SATURDAY & SUNDAY. ROSS DISTRIBUTING COMPANY, 78 SOUTH STATE, (P.O. Box 234), PRESTON ID 83263. (208) 852-0830. FAX (208) 852-0833. BNB654

WRITTEN EXAMS SUPEREASY. Memory aids from psychologist/engineer cut studytime 50%. Novice, Tech, Gen: \$7 each. Advanced, Extra: \$12 each. Moneyback guarantee. Bahr,

Dept 73-8, 1196 Citrus, Palmbay FL 32905. BNB691

ROSS \$\$\$\$ USED August SPECIALS: KENWOOD TS-530S \$619.90, R-300 \$189.90, T-599D & R-599D \$509.90, ICOM IC-211 \$389.90, IC-271H \$689.90, IC-245SSB \$249.90, IC-255A \$179.90, RM-2 AS IS \$29.90, KAYPRO 10, 10 MEG. \$999.90, KAYPRO-2 \$499.90, COLLINS KWM-3803 FILTERS NB.SP. \$1995.90, ETO 76A \$1299.90, 374A \$1795.90, ROBOT 400 \$319.90. LOOKING FOR SOMETHING NOT LISTED?? CALL OR WRITE. WE HAVE OVER 235 USED ITEMS in stock. MENTION AD. Prices cash, F.O.B. PRESTON. HOURS TUESDAY-FRIDAY 9:00 TO 6:00, 9:00-2:00 P.M. MONDAYS. CLOSED SATURDAY & SUNDAY. ROSS DISTRIBUTING COMPANY, 78 SOUTH STATE, P.O. BOX 234, PRESTON ID 83263. (208) 852-0830. FAX (208) 852-0833. BNB709

\$50 PACKET DIGICOM > 64—A fantastic software based PACKET system for the Commodore 64. Order KIT #154 for \$49.95 or Assembly #154 for \$79.95, both include FREE DISC. Add \$3.50 s/h. A & A Engineering, 2521 W. LaPalma, #K, Anaheim CA 92801. (714) 952-2114. MC or VISA accepted. BNB732

HAM TRADER YELLOW SHEETS. In our 28th year. Buy, Swap, Sell ham radio gear. Published twice a month. Ads quickly circulate, no long wait for results. Send business size SASE for sample copy. \$13 for one year (24 issues). P.O.B. 2057, Glen Ellyn IL 60138-2057 or P.O.B. 15142, Seattle WA 98115. BNB741

\$\$\$\$\$ SUPER SAVINGS \$\$\$\$\$ on electronic parts, components, supplies, and computer accessories. Send one dollar for 1-year subscription to our 40-page catalogs and their supplements. Get on our mailing list. BCD ELECTRO, PO Box 830119, Richardson TX 75083 or call (214) 343-1770. BNB749

WANTED: Ham Equipment and other property. The Radio Club of Junior High School 22 NYC, Inc., is a nonprofit organization, granted 501(C)(3) status by the IRS, incorporated with the goal of using the theme of ham radio to further and enhance the education of young people nationwide. Your property donation or financial support would be greatly appreciated and acknowledged with a receipt for your tax deductible contribution. Labor day and the new term are almost here. Do it, don't wait till the end of the year, make your decision to donate that equipment now. We depend on you. Please write us at: PO Box 1052, New York NY 10002. Round the clock Hotline: (516) 674-4072. Thank you! BNB762

INDIVIDUAL PHOTOFAC FOLDERS. #10 to #1400, \$4.00. #1401 up, \$6.00. Sam's books, \$7.00. Postpaid. Allen Loeb, 414 Chestnut Lane, East Meadow NY 11554. BNB766

AVANTEK ATF10135 \$12.00, MMIC's, P.C. board, SASE: WA31AC, 7148 Montague St., Philadelphia PA 19135. BNB771

HAMLOG COMPUTER PROGRAM Full features. 17 modules. Auto-logs, 7-band WAS/DXCC. Apple \$19.95. IBM, CP/M, KAYPRO, TANDY, CR8 \$24.95. 73-KA1AWH, PB 2015, Peabody MA 01960. BNB775

ELECTRON TUBES: All types & sizes. Transmitting Receiving, Microwave... Large inventory = same day shipping. Ask about our 3-500Z special. Daily Electronics, PO Box 5029 Compton, CA 90224. 800-346-6667. BNB792

QUALITY QSL CARDS, RUBBER STAMPS, Envelopes and printed letterhead. Send 45c postage or SASE for samples. Large selection at attractive prices. Sandollar Press, P.O. Box 30726, Santa Barbara CA 93130. BNB812

HUGE K1BV DX AWARDS DIRECTORY, complete rules for over 1015 certificates, 102 countries, 230 pages. \$15.50 postpaid. Ted Melinosky, 525 Foster St., South Windsor CT 06074-2936. BNB835

100 QSL CARDS \$8! Shipped postpaid. Free samples. Shell Printing, KD9KW, PO Box 50A, Rockton IL 61072. BNB859

THE NATIONAL HAM SHOPPER "NHS." Monthly buy, sell, trade publication. Why keep that OLD RIG around? You could turn it into CASH\$ or another rig you always wanted. Adds are quickly advertised and answered for fast results. As a NEW SUBSCRIBER you can place one FREE ADD (with a 60 word limit). Add Rate: Noncommercial 0.25/word; Commercial 0.60/word. Subscription: \$10.00/year, \$20/2 years. SEND TO: NHS, PO BOX 10738, ELMWOOD CT 06110. BNB865

CURRY COMMUNICATIONS proudly introduces a complete line of easy to build kits for L.F. and 1750 meters. Please write for brochure. Curry Communications, 852 North Lima Street, Burbank CA 91505. BNB874

WANTED: All types of Electron Tubes. Call toll free 1 (800)421-9397 or 1 (612) 429-9397. C & N Electronics, Harold Bramstedt, 6104 Egg Lake Road, Hugo MN 55038. BNB878

RIT KITS for most transceivers, \$15. Info only, send SASE. Loren Wallen KA7AZM, 6323 S.W. 100th, Tacoma WA 98499. BNB885

Barter 'N' Buy advertising must pertain to ham radio products or services.

- Individual (noncommercial) 50c per word
- Commercial \$1.50 per word

Prepayment required. Count only the words in the text. Your address is free. 73 cannot verify advertising claims and cannot be held responsible for claims made by the advertiser. Liability will be limited to making any necessary corrections in the next available issue. Please print clearly or type (double-spaced).

No discounts or commissions are available. Copy must be received in Peterborough by the first of the second month preceding the cover date. Make checks payable to 73 Magazine and send to: Donna DiRusso, Barter 'N' Buy, Box 278, Forest Road, Hancock, NH 03449.

PROPAGATION

Jim Gray W1XU

Jim Gray W1XU
210 Chateau Circle
Payson AZ 85541

from sunset to dawn, and 30 meters will be a good nighttime band. Good daytime short skip will be available on all bands.

Late Summer Forecast

August will be typical of the summer months, with moderate solar activity. Expect DX on 10 meters, and around-the-clock DX on 20 meters. Twelve and 17 meters will be somewhere in between.

A very active sun will cause geomagnetic field disturbances at times, and there will be frequent solar flares. Check the daily charts for expected Good (G), Fair (F), and Poor (P) days.

Day-to-day conditions follow below, as shown on the calendar.

Forty meters will provide DX

QUANTITY DISCOUNTS ON TEKTRONIX DUAL TRACE #661 SCOPES (DC-3500 MHz). Excellent condition, \$60 ea (lots of 10—\$50 ea). Also: Hewlett-Packard Signal Generators 1.8-4 GigaHertz, excellent condition, \$50 ea (lots of 10—\$40 ea). Also: Various signal generators 1-7 GigaHertz, \$50 ea (lots of 10—\$40 ea). F.O.B. WW5B, PO Box 460, Brookshire TX 77423. (713) 934-4659. BNB886

DUST COVERS—Protect your valuable Radio Gear. Custom made, beautiful fit. Send Make/dimensions. Most Radios, \$12.95. Catalog, \$1. Dinosaur Covers, 173 Foster Road, Lake Ronkonkoma NY 11779. BNB888

SUPER HAM PROJECTS & USED GEAR LISTS! Send SASE to: WA4DSO, 3037 Audrey Dr., Gastonia NC 28054. BNB890

SURPLUS CATALOG. 72 pages. \$2. Surplus, PO Box 276, Alburg VT 05440. BNB891

220 MHz AMP WANTED. MINT ENCOMM 250 WATT MODEL ONLY. CONTACT WA9KLZ at R.R. 4 BOX 15A, FLOWER IN 47944. OR CALL (317) 869-4073. BNB892

JARFEST '89, BENSON NC Oct 1. JOHNSTON AMATEUR RADIO SOCIETY, PO BOX 1154, SMITHFIELD NC 27577. BNB893

BIRD ELEMENTS, WATTMETERS, DUMMY LOADS—Buy and Sell. (609) 227-5269. Eagle, 100 Dearborne Ave. Blackwood NJ 08012. BNB894

ANTIQUE RADIO TUBES—Unused, original boxes. "Loctals," battery types also. George Hoover, PO Box 521, Gouverneur NY 13642. BNB895

MOSLEY 75 METER 2-element linear loaded beam—82FT elements—36FT boom—one of a kind prototype—works great, used 3 months, sold QTH must sell antennas—cost \$2900, sell \$1497—KK4WW, PO Box 1, Blacksburg VA 24063. (703) 382-4458. BNB896

FOR SALE—TEMPO 2020 Excellent Condition, has 11 meters plus New D104, \$400 plus shipping. Call Gary (207) 778-4822. BNB897

SATELLITE TV VIDEOCIPHER II CHIPS Send SASE for info. 3715 Murdoch Ave. 109, Parkersburg WV 26102. BNB898

TRANSMITTING TUBES: Unused EIMAC 4-250 and 2-1000 transmitting tubes. Make an offer! George Foster, 29 Walcott Valley Dr., Hopkinton MA 01748. BNB899

MAKE YOUR OWN REPEATERS Motorola Micor Radios 45 watt, 4 freq. 136-150 MHz \$80.00. Motorola Micor

Radios 45 watt, 8 freq. 136-150 MHz \$120.00. Motorola Motracs Radios 25 MHz \$32.00. Micor Access Groups 4 freq. Scan Head, spkr., mic, cable \$75.00. Micor Access Groups 8 freq. Scan Head, spkr., mic, cable \$100.00. GE Exec 11's Radio 45 watt, 1 freq. 136-150 MHz \$100.00 with all accessories \$200.00. GE Exec 11 Radio 50 watt, 42-50 MHz \$100.00 with all accessories \$200.00. EM-2 DTMF mics with Micor, Mitreks, Syntor Plugs, hard wire changeable with schematic \$20.00. DTMF Encoders with lite, choice of Plug Micor or Master II \$30.00 each. LAMBDA Power Supplies LNS-P-12, 120 volts, 12 volt DC 14 Amp. \$100.00. Wolfe Communications, 1113 Central Ave., Billings MT 59102. (406) 252-9220. BNB900

KAM C-64 Does anyone know of any good software, all mode for this pair, other than "Kanterm." WB5JAP, 2109 Sandy Ln, Irving TX 75060. BNB901

SUPER HAM QTH St. Augustine FL. Anastasia Island. Beautiful 2 Bedroom 2 Bathroom house on large plot. View Intercoastal, walk to Ocean beach. Backyard borders saltwater canal. All appliances including central air. Mint condition only 3 years old. Asking \$89,500.00. (516) 271-5784 night (516) 367-8420 daytime ask for Fred (N2JCD). BNB902

ICOM, KENWOOD & YAESU OWNERS: 8 Pole & 10 Pole Crystal Filters & monthly informative individual Newsletters! Our 10th year! Ask yourself these questions: Are you continually being interfered with during QSO? You can't seem to pull out a weak signal in the QRM? Yes, to either, purchase our SSB or CW filters. Send 0.45 SASE for free catalog. International Radio & Computers, Inc., 751 SW Macedo Blvd., Port St. Lucie FL 34983. (407) 879-6868. BNB903

QSLs & RUBBER STAMPS—TOP QUALITY! States, World Maps, USA, Key, Shuttle, Globe QSLs. Report Form Rubber Stamps. More! Samples \$1.00 [Refundable With Order]. Ebbert Graphics D-7, Box 70, Westerville OH 43081. BNB904

CW IDENTIFIER: 700 Hz Sinewave, Accurate 10-Minute Timer, 9-12VDC, Instructions, Guaranteed. \$79.95. DMR Oil Tools, Inc., 6126 Rex Drive, Dallas TX 75230-3429. (214) 891-0509. BNB905

R-390A PARTS LIST SASE. CPRC-26 Infantry Manpack Radio, compact, 6 Meter FM, Receiver-Transmitter sections, case, antenna, crystal, handset: \$22.50 apiece complete, \$39.50/pair. Patrol Seismic Intrusion Device ("PSID") TRC-3: \$42.50 apiece, \$147.50/set of four. Military-spec TS-352 Voltohm/Multimeter, leads, information: \$12.50. Add \$4.50/piece shipping, \$9 maximum. Baytronics, Box 591, Sandusky OH 44870. BNB906

EASTERN UNITED STATES TO:												
GMT:	00	02	04	06	08	10	12	14	16	18	20	22
ALASKA	15	—	—	—	—	20	20	20	—	—	—	15
ARGENTINA	15	20	20	20	—	—	—	—	—	10	10	10
AUSTRALIA	—	—	—	20	20	20	15	15	15	—	—	—
CANAL ZONE	15	15	20	20	20	—	20	20	15	10	10	10
ENGLAND	20	20	40	—	—	20	—	15	15	20	20	20
HAWAII	15	15	15	20	20	40	20	—	—	—	15	10
INDIA	15	20	—	—	20	20	—	—	—	—	—	—
JAPAN	15	—	—	—	20	20	20	—	—	—	—	15
MEXICO	15	15	20	20	20	—	20	20	15	10	10	10
PHILIPPINES	20	15	20	20	—	—	20	—	—	—	—	—
PUERTO RICO	15	15	20	20	20	—	20	20	15	10	10	10
SOUTH AFRICA	—	—	—	20	20	—	—	15	15	15	20	20
U.S.S.R.	20	20	20	20	—	—	20	—	—	15	15	20
WEST COAST	15	15	80	80	80	—	20	20	20	20	15	15

CENTRAL UNITED STATES TO:												
ALASKA	—	15	15	—	—	20	20	20	20	—	—	—
ARGENTINA	15	15	20	20	—	—	—	—	—	10	10	10
AUSTRALIA	15	15	15	20	20	20	20	20	—	—	—	—
CANAL ZONE	15	15	20	20	20	20	20	20	20	15	10	10
ENGLAND	20	20	20	40	—	—	—	—	—	—	—	15
HAWAII	10	15	15	20	20	20	20	20	—	—	—	—
INDIA	20	20	—	—	—	20	—	—	—	—	—	—
JAPAN	—	15	15	—	—	20	20	20	20	—	—	—
MEXICO	15	15	20	20	20	20	20	20	20	15	10	10
PHILIPPINES	20	20	15	20	—	—	—	—	—	—	—	20
PUERTO RICO	15	15	20	20	20	20	20	20	20	15	10	10
SOUTH AFRICA	—	—	40	20	—	—	—	—	15	20	20	—
U.S.S.R.	20	20	20	—	—	—	—	—	—	15	15	20

WESTERN UNITED STATES TO:												
ALASKA	15	15	20	20	20	20	20	20	15	20	—	15
ARGENTINA	10	15	15	20	20	—	20	20	—	—	—	15
AUSTRALIA	10	10	15	15	20	20	40	40	20	—	—	—
CANAL ZONE	15	15	20	20	20	40	80	—	—	15	15	15
ENGLAND	15	20	20	20	—	—	—	20	15	15	—	15
HAWAII	15	15	15	20	20	40	40	20	—	—	15	10
INDIA	—	—	15	—	—	—	20	20	20	15	—	—
JAPAN	15	15	—	20	20	20	40	20	20	20	—	15
MEXICO	15	15	20	20	20	40	80	—	—	15	15	15
PHILIPPINES	—	—	15	—	—	20	20	20	15	15	—	—
PUERTO RICO	15	15	20	20	20	40	80	—	—	15	15	15
SOUTH AFRICA	—	—	—	20	20	—	—	20	20	15	—	—
U.S.S.R.	20	20	20	20	20	—	—	—	—	—	—	—
EAST COAST			80	80	80	—	20	20	20	20	15	15

AUGUST						
SUN	MON	TUE	WED	THU	FRI	SAT
		1	2	3	4	5
		F	F-P	F-G	G	G
6	7	8	9	10	11	12
G	G	G	G	G	G	G
13	14	15	16	17	18	19
G	G	G	G-F	F	F-P	P
20	21	22	23	24	25	26
P	P-F	F-G	G	G	G-F	F
27	28	29	30	31		
F-P	P	P-F	F-G	F-G		

This is an Amateur Radio License

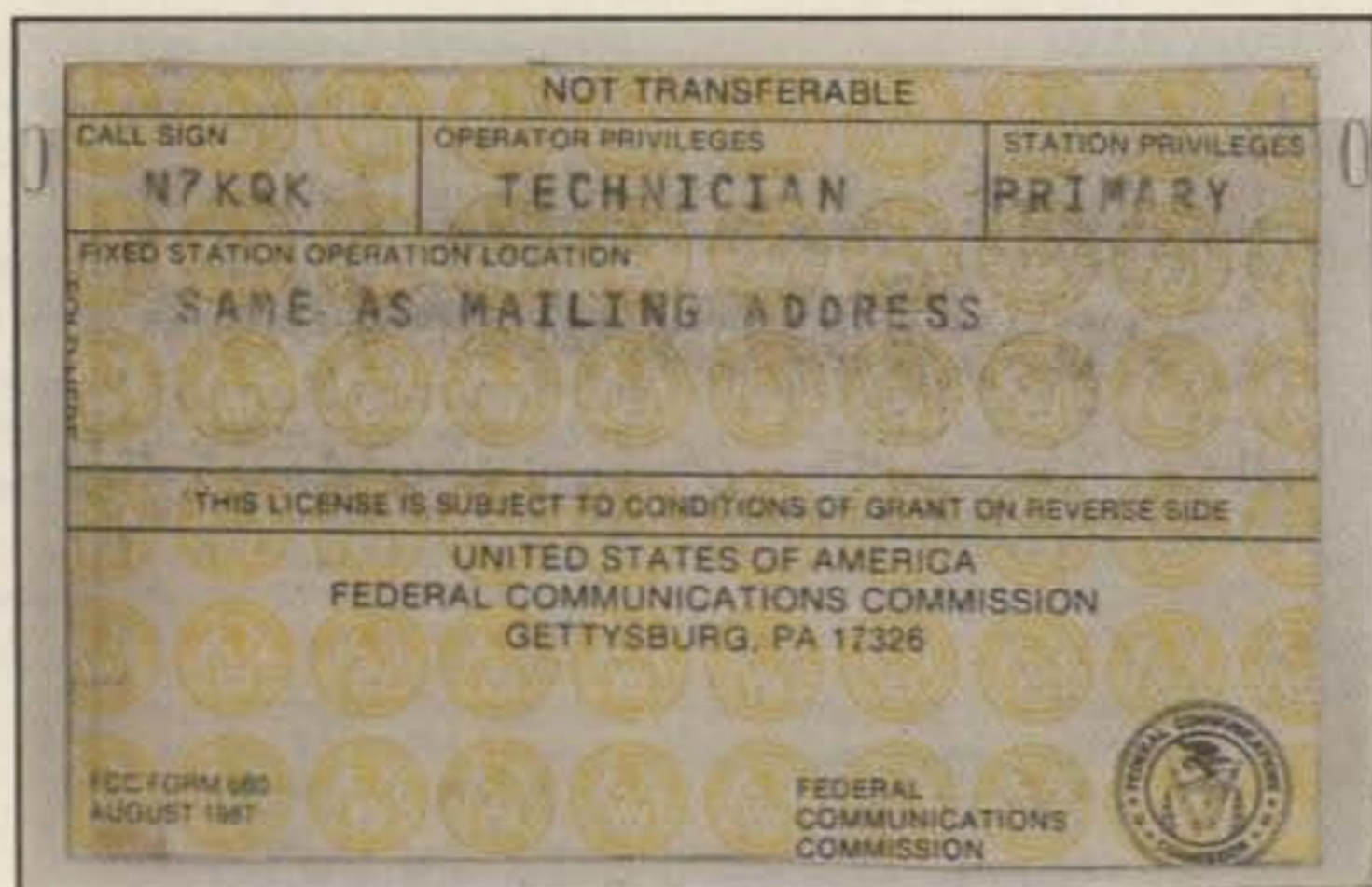

This is an Amateur Television License



That's right, they are exactly the same. Your technician or higher class amateur radio license gives you the right to own and operate your own amateur television station.

It's Easy....

If you can operate a video camera, you can operate the new AEA Model FSTV-430. The FSTV-430 transceiver connects to the video output of your camera and transmits and receives live or taped video. You can even use two cameras for studio-like operation from your shack.

Fast Scan Television with the new FSTV-430 from AEA gives you live, color television that rivals broadcast quality. In fact, the AEA Vestigial Sideband (VSB) technique is similar to that used by broadcasters.

Inexpensive...

The video camera or cam-corder you bought is the most expensive part of a fast scan television system. The AEA Model FSTV-430 is the only transceiver you need. Connect the camera, a 430 MHz antenna, (an amplifier if you want stronger signals) and you're on the air.

And Fun....

Think about it. You can share more than just conversation with your amateur friends. Show your friends the new transceiver you bought, that special antenna project you're working on, or just chew the fat.

For more information on the FSTV-430 and other exciting amateur television products, please contact
Advanced Electronic Applications, Inc.
 P.O. Box C-2160
 Lynnwood, WA 98036
 206-775-7373



AEA Retail \$499.95
Amateur Net \$439.95

TWO OF AMERICA'S MOST POPULAR FM STATIONS.



No wonder Yaesu's FT-212R Series and FT-4700RH mobiles are so popular.

Not only are the features unique and plentiful. The operation hassle-free. And the mounting options flexible. But also, each radio now features a built-in PL board. Plus *you* choose the optional mic that best fits your operating and budget needs.

FT-212R SERIES. MOBILES THAT DOUBLE AS ANSWERING MACHINES.

FT-712R take messages while you're away (with DVS-1 option)! 45-watt output (35W on 440 MHz). Built-in PL encode/decode. 18 memories. Auto repeater shift. Scanning routines. Offset tuning from any memory channel. Extended receive. Audible command verification. High/low power switch. Oversize amber display. Choice of optional mic. More.

FT-4700RH. DUAL-BAND PERFORMANCE, REMOTE-HEAD DESIGN.

Mount the FT-4700RH almost anywhere — the "brains" on your dash, visor, or door; the "muscle" under your seat. 50 watts on 2 meters, 40 watts on 70 cm. Full crossband duplex. Simultaneous monitoring of each band, complete with independent squelch settings on the main and secondary bands. Built-in PL encode/decode. 9 memories (each



band). Extended receive. Reverse repeater shift. High/low power switch. Patch cord for remote mounting. Bright LCD display. Backlit controls. Choice of optional mic. More.

Want more information? Call **(800) 999-2070** toll-free. Or ask your dealer about Yaesu's FT-212R Series and FT-4700RH mobiles today. Two of America's favorites.

Choose your optional mic: MH-15 C8 DTMF mic, or MH-15 D8 DTMF auto-dialer mic



YAESU USA 17210 Edwards Road, Cerritos, CA 90701
(213) 404-2700. **REPAIR SERVICE:** (213) 404-4884.
PARTS: (213) 404-4847.

YAESU

KENWOOD

...pacesetter in Amateur Radio

NEW!

Affordable DX-ing!

TS-140S

HF transceiver with general coverage receiver.

Compact, easy-to-use, full of operating enhancements, and feature packed. These words describe the new TS-140S HF transceiver. Setting the pace once again, Kenwood introduces new innovations in the world of "look-alike" transceivers!

- **Covers all HF Amateur bands with 100 W output.** General coverage receiver tunes from 50 kHz to 35 MHz. (Receiver specifications guaranteed from 500 kHz to 30 MHz.) Modifiable for HF MARS operation. (Permit required).
- **All modes built-in.** LSB, USB, CW, FM and AM.
- **Superior receiver dynamic range** Kenwood DynaMix™ high sensitivity direct mixing system ensures true 102 dB receiver dynamic range.

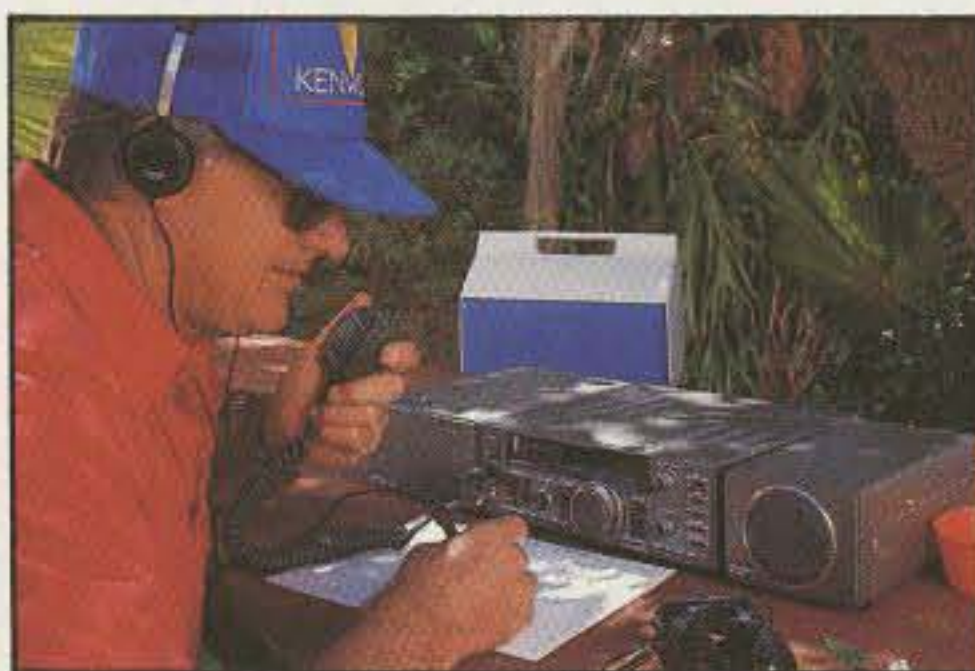

- **New Feature! Programmable band marker.** Useful for staying within the limits of your ham license. For contesters, program in the suggested frequencies to prevent QRM to non-participants.
- **Famous Kenwood interference reducing circuits.** IF shift, dual noise blankers, RIT, RF attenuator, selectable AGC, and FM squelch.

- **M. CH/VFO CH sub-dial.** 10 kHz step tuning for quick QSY at VFO mode, and UP/DOWN memory channel for easy operation.
- **Selectable full (QSK) or semi break-in CW.**
- **31 memory channels.** Store frequency, mode and CW wide/narrow selection. Split frequencies may be stored in 10 channels for repeater operation.
- **RF power output control.**
- **AMTOR/PACKET compatible!**
- **Built-in VOX circuit.**
- **MC-43S UP/DOWN mic. included.**

Optional Accessories:

- **AT-130** compact antenna tuner • **AT-250** automatic antenna tuner • **HS-5/HS-6/HS-7** headphones • **IF-232C/IF-10C** computer interface
- **MA-5/VP-1** HF mobile antenna (5 bands)
- **MB-430** mobile bracket • **MC-43S** extra UP/DOWN hand mic. • **MC-55** (8-pin) goose neck mobile mic. • **MC-60A/MC-80/MC-85** desk mics.
- **PG-2S** extra DC cable • **PS-430** power supply
- **SP-41/SP-50B** mobile speakers • **SP-430** external speaker • **TL-922A** 2 kW PEP linear amplifier (not for CW QSK) • **TU-8** CTCSS tone unit
- **YG-455C-1** 500 Hz deluxe CW filter, **YK-455C-1** New 500 Hz CW filter.



TS-680S

All-mode multi-bander

- 6m (50-54 MHz) 10 W output plus all HF Amateur bands (100 W output).
- Extended 6m receiver frequency range 45 MHz to 60 MHz. Specs. guaranteed from 50 to 54 MHz.
- Same functions of the TS-140S except optional VOX (VOX-4 required for VOX operation).
- Pre-amplifier for 6 and 10 meter band.



Complete service manuals are available for all Kenwood transceivers and most accessories. Specifications, features, and prices are subject to change without notice or obligation.

KENWOOD

KENWOOD U.S.A. CORPORATION
2201 E. Dominguez St., Long Beach, CA 90810
P.O. Box 22745, Long Beach, CA 90801-5745