

73

Amateur Radio

A WGE Publication

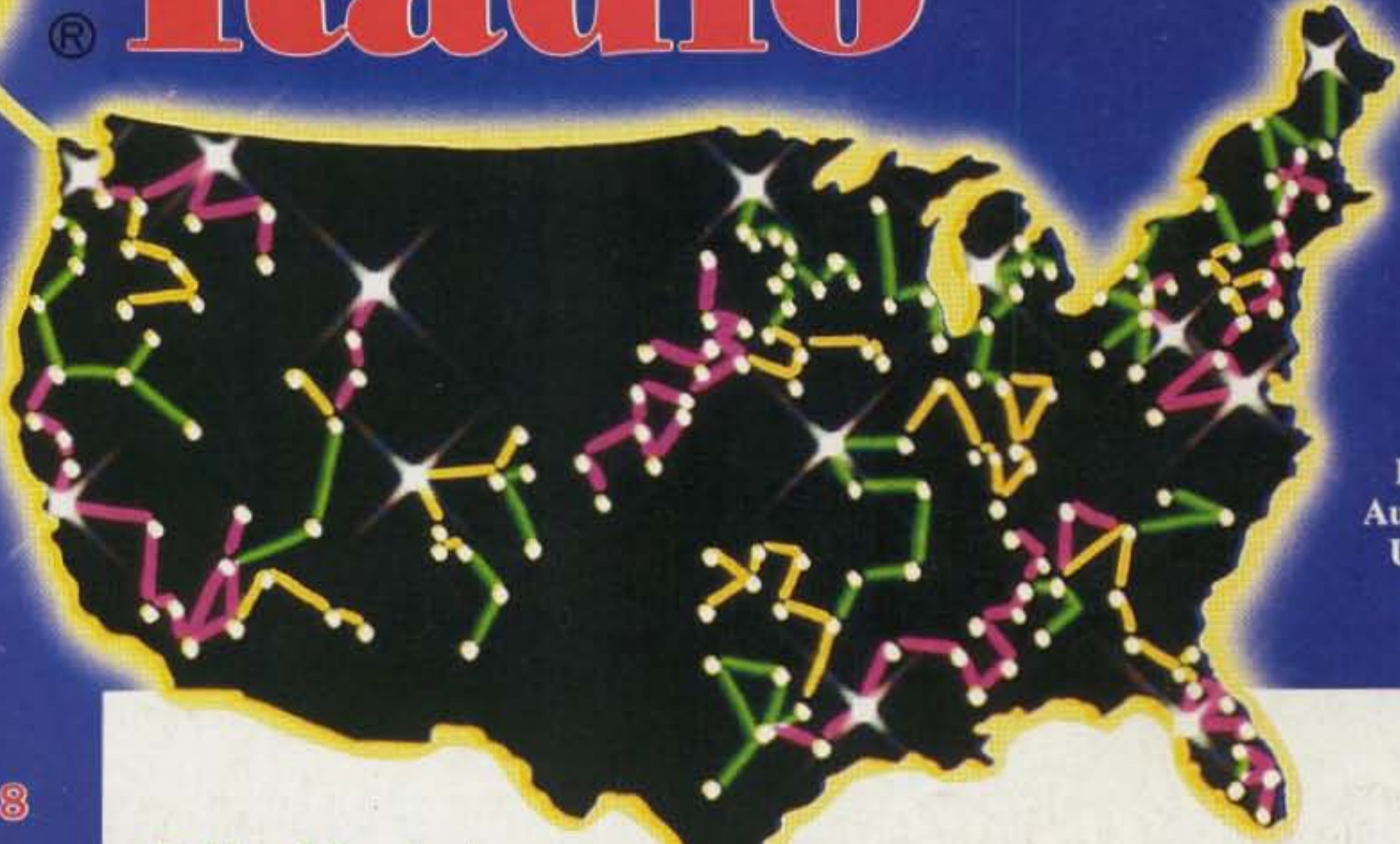

SPECIAL PACKET ISSUE!

Issue #311
August 1986
USA \$2.95
CAN. \$3.95

Get Started... **page 28**

What's New... **page 50**

Ab... **page 68**

•Buy... **page 58**

•Mo... **page 34**

•Di... **page 74**

•Pa... **page 58**

•AX... **page 34**

•Ne... **page 74**

Build a Packet Tuning Indicator!

page 40

plus:
Easy Connect Alarm **page 66**
Packet Buying Guide **page 88**
Packet Q&A **page 80**

Table of Contents

A Packet Primer For the totally bewildered—learn the mechanics of packet without having to ask embarrassing questions. WIBEL	28	Connect Alarm! A simple add-on for your TNC that screeches when someone connects to your station. This is a one-hour project (we're timing you!). K7YZZ	66
How To Make Friends At 1200 Baud Answers the question "What do I do with it?" that you asked after reading the primer. This article explains the operating side of packet. W2JUP	34	Survival Training For Mountaintop Digipeaters The amazing story of a club with a purpose: to blanket the state of California with digipeaters. WB6RAL	68
Precision Packet Tuning Complete plans for building what could be the world's best packet/RTTY tuning indicator. It's all digital and has a resolution of 10 Hz! ... WB2OSZ	40	Beyond Level Two The philosophy of networking and the future of amateur packet radio. Read only after successfully completing pages 1-73. KA9Q	74
Seeing Packet Radio With Different Eyes How a blind ham copes with an inherently visual mode. N7FDS	48	Lightning Never Strikes These simple precautions can save your rig...or your life. W0WUZ	79
So You Want To Be A Sysop? You may change your mind! Learn the secrets of a successful packet bulletin board station. WB2MNF	50	And If That Isn't Enough... If you're <i>still</i> totally bewildered about packet, join this question-and-answer round table. NK6K	80
Birds 'N' Bauds Amateur satellite builders from three countries discuss what's in store for packet radio in space. NK6K, JA2PKI, DK1YQ, DB2OS, DJ0HC/KE6MN	58	On The Shelf A bibliography of the seminal works in packet radio. NK6K	86
		73's Packet Buying Guide At-a-glance comparisons of everything on the packet market (complete with prices). Staff	88
		Kit Corner: The DSE 500-MHz Frequency/Period Counter KW1O	90

Reviews

A computer on a drive: Ampro's CP/M Little Board. WA8WTE/4	24
Driving the computer: Hamcom terminal software from AEA. AE5V	26

Departments

108 Barter 'N' Buy	4	Never Say Die	89	Satellites
110 Dealer Directory	22	New Products	100	73 International
96 Feedback	110	Propagation	92	Special Events
18 Letters	7	QRX		
97 List of Advertisers	10	QSL of the Month		



NEW!

ICOM Dual Bander

IC-3200A



The Most Compact Dual Bander at the Smallest Price

Finally there's a compact full featured 25 watt FM dual bander that's simple in design and operation, plus very affordable...the IC-3200A.

Dual Bands. The IC-3200A covers both the 2-meter (140.000-150.000MHz) and 70cm (440.000-450.000MHz) bands. The IC-3200A also features fully programmable offsets in 5KHz steps for MARS and CAP repeater operation.

25 Watts. The IC-3200A delivers 25 watts of output on both bands. Or the low power can be adjusted to one to ten watts.

Compact. The IC-3200A is only 5½"W x 2"H x 8½"D.

Simple to Operate. With only 14 front panel controls, the IC-3200A is by far the easiest dual bander to use.

Memory Lockout. For scanning only certain memory channels, ICOM utilizes a memory skip (M SKIP) function.

10 Tunable Memories. To store your favorite frequencies, 10 memories are provided. Each memory will store the receive frequency, transmit offset, offset direction and PL tone. Each memory can be tuned up or down when

selected, yet automatically returns to the original frequency when reselected. All memories are backed up with a lithium battery.

Scanning. The IC-3200A has four scanning systems... memory scan, band scan, program scan and priority scan.

Other Outstanding Standard Features:

- New LCD display, easy to read in bright sunlight
- Tone encoder (all PL/subaudible tones built-in)
- IC-HM14 mic with up/down scan and DTMF

- One antenna connector (Duplexer already installed)
- Variable tuning increments 5 and 15KHz (2-meters) 5 and 25KHz (70cm)
- Frequency dial lock
- Dual VFO's
- Mounting bracket

Optional Accessories. An optional IC-PS30 system power supply, voice synthesizer and IC-SP10 speaker are available.

See the IC-3200A at your local ICOM dealer for the best buy on a full featured dual bander.



First in Communications

ICOM America, Inc., 2380-116th Ave NE, Bellevue, WA 98004 / 3331 Towerwood Drive, Suite 307, Dallas, TX 75234

All stated specifications are approximate and subject to change without notice or obligation. All ICOM radios significantly exceed FCC regulations limiting spurious emissions. 3200A381

WORLDWIDE DISTRIBUTION



HAM RADIO OUTLET

LARGEST HAM OUTLET IN THE WORLD

NEW ATLANTA STORE!
EASY SERVICE FOR
OUR EASTERN CUSTOMERS

7 STORE BUYING POWER

ICOM IC-R71A



Superior Grade General Coverage Receiver

SALE! CALL FOR PRICE

ICOM

IC-3200A DUAL BANDER

Covers Both 2 Meters & 70 cm



LATEST EDITION

ICOM IC-1271A



1.2 GHz Transceiver:
The First Full-featured
1240-1300 MHz Transceiver
AT GREAT LOW, LOW PRICES

ICOM

IC-28A/28H

NEW



2-METER MOBILES
IC-28A (25w) IC-28H (45w)

SPECIAL NEW PRICE!

NOW! RAPID DELIVERIES FROM OUR OUTLETS

COAST TO COAST

To Our Customers

ICOM HAND-HELD VHF/UHF

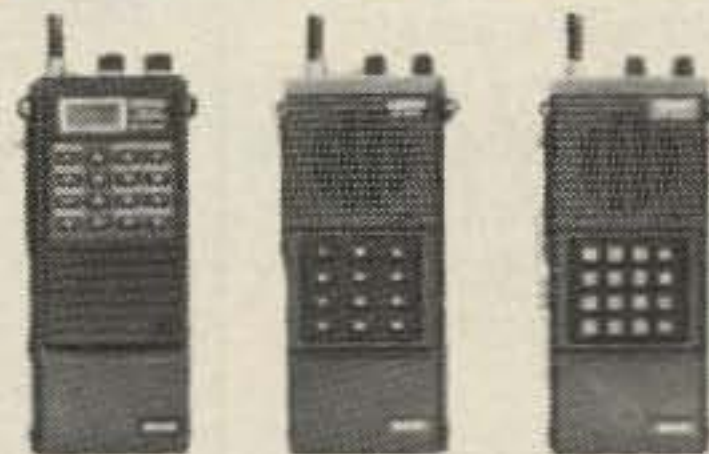

IC-02AT IC-2AT IC-3AT
IC-04AT IC-4AT

ICOM IC-735



The Latest in ICOM's Long Line of HF Transceivers

CALL FOR LOW, LOW PRICE

ICOM IC-R7000



25 MHz-1300 MHz

IN STOCK FOR IMMEDIATE DELIVERY

ICOM IC-751A



HF TRANSCEIVER

SPECIAL NEW PRICE!



Bob Ferrero W6RJ
President
Jim Rafferty N6RJ
VP So. Calif Div.
Anaheim Mgr.

ANAHEIM, CA 92801
2620 W. La Palma
(714) 761-3033, (213) 860-2040
Between Disneyland & Knotts Berry Farm

ATLANTA, GA 30340
6071 Buford Hwy.
(404) 263-0700
Neil, Mgr. KC4MJ
Doraville, 1 mi. north of I-285

BURLINGAME, CA 94010
999 Howard Ave.
(415) 342-5757
George, Mgr. WB6DSV
5 miles south on 101 from SFO

OAKLAND, CA 94606
2210 Livingston St.
(415) 534-5757
Joe, Mgr. K50S
17N-5th Ave./17S-16th Ave.

PHOENIX, AZ 85015
1702 W. Camelback Rd.
(602) 242-3515
Bob, K7RDH
East of Hwy. 17

SAN DIEGO, CA 92123
5375 Kearny Villa Rd.
(619) 560-4900
Tom, Mgr. KM6K
Hwy. 163 & Claremont Mesa Blvd.

VAN NUYS, CA 91401
6265 Sepulveda Blvd.
(818) 988-2212
Al, Mgr. K6YRA
San Diego Fwy.
at Victory Blvd.

STORE HOURS
10 AM-5:30 PM
CLOSED SUNDAYS

FREE SHIPMENT
Most items UPS surface

CALL TOLL FREE (800) 854-6046

Toll free including Hawaii. Phone Hrs: 7:00 am to 5:30 p.m. Pacific Time. California, Arizona and Georgia customers call or visit nearest store. California, Arizona and Georgia residents please add sales tax. Prices, specifications, descriptions subject to change without notice.



THINGS TO LOOK FOR (AND LOOK OUT FOR) IN A PHONE PATCH

- One year warranty.
- A patch should work with any radio. AM, FM, ACSB, relay switched or synthesized.
- Patch performance should not be dependent on the T/R speed of your radio.
- Your patch should sound just like your home phone.
- There should not be any sampling noises to distract you and rob important syllables. The best phone patches do not use the cheap sampling method. (Did you know that the competition uses VOX rather than sampling in their \$1000 commercial model?)
- A patch should disconnect automatically if the number dialed is busy.
- A patch should be flexible. You should be able to use it simplex, repeater aided simplex, or semi-duplex.
- A patch should allow you to manually connect any mobile or HT on your local repeater to the phone system for a fully automatic conversation. Someone may need to report an emergency!
- A patch should not become erratic when the mobile is noisy.
- You should be able to use a power amplifier on your base to extend range.
- You should be able to connect a patch to the MIC and EXT. speaker jack of your radio for a quick and effortless interface.
- You should be able to connect a patch to three points inside your radio (VOL high side, PTT, MIC) so that the patch does not interfere with the use of the radio and the VOL. and SQ. settings do not affect the patch.
- A patch should have MOV lightning protectors.
- Your patch should be made in the USA where consultation and factory service are immediately available. (Beware of an inferior offshore copy of our former PRIVATE PATCH II.)

**ONLY
PRIVATE PATCH III
GIVES YOU ALL
OF THE ABOVE**

PRIVATE PATCH III

SIMPLEX SEMI-DUPLEX INTERCONNECT

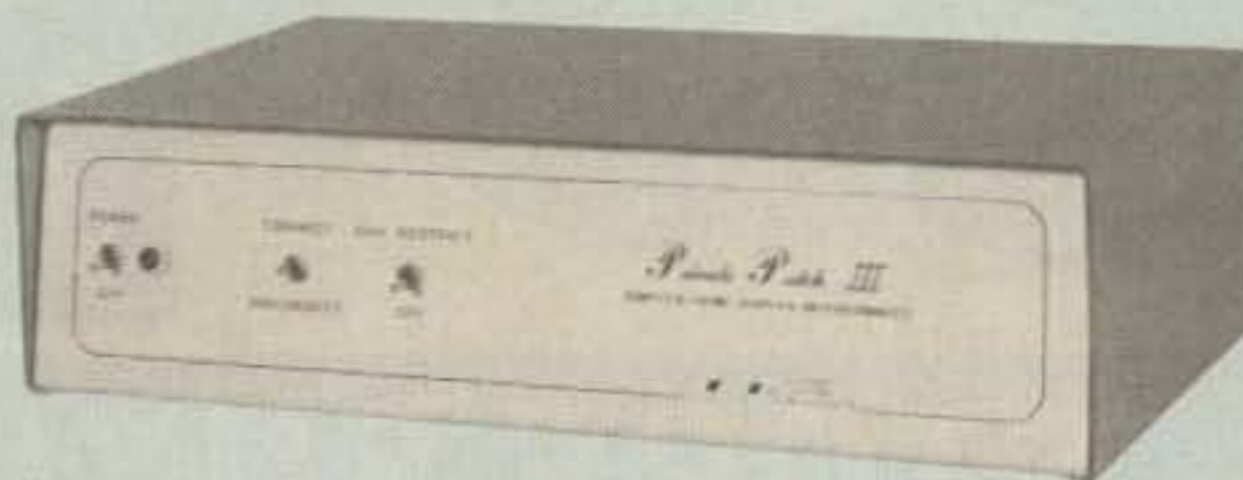

The telephone is the most powerful mode of communications... PRIVATE PATCH III gives you full use of your home telephone from your mobile and HT radios!

With only three simple connections to your base station radio, PRIVATE PATCH III will give you more communications power per dollar than you ever imagined possible.

Suddenly the utility of your radio is drastically increased. There are new sounds... dial tones, ring tones, CW ID and the sound of voices you never expected to hear on your mobile or HT radio! What a convenience!

PRIVATE PATCH III frees you from memberships, cliques and other hassles common to many repeater autopatches. You can call who you want, when you want and for as long as you want. You can even receive your incoming calls!

To Learn more about PRIVATE PATCH III and the advantages of the VOX concept, call or write for our four page brochure today!

PARTIAL LIST OF FEATURES

- OPERATES SIMPLEX, THROUGH REPEATERS, OR DUPLEX ON REPEATERS • VOX BASED • TOLL RESTRICT (Digit counting and programmable first digit lockout) • SECRET CODE DISABLES TOLL RESTRICT FOR ONE TOLL CALL—Automatic re-arm • AUTOMATIC BUSY SIGNAL DISCONNECT
- CONTROL INTERRUPT TIMER (Maintains positive mobile control) • CW ID When you connect again on disconnect. Free ID chip. • SELECTABLE TONE OR PULSE DIALING • MOV LIGHTNING PROTECTORS • THREE DIGIT ACCESS CODE (e.g. *91) • RINGOUT (Reverse patch) Ringout inhibit if channel busy.
- RESETTABLE THREE MINUTE TIMER • SPARE RELAY POSITION • 115VAC SUPPLY

DEALERS

- | | |
|--|--|
| AMATEUR ELECTRONIC SUPPLY
Milwaukee WI, Wickliffe Oh,
Orlando FL, Clearwater FL,
Las Vegas NV | MADISON ELECTRONICS SUPPLY
Houston, TX |
| BARRY ELECTRONICS CORP.
New York, NY | MIAMI RADIO CENTER CORP.
Miami FL |
| COLES COMMUNICATIONS
San Antonio TX | MIKES ELECTRONICS
Ft. Lauderdale, Miami FL |
| EGE, INC.
Woodbridge, VA | N&G DISTRIBUTING CORP.
Miami FL |
| ERICKSON COMMUNICATIONS
Chicago IL | PACE ENGINEERING
Tucson AZ |
| HAM RADIO OUTLET
Anaheim CA, Burlingame CA,
Oakland CA, Phoenix AZ,
San Diego CA, Van Nuys CA | THE HAM STATION
Evansville IN |
| HENRY RADIO
Los Angeles CA | TEXAS TOWERS
Plano, TX |
| INTERNATIONAL RADIO
SYSTEMS
Miami, FL | TNT RADIO SALES
Robbinsdale, MN |
| JUNS ELECTRONICS
Culver City CA | WESTCOM
San Marcos, CA |
| | CANADA:
DOLLARD ELECTRONICS
Vancouver, BC
SKYWAVE RADIO SYSTEMS, LTD
Burnaby, B.C. |

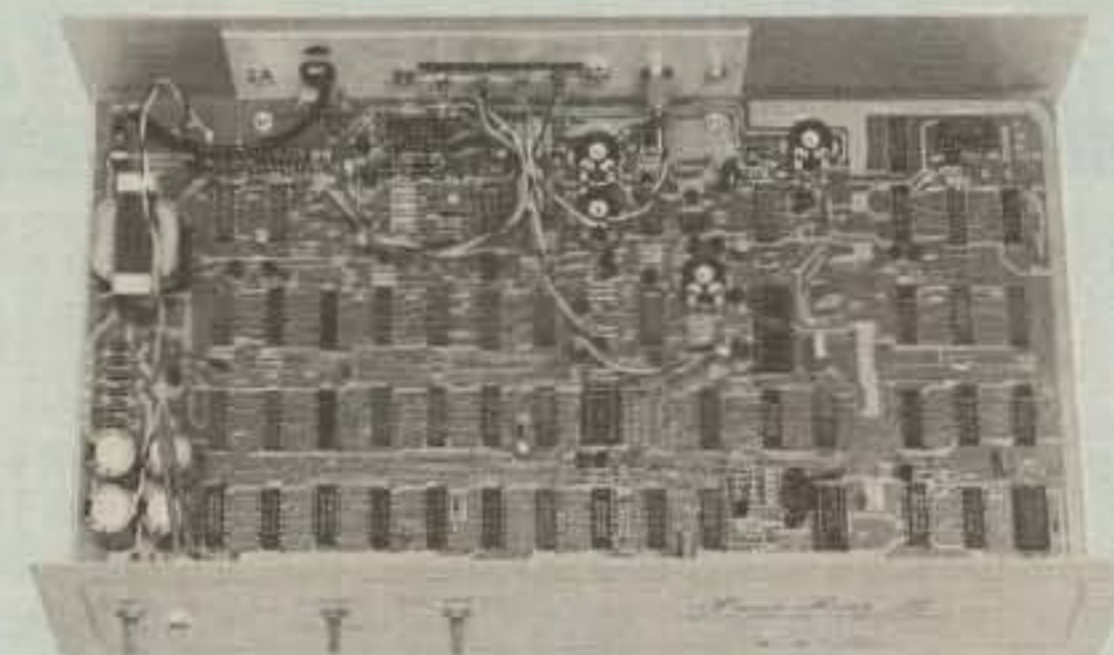

12



**CONNECT
SYSTEMS**

INCORPORATED 23731 Madison St., Torrance, CA 90505

(213) 373-6803



73 Amateur Radio

AUGUST 1986

ISSUE #311

Have you heard about packet radio? Probably you have, but you are a bit fuzzy on the subject. Don't bother looking in the other ham rags for help... at best you'll find a rehash of some "See Packet Run" article. This magazine is a complete course on a single subject. We've done everything possible to cram every available scrap of information on packet radio into 112 pages: Some monthly columns were omitted, others trimmed down (they'll all be back in September). The result is a series of articles that will take you from knowing nothing about digital communications to pondering the intricacies of system networking.

A Packet Primer

28

We start our packet blowout with a close look at what packet radio actually is, laying the groundwork for the rest of the magazine. This is the nuts-and-bolts stuff, the ACKs and NACKs and frames that make everything work. Here is where you'll find out what a TNC does. (Admit it: You've heard about packet and would like to try it, but you're afraid to ask stupid questions. Well, now you can be Joe Packet without being embarrassed!)

How To Make Friends at 1200 Baud

34

Introducing humans (hams, at least) into a computer-controlled environment can get a bit tricky. W2JUP explores the etiquette of AX.25; what settings to use on your TNC and why. This is the "how-to-do-it" companion to the "how-does-it-work" article... you should read them both in one sitting.

Precision Packet Tuning

40

Did you think that there were no construction articles? John Langner's cooked up a tuning indicator for packet (RTTY, if you insist) that you won't believe. This gadget has a resolution of 10-20 Hz, needs no calibration, and lets you dead-eye a signal in about 10 seconds. It's easy to build, too.

Seeing Packet With Different Eyes

48

We've all heard about the effectiveness of RTTY for people with a hearing impairment. But what about the blind? Can packet work for them? Obviously it can, or we wouldn't have an article about it.

So You Want To Be A Sysop?

50

You may decide otherwise! If you really have your heart set on a packet bulletin board system, here's all the information you need to get one on the air. Beware: It takes more than a pair of disk drives and a TNC to run a BBS.

Birds 'N' Bauds

58

An excellent overview of packet radio in space, written by the men who built the satellites. Covered are UoSAT-OSCAR-9 and -11, JAS-1 (scheduled for launch at the end of July), and Phase 3C. (Phase 3C's launch has been delayed due to problems at Arianespace.)

Connect Alarm!

66

Another construction project—this time an audible connect indicator for your TNC-1 or TNC-2. If it takes you more than an hour to build, you should turn in your license.

Survival Training For Mountaintop Digipeaters

68

The true story of a club with a grand vision: To cover the entire state of California (where else?) with digital repeaters. Did it work? If we told you, you wouldn't read the article, would you?

Beyond Level Two

74

Don't turn to this treatise unless you thoroughly understand everything on pages 1-73. The subject is networking and the future of packet radio. Actually, the premise is that networking is the future of packet radio. Phil Karn leads you head first into the most controversial topic in ham radio since no-code licensing.

And If That Isn't Enough...

80

Just in case you've read this far and are still a bit confused (about packet, that is), take a deep breath and let Harold NK6K fill in the gaps.

We'd like to publicly thank Harold Price NK6K for his work on this project. It is, in fact, Harold's issue: He assembled the authors, enforced the deadlines, and processed the manuscripts before uploading them to our computer. We couldn't have done this without him.—Eds.

"I never want to do this again as long as I live!"—NK6K

Extra copies of this issue are available for \$4.50—send a check or money order to 73 Back Issues, WGE Center, Peterborough NH 03458-1194.

Editorial Offices: WGE Center, Peterborough NH 03458-1194, phone: 603-525-4201. **Advertising Offices:** WGE Center, Peterborough NH 03458-1194, phone: 800-722-7790. **Circulation Offices:** WGE Center, Peterborough NH 03458-1194, phone: 603-525-4201. **Manuscripts:** Contributions in the form of manuscripts with drawings and/or photographs are welcome and will be considered for possible publication. We can assume no responsibility for loss or damage to any material. Please enclose a stamped, self-addressed envelope with each submission. Payment for the use of any unsolicited material will be made upon acceptance. All contributions should be directed to the 73 editorial offices. "How to Write for 73" guidelines are available upon request. US citizens must include their social security number with submitted manuscripts. **Subscription Information:** Rates: in the United States and Possessions: One Year (12 issues) \$24.97; Two Years (24 issues) \$45.47. Elsewhere: Canada and Mexico—\$39.00/1 year only, US funds. Foreign surface mail—\$45.00/1 year only, US funds drawn on US bank. Foreign air mail—please inquire. To subscribe, renew or change an address: Write to Subscription Department, PO Box 931, Farmingdale NY 11737. Send Canadian changes of address to: 73, PO Box 1051, Fort Erie, Ontario CANADA L2A 5N8. Return postage guaranteed. For renewals and changes of address, include the address label from your most recent issue of 73. For gift subscriptions, include your name and address as well as those of gift recipients. For questions concerning your subscription and to place subscription orders, please call us toll free at 1-800-645-9559 between 9 am and 5 pm or write to 73, Subscription Department, PO Box 931, Farmingdale NY 11737. **73 Amateur Radio** (ISSN 0745-080X) is published monthly by WGE Publishing, WGE Center, Peterborough NH 03458-1194. Second class postage paid at Peterborough NH 03458 and at additional mailing offices. Canadian second class mail registration number 9566. Entire contents copyright © 1986, WGE Publishing. All rights reserved. No part of this publication may be reprinted or otherwise reproduced without written permission from the publisher. Microfilm Edition—University Microfilm, Ann Arbor MI 48106. **Postmaster:** Send address changes to 73 Amateur Radio, Subscription Services, PO Box 931, Farmingdale NY 11737. Nationally distributed by International Circulation Distributors. **Legal Notice:** Your reading this notice is hereby construed as acceptance of a legally binding contract with the publisher of 73, just as opening the cellophane on a software package binds the buyer to the printed contract therein. Your primary duty as a contractee is to help your fellow 73 readers enforce the FCC regulations. For example, the FCC rules clearly state that it is totally and completely illegal to create intentional interference on our ham bands—right? Okay, your duty is clear. The next time you hear a pileup trying to contact a DX station it is your bound and duty to put a halt to this illegal practice. You don't believe for one instant that every station in that pileup doesn't know full well that he is intentionally interfering with other stations, do you? You must stop this chaos—this flagrant violation of the FCC regulations. Leave no DX pileup unturned as you seek your goal of amateur self-policing perfection. Remind them that list operation is within the FCC rules, as long as it is orderly. Once you have the dirty DX situation under control you can start to work on contests. I've several reports of contest stations interfering with each other, despite the FCC rules specifically prohibiting this dastardly activity. Remind these criminals of the penalties for willful violation of the FCC regulations—heavy fines and long prison terms. Perhaps we should petition the FCC to change the rules, making it a punishable offense to have one's call appear on the DX Honor Roll—since there is no way to achieve this disgrace without hundreds of hours of illegal operating. The paper on this page has been specially treated so your fingerprints cannot be removed or smudged, so there is now irrefutable proof of your contractedness. Too bad.

NEVER SAY DIE



WANT TO DESIGN SOMETHING?

Presumably you've been horsing around with amateur radio for a while now. Okay, how much have you learned? Are you the kind of ham who made it courtesy of Dick Bash and hasn't made an effort to learn more? Or have you been working on your theory so you have more than a vague idea of what's going on in your rice box?

What could be simpler than to build a battery charger? Are you up to it, or is something as simple as that a mystery to you? Forsooth! Well, let me whet your imagination by explaining that in fact there is an enormous need for a battery charger. Indeed, if you could put just the right battery charger on the market I think you'd be able to sell millions of 'em.

Now, with that simple clue, can

you describe the battery charger I have in mind? That's a test of your inventor's IQ. What kind of battery charger which (as far as I know) isn't available is so desperately needed it might sell in the millions? It's one you yourself have often wished you had.

Tsk, how am I going to make a real ham out of you? How am I going to help you to get rich when you're a lazy thinker? Haven't you any entrepreneurial spirit? Are you really going to spend the entire rest of your life calling in on the same net every night?

You've got NiCd batteries in your HT, right? If you're like me, you've also got 'em in your picocomputer, a portable disk drive, a bunch of toys, a cassette recorder, portable telephone, and so on. I've got a wide variety of NiCd chargers... keep 'em in a box on the closet shelf. But the big problem with NiCds... and I sure hope this

isn't news to you... is that they must be completely discharged every now and then so they won't develop a memory and hold only a short charge.

Exercising all my NiCds is not something I tend to remember to do, with the usual result that I often find my HT fading away after a couple hours of work instead of lasting all day. Or I find the low-battery light blinking on my computer. Drat! Now why in hell doesn't someone make a NiCd charger which will do the exercising automatically every few days... maybe in the middle of the night?

Is that something that is technically beyond your competence? Yes, I know NiCds don't drop their voltage very much before suddenly dying, but they do drop enough so you should be able to measure it and come up with an intelligent NiCd charger/recharger. If this is too much for you, perhaps it's time for some serious thought about learning the fundamentals of electricity. It's really about time, isn't it?

Would you enjoy it if I found someone to get started with a course in 73? Lordy, that could run for years, a chapter a month! If you're not serious about wanting to learn—if you'd rather not bother to know more about electricity and radio, okay. If I take the space—perhaps six pages a month—will you take an hour or so every month to read it and send in your homework?

One of the difficulties with learning electronics is the lack of any good self-teaching texts. Most textbooks are designed to be used as supplements for school classes, so they're more references than self-teaching books. The ARRL Handbook is fine as a handbook, but it's a ball-breaker when you try to use it to learn some-

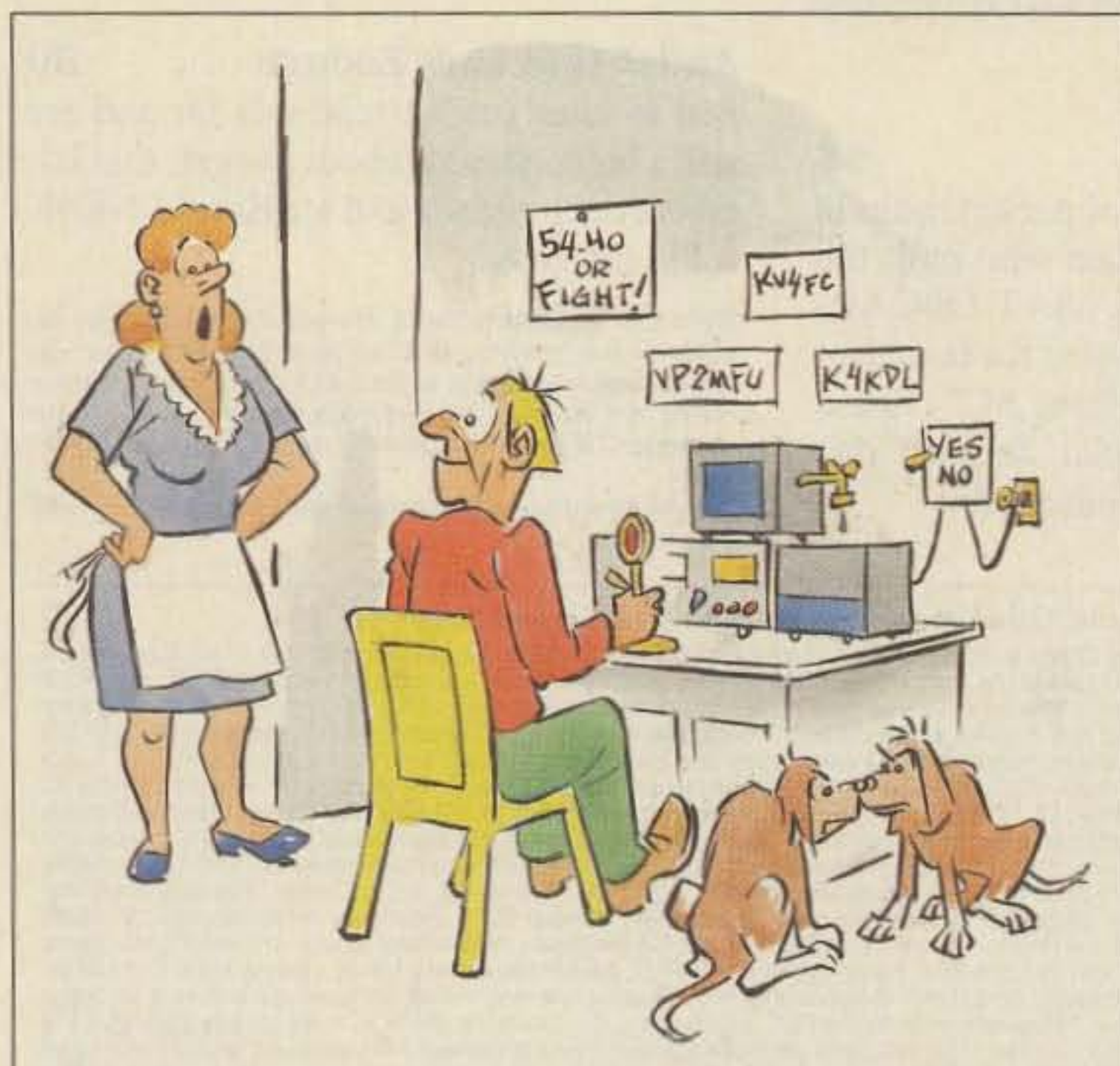

"I know you need the extra space for ham radio... so my mother is moving out!"

STAFF

PUBLISHER
Wayne Green W2NSD/1
ASSOCIATE PUBLISHER
Stuart Norwood

EDITOR
Perry Donham KW1O
MANAGING EDITOR
Chris Schmidt KA1MPL
PRODUCTION EDITOR
Steve Jewett KA1MPM

INTERNATIONAL EDITOR
Richard Phenix

COPY EDITOR
Robin Florence

EDITORIAL ASSISTANT
Carole Macioci

ASSOCIATES
John Edwards KI2U
Bill Gosney KE7C
Jim Gray W1XU
Dr. Marc Leavey WA3AJR
Bill Pasternak WA6ITF
Harold Price NK6K
Peter Putman KT2B
William Smith N6MQS

**ART DIRECTOR/
PRODUCTION SUPERVISOR**
Dianne Ritson

DESIGNER
Susan Hays

ADVERTISING
1-603-525-4201
1-800-722-7790

SALES MANAGER
Nancy Ciampa-Mallette

ADVERTISING SALES
Penny Brooks KA1GAW

ADVERTISING COORDINATOR
Lisa DiRusso

MARKETING MANAGER
Hope Currier

WGE PUBLISHING, INC.

VICE PRESIDENT, PUBLISHING
Jim Connell

VICE PRESIDENT, DEVELOPMENT
James S. Kendrick

CHIEF FINANCIAL OFFICER
Richard Yee

BUSINESS MANAGER
David P. Raether

PRODUCTION MANAGER
Bill Heydolph

SYSTEMS MANAGER
Sara B. Philbin

TYPESETTING/PAGINATION
Bob Dukette, Linda Drew, Susan Allen

GRAPHICS SERVICES
Dick Clarke, Sue B. Flanagan,
Dan Croteau, Liz McGrath, Cindy
Pirkey, Betsy Roberts, Deborah Siok

Editorial Offices
WGE Center
Peterborough, NH 03458-1194
603-525-4201

Wayne Green Enterprises is a division of International Data Group.

73 Amateur Radio (ISSN 0745-080X) is published monthly by WGE Publishing, Inc., a division of Wayne Green Enterprises, Inc., WGE Center, Peterborough NH 03458-1194. Entire contents © 1986 by WGE Publishing, Inc. No part of this publication may be reproduced without written permission from the publisher.

Continued on page 10

KENWOOD

...pacesetter in Amateur radio

Here Now!
TM-3530A
220 MHz

Power-Full...70 Watts!

TM-2570A/2550A/2530A/3530A

Sophisticated FM transceivers

Kenwood sets the pace again! The all-new "25-Series" brings the industry's first compact 70-watt 2-meter FM mobile transceiver. There is even an *auto dialer* which stores 15 telephone numbers! There are four versions to choose from: The TM-2570A 70-watt, TM-2550A 45-watt, TM-2530A 25-watt and the TM-3530A 220 MHz, 25-watt.

- First 70-watt FM mobile (TM-2570A)
- First mobile transceiver with telephone number memory and auto-dialer (up to 15 seven-digit phone numbers)
- Direct keyboard entry of frequency
- Automatic repeater offset selection — a Kenwood exclusive!
- Extended frequency coverage for MARS and CAP (142-149 MHz; 141-151 MHz modifiable)
- 23 channel memory for offset, frequency and sub-tone
- Big multi-color LCD and back-lit controls for excellent visibility

- Front panel programmable 38-tone CTCSS encoder includes 97.4 Hz (optional)
- 16-key DTMF pad, with audible monitor
- Center-stop tuning — another Kenwood exclusive!
- Frequency lock switch
- New 5-way adjustable mounting system
- Unique offset microphone connector — relieves stress on microphone cord

Large heatsink with built-in cooling fan (TM-2570A)



- High performance GaAs FET front end receiver
- HI/LOW Power switch (adjustable LOW power)
- TM-3530A covers 220-225 MHz
- Digital Channel Link (optional)

DCL Introducing... Digital Channel Link

Compatible with Kenwood's DCS (Digital Code Squelch), the DCL system enables your rig to **automatically** QSY to an open channel. Now you can automatically switch over to a simplex channel after repeater contact! Here's how it works:

The DCL system searches for an open channel, remembers it, returns to the original frequency and transmits control information to another DCL-equipped station that switches **both** radios to the open channel. Micro-processor control assures fast and reliable operation. The whole process happens in an instant!



Actual size front panel

Optional Accessories

- TU-7 38-tone CTCSS encoder
- MU-1 DCL modem unit
- VS-1 voice synthesizer
- PG-2K extra DC cable
- PG-3A DC line noise filter
- MB-10 extra mobile bracket
- CD-10 call sign display
- PS-430 DC power supply for TM-2550A/2530A/3530A

- PS-50 DC power supply for TM-2570A
- MC-60A/MC-80/MC-85 desk mics.
- MC-48 extra DTMF mic. with UP/DWN switch
- MC-42S UP/DWN mic.
- MC-55 (8-pin) mobile mic. with time-out timer
- SP-40 compact mobile speaker
- SP-50 mobile speaker
- SW-200A/SW-200B SWR/power meters
- SW-100A/SW-100B compact SWR/power meters
- SWT-1 2m antenna tuner

KENWOOD

TRIO-KENWOOD COMMUNICATIONS
1111 West Walnut Street
Compton, California 90220

Complete service manuals are available for all Trio-Kenwood transceivers and most accessories. Specifications and prices are subject to change without notice or obligation. Specifications guaranteed on Amateur bands only.

KENWOOD

...pacesetter in Amateur radio

NEW
Compact 45 W 2 m

45 Affordable Watts!

TM-201B/401B

Super-compact mobile transceivers

The TM-201B boasts a powerful 45 watts output, easy-to-operate front panel controls, and ultra-compact size. The GaAsFET receiver front end provides high sensitivity and wide dynamic range. Receive and transmit characteristics are tailored for minimum distortion and excellent audio quality. Both the TM-201B and the TM-401B are supplied with a high-quality external speaker, 16-key DTMF microphone and mounting bracket.

- 45 watt output, with HI/LO power switch (TM-401B has 25 watts output.) 5 W low.
- Dual digital VFOs
TM-201B covers 142-149 MHz, includes certain MARS and CAP frequencies
TM-401B covers 440-450 MHz
- 5 memories plus "COM" channel, with lithium battery back-up



- Programmable, multi-function scanning
- High quality external speaker supplied
- Audible beeper confirms operation

Optional accessories:

- PS-430 power supply
- TU-3 or TU-3A two frequency tone encoder
- FC-10 frequency controller
- MC-55 (8-pin) mobile microphone
- SP-40 compact mobile speaker

- SP-50 deluxe mobile speaker
- SW-100A/B SWR/power meters
- SW-200A/B SWR/power meters
- SWT-1 2 m antenna tuner
- SWT-2 70 cm antenna tuner
- PG-2K extra DC cable
- PG-3A DC line noise filter
- MB-201 extra mobile bracket



Optional FC-10 frequency controller

Convenient control keys for frequency UP/DOWN, MHz shift, VFO A/B, and MR (memory recall or change memory channel).

More information on the TM-201B/401B is available from authorized dealers.



TM-401B is similar to the TM-201B, but covers 440-450 MHz and is 25 watts. Specifications and prices subject to change without notice or obligation. Complete service manuals are available for all Trio-Kenwood transceivers and most accessories.

25th
Anniversary

KENWOOD

TRIO-KENWOOD COMMUNICATIONS
1111 West Walnut Street
Compton, California 90220

Disclaimer

OUR SHARPER READERS will notice that this issue of 73 is slightly different—we've devoted nearly every page to coverage of packet radio, this month's special topic. What a tough decision! On one hand, we had an entire magazine's worth of great packet articles. On the other, we had all of our regular columns and departments. In the background was the reality that there are only so many pages to put things on. Should we leave out important articles, or leave out the columns? We took a look at what the other ham rags were doing with packet. Pretty wimpy. So, we decided to go for broke (just a figure of speech!) and make this issue a packet instruction manual. Everything that you need to know about packet radio is in this magazine. Next month, all of your favorite departments will return as we take a look at the world below 30 MHz.

Reaching Out

MIKE NEARY, obviously a devout follower of QRX as well as the space program, mailed in the results of the National Space Institute's (now the National Space Society) **Space Outreach '85**. The program solicited ideas from the public as to potential uses of space; suggestions had to be made in 750 words or less. The panel of judges included Walter Boyne, Director of the Smithsonian's National Air and Space Museum; Evert Clark, Technology Editor of *Business Week*; and former astronaut Michael Collins. Ten ideas were selected for awards, including one from **Patrick Gowen** of Norwich, England, who wants to put a radio beacon on the moon. (Mike Neary: "Personally, I'd rather see a repeater, but I guess you've got to start somewhere!") Other interesting projects in the top ten were an Earth/space television channel (an imaging satellite in a figure-eight orbit around the Earth and the Moon, sending continuous real-time pictures from space), a space ark which would carry the genetic codes of all life on Earth, and a Space Debris Collection System designed to clean up all of the junk floating around in low-Earth orbit. More than 1,000 ideas were presented to the Outreach panel; the collected entries were compiled and presented to the Congress, NASA, and the National Commission on Space.

Youngest YL?

WE HAVE A CLAIM on file for the title, "Youngest Licensed Lady." **Jill Kristine Dietrich KA9VGW** is five years old and recently passed her Novice exam with perfect copy on the Morse test and only one question missed in the written portion. Jill attends kindergarten

in Bremen, Indiana. Her father, **Jeff Dietrich WB9ZHV**, says that Jill became interested in ham radio at the age of three, and that she also enjoys riding her bicycle, coloring, camping, playing with the piano, and playing with her three-year-old sister, who also shows an aptitude for the code. Jill's first contact was with **KA0WGQ** in Flatriver, Missouri, using a Kenwood TS-520S. Are there any challengers to the title? Let QRX know, and be sure to send a picture along.

Compu-Guide

EDITION 3.0 of *The DXer's Guide to Computing* is now available from Radio Sweden International. This is a 35-page manual that covers a wide variety of computer applications in the ham shack, including RTTY, packet, and computer control of receivers. I was really surprised to read that, while 55% of American hams own a computer (the number for 73 readers is close to 70%), *only 23%* of Japanese amateurs own one! (According to a survey taken by Japan's *CQ Ham Radio*.) The book is pretty thorough; you can get a copy by sending U.S. \$3 to Radio Sweden International, S-105, 10 Stockholm, Sweden.

CQ Writers

IF YOU SPEAK ENGLISH, you could write for 73. We are looking for columnists to cover every aspect of ham radio: EME, DXing, rag-chewing, antennas (especially antennas!), slow-scan, fast-scan, satellites, or whatever. If you are active on one particular band, be the columnist for that band—we'll have a short column for 80m, 160m, and so on . . . all you have to do is report what's going on on your

band. As a columnist, you'll have to send in about five double-spaced typewritten pages every month, plus photos and diagrams. If you want to give it a shot, make up a couple of sample columns and mail them in. If they're lousy we'll tell you they're lousy, but we'll also help you improve them. We also have our readers voting on all of the columns, so if in three or four months you're on the bottom of the heap, you're out of there. Think seriously about giving this a try. We'll pay you a little money—not a lot, but enough to help you buy some toys. Mail your sample columns to Perry Donham KW10, 73 Magazine, WGE Center, Peterborough NH 03458. Good luck!

Haney Vo-Tech

THE HANEY VOCATIONAL TECHNICAL CENTER is looking for donations of ham equipment, books, and materials for use in a course on amateur radio. It looks as if the school system is allocating no money for the project (typical), so the classes will have to use whatever comes in. **Mike Adams N4EVS**, instructor for the course, points out that any item donated is deductible from your income taxes at the cost of replacement, no matter what the condition of the item is. In fact, Mike suggests that non-working gear would be great for practicing troubleshooting and repair. Once the program gets rolling, a complete ham shack will be set up at the school for the students' use. If you have an item that you would like to donate, drop Mike a postcard stating what you have, the estimated cost of shipping (the school will pick up the tab), and your phone number. Send it to Mike Adams N4EVS, Haney Vocational Technical Center, 3016 Highway 77, Panama City FL 32405.



Is Jill KA9VGW the youngest YL licensed?

Break the Bank

REMEMBER THE CASE of the bugged beads? The company that cracked that caper is back on the trail...this time they're after low-lives who try to break the bank at casinos by using computer technology. **CCS Communication Control, Inc.**, has developed the CD-101 Computer Detector. Pit bosses run wire antennas down their legs and arms, and attach a control unit to their belt. Discreet alarms go off when the unit detects computer hash (I wonder if they get interference from nearby TRS-80s?). The security crew can dress and walk around naturally (or as naturally as they can get with wires running taped to their arms and legs), providing a very low-key guard against compu-cheaters. The price? Only \$22,000.

Double Eagle

ASTATIC CORPORATION, maker of the famous D-104 microphone, has "confirmed the rumor" that a new mike is in the works. (Actually, the only rumor I heard was in a press release from Astatic.) The new model is the D-204, a scaled-down version of the lollipop that sports an adjustable preprocessor and the same chrome finish as the D-104. The new microphone will be marketed as the Silver Classic.

Lowfing

LOOKING FOR A REAL CHALLENGE? Why not try putting out a signal on 1750 meters? *The Lower Letter*, published by Hal Murken NQ2Y, crossed my desk recently, and it looks as though activity on the band is beginning to gear up for the winter season. The 1750-meter band (160-190 kHz) is set aside for low-power stations under Part 15 of the FCC rules and regs; no license is required. There's a limit of one Watt output and a restriction on antennas and feeders (they can't exceed 50 feet), but a look at the list of beacons in the *Letter* indicates that activity on the band is growing. If you're interested, send Hal a few bucks and several SASEs; his address is 19 Hobby Lane, Oakland NJ 07436.

VE Two-Way

VE3CNE, the official ham station of the **Canadian National Exhibition**, will be on the air from August 13th to September 1st daily from 10 a.m. to 10 p.m. local time. The station is located in the Arts and Crafts Building east of the Dufferin gate, and visitors are encouraged to drop by and operate. Look for VE3CNE on the air according to this schedule (time is in UTC): Phone—3.790 at 0200; 7.250 at 1800; 14.180 at 1900; 21.250 at 2000; and 28.550 at 1700. CW—3.710 at 0230; 7.125 at 1830; 14.040 at 1930; 21.150 at 2030; and 28.150 at 1730. This operation is not to be confused with VE7EXPO, on the air through October 13th from the **World's Fair of Transportation and Communication** in Vancouver. VE7EXPO is

on practically every amateur band and mode from 160 meters to 1.2 GHz, so you should have no trouble finding them.

The Shootist

THIS FROM JOE MOELL K0OV, via Bill Pasternak WA6ITF of *Westlink*: An armed man apparently in search of a clear television channel shot and killed a CB radio in La Habra, California. According to the police, Dennis Carrico was operating his CB radio when a man with a gun walked in, told Dennis to get out of the way, shot the rig three times, then walked away.

OARS Well

THE OLYMPIA (WA) AMATEUR RADIO SOCIETY is trying to stir up some interest in their **Worked OARS Certificate**. To qualify for this coveted award, OARS members must work 10 other OARS stations, western Washington hams must find 5 OARS stations, and the rest of the world need only work 3 stations. All bands and modes are valid, but there are no special endorsements to the WOARC. You also must mention during the QSO that you are working toward the certificate. Once you've worked your quota, send a 9" x 12" SASE to Certificate, Olympia Amateur Radio Society, PO Box 5582, Lacey WA 98503, along with a log showing the date, time, frequency, and the name of each contacted operator.

World View

STUDENTS AT LESTER PEARSON COLLEGE in Victoria, British Columbia, are getting a taste of the freedom of amateur radio. Pearson is one of five World Colleges sprinkled across the globe whose function is to bring together young people of many different nationalities. Pearson, whose president is Prince Charles, has students from 60 countries. The school runs an amateur station (VE7LPC) with equipment donated by the Victoria Kiwanis Club. Pearson has graduates all over the world, including JO1UKS, OA4BIK, C6ADG, PA3BEW, VE7FLP/5Z4, and the husband/wife team of OA4BBU and YV5HFF, who met each other at the club station. VE7LPC is sponsored by Ron Parrett VE7TG.

Thai Ones On

AMATEUR RADIO IN THAILAND is about to become legal. According to Tony Waltham HS1AMH of the *Bangkok World News*, ham radio was never really illegal in Thailand, but in the past had been officially sanctioned only for special events such as contests. There was, in effect, an "understanding" with the authorities. The Radio Amateur Society of Thailand has been working for quite some time to get ham activity officially recognized, and RAST officers and members of the government Post and Telegraph Department have worked out a draft of regulations for an

amateur service in the country. It has only been a few months since the National Security Council stated that amateur radio is an activity "that is not detrimental to society." Three license classes are called for in the draft regulations, including a no-code VHF license.

Good News, Etc.

THE GOOD NEWS is that the AMSAT Phase-3C spacecraft has successfully completed thermal/vacuum testing at the Martin-Marietta facility in Denver. A few bugs surfaced and were corrected. During the tests, the first JL downlink QSO was conducted by Rip Ripportella WA2LQQ and Karl Meinzer DJ4ZC. Karl was on mode L (24 cm up, 436 MHz down), while Rip used mode J (2 meters up, 436 MHz down); the uplink frequencies were chosen to produce an identical downlink frequency. The bad news is the recent failure of the European Space Agency's Ariane-2 booster, the fourth failure in 18 launches. Phase-3C is scheduled to ride the maiden flight of the Ariane-4 rocket in November, but Arianespace has suspended all operations until an investigation of the Ariane-2 failure is complete. The rocket was detonated after its third stage failed to ignite, destroying the \$55 million Intelsat V satellite on board. This catastrophe comes on the heels of the ill-fated space shuttle launch in January, the explosion of a Titan booster in April, and the crash of a NASA Delta rocket in May. The western world is basically without access to space. (A recent editorial on National Public Radio's *All Things Considered* suggested that we ask the Soviets, with their 90% efficiency record, to launch our satellites for us.) It now looks as though Phase-3C will be delayed until 1987.

Meanwhile . . .

ALL IS NOT SO GLUM on the satellite scene. By the time you read this, the first Japanese-built amateur bird, JAS-1, should be off the ground and into orbit. The launch is scheduled for 2030 UTC on July 31st. Information about the digital side of both JAS-1 and Phase-3C can be found in this month's article, "Birds 'N' Bauds," on page 58. (There's a story behind that title which deals with a bar in Dayton, Ohio, called "Lips 'N' Sips," but we'll save that tale for another time.)

Thanks

ANOTHER MONTH OF QRX comes to an end. I'd like to thank everyone who makes this column possible, especially Tony Waltham HS1AMH, Roy Parrett VE7TG, Jeff Dietrich WB9ZHV, Dona Wolfe N7HOE, Bill Pasternak WA6ITF and *Westlink*, Thelma Woodhouse VE3CLT, Larry Reid VE7LR, Hal Murken NQ2Y, Mike Adams N4EVS, Mike Neary, *Sweden Calling DXers*, and *Amateur Satellite Report*. Send your news items and photos to QRX, 73 Magazine, WGE Center, Peterborough NH 03458, and we'll do our best to get 'em in.

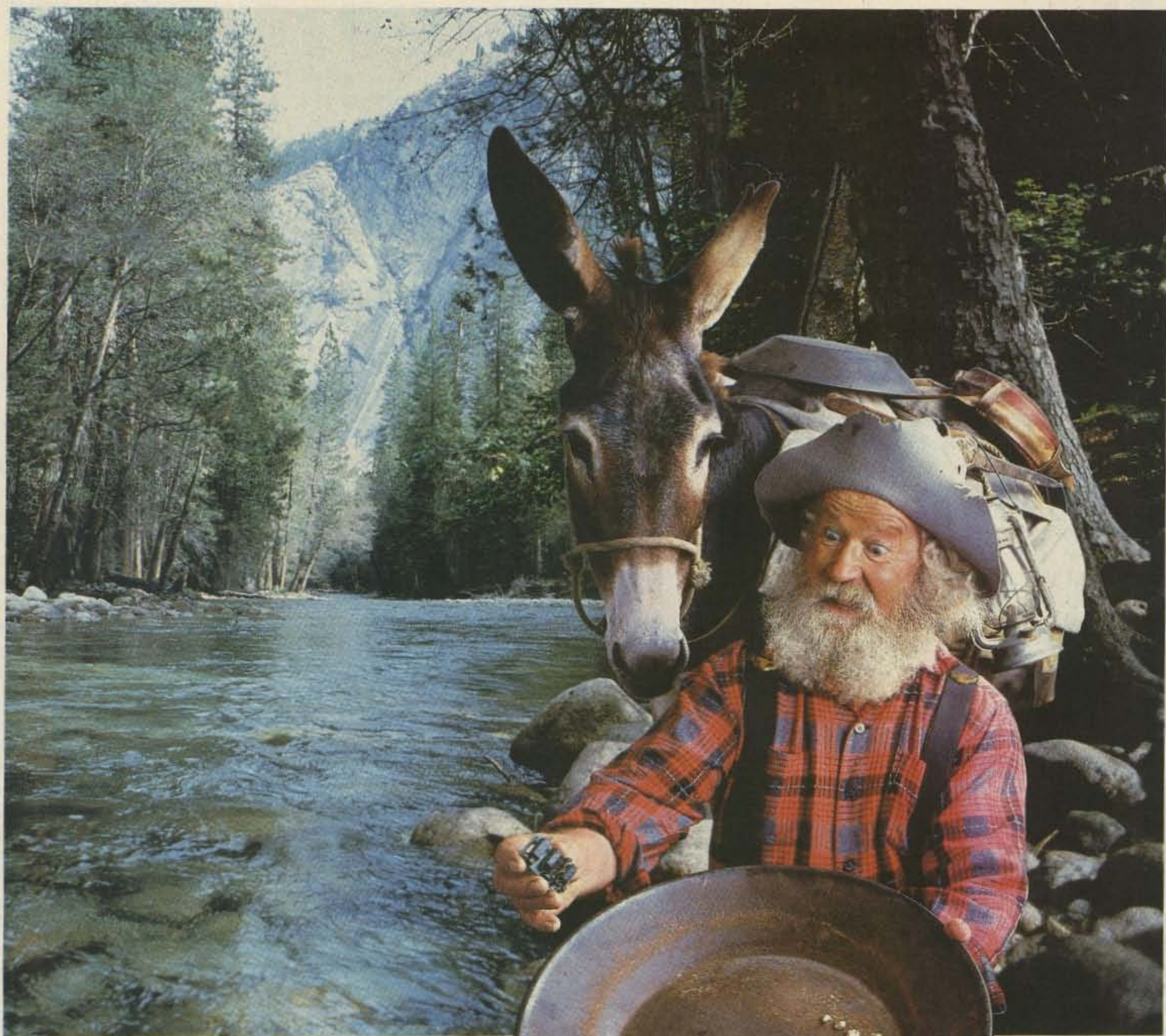

Eureka!

We just struck gold with a miniature, high quality and very reliable DTMF decoder at a rock bottom price of \$59.95. Our DTD-1 will decode 5040, 4 digit codes with the security of wrong digit reset. It contains a crystal controlled, single chip DTMF decoder that works great in bad signal to noise environments and provides latched and momentary outputs. Why carry that heavy gear when its size is only 1.25 x 2.0 x .4 inches and it comes with our etched in stone, legendary, one year warranty.

Instead of sifting through the field...searching, use our super quick one day delivery and cash in on a rare find.

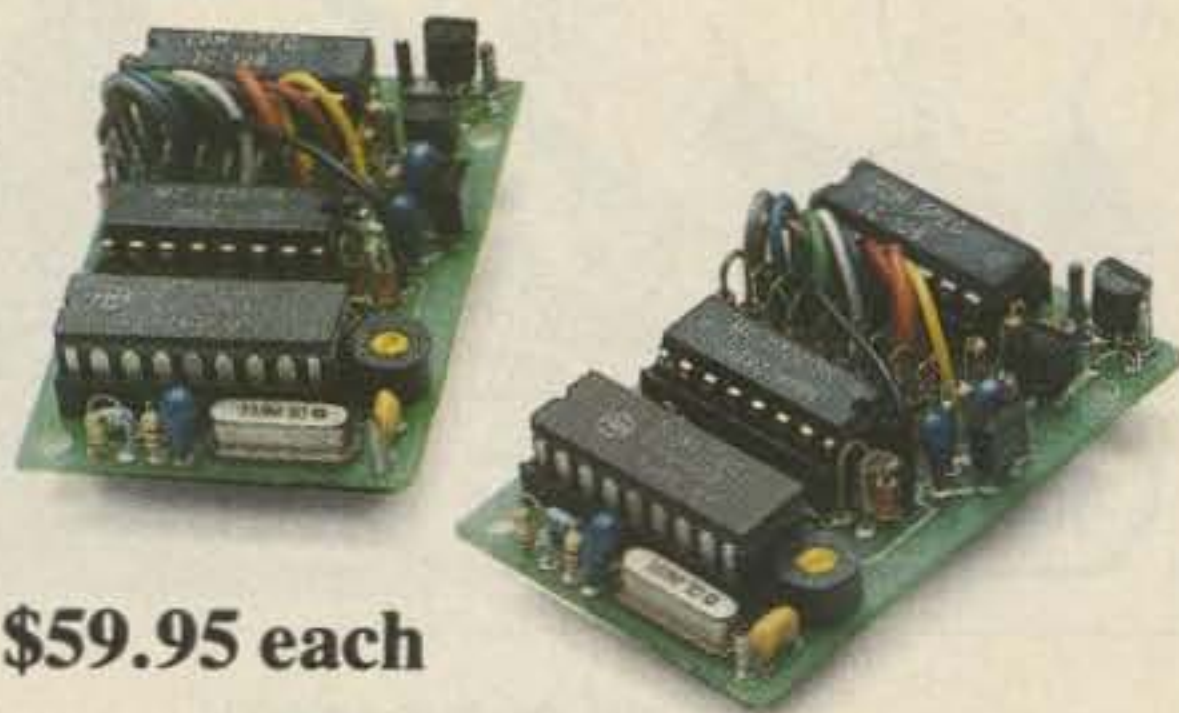

\$59.95 each

COMMUNICATIONS SPECIALISTS

426 W. Taft Ave., Orange, CA 92665-4296
 Local (714) 998-3021 • FAX (714) 974-3420
 Entire U.S.A. 1-800-854-0547

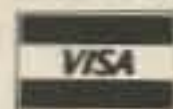

NEVER SAY DIE

from page 4

thing. It is better used for reference than for teaching.

If I don't hear from you about this I'll have your number.

Now, back to the NiCd exerciser—let's get to work and see who can come up with the most elegant design. It should be able to handle any given voltage. My NiCd chargers are in 3-V, 5-V, 6-V, 8.5-V, 12-V, and 25-V sizes. The 25-V charger is for a portable printer. Naturally I took the damned printer with me on a trip to Asia, but managed to forget the doubledamned charger. I shopped Akihabara in Tokyo from one end to the other looking for a 25-V charger. None at any price! And wouldn't you know the manufacturer used a small rocker switch on the printer which of course turned itself on in my suitcase so it arrived in Tokyo completely discharged. Phooey.

Let's see what you can come up with to sense when NiCds need to be recharged—then to completely discharge and recharge them. There should be some indication on the charger as to where you are in the cycle. Have you ever seen a NiCd charger which gave you the slightest hint as to how charged you are? That's ridiculous!

Now look here, you've been putting up with this NiCd nonsense as long as I have and you haven't made a move to do any-

thing about it. How many of you dutifully discharge your NiCd packs every few days? How many of you keep a timer by your charger so you'll not overcharge? I don't even recall ever seeing a NiCd charger with a timer built in—and these damned things don't do at all well when trickle-charged.

You say that building a voltage-sensing chip into a charger is beyond you? That even building a timer chip has you in a panic? Say, we've got to get you going with some simple building projects and get your ham juices running. Back when we used to have lots of kids coming into the hobby, most of 'em weren't fazed by little things like that. Naturally, now that we have a geriatric hobby, we can't expect old people to be able to actually learn anything. Old brains are so totally frozen with bad habits that they're unable to learn even the simplest of new things...right? You can't teach an old dog new tricks you're telling me, right? Pant, pant.

The next time you're in a bookstore check the animal stacks and take home a Barbara Woodhouse book on training old dogs. It turns out they're not much more difficult to train than young ones. Just because you've spent the last few years avoiding the technical articles in the ham magazines doesn't mean you can't learn. It does mean you'll have to make do with less Tom

Selleck and those brain-damaging sitcoms we use to keep our children stupid.

Speaking of children, the chances are that unless you've been working DX every night, you have some around the house. Take a check and see. Even if you've been DXing, the likelihood is that your wife hasn't, so there should be some kids around, even if they aren't yours. Ask about it when you get through reading this.

Let's see, with the average ham age now at 56 and rising, your kids must be around 34 or so. Hey, that means they probably have kids around 12—just the right age for exposure to amateur radio. If you do it right the infection will last a lifetime. It's incurable when properly set. I don't know your infallible system for spreading our common infection, but one I've found remarkably effective is the use of negative psychology. "Don't ever let me see you anywhere near Grandpa's ham rig." That's all it usually takes to create a situation they can't resist. Let me know what works for you.

If I got you thinking on the NiCd exerciser/charger, you may start looking for more gadgets to whip up. One thing we've been needing for years is a simple automatic ID system for our rigs. Yes, I know about the Morse-code ID we use with repeaters. I haven't run into anyone using one of those on his own rig. I don't expect to. If you run it slow enough so people can copy it, it's a nuisance. If you run it fast, no one can copy it.

Okay, you inventor-oriented readers should already have the new ID system almost designed. My approach would be to use a computer—probably a C-64, since there are so many of 'em and they're el cheapo if you don't have one yet. I'd then set up a 9600-baud clock and have the ID unit send out the code. Let's see, we'll need a protocol for this...need to come up with a format.

At 9600 baud how long will it take to send a six-character ham call...maybe eight if it's a portable...plus two for the state and two for counties? If you can't figure that out you're indeed in trouble. Using ASCII we have eleven bits per character...a start bit, eight for the character, one stop bit, and one for parity checking. So we need to send 132 bits. At 9600 baud...where

bauds are bits per second...we'd be able to get that through the pipe in 14 milliseconds. That's just over a hundredth of a second. Heck, that shouldn't eat into our talking time too badly. Yes, I know there are some old-timers who don't even leave that much time between draws.

If our rigs were set so they'd send hundredth-second ID bursts, we'd be able to call CQ with these miniscule bleeps. We might even be able to type in the call letters of the station we're calling and send a double bleep, getting the establishment of a contact down to a 30th of a second.

The next step is obvious. Just think back twenty years to 99% of the contacts you've made. You've been saying exactly the same thing almost word for word for years. I know you have because I've been listening to you. I've heard you tell the other chap what rig you're using. Thirty seconds later he's forgotten, if he ever heard you in the first place. He also could care less what antenna you're using.

If he really wanted to know your name and QTH, he could look it up in his *Callbook*. So when it comes down to it, the only remnant of a contact a day or two later is the call letters. Signal reports? Come ON now! Just put down a 59 and forget it. The next time I print up some logs I think I'll just fill in the report column with 59s and leave a small extra column for dB over S9. That's the baloney column.

So if all we need from a contact is the call letters, we're moving right along. The next move is to get your rig to automatically find a clear channel and start sending periodic call bleeps. When the autotune receiver of another operator comes to your bleep, it'll respond with its call bleep...and you've got a contact once you acknowledge his call. Your printer should print out the QSL card for you on a continuous QSL form which you can tear off every day or so and send off to the bureau.

Your computer will log all the contacts, keeping track of counties, zip codes, states, ARRL countries, IARU countries, CQ zones, and ITU zones worked—printing out daily, weekly, monthly, yearly, and cumulative scores. You might want it to keep track of your fastest worked-all-continents time, too. Can we get that down



QSL OF THE MONTH

To enter your QSL, mail it in an envelope to 73, WGE Center, 70 Rte. 202 N., Peterborough NH 03458, Attn: QSL of the Month. Winners receive a one-year subscription (or extension) to 73. Entries not in envelopes cannot be accepted.

Uncle Ben says...

**"I give you
much more than
just the lowest price..."**

When you get that exciting new piece of equipment *from me*, you know you are going to be completely happy... I see to it, personally! I also give you earliest delivery, greatest trade-in allowances, my friendly assistance in every possible way.

Just ask any of the many thousands of hams all over the world who have been enjoying my friendly good service for over a half a century.

73, Uncle Ben, W2SOH



"Uncle Ben" Snyder, W2SOH
the head man of

HARRISON

"HAM HEADQUARTERS,
USA®" ...Since 1925!

• **CALL ME...**

(516) 293-7995

HARRISON

HAS THEM ALL!

KENWOOD

• **WRITE ME...**

For my prompt,
personal reply.

• **SEE ME...**

At one of the world's largest
Ham Supply Centers!



Kenwood TH21AT, 31AT, 41AT



Kenwood TM-2570A



Kenwood TS-940S

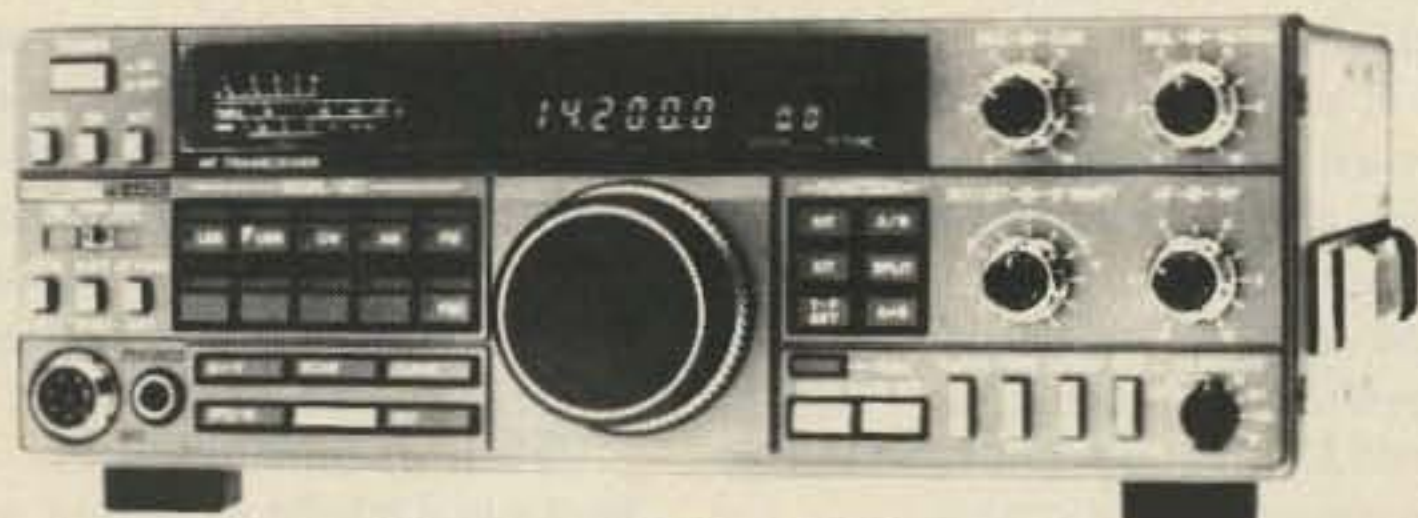

Kenwood TS-440S



Kenwood TR-2600, TR-3600



Kenwood TS-711A (2m)
TS-811A (70 cm)



HARRISON RADIO

...Since 1925!

"HAM HEADQUARTERS, USA"

2263 Route 110 (at Smith St.)
E. Farmingdale, NY 11735

1-(516) 293-7995

CHARGE IT!

under one second without planning it ahead?

Your receiver can tune for the ID bleeps and show you the call on its screen. You can easily program it to call only specific prefixes. Hey, here's your chance to be the first ham to work one hundred countries in alphabetical order! It'll make checking for DXpeditions a snap. It might even make DXpeditions simple since the operator would no longer have to actually be there. You could just send the rig in a box—have someone put up a dipole, plug it in and turn it on. Low-life DXers might set their DXpedition rig up so only they could contact it. I know a DXer who fits that description perfectly... right, Frank? Are you still pulling those bogus rare DX cards out of your coat pocket at hamfests and club meetings?

The nice thing about this is we'll be able to get rid of the pileups. That'll be a disappointment to the 10-kilowatt crowd, those who get more joy from squashing dozens of DXers than from the contacts they make. By the way, chaps, pileups are absolutely illegal and you know it. I don't want to ever hear you sanctimoniously talking to anyone about rules and regulations if you ever get into a pileup.

You know the ham rules as well as I and it's illegal to create intentional interference. Is there any other name for plonking your signal on top of someone else calling a DX station? You know damned well there are others on the frequency, so you know full well you are as illegal as all hell. You know you are breaking the law... that you are thusly a creep and a scuzzball... unless I get the contact.

There's another invention for you. You sharp inventors have already figured out what I'm going to suggest. Let's see a circuit which detects a pileup on frequency and sends 1,000 volts at high amperage through the microphone to a steel plate in the operating chair if the transmit button is pushed. We'll get those pileups down to manageable size for me yet.

I don't know if 1,000 volts is enough. Maybe you can recommend some DX ops who should be recruited to check out the optimum voltage. It'd make a good article for 73, right?

NEXT: MADE IN KOREA?

How long before we start seeing

some ham gear made in Korea? With the plummeting of the dollar vs. the yen, the Japanese are busy moving production to Korea. You see, the Korean won is tied to the dollar, not the yen.

The Koreans are already busy flooding the U.S. with color TV sets and VCRs. Look for more and more consumer electronics to come from there... mainly from the two giant Korean firms, Samsung and Gold Star. Both of them are already in production on 8mm cameras and VCRs, so they're not seriously lagging in technology... which they've been buying from Japan, there being very few Korean engineers or technicians.

Being so close to Japan, the Koreans have been hiring Japanese engineers and technicians to fly over on weekends to moonlight. The Koreans, by not encouraging amateur radio for youngsters in Korea, have gotten themselves in the same fix we have... they haven't the needed technical people. They're fortunate to have Japan close by so they can import the needed talent on weekends... we're too far away, so we're just plain up the creek.

If Japan isn't careful they could end up losing all of the consumer electronic industries to Korea... and with them would go the whole supporting infrastructure of parts manufacturing. Indeed, this has been rapidly moving to Korea, too. You know, even if we could scrape enough engineers and technicians together to get consumer electronics manufacturing going in the U.S., we no longer have the parts we'd need... the resistors, capacitors, transformers, coils, circuit boards, and so on. Most of the firms making those went the same way our American manufacturers did... pffft.

No, we don't have amateur radio to blame totally for this debacle. The American tax structure did its part to destroy investment here, too. When I was interested in building a product to sell in Europe I priced making it here and shipping it over vs. making it there. I found that if I wanted to invest \$250,000 in a plant here to make the product I'd first have to earn a second \$250,000 and give that to the IRS in taxes. If I wanted to set up exactly the same plant in Ireland I found I'd only have to send over \$125,000. Ireland would then match it... help me find a good manufacturing site... and pay to train workers or even

pay to send them to the U.S. for training. The bottom line was that I'd get four times the bang for my buck by opening a plant in Europe... plus I'd have further tax advantages from manufacturing in a Common Market country... and a tax holiday for several years in Ireland. You can see how our tax situation drove a large part of our manufacturing out of the country. I formed an Irish branch of my company, just as did Apple, Memorex, and many other U.S. firms. It's the people who write dumb tax laws who are the problem, not the businessmen who prefer to avoid them.

Smaller firms aren't equipped to handle an overseas branch, so they either make a go of it in spite of the tax situation... or don't. Our shortage of engineers and technicians has hurt this group the most, virtually eliminating them as competition.

This is not a new situation. Over ten years ago, when FM and repeaters were just getting up steam, Standard Radio was our largest ham gear supplier. They made HTs, mobile FM rigs, and even repeaters. Indeed, it was a Standard repeater I took over to Amman and set up as JY73 back in 1973 on .34/.94.

When I visited the Standard sales offices in Los Angeles I found the service department was made up almost entirely of Japanese hams. They'd given up on finding American technicians, so they'd had to bring Japanese hams over.

I've tried to interest the Koreans in using amateur radio as a way to develop more of their desperately needed engineers and technicians, but the political situation there is a difficult one. Perhaps, if we're able to get enough hams for a DXpedition to Seoul in October, we'll be able to get 'em more interested in developing more Korean amateurs.

If you do go on the trip I think you'll have an opportunity to see one of the most modern, highly automated electronic factories in the world. We'll see if they start getting into making ham gear as well as other consumer electronic equipment... and cars.

BETTER HAMFESTS

Perhaps there is a need for a hamfest organizer's newsletter. I see innovative hamfest ideas here and there, but on the other hand I see some hamfests which sure could use major consulting from an expert. Having probably been

to more hamfests than any other living ham, I'll get the ball rolling here with some ideas. Lordy, I've been to hamfests all around the world! Here are some random thoughts you might pass along to your next hamfest committee:

There are four general groups you want to attract and each requires a different pitch. First come the industry people for the exhibit area. Second are the flea marketers. Third are the local hams. Fourth are the hams from up to about 200 miles outside the local area.

The industry people who are most important to you are the ham dealers. Of secondary importance are manufacturers, which includes the magazines. You'll increase the industry exhibits by emphasizing the quantity and quality of the attendance... but don't be tempted to exaggerate it... most of us have been to enough hamfests to be able to make surprisingly accurate estimates. You have to let industry people know a year ahead so they can set their plans. And please, don't have your hamfest conflict with another major hamfest!

Since most industry people come from afar, be sure to let them know about any nearby attractions such as theme parks. You might also make up a special map showing the location of restaurants and shopping areas... perhaps with some recommendations. This will help out-of-town ham visitors too.

You might arrange for an exhibitor meeting on Friday night. Provide a meeting room and refreshments. Also, even if you have to increase the booth price a bit, consider having an exhibitor lounge with some coffee and snacks in the morning and sandwiches for lunch so they don't have to get on the chow lines and waste valuable sales time to get food. Coffee and doughnuts in the a.m. are greatly appreciated. Dayton has a separate exhibitor's lounge. Orlando and Miami provided nice exhibitor lunches.

You might include brochures for local attractions in your mailings. That might get out-of-town industry people to bring their families and come a day early or stay a day late—and help bring 'em back again next year.

Have you thought to have someone go around to take pic-

Continued on page 107

When we set out to make the best amateur radio equipment in the world, we had some pretty tough standards to live up to ...

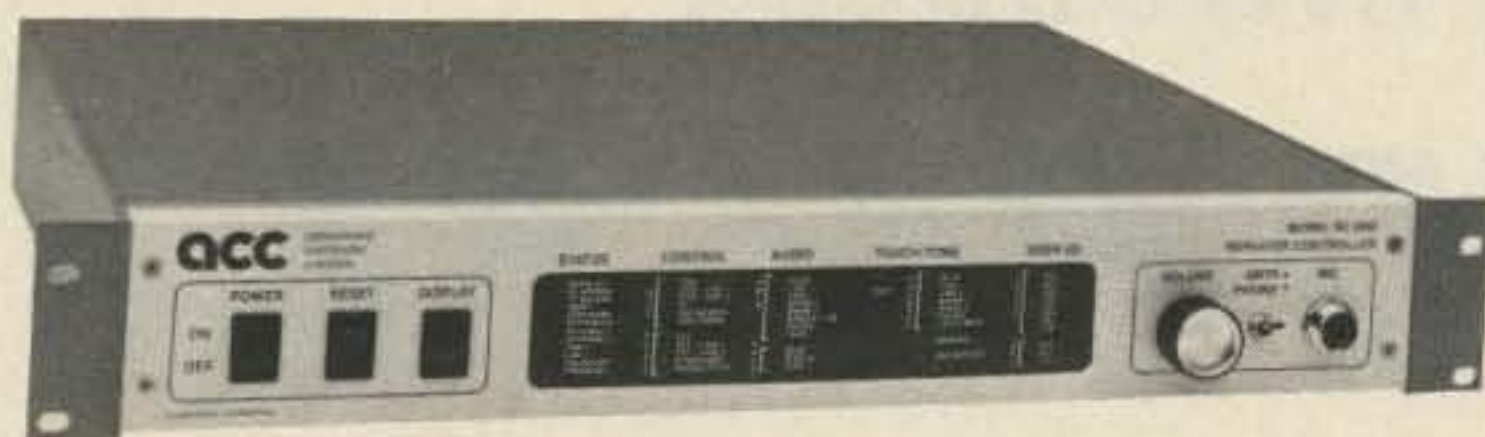

... yours

... and ours.

So we designed the **RC-850 Repeater Controller**, the industry's top of the line repeater control system. Now in it's "third wave" of innovation, thanks to its designed for the future architecture and new software releases. The '850 defines the industry standard in repeater control systems.

- Fully remotely programmable with Touch-Tone commands
- Front panel LED display
- Over 300 word customized male and female speech synthesis vocabulary
- Time/day of week Scheduler with 10 set-up states, 30 changeovers and events, over 100 scheduled items for hands off operation and automatic reminders.
- Full or half duplex autopatch, autodial (250 numbers), emergency autodial, reverse autopatch, antodialer, toll restrict including telephone exchange tables, supports remote and multiple phone lines
- Informative remotely programmable ID's (17), tail messages (13), bulletin boards (5)
- 16 channel voice response analog metering, automatic storage of min/max values on each channel, values may be read back on command or may be included in any programmable messages
- Supports synthesized remote base transceivers and full duplex links
- Individual user access codes to selectable features
- Mailbox for user-to-user, and system-to-user messages
- Paging - two-tone, 5/6 tone, DTMF, CTCSS, HSC display, user commandable and may be included in programmable messages (i.e. alarms)
- Easy hookup to any repeater

If your repeater budget can't afford the '850, we offer the **RC-85 Repeater Controller**, which we like to call the "second best repeater controller in the world". It's a scaled down, simplified version of our '850, but overall, it offers more capability and higher quality than anyone else's control equipment at any price.

- Remotely programmable with Touch-Tone commands
- Over 175 word customized male speech synthesis vocabulary
- Selectable "Macro sets" for easy control operator selection
- Autopatch, autodial (200) numbers, emergency autodial, reverse patch
- Remotely programmable informative ID's (7), tail messages (3), bulletin board (2)
- Supports synthesized remote base transceiver, control receiver, alarm
- Selectable, informative courtesy tones
- Talking S-meter, Two-tone paging
- Easy hookup to any repeater

For those who like to "roll their own", we can get you off to a rolling start with our **ITC-32 Intelligent Touch-Tone Control Board**. Much more than just a decoder, it's a mini-control system of its own, with the basic repeater and remote base functions built-in. And it can be tailored by you with its Personality Prom.

- 28 remotely controllable latched or pulsed logic outputs
- 4 alarm or remote sensed logic inputs
- Response messages to confirm command entry
- Repeater functions including COR, IDer, timers, courtesy tone, etc.
- Remote base functions including control of synthesized transceiver

Our new **Digital Voice Recorder** lets you remotely record ID's, tail messages, and various other response messages for automatic playback through your repeater. Audio is stored digitally with no-compromise reproduction quality in up to eight megabits of memory. The DVR can support up to three independent repeaters for a low per-channel cost. Its Touch-Tone activated voice mailbox lets your users easily record messages for other users when they aren't around.

- Remotely recordable, variable length audio tracks, accessed from controller messages
- Top quality, no compromise audio reproduction
- Supports up to three repeaters for cost effective installation
- Expandable to roughly 6 minutes of speech in 8 megabits of memory
- Easy interface to RC-850, RC-85 controllers, or to any stand-alone repeater

QST: Attention All Hams

If you own a shack, you should know about ShackMaster™.

ShackMaster lets you carry your home station with you in the palm of your hand. It acts as your gateway to the world, linking your handheld transceiver to your high performance HF station. Now, instead of your valuable home equipment being available to you 1% of the time, it's available 99% of the time! Whether around the house, in the yard, or across town, ShackMaster lets you take it with you.

But that's just part of ShackMaster's story. It lets you communicate with the family by handling third party traffic - its electronic mailbox and intercom let you keep in touch. And a simplex patch lets you place important calls directly through your home phone.

- Crossband linking - VHF/UHF to HF
- Telephone access to your home station
- BSR Home Control interface
- Electronic Mailbox
- ShackPatch™ intercom into the shack
- PersonalPatch™ simplex autopatch

All our products are documented with high quality, easy to read manuals. Our goal is to advance the state of the repeater art. But most of all, our products put the FUN back into the FUN MODE!



To order one of these advanced control products, call 408-749-8330. Technical manuals are available for purchase and the amount paid is applied as a deposit on the equipment. For specifications and a copy of our ACC Notes newsletter, just write or send in your QSL card to:



advanced
computer
controls, inc.

10816 Northridge Square • Cupertino, CA 95014

(408) 727-3330

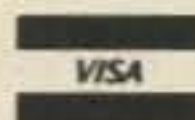

Visa and Mastercard accepted.

Kantronics Introduces

2400 BAUD PACKET

*Not Just For All Computers
But For All TNC's Too!*

WHY 2400 BAUD?

Packet channels are congested, and faster is better. So Kantronics has designed a 2400 baud PSK (phase shift keying) modem and included it in an all new KPC-2400. In addition, we are making this modem available in PC-board form to add to your TNC-1 or TNC-2, cables included! If you have a KPC-1 or KPC-2, we'll take it in trade for a new KPC-2400.

Since October 28, 1982, the rules have allowed for baud rates up to 19.6K. Of course, we've

all been operating at 1200 baud with

Bell 202 (1200 baud) standard tones. However, the bandwidth of our radios is fully capable of running up to 2400 baud, giving us congestion relief. Our phase shift modem (PSK) takes advantage of the bandwidth available and the reasonable linearity of the audio channels, and it is designed with the V.26TER CCITT specification in mind. To add to your TNC or trade for a new KPC-2400, see facing page.



KPC-2400

*All the Features of KPC-2
Plus 2400 Baud*

KPC-2400 Features

- AX.25 version 2 software
- Supports multiple connects
- All EPROM software is Kantronics written and U.S. copyrighted
- Advanced software HDLC, eliminating expensive chips
- In-house programmers/engineers
- In-house service representatives
- Periodic updates
— we keep you on the air

When we set out to design the KPC-2400™, we wanted it to be compatible with existing units, and it is. The KPC-2400 features both the KPC-2 modem for 300 baud HF and 1200 baud VHF work, and a new phase shift keying (PSK) modem for 2400 baud operation. All modes are software selectable with HBAUD command!

In addition, we've retained the RS-232/TTL jumper for easy direct interface to PC compatibles or the VIC/C-64 series. Hence, with the KPC-2400 you get HF, VHF, and 2400 baud packet with all computers that have a serial port, all in one!

The KPC-2400 of course, retains the version 2 software with multiple connects, and we've included an on-board memory diagnostic routine too.

Suggested Retail \$329.00

Speed up your local area network with the new **2400 TNC Modem™**. The 2400 TNC Modem is a PC-board that mounts directly above your existing TNC PC-board. By adding the 2400 TNC Modem to TNC-1 or 2, you gain 2400 baud while retaining 1200 baud operation, switch selectable.

Two 2400 TNC Modems will be available—one for TNC-1's, and another for TNC-2's. If you purchased a TNC-1 or TNC-2, manufactured or kit version, the 2400 TNC Modem should be compatible. If you have a home brew case, the installation may require case modification.

The 2400 TNC Modem will be available in late June. You may order the 2400 TNC Modem through a Kantronics dealer or directly through Kantronics, using check, money order, Visa or Mastercard. *Suggested Retail \$149.00 (includes shipping).*

Speed Up Your TNC-1 Or TNC-2 To **2400 BAUD**

Trade In Your KPC-1 Or KPC-2 For a New KPC-2400

That's right—Now you can trade in your Packet Communicator (KPC-1), or KPC-2, and for just \$149.00, you'll receive a NEW KPC-2400!

It's easy. All you have to do is fill out the KPC-2400 *EXCHANGE SCHEDULING FORM*, and mail it to Kantronics with check, money order, Visa or MC number. You'll be scheduled for exchange and notified by mail when to return your KPC-1 or KPC-2 to Kantronics. Once we receive your unit, a new KPC-2400 will be shipped directly to you.

You may also schedule your exchange by calling the Kantronics order desk and giving your Visa or MC number. Just call (913)842-7745 between 9-12, 1-4 (Central Standard

**KPC-2400
EXCHANGE SCHEDULING FORM**

To schedule your KPC-2400 exchange, please fill out the information below and mail this form, including \$149.00 payment (shipping included) to **Kantronics, 1202 E. 23rd Street, Lawrence, KS 66046**. You will be notified by mail of your authorization number, and scheduled exchange date. **DO NOT RETURN YOUR UNIT WITH THIS FORM.** This form is being used to SCHEDULE returns.

When it is time to return your unit, please **DO NOT SEND BACK ANY CONNECTORS, CABLES OR POWER SUPPLIES**. Send back only the unit itself. Any cables, connectors, or power supplies received will not be returned. You will receive a new manual and a 9-pin connector with your new KPC-2400.

Name _____ Call Sign _____
 Address _____
 City _____ State _____ Zip _____
 Phone() _____ Date _____
 Unit to be exchanged (check one) _____KPC-1 _____KPC-2
 Serial Number _____
 Payment (check one) _____Check or Money Order
 _____VISA
 _____Master Card
 VISA or Master Card Number _____
 Exp. Date _____

Any unit returned to the factory without payment, authorization number and prior scheduling will not receive priority placement.

Time) Monday-Friday, and we'll take it from there.

To guarantee a quick turn-around time, Kantronics is *scheduling ALL exchanges*, and assigning authorization numbers. Any unit returned to the factory without prior scheduling and authorization number will not be given priority placement.

In repeaters, there's **NO COMPARISON**

For your new or upgraded Repeater System, you won't find a better quality or higher performance machine than the New SCR2000X.

This highly advanced unit includes a wide array of DTMF Remote Control Functions, Automatic Digital Controls, and a full complement of front panel local control, test and metering functions. The 2000X is a commercial grade repeater which provides RF performance superior to any competitive unit. *And it's built to last—for years and years—by Spectrum...the people with over a decade's experience in worldwide repeater/link systems.*

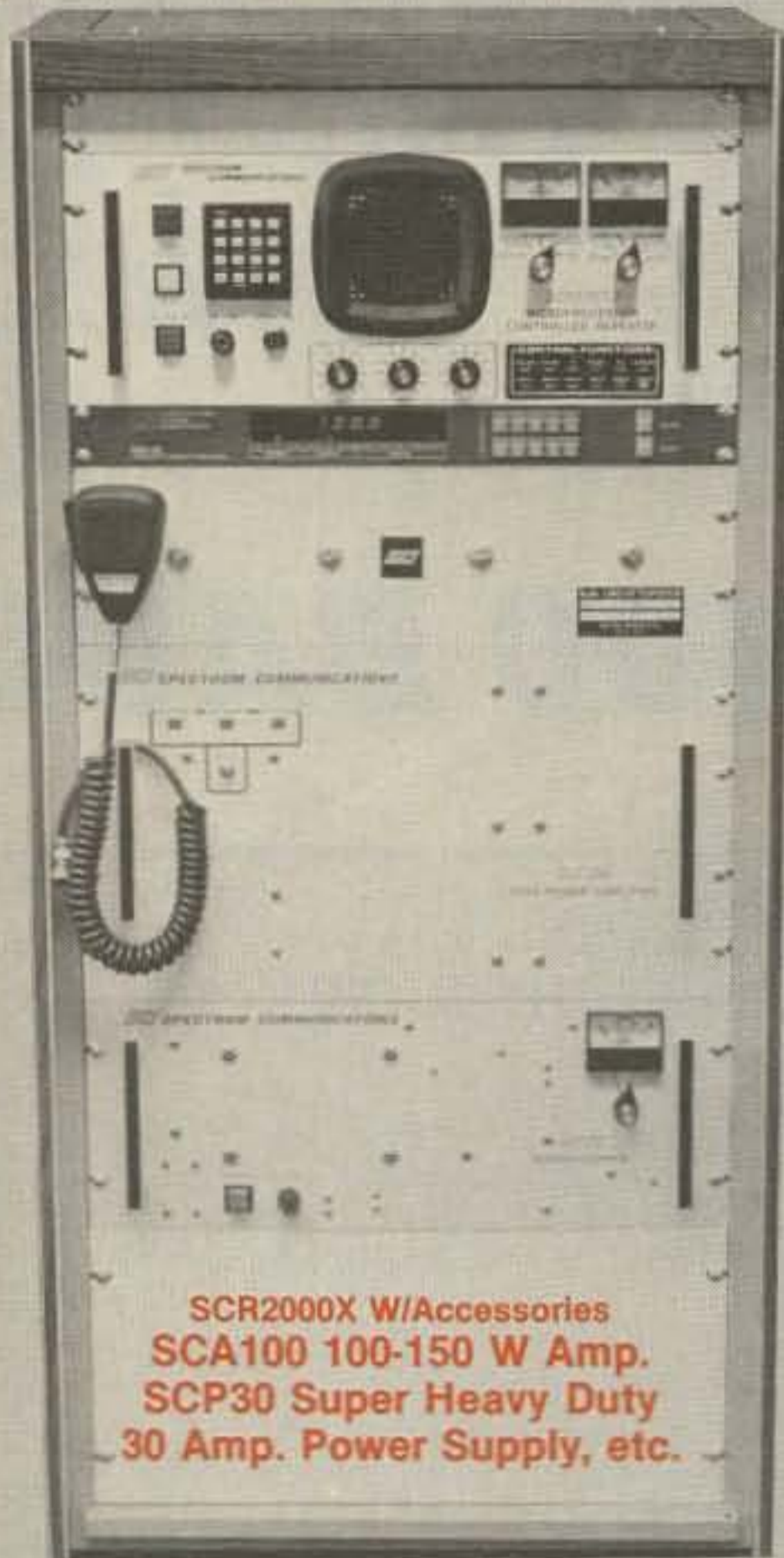

SCR2000X W/Accessories
SCA100 100-150 W Amp.
SCP30 Super Heavy Duty
30 Amp. Power Supply, etc.

STANDARD FEATURES

- Autopatch/Reverse Patch, W/O & 1 inhibit
- Dial Pulse Converter
- Phone line & "over the air" command modes. Virtually all functions may be turned on/off remotely.
- Touch Tone Control of 'Timeout', 'Hang Time', Patch Timeout, TX Inhibit/Reset, Patch & Reverse Patch Inhibit/Reset, P.L. ON/OFF (w/optional P.L. board), etc.
- Up to 6 Auxiliary Functions. More with TTC300.
- Full 16 Digit Decoding with Crystal Controlled Decoder IC
- Touch Tone Mute
- Unique Courtesy Tones
- Timeout Warning Tones
- Automatic CW ID & ID Command
- Microprocessor Memory 'Battery Backup'
- Autopatch AGC for constant levels
- Local Status Indication via 12 Function panel LED Display
- Front panel Touchtone Pad for Local Control & Phone line access.
- Full Panel Metering: Rcvr. & Xmtr. functions plus Voltages & Currents
- New-Improved: RCVR, UHF Xmtr., Power Supply!
- 30-75 Watt VHF & UHF Models
- 100-150 Watt Final Amps Available
- Autodialer
- "Kerchunk Killer"

SPECTRUM'S 2000X

Microprocessor controlled repeater

"The Repeater of the Future"—Available Today!

FCC Type Accepted for Commercial Service

And that's not all... We also make SCR77D Desktop/Portable Repeaters

- Ideal for low power local use
- Portable/Mobile at the scene of an Emergency
- Increase coverage at parades or other Public Service events
- "Mountaintopping" with battery pack
- Full Duplex Computer/Data Links
- Compact, Rugged
- Self Contained



- 10W UHF. Built-in Duplexer
- 15W VHF, External Dpxr.
- Optional Autopatch & P.L.
- AC or 12 VDC Input



Rcvr., Xmtr., Control Boards, Duplexers, Antennas, Cabinets, Xcvrs, etc., also available. Amateur & Commercial.

SPECTRUM COMMUNICATIONS ✓51

DEPT. S6 • 1055 W. GERMANTOWN PIKE • NORRISTOWN, PA 19403 • (215) 631-1710 • TLX 846-211

SAVE MONEY!

CALL
FREE



1-800-237-3063

7 A.M. TO 5 P.M. MON-THURS
(IN CONTINENTAL U.S. EXCEPT FL)

FOR ALL YOUR
**CRYSTAL
NEEDS!**

General Communication
Industry • Marine VHF
Amateur • Scanners
CB Standard & Special
Microprocessor

GET YOUR FREE
1986 CATALOG



SINCE
1965

Call or write:

JAN CRYSTALS

P.O. Box 06017
Fort Myers, FL
33906-6017

(813) 936-2397

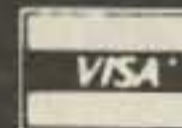

Flea Market Distributors VE Exams
Computers ARRL Forum

FAIRFIELD COUNTY HAMFEST

9:00 AM - 5:00 PM

Sunday, September 7, 1986

Norwalk National Guard Armory
Merritt Parkway Exit 38
Norwalk, Conn.

Door Prizes

Refreshments

Technical Presentations

Special Prize Drawing
for Early Registration
P.O. Box 326
West Haven, CT 06516

Talk In On
147.39/.99 RPT
146.520 Simplex

Admission \$ 3.00
Tailgate \$ 5.00
Tables \$10.00

I'M BACK! . . . WAYNE W2NSD/1

Here are ten reasons why you're going to be all upset with yourself if you don't subscribe to 73—Now!

- 1.) If we're going to get amateur radio growing again I'm going to need your help. I can do it, but not alone.
- 2.) You're going to enjoy the new life in 73—articles on how and why you can get involved with packet radio, OSCAR, traffic handling, DXing, cross-band repeaters, RTTY, slow-scan, and so on.
- 3.) You won't want to miss 73's bargain DXpeditions—starting with Asia this October— going to Sarawak 9M8 Brunei V85 and Sabah 9M6.
- 4.) Will I be able to get 800,000 new hams licensed *per year* in China? I think I can—and you will want to read how I'm going to do it. I'll even tell you how to get such a program going in the U.S. We sure could use it!
- 5.) Are you interested in 73 reader evaluations of ham gear? Now you can vote on your gear and read what the other 73 readers think of theirs.
- 6.) Want to find out just how bad an operator you are? Read the LID list in 73 and weep. Better yet, shape up!
- 7.) How about building stuff? I'll be running all the simple construction projects I can get in 73. Better get out your soldering pencil and tin it.
- 8.) I have a whale of a lot of fun building gadgets, typing away on RTTY, working high-speed CW, making DX contacts on 10 GHz from a local mountain (DX being a new state), working a new country on 20m, getting on the air from some very rare spot. . . stuff like that. Don't stay in a rut with your hamming, there are just too many fun things to do—and I'll be writing about 'em in 73.
- 9.) I've forgotten what this was, but it was very important and persuasive. If I could remember it you'd call my 800 operator immediately with your subscription. You'll never forgive yourself if you miss out on this one. . . I remember that much! I think it had something to do with a whole lot of money—perhaps a free trip somewhere. Check 73 for the details.
- 10.) We're going to be reprinting some of the funniest ham humor from 73's sordid past. A medical checkup is recommended before reading.
- 11.) (bonus) Yes, I know 73 got pretty dull last year—well, well, I'm back and whatever 73 is, it won't be dull. Better get a refill on your Diazide so you won't be after me for giving you apoplexy when you read my editorials.

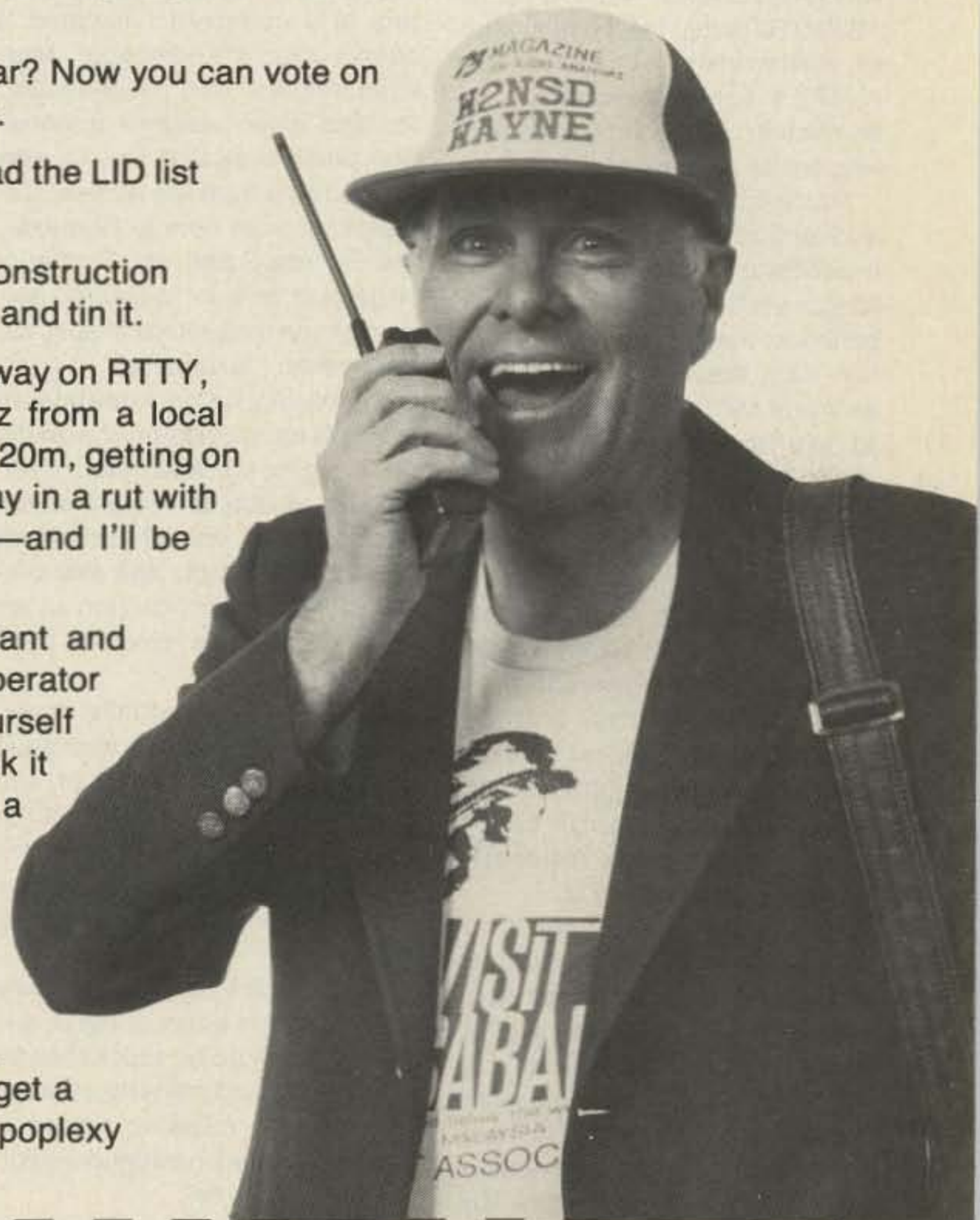

Call: 1-800-722-7790

Send in the coupon—or call my 800 operator and get started with 73. It's only \$19.97 a year, or three years for \$50. (Three's obviously the best deal. Three years from now you'll wish you'd bought six.) You can send a check or your credit card info. Remember, procrastination is the thief of 73, so do it now. Look, you've got my guarantee: Either you enjoy 73 or you can ask for your money back. Y'all write, y'hear?

**Wayne Green W2NSD/1
Editor/Publisher—again**

YES! Enter my subscription to
73 Magazine starting with the next issue.

Name _____

Call _____

Address _____

City _____ State _____ Zip _____

Check Amex. MC BA

Expiration date: _____

CALL: 1-800-722-7790

73 Magazine WGE Center Peterborough, NH 03458 USA

768600

LETTERS

OPEN REPLY

Richard Baldwin W1RU
President, IARU

I have read with great interest and considerable dismay the "open letter" addressed to you by Herbert Schoenbaum KV4FZ published in the May, 1986, issue of 73 Magazine. As Net Control for the Caribbean Maritime Mobile Net (7082.5 kHz, 1100 UTC to 1200 UTC daily), I feel I must take considerable exception to KV4FZ's across-the-board condemnation of cruising yachtsmen who are also hams.

Mr. Schoenbaum is completely in error that "cruisers" do not feel it necessary to obtain reciprocal licenses in foreign ports. In my experience, the vast majority do obtain such licenses, and are well aware of the necessity for doing so. We have files of information available to facilitate this licensing, and are frequently asked for it. Certainly, there is a small minority [of yachtsmen] who do not accept the concept and operate illegally. These are soon eliminated from our net operations, if there is any question at all. I just wonder how Mr. Schoenbaum obtains his alleged information on these so-called "illegals" or "pirates." He currently resides in Ohio!

Further, if a cruising yacht obtains a C6A reciprocal or any other and takes a few days' cruise away from that jurisdiction or waters, then returns, it is certainly not only legal, but required that he use his U.S. callsign aboard his U.S. registered or documented vessel while in international waters. On his return to the port where his reciprocal license was issued, he must again, of course, use that callsign designation. A case in point—the British Virgin Islands are only 40 miles from St. Croix. Boats going to the BVI use their U.S. callsigns en route, then obtain a BVI VP2V reciprocal on arrival and use it in BVI waters. They can cross over and back many times, using their U.S. call en route and their VP2V recip. while in BVI territory. That recip. is good for one year, whether in BVI waters or not.

Mr. Schoenbaum's allegations that cruising yachtsmen only use

their ham radio to make phone patches is ridiculous. I have managed my net for about two years, taking up to 30 daily check-ins, and doubt if I've been asked to make over a dozen patches in that time! Those who do ask for and make patches are usually in areas where there is no phone service, or it is poor at best.

And his contention that "cruisers" seldom get on the air on the high seas in true international waters is a complete falsehood. I cannot count the number of "Maritime Mobiles" I've passed traffic for and given weather information, port information, etc., to, who are en route from the Azores, Canaries, or from here to Bermuda, the Panama Canal, etc. Further, a large part of our "cruisers" seldom get on their radios in port, as, rather than "luxuriating" in a foreign marina being entertained, they are too darned busy working on their boats and, yes, even working at jobs. Mr. Schoenbaum seems to feel that all yachtsmen are wealthy idlers, and this perhaps has led him to zero in on them from pure envy of their lifestyle!

I have met personally many, many of these folks, and have found them all fully aware of, and accepting of, the legalities of the use of ham radio aboard their boats and in foreign ports. A large portion were hams long before going sailing.

We provide a service, the name of the game in amateur radio, and have been directly responsible for saving lives and property, locating overdue or missing vessels, providing local navigation information, and so on.

KV4FZ, whom I've known personally for about 10 years, is an extremely knowledgeable electronics expert. I seriously doubt he has ever set foot on a blue-water cruising yacht for a real cruise. Therefore, I feel he should confine his expertise to electronics and refrain from his Quixotic zeal in chasing "pirates" and interfering with the operations of the various Maritime Mobile Nets!

Louis K. Bean KV4JC
St. Croix USVI

I'm really tired of hearing the constant bickering between KV4FZ and the Maritime Mobile Net. It's

been in and out of the ham magazines for years—always the same accusations, always the same indignation. You want trouble? Let's talk about the taxi drivers in New York using two meters. Let's talk about the contras in South America running around with their IC-02ATs. Who cares if a couple of yachtsmen use 20 meters for phone patches? At least they're hams.

There are more important things to worry about than whether a ham is where he says he is. You guys seem to forget that ham radio is a hobby, not a religion. Until someone comes up with something intelligent to say, you'll not see another word on the subject in 73.—KW10.

DIGITALIS

I like the proposal for a digital-radio service. Ideally this should be part of ham radio, but it can never be due to the emotional issue of Morse code. If this service had been available three years ago, I would have never gotten a ham ticket.

Earl Morris N8ERO
Midland MI

That's exactly what the opponents of the Public Digital Radio Service are saying. Although amateur packet radio and the PDRS are fundamentally different, most people would flock to the "no-code" PDRS, leaving ham radio in the lurch.

Believe it or not, we have another shot at a no-code amateur license. It looks as though the Novice Enhancement proposal will be approved—once it is in place, we'll put on the pressure to drop the 5-wpm code requirement from the Novice license.

No-code is far from dead—the FCC is in favor of it, the ham manufacturers are in favor of it, and you and I are in favor of it. The crucial missing piece is the Board of the ARRL, and I have the feeling that with sufficient pressure from the membership of the League, the Board would endorse a no-code license. Remember, Earl, that ARRL Directors are basically politicians, and politicians have been known to change their minds.—KW10.

TECHNOFLUBS

My career is electronics, for which I have always had a spiritual

love. I owe most of my success to ham radio; electronics education in America is disgraceful! My high school friends and I started an informal club to teach ourselves electronics (in the late 50s) because there was no other way to learn it.

We were denied permission for a ham station at school. The attitude there seemed to be, "We, the intellectual elite, don't understand electronics; therefore, it is irrelevant." We were reduced to conspiracy—having gotten the runaround after requesting nicely that the school library subscribe to *Popular Electronics*, we mailed a subscription form in the school's name, checking the squares marked 5 YEARS and BILL ME LATER. It worked!

It's impossible to learn anything in the public school system that leads to occupations better than teaching. If teachers knew such things as electronics, they could get real jobs! The back half of my high school physics book was filled with good electronic stuff, but the teacher never reached it.

I expected to learn "real" electronics at a state university's engineering school, and was badly disillusioned by a faculty of frustrated physicists and mathematicians with no practical experience. Several of them could not speak understandable English. The prevailing educational theory there was, "If you know all of the generalities, you can derive all of the specifics." More academic elitism! Though I managed to graduate, I feel that most of my time was wasted. The most useful knowledge I gained in college came from ham radio, through association with the university's club station.

Professional educators apparently still espouse the effete and fraudulent theory that a teacher doesn't need to know the subject matter, but only how to teach. My city has a fair amount of electronics industry—a local high school grudgingly offered a basic electronics course, employing a teacher who attempted to explain the "shematic" diagram of a "superheat" receiver.

There are still a few excellent technical institutes staffed by real electronics people instead of "educators." Is the dwindling number of young hams any surprise, when high school students are advised by teachers and peers that a technical education isn't a "real" education, and that engineering is bad because engineers design

COM-SHACK 64 SIMPLEX OR DUPLEX SHACK CONTROL

AUTOPATCH * H.F. REMOTE * REPEATER CONTROL

* C64 CONTROLS YOUR FT 757 * IC 735 * TS 440/940 WITH YOUR H.T!
 * CHOOSE EITHER SIMPLEX OR FULL DUPLEX CONTROL SYSTEM
 * ALL CONTROL FUNCTIONS ARE ACKNOWLEDGED WITH A CLEAR **MALE** OR **FEMALE** VOICE! * VOICE CLOCK, SET TIME FROM YOUR H.T.!
 * USER FRIENDLY MENU FOR EASY START UP!

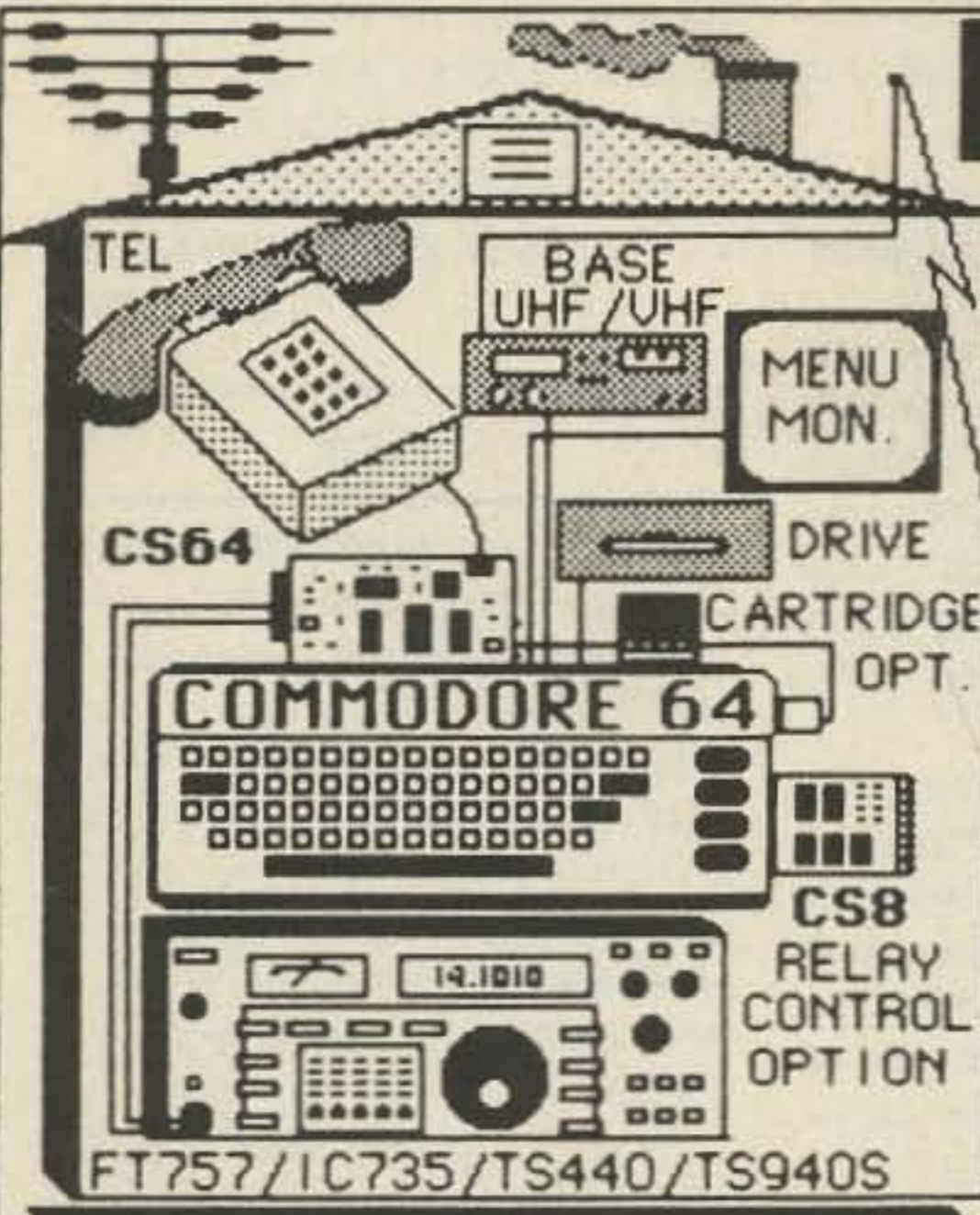

NEW VOICE CLOCK!

AUTOPATCH TONE OR PULSE, CALL WAITING, ANSWER SECOND INCOMING CALL, LAST NUMBER MEMORY, VOICEPAGE ON INCOMING CALL * AUTODIAL NUMBER

H.F. REMOTE 9 MEMORY FREQUENCIES, SCAN UP, DOWN, FAST, SLOW * ENTER OR RECALL ANY FREQ. FROM MEMORY * CHANGE MODES USB/LSB /FM/AM CONTROL 8 RELAYS (CS8 OPTION) ON/OFF WITH VOICE CONFIRMATION * TIMER AUTO RESETS WITH DTMF TONES

SIMPLEX SYSTEM **MODEL CS64 SIMPLEX**
 MENU SETS UP ALL TIMING WINDOWS, TIME BETWEEN WINDOWS, TIMERS, ACCESS CODES, CALL SIGN * LISTENS FOR CLEAR FREQ. BEFORE TRANSMITTING

BUILD YOUR OWN DTMF RECEIVER! **TOUCHTONE DECODER KIT**

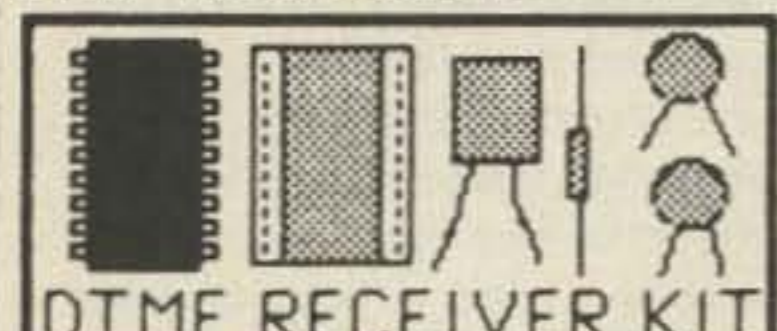

* SSI 201 DTMF RECEIVER KIT
 * RECEIVE ALL 16 DTMF DIGITS
 * NO ADDITIONAL FILTERING
 * OUTPUT BCD OR HEX FORMAT
 * LOW POWER DRAIN (29MA/12V)
 KIT INCLUDES 3.58 MHZ XTAL 22 PIN IC SOCKET, RESISTOR, CAPACITORS, DATA SHEET SCHEMATICS, EASY TO BUILD **MODEL TTK \$ 22.95**

4 DIGIT SEQUENCE DECODER (ON/OFF)

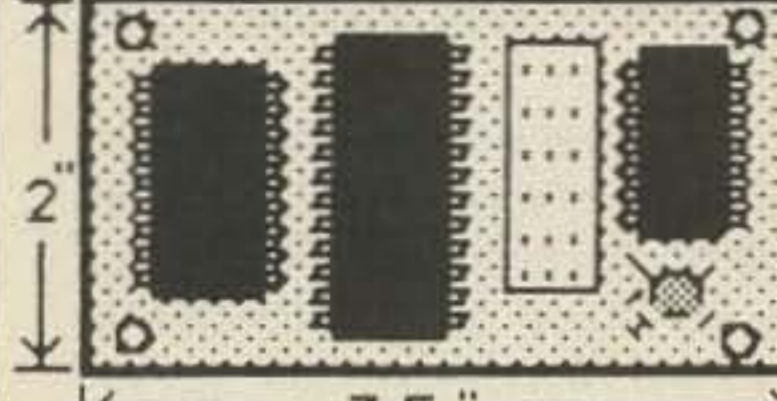

* WIRED AND TESTED, 5 TO 12V.
 * USER PROGRAMMABLE 50,000 COMBINATIONS ANY 16 DTMF TONES * SEND CODE ONCE TO TURN ON; AGAIN TO TURN OFF * MOMENTARY AND LATCHING OPEN COLLECTOR TRANSISTOR OUTPUTS * CUSTOM IC ASSURES HIGH RELIABILITY LED DECODE INDICATOR * INSTRUCTIONS & SCHEMATIC USE AS REPEATER ON/OFF **MODEL TSD \$59.95**



DTMF TO RS-232 300 BAUD INTERFACE
 USE YOUR COMPUTER TO DECODE DTMF TOUCHTONES
 * RECEIVE ALL 16 DIGITS AS FAST AS THEY CAN BE TRANSMITTED * EASILY PROGRAM YOUR COMPUTER IN BASIC TO DECODE MULTIDIGIT "STRINGS", DISPLAY DIGITS, SOUND ALARMS, OBSERVE SECRET CODES * SIMPLE TO INSTALL; HOOK 12 VDC, AUDIO & TWO WIRES TO YOUR COMPUTER -- ENTER A SIMPLE BASIC PROGRAM (PROVIDED) AND BEGIN TO DECODE * INCLUDES DATA LED; WIRED AND TESTED -- **MODEL DAP \$ 89.95**

ICOM IC-02AT USER'S "AUDIO BLASTER"

MODULE INSTALLS INSIDE THE RADIO IN 10 MIN. BOOST AUDIO TO NEARLY ONE WATT! * LOW POWER DRAIN (4MA STAND-BY) * COMPLETE INSTALLATION INSTRUCTIONS INCLUDED * CORRECTS THE LOW AUDIO PROBLEM * 1000'S OF SATISFIED CUSTOMERS! FOR IC02AT/IC04AT/IC2AT **MODEL AB1 \$19.95**

DUPLEX SYSTEM & REPEATER CONTROL

REPEATER * H.F. REMOTE * AUTOPATCH **MODEL CS64R**
 ALL ABOVE FEATURES PLUS REPEATER CONTROLLER, WITH HANG TIME, COURTESY BEEP, REPEATER ON/OFF ACCESS CODES, AUTOMATIC VOICE ID ALL TIMERS SET FROM START-UP MENU * YAESU 2700 UHF/UHF MAKES INSTANT CROSSBAND REPEATER. NO DUPLEXER REQUIRED

MODEL CS64 (SIMPLEX) \$229.95
MODEL CS64R (DUPLEX) \$249.95
 INC. SOFTWARE DISK - HARDWARE - CABLES - MANUAL
 OPTIONAL CMOS AUTOLOAD CARTRIDGE FOR HILLTOP USE: **MODEL CS64R/CART \$ 99.95**
 USB/LSB KIT FOR FT757 **MODEL CSR64 \$29.95**

CS-8 LATCH CONTROL OPTION

TURNS UP TO EIGHT DEVICES ON AND OFF WITH VOICE CONFIRMATION WHEN IN THE H.F. REMOTE MODE * 3 DPDT 2 AMP RELAYS INCLUDED & 5 MORE OPEN COLLECTOR 100MA. OUTPUTS * PLUGS INTO JOYSTICK PORT * INC 24 PIN CONN **MODEL CS-8 \$79.95**

TWO METER REMOTE CONTROL

"REMOTE-A-PAD" ROW-COLUMN MAXIMUM FUNCTION CONTROL!
 KEYPAD CONTROL PLUS 2 FOUR DIGIT SEQUENCE DECODERS (TSD) * USE THIS BOARD TO CONTROL ANY 16 DIGIT KEYPAD REMOTELY WITH DTMF * SIMPLY HOOK 4 ROWS & 4 COLUMNS FROM YOUR KEYPAD YOU WISH TO CONTROL TO THE RAP-1 * UNLEASH THE POWER OF YOUR RIG'S MICROCOMPUTER * SCAN, ENTER FREQUENCIES TURN YOUR LINKS ON & OFF. CONTROL KENWOOD 2500/7950 & MORE, ADD 2MTR REMOTE TO CS64 **MODEL RAP-1 \$ 149.95**

ENGINEERING CONSULTING

583 CANDLEWOOD ST. BREAR, CA. 92621 TEL 714-671-2009

NAME _____
 ADDR. _____
 CITY _____ STATE _____
 MC/VISA # _____

MODEL () \$ _____
 MODEL () \$ _____
 TOTAL \$ _____
 TEL () _____
 CALL _____
 ZIP _____
 EXP _____

weapons? Does Japan have such a problem?

Name withheld

I spent a year in the Electrical Engineering department of a large eastern university, and was sickened to see senior EE students who couldn't tell the difference between a capacitor and a resistor. They could solve equations and even design circuits using resistance and capacitance, but they had no practical experience at all. One day, I stood quietly and watched while two graduate students attempted to solder a transistor to a printed-circuit board—without solder! They were trying to melt the leads.

I'll bet that in Japan things are not much different. I realize that every child in Japan is taught electronics in school, and I recognize the preeminence the country has in the electronics industry. In America, every child is taught mathematics in school. Are we a country brimming with mathematicians? Of course not.

Two things account for Japan's success in the electronics industry. First, the Japanese are extremely good at copying other people's technology. Second, the Japanese government and the industry work side by side to make certain that they remain on top of the heap. The result is that electronic products are made with a higher quality and a lower price than we can ever hope to achieve. Improving our technical education is useless unless we can also bring production costs down to a reasonable level.

It's crazy to buy American products just because they're American; I refuse to pay twice as much for a product half as good as what I can get from overseas.

By the way, why did you want your name withheld? Are you still hiding from your high school librarian?—KW10.

10 METERS OR 11?

The recent tragedy on Mt. Hood, where nine teenagers lost their lives, prompted some thoughts on how ham clubs could help to prevent such occurrences. Not by providing emergency communications after the fact, which is done now, but rather to interest climbing club members, who are mostly young people, in getting ham licenses so that they would always have communications with them during their climbs.

There are a number of occurrences of lost hikers and climbers each year in the Pacific Northwest, and I am sure that it happens throughout the country. These events cost a substantial amount of money in terms of rescue activity, to say nothing of the risks taken by rescue personnel.

It seems to me that it would be an excellent project for a ham club to acquaint climbing and hiking clubs with the wonders of having amateur radio with them on excursions to the wilderness. There may be thousands of new, young recruits for the ham ranks to boot.

The main activity, as I see it, would be to tell climbing clubs about VHF and repeaters, and the natural combination of mountain-climbing and ham radio. The emergency aspect is a bonus. Could this be another incentive for no-code exams in the VHF and UHF bands?

I am challenging a local club to start something along these lines and I would request, since you have been prodding clubs to get going on new recruits, that you could make a similar challenge on a national scale. How about it?

**Niel Classon W7NYB
Renton WA**

I hate to say it, but you would be better off telling the clubs about CB. Their public-service record is just as good as ours, and there are about ten times as many CBers as there are hams. There's even a national CB emergency channel, something we hams haven't thought of.—KW10.

AM-ATEUR RADIO

One of the main reasons that yours and other fast-buck ham magazines ignore AM is that there is *no money* in it for you—no big, glossy ads. You cater to the bucks, and the Japs have them.

Heaven forbid! If too many hams started using AM, it would cut down on your business. After all, most AMers are running old junkers 25–30 years old. That's not the worst of it: Supposing, horror of horrors, that new hams and others started building AM transmitters from old black-and-white tube-type TV sets. It would be disastrous—for your business, that is.

So please, spare us all that crapola about the state of the art. AM phone is still an efficient and

effective means of communication. We know you are mainly out for the payola.

**Fred Huntley W6RNC
Nevada City CA**

What, you mean there's money to be made in ham radio? Get with it, Fred, AM is about as efficient as spark. I suppose when CW came around, there were still a few spark-forever fanatics who clung on to the very end, and that's the way it will be for AM.

If AM is so hot, why isn't anyone writing about it? We don't toss AM articles into the garbage; we don't get any AM articles. The reason is that ham radio has moved on... if you're stuck in the hobby of 40 years ago, I feel sorry for you.—KW10.

LEND ME UR EAR

Your editorial about the proposed Electronic Communications Privacy Act (ECPA) was to the point, as usual, but didn't tell your readers what to do about it. Calling your Congressman's office and just leaving your opinion with a receptionist doesn't help. You have to get through to the decision-makers.

I called my legislators and asked to speak with the staff member responsible for communications issues. These staffers are responsible for reviewing pending legislation and often determine how a legislator votes on an issue.

In speaking with these staffers, I found that none had read the bill, and only one had a vague idea what it was about! After explaining what the bill was (I had called a Senator in January to ask for a copy of the proposal, which I promptly received), I ran through my list of objections. All three staffers seemed interested in my objections. Letters were sent to the three reiterating my conclusions. I tried to be as logical and objective as possible—emotional pleas just won't work. Representative Judd Gregg seems to have changed his position, and Senator Gordon Humphrey appears now to understand the issues.

I'll bet that my communications about ECPA are the only ones received by these legislators. As such, they will carry a lot of weight. The key is to effectively communicate with the decision-makers in government. You must speak with the proper staff mem-

ber and follow up your conversation with a letter. We can have a large say in legislation if we just influence the right people.

**Peter M. Bealo WB2MJG/1
Salem NH**

SUB CW

While I was reading *Never Say Die* in the April issue of 73, I was somewhat surprised, or should I say impressed, to learn that Wayne does scuba diving. I have been diving for only five years, but have enjoyed amateur radio for more than 30 years. I hold an Extra-class ticket and a Master Diver Trainer (instructor) certification.

As a diving instructor, I offer a specialty diving course entitled *Underwater Communications Using International Morse Code*. In the course I teach CW up to five wpm and the different ways to use CW underwater, and I encourage my students to go on for their Novice license (the course material includes a ham license manual).

The marriage of diving and amateur radio is becoming very popular with the course members. It is drawing the divers into ham radio and the amateurs into diving.

A side benefit to all of this is that when I take a group of divers to the Caribbean each summer, I have a ready-made group of hams to make a mini-DXpedition. As you well know, what could be more exciting than a dive trip and DXpedition to some exotic island? This kind of excitement is most appealing to the age group the diving industry is trying to attract—the age group that amateur radio needs.

This may be a small contribution to make to solve the problems confronting amateur radio and its lack of growth, but for the past year the local radio club and Novice class has produced no new hams. During this same time period my classes are getting the attention from the would-be hams.

There are all kinds of possibilities for the future, maybe an international club of some kind for amateurs who are also active divers to promote diving trips and DXpeditions. Maybe a net to discuss different diving activities; the next best thing to diving is a good rag-chew about diving!

**Bill Wheeler K0DEW
Lebanon MO**



P.C. ELECTRONICS 2522 S. PAXSON LN. ARCADIA CA 91006 (818) 447-4565
 TOM W6ORG MARYANN WB6YSS
 Compuserve 72405,1207

-28



SEE US AT
 DAYTON
 BOOTH 359

AMATEUR TELEVISION

ATV MADE EASY WITH OUR SMALL ALL IN ONE BOX TC70-1 TRANSCEIVER AT A SUPER LOW \$299 DELIVERED PRICE.

TC70-1 FEATURES:

- 10 pin VHS color camera and RCA phono jack video inputs.
- Crystal locked 4.5 MHz sound subcarrier.
- PTL (Push To Look) T/R switching.
- Sensitive UHF GaAsfet tuneable downconverter.
- Two frequency 1 watt pep xmtr. 1 crystal included.
- Xmit video monitor outputs to camera and phono jack.
- Small 7 x 7 x 2.5" for portable, mobile, or base.
- Draws only 500 ma (exc. camera) at 13.8 vdc.

Just plug in your camera, VCR, or computer composite video and audio, 70 cm antenna, 12 to 14 vdc, and you are ready to transmit live action color or black and white pictures. Sensitive downconverter tunes the whole 420-450 MHz band down to channel 3 on your TV set to receive. Both video carrier and sound subcarrier are crystal controlled. Specify 439.25, 434.0, or 426.25 MHz. Extra crystal \$15.

WHAT ELSE DOES IT TAKE TO GET ON ATV?

Any tech class or higher amateur can get on ATV. If you already have a source of video and a TV, it costs about the same as getting on 2 meters. Now you can be seen as well as heard.

DX with TC70-1s and KLM 440-27 antennas line of sight and snow free is about 22 miles, 7 miles with the 440-6 for portable use such as parades, races, search and rescue, etc. You can add one of the two ATV engineered linear amps listed below for greater DX.

At 70 cm, antenna height and gain is all important. Foliage can absorb much of the power. Also low loss tight braided coax such as the Saxton 8285 must be used along with type N connectors.

The TC70-1 has full bandwidth for color, sound, and computer graphics. You can now show the shack, computer programs, home video tapes and movies, repeat SSTV or even space shuttle video if you have a Home Satellite Receiver.

20 WATT SPECIAL . . \$399

SAVE \$15 on the TC70-1 & ELH-730G when purchased together.

All prices include UPS surface shipping in cont. USA.

ACCESSORIES:



Mirage D24N-ATV 50 watt amp \$189
 ATV, SSB, FM. 9 amps.

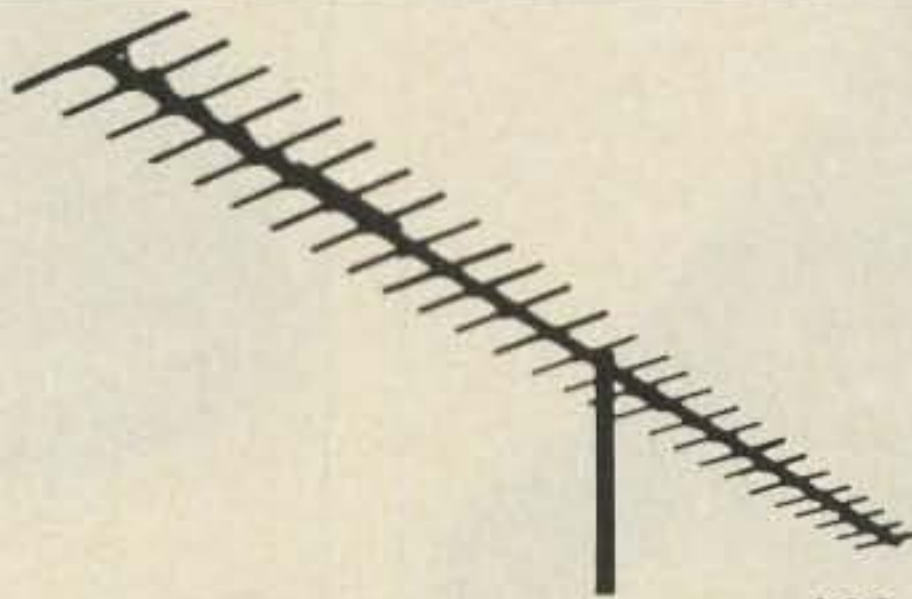

KLM 440-27 14.5 dbd antenna . . \$89
 KLM 440-6 8 dbd antenna \$38

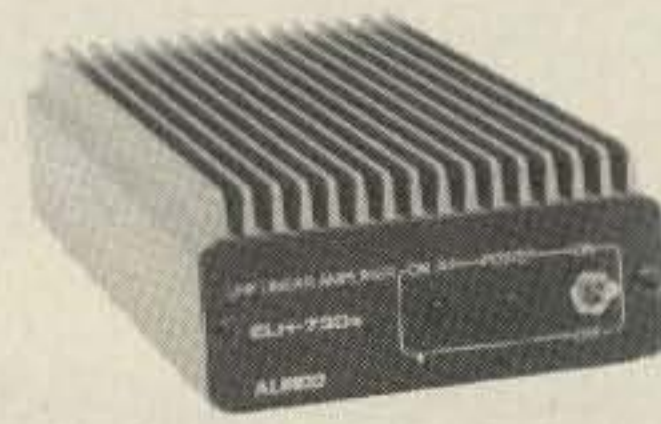

Alinco ELH-730G 20 watt amp \$115
 ATV, SSB, FM. 4.5 amps

HAMS! Call or write for for full line ATV Catalog.

NEW PRODUCTS

AEA PK-232 MULTIMODE CONTROLLER

The Pakratt™ model PK-232 multimode controller is now available from Advanced Electronic Applications. The PK-232 is a complete Morse/RTTY/ASCII/AMTOR/packet terminal unit which interfaces with any computer having an RS-232 port.

A front-panel switch allows selection of one of two radios for easy HF/VHF selection, and a discriminator-style tuning indicator is included. Twenty-one indicators monitor mode and status.

The PK-232 retails for \$319, and will be available August 1st. For complete specifications, please contact AEA, PO Box C-2160, Lynwood WA 98036-0918. Reader Service number 163.

YAESU FT-767GX

Yaesu USA has introduced the FT-767GX HF/VHF/UHF multimode transceiver. The FT-767GX comes equipped for HF operation, and optional modules are available to extend coverage to 6m, 2m, and 70 cm. The rig outputs 100 Watts on CW, SSB, AM, FM, and FSK.

Factory-installed features include an automatic antenna tuner for 160-10 meters, a CW filter, an electronic keyer, a speech processor, a digital wattmeter/swr meter, and a dual-vfo tracking system for OSCAR or repeater operation.

The FT-767GX is priced at \$1,759.95; modules for 2m and 6m are \$169.95. For complete

specifications, contact Yaesu USA, PO Box 49, Paramount CA 90723-0049. Reader Service number 152.

CUSTOM KNOBS

Custom-printed knobs and dials are available from Selco Products. Virtually any logo, numeral, symbol, or line can be printed with a character height of as little as 1mm. A wide variety of shapes can be printed on, and it is possible to print lines around a corner. Knobs and dials come in black, gray, white, and clear, and can be overprinted in a variety of colors.

For more details and samples, contact Selco Products Co., 7580 Stage Road, Buena Park CA 90621. Reader Service number 153.

NEW MERCER DMM

Mercer Electronics, a division of Simpson, has introduced the model 9370 autoranging digital multimeter. The 9370 measures up to 1,000 V dc in 5 ranges, up to 750 V ac in 4 ranges, up to 10 Amps in 2 ranges, and up to 2 megohms. A memory mode stores a zero offset of 99 counts. Also included is an audible continuity tester.

The model 9730 retails for \$59. For more information on the entire line of Mercer test equipment, contact Mercer Electronics, 859 Dundee Ave., Elgin IL 60120; (312)-697-2265. Reader Service number 158.

ICOM IC-48A

The IC-48A 440-MHz compact

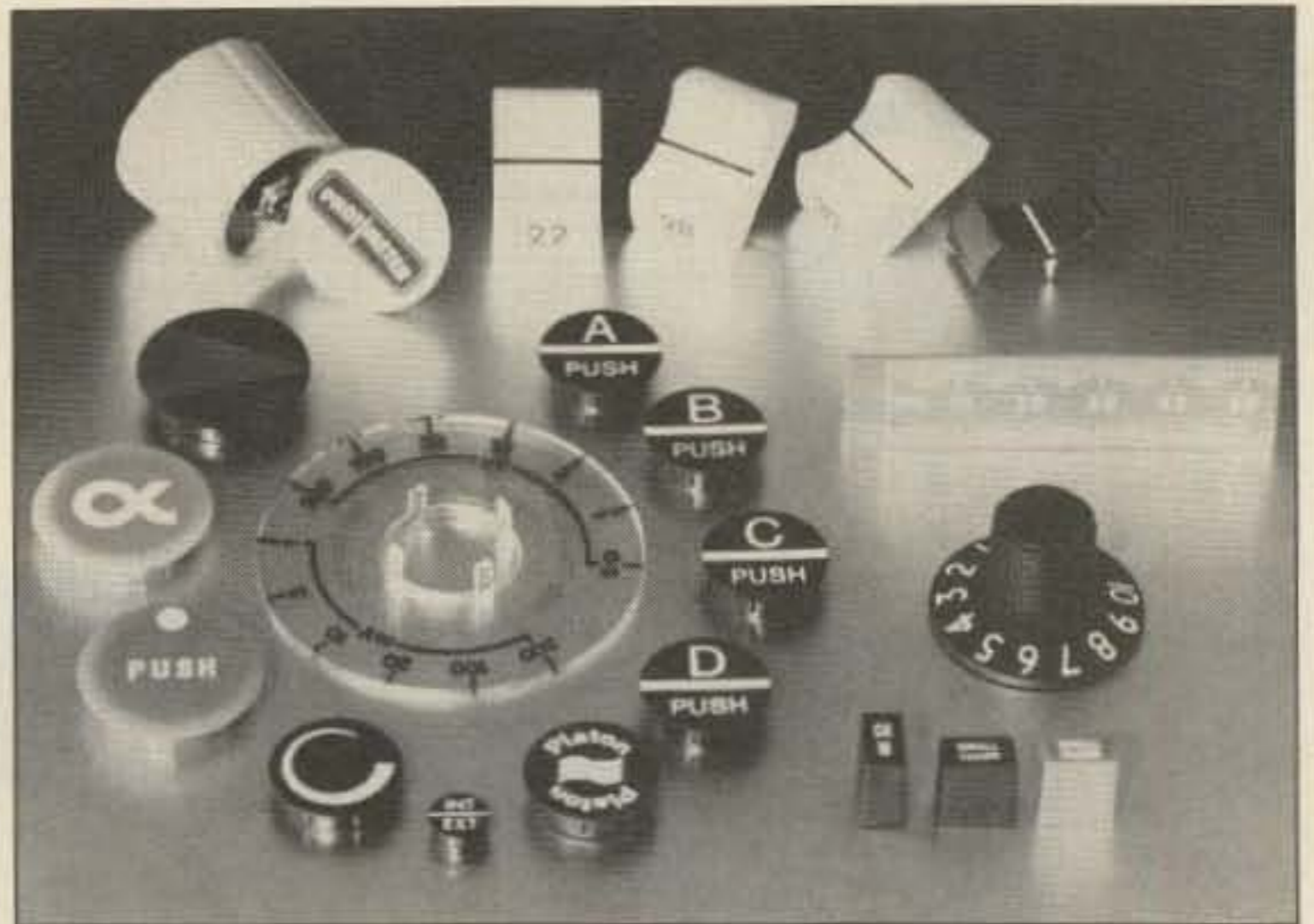

Custom printing services available from Selco.

mobile transceiver is now available from ICOM America. The IC-48A covers 440-450 MHz with an output of 25 Watts. Features include a large LCD with auto-dimmer, and 21 scannable memory channels. For more information, please contact ICOM America, Inc., PO Box C-90029, Bellevue WA 98009-9029.

JOHNSON CHALLENGERS

The E.F. Johnson Company has introduced a new series of VHF/UHF mobile radios. The Challenger™ UHF mobile (15 Watts) and VHF mobile (20 Watts) come with eight synthesized channels and programmable priority scan. The Challenger Plus™ UHF mobile (30 Watts) and VHF mobile (40 Watts) feature 19 channels and dual priority scanning. Both Challenger models offer multi-tone Call Guard™, multi-code digital Call Guard, a timeout timer, a monitor, and a user-programmable scan list.

For complete details, contact

Diversified Energies, Inc., E.F. Johnson Company, 201 South Seventh Street, Minneapolis MN 55402. Reader Service number 156.

8-POLE CRYSTAL FILTERS

International Radio now has 8-pole crystal filters available for the Kenwood TS-440 and the ICOM IC-751, IC-751A, IC-730/740/745, R-70/71, and IC-271/471/720/720A. Prices range from \$60 for individual filters to \$150 for a 2.1-kHz matched SSB crystal set.

For a brochure describing these and other products, send an SASE to International Radio, Inc., 747 South Macedo Blvd., Port St. Lucie FL 33452. Reader Service number 157.

MOBILE CATALOG

A 56-page catalog of mobile antennas, portables, and accessories for the mobile market has been published by Antenna, Inc. Complete mechanical and electrical specifications are offered



The ICOM IC-48A.



E.F. Johnson's Challenger™ VHF/UHF mobile radio.

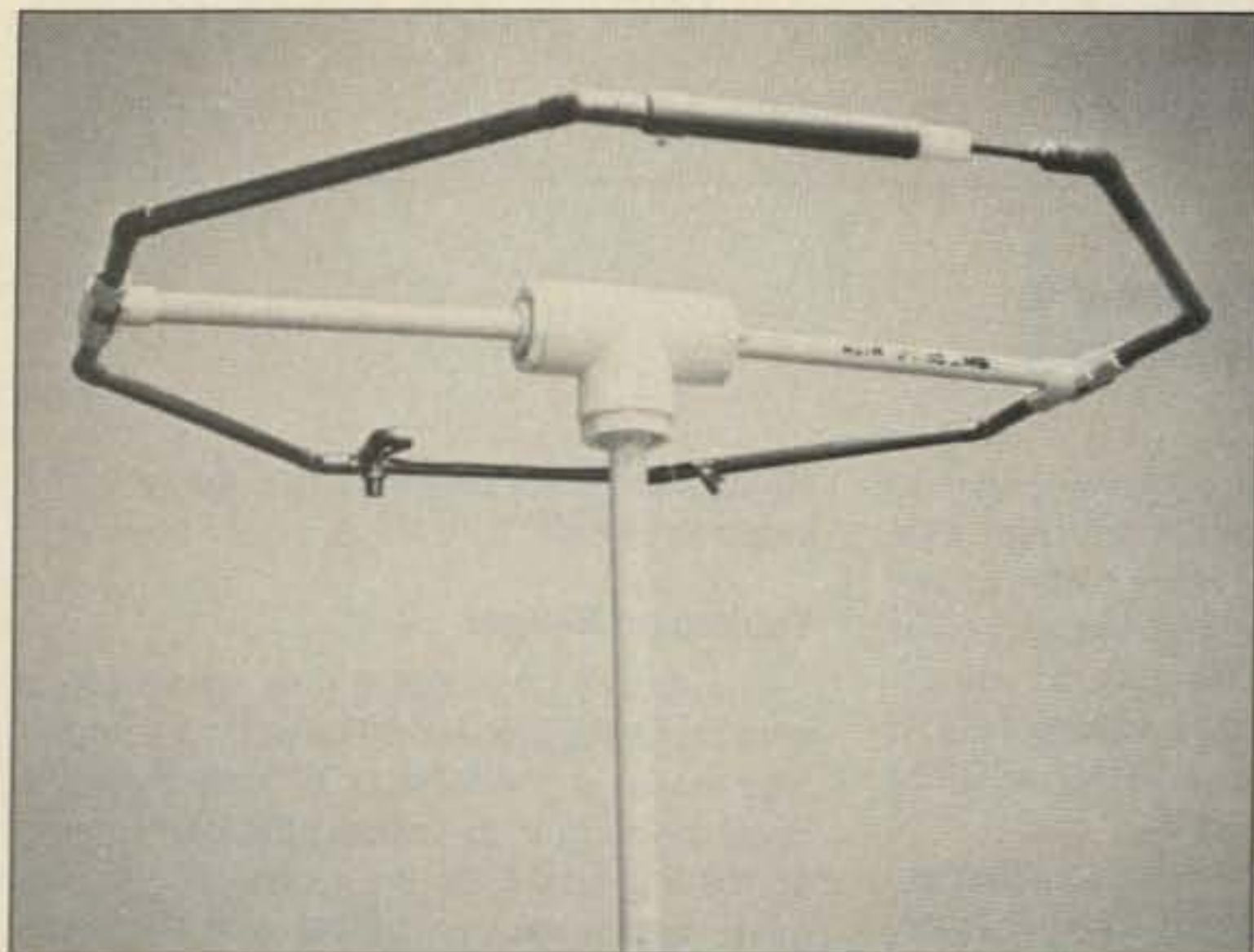

Advanced Design Network's Microloop antenna.

for antennas covering 25-1,000 MHz.

To receive a copy of the catalog, write or telephone *Celwave*, Route 79, Marlboro NJ 07746; (201)-462-1880. Reader Service number 159.

MICROLOOP ANTENNAS

Advanced Design Networks has announced their Microloop series of small HF antennas. Across-the-loop dimensions range from 27 inches for 10 meters to 104 inches for 40 meters. The antennas may be mounted horizontally or vertically, and can handle 200 Watts PEP.

A six-page overview of Microloop design concepts and installations is available by writing

Advanced Design Networks, Inc., 8601 66th Street North, Pinellas Park FL 33565. Reader Service number 154.

APPLE TEKDRAW

Tekdraw, a graphics software package for the Apple II family, is now available from Computer Aided Instructional Systems. Using Tekdraw, you can design schematics, circuit boards, architectural layouts, certificates, charts, graphs, and so on. The Koala Pad, a joystick, or game paddles may be used as the input device.

The system includes predrawn symbols which can be selected, rotated, and positioned on the screen. Tekdraw will save, recall, and print your designs.

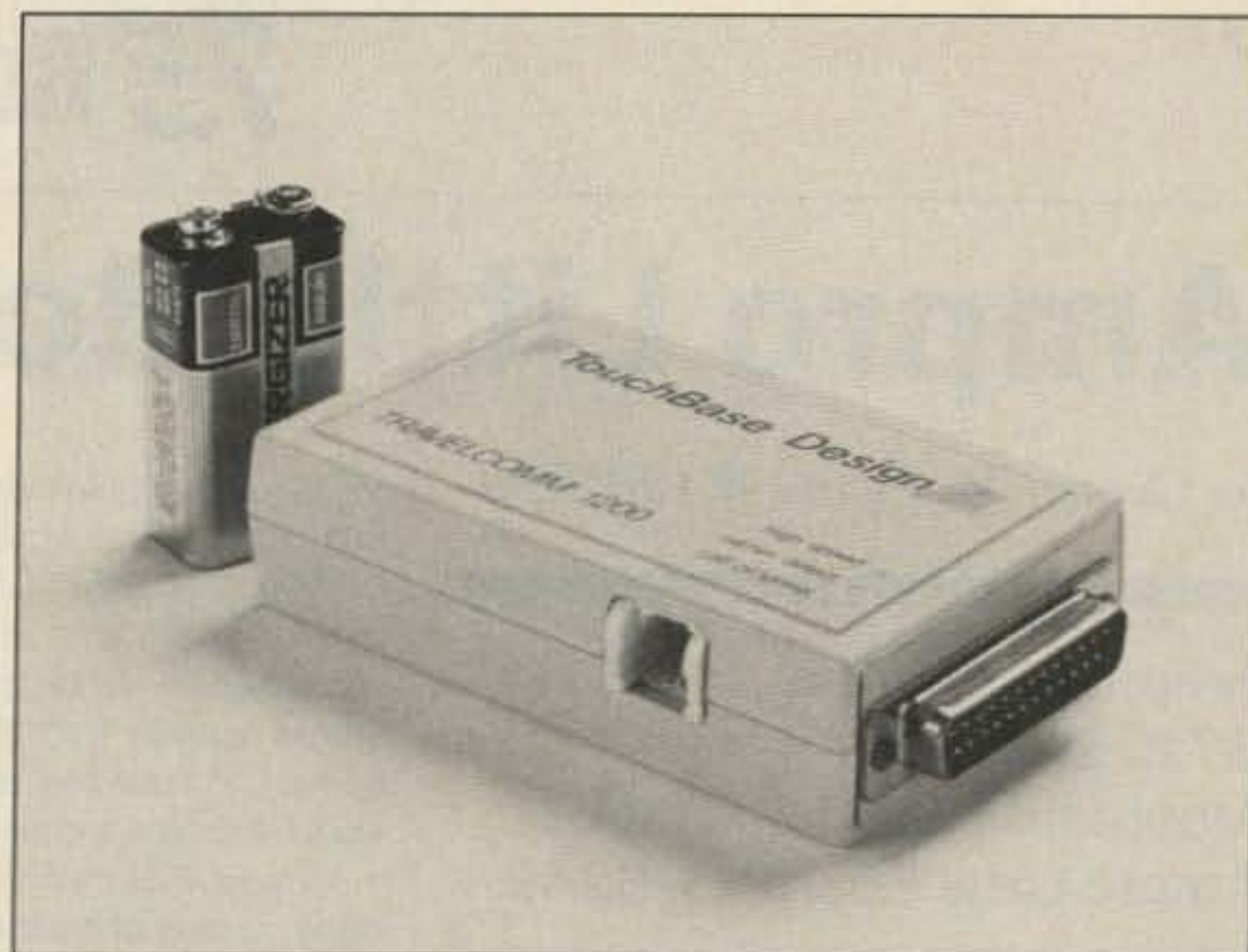

The TravelComm 1200 portable modem marketed by Technigroup.

The software package, including a graphics utility section, sells for \$69.95. For more details, contact *Computer Aided Instructional Systems*, Box 177, Building 5, Service Drive, Holly MI 48442. Reader Service number 161.

TRAVELCOMM 1200™

Technigroup, Inc., has announced the TravelComm 1200 portable modem. Designed for use with portable computers, the 300/1200-baud modem operates for about thirty hours on a 9-volt battery (included). Connection to the computer is made via a DB-25 (RS-232C) connector, and an RJ-11 modular phone jack handles the telephone line (a phone cord is provided with the modem).

For further information, please contact *Technigroup, Inc.*, 16 Green Acre Lane, Northport NY 11768; (516)-261-0423. Reader Service number 162.

MIRACLE RODS

Miracle Rod of Glasgow, Kentucky, now offers a low-temperature brazing rod for aluminum. The fluxless rods may be used with a propane torch to repair breaks in antennas, to braze cavities, and to weld joints as simply as soldering. The rods have a high conductivity, and melt at 730-740 degrees.

For complete information, please contact *Miracle Rod*, PO Box 791, Glasgow KY 42141. Reader Service number 160.



The Key Element

SSB clarity starts at the microphone...

If you are not satisfied with the 'sound of your station'—it's no wonder—most "communications" mics you use were designed for industrial paging or p.a., not for the sophisticated SSB techniques. The HC-3 response gives maximum articulation for getting through DX pile-ups and has set the new standard for all.

You can easily install this small, advanced Heil element into your present old mic or order the new Heil HM-5 SSB mic using the high quality HC-3.

For more details or to order the Heil HC-3 element at \$19.95, the HM-5 SSB Mic at \$54.95, contact HEIL, LTD., Marissa, IL 62257 (618) 295-3000 (add \$3.00 shipping).



Hams who care about maximum results in getting over, around and through DX pile-ups now have another weapon in their arsenal... The Key Element!

HEIL SOUND Hearing Is Believing... 108

THE FORMULA FOR TWO METER DX: MTT144/28R + MML144/200S = VUCC!

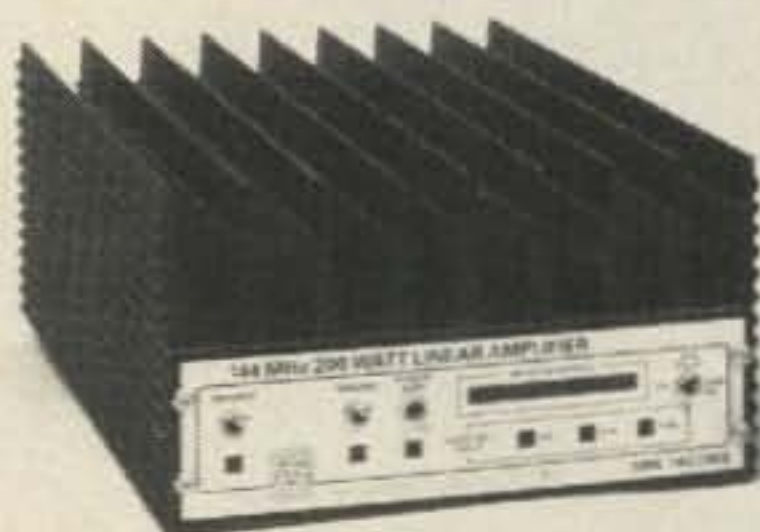

MICROWAVE MODULES LTD.



Working the two meter band on all modes is a snap with Microwave Modules. Our complete line of transverters, receiving converters and solid-state power amplifiers make it possible! Now, you can work SSB, CW, FM or AM

with your HF multimode transceiver. Discover the thrill of Aurora, Tropo scatter, Sporadic-E, Meteor Scatter and even moonbounce!

29

THE "PX" SHACK

52 Stonewyck Drive
Belle Mead, New Jersey 08502
(201) 874-6013



Ampro Little Board

by George M. Ewing WA8WTE/4

Ampro Computers, Inc.
67 E. Evelyn Ave.
Mountain View CA 94041
Ampro Little Board™—\$249

There is a phenomenon in a rapidly growing and changing technology like personal computers that is usually called the "price knee" or "crossover point." This is a point in time in which the price for an older generation of machines is dropping quickly, and the cost of the new generation, initially fairly high, is also starting to fall. At some point, the cost-effectiveness ratio crosses over, and the new technology becomes cheaper and better than the old, even though the price of the old may be falling faster.

At some time in the last year or two, we appear to have reached that point with 8-bit CP/M computers. The older machines, such as the Heath H-89 and others that use the 8K 4116 memory chips plus large numbers of TTL and LS-family chips, are being replaced

by newer machines designed from scratch to take advantage of the more efficient 64K DRAMs, custom LSI, and other technologies that lower the chip count and reduce power consumption. Of course, the stiffest competition is actually from the rival 8086/8088 and 68000 CPU families, but even within the CP/M world, things are changing fast.

Why a CP/M machine? There are a tremendous number of inexpensive or free public-domain programs available that are of interest to the amateur, everything from elaborate RTTY and logging programs to those for circuit analysis and filter or antenna design.

A good friend of mine, Jeff KB2JN, had been planning for some time to get an inexpensive CP/M computer to supplement his IBM PC and other personal and home machines. He looked at a number of options, including a used Heath H-89 or H-19 upgrade, an Apple with 80-column and CP/M cards, a Commodore 128, or the possibility of building up a system using a surplus Xerox 820, Big Board, Kaypro, Televideo, or Osborne board. After much deliberation, he decided instead on the Ampro Little Board, and I agreed to help him put his system together despite my built-in prejudice in favor of Heathkit/Zenith products. The rapidly dropping price of the Little Board, coupled with its simplicity, small size, and rel-

atively low power consumption, made it look very promising.

Equipment Needed

The Ampro Little Board (this discussion is only about the Z-80A CP/M machine—Ampro also makes a 16-bit MS-DOS Little Board) is designed to fit in the same physical footprint as the PC board for the typical 5-1/4" disk drive, and to be compatible with the same voltage and power requirements. The power connector is even the same edge connector that most drive manufacturers use. This makes packaging a homemade Little Board system a snap; almost any surplus drive enclosure or larger terminal will do.

A sheet of surplus 1/2" acrylic plastic picked up for a dollar at the Rochester, New York, hamfest flea market was adequate as a base plate for Jeff's ham-shack system, since we intended it to spend its whole life in the same spot on a shelf. For a system that is to be moved around, a surplus drive enclosure or one of the low-profile metal cases sold for IBM or Apple clone builders is fine, or the board can be mounted with a little effort in most terminal enclosures. The small size and low power consumption (and less resulting heat) make this a good option.

Besides a cabinet, the Ampro builder needs a power supply, 5-1/4" soft-sector disk drives (up to four), and some kind of RS-232 serial terminal to act as a console. (Unlike the Xerox-820 and Big Board, the Little Board requires a separate full terminal instead of just a keyboard and monitor.) All these items are available at reasonable cost; check surplus and mail-order catalogs and the ads in ham and computer magazines. We decided to use a surplus IBM 60-Watt power supply, perfectly adequate for the Little Board and a couple of drives. These supplies are widely available and a real bargain right now, as thousands of IBM freaks are pulling them out of their PCs and replacing them with heavier supplies for a hard-disk upgrade.

We selected two full-height 40-track drives, as the full-height drives are usually cheaper than half-height, and space was no problem with our layout. If you're going to stuff a couple of drives into a Heath H-19 terminal case or build up a briefcase portable RTTY machine, half-height drives might be worth a few extra dollars in saved space. If you're operating battery portable, the newer half-height drives may also use a little less power.

If the power supply you're using doesn't already include a cooling fan, putting in one of the smaller, quieter muffin fans is good reliability insurance. The thermal design and layout of your enclosure will determine if it's absolutely essential, but it's silly not to include a

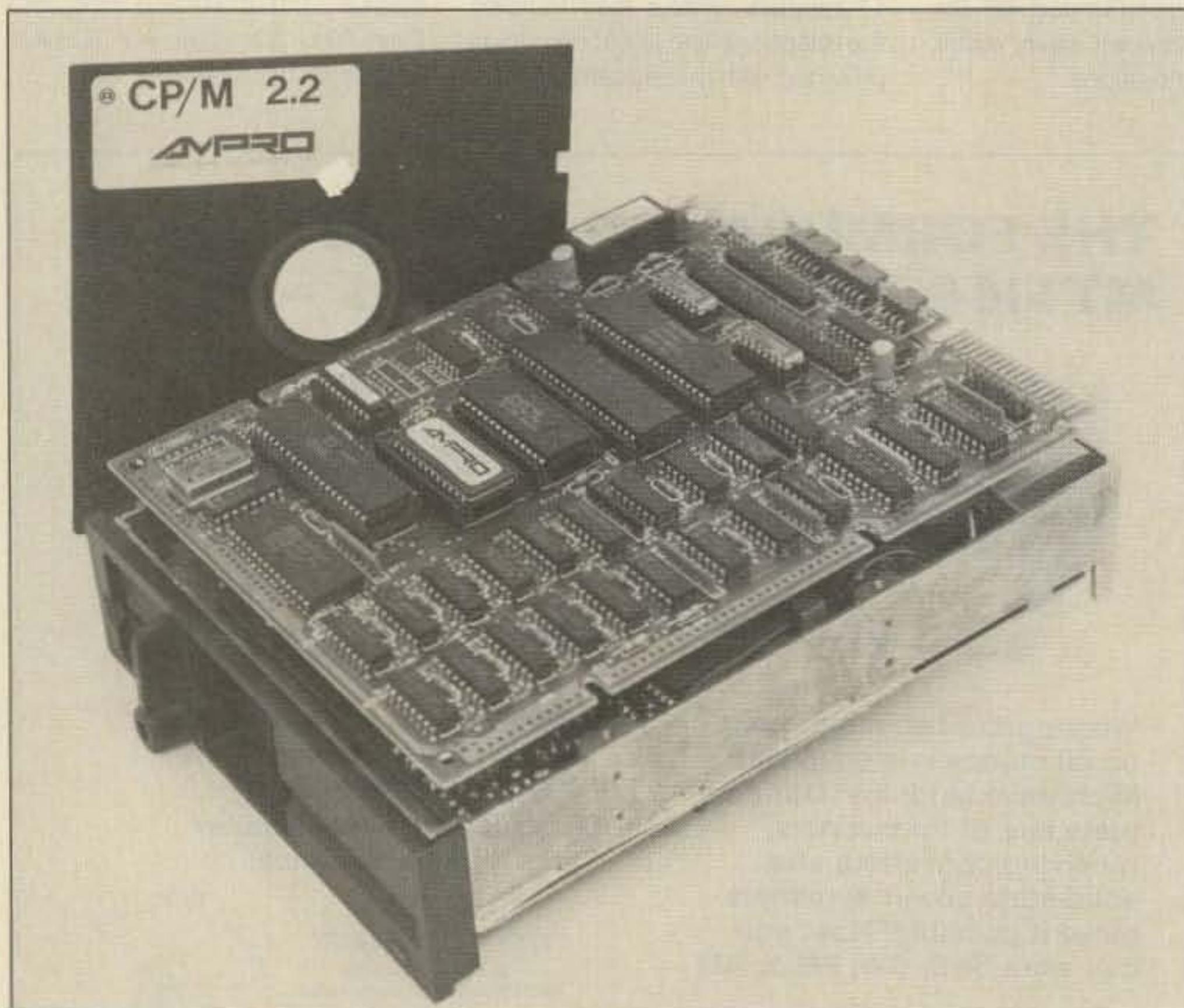

Photo A. The Little Board Plus, which includes an SCSI interface.

fan except in the most extreme low-power, battery-operated briefcase designs, where every Watt-hour is critical.

For a terminal, Jeff decided for the time being simply to use his existing IBM PC in terminal mode with a public-domain communications program. If you don't happen to have an IBM PC lying around, another possible option is to use an inexpensive home computer such as an Atari or Commodore, with a serial port configured as a terminal. New Atari 800XLs were going for \$39 or 3 for \$99 in local toy stores around Christmas last year! Inexpensive surplus terminals also are widely available. If I decide to build this system for myself, I'll probably look for a good used Heath H-19, as it already has a front-panel knockout for two half-height drives. The similar Radio Shack DT-1 is another good bet.

Remember, though, that the terminal you choose will have some effect on what software will work with the computer. Public-domain programs that are written for a particular keyboard and display, such as a Heath-19 or a Lear Siegler ADM-3A, may need to be modified to work with a nonstandard keyboard and display. I would not recommend a 40-column display for serious word processing or spreadsheets, for example. For RTTY and CW operating, or for routine QSL logging and calculations, a cheap, used home computer and a junk B&W TV set may be perfectly adequate.

Besides the main components already mentioned, you'll need some cables and connectors. The drives need 34- or 35-conductor ribbon cable and standard 5-1/4" disk-drive edge connectors, one more than the number of drives, as the connector on the Little Board is identical. If you are building a two-drive system, you'll need three connectors; for a four-drive system, five; etc. If you wire the connectors yourself, make sure that the signals are on the even-numbered conductors and the odd ones are grounded.

Using shielded ribbon cable and keeping the length as short as possible will help reduce RFI, both in terms of QRM generated by the computer and computer glitches caused by rf from the station transmitter getting into the system. A grounded metal enclosure for the system plus filtering and bypassing on the power cord will help, too.

Check your Ampro manual and the data sheets and schematics for the drives themselves. Normally, a terminating resistor network goes only on the last drive in the chain and is not needed on the others. You'll also need a power cable and connectors for the board and drives and provisions for bringing the power-on light and reset button line out from the board connector to a convenient location.

The WD-1770 disk-controller chip can handle up to four soft-sector drives in various combinations of single- or double-sided and 48 or 96 tracks per inch (tpi)—40- or 80-track. The CP/M boot disk provided by Ampro is single-sided, 40-track, however, so you'll need at least one of these drives to get your system up and running. Also, in order to use DISKCOPY (one of the disk-copying utilities provided with the Little Board operating sys-

The (Original) Ampro Little Board at a Glance	
Board	
Dimensions	7-3/4" x 5-3/4" x 3/4"
CPU	Z-80A at 4 MHz
RAM	64K (eight 64K DRAM chips)
ROM	One 8-bit (2732) EPROM for initialization
I/O	Two RS-232 serial ports, one 75-9600 baud, one 75-38,400 baud, plus one Centronics parallel printer port. One serial port is used to communicate with any RS-232 serial terminal as console.
Disk I/O	Western Digital WD-1770 disk-controller chip can drive one to four 5-1/4" soft-sector disk drives, in any combination of 48 tracks per inch (tpi) and 96 tpi, single- or double-sided drives. Step rates are selectable.
Power Consumption	+5 V dc @ 750 mA, +12 V dc @ 50 mA (The -12 V dc for the RS-232 serial ports is generated on-board.)
Operating System	CP/M 2.2, plus extra utilities and ZCPR enhancements
Price	\$249 list (model 1B-1, qty. 1-4, as of April, 1986)
Manufacturer	Ampro Computers, Inc. 67 E. Evelyn Ave. Mountain View CA 94041 (415)-962-0230

(Note: Since KB2JN and I began this project, Ampro has begun phasing out the Original Little Board in favor of a newer version, the Little Board Plus, which includes an added SCSI interface on the same size circuit board. They also now sell a line of piggyback SCSI I/O and STD bus boards which will work with other Z-80 computers as well as the original Little Board. Interested amateurs should inquire about prices, etc., as they probably will have changed by the time this review sees print.)

tem software), you will need at least two drives of the same kind.

Documentation

The manual provided with the Little Board has 135 8-1/2" x 11" pages. About a third of this is assembly and operating instructions for the user, and the rest is reprints of data sheets for the key ICs, such as the Z-80A CPU and the Western Digital WD-1770. This seemed a bit on the skimpy side at first to an old Heath/Zenith user, but if you consider the fact that the Little Board not only comes assembled and tested except for cables and peripherals but is also inherently much simpler than older generation Z-80 machines, the manual is more than adequate for the everyday routine user.

Ampro does provide an optional Technical Support Package for customers who are going to use the Little Board in custom or OEM applications. I prefer a large schematic with everything mapped out on one sheet, but the modular schematics provided with the Little Board are clear and easy to read, adequate for most routine troubleshooting.

Software

As for software, the Little Board comes with two complete operating system CCPs, both regular Digital Research CP/M v. 2.2, and ZCPR3 (an enhanced operating system that is compatible with regular CP/M but includes more sophisticated capabilities). You could write a book-length review just on ZCPR; many user groups have several disks filled with help files and special utilities. The most obvious advantages for the beginner are the

way file directories and user numbers can be manipulated. ZCPR will allow you to make a file of any disk's directory without retyping, and will shuffle files from disk to disk and user area to user area very easily—something that is difficult or impossible to do from stock CP/M.

ZCPR will also create an optimal path search for a file that's not on the currently logged disk, and the DIR.COM version of the directory utility provided by Ampro allows an almost mind-boggling array of possible arguments and parameters in addition to the stock CP/M DIR A: or DIR B:. You can hide secret files in different user areas and still access and execute them from the currently logged user area and disk—once you know how. This might be important for classroom use, where different students may have to share disk files in different user areas. For myself, being able to PIP together a comprehensive disk library directory without hours of retyping is the most valuable feature.

Besides the usual CP/M utilities like PIP, ED, STAT, and so on, Ampro provides other utilities. AMPRODISK allows you to format, copy, and verify a disk. This is similar to the combined utilities of FORMAT and DUP from Heath and some other manufacturers. MULTIDISK.COM allows you to read and write to other soft-sector CP/M (and CP/M-86) disk formats. It will not allow reading and writing of Heath/Zenith hard-sector or Apple 35-track formats, though. UNERASE.COM allows you to recover an accidentally erased disk file, providing that the disk hasn't been physically over-written or reformatted. STARTUP.COM allows automatic execution of programs upon

power-up or reset. MULTIFMT.COM allows you to format a blank disk in other soft-sector formats, including CP/M-86 formats for some 16-bit computers. SWAPCOPY.COM allows you to copy files from one disk to another using a single drive. DISK7.COM is a sort of enhanced combination of STAT and PIP for manipulating files.

The Multidisk and Multiformat programs are very impressive and support a wide assortment of disk formats, including relatively obscure ones such as Heath Lifeboat and TRS-80 Montezuma CP/M. To use the programs, one of the regular drives is reconfigured as disk E: (for Emulate) and the parameters are selected from a menu.

Conclusions

The Ampro Little Board is a very good little, single-board computer. Besides the small size and low power consumption already mentioned, there are several other positive features. The Z-80A runs at 4 MHz, twice as fast as many early CP/M machines. The memory-management and refresh circuitry is entirely digital, and does not have discrete RC networks, one-shots, and other parts cluttering up the path. This, combined with the physically small size and low chip count, makes for very reliable operation.

One of the two RS-232 serial ports provided will run as fast as 32,400 baud. If your terminal can handle it when serving as a console, running at 19,200 or 32,400 baud instead of the older standard of 9600 baud will result in an amazing speedup in writing to the screen, especially important with I/O-intensive programs like games with graphics. Actual graphics capability will be limited, of course, by your terminal and the CP/M software you are running.

The price has fallen to true bargain levels; Ampro factory ads in ham magazines dated January, 1986, give a list price of \$249 in single-unit quantities, and some dealers may even discount this. This is \$50 cheaper than just a soft-sector controller card for Heath H-89!

On the negative side, the most serious limitation on the original Little Board is the fact that you have only two RS-232 serial ports and one Centronics parallel printer port. With one serial port tied up talking to your terminal as a console, that leaves just one, putting you in the same boat as stock Kaypro II users. If you want to use both a modem (or RTTY TU) and a serial printer, for example, you have to kluge up a switching or transfer box, or else use an extra-cost parallel-to-serial adapter on the Centronics port to drive the printer.

Also, the serial ports support data only on pins 2 and 3, and handshaking on pins 5 and 20 (CTS and DTR). If you have a fancy modem that uses other lines for handshaking, carrier detect, etc., there may be some problems getting it working, especially for the relatively inexperienced beginner. Unlike some other computers, there is no physical difference between a DCE and a DTE port, which can also be confusing for a beginner. The manual does explain how to get a modem working by inverting pins 2 and 3 plus 5 and 20, though.

Unlike the older Z-80 computers such as the H-8, H-89, and many S-100 systems, there is no bus expansion connector on the original Little Board. This makes adding extra I/O ports and other hardware options fairly difficult. About the only practical approach is for boards that plug piggyback directly into the Z-80 socket. There is at least one manufacturer of clock/calendar boards that work this way and that are relatively inexpensive. Ampro does sell an SCSI expansion card as a \$99 extra-cost option to allow additional I/O to be added, and the company has announced a new version of the Little Board, the Little

Board Plus™, which includes the SCSI port on the card for about \$40 more. This looks like a worthwhile option for more ambitious users and is cheaper than buying the Little Board and SCSI card separately, or even the \$59 SCSI upgrade kit. Ampro also sells hard-disk packages, an STD bus adapter, and other options.

In closing, then, the Ampro Little Board is an inexpensive, reliable, and physically small CP/M computer. For applications like custom briefcase computers or low-cost systems for a student or amateur on a budget, it's a good buy indeed. Reader Service number 151. ■

Hamcom Terminal Software

by E. Benson Scott AE5V

Advanced Electronic
Applications, Inc.
PO Box C-2160
Lynnwood WA 98036
Hamcom—\$49.95

With the advent of digital communications and the increasing use of computers in the shack, one is always looking for easier and more efficient ways to combine functions. AEA (Advanced Electronic Applications) markets a program written and supported by Emile Alline NE5S. The program, Hamcom, produces a complete Morse, Baudot, ASCII, and packet communications program for the IBM PC or compatibles. The software has been revised several times; I'll review 4.E, the most recent version. No more will you have to have separate programs for RTTY and packet communications; Hamcom has combined the best of both worlds into one very usable terminal program.

The software is written in Basic, with files on one double-sided, double-density disk. The programs have been compiled to facilitate use and speed enhancement. Other than a brief instruction sheet for setting up the interface connections and a two-page review of the program, all documentation and instructions are included on the disk and can be read from the screen or printed. When printed, the material is 5-1/2 full pages of information including a very nice summary of the control functions.

The setup and default menu is easily and quickly configured. No special knowledge of the computer is required. Line widths from 30 to 80 characters can be programmed. Ten pre-program messages in each code (ASCII, Baudot, CW, and packet) can be written at this time or at any later date. One nice feature is available for those individuals with early IBM equipment with single-sided format: The program is set up so that owners can use single-

sided disks in drives A: and B: and not have to purchase double-sided, double-density disk drives.

An IBM PC compatible computer or PCjr with a minimum of 80K of RAM is required. One serial port is necessary to receive the information from the packet TNC or RTTY/CW demodulator.

Codes

The program is menu driven: ASCII, Baudot, CW, packet, setup, and CW practice are options that can be selected. After one decides which code format to use, the next set of options—setting up speed and other parameters—immediately appears. For the advanced user, more unusual formats can be transmitted and received, but for the neophyte, there is nothing to know except which code and speed are desired.

The ASCII section of the program normally operates at 110 or 300 baud, but is variable enough to allow essentially any combination of baud, bits, or parity allowed by DOS.

The Baudot section allows transmission and reception at 60, 66, 75, and 100 wpm. These options should allow for reception of all but the most unusual protocols.

The CW section allows transmission and reception at any speed from five to approximately 100 wpm and is primarily limited by the demodulator interfacing with the radio and computer.

The packet radio section allows one to transmit and receive packet radio using a terminal node controller (TNC). Variable communication rates are allowed between the computer and the TNC.

A very useful portion of the software includes CW practice. Characters may be sent at a fixed rate or as you enter them into the keyboard. For those learning or practicing the art of CW, character speeds are not dependent on word speeds, and variable spacing is quite easy to incorporate into the setup. The speed will slowly but automatically increase if you desire.

Features

Each of the code formats uses a split-

screen technique, allowing transmit and receive buffers to remain independent. Should you have a color monitor, color options are available. Splitting the screen is a status line, which can be moved up or down. This line includes the format, speed, transmit or receive status, local time and date, as well as the disk-saving status, printer status, diddle, and WRU status.

Pre-programmed disk-saved messages up to 256 characters are allowed in each of the code sections of the program, making a total of 40 available. This is a nice feature in that the RTTY station can be listed in the RTTY section of the program and will not interfere with the description of the packet station in the packet portion of the program.

A more unique and fun feature is the ability to capture and save text in either the transmit or receive mode "on the fly" using function keys. Tapping the function key the first time begins the capture; tapping it a second time ends the capture. This material can then be saved or entered into text at a later time with a two-keystroke entry. The transmit and receive buffers are not limited by the program, only by your hardware capacity.

Interfacing with a TNC or RTTY/CW demodulator is quite straightforward. For using most of the newer demodulators or TNCs, all one has to do is plug one end of the RS-232 cable into the computer and the other into the demodulator or TNC. For those with other connection options, instructions come with the program for connecting the push-to-talk (PTT) line, CW transmit-receive lines, ASCII/Baudot transmit-receive lines, and ground.

Conclusions

Packet radio is the most rapidly growing fragment of our hobby. With Hamcom, a terminal program is set up to work with a TNC, alleviating a number of problems associated with some computer terminal programs (such as not allowing control characters other than the standard letters, numbers, and spaces to be transmitted). The packet portion of the program is also different in that it allows you to transmit and receive essentially simultaneously. Transmitted lines are shown in reverse video.

For the beginner, a very useful feature is the ability to use the Hamcom program without it being attached to a demodulator or TNC. In this way, one can become quite adept at using the available functions without confusing all those listening on the air.

Having used several other RTTY programs for other computers and dedicated terminals, I found this software package easy to use and thoroughly thought out. There are very few RTTY/ASCII programs available for the IBM PC. Because the PC is one of the least frequently used computers in the hamshack, software is not as readily available as for some of the smaller computers, such as the Commodore. If one is looking for a computer terminal program to function with a variety of interfaces and provide flexibility, AEA's program might very well fit the bill at a reasonable cost. Reader Service number 152. ■

"When You Buy, Say 73"

CUT YOUR LOSSES

Portable radios can be a trade-off. In return for mobility you get loss of performance.

Well now you can cut your losses significantly. All you need is the new Larsen UHF KūLDUCKIE® KD14-HW half-wave antenna.* It's a mouthful but it'll do your ears a lot of good.

Because it's half-wave, the KD14-HW is fully resonant despite the poor ground plane portables are faced with. Under ideal ground plane conditions, it delivers performance equal to a full quarter-wave. And that's a powerful improvement over most portable antennas!

And because it is inherently resonant, the KD14-HW can also be easily remoted with a length of coax.

The KD14's flexible, easy-to-get-along-with radiating element measures a scant 12 inches. At the base is a 3/4 inch impedance transformer that gives added strength.

The KD14 half-wave series is also available in a collapsible 2-meter version.

Cut your losses and improve your gain when you operate with the new Larsen UHF KūLDUCKIE® KD14-HW, with no-nonsense warranty. You can see it at your favorite amateur dealer.

*For units with BNC output.



Larsen Antennas The Amateur's Professional™

See your favorite amateur dealer or write for a free amateur catalog.

IN USA: Larsen Electronics, Inc. / 11611 N.E. 50th Ave. / P.O. Box 1799 / Vancouver, WA 98668 / 206-573-2722
IN CANADA: Canadian Larsen Electronics, Ltd. / 149 West 6th Ave. / Vancouver, B.C. V5Y 1K3 / 604-872-8517

LARSEN® KūLROD® AND KūLDUCKIE® ARE REGISTERED TRADEMARKS OF LARSEN ELECTRONICS, INC.

A Packet Primer

First you've got to know the lingo.

Packet radio is now very popular, and dozens of amateurs purchase new equipment weekly to get on the air using this new mode. This article will discuss why this new mode is so popular and evaluate the advantages of using packet in comparison with other digital modes.

Join the Packet Radio Revolution!

You may recall that the introduction of machinery into manufacturing during the 18th century greatly changed the way of life in England and other countries. That major change, called the industrial revolution, substituted the power and speed of machinery for the power of man's own muscle and that of animals. That revolution has shaped our way of life today more than anything else.

Today there is a revolution going on in the technical world that ranks in importance with the industrial revolution. Many persons are calling it the information revolution—and packet radio is a part of it. This revolution is based on bringing the power of computers to the process of handling information. It has already changed our way of living and will continue to do so in the future. Its theme is well expressed in an advertising phrase used by a large corporation: Men should think, machines should work. The advent of com-

puterized data processing allows people to emphasize their creative skills and leave the sorting, filing, retrieving, and moving of information to the machines.

The information revolution is primarily sparked by the science of microelectronics, which produces integrated circuits. The lure of something for nothing is very appealing. Haven't you ever wished that you had a printing press to run off a few greenbacks? Well, that's almost the way it is with integrated circuits. Greatly simplified, the process is a form of printing. Much time goes into designing the circuits and photo masks and setting up the equipment, but when everything is completed, the production line turns out thousands of circuits for pennies each. In fact, for many medium-scale integrated circuits, the cost of the package is greater than the cost of the silicon chip inside.

The above trivia is at the heart of the information revolution and the explosion of microcomputers. The spread of microprocessors has been dramatic, covering far more than just microcomputers. I know there is a microprocessor in my microwave oven, my clothes washer (I took it apart), and my automobile ignition, air conditioner, and cruise control. No telling what other device has one in it. The same is true of the ham shack. My

handie-talkie, mobile FM rig, HF transceiver, and VHF multimode rigs all are microprocessor controlled. They do the work (when I can remember the proper commands) and I have the fun.

What About Packet Radio?

I believe packet radio is the branch of the information revolution that extends into amateur radio. The power of the microprocessor enables us to have new and more reliable forms of communication. Over the next few years we will see tremendous improvement in the way we are able to pass along information. Packet will not replace CW or phone modes because they are practiced for the enjoyment they bring, but we will see a powerful amateur digital network created that will transform the way we communicate.

At its most basic level, packet is simply another way for amateurs to pass information between them, and in that respect it is no different from the spark-gap transmissions used by the early practitioners of our hobby. With microprocessors in our bag of tricks now, we can move more information in more interesting ways. Each new mode in amateur radio over the years has added to the quality or quantity of information exchanged.

Let me give you an example you must have experienced yourself: Someone visiting your neighbor meets you on the street and comments on your antenna farm. He mentions that he knows a ham just down the street back home and wonders if you could call him to see how things are going. You wonder how to explain the difficulty of contacting that ham—you don't know his callsign, his equipment, his operating habits, etc. It would be a multi-million-to-one shot to turn on your rig and contact him, even if you knew his callsign. So you make some excuse and suggest that he use the telephone.

Now look at how that scene might play when we have an amateur digital network.

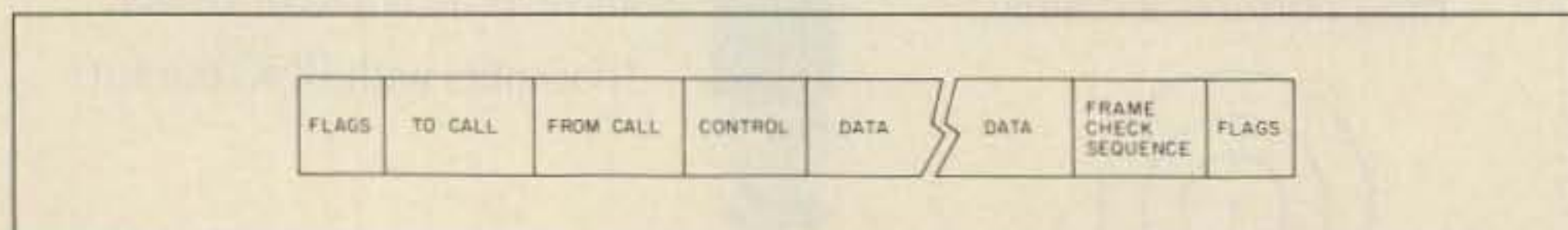

Fig. 1. Schematic representation of a frame.

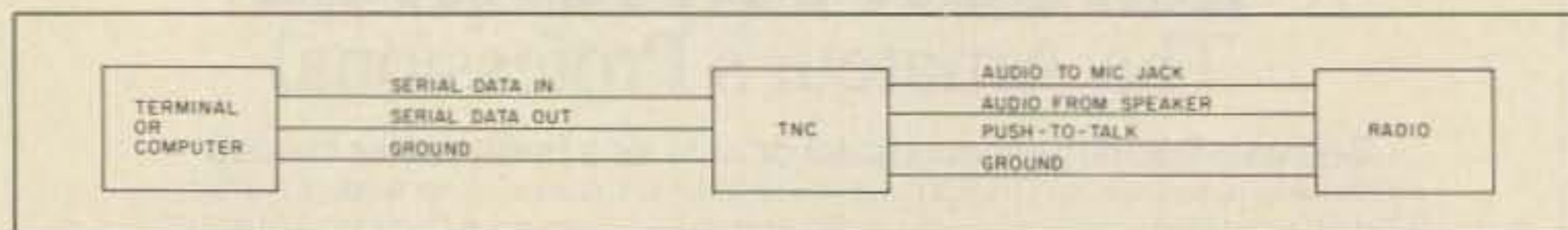

Fig. 2. The minimum equipment required to get on packet.

You obtain some portion of the back-home ham's identification: perhaps his last name and city or his street and city. Then you use your packet terminal to access the network information server. You provide it with the information you have obtained and in turn receive a listing of possible names, call-signs, and addresses, plus any needed routing information. Your visitor can then identify the amateur, and you can send a message using the network. If the other ham is currently on the air, the message is delivered right away. If his station is not operating, the message is stored for him and you are informed of the situation. It's rather like making a phone call, but it is all done via amateur radio. Using the same techniques, you could also have sent him a text file, a computer program, or a video display or picture, or even operated his equipment remotely. Very convenient!

One of the words we hear all the time is "digital." In the strictest sense, hams have been doing digital communication for many decades—they call it CW. Radioteletype (RTTY) and more recently amateur teletype over radio (AMTOR) have become popular forms of digital communication. Packet is also digital, but it has increased capabilities compared with other digital modes because of the advanced techniques used to address and transmit the information.

What Does Packet Do That Other Digital Modes Do Not?

Packet offers several distinct advantages over older digital modes:

1. Robust error detection. It's 1,000 times more comprehensive than AMTOR.
2. Networking. The packet addressing technique allows a series of stations to repeat packets to each other, thus forming a network.
3. Compatibility with computers. Packet supports the transfer of binary data (computer programs) and is the only error-detecting mode supporting the full ASCII encoding used on most computers found in the ham shack.
4. Compatibility with other modes. Packet may be used to transfer any type of information that is in digital form. Thus with proper encoding, the advantages of error detection and networking may be applied to voice and video signals.
5. Speed. HF packet operates at 300 baud, which is some five times faster than RTTY or AMTOR. On VHF, the FCC allows higher speeds, and 1200 baud is commonly used. That is 10 to 20 times faster than RTTY. In the future, data rates of 9600 baud, 56,000 baud, and higher will be used.

Protocols

A protocol can be viewed as a set of exact rules that describe the actions one takes in response to the actions of others, or the actions one should take to elicit a certain response from others. In human interaction, protocols are usually referred to as "etiquette." Most protocol specifications are lengthy, because to be useful they must

cover every action and event that is likely to occur.

CW uses a single tone, and the informa-

tion is transmitted by turning the tone on and off according to an agreed-upon code (Morse). There is a simple protocol for CW

WHAT'S IN A TNC?

The initials TNC (pronounced teen-see, and only rarely "Tink") have become synonymous with packet radio in the amateur service. It's the wrong name, but it's too late now. An early amateur digital experimenter designed a device called a Terminal Node Controller as part of a two-part system that included a Station Node Controller. Other experimenters used the TNC as a separate unit in experiments of their own, keeping the same name. The original TNC/SNC project has since faded into the mists of time,

and what we now call a TNC is actually a Packet Assembler Disassembler (PAD). A PAD connects a device (such as a terminal or computer) that does not "speak" the network protocol to the network. It collects characters one at a time, assembles them into packets, and sends them out into the network. It also takes packets from the network, disassembles them into individual characters, and sends them to the terminal or computer. If you substitute TNC for PAD when reading non-amateur packet literature, you won't be far wrong.

If you open up a TNC, you'll find a general-purpose computer hiding under the hood, chained to a communications chip and modem. As shown in Fig. 3, a TNC is a fairly standard microcomputer, with RAM for storage, ROM for the program, a CPU to make it run, and a serial chip to talk to your terminal or computer. Most TNCs also have an HDLC chip, sometimes as a part of the serial chip. HDLC (High Level Data Link Control) is one of many names used to describe the format of the data sent out over the radio. TNCs with a hardware HDLC chip will be able to run at higher data speeds than TNCs with a "software HDLC." As a practical matter, this is only important if you want to use your TNC with the new satellites coming up (see the article about digital satellites in this issue), or if you want to use the higher speed modems that are beginning to be available. Today, at least, the cost of the units with and without hardware HDLC is about the same.

Another element of a TNC is the modem. The first TNCs did not have modems included as an integral part; the modems were "outboard." In the early days, hams standardized on the Bell 202 modem tones. They did this in following two of the most time-honored of amateur traditions, easy and cheap. Easy—the Bell 202 tones of 1200 Hz and 2200 Hz, designed to fit nicely in a standard telephone bandwidth, also fit nicely into the microphone jack of an amateur 2-meter FM transmitter. No modifications to the radio were required. Cheap—surplus 202 modems were available for less than \$100. In the early home-brew days of packet, Bell 202 was the standard, for TNC-based experimentation at least.

When the everything-included TNC kits came out, a modem circuit using the 202 standard was included on the TNC board. After all, the only other people out there to talk to were using home-brew TNCs. Later on, most TNC manufacturers realized that 1200 baud would eventually be too slow, and made their TNCs with a connector that bypassed the on-board modem. This allows for higher speeds, as well as for different standards, such as the PSK modems to be used by the new fleet of digital spacecraft.

The final block in Fig. 3 is the watchdog timer. This is a device that monitors the PTT line that keys your transmitter. The watchdog timer makes sure that the radio is not keyed for an excessive amount of time, should some problem occur in the TNC software. This is not only the neighborly thing to do, it makes the FCC happy as well. Section 97.80 of the amateur rules states: "(a) When under automatic control, devices must be installed and procedures must be implemented which will ensure compliance with the rules when the control operator is not present at the control point of the amateur station."

The watchdog timer is one such device—a cheap and easy way to help make sure that a software or other problem in your TNC doesn't cause your station to come on the air and stay on, jamming out the frequency. Most TNCs have this feature, others have it as an option, and some don't have it at all. If you plan to run your station unattended, look into the matter. To somewhat confuse things, there are two types of watchdog timers. The one included on some TNCs is a PTT timer, but you will sometimes hear of watchdog timers used for digipeaters. These are used to jump-start the TNC itself if it crashes for any reason, and are in general required only for remote locations. See WB6RAL's article on mountaintop digipeaters in this issue.

In general, a TNC contains everything needed to put you on packet radio; all you add is the terminal or computer and a radio.

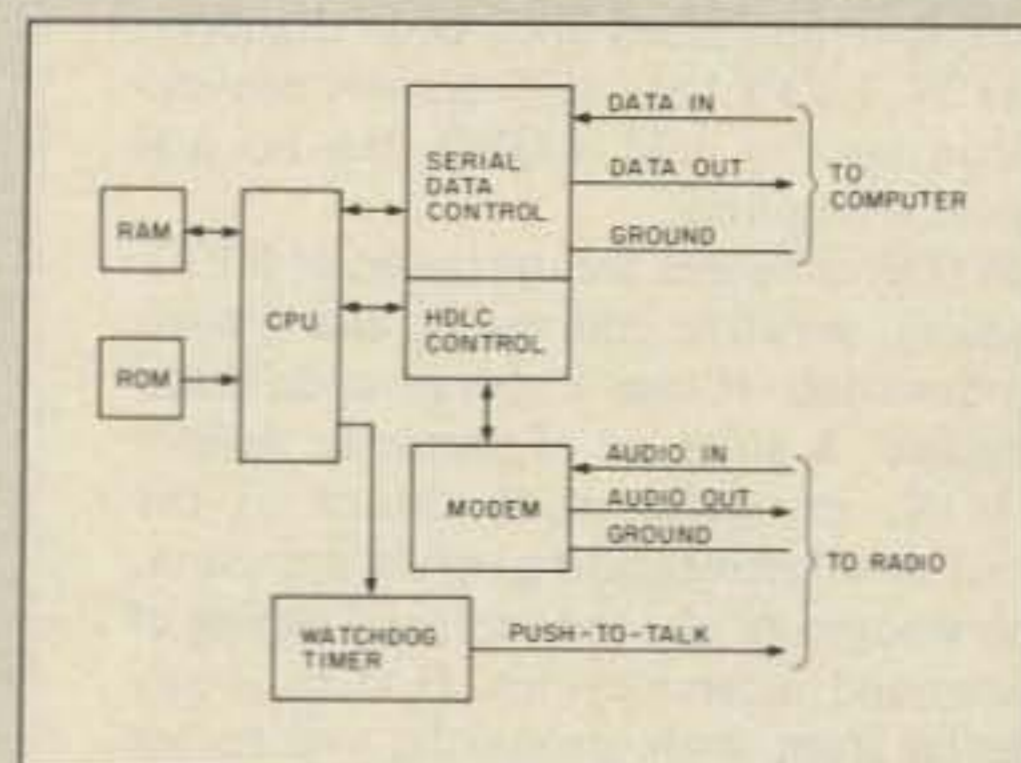

Fig. 3. The major elements of a TNC.

operators based on prosigns such as KN and Q signals.

RTTY uses two tones, and the information is transmitted by switching back and forth between them (frequency shift keying—FSK) according to an agreed-upon code (Baudot). As in CW, RTTY has some operator conventions on how to hold a QSO, but no real protocol is required.

AMTOR enhances the operation of RTTY by adding selective addressing and limited error detection. It uses a special code based on Baudot. A strict set of protocols defines AMTOR, involving such things as the method of selective calling, error detection, acknowledgment of good data, and timing of transmit and receive cycles. If there is any deviation from those protocols, you're not doing AMTOR any longer.

Packet basically uses the ASCII code for character representation, although binary data (object code) and digitized voice, video, and telemetry may be transmitted equally well. Packet currently uses FSK just as RTTY does, but that modulation technique is not required. Future equipment will use modulation techniques adapted for higher data rates. Protocols are the major source of packet's power and usefulness, and are mainly a matter of software. The protocols used by packet are far more complex than any protocol used in amateur radio to date. This is in part necessary because a computer is inherently less "intelligent" than a human—less so than even the most reprobate kerchunker. A computer has no common sense whatsoever. The kerchunker's sense is debatable.

Protocol History

The microprocessor revolution has made possible low-cost equipment that will automatically follow complicated protocols for the operator. Packet protocols (and hardware) have been adapted from commercial computer terminal networks. In a large office building with 400 to 1,000 terminals operating from a mainframe computer, you don't want to run a separate piece of coax to each terminal. In that situation, all the terminals are probably daisy-chained on one run of cable. When the host computer desires to transmit to a particular terminal, it places the identification of the intended terminal in the header of the message. All terminals listen to all messages and only the one seeing its own identification will respond to the message.

Packet radio uses this same technique, except an rf channel is substituted for the cable. The formats used in addressing the messages, the timing factors in sharing a channel, and numerous other items make up protocols. Various layers of protocol deal with different portions of the information transfer. Lower-layer protocols deal with the type of signal voltages and connections, the modulation techniques and data encoding, etc. Higher-layer protocols deal with addressing messages through the network, converting data formats among differing computers and terminals, handling file transfers and remote

BETTER HOMES AND SHACKS—SOME TNC-EQUIPPED STATIONS

Packet radio stations come in all shapes and sizes. Photo A shows a small portable configuration. This is the traveling road-show station used by NK6K at packet demonstrations. There are several portable computers and TNCs that will fit the same footprint. The radio is a 2-meter HT; the 6-volt cells power the TNC. The smallest, lowest power TNC is the GLB PK1-L (not pictured). GLB's ads say the size is 4.5" x 5.9" x 1.0" and it draws about 25 mA typical power. I've seen one running at a show on a 9-volt battery. Packet stations similar to the one shown here have been on boats and planes and in other interesting places. A station very similar to the one pictured here using a Radio Shack TRS-80 Model 100, a specially built TNC-2, a specially modified Motorola radio, and a special container is ready to be qualified to fly on the next Shuttle Amateur Radio Experiment (SAREX) flight.



Photo A.



Photo B.



Photo C.

Photo B shows a fully equipped packet station, ready for action on HF, VHF, UHF, OSCAR-10, and UoSAT-OSCAR-11. It is also running a bulletin board system on the IBM-PC. The closeup in Photo C shows (top to bottom, left to right): TAPR TNC-1, azimuth and elevation rotor control for the satellite antennas, Uo-11 command encoder and decoder, power supply, TAPR TNC-2, IC-251 two-meter radio for local packet and satellite downlink, IC-451 430-440-MHz radio for satellite uplink, polarization switches for the satellite antennas, UTC clock (the photo was taken very late at night), Bearcat scanner to receive packets in the commercial bands*, R-1000 general-coverage receiver, TS-830 for HF packet, 440-450 transceiver for local chit-chat, and HF antenna tuner. Packet can be used to enhance your station in whatever activity you're engaged in. Unattended CW DX spotters nets anyone? How about a worldwide EME schedule data base?

Photo D shows Skip Hansen WB6YMH's very neat arrangement for an automated BBS station. The entire station is mounted in a 19" rack cabinet. From top to bottom are: thin white box housing a TAPR TNC-1, a shelf containing a TNC-2, a phone and dial-up modem, a vintage IMSAI 8080 computer, a UHF and a VHF radio, four 8" disk drives, the CRT for a Xerox 820 computer, and another white box containing a Xerox 820. This rack actually contains two BBS systems, one on packet and one attached to the phone lines. There is no connection between the two systems, which is the best way to avoid third-party problems. The Xerox 820 runs a standard CP/M system; WB6YMH-2 is a host, file-server, and a mailbox system.

Photo E shows a very simple system consisting of a two-meter radio (with amplifier), an Apple-II computer, and a TNC-1 mounted in the black box under the CRT. The photo is actually deceptively simple, since this station is also the busiest BBS in the Los Angeles basin. A station need not be sprawling to get a job done. This station is N6BGW-9, run by Scott Avent.

*I'd like to point out that amateur TNCs which were designed by hams in garages are in use in the commercial services. TNCs are in use in a variety of places around the world doing various jobs. This is the best example in recent years of amateurs living up to Part 97.1(c) of the FCC rules: "Continuation and extension of the amateur's proven ability to contribute to the advancement of the radio art." Why are amateur-designed TNCs showing up in the real world? They're cheap and easy to use, of course. Amateur doesn't mean unprofessional.



Photo D.



Photo E.

data-base accesses, etc. At the highest layer, protocols deal directly with the user or his program and perform work for the user without making him aware of the part the network is playing.

AX.25 Protocol

Much of the progress to date in packet radio is due to the adoption of a standard link-layer protocol that makes packet equipment from all manufacturers fully compatible. This protocol is AX.25, the amateur version of the international X.25 protocol. Other protocols were used originally, and some areas have not converted to the AX.25 standard, but layer 2 protocol is no longer an open issue. Development and experimentation with layer 3 and 4 protocols is going on, but no standardization is likely in the near future. Much experimentation will be done to determine which method(s) will work best in the amateur-radio environment.

What Does a Packet Look Like?

A more appropriate heading here probably would be "What does a frame look like?" A TNC transmits frames, which include flags, addresses, commands, information, and error-checking information. The user's information is properly called a packet of data. Popular usage, however, calls the whole frame a packet. The frame begins with a flag consisting of a special series of ones and zeros. (Remember, at the digital level, everything is either a one or a zero.) Next come the call signs of the sending station, the station intended to receive the frame, and all those stations that are to repeat the frame on the way to its destination. Then a field identifies the type of frame being sent—connection request, acknowledgment, or status polling, for example. If the frame is supposed to contain data, the control field is followed by a packet of data.

Next comes an error-checking field, which works like this: The entire frame (including addresses, etc.) is made an input to a mathematical formula (think of it as long division). The remainder from that operation is included in the frame in the Frame Check Sequence field. When the frame arrives, the same mathematical formula is applied. If the remainders are equal, then the frame is presumed to be error-free. If the new remainder is not the same, no attempt is made to correct the data. Instead, the frame is thrown away and retransmitted.

Fig. 1 shows a schematic representation of a frame. Remember, a microprocessor takes care of all of this for you, and at the end of the process presents you with the data contained in each frame.

Networking

Protocols make networking possible. The techniques described above for the computer terminals are even more valuable in the amateur environment. While a RTTY or AMTOR station can talk directly to only one other station, packet stations can extend their range by using other packet stations as repeaters. These digital repeaters are not the

1986 CALLBOOKS

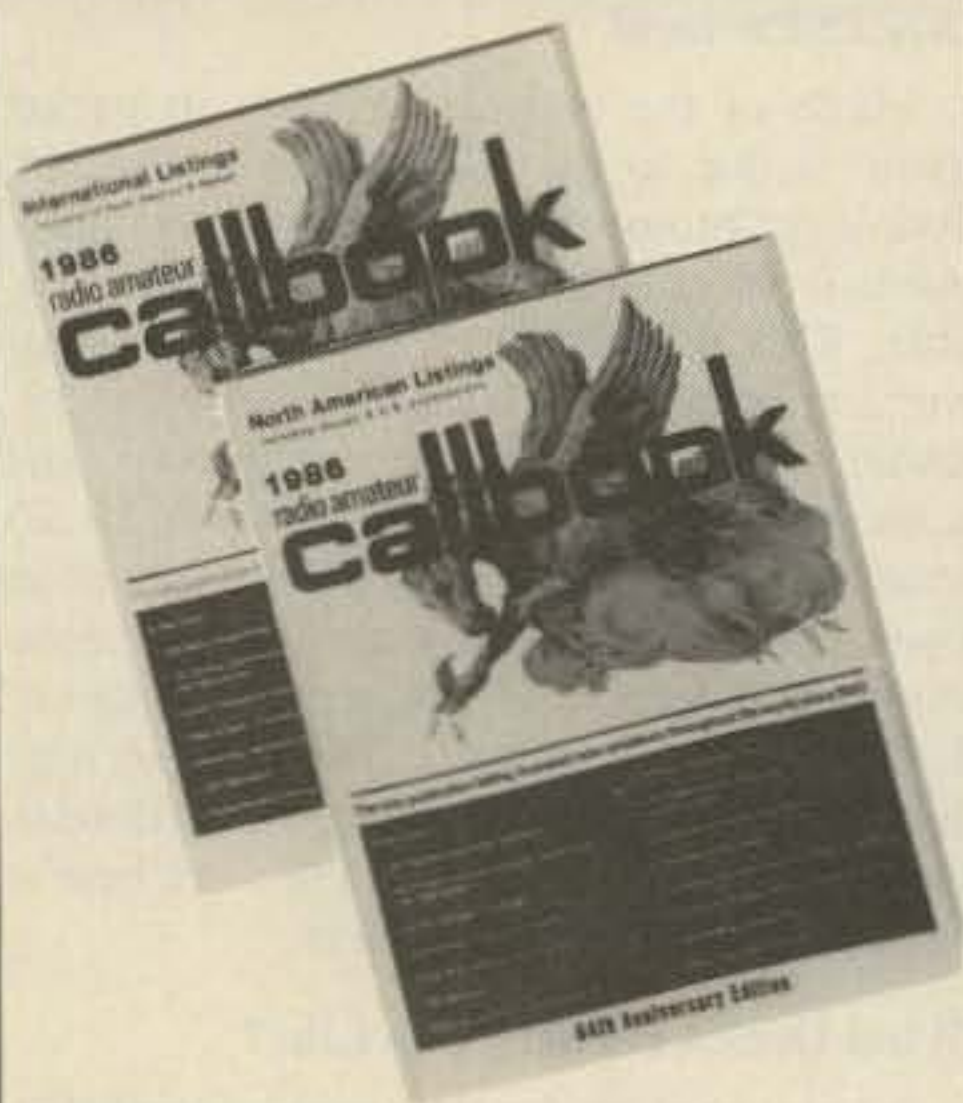

The "Flying Horse" has a great new look!

It's the biggest change in Callbook history! Now there are 3 new Callbooks for 1986.

The North American Callbook lists the amateurs in all countries in North America plus those in Hawaii and the U.S. possessions.

The International Callbook lists the calls, names, and address information for licensed amateurs in all countries outside North America. Coverage includes Europe, Asia, Africa, South America, and the Pacific area (exclusive of Hawaii and the U.S. possessions).

The Callbook Supplement is a whole new idea in Callbook updates. Published June 1, 1986, this Supplement will include all the activity for both the North American and International Callbooks for the preceding 6 months.

Publication date for the 1986 Callbooks is December 1, 1985. See your dealer or order now directly from the publisher.

- | | |
|---|---------|
| <input type="checkbox"/> North American Callbook
incl. shipping within USA | \$25.00 |
| incl. shipping to foreign countries | 27.60 |
| <input type="checkbox"/> International Callbook
incl. shipping within USA | \$24.00 |
| incl. shipping to foreign countries | 26.60 |
| <input type="checkbox"/> Callbook Supplement, published June 1st
incl. shipping within USA | \$13.00 |
| incl. shipping to foreign countries | 14.00 |

SPECIAL OFFER

- | | |
|---|---------|
| <input type="checkbox"/> Both N.A. & International Callbooks
incl. shipping within USA | \$45.00 |
| incl. shipping to foreign countries | 53.50 |

Illinois residents please add 6 1/4% sales tax.
All payments must be in U.S. funds.

RADIO AMATEUR
callbook INC.



Dept. B
925 Sherwood Dr., Box 247
Lake Bluff, IL 60044, USA

31

Tel: (312) 234-6600

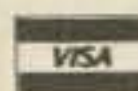

same as the FM voice repeaters we are used to. In fact, any packet station can be a digipeater. Remember that each packet station listens to every transmission on the frequency to see if that transmission is addressed to it. It also looks at each transmission to see if it is supposed to be repeated. The addressing information specifies which stations are to repeat the information and in what order they are to repeat it. Thus a chain of repeater stations may pass along a message and carry it a long distance beyond the local area. That is the basis of networking.

Packet Is Fun

Enough of the theory and history! Packet is loads of fun. Thousands of hams use packet for rag-chewing just as they do any other mode. You can share the channel with a dozen other conversations and watch them all at once if you like. Or you can limit your screen to displaying only what is sent by the person with whom you are conversing.

A major pastime on packet is non-real-time communication. Real-time communication is when both parties in the conversation are on the air at the same time. In amateur radio, the further apart two real-time stations are, the greater the chance that one of the parties is either up late, up early, skipping work, or retired. In non-real-time communication, only one party needs to be on the air at a time. The originator of a message leaves the message on a "mailbox," which stores it for later retrieval. This is similar to leaving a written message taped to the refrigerator door for a family member who won't be home when you are. As long as the mailbox is accessible 24 hours a day, communication can occur between two persons regardless of whether they are both on the air at the same time or not. This frees the amateur from the tyranny of the clock—and the ionosphere.

There are numerous mailboxes or bulletin-board stations active on packet. ARRL bulletins, newsletters, computer files and programs, and many public and personal messages are available on these computer systems for access by anyone within packet range (and remember that packet range is greatly extended by the use of digipeaters). The network automatically forwards messages to the mailbox serving the addressee. It is very thrilling (and convenient) to check into your local mailbox and get messages from numerous states and several countries.

What does it take to get on packet radio? The minimum equipment is a terminal node controller (TNC), which is the packet controller; a 2-meter FM radio and antenna; and either a computer or a terminal (see Fig. 2).

The TNC is the device that contains the microprocessor that does most of the work of getting your information sent and received. There are now a variety of TNCs to choose from, in a variety of price ranges and capabilities. There will no doubt be ads for several TNCs in this issue of 73. Many

radio stores have TNCs on display, and most clubs have at least one person on the air with packet. Although it takes many words to describe what packet is, it only takes a few minutes to see what it can do when you get a demonstration.

Packet can be used with any radio capable of sending voice—i.e., those with microphone jacks—and can be sent anywhere the F1 emission is permitted. In practice, taking various gentlemen's agreements into account, packet is in the "RTTY" portion of the HF bands, all but the "CW only" portions of the 6- and 2-meter bands, and everywhere else. Avoid repeaters where digital is not welcome and, of course, don't interrupt a conversation in progress on simplex channels. The most common radio used for packet today is the 2-meter FM rig.

The terminal is any device that has a keyboard for inputting information and commands to the packet controller, and a screen or printer for displaying the information that comes in from the controller. If you use a computer as a terminal, it needs to have communication software to make it act like a terminal. Any software that works with a telephone modem will work fine with a packet controller. In general, any stand-alone terminal will work, as will any computer equipped to handle an external mode. The key words to look for are "serial," "RS-232," and "ASCII."

The Future

As more and more packet stations come on the air, there is increased support for a good network. Since the radio and computer gear to form such a network is not inexpensive, clubs are forming to take on the job of supplying such equipment. Many traditional clubs are showing more packet awareness and will be willing to support a packet repeater or network node, just as they have supported an FM voice repeater in the past.

Satellites will play an exciting and important role in the packet network. OSCAR 10 is used for packet connections, and OSCAR 11 carries the Digital Communications Experiment. Future satellites will provide even more packet services. JAS-1 should be up about the time you read this and will provide a space-borne store-and-forward mailbox capability.

Within a few years, the nationwide network described above will be in place. Certain amateurs or clubs will operate high-capacity micro- or minicomputers on the network to provide on-line access to information of interest to amateurs. This includes things such as special interest groups for various types of amateur activity, indexes to magazine articles, propagation forecasts, and technical data and specifications. It is really going to be convenient, useful, and lots of fun. Please read the additional articles in this series for more information on packet satellites, mailboxes, operating practices, and other interesting information. Join a local or national packet club, get some packet equipment, and "meet me on the keys." ■

NEW! Lower Price Scanners

Communications Electronics,™ the world's largest distributor of radio scanners, introduces new lower prices to celebrate our 15th anniversary.

Regency® MX7000-GS

List price \$699.95/CE price \$469.95
10-Band, 20 Channel • **Crystalless** • AC/DC
Frequency range: 25-550 MHz, continuous coverage and 800 MHz to 1.3 GHz, continuous coverage.
The Regency MX7000 scanner lets you monitor Military, Space Satellites, Government, Railroad, Justice Department, State Department, Fish & Game, Immigration, Marine, Police and Fire Departments, Broadcast Studio Transmitter Links, Aeronautical AM band, Aero Navigation, Paramedics, Amateur Radio, plus thousands of other radio frequencies most scanners can't pick up. The Regency MX7000 is the perfect scanner to receive the exciting 1.2 GHz, amateur radio band.

Regency® Z60-GS

List price \$299.95/CE price \$179.95/SPECIAL
8-Band, 60 Channel • **No-crystal scanner**
Bands: 30-50, 88-108, 118-136, 144-174, 440-512 MHz.
The Regency Z60 covers all the public service bands plus aircraft and FM music for a total of eight bands. The Z60 also features an alarm clock and priority control as well as AC/DC operation. Order today.

Regency® Z45-GS

List price \$259.95/CE price \$159.95/SPECIAL
7-Band, 45 Channel • **No-crystal scanner**
Bands: 30-50, 118-136, 144-174, 440-512 MHz.
The Regency Z45 is very similar to the Z60 model listed above however it does not have the commercial FM broadcast band. The Z45, now at a special price from Communications Electronics.

Regency® RH250B-GS

List price \$659.00/CE price \$329.95/SPECIAL
10 Channel • 25 Watt Transceiver • **Priority**
The Regency RH250B is a ten-channel VHF land mobile transceiver designed to cover any frequency between 150 to 162 MHz. Since this radio is synthesized, no expensive crystals are needed to store up to ten frequencies without battery backup. All radios come with CTCSS tone and scanning capabilities. A monitor and night/day switch is also standard. This transceiver even has a priority function. The RH250 makes an ideal radio for any police or fire department volunteer because of its low cost and high performance. A 60 Watt VHF 150-162 MHz, version called the RH600B is available for \$454.95. A UHF 15 watt version of this radio called the RU150B is also available and covers 450-482 MHz, but the cost is \$449.95.

NEW! Bearcat® 50XL-GS

List price \$199.95/CE price \$114.95/SPECIAL
10-Band, 10 Channel • **Handheld scanner**
Bands: 29.7-54, 136-174, 406-512 MHz.
The Uniden Bearcat 50XL is an economical, hand-held scanner with 10 channels covering ten frequency bands. It features a keyboard lock switch to prevent accidental entry and more. Also order part # BP50 which is a rechargeable battery pack for \$14.95, a plug-in wall charger, part # AD100 for \$14.95, a carrying case part # VC001 for \$14.95 and also order optional cigarette lighter cable part # PS001 for \$14.95.

NEW! Scanner Frequency Listings

The new Fox scanner frequency directories will help you find all the action your scanner can listen to. These new listings include police, fire, ambulances & rescue squads, local government, private police agencies, hospitals, emergency medical channels, news media, forestry radio service, railroads, weather stations, radio common carriers, AT&T mobile telephone, utility companies, general mobile radio service, marine radio service, taxi cab companies, tow truck companies, trucking companies, business repeaters, business radio (simplex) federal government, funeral directors, veterinarians, buses, aircraft, space satellites, amateur radio, broadcasters and more. Fox frequency listings feature call letter cross reference as well as alphabetical listing by licensee name, police codes and signals. All Fox directories are \$14.95 each plus \$3.00 shipping. State of Alaska-RL019-1; State of Arizona-RL025-1; Baltimore, MD/Washington, DC-RL024-1; Buffalo, NY/Erie, PA-RL009-2; Chicago, IL-RL014-1; Cincinnati/Dayton, OH-RL006-2; Cleveland, OH-RL017-1; Columbus, OH-RL003-2; Dallas/Ft. Worth, TX-RL013-1; Denver/Colorado Springs, CO-RL027-1; Detroit, MI/Windsor, ON-RL008-3; Fort Wayne, IN/Lima, OH-RL001-1; Hawaii/Guam-RL015-1; Houston, TX-RL023-1; Indianapolis, IN-RL022-1; Kansas City, MO/KS-RL011-2; Long Island, NY-RL026-1; Los Angeles, CA-RL016-1; Louisville/Lexington, KY-RL007-1; Milwaukee, WI/Waukegan, IL-RL021-1; Minneapolis/St. Paul, MN-RL010-2; Nevada/E. Central CA-RL028-1; Oklahoma City/Lawton, OK-RL005-2; Orlando/Daytona Beach, FL-RL012-1; Pittsburgh, PA/Wheeling, WV-RL029-1; Rochester/Syracuse, NY-RL020-1; San Diego, CA-RL018-1; Tampa/St. Petersburg, FL-RL004-2; Toledo, OH-RL002-3. New editions are being added monthly. For an area not shown above call Fox at 800-543-7892. In Ohio call 800-621-2513.

NEW! Regency® HX1500-GS

List price \$369.95/CE price \$239.95
11-Band, 55 Channel • **Handheld/Portable**
Search • Lockout • Priority • Bank Select
Sidelit liquid crystal display • **EAROM Memory**
Direct Channel Access Feature • Scan delay
Bands: 29-54, 118-136, 144-174, 406-420, 440-512 MHz.
The new handheld Regency HX1500 scanner is fully keyboard programmable for the ultimate in versatility. You can scan up to 55 channels at the same time including the AM aircraft band. The LCD display is even sidelit for night use. Includes belt clip, flexible antenna and earphone. Operates on 8 1.2 Volt rechargeable Ni-cad batteries (not included). Be sure to order batteries and battery charger from accessory list in this ad.

Bearcat® 100XL-GS

List price \$349.95/CE price \$203.95/SPECIAL
9-Band, 16 Channel • **Priority** • Scan Delay
Search • Limit • Hold • Lockout • AC/DC
Frequency range: 30-50, 118-174, 406-512 MHz.
The world's first no-crystal handheld scanner now has a LCD channel display with backlight for low light use and aircraft band coverage at the same low price. Size is 1 3/8" x 7 1/2" x 2 3/8". The Bearcat 100XL has wide frequency coverage that includes all public service bands (Low, High, UHF and "T" bands), the AM aircraft band, the 2-meter and 70 cm, amateur bands, plus military and federal government frequencies. Wow...what a scanner!
Included in our low CE price is a sturdy carrying case, earphone, battery charger/AC adapter, six AA ni-cad batteries and flexible antenna. Order your scanner now.

Bearcat® 210XW-GS

List price \$339.95/CE price \$209.95/SPECIAL
8-Band, 20 Channel • **No-crystal scanner**
Automatic Weather • Search/Scan • AC/DC
Frequency range: 30-50, 136-174, 406-512 MHz.
The new Bearcat 210XW is an advanced third generation scanner with great performance at a low CE price.

NEW! Bearcat® 145XL-GS

List price \$179.95/CE price \$102.95/SPECIAL
10 Band, 16 channel • AC/DC • Instant Weather
Frequency range: 29-54, 136-174, 420-512 MHz.
The Bearcat 145XL makes a great first scanner. Its low cost and high performance lets you hear all the action with the touch of a key. Order your scanner from CE today.

TEST ANY SCANNER

Test any scanner purchased from Communications Electronics™ for 31 days before you decide to keep it. If for any reason you are not completely satisfied, return it in original condition with all parts in 31 days, for a prompt refund (less shipping/handling charges and rebate credits).

NEW! Bearcat® 800XLT-GS

List price \$499.95/CE price \$317.95
12-Band, 40 Channel • **No-crystal scanner**
Priority control • Search/Scan • AC/DC
Bands: 29-54, 118-174, 406-512, 806-912 MHz.
The Uniden 800XLT receives 40 channels in two banks. Scans 15 channels per second. Size 9 1/4" x 4 1/2" x 12 1/2".

OTHER RADIOS AND ACCESSORIES

Panasonic RF-2600-GS Shortwave receiver....\$179.95
RD95-GS Uniden Remote mount Radar Detector....\$128.95
RD55-GS Uniden Visor mount Radar Detector....\$98.95
RD9-GS Uniden "Passport" size Radar Detector...\$199.95
BC-WA-GS Bearcat Weather Alert™.....\$49.95
DX1000-GS Bearcat shortwave receiver SALE...\$349.95
PC22-GS Uniden remote mount CB transceiver...\$99.95
PC55-GS Uniden mobile mount CB transceiver...\$59.95
R1060-GS Regency 10 channel scanner SALE...\$92.95
MX3000-GS Regency 30 channel scanner.....\$229.95
XL156-GS Regency 10 channel scanner.....\$139.95
UC102-GS Regency VHF 2 ch. 1 Watt transceiver...\$124.95
P1405-GS Regency 5 amp regulated power supply...\$69.95
P1412-GS Regency 12 amp reg. power supply...\$164.95
MA256-GS Drop-in charger for HX1200 & HX1500...\$84.95
MA518-GS Wall charger for HX1500 scanner.....\$14.95
MA516-GS Carrying case for HX1500 scanner....\$14.95
MA257-GS Cigarette lighter cord for HX12/1500...\$19.95
MA917-GS Ni-Cad battery pack for HX1200.....\$34.95
SMMX7000-GS Svc. man. for MX7000 & MX5000...\$19.95
SMMX3000-GS Service man. for Regency MX3000...\$19.95
B-4-GS 1.2 V AAA Ni-Cad batteries (set of four).....\$9.95
B-8-GS 1.2 V AA Ni-Cad batteries (set of eight)....\$17.95
FB-E-GS Frequency Directory for Eastern U.S.A....\$14.95
FB-W-GS Frequency Directory for Western U.S.A....\$14.95
ASD-GS Air Scan Directory.....\$14.95
SRF-GS Survival Radio Frequency Directory.....\$14.95
TSG-GS "Top Secret" Registry of U.S. Govt. Freq....\$14.95
TIC-GS Techniques for Intercepting Comm.....\$14.95
RRF-GS Railroad frequency directory.....\$14.95
CIE-GS Covert Intelligencet, Elect. Eavesdropping...\$14.95
A60-GS Magnet mount mobile scanner antenna...\$35.95
A70-GS Base station scanner antenna.....\$35.95
USAMM-GS Mag mount VHF/UHF ant. w/12' cable...\$39.95
USAK-GS 3/4" hole mount VHF/UHF ant. w/17' cable...\$35.95
USATLM-GS Trunk lip mount VHF/UHF antenna....\$35.95
Add \$3.00 shipping for all accessories ordered at the same time.
Add \$12.00 shipping per shortwave receiver.
Add \$7.00 shipping per scanner and \$3.00 per antenna.

BUY WITH CONFIDENCE

To get the fastest delivery from CE of any scanner, send or phone your order directly to our Scanner Distribution Center™. Michigan residents please add 4% sales tax or supply your tax I.D. number. Written purchase orders are accepted from approved government agencies and most well rated firms at a 10% surcharge for net 10 billing. All sales are subject to availability, acceptance and verification. All sales on accessories are final. Prices, terms and specifications are subject to change without notice. All prices are in U.S. dollars. Out of stock items will be placed on backorder automatically unless CE is instructed differently. A \$5.00 additional handling fee will be charged for all orders with a merchandise total under \$50.00. Shipments are F.O.B. Ann Arbor, Michigan. No COD's. Most products that we sell have a manufacturer's warranty. Free copies of warranties on these products are available prior to purchase by writing to CE. Non-certified checks require bank clearance. Not responsible for typographical errors.

Mail orders to: Communications Electronics,™ Box 1045, Ann Arbor, Michigan 48106 U.S.A. Add \$7.00 per scanner for R.P.S./U.P.S. ground shipping and handling in the continental U.S.A. For Canada, Puerto Rico, Hawaii, Alaska, or APO/FPO delivery, shipping charges are three times continental U.S. rates. If you have a Discover, Visa or Master Card, you may call and place a credit card order. Order toll-free in the U.S. Dial 800-USA-SCAN. In Canada, order toll-free by calling 800-221-3475. WUI Telex anytime, dial 671-0155. If you are outside the U.S. or in Michigan dial 313-973-8888. Order today.

Scanner Distribution Center™ and CE logos are trademarks of Communications Electronics Inc.

† Bearcat is a registered trademark of Uniden Corporation.
‡ Regency is a registered trademark of Regency Electronics Inc. AD #070286-GS

Copyright © 1986 Communications Electronics Inc.

For credit card orders call
1-800-USA-SCAN

**COMMUNICATIONS
ELECTRONICS INC.**

Consumer Products Division

P.O. Box 1045 □ Ann Arbor, Michigan 48106-1045 U.S.A.
Call 800-USA-SCAN or outside U.S.A. 313-973-8888

Regency
RH250



Regency
MX7000

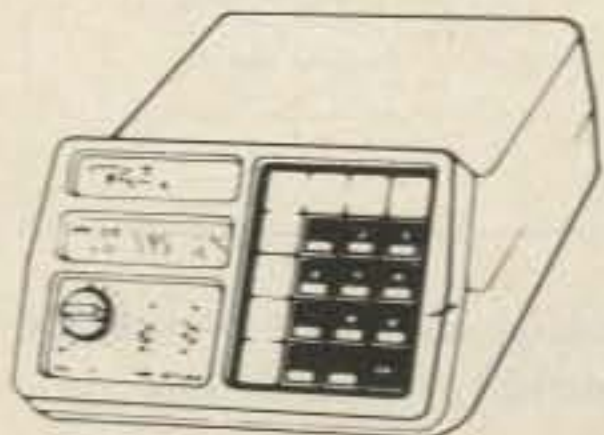

Regency
HX1500



How To Make Friends At 1200 Baud

W2JUP's guide to AX.25 etiquette.

The first time you hear the stuff, your reaction might be: Your squelch control is open, you've got intermod on 145.01, the Army Reserve has fired up the local military radar site, or even a lovesick wasp with asthma is trapped inside your HT.

So you reset the squelch control, verify that the radar site is not up, and spray the inside of your HT with bug killer. But after you've heard the noise for the nth time, you begin to notice a slightly musical tone to it—once you've realized it's some kind of radio signal. But it's unlike anything you've ever heard on ham radio. You're listening to what many professionals see as the future of data communication, and what some amateurs call the future of ham radio. You're hearing packet radio.

Now that you know that it's packet radio, your reactions may fall into various categories:

- The Archie Bunker types: "Aw jeez, Edith, them theah digital joiks is spreadin' all over and lousin' up all our verce channels."
- The computer-enthusiast types with the lower-class tickets: "Hmm. I guess it's time to think about upgrading my ticket."
- The experienced RTTYers: "Ho hum. It'll never last, it's too complicated for hams."
- The "professional" hams: "Hmm! I wonder how much this will cost."

Regardless of the category into which you fall, these bursts of strange sounds flowing through your loudspeakers represent the latest technology brought into the amateur-radio art from established commercial practices. In addition to digital fun cavorting across the

ethereal spectrum with buckets full of bits, bytes, and bauds, packet radio brings a new concept of the "network" to amateur-radio operation.

Although hams have operated nets since the beginning of the service, the packet-network idea is very different: Each packet-network user must work in a manner not previously required—by using "shared resources." In spite of their dedication of time and equipment, unless members of a packet-radio community understand the basic capabilities and limitations of the equipment and the mode and give sufficient thought to planning and living together, the packet-radio network cannot survive.

Different Strokes for Different Folks

Although our packet networks are very new, in many major metropolitan areas you can already see several types of packet operation on a single channel: direct keyboard-to-keyboard live QSOs (like conventional RTTY); keyboard-to-keyboard live QSOs via packet repeaters (digipeaters); sending/receiving "mail" messages, files, and programs between live keyboards and PBBSS; automatic mail forwarding between PBBSS—either direct or via one or more digipeaters; and personal packet mailboxes and packet "answering machines."

Is it possible for all these diverse applications to co-exist on a single channel? The answer depends on the behavior of each packet system operator. This article offers a few collected thoughts and suggestions about: bandwidth of transmitted signals, transmitter

keying characteristics and time constants, receiver age time constants, TNC parameter values (especially "timing"), beacons, and channel courtesy and good manners.

Packet Radio—The Shared Resource

Successful packet-radio operation requires a level of cooperation among station operators previously unknown in traditional CW, SSB, and RTTY practices on HF. VHF packet operation must be carefully coordinated and channelized. The "independent" operator cannot survive; no one stands alone in packet radio. Each packet-radio user has a direct effect on the performance of the network and the network's usefulness to the community.

Several regional and local frequency-coordination councils have already begun to coordinate or "assign" selected channels on VHF/UHF bands to "exclusive" packet-radio service. In many areas, packet operations on the two-meter band are channelized on 20-kHz centers between 144.90 and 145.10 MHz.

We can share our limited packet spectrum resources successfully. Our success depends on each packet station operator paying special attention to factors that were not quite so critical in non-packet days. Let's take a look at some of them.

Bandwidth

Bandwidth is the amount of space we occupy in the spectrum, and depends on the modulation index and data rates. This factor includes the "deviation" of the FM/PM signal, the frequencies of the tones modulating the carrier, keying and baud rates, and the nature of the data being transmitted.

In Part 97.65, the FCC defines bandwidth as "the width of the frequency band, outside of which the mean power of any emission is attenuated by at least 26 decibels below the mean power level of the total emission. A 3-kHz sampling bandwidth is used by the FCC in making this determination."

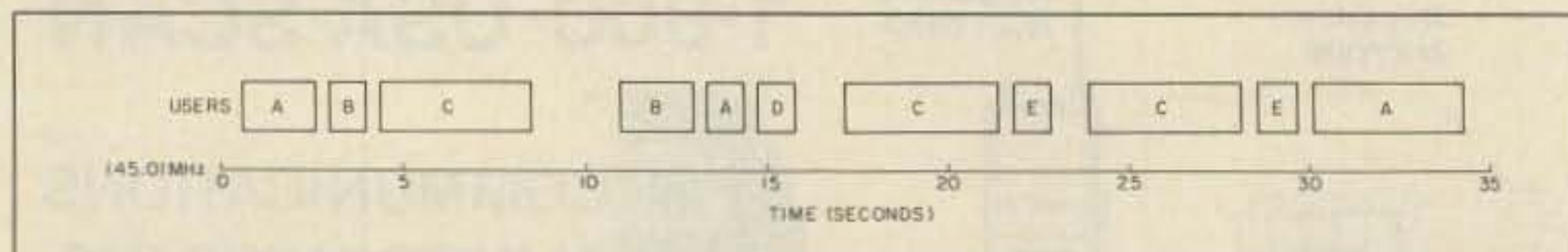

Fig. 1. Packet users share a frequency on a time scale much smaller than any previously experienced in amateur radio. A misadjustment at one station can perturb several others.

Although audio distortion and poor frequency response contribute to increasing the error rate and the packet transmission problem, the bandwidth factor that varies the most and generally does the most damage is deviation—a factor that any operator can easily control. The general rules used in establishing “proper” deviation in voice service are detrimental to your packet’s health.

To prevent transmitting an excessively broad FM/PM signal, deviation must be kept lower than that normally used in voice service. We must walk a fine line between our deviation being too low, resulting in poor or unacceptable signal-to-noise ratios in weak rf signals at the distant receiver, and deviation being too high for the distant receiver’s i-f and demodulation circuits to decode successfully. Either extreme results in high error rates, poor decoding, invalid frames, excessive retries, timeouts, untimely disconnects, and unnecessary reconnection attempts.

Many packet operators use the same radio for packet that they use in voice operation and connect their TNC’s AFSK output to the radio’s microphone input. In some cases satisfactory results are obtained. When there are problems, they may arise from the way the radio has been set up—microphone amplifier gain and deviation limiting or audio agc action. Most radios coming from Japan (and most of them do these days!) arrive with the deviation set so that the average U.S. ham will enjoy rather high deviation. This characteristic may be due to the fact that in Japan there are few repeaters, simplex operation is the accepted concept, and the radios are set up in factory production test fixtures for some value of deviation obtained with a given value of audio tone input. One theory has it that the input setup values represent the typical soft-spoken local user.

When it’s possible, the TNC’s AFSK output should be connected to some internal point after all speech processing, at the input to the usual varactor modulator. Many radios offer a separate input for tone encoders and DTMF push-button pads. If they’re available, that’s probably the best point at which to inject the AFSK tones. Any possibility of distorting the AFSK signals by over-driving the microphone input amplifier, diode clipping, or excessive audio agc action can be eliminated.

Carson’s Bandwidth Rule defines the approximate bandwidth requirements of communications system components for a carrier signal that is modulated by a continuous or broad spectrum of frequencies rather than a single frequency. In most amateur packet-radio operation, the modulation index (peak deviation divided by the highest modulating tone frequency) will be greater than 1, and the bandwidth is:

$$Bw = 2(Df + 2Fm)$$

Bandwidth equals twice the sum of the peak deviation (Df) and twice the highest modulating frequency (Fm). Table 1 shows these values for the two tones used in VHF/UHF packet radio (Bell 202 tones).

Modern FM receivers have 6-dB i-f band-



Photo A. One of the more common types of packet stations among new packeteers is the Commodore-64 based system which uses either a stand-alone TNC or a unit specially designed for the C-64—like the one pictured here, AEA’s PK-64. This station belongs to Colin Hall, G4JPZ/W6. It features (top to bottom, left to right): CRT, antenna rotor, C-64; antenna switches, antenna rotor; C-64 disk drive, power switch for PK-64 (home-brew), PK-64; HF tuner, VHF radio, HF radio.

widths on the order of 12 to 15 kHz. The better (more selective) the receiver i-f is, the greater the tendency for the receiver to distort highly deviated signals and send distorted audio output to the TNC. The TNC’s demodulator may “barf” on the audio, fail to decode the packet frame properly, throw the frame away, and sit there waiting for the retries (the retransmission of a packet whose reception was not acknowledged). Retries are to be avoided, especially when a frame should have been received but wasn’t.

During the past several years, I’ve “fixed” dozens of “I can’t connect!” complaints by helping the stricken newcomer to reduce his deviation to a point at which the receiving station’s equipment had something better than “square-wave audio” to demodulate.

We must also consider operation on channels 20-kHz wide. If we are to permit nearby

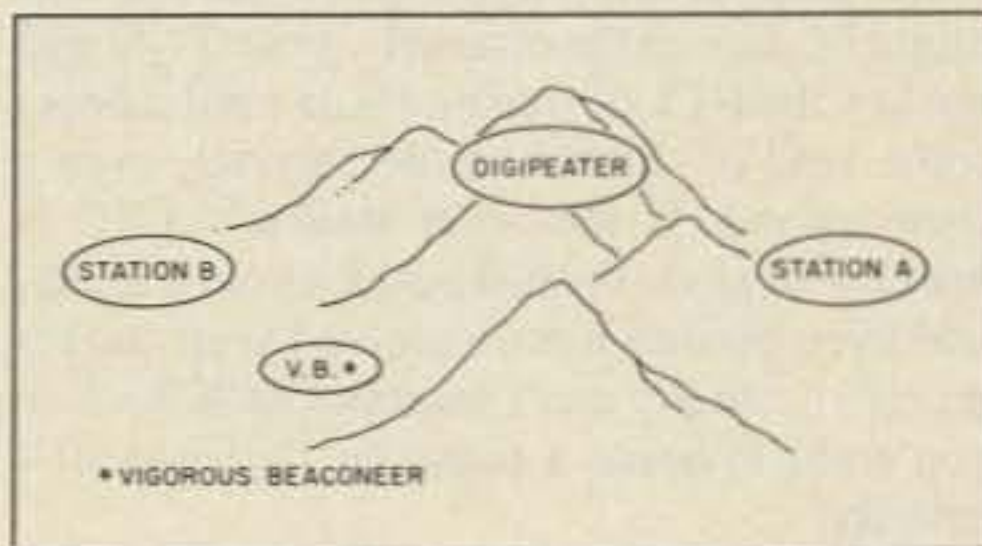

Fig. 2. Station A is shielded by hills and can’t hear the vigorous beconeer. Although station A thinks the frequency is clear, if he transmits while the beconeer is transmitting, the packets will collide at the digipeater. Packets from station A to station B will have to be retried more often, adding to congestion on the channel.

packet stations to operate on adjacent channels, it is clear that each adjacent-channel user’s peak deviation must be held below 4 kHz to prevent sideband energy from invading the next channel. As a general rule, transmitter peak deviation should be held to a value between 2 and 3.5 kHz. The other guy’s receiver will like it, and your neighbor on the next channel will appreciate your courtesy. Don’t be a deviant with your deviation!

Software

Many newcomers (and some experienced packeteers as well!) appear to be intimidated by the numerous TNC parameters. Some users seem to be afraid to change any of the values. Well, fear not! Your TNC will not dissolve into a cloud of vaporized chips, nor will your radio leap off the table. There is nothing sacred about most settings. Many values were made variable to permit the user to make changes in accordance with each local circumstance and condition. The specific tuning parameters referred to below reference the TAPR command set used on most TNCs.

A lot of this fear-of-change attitude relates to timing values like FRACK, DWAIT, TXDELAY, and some frame-size and “window” settings like PACLEN and MAXFRAME.

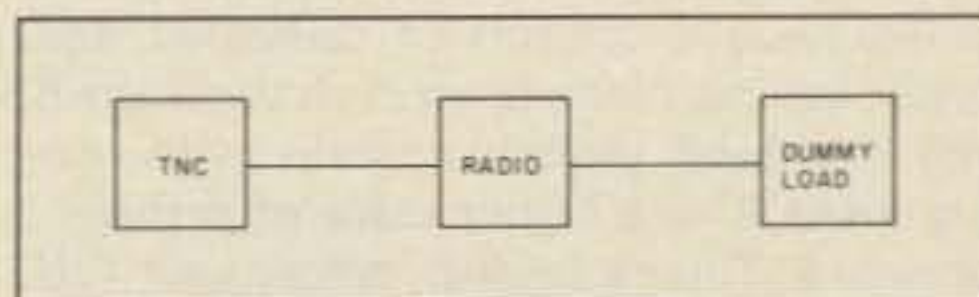

Fig. 3. The proper setup for sending “capture buffer open, digi on” beacons.

Tone Frequency 1200 Hz		Tone Frequency 2200 Hz	
Deviation (kHz)	Bandwidth (kHz)	Deviation (kHz)	Bandwidth (kHz)
1	6.8	1	10.8
2	8.8	2	12.8
3	10.8	3	14.8
4	12.8	4	16.8
5	14.8	5	18.8
6	16.8	6	20.8
7	18.8	7	22.8
8	20.8	8	24.8
9	22.8	9	26.8
10	24.8	10	28.8

Table 1. Bandwidth resulting from modulating an FM signal at various deviations with standard packet-radio tones.

User Type	Time msec	TNC-1 DWAIT	TNC-2 DWAIT
Digipeaters	*	*	*
Keyboard users	160	4	16
BBS/UNIX Nodes, etc.	320	8	32
User file transfer	480	12	48

* DWAIT is ignored for digipeated frames.

Table 2. DWAIT settings for various types of activity.

QRL—I am busy (Don't connect!)
QRR—I am ready for automatic operation (OK connect)
QRU—I have nothing for you
QRV—I am ready
QSO—I can communicate with (callsign)
QSR—Repeat your call on the calling frequency, did not hear you
QSX—I am listening on (frequency)
QTC—I have traffic for (callsign)
QTU—My station is open from (hours-to-hours)
QTV—Listen for me on (frequency)

Table 3. Clever Q-signals that can be used in a beacon text.

Here are some thoughts on the use of the timing parameters available in your TNCs. Perhaps a couple of ideas expressed here might clarify a few implications not fully explained in the vendors' manuals.

FRACK

This value is the number of seconds that your TNC will wait for an acknowledgement (ACK) before sending a retry packet. If you have a really good path to the other station and the packets are very solid, you can leave this value at the default setting of 3 seconds. Reducing FRACK doesn't really increase the speed at which packets are transferred. But if the channel is busy and there are many stations on, especially if there's a PBBS (public bulletin-board system) or dedicated digipeater serving multiple users on the channel, you'll probably get better results by increasing FRACK to a higher value of perhaps 6 or even 8. This means that, before your TNC sends a retry, it will wait longer to decide that the other station never got your last packet. This is especially important if the station

to which you're connected hears lots of packets from other stations that you may not be hearing.

Remember that these TNCs have CSMA (Carrier Sense Multiple Access): The TNC listens on the channel, and if it hears data—or noise, intermod, or open squelch that it thinks might be data on the channel—your TNC will not key the PTT or transmit data until it hears some kind of silence on the channel, even a bare second. If the other station's TNC is hearing all kinds of stuff besides your signals, and even though it has received your packet nicely, it usually can't send the ACK back to you until it hears a pause in the channel's activity.

The distant TNC may be sitting there having swallowed dandy data, ready to ACK, and meanwhile your TNC (set with too short a FRACK value) thinks that your last packet got trashed and decides to send a second (or third, or...) copy. And so the confusion builds—collisions and eventual timeouts and disconnects are the result.

If you're working into a PBBS (especially

through a busy community digipeater), try operating with higher FRACK settings in your TNCs during the busiest hours. These are the times when collisions, noise, and intermod are at their worst levels. Because the PBBS' TNC may be hearing lots of other things when it is listening for you, the CSMA feature in the TNCs may prevent the PBBS from answering you promptly. Therefore, if FRACK is too short for the existing conditions, your system will automatically retry each packet. The net result again is excessive timeouts and disconnects. I suggest strongly that for working the local PBBS during the evening and weekend hours set FRACK to 8! That will help the PBBS during its wait for a brief clear spot between bursts of everyone else's packets.

Slow down! What's the rush? Increase FRACK when the channel is busy or when you're working through a station or digipeater in a high-elevation location. Try to understand what the systems are attempting to do.

TXDELAY

This is the length of time (the units vary on different TNCs) that your TNC will wait between the moment when it keys PTT to put your rig on the air, and when the TNC actually unlatches and sends the packet data out to the rig.

During the TXDELAY period, the TNC sends a stream of contiguous FLAG fields (01111110), until it begins the actual frame contents. Some of you may think of TXDELAY only in regard to the time it takes for your transmitter to switch on and develop power. TXDELAY must also be considered in terms of how long it takes for the other station's receiver to unquench and recover its full sensitivity after its transmitter shuts off. Some radios take a relatively long time between "transmitter-off" and "receiver-on."

If your TXDELAY setting is too short for the other station's receiver recovery time, that station may not be able to successfully decode the SYNC FLAG (8 bits) at the beginning of your packet frame; its system will not see a valid packet; you'll get no ACK; you retry; the other station still gets no sync; etc. The end result is lots of unnecessary retries, timeouts, disconnects, and frustration.

AXDELAY and AXHANG

If you are not going through a voice repeater or a series of non-packet auxiliary and link systems, these values should be left at zero. They are basically irrelevant in the straight digital world.

MAXFRAME

This is the number of frames (packets) sent in a single transmission by your station. You can send from one to seven. Although it may seem contradictory, in many cases MAXFRAME=1 can produce the best throughput (amount of information transferred in a given time period or session).

If you're on an empty channel (?) transferring longish files—either text or binary data—with a nearby station over a very solid

path, you can leave MAXFRAME at the default value of 4. If you have a path with a problem or two and are seeing retries due to conditions or collisions, set MAXFRAME to a lower value. That way, the distant end has fewer contiguous frames to decode and validate, and the channel has a bit more breathing space through which other stations can slip a packet now and then. If retries become frequent, set MAXFRAME to 1. You and your partner have a better chance of getting the ACKs back. Remember this—if the distant station decodes your packet properly and sends you an ACK, your TNC must also receive the returning ACK! It's a bummer when the other guy's good ACKs are getting trashed on the way back to you!

PACLEN

This is the maximum number of octets or bytes (characters that you type) that can be squeezed into one packet frame. The AX.25 maximum is 256 bytes. The default value is 128 bytes.

Don't get into the lazy habit of typing endless lines of stuff with never a carriage return, depending on your TNC to packetize and send the stuff after the 128th character you type. Even on the C-64's 40-column screen, it's easy to judge when you've typed between a line-and-a-half and two full lines. Type a carriage return after the last word that fits nicely before the end of the second line. That way, you'll be sending packet frames with just under 80 bytes, and the probabilities improve for your successful packet. On a busy channel, the shortest packets get the best results!

In addition to packet length, carriage returns are important in maintaining visual fidelity. Remember that just because your terminal, computer, or TNC has inserted a local carriage return when echoing data to you, it probably has not put in a carriage return for the other user. This usually results in run-on, hard-to-read text at the distant end. Some PBBSs will ignore message text if the line length before a carriage return is more than 80 characters.

On an 80-column screen, 128 characters are a bit more than 1-1/2 lines of typing. On the C-64's screen, that's more than three lines of typing. If the going gets rough judging by the retries over a lousy path, or there are lots of collisions with other stations, reduce PACLEN to 64 or even to 32. The shorter the packet frame's length is, the greater the probability of getting a good packet through.

Experience is showing that, on busy channels (especially with PBBSs and digipeaters), increasing FRACK and TXDELAY, while reducing PACLEN, can actually improve your throughput rather than degrade it!

Remember—there's nothing sacred about the TXDELAY, FRACK, MAXFRAME, and PACLEN default values. Experiment with other values and see what happens. It can only help—it will never hurt.

DWAIT

This is the length of time that your TNC

will wait after last hearing data on the channel before starting the TXDELAY timer to key your transmitter's PTT line, unless the TNC is waiting to transmit digipeated packets. DWAIT is particularly important when working with digipeaters on a busy channel. Remember that DWAIT is affected by your TXDELAY setting, and for best results should be set at some value established in agreement with other local packet operators.

DWAIT's main function is to help prevent or reduce collisions with digipeated packets. Dr. Tom Clark W3IWI suggests the TNC timings in Table 2 to improve channel throughput when PBBSs, digipeaters, and keyboard-to-keyboard users share a common channel.

RETRIES

This is the number of times your TNC will repeat the same packet to the distant station if your TNC has not received an ACK. Good practice is to set RETRIES for the lowest number that can be effective in any given condition. The default value of 10 is reasonable for general operation. But if you're trying to force lengthy packets through five digipeaters over marginal paths in busy channel hours, RETRIES = 15 (maximum number) will probably do nothing more than antagonize the rest of the troops on the channel.

***"I expect to answer
my terminal when
it beeps—I get cranky
when I see that
it's merely another
nonsense beacon
carrying BELL signals."***

Note that on some TNCs, RETRIES=0 sets an infinite number of retries! In the metro New York, Chicago, Miami, and Los Angeles areas, this is guaranteed to earn you a late-night visit from one of those fellas with the long coats and black leather gloves. Punishing the channel and its population with large quantities of fruitless retries is not the best way to win the local packet popularity contest.

Beacons

If the renowned anthropologist Margaret Mead were still alive, she could study the packet channel population as she did the puberty rituals of the Trobriand Islanders. Upon reaching puberty, each young male anoints himself with bright red mud and parades around the village for a month, thus advising all young unattached females of his new maturity and availability.

Judging by each week's new beacons on our local area channels—you know, the bea-

cons that come on every two to six minutes and give us callsign, name, QTH in painful detail, and "digipeater on, buffer save to disk enabled"—new packeteers seem much like the Trobrianders. This must be a "packet puberty" ritual: "Here I am. Come and use me!"

You can't legislate common sense. Either a person has it or not. Seems some people need that beacon to reinforce their ego and make sure that the packet community at large knows that they have packet radio.

What could be more redundant than a beacon like those we see from stations (some of whose callsigns show them to be "old-timers") advising us regularly that they are running a "Packet Radio Communications Facility"? No kidding! It must take Dick Tracy to figure out that a packet beacon emanates from a "Packet Radio Communications Facility"! Now tell us something we don't know! Some of these "vigorous beacons" have had their callsigns used to test the operation of the LCALLS (ignore packets) routines in the TNC-2 and PK-80!

Most of these ludicrous beacon texts could be stuffed into the CTEXT file, so that the nonsense about "BUFFER OPEN—AUTOSAVE TO DISK ENABLED" would be sent only to the station that connects to them. But, unfortunately, that would take a generous dose of common sense and a bit of time to read the equipment manual, add two and two, and not get 22.

It's beginning to remind me of what happened to the older two-meter operators when the two-meter repeater infestation started and the air was filled with nonsense. That certainly spurred the development of 440! I wonder how long it's gonna take the technology-oriented packet people to move up to 220 and 440 and 1296 megs so that the "beacon freaks" can have these channels all to themselves.

It's so easy to find out if your buddy is running his digipeater. All you do is loop back (connect to yourself) through his station. If you get a connection, guess what? His digi is ENABLED! If not, oh well.

Are Beacons Justifiable?

In my opinion, there is very limited justification for beacons on a packet channel. The problems come from the way people use them. Here's what I mean:

Beacons are not inherently bad—their intended purpose is misunderstood, and they are frequently misused by newcomers. The beacon can still perform vital functions when properly written and appropriately used. This is especially true as we begin to expand into collateral or additional packet channels on two meters and on the other bands.

Understand the origin of the beacon feature—why it was provided. It really was an important option in the early 1980s when the packet-radio world was a vast wasteland and we needed efficient means of letting the world know that someone was alive, well, and available on the channel and ready for connecting. The beacon also provided an ex-

cellent source of test messages for lining up the early TNCs when there were no other means of testing the kits.

As we all know now, packet radio is *no wasteland*. In many large cities, we already have more users than our primary channel can handle most of the time. For the primary channels in metropolitan areas, the beacon function has outlived its original design intent. Beacons should be re-evaluated and tailored carefully and specifically to present (and future) conditions of channel purpose, assignment, and occupancy.

Apparently some users don't know what a beacon text will look like on the distant station's screen. They put their callsign in their beacon text, not realizing that their callsign will be displayed in the header text on almost all systems—unnecessary, redundant information.

Apparently some users don't know the default conditions of most TNCs. Nearly all of them (and I have tested five types) will boot up with DIGIPEAT enabled and will perform the digipeat function unless you tell them not to. So, why use the beacon text to advise everyone on the channel of something that can be assumed automatically?—more unnecessary information.

Some users feel the need to tell the channel that their "buffer save to disk is enabled." That's something else the rest of the users can assume. With the proliferation of the smarter TNCs like the TNC-2 types and the PAKRATTs, with smart buffers and auto-connect messages, the receiving TNC itself can provide this information *after* the user connects to it—it's not needed as part of the beacon text.

Some users feel compelled to suggest connection paths in the beacon text. Any reasonable TNC with a trace or special header function permits the others on channel to derive the beacon path when and if they need it—more unneeded data.

What is needed in a "meaningful" beacon text? Here are my suggestions: absolute brevity—minimum bytes to get the idea across; name of operator; QTH in City, State format; grid locator in XXNNnn format; special *temporary* information, such as test conditions, new operating hours, power reductions, changes in effect, and directed messages like "W2XXX PLS CALL ME URGENT"; Q-signals cleverly used, as originally intended (see Table 3); international Z-signals (available on request); and a generous dose of common sense.

What is undesirable in a "meaningful" beacon text? Anything unessential; long-winded information that never changes; "cutesy" graphics, such as lines of asterisks, parentheses, center-screen formatting (in short, save the arts and crafts for 80-meter RTTY); and ego trip and "show-off" messages.

Beacon Timing

There is absolutely no justification for sending a beacon every one, two, or three minutes. In many metropolitan areas, there's little justification for basing the beacon

timing to the AFTER routine. On a primary channel like 145.01, there is no harm in an *informative* beacon every 30 minutes—let's face it, that's all the channel can handle without strangling. That's still 48 beacon messages in 24 hours! On auxiliary channels like 145.03, .05, .07, and .09, a beacon every 15 minutes will let the world know you're there. The gang won't find out any faster if the beacon is sent every two minutes.

Once a user has joined a local packet-radio club, or his station has shown up on a packet network map of his area, the rest of the local area users will know who he is, where he is, and in general everything that *they* wish to know about him and his operation. At that point, the beacon will become of less importance, and the beacon intervals can be reduced to simply indicate that the station is in fact alive and well on the channel and available for normal service.

The only constraint on the use of the beacon feature is the requirement for the generous use of ordinary common sense, lightly tempered with some patience on the part of the old packet hands, and a more tolerant, more

"Repeated attempts to log on to a PBBS that is already in use will certainly result in winning the 'Most Unpopular User of the Week' award given by area sysops."

tutorial approach to the new kids on our packet-radio block. We can't expect them to understand everything about our packet mode the day they first put their packet boxes on the air. The manufacturers' manuals are close to worthless when it comes to instructions on good on-the-air operating practices and procedures.

Beaconers and the PBBS

If you want to use a PBBS as a digipeater for your convenience, I'd suggest a bit of common sense and courtesy. For example:

Don't digipeat your beacons through the PBBS! That's not what a PBBS is all about. Digipeat your beacons through someone else. (Beacons are doubly offensive when your system sends them through a PBBS while someone else is trying to download a file or read the mail.)

If you're using the local PBBS as a digipeater, don't stick BELL commands in your stuff unless you have some legitimate reason for ringing someone's bell. I'm referring to the Control-G character. I expect to answer my terminal when it beeps—I get cranky when I see that it's merely another

nonsense beacon carrying BELL signals. Baloney!

If your beacon has something important to say, like a club meeting notice, an urgent call for a contact, or anything *other* than another pointless ego trip, send the beacon through some other available digipeater.

Good Manners and the PBBS

For those newcomers who may not be familiar with PBBS operations, please be advised that most PBBSs are *not* multi-user systems, nor can they accept or handle multiple connections. This means, in plain English, *first come, first served!* If you see that the PBBS is already being used by another station when you wish to use the PBBS, you must wait your turn. Your CONNECT REQUEST sent while someone else is logged on will produce the following results:

- You will get the "(PBBS CALLSIGN) BUSY" message and a DISCONNECT.
- The station logged on to the PBBS will see a message on his/her screen stating that "W2XXX just tried to connect" or the like.
- The PBBS sysop will see the same message on the local console screen if he/she happens to be watching.
- The PBBS will issue the "W2XXX just tried to connect" to the channel in general.
- If the logged-on user station happens to be downloading a file to disk, some PBBS systems will place the "W2XXX just tried to connect" in the downloaded file just as though it were a native part of the file. The user will then have to edit the received file or program to remove the junk strings.

Repeated attempts to log on to a PBBS that is already in use will certainly result in winning the "Most Unpopular User of the Week" award given by area sysops. These packet systems, their channels, and the PBBSs are all based on the concept of the "shared resource." Wait your turn to get your share when using a PBBS. If you see the PBBS already sending protocol packets to another station, wait until the current user has logged off, pause about 30 seconds to permit the PBBS to recycle itself, and then issue the CONNECT REQUEST.

Sorry if this all sounds like a new, "digital" version of the old two-meter "Repeater God" story, but some of the PBBS sysops have as much as \$5,000 worth of computers, TNCs, radios, and antennas at your service. It's their station and their legal responsibility. Therefore, any PBBS sysop reserves the right to decide how, when, and by whom his system will be used.

Common sense is all that's required. Try some—it doesn't cost much.

"Coordinated" Packet Channels

There seems to be growing misunderstanding about the use of so-called "packet channels" (145.01, .03, .05, .07, and .09 in many areas).

The practice of sending long programs and files between two packet stations *in direct*

connection indicates that some people may have the impression that packet channels are the *only* channels where packet radio can be used. *This is categorically false!* You can use packet radio on *any* channel on which F1 emissions are authorized. This includes most of two meters. Common sense dictates that you avoid using those repeaters whose user support groups do not desire packet communications on the repeater, as well as observing other gentleman's agreements and band plans, satellite passbands, DX calling frequencies, etc.

If two stations wish to transfer files back and forth and can make direct connection (without a digipeater or other intermediate relay mode), these stations should move off of the "packet channels" to conduct *direct* station-to-station file transfers. In that manner, the limited number of packet channels can remain free for the users who need the available digipeaters or wish to have a comfortable keyboard-to-keyboard chat or move a message in or out of the local PBBS without having to battle the intense, rapid-fire barrage of frames running between the stations involved in the extended file transfers.

It's only common courtesy to operate under the assumption that these packet channels are a shared resource. It's hard to share the channel with two guys who are running with super-tight TNC timings and completely monopolizing the channel with flying fields and frames.

I don't believe that the frequency-coordinating councils intended to imply, nor should any packeteer infer, that packet radio *can only be used* on these coordinated packet channels. This coordination was done to give the growing packet fraternity a "home" separated from the "traditional" voice simplex channels and repeater channels. It also serves as a notice to voice users who want to avoid automated stations using a 40-millisecond window to check to see if the frequency is in use.

There is absolutely *no reason* why long files cannot be transferred between two stations in direct connection using the simplex channels available throughout the bands—with a bit of care, courtesy, and common sense. You *must* listen on the intended operating channel *before* transmitting. If an SSB or FM voice contact is in progress, the old rules still apply; don't knowingly dump tons of packets on top of a voice communication in progress.

Advanced technology will never be a replacement for courtesy and common sense. The latter talents are sometimes more important than the former.

A Wee Packet Philosophy

It's really up to us to teach each other and help the mode grow in orderly fashion, rather than merely criticize others. Those of us who are fortunate in having more experience and understanding more about packet radio and its unique qualities have a real moral and technical obligation to serve as mentors towards those who know less but want to know more. ■

"When You Buy, Say 73"

CONTINUOUS COVERAGE FOLDED DIPOLE ANTENNA

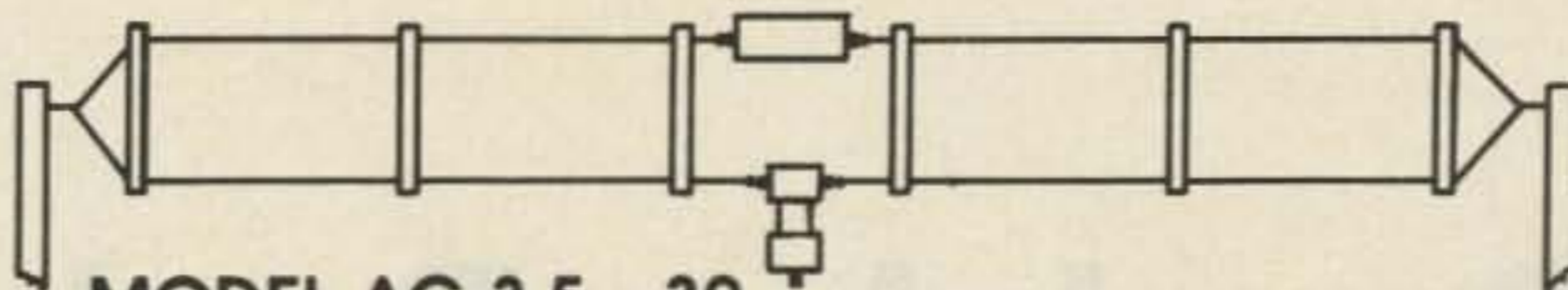

MODEL AC 3.5 - 30
(formerly Model 370-15)

- Fully Assembled
- 52 OHM
- Only 90 feet long
- SWR less than 2:1 from 3.5 thru 30 MHz. Average SWR 1.4:1
- Will handle 1 KW power (2 KW PEP)
- Can be installed as flat top, sloper, or inverted "V"
- Used the world over in government & commercial communication installations
- Ideal for all operations - amateur, commercial, MARS - any frequency from 3.5 - 30 MHz

PRICE \$167.50

PLUS \$3.00 Shipping and Handling

PATENTED

53

ALL OUR PRODUCTS MADE IN USA



BARKER & WILLIAMSON

Quality Communication Products Since 1932

At your Distributors. Write or call.

10 Canal Street, Bristol PA 19007

(215) 788-5581

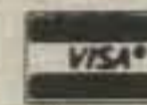

SPECIALIZED COMMUNICATIONS FOR TODAY'S RADIO AMATEUR!



If you are ACTIVE in FSTV
SSTV, FAX, OSCAR, PACKET,
RTTY, EME, LASERS,
or COMPUTERS, then you need

"THE SPEC-COM JOURNAL™"

Published 10 Times
Per Year
By WB0QCD
(Serving Amateur Radio Since 1967!)

SIGN UP TODAY AND GET 3 BACK ISSUES "FREE"!

Join our growing membership at the regular \$20 per year rate and we will send you 3 back issues (of your choice) absolutely "free"! We also have 2 and 3 year discounts at just \$38 and \$56. Foreign surface and air mail subscriptions also available, please write for details. Add \$2.00 for a special 19-year "master article index" issue. Allow 2-3 weeks for your first issue.

35

THE SPEC-COM JOURNAL
P.O. BOX H,
LOWDEN, IOWA 52255

Credit Card Orders (5% added)

Iowa Residents Add 4% State Sales Tax

Precision Packet Tuning

Build the ultimate digital tuning indicator for packet or RTTY.

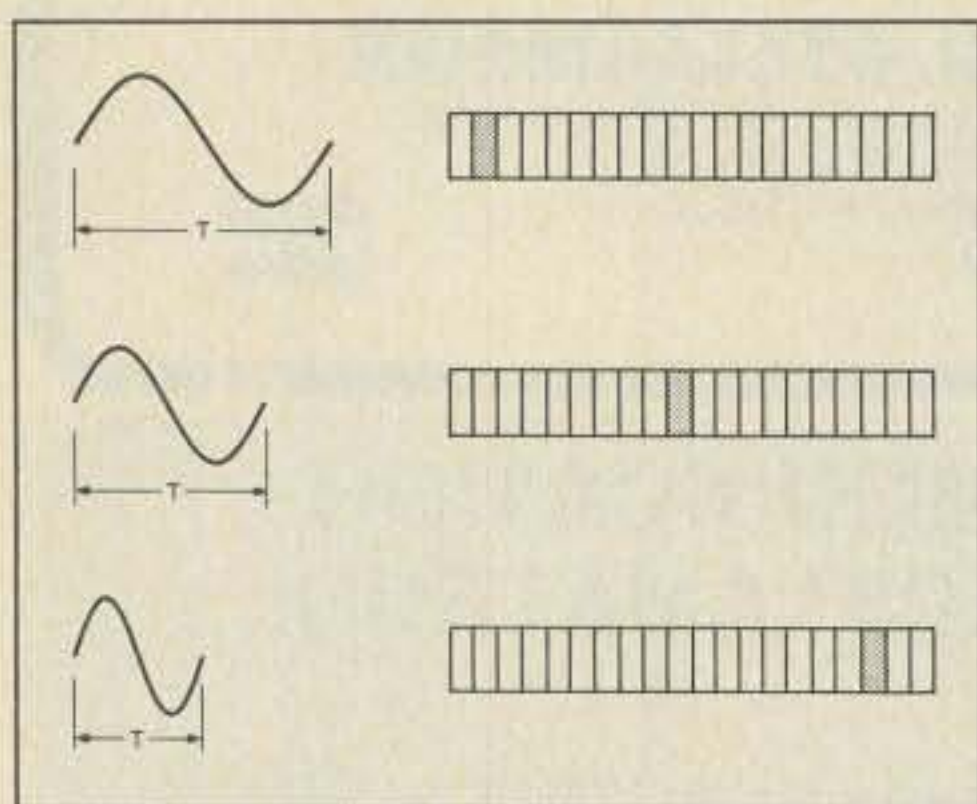

Fig. 1. Appearance of display for a single tone.

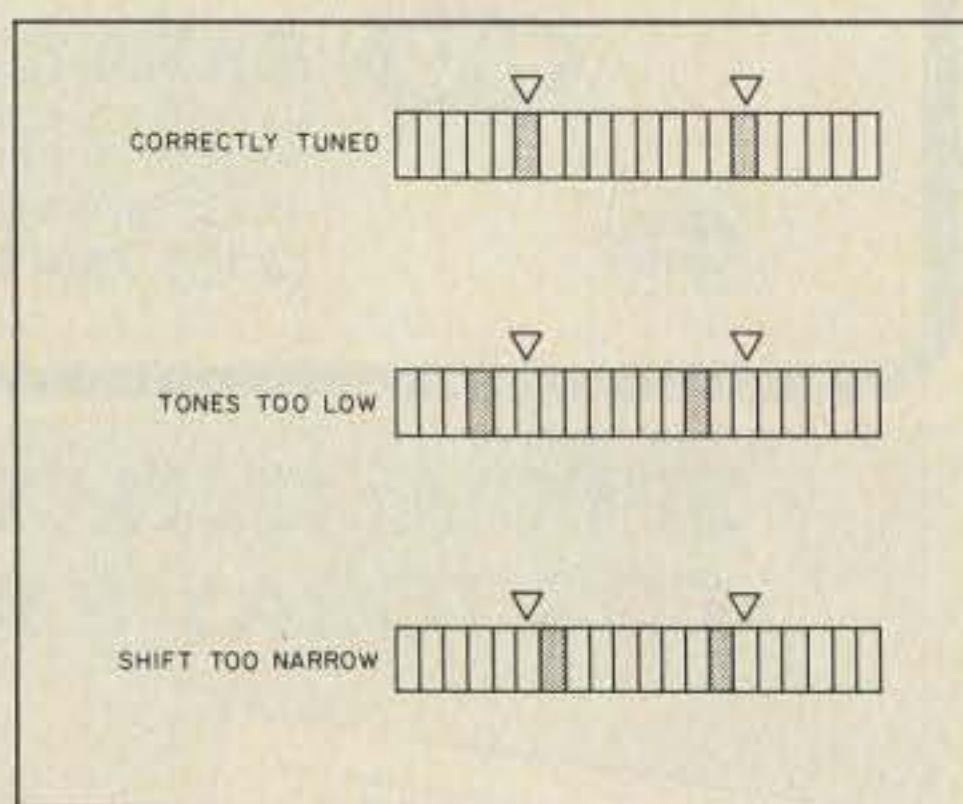

Fig. 2. Appearance of display for AFSK signals.

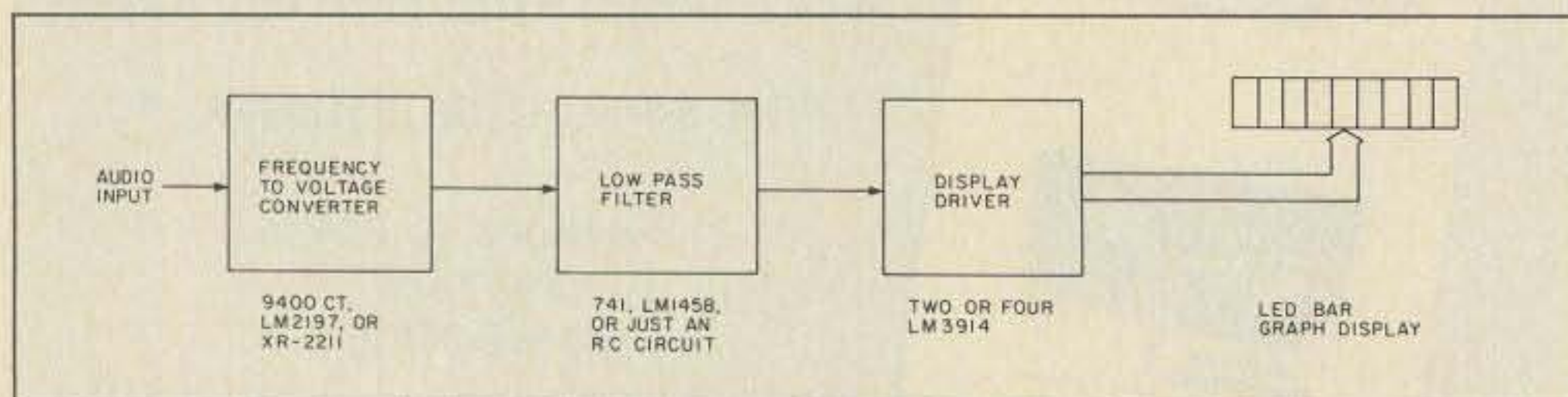

Fig. 3. Block diagram of most analog tuning indicators.

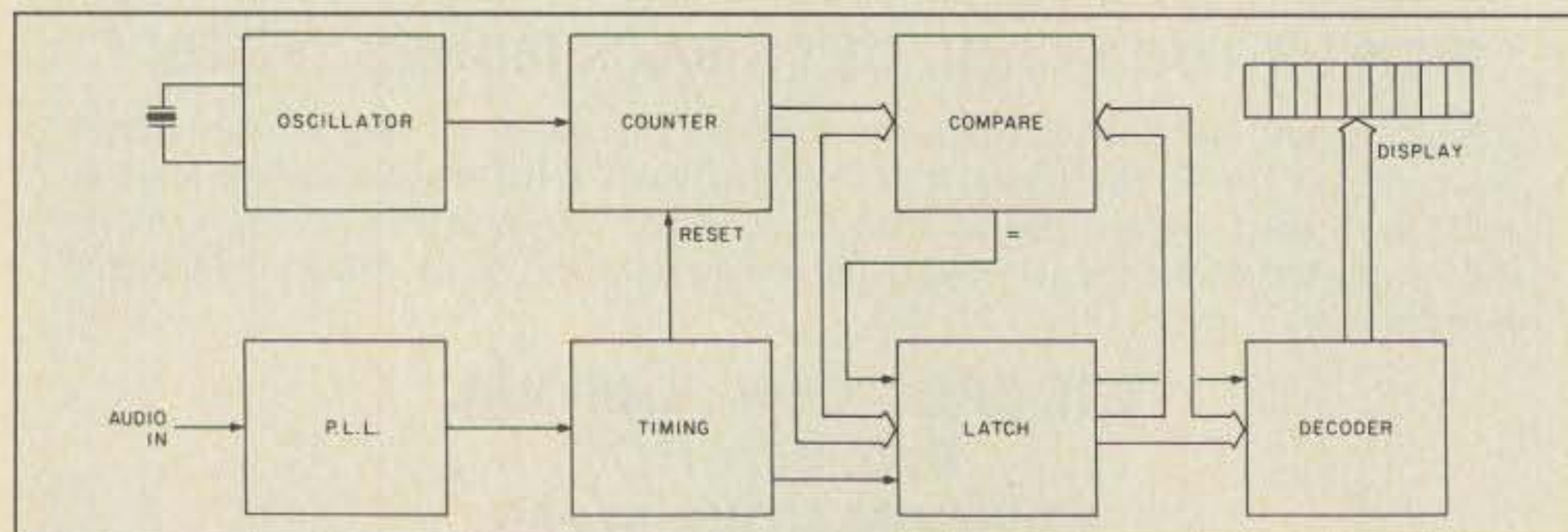

Fig. 4. Block diagram of digital tuning indicator.

Some aspects of RTTY have changed quite a bit during the last 40 years. Toroids, vacuum tubes, and Model 15 Teletypes® have been replaced by integrated circuits. Other things are still the same. Most people are still using 60-word-per-minute Baudot code. And, judging by my observations, most people are still using signal-strength meters, dual-ellipse patterns on oscilloscopes, or just random fiddling with the dial to tune in signals. Two stations conversing are rarely right on the same frequency.

These traditional techniques may be adequate for old-fashioned RTTY, but HF packet is *much* more difficult! Instead of 5-minute monologues, you must catch 1-second bursts on a channel often shared by several concurrent conversations. If you miss a few bits, you don't just get some garbled characters in part of a continuous stream. The whole packet is discarded and you don't know how long it will be until the next one is sent. Tuning, therefore, is more critical. For best results, you should be no more than 20 Hz off frequency. Forget about receiving anything if you're 50 Hz off.

A few years ago, a new type of RTTY tuning indicator appeared. It uses a light-emitting-diode (LED) bar-graph display to indicate the frequency of the incoming audio signal. Fig. 1 illustrates the basic idea. Each LED segment corresponds to a small range of audio tones, typically around 10-to-25-Hz wide. As the audio frequency increases, a different segment farther to the right is activated.

When an audio-frequency-shift-keyed (AFSK) signal is present, two bright spots appear along the display—as shown in Fig. 2. You can see instantly if the tones are too low or too high, and if the shift is correct.

The first device of this type (that I know of) was the Toni-Tuna.¹ (Fig. 3 shows a block diagram.) It uses a frequency-to-voltage converter, a low-pass filter, and some 3914 bar-graph display-driver chips. Recent products such as the HAL SPT-1² and AEA TI-1³ are minor variations of this circuit. The TAPR Tuning Indicator⁴ is a little different in that it has a single dot that moves with the average of the minimum and maximum peak frequencies. This has the unfortunate property of producing the same appearance for a steady carrier as for an FSK signal of any shift.

The simplicity and low cost of these analog devices are attractive, but they have some serious shortcomings. To calibrate them, you need a very accurate source of tones such as a signal generator and digital frequency counter. Adjacent LED segments correspond to frequencies that differ by only about 1%. Would you trust a cheap analog circuit to stay well within this tolerance with temperature changes, voltage fluctuations, and component aging?

The TimeKit Blinky⁵ looks similar on the outside but works on a much different principle. It has six bandpass filters centered at 1.2, 1.5, 1.7, 1.9, 2.1, and 2.3 kHz, each driving a different LED. With each LED representing at least a 200-Hz range of tones, this has nowhere near the accuracy required for packet.

To overcome the weaknesses of the analog circuits, I built a device with the same type of display but with mostly digital circuitry behind it⁶ (see the block diagram in Fig. 4). First, a phase-locked loop (PLL) locks onto the strongest frequency in the audio signal. A crystal-controlled counter measures the period of each cycle, and the corresponding LED segment is activated. The digital approach is far more accurate and does not require calibration. Even with the cheapest crystal, temperature variations, power-supply fluctuations, and component aging, the accuracy is still at least an order of magnitude better than the display resolution.

The digital approach also has a novel feature that really helps clean up the display appearance for noisy signals. The LED numbers for the current and preceding audio cycles are compared. The display is disabled when they are different. Thus, there is less of a tendency to get a blur as the input frequency is changing. The display comes on only when the frequency stays put for a while. The result is a much sharper display for noisy signals.

This article describes an entirely new circuit that operates on the same principle but has the improvements listed below:

1. Fewer chips.
2. Operates on single voltage supply.
3. Uses a cheap and readily available color-burst crystal instead of a different custom crystal for each frequency range.
4. More flexible mapping of the frequency to display segments.
5. The display is blanked with no input signal.

LED Display Segment Number	EPROM Output For On	EPROM Output For Blanked
1	1110 0000	1111 0000
2	1110 0001	1111 0001
3	1110 0010	1111 0010
.	.	.
.	.	.
15	1110 1110	1111 1110
16	1110 1111	1111 1111
17	1101 0000	1111 0000
18	1011 0001	1111 0001
19	0111 0010	1111 0010

Table 1. Mapping of EPROM output to LED segment selection.

Freq.	Count	LED	EPROM Addr.	Content
.
.
.	282	4	1000 1101 0xxx	1110 0011
.	281	4	1000 1100 1xxx	1110 0011
1600	280	5	1000 1100 0xxx	1110 0100
.	279	5	1000 1011 1xxx	1110 0100
.	278	5	1000 1011 0xxx	1110 0100
.	277	6	1000 1010 1xxx	1110 0101
.
.
1800	248	15	0111 1100 0xxx	1110 1110
.
.
.

Table 2. Sample of mapping of frequency to desired LED display segment.

EPROM Start Addr.	LED For Previous Cycle								Count	LED	Center Freq.	
	1	2	3	4	5	6	7	8				
	9	10	11	12	13	14	15	16				
08e0	f2	f2	<u>e2</u>	f2	f2	f2	f2	f2	!	284	3	1572
08d8	f3	f3	<u>e3</u>	f3	f3	f3	f3	f3	!	283	4	1578
08d0	f3	f3	<u>e3</u>	f3	f3	f3	f3	f3	!	282	4	1583
08c8	f3	f3	<u>e3</u>	f3	f3	f3	f3	f3	!	281	4	1589
08c0	f4	f4	<u>e4</u>	f4	f4	f4	f4	f4	!	280	5	1595
08b8	f4	f4	<u>e4</u>	f4	f4	f4	f4	f4	!	279	5	1600
08b0	f4	f4	<u>e4</u>	f4	f4	f4	f4	f4	!	278	5	1606
08a8	f5	f5	<u>e5</u>	f5	f5	f5	f5	f5	!	277	6	1612
08a0	f5	f5	<u>e5</u>	f5	f5	f5	f5	f5	!	276	6	1618
0898	f5	f5	<u>e5</u>	f5	f5	f5	f5	f5	!	275	6	1624

Table 3. Portion of EPROM contents for blanking when frequency changes. Locations causing display to be enabled are underscored.

6. More digital processing of the signal to clean up the display appearance.

Circuit Description

In the upper left corner of Fig. 5, the audio enters U1, a PLL, which tries to track the audio signal. Pin 5 is low when U1 thinks it is locked onto something. The XR-2211 has no voltage-controlled-oscillator (vco) output

available outside the chip, so I used U2 to extract it from the timing capacitor.

During most of each audio cycle, U5B and U6 are busy counting away. At the end of the audio cycle, U3 controls the following sequence of events: clear frequency divider (U5A), causing counter (U5B and U6) to stop; enable the EPROM (U7); wait awhile for the counter to settle down; grab the

EPROM Start Addr.	LED For Previous Cycle								Count	LED	Center Freq.	
	1	2	3	4	5	6	7	8				
	9	10	11	12	13	14	15	16				
08e0	f2	f2	e2	<u>e3</u>	f2	f2	f2	f2	!	284	3	1572
08d8	f3	f3	<u>e2</u>	e3	f3	f3	f3	f3	!	283	4	1578
08d0	f3	f3	f3	e3	f3	f3	f3	f3	!	282	4	1583
08c8	f3	f3	f3	e3	<u>e4</u>	f3	f3	f3	!	281	4	1589
08c0	f4	f4	f4	<u>e3</u>	e4	f4	f4	f4	!	280	5	1595
08b8	f4	f4	f4	f4	e4	f4	f4	f4	!	279	5	1600
08b0	f4	f4	f4	f4	e4	<u>e5</u>	f4	f4	!	278	5	1606
08a8	f5	f5	f5	f5	<u>e4</u>	e5	f5	f5	!	277	6	1612
08a0	f5	f5	f5	f5	f5	e5	f5	f5	!	276	6	1618
0898	f5	f5	f5	f5	f5	e5	<u>e6</u>	f5	!	275	6	1624

Table 4. Hysteresis added to prevent flickering at the boundaries. Locations differing from preceding figure are underscored.

EPROM output in the latch (U8); clear the counter; and start counting for the next audio cycle.

The EPROM maps the count, proportional to the audio cycle period, into the appropriate LED segment. It also does a few other little tricks as we'll see later. Finally, U8 and U9 drive the LED display.

Construction

Fig. 6 contains the pattern for etching a PC board for those who wish to make their own. Fig. 7 contains the parts placement guide. Note that six jumpers are required. One of them has one end in either the JP1 or the JP2 hole depending on the input frequency range. If you have an extra 200 milliamps of 5 volts available, U10 can be bypassed. Otherwise, the unit can be powered from your 12-volt

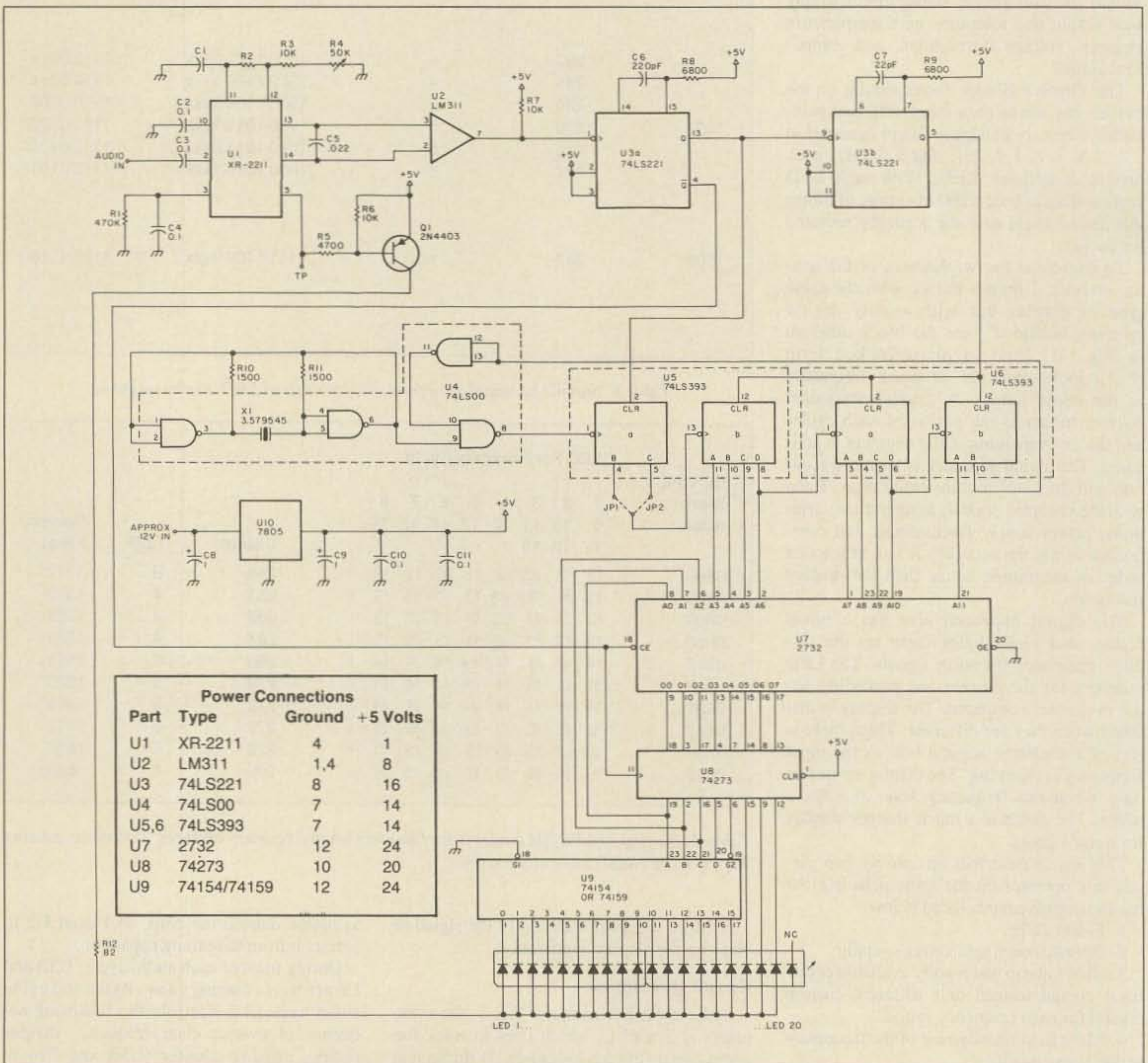

Fig. 5. Schematic.

WE SHIP WORLDWIDE

Barry Electronics Corp.

WORLD WIDE AMATEUR RADIO SINCE 1950

Your one source for all Radio Equipment!

For the best buys in town call:
212-925-7000
Los Precios Mas Bajos en
Nueva York...



MAY We Help You With the Best in Commercial and Amateur Radios? Jan KB2RV, Toni, Kitty WA2BAP, Mark K2CON

KITTY SAYS: WE ARE NOW OPEN 7 DAYS A WEEK.
Saturday & Sunday 10 to 5 P.M.

Monday-Friday 9 to 6:30 PM Thurs. to 8 PM
Come to Barry's for the best buys in town.



ONV Safety belts-in stock



ICOM

IC-R71A, 751A, 745, 28A/H, 37A, 48A, R-7000, 1271A, 271A/H, 3200A, 471A/H, 735

KENWOOD



Antennas

- A-S
- Cushcraft
- Hy-Gain
- Hustler
- KLM
- METZ
- Mini-Products
- Mosley

- YAESU FT-1/2/703R
- FT-2/709R/H
- FT-1903/1123

- ICOM IC2AT/12AT
- IC02AT
- IC-04AT
- IC-A2/U16

- Land-Mobile H/T
- Midland/Standard
- Wilson Maxon
- Yaesu FTC-2203, FT-4703
- Icom IC-M12 (Marine) M700
- Tempo M-1

TS440S/AT, R-1000, R-2000, TS-940 S/AT
TM-201B, TR26/3600A, TM2570A/50A/30A
TR-751A Kenwood Service/Repair
TH21/31/41AT, TM-211A/
411A & TS-711A/811A
TM-3530A

COMPU-FIRE EXTINGUISHERS
EXL-5000E RTTY/AMTOR TERMINAL



Alinco Power Supplies



SMART PATCH

CES-Simplex Autopatch 510-SA Will Patch FM Transceiver To Your Telephone Great For Telephone Calls From Mobile To Base. Simple To Use

PRIVATE PATCH III in stock

Budwick ANT. Products

FLUKE 77 Multimeter

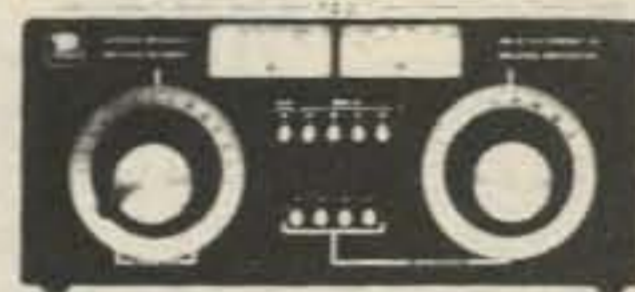

Nye MBV-A 3 Kilowatt Tuner

VoCom/Mirage/Daiwa
Tokyo Hy-Power
Amplifiers &
5/8λ HT Gain
Antennas IN STOCK

AMERITRON AMPLIFIER AUTHORIZED DEALER



Yaesu FTR-2410, Wilson
ICOM IC-RP 3010 (440 MHz)
ICOM IC-RP 1210 (1.2 GHz)

SANTEC
ST-222/UP
ST-20T
ST-442/UP
HT-7

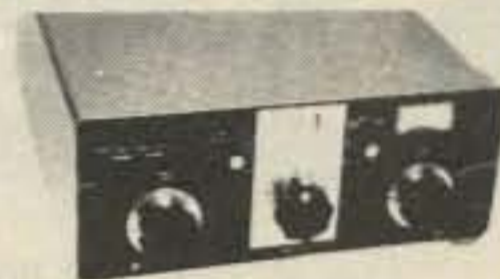

Soldering Station,
48 Watts, \$68
JBC soldering line in stock.
MICROLOG-ART 1, Air Disk,
SWL, Morse Coach

Computer Interfaces
stocked: MFJ-1224
AEA CP-1, PK-80, DR.DX
CP-100, PK-64, Dr. QSO,
PK-232, PM-1



ALPHA AMPLIFIERS

MFJ Models
422, 313, 989B, & 941D

MURCH
Model
2000 A,
A-LS, B
in stock



SANGEAN Portable Shortwave Radios



HEIL
EQUIPMENT
IN STOCK

KANTRONICS

UTU, Interface II, UTU-XT,
KPC2400, Packet Comm. II

EIMAC
3-500Z
572B, 6JS6C
12BY7A &
4-400A



BIRD
Wattmeters &
Elements
In Stock

AEA 144 MHz
AEA 220 MHz
AEA 440 MHz
ANTENNAS

Complete Butternut Antenna
Inventory In Stock!

DIGITAL FREQUENCY COUNTERS

Trionyx-	Pro-Com Engineering
Model TR-1000 0-1 GHz	1200HH
0-600 MHz	0-1.3 GHz 1296HH

Long-range Wireless
Telephone for export in stock

BENCHER PADDLES,
BALUNS, AUDIO FILTERS,
IN STOCK

MIRAGE AMPLIFIERS
ASTRON POWER SUPPLIES
Saxton Wire & Cable



New TEN-TEC

2591HT, Corsair II, Argosy II, Century 22, 2510 RX-325

Tri-Ex Towers
Hy-Gain Towers
& Antennas, and
Roters will be
shipped direct to
you FREE of
shipping cost.

MAIL ALL ORDERS TO BARRY ELECTRONICS CORP., 512 BROADWAY, NEW YORK CITY, NY 10012.

New York City's LARGEST STOCKING HAM DEALER COMPLETE REPAIR LAB ON PREMISES

"Aqui Se Habla Espanol"

BARRY INTERNATIONAL TELEX 12-7670
MERCHANDISE TAKEN ON CONSIGNMENT
FOR TOP PRICES

Monday-Friday 9 A.M. to 6:30 P.M. Thursday to 8 P.M.
Saturday & Sunday 10 A.M. to 5 P.M. (Free Parking)

AUTHORIZED DIST. MCKAY DYMEK FOR
SHORTWAVE ANTENNAS & RECEIVERS.

IRT/LEX-"Spring St. Station"

Subways: BMT-"Prince St. Station"

IND-"F" Train-Bwy. Station"

Bus: Broadway #6 to Spring St.
Path-9th St./6th Ave. Station.

Commercial Equipment
Stocked: ICOM, MAXON,
Midland, Standard, Wil-
son, Yaesu. We serve
municipalities, busi-
nesses, Civil Defense,
etc. Portables, mobiles,
bases, repeaters...

We Stock: AEA, ARRL, Alpha, Ameco, Antenna Specialists, Astatic, Astron, B & K, B & W, Bencher, Bird, Butternut, CDE, CES, Collins, Communications Spec. Connectors, Covercraft, Cushcraft, Daiwa, Dentron, Digimax, Drake, ETO (Alpha), Eimac, Encomm, HeilSound, Henry, Hustler (Newtronics), Hy-Gain, Icom, KLM, Kantronics, Larsen, MCM (Daiwa), MFJ, J.W. Miller, Mini-Products, Mirage, Newtronics, Nye Viking, Palomar, RF Products, Radio Amateur Callbook, Rockwell Collins, Saxton, Shure, Telex, Tempo, Ten-Tec, Tokyo Hi Power, Trionyx TUBES, W2AU, Waber, Wilson, Yaesu Ham and Commercial Radios, Vocom, Vibroplex, Curtis, Tri-Ex, Wacom Duplexers, Repeaters, Phelps Dodge, Fanon Intercoms, Scanners, Crystals, Radio Publications.

WE NOW STOCK COMMERCIAL COMMUNICATIONS SYSTEMS
HAM DEALER INQUIRES INVITED PHONE IN YOUR ORDER & BE REIMBURSED

COMMERCIAL RADIOS stocked & serviced on premises.

Amateur Radio Courses Given On Our Premises, Call

Export Orders Shipped Immediately. TELEX 12-7670

ALL
SALES
FINAL

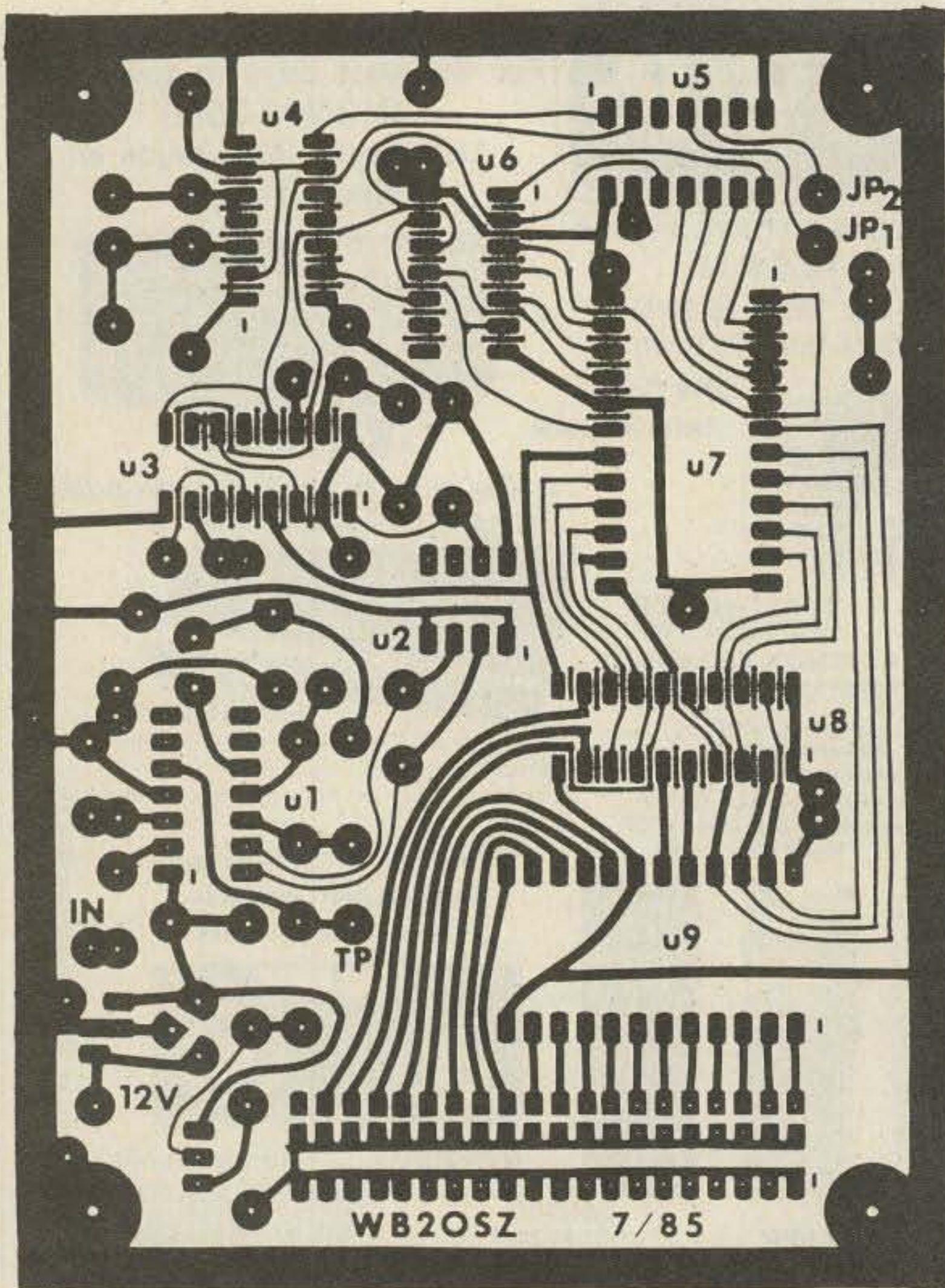

Fig. 6. Full-size pattern for single-sided PC board.

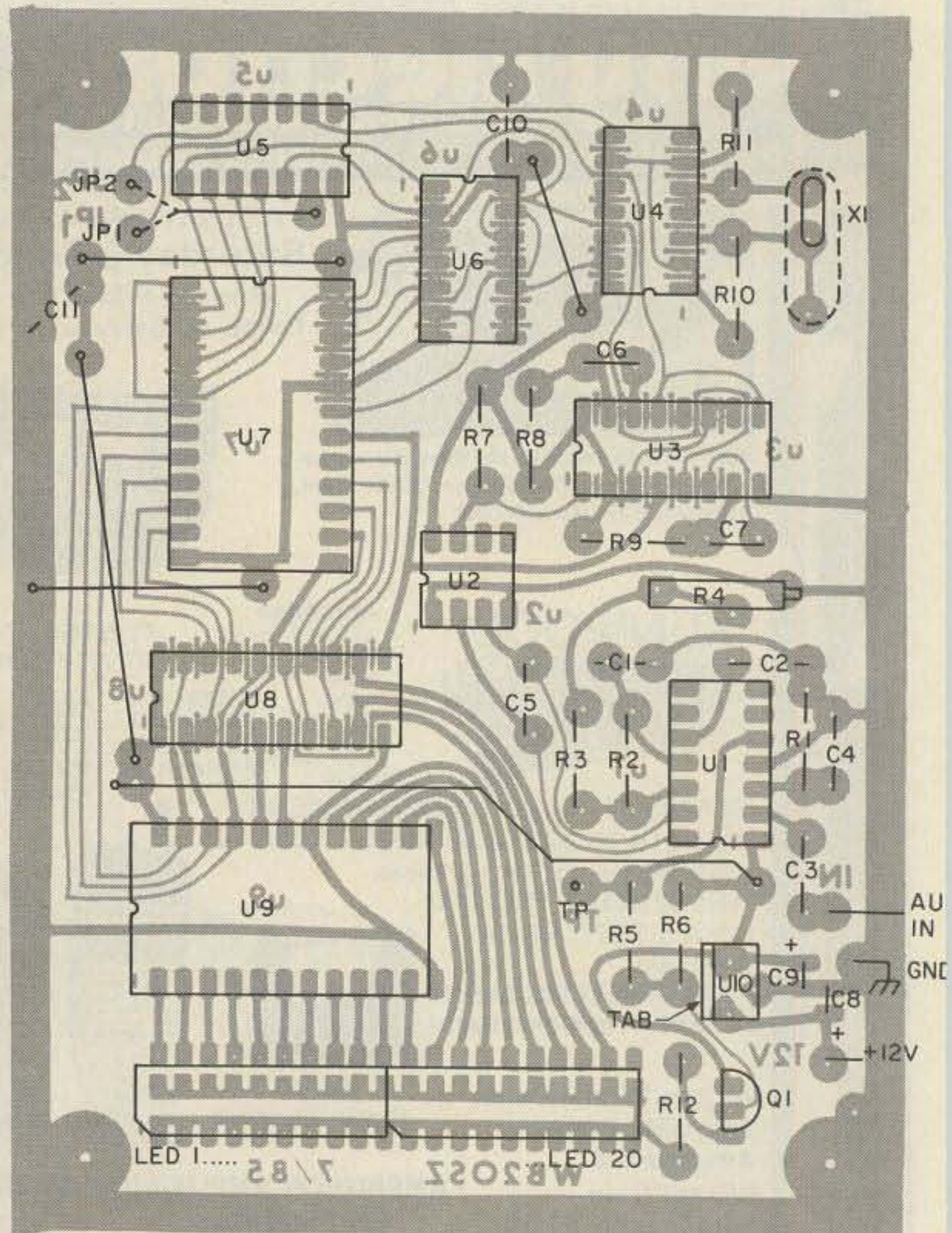

Fig. 7. Parts placement guide.

transceiver supply, or a separate supply can be constructed (Fig. 8).

The PC board has an extra hole, so a crystal in either an HC18/U or an HC33/U holder can be used. There is also an extra row of holes, so the LED displays can be mounted flat on the board or on right-angle sockets. I constructed a 40-pin right-angle socket from three 16-pin right-angle sockets, using a saw, a file, and some glue. Some may wish to build a larger display with different colors of discrete LEDs.⁷ A few people wrote to me and reported that it makes a more dramatic display.

Mostly 74LS parts were used instead of regular TTL, for reduced power consumption. U8 and U9 are exceptions, because more current-sink capability is required to drive the display. Pay particular attention to the orientation of the ICs; they go in all different directions. Be sure to use mylar™ and mica capacitors where indicated in the parts list. Disc ceramic capacitors are very unstable and should not be used in timing circuits where accuracy is important.

The EPROM

In this section, I'll try to retrace the thought process that went into generating the data for the EPROM. It can get rather tedious. If you get lost, just skip to the next section.

First, let's look at the required EPROM output for selecting each of the LED seg-

ments. The four high-order bits (07-04) from the EPROM are enable signals. A logic zero at bit 7, 6, or 5 activates LED segment 19, 18, or 17, respectively. When bit 4 is zero, U9 selects one of the remaining LEDs based on the four low-order bits.

Thus, LEDs 1 through 16 are selected by the bit pattern 1110nnnn, where nnnn is 0000 through 1111. LEDs 17, 18, and 19 are selected by 1101xxxx, 1011xxxx, and 0111xxxx, respectively, where xxxx doesn't matter. Note that the low-order bits in the middle column of Table 1 continue to be incremented for a reason to be explained later. The final column is the same except all the enable signals have been set to 1. These are for cases in which the display should be blanked. The low-order bits still contain a hint as to which LED would have been on if the display hadn't been blanked.

The next step is to fill in the proper EPROM locations with values from the preceding chart. Let's take the 1600/1800-Hz tone pair as an example. I decided arbitrarily that LEDs 5 and 15 should correspond to these audio frequencies and placed small triangular pieces of plastic tape above them on the display.

When the crystal frequency is divided

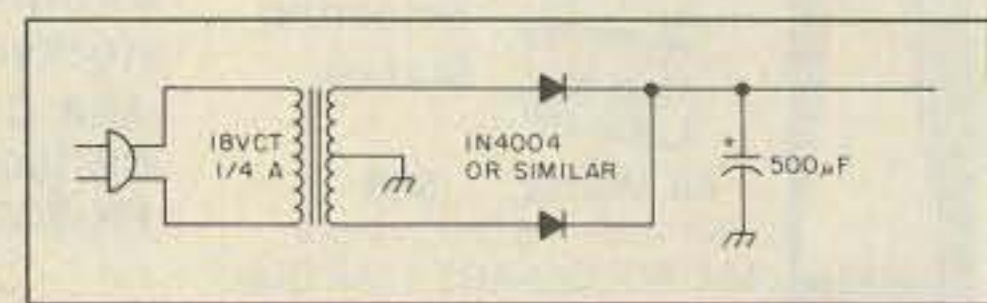

Fig. 8. Ac power supply for use when roughly 12 V dc is not available.

by 8 (by U5A), divided again by the audio input of 1600 Hz, and rounded to the nearest integer, you would expect a count of 280. Actually, a slight correction must be made to compensate for the clock cycles not counted while the one-shots are active, so the real count is 279. Similarly, a count of 248 is obtained for 1800-Hz input. The EPROM locations for a count of 279 are filled with the pattern to activate LED 5. The bit pattern for LED 15 is placed in locations for a count of 248. From here, some interpolation and extrapolation was used to fill in other nearby locations (Table 2).

After repeating the process for four other

Modem Tones	Dial for USB	Dial for LSB
1070/1270	14,100.13	14,102.47
1600/1800	14,099.60	14,103.00
2025/2225	14,099.175	14,103.425

Table 5. Dial settings for USB and LSB.

common tone pairs, I plotted the data to make a visual check and made some more minor adjustments. The result is in Fig. 9. All of this was done before the circuit was built.

By now you're probably wondering why there are eight memory locations for each count. The next evolutionary step was to add blanking while the input frequency was changing. The goal was to enable the display only when the same LED was selected for two consecutive audio cycles. The result is bright spots where the frequency stays still for a while and dimming of the blur as it moves around.

Note that the three low-order bits of the previous LED number are used as the low-order bits of the EPROM address. Table 3 illustrates the new contents. Hexadecimal notation has replaced the binary to make the chart more compact. For a count of 278 through 280, LED 5 is the desired result. Note, however, that the display is enabled (output e3) only if LED 5 or 13 was selected the previous time. My original circuit used a 7485 to compare the low-order four bits of the LED number. In my observations, it looked as if the PLL couldn't move that far in one audio cycle; so, in practice, comparing only the three low-order bits is adequate. Doubling the EPROM size and comparing the four low-order bits would be a worthwhile experiment, especially if the PLL was modified to track higher data rates.

Finally, a tone right on the edge between two LED segments would result in flickering. I added a small amount of hysteresis, so a frequency right at a boundary would stay with one LED or the other (Table 4).

Fig. 10 contains a complete annotated copy of the EPROM data in Intel Hex Format. Each line contains a colon to indicate the beginning of a record, two hexadecimal digits for the data byte count (always 08 in this case), four hexadecimal digits for the starting address, two zeros for the record type, a variable number of data bytes, and two hexadecimal digits for a checksum. Anything preceded by an exclamation mark is a comment. These comments will probably have to be removed before feeding this data into most EPROM programming systems.

The Weak Link

The weakest link of the whole system is the phase-locked loop. Following the spec sheet and application notes, I first tried 150k and .0047 uF for R2 and C1. This resulted in very poor tracking of the audio signal. The loop was under-damped, resulting in excessive overshooting of the input frequency. After recomputing C1 for critical damping, the vco was rather sluggish about tracking shifts in frequency.

After lots of experimentation, 47k and .0025 uF seemed to be a good compromise for several tone pairs. All the experimentation up to this point had been done with a locally generated 300-baud AFSK signal. It did not work well at all with real signals from a radio.

After more tweaking, testing, and fiddling,

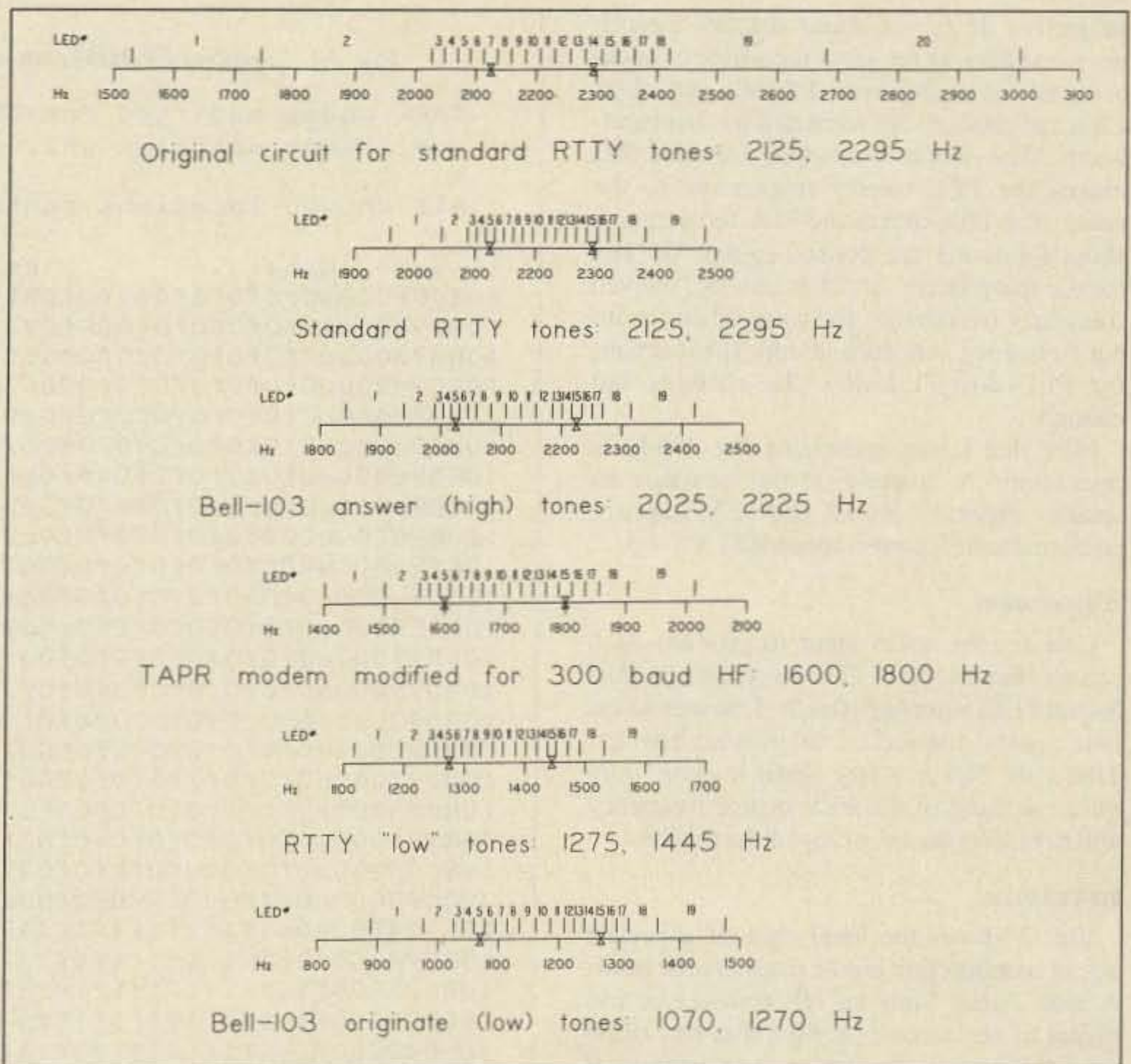

Fig. 9. Frequency ranges of LEDs.

Parts List

C1	.002-uF mylar or mica
C2, 3, 4, 10, 11	0.1-uF disc ceramic
C5	.022-uF mylar
C6	220-pF mica
C7	22-pF mica
C8, 9	1-uF tantalum
LED1-20	Two 10-segment LED bar-graph displays such as MV57164
Q1	2N4403 or similar PNP
R1	470k
R2	120k
R3, 6, 7	10k
R4	50k multi-turn pot
R5	4,700 Ohms
R8, 9	6,800 Ohms
R10, 11	1,500 Ohms
R12	82 Ohms
U1	XR-2211, FSK Demodulator/Tone Decoder
U2	LM 311, Comparitor
U3	74LS221, Dual monostable multi-vibrator
U4	74LS00, Quadruple 2-input NAND
U5, 6	74LS393, Dual 4-bit binary counter
U7	2732, Erasable Programmable Read Only Memory (Available for \$8 from author. Be sure to specify one of the five tone pairs desired from Fig. 9.)
U8	74273, Octal D-type flip-flops
U9	74154 or 74159, 4-line-to-16-line decoder
U10	7805, 5-volt regulator
X1	3.579545-MHz color-burst crystal
misc.	Heat sink for U10
	Socket for U7
	Optional right-angle sockets for LEDs

subjective decisions about display cleanliness, and playing the same recording of packet signals over and over, I finally settled on 120k and .002 uF. R2 basically sets the bandwidth. Too much bandwidth (smaller R2) makes the PLL overly responsive to the noise. Too little makes the PLL too sluggish about following the desired signal. C1 sets the damping factor. If C1 is too big, the vco frequency overshoots and rings when the input frequency suddenly jumps. If too small, the PLL doesn't follow the changes fast enough.

Note that I was optimizing for 300-baud operation. A slightly larger resistor or smaller capacitor would probably improve performance for lower-speed RTTY.

Adjustment

Connect the audio input to ground. Also connect the test point (TP) to ground. Adjust R4 until LED number 10 is lit. Disconnect the two points connected to ground earlier. That's all! Never worry about it again. Any minor drifting of the PLL center frequency will not affect the accuracy of the device.

Installation

Fig. 2 shows the ideal case of a perfect signal coming right out of a signal generator. A real signal from an HF transceiver has plenty of noise and distortion that will cause the cleanliness of the display to deteriorate. If you connect the tuning indicator directly to the speaker, a pleasant display will be obtained only for a fairly strong and clean signal. For more typical signals, the audio must be cleaned up.

All good quality RTTY terminal units (or packet modems) start with a bandpass filter to select the frequency range of interest and attenuate the rest. After this bandpass filter is the proper place to connect the tuning indicator. If you are using a TAPR TNC-1 or one of the many clones, obtain the signal from pin 1 of U20. This is the output of the low-pass filter after the switched capacitor bandpass filter. If you're in doubt as to where to make the connection to your system, send me a copy of the modem schematic and an SASE.

(Note: Simple PLL demodulators such as this enjoyed a brief popularity on RTTY a few years ago. Soon, most people realized they just didn't work very well with noisy HF signals and went back to the good old-fashioned designs with separate mark and space filters. The packet crowd had to rediscover this fact, and only recently have packet equipment manufacturers begun to offer better quality modems for HF use.)

HF Packet Frequency Specification

Suppose you were having a RTTY QSO with someone in England. Your transceiver's display says 14,085.00 kHz. What would be displayed on his transceiver? Probably 14,081.43—more than 3.5 kHz different! How can this be?

Almost all amateur HF RTTY uses 170-Hz frequency shift keying (FSK). This is usually produced by generating an audio-frequency-

Fig. 10. Complete EPROM contents for use with 1600/1800-Hz tones.

```

! TAPR modem modified for 300 baud HF: 1600, 1800 Hz
! Use jumper position JP2.

! All unused locations contain FF.
!
! addr data... cs count LED center freq
:0809f000e0f0f0f0f0f0f0f0f0f08f ! 318 1 1404
:0809e800e0f0f0f0f0f0f0f0f0f097 ! 317 1 1409
:0809e000e0f0f0f0f0f0f0f0f0f09f ! 316 1 1413
:0809d800e0f0f0f0f0f0f0f0f0f0a7 ! 315 1 1418
:0809d000e0f0f0f0f0f0f0f0f0f0af ! 314 1 1422
:0809c800e0f0f0f0f0f0f0f0f0f0b7 ! 313 1 1427
:0809c000e0f0f0f0f0f0f0f0f0f0bf ! 312 1 1431
:0809b800e0f0f0f0f0f0f0f0f0f0c7 ! 311 1 1436
:0809b000e0f0f0f0f0f0f0f0f0f0cf ! 310 1 1441
:0809a800e0f0f0f0f0f0f0f0f0f0d7 ! 309 1 1445
:0809a000e0f0f0f0f0f0f0f0f0f0df ! 308 1 1450
:08099800e0f0f0f0f0f0f0f0f0f0e7 ! 307 1 1455
:08099000e0f0f0f0f0f0f0f0f0f0ef ! 306 1 1459
:08098800e0f0f0f0f0f0f0f0f0f0f7 ! 305 1 1464
:08098000e0f0f0f0f0f0f0f0f0f0ff ! 304 1 1469
:08097800e0f0f0f0f0f0f0f0f0f007 ! 303 1 1474
:08097000e0f0f0f0f0f0f0f0f0f00f ! 302 1 1479
:08096800e0f0f0f0f0f0f0f0f0f017 ! 301 1 1484
:08096000e0f0f0f0f0f0f0f0f0f01f ! 300 1 1488
:08095800e0f0f0f0f0f0f0f0f0f027 ! 299 1 1493
:08095000e0e1f0f0f0f0f0f0f03e ! 298 1 1498
:08094800e0e1f1f1f1f1f1f1f140 ! 297 2 1504
:08094000f1e1f1f1f1f1f1f1f137 ! 296 2 1509
:08093800f1e1f1f1f1f1f1f1f13f ! 295 2 1514
:08093000f1e1f1f1f1f1f1f1f147 ! 294 2 1519
:08092800f1e1f1f1f1f1f1f1f14f ! 293 2 1524
:08092000f1e1f1f1f1f1f1f1f157 ! 292 2 1529
:08091800f1e1f1f1f1f1f1f1f15f ! 291 2 1534
:08091000f1e1f1f1f1f1f1f1f167 ! 290 2 1540
:08090800f1e1f1f1f1f1f1f1f16f ! 289 2 1545
:08090000f1e1f1f1f1f1f1f1f177 ! 288 2 1550
:0808f800f1e1e2f1f1f1f1f1f18f ! 287 2 1556
:0808f000f2e1e2f2f2f2f2f2f291 ! 286 3 1561
:0808e800f2f2e2f2f2f2f2f2f288 ! 285 3 1567
:0808e000f2f2e2e3f2f2f2f2f29f ! 284 3 1572
:0808d800f3f3e2e3f3f3f3f3f3a1 ! 283 4 1578
:0808d000f3f3f3e3f3f3f3f3f398 ! 282 4 1583
:0808c800f3f3f3e3e4f3f3f3f3af ! 281 4 1589
:0808c000f4f4f4e3e4f4f4f4f4b1 ! 280 5 1595 X
:0808b800f4f4f4f4e4f4f4f4f4a8 ! 279 5 1600 X
:0808b000f4f4f4f4e4e5f4f4f4bf ! 278 5 1606 X
:0808a800f5f5f5f5e4e5f5f5f5c1 ! 277 6 1612
:0808a000f5f5f5f5f5e5f5f5f5b8 ! 276 6 1618
:08089800f5f5f5f5f5e5e6f5f5cf ! 275 6 1624
:08089000f6f6f6f6f6e5e6f6f6d1 ! 274 7 1630
:08088800f6f6f6f6f6f6e6f6f6c8 ! 273 7 1635
:08088000f6f6f6f6f6f6e6e7df ! 272 7 1641
:08087800f7f7f7f7f7e6e7e1 ! 271 8 1648
:08087000f7f7f7f7f7e7e7d8 ! 270 8 1654
:08086800e8f7f7f7f7e7e7ef ! 269 8 1660
:08086000e8f8f8f8f8f8f8e7f1 ! 268 9 1666
:08085800e8f8f8f8f8f8f8f8e8 ! 267 9 1672
:08085000e8e9f8f8f8f8f8f8ff ! 266 9 1678
:08084800e8e9f9f9f9f9f9f901 ! 265 10 1685
:08084000f9e9f9f9f9f9f9f9f8 ! 264 10 1691
:08083800f9e9f9f9f9f9f9f900 ! 263 10 1698
:08083000f9e9eaf9f9f9f9f917 ! 262 10 1704
:08082800fae9eafafafafafa19 ! 261 11 1711
:08082000fafaeafafafafafa10 ! 260 11 1717
:08081800fafaeaeafafafafa27 ! 259 11 1724
:08081000fbfbfaebfbfbfbfb29 ! 258 12 1730
:08080800fbfbfbfbfbfbfbfb20 ! 257 12 1737
:08080000fbfbfbfbfbfbfbfb37 ! 256 12 1744
:0807f800fcfcfcfcfcfcfcfc3a ! 255 13 1751
:0807f000fcfcfcfcfcfcfcfc31 ! 254 13 1758
:0807e800fcfcfcfcfcfcfcfc48 ! 253 13 1765
:0807e000fdfdfdfddecdfdfd4a ! 252 14 1772

```

:0807d800fdfdfdfdfdedfd41	!	251	14	1779	
:0807d000fdfdfdfddeedfd58	!	250	14	1786	
:0807c800fefefefefeedeefe5a	!	249	15	1793	X
:0807c000fefefefefefeeefe51	!	248	15	1800	X
:0807b800fefefefefefeeefe68	!	247	15	1807	X
:0807b000fffffffffffeefe6a	!	246	16	1815	
:0807a800fffffffffffeefe61	!	245	16	1822	
:0807a000d0fffffffffffe98	!	244	16	1830	
:08079800d0f0f0f0f0f0f0ffa	!	243	17	1837	
:08079000d0f0f0f0f0f0f001	!	242	17	1845	
:08078800d0b1f0f0f0f0f048	!	241	17	1852	
:08078000d0b1f1f1f1f1f14a	!	240	18	1860	
:08077800f1b1f1f1f1f1f131	!	239	18	1868	
:08077000f1b1f1f1f1f1f139	!	238	18	1876	
:08076800f1b1f1f1f1f1f141	!	237	18	1883	
:08076000f1b1f1f1f1f1f149	!	236	18	1891	
:08075800f1b172f1f1f1f1d0	!	235	18	1899	
:08075000f2b172f2f2f2f2d2	!	234	19	1908	
:08074800f2f272f2f2f2f299	!	233	19	1916	
:08074000f2f272f2f2f2f2a1	!	232	19	1924	
:08073800f2f272f2f2f2f2a9	!	231	19	1932	
:08073000f2f272f2f2f2f2b1	!	230	19	1941	
:08072800f2f272f2f2f2f2b9	!	229	19	1949	
:08072000f2f272f2f2f2f2c1	!	228	19	1958	
:08071800f2f272f2f2f2f2c9	!	227	19	1966	
:08071000f2f272f2f2f2f2d1	!	226	19	1975	
:08070800f2f272f2f2f2f2d9	!	225	19	1984	
:08070000f2f272f2f2f2f2e1	!	224	19	1993	
:0806f800f2f272f2f2f2f2ea	!	223	19	2001	
:00000001ff					
⌘					

shifted signal and feeding it into an SSB transmitter. By convention, the *higher* radio frequency is the "mark" frequency (idle or data "1"). In the United States, audio tones of 2125 and 2295 Hz are most common. The *lower* audio frequency is the mark tone. To make this correspond to the higher radio frequency, the LSB mode is used. In some other parts of the world, audio tones of 1275 and 1445 are more common. In this case the *higher* tone is mark so USB is used.⁸

Both stations are operating on the same frequency, but their transceivers indicate different frequencies. How can frequencies be described for skeds, nets, or other purposes? The common solution is to specify the radio frequency of the mark state. Taking the earlier example, $14,085.00 - 2.125 = 14,082.875$. For the other station, $14,081.43 + 1.445 = 14,082.875$, which is the same. Each station performs the required calculation for its particular audio tones and USB/LSB mode.

We have a similar problem with HF packet, which has suddenly become very popular. Like RTTY, it is usually transmitted by feeding an AFSK signal into an SSB transceiver. I've heard of people using 170-, 200-, 600-, and 1000-Hz shift, but 200 seems to be by far the most popular. Some people are using Bell 103 type modems with 2025 and 2225 tones (or 1070/1270). Others are using modified TAPR modems with TAPR's suggested 1600- and 1800-Hz tones. Many are using LSB. Some may be using USB. These are all compatible as long as the shift and baud rate are the same. Packet radio doesn't really have absolute "mark" and "space" states. The encoding scheme uses transitions and lack of transitions to convey a 0 and 1, respectively. Therefore, your signal can never be "upside down," as is possible with RTTY.

How would you set your transceiver to meet another station at 14,101.3 kHz? From the previous discussion, it should be clear that several packet stations all with the

same numbers on their displays could be sending signals on significantly different frequencies. As with RTTY, the obvious solution is to specify the actual radio frequency rather than the dial setting. Each operator would then make the necessary adjustment for his particular audio modem tones and sideband setting.

Should the higher or lower frequency arbitrarily be picked as the signal frequency? As mentioned earlier, there isn't one frequency that is the "mark" or idle state. It seems to me that using the midpoint between them would make the most sense. When using USB, subtract the average of your modem tones from the signal frequency to get the dial setting. When using LSB, add, instead. Using 14,101.3 again as an example, the settings in Table 5 would be used.

Conclusion

Just so no one is misled, I'd like to reiterate the fact that the display will not look like the ideal case in Fig. 2 unless you connect the tuning indicator to a local AFSK generator. The various types of noise and distortion introduced by the HF radio link will cause some blurring of the bright spots and random flickering in other LED segments.

And now the big question: Why use this circuit instead of the simpler analog variety? The much greater accuracy (without any calibration required!) and greater flexibility of the digital approach sound great, but how do they work under actual operating conditions? To find out, I breadboarded an exact copy of one of the commercial products mentioned earlier to make a side-by-side comparison. With some 20-meter RTTY, there wasn't a lot of difference.

Next I located some 300-baud packet activity, and I was very pleased with the results. My circuit produced two very distinct bright spots, with some smearing across a few LED segments, and a little random flickering all over from the noise. Overall, the display had a good contrast, and it was very easy to tune in signals within 10 or 20 Hz. The commercial unit clone had a solid blur across most of the display. Some spots close to the ends of the blur were brighter than the rest, but there really wasn't much contrast. ■

References

1. A. J. Oakley G4HYD, "The Toni-Tuna," *Radio Communication*, August, 1982.
2. Paul K. Pagel N1FB, "New Products—HAL SPT-1 Tuning Indicator," *QST*, August, 1985.
3. Paul K. Pagel N1FB, "New Products—AEA TI-1," *QST*, September, 1985.
4. Dan Vester KE7CZ, "TNC Modem Tuning Indicator #2," *PSR Quarterly*, October, 1985.
5. Dave Ingram K4TWJ, "CQ Reviews: The TimeKit Blinky SSTV/RTTY Tuner," *CQ*, November, 1983.
6. "RTTY Tuning: The New Solution," *73*, March, 1983.
7. Jack Miller W1PDI, "Perfection Plus," *73*, June, 1985.
8. Ian Wade G3NRW, "RTTY Tutorial," *DATACOM*, Summer, 1985.

BUILD THE KIT

A complete kit of parts, including a high-quality double-sided printed circuit board, is available from Valley Electronics. The kit version is slightly different from the unit presented in this article; a larger EPROM is used which covers two frequency pairs, and several cosmetic changes have been made to the PCB.

Order Number	Description	Price
88601	Digital Tuning Indicator kit	\$79.95
88602	Kit without enclosure	\$72.95
88603	Semi-kit—PCB and EPROMS only	\$22.95

All prices include shipping and handling.

Send your check or money order to Valley Electronics, PO Box 1101, Hillsboro NH 03244.

Seeing Packet Radio With Different Eyes

The Versabraille II system allows blind hams to get connected.

A man sits with his hands resting lightly on his plastic-like display, his TAPR TNC-2 by his side, waiting for his first real contact on packet. Finally, it comes through! He races his hands across the display with eager anticipation of knowing who it is! He sees "CONNECTED TO N7ERZ." He has finally reached his goal in amateur radio—to be able to communicate with other hams through the latest and greatest digital communication mode.

Hello to all of you fellow packeteers. I have written this article to tell you of a recent

development for the blind regarding this new mode of digital communication, known by all of us as packet radio. Through the latest computer technology, Telesensory Systems, Inc., has enhanced character-oriented communications for blind users with its Versabraille II system. The system is both a word processor and a communications terminal. Its great flexibility allows for easy use with almost any TNC. It has a disk-based operating system for easy and fast access. I'll first take a look at the technical aspects of the Versabraille II before relating it to packet.

The computer is smaller than you would expect: 15" x 10" x 3", and its approximate weight is 10 pounds. The display is the strip just above the keyboard. It is only 20 characters wide, not quite the typical 80 columns offered by screen monitors. The 120 pins that make up the output serve as the link to the outside world for the blind user by means of touch. The pins are displayed in a typical braille-cell formation. The braille cell consists of six dots, which make up all letters, numbers, punctuation, etc. The pins move up and down, much like a dot-matrix print head.

But wait, if you sit down and try to figure out how many combinations you can have with six dots, you realize it is not nearly enough for the wide range of control characters and higher ASCII values that are used in packet communications. Therefore, the Versabraille II uses an outstanding translation program that allows the blind user to use shifted and chorded characters (one with which the space bar is simultaneously depressed along with its braille character) to produce all 128 standard ASCII values.

As for the brain of this machine, the Versabraille II system uses a CMOS Intel 8085 CPU and a 96K memory system. The user has 32,752 bytes available; the rest of the memory space is used for ROM program storage.

Now we know how the braille is shown. But how does one put characters into it? This is done by the keyboard just below the display. It is a rubberbrane-type keyboard. This is very nice, for it allows for almost silent typing. Twenty-four keys make up its foundation. Six of these are used to produce the six braille characters. To the left of these keys is an additional set of 12 keys, the numeric keypad. These keys are used for certain editing features and for fast numeric input. Just slightly above the braille display and to the left are the cursor control keys. Since the computer is menu-driven, these keys select menu items. They are also used to



Photo A. The author and AG7H demonstrate packet-by-feel.

move a page of text through the 20-character window. And then, of course, there is the space bar.

On the back panel, there are two standard RS-232 interface ports, one for DTE (data terminal equipment) and the other for DCE (data computer equipment). This is the place where a TNC is connected to the Versabraille system. The braille computer has a standard female 25-pin connector, so I cabled it and my TNC-2 together by using a double-male cable. That is all the interface takes as far as hardware is concerned.

The computer can be configured to connect to a number of different types of devices, so care must be taken when setting all the parameters. Baud rate, data bits, stop bits, duplex, parity, device control character input (DC IN), device control character output (DC OUT), DTR, DSR, CTS, and RTS are the basic parameters that most computers deal with. Many other parameters control the way the Versabraille's display translator will interpret incoming data. After all parameters are set correctly, communication with the TNC is possible.

Versabraille and the TNC

I knew that my Versabraille computer would work fine with a TNC; the only thing I lacked was a TNC. Where would I get one? How? The answer came soon after I attended the annual meeting of Tucson Amateur Packet Radio, otherwise known as TAPR. I gave a demonstration of braille packet there, using a

friend's TNC along with the Versabraille II. Little did I know that this demonstration would produce a big return on the investment of my time and effort. I was nearly speechless when I received a call from a very good friend who started me in all of this packet venturing. He exclaimed, "Jeff, your dream has come true. TAPR is donating a TNC-2 board to you!"

My heart leaped with joy after hearing the news, but deep inside it still did not seem real to me. When Lyle Johnson, President of TAPR, arrived one afternoon with my TNC-2 in hand, I finally knew that the door had been opened for new and exciting challenges. It was like a new beginning of the hobby—as though I just got a new ticket. TAPR wants me to develop interface software so that other blind operators can easily participate in packet radio.

The Versabraille comes with a terminal-emulation package, which connects the display and keyboard to the serial port. I can read the display fast enough to keep up with packet conversations at 1200 baud. But soon after becoming quite experienced with the board, I found that I wanted to communicate at a faster baud rate between the braille computer and the TNC. The problem is that at 9600 baud, the braille cells would just jump out of my reach, requiring me to constantly scroll through the 9K data buffer. One of my first goals is to write a program to remove the callsigns from monitored text, to speed up my reading.

But overall, no big problems have arrived. Many people have asked me why I use braille, why not just use a synthesizer. This may be a much cheaper route to take (a complete Versabraille system costs about \$6,000), but after having some experience with packet using a voice synthesizer, I find it to be quite inadequate for such high-speed communication. It takes away the realism of some of packet's most outstanding features. Some of the technical data files on bulletin board systems are not easily "spoken"—a network map, for example. If you are interested in technical information on interfacing a TNC to your synthesizer, please contact me.

These two ways of using packet radio for the blind are just a beginning. Our growing technology promises more and exciting possibilities for all. If any of you would like more information regarding the Versabraille II system, please contact me. I would be happy to share ideas with you. Let us all put our heads together and tackle this new venture. Who knows, since the Versabraille II is completely programmable, the possibilities are almost endless. Remember, feeling is believing.

I would like to thank the man who made my dream reality—Ron Bates AG7H. If it were not for him, this whole venture would still be a dream. He has also helped with technical guidance regarding the hardware interfacing of the computer and the TNC-2. Thanks again, Ron. ■

DOCKING BOOSTER

Converts Your
HT to a Powerful
Mobile Unit



- 30 watts output
- GaAs FET pre-amp
- Fits on car door
- 2 Meters or 70 cm
- Icom
- Kenwood
- Yaesu

NAVAL ELECTRONICS, INC.
5417 Jetview Circle • Tampa, FL 33614
Phone: 813-885-6091 • Telex: 289-237 (NAVL UR)

New for
KENWOOD TH-21AT, 31AT, 41AT
a *Fastcharger*



SPECIAL SALE!

~~\$54.95~~

Now **\$49.95**

Save \$15.00 when ordering
charger with accessories kit.

+ \$3.00 shipping and handling
FL. res. add 5% sales tax

Features:

- Charges in 15 minutes
- Automatic Voltage cut-off
- Battery doesn't heat-up
- 12v-14vdc input
- No memory
- Proven in daily use

Optional AC adapter with DC and mobile cords
available ~~\$19.95~~ \$9.95

Charge-Rite

Call and talk with
Paul WB4WIG or
Dr. "S", WA4DRV

P.O. Box 4175, Vero Beach, FL 32964 (305) 476-8580

So You Want To Be A Sysop?

It's not as easy as it looks.

Nothing has more potential for adding to a packet network than a packet bulletin-board system (BBS). On the other hand, nothing can cause more trouble for a packet network than a BBS. The impact—good or bad—is determined by the skill, planning, and investment of time and funds of the system operator (sysop).

This article describes some of the trials, tribulations, frustrations, and rewards of being a packet BBS sysop. Although written primarily for those considering setting up a BBS, it will also be useful to those who use the BBSs—both to improve their skills as users and to give them some idea of what a sysop has to do to keep the system operating.

Decision Time

Becoming a packet BBS sysop requires a lot more than buying a computer, wiring it up to a TNC, throwing in a couple of disks, and

dialing 145.01 on your rig. In many areas where packet is growing at an amazing rate, frequency time is becoming a valuable commodity and a badly operated BBS can do considerably more harm than good.

Before you embark on setting up a BBS, some planning is in order. You have to look at the packet activity in your area and decide how you can best enhance it with your BBS. The following are several things to be considered:

What user group are you serving?

Who is going to be served by your BBS? What need is there for the system you want to establish? If you are going to be the only system in your area, the answer may be obvious. If you represent a certain group of hams who will use it, that's easy, too. But if you already have one or more local BBSs, what is your system going to add? Are there people out there who need your system? What are they looking for? Is there already a good

mail/message service? Do you have access to information that others don't have? Do you have HF equipment that will let you set up a gateway?

Sit down before you start and map out the objectives of your station. It will help you decide how to configure and operate it.

What frequency is best?

What frequency (or frequencies) are you going to use? Where is most of the packet activity currently located? If you set up on the main frequency, are you going to increase the traffic unbearably? Are there other BBSs on that frequency that operate frequently? If so, there's a good possibility that you'll spend most of your time colliding with each other and nothing will get through. Maybe the best



Photo A. Typical W0RLI/WA7MBL BBS and gateway station. The station includes an IBM-PC clone, two TNCs, a VHF radio, and an HF radio. This is WB6KAJ-1, run by Lee Dusbabek.



Photo B. Closeup of the station pictured in Photo A. The center box is the AEA PM-1 HF modem. Many HF stations are discovering that a modem optimized for HF operations makes a big difference in the number of packets heard without retries. Modified RTTY TUs have also been used with success. The modem included with most TNCs is either a generic PLL-type design or a modem chip designed for telephone use. In some cases, performance of these modems on a noisy HF link is marginal.

thing is to find another frequency and give local users an alternative.

How are you going to forward mail to other BBSs? What frequencies are now used in your network? Can you access those frequencies while operating on others? Do you need to invest in a second TNC and rig to let you forward on one frequency while handling most of your users on another?

Is there a packet frequency-coordination plan in effect for your area? If so, does your planned operation agree with those allocations? Have you notified the frequency-coordination group that you want to put up a BBS? Do you have to?

What services are you going to provide?

Packet radio BBSs can provide a number of different services to their users. What services are you going to provide to yours? I'll discuss the options later in this article.

Being a Good Sysop

There are several things to consider before taking your checkbook in hand and wandering off to the nearest computer-fest. When you put a BBS station on the air, you're taking on a responsibility to the other BBSs and packet users in your area. You're going to put a computer, which can blast out packets at a fantastic rate, on a scarce frequency that others are trying to use for their own communications. You're going to make a system available that, with poor planning on your part or because of an uninformed user, can virtually block a frequency from other use. In my view, you have taken part of a resource that belongs to others, so you have to give something back to make it an even trade.

There are a number of things that I believe a sysop has to do to provide a positive contribution to a packet network. Some of these are:

Enhance, not harm, packet communications.

Make sure that you operate your BBS so it enhances the capabilities of the network. This means conserving precious frequency time. Don't let your BBS spout off a 10-line greeting to everyone who connects. Don't send a 7-line beacon with your name, call, location, and last connect date. Keep your prompts, menus, and commands as short as possible. Remember—while you're sending a 10-line log-on message, someone else is waiting on the frequency for a response from the packet he just sent to his friend across town.

Also, be sure that you have the proper TNC settings for BBS use. I'll discuss these settings later on. Keep in mind that with improper TNC settings, a computer can tie up a frequency and allow *nothing* else to get through. If you do this too often, you'll wind up being hated by every packet operator in your area. Realize that on a common frequency, the BBS should have *lowest* priority.

Deliver the mail.

When you put up a BBS that supports user-to-user messages, you're inviting users to place their traffic there and you're promising

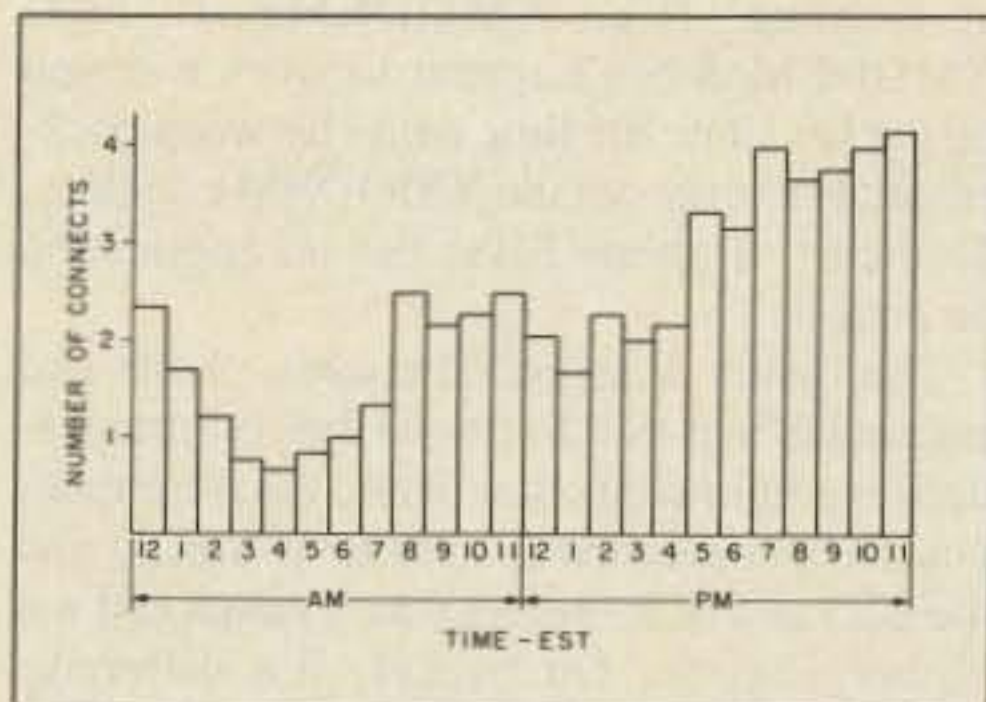

Fig. 1. Most BBS systems are up 24 hours a day. This graph shows the average number of connects by time of day at WB2MNF in March of 1986. The average connect time was 7.7 minutes.

to make your best effort to deliver it. You aren't the U.S. Postal Service, but you shouldn't entice users to leave mail on your system and then not make sure that it gets delivered.

The BBS has to be available when people want to use it. In my experience, this means 24 hours a day, every day. If you decide to put your BBS up during the day, but take it down at night when you need the computer, you'll prevent mail that users have placed there from being delivered. Part-time BBSs aren't effective—people can't use them reliably. If you want to be a good sysop, you have to dedicate a computer to the BBS. This may not mean that you can't use it for something else at the same time—I'll talk a little later about using multi-processing programs on the PC BBSs to let the computer do double duty.

Unless your users are only going to place messages to other local users on your BBS, you have to find a way to deliver messages to those out of your coverage area. In many areas (EASTNET, for example), there is a sophisticated network of forwarding arrangements established to efficiently move mail into and out of the area, as well as handling mail passing through. Any BBS set up in that network that is not coordinated with the other stations can cause major problems for the other stations by dumping mail into the network that the network doesn't know how to deliver. This BBS could also deny its users access to the rest of the network by not participating in coordinated forwarding. Unless you're the only BBS within range of your station, you *must* coordinate mail forwarding with the other BBSs.

Maintain your system.

Keeping a BBS on the air requires a lot of maintenance. Many sysops spend at least an hour every night reading mail, untangling the mail file, removing outdated messages, installing new versions, etc. New versions may crash, which can take two to three hours to fix. Hardware fails, too, and you have to do a certain amount of hardware maintenance. If you don't do this, you won't be able to serve your users properly.

Add something to the information.

Generally a BBS fills up with reasonably good information supplied by users.

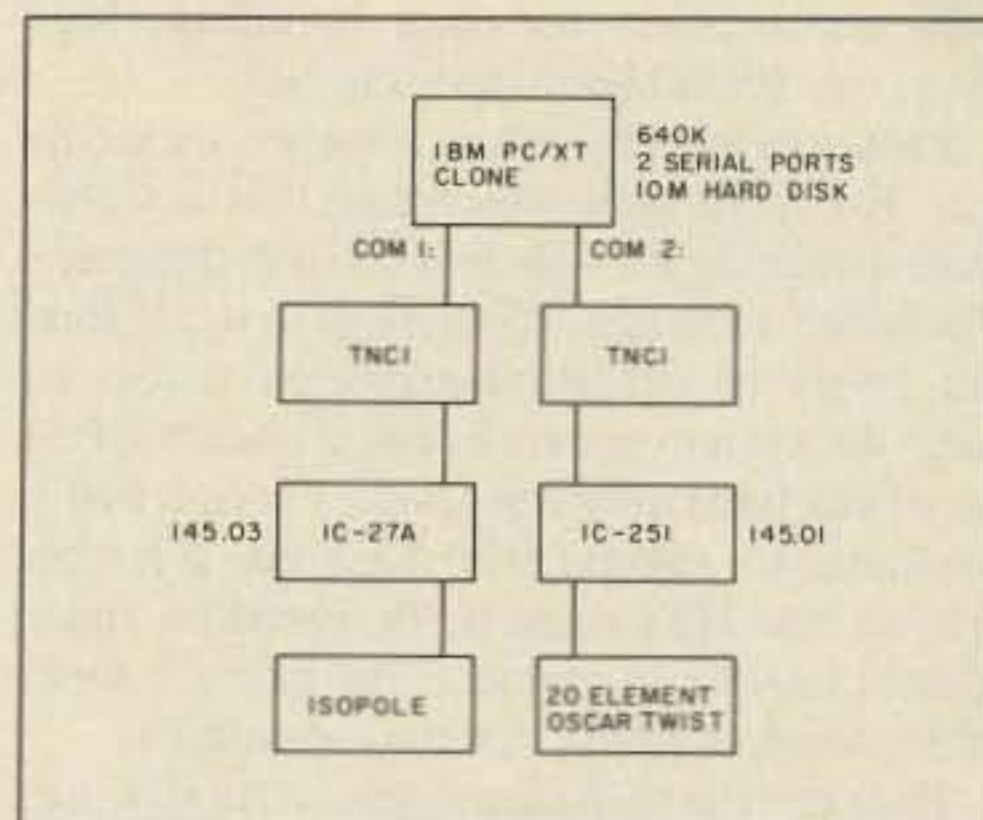

Fig. 2. The BBS system at WB2MNF.

Since you have access to the BBS any time you want it, though, and since you can transfer data faster than anyone accessing it over packet can, it behooves you to add to the information on the BBS. Maybe you're a CompuServe user and can get the *W5YI Report* from HAMNET. Perhaps you can get the useful messages from DRNET, or can post the Keplerian elements for OSCAR. You ought to find some way to add to what your users post.

Be ready to answer questions.

Since the BBS is always there for someone to use, and you obviously know something about packet radio or you couldn't have set it up, don't be surprised if you start getting questions from new users (or old ones) about everything under the sun. Expect your phone to start ringing at least once a week. Expect to see four or five messages a day from users wanting to know about anything at all. Be ready for this and find your own sources for information.

Set a good example.

Whether you like it or not, a BBS takes a high profile in packet activity. It's always on the air and people see it a lot. It is usually the first thing a new user sees. If you're using improper TNC settings (too short a DWAIT, too long a TXDELAY, too many BEACONS, etc.), you're encouraging others to do the same. Make sure that your station is set up properly. It'll help other people get theirs right.

Software Considerations

Any computer system is composed of two parts—the software and the hardware. With most applications, the software comes first in determining the configuration of the system, and the hardware is selected to fit the software. Packet BBSs are no exception.

There are certain factors that you should consider when you select packet BBS software. Packet has some special capabilities that can be utilized to enhance the BBS operation. There are also some things about packet that differ substantially from telephone BBSs, making the latter generally unsuitable for packet use.

First, in packet the caller is identified from the connect message. The BBS knows who you are from the beginning—you don't have to identify yourself. This enhances several

BBS capabilities—message handling, logging, etc. BBSs should use this fact.

Packet radio is by nature a nonsecure medium. Everyone sees everything that is transmitted over the air—there's no such thing as a "private" message. It's useless to use different levels of password-protected access to keep the system secure because packet BBSs generally have only one level of access that's available to anyone who logs on. For this reason, the BBS must be designed to allow almost anyone to connect, but prevent them from doing anything that they shouldn't.

Packet transmissions are virtually error-free because of the AX.25 protocol. Thus, there's no need to add an addition-

al protocol (like XMODEM). In fact, XMODEM doesn't appear to work too well on packet since the time delay between packets tends to time out the XMODEM counters. That part of phone BBSs has no application on packet.

The major difference between phone and packet BBSs is the sharing of the communications medium with other users. On the phone, you have the entire system to yourself, and the BBS can be as verbose as it wants and not bother anyone. On packet, it's different. There are any number of users on the BBS frequency, and a BBS that sprays unnecessary packets out is not very welcome. In particular, menus are a bad idea—they take

too much time to transmit, and most users quickly learn the commands anyway. Also, phone BBSs frequently send extra line feeds in between messages to the user, which detract from the throughput on the frequency. In general, then, phone BBSs are not usually suitable for packet use.

What's Available?

There are a number of different BBSs available for packet use. If you look hard enough you can probably find something that will work on almost any computer. I've seen them for the Commodore 64, the TRS-80 Model 100, and the IBM PC. I'm not really familiar with these, so I won't discuss them in any more detail, except to say that if you decide to put something on the air, please make sure that it's appropriate for packet use.

There are two major packet BBS systems that operate in the EASTNET link. Since I'm familiar with them and not with the others, this article will focus on them.

The WØRLI MailBox system was written around 1984 by Hank Oredson WØRLI. It is written in 8080 and Z-80 assembler specifically for the Xerox 820 computer. Until recently, this computer was the optimal computer for the ham/computer hobbyist because he could pick up fairly good boards for between \$50 and \$75, add on two 8-inch disk drives, and put a power supply on to get a pretty good 64K CP/M computer. The Xerox 820 has two serial communications ports, which makes it ideal for packet applications. It's still a good machine, but the advent of the \$700 PC clone is quickly eating into the market.

To take best advantage of the 820, Hank modified its CP/M specifically for the 820 and MailBox. It won't work on any other computer (so don't ask). Hank makes the source code available on disk, though; so if you're a good 8080/Z-80 programmer, you might want to take a crack at making it work on a different computer.

MailBox supports a number of special features for packet use, including: identification of the calling station at logon from the CONNECTED message; notification of waiting messages at logon; categories of messages, including bulletins and private mail; uploads and downloads of files; notification of another station waiting to use MailBox; "talk to the sysop" paging; capture buffers for sysop use when MailBox is down; automatic forwarding of messages to other MailBox systems; monitoring and logging of frequency activity; and many more. I'd guess that there are at least 100 of these systems operating all over the world.

The other system gaining widespread use is the WA7MBL clone of the WØRLI system. Written by Jeff Jacobsen for the IBM PC, this system looks like the WØRLI system to the user. Almost unbelievably, Jeff wrote the program in Turbo Pascal from Hank's 8080 source code without ever having used a WØRLI MailBox! It has a few features that WØRLI doesn't (and vice versa), but the main advantage of the WA7MBL system

TNC PARAMETERS

The parameters used on the TNC are critical to how well the BBS operates. Some parameters, like ABAUD and PARITY, are determined by the BBS hardware and software. Others, like TXDELAY, are a function of the radios. Of interest here are the parameters that control the way the TNC feeds the packets into the network: DWAIT, FRACK, RETRY, PACLEN, and MAXFRAME. These should be fine-tuned to the characteristics of the network. These are TNC-1 parameters. TNC-2 users adjust accordingly.

DWAIT controls the amount of time that the TNC will wait after seeing a clear frequency before it sends a waiting packet. It thus determines the priority of the stations on the frequency. A station with a DWAIT of 2 will always jump ahead of a station with DWAIT of 15. Since a BBS station sending a long file could literally shut down a frequency by using a low DWAIT, it must use a higher one to allow the shorter packets from the keyboard-to-keyboard people to go through. A BBS on a shared frequency should use a DWAIT of about 15 to be sure that the other users have a shot at the frequency. On a dedicated BBS frequency, though, a lower number should be used to increase throughput.

FRACK is the amount of time that the TNC will wait after sending a packet and not receiving an acknowledgment before sending the same packet again. FRACK should be set considering the load on the network. When the network is heavily loaded, an acknowledgment packet may wait at a station for several seconds until the frequency is free. If the sending station has FRACK set too low, it will re-send the same packet even though the receiving station heard it the first time. This creates needless clutter and slows down the transfer of the data. For normal use a FRACK of 4 should be appropriate, while on moderately heavy links a FRACK of 8 or more is better.

RETRY governs the number of times the BBS will repeat a packet before giving up. This is important for a BBS sending long packets, especially those in the opening greeting message. Often a station will connect with a BBS, but won't hear the BBS well enough to hear its packets. If RETRY is set high, the BBS will pump out its three- or four-line greeting message into the ether many more times than necessary. In general, if a station requires more than about five retries to use a BBS, the link isn't good enough and he shouldn't try it. We have our RETRY set to 6.

PACLEN determines the number of characters in the packet. Most TNCs are set to default to a PACLEN of 128 characters, but there are circumstances where a higher or lower setting may be appropriate. If conditions are bad, a shorter packet has a higher probability of making it through, and PACLEN should be reduced, possibly as low as 40. On the other hand, on a clear frequency with local links, PACLEN can be increased up to 256.

MAXFRAME sets the number of frames to be contained in a single transmission. A MAXFRAME of 4 means that four packets are sent at once. Like PACLEN, this parameter is also sensitive to frequency conditions. If conditions are good, using a higher MAXFRAME improves the speed of the data transfer, since more data is being sent in each transmission. On the other hand, if many packets are not getting through, a higher MAXFRAME means that more data is being wasted each time and that a better throughput could be achieved by reducing MAXFRAME.

Here are some recommended settings for these parameters:

- For a frequency shared with other users and BBS stations with moderate load: DWAIT 15, FRACK 6, RETRY 6, PACLEN 128, MAXFRAME 3.
- For a frequency heavily loaded with users, BBSs, and digipeaters: DWAIT 15, FRACK 10, RETRY 8, PACLEN 80, MAXFRAME 1.
- For a dedicated BBS frequency with no keyboard-to-keyboard users and strong links: DWAIT 2, FRACK 4, RETRY 4, PACLEN 256, MAXFRAME 6.

You should review the performance of your BBS and its impact on the frequency at frequent intervals, and adjust these parameters as appropriate.

is that it runs on the PC. This means that you have 360K floppy disks instead of the 241K disks for the 820. You can also put on a hard disk (I have a 10-megabyte hard disk on my system) and have almost unlimited storage. Jeff hasn't released the source code for the system (so don't ask) because it's still being tested. By the time this article appears, though, it may be available for general use.

There is also some basic documentation available for these systems, written by WB2MNF. The manual for the WØRLI system is fairly up-to-date and somewhat long (about 75 pages). The WA7MBL manual is a little shorter and less complete—hopefully it will grow over the summer when WB2MNF has more chance to work on it.

The disks and manuals are being handled by Wes Morris K7PYK at 7422 E. McKinley Street, Scottsdale AZ 85257; (602)-945-6079 or 946-8356. Wes will send you the disks and documentation for either the WA7MBL or WØRLI system for postage costs. Contact him for current prices.

Software Support

An important factor in setting up a BBS system is support from people who know what they are doing. One rule should be followed: *Don't call Jeff or Hank with questions!* With hundreds of installations springing up over the country, neither of these guys has the time to help every sysop get going. It's also best for the network to let Jeff and Hank spend their time writing code for the BBS systems, not talking on the phone.

So who do you call? The best place to start is your local sysop. He's obviously conquered the system or he wouldn't be on the air. Drop him a note on the BBS and tell him what you've decided and ask for help.

If there's no BBS in your area and nobody knows anything about them, you might want to check out the HAMNET SIG on CompuServe. There's an active packet group there and a special section for BBS sysops. A lot of active sysops hang out there and you can get answers quite quickly.

Equipment

As in any type of computer application, the availability of software determines the hardware to use. As I just described, there are two major types of packet BBSs in wide use—one running on an IBM PC or clone, the other on a Xerox 820. It doesn't take a whole lot of deductive ability to see that if you want to use either of these programs, you'll have to use one of these computers.

Xerox 820's were available in quantity about a year ago, but good ones are getting few and far between. A number of BBS operators who ran them and switched to PCs may have them assembled and for sale, so check around on the boards.

The PC clone is getting cheaper every day. Systems are offered at hamfests and computefests for less than \$800, complete with disk drive (or two), keyboard, monitor, and a very IBM-looking case. Check these things out and be sure that you know what you're getting. Although the WA7MBL BBS will run in

256K, many sysops use DoubleDos or some other multi-processing program to use the computer for something else while the BBS is running, and this will require much more memory.

You also might want to look into using a hard disk. Prices for these are dropping quickly, to the extent that a 10-megabyte hard drive will cost only about \$125 more than a floppy drive. It's definitely the way to go if you can afford it.

A TNC is obviously required to set up a BBS system. With the plethora of TNCs springing up, some discretion should be exercised in deciding which one you should use.

The TNC you choose has to be supported by the BBS software. The WØRLI and WA7MBL systems support the TAPR command set, used by the TNC-1, the TNC-2, and their clones. If you use one of these TNCs, you're pretty safe. If you want to use something else, you should check with a sysop using the TNC you're considering to be sure that it works OK with the software.

The other consideration is how many TNCs you want to put up. Both BBS packages support two TNCs and rigs, allowing the BBS to cover two different frequencies, bands, baud rates, etc. This allows the WB2MNF BBS to access EASTNET on its primary frequency of 145.01, while also using 145.03 for local stations that only want to work the BBS. It also allows KC2TN to "gateway" messages from 2 meters to a group of BBS stations operating on 20 meters for long-haul traffic forwarding, and lets WB2RVX keep a port on 145.01 while maintaining capabilities for 9600-baud forwarding on 220 MHz when that becomes a reality.

The problem generally is that the primary frequency, which is where you want to do your forwarding, is generally too busy to support another BBS. You have to decide how you're going to maintain contact with the forwarding network without clobbering the stations on that frequency with "yet another BBS." Two TNCs and rigs may be the way around this.

Message Forwarding

One of the most useful features of a BBS is the ability to handle personal messages between packet users in the network. By "personal messages," I mean messages specifically addressed to an individual from another station. Stations logging into a BBS can be greeted by name and told of messages waiting for them. Messages are addressed to a specific callsign or to a designated name like ALL or NTS.

Packet radio jumped up a notch when WØRLI released the message-forwarding capability of his MailBox system. This allows the sysop to develop a forwarding file that lists the paths to other BBS stations and the calls of stations whose mail should be forwarded to that station. When a station leaves a message addressed to a station at a distant BBS, the local BBS will, at its appointed time, go off-line and connect with the distant BBS and send the message there.

With good coordination of sysops in a net-

work, messages can be daisy-chained over long stretches in a remarkably short period of time, being relayed by a number of BBS stations along the way. This generally occurs overnight (except on HF), and it all happens without operator intervention. A message may show up from the south on a BBS, which will promptly relay it to the next station to the north—all without the sysop doing anything. The EASTNET network has reliable message forwarding from Canada down through Virginia and west to Pittsburgh on VHF.

Considerations

As a mail server, you should know about certain requirements on the BBS system. Some of these are:

Maintenance—If you want to handle a lot of mail, be prepared for more than the usual amount of maintenance. Mail files have to be compacted, old messages must be removed, and occasionally messages have to be recovered from system crashes.

Forwarding—You also have to coordinate mail forwarding with the other sysops in the network. It's important to know how to get mail to other BBSs, and it takes a coordinated effort to do it. If you expect to handle mail and can reach another BBS, get in contact with the sysop and work out the forwarding times and stations list with him.

Disk space—Mail files take a lot of space on a BBS. When I was running the WØRLI software on the Xerox, my whole B drive was mail files. I couldn't put anything else on there. This limited my ability to handle files—I just didn't have room to put up the *Gateway* newsletter every two weeks. Keep this in mind when you're planning your system. (*Gateway* is the bi-weekly packet-radio newsletter published by the ARRL. Excerpts suitable for transmission on the amateur bands can be found on many BBS systems. The full paper issue is available by subscription.)

File Transfers

The WØRLI and WA7MBL BBS systems will handle files as well as messages. Files may contain any type of information—text, programs, data, etc. Some of the files that I have on my system are issues of *Gateway*, tracking programs for the TRS-80 Model 100, minutes of the local packet organization, programs for the PC, news items downloaded from CompuServe, the text of relevant FCC issuances, a current set of Keplerian elements for ham-radio satellites, and descriptions of how to use the BBS. These can be loaded onto the BBS by the sysop, as well as by users.

There are a number of sources for these files. Some are created by the sysop or from messages sent by others. Some, like the ARRL bulletins, come from a different amateur-radio medium. Others may come from land-line BBSs, from commercial timesharing services like CompuServe's HAMNET special interest group, from DRNET or USENET, or from BBS users who have access to these services. With good coordination among sysops, many can be forwarded from BBS to BBS.

The sysop has a responsibility to try to get useful information to his users. Many sysops spend their own money on commercial services to get information that isn't available elsewhere. Whether you do this or not is up to you, but if you let the files on your BBS stagnate, you're not adding as much as you could to the packet network.

Don't overlook the opportunity for your users to contribute files to the packet network. Many packet users have access to these types of services also. If you can enlist the aid of a few individuals to help you keep your files up-to-date, it will save you a lot of time and make your BBS more useful to the local packet community.

Programs

One good use of packet radio that hasn't been explored a lot is the transfer of computer programs. If your users include a number of computer hobbyists, this might be an interesting area for you. Programs can be either ASCII text files (Basic programs or other source-code files) or, with a little adaptation on both ends, binary files.

First, though, you have to consider a few things. What kind of computers are you going to serve? What do most of your potential users have? Most will probably have a different type of computer than you do, which means that you may not be able to run the programs that are going to be transferred through your BBS. That shouldn't be too much of a problem, but it might be a little disconcerting to you.

Commodore 64 computers use a strange version of ASCII called PETASCII. This means that you can't just read an ASCII Basic into a C-64—before you send the file, you have to convert it from PETASCII to ASCII, then convert it on the other end back into PETASCII.

IBM PCs and clones use Basic programs as straight ASCII files, so they can be transferred with little additional work. If you want to transfer COM or EXE files, though, you have to convert them to hexadecimal format before you transfer them to the BBS. This is because the BBS programs described in this article operate in CONVERSE mode, which doesn't pass all binary characters, rather than in TRANSPARENT mode, which does.

There are several programs that will perform this conversion—the one we use at WB2MNF is called HC.COM and came from CompuServe. There's also a Basic program called MAKEHC.BAS, which will create the file HC.COM. The advantage to MAKEHC.BAS is that it's ASCII and can be downloaded directly by any user, who then runs it to create HC.COM. Once he has HC.COM, he can convert back to COM or EXE the files that you had to convert to hexadecimal on the BBS. HC.COM goes both ways—from COM or EXE to hexadecimal and back.

Many computers use Basic as a sort of operating system. These computers may or may not accept Basic programs in ASCII format. Frequently Basic is "tokenized"—each Basic command or keyword is held as a specific symbol rather than the text of that

word. Thus, instead of holding the PRINT command as the letters P-R-I-N-T, Basic would use a single 8-bit symbol to represent the PRINT command. The TRS-80 Model 100 uses this approach, as do a number of other computers.

Many of these computers provide for converting tokenized Basic to ASCII text, and this would be the easiest way to transfer these files through the BBS systems. Failing this, they would have to be converted to hexadecimal files as described above.

How Big Can Programs Be?

Another consideration relating to transfer of program files is the capacity of the network to pass large files. If your BBS operates on a dedicated BBS frequency, you can probably pass quite large files. On the other hand, if you share a frequency with other BBSs and users, your capacity for large file transfers is quite limited. On the 145.01 general frequency used in our area, the maximum file size that can generally be passed without losing the connection is about 15,000 bytes. On 145.03, which is a dedicated BBS frequency, we have transferred files in excess of 60,000 bytes with no problems. Since making a hexadecimal file out of a COM file will double its size, and since many interesting COM files are larger than 20,000 bytes, you may be limited in your ability to transfer anything useful by the capacity of the network in your area.

One side note: The problem with passing binary files occurs only with BBSs that can't operate in TRANSPARENT mode. If you're transferring files between two TNCs and can operate that way, there's nothing stopping you from transferring binary data.

Getting Set Up

Once you've worked out all the nontechnical aspects of getting the BBS operational (you know what frequency you're going on, how you're going to forward mail, where you're going to get file data, etc.), it's time to start hooking things together. The hookup between the radios and the TNCs isn't too complicated, and I'll assume that you've been able to do that already. The TNC connects to the serial port of the computer with an RS-232 cable similar to the one used to hook up a modem. You have to be sure that you have all of the pins of the cable connected from one connector to the other since various versions of both systems use the handshaking lines of the cables to tell the computer and the TNC when the other is ready.

You also have to configure some files for the BBS. Both systems have configuration files, which allow you to customize the boards to a large degree. Generally you can alter anything the BBS says to a user—the greeting message, prompts, error messages, etc. Edit the configuration files, read the explanation on the lines, and change the information appropriately.

The forwarding file also has to be set up. This file is called FWD.TNC on both systems and determines which messages get forwarded to which BBS stations. It also determines

which hours you will forward and which you won't. This allows you to avoid forwarding mail during prime times when the frequencies are in heavy use.

Forwarding files specify where messages addressed to certain stations should go. The format of a forwarding file is:

```
FAsseeC bbs VIA digi1, digi2
station1
station2
etc.
*** EOF
```

where *ss* is the starting hour for forwarding, *ee* is the ending hour for forwarding, *bbs* is the call of the BBS to which you wish to forward mail, *digi1* and *digi2* (and any other digipeaters) are the digipeaters through which you have to digipeat to get to the BBS, and *station1*, *station2*, etc. are the stations whose mail should be forwarded to the BBS.

Stations that originate messages specify that mail should be forwarded to a distant BBS by following the call of the addressee with an @ sign and the call of the distant BBS. Thus, to send mail to WB2AFM, who receives his mail at the W1AW BBS, the command is: S WB2AFM @ W1AW. This presumes that the BBS at which the message was originated has W1AW in its forwarding file.

Sometimes your BBS can't forward to the destination BBS directly and must send messages to an intermediate BBS, which will then take care of forwarding it on down the line. This happens in EASTNET quite frequently. If a message is originated on the W3IWI BBS in Maryland and is addressed to a station using the W1AW BBS, W3IWI doesn't attempt to forward it directly to W1AW. Instead it will send it to WB2RVX in southern New Jersey, which will forward it to WA2SNA-2 in northern New Jersey, which may forward it to AI2Q on Long Island, New York, which may deliver it at W1AW. This all happens automatically without the manual intervention of the sysop, and generally occurs overnight. As you can imagine, though, it requires a lot of coordination among the sysops to be sure that the messages get going in the right direction.

You'll have to get together with the sysops in your area to decide on forwarding times. Each station in a network is assigned a time to forward messages to the other stations. Times must be coordinated so that two stations don't try to forward to each other at the same time.

A Real Live BBS System

It might be useful to look at an operating BBS station to see how things might be organized. The BBS at WB2MNF has been operating since November of 1984, first on a Xerox 820 running the WØRLI program and recently using a PC/XT clone dedicated to the BBS with the WA7MBL code. We handled over 7,000 messages on the 820 and are up to about message 1,500 on the PC.

The PC has a 10-megabyte hard disk, which provides for plenty of storage space. About 5 megabytes is filled with packet files,

with the rest used for other things. The disk is divided into "directories," which separate the files into logical groups. I have directories for AMSAT, ARES, GATEWAY, MODEL100, IBMPC, and several other areas of interest.

I use the DoubleDos program available from SoftLogic, which lets me run the BBS program on one "side" and still have access to the computer on the other. I can switch between them at will. Others who "share" their computers with the BBS may use DoubleDos, DesQview (from Quarterdeck Software), or some other multi-tasking program to use the computer for something else while the BBS is running.

The WA7MBL program lets you operate the BBS with two different TNCs and radios on two different frequencies. The primary frequency in our area is 145.01; it's crowded almost constantly, so I run one port on 145.01 and the other on 145.03. When one is in use the other is unavailable, but it does provide access for distant users on .01 while letting more local users enjoy less QRM on .03. I have two TAPR TNC-1s connected to an IC-27A and an Isopole on .03, and an IC-251 and OSCAR twist on .01. Although not optimal, this lets me cover most of the local service area.

Personal Message System

One message-handling system that has received surprisingly little attention is the Personal Message System (PMS). A PMS is a

BBS system that handles data only for its sysop. At first glance this may seem a bit selfish, but under careful consideration it makes a lot of sense.

A PMS allows the sysop to compose a message to another station without having to be connected to a BBS. The message stays on the PMS and can be read by the addressee if he happens to log in. If not, the PMS forwards the message to the addressee (if he also has a PMS) or to the addressee's BBS. This can happen overnight or during other periods of light use of the frequency. It also makes things a lot easier for the user—at night you type in all of your mail, and by the next morning it's been delivered to the destinations and you have new mail that was forwarded to you. It's the difference between having mail delivered to your front door or having to go to the post office.

Any of the BBS software mentioned earlier can be used as a PMS. There are also default parameters in the forwarding files that let you say, in essence, "Send any mail not addressed to me to the W1ABC BBS." This lets you forward all outgoing mail to your local BBS, which will then distribute it into the network.

If you don't happen to have a PC or Xerox 820 to use for a PMS, but would like to try a receive-only system, W3IWI demonstrated that the TNC-2 and clones can be set up to operate that way. The W0RLI and WA7MBL BBS systems look for the following sequence of responses when connected to a BBS to

which they are forwarding: the > character at the end of the prompt line, two lines ending with a <cr> character, and another > character at the end of the next prompt line.

This sequence can be programmed into the CTEXT of the TNC-2 and should be repeated to allow several messages to be forwarded during one connect. The computer connected to the TNC should have a "capture buffer" or "save to disk" enabled to record the forwarded messages. Finally, the MONITOR function on the TNC should be turned off to keep from filling the buffer with every packet that comes through.

Packet users wanting to use this system should notify their local sysop that they want to accept forwarding. The sysop will then add their station to the forwarding files of the BBS, and any messages arriving at the BBS should be forwarded to them at the next forwarding time.

Conclusions

If being a sysop doesn't sound like the picnic that you thought it might, then you haven't missed the point of this article. Packet-radio bulletin-board systems are an important addition to local packet activity and will form an important part of the ever-expanding packet network. There's a lot to making them work effectively, though, and sysops should be aware of the considerations surrounding their operation. Even if you don't want to be a sysop, knowing what a sysop has to go through can help make you a better user. ■



MAGGIORE ELECTRONIC LAB.

Manufacturers of Quality Communications Equipment

- Repeaters
- Links
- Remote Base
- Low Band, VHF, UHF
- Receivers
- Transmitters
- Antennas



Hi Pro 'E'

EXPANDABLE REPEATER SYSTEM

- Standard and Computerized Controllers
- Standard and Computerized Auto Patches
- Duplexers

- A NEW CONCEPT IN REPEATER DESIGN, THE Hi Pro "E" IS AN EXPANDABLE REPEATER WITH THE FOLLOWING FEATURES: A BASIC REPEATER WHICH WOULD INCLUDE A COMPLETE RECEIVER, TRANSMITTER, COR, FRONT PANEL CONTROLS AND INDICATORS, LOCAL SPEAKER AND MIC JACK AND CAPABLE OF FUTURE EXPANSION. ALL HOUSED IN AN EXTREMELY RUGGED, ENCLOSED, 19-INCH RACK MOUNTABLE CABINET.
- THIS SYSTEM CAN BE EXPANDED AT TIME OF PURCHASE OR CAN BE AN AFTER-PURCHASE ADD ON. THE ADD ONS ARE—HIGHER POWER, 110/220 VAC POWER SUPPLY, IDENTIFIER, AUTO PATCH, OR COMPUTER CONTROLLERS. IN ADDITION TO THESE ADD ONS AN ADDITIONAL RECEIVER AND TRANSMITTER CAN BE MOUNTED INTERNALLY FOR USE AS CONTROL LINKS, REMOTE BASE OR DUAL BAND OPERATION, ETC.
- AN EXTENSION PANEL IS AVAILABLE FOR LOCAL MONITORING OF THE REPEATER AND CONTAINS ALL NECESSARY METERING, STATUS LIGHTS AND INDICATORS. ALL ADD ONS ARE AVAILABLE FROM THE COMPANY AND ARE COMPLETE INCLUDING INSTRUCTIONS. THE Hi Pro "E" IS AVAILABLE IN NOVEMBER.

MAGGIORE ELECTRONIC LAB.

600 Westtown Rd.

West Chester, PA 19382

Phone (215) 436-6051

Telex 499 0741 MELCO

✓47

WRITE OR CALL FOR OUR COMPLETE CATALOG

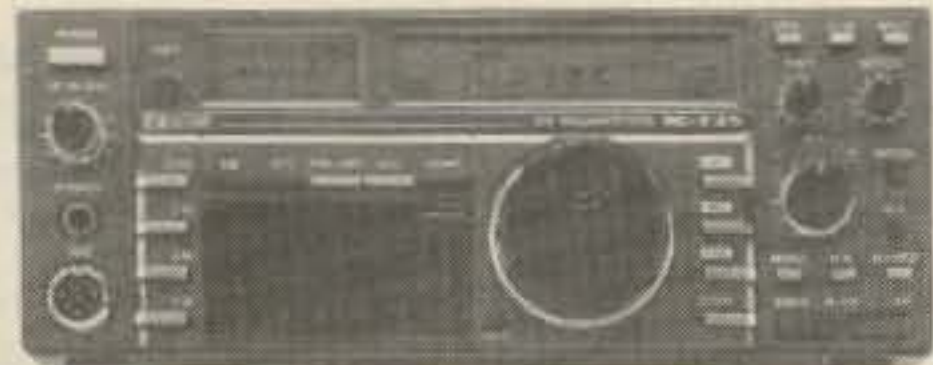

HF Equipment	Regular	SALE
IC-735 HF transceiver/SW rcvr/mic	889.00	769 ⁹⁵
PS-55 External power supply	169.00	149 ⁹⁵
AT-150 Automatic antenna tuner	399.00	359 ⁹⁵
FL-32 500 Hz CW filter	59.50	
EX-243 Electronic keyer unit	50.00	
UT-30 Tone encoder	16.50	



IC-745 9-band xcvr w/.1-30 MHz rcvr	999.00	799 ⁹⁵
PS-35 Internal power supply	169.00	149 ⁹⁵
EX-241 Marker unit	20.00	
EX-242 FM unit	39.00	
EX-243 Electronic keyer unit	50.00	
FL-45 500 Hz CW filter (1st IF)	59.50	
FL-54 270 Hz CW filter (1st IF)	47.50	
FL-52A 500 Hz CW filter (2nd IF)	96.50	89 ⁹⁵
FL-53A 250 Hz CW filter (2nd IF)	96.50	89 ⁹⁵
FL-44A SSB filter (2nd IF)	159.00	144 ⁹⁵
SM-6 Desk microphone	40.00	
HM-12 Extra hand microphone	39.50	
MB-12 Mobile mount	21.99	



IC-751 9-band xcvr/.1-30 MHz rcvr	1399.00	999 ⁰⁰
IC-751A 9-band xcvr/.1-30 MHz rcvr	1499.00	1299
PS-35 Internal power supply	169.00	149 ⁹⁵
FL-32 500 Hz CW filter (1st IF)	59.50	
FL-63 250 Hz CW filter (1st IF)	48.50	
FL-52A 500 Hz CW filter (2nd IF)	96.50	89 ⁹⁵
FL-53A 250 Hz CW filter (2nd IF)	96.50	89 ⁹⁵
FL-33 AM filter	31.50	
FL-70 2.8 kHz wide SSB filter	46.50	
HM-12 Extra hand microphone	39.50	
SM-6 Desk microphone	40.00	
RC-10 External frequency controller	35.00	
MB-18 Mobile mount	21.99	

Other Accessories:	Regular	SALE
PS-15 20A external power supply	149.00	134 ⁹⁵
PS-30 Systems p/s w/cord, 6-pin plug	259.95	234 ⁹⁵
OPC Opt. cord, specify 2, 4 or 6-pin	10.00	
SP-3 External speaker	54.50	
SP-7 Small external speaker	49.00	
CR-64 High stab. ref. xtal (745/751)	56.00	
PP-1 Speaker/patch (specify radio)	139.00	129 ⁹⁵
SM-8 Desk mic - two cables, Scan	69.95	
SM-10 Compressor/graph EQ, 8 pin mic	119.00	109 ⁹⁵
AT-100 100W 8-band auto. antenna tuner	399.00	359 ⁹⁵
AT-500 500W 9-band auto. antenna tuner	499.00	449 ⁹⁵
AH-2 8-band tuner w/mount & whip	549.00	489 ⁹⁵
AH-2A Antenna tuner system, only	429.00	389 ⁹⁵



Check the Prices at AES®!

Other Accessories cont.		Regular	SALE
GC-4 World clock • (CLOSEOUT) •		99.95	69 ⁹⁵
GC-5 World clock		79.95	
HF linear amplifier		Regular	SALE
IC-2KL 160-15m solid state amp w/ps		1795.00	1389
6-meter VHF Portable		Regular	SALE
IC-505 3/10W 6m SSB/CW portable		469.00	419 ⁹⁵
BP-10 Internal Nicad battery pack		79.50	
BP-15 AC charger		12.50	
EX-248 FM unit		49.50	
LC-10 Leather case		34.95	
VHF/UHF base multi-modes		Regular	SALE
IC-551D 80W 6-meter SSB/CW		735.00	649 ⁹⁵
EX-106 FM option		125.00	112 ⁹⁵
BC-10A Memory back-up		8.50	
IC-271A 25W 2m FM/SSB/CW		735.00	649 ⁹⁵
AG-20 Internal preamplifier		56.95	
IC-271H 100W 2m FM/SSB/CW		944.00	789 ⁹⁵
AG-25 Mast mounted preamplifier		84.95	
IC-471A 25W 430-450 SSB/CW/FM xcvr		839.00	729 ⁹⁵
AG-1 Mast mounted preamplifier		89.00	
IC-471H 75W 430-450 SSB/CW/FM		1149.00	989 ⁹⁵
AG-35 Mast mounted preamplifier		84.95	
Accessories common to 271A/H and 471A/H			
PS-25 Internal power supply for (A)		99.00	89 ⁹⁵
PS-35 Internal power supply for (H)		169.00	149 ⁹⁵
PS-15 External power supply		149.00	134 ⁹⁵
SM-6 Desk microphone		40.00	
EX-310 Voice synthesizer		41.25	
TS-32 CommSpec encode/decoder		59.95	
UT-15 Encoder/decoder interface		12.50	
UT-15S UT-15S w/TS-32 installed		79.95	
VHF/UHF mobile multi-modes		Regular	SALE
IC-290H 25W 2m SSB/FM, TTP mic		549.00	479 ⁹⁵
IC-490A 10W 430-440 SSB/FM/CW		649.00	569 ⁹⁵
VHF/UHF/1.2 GHz FM		Regular	SALE
IC-27A Compact 25W 2m FM w/TTP mic		389.00	349 ⁹⁵
IC-27H Compact 45W 2m FM w/TTP mic		429.00	379 ⁹⁵
IC-28A 25W 2m FM, UP/DN mic		419.00	369 ⁹⁵
IC-28H 45W 2m FM, UP/DN mic		449.00	399 ⁹⁵
UT-29 Tone squelch		41.00	
HM-16 Speaker/microphone		39.00	
IC-37A Compact 25W 220 FM, TTP mic		449.00	349 ⁹⁵
IC-47A Compact 25W 440 FM, TTP mic		489.00	429 ⁹⁵
PS-45 Compact 8A power supply		112.95	99 ⁹⁵
UT-16/EX-388 Voice synthesizer, 47A		31.00	
SP-10 Slim-line external speaker		31.95	
IC-3200A 25W 2m/440 FM w/TTP		569.00	469 ⁹⁵
UT-23 Voice synthesizer		31.00	
AH-32 2m/440 Dual Band antenna		32.95	
Larsen PO-K Roof mount		20.00	
Larsen PO-TLM Trunk-lip moun		20.18	
Larsen PO-MM Magnetic mount		19.63	
IC-1271A 10W 1.2 GHz SSB/CW Base		1049.00	929 ⁹⁵
PS-25 Internal power supply		99.00	89 ⁹⁵
EX-310 Voice synthesizer		41.25	
TV-1200 ATV interface unit		115.00	106 ⁹⁵
UT-15S CTCSS encoder/decoder		79.95	
IC-120 1W 1.2 GHz FM Mobile		499.00	449 ⁹⁵
ML-12 1.2 GHz 10W amplifier		339.00	299 ⁹⁵
Repeaters		Regular	SALE
RP-3010 440 MHz, 10W FM, xtal cont.		1049.00	949 ⁹⁵
RP-1210 1.2 GHz, 10W FM, 99 ch. synth		1259.00	1129
Cabinet for RP-1210 or 3010		269.00	



Hand-held Transceivers	
Deluxe models	Regular SALE
IC-02AT for 2m	369.00 299 ⁹⁵
IC-04AT for 440 MHz	399.00 339 ⁹⁵
Standard models	Regular SALE
IC-2A for 2m	239.00 189 ⁹⁵
IC-2AT with TTP	269.50 209 ⁹⁵
IC-3AT 220 MHz, TTP	299.95 249 ⁹⁵
IC-4AT 440 MHz, TTP	299.95 249 ⁹⁵

Accessories for Deluxe models		Regular
BP-7 425mah/13.2V Nicad Pak - use BC-35		67.50
BP-8 800mah/8.4V Nicad Pak - use BC-35		62.50
BC-35 Drop in desk charger for all batteries		74.95
BC-60 6-position gang charger, all batts	SALE	349.95
BC-16U Wall charger for BP7/BP8		19.95
LC-11 Vinyl case		18.49
LC-14 Vinyl case for Dlx using BP-7/8		18.49
LC-02AT Leather case for Dlx models w/BP-7/8		39.95
Accessories for both models		Regular
BP-2 425mah/7.2V Nicad Pak - use BC35		42.50
BP-3 Extra Std. 250 mah/8.4V Nicad Pak		31.25
BP-4 Alkaline battery case		13.75
BP-5 425mah/10.8V Nicad Pak - use BC35		49.50
CA-5 5/8-wave telescoping 2m antenna		18.95
FA-2 Extra 2m flexible antenna		10.00
CP-1 Cig. lighter plug/cord for BP3 or Dlx		10.75
CP-10 Battery separation cable w/clip		19.99
DC-1 DC operation pak for standard models		18.75
EX-390 Bottom slide cap		4.95
MB-16D Mobile mtg. bkt for all HTs		21.99
LC-2AT Leather case for standard models		39.95
RB-1 Vinyl waterproof radio bag		30.00
HH-SS Handheld shoulder strap		14.95
HM-9 Speaker microphone		39.00
HS10 Boom microphone/headset		19.50
HS-10SA Vox unit for HS-10 & Deluxe only		19.50
HS-10SB PTT unit for HS-10		19.50
ML-1 2m 2.3w in/10w out amplifier	SALE	89.95
SS-32M Commspec 32-tone encoder		29.95

Receivers		Regular	SALE
R-71A 100 kHz-30 MHz, 117V AC		\$849.00	689 ⁹⁵
RC-11 Infrared remote controller		59.95	49 ⁹⁵
FL-32 500 Hz CW filter		59.50	
FL-63 250 Hz CW filter (1st IF)		48.50	
FL-44A SSB filter (2nd IF)		159.00	144 ⁹⁵
EX-257 FM unit		38.00	
EX-310 Voice synthesizer		41.25	
CR-64 High stability oscillator xtal		56.00	
SP-3 External speaker		54.50	
CK-70 (EX-299) 12V DC option		10.95	
MB-12 Mobile mount		21.99	
R-7000 25 MHz-2 GHz scanning rcvr		969.00	849 ⁹⁵
RC-12 Infrared remote controller		59.95	
EX-310 Voice synthesizer		41.25	
AH-7000 Radiating antenna		89.95	(7)

HOURS • Mon. thru Fri. 9-5:30; Sat. 9-3
 Milwaukee WATS line: 1-800-558-0411 answered evenings until 8:00 pm Monday thru Thursday.
Please use WATS lines for Ordering
 use Regular lines for other Info and Service dept.

All Prices in this list are subject to change without notice.

Order Toll Free: 1-800-558-0411 In Wisconsin (outside Milwaukee Metro Area) 1-800-242-5195

AMATEUR ELECTRONIC SUPPLY® Inc.

4828 W. Fond du Lac Avenue; Milwaukee, WI 53216 • Phone (414) 442-4200

AES® BRANCH STORES

Wickliffe, Ohio 44092		Orlando, Fla. 32803		Clearwater, Fla. 33575		Las Vegas, Nev. 89106		Chicago, Illinois 60630	
28940 Euclid Avenue		621 Commonwealth Ave.		1898 Drew Street		1072 N. Rancho Drive		ERICKSON COMMUNICATIONS	
Phone (216) 585-7388		Phone (305) 894-3238		Phone (813) 461-4267		Phone (702) 647-3114		5456 N. Milwaukee Avenue	
Ohio WATS 1-800-362-0290		Fla. WATS 1-800-432-9424		No In-State WATS		No In-State WATS		Phone (312) 631-5181	
Outside Ohio 1-800-321-3594		Outside Florida 1-800-327-1917		No Nationwide WATS		Outside Nevada 1-800-634-6227		Outside Illinois 1-800-621-5802	

SAVE on these AES/KENWOOD Specials!



TW-4000A 25W, 2m/440 FM dual band Xcvr
Call for New Low Sale Price

TU-4C Programmable encoder (\$39⁹⁵ Value)
Now only \$1 with TW-4000A purchase.

TM-2570A 70W, 2m FM Transceiver w/TTP
Call for Sale Price

TU-7 Programmable encoder (\$24⁹⁵ Value)
Now only \$1 with TM-2570A purchase.

R-11
SW Receiver
CLOSEOUT
SAVE \$50

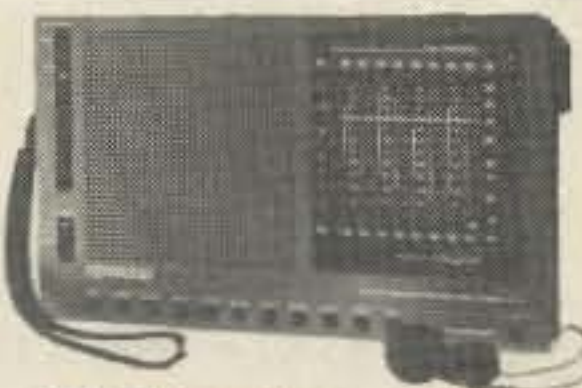

Features: 11 bands - AM, FM broadcast + 13, 16, 19, 22, 25, 31, 41, and 49M SW bands. No BFO. Bandspread tuning, meter, 3" speaker, record/phone jacks, whip/ferrite antennas. 7 1/2" w x 4 1/2" h x 1 1/2" d, requires 4 'AA' cells. Soft case and earphone, shown with optional HS-7 micro-headphones (\$19⁹⁵)... **Closeout \$69⁹⁵**

FM or Microphone • FREE!



with **KENWOOD TS-430S**

For a Limited time, purchase the TS-430S at our normal Low Sale Price and receive your choice of the optional MC-42S Up/Down hand Microphone or FM-430* FM Unit at . . . **NO EXTRA CHARGE.**

*The FM-430 provides HF FM transmit and receive capability on bands where authorized.

Call for our Low Sale Price!

Due to changing prices and limited quantities, all listings in this page are subject to change without notice. Please check with salesperson when ordering.



FREE Extra Battery!

For a Limited time! . . . Purchase a TR-2600A or TR-3600A at our LOW Sale Price and receive an extra PB-26 battery pack - **FREE!**

or

Purchase any of the TH-Series handhelds at our LOW Sale Price and receive an extra PB-21 battery pack - **FREE!**

Call for Sale Prices



Only a few left!

KENWOOD DFC-230 Digital Frequency Controller for TS-120S, 130S/SE, 530S, 830S. 20 Hz steps, 4 memories, scan, UP/DN mic. **Closeout \$169⁹⁵**

Order Toll Free: 1-800-558-0411

In Wisconsin (outside Milwaukee Metro Area)
1-800-242-5195

AMATEUR ELECTRONIC SUPPLY[®] Inc.

4828 W. Fond du Lac Avenue; Milwaukee, WI 53216 - Phone (414) 442-4200

AES BRANCH STORES

WICKLIFFE, Ohio 44092
28940 Euclid Avenue
Phone (216) 585-7388
Ohio WATS 1-800-362-0290
Outside Ohio 1-800-321-3594

ORLANDO, Fla. 32803
621 Commonwealth Ave.
Phone (305) 894-3238
Fla. WATS 1-800-432-9424
Outside Florida 1-800-327-1917

CLEARWATER, Fla. 33575
1898 Drew Street
Phone (813) 461-4267
No In-State WATS
No Nationwide WATS

LAS VEGAS, Nev. 89106
1072 N. Rancho Drive
Phone (702) 647-3114
No In-State WATS
Outside Nevada 1-800-634-6227

Associate Store

CHICAGO, Illinois 60630
ERICKSON COMMUNICATIONS
5456 N. Milwaukee Avenue
Phone (312) 631-5181
15 min. from O'Hare!

Please use WATS line for Ordering and Price Checks. For other Info and Service Dept., please use our Regular lines.

Contact AES[®]
for all of your
KENWOOD needs!

- ★ Low Prices ★ Large Stocks ★ Fast Service
- ★ Top Trades ★ Toll Free Ordering line
- ★ **AES[®]** Ships Coast to Coast

HOURS: Mon. thru Fri. 9-5:30; Sat 9-3



USE YOUR CREDIT CARD



Note: Our TOLL FREE Ordering line 1-800-558-0411 is answered until 8 pm CST Monday thru Thursday.

Clip out this handy Coupon and Mail Today!

TO: AMATEUR ELECTRONIC SUPPLY[®]
4828 W. Fond du Lac Avenue
Milwaukee, WI 53216

I am interested in the following new KENWOOD Equipment:

I have the following to TRADE (What's your DEAL?)

Rush me your quote - I understand that I am under no obligation.

Name _____

Address _____

City/State _____ Zip _____

Harold Price NK6K
 Tak Okamoto JA2PKI
 Hanspeter Kuhlen DK1YQ
 Peter Guelzow DB2OS
 Donald Moe DJ0HC/KE6MN

Birds 'N' Bauds

Satellites are going digital in a big way—five international experts combine to define our place in space.

The packet-radio revolution has slipped the surly bonds of Earth and is headed for orbit. Two amateur spacecraft slated for launch in 1986 have dedicated general-access digital links. A satellite already in orbit carries a digital store-and-forward communications experiment. Digital communications figures into the plans of several satellites currently on the drawing boards. This article will discuss digital activity on the high frontier, and will help you prepare to use the new digital fleet as it becomes available.

The first section of this article (written by Harold Price NK6K) supplies a bit of background and discusses the digital facilities of UoSAT-OSCAR-9 and -11. The second section (written by Tak Okamoto JA2PKI) describes the mailbox on the JAS-1 spacecraft, scheduled for launch on August 1st of

this year. The third section (written by Hanspeter Kuhlen DK1YQ, RUDAK Experiment Project Leader; Peter Guelzow DB2OS, Deputy RUDAK Project Leader; and Donald Moe DJ0HC/KE6MN, Member of RUDAK Group) describes the RUDAK packet transponder, which is slated to be a part of Phase-3C, scheduled for launch in October.

This article is not intended to be a general satellite tutorial, rather it is a survey of the interesting things going on digitally, to entice you into finding out more. See reference one for an excellent text on amateur satellites for both the beginning and advanced amateur.

INTRODUCTION

Microprocessors and digital communications have played a part in all of the recent amateur spacecraft. They have usually been

dedicated to telemetry and command functions, however, as well as on-board control. The AMSAT-OSCAR 10 (AO-10) spacecraft is completely dependent on its on-board computer for control. The UoSAT-OSCAR-9 (Uo-9) and Uo-11 spacecraft can be controlled directly from the ground, but each carries several microprocessors that carry out autonomous spacecraft control under normal conditions. Although these and previous spacecraft use digital data to send telemetry and receive commands, the spacecraft launched in 1986 will be the first to carry digital equipment as part of the two-way communications payload accessible to the amateur community at large.

Spacecraft can be used to enhance digital communications in several ways. The first is as a one-way digital beacon. Uo-9 and Uo-11 transmit informational bulletins as well as spacecraft telemetry. The data format is easy to decode, and receive-only ground stations are easy to build.

One two-way application is simply to use a spacecraft as an analog repeater. AO-10 serves in this capacity now. It receives rf on one band and simultaneously retransmits it on another band, with no processing of the signal. Any mode can be repeated by the satellite, including SSB, RTTY, SSTV, and packet. Power-inefficient modes such as FM, while they are repeated like any other signal, are not permitted on AO-10. Packet can be sent through AO-10; in that respect, AO-10 acts like any normal voice repeater—any re-



Photo A. Dr. Martin Sweeting G3YJO, UoSAT Project Director, listens to the Uo-9 spacecraft with a hand-held 2-meter FM radio. The antenna array in the background is used for commanding and data collection.

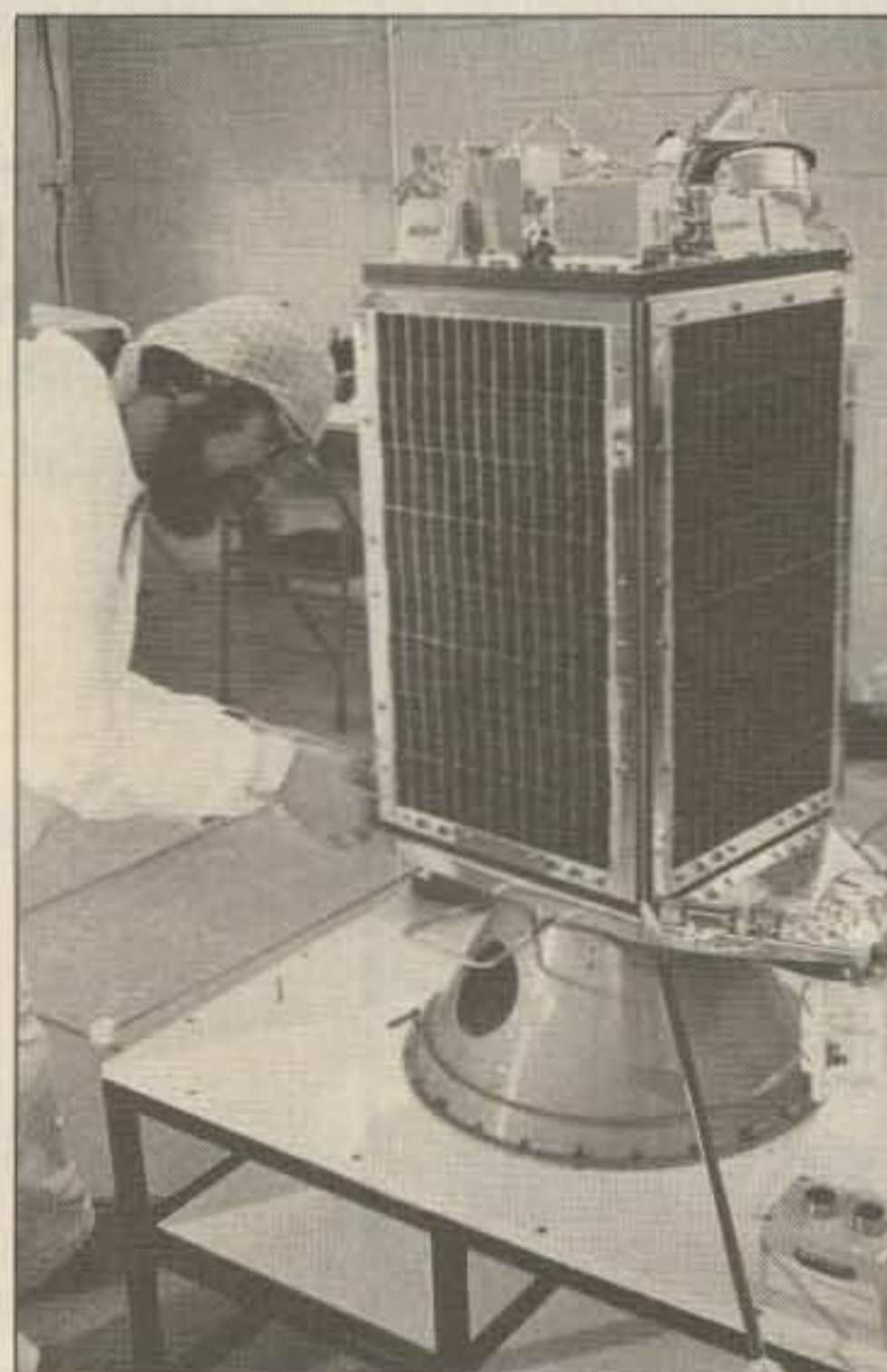

Photo B. The UoSAT-OSCAR-11 spacecraft. Ian Ferebee G6BTU is attaching a solar array panel.

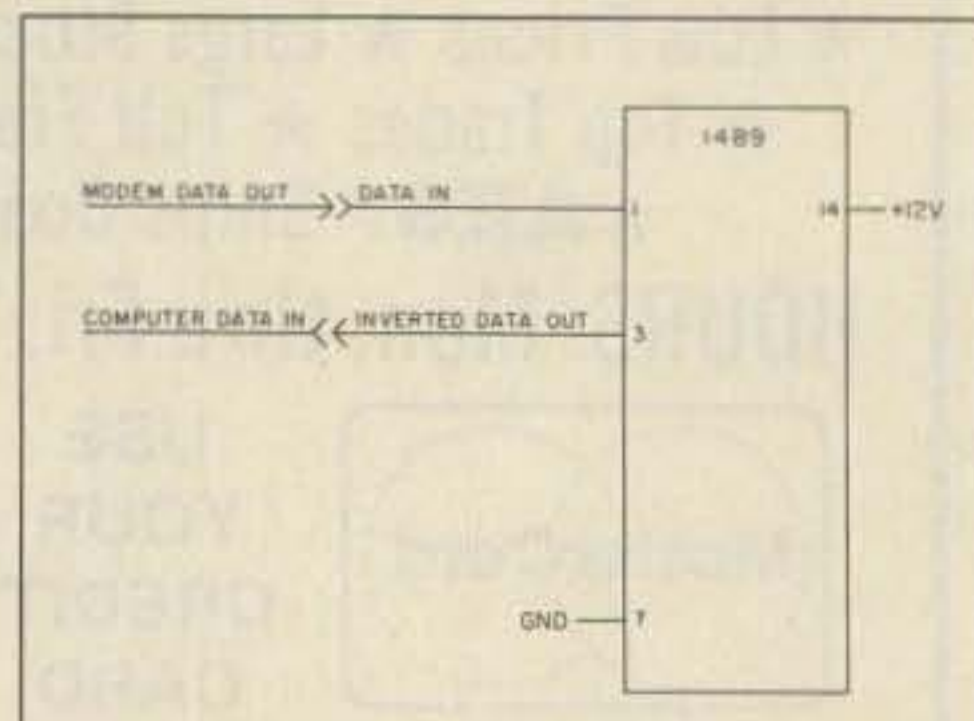

Fig. 1. Crude RS-232 inversion circuit for reading Uo-11 data.

peater on a mountain 33,000 km high, that is.

A second two-way use of a spacecraft is as a digipeater. There are several advantages to this style over the AO-10 method where packet is concerned. First, packets are checked for accuracy in orbit before being repeated. This saves time otherwise wasted by downlinking a damaged packet. Second, each packet starts "fresh" from the orbiting digipeater. Since it is regenerated, the repeated packet does not already suffer from the effects of getting to the spacecraft (free-space loss, transponder loss, etc.); it need only make it from space to the ground.

The best space-based digipeater is one that is visible for long periods of time and covers a lot of ground. The RUDAK module on the Phase-3C spacecraft will serve in this function. Phase-3C will be visible for as long as nine hours at a time, and can digipeat packets to more than 1/3 of the Earth's surface for a large portion of that time.

A third two-way use of a spacecraft is as a mailbox, which stores information for later retrieval. A store-and-forward satellite, as this class is called, can deliver messages on a worldwide basis using only a single satellite. A satellite in the proper orbit could continually gather and deliver messages as it moves over the globe. A low-orbit satellite is well-suited for this task since it makes many passes overhead each day. Such a satellite is not well-suited for use as a digipeater, though, because only small (compared to Phase-3 orbits) areas can see the satellite at one time. The JAS-1 spacecraft will serve in a mailbox role; Uo-11 is already performing this function on a limited basis.

UoSAT Spacecraft

We'll start our discussion of specific spacecraft with two that are in orbit now: Uo-9 and Uo-11.

Uo-9

The UoSAT-OSCAR-9 spacecraft was the first to offer high-speed digital telemetry from orbit. Previous spacecraft had sent telemetry by using Morse code, and some could even receive messages from ground command stations for playback on the Morse beacon. Uo-9 runs standard ASCII data at 1200 baud, and can thus send many thousands of characters in a pass. Uo-9 carries a regular bulletin service, with bulletin sizes in the 5-to-10K range. The bulletins carry information about amateur satellites, including operating schedules and orbit predictions, and are transmitted in plain text.

Uo-9 transmits using FM at 145.825 MHz. It can be heard on a hand-held from out in your front yard (see Photo A). To recover data, however, you will probably need a beam antenna. For best results, you will also need to know when to listen. A variety of orbit-prediction programs are available for nearly all makes of computers, including TS-1000, VIC-20, C-64, TRS-80, Apple, and IBM PC. Contact AMSAT for information (PO Box 27, Washington DC 20044).

Any Bell 202 standard 1200-baud modem can be used to read the Uo-9 data stream. The

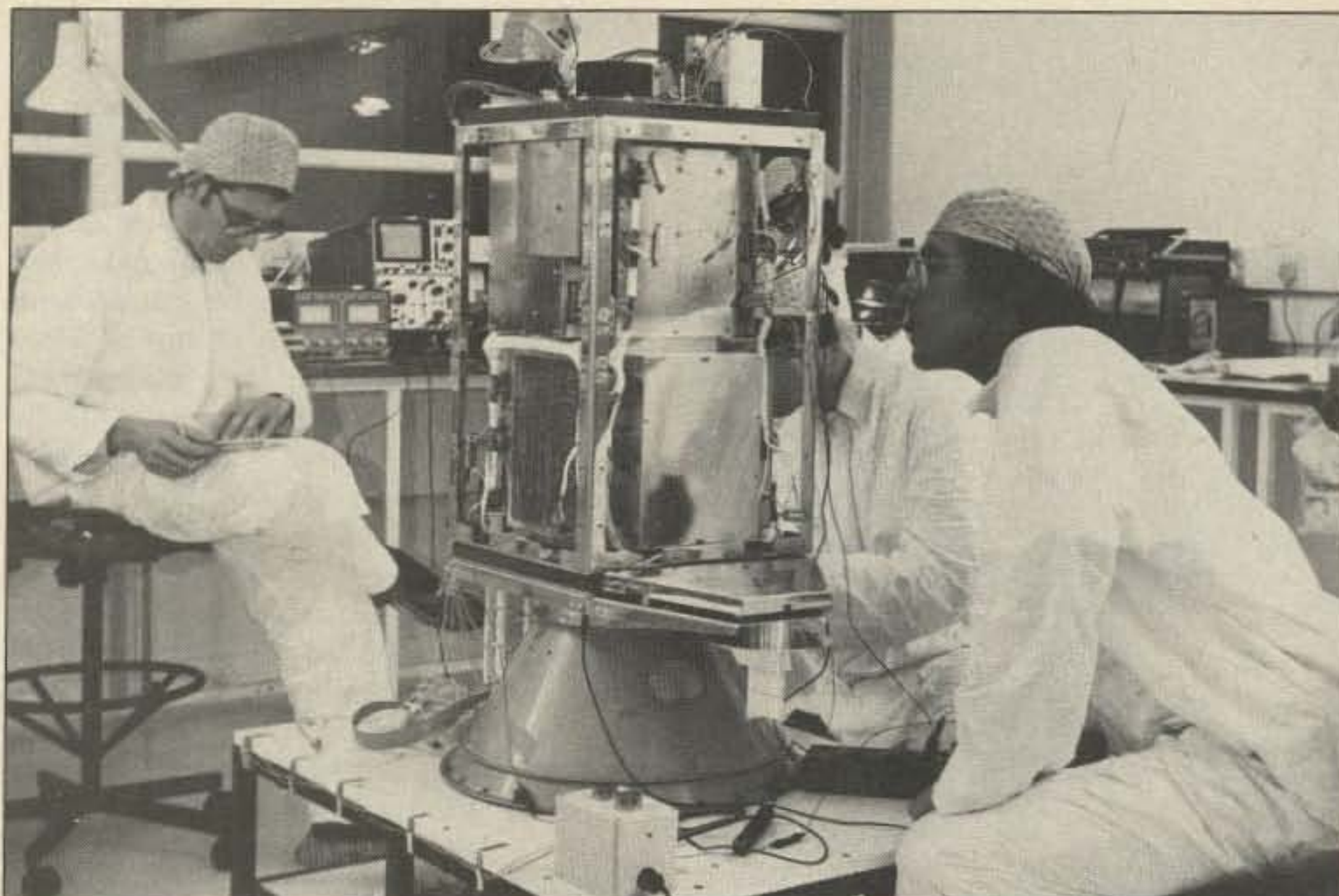

Photo C. Uo-11 under construction at the University of Surrey.

Bell 202 standard uses 1200-Hz and 2200-Hz tones. Surplus modems are available at larger computer swap meets in the \$25-to-\$90 range. Most 1200-baud modems used with personal computers are *not* suitable, however. They use the Bell 212 standard, which is a horse of a different color. The 1986 ARRL *Handbook* describes a simple modem that can be built from scratch. The bulletins are transmitted in clear text, and are sent at regular intervals. Telemetry and other data are alternated with the bulletins. For stations currently beyond the reach of the VHF and HF packet network, the Uo-9 bulletins present information weeks or months before the paper periodicals.

Uo-9 was launched in October, 1981, and carries a number of experiments. Uo-9 is

similar in appearance to its sister craft Uo-11, pictured in Photo B.

Uo-11

Uo-9 offers a one-way bulletin service. The main spacecraft computer's memory is used to contain the message text, and the main computer is used to transmit the bulletins. Because of this, only the primary control station is able to upload bulletins. Uo-11, on the other hand, has a separate processor with its own data storage. This permits experimentation with an orbiting store-and-forward mailbox with reduced hazard to the spacecraft itself. A store-and-forward capacity means that messages are uploaded to the spacecraft and held there until a second ground station commands their retrieval.

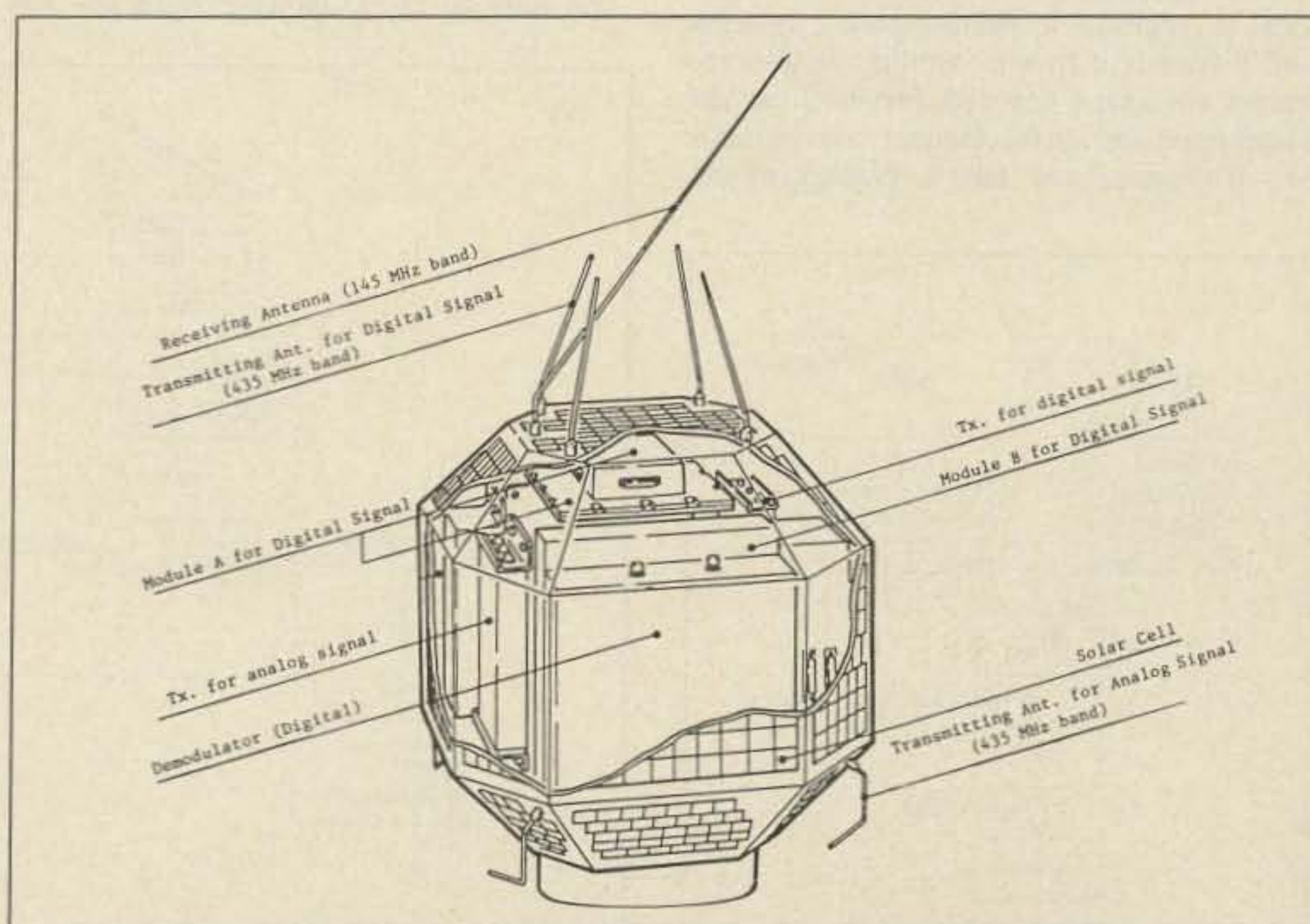

Fig. 2. JAS-1, showing internal packaging and antennas.

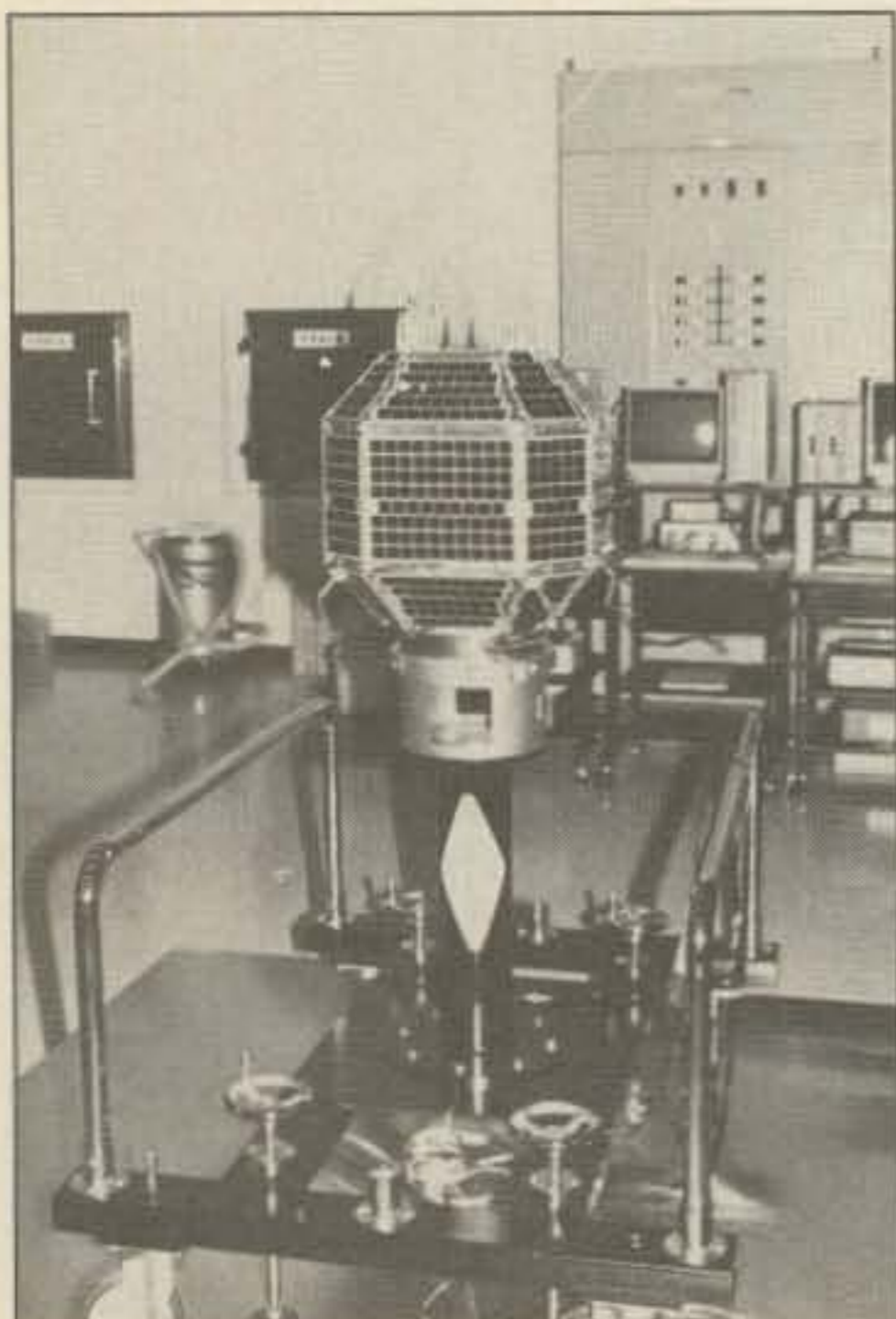

Photo D. JAS-1.

The Digital Communications Experiment (DCE) provides this service. The DCE is a self-contained microcomputer carried as one of several experiment modules on board Uo-11. It was designed and built by amateurs and others in Canada and the United States. The DCE contains 126K of memory for program and message storage. In the current software configuration, 96K is available for messages. The DCE contains an NSC-800 microprocessor, which behaves like a CMOS Z-80.

Although the DCE is a separate facility, it still shares the main downlink beacons and command uplink frequencies. This limits the number of stations that can transmit messages directly to Uo-11. Therefore, the Uo-11 DCE is best suited for access via gateway stations. A Uo-11 gateway station collects traffic from local or regional terrestrial packet systems and forwards it to the satellite. It also retrieves messages destined for its area and distributes them. In this manner, a large number of amateurs can take advantage of the

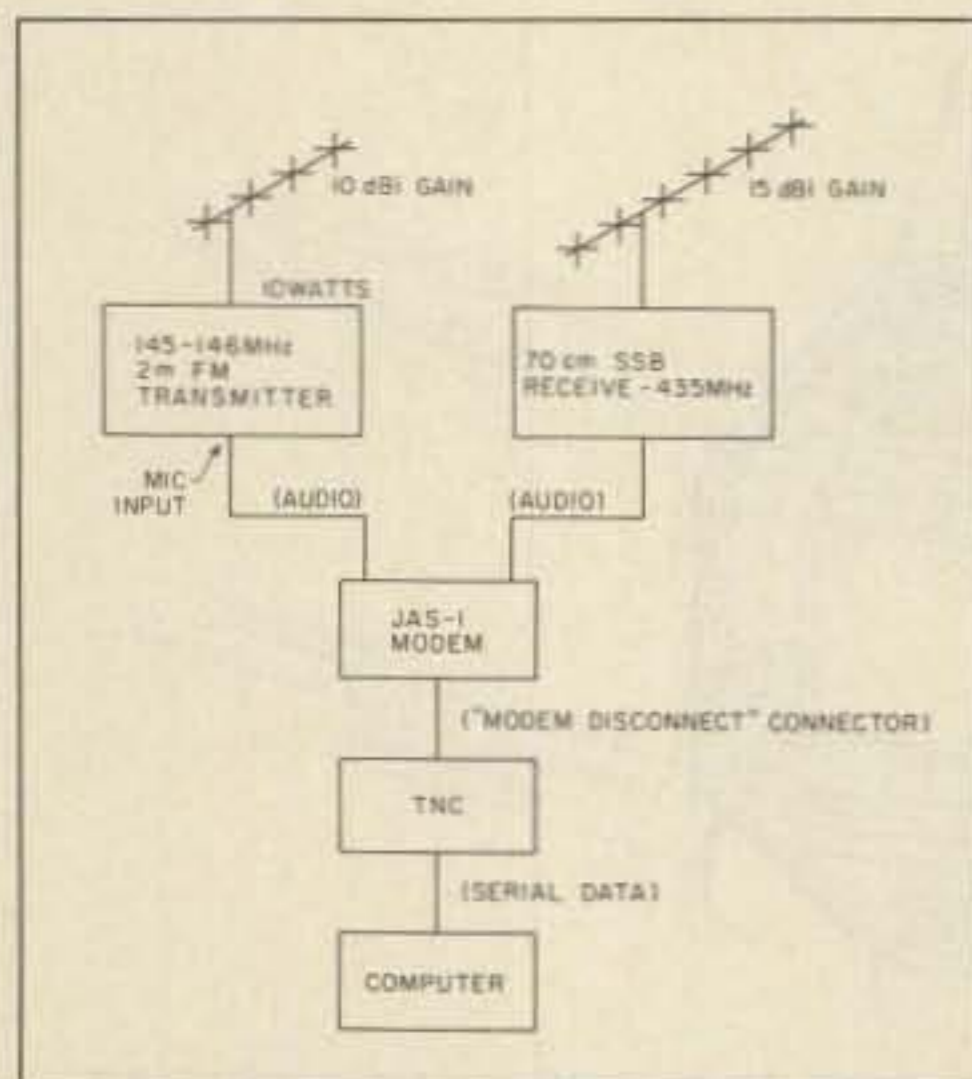

Fig. 3. JAS-1 digital ground station.

DCE even though only a few can transmit to it directly.

The DCE is also being used for large file transfers. These files usually contain technical papers, bulletins, and newsletters. In the past few months, nearly one million characters have been passed between ground station NK6K in Los Angeles and ground station G0/K8KA at the University of Surrey. These two persons collaborated on a paper, transferring a 20K file six times across the Atlantic in a few days.² There were three active gateway stations in May of 1986; several more are planned for the near future. Many messages have been relayed to and from the ground-based packet network, and the techniques learned and the software developed will be directly applicable to JAS-1 gateways. As discussed later, JAS-1 will be available to anyone, and a large number of direct and gateway users are anticipated.

Uo-11 also carries bulletins similar to those on Uo-9. It transmits ASCII data with the same modem tones as Uo-9, but the sense of the mark and space tones is reversed—Uo-11 data is "upside down"; in the U.K., the BBC microcomputer considers this to be "right-side up." To decode Uo-11 data with whatever you have to decode Uo-9 data will require inverting the data stream. The possibly least-elegant solution to this problem is presented in Fig. 1. Its advantage is that it will work in-line between the modem serial output and the computer's serial input. Its disadvantage is that it works only with computers that can deal with RS-232 data swinging between 0 and +12 volts. My IBM PC has no problem with these levels, and neither does a vintage S-100 CP/M system.

Uo-11 was launched in March, 1984, from California. It transmits on the same frequency as does Uo-9: 145.825 MHz.

JAPAN AMATEUR SATELLITE-1 (JAS-1)

(A note to our Japanese readers—Tak

Okamoto JA2PKI/N6MBM, a temporary resident of southern California, returned to Japan shortly after this collaborative article was begun. I've expanded on one or two items. If something below is not said in the Japanese way, my apologies. It's not Tak's fault; he did his best not to get tainted by California while he was here. I'm sure any behavioral aberrations are temporary and will soon wear off now that he has returned home.—NK6K)

JAS-1 is an amateur radio satellite, promoted by JARL (the Japanese national radio society) as a joint venture with NASDA (the national space agency). NEC (a large electronics company) constructed the "system" units (space frame, power supply, etc.), while JAMSAT (the national amateur satellite group), with its selected volunteer JAS-1 project team, designed and built the "mission" units (transponders, telemetry/command, and housekeeping microcomputer) and ground support systems.

JAS-1 has been completed and has passed all the necessary tests. It is in a clean room waiting for the launch, currently scheduled for August, 1986.

JAS-1 Mission Objectives

JAS-1, like Uo-11 and Phase-3C, is a shared mission; packet radio is not its only task. Since this is the first craft in its series, we'll take a broad look at the spacecraft and its mission before delving into the packet specifics. The objectives of JAS-1 follow:

- To provide reliable worldwide amateur radio communications.
- To enable radio amateurs to study tracking and command techniques.
- To offer an in-space "proving ground" for radio-amateur-developed and -built transponders and subsystems.
- To provide NASDA an opportunity to carry out a "multi-payload" launch using their

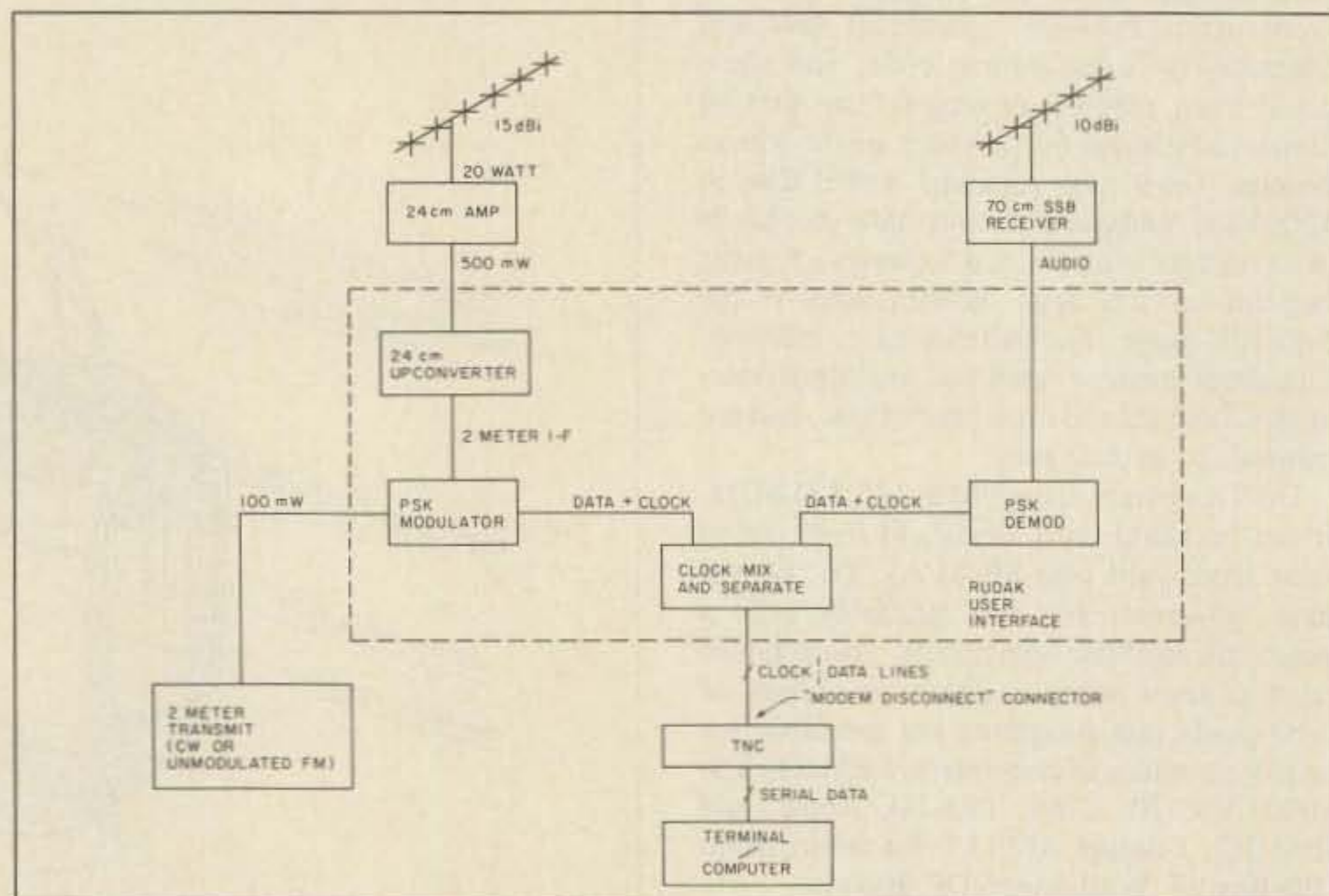

Fig. 4. RUDAK ground station.

new "H-1" launcher. (NASDA has never engaged in a multi-payload launch; thus, the JAS-1 project will offer NASDA an excellent opportunity by providing them with an active payload having its own telemetry beacon and transponder for ranging.)

The spacecraft takes the form of a 26-facet polyhedron, which measures 400 mm x 400 mm x 470 mm and weighs 50 kilograms (see Photo D and Fig. 2). JAS-1 will be launched into a circular orbit by a two-stage rocket. The orbit will be low, about 1500 km, but higher than the Uo-11 orbit of 800 km. JAS-1 will have an inclination of 50 degrees, which will result in a different cycle of passes from most previous low-orbit amateur satellites. Since most tracking of amateur satellites is done with computers, this will pose no problem. JAS-1 will take 120 minutes to circle the Earth, and will be visible for about 20 minutes per pass. There will be approximately eight passes per day.

JAS-1 carries two separate mode-J (2 meter up, 70 cm down) transponders. One is a linear transponder, and the other is a digital "store-and-forward" transponder, mainly for non-real-time communication between stations located in different time zones.

The reasons for selecting mode J for this first Japanese amateur radio communications satellite are:

a) It is becoming increasingly difficult to use 145 MHz for a satellite downlink because of man-made electrical noise and other interference. This is especially true in Japan where the 2-meter band is crowded with simplex activity.

b) The planners of JAS-1 wanted to provide a successor to AMSAT OSCAR-8's mode J, which was originally developed by JAMSAT's engineering team back in 1976.

c) 435 MHz is much quieter than 145 MHz as a downlink band; it is comparatively free from man-made noise and sky-temperature effects.

Communications Parameters

The standard analog linear transponder is called mode JA. The passband will be 100 kHz wide. The transponder will have an output of 1 Watt PEP. Ground stations will need an uplink power of 100 Watts eirp. The sidebands will be reversed—i.e., the uplink is LSB, the downlink is USB. There will be a 100-mW CW beacon switchable to PSK when needed. See Table 1 for details.

The digital transponder is called mode JD. There will be four 145-MHz-band input channels using Manchester-coded FM for the uplink. Ground stations will need a transmit power of 100 Watts eirp. There will be one downlink channel in the 435-MHz band using PSK; the output will be 1 Watt rms. See Table 2 for details.

The data format is HDLC. The protocol is AX.25 level 2 version 2. The data-transfer rate is 1200 bps for both uplink and downlink.

The reasons for not using Bell 202 type FSK modulation are:

a) To reduce the parts count on board JAS-1. Using Manchester-coded FM for uplink

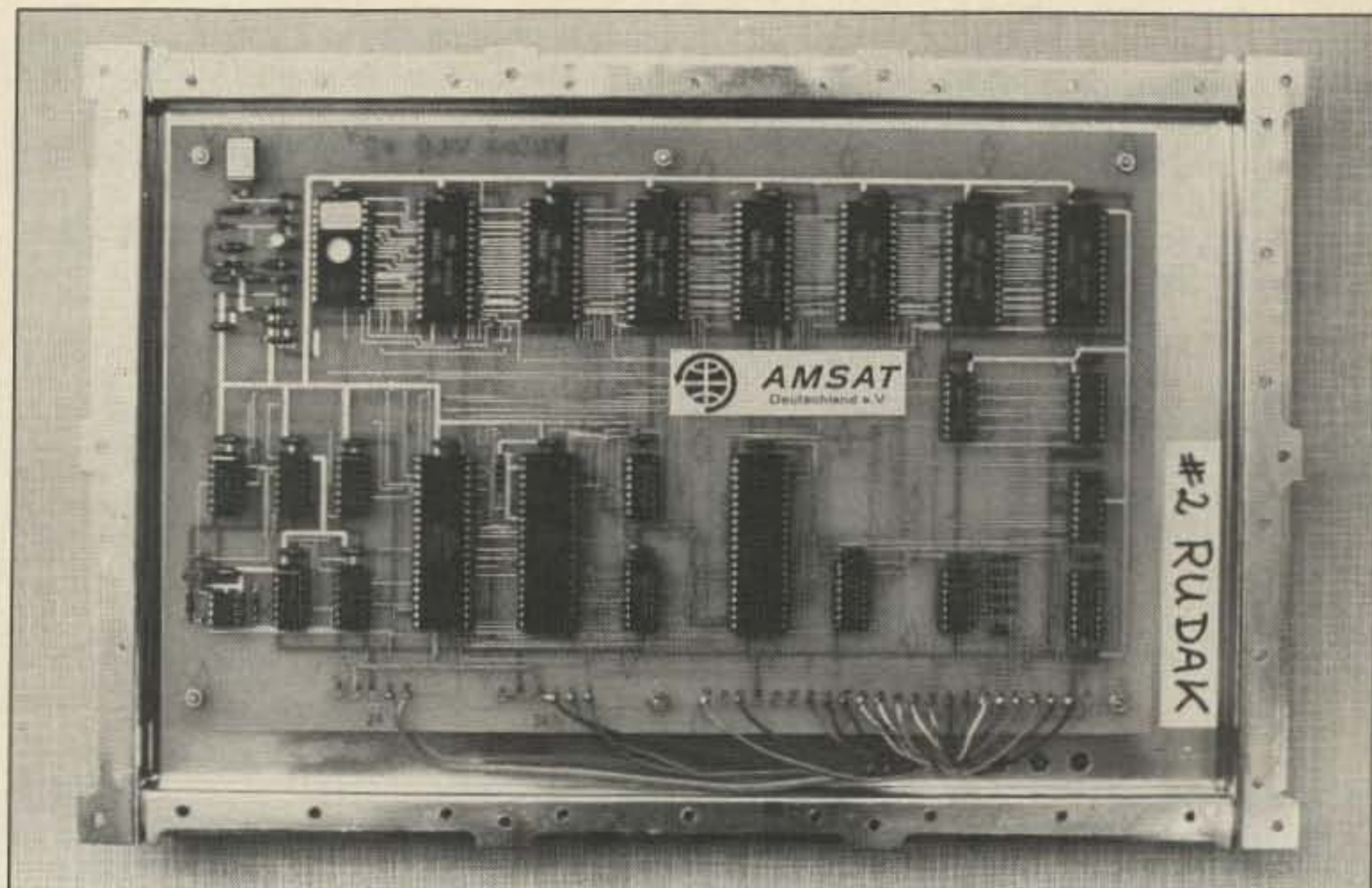

Photo E. RUDAK engineering prototype #2.

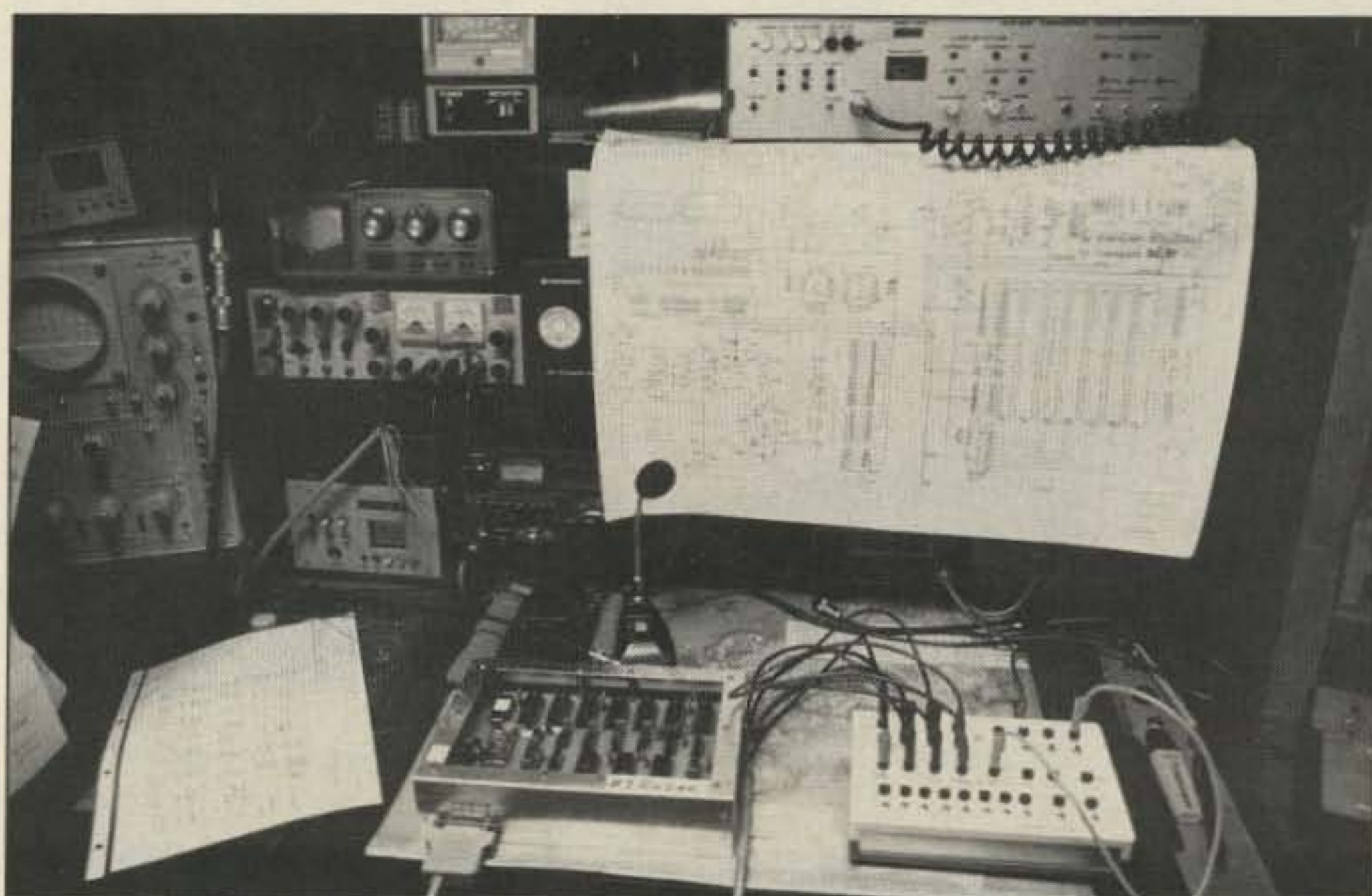

Photo F. RUDAK wire-wrap prototype.

reduces JAS-1's on-board decoder chip count by 16.

b) To improve the downlink margins. Due to JAS-1's tight power budget, only 1 Watt is generated by the downlink transmitter. A more efficient modulation scheme like PSK is required.

JAS-1 will be a store-and-forward system, but not a real-time digipeater. Digipeating is not an effective use of a low-orbit satellite such as JAS-1, which has a limited communication footprint and visibility time.

JAS-1 has four uplink channels and one downlink channel. This is because of the difference in channel efficiency between uplink and downlink. An uplink channel is shared by several ground users. Since the ground users can't hear each other and are listening to the downlink channel anyway, the uplinks are subject to packet collisions. This scheme is called "Pure ALOHA," and is known

to have a theoretical maximum channel throughput of 18.4%. The JAS-1 downlink is much more efficient, since only JAS-1 transmits there. To balance capacity, as well as add redundancy, four uplink channels are used.

The combined uplink efficiency is then $4 \times 18.4\%$, or 73.6%. The remaining downlink time is used for general messages and telemetry data.

JAS-1 will accept a connect from only one station at a time with the software scheduled for initial use. Multiple connections will be supported in subsequent software updates. General packet operation is scheduled to begin in November of 1986.

Spacecraft Digital Hardware

The microprocessor is a MIL-STD-883B screened NSC-800 running with a 1.6-MHz clock. This is the only processor on board. It

controls the digital transponder and also acts as an IHU (Integrated Housekeeping Unit).

The on-board memory has a 1.5-megabyte physical storage capacity and uses 48 chips of NMOS 256K DRAMs. A hardware-based error-detection/correction circuit is incorporated to protect the entire 1.5 megabytes and

provide a 1-megabyte error-free memory area. The system program occupies some 32K; the rest is used for message storage.

The memory unit is physically divided into four identical 256K memory cards, any one of which can be assigned as the system area. Up to three cards can be turned off. This

design provides system redundancy and allows command stations to control power consumption without a total loss of service.

JAS-1 has five hardware HDLC controllers. Four of them are for the uplink channels and one is for the downlink channel. In total, these controllers consist of some 140 CMOS MSIs, yet their power consumption is less than that of a single NMOS LSI HDLC controller like WD-1933.

JAS-1 does not have any ROM but has a simple hardware boot-strap circuit instead. This design is to increase system flexibility and reliability.

Uplink passband:	145.90 MHz–146.00 MHz (LSB)
Downlink passband:	435.80 MHz–435.90 MHz (USB)
Beacon frequency:	435.795 MHz
Translate frequency:	581.80 MHz
Transponder output:	1 Watt PEP
Required uplink power:	100 Watts eirp

Ground Stations

The ground-station setup that was used for AMSAT OSCAR-8 mode J can be used for JAS-1 mode JA. A station with a 10-Watt 2m SSB transmitter, a 10-dBi beam for uplink, and a 70-cm receiver with low noise figure with a 15-dBi beam for downlink should be adequate for the job.

To use the JD transponder, FM mode is required for the 2m transmitter. Antennas and power levels are the same as for the mode-JA transponder. Since JAS-1 uses the standard AX.25 protocol and 1200-bps data rate, ground stations will be able to use a TAPR-style TNC, a 2m FM transmitter, and a 70-cm receiver without modification. A mode-JD station is shown in Fig. 3.

The JAS-1 modem, a special interface board, will be made available containing the Manchester modulator and an audio PSK demodulator to allow connection to the "modem disconnect" connector of TAPR TNC-1- and TNC-2-style TNCs. TNCs that don't have a provision for an external modem, such as the Kantronics Packet Communicator, will not be suitable for use with JAS-1. The modem connects to the audio input and PTT of the 2m FM transmitter and to the audio output and frequency control (option) of a 70-cm SSB receiver. JARL is working with TAPR to produce JAS-1 modem kits.

Although JAS-1 will be available for direct access by any amateur, non-satellite-equipped users can still take advantage of its message transfer facilities by the use of JAS-1 gateways. Gateway stations will be connected to local and regional packet networks as well as to JAS-1. JAS-1 can then be used as a relay between gateway stations and, therefore, between amateurs using the gateways to pass traffic.

RUDAK

In October of 1986, another Phase-3 satellite will be carried by an ARIANE IV launcher from the European space center (CSG) in Kourou into its elliptical orbit. A new type of amateur radio transponder will then come into service for the first time—RUDAK.

What Is RUDAK?

Basically, RUDAK is a freely programmable general-purpose computer with 56K RAM. A ROM operating system (ROS) provides general initialization after power-on.

Table 1. Mode JA parameters.



Photo G. DL2MDL, DB2OS, and DK1YQ performing digital link testing on RUDAK using four user stations.



Photo H. DL2MDL, DG2CV, DK1YQ, and DB2OS discuss final changes necessary in the processor circuit.

Similar to a TNC board for packet radio, it will be programmed to provide a "TNC in the sky." Two links—one uplink from the ground to RUDAK and one downlink from RUDAK to the ground—provide the communications channel through an intelligent hardware interface. RUDAK is a German acronym for Regenerativer Umsetzer fuer digitale Amateurfunk-Kommunikation (regenerating translator for digital amateur radio communications).

What can RUDAK do for you? First, it acts like any other packet-radio station, by digipeating packets in real time between two stations that are both within view of the satellite.

Second, it will periodically insert bulletin packets into the downlink data flow, such as the momentary values for mean anomaly, orbit number, time, doppler shift (in reference to the equator), age of the linear transponder, etc. The information is kept current by a constant data exchange between the satellite's main computer and the RUDAK processor.

Third, it will support a "robot" mode, which permits brief connects to the satellite for retrieving specific information of limited interest, such as orbital parameters, attitude information, transponder operating schedule, etc. To prevent a complete clogging of the system during periods of high traffic volume through RUDAK, a "list" type operation will be implemented. This operation will automatically limit the digipeated packets to those from stations that have signed onto the list by connecting to one of RUDAK's robot ports. This list will be constantly updated based on disconnects, timeouts, and other factors. Additionally, AMSAT or IARU bulletins can be periodically transmitted.

What does the RUDAK experiment consist of and what's necessary to participate? Let's start with the originating point of a packet that RUDAK will relay, the ground station. First, the packet is generated in the usual way in a TNC, but the internal FSK modem is disconnected. The transmit signal (data and clock) plus PTT are routed to a 2400-baud BPSK modulator, which forms a part of the transmitter on 1269.675 MHz \pm 7.5 kHz to compensate for doppler and other frequency errors. Uplink power needs to be on the order of 20 Watts into a right-hand circularly polarized 15-dBi gain antenna, or approximately 650 Watts eirp.

The demodulator in the RUDAK receiver scans within a 15-kHz-wide capture window at a rate of 10 times per second. The appropriate TNC parameters will be provided in the automatic beacon packets. The packet is processed and routed to the downlink transmitter on 435.675 MHz using PSK modulation at 400 baud (or alternatively 1200 baud, depending on link conditions). This beacon will be in operation continually, except when mode B is switched on for brief intervals. Mode B is the 70 cm up/2 meter down mode that OSCAR 10 uses most of the time.

The RUDAK signal can be received using a standard SSB receiver, a 10-dBi right-hand circularly polarized antenna, and a preamplifier with a noise figure of 5 dB, which will

achieve an estimated bit error rate of better than 10^{-5} . The audio signal is then fed into a PSK demodulator, where the data and clock signals are recovered. These two signals are sent to the corresponding TNC inputs.

The difference in uplink and downlink baud rates (2400/400) is due to the nature of the uncoordinated time-division multiple access to the system by the ground stations

(ALOHA-TDMA). The collisions between stations on the uplink frequency result in only an average of 18% of the uplinked data getting through. This is because these stations can't hear each other. To balance out the downlink's 100% capability (only RUDAK is on the downlink), the uplink is run much faster. JAS-1 addresses the same problem in a different way—by offering multiple uplinks.

Uplink channel 1:	145.850 MHz
Uplink channel 2:	145.870 MHz
Uplink channel 3:	145.890 MHz
Uplink channel 4:	145.910 MHz
Uplink data format:	Manchester-coded FM, 1200 baud, AX.25
Downlink channel:	435.910 MHz
Downlink data format:	PSK, 1200 baud, AX.25
Downlink power:	1 Watt rms
Required uplink power:	100 Watts eirp

Table 2. Mode JD parameters.

Uplink frequency:	1269.675 MHz \pm 7.5 kHz
Uplink data format:	2400-baud biphase PSK, AX.25 protocol
Required uplink power:	650 Watts eirp
Downlink frequency:	435.675 MHz
Downlink data format:	400-baud biphase PSK, AX.25 protocol
Downlink antenna gain:	10 dBi, RHCP

Table 3. RUDAK parameters.

WHAT'S IN A NAME?

The casual observer of the amateur satellite scene might get the impression that there are several more amateur satellites than there actually are. Depending on the vintage of an article—i.e., whether the spacecraft under discussion had been launched at that time or not—you may see a satellite called by a name other than the one you're used to. For example, UoSAT-A, UoSAT-1, and UoSAT-OSCAR-9 are all the same craft.

Any really good name will contain at least one acronym. OSCAR stands for Orbiting Satellite Carrying Amateur Radio. AMSAT refers to the name used by the Radio Amateur Satellite Corporation, headquartered in Washington DC. The AMSAT moniker was picked up by other national groups as they formed: e.g., AMSAT-DL (Germany), AMSAT-UK (England), and JAMSAT (Japan). The original AMSAT, based in the United States, is pondering the bylaw changes necessary to become AMSAT-NA (North America). AMSAT (no suffix) would then refer to the international community of radio amateur satellite enthusiasts. UoSAT means University of Surrey Satellite, referring to those satellites designed and built by radio amateurs and others at the University of Surrey in Guildford, England. These acronyms are strung together to form a satellite's name.

Satellites carry different names pre-launch than they do post-launch. There are several reasons, perhaps one is for the same reason you say "break a leg" backstage before the curtain goes up. It also keeps order of manufacture separate from order of launch, for those lucky enough to have more than one in progress at a time. Satellites are usually lettered before launch, and numbered after. This is true in industry as well; LANDSAT-D became LANDSAT-4 after reaching orbit. Spacecraft that don't make orbit don't get numbers. The ARIANE launcher for AMSAT's Phase-3A spacecraft failed shortly after liftoff, and it never became OSCAR-9. The second Phase-3 model built, Phase-3B, became OSCAR 10 because UoSAT-A beat it into orbit. Simple, see?

One other confusing factor is UoSAT-2 versus UoSAT-OSCAR-11 (abbreviated Uo-11). These are both post-launch names for UoSAT-B, and both names are used at various times in various places. The Uo-11 mission patch says UoSAT-2, the QSL card says UoSAT-OSCAR-11. Keep on your toes and you won't get caught.

A possible confusion on the horizon is Japan's JAS-1. Will it remain JAS-1 once on orbit? Will they want it to have an OSCAR number, and will it be abbreviated JO-n? Only time will tell. It seems a safe bet that Phase-3C will get a name in the AO-n series.

The Russian amateur satellites are usually given numbers in the RS series. See page 3-8 in reference 1.

It's easy to imagine how just listening to the downlink will provide interesting information on communications conditions—worldwide QSOs as well as general bulletins. Since the design philosophy of the communications links has been directed toward supporting individual users, it is recommended that stations make normal QSO-type contacts rather than set up gateway stations to transfer large blocks (e.g., file transfers, mailboxes). As the satellite is visible for long periods of time per orbit, the QSOs can occur in real-time rather than being handled in a store-and-forward fashion.

Ground-Station Digital Requirements

A RUDAK ground station (see Fig. 4) makes use of a regular packet terminal node controller (TNC). For the majority of the TNCs—e.g., TAPR TNC-1, AEA PKT-1, or Heath HD-4040—the only software modification required is an updated EPROM to handle a hardware bug in the WD-1933/35 HDLC controller. Otherwise, only a PSK modem for 400/2400 bps has to be connected to the external modem jack in the TNC.

Other TNCs, such as the Kantronics Packet Communicator, or various software solutions are unfortunately not suitable due to the software and/or hardware restrictions. The TNC must be capable of operating full duplex at different transmit/receive baud rates and support the connection of an external modem. The TNC-2-type TNCs need to

have a wire added to permit external data clocking.

Besides the normal equipment, a RUDAK User Interface is required, which is under development by the RUDAK group and AMSAT-DL. This interface consists of an upconverter (which translates a 2m signal to 24 cm and modulates the carrier with 2400-bps BPSK) and the AMSAT-AFREG, the BPSK demodulator for the 400-bps downlink. Additionally, various buffers and controls for switching the different signal paths and a power supply are needed. The various schematics, especially for the AMSAT-AFREG and the upconverter, will be published by AMSAT-DL when the design is completed.

RUDAK Hardware

How does RUDAK work? RUDAK is a nonlinear transponder, which is totally separate from the linear L-band transponder and its associated agc level, even though the rf and i-f stages are housed in the mode-L transponder. The BPSK demodulator, the processor unit, and the power conditioning unit are installed in a separate housing, consisting of two chambers. Photo E shows the processor unit side of engineering prototype model #2; Photo F shows the wire-wrap version on the test bench. At the time this article was prepared, the flight version had just been completed and tested, prior to shipment to Golden, Colorado, for satellite integration.

What kind of hardware is used? The center

piece of the RUDAK experiment is the processor. Its structure resembles an 8-bit home computer with a 64K addressing range. The CPU, a 65SC02, is a CMOS version from the well-known 6500 processor family. The RAM section consists of 56K, organized as 7K x 8K.

Out of all of the various new intelligent communications controllers, the well-known Z80-SIO (84C40) was selected for the AX.25 interface, as it was the only one available in CMOS when engineering work began. A second interface uses a 65SC22 VIA to provide data and program exchange with the satellite's main computer.

The ROM operating system contains a minimal operating system, consisting of the relevant routines needed for processor initialization prior to loading the main operating system, including RAM tests and initial telemetry. This arrangement assures the independent programmability of RUDAK, even in orbit. The main operating system is a variant of the IPS operating system, developed for OSCAR-10 by Dr. Karl Meinzer DJ4ZC. Measurements indicate that the power consumption of the entire 64K computer will be considerably less than 500 mW!

By the time this article is published, many steps will have been performed to prepare RUDAK and the satellite for launch, including thermal vacuum testing, vibration testing, and system performance testing. Photos G and H show a few members of the RUDAK team from Munich, West Germany, at work.

Where do I get more information? A user manual is in preparation, which will contain complete user information, such as schematics and parts lists to build the special equipment required for RUDAK operation, operating guidelines, link parameters, and access procedures for the robot modes. Various AMSAT-DL and AMSAT-NA publications will carry information on RUDAK. The Uo-9 and Uo-11 spacecraft will carry current information as the pre-launch, launch, and checkout activities occur.

WRAPUP

If you are interested in digits in space, 1986 should be a banner year. If you are interested in passing data through the network, you should be aware that in the future, much of the DX traffic will pass through the satellites discussed here. For the most in-depth coverage of the amateur satellite program, join one of the AMSAT organizations worldwide and get their journals. Come on up! ■

References

1. Martin R. Davidoff K2UBC, *The Satellite Experimenters Handbook*, ARRL, 1984.
2. H. Price NK6K and J. Ward K8KA, "The Uo-11 DCE Message Store-and-Forward System," Proceedings of the 5th ARRL Computer Networking Conference, ARRL, 1986.

Acknowledgements

Some parts of the RUDAK section were previously published by AMSAT-DL. Translation by Donald Moe DJ0HC/KE6MN.

\$89

IBM PC PACKET COMMUNICATIONS





The **ULTRALINK 1200**... add the dimension of Packet Communications to your IBM Computer. Bell 202 (1200 baud half-duplex) & 103 (300 baud full-duplex.) Also suitable for phone line communication.

Phone Orders (213) 217-0500

California Digital • 17700 Figueroa St., Gardena, CA 90248

DIRECTION FINDING?

- ★ Interference Location
- ★ Stuck Microphones
- ★ Cable TV Leaks
- ★ Security Monitoring



- ★ VHF and UHF Coverage
- ★ Computer Interface
- ★ Speech Synthesizer
- ★ 12 VDC Operation

New Technology (patent pending) converts any VHF or UHF FM receiver into an advanced Doppler shift radio direction finder. Simply plug into receiver's antenna and external speaker jacks. Uses four omnidirectional antennas. Low noise, high sensitivity for weak signal detection. Call or write for full details and prices.



DOPPLER SYSTEMS, INC.

5540 E. Charter Oak, (602) 998-1151
Scottsdale, AZ 85254

All Mode Communication Terminal

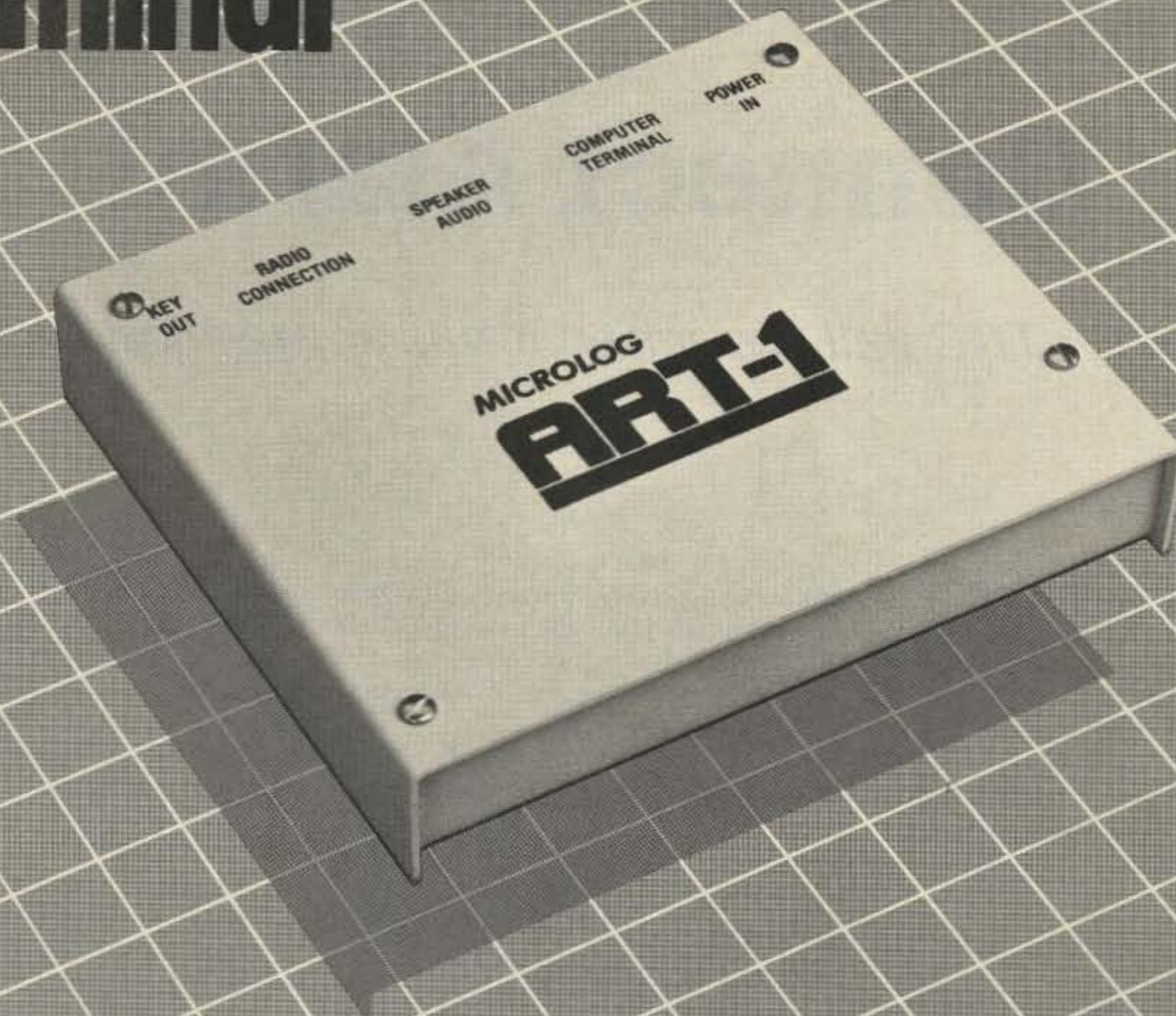

When is Microlog going to get into Packet?

Thanks for waiting, you'll be glad you did. We've packed a lot into the ART-1, because we knew you wanted a truly ALL-MODE Remote Terminal, without any extra pieces or RATTS nest of wiring required, and, 'NO COMPROMISE' performance. Start now with full capability Receive & Transmit on RTTY, CW, & AMTOR for \$199, and later add Packet capability *inside* the shielded, all-metal ART-1 case. Plug in the ART-1 with one cable to your computer, make the connections to your radios, and forget it. All control functions and tuning indicators are via the keyboard and video. Small enough to go anywhere, and available now for your Commodore 64/128. Packet operation uses either TAPR compatible, or easy Microlog direct control commands not possible with conventional ASCII terminals. Packet option includes a separate internal computer enhanced demodulator optimized for 1200 baud, and *dual-radio* support for HF & VHF. It's like having two interactive terminals. (What good is a multimode unit that can only connect to ONE

radio?) You've come to expect performance *and* value from MICROLOG, the ART-1 delivers!

Here are a few of its many features:

- on screen tuning indicators
- full or split-screen on all modes
- auto-load memories
- output to commodore printers
- full speed operation, morse to 99 wpm. Baudot to 132 wpm, ASCII to 300 Baud
- 4 mode AMTOR
- WRU
- independent RX/TX normal/invert
- pitch reference CW tuning
- real-time disk communication
- break buffer
- random code generator
- RX/TX of basic programs
- 24 hr. clock
- no extra power supply needed when used with Commodore Computers
- unshift on space
- foxtest and more.

MICROLOG

INNOVATORS IN DIGITAL COMMUNICATION

18713 Mooney Drive Gaithersburg, Md. 20879
301 258-8400

Connect Alarm!

Let your TNC call you when it has something to say.

The packet mode of communication is becoming one of the most popular phases of amateur radio. One of my projects upon recent retirement was to get a packet system assembled and in operation, initially on VHF, then expanding it to HF capability.

One of the first packet-gadget things I built for my TAPR-1 TNC was a connect-alert unit. The idea for this gadget was given to me by Gervie W7FEN, who already had added it

to his system. I built the little unit and it worked as expected. A few months later, Louie WA7BHK bought an AEA PK-80 TNC, and having seen my system, asked me if the connect-alert portion of that circuit could be used on his TNC.

A look at the circuit of the PK-80, which is a clone of the TAPR-2 TNC, revealed that the

desired signals and power for the alert circuit could be taken from the DB25 (J1) connector on the rear of the TNC. No internal connections requiring opening up of the PK-80 were necessary. A connect-alert unit was built and hooked to Louie's TNC. The little beeper sounds off as designed whenever there is a connect to his system.

Construction

The little Packet Connect Aural Alert unit was built in a small plastic cabinet. The metal cover was replaced with a piece of Formica cabinet-top material to reduce the possibility of unwanted short circuits. The plastic sonic beeper unit was attached to the cover by a dab of epoxy cement. A small terminal lug strip was attached to the underside of the plastic cover to support the few components used in the circuit. (Be sure to observe the proper polarity of the tantalum condenser and the sonic alert unit when connecting them into the circuit.)

Testing

The circuit of the connect-alert unit is easily bench-tested by applying 12 volts to the proper points and then momentarily connecting pin 8 of the CD4011 to ground, then to plus 12 volts. If all is wired correctly, the beeper will sound off with a short shrill burst of sound.

Operation

With the alert unit control cable wired properly to pins 7, 8, and 9 of the DB25 (J1) connector for the PK-80, at power-up of the PK-80 a short beep should be heard from the unit. This is a quick self-test feature of the system. Each time thereafter when a connect is made with another station the aural alert beep will be heard.

This packet gadget should be of help to those getting set up for the latest and most interesting world of packet communication. Best of luck, and CWUL (Connect With You Later). ■

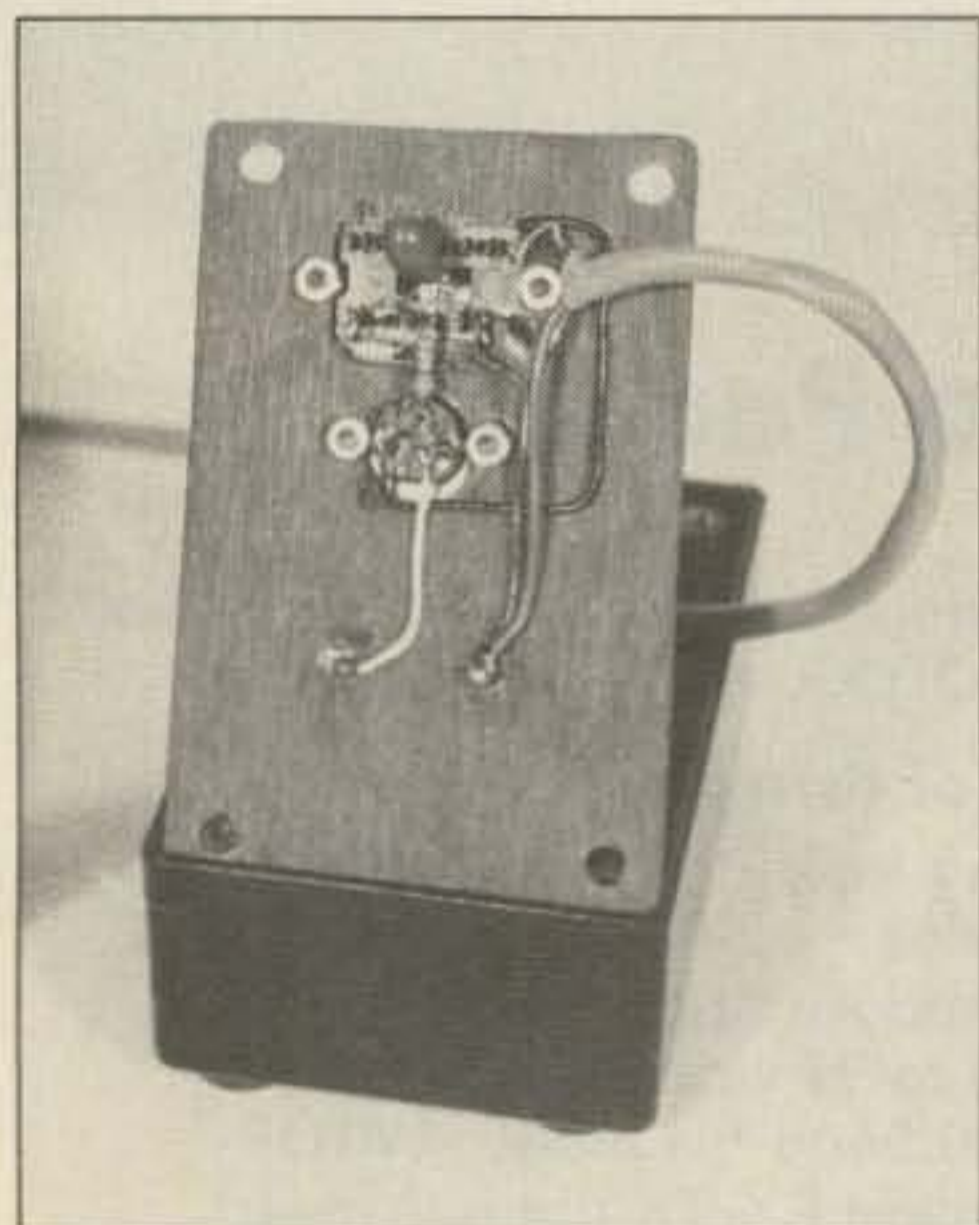

Photo A. Inside the connect-alert unit.



Photo B. The completed alarm.

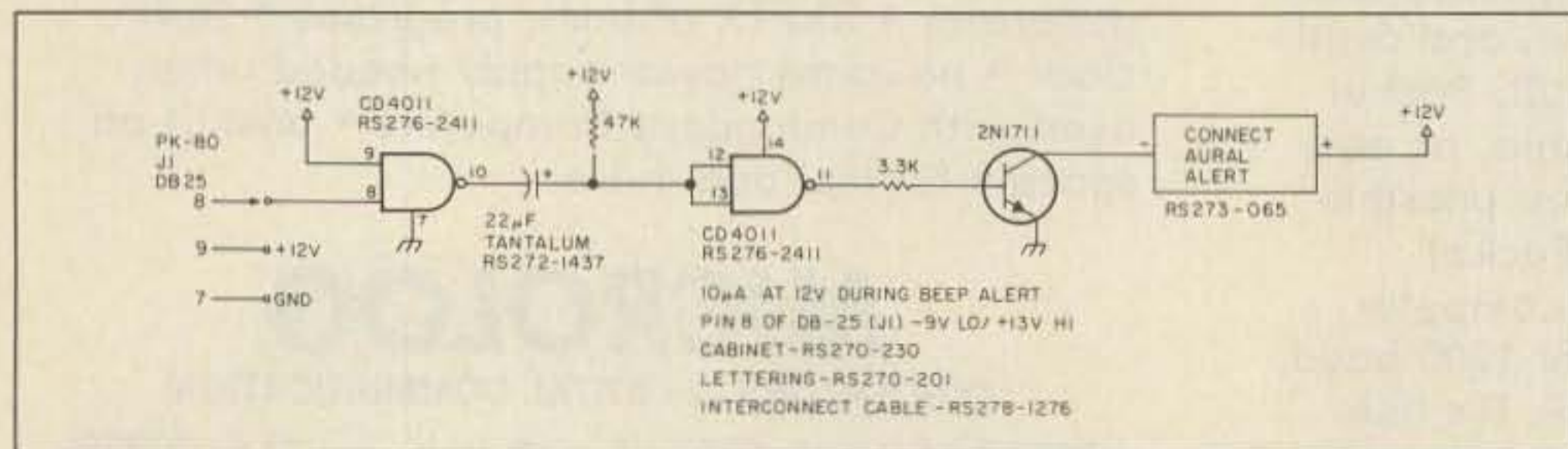
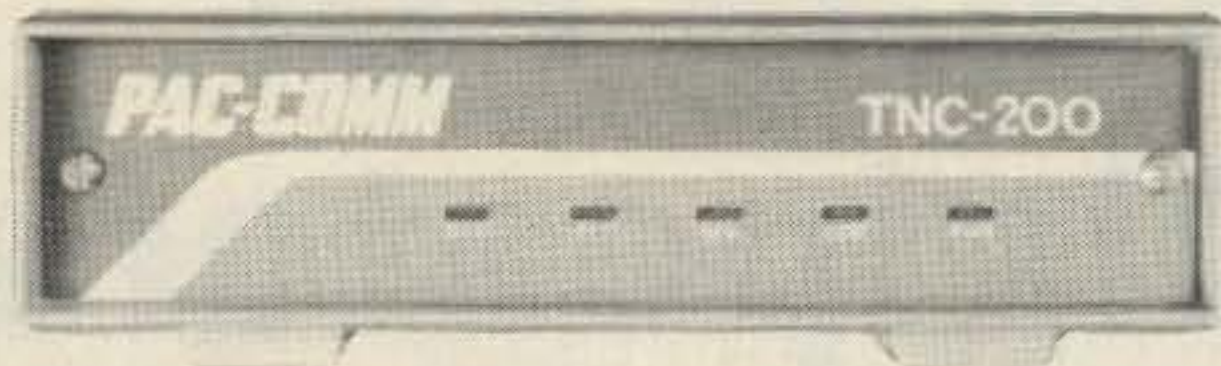

Fig. 1. Schematic diagram.

PAC-COMM

GIVES YOU MORE CHOICES

TNC-200



- World-standard TAPR hardware design
- Internal modem operates at 1200 or 300 baud
- Active filter improves modem sensitivity
- Five labeled LED status indicators
- Terminal baud rates 300,1200,2400,4800,9600
- Works with any RS-232 terminal or computer
- Battery backup for 16K RAM memory
- CMOS draws only 135ma (typ), NMOS 250ma (typ)
- World-standard TAPR software command set
- AX.25 Version 2 protocol fully implemented
- Up to 10 simultaneous connections
- Supports Level 3 networks (in development)

	<u>CMOS</u>	<u>NMOS</u>
Assembled and Tested	\$219.95	\$199.95
Full Kit with cabinet	\$169.95	\$154.95
Kit without cabinet	\$144.95	\$129.95
Hard-to-find Parts	\$ 84.95	\$ 79.95
PC Board and Assy Manl		\$ 39.95
Reference Manual (100+ pages)		\$ 9.95
Command Reference Card		\$ 2.00
Cabinet with End-plates		\$ 29.95

PTU-200

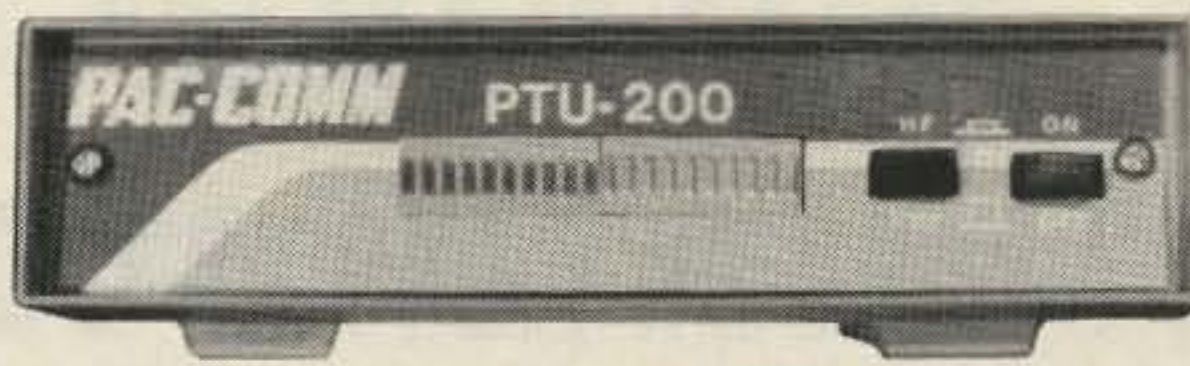

Packet Tuning Indicator/HF Modem

- Single push button selection of HF/VHF
- Active bandpass filter helps copy in QRM
- 20 segment red LED bar graph display
- Internal TAPR-design modem
- Power switch controls both PTU and TNC
- Works with any TAPR TNC-1 or TNC-2 clone
- Cabinetry matches TNC-200 design
- Installation is simple and convenient

Assembled and Tested	\$149.95
Full Kit and Cabinet	\$114.95

MACPACKET

Terminal Software for Macintosh

- Pull down menus, split screen
 - Works with any "TNC-2" or clone
 - stored digipeater routing tables
 - File upload and download and more
- Available now for only \$69.95

PC-PACKET

Terminal Software for your PC

- Split screen or multi-color display
- Multiple, scrolled pages of rec/xmit buffer
- Fully configurable PC and TNC parameters
- Works with all TNC's (including GLB PK-1)
- Pop-up windows for operator interface
- User-definable function keys
- Printer/disk logging, DOS access

Available now for only \$49.95

PC-100

Dual Port Packet Controller

- Dual Port TNC on a half size card
- Use With your PC or compatible
- TNC software included
- Dual 300/1200 high performance modems
- Provisions for high speed external modem
- Use as Network Controller, Gateway, etc.

Assembled and tested	\$189.95
Full kits from	\$149.95

ORDER TOLL-FREE
800-835-2246 ext. 115

Dealer inquiries welcome

Sales and Technical Information Call
813-689-3523

SEND FOR OUR FREE CATALOG

FREE SHIPPING IN CONTINENTAL USA

ASK US ABOUT OUR VOLUME DISCOUNT PROGRAM

Florida addresses must add 5% sales tax



PAC-COMM PACKET RADIO SYSTEMS, INC.

4040 W. KENNEDY BLVD., TAMPA, FL. 33609

TELEX 6502881526 mci



Survival Training For Mountaintop Digipeaters

A ROM with a view.

It was mid-afternoon, late by mountaintop standards. From the ground, the clouds seemed motionless. The air was moist, still, and quiet. Up on the tower it was another story. Greg WB6ASR, leaning unsupported

50 feet above the ground, was constructing an antenna on the tower from parts pulled from his parka pockets. Fifty-mile-per-hour gusts squeezed the moisture from the cloud onto anything they touched. It was cold, it was wet, and we were late.

Later, with the antenna constructed and

coax routed, we repaired to the building to continue testing the digipeater we were fixing. Finally satisfied that the digipeater was operational, we packed up the wattmeters, the portable computers, and the multiple toolboxes. We had just installed a brand new radio and new switching power supply. We had upgraded the digital hardware and installed the latest version of the digipeater software. And, as a final precaution, we had installed a watchdog timer, which would perform a "hard" reboot of the digipeater every 15 minutes. Any single improvement would have been enough; we did them all.

It was very late when we finally arrived home. No matter. We *had* to test the digipeater, now so far away. It was still there. It worked well.

As the uptime data accumulated over the next few weeks, it became obvious that we had done well. This was another "zero-downtime" site. Then, three weeks later, a seven-minute outage. The next day, another. Without pattern, without reason, and a five-hour drive from civilization, our digipeater was hiccuping. Without the watchdog timer, it would have gone down for good.

Most users were unaware of the difficulties at our digipeater. It was heavily used and seemed reliable. Only we saw the downtime statistics piling up; we began to plan our next trip to the hill.

Introduction

This article describes a network of mountaintop digital repeaters covering the state of California. This network was installed by our radio club, the W6AMT ARC, in early 1985 and has been in continuous use ever since. Fig. 1 is a map of the system showing the relative locations of the major sites and California population centers.

This article is divided into three parts: the goals of the network, the trials and tribulations of putting (and keeping) the network

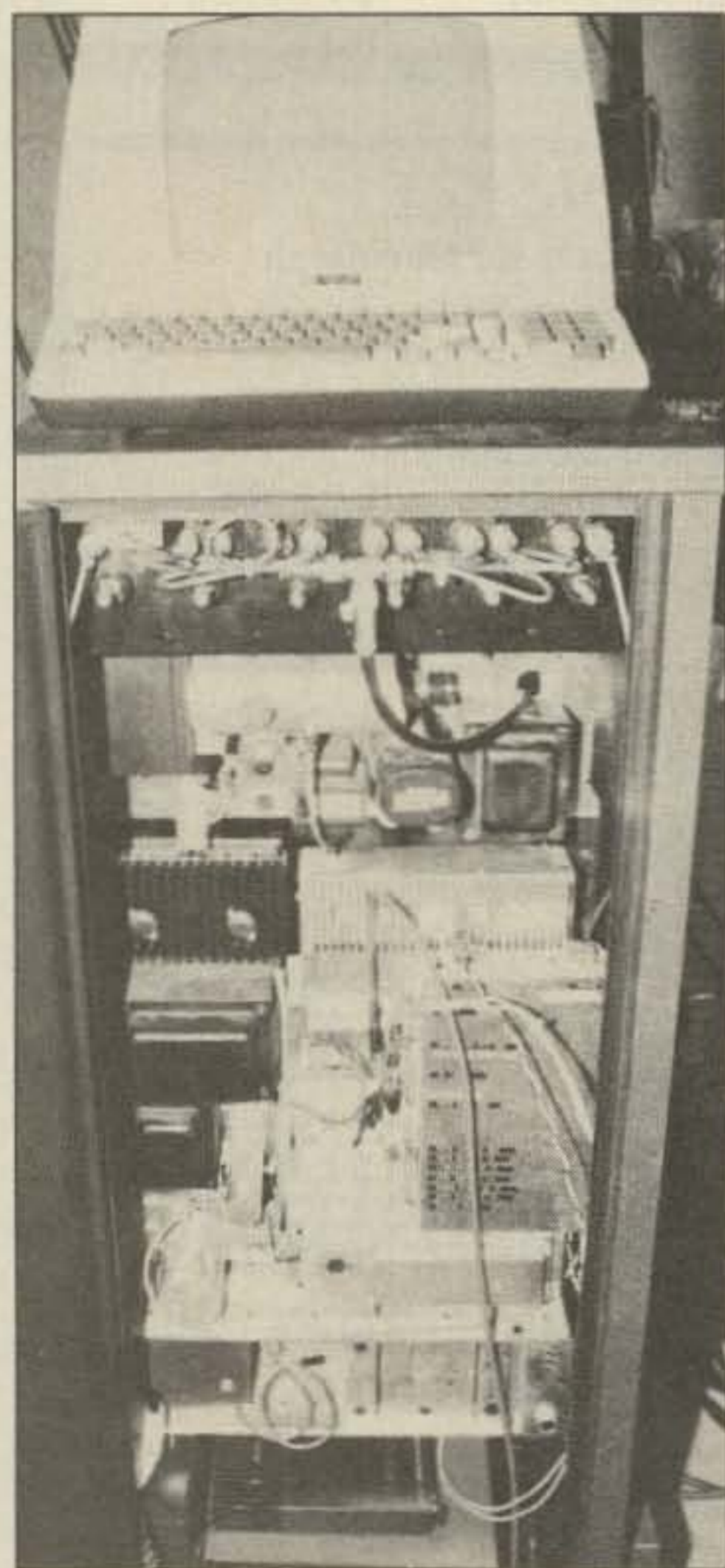

Photo A. Well-dressed mountaintop equipment racks now sport computer terminals. This digipeater requires 5-1/4" of this equipment bay.



Photo B. A two-meter pass cavity is much like an antenna: If it is small enough to be convenient, it is too small. This one is 24" tall and 9" in diameter.

components up, and the direction the network is taking.

Mountaintop Digipeater Networks

Our first step in designing our communication network was to define the goals of the network: We wanted to move data reliably, expand the network as technology progressed, serve the major population centers in California, and have fun building it.

The first part of the network structure to plan was the locations of the digipeaters (digital repeaters). These locations were dictated by the major population centers in California. The proximity of the digipeaters was determined by their range and the desire to have as little overlap (mutual interference) as possible. As soon as the ideal locations for network digipeaters became settled, site acquisition started.

The hardware for the network was selected with a design goal of zero-downtime. Previous experience in mountaintop remote-base and voice-repeater equipment was a good start: There was no desire to invent anything if an acceptable solution was already available. Many industry professionals were consulted and potential pitfalls were identified in advance. Unfortunately, there was little real experience in combining mountaintops, computers, and radios, so we fell somewhat short of zero-downtime.

Finally, we had to choose the software for the network. It was not thought to be an issue at first but has become the major issue within the community. Network software will be discussed in greater detail later in this article and in other articles in this issue. Additionally, a bibliography is included for the serious digipeater student.

Selecting Digipeater Sites

There are several methods that can be used to cover California with reliable data communications. They fall into two generic categories: low-level digipeaters and high-level digipeaters.

We describe a digipeater as "low level" when it is planned to have a range of about 20 miles—the range of most "home" digipeaters. Building an amateur digital communications network with many low-level machines has several advantages. Since by implication such a network would be composed primarily of home stations, the cost to our organization would actually be less; all we would have to do to get the coverage we wanted would be to "find" the stations that were in the "right" places. Easy. This network would also be *much* easier to maintain because each node would take care of itself.

There are also some disadvantages. Sometimes there are *no* people in the gaps between population centers. Other times there are too many people to allow "picking" one without everyone else asking, "Why not me?" Additionally, a low-level digipeater network has a fatal flaw: It requires more "hops" in any long path connection than the

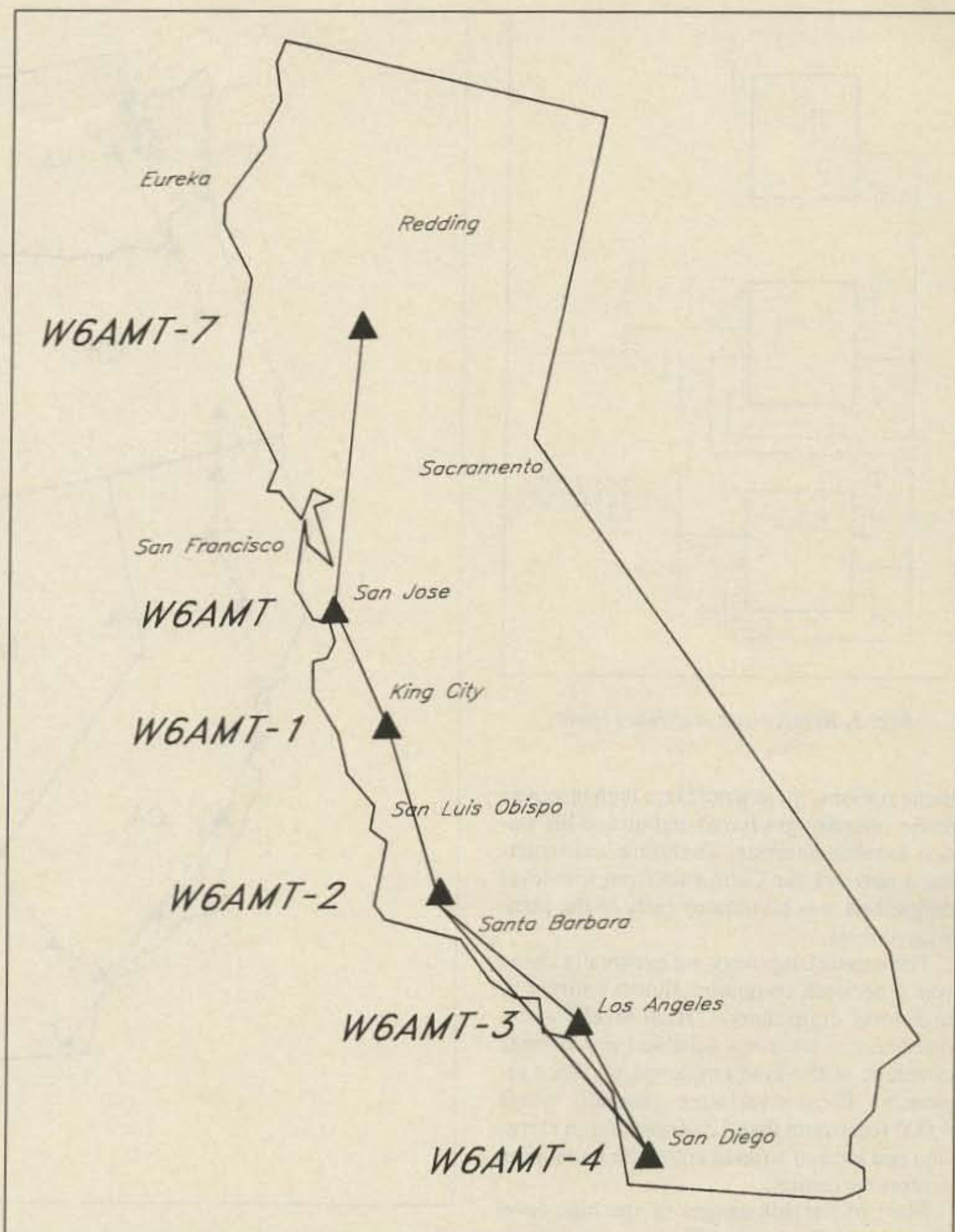

Fig. 1. The AMT Packet Radio Network on 145.01 MHz as of May, 1986 (diagram by WB6ASR).

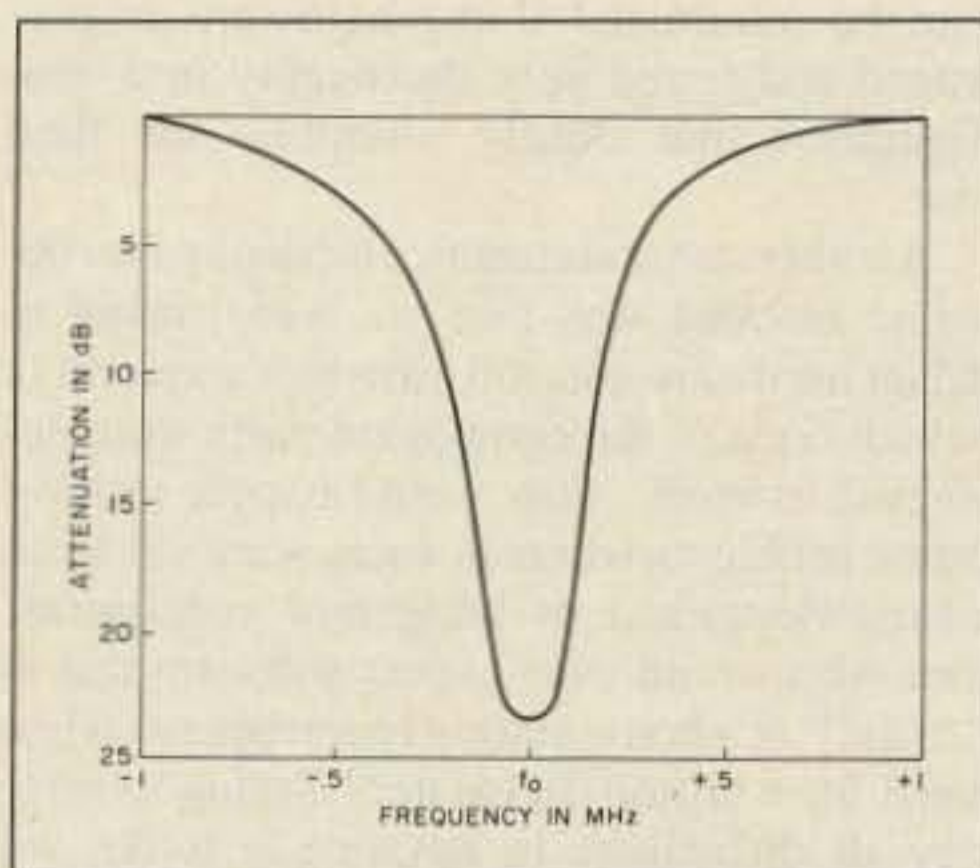

Fig. 2(a). Notch-cavity response curve.

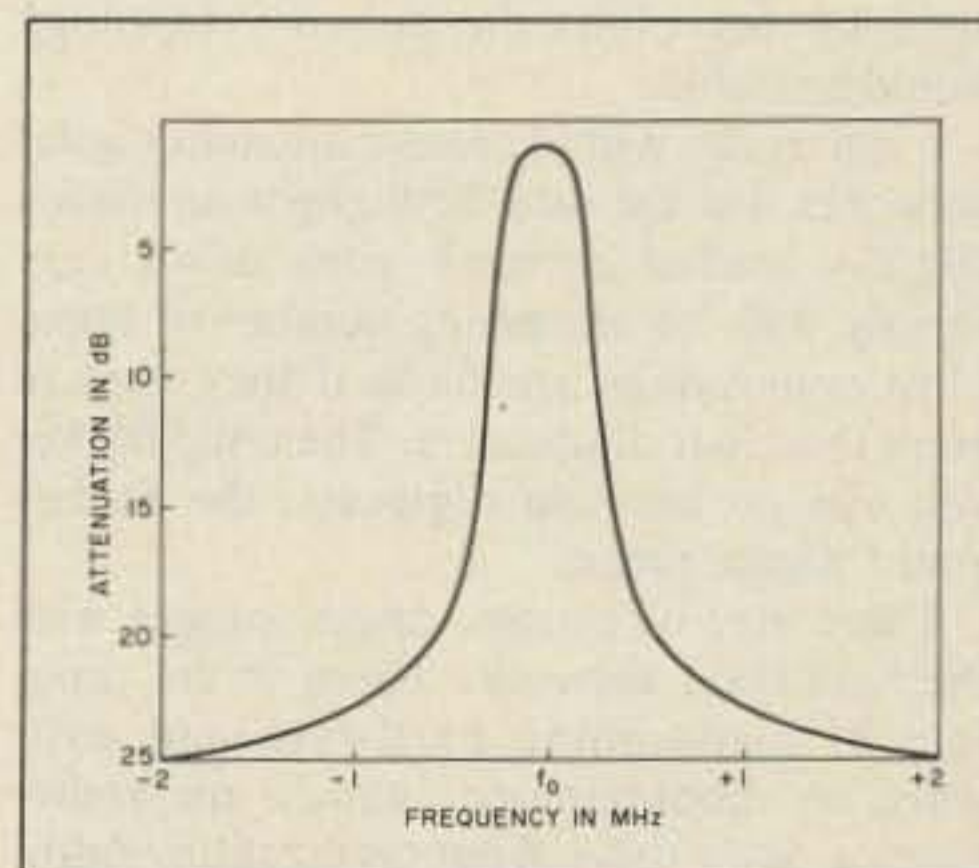

Fig. 2(b). Pass-cavity response curve.

packet-radio lingua franca, AX.25, will allow. Eight digipeaters are all you can request, and there were too many miles between major population centers for this number to be sufficient. The design goal was to have Portland, Oregon, connect to Los

Angeles with those eight hops. Greater distances were to be handled by using mailboxes along the way.

Another failing of a low-level digipeater network is that paths would always be changing; since the network depends on many

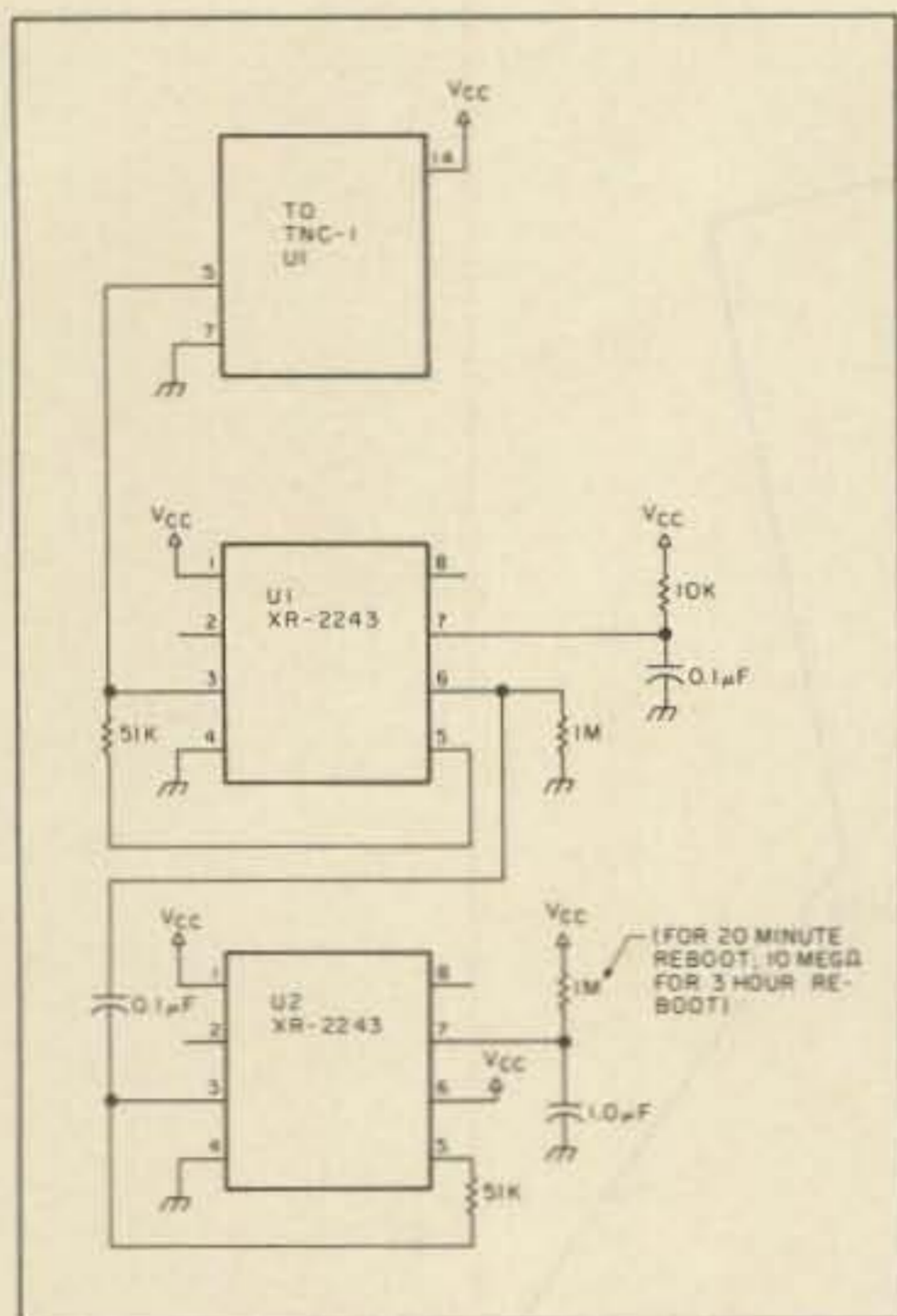

Fig. 3. Remote-site watchdog timer.

home stations, there would be a high turnover as the operator got bored and turned his station to other interests. Therefore, constructing a network for California from low-level digipeaters was eliminated early in the planning process.

The network topology we eventually chose was a network composed almost entirely of high-level digipeaters. "High level" is defined here as locations suitable for wide area coverage of the kind employed by voice repeaters. These sites were generally about 4,000 feet (more than 1,000 meters) in elevation and located so as to cover the population centers we desired.

Most of the advantages of the high-level digipeaters are obvious: There was less hardware in the network, fewer hops were required to cover a given distance, and, since the hardware and locations would be managed by our club, the network topology would be stable.

It is a truism within present amateur digital networks that the data throughput on even a slightly loaded network goes down very rapidly with an increasing number of hops. Most connections are futile if they contain more than four digipeaters. Thus, the farther you can go between digipeats, the farther your "digital range."

There are, of course, disadvantages with the high-level network. There is the problem of maintaining hardware and software on mountaintops, which are sometimes a day's drive from civilization. Additionally, it turned out that computers and mountaintops do not get along very well together.

Hardware Issues

Because high-level digipeater sites tend to be placed well away from civilization, hardware maintenance must be accomplished after a long drive. Problems

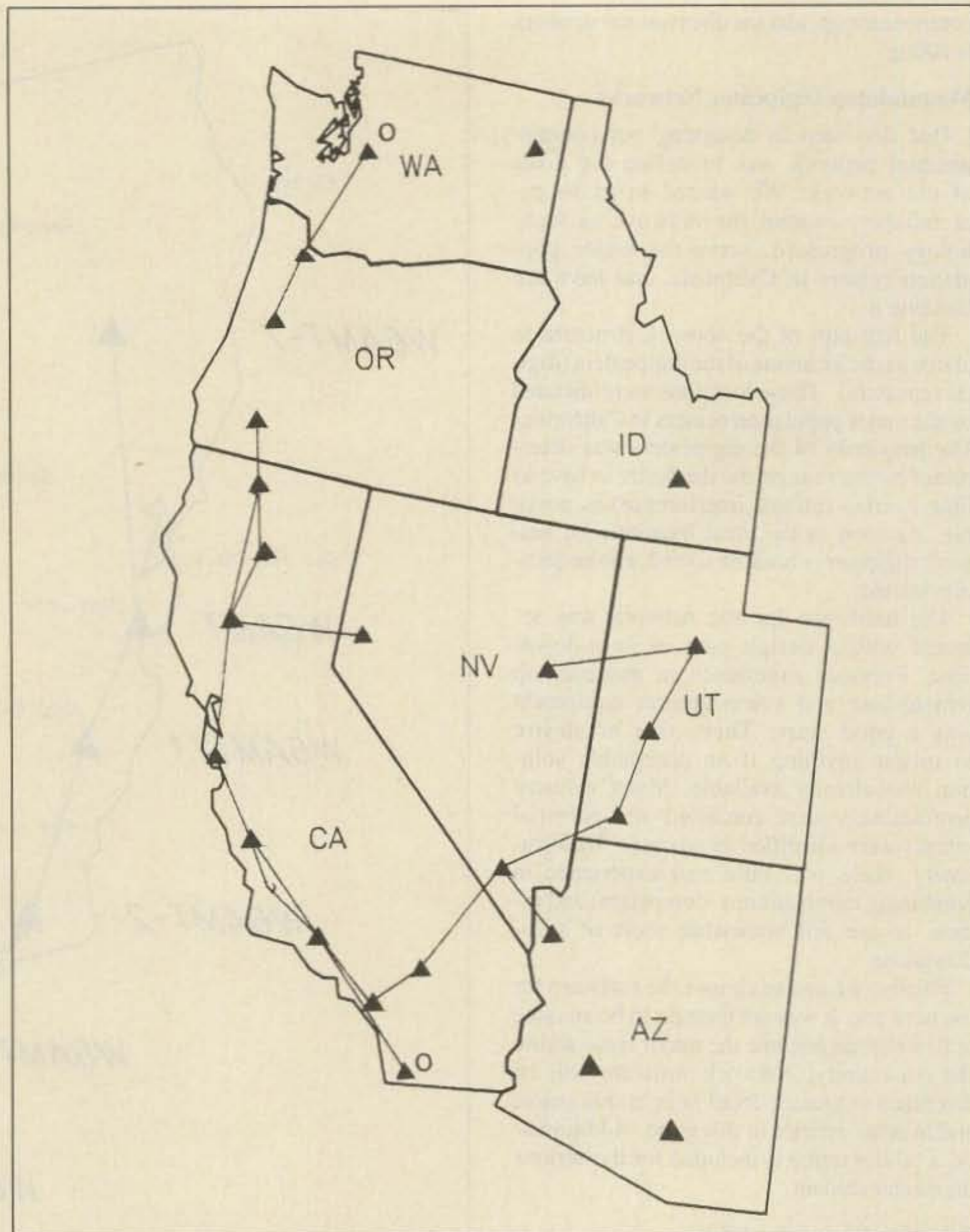

Fig. 4. WESTNET as of May, 1986. Triangles represent digipeaters and circles represent mailboxes (diagram by WB6ASR).

can be minimized if the hardware is packaged and tested very thoroughly in a configuration that closely resembles the final one.

Another site maintenance difficulty that became obvious was that we were trying to adapt hardware and software into a system in which none of the component parts were designed to work. One would expect to have some problems where corners were cut as an acknowledgment of budgetary constraints. But who would ever expect software that is "solid" at a home station to misbehave when used for a hilltop digipeater? Trying to foresee all difficulties in advance is futile; we discuss those we encountered and invite correspondence.

When we put up our first digipeater, it was basically just a transported home station. We had some experience in the environment of a mountaintop and figured that we knew what the radios would do. As for the computer stuff, "What could go wrong? After all, it's digital!" Radio amateurs, howev-

er, have had little experience with hilltop computers.

The fact that we have a network up that carries as much traffic as it does shows that you do not have to go out and buy expensive commercial equipment of possibly limited availability; you merely should be aware of the environment your equipment is going to be immersed in. Remote locations are a much more hazardous environment than we at first thought—but almost anything can eventually be managed if anticipated.

We Picked Mountaintops

Having looked at the pros and cons of building a mountaintop digital communication network, and despite the fact that there was no one else in California to "connect" to on 145.01 MHz, we decided to put our hardware up. The digipeaters went up one by one over a period of about three months. This turned out to be fortuitous timing as it corresponded to some very explosive

growth in the packeteer population within California.

That the approach of placing digipeaters high and far apart was a successful one was immediately apparent. Single-hop QSOs covering more than 200 miles became commonplace. Other states became workable for the first time over paths that were unknown before this time. An example of this was the connection in early March, 1985, of Jack WA7DIA using his WA7DIA-1 digipeater in Reno, Nevada. Previously unheard-of distances became an everyday occurrence. Packets were "heard" in Oregon and in the mountains near Las Vegas. The outcome was obvious to those with foresight: network saturation.

Some disadvantages also became apparent. With a single digipeater in sight of so many stations, users started to wonder why they couldn't get digipeated. The common complaint was, "Why doesn't the digipeater hear me? I'm running 200 Watts." The digipeater itself usually ran some tens of Watts (which was plenty), so what was the problem?

We wandered up to the hill for a prime-time look at the problem. We hooked up our terminal and sat back for an enjoyable operating session. When we turned it on, we were amazed: We saw nothing but continuous packets going by. People trying to use the digipeater, people using other digipeaters within range, people talking to people simplex. People and more people. It was a wonder that anything got through at all! We called this the "white lightning" effect and are still wondering what to do about it.

Another problem that showed up early on was the number of "Dufus" packets. Dufus is that brand new packeteer. He is still trying to figure out all the settings and options on his latest TNC. You gather he is obviously a little lost from the things he is saying to others who try to contact him. He has lots of company. I guess it is to be expected since packet radio is still a very new mode. There were so many problems with Dufus and his friends that sometimes our digipeaters carried beacons outlining suggested operator settings for the TNCs "out there."

Mountaintop Characteristics

Our club has many great memories of mountaintops. We spent many VHF/UHF contests atop hills. The weather got a little chilly but it was never terrifying. Putting hardware up and leaving it up is quite different. The benign rocks and trees you see during the day when you are tightening bolts and routing coax become downright hostile when you turn your back. Exposed hardware does not merely break, it disappears.

Weather

The primary villain is wind. If the weather gets cold, ice and snow will also add to the misery your hardware must undergo. Ice increases the wind load, while snow, if deep enough, will make a shambles of your swr. Coaxial-cable routing should be done carefully. If routed where it will swing in the wind or be used as a support by someone else

Problem	Solution
NOVRAMs	PROMs
v2 transfer	Better software
Drift with temperature	Better pots for the TNC
RFI	Toroids, filters, chassis sanding, grounding, 9913 coax, bypassing, etc.
EMI	Ditto
Relays	IC-28Hs, IC-27Hs, GE-MVPs, Motorola Moxys
Sabotage	Locked cabinets—remember to lock up cavities
Desense	Cavities, antenna placement, coax routing, prayers

Table 1.

working on the mountain, it will not last. The last thing to remember is to have plenty of weatherproofing putty on hand to seal the weather out at the coaxial-cable entry point to the building.

Mountaintops display extremes of temperature—sometimes more than 100 degrees in a day. Hopefully, the shelter housing the digipeater moderates the outside temperature somewhat. There will be both short- and long-range temperature swings to endure.

One problem we found with some of our digipeaters was that the modem tones produced by the TNC drifted. The drift was compounded by the changes in humidity accompanying the temperature changes. After fighting it for a while, we gave in and replaced the cheap carbon single-turn pots that came with our TNCs with 10-turn wire-wound pots. The drift is still there, but the TNC can go years without recalibration.

Before we get off the subject, it should be mentioned that heat, being the great killer of electronic equipment, should not be allowed to build up. All the sites should have exhaust fans that are placed to minimize intake of dust. Mountains are quite dusty.

Power

Another topic unique to hilltops is the kind of power you are going to have to use for the digipeater. The power that gets supplied to the top (if you are fortunate to have commercial power supplied to the site) arrives after a long journey. If you put your trusty power-line monitor on ac, you would get a picture of chaos. Power dips, voltage surges, and lightning-induced peaks all are trying to get through your power supply and kill your digipeater.

If the hill supplies battery backup that someone else has made operational and is maintaining, and you are invited to use it, by all means, go ahead. However, if you are thinking of adding battery backup to your digipeater, realize that there are many costs associated with batteries. They take up a lot of space, they require maintenance, and they are expensive. On the other hand, batteries might be the only way to get reasonable up-time from your digipeater.

Some mountaintops have an emergency backup generator. This is usually a beast of a generator that is set to come on a given time after the commercial mains drop out. This

power source has all the problems of commercial power with the added feature that the line frequency can vary. This is a problem for some types of switching power supplies.

Another topic worth covering while discussing digipeater power sources is the trade-off between switching and linear power supplies. Switching power supplies operate more efficiently, weigh less per Watt, and occupy less space. Because they are more efficient, they generate less heat. Thus, all things being equal, switching power supplies increase system reliability. The trade-off is that "switchers" cost more, and the less expensive ones are sensitive to power-line quality. We use switching power supplies in most of our sites primarily for saving space and have been very satisfied with the resultant system reliability.

Electronic Environment

One aspect of mountaintop operation that is not confined to mountains alone is the number and variety of rf generators that can be located very close to the digipeater. Some sites have very high power transmitters operating continuously. This has the advantage of presenting a known environment to operate in, but also the potential disadvantage of producing very high rf seemingly everywhere. Other sites have a larger number of much lower powered transmitters, which operate at irregular intervals. It is often difficult to perfect the digipeater in this type of environment because the problems occur when two or more of the co-located transmitters transmit simultaneously.

The best method we have found for obtaining reliable rf performance at the digipeater is to utilize a "pass cavity" or two between the digipeater radio(s) and the antennas. This is possible because the digipeater is a simplex device: It operates on a single frequency for both transmit and receive. A properly adjusted pass cavity blocks all other non-harmonically related rf energy from the digipeater radio's "front end." It has the added benefit of attenuating any spurious energy produced by the digipeater. This makes the packet-radio box a good neighbor. Some sites have a particularly tough problem with co-located transmitters that are also very close in frequency. This type of problem can be solved through the use of a "notch cavity," which has its notch set to the interfering transmitter's frequency. A good quality cavi-

ty can be quite sharp, as indicated by Figs. 2(a) and 2(b). It is one of the best investments anyone considering a high-level digipeater can make.

Operating a TNC in close proximity to a great deal of rf energy was not one of our design considerations. We had problems with rf getting into the TNC and causing anomalous performance. We had already put the cavity on the radio, so other radios were not bothering our TNC—our own transmitter was. And it was a hassle. Everything would work perfectly until we tightened the last screw. Since we could no longer test the TNC ourselves (because we had to disconnect our terminal), we had to depend on the reports of others. They would say that the TNC was "loud, but it didn't transmit very long." We named this problem the "short problem." It turned out that when our TNC got a large enough dose of our own rf, it would transmit only quarter-second bleeps of bogus data. This was eventually cured by bypassing the TNC leads (mostly power leads), putting toroids on the leads to choke the rf, and, as a temporary expedient, reducing the power out of the digipeater transmitter.

EMI and RFI

One of the problems in operating radio equipment near computers is that computers are "noisy." They generate noise and spurious signals all over the spectrum. This problem has the name electromagnetic interference (EMI). It sometimes seems that most of the popular TNCs had one of their loudest birdies right on the frequency we chose to put the digipeater on. On either side of 145.01 MHz, everything was quiet, but tune to .01 and there was an S9, slightly off-channel signal!

There is no easy solution to this. The signal was there and didn't want to be moved. We turned to the books on the subject, which proposed all sorts of solutions. We tried them in order, each improving the situation a bit, until we were satisfied.

The most important step in reducing the ill effects on our radio from the signals being generated by the digital circuitry in the TNC was to bite the bullet and shield the TNC from the radio. This meant that the TNC enclosure had to be made into an rf-tight box. After scraping the paint off the box (to better the electrical contact) and putting more screws into the sides, we tackled the power and signal leads coming out of the TNC enclosure. One last tactic was to use high-quality, well-shielded coax. We wanted signals to enter the radio only from the antenna, not to come into the coax unintended.

Equipment Selection

Mountaintop digipeaters are no fun if they are down, and they are down longer if they are hard to maintain. Several sites are far enough away from the home QTH that the distance we had to travel became intimidating. Anything we could do to forestall a trip to the hill was worth the effort. Equipment was selected (after the first digipeaters taught us the hard way) for reliable service in digipeater use. Digipeater use is quite different from most other services. Its characteristics are low duty cycle (the average packet is a second or so long) and a large number of transmissions per unit time. A busy packet channel will average more than ten packets (transmissions) per minute...all up and down the state...thousands per day.

The equipment of choice is solid-state throughout, has no mechanical relays anywhere in the PTT (push-to-talk) logic, recovers unaided from vagaries in the power supplies, is capable of being well (enough) shielded, and reboots itself if the computer goes down. Suitable equipment is available in the amateur radio or commercial radio industries.

The only piece of hardware that we could not buy off the shelf and either use directly or modify for use was the watchdog timer mentioned earlier. We built ours to be "field installable" on a small PC board that con-

nected to the TNC via a ribbon cable. We simply removed U1 (of our TNC-1s) and plugged our board in. The reset time was set to reboot fairly often. The thought was that if we rebooted every 15 or so minutes, we would lose a packet due to rebooting less than one tenth of one percent of the time. Fig. 3 is a schematic of the watchdog and has details of operation and installation.

Software Challenges

Not all the problems confronting the mountaintop digipeater are hardware. The rest are software or software related. The protocol that all TNCs "speak" to each other is called AX.25. It was derived directly from an internationally established digital communication protocol, X.25. This protocol is specified in two versions with version two (AX.25 v2) being somewhat more powerful. As users of the digipeater system started to use v2, it was discovered that the digipeaters in the network would not digipeat the v2 packets. We needed a bug fix. After casting about for some months, we got lucky and acquired some PROMs with software that would digipeat v2 packets. Some TNCs still being produced cannot handle AX.25 v2 packets. Be careful if you are planning a digipeater.

The only other software-related problem within the scope of this article is not really a software problem at all. It turns out that the TNC-1s we were using would "forget" their own callsign. The callsign information is held in a nonvolatile RAM, in which the user customizes his TNC. Ours became volatile. We joked that NOVRAMs did not work above 2,000 feet, but the real culprit was the TNC itself. A design error was occasionally corrupting the NOVRAM. The good news was that it happened only when rebooting. The bad news was that our digipeaters were being hard-booted up to 50 times a day by their watchdogs. The solution turned out to be straightforward: We "blasted" the digipeater call and other particulars into the PROMs that held the software and did not use the unreliable NOVRAM.

Table 1 lists most of the problems we encountered and the solutions we implemented. The solutions are not perhaps the most elegant, but they are guaranteed to work.

Future Direction for High-Level Networks

The following is a subjective discussion of some future directions amateur digital communication networks will be taking:

- The mountaintop nodes of future networks will have much more "power" than today's meager digipeaters.

Several trends and facts will drive the mountaintops to provide many more user services than they do now. Any attempts to leave the complex stuff on the ground invariably require links to the hilltops. These links are sources of error and network failure. Keeping the complex stuff on the mountain eliminates a lot of hardware; network reliability is the prime driver.

- These will become dual-port and then multi-port digipeaters.

Dual-port and multi-port digipeaters are

GLOSSARY

Connect	A situation in which both you and the station you are talking to are in synchronization. His computer is talking to your computer, and all you see is error-free text being printed. Can be several hops.
Digipeater	Digital repeater. Receives data packet over the air and decodes the packet to see if retransmission is requested. If so, the digipeater retransmits the data.
EMI	Electromagnetic interference—generic term used here to describe interfering signals that are unintentionally passed around your equipment.
Hops	Digipeater "relays."
LAN	Local area network—those operators who can link to you through the same digipeater.
Link	See connect.
Packeteer	Packet radio operator.
RFI	Radio frequency interference—generic term for the situation in which your radios are causing malfunctions in other equipment.
TNC	Terminal node controller—the box between your radio and the computer terminal. Contains a computer that performs the retransmission and "link maintenance"—tries to synthesize an error-free path.
User	An operator who believes everything you tell him.
WAN	Wide area net—all the operators who are capable of being connected to.

necessary to allow the LANs that have developed on separate frequencies (and perhaps that have separate digital protocols) to interconnect. HF, satellites, and other developing communication technologies are going to want to be interconnected.

- We will see common use of hilltop mass-storage systems.

There is just too much flux in the software amateur networks are running to update your system with a new set of PROMs with every new software release. Uploading data from the ground is the preferred method of updating both digipeaters and geosynchronous satellites. The former are little more accessible than the latter. Additionally, there is much data that will be collected by the mountaintop digipeater for its own use. Winchester drives on mountaintops are just one cost-effective solution.

- There will be several different protocols in use in the near future. Therefore, the networks are going to have to support multiple protocols to be maximally useful.

There is no dearth of processor power these days. There is no excuse not to put every protocol that will fit into the computer's memory onto the hilltops.

- Other resources that mountaintop digipeaters (or digipeaters in general) will be providing users are mailboxes, execution servers, and data base servers. This is just a further economy of overall network resources.

Future software, though more complex, will be much more reliable. One of the frustrations of present TNCs is that supporting the software by adding features or squashing bugs is very difficult. Software that is easy to support will be used. Support includes available source code, relatively common support environment, and available expertise in the details of said software.

Summary

When we first planned a statewide network, the task to be accomplished seemed obvious: move data reliably. As our thinking progressed, additional goals became clear. There were other (more or less) compatible digipeaters to link to. There were problems with overlapping coverage and propagation-dependent paths. There was (sigh) intentional interference. There were changes to the underlying AX.25 protocol which necessitated software upgrade to the hilltops. There were plans, plans, and more plans. The future had to be accommodated; the network was in danger of being obsolete before it was completely operational.

Now, the network is up and there are many other groups and individuals linked together. Fig. 4 illustrates the extent of the Western United States packet-radio network (commonly called WESTNET). Development proceeds at a rapid pace (for amateur radio). One thing is certain: Tomorrow's networks will be more fun than those of today. ■

Reference

D. W. Davies, et al, *Distributed Systems*, Springer-Verlag, 1981.

"When You Buy, Say 73"

CALL OR WRITE

Amp
Supply Co.

for our
Summer Specials

1200 Watt and Full Legal Limit
Amplifiers Tuners
Accessories and Parts

208 Snow Ave., PO Box 147
Raleigh, No. Caroline 27602
919-821-5518
TELEX: 980131 WDMR

✓111

BEST PRICE ON

KENWOOD
TM-2530A
TM-2550A
TM-2570A

Toll-free outside Ohio:
800 431-3939
Inside Ohio:
614 866-4267

Universal is a Kenwood authorized dealer
in business over 35 years!

UNIVERSAL AMATEUR RADIO INC
1280 AIDA DRIVE, COLUMBUS, OHIO
(Reynoldsburg) 43068

✓104

Watch
this
Spot!



**The Big "O" is coming.
Mark Your Calendar
for March 13th,
14th & 15th, 1987.
For Information call
(305) 422-ARRL
KC4CT**

✓96

Completely New!

**Get Gest Software Package
for serious SSTV hams.**

Totally new, unrivaled SSTV software system for the Robot 1200C. Features 14 main menus with total of more than 70 functions including 256K color palette, 65K colors on-screen capacity system!

Now available to the amateur market.

Send check or money order.
\$599. per system.

✓114
Torontel Technology Ltd.
174 Bellany Rd. N. Scarborough Ontario
Canada, M1J2L5
416-292-9952

ALPHA AMPLIFIERS

"If you want the finest"



Model	List	Sale
77DX	\$5450	CALL FOR LATEST PRICE
78	\$3495	
374A	\$2595	
76A	\$1985	
76PA	\$2395	
76CA	\$2695	

**Phone Don Payne, K41D,
for Brochure**

Personal Phone—(615) 384-2224
P.O. Box 100
Springfield, Tenn. 37172

✓107

PAYNE RADIO

Q: Do you check the actual operating frequency of your rigs from time to time using a good frequency counter?

A: A 500 MHz pocket frequency counter, with 4 digits (switchable to 6) only \$49.95. 500 MHz handheld frequency counter, 7 big digits \$79.95.

Q: Do your rigs copy the really weak signals????

A: PA-19 Preamp, 0.5 to 200 MHz, 19 db (10x) gain \$9.95.

DIGITREX ELECTRONICS
division of NCI
10073 North Maryann
Northville, MI 48167

✓106

Personal checks or money orders are accepted.
Or call in a COD Phone 313-348-7313 NOW

Beyond Level Two

High-level networking comes to packet radio.

Most of the packet articles in this issue of 73 have been aimed at non-packet users or new packet users. A few were targeted for second-year students. This article is for the user who is ready to take the advanced packet course. It discusses issues at the center of the next round of technical development. If you are at the advanced level, read on and get ready to help out. If you aren't quite there yet, scan through and start to pick up some of the terms and concepts. If this issue was your first exposure to packet radio, take heart, this space could have been four more pages of Never Say Die.—NK6K

It is an exciting time for amateur packet radio. In this young facet of our hobby, things happen fast. Just as the new packeteer is getting started, he or she is immediately bombarded with all sorts of arcane buzzwords like "protocols" and "layering" and "level 3," spoken by people who always seem to be arguing passionately with each other, usually about things like "datagrams" and "virtual circuits." The poor neophyte must think: "It was bad enough when computers came to ham radio, but this is *communications*, a subject I'm supposed to know something about!"

In this article I hope to dispel some of the mysteries surrounding the new developments in packet-radio protocol. This *is* communications, so there really isn't much that's fundamentally different from what you already know from being a ham. Computer networks are nothing more than automated traffic nets, using computers instead of human beings to move messages around. Of course a computer, being both faster and dumber than you or I, can't (and shouldn't try to) do everything in exactly the same way as a human. This often has quite an effect on what uses are (or aren't) practical. But the underlying ideas are the same, and I think you'll easily see them.

The Story So Far

As has long been the case with CW, phone, and RTTY, packet radio has standard procedures for initiating and terminating QSOs, and for exchanging information during the QSO. In computer lingo, such procedures are called protocols. The only real difference is that packet-radio protocols are much more formal than the protocols for, say, an SSB

rag-chew. This is because packet-radio protocols are carried out by computers, which lack human traits—such as common sense. Every little detail, no matter how "obvious," has to be spelled out because computers will do exactly what you *tell* them to do, not necessarily what you want them to do.

Almost all amateur packet-radio work is currently done with what is commonly known as the "AX.25 Link Layer Protocol."¹ Virtually all the packet Terminal Node Controller (TNC) boards now sold have AX.25 programmed into them. AX.25 began life as the link-layer portion of the CCITT X.25 protocol.² X.25 is the protocol used by customers to access packet-switched public data networks operated by common carriers such as GTE Telenet and Uninet in the USA, and by the Postal, Telephone, and Telegraph (PTT) agencies in many other countries. The link-layer portion of X.25 is also known as LAPB (Link Access Procedures Balanced). LAPB itself belongs to a class of link procedures known as HDLC (High-level Data Link Control). HDLC was originally developed by IBM, and it is now an International Standards Organization (ISO) standard. (To quote Tanenbaum: "The nice thing about standards is that you have so many to choose from; furthermore, if you do not like any of them, you can just wait for next year's model."⁶)

HDLC is popular in the commercial world, and several manufacturers make integrated circuits that support it. HDLC is a *synchronous* protocol; that is, it lacks the start and stop bits that surround each character in ordinary (asynchronous) RTTY and ASCII transmissions. This improves the efficiency of the transmission at the expense of slightly increased complexity.

As mentioned earlier, X.25/LAPB/HDLC is the protocol used on landline links into common-carrier networks. Since these links are "point-to-point" (i.e., they lack the one-to-many, "broadcast" nature of radio), LAPB lacks addressing. To make it usable on a shared radio channel, addresses (amateur call signs) were added to LAPB, making AX.25. With this change, the shared rf channel became a true network, with packets implicitly "switched" among stations by virtue of the source and destination addresses always carried in each packet header. This is very similar to several commercial local area

networks, the best known being Ethernet.³ (Ethernet is often described as "packet radio on a cable.")

The underlying medium (coax cable or rf channel) is "stateless," that is, it "remembers" nothing from one packet to the next. Each packet must therefore contain all of the information necessary to get it to the proper destination. For this purpose, Ethernet and AX.25 both include full source and destination addresses in every packet, and the resulting packets are known as "datagrams." Since the notion of a "connection" requires something to remember who you are connected to, the endpoints have to do this themselves.

In Ethernet, connections (if desired) are left up to a separate, higher-level protocol; in AX.25, it is "built in" in the form of LAPB. AX.25 therefore consists of two halves: a lower "sublayer" that handles addressing on a packet-by-packet basis, and an upper sublayer based on LAPB that sets up a connection, retransmits packets when they are lost, and takes down the connection when it is no longer needed. It is possible to bypass AX.25's upper sublayer with the "UI" (Unnumbered Information) frame. UI frames are sent without regard to connections, guaranteed delivery, and so forth. Currently, the most common use of the UI frame is for broadcasting information (such as beacons) to all stations in a local area.

Why AX.25 Level 2 Isn't Enough

If the entire amateur "network" consisted of a common rf channel that allowed every user station in the world to communicate directly with everyone else (and assuming of course that this channel had enough capacity to handle everyone's traffic) our problems would be over. The closest we can come to this is a satellite channel. Even a satellite, though, can never see more than 1/2 of the world at any one time, has limited bandwidth, and requires specialized ground-station equipment. On the ground the problem is worse; only a tiny fraction of the stations one might want to communicate with are likely to be within direct VHF/UHF or even HF range.

Most networks in the world, not just the amateur ones, are like this. In order for most stations in the network to communicate, their

messages have to be relayed through intermediate stations, a practice familiar to hams from the very first days of amateur radio (and reflected in the second "R" in "ARRL"). The complications that result from this fact of life are what makes networking such a difficult, interesting, and/or lucrative (depending on your profession) problem. Problems such as routing (choosing one of many possible indirect paths through a web of transmission links), congestion control (alleviating or preventing traffic jams at "hot spots" in the network), and load sharing (getting the best use out of expensive investments) have occupied the minds of telephone company engineers, highway planners, and airline executives for many years. The amateur community is only now realizing the full scope of the challenges we face in building a practical, large-scale packet-radio network. Those who answer this challenge will find it a highly rewarding and educational experience.

As a temporary, partial solution to the lack of a universally accessible rf channel, AX.25 provides the "digipeater." This is a device that receives properly addressed packets and repeats them after a short delay, usually on the same channel. Digipeaters are very simple, stateless devices; they remember nothing from one packet to the next. Therefore, each packet to be routed through a digipeater must specify the digipeater's address. So we already have true networks out there, traversed by packets containing "source routes" (the list of digipeaters placed in each packet by the sender).

So AX.25 level 2 is certainly doing quite a bit more than its originally intended "link-layer" job. There also seems to be universal agreement that the current protocol by itself is just not up to the task. A network layer built solely out of digipeaters performs badly for the following reasons:

1. Acknowledgements in AX.25 are all end-to-end. If a packet is lost halfway down a chain of digipeaters, it must start all over again back at the source. While end-to-end acknowledgments are both necessary and sufficient to guarantee the *correctness* of a data transfer, it is obvious that performance can be very bad.

2. At present, digipeaters cannot automatically route packets based on destination addresses. As mentioned earlier, the sending station must specify in the packet the entire route to be followed. This can result in wastefully large packet headers, especially when a long chain of digipeaters is being traversed. Worse, the sending operator often does not know what digipeaters are available outside his local area, and even if he does he may not know which are the best routes to use. It *would* be possible to build a digipeater to route packets automatically based on their destination addresses. However, when routes change it is possible for the network to deliver packets in a different order than they were sent, and LAPB was never designed to handle this situation.

Digipeaters were intended as temporary stopgaps to provide connectivity until smarter "packet switches" could be built to

replace them. The idea was that AX.25 level 2 connections would be established only between stations having a direct rf path, and that a higher-level protocol would be supported by these switches to relay actual user traffic. As everyone knows, the popularity of amateur packet radio virtually exploded before these protocols had a chance to be developed and tested.

Divide and Conquer

Before describing the work that is underway to build an amateur packet network that solves the problems associated with digipeaters, it is a good idea to review some helpful principles. A large, complex system (such as a computer network) is almost always more manageable when it is structured as a hierarchy. Virtually every organization with more than a few people (such as a business) is organized in this way, so this should be familiar to just about everyone.

"The nice thing about standards is that you have so many to choose from; furthermore, if you do not like any of them, you can just wait for next year's model."

Organizing systems into hierarchies is useful whether the "components" be hardware, software, or people. Consider a person who wants to send a letter. He or she addresses an envelope and puts the letter in a mailbox. It is picked up by the Postal Service, and depending on how far it must go, the letter may take several truck and plane rides and pass through several post offices before arriving at the destination.

People sending and receiving mail need not concern themselves with the inner workings of the postal system. These are unnecessary details most people don't need (or want) to know anything about, so they are hidden from view. In turn, mail clerks have no business reading the mail they handle. All the information they need to do their jobs is written on the outside of each envelope in a standard, well-defined way, and the contents of the letter are delivered unchanged. There are also envelopes inside of envelopes; for example, a batch of letters all going to San Francisco can be placed in a sack for shipment. Now the truck drivers or airline cargo handlers need not handle individual letters; they need look only at the single destination written on the outside of the sack.

Several key principles are in use here.

1. Detail hiding: Each level in the hierarchy hides the unimportant details of how it goes about its job from the levels above it.

2. Encapsulation: Each level expects that the information it passes through a lower level will emerge unchanged.

3. Procedural standardization: The procedures used for peer-peer communication (e.g., the language used by correspondents in their letters, the procedures for scheduling and tracking postal truck shipments) are agreed on by the parties involved.

4. Interface standardization: Each pair of adjacent layers must agree on the exact services to be provided and the language to be used for communication between the layers. For example, the postal services maintain lists of routing codes (zip codes in the U.S.) and standard abbreviations. It also expects to find destination addresses written on the outside of envelopes in a standard way.

Clearly, a well-organized, hierarchical structure (along with the features just listed) is vital for something as large as the postal system to function, and this is even more important in a computer network. The amateur packet-radio network has already become one of the most complex systems ever built by hams, and a clear picture of how all the pieces fit together is essential in making it all work.

Fortunately, there is much outside experience that we can draw from in designing our network. Packet switching originated in experiments begun in the late 1960s by the U.S. Defense Advanced Research Projects Agency (ARPA). These projects were so successful that by the mid-1970s companies were forming to market packet-switching services commercially. Efforts began to standardize the interface protocols between a public network and its users; this resulted in the widely used X.25 protocol.

Many similarities between the components of the networks built by different groups were seen. From the need to describe these components in a reasonably uniform way, the *International Standards Organization Reference Model for Open Systems Interconnection (ISO RM)* was devised.⁴ The *ISO RM* defines a set of seven hierarchically arranged "layers," each providing functions often found in a computer network. It is very important to remember that the *ISO RM* is only a guide for describing existing computer networks. It was never intended to be a set of requirements for how they must be built, and in fact the component layers in many existing networks do not correspond exactly to those in the *ISO RM*.

The seven layers in the *ISO RM* are, from low to high: Physical, Link, Network, Transport, Session, Presentation, and Application. It is common to refer to a layer by level number, e.g., "level 1" is synonymous with the Physical layer, "level 2" with the Link layer, and so on. Since it takes a fair bit of space to properly cover the *ISO RM*, I'll give just a brief outline here and refer the interested reader to any of the excellent descriptions that have appeared elsewhere.^{5,6}

1. The Physical layer handles the electrical aspects of communication between two points. The pinouts of a connector, the modulation scheme of a modem, and the signaling rates are examples of things usually considered to be in this layer.

2. The Link layer handles the procedures for the transmission of blocks of data (often called frames) between two points in direct physical communication. It provides the means for distinguishing the beginning and end of each block of data, and usually ways to handle arbitrary data streams (transparency) as well. The link layer may or may not take special steps (such as retransmissions and acknowledgments) to improve reliability, although this is not always done.

3. The Network layer handles addressing and routing, essential facilities if a network is to have more than two stations and allow communication between stations that do not have a direct physical link (i.e., their communications have to be relayed through other stations).

4. The Transport layer is the first "end-to-end" layer; it manages network facilities on behalf of the higher layers and generally ensures the accuracy and reliability of data transfers on an end-to-end basis. It sometimes provides end-to-end "flow control," that is, it helps keep the destination (and the network) from becoming overloaded by sending data only when the destination is ready for it.

5. The Session layer is, unfortunately, somewhat vaguely defined. It is supposed to "manage" the transport facilities (although, in a sense, every layer "manages" the layer below it). It routes data between the transport protocol and the various program modules that require network services. It also provides special services that might be needed when a transport connection is established or torn down.

6. The Presentation layer loosely covers anything having to do with data formatting. Character sets (e.g., ASCII), the "escape sequences" used for special functions on CRT terminals, end-to-end encryption, and data compression are all generally thought of as Presentation layer functions.

7. The Application layer is the *raison d'être* for all the other layers: It is the program which needs to communicate (presumably on behalf of a human user somewhere) with another program in a different computer system.

That the ISO model is still around is a good indication that it includes many fairly fundamental ideas, and so it is still useful in describing computer networks. But networking technology has evolved in the meantime, and so in many cases a layer whose "job" seemed well defined and necessary at the time is no longer considered very important; likewise, other layers become complex enough that many people begin to think of their tasks as really being several "sublayers."

Another view is the U.S. Department of Defense Protocol Reference Model (also known as the "ARPA Reference Model").⁸ The ARPA model has only four layers (from low to high): Subnet, Internet, Host-Host, and Application. While similar in many respects to the ISO model, the fundamental concept in the ARPA model is the "internet-work" (the ARPA protocols are often referred to as the "Internet Protocols"). The

Internet consists of an interconnected set of dissimilar "subnetworks," each with its own internal network protocol "underneath" the ARPA protocols in the hierarchy. This is just a generalized extension of the hierarchy concept wherein an entire network is treated as just one "link" in an even bigger "internet-work." There is only one protocol at the Internet layer, and this is naturally enough called the Internet Protocol (IP). The most important ARPA Host-Host protocols are the Transmission Control Protocol (TCP) and the User Datagram Protocol (UDP).

There is still quite a bit of similarity between these two models. They are both based on the fundamental idea of a hierarchy of functions; each has functions which are done on an end-to-end basis and others which are not. What's important in both models is the relative position of a component in the hierarchy, not the fixed "level" designation it might have. (See⁷ for an amusing proof that $N = N + 1$ for any value of N when the relative nature of layers is ignored).

Since ARPA pioneered the (now very popular) concept of "internetting," it was not reflected in the original *ISO RM*. Therefore, the *ISO RM* has begun to sprout "sublayers," particularly at the Network layer (level 3). ARPA's Subnet layer corresponds to everything from the lower half of the ISO Network layer ("level 3A") and down, while the ARPA Internet layer corresponds to the upper half of the ISO Network layer ("level 3B"). The ARPA Host-Host layer performs the functions usually associated with ISO levels 4 and 5 (Transport and Session), while Presentation layer functions were considered application-specific enough to be merged with the ARPA Application layer.

New Developments

Now that we've reviewed the ISO and ARPA models, the fact that "AX.25 level 2" does quite a bit more than "link-layer" functions should become clear. The addressing portion of AX.25 seems to correspond most closely to the ISO Network layer, while the LAPB portion (that part which manages connections and retransmits lost packets) seems most like the Transport layer. Now that we've laid down a "divide and conquer" foundation, we can finally discuss in detail the various proposals for solving the problems we have in our current network. This is, of course, where the real fun is. In a field as fast-moving as computer networking, plenty of heated controversies arise. Some things, like the order in which the bytes of a packet header should be transmitted on a channel, are akin to deciding whether cars should be driven on the left or right side of the road. Clearly, which procedure is actually chosen is much less important than getting everybody to do it the same way!

Other issues, such as where (or if) a given function ought to be performed, are much more fundamental and reflect the different philosophies, objectives, and biases of the various designers. Some of these differences can be very deep, which is why the (often heated) discussions about them are common-

ly known as the Holy Protocol Wars. The mere existence of a controversy, however, usually indicates that no single approach is ideal in all situations, so it is very important to understand fully the pros and cons of each side.

As mentioned earlier, the current "packet switches" in our networks (i.e., digipeaters) are completely stateless, and this accounts for some of our problems (large packet headers, lack of hop-by-hop acknowledgments). So one question is: "How much state should be added to each packet switch to solve these problems?" To do hop-by-hop acknowledgments, for example, the switch will have to hold each packet in a buffer, retransmitting it if necessary until the next switch acknowledges it.

To eliminate the need for the user to specify the complete "source route" in each packet, the switch will need to maintain its own "routing table." Given the information carried in each packet, this table determines where the packet should be sent next. Should this routing table be based solely on destination addresses (thereby requiring the destination address to be carried in each packet), or should it also contain information about whatever end-to-end "connections" that might exist so that each packet need not carry the entire address? This is the crux of the famous "datagram vs. virtual circuit" argument. A virtual-circuit (also called "connection-oriented") network requires that each switch along the path be notified in advance of the transmission of data, so that a fixed route for the data can be set up. The CCITT protocols, such as X.25 and X.75, are generally in this class. In contrast, in a datagram ("connectionless") network, the intermediate packet switches handle each packet as a self-contained entity without regard to any end-to-end connections that might exist at a higher layer (generally at level 4, the Transport layer). The ARPA Internet Protocol is in this category.

Rather than delve more deeply into the issues (and risk cries of "foul" and "equal time" from the virtual-circuit advocates, since I'll admit to being the chief advocate of the datagram approach) I refer the interested reader to the papers published in the Fourth ARRL Computer Networking Conference.⁹

Routing and Addressing

Presently, AX.25 requires the user to specify a digipeater path to any non-local destination. Obviously it would be very desirable to automate this task, because it is at best tedious, and at worst impossible when the necessary information about a remote area isn't available. The "real" network towards which we are evolving will do this automatically, so the user will only have to give the destination address. Packet switches will determine their own routes to each destination and regularly exchange this information with other packet switches. In the worst case, each packet switch would have to maintain a complete list of every other station in the network along with the next hop to be used in reaching that station.

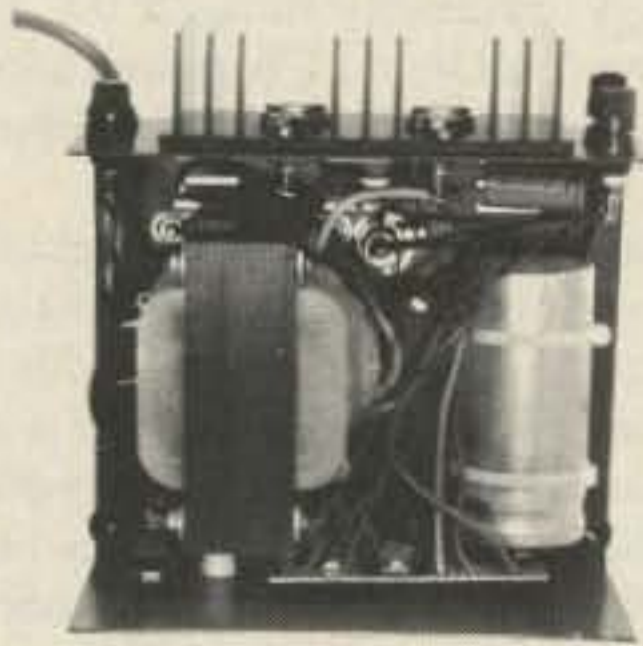

INSIDE VIEW - RS-12A

ASTRON POWER SUPPLIES

• HEAVY DUTY • HIGH QUALITY • RUGGED • RELIABLE •

RS and VS SERIES SPECIAL FEATURES

- SOLID STATE ELECTRONICALLY REGULATED
- FOLD-BACK CURRENT LIMITING Protects Power Supply from excessive current & continuous shorted output.
- CROWBAR OVER VOLTAGE PROTECTION on all Models except RS-4A.
- MAINTAIN REGULATION & LOW RIPPLE at low line input Voltage.
- HEAVY DUTY HEAT SINK • CHASSIS MOUNT FUSE
- THREE CONDUCTOR POWER CORD
- ONE YEAR WARRANTY • MADE IN U.S.A.

PERFORMANCE SPECIFICATIONS

- INPUT VOLTAGE: 105 - 125 VAC
- OUTPUT VOLTAGE: 13.8 VDC \pm 0.05 volts (Internally Adjustable: 11-15 VDC)
- RIPPLE: Less than 5mv peak to peak (full load & low line)



MODEL RS-50A



MODEL RS-50M



MODEL VS-50M

RM-A Series



MODEL RM-35A

19" X 5 1/4" RACK MOUNT POWER SUPPLIES

Model	Continuous Duty (AMPS)	ICS* (AMPS)	Size (IN) HXWXD	Shipping Wt. (lbs.)
RM-35A	25	35	5 1/4 x 19 x 12 1/2	38
RM-50A	37	50	5 1/4 x 19 x 12 1/2	50
• SEPARATE VOLT & AMP METERS				
RM-35M	25	35	5 1/4 x 19 x 12 1/2	38
RM-50M	37	50	5 1/4 x 19 x 12 1/2	50

RS-A SERIES



MODEL RS-7A

MODEL	Continuous Duty (Amps)	ICS* (Amps)	Size (IN) H x W x D	Shipping Wt (lbs)
RS-4A	3	4	3 3/4 x 6 1/2 x 9	5
RS-7A	5	7	3 3/4 x 6 1/2 x 9	9
RS-7B	5	7	4 x 7 1/2 x 10 3/4	10
RS-10A	7.5	10	4 x 7 1/2 x 10 3/4	11
RS-12A	9	12	4 1/2 x 8 x 9	13
RS-20A	16	20	5 x 9 x 10 1/2	18
RS-35A	25	35	5 x 11 x 11	27
RS-50A	37	50	6 x 13 3/4 x 11	46

RS-M SERIES



MODEL RS-35M

- Switchable volt and Amp meter

MODEL	Continuous Duty (Amps)	ICS* (Amps)	Size (IN) H x W x D	Shipping Wt (lbs)
RS-12M	9	12	4 1/2 x 8 x 9	13
RS-20M	16	20	5 x 9 x 10 1/2	18
RS-35M	25	35	5 x 11 x 11	27
RS-50M	37	50	6 x 13 3/4 x 11	46

VS-M SERIES



MODEL VS-20M

- Separate Volt and Amp Meters
- Output Voltage adjustable from 2-15 volts
- Current limit adjustable from 1.5 amps to Full Load

MODEL	Continuous Duty (Amps)			ICS* (Amps) @ 13.8V	Size (IN) H x W x D	Shipping Wt (lbs)
	@ 13.8VDC	@ 10VDC	@ 5VDC			
VS-20M	16	9	4	20	5 x 9 x 10 1/2	20
VS-35M	25	15	7	35	5 x 11 x 11	29
VS-50M	37	22	10	50	6 x 13 3/4 x 11	46

RS-S SERIES



MODEL RS-12S

- Built in speaker

MODEL	Continuous Duty (Amps)	ICS* Amps	Size (IN) H x W x D	Shipping Wt (lbs)
RS-7S	5	7	4 x 7 1/2 x 10 3/4	10
RS-10S	7.5	10	4 x 7 1/2 x 10 3/4	12
RS-10L(For LTR)	7.5	10	4 x 9 x 13	13
RS-12S	9	12	4 1/2 x 8 x 9	13
RS-20S	16	20	5 x 9 x 10 1/2	18

This is because amateur-radio callsigns (at least in the U.S.) do not give any definite indication of the station's location; a licensed amateur is free to move anywhere in the country while retaining the same callsign. This is an example of what is called "flat addressing," where addresses don't necessarily indicate anything about location within the network. Because the stations can move at will, flat addressing is clearly a great convenience to the user. The only requirement is that each address be unique, and the government already guarantees this to be true with amateur-radio callsigns.

(One clever way to allocate flat addresses in a non-amateur network without explicit central coordination is to use the serial numbers on paper money; tape a dollar bill to your computer and the government again guarantees you a unique number.) Flat addressing is just fine when everyone has a direct path to everybody else, since you don't have to keep a big routing table.

The alternative to flat addressing is hierarchical addressing, where the approximate location of each station is encoded in its address. An example of this is the telephone network; the area code locates the phone to a state or portion of a state, while the exchange generally narrows the area to a town or portion of a city. While less convenient to the user (you have to change your phone number when you move), hierarchical addressing clearly saves an enormous amount of routing table space. (With the cost of computer memory plummeting toward zero, though, it is not unthinkable that flat addressing even in the telephone network could become practical in the future.)

For the near future, however, it seems likely that some form of hierarchical addressing will be used in the new networks being designed. This means that the network will need more than just the callsign of the station you want to communicate with. Fortunately, the user need not be concerned with having to remember everyone else's network address. Special stations could be set up to provide "directory assistance" service, and this service can be checked automatically by the user's computer each time he wishes to communicate.

Transport Protocols

As mentioned earlier, there are two schools of thought on which "true" network (level 3) protocol ought to be used in amateur packet radio so that AX.25 could go back to being "just" a link-level protocol. It turns out that the internetworking protocols developed by ARPA (IP, based on datagrams) and CCITT (X.75, intended for the interconnection of Public Data Networks operated by different companies or countries, and based on interconnecting X.25 virtual circuits) are both possible bases for building an amateur network. (Consider a local rf "community" to be the subnetworks making up the amateur radio internetwork.) Both can operate on top of AX.25 level 2 as the subnetwork (local area) protocol, using it to provide the hop-by-hop acknowledgments which are generally

considered necessary for performance reasons in amateur packet radio. (Other link-level protocols are also suitable for use under IP; see¹⁰ for a detailed discussion.)

Most networks, datagram or virtual circuit, do a very good job of getting packets to their destination. No network, though, can guarantee absolute 100% reliability—just as the U.S. Postal Service can't guarantee that they'll *never* lose a letter. Recovering from these (hopefully rare) losses is the job of the Transport layer.

The Transport layer operates on an "end-to-end" basis. It detects when packets get "lost in the mail," taking action to make sure that the lost information is retransmitted. The Transport layer is relevant here because its design is heavily influenced by the services provided (or not provided) by the network.

The Transport (level 4) protocols used to provide flow control and error recovery on an end-to-end basis would be the ARPA Transmission Control Protocol (TCP) in the case of IP, or one of the simpler "X.224 Transport Classes" in the case of X.75. Here we see an example of a tradeoff in the network design: A datagram-based network has simpler packet switches than a virtual-circuit network, but requires a more complex transport protocol.

Development Status

Considerable progress has been made in the implementation of these protocols in the amateur service. At the 5th Amateur Radio Computer Networking Conference, sponsored by the ARRL at Orlando in March of 1986, the following demonstrations were given:

1. The ARPA protocols: IP (network); TCP and UDP (connection-oriented and connectionless transport protocols, respectively); Telnet, FTP, and SMTP (the presentation-layer protocols for remote login, file transfer, and mail transfer, respectively). I wrote these protocols in C and demonstrated them on a Xerox 820, although my code has also been ported to a variety of other processors. (The source code is available free of charge to anyone wanting to experiment with it for noncommercial applications; send me a blank 5.25" DSDD MS-DOS or 8" SSSD CP/M floppy with return SASE.)

2. A virtual-circuit network-level protocol based on a modified form of CCITT X.75. It was written in Z-80 assembler by Howie Goldstein N2WX and run on the TAPR TNC-2. Connections were established on an end-to-end basis, with hop-by-hop acknowledgments provided by the AX.25 link layer. Persons interested in experimenting with this software should contact Howie.

Conclusions

This is indeed an exciting time for amateur packet radio. Although this article was necessarily brief, I hope that you have gained some understanding of the considerable progress being made in the area of higher-level protocols. These developments will be an essential part of a unified network operating on a national and international scale that will be both more efficient and easier to use than

the local-area networks that exist today. This will foster an even closer coupling between personal computers and radio communications. The ARRL sponsors activities to promote and coordinate the development of this technology, primarily through the Ad Hoc Committee on Digital Communications and the annual Amateur Radio Computer Networking Conferences.

The uses to which the amateur network will be put are limited only by our imaginations. The potential of this network for public service and disaster communications is clearly enormous. It will provide the opportunity for amateurs to gain inexpensive, hands-on experience with a technology very relevant to the non-amateur world. On the basis of these and other achievements, amateur packet-radio networking has done and will continue to do much to advance the Basis and Purpose of the Amateur Radio Service as stated in FCC Part 97.1.

The possibilities are limitless, so if you have an interest in contributing to this effort, by all means jump right in! One request, though: Please let the rest of us know what you're up to. Write papers and articles on your work whenever you feel you have something of interest. Some very interesting packet-radio developments have gone largely unnoticed because the people involved never thought it worth mentioning! ■

References

1. Terry Fox WB4JFI, ed., "AX.25 Amateur Packet-Radio Link-Layer Protocol Version 2.0," ARRL, 1984.
2. International Telegraph and Telephone Consultative Committee (CCITT), "X.25, Interface between data terminal equipment (DTE) and data circuit-terminating equipment (DCE) for terminals operating in the packet mode on public data networks," 1984.
3. R. M. Metcalfe and D. R. Boggs, "Ethernet: Distributed Packet Switching for Local Computer Networks," *Communications of the ACM*, Vol. 19, July, 1986, pp. 395-404.
4. H. Zimmermann, "ISO Reference Model—The ISO Model of Architecture for Open Systems Interconnection," *IEEE Transactions on Communications*, Vol. COM-28, April, 1980, pp. 425-432.
5. *ARRL Handbook for the Radio Amateur*, 1986, pp. 19-26 to 19-48.
6. A. S. Tanenbaum, *Computer Networks*, Prentice Hall, 1981.
7. J. Postel and D. Cohen, "The ISO Reference Model and Other Protocol Architectures," IFIP-83.
8. DoD Protocol Reference Model, Sytek Corp., Tech report 7172/201/01, September 1982.
9. P. Karn, "TCP/IP: A Proposal for Amateur Packet Radio Levels 3 and 4," Proceedings of the Fourth ARRL Computer Networking Conference, San Francisco, March 30, 1985. See also papers in the same conference by Fox, Beattie, Moulton, and others.
10. P. Karn and B. Lloyd, "Link Level Protocols Revisited," Proceedings of the Fifth ARRL Computer Networking Conference, Orlando, March 9, 1986.

Lightning Never Strikes

Ham radio vs. Mother Nature: Can you survive? Protect your investment—and your life—with these few simple precautions.

Since my article, "Defuse RFI," appeared in the October, 1983, issue, I've been bombarded by requests for more information on lightning protection and grounding in general, so here is some simple information that covers just about any grounding situation.

When Ben Franklin invented the lightning rod, it kept the barns from burning down, but Ben went to his grave wondering why no one had ever seen lightning strike one, even though he had solved the problem.

The reason is very simple: A lightning rod doesn't attract electrical atmospheric discharges, it establishes a constant electrical drain which, in effect, neutralizes an area of approximately 500 square yards. Therefore, lightning will strike a tree because the tree's resistance is higher than that of the ground (which has a very low resistive value).

Living where thunderstorms are born, I've had a lot of experience in protecting homes where the owners have lost TVs, stereos, microwave ovens, and even atrium water pumps. Usually I'm the last one called: The first recourse is usually to call a TV repair shop—getting a man to come out

and survey the situation and give an estimate (usually over \$1000) based on a lot of wrong approaches and a lack of fundamental knowledge (which unfortunately is typical). At this point the home-owner calls a consulting engineer (me), figuring it can't cost much more, and wants a second opinion. I quote about \$200 for parts and labor and come out smelling like a rose money- and reference-wise. The following is a handy "instruction manual" on how to do it simply and correctly.

The first step is to drive a 6–8-foot ground rod next to the foundation of the building, where moisture is retained by capillary action. Don't use the "saddle" clamp that comes with the ground rod since it is subject to electrolysis and will loosen all by itself—go to an auto supply store and get a stainless-steel, worm-drive, universal fuel-hose clamp about ¼" larger than the diameter of the ground rod. Don't over-tighten this clamp as it strips out at about 6 psi; so good and tight is tight enough for the ground connection (it won't loosen). Waterproof with acrylic spray, silicone seal, or nail polish.

I then use a 10-foot section of TV steel mast, a 5-foot tripod, a trailer-hitch ball, and

enough #8 wire to reach from one lag screw of the tripod mount to the ground rod. According to the U.S. electrical code, the wire does not need to be insulated, but no splices are permitted. The tripod mounting should be waterproofed with roofing tar or silicone seal. The ball is welded to the top of the mast section. The final step is simply to in-

stall a GE 120-volt MOV (metal-oxide varistor) on each side of the 220-volt drop to power company ground (the bare wire) in the fuse or breaker box, after the fuse or breakers, so the breaker will "pop" if the varistor shorts out. Turn the breakers off or remove the fuses when doing this.

For a ham with a roof-mounted antenna, all that's necessary is to run the #8 wire from the mount to the ground rod as previously explained and add the MOVs. The coax should be broken, a PL-259 installed on each end (at the antenna mount), and a double-female coax lightning arrestor (Blitz Bug, etc.) installed at the splice and attached to the antenna mount with a stainless-steel, universal water-hose clamp (auto supply store). This must be waterproofed with high quality electrical tape (Scotch 33 or 88) or Coax-Seal putty. The same instructions apply to a tower, with the exception of an additional 6–8-foot ground rod installed at the tower's base. If the tower is 50 feet or less from the building, it's covered by the "drain effect" area (assuming a "non-isolated" antenna—otherwise it creates its own drain effect).

In one dramatic case, a home-owner sustained a direct hit on the utility pole and "pig" feeding his house that literally blew the pole out of the ground. After the power company crew replaced the pole and transformer, the person checked out every electrical device in the house and found he hadn't lost a light bulb! He called me and said to use him as a reference anytime (he's a pilot for United Airlines) and confessed he had had doubts as to the effectiveness of my work, but not anymore!

In summation, I well understand the nature of the human condition as to "What's in it for me?" outside of the obvious protection. Well, it's been my experience that a properly grounded station will enjoy a 1–2 S-unit improvement transmitting and receiving, a condition in itself that makes the job worth doing! ■

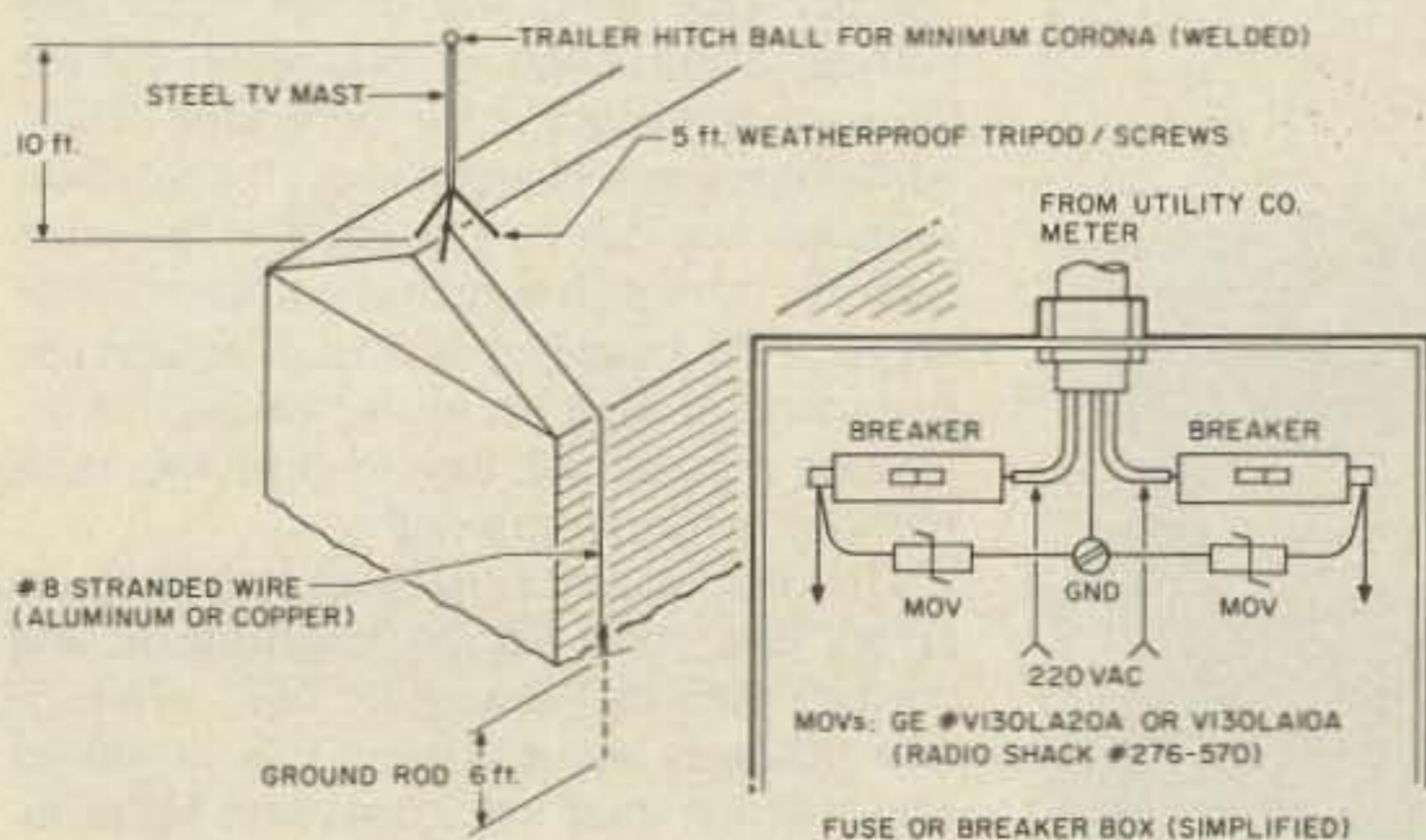

Fig. 1. Simple precautions to protect your home from lightning.

And If That Wasn't Enough . . .

NK6K takes questions from the audience.

Most of the articles in this issue are tutorial in nature, rather than Question and Answer. Wishing to leave no stone unturned in the quest to get you interested in packet radio, we present: Packet Q & A.

The first envelope, please:

Q: What is packet radio?

A: Come on, you can do better than that. Unless you have been actively trying to avoid hearing anything about packet, you at least know that packet is a way of sending information over radio with computer assistance. The word "packet" is even appearing in the teeny-weeny print of the "section news" in *QST*. Packet is in use by all facets of the hobby, from the purely technical side (computer nerds) to the purely communications side (traffic handlers). The box you add to your station to do packet with is called a terminal node controller (TNC).

Q: Fine, but what's in it for me?

A: Now we're getting down to it, eh? If you are interested in computer networking, amateur packet radio is the perfect outlet for your creative talents. The packet technical scene is a vast open area of work waiting to be done.

If you are not a computer experimenter, but want to be well informed about amateur radio in general, packet-based information systems are sprouting up like weeds. On the local bulletin board systems (hold that question for later) here in Los Angeles, you can find the latest AMSAT bulletins and orbit predictions; the latest ham news from the *ARRL Letter*, the *W5YI Report*, and various other sources; the text of the latest FCC notices; and, of course, news from the world of packet. Other areas carry any of several DX bulletins and propagation forecasts. International newsletters are starting to become more common as links overseas are established.

Packet can also be used to just chat with others.

Q: What is a bulletin board system?

A: As the name implies, a bulletin board system (BBS) is a place to store bulletins so that others can read them. A BBS consists of a computer that has space to store messages and files and a program that allows hams to leave and retrieve them. The messages may be of general interest (like getting a propagation forecast or asking for a loan of a wattmeter) or they may be specific (like confirming an 80-meter schedule).

Q: You sound as if packet is the only mode that has that stuff. Aren't there RTTY-based bulletin board systems?

A: Yes there are, but BBS use has become widespread with packet. The first reason is that packet is faster. On two meters, packet is running at about 1,440 wpm, as opposed to 100 wpm maximum for Baudot-RTTY. In numbers that mean something, on two meters it would take about 26 minutes to send the latest AMSAT news at 100 wpm Baudot and about 2.5 minutes using packet. It would take 52 minutes to transmit the *ARRL Letter* on RTTY and five minutes on packet. Because of this, not many people would consider putting a large newsletter on a RTTY mailbox—there wouldn't be enough time in the day for 20 or more people to read it.

The second reason is that packet shares the channel. Due to the way packet works (and you can ask that later), several people can use the same frequency at the same time. Thus, while someone is chatting about the weather, someone else can be reading a propagation forecast. Although both acts will take a little longer if the frequency is shared, at least one party isn't gritting his teeth, waiting for the seventh person that day to read the same message before he can chat.

The final reason is that packet detects any errors that occur during transmission and corrects them by "asking for fills." Thus, it now becomes possible to reliably download files where a small error can cause big problems, like files containing orbit predictions or a file listing the times when the Heard Island



Photo A. The N6BGW-9 BBS, running semi-unattended on 146.745 MHz.

DXpedition will be on 80 CW. If you get a wrong number, you'll be wondering why the band is so quiet.

Q: I get my news by listening to Bud replay the *Westlink* tape on the local repeater. Why should I invest in new gear?

A: A bulletin board system is there when you are. If you want to get your news from Bud, you have to be there when Bud is holding forth on the repeater. If you get moved to the night shift at work, there goes your news. A BBS (a non-real-time system) frees you from the clock and Bud's schedule. You can even talk to Bud on the BBS or leave him messages that he can read when he's available, and Bud can store messages for you when you're not.

Q: All this is fine, but I'm a HAM, not a news hawk. If I want news I'll watch cable. What good is packet to real hams and not computer nerds?

A: In addition to the above types of activity, packet is used by hams who simply want to chat, just as on RTTY, AMTOR, and CW.

Q: But what do you talk about?

A: Anything of mutual interest or even of unilateral interest. Packet just moves the characters; what you put in is up to you.

Q: My buddy told me packet is only one-on-one, that you can't have a round-table discussion.

A: You can have a round-table discussion on packet, either one-to-many or many-to-many. These work best when everyone can hear everyone else, either directly or through a duplex repeater. Every Monday night in the Los Angeles area, at 9 p.m. on the N6GPP repeater (146.145 in/146.745 out), a packet round table is held. One occurred last night while I was writing this.

The way it works is everyone connects up in pairs and sets the packet equipment up so that other conversations are also displayed. Everyone can now see everyone else. Because N6GPP is a digital duplex repeater (described later), any packet sent by you that is heard by your connect partner will be heard by everyone else. Any packet missed by everyone else will also have been missed by your partner, and your TNC will resend it.

In the net last night, there were 30 people checked in. In the time the major portion of the net occurred—from 9 p.m. to 11:30 p.m.—69,000 characters were sent. This is a count of characters actually typed by someone, and does not include retransmissions or callsigns. That comes out to about 460 characters per minute, or 92 wpm. That doesn't mean that there were any 92-wpm typists on the net; 30 people typing at 3 wpm would have the same effect.

Q: What do you talk about in a packet round table.

A: Anything you want. Topics discussed on last night's net included: The Stoner proposal for a Public Digital Radio Service; AMSAT's upcoming Phase-3C launch; no code, with support for and against; the number of repeaters in England; hard disk problems with a local mailbox; tightrope-walking pigs (don't ask me why); how to get more people interested in amateur radio; open versus closed



Photo B. This station is equipped for packet use on HF, VHF, UHF, and OSCAR 10. See text.

repeaters on 70 cm; autopatches, good or bad; compact digital audio discs and the music on them; Captain Midnight of HBO fame; and a lot of miscellaneous background chatter.

In general, you talk about the same things anyone talks about on a ham net.

Q: Real hams don't use nets. Can I call CQ?

A: Yes. You can direct your CQ into distant areas by using packet repeaters called digipeaters, and you can include text with the CQ—for example, "CQ anyone who wants to talk about fly fishing." You can also set your TNC up so that it displays only packets sent by people calling CQ. In fact, you can set up some TNCs to not display packets from certain people, so if someone is sending data you don't want to see, you don't have to see it. There is *no* truth to the rumor that TNCs come from the factory trained to ignore packets containing editorials from W2NSD/1.

Q: Speaking of callsigns with "/" characters in them, my TNC won't let me use my full call, G4JPZ/W6. Why not?

A: The number of characters devoted to storing the callsign of packet stations was a Big Issue in ye olden days. The call is sent in every packet, and the fewer characters of overhead, the better. The number agreed on was six, as this would contain all the characters needed to uniquely identify a station using the call assigned by its home government.

Q: What does the number in packet callsigns like WB6YMH-2 mean?

A: Each TNC must have a unique identifier. Because a ham can own more than one TNC, just as he can own more than one radio, it is necessary to have a way to distinguish the various TNCs owned by WB6YMH. The number, called a secondary station identifier (SSID), is used for that purpose. SSIDs run from 0 to 15; 0 is assumed if no number is stated. There have been various schemes purposed to "band plan" the numbers—e.g., 0 is your personal station, 1 is your first digipeater, 7 is your satellite gateway, etc.—but

none of them have yet caught on. There are too many types of stations and not enough numbers.

Q: Is packet used for public service?

A: I'll give you an example. Pittsburgh, Pennsylvania, recently had a marathon, and as usual hams supplied public-service communications. Packet was used to move information on downed runners from out on the course to the finish line, where family and friends waited. A packet base station was set up at the end of the course, consisting of a Compaq computer running a data-capture program, a TNC-1, and a printer. A battery-powered mobile packet station was placed in a truck that drove along the course. This station, made up of a Data General 1 laptop computer and a TNC-2, stopped at 15 aid stations, gathering names and dispositions for relay to the finish line. The names were typed on a keyboard only once; after they were transferred via packet to the base station, they were printed by the computer and posted in the reunion area. Two digipeaters were used at different points along the 26-mile course: W3VC and WA3YOA-3. N3CVL and W3MC ran the base station; WA3HGW was in the truck.

Q: I hear a lot of different names for repeaters in the packet world. Why are there so many kinds, and what's wrong with using just a regular repeater?

A: The major types of repeaters you'll hear about are voice repeater, digipeater, dual-port digipeater, and digital duplex repeater. We'll take them one at a time.

The term **voice repeater** refers to the traditional repeater commonly found in the two-meter band. In most such repeaters, the audio output from a receiver is passed more or less directly to the audio input of a transmitter. Any FM signal heard by the receiver is sent out of the transmitter. It is therefore possible to send packets through a "voice" repeater. It is inadvisable to do so, however, on any repeater in which the user support communi-

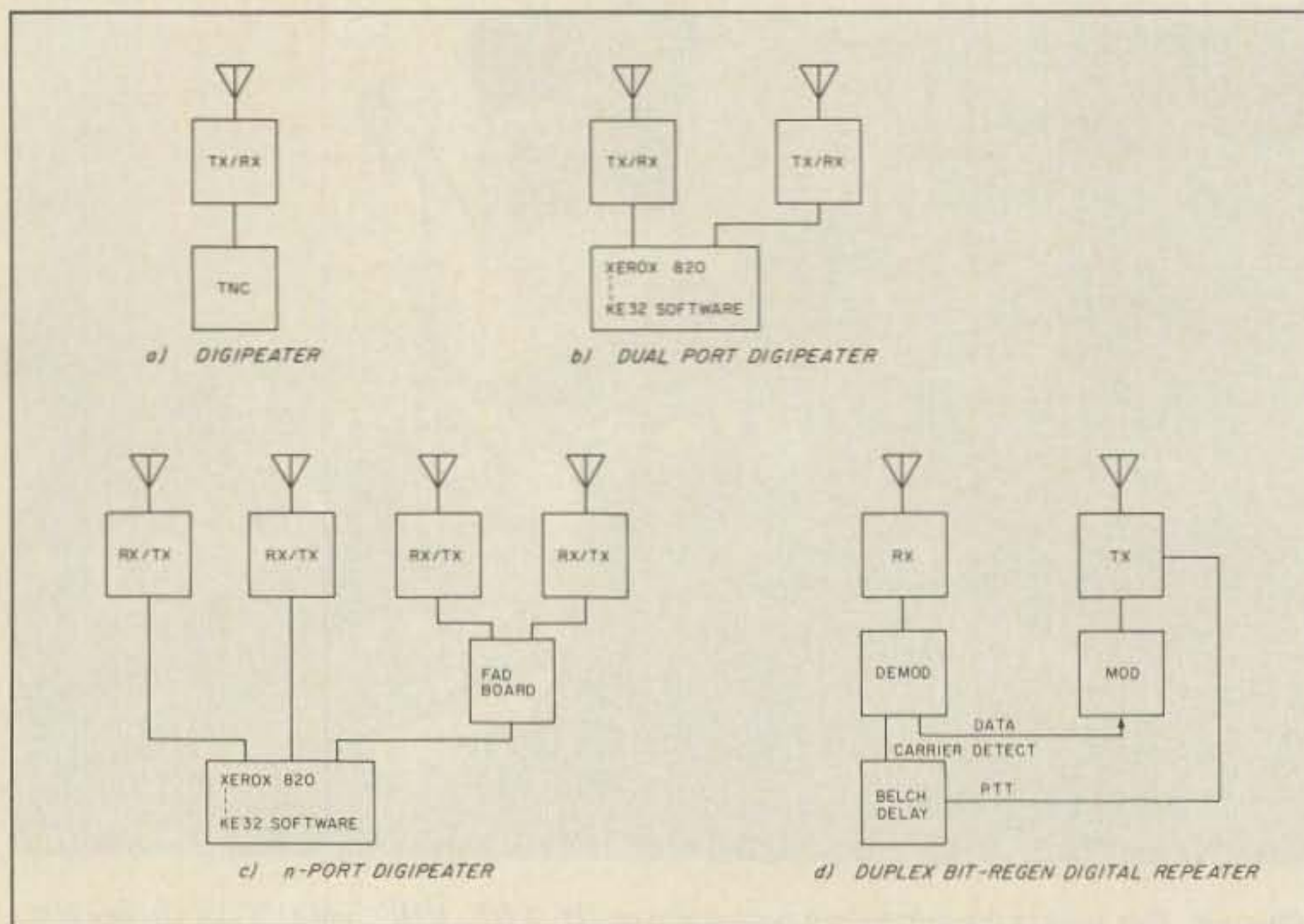

Fig. 1. Packet repeater configurations.

ty is not interested in such activity. Nothing is more certain to bring the villagers up the winding path to your castle's digital laboratory with torches and flaming pitch than pumping "braaaaap" through the local voice repeater during the nightly bull session.

By "user support community," I mean those individuals who make up the repeater group and support the repeater with time, talent, or other resources to keep it running. Cretins who think the repeater is a public utility can be ignored as always. There are plenty of other frequencies around, so stay away from the "No Digital" voice repeaters, and we'll hope they stay away from the 145.0 through 145.1 digital area. Fortunately, only a few of the misguided individuals in the

"My license says I can transmit anywhere Part 97 says I can" group have found their way into packet.

A **digipeater** is a digital-only device. As shown in Fig. 1(a), it is the simplest of all packet devices, consisting of a TNC and a transceiver. A terminal is used initially to set the TNC's parameters, but it is not required for operation. A digipeater is a simplex repeater. It listens for packets on a frequency, checks them for accuracy, and then retransmits them on the same frequency. Any packet station can serve as a digipeater. Stations intended for remote or mountaintop service are usually "hardened" (see "Survival Training For Mountaintop Digipeaters" in this issue).

Digipeaters can be "linked" in chains of two or more on a packet-by-packet basis. The callsigns of digipeaters can be placed in a packet along with the source and destination stations. Each digipeater repeats the packet in turn, which can send the packet hundreds of miles. Although this scheme does have its limits, digipeating allows simple linking without requiring multiple radios and antennas at the digipeater site.

A **dual-port digipeater**, shown in Fig. 1(b), is a more complex version of the standard digipeater. It was first developed by Jon Bloom KE3Z and others at the ARRL lab in Newington, Connecticut. A dual-port digipeater can digipeat packets on two radios at the same time. Although this is more complex in terms of rf, the advantage is that two frequencies can easily be linked together. Packets received on one frequency can be repeated on the same frequency or on another one by the other radio. Which frequency is used is controlled by tables in the digipeater's software. Aside from linking packet communities on two frequencies, the dual-port digipeater can be used to move packets off of a heavily used local frequency and onto a "backbone" frequency.

For example, suppose that most of the packet users on the East Coast were on 145.01 MHz. If you try to use a string of four standard digipeaters on 145.01 to connect to someone 300 miles away, you would have to contend with all the other users of 145.01 throughout the 300-mile range. Obviously, if 50 people are trying to share a single frequency equally, the most you'll get for yourself is 1/50, which isn't much. Now let's assume that there is a dual-port digipeater at both ends of the chain, one where you are and one 300 miles away. You transmit your packet on 145.01, and it is retransmitted on a second frequency, perhaps 220.95 MHz. Your packet could then go down a string of standard digipeaters on 220.95 until it gets to the end, where it would be repeated back onto 145.01. The advantage is that you've bypassed all the local traffic on 145.01 between the two ends. A "backbone" is just like an interstate highway. If access is limited to occasional on-ramps, it can be used to bypass business districts.

An **n-port digipeater** is just a bigger dual-port digipeater. As shown in Fig. 1(c), you can add as many ports (places to stick radios) as the hardware will bear. The original dual-port code was first implemented on a Xerox 820, which had two ports. A device called a FAD board, designed by the FADCA group in Florida and available from TAPR, extended that capability to four ports. Contact KE3Z at the ARRL if you want a copy of the software.

A **digital duplex repeater** is much like a voice repeater except that bits are passed between the receiver and transmitter rather than audio. Fig. 1(d) shows such a device. Audio from the receiver is passed to a demodulator. Data from the demodulator is passed first to a modulator and then to the transmitter, which is transmitting on a frequency other than the receive frequency.

```

-----
To: NK6K De: WA9PMQ Re: HF Message Returned
-----
Msg# TR Size To From @ BBS Date Title
4107 Y 1116 WA9PMQ NK6K W3IWI 860522 Message from UO-11 DCE
Via WB2RVX: 5118 From NK6K Rcvd 860522/1007z, Sent 860522/1515z
Via WA2SNA-1: 5171 From NK6K Rcvd 860522/0923z, Sent 860522/1001z
@ U2JUP : 1189 NK6K R-860521/2147 S-860522/0522 EDT
@ NE1H : NK6K 536 R-860521/0941 S-860521/2151
Via W1AW: 6251 From NK6K Rcvd 860521/1228, Sent 860521/1338
At WB1DZK: 543 From NK6K Rcvd 860520/1229, Sent 860520/1626
Via N1DKF: 6318 From NK6K Rcvd 860521/0722z, Sent 860521/0828z
Via K1UGM: 1461 From NK6K Rcvd 860521/0257z, Sent 860521/0723z
Via W0RLI: 514 From NK6K Rcvd 860521/0249z, Sent 860521/0255z
Via W0RLI: 1015 From NK6K Rcvd 860521/0248z, Sent 860521/0248z
Via KD6SQ: 38 From NK6K Rcvd 860520/1842z, Sent 860521/0247z
A | --- At NK6K : 82 From NK6K Rcvd 860520/1134, Sent 860520/1139
| | Gary,
| | B | Here's your message routed from the DCE back to you. I downlinked
| | C | it around 18:00 utc May 20. Please send this message back on the
| | D | DCE so I can get the forwarding times. Thanks, Harold.
| |
| | --- To: NK6K, CO/K8KA De: WA9PMQ Re: Demo
| | D | This is a demo of UoSat-2 to Mr. James Munez, Washington rep
| | | of the Space Studies Institute, Arlington, VA.
| | | 73, Gary
-----

```

Fig. 2. The mail-forwarding network in action. D) The original message sent on Uo-11. C) That message as sent eastward from Los Angeles. B) The message as it arrived in Washington DC. Each BBS that forwarded it has placed an ID stamp in the message. A) The received message as sent to Los Angeles again on Uo-11.

ALL BAND TRAP VERTICAL ANTENNAS!

FULL 1/4th WAVE - All Bands! Automatic Selection with proven Hi-Q Traps. 5 Models-ALL self supporting - Ground or roof mount. HI STRENGTH FIBERGLASS TUBING OVER -ALL NO WOBBLY, LUMPY TRAPS - NO UNSIGHTLY CLAMPS needed - Size 1 1/4" all the way up - Traps hidden inside. You can use it in a 1 ft. sq. Backyard FOR APARTMENTS, MOBILE HOMES - CONDOS etc. where minimum space and neat appearance is MANDATORY! Instant "Drive In" ground mount (included). Use with or without radials (included) (All angle roof mount - Extra) COMPLETELY PRE-TUNED - NO ADJUSTMENTS NEEDED EVER! NO TUNER NEEDED FOR MOST TRANSCIVERS! Use - RGPU feedline, any length! 2000 Watt PEP, input power. Shipped - PREPAID IN USA Assemblies in 10 min. using only screwdriver. WEATHERPROOF!

No.-AVT80-10	5 Band	25'6"	\$199.95
No.-AVT40-10	4 Band	18'9"	\$139.95
No.-AVT20-10	3 Band	11'4"	\$109.95
No.-AVT80-10-3	6 Band	24'8"	\$229.95
No.-AVT40-10-3	5 Band	17'9"	\$159.95

SEND FULL PRICE FOR PP DEL IN USA (Canada is \$10.00 extra for postage, clerical, Customs) or order using VISA, MASTER CARD or AMER-EXP. Ph 1-308-236-5333 9AM-6PM weekdays. We ship in 2-3 days. All Antennas Guaranteed for 1 year - 10 day money back trial. Free Inf.

WESTERN ELECTRONICS ✓39
Dept. A7 Kearney No. 68847

TRS-80* RTTY



- ROM-116
- RTTY-CW
- TRS-80 MOD III/IV

*Trademark of Tandy Corp.

THE MARTIN CO. (206)653-9596
P.O. BOX 982 MARYSVILLE, WA 98270

MULTI-BAND SLOPERS

ALSO: DIPOLES & LIMITED-SPACE ANTENNAS

Outstanding performance of W9INN antennas is well known. Now enjoy multi-band BIG-SIGNAL reports! Automatic bandswitching - Very low SWR - Coax feed - 3kw power - Compact - FULLY ASSEMBLED to your specified center frequency each band - Easy to install - Very low profile - Complete instructions - Your personal check accepted

4 BAND SLOPER - 160, 80, 40, 30, or 20M	50 ft. long	\$ 48 ppd
3 " " " " " " " " " " " " " " " "	60 ft. "	\$ 43 "
2 " " " " " " " " " " " " " " " "	40 ft. "	\$ 35 "
NO-TRAP DIPOLE - 160, 80, 40M	113 ft. long	\$ 71 "
2 " " " " " " " " " " " " " " " "	85 ft. "	\$ 55 "
3 BAND SPACE-SAVER DIPOLE - 160 thru 10M*	46 ft. long	\$ 85 ppd

* Requires wide-range tuner (80, 40, 20, 15M without tuner)

SEND SASE for complete details of these and other unique antennas
W9INN ANTENNAS 312-394-3414
BOX 393-S MT. PROSPECT, IL 60056 ✓38

CB-TO-10 METERS

We specialize in CB radio modification plans and hardware. Frequency and FM conversions, books, kits, repairs, high-performance accessories. Our 11th year! 16-page catalog, \$2.

CBC INTERNATIONAL, P.O. BOX 31500X
PHOENIX, AZ 85046

PORTAQUADS

2-MTR & 220 MHz
FOLDS INTO CASE CA. ADD
SPECIFY BAND \$73.95 6% TAX

RADIO ENGINEERS

3941 MT. BRUNDAGE AVE.
SAN DIEGO CA. 92111
(619) 268-7988 ✓32

MASTER MORSE CODE IN 40% LESS TIME!

Method Eliminates the 10 - 13 WPM Plateau
ADOPTED BY THE U.S. MILITARY AS THE NEW TRAINING STANDARD

INSTRUCTION NOW OFFERED ON AUDIO TAPES or OUR NEW COMPUTER PROGRAM FOR THE COMMODORE 64. Both methods teach the entire ALPHABET, NUMBERS, PUNCTUATION and SPECIAL CHARACTERS in 39 TRIALS at 20 WPM.

Specify Audio Tapes (five cassettes), Floppy Disk or Computer Cassette.
\$19.95 (IL. RES. include \$1 sales tax)

✓77 TSG, P.O. BOX 3897, CARBONDALE, IL. 62902

QEP's COAXIAL SALE

✓30 BELDEN 9913 low loss	185/500 ft. or .38/ ft.
BELDEN 8267 RG-213	195/500 ft. or .39/ ft.
BELDEN 8214 RG-8	149/500 ft. or .33/ ft.
BELDEN 8237 RG-8	145/500 ft. or .32/ ft.
BELDEN 9258 RG-8X	80/500 ft. or .17/ ft.

AMPHENOL Connectors & Adaptors

UG-21D N-type Male Cable end	\$3.00
UG-21D Fitted for 9913 cable	\$4.50
PL-259 UHF Plug (silver)	\$1.65
UG-146 N plug to UHF jack	\$7.50
UG-83 N jack to UHF plug	\$8.50
UG-29 N-type barrel conn.	\$4.75

SETH THOMAS 13-inch 24-hour station clock \$28.95

SAME DAY SHIPPING

110-4 Route 10, E. Hanover, N.J. 07936, 201/887-6424

YOU'VE READ THE ARTICLE, NOW BUILD THE KIT!

The Digital RTTY/Packet Tuning Indicator featured in this month's "Precision Packet Tuning" (p. 40) is available in kit form. This is easily one of the most accurate tuning aids ever devised (resolution of 10 Hz with no calibration required!). If you are serious about packet or RTTY, you won't be happy with any other tuning device.

This kit is slightly different from the article version; it includes a larger EPROM to give you switch-selectable HF/VHF tone pairs. The PCB is double-sided and solder-masked.

Item #	Description	Price
88601	Digital Tuning Indicator kit, complete	\$79.95
88602	Digital Tuning Indicator kit without cabinet	\$72.95
88603	Digital Tuning Indicator PCB and EPROM	\$22.95
88601/OPT	Options (extra 50k pot and switch)	\$ 6.50

Send your check or money order to Valley Electronics, PO Box 1101, Hillsboro NH 03244.



the HAM STATION

P.O. Box 4405
220 N. Fulton Ave.
Evansville, IN 47710

Stores Hours
MON-FRI 9AM-6PM
SAT 9AM-3PM

WARRANTY SERVICE CENTER FOR:
ICOM, YAESU, TEN-TEC

TERMS:

Prices Do Not Include Shipping.
Price and Availability Subject to
Change Without Notice
UPS COD \$2.50 Per Package

MOST ORDERS SHIPPED
SAME DAY

YAESU



YAESU FT209RH
5 watts
10 Memories

CALL FOR YOUR
SPECIAL PRICE



ICOM

- 25 watts
- large LCD readout
- wideband coverage
- 21 memory channels

NEW!

IC-28A
2 Meter Mobile

Ham Net \$419.00 Call for
Special Introductory Price



Welz Meters

WELZ

Lots of Welz
Meters in Stock
Call for Special
Pricing and
Details



FT270R

YAESU

10 Memories
45 Watts
With FTS-8
ORDER NOW



TENTEC

2510 Mode B
Satellite Station



ICOM

- all modes built in
- QSK up to 40 wpm
- built-in 500 Hz CW filter
- electronic keyer included
- 100% duty cycle

NEW!

IC-751A
HF Transceiver

Ham Net \$1499.00 Call for
Special Introductory Price

AEA • ARRL • ALINCO • ALLIANCE • ALPHA DFLTA • AMECO • AMERITRON • ANTENNA SPECIALISTS • ASTRON • B&W • BENCHER • BUTTERNUT • CSI • CALI BOOK • COMMUNICATION SPECIALISTS • CUSHCRAFT • DAIWA • DATASCAN • HEIL • HUSTLER • HYGAIN • ICOM • KDK • KLM • KANTRONICS • KEN PRO • LARSEN • MFJ • MICROLOG • MIRAGE • NYE • ROHN • SANTEC • SHURE • TEN TEC • TOKYO HY-POWER • UNADILLA • VALOR • VIBROPLEX • WELZ • YAESU

ORDERS AND PRICE CHECKS ONLY, PLEASE
INFORMATION AND INDIANA
SERVICE DEPT.

1-800-523-7731
812-422-0231
812-422-0252



Photo C. Is I/O The Dog (NK6K-4) burying the CW key. . .



Photo D. . . . or is he resurrecting it?

The advantage of this over an audio repeater is that each bit starts fresh at the transmitter. The output audio can be more closely controlled. The advantage over a digipeater is speed; the packet is retransmitted as it is received, rather than being repeated after it has been completely received and checked. Another advantage is that, except in fringe areas, each station listening to the output of the repeater will hear exactly what every other station is hearing. If one station correctly received a packet, chances are good that all other stations in range of the repeater heard it as well. This makes packet round-table sessions much easier to hold.

The disadvantage over digipeaters is that a duplex repeater will retransmit a damaged packet (one that is weak at the receiver or that has suffered a packet collision) when two packets from different stations start at the same time. Duplex repeaters cannot be linked as simply as simplex repeaters, since a second pair of frequencies must be used. The N6GPP digital duplex repeater in southern California avoids this problem by being a hybrid. It is also a dual-port digipeater; one port is connected to a simplex frequency, the other to the duplex repeater. Packets received via the duplex input can be digipeated out on the third frequency and vice versa.

Q: I also hear about things like bulletin boards, mailboxes, file servers, and hosts. Are they the same or different?

A: These names all refer to basically the same thing: a computer attached to a TNC, performing a central service for other packet users. They all look the same at the hardware level; each is a personal computer and has a certain amount of disk space. The different names specify the type of service offered by the system. The names are not standardized, and there is some overlap.

A **mailbox** implies that only a mail storage service is provided. Messages, usually limited in length by software or convention, can be stored. They can be addressed to individuals or groups. A facility usually exists to

retrieve messages based on whom they are sent to or who sent them. Each message has a title tagged to it, which can be displayed as a quick summary of the contents of the mailbox.

A **file server** stores only files. The files can contain messages, but a file server does not have fancy retrieval methods. Files are stored by name and retrieved by name; they do not have addresses. Files can be any size, and usually contain long reports, newsletters, digipeater maps, etc.

A **bulletin board system** is a combination of a mailbox and a file server. It has a mailbox facility as well as a place to store large files. This is the most common system found. Messages can be placed in the mailbox that describe the contents of files placed in the file area.

A **host** system is potentially the most powerful system of all. In all of the above systems, a program is running that "talks" to the user and provides the various services. In a host system, the user is talking directly to the computer's operating system, just as if he were at the local keyboard. He can run a variety of programs, including a mailbox program if one is available. One common program found on amateur packet hosts is a satellite orbit prediction program for tracking OSCAR satellites. Games are also common. Any computer can be used; I have seen both UNIX and CP/M systems running on packet.

There are many different software packages available to implement all of the above types of network service packet stations on almost any computer. All of them have been written by hams or adapted from other sources by hams. Software exists for Commodore 64, Apple, generic CP/M, generic MS-DOS, TRS-80 (all models including the 100), UNIX, and at least one Data General Mini. The quickest way to get on the trail of this software is to leave a message to the sysop of your local BBS. Another good place is "So You Want To Be A Sysop" in this issue. Several photos of packet BBS systems

are scattered throughout this issue as well.

Q: Is unattended operation of packet stations legal?

A: Yes. The FCC recently issued a Report and Order on PR docket 85-105 which made several changes to the rules explicitly permitting such operation. One example:

Section 97.69 on digital communications is amended by adding a new paragraph (d), as follows: An amateur station may be under automatic control when transmitting digital communications on frequencies 50 MHz and above.

Other sections were added defining automatic control, and requiring that devices and procedures be used to ensure compliance with the rules. A controversial section that did not permit automatic control while transmitting third-party traffic was temporarily waived, pending review. The point of contention is too complex to treat well here, but basically has to do with the traditional definition of third party as communications that do not occur on behalf of the control operator. Since most of the traffic flowing on the path between Boston and New York has little to do with the control operator of a digipeater on that path, that digipeater would not have been permitted to run unattended. The packet world prefers to see third-party traffic defined as communications where one of the parties is not an amateur. Traffic originated by amateurs and destined for amateurs would not be third party, and would be permitted in all cases.

The other point packeteers made with the FCC on this topic was that once "real" third-party traffic (i.e., from a non-ham) was entered by a ham into the network, it need not be considered third party while in the network. The amateur who started it on its way has already made sure it complies with the rules. As I said above, the no-third-party provision was waived, pending review. The FCC asked that packet stations be vigilant, and be on the lookout for abuses and non-amateur use of the network.

Photo A shows a mailbox system running in the unattended mode. Hefner fans, can you spot the Bunny?

A final comment. The term "automatic control" as used in the FCC rules means that the station is unattended. When packet people talk about an automated station, it sometimes means that the actual mechanics of message relaying is automatic and that an operator is still present and is "at the control point." Thus, if you hear someone talking about automatic relay of messages on an HF station (below 50 MHz), it isn't necessarily illegal, so long as someone is actually at the control point. Unattended operation of an HF transmitter, automatically relaying messages or not, is not permitted under the current rules.

Q: All of the pictures of ham shacks in this issue look staged. Everything is too clean.

A: Well, maybe folks did clean up a bit before the photos were taken. Therefore, in the interest of truth in advertising, we present Photo B. This is from the old days of packet, when bearded experimenters toiled in basements (East Coast) or garages (West Coast), and nothing was in cabinets. To see if you qualify as a packet pioneer, try to spot the TNCs in this picture. There are two of them in clear view. This shack belongs to WA6JPR, who started up packet in the Los Angeles area back in 1981. The photo is from late 1983.

Q: I've heard both good and bad things about packet on the HF bands: stories about automatic cross-country message forwarding with coast-to-coast relay 24 hours a day, and also that HF packet is "unusable." Who's telling the truth?

A: Both have elements of truth.

Fig. 2 shows the amateur packet network in full swing, and is a look at things to come. It shows a message that was sent from the East Coast to the West Coast on the UoSAT-OSCAR-11 (Uo-11) satellite's digital mailbox, then was sent back to the East Coast using the forwarding BBS network, and then sent back to the West Coast using Uo-11 again.

The Uo-11 system is briefly described in "Birds 'N' Bauds" in this issue; forwarding BBS systems are mentioned in "So You Want To Be A Sysop." In the forwarding BBS system, the message is automatically passed from one mailbox to another, using direct VHF paths, strings of digipeaters, or HF. Each system adds a line to the front of the message when it is passed on. Although one of the systems has its clock set wrong, and some use UTC while others use local time, you can see how long the message took as it passed from place to place.

The path the message takes is not necessarily fixed; HF propagation and VHF equipment outages affect the path from hour to hour and day to day. Each system tries to pass the message closer to its destination using the best path available.

Today, this system can take longer than the human-directed CW/phone NTS system to deliver a message. On the other hand, the NTS system is more labor intensive, requiring humans to copy the messages by hand. As the packet network gets "smarter," mes-

sages will travel through the most optimum path. The NTS system is already taking advantage of packet systems in those situations where they offer the best or additional service. Traditional NTS networks are used where they offer the best service.

But we've moved away from the question slightly. The above discussion shows that the packet network is functioning. But is HF packet the panacea that some claim it to be?

Packet offers "perfect copy," where perfect is 99.999% plus a harder-to-quantify number of more nines to the right of the decimal point. (See the June NK6K > Packet column for a further discussion.) Packet does this by repeating a packet until it is received perfectly. The problem is that on a noisy HF channel, perfect can be a long time coming. Take a look at the following line of text as it might be received by an RTTY station on a noisy 20-meter frequency:

THE QICK BR WN FOXSJUMQS OVE
?FD. DOGS BACK

A human operator can make a pretty good guess that it was transmitted as "THE QUICK BROWN FOX JUMPED OVER THE LAZY DOGS BACK." Even though the message was only 69% correct, the information was passed. On packet, the message would have been rejected, and no information would have been passed. Score one for RTTY.

Now let's look at the following line of text, received by an HF RTTY BBS system:

TYPE ORBITS144

Can you tell that this was sent as "TYPE ORBITS134"? No, and neither can the BBS system, which proceeds to send you 15 minutes of last week's orbital elements. The packet system 20 kHz up the band took three tries to get the line through, but now it's reading this week's elements. Score one for packet.

We're off the path again. The question was "Is HF packet really usable?" It comes down to two things: hardware and user training. The RTTY community has spent many years perfecting terminal units (TUs) that can reach down into the noise and pull out signals. The packet community, flushed with the success of the "cheap and easy" Bell 202 modems used on two-meter FM, started out in HF using another "cheap and easy" source of modems, the Bell 103 standard.

This standard grew in packetdom for the same reason the Bell 202 standard did. The first person who promoted HF packet had a ready supply of Bell 103 modems, and he made some available to friends. Thus, first HF users were on a 200-Hz shift, and each new user after that used the same standard. The simple modems on the kit TNCs and the later TNCs based on them were retuned for 200 Hz and pressed into HF service. The reduced-parts-count TNCs used a telephone modem chip with the same standard and, presto, an HF modem. All of these modems are less than optimum and miss some bits. Any time a packet must be repeated, the frequency becomes more crowded. More

crowding leads to more bad packets and to more crowding.

A close look at the modems on TAPR-style TNCs was done over the last winter to try to improve HF performance. The changes published give an improvement, primarily a reduced requirement for precise tuning. More importantly, some manufacturers are addressing the problem by making real HF modems available that are designed like HF TUs and not like telephone modems, for example the AEA PM-1. Hams are also beginning to modify RTTY TUs and use them for packet. You can either buy a \$1,000 linear amplifier for your station or a \$150 modem for the station you're trying to talk to. As more serious HF users upgrade their modem capability, you'll notice that your station seems to get out better.

I also mentioned user training as a factor in HF viability. There are upwards of 70 parameters on a TNC. As shipped, most of the defaults are correct for VHF use. Many are dead wrong for HF use. The parameters that will have the most effect are the packet length and the retry timer (FRACK). Experiment with these values for the best performance on HF.

One final thought on this facet of HF operating. There are many forwarding BBS systems present on HF. Most of them are on 14.107 MHz. These systems pass cross-country traffic funneled through from the larger number of VHF BBS systems and thereby benefit a large number of hams. If you connect to these systems on 14.107 or carry on a non-BBS QSO on that frequency, the forwarding systems can't forward. These stations must congregate on a single channel to forward the mail, but individuals are free to roam. Please do so. If you have another way to access the national forwarding system, like a local VHF BBS, please use it instead. If you do see an interesting DX station working a BBS to get news he can't get another way, once you contact him move off to another frequency. If this sounds like the concept of a calling frequency, it is. The more things change, the more they stay the same.

Q: How is DX on packet?

A: I knew you'd ask that, so I forwarded some messages to various VHF and HF BBS stations asking for DX information. In less than a week I received four responses back through the forwarding system. Compiled from lists supplied by W0RLI, WD4BIW, W9ZRX, and N1DL, and a letter to WB9FLW from DU1POL, here is a list of countries with known HF packet activity: 5H3, 5V, 9K2, 9M, CN8, DL, DU, EA, F, G, GW, HB, HK, I, JA, KH6, KL7, KP4, LA, OH, ON, OX, PA, PJ, PY, SM, TI, VE, VK, W, XE, YB, ZF1, ZL, ZS.

There are probably more reports on the way, and there are new countries coming online every month.

Q: Will CW be replaced by packet, never to be heard from again?

A: Of course not. On the other hand, see Photos C and D.

Class dismissed. ■

On The Shelf

Most amateur packet bibliographies I've seen recently are endless lists of books and articles. In this one, I'll mention only a few, but I'll tell you why you might want to take the trouble to look them up. Most of these references contain bibliographies of their own, so you should have no lack of sources with a little effort.

Introductory Material

H. Price, "What's All This Racket About Packet," *QST*, July, 1985.

H. Price, "Packet Radio—A Closer Look," *QST*, August, 1985.

These are basic introductions to packet articles. The second article uses the TNC-2 to describe what's in a TNC.

J. Grubbs, *Get *** CONNECTED to Packet Radio*, Qsky, 1986.

This is the first book published that addresses the operational aspects of amateur packet radio as practiced in 1985-1986. It takes you from picking out a TNC up through your first connect and briefly touches on many other topics. This is the first of what will be an avalanche of "how to use it" rather than "how it works" books. This is certainly a niche that needs to be filled. While intending to keep the material basic, the author includes an extensive list of references for further study if a topic catches your fancy. A list of packet organizations and equipment suppliers is also included.

Several other slightly more technical introductory articles have been written. They are a bit dated now as most of them refer to the TNC-1-style TNC, but much of the information is still valid. They are:

M. Morrison, D. Morrison, and L. Johnson, "Amateur Packet Radio Part 1 and Part 2," *Ham Radio*, July and August, 1983.

L. Johnson, "Join the Packet Radio Revolution Parts 1, 2, and 3," *73*, September, 1983; October, 1983; January, 1984.

And one piece from the history section:

D. Borden and P. Rinaldo, "The Making of an Amateur Packet-Radio Network," *QST*, October, 1981.

This was my and many other's first exposure to coordinated amateur packet activity. In 1981, many groups were working on digital experimentation, but not all groups knew about each other. I can remember the first time I read it, lying in bed after midnight leafing through that month's *QST*. I also remember very clearly thinking that amateurs would never agree on a standard to the level necessary to build a North American network. This article is interesting

now mainly for its historical value, and it includes a list of other articles of historical interest.

Technical

A. Tanenbaum, *Computer Networks*, Prentice-Hall, 1981.

You used to be able to tell the true amateur packet pioneers because they had a copy of this textbook on their shelves. It was almost required reading back in the pre-boom days, and you found out about it through word of mouth. TAPR included it in the bibliography in the manual for the TNC-1, and its fame in amateur circles grew. Back then you had to special-order one or live near a university book store. Last month I came across a stack of them in a local ham radio store. This is a real textbook; I paid \$30 for mine. It gives a very readable overview of the field of computer networking. If you want an understanding of the basic technical issues of packet radio and where our network fits into the world of networks in general, buy or borrow a copy of this book.

The 1986 ARRL *Handbook*.

The *Handbook* underwent a major upgrade in 1985, and 1986 adds even more pages on digital topics. If you've been buying a handbook every 15 years or so, which used to be often enough, break your cycle and buy one this year. I can't say enough good things about it, even about the non-digital sections.

Packet radio is discussed on pages 19-23 to 19-50, and various related topics are scattered around the book.

Terry L. Fox, *AX.25 Amateur Packet-Radio Link-Layer Protocol*, ARRL, 1984.

This is a must read for people who want to write their own AX.25 code, or who want to know how AX.25 really works. AX.25 represents the most exacting set of specifications amateurs have ever lived by, at least until the networking protocols are agreed on. This book documents the outcome of various mandates, agreements, negotiated settlements, and faits accomplis that make up any protocol. It is written in standard protocoles, which makes for dry reading. This book is not for the weak of heart, and it won't tell you how to operate a packet station.

The ARRL Amateur Radio Computer Networking Conferences

The development of packet radio is the best documented effort in amateur radio history. The most obvious reason is that nearly all of the correspondence between developers was done using computers and electronic mail.

These are easy to save and easy to expand into a technical paper. The papers are then easy to print and publish. The ARRL has sponsored, along with various technical groups, a series of computer networking conferences. In addition to serving as a common meeting place for in-person talks, it is also a good deadline to work against for getting your thoughts down in writing and getting them in the public eye. There have been five such conferences since 1981, the most recent one in Orlando in March, 1986. The papers presented there are published, with no editing, by the ARRL. Conferences 1-4 are now available in a single volume; the 5th conference is available separately. Along with volumes 1-4, you get all of the issues of the *Gateway* newsletter from August, 1984 through September, 1985, which document a lot of packet doings on their own.

Altogether, there are more than 600 pages of information, more than 100 articles, and 40 authors. Read these, and come to the 6th conference, which will probably be held on the West Coast. One warning: Not all of the implementation plans you'll read here ever made it past the paper stage.

Amateur Packet Radio in Non-Ham Publications

I include this section because I'm concerned about the long-term viability of the Amateur Radio Service in view of the frightening statistics that the average age of a ham is increasing one year per year, and that 0% of the respondents to the Fun! poll this year were in the 16-21 year age bracket. Packet radio is one of the more interesting things we can use as a hook to get new people into the service. Here are some non-ham publications where amateur packet has appeared. It may be easier to get a friend to read a copy of *Byte* than it would be to start him out with a magazine whose cover features an older gentleman in a suit and tee-shirt talking into a small box. At least initially anyway.

P. Karn, H. Price, and R. Diersing, "Packet Radio in the Amateur Service," *IEEE Journal on Selected Areas in Communications*, May, 1985.

J. Markoff, "Bulletin Boards in Space," *Byte*, May, 1984.

J. Markoff, "Satellite Promises Low-Cost Communications," *Infoworld*, January 23, 1984.

H. Price, "PACSAT," *Personal Communications*, September, 1985.

G. Zorpette, "The High-Tech Hobbyhorse," *IEEE Spectrum*, May, 1985. ■

RAMSEY

THE FIRST NAME IN ELECTRONIC TEST GEAR

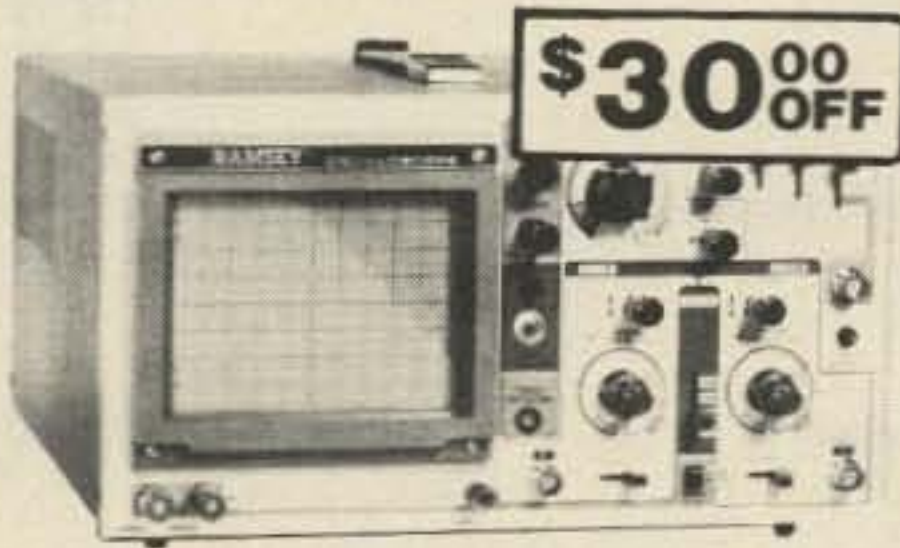

\$30⁰⁰ OFF

Save \$30 on the RAMSEY 20MHz Dual Trace Oscilloscope

Unsurpassed quality at an unbeatable price, the Ramsey oscilloscope compares to others costing hundreds more. Features include a component testing circuit for resistor,

capacitor, digital circuit and diode testing • TV video sync filter • wide bandwidth & high sensitivity • internal graticule • front panel trace rotator • Z axis • high sensitivity x-y mode • regulated power supply • built-in calibrator • rock solid triggering

Was \$399.95 NOW ONLY **\$369⁹⁵** high quality hook on probes included



NEW RAMSEY 1200 VOM MULTITESTER

Check transistors, diodes and LEDs with this professional quality meter. Other features include, decibel scale • 20K volt metering system • 3 1/4" mirrored scale • polarity switch • 20 measuring ranges • safety probes • high impact plastic case

\$19⁹⁵ test leads and battery included



NEW

RAMSEY D-4100 COMPACT DIGITAL MULTITESTER

Compact sized reliability and accuracy. This LCD digital multimeter easily fits in your pocket, you can take it anywhere. It features full overload protection • 3 1/2 digit LCD readout • recessed input jacks • safety probes • diode check function • 2000 hours battery life

\$22⁹⁵ test leads and battery included

NEW 35 MHz DUAL TRACE OSCILLOSCOPE

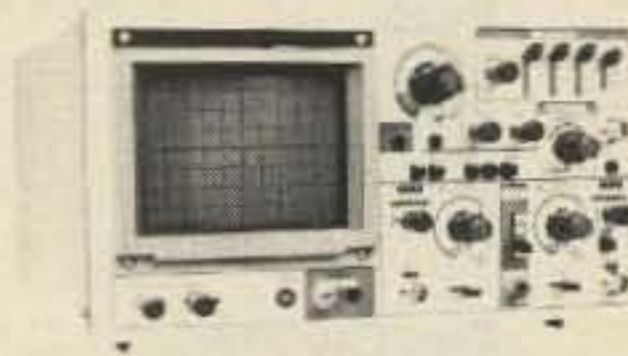

A heavy duty and accurate scope for service as well as production use. Features include • wide frequency bandwidth • optimal sensitivity • extremely bright display • delayed triggering sweep • hold off • ALT trigger • single sweep • TV sync • 5X magnification • XY or XYZ operation • HF/LF noise reduction

3500 Dual Trace Oscilloscope
\$499⁹⁵ includes 2 high quality probes

ALL OSCILLOSCOPES INCLUDE 2 PROBES

NEW 15 MHz DUAL TRACE PORTABLE OSCILLOSCOPE

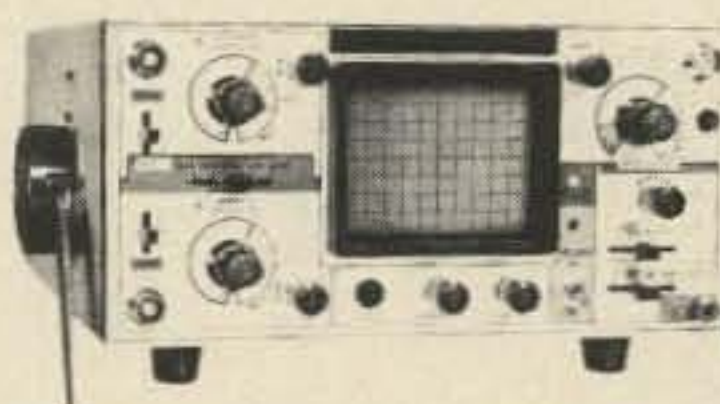

Ideal for field/bench applications, this scope can display up to 15 MHz signals. Internal battery pack allows up to 2 hours operation on a single charge. Features include • built-in battery charger • 5X horizontal magnification • high brightness CRT • front panel trace rotator • internal rechargeable battery pack

2500 Portable Oscilloscope
\$449⁹⁵ includes 2 high quality probes

MINI KITS—EASY TO ASSEMBLE, FUN TO USE BEGINNERS & PROS WILL HAVE A GREAT TIME WITH THESE KITS

FM MINI MIKE

A super high performance FM wireless mike kit! Transmits a stable signal up to 300 yards with exceptional audio quality by means of its built in electret mike. Kit includes case, mike, on-off switch, antenna, battery and super instructions. This is the finest unit available.

FM-3 Kit **\$14.95**
FM-3 Wired and Tested **19.95**

Color Organ

See music come alive! 3 different lights flicker with music. One light each for, high, mid-range and lows. Each individually adjustable and drives up to 300 W. runs on 110VAC.

Complete kit, ML-1 **\$8.95**

Video Modulator Kit
Converts any TV to video monitor. Super stable, tunable over ch. 4-6. Runs on 15V. accepts std. video signal. Best unit on the market! Complete kit, VD-1 **\$7.95**

Led Blinky Kit
A great attention getter which alternately flashes 2 jumbo LEDs. Use for name badges, buttons, warning panel lights, anything! Runs on 3 to 15 volts. Complete kit, BL-1 **\$2.95**

CPO-1
Runs on 3-12 Vdc 1 wall out. 1 KHZ good for CPO, Alarm, Audio Oscillator. Complete kit **\$2.95**

Super Sleuth
A super sensitive amplifier which will pick up a pin drop at 15 feet! Great for monitoring baby's room or as general purpose amplifier. Full 2W rms output, runs on 6 to 15 volts, uses 8-45 ohm speaker. Complete kit, BN-9 **\$5.95**

FM Wireless Mike Kit

Transmits up to 300' to any FM broadcast radio, uses any type of mike. Runs on 3 to 9V. Type FM-2 has added sensitive mike preamp stage.

FM-1 Kit **\$3.95** FM-2 Kit **\$4.95**

Whisper Light Kit

An interesting kit, small mike picks up sounds and converts them to light. The louder the sound, the brighter the light. Includes mike, controls up to 300 W. runs on 110 VAC.

Complete kit, WL-1 **\$6.95**

Tone Decoder

A complete tone decoder on a single PC board. Features 400-5000 Hz adjustable range via 20 turn pot, voltage regulation, 567 IC. Useful for touch-tone burst detection, FSK, etc. Can also be used as a stable tone encoder. Runs on 5 to 12 volts. Complete kit, TD-1 **\$5.95**

Siren Kit

Produces upward and downward wail characteristic of a police siren, 5 W peak audio output, runs on 3-15 volts, uses 3-45 ohm speaker. Complete kit, SM-3 **\$2.95**

50 Hz Time Base
Runs on 5-15 VDC. Low current (25ma) 1 min/month accuracy TB-7 Kit **\$5.50**
TB-7 Assy **\$9.95**

Universal Timer Kit

Provides the basic parts and PC board required to provide a source of precision timing and pulse generation. Uses 555 timer IC and includes a range of parts for most timing needs.

UT-5 Kit **\$5.95**

Mad Blaster Kit

Produces LOUD ear shattering and attention getting siren like sound. Can supply up to 15 watts of obnoxious audio. Runs on 6-15VDC.

MB-1 Kit **\$4.95**

30 Watt 2 mtr PWR AMP

Simple Class C power amp features 8 times power gain, 1 W in for 8 out, 2 W in for 15 out, 4 W in for 30 out. Max output of 35 W, incredible value, complete with all parts, less case and T-R relay.

PA-1, 30 W pwr amp kit **\$22⁹⁵**

TR-1, RF sensed T-R relay kit **6⁹⁵**

Power Supply Kit

Complete triple regulated power supply provides variable 6 to 18 volts at 200 ma and +5 at 1 Amp. Excellent load regulation, good filtering and small size. Less transformers, requires 6 3V (a 1 A and 24 VCT. Complete kit, PS-3LT **\$6⁹⁵**

CT-70 7 DIGIT 525 MHz COUNTER

Lab quality at a breakthrough price. Features • 3 frequency ranges each with pre amp • dual selectable gate times • gate activity indicator • 50mV @ 150 MHz typical sensitivity • wide frequency range • 1 ppm accuracy

\$119⁹⁵ wired includes AC adapter

CT-70 kit **\$99.95**

BP-4 nicad pack **8.95**

CT-50 8 DIGIT 600 MHz COUNTER

\$169⁹⁵ wired

CT-50 kit **\$139.95**

RA-1 receiver adapter kit **14.95**

CT-90 9 DIGIT 600 MHz COUNTER

The most versatile for less than \$300. Features 3 selectable gate times • 9 digits • gate indicator • display hold • 25mV @ 150 MHz typical sensitivity • 10 MHz timebase for WWV calibration • 1 ppm accuracy

\$149⁹⁵ wired includes AC adapter

CT-90 kit **\$129.95**

OV-1 0.1 PPM oven timebase **59.95**

BP-4 nicad pack **8.95**

CT-125 9 DIGIT 1.2 GHz COUNTER

\$169⁹⁵ wired includes AC adapter

BP-4 nicad **\$8.95**

DM-700 DIGITAL MULTIMETER

Professional quality at a hobbyist price. Features include 26 different ranges and 5 functions • 3 1/2 digit, 1/2 inch LED display • automatic decimal placement • automatic polarity

\$119⁹⁵ wired includes AC adapter

DM-700 kit **\$99.95**

MP-1 probe set **4.95**

PS-2 AUDIO MULTIPLIER

The PS-2 is handy for high resolution audio resolution measurements, multiplies up in frequency • great for PL tone measurements • multiplies by 10 or 100 • 0.01 Hz resolution & built-in signal preamp/conditioner

\$49⁹⁵ wired

PR-2 kit **\$39.95**

PR-2 COUNTER PREAMP

The PR-2 is ideal for measuring weak signals from 10 to 1,000 MHz • flat 25 db gain • BNC connectors • great for shifting RF • ideal receiver/TV preamp

\$44⁹⁵ wired includes AC adapter

PR-2 kit **\$34.95**

PS-10B 1 GHz PRESCALER

Extends the range of your present counter to 1 GHz • 2 stage preamp • divide by 1000 circuitry • super sensitive (50 mV typical) • BNC connectors • 1 GHz in, 1 MHz out • drives any counter

\$79⁹⁵ wired includes AC adapter

ACCESSORIES FOR RAMSEY COUNTERS

Telescopic whip antenna—BNC plug **\$ 8.95**
High impedance probe, light loading **16.95**
Low pass probe, audio use **16.95**
Direct probe, general purpose use **13.95**
Tilt bail, for CT-70, 90, 125 **3.95**



PHONE ORDERS CALL
716-586-3950

TELEX 466735 RAMSEY CI

RAMSEY ELECTRONICS, INC.
2575 Baird Rd.
Penfield, N.Y. 14626

73's Packet Buying Guide

Company	Product	Features	Price
AEA PO Box C-2160 Lynwood WA 98036	PK-64 Pakratt	TNC for the C-64/128	\$219.95
	HFM-64	Optional HF modem for the PK-64	119.95
	PK-64/HFM-64	Package deal	309.95
	PK-80	General-purpose TNC-2	219.95
	PM-1	Stand-alone HF modem	169.95
	PK-232	RS-232-based CW/RTTY/AMTOR/packet system	319.00
Amateur Packet Alaska AX.25 Communications Trail Ester AK 99725	VHF/HF switch	1200-to-300-baud switching	30.00
Amateur Wholesale Electronics 8817 SW 129th Terrace Miami FL 33176	Tono EXL-5000E	Packet/RTTY/CW/AMTOR terminal	795.00
ARRL 225 Main Street Newington CT 06111	Gateway	Packet newsletter (ARRL member)	6.00
		Packet newsletter (Non-member)	9.00
Bill Ashby and Son Box 332 Pluckemin NJ 07978	Pac/Net	HDLC system	240.00
Brincomm Technology 3155 Resin Street Marietta GA 30066	MacPacket	User-friendly Macintosh packet software for TNC-1/TNC-2/Kantronics (specify)	69.95
Computer Trader Magazine 1704 Sam Drive Birmingham AL 35235		Extensive packet coverage	15.00
Hamtronics 65-D Moul Road Hilton NY 14468	MO-202	FSK modulator 1200/2200 Hz, kit	38.00
	DE-202	FSK demodulator 1200/2200 Hz, kit	38.00
	PPA-144	Fast T-R amp (1 ms), 144 MHz, 2 W in/50 W out, kit	142.00
	PPA-220	Fast T-R amp (1 ms), 220 MHz, 2 W in/50 W out, kit	142.00
HAPN Box 4466, Station D Hamilton, Ontario Canada L8V 4S7	Plug-in TNC	For the IBM PC	
		Bare board	75.00
		A&T (assembled and tested)	199.00
GLB 151 Commerce Pkwy. Buffalo NY 14224	PK-1L	Low-power miniature TNC	179.95
	TNC-2A	TNC-2 kit (NMOS)	154.95
		TNC-2 kit (CMOS)	169.95
	PK-1	TNC-1 board without case	99.95
		Board with case	134.95
		Board, case, power supply, and cables	154.95
Heath Dept. 011-402 Benton Harbor MI 49022	HD-4040	TNC-1 kit (includes HDA-4040-1 and -2)	199.95
	HDA-4040-1	Status indicator/connect alarm for any TNC-1	24.95
	HDA-4040-2	HF kit for HD-4040	9.95
Kalt & Associates 2440 E. Tudor Road Suite #138 Anchorage AK 99507	Pak-Comm	IBM software	49.95
Kantronics 1202 E. 23rd Street Lawrence KS 66046	KPC-2	TNC with built-in HF modem, multiple connects	219.00
	Packet video	How-to video tape	25.00
	KPC-2400	2400 baud TNC, multiple connects	329.00
	2400 TNC modem	Upgrades any TNC-1 or -2 to 2400 baud	149.00
MFJ Box 494 Mississippi State MS 39762	MFJ-1270	TNC-2	129.95
Microlog 18713 Mooney Drive Gaithersburg MD 20879	ART-1	Morse/Baudot/AMTOR/packet for VIC-20/C-64/128	299.95
Micro Supply Organization 4909 Stockdale Hwy. #180 Bakersfield CA 93309	MBC-1160	Dedicated packet terminal with Sanyo computer (Wordstar, Calcstar, and Infostar) and TNC-2	699.00
Pac-Comm 4040 W. Kennedy Blvd. Tampa FL 33609	TNC-200	TNC-2 (CMOS) A&T	219.95
		TNC-2 (NMOS) A&T	199.95
	MacPacket	Kits	39.95 to 169.95
		Software for the Macintosh	69.95
Packeterm Box 835 Amherst NH 03031	IPT	Complete packet terminal system	995.00
FADCA 812 Childers Loop Brandon FL 33511	Packet Radio Magazine	Packet-specific publication	15.00
QSKY Publishing PO Box 3042 Springfield IL 62708	Get ***Connected to Packet Radio	Introductory book	12.95
Watt Engineering PO Box 1848 Goleta CA 93116	Connect alarm	For TNC-2/AEA PK-80	
		Kit	16.89
		A&T	22.64

TUBES

105



AERO ELECTRONICS
Electron Tubes for Industry

Toll Free (except CA)
(800) 421-4219

IN CALIFORNIA
(800) 556-6700

2129 Venice Boulevard Los Angeles California 90006 USA

Telephone
(213) 737-7070

Telex 673565
Cable Aero LSA

SATELLITES

USING THE AO-10 PREDICTIONS

Apogee predictions for the month of August are provided for three sections of the United States: Washington, D.C.; Denver, Colorado; and Los Angeles, California. Times are in UTC and apogee in this case is mean anomaly 128 rounded to the nearest whole hour. Use the chart as a guide in aiming your antenna, then fine-tune the azimuth and elevation values to peak the satellite's beacon signal. If you require more accurate orbital predictions, contact AMSAT at PO Box 27, Washington DC 20044.

AMSAT-OSCAR 10 APOGEE PREDICTIONS August 1986

DAY	TIME	WASH		DENVER		LA	
		AZ	EL	AZ	EL	AZ	EL
1	0620	128	4				
3	1637					237	3
4	1556					231	9
5	1515			232	3	223	15
6	1434			225	9	215	21
7	1353			217	14	206	25
8	1313	232	4	208	18	196	28
9	1232	225	10	199	21	185	30
10	1151	217	15	189	23	174	30
11	1110	209	19	178	24	163	28
12	1029	199	23	168	23	153	25
13	0948	189	25	158	21	143	21
14	0907	178	25	148	18	135	15
15	0826	168	24	140	13	128	9
16	0745	157	22	132	8	121	3
17	0704	148	19	125	2		
18	0623	139	14				
19	0542	131	9				
20	0501	124	3				
21	1600					242	0
22	1519					236	7
23	1438			238	1	229	13
24	1357			231	7	222	19
25	1316			223	13	213	24
26	1235	238	2	215	17	203	28
27	1155	231	8	206	21	192	31
28	1114	224	14	196	24	181	32
29	1033	215	19	185	26	169	31
30	0952	206	23	174	26	158	29
31	0911	196	25	164	24	148	25

COMMERCIAL- AVIONICS- SOLID STATE- DIPOLE- LONG WIRE- MILITARY- MARINE

"THE AMERICAN ORIGINAL"

MADE IN AMERICA BY AMERICANS 101

MAXCOM

AUTOMATIC ANTENNA MATCHER

FOR ALL S.S.B. RADIOS

"ONE ANTENNA 100 KHZ. TO 200 MHZ."

MAXCOM has made Global Communications Simple!!!

TEN MODELS:

150 WATTS TO 10,000 WATTS
\$299. TO \$1,999.

**VSWR 1.5:1
OR LESS**

**FIVE YEAR
GUARANTY
ON
MOST MODELS**

SOLD BY SERIOUS, PRACTICAL RADIO DEALERS YOU REALLY NEED

"THE ONLY ANTENNA SYSTEM YOU REALLY NEED"



Absolutely no tuning with a MAXCOM system.
Simply connect, dial your frequency and talk...
That's it. just TALK.

OVER 3000 MAXCOM STATIONS WORLD WIDE
MAXCOM, INC. BOX 502, FT. LAUD., FL. 33302
305-527-5172 © 1986 Maxcom, Inc.

THE BOTTOM LINE: "MAXCOM WORKS"

HOT!!

Turn Your Computer Into A

\$129.95

(C64 Version)

**DIGITAL
STORAGE
OSCILLOSCOPE**



And More With The
MB230 WORKSHOP



OSCILLOSCOPE



VOLTMETER



MOTOR AND GEARS

The MB230 is designed for use with your home or personal computer. It is a complete Electronic Instrument and Electro-Mechanical Workshop which contains Interface Unit, D.C. Motors, Gears, Sensors, Construction Components, Disk Based Software and instructions for 50 sample projects.

Included are:

- Digital Storage Oscilloscope
- Digital Voltmeter
- Digital Speech & Sound (Record/Playback)
- A/D-D/A Conversion
- D.C. Motor Control (Var. Speed)
- Infrared Control
- Motors, Gears, Generators
- Motorized Mechanical Robotics
- Cars, Cranes, Toys, Etc.

The heart of the MB230 Workshop is the B100 Interface Unit which connects to all types of sensors and is able to control lights, motors, relays and other external devices. The MB230 manual contains suggestions and instructions for many advanced projects such as antenna positioning and relay control.

Available for the following computers:

- Commodore 64 (\$129.95), Apple 2+, 2E (\$159.95), Atari 800 (\$139.95).
- Coming soon for IBM, Amiga, Atari 520ST.

To order or for more information call toll free 1-800-824-2549.
Cashier's check, Money order, VISA, or Mastercard orders accepted.

Order now to avoid delay!

ALL ORDERS SHIPPED UPS BLUE
AT NO EXTRA CHARGE

84

MULTIBOTICS, INC.

2561 South 1560 West
Woods Cross, Utah 84087

Kit Corner: The DSE 500-MHz Frequency/Period Counter

Looking for an inexpensive 500-MHz frequency counter? If you're willing to spend a few hours with a soldering iron, you can put together the Dick Smith Electronics kit #K-3439 for about \$90. Accuracy is on the order of ± 50 Hz for most measurements, which is close enough for almost every application.

The unit is built around a single-chip frequency counter, the 7216B, which includes an oscillator, data counters, and display decoders and multiplexers. The basic instrument will measure frequencies up to 50 MHz; an optional prescaler kit (#K-3432, \$23) extends the range to 500 MHz.

In addition to measuring frequency, the unit also can be set up to display the period of a signal for between one and one thousand input cycles. This method is a bit more precise (though not more accurate) than the standard frequency-display mode.

Appearance

The plastic front panel is silk-screened and

pre-cut. Insulated BNC connectors are provided for the input jacks. Seven large, easy-to-read LEDs make up the display, which sits behind a red plastic filter.

The case is a plastic four-piece affair, and that has been designed to accommodate a wide variety of circuit boards. There are about thirty mounting posts in the bottom of the case; you only need four of them. The rest must be cut away or ground down, which I thought was a bit of a nuisance. It took me about three passes with a grinder to get the board to sit properly.

Construction

Warning: This is *not* a hold-you-by-the-hand kind of kit! If you are spoiled by Heathkit-style manuals which advise you to "place R20 (red-black-brown) in position C after carefully bending the leads," you will be catatonic after reading, "Now mount the resistors and capacitors." I found that grabbing parts out of a giant pile and matching them to the schematic was really fun! It made me feel like I was really building

something, rather than just mimicking someone else.

There were a few snags. The worst was caused by the parts-placement diagram in the manual—the parts were there, but the circuit pattern under them was missing. Most of the time it was easy to guess where a part went, but in several instances I had to put the board behind the diagram and hold it up to the light. Also, the instructions for wiring the ac transformer are a bit vague, and I had to resort to tracing leads on the PC board to decide where the wires from the secondary were to go.

Take care to read *all* of the notes that surround the placement diagram—I didn't, and ended up unsoldering a few parts that I'd put in the wrong places.

I was disappointed to find that no sockets were provided for the ICs. The manual states that "sockets may be purchased." This is inexcusable—I can't believe that three or four sockets would raise the price of the kit more than a dollar or two. It just doesn't make any sense not to socket ICs.

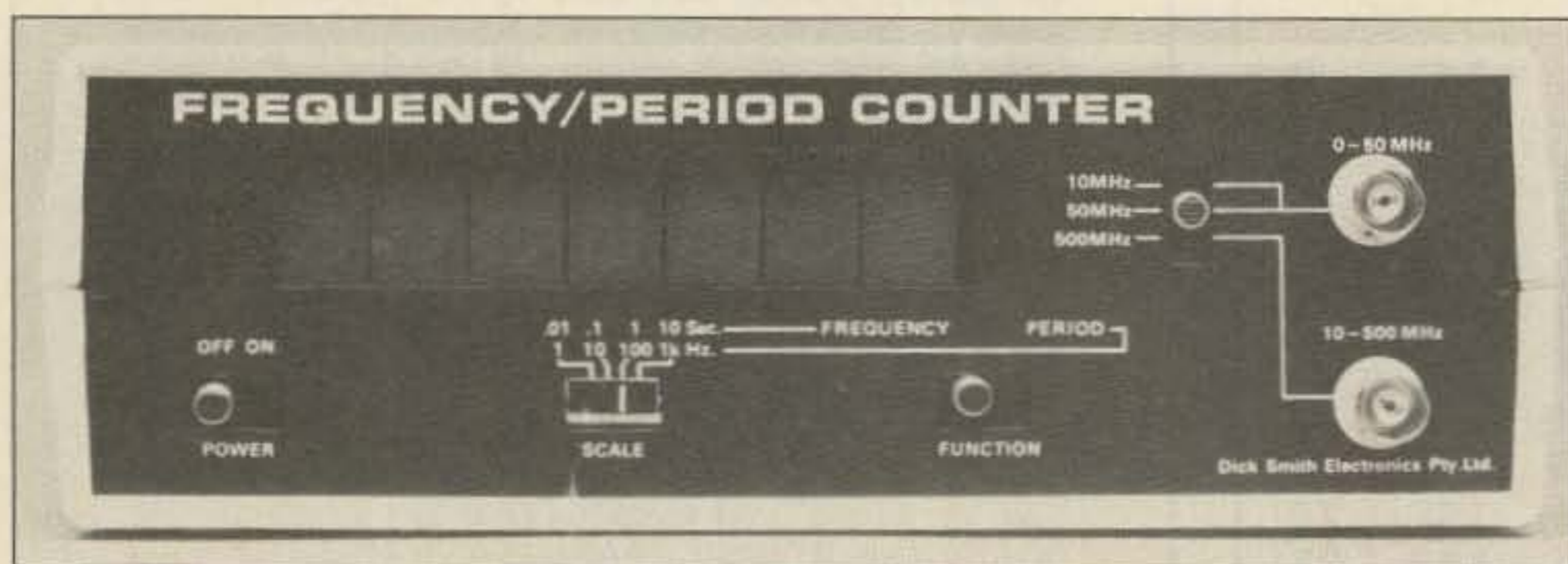

Photo A. DSE's inexpensive frequency/period counter.

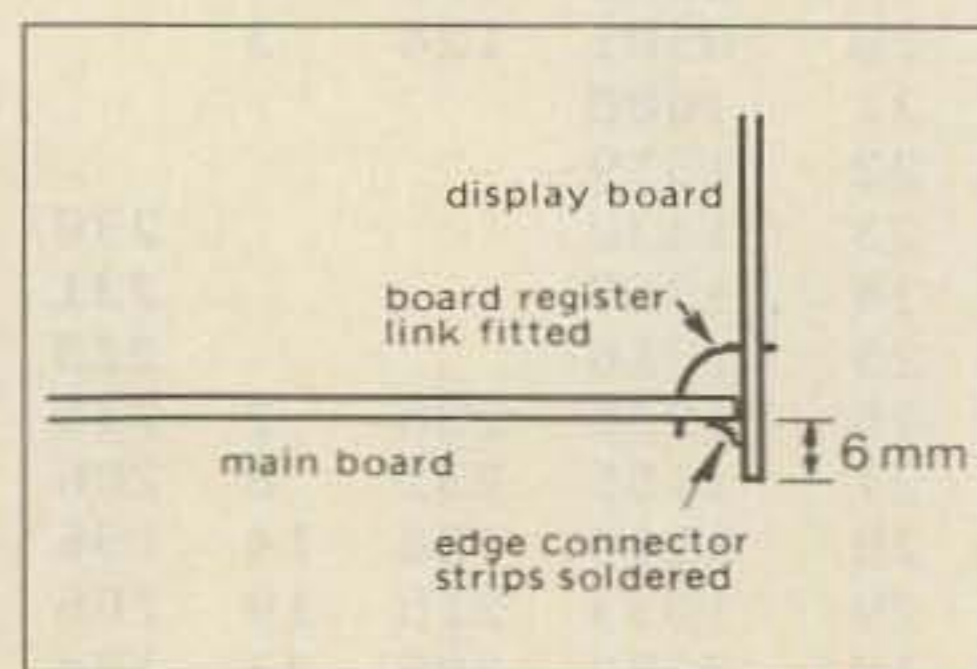

Fig. 1. You're instructed to join two circuit boards with solder fillets.

Another disappointment was the method used to mount the display. The frequency counter uses a main board for the counter and input circuitry, and a display board which holds the LEDs and switches. All of the wiring to the LEDs and switches is accomplished with PC traces; the traces on the main board mate with those on the display board. This is great for cutting down on the number of connections, but to join the two boards, the instructions ask you to use solder fillets (Fig. 1.) This may work if the boards fit perfectly together, but in my kit there was a gap of about 1/4" to fill!

At first I thought, "Well, they must know what they are doing," and I actually attempted to hook the boards together with solder bridges. I ended up ripping two solder pads completely off of the board.

I finally gathered a few dozen of the resistor leads that were scattered about my desk and formed them into connecting fingers. This worked really well; the leads were flexible enough to let me bend them around to get the boards to fit into the case. And I didn't have to worry about solder bridges forming the only electrical connection to the display board.

Apart from the problems I've already mentioned, I thought that the construction manual was fairly well done. Quite a bit of space is devoted to explaining the circuit in minute detail. Unfortunately, the manual was intended for an Australian audience, so you have to put up with power cords having blue, green,

and brown wires, and with color-burst oscillators running at 4.433619 MHz. The wording in some cases is difficult to understand, but a careful re-read will clear things up in most instances.

Operation

With the counter tucked neatly into its case, I switched on the power and was pleasantly surprised not to see wisps of smoke. I don't have a signal generator, so I checked the clocks in all of my computers, the output of all of my rigs, and so on. An oscillator I built around a TV color-burst crystal was off only a Hertz or so; that made me feel pretty comfortable about the accuracy of the counter.

Obviously, this is not a lab-standard frequency counter, but then you're not paying lab-standard prices, either. I've found that the accuracy and precision of the unit is sufficient for 99% of the applications around the shack—most of the time I just want to know whether a circuit is oscillating or not. I do suggest that you spend the extra few dollars for the 500-MHz prescaler, especially if you have VHF/UHF gear.

I encountered minor frustrations while building this kit, but none of the problems were insurmountable. The unit works great, and I think you'll not find a 500-MHz frequency counter at a better price.

For more information, please contact Dick Smith Electronics, PO Box 8021, Redwood City CA 94063; (800)-332-5373. ■

PACKET
CONNECT-ALARM
for the TNC-2 and clones

Are you out of the room when another station is trying to connect to you? A LOUD BEEP FROM THE CONNECT-ALARM LETS YOU KNOW WHEN SOMEONE IS TRYING TO REACH YOU. Works with the TAPR TNC-2, PAC-COM TNC-2, and A E A PK-80. The beep time is screwdriver adjustable from a fraction of a second all the way to a long 9 seconds. Fits entirely inside the TNC-2 chassis. Easy four wire hookup to TNC-2 board. Furnished with top quality I.C. cermet sealed trimpot, piezo buzzer and a 1.5 inch square glass-epoxy board.

Complete Kit \$16.89 • Assembled Unit \$22.64
Shipping add \$2.00

SEND S.A.S.E FOR MORE INFORMATION

WATT ✓98
ENGINEERING
(805) 564-3682 to order
(805) 964-0099 tech info
Visa Mastercard Accepted
Money back guarantee

P.O. Box 1848 Goleta, CA 93116

SYNTHESIZED SIGNAL GENERATOR

MADE IN USA

MODEL SG-100F
\$429.95 delivered

• Covers 100 MHz to 199.999 MHz in 1 kHz steps with thumbwheel dial • Accuracy +/- 1 part per 10 million at all frequencies • Internal FM adjustable from 0 to 100 kHz at a 1 kHz rate • External FM input accepts tones or voice • Spurs and noise at least 60 dB below carrier • Output adjustable from 5-500 mV at 50 Ohms • Operates on 12 Vdc @ 1/2 Amp • Available for immediate delivery • \$429.95 delivered • Add-on accessories available to extend freq range, add infinite resolution, AM, and a precision 120 dB attenuator • Call or write for details • Phone in your order as fast COD shipment.

✓79

VANGUARD LABS
196-23 Jamaica Ave., Hollis, NY 11423
Phone: (718) 468-2720 Mon.-Thurs.

Featured in this issue!



Thousands Sold! only \$89.95
Cat K-3439

Get Pro Quality at Hobbyist Prices!

"The DSE kit packs more features than some counters costing three or more times as much." *J. Daniel Gifford in Dec. '85 Modern Electronics*

Superb design featuring the latest IC technology makes this kit easy to build and reliable to use. Measures up to 50 MHz in two ranges (or higher with the prescaler kit below!). Features 4 gating periods from 0.01 to 10 seconds, 7 segment display, 4 period measuring ranges, high input sensitivity, accuracy typically better than .005%, 110V operation. What more could you ask for? DSE has it all!

DSE Digital Frequency/Period Counter Kit

DSE Prescaler Kit

A mate to the Frequency Counter Kit, this valuable add-on fits the existing PC board and extends the counter's range for professional operation at 10-500 MHz.

\$22.50
Cat K-3432

Find that hidden transmitter!

- 50-500 MHz range • 170° calibration • 12V
- Internal alignment reference • Stable digital circuitry
- Self-aligning commutating filters
- Adjustable internal monitor speakers

\$99
Cat K-6345

Radio Direction Finder Kit



Visit our Retail Centers!

BERKELEY: 2474 Shattuck Ave. (415) 486-0755
REDWOOD CITY: 390 Convention Way (415) 368-8844
SAN JOSE: 4980 Stevens Creek Blvd. (408) 241-2266
LOS ANGELES: 1830 Westwood Blvd. (213) 474-0626
HEAD OFFICE: 390 Convention Way Redwood City, CA 94063



OVER 2000 SOLD

2M VHF Transceiver Kit

\$159
Cat K-6308

"When was the last time you built a kit that was really fun?..."
"This is a fun kit to build & a useful rig around the house & car."
Peter H. Putman KT2B in May '86
73 for Radio Amateurs

- Frequency: 144-148 MHz in 10kHz steps (5 kHz offset) • FM operation
- Dual conversion superheterodyne receiver • 13.8 VDC 2.5A (15W output)
- Sensitivity: 0.5µV for 12dB quieting • Selectivity: >60dB 25kHz

MAIL ORDERS

P.O. Box 8021
Redwood City, CA 94063

14 DAY MONEY-BACK GUARANTEE

We ship UPS Ground unless otherwise specified. Add 5% for shipping (\$1.50 min.) 20% outside USA (\$4 min.) Add \$1.50 for handling. California residents please add sales tax.

ORDER TOLL FREE:

1-800-332-5373

In California call 1-415-368-1066

Get Your 1986/87 DSE Catalog Now!

Send me the new 148 page catalog! Here's \$1 for postage & handling.

Name _____
Address _____
City _____
State _____ Zip _____

DICK SMITH ELECTRONICS

P.O. Box 2249 Redwood City CA 94064

SPECIAL EVENTS

Listings in this column are provided free of charge on a space-available basis. The following information should be included in every announcement: sponsor, event, date, time, place, city, state, admission charge (if any), features, talk-in frequencies, and the name of whom to contact for further information. Announcements must be received by 73 Magazine by the first of the month, two months prior to the month in which the event takes place. Mail to Editorial offices, 73 Magazine, WGE Center, Peterborough, NH 03458-1194.

COAST GUARD FESTIVAL JUL 30-AUG 3

The North Ottawa ARC will operate KA8USK aboard the U.S. Coast Guard Cutter *Macinaw* July 30-August 3 from 1700-0100 UTC as part of the Grand Haven Coast Guard Festival. Suggested frequencies: SSB-3.875, 7.265, 14.250; CW-7.050, 7.110, 14.050. For a commemorative certificate, send QSL and a 9 x 12 SASE to NOARC, Box 44, Ferrysburg MI 49404.

JACKSON HOLE WY AUG 1-3

The ARRL Rocky Mountain Division Convention and the 54th annual Wyoming, Idaho, Montana, and Utah Hamfest will be held August 1-3 at the Virginian Motel. For special room rates, call the motel and mention "Hamfest." The A1 campground is next to the motel for first-come, first-served basis. For more information, contact George Siegel, 130 E. 17th Street, Idaho Falls ID 83401; (208)-523-7433.

OHIO STATE FAIR AUG 1-17

The Columbus ARA will be operating special-event station W8TO on August 1-17 to promote the Ohio State Fair. Operation will be on 80 through 10 meters. Times and frequencies to be determined by persons manning the booth at the fair (11 a.m. to 9 p.m. EDT daily). A valid exchange includes name, QTH, and RST. For a commemorative certificate, send a log extract or QSL card and an SASE to W8TO, Attn: State Fair Event Coordinator, 280

East Broad Street, Columbus OH 43215.

PRO-FOOTBALL WEEKEND AUG 2-3

The Canton ARC will operate special-event station W8AL to celebrate the Pro-Football Hall of Fame's Greatest Weekend on August 2-3, from 1700 to 2200 UTC each day. Operating frequencies will be: SSB-14.270 and 7.270; CW-14.060 and 7.060. For a special H.O.F. QSL card, send your card with an SASE to Randy Phelps KD8JN, 1226 Delverne Ave. SW, Canton OH 44710.

AVIATION EXHIBITION AUG 2-3

The Fox Cities ARC will operate station W9KKK August 2-3 from 1300-2200 UTC in conjunction with the 34th annual EAA International Fly-in Convention and Sports Aviation Exhibition in Oshkosh, Wisconsin. Suggested frequencies: 3.875, 7.250, 14.250. Send QSL and SASE to Dick Roll W9TA, 933 Melissa Street, Menasha WI 54952.

MT. DAVIS EXPEDITION AUG 2-3

The Somerset County ARC will begin an expedition to Mt. Davis, the highest point in Pennsylvania, on August 2. Station AK3J will operate from 12 noon on August 2 to 12 noon on August 3 (EDT) in the lower 100 kHz of the General-class phone frequencies on 20, 40, and 80 meters; 10 and 15 meters depending on propagation; and 2m SSB. For an 8-1/2 x 11 certificate, send a QSL and large SASE to SCARC-Mt. Davis, RD#5, Box 223A, Somerset PA 15501.

VALPARAISO IN AUG 3

The Porter County ARC will hold its hamfest on August 3, beginning at 8 a.m., at the 49'er Drive-In Theatre on State Road 49 in Valparaiso, Indiana. Admission is \$3. Talk-in on 147.96/.36 and .52 simplex. For more information, write to PCARC, PO Box 1782, Valparaiso IN 46383.

ANGOLA IN AUG 3

The Steuben County RA will

present its 28th annual FM Picnic and Hamfest at Crooked Lake, Angola, Indiana, on August 3. Two miles north of Angola, I-69 to Crooked Lake Exit. Admission is \$2.50. Inside tables for exhibitors and vendors available. Talk-in on 146.52 and 147.81/.21.

BERRYVILLE VA AUG 3

The Shenandoah Valley ARC will sponsor its 36th annual Winchester Hamfest on August 3, from 7 a.m. to 3 p.m., at the Clarke County Ruritan Fairgrounds on Route 7, two miles west of Berryville, Virginia. Admission is \$4, women and children under 12 are free. Tailgaters and limited tables \$5. Talk-in on 146.22/.82 and 146.52 simplex. For further information, call Rob Kinsley NT4S at (703)-869-5113, or write SVARC at PO Box 139, Winchester VA 22601. Exams on August 2 at 9 a.m.—call Walt Quitter NC4B at (703)-869-5241, or send an SASE to 367 Buckingham Drive, Stephens City VA 22655.

WEST MIFFLIN PA AUG 3

The South Hills Brass Pounders and Modulators ARC will hold its 49th annual hamfest on August 3 at the south campus of Allegheny Community College, located in West Mifflin, Pennsylvania, about seven miles south of Pittsburgh. Talk-in on 146.13/.73 and 146.52. For further information, contact Doug Wilson WA3ZNP, 185 Orchard Avenue, Emsworth PA 15202; (412)-761-1851.

49TH SOAP BOX DERBY AUG 7-9

The Cuyahoga Falls ARC will operate special-event station W8VPV on August 7-8, from 6 p.m. to 11 p.m. EDT each day, and on August 9 from 9 a.m. to 3 p.m. EDT, at Derby Downs, Akron, Ohio, for the 49th running of the All American Soap Box Derby. Evening frequencies are 7.250 and 3.940. Daytime frequencies are 7.250 and 14.270. For a certificate, send a 9 x 12 SASE to W8VPV, PO Box 614, Cuyahoga Falls OH 44222, by September 15.

RIPLEY WV AUG 9

The Jackson County ARC will sponsor its 9th annual hamfest on August 9 at the Jackson County Junior Fairgrounds, six miles west of Ripley, West Virginia. Admis-

sion is \$3. Talk-in on .07/.67. For further information, contact Les Shockey WB8SNO, RFD 2 Box 36, Sandyville WV 25275.

INDIANAPOLIS IN AUG 9

The WA9SNT ARC will hold its annual swapfest on August 9, from 8 a.m. to 4 p.m., at ITT Technical Institute (across from the pyramids) in Indianapolis, Indiana. Flea-market setup begins at 6 a.m. Admission \$2, students \$1. Flea-market space \$1. Talk-in on 146.94. For additional information, contact Dave Johnston K9HDQ, c/o ITT Technical Institute, 9511 Angola Court, Indianapolis IN 46268; (317)-875-8640.

JACKSONVILLE FL AUG 9-10

Six major ARCs will sponsor the 13th annual Greater Jacksonville Hamfest and Northern Florida ARRL Section Convention, from 9 a.m. to 5 p.m. on August 9 and from 9 a.m. to 3 p.m. on August 10, at the Civic Auditorium on Water Street in downtown Jacksonville. Registration is \$4, children under 16 free. Swap tables are \$9 per day or \$15 for the weekend. Exams at 1 p.m. on August 9—free for Novice, others \$4. Talk-in on the W4IZ (.16/.76) repeater. For commercial booths and swap tables, send inquiries to Greater Jacksonville Hamfest, PO Box 10623, Jacksonville FL 32207; (904)-350-9193.

ESSEX JUNCTION VT AUG 9-10

The Burlington ARC will celebrate its 50th Anniversary at the Burlington International Hamfest on August 9-10, all day both days, at the Champlain Valley Fairgrounds in Essex Junction, Vermont. Admission \$4 U.S., \$5 Canadian. Children under 12 free. Campers \$5 U.S. per night. Talk-in on 146.34/.94. For more information, contact Barb Kimball N1DLE, 1 Sundown Drive, Williston VT 05495; (802)-878-5555.

MARION IN AUG 10

The Grant County ARC will hold its 7th annual hamfest August 10 at the 4-H Fairgrounds in Marion, Indiana, beginning at 8 a.m. \$2 donation in advance, \$3 at the gate. \$2 reservation for an 8-foot table. License exams will be given. For more information or tickets, send an SASE to Brooks

WORLD-TECH PRODUCTS



SALE PRICE
\$34.95

List Price \$44.95
Model
M3111A (S)

KNOW THE TIME

ANYWHERE - EVERYWHERE - INSTANTLY

- 12/24 Hour Time Piece.
- Easy to read local time in cities around the world.
- Gold or silver time piece handsomely displayed in a smoked acrylic or clear stand.
- Daylight/Nighttime shown on 24-hr. dial.
- Accuracy assured to ± 15 seconds per month with quartz movement.
- Time piece diameter 6½", height 9", width 8".
- Uses 1 "AA" battery, not included.

ORDER YOUR CLOCKS TODAY

For Information Call (813) 442-5862
For Orders 1-800-835-2246 EXT216

Florida resident add 5%. Please add \$2.50 for shipping, or write: 1233 Kapp Dr., Clearwater, FL 33575

93

PACKET RADIO

for the

Apple Macintosh

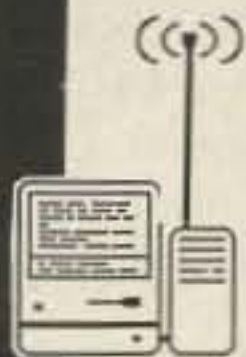

- Enhances your TNC so you can enjoy Packet Radio!
- Split screen display to separate, send and receive data.
- Full Macintosh User Interface.
- TNC Commands and Parameters on pull down menus.

- Routing file for digipeater routes.
- File transfer using Session Layer protocol.
- Command procedure files.
- Free upgrades for one year after purchase.
- Packages and supported TNCs:

MacPacket/TAPRterm \$69.95
-TAPR TNC-2 -AEA PK-80

-GLB TNC-2A
-MFJ Electronics MFJ-1270
-Mac Comm TNC-200

MacPacket/TAPRterm \$69.95
-TAPR TNC-1 -AEA PKT-1

MacPacket/KANterm \$69.95
-Heath HD-4040
-Kantronics Packet Communicator
(KPC-1 V2.0 & KPC-2)

available from dealers from:

Brincomm Technology
3155 Resin Street
Marietta, GA 30066

Georgia residents add appropriate state sales tax.
Macintosh is a trademark licensed to Apple Computer, Inc.

102

WORLD FAMOUS

CURTIS KEYSERS



New

Write for Brochures 8044ABM-\$19.95
8044/8044B still \$16.70 ppd (plus \$1.75 shipping)

CURTIS ELECTRO DEVICES, INC.
(415) 964-3846
Box 4090, Mountain View CA 94040

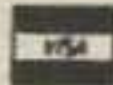

WORLD FAMOUS

CURTIS KEYSERS



Write for Brochures K5-\$44.95
8044/8044B still \$16.70 ppd (plus shipping)

CURTIS ELECTRO DEVICES, INC.
(415) 964-3846
Box 4090, Mountain View CA 94040

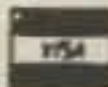

ESTABLISH A HAM TESTING CENTER IN YOUR AREA

As of 1984, all ham radio license testing is handled by the amateur radio community itself. Teams of three Extra Class volunteer examiners (VE's) can now conduct all ham license upgrade examinations.

Administering Technician through Extra Class examinations is no harder than administering Novice examinations — which VE's have done for decades. We offer... fastest VE accreditation, complete instructions, immediate testing... with testing fees (expense reimbursement) shared with the VE team.

Send an SASE today for a VE application if you are an Extra Class amateur and serious about conducting periodic amateur radio examination sessions in your area so that others may upgrade.



W5YI-VEC
P.O. Box #10101
Dallas, TX 75207
(817) 461-6443

Let's get Amateur Radio growing again!

DEN-TRONICS

Amateur Radio & Computers
6102 Deland Road • Flushing, MI 48433
(313) 659-1776

"YOUR PACKET CONNECTION"

Kantronics • Microlog • AEA • Merlin
Software for popular computers:

AEA Software

Kantronics Software

MBA-TOR
Apple
H-89
DDX-64
SWL TEXT
IBM
DQ-64

Hamssoft
Amtar
Hamtex
Amtorsoft
Supertap

103



Crystal Filters

For most Ham Rigs from:
KENWOOD • YAESU • HEATHKIT
Also Drake R-4C/7 Line, COLLINS 75S3-B/C
and ICOM FL44A, FL52A, FL53A clones.

Finest 8-pole Construction
ALL POPULAR TYPES IN STOCK
CW • SSB • AM
ASK ABOUT OUR MONTHLY
UNADVERTISED SPECIALS

Phone for Information or to Order.
VISA/MC or COD accepted
Why risk disappointment? Buy time-tested Fox-Tango Filters to be sure!

FOX-TANGO Corp.

Box 15944, W. Palm Bch, FL 33416
Telephone: (305) 683-9587
European Agent: INGOIMTEX, Post Fach 2449,
D8070 Ingolstadt, West Germany

58

this publication is available in microform



University Microfilms International

300 North Zeeb Road
Dept. P.R.
Ann Arbor, MI 48106
U.S.A.

18 Bedford Row
Dept. P.R.
London, WC1R 4EJ
England



"...received my moneys worth with just one issue..."

—J. Trenbick

"...always stop to read CTM, even though most other magazines I receive (and write for) only get cursory examination..."

—Fred Blechman, K6UGT

U.S.A. \$15.00 for 1 year
Mexico, Canada \$25.00
Foreign \$35.00(land) - \$55.00(air)
(U.S. funds only)
Permanent (U.S. Subscription) \$100.00
Sample Copy \$3.50

CHET LAMBERT, W4WDR
1704 Sam Drive • Birmingham, AL 35235
(205) 854-0271

11

Crystal Filters, 8 & 10 Pole for Kenwood, ICOM, and YAESU



NEW TS-440S SSB 2.1 kHz matched filter set: consists of one each 455kHz and one 8.8MHz 8 pole crystal filters - \$150.00

TS-440S/430 2 Crystal Filter Package consists of 2.1 or 1.8 kHz SSB, 400 Hz or 250 Hz CW filters - \$110.00; Individual crystal filters - \$60.00 each.

TS-940/930 CW 400 Hz 8-Pole match set, mounted on printed circuit boards - \$150.00.

TS-940/930 SSB - 2.1 kHz 8-pole matched set. - \$150.00

930/940 SSB - Electronic Switch Kit - Transmit through original filters - \$30.00

TS-430 - SSB 2.1 kHz Cascade Kit - \$75.00

NEW FOR ICOM RADIOS

EXACT replacement for FL-44A \$99.00

EXACT replacement for FL-52A \$85.00

For ICOM 271/471

8 & 10 pole SS band filters \$85.00/110.00

CW 400 Hz \$85.00

FL30, FL32 & FL45 wire-in replacements \$60

Check RS# for NEW filter selection guide covering many other radios.

INTERNATIONAL RADIO INC.

747 SW South Macedo Blvd. Port St. Lucie FL 33452

(305) 879-6868

97



Clark WB9EAP, 2202 South Boots Street, Marion IN 46953.

**ST. CLOUD MN
AUG 10**

The St. Cloud ARC will hold a hamfest August 10 at Lake George in St. Cloud, Minnesota, near downtown, off MN 23 and U.S. 52. \$3 ticket donation. Talk-in on .34/.94 primary, .615/.015 secondary. For more information, contact SCARC, Box 141, St. Cloud MN 56302.

**WARRINGTON PA
AUG 10**

The Mid-Atlantic ARC will hold its annual hamfest on August 10, 8 a.m. to 3 p.m., at the Bucks County Drive-In Theatre, Rte. 611, Warrington, Pennsylvania, five miles north of the Willow Grove Exit on the PA Turnpike. Tailgate setup begins at 7 a.m. Admission is \$3 with \$2 additional for each tailgate space. Tables not provided. Talk-in on WB3JOE/R (147.66/.06) or 146.52. For information, write MARC, PO Box 352, Villanova PA 19085, or call Bob Josuweit WA3PZO at (215)-449-9727.

**GEORGETOWN KY
AUG 10**

The Bluegrass ARS will hold the Central Kentucky ARRL Hamfest on August 10, from 8 a.m. to 4 p.m., at Scott County High School, Longlick Road and U.S. Rte. 25, Georgetown, Kentucky. Admission \$4 in advance, \$5 at the door. Outside flea-market space free. Technical forums, exams, and exhibits. Talk-in on .16/.76. For information or tickets, send an SASE to Scott Hackney KI4LE, 629 Craig Lane, Georgetown KY 40324.

**LANCASTER OH
AUG 10**

The Lancaster and Fairfield County ARC will hold its annual hamfest on August 10, from 8 a.m. to 4 p.m., at the Fairfield County Fairgrounds in Lancaster, Ohio. Admission \$3 in advance or \$4 at the door. Limited tables \$4 in advance or \$5 at the door. Table space \$3 in advance or \$4 at the door. Talk-in on 147.63/.03 or 146.52 simplex. For more information, write to Lancaster ARC, Box 3, Lancaster OH 43130.

**WILLOW SPRINGS IL
AUG 10**

The Hamfesters RC will hold its 52nd annual hamfest on August 10 at Santa Fe Park, 91st and Wolf

Rd., Willow Springs, Illinois, to celebrate its 53rd year of service to ham radio in the Chicago area. Gates open at 6 a.m. \$3 donation in advance, \$4 at the gate, children under 15 free. \$25 donation from exhibitors per 8-foot table in the pavilion. Talk-in on 146.52. For tickets, send an SASE and check to PO Box 42792, Chicago IL 60642. For general information, call (312)-598-4802.

**LOUISVILLE OH
AUG 10**

The Tusco W8ZX and Canton W8AL ARCs will present the 12th annual Hall of Fame Hamfest on August 10 at the Nimishillen Grange, 6461 Easton St., Louisville, Ohio. Registration is \$2.50 advance, \$3 at the gate. 30" by 96" tables available at \$5 each (must reserve by August 1). Talk-in on 146.52/.52 and 147.72/.12. For more information or reservations, contact Bill MacNealy WD8LFM, RR#1 Box 442, Bolivar OH 44612; (216)-874-3483.

**CAMP FORREST REUNION
AUG 15-16**

The Middle Tennessee ARS will hold its first national reunion at Camp Forrest in Tullahoma, Tennessee, to commemorate the camp's use as a training center and POW camp during WWII. The club will operate station W4UOT from 6 p.m. to 10 p.m. (CDT) August 15 and from 1 p.m. to 10 p.m. (CDT) August 16. Frequencies: SSB—3.860, 7.235, and 14.240; CW—3.737 and 7.137. For more information or a commemorative certificate, send an SASE and QSL to George Stone WD4CYV, 712 First Ave., Tullahoma TN 37388; (615)-455-5993.

**BREWSTER NY
AUG 16**

The Putnam Emergency Amateur Repeater League is having its Electronics Extravaganza on August 16 at the J. F. Kennedy Elementary School in Brewster, New York, from 9 a.m. to 4 p.m. Admission is \$3, children under 12 free with adult. Indoor tables \$10 (with one admission), tailgating \$5. FCC exams. Talk-in on 144.535/145.135. For information, contact R. Dillon N2EFA, RFD#7, Noel Court, Brewster NY 10509.

**RHINELANDER WI
AUG 16**

The Northwood ARC will hold a swapfest on August 16, at South Park School, 511 South Pelham St., Rhineland, Wisconsin, from

9 a.m. to 3 p.m. Setup begins at 8 a.m. Admission is \$1. Talk-in on 146.34/.94. Exams given for Tech and above, \$4. For more information, contact Leonard Bauman K9RMN, 1312 Dorothy St., Rhineland WI 54501; (715)-369-3296.

**ROCHESTER IBM 30TH
AUG 16**

The IBM RC will operate special-event station WD0GNK on August 16 from 1400-2100 UTC to celebrate the 30th anniversary of the IBM Corporation in Rochester, Minnesota. Frequencies: phone—14.240, 7.280; CW—7.140; and 146.22/.82. For a certificate, send a QSL and SASE to WD0GNK—IBM RC, IBM Corp., Department 868, Highway 52 North, Rochester MN 55901.

**GREEN BAY WI
AUG 16**

The Green Bay Mike & Key Club will hold its summer swapfest on August 16 at a new location: Community Service Center, 1673 Dousman St., Green Bay, Wisconsin (take the Dousman/Shawano Ave. Exit off Highway 41). Doors open at 7 a.m. Free admission. 8-foot tables \$5; four-table limit (by reservation only); send SASE with name, call, address, and check payable to Green Bay Mike & Key Club, c/o Cathy Strommen KD9WO, 1500 Main St., Green Bay WI 54302. Exams given (register with Larry KD9IA, 1005 S. East St., Apt. 111, Appleton WI 54915). Talk-in on 147.72/.12 and 147.96/.36.

**RAILROAD DAYS
AUG 16-17**

Great Plains ARC station KC0CP will operate from Oelwein, Iowa, in conjunction with Railroad Days. Frequencies will be 14.235, 7.235, and 3.970, ± 10 kHz. For a certificate, send QSL and SASE to KC0CP, Box 203, Oelwein IA 50662.

**HUNTSVILLE AL
AUG 16-17**

The Huntsville, Alabama, RC will hold Alabama's largest hamfest on August 16-17, at the Von Braun Civic Center, beginning at 9 a.m. each day. Admission is free, flea-market tables \$8. Talk-in on 146.34/.94. Exams Saturday at 9 a.m. at the Huntsville High School. For further information, call Frank Brown at (205)-852-6324 (motels), Alen Forney at (205)-837-5936 (dealers), or Dave or Gwenn Givens at (205)-883-2760 (flea market).

**TACOMA WA
AUG 16-17**

The Radio Club of Tacoma (W7DK) will celebrate its 70th anniversary at the 18th annual Tacoma Hamfair, August 16-17 at the Pacific Lutheran University in Tacoma, Washington. Registration \$5, banquet \$10, dormitory rooms \$14 (single) or \$20 (double), reserved parking \$2. Exams given. Talk-in on 147.28. Register with Grace Teitzel AD7S, PO Box 45079, Tacoma WA 98445, or call Eva Anderson WB7QNS at (206)-564-8347.

**SAN ANGELO TX
AUG 16-17**

The San Angelo ARC will celebrate the Texas Sesquicentennial at the CENTEX Hamfest '86, August 16-17, at the San Angelo Convention Center. Preregistration is \$5, \$7 at the door. Exams given. Talk-in on 3.922, 7.213, .52, and .34/.94. The club will also operate special-event station W5QX. Commemorative QSL cards are available. For more information, write to SAARC, Box 3751, San Angelo TX 76902.

**GEORGETOWN DE
AUG 17**

The Sussex ARA will sponsor the Delmarva Hamfest on August 17 at Del. Tech. Community College, from 8 a.m. to 4 p.m. The college is located west of Georgetown on Delaware 18, a quarter mile from the U.S. 113 intersection. Advance registration is \$2.50, \$3 at the gate. Inside tables are \$3, tailgating \$2. Exams given. Talk-in on 147.075 and 146.52. For information and advanced ticket registration, write Delmarva Hamfest, Rte. 2, Box 244G, Georgetown DE 19947.

**ARGOS IN
AUG 23**

The Marshall County ARC will hold its hamfest on Saturday, August 23, at the Marshall County 4-H Fairgrounds on State Rte. 10 between U.S. Bypass 31 and Business 31, from 8 a.m. to 2 p.m. Advance tickets \$2, \$3 at the door. Indoor and outdoor areas; numerous electrical outlets; 8-foot tables \$5. For further information, write the Marshall County ARC, PO Box 151, Plymouth IN 46563, or call Bob Nellans KB9DE at (219)-892-5224.

**OAKLAND NJ
AUG 23**

The Ramapo Mountain ARC

(WA2SNA) will present its 10th annual flea market on August 23 at the Oakland American Legion Hall, 65 Oak Street, Oakland, New Jersey, 20 miles from the GW Bridge. Admission \$1, non-ham family members free. Indoor tables \$6.50, tailgating \$3. Talk-in on 147.49/146.49 repeater and 146.52 simplex. For info and advance space reservation, send an SASE to Frank Lee KA2ALS, 989 Crystal Lake Terr., Franklin Lakes NJ 07417; (201)-337-2290, or Tom Risseuw N2AAZ, 63 Page Drive, Oakland NJ 07436; (201)-337-8389 (after 6 p.m.).

ITHACA NY AUG 23

The Tompkins County ARC will sponsor its annual Finger Lakes Hamfest August 23 from 8 a.m. to 4 p.m. at the Trumansburg Fairgrounds, 12 miles northwest of Ithaca, New York, on Rte. 96. \$3 admission and \$1 for flea-market space. Reserved indoor tables \$5 each. Children under 14 free. Talk-in on .37/.97 or .52. For information, contact David G. Flinn W2CFP, 866 Ridge Rd., Lansing NY 14882; (607)-533-4297.

DAYTON OH AUG 23-24

The Dayton Microcomputer Association will hold Computerfest '86 on August 23-24 from 10 a.m. to 6 p.m. at Dayton's Hara Arena, located off I-75 at the Needmore Exit (#58). Admission is \$2, children under 12 free. Flea-market spaces \$10 before July 1, \$15 afterwards. For more information or to reserve space, call Mark Hanslip at (513)-268-7225, or write to Computerfest '86, 143 Schloss Lane, Dayton OH 45418-2931.

VIRGINIA BEACH VA AUG 23-24

The 1986 ARRL Roanoke Division Convention and 11th annual Hamfest and Computer Fair will be held August 23 and 24 from 9 a.m. to 5 p.m. at the Virginia Beach Pavilion. Admission is \$5 in advance, \$6 at the door. Flea-market tables \$5 per day, electricity \$10 extra for both days. Pre-registered exams given Sunday at 9 a.m. For information and tickets, contact Manny Steiner K4DOR, 3512 Olympia Lane, Virginia Beach VA 23452; (804)-340-6105.

ST. CHARLES MO AUG 24

The St. Charles ARC will sponsor HAMFEST86 on August 24 at Blanchette Park (new site) in St.

Charles, Missouri, from 7 a.m. to 2:30 p.m. Free admission. \$2 donation for tailgate flea market. Forums and FCC exams at 10 a.m. Talk-in on 146.07/.67 repeater, 146.52 simplex. For more information, contact Eric Koch NF0Q, 2805 Westminister, St. Charles MO 63301; (314)-946-0948.

SAGINAW MI AUG 24

The Five County Swap-N-Shop committee of Michigan will sponsor its 10th annual Swap-N-Shop August 24 at the Saginaw Civic Center, beginning at 8 a.m. Advance tickets \$2, \$3 at the door. \$7.50 for an 8-foot table, \$3 per car for a covered "trunk sales" area. Talk-in on 147.84/.24 and 146.52. For more information, call Don at (517)-893-3475. For advance tickets and table reservations, send check to Five County Swap-N-Shop, PO Box 1783, Saginaw MI 48605-1783.

MARYSVILLE OH AUG 24

The Union County ARC will present the 10th annual Marysville Hamfest and Auction on August 24 at the Fairground in Marysville, Ohio (near Columbus). Gates will open at 6 p.m. on Saturday for free overnight camping. Advance tickets are \$3, \$4 at the gate, children are free. \$1 per 10-foot flea-market space, electric power is \$2 extra. No tables available. Talk-in on 146.52 or 147.99/.39. For further information, contact Gene Kirby W8BJN, 13613 U.S. 36, Marysville OH 43040; (513)-644-0468. Include an SASE.

BLUEFIELD WV AUG 24

The East River ARC will sponsor the Bluefield Hamfest on August 24 from 9 a.m. to 3 p.m. at the Brushfork Armory, one mile north of Bluefield, West Virginia, on U.S. 52. Admission is \$4, children under 12 free. Walk-in exams at 9 a.m. Talk-in on 144.89/145.49 and 146.52. For more information, write to Jim Perdue KC8NG, Rte. 5, Box 457, Bluefield WV 24701.

CAMP HILL PA AUG 24

The Central Pennsylvania Repeater Association will hold its annual Electronic Exhibit/Ham/Computerfest on August 24 at the Penn Harris Inn and Convention Center, Routes 11 and 15, Camp Hill, Pennsylvania. Gates open at 8 a.m. \$4 admission, XYs and children under 12 free. Exams be-

gin at 9 a.m. Talk-in on 145.47 (WA3KXG) and 146.52. For hotel reservations, call Penn Harris Inn & Convention Center at (717)-763-7117; mention CPRA for reduced rates. For more information or reservations, contact Paul McDonnell N3BKI, 1207 Apple Drive, Mechanicsburg PA 17055; (717)-697-1880 (12 noon to 8 p.m.).

MULLICA HILL NJ AUG 24

The Gloucester County ARC will celebrate its 27th year at its 8th annual hamfest on August 24 from 8 a.m. (7 a.m. setup) to 4 p.m. at the Gloucester County 4-H Fairgrounds, Rte. 77, Mullica Hill, New Jersey. Tickets are \$3.50 in advance, \$4 at the gate. Sellers additional \$4 per space or \$4.50 with ac power. Indoor tailgating. Exams at 9:30 and 1:30 at Stephen's Hall. Talk-in on 147.78/.18 and 146.52. For information and advance tickets, write to GCARC, PO Box 370, Pitman NJ 08071, or call John K2FJ at (609)-589-2318, Milt K3WIL at (609)-845-7000 (daytime), or Ginny Martin N2FJM at (609)-694-4442 (evenings).

LABOR DAY TRAVEL AUG 30-SEP 1

The Tri-City ARC will operate special-event station KA1BB from the Waterford, Connecticut, I-95 weigh station to promote safe Labor Day holiday auto travel. This event is in conjunction with the fourth annual Stay-Awake Coffee Stop offered by BSA Troop 24 of Niantic CT. Mobile operators are especially encouraged to call. Operation will be from 1700 UTC August 30 through 2300 UTC September 1 on 14.295, 7.245, and 3.395 (phone) and on 7.130 (CW). Talk-in to coffee shop on FM 146.52 direct and CB channel 19. QSL via Tri-City ARC, PO Box 686, Groton CT 06340. For information, please contact Bob Dargel KA1BB, 8 Willow Lane, East Lyme CT 06333; (203)-739-8016 or (203)-446-7325 (work).

OK CORRAL AUG 30-SEP 1

The Old Pueblo RC will operate its 5th annual special-event station W7GV from 1300 UTC August 30 to 2200 UTC September 1, from the famous OK Corral at Tombstone, Arizona, site of the famous shoot-out between the Earps and Clantons in 1881, in celebration of the Rendezvous of the Gunfighters. Frequencies: SSB—21.380, 14.280, 7.280, and 3.980; CW—14.060, 7.130, and

3.730. Send a QSL with an 8-1/2 x 11 envelope and 40 cents postage to W7GV, PO Box 42601, Tucson AZ 85733.

LEBANON TN AUG 31

The Short Mountain Repeater Club will sponsor the Lebanon Hamfest on August 31 at the Cedars of Lebanon State Park, U.S. Highway 231, Lebanon, Tennessee. Bring your own tables. Talk-in on 146.31/146.91. For further information, contact Mary Alice Fanning KA4GSB, 4936 Danby Drive, Nashville TN 37211.

LANCASTER PA AUG 31

The Red Rose Repeater Association will hold a computerfest on August 31 from 9 a.m. to 3 p.m. at the Guernsey Sales Pavilion, four miles east of Lancaster on Rte. 30 at Rte. 896. \$3 donation, children under 14 free when accompanied by an adult. Talk-in on 147.015. For information, send a SASE to Computerfest Committee, PO Box 5029, Lancaster PA 17601.

SCHAUMBURG SEPTEMBERFEST AUG 31

The Schaumburg ARC will operate club station WB9TXO on August 31 from 1600-2100 UTC from the grounds of the Schaumburg Septemberfest. Suggested frequencies are 7.286, 14.286, and 21.386. For a certificate, send a QSL to SARC, PO Box 94251, Schaumburg IL 60194.

BLOOMINGTON IN AUG 31

The 9th annual Bloomington Hamfest will be held on August 31 from 8 a.m. to 2 p.m. at the 147.78/.18 repeater site at 2335 Vernal Pike off the SR 37 bypass. Admission \$2. No tables available. Exams given. For further information, contact Bob Myers K9KTH, 306 S. Fairview Street, Bloomington IN 47041; (812)-332-1105. Include an SASE.

NORWALK CT SEP 7

The Fairfield, Norwalk, Stamford, and West Haven ARAs will sponsor the Fairfield County Hamfest on September 7 from 9 a.m. to 5 p.m. at the Norwalk National Guard Armory, off Exit 38 Merritt Parkway. Admission is \$3, tailgating \$5, tables \$10, power free. Talk-in on 147.39/.99 and 146.52. To register, write to PO Box 326, West Haven CT 06516.

I'll do it! Send me the cards and quantities indicated below.

Style: W X Y

Quantity: 100 — \$8.97
 250 — \$19.97
 500 — \$39.97

Please print your name and address exactly as it will appear on your cards:

Please add \$1 postage & handling

Name _____ Call _____

Address _____

City _____ State _____ Zip _____

Check Amex MC VISA Expires _____ # _____

Please allow 4 to 6 weeks for delivery. 73 Magazine, WGE Center, Peterborough NH 03458, Attn: QSL Orders 767600

THEY'RE BACK



Style W



Style X



Style Y

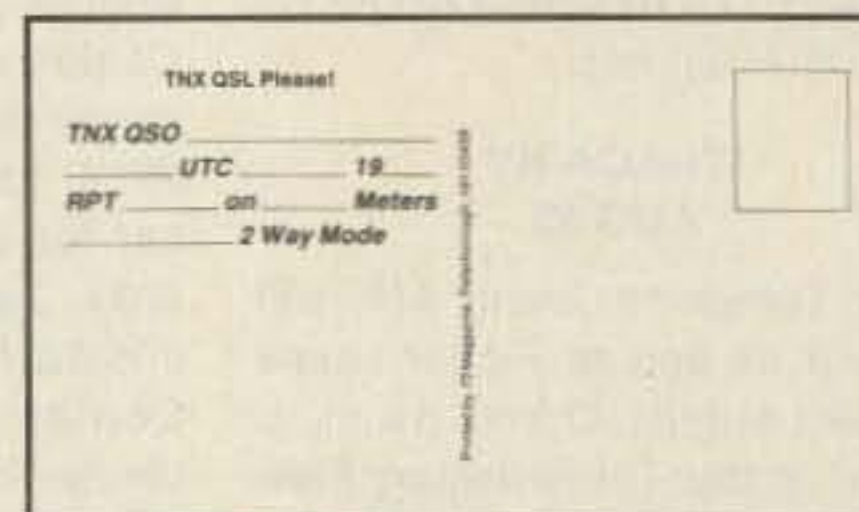

Reverse

The quality QSLs you've been looking for are here—at an incredibly low price! These cards are printed in two colors (blue globe or satellite, black type) on heavy, glossy stock. Now you can afford to QSL 100%!

• Order now before we regain our senses •

FEEDBACK

In our continuing effort to present the best in amateur radio features and columns, we've decided to go directly to the source—you, the reader. Below, the articles and columns in this issue are assigned numbers. These numbers correspond to those on the "Feedback" card opposite this page. On the card, please check the box which honestly represents your opinion of each article or column.

"What's in it for me?" comes the cry from our faithful readers. Besides the knowledge that you're helping us find out what you like (and don't like), we'll draw one Feedback card each month and award the lucky winner a free one-year subscription (or extension) to 73.

To save some money on stamps, why not fill out the Reader Service card, the Product Report card, and the Feedback card and put them in an envelope. Toss in a damning or praising letter to the editor while you're at it. You can also enter your QSL in our QSL of the Month contest. All for the low, low price of 22 cents!

Feedback #	Title	Feedback #	Title
1	A Packet Primer	14	Kit Corner: The DSE 500-MHz Frequency/Period Counter
2	How To Make Friends At 1200 Baud	15	Review: Ampro Little Board
3	Precision Packet Tuning	16	Review: Hamcom Terminal Software
4	Seeing Packet Radio With Different Eyes	17	Barter 'N' Buy
5	So You Want To Be A Sysop?	18	Letters
6	Birds 'N' Bauds	19	Never Say Die
7	Connect Alarm!	20	New Products
8	Survival Training For Mountaintop Digipeaters	21	Propagation
9	Beyond Level Two	22	QRX
10	Lightning Never Strikes	23	Satellites
11	And If That Isn't Enough...	24	73 International
12	On The Shelf		
13	73's Packet Buying Guide		

Congratulations to **Ralph A. Tafel WA8RLV**, this month's winner of a one-year subscription.

ADVERTISERS

R.S.#	Advertiser	Page
85	AEA	112
152	AEA	26
163	AEA	22
1	Advanced Computer Controls	13
154	Advanced Design Networks	23
105	Aero Electronics	89
*	Amateur Electronic Supply	56, 57
4	Amidon Associates	103
111	Amp Supply Co.	73
151	Ampro Computers	24
16	Astron Corp.	79
53	Barker & Williamson	39
41	Barry Electronics	43
9	Bill Ashby & Son	103
102	Brincomm Technology	93
90	Britt's 2-Way Radio	105
*	CBC International	83
*	California Digital	64
159	Celwave	23
46	Charge-Rite	49
80	Colorado Communications Center	107
59	Communications Electronics	33
10	Communications Specialists	9
161	Computer Aided Instructional Systems	23
99	Computer Supplies of Peterborough	77
11	Computer Trader	93
12	Connect Systems, Inc.	2
*	Cost Effective Components	105
116	Curtis Electro Devices	93
103	Dentronics	93
*	Dick Smith Electronics	91
106	Digitrex	73
156	Diversified Energies	22
15	Doppler Systems	64
*	Engineering Consulting	19
*	Fairfield County Hamfest	16
58	Fox-Tango	93
17	GLB Electronics	110
72	Glen Martin Engineering	103
20	Ham Radio Outlet	1
*	The Ham Station	83
*	Hamtronics	101
94	Harrison Radio	11
18	Heath Company	97
108	Heil Ltd.	23
109	Heil Ltd.	103
110	Heil Ltd.	103
*	ICOM America, Inc.	Cov. II, 22, 109
97	International Radio	93
157	International Radio	22
22	Jan Crystals	16
100	Kantronics	14, 15
*	Kenwood	5, 6, Cov. IV
23	Larsen Antennas	27
*	The Laser Press	106
24	MFJ Enterprises	98, 99
47	Maggiore Electronic Lab	55
*	The Martin Company	83
101	Maxcom	89
158	Mercer Electronics	22
26	Micro Control Specialties	106
70	Microlog Corp.	65
160	Miracle Rod	23
91	Mirage/KLM	111
84	Multibotics	89
95	Naval Electronics	49
50	Nemal Electronics	105
96	Orlando Hamcation and Computer Show	73
107	Payne Radio	73
44	Pac-Comm Packet Radio Systems	67
28	P.C. Electronics	21
29	The PX Shack	23
30	QEP's	83
31	Radio Amateur Callbook, Inc.	32
32	Radio Engineers	83
33	Radiokit	106
34	Ramsey Electronics	87
73	Back Issues	103
	QSLs	96
	Subscriptions	17
	Toll-Free #	106
153	Selco Products Co.	22
35	Spec-Com Journal	39
51	Spectrum Communications	16
77	TSG	83
162	TechniGroup	23
114	Torontel Technology	73
104	Universal Amateur Radio	73
*	University Micros	93
*	Valley Electronics	83
79	Vanguard Labs	91
*	WSYI-VEC	93
38	W9INN Antennas	83
98	Watt Engineering	91
39	Western Electronics	83
93	World-Tech Products	93
40	Yaesu Electronics	Cov. III
152	Yaesu Electronics	22

* Please correspond with this company directly.



"Universal" Terminal Interface for computer or non-computer operation



µMatic Memory Keyer adds programmable excellence to CW



FCC Certified Terminal Node Controller



Automatic Antenna Tuner



Antenna Noise Bridge/300 kHz to 30 MHz SWL Antenna/VLF Converter/Touch Tone Decoder for Remote Control Reception



25 MHz Oscilloscope with Built-in Component Tester



Deluxe QRP CW Transceiver and Power Supply

Free hi-tech catalog



A very special electronics and computer guide that brings you the exciting world of amateur radio kitbuilding and much more

The Heathkit® Catalog is filled with high-quality HAM radio products that you'll enjoy. Plus you'll get the unique challenge and satisfaction of kitbuilding. So send NOW for your FREE Heathkit Catalog.

Yes! I want to see what kitbuilding can do for me.

Send to: Heath Company, Dept. 011-442
Benton Harbor, Michigan 49022

Name _____

Address _____

City _____ State _____

A subsidiary of Zenith Electronics Corporation AM-448R1 Zip _____



MFJ ACCESSORIES

300 WATT ANTENNA TUNER HAS SWR/WATTMETER, ANTENNA SWITCH, BALUN. MATCHES VIRTUALLY EVERYTHING FROM 1.8 TO 30 MHz.



\$99.95 MFJ-941D

NEW FEATURES

MFJ's fastest selling tuner packs in plenty of new features!

- **New Styling!** Brushed aluminum front. All metal cabinet.
- **New SWR/Wattmeter!** More accurate. Switch selectable 300/30 watt ranges. Read forward/reflected power.
- **New Antenna Switch!** Front panel mounted. Select 2 coax lines, direct or through tuner, random wire/balanced line or tuner bypass for dummy load.
- **New airwound inductor!** Larger more efficient 12 position airwound inductor gives lower losses and more watts out. Run up to 300 watts RF power output. Matches everything from 1.8 to 30 MHz: dipoles, inverted vee, random wires, verticals, mobile whips, beams, balanced and coax lines. Built-in 4:1 balun for balanced lines. 1000V capacitor spacing. Black. 11x3x7 inches. Works with all solid state or tube rigs. Easy to use, anywhere.

RTTY/ASCII/CW COMPUTER INTERFACE

MFJ-1224
\$99.95



Free MFJ RTTY/ASCII/CW software on tape and cable for VIC-20 or C-64. Send and receive computerized RTTY/ASCII/CW with nearly any personal computer (VIC-20, Apple, TRS-80C, Atari, TI-99, Commodore 64, etc.). Use Kantronics or most other RTTY/CW software. Copies both mark and space, any shift (including 170, 425, 850 Hz) and any speed (5-100 WPM RTTY/CW, 300 baud ASCII). Sharp 8 pole active filter for CW and 170 Hz shift. Sends 170, 850 Hz shift. Normal/reverse switch eliminates retuning. Automatic noise limiter. Kantronics compatible socket plus exclusive general purpose socket. 8x1 1/4x6 in. 12-15 VDC or 110 VAC with adapter, MFJ-1312. \$9.95.

RX NOISE BRIDGE

Maximize your antenna performance!



\$59.95 MFJ-202B

Tells whether to shorten or lengthen antenna for minimum SWR. Measure resonant frequency, radiation resistance and reactance.

New Features: individually calibrated resistance scale, expanded capacitance range (± 150 pf) Built-in range extender for measurements beyond scale readings. 1-100 MHz. Comprehensive manual. Use 9 V battery. 2x4x4 in.

INDOOR TUNED ACTIVE ANTENNA

NEW! IMPROVED! "World Grabber" rivals or exceeds reception of outside long wires! Unique tuned Active

Antenna minimizes intermode, improves selectivity, reduces noise outside tuned band, even functions as preselector with external antenna. Covers 0.3-30 MHz. Tele scoping antenna. Tune, Band, Gain, On-off bypass controls. 6x2x6 in. Uses 9V battery, 9-18 VDC or 110 VAC with adapter, MFJ-1312, \$9.95. **MFJ-1020A \$79.95**



POLICE/FIRE/WEATHER 2 M HANDHELD CONVERTER

Turn your synthesized scanning 2 meter handheld into a hot Police/Fire/Weather band scanner!

\$39.95 MFJ-313

144-148 MHz handhelds receive Police/Fire on 154-158 MHz with direct frequency readout. Hear NOAA maritime coastal plus more on 160-164 MHz. Converter mounts between handheld and rubber ducky. Feedthru allows simultaneous scanning of both 2 meters and Police/Fire bands. No missed calls. Crystal controlled. Bypass/Off switch allows transmitting (up to 5 watts). Use AAA battery. 2 1/4x1 1/2x1 1/2 in. BNC connectors.



MFJ/BENCHER KEYS COMBO

MFJ-422
\$119.95

The best of all CW worlds - a deluxe MFJ Keyer in a compact configuration that fits right on the Bencher Iambic paddle! MFJ Keyer - small in size, big in features. Curtis 8044-B IC, adjustable weight and tone, front panel volume and speed controls (8-50 WPM). Built-in dot-dash memories. Speaker, sidetone, and push button selection of semi-automatic/tune or automatic modes. Solid state keying. Bencher paddle is fully adjustable; heavy steel base with non-skid feet. Uses 9 V battery or 110 VAC with optional adapter, MFJ-1305, \$9.95.



VHF SWR/WATTMETER

Low cost VHF SWR/Wattmeter! Read SWR (14 to 170 MHz) and forward/reflected power

MFJ-812 **\$29.95**



at 2 meters. Has 30 and 300 watts scales. Also read relative field strength. 4x2x3 in.

1 KW DUMMY LOAD

MFJ-250 **\$39.95**

Tune up fast, extend life of finals, reduce QRM! Rated 1KW CW or 2KW PEP for 10 minutes. Half rating for 20 minutes, continuous at 200 W CW, 400 W PEP. VSWR under 1.2 to 30 MHz, 1.5 to 300 MHz. Oil contains no PCB. 50 ohm non-inductive resistor. Safety vent. Carrying handle. 7 1/2x6 3/4 in.



24/12 HOUR CLOCK/ID TIMER

MFJ-106
\$19.95 NEW

Switch to 24 hour UTC or 12 hour format! Battery backup



maintains time during power outage. ID timer alerts every 9 minutes after reset. Red LED .6 inch digits. Synchronizable with WWV. Alarm with snooze function. Minute set, hour set switches. Time set switch prevents mis-setting. Power out, alarm on indicators. Gray and black cabinet. 5x2x3 inches. 110 VAC, 60 Hz.

DUAL TUNABLE SSB/CW/RTTY FILTER

MFJ-752B **\$99.95**



Dual filters give unmatched performance! The primary filter lets you peak, notch, low pass or high pass with extra steep skirts. Auxiliary filter gives 70 db notch, 40 Hz peak. Both filters tune from 300 to 3000 Hz with variable bandwidth from 40 Hz to nearly flat. Constant output as bandwidth is varied; linear frequency control. Switchable noise limiter for impulse noise. Simulated stereo sound for CW lets ears and mind reject QRM. Inputs for 2 rigs. Plugs into phone jack. Two watts for speaker. Off bypasses filter. 9-18 VDC or 110 VAC with optional adapter, MFJ-1312, \$9.95.

ORDER ANY PRODUCT FROM MFJ AND TRY IT-NO OBLIGATION. IF NOT SATISFIED, RETURN WITHIN 30 DAYS FOR PROMPT REFUND (less shipping).
• One year unconditional guarantee • Made in USA
• Add \$5.00 each shipping/handling • Call or write for free catalog, over 100 products.

MFJ

MFJ ENTERPRISES, INC.
Box 494, Mississippi State, MS 39762

TO ORDER OR FOR YOUR NEAREST DEALER, CALL TOLL-FREE
800-647-1800. Call 601-323-5869 in Miss. and outside continental USA
Telex 53-4590 MFJ STKV



AFFORDABLE PACKET RADIO FROM MFJ

An identical TAPR TNC 2 clone with a new cabinet and added features ... for an incredible \$129.95!



MFJ-1270
\$129.95

Join the exciting packet radio revolution and enjoy error-free communications ... for an incredible \$129.95! MFJ brings together efficient manufacturing and TAPR's (Tucson Amateur

Packet Radio) leading edge technology to bring you affordable packet radio. You get a nearly identical clone of the widely acclaimed TAPR TNC 2 with identical software and hardware. It's in a new cabinet and includes a TTL serial port for extra versatility.

All you need is your rig, home computer with a RS-232 serial port and a terminal program. If you have a Commodore 64, 128 or VIC-20 you can use MFJ's optional Starter Pack to get on the air immediately. You get interfacing cable, terminal software on tape or disk and complete instructions ... everything you need to get on packet radio. Order MFJ-1282 (disk) or MFJ-1283 (tape), \$19.95 each.

Unlike machine specific TNCs, you never have to worry about your MFJ-1270 being obsolete because you change computers or because packet radio standards change. You can use any computer with an RS-232 serial port and an appropriate terminal program. If packet radio standards change, software updates will be made available as TAPR releases them. Also speeds in excess of 56K bauds are possible with a suitable external modem! Try that with a machine specific TNC or one without hardware HDLC as higher speeds come into widespread use. You can also use the MFJ-1270 as an inexpensive digipeater.

It features the latest AX.25 Version 2.0 software, hardware HDLC for full duplex, true Data Carrier Detect for HF, 16K RAM, simple operation plus more. Join the packet radio revolution now and help make history. Order the MFJ-1270 today.

Here are MFJ's latest and hottest products for improving your station's performance.

SUPER KEYBOARD

MFJ-496
\$169.95



Price slashed 50% to \$169.95! Get a full feature Super Keyboard that sends CW/RTTY/ASCII for the price of a good memory keyer.

You get the convenience of a dedicated keyboard—no program to load—no interface to connect—just turn it on and it's ready to use.

This 5 mode Super Keyboard lets you send CW, Baudot, ASCII, use it as a memory keyer and for Morse Code practice. You get text buffer, programmable and automatic message memories, error deletion, buffer preload, buffer hold.

TRIPLE OUTPUT LAB POWER SUPPLY

MFJ-4002 **\$149.95**



Lab quality power supply gives you plenty of voltage and current for all your analog and digital circuits. 3 completely isolated outputs: 2 variable 1.5-20 VDC at 0.5 amp and a fixed 5 VDC at 1 amp. Connect in series or parallel for higher voltage and current. It's short circuit protected, has excellent line (typ. 0.01%/V) and load regulation (typ. 0.1%). Lighted meters monitor volt./cur. 12x3x6 in. 110 VAC.

CROSS-NEEDLE SWR/WATT METER

MFJ-815 **\$59.95**

MFJ's cross-needle SWR/Wattmeter gives you SWR, forward and reflected power—all at a single glance! SWR is automatically computed

—no controls to adjust. Easy-to-use push buttons select three power ranges that give you QRP to full legal limit power readings. Reads 20/200/2000 W forward, 5/50/500 W reflected and 1:1 to 1:5 SWR on easy-to-read two color scale. Lighted meter. Needs 12 V. ±10% full scale accuracy. 6½ x 3¼ x 4½ inches.



2 KW COAX SWITCHES

Instantly select any antenna or rig by turning a knob. Organizes coax cables and eliminates plugging and unplugging. Unused terminals are grounded to protect

your equipment for stray RF, static and lightning. 2 KW PEP, 1 KW CW. For 50 to 75 ohm. Negligible loss. SWR, and crosstalk gives high performance. SO-239s. Convenient desk or wall mounting.

MFJ-1702, \$19.95. 2 positions. Cast aluminum cavity construction gives excellent performance up to 500 MHz with better than 60 dB isolation at 450 MHz. Heavy duty, low loss switch has less than 20 milliohm contact resistance, less than 0.2 dB loss and SWR below 1:1.2. 2 x 2½ x 1 inches.

MFJ-1701, \$29.95. 6 positions. White markable surface for recording ant. positions. 8½ x 1½ x 3 in.

MFJ-1702
\$19.95



\$29.95 MFJ-1701



ANTENNA CURRENT PROBE

MFJ-206 **\$79.95**

This new breakthrough MFJ Antenna Current Probe lets you monitor RF antenna currents—no connections needed! Determine current distribution, RF radiation pattern and polarization of antennas, transmission lines, ground leads, building wiring, guy wires and enclosures.

- Indicate transmission line radiation due to high SWR, poor shielding or antenna unbalance.
- Detect re-radiation from rain gutters and guy wires that can distort antenna field patterns.
- Detect RF radiation from ground leads, power cords or building wiring that can cause RFI.
- Determine if ground system is effective.
- Pinpoint RF leakage in shielded enclosures.
- Locate the best place for your mobile antenna.
- Use as tuned field strength meter.

Monitors RF current by sensing magnetic field. Uses an electrostatically shielded ferrite core, FET RF amplifier, op-amp meter circuit for excellent sensitivity, selectivity. 1.8-30 MHz. Has sensitivity, bandswitch, tune controls, telescoping antenna for field strength meter. 4 x 2 x 2 inches.



MFJ's Best VERSA TUNER

MFJ-949C **\$149.95**



MFJ's best 300 watt tuner is now even better! The MFJ-949C all-in-one Deluxe Versa Tuner II gives you a tuner, cross-needle SWR/Wattmeter, dummy load, antenna switch and balun in a new compact cabinet. You get quality conveniences and a clutter-free shack at a super price.

A new cross-needle SWR/Wattmeter gives you SWR, forward and reflected power—all at a single glance. SWR is automatically computed with no controls to set. Has 30 and 300 watt scale.

Run up to 300 watts RF output—and match coax, balanced lines or random wires from 1.8 thru 30 MHz. Tune out SWR on dipoles, vees, long wires, verticals, whips, beams/quads. 10x3x7 in.

DIGITAL SWR/WATTMETER

MFJ-818
\$89.95

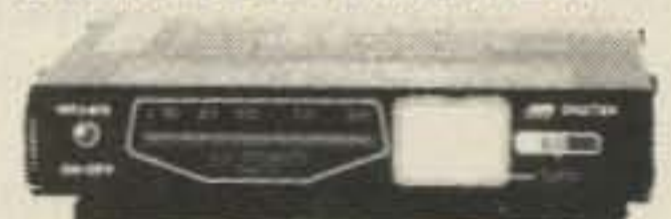

Fully automatic Digital SWR/Wattmeter reads SWR 1:1 to 1:9.9 directly and instantaneously—no SWR knob to set. Huge 0.6 inch bright orange digits make across-the-room reading easy. 12 segment LED bar graph wattmeter gives instantaneous PEP readings up to 200 watt RF output.

Good, bad, mismatch tri-color LEDs indicate SWR conditions. Small size (5½ x 4¼ x 1 in.) and easy-to-read digital display makes it ideal for mobile use. For 50 ohm systems. 1.8-30 MHz. 12 VDC or 110 VAC with MFJ-1312, \$9.95.

MOBILE ANTENNA MATCHER

MFJ-910 **\$19.95**

Lower your SWR and Get more power into your mobile whip for solid signals and more QSOs. Your solid state rig puts out more power and generates less heat. For 10-80 meter whips. Easy plug-in installation. Complete instructions. Fits anywhere, 2½x2½ in.



ORDER ANY PRODUCT FROM MFJ AND TRY IT-NO OBLIGATION. IF NOT SATISFIED RETURN WITHIN 30 DAYS FOR PROMPT REFUND (less shipping).
• One year unconditional guarantee • Add \$5.00 each shipping/handling • Call or write for free catalog, over 100 products.

MFJ

MFJ ENTERPRISES, INC.
Box 494, Mississippi State, MS 39762

TO ORDER OR FOR YOUR NEAREST DEALER, CALL TOLL-FREE

800-647-1800

Call 601-323-5869 in Miss. and outside continental USA Telex 53-4590 MFJ STKV





AUSTRALIA

Jim Joyce VK3YJ
44 Wren Street
Altona 3018
Victoria
Australia

VK7 QSL BUREAU

From Chas Harrison VK7CH comes an interesting report on the last three years of the VK7 QSL Bureau.

A point of interest is that there appears to be a 3,000-card shortfall each year between cards coming in and cards going out. A second point that affects all amateurs waiting for their VK7 cards, whether it be for their "Tassie Devil" award or just a confirmation, is the time delay the bureau has waiting for packets of cards from overseas bureaux. QSL cards for the last three years are shown in Table 1. The peak year was 1980, with a total of 49,062 cards.

In and out cards are inflated this year by 7-8,000 by cards received from overseas bureaux for VK75A, the special anniversary call, and these had to be sent on to VK3.

A noticeable number of overseas bureaux now send cards at longer intervals. Only two lots have been received during the year from both the U.S.A. and U.S.S.R.

MACQUARIE ISLAND

In another snippet from VK7 comes the news that Sjored VK7ZSJ, or "Sojo" as he is called by his friends, left Hobart in early March for Macquarie Island, where he will stay for the winter and will operate as VK0SJ for at least the next nine months. He will take his HF gear, with the TONO

for RTTY and 2m gear for the robot satellites.

A keen group of VK3ers have pooled in and given Sojo, on loan for the year, a callsign keyer for the 2m and 6m beacon, a 6m transceiver, a 6m and 2m linear, 6m and 2m yagis, and power supplies. So, says Sojo, "Keep an ear out" on the 6m and 2m bands for the beacon. The exact frequencies will be announced when the equipment is installed and minimum interference with scientific equipment is determined.

If you are interested, keep an ear out on his regular HF skeds with VK7VK, VK7HK, or VK7RM around 0900 UTC on 14.120 MHz, also on Mondays and Fridays at 0930 UTC on 7.085 MHz. QSL is via VK7RM; no CW as Sojo has a limited call in VK.

Why no CW, you might ask? Australian amateurs have been granted a concession by our DOC. Those holding a lower class license than the full call (e.g., Novice, Limited, or a combination of both) are granted full call license privileges while operating from remote areas such as Antarctica, Willis Island, Heard Island, etc., for the duration of their stay in these places. Their license automatically reverts back to their original class when they leave. As Sjored is very, very competent technically, all the limited license means is that he has never either sat for or passed the CW examination to upgrade to full call privileges within Australia.

PREDECESSORS PRAISED

At the WIA's 75th Anniversary Dinner, Mr. R.E. Butler, Secretary General of the ITU, in front of an assemblage that included our Governor, plus other distinguished people, gave praise to our sometimes forgotten experimenters of the past. He stated that he was "deeply honored [to speak before] the oldest institute of its kind in the world."

Mr. Butler noted that amateur radio was the only hobby provided for by the International Telecommunications Convention, which defined it as an activity carried on by duly authorized persons interested in radio technique "solely with a personal aim, and without pecuniary interest." This provided a precedent for the 1971 naming of the Amateur Satellite Service at the World Administrative Radio Conference for Space Telecommunications.

The Secretary General said that the worldwide recognition emerged over decades from the solid and reliable characters of renowned radio enthusiasts in Australia and elsewhere. Even before the WIA, came "the example and brilliance of Sir Charles Todd and his team for... the overland telegraph," he noted, adding mention of the first public demonstration of wireless telegraphy by Professor William Bragg in 1897, at the University of Adelaide.

Lauding the regularly received help over the years from the "Post Office," Mr. Butler then recalled the names and exploits of Jenvey, Bartholomew, Maclurcan, Read, Coxon, Davis, Traeger, Reverend Flynn, and Sidney Witt. He spoke of "Fisk and Hooke, and a legion of talented engineers" without whom there never could have developed The Flying Doctor Service, School of the Air, civil aviation, or The Public Telegraph Service, not to mention the many outback centers' services.

Remarking that radio amateurs were involved in exploring space long before its material use, he concluded, "Allow me to salute the predecessors who set the promotion of the radio techniques in action and I wish the institute long service and prosperity."



AUSTRIA

Osterreichischer
Versuchssenderverband
Theresiengasse 11
A-1180 Vienna
Austria

The O.V.S.V. (an IARU member) announces its Austrian prefix contest (AOEC 160m), which will take place the third weekend in every November, 1800 UTC Saturday to 0700 UTC Sunday, on 1810-1950 kHz. (Participants

must be careful to observe their national regulations for 160m!)

CW only, licensed radio amateurs worldwide (in Austria, OVSV-members only) and SWLs are eligible. Contest call: CQ TEST/CQ OE; exchange: RST and serial number starting with 001; Austrian stations give RST and a three-digit number for the individual ADL (Austrian District Locator).

Count one point for each contest QSO, with multipliers: each worked Austrian call area 2, and 1 multiplier count for each ADL and for each prefix worked. The total score is the sum of all QSO points times the sum of all multiplier points. Log format for reporting should be A4 size, written on one side only. The AOEC standard log and summary sheet is preferred and may be requested (forms 017 and 018). Write to OVSV-AOEC160m at the above address.

Please send entries to OVSV-AOEC160m also, postmarked no later than December 31 of the contest year, accompanying the summary sheet(s) with the statement: "I declare that this station was operated strictly in accordance with the rules of the contest as well as within the national radio regulations."

Unmarked duplicate logsheets will not count and will result in a 5-point reduction in score. Certificates will be awarded to the 10 leading entries from each continent; results will be reported to IARU Region 1 and each society from which came entries.



FRANCE

Claude Guee FD1DGY
11 Rue Emile Labiche
28100 Dreux
France

After a long silence due to a car crash and some other QRM, here is some news from France, for a 73 Magazine that is more and more interesting! Bravo!

NEW CALLS

You can hear calls like FB1XYZ between 7.020-7.040, 14.050-14.100, 21.050-21.150, and 28.000-28.100. These are QRP stations—20 Watts—and new beginners. Without code tests, these beginners should be FA1XYZ, with only some channels on the

	1985	1984	1983
Cards received	10,455	11,015	16,300
Cards sent	7,096	7,672	11,696
Total	17,551	18,687	27,996

Table 1. QSL cards.

THE MOST AFFORDABLE REPEATER

ALSO HAS THE MOST IMPRESSIVE PERFORMANCE FEATURES

(AND GIVES THEM TO YOU AS STANDARD EQUIPMENT!)

BAND	KIT	WIRED
6M, 2M, 220	\$630	\$880
440	\$730	\$980

(Also available for commercial bands)



FEATURES:

- SENSITIVITY SECOND TO NONE; 0.15 uV (VHF), 0.2 uV (UHF) TYP.
- SELECTIVITY THAT CAN'T BE BEAT! BOTH 8 POLE XTAL FILTER & CERAMIC FILTER FOR > 100dB AT ± 12KHZ. HELICAL RESONATOR FRONT ENDS TO FIGHT DESENSE & INTERMOD.
- OTHER GREAT RECEIVER FEATURES: FLUTTER-PROOF SQUELCH, AFC TO COMPENSATE FOR OFF-FREQ TRANSMITTERS, SEPARATE LOCAL SPEAKER AMPLIFIER & CONTROL.
- CLEAN, EASY TUNE TRANSMITTER; UP TO 20 WATTS OUT (UP TO 50W WITH OPTIONAL PA).

HIGH QUALITY XMTR & RCVR MODULES FOR REPEATERS, LINKS, TELEMTRY, ETC.

- **R144/R220 FM RCVRs** for 2M or 220 MHz. 0.15uV sens.; 8 pole xtal filter & ceramic filter in i-f, helical resonator front end for exceptional selectivity, > 100dB at ± 12kHz, best available today. Flutter-proof squelch. AFC tracks drifting xmtrs. Xtal oven avail. Kit only \$138.
- **R451 FM RCVR** Same but for uhf. Tuned line front end, 0.3 uV sens. Kit only \$138.
- **R76 FM RCVR** for 10M, 6M, 2M, or 220. As above, but w/o AFC or hel. res. Kits only \$118. Also avail w/4 pole filter, only \$98/kit.
- **R110 VHF AM RECEIVER** kit for VHF aircraft or ham bands or Space Shuttle. Only \$98.



- **TA51 VHF FM EXCITER** for 10M, 6M, 2M, or 220 MHz. 2 Watts continuous, up to 3W intermittent. Kit only \$68
- **TA451 UHF FM EXCITER** 2W cont., up to 3W intermittent. Kits only \$68. Xtal oven avail.
- **VHF & UHF LINEAR AMPLIFIERS.** For either FM or or SSB. Power levels from 10 to 45 Watts to go with excitors & xmtg converters. Several models. Kits from \$ 78.

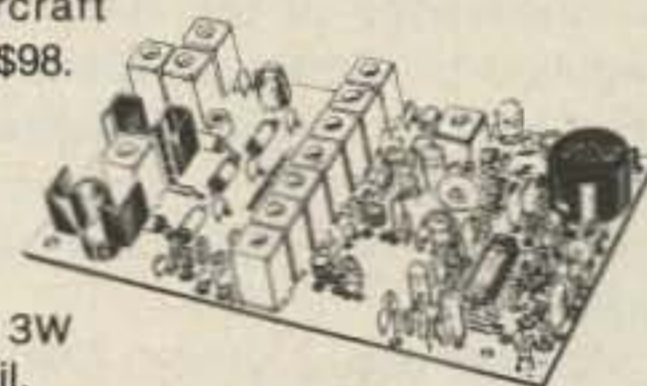

NOW—FCC TYPE ACCEPTED TRANSMITTERS, RECEIVERS, AND REPEATERS AVAILABLE FOR HIGH-BAND AND UHF. CALL FOR DETAILS.

RECEIVING CONVERTERS

Models to cover every practical rf & if range to listen to SSB, FM, ATV, etc. NF = 2dB or less.



Antenna Input Range	Receiver Output
28-32	144-148
50-52	28-30
50-54	144-148
144-146	28-30
145-147	28-30
144-144.4	27-27.4
146-148	28-30
220-222	28-30
220-224	144-148
222-226	144-148
220-224	50-54
222-224	28-30

VHF MODELS

Kit with Case	\$49
Less Case	\$39
Wired	\$69

UHF MODELS

Kit with Case	\$59	432-434	28-30
Less Case	\$49	435-437	28-30
Wired	\$75	432-436	144-148
		432-436	50-54
		439.25	61.25
		902-928	422-448

SCANNER CONVERTERS Copy 806 MHz band on any scanner. Wired/tested ONLY \$88.

TRANSMIT CONVERTERS

For SSB, CW, ATV, FM, etc. Why pay big bucks for a multi mode rig for each band? Can be linked with receive converters for transceive. 2 Watts output vhf, 1 Watt uhf.

For VHF, Model XV2

Kit \$79
Wired \$149
(Specify band)

Exciter Input Range	Antenna Output
28-30	144-146
28-29	145-146
28-30	50-52
27-27.4	144-144.4
28-30	220-222*
50-54	220-224
144-146	50-52
144-146	28-30

For UHF, Model XV4

Kit \$79
Wired \$139

Exciter Input Range	Antenna Output
28-30	432-434
28-30	435-437
61.25	439.25
144-148	432-436*

* Add \$20 for 2M input

VHF & UHF LINEAR AMPLIFIERS. Use with above. Power levels from 10 to 45 Watts. Several models, kits from \$78.

LOW-NOISE PREAMPS

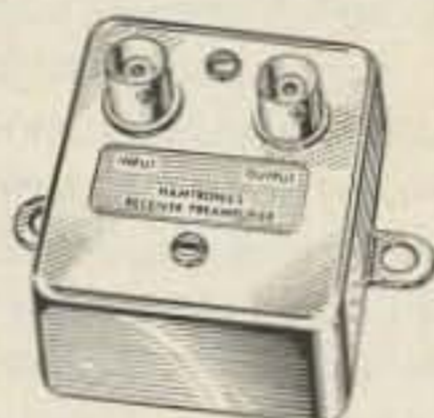

Hamtronics Breaks the Price Barrier!

*

No Need to Pay \$80 to \$125 for a GaAs FET Preamp.

FEATURES:

- Very Low Noise: 0.7dB VHF, 0.8dB UHF
- High Gain: 13 to 20dB, Depending on Freq.
- Wide Dynamic Range for Overload Resistance
- Latest Dual-gate GaAsFET, Very Stable

MODEL	TUNES RANGE	PRICE
LNG-28	26-30 MHz	\$49
LNG-50	46-56 MHz	\$49
LNG-144	137-150 MHz	\$49
LNG-160	150-172 MHz	\$49
LNG-220	210-230 MHz	\$49
LNG-432	400-470 MHz	\$49
LNG-800	800-960 MHz	\$49

HELICAL RESONATOR PREAMPS

Low-noise preamps with helical resonators reduce intermod and cross-band interference in critical applications. 12 dB gain.

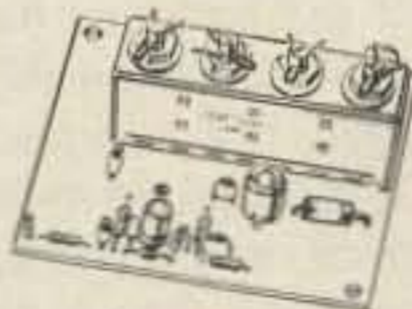

MODEL	TUNING RANGE	PRICE
HRA-144	143-150 MHz	\$49
HRA-(*)	150-174 MHz	\$49
HRA-220	213-233 MHz	\$49
HRA-432	420-450 MHz	\$64
HRA-(*)	450-470 MHz	\$64

* Specify Center frequency desired

MINIATURE PREAMPS

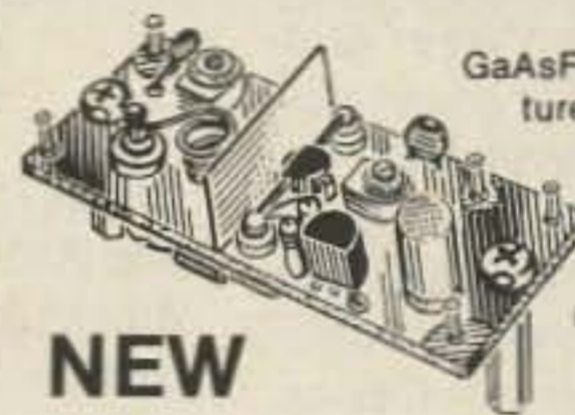

GaAsFET Preamps with features similar to LNG, except designed for LOW COST and SMALL SIZE: only 5/8"W x 1-5/8"L x 3/4"H. Easily mounts inside many radios.

NEW

Model LNW-(*) Only \$19/kit, \$34wired

Models available to tune the following bands: 25-35, 35-55, 55-90, 90-120, 120-150, 150-200, 200-270, and 400-500 MHz.

*Specify band

IN-LINE PREAMPS

NEW



GaAsFET Preamp with features like LNG. Automatically switches out of line during transmit. Use with base or mobile transceivers up to 25W. Tower mtg hdwr incl.

MODEL	TUNES RANGE	KIT	WIRED
LNS-144	120-175 MHz	\$59	\$79
LNS-220	200-240 MHz	\$59	\$79
LNS-432	400-500 MHz	\$59	\$79

ACCESSORIES

- **MO-202 FSK DATA MODULATOR.** Run up to 1200 baud digital or packet radio signals through any FM transmitter.
- **DE-202 FSK DATA DEMODULATOR**
- **COR-2 KIT** With audio mixer, local speaker amplifier, tail & time-out timers.
- **COR-3 KIT** with "courtesy" beep".
- **DTMF DECODER/CONTROLLER KITS**
- **AUTOPATCH KITS.** Provide repeater autopatch, reverse patch, phone line remote control of repeater, secondary control.
- **CWID KITS**
- **SIMPLEX AUTOPATCH**

- Send \$1 for Complete Catalog (Send \$2.00 or 4 IRC's for overseas mailing)
- Order by phone or mail • Add \$3 S & H per order (Electronic answering service evenings & weekends)
- Use VISA, MASTERCARD, Check, or UPS COD.

hamtronics, inc.

65-D MOUL ROAD • HILTON NY 14468

Phone: 716-392-9430

Hamtronics® is a registered trademark

2-meter band and without repeater access.

Test exams are now carried out on the "Minitel" system, in different centers. (This is the French directory computer system issued from the PTT, allowing for a lot of services including this opportunity for direct examinations.) According to the authorities, only 30% of the candidates are failing, and these mainly because of lack of knowledge of the rules and regulations. Generally speaking, the candidates prefer this system; results show that a radio-club training is very helpful for the successes.

Another use of Minitel: Owners of terminals can receive directly from CNET propagation conditions, which are updated every day.

RECIPROCAL AGREEMENTS

There now are reciprocal operating agreements between Luxembourg, Monaco, West Germany, and France: licenses now are permanent. Maybe this is a first step toward a full European license. Others should apply to: DTRE CGRP, Service Amateur, BP 75, 94002 Creteil Cedex, France. Your call in France will be, for example, F/W, for at least three months (and for a year, eventually). The former F0 calls do not exist anymore. Countries now having reciprocal agreements with France are Australia, Austria, Belgium, Brazil, Canada, Denmark, Greece, Israel, Italy, Ivory Coast, Netherlands, New Zealand, Norway, Portugal, Spain, Sweden, Switzerland, United Kingdom, the U.S.A., and Yugoslavia. Under negotiation are agreements with Argentina, Monaco, Ireland, Oman, and Japan.

MISCELLANY

The QSL Bureau via Reseau des Emetteurs Francais (REF) address now is BP 273, 81209 Mazamet, France. While HQ is still in Paris, some activities are being decentralized to save money.

SWLs have received an official call after waiting for years. Now they can send nice QSL cards, like F11XYZ. Other modifications include FF for club stations—for example, F6KXY becomes FF6KXY; Corsica is IK instead of FC; Antarctica and Austral Islands are FT instead of FB.

Law Story: Very bad news—now it is not allowed to install any aerial of a size bigger than 4 meters (13 feet) without authoriza-

tion, for reception or emission. No minibeam but now microbeam!

Arsene: The French amateur satellite is alive and the launch should be scheduled by the end of the year. Two modes will be available: B and F.

F0OX (Clipperton Harbor) will become a permanent base. Two months ago the French government announced a project of a harbor for fishing boats on this famous atoll. This would mean the end of one of the most attractive DX contacts...but wait and see....

TP21. Conseil de l'Europe, Strasbourg, France: This new call is not yet on the air. Delayed due to an unexpected amount of formalities. (CDXC information.)

Best 73 from France.

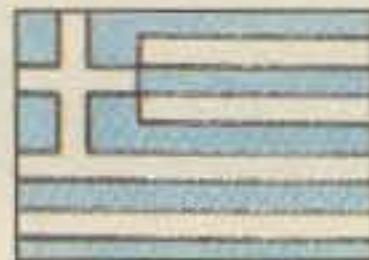

GREECE

Manos Darkadakis SV1IW
Box 23051
Athens 11210
Greece

In my previous column, I analysed the hardware of our newest repeater (R0) and I will continue here to describe its software part, too. Speaking about the software, somebody might wonder why it was necessary. The answer is because the repeater is far away from Athens on a mountaintop, some 1,600 meters above sea level, and besides that, it is very difficult to go during winter time because of the snow, even for the two local hams in Kalamata, a nearby city.

Let's see now what the logic does. At first it checks every two hours the capacity of the batteries, and if the batteries have more than 60 Ah then the R0 is on high power, but if capacity is between 30-60 then R0 switches to low power, and if capacity is lower than 30 Ah then it goes to self-protecting mode during which it sends only its ID if triggered and the telemetry every two hours.

There is no restriction of repeater operating time during summertime, but during winter it depends on many factors. If the photovoltaic panels cannot supply charging current at all, then R0 can operate on high power for three days if operated 4-5 hours daily; after three days, its logic will switch it to low power and can

again be operative for six more days (4-5 hours daily).

If still no current is coming from the panels, it goes to self-protection mode and only sends the telemetry in high power for 25 more days. If things still look gloomy, it then goes to sleep. Every time the repeater sends information about its state during the telemetry, if it is on low power it sends SV3A Low Power. If it is not working because of the batteries, it sends SV3A Idle Mode. And finally, when closed, it sends SV3A Closed.

The whole system can be telecommanded and some corrections can even be made from distance. There is also a station devoted to record every telemetry transmission from it. At the end of the day, all information is entered in a computer and further analysis is made. Useful conclusions can then be extracted in order to help more of these self-contained units to be installed all over Greece.

Additionally, when R0 sends 00 during the hot summer days, that means that the temperature sensor is giving overflow and temperature is over 40 C. If it gives M5 or M10, that means that temperature is below zero—minus 5 or 10.

Finally, the repeater sends its ID after the end of someone's transmission, and, if more than 3-1/2 minutes after the last one was sent, timeout is set on 95 seconds.

Now, eight months after the repeater's installation, everything goes perfectly OK. We had no problems during winter time, and it looks as if our new friend is very promising as the first member of a new generation of repeaters in our country. We hope to have some more repeaters like this installed here in Greece before long, but don't worry: You'll be the first to know, here in 73 Magazine!



INDONESIA

Erlangga Suryadarma
YB0BZZ/V85BZ
ORARI National QSL Bureau
PO Box 96
Jakarta 10002
Indonesia

(73 International welcomes Indonesia, and its representative, YB0BZZ, QSL Manager and IARU Region III Liaison Officer, who has provided most of the following information. Much of this came from

a paper he and Ben S. Samsu YB0EBS prepared for last November's IARU Region III meeting in New Zealand.)

Unlike many neighboring countries, Indonesia has not abolished or curbed all ham activity. All Indonesian hams must by law be members of ORARI (Organisasi Amatir Radio Indonesia), and there are no provisions for guest operators at present.

The Amateur Radio Service began here in the 30s when the country was the Netherlands East Indies. Two pioneers worthy of mention were Rubin Kain YB1KW (licensed in 1932) and B. Zulkarnaen YB0AU (licensed in 1933), silent keys as of 1981 and 1984, respectively.

All amateur radio activity was suspended by the Japanese occupation authorities at the beginning of World War II, but a number of stations went underground fighting for Indonesian independence. When independence was proclaimed in 1945, the declaration was transmitted throughout Indonesia and the world using a "simple homemade revolutionary radio" constructed by Gunwan YB0BD; the rig now occupies a place of honor in Indonesian independence history and is on exhibit in the Indonesia National Museum.

During the next four years (ending December 27, 1949 with the Dutch ceding sovereignty), a young amateur by the name of Syarifuddin built home-brew transceivers, which were used to maintain communications between the Indonesian islands—particularly between Java and Sumatra. He now is a high-ranking professional in the Directorate General of Post and Telecommunications and a supervisor for ORARI.

Internal security problems led to the suspension of any non-governmental radio services activity from 1950 to 1967. In 1967, the Amateur Radio Service was re-established. At present, amateurs are subdivided into three classes of skill and proficiency, with only the top class being permitted to contact foreign amateur stations. All belong to the "Lokal" (district) level of ORARI, which is part of the "Daerah" (provincial) level of ORARI.

Foreign citizen radio amateurs, upon issuance of a temporary residence permit, are permitted to apply for amateur operating privileges on a reciprocal basis. This is

BACK ISSUES

October 1984

Fall antenna issue—9 skyhooks!

November 1984

Color Computer SSRV, TVI cure

December 1984

Touchtone data display, transistor tutor, line conditioner

January 1985

ICOM mods, extra VIC-20 memory, shoestring RTTY

February 1985

OSCAR uplink amp, HF helicates, 6-meter CB

March 1985

Volunteer exams, talking repeater controller

April 1985

Dayton Hamvention special! Ishmod's Journal, the amazing Hat-Tenna

May 1985

Antennas! A baker's dozen

June 1985

Special issue—RTTY, 9N1MM profile

July 1985

Dayton in pictures, world's largest array, add-on digital display

September 1985

1985's Hottest Antennas—Nine skywires!

October 1985

25th Anniversary Special! Inspecting floppy disks, WWII spy radio, 1296-MHz downconverter

November 1985

Holiday Shopping Guide, short 160m antenna, HF-to-Oscar transceiver, simple signal generator

December 1985

IC-730 FM Mod, one-chip FAX, 1985 index

January 1986

Text-to-speech algorithm, perfect RTTY filter, state machines

February 1986

HT accessories, more VIC-20 RAM, TR-2400 scanning, FT-101E RIT

March 1986

Extra FT-107 memories, speed dialer, digital IC trainer

In each back issue, you'll also find our regular features as well as reviews and new product announcements.

Each back issue costs \$3.50 plus \$1.00 shipping and handling. On orders of 10 or more back issues, there is a flat \$7.50 shipping and handling fee. Send your check or money order to 73, Attn: Back Issue Orders, WGE Center, Peterborough, NH, 03458-1194

TEN FM

JOIN THE FUN and EXCITEMENT!

10 FM is putting the "HAM" back into amateur radio!



\$65.00 + \$3.00 UPS
FM 10 KIT

FM 10 includes tested HY GAIN 02A CB board. True FM discriminator/deviation kit crystal, and 6 page instructions. All you need is a chassis and CB microphone.

HAMFEST SPECIAL \$33.00

Same as above, less filter and RPT kit

DISCRIMINATOR/DEVIATION KIT \$12.95

10 MTR 100 WATT RF AMP BOARD \$4.00



HEIL, LTD. ✓109
Marissa, IL 62257
618-295-3000
The One-Stop Parts House for 10 FM!

WORK THE WORLD ON AN HT!

The RB-1 easily interties 2 transceivers. A 220 or 450 ng can intertie to control a fixed station. By utilizing the squelch of the new TS 430 or IC-740, the HF bands can even be worked from the HT. UHF to VHF — VHF to HF.

- Simple to connect - all connectors supplied.
- Can be used as simple RPTR control.

REMOTE BASE INTERTIE

\$49⁹⁵ **RB-1**
+ \$3.00 shipping



HEIL, LTD ✓110
Marissa, IL 62257
618-295-3000



SAVE TIME and MONEY with THE HAZER

Bring things down for safety and convenience.

Never climb your tower again with this elevator system. Antennas and rotator mount on HAZER, complete system trans tower in verticle upright position. Safety lock system operates while raising or lowering. Never can fall.

Complete kit includes winch, 100 ft. of cable, hardware and instructions. For Rohn 20 and 25 G Towers.

Hazer 2 - Heavy duty alum. 12 sq. ft. load \$297.00 ppd.
Hazer 3 - Standard alum. 8 sq. ft. load \$213.00 ppd.
Hazer 4 - Heavy galv. steel 16 sq. ft. load \$278.00 ppd.
Ball Thrust bearing TB-25 for any of above \$42.50 ppd.

Martin also mfgs. aluminum towers specifically engineered for use with the HAZER. Two sizes - M-13 (13" wide) and M-18 (18" wide). Also a truly self-supporting galvanized steel tower. Send for free details.

Satisfaction guaranteed. Call today and charge to Visa, MasterCard or mail check or money order.

GLEN MARTIN ENGINEERING INC.
P.O. BOX 7 253
Boonville, Mo. 65233
816-882-2734



IRON POWDER and FERRITE PRODUCTS

AMIDON
Associates

Fast, Reliable Service Since 1963

Small Orders Welcome

Free 'Tech-Data' Flyer

Toroidal Cores, Shielding Beads, Shielded Coil Forms
Ferrite Rods, Pot Cores, Baluns, Etc.

12033 OTSEGO STREET, NORTH HOLLYWOOD, CALIFORNIA 91607

PACKET RADIO



ASCII—USA/AX.25 HDLC CONVERTER

USA/AX.25 is the AMRAD approved digital format STANDARD used on amateur packet radio networks.

PAC/NET board only \$80.00
Assembled/Tested. No ICs. 90 day warranty

Package of all ICs except 2-2716 EPROMs \$80.00

PAC/NET SYSTEM

PAC/NET SYSTEM \$240.00

System Tested 4.5 x 6" board complete with all ICs and programmed EPROMs personalized for each purchaser. Requires only single 8-10 volt 1/2 amp power. 1 year guarantee of hardware/software/AX.25 standard RS232 serial ASCII at any user baud rate. RS232 HDLC for 202 modem used for AFSK or direct to RF equipment for FSK.

Custom Systems Custom Programming

BILL ASHBY
AND SON ✓9

K2TKN—KA2OEG 201-658-3087
BOX 332 PLUCKEMIN N.J. 07978

YBØBZZ

DXCC, WAC, WAF, WFX, CQDX, 73DX, RTW, DUF, EUDXD, ADXA, 100V, C22
DU-UN, IARU 1.3, IDX, VKCA, CHC-A 1, AN, UN, TM, TP



ERLANGGA SURYADARMA - P.O. BOX 2058 - JAKARTA 10001 - INDONESIA - ZONE 28.

possible now for nationals of the U.S.A., the United Kingdom, Canada, Australia, the Federal Republic of Germany, the Netherlands, Sweden, Belgium, France, Argentina, and Finland.

Growth of activity was slow between 1967 and 1980 (from about 200 hams to about 5,000), but with some new simplified regulations and new availability of ready-for-use (factory-built) rigs, there was a big rush for amateur tickets. It seems likely that 40,000 will prove to be an accurate figure for early 1986 despite an alarmingly high dropout rate among the Novices (80% of the total membership of ORARI), about half of whom do not renew their licenses. Burdensome procedures involved in renewing may have a lot to do with this.

ORARI is currently involved in hard work to achieve better structure and organization, simpler regulations, and more professional operation in all ham matters. International *Callbook* material is badly out of date, "and it is suggested that all correspondence and QSLs be handled through the ORARI National QSL Bureau" (address above).

RADIO SOCIETY BEHIND A BAMBOO CURTAIN

The existing general rules for amateurs issued by the Directorate General of Post and Telecommunications were derived from outdated 1968 material—a time when sophisticated UHF/VHF/RTTY/SSTV/AMSAT, etc. were unknown in Indonesia. However, within the last three years, a "gap" has occurred between the rules and common "incorrect practices" of so-called "radio operators."

ORARI has constantly submitted concepts and ideas to improve the existing rules, but the government has to concentrate efforts on the development of a national

communications system, so that little attention has been paid to ORARI beyond the regular State Examination to accommodate the enthusiasts. ORARI still hopes, however, that more comprehensive regulations will be available before the end of the year.

While ORARI has 40,000 registered members, only a mere 5% are DXers. The majority squeezed themselves into the crowded VHF/UHF band. This creates the impression of "a radio society behind a bamboo curtain" to the amateurs of the outside world, due to the scarcity of the international contacts established.

A lack of training on DX matters among senior amateurs, some shy and uncertain of their English, did not set an example for younger amateurs to follow. Between 1967 and 1982 the radio society had only seven DXCC holders! With the establishment of training programs in the past two years, 15 DXCC awards have been made, including one 5BDXCC, for a total now of 23.

Continued next month.



THAILAND

*Tony Waltham HS1AMH
c/o Bangkok World Newspaper
Soi Saladaeng
Bangkok 10500
Thailand*

Amateur radio in Thailand is about to be legalized. Indeed, by the time that you read this it will most likely be a fact, for the final draft of the legislation—the provisions for administration, the separate license classes and required qualifications—has been prepared by the Thai Post and Telegraph Department.

It is not that amateur radio was

ever illegal, and no, don't disallow any HS contacts you may have had. It is simply that up until now our hobby has been officially sanctioned only for special events, such as contests. Prior to that, members of the Radio Amateur Society of Thailand operated according to an understanding with the authorities.

Late last year the National Security Council approved amateur radio as being an activity not detrimental to society (or security), thanks to a petition led by the Post and Telegraph Department.

Senior members of the Radio Amateur Society of Thailand have also played an active behind-the-scenes role in getting the activity recognized and legitimized.

In a series of meetings following the NSC's approval of amateur radio in principle, RAST members and senior PTT officials worked out a draft for the regulations and administration of the hobby. At the time of writing, the following salient points regarding amateur radio have emerged:

- The minimum age for applicants for a license will be 15 years of age, and they should be Thai nationals.
- Qualified foreign residents will be able to apply to operate under reciprocal operating privileges to be set up with corresponding administrations abroad.
- A National Security Council or Police clearance would be required before an amateur radio license will be issued, while membership of the Radio Amateur Society of Thailand will also be a requirement as the society will play a major role in controlling the activity, especially on HF.
- Three license classes are envisaged: a Novice class offering VHF only, with the full two-meter spectrum available; a secondary HF class with a Morse code requirement; and a first-class license with Morse code capability both in the Thai language and in English being required.
- Those applying for an amateur

radio license will need to be seconded or endorsed as a person of good standing by a member of the radio club.

• A basic knowledge of English will be required for an HF class license. This is to enable Thais to be able to conduct a basic QSO with radio amateurs abroad.

These are just some of the points in the draft for the administration of amateur radio in Thailand which have taken both international and national considerations into account.

RAST also has filed an application with the PTT to operate a club station for demonstration and training purposes after the regular monthly club meetings at the Singha Bier Haus (conducted from 11 a.m. on the first Sunday of each month). Initially, club stations are envisaged by the authorities, with the first two being at the Asian Institute of Technology and at the Science Museum in downtown Bangkok.

It is hoped that operations from private homes will be permitted later, but progress will be on a step-by-step basis; to have a fully legislated amateur radio service in Thailand is an achievement in itself—one for which RAST has been actively campaigning for 22 years.

For most DXers, the best chance to contact Thailand will be during one of the major international contests which the club's members operate with the call-sign HSØA. Typically, we make between 3,000 and 4,000 QSOs in a 48-hour period, and often stateside stations give us reports of 5 and 9 plus 20, "and I'm surprised no one else is calling you."

It seems that all too often U.S. and even European stations swing their beams away from Asia while the band is still open—and miss a chance if they need Thailand or Zone 26.

For everyone's diary, Table 2 shows the major international contests which we intend to participate in over the coming year. ■

Date	Contest	Mode
Jun 21/22	All Asia	Phone
Jul 12/13	IARU	Phone/CW (begins 7 p.m. July 12 for 24 hours)
Jul 19/20	SEANET	CW
Aug 16/17	SEANET	Phone
Aug 23/24	All Asia	CW
Oct 25/26	CQWW	Phone
Nov 22/23	CQWW	CW

Table 2. Major international contests Thailand will participate in.

Special Purchase
LAP COMPUTER
FULL FACTORY WARRANTY

BUILT IN 300 BAUD MODEM
 Built in spread sheet, similar to Lotus Terminal Emulator to Communicate with Personal or Mainframe Computers

IT'S A HANDS FREE PHONE
 Comes with Rechargeable Batteries and Charger. Options Available Serial or Parallel Port Workstate Printer

workSlate
 BY CONVERGENT TECHNOLOGIES

THE MOST PORTABLE TERMINAL

OUR BEST PRICE EVER **\$295.00** ORIGINALLY \$1195.00

INCLUDES FREE SOFTWARE WORTH \$88.00
 Information and Consultant Services Software

OTHER SOFTWARE PACKAGES • WITH PURCHASE ONLY

Cash Management	\$15.00	Insurance Analyzer	\$15.00
Financial Statements	(2) \$15.00	Real Estate	\$15.00
Inventory Analysis	\$15.00	Electronic Mail	\$15.00
Marketing Management	\$15.00	Information Services	\$15.00
Sales Recorder	\$15.00	Loan Analysis	\$15.00
Travel	\$15.00	Portfolio Analysis	(2) \$15.00

15 Day Money Back Guarantee

CEC
 1745 Adrian Road, No. 1
 Burlingame, CA 94010
 415/342-4058
 800/228-3411

NEMAL ELECTRONICS

Your Authorized Distributor For  **BELDEN**

INTRODUCTORY SALE!

Belden No.	Nemal No.	Description	Per 100 ft.	Per ft.
8214	1102B	RG8 /U Foam 96%	\$45.00	.50
8237	1100B	RG8/U Poly 96%	39.00	.44
8241	1500B	RG59/U Poly 96%	13.00	.15
8267	1130B	RG213/U Poly 96%	53.00	.59
9269	1600B	RG52A/U Poly 96%	15.00	.17
8216	1450B	RG174/U Poly 96%	12.00	.14
9913	1180	Low Loss 50 Ohm	46.00	.58

OTHER QUALITY CABLES

Nemal No.	Description	Per 100 ft.	Per ft.
1110	RG8X 95% Shield (mini 8)	15.00	.17
1130	RG213/U Mil Spec. 96% Shield	34.00	.36
1140	RG214/U Mil Spec. - Silver	155.00	1.65
1705	RG142B/U Teflon - Silver	140.00	1.50
1310	RG217/U 5/8" 50 Ohm Dbl. Shld.	80.00	.85
1470	RG223/U Mil Spec. - Silver	80.00	.85

ROTOR CABLE — 8 COND.

8C1822	2-18 Ga., 6-22 Ga.	19.00	.21
8C1620	2-16 Ga., 6-20 Ga. Heavy Duty	34.00	.36

HARDLINE — 1/2"

FXA12	Smooth Alum. w/black jacket	79.00	.89
FLC12	Corrug'd. Copper (EQ. Helix LDF)	159.00	1.69

CONNECTORS — MADE IN U.S.A.

NE720	Type N for Belden 9913		4.75
PL259	Standard Plug for RG8, 213		.65
PL259AM	Amphenol PL259		.89
PL259TS	PL259 Teflon/Silver		1.59
UG21D	Type N for RG8, 213, 214		3.00
UG175	Adapter for RG58		.22

Call or write for complete Price List
 Shipping: Cable — \$3.00 per 100 ft. COD add \$2.00.
 Connectors — and 10%, \$3.00 minimum Florida Residents add 5%.
 Orders under \$20 Add \$2 Handling

Nemal's new 32-page Cable & Connector Selection Guide now available at no charge with orders of \$50 or more or at a cost of \$4.00 individually.

NEMAL ELECTRONICS

12240 N.E. 14th Ave., Dept. S., Miami, FL 33161
 Telephone (305) 893-3924

Dan's Got It All



IC-751



IC-745



IC-02A



TS-930S



TS-940S



FT-980 CAT



FT-757 GX



FT-209 RH



KANTRONICS
KPC-2
PACKET
COMMUNICATOR II



WELZ CORP.
VSWR/POWER METERS



SANTEC
ST-200ET
ST-400ET





Britt's 2-Way Radio Sales & Service

2508 Atlanta Street
 Smyrna, Georgia 30080
 Belmont Hills Shopping Center
 (404) 432-8006

All Of These "Goodies" And Many More At Super Savings.
 Come See Us Or Call 1-800-241-2027.

• Next Month in 73 •

Every amateur's favorite topic:

ANTENNAS!

(Well, second-favorite after the weather. Actually, rigs are pretty popular too, so maybe antennas are third-favorite. Then again, there's a lot to be said for . . .)

RECEIVE OSCAR 10 TELEMETRY



Complete Kit

\$139.95

plus \$3.00
shipping and
handling

PSK DEMODULATOR—

decodes satellite's housekeeping status reports, environmental data collected and plain text bulletins

INPUT—

audio output of SSB receiver or cassette player.

OUTPUT—

RS232 compatible serial bit stream at 1200 baud.

1986-87
CATALOG
\$1.00



33 RADIOKIT
JX 411 S
Greenville, NH
03048
(603) 878-1033
telex 887697

MOVING?

Subscription Problem?

Call our toll-free number:

1-800-227-5782

Monday through Friday
9 a.m. through 5 p.m. EST

Please have your mailing label in front of you, as well as your cancelled check or credit card statement if you are having problems with payment.

QSL

LASER PRINTED
QSLs

Top Quality - Low prices
Write for Information

THE LASER PRESS

P.O. BOX 876
MOUNDSVILLE WV 26041

here is the next generation Repeater

MARK 4CR

The **only** repeaters and controllers
with REAL SPEECH!

No other repeaters or controllers match Mark 4 in capability and features. That's why Mark 4 is the performance leader at amateur and commercial repeater sites around the world. Only Mark 4 gives you Message Master™ real speech • voice readout of received signal strength, deviation, and frequency error • 4-channel receiver voting • clock time announcements and function control • 7-helical filter receiver • extensive phone patch functions. Unlike others, Mark 4 even includes power supply and a handsome cabinet.

Call or write for specifications on the repeater, controller, and receiver winners.

Create messages just by talking. Speak any phrases or words in any languages or dialect and *your own voice* is stored instantly in solid-state memory. Perfect for emergency warnings, club news bulletins, and DX alerts. Create unique ID and tail messages, and the ultimate in a real speech user mailbox — only with a Mark 4.



MICRO CONTROL SPECIALTIES

Division of Kendecom Inc.

23 Elm Park, Groveland, MA 01834 (617) 372-3442

COLORADO COMM CENTER

KENWOOD



TR-2600
2.5W/300MW (swt cable) 2 Meter hand held transceiver
• LCD Readout
• 10 Memories W/ Lithium Back-up
• Band and Memory Scan



TH-21AT
• Compact Pocket Size
• 1 Watt
• Opt. 500 M.A. Battery

TM-2570



• First 70 Watt FM Mobile • First with Memory & Autodialer • 23 Channel Memory • Front Panel Programmable CTCSS

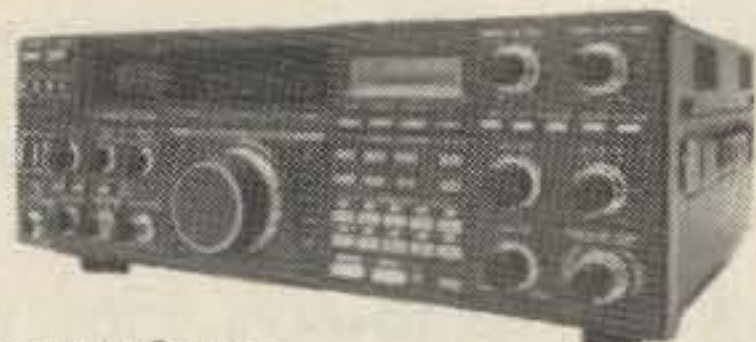

• Programmable Scanning
• High Stability Dual Digital VFO's
• 40 Channel Memory
• General Coverage Receiver

TS-940S
"DX-cellence"

800-227-7373

- | | |
|-------------|--------------|
| • AEA | • KANTRONICS |
| • ALINCO | • KDK |
| • ASTRON | • KENPRO |
| • AVANTI | • KENWOOD |
| • B&W | • KLM |
| • BENCHER | • LARSEN |
| • BUTTERNUT | • MFJ |
| • CUSHCRAFT | • MIRAGE |
| • DAIWA | • NYE VIKING |
| • HAM-KEY | • QUATRON |
| • HUSTLER | • SANTEC |
| • HYGAIN | • WELZ |
| • ICOM | • YAESU |

COD'S WELCOME

YAESU



FT-209RH
• 5 Watts
• 10 Memories
• LCD
• Compact



FT-2700R
• Duo-Band Full Duplex
• 25 Watt

FRG-9600



• 100 Memories
• 60 MHz - 905 MHz Continuous

✓80

525 East 70th Avenue, 1 West, Denver, CO • 80229 • 303-288-7373

NEVER SAY DIE

from page 12

tures of the exhibits for use in your next year's brochure?

Remember to send a letter to the exhibitors after the show, getting their input—and possibly some good quotes for your next year's sales pitch. You'll also get some ideas on ways to improve.

The local hams already know about your local attractions, so you don't have to lay that on 'em, but those from further out may know less about it than you think. You might get them to come in Thursday night and spend Friday with their families having family fun—with perhaps a three-hour Friday evening hamfest opener for the commercial exhibits—say 4-7 p.m. This could be the same time the flea marketers come in and set up their tables. The industry meeting could then begin at 7, complete with some snacks.

It's often difficult to get your

local hams to come. I frequently hear any number on the local repeaters who aren't bothering. You need to come up with a spiff to get these dead heads off their duffs. Prizes will usually do it. Not so much big ones as a lot of smaller ones and a big to-do about how many prizes there are.

You might think in terms of arranging meetings of special interest groups—and I mean beyond a talk on the program. Do you have a time and place for the 10/10 fanatics to meet? The 12/12ers? The SWOTs? SSTV's? RTTY's? Packet radio? Certificate hunters? DXers? 160m? UHFers? Microwavers? 6m? County hunters? OSCAR users? Repeater owners? Repeater coordinators? Weather satelliters? YLRL? Traffic handlers? Emergency net groups? Give each group a time and place to meet and you'll pull 'em out of the woodwork.

How about having some stickers for each of these fanatic groups available when the hams sign in so they'll be able to spot their fellow fanatics? If you're keeping a data base of the hams who register you can also key in their interest and make it easier to get them back next year with special programs of particular interest to them. Today's computers make this simple.

Now, I mentioned the critical importance of ham dealers. Hams may enjoy getting on the air, but most of all they enjoy buying something new. With enough dealers, your attendees will have a wide variety of ham gear available and at reasonable prices. I suggest, in addition to the usual brochures and mailings, that you call ham dealers and tell them what a bunch of buying fanatics you have ready to unleash on their piles of rapidly aging ham gear inventory. Here's the place to bring the stuff that has been gathering dust—mark it down and turn it into money.

It won't hurt if you can round up a few club members to help dealers move their stuff in (and out, later). Can you provide a club

member to relieve smaller exhibitors at their booth so they can get around and see the hamfest for an hour?

To find out how good your speakers are, make up some forms to report on which forums were attended and how interesting they were. This will give you a good idea of how many attended each forum and whether you need to look for someone more interesting next year. You can make sure these reports are handed in at the end of the hamfest by having a special post hamfest drawing.

Well, there are some ideas... let's see what you can do with 1987!

Hmmm, you say you want me to come and give a talk? Sorry, I'm pretty well booked up for 1987. Of course, if you have the budget, I might be able to make an exception. In general I'll be planning to see you at Miami, Orlando, Dayton, Dallas, or Atlanta. Don't let me down. Remember, amateur radio and 73 are at the very best nonprofit ventures for me, so my priorities tend to lean toward digital audio, 8mm video, publishing, and computer shows. ■

BARTER 'N' BUY

Individual (noncommercial) 25c per word
Commercial 60c per word

Prepayment by check or money order is required with your ad. No discounts or commissions are available. Please make your payment to 73.

Advertising must pertain to amateur radio products or services. No special layouts or positions are possible. All advertising copy must be submitted typewritten (double-spaced) and must include full name and address. Copy limited to 100 words, maximum. Count only words in text. Address, free.

73 cannot verify advertising claims and cannot be held responsible for claims made by the advertiser. Liability will be limited to making any necessary corrections in the next available issue.

Copy must be received in Peterborough by the 5th of the second month preceding the cover date.

Make checks payable to 73 Magazine and send to: Hope Currier, 73 Magazine, WGE Center, Peterborough NH 03458-1194.

MILITARY TECHNICAL MANUALS for old and obsolete equipment. 60-page catalog, \$3. Military Technical Manual Service, 2266 Senasac Ave., Long Beach CA 90815. BNB045

HAM RADIO REPAIR, tube through solid state. Robert Hall Electronics, PO Box 8363, San Francisco CA 94128; (408)-729-8200. BNB219

QSLs to order. Variety of styles, colors, card stock. W4BPD QSLs, PO Drawer DX, Cordova SC 29039. BNB260

THE DX'ERS MAGAZINE. Up-to-date, informative, interesting. Compiled and edited by Gus Browning W4BPD, DXCC Honor Roll Certificate 2-4. Send for free sample and subscription information today. PO Drawer DX, Cordova SC 29039. BNB261

INDIVIDUAL PHOTOFAC FOLDERS. #1 to #1400, \$3 postpaid. Loeb, 414 Chestnut Lane, East Meadow NY 11554. BNB312

IMRA—International Mission Radio Association. Forty countries, 800 members. Assists missionaries with equipment loaned, week-day net. 14.280 MHz, 2-3 p.m. Eastern. Brother Bernard Frey, 1 Pryer Manor Road, Larchmont NY 10538. BNB326

ELECTRON TUBES: receiving, transmitting, microwave—all types available. Large inventory means next-day shipment in most cases. Daily Electronics, PO Box 5029, Compton CA 90224; (213)-774-1255. BNB330

RADIO TRANSCRIPTION DISCS WANTED. Any size, speed. W7FIZ—WG, Box 724, Redmond WA 98073-0724. BNB347

ELECTRON TUBES—Radio and TV types. 80% off list price—huge inventory! Also, industrial types. Send for free catalog today or call toll-free (800)-221-5802. Box SC, Transleteronics, Inc., 1365 39th St., Brooklyn NY 11218. BNB370

CABLE TV CONVERTERS and equipment. Plans and parts. Build or buy. For information, send an SASE to C & D Electronics, PO Box 1402, Dept. 73, Hope AR 71801. BNB383

QSL CARDS: 100 for \$6.25 and 500 for \$20 postpaid—SASE for a sample: Ken Hand WB2EUF, PO Box 708, East Hampton NY 11937. BNB388

XEROX MEMORYWRITER—parts, assemblies, boards, manuals, Free help with service problems. W6NTH, Box 250, Benton AR 72015; (501)-776-0920. BNB404

HAM TRADER YELLOW SHEETS, in our 24th year. Buy, swap, sell ham-radio gear. Published twice a month. Ads quickly circulate—no long wait for results. SASE for sample copy. \$10 for one year (24 issues). PO Box 2057, Glen Ellyn IL 60136-2057. BNB412

QSL CARDS—Look good with top quality printing. Choose standard designs or fully customized cards. Better cards mean more returns to you. Free brochure, samples. Stamps appreciated. Chester

QSLs, 310 Commercial, Emporia KS 66801. BNB434

KENWOOD 430S OWNERS! Stop Scan stops the scan on busy channels. After they clear, scan continues automatically! Reviewed in 73 2/85. \$19.95 (assembled \$29.95). Shipping \$2.50. JABCO, R1 Box 386, Alexandria IN 46001. BNB438

NEW Spectrum Analyzer/Monitor Receiver kit \$60. Send SASE for details. Science Workshop, Box 393, Dept. 73, Bethpage NY 11714. BNB440

MARCO—Medical Amateur Radio Council, Ltd. Operates daily and Sunday nets. Medically oriented amateurs (physicians, dentists, veterinarians, nurses, physio-therapists, lab technicians, etc.) invited to join. Presently over 550 members. For information, write MARCO, Box 73's, Acme PA 15610. BNB441

1986 'BLOSSOMLAND BLAST' Sunday, October 5, 1986. Write "BLAST," PO Box 175, St. Joseph MI 49085. BNB446

YAESU OWNERS—Hundreds of modifications and improvements for your rig. Select the best from 14 years of genuine top-rated Fox-Tango Newsletters by using our new Comprehensive Index. Only \$4 postpaid with Rebate Certificate creditable toward Newsletters purchases. Includes famous Fox-Tango Greensheet and Filter information for your rig (if specified). N4ML, FTC, Box 15944, W. Palm Beach FL 33416; (305)-683-9587. BNB448

C-64 AND C-128 SOFTWARE: Send SASE for list. PO Box 387, Chillicothe OH 45601. BNB449

WANTED, MILITARY/COMMERCIAL Collins radio equipment. We need 618T, ARC-94, ARC-102, RT-712/ARC-105, ARC-114, ARC-115, ARC-116, ARC-159, ARC-164, ARC-186, ARN-118, RT-1159A, 718F-1/2, 719A, MRC-95, MRC-108, antenna couplers 490T-1, 490T-2, 490T-9, 490S-1, CU-1658A/ARC, CU-1669/GRC. Top dollar paid or trade for new amateur gear. Write or phone Bill Slep, Slep Electronics Company, Highway 441, Otto NC 28763; (704)-524-7519. BNB452

K7NH SATELLITE-TRACKING PROGRAMS with world map and real-time operation. Fastest and

easiest to use full-featured programs available. Hundreds sold. Timex and VIC-20, \$15. C-64, \$18. IBM, \$24. N H Enterprises, 22104 66th Ave. West, MTLK TERR WA 98043. BNB453

BEAM HEADING CHART: 10-page report in binder with 9 data fields calculated from your exact QTH to over 540 DX locations. \$9.95 from John Daley KB6JGH, PO Box 4794, San Jose CA 95150. BNB454

CODE TEST BLUES? Let E-Z-R code cassettes solve your problem. Audio tape set for Novice, General, or Extra—just \$10.50. New proven method. Details for an SASE. JERLS, PO Box 1193T, Bedford VA 24523. BNB457

TOWER CLIMBING SAFETY BELTS and accessories. Free specs. Avatar Mag., 1147 N. Emerson #7, Indianapolis IN 46219-2929. BNB458

MICROWAVE VCOs, Watkins-Johnson V901, 3.6 GHz to 5.0 GHz, \$40 postpaid. S. Bode, 2248 Lockwood, Carrollton TX 75007. BNB460

POWER LINE or electrical noise bothering you? Learn causes, detection methods, and cures from former power company communications technician. \$3.50. John W. Spence AC5K, Dept. 73, 465 Creekwood Drive, Silsbee TX 77656. BNB461

THE SCIENCE & TECHNOLOGY COLLECTOR—new magazine for buyers, sellers, collectors of all kinds of hardware, old and new: electronic, optical, photographic, laboratory, computer, navigation, and more! Hundreds of items for sale, free classified ad service. \$3 special introductory price for first issue. 241A East Main St., Westborough MA 01581. BNB462

CB TO 10 METERS: FM kits, frequency modification hardware, plans, books, high-performance accessories. Catalog \$2. CBCI, Box 31500A, Phoenix AZ 85046. BNB463

FIND OUT what else you can hear on your general-coverage transceiver or receiver. Join a shortwave radio listening club. Complete information on major North American clubs and sample newsletter \$1. Association of North American Radio Clubs, PO Box 462, Northfield MN 55057. BNB464

IC-02AT

ICOM 2-Meter Handhelds

If you want a 2-meter handheld with exceptional features, quality built to last and a wide variety of interchangeable accessories, take a look at the ICOM IC-02AT and IC-2AT handhelds.

Frequency Coverage. The IC-02AT covers 140.000 through 151.550MHz and the IC-2AT, 141.500 through 149.994MHz...both include frequencies for MARS operation.

IC-02AT Features. ICOM's top-of-the-line IC-02AT handheld has the following outstanding features:

- DTMF direct keyboard entry
- LCD readout
- 3 watts standard, 5 watts optional (with IC-BP7 battery pack)
- 10 memories which store duplex offset and PL tone (odd offset can be stored in last 4 memories)
- Frequency dial lock
- Three scanning systems: priority, memory and programmable band scan (selectable increments of 5, 10, 15, 20 or 25KHz)

IC-2AT Features. The IC-2AT is ICOM's most popular handheld on the market. The IC-2AT features a DTMF pad, 1.5 watts output and thumbwheel frequency selec-

tion. The IC-2A is also available and has the same features as the IC-2AT except DTMF.



Accessories. A variety of slide-on battery packs are available for the IC-02AT and IC-2AT, including the new long-life 800mAh IC-BP8 which can be used with both handhelds.

Other accessories include the HS-10 boom headset, HS-10SB PTT switchbox, HS-10SA VOX unit (for IC-02AT) and an assortment of battery pack chargers.

The IC-02AT and IC-2AT come standard with an IC-BP3 NiCd battery pack, flexible antenna, AC wall charger, belt clip, wrist strap and ear plug. See the IC-02AT and IC-2AT 2-meter handhelds at your local ICOM dealer.

Often imitated,
never duplicated.



First in Communications

ICOM America, Inc., 2380-116th Ave NE, Bellevue, WA 98004 / 3331 Towerwood Drive, Suite 307, Dallas, TX 75234

All stated specifications are approximate and subject to change without notice or obligation. All ICOM radios significantly exceed FCC regulations limiting spurious emissions. 02AT185

PACKET RADIO GOES PORTABLE

GLB ELECTRONICS

presents



Model PK1-L

- LOW 25 mA Current drain.
- Designed for portable or solar-powered stations.
- Miniature size—Lightweight
- Rugged all metal, shielded enclosure.
- On-board Lithium Battery RAM backup.
- On-board watchdog for reliability.
- Standard DB-25 Connectors.
- Output signal indicates "Connected" Status.
- Does not require squelched audio.
- Comes with 8K of RAM.
- Remote Command Mode for Unattended operation.
- Hardware command lockout for security.
- Commands compatible with our Model PK1.
- Retains all other features of the Model PK1.
- Extra I/O lines for special applications.

Power requirement:
9 to 15 Volts DC @ 25 mA typical

Dimensions:
4.6 X 5.90 X 1.0 inches

Total Weight:
12 ozs.

PK1L—Wired and Tested
List—
Amateur net—

\$209.95
\$179.95

GLB MODEL TNC-2A KIT

Just when you thought TAPR TNC-2 Kits were a thing of the past, GLB — the first commercial producer of Packet Controllers — Joins the "TAPR Revolution" at last!

GLB is now the exclusive supplier of TNC-2 Kits.

Hardware
Software
Documentation

by TAPR



GLB Model TNC-2A Kit

COMPLETE KIT ONLY

\$154.95 NMOS

\$169.95 CMOS

+ shipping

Contact GLB for information on our full line of Packet Controllers



GLB ELECTRONICS, INC.

151 Commerce Pkwy.,
Buffalo, NY 14224
716-675-6740 9 to 4

DEALER DIRECTORY

Fontana CA

Complete lines—ICOM, Mirage, KLM, Larsen, Astron, B & W. Over 4000 electronic products for the hobbyist. Also CB and business radios. Serving you from a 6000 sq. ft. store. Fontana Electronics, 8628 Sierra Ave., Fontana CA 92335, 822-7710.

San Jose CA

Bay Area's newest amateur radio store. New & used amateur radio sales & service. We feature Kenwood, ICOM, Azden, Yaesu, Ten-Tec, Santec & many more. Shaver Radio, Inc., 1775A S. Winchester Blvd., Campbell CA 95008, 370-6665.

Littleton MA

The reliable ham store serving NE. Full line of ICOM & Kenwood, Drake, Daiwa, B&W accessories. Curtis & Trac keyers. Larsen, Hustler, Telex/Hy-Gain products. Mirage amps., Astron P.S., Alpha Delta protectors. ARRL & Kantronics instruction aids. Whistler radar detectors. Full line of coax fittings. TEL-COM Electronic Communications, 675 Great Rd. (Rt. 119), Littleton MA 01460, 486-3400/3040.

Preston ID

Ross WB7BYZ has the largest stock of amateur gear in the Intermountain West and the best prices. Call me for all your ham needs. Ross Distributing, 78 So. State, Preston ID 83263, 852-0830.

New Castle DE

Factory authorized dealer! Yaesu, ICOM, Ten-Tec, KDK, Kenwood, AEA, Kantronics, Santec. Full line of accessories. No sales tax in Delaware. One mile off I-95. Delaware Amateur Supply, 71 Meadow Road, New Castle DE 19720, 328-7728.

Derry NH

Serving the ham community with new and used equipment. We stock and service most major lines: AEA, Astron, B&W, Cushcraft, Encomm, Hy-Gain, Hustler, ICOM, Kenwood, KLM, Larsen, Mirage, Mosley; books, rotors, cable and connectors. Business hours Mon.-Sat. 10-5, Thursday 10-9. Closed Sun./Holidays. Rivendell Electronics, 8 Londonderry Road, Derry, NH 03038, 434-5371.

DEALERS

Your company name and message can contain up to 25 words for as little as \$150 yearly (prepaid), or \$15 per month (prepaid quarterly). No mention of mail-order business or area code permitted. Directory text and payment must reach us 60 days in advance of publication. For example, advertising for the November '86 issue must be in our hands by September 1st. Mail to 73 Amateur Radio, WGE Center, Peterborough, NH 03458. ATTN: Hope Currier.

PROPAGATION

Jim Gray W1XU

EASTERN UNITED STATES TO:

GMT: 00 02 04 06 08 10 12 14 16 18 20 22

ALASKA						20	20					
ARGENTINA	20	20	20	40				20	20	15	15	15
AUSTRALIA		20	20	20	40	40	20					
CANAL ZONE	15	40	40	40	40 ¹	40			15	15	15	10
ENGLAND			40 ¹	40				20	20	20	20	20
HAWAII			20		40			20				
INDIA												
JAPAN						20	20					
MEXICO	15	40	40	40	40 ¹	40			15	15	15	10
PHILIPPINES								20				
PUERTO RICO	15	40	40	40	40 ¹	40			15	15	15	10
SOUTH AFRICA			40	40		20	20					20
U. S. S. R.								20	20		20	
WEST COAST	20	40	40	40 ¹	40 ¹	40						20

CENTRAL UNITED STATES TO:

ALASKA			20	20					20	20		
ARGENTINA	15	20	20	40				20	20		15	15
AUSTRALIA	15	20	20	20	40 ¹	40						20
CANAL ZONE	15	20	20	20	40 ¹	40	20	20	15	15	15*	10
ENGLAND	20	40						20	20		20	20
HAWAII	15	15	20	20	20	40	20	20				
INDIA												
JAPAN			20	20					20	20		
MEXICO	15	20	20	20	40 ¹	40	20	20	15	15	15*	10
PHILIPPINES			20	20				20	20			
PUERTO RICO	15	20	20	20	40 ¹	40	20	20	15	15	15*	10
SOUTH AFRICA								20				20
U. S. S. R.									20		20	

WESTERN UNITED STATES TO:

ALASKA			20	20							20	
ARGENTINA	15	20	20	40	40			20	20		15	15
AUSTRALIA		20	20	20	20	40 ¹	40 ¹			20	15	15
CANAL ZONE	15	15	20	20 ¹	40 ¹	40			20	20	15	15
ENGLAND	20								20	20		20
HAWAII	20	15	15	20	20	20 ¹	40 ¹	40	20		20	20
INDIA				20						20		
JAPAN			20	20						20		
MEXICO	15	15	20	20 ¹	40 ¹	40			20	20	15	15
PHILIPPINES				20						20		
PUERTO RICO	15	15	20	20 ¹	40 ¹	40			20	20	15	15
SOUTH AFRICA			40								20	
U. S. S. R.										20		
EAST COAST	20	40	40	40 ¹	40 ¹	40						20

Notes: Solar activity low. Geomagnetic field unsettled to active during days designated as 'F' or 'P'. Propagation conditions on HF bands typical for midsummer. Static on 160/80/40/20 on many days. 20 open until long after dark. 15 openings—short skip. 10 open occasionally—mostly sporadic-E. VHFers look for meteor/tropo propagation.

G = Good, F = Fair, P = Poor

AUGUST						
SUN	MON	TUE	WED	THU	FRI	SAT
					1	2
					P-F	F
3	4	5	6	7	8	9
F-P	P	P-F	F	F-G	G	G
10	11	12	13	14	15	16
G	G	G	G	G	G	F
17	18	19	20	21	22	23
F	F-P	F-P	P	F	F-G	G
24	25	26	27	28	29	30
G	G	G	G	G	G-F	F
31						
F-P	G	G	G	G	G	F

The BEST is still
"made in U.S.A."



MIRAGE/KLM

Under New Ownership

**American made RF Amplifiers and Watt/SWR Meters
of exceptional value and performance.**

• 5 year warranty • prompt U.S. service and assistance

RF AMPLIFIERS

2 METERS-ALL MODE

B23 2W in = 30W out
(useable in: 100 mW-5W)

B108 10W in = 80W out
(1W = 15W, 2W = 30W) RX preamp

B1016 10W in = 160W out
(1W = 35W, 2W = 90W) RX preamp

B3016 30W in = 160W out
(useable in: 15-45W) RX preamp
(10W = 100W)

220 MHz ALL MODE

C106 10W in = 60W out
(1W = 15W, 2W = 30W) RX preamp

C1012 10W in = 120W out
(2W = 45W, 5W = 90W) RX preamp

C22 2W in = 20W out
(useable in: 200mW-5W)

RC-1 AMPLIFIER

REMOTE CONTROL

Duplicates all switches, 18' cable

WATT/SWR METERS

- peak or average reading
 - direct SWR reading
- MP-1** (HF) 1.8-30 MHz
MP-2 (VHF) 50-200 MHz

430-450 MHz ALL MODE

D24 2W in = 40W out
(1W = 25W)

D1010 10W in = 100W out
(1W = 25W, 2W = 50W)

Available at local dealers throughout the world.

MIRAGE/KLM
COMMUNICATIONS EQUIPMENT, INC.

16890 Church St., Morgan Hill, CA 95037, (408) 779-7363

RS-232 Compatible

Goodbye to Packet Only Controllers



PAKRATT™
Model PK-232

Late last year AEA broke new ground by introducing the first five mode amateur radio computer interface with Morse, Baudot, ASCII, AMTOR, and Packet...the PK-64. Now AEA has another breakthrough....the PK-232.

Five Mode Versatility

The PK-232 makes any RS-232 compatible computer or terminal the complete Amateur digital operating position. By using a simple terminal program any computer with a standard RS-232 I/O can connect directly to the PK-232 and be ready for operation in minutes. The internal autobaud program allows 300, 1200, 2400, 4800, and 9600 baud communication between the computer and the PK-232. All decoding, signal processing, and protocol software, for Morse, Baudot, ASCII, AMTOR, and Packet, is on ROM in the PK-232. The PK-232 is a Z-80A based system and has hardware HDLC using the Zilog 8530 SCC. The internal modem of the PK-232 can transmit Packet at baud rates of 300 and 1200, with the option of using an external modem for 2400, 4800, and 9600 baud.

An Operators Dream

With twenty-one front panel indicators it's easy to monitor operation. Separate indicators show operating mode, current operating status, and data carrier detect. A front panel switch allows selection of two separate radio connectors, no more switching cables when jumping from HF to VHF. The front panel threshold control adjusts squelch for both HF and VHF. The AEA standard discriminator style tuning indicator makes tuning easy in any mode and on any band.

Serious VHF/HF/CW Modem

The PK-232 also includes a no compromise VHF/HF/CW modem with an eight pole bandpass filter followed by a limiter discriminator with automatic threshold correction. Once the operating mode is selected the modem automatically selects the proper bandwidth, 200 Hz for CW, 450 Hz for HF, or 2600 Hz for VHF. Transmitter tones are low distortion sine wave phase continuous AFSK. The PK-232 will receive wide shift RTTY signals, but only transmits 200 Hz shift on HF.



Prices and specifications subject to change without notice or obligation

AEA Quality and Price

All this plus the high quality you expect from AEA. An easy to read and understand manual, most cables and connectors included, and a service department to answer your questions. The PK-232 is the one unit that does it all with your IBM, Apple, Radio Shack, or almost any computer. With an Amateur Net price of \$319.95 you can't wait any longer. Call your local AEA dealer and order the new PK-232 today.

AEA
Brings you the
Breakthrough!

© 1986
ADVANCED ELECTRONIC APPLICATIONS, INC.

Advanced Electronic Applications, Inc.

P.O. Box C-2160, Lynnwood, WA 98036-0918

(206) 775-7373 Telex 6972496 AEA INTL UW

Introducing the next logical step.

Yaesu's Dual Band Handie.

Two affordable radios in one—that's exciting.

Yaesu's dual-band FT-727R packs our best HT know-how into one compact design. At a price that's in step with your ham budget.

Hit hard-to-reach repeaters with a powerful 5 watts on both 2 meters and 440 MHz.

Work the bands quickly and easily with a wealth of microprocessor-controlled commands:

Jump between the separate VHF and UHF VFO registers. Ten memories store any VHF or UHF frequency, and tone encode/decode information. (Four memories retain repeater shift data).

Scan the memory channels, the entire band, or a band segment. And return to any special frequency with the priority feature.

Use link repeaters by programming TX on one band and RX on another.

Conserve power with the battery saver. It lets you monitor silently while drawing negligible current.



And measure your battery level with the digital battery voltmeter. There's even a "Low Battery" LED.

Finally, your operation is rounded out with features like VOX capability. A one-touch repeater reverse switch. An LCD readout with illumination lamp. A high/low power switch. Remote computer control capability. An optional CTCSS module. And Yaesu's full line of optional accessories.

So step up your operating capability now with the logical choice in HT operation.

Yaesu's dual-band FT-727R.

YAESU

Our 30th Anniversary.

Yaesu USA
17210 Edwards Road, Cerritos, CA 90701
(213) 404-2700
Customer Service: (213) 404-4884
Parts: (213) 404-4847

Yaesu Cincinnati Service Center
9070 Gold Park Drive, Hamilton, OH 45011
(513) 874-3100

Prices and specifications subject to change without notice.

KENWOOD

...pacesetter in Amateur radio

All New
Compact HF!

“DX-citing!”

TS-440S Compact high performance HF transceiver with general coverage receiver

Kenwood's advanced digital know-how brings Amateurs world-wide “big-rig” performance in a compact package. We call it “Digital DX-citement”—that special feeling you get every time you turn the power on!

• **Covers All Amateur bands**

General coverage receiver tunes from 100 kHz—30 MHz. Easily modified for HF MARS operation.

• **Direct keyboard entry of frequency**

• **All modes built-in**
USB, LSB, CW, AM, FM, and AFSK. Mode selection is verified in Morse Code.

• **Built-in automatic antenna tuner (optional)**

Covers 80-10 meters.

• **VS-1 voice synthesizer (optional)**

• **Superior receiver dynamic range**

Kenwood DynaMix™ high sensitivity direct mixing system ensures true 102 dB receiver dynamic range. (500 Hz bandwidth on 20 m)

• **100% duty cycle transmitter**

Super efficient cooling permits continuous key-down for periods exceeding one hour. RF input power is rated at 200 W PEP on SSB, 200 W DC on CW, AFSK, FM, and 110 W DC AM. (The PS-50 power supply is needed for continuous duty.)

• **Adjustable dial torque**

• **100 memory channels**

Frequency and mode may be stored in 10 groups of 10 channels each. Split frequencies may be stored in 10 channels for repeater operation.

• **TU-8 CTCSS unit (optional)**

Subtone is memorized when TU-8 is installed.

• **Superb interference reduction**

IF shift, tuneable notch filter, noise blanker, all-mode squelch, RF attenuator RIT/XIT, and optional filters fight QRM.

• **MC-42S UP/DOWN mic. included**

• **Computer interface port**

• **5 IF filter functions**

• **Dual SSB IF filtering**

A built-in SSB filter is standard. When an optional SSB filter (YK-88S or YK-88SN) is installed, **dual** filtering is provided.

• **VOX, full or semi break-in CW; AMTOR compatible.**



Optional accessories:

- AT-440 internal auto. antenna tuner (80 m—10 m)
- AT-250 external auto. tuner (160 m—10 m)
- AT-130 compact mobile antenna tuner (160 m—10 m)
- IF-232C/IC-10 level translator and modem IC kit
- PS-50 heavy duty power supply
- PS-430/PS-30 DC power supply
- SP-430 external speaker
- MB-430 mobile mounting bracket
- YK-88C/88CN 500 Hz/270 Hz CW filters
- YK-88S-88SN 2.4 kHz/1.8 kHz SSB filters
- MC-60A/80/85 desk microphones
- MC-55 (8P) mobile microphone
- HS-4/5/6/7 headphones
- SP-40/50 mobile speakers
- MA-5/VP-1 HF 5 band mobile helical antenna and bumper mount
- TL-922A 2 kw PEP linear amplifier
- SM-220 station monitor
- VS-1 voice synthesizer
- SW-100A/200A/2000 SWR/power meters
- TU-8 CTCSS tone unit
- PG-2C extra DC cable.

Kenwood takes you from HF to OSCAR!



25th
Anniversary

KENWOOD

Complete service manuals are available for all Trio-Kenwood transceivers and most accessories. Specifications and prices are subject to change without notice or obligation.

TRIO-KENWOOD COMMUNICATIONS
1111 West Walnut Street
Compton, California 90220