

# 73<sup>®</sup>

# Amateur Radio's Technical Journal

 A Wayne Green Publication

## 9 Projects to Build and Use!

**More "Fun" Rigs**  
Page 48

**Better  
Breadboards**  
Page 52

**Autodialer  
Spectacular**  
Page 40

**Blockbuster  
SSB Rig!**  
Page 12

**BBC: Queen of  
the Airwaves**  
Page 68

**1982  
40/80m, 160m  
Contest Results**  
Page 103

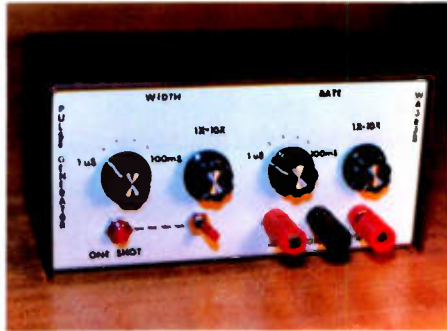

**Pulse King—100**

### Action Machine for 20

Are home-brew rigs a lost art? Not yet! Here's an SSB transceiver you can build. **WB51PM** 12

### An Alarming Procedure

This false-proof repeater emergency alert won't tie up expensive equipment. **WA1LCF, K1FNX** 24

### Trimming the Fat from ATV

Why use 3 MHz when 500 kHz will do? WB6FHD proposes a way. **WB6FHD** 32

### The Forgetful Autodialer Puzzle

Even Sherlock couldn't figure out how to make an autodialer that reprograms with no hardware changes. Elementary, says dear Bati. **W7BBX** 40

### My Own Silver Mine

For W1FLP, reclaiming silver from photographic fixer is cheap, easy and profitable. King Midas should have had it so good. **W1FLP** 46

### Fun-Equipment Revisited

Here are higher-band versions of the ever-popular Fun-Mitter and Fun-Amp. They are based on the Fun-Philosophy: cheap and simple. **WA0RBR** 48

### The Ultimate Breadboard

There used to be two styles of prototypes—rat's nest and cramped. Now there is a third style—simple. **N6BW** 52

### Beating the Untraceable Buzz

Man-made interference doesn't have to destroy reception. Not when you use W1GV's buzz-beating antennas. **W1GV/4** 56

### The Care and Feeding of Optoelectronics

There are many ways to make these devices earn their keep. Here is one. **K3VDB** 62

### International Success Story: The BBC

From its battery of transmitters, the BBC fires a daily salvo of news and entertainment around the world. No commercials, either. **Peterson** 68

### Active-Filter Design Made Easy

Using this BASIC program, if you don't like the design, then scrap it. All you lose is a few seconds. **WD4HPC** 78

### The Cornerstone of Equipment Failure: Heat Damage

The proper heat sink will preserve transistors. Learn how to keep your circuitry from resembling a core meltdown. **Shamburger** 84

### Your January Home-Brew Project

No frills—just a solid \$10 SSB exciter for HF. Who says hams don't build anymore? **VE7DOD** 92

### King of the Pulse Generators

One-shot or a train, TTL or CMOS, this generator will fit the bill. It's just what your test bench always wanted. **WA3RJS** 100

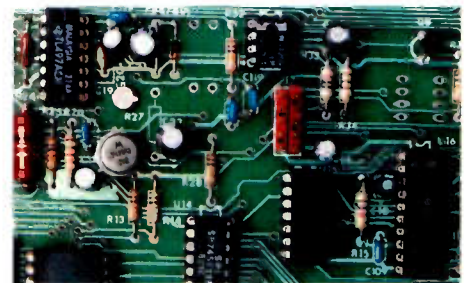

**Repeater Controller—126**

**Never Say Die—6**  
**Satellites—101**  
**Contests—102**  
**Reader**  
**Service—114**  
**Social Events—115**  
**Letters—116**  
**Circuits—124**  
**Review—126**  
**RTTY Loop—130**

**Fun!—132**  
**Corrections—134**  
**DX—138**  
**Awards—140**  
**New Products—142**  
**Ham Help—144**  
**Dealer**  
**Directory—162**  
**Propagation—162**

# ICOM's Complete Ham Catalog

Radios, Accessories and Prices (October 30, 1982)

*Pick one up now  
at your ICOM dealer!*



IC-720A

IC-730

IC-740

IC-R70

HF



IC-251A

IC-22U

IC-25A

IC-290H

IC-2A

IC-2AT

IC-202S

VHF



IC-451A

IC-45A

IC-490A

IC-4AT

IC-4A

IC-402

UHF



IC-3A

IC-3AT

220



IC-551D

IC-560

IC-505

6M



IC-2KL

IC-AT500

IC-5M5

Phone Patch

IC-HP1

IC-SP3

ACC



**ICOM**

The World System

# 5-STORE BUYING POWER in action!

**KENWOOD**

**NEW!**



**TR-7950**  
2M, 45 WATTS,  
21 CHAN. MEMORY.

**TR-2500**

**CALL FOR  
SPECIAL PRICES**

**TS-930S**

W/ANTENNA  
TUNER

**\$1799 w/FREE**  
**SAVE \$230**



SP-930 spkr.  
MC-60A Mic.  
YK-88C-1 Filter

**TS-830S**  
TRANSCEIVER

**BARGAIN  
PACKAGE**

w/**FREE**  
SP-230 Spkr.  
YK-88C CW Filter

**\$949<sup>95</sup>**



A \$1084.85 VALUE

**SALE!**  
**ANTENNAS/  
TOWERS**

**KLM KT-34A**

4 ELEMENT TRIBANDER  
REGULAR \$389.95

**SALE \$309**

**KLM KT-34XA**

6 ELEMENT TRIBANDER  
REGULAR \$569.95

**SALE \$459**

CALL FOR OTHER KLM PRICES.

**MIRAGE**



**SALE!**

**2 METER  
AMPLIFIERS**

**B-3016** 30W in, 160W out.  
REG. \$239.95 **\$199.95**

**B-1016** 10W in, 160 W out.  
REG. \$279.95 **\$249.95**

**B-108** 10W in, 80W out.  
REG. \$179.95 **\$159.95**

**B-23** 2W in, 30W out.  
REG. \$89.95 **\$79.95**



**YAESU  
HANDHELDS**

2 METER FT-208R

70CM FT-708R

EACH

**SALE \$289<sup>95</sup>**



TRI-EX W51 TOWER with  
KLM-KT-34A **\$1099**

TRI-EX W51 TOWER with  
KLM KT-34XA. **\$1239**

TRI-EX W51, 51' TOWER  
Reg. \$999.95 **\$829.95**

PRICES ARE FOE CALIF. EXCEPT FOR  
CERTAIN COMB NATIONS. INQUIRE.



**ICOM**

**BIG "666" DEALS**

**IC-730**

LIMITED QUANTITY. ACT!



REGULARLY \$829

**SALE \$666**

**IC R-70**

ICOM's GREAT NEW GENERAL  
COVERAGE RECEIVER.



REG.  
\$749

**SALE \$666**

**FREE SHIPMENT (U.P.S. Brown)**

CONTINENTAL U.S.A.

EXCEPT FOR SOME ALPHA, TRI EX and KLM ITEMS.

**FREE  
PHONE 800 854-6046**

9:30AM to 5:30PM PACIFIC TIME.

**OVER-THE-COUNTER, 10AM to 5:30PM.**

**MONDAY THROUGH SATURDAY**

CALIFORNIA CUSTOMERS PLEASE PHONE OR VISIT LISTED STORES.

**ANAHEIM, CA 92801**

2620 W. La Palma,  
(714) 761-3033 (213) 860-2040  
Between Disneyland & Knott's Berry Farm

**BURLINGAME, CA 94010**

999 Howard Ave., (415) 342-5757  
5 miles south on 101 from S.F. Airport.

**OAKLAND, CA 94609**

2811 Telegraph Ave., (415) 451-5757  
Hwy 24 Downtown. Left 27th off-ramp.

**SAN DIEGO, CA 92123**

5375 Kearny Villa Road (619) 560-4900  
Hwy 163 & Clairemont Mesa Blvd.

**VAN NUYS, CA 91401**

6265 Sepulveda Blvd., (213) 988-2212  
San Diego Fwy at Victory Blvd.

AEA · ALLIANCE · ALPHA · AMECO · AMPHENOL · ARRL · ASTRON  
· AVANTI · BENCHER · BERK-TEK · BIRD · B&W · CALLBOOK · CDE  
· COLLINS · CUBIC · CURTIS · CUSHCRAFT · DAIWA · DATONG

· DENTRON · DRAKE · DX ENGINEERING · EIMAC · HUSTLER  
· HY-GAIN · ICOM · J.W.MILLER · KENWOOD · KLM · LARSEN  
· LUNAR · METZ · MFJ · MICRO · LOG · MINI · PRODUCTS

· MIRAGE · NYE · PALOMAR · ROBOT · ROHN · SHURE · SWAN  
· TELEX · TELREX · TEMPO · TEN-TEC · TRISTAO · VOCOM  
· YAESU and many more!

Prices, specifications, descriptions subject to change without notice. Calif. residents please add sales tax

**SERVING HAMS  
BETTER.**

North...south...east...west.

Bob Ferrero, W6RJ  
Jim Rafferty, N6RJ  
other well known hams  
give you courteous,  
personalized  
service.



**HAM  
RADIO  
OUTLET™**

## R-X Noise Bridge

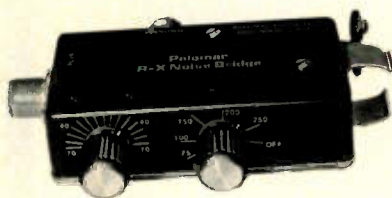

- Learn the truth about your antenna.
- Find its resonant frequency.
- Adjust it to your operating frequency quickly and easily.

If there is one place in your station where you cannot risk uncertain results it is in your antenna.

The Palomar Engineers R-X Noise Bridge tells you if your antenna is resonant or not and, if it is not, whether it is too long or too short. All this in one measurement reading. And it works just as well with ham-band-only receivers as with general coverage equipment because it gives perfect null readings even when the antenna is not resonant. It gives resistance and reactance readings on dipoles, inverted Vees, quads, beams, multiband trap dipoles and verticals. No station is complete without this up-to-date instrument.

Why work in the dark? Your SWR meter or your resistance noise bridge tells only half the story. Get the instrument that really works, the Palomar Engineers R-X Noise Bridge. Use it to check your antennas from 1 to 100 MHz. And use it in your shack to adjust resonant frequencies of both series and parallel tuned circuits. Works better than a dip meter and costs a lot less.

The price is \$59.95 in the U.S. and Canada. Add \$3.00 shipping/handling. California residents add sales tax.



Send for **FREE** catalog describing the R-X Noise Bridge and our complete line of SWR Meters, Preamplifiers, Toroids, Baluns, Tuners, VLF Converters, Loop Antennas and Keyers.

# Palomar Engineers

Box 455, Escondido, CA 92025  
Phone: (619) 747-3343

# FLEXI- BILITY



AEA once again breaks new ground in the code communications field with the new model MBA-RC reader/code converter. The MBA-RC decodes Morse, Baudot or ASCII signals off the air and displays them on a large 32 character alphanumeric vacuum fluorescent display. In addition, it will output Morse code for keying your transmitter. It will also generate RTTY (Baudot or ASCII AFSK two tone output. (170 or 850 Hz shifts.) Any of the acceptable input codes can be converted to any of the specified output codes (any speed to any speed). If you have any of the common Baudot RTTY terminals as an example, you can now send and receive Morse and ASCII with your keyboard and printer. You can even generate ASCII or BAUDOT RTTY using your Morse hand key or memory keyer.

Get the details. Write for our free product catalogue or better yet, see your favorite dealer.

Prices and Specifications subject to change without notice or obligation.  
Software ©copyright by AEA.

**ADVANCED ELECTRONIC  
APPLICATIONS, INC.**  
P.O. Box C-2160,  
Lynnwood, WA 98036  
(206) 775-7373  
Telex: 152571 AEA INTL

## AEA Brings you the Breakthrough!

## INFO

### Manuscripts

Contributions in the form of manuscripts with drawings and/or photographs are welcome and will be considered for possible publication. We can assume no responsibility for loss or damage to any material. Please enclose a stamped, self-addressed envelope with each submission. Payment for the use of any unsolicited material will be made upon acceptance. All contributions should be directed to the 73 editorial offices. "How to Write for 73" guidelines are available upon request.

### Editorial Offices:

Pine Street  
Peterborough NH 03458  
Phone: 603-924-9471

### Advertising Offices:

Elm Street  
Peterborough NH 03458  
Phone: 603-924-7138

### Circulation Offices:

Elm Street  
Peterborough NH 03458  
Phone: 603-924-9471

### Subscription Rates

In the United States and Possessions:  
One Year (12 issues) \$25.00  
Two Years (24 issues) \$38.00  
Three Years (36 issues) \$53.00

### Elsewhere:

Canada and Mexico—\$27.97/1 year only, U.S. funds. Foreign surface mail—\$44.97/1 year only, U.S. funds drawn on U.S. bank. Foreign air mail—please inquire.

### To subscribe, renew or change an address:

Write to 73, Subscription Department, PO Box 931, Farmingdale NY 11737. For renewals and changes of address, include the address label from your most recent issue of 73. For gift subscriptions, include your name and address as well as those of gift recipients.

### Subscription problem or question:

Write to 73, Subscription Department, PO Box 931, Farmingdale NY 11737. Please include an address label.

73: *Amateur Radio's Technical Journal* (ISSN 0098-9010) is published monthly by 73, Inc., a subsidiary of Wayne Green, Inc., 80 Pine Street, Peterborough NH 03458. Second class postage paid at Peterborough NH 03458 and at additional mailing offices. Entire contents copyright © 1982, Wayne Green, Inc. All rights reserved. No part of this publication may be reprinted or otherwise reproduced without written permission from the publisher. Microfilm Edition—University Microfilms, Ann Arbor MI 48106. Postmaster: Send address changes to 73, Subscription Services, PO Box 931, Farmingdale NY 11737.

introducing a new dimension...

# COMPUTERIZED ANTENNA CONTROL FROM PRO-SEARCH™

For Contesters,  
DX'ers, Handicapped  
Operators and General  
Purpose Ham  
Operators:

The Most Advanced  
Antenna Control  
Available...

- The Only  
Computerized Unit
- The Only Talking  
Unit
- The Only Scanning  
Unit
- The Only  
Programmable Unit
- The Only Automatic  
Braking Unit

#### Contesters:

Pro-Search seeks out a  
pre-programmed heading, plus  
stores various common head-  
ings and automatically scans  
for those rare multipliers,  
giving the operator hands-free  
operation and more time for  
contesting.

#### DX'ers:

Pro-Search loads in short path  
and long path headings and  
with the touch of a button, the  
system works between both  
headings. Plus you have all of  
the other features of the Pro-  
Search to aid you in catching  
that rare DX station.

#### Handicapped Operators:

Pro-Search offers ease of  
operation...control the entire  
system with just one touch. A  
talk loop...vocally calls out the  
headings, allowing blind opera-  
tors to accurately program and  
hear their headings.

#### General Purpose Operators:

Pro-Search has numerous  
features.  
Pre-set beam headings for  
CEDS, VHR WORK, and many  
others. Current headings can  
be read, by displaying the  
present directions with LEDs.  
Pro-Search also displays and  
stores the last station worked,  
which can be recalled by the  
Auto-Locate system with the  
touch of a button.



Current Heading  
Display

Last Heading Display  
and Visual Confirmation  
of Computer Instructions

Programmable  
Keyboard and Memory  
Functions

Pro-Search Is  
Adaptable To Many  
Systems, Simple  
To Install.

Pro-Search is NOW  
available for most  
popular rotors: CDE,  
HY-GAIN, TELREX,  
WILSON, ALLIANCE,  
and FROP-PITCH.

Disconnect your  
present antenna  
control system and  
connect ours.

Some modifications  
are necessary  
depending on type of  
rotor.

#### To Order:

1-800-325-4016  
1-314-994-7872 (Missouri)

#### Or write:

Pro-Search Electronics  
A Division of Wurdack and  
Associates, Inc.  
10411 Clayton Road  
Suite 305  
St. Louis, Missouri 63131

\*Patent Pending

**PRO-SEARCH**  
Reaching The World



# W2NSD/1 NEVER SAY DIE

editorial by Wayne Green



## IT'S SNOW FUN

Are you going to be wasting your time the second week of January chasing some fool DXpedition around twenty meters or are you going to be out with a bunch of us on the slopes of Aspen, HTing it and having a ball? That's the low season in Aspen, so the prices are still a bargain... and it's right after the Winter Consumer Electronics Show in Las Vegas, if you're in the electronics industry.

During the day, Chuck Martin WA1KPS (Tufts Electronics) will be leading the kamikaze group down the expert slopes, while I'll be struggling to keep up with the geriatric crowd and their walkers on the gentler slopes. It is a lot of fun to ski with fellow hams... keeping in touch with HTs. And it's even more fun to get together for dinner at some of the famous Aspen restaurants and talk over the ham industry, DXing, and so on.

If you can get away January 8-12, we'll be skiing out of The Limelight Hotel (again), so don't miss the Eighth Ham Industry

Winter Symposium... obviously an historic event. We're expecting ham manufacturers there as well as dealers, so there should be some brisk discussions on discounts, service support, needed new products, technical advances, and so on.

## THE VIEW FROM OVERSEAS

With such a heavy percentage of our DX contacts going not much further than an exchange of names, locations, and, possibly, in some rare cases, a recitation of the equipment being used, not only are we failing most of the time to live up to one of the fundamental rationales for amateur radio—the development of international friendship—but also we are wasting an impressive technology. When is the last time you got on the air and had a half-hour contact with someone in a relatively rare DX country?

Rather than lecture you and try to make you feel guilty for maintaining the most eternal tradition of amateur radio, meaningless contacts, I'd rather

go about this in a positive fashion. I recognize that one of the problems when you meet someone new is to find a field of mutual interest about which to talk. Most of us are so used to our own areas that we tend to forget that though they are pedestrian to us, they might be of considerable interest to someone overseas.

Sure, the chap in a small town in Germany will go to a fair in his area just as you may in yours. But there the similarity ends. While the fair I go to may offer Italian hot-sausage sandwiches with fried onions and green peppers, fruit salad, green salad in a pita-bread pouch, fried dough, french-fried onion rings, french fries, do-it-yourself ice cream sundaes, and corn on the cob, my friend in Germany will be eating a wide variety of sausages, hot potato salad, grilled fish, pigs' knuckles, shashliks, and drinking new wine or a special seasonally-produced type of beer. At French fairs, the fare is again different, but no less delicious.

In order to work toward bringing amateurs together on a worldwide basis, I'd like to solicit regular reports on hamming overseas via a group of correspondents. If you are living in some area of the world which should be reported on in 73... or if you know someone who might be interested in such, I'd like to hear from you.

What I have in mind is a regular...perhaps monthly for many areas...report on any news of interest to hams around the world. I think many of us would like to know about contests which are coming up which are organized in your area. We'd like to know about new certificates. We'd like to

know about any outstanding ham conventions. We'd like to know about ham products which are made in your area. We'd like to know more about the growth of hamming, any special developments, important rule changes, how to get a visitor's license, and so on.

What areas? I'm open to suggestions. Perhaps we'd like to hear from the U.K., Germany, France, Benelux, Scandinavia, Southern Europe, the Mediterranean area, the Mideast, India, Japan, Southeast Asia, Australia-New Zealand, Oceania, South America, the Caribbean... and so on?

Regular correspondents will not only be paid for the reporting work, but also will get special press passes from the magazine, special QSL cards, business cards, and other such documents to help them with their reporting contacts.

This would be a good medium for bringing up area problems for world discussion. It would help us know more about coming and past DXpeditions. We might be able, with such a widespread correspondent system, to develop some sort of network of ham help to meet traveling hams and make them welcome. We would be better able to keep things like local net frequencies known, repeater channels publicized, and so forth.

I would love to have some correspondents from Iron Curtain countries, recognizing that they might prefer to be paid in magazine subscriptions and books rather than American cash, which can be a problem.

If you have any good friends in spots around the world who you think might be able to provide a continuing series of interesting reports, you might drop them a line with a copy of this editorial and suggest the idea. Or you could bring it up on the air... give you something of interest to talk to them about. The prestige of being published in an international magazine can help a person substantially, sometimes. I remember when I first ran into that. It was in 1956 and I was visiting St. Thomas and Dick Spenceley KV4AA. I was the editor of *CQ* at the time, which I didn't think of as being of much importance. Well, I stopped by a store downtown, happened to mention Dick, and was told how important he was, doing a DX column for an international magazine! Hmmm. It

## NEW BAND APPROVED

The FCC has approved use of the 10-MHz band, but amateur operation is limited and the Commission did not release the new rule without a cautionary note.

According to the rule, most of the frequencies from 10.1 to 10.15 MHz are available to hams, except for a slice from 10.109 to 10.115 MHz. That section is still reserved for government use.

General-, Advanced-, and Extra-class licenses are allowed to transmit CW and RTTY (FSK and AFSK) with a final input power of up to 250 W. In its decision, the Commission cited the "limited size" of the band and the "temporary nature" of the ruling.

The FCC's action is valid until the Senate takes action on the WARC treaty, leaving present limitations open for change. Although 30 meters has been a possibility since the 1979 WARC convention, approval of the treaty was delayed.

Though the FCC previously denied an ARRL petition requesting use of the band, the amendment did not directly address the Commission's change of mind.

"Strong interest" in the amateur community was cited as a reason for the decision, but the Commission warned that since its action is subject to future Senate decisions about the treaty, the amendment "may be effective for only a brief period."

The FCC added that hams would be "ill-advised to invest heavily in equipment which can only be used in this band."—WB8JLG.

# Scan the World.

# NEW



**SSB, CW, AM, FM, digital VFO's, 10 memories, memory and band scan, dual 24-hour clocks...**

## R-2000

The R-2000 is an all mode SSB, CW, AM, FM receiver that covers 150 kHz–30 MHz in 30 bands. New microprocessor controlled operating features and an UP conversion PLL circuit provide maximum flexibility and ease of operation to enhance the excitement of listening to stations around the world. Key features include digital VFO's, ten memories that store frequency, band, and mode information, memory scan, programmable band scan, fluorescent tube digital display, and dual 24-hour clock with timer.

### R-2000 FEATURES:

- **Covers 150 kHz–30 MHz in 30 bands.** Uses innovative UP-conversion digitally controlled PLL circuit. UP/DOWN band switches (1-MHz step). VFO's continuously tuneable across 150 kHz–30 MHz.
- **All mode: USB, LSB, CW, AM, FM.** Provides expanded flexibility in receiving various signal types. Front panel mode selector keys, with LED indicators.
- **Digital VFO's for best stability.** 50-Hz step, switchable to 500-Hz or 5-kHz, using front panel pushbutton switches. F, LOCK switch provided.
- **Ten memories store frequency, band, and mode data.** Complete information on frequency, band, and mode is stored in memory, assuring maximum ease of operation. Each memory may be tuned as a VFO. Original memory frequency may be recalled. AUTO, M switch for automatic storage of current operating data, or when off, selective storage of data using M, IN switch.

- **Lithium battery memory back-up.** (Est. 5 yr. life.)
- **Memory scan.** Scans all memories, or may be programmed to scan specific memories. HOLD switch interrupts scanning. Frequency, band, and mode are automatically selected in accordance with the memory channel being scanned. The scanning time is approximately 2 seconds per channel.
- **Programmable band scan.** Scans automatically within the programmed bandwidth. Memory channels 9 and 0 establish upper and lower scan limits. HOLD switch interrupts scanning. Frequency may be adjusted, using the tuning control, during scan HOLD.
- **Fluorescent tube digital display (100-Hz resolution).** Built-in 7 digit fluorescent tube digital display indicates frequency or time, plus memory channel number. DIM switch provided. The display may be switched to indicate CLOCK-2, FREQUENCY, CLOCK-1, and timer ON or OFF by the front panel FUNCTION switch.
- **Dual 24-hour quartz clocks, with timer.** Permits programming two different time zones. Timer for ON and OFF programming. Timer REMOTE output on rear panel (not for AC power).
- **Three built-in IF filters with NARROW/WIDE selector switch. (CW filter optional.)** 6 kHz wide or 2.7 kHz narrow on AM. 2.7 kHz automatic on SSB. 2.7 kHz wide on CW, or, with optional YG-455C filter installed, 500 Hz narrow. 15 kHz automatic on FM.
- **Squelch circuit, all mode, built-in, with BUSY indicator.**
- **Noise blanker built-in.** Eliminates pulse-type noise on SSB, CW, and AM.
- **Large front mounted speaker.**
- **Tone control.**
- **RF step attenuator. (0-10-20-30 dB.)** Four step attenuator, plus antenna fuse.
- **AGC switch. (Slow-Fast.)**
- **"S" meter, with SIFPO "S" scale.**
- **High and low impedance antenna terminals.** A high impedance (500 ohm) terminal, and a low impedance (50 ohm) co-axial connector are provided.
- **100/120/220/240 VAC, or 13.8 VDC operation.** (Optional DCK-1 cable kit required for 13.8 VDC.)
- **Other features.**
  - RECORD output jack.
  - Audible "beeper" (through speaker).
  - Carrying handle.
  - Headphone jack.
  - External speaker jack.
- **Optional accessories:**
  - HS-4, HS-5, HS-6 headphones.
  - DCK-1 DC cable kit.
  - YG-455C 500-Hz CW filter.
  - HC-10 World, digital quartz clock.

More information on the R-2000 is available from all authorized dealers of Trio-Kenwood Communications  
1111 West Walnut Street  
Compton, California 90220.

**KENWOOD**  
...pacesetter in amateur radio

# STAFF

**PUBLISHER/EDITOR**  
Wayne Green W2NSD/1

**EXECUTIVE VICE PRESIDENT**  
Sherry Smythe

**ASSISTANT PUBLISHER/EDITOR**  
Jeff DeTray WB8BTH

**MANAGING EDITOR**  
John Burnett

**ASST. MANAGING EDITOR**  
Susan Philbrick

**EDITORIAL ASSISTANTS**  
Nancy Noyd  
Richard Phenix  
Steve Jewett

**TECHNICAL EDITOR**  
Avery L. Jenkins WB8JLG

**ASSISTANT TO THE PRESIDENT**  
Matthew Smith KA1EI

**ASSOCIATES**  
Robert Baker WB2GFE  
John Edwards K1ZU  
Bill Gosney KE7C  
Sanger Green  
Chod Harris VP2ML  
Dr. Marc Leavey WA3AJR  
J. H. Nelson  
Bill Pasternak WA6ITF  
Peter Stark K2OAW

**PRODUCTION MANAGER/ PUBLICATIONS**  
Nancy Salmon

**ASST. PRODUCTION MANAGER/PUBLICATIONS**  
Michael Murphy

**ADVERTISING GRAPHICS MANAGERS**

Scott W. Philbrick  
Fiona Davies  
Bruce HedIn  
Jane Preston

**PRODUCTION**  
Frances Benton  
Linda Drew  
Denzel Dyer  
Phil Geraci  
Donna Hartwell  
Louis Marini  
Dianne K. Ritson  
Anne Rocchio  
Mary Seaver  
Deborah Stone  
Theresa Verville  
Judi Wimberly  
David Wozmak

**PHOTOGRAPHY**  
Thomas Villeneuve  
Sandra Dukette  
Laurie Jennison  
Irene Vall  
Robert M. Villeneuve

**TYPESETTING**  
Sara Bedell  
Marie Barker  
Melody Bedell  
Michele DesRochers  
Jennifer Fay  
Lynn Haines  
Linda Locke  
Nancy Wilson-Newman  
Debbie Nutting  
Karen Stewart

**GENERAL MANAGER**  
Debra Wetherbee

**CONTROLLER**  
Roger J. Murphy

**ACCOUNTING MANAGER**  
Knud Keller KV4GG/1

**CIRCULATION MANAGER**  
Patricia Ferrante  
603-924-9471

**BULK SALES MANAGER**  
Ginnie Boudrieau  
1-(800)-343-0728

**ADVERTISING**  
603-924-7138  
Jim Gray W1XU, Mgr.  
Nancy Ciampa, Asst. Mgr.  
Ross Kenyon KA1GAV  
Cornelia Taylor

sure cut a lot of ice in St. Thomas. I was sorry to hear that Dick passed away recently... we'll all miss that incredible fist of his. Any serious CW operator could tell Dick instantly by the perfection of his fist.

Please give me a hand with this so that we can bring amateurs worldwide together a bit. The end result will be a lot more interesting things for us to talk about... perhaps bringing more DX operators onto our bands. Ops in rare countries sure get sick of endless demands for instant contacts and QSL cards. I get ham magazines from the U.K., South Africa, Malaysia, Australia, and so on, so I have a fair idea of what is going on... but 99.99% of you don't have that sort of input or the resources to pay for such a wide variety of magazines. Columns devoted to

*Continued on page 118*

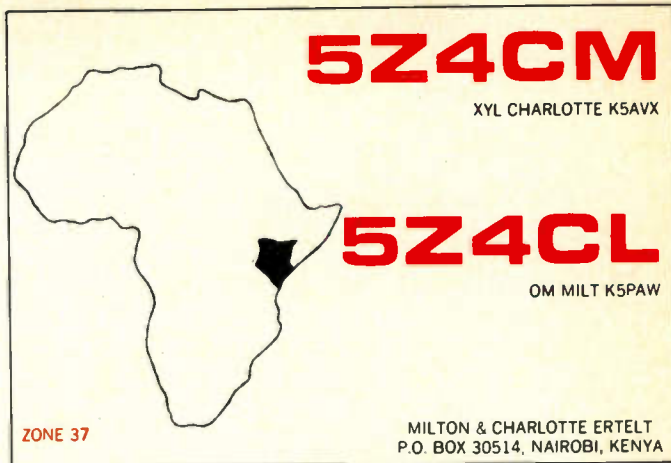

## QSL OF THE MONTH

This month's winning QSL comes from a Baptist mission in Kenya, the home of Milton (5Z4CL) and Charlotte (5Z4CM) Ertelt. The design is simple and informative, using only two colors to achieve a striking contrast.

Few cards are as succinct as this one, telling the reader at a glance where in the world the station is located. And from a distance, Charlotte and Milton's calls stand out clearly, leaving no doubt that this QSL is probably the pride of many a DXer's shack.

Entering 73's QSL contest is easy—send your QSL, in an envelope, to: Editorial Offices, 73, Peterborough NH 03458. Specify a book from 73's Radio Bookshop; if your card is chosen, we'll be happy to send the book along to you. Entries which are not in an envelope or do not specify a book will not be considered.

## Well... I Can Dream, Can't I?

by Bandel Linn K4PP

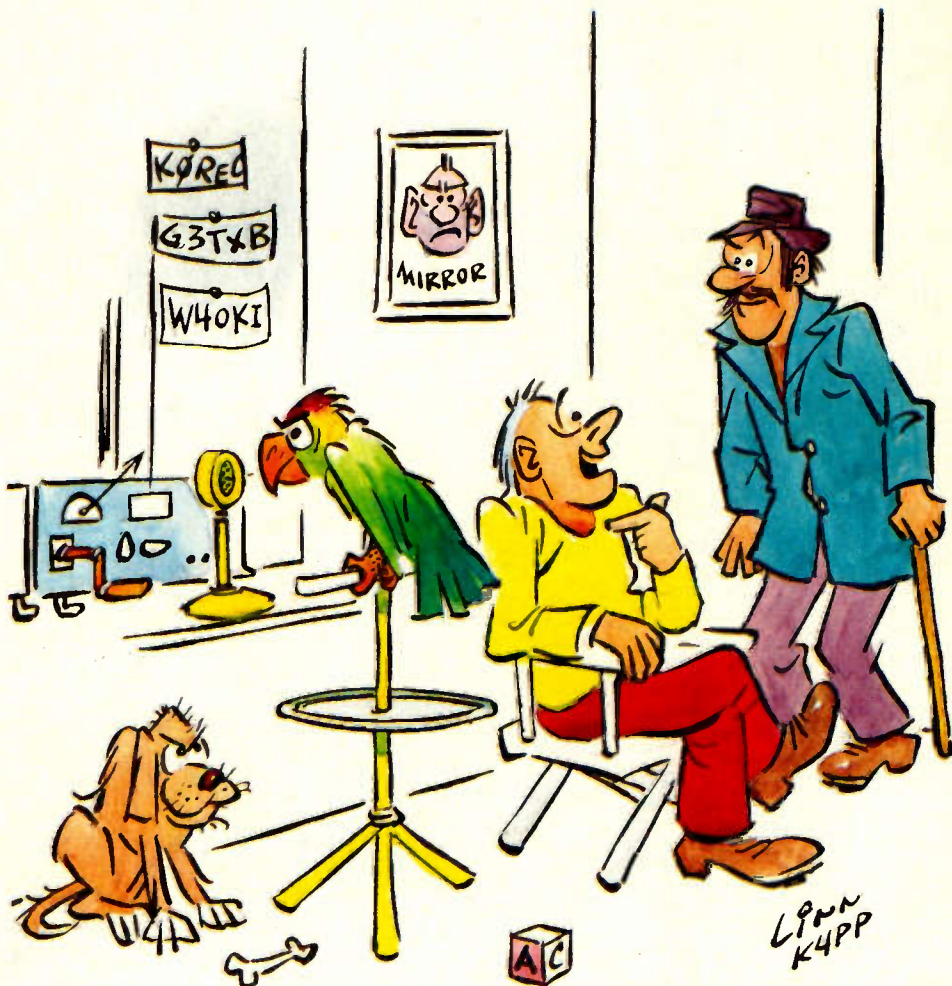

"I don't do anything much! He calls CQ and answers all questions!"



# At Last.

A microthin, synthesized, programmable, sub-audible tone encoder that fits inside the ICOM IC-2AT.

Need we say more?

\$29.95



**COMMUNICATIONS  
SPECIALISTS**

426 West Taft Avenue, Orange, CA 92667  
800/854-0547 California: 714/998-3021



**HL-32V** — This Little Beauty is the first of our compact, low profile amplifiers for use with handheld radios. For VHF operations, this unit produces 10W to 25W output with drive from your 0.5W to 3W handheld. Excellent for mobile use in your car.

Turn it on with the convenient front panel controls, including Power LED and Transmit LED, or slip the package under the seat out of sight and out of mind.

Low insertion loss on receive and selectable power level design provides low VSWR to the transceiver.

Use with any talkie from 0.5W to 3W for 10W to 25W output.

The HL-32V operates linear mode for SSB or FM (switch selected), and the best news of all: the price is only \$89.95 suggested retail! At your favorite dealer now!



**HL-20U** New Product Preview — Another super compact from Tokyo Hy-Power Labs . . . This one is for UHF, and it's beautiful, with the controls on the brushed metal face panel to make operation as easy as touch-and-go.

The ultra compact HL-20U is a basic amplifier for all UHF handheld radios, and it can accept input levels from 200mW to 3W, to produce a big 20W output signal.

Your UHF handheld operations have never experienced anything like this surprising little amplifier from Tokyo Hy-Power Labs. Price and availability of the HL-20U will be announced soon.

 TOKYO HY-POWER LABS, INC.

Long the quality leader among fine Japanese communications equipment manufacturers, TOKYO HY-POWER LABS now makes these outstanding units available to you through American dealers. Now you can get our advanced features and quality at your kind of prices.

# PRECISION MATCHING PAIR



**HC-150**  
&  
**HC-2000**

Tokyo Hy-Power Labs' HC-150 tuner, with an accurate 200W 3-30 MHz power meter/VSWR bridge and sturdy, quality-built coax or wire line antenna coupler, provides smooth, precision matching from any barefoot transceiver to antenna between 10 and 200 ohms. For a most reasonable sum of \$99.95.

If stompin' through the QRM at the edges of the band, where somehow the DX always seems to be, and where the VSWR usually heads for the sky, is your kind of thing; the HC-2000 is your kind of coupler. It can provide a matched antenna, while ready for both forward and reflected power at the same time on the accurate dual meter VSWR/wattmeter. At \$349.95 suggested retail, the HC-2000 can handle the output resulting from the full legal limit input to your linear amplifier.

The next time you want to make a lumpy line flat or to make a long line perform as it should, use a quality built, quality performing Tokyo Hy-Power Labs antenna coupler.

 **TOKYO HY-POWER LABS, INC.**  
SAITAMA, JAPAN

Distributed by  
**Encomm, Inc.** ✓ 208  
2000 Avenue G, Suite 800, Plano, Texas 75074  
Phone (214) 423-0024 TLX 79-4783 ENCOMM DAL

When it comes to

# QSL's...



it's the  
**ONLY BOOK!**

US or Foreign Listings

## 1983 callbooks NOW READY!

Here they are! The latest editions of the world-famous Radio Amateur Callbook are available now. The U.S. edition features over 400,000 listings, with over 75,000 changes from last year. The Foreign edition has over 370,000 listings, over 50,000 changes. Each book lists calls and the address information you need to send QSL's. Special features include call changes, census of amateur licenses, world-wide QSL bureaus, prefixes of the world, international postal rates, and much more. Place your order for the new 1983 Radio Amateur Callbooks, available now.

	Each	Shipping	Total
<input type="checkbox"/> US Callbook	\$19.95	\$3.05	\$23.00
<input type="checkbox"/> Foreign Callbook	\$18.95	\$3.05	\$22.00

Order both books at the same time for \$41.95 including shipping.

Order from your dealer or directly from the publisher. All direct orders add shipping charge. Foreign residents add \$4.55 for shipping. Illinois residents add 5% sales tax.



### SPECIAL OFFER!

Amateur Radio  
Emblem Patch  
only \$2.50 postpaid

Pegasus on blue field, red lettering. 3" wide x 3" high. Great on jackets and caps.

ORDER TODAY!

61

RADIO AMATEUR  
**callbook** INC.

Dept. B  
925 Sherwood Drive  
Lake Bluff, IL 60044, USA

# HUSTLER HF MOBILES DELIVER FIXED STATION PERFORMANCE

Hustler HF antennas deliver outstanding signal reports — wherever you're mobile!

Design your own HF mobile from a full selection of top-quality; U.S.-made stainless steel ball mounts, quick disconnects, masts, springs, and resonators. You can cover any 6-to-80-meter band. Choose from medium or high power resonators with broadest bandwidth and lowest SWR for optimum performance on any band. Easy band change and garaging with Hustler's fold-over mast, too.



Ask any ham — the best HF mobiles on the road come from: Hustler — still the standard of performance.



3275 North "E" Avenue  
Kissimmee, Florida 32741

An **AMERICAN** Company

## HI-Q BALUN

- For dipoles, yagis, inverted vees & doublets
- Replaces center insulator
- Puts power in antenna
- Broadbanded 3-40 MHz
- Small, lightweight and weatherproof
- 1:1 Impedance ratio
- For full legal power and more
- Helps eliminate TVI
- With SO 239 connector



only \$12.95

### HI-Q ANTENNA CENTER INSULATOR



Small rugged, lightweight weatherproof. Replaces center insulator. Handles full legal power and more.

\$6.95 With SO 239 connector

### HI-Q ANTENNA END INSULATORS



Rugged, lightweight, Injection molded of top quality material, with high dielectric qualities and excellent weatherability. End Insulators are constructed in a spiral unending fashion to permit winding of loading coils or partial winding for tuned traps.

- May be used for Guy wire strain insulators
- End or center insulators for antennas
- Construction of antenna loading coils or multiband traps

\$4.95

## DIPOLES

MODEL	BANDS	LENGTH	PRICE WITH HI-Q BALUN	WITH HI-Q CENTER INSULATOR
<b>Dipoles</b>				
D-80		80,75	130	\$31.95 \$27.95
D-40		40,15	66	28.95 24.95
D-20		20	33	27.95 23.95
D-15		15	22	26.95 22.95
D-10		10	16	25.95 21.95
<b>Shortened dipoles</b>				
SD-80		80,75	90	35.95 31.95
SD-40		40	45	32.95 28.95
<b>Parallel dipoles</b>				
PD-8010	80,40,20,10,15		130	43.95 39.95
PD-4010	40,20,10,15		66	37.95 33.95
PD-8040	80,40,15		130	39.95 35.95
PD-4020	40,20,15		66	33.95 29.95
<b>Dipole shorteners — only, same as included in SD models</b>				
S-80		80,75		\$11.95 pr
S-40		40		\$10.95 pr

All antennas are complete with a HI-Q Balun or HI-Q Antenna Center Insulator, No. 14 antenna wire, ceramic insulators, 100 nylon antenna support rope (SD models only 50) rated for full legal power. Antennas may be used as an inverted V and may also be used by MARS or SWLs.

Antenna accessories—available with antenna orders  
Nylon guy rope 450# test 100 feet \$4.49  
Ceramic (Dogbone Type) antenna insulators \$1.50 pr  
SO 239 coax connectors .55

All prices are postpaid USA 48  
Available at your favorite dealer or order direct from

Dealer Inquiries Invited  
**Van Gorden Engineering**

BOX 21305 B, SOUTH EUCLID, OHIO 44121

# Action Machine for 20

*Are home-brew rigs a lost art? Not yet!  
Here's an SSB transceiver you can build.*

I designed and built mini'ceiver 20 to learn something about SSB transceiver design. Several times in the course of the project I became convinced that I was learning more about SSB transceiver design than I ever wanted to know! Anyway, mini'ceiver has worked out and it's quite a conversation piece on the air. You can run mini'ceiver from a lantern battery, which opens up a number of possibilities. I have made an effort to use readily-available parts and easy-to-tune circuits in

mini'ceiver, so I feel you will have a good shot at making it work if you want to give it a try.

This article covers mini'ceiver's circuit operation once over lightly and then, in some detail, the circuit schematics. No math or theory here, just a shirt-sleeve discussion of the circuitry and how well it seems to work. If you are game at this point, I'll then give you some hints on how to build and tune up mini'ceiver, and I'll wind up with some ideas on accessories, possible de-

sign alternatives, and operation. If you've always wanted to build a good size project from scratch but never quite got around to it, this article is written for you. I'll try to give you an idea of what you've been missing.

## Mini'ceiver Circuit Operation

Let's first look at Fig. 1, mini'ceiver's block diagram. Mini'ceiver is a 20-meter single-conversion superheterodyne transceiver boiled down to the basics. A conventional 9-MHz i-f frequency is used.

In the receive mode, an incoming signal in the 14.25-14.30-MHz range is routed through the receiver antenna switch to a dual-gate MOSFET mixer where it is mixed with the vfo signal (vfo range is 5.250-5.300 MHz). The mixer's difference output, at 9 MHz, is routed through the receiver side of the T/R filter switch to the four-pole crystal filter, which provides the receiver's selectivity. The i-f output from the crystal filter is amplified by a single-stage IC amplifier which can provide a voltage gain of up to about 1000. The

output from the i-f amplifier is mixed with the 8.9985-MHz bfo in the MOSFET product detector, recovering, typically, 5 mV of audio.

The audio output from the product detector is amplified by the low-level audio amplifier and then routed to the agc amplifier and the volume control. The agc amplifier further amplifies the audio to around five volts peak-to-peak and then detects this signal to develop the agc control voltage. Meanwhile, audio from the volume control is routed to the audio power amplifier and on to the speaker jack. While in the receive mode, the transmit circuitry is disabled by switching off the +T supply voltage.

In the transmit mode, the +T voltage is switched on as the +R voltage is switched off, enabling the transmitter circuitry as the receiver circuitry drops out. Low-level speech signals from the microphone are amplified to about 1.5 volts peak-to-peak by the speech amplifier and applied to the balanced-modulator audio input. Here the audio is mixed with the bfo signal in an IC double-balanced mod-

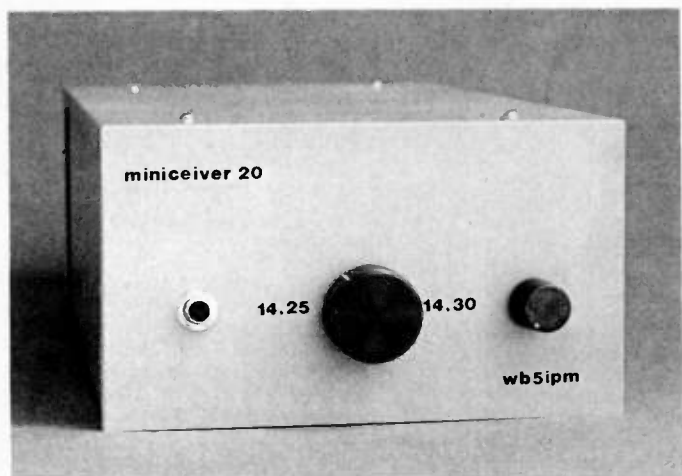

Photo A. Mini'ceiver 20 is an SSB transceiver boiled down to the basics.

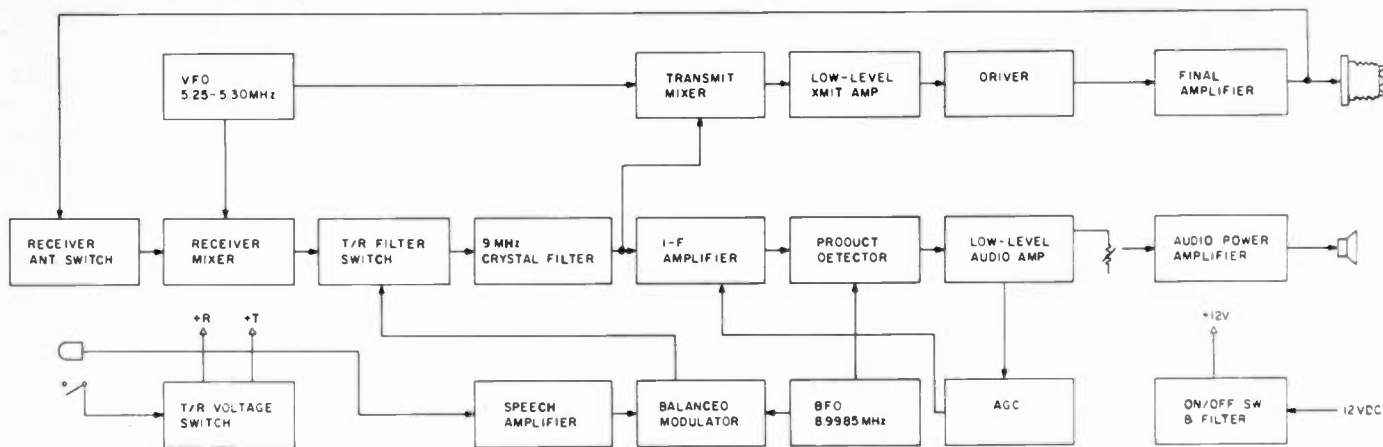

Fig. 1. Mini'ceiver 20 block diagram.

ulator. The double-sideband output from the modulator is routed through the transmit side or the T/R filter switch to the crystal filter. The crystal filter strips off the unwanted lower sideband and routes the 9-MHz SSB signal to the transmit mixer. At the transmit mixer, the 9-MHz SSB signal is mixed with the vfo signal and the sum output at 14 MHz is developed in the transmit mixer's tuned output circuit.

The 14-MHz SSB signal next is amplified by two MOSFET low-level transmit amplifiers to about 600 mV peak-to-peak. The driver stage boosts this signal to about 200 mW and the final amplifier to about 1.5 W. The output from the final is sent to the antenna. Since the receiver antenna switch is open in the transmit mode, the receiver mixer is protected from overload.

The +R and +T power-supply voltages are alternately switched on under the control of the microphone PTT switch. All in all, mini'ceiver is a simple and straightforward design.

### T/R Voltage Switch

Almost every modern SSB transceiver design incorporates digital logic, and mini'ceiver is no exception. Refer to Fig. 2, the T/R voltage switch schematic. A 4093BE CMOS quad Schmitt NAND gate is the heart of this circuit. When

the PTT switch is open, +12 V dc is applied to R1 and on through the gate interconnections to pull R3 low at pin 10. This turns on Q1 and supplies +R to most of the receiver circuitry. +R also turns on Q4, which helps pull down the +T voltage on a transmit-to-receive transition. Meanwhile, pin 11 is at +12 V dc and Q2, +T, and Q3 are off.

When the PTT switch is closed, the input side of R1 is grounded, which first allows pin 10 to go to 12 V dc, shutting off Q1 and Q4. About 30 milliseconds later pin 11 will go low, turning on Q2 and Q3, supplying +T to the transmit circuitry and clamping +R to ground. R2 and C3 account for the time that both +R and +T are off during a receive-to-transmit or transmit-to-receive transition. R1 and C2 simply form a glitch filter. Schmitt inputs were chosen

for reliable logic switching with the slow rise times provided by R1-C2 and R2-C3.

The vfo, bfo, audio power amplifier, and the collectors of the transmitter driver and final amplifier are continuously supplied with +12 V dc from the input power jack. C1 provides dynamic filtering for operating from dry cell batteries, etc.

### Vfo and Bfo

Fig. 3 provides the vfo and bfo schematics. We'll start with the latter. The bfo is a grounded-base crystal oscillator designed to work with a series-resonant 8.998500-MHz crystal. It is easily tuned  $\pm 300$  Hz, which allows you to tailor the "sound" of the rig somewhat. It will provide a 5-V peak-to-peak output when loaded by the product detector and balanced modulator. This is a

must. I first had the bfo circuit on the receiver main board. I also had about two volts of bfo in the i-f amplifier output, plus all the local AM radio stations, etc! Keep the bfo shielded from the i-f amplifier; that is sage advice.

The vfo consists of a buffered Hartley oscillator designed along recently-published guidelines.<sup>1</sup> I found the vfo to be quite stable. Tuning is very fast; you may want to use a reduction drive if you don't have a steady hand. R18 allows the vfo output to be adjusted to 5 V peak-to-peak. The vfo also is built in a minibox, primarily for its own protection. The box helps stabilize temperature and shield the vfo from other rf signals.

### Receiver Rf Section

CR3, CR4, R24, R25, R26, C28, and C29 form the receiver antenna switch. In the

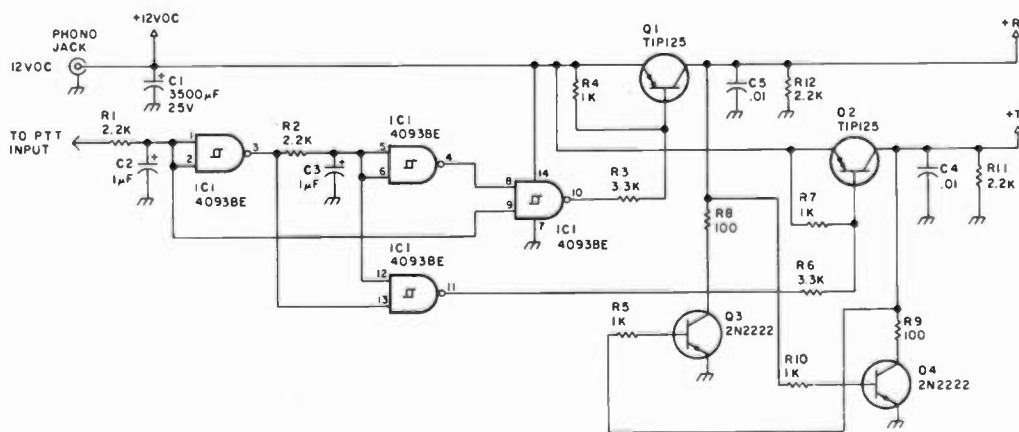

Fig. 2. T/R voltage switch.

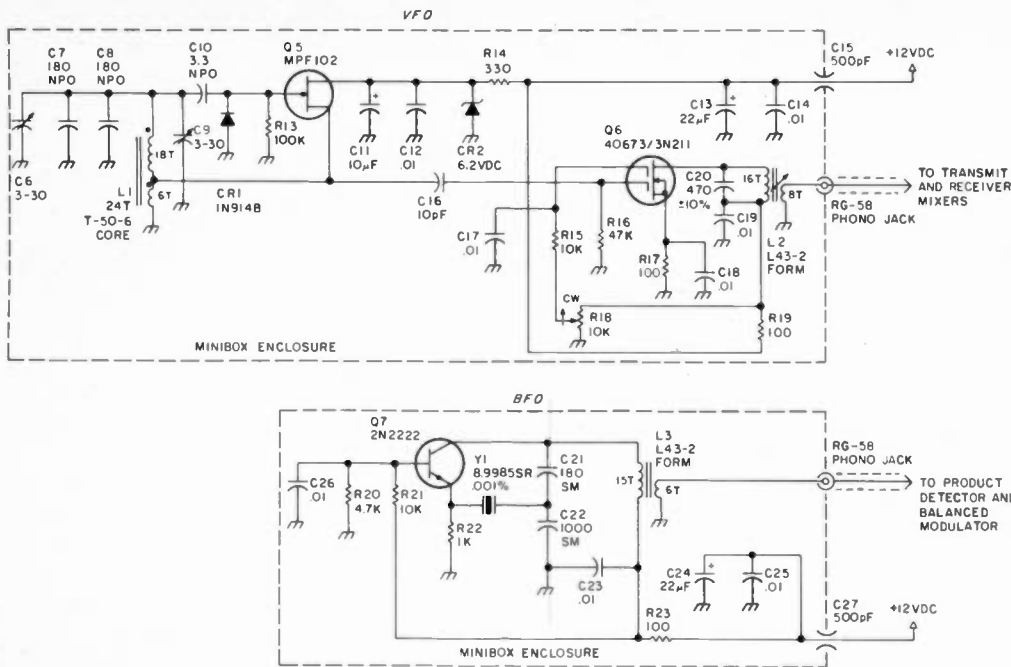

Fig. 3. Vfo and bfo schematics.

receive mode, R25 supplies current to CR3-R24 and CR4-R26 from +R. CR3 and CR4 are forward-biased with about 5 mA dc and appear to small rf signals from the antenna as 25-Ohm resistors. Receiver signals thus easily can pass through C28 and C29, which are dc blocking capacitors, and the two forward-biased diodes to the input transformer of the mixer.

When the bias to the diodes is removed in the transmit mode, the diode switch opens. Notice that when the

rf output from the final amplifier is positive, CR3 is reverse-biased so little signal makes it to the mixer input transformer. When the rf output from the final is negative-going, CR3 is forward-biased so the rf signal appears at R25. However, CR4 is now reverse-biased, blocking the rf output from reaching the mixer input.

The use of this type of diode switch eliminates the need for a mechanical relay. Purists would probably add some rf chokes in series with the biasing resistors

and might use PIN diodes; however, I'm not a purist — just cheap.

The receiver mixer employs the often-used 40673 (Q8) which is adequate for this application. We now come to the second diode switch in the mini-ceiver, which is used to switch signals to the crystal filter from either the receiver mixer or the double-balanced modulator. CR5 forms half the switch; CR8 (Fig. 6) forms the other half. When +R is on, CR5 is conducting about 6

mA dc, again providing a low-loss path to small rf signals. Meanwhile, CR8 is back-biased, isolating the balanced modulator from the receiver mixer output and crystal-filter input. R30 is the biasing resistor for CR5. R31 establishes a suitable input impedance for the crystal-lattice filter.

The crystal-lattice filter uses four crystals, two cut for series-resonance 750 Hz below center frequency and two cut for series-resonance 750 Hz above center frequency. The overall 6-dB bandwidth appears to be about 2200 Hz. Unwanted sideband suppression is around 26 dB (5%) at 1000 Hz, which is OK for QRP.

While the filter can be built for under \$30, you won't hurt my feelings if you use a commercial filter here. Remember to adjust R31 and R32 to suit the commercial filter's termination impedance if you decide to go this route.

I've always had good luck with the MC1350 i-f amplifier (IC2). It exhibits high but stable gain when properly terminated and smooth forward agc action, assuming you keep the bfo signal out of it. The value of R40 and the turns ratio of L6 were chosen for high stable gain. I



Photo B. Typical mini-ceiver SSB voice waveform. About 1.5-W p-p output.

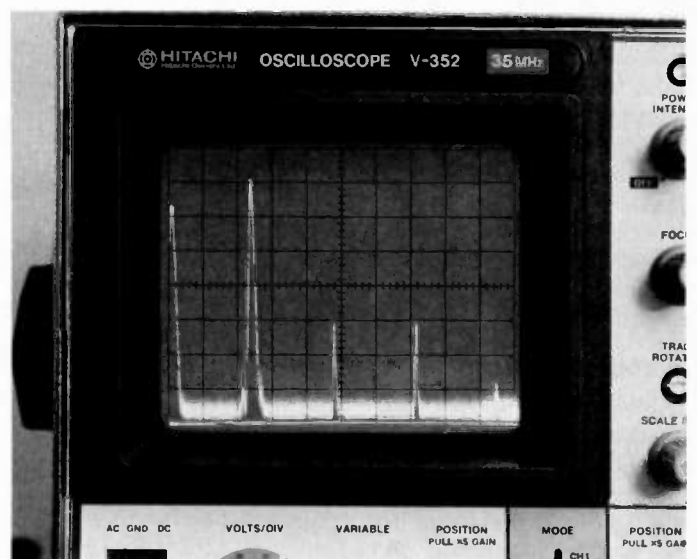

Photo C. Output spectrum consists primarily of the fundamental and harmonics. All spurs are more than 40 dB down.

# REGAL RTTY



By popular acclaim – the leader and king of radio teleprinter communications – the HAL DS3100ASR and ST6000. When combined with the MSO3100 Message Storage Option and a hard-copy printer, you have the premier RTTY station. Discriminating operators the world-over choose the DS3100 and ST6000 for their stations over any other equipment. The DS3100 and ST6000 have set new standards of comparison for commercial and amateur RTTY data communications; they are representative of the high standards of quality and performance for which HAL is known throughout the world. Put your best RTTY signal forward with the DS3100 and ST6000!

- Send and receive ASCII, Baudot and Morse code
- Full length 72 character lines and 24 line screen
- True "ASR" operation – pretype while receiving
- 50 Line pretype, on-screen transmit buffer
- 150 Line receive display buffer
- MSO3100 adds 450 lines of MAILBOX message storage
- P31 green, 12 inch display screen is built-in
- Control functions are clearly marked on keytops
- On-screen status indicators with real time
- Upper-lower case ASCII with ALL control codes
- 45, 50, 57, 74, 100 baud Baudot
- 110, 150, 300, 600, 1200, 1800, 2400, 4800, and 9600 baud ASCII – full or half duplex
- 1 to 175 wpm send and receive Morse code
- Current loop or RS232 I/O interface
- ST6000 has tuning oscilloscope and loop supply
- Three RTTY shifts: 170, 425, or 850 Hz
- Multiple active RTTY filters and detector stages
- Crystal controlled RTTY transmit tones
- Printers available for hard-copy of all 3 codes

Write or call for more details. See the DS3100, MSO3100, ST6000, and printers at your favorite HAL dealer.



**HAL COMMUNICATIONS CORP.**

BOX 365

URBANA, ILLINOIS 61801

217-367-7373

✓345

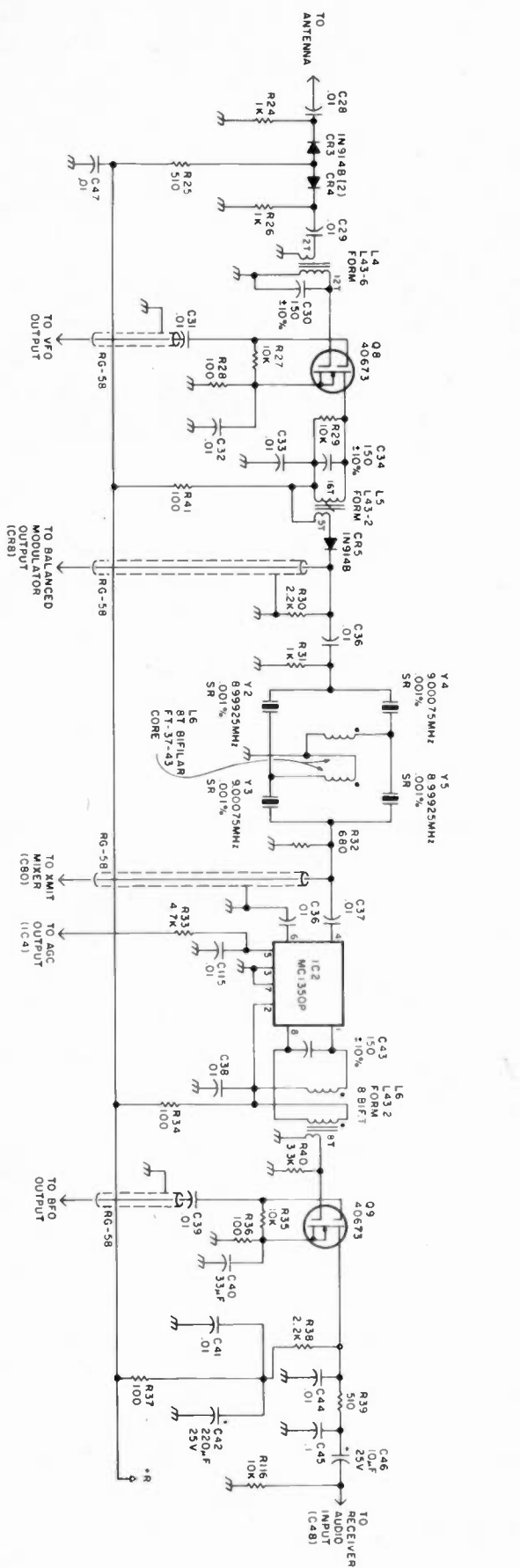

Fig. 4. Receiver rf schematic.

don't suggest pushing the IC harder by raising the value of R40. You don't need the extra gain and accompanying headache.

The faithful 40673 MOSFET is again in service as a product detector at Q9. Notice the heavy audio bypassing and decoupling.

### Receiver Af Section

Refer to Fig. 5. An LF353 dual op amp (IC3) is used as the receiver low-level audio amplifier. R47 allows the audio gain to be trimmed out to suit. C50 and C51 help roll off the high-frequency response of the audio section. The LM383 audio power amplifier, IC5, is somewhat of a power overkill, but it provides low-distortion audio at normal listening levels—much better than trying to push an underrated audio section too hard.

IC4 is another LF353, this time used as an agc amplifier and detector. I seem to get the best results with audio-derived agc when the base audio frequencies are rolled off—which explains the small value of C54. R57 controls the agc attack time and R58 controls the release time. Of course, changing C58 messes up both time constants. Agc characteristics are quite subjective, so feel free to experiment here. You might consider agc something of a luxury on a basic transceiver. On 20 meters, I don't.

### Speech Amp, Balanced Modulator, and Transmit Mixer

Fig 6 details the above-mentioned circuitry. Again an LF353 is used as a two-stage audio amplifier (IC6). This time it is rigged to provide a high-impedance input to the microphone. Since high-impedance audio circuits make me nervous, I heavily decoupled the input from rf. A 1496N double-balanced mixer (IC7) is employed as the balanced modulator and works quite well. At least 40 dB of carrier

suppression is easily obtained by adjusting R77. Notice the other end of the T/R filter switch (CR8) at the output of the balanced modulator.

After being routed through the crystal filter to do away with the lower sideband, our 9-MHz SSB signal is ready to be translated to 14 MHz. It was at this point that I started learning too much about SSB transceiver design. I won't bore you with all the mixer circuits that didn't work. Let me just say that I have seen just about every picket fence display on my spectrum analyzer that I could imagine (see "Poor Man's Spectrum Analyzer," 73, August, 1982). The biggest problem was the 3rd harmonic of the vfo at 15 MHz. Now you can supposedly get this out with a carefully designed multiple bandpass filter, but it sort of compromises our simple-to-build theme. Fortunately, there is another way.

First, start with a 1496N double-balanced mixer. Next, don't drive the carrier port (pin 8) with more than 70 mV peak-to-peak of vfo signal. This leaves the mixer pretty much in "linear" operation so that not much 3rd harmonic of the vfo appears in the mixer output. (Refer to the spectrum photo, which tells the story.) Anyway, we now have a clean 14-MHz SSB signal, so on to the transmit amp chain.

### Transmit Amplifier Chain

Referring to Fig. 7, we find the transmit amplifier chain uses both tuned and broadband stages. Q11 and Q12 are tuned low-level amplifier stages. There is more potential gain in these stages than needed, so the turns ratio at L9 is not for impedance matching, it's to "throw away" some extra gain without lowering Q. The turns ratio at L10 provides a suitable match between the drain of Q11 and the 30-Ohm or so input im-



# hy-gain<sup>®</sup> MONOBANDERS MAXIMUS

**MAX. MECHANICAL INTEGRITY,  
ELECTRICAL PERFORMANCE,  
SPACE SAVINGS AND SELECTION**

MODEL NO.	AVERAGE GAIN		NO. OF ELEMENTS	LONGEST ELEMENT		BOOM LENGTH		TURNING RADIUS		BANDS	SHIPPING WEIGHT	
	db	db		ft	m	ft	m	ft	Meters		lbs	kg
402BAS	4.9	25	2	45.9	14	16.1	4.9	25	7.6	40	47	21.3
204BAS	10	25	4	36.5	11.1	26	7.9	22.5	6.7	20	55	25
205BAS	11.6	35	5	36.5	11.1	34	10.4	25	7.6	20	77	35
155BAS	12	25	5	24.5	7.5	26	7.9	17.5	5.3	15	42	19
105BAS	12	35	5	18.5	5.6	24	7.3	15	4.6	10	29	13

3-Element Monobanders also available  
Optional BN-86 balun recommended for above antennas.

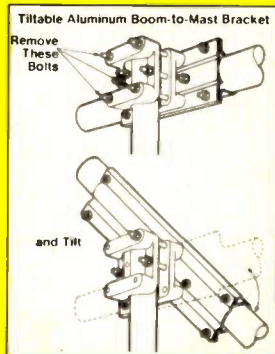
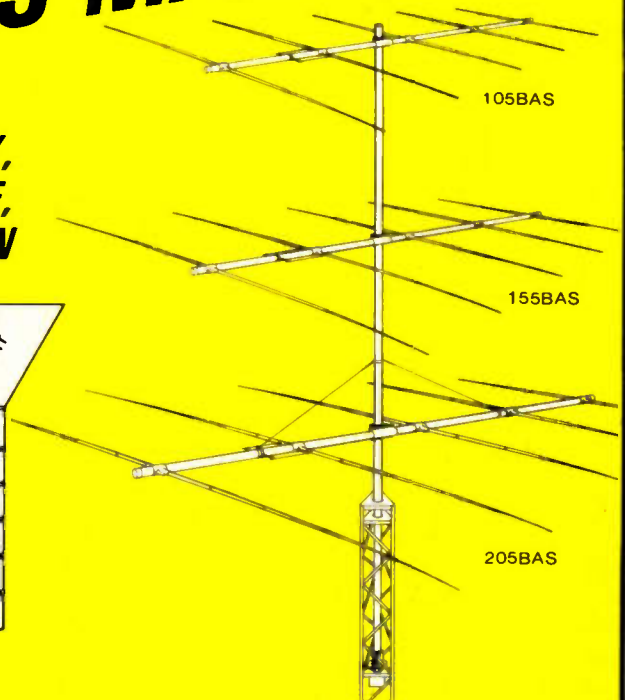

MECHANICALLY Hy-Gain monoband antennas employ the best materials available and are fabricated with accurate tooling for an integral balance so all parts work together. For example, our element-to-mast brackets are the best in the industry and our tiltable mast-to-boom clamps are unique. Stainless steel hardware is chemically passivated to eliminate rust. All tubing and parts are deburred and finished so you don't have to re-manufacture the antenna before installation. It all adds up to antennas with maximum mechanical integrity that withstand 80 mph (129 km/h) windloads and radial ice.

ELECTRICAL performance is not based on theoretical calculations alone but is tuned and tested for optimum results on our government approved test range. Hy-Gain's factory tuned 52 ohm Beta Match is exclusive and assures positive dc ground for lightning protection and reduced precipitation static. Though sometimes unconventional, our meticulous element spacing assures maximum F/B ratio and uncompromising power gain. VSWR at resonance is less than 1.5:1. All Hy-Gain monobanders handle maximum legal power. In short, electrical performance is at maximum by design and requires no re-tuning.

SPACE problems are virtually eliminated. Even our largest monoband antennas fit most residential lots. And thanks to Hy-Gain's careful materials selection and superb mechanical engineering, the weight and windload of antennas is at an absolute minimum to permit stacking on conventional heavy duty towers and rotators. This gives you maximum DX performance even with limited space.

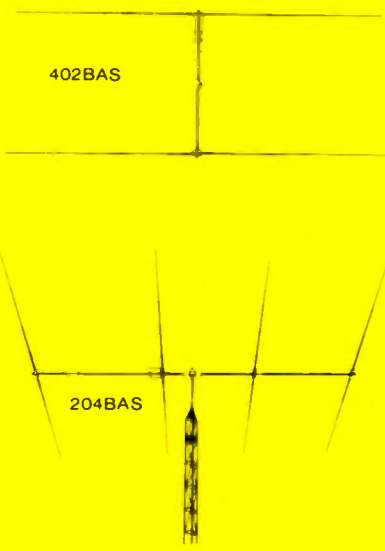

### MONOBAND BEAMS

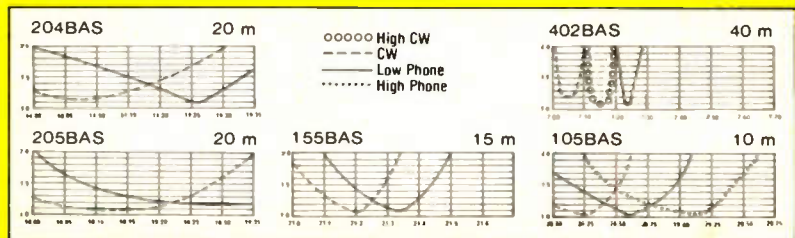

Hy-Gain Monobander Antennas Maximus  
at Better Amateur Dealers

**TELEX hy-gain**

TELEX COMMUNICATIONS, INC.

9600 Aldrich Ave. So., Minneapolis, MN 55420 U.S.A.  
Europe: Le Bonaparte - Office 711, Centre Affaires Paris-Nord, 93153 Le Blanc-Mesnil, France.

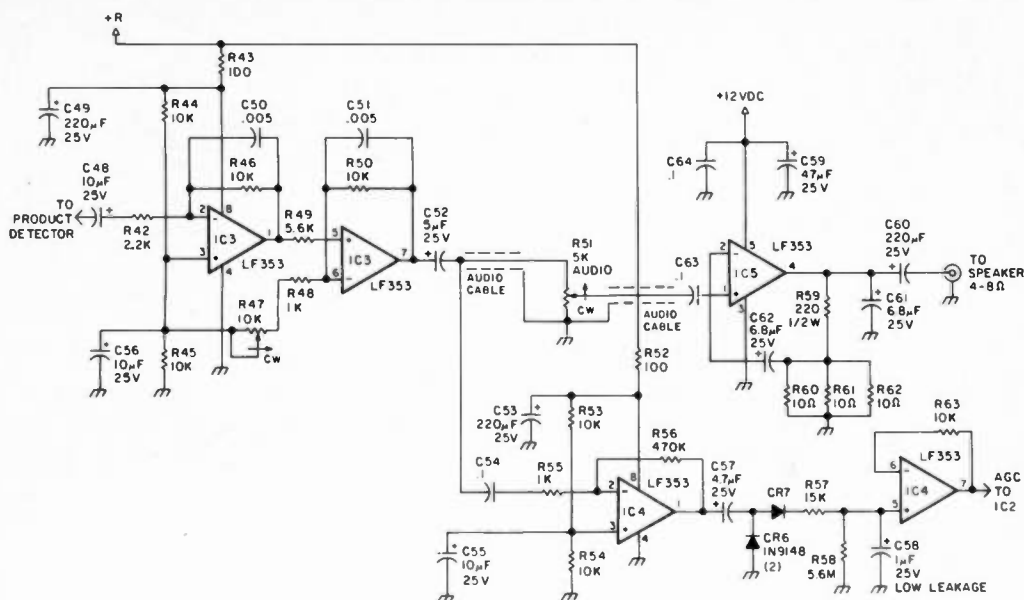

Fig. 5. Receiver af schematic.

pedance of the driver. The driver is the broadband stage. The same feedback that sets the broadbanding on this stage pretty much ensures low-frequency stability, which is what I was after. It seems a little hard to find a suitable driver for HF work, but the 2N3866, which often is used in cable TV systems, is very easy to find. Since it is a VHF transistor,

feedback for the sake of stability seems prudent in an HF driver application.

L12 matches the output of the driver to the 5-Ohm or so input impedance of the final amplifier. A single pi network of rather low Q transforms the assumed 50-Ohm antenna impedance to around 35 Ohms, setting up the 1.5-W output with some room to spare. L16 and C108

form a series-resonant trap that takes care of the 2nd harmonic, which is the only offending spur. Notice that the bias to both the driver and the final amplifier are switched by +T. Despite some deliberate and under-berate attempts, I've not managed to zing the final (probably because I have a spare). Harmonic suppression appears to be fairly in-

sensitive to antenna impedance, which is characteristic of series trap suppression. R99 allows you to adjust the overall gain of the amplifier chain.

### Mini'ceiver Construction

I feel that you will have a good chance of successfully building the mini'ceiver, or your customized version of it, if you are comfortable using a triggered oscilloscope in troubleshooting and have built several kits and scratch-built projects. Or, of course, if you can get help from a friend and/or someone in your club or repeater group with the above experience. I'm not trying to discourage anyone; I just want you to have a good chance for success if you embark on the project. Building and experimenting is great fun, and I want it to stay that way for you. I believe that you can build mini'ceiver for about \$200, maybe less if you have a big junk box.

### Parts

See below for the list-

### Parts List

Component	Ref#	Supplier#
4093BE	IC	IC1
1350P	IC	IC2
1496N	IC	IC7-8
LF353	IC	IC3-4,6
LM383	IC	IC5
TIP125	DBJT	Q1-2
2N2222	BJT	Q3-4,7
MPF102	JFET	Q5
40673	MOSFET	Q6,8-10
2N3866	BJT	Q12
MRF476	BJT	Q13
1N914B	Diode	CR1-8,10
1N4001	Diode	CR9
8.998500 MHz	.001% SR crystal	Y1
8.999250 MHz	.001% SR crystal	Y2,5
9.000750 MHz	.001% SR crystal	Y3-4
L43-2	Coil form	L2,5-7
L43-6	Coil form	L4,8-10
FT-37-43	Toroid	L6
FT-50-61	Toroid	L11
T-50-6	Toroid	L14-16
3-30 pF	Var. cap., 1/4" shaft	C9
3-30 pF	Var. cap., PC mount	C6
80-300	Arco trimmer	C114
4-40	Arco trimmer	C108
5% NPO	Ceramic cap	C7-8,10
10% TS	Ceramic cap	C20,30,34
		43,76-77
		88, 91

5% SM	Silver mica cap	C21,22	2,4,8
		C105-107	
500 pF	Feedthrough cap, threaded type	C15,17	1
1 uF	Low-leak cap	C58	7
CU-3000A	Bud minibox		2
CU-3011A	Bud minibox		2

Note: Other components are garden variety 1/4- and 1/2-W resistors, +80, -10% 50-V ceramic capacitors, and standard electrolytic capacitors.

### Suppliers:

1. Alaska Microwave Labs, 4335 E 5th Street, Anchorage AK 99504; (907)-338-0340.
2. Allied Electronics, 401 E 8th Street, Fort Worth TX 76102; (817)-336-5401.
3. Amidon Associates, 12033 Otsego Street, N. Hollywood CA 91607; (213)-760-4429.
4. Jameco Electronics, 1355 Shoreway Road, Belmont CA 94002; (415)-592-8097.
5. Jan Crystals, 2400 Crystal Drive, Fort Meyers FL 33906; (813)-936-2397.
6. RadioKit, Box 411S, Greenville NH 03048; (603)-878-1033.
7. Radio Shack.
8. Semiconductors Surplus, 2822 N 32nd Street #1, Phoenix AZ 85008; (602)-956-9423.

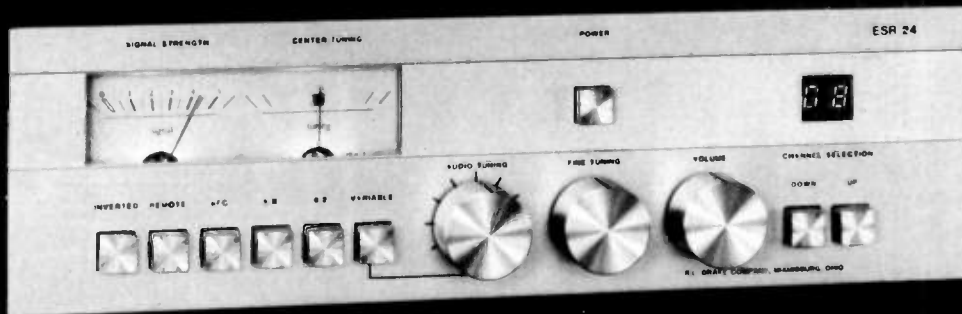

## **DRAKE ESR-24 Satellite TV Receiver**

• All 24 Satellite Channels • Attractive Styling • Digital Display • UP/Down Channel Button Control • Fixed and Variable Audio Tuning for all Subcarriers • Normal/Inverted Video Switching • Signal and Tuning Meters • Single and Double Down Conversion Models • AFC for drift-free operation • Remote Control and Remote Metering Options

### Satellite TV System - AES Package Deal

Includes: • Wilson MD-11B Antenna with Polar Mount • Drake ESR-24 Satellite Receiver w/Down Converter • 120° LNA • Scaler Feed • LNA Rotor

**All for \$1895<sup>00</sup>** - For Details - Call Paul Wittkamp, WA9TFG at our Milwaukee TVRO Headquarters

Options: RF Modulator - \$59<sup>95</sup>; Splash Proof Box - \$24<sup>95</sup>; 100° LNA - \$60<sup>00</sup> extra; Cables



Paul Wittkamp  
WA9TFG

### **WILSON** Microwave Satellite MICROWAVE SYSTEMS, INC. TV Antenna

Model MD-11B New, improved 11' parabolic polar mounted antenna, the perfect companion for the DRAKE ESR-24 receiver. Includes a polar mount which is simple to install utilizing a single pedestal, rotatable base. Anchor bolts are simply set into postholes & concrete; professional concrete work & leveling are not necessary. Two men can install antenna in 3 hours after concrete hardens. Works well in any location in the U.S. Adjustable declination angle sweeps true for all parts of the country; azimuth crank is interchangeable for either East or West coast locations.

#### MD-11B Specifications:

##### ANTENNA

Diameter ..... 11' or 3.35m  
Construction ..... 12 panels, 18 ga. steel  
Finish ..... Tan, zinc primer  
Weight ..... 225 pounds  
Wind-operational... 50 mph steady load  
Survival ..... 100 mph steady load  
Temperature range ..... -60 to +125°  
Frequency ..... 3.7 to 4.2 GHz  
VSWR ..... 1.25 or less  
Gain ..... 41 dB  
F/D Ratio ..... 44  
1/2 power beamwidth ..... 1.5°

##### MOUNT

Type ..... True polar, rotatable base  
Construction ..... 1/4" - 3/8" steel  
Weight ..... 300 pounds  
Finish ..... Brown  
Foundation ..... 4 holes 6" x 4"  
Azimuth Sweep ..... 91°  
Elevation ..... 66°

##### MISCELLANEOUS

Total shipping weight ..... 660 pounds  
Installation Time ..... 2 men, 3 hours  
Warranty ..... 6 months

Shipped F.O.B.  
Milwaukee, WI or  
Las Vegas, NV

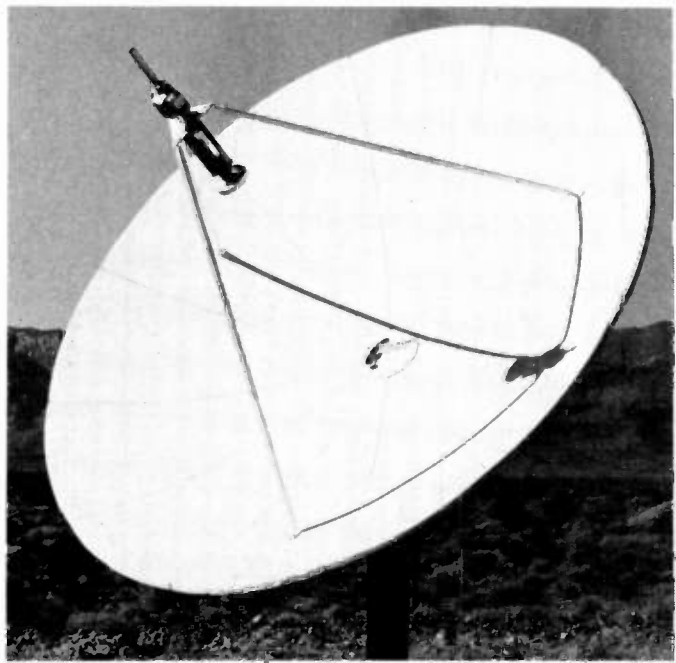

**Order Toll Free: 1-800-558-0411**

In Wisconsin (outside Milwaukee Metro Area)  
1-800-242-5195

# AMATEUR ELECTRONIC SUPPLY <sup>®</sup> Inc.

4828 W. Fond du Lac Avenue; Milwaukee, WI 53216 - Phone (414) 442-4200

### AES BRANCH STORES

**WICKLIFFE, Ohio** 44092  
28940 Euclid Avenue  
Phone (216) 585-7388  
Ohio WATS 1-800-362-0290  
Outside Ohio 1-800-321-3594

**ORLANDO, Fla.** 32803  
621 Commonwealth Ave.  
Phone (305) 894-3238  
Fla. WATS 1-800-432-9424  
Outside Florida 1-800-327-1917

**LAS VEGAS, Nev.** 89106  
1072 N. Rancho Drive  
Phone (702) 647-3114  
No In-State WATS  
Outside Nevada 1-800-634-6227

Call Paul Wittkamp at AES Milwaukee  
Toll Free • 1-800-558-0411  
for all Satellite TV information

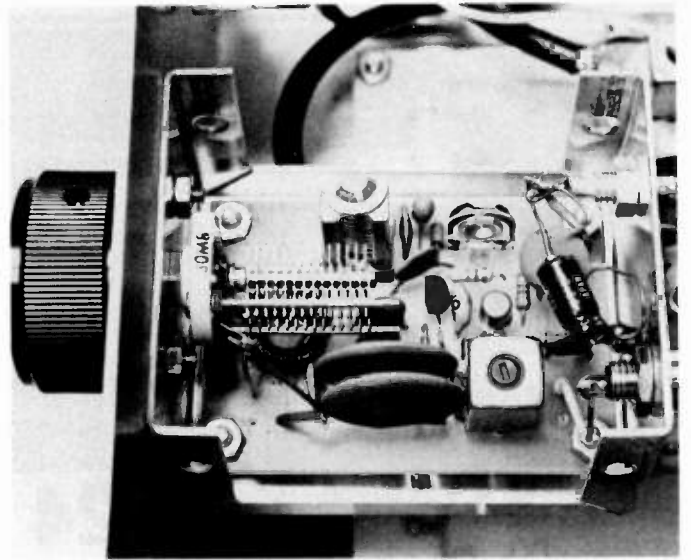

Photo D. Vfo construction detail.

ing of all major parts. As I promised, the parts are readily available. You might have a little trouble finding the NPO capacitors, but many radio-TV parts houses stock them. Keep in mind that one of your best sources for parts information is just a CQ or two away—just don't conduct your purchases directly on the air!

### Chassis

I built my mini-ciever in a 12" L x 7" W x 4" H Bud CU-3011A minibox, and used two 2 3/4" L x 2-1/8" W x 1-5/8" H Bud CU-3000A miniboxes within to house the vfo and bfo. As you can see in the construction photos, I put the power supply, receiver, speech amp, balanced modulator, and transmitter mixer on a main board and the transmit amp chain on a smaller piggyback board. This worked out successfully. However, I plan to use two cards of the same size mounted vertically, each facing out, in the next mini-ciever. In this case, I would put most of the transmitter circuitry on one card. If you decide on this layout, keep the speech amplifier and final rf amp at opposite ends of the transmitter board!

### Circuit Boards

The layout of high-gain rf

and audio PC boards is something of an art form. For a one-shot project, it's hard to beat the use of single-sided (2-ounce copper) circuit board with the copper on the component side used as a ground plane. Notice that the transmit amplifier chain is built in this way. It's generally faster to duplicate a circuit using this approach than to go through the process of lifting circuit board art, exposing resist, etching, etc.

I've outlined the approach I like to use in an earlier article, but it's worth going through again. If nothing else, it makes component substitutions a snap. Get some drafting vellum with a light blue 1/10th-inch grid on it. After you have gathered all the parts for a circuit, you can begin developing the board layout. Start by mulling over the schematic and inspecting the components. Then lay out the components on the grid paper and think through their interconnection. Juggle the components around as needed for a neat arrangement that minimizes trace lengths and crossovers. If you think in terms of circuit strips, it makes things easier.

After you have the layout and interconnection for a section of the circuit visualized, pick up the components and sketch in their

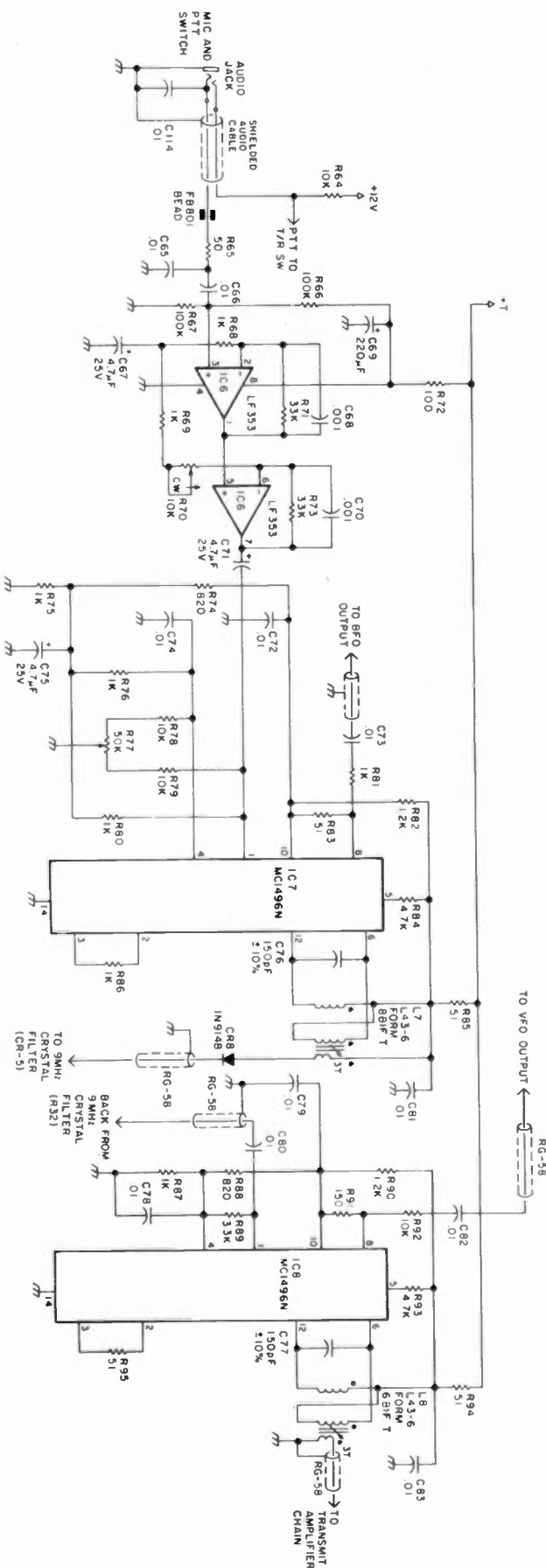

Fig. 6. Speech-amp, balanced-modulator, and transmit-mixer schematic.

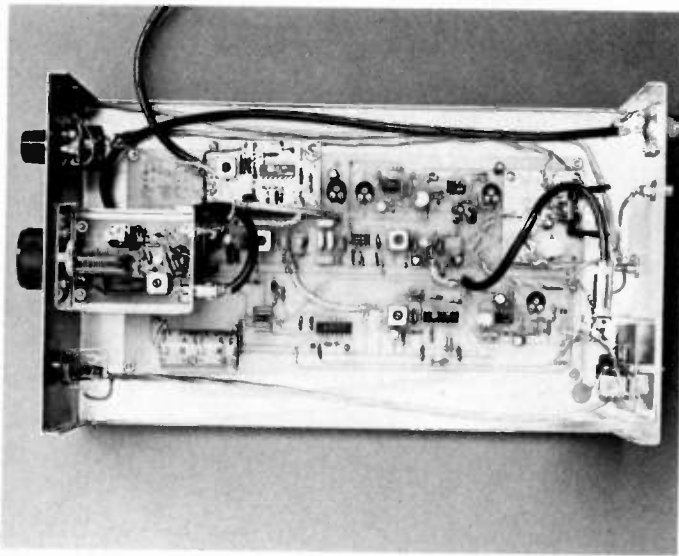

Photo E. View of the main board, which includes the receiver, speech amp, balanced modulator, and transmit mixer.

outlines on the vellum. Show the component interconnections underneath the circuit board with dotted lines. You will be surprised how fast this goes. Remember that all ground connections are on top. Be careful to keep input and output connections of high-gain rf and audio stages separated.

Once the layout is complete, you can tape it directly to your circuit board blank. Drill through the layout and the circuit board each place a component lead or wire goes through the board. I use about a #62 bit for most holes except IC leads, where I use a #68 bit. It's easy to enlarge holes later as needed for the bigger component leads.

After all the holes are drilled, lightly countersink them with a 3/32" bit—except those which are going to be direct ground connections. The countersinking keeps the leads from shorting out on the ground plane. After cleaning the board and perhaps tin-plating it, you can begin installing components. They are interconnected under the board by their leads and/or bus wire. Remember to keep connections as short as possible and watch input-output routing around high-gain stages.

### Rf Coils and Transformers

Radio Shack currently markets a packet of magnet wire in three gauges: part number 278-1345. This type of wire can be stripped simply with hot solder, so it's ideal for rf coil and transformer applications. Use the 30-gauge wire for winding all the shielded transformers. Use the 22-gauge wire for winding all the toroids except L6 and L14, where the 26-gauge wire will be easier to use. I used a small 10-uH molded choke for L13. However, this should not be too critical. If you have trouble finding a molded choke, try 16 turns or so on an FT-50-61 ferrite core. It might be a good idea to put a 10-Ohm resistor in series with this choke to avoid any surprise resonances.

You will notice a number of bifilar windings are used. I use an electric drill to pretwist pairs of wires to about 6-8 turns per inch. Use an ohmmeter to figure out which wire is which after winding the bifilar coils. On the shielded coils, bring the bifilar pairs out together at each end of the bifilar winding and then separate and tin them under the circuit board. Don't try to solder directly to the coil-form posts on these transformers. You'll wind up a post short.

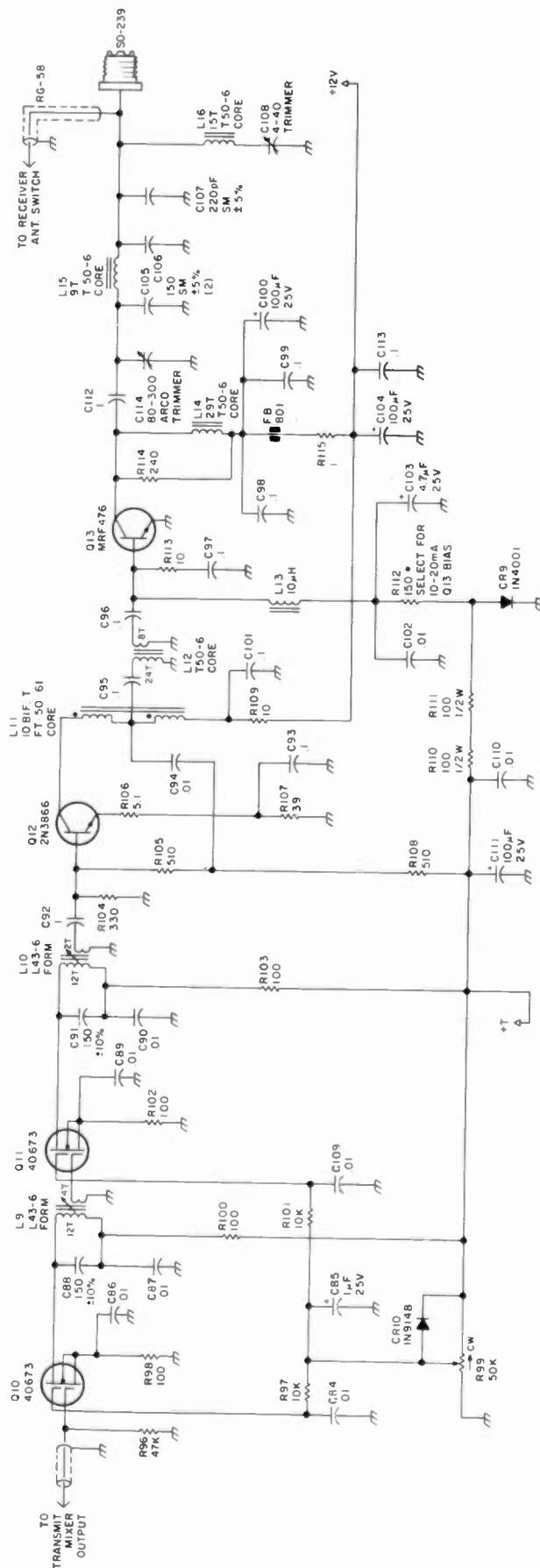

Fig. 7. Transmit-amplifier chain.

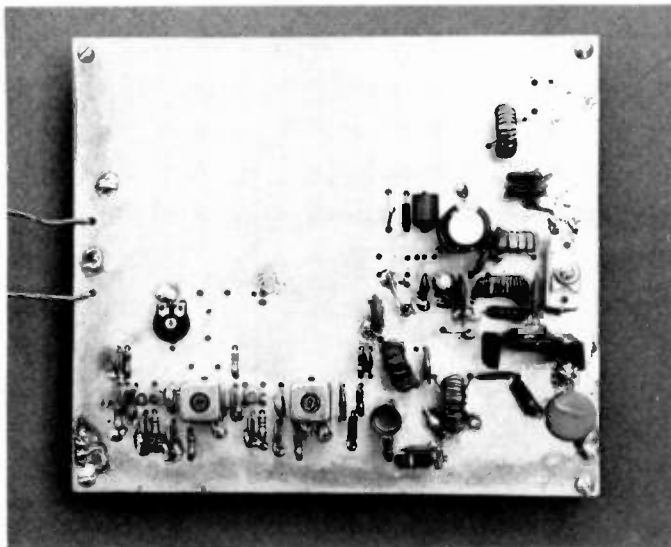

Photo F. Top view of the transmit amplifier chain. Note the "stovepipe" driver heat sink.

You may find the vfo and bfo a little tight to construct since they have to fit in their respective miniboxes. With a little patience everything will fit. For the vfo, it's probably best to etch the copper off the circuit board except around the edges. Hopefully, the vfo detail photo will help with the layout.

#### Heat Sinks

The audio power amplifier, transmit final amplifier, and transmit driver should all have heat sinks. I made a "stovepipe" heat sink out of copper sheet for the 2N3866 driver. Standard commercial heat sinks were used elsewhere.

#### Tune-Up

Recommended test equipment for tuning up mini'ceiver includes a triggered oscilloscope with at least a 20-MHz bandwidth, a multi-band HF transceiver, a dummy load, a frequency counter, and an audio oscillator. Luxury items for tune-up include a grid-dip oscillator, an rf signal generator with a step attenuator, a two-tone oscillator, and, of course, a spectrum analyzer.

#### Power Supply and T/R Voltages

You can run a mini'ceiver off a 12-V-dc, 1-A supply. Be-

fore powering up the rest of the circuitry, test the T/R voltage switch for proper action. Check the collectors of Q1 and Q2 in each PTT switch position for proper on/off action. You did wire the microphone jack up right, didn't you?

#### Bfo and Vfo Tune-Up

Apply +12 V dc to the vfo and check for oscillation with the scope at C16. Fully mesh tuning capacitor C9 and adjust C6 for operation around 5.250 MHz. Unmesh C9 and confirm operation at about 5.300 MHz. Set C9 about mid-range and peak L2 while looking at the vfo output. Then adjust R18, clockwise from the bottom, for a 5-V peak-to-peak output. Putting the top on the vfo will change its operating frequency somewhat, so you may want to tune and try a couple of times until you get it on frequency with the top on.

Apply +12 V dc to the bfo and back the slug nearly out of L3. While monitoring the output of L3 with the scope, slowly run the tuning slug in until oscillation starts. Peak the oscillator output. You should get about a 5-V peak-to-peak output. Check oscillation frequency with your counter

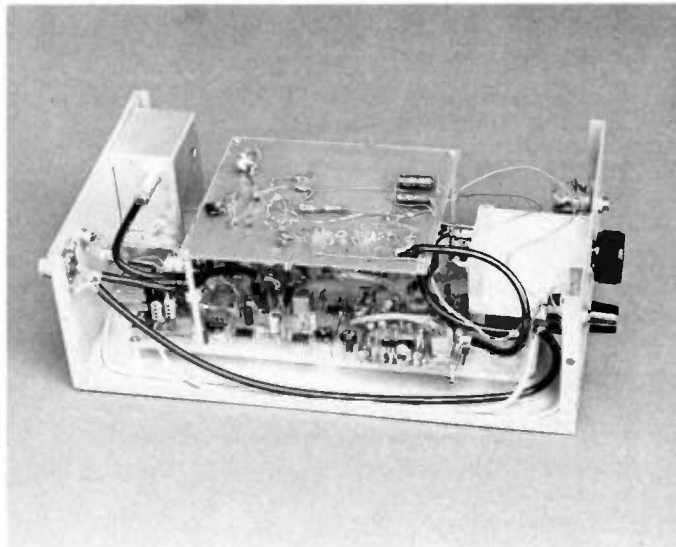

Photo G. Overall view of the mini'ceiver circuitry with the transmit amplifier card in place. The bfo is housed in the small minibox in the back.

and fine-tune the slug in L3 for operation at 8.998500 MHz. The bfo must be loaded with the product detector and balanced modulator for proper operation. It's a good idea to put a small hole in the top of the bfo minibox over L3 to allow for touch-up adjustment of the slug with the minibox top in place.

#### Receiver Tune-Up

Run the tuning slugs in on L4, L5, and L6 so that the tops of the slugs are just slightly above the top of the shield cans. Set the volume control and R47 at mid-range. You should now be able to hear 20-meter SSB signals on your antenna or on a 15' piece of wire stuck in the antenna jack.

Fire up your other HF rig into a dummy load at low output power and set its output frequency for about 14.275 MHz. Tune the mini'ceiver to find the signal. Once found, monitor pin 7 on IC4 (the agc output) and peak L4, L5, and L6 for maximum agc output. If you see the agc voltage peaking above 6 V dc during tuning, reduce your signal level a bit. You can now adjust R47 to suit. Back this pot down a bit if you run into high-volume audio distortion or

instability when running off dry cells.

#### Transmitter Tune-Up

Hook mini'ceiver to a 50-Ohm dummy load. Short the PTT input on the mike jack to ground. Check the voltage across R115. It should be around 20 mV dc, which indicates a 20-mA quiescent bias on Q13. If it's much off this value, replace R112 with a larger or smaller resistor as needed to bring the bias in range. Incidentally, if you have trouble finding a 1-Ohm resistor for R115, you can use a 10-Ohm resistor (200 mV dc), but short the resistor out after setting up the bias.

Input a single audio tone of about 8 mV peak-to-peak into the audio side of the mike jack. Adjust R70 for a 1.5-V peak-to-peak audio signal at pin 1 of IC7. Hook the scope to the anode of CR8 and peak L7. You will see a waveform that looks like an AM signal with 20-40% modulation, about 400 mV peak-to-peak. Check pin 1 of IC8 for a fairly clean 150-200-mV CW signal. Look at the output of L8 and peak for a 14-MHz signal of about 150-200 mV. Move the scope to the output of L10 and peak L9, L10, and R99. Adjust R99 for a lower bias

voltage to Q10 and Q11 if the output of L10 is more than 500 mV peak-to-peak. Check the output of Q12 at C59 for about a 5-V peak-to-peak signal.

Hook the scope to the output of the amplifier chain (SO-239 connector) and peak C114. This is broad tuning, so watch carefully. You should have about 25 V peak-to-peak of rf output. Find the 2nd harmonic of mini'ceiver's output on 10 meters and tune C108 for a null. Tuning is quite sharp, so tune carefully. C108 can also be tuned to peak the 2nd harmonic; be sure you tune for *minimum* output on 10 meters. You can use a short piece of wire for a receive antenna on your 10-meter rig since it's in the same room with mini'ceiver.

Disconnect the jumper and audio oscillator from the microphone jack and plug in the mike. Readjust R70 a bit, if needed, for an

SSB voice signal similar to the one in Photo B. Be careful not to push too hard; there is enough flat-topping out there already.

### Operation

Now the moment of truth. The results you get with mini'ceiver depend heavily on your antenna system, but this is true of any station. I think you will be surprised. I've gotten clean audio reports (except when I tried a narrower crystal filter!) and moderate signal strength reports which is expected for QRP. The fact that mini'ceiver is home-brewed does generate QSO interest.

### Mods and Alternative Circuitry

An S-rf-output meter can be added easily if you like to watch meters jiggle. For the S-meter, monitor the agc voltage which will vary from about 4 to 7 V. Add a 2:1 resistive divider across the rf

output (about 1k total load) and then detect the peak rf voltage at the divider output with a diode-capacitor rf detector. This should give you about 6 V peak to drive the meter. Use a toggle switch to switch modes on the meter.

There is enough room left to add an "afterburner" if you feel you need a little more power. I suggest using an MRF477, which should take you easily into the 25-W range. No more lantern battery operation, though. The receiver antenna switch should be moved to the collector side of the matching network in this case. I don't suggest this unless you have already done some rf amplifier design.

Mini'ceiver should be fairly easy to put on other HF bands by adding the appropriate crystal oscillator and another 1496 mixer to achieve a suitable vfo output range, along with adjust-

ing L and C values as needed.

### From Here

You can never really finish an electronic design (or a computer program for that matter) and mini'ceiver is no exception. There are many ways the design can be improved. If you have an idea, try it! Experimenting is fun. If you would like to ask me a question about mini'ceiver, please send an SASE. 73! ■

### References and Readings

- "Progressive Communications Receiver," Wes Hayward and John Lawson, QST, November, 1981.
- Solid State Design for the Radio Amateur*, Wes Hayward and Doug DeMaw, ARRL publication.
- Crystal Oscillator Design and Temperature Compensation*, Marvin Frerking, Van Nostrand Reinhold.
- Introduction to Radio Frequency Design*, Wes Hayward, Prentice-Hall. (Excellent if you can handle higher math.)

## \*\*\*\*\* 2300 MHz VARIABLE DOWNCONVERTER \*\*\*\*\*

### ANTENNA KIT

\$16.95

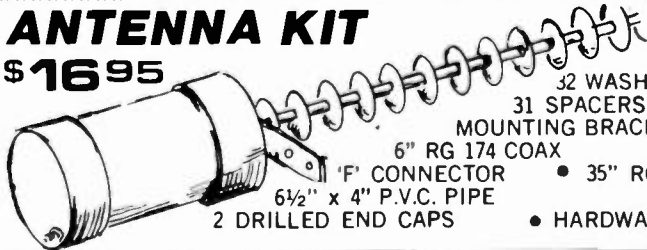

- 32 WASHERS
- 31 SPACERS
- MOUNTING BRACKET
- 6" RG 174 COAX
- 'F' CONNECTOR
- 6 1/2" x 4" P.V.C. PIPE
- 2 DRILLED END CAPS
- 35" ROD
- HARDWARE

### PARTS

- Converter P.C. Board Plated through holes for stability.....\$4.95
- Power Supply
- P.C. Board .....2.95
- MRF 901 .....2.00
- NEO2135 .....4.95
- 2835 Diodes ..... .95
- .001 Chip Caps. .... 10/3.95
- Choke Set of 4.....1.95
- LM 317 Regulator 1.25
- 'F' Connectors
- Chassis ..... .50
- Wall Transformer
- 12 VAC 700 MA.....4.95
- 'U' Bolt ..... .95
- BALUN
- 75 to 300 ohm.....1.95
- BALUN
- for rabbit ears...2.95
- \*RG 59/U COAX
- WITH CONNECTORS
- FACTORY MADE
- 100 Ft. .... \$17.50
- 50 Ft. .... 9.50
- 25 Ft. .... 5.75
- 3 Ft. .... 2.50

### CONVERTER KIT

\$16.95

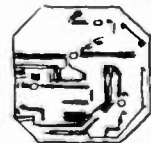

P.C. BOARD PRE-DRILLED SOLDER PLATED WITH PLATED THROUGH HOLES FOR A MORE STABLE PICTURE.

- NEW!!
- 2137 HOT TRANS...
- 3 MRF 901 TRANSISTOR
- 2 HP 2835 Diodes
- 6 .001 Chip Caps.
- 9 Resistors
- 4 Prewound chokes
- 1 Electrolytic Cap.
- 1 Pre Made Probe



★ WIRED P.C. BOARD TESTED, READY TO CONNECT TO CAN WITH PROBE & CABLE CONNECTOR ATTACHED. \$24.95

### POWER SUPPLY KIT

\$16.95



- POWER TRANSFORMER
- COURSE TUNE POT.
- FINE TUNE POT.
- 3 'F' CONNECTORS
- RESISTORS & CAPS
- LED WITH HOLDER
- TERMINAL STRIP

- P.C. BOARD
- RF CHOKE
- KNOB
- WIRE
- 2 SWITCHES
- 4 DIODES
- LM 317 REG.

WOOD GRAIN CABINET WITH SILK SCREENED front and back \$10.95 Extra  
BUILT POWER SUPPLY.....\$34.95

Complete Down Converter System  
INCLUDES ANTENNA KIT  
POWER SUPPLY KIT  
CONVERTER KIT  
SPECIAL \$49.95

### QUANTITY DISCOUNTS

Any Price in Adv.

10 pcs.	12% off
25 pcs.	18% off
50 pcs.	25% off
100 pcs.	30% off
1000 pcs.	35% off

No Mixing for Quantity Discount

We will tune converter board for \$12.50  
trouble shoot add .....7.50  
trouble shoot power supply. \$12.50  
plus any parts needed.

We will accept telephone orders for Visa & Mastercard  
No C.O.D. Orders  
TO ORDER CALL 317-291-7262  
800-428-3500  
Complete kit weighs 10 lbs. Please add sufficient postage  
6254 LaPas Trail  
Indianapolis, Indiana 46268

# ELECTRONIC RAINBOW

# An Alarming Procedure

*This false-proof repeater emergency alert won't tie up expensive equipment.*

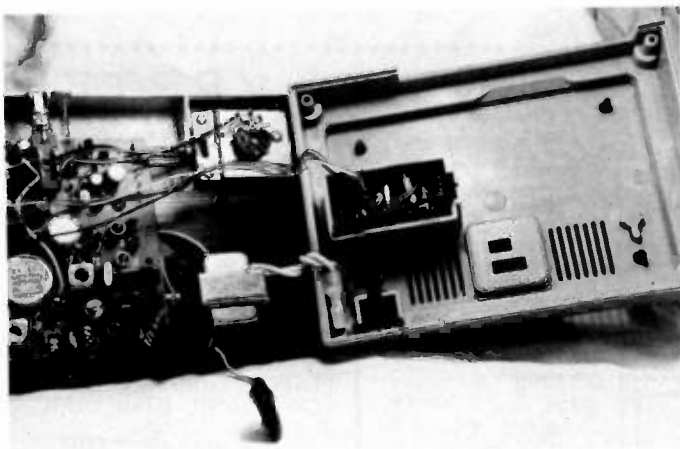

Decoder board mounted in battery compartment.

Melvyn G. Morris WA1LCF  
Michael Polimer K1FNX  
140 Hampton Road  
Sharon MA 02067

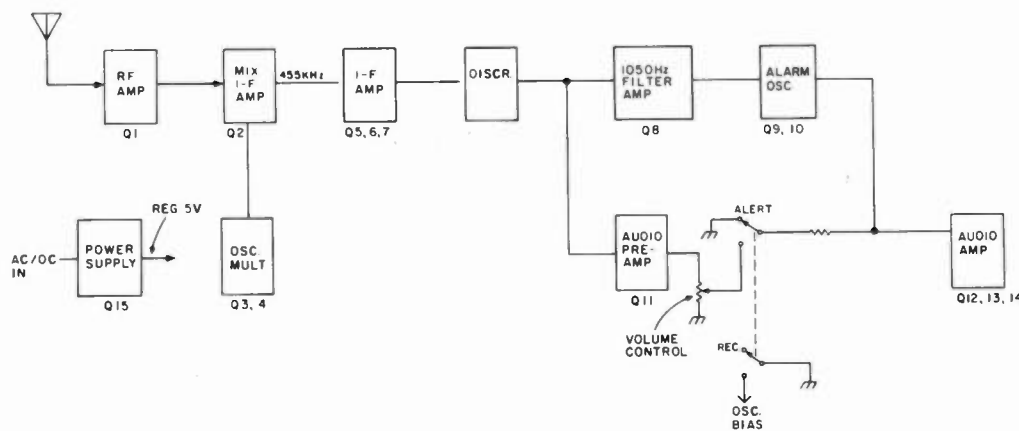

Fig. 1. Block diagram.

**T**wo-meter repeaters provide reliable communication for relatively large areas surrounding the repeater site. There has long been a need for a reliable warning or alert system operating through a repeater for civil defense, RACES, emergency, and similar type requirements. In particular, if this need is required in the specific area within the locale of a repeater, then the approach described here-



in will prove more than satisfactory.

On the assumption that a secure alert signal must be coded in some way, it becomes readily apparent that the receiver/decoder must be immune (i.e., secure) from false triggering. The problems associated with using a repeater manifest themselves through the types of signals transmitted. For example: engine whine, noise, voice characteristics, whistling, and other distortions contained in speech must not falsely trigger the alarm mechanism. The receiver, therefore, must be of sufficient sensitivity to operate within a given signal-strength area and contain a decoder. The repeater must be able to pass the coded signal with sufficient amplitude to activate the alarm mechanism.

Additional requirements are that any operator can initiate the alarm without the necessity of a special code generator and that existing 2-meter receivers not be pressed into service to monitor and decode the alarm signals. (A previously published article out of Canada described the use of a 2-meter transceiver with a "listening" decoder placed in front of the speaker to receive and decode the alarm signal. Not only does this tie up a piece of very expensive equipment—but also it implies that the user must listen to every QSO and not forget to turn up the audio volume.) Finally, and above all, the receiver and code generator must be inexpensive.

With the rudimentary specifications as set forth above, a search was conducted into readily available equipment that could be modified for the task. After some deliberation it was decided that a crystal-controlled FM weather radio of the type used by mariners for monitoring NOAA

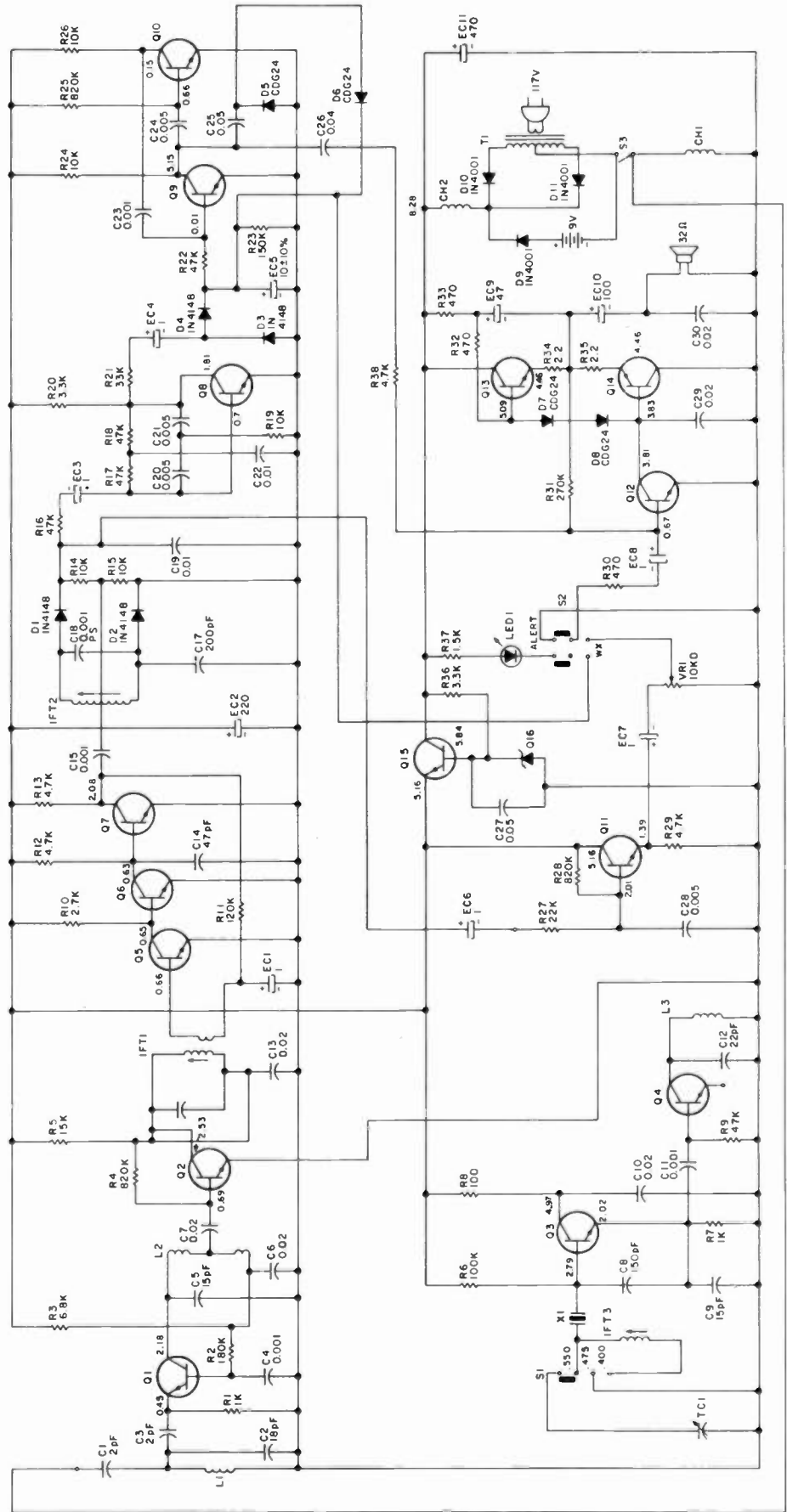

Fig. 2. Schematic diagram of unmodified Weatheradio.

weather broadcasts that also contains the built-in decoder for NOAA-broadcast weather alerts would be ideal. The Radio Shack Weatheradio Alert (catalogue #12-154) was selected and was used as the basis for design.

In the event of a weather emergency, NOAA transmits a tone (1050 Hz) which activates an alarm in the receiver which in turn alerts the listener to activate the

audio portion of the receiver and listen to the detailed weather info. (Most weather-alert receivers allow the user to deactivate the audio while still keeping the receiver in the monitor mode.) Normally transmitted speech does not activate the system since a relatively long transmit time (seconds) is required of the coding signal and it is believed that NOAA also "notches out" 1050 Hz during non-coded transmissions.

Before describing the modifications and design philosophy of our alert receiver, a cursory look at a simplified block diagram of the unmodified weather radio is necessary (Fig. 1).

The incoming rf is supplied (via a link to the ac power cord) to an rf amplifier. A crystal-controlled LO drives a diode multiplier and is loosely coupled to the input of a mixer stage. The output of the mixer (455 kHz) drives a tuned i-f amplifier and discriminator which provides detected audio to the audio preamplifier and to the 1050-Hz filter. In the normal listening (WX) mode the audio is boosted through the audio amplifier and drives the speaker. In the monitor (or alert) mode the alarm oscillator is enabled and the output of the volume control is disconnected from the audio amplifier and speaker. Reception of a 1050-Hz tone will trigger the oscillator and the signal thus produced will be amplified via the audio amplifier and sound the alert. (There are some auxiliary features which will be described in the discussion on modifications.)

162.400, 162.475, and 162.550. This is facilitated in the unmodified alarm receiver by operating the crystal padded with either a capacitor, an inductor, or nothing. A three-position switch on the rear of the unit is provided for this purpose. Since we will be operating on a fixed frequency, this is an unnecessary feature and must be disabled. (We set the switch in the "unpadded" position and epoxied it in place.)

The repeater frequency we are using is 146.865-MHz output. The rf stages must be retuned to this frequency as well as selecting a new crystal which will provide an i-f of 455 kHz when operating in conjunction with this frequency. A crystal frequency of 16.202 MHz is used to generate 455 kHz when operating with the "central" NOAA frequency of 162.475 MHz. Working backwards,  $162.475 \text{ MHz} - 455 \text{ kHz} = 162.02 \text{ MHz}$ . It becomes obvious then that the multiplier is operating at a multiplication factor of 10. At the repeater operating frequency of 146.865, a crystal of  $(146.865 - 455 \text{ kHz})/10 = 14.641 \text{ MHz}$  is required for the LO. (The crystal can be purchased from: Sentry Mfg. Co., Chickasha, Oklahoma; #SCM-18, HC-25/ $\mu$  case with wire leads, 15-pF load.)

NOAA broadcasts operate on frequencies of

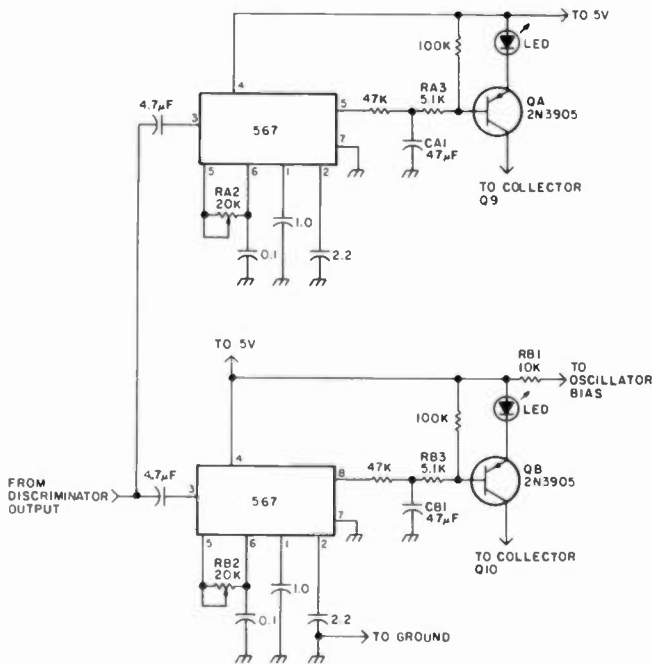

Fig. 3. Decoder subassembly schematic.

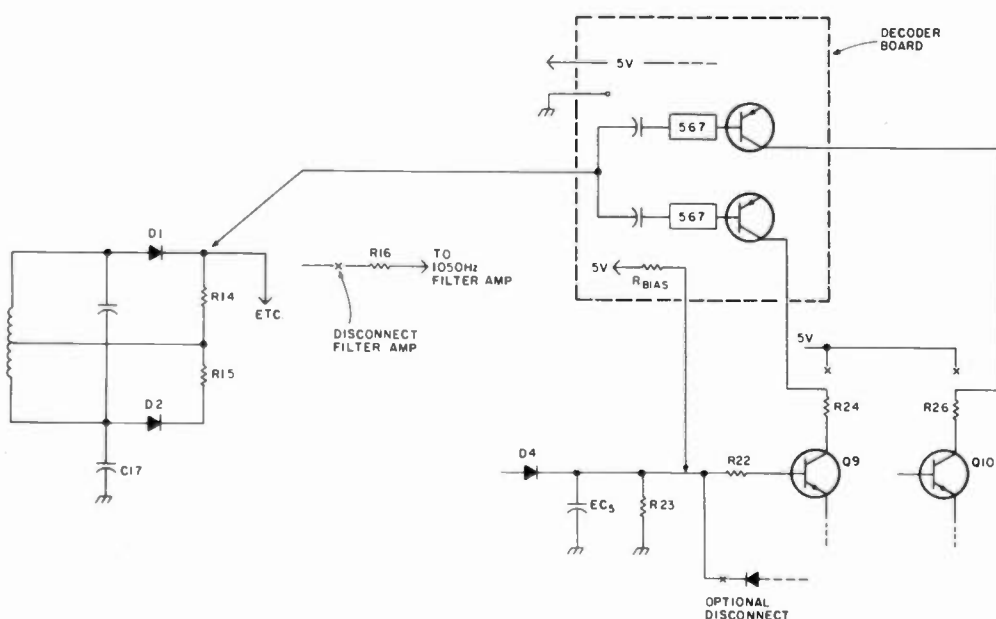

Fig. 4. Connecting the decoder board to the receiver.

With this determined and the planned use of the 1050-Hz coding signal, we set off to modify the receiver. First we applied a signal at the NOAA frequency of 162.475 MHz FM modulated with 1050 Hz (3-kHz deviation) and measured the output of the discriminator at the point where the alarm would just trigger. We observed the output of the signal generator and used this output (in microvolts) as the target sensitivity at the repeater frequency. On the trial unit this was observed as approximately 1  $\mu$ V. Next we replaced the crystal, ob-

# Boman

# A WORLD AHEAD OF THE COMPETITION

TOLL FREE INSIDE CA: (800) 352-2553 OUTSIDE CA: (800) 421-2533

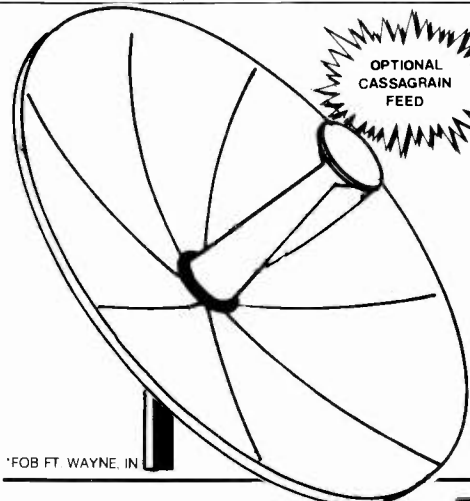

OPTIONAL  
CASSAGRAIN  
FEED

## PRODELIN SUPER DISH

THERMO COMPRESSION MOLDED

**\$499<sup>50</sup>**  
DISTR. PRICE

The BOMAN SA-3000 is a THERMO-COMPRESSION MOLDED Satellite Antenna... NO MORE GRIEF! FEATURES: ■ 3.0 meter diameter ■ 8 interlocking fiberglass sections for quick, precise assembly ■ Unique design allows for superior stress resistance to withstand extreme environmental changes... NO MORE GRIEF!



ORDER WITH:

- A - 100° Low Noise Converter (LNC)
- B - 110° Low Noise Converter (LNC)
- C - Down Converter

**\$399<sup>50</sup>**  
DISTR. PRICE

## SR-800 RECEIVER

The Boman SR-800B Satellite Receiver uses advanced technology to provide high quality reception at a very affordable price. Features: ■ 24 channel capability ■ 6 audio channels ■ fine tuning control ■ AFC ■ illuminated signal strength meter ■ attractive design fits any decor.

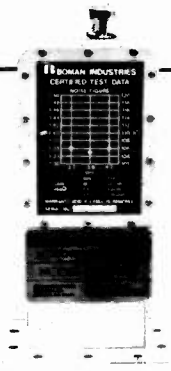

### MODEL LNA-915 LOW NOISE AMPLIFIER 110° K OR BETTER

All BOMAN MICROWAVE AMPLIFIERS are 100% tested and marked for each guaranteed test parameter before they are released. All measurements are taken with equipment calibrated and maintained in accordance with military standard MIL-C-45662.

QTY.	OPEN ACCT	Pay w Order
10 UNITS	\$443.89	\$399 <sup>50</sup>
30 UNITS	\$421.67	\$379 <sup>50</sup>
60 UNITS	\$388.33	\$349 <sup>50</sup>
600 UNITS	\$366.11	\$329 <sup>50</sup>
1000 UNITS	\$332.77	\$299 <sup>50</sup>



**BOMAN INDUSTRIES**  
SATELLITE PRODUCTS DIVISION  
9300 HALL RD., DOWNEY, CA 90241  
(213) 869-4041

157

## The "NEW" Polar-matic Ultra Feed

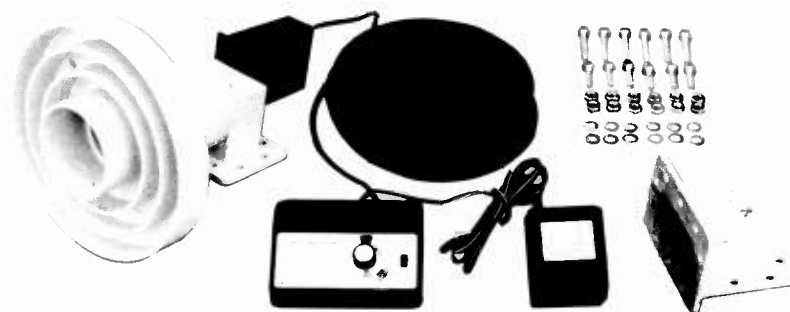

Improve your system quality with the EFH-75 Microwave Feed. It offers precision polarity selection using the attractive control shown here.

INSTALLATION FEATURES: 130 ft. of 3 conductor wire included - TERMINALS attach at each end - NO MORE SPLICING - Molded terminal posts on motor cover - Painted part prevents corrosion - ON-OFF switch on control box - Power-on light on control box - All necessary hardware included.



PRECISION CONTROL WITH ON/OFF SWITCH AND L.E.D. INCLUDES "NO SLIP" CONTACT TAPE

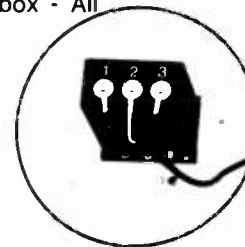

WEATHER PROOF TERMINAL STRIP TO INSURE YEAR AROUND CONNECTION. (NO MORE SPLICING)

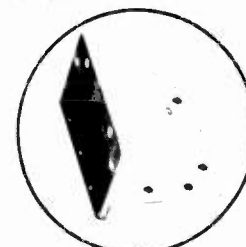

RIGHT ANGLE ADAPTER PERMITS VERTICAL OR RIGHT ANGLE L.N.A. MOUNTING

**ALL NEW**  
**\$99<sup>50</sup>**

DISTRIBUTOR PRICE

Toll Free Inside Ca: (800) 352-2553 Outside (800) 421-2533

### SAMPLE VOLUME DISCOUNT COUPON

Submit this coupon with your order, and/or payment, and receive one EFH-75 POLAR-MATIC FEED for evaluation purposes at the 24 lot price (Limit one per customer) \$99<sup>50</sup>

NAME \_\_\_\_\_  
COMPANY \_\_\_\_\_  
ADDRESS \_\_\_\_\_  
CITY \_\_\_\_\_ STATE \_\_\_\_\_ ZIP \_\_\_\_\_  
PHONE \_\_\_\_\_

served that the LO was operating, and proceeded to re-tune the rf and LO stages. Unable to lower the tuned frequency adequately by squeezing the inductor coils closer together, we added capacitors in parallel to the tank circuits to bring the tuning in range of the coils. All the while we monitored the output of the discriminator and tuned for maximum output of the 1050-Hz signal. With judicious twisting

and squeezing of the coils we were able to match the sensitivity observed at the NOAA frequency.

A hastily designed 1050-Hz tone generator was implemented and the receiver was put to the test. It triggered obediently in response to the coded signal—as well as from alternator whine and anybody who spoke with the right quantity of 1050-Hz energy! We quickly deduced that any decoding scheme that was dependent on a single

frequency was doomed to a similar fate. In order to minimize the cost of the decoding circuitry, we decided against any scheme which required timing sequences. We also felt that the more complicated the scheme, the larger (and more costly) the decoder would be, and we did have space limitations within the receiver.

The solution decided upon was to code and decode a single two-tone composite signal much like that

used in the Bell Touch-Tone™ system. In fact, for purposes of simplicity and availability, we designed around an actual DTMF tone pair. The 1050-Hz filter/amplifier was of no further use; therefore, it was bypassed. A small printed-circuit board containing the two tone decoders and their associated drivers was designed to fit into the backup battery compartment. (The backup battery would be glued to the receiver case using double-sided masking tape.) A detailed description of the electrical design and receiver modifications follows.

To understand how our decoder design developed, it is first necessary to understand the operation of the unmodified decoder-alarm circuit. Transistors Q9 and Q10 are operated as a triggered astable multivibrator. R22 and R23 keep the pair in an untriggered state by keeping Q9 off in the ab-

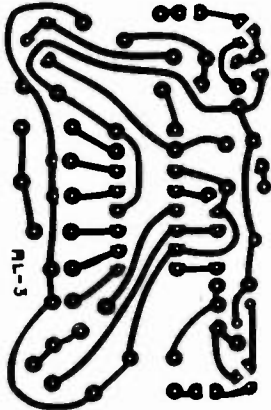

Fig. 5. PC board.

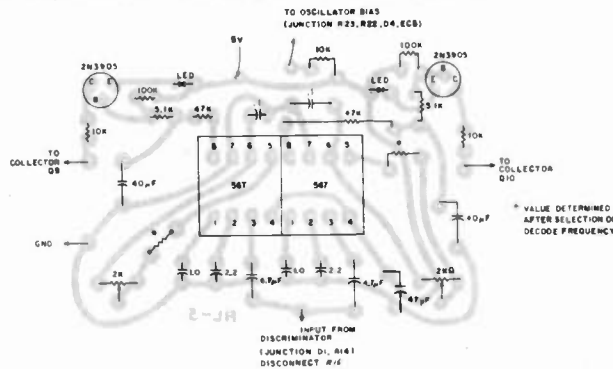

Fig. 6. Component layout. If resistors marked with asterisks are not used, they must be replaced by jumpers.

## UNIVERSAL M-600 MULTI-MODE AND CRYPTO-DECODER

— NEW —  
DECODES:

TOR-SITOR  
BIT INVERSION  
WEATHER FORMAT  
NON STANDARD SHIFT



The M-600 converts these Codes plus RTTY (Baudot & ASCII) to video and will drive a Serial or Parallel printer for hard copy. Baudot speeds from 60 to 132 WPM and ASCII from 110 to 1200 Baud rates. Morse reception, auto range up to 60 WPM. The M-600 has 3 fixed shifts and 1 tunable shift. Multiple scroll inhibit and un-shift on space are included along with a built-in self-test system. Isolated loop MIL-188 or RS232 and optional parallel ASCII.

**CONTACT US FOR FURTHER INFORMATION**

Phone: (614) 866-4605 \$799.95  
MC & VISA Accepted (shipping extra)

**UNIVERSAL ELECTRONICS INC.**

1280 AIDA DRIVE, REYNOLDSBURG, OHIO 43068

## ALL NEW H.F. 10/160 METER SOLID STATE P.L.L. TRANSCEIVER



**USB-LSB**

4 Memories  
3 Way Auto-Scan  
Includes New Bands  
3-Step Tuning Speed  
IF Tune ± 1 KHZ  
Built-in Dual VFO

**CW-W CW-N**

200 W. PEP (160M-12M)  
100 W. PEP (10M)  
Built-In Power Supply  
AC-120 VAC  
DC-13.8 V -Ground  
External ALC  
13.5 VDC Relay



**JUST SLIGHTLY AHEAD**

1275 N. GROVE ST.  
ANAHEIM, CA 92806

TO ORDER OR  
DLR INFO. CALL  
(714) 630-4541

✓ 318

NOTE: Price. Specifications subject to change  
without notice and obligation

sence of any external bias current. When the coded 1050-Hz signal is received and passed through the 1050-Hz twin-T filter/amplifier (Q8), it is rectified and doubled via D3, D4, and EC4. The resulting dc is applied to the base of Q9 through R22 as a trigger current. The multivibrator then oscillates. Diode D6 rectifies the oscillator output and feeds it back to the input of Q9, thereby maintaining the alarm even after the initial trigger signal is removed. Depending on the desired mode of operation as an alert receiver, this may or may not be a desirable feature. This will be discussed later.

The two-tone-decoder design is a relatively straightforward adaptation of a standard NE567 design. Two decoders are connected in parallel and drive a pair of PNP trigger amps. In order to use as much of the existing receiver as possible, it was decided to disconnect the collectors of the multivibrator transistors from the supply rail and drive each of them from the tone decoders. In this way the oscillator cannot function unless both tones are present, thereby acting as an AND gate as well as an oscillator. The PNP trigger amps (Fig. 3) provide the necessary inversion of the 567 output as well as a convenient node to add some time delay to the decoding functions. (To prevent accidental triggering, a time delay was added to the decoding spec.)

Referring to Fig. 3, the output of either 567 (pin 8) goes low when the correct tone is presented to its input. This in turn provides bias current for the base of the PNP (QA or QB), but not until CA1, B1 is first discharged (providing the time delay). The LEDs in the emitters of the PNPs necessitate that the base drop an additional two diode drops (in addition to VBE) before the PNP can turn on again for time delay

purposes. (They also add the additional feature of illuminating for test purposes.)

As mentioned above, when both PNPs are on, the multivibrator can oscillate. Note: Since the 1050-Hz filter/amp is disconnected, a permanently enabling bias voltage is applied to multivibrator transistor Q9 through RB1 on the decoder board. Potentiometers RA2 and RB2 permit tuning the tone decoders for the desired frequency. Refer to Fig. 4 for the modified schematic showing points of connection (and disconnection). Figs. 5 and 6 show the PC layout and an assembled board, respectively.

Some final comments are in order. We decided not to depend on rf coupled through the power line for our input. A banana jack was mounted on the case and connected to the rf input through a small capacitor. An inexpensive ¼-wave antenna was implemented using a piece of #10 electrical wire soldered into a banana plug.

Also, for the needs of the Sharon, Massachusetts, Civil Defense group for whom this receiver was designed, the latching diode (D6) was disconnected. Our philosophy is that in time of civil emergency the intent of generating an alarm is to alert available personnel. If within the vicinity of the receiver, they will respond by switching to the audio mode and following the broadcast instructions coming over the repeater. If they are not around or available, latching the alarm will not serve any useful purpose. This is obviously a policy decision based on individual need.

One of the obvious advantages of this system is that any DTMF tone pair can be used. Using # or \* has the advantage that they are not normally used tones in a repeater with a phone patch. If, however, it is felt that using known (and easily generated) tones can cause



### The New Standard in High Performance Repeater Control...

- Room to grow: BUILT IN! - Features intelligent remote control and meter readback. Interfaces to synthesized remote bases and links. Planned software upgrade path.
- SUPPORT - We invented the "Computer Controlled Talking Repeater," so we know how to provide the applications assistance, and long term support so crucial to a computer based product.
- FRIENDLY, POWERFUL, EASY TO USE - Human engineered to be your "assistant" at the repeater, with capability second to none.
- REMOTELY CONFIGURABLE - Change command codes, messages, tone characteristics, timing, and more, remotely! Reliable storage in E<sup>2</sup>PROM.
- BRING YOUR REPEATER SYSTEM INTO THE 80'S - Starting at less than \$1200!

### The RC-850 Repeater Controller!

Call or write for detailed specifications.

Manual and demonstration cassette tapes available separately.

**acc** advanced computer controls

10816 Northridge Square  
Cupertino, CA 95014  
(408) 253-8085

124

false alarms, then any pair can be used simply by designing simple multivibrator oscillators driving speakers and holding them against the microphone of a transmitter. Only authorized personnel would be issued coders.

The first prototype was built using perfboard and placed in continuous operation in the spring of 1980. As of this writing it has never "falsed" yet and continues to respond when needed upon adequate application (several seconds) of the coded tone pair. The unit is self-tested merely by unplugging and replugging the ac power by virtue of the momentary-charging current to the two time-delay capacitors, CA1 and CB1, applied through the base-emitter junction of the PNP drivers. That, by the way, is why the capacitors are connected to ground and not the supply rail, and why resistors RA3 and RB3

are required (to prevent burnout of the junctions).

One final comment: A more secure three-tone system is possible with no further modification of the receiver. Merely reconnect the 1050-Hz filter/amp (disconnecting the bias resistor RB1) and now a simultaneous three-tone signal (of which 1050 Hz is one) is necessary to trigger the alarm. Of course a proper three-tone generator would have to be designed. Other options are available if the filter frequency is altered from 1050 Hz.

We believe this design achieved our initial objective of providing a relatively inexpensive alert receiver with minimal modifications and additions to an existing receiver. At the same time it did not require an elaborate code-generating device. It also does not require modifications to or need the use of other 2-meter equipment. ■

# COMPUTERIZED MORSE KEYERS

AEA, the first company to introduce microcomputerized products to the Amateur Radio market, is proud to announce the second generation of computerized electronic keyers. Each keyer is pre-programmed, no computer language is required of the operator. The easy to use keypads eliminate up to 75 switches or potentiometers, thereby greatly simplifying the operation of such sophisticated keying systems. We invite you to compare the features of our keyers (shown below) to ANY others.

IMPORTANT KEYS AND/OR TRAINER FEATURES	AEA MM-2	AEA KT-2	AEA CK-2
Speed Range (WPM)	2-99	1-99	1-99
Memory Capacity (Total Characters)	500	N/A	500
Message Partitioning	Soft	N/A	Soft
Automatic Contest Serial Number	Yes	N/A	Yes
Selectable Dot and Dash Memory	Yes	Yes	Yes
Independent Dot & Dash (Full) Weighting	Yes	Yes	Yes
Calibrated Speed, 1 WPM Resolution	Yes	Yes	Yes
Calibrated Beacon Mode	Yes	N/A	No
Repeat Message Mode	Yes	N/A	Yes
Front Panel Variable Monitor Frequency	Yes	Yes	Yes
Message Resume After Paddle Interrupt	Yes	N/A	Yes
Semi-Automatic (Bug) Mode	Yes	Yes	Yes
Real-Time Memory Loading Mode	Yes	N/A	Yes
Automatic Word Space Memory Load	Yes	N/A	Yes
Instant Start From Memory	Yes	N/A	Yes
Message Editing	Yes	N/A	Yes
Automatic Stepped Variable Speed	No	No	Yes
2 Presettable Speeds, Instant Recall	No	No	Yes
Automatic Trainer Speed Increase	Yes	Yes	N/A
Five Letter or Random Word Length	Yes	Yes	N/A
Test Mode With Answers	Yes	Yes	N/A
Random Practice Mode	Yes	Yes	N/A
Standard Letters, Numbers, Punctuation	Yes	Yes	N/A
All Morse Characters	Yes	Yes	N/A

For more information write AEA, or better yet see your favorite dealer for a demonstration.

Software ©copyright by AEA.

PRICES AND SPECIFICATIONS SUBJECT TO CHANGE WITHOUT NOTICE OR OBLIGATION.

**ADVANCED ELECTRONIC APPLICATIONS, INC.**

P.O. Box C-2160,  
Lynnwood, WA 98036  
(206) 775-7373

Telex: 152571 AEA INTL

## MM-2



MorseMatic™

## KT-2



Keyer Trainer

## CK-2



Contest Keyer

**AEA**  
Brings you the  
breakthrough!

## HURDLE THE HUMP



WITH TWIN OAKS CW TRAINING PROGRAMS

## CW TEACHING SYSTEMS

Twin Oaks Associates is a partnership of mental health professionals who are hams interested in helping others to learn CW. Twin Oaks has developed three Morse code teaching systems on tape which represent the careful application of psychological principles to learning. They help students learn to recognize and copy Morse characters at a very high speed.

The first set of tapes is called System 12 ©. It is designed for the ham who may have a Novice or Technician class license but can't "get over the hump" to pass the General class code test. System 12 takes students past 15 words per minute on five carefully-structured, successive-demand, 60-minute cassettes.

The second training program is called System 24 ©. It assumes that the student is able to copy comfortably at 9 or 10 words per minute but would like to go after the amateur Extra class license. This program is on five 60-minute cassettes and carries the student past 30 words per minute.

The third teaching system, the System 12 Alphabet Book ©, is designed for persons who know absolutely nothing about Morse code. It may be used, however, by persons who are not thoroughly comfortable at 5 words per minute, and it is useful for either classroom or self-instruction.

Each program, or system, comes with its own carefully-written study guide. Systems 12 and 24 cost \$30 each, and the System 12 Alphabet Book costs \$15.



GET HUMPIN'—  
ORDER TODAY!

TWIN OAKS ASSOCIATES  
ROUTE 5, BOX 37  
KNOXVILLE IA 50138

# Barry Electronics Corp.

WE SHIP WORLDWIDE

WORLD WIDE AMATEUR RADIO SINCE 1950

Your one source for all Radio Equipment!



**We Will Not Be Undersold Call:**  
**212-925-7000**



Wherever I go, I take my Radio!

**KITTY SAYS: FOR THE BEST PRICES IN TOWN, BUY AT BARRY'S. All merchandise 100% guaranteed. Low, low prices. FOR ORDERS ONLY PLEASE CALL: 1-800-221-2683.**

**YAESU**



IC-R70, IC-720A, IC-730, IC-740, IC-25A, IC-251A, IC-2KL, IC-451A, IC-290H, IC-45A



FT-ONE, FT-102, FT-101ZD, FT-707, FT-230R, FT-480R, FT-720RU, FT-290R, FRG-7700, FT-625RD

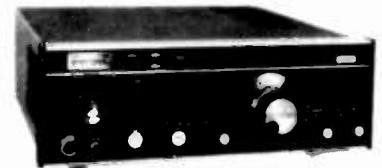

DRAKE TR-5, TR-7A, R-7A, L-7, L-15, Earth Satellite Receiver ESR-24, THETA 9000E & 500, Digital Multimeter Model #8550-\$95.00



ROBOT Slow Scan TV 400 & 800

YAESU FT-208R FT-708R

ICOM IC2AT IC3AT IC4AT  
Land-Mobile H/T Wilson Mini-Com II Yaesu FTC-2203, FT-4703 Icom IC-M12 (Marine) IC-H12



**SMART PATCH**

CES-Simplex Autopatch 510-SA Will Patch FM Transceiver To Your Telephone. Great For Telephone Calls From Mobile To Base. Simple To Use - \$319.95.

**POWER PACKET**  
VoCom Power Amplifier & 5/8" HT Gain Antennas IN STOCK

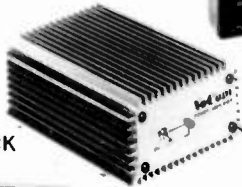

SANTEC ST-144/UP ST-440/UP



**KANTRONICS**  
Mini-Reader, Field Day Interface, Code Tapes In Stock

**BIRD**  
Wattmeters & Elements In Stock



MIRAGE B-23, B-1016, B-108, B-3016, C-22, C-106, D-24, D-1010

Dentron Amplifiers, Tuners, Receivers Stocked: Clipperton T, Clipperton L, GLA-1000B, GLT-1000, Gallon, MLA-2500 2 Meter 1800 Watts Linear, MLX Mini Transceiver, The Scout C.A.P. Transceiver, Horizon One Transceiver, Station One CW Radio Station. Write for specs, or call.

EIMAC 3-500Z 572B, 6JS6C 12BY7A & 4-400A



AEA 144 MHz AEA 440 MHz ANTENNAS

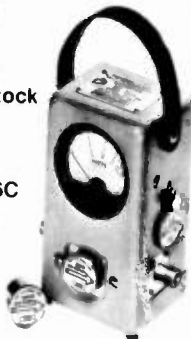

**NEW IMPROVED MURCH** Model UT2000B

**BENCHER PADDLES & Vibroplex Keys** In Stock!!

**DIGITAL FREQUENCY COUNTER**

Trionyx-Model TR-1000 0-600 MHz  
Digimax Model D-510 50 Hz-1GHz



Tri-Ex Towers Hy-Gain Towers & Antennas, and Rotors will be shipped direct to you FREE of shipping cost.

**New York City's LARGEST STOCKING HAM DEALER COMPLETE REPAIR LAB ON PREMISES**

MAIL ALL ORDERS TO BARRY ELECTRONICS CORP., 512 BROADWAY, NEW YORK CITY, NY 10012.

BARRY INTERNATIONAL TELEX 12-7670  
TOP TRADES GIVEN ON YOUR USED EQUIPMENT

STORE HOURS: Monday-Friday 9 to 6:30 PM  
Saturday & Sunday 10 to 4 PM (Free Parking)

AUTHORIZED DIST. MCKAY DYMEK FOR SHORTWAVE ANTENNAS & RECEIVERS.

Subways: IRT/LEX-"Spring St. Station"  
BMT-"Prince St. Station"  
IND-"F" Train-Bwy. Station"

Bus: Broadway #6 to Spring St.

**"Aqui Se Habla Espanol"**

We Stock: AEA, ARRL, Alpha, Ameco, Antenna Specialists, Astatic, Astron, B & K, B & W, Bash, Bencher, Bird, Butternut, CDE, CES, Collins, Communications Spec. Connectors, Covercraft, Cubic (Swan), Cushcraft, Daiwa, Dentron, Digimax, Drake, ETO (Alpha), Eimac, En-comm, Henry, Hustler (Newtronics), Hy-Gain, Icom, KLM, Kantronics, Larsen, MCM (Daiwa), MFJ, J.W. Miller, Mini-Products, Mirage, Newtronics, Nye Viking, Palomar, RF Products, Radio Amateur Callbook, Robot, Rockwell Collins, Saxton, Shure, Swan, Telex, Tempo, Ten-Tec, Tokyo Hi Power, Trionyx TUBES, W2AU, Waber, Wilson, Yaesu Ham and Commercial Radios, Vocom, Vibroplex, Curtis, Tri-Ex, Wacom Duplexers, Repeaters, Phelps Dodge, Fanon Intercoms, Scanners, Crystals.

WE NOW STOCK COMMERCIAL COMMUNICATIONS SYSTEMS  
DEALER INQUIRIES INVITED. PHONE IN YOUR ORDER & BE REIMBURSED.

**Amateur Radio Courses Given On Our Premises**

**Export Orders Shipped Immediately.**

# Trimming the Fat from ATV

Why use 3 MHz when 500 kHz will do?  
WB6FHD proposes a way.

My colleagues of the Southern California Amateur Television Club have been asking me to submit an extended article to *73 Magazine* since my brief presentation of this concept at our monthly club meeting, July, 1980, and its subsequent publication in our August newsletter. My purpose in publishing this article is to stimulate those of my radio amateur colleagues blest with true scientific creativity to develop this concept into a refined state-of-the-art system of global amateur radio television communication.

The development of a practical narrowband system of real television, in the true sense of the word, is of tremendous importance at this time, because every time we turn around, this or the other big commercial interest wants to lobby the FCC to give them portions of our amateur bands for their own private use, even though other amateurs in other countries still continue to use these same frequencies. My proposal not

only will result in making it possible to transmit a picture almost similar in quality to a commercial television station, but will do it in only one-twelfth of the usual channel bandwidth normally required. It will do this as low as six meters if we get together and petition the FCC with a proposal for experimental narrowband television privileges on the almost disused upper three-fourths of the band.

Another reason I want the experimentation to be on six meters is that occasionally there are some pretty good band openings into other countries.

I want to give thanks to Al Lipkin W3AEH, whose narrowband TV article in the 1964 *ATV Experimenter Anthology* (by *73 Magazine*) inspired me to carry his idea through the next few logical steps to the present engineering conceptualization of the entire system, all the way from camera to TV receiver. I sincerely hope that this article will start an avalanche of contributions by

other engineers—as happened with SSTV exactly twenty years ago.

My profession is electronics-concepts design engineering, but I was caught in the aerospace layoffs of 1969 and have not been active in it since then. This means I am not up on the newest devices and technology, and accordingly will not submit any schematics.

The most interesting things about this proposal are that:

- The entire channel, video and sound combined, can be fitted into a bandwidth of only 500 kHz.

- The video and sound signals are generated independently, each crystal-controlled, both just above 10 MHz.

- Using simple SSB techniques (but no balanced modulator), the lower vestigial video sideband is completely filtered out, like an SSB signal, while retaining the carrier (for the present, but some day...?).

- The signal is now heterodyned from just above 10 MHz upward in frequency to the region between 51 and 54 MHz, where the maximum video modulating frequency will be less than one percent of the final transmitting carrier frequency, as with good engineering practice.

- The scanning standards will be: 225 lines per frame,

4:1 interlace, 15 frames per second, 60 fields per second, 56.25 lines per field.

The horizontal deflection frequency will be 3,375 Hz, and the vertical deflection frequency will be 60 Hz. The synchronizing pulses for the TV camera are generated by solid-state frequency divider-comparators and a phase-locked loop. The master frequency for the countdown (frequency-dividing) sequence will be 13,500 Hz.

To obtain the horizontal sync pulses, some of the master-frequency oscillator output goes to a divide-by-four device, output, 3,375 Hz. To obtain the vertical sync pulses, some of the master-frequency oscillator output (13,500 Hz) goes to a series of divide-by devices (see Fig. 1) resulting in an output of 60 Hz. This sync generator will provide the camera's modified horizontal and vertical sweep oscillator/amplifiers with the complex sync necessary to scan a 225-line, 4:1 interlace raster on the camera's vidicon image tube.

If the usual practice of ATVers is to be the case, this system will work fine, as there will be no discernible flicker if the motion in the image is not excessively rapid. We ATVers who use vidicon TV cameras know better than to either pan the camera quickly or go suddenly from a bright to a

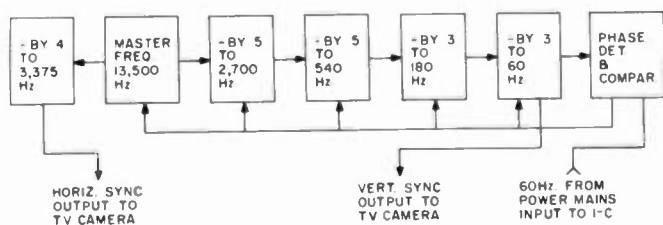

Fig. 1. The sync-generator countdown frequency-divider chain.



dimly-illuminated scene, as we get smear in the image. The reduced horizontal scan rate will increase the vidicon's light sensitivity due to the photoelectric/photon-charge-storage principle, so an ordinary table lamp should suffice to light up the shack.

You might ask, why use only 225 lines in the image? Commercial television uses 525 lines; wouldn't the picture have less than half the sharpness, resolution, and detail of standard TV? Believe it or not, unless you have a huge screen and are almost sitting on the set, you probably won't even notice the difference. Have you seen how sharp the picture is on a 14" surveillance-camera monitor TV screen, or how crisp the detail is on your living room TV set when the kids are playing with the TV game? Those security systems and the TV games have one thing in common: The images are non-interlaced, and provide an image of only 262.5 lines on a security monitor or on any TV set.

I'm sure you're all wondering by now how a TV set can receive both a 525-line and 262.5-line image! Did you know that when your TV set is not receiving a signal, it is scanning only 262.5 lines on the screen? Whether or not you're receiving a signal, an interlaced signal or a non-interlaced signal, the TV set's scan oscillators don't change frequency. The 2:1 interlace system used in commercial television allows twice the number of scanning lines (and, therefore, vertical image detail) to be scanned by the TV camera than its scan-system oscillators, actually operating at no difference in frequency, would normally scan.

Whether the camera is scanning 262.5 lines or 525 lines, the maximum video frequency in the camera output is exactly the same.

A 525-line non-interlaced picture would require a horizontal deflection frequency of twice that used for an interlaced system, and the maximum video frequency also would be twice that of an interlaced system. As for the difference between the 262.5-line picture which was discussed earlier and a 225-line picture, the difference amounts to only 37.5 lines—slightly noticeable, yes, but only if you had a 262.5-line picture being displayed on another TV set of the same screen size alongside.

In practice, a 14" screen is about the largest practical size for a 225-line TV system, and at a viewing distance of eight feet, no line structure can be resolved by the eye. The 4:1 interlace system outlined in this proposal consists of transmitting four coarse-scan fields, each consisting of 56.25 lines, in 1/15 of a second, to form a complete frame of 225 interlaced scanning lines.

The requirements for designing a 4:1 interlace system are as follows: The master frequency must end in a zero, and each divider stage downward in frequency must also end in a zero, all the way down to the mains-power frequency. The vertical scanning frequency must be the same as and lock to the mains-power frequency. The horizontal scanning frequency must be 1/4th of the master frequency, and end in the whole number five. The total number of lines comprising a frame, when divided by four, must end in the decimal .25 in the lines-per-field count.

Only a very limited number of different 4:1 interlace line-count systems which are mathematically possible are practical for a television system of this kind, and far fewer can be constructed to work, much less work reliably, if a rela-

tively high frequency must be divided to a far lower frequency in just one device. This is because of these three big problems to be solved: stability, obtainability, and cost.

The following is for a 225-line-per-frame system with a 3×4 aspect ratio: The horizontal deflection frequency of 3,375 Hz is derived by multiplying the rate of frames per second (15) times the line count per frame (225). If the line-per-frame count is divided by four, we get the line-per-field count of 56.25, as four of these interleaved fields are scanned consecutively to form one complete frame. The usable lines and portions thereof for the image with any line-count or aspect-ratio scan system are approximately and on the average only 5/6ths of the total lines scanned, due to loss of lines during vertical retrace time, vertical and horizontal overscan on the camera image tube, and other scanning efficiency factors.

To calculate the maximum video frequency which will be produced by a television system, we first consider the aspect ratio (the ratio of height to width). In America, we use an aspect ratio of three units high to four units wide, or 3×4. Converting the 225-lines per frame to picture elements (pixels), we have 225 pixels vertically. As we have a 3×4 aspect ratio, 225 pixels is therefore only 3/4ths of what must be the horizontal pixel count; it follows that the horizontal pixel count is 300. The total number of pixels per frame, then, is 67,500, and multiplied times 15 frames per second is 1,012,500.

We must now divide this large number by 2, as at this point it must be understood that the maximum video frequency consists of alternate black and

white squares on each scanning line, a black and white pair equaling one full cycle. When the video signal is closely examined, however, it is found that only the black (or only the white) squares count as the maximum measured video frequency. Therefore, 1,012,500 cycles divided by 2 is 506,250, and as we only have 5/6th efficiency, it follows that the maximum video frequency is 421,875 Hz.

For the sake of making things slightly easier, divide the product of total pixels times "rep-rate" by 2.4. (1,012,500 divided by 2.4 is 421,875.) Using the same system to calculate the maximum video frequency of a conventional commercial TV camera, 525 pixels × 700 pixels is 367,500 pixels × 30 frames/second is 11,025,000 divided by 2.4 is 4,593,750 Hz.

In commercial practice, a filter limits the maximum video frequency to 4,000,000 Hz. As this 225-line system is incompatible with commercial television standards, it must be pointed out that commercial vacuum-tube TV camera and TV sets can be modified easily to a 225-line system, and what's more, I'll tell you just how to do it, too!

To begin with, the vertical deflection circuits in both TV cameras and TV sets aren't touched at all, as both systems are locked to 60 Hz. The TV camera conversion, first of all, must have the solid-state sync-generator board installed within, along with its power source. The horizontal-sweep circuitry will have to be modified from a frequency of 15,750 Hz to 3,375 Hz. If the vidicon won't fully scan horizontally, either more energy is required or the associated deflection coil hasn't enough inductance to give a good reactive load at this much lower deflection frequency.

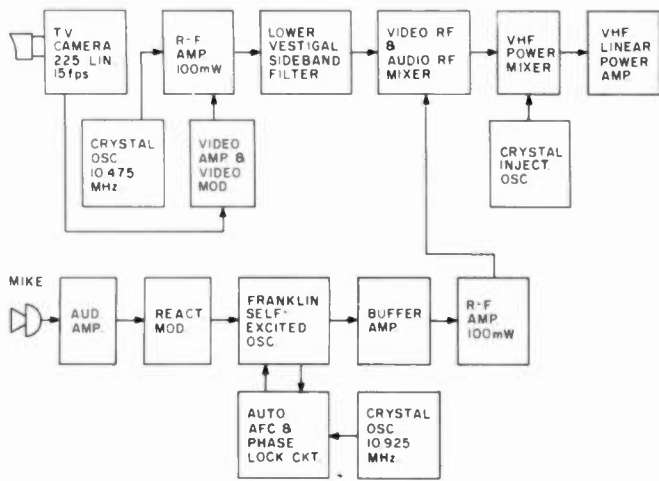

Fig. 2. The rf-generator video and audio-exciter chain.

Instead of the high-impedance horizontal-sweep tube, a silicon PNP transistor may have to be used, as its output impedance is low, and at 3,375 Hz it will be "looking into" a load which will be closer to a correct impedance match.

The receiver conversion will be fun. The horizontal-oscillator/amplifier circuit will continue to provide the picture tube with high voltage, but that's all. The afc circuit will be disconnected from both the horizontal oscillator and the horizontal-output transformer, and the horizontal deflection coils will be disconnected from the same transformer. A solid-state horizontal-oscillator/amplifier circuit will be built using the latest state-of-the-art phase-locked-loop technology to "lock the sync" even under adverse conditions of heavy QRM.

As with the TV camera, a silicon PNP transistor will likely be required to directly drive the horizontal-deflection coils. The metal case of the transistor will be grounded directly to the metal chassis of the TV set (and remember, the transistor's case is the collector) and the emitter will be connected to the sawtooth-scan side of the horizontal-deflection coils. The other end of the same coils will go to the plus side of the

transistor's power supply. Since both the horizontal sweep frequency and the circuit impedances are now much lower than before, the diode damper normally required in the horizontal-output circuit should not be needed. Of course, the one in the high voltage power supply will naturally remain, as it is part of the "bootstrap" power supply associated with the high-voltage circuit to the picture tube.

An electron-beam squelching circuit will have to be added to put a dc voltage on the picture tube's electrode which blanks out the vertical retrace lines, because when no signal is being received to cause a fully 4:1 interlaced raster to appear on the screen, the free-running deflection circuits in the modified TV receiver will be scanning only 56.25 lines on the picture tube. This much-reduced scan of only one field will be intensely bright and will permanently damage the phosphorescent coating on the face of the picture tube with ugly brown horizontal streaks from which little or no useful light will come. Remember, 3,375-Hz horizontal-scan frequency divided by 60 Hz vertical-scan frequency equals 56.25 lines on the picture tube!

Now, on to the signal cir-

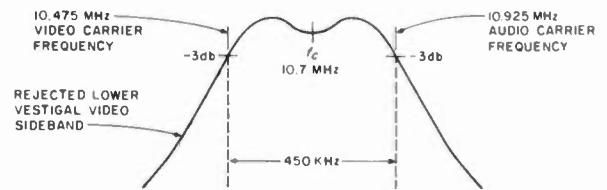

Fig. 3. The over-coupled, double-humped-response curve of the modified 10.7-MHz i-f transformer used in the output/filter circuit of the video-modulated rf amplifier.

cuits. The TV set's tuner must have the swamping resistors removed to narrow down the band-pass to around 500 kHz. The channel 2 coils will be our concern here, as the signal coils will be centered between 51 and 54 MHz, say, 52.5 MHz. The oscillator will be modified to tune this range, but 23 MHz above. Why 23 MHz? Only the older TV sets had an i-f that low; all modern TV sets use 40-MHz i-f amplifiers! Well, first of all, the modern i-fs are twice as broad as we need, so they'll have to go—and be replaced with some Miller (or other) bifilar-wound 20-MHz i-f transformers, with best Q at around 23 MHz. All of the swamping resistors associated with the former i-f transformers are to be removed, of course. All of the i-fs will be tuned to the same frequency, not only for best gain, but with three i-f stages—optimum bandwidth, too. At the output of the last i-f stage, the band-pass should be around 500 kHz at -3 dB.

If it is desired to use an intercarrier sound-recovery system, it will operate on a frequency of 450 kHz, as this is the heterodyne difference frequency between the picture and sound carrier frequencies. 455 kHz i-f transformers will tune down here easily. The sound system is NBFM with plus and minus 5-kHz deviation. Another way to recover the sound is by using a low-band FM communications receiver made to tune below 30 MHz to the region between 22 and 24 MHz.

The local oscillator should be converted from crystal control to self-excited, with the tuning control on the front panel. An afc circuit should be added to prevent drifting off center frequency.

Now we get to the *piece de resistance*, the rf generator. A block diagram is shown in Fig. 2. The video circuit will consist of a crystal-controlled oscillator driving a very low-powered amplifier with an output below 100 mW. This amplifier will be grid- or cathode-modulated by a video amplifier/modulator, supplied with composite negative-going video and sync by the modified TV camera. The output of the video-modulated amplifier will pass through a lower vestigial video-sideband filter composed of a large 10.7-MHz FM i-f transformer with overcoupled primary and secondary windings; this is in order to slightly broaden the bandpass and form the characteristic double-humped response curve.

Other components of the filter include a tunable 10.7-MHz series-T rejection trap, and a few crystals—in order to put a deep, wide notch just below the video-carrier frequency so that the lower vestigial video sideband will be completely filtered out. The video-carrier crystal oscillator will operate at a frequency of 10.475 MHz. The audio-carrier crystal oscillator will operate at a frequency of 10.925 MHz. These two frequencies are 450 kHz apart; both are sym-

# MFJ ANTENNA TUNERS <sup>16</sup> MODELS

## MFJ-941C 300 Watt Versa Tuner II

Has SWR/Wattmeter, Antenna Switch, Balun. Matches everything 1.8-30 MHz: dipoles, vees, random wires, verticals, mobile whips, beams, balanced lines, coax lines.



*Ham Radio's most popular antenna tuner. Improved, too.*

**\$89<sup>95</sup>**  
(+ \$4)

**Fastest selling MFJ tuner . . .** because it has the most wanted features at the best price.

**Matches everything from 1.8-30MHz:** dipoles, inverted vees, random wires, verticals, mobile whips, beams, balanced and coax lines.

Run up to 300 watts RF power output.

**SWR and dual range wattmeter** (300 & 30 watts full scale, forward/reflected power). **Sensitive meter** measures SWR to 5 watts.

**Flexible antenna switch** selects 2 coax lines, direct or through tuner, random wire/balanced line, or tuner bypass for dummy load.

**12 position efficient airwound inductor** for lower losses, more watts out.

**Built-in 4:1 balun** for balanced lines. 1000V capacitor spacing.

**Works with all solid state or tube rigs.**

**Easy to use, anywhere.** Measures 8x2x6", has

S0-239 connectors, 5-way binding posts, finished in eggshell white with walnut-grained sides.

**4 Other 300W Models:** MFJ-940B, \$79.95 (+ \$4), like 941C less balun. MFJ-945, \$79.95 (+ \$4), like 941C less antenna switch. MFJ-944, \$79.95 (+ \$4), like 945, less SWR/Wattmeter. MFJ-943, \$69.95 (+ \$4), like 944, less antenna switch. Optional mobile bracket for 941C, 940B, 945, 944, \$3.00.

### MFJ-900 VERSA TUNER



MFJ-900  
**\$49<sup>95</sup>**  
(+ \$4)

### MFJ-949B VERSA TUNER II



MFJ-949B  
**\$139<sup>95</sup>**  
(+ \$4)

### MFJ-962 VERSA TUNER III



MFJ-962  
**\$229<sup>95</sup>**  
(+ \$10)

**Matches coax, random wires 1.8-30 MHz.**

**Handles up to 200 watts output;** efficient airwound inductor gives more watts out. 5x2x6".

**Use any transceiver,** solid-state or tube.

**Operate all bands with one antenna.**

#### 2 OTHER 200W MODELS:

**MFJ-901, \$59.95 (+ \$4),** like 900 but includes 4:1 balun for use with balanced lines.

**MFJ-16010, \$39.95 (+ \$4),** for random wires only. Great for apartment, motel, camping, operation. Tunes 1.8-30 MHz.

**MFJ's best 300 watt Versa Tuner II.**

**Matches everything from 1.8-30 MHz,** coax, randoms, balanced lines, up to 300W output, solid-state or tubes.

**Tunes out SWR** on dipoles, vees, long wires, verticals, whips, beams, quads.

**Built-in 4:1 balun, 300W, 50-ohm dummy load,** SWR meter and 2-range wattmeter (300W & 30W).

**6 position antenna switch** on front panel, 12 position air-wound inductor; coax connectors, binding posts, black and beige case 10x3x7".

**Run up to 1.5 KW PEP,** match any feed line from 1.8-30 MHz.

**Built-in SWR/Wattmeter** has 2000 and 200 watt ranges, forward and reflected.

**6 position antenna switch** handles 2 coax lines (direct or through tuner), wire and balanced lines.

**4:1 balun, 250 pf 6KV cap, 12 pos. inductor,** Ceramic switches. Black cabinet, panel.

**ANOTHER 1.5 KW MODEL: MFJ-961, \$189.95 (+ \$10),** similar but less SWR/Wattmeter.

**MFJ-10, 3 foot coax with connectors, \$4.95.**

### MFJ-984 VERSA TUNER IV



MFJ-984  
**\$329<sup>95</sup>**  
(+ \$10)

### MFJ-989 VERSA TUNER V



MFJ-989  
**\$329<sup>95</sup>**  
(+ \$10)

**Up to 3 KW PEP** and it matches any feedline, 1.8-30 MHz, coax, balanced or random.

**10 amp RF ammeter** assures max. power at min. SWR. SWR/Wattmeter, for.ref., 2000/200W.

**18 position dual inductor,** ceramic switch.

**7 pos. ant. switch, 250 pf 6KV cap. 5x14x14".**

**300 watt dummy load. 4:1 ferrite balun.**

**3 MORE 3 KW MODELS: MFJ-981, \$239.95 (+ \$10),** like 984 less ant. switch, ammeter.

**MFJ-982, \$239.95 (+ \$10),** like 984 less ammeter, SWR/Wattmeter.

**MFJ-980, \$209.95 (+ \$10),** like 982 less ant. switch.

**New smaller size matches new smaller rigs —** only 10.3/4Wx4.1/2Hx14.7/8D".

**3 KW PEP, 250 pf 6KV caps.** Matches coax, balanced lines, random wires 1.8-30 MHz.

**Roller inductor, 3-digit turns counter plus spinner knob** for precise inductance control to get that SWR down.

**Built-in 300 watt, 50 ohm dummy load.**

**Built-in 4:1 ferrite balun.**

**Built-in lighted 2% meter** reads SWR plus forward/reflected power. 2 ranges (200 & 2000W).

**6 position ant. switch.** Al. cabinet. Tilt bail

To order or for your nearest dealer

Master Charge  
**CALL TOLL FREE**  
**800-647-1800**  
VISA

For tech. info., order or repair status, or calls outside continental U.S. and inside Miss., call 601-323-5869.

• All MFJ products unconditionally guaranteed for one year (except as noted).

• Products ordered from MFJ are returnable within 30 days for full refund (less shipping).

• Add shipping & handling charges in amounts shown in parentheses.

Write for FREE catalog, over 80 products

**MFJ ENTERPRISES, INCORPORATED**

Box 494, Mississippi State, MS 39762

metrically on opposite sides of the 10.7-MHz center frequency of the i-f transformer, and both, therefore, are the same number of dBs down on the transformer's response curve.

The FM audio signal's rf does not pass through the same i-f transformer used in the output/filter circuit of the video-modulated rf amplifier, but it will pass through a similar transformer in the output of the video rf/audio rf mixer. The 10.925-MHz FM audio generator will have one crystal oscillator and one afc phase-locked loop self-excited oscillator, both operating on the same frequency. The time constant of the afc/phase-lock circuit will allow for FM carrier deviation.

Now comes the rest of the answer to the question I'm sure all of you are asking by now, which is: Why does he keep harping on six

meters? Doesn't he know that the FCC would never allow "that sort of thing," and hasn't he heard about the "national band-apportionment plan"? Well, I'll tell you, at the risk of sounding like some sort of rebel.

First of all, about FCC—how many of you can remember back when we could do anything we wanted to do on those ultrashortwave bands? I do! As for this so-called national band-appointment plan, how many of you out there really agree wholeheartedly with how two meters and now 220 have been and are being chopped up into neat little slices for all of those open and closed machines?

Where are those "wide open spaces" we knew in the 40s and 50s where we had megacycles to burn? I know, I know—progress! OK, fine. Two things I know: A long time ago, I

read somewhere that no one has a monopoly or right to any "personal" frequency in the "ham bands"—and I've got a box full of crystals for six and two meters and I guess a lot of them must fall across repeater-band edges and outputs!

'Nuff said? I think so, too, so let's get back to business. By now, at least a few of you must be wanting to say, Hey! How can a country with a different main-power frequency than ours send us a picture with a 50-Hz vertical-deflection frequency and some cockamamie horizontal frequency and we receive it?

That's easy! All you have to do is remember that your TV set doesn't care what it gets—just design enough latitude into your horizontal and vertical hold controls and their phase-locked-loop circuits, and you can reach out and hold

on to the "man in the moon"!

Next question: How about color? Thought you'd never ask!

Let's get black and white off the ground first (!) but, since you won't get any sleep unless I tell you, here goes. Yes, of course, the present American or European systems can be converted to work with my system. The TV receiver should have many adjustments (like a scope) so that any scan system, type, and polarity of sync or modulation can be received. Incidentally, I've got another, even narrower-band system of real TV which I can tell you about. It would fit into an FM channel. Of course, it wouldn't have nearly the definition or quality of what I'm offering you here. However, I'll give you one more hint. It would be like slow scan, but real TV. Cheerio! ■

## WHEN YOU NEED JUST A LITTLE MORE AUDIO

The **FASTRAK**® model 2003 audio amplifier module produces 250 mW of low THD audio. This transformerless design has a low parts count and does not require a heatsink.

The model 2003 features a dc-operated volume control. Output level is selected by changing a dc voltage with an on-board pot, remote pot or micro-computer D/A interface.

- ▶ Low-Z, ac-coupled output drives speaker or headphones.
- ▶ Dc-type volume control assures hum-free operation without using shielded cable to the volume control.
- ▶ No interstage transformers or heatsinks.
- ▶ Compatible with other **FASTRAK**® modules, such as the model 2002 sound synthesizer.
- ▶ One evening assembly using 3.6 by 1.0 inch pc board and instructions supplied.
- ▶ Price: \$9.45

Price includes: glass-epoxy, etched, plated, drilled pc board; instruction manual; postage in U.S.A. (Ohio residents add 5% sales tax).

Send \$1.00 for illustrated **FASTRAK**® product catalog and refund coupon.



**PROHAM ELECTRONICS INCORPORATED**  
34620 LAKELAND BLVD. EASTLAKE OH 44094  
(216) 951-2110

# SATURN V

## STATE-OF-THE-ART

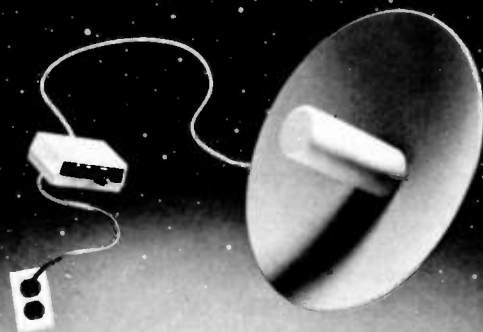

The Saturn V is a deep fringe microwave receiver for homeowners that are outside of the service area of local pay TV stations (i.e., HBO, Showtime). It is normally used within line of sight of a transmitting tower in a 50 mile range and is simply attached to your TV antenna mast. This unit is completely ready to install including all cable and mounting hardware. It is designed to be installed by the homeowner.

We accept MasterCharge & Visa.

Microwave and Satellite Systems  
**JDL**  
Industries <sup>TM</sup>

1-3	\$165.00
4-11	\$120.00
12-49	\$105.00
50-99	\$ 95.00
100-149	\$ 85.00
150-up	\$ 80.00

4558 Auburn Blvd., Suite 208  
Sacramento, California 95841 (916) 454-2190 ✓82

## SWD-1 VIDEO CONVERTER

FOR CABLE TV



The SWD-1 Video Converter is utilized on cable TV systems to remove the KHz's signal from a distorted video (channel 3 in/out) and also pass thru the normal undistorted/detected audio signal. Rocker switch selects operating mode to remove KHz's distortion from the video or pass all other channels normally. Simple to assemble—less than 30 minutes. Pre-tuned. Input/output Channel 3. Impedance 75 ohms. 117VAC.

SWO-1 Video Converter Kit ..... \$69.95

## VTR ACCESSORIES

### SIMPLE SIMON VIDEO STABILIZER



Simple Simon Video Stabilizer, Model VS-125, eliminates the vertical roll and jitter from "copy guard" video tapes when playing through large screen projectors or on another VTR. Simple to use, just adjust the lock control for a stable picture. Once the control is set, the tape will play all the way through without further adjustments. Includes 12V power supply.

VS-125 Video Stabilizer, wired ..... Reg. 54.95... **\$39.95**

NEW VCR Quality

### MODULATOR

Not a Game Type Modulator

The MPS-1 Kit converts Video/Audio signals to a crystal controlled RF output for TV Channels 3 and 4. The MPS-1 Modulator inputs are designed to match all TV Cameras and VCR's and features a voltage regulated power supply, power switch and LED Indicator. No Tuning Required. Operates on 117VAC.

Assembly Time Approximately 5 Minutes

MPS-1 Kit ..... **\$39.95**

## UHF ANTENNAS and ACCESSORIES

### MDS-AMATEUR-ETV 32 ELEMENT

#### YAGI ANTENNA



• 1.9-2.5 GHz • Not A Kit

• 23dB Average Gain • 38 1/2" Long

• Die Cast Waterproof Housing with 4 1/4" x 2 1/4" Area for Electronics

• Includes P.C. Probe, F-61 Connector and Mounting Hardware

MAE-2 32 Element YAGI Antenna ..... **\$23.95**

### Kato Sons' Down Converter Kit ★1.9 - 2.56GHz★

Designed for Simple Simon by former Japanese CQ Amateur Magazine's UHF Editor/Engineer. Unit utilizes new ingenious Printed Circuit Probe for maximum gain. Circuit board fits inside MAE-2 antenna housing. Requires 1 hour assembly. IC and capacitors pre-soldered.

Model KSOC-KIT 1.9 - 2.5GHz Down Converter Kit ..... **\$34.95**

### Kato Sons' Regulated Variable DC Power Supply

For use with KSOC-KIT 1.9 - 2.5GHz Down Converter. Completely assembled with Attractive Cabinet, TV/Converter Mode Switch, Frequency Control and LED Indicator.

Model KSPS-1A Assembled Power Supply ..... **\$23.95**

### ORDER ALL THREE ITEMS

MAE-2, KSOC-KIT and KSPS-1A for Only. **\$74.95**

Regular price if ordered separately \$82.85

— CO-AX CABLES ARE NOT INCLUDED —

## ZYZX VHF-UHF Wideband Antenna Amplifier



### Revolutionary New HYBRID IC Broadband Amplifiers

50 MHz - 900 MHz Model ALL-1 12dB Gain

Model ALL-2 35dB Gain

These units are not available anywhere else in the world. Each unit will serve many purposes and is available in Kit or Assembled form. Ideal for outdoor or indoor use. I/O impedance is 75 ohms. Amplifiers include separate co-ax feed power supply. Easily assembled in 25 minutes. No cable capacitors to tune or adjust.

ALL-1 Complete kit w/power supply ..... **\$24.95**

ALL-1 Wired/Tester w/power supply ..... **\$34.95**

ALL-2 Complete kit w/power supply ..... **\$34.95**

ALL-2 Wired/Tester w/power supply ..... **\$44.95**

## Our New STVA 14.5dB GAIN, 14 ELEMENT CORNER REFLECTOR YAGI ANTENNA



STVA-3 Yagi Antenna, 14.5dB Gain, Selectable 75 or 300 ohm Channel 60-80. **\$19.95**

STVA-4 Yagi Antenna, 14.5dB Gain, Selectable 75 or 300 ohm Channel 44-52. **\$19.95**

RC-59/U 75 ohm Low Loss Coax Cable, \$1.29/ft. F-59 Coax Connector, \$ .39 ea.

MT-1 Special UHF 75-300 ohm Matching Transformer, \$1.45 ea.

# Switch to Bambi™!

## Electronically

Bambi Electronic Video Switch ... makes switching of your VCR/VTR, Pay TV Decoders, Cable TV, Video Discs, Video Games, Closed Circuit TV, Antennae and Microcomputer as easy as pushing buttons.

The Bambi Electronic Video Switch is an electronic switching network which can accept up to six different sources of video signals and provide the flexibility of directing the inputs to any or all of the three outputs.

Now you can eliminate ... the drudgery of disconnecting and reconnecting your video equipment each time you use it ... the tangled mess of cables which are impossible to trace out ... not being able to use more than one function at a time.

Bambi lets you enjoy using your video equipment the way it should be ... electronically and on line at the push of a button.

Model BEVS-1 Completely Wired and Assembled. Includes comprehensive Instruction/Operation Manual and Decal Set for customizing your Video Switch installation.

**\$129.95**

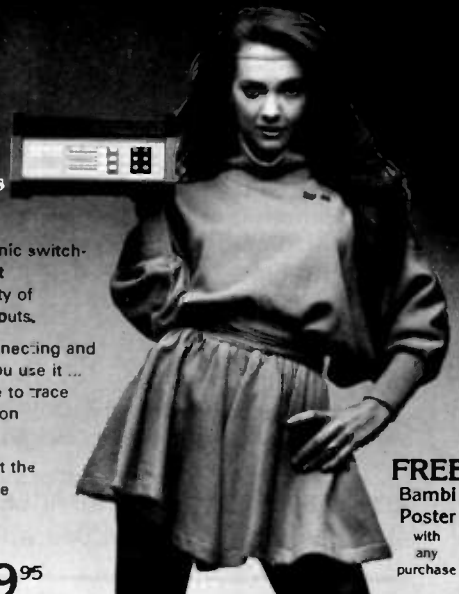

FREE Bambi Poster with any purchase



Bambi's front panel was designed with the user in mind. Computer styled construction, with soft-touch keyboard (rated for over 10 million operations), arranged in matrix form allows easy input/output selection without referring to charts. Functions selected through the keyboard are immediately displayed on the 18 LED status indicators.



Check the quality of Bambi against that of much higher priced competition. All solid state electronic switching provides low attenuation (3dB), wide frequency response (40-890 MHz), and excellent isolation between signal sources (each I/O section individually shielded for 65dB min. isolation).



### Bambi's Specifications:

- Input/Output Impedance 75 ohm
- Signal Loss 3dB ±1dB
- Noise 4dB ±1dB
- Input Return Loss 12dB min.
- Isolation 65dB min.
- Power Req. 117VAC 60 Hz, 2W
- Dimensions 10 1/2" W x 6" D x 3 1/4" H
- Weight 4 1/2 lbs

## 7+11 SWD PARTS KITS

### MITSUMI

#### VARACTOR

#### UHF TUNER

Model UES-A56F

**\$24.95**

Freq. Range UHF 470 - 809MHz

Antenna Input 75 ohms

Channels 14-83 Output Channel 3



Kit No	PART No	DESCRIPTION	PRICE
1	1VT1-SWD	Varactor UHF Tuner, Model UES-A56F	\$24.95
2	2CB1-SWD	Printed Circuit Board, Pre-Drilled	18.95
3	3TP7-SWD	P.C.B. Potentiometers, 1-20K, 1-1K, and 5-10K ohms, 7-pieces	5.95
4	4FR35-SWD	Resistor Kit, 1/4 Watt, 5% Carbon Film, 32-pieces	4.95
5	5PT1-SWD	Power Transformer, PRI-117VAC, SEC-24VAC, 250ma	6.95
6	6PP2-SWD	Panel Mount Potentiometers and Knobs, 1-1KBT and 1-5KAT w/Switch	5.95
7	7SS14-SWD	IC's 7-pcs, Diodes 4-pcs, Regulators 2-pcs, Heat Sink 1-piece	29.95
8	8CE9-SWD	Electrolytic Capacitor Kit, 9-pieces	5.95
9	9CC3-SWD	Ceramic Disk Capacitor Kit, 50 W.V., 33-pieces	7.95
10	10CT-SWD	Variable Ceramic Trimmer Capacitor Kit, 5-65pfd, 6-pieces	5.95
11	11L4-SWD	Coil Kit, 18mhs 2-pieces, 22µhs 1-piece (prewound inductors) and 1 T37-12 Ferrite Toroid Core with 3 ft. of #28 wire	5.00
12	12ICS-SWD	I.C. Sockets, Tin inlay, 8-pin 5-pieces and 14-pin 2-pieces	1.95
13	13SR-SWD	Speaker, 4dB" Oval & Prepunched Wood Enclosure	14.95
14	14MISC-SWD	Misc. Parts Kit Includes Hardware (8/32, 8/32 Nuts, & Bolts), Hookup Wire, Ant. Terms, OPDT Ant. Switch, Fuse, Fuseholder, etc.	9.95
When Ordering All Items, (1 thru 14), Total Price			139.95

## 7+11 PWD PARTS KITS

### INTRODUCING OUR 7+11 PWD PARTS KITS



Kit No	PART No	DESCRIPTION	PRICE
1	1VT1-PWD	Varactor UHF Tuner, Model UES-A56F	\$24.95
2	2CB1-PWD	Printed Circuit Board, Pre-drilled	18.95
3	3TP11-PWD	PCB Potentiometers 4-20K, 1-5K, 2-10K, 2-5K, 1-1K, and 1-50K (11 pieces)	8.95
4	4FR-31-PWD	Resistor Kit, 1/4W, 5% 29-pcs, 1/2 W 2-pcs	4.95
5	5PT1-PWD	Power Transformer, PRI-117VAC, SEC-24VAC at 500ma	9.95
6	6PP2-PWD	Panel Mount Potentiometers and Knobs, 1-1KBT and 1-5KAT with switch	5.95
7	7SS17-PWD	IC's 7-pcs, Diodes 4-pcs, Regulators 2-pcs Transistors 2-pcs, Heat Sinks 2-pcs	29.95
8	8CE14-PWD	Electrolytic Capacitor Kit, 14-pieces	6.95
9	9CC20-PWD	Ceramic Disk Capacitor Kit, 50 WV, 20-pcs	7.95
10	10CTS-PWD	Variable Ceramic Trimmer Capacitor, 5-85pfd, 5-pieces	4.95
11	11L5-PWD	Coil Kit, 18mhz 3-pcs, 22µhs 1-piece (prewound inductors) and 2 T37-12 Ferrite Toroid cores with 6 ft. #28 wire	6.00
12	12ICS-PWD	IC Sockets, Tin inlay, 8 pin 4-pcs, 14 pin 1-pc and 18 pin 2-pcs.	2.95
13	13SR-PWD	Enclosure with PM Speaker and Pre-drilled Backpanel for mounting PCB and Ant. Terms	14.95
14	14MISC-PWD	Misc. Parts Kit Includes Hardware, (8/32, 8/32 Nuts & Bolts), Hookup Wire, Solder, Ant. Terms DPDT Ant. Switch, Fuse, Fuseholder, etc.	9.95
15	15MC16-PWD	Mylar Capacitors, 14-pcs and Silver Mica Capacitors 2-pieces	7.95
When Ordering All Items, (1-16), Total Price			159.95

**CUSTOMER NOTICE:** BUY WITH CONFIDENCE ... BEWARE OF LOW QUALITY IMITATORS. All of our kits consist of New, 1st Class, RF Quality, Parts Engineered for Optimum Operation, not factory seconds or stock close-outs. We service your completed kits that you've purchased and built. You will never get stuck with a BAG OF PARTS when ordering from Simple Simon.

## SIMPLE SIMON ELECTRONIC KITS,™ Inc.

3871 S. Valley View, Suite 12, Dept. 7, Las Vegas, NV 89103

NEED NO MORE OF AN ITEM? WRITE FOR QUANTITY DISCOUNTS

In Nevada Call: **702-871-2892**

**1-800-782-3716**

Outside Nevada Call:

Available by Mail Order Only Send Check\* or Money Order. Minimum Order: \$16.95. Add 10% Shipping and Handling on orders under \$40.00. For orders over \$40.00, add 5%. Minimum Shipping and Handling \$2.00. Cat. \$1.00 — VISA and Mastercard Acceptable — \*Check orders will be held 30 days before shipping.

# DAYTON Hamvention®

**APRIL 29, 30, MAY 1, 1983**

Hara Arena and Exhibition Center — Dayton, Ohio

Meet your amateur radio friends from all over the world at the internationally famous Dayton HAMVENTION.

Seating will be limited for Grand Banquet and Entertainment on Saturday evening so please make reservations early. Banquet speaker is Bill Leonard, W2SKE, former president of CBS News.

If you have registered within the last 3 years you will receive a brochure in late February. If not write Box 44, Dayton, OH 45401.

- ★ Technical Forums
- ★ ARRL and FCC Forums
- ★ GIANT 2-day Flea Market  
Saturday and Sunday
- ★ New Products and Exhibits
- ★ Grand Banquet
- ★ Women's Activities
- ★ Home-Brew Equipment  
Forum
- ★ Special Group Meetings
- ★ YL Forum
- ★ Personal Computers Forum
- ★ CW Proficiency Awards
- ★ Amateur of Year Award
- ★ Special Achievement  
Awards

Nominations are requested for Radio Amateur of the Year and Special Achievement Awards. Nomination forms are available from Awards Chairman, Box 44, Dayton, OH 45401.

For special motel rates and reservations write to Hamvention Housing, 1406 Third National Bldg., Dayton, OH 45402.  
**NO RESERVATIONS WILL BE ACCEPTED BY TELEPHONE.**

All other inquiries write Box 44, Dayton, OH 45401 or phone (513) 849-1720.

**Admission:** \$7.50 in advance. \$9.00 at door. (Valid for all 3 days)

**Banquet:** \$14 in advance. \$16 at door.

**Flea Market Space:** \$15 in advance. (Valid for both days)

Make checks payable to Dayton HAMVENTION, Box 2205, Dayton, OH 45401.

Bring your family and enjoy a great weekend in Dayton. Sponsored by the Dayton Amateur Radio Association, Inc.

## Hy-Gain Antennas

TH7DXS 7 element triband beam	\$ 376.00
TH5HK2S 5 element triband beam	309.00
TH3HK3S 3 element triband beam	215.00
TH3JrS 750W PEP 3 el tribander	156.00
TH2HK3S 2 element triband beam	134.00
TH6 to TH7DXS conversion Kit	135.00
20SBAS 20m 5 element "Long John"	292.00
15SBAS 15m 5 element "Long John"	175.00
10SBAS 10m 5 element "Long John"	114.00
18AVT/WBS 80-10m trap vertical	87.50
14AVG/WBS 40-10m trap vertical	51.00
V2S 2m colinear gain vertical	37.50
BN-86S Beam mount 1:1 balun	17.00

Full line available at big savings!

## Hy-Gain Crank-up Towers

HG-33MT2 Side supported	\$ 744.00
HG-35MT2 Side supported	546.00
HG-50MT2 Side supported	754.00
HG-37SS Self-supporting	642.00
HG-52SS Self-supporting	923.00
HG-54HD Self-supporting	1500.00
HG-70HD Self-supporting	2351.00

Crankups freight prepaid in continental US

## Hustler

5BTV 80-10m vertical	\$ 100.00
4BTV 40-10m vertical	79.00
G7-144 2m colinear vertical	99.00
G6-144B 2m colinear vertical	68.00
MO-1,2 HF mobile masts	18.50
RM-10 10m resonator	9.00
RM-15 15m resonator	9.00
RM-20 20m resonator	12.00
RM-40 40m resonator	13.75
RM-75 75m resonator	14.75
RM-80 80m resonator	14.75
BM-1 Bumper mount	13.00
SSH-2 S.S. ball mount	14.00
HOT "Hustloff" mount	14.00
SF-2 2m 5/8 mobile whip	9.00

Entire line at super savings!

## THE ANTENNA BANK

6460H General Green Way  
Alexandria, Virginia 22312  
703-569-1200

All prices subject to change without notice

## Rohn Towers

20G 10 ft section	\$ 29.50
20AG0 top section	32.75
25G 10 ft section	41.00
25AG0 top section	53.50
45G 10 ft section	93.75
45AG0 top section	104.75
BX48 6 sq ft max	204.00
HBX48 10 sq ft max	253.00
HDBX48 18 sq ft max	316.00
FK2548 48 ft foldover	794.00
FK4544 44 ft foldover	1117.00

## Diawa/Miller

CS-201 2 way coax switch	\$ 20.00
CS-401 4 way coax switch	62.00
CN-520 HF SWR/Power meter	59.00
CN-540 VHF SWR/Power meter	69.00
CN-550 UHF SWR/Power meter	76.00
CN-620B HF/VHF SWR/Power meter	107.00
CN-720B HF/VHF SWR/Power meter	150.00
CNW-418 auto tuner/meter	168.00
CNW-518 auto tuner/meter	285.00

## Mini-Products

HQ-1 "Mini-Quad" 6,10,15,20m	\$ 129.95
B-24 "Mini-Beam" 6,10,15,20m	99.00
RK-3 3rd element for B-24	67.00

ORDERS ONLY: 800-336-8473

ALL others call: (703) 569-1200

No COD - We ship UPS

Allow two weeks for delivery

Shipping cost not included

We reserve the right to limit quantities

We gladly except VISA and MASTERCARD

## Cushcraft Antennas

A4 4 element triband beam	\$ 224.50
A3 3 element triband beam	172.50
R3 Gain triband vertical	224.50
AV5 80-10m trap vertical	88.50
AV4 40-10m trap vertical	81.50
AV3 20-10m trap vertical	44.20
32-19 19 element 2m "Boomer"	81.50
214B 14 element 2m "Jr Boomer"	68.00
214FB 14 element FM "Jr Boomer"	68.00
A147-11 11 element 2m beam	37.50
A144-10T 10 element 2m twist beam	44.20

Full line available at great savings!

## Rotors

HDR-300 Digital readout 25 sq ft	\$ 427.00
T2X "Tailtwister" 20 sq ft	244.00
HAM-IV 15/7.5 sq ft	195.00
CD-45 8.5/5 sq ft	102.75
AR-22XL 3/1.5 sq ft	49.95
HD-73 Dual speed 10.7 sq ft	89.00
U-100 Approx. 3 sq ft	42.00
8 cond rotor cable	.16/ft
6 cond rotor cable	.15/ft
4 cond rotor cable	.075/ft

## MFJ Enterprises

MFJ-900 200 Watt Versa Tuner	\$ 41.95
MFJ-941C 300 watt Versa Tuner II	77.55
MFJ-949B 300 watt Versa Tuner II	117.55
MFJ-962 1500 watt Versa Tuner III	193.15

Other MFJ products at similar savings!

## Coax and Wire

RG-213/u Milspec 95% shield	.28/ft
RG-8/u "Superflex" foam	.24/ft
Mini-8 foam	.12/ft
RG-58/u "Superflex" foam	.12/ft
#14 stranded copper 50,75,100,or 150 ft	.05/ft
#14 copperweld 50 ft multiples	.075/ft

# SPEEDCALL'S NEW #312 TOUCH-TONE DECODER ENDS RADIO BACKGROUND "CHATTER" FOREVER.

Output: Single open collector output, 200mA  
 Input Signal Range: 20 mV to 6 V (flat input).  
 Code Capacity: 3 to 8 digits address plus select any of the 16 touch-tone digits as desired.  
 Battery Voltage: 13.8 VDC Nom. (9 to 16 VDC) @ 30 mA nominal on standby.  
 Assembled Dimensions: 3/4" high, 2-1/8" wide and 3-3/4" long.

Ideal Gift Item!  
**Introductory offer**  
**\$89.**

Shipping & handling charges included

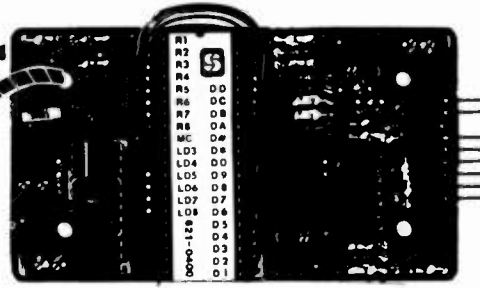

- LOW COST COMMERCIAL GRADE KIT!
- EASY TO ASSEMBLE COMPACT UNIT!
- STATE-OF-THE-ART FLEXIBILITY!

To order, send check or money order to:



DEPARTMENT "K"  
**SPEEDCALL CORPORATION**



2020 National Avenue • Hayward, California 94545

✓ 198 415-783-5611

(California Residents add 6% Sales Tax)

Speedcall Corporation, with 20 years of reliability and know-how in the Mobile Radio Industry, now offers the Model 312K; a unique, low-cost DTMF selective call Touch-Tone® Decoder. It's specially designed in kit form for radio buffs, with all of the quality and performance that made Speedcall #1 in signaling!

No more annoying background chatter, no more missed calls. At last it's possible for individuals and repeater groups to have their own personal and emergency touch-tone DTMF network! And you may use all 16 touch-tone digits to expand your selection of formats and permit special control applications.

We accept VISA, MC, C.O.D., CHECK or M.O.

## FIRST QUALITY COMPONENTS - NOT MAIL ORDER "SECONDS"

Min. order \$10.00 - add 5% Shpg and \$1.00 Ins

### ARIES ZERO INSERTION FORCE SOCKETS -



cam actuated true zero insertion - tin plated solder tail pins - capable of being plugged into dip sockets, including wire wrap

Stock No.	No. Pins	1-24	25	50
11055	24	4.35	3.90	3.60
11056	28	4.50	4.05	3.75
11057	40	5.95	5.35	4.95
11058	64	10.50	9.45	8.70

### RESISTOR ASSORTMENT 82508 - 700 pcs (1 each below assortment) \$22.50

Stock No. 82501 10 ea. of 10-12-15-18-22-27-33-39-47-56 OHM  
 Stock No. 83502 10 ea. of 68-82-100-120-150-180-220-270-330-390 OHM  
 Stock No. 82503 10 ea. of 470-560-680-820-1K-1.2K-1.5K-1.8K-2.2K-2.7 OHM  
 Stock No. 82504 10 ea. of 3.3K-3.9K-4.7K-5.6K-6.8K-8.2K-10K-12K-15K-18K OHM  
 Stock No. 82505 10 ea. of 22K-27K-33K-39K-47K-56K-68K-82K-100K-120K OHM  
 Stock No. 82506 10 ea. of 150K-180K-220K-270K-330K-390K-470K-560K-680K-820K OHM  
 Stock No. 82507 10 ea. of 1M-1.2M-1.5M-1.8M-2.2M-2.7M-3.3M-3.9M-4.7M-5.6M OHM

### TI WIRE WRAP SOCKETS

Tin plated phosphor bronze contact - 3 wrap



Stock No.	No. Pins	1-24	25	100
11301	8	.45	.40	.36
11302	14	.66	.59	.54
11303	16	.72	.64	.58
11304	18	.82	.73	.66
11305	20	1.11	.99	.90
11306	22	1.26	1.12	1.02
11307	24	1.41	1.25	1.14
11308	28	1.71	1.52	1.38
11309	40	2.31	2.05	1.86

### TI LOW PROFILE SOCKETS

Tin plated phosphor bronze contact - 1cl pins with gas tight seal



Stock No.	No. Pins	1-24	25	100
11201	8	\$.15	\$.13	\$.12
11202	14	.18	.15	.14
11203	16	.21	.18	.16
11204	18	.24	.21	.19
11205	20	.27	.24	.21
11206	22	.30	.26	.23
11207	24	.33	.30	.25
11208	28	.38	.34	.29
11209	40	.53	.45	.40

### WILD ROVER

Touch switch capsule  
 Operating motion is "005" without the use of a levered arm. Extremely fast on and off with low noise. Normally open - rated 115 VAC, 1.5 amp-30 microhm resistance - .615 radius by .160 thick.



Stock No.	1-9	10	25
12098	\$ 1.28	\$ 1.12	\$ .95

### 60/40 ROSIN CORE SOLDER

Stock No.	Dia	Length (feet)	Weight (oz.)	Price
50075	.062	9	1.5	\$1.16
50076	.062	25	4	2.39
50077	.062	50	8	4.25
50078	.032	33	1.5	1.31
50079	.032	88	4	2.47
50080	.032	175	8	4.57



### ELPAC POWER SUPPLIES - DC/DC CONVERTERS



SINTEC Stock No.	ELPAC Part No.	Input Voltage (VDC)	Output Voltage (VDC)	Output Current (mA)	Dimensions (HxWxD) in inches	Price
13825	CB3601	3.0-7.0	12.0-6.0	0-25	48x51x3.05	7.95
13826	CB3811	3.0-7.0	12.0-6.0	0-25	48x51x3.05	7.95
13827	CB3602	3.0-7.0	15.0-7.0	0-20	48x51x3.05	7.95
13828	CB3812	3.0-7.0	15.0-7.0	0-20	48x51x3.05	7.95
13829	CB3604	3.0-7.0	28.0-7.0	0-10	48x51x3.05	7.95
13830	CB3814	3.0-7.0	28.0-7.0	0-10	48x51x3.05	7.95

13801 - Floppy Disc Power Supply For Winchester Drives \$109.00

### Special of the Month!



Stock No. 82503 \$75.00

Full 1 year warranty

**DIGITAL MULTIMETER**  
 Single rotary switch operation. Large, easy to read 5 3-1/2 digit display. 800 hours operating life with single 9v battery. Seven functions - (DC Volts, DC Amps, Ohms, AC Volts, AC Amps, Diode and Resistor Junction, Audible Continuity Check)

Stock No. Carrying case with belt loop \$7.50

### MODUTEC



Miniclamp AC Volt-Ammeter allows singling one conductor out of many without disarrangement.

Stock No.	AC Amperes	Price
13730	0-25A	\$39.50
13731	0-50A	39.50
13732	0-100A	39.50

**ACCESSORY LINE SPLITTER**  
 allows fast readings of AC power consumption of plug in equipment without separation of leads.  
 Stock No. 13727 \$9.95

**POCKET SIZED BATTERY TESTER**  
 for all types of small batteries from 1.35v to 4.5v  
 Stock No. 13733 \$13.95

**VOLT-CATOR**  
 automotive diagnostic meter plugs into lighter socket and indicates battery condition and charging rates.  
 Stock No. 13736 \$15.95

**AC VOLTAGE TESTER**  
 plugs into any 110v service receptacle to check time voltage over 50-150 VAC  
 Stock No. 13735 \$14.95

**VOM-MULTITESTER**  
 versatile Volt-Ohm-Milliammeter in small package  
 Stock No. 13729 \$13.95

### ELPAC POWER SUPPLIES - SOLV SERIES FULLY REGULATED

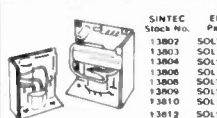

SINTEC Stock No.	ELPAC Part No.	Output Voltage	Output Current	Dimensions (HxWxD) in inches	Price
13802	SOLV15-5	5	3.0A	47.18x44.2	39.95
13803	SOLV15-12	12	1.5A	47.18x44.2	39.95
13804	SOLV15-15	15	1.2A	47.18x44.2	39.95
13806	SOLV15-24	24	0.75A	47.18x44.2	39.95
13808	SOLV30-5	5	3.0A	5.91x4.71x3.316	59.95
13809	SOLV30-12	12	1.2A	5.91x4.71x3.316	59.95
13810	SOLV30-15	15	0.8A	5.91x4.71x3.316	59.95
13812	SOLV30-24	24	2.0A	5.91x4.71x3.316	59.95

13802-1 Data Sheet for SOLV Series 25

### PIN FORMING TOOL

puts IC's on their true row to row spacing. One side is for 300 centers. Flip tool over for devices on 600 centers. Put device in tool and squeeze.

ONE TOOL DOES 8 THRU 40 PINS!  
 Stock No. 11059 \$12.95

### OK MACHINE AND TOOL



**IC INSERTION/EXTRACTION KIT**  
 includes DIP IC extractors and inserter/inserters to accommodate all IC's from 14 to 40 pins. Tools that engage conductive surfaces are CMOS safe and include ground no. tags.  
 Stock No. 13309 \$37.74



**SOCKET WRAP ID**  
 DIP socket sized plastic panels with numbered holes in pin locations. Separate socket reference are affixing to identify pins. Also write on them for location. IC part number, function, etc. Simplifies initial wire wrapping, troubleshooting and repair.  
 \$1.82 per pack

### IC EXTRACTOR

One-piece spring steel construction. Will extract all LSI, MSI and SSL devices with 8 to 24 pins.  
 Stock No. 13313 \$2.10

**SINTEC** Drawer Q Milford CO. NJ 08848-9990



**TOLL 800-526-5960**  
**FREE** In NJ (201) 996-4093

Send for Free Catalog - over 1100 parts

# The Forgetful Autodialer Puzzle

*Even Sherlock couldn't figure out how to make an autodialer that reprograms with no hardware changes. Elementary, says dear Batie.*

Howard F. Batie W7BBX  
12002 Cheviot Drive  
Herndon VA 22070



Photo A.

Among some autodialer designs for 2-meter mobile autopatch use, a common limitation has been a lack of programming flexibility.<sup>1,2,3</sup> Although it is much easier to design and implement a diode-logic or PROM scheme for storing phone numbers, changing or adding a telephone number can be quite inconvenient for hard-wired systems or PROM-based designs. In this design, programming is done directly from the tone-encoder keyboard and allows programming of up to eight phone numbers. Numbers which are not programmed can be dialed directly from the keyboard in the normal manner.

The primary disadvantage of a RAM-based design is the requirement to continuously power the RAM to overcome its volatility. However, when you consider that an ample power source is available at both places in which an autodialer has a real application (your car and the shack), the disadvantage is more than offset by the ability to

reprogram the memories very quickly and easily. Since the circuit described here has a total continuous current drain of only about 45 mA from a 12-15-volt source, it may be connected directly to the car battery without fear of running it down, since cars usually do not sit idle for weeks at a time. If complete disconnection is necessary, each phone number can be reprogrammed as quickly as the phone number can be manually dialed.

The RAM used was carefully selected after considering all available CMOS and bipolar memories; the logic support circuitry was then designed to meet the needs of the RAM. The most important constraints were that the RAM have bidirectional input/output lines and that these lines be tri-state. These requirements were necessary in order to significantly reduce the circuit complexity and cost while still permitting the keyboard to be used manually without affecting the stored phone numbers. Of secondary importance, it was desired that the RAM



be organized 8 bits wide to allow direct interface with the seven data lines of a 3x4 keyboard matrix. The RAM selected was the Texas Instruments TMS 4036 since it met all of these requirements.

### Description

Fig. 1 shows the complete autodialer schematic; connections to the transceiver are shown in Fig. 2. The autodialer memory holds up to eight numbers of up to seven digits each (\* and # count as digits); therefore, the number actually stored may be either a standard 7-digit telephone number or an autopatch access code of from 1 to 7 digits in length. The total number of phone numbers in memory is a function of the RAM organization, in this case 64x8. With selection of a different RAM, more or fewer telephone numbers could be stored. For example, if the RAM organization were 128x8, sixteen phone numbers could be stored. Eight 8-bit words are required to completely store each 7-digit telephone number.

Inclusion of D2 and D3 drops the voltage supplied to the RAM from +5.0 volts down to about +3.5 volts. This decreases the current required by the entire autodialer from 65 mA to about 40-45 mA. Reliable data retention is maintained with this RAM as long as the Vcc pin remains above +2.8 volts dc.

In addition to direct programming from the encoder keyboard, other features of the autodialer include a speed control to vary the rate of readout, an on-board audio amplifier to allow you to hear the tones sent to the transceiver, a visual indication to aid in both programming and readout, and a minimum number of controls. The autodialer may also be used as a "standard" tone encoder to manually dial

phone numbers or access codes which are not programmed directly into the memories.

### Operation

Selection of one of the eight stored phone numbers is accomplished by depressing the appropriate keyboard digit (1-8) while holding down the SELECT push-button, S3. This action latches the logic state of

three RAM address lines (A0, A1, and A2), and is used to select the desired phone number location for either autodial readout or programming. The selected phone number will then be available until a new one is selected; neither manual operation of the keyboard nor autodialing the stored phone number will alter the selection of the phone number.

To program the autodialer, the phone number digits are keyed in on the tone encoder keyboard with the PROGRAM push-button, S2, held down. This action routes the U8b output pulse produced by each keyboard digit depression to the clock input of the counter, U10. When each digit key is depressed, LED1 will light for about half a second; when it goes out,

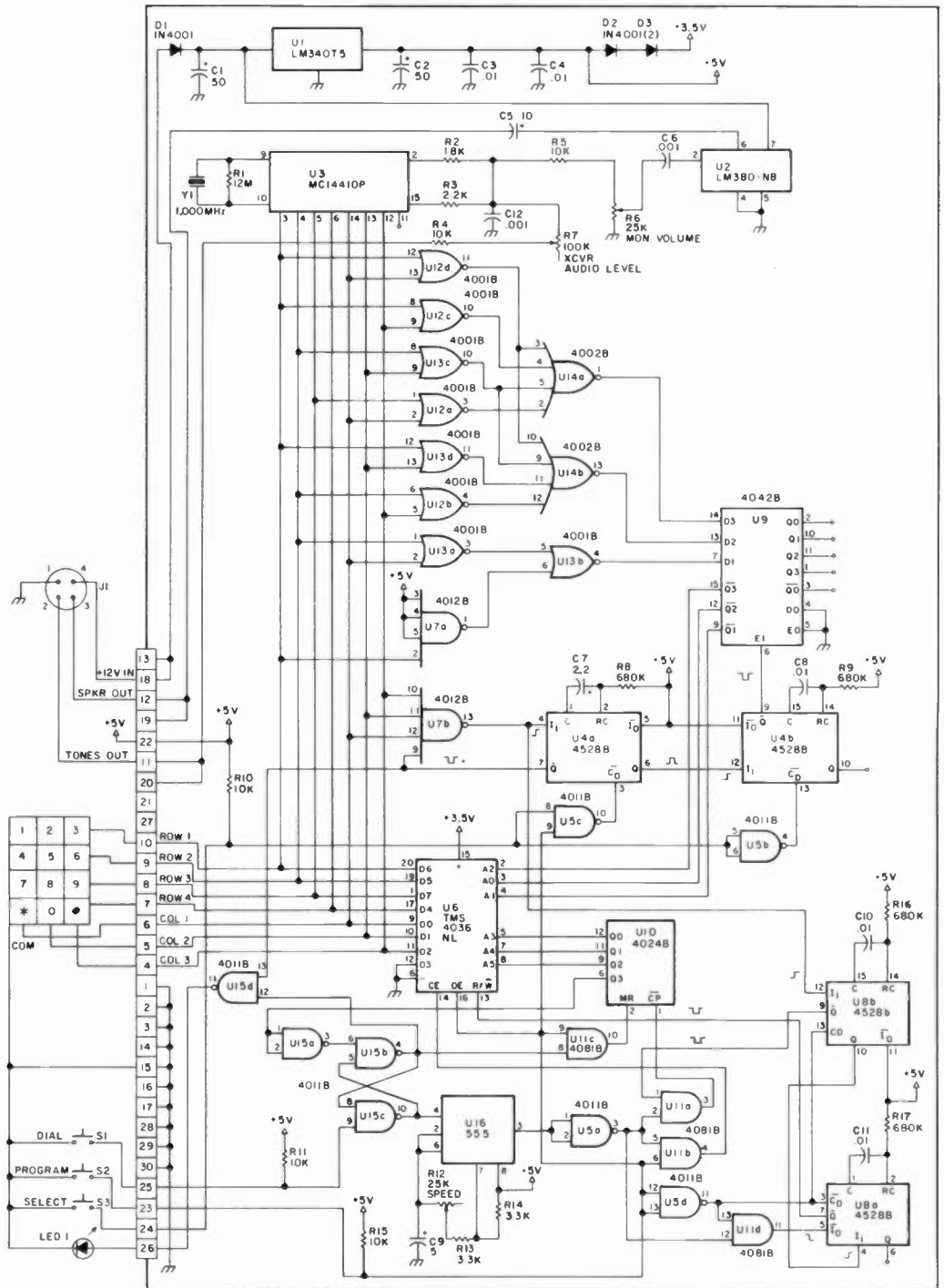

Fig. 1. Schematic diagram.

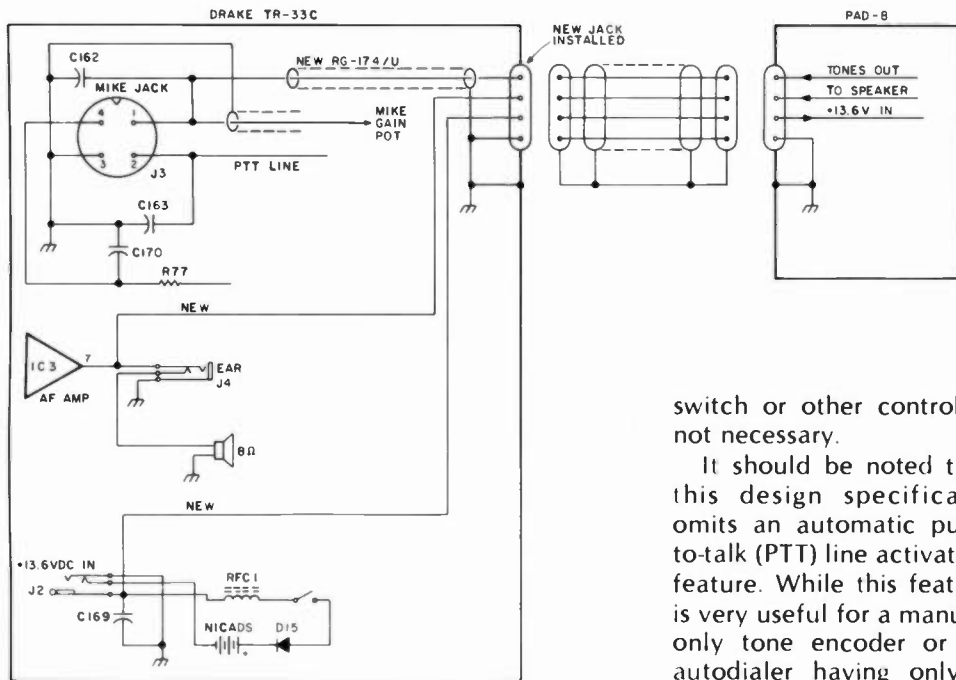

Fig. 2. Typical transceiver connection detail.

that digit has been programmed in and the next digit may be programmed. If only four digits are to be programmed (as in an access code), they are keyed in in the same manner.

Then, after the last digit has been entered, tap the DIAL push-button, S1, while keeping the PROGRAM button down. This activates the clock and steps the address counter, U10, through the remaining memory addresses for the selected phone number. Whatever information may have been stored previously in the latter part of the 8-digit memory segment is automatically erased. The LED will light up while the clock cycles through the unused digits; when it goes out (or when all the digits have been entered into the memory), re-

lease the PROGRAM push-button, and the memory is ready to be autodialed.

To read out (autodial) a phone number, simply select the phone number you want and press the DIAL push-button, S1. LED1 will light up during the autodialing sequence; when it goes out, the number has been completely autodialed.

In the manual mode, the tri-state memory data lines are always in the high-impedance OFF state; the keyboard activates the tone encoder, U3, and the encoder tones are fed directly to the transmitter mike input. Since the autodialer is always ready to dial a phone number manually (except when programming or during autodial readout), a separate manual/autodial

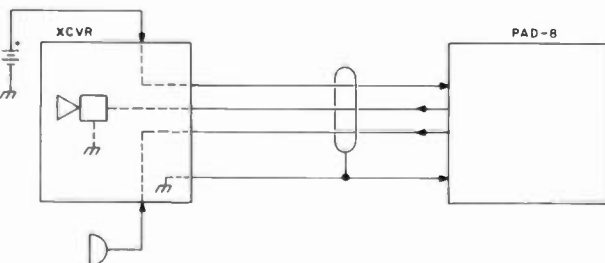

Fig. 3. Connection as shown for Fig. 2. Power is derived from transceiver and transceiver speaker is used for monitor.

switch or other control is not necessary.

It should be noted that this design specifically omits an automatic push-to-talk (PTT) line activation feature. While this feature is very useful for a manual-only tone encoder or an autodialer having only a PROM-based scheme for storage of phone numbers, incorporation into a key-

board-programmable autodialer based on a RAM design is actually undesirable. In a ROM-based scheme, the manual keyboard is used only for dialing unprogrammed numbers; however, in a keyboard-programmable RAM-based scheme such as this one, the keyboard serves two additional functions—selection of the phone number to be autodialed and programming of the actual digits. This also eliminates panel clutter by making additional controls unnecessary. Inclusion of the automatic PTT feature on a keyboard-programmable autodialer would activate the transmitter when selecting or programming a phone number. This is undesirable and was avoided, allowing off-the-air phone number selection, programming, and autodial readout monitoring. The microphone PTT switch is used in the normal manner to key the transceiver for both speaking and for autodialing.

### Construction

A conscious effort was made to keep the overall size of the finished autodialer to the minimum nec-

essary, so that installation in the car would not be hampered by a bulky cabinet. A large and expensive multi-deck rotary switch for phone number selection was eliminated from an earlier design, as was an internal monitor speaker. The final PC board design and layout now incorporates keyboard-selection of the phone numbers and still retains the on-board audio amplifier to permit monitoring the encoder tones in the speaker of your transceiver.

The requirement for bulky panel controls in an earlier project<sup>4</sup> has been eliminated by incorporating the panel control functions within the logic design. The result is a very compact unit which retains all the necessary features. A standard LMB enclosure (CR-531) was chosen, based on its small size and neat appearance, and the PC board was laid out to conform to it.

The PC board itself measures 2½" × 5¼" (6.35 cm × 13.34 cm), is of top-quality commercial-grade G-10/FR-4 material, is double-sided with plated-through holes, and contains all of the components required except the three panel push-buttons, the input/output jack, and the LED. Connection to all panel controls is eased by providing all required logic and power signals to a central location on the PC board; a ribbon cable can then be used to interconnect the PC board with the panel controls. All panel, signal, and panel-control lines are also available at the dual, 15-pin edge-conductor fingers on the PC board (0.156"/3.96 mm spacing). By laying out the PC board in this fashion, maximum flexibility is afforded for selection of any convenient-sized cabinet or, if desired, the panel controls can be remoted entirely from the autodialer PC board through an edge connector.

# TERMINALL



# apple\* + TRS-80\*

## MORE FOR YOUR MONEY.



**TERMINALL** is a hardware and software system that converts your personal computer into a state of the art communications terminal. Terminall features simple connections to your computer and radio plus sophisticated and reliable software.

## Simplicity

**TERMINALL** was designed from the outset to be easy to connect to your radio and easy to use. Plug into your receiver headphone jack and copy Morse Code or radioteletype (RTTY). Plug into your CW key jack and send Morse Code. Attach a microphone connector and send Baudot or ASCII RTTY using audio tones (AFSK). That's all there is to hooking it up.

The software is loaded into your computer from disk or cassette. Enter your callsign and the time and you will start receiving immediately. No settings or adjustments are necessary to receive Morse Code, it's fully automatic -and it works! You may type your message while receiving or transmitting.

You will be on the air, receiving and transmitting in any mode, in minutes. As we said, **TERMINALL** is simple.

## More for your money.

■ **TERMINALL** has the RTTY terminal unit - demod and AFSK - built in. This results in a lower total cost.

■ **Fantastic Morse reception.** Six stage active filter demodulator copies the weak ones. Auto adaptive Morse algorithm copies the sloppy ones. Received code speed displayed on status line.

■ **Outstanding documentation.** Professionally written, 90 page user manual contains step-by-step instructions.

■ **Built in, separate, multi-stage, active filter RTTY and CW demodulators.** No phase lock loops. RTTY demodulator has 170 and either 425 or 850 Hz shift-

keyboard selectable - and uses either the panel meter or scope outputs for easy tuning. Copy the weak ones. Copy the noisy ones. Copy the fading ones.

■ **Built in crystal controlled AFSK.** Rock stable for even the most demanding VHF or HF applications. A must on many VHF RTTY repeaters.

■ **Built in 110 or 220 volt AC power supply.**

■ **Built in parallel printer driver software.** Simply attach a parallel ASCII printer (e.g. the EPSON MX-80) to your printer port to obtain hardcopy in all modes.

■ **Multi level displays** - allows examining and editing of historical text.

■ **Word wrapping,** word mode editing, diddle, ignore carriage returns, user programmable end of line sequence, adjustable carriage width, multiple user-defined WRU, transmit delay (fixed, none

## NO COMPROMISE HARDWARE.

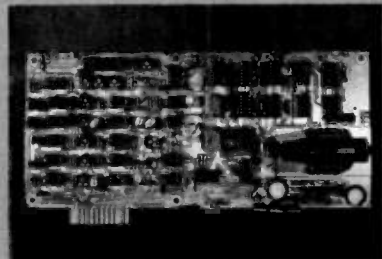

or auto adaptive), break mode and more!

■ **The all-in-one TERMINALL design** makes it great for use on HF or VHF. Ham, Commercial SWL or MARS! SWL's: **TERMINALL** may be jumped for either 425 or 850 Hz reception to copy news and weather services.



15 Day Money Back Trial Period on Factory Direct Orders

## System Requirements

**TERMINALL T1** Communications terminal for the TRS-80 Model I. Requires a Model I TRS-80, 16K RAM and Level II BASIC. Includes software on cassette and disk, assembled and tested hardware and an extensive instruction manual. \$499.

**TERMINALL T3** Communications terminal for the TRS-80 Model III. Requires a Model III TRS-80, 16K RAM and Model III BASIC. Includes software on cassette and disk, assembled and tested hardware and an extensive instruction manual. \$499.

**TERMINALL T2** Communications terminal for the APPLE II. Requires an APPLE II or APPLE II PLUS with 48K RAM and disk. Software is provided on disk in DOS 3.2 format; Use MUFFIN utility to convert to DOS 3.3 format. Includes software on disk, assembled and tested hardware and an extensive instruction manual. \$499.

Add \$4.00 shipping U.P.S. reg. delivery - CA residents add 6% sales tax.

**TO ORDER (209) 634-8888 or 667-2888**

We are experiencing telephone difficulties. Please keep trying.



**MACROTRONICS, inc.** ®

1125 N. Golden State Blvd.  
Turlock, California 95380

\*TRS-80 is a Registered Trademark of Tandy Corp.  
Apple is a Registered Trademark of Apple Computer Inc.  
1 yr. parts & labor limited warranty.



**The communications terminal that does it all!**

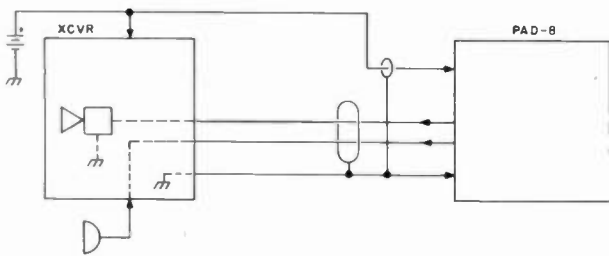

Fig. 4. Autodialer power is derived directly from car battery; transceiver speaker is used for monitor.

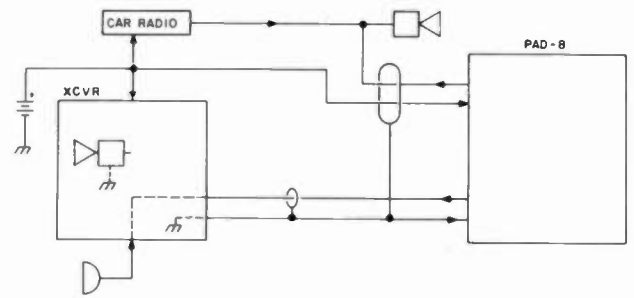

Fig. 5. Autodialer power is derived directly from car battery; car radio speaker is used for monitor.

### Installation and Adjustment

Autodialer interconnections to your 2-meter transceiver include the +13.6-volt supply line, tone encoder output, and the audio amplifier output; these should be shielded between the autodialer and transceiver as shown in Fig. 2. The TONE jack on the rear of my Drake TR-33C was replaced with an audio DIN jack. Although a six-pin jack was used (for possible future access to other parts of the transceiver), only the three lines mentioned above plus ground are required by the autodialer.

The supply line can be run to a +13.6-volt source separate from the transceiver, if desired, permitting use of a standard 2-wire shielded mike case between the autodialer and transceiver. The autodialer tone-encoder output is extended through a short piece of RG-174/U to the transceiver microphone jack; the coax shield need not be grounded at the mike-jack end. The audio amplifier, U2, is connected directly to the transceiver speaker; normal transceiver audio is not affected and this arrangement eliminates the need for a separate speaker. The wire to the speaker inside the transceiver cabinet need not be shielded. The tone encoder output can be interfaced directly with either low-impedance microphone inputs (e.g., TR-33C) or with high-impedance inputs (e.g., the Heath HW-2036A).

Only three adjustments are necessary for proper

operation of the autodialer. The speed is set by R12 to give a total autodial duration of about one second for all seven digits. The tone encoder output level into the transceiver microphone input is adjustable by R7. If a deviation meter is available, the tone-encoder output may be set to yield a deviation of about 4.5 kHz when any keyboard digit is held down.

Alternatively, the level may be adjusted by ear with the help of another operator on the repeater to a point which gives reliable autopatch access and dialing operation but which does not sound distorted (over deviated). The last adjustment is to set the audio-amplifier output level to give a comfortable and undistorted speaker volume under road conditions. R7 is the trimmer which does this. If the external audio monitor is not desired, R5, R6, C5, C6, and U2 can be eliminated altogether.

### Final Notes

The addition of the autodialer described here has made a great improvement in the ease and enjoyment of using the local autopatch repeaters and has certainly decreased the risk of becoming a potential traffic statistic while trying to dial a phone number. Further, the ability to rapidly and conveniently program or reprogram phone numbers in the memories is greatly appreciated, especially when access codes are changed periodically. In addition, performance of

the autodialer has been absolutely flawless throughout three very cold winters and hot summers, and I'm looking forward to many more years of enjoyable repeater autopatch use with this autodialer.

The printed-circuit board for this project and a 10-page illustrated step-by-step assembly manual are available from me for \$10.00 postpaid in the US. I'll be happy to answer

questions about the autodialer, but please include an SASE. ■

### References

1. Crawford, John, "An Automatic Dialer for Deluxe Mobile," 73, January, 1976.
2. Lloyd, Bob, "Mobile Autodialer," 73, June, 1976.
3. McEwan, Don, "A No-Hands Telephone Dialer," 73, January, 1977.
4. Batie, Howard, "A Programmable Contest Keyer," *Ham Radio*, April, 1976.

### Parts List, PAD-8

C1—50- $\mu$ F, 16-V tantalum	Y1—1.000 MHz crystal
C2—50- $\mu$ F, 16-V tantalum	
C3—.01- $\mu$ F, 16-V disc ceramic	LMB CR-531 cabinet
C4—.01- $\mu$ F, 16-V disc ceramic	
C5—10- $\mu$ F, 10-V tantalum	Digitran KL-0054 keyboard
C6—.001- $\mu$ F, 16-V disc ceramic	
C7—2.2- $\mu$ F, 10-V tantalum	IC Sockets:
C8—.01- $\mu$ F, 16-V disc ceramic	8 pin—2
C9—4.7- $\mu$ F, 10-V tantalum	14 pin—8
C10—.01- $\mu$ F, 16-V disc ceramic	16 pin—4
C11—.01- $\mu$ F, 16-V disc ceramic	20 pin—1
C12—.001- $\mu$ F, 16-V disc ceramic	
	#4 Hardware:
D1-D3—1N4001 Si rectifier	3/4" bolts—4
	1/4" bolts—4
J1—MAS-4/MAB-4 (two)	Nuts—16
	Lockwashers—16
LED—MV5023 or equivalent	8" 12-conductor ribbon cable
S1-S3—SPST mom. push-button (normally open)	
U1—LM340T5, uA7805, etc. (TO-220 case)	
U2—LM380 (8-pin) Do not substitute	
U3—MC14410P Do not substitute	
U4—MC14528B, CD4528B, etc.	
U5—MC14011B, CD4011B, etc.	R1—12 meg, 1/4 W
U6—TMS 4036NL Do not substitute	R2—1.8k, 1/4 W
U7—MC14012B, CD4012B, etc.	R3—2.2k, 1/4 W
U8—MC14528B, CD4528B, etc.	R4, R5—10k, 1/4 W
U9—MC14042B, CD4042B, etc.	R6—25k PC trimmer
U10—MC14024B, CD4024B, etc.	R7—100k PC trimmer
U11—MC14081B, CD4081B, etc.	R8, R9—680k, 1/4 W
U12—MC14001B, CD4001B, etc.	R10, R11—10k, 1/4 W
U13—MC14001B, CD4001B, etc.	R12—25k PC trimmer
U14—MC14002B, CD4002B, etc.	R13, R14—3.3k, 1/4 W
U15—MC14011B, CD4011B, etc.	R15—10k, 1/4 W
U16—NE555V, LM555, etc.	R16, R17—680k, 1/4 W

MICROLOG  
**ACT-1**

**\$995\***



## MEMORY BACK-UP AND HIGH SPEED PRINTER OUTPUT\*

### Never Lose Your Memory Again!

All "Here-is" memories, ID's and all keyboard input parameters are retained for 2 weeks by the internal Ni-Cad battery & charging circuit. Load up the memories, carry the ACT-1 out to your field-day site and be ready to go as if you never turned it off! Also included in this option package is the high speed code converted RS-232 serial printer output.

The best gets better at MICROLOG Corp.  
18713 Mooney Dr., Gaithersburg, MD 20879  
Tel. 301-258-8400      TELEX 908153.

**MICROLOG**

51

INNOVATORS IN DIGITAL COMMUNICATION

- SIMPLE DIRECT CONNECTION to your Transceiver.
- COMPLETE SYSTEM, built-in Demodulator & AFSK Modulator with keyboard programmable tone pairs from 500 to 3000 Hz.
- SPLIT-SCREEN operation with keyboard selectable line location
- 1400 character text buffer.
- TEN, 40 CHAR. programmable message memories (doubles with BATT. BACKUP), plus ID's WRU & SELCALs.
- RANDOM CODE generator & hand key input for practice.
- Baudot 60 to 132 WPM.
- ASCII 110 & 300 baud.
- SYNC-LOC MODE for improved ASCII operation.
- RECORDER INTERFACE for "BRAG-TAPE" or recording off-the-air.
- CODE CONVERTED printer output in Baudot or ASCII.
- SSTV/GRAPHICS transmit.
- FULL 63 KEY Computer grade keyboard.

\*9" monitor \$199. Battery Backup & RS232 print \$125.

# My Own Silver Mine

*For W1FLP, reclaiming silver from photographic fixer is cheap, easy, and profitable. King Midas should have had it so good.*

I recently purchased a brand spanking new Azden 2m rig. As I was installing it in the mobile, I came to the realization that my total cost was \$2.50—yes, that is correct—two dollars and fifty cents! No, it was not “hot!” I paid a local dealer full list price.

Knowing that many brother hams are also amateur photographers, I thought they might have an interest in how to obtain

goodies for the shack at a relatively low cost. The secret is in silver reclamation.

Silver reclamation is generally thought to require expensive capital equipment and in large photo labs it does, but for the amateur, the equipment can be very simple. How simple is determined by the amount of silver-saturated solution you have, how rapidly you obtain it, and how fast you want to reclaim it.

The silver-saturated solution referred to is the photographic fixer in every darkroom. The process of fixing photographic film removes the unexposed silver crystals from the film. This silver remains in solution in the fixer. The more film processed, the more silver in solution.

With the price of silver what it is, it doesn't take much math to find the “break-even” point at which investment in capital equipment is desirable.

For hams, using their innate ability to scavenge junk boxes to produce working apparatus, there is an inexpensive, easy method to reclaim impressive amounts of silver at very low cost.

The method I use is electrolysis. Basically, it is accomplished by passing a current (dc) through the solution, thereby “plating” out the silver. Industrial concerns use large containers with large currents and constant circulation of the solution.

I will not get into the math required to determine the current and voltages; the important parameter is the current density required to reclaim 90% to 98% pure silver. The current density needed is determined by the amount of silver in solution, the surface area of the electrodes, and the level of circulation of the solution. A typical electrolysis circuit is shown in Fig. 1.

Any dc supply can be used; regulation is not required. A simple half-wave rectifier without filtering will do fine.

The simple system I use is a 1.5-V alkaline battery, a potentiometer, a 0-50 mA dc meter, a stainless steel rod, and a carbon rod. The 1.5-V battery and the pot can be replaced by any available power supply, with an increase in the cost of silver recovery.

When a dc current is passed through the solution, the silver is plated out onto the stainless steel rod.

It is important to monitor this plating process until you arrive at the correct dc current (current density) for your individual setup. The plated silver should appear white to light cream-colored. If it appears dark cream to brown, the current density is too high. A darker color means that higher amounts of contaminants are being plated out.

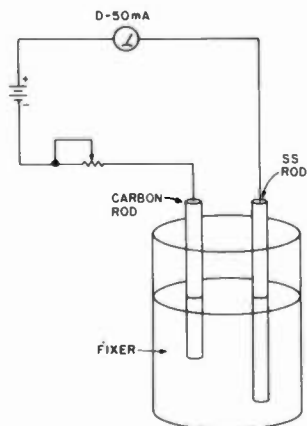

Fig. 1. Typical electrolysis circuit.

**RTTY - 50**  
Basic Terminal Unit

- 60 mA Loop Keying
- PLL Demod w/2 pole filter
- AFSK Generator

**\$79<sup>00</sup>**

Call or write for FREE catalog with over 65 P.C. Boards & Kits.

**RTTY - 100**  
Expanded Version of the Popular  
RTTY - 50

- AFSK
- 850/170
- TTL & RS232
- 60 mA Loop
- Loop Supply
- Auto Start
- 4 Pole Filters
- AGC (80db)

**\$189<sup>00</sup>**

**COMMUNICATIONS DESIGN INC.**

1105 Lehr St. — West Memphis, Arkansas 72301  
(501) 735-4568

**COMMUNICATIONS**

**SERVICE  
SPECIALIST**

LOW RATES REPEATERS

45 DAY WARRANTY! MARS MODS



A HAM RADIO STORE THAT SPECIALIZES IN SERVICE!!!



We are in the business of providing top quality repairs on all types of amateur radio equipment. A complete line of parts is kept on hand to provide you with an extremely fast turnaround.

VOTUC COMMUNICATIONS CO.

146 B RIVER AVE.

MASONTOWN, PA 15461 ✓ 200

PHONE  
(412)-583-2131

GUY  
N2CJW

Reduce the current. The color changes can be seen in seconds, so if it has not been dark for more than a few minutes, no harm has been done.

High current densities without circulation of the solution will result in lowered purity of the plated-out silver plus a chemical change in the fixer that will reduce the amount of silver you can reclaim.

When the silver has built up to a thickness of between 1/8 inch to 1/4 inch, remove the stainless steel bar holding the silver, rinse it in warm water, and let it dry.

To remove the silver, spread out a plastic or paper sheet, strike the plating sharply with a screwdriver, and it will crack. Simply chip off the plating until it is all removed. Return the stainless steel bar to the silver mine and continue.

Of course, this mine is not bottomless. The fixer

solution will eventually become so low in silver content that it must be replaced with fresh solution. Fresh solution, in this case, means solution that has been used to process film and is no longer useful for fixing film because it is saturated with silver.

There are many methods to determine the useful plating life, i.e., silver content, of the fixer. The easiest but least accurate is the color of the solution. When it turns the color of medium strength tea, replace it. The more accurate method is to use the Kodak Silver Estimating Test Papers, cat. no. 1965466. When dipped in the solution, this test paper will turn from its normal yellow to some shade of brown. The darker the color, the higher the silver content remaining in solution. There is a color comparison chart on the back of the Kodak folder. I generally discard the fixer at a remaining silver level of 1 gram/liter.

To set up this simple silver mine, I used a carbon rod from a discarded D-cell battery, a 6-inch stainless steel rod, a 1-lb. plastic margarine container, and a battery, pot, and meter as previously described.

With no agitation of the solution, I maintain a current of 5 mA. I have been plating out approximately 3 ounces troy of silver per month. I am blessed with the availability of 12 gallons of fixer every 12 weeks that has a silver content of approximately 10 grams/liter. The amount of silver you recover per liter will depend upon its starting silver content, i.e., how much film has been processed through it and the average image content of the film.

The effect of the film image on silver content is that a very dark image has most of the silver left in the film. Conversely, a light image has had most of the silver removed. The Kodak test

**GIANT  
HEAVY DUTY  
ALL PURPOSE TARPULINS**

12 x 16	\$23	26 x 40	\$89
16 x 20	\$32	26 x 55	\$115
20 x 20	\$36	30 x 60	\$145
18 x 24	\$38	50 x 100	\$390
18 x 32	\$50	60 x 120	\$547
20 x 30	\$50	50 x 150	\$562

Before Midnight Jan. 23

VIKING Ind. will send any of the above size tarpaulins to any reader of this publication who reads and responds to this test before midnight Jan. 23. Each tarpaulin lot (#Z-18,PVC) is constructed of high density fabric (with virgin grade ingredients, supplied by Gulf Oil Co., Dow Chemical Co., and Union Oil Co.) with nylon reinforced rope hems, double lock stitched hems, electronically welded seams, 100% water proof, #4 (1/2" dia.) metal grommets set on 3ft. centers with reinforced triangular corner patches and are recommended for all heavy duty use. all yachts and sailboats, and all bulk or pallet rlding materials, and will be accompanied with a LIFETIME guarantee that it must perform 100% or it will be replaced free. Add \$7 handling & crating for each tarp ordered. Viking Ind. pays all shipping. Should you wish to return your tarpaulins you may do so for a full refund. Any letter postmarked later than Jan. 23. will be returned. LIMIT: Fifty (50) tarps per address, no exceptions. Send appropriate sum together with your name & address to: Tarp Test Dept. #124DJ, Viking Ind., 6314 Santa Monica Blvd., L.A., CA., 90038, or for fastest service from any part of the country call collect, before midnight 7 days a week (213) 462-1914 (Ask exchange operator for) TARP TEST #124DJ, have credit card ready.

papers can be used to determine this silver content and, barring the probable contamination of the fixer with other chemicals, can be used as a guide to the useful life of the fixer.

The above method requires monitoring but twice daily and fixer replacement when required. If you have plenty of fixer and/or want a faster recovery rate, simply provide a means of gentle agitation. I have successfully used an old clock motor with a plastic shaft with a 1/2-inch by 2-inch paddle connected to the sweep second-hand shaft immersed in the fixer. This has yielded about an ounce a week. Larger electrodes, higher currents, greater agitation, and larger solution containers will of course increase the recovery rate.

So why throw good money down the drain? Dig into that silver mine and buy some more ham gear. ■

# Fun-Equipment Revisited

Here are higher-band versions of the ever-popular Fun-Mitter and Fun-Amp. They are based on the Fun-Philosophy: cheap and simple.

Mark Oman WA0RBR  
528 Deines Court  
Ft. Collins CO 80525

Home-brewing is alive and well! I reached this conclusion following the response to the publication of my series of "Fun" home-brew gear.<sup>1,4</sup> Response to the simple, low-cost home-brew units has been great, indicating that hams are still building at least some of their own gear. From nearly-Novices to long-time Extras, hams have built the Fun rigs and have discovered that building is easy, fun, and very rewarding.

Many requests have been received asking for different band coverage of the Fun-Mitter and its companions. This article is the result of those requests. It describes a simple CW transmitter for 15 or 20 meters operating off 24 volts and modification of the

20-Watt Fun-Amp for operation on the same bands.

The Fun-Ceiver and Fun-Oscillator are not included in this article on modifications due to instability problems at higher frequencies. Frequency stability is of prime importance with today's rigs and it is just too difficult to obtain the type of results desired on the higher frequencies and still maintain the objectives of the gear.

This second version of the Fun-Mitter is a five-Watt-output, crystal-controlled CW transmitter that uses either low-cost FT243 crystals at one-third the operating frequency or HC6U fundamental crystals on the operating frequency. If the variable crystal oscillator (vxo) capacitor is installed (C option), the frequency can be varied by as much as 10 kHz from the crystal frequency, using HC6U crystals.

This coverage allows enough flexibility to provide plenty of frequencies with only a few crystals. Crystals are cheap, easy to obtain, reliable, and very stable. They make simple transmitters easy for all of us to build!

## Philosophy

An early objective with the Fun-Mitter and Fun-Amp was to design simple gear that was easy to build with parts that could be obtained from Radio Shack. The Mark II versions of these rigs follow the same objective with only the crystal and its socket not being found at Radio Shack. Other objectives: costs of less than \$25 each, no tuning adjustments, and same size PC boards (2¼" × 3").

These objectives are continued in the higher-band versions. A twenty-meter transmitter and amplifier can easily be built in an afternoon and put on the air

without adjustments. (The reader is strongly urged to review the articles on the Fun-Mitter and Fun-Amp for detailed construction and design descriptions.)

## Circuit

The circuits remain unchanged from the original designs. The resonant circuit and filter values, however, must be changed to allow operation on the higher frequencies. Radio Shack rf chokes and disc ceramic capacitors again were used.

The Fun-Mitter schematic is reproduced in Fig. 1. The Pierce oscillator operates on the operating frequency using either third overtone or fundamental crystals. (A third overtone is simply three times the value marked on the crystal.) For example, to operate the transmitter on 14.060 MHz, either a 14.060-MHz fundamental crystal can be used or a 4.383-MHz crystal can be operated on its third overtone. (This allows the use of cheaper FT243 crystals in the Fun-Mitter.) Also, on fifteen meters many of the same crystals used for forty meters, when operating on their third overtone, will provide the frequency coverage desired.

Fundamental mode crystals in an HC6U holder do, however, have the advantage of more frequency range when used with the vxo capacitor (C option). I have had several HC6U crystals, however, that do not provide a stable, clean oscil-

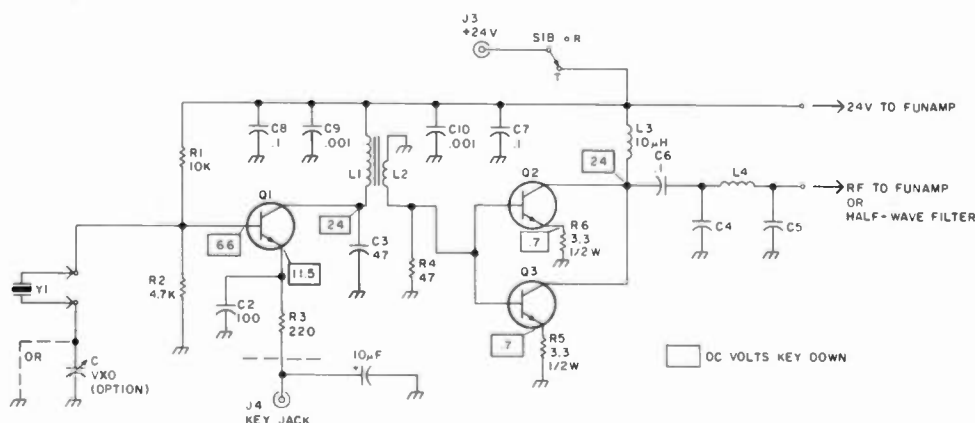

Fig. 1. Schematic of 15/20-meter Fun-Mitter. Reference designators remain the same as in the original Fun-Mitter article in order to match the parts locator for the PC board. Capacitance values less than 1 are in  $\mu\text{F}$ .



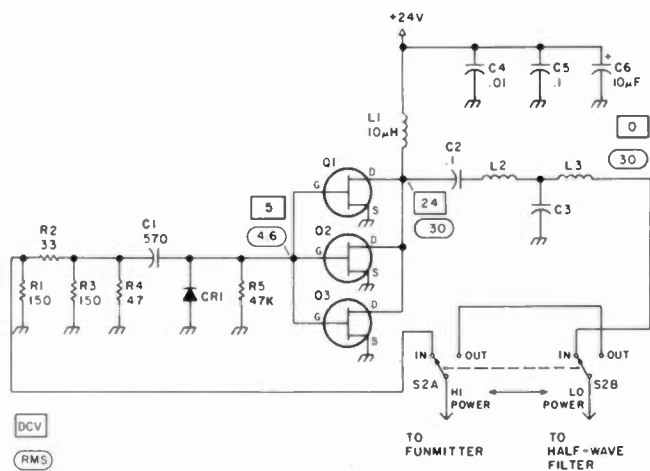

Fig. 2. Schematic of 15/20-meter Fun-Amp.

lator signal, probably due to the higher-than-normal power used in the Fun-Mitter oscillator stage. Although the FT243 will have a range of only approximately 1 kHz with the vxo, it will provide better and more reliable operation. (FT243 4.3- or 7-MHz crystals for use on twenty or fifteen third overtone will not oscillate on exactly three times the marked frequency. Depending on the crystal, they may be as much as 10 kHz lower than the marked frequency. Keep this in mind when ordering.)

L1 and C3 determine the resonant frequency of the oscillator. If L1 is constructed correctly, the oscillator should oscillate with no adjustments. A three-turn winding (L2) over L1 operates as a transformer to match the collector impedance of Q1 to the base impedance of Q2, Q3 and provide drive. Q2 and Q3 operate in parallel as a class C amplifier which provides good efficiency.

These 2N3866 transistors, Q2 and Q3, are being pushed to their limits in the

Photo A. Front view of twenty-meter version of Fun-Mitter/Fun-Amp.

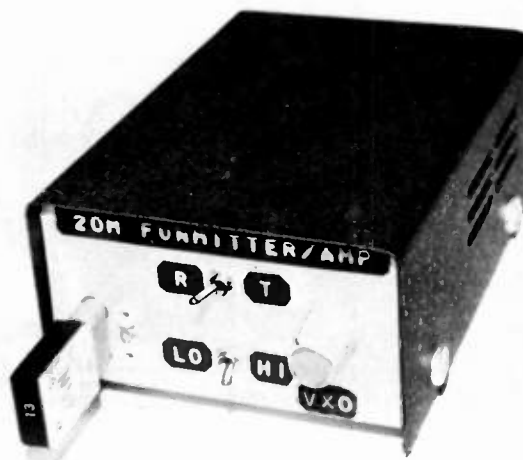

Fun-Mitter circuit. Under some load conditions, some hams have discovered that Q2 and Q3 can be destroyed. To avoid this, either reduce the supply voltage to 20 to 22 volts or increase the value of R5 and R6 to 4 to 5 Ohms. Also, the 2N3866 part can be replaced with the much more rugged 2N3553. The only other components needing change are C4, C5,

and L4 which, together, comprise a pi-network filter. Component values are given in the Parts Lists.

The Fun-Amp schematic is reproduced in Fig. 2. Using the Fun-Amp on other frequencies is even easier than using the Fun-Mitter on other frequencies. Only L2, L3, and C3 need to be modified. The input remains completely un-

### Parts Lists

#### Fun-Mitter—Fig. 1

C1-C10	Ceramic disc	272-xxx
C3	20m—47 pF	
	15m—47 pF	
C4,C5	20m—220 pF	
	15m—160 pF (2 220 in series, 1 47 in parallel)	
C option	Broadcast variable (any small variable with maximum capacitance of 100 to 300 pF will work)	
J3	Phono jack	274-386
J4	Phone jack	274-252
L1	20m—20 turns removed	273-101
	15m—24 turns removed	273-101
L2	3 turns wound over Q1 end of L1	
L3	10 μH	273-101
L4	20m—25 turns removed	273-101
	15m—27 turns removed	273-101
Q1	RS-2009	276-2009
Q2,Q3	RS-2038	276-2038
R1-R4	¼ Watt	271-1xxx
R5, R6	Each is three 10 Ω, ½ W	
	271-001 in parallel	
S1	DPDT toggle	275-1546
Y1	Crystal—FT243, HC6U	

#### Fun-Amp—Fig. 2

C1-C5	Ceramic disc	272-xxx
C1	570 pF (470 and 100 in par.)	
C3	20m—250 pF (2 47 pF in series, 1 220 in parallel)	
	15m—160 pF (2 220 pF in series, 1 47 pF in parallel)	
C6	10 μF, 35 V dc	272-1013
CR1	1N914 small signal silicon	276-1122
L1	10 μH	273-101
L2	20m—26 turns removed	273-101
	15m—28 turns removed	273-101
L3	20m—24 turns removed	273-101
	15m—26 turns removed	273-101
Q1-Q3	VN67AF VMOS FET	276-2071
R1,R3	150Ω, ½ W	271-013
R2	33Ω, ½ W	271-007
R4	47Ω, ½ W	271-009
R5	47kΩ, ¼ W	271-1342
S2	DPDT toggle	275-1546
	TO-220 heat sink (3)	276-1363
	Case	270-252
	Hardware	64-3012
	Wire	64-3019
	Coax	

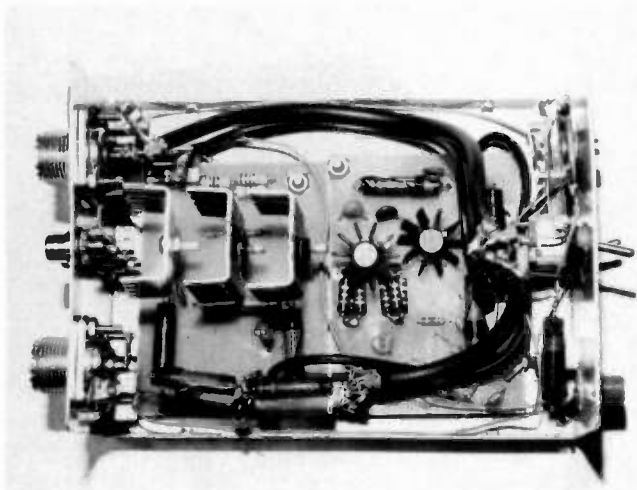

Photo B. Inside view of twenty-meter version of Fun-Mitter/Fun-Amp. The coil shown connected between the crystal and C (optional) does not exist in the final version of the Fun-Mitter.

changed. This circuit operates very well at 15 and 20 meters due to the excellent frequency characteristics of Q1-Q3. A detailed circuit description is given in the Fun-Amp article.

Two additions have been made to the higher-frequency versions of the transmitter and amp. Fig. 3 shows a half-wave harmonic filter which reduces harmonic radiation. Also, a 10- $\mu$ F capacitor (272-1013) has been added at the key jack (J4) to shape the keyed waveform and eliminate any key clicks.

### Construction

Even though the Fun-Amp and Fun-Mitter are "goof-proof" projects, care and thought must be put into their construction. Although the fifteen- and twenty-meter versions are as simple as the earlier models, it might be helpful to review some pitfalls to watch for.

For best results, use of a PC board is strongly recommended.<sup>5</sup> Refer to the earlier articles for the patterns and component locators. The 2 1/4" by 3" format shown in Photo B is small enough to allow mounting flexibility. I would suggest that this format be followed. Combining several bands, amplifier, transmitter, etc., on one board can lead to

problems, particularly if you are inexperienced in homebrew.

Before building, develop a plan as to how you will load the boards, assemble the unit, and test. After the plan is developed, proceed carefully. Most problems are due to misloaded parts, poorly soldered connections (rosin-core solder is a must!), faulty components, and hasty build-and-test. Most of these problems can be avoided by developing a plan and carefully and thoughtfully following it.

Radio Shack rf chokes are used as inductors by removing turns as necessary. Fifteen- and twenty-meter circuits require less inductance and, therefore, the coils will have fewer turns. In constructing the coils, be sure that the exact number of turns is removed and that insulation is scraped from the end of the wire that will be resoldered to the coil form. The three-turn Fun-Mitter coil (L2) that is wound over L1 should be wound in the same direction as the turns of L1. Also, wind it over the end of L1 that is mounted nearest Q1. The excess wire cut off when the turns are removed is excellent for wiring L2. Refer to Photo B for a view of the coils.

It is best to construct a

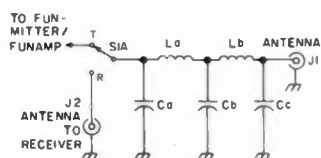

Fig. 3. Half-wave filter for 15/20-meter Fun-Mitter/Fun-Amp. The filter reduces any harmonic radiation to below acceptable levels. It is wired using point-to-point wiring between the antenna connector and S1. The filter provides receiver filtering by placing it before the receiver antenna connector. Values are as follows: use 273-101 10  $\mu$ H rf choke with turns removed; 272-xxx series ceramic caps.

	20m	15m
Ca	220	150 (100 & 47 in parallel)
Cb	440 (2 220 in parallel)	320 (100 & 220 in parallel)
Cc	220	150 (100 & 47 in parallel)
La	26 turns removed	28 turns removed
Lb	26 turns removed	28 turns removed

single band in one box rather than combining bands. This is slightly more costly due to duplication of some parts, but it eliminates switching problems completely.

An advantageous modification to the Fun-Mitter is to allow a "spotting" function. This is helpful when finding your frequency on your receiver without transmitting on the air. This is accomplished by continuously applying 24 V to the oscillator stage. To do this, break the connection between L1 and L3, then connect L1 directly to 24 V. Also, one end of R1 is removed from the circuit board and a wire from it run to the 24-V side of L1. With this modification, pressing the key will produce a note in the receiver with the send/receive switch set to receive. See Fig. 4 for details of the modification.

Crystals can be obtained very easily. After deciding on either FT243 third over-

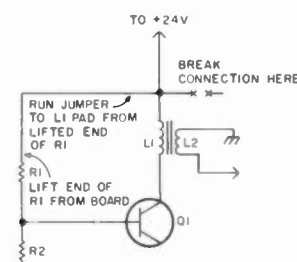

Fig. 4. Modification to allow "spotting" of transmitter (use when using PC pattern from the February, 1981, 73).

tone or HC6U fundamental, both crystals and sockets can be ordered from a supplier such as CW Crystals or Jan Crystals.<sup>6</sup>

### Adjustment

Adjusting the high-frequency Fun-Mitter and Fun-Amp is just as easy as with the low-band versions. Again by thinking carefully through the process, the rig can be set up without problems in a short time.

If possible, find a VOM to use at this stage. Although not absolutely necessary, it is much more helpful and educational to see what is happening during tune-up. Begin by ensuring that you do indeed have a 24-V source (either lantern batteries or the Fun-Mitter power supply). Measure the voltage. With +24 V disconnected, measure the resistance at the voltage-input connector to ensure that no shorts exist to ground (use Ohms scale).

It is essential that a dummy load be connected to the antenna connector at all times during tune-up. For the Fun-Mitter/Fun-Amp combination, a dummy load capable of dissipating 20 Watts will be needed. Without a load, the transistors will be destroyed quickly.

The final step in tune-up is to attach an ammeter and begin testing! Connect an ammeter capable of measuring at least 1.5 Amps in series in the +24 line going to the gear. Set the T/R switch (S1) to "transmit." With the Fun-Amp switched

out, the meter should read around 300 mA with the key pressed. Switching the Fun-Amp in should produce a reading of around 1.2 Amps with the key down, indicating a power input of around 30 Watts.

As can be seen, there are no adjustments to be made. This is one of the beauties of the gear. After building the units carefully, they should work the first time with no adjustments!

If trouble is encountered, check the following:

1. Isolate the problem to a stage—Fun-Mitter, Fun-Amp; if Fun-Mitter, does oscillator work?
2. Measure voltages at collectors and drains of transistors with T/R switch in T position (should read 24 V).
3. Check for wiring errors.
4. Check soldering.

### Operating

The thrill of home-brew construction comes in the

actual operation. Making contacts with gear you built yourself is fun! The high-frequency Fun-Mitter and Fun-Amp easily will produce worldwide contacts. Twenty Watts on 15 or 20 meters can bring in contacts from all continents easily.

With the capability of 15-through 80-meter operation with the Fun gear, WAS, WAC, and DXCC are all within reach. Good luck! ■

### References

1. "The Fun-Mitter—A Goof-Proof Rf Project," 73, February, 1981.
2. "The Fun-Geiver," 73, July, 1981.
3. "The Fun-Oscillator," 73, February, 1982.
4. "The Fun-Amp," 73, May, 1982.
5. PC boards may be obtained from the author for \$7.00 ppd. each. (For both originals and modified.)
6. CW Crystals, 570 N. Buffalo St., Marshfield MO 65106; Jan Crystals, 2400 Crystal Drive, Ft. Myers FL 33906.

## 1900 - 2500 MHZ KITS

### DOWN CONVERTER KIT \$19.95

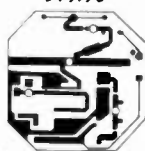

### ANTENNA KIT \$19.95



### POWER SUPPLY KIT \$19.95



### 1 P.C. BOARD PRE-DRILLED AND SOLDER FLOWED

- 3 MRF901 TRANS.
- 2 HP DIODES
- 6 CHIP CAPS "LARGE"
- 8 RESISTORS
- 4 PREPARED COILS, FACTORY WOUND
- 1 10 MFD CAP.

### 33 WASHERS 32 SPACERS

- 1 3 FOOT ROD
- 2 NUTS
- 1 8" PVC PIPE
- 2 4" END CAPS
- 1 MOUNTING BAR
- 1 "F" CONNECTOR
- 1 NUT AND BOLT

### 1 P.C. BOARD

- 1 POWER TRANSF.
- 1 317L ADJUSTABLE REGULATOR
- 1 FINE TUNING POT. WITH SWITCH
- 1 COARSE TUNING POT.
- 2 KNOBS
- 3 "F" CONNECTORS
- 4 POWER DIODES
- 1 RF CHOKE
- 3 RESISTORS
- 3 DISK CAPS.
- 1 1000 MFD CAP.
- 1 DPDT MINI TOGGLE SWITCH
- 1 LED WITH HOLDER

### SUPPLY CABINETS

ALUMINUM CABINETS PREPARED TO FIT POWER SUPPLY KIT \$9.95

### MANUFACTURED CABLE SETS

100FT. PLUS 37T.....\$19.95  
150FT. PLUS 37T.....\$15.95  
50FT. PLUS 37T.....\$12.95

### DISCOUNTS

2 TO 9.....10%  
10 TO 24.....15%  
25 TO 49.....20%  
50 TO 99.....25%  
100 TO 999.....30%  
1000 UP.....40%  
DIFFERENT KITS CAN NOT BE ADDED FOR QUANTITY DISCOUNTS.

### MAIL ORDERS

ADD \$5.00 FOR SHIPPING AND HANDLING. TRIONYX IND. INC. INDIANA RESIDENTS ADD 4% SALES TAX. 6219 COFFMAN RD. INDIANAPOLIS, IND. 46268 ✓ 104 (317) 291-7280 (317) 291-2995



### TUSA

A WHOLE NEW WORLD OF TV VIEWING WITH TUSA'S NEW MODEL CVU-40, 40 CHANNEL CABLE TV CONVERTER. Receive all the EXTRA CABLE TV "MIDBAND" & SUPERBAND CHANNELS on your UHF DIAL.

Eliminates the need for renting or leasing this stable and reliable system. Converts extra cable TV channels so they can be received on the UHF tuner of your TV set.

**A MUST FOR VIDEO-TAPING FROM CABLE TV!** The system allows you to program both pay (pay TV decoder required) and standard cable channels for taping on any VCR — while you are watching a different channel on your TV.

Simple to install and operate on any make of TV with UHF.

Now **\$28.95** ea. PLUS POSTAGE

**NOW AVAILABLE**  
NEW TUNEABLE DELUXE MODEL CVU-1000 **\$34.95** ea.

**WINEGARD**  
75 OHM UHF YAGI ANTENNAS

12 db GAIN  
CHANNELS 44 - 52  
\$8<sup>95</sup> EA  
6 OR MORE  
\$6<sup>95</sup> EA

OPTIONAL Winegard UHF Antenna (HMF 18db Gain) \$39<sup>95</sup> ea.

**BRAND NEW UHF VARACTOR TUNERS**

Sonyo 45 MHz Output **\$24.95** ea.  
Mitsumi 45 MHz Output

Call for Quantity Prices

### POPULAR IC's

TOP QUALITY NO SECONDS

TYPE	DESCRIPTION	1 ea	10 UP
LM-300N	2 watt Audio Power Amp	\$1.49	\$1.29
LM-308N3	Low Voltage Audio Amp	1.59	1.29
	100WVWV	3.50	3.18
NE-564N	Digital Phase Locked Loop	1.49	1.29
LM-565N	Phase Locked Loop	1.89	1.44
LM-733N	Video Amp	2.49	1.85
MC-1330	Video Detector	2.49	1.85
MC-1349	Video II Amp	1.75	1.55
MC-1350	Video II Amp	2.99	2.09
MC-1352	Video II Amp AGC	1.95	1.78
MC-1356	Audio II Amp	3.19	2.87
MC-1374F	R.F. Modulator	85	79
MC-1458	Dual Comp. Op Amp	1.79	1.59
MC-1496N	Balanced Mod/Demodulator	13.72	Call
MC-6121	Hybrid Amplifier	4.49	3.95
LM-1800	PLL Stereo Decoder	2.95	2.49
LM-1889	Video Modulator	1.39	1.25
LM-7805	5 Volt Positive Volt. Reg.	1.39	1.25
LM-7808	8 Volt Positive Volt. Reg.	1.39	1.25
LM-7812	12 Volt Positive Volt. Reg.	1.39	1.25
LM-7815	15 Volt Positive Volt. Reg.	1.39	1.25
LM-7818	18 Volt Positive Volt. Reg.	1.39	1.25
LM-7824	24 Volt Positive Volt. Reg.	1.39	1.25

<h3>POPULAR MICROWAVE PARTS</h3> <p>MRP 001 ..... \$2.75 9-Up ..... 2.19 MRP 011 ..... 3.45 9-Up ..... 3.12 MSD 001 ..... 95 CHIP CAPS - .001 mfd ..... 50 26-Up ..... 30 2N4663 (formerly MRF 802) ..... 11.90</p>	<h3>MV-2109</h3> <p>33pf Tuning Diode 1-9 ..... \$1.20 ea. 10-Up ..... 89 ea.</p> <p>5% MICA CAPS 5% 10pf 42 ea. \$60pf 90 ea ea. 43pf 36 ea. 1200pf 106 ea ea. 110pf 36 ea. 3000pf 139 ea.</p>	<h3>Radial Lead Caps</h3> <p>1-11 825 ea. 12 or more 16 ea. 1 mfd @ 35V 1-11 25 ea. 12 or more 18 ea. +70 mfd @ 35V 1-11 59 ea. 12 or more 49 ea. 1000 mfd @ 35V 1-11 99 ea. 12 or more 69 ea. 2200 mfd @ 35V 1-11 129 ea. 12 or more 109 ea. 2200 mfd @ 50V 1-11 169 ea. 12 or more 139 ea.</p>	<h3>Axial Lead Caps</h3> <p>1-11 99 ea. 1000 mfd @ 50V 1-11 99 ea. 12 or more 79 ea. 2200 mfd @ 35V 1-11 139 ea. 12 or more 119 ea. 3300 mfd @ 35V 1-11 139 ea. 12 or more 119 ea. 100V ± 10% Polyester Film (Mylar) 1-11 19.99 100.999 .001mf 20 15 10 2022mf 20 15 10 33mf 20 15 10 33mf 20 15 10 1mf 20 15 10 22mf 30 27 22</p>
---	---	--	--

### CABLE CONNECTOR

F-59 Male connector for RG-59U cable. Complete with ferrule. Mates with female "F" connectors.

20c ea.  
100 for \$14.70

### TUSA MAX-2 LOW LOSS MATCHING TRANSFORMERS

Indoor 75-300 ..... \$1.29  
10-Up ..... .98  
Outdoor 75-300 ..... 1.69  
10-Up ..... 1.49

### PROJECT BOXES

Woodgrain

This box is 11 1/2" W - 4 1/2" H - 8 1/2" D with a removable aluminum U-shaped chassis 11" W - 3 1/2" H - 6" D inside.

12.50 ea.  
4 or more \$10.95 ea.

### UHF - VHF - FM SPLITTER

40-900 MHz

TUSA MAX-3  
Low Loss 3.5-4 db, Low VSWR  
Waterproof Housing

\$2.49 ea.

### SURPLUS AUDIO & VIDEO RF MODULATORS

Hook up sheet included  
Now \$5.49 ea. While They Last \$6.95 ea.

### WINEGARD DELUXE A-B SWITCH

For CATV - MATV - VCR  
75 ohm - 90 db Isolation  
While They Last \$6.95 ea.

### SURPLUS SYLVANIA VHF VARACTOR TUNERS

45 MHz output. Channels 2 through 13 as well as the mid-band channels. Schematic included.

WHILE THEY LAST! \$13.95 ea.

### POPULAR MISCELLANEOUS PARTS

10K Volume Control w/IN DPDT switch ..... \$1.49  
10-Up ..... 1.19  
10K 10 Turn w/Thumbwheels  
1-12 ..... .39  
13-50 ..... .35  
Toroids - T30 12 ..... .26  
20-Up ..... .25  
Toroids - T32 ..... .38  
20-Up ..... .25

## HIGH PERFORMANCE PRESELECTOR-PREAMP

The solution to most interference, intermod, and desense problems in AMATEUR and COMMERCIAL systems.

Typical rejection:  
± 600 KHz @ 144 Mhz: -28dB  
± 1.6 Mhz @ 220 Mhz: -40dB  
± 5 KHz @ 450 Mhz: -50dB

Price - \$69.95 bipolar w/RCA jacks  
Connector options: BNC \$5, UHF \$6, N \$10  
SUPER HOT! GaAs Fet option \$20

- 40 to 1000 Mhz - tuned to your frequency
- 5 large helical resonators
- Low noise - High overload resistance
- 8 dB gain - ultimate rejection > 80 dB
- 10 to 15 volts DC operation
- Size - 1.6 x 2.6 x 4.75" exc. connectors
- FANTASTIC REJECTION!

## AUTOMATIC IDENTIFIERS

ID-1

ID-2

- For transceivers and repeaters - AMATEUR and COMMERCIAL
- Automatic operation - adjustable speed and amplitude
- Small size - easy installation - 7 to 15 volts DC
- 8 selectable, reprogrammable messages - each up to 2 min. long
- Wired, tested, and programmed with your message(s)  
Model ID-1 - \$39.95 Model ID-2 w/2 to 10 minute timer - \$59.95

We offer a complete line of transmitter and receiver strips and synthesizers for amateur and commercial use.  
Request our free catalog. Allow \$2 for UPS shipping - Mastercard and VISA welcome

## GLB ELECTRONICS

1952 Clinton St. Buffalo, NY 14206  
716-824-7936, 9 to 4

# The Ultimate Breadboard

*There used to be two styles of prototypes—rat's nest and cramped. Now there is a third style—simple.*

There are at least a dozen different boards on the market intended for prototyping and one-of-a-kind construction projects. Most that I have used in my ham activities, in the classes at Los Angeles Access, and professionally have either been lacking in flexibility and ease of construction or are difficult to circuit trace.

Of the commonly-available types, the wire-wrap board, for example, is extremely difficult to circuit trace, especially when the

component density reaches a certain point. This is complicated by the fact that components must be placed in IC header plugs.

The widely-used perf-board-type with general-purpose foil pads is much too cramped, lacks definite locations for ICs, is too difficult to circuit trace, and is prone to solder bridges.

The third common type, consisting of many small squares, works reasonably well for small projects. However, it becomes entirely too large for bigger

circuits. It also lacks definite locations for components, especially ICs.

The board shown here solves many of the problems by combining a number of the good features of all systems into one, all contained on a standard  $4\frac{1}{2} \times 6\frac{1}{2}$ " 22-pin edge-connect card. The connector may be cut off easily if it is not used.

The basic features of the board are sixteen 16-pin DIP patterns for small ICs and one 40-pin pattern for larger ICs such as microprocessors, UARTs, etc. Alternately, the larger pattern will accommodate two additional 16-pin ICs.

Two continuous power rails run throughout the board and are available on both sides of all IC patterns. There is also a set of pads and a foil area for a 3-terminal tab-type regulator. On the opposite end from the

edge connector are a number of small pads for switches or indicator LEDs.

## Locating Components

Components may be mounted on either side of the board. In some cases, #60 holes will have to be drilled in the plain pads for this. For experimenting, however, all components including the ICs are best placed on the foil side. This leaves the entire circuit in view without turning the board over. In this way, the circuit is much easier to visualize.

For more permanent projects, some of the larger components and the ICs are best placed on the non-foil side. Buses of many wires are also better on the back to keep them out of the way during testing and repair. Resistors, small capacitors, and most interconnecting wires should be on the foil side.

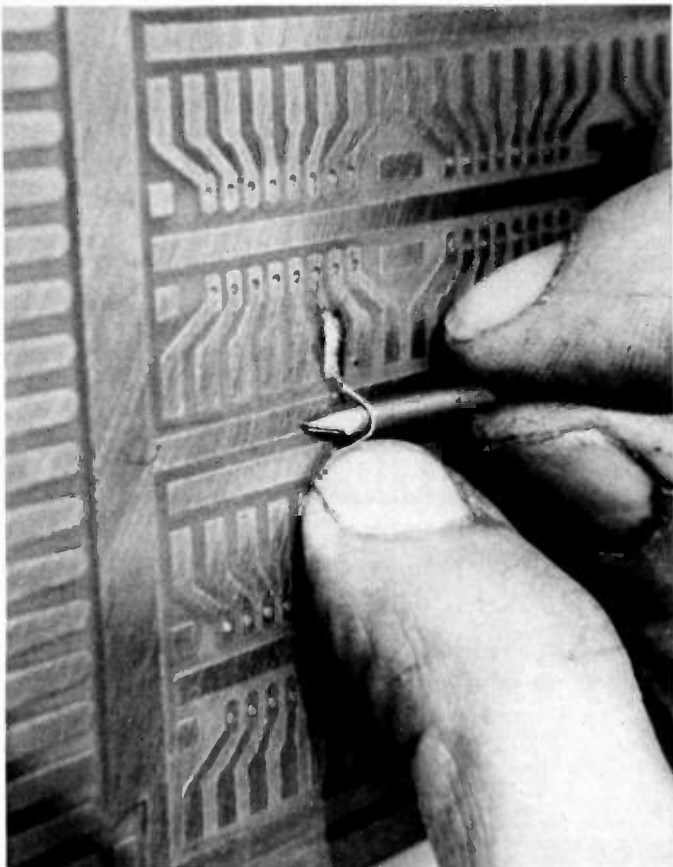

*Forming a short jumper from bare wire using a small round tool and the end of your finger.*

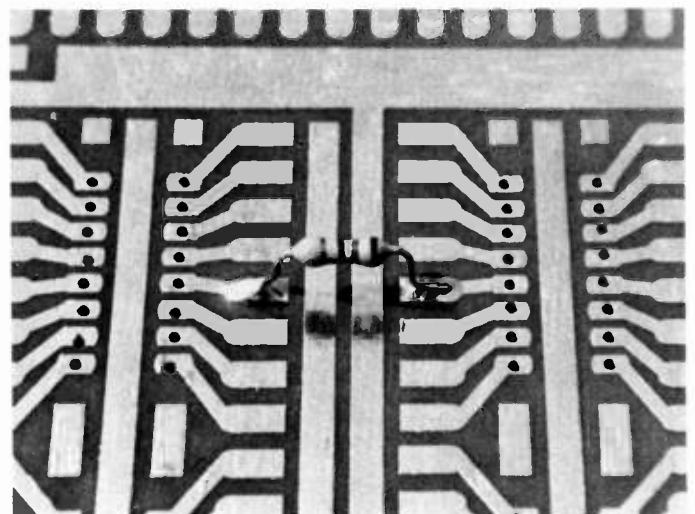

*A component properly formed and soldered to the board.*

AZDEN ★ NEW! ★ AZDEN ★ NEW! ★ AZDEN ★ NEW! ★ AZDEN

THE GIANT **AZDEN**® COMPANY  
**REVOLUTIONIZES THE STATE OF THE ART**  
**AWE AND AZDEN. INTRODUCE THE BRILLIANT NEW PCS-2800**  
**MICROCOMPUTER CONTROLLED**  
**SUPERIOR COMMERCIAL GRADE**  
**10 METER**  
**FM TRANSCEIVER** **SPECIAL**



\$229.<sup>00</sup>



**COMPARE THESE FEATURES**  
**WITH ANY UNIT AT ANY PRICE**

- **FREQUENCY RANGE:** Receive and transmit: 28.000 to 29.995 MHz, 10KHz steps with built-in - 100 KHz repeater offset.
- **ALL SOLID STATE-CMOS PL DIGITAL SYNTHESIZED.**
- **SIZE: UNBELIEVABLE! ONLY 6 3/4" x 2 3/8" x 9 3/4". COMPARE!**
- **MICROCOMPUTER CONTROLLED:** All scanning and frequency-control functions are performed by microcomputer.
- **DETACHABLE HEAD:** The control head may be separated from the radio for use in limited spaces and for security purposes.
- **SIX-CHANNEL MEMORY:** Each memory is re-programmable. Memory is retained even when the unit is turned off.
- **MEMORY SCAN:** The six channels may be scanned in either the "busy" or "vacant" modes for quick, easy location of an occupied or unoccupied frequency. **AUTO RESUME. COMPARE!**
- **FULL-BAND SCAN:** All channels may be scanned in either "busy" or "vacant" mode. This is especially useful for locating repeater frequencies in an unfamiliar area. **AUTO RESUME. COMPARE!**
- **INSTANT MEMORY-1 RECALL:** By pressing a button on the microphone or front panel, memory channel 1 may be recalled for immediate use.
- **MIC-CONTROLLED VOLUME AND SQUELCH:** Volume and squelch can be adjusted from the microphone for convenience in mobile operation.
- **DIRECT FREQUENCY READOUT:** LED display shows operating frequency, NOT channel number. **COMPARE!**
- **TEN (10) WATTS OUTPUT:** Also 1 watt low power for shorter distance communications. LED readout displays power selection when transmitting.
- **DIGITAL S/R/F METER:** LEDs indicate signal strength and power output. No more mechanical meter movements to fall apart!
- **LARGE 1/2-INCH LED DISPLAY:** Easy-to-read frequency display minimizes "eyes-off-the-road" time.
- **PUSHBUTTON FREQUENCY CONTROL FROM MIC OR FRONT PANEL:** Any frequency may be selected by pressing a microphone or front-panel switch.
- **SUPERIOR RECEIVER SENSITIVITY:** C.28 uV for 20-dB quieting. The squelch sensitivity is superb, requiring less than 0.1 uV to open. The receiver audio circuits are designed and built to exacting specifications, resulting in unsurpassed received-signal intelligibility.
- **TRUE FM, NOT PHASE MODULATION:** Transmitted audio quality is optimized by the same high standard of design and construction as is found in the receiver. The microphone amplifier and compression circuits offer intelligibility second to none.
- **OTHER FEATURES:** Dynamic Microphone, built in speaker, mobile mounting bracket, external remote speaker jack (head and radio) and much, much more. All cords, plugs, fuses, microphone hanger, etc. included. Weight 6 lbs.
- **ACCESSORIES:** 15' REMOTE CABLE...\$29.95. FMPS-4R A/C POWER SUPPLY...\$39.95. TOUCHTONE MIC. KIT...\$39.95. EXTERNAL SPEAKER...\$18.00.

**AMATEUR-WHOLESALE ELECTRONICS** ORDER NOW TOLL FREE

8817 S.W. 129th Terrace, Miami, Florida 33176  
 Telephone (305) 233-3631 • Telex: 80-3356

U.S. DISTRIBUTOR DEALER  
 INQUIRIES INVITED

**1-800-327-3102**

CREDIT CARD HOLDERS MAY USE OUR TOLL FREE ORDERING NUMBER.

## Attaching Components

The biggest mistake most first-time users of the board make is looping components too high. Keep everything as tight against the board as possible. All components should be pre-formed, with leads kept as short as possible. After soldering, give the component or wire a gentle bend back and forth to relieve lead stress. This is important, especially when connecting another component to the same spot, as it will prevent the first component from moving when the solder is remelted.

Do not connect components in midair. Even if you have to tie one end of a component to an unused pad and complete the connection with a piece of wire, the final result will be much neater and less likely to be damaged by subsequent handling. By the same token, it is wise to use

the same technique to avoid crossing components over ICs. If you have to replace the IC at a later date, it will be much easier if you do not have to remove other components.

For long interconnections, use insulated wire. For close or adjacent pads, bare tinned wire is best. To jump over a pad or rail, form the bare wire as you install it. Using a long piece, solder one end first. After the solder hardens, bend the long end up at about a 45° angle. Next place a small round tool, like a common nail, on the pad to be jumpered. It will be easy, then, to bend the wire down over the nail into contact with the pad to which it is to be soldered. Clip the end with small diagonal cutters and then solder.

I recommend wire-wrap wire for use on the board. It is available in inexpensive small rolls at most electronic parts stores. It has solid

conductor and heat-proof insulation. Stranded wire or wire with ordinary PVC plastic insulation is very hard to work with. You also may need to buy a little stripping tool—ordinary strippers often work poorly on wire-wrap wire.

## Plan Your Work

It is quite a temptation, because of the ease of construction using the board, to simply grab components, wire, and solder and to begin building without planning. Even if you are doing original design work, give the layout of the board some preliminary thought. I find it invaluable to literally draw out the project in pencil. The main benefit is in reducing the number of "across-the-board" wires. It's not possible to eliminate them all, but a little planning reduces the number and makes the final board much neater and easier to repair in the future.

## Conclusion

For original design work, for student use, and for producing permanent repeater control systems, the board has become very popular in my local group. Personally, I like it best for "one-of-a-kind" projects that appear in ham magazines. Many articles do not contain board layouts. The board has provided a very satisfactory and quick means to build such projects. It also greatly facilitates modification of published circuits to one's own needs in a form that is genuinely permanent.

The prototype board is available commercially from W6ELECTRONICS, PO Box 5515, Pasadena CA 91107, for \$6.95 (California residents add 6% sales tax). For home construction, a photographic negative is available for \$4.95. The board is made of G-10 glass epoxy, drilled, and rosin-coated. ■

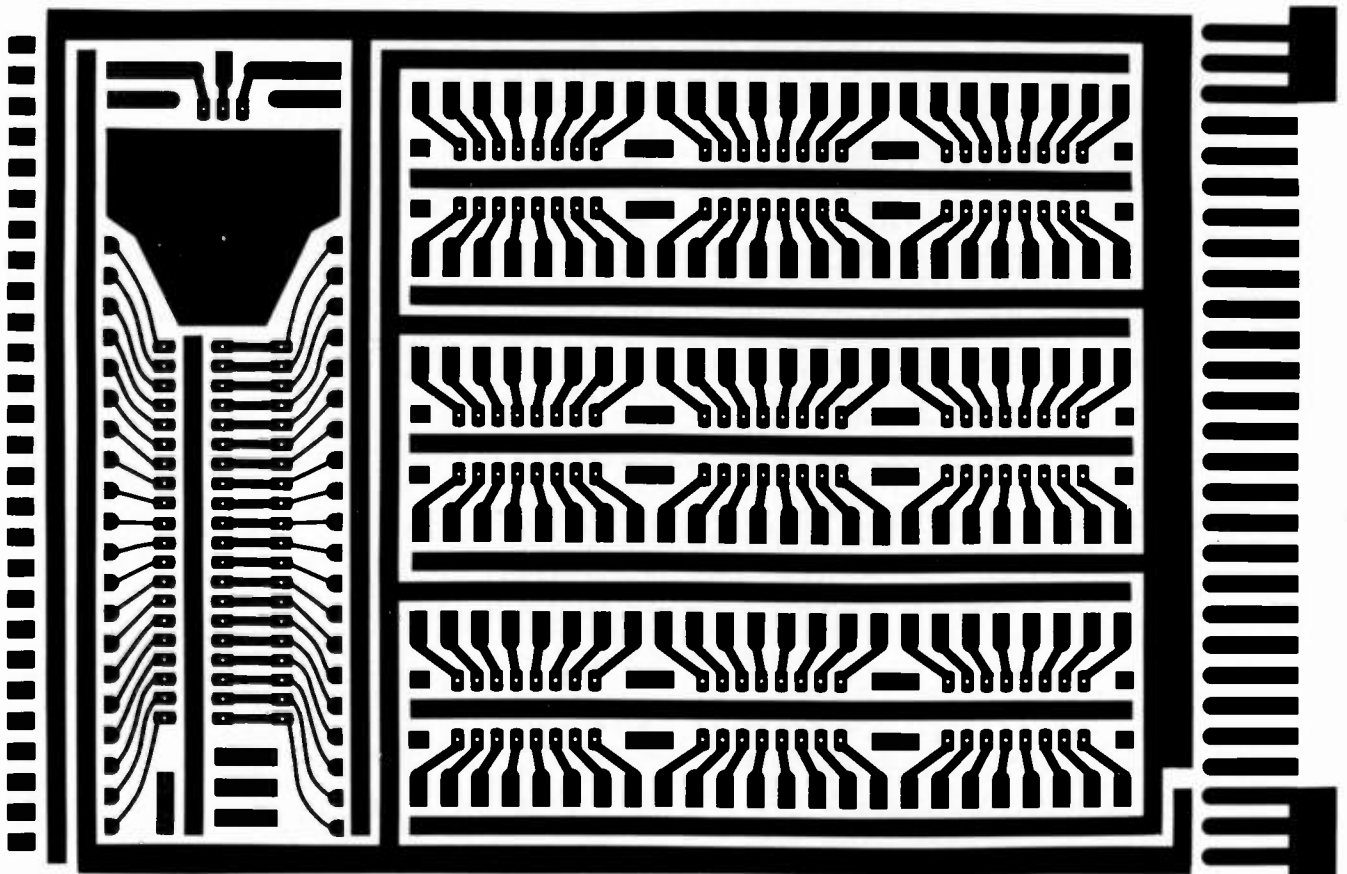

Fig. 1. The better prototyping board.

# RF-Power!

**Super Stick II & III**  
 +9db 5/8 wave + 3db 1/4 wave  
 Plus a 2 Meter or 220 MHz Duck  
 For Under A Buck

**\$19<sup>99</sup> + 1¢**  
 For The Duck

## THE WORD IS OUT!

The SSII 2 meter & SSIII 220 MHz 5/8 wave ants. exhibit 9 db gain over a short rubber duck when fully extended and 3db when collapsed to a quarter wave. The SSII or SSIII is the solution to many of those fringe area problems that plague every repeater system. With the Tuned Antenna's exclusive modular construction you can replace or exchange any of the 15 types of base connectors, plus the telescopic section may be replaced for only \$5.00. The tuned loading coil/spring is soldered to the machined end caps not swaged...And there are no ticky tacked capacitors or leads in the SSII or SSIII's loading coil to break.

There are no short cuts in designing and building quality ants. The Super Stick ants. are the only 5/8 wave ants. that spec gain in db at a 1/4 wave and 5/8 wave over a rubber duck. These gain figures were obtained from extensive field testing on HT's. Now you know why the word is out. The SSII & SSIII ants. give your HT more effective power. Call one of our 112 dealers today.

*New!* **MOBIL LINE**

1/4 wave antenna with magnetic base

**\$ 14<sup>95</sup>**

Truly a portable 1/4 wave 2 meter 220 or 440 MHz magnetic based antenna to withstand over 55 MPH. Weather resistant fiberglass whips, black or white. Cutting chart incl.

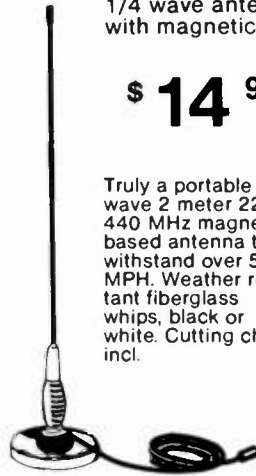

**WITH NMO TYPE BASE**

5/8 wave 2 meter mobile antenna with cable...

**\$29<sup>95</sup>**

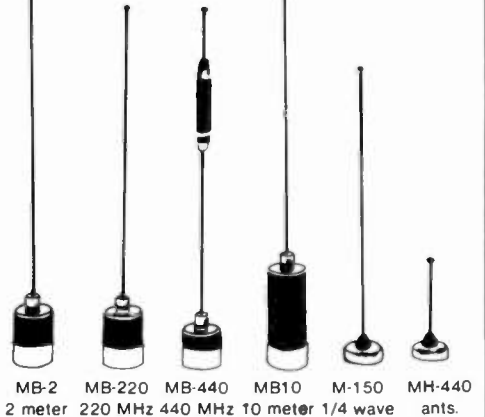

MB-2 2 meter MB-220 220 MHz MB-440 440 MHz MB10 10 meter M-150 1/4 wave MH-440 ants.

Terms: C.O.D. check or money order  
 Please add \$2.00 for first antenna and \$1.00 for each additional antenna to cover shipping and handling.

To Order Call

**(619) 268-0720**



57

**THE TUNED ANTENNA CO. 9520 Chesapeake Dr., #606, San Diego, CA 92123**

*... at last - everything at your fingertips !!!*



**\$184<sup>50</sup>**

Radio Equipment NOT Included  
 F.O.B. Culver City  
 (CA Residents add 6% sales tax)

Bring ORGANIZATION & CONVENIENCE to your HAM Station! Eliminate clutter and provide lots of space for everything you need - Tuners, VFO, CW Keyers, Filters, Telephone, Log Book, Etc...

- ANGLED REAR SHELF
- ALL PARTS FITTED
- STURDY CONSTRUCTION
- WALNUT or PECAN FINISH

Floor space: 39" w by 30" d.  
 Also: 51" w by 30" d - \$199.50

Dealers Inquiries Invited

**A Finely Crafted Piece of Furniture With a REAL Purpose . . .**

Call : (213) 837-4870 or Write for Information

**S-F Amateur Radio Services**

65

4384 Keystone Ave., Culver City, CA 90230

**LACOMBE** DISTRIBUTORS

Louisiana's Only Authorized

**ICOM** Dealer

Large selection of Amateur and Marine Communications Equipment Available

Call for Quotes

**800-336-4799**

Lacombe Distributors  
 Davis & Jackson Road  
 P.O. Box 293  
 Lacombe LA 70445  
 (504) 882-5355



# Beating the Untraceable Buzz

*Man-made interference doesn't have to destroy reception. Not when you use W1GV's buzz-beating antennas.*

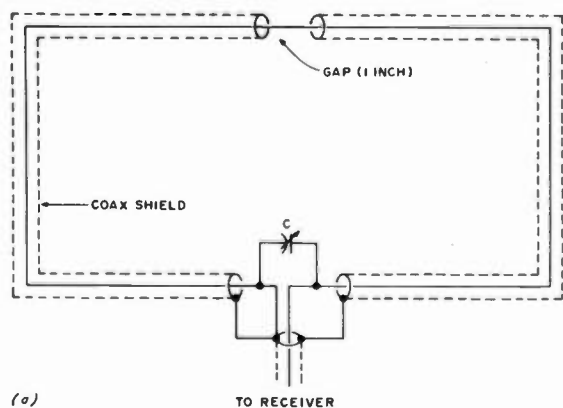

(a)

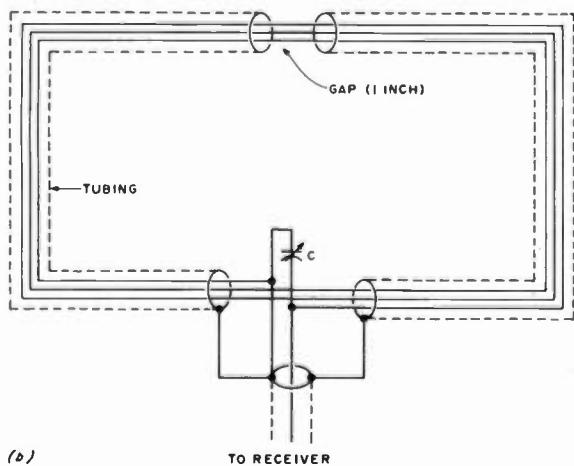

(b)

Fig. 1. Two versions of the shielded loop. (a) A single-turn version may be constructed using tubing and heavy wire or by using coaxial cable. The value of C will have to be determined by experimentation, although a 365-pF receiving-type variable usually will suffice. (b) A multi-turn loop is shown. Circumference of the loop should be about 0.15 wavelength in either case, although it may be considerably less if a preamplifier is used. See text.

Stan Gibilisco W1GV/4  
PO Box 561652  
Miami FL 33156

You've just moved into a new apartment or a new house for rent and the landlord has given his okay to your putting up a four-band trap vertical on the roof. (Miracles do happen!) So you blithely install your new station console, trying to improve the layout still further over what you had

Frequency MHz	Circumference Feet	Meters
1.8	78	(24)
3.5	40	(12)
7	20	(6.1)
10	14	(4.3)
14	10	(3.1)
18	8	(2.4)
21	7	(2.0)
24	6	(1.8)
28	5	(1.5)

Table 1. Circumference of a shielded loop for various frequencies. These circumferences represent 0.15 wavelength for the indicated bands. If a preamplifier is used, the loop may be used at frequencies below that where it is 0.15 wavelength.

the last time; you painstakingly solder every PL-259 onto the interconnecting cables. You ground your equipment with a bus bar of 1/4-inch copper tubing running to a cold-water pipe only three feet away. You install 20 radials on the roof for each band (80 in all, and with the best stranded No. 16 wire). Finally, everything is ready to go.

You turn on the receiver. A solid installation, this, you proudly think to yourself. Not a DX killer, to be sure, but it's well built and there should be plenty of good hamming ahead. The S-meter reads a steady S9 + 20. You turn up the volume: ZZZZZZ! Up and down the band you tune. The noise limiter does no good; the pulses must be too broad. ZZZZZZ! So much for 20 meters.

Switch to 40. Peak up the preselector. ZZZZZZ! S9 + 30. Damn. Switch to 15. Peak it up. ZZZZZZ! Only S9. Oh, great! Why even try 10? Why make yourself depressed needlessly?

## The Search Begins

The next step, of course, is to switch off everything



in the place except the rig. Thwack! Thwack! Thwack! One circuit breaker after another. And from the shack, several rooms away, you can hear the receiver with the volume up to 3:00: ZZZZZZ—it stops! Your heart leaps. Whoops, that was the shack. Thwack! ZZZZZZ...

The XYL shouts, "Will you turn that thing down and stop fussing with the lights? I'm trying to watch TV and iron!"

All your clocks were set to WWV from your watch, which you had to set at a friend's QTH because you can't even hear WWV at yours. Now all the clocks are out of whack since you played with the breakers.

You run all over the yard, using a little, plastic 6-transistor AM radio your Aunt Jenny gave you for Christmas back in '65 and you've hardly used for anything until now. Some places the noise is louder, some places softer. But there is no logical pattern. It's everywhere, but it's centered nowhere.

You try to DF (direction find) using the ferrite loopstick in the little radio. There is a sharp null in the direction of either the elm tree out front, or else 180 degrees opposite, from somewhere under the driveway. Move into the backyard. It's either coming from the rising full moon or else from the base of the swing set.

No power transformers of any consequence in the area. The noise is constant, around the clock. You get up at 5:00 am: ZZZZZZ! You come home for lunch (actually, instead of lunch). ZZZZZZ! Your stomach growls.

You'll never get rid of it.

### You Could Search More

Oh, yes, eventually, if you search long and hard

enough, you'll find it. Maybe it's an electric blanket in a neighbor's house. But, then, who uses an electric blanket for 24 hours out of every day? A refrigerator? Maybe, but they don't run continuously, unless... unless there is not enough of that coolant stuff in them. Hmmm.

It's not a street lamp starter, since it happens during the day. A fluorescent lamp starter, maybe? Well, who leaves a fluorescent lamp on for 24 hours a day? You might snoop around the neighborhood at 4:00 am or so and see if anybody has any fluorescents on. But, no, you might get arrested or mugged or something.

Maybe it's a thermostat mechanism. God help you.

### What Can You Do?

Although I've made light of all this, it's not exactly funny when it happens. And sometimes you just will not, by any reasonable means, be able to locate and/or eliminate a source of man-made noise. If it's somebody's refrigerator without coolant, maybe it will burn up some day. A noisy fluorescent light starter will eventually fail and have to be replaced. Lot of good that does you now.

The situation is not hopeless, though. Noise has different characteristics than signals. There are ways of getting your antenna system to favor those single-frequency signals that you want to hear, while discouraging that wide-band hash that you can't stand to hear.

There are basically three methods of doing this. You can use them in combination if necessary. They will almost always provide significant improvement. These methods are: 1) Shielded-loop antennas; 2) High-Q antennas; 3) Noise-cancelling antennas. Let's look at these one by one.

Incidentally, these anten-

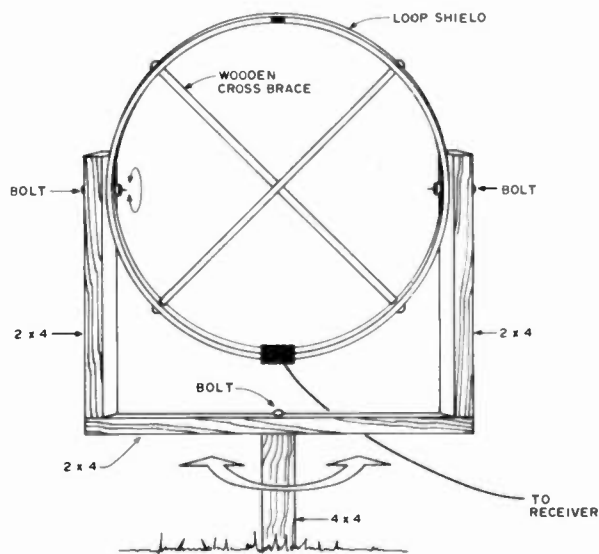

Fig. 2. A method of azimuth/elevation mounting that allows the shielded loop to be pointed towards the focal direction of a noise source. This kind of mount is practical only up to a certain size—about an 8-foot-diameter loop. The loop shield should be constructed from copper tubing if this kind of mounting is used.

nas are for receiving only. If you have a transceiver, some sort of switching device, such as a relay, will have to be used. These antennas will all prove quite lousy for transmitting.

### The Shielded Loop

Fig. 1 shows two types of shielded-loop antennas. Fig. 1(a) is a schematic diagram of a single-turn loop, which may be constructed from coaxial cable. The loop is tuned to resonance by capacitor C, which may be a common 365-pF receiving-type variable available at most Radio Shack stores. It may be necessary to parallel this capacitor with a 330-pF fixed capacitor if resonance cannot be obtained with the variable by itself.

The loop should have an overall circumference of about 0.15 wavelength. Essentially, it is a single-band affair. If used on a band much lower than where it is 0.15 wavelength, the antenna will not pick up signals very well. If used on a much higher frequency, the antenna will pick up more noise. Nevertheless, you

can probably get away with using it at half the design frequency and still get fair results. The loop may be placed on an "X" brace made out of wooden dowels or 2 by 4s, taped to an inside closet wall, or even put up in a tree.

The "shielding" of the loop obviously is not complete. Actually, it is electrostatic (Faraday) shielding, which shorts out the electric component of the signal while letting the magnetic part pass. For some reason, man-made noise seems to be transmitted mostly by capacitive coupling, as an electric field. But signals have both a magnetic and electric component. The result is that the noise gets attenuated more than the signals.

At Fig. 1(b), we have a multi-turn shielded antenna. The overall physical-circumference should still be 0.15 wavelength. The shield may be constructed out of copper or aluminum tubing. The loop should have four to six turns; too many turns will lower the Q of the antenna and this will adversely affect its noise per-

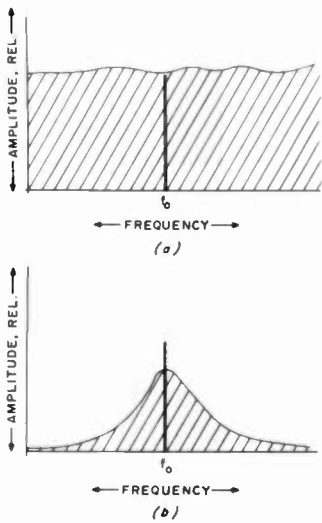

Fig. 3. Effect of increasing the Q of an antenna system. (a) The antenna system has essentially no selectivity. The signal, at frequency  $f_0$ , is buried in the noise. (b) A selective circuit is used in the antenna system. The total amount of noise (area under the curve) is smaller and this results in fewer high-order mixing products, which actually reduces the noise level at  $f_0$ . But the signal level remains unchanged, improving the signal-to-noise ratio.

formance. (Part of the noise attenuation of the shielded loop is the result of its high Q, which we will discuss later.) Several turns, however, provide for more "sensitivity" than just one. One word of warning: It is a physical contortion of considerable difficulty to find a way to get several turns through the tubing without a good deal of cussing and high blood pressure.

Table 1 gives the circumference of an 0.15-wavelength loop at various frequencies. The loop may be a square, pentagon, hexagon, octagon, or perfect circle. The circle is geometrically best. A long, skinny rectangle will not work too well. You should try to get the largest possible area for the circumference allowed, and keep it all in the same plane.

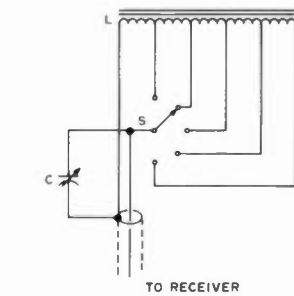

Fig. 4. A ferrite loopstick antenna with multiple taps. The taps should be chosen so that C may be adjusted for resonance on each band used. See text for discussion of inductance values.

A shielded loop does have a directional pattern. The antenna will respond to signals in any direction except right along the axis. There is a sharp null in the line of the axis. The null is so sharp that signals propagated via the sky wave will never fall into it because of their multipath nature. Local signals might possibly fall into the null; just move the antenna a little and they'll come up. Of course, the noise can be nulled out if the antenna is oriented just right. This will provide even more attenuation to an already weakened foe.

### Nulling It Out

The noise that is causing you so much frustration may originate in a single device, but it is probably being transmitted all over the place by the ac power lines. Therefore, it may be coming from all around. However, noise will always have a focal direction. Mathematically, all the noise combines in such a way that it may be considered to be coming from one single direction. (It's sort of like gravity. Even parts of the Earth that aren't straight under you are pulling at you, but it all averages out to a straight down force.) This axiom holds true as long as it's only one fluorescent light, thermostat, or elm tree that is responsible. If

there are two independent culprits, each one will have its own focal direction, and you won't be able to null them both out at once. But chances are that there is only one source of noise. (It is just too horrible to even consider that there might be more!)

Fig. 2 shows a method of mounting a shielded loop so that its null can be pointed in any direction. The focal direction might even be straight overhead, so the antenna must be capable of pointing in the vertical as well as the horizontal plane. The XYL won't let you put such a contraption in the living room? Well, try the attic or the backyard, then. Or even the roof.

It may take some time to find the focal direction of the noise, since the antenna null is so sharp. But once you've found it, there may be as much as a 20-dB drop in the noise level—and this is in addition to the improvement that results from the electrostatic shielding. Now you should be able to hear some signals. Let that guy's refrigerator run until it burns itself out.

### High-Q Antennas: The Ferrite Loopstick

Man-made noise differs in another way from signals. The signal you want to hear is never more than 3 kHz wide on the HF bands (unless you want to listen to AM shortwave music broadcasts, which take up about 10 kHz). The noise, however, is hundreds or even thousands of kHz wide.

The higher the Q (the narrower the bandwidth) of the antenna system, the smaller the total amount of noise that gets into the receiver. But that little 3-kHz signal will all be passed. This effect is shown in Fig. 3. The less total noise that gets to the receiver front end, the

less noise that will appear within that 3-kHz signal "window," since there will be a lower level of high-order mixing products. Thus, the signal-to-noise ratio will be better.

The shielded-loop antenna, discussed earlier, has a fairly high Q. It can be maximized by using a single turn of very heavy wire inside a piece of tubing, or else by using RG-8/U coaxial cable for the loop section. A preamplifier with rf tuning may be added at the receiver input with any antenna in order to increase the Q. There are several commercially made units available. Ameco Equipment Company (12033 Otsego Street, North Hollywood CA 91607) makes one called the PT-2 that tunes 160 through 6 meters.

An antenna with very high Q can be constructed using a ferrite rod. Just wind several turns of enameled copper wire on the ferrite core from the antenna in Aunt Jenny's at-last-useful AM transistor job. Ferrite sticks are available commercially from Amidon Associates (275 Hillside Avenue, Williston Park NY 11596). The coil should be tuned to resonance using a variable capacitor. Fig. 4 shows a multiband ferrite antenna system with multiple taps.

The exact number of turns that will provide resonance on the desired band using a 365-pF variable capacitor at C will have to be found by trial and error, unless there is data included showing inductance vs. number of turns for your particular stick. Table 2 shows the values of inductance that will provide resonance with 200 pF of capacitance (about the middle of the range of a 365-pF variable) at various frequencies.

A ferrite antenna, complete with azimuth/elevation mount and a built-in

# 80M IN 24 FT!



Put a broad bandwidth 80M dipole in 24 ft with the SLINKY DIPOLE® antenna. Comparable low SWR, space savings and performance on ALL HF bands, including SWL and WARC. Complete kit: 2 special 4" coils, 50' RG-58/U coax, balun kit, mounting hardware and instructions. Great for apartments, condominiums, motels and vacation use. Easy set up and adjustment.

Ask for **FREE** antenna comparison sheet

**Blacksburg Group**  
Box 242 Suite 500  
Blacksburg, Virginia 24060  
703/951-9030

**49.95 postpaid** (in U.S.A.)  
Money Back Guarantee  
Virginia residents  
add 4% sales tax

118



# Orbit



**ORBIT** is the Official Journal for the Radio Amateur Satellite Corporation (AMSAT), P.O. Box 27, Washington, DC 20047. Please write for application.

For a **FREE SAMPLE COPY** please send \$1 to cover First Class Postage and handling to: Orbit, 221 Long Swamp Road, Wolcott, CT 06716.

# UNIVERSAL COMMUNICATIONS

A Division of Innovative Labs, Inc.

## KIT #1

- DOWNCONVERTER ..... \$19.95
- VARIABLE POWER SUPPLY ..... \$19.95
- CIGAR ANTENNA ..... \$19.95
- ★ Kit Special — buy all three..... \$49.95
- SAVE \$10.00**

## KIT #2

- DOWNCONVERTER ..... \$19.95
- VARIABLE POWER SUPPLY ..... \$19.95
- KD 44 DISH ANTENNA..... \$47.95
- ★ Kit Special — buy all three..... \$79.95
- SAVE \$7.90**

## ASSEMBLED SPECIAL

- ASSEMBLED DOWNCONVERTER .... \$39.95
- ASSEMBLED VARIABLE POWER SUPPLY..... \$29.95
- CIGAR ANTENNA ..... \$19.95
- ★ Assembled Special — buy all three..... \$79.95
- SAVE \$10.00**

## Great Gift Ideas for the Holiday Season

- SUPERVERTER I assembled only .... \$109.95**  
crystal not included
- SELECTIVE PREAMPLIFIER..... \$26.95**
- HIGH GAIN TRANSISTOR..... \$6.95**
- DRIFT MODIFICATION..... \$1.25**
- KD44 DISH ANTENNA..... \$47.95**

1691 Downconverter, built & tested only . . . call for price

For information or ordering  
**(817) 860-1641**

Hours, 8:30-5:00 CST; Mon.-Fri.

# UNIVERSAL COMMUNICATIONS

P.O. Box 339  
Arlington, TX 76004-0339



Frequency MHz	Inductance $\mu\text{H}$
1.8	39
3.5	10
7	2.6
10	1.3
14	0.65
18	0.39
21	0.29
24	0.22
28	0.16

Table 2. Inductance required to resonate with 200 pF of capacitance (the middle range of a 365-pF variable) at various frequencies. This data may be used in conjunction with data provided with commercially available ferrite rods, for the purpose of making a ferrite loopstick antenna.

preamplifier, is available from Palomar Engineers (Box 455, Escondido CA 92025) at the time of writing.

The ferrite loopstick is not electrostatically shielded, but it does tend to favor inductive coupling over capacitive. It is easier to work with mechanically, especially at lower frequencies. Simply orient the loopstick until a null occurs in the noise background. The null will be very sharp.

Need this last comment be made? Let's not take any chances. Don't try using a toroid core for this antenna. It won't work.

### Noise-Cancelling Antennas

There's still another characteristic of noise that makes it different from signals. Oddly enough, this is the very resemblance of noise to a signal, with a unique focal direction. You hear the noise on the same frequency as a given signal; the noise may be thought of as a local signal. As such, using two antennas to combine the noise in opposite phase, the noise can be "cancelled out."

Fig. 5 illustrates one such system. The spacing between the two inductively-loaded vertical dipoles

need not be very great, but it should be as large as practical without exceeding a quarter wavelength. The elements themselves may be very short. In fact, shortening them increases the Q, which will add to the noise-reducing effectiveness.

One antenna is fed 180 degrees out of phase with respect to the other. The easiest way to do this is to make the phasing lines the same length, but feed one of the antennas upside down with respect to the other. That is, if one antenna has the feedline center conductor going to the top section, the other antenna should have its feedline going to the bottom. In the plane equidistant from the two antennas, phase cancellation will occur. This is a vertically-oriented plane, and by rotating the entire system through 180 degrees, any focal direction can be put into the null plane.

It is possible, but not likely, that a signal will arrive from a direction that lies in the same plane as the noise, once the noise has been cancelled out. Sky-wave signals, since they arrive from a varying direction (ionospheric shift), may fade more if this happens. Local signals will be attenuated considerably.

This particular kind of antenna is mentioned here to illustrate the third way that signals can be distinguished from noise. As described, it will not work as well as the shielded loop or the ferrite antenna. But this scheme could conceivably be used with two shielded loops or ferrite antennas! Actually, pointing these two types of antennas at the focal direction of the noise is a means of phase cancellation. But even more cancellation could be obtained by using two such antennas, both pointed at the focal direction of the noise and then combined

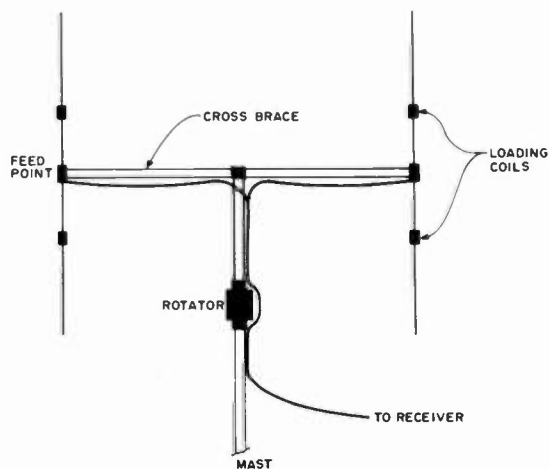

Fig. 5. Using two antennas to obtain phase cancellation of the noise. This particular system uses two inductively-loaded vertical dipoles. This system is illustrated primarily to demonstrate the third difference between signals and noise; this antenna by itself will not work as well as a shielded loop or a ferrite antenna.

so that the small amount of remaining noise from each antenna arrives at the receiver in opposing phase.

### Which One?

In a noisy environment, probably the best choice is the shielded loop. Using a selective preamplifier, one shielded loop can be used on several bands; it should be constructed for the highest band used. On lower frequencies, the value of capacitor C will have to be increased by paralleling it with fixed capacitors. The preamplifier will allow reception on lower bands because of its gain.

Perhaps there is no good place to put a shielded loop with azimuth/elevation mounting, and you can't get enough noise attenuation unless the antenna can be oriented towards the focal direction of the noise. Then, the next best choice is the ferrite loopstick. It can be put right at the operating desk! The ferrite antenna will probably not be quite as effective as a shielded loop. The null will not be as well defined (though still quite sharp) and its discrimination against electrostatic coupling will not be quite as good. But it can still be used to advantage.

### Conclusion

Noise differs from signals in three ways: 1) Noise is transferred mostly by electrostatic coupling, but signals are transferred by electromagnetic fields; 2) Noise is broadbanded, but signals occupy only a small part of the spectrum; 3) Noise has a unique and usually constant focal direction at a given frequency, and it will usually be in a different focal direction than desired signals. These three differences are taken advantage of by: 1) Faraday shielding; 2) High-Q antenna circuits; 3) Phase cancellation.

These three methods of dealing with noise may be used individually or in combination. A shielded loop with azimuth/elevation mounting takes advantage of all three of the differences between signals and noise. It has electrostatic shielding, has a high Q, and may be oriented to null out the noise. A ferrite loop can be used when the shielded loop is impractical because of space limitations, either in reality or in the imagination of an XYL or landlord.

Good luck! Carry on the search for the noise source by all means. But at least get on the air in the meantime. ■

Introducing our Latest Model — NOVAX II

**SIMPLEX / DUPLEX  
AUTOPATCH**

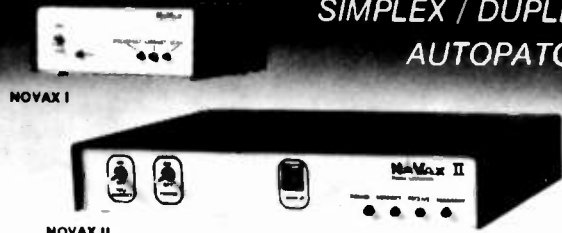

**NOW TWO MODELS TO  
SERVE YOU BETTER  
YOUR OWN PRIVATE AUTOPATCH**



NOVAX interfaces your standard 2 meter; 220; 450; etc. Base station and telephone, using a high speed scan switching technique so that you can direct dial from your automobile or with your HT from the backyard or poolside — Automatically... Easy installation transceivers, featuring solid state switching, offer best results... Available interfaced with an ICOM 22U.

FEATURES	NOVAX I	NOVAX II
• 3 min. Call duration timer	YES	YES
• Up to 45 sec. activity timer	YES	YES
• Single digit Access Control	YES	NO
• DTMF (Touch Tone)* phone connection	YES	YES
• 4 digit Access Control	NO	YES
• Toll Restrict	NO	YES
• LED Digital Display	NO	YES
• Vinyl covered alum. case size	5" x 6" x 2"	10" x 8" x 1 1/2"
• Directly Interfaces with Repeater	NO	YES
• Rotary Dial System (incl. Last digit dial)	NO	YES—"Option"—\$49.95
• Ring Back (reverse autopatch) "Option"	YES—\$39.95; Kit \$29.95	YES—Wired—\$39.95
• Price	Kit: \$169.95/wired \$219.95	Wired only \$279.95
N.Y.S. Res. add approx. Sales Tax	SHIPPING ADD \$3.50 in U.S.A.	

To order, send check, money order to:  
**MASTER CHARGE AND VISA ACCEPTED**  
 CURRENT DEVELOPMENT CORPORATION (formerly R.W.D. Inc.)  
 Box 162 - Tudman Rd. Westmoreland, N.Y. 13490 or Phone 315-829-2785  
 \* Trademark ITT

**DO YOU  
KNOW  
THIS MAN?**



He is a leader in the community, at home, at work, and in Ham Radio. He could be a Brass Pounder, a dyed-in-the-wool phone man, an avid DXer, a staunch VHF'er or maybe he's just nuts about RTTY or ATV. Maybe he or she is lurking in your household, posing as a husband, wife, father, brother, sister, or even your next door neighbor or someone just down the block. This shadowy unknown person is sought to join an impressive group of formerly unrecognized hams including such notables as Ed Tilton, W1HDQ and Senator Barry Goldwater, K7UGA.

Have you guessed who we're searching for? Right... It's the "Ham of the Year" to be honored at the Dayton Hamvention on April 30, 1983. If you know this person, why not grab a pen and turn him or her in for a great reward. Get all the facts—fully detailed—and send in your nomination NOW. This award is not for one-time achievement, but for continued all-around outstanding performance and contribution to civic and Ham activities.

There is a separate award for one-time special achievements including DX-peditions, emergency work, or excellence in some technical area of Ham Radio. So if you feel you know some worthy Ham who should be recognized for his work, why not give him a chance and send in a nomination now to the Dayton Hamvention. There are many amateurs in our ranks deserving our recognition. All that's needed is someone to nominate them. Who knows, you may have a winner in your own backyard... Hurry... deadline for all nominations is April 1, 1983. ALL NOMINATIONS AND CORRESPONDENCE FOR FURTHER INFORMATION SHOULD BE SENT TO:

**Dayton Hamvention**  
 ATTN: AWARDS CHAIRMAN  
 P.O. BOX 44 DAYTON OHIO 45401

**HAL'S NEW YEAR'S SPECIALS**

- HAL 2304 MHz DOWN CONVERTERS (FREQ. RANGE 2000/2500 MHz)
- 2304 MODEL #1 KIT BASIC UNIT W/PREAMP LESS HOUSING & FITTINGS ..... \$19.95
- 2304 MODEL #2 KIT (with preamp) ..... \$29.95
- 2304 MODEL #3 KIT (with High Gain preamp) ..... \$39.95
- MODELS 2 & 3 WITH COAX FITTINGS IN & OUT AND WITH WEATHER-PROOFED DIE CAST HOUSINGS
- BASIC POWER SUPPLY ..... \$19.95
- POWER SUPPLY KIT FOR ABOVE WITH CASE ..... \$24.95
- FACTORY WIRED & TESTED ..... \$34.95

ANTENNAS & OTHER ACCESSORIES AVAILABLE. SEND FOR MORE INFO.

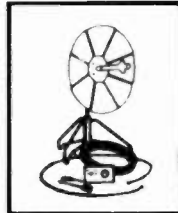

**2100-2500 MHZ**

\*HMR-II COMPLETE UNIT  
 COMPLETE SYSTEM AS SHOWN. NOT A KIT. INCLUDES A PC BOARD, POWER SUPPLY, CABLES & CONNECTORS—PRE-ASSEMBLED AND TESTED. 24dB GAIN OR GREATER.

- 1 UNIT..... \$149.95
- 2 UNITS..... \$139.95 ea.
- 3 OR MORE UNITS..... \$129.95 ea.

\*HAM MICROWAVE RECEIVER

**PRE-SCALER KITS**

- HAL 300 PRE (Pre-drilled G-10 board and all components) ..... \$14.95
- HAL 300 A/PRE (Same as above but with preamp) ..... \$24.95
- HAL 600 PRE (Pre-drilled G-10 board and all components) ..... \$29.95
- HAL 600 A/PRE (same as above but with preamp) ..... \$39.95

**TOUCH TONE DECODER KIT**

HIGHLY STABLE DECODER KIT. COMES WITH 2 SIDED PLATED THRU AND SOLDER FLOWED G-10 PC BOARD, 7-567's, 2-7402, AND ALL ELECTRONIC COMPONENTS. BOARD MEASURES 3-1/2 x 5-1/2 INCHES. HAS 12 LINES OUT. ONLY \$39.95

- NEW—16 LINE DELUXE DECODER \$69.95
- DELUXE 12-BUTTON TOUCH-TONE ENCODER KIT UTILIZING THE NEW ICM 7206 CHIP PROVIDES BOTH VISUAL AND AUDIO INDICATIONS! COMES WITH ITS OWN TWO-TONE ANODIZED ALUMINUM CABINET MEASURES ONLY 2 1/4 "x3 3/4 " COMPLETE WITH TOUCH-TONE PAD, BOARD, CRYSTAL, CHIP AND ALL NECESSARY COMPONENTS TO FINISH THE KIT. PRICED AT \$29.95
- NEW—16 LINE DELUXE ENCODER \$39.95
- HAL ECD—16 LINE DELUXE ENCODER INCLUDES PC BOARD, ALL PARTS & CASE \$39.95

HAL ECD—12 LINE DELUXE ENCODER COMPLETE WITH PC BOARD, ALL PARTS & CASE \$29.95  
 ACCUKEYER (KIT) THIS ACCUKEYER IS A REVISED VERSION OF THE VERY POPULAR WB4VVF ACCUKEYER ORIGINALLY DESCRIBED BY JAMES GARRETT, IN QST MAGAZINE AND THE 1975 RADIO AMATEUR'S HANDBOOK \$16.95

ACCUKEYER—MEMORY OPTION KIT PROVIDES A SIMPLE, LOW COST METHOD OF ADDING MEMORY CAPABILITY TO THE WB4VVF ACCUKEYER. WHILE DESIGNED FOR DIRECT ATTACHMENT TO THE ABOVE ACCUKEYER, IT CAN ALSO BE ATTACHED TO ANY STANDARD ACCUKEYER BOARD WITH LITTLE DIFFICULTY \$16.95

BUY BOTH THE MEMORY AND THE KEYS AND SAVE  
 COMBINED PRICE ONLY \$32.00

**PRE-AMPLIFIER**

- HAL-PA-19 WIDE BAND PRE-AMPLIFIER, 2-200 MHz BANDWIDTH (—3dB POINTS), 19 dB GAIN FULLY ASSEMBLED AND TESTED \$8.95
- HAL-PA-1.4 WIDE BAND PRE-AMPLIFIER, 10 MHz TO 1.4 GHz, 12dB GAIN FULLY ASSEMBLED \$12.95

**CLOCK KIT**—HAL 79 FOUR-DIGIT SPECIAL—\$7.95. OPERATES ON 12-VOLT AC (NOT SUPPLIED) PROVISIONS FOR DC AND ALARM OPERATION.

**6-DIGIT CLOCK • 12/24 HOUR**

COMPLETE KIT CONSISTING OF 2 PC G-10 PRE-DRILLED PC BOARDS, 1 CLOCK CHIP, 6 FND COMM. CATH. READOUTS, 13 TRANS., 3 CAPS, 9 RESISTORS, 5 DIODES, 3 PUSHBUTTON SWITCHES AND INSTRUCTIONS. DON'T BE FOOLED BY PARTIAL KITS WHERE YOU HAVE TO BUY EVERYTHING EXTRA. WILL RUN OFF ANY 12-VOLT AC SUPPLY. PRICED AT \$12.95

CLOCK CASE AVAILABLE AND WILL FIT ANY ONE OF THE ABOVE CLOCKS. REGULAR PRICE... \$6.50 BUT ONLY \$4.50 WHEN BOUGHT WITH CLOCK.

SIX-DIGIT ALARM CLOCK KIT FOR HOME, CAMPER, RV, OR FIELD-DAY USE. OPERATES ON 12-VOLT AC OR DC, AND HAS ITS OWN 60-Hz TIME BASE ON THE BOARD. COMPLETE WITH ALL ELECTRONIC COMPONENTS AND TWO-PIECE, PRE-DRILLED PC BOARDS. BOARD SIZE 4" x 3". COMPLETE WITH SPEAKER AND SWITCHES. IF OPERATED ON DC, THERE IS NOTHING MORE TO BUY\* PRICED AT \$16.95

\*TWELVE-VOLT AC LINE CORD FOR THOSE WHO WISH TO OPERATE THE CLOCK FROM 110-VOLT AC WHEN PURCHASED WITH CLOCK KIT \$2.95

SHIPPING INFORMATION: ORDERS OVER \$25 WILL BE SHIPPED POST-PAID EXCEPT ON ITEMS WHERE ADDITIONAL CHARGES ARE REQUESTED. ON ORDERS LESS THAN \$25, PLEASE INCLUDE ADDITIONAL \$2.00 FOR HANDLING AND MAILING CHARGES. SEND 20¢ STAMP FOR FREE FLYER.

DISTRIBUTOR FOR  
 Akuma Tower-AP Products  
 (We have the new Hobby-Blox System)



**HAL-TRONIX**  
 P. O. BOX 1101  
 SOUTHGATE, MICH. 48195  
 PHONE (313) 285-1782

# The Care and Feeding of Optoelectronics

*There are many ways to make these devices earn their keep. Here is one.*

**C**an you really see which way the wind is blowing with optoelectronics?

The answer to that question is yes—with a little help from you.

The subject of this article is General Electric's H21A1

photo-coupler interrupter module. This module has two components: an infrared LED light source called the emitter, and a photo transistor called the detector.

I think you are safe in

believing this so far, because I just read it in an optoelectronics manual.

The H21A1 module has a gap in its housing. The emitter is mounted on one side of the gap and the detector on the other. You may think someone planned it that way because now, if you

want to, you can make this little black thing do something to earn its keep. For instance, if you pass something opaque through the gap, you will interrupt the output of the emitter. Do you think that's why GE calls it a photo-coupler interrupter module?

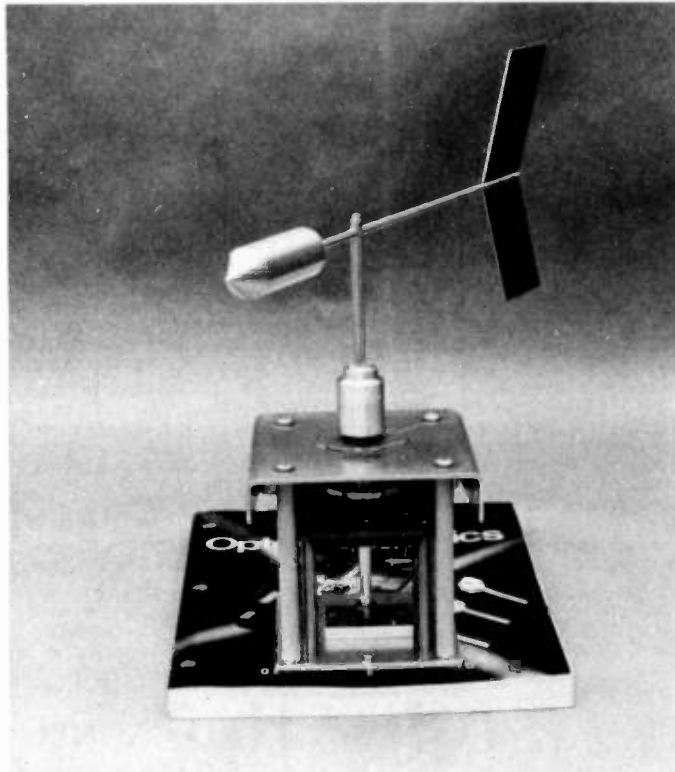

Photo A. Wind-direction indicator with the weather cover removed.

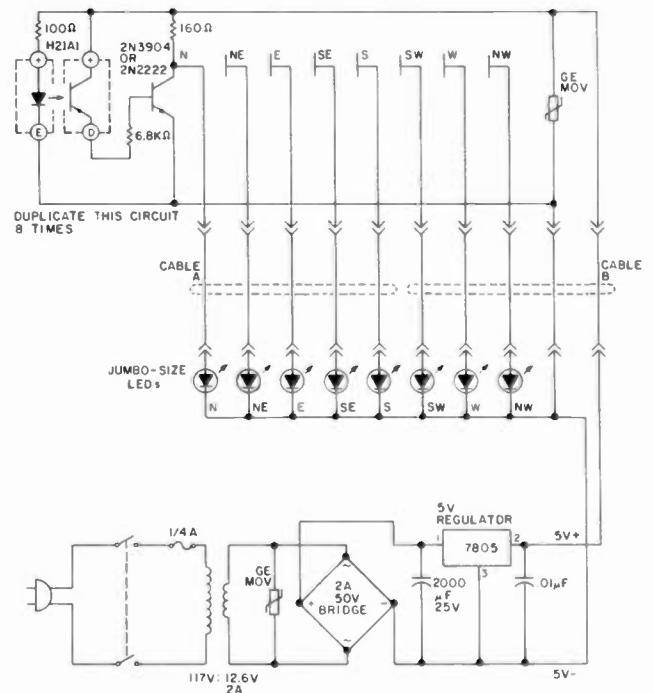

Fig. 1. The H21A1, detector side, is not shown physically correctly drawn here—look on top of the device for the correct pinout. All resistors are 1/4 Watt; capacitors are μF.

The interrupter module is just one of many types of photo couplers. To mention a few, the reflector module could be used somewhat like the interrupter module except that the light source must be bounced off a reflective surface and back to the detector. There are discrete emitter and detector units, and also a whole family of optocouplers in which the emitter and detector are sealed into one cube with no way of anything getting between them, which offer as high as 4000-volts isolation between the input and the output. I have mentioned but a few that are available (most of them cheap). And that brings me to the reason for my taking your time while you read this.

My purpose is to tell you how I used an interrupter-type module in a project and to get you interested enough to think about using optoelectronics in your next project. The more you know about them the more

jobs you will see that they can do for you.

I sort of hinted at the beginning that I know how to make the H21A1 (actually, 8 of them) tell which way the wind is blowing, so I better get to it. The construction part is a mix of electronics and mechanics. The device, in case you haven't guessed, is a wind-direction indicator.

As you can see in the photos, there are some machined parts used on the model. Don't let this scare you; in almost every case, there is an alternative way to fabricate the same part with hand tools. I will suggest ways as we go along. On the other hand, the fellow with a lathe or machine shop could have a good time developing this project even further. The model pictured here has been perfected only to the point that it works reliably in all weather experienced here in Pennsylvania, and it should continue to work for

many years. That is to say, don't be afraid to use the ideas and hardware available to you.

The most important points to remember when planning your construction are that (1) the bearing friction should be low enough so that a gentle breeze will have enough force on the tail of the vane to keep it headed into the wind, (2) you must devise a way of mounting it to your tower or pole, and (3) when it's all finished you must have some means of weather-sealing it.

Photo A shows the wind-direction indicator fully assembled except for the weather cover. The vane boom is 3/16 × 12-inch-long aircraft aluminum rod. (I might mention at this time that all parts were made from T3 aluminum.) The tail is 1/16 × 6 inches and has just about 13 square inches of surface. The vane boom is mounted to the axle or vertical shaft 2/3 of the length of the boom in front of the tail, or 1/3 of the way back of the nose. So, to balance this proportionately heavier than the tail. The nose is 1 × 3 inches long and is

threaded onto the boom. A 1/16-inch slit has been milled into the boom to accept the tail, but a flat surface filed on the boom with the tail screwed to it would be just as good. The nose could be epoxied to the boom if there is no threading tool available.

The axle or vertical shaft is a 1/4 × 9-inch rod with a 3/16-inch hole drilled in it near the top to accept the vane boom. A hole was drilled and tapped into the end of the shaft down through the vane boom and on into the shaft another half inch to secure the boom to the shaft.

Photo B is an exploded view. It shows the next component on the way down the shaft—the top bearing weather seal. This rotates with the shaft and, together with a piece of pipe that is epoxied to the top support frame, prevents the elements from getting into the bearing.

The top support frame is 4-7/16 inches deep (as viewed in Photo B) and 4-5/8 inches wide. It provides a mounting surface in the back and was formed from 1/8-inch stock. The back two corners were welded for strength. The inner bear-

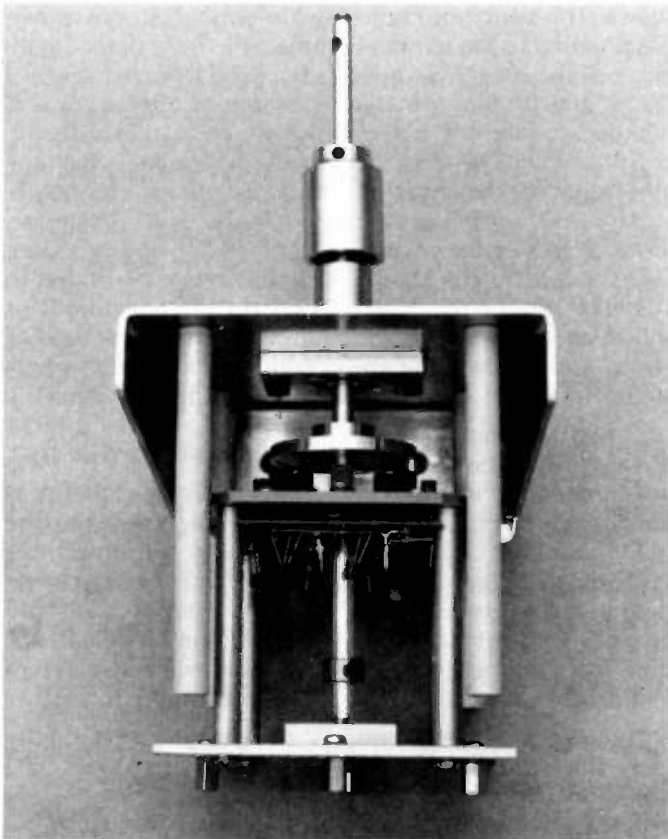

Photo B. An exploded view with the vane boom removed.

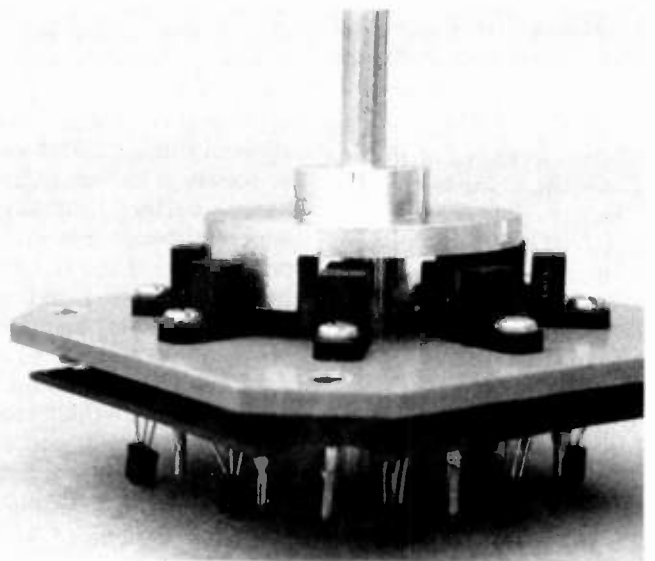

Photo C. A view of the H21A1s mounted on their fiberglass substrate and the disc interrupter tab rotating through the H21A1 gap. Mounted underneath is the PC board with the rest of the circuit components.

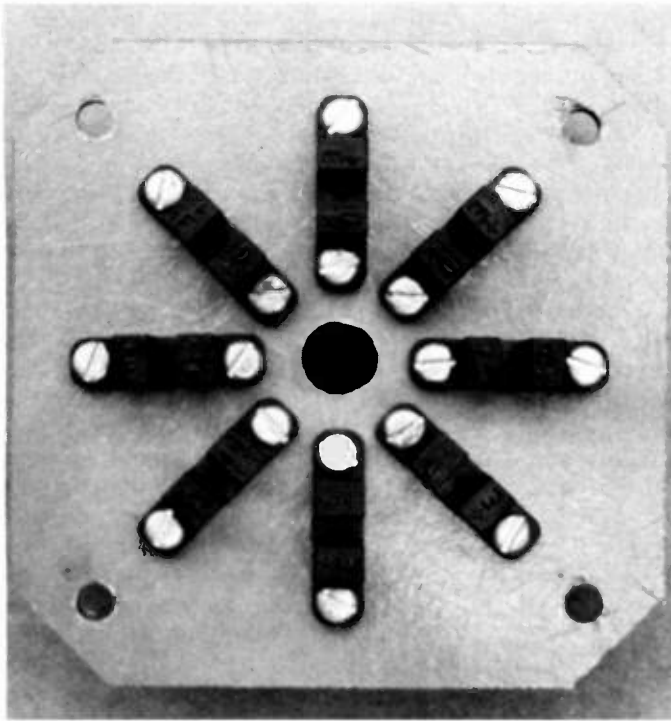

Photo D. The eight H21A1s in a 1-11/16" circle (measured to the center of the gap).

ing seal is 3/4-inch i.d. conduit 1-1/8 inches high. The outer bearing seal is 5/8-inch i.d.  $\times$  1-3/8 inches high.

The next component down the shaft is the top bearing. I used ball bearings pressed into a bearing block to facilitate mounting and alignment, but a neat hole in a hunk of brass would be just as good. It would then be smart to use a brass or steel shaft, because brass and aluminum don't get along, especially out in the weather.

The next component down the shaft is the disc interrupter. It rotates with the shaft and is the component that actually tells the optoelectronics interrupter module which way the wind is blowing. (More about that later.) The disc interrupter used in this model was machined from a piece of solid round stock. As seen in Photo C, it is merely a disc with a collar and set screw to secure it to the shaft, and with a right angle tab on it. An easier way to make the disc would be to use the top portion of a

small soup can and epoxy a collar to the top to secure it to the shaft. My disc-interrupter tab runs in a 1-11/16-inch circle and is 3/8-inch deep. The width of the tab is cut so that it covers two interrupter modules. (More about that later.) The H21A1's gap is 3/32-inch wide so I made the tab 1/16-inch thick.

Photo D is a top view of the heart of the whole thing, the eight H21A1 interrupter modules mounted in their circle on a piece of fiberglass epoxy board 1/8-inch thick  $\times$  3-1/4 inches square. This would have been a perfect situation in which to design and etch a printed circuit board. At the time, however, I did not have on hand PC board material thick enough to do the job. I think it should be at least 1/8-inch-thick stock to get the thermal and mechanical stability needed.

As you can see in Photo E, I used a piece of Radio Shack "do all" board. The leads from the H21A1s were stuck through the board and soldered first, to set the spacing be-

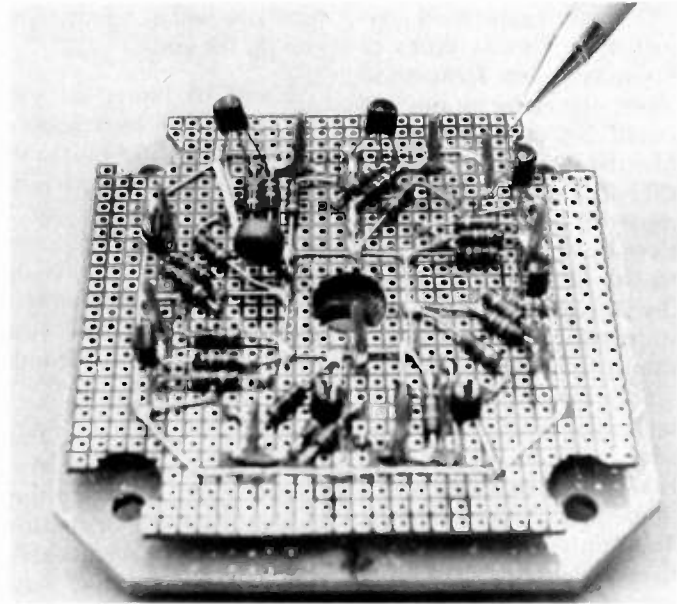

Photo E. The electronic components mounted on what we call a "do all" PC board. The pencil is pointed at one of the ten pins used to terminate the cable coming from the readout LEDs in the shack. The component at 10:00 o'clock near the shaft hole that looks like an overweight disc capacitor is the MOV.

tween the two boards. Then the positive bus (near the center of the board) and the negative bus (around the outside of the board) were put down. After that, it's just as the schematic shows. The pencil in Photo E is pointing to the terminal pin on the negative bus. There are 10 pins on the board; two are for power (+5 V and -5 V), and the other eight are the direction signals that are being sent down to the wind direction LED readout in the shack. The male pins on the board will mate with female pins on the end of the cable going to the shack.

I tried various methods of reducing the number of conductors needed in the interconnection cable, BCD, etc., but when the smoke cleared (get it?), two runs of inexpensive 5-conductor TV-antenna rotor wire were found to work fine.

The eight H21A1s are spaced every 45° around the circle. Consequently, with the eight LEDs placed on the compass rose in the shack, you are able to de-

termine if the wind is out of the north, northeast, east, southeast, south, southwest, west, or northwest merely by observing the LEDs. However, by making the disc interrupter tab wide enough to cover two adjacent interrupter modules, two LEDs are lit. So, for example, if the south and the southeast LEDs are lit, we can assume that the wind is out of the south-southeast, or approximately 157°. Obviously, more H21A1s could be added to increase the resolution. At this point, some method of reducing the number of cable conductors between the aerial unit and the readout panel would be necessary.

The electronic theory is super simple. When the disc interrupter tab interrupts the emitter light source, the photo transistor turns off, turning the 2N3904 off, hence allowing the appropriate LED to light.

Any 5-volt power supply that can deliver at least 500 mA continuously will work. The General Electric MOV is for transient voltage-spike protection. I used the



V47ZA7 because I had them; a better choice could be made.

So far, there has been no need for rf suppression, but that is not to say you may not need to add a bypass capacitor or two.

The next to last thing on the shaft is the 1/4-inch collar. It is secured to the shaft with a set screw and rests on top of the lower bearing. It prevents the shaft from falling through. As you can see in Photo B, the collar is not in place because this is an exploded view.

Photo F shows an exploded view with the 3-3/4-inch spacer screws removed from the bottom plate. You also can see the four small 3/4-inch spacers on the bottom of the bottom bearing plate. These spacers will be used to secure the weather cover.

All of the spacers could be substituted for with all-thread rod, and then you would use the nuts to adjust

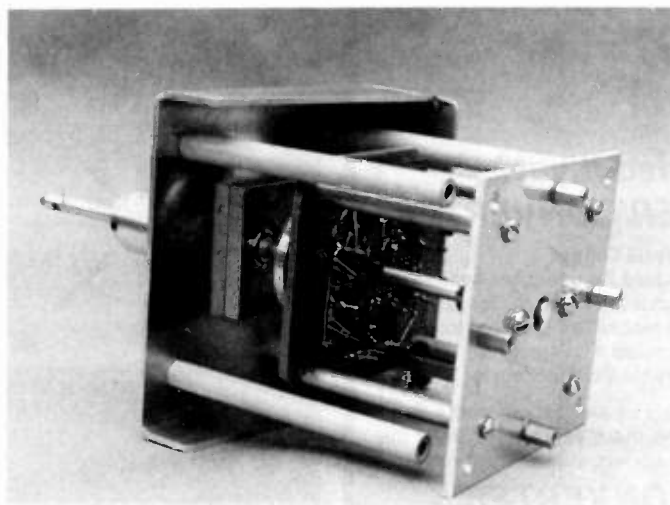

Photo F. An exploded view from the front looking up at the wind-direction indicator.

your spacing. The bottom bearing and bearing block are identical to the top bearing and bearing block.

The weather cover is nothing more than a five-sided box that slides up over the lower bearing plate and butts against a cork gasket glued to the bottom side of the top support frame (gasket or cover

not pictured). A fruit or soup can of the proper size also would work for a weather cover.

After the machine was fully assembled and tested, I disassembled it so that I could wash all the metal parts with dishwashing detergent. Then everything was sprayed with clear Krylon™, including the elec-

tronics board but excluding the H21A1 board.

Photo G is a view of the wind-direction readout panel with its eight LEDs, etc. On a sub-panel on the rear, the power-supply components and cable terminal blocks are located. On the right is the companion meter that I hope in the near future will indicate wind velocity (not ac Amps). My plans for this meter as they stand now are to perfect a 4-inch cup anemometer to the point that it will indicate wind velocity with the additional feature of generating 7 to 10 Watts to be used to light a small lamp or to charge the HT battery.

Tune-up of this little gem is pot pie. Just mount it in the air on whatever structure you plan to use. Point the nose of the wind vane north and by using the set screw in the disc interrupter collar, clamp the tab so it is centered through the H21A1 that you have designated north. Be sure the vane still rotates freely. Secure the weather cover in place, then go down to the shack, turn the power supply on, and watch the LEDs blink. It is that simple. Of course, you knew it was going to work before you put it in the air. Hi, hi!

A word about finding parts and materials. If you can't get the H21A1s locally, see Reference 1. I found a shop in my area where I can buy a foot of this and an inch of that, plus getting some good advice to boot. I found this shop by talking to a fellow who is building an experimental aircraft. They use the same types of material. Perhaps you can find an experimental aircraft club in your area, or you can get your material where I got mine. See Reference 2.

I would be very remiss if I did not implicate my collaborators in this project: Fred Jones K3CVM,

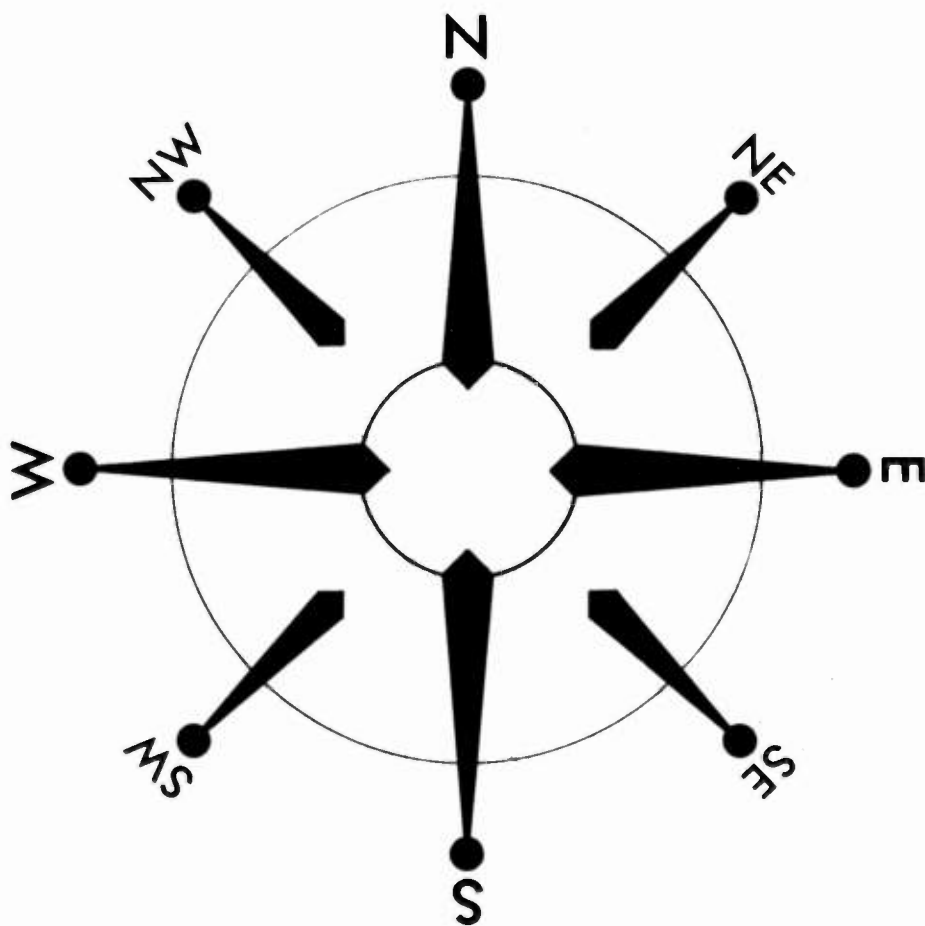

Fig. 2. Here is your ready-to-use compass rose!



**FAST  
SCAN**

**\$399**

**Have you tried it yet?  
ATV TRANSMITTER/CONVERTER**



**TC-1**

- \*10 Watts Output
- \*Standard Frequencies Available
- \*Broadcast Standard Sound
- \*High-resolution & color video
- \*Regulated AC Supply Built In
- \*Tunable Downconverter & Preamp

Connect to the antenna terminals of any TV set, add a good 450 MHz antenna, a camera and there you are... Show the shack, home movies, computer games, video tapes, etc.

**ATV DOWNCONVERTER**

For those who want to see the ATV action before they commit to a complete station, the TVC-4 is for you. Great for public service setups, demos, and getting a buddy interested. Just add an antenna and a TV set tuned to CH. 2, 3, or 4 and plug in to 117 volts a.c. **\$89.00**

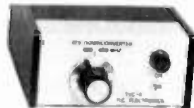

**TVC-4**

**TVC-4L extra low-noise version... \$105 delivered in USA**

**HOMEBREWERS: ASK FOR OUR BASIC FOUR-MODULE PACKAGE**

CALL OR WRITE FOR OUR COMPLETE LIST OF SPECIFICATIONS, station set-up diagrams, and optional accessories which include antennas, modulators, detectors, test generators, cameras, etc. WE ARE A FULL-LINE SUPPLIER OF ALL YOUR ATV NEEDS.

TERMS: VISA or MASTER CARD by telephone or mail, or check or money order by mail. All prices are delivered in USA. Allow three weeks after order for delivery.

**P.C. ELECTRONICS** (213) 447-4565  
Tom W8ORG Maryann W86YSS 2522 Paxson Lane,  
Arcadia, California 91006

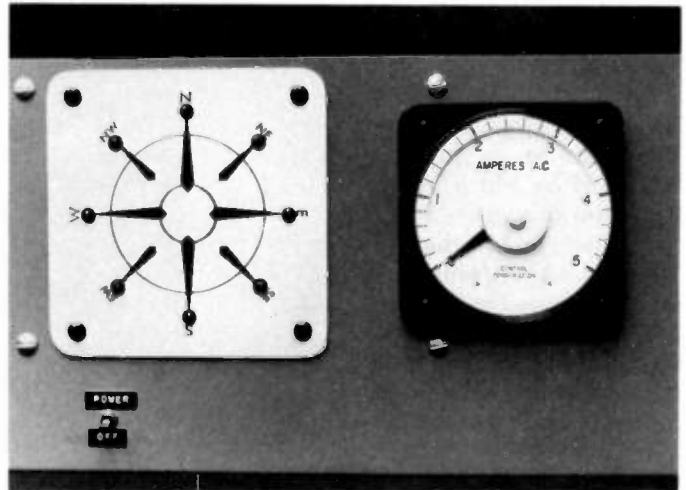

Photo C. The readout panel with the eight-point compass rose on the left and the meter that will indicate wind velocity on the right.

Don Zarfos K3OAP, Tim Burke WA3KYD, Jim Erisman WB3ERZ, Russ Hut, and Jim Williams. Thanks, fellows. ■

2. The Dillsburg Aeroplane Works  
RD #3  
Dillsburg PA 17019  
(717)-432-4589

3. Optoelectronics  
General Electric Co.

**References**

1. Rosen Electronics, Inc.  
215 S. George St.  
York PA 17403  
(717)-843-7881

4. *Transient Voltage Suppression Manual*  
Second Edition  
General Electric Co.

**QUALITY SPECIALS**

**SOPHISTICATED I.C.'S**

DATA SHEETS AND APPROPRIATE APPLICATION NOTES ARE PROVIDED FREE WITH ALL INTEGRATED CIRCUITS LISTED BELOW

PART # & MANUF.	DESCRIPTION	PRICE (ea.)
RD004 (LSI COMP. S/S)	CMOS DIVIDER I.C. HAS TRUTH-TABLE SELECTABLE INPUT TO YIELD DIVIDE BY 10, 100, 1000, or 10000 OUTPUTS	1 3.50
LS703 (LSI COMP. S/S)	DIC. 10 MHz 5 1/2 DECADE MOS UP COUNTER WITH 8 DECADE LATCH AND MULTIPLEXED BCD OUTPUTS AND DIGIT STROBES. ACCESS TO LSD LATCHES ALLOWS ATTACHMENT OF PRESCALERS FOR COUNTING TO 500MHz	593.75
LS720 (LSI COMP. S/S)	14 PIN DIP AUTOMOTIVE/MARINE ANTI-THEFT DIGITAL LOCK CIRCUIT HAS 8,000 4-DIGIT COMBINATIONS WITH 25 MICROAMP STANDBY. 'SAVE' MODE FOR VALET PARKING	1 3.50
ZNA50E (PERMANT)	3 1/2 DIGIT. DIGITAL MULTIMETER I.C. WITH LCD DRIVE ON CHIP CLOCK AND REFERENCE. A COMPLETE DMM CIRCUIT CAN BE MADE WITH 3 PASSIVE EXTERNAL COMPONENTS	141.25
FE0201D (AND COMP.)	3 1/2 DIGIT LCD DISPLAY	512.00
TSC128 (TELETYPE)	3 1/2 DIGIT AND CONVERTER. LCD DRIVER DESIGNED FOR LOW POWER APPLICATIONS (90mW) WITH A 9V BATTERY (EQUIVALENT TO INTERSIL 7128)	116.95

**CAPACITORS**

DIPPED TANTALUMS		COMPUTER GRADE	
1-99(00)	100-(00)	mil	WDC PRICE (each)
1 mfd/35V	\$ 30	2,250	100 \$3.95
33mfd/35V	30	4,000	50 3.95
1 mfd/50V	30	12,000	50 5.00
1.5 mfd/20V	30	21,000	40 3.95
2.2 mfd/15V	30	27,000	30 4.95
8.8 mfd/25V	50	33,000	25 5.95
68 mfd/10V	80	180,000	20 8.95

AXIAL ELECTROLYTICS		RADIAL ELECTROLYTICS	
1-99(00)	100-(00)	1-99(00)	100-(00)
1 mfd/40V	1.15	2.2mfd/25V	1.15
1.5mfd/25V	15	4.7mfd/35V	15
4.7mfd/15V	15	33 mfd/25V	15
10 mfd/30V	17	47 mfd/16V	15
47 mfd/25V	17	220 mfd/25V	15
150 mfd/10V	17	330 mfd/25V	15
220 mfd/10V	27	470 mfd/25V	35
470 mfd/25V	50	560 mfd/20V	35
1000 mfd/25V	70	1000 mfd/25V	70
2200 mfd/10V	70	2200 mfd/10V	70
2200 mfd/40V	85	3300 mfd/10V	50

**MISCELLANEOUS**

DESCRIPTION	PRICE (ea.)
28 PIN S.T. LOW PROFILE I.C. SOCKETS (TRM PLATED)	1 90
40 PIN S.T. LOW PROFILE I.C. SOCKETS (TRM PLATED)	1 55
1K or 25K SLIDE POTENTIOMETERS	1 75
250 OHM HORIZONTAL TRIM POT	1 50
1 MEG OHM HORIZONTAL TRIM POT	1 50
220 KIL OHM HORIZONTAL TRIM POT	1 50
POWER LINE FILTER (SURPLUS) 5 AMP. 250VAC, 50/60Hz	35.00
POWER LINE FILTER (SURPLUS) 15 AMP. 115/250V, 50/60Hz	48.00

**GOLDSMITH  
SCIENTIFIC**

CORPORATION  
P.O. BOX 318, COMMACK, NY 11725  
PHONE ORDERS WELCOME—(516) 979-7944  
MINIMUM ORDER \$10.00—U.S. FUNDS ONLY  
NEW YORK STATE RESIDENTS ADD SALES TAX  
POSTAGE—ADD 5% PLUS \$1.50 INSURANCE. C.O.D. \$2.00 EXTRA  
AVAILABILITY OF CERTAIN ITEMS MAY BE LIMITED



**2 METER 90 WATT OUTPUT  
AMPLIFIER WITH 18 DB GAIN PREAMP**



Model 90PL  
FOR ONLY **\$139.95\***  
FACTORY DIRECT PLUS SHIPPING

- FREQUENCY range 144 - 148 MHz
- OPERATION FM or SSB (completely linear) Class AB1
- RF DRIVE 1 to 30 watts
- KEYING RF activated with high quality relays
- SSB operation built in delay
- POWER REQUIREMENTS typical 10 watts drive, 13 amps at 13.8 VDC
- IDLE current 20 milli
- MOBILE or FIXED operation
- PREAMP 18DB gain minimum
- NOISE FIGURE less than 1.5 DB
- PREAMP KEYING independent — separately RF activated relays
- CONSTRUCTION wrap around aluminum heat sink 2 pieces 360 degrees cooling
- SIZE 7"(w) x 6"(d) x 3"(h) — WEIGHT 3 lbs. 9 ozs.
- IMMEDIATE SHIPMENT

**SPECIAL OFFER**

**Matching Power Supply**

**\$99.95\***  
PLUS SHIPPING

15 AMP SUPPLY wt. 13 lbs. size 8"(w) x 5"(h) x 6"(d)  
IMMEDIATE SHIPMENT  
ALL PARTS AND LABOR WARRANTED ONE FULL YEAR

VJ90PL Amplifier \$139.95 plus \$3.00 shipping  
VJ15 POWER SUPPLY \$99.95 plus \$7.00 shipping  
\*Prices USA only

**POWER MEASUREMENT  
AT 13.8VDC**

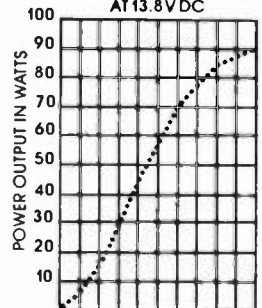

**POWER CHART**

VISA, MASTER CHARGE, M.O. or C.O.D. • PHONE (713) 477-0134

**V-J PRODUCTS, INC.** 505 East Shaw, Pasadena, Texas 77506

SERVING THE ELECTRONICS INDUSTRY SINCE 1965

# Introducing Corsair



## A New No-Compromise HF Transceiver

The CORSAIR is an extraordinary new HF transceiver. Every function operates without compromise. New unique features make it a delight to operate.

A new front end provides extreme sensitivity, low internal noise and high dynamic range to bring weak signals to life. For even greater overload prevention, the integral rf preamplifier can be switched out. More effective than the usual rf attenuator.

The filtering system, a TEN-TEC exclusive, virtually switches to privacy. It starts with a superb 2.4 kHz 12-pole ladder sideband filter system, standard. It provides variable bandwidth for ssb, great for today's crowded phone bands. A novel pass band tuning circuit allows a received signal to be moved within the pass band to its optimum position with respect to QRM. Optional narrow band filters are available for ssb, cw and RTTY, all switched from the front panel. The ultimate in QRM reduction.

Full cw break-in opens a window on the band while transmitting, turning monologues into conversation. Or, if conditions dictate, just switch to semi-break-in. And no VOX adjustment when changing modes.

A versatile offset tuning system allows the receiver and transmitter to be tuned separately with a  $\pm 1$  kHz range for fine tuning or  $\pm 4$  kHz for working off frequency. For net operation, both can be moved simultaneously.

Reliability is designed in. The CORSAIR system is so rugged it will operate into infinite SWR. And we guarantee it unconditionally (except for lightning) for one year. The CORSAIR is designed for 100% duty cycle, ideal for RTTY, SSTV and of course, contests.

Beauty is more than skin deep. The contemporary styling with the blackout LED frequency display (last digit in green), the baked-on textured bronze/black finish with aluminum trim will retain its handsome appearance permanently. Beneath its sleek exterior is a carefully crafted chassis packed with performance.

There are many other features, each with superb performance. An effective speech processor, notch filter, adjustable noise blanker, signal spotter, three position AGC, threshold ALC, simplified VOX, all controlled from the front panel. In addition, the CORSAIR has a compression loaded speaker, less than 2% audio distortion, and full accessory connections including remote bandswitch output. It even has a volume equalizing headphone output.

The CORSAIR is a total system of pure operating pleasure—it really must be put through its paces to be fully appreciated. Its smooth controls, comfortable and logically spaced, give it the feel of a superlative transceiver. One that will be a faithful companion for the years ahead.

All TEN-TEC products are completely manufactured in the U.S.A., in the foothills of the Great Smoky Mountains.

Model 560, CORSAIR transceiver . . . . . \$1169.  
See your TEN-TEC dealer or write for full information.

**TEN-TEC, INC.**  
SEVIERVILLE, TENNESSEE 37862

# International Success Story: The BBC

*From its battery of transmitters, the BBC fires a daily salvo of news and entertainment around the world. No commercials, either.*

Roger N. Peterson  
25 Orchard Lane  
New Canaan CT 06840

**A**sk just about any short-wave radio listener or look at the most recent listener-preference studies on international broadcasters, and you'll get the same an-

swer. The British Broadcasting Corporation (BBC) ranks number one.

There are a number of reasons for this popularity ranking, and I was turning them over in my mind as I walked down The Strand in London on a sunny day on my way to the BBC headquarters in Bush House, near Fleet Street. Some cynics say that the only reason for BBC popularity is that it is on the air more often and on more places on the dial than any other international broadcaster.

There is some truth to this, although the facts are not quite as above. The BBC ranks only fifth among international broadcasters for the amount of time on the air, per week. The USSR is first, followed by the US (Voice of America plus Radio Free Europe), the Republic of China (Radio Peking), and West Germany (Deutsche Welle). However, from the standpoint of pro-



*Bush House, home of the BBC's External Services, in The Strand, London. (All photos BBC copyright.)*

grams in English that can be heard here in North America, the BBC does indeed lead all the others. You can hear the BBC round-the-clock in the US and Canada, and this beats such big North American broadcasters as the Voice of America, AFRTS (US Armed Forces Radio), and the popular CBC Northern Service in Canada.

It also is true that BBC programs are often "all over the dial" on your receiver. During many hours of the day, you can pick up their broadcasts on three, four, or even more different frequencies. This is because of its unusually strong transmission facilities—79 transmitters, 47 of them in four different locations in Britain and 32 in eight overseas relay stations, including the US, Canada, and the Caribbean. At certain hours, the Russians offer even more frequencies to the US listener, but only the BBC provides this multi-band reception for most of the twenty-four hours.

While these technical advantages give the BBC a big boost over competition, they are not the only reasons for its popularity among listeners. The great reputation for world news coverage makes the BBC unique among international



The control room at Bush House, London, home of the BBC External Services. World Service programs are broadcast 24 hours a day from these facilities in English and 38 other languages.

broadcasters. The BBC broadcasts more than 250 news programs a day from its headquarters in London. They are all prepared in an ultra-modern newsroom with electronic readout aids of all kinds, and with a staff that numbers over 100. It may be the world's largest newsroom and, at this writing, certainly the most modern as it was completed just over a year ago.

News is fed into this giant

news machine by BBC correspondents from all over the world and by the international news agencies. Another important source is the famous BBC Monitoring Service. This BBC Division, located at Caversham Park, some 50 miles from London, provides round-the-

clock reports on the contents of selected broadcasts from foreign radio stations. This supplements the agencies' and foreign correspondents' reports.

The BBC Monitoring Service provides a *Summary of World Broadcasts* every day and, in addition to sending

#### A GUIDE TO BBC WORLD NEWS BROADCASTS

Time (GMT)	Best Frequencies (MHz)
0000, 0200, and 0300	5.975, 6.12, 6.175, 7.325, 11.750, 15.260
0400, 0500, and 0600	5.975, 6.175, 9.510, 15.070
0700	6.175, 9.510, 15.070
0800 and 0900	9.510, 15.070
1100 and 1300	6.195, 9.510, 11.775, 15.070
1600 and 1700	15.070, 15.260, 17.830, 21.710
1800	15.070, 21.71
2000	6.175, 15.070
2300	5.975, 6.175, 7.325, 15.070

#### BBC AND THE FALKLAND ISLANDS CRISIS

BBC is at its best reporting on significant news events, and the Falkland Islands crisis certainly was a good example. First of all, the regular news broadcasts generally were an hour or so ahead of the wire services or what your local radio or TV station reported. You heard it first on BBC if you tuned it in. Second, BBC has special programs to deal with current newsworthy events, and the Falkland situation was no exception. On May 2, right after the air attack on the Argentine-held airfields on the Islands, the BBC preempted one of its most popular programs, *Letter From America*, for an interview with several military experts.

These special programs generally come right after major news programs such as their 1100, 2000, 0000, and 0200 GMT broadcasts, but they can come at any time, as the BBC thinks nothing of interrupting regular programs for something special.

Finally, the BBC has always had a special weekly broadcast to the Falklands on Sunday afternoon from 2209 to 2245 GMT on 9.915 and 12.040 MHz. I heard the one right after the Argentine invasion on April 4, and it was excellent. It included a message from the British Foreign Secretary, a review of British press opinions, and even special messages to relatives. The program was very easy to receive in the Northeast, where I reside. Check it out at the above times and frequencies.

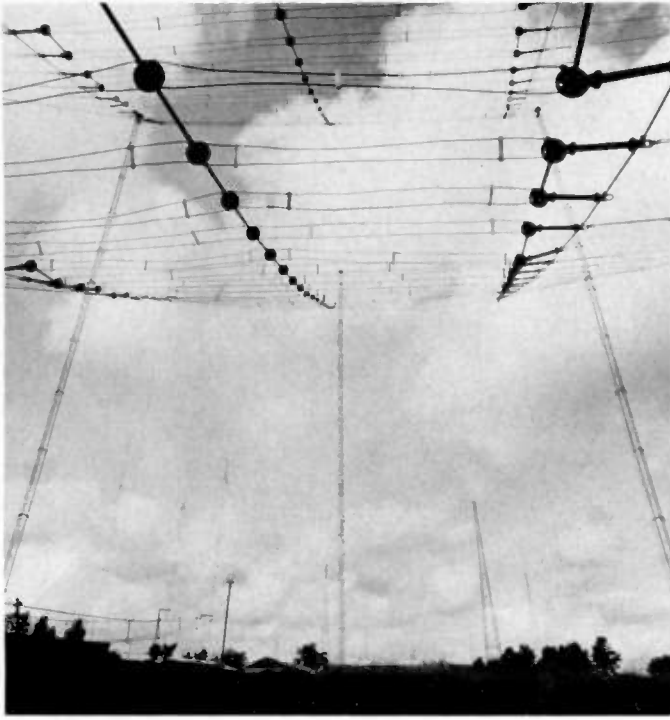

A view of the antenna farm for the BBC's broadcasts to North America. The signal is loud and strong to the US.

it to the BBC News Staff, supplies it on a subscription basis to other governments, news agencies and newspapers, universities, research institutes, industrial and commercial organizations, and private individuals.

World news can be heard in North America seventeen times a day (see box). In addition, back-up programs on the world events are offered daily. Some of the

most popular of these (as of last year) are:

- *Outlook*—an up-to-the-minute look at people, events, and opinions together with the latest UK news, sports, and weather.
- *Twenty-Four Hours*—analysis of the main news of the day plus reviews of the British press.
- *The World Today*—examines thoroughly one topical aspect of the international scene.

- *Commentary*—background to the news from a wide range of specialists.

- *Radio Newsreel*—news of events as they happen, and dispatches from BBC correspondents all over the world.

- *New About Britain*.

- *British Press Review*—Survey of editorial opinion in the press.

- *Financial News*—including news of commodity prices and significant moves in currency and stock markets.

In addition to these daily reports, the BBC also offers a number of weekly review-type programs on current events and special interest subjects. Among the most popular:

- *Financial Review*—a look back at the financial week.

- *Business Matters*—a weekly survey of commercial and financial news.

- *From Our Own Correspondent*—BBC reporters comment on the background to the news.

- *From the Weeklies*—a review of the British weekly press.

- *Listening Post*—a weekly survey of comment from radio stations around the world.

While the BBC has no rival for its extensive coverage of news, it also leads the way in many other types of programs—sport, drama, light entertainment, and music. These can be divided into two categories—monthly features and regular programs.

A typical month will have anywhere from 12 to 16 feature programs. These range from general interest to special interest subjects. Some are only for the “intellectuals,” and others are for the “common man.” In June, for example, the Queen’s Birthday Parade (better known as “Trooping the Colours”) is broadcast from London with all the music and pageantry you

would expect. The BBC also has had weekly programs called “The Poetry of Europe,” “The Movie Moguls,” and “Medical Hypnosis.”

Music is an important part of BBC programming. In fact, no other international broadcaster comes close to providing the number of musical programs—both classical and “Pops”—as does the BBC. Every month there are eight or nine special programs making their bows. Regular music programs include “Concert Hall,” “Talking about Music,” and a long-time BBC favorite, “The Pleasure’s Yours,” where Gordon Clyde plays classical requests. Another, “Classical Record Review,” reports on new releases.

Classical music is not the only thing that the BBC provides listeners who dig instruments and vocal sounds. For the rock devotee, there is the weekly “John Peel” show where the host selects tracks from a newly released album and singles from the progressive rock scene in London. “Jazz for the Asking” is a popular weekly request show, and “Top Twenty” lets you listen to all the big hits. “Terry Wogan’s Album Time” is a weekly show for those people who like the easy-listening kind of music, and there are many more of the same on the BBC every week.

Another area where BBC programming leads the way is in drama. There are four regular weekly features plus specials for the particular month. Total air time per week for this type of show is about 16 hours. A regular drama program is “Thirty Minute Theater.” This often shows plays by such famous writers as Dorothy L. Sayers, Terrence Rattigan, and Oscar Wilde.

“Play of the Week,” “Radio Theater,” and “Short Story” are other regular drama programs.

#### SOME POPULAR BBC PROGRAMS (All Times GMT)

Letter From America (Alistair Cooke)	Sundays 0545, 1115, 1645, 2315
Letterbox	Fridays 1415; Saturdays 2315; Sundays 0515, 2015
Look Ahead (Program Previews)	Daily 0940; weekdays 1943
In The Meantime	Thursdays 2120; Fridays 0150, 1115
Outlook	Weekdays 1900, 1515, 0115 (Tuesday-Saturday)
Anything Goes	Saturdays 1215; Mondays 0330, 0830
Concert Hall	Sundays 1515
Top Twenty (Hit Records)	Wednesdays 1830, 2330; Thursdays 1215
New Ideas	Saturdays 0530, 1015, 2230; Wednesdays 1725
Good Books	Saturdays 2015; Sundays 0215
Jazz For The Asking	Wednesdays 2130



Margaret Howard hosts the very popular "Letterbox" program on the BBC. Hear it on Fridays at 1415, Saturdays at 2315, or Sundays at 0515 and 2015 GMT.

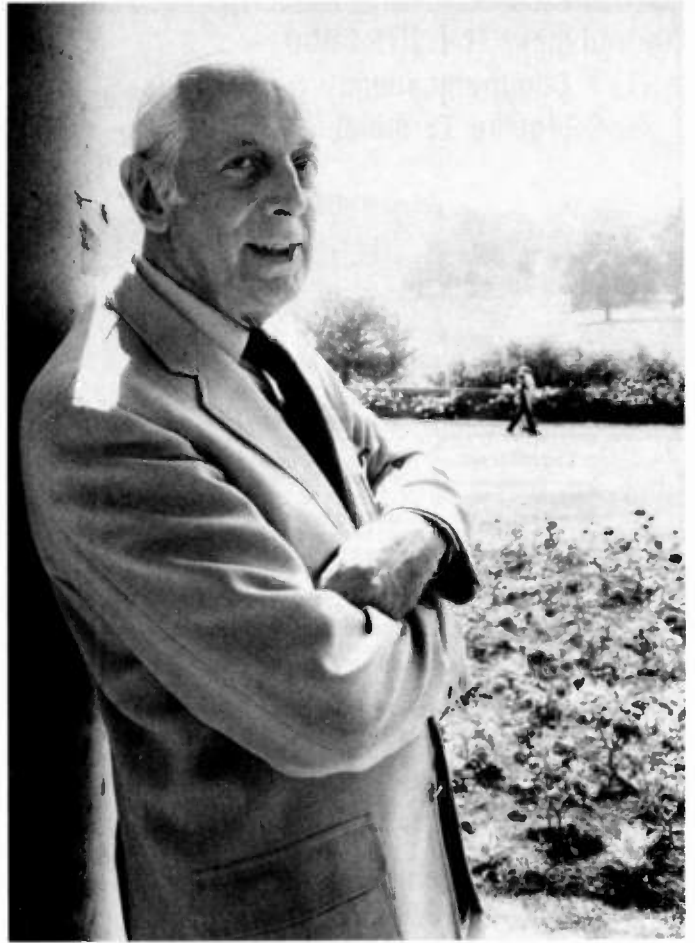

Alistair Cooke is heard every Sunday on the BBC with his popular "Letter From America" program. Listen to it at 0545, 1115, 1645, or 2315 GMT.

Book lovers hear the following programs every week: "Book Choice," "Good Books," and "Paperback Choice." For those interested in science and hobbies, "Discovery" covers advanced developments in science, "New Ideas" gives you news of the latest British products and inventions of particular interest to the home owner and small businessman, "Science in Action" lives up to its name, and "Time Off" is a program devoted to hobbies, pastimes, and entertainment.

Religion is not overlooked at the BBC, either. Services broadcast from famous English cathedrals and churches can be heard on Sundays and Mondays. Two other programs are "Report on Religion," a weekly magazine of religious news and views, and a

daily program called "Reflections."

Sports occupy a prominent part of the BBC weekly schedule, but a good many of these broadcasts are "very British indeed"—rugby, cricket, British football—and do not have a great appeal to the average US audience. If you have any British expatriates in your area, you can get them really excited by inviting them over to hear something like England versus Scotland in football.

BBC programs are very carefully researched by surveys and opinion polls. A Listener Panel (of which I am a member) is made up of 88% foreign nationals and 12% British expatriates and is asked to vote on individual programs and/or subjects on a regular basis. Panel voting accounts for

the unusual number of drama programs and for the addition of a new business news program ("Financial Review," mentioned above). Over 50% of the panel apparently wanted more business news.

Research indicates that one of the most popular BBC weekly programs is Alistair Cooke's "Letter from America." Back in 1946, the BBC commissioned Cooke to deliver a series of radio talks on the subject of the USA where he had been living and working for more than a decade. The original plan called for thirteen weekly programs, but it has never stopped in all these years. It may well be the longest-running series in radio history. Listen to it on Sundays at 0545, 1115, 1645, or 2315 GMT.

One other BBC program that continues to score high

marks is "Letterbox." This is a show where several people simply read letters (often complaints or suggestions for BBC programming) from listeners, and the BBC replies. On the surface, it doesn't sound very fantastic. However, the people on the show are so funny—with British wit and satire—that it has become one of the big BBC hits. Hear it on Fridays at 1415, Saturdays at 2315, and Sundays at 1515 and 2015 GMT.

At this point you might well be thinking about why the British go to all the trouble and expense of providing such a wealth of programs to the shortwave radio listeners of the world. To understand their motives we should examine the basics of the whole BBC foundation.

The letters "BBC" were first used in 1922 when the

## Introducing The SRT-3000 RTTY Communications Send-Receive Terminal

SRT-3000  
List  
\$995.00  
Introductory  
Price  
**\$795.00\***

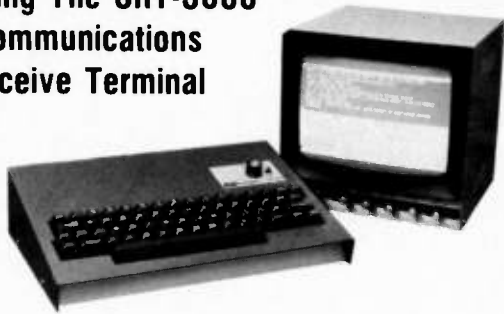

• Built-in demodulator & AFSK modulator for 170,425,850 Hz shifts, high and low tone pairs • 60,66,75,100,132 WPM Baudot, 110,300 Baud ASCII, 5-99 WPM Morse • 1000 character text buffer with BREAK feature • Ten 80 character message memories with battery backup • Selectable display formats, 24 lines x 72 characters (2 pages), 24 lines x 36 characters (4 pages), 16 lines x 36 characters (6 pages) • Split screen operation • On screen status line displays a tuning bar, mode, speed, shift, tone pair, normal/reverse, USOS, WRU, SELCAL, buffer mode and buffer count • Cassette interface for long "Brag Tapes" or unattended message storage • Baudot and ASCII printer outputs • Built-in audio monitor • Built-in 110 VAC power supply • Other features—PTT control, WRU, SELCAL, sync idle, CW ID, USOS, auto-start, full or half duplex, scope outputs, weight control, intercharacter spacing, reverse video, RS-232, word wrap around • Compact size only 13.3 x 10.3 x 4 inches • Made in USA.

\*Introductory prices good thru Feb. 28, 1983.  
Optional 9" video monitor shown \$149.00.

Send For  
Free Information

# DGM ELECTRONICS, INC.

787 Briar Lane, Beloit, Wis. 53511  
(608) 362-0410

British Broadcasting Company was formed and when regular daily broadcasts began. In those days, the BBC was a commercial organization, but one that operated under a license on conditions which would have prevented it—even if it wanted to—from turning broadcasting into a moneymaker for the shareholders. From the start, it placed the interests of the public above all. The result was that the British developed a genuine public service broadcasting system, paid for by its audience through their receiving licenses. In 1927, the Company became the British Broadcasting Corporation. It is a public corporation constituted by Royal Charter and holding a license from the Minister responsible for broadcasting. Thus the BBC is neither a government department nor a commercial concern.

The External Services,

which is what we hear on our shortwave receivers, are an integral part of the BBC, operating under the same charter as the domestic service and sharing the same traditions. Unlike the domestic service (which is financed by annual "listener licenses"), the External Service is paid for by Parliamentary grants-in-aid. The government prescribes the languages which are broadcast and the length of time each is on the air, but editorial control rests with the BBC.

External broadcasting from Great Britain began in 1932 with a service in English. A few years later, the BBC was asked by the government to broadcast in other languages, the first of which was Arabic. During the early days of World War II, the BBC was a constant ray of hope for the people in France and other Nazi-occupied countries. I

can well remember, as an airman shot down in France a few weeks before the invasion and hiding in a French farmhouse, listening to the BBC on the family radio. The BBC used to send coded messages to the French underground during those days.

Today, the External Services broadcast to the world in English and 38 other languages for over 100 hours every day. These programs originate mainly from the 52 studios in Bush House in London.

While the British Empire is no longer the world power that it once was and no longer has all those colonies on which "the sun never sets," it still has thousands of citizens and expatriates living abroad. The BBC brings information and entertainment from home and helps them keep their ties to the mother country. This, of course, is a prime objective of BBC broadcasting overseas.

Naturally, the BBC is interested also in presenting its own point of view to citizens of other countries around the world. The BBC estimates that about 75 million adults listen regularly (once a week or more) to its External Services. The English broadcasts are heard by about 25 million.

Like all international shortwave broadcasters, BBC programs and frequen-

cies change from month to month. How can you keep up-to-date with these constant changes? Basically there are two ways to do it—by your radio receiver and by print. The BBC has three programs which will help you keep abreast of things. First is a show called "Look Ahead" which previews programs for each day. "In the Meantime" is a program which tells you what is new in BBC programs. And third, there is a program called "Waveguide" which covers frequency changes, propagation estimates, and other things which help you to keep tuned well to the BBC.

Serious listeners to the BBC will be interested in receiving a monthly copy of "London Calling." This publication is sent airmail from London every month, previewing programs and giving frequency changes so that the listener is right on top of BBC broadcasts a month ahead of time. Unfortunately, this is not a free publication and the cost to subscribers in the US is \$13.00 per year. You can get a free sample copy, however, by writing BBC World Service, PO Box 76, Bush House, London WC2B 4PH. Or, to save yourself the cost of an overseas air-mail stamp, direct your order to: British Broadcasting Corporation, 630 Fifth Avenue, New York NY 10019. ■

### BEST BBC FREQUENCIES FOR NORTH AMERICA

Time (GMT)	Frequencies (MHz)
0000-0230	15.07, 15.26, 11.75, 7.325, 6.175, 6.12, 5.975
0230-0330	11.75, 9.60, 9.51, 7.325, 6.175, 6.12, 5.975
0330-0630	9.51, 6.175, 5.975, 15.07
0630-0730	15.07, 9.51
0915-1100	11.750, 9.740, 15.07
1100-1330	21.55, 15.07, 11.75, 9.51, 6.195
1300-1500	21.71, 15.07
1500-1745	21.71, 17.83, 15.40, 15.26, 15.07
1745-2000	15.07, 9.41, 12.095
2000-2100	21.56, 15.26, 15.07, 6.175
2100-0000	15.26, 15.07, 6.175
2200-0000	15.42, 11.75, 9.59, 9.51, 6.12, 15.07
2300-0000	7.325, 5.975

This chart effective summer, 1982. Some changes will take place in the fall.



New!  
**AZDEN® PCS-4000**

Small—yet so Sophisticated...  
 so Advanced—there is  
**No Comparison!**

**FEATURES SO  
 UNIQUE AND  
 OF SUCH  
 SUPERIOR  
 COMMERCIAL-  
 GRADE  
 QUALITY,  
 THAT...**



**IT CARRIES A 1 YEAR LIMITED WARRANTY!**

- **8 MHz COVERAGE, CAP/MARS BUILT IN:** 142,000-149,995 MHz in selectable steps of 5 or 10 kHz. **COMPARE!**
- **TINY SIZE:** Only 2" H x 5.5" W x 6.8" D! **COMPARE!**
- **MICROCOMPUTER CONTROL:** At the forefront of technology!
- **UP TO 8 NON-STANDARD SPLITS:** Ultimate versatility for CAP/MARS. **COMPARE!**
- **16-CHANNEL MEMORY IN TWO 8-CHANNEL BANKS:** Retains frequency and standard offset.
- **DUAL MEMORY SCAN:** Scan memory banks either separately or together. **COMPARE!**
- **TWO RANGES OF PROGRAMMABLE BAND SCANNING:** Limits are quickly reset. Scan the two segments either separately or together. **COMPARE!**
- **FREE AND VACANT SCAN MODES:** Free scanning stops 5 seconds on a busy channel. Vacant scanning stops on unoccupied frequencies.
- **DISCRIMINATOR SCAN CENTERING (AZDEN EXCLUSIVE PATENT):** Always stops on frequency.
- **TWO PRIORITY MEMORIES:** Either may be instantly recalled at any time. **COMPARE!**
- **NICAD MEMORY BACKUP:** Never lose the programmed channels!
- **FREQUENCY REVERSE:** The touch of a single button inverts the transmit and receive frequencies, no matter what the offset.
- **ILLUMINATED KEYBOARD WITH ACQUISITION TONE:** Unparalleled ease of operation.
- **BRIGHT GREEN LED FREQUENCY DISPLAY:** Easily visible,

- even in direct sunlight.
- **DIGITAL S/Rf METER:** Shows incoming signal strength and relative output.
- **BUSY-CHANNEL AND TRANSMIT INDICATORS:** Bright LEDs show when a channel is busy and when you are transmitting.
- **FULL 16-KEY TOUCHTONE™ PAD:** Keyboard functions as autopatch when transmitting.
- **PL TONE:** Optional PL tone unit allows access to PL repeaters. Deviation and tone frequency are fully adjustable.
- **TRUE FM:** Not phase modulation. Unsurpassed intelligibility and fidelity.
- **25 WATTS OUTPUT:** Also 5 watts low power for short-range communication and battery conservation. (Transmitter power is fully adjustable)
- **SUPERIOR RECEIVER:** Sensitivity is 0.2 uV for 20-dB quieting. Audio circuits are designed to rigorous specifications for exceptional performance, second to none. **COMPARE!**
- **REMOTE-CONTROL MICROPHONE:** Memory A-1 call, up/down manual scan, and memory address functions may be performed without touching the front panel! **COMPARE!**
- **OTHER FEATURES:** Dynamic microphone, built-in speaker, mobile mounting bracket, remote speaker jack, and all cords, plugs, fuses and hardware are included.
- **ACCESSORIES:** CS-6R 6-amp AC power supply, CS-AS remote speaker, and Communications Specialists SS-32 PL tone module.
- **ONE-YEAR LIMITED WARRANTY**

EXCLUSIVE DISTRIBUTOR:

**AMATEUR-WHOLESALE ELECTRONICS**

**TOLL FREE... 800-327-3102**

8817 S.W. 129th Terrace, Miami, Florida 33176 Telephone (305) 233-3631 Telex: 80-3356

MANUFACTURER:

**AZDEN**

**JAPAN PIEZO CO., LTD.**

1-12-17 Kamirenjaku, Mitaka, Tokyo, 181 Japan

Telex: 781-2822452



# DUAL DRIVE TRIBANDERS

- 20, 15 and 10 meters • Wideband. Low SWR. No tuner needed
- Exclusive phased dual drive gives higher gain • Exclusive coaxial capacitors have lower losses, higher Q • Transmitter power is radiated not lost in the traps • Full power low loss balun. Gives improved beam pattern

TET Antenna Systems presents three full size trap multiband beams to meet every amateur need. 5 element, 4 element, and 3 element models all with the exclusive TET dual phased drive. This famous drive system originated with HB9CV and was perfected by JA3MP. When you buy TET dual drive you know you have the best. It has more gain - just like adding another parasitic element. And wide bandwidth so you can use your solid-state transceiver on both phone and CW without a tuner.

Only the highest quality materials are used throughout. All aluminum tubing is 6061-T6 alloy. Stainless steel fasteners are provided for all electrical connections. Tubing is cut and predrilled to precision tolerances for easy one afternoon assembly. Light weight and low wind area designs permit use of simpler support structures.

All models feature full 3 Kw PEP power handling, VSWR typical 1.5 or less across all of 20, 15 and, on 10 meters, from 28.0 to 29.2 MHz. Drive impedance is 50 ohms and maximum element length 27'. They accommodate masts from 1 1/2" to 2" diameter, withstand winds to 100 mph and are furnished complete with a low loss balun that easily withstands full rated power. For gain and front-to-back ratio specifications write or call the factory.

	HB35T	HB43SP	HB33SP
Boom Length:	24' 7"	19' 8"	13' 2"
Turn Radius:	18' 10"	16' 9"	15'
Wind Area Ft <sup>2</sup> :	7.9	6.6	4.7
Wind load lbs. @ 80 mph:	160	132	102
Boom Dia.:	2"	2"	1-5/8"
Weight, lbs.:	50	38	27
Price:	\$349.95	\$239.95	\$199.95
	+ shipping	+ shipping	+ shipping

## TET ANTENNA SYSTEMS

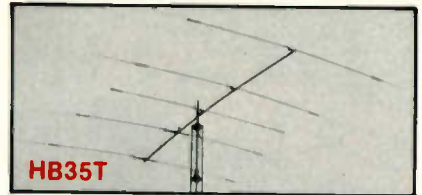

HB35T

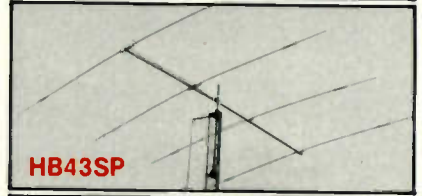

HB43SP



HB33SP

Send for free catalog describing these dual drive beams, our VHF Swiss quads, roof-mount towers, elevation rotators and more. Don't wait any longer to start working rare DX. Order your dual-drive beam today!

BY MAIL:

TET Antenna Systems  
1924-E W. Mission Road  
Escondido, CA 92025



BY PHONE: 714-743-7025 ✓ 170

## "BEEPER III"

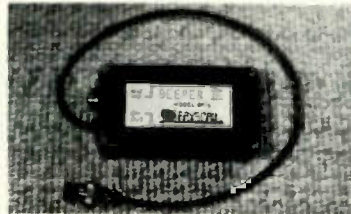

"THE PROFESSIONAL TOUCH COMES TO AMATEUR RADIO!"

"BP-3 automatically provides a gentle high frequency beep at the beginning of each transmission and a low beep at the end. Virtually eliminates "talk-over"! Operates for up to one year on a single 9-V battery (not supplied). Can be directly interfaced to any transceiver which is keyed by grounding the PTT line (the PTT line voltage must be positive, not greater than 24 VDC, nor the current greater than 100 ma.) Works with virtually all modern gear. You've heard it, now you can have it!"

### "ADD THE BEEP!"

- BP-3A Complete with case, cable, Standard 4-pin connectors ..... **39.95 pp**
  - BP-3B As above except without connectors. Add your own ..... **36.95 pp**
  - BP-3C Circuit-board version for custom installation ..... **29.95 pp**
- All units assembled/tested. OH residents add 6% Sales Tax"

**FAXSCAN INC.** ✓ 85  
3148 Dorf Drive • Dayton, Ohio 45418 TM

## ANTECK, INC.

Store Hours: Mon-Thurs 8-5 MST.

- STAINLESS STEEL WHIP—FIBERGLASS LOADING COIL
- PATENT APPLIED. NO COILS TO CHANGE
- LESS THAN 1.5 VSWR (ENTIRE TUNING RANGE)
- TUNE 3.2 TO 30 MHz FROM THE OPERATORS POSITION
- FAST AND SLOW SCAN RATES

The Model MT-1RT mobile antenna tunes 3.2 to 30 MHz inclusive. 750 watts CW, 1500 watts PEP for hams, military, MARS, CAP, and commercial service. Center loaded for high efficiency. Enables tuning to exact resonance to wanted frequency. Allows full output from solid state finals. No worry about reduced output from shut down circuits. Output is unaffected by moisture and the elements. Tuned by a control box at the operator's position. Mast section contains a double action hydraulic cylinder driven by two miniature hydraulic pumps and 12 volt DC motors for positive control. No creeping during operation or mobile motion. Can be removed up to 500 ft. from antenna.

- MT-1RT amateur net \$240.00
- MT-1RTR (retro kit for all MT-1's) \$118.00
- MT-1 amateur net 129.95
- MT-1A (marine) stainless steel \$179.95

- 9.00 UPS shipping in U.S.
- 7.00 UPS in U.S.
- 7.00 UPS in U.S.
- 7.00 UPS in U.S.

✓ 356

Route 1, Box 415

**ANTECK, INC.** Hansen, Idaho 83334 208-423-4100



## ALL YOUR GEAR AT YOUR FINGERTIPS IN A CONVENIENT CONSOLE DESK

- Requires only 60" corner space
- Formica desk top and shelves
- Shelf height adjustable
- Solid maple legs
- \$495.00 check or M.O.
- Shipped freight collect
- Allow 30-45 days delivery

Send for detailed brochure

**CQ PRODUCTS**  
8280 Janes Ave.  
Suite 137-1700  
Woodridge, IL. 60517

✓ 152



(Chair and equipment not included)  
Weight of table is 250 lbs.

# WHY COMPRO- MISE

Others claim more gain for their antennas than the IsoPole™ antennas, but none can beat the IsoPole for HONEST on-the-horizon omni-directional gain unless you are willing to spend at least THREE TIMES AS MUCH!!! The IsoPole is easiest of ALL competitive models to assemble, has a weather protected, factory-tuned matching network, (no more aggravating SWR variations with weather changes), uses all stainless steel hardware, and is designed to withstand severe icing and wind conditions. The IsoPole antenna is UPS shippable without the standard 10 foot 1¼ inch TV mast. You can buy the mast from your local ham dealer, hardware store, or Radio Shack™ store for less than the shipping costs of a single mast. When good strong, low cost 10 foot sections of mast are so easily available, why compromise by using several shorter pieces that have to be joined together?

For more details, please write for our latest catalog or visit your favorite dealer.

Prices and Specifications subject to change without notice or obligation.

## ADVANCED ELECTRONIC APPLICATIONS, INC.

P.O. Box C-2160,  
Lynnwood, WA 98036  
(206) 775-7373  
Telex: 152571 AEA INTL

**AEA** Brings you the Breakthrough!



### WHY SETTLE FOR HALF THE BAND?

Enjoy super-gain, low VSWR, and FULL COVERAGE, 144 through 148 MHz, with less weight and windload. Dual-driven elements, balanced feed for a better match and clean pattern.

Bandwidth:	144-148 MHz	Balun:	2KW 4:1
Gain:	15.5 dBd	Boom:	21' 5/1 1/2"
VSWR:	1.2:1 & less	Windload:	1.6 sq ft
Beamwidth:	28°	Weight:	9 lbs

CIRCULAR POLARIZED For the Phase IIIB satellite and terrestrial DX, ATV, and FM. Minimizes multipath and flutter fading. Rugged symmetrical construction.

Bandwidth:	420-450 MHz
Gain:	12 dBdc
VSWR:	1.5:1 & less
F/B:	20 dB

Baluns:	2KW, 4:1 (2)
Boom:	88"/1"

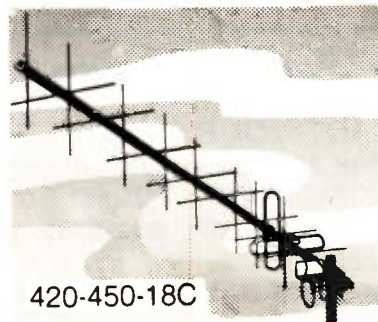

Windload:	.5 sq ft
Weight:	3.6 lbs

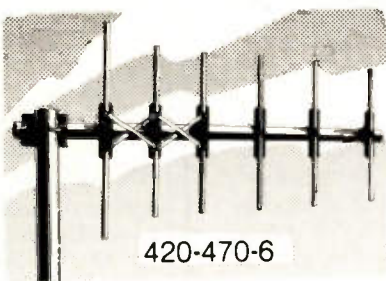

420-470-6

Boom:	2'1" O.D.
Weight:	1.2 lbs

IDEAL for point-to-point and repeater control. Rear-mounted, vertically polarized, compact. Continuous coverage, 420-470 MHz. Direct coax feed suitable for most installations.

Bandwidth:	420-470 MHz
Gain:	8dBd
VSWR:	1.2:1 & less

Beamwidth:	60°
F/B:	20 dB, min

### SEE YOUR KLM DEALER:

**KLM** Electronics, Inc. P.O. Box 816, Morgan Hill, CA 95037  
(408) 779-7363

# It's Hard To Be Humble When You're Number One On 2 Meters!



The best selling and performing 2 meter FM rig in the USA, gives you more for your money.

25 watts, Touchtone® mike, 10 memories with built-in memory retention, scanning priority channel, sub-audible tone module built-in . . . and much, much more!

Call or write for brochure.



ORDER NOW DIRECT  
CALL TOLL FREE

## 800-251-4141

This number for ORDERS ONLY!

ORDER DIRECT or at your dealer!  
DISTRIBUTED BY:



Central & South American orders:  
PHONE: (305) 592-7016

KDK DISTRIBUTING CO., INC. ✓81

762 S. GALLATIN RD. (MADISON SQUARE SHOPPING CTR.) - MADISON, TN 37115 - PHONE (615) 865-7949 - TLX56-8652

INCLUDES Tone Pad Microphone and all accessories.  
Shipping: \$5.00 Eastern U.S.A. \$7.50 Western U.S.A.

FM2030

# \$309

Mail Order - CDD - Bank Cards

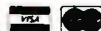

Company reserves the right to change specifications and prices without notice.

## 15 Meter Mobile CW & USB

START YOUR DAY ON A GOOD KEY!!!

WORK OTHER HAMS LIKE: XE2BGM, ZL1PQ, KL7JFV, EA7EU, NN3SI, DJ8RR, DL0BBC, US6AK, JA3JMP, PY2-CPQ, FO8GW, KM6FF, VK2BD, OE8MOK, OA4ARB, G3BRW, VE7DYX, CE1BL, W1AW



High 10W (PEP) low 2W (PEP): VFO tuning; noise blanker; fine-tuned SB, KHz ± CW off-set; digital frequency counter; 13.8V dc @ 3A, negative ground; L 9.5" x W 9" x H 2.5"; weight (2.3 kg) 5.7 lbs.; mobile mounting bracket.



JUST SLIGHTLY AHEAD

SOON - NEW  
10-160 METERS

DLR. INFO. & ORDER. CALL

1275 N. GROVE ST.  
ANAHEIM, CALIF, 92806 (714) 630-4541

NOTE: Price, specifications subject to change without notice and obligation.

✓318

## WORK THE U.H.F. BANDS

Add a transverter or converter to your existing 10m, 6m or 2m equipments. Choose from the largest selection of modules available for DX, OSCAR, EME, ATV.

### TRANSVERTERS

MMT 50-144 \$209.95

MMT 144-28 \$199.95

MMT 432-28 (S) \$299.95

MMT 439-ATV \$349.95

MMT 1296-144 \$374.95

OTHER MODELS AVAILABLE  
write for details



### POWER AMPLIFIERS

all models include RF VOX & Low Noise RX Pre-Ampl.  
(no pre-amp in MML432-100)

2 Meters:	100W output	MML144-100-LS	1W or 3W in	\$284.95
	100W output	MML144-100-S	10W input	\$264.95
	50W output	MML144-50-S	10W input	\$239.95
	30W output	MML144-30-LS	1W or 3W in	\$124.95
	25W output	MML144-25	3W input	\$114.95

432 MHz:	100W output	MML432-100	10W input	\$444.95
	50W output	MML432-50	10W input	\$239.95
	30W output	MML432-30-L	1W or 3W in	\$ ask

1268-1296 MHz: Coming soon. Watch for details.

### ANTENNAS (incl. 50 ohm balun)

2 Meter J-Beams:	12.3 dBd gain	
8 over 8 Horizontal pol	D8-2M	\$63.40
8 by 8 Vertical pol	D8-2M-vert	76.95
1250-1300 MHz Loop-Yagi	1296-LY	\$49.75

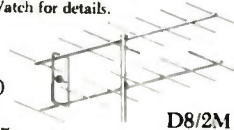

D8/2M

Send 36¢ stamps for full details of all our VHF/UHF items.

Pre-selector filters  
Low-pass filters  
Varactor triplers  
Pre-amplifiers

Transverters  
Converters  
Antennas  
Crystal Filters



Spectrum International, Inc.  
Post Office Box 1084S  
Concord, Mass. 01742 USA

✓436

# REMOTE -O- MIKE



\$ **34<sup>95</sup>**

## FM Wireless Mike

- Range—up to 300 ft.
- FM Audio
- XTAL Controlled
- Simple Hook-up
- Reliable years of service

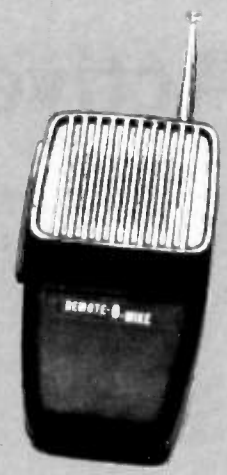

Stop: The steering wheel mike cord tangle. Stop: Running back and forth to answer a call on your radio. Stop: The inconvenience of being tied to your radio during long QSO's. The Remote-O-Mike may be connected to any HF, VHF or UHF ham transceiver. Just connect the Remote-O-Mike receiver to the mike input jack and each time you press the PTT button on your cordless mike your ham rig will function as your normal mike. The Remote-O-Mike receiver will provide both the PTT and audio to your ham rig.

Use in and around the house, auto, boat, etcetera. Just like a repeater with a range of up to 300 ft. Each Remote-O-Mike includes a XTAL controlled wireless FM mike and FM receiver. How do you spell mike cord tangle relief (Remote-O-Mike) Order today for your mike cord relief.

FM RECEIVER

WORKS ON ANY RADIO—MOBIL OR BASE



57

To Order Call (714) 268-8131—Free Shipping

Discount Ham Radio 9520 Chesapeake Dr., #606 A, San Diego, CA 92123

## GOTHAM ANTENNAS

(305) 294-2033



SMALL LOT TRAP DIPOLES ✓417

MODEL	BANDS	LGTH	PRICE
TSL 8040	80 40	78'	\$49.95
TSL 4020	40.20 15	40'	\$47.95

SMALL LOT SHORTENED DIPOLES

MODEL	BANDS	LGTH	PRICE
SL 8010	80.40 20	75'	\$59.95
		15 10	
SL 160	160	130'	\$38.95
SL 80	80	63'	\$37.95
SL 40	40.15	33'	\$36.95

FULL SIZE PARALLEL DIPOLES

MODEL	BANDS	LGTH	PRICE
FPD-8010	80 40 20.	130'	\$49.95
		15 10	
FPD-4010	40.20 15 10	63'	\$44.95

NEW! PORTABLE VERTICAL! IDEAL FOR APARTMENTS, CAMPING, TRAILERS!

Folds to 5' Package. No Radials. Required. Fully Assembled Full Legal Limit. 1:1 VSWR

MODEL	BANDS	HGHT	PRICE
PV-8010	80.10	13'	\$59.95

PROVEN DESIGN GOTHAM ALL BAND VERTICALS

MODEL	BANDS	LGTH	PRICE
V-160	160.80.40.20.	23'	\$44.95
		15 10 6	
V-80	80.40.20	23'	\$42.95
		15.10.6	
V-40	40.20 15 10 6	23'	\$40.95

FAMOUS GOTHAM QUADS

2 Elements—3 Bands Complete \$149.95

CHAMPIONSHIP GOTHAM BEAMS

Full Size Complete from \$99.95

DEALER INQUIRIES INVITED

CALL OR SEND LARGE SASE FOR CATALOG Shipping: Dipoles & Verticals

\$2.50 USA. \$7.00 Canada. \$5.00 FPO, APO

Beams & Quads Shipped UPS or Freight

Collect Fla. Add 5% Sales Tax

1415 First St. • Key West, FL 33040

# SUPER-RATT™

The Complete RTTY Communications Program for the 80's

ONLY \$59.95 POSTPAID!



- For your 48K Apple II with one disc drive
- Works with all tuning units.
- Verified File Transfer™ assures error-free communication
- Full Radio Bulletin Board System™
- "Open" Program—easy for you to modify

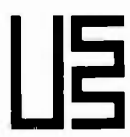

UNIVERSAL SOFTWARE SYSTEMS, INC.  
9 SHIELDS LANE · RIDGEFIELD, CT 06877  
(203) 438-3117

VISA/M.C. OK

# Active-Filter Design Made Easy

*Using this BASIC program, if you don't like the design, then scrap it. All you lose is a few seconds.*

B. E. Taylor WD4HPC  
922 Reaves Street  
Jackson MS 39204

There have been many articles on active bandpass filters in the electronics/amateur publications. Most of the articles are

recipes, i.e., if you want my performance, duplicate my circuit. The rest have been tutorial articles which are mathematical in nature.<sup>1,2</sup> There is a section on multiple-feedback bandpass (MFB) filter design in the 1979 ARRI *Handbook*,<sup>3</sup> and there are at least two books

devoted to active filter design.<sup>4,5</sup>

The equations used in designing the most common type of active bandpass filter—the second-order, MFB filter—can be solved nearly as easily as the name of the filter can be pronounced. The problem is that all of

the design parameters and the component values are interdependent. Changing any one can lead to changes in others, which leads to more calculations.

This is just the sort of calculation that is ideally suited for computer evaluation. The program described in

## Program listing.

```
10 REM BANDPASS BASIC
20 REM BY B. E. TAYLOR WD4HPC
30 REM FOR SECOND ORDER MULTIPLE FEEDBACK BANDPASS FILTERS
100 R1=0
199 REM INPUT SECTION - OPTIONS FOLLOW
200 PRINT "YOUR CHOICES ARE AS FOLLOWS"
210 PRINT "1 - CHOOSE R1, R3, R5 AND C"
220 PRINT "2 - CHOOSE G, Q, F AND C"
230 PRINT "3 - CHOOSE R1, F, Q AND C"
240 PRINT "4 - SCALE FREQUENCY BY CHANGING CAPACITORS"
250 PRINT "5 - SCALE FREQUENCY BY CHANGING RESISTORS"
260 PRINT "6 - SCALE IMPEDANCE OF COMPONENTS"
270 PRINT "7 - DO CALCULATIONS FOR CASCADED SECTIONS"
280 INPUT "ENTER THE NUMBER CORRESPONDING TO YOUR CHOICE";M
300 IF M=1 THEN 1000
310 IF M=2 THEN 2000
320 IF M=3 THEN 3000
330 IF M=4 THEN 5000
340 IF M=5 THEN 5300
350 IF M=6 THEN 5600
360 IF M=7 THEN 6000
370 GOTO 280
999 REM DESIGN A FILTER BY SPECIFYING ALL COMPONENTS
1000 INPUT "R1";R1,"R3";R3,"R5";R5,"C";C
1010 C=C*1E-6
1020 G=.5*R5/R1
1030 Q=SQR((R1*R5+R3*R5)/(4*R1*R3))
1040 F=Q/(6.2832*R1*C*G)
1050 GOTO 4000
1999 REM DESIGN A FILTER BY SPECIFYING ALL PARAMETERS AND C
2000 INPUT "G";G,"F";F,"Q";Q,"C";C
2010 W=6.2832*F
2020 C=C*1E-6
2030 R1=Q/(W*G*C)
2040 R5=2*G*R1
2050 R3=R1*R5/(4*Q*Q*R1-R5)
2060 IF Q>R3 THEN PRINT "NOTE - NEGATIVE VALUE OF R3"
2070 GOTO 4000
2999 REM DESIGN BY SPECIFYING INPUT IMPEDANCE, Q,F AND C
3000 INPUT "R1";R1,"Q";Q,"F";F,"C";C
3010 W=6.2832*F
3020 C=C*1E-6
3030 G=Q/(W*R1*C)
3040 R5=2*G*R1
3050 R3=R1*R5/(4*Q*Q*R1-R5)
3060 IF Q>R3 THEN PRINT "NOTE - NEGATIVE VALUE OF R3"
3070 GOTO 4000
3999 REM OUTPUT SECTION FOR ABOVE SEGMENTS
4000 PRINT
4010 PRINT
4020 PRINT "FOR THIS DESIGN"
4030 PRINT "R1=";R1;"OHMS"
4040 PRINT "R3=";R3;"OHMS"
4050 PRINT "R5=";R5;"OHMS"
4060 C1=C*1E6
4070 PRINT "C=";C1;"MICROFARADS"
4080 PRINT "F=";F;"HERTZ"
4090 PRINT "Q=";Q
4100 PRINT "G=";G
4110 PRINT
4120 PRINT
4130 INPUT "DO YOU WISH TO CONTINUE - Y OR N";X$
4140 Y1$="N"
4150 Y2$="Y"
4160 IF X$=Y1$ THEN 9999
4170 IF X$=Y2$ THEN 200
4180 GOTO 4130
4999 REM SCALE FREQUENCY BY CHANGING CAPACITORS
5000 IF R1>0 THEN 5030
5010 PRINT "CANNOT SCALE UNTIL VALUES ARE DETERMINED"
5020 GOTO 200
5030 INPUT "NEW FREQUENCY";F0
5040 C=C*F/F0
5050 F=F0
5060 GOTO 4000
5299 REM SCALE FREQUENCY BY CHANGING RESISTORS
5300 IF R1=0 THEN 5010
5310 INPUT "NEW FREQUENCY";F0
5320 D=F/F0
5330 R1=R1*D
5340 R3=R3*D
5350 R5=R5*D
5360 F=F0
5370 GOTO 4000
5599 REM SCALE IMPEDANCE OF ALL COMPONENTS
5600 IF R1=0 THEN 5010
5610 INPUT "NEW VALUE OF CAPACITOR";C0
5620 B=C0*1E-6/C
5630 C=F0*1E-6
5640 R1=R1/D
5650 R3=R3/D
5660 R5=R5/D
5670 GOTO 4000
5999 REM CASCADE IDENTICAL SECTIONS
6000 INPUT "HOW MANY SECOND ORDER SECTIONS";N
6010 INPUT "Q PER SECTION";Q1,"GAIN PER SECTION";G1
6020 B=2+(EXP(1.06(2)/N)-1)/(Q1*Q1)
6030 W1=.5*B+.5*SQR(B*B-4)
6040 W2=.5*B-.5*SQR(B*B-4)
6050 Q=SQR(W1)*SQR(W2)
6060 Q=1/Q
6070 PRINT "FOR ;N; SECTIONS EACH OF Q=";Q1
6080 PRINT "THE TOTAL Q IS";Q
6090 G=EXP(1.06(G1))
6100 PRINT "THE GAIN OF THE SYSTEM IS";G
6110 PRINT
6120 GOTO 4120
9999 END
```

this article was written to allow one to perform computer-aided design of second-order MFB filters.

The circuit diagram of an MFB filter is shown in Fig. 1. The labeling of the components is the same as that used in the program. The equations for performing the design are listed in Table 1. Most general-pur-

pose op amps can be used in the filter.

This program has been written in such a manner as to be as versatile as possible. It should be helpful to the person wishing to design a filter of specified parameters and equally useful to the person who wishes to alter some parameter or component value in

an existing MFB filter design. Take note: There are intrinsic limitations on the Q, gain, and center frequency of MFB filters which are not discussed in this article. The reader who is unfamiliar with these limitations should consult one of the references at the end of this article.

The program has seven

possibilities for design, as follows:

1) Specify the values for R1, R3, and R5 in Ohms and C in uF. The program will calculate Q, G (the pass-band gain), and F (the center frequency, in Hz). This segment is useful in checking the parameters of a filter using the values of the available components.

### Sample printout.

YOUR CHOICES ARE AS FOLLOWS

```
1 - CHOOSE R1, R3, R5 AND C
2 - CHOOSE G, Q, F AND C
3 - CHOOSE R1, F, Q AND C
4 - SCALE FREQUENCY BY CHANGING CAPACITORS
5 - SCALE FREQUENCY BY CHANGING RESISTORS
6 - SCALE IMPEDANCE OF COMPONENTS
7 - DO CALCULATIONS FOR CASCADED SECTIONS
ENTER THE NUMBER CORRESPONDING TO YOUR CHOICE? 1
R1? 68E3
R3? 4.3E3
R5? 180E3
C? .015
```

FOR THIS DESIGN

```
R1= 68000 OHMS
R3= 4300 OHMS
R5= 180000 OHMS
C= .015 MICROFARADS
F= 393.253 HERTZ
Q= 3.3357
G= 1.32353
```

DO YOU WISH TO CONTINUE - Y OR N? Y

YOUR CHOICES ARE AS FOLLOWS

```
1 - CHOOSE R1, R3, R5 AND C
2 - CHOOSE G, Q, F AND C
3 - CHOOSE R1, F, Q AND C
4 - SCALE FREQUENCY BY CHANGING CAPACITORS
5 - SCALE FREQUENCY BY CHANGING RESISTORS
6 - SCALE IMPEDANCE OF COMPONENTS
7 - DO CALCULATIONS FOR CASCADED SECTIONS
ENTER THE NUMBER CORRESPONDING TO YOUR CHOICE? 2
G? 1.33
F? 400
Q? 3.0
C? .015
```

FOR THIS DESIGN

```
R1= 59832.5 OHMS
R3= 4773.68 OHMS
R5= 159155 OHMS
C= .015 MICROFARADS
F= 400 HERTZ
Q= 3
G= 1.33
```

DO YOU WISH TO CONTINUE - Y OR N? Y

YOUR CHOICES ARE AS FOLLOWS

```
1 - CHOOSE R1, R3, R5 AND C
2 - CHOOSE G, Q, F AND C
3 - CHOOSE R1, F, Q AND C
4 - SCALE FREQUENCY BY CHANGING CAPACITORS
5 - SCALE FREQUENCY BY CHANGING RESISTORS
6 - SCALE IMPEDANCE OF COMPONENTS
7 - DO CALCULATIONS FOR CASCADED SECTIONS
ENTER THE NUMBER CORRESPONDING TO YOUR CHOICE? 3
R1? 50E3
Q? 3
F? 400
C? .015
```

FOR THIS DESIGN

```
R1= 50000 OHMS
R3= 4849.77 OHMS
R5= 159155 OHMS
C= .015 MICROFARADS
F= 400 HERTZ
Q= 3
G= 1.59155
```

DO YOU WISH TO CONTINUE - Y OR N? Y

YOUR CHOICES ARE AS FOLLOWS

```
1 - CHOOSE R1, R3, R5 AND C
```

```
2 - CHOOSE G, Q, F AND C
3 - CHOOSE R1, F, Q AND C
4 - SCALE FREQUENCY BY CHANGING CAPACITORS
5 - SCALE FREQUENCY BY CHANGING RESISTORS
6 - SCALE IMPEDANCE OF COMPONENTS
7 - DO CALCULATIONS FOR CASCADED SECTIONS
ENTER THE NUMBER CORRESPONDING TO YOUR CHOICE? 4
NEW FREQUENCY? 600
```

FOR THIS DESIGN

```
R1= 50000 OHMS
R3= 4849.77 OHMS
R5= 159155 OHMS
C= .01 MICROFARADS
F= 600 HERTZ
Q= 3
G= 1.59155
```

DO YOU WISH TO CONTINUE - Y OR N? Y

YOUR CHOICES ARE AS FOLLOWS

```
1 - CHOOSE R1, R3, R5 AND C
2 - CHOOSE G, Q, F AND C
3 - CHOOSE R1, F, Q AND C
4 - SCALE FREQUENCY BY CHANGING CAPACITORS
5 - SCALE FREQUENCY BY CHANGING RESISTORS
6 - SCALE IMPEDANCE OF COMPONENTS
7 - DO CALCULATIONS FOR CASCADED SECTIONS
ENTER THE NUMBER CORRESPONDING TO YOUR CHOICE? 5
NEW FREQUENCY? 800
```

FOR THIS DESIGN

```
R1= 37500 OHMS
R3= 3637.33 OHMS
R5= 119366 OHMS
C= .01 MICROFARADS
F= 800 HERTZ
Q= 3
G= 1.59155
```

DO YOU WISH TO CONTINUE - Y OR N? Y

YOUR CHOICES ARE AS FOLLOWS

```
1 - CHOOSE R1, R3, R5 AND C
2 - CHOOSE G, Q, F AND C
3 - CHOOSE R1, F, Q AND C
4 - SCALE FREQUENCY BY CHANGING CAPACITORS
5 - SCALE FREQUENCY BY CHANGING RESISTORS
6 - SCALE IMPEDANCE OF COMPONENTS
7 - DO CALCULATIONS FOR CASCADED SECTIONS
ENTER THE NUMBER CORRESPONDING TO YOUR CHOICE? 6
NEW VALUE OF CAPACITOR? .02
```

FOR THIS DESIGN

```
R1= 18750 OHMS
R3= 1818.67 OHMS
R5= 59683 OHMS
C= .02 MICROFARADS
F= 800 HERTZ
Q= 3
G= 1.59155
```

DO YOU WISH TO CONTINUE - Y OR N? Y

YOUR CHOICES ARE AS FOLLOWS

```
1 - CHOOSE R1, R3, R5 AND C
2 - CHOOSE G, Q, F AND C
3 - CHOOSE R1, F, Q AND C
4 - SCALE FREQUENCY BY CHANGING CAPACITORS
5 - SCALE FREQUENCY BY CHANGING RESISTORS
6 - SCALE IMPEDANCE OF COMPONENTS
7 - DO CALCULATIONS FOR CASCADED SECTIONS
ENTER THE NUMBER CORRESPONDING TO YOUR CHOICE? 7
HOW MANY SECOND ORDER SECTIONS? 4
Q PER SECTION? 3
GAIN PER SECTION? 1.59
FOR 4 SECTIONS EACH OF Q= 3
THE TOTAL Q IS 6.89688
THE GAIN OF THE SYSTEM IS 6.39129
```

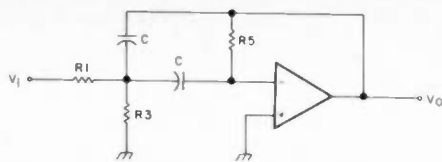

Fig. 1. Schematic of a second-order, multiple-feedback band-pass filter. The notation is the same as that of the program.

$$R1 = \frac{Q}{2\pi FGC}$$

$$R3 = \frac{Q}{2\pi FC(2Q^2 - G)}$$

$$R5 = \frac{Q}{\pi CF}$$

Table 1.

2) Specify the values of G, F, Q, and C. The program will calculate the values of R1, R3, and R5. Since resistors are usually more readily available than capacitors, this portion should be useful when the gain, Q, and center frequency are critical to the proper operation of the device.

3) Specify the values of R1, Q, F, and C. This seg-

ment is useful if one is trying to achieve a certain input impedance and the gain is not too critical.

4) This section allows one to change the center frequency of a previously designed filter by changing the value of the capacitors.

5) In this segment, one can change the center frequency by changing the value of the resistors.

6) This segment scales the impedance of the components in an MFB filter while retaining the same F, Q, and G. One chooses the new value for the capacitors and the program calculates the values of the resistors to maintain the same Q, F, and G. This is a

useful feature if the desired values of C are not available and substitutes must be used.

7) This section allows one to predict the net Q and G of cascaded identical MFB sections. For example, three sections each of gain 2.0 and Q=1.0 yield a net gain of 8.0 and a net Q of 1.96. Thus, there is a law of diminishing returns for the Q of cascaded sections. An unrealistic calculation shows that 120 cascaded sections each of Q=2.0 would yield a net Q of 26.3!

The program has been written so that only the desired sections need be entered into the computer, in case a mass-storage device is not available. The program should run with no difficulty on any computer in which the BASIC has both floating-point arithmetic and string variables. Only minor modification would be needed to run the program on a machine that

does not have string variables. This program has been run successfully on an 8K Pet.

To illustrate the use of the program, a sample print-out has been included. It should be mentioned that several of the computer-generated designs were built on a breadboard and that the measured performance agreed very well with the theoretically predicted performance. ■

#### References

1. "Design Your Own Active Filters," H. M. Berlin, *QST*, June, 1977.
2. "Active Bandpass Filters," T. A. Conboy, *Ham Radio*, December, 1977.
3. *The Radio Amateur's Handbook*, Fifty-sixth edition, American Radio Relay League, Newington CT.
4. *The Active Filter Cookbook*, #21168, Howard W. Sams, Indianapolis IN, 1975.
5. *Design of Active Filters, With Experiments*, H. M. Berlin, #21359, Howard W. Sams, Indianapolis IN, 1978.

## FILTER CASCADING

The most cost-effective way to improve the selectivity of any receiver - old or new - is to improve its IF filtering. A Fox-Tango Cascading Kit puts a high-quality steep-sided 8-pole filter in series with your present filter(s), both SSB and CW. The result is narrower Bandwidth and better Shape Factor, both of which dramatically reduce adjacent channel QRM - a necessity in today's crowded bands.

#### CONSIDER THESE KIT FEATURES

- Easy installation - 30 minute average.
- No drilling, switching, alignment.
- 16 poles of filtering yield:
  - Filter Shape Factor as high as 1.19.
  - Ultimate Rejection better than 100dB.
  - Works wonders on SSB; improves CW.
- Compensates for Filter insertion loss.
- Complete instructions, clear diagrams.
- No RX audio impairment, TX unaffected.
- Includes Filter and all needed parts.
- Fits all models of Series - any letter.
- All Filters 8-pole - Guaranteed One Year.

#### SPECIFY KIT WANTED WHEN ORDERING

YAESU FT101 \$75; FT101ZD \$70; FT107 \$75; FT901/2 \$65; FR101 \$55 (filter only); KENWOOD TS520/R599 \$70; TS820 \$70; TS830/RB20 \$150 (Two Filters); HEATH SB104A \$60.

Shipping \$3 (Air \$5). FL Sales Tax 5%

In addition to the above, FOX-TANGO stocks a wide line of \$55 SSB, CW, and AM 8-pole filters for Yaesu, Kenwood, Drake R4C and 7-line, and Heathkit. Also, special filters made to order. Send specs for quote.



#### GO FOX-TANGO - TO BE SURE!

Order by Mail or Telephone.  
AUTHORIZED EUROPEAN AGENTS  
Scandinavia: MICROTEC (Norway)  
Other: INGOIMPEX (West Germany)

#### FOX TANGO CORPORATION

Box 15944S, W. Palm Beach, FL 33406  
Phone: (305) 683-9587 ✓ 323

## ALL BAND TRAP ANTENNAS!



PRETUNED - COMPLETELY ASSEMBLED - ONLY ONE NEAT SMALL ANTENNA FOR UP TO 7 BANDS! EXCELLENT FOR CONGESTED HOUSING AREAS - APARTMENTS LIGHT - STRONG - ALMOST INVISIBLE!

FOR ALL MAKES & MODELS OF AMATEUR TRANSCEIVERS - TRANSMITTERS - GUARANTEED FOR 2000 WATTS SSB 1000 WATTS CW INPUT FOR NOVICE AND ALL CLASS AMATEURS! IMPROVED DESIGN!

COMPLETE AS SHOWN with 90 ft. RG58U-52 ohm feedline, and PL259 connector, Insulators, 30 ft. 300 lb. test dacron end supports, center connector with built in lightning arrester and static discharge - molded, sealed, weatherproof, resonant traps 1"X6"- you just switch to band desired for excellent worldwide operation - transmitting and receiving! Low SWR over all bands - Tuners usually NOT NEEDED! Can be used as inverted V's - slopers - in attics, on building tops or narrow lots. THE ONLY ANTENNA YOU WILL EVER NEED FOR ALL DESIRED BANDS - WITH ANY TRANSCEIVER - NEW - EXCLUSIVE! NO BALUNS NEEDED!

80-40-20-15-10-6 meter - 2 trap --- 104 ft. with 90 ft. RG58U - connector - Model 998BUC ... \$89.95  
40-20-15-10 meter --- 2 trap --- 54 ft. with 90 ft. RG58U - connector - Model 1001BUC ... \$88.95  
20-15-10 meter --- 2 trap --- 26ft. with 90 ft. RG58U - connector - Model 1007BUC ... \$87.95

SEND FULL PRICE FOR POSTPAID INSURED. DEL. IN USA. (Canada is \$5.00 extra for postage - clerical - customs etc) or order using VISA - MASTER CARD - AMER. EXPRESS. Give number and ex. date. Ph 1-308-236-5333 9AM - 6PM week days. We ship in 2-3 days. ALL PRICES MAY INCREASE. SAVE - ORDER NOW! All antennas guaranteed for 1 year. 10 day money back trial if returned in new condition! Made in USA. FREE INFO. AVAILABLE ONLY FROM

WESTERN ELECTRONICS

Dept. A7-1

Kearney, Nebraska, 68847 ✓ 80

## PORTAPEATER™

\$179.00 assembled unit

### M100 A INSTANT REPEATER ANY BAND ANY MODE

\$99.00 assembled board

• 4 Channel PROM CW I Der

• VOX or COR operation

• 250 volt switching capability

• An Instant Repeater

• Works with any type radios

• Complete Timer Functions

• Built In Test Functions

• 20 Page Technical Manual



(Fully tested, programmed, assembled) ✓ 302

W-S ENGINEERING P.O. BOX 58, PINE HILL, N.J. 08021  
(201-852-0269)





## Stuck with a problem?

Our TE-12P Encoder might be just the solution to pull you out of a sticky situation. Need a different CTCSS tone for each channel in a multi-channel Public Safety System? How about customer access to multiple repeater sites on the same channel? Or use it to generate any of the twelve tones for EMS use. Also, it can be used to access Amateur repeaters or just as a piece of versatile test equipment. Any of the CTCSS tones may be accessed with the TE-12PA, any of the audible frequencies with the TE-12PB. Just set a dip switch, no test equipment is required. As usual, we're a stickler for 1 day delivery with a full 1 year warranty.

- Output level flat to within 1.5db over entire range selected.
- Immune to RF.
- Powered by 6-30vdc, unregulated at 8 ma.
- Low impedance, low distortion, adjustable sinewave output, 5v peak-to-peak.
- Instant start-up.

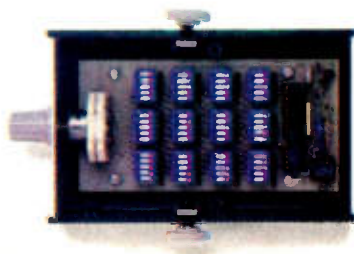

### TE-12PA

67.0 XZ	85.4 YA	103.5 1A	127.3 3A	156.7 5A	192.8 7A
71.9 XA	88.5 YB	107.2 1B	131.8 3B	162.2 5B	203.5 M1
74.4 WA	91.5 ZZ	110.9 2Z	136.5 4Z	167.9 6Z	
77.0 XB	94.8 ZA	114.8 2A	141.3 4A	173.8 6A	
79.7 SP	97.4 ZB	118.8 2B	146.2 4B	179.9 6B	
82.5 YZ	100.0 1Z	123.0 3Z	151.4 5Z	186.2 7Z	

- Frequency accuracy,  $\pm 1$  Hz maximum  $-40^{\circ}\text{C}$  to  $+85^{\circ}\text{C}$
- Frequencies to 250 Hz available on special order.
- Continuous tone

### TE-12PB

TEST-TONES:	TOUCH-TONES:	BURST TONES:
600	697 1209	1600 1850 2150 2400
1000	770 1336	1650 1900 2200 2450
1500	852 1477	1700 1950 2250 2500
2175	941 1633	1750 2000 2300 2550
2805		1800 2100 2350

- Frequency accuracy,  $\pm 1$  Hz maximum  $-40^{\circ}\text{C}$  to  $+85^{\circ}\text{C}$
- Tone length approximately 300 ms. May be lengthened, shortened or eliminated by changing value of resistor

**\$89.95**

✓ 15

**COMMUNICATIONS SPECIALISTS**

426 West Taft Avenue, Orange, California 92667  
(800) 854-0547/California: (714) 998-3021



# Super Loaded Or "Basic" Repeater / Link Systems -

**NEW**

**Spectrum's Got Back!**

VHF/UHF LINK CONTROL RCVR.

COMMERCIAL VHF/UHF TRANSCEIVERS



**NEW SCR77**

SCR1000/4000 & XCVFS. F.C.C. TYPE ACCEPTED FOR COMMERCIAL SERVICES.

Shown in Optional Cabinet

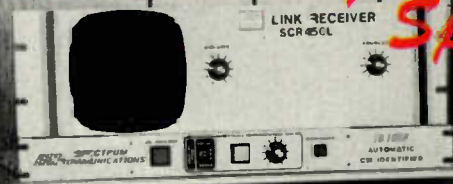

Spectrum now makes 2 lines of Repeaters—the world famous 'Super Deluxe' SCR1000/4000, and our new Low Cost line of SCR77 Repeaters/Link Transceivers.

The New SCR77 10-30 Wt. Repeaters maintain the quality of design, components and construction which have made Spectrum gear famous throughout the world for years. However, all of the "bells & whistles" which you may not need or want have been eliminated—at a large cost savings to you! The SCR77 is a real "work-horse" basic machine designed for those who want excellent, super-reliable performance year after year—but no frills! ("PL", 12 Pole IF Filter, Front End Pre-selector, and a 30 Wt. Transmitter are the only built-in options available; but Autopatch, Remote Control, and other equipment can be connected via the rear panel jack)

Of course, if you do want a full featured/Super Deluxe Repeater, with higher power (30-75 Wts.), and a full list of "built-in" options, then you want our SCR1000 or 4000—'The Ultimate in Repeaters'. Available with Full Autopatch/Reverse Patch/Land-Line Control Touch Tone Control of various repeater functions; 'P.L.'; "Emergency Pwr. ID"; various Tone 5 Timer Units, etc. Rack mount Link Rcvrs & Xmtrs also available.

Call or write today for data sheets & prices! Sold Factory Direct or through Export Sales Reps only. Get your order in A.S.A.P.!

NOW LOCATED IN OUR NEW LARGER PLANT!  
THANKS FOR YOUR 8+ YEARS OF SUPPORT!



**SPECTRUM**  
Export Orders Welcomed

1055 W. GERMANTOWN PK., DEPT S1

# Spec Comm Repeater Boards & Sub-assemblies

These are Professional "Commercial Grade" Units—Designed for Extreme Environments (–30 to +60° C).  
All equipment assembled & tested. For 2M, 220 MHz & 450 MHz!

## SCR200 & SCR 450 BOARD

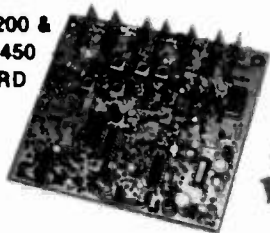

10M ALSO AVAILABLE



## SCR200 VHF Receiver Board

- **Totally New Advanced Design!**
- 8 Pole Front End Filt. + wide dynamic range—reduces overload, spurious Resp. & IMs!
- Sens. 0.3  $\mu$ V/12dB SINAD typ.
- Sel. -6dB @  $\pm$  6.5 KHz. -130dB @  $\pm$  70KHz. (8 Pole Crystal + 4 Pole Ceramic Filtr.
- 'S Meter,' Discriminator & Deviation Mtr. Outputs!
- Exc. audio quality! Fast squelch! w 0.0005% Crystal. ("Super Sharp" IF Filt. also avail.)

## SCR200 Receiver Assembly

- SCR200 mounted in shielded housing
- Completely asmbld & tested, w/F.T. caps, SO239 conn.
- As used in the SCR1000. Ready to drop into your system! High Recommended!

• Also available in 19" Rack Mount  
SCR450 UHF Receiver Bd. or Assy.

- Similar to SCR200, except 420-470MHz

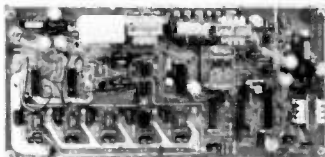

## SCAP Autopatch Board

- Provides all basic autopatch functions
- Secure 3 Digit Access; 1 Aux On-Off function, Audio AGC; Built-in timers, etc. Beautiful Audio!
- Q1 inhibit bd. also available
- Write/call for details and a data sheet

## RPCM Board

- Used w/SCAP board to provide "Reverse Patch" and Land Line Control of Repeater
- Includes land line "answering" circuitry

## ID250 CW ID & Audio Mixer Board

- Adjustable ID tone, speed, level, timing cycle
- 4 Input AF Mixer & Local Mic amp
- COR input & xmtr. hold circuits
- CMOS logic, PROM memory—250 bits/channel
- Up to 4 different ID channels!
- Many other features. Factory Programmed



FL-6

## FL-6 Rcvr. Front-End Preselector

- 6 Hi Q Resonators with Lo-Noise Transistor Amp (2M or 220 MHz).
- Provides tremendous rejection of "out-of-band" signals without the usual loss! Can often be used instead of large expensive cavity filters
- Extremely helpful at sites with many nearby VHF transmitters to "filter-out" these "out-of-band" signals

## CTC100 Rptr. COR Timer/Control Bd.

- Complete solid state control for rptr. COR. "Hang" Timer. "Time-Out" Timer, TX Shutdown/Reset, etc
- Includes Inputs & Outputs for panel controls & lamps

## Repeater Tone & Control Bds.—For SCR1000/4000 & CTC100/ID250 only

### TRA-1 "Courtesy Tone Beeper" Board

- Puts out a tone beep apx. 1 sec. after RX sig drops—thus allowing time for breakers
- Resets T.O. Timer after "beep"

### TMR-1 "Kerchunker Killer" or "Time Out Warning Tone" Bd.

- For One of above 2 functions
- "Kerchunker Killer" provides adj. delay (0-10 sec.) for initial rptr. access. Auto-Reset at end of QSO
- T.O. Warning Tone provides alerting "warble tone" apx. 10 sec. before "time out"



## PSM-1 Repeater Power Supply Mod Kit

- For SCR-1000 or SCR-4000
- Replaces Darlington Pass Tr.—for improved reliability
- Includes new overvoltage "Crowbar" shutdown circuit.
- Complete kit, w/assembled PC board. \$19.50 + \$3.50 shipping/handling.



## PRM200 Power Supply Filter Cap/Regulator/Metering Board

- As used in the SCR1000 as main part of 13.8VDC/8A Pwr. Sply.
- Includes 14,000  $\mu$ F Filter Cap, Reg. IC and Driver Trans., V/I Meter shunts and cal pots.
- Requires Xfmr., Br. Rect., Pass Tr./Heat Sink, (Optional Meter), for complete supply.



SCT410 XMTR. ASSY.

10M ALSO AVAILABLE

## SCT110 VHF Xmtr/Exciter Board

- 7 or 10 Wts. Output. 100% Duty Cycle!
- Infinite VSWR proof.
- True FM for exc. audio quality
- Designed specifically for continuous rptr service. Very low in "white noise"
- Spurious -70 dB. Harmonics -60 dB
- With .0005% xtal.
- BA-10 30 Wt. Amp board & Heat Sink, 3 sec. L.P. Filter & rel. pwr. sensor. BA75 75 Wt. unit also available.

## SCT110 Transmitter Assembly

- SCT110 mounted in shielded housing
- Same as used on SCR1000
- Completely asmbld. w/F.T. caps, SO239 conn.
- 10, 30, or 75 Wt. unit.

## SCT410 UHF Transmitter Bd. or Assy.

- Similar to SCT110, 10 Wts nom
- Avail. w/ or w/o OS-18 Super High Stability Crystal Osc./Oven.
- BA-40 40W. UHF AMP. BD. & HEAT SINK.

## PCB-1 Xmtr. Power Control Board

- For SCT110 or SCT410 Exciters
- Varies B+ to control Pwr. Out
- Switchable Hi, Low, or Med. Pwr. out, locally or remotely. Adj. levels.



TTC100 Touchtone

Control Board

Interface to  
any Radio or AT system!

- 3 digit ON, 3 digit OFF control of a single repeater function, or (optional) 2 functions (2 digits ON/OFF each).
- Can be used to pull in a relay, trigger logic, etc.
- Typically used for Rptr., ON/OFF, HI/LO Pwr PL ON/OFF, Patch Inhibit/Reset, etc.
- Stable anti-falsing design 5s limit on access
- For add'l function(s), add a "Partial TTC" board

# COMMUNICATIONS CORP.

INQUIRE ABOUT 'SURPLUS' RX & TX BOARDS. REDUCED PRICE!

Norristown, PA 19401 • (215) 631-1710

Call, or  
Send for  
Data Sheets!

# The Cornerstone of Equipment Failure: Heat Damage

*The proper heat sink will preserve transistors. Learn how to keep your circuitry from resembling a core meltdown.*

Kenneth H. Shamburger  
1413 Glendale  
Greenville TX 75401

**H**eat is a hazard to all electronics projects. Many electronics enthusiasts have experienced the displeasure of watching a prized project destroy itself with heat. Understanding heat transfer and heat-sink selection is necessary to avoid this hazard.

This article explains the fundamentals of heat-sink selection, which are easy to understand and apply. It begins with a review of the ways heat is transferred, ex-

plains how to calculate the temperature inside a semiconductor component, provides an example of heat-sink selection, and contributes some hints for interpreting semiconductor and heat-sink thermal specifications.

## The Review

"Heat transfer" is more accurate in describing the removal of heat than "heat flow." The word "flow" limits the possibilities we associate with the phenomenon to a single action—such as water flowing. Heat is transferred by three mechanisms.

It is transferred by radiation as an electromagnetic

wave. The heat transmitted from the sun through the vacuum of space to the Earth is an example of radiation.

Heat is transferred by conduction when two objects are in contact. A soldering iron melts solder by conduction.

Heat is transferred by convection when a fluid medium, such as air, moves across the surface of an object. The air drawn through the radiator of your automobile cools the radiator by convection. When air is blown across an object, it is called *forced* convection. But, the air surrounding a warm object will rise, causing cooler air to replace it without the aid of a fan. When air is allowed to circulate by heating, it is called *natural* convection.

Heat is transferred from semiconductor devices by all three mechanisms, as illustrated by the transistor in Fig. 1. It is radiated from the transistor chip to the case (a) and is conducted to the case where the substrate and case are in contact (b). The heat trans-

ferred to the case distributes itself throughout the case by conduction and, then, is transferred to the surrounding air by convection (c). If a heat sink is attached to the transistor, heat is transferred from the transistor case to the heat sink by conduction and to the surrounding air by convection. Also, it is radiated from the case and heat sink to objects nearby.

However, the amount of heat transferred by radiation is a small percentage of the heat transferred by convection. For this reason, the heat transfer equations typically used in heat-sink selection calculate only the heat transferred by natural convection. Similarly, the heat transferred by radiation from the chip to the case does not receive special attention in the calculations. And despite the inaccuracy, convenience makes us think of heat as flowing. These simplifications ease the analysis process.

Not all heat generated in the transistor is transferred to the air. Each segment of

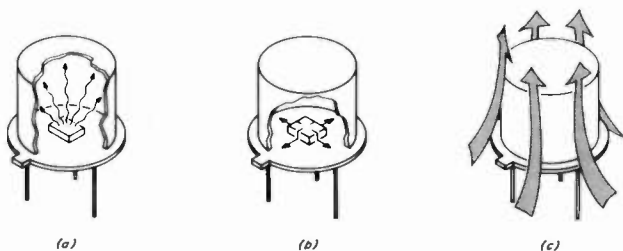

Fig. 1. Heat transfer from a transistor: (a) from chip to case by radiation; (b) from chip to case by conduction; (c) from case to air by convection.

the path between the chip and the air resists heat flow in a manner similar to a resistor resisting current flow. The heat retained in the transistor because of this impedance causes the temperature of the chip to rise. Our goal is to determine the temperature of the transistor chip. The chances of its destruction then can be evaluated.

### The Fundamentals

In classical physics, equations have been developed for calculating the amount of heat transferred; they are not complicated. However, their solution depends upon parameters which are difficult to evaluate in practice. For this reason, engineers have devised equations which do not use these parameters, but which make heat flow analogous to electric current flow. In this analogy, a heat source is analogous to a current source, thermal resistance to electrical resistance, and temperature to voltage. The equation relating them is like Ohm's Law and says that *the difference in temperature (voltage drop) across a thermal resistance is equal to the thermal resistance multiplied by the heat (current) flowing through the resistance.* This thermal equivalent to Ohm's Law is expressed by the equation  $T = \theta P$ .

The symbol  $\theta$ , with subscripts to indicate the circuit connections, commonly represents thermal resistance. For example,  $\theta_{JC}$  is the thermal resistance between the transistor chip and its case. (The capital "J", for junction, is used widely to represent the source of heat in semiconductor components.) Values of thermal resistance for semiconductor components and heat sinks are usually obtained from their respective specifications. In an electronic component, heat originates as

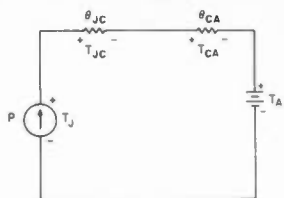

Fig. 2. Thermal circuit for a semiconductor.

power dissipated by the device. The thermal analogy carries this into the electrical thermal model by making power, identified by a capital "P," equal to heat. (Sometimes the lowercase "q" is used to represent power because this symbol is used for heat in physics.)

### The Calculations

Our goal is twofold. First, we must determine the temperature of the semiconductor chip. If this temperature exceeds a safe value, we must determine the thermal specifications for a heat sink which will provide adequate transfer away from the transistor. Using the electrical thermal analogy, the calculations involved in both tasks are similar to electric circuit calculations.

A diagram for the thermal circuit of a transistor is illustrated in Fig. 2. The unique feature of this diagram is the voltage source labeled  $T_A$ . This addition does not alter the validity of the model. The properties of the theoretically perfect current source (labeled P) do not allow current to flow backward through it. Since it is the only source of current in the circuit, the current flowing through the circuit equals P. The voltage source is simply a way of representing the temperature of the surrounding air (called the *ambient temperature*). It is convenient to include it so that the ambient temperature appears in Kirchoff's voltage equations for the circuit. Some people, choosing to account for  $T_A$  later

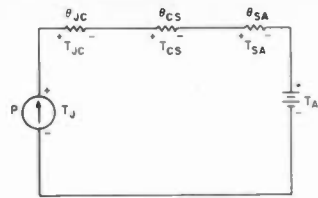

Fig. 3. Thermal circuit for a semiconductor with a heat sink.

in the analysis, do not include this source.

A resistor represents the thermal resistance of each segment along the path between the semiconductor junction and the ambient. Each segment can be identified by the letters comprising its subscripts. Beginning at the junction, these are JC for junction-to-case and CA for case-to-ambient.

The thermal analogy for Kirchoff's Voltage Law says that the temperature of a semiconductor chip is equal to the sum of the temperature drops around the remainder of the circuit. This is expressed by the equation  $T_J = T_{JC} + T_{CA} + T_A$ , where  $T_J$  is the semiconductor chip temperature,  $T_{JC}$  is the temperature drop across  $\theta_{JC}$ ,  $T_{CA}$  is the temperature drop across  $\theta_{CA}$ , and  $T_A$  is the ambient temperature. The values of  $T_{JC}$  and  $T_{CA}$  can be calculated from the thermal equivalent of Ohm's Law. Substituting these into the above equation, the junction temperature equation becomes  $T_J = (\theta_{JC} + \theta_{CA})P + T_A$ .

Many times, a manufacturer specifies a value for  $\theta_{JA}$ , which is the thermal resistance between the junction and the ambient.  $\theta_{JA}$  is equal to the sum of  $\theta_{JC}$  and  $\theta_{CA}$  and may be used in the preceding equation instead.

A thermal circuit which includes the thermal resistances associated with a heat sink is illustrated in Fig. 3. The case-to-ambient resistance,  $\theta_{CA}$ , has been replaced by two resistances, the case-to-sink resistance,  $\theta_{CS}$ , and the sink-to-ambient resistance,  $\theta_{SA}$ . When

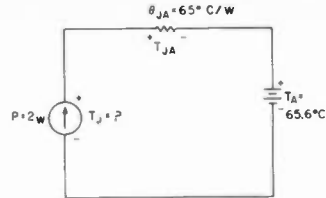

Fig. 4. Thermal circuit for the example without a heat sink.

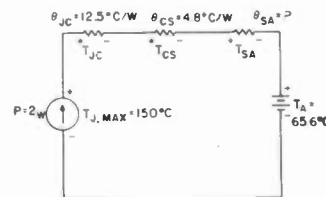

Fig. 5. Thermal circuit for the example with a heat sink.

these are substituted for  $\theta_{CA}$ , the equation for the semiconductor junction temperature becomes  $T_J = (\theta_{JC} + \theta_{CS} + \theta_{SA})P + T_A$ . A heat sink is selected on the basis of its  $\theta_{SA}$ , which characterizes its ability to transfer heat into the surrounding air. To determine the largest value of  $\theta_{SA}$  that will maintain a safe semiconductor temperature, the equation is solved for  $\theta_{SA}$ . This yields the following equation:  $\theta_{SA} = [(T_J - T_A)/P] - (\theta_{JC} + \theta_{CS})$ .

### An Example

Suppose you are designing an audio amplifier. You have estimated the power dissipation of the output transistor at 2 Watts. Having selected a transistor, you determine the relevant parameters from the transistor data sheet. These parameters are the maximum allowable power dissipation ( $P_{max}$ ), the maximum operating junction temperature ( $T_{J,max}$ ), the junction-to-case thermal resistance ( $\theta_{JC}$ ), and the junction-to-ambient thermal resistance ( $\theta_{JA}$ ). The values you found are listed below.

$P_{max} = 10$  Watts  
 $T_{J,max} = 150^\circ\text{C}$   
 $\theta_{JC} = 12.5^\circ\text{C/W}$   
 $\theta_{JA} = 65^\circ\text{C/W}$

Also, you note that the

**MAXIMUM RATINGS**

Rating	Symbol	2N6034 2N6037	2N6035 2N6038	2N6036 2N6039	Unit
Collector-Emitter Voltage	V <sub>CEO</sub>	40	60	80	V <sub>dc</sub>
Collector-Base Voltage	V <sub>CB</sub>	40	60	80	V <sub>dc</sub>
Emitter-Base Voltage	V <sub>EB</sub>	← 5.0 →			V <sub>dc</sub>
Collector Current - Continuous	I <sub>C</sub>	← 4.0 →			A <sub>dc</sub>
Collector Current - Peak	I <sub>C</sub>	← 8.0 →			A <sub>dc</sub>
Base Current	I <sub>B</sub>	← 100 →			mA <sub>dc</sub>
Total Power Dissipation @ T <sub>C</sub> = 25°C	P <sub>D</sub>	← 40 →			Watts
Derate above 25°C	P <sub>D</sub>	← 0.32 →			W/°C
Total Power Dissipation @ T <sub>A</sub> = 25°C	P <sub>D</sub>	← 1.5 →			Watts
Derate above 25°C	P <sub>D</sub>	← 0.012 →			W/°C
Operating and Storage Junction Temperature Range	T <sub>J</sub> , T <sub>stg</sub>	← -65 to +150 →			°C

Item 1: maximum power dissipation at specified case temperature and derating.  
 Item 2: maximum power dissipation at specified ambient temperature and derating.

Item 3: maximum junction operating temperature.

Item 4: specified thermal resistance  $\theta_{JC}$ .

Item 6: derating curves for case and ambient temperatures.

**THERMAL CHARACTERISTICS**

Characteristic	Symbol	Max	Unit
Thermal Resistance, Junction to Case	$\theta_{JC}$	3.12	°C/W
Thermal Resistance, Junction to Ambient	$\theta_{JA}$	83.3	°C/W

\*Indicates JEDEC Registered Data.

Item 5: specified thermal resistance  $\theta_{JA}$ .

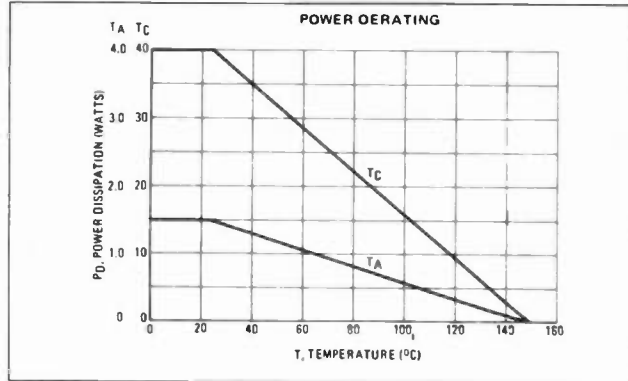

Fig. 6. Semiconductor thermal specifications and parameters.

transistor is in a TO-202 (plastic) case. In addition to these specified parameters, you have ascertained that the temperature of the air surrounding the transistor will not exceed 150° F (65.6° C). Good design practice suggests that you use a value between 10 and 20 percent greater than your estimated value for this temperature, as a safety factor, which you have done. (A diagram of the thermal circuit is shown in Fig. 4.)

Because your first concern is whether your transistor needs a heat sink, you use the value specified for

$\theta_{JA}$  to calculate T<sub>J</sub> as follows:

$$T_J = (\theta_{JA})P + T_A$$

$$T_J = (65)2 + 65.6$$

$$T_J = 195.6^\circ\text{C}$$

The calculated value of T<sub>J</sub> is greater than the specified maximum operating junction temperature (T<sub>J,max</sub>) by 45.6° C.

The next step is to determine the thermal resistance required of the heat sink. This is accomplished by solving the equation for  $\theta_{SA}$  after substituting the value of T<sub>J,max</sub> for T<sub>J</sub>. However, the value of one other parameter, the case-to-sink thermal resistance,  $\theta_{CS}$ , must be determined before

this equation can be solved.  $\theta_{CS}$  depends upon the method used to mount the transistor. It usually is provided in a table by heat-sink manufacturers and, occasionally, semiconductor manufacturers. Table 1 lists values of  $\theta_{CS}$  for some common transistor case types and mounting methods.

After obtaining a value of 4.8° C/W for  $\theta_{CS}$ , the completed thermal diagram is shown in Fig. 5.  $\theta_{SA}$  is calculated as follows:

$$\theta_{SA} = [(150 - 65.6)/2] - (12.5 + 4.8)$$

$$\theta_{SA} = 24.9^\circ\text{C/W}$$

A heat sink with a thermal resistance of 24.9° C/W or less will provide adequate heat transfer. A number of small, inexpensive heat sinks with a  $\theta_{SA}$  of 20° C/W for the TO-202 case style are available. You simply select one which meets your mounting requirements.

**The Semiconductor Specs**

Except for saying that they are found in the manu-

facturers' data sheets, details of how the values for thermal resistances are obtained have not been discussed. Yet determining these values from the specifications sometimes requires skill. Familiarity with the types of data most likely to appear in the data sheet is necessary to success. With the aid of the data sheet appearing in Fig. 6, this data and its interpretation are described in the following paragraphs.

The data sheet in Fig. 6 was chosen to illustrate common methods of specifying semiconductor thermal specifications for two reasons. First, all of the specifications are labeled clearly and are arranged into a single, logical area of the specification. This is not true of all semiconductor data sheets. Often, thermal specifications, particularly for linear integrated circuits, are placed in notes. (The entire data sheet should be read before concluding that they have been

Case Style	Metal-to-Metal		Insulated	
	Dry	Lubricated	Dry	Lubricated
TO-3	0.5	0.1	1.3	0.36
TO-66	1.5	0.5	2.3	0.9
TO-83	—	0.1	—	—
TO-94	—	0.1	—	—
TO-126	2.0	1.3	4.3	3.3
TO-127	1.6	0.8	2.6	1.8
TO-202	1.3	0.9	4.8	2.0
TO-220	1.2	1.0	3.4	1.6

Table 1. Case-to-sink thermal resistance in °C/W.

omitted.) The second reason for selecting the data sheet shown in Fig. 6 was that it contained all of the data relating to thermal specification. A typical data sheet will provide only a portion.

Thermal resistance is specified by direct specification, by derating, and by thermal-related parameters. A manufacturer uses direct specification when he tabulates thermal resistance in data sheets. The designer simply inserts the specified values into his thermal equations. Items 4 and 5 of Fig. 6 illustrate direct specifications.

A derating specifies how quickly the maximum power dissipation must be decreased as the case or ambient temperature increases. A derating may be given by statement (illustrated by items 1 and 2) or by curve (illustrated by item 6). A numeric value for thermal resistance is needed for the thermal analysis. The technique for determining a number from this kind of specification is more easily explained using an example.

The derating (item 1) indicates that the 2N6034 has a maximum power dissipation of 40 Watts at a case temperature of 25° C. It also indicates that this should be derated at 0.32 W/°C above 25° C. The derating is assumed to be linear above the specified temperature unless otherwise specified. This means that for every degree increase in case temperature, the dissipated power must be decreased by 0.32 Watts.

An examination of the electrical thermal model in Fig. 2 causes us to conclude that the power has to be decreased because junction-to-case thermal resistance is limiting heat flow from the device. Furthermore, the rate at which the power must be decreased as the temperature increases is related to the value of this thermal resistance. Actual-

ly, the rate of derating is the reciprocal of the thermal resistance. Thus, the junction-to-case thermal resistance for the 2N6034 can be calculated:

$$\theta_{JC} = 1/0.32$$

$$\theta_{JC} = 3.125^\circ \text{C/W}$$

The same technique can be applied to determine the junction-to-ambient thermal resistance from the derating in item 2.

The type of thermal resistance specified is indicated by the location of the specified temperature. The subscript attached to the temperature symbol identifies this location.

Frequently, a manufacturer will provide a derating curve, such as the one illustrated in Fig. 7, which provides the same information in graphical form. The horizontal axis indicates temperature. In this curve, it is temperature at the case. The vertical axis is the maximum dissipated power allowed at the indicated temperature. To find the thermal resistance from a derating curve, divide the difference in temperature by the difference in dissipated power. From Fig. 7, the temperature changes from 25° C to 150° C, which is 125° C. The change in dissipated power over this temperature range is from 40 Watts to 0 Watts, a difference of 40 Watts. Thus,  $\theta_{JC}$  is calculated by dividing 125 by 40.

$$\theta_{JC} = 125/40$$

$$\theta_{JC} = 3.215^\circ \text{C/W}$$

Notice (in item 6 of Fig. 6) that Motorola gave a derating curve for both case and ambient temperatures. Each curve is labeled with the appropriate temperature.

A manufacturer may not specify either a thermal resistance or a derating. However, a knowledgeable designer can determine a derating specification from other specifications and calculate the thermal resistance from this derating.

The key to determining a derating curve for a semi-

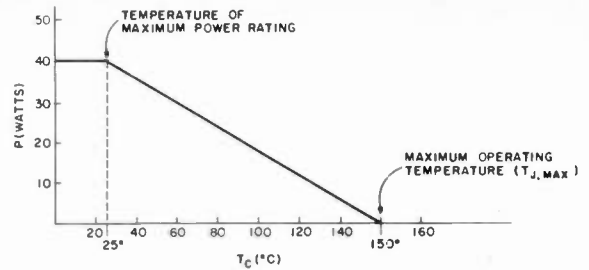

Fig. 7. Transistor power derating curve.

conductor is to find two points of the curve above the temperature where it begins to slope downward. Among other parameters, the derating curve specifies the temperature above which the device can no longer be operated, that is,  $T_{J,max}$  (see Fig. 7). At this temperature, the power must be zero. This is equivalent to saying that the current must equal zero in the electrical thermal circuit (Fig. 2).

Because no current is flowing in the circuit, no temperature is dropped across either  $\theta_{JC}$  or  $\theta_{CA}$ . Thus, the maximum operating temperature of the device must equal the maximum operating ambient temperature and the maximum operating case temperature. When the manufacturer specifies  $T_{J,max}$ , one point on both the ambient and the case temperature derating curves is known. The second point on the derating curve is established as the temperature where the maximum power dissipation is specified.

For example, the following are specified for the 2N6034 (items 1 and 3).

$$P_{max} = 40 \text{ Watts} @ T_C = 25^\circ \text{C}$$

$$T_{J,max} = 150^\circ \text{C}$$

The fact that this data agrees with the derating curve can be verified by comparing these two points on the derating curve labeled  $T_C$  in Fig. 6, item 6. Though Motorola seems to specify  $P_{max}$  as part of the derating specification, the appearance is created by the organization of the data

sheet. The common practice is to specify that parameter, though no derating is specified.

Typically, the values of thermal resistance calculated from the derating curve and from the power and temperature specifications will agree with the specified thermal resistances within a few percent. Have you calculated  $\theta_{JA}$  by the above methods to find how closely they agree to its specified value?

As a designer searches for thermal specifications, he will discover that either  $\theta_{JA}$  or  $\theta_{JC}$ , but not both, is specified for a number of devices. Also, these specifications will be void of data which allows calculation of the unspecified value. This is true because manufacturers specify the parameters they believe relevant to the use of the device being specified, as they understand its application. In this regard, a device may fall into one of three categories.

It may have a specific function and the designer is not expected to concern himself directly with the power dissipation versus temperature relationship. For example, an SN7400 TTL quad NAND logic gate has a specific function. In this case, the manufacturer specifies the maximum temperature of operation for the device. The designer is expected to limit the ambient temperature to a value such that the specified value is not exceeded.

A device may be designed for use with or without a heat sink. These devices,

# AT LAST!

This service will be available nationally. Lab tested & time proven modifications professionally installed in your amateur Handy-Talkie 2M, 220, 440, MH2 transceiver by Henry Radios warranty technicians (KNOWN AS "A&W PRODUCTIONS")



## HAVE ALL PL TONES AVAILABLE AT YOUR FINGER TIPS

Outboard the dip switch! Have it neatly inlaid into the back cover of your Handy-Talkie making all 32 PL Tones Selectable at a moment's notice.

**\$25** Got your own PL? Send it to us with your Handy-Talkie unit and we do the professional installation for you.

**\$55** We will install a new PL and inlay the dip switch into the back cover of your Handy-Talkie ready to operate.

Send us your Handy-Talkie unit and a check or money order plus \$3.50 for shipping and handling payable to **A&W PRODUCTIONS, INC.**

For **TEMPO** units the dip switch is inlaid into the Push-to-Talk bar. The **TEMPO S-15** will have the dip switch inlaid into the back cover.

**\$45** We will install a **NEW BATTERY BEATER** in your **TEMPO S-1, S-2, S-4, S-5** READY to operate. Your New Battery Beater will use the same jack as the charger with no new holes and regulation circuits built into unit. Comes with Cigar Lighter Adapter with internal fuse.

**CONTACT A&W PRODUCTIONS FOR SPECIAL MODIFICATIONS YOU MAY WANT TO HAVE DONE. WE SPECIALIZE IN THE TEMPO HANDY-TALKIES.**

WE ARE AN OFFICIAL "TEMPO" REPAIR STATION  
ALL WORK GUARANTEED FOR 30 DAYS. SEND YOUR HANDY-TALKIE AND A CHECK OR MONEY ORDER TO:

**A&W PRODUCTIONS** ✓164  
3305 Pico Blvd., Santa Monica  
California 90405 (213) 828-9310

being rated between 0.25 and 5 Watts dissipation without a heat sink, usually are classified as small or intermediate power devices. An example is the 2N6034 Darlington used in the above examples. Both  $\theta_{JA}$  and  $\theta_{JC}$  are specified for these devices.

Lastly, a device may be classified for use only with a heat sink. These are the high-power devices, such as the 2N3055. The data manuals commonly provide only the data required to determine the heat-sink requirements.

## The Heat-Sink Specs

Values of thermal resistance for heat sinks are more easily determined from data sheets than are those for semiconductors. Thermal resistance for a heat sink can be provided by either of two methods. The first is by direct statement, as in the case of semiconductors. The second method is by curve, as illustrated in Fig. 8. The horizontal axis is heat as power dissipated. The vertical axis shows the temperature difference between the heat sink and ambient caused by

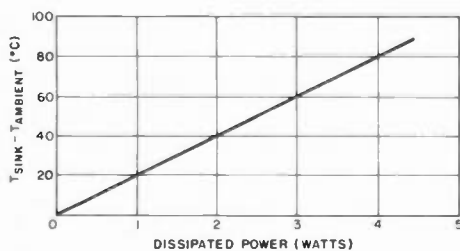

Fig. 8. Heat-sink thermal rating curve.

the heat flow. To find the thermal resistance, simply find the temperature difference caused by the heat flowing in your thermal circuit. Then, divide the temperature difference by that power.

In the example where we calculated  $\theta_{SA}$ , the audio output transistor dissipated 2 Watts. The curve in Fig. 8 shows a temperature difference of 40° C at a 2-Watt power dissipation. Thus, the thermal resistance is:

$$\theta_{SA} = 40/2$$

$$\theta_{SA} = 20^\circ \text{ C/W}$$

Sometimes, the thermal resistance curve is nonlinear, meaning that  $\theta_{SA}$  changes as the dissipated power increases. Thus, it will not be a straight line, as shown in Fig. 8. Usually, it is straight. In either case, this technique determines  $\theta_{SA}$  easily.

All manufacturers provide curves with essentially the same data. The only difference is the axis labeling. For example, IERC labels the vertical axis on some of their data sheets "maximum sink temperature rise above ambient (°C)." To avoid confusion, simply remember the thermal equivalent of Ohm's Law: A temperature difference is caused by heat flowing through a thermal resistance.

One other factor must be considered during heat-sink selection. The thermal resistance of a heat sink is specified for a specific physical orientation of the heat sink. (This is true of semiconductors, also.) Except for heat sinks which are designed for special applications, the manufacturer specifies the resistance for *maximum unobstructed natural convection*. To understand the meaning of this, recall that natural convection depends upon heated air rising to be replaced by cooler air. A heat sink operates properly when air can circulate freely across the maximum area of every fin. This means that it should be mounted

with its fins vertical. Also, the ends should be kept clear to allow unobstructed entry of air between the fins at the bottom and exit from the top. *Your mounting constraints should always be considered during heat-sink selection.*

## Summary

The principles involved in heat-sink selection are now complete. The thermal circuit and its electrical equivalent provide a theoretical model for easy analysis of thermal phenomena. Thermal resistances for an equivalent circuit are determined from the manufacturers' data sheets. Applied to the thermal circuit, Ohm's Law and Kirchoff's Voltage Law, which are understood by those who work with electrical circuits, allow calculation of the semiconductor junction temperature. The calculated temperature is compared to the maximum temperature specified by the manufacturer to determine the necessity of a heat sink. If a heat sink is required, the maximum semiconductor temperature is substituted into the equations to determine the maximum thermal resistance for a heat sink which will limit the junction temperature to a safe value.

Two criteria are used to select a heat sink: Its thermal resistance must be less than the calculated maximum value and its mounting must be consistent with the designer's application. Heat-sink selection using these criteria completes the process.

## Acknowledgements

The semiconductor data contained in Fig. 6 was reproduced from page 4-195 of the *Power Device Data Manual*, 1st Edition, copyright 1978 by Motorola Semiconductor Products, Inc., Phoenix, Arizona. Permission to print this portion of the manual was provided by Motorola. ■



# SELECT YOUR FAVORITE FEATURE



Yes, the **CT2100** has the features you want – and built-in, too! The **CT2100** has been designed by the RTTY people at HAL for optimum operator convenience. No “hidden” keyboard controls to remember – it’s all on the front panel, arranged for serious operators. Why settle for a compromise or imitation when you can have the **CT2100**? Compare feature for feature; you’ll find that the **CT2100** offers the most performance and flexibility for your dollar.

- Send or receive ASCII, Baudot, or Morse code
- RTTY and Morse demodulators are built-in
- RTTY speeds of 45, 50, 74, 100, 110, 300, 600, and 1200 baud – ASCII or Baudot
- Four RTTY modems: “high tones”, “low tones”, “103 Modem tones”, and “202 Modem tones”
- Three shifts for high and low tones (170, 425, and 850 Hz)
- Crystal-synthesized transmit tones
- Send and receive Morse code at 1 to 100 wpm
- Characters displayed on 24 line screen
- Choose either 36 or 72 characters per line
- 2 pages of 72 character lines or 4 pages of 36 character lines
- Split-screen for pretyping transmit text
- Audio, current loop, or RS232 data I/O
- Printers available for hard-copy of all 3 codes
- On-screen RTTY tuning bar plus LED indicators
- ALL ASCII control characters; half or full duplex
- Brag-tape storage of 8-256 character messages in MSG2100 EPROM option
- Two programmable HERE IS messages

Write or call for more details. See the CT2100, KB2100, Printer, and Video Monitor at your favorite HAL dealer.



**HAL COMMUNICATIONS CORP.**

BOX 365

URBANA, ILLINOIS 61801

217-367-7373

345

# GEAR FOR THE EARS

## TS-930S

Filters	
YK-88A-1	\$59.95
YK-88C-1	69.95
YG-455C-1	89.95
YG-455CN-1	107.95
SP-930	79.95
HC-10	92.95
MC-60	69.95

## TR-5

PS-75	\$143.00
-------	----------

## IC-740

EX 241 (Marker)	\$20.00
EX 242 (FM unit)	39.00
EX 243 (Elec. keyer)	50.00
FL44	159.00
FL45	59.50
FL52 (455 kHz, 500 Hz CW filter)	TBA
FL53 (455 kHz, 250 Hz CW filter)	
FL54 (9mHz, 270 Hz, CW filter)	
SP4	24.95
SP3	49.50
PS15	149.00

## FT-102

FV102DM	\$295.95
XF8.9KC 600 Hz 8-pole CW	
CW filter	50.00
XF8.9 KCN 300 Hz 8-pole	
CW filter	50.00
XF8.9KA 6 KHz 8-pole AM filter	50.00
XF10.7KC 800 Hz 6-pole 3rd	
IF CW filter	45.00
RAM Unit Memory back-up	
board	20.00
KY-ONE Curtis 8044 keyer unit	45.00
DC cable for FT-ONE	15.00
FM-ONE FM unit	59.00
YM-34 Desk microphone	31.00
YM-35 Scan noise canx mobile	
mic	20.00
YM-36 Noise canx mobile mic	20.00
YM-37 Mobile microphone	10.00
YM-38 Scan desk microphone	39.00
MD-1B8 Desk microphone	69.00
MH-1B8 Mobile microphone	20.00
SP-901P Speaker/patch	76.00

### MASTERCARD VISA

All prices fob Houston except where indicated. Prices subject to change without notice, all items guaranteed. Some items subject prior sale. Texas residents add tax. Please add sufficient postage, balance collect.

**MADISON**  
**Electronics Supply**  
 1508 McKinney  
 Houston, Texas 77010  
 713-658-0268

## SWR & Power Meter

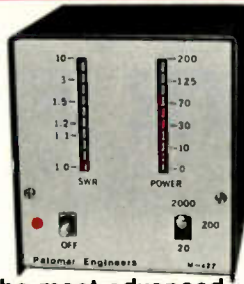

- **The most advanced automatic computing RF measuring instrument in amateur radio.**
- **Logarithmic SWR scale.**
- **Power ranges 20/200/2000 watts.**
- **Frequency range 1-30 MHz.**

**Automatic.** No "set" or "sensitivity" control. Computer sets full scale so SWR reading is always right. Complete hands-off operation.

**Light bar display.** Gives instant response so you can see SSB power peaks. Much faster than old-fashioned panel meters. Baton switch selects three power ranges.

**Logarithmic SWR display.** Computer expands the display where you need it so it's easier to see, easy to use.

**Computer operated.** Now an analog computing circuit and digital comparator automatically compute SWR regardless of power level. Frees you from checking zero, setting a "sensitivity" knob and from squinting at old-fashioned cross pointer mechanical meters. With this new meter computing is done electronically and displayed with moving light bars. Individual bars for SWR and power.

**Model M-827 Automatic SWR & Power Meter** \$119.95 in the U.S. and Canada. Add \$3 shipping/handling. California residents add sales tax.



### ORDER YOURS NOW!

Send for **FREE** catalog describing the **SWR & Power Meter** and our complete line of **Noise Bridges, Pre-amplifiers, Toroids, Baluns, Tuners, VLF Converters, Loop Antennas and Keyers.**

**Palomar Engineers**

1924-F West Mission Rd.  
 Escondido, CA 92025  
 Phone: (619) 747-3343

# DISPLAY YOUR STUFF

With the AEA MBA-RO Reader

Automatic display of transmitted and received Morse and RTTY coded signals has come of age. It is proving to be most worthwhile for improving one's own transmitted "fist" and for allowing SWL's or visitors the opportunity to experience the thrill of Amateur Radio coded transmission.



While no machine can yet match the ability of a skilled CW operator in copying poor fists or signals buried in the noise, the MBA-RO by AEA excels even when compared against units costing much more. The large 32 character display allows much easier reading than shorter displays, especially at higher speeds such as 60 WPM or 100 WPM RTTY. The MBA-RO also features dual filters for RTTY decoding of either 170 Hz or 425 Hz (easily changed to 850 Hz) shift transmissions.

For more details, write for our latest catalog or visit your favorite dealer.

Prices and Specifications subject to change without notice or obligation. Software ©copyright by AEA.

**ADVANCED ELECTRONIC APPLICATIONS, INC.**  
 P.O. Box C-2160,  
 Lynnwood, WA 98036  
 (206) 775-7373  
 Telex: 152571 AEA INTL

**AEA** Brings you the Breakthrough!

The BEST is still  
"made in U.S.A."



# MIRAGE

American made RF Amplifiers and Watt / SWR Meters  
of exceptional value and performance.

• 5 year warranty • prompt U.S. service and assistance

## RF AMPLIFIERS

### 2 METERS-ALL MODE

**B23** 2W in = 30W out \$89.95  
(useable in: 100 mW-5W)

**B108** 10W in = 80W out \$179.95  
(1W = 15W, 2W = 30W) RX preamp

**B1016** 10W in = 160W out \$279.95  
(1W = 35W, 2W = 90W) RX preamp

**B3016** 30W in = 160W out \$239.95  
(useable in: 15-45W) RX preamp

### 220 MHz ALL MODE

**C106** 10W in = 60W out \$199.95  
(1W-15W, 2W = 30W) RX preamp

**C1012** 10W in = 120W out \$289.95  
(2W = 45W, 5W = 90W) RX preamp

**C22** 2W in = 20W out \$89.95  
(useable in: 200mW-5W)

### RC-1 AMPLIFIER

**REMOTE CONTROL** \$24.95  
Duplicates all switches, 18' cable

## WATT / SWR METERS

- peak or average reading
  - direct SWR reading
- MP-1** (HF) 1.8-30 MHz  
**MP-2** (VHF) 50-200 MHz  
\$119.95

### 430-450 MHz ALL MODE

**D24** 2W in = 40W out \$199.95  
(1/2W = 24W, 1W = 70W)

**D1010** 10W in = 100W out \$319.95  
(2W = 25W)

Available at local dealers throughout the world.

**MIRAGE**  
COMMUNICATIONS EQUIPMENT, INC.

P.O. Box 1393, Gilroy, CA 95020 (408) 847-1857

# Your January Home-Brew Project

*No frills—just a solid \$10 SSB exciter for HF.  
Who says hams don't build anymore?*

**P**romises, promises. How can any SSB exciter be inexpensive when an i-f filter is needed? I have been regaled with plans for inexpensive SSB generators, but the operative paragraph usually describes how the filter was found deep in the

bowels of the faithful junk box or bought for a song from an unsuspecting entrepreneur at the last flea market. I have always arrived just as the last treasure has been sold. The promise of an inexpensive exciter eluded me.

So what am I offering you? Another inexpensive SSB exciter. This time the operative paragraphs will describe how you can make a very satisfactory crystal i-f filter for less than \$10.00 which needs no critical tuning or messy and unpredictable crystal grinding. I will then describe how I used it in a 15-meter exciter.

If all you want is a simple i-f filter, this could be built as described by the schematic and you would be pleasantly impressed by its performance. For those who are innovators and have other crystals which are the same in frequency, there are general design rules for making two-, three-, and four-crystal filters. Fig. 2 gives the normalized capacitance values for these. To find the actual value of

This simple filter is made using four of the ubiquitous 3.58-MHz television crystals in a ladder configura-

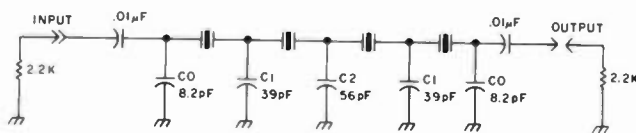
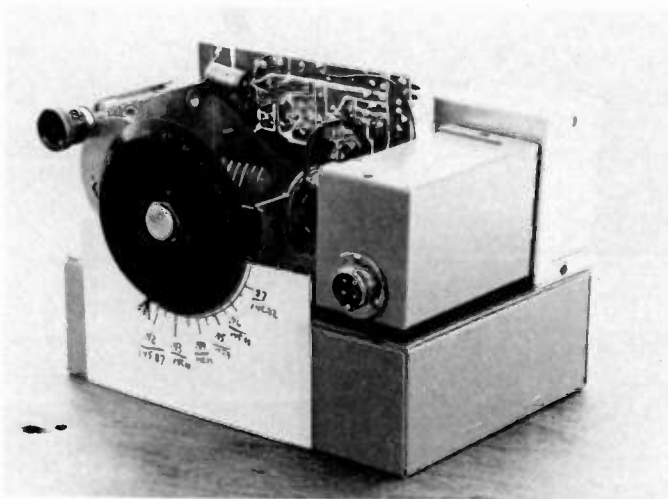
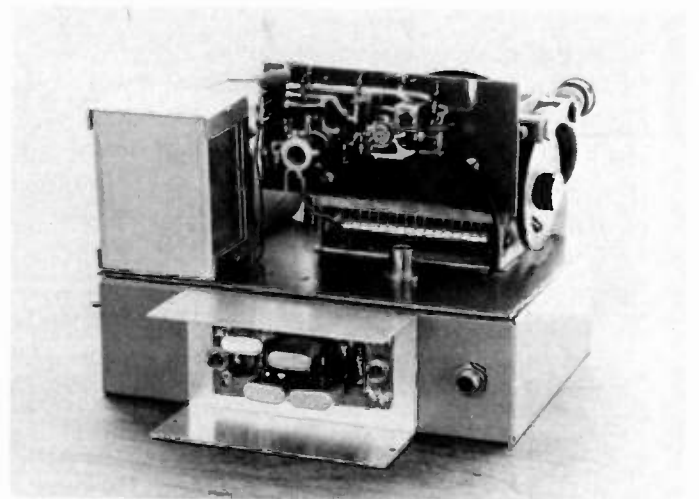

Fig. 1. A 3.58-MHz crystal-lattice SSB i-f filter with an audio bandwidth of 2 kHz and 2.2k input and output impedance.



The prototype 15-meter SSB exciter.



The exciter displaying the crystal filter mounted in a minibox for shielding.

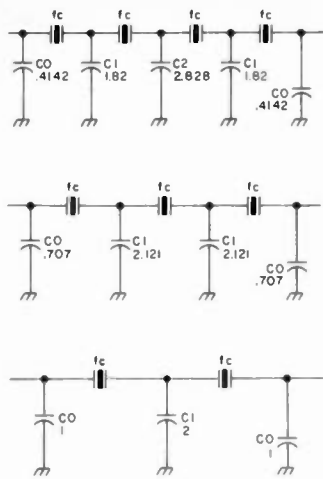

Fig. 2. To find the actual value of the shunt capacitors, multiply the coefficient beside each capacitor by  $1/(2\pi fR)$ , where  $f$  is the crystal frequency and  $R$  is the filter design impedance.

each capacitor, the coefficient beside each capacitor must be multiplied by  $1/(2\pi fR)$  where  $f$  is the resonant frequency of the crystals in Hertz and  $R$  is the design input and output impedance in Ohms. For the suggested filter using the 3.58-MHz crystals,  $R$  was chosen to be 2.2k Ohms—thus  $1/(2\pi fR) = 20$  pF.  $C_0 = .4142 \times 20$  pF = 8.284 pF = 8.2 pF;  $C_1 = 1.82 \times 20$  pF = 36.40 pF = 39 pF;  $C_2 = 2.828 \times 20$  pF = 56.56 pF = 56 pF.

If the impedance was chosen to be 1.8k Ohms, then  $C_0 = 10$  pF,  $C_1 = 47$  pF, and  $C_2 = 68$  pF. Thus, the impedance which is chosen to work toward is flexible, but there are a few considerations to notice. As the impedance is lowered, the passband of the filter is reduced and the insertion loss will increase. On the other hand, as the impedance is increased, the passband widens but the ripple in the passband also increases. As well, the low capacitance values for higher impedances make stray capacitance more troublesome.

This technique has been used by others to make

filters using surplus crystals in the 8-to-12-MHz ranges as well. It was stated that a design impedance of 800 to 1000 Ohms was usable at that frequency for an SSB filter. A design impedance of 1500 Ohms was usable at 5 MHz.

In putting this filter into a circuit, it is imperative that it be properly terminated in its design impedance, both on the input and output. Neglecting this can give a very high passband ripple.

Now, you may think, we have the filter, but there is always a need for carrier-oscillator crystals. Good news! The series resonant frequency of the crystals controls the lower limit of the passband, so one more crystal identical to those used in the crystal filter will allow selection of the upper sideband. How easy can it be?

Listening to OSCAR 8, mode A has whet my appetite for a taste of operating through this satellite. One constraint seems to be that one should have full-duplex capabilities for the most success, but I had no VHF equipment and only one HF transmitter. I built a simple transmitting converter with five Watts output on 2 meters for one-milliwatt input on 15 meters. This gave

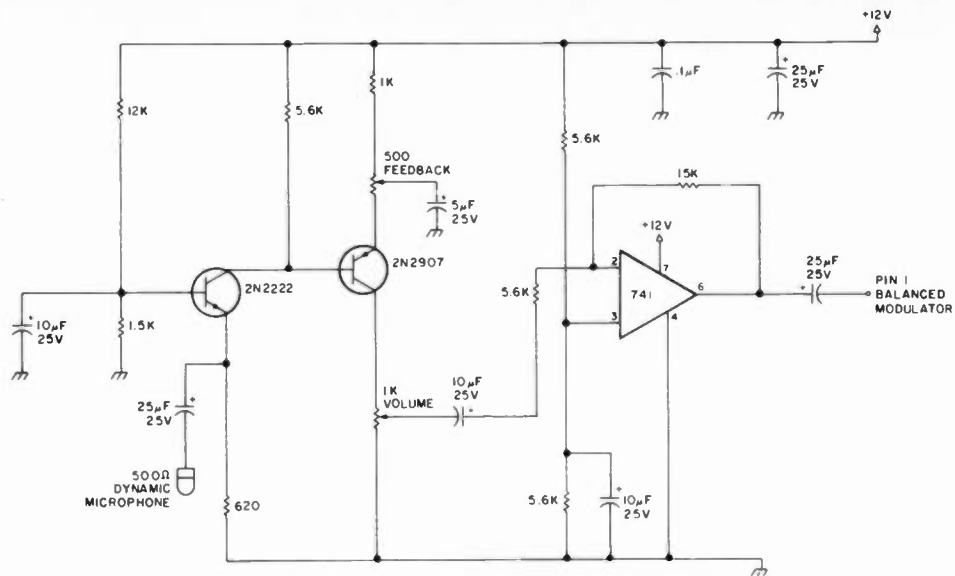

Fig. 3. Microphone amplifier.

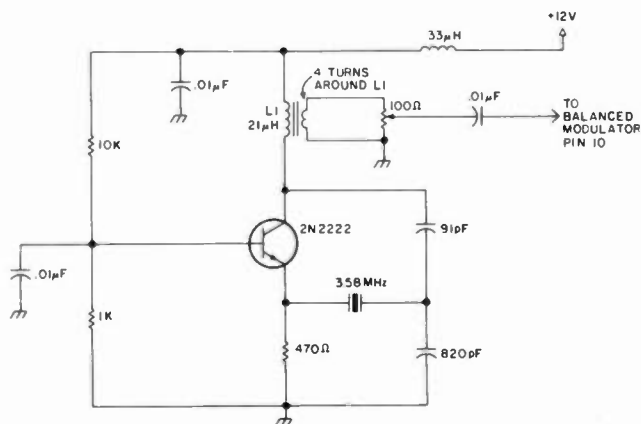

Fig. 4. Carrier oscillator. All resistors are  $\frac{1}{4}$  Watt. L1 could be Miller part 46A225CPC with a 4-turn secondary added, available from Radiokit, Box 411H, Greenville NH 03048.

me VHF capability. I first proposed to excite this with a CW signal; then the idea of a DSB exciter was entertained before I discovered the inexpensive crystal filter just described. I then could proceed with a full SSB exciter with an output power of one milliwatt on 15 meters. The design philosophy was very simple—I used the parts I had easily available to build a basic transmitter without bells and whistles. This was done and I am happy with the results.

#### Microphone Amplifier

The microphone amplifier described in Fig. 3 must match a low-impedance dynamic microphone to a

low-impedance, balanced-modulator input while increasing the microphone output of 2 mV to one volt. The first stage is a common base amplifier to take advantage of the low input impedance and high voltage gain of this configuration. This directly drives a common emitter amplifier with adjustable feedback in the emitter to control the gain of this stage. The output stage is the common 741 operational amplifier, used for its very low output impedance which easily drives the 100-Ohm audio input of the balanced modulator. If you have other microphones, you will need different amplifier circuits than this. Just remember to

use a low-impedance output circuit to successfully drive the balanced modulator.

### Carrier Oscillator

The crystal-controlled Colpitts oscillator (Fig. 4) was chosen as the carrier oscillator because it is very easy to get operating and the crystal vibrates in its series resonant mode. The output is terminated in a 100-Ohm variable resistor

which allows for the adjustment of the carrier level for best carrier suppression in the balanced modulator. Inductor L1 was found in a Poly Paks assortment and a four-turn secondary was added. Miller part 46A225CPC also could be used for L1.

### Balanced Modulator

This is the popular

MC1496 double-balanced modulator which, when built with reasonable care, works very well (see Fig. 5). The first one was built on the same PC board as the crystal filter, but the resulting 30-dB carrier suppression was disappointing. With proper shielding of the carrier oscillator and crystal filter, this suppression was increased to a usable

50 dB. The balanced-modulator output is greater than is needed by the carrier mixer and also greater than can be passed by the filter. With this in mind and having a need for a resistive input-filter termination, the balanced modulator is output into a resistive pad, the value of which is chosen to give maximum linear conversion mixer output without limiting while retaining maximum carrier suppression.

### Carrier Mixer

The 3.58-MHz single-sideband output of the crystal filter must be converted to the desired 21.5-MHz band to be usable. In order to properly terminate the filter and provide impedance conversion, an FET buffer amplifier is included which drives the 600-Ohm input of the TL442 balanced mixer (Fig. 6). This integrated circuit was chosen as it uses few biasing components and has good carrier suppression without balancing controls. If desired, the MC1496 could be used with equally good results if the TL442 is hard to find.

With this situation in mind, a carrier mixer was built using the easily found MC1496 double-balanced mixer. I had good success with it as well. This mixer circuit, shown in Fig. 7, is almost identical to the balanced modulator. R1, between pins 2 and 3, was made variable, enabling me to set the gain of the stage and thus control the drive to my transmitting converter. The output was made single-ended instead of balanced, so I could use the same tuned circuit as was used for the TL442 mixer. The input drive circuit was made a source follower to properly match the lower input impedance of the new circuit. The SSB drive level into the mixer is adjusted so that the maximum input does not cause the output

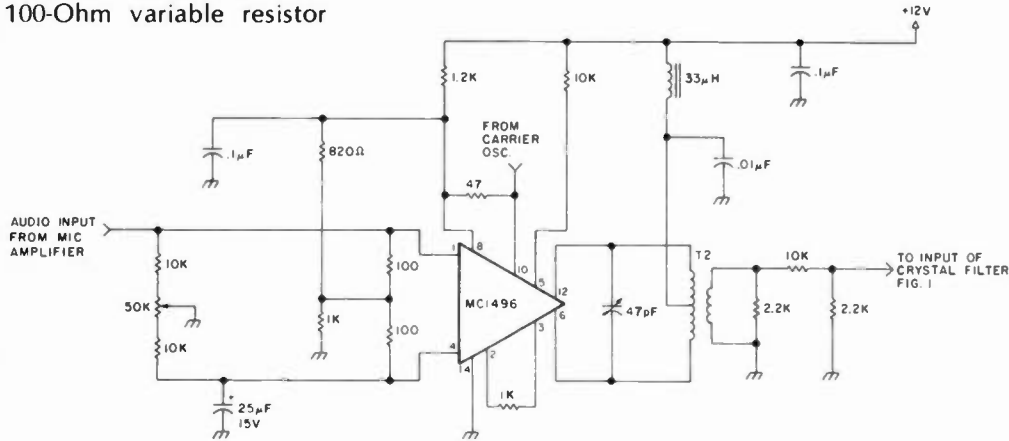

Fig. 5. Balanced modulator. All resistors are 1/4 Watt. T2: 42 uH; primary - T50-2 - 91 turns c-t bifilar wound #34; secondary - 30 turns wound over primary.

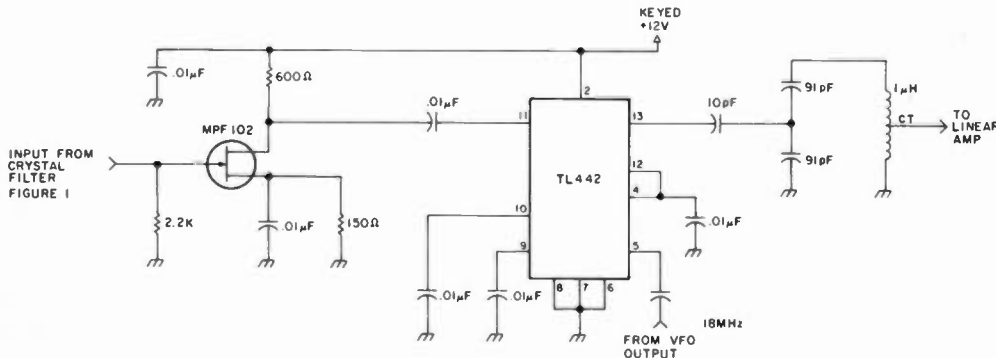

Fig. 6. Carrier mixer.

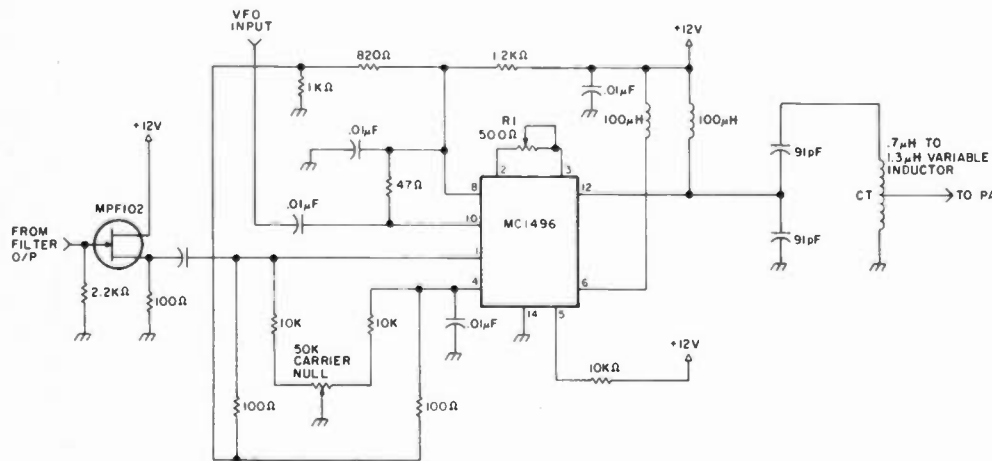

Fig. 7. Carrier mixer using the MC1496 double-balanced mixer.

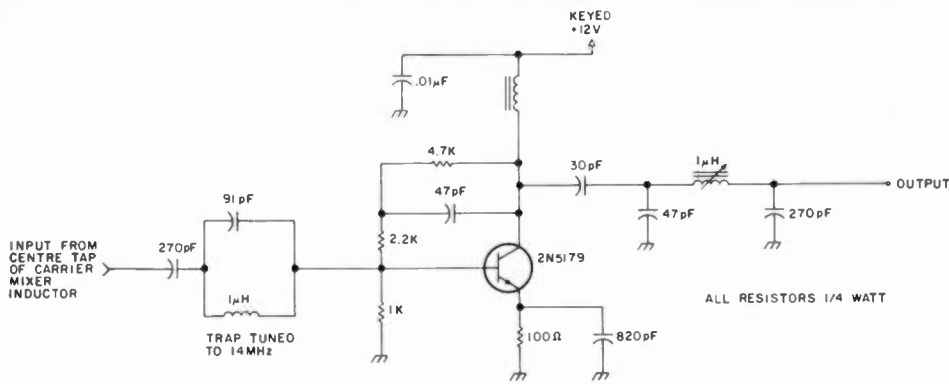

Fig. 8. Linear amplifier.

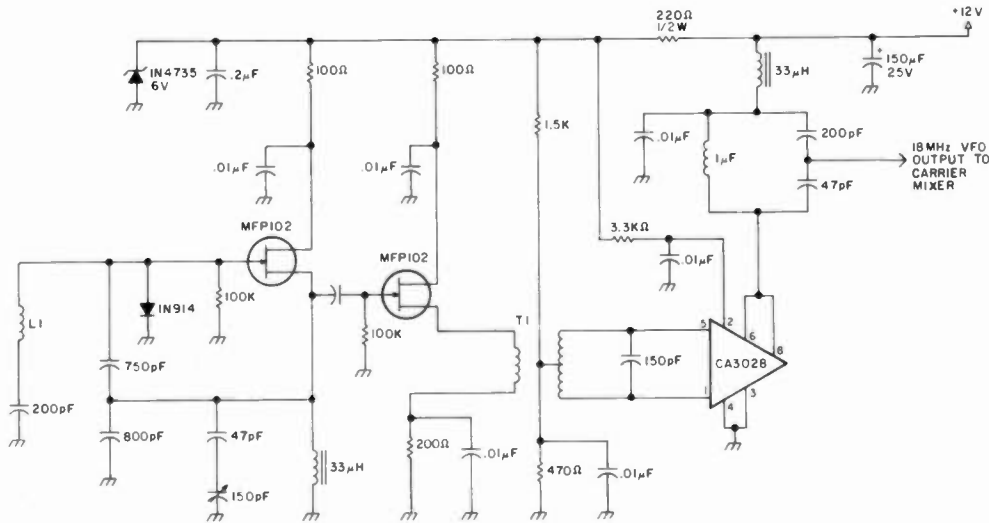

Fig. 9. Vfo. L1: 23 turns of #22 enameled wire close-wound on 3/8"-diameter ceramic form. T1: Primary—25 turns #34 enameled wire on Amidon toroid T25-6; secondary—28 turns center-tapped #34 enameled wire wound over primary.

to limit. The output is adjusted by R1 to properly drive the PA stage, and the carrier null potentiometer is adjusted for minimum vfo output. Usually it will be sufficient, in this service, to set the null pot at its midpoint. Carrier suppression is less critical here than in the balanced modulator.

### Linear Amplifier

The linear amplifier (Fig. 8) supplies about 1 milliwatt output, sufficient to drive my transmitting converter to full output. An input series trap tuned to 14 MHz was included to reduce the level of the undesired mixer product (probably an unnecessary frill but, having the parts, it was easy to include). If greater output is desired, the collector-base negative feedback

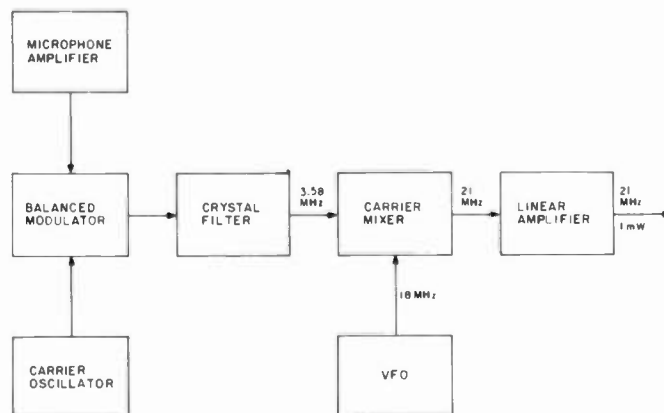

Fig. 10. Block diagram of exciter.

could be reduced or more stages of amplification included.

### Vfo

The variable frequency oscillator (Fig. 9) is the series-tuned Colpitts or Clapp oscillator driving a push-push doubler to pro-

vide an 18-MHz carrier for the conversion mixer. The doubler is made with a CA3028 differential amplifier with its outputs in parallel.

### Building Ideas

This exciter was built in the modular configuration

which allowed for engineering changes at a whim (also called mistake rectification), and many ideas were tried as I went along. All circuits were put on printed circuit boards as this makes for neat construction. The vfo and carrier oscillator are on single-sided board and the others are on double-sided board. I also put the carrier oscillator and the crystal filter in their own shielded enclosures to reduce the carrier feed-through, interconnecting the units with RG-174 coaxial cable and audio-cable connectors. A block diagram of my exciter is shown in Fig. 10.

Many parts values may be questioned, and I assure you that I would not argue for their absolute value. My choice has been controlled very much by availability. I had some 1-uH variable inductors bought from Digital Research Corporation of Texas, a bag of assorted inductors and chokes from Poly Paks, some dipped-mica capacitors removed from surplus boards, and assorted resistors.

What I had was used to design circuits that would do the job without my buying every component as a special part. For example, bias circuits can usually be changed if the voltage division provided remains the same. Tuned circuits are flexible because resonance is controlled by both L and C and both can be changed to meet your needs. Amidon Associates can supply a flyer containing a very accurate chart for winding inductors on their various toroid cores if you have a particular capacitor you want to use in a resonant circuit. Bypass capacitors can be chosen from many values which will effectively provide a short to ground for the signal frequency. A command transmitter capacitor was used to provide vfo tuning, but any

# A Breakthrough

## for Amateur and Commercial Repeater Users.

**DIVERSITY RECEPTION**—the ability to add a second receiver to your repeater system—can now be a reality for even the small user. The Pegasus VS-2 will allow your repeater to "listen" to two receivers simultaneously and to noiselessly switch between receivers as often as necessary to adjust for fading and nulls. This is particularly useful for repeaters that wish to provide coverage for hand held users or where receiver desense is a problem. You supply the second receiver & RF link and the VS-2 does the rest. Complete instructions and diagrams included with the VS-2.

# \$179<sup>00</sup>

Postpaid

Pegasus Electronics, Inc.  
88 New Dorp Plaza  
Suite 106  
Staten Island, NY 10306  
(212) 667-9137  
Affiliated with Comsec Corp.



✓201

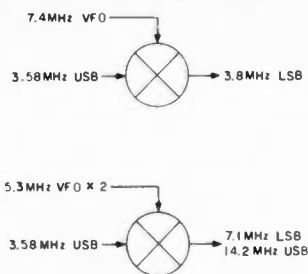

Fig. 11. Suggested conversion schemes for amateur-band exciters.

comparable variable capacitor would do just as well. The transistors used are common, inexpensive, and easily substituted with something you may have on hand.

### Ideas

This crystal filter and single-sideband generator could be used in many other ways (see Fig. 11). Using a vfo frequency of 7.3 MHz would give a lower sideband output on 75 meters. Doubling the output of an auxiliary 5-MHz

vfo would provide an upper sideband signal on 20 meters or a lower sideband signal on 40 meters. Many refinements are also possible which would make this exciter more versatile, but even without them it is possible to have an exciter with a quality single-sideband filter for very little.

The following parts may not be listed by advertisers, but they usually can supply them:

- MC1496—Godbout Electronics, Jameco Electronics.
- TL442—Active Component Sales Corp., Box 1035, Framingham MA 01701.
- CA3028—Aldelco. ■

### References

1. J. Pochet F6BQP, "Crystal Ladder Filters," *Wireless World*, July, 1977, p. 62.
2. Pat Hawker G3VA, "Technical Topics," *Radio Communication*, June, 1977, p. 448.
3. Amidon Associates, 12033 Otsego St., N. Hollywood CA 91607.

## NEW TS830S for \$150?

Yes indeed! Just add a Matched Pair of top-quality 2.1KHz BW (bandwidth) Fox Tango Filters. Here are a few quotes from users:

- "... Makes a new rig out of my old TS830S! ..."
- "... VBT now works the way I dreamed it should..."
- "... Spectacular improvement in SSB selectivity..."
- "... Completely eliminates my need for a CW filter..."
- "... Simple installation - excellent instructions..."

The Fox Tango filters are notably superior to both original 2.7KHz BW units but especially the modest ceramic 2nd IF; our substitutes are 8-pole discrete-crystal construction. The comparative FT vs Kenwood results? VBT OFF — RX BW: 2.0 vs 2.4; Shape Factor: 1.19 vs 1.34; 80dB BW: 2.48 vs 3.41; Ultimate Rejection: 110dB vs 80. VBT SET FOR CW at 300Hz BW — SF 2.9 vs 3.33; Insertion Loss: 1dB vs 10dB.

### AND NOW A NEW TS 930S!

Tests prove that the same filters improve the '930 even more than our '830. Don't buy CW filters—not even ours. You probably won't need them!

**INTRODUCTORY PRICE: (Complete Kit)...\$150**  
Includes Matched Pair of Fox Tango Filters, all needed cables, parts, detailed instructions. Specify kit desired: FTK-830 or FTK-930.  
Shipping \$3 (Air \$5). FL Sales Tax 5%

### ONE YEAR WARRANTY

**GO FOX-TANGO - TO BE SURE!**

Order by Mail or Telephone.  
AUTHORIZED EUROPEAN AGENTS  
Scandinavia MICROTEC (Norway)  
Other: INGOIMPEX (West Germany)



### FOX TANGO CORPORATION

Box 15944S, W. Palm Beach, FL 33406  
Phone: (305) 683-9587 ✓323

### VIDEOSCAN 1000 - HIGH RESOLUTION SSTV



Rivals Commercial TV Quality



New generation amateur-standard scan converter sends and receives sharp pictures with up to 16 times better resolution than earlier units. Three scan rates, optional call sign and much more. Easy to use. Amateur, phone line TV, surveillance, teleconferencing, etc. Free "How To Get Started In SSTV".  
Kit: VS-K \$595.00 Wired: VS-F \$795.00 Shipping: \$6.00

**MORSE-A-KEYER -- CW Keyboard** Kit: MAK-K \$159.95 Wired: MAK-F \$199.95 Shipping: \$5.00  
Wisconsin residents add 5% Wisconsin State Sales Tax to all items.

Call or write for FREE brochures, Factory Direct — WE'RE AS NEAR AS YOUR PHONE!

Microcraft Corporation

P. O. Box 513G,

Telephone: (414) 241-8144  
Tiensville, Wisconsin 53092

✓50

### CODE STAR - ALL MODE CODE READER

More Features Per Dollar Than Anything Else!



Ideal for novices, SWLs and seasoned amateurs. Built-in code-practice oscillator and speaker. Copies Morse, RTTY and ASCII. Large LEDs. Easy to connect and operate. Automatic speed tracking. Excellent digital/analog filtering. 12VDC or 120VAC with AC adapter provided. Compact. 2lbs. Connect computer (like VIC-20) printer with optional ASCII output port.  
Kit: CS-K \$159.95 Wired: CS-F \$219.95 Shipping: \$5.00  
ASCII Port: Kit: CS-1K \$59.95 Wired: CS-1F \$79.95

DX-Notes Have Gained Wide Acceptance	*In the Amateur Media	JARL Awards Kit
*At DAYTON Hamvention	*All across the USA	*Highly Acclaimed Worksheets
*5B DXCC PLUS	: DX-Notes Invites Comparison	*AJD 10 Call Areas
*SEVEN Wide W/C Columns	: *Compare Accuracy	*WAJA 47 Prefectures
*Log Entire DX Callsign	: *Compare Efficiency	JCC 647 Cities
*YOU Choose Modes/Bands	: *Compare Useability	*JCG 569 Guns
*Buro *3rd Party *More	: *Compare Convenience	Complete with JARL Information
*Enter YOUR Atlas Page #	: *Compare Completeness!	*Logical Organization
*CQ Zone *IARU Continent	: PLUS PREFIX Cross Reference	*Efficiency Engineered
*Unique "Rareness" Guide	: 1200+ Current, Commemorative	Alphabetical Cross Reference
*Latitude *Longitude	: Special Event & Historic	*Determine the JARL Code #
PLUS Info Computed for YOUR QTH:	Prefixes Indexed	*Available ONLY from KH6MD
*Time Zone Difference	: PLUS COUNTRY Cross Reference	*1400 Entries Listed
*EXACT Beam Heading	: 500+ Possessions, Islands,	PLUS FREE Bonus
*Miles *Kilometers	: Deleted, ETC Names Listed	**3075 US Counties Listing
PLUS FREE Bonus **5B WAZ Kit	: BUY DX-Notes Just \$12.95PPd	JARL Awards Kit Just \$7.95PPd

Send Call, Name, Address, Latitude, Longitude, Time Zone AND Check or Money Order To:  
KH6MD Randall Sherman POB 158 Kahului, Maui, HAWAII 96732 ✓147



## Subscription Problem?

73 Magazine does not keep subscription records on the premises, therefore calling us only adds time and doesn't solve the problem.

Please send a description of the problem and your most recent address label to:

73 Magazine  
Subscription Dept.  
PO Box 931  
Farmingdale, NY 11737

Thank you and enjoy your subscription.

**this publication  
is available in  
microform**



University Microfilms International

300 North Zeeb Road  
Dept. P.R.  
Ann Arbor, MI 48106  
U.S.A.

18 Bedford Row  
Dept. P.R.  
London, WC1R 4EJ  
England

## PRESERVE 73 MAGAZINE BINDERS & FILE CASES

Keep your issues of 73 Magazine together, handy and protected in handsome and durable library files or binders. Both styles bound in red leatherette with the magazine logo stamped in gold.

Files: Each file holds 12 issues, spines visible for easy reference, \$5.95 each, 3 for \$17.00, 6 for \$30.00

Binders: Each binder holds 12 issues and opens flat for easy reading. \$7.50 each, 3 for \$21.75, 6 for \$42.00

(Postage paid in USA. Foreign orders include \$2.50 per item)

Please state years: 1977 to 1983

Send check or money order to:

JESSE JONES BOX CORP.

P.O. Box 5120

Philadelphia, PA 19141

Allow 4 to 6 weeks for delivery

## Guide To RTTY Frequencies

**NEW**



100% totally NEW edition comprising details on 5500 frequencies and stations. The original and ONLY authoritative list of most shortwave commercial, military, press, aeronautical, embassy and weather broadcasting RTTY stations. Complete worldwide details on shift, speed, power, location, schedules, press station beam headings, formats, special ID's, etc. Independent lists by frequency and call signs. Official schedules of press stations. Introductory text reveals what's happening in commercial RTTY, how to recognize Russian, Cyrillic and Arabic transmissions. Other special features in this 2nd Edition—176 pages—available late December.

In USA: \$9.95, Book Mail, or \$12.00, UPS

Outside USA: US\$11.00, Book Mail

Outside USA: US\$15.00, Airmail

**GILFER SHORTWAVE**

Dept. #731, Box 239, Park Ridge NJ 07656

If you need

# QUARTZ CRYSTALS

—one or hundreds—

## YOU NEED JAN

- high stability
- prompt service
- cost savings

- General Communication
- Industry
- Marine VHF
- Scanners
- Amateur Bands
- CB Standard
- CB Special
- Microprocessor

**JAN  
CRYSTALS**

39

Call or Write

**JAN CRYSTALS**

P.O. Box 06017

Ft. Myers, Fl. 33906-6017

All Phones (813) 936-2397

## PERFECT ? ANTENNA

FOR  
10-15-20 METERS

VERTICAL

OMNI-GAIN

HALFWAVE  
END FED

NO RADIALS

NO REFLECTED  
POWER

BROADBAND

FIXED OR  
PORTABLE

REMOTE TUNING

2 KW PEP

UPS SHIPPABLE

# R3

R3 may be the perfect antenna for condominiums, apartments, small lots or any limited space situation. It is a great antenna for hams who are concerned about neat appearance and maximum performance.

R3's self supporting radiator is only 21ft-6.4m high x 1ft .304m wide at the base. Assembly is quick and easy for portable, marine, field day, DX-peditions, or fixed installations. It is complete with remote tuner.

AVAILABLE THROUGH  
DEALERS WORLDWIDE



**cushcraft**  
CORPORATION

THE ANTENNA COMPANY  
P.O. Box 4680  
Manchester, NH 03108 USA  
TELEX 953050

106

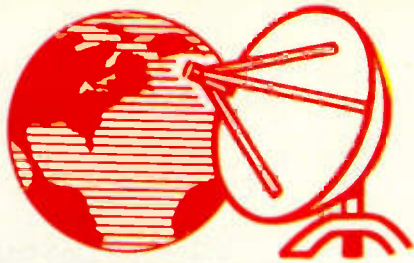

## SATELLITE TELEVISION SYSTEMS

**WE WILL NOT BE UNDERSOLD!!**

Complete Systems, Antennas,  
Receivers, LNA's & Accessories

**CALL US TODAY!** ✓320

**812-238-1456**

**hoosier  
electronics**

"Nation's Largest Total Communications Distributor"

P.O. BOX 3300 • TERRE HAUTE, INDIANA 47803

# BARKER & WILLIAMSON'S PORTABLE ANTENNA

MODEL  
370-10



Designed for  
APARTMENTS — MOTELS — VACATIONS  
Quick Simple Installation. Operates on 2, 6,  
10, 15, 20 and 40 meters. All coils supplied.  
Only 22-1/2 inches long. Weighs less than  
2 lbs. Supplied with 10 ft. RG 58 coax and  
counter poise. Whip extends to 57 inches.  
Handles up to 300 watts.

VSWR—1.1:1 when tuned

Write for more details and other B&W products



BARKER & WILLIAMSON, INC.  
10 CANAL STREET  
BRISTOL, PA. 19007  
215-788-5581



# Star View Systems™



## STAR VIEW MODEL 12K

- Complete System
- Easy to Install
- Reasonably Priced
- UPS Shippable  
Weight 125 Pounds
- More than 100  
Channels Accessible

### THE STAR VIEW 12K SYSTEM KIT CONTAINS:

- 12 Foot Antenna
- Azimuth Elevation Mount
- 24 Channel Receiver
- 120° Low Noise Amplifier
- Feed Horn
- Cables & Connectors
- No Modular Included

(May be ordered separately for \$79.95)

Available through your local Creig Star View dealer • Call or write for information •  
Dealership inquiries welcome • Price subject to change without notice.

**\$2595.00**

**H&R COMMUNICATIONS, INC.** Subsidiary of Craig Corp.  
Route 3, Box 103G  
Pocahontas, Arkansas 72455

Call 800-643-0102  
or 501-647-2291

## Alaska Microwave Labs

4335 E. 5TH STREET ANCHORAGE, ALASKA 99504  
(907) 338-0340 DEPT 73

### CHIP CAPACITORS

1.2, 2.2, 3.3, 4.7, 6.8, 10, 18, 22, 27, 47, 100, 120,  
180, 220, 270, 330, 390, 470, 560, 680, 820, 1K, 1.2K,  
1.8K, 3.9K, 8.2K, 10K, 100K \$ 60

### GaAs FETS

MGF1400 NF 2.0DB @ 4GHZ MAG 15DB \$19.00  
MGF1412 NF 0.8DB @ 4GHZ MAG 18DB \$85.00  
MCF1200 NF 1.00DB @ 1GHZ NF 2.2DB & MAG 14DB @  
4GHZ \$14.00

### COAX CONNECTORS

BNC CHASSIS MOUNT SQUARE FLANGE \$1.95  
BNC PLUG FOR RG-58 \$1.95  
SMA CHASSIS MOUNT SQUARE FLANGE \$6.10  
SMA CHASSIS MOUNT PLUG SQ. FLANGE \$8.50  
SMA CHASSIS MOUNT STRIP-LINE TAB \$6.75  
SMA PLUG FOR RG-58 \$6.75  
SMA PLUG FOR RG-174 \$6.75  
SMA PLUG FOR 141 SEMI RIGID \$3.98  
TYPE N CHASSIS MOUNT SQUARE FLANGE \$3.75  
TYPE N PLUG FOR RG-9/RG-8 \$3.75  
TYPE N DOUBLE MALE \$7.25  
TYPE N FOR 141 SEMI-RIGID \$15.00  
TYPE N CHASSIS MOUNT PLUG SQUARE FLANGE \$14.00

### SILVER PLATING KIT

Will plate Copper, Brass, Bronze, Nickel, Tin, Pewter,  
Gold, and most white metal alloys \$36.00

### VTO

V72T-1 2.7GHZ TO 3.2GHZ MIN POWER OUT 10 MW  
TUNING VOLTAGE 0 TO 20V Vcc -15 VDC @ 50 MA \$98.00  
V82T-1 SAME AS V72T-1 BUT FREQ.3.6GHZ TO 4.2GHZ \$98.00

### TEFLON CIRCUIT BOARD DBL SIDED 1 OZ

APPROX 3.25" x 5.0" 010 \$5.50  
APPROX 3.25" x 5.0" 0312 \$6.50  
APPROX 3.25" x 5.0" 0625 \$10.50

### FEED-THRU CAPACITORS

1000 PF SOLDER TYPE \$ 50  
470 PF SOLDER TYPE \$ 50

### LEADLESS CERAMIC CAPACITORS

1000 PF \$ 25  
NO WARRANTY ON SEMICONDUCTORS

OPEN AT 8 PM EST CLOSED 8PM PST  
ORDERS ARE POSTAGE PAID  
COD - VISA - MASTERCARD



# King of the Pulse Generators

*One-shot or a train, TTL or CMOS, this generator will fit the bill. It's just what your test bench always wanted.*

Ronald A. Miara WA3RJS  
8803 Entield Court, #22  
Laurel MD 20708

This handy pulse generator is built around two commonly available under-a-dollar ICs. Both pulse width and repetition rate are continuously variable over six decade ranges from one microsecond to one second. Normal and inverted pulse train outputs are available, and a one-shot feature allows the user

to output a single pulse by depressing a front-panel push-button switch. The outputs are TTL and 5-V-dc CMOS compatible.

To operate the generator, the desired repetition rate range is selected with switch S1. (Repetition rate is the time between the occurrence of each pulse and is equal to the reciprocal of the frequency of the pulse train.) The ranges that may be selected by S1 are: 1  $\mu$ s,

10  $\mu$ s, 100  $\mu$ s, 1 ms, 10 ms, and 100 ms. Variable resistor R1 is then used to tune the repetition rate between

one and ten times the range value selected by S1. For example, if S1 is set to 10  $\mu$ s and R1 is set to 1X (fully

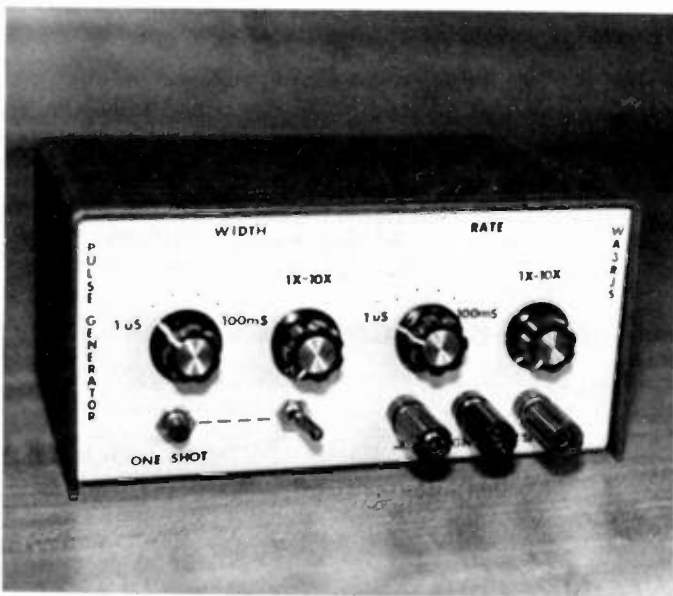

Pulse generator.

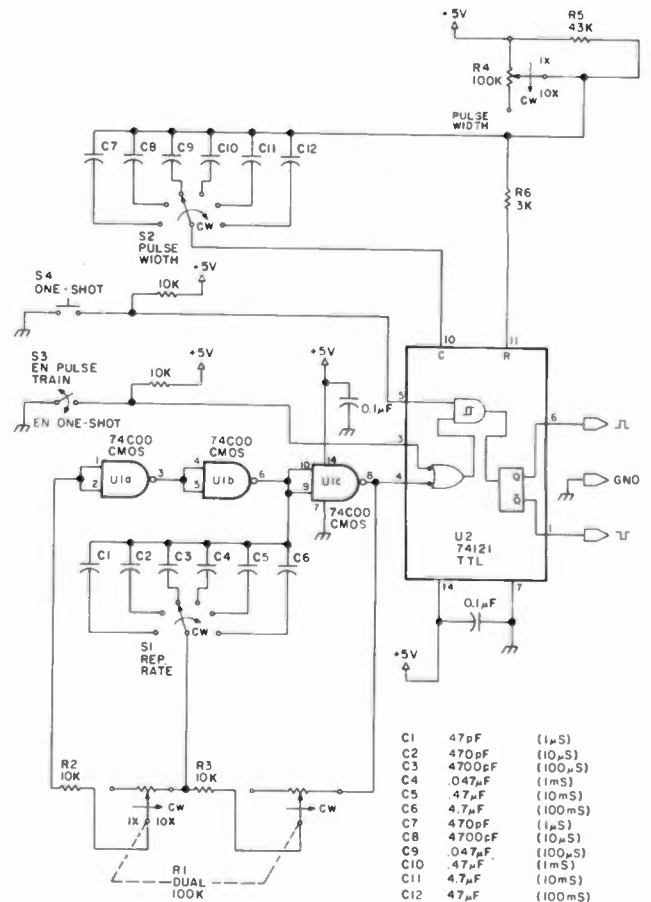

Fig. 1.

counterclockwise), a pulse will occur every 10  $\mu$ s. R1 may then be tuned up to ten times this value (10X, fully clockwise), in which case a pulse will be output every 100  $\mu$ s.

Pulse width is similarly set with S2 and R4. S2 selects the same range values as S1, and R4 is used to tune the pulse width from one to ten times the value selected by S1. Pulse widths with duty cycles up to 90% may be set up. (Duty cycle is defined as the ratio of time the pulse is on to the time of a complete cycle, times one hundred. An ordinary square wave would then have a 50% duty cycle since it is on half the time of a complete cycle.)

To use the pulse generator as a one-shot, switch S3 is closed, disabling the output pulse train. Push-button switch S4 is then depressed and released to output a single pulse from U2.

Refer to the schematic (Fig. 1) to understand how

the pulse generator works. Three NAND gates in U1 are configured with capacitors C1 through C6, variable resistor R1, and resistors R2 and R3 to form a square-wave oscillator. The frequency of this oscillator determines the repetition rate of the generator. The resistors were chosen to produce repetition rates in convenient decade ranges. The oscillator drives one-shot generator U2. Capacitors C7 through C12, variable resistor R4, and resistors R5 and R6 determine the width of the pulses output from U2. The values of these resistors and capacitors were also chosen to produce pulse widths in decade ranges. Since the oscillator driving U2 causes pulses to be output at a periodic rate, the output of U2 becomes the output of the pulse generator.

Construction of this unit is not critical. Short lead lengths and an all-metal en-

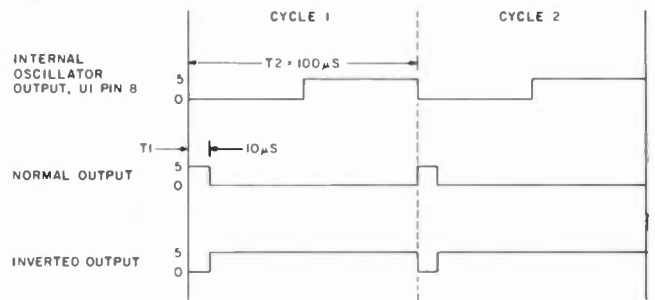

Fig. 2. Pulse generator timing diagram. This shows a pulse train which has a 10- $\mu$ s pulse width and a 100- $\mu$ s repetition rate. The duty cycle is equal to 10  $\mu$ s divided by 100  $\mu$ s times one hundred percent, which equals 10 percent.

closure should be used to ensure a clean and stable pulse-train output. U1 (74C00) should be CMOS, not TTL, to ensure that the oscillator will work. The accuracy of the pulse width and repetition rate depends on the tolerance of the resistors and capacitors used and how carefully the front-panel multiplier controls are labeled (from 1X to 10X). Since I normally use an oscilloscope to set up my pulse generator, I used sim-

ple front-panel labeling and rely on the scope for calibration of the pulse train. Simple front-panel labeling also keeps the cabinet size small since less space is required on the front panel. My unit is powered by four penlight batteries which drive a miniature three-terminal +5-V-dc regulator IC (LM309H).

The small size and low cost of this handy pulse generator should make it a nice addition to any ham's workbench. ■

## SATELLITES

Late September brought amateur satellite enthusiasts something to cheer about for a change. On the 20th, the University of Surrey amateur scientific satellite (UoSAT) was rescued from oblivion when ground controllers managed to turn its telemetry beacons off for the first time since April. By the time you read this, UoSAT may already be back in full operation.

The trouble with UoSAT (also known as UoSAT-OSCAR 9 or, more simply, UO-9) began when both the 2-meter and 70-cm beacons were accidentally commanded on at the same time. The effect was to desense both receivers aboard the bird, making it impossible for UoSAT to "hear" instructions from the ground. Even the massive 26-dB-gain 2-meter EME array of K1WHS proved insufficient to break through.

After an enormous expenditure of time and effort, the spell was finally broken on 70 cm when the UoSAT salvage team obtained the services of a little-used 150-foot dish antenna at SRI International in California. With a gain at 70 cm of 46 dB and an erp approaching 12 megawatts, the big dish did the trick, though not without practically being rebuilt by the UoSAT gang in the process.

Fortunately, UoSAT seems none the worse for the experience. The satellite, which does not carry communications transponders, continues to send a steady stream of scientific data earthward. In addition to telemetry beacons at 145.825 and 435 MHz, look for HF beacons at 7.05, 14.002, 21.002, and 28.510 MHz. An on-board TV camera may be activated as well.

Ever since the failure of the European Space Agency (ESA) Ariane rocket during its fifth flight (September 9), the date for the launch of AMSAT's Phase IIIB satellite has been anyone's guess.

The best bet is now sometime in mid-April, assuming no further problems arise.

Thanks to AMSAT *Satellite Report*.—Jeff DeTray WB8BTH, 73 Staff.

### Amateur Satellite Reference Orbits

Date	OSCAR 8		RS-5		RS-6		RS-7		RS-8		Date
	UTC	EQX	UTC	EQX	UTC	EQX	UTC	EQX	UTC	EQX	
Jan 1	0113	97	0041	38	0008	33	0108	46	0041	36	1
2	0118	98	0036	38	0152	61	0059	45	0038	37	2
3	0122	99	0030	38	0136	59	0049	44	0035	38	3
4	0127	101	0025	39	0121	56	0039	43	0032	39	4
5	0131	102	0020	39	0105	54	0030	42	0030	39	5
6	0135	103	0014	39	0050	52	0020	41	0027	40	6
7	0140	104	0009	39	0035	49	0010	40	0024	41	7
8	0001	79	0004	39	0019	47	0001	39	0021	42	8
9	0006	80	0158	69	0004	45	0150	68	0018	43	9
10	0010	82	0153	70	0147	72	0141	67	0016	44	10
11	0014	83	0147	70	0132	70	0131	67	0013	44	11
12	0019	84	0142	70	0116	67	0121	66	0010	45	12
13	0023	85	0137	70	0101	65	0112	65	0007	46	13
14	0028	86	0131	70	0046	63	0102	64	0004	47	14
15	0032	87	0126	71	0030	60	0053	63	0001	48	15
16	0036	88	0121	71	0015	58	0043	62	0158	79	16
17	0041	90	0115	71	0158	86	0033	61	0156	79	17
18	0045	91	0110	71	0143	83	0024	60	0153	80	18
19	0050	92	0105	71	0127	81	0014	59	0150	81	19
20	0054	93	0059	72	0112	79	0004	59	0147	82	20
21	0059	94	0054	72	0056	76	0154	88	0144	83	21
22	0103	95	0049	72	0041	74	0144	87	0142	84	22
23	0107	96	0043	72	0026	72	0135	86	0139	84	23
24	0112	98	0038	72	0010	69	0125	85	0136	85	24
25	0116	99	0033	72	0154	97	0115	84	0133	86	25
26	0121	100	0027	73	0138	94	0106	83	0130	87	26
27	0125	101	0022	73	0123	92	0056	82	0127	88	27
28	0129	102	0017	73	0107	90	0046	81	0125	88	28
29	0134	103	0011	73	0052	87	0037	81	0122	89	29
30	0138	104	0006	73	0037	85	0027	80	0119	90	30
31	0143	105	0001	74	0021	83	0017	79	0116	91	31
Feb 1	0004	81	0155	104	0006	80	0008	78	0113	92	1
2	0008	82	0149	104	0149	108	0157	107	0111	93	2
3	0013	83	0144	104	0134	106	0148	106	0108	93	3
4	0017	84	0139	104	0118	103	0138	105	0105	94	4
5	0022	85	0133	105	0103	101	0128	104	0102	95	5
6	0026	86	0128	105	0048	99	0119	103	0059	96	6
7	0030	88	0123	105	0032	96	0109	102	0056	97	7
8	0035	89	0117	105	0017	94	0059	102	0054	98	8
9	0039	90	0112	105	0001	92	0050	101	0051	98	9
10	0044	91	0107	106	0145	119	0040	100	0048	99	10
11	0048	92	0101	106	0129	117	0030	99	0045	100	11
12	0052	93	0056	106	0114	114	0021	98	0042	101	12
13	0057	94	0051	106	0059	112	0011	97	0040	102	13
14	0101	96	0045	106	0043	110	0002	96	0037	102	14

# CONTESTS

Robert Baker WB2GFE  
15 Windsor Dr.  
Atco NJ 08004

## WORLD COMMUNICATION YEAR

Starts: 0001 GMT January 15  
Ends: 2400 GMT January 15

On November 19, 1981, the United Nations General Assembly adopted a resolution proclaiming 1983 a "World Communication Year: Development of Communications Infrastructures." The basic objectives of the WCY are: (1) to provide the opportunity for all countries to undertake an in-depth review and analysis of their policies on communications development, and (2) to stimulate the accelerated development of communications infrastructures. The Potomac Valley Radio Club is sponsoring this contest in support of the World Communication Year.

All licensed radio amateurs worldwide are eligible to participate. There will be two categories: single operator and multi-operator. Both categories are mixed-mode. Only stations using one transmitter are eligible for an award. The same station may be worked once on each band. Telephony (including SSTV) and Telegraphy (including RTTY) emissions count as separate bands. No cross-emission contacts are allowed. The main objective is to contact as many other amateurs as possible, anywhere in the world, using 1.8 MHz to 275 GHz, excluding the 10-, 18-, and 24-MHz bands.

### EXCHANGE:

All stations will send their ITU region and their ITU zone. For example, the following stations would send the listed exchanges: DL1AA, 128; W1AAA, 208; and JA1AAA, 345.

### SCORING:

QSO points are 4 points per QSO outside your ITU region, 2 points if inside your

## ZERO-DISTRICT QSO PARTY

Starts: 2000 GMT January 8  
Ends: 0200 GMT January 10

Organized by the Mississippi Valley Radio Club. Stations outside of zero district will work zero stations only, zeros may work any station. The same station may be worked once on each band and each mode. However, mobile stations may be worked each time they change counties.

### EXCHANGE:

RS(T) and ARRL section. Zero-district stations also must send county.

### FREQUENCIES:

3560, 7060, 14060, 21060, 28060, 3900, 7270, 14300, 21370, 28570, 3725, 7125, 21125, and 28125.

### SCORING:

Multiply the number of zero-district counties by the number of contacts. Zeros score by adding ARRL sections, zero-district counties, and DXCC countries worked and then multiplying by total contacts.

### ENTRIES & AWARDS:

Certificates will be issued to all entrants who submit a log and an SASE. Endorsements will be given for the high score in each ARRL section, DX country, and Novice/Technician Class. Mail logs by February 15th to: W8SI, 3528 W. Columbia, Davenport IA 52804. Include an SASE for log forms or results.

# The RARA RAG

## NEWSLETTER OF THE MONTH

Beauty is not just skin deep. At least, not in the winner of this month's newsletter contest, *The Rara Rag*, published by the Rochester Amateur Radio Association.

The thoroughly professional look of *The Rag* includes typeset and printed text, with even margins on both sides, headlines, cutoff lines, and clean graphics. It is all printed in booklet format on heavy paper.

But the beauty doesn't stop there. *The Rag's* contents go way beyond the usual list of upcoming events, meeting dates, and president's message. One extra feature of the newsletter is "Cop's Corner," which keeps members posted on local street construction and emergency service.

For history buffs, there is "*The Rara Rag* 20 Years Ago," and to bring the reader up to date, the editors have included news shorts from the *W5YI Report* and other news services. Other features include news of the club's various special interest groups, a fitting forum for what appears to be an exceptionally active club.

Congratulations to Editor Ronald Jakubowski K2RJ and his staff for putting together a club newsletter that reads as good as it looks.

To enter your club's newsletter in our contest, send a copy to: Editorial Offices, 73, Peterborough NH 03458.

ITU region but outside your zone, and 1 point if inside your ITU zone. The multiplier is the number of ITU zones worked on each band. For final score, multiply the total QSO points for all bands by the total zones worked for all bands.

### AWARDS:

A plaque will be awarded to the high-scoring station of each category (single- and multi-operator) in each of the three ITU regions. A certificate will be awarded to the high-scoring entrant of each category in each ITU zone. In addition, a certificate will be awarded to one UHF/microwave station of each ITU zone judged to have displayed the most outstanding achievement. Members of PVRC may not receive awards.

### ENTRIES:

All entrants are to use a suitable log form and summary sheet of their choice. Logs should include times in GMT, bands, calls, complete exchange, and QSO points for each QSO. Multipliers should be clearly marked in each log. Cross-check sheets (dupe sheets) are required if more than 200 QSOs are made on any band.

Summary sheets should be a single page and show number of QSOs, QSO points, zone multiplier for each band, and the total score. The summary sheet must contain the entrant's call sign, region, zone, name, and address. Multi-operator stations must list the name and call (if any) of each operator. Entries for the special UHF/microwave award should be indicated on the front of the summary sheet with a description of the basis of the UHF/microwave award written on the back of the summary sheet.

Entries must be postmarked by Febru-

ary 28th and mailed to: PVRC, PO Box 337, Crownsville MD 21032.

Each entrant agrees to be bound by the provisions of the rules, by the regulations of his licensing authority, and by the decisions of the Amateur Radio Activity Awards Committee. An entry may be disqualified if the overall score is reduced by more than two percent. An entry will be disqualified if more than two percent of duplicates are left in the log. A penalty of 8 QSO points will be assessed for each duplicate QSO or for each miscopied call sign or exchange found by the awards committee.

## HUNTING LIONS IN THE AIR CONTEST

Starts: 1200 GMT January 15  
Ends: 1200 GMT January 16

The contest is sponsored by Lions Club International and coordinated by Lions Club Rio de Janeiro Arpoador, Brazil. Participation in the contest is open to all duly licensed radio operators, Lion and non-Lion. There are two modes: phone and CW. Participation in both modes is allowed but points are counted separately. All amateur stations participating must operate within their licensing regulation. Separate categories will exist for single operators and radio clubs/societies. Multi-operators may participate, but each prefix must be listed on the log.

Use all bands, 80 through 10 meters. Only one QSO with the same station on each band may be counted. Remember that phone and CW are counted separately!

### EXCHANGE:

RS(T) and sequential QSO number. When a contact is made with any Lion,

# CALENDAR

Jan 1	ARRL Straight Key Night
Jan 8	73 40-Meter Worldwide SSB Championship
Jan 8-9	ARRL QSO Party—CW
Jan 8-10	Zero-District QSO Party
Jan 9	73 80-Meter Worldwide SSB Championship
Jan 9-10	ARRL QSO Party—Phone
Jan 15	World Communication Year Amateur Radio Activity
Jan 15-16	73 160-Meter Worldwide SSB Championship
Jan 15-16	Hunting Lions in the Air Contest
Jan 15-16	QRP CW Contest
Jan 15-16	ARRL VHF Sweepstakes
Jan 22-23	Texas QSO Party
Jan 22-23	North Dakota QSO Party
Jan 29-Feb 6	ARRL Novice Roundup
Feb 5-6	New Hampshire QSO Party
Feb 5-6	South Carolina QSO Party
Feb 19-20	YL ISSB QSO Party—Phone
Feb 19-20	ARRL International DX Contest—CW
Feb 26	RTTY World Championship Contest
Mar 5-6	ARRL International DX Contest—Phone
Mar 12-13	YL ISSB QSO Party—CW
Apr 9-10	CARF Commonwealth Phone Contest
Apr 9-10	ARRL QSO Party—CW
Apr 16-17	ARRL QSO Party—Phone
Jun 11-12	ARRL VHF QSO Party
Jun 25-26	ARRL Field Day
Jul 9-10	IARU Radiosport Championship

## VOLUNTEERS NEEDED

How would you like to be on the "inside" of a major amateur-radio contest? Here's your chance!

We're looking for volunteers to become members of the 73 Contest Committee. Anyone with an interest in contesting and a willingness to work hard is welcome. Committee members will help with the following:

1. Contest rules and ethics
2. Forms and correspondence
3. Log checking and scoring
4. Filling out and mailing awards

Heading up the contest committee is KE7C. Please drop him a note (with SASE) and let him know you can help. Write to Bill Gosney KE7C, 73 Contest Committee, 2665 North Busby Road, Oak Harbor WA 98277.

We want YOU on the 73 Contest Team!

Leo, or Lioness, the name of the club contacted should be clearly identified.

**SCORING:**

QSOs within the same continent count 1 point while those between different continents count 3 points. Score 1 extra bonus point for each QSO with a member of a Lions Club, Leo Club, or Lioness Club and 5 points for a QSO with a member of the Lions Club Rio de Janeiro Arpoador. Contacts between Brazilian stations will count only 2 extra points. Contacts between members of the Arpoador club will not count any bonus points.

**AWARDS:**

For single-operator entries the Lions Club International will present trophies for first, second, and third place on both modes. Fourth through tenth places will receive plaques. A trophy will be presented to the first-place radio club/society on both modes. In addition, each log sent by participants with a minimum of 5 contacts will receive a special certificate. The contest committee will also select and award the most active Lions Club participating in the contest.

**ENTRIES:**

Keep a separate log for each mode. Each participant will note in the logs the callsign and information exchanged. Confirmation of contacts will be made by comparing the logs of the participants. Participants should send their logs by air mail not later than 30 days after the contest to: Contest Committee, Hunting Lions In the Air, Lions Club of Rio de Janeiro Arpoador, Rua Souza Lima #149, Apt. 402, 22081 Rio de Janeiro, RJ, Brazil.

**MICHIGAN QRP CLUB  
CW CONTEST**

**Starts: 1500 GMT January 15  
Ends: 1500 GMT January 16**

This is a CW-only, all-bands (160-10-meter) QRP contest sponsored by the Michigan QRP Club. The contest is open to all amateurs and all are eligible for awards. General call will be "CQ QRP DE..." Each station will be competing within their own state, province, or country in one of three categories: 1) one Watt or less of output power, 2) five Watts or less of output power, and 3) over five Watts of output power.

**EXCHANGE:**

RST, QSO number, and power output.

**SCORING:**

Each contact is worth one QSO point. Multiply total QSO points (all bands) by the number of states, provinces, and countries worked per band for total points. If using emergency power (100% natural and 100% battery) then apply a 1.5 bonus multiplier.

**AWARDS:**

Certificates will be awarded to the highest-scoring stations in each state, province, or country.

**ENTRIES:**

Log information must include: full log data with a separate log for each band, name, address, equipment used, and power output. Logs must be received by the contest manager no later than six weeks after the end of the contest. WIVE stations please send an SASE, all others please send 2 IRCs if contest results are desired. Address all entries to: Contest Manager, Michigan QRP Club, 281 Crescent Drive, Portland MI 48875.

**THE NORTH DAKOTA  
QSO PARTY**

**0000 to 0800 and 1600 to 2400  
GMT January 22,  
0800 to 1600 GMT January 23**

Sponsored again by the Red River Radio Amateurs of Fargo, North Dakota. Work stations once per band and mode.

**EXCHANGE:**

RS(T) and state, province, country, or North Dakota county. Novices, please indicate Novice status.

**FREQUENCIES:**

Phone—1835, 3905, 7280, 14295, 21380, 28580.  
CW—1810, 3540, 7035, 14035, 21035, 28035.  
Novice—3725, 7125, 21125, 28125.

**SCORING:**

Phone contacts count 10 points, CW 20 points, and RTTY 50 points. North Dakota stations count an additional 100-point bonus for working five Novices. North Dakota stations multiply score by total of states, provinces, and countries worked (max 53).

**ENTRIES & AWARDS:**

Certificates to state, province, and country winners. Plaque to North Dakota winner and highest scorer outside North Dakota. Mail logs by February 28th to: Bill Snyder W0LHS, Box 2784, Fargo ND 58108-2784. Include a large SASE for results.

**TEXAS QSO PARTY**

**Starts: 0000 GMT January 22  
Ends: 2400 GMT January 23**

Sponsored by the West Texas Amateur Radio Club of Odessa, Texas. Use all bands and modes. Each station may be worked again upon each county change. Single-operator entries only. CW QSOs must be in CW subbands only.

**EXCHANGE:**

QSO number (beginning with 001) and state, province, country, or Texas county.

**FREQUENCIES:**

Novice—3710, 7110, 21110, 28110.  
Phone—3940, 7260, 14280, 21370, 28600.  
CW—3565, 7065, 14065, 21065, 28065.

**SCORING:**

All non-Texas stations score points as follows: Phone contact with fixed station in Texas—1 point. CW contact with fixed station in Texas—2 points. Phone contact with mobile station in Texas—5 points. CW contact with mobile station in Texas—7 points. Multiply by the number of Texas counties worked (254 max).

All Texas stations score 1 point per contact on phone, 2 points on CW regardless whether fixed or mobile. Multiply by the number of states, countries, and Canadian provinces worked.

**AWARDS:**

Plaques to top scores: US, US Novice, DX, Canada, Texas fixed, Texas mobile, Texas Novice. Certificates to top score in each state, country, and province. Certificates also to top 10 Texas stations. Special awards as activity dictates.

**ENTRIES:**

All logs must be received by March 15th. Mail entries to: WTARC, PO Box 9944, Odessa TX 79762-0041.

# RESULTS

**THE 1ST ANNUAL 40/80 PHONE CONTEST  
—A TREMENDOUS SUCCESS—**

"Truly unbelievable, it was fantastic, like catchin' fish in a barrel..." Those were the words and phrases echoed by nearly every contestant in 73's First Annual 40- and 80-Meter Phone Contest. There is little doubt that this event will remain on the contest calendar for many years to come. We are grateful to those who made it all happen!

After the dust had finally settled, VE5DX became the World 40-Meter Phone Champion for single-operator stations. Congratulations to you Jim, a superb performance. I4YNO and company firmly took the World 40-Meter Championship for the multi-operator category. Fantastic job, fellas!

On 80 Meters, I3MAU is the World Single-Operator Phone Champion, and the group at N9NC tied down the winning score to take the world multi-operator title. Fabulous scores for such a difficult band.

Combining both the 40- and 80-meter contest scores, CN8CO became the 1982 Low-Band Champion for single operators while VE2ZP and crew took top honors in the multi-operator category. Take a look at the scoring summary, to see an impressive job by two top-notch stations.

Who made the most contacts, you ask? Among 40-meter single ops, VE5DX made 972 QSOs, followed by KK9A (856) and W9RE (851). In the 40-meter multi-op standings, N9NB was credited with 1098 QSOs, followed by a distant second, KD4TQ, with a demanding 972 contact total. On 80 meters, considering band conditions, the competition was just as fierce. N7DF from Utah tallied 700 QSOs for the single-operator category, while VE5XK accumulated 672 contacts on the band. In the 80-meter multi-operator class, N9NC and crew mustered 793 contacts with VE2ZP (597) and W4CN (564) trailing.

Looking at the combined contest scores for both bands, N7DF turned in 1188 QSOs with 931 QSOs registered by second-place finisher KC4QV in the single-operator category. For multi-ops, VE2ZP recorded 1271 QSOs followed by N4BAA of Florida with 1066 contacts.

Was the band open? Well on 40-meters the following stations turned in 30 or more DX country multipliers: I4YNO (59), I5MPK (44), YV5ANE (44), W9RE (41), N3AMK (40), VE5DX (39), VE2ZP (38), CN8CO (38), JA2BAY (35), LX1JX (35), N4BAA (33), N9NB (31), and KJ9D (31). As expected, the 80-meter DX totals were somewhat less with the following stations scoring 20 or more DX multipliers: I3MAU (58), CN8CO (53), KQ2M (39), DA1RE (34), WB2DHY (30), I5MPK (29), N4BAA (28), K8CS (28), DF9ZP (27), ZF2DX (27), N7DF (24), JA1ELY (22), AK1A (22), and OK1KZ (22).

One of the most interesting aspects of tallying any contest is the opportunity to summarize the equipment used by competing stations. Every year brings new surprises.

Which antenna dominated on which band? Naturally the wire (economy version) array led the pack. Look at the statistics:

40-Meter Antennas		80-Meter Antennas	
Dipole/inverted vees	39.8%	Delta loop	11.1%
Monoband vertical	11.6%	1/4-wave sloper	11.1%
Delta loop	9.3%	Full-wave vertical	8.3%
Trap vertical	9.3%	Trap vertical	8.3%
2-element yagi	7.0%	Phased verticals	5.5%
1/4-wave sloper	4.6%	3-element wire yagi	5.5%
2-element delta loop	4.6%	Inverted-L	2.7%
2-element wire beam, bobtail curtains, 2-element quads, 3-element yagls, and phased verticals	2.3% each	2-element delta loop	2.7%

Of all the stations that turned in entries, 28% declared that they were running completely "barefoot!" while 2% stated that they were running 500 Watts, 15% were running a kilowatt, and a dramatic 55% were radiating two kilos! What were they using as exciters? 39.7% of the contestants claimed to be running Kenwoods, 21.3% were running Yaesu gear, 22.4% were operating Drake equipment, 6.5% were Collins, while the remaining 10.1% were divided amongst Ten-Tec, Icom, Heathkit, Tempo, and yes, even home-brew equipment.

So what does all this add up to? ... a debut not to be forgotten, an event full of surprises which left a lasting impression on all who witnessed this two-day extravaganza.

This brings us to the second annual event which is just around the corner. Look for the 40- and 80-meter contest announcement in last month's issue of 73. This year the event is being split into two separate parts. The World 40-Meter Phone Championship will be held on January 8, while the World 80-Meter Phone Championship event is scheduled for the following day, January 9, 1983. Each promises to become a record breaker in its own right. For all the details, send your SASE directly to the official contest address, attention Billy Maddox, 468 Century Vista Drive, Arnold MD 21012.

So start pruning your antennas. I intend to work each one of you on both bands so mark the dates on your calendar. Get on the band right now and begin telling other amateurs about the contest, especially the DX stations. Pitch in and pass the word! Good luck in the contest.

*Continued*

### 40/80-METER CONTEST SOAPBOX

"Glad to take part, even if it was just a little bit. Really enjoyed it!"—N1BMV.  
 "Lots of fun. Am going to try 80 meters next year."—KA1CDC.  
 "Super contest. . . I know I'll be back next year!"—WA1ZAM.  
 "Too many carriers and foreign broadcasts on 40!"—KA2HTH.  
 "My first contest ever. Really enjoyed it and am looking forward to next year."—WB2IWI.  
 "The gang here had a blast."—KF2X.  
 "Fine contest but I suggest limiting the action to the general portion of the band."—N3AWS.  
 "Would have liked to have participated more. Look for me again next year."—W3ICM.  
 "You've got another winner!"—K3IXD.  
 "Great contest—lots of great contacts were made on the 40 this weekend."—KF3M.  
 "Hope to get a vfo and increase my multiplier total. Sure enjoyed the contest."—K3CN.  
 "Enjoyed the contest and, once and for all, recognized the District of Columbia as a separate multiplier!"—W3USS.  
 "Good propagation at times. Fantastic turnout. Should be a classic event."—N4BAA.  
 "Great contest with lots of potential as the years go by."—N4UH.  
 "Had a very good time and worked some new states."—N5AFV.  
 "TNX for sponsoring this enjoyable contest. Had a great time on 40."—N5CPO.  
 "Whoeee, quite an event!"—K5NQ.  
 "Learned a lot about my station. Looking forward to next year."—WB5YWO.  
 "Better to have the 40-meter test on CW rather than SSB."—N6JM.  
 "A very good contest. Not much heard during the daytime."—W6YMH.  
 "Thanks for staging this contest, I enjoyed it immensely. Hope to be back next year to improve the score."—KA7AKQ.  
 "Where were the VEs? Great stateside turnout!"—N7DF.  
 "Where were the JAs?"—KB7G.  
 "Let's do it again next year!"—AK7J.  
 "Great contest and I'll be back next year!"—K7PGL.  
 "Fine contest idea, thanks to 73. Lots of activity on the bands. Wish there was more DX on 40."—N8ATR.  
 "Damn fun despite the tremendous big guns. I'll give it a shot again next year."—KC8G.  
 "Very successful debut. Good time of year too! See you next year for sure!"—W8VEN.  
 "I seem to have scored very well. Lots of good contacts to be had."—KK9A.  
 "Everyone involved has my congratulations. I wish all contests were this much fun."—KJ9D.  
 "Surprised at the number of stations on the 40-meter band. Broadcast stations really got fierce! Will try 80-meters next year."—K9FMR.  
 "Bands were in great shape. Had a great time."—KB9TI.  
 "Activity and band conditions were excellent. Korea on 15 was a new one for me!"—K0CS.  
 "Great contest. Nice to work a contest that doesn't take up all weekend. Family-man special!"—WA0IDK.  
 "Excellent contest. Definitely will be back next year."—K0UK.  
 "WB4OXZ and I found it rough going on 80. Worth every minute of it though. Had a ball."—C6ADV.  
 "Definitely should become one of the biggies! Unbelievable participation for a first time event!"—CN8CO.  
 "Fun contest. I'll tell more Europeans about it."—DL8UI.  
 "I know why CW is beautiful now—very hard on phone with 50 Watts. There's always next year."—G3WKS.  
 "My first touch of 40- and 80-meter contesting and I loved it."—H44SH.  
 "Marvelous contest though conditions weren't the best for me. Am looking forward to next year."—H8GB.  
 "Nice contest indeed. We hope to do better next year."—I4YNO.  
 "Very good contest. Not much activity in JA-land on contest."—JA1FFY.  
 "Lots of activity on 40-meters but not many Europeans. See you again next year."—LA5YF.  
 "Good propagation but no Europeans in the contest. Maybe next year it will get more attention."—LX1JX.  
 "Very good idea to establish this contest. Hope more Europeans hear about it! See you next year."—OK2BLG.  
 "Thanks for the contest, a very good idea. Enjoyed 80 meters."—OX3ZM.  
 "Didn't work a single North American station."—PA3AZM.  
 "Nice contest with good propagation. Wish W/VEs would listen below 3.800 MHz. Very strong in Europe!"—SM4CAN.  
 "Great contest and is sure to grow as it gets more publicity."—VE1AJJ.  
 "Thoroughly enjoyed the contest. Very well conceived, very well attended—a definite winner!"—VE2ZP.  
 "Appreciate the contests. 80 was very difficult with 20+ static. USA stations forget we can only work 3.5-3.7 on phone."—VK5BW.  
 "Very little activity in Romania. Maybe advertisements will help."—YO4BXX.

### W/VE 40-METER SINGLE OPERATOR

Callsgn	QTH	QSOs	QSO Pts.	St/Pr.	DX	Total	KJ7R(-)	ID	161	183	40	11	9333
VE5DX(W)	SASK	972	1192	56	39	113240	VE1AJJ*	NB	143	179	42	10	9308
W9RE*	IN	851	1084	56	41	105148	KR8X	OH	262	262	35		9170
N3AMK*	PA	771	1042	55	40	99180	AK3J	PA	144	208	38	5	8944
KK9A(-)	IL	856	1093	57	25	87440	W2FTY(-)	NY	114	162	36	13	7938
KA1XN*	MA	761	802	56	23	63358	N8TN	OH	200	233	32	3	7922
WB8JBM*	OH	759	823	56	19	61725	WA4LRO	TN	123	133	38	11	6517
KC4OV*	TN	600	736	67	14	59616	K5UCV	TX	127	164	35	3	6232
KC5NQ*	TX	663	730	55	18	53290	W8DN	OH	112	139	41	2	5977
KC3N(-)	PA	674	872	53	3	48832	N9AML(-)	IN	107	161	37		5957
N8AKY(-)	MI	441	598	53	21	44252	KB7G(-)	WA	120	136	37	6	5848
KF3M	PA	675	829	48	5	43937	KD4WY(-)	NC	140	157	33		5181
WA0IDK*	MN	539	639	51	13	40896	W3ARK	PA	206	206	24		4944
N7DF*	UT	488	547	51	11	38290	WB5YWO(-)	OK	121	130	35	3	4940
KA1CDC(-)	MA	516	661	48	4	34372	WD8MOV	OH	53	111	24	20	4884
KC8JH(-)	OH	400	460	52	20	33120	K1NCD(-)	CT	106	165	29		4785
N8ATR	OH	477	637	45	6	32487	W3ETB	PA	125	167	25	3	4676
VE2RV*	QU	305	397	55	25	31760	WA3JXW	PA	136	136	34		4624
KL7HHX(-)	AK	289	570	40	14	30780	K17M(-)	OR	89	107	30	13	4601
K3MRG	PA	380	551	53		29203	WB9OBX(-)	WI	157	157	29		4553
K4HAV(-)	GA	434	535	45	9	28890	WA2HCC(-)	NJ	110	156	25	3	4368
WD4IBO	GA	484	570	47	2	27360	N5CPO	TX	94	118	37		4366
K9MWM(-)	CO	468	495	50	5	27225	N5CMF	TX	81	97	43		4171
W1MX(KA1R)	MA	370	444	46	15	27084	N5AFV	OK	102	119	35		4165
K5ZD(-)	TX	353	372	52	10	23064	KF1B	CT	77	98	29	13	4116
WB0JFL(-)	IA	286	397	46	10	22052	N4DEF	GA	108	127	29	3	4064
W3BGN	PA	259	430	42	8	21500	K4FPF	VA	82	111	31	4	3885
WA8YTM(-)	WV	423	483	34	7	19703	N3AWS	PA	93	123	29		3567
NF4F(-)	TN	348	357	45	5	17850	W8VEN	WV	96	98	34	1	3430
K7PGL(-)	MT	284	297	42	13	16335	KJ2N	NJ	63	92	20	16	3312
KA4RKD(-)	AL	278	335	44	4	16080	K3ND	PA	89	99	32	6	3267
K3IXD(-)	MD	220	259	45	3	15022	W5GVP	TX	80	94	30	4	3196
WB2THN*	NY	263	266	48	6	14364	W3AP	PA	73	100	27	4	3100
NR4S	TN	218	349	38	3	14309	W6YMH*	CA	72	81	28	9	2997
WA2HFIO	IL	250	269	45	4	13181	K1VUT	MA	94	98	26	4	2940
WA0TKJ(-)	KS	135	198	35	28	12474	N0CZO(-)	ND	81	95	29		2755
KA9CTM	IL	196	240	46	1	11280	W4KMS	VA	87	87	29		2523
AA4FF(-)	VA	161	189	40	19	11151	KJ9R	IL	84	84	30		2520
W8ANM	OH	196	259	37	4	10619	WB8YEW	OH	78	78	32		2496
N4ARO	TN	213	243	39	3	10026	KC7EH	OR	52	68	24	12	2312
WB9UZR	IL	174	290	32	2	9860	K8CV	MI	56	63	29	7	2268
W5PWG	TX	154	184	43	9	9568	KC8P	MI	66	66	32		2112
							KC8GN	OH	66	67	30		2010
							K8JOS	OH	64	80	25		2000



WA2IFS	NJ	35	59	9	17	1534
NL7D	AK	34	67	20	1	1407
KB0C(-)	MN	51	52	24	1	1300
KA7AKQ	WA	48	49	24	1	1225
K3ZJ(-)	DC	70	70	16		1120
N1ADX	MA	46	91	10		910
WD8OYF	OH	53	53	16		848
WD8MRF	OH	49	82	15		735
WA0WWW	MN	32	32	32		704
W3YA	PA	44	44	15		660
W7ABX(-)	NV	26	30	14	4	540
KB9IT	IL	39	39	11		429
N6JM	CA	19	20	15	1	320
AK7F	WA	10	10	8		80
N2DCH	NY	9	9	7		56

\* District champion  
 (-) State/provincial champion  
 (W) Contest winner

**W/VE 40-METER MULTI-OPERATOR**

Callsign	QTH	QSOs	QSO Pts.	St/Pr.	DX	Total
N9NB(W)	IN	1098	1329	54	31	112965
KD4TQ*	KY	972	1208	55	24	95432
VE2ZP*	QUE	704	909	57	38	86355
KJ9D*	IN	681	927	53	31	77868
N4BAA(-)	FL	645	772	53	33	66392
KF2X*	NY	565	774	48	27	58050
N4FKF	KY	303				16069
KA2HTH(-)	NY	267	422	28		11816
W3YA*	PA	44	44	15		660

\* District champion  
 (-) State/provincial champion  
 (W) Contest winner

**DX 40-METER SINGLE OPERATOR**

Callsign	QTH	QSOs	QSO Pts.	St/Pr.	DX	Total
YV5ANE(W)	Venezuela	359	732	46	44	65880
CN8CO*	Morocco	361	744	44	38	61008
H44SH*	Solomon Is.	291	581	45	20	37765
LA5YF*	Norway	221	513	37	26	32319
JA2BAY*	Japan	205	390	38	35	28470
HI4AGE*	Dom. Rep.	209	417	45	17	24603
CT4KO*	Portugal	169	350	33	20	18550
YV3BQS	Venezuela	155	312	32	23	17160
VK5BW*	Australia	157	306	21	22	13158
LX1JX*	Luxembourg	119	246	1	35	8856
DL8UI*	West Germany	72	139	19	16	4865
JA1ELY	Japan	68	130	22	15	4810
SM4CAN*	Sweden	23	46	15		690
OK1AGN*	Czechoslovakia	17	50	1	12	650
I4CSP*	Italy	21	38	1	12	494
G3WKS*	England	14	44	6	6	264
YO9CUF/3*	Romania	18	23	10	230	
G5EBA	England	11	22	9	198	
JA1FFY	Japan	9	17	3	5	136
PA3AZM*	Netherlands	9	18	6	108	
YO4BXX	Romania	10	20	5	100	
YO3KWJ	Romania	3	6	3	18	

(W) Contest winner  
 \* DX country champion

**DX 40-METER MULTI-OPERATOR**

Callsign	QTH	QSOs	QSO Pts.	St/Pr.	DX	Total
I4YNO (W)	Italy	672	1400	33	59	128800
I5MPK*	Italy	590	1206	44	45	107334

(W) Contest winner  
 \* DX country champion

**W/VE 80-METER SINGLE OPERATOR**

Callsign	QTH	QSOs	QSO Pts.	St/Pr.	DX	Total
KQ2M(W)	NY	510	666	52	39	60606
N7DF*	UT	700	739	54	24	57642
K0CS*	MO	552	635	53	28	51435
WB2DHY*	NY	346	545	48	30	42510
VE5XK*	SASK	672	681	54	8	42222
K2SWP(-)	NY	492	530	50	15	34450
KB9MW*	IL	530	570	52	7	33630
N8ATR*	OH	311	326	47	11	32487
NA6T*	CA	373	454	51	19	31850
N8AKY(-)	MI	439	453	50	11	27633
K0UK(-)	CO	407	417	49	7	23352
KC4OV*	TN	331	342	46	10	19152

KC8JH(-)	OH	335	342	46	7	18126
WA1ZAM*	MA	363	367	45	4	17983
KB3ND*	PA	294	305	45	10	16775
KI7M(-)	OR	232	271	53	6	15989
N4ARO(-)	TN	254	259	49	4	13727
AK1A(-)	NH	168	206	41	22	12978
W6TPH(-)	CA	228	240	41	12	12720
KD4XR(-)	AL	244	248	41	3	10912
W4PZV(-)	FL	141	161	46	18	10304
VE1AJJ*	NB	149	178	40	17	10146
W3BGN(-)	PA	152	198	30	19	9702
KA1R(-)	MA	202	209	30	7	7733
KC5LK*	MS	159	161	45	2	7567
WA1TCA(-)	CT	149	154	40	5	6930
W3AP	PA	144	160	38	3	6560
N0ZA	CO	112	125	41	11	6500
WA21FS(-)	NJ	128	133	42	5	6251
KB8WB	OH	119	126	42	7	6174
KK8L	OH	150	150	36		5400
WB2TKB	NY	126	131	36	4	5240
N8TN	OH	153	153	33		5049
W5PWG(-)	TX	114	119	39	3	4998
WA0WWW	MN	118	118	38		4484
KF1B	CT	94	102	35	8	4386
WD8MRF	OH	90	95	37	3	3800
N1SR	MA	90	99	33	5	3762
KR8X	OH	133	133	28		3724
WB8YEW	OH	94	96	37		3552
W8VEN(-)	WV	97	97	34		3298
W8ANM	OH	88	88	36		3168
KJ2N	NJ	87	99	31	6	3069
N1BMV	CT	100	100	27		2700
W1GOM(-)	OK	71	74	32	3	2590
K3ND	PA	71	78	29	5	2516
W4KMS(-)	VA	76	76	31		2356
W3ETB	PA	82	86	25	1	2336
K3ZJ(-)	DC	94	95	22	1	2185
VE1QO*	QUE	74	79	22	5	2133
WD8MOV	OH	55	59	29	2	1829
KB7M(-)	WY	55	55	30		1650
WB2IWI	NY	72	72	20		1440
W2FTY	NY	47	48	27	1	1344
K1NCD	CT	58	58	22		1276
AK7F(-)	WA	43	45	26	2	1250
WB9OBX(-)	WI	51	51	21		1155
W1LUG	MA	52	52	21		1092
K8CV	MI	40	40	27		1080
WD8OYF	OH	47	47	20		940
KB9IT	IL	43	43	19		817
K4FPF	VA	41	41	19		779
N0CMC(-)	ND	26	26	20		520
W6YMH	CA	28	28	17		476
AK7J(-)	AZ	19	19	16		304
W3ICM(-)	MD	21	22	10	1	242
N2DCH	NY	20	20	11		220
W7ABX(-)	NV	20	20	10		200
NL7D(-)	AK	11	20	3	1	80
KA7AKQ	WA	8	8	3		24

\* District  
 (-) State/provincial  
 (W) Contest winner

**W/VE 80-METER MULTI-OPERATOR**

Callsign	QTH	QSOs	QSO Pts.	St/Pr.	DX	Total
N9NC(W)	IN	793	812	54	17	57652
VE2ZP*	QUE	567	597	53	18	42387
N4BAA*	FL	421	456	52	28	36480
W4CN(-)	KY	564	581	50	11	35441
KF2X*	NY	413	432	48	11	25488
AJ1E*	MA	345	369	40	17	21033
N4FKF	KY	212				8692
WB0TCF*	MO	93	118	37		4366
W3YA*	PA	2	2	1		2

\* District  
 (-) State  
 (W) Contest winner

**DX 80-METER SINGLE OPERATOR**

Callsign	QTH	QSOs	QSO Pts.	St/Pr.	DX	Total
I3MAU(W)	Italy	507	983	40	58	96334
CN8CO*	Morocco	441	882	23	53	67032
C6ADV*	Bahamas	296	316	52	16	21488
HI8GBG*	Dom. Rep.	149	294	49	9	17052
OK1MSM*	Czechoslovakia	165	320	52		16640
HI8GB	Dom. Rep.	145	284	41	10	14484

DF9ZP*	West Germany	121	239	26	27	12667
ZF2DX*	Grand Cayman	149	178	42	27	12282
OX3ZM*	Greenland	117	234	28	18	10810
YV3BQS*	Venezuela	96	192	35	16	9792
JA1ELY*	Japan	128	216	18	22	8240
DA1RE	West Germany	107	200		34	6800
H44SH*	Solomon Is.	69	137	19	15	5658
8P6KX*	Barbados	78	106	25	17	4452
JH7JGG	Japan	89	159	14	9	3657
OK1KZ	Czechoslovakia	52	89	1	22	2047
OK1AGN	Czechoslovakia	37	73	4	15	1387
SM4CAN*	Sweden	30	60	11	9	1200
OK2BLG	Czechoslovakia	26	51	14	7	1071
I4CSP*	Italy	38	70	1	14	1050
G5EBA*	England	32	62		14	868
DL8UI	West Germany	20	39	7	6	507
YO4BXX*	Romania	21	41		9	369
PA3AZM*	Netherlands	18	36		10	360
DF3AO	West Germany	17	34	6	4	340
JA5AUC	Japan	16	28	7	3	280
VK5BW*	Australia	13	22	1	9	220
JA3HTT	Japan	9	16		6	96
YO3KWJ	Romania	6	11		4	44

\* DX country

(W) Contest winner

Check log: YO6LV

#### DX 80-METER MULTI-OPERATOR

Callsign	QTH	QSOs	QSO Pts.	St./Pr.	DX	Total
I5MPK(W)	Italy	191	376	30	29	22184

(W) Contest winner

#### W/VE COMBINED 40/80-METER SINGLE OPERATOR

Callsign	QTH	QSOs	QSO Pts.	St./Pr.	DX	Total
N7DF(W)	UT	1188	1286	105	33	180040
KC4OV*	TN	931	1078	113	24	147686
N8AKY*	MI	880	1051	103	32	141885
N8ATR	OH	788	963	92	17	104967
KC8JH	OH	735	802	98	27	100250
W3BGN*	PA	411	628	72	27	62172
N4ARO	TN	467	502	88	7	47690
VE1AJJ*	NB	297	357	82	27	38913
KI7M*	OR	321	378	83	19	38556
W5PWG*	TX	268	303	82	12	28482
W8ANM	OH	284	347	73	4	26719
N8TN	OH	353	386	65	2	25862
KR8X	OH	395	395	53		20935
W3AP	PA	217	260	65	7	18720
KF1B*	CT	171	200	64	21	17000
W2FTY*	NY	161	210	63	14	16170
WA2IFS	NJ	163	192	51	23	14016
KJ2N	NJ	150	191	51	22	13943
W3ETB	PA	207	253	50	4	13662
W8VEN	WV	193	195	68	1	13455

WB8YEW	OH	108	170	53	22	12750
K3ND	PA	160	177	61	11	12744
K1NCD	CT	164	223	51		11373
WA0WWW*	MN	150	150	70		10500
WB9OBX*	WI	208	208	50		10400
W4KMS	VA	163	163	60		9780
WD8MRF	OH	139	177	52	3	9735
K4FPF	VA	123	152	50	4	8208
K8CV	MI	96	103	56	7	6489
K3ZJ	DC	164	165	38	1	6435
W6YMH*	CA	100	109	45	9	5886
WD8OYF	OH	100	100	36		3600
KB9IT	IL	82	82	30		2460
NL7D	AK	45	87	23	2	2175
AK7F	WA	53	55	34	2	1980
KA7AKQ	WA	56	57	27	1	1596
W7ABX	NV	46	50	24	4	1400
N2DCH	NY	29	29	18		522

\* District award

(W) Contest winner

#### W/VE COMBINED 40/80-METER MULTI-OPERATOR

Callsign	QTH	QSOs	QSO Pts.	St./Pr.	DX	Total
VE2ZP(W)	QUE	1271	1506	110	56	249996
N4BAA	FL	1066	1228	105	61	205076
KF2X	NY	978	1206	96	36	161604
W3YA	PA	46	46	16		736

(W) Contest winner

#### DX COMBINED 40/80-METER SINGLE OPERATOR

Callsign	QTH	QSOs	QSO Pts.	St./Pr.	DX	Total	
CN8CQ(W)	Morocco	802	1626	67	91	256908	
H44SH	Solomon Is.	360	718	64	35	71082	
YV3BQS	Venezuela	251	504	67	39	53424	
JA1ELY	Japan	196	346	40	37	26642	
VK5BW	Australia	170	328	22	31	17384	
DL8UI	West Germany	92	178	26	22	8544	
OK1AGN	Czechoslovakia	54	123	5	27	3936	
SM4CAN	Sweden	53	106	26	9	3710	
I4CSP	Italy	59	108		2	26	3024
G5EBA	England	43	84		23	1932	
PA3AZM	Netherlands	17	54		16	864	
YO4BXX	Romania	31	61		14	854	
YO3KWJ	Romania	9	17		7	119	

(W) Contest winner

#### DX COMBINED 40/80-METER MULTI-OPERATOR

Callsign	QTH	QSOs	QSO Pts.	St./Pr.	DX	Total
I5MPK(W)	Italy	781	1582	74	74	234136



KK9A.



From left to right: I4ZNU, I4OUT, I4JMY, and I4YNO.

## W9RE AND W8NGO 160-METER WORLD CHAMPIONS

"The most activity ever heard on 160"... "Best contest I've ever operated"... "An absolute winner!"... "Definitely will try again next year." These welcome comments were heard again and again in the wake of 73's 1982 "top-band" event. "Wrapped up my Worked All States"... "Thanks to the contest I worked another new country!" These were some of the rewards earned for just a few hours of contest operation by nearly 1500 participants.

If you're a supporter of 160 meters, you can't help but notice how much the contest has grown since its inception some 3 years ago. The bright future of this world-championship event seems assured.

Year	Participants
1980	569
1981	917
1982	1482

This year, W9RE single-handedly produced 1118 QSOs, 58 states and provinces, and 8 DX countries to become the 1982 World 160-Meter Phone Champion for single-operator stations. Mike managed to beat second-place finisher and 1981 World Champion W8LRL by a margin of 136 QSOs and 20,000 points. A race as close as this, involving two of the most prominent stations on the band, sets the stage for our 1983 event just around the corner. The upcoming contest will decide the best two out of three.

Both W9RE and W8LRL are to be congratulated for their superb performance in our own "survival of the fittest." Who will surpass W9RE's 1118 QSOs which now establishes a world record on 160?

In the multi-operator category, the crew members at W8NGO are the 1982 World Champions. They compiled 877 QSOs, 56 states and provinces, and 4 DX countries for a total score of 273,900 contest points. The gang at W4CN, last year's World Championship station, finished second with a total of 238,950 points. It was a very close race for the top slot, with only 73 QSOs and 1 multiplier separating the two stations. Here again, the 1983 contest will decide the best two out of three, since last year's champions finished second this time.

Of all the single-operator entries, the following stations compiled 500 or more QSOs: W9RE (1118), W8LRL (982), WB3GCG (932), WD8CRY (762), WB0CMM (722), W1CF (697), K9JD (622), NBATR (582), N5JB (579), KC8P (561), K9QLL (552), W3BGN (524), and N5CG (502).

In the multi-operator class, 500 or more QSOs were earned by the following stations: W8NGO (877), W4CN (804), AK2E (688), K9ZUH (677), W9ZX (512), and K9YUG (504).

W9RE worked the most states and provinces (58) for the single-operator class, followed by W8LRL and WB3GCG with 57; K9RJ with 56; KC8P, WD8CRY, K9JD, N5JB, WB0CMM, and K9QLL with 55; W1CF, W9DUB, and W0CM with 54; N5CG,

W4VKK, KB8HW, and W2FJ with 53; K1MNS, W5ZY, KA0HIG, and KA7BTQ with 52; and KC4OV, K0STF, WA2GZB, N7DF, and K1LPS with 51 WVE multipliers.

For the multi-operator category, W8NGO, K9YUG, and K9ZUH accumulated the most WVE multipliers, with 56 each; AK2E had 54, W4CN had 53, K0UK had 52, and W9ZX had 51 states and provinces.

Screening all logsheets, EA5ET worked 17 DX countries, followed by G3XWZ/A with 15 countries; W8LRL with 13; N4IN, OK1AVG, and W1CF with 12; WB3GCG and VE1YX with 11; and ZF2DX with 10.

After all the contest entries have been tabulated, it is rewarding to analyze the station equipment and antennas used by the participants. The tables below tell the story.

Equipment	Usage	1/4-wave sloper	9.3%
Kenwood	38.5%	Trap vertical	9.3%
Yaesu	27.0%	Shunt-fed tower	7.9%
Drake	20.5%	Vertical (1/2, full wave)	7.9%
Icom	4.9%	Long wire	5.7%
Ten-Tec	3.3%	1/2-wave sloper	2.8%
Collins	2.4%	Quad, delta loop,	
Hy-Gain, Astro,		5-element yagi,	
Heath, Signal One	.85% each	windom, zepp	.9% each

Equipment used in the 160-Meter Phone Contest.	Usage	Receive antennas only:	
		Beverage	10.7%
		Loop configuration	1.9%

Antenna	Usage	Antennas used in the 160-Meter Phone Contest.
Dipole/inverted vee	37.3%	
Inverted-L	15.3%	

The success of this very popular contest would not have been possible without the dedication of two superb gentlemen of the "gentleman's band." Our special thanks to Dan WA2GZB and Ed K3IXD who both tackled the responsibilities of scoring all the entries and corresponding with the entrants. These gents have been involved with this world-championship contest ever since its founding some three years ago. Both have burned the midnight oil countless nights when the rest of us were enjoying the openings on the band.

The 4th annual contest is just around the corner. After you read these results, pass them on to your friends on 160. Be sure they're aware of our world-championship contest, scheduled for January 15-16, 1983. If you think this year's scores were record breakers, wait until January 1983! With the relaxation of the FCC rules on this band, we expect to see nearly 2,000 stations participating. I'll be there, how about you?

### WORLD 160-METER PHONE CHAMPIONSHIP MULTI-OPERATOR STATIONS

Call sign	State	QSO	St/Pr.	DX	Points
W8NGO (W)	MI	877	56	4	273,900
W4CN*	KY	804	53	6	238,950
AK2E*	NY	688	54	8	224,750
K9ZUH*	IN	677	56	6	213,280
K9YUG	IL	504	56	4	152,400
K0UK*	CO	467	53	5	137,120
W9ZX	IL	512	51	—	130,560
N8AKY*	MI	369	50	3	98,580
KB0TJ	CO	324	50	—	81,000
AA1K3*	DE	279	46	7	75,525
KB8AC*	OH	244	44	1	56,350
N4DBR	KY	219	40	—	43,800
K0UR*	KS	189	43	1	41,800
W0CEM	KS	143	45	1	31,970
WD8NJR	MI	133	40	1	27,470
KB0SF	CO	136	40	—	27,200
DF5ZD/A*	Germany	35	—	6	3,135

(W) World Champion for 1982  
\* State/Provincial/DX Country Champion  
Disqualified: WB8JBM

### 160-METER CONTEST SOAPBOX

"A very excellent test. Something should be done about improving the conditions, however (hi)." —W1BB.  
 "Suggest you give a multiplier of zero for all kW stations. With their excess power, that would certainly thin the results considerably." —AA1K.  
 "My first try at a contest. Hope I help those needing Rhode Island." —W1LOV.  
 "Excellent conditions the first night. Sure was a fantastic contest and I'm really looking forward to next year, now more than ever." —K1LPS.  
 "Lots of activity. The band was extremely crowded." —K1NBN.  
 "A very fine event! Many big signals, and there were more stations on the band than I have ever heard on 160 meters!" —K2DWI.  
 "Had nothing but antenna problems the 1st night. Blew a borrowed rig to top it off. I'll be back next year though." —AK2E.

"Excellent first-night European opening." —N4IN.  
 "Score would have been higher but had 300 kHz interference from an op who lives just down the road. He deliberately QRMs and the FCC has given him warnings about it." —W4PZV.  
 "My first 73 contest. Had a great time. Will have a better receiving setup next year." —W4TMR.  
 "The most enjoyable contest I've ever been in!" —W4TWW.  
 "A bunch of activity on the band. Hardly any DX." —W3ZPF.  
 "Must say there was much activity and I certainly enjoyed it very much." —N5CG.  
 "Enjoyed the contest. Sounded like 20 meters. The strobe light atop my 300 vertical gave my receiver fits throughout the contest." —W5GFR.  
 "Thanks for a fine 160-meter contest." —AE5H.  
 "Nice contest. Ended up doing surgery and missed half of it, unfortunately." —K5JZN.  
 "Lots and lots of QRM!" —W5LFG.  
 "Very interesting contest. Sure enjoyed it." —KC5LK.  
 "Sure had lots of fun in the contest. Lots of QSOs and lots of QRM." —K6ANP.  
 "Great contest. Wish I could have worked the entire event." —WD6EFU.  
 "Enjoyed it, as I'm sure everybody did. Second night was not as good as the first. Doubled last year's score, though." —W6WBY.  
 "Had to work both nights but managed to slip in a few Nevada multipliers for the stations on the band." —W7ABX.  
 "Sounds like the contest is growing every year. Had a great time as did everyone I talked to." —K7BTO.  
 "Daytime contacts are okay but too bad you couldn't work a station a second time if you worked him the night before." —N7DF.  
 "Sure enjoyed the contest. Lots of stations heard on the band." —WB7FDQ.  
 "Super contest! I did better than last year and it sure helps toward my 6-band WAS award. See you again next year." —AK7H.  
 "Very enjoyable contest. Amazed at the number of stations on the band. All were very courteous. It was a real gentleman's contest." —K7SFN.  
 "Great contest. Heard a lot of activity from my QTH here in Montana. Plenty of QRM, too." —K7VIC.  
 "Daytime bonus points should be deleted." —KC8A.  
 "Had lots of fun and looking forward to 1983. The contest is definitely growing each year. Thank you, 73!" —N8AKY.  
 "S-9 power-line noise throughout the contest!" —W3CV.

Continued

"A fun, gentlemanly affair. Worked maybe 12 calls on 160 the last 35 years. This weekend I managed over 700 contacts!"—WD8CRY.

"Sounded like everyone had a great time."—K8HF.

"42 states worked. Not bad for a 25-foot helical-wound vertical with only 5 radials."—KC8NR.

"Enjoyed the contest very much. I think it is the best one held on 160!"—KC8P.

"Sure enjoyed the contest. Lots and lots of stations were on, I see."—AA8S.

"Daytime bonus was confusing. Had a great time, though."—K8US.

"The first 160-meter contest ever for me. I invited the Smoke Valley ARC over to help me out."—W0CEM.

"Unbelievable activity this year. 73 has done it again!"—WB0CMM.

"My first effort on 160-meter contesting. I was really impressed with the turnout. Had loads of fun."—KA0HIG.

"Sorry, no US stations heard on the band. . . just Europeans."—DF5ZD/A.

"Had a special 160-meter license and heard only Europeans."—EA3CCN.

"A very popular contest according to the turnout. Good luck."—KH6J.

### WORLD 160-METER PHONE CHAMPIONSHIP SINGLE-OPERATOR STATIONS

Call sign	State	QSO	StJPr.	DX	Points	W4TWW	SC	179	41	3	40,040
W9RE (W)	IN	1118	58	8	371,580	W8DN	OH	177	39	2	36,285
W8RLR*	WV	982	57	13	350,700	K1NBN*	ME	175	39	2	35,465
WB3GCG*	MD	932	57	11	322,660	WB7OZM*	OR	191	33	1	32,980
W1CF*	MA	697	54	12	236,280	AI0Z	IA	154	41	1	32,550
WD8CRY*	MI	762	55	6	234,240	WB4ZPF	VA	154	39	2	31,980
WB0CMM*	CO	722	55	8	230,895	W4YZX	NC	165	35	1	30,880
KJ9D*	IN	622	55	4	184,670	AK7H	WA	130	42	4	30,820
KC8P	MI	561	55	5	169,800	WA5NFC*	AR	156	34	2	28,620
N5JB*	TX	579	55	3	169,650	WA9FTV	IL	130	41	1	27,510
N8ATR*	OH	582	50	5	164,640	KC8JH	OH	123	41	2	26,660
K9QLL*	IL	552	55	3	160,950	K3XA/MM	NY/MM	124	34	6	26,400
W0CM*	KS	484	54	6	147,600	K4YFH	NC	176	30	—	26,400
K9RJ	IL	471	56	4	142,500	K1ECK	MA	167	24	5	24,505
KB8HW	MI	491	53	3	138,320	K8US	OH	143	34	—	24,310
N5CG*	OK	502	53	1	135,810	K5JZN	OK	110	43	—	23,650
W3BGN*	PA	524	45	4	135,730	N0ZA	CO	99	43	2	22,725
W9DUB*	WI	473	54	3	135,660	N7AKU	NV	138	31	1	22,400
KC4OV*	TN	479	51	3	130,140	WA9RHU	IL	118	35	1	21,420
K1MNS*	NH	436	52	3	120,725	ZF2DX*	Grand Cayman	82	37	10	21,150
K1LPS*	VT	440	51	3	119,610	VE7WJ*	BC	110	33	3	20,160
W4TMR*	NC	461	48	6	117,720	W6OU*	Ail.	127	30	1	19,995
KA7BTO*	ID	368	52	7	111,805	W3CV	PA	92	40	1	19,270
K0STF*	SD	401	51	3	109,080	VE7ERY	BC	100	38	—	19,000
W4VKK*	GA	367	53	4	106,020	WB9LFD/1	CT	119	29	2	18,755
W2FJ*	NJ	347	53	6	104,430	W4KMS	VA	109	31	2	18,315
N7DF*	UT	362	51	5	103,880	AA4FF	VA	126	27	2	18,270
N4IN*	FL	318	48	12	101,100	K4OD	VA	112	30	1	17,515
KA0HIG*	IA	338	52	3	93,775	W6WBY	CA	105	32	1	17,490
W5YZ*	NM	333	52	3	92,950	K8SVT	OH	116	30	—	17,400
K4AQQ	FL	331	49	5	90,720	WA2ORX	NY	103	31	1	16,640
VE1YX*	NS	292	47	11	88,740	VE1BPY*	PEI	93	33	2	16,625
N4MM*	VA	336	48	4	88,400	VE2OG	Quebec	93	34	—	15,810
K2BQ*	NY	285	49	8	84,075	K8AQM	MI	117	27	—	15,795
KD4NI	VA	315	49	3	78,645	VE2OO	Quebec	101	27	3	15,300
KG4W	VA	347	46	1	77,315	K9CGD	IL	89	31	2	14,585
VE2ZP*	Quebec	343	42	2	75,900	KB8YE	OH	85	30	1	13,330
W4PZV	FL	259	49	7	74,760	W5LFG	TX	98	27	—	13,230
K7SFN*	NV	293	50	1	74,715	K2MN	NY	95	26	1	13,095
N4ARO	TN	289	48	3	74,460	W1BB	MA	72	30	3	12,375
N3CO	MD	283	43	3	73,580	WD8LCD	MI	101	22	—	11,110
WB7FDO*	AZ	266	50	3	71,285	W1LUG/4	VA	85	23	1	10,320
K7VIC*	MT	263	49	4	70,490	W4HVU	FL	71	25	2	10,260
WA2GZB	NJ	253	51	3	69,120	W1LOV*	RI	94	21	—	10,185
NA4D*	KY	251	49	3	66,040	KB0W/6	CA	71	26	—	9,230
W8QBF	OH	303	39	3	62,730	WD8MRF	OH	73	24	—	8,760
N0AN	IA	246	50	—	61,500	VE5XU*	Sask.	60	26	—	7,930
WA0OFH*	WA	179	48	7	61,410	WD8LCN	MI	62	25	—	7,750
K3IXD	MD	252	47	1	60,960	KB7M*	WY	58	23	3	7,540
W0HW*	MN	235	50	1	60,435	G3XWZ/A*	England	94	—	15	7,450
AA8S	OH	304	36	2	58,140	K8HF	OH	59	23	—	6,785
W5GFR	TX	240	41	5	56,350	EA6ET*	Balearic Is.	57	1	17	5,130
K3LGC*	DE	237	40	2	54,600	WD6EFU	CA	44	20	—	4,600
KB3MI	PA	215	46	3	53,410	OK1AVG*	Czech.	71	—	12	4,260
AE5H*	MS	254	40	1	52,480	W7ABX	NV	50	17	—	4,250
W3ICM	MD	243	39	3	51,650	KB8UO	MI	62	13	—	4,030
VP9BO*	Bermuda	251	35	5	51,200	KB7WN	WY	33	20	—	3,400
KK8L	OH	251	38	2	51,000	W1GOM/5	OK	35	18	—	3,150
WB4TUO	TN	192	48	4	50,960	EA3CCN*	Spain	26	—	8	3,120
K2DWI	NY	245	39	2	50,635	AK7F	WA	40	13	1	2,870
KC8A	MI	253	37	1	48,260	KJ7I	AZ	35	15	—	2,625
K4CNW*	SC	215	44	—	47,300	K8CV	MI	32	16	—	2,560
K6ANP*	CA	201	42	3	45,900	KA7HBS	WY	28	16	—	2,240
W3AP	PA	235	35	2	44,955	KH6IJ*	HI	29	15	—	2,175
N8TN	OH	233	37	1	44,460	KA8MSQ	MI	50	7	—	1,750
WB1CWZ*	CT	252	33	2	44,450	8P6KZ*	Barbados	16	7	6	1,495
KC5LK	MS	206	41	1	43,680	VE7FBS	BC	23	10	—	1,150
VE4WR*	Manitoba	176	49	—	43,120	W3ETB	PA	14	10	1	825
W4OWJ	FL	167	45	5	43,000	N8ASB	MI	13	1	—	130
KC8NR	WV	190	44	1	42,750	KA8ALO	MI	8	1	—	80
AE3T	PA	185	42	2	41,140	K9GDF	WI	4	2	—	40
K2FL	NJ	200	34	3	40,600						
WB0UFL	IA	196	43	—	40,140						

(W) World Champion for 1982  
\* State/Provincial/DX Country Champion

## WORLD TIME WATCH

the first microprocessor watch made especially for hams



- 24 hr. timer
- microprocessor
- water resistant
- solar assist
- New Low Price**  
—\$59.95

The HAM-1 functions include local time, world time, (G.M.T. too) count-up and count down chronometer, day, month, date, alarm and hourly chime. It's ideal for log-keeping, DX time conversion and 10 minute I.D. timing. The HAM-1 features a high contrast Seiko display and solar cell battery assist. Battery life is better than 4 years. The HAM-1 is water resistant to 20 meters, the case is 100% solid stainless steel and the crystal is scratch resistant mineral glass. The HAM-1 is rugged and durable and has a 1 year warranty.

### 2 METER AMPLIFIER \$39.95



- 2 Wafts In, 10 Watts Out • V.S.W.R. Protected • Can be Used for F.M. & S.S. B.
- Led Status Indicators • Low Loss SO-239 Connectors • Current Drain Less Than 2.5A at 13.6 V.D.C. • Massive Heatsink • Built In T/R Switch

### TEMPO S-1 UPGRADE KITS \$39.95

Upgrade your early Tempo S-1 to current Production Specifications, kits include: • 450 M.A.H. Battery Pack • New Case Assembly • All New Escutcheons • Spkr./Mic. Jack w/Dust Cap • New Earphone & Jack • P.C.B. and Parts for Easy Installation • Detailed Instruction Manual • For Radios With & Without T.T. Pad.

Other Accessories Available:

- Spkr/Mic. Designed for S-1's. . . . \$24.95
- Heavy Duty Belt Clip. . . . . 7.50
- Flex Antenna . . . . . 6.00

To Order Call or Write to:

ADVANCED COMMUNICATIONS  
INTERNATIONAL ✓448  
2411 Lincoln Avenue  
Belmont, CA. 94002 U.S.A.  
(415) 595-3949

Add \$3.00 per order for shipping & handling. California residents add 6% sales tax. Visa, Master Charge accepted.

## MOR-GAIN

1/2-size (75M only 66')

Multi-Band (5, 4, 3 bands)  
80/75M thru 10M

Broadbanded - no traps used

Prices start at \$82.50

## MOR-GAIN

**THE MOR-GAIN HD DIPOLES** are the most advanced, highest performance multi-band HF dipole antennas available. Patented design provides length one-half of conventional dipoles. 50 ohm feed on all bands, no tuner or balun required. Can be installed as inverted VEE. Thousands in use worldwide. 22 models available including two models engineered for optimum performance for the novice bands. The Mor-Gain HD dipoles N/T series are the only commercial antennas specifically designed to meet the operational requirements of the novice license. Our 1-year warranty is backed by nearly 20 years of HD dipole production experience.

For detailed 10-page brochure, write or phone directly to **MOR-GAIN**, P.O. Box 329T, Leavenworth, Ks. 66048, Tel. (913) 682-3142.

✓206

## MOR-GAIN



### 4511 RTTY Interface for TRS-80\* Color Computer Owners

- Simply plug into Program Pak\* slot.
- No software to load, it is in ROM.
- Split screen features word wrap and continuously displays status.
- Selective calling stores incoming messages on cassette tape.
- Baudot and ASCII modes.
- Standard EIA signals to your T.U.
- Complete documentation supplied.

### 4511 RTTY Interface ✓171 **\$169.95**

RIDGE  
SYSTEMS  
CO., INC.

Tested & assembled. 90 day warranty; we pay shipping. Mass residents add 5% sales tax.

\*A trademark of Tandy Corp.  
P.O. Box 772, Acton, MA 01720 (617) 264-4251

## DIRECTION FINDING?



- ★ No Receiver Mods
- ★ High Sensitivity
- ★ 135-165 MHz Standard Range
- ★ Mobile, Base or Remote Use
- ★ Bright LED Display
- ★ Optional Digital Readout
- ★ Optional Serial Interface
- ★ Kits or Assembled Units
- ★ 12VDC Operation
- ★ 90 Day Warranty

New Technology (patent pending) converts any VHF FM receiver into an advanced Doppler Direction Finder. Simply plug into receiver's antenna and external speaker jacks. Use any four omnidirectional antennas. Low noise, high gain for weak signal detection. Use serial AFSK option for remote display or tape recording data. Kits from \$270. Assembled units and antennas also available. Call or write for full details and prices.

**DOPPLER SYSTEMS**  
5540 E. Charter Oak  
Scottsdale, AZ 85254  
**(602) 998-1151**

✓425

# Dealers . . . SELL

Selling 73 Magazine will make money for you. Consider the facts:

**Fact #1:** Selling 73 Magazine increases store traffic—our dealers tell us that 73 Magazine is the hot-test-selling amateur radio magazine on the newsstands.

**Fact #2:** There is a direct correlation between store traffic and sales—increase the number of people coming through your door and you'll increase sales.

**Fact #3:** Fact #1 + Fact #2 = INCREASED SALES, which means more money for you. And that's a fact.

For information on selling 73 Magazine, call 800-343-0728 and speak with Ginnie Boudrieau, our bulk sales manager. Or write to her at 73 Magazine, 80 Pine St., Peterborough, NH 03458.

## 73 MAGAZINE

80 Pine Street Peterborough, NH 03458  
800-343-0728

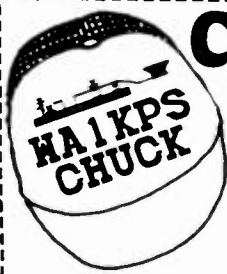

# CALL LETTER

ONLY \$5 **HATS** ✓ 187

101 Elm St Suite 4  
Peterborough, NH 03458

Hats Are One Size Fits All w/ Nylon Mesh Back

LINE 1  Morsekey   My Own Logo

CIRCLE ONE  
Green Blue Red Gold

LINE 2

LINE 3

Or



Introduced and the talk of the Dayton Hamfest these Attractive and Durable Call Letter Hats are just the thing for Hamfests, Field Day, contests and Club Activities. Messages are printed by computer and can be up to 6 lines of 18 small letters, 3 lines of 9 large letters or any combination. The Morse Key or your logo takes one large line. Discounts for Club orders and Free logo with orders for 12 and up. Once your logo is on file with us it is free with any quantity, and remember every hat can have a different call or message.

# CALL LETTER T SHIRTS

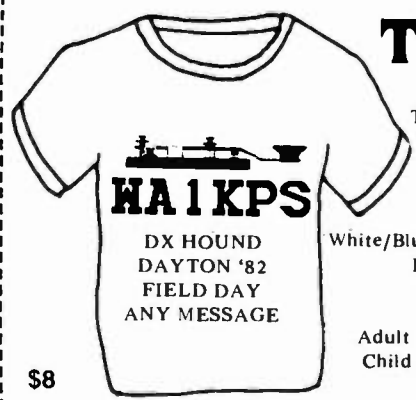

T-Shirts are Highest Quality  
50/50 Cotton Polyester

COLOR  
White/Blue Trim White/Red Trim  
Light Blue Tan

SIZE  
Adult Sm Med Lrge X-Lrge  
Child 2-4 6-8 10-12 14-16

\$8

LINE 1  Morsekey   My Own Logo (Provide B & W Copy)

LINE 2

LINE 3

LINE 4

LINE 5



Our comfortable and durable T-Shirts are the finest quality available. Make up your own message, DXCC, WAS, WAC, Hams do it with higher frequency, DX Hound, DX-Peditions, Please QSL and any other message. Up to six lines of 10 large letters each or up to 12 lines of 20 small letters each. Discounts for Club orders and FREE logo with orders for 12 or more. FAST MAIL ORDER !!

CALL LETTER HATS 101 Elm St. Suite 4, Peterborough, NH 03458

Name \_\_\_\_\_  
Address \_\_\_\_\_  
City \_\_\_\_\_ State \_\_\_\_\_ Zip \_\_\_\_\_  
Card  Money Order  Charge Card  Exp Date \_\_\_\_\_  
Signature \_\_\_\_\_

ORDER BLANK Add \$2 To Total For Shipping Charges

**AZDEN PCS-4000**  
ADVANCED MICROCOMPUTER CONTROL - 16 MEMORIES - 25 WATTS - SUPER COMPACT 142-150 MHZ - ANY SPLITS - ONE-YEAR WARRANTY -  
ALSO: PCS-300 HT, PCS-2800 10M FM, accessories, etc.

**KDK FM-2030**  
EASY TO OPERATE - SINGLE-KNOB TUNING - RIT - 10 MEMORIES - 25 WATTS - SCAN BAND OR MEMORIES - TT MIC. WITH UP/DOWN FREQ. CONT. - ANY SPLITS BEEPS AT MEMORY BAND LIMITS FOR EYES-OFF OPERATION

**Special discounts - call for quote**  
**B. G. CARL ELECTRONICS**  
11128 Claire Ave. Northridge, CA 91326  
Call: 1-213-363-1216 (anytime) Bryan AG6R

**COMPARE the HAZER™ with foldover + telescoping towers**

- Antenna systems mount on Hazer-Hazer follows parallel to outside of tower - Raise to tower top or lower completely to ground level.
- Safety lock system on Hazer operates while raising-lowering & in normal position. Never can fall.
- Weight transferred directly to tower. Winch cable used only for raising & lowering.
- Will support most antenna arrays up to 20 sq. ft.
- High quality materials & workmanship
- Safety - speed - convenience - smooth travel
- Ease to install and use
- For Rohn 20 & 25 tower - Other towers on request. Complete with winch, 100 ft. of cable, hardware and Instructions.

HAZER II Heavy alum. \$279.95 • \$17.00 UPS  
HAZER III Standard alum. \$199.95 • \$13.00 UPS  
HAZER IV Heavy gal. steel \$249.95 • \$28.00 UPS  
Specify mast diameter when ordering.  
MARTIN ENGINEERING P.O. BOX 253 BOONVILLE, MO 65233  
✓ 134 816-882-2734

# RADIO BOOKSHOP

## FOR THE NOVICE

New, updated editions  
of our famous novice  
license study guide and novice study tapes.

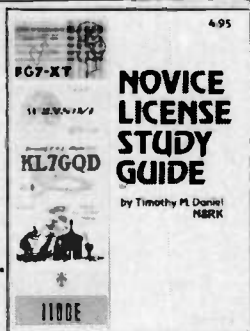

● **NOVICE LICENSE STUDY GUIDE**—by Timothy M. Daniel N8RK. Here is the most up to date novice guide available. It is complete with information about learning Morse Code, has the latest FCC amateur regulations and the current FCC application forms. This guide is *not* a question/answer memorization course but rather it emphasizes the practical side of getting a ham license and putting a station on the air. It reflects what the FCC expects a Novice to know without page after page of dull theory. The most current information still available at last year's price. SG7357 \$4.95.

● **NOVICE STUDY TAPES**—If you are just getting started in ham radio, you'll find these tapes indispensable! This up-to-the-minute revision of the 73 Study Course is the perfect way to learn everything you need to breeze through the Novice written exam. Theory, FCC regulations, and operating skills are all covered, and you'll be amazed at how fast you learn using these tapes!

Once the test is behind you, these tapes will go right on being useful, because they are packed with the latest information on setting up your own ham station, and getting on the air.

Thousands of people have discovered how easy learning from cassette can be—order now and enter the fascinating world of ham radio! CT7300 Set of 3—\$15.95.

Scientists have proven that you learn faster by listening than by reading because you can play a cassette tape over and over in your spare time—even while you're driving! You get more and more info each time you hear it. You can't progress without solid fundamentals. These three hour-long tapes give you all the basics you'll need to pass the Novice exam easily. You'll have an understanding of the basics which will be invaluable to you for the rest of your life! Can you afford to take your Novice exam without first listening to these tapes?

Special Offer! Both Novice License Study Guide  
and Novice Study Tapes \$19.95 Order NP7300.

## GENERAL LICENSE STUDY GUIDE

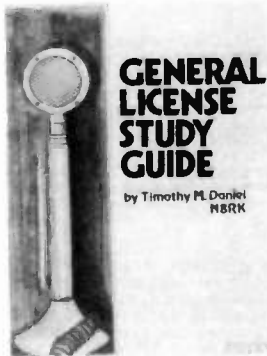

**GENERAL LICENSE STUDY GUIDE**—By Timothy M. Daniel N8RK This is the complete guide to the General License. Learning rather than memorizing is the secret. This is not a question-and-answer guide that will gather dust when the FCC issues a new test. Instead, this book will be a helpful reference, useful long after a ham upgrades to General. Includes up-to-date FCC rules and an application form. Order yours today and talk to the world. SG7358 \$6.95



● **QSL CARDS**—73 turns out a fantastic series of QSL cards at about half the cost of having them done elsewhere because they are run as a fill-in between printing books and other items in the 73 Print Shop. 250 Style W—QW0250—for \$8.95; 500 Style W—QW0500—for \$13.95; 250 Style X—QX0250—for \$8.95; 500 Style X—QX0500; 250 Style Y—QY0250—for \$8.95; 500 Style Y—QY0500—for \$13.95. Allow 6-12 wks. for delivery.

**LIBRARY SHELF BOXES**—These sturdy white corrugated, dirt boxes each hold a full year of 73, *Microcomputing* or *80 Micro*. With your order, request self-sticking labels for any of the following: 73, *Microcomputing*, *80 Micro*, *CQ*, *QST*, *Ham Radio Personal Computing*, *Radio Electronics*, *Interlace Age*, and *Byte*. Order 1—BX1000—for \$2.00; order 2-7—BX2002—for \$1.50 each; order 8 or more—BX1002—for \$1.25 each.

● Preserve and protect your collection for a lifetime! Order these handsome red binders with gold lettering. \$7.50 for 1, 3 for \$21.75, 6 for \$42.00. (Postpaid within USA, please add \$2.50 per order outside USA.) Check or money orders only, no phone or C.O.D. orders. 73 Binders, P.O. Box 5120, Philadelphia, PA 19141.

\*NOTE—Above address for Binders only.

### For Your Ham Shack 73 Magazine Binders

\*Use the order card in this magazine or itemize your order on a separate piece of paper and mail to: 73 Radio Bookshop • Peterborough NH 03458. Be sure to include check or detailed credit card information. No C.O.D. orders accepted. \$1.50 for the first book, \$1.00 each additional book for U.S. delivery and foreign surface. For foreign airmail \$10.00 per book. Please allow 4-6 weeks for delivery. Questions regarding your order? Please write to Customer Service at the above address. (Prices subject to change on books not published by 73 Magazine.)

# 73

## Code Tapes

any four tapes for  
\$15.95! \$4.95 each

### "GENESIS"

**5 WPM**—CT7305—This is the beginning tape for people who do not know the code at all. It takes them through the 26 letters, 10 numbers and necessary punctuation, complete with practice every step of the way using the newest blitz teaching techniques. It is almost miraculous! In one hour many people—including kids of ten—are able to master the code. The ease of learning gives confidence to beginners who might otherwise drop out.

### "THE STICKLER"

**6+ WPM**—CT7306—This is the practice tape for the Novice and Technician licenses. It is made up of one solid hour of code, sent at the official FCC standard (no other tape we've heard uses these standards, so many people flunk the code when they are suddenly—under pressure—faced with characters sent at 13 wpm and spaced for 5 wpm). This tape is not memorizable, unlike the zany 5 wpm tape, since the code groups are entirely random characters sent in groups of five.

### "BACK BREAKER"

**13+ WPM**—CT7313—Code groups again, at a brisk 14 per so you will be at ease when you sit down in front of the steely-eyed government inspector and he starts sending you plain language at only 13 per. You need this extra margin to overcome the panic which is universal in the test situations. When you've spent your money and time to take the test, you'll thank heaven you had this back-breaking tape.

### "COURAGEOUS"

**20+ WPM**—CT7320—Code is what gets you when you go for the Extra class license. It is so embarrassing to panic out just because you didn't prepare yourself with this tape. Though this is only one word faster, the code groups are so difficult that you'll almost fall asleep copying the FCC stuff by comparison. Users report that they can't believe how easy 20 per really is with this fantastic one hour tape.

### "OUTRAGEOUS"

**25+ WPM**—CT7325—This is the tape for that small group of overachieving hams who wouldn't be content to simply satisfy the code requirements of the Extra Class license. It's the toughest tape we've got and we keep a permanent file of hams who have mastered it. Let us know when you're up to speed and we'll inscribe your name in 73's CW "Hall of Fame."

**BACK ISSUES**—Complete your collection; many are prime collectables now, classics in the field! A full collection is an invaluable compendium of radio and electronics knowledge!

73300	73 BACK ISSUE—BEFORE JULY 1980	\$ 3.00
73350	73 BACK ISSUE JULY 1980 THRU OCT. 1981	\$ 3.50
73350P	73 BACK ISSUE NOV. 1981 TO PRESENT	\$ 3.50
73005	73 BACK ISSUE—5 YOUR CHOICE	\$10.75
73010	73 BACK ISSUE—10 YOUR CHOICE	\$16.00
73025	73 BACK ISSUE—25 YOUR CHOICE	\$27.00
73125	73 BACK ISSUE—25 OUR CHOICE	\$14.00

Shipping: Please add \$1.00 per magazine. Orders of ten magazines or twenty-five magazines add \$7.50 per order.

FOR TOLL FREE ORDERING CALL 1-800-258-5473

# RADIO BOOKSHOP

## HAND BOOKS FOR THE HAMSHACK

**THE COMPLETE SHORTWAVE LISTENER'S HANDBOOK**, 2nd EDITION by Hank Bennett and Harry L. Helms. This comprehensive volume contains loads of new information from all over the world on the latest developments in SWL technology clubs, associations, practices and stations. A thorough guide to stations of the world by general continental area and frequency is included. BK1241 \$9.95

**THE TEN METER FM HANDBOOK**—by Bob Hell K9EID. This handbook has been published to help the ten meter enthusiast learn more about the many methods of conversions and tricks that are used to make existing units work better. Join the great "tinkerers" of the world on ten FM and enjoy the fantastic amount of fun in communicating with amateur stations worldwide on ten meter FM. BK1190 \$4.95.

**THE PRACTICAL HANDBOOK OF AMATEUR RADIO FM REPEATERS**—by Bill Pasternak WA6ITF (author of 73 Magazine's monthly column "Looking West") This is the book for the VHF/UHF FMer, compiled from material submitted by over a hundred individuals, clubs, organizations and equipment manufacturers. A "must have" for your ham shack shelf. BK1185 \$12.95.

## THE 73 TEST EQUIPMENT LIBRARY

**VOL. II AUDIO FREQUENCY TESTERS**—Jam-packed with all kinds of audio frequency test equipment. If you're into SSB, RTTY, SSTV, etc., this book is a must for you... a good book for hi-fi addicts and experimenters, too! LB7360 \$1.95.

**VOL. III RADIO FREQUENCY TESTERS**—Radio frequency waves, the common denominator of amateur radio. Such items as SWR, antenna impedance, line impedance, RF output, and field strength; detailed instructions on testing these items includes sections on signal generators, crystal calibrators, grid dip oscillators, noise generators, dummy loads, and much more. LB7361 \$1.95.

**VOL. IV IC TEST EQUIPMENT**—Become a troubleshooting wizard! Here are 42 home construction projects for building test equipment to work with your ham station and in servicing digital equipment. Plus a cumulative index for all four volumes for the 73 TEST EQUIPMENT LIBRARY. LB7362 \$1.95.

ALL THREE OF THE ABOVE ONLY \$4.95 ORDER LB7365

**RF AND DIGITAL TEST EQUIPMENT YOU CAN BUILD**—BK1044—Rf burst, function, square wave generators, variable length pulse generators—100 kHz marker, i-f and rf sweep generators, audio osc, airt signal injector, 146 MHz synthesizer, digital readouts for counters, several counters, precaler, microwave meter, etc. 252 pages. BK1044 \$5.95.

## FOR THE CONTESTER

**THE CONTEST COOKBOOK**—This book reveals the secrets of that elite group of operators who top the list when the contest results are published. It contains detailed suggestions for the first-time contestee as well as tips for the advanced operator. Domestic, DX, and specialty contests are all discussed, complete with photographs and diagrams showing the equipment and operating aids used by the top scorers. For the serious contestee. BK7308 \$5.95.

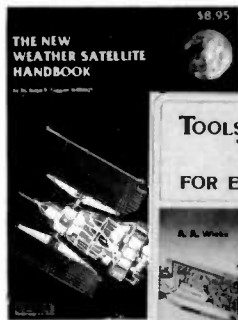
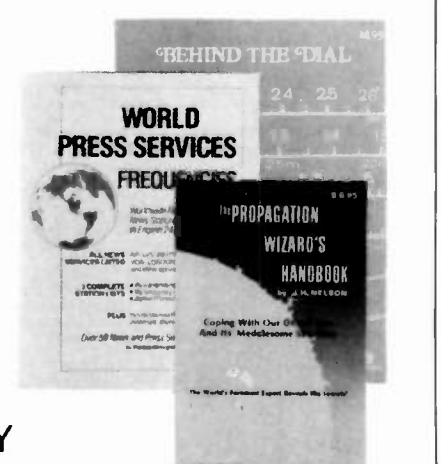

**TOOLS & TECHNIQUES FOR ELECTRONICS**—by A. A. Wicks is an easy-to-understand book written for the beginning kit-builder as well as the experienced hobbyist. It has numerous pictures and descriptions of the safe and correct ways to use basic and specialized tools for electronic projects, as well as specialized metal-working tools and the chemical aids which are used in repair shops. BK7348 \$4.95.

**BEHIND THE DIAL**—This book explains, in detail, what's going on on all the frequencies, from shortwave up to microwave. It gives the reader a good idea of what he can find and where to find it, including some of the secret stations such as the C.I.A. and the F.B.I. Everything is covered short of microwave monitoring. Anyone interested in purchasing a shortwave receiver should have a copy of this book. Surveillance, station layout consideration, antenna systems, interface, and the electromagnetic spectrum are included. BK7307 \$4.95

**THE NEW WEATHER SATELLITE HANDBOOK**—by Dr. Ralph E. Taggart WB8DQT. Here is the completely updated and revised edition containing all the information on the most sophisticated and effective spacecraft now in orbit. This book serves both the experienced amateur satellite enthusiast and the newcomer. It is an introduction to satellite watching, providing all the information required to construct a complete and highly effective ground station. Solid hardware designs and all the instructions necessary to operate the equipment are included. For experimenters who are operating stations, the book details all procedures necessary to modify equipment for the new series of spacecraft. Amateur weather satellite activity represents a unique blend of interests encompassing electronics, meteorology and astronautics. Join the privileged few in watching the spectacle of earth as seen from space on your own monitoring equipment. BK7383 \$8.95.

## THE 73 TECHNICAL LIBRARY



**THE CHALLENGE OF 160**—The growth of amateur radio today is encouraging the use of 160 meters. All the information necessary to get started on this unique band, the all-important antenna and ground systems are described in detail. Also, how to get on, top-band operating tips, top-band transmitters, propagation, weather receiving equipment, and more are covered in full. The introduction contains interesting photos of Stew Perry's (the King of 160) shack. This reference is useful to new and experienced top-band operators. BK7309 \$4.95

**INTERFERENCE HANDBOOK**—by William R. Nelson, WA6EQG—This timely handbook covers every type of RFI problem and gives you the solutions based on practical experience. Covers interference to TV, radio, hi-fi, telephone, radio amateur, commercial and CB equipment. Power line interference is covered in depth—how to locate it, cure it, work with the public, safety precautions, how to train RFI investigators. Written by an RFI expert with 33 years of experience, this profusely illustrated book is packed with practical easy-to-understand information. BK1230 \$8.95.

**OWNER REPAIR OF RADIO EQUIPMENT**—by Frank Glass K6RO. Here's a book that will teach you an approach to troubleshooting without a shack full of test equipment. Written in a narrative, non-mathematical style, it will encourage you to successfully fix your own rig problems 80 to 90% of the time. Even if you don't want to fix, you can learn a lot about how things work and fall. Add to your library and personal expertise. BK7310 \$7.95.

NEW

**EVERYTHING YOU ALWAYS WANTED TO KNOW ABOUT AMATEUR TELEVISION**, (but were afraid to ask) —By Mike Stone WB0QCD. This book is a complete guide to setting up your own amateur radio television station. It contains—A history, what equipment you need, video theory, cameras, recorders, lighting, special effects, sound ATV DXing, mobile FSTV, ATV repeaters, ATV groups, building projects, test equipment, dealer directory, a cumulative index of over 1000 articles on amateur TV and much more. This is the new, 1982 edition. From the publishers of *Amateur Television Magazine*. \$9.95 BK1244

**WORLD PRESS SERVICE FREQUENCIES**—by Thomas Harrington Can't wait to hear the evening news, or are you wondering about the news that you aren't hearing? Receive by Radio Teletype (RTTY) all the world news and financial happenings from the world capitals on a 24 hour a day basis. This book gives you the frequencies and times of broadcast of such news services as AP, UPI, Reuters, TASS, VOA and London Press. Also included is an introduction to RTTY with information on equipment, antennas, abbreviations—everything you need to get started in RTTY. BK1202 \$7.95.

**SSB... THE MISUNDERSTOOD MODE**—by James B. Wilson. Single Sideband Transmission... thousands of us use it every day, yet it remains one of the least understood facets of amateur radio. J. B. Wilson presents several methods of sideband generation, amply illustrated with charts and schematics, which will enable the ambitious reader to construct his own sideband generator. A must for the technically-serious ham. BK7351 \$5.50.

**PROPAGATION WIZARD'S HANDBOOK**—by J. H. Nelson. When sunspots riddled the worldwide communications networks of the 1940s, John Henry Nelson looked to the planets for an answer. The result was a theory of propagation forecasting based upon interplanetary alignment that made the author the most reliable forecaster in America today. The book provides an enlightened look at communications past, present, and future, as well as teaching the art of propagation forecasting. BK7302 \$6.95.

\*Use the order card in this magazine or itemize your order on a separate piece of paper and mail to: 73 Radio Bookshop • Peterborough NH 03458. Be sure to include check or detailed credit card information. No C.O.D. orders accepted. \$1.50 for the first book, \$1.00 each additional book for U.S. delivery and foreign surface. For foreign airmail \$10.00 per book. Please allow 4-6 weeks for delivery. Questions regarding your order? Please write to Customer Service at the above address. (Prices subject to change on books not published by 73 Magazine.)

FOR TOLL FREE ORDERING CALL 1-800-258-5473



# RADIO BOOKSHOP

## ANTENNA BOOKS

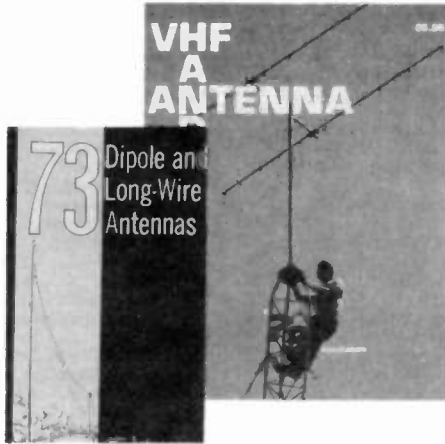
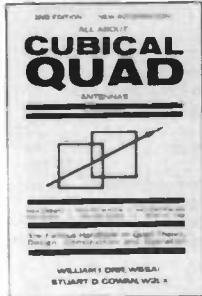

**VHF ANTENNA HANDBOOK**—The new *VHF Antenna Handbook* details the theory, design, and construction of hundreds of different VHF and UHF antennas... a practical book written for the average amateur who takes joy in building, not full of complex formulas for the design engineer. Packed with fabulous antenna projects you can build. BK7368 \$5.95.\*

**BEAM ANTENNA HANDBOOK (New 5th edition)**—by William I. Orr & Stuart D. Cowan. Yagi beam theory, construction and operation. Information on wire beams, SWR curves and matching systems. A "must" for serious DXers. BK1197 \$5.95.

**THE RADIO AMATEUR ANTENNA HANDBOOK**—All about wire antennas, beams, tuners, baluns, coax, radials, SWR and towers. Clear and complete information. BK1199 \$6.95

**VHF HANDBOOK FOR RADIO AMATEURS**—Contains information on FM theory, operation and equipment, VHF antenna design and construction, satellite-EME, and the newest solid-state circuit. BK1198 \$6.59\*

**SIMPLE, LOW-COST WIRE ANTENNAS FOR RADIO AMATEURS**—All new data and everything you want to know about low-cost, multi-band antennas, inexpensive beams, "invisible" antennas for hams in "tough" locations. BK1200 \$6.95

**73 DIPOLE and LONG-WIRE ANTENNAS**—by Edward M. Noll W3FOJ. This is the first collection of virtually every type of wire antenna used by amateurs. Includes dimensions, configurations, and detailed construction data for 73 different antenna types. Appendices describe the construction of noise bridges, line tuners, and data on measuring resonant frequency, velocity factor, and swr. BK1016 \$5.50.\*

**ALL ABOUT CUBICAL QUAD ANTENNAS (2nd edition)**—The "Classic" on Quad design, theory, construction, and operation. New 2nd edition contains new feed and matching systems and new data. BK1196 \$5.95.\*

**HOW TO DEFEND YOURSELF AGAINST RADAR**—by Bruce F. Bogner and James R. Bodnar, a lawyer and radar expert. This book gives you the ammunition to challenge the radar "evidence" that usually leads to a speeding conviction. The major part of the book details the inner workings of radar—you'll become more of an expert than most police officers and judges. The remainder of the book outlines how to defend yourself against a speeding ticket—the observations, measures and testimony you must obtain to defend yourself without the help of a lawyer. The price is a lot less than a fine! BK1201 \$6.95.\*

## MICROCOMPUTER BOOKS

**THE SELECTRIC INTERFACE**—by George Young. You need the quality print that a daisy wheel printer provides but the thought of buying one makes your wallet wilt. **SELECTRIC™ INTERFACE**, a step-by-step guide to interfacing an IBM Selectric I/O Writer to your microcomputer, will give you that quality at a fraction of the price. George Young, co-author of *Kilobaud Microcomputing* magazine's popular "Kilobaud Classroom" series, offers a low-cost alternative to buying a daisy wheel printer. **SELECTRIC INTERFACE** includes: step-by-step instructions, tips on purchasing a used Selectric, information on various Selectric models, including the 2740, 2980, and Dura 1041, driver software for Z80, 8080, and 6502 chips, tips on interfacing techniques. With **SELECTRIC INTERFACE** and some background in electronics, you can have a high-quality, low-cost, letter-quality printer. Petals not included. BK7388 \$12.97

**40 COMPUTER GAMES FROM KILOBAUD MICROCOMPUTING**—Forty games in nine different categories. Games for large and small systems, and a section on calculator games. Many versions of BASIC used and a wide variety of systems represented. A must for the serious computer gamesman. BK7381 \$7.95\*

**KILOBAUD CLASSROOM**—By George Young and Peter Stark. Learning electronics theory without practice isn't easy. And it's no fun to build an electronics project that you can't use. *Kilobaud Classroom* the popular series first published in *Kilobaud Microcomputing*, combines theory with practice. This is a *practical* course in digital electronics. It starts out with very simple electronic projects, and by the end of the course you'll construct your own working microcomputer! BK7386 \$14.95

**HOBBY COMPUTERS ARE HERE!** If you want to come up to speed on how computers work—hardware and software—this is an excellent book. It starts with fundamentals and explains the circuits and the basics of programming, along with a couple of TVT construction projects, ASCII, Baudot, etc. This book has the highest recommendations as a teaching aid. BK7322 \$2.47.

**TEXTEDIT—A Complete Word Processing System in kit form**—by Irwin Rappaport. **TEXTEDIT** is an inexpensive word processor that you can adapt to suit your needs, from writing form letters to large texts. It is written in modules, so you can load and use only those portions that you need. Included are modules that perform right justification, ASCII upper/lowercase conversion, one-key phrase entering, complete editorial functions, and much more! **TEXTEDIT** is written in TRS-80™ Disk BASIC, and the modules are documented in the author's admirably clear tutorial writing style. Not only does Irwin Rappaport explain how to use **TEXTEDIT**; he also explains programming techniques implemented in the system. **TEXTEDIT** is an inexpensive word processor that helps you learn about BASIC programming. It is written for TRS-80 Models I and III with TRSDOS 2.2/2.3 and 32K. \*TRS-80 and TRSDOS are trademarks of the Radio Shack Division of Tandy Corporation. BK7387 \$9.97

**SOME OF THE BEST FROM KILOBAUD/MICROCOMPUTING**—A collection of the best articles that have recently appeared in *Kilobaud/MICROCOMPUTING*. Included is material on the TRS-80 and PET systems, CP/M, the 8080/8085/Z80 chips, the ASR-33 terminal. Data base management, word processing, text editors and file structures are covered too. Programming techniques and hardware construction projects for modems, high speed cassette interfaces and TVTs are also included in this large format, 200 plus page edition. BK7311 \$10.95.\*

**THE NEW HOBBY COMPUTERS**—This book takes up from where "HOBBY COMPUTERS ARE HERE!" leaves off, with chapters on Large-Scale Integration, how to choose a microprocessor chip, an Introduction to programming, low-cost I/O for a computer, computer arithmetic, checking memory boards... and much, much more! Don't miss this tremendous value! BK7340 Only \$2.47.

\*Use the order card in this magazine or itemize your order on a separate piece of paper and mail to: 73 Radio Bookshop • Peterborough NH 03458. Be sure to include check or detailed credit card information. No C.O.D. orders accepted. \$1.50 for the first book, \$1.00 each additional book for U.S. delivery and foreign surface. For foreign airmail \$10.00 per book. Please allow 4-6 weeks for delivery. Questions regarding your order? Please write to Customer Service at the above address. (Prices subject to change on books not published by 73 Magazine.)

## COOK BOOKS

**TTL COOKBOOK**—by Don Lancaster. Explains what TTL is, how it works, and how to use it. Discusses practical applications, such as a digital counter and display system, events counter, electronic stopwatch, digital voltmeter and a digital tachometer. BK1063 \$9.50.\*

**CMOS COOKBOOK**—by Don Lancaster. Details the application of CMOS, the low power logic family suitable for most applications presently dominated by TTL. Required reading for every serious digital experimenter! BK1011 \$10.50.\*

**TVT COOKBOOK**—by Don Lancaster. Describes the use of a standard television receiver as a microprocessor CRT terminal. Explains and describes character generation, cursor control and interface information in typical, easy-to-understand Lancaster style. BK1064 \$9.95.\*

**IC OP-AMP COOKBOOK**—by Walter G. Jung. Covers not only the basic theory of the IC op amp in great detail, but also includes over 250 practical circuit applications, liberally illustrated. 592 pages, 5 1/2 x 8 1/2, softbound. BK1028 \$14.95.\*

## THE WELL EQUIPPED HAM SHACK

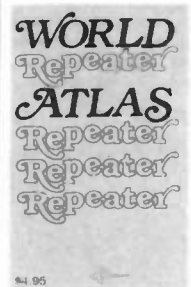
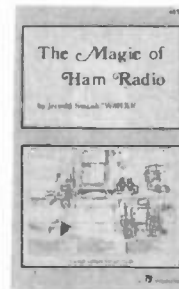

**WORLD REPEATER ATLAS**—Completely updated, over 230 pages of repeater listings are indexed by location and frequency. More than 50 maps pinpoint 2000 repeater locations throughout the USA. Foreign listings include Europe, the Middle East, South America, and Africa. BK7315 \$2.00

**THE MAGIC OF HAM RADIO**—by Jerrold Swank W8HXR. Under various call signs, W8HXR has been heard on the ham bands since 1919. He has watched amateur radio grow from the days of Model A spark coils to an era of microprocessors and satellite communications. Jerry has responded to calls for help from earthquake-stricken Managua and tornado-ravaged Xenia. Antarctica, one of man's loneliest outposts, has been a bit less lonely, thanks to Jerry's tireless phonepatching efforts. Drawing on his own colorful experiences and those of many other hams, Jerry has compiled this word-picture of ham radio during the past six decades. BK7312 \$4.95

**A GUIDE TO HAM RADIO**—by Larry Kahner WB2NEL. What's Amateur Radio all about? You can learn the basics of this fascinating hobby with this excellent beginner's guide. It answers the most frequently asked questions in an easy-going manner, and it shows the best way to go about getting an FCC license. A Guide to Ham Radio is an ideal introduction to a hobby enjoyed by people around the world. BK7321 \$4.95.\*

**WORLD RADIO TV HANDBOOK 1982, 25TH EDITION**—This book is the bible of international broadcasters, providing the only authoritative source of exact information about broadcasting and TV stations world wide. This 1981 edition is completely revised, giving comprehensive coverage of short, medium and long wave, 560 pages of vital aspects of world listening. BK1184 \$16.50

FOR TOLL FREE ORDERING CALL 1-800-258-5473

# ADVERTISERS

\*Please contact these advertisers directly.  
To receive full information from our advertisers please complete the postage-paid card.

R. S. No.	Page	R. S. No.	Page	R. S. No.	Page	R. S. No.	Page
2	AEA/Advanced Electronic Applications . . . . . 4, 30, 75, 90, 121, 131	*	Dayton Hamvention . . . . . 38, 61	*	Kenwood . . . . . 7, Cov. IV		Moving . . . . . 136
115	A5 ATV Magazine . . . . . 145	*	DGM Electronics, Inc. . . . . 72	204	KLM Electronics . . . . . 75		Subscriptions . . . . . 97, 135, 136
164	A & W Productions . . . . . 88	*	Digi Com Engineering, Inc. . . . . 121	452	Lacombe . . . . . 55		University Microfilms . . . . . 97
448	Advanced Communications International . . . . . 109	57	Discount Ham Radio . . . . . 77	477	Lewis Construction Co. . . . . 123		* Simple Simon Electronics Kits . . . . . 37
124	Advanced Computer Controls . . . . . 29	425	Doppler Systems . . . . . 109	77	M-Squared Engineering, Inc. . . . . 121		486 Simpson Electric Co. . . . . 142
476	Advanced Computer Controls . . . . . 126	453	EGE, Inc. . . . . 133	44	Macrotronics, Inc. . . . . 43		112 Sintec Co. . . . . 39
*	Alaska Microwave Labs . . . . . 98	146	Electronic Rainbow Industries, Inc. . . . . 23	45	Madison Electronics . . . . . 90		367 Slep Electronics . . . . . 144
20	All Electronics Corp. . . . . 146	477	Electronic Rainbow Industries, Inc. . . . . 126	134	Martin Engineering . . . . . 110		* Spectronics . . . . . 137, 160
*	Amateur Electronic Supply . . . . . 19	*	Electrovalue Industrial, Inc. . . . . 146	205	Metheny Corp. . . . . 145		68 Spectrum Communications . . . . . 82, 83
5	Amateur-Wholesale Electronics . . . . . 53, 73	479	Encon . . . . . 143	478	Metheny Corp. . . . . 128		436 Spectrum International, Inc. . . . . 76
483	Amateur-Wholesale Electronics . . . . . 142	400	Engineering Consulting Service . . . . . 146	47	MFJ Enterprises . . . . . 35, 129, 131, 133		198 Speedcall Corp. . . . . 39
356	Anteck, Inc. . . . . 74	22	Fair Radio Sales . . . . . 145	48	MHz Electronics . . . . . 148-157		69 Surplus Electronics . . . . . 145
169	A. P. Systems . . . . . 123	85	Faxscan, Inc. . . . . 74	50	Microcraft Corp. . . . . 96		183 Tayco Communications . . . . . 125
*	Associated Radio . . . . . 137	323	Fox-Tango Corp. . . . . 80, 96	51	Microlog . . . . . 45		* Telex Communications . . . . . 17
186	Atomtronics . . . . . 119	178	Galaxy Electronics . . . . . 145	196	Microtek . . . . . 145		* Ten-Tec, Inc. . . . . 67
130	Auto Connect . . . . . 129	*	Gilfer Shortwave . . . . . 97	487	Midian Electronics . . . . . 142		170 TET Antenna Systems . . . . . 74
*	Autek Research . . . . . 131	143	GLB Electronics . . . . . 51	*	Mirage Communications . . . . . 91		* The Antenna Bank . . . . . 38
469	BG Carl Electronics . . . . . 110	417	Gotham Antenna . . . . . 77	206	Mor-Gain . . . . . 109		118 The Blacksburg Group . . . . . 59
11	Barker & Williamson, Inc. . . . . 98	195	Goldsmith Scientific Corp. . . . . 86	318	National Comm. Group Co. . . . . 28, 76		449 The Ham Shack . . . . . 133
305	Barry Electronics Corp. . . . . 31	132	Grand Systems . . . . . 146	481	National Microtech . . . . . 142		557 The Tuned Antenna . . . . . 55
439	Ben Franklin Electronics . . . . . 125	86	H & R Communications . . . . . 98	412	Nemal Electronics . . . . . 115		* Thermax Corp . . . . . 137
157	Boman Industries . . . . . 27	31	Hal-Tronix . . . . . 61	137	Nuts & Volts . . . . . 146		208 Tokyo Hy-Power Labs, Inc. . . . . 10
*	Butternut Electronics Corp. . . . . 119	345	Hal Communications . . . . . 15, 89	* Orbit Magazine . . . . . 59		104 Trionyx Industries . . . . . 51	484 Tripp-Lite . . . . . 143
187	Call Letter Hats . . . . . 110	* Ham Radio Outlet . . . . . 3		* P. C. Electronics . . . . . 66		197 Twin Oaks & Associates . . . . . 30	* Universal Communications . . . . . 59
92	Ceco Communications, Inc. . . . . 121	33	Hamtronics, NY . . . . . 158, 159	* Palomar Engineers . . . . . 4, 90, 142		* Universal Electronics . . . . . 28	189 Universal Software . . . . . 77
89	Clutterfree Modular Consoles . . . . . 119	460	Handi Tek . . . . . 146	159	Parsec Communications . . . . . 145		* V-J Products, Inc. . . . . 66
150	Commtek . . . . . 125	360	Hoosier Electronics . . . . . 98	201	Pegasus Electronics Ind. . . . . 96		488 Varlan Associates . . . . . 142
382	Communications Concepts, Inc. . . . . 137	* Hustler, Inc. . . . . 11		182	Peterson Electronics . . . . . 146		* Van Gorden Engineering . . . . . 11
*	Communications Design . . . . . 47	78	ICOM . . . . . Cov. II, 143	485	PolyPhaser Corp. . . . . 143		311 Vanguard Labs . . . . . 145
15	Communications Specialists . . . . . 9, 81	445	Independent Crystal Supply . . . . . 146	* Proham Electronics . . . . . 36		* Viking Industries . . . . . 47, 117	90 VoCom Products . . . . . 144
184	Contemporary Electronics Products . . . . . 144	165	Instant Software . . . . . 139	191	Pro-Search Electronics . . . . . 5		200 Votuc Communications . . . . . 47
152	CQ Products . . . . . 74	36	International Crystal . . . . . 125	61	Radio Amateur Callbook, Inc. . . . . 11		480 W9AV (Code Translator) . . . . . 143
*	Crown Micro Products . . . . . 119	39	Jan Crystals . . . . . 97	61	Radio World . . . . . 115		* W9INN Folded Unifroid Antennas . . . . . 144
21	Current Development Corp. . . . . 61	72	JDL Industries . . . . . 36	397	Ramsey Electronics . . . . . 147, 161		302 W-S Engineering . . . . . 80
106	Cushcraft Corp. . . . . 97	354	Jensen Tools, Inc. . . . . 145	147	Randall Sherman . . . . . 96		80 Western Radio Electronics . . . . . 80
346	Data Service Co. . . . . 144	* Kantronics, Inc. . . . . 99		156	RF Electronics . . . . . 51		154 Westland Electronics . . . . . 129
		81	KDK Distributing Comp., Inc. . . . . 76	171	Ridge Systems Co., Inc. . . . . 109		83 Yaesu Electronics Corp. . . . . Cov. III
				171	Rivendell Associates . . . . . 123		
				207	Russ Software Ltd. . . . . 146		
				65	S-F Amateur Radio Services . . . . . 55		
				500	73		
					Books . . . . . 97, 111-114, 136, 141		
					Dealer Ad . . . . . 110		



# BOOKS, ETC.

To order, complete the postage-paid card, or itemize your order including detailed credit card information or check and mail to: 73 Magazine/Mail Order Dept./Peterborough NH 03458.

Catalog#	Item	Price	Catalog#	Item	Price	Catalog#	Item	Price	Catalog#	Item	Price
73300	73 BACK ISSUE—BEFORE JULY 1980	\$ 3.00	BK7309	CHALLENGE OF 160	\$ 4.95	BK7310	OWNER REPAIR OF RADIO EQUIPMENT	\$ 7.95	SG7358	STUDY GUIDE—GENERAL CLASS	\$ 6.95
73350	73 BACK ISSUE—JULY 1980 THRU OCT 1981	\$ 3.50	BK1011	CMOS COOKBOOK	\$10.50	BK1185	THE PRACTICAL HANDBOOK OF FM REPEATERS	\$12.95	BK1190	THE TEN METER FM HANDBOOK	\$ 4.95
73350P	73 BACK ISSUE—NOV 1981 TO PRESENT	\$ 3.50	CT7305	CODE TAPE—5 WPM	\$ 4.95	BK7302	PROPAGATION WIZARD'S HANDBOOK	\$ 6.95	LB7360	TEST EQUIP LIB V2—AUDIO TESTERS	\$ 4.95
73005	73 BACK ISSUE—5 YOUR CHOICE	\$10.75	CT7306	CODE TAPE—6 + WPM	\$ 4.95	QW0250	OSL CARDS—STYLE W—250	\$ 8.95	LB7361	TEST EQUIP LIB V3—RADIO EQUIP	\$ 4.95
	Add \$1.00 per magazine for shipping		CT7313	CODE TAPE—13 + WPM	\$ 4.95	QW0500	OSL CARDS—STYLE W—500	\$13.95	LB7362	TEST EQUIP LIB V4—IC TEST EQ.	\$ 4.95
73010	73 BACK ISSUE—10 YOUR CHOICE	\$16.00	CT7320	CODE TAPE—20 + WPM	\$ 4.95	QX0250	OSL CARDS—STYLE X—250	\$ 8.95	BK7387	TEXTEDIT—WORD PROCESSING KIT	\$9.97
73025	73 BACK ISSUE—25 YOUR CHOICE	\$27.00	CT7325	CODE TAPE—25 + WPM	\$ 4.95	QX0500	OSL CARDS—STYLE X—500	\$13.95	DS7387	TEXTEDIT—DISK	\$19.97
73125	73 BACK ISSUE—25 OUR CHOICE	\$14.00	CT7394	CODE TAPES (ANY FOUR ABOVE)	\$15.95	QY0250	OSL CARDS—STYLE Y—250	\$ 8.95	BK7348	TOOLS & TECHNIQUES	\$ 4.95
	Add \$7.50 per order for shipping		BK1241	THE COMPLETE SHORTWAVE LISTENER'S HANDBOOK	\$ 9.95	QY0500	OSL CARDS—STYLE Y—500	\$13.95	BK1063	TTL COOKBOOK	\$ 9.50
BK1196	ALL ABOUT CUBICAL QUAD ANTENNAS	\$ 5.95	BK7308	THE CONTEST COOKBOOK	\$ 5.95	BK1199	THE RADIO AMATEUR ANTENNA HANDBOOK	\$ 6.95	BK1064	TVT COOKBOOK	\$ 9.95
BK7384	ANNOTATED BASIC, VOL. 1	\$10.95	BK7381	40 COMPUTER GAMES	\$ 7.95	BK1044	RF & DIGITAL TEST EQUIPMENT	\$ 5.95	BK7382	UNDERSTANDING & PROGRAMMING MICROCOMPUTERS	\$10.95
BK7385	ANNOTATED BASIC, VOL. 2	\$10.95	BK1244	EVERYTHING YOU ALWAYS WANTED TO KNOW ABOUT AMATEUR TV	\$ 9.95	BK1016	73 DIPOLE & LONG WIRE ANTENNAS	\$ 5.50	BK7368	VHF ANTENNA HANDBOOK	\$ 5.95
BK1197	BEAM ANTENNA HANDBOOK	\$ 5.95	BK7321	A GUIDE TO HAM RADIO	\$ 4.95	BK1000	SHELF BOX—1	\$ 2.00	BK1198	VHF HANDBOOK FOR RADIO AMATEURS	\$ 6.95
BK7307	BEHIND THE DIAL	\$ 4.95	BK7322	HOBBY COMPUTERS ARE HERE	\$ 2.47	BX1001	SHELF BOXES—2-7	\$1.50 each	BK1202	WORLD PRESS SERVICE FREQUENCIES	\$ 7.95
			BK1201	HOW TO DEFEND YOURSELF AGAINST RADAR	\$ 6.95	BX1002	SHELF BOXES—8 AND UP	\$12.25 each	BK1184	WORLD RADIO TV HANDBOOK	\$16.50
			BK1028	IC OP AMP COOKBOOK	\$14.95	BK1200	SIMPLE LOW COST WIRE ANTENNAS FOR RADIO AMATEURS	\$ 6.95	BK7315	WORLD REPEATER ATLAS	\$ 2.00
			BK1230	INTERFERENCE HANDBOOK	\$ 8.95	BK7311	SOME OF THE BEST FROM KILOBAUD	\$10.95			
			BK7386	KILOBAUD KLASROOM	\$14.95	BK7351	SSB THE MISUNDERSTOOD MODE	\$ 5.50			
			BK7312	MAGIC OF HAM RADIO	\$ 4.95	SG7357	STUDY GUIDE—NOVICE CLASS	\$ 4.95			
			BK7340	THE NEW HOBBY COMPUTERS	\$ 2.47						
			BK7383	THE NEW WEATHER SATELLITE HANDBOOK	\$ 8.95						
			CT7300	NOVICE THEORY TAPES	\$15.95						

SHIPPING AND HANDLING CHARGES: \$1.50 for the first book, \$1 for each additional book for US delivery and foreign surface \$10 per book for foreign airmail.

# SOCIAL EVENTS

Listings in this column are provided free of charge on a space-available basis. The following information should be included in every announcement: sponsor, event, date, time, place, city, state, admission charge (if any), features, talk-in frequencies, and the name of whom to contact for further information. Announcements must be received at 73 Magazine by the first of the month, two months prior to the month in which the event takes place. Mail to Editorial Offices, 73 Magazine, Pine Street, Peterborough NH 03458.

## SOUTH BEND IN JAN 2

A hamfest swap & shop will be held on Sunday, January 2, 1983, at Century Center, downtown on US 33 One Way North between the St. Joseph Bank building and the river, South Bend IN. Tables are \$3.00 each in a carpeted, half-acre room. The Industrial History Museum is in the same building. Four-lane highways lead to the door from all directions. Talk-in on 52.52, .99.39, 93.33, .78.18, 69.09, 145.43, and 145.29. For more information, contact Wayne Werts K9IXU, 1889 Riverside Drive, South Bend IN 46616, or phone (219) 233-5307.

## WEST ALLIS WI JAN 8

The West Allis Radio Amateur Club will hold its 11th annual Midwinter Swapfest on Saturday, January 8, 1983, beginning at 8:00 am, at the Waukesha County Exposition Center. Tickets are \$2.00 in advance and \$3.00 at the door. Tables are \$2.00 in advance and \$3.00 at the door. For advance reservations, send an SASE to WARAC, PO Box 1072, Milwaukee WI 53201.

## OAK PARK MI JAN 9

The Oak Park Amateur Radio Club will hold its annual Swap 'n Shop on Sunday, January 9, 1983, from 8:00 am to 3:00 pm, at Oak Park High School, southwest corner of Coolidge and Oak Park Boulevard, Oak Park MI. There will be ample parking and refreshments. Talk-in on 146.52. For prepaid table reservations, write OPARC, 14300 Oak Park Boulevard, Oak Park MI 48237.

## RICHMOND VA JAN 16

The Richmond Amateur Telecommunications Society will hold Richmond Frost-fest '83, the annual winter ham radio and computer show, on Sunday, January 16, 1983, at the state fairgrounds, Richmond VA. General admission is \$4.00. All flea-market and commercial exhibit spaces will be indoors in a 30,000-square-foot exhibit building.

## SOUTHFIELD MI JAN 30

The Southfield High School Amateur Radio Club will hold their 18th annual Swap & Shop on January 30, 1983, from 8:00 am to 3:00 pm, at Southfield High School, 24675 Lahser, Southfield MI. Doors will open at 6:00 am for exhibitors. Admission is \$2.50. Reserved tables (payable in advance) are \$18.00 for two 8-foot tables and \$9.00 for each additional reserved table. Tables also will be available at the door. There will be food and parking. All profits go toward electronics scholarships and to support the

activities of Southfield High School's amateur radio club. For more information or reservations, write Robert Younker, Southfield High School, 24675 Lahser, Southfield MI 48034, or phone (313) 354-7372 from 8:00 am to 10:30 am or (313) 354-8210 from 10:30 am to 3:00 pm Monday through Friday.

## ARLINGTON HEIGHTS IL FEB 6

The Wheaton Community Radio Amateurs will hold their hamfest on February 6, 1983, at Arlington Park Race Track Expo Center, Arlington Heights IL. Tickets are \$3.00 at the entrance and \$2.50 in advance. Doors will open at 8:00 am. Flea market tables are free and plenty of floor space will be available. There will be a large commercial area (including a com-

puter section), awards, and clear, paved parking. Talk-in on 146.01/61 and 146.94. For general information, call W9JTO at (312) 231-9524. For advance tickets, send an SASE to WCRA, PO Box QSL, Wheaton IL 60187.

## MANSFIELD OH FEB 13

The ARRL-approved Midwinter Hamfest/Auction will be held on Sunday, February 13, 1983, beginning at 8:00 am, at the Richland County Fairgrounds, Mansfield OH. Tickets are \$2.00 in advance and \$3.00 at the door. Tables are \$5.00 in advance and \$6.00 at the door. Half tables are available. Talk-in on 146.34/94. For additional information or advance tickets, contact Harry Fretchen K8HF, 120 Homewood Road, Mansfield OH 44906, or phone (419) 529-2801 or (419) 524-1441.

## MARLBOROUGH MA FEB 20

The Algonquin Amateur Radio Club will hold its annual flea market on Sunday, February 20, 1983, at the Marlborough Jr. High School, Marlborough MA. Admission

is \$1.00 and children under 12 will be admitted free. The doors will open at 9:00 am for dealers and 10:00 am for buyers. Refreshments will be available. Tables reserved before February 12, 1983, are \$7.00; any remaining tables will be \$10.00 at the door. Talk-in on 146.01/61 and 146.52. For table reservations or more information, contact Algonquin ARC, PO Box 258, Marlborough MA 01752.

## GLASGOW KY FEB 26

The Glasgow Swapfest will be held on Saturday, February 26, 1983, beginning at 8:00 am Central time, at the Glasgow Flea Market Building, 2 miles south of Glasgow just off highway 31E, Glasgow KY. Admission is \$2.00 per person. There is no additional charge for exhibitors. The first table per exhibitor will be free, and extra tables will be available for \$3.00 each. There will be a large heated building, free parking, free coffee, and a large flea market. Talk-in on 146.34/94 or 147.63/03. For further information, write Bernie Schwitzgebel WA4JZO, 121 Adairland Court, Glasgow KY 42141.



**CENTRAL NEW YORK'S MOST COMPLETE HAM DEALER**



ROBOT 800



ICOM IC-720



KENWOOD TS830S



DRAKE TR7DR7



YAESU FT707

Featuring Kenwood, Yaesu, Icom, Drake, Ten-Tec, Swan, Dentron, Alpha, Robot, MFJ, Tempo, Astron, KLM, Hy Grain, Mosley, Larsen, Cushcraft, Hustler, Mini Products, Bird, Mirage, Vibroplex, Bencher, Info-Tech, Universal Towers, Callbook, ARRL, Astatic, Shure, Collins, AEA. We service everything we sell!

Write or call for quote. You Won't Be Disappointed.

We are just a few minutes off the NYS Thruway (I-90) Exit 32

OUT OF STATE  
ORDER TOLL FREE  
800-448-9338

ONEIDA COUNTY AIRPORT TERMINAL BUILDING  
ORISKANY, NEW YORK 13424  
N. Y. Res. Call (315) 736-0184

Warren - K2IXN  
Bob - WA2MSH  
Al - WA2MSI

## NEMAL ELECTRONICS

### COAXIAL CABLE SALE

**This Month's  
Specials**

**Same Day  
Shipping**

<p><b>POLYETHYLENE DIELECTRIC</b></p> <p>RG213 noncontaminating 95% shield mil spec. 36c/ft.</p> <p>RG174/U mil spec. 96% shield 10c/ft.</p> <p>RG11U 96% shield. 75-ohm mil spec. 25c/ft.</p> <p>RG8U 96% shield, mil spec. \$27.95/100 ft. or 31c/ft.</p> <p>RG6A/U double shield, 75-ohm 25c/ft.</p> <p>RG58A/U stranded mil spec. 12c/ft.</p> <p>RG58 mil spec. 96% shield 11c/ft.</p> <p><b>LOW LOSS FOAM DIELECTRIC</b></p> <p>RG8X 95% shield (black, white or gray) \$14.95/100 ft.</p> <p>RG8U 80% shield 17c/ft.</p> <p>RG58U 80% shield 18c/ft.</p> <p>RG58U 95% shield 07c/ft.</p> <p>RG59U 100% foil shield, TV type \$7/100 ft.</p> <p>RG8U 97% shield 11 ga. (equiv. Belden 8214) 31c/ft.</p> <p>Rotor Cable 8-con. 2-18 ga. 6-22 ga. 19c/ft.</p>	<p><b>CONNECTORS MADE IN USA</b></p> <p>Amphenol PL-259 79c</p> <p>PL-259 push-on adapter shell 10/\$3.89</p> <p>PL-259 &amp; SO-239 10/\$5.89</p> <p>Double Male Connector 11/\$1.79</p> <p>PL-258 Double Female Connector 9c</p> <p>1 ft. patch cord w/RCA type plugs each end. 3/\$1.00</p> <p>Reducer UG-175 or 176 10/\$1.99</p> <p>UG-255 (PL-259 to BNC) 3/\$3.50</p> <p>Elbow (M359) 11/\$1.79</p> <p>F59A (TV type) 10/\$2.15</p> <p>UG 21D/U Amphenol Type N Male for RG8 3/\$3.00</p> <p>BNC UG88C/U, male 11/\$1.25</p> <p>3/16 inch Mike Plug for Collins etc. 11/\$1.25</p> <p>UG273 BNC to PL-259 3/\$3.00</p>
--	---

FREE CATALOG  
COD add \$1.50—FLA. Res. add 5% Sales Tax

**Connectors—shipping 10% add'l, 2.50 minimum**

Cable—shipping \$3.00 1st 100 ft., \$2.00 each add'l 100 ft.

1327 NE 119th Street, Dept. RLO, No. Miami, FL 33161 Call (305) 893-3924

# LETTERS

## FIGHT CITY HALL

OK, Wayne, I've sat here every month and read how you think that the code requirement is hindering the growth of amateur radio. I think you are missing a problem facing amateur radio that is much bigger than a code requirement. The problem that I am referring to is local ordinances that restrict or prohibit amateur towers and antennas.

I can only imagine the number of hams who have worked hard to upgrade and feel that now is the time to put up that dreamed-of antenna system only to have their local government say it's illegal, so take it down. Why upgrade anymore? In fact, why even continue on with ham radio? It is truly disheartening to be told not to practice your hobby to its ultimate limit and enjoyment.

Believe me, fighting city hall is no fun (well, maybe a little fun when you win). I speak from experience. In my city, Cerritos, California, it took about 2 years of fighting city hall to get our ordinance changed. Led by George Goumas N6AWF, we outlasted our city officials by getting to meetings at 7:00 pm and often not being able even to begin our presentation as to why our ordinance should be changed until 1:00 or 2:00 am. Well, our perseverance paid off with a new ordinance that allowed us to go to 70 feet with a conditional use permit.

Wayne, if it had not been for many out-of-town hams who came and helped to fill up the council chambers, we would never have made it. Of the 100-plus hams in our city, only a handful were interested enough to come out for our hearings. It was the backing of the out-of-towners that saved our bottoms.

I applied for the first permit under the new ordinance. It was granted after a two-hour discussion with neighbors who claimed I was causing them continuous interference. A well-kept log book blew that argument away. I really thought that my permit was to end up on the scrap pile after a 137-signature petition against me was presented to the council. For a number of reasons that I won't go into, it had no effect.

From these experiences I have come to some conclusions that I would like to share with all amateurs. First of all, most of you don't care about what is going on around you until it hits you square in the face. Amateurs need to fight for their property rights as home owners. I have a little 50' x 100' piece of property that I'd like to call mine, but it is never mine when I have people telling me I can't practice a hobby that's not noisy or harmful. It's a lot easier to keep restrictive laws off the books than it is to change existing laws. Each amateur should make it his (or her) business to keep tabs on what is going on in his city. Finally, don't assume that because the guy a mile away has up a tower and antennas that there are no laws against it in your city. It may be that no one has complained to the city so they just haven't taken the time to tell the amateur to remove it.

Wayne, as much as I dislike fighting with my local government, I'll never stop fighting. It looks as if I will be moving in the next year so that I will probably have to go through the permit process again. Local governments are slowly taking away our personal freedoms. If you don't believe it, just check to see what kinds of no-nos are on your local government's books. These

ordinances will range from what color you are allowed to paint your house to what you are allowed to park in your driveway. Believe me, restrictive antenna ordinances are becoming more of a widespread problem than you will ever know and are certainly more of a problem than a code test.

Carol Green KK6V  
Cerritos CA

P.S. Since writing you this letter, our city is trying to pull the wool over our eyes again. They have decided to take the new ordinance and put it back into the Planning Commission for further study. So far through all of this, we have received no League backing. If the ARRL won't help us this time then I suspect that 100-plus amateurs in this city will no longer have any reason for belonging to the League because amateurs that cannot operate have no reason for belonging to an organization that deals with the operation of amateur radio stations.

## HYPOCRISY

How far have we progressed in ham radio? Is it possible that our technology has passed our intelligence? Can it be that many of our population lean towards hypocrisy?

One of the most common comments one hears on the air is, "Ham radio is so great, it has something for everyone." I suppose they speak of the hobby where, if you have the money, you can own monobanders on each band, several transceivers, and amplifiers. Do we include the other guy? The one who lives by the dipole and no amplifier? Which hobbyist is more important?

Looking back, more than half of what I now have collected I owe to a list or a net of some kind. Myself, I have never taken a relayed report, which some seem so concerned about. The percentage of people who operate with the same self-dignity set of rules I operate with is probably 98 percent.

I have sat in awe at my station listening to what some say is the only way to work a DX station (the pileup). I have heard gentlemen such as FB8WG and A51PN (and the list could go on) try to dig a call or just a letter out of the pileup; being unable to do so because people kept calling so long, they just go QRT or QSY.

Gentlemen, channel efforts towards making ham radio a better hobby. During contests, for example, stations all over the bands run 20-30 kHz wide. These guys don't care, because it keeps others from moving close. Why not focus support towards alloting overlapped segments of the General and Advanced band, i.e., 14250-14300 kHz. This way, non-contesters are not forced out of their weekend of operating. How many lists or nets mess up the whole band for others throughout the entire weekend? I suppose that's OK, though, because somewhere, someone up there likes contests.

I firmly believe that the majority of the old-timers that are against lists or such have all or nearly all of their countries and have done so during times when the ham population was one-tenth what it is today. I would like to see them start over with a dipole and barefoot.

I hope any kind of stand against lists and/or nets is only a rumor. Let us consider how much control any organization which

is supposed to help hams should have over how we make a contact.

I feel the desire for the coveted accomplishment in each of us will stop the taking of the invalid report. Those who are dishonest will find a way to be dishonest in every facet of ham radio, no matter what rules are set.

Gentlemen, ponder this and let's all try to improve what we have and not take away that which each of us is entitled to.

Philip Pritchett N6ATS  
Mounds OK

## VENDOR SERVICES

You know the cliché: Each of us is eager and ready to take pen in hand and complain, grumble, bellyache, etc., against or about some vendor or products or services. But to say something nice about someone or something, that is another scenario, and here comes one.

I have been a ham for about four years, starting at the tender age of 57. In this relatively brief period I have sampled the wares and services of many vendors selling to amateur radio people. Overall, it has been a pleasant experience, but let me single (or is it double) out two vendors from the many I have experienced.

First—Trio Kenwood, makers of fine rigs for two-meter and HF operation along with excellent, if somewhat expensive, audio gear. I have been particularly impressed with service out of their Compton, California, site. They are professional and timely, either by mail or through the reception desk. One gets to speak to a technician right up front, and if the one serving you is not familiar with your particular rig he goes for help in the back room. The rule is courtesy and the proper amount of sympathy. When appropriate, charges are less than the "minimum" posted in the reception area. Service time is often less than posted minimum time. All in all, *real* service after the sale!

I am equally happy with the products and service from Communications Specialists, Orange, California, makers of tone generators for PL applications. Customer service by telephone has always been polite and efficient. You get the feeling that they care about their customers. On several occasions, they have given no-charge service well after the end of the warranty period, service required by my clumsiness rather than product failure. Again, a company that unstintingly backs up its product.

I would like to hear from other hams with similar experiences.

I. Orlitzky KA6CLE  
Venice CA

## BE AN ELMER

For the past several months I have been reading letters directed to you by proponents and opponents of code-free licensing. I have yet to read one letter that addresses the central issue, which I believe is how we as amateurs propose to make our hobby better.

I struggled with the code and theory as, probably, most do... my callsign attests to that. The pivotal feature is that perseverance and desire can get most everyone past the hurdles. I do not feel that 20-wpm code... 13-wpm code... nay, even 5-wpm code, nor Mr. Bash's crib text detract from amateur radio; neither do I feel that those things support ham radio. I feel amateur radio's biggest asset lies in the individual hams who comprise our society and the

fact that ham radio is a challenging and just plain fun hobby.

Each and every one of us, the already-licensed hams, should do our part to fascinate, encourage, instruct, and support non-hams in the acquisition of an amateur license. We should, on an individual basis, be Elmers to any who show an interest. We should, as groups or clubs, promote and participate in spreading the word that ham radio is fun by supporting and teaching classes. Learning aids are available. 73, Heathkit®, the ARRL, Ameco, and others publish many fine learning aids. The FCC, while not always as responsive as we would like, is the arbiter of our licensing exams and makes those exams available on schedule and without prejudice.

What may be missing is the incentive for us as individual hams or groups of hams to encourage others. I propose that 73 spearhead an effort to encourage hams to teach others about ham radio. How?

1) Awards: I propose that 73 offer awards to individuals and clubs, similar to operating awards, for getting amateurs licensed.

2) Instructor training: Most of us can learn but many require help in the form of syllabi, group instructional aids, and teaching techniques to enable us to help others. Publish these aids.

3) Public knowledge: Advertise to make the public aware of amateur radio. The ARRL does this to some extent—more is needed.

4) Hotline: Match Elmers (either individuals or clubs) with prospective amateurs needing help. Might work like an computer dating service. A national 800 number hotline is one possibility.

5) Service awards: Encourage clubs to promote themselves by offering club awards for participation in activities like SETS, RACES, MARS, etc.

These are some of the possibilities. There are probably many more ideas which would work better or attack a different front. Not everyone wants to become a radio amateur. For one thing it requires some discipline and effort and not everyone is willing to devote the necessary energy. I feel that everyone who is willing to make the necessary commitments should be given all the help possible by all of us amateur radio operators everywhere.

Jeff Barstow WD8DLK  
Rodney MI

## BASH REFORM

I am a 15-year-old at Hereford High, and I am writing about the public outcry (what little there is of it) towards Bash Educational Services. In 73 for November, you reported the failure of 89 percent of one of Bash's classes and restated your opposition to the books and classes. I must admit that I have great respect for anyone who takes a firm stand for their own opinions. However, I do disagree with you on the "Bash Book" debacle.

When you really think about it, Bash's system was a radical concept, but as with all once-new ideas, an improvement is needed (not a ban).

Now think about this: You have to admit that for anyone intent on passing "Big Brother's" exam for upgrade it is a Herculean effort to find all of the information (much less, carry the ton of books needed) for passing the bewitching exam; even the *ARRL Study Guide* is nowhere near enough. Anyone who has no prior knowledge of the theory will quickly find out that the *Study Guide* is a good book for introducing them to the theory but in no way prepares them for the double- and triple-talk used by the FCC to befuddle our minds. If you get all of

the necessary books to study out of, you wind up studying a lot of information, 70 percent of which you will probably never use or want to know or is not even on the test. All of this useless information mainly serves its purpose by wandering around our minds and mingling with the facts needed. This usually causes a nasty surprise in the form of a failure.

My idea for improvement is a simple change. Continue collecting Qs and As from tests but not for printing in cheat books. I would simply use these and take all of the ham-radio-related books I could get (if I had the sources) and find all I could in the way of theory and facts to back up all of the answers. Take these arranged facts and write them into an easy-to-understand form of writing with flavor and a small vocabulary (you want more young hams; write it so we can understand you). Without using boring, dragging wording, present the theory well, and towards the end of the book introduce readers to the language used by the FCC and get them very familiar with it. Also, a copy of the regs in FCC form with simple English definitions would be desired by many people.

I think that anyone bringing out such a book would end the era of the Bash Books. I know that my idea is not new, but I have yet to see it in the print of a large magazine.

Thank you for your good magazine and for your time.

Glen White NA5Z  
Hereford TX

### YOU'RE MY TYPE

Your last two issues of 73, namely October and November, have been more my type of magazine. Since I keep my own notebook of the interesting articles I see in the mags, you have kept me busy lately. You see, I look for articles that look interesting to put on the breadboard and play with and when I've played with one long enough and it looks like a good project to finish, so much the better.

In regard to your continually pressing for more amateurs, I feel that I must put in my two bits' worth. Of all the 50 or more notices that have passed their exams around here the past two years or so, there are only about two or so on the air. Everyone is interested in DX—how far can we get out, etc. The biggest problem seems to be money. Very few seem to be interested in building. Frankly, I think we need a good set of textbooks that will take the prospective ham from beginning to end.

I'm all for your computer networks, but so far your computer articles are way over my head and I cannot afford the price of a computer to figure them out. The day you can show me 73 articles where I can borrow my wife's portable TV set and, with the minimum of cost, put it on the air, that will be the day. You'll have to hurry, though: I'm 74 years old.

Laurence A. Knutson W9SFL  
La Crosse WI

### SCHOLARSHIPS

The officers and directors of the ARRL Foundation announce the recipients of two awards for the 1982-83 academic year. The Long Island School Scholarship, for youths attending Long Island colleges or universities, has been granted to Paul Michael Silverman KA2DSP, of Levittown NY. He entered State University of New York at Farmingdale in September to pursue courses in electronics technology. The

\$250 ARRL Foundation-administered award was given to this young man for demonstrated interest and excellence in promoting amateur radio and for aspiring to an electronics career.

The YL ISSB Memorial Scholarship has been awarded, for the second successive year, to Larry Edwin Smith, Jr. WB9UKE. The awarding of \$709 to Larry concludes the ARRL Foundation's administration of this scholarship fund for YL ISSB. Larry pursues associate and bachelor's degrees in electronics engineering, aspires to a career with NASA communications, holds amateur Extra and 2nd class commercial licenses, has maintained an A academic average, and has been very active in extracurricular activities at Vincennes University.

ARRL Foundation-administered scholarships are open to all applicants, qualifications and specific criteria being reviewed by screening boards consisting of ARRL Foundation officers and directors and panels provided by sponsoring organizations. Application closing date is May 1, 1983, for the next academic year.

Andrea T. Parker K1WLX  
Secretary, ARRL Foundation  
Newington CT

### FINDING BIRDS

Finally, I have found why the RS-n satellites aren't where they were supposed to be: The tracking program was wrong! I'm referring to "Tracker—The Ultimate OSCAR Finder," p. 88, 73 Magazine, January, 1981. The computation for satellite longitude is correct only for satellites with inclination greater than 90 degrees. The sign of the variable SO needs to be changed for satellites like the recent Russian ones with inclination less than 90 degrees. I take care of it in my revised Apple version this way:

$$2010 CA = \cos(IN); SO = -SO / CA / (ABS(CA)) + CO * RD + RD * TI/4$$

There are many ways to accomplish this sign change; this is the mathematician's way.

Actually, this program is not the only place this error is made. The RSGB VHF Handbook puts that correction for inclination on the TI/4 term. The reference that I found to explain this correction is by Bryan Leipper, "Circulation Orbits with Simple Computing Systems," QST, February, 1979, pp. 38-42.

Dr. Gerald N. Johnson KØCQ  
Ames IA

Thanks for the tip, Gerald. We thought the Russians were just being obstinate.—Eds.

### NO FAULT, PCBs

I just finished reading "Avoiding the Electrical Nightmare," on page 64 of the October issue regarding the unusual voltages encountered by N4UH of Cleveland, North Carolina. I was prompted to write because, while his technical analysis is correct, his terminology is not. There is a great difference between a "ground fault" and the condition he describes which is an "open neutral."

A true ground-fault condition is just what the name implies—a fault to ground, or earth. Visualize your electrical panel and the wires in it for a moment. The black wire from the breaker is the neutral or return part of the circuit. An electric light connected between the black and white conductors completes the circuit. The current flowing

"out" the black wire is equal in magnitude to the current flowing "in" the white wire. If we introduce a fault into the circuit (such as a broken insulation protecting the black wire from shorting to the panelboard box), then current will flow through the light fixture and back out as before, but also through the black wire to the insulation fault to ground and back to the neutral at the point where the neutral and ground are common. This is a ground fault and the current flowing in the ground conductor is not equal to the current flowing in the neutral return.

Ground-fault circuit interrupters (GFI or GFCI) are devices that sense the current flowing out the black wire and the current flowing in the white wire. If the difference is greater than 5 mA (for the typical residential units), then the device interrupts the current. If the fault from the black wire to ground was through your arm, you would be most appreciative.

The fault described in the article is an entirely different problem. The problem experienced by N4UH was an open neutral. The return conductor (the white wire) was open, creating a voltage-divider effect between the legs of the power system.

The National Electrical Code (NFPA-70-1981) requires that all electrical systems be grounded. The grounding should be accomplished at a single location. This location, as required by the code, is at the supply side of the service at the main service disconnect. This is the only location where the neutral and ground are brought together. All of the uninsulated ground wires running around in your Romex are for the purpose of extending this ground point to each and every receptacle and light fixture in your house. A ground fault at any location in your home will cause the ground conductor to carry the return current back to the common point with the neutral at the service disconnect.

It should be noted that the type of problem encountered is rare and should not cause alarm on the part of those with aluminum service-entrance conductors. Utility practices vary but always account for the problems of aluminum oxidation. Aluminum connections, if properly made, are very reliable and need not be of concern to the homeowner. (This applies to the larger sizes of aluminum and not necessarily to aluminum branch-circuit wiring, but that would be the subject of an entire article in itself.)

As long as I am writing, I also would like to extend a word of caution regarding the article on page 29, "Dissertation Upon Roast Pig," by N6TO. The transformers obtained from the utility most likely were immersed in mineral oil. A few transformers are still in circulation, however, which contain polychlorinated biphenyl (PCB). PCB is a major component in coolant known as "Askarel." This is nasty stuff which is very toxic and must be disposed of in accordance with EPA regulations. Under no circumstances should you attempt to use a transformer that contained this coolant. The utility should not even consider selling you a transformer which contains PCB. Because the utility may not know which transformers contain PCB, you may discover one by mistake. In addition to transformers, some high-voltage capacitors used in commercial equipment a few years back also contained PCB insulating material. Be cautious with all surplus and used electrical components containing oil for cooling or insulation.

Dave Olsen KL7K  
Anchorage AK

## AMERICAN & METRIC 62-PIECE HEAVY DUTY INDUSTRIAL TOOL CHEST

\$28

Before Midnight Jan. 23

We will send to each reader of this publication who reads and responds to this test before midnight Jan. 23, a 62-piece American and Metric Heavy Duty Industrial tool set and metal storage chest containing all the basic and special tools necessary to service and repair domestic and foreign trucks, tractors, autos, and all heavy industrial machinery. Consists of 7 American 3/8 inch drive sockets (3/8", (7/16"), (1/2"), (9/16"), (5/8"), (11/16"), (3/4"), 9 American 1/4 inch drive sockets (3/16"), (7/32"), (1/4"), (9/32"), (5/16"), (11/32"), (3/8"), (7/16"), (1/2"), 9 Metric 3/8 inch drive sockets, (9MM), (10MM), (11MM), (12MM), (13MM), (14MM), (16MM), (17MM), (19MM), 9 Metric 1/4 inch drive sockets, (4.5MM), (5MM), (6MM), (7MM), (8MM), (9MM), (10MM), (11MM), (12MM). A 3/8 inch fine tooth ratchet with quick release drive combination-forward and reversible, a 1/4 inch x 3/8 inch adapter, a 3/8 inch drive extension bar 3 inch. A 3/8 inch spark plug socket with oil resistant insert and speed installation and removal. An 18-piece industrial steel ignition wrench set, complete set of spark plug gap setting gauges for any type of spark plug. One 1/4-drive heavy screwdriver. (One) large set of feeler gauges, industrial "Phillips" heavy duty and "regular" screwdriver. All tools are drop forged alloy steel for durable heavy duty repair work, and will be accompanied with a LIFETIME guarantee that it must perform 100% or it will be replaced free. Add \$7 handling and crating for each Tool Chest requested, we pay all shipping. Should you wish to return your tools, you may do so for a full refund. Any letter postmarked later than Jan. 23 will be returned. LIMIT: Six (6) sets per address, no exceptions. Send appropriate sum together with your name and address to: Tool Test Dept. #120DW, Viking Ind., 6314 Santa Monica Blvd, Los Angeles, CA 90038, or for fastest service from any part of the country, call collect before midnight 7 days a week (213) 462-1914 (Ask for) TOOL TEST, #120DW, have credit card ready.

# W2NSD/1 NEVER SAY DIE

editorial by Wayne Green

from page 8

bringing world reports to 73 could do the job.

We do have a world hobby, so let's see if we can get it together more.

## HAMMING FOR CREDIT?

Down in Georgia there is a proposal to have ham classes count for educational credits. That's a good move.

There is a desperate need to get amateur radio going again in our schools and this approach could generate some interest for the students. It would be a way of, so to say, paying the students back with credits as well as in fun.

Though it is old hat to 73 readers to read about the needs America has for technical people...I've been writing about that for several years now...I see that the general media are getting more concerned over the problem. Even the normally liberal writers are getting to worry about the overwhelming loss of technical consumer products to Japan.

With the increasingly rapid development of video technology, microcomputers, data access over the phone or via television stations, video teleconferencing, satellite services, 100-channel TV cables, and so on, it is getting ever more difficult for the general public to ignore the coming developments. They've even been noticing that almost all of the recent developments have been coming from Japan and figured out that this just might make it difficult for America to catch up once we fall seriously behind.

Articles about this have been appearing with increasing regularity in *Newsweek*, *Time*, *Business Week*, *Fortune*, and so on. The situation is getting so serious that a small handful of our educators is beginning to get uneasy. When a problem reaches that level, you know it has to be serious.

Naturally, there are pressures for our government to force

Americans to buy more expensive and technically-inferior products just because they are made here instead of in Asia... just as there are heavy pressures to force Americans to buy crummier cars because they are made here. I'd like to see more interest in American productivity, American pride in perfection, and American unions promoting something besides the highest pay possible... with the result that the products are priced out of the market.

But that's another problem... to some degree. The key to any American success in communications and computers in the next twenty years lies in our having the technically-qualified people to invent the products, manufacture them, sell them, operate them, and service them. This is going to take an enormous number of engineers, technicians, and scientists... vastly beyond anything which we even have in prospect to develop in this country.

Only Japan has laid the groundwork to develop the high-technology people who are going to be needed to provide the whole world with video, computers, information, and other technical services which are going to be the key to personal happiness, business success, and educational achievement in, say, twenty years.

While we're busy lowering our academic standards and seeing our proponents of liberal-arts education winning most of the battles in academia, we see Japan loading their schools with enthusiastic technically-inclined students. Do you realize that there are over 900,000 amateur radio operators in Japan today? They have us outnumbered in active hams by a margin of at least three to one... possibly four to one... and Japan has only half of our population! They are running rings around us.

Amateur radio has never been a very popular hobby in America. Even when we were growing at our greatest rate, back in the 1950s, we were growing at only

about 11% per year, which was about 22,000 newcomers. Then, with the "incentive licensing" disaster of the 1960s, we fell to zero growth (and worse). Now we're back into a growth mode, but not an impressive one.

Unless the Japanese technology program runs out of steam, their teenagers will be doubling the number of hams in Japan in the next three years, while at our rate of growth we are looking at about eight years for a doubling of our hams.

There has been some criticism of calls for more engineers with a reminder that only a few years ago massive numbers of engineers were dumped and were unable to find work. To a degree, that is right. But what is glossed over in that response is that the engineers and technicians who joined the unemployed were those who had not kept up with the changes in technology. There has never been any surplus of technically-trained people.

Remember that by 1970 it had dawned on even the most backward of firms that solid state was here and unavoidable. This was when the axe fell. Those engineers who were living in the good old tube days were suddenly not needed. This axe was wielded again when the industry discovered ICs and had no further use for engineers who could not cope with them. Each new generation of electronics is going to be ruthless in weeding out the people who do not adapt.

Today, the need is for young engineers and technicians. Our schools have been almost totally emptied of these talented people, leaving the over-40 remnants of previous technologies to try to teach things they haven't bothered to fully understand. This does not bode well for our schools or the next generation of kids... the ones we're depending on to cope with the Japanese incursions.

Amateur radio can help, at least to a degree. By interesting teenagers in a high-tech hobby, we may be able to develop the engineers and technicians we need, both for industry and for our schools as teachers. Of course, the exceedingly slow growth of amateur radio over the last twenty years has meant that the average age of amateurs has been rising steadily, with the result that within our ranks we have few qualified

teachers to get new hams started. The technical competence of hams as compared with industry has been dropping for twenty years, where at one time hams were a cut above the average engineer or technician.

I can remember the time when hams were responsible for virtually every major breakthrough in radio communications. Now we can merely point out that long ago hams pioneered FM, NBFM, SSB, SSTV, RTTY, and so on. We old, doddering relics of the past can remember the pride of those olden days. But the world is ruthless; it wants to know what you've done for it lately. Not much.

The plan for giving scholastic credits for ham classes is a fine move; let's see if we can get that idea spread around. I'll be interested in getting articles for 73 on proven ways of getting teenagers interested in amateur radio and on successful programs to get amateur radio growing.

In the meanwhile, I'd like to see a lot more articles in 73 on current technologies. Perhaps we can get amateur radio back into developing some inventors and pioneers of new techniques. Running articles on designing and building kilowatt tube-powered linear amplifiers is not it... unless someone designs a digital automatic-tuning device.

There is no shortage of things to invent which are well within our technical capability... if we let ourselves go and get cracking on it. For instance, we could use a system for automatic identification of transmitters so that our receivers would indicate the call of the station being tuned in as we tune. This could be done via an ASCII signal sent on a subcarrier, thus furnishing the receiver a reference signal to use for automatic tuning. Once we have that development, we will be ready for receiver-tuning systems which will be automatic, alerting you when chosen prefixes or calls are tuned in.

This could be a great stride ahead for amateur radio, pioneering a new digital communications technology which could be quickly applied to CB, two-way, and most other communications services. It could help to bring about some extensive changes in amateur radio operation, too... perhaps the first real changes in over 50 years. Except for the development of

# RTTY/CW For the TRS-80\*

\* A Trademark of the Tandy Corp.



## ROM-116

Now includes:

- TEXT EDITING
- RTTY PICTURES
- SAVE TEXT TO DISK *Detailed brochure available on request.*

## Featuring:

**1200 BAUD OPERATION.** Not limited to 110 baud because of timing loops. 60, 66, 75 & 100 W. P. M. Plus 110, 150, 300, 600 & 1200 baud operations possible.

**FLEXIBILITY OF OPERATION.** Instantly change: Baud Rates; Program Mode (ASCII/Baudot); Program Status.

**SPLIT SCREEN VIDEO.** Transmit & receive data displayed separately.

**REAL TIME.** Automatic CW/ID without user intervention. Automatically updates at end of month or year.



Other features include:

- Two Serial Ports
- Fourteen Buffers
- Automatic CW/ID
- Transmit Control
- Selective Call Feature
- Error Correction & Editing
- Word Wrapping
- Easy to Interface
- 30 Day Unconditional Guarantee
- Hardware Requirements:  
TRS-80 Model I or III 16K  
EXTERNAL TERMINAL UNIT  
REQUIRED

606 State Street, P.O. Box 892-R • Marysville, WA 98270 • (206) 659-4279

## CW MORSE for the TRS-80\* COLOR COMPUTER

*Our Plug-in Morse-Pak<sup>©</sup> interfaces the Color Computer to your transceiver and allows you to communicate in CW Morse Code through the computer.*

- ★Installs in minutes★
  - ★Simple to operate★
  - ★Handles code speeds up to 60 wpm★
- many more features



We stock a complete line of color computer accessories, including:

• Floppy disk controllers • Serial I/O Ports • Add-on EPROM kits • Plug-in Breadboards • RAM Expansion kits, 16K-64K • and more

Write for brochure to:

ATOMTRONICS ✓186  
3195 ARIZONA AVE.  
LOS ALAMOS, NM 87544

\*Tandy Corporation



## Organize your shack with a CLUTTERFREE MODULAR CONSOLE \$203.35

- Large, 42" H x 57" W x 29" D
- Strong groove-construction
- Mar-resistant wood grain finish
- Options, drawers & face plate
- For ham or home computer
- Visa and Master Charge

## CLUTTERFREE MODULAR CONSOLES

P.O. Box 5103 Tacoma, WA 98405  
(206) 272-0713 ✓89

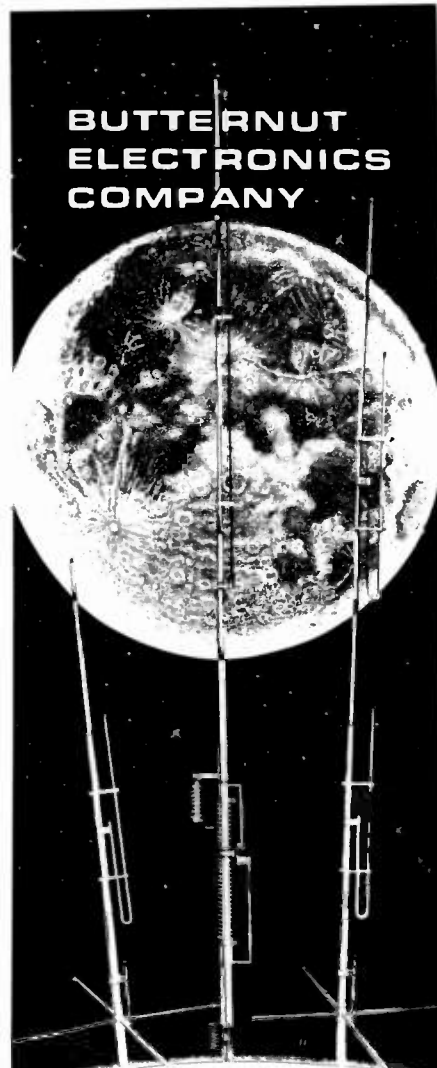

# THE WINNERS

Model HF6V Completely automatic bandswitching 80 through 10 plus 30 meters. Outperforms all 4- and 5-band "trap" verticals of comparable size. Thousands in use worldwide since December '81! 160 meter option available now. retrofit kits for remaining WARC bands coming soon. Height 26 ft/7.8 meters; guying not required in most installations.

Model 2mCV "Trombone" — omnidirectional collinear gain vertical for 2 meters having the same gain as "double-A" types, but the patented "trombone" phasing section allows the radiator to remain unbroken by insulators for maximum strength in high winds. No coils "plumber's delight" construction and adjustable gamma match for complete D.C. grounding and lowest possible SWR. Height: 9.8 ft/2.98 meters.

**NEW** Model 2mCV-5 "Super-Trombone" Same advanced features as the basic 2mCV but a full wavelength taller with additional "Trombone" phasing section for additional gain. Height 15.75 ft/4.8 meters.

All BUTTERNUT ANTENNAS use stainless steel hardware and are guaranteed for a full year. For further information on these and other BUTTERNUT products write for our FREE CATALOG!

## BUTTERNUT ELECTRONICS

GARY AIRPORT, BOX 356 E. RTE 2  
SAN MARCOS, TEXAS 78666

the vfo, our Morse-code communications has changed hardly at all in 50 years. And other than the shift to SSB, phone communications is almost identical to hamming of 50 years ago, complete with pileups on DX, jamming, endless nets, and so on.

We've had practical RTTY on the ham bands for over thirty years and there still is no noticeable dent in traffic handling as a result. Amateur radio, which at one time was the spawning ground for new technologies, has turned into the most rigid and unchangeable remnant of the past.

You invent it and we'll publish it...okay? Let's get amateur radio into gear for the first time in years. The last change of any sort was over ten years ago when we went to FM and repeaters on two meters. Unfortunately we contributed little technically in this move, merely taking advantage of the already-existing technology developed for two-way commercial operating. Now let's do some pioneering for a change.

### DIGITAL MANIA

With the new freedoms being granted by the FCC, I'd like to see some serious experimenting on our bands with digital techniques. Ham radio is never going to go anywhere unless we get busy and take advantage of the recent technological advantages in ICs.

For one thing, isn't it about time that the RTTY crowd stopped puttering around, dodging QRM, and came up with some circuits which will dig out those weak signals and copy them? I tried a recently-advertised computerized-RTTY setup and was astounded to find out how crummy it was...even as compared with the circuits we were building back in 1948. Almost any kind of interference sent it into spasms of incomprehension.

Fellows, I have some news for you. You should be designing RTTY gear which uses the cheapo computers such as the Timex 1000 (Sinclair ZX81), the Atari 400, the VIC-20 and so on. Your circuit should make it duck soup to tune in a signal...and copy should be 100%, despite CW or other neighboring RTTY signals. You should copy through QRM, QRN, jamming, fading, with any shift, and so on. Let's get cracking at this and stop horsing around with junk

which falls apart as soon as a vindictive CW-monger gets on channel. There is, as you may not know, apparently an unlimited supply of CW jammers, all with unlimited time to sit and trash RTTYers. Perhaps we should devise a certificate, with yearly awards.

And while one contingent is doing the inventing which should have been done several years ago but which was prevented by the FCC, bless 'em, others of you should grab your chips and start working seriously on automatic identification for transmitters. Some early experiments indicated that a system would work using a frequency-shifted subaudible tone, but we need to do a lot more work on this. If someone can come up with a relatively simple system which can be built into every transmitter, we can save the several eons of time every year which are presently wasted with redundant identification. Just think of the saving on pileups alone, where perhaps around five thousand stations are giving their calls from fifty to one hundred times per minute, hour after hour. There is a zero in Minnesota with the unofficial record of 117 complete identifications in one minute! A record to be envied. I understand there is a move to get this amazing chap on "People Are Weird."

Once we have a fairly fast automatic-identification system, we'll be able to instantly read out the call of any station tuned in on our receiver. We'll also be able to build in a microprocessor to check the call for wanted calls or prefixes. Those rare ones can come and go pretty fast sometimes, so why miss one just because he is 50 kHz down the band from where you are working? With an automatic tuning system (dual tuning, of course), one receiver tuner will be on your channel for you while the other is scanning the band, checking out the prefixes.

And a couple of years later, the whole thing will be in an HT for us. Just ask any of the early two-meter folk about the first FM rigs and compare them with the programmable, scanning-all-channel HTs of today. You know what we haven't seen yet? Anything!

So, while all you old-timers sit around and fondle your 807s, we're looking to the youngsters to stop fooling around with girls,

get going with their pile of ICs, and invent us out of the 1930s morass that amateur radio is in today. The technology is here. The parts are here. The need is here...and riches are awaiting the entrepreneurs who make it happen.

One thing is for sure...if you invent it, I'm anxious to publish your articles in 73 and get the ball rolling.

### HELP!

Every now and then I see a notice that the League is looking for some hams to add to their staff. Fine, I suppose, though my understanding is that the place is very, very structured. It also isn't growing much, in case you haven't read their yearly report. When I say it isn't growing much, I mean that the League has been losing members at an increasing rate for the last few years. That would make me nervous.

Now, while they've been shrinking away, my little empire has been growing steadily. They need people to replace those who have bailed out. I need people to help us grow even more...and I don't think anyone would really characterize this place as rigidly structured.

In addition to needing a good all-around ham or two to test ham gear and write reviews, to keep the W2NSD/1 hamshack state-of-the-art in RTTY, slow scan, repeaters, antennas, and so on, we also need someone to keep our microcomputers running. We have a hundred or more around here and the darned things keep breaking. I think we could keep a compulsive technician exceedingly happy.

Our audio department has a serious need for a technician to be on top of all the digital recording techniques and assure us that our digital and audio cassettes are first-rate.

For people who for twisted psychological reasons are not particularly interested in living in the finest area of the whole country (the world?), we do have some part-time jobs available which can be done from anywhere. These call for a good deal of responsibility, of course. We're building our national network of sales people and have several nice areas still open. This would entail getting out to visit computer and electronics stores about three days a week to make sure that they are well

stocked with our magazines, books, and computer programs.

In Peterborough, we have open positions for people with PR and advertising experience, sales, editing, writing, graphic arts, photography, and so on. In the next year, we expect to add at least 100 people to the staff...possibly 200, if we can find them.

We're looking for non-smokers who are more interested in developing careers than in just landing a job. We'll be able to keep up our growth only if we keep up our enthusiasm and innovation. Indeed, we've been growing briskly for seven years now, and by the end of this month, we expect to be about five times the size of the ARRL.

So, if you are not a smoker and you're looking for a place to put your outstanding talents to work where they can do the most good...and where you will be able to learn more and grow, think in terms of Peterborough. Send along a letter detailing why we can't go a step further without you...and a resume.

### COMPUTERIZING

With over 40% of the 73 readers computerized...and with thousands more eyeing the Timex computer...I'd like to make sure there is no misunderstanding. I want to see you experimenting with amateur radio applications of these contraptions and writing up your results for 73. The readers are interested in articles on getting rid of computer noise...in protecting the computers from interference from the rig...in RTTY applications...high-speed code...beam aiming...log keeping...automatic QSLing...packet communications...and so on.

Unless you write up the results of your work, it will be wasted...giving only you the benefit. The more you write about what you are doing, the more hams will join you in experimenting and developing new ideas—and we'll all benefit.

Remember, too, that the market is just starting to open up for add-ons for the low-end computer systems. There are millions to be made by those who come up with practical new ideas. We've already seen dozens of new millionaires as a result of the recent microcomputer developments...and we haven't seen anything yet. With



## M<sup>2</sup> ENGINEERING'S VHF H.T. CONVERTERS

- DOUBLE BAND HC-V, HC-U2
- SINGLE BAND HC-V220
- BI-LATERAL PROTECTION AGAINST ACCIDENTAL TRANSMISSION FOR UP TO 5 WATTS

• STANDARD BNC CONNECTORS

• HC-V  
154 - 158  
159 - 163

• HC-U2  
460 - 464  
480 - 484

• HC-V220  
221 - 225

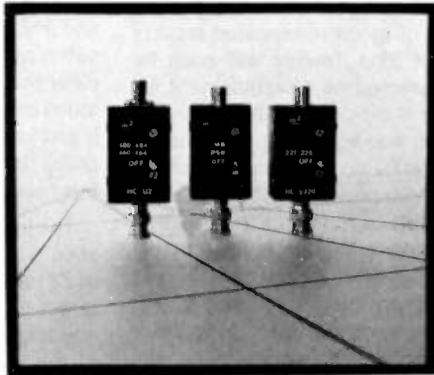

HC-U2  
\$59.95

HC-V  
\$39.95

HC-V220  
\$54.95

• USES SINGLE AAA CELL

• LOW LOSS COUPLING TO ANTENNA

• "OFF" RETURNS TO NORMAL TRANSCIEVER OPERATION

• SIZE: approx. 2 x 1.5 x 1.5

• WEIGHT: 3.9 ozs.

✓77  
**M-SQUARED ENGINEERING, INC.**  
1446 LANSING AVE.  
SAN JOSE, CA. 95118  
CALL SANDY 408-266-9214

DEALERS WELCOME

Shipping included  
Calif. residents add 6.5% sales tax

Don't Be Left Out in the Cold with the Russian Woodpecker

## GET A MOSCOW MUFFLER™

Another first from AEA. The Woodpecker Blanker, WB-1 really works. This unit effectively blanks the pulsing interference of the Russian Woodpecker. Two versions are available, the WB-1 for use with communication receivers and WB-1C for use with all popular transceivers.



This extremely useful accessory is designed for direct insertion between your receiver (or transceiver) and the antenna. It is both MORE EFFECTIVE than I.F. type blankers and requires NO MODIFICATIONS to your receiver! The unit operates from a 13 VDC ± 2 VDC power source at less than 575 mA. (AEA AC wall unit AC-1 will operate the blanker.)

The blanker works well on both CW and SSB modes that are being interfered with by a woodpecker. Controls on the front panel include; four push button switches, a synchronize control and a width control. The WB-1 also features a low-noise untuned broadbanded 6 db gain pre-amp which can be selected with or without the blanker enabled. The WB-1C uses the same circuitry but includes a carrier operated relay (COR). This provides protection to the receiver section during transmissions from the attached transceiver.

For more details, write for our latest catalog or visit your favorite dealer.

Prices and Specifications subject to change without notice or obligation.

**ADVANCED ELECTRONIC APPLICATIONS, INC.** ✓2

P.O. Box C-2160,  
Lynnwood, WA 98036  
(206) 775-7373

Telex: 152571 AEA INTL

**AEA** Brings you the Breakthrough!

## Your Ham Tube Headquarters!

TOLL 800-221-0860 FREE TUBES

3-400Z	\$85.00	6883B	\$6.75
3-500Z	\$85.00	7360	\$9.15
4-400A	\$80.00	7735A	\$29.50
4CX250B	\$50.00	8122	\$98.00
572B	\$39.50	8156	\$10.95
811A	\$12.00	8844	\$29.50
813	\$35.00	8873	\$175.00
6146B	\$6.50	8874	\$160.00
6360	\$4.25	8877	\$450.00
		8906	\$10.50

E.F. JOHNSON Sockets for 4CX250B & 4-400A @ \$9.95

SEMICONDUCTORS		RF CONNECTORS	
MRF 245/5D1416	\$30.00	PL 259	10/\$4.95
MRF 454	\$18.95	PL 258	10/\$8.95
MRF 455	\$12.50	UG 175/176	10/\$1.80
		UG 255/U	\$2.50 ea.
MRF 644/5D1088	\$19.95	UG 273/U	\$2.25 ea.
2N3055	\$ 9.95	M 358	\$2.50 ea.
2N6084	\$12.50	M 359	\$1.75 ea.
		Type "N" twist-on (RG8/U)	\$4.75

TOP BRAND Popular Receiving Tube Types  
FACTORY BOXED 75/80% OFF LIST

FREE LIST Available

Includes full line of RF Power Transistors.  
Minimum Order \$25.

Allow \$3.00 Minimum for UPS Charges

Write or phone for free catalog.

TUBES—BOUGHT, SOLD AND TRADED

**Ceco**  
Since 1922

Premium Prices Paid  
For EIMAC Tubes

**COMMUNICATIONS, Inc.**  
2115 Avenue X  
Brooklyn, NY 11235  
Phone (212) 646-6300 ✓92

## FOURTH GENERATION SATELLITE RECEPTION NOW!

With D.C.E.'S 70 MHZ VIDEO PROCESSOR BOARD

### FEATURES:

- I.F. Strip Includes S.A.W. BP Filter
- Discrete 70 MHZ PLL Demodulator
- Full AGC & AFC
- Normal/Reverse Video
- On Board Power Supply Regulation

The most advanced Satellite Video Processor Available KIT.....\$324.00 ASSEMBLED...\$449.00

**DigiCom Engineering, Inc.**

P.O. BOX 1656  
KODIAK, ALASKA 99615  
(907) 486-5118

ORDERING INFORMATION: Check, M.O. or C.O.D.'s accepted. Airmail shipping costs within U.S. included in price (allow 1 week for delivery). Foreign orders include \$5.00 for shipment by air.

hundreds of thousands of Timex computers being sold, just about any useful accessory for it will be able to generate millions in sales.

In order to encourage this development, *Microcomputing* will be devoting a special section to the low-end computers. We need not only interfaces, programs on cassettes, and so forth, but we may also have a need for better ROM character generators and operating systems, plug-in ROM programs, and so on.

I've helped a lot of people get very wealthy in the microcomputer business... and I can help you, if you are seriously interested. I write about this in my editorials in *Microcomputing*, *80 Micro*, and *Selling Micros*, and I'll be covering this aspect in *in-Cider*, too. It's fun to be rich, and the opportunities are almost unending. As a ham, you have an inside track, if you have the will.

#### HOW'S THE ARRL DOING?

Too bad you didn't get the *QST* annual report... and read it. In amongst the lavish self-praise... an orgy of it... are the stark financial figures, and they are so dark-cloud that they tend to cut through the baloney. Membership is down. And despite the massive increase in the subscription price for *QST*, the income for the League has not even kept up with inflation. Nowhere near it!

The financial management in any normal business would call for the immediate replacement of the people responsible. Of the 74 stocks and bonds in which the League has put the money they've made in profits in past years... being a nonprofit corporation they have to salt away all that money rather than distribute it to the stockholders... only eight are worth more now than they paid for them. Maybe you were wondering who was investing in oil companies, railroads, and so on. Heh, heh... you are.

They seem to have concentrated on economizing on membership benefits such as awards, cutting that by 76% in 1981. This is balanced by an increase in unemployment compensation which went up by 973%... yep, almost ten times, as staffers went through the old revolving door. That's quite a one-year record.

Automobile expenses only

went up 370% in the year. Are they providing limousines for the top echelon these days? We did see healthy cuts in such pork-barrel items as ARRL headquarters expenses, which were 70% higher in 1978. And the W1AW expenses came down, too. They were 51% higher in 1980. It looks as if someone made a trip somewhere, because while there were no overseas expenses chalked up in 1980, they managed to spend \$17,762 in 1981. That's a very nice trip!

Unless you take a serious interest in League financial matters, you have no beef about what they are doing. You are a stockholder of the corporation and should look into how your money is invested. You might even question why the HQ people are salting away millions in stocks and bonds, losing your shirt for you with poor investments, when perhaps they should be spending your money on more services... or, even better, in encouraging some growth in amateur radio.

A million-dollar budget to produce some first-rate films about the excitement of amateur radio... about the benefits of amateur radio to our country... about how to start a high-school ham club... could get amateur radio growing again. We have plenty of friends in television broadcasting to see that the films would get on the air. And a million dollars wouldn't even put a big dent in the bankroll they've built up. It might keep them from blowing so much on lousy investments... and, after all, isn't that what the money *should* be used for?

Look, I know you hate to have me carping about the League... but I'm not giving the League hell right now. I'm giving *you*, the League member, hell. The chaps at HQ will do whatever they want with your money if you don't say anything. It's only by your being a silent partner to the crime that all this money has just plain been thrown away. You haven't been paying attention. You haven't been insisting on meeting with your directors and finding out from them what the situation at HQ is... and they are not going to level with you unless you push them. They'll put the pressure on for membership benefits... and for promotion of the hobby... but only if you lean on them.

The League, under the direc-

tion of the directors you have elected, has been spending a pittance on membership benefits and promotion of the growth of the hobby. Get after 'em... let's see some growth.

#### MAJOR LEAGUE CHANGES AFOOT?

Knowing how undependable the rumor mills are, I don't put a lot of stock in repeated reports that Skip Tenney will soon be promoted as a replacement for Vic Clark as president. Tenney, well known as the publisher of *Ham Radio* magazine, either has sold or seems about to sell what is left of his magazine, so that would make him both available and eligible for the spot.

The move makes sense, too, when you consider how close Tenney has worked with the League all these years. At times, it has seemed as if he were almost an untitled League official. Being independently wealthy, Tenney wouldn't be restricted by the lack of remuneration which goes with the position.

A lack of expected aggressiveness on the part of the recently-appointed president seems to have sparked the search for someone to help take hold of the organization and get it into shape. Many of the directors feel that it is important to have a businessman with experience helping to guide the League into safer financial waters... and perhaps stem the growing loss of *QST* subscribers.

Others of the directors like Vic and feel that he should have more of a chance to get things turned around... to, so to speak, haul the old boat out of the water and scrape off the barnacles. I've personally always held Vic in the highest regard as a ham and a DXer. The directors should realize that even with a relatively small organization such as they have at HQ, people get set in their ways and it is difficult... often very difficult... to bring about changes, no matter how badly they are needed. My unasked-for council would be to give Vic more time and not rush with Tenney.

#### BUILDERS VS. BUYERS?

Sometimes I get the impression that people will believe just about *anything*! First, we had a bunch of old hams, probably irritated because they had to change from AM to SSB, grous-

ing that hams weren't building any more. I still hear that chorus when I visit some ham clubs, many of which seem to have been taken over by old old-timers.

When I point out that there are more ads for parts in 73 these days percentage-wise than there were in *QST* forty years ago, they look shifty-eyed and shut up... at least until I'm safely out of earshot. The fact is clear that hams are building as much or more than they ever did. It just isn't the old ones who are doing it. Possibly they're too busy watching television.

The increased coverage of relatively simple building projects in 73 has sparked a lot more interest in building and experimenting. Fine... for that's one of the great pleasures of electronics and hamming. I put quite a few years in at the workbench myself, with a barn full of old gear I built to show for it... and a twisted pelvis from standing on one foot for about twenty years. The local chiropractor has given up trying to straighten it... and I've stopped seriously trying to lift anything heavy. I've paid my dues in building.

There is a gross misunderstanding on the part of some of the manufacturers in the industry. This is odd, because it really means that they have been reacting emotionally and not giving any serious thought with some research.

This has to do with the interesting concept that hams who build are not very good customers for commercial equipment. The facts are the opposite, as even a few moments of contemplation will make clear. The major buyers of new equipment are the exact same people who are also building gadgets. How come? Let's look at it.

First, a little lesson in economics. Way, way back, in the early days of amateur radio, hams built their own receivers and transmitters. There were only a handful of hams then, so there wasn't enough of a market to warrant commercial equipment for them. Then, when the first commercial receiver was put on the market, the home construction of receivers virtually stopped. Hams quickly realized that a home-built project would cost more, have a smaller resale value, and not work as well as a commercial receiver. They did just what you and I

would do in the circumstances: They bought their receivers.

I came along just shortly after these halcyon days, getting started as a shortwave listener along about 1936 and doing my first pirate operating (called bootlegging then) in 1938. There were no practical transmitters for hams as of that time, there being only about 40,000 licenses. These came along after WWII, when our ranks had swelled to about 80,000. But we did have some beautiful receivers and the hams ate them up.

As a teenager, I was living in Brooklyn and I made it my business to visit as many of the active hams as I could. In those days virtually every licensed ham was active. I visited well over a hundred hams and found just one who had built his own receiver. It really wasn't practical from any viewpoint.

Once transmitters got practical, hams stopped building transmitters... with a few exceptions. We've always had a few stranger-than-normal hams, but not many. I went the same route myself, buying war-surplus rigs and converting them. I did build power amplifiers... but only because they weren't commercially available.

Much of my own building was involved with complex RTTY gear, autocal circuits so that my RTTY could work automatically, and so on. Those of us building this sort of stuff were getting into digital electronics... back in the late 40s... 35 years ago!

But then, as now, we bought our rigs and receivers. Further, then, as now, when we bought our commercial equipment we went for the best and the newest we could get. This was only natural since we were deeply involved with hamming and wanted to get the best out of the hob-

by. Why would I go to the trouble of spending two weeks designing and building a piece of Teletype® equipment and then hook it to a crummy receiver? No way! I went for the best and so did the rest of the builders. They're still doing this.

Today hams are building gadgets and enjoying it. But you can bet that these active hams are also very particular about the commercial gear they buy. You can also bet that they are lying in wait for anything new that comes along. These chaps are the best of customers for the industry because they are the most deeply involved.

It is the older hams who already have their KWM-2s who sit and rag-chew, who talk endlessly on nets, who are the bane of the industry, not the enthusiastic builders and experimenters. We are fortunate in that we do have a magazine in the ham field devoted to these nice old men, complete with pages and pages of "operating news" for them to read each month.

When you consider what an incredible bargain ham gear is today, I get a bit aggravated when I hear someone griping about the high cost of it. Lordy! When I got started in hamming we had crystal-controlled transmitters and each crystal cost about \$3.50. Not bad—until you translate that into 1983 dollar-ettes, which puts those nice little crystals at about \$63 each.

The cheapest hunk-of-junk ham receiver on the market, the Hallicrafters Sky Buddy, cost \$19.50. Cheap? Well, my friend, if we look at the comparable prices for other things, that comes to about \$350 today. The average ham wanted something better, running around \$80, or about \$1,500 in today's puny money.

No, we're getting incredible

bargains today as a result of the solid-state revolution, ICs, and mass production. Japan, with nearly one million licensed hams, has such a huge market for new ham gear that the production quantities have brought down the cost of manufacture to much less than one half what it would be without them. Each doubling of production normally drops the cost of manufacture about 15% or so.

So, though we hams are building more than ever before, we also are buying as much as we can get commercially made... and getting incredible value for our investment.

#### ARE YOU MISSING THE DX?

Now, I suppose I should shut my typewriter off and not let you know what is going on. I've been sneaking around twenty meters lately and I want to let you know that you are missing out. The band has been super in recent weeks, and the DX is rolling in at all hours of the day and night.

Just in the last couple of days, I've had contacts with the following, to give you an idea: ZL2WM, ZL1VY, PY2CYT, PY1BFZ, HR1RBM, 7X2BK, VK6RU, IK7AGT, EZ7BXP, 4Z4JS, EA3CXG, N3RD/VP9, JX1JO, PY0ZZ, HH2MC, TU2HJ, PP6ACP, ZS1DG, ZS6WB,

ZS4AF, PR7SSM, S83MMK, TU2LM, ZS6BRD, ZS6BNS, ZS4D, JY3ZH, JY4MB, JY5ZM, YI1BGD, 7X5SI, LX1JAS, Y27FN, Y56FN, SM7DLZ, WB5VIH/DU2, VK6CF, VS6CT, HL9RT, UA0JBN, EA9NG, U9H, UK0SBB, 8Q7AV, 3BD8DB, OD5FB, HZ1AB, 4S7EA, T32AF, F5RV/FC, VU9GI, VU9CK, ZL4OY/A, OH0W... and so on.

Besides some bragging about working DX, the above list is indicative of what you can do if you get on the air with a reasonably good rig and antenna. It's there, with thousands of DX operators looking for you. While some put up with contest-style operating, whacking out the contacts for QSLS and the good old ARRL Honor Roll listings, most of them will stop this nonsense and be most interesting to talk with if you ask them some questions. Most of them love to talk... and they love most to talk about the most interesting subject in the whole world: themselves.

Think what an impression hamming could make on innocent teenagers if they could hear us talking with Christmas Island out in the middle of the Pacific Ocean! Or some chap in Baghdad! They're there, looking for you. Where are you?

### LIMITED SPECIAL \$555.00

**HAMEG**

Oscilloscopes

20 MHz  
DUAL TRACE

to meet every need



- WITH PROBES: x1 & x10
- ONE YEAR FULL WARRANTY
- SOLID STATE
- ASSEMBLED & CALIBRATED
- NEW RECTANGULAR CRT

MODEL HM-203

(603)434-5371

DEALER INQUIRIES INVITED

✓ 133

*Rivendell Assoc.*

RFD-5

DERRY, N.H. 03038

WARNER HILL

### SATELLITE TV SYSTEMS

"COMPARE OUR QUALITY, PRICES AND SERVICE!"

#### WE MANUFACTURE:

PARABOLIC DISHES  
POLAR MOUNTS  
DEMO TRAILERS  
CUSTOM PARTS

MOTORIZATION SYSTEMS  
LNA HOLDERS  
ALUMINUM HORNS

#### WE STOCK:

WASHBURN  
KLM  
AVANTEK  
GARDINER

GILLASPIE  
DRAKE  
LOWRANCE

ALLIANCE  
ATV  
CABLE & CONNECTORS  
SWITCHES & HARDWARE

CALL, WRITE OR ✓ FOR OUR LATEST BROCHURE AND PRICES.

AUSTIN C. LEWIS  
K4GGC  
901-784-2191

LEWIS CONSTRUCTION CO.  
P.O. BOX 100  
HUMBOLDT, TN. 38143

"IN BUSINESS AT THIS LOCATION SINCE 1964" ✓452

# LINEAR PLANBOOK

2 TO 400 MHZ

15 to  
1000 WATT

14 Different Models, 100 pgs  
\$11.95

**A.P. Systems**

Box 263 sm.

Newport, RI 02840 (401) 846-5627

✓ 169

# CIRCUITS

Do you have a technique, modification, or easy-to-duplicate circuit that your fellow readers might be interested in? If so, send us a concise description of it (under two pages, double-spaced) and include a clear diagram or schematic if needed.

In exchange for these technical gems, 73 offers you the choice of a book from the Radio Bookshop, to be sent upon publication. Submit your idea (and book choice) to: Circuits, Editorial Offices, 73 Magazine, Peterborough NH 03458. Submissions not selected for publication will be returned if a SASE is enclosed.

1/4 in. PHONE JACKS

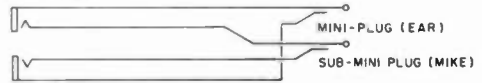

**"STAR-SET" HEADSET CONVERSION:** This adapter will enable you to use "Star-Set" headsets with an Icom IC-2AT (or a similar HT). The IC-2AT has about 1-2 volts present in the mike line to power an external electret condenser mike. This voltage is used to power the "Star-Set" as well. To key the PTT, you use the mike mute switch on the belt clip of the "Star-Set." The PTT works by completing the mike circuit. If you want to use the set on both the radio and a telephone, simply unplug it, because no changes are made in the headset. Use shielded wire in the adapter to prevent rf feedback. If you don't receive anything, reverse the plugs, marking them after you have determined the proper placement. —Joe Eisenberg WA0WRI, Lincoln NE.

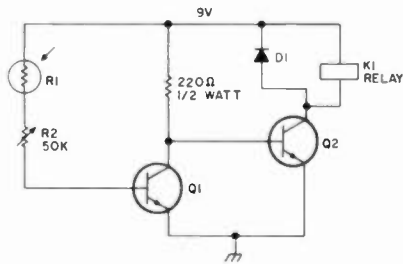

Fig. 1.

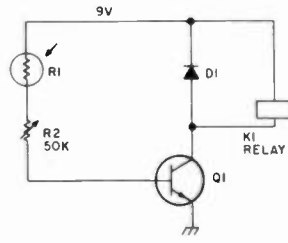

Fig. 2.

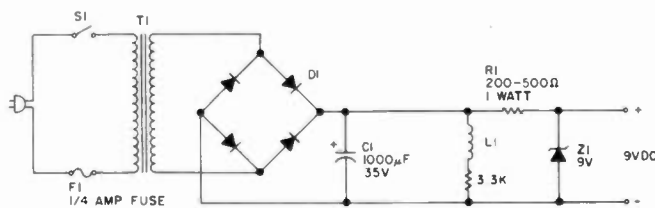
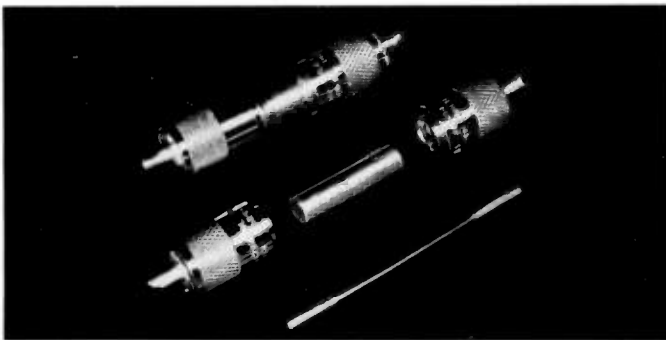

Fig. 3.

**LIGHT-ACTIVATED RELAY:** Fig. 1 shows a circuit which will trip relay K1 when the light-sensitive resistor R1 is in the darkness. A buzzer can be attached to K1 to indicate that the lights have dimmed. Any small signal diode can be used for D1, which suppresses the high-current inductive kickback, thus protecting Q2. Any NPN transistor can be used for Q1 and Q2. R1 is a cadmium-sulphide resistor which has 5 megohms resistance in darkness and 100 Ohms' in bright light. The resistor can be located away from the rest of the circuit. Fig. 2 is a light-activated relay; the same components are used as in Fig. 1. A power supply circuit is shown in Fig. 3. R1 is a one-Watt resistor valued between 200-500 Ohms. —Alan Weinberg KR7D, Tucson AZ.

**CONVERTING THE DRAKE TR-7 TO RECEIVE VLF WITHOUT THE AUX-7:** This is a simple modification for the Drake TR-7 which will enable the unit to receive 0-to-1.5 MHz. Open the unit and locate U9003. Remove the wire from pin 14 of this IC. Carefully solder a 6.5-inch insulated hookup wire to pin 14 and connect the other end of the wire to the unused terminal on the STORE switch. Replace the cover. To receive below 1.5 MHz, you must set the bandswitch to 1.5, press STORE, press the DOWN switch once, and then release the STORE switch. The UP/DOWN switch will now select the VLF band in 1.5-MHz segments. Repeat the sequence, and the unit will then tune 0-500 kHz. The antenna for the lower bands should be connected to pin 7 on the accessories connector (see pages 3-7 of the manual). This modification does not affect the usual operation of the STORE switch. —Andrew H. Kilpatrick K4YKZ, Longwood FL.



**RIGID MALE-TO-MALE UHF CONNECTOR:** Materials required are two PL-259 connectors, a straight length of no. 10 AWG 3-1/2 inches long, and a straight length of 3/8-inch o.d., 5/16-inch i.d. copper tubing, 1-1/8 inches long. (You can find the tubing in the plumbing department of many hardware stores.) After cutting the tubing, be sure to deburr the inside and outside edges of both ends. Then place PL-259s on either end, connecting the center pins with the no. 10 wire. Solder the assembly together using a large enough iron to avoid cold solder joints. —Gary Legel N6TO, Fullerton CA.

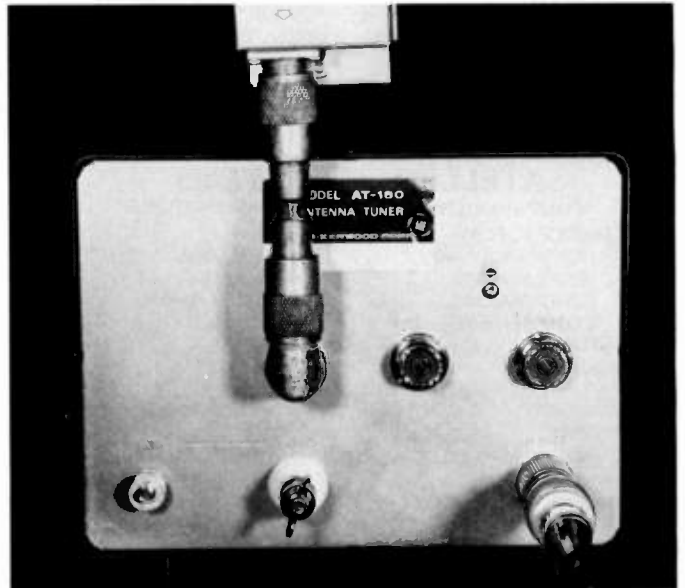

# KEEP IT SIMPLE!

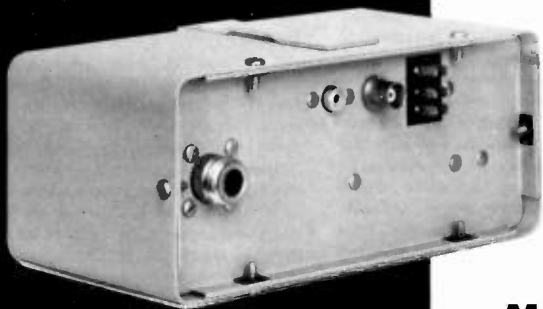

Call or write our sales department for specification sheet and pricing

## Building a TVRO receiver? Get a 4 Ghz signal down to 70 Mhz the SIMPLE way...

### ICM RF DOWNCONVERTER

Input filter for superior performance and interference protection. Built-in DC block. Mounts near LNA in environmental protective case. Converts 3.4-4.2 Ghz signal down to 70 Mhz in two stages. 70 Mhz signal is fed to receiver at lower loss with RG-59 or equivalent. Standard input and output connectors for easy use.

Can be used in multiple installations without need for isolators or other filters.

**Specifications:** Conversion gain 25 db nominal. Tuning voltage +4-16 VDC nominal. Power requirements 22 to 30 VDC @ 300 ma. (including LNA) Size 3"X4"X7", weight 1 lb.

International Crystal Manufacturing Company, Inc.

10 N. Lee, P.O. Box 26330, Oklahoma City, OK 73126



## MICROWAVE AND SATELLITE TELEVISION

The standard RP downconverter package shown below gives you a proven 2150 Mhz downconverter mounted in a weathertight antenna that features low wind loading and easy installation.

All downconverters use microstrip construction for long and reliable operation. A low noise microwave preamplifier is used for pulling in weak signals. The downconverters also include a broad-band output amplifier matched to 75 ohms. The RP model is recommended for up to 15 miles. Over the range of 15 to 25 miles the RP+ which has a lower noise and higher gain RF amplifier stage, provides better television reception. For installations over 25 miles, an RPC unit which uses a separate antenna is available. All models are transient voltage protected by surge protection on both the power supply and the converter inputs. All models are warranted for one year.

The DCI 466 is a completely self-contained **IMAGE REJECTION DOWN CONVERTER** that is used for TVRO downconversion at the Satellite antenna where optimum signal to noise ratio can be obtained. The DCI 466 converts the TVRO band to 70 Mhz. The unit's DC power and a 17 to 25 volt local oscillator tuning voltage are superimposed on a single RG 59 line for easy installation. The unit has an on board IF amplifier matched to 75 ohms that gives plenty of drive for long cable runs. The overall conversion gain is 25db. Image rejection is a minimum of 20 db. \$300 in singles.

Write for details on our low priced model VCO 40 voltage controlled oscillators in the four pin TO-8 package that cover the TVRO band. Also check our 120 degree low noise amplifier for low cost satellite ground stations.

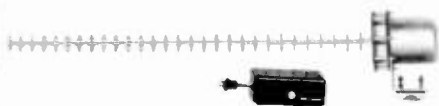

### INTEGRATED ELECTRONICS

PO BOX 204  
CARLISLE MA 01741  
617-369-0536

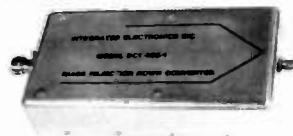

## SALE SALE SALE GOING-OUT-OF- BUSINESS SALE

Last Day-Dec 31<sup>ST</sup>  
1982  
CALL US!

If we have what you want in stock we will beat ANYONE'S price and ship it FREE!

No charge cards...  
cash or cashier's check

Ben Franklin Electronics  
115 1/2 N. Main Hillsboro KS 67063  
316-947-2269

### FROM TAYCO... MAGNAVOX FV 25 - 26 CHANNEL CABLE TV CONVERTER and REMOTE CONTROL



Get The Most From Cable TV  
VHF-MIDBAND-SUPERBAND

- Select any channel with easy pushbutton tuning from up to 25' away • Perfect for the bedroom TV
- Saves wear on TV tuner - avoid costly repairs
- Ideal for the handicapped • Easy 5 minute installation
- Receives those EXTRA channels your TV can't get
- Works with any TV • 90 Day Guarantee

2-way Splitter 2.19  
"F" Fittings .23 ea - 10/1.80  
Belden RG-59 .11/ft.  
24 Hour Order Line (607) 962-7313  
Order Direct From  
NYS Add Tax  
Buy 2 - We Pay Shipping  
C.Q.D.'s - \$1.50 extra

TAYCO COMMUNICATIONS  
R3 - 146A Narrows Ck. Rd. - Corning N.Y. 14830  
- DEALERS WANTED -

## CONTACT-80...

An ultra sophisticated yet simple to operate RTTY System for the demanding operator at an affordable price.

### Features:

- Disk I/O; SAVE, LOAD, KILL & DIR...
- TRI-SPLIT screen, user defined...
- 10 CANNED MESSAGES
- DYNAMIC BUFFER ALLOCATION...
- Live HARDCOPY for parallel printers...
- Keyboard CONTROL of STATION
- AUTO-ID; RTTY, CW (selectable ON/OFF)...
- CLOCKED OUTPUT rate...
- All BAUDOT speeds plus ASCII (110)...
- NAME, DATE, TIME from computer...
- On screen BIT PATTERN SCOPE...

Requires TRS-80, MOD-III with your CALL SIGN plus TU with 60ma loop.

DISK I/O; VERSION... \$279.00

CASSETTE I/O; VERSION... \$229.00

Post Paid

## CommTek

4493 Orleans Dr., Dunwoody, GA 30338  
(404) 946-9314

# REVIEW

## ELECTRONIC RAINBOW SATELLITE TELEVISION RECEIVER KIT

Like a lot of hams who have developed an interest in satellite TV, I have been reading about and watching the market for the last couple of years for a satellite receiver that had all the features I wanted and the right price as well. Most of these factory-wired units' price tags still hung up there in the high dollar range, while kits for these receivers were few and did not enjoy the best publicity from articles I had read. I felt a kit was the best means to meet my end. Having built quite a variety of electronics kits and semi-kits down through the years, I felt that I could handle a quality kit without too much difficulty.

Browsing around the hamfest at Indianapolis back in July, I spotted a few satellite antennas set up around the area and visited each booth to check out their wares. Most of the equipment was factory-assembled, high-priced, turn-key stuff, not for me. Then I happened by the booth where Electronic Rainbow was showing its latest offering to the industry. The owner Ron Ross and I had met at various hamfests and I knew he handled quality products. Ron had his satellite receiver hooked up and it had a crisp, clear picture. I checked the spec and price sheets he had on hand and was very impressed with the features his satellite kit offered, like built-in rf modulator, detent tuning, variable audio from 5.5 to 7.5 MHz, a/c, LNA power supply, remote tuning jacks and

baseband jacks for the optional remote tuning control, and stereo decoder along with many other features found only on much higher-priced units.

I asked Ron if the units were available yet and he said in a couple of weeks. They were presently getting the assembly manual ready for the printers. I left with an order form and spec sheet so I could review the receiver and make up my mind at home. About a week later, I sent my order in for the kit and looked forward to getting started on my very own satellite TV receiving system.

A few weeks went by and I decided to call Ron and check on my order. He told me that they were just about ready to ship the units with a photocopied manual because the printer did not have the final manuscripts yet.

I immediately saw a chance to get my receiver quicker and help out Ron with comments from the consumer point of view. I suggested that if he could sell me a receiver right away, I would be happy to give him some feedback on the assembly of the units from a builder's standpoint. Ron accepted my offer and I picked up my receiver the next day.

After sorting through the kit and checking parts (a few were missing as we both expected), I dove into the manual and read it from cover to cover, picking out minor errors and missing points that would help a builder do a better job of assembly and ensuring that the unit would work upon completion. I have had a few bad experiences with kits where even experienced builders

would pull their hair out trying to figure out the sequence of assembly. This is not the case with the Electronic Rainbow satellite receiver kit. I found the manual to be very easy to follow; there was very little chance for error in the step-by-step assembly of this quality receiver kit.

Fortunately, I had a week's vacation coming and I decided to use it to put together my kit. I was able to assemble the kit in approximately 15 to 20 hours, making numerous trips to Electronic Rainbow for changes in the manual and a few parts that were missing or wrong.

I completed the receiver and was looking forward to checking it out on Ron's antenna, since I did not have one yet. The final alignment was to be done with an actual picture from the satellite. The receiver kit had all the sections, such as the 70-MHz filter, the remote downconverter, and oscillator pre-wired and tested, so final alignment was a simple matter of adjusting the picture, sound, and rf modulator under operating conditions according to the step-by-step instructions in the manual using a VOM to check power-supply voltages.

Even though the main board of the receiver has all the parts on it, the board is divided into six sections with each of the sections having an A and B part for very easy assembly. All the parts are in zip-lock bags for each of the sections of the board, making it much easier to find them.

I had to wait a week or so for Ron's design engineer, Paul Turner, to return from vacation, so his ace assembler, Terri Murphy, and I finished off the few changes in the manual. When the final printing came back from the printer, she could add all the changes to complete and update the fine-quality manual, which was all the individual sections shown in halftones, making placement of the parts on the silk-screened boards a simple matter.

Finally, when Paul returned, Ron asked me over to his shop and the receiver was hooked up along with my downconverter to the bench monitor; when Paul flipped the monitor onto channel 3, there was the picture from transponder 11 MTV, clear as a bell. I was really happy that the unit worked the first time. Paul made his way through the individual trimmers for each of the 24 channels (transponders), peaking and adjusting the sound for a perfect picture on each. He let the unit burn in for about 30 minutes to be sure everything was okay and then put the cover back on the very attractive cabinet. Off I went like a kid with a new toy, proud as could be that my kit was finally ready to go.

In conclusion, I am sure that the Electronic Rainbow satellite TV receiver kit will be a popular item for those builders who have waited so long for just such a product. I plan to use my receiver with a Wilson MD 11 B antenna, Locom LNA, Chapperal super feed, and Beachcraft polarizer. I will be glad to answer any questions about any of these items. Please write only and include a self-addressed stamped envelope.

The complete satellite TV receiver kit costs \$395.00. For further information on the receiver, board kit, or manual, contact Ron Ross or Paul Turner at *Electronic Rainbow, Inc.*, 6254 LaPas Trail, Indianapolis IN 46268, (317) 291-7262. Reader Service number 477.

J. E. Beightol, Jr. WB9ZNU  
Indianapolis IN

## ADVANCED COMPUTER CONTROLS' MODEL RC-850 REPEATER CONTROLLER

Imagine, if you will, the amateur repeater that I'm about to describe. It can be controlled via telephone, over a UHF control link, through the main repeater receiver,

and, of course, locally at the repeater site. All you need is a touchtone™ encoder and the necessary codes.

If you call the repeater on the telephone, it answers the phone (with a message you've chosen) and waits ten seconds to receive a valid command. After you enter a code, the repeater verifies *in* voice over the telephone the function that has been selected. It does the same if you enter a command through the main receiver, except that the acknowledgment comes back to you over the air.

If you want to check your touchtone pad, you only need to enter a test prefix followed by a series of keys. The repeater reads your entry sequence back to you, again in voice. And that's only the beginning of what the repeater will do for you. It can evaluate received signals for frequency error, deviation, and percent quieting and give a similar voice response back to the user. Maybe you would like to check conditions at the repeater site from the comfort of your favorite armchair. No problem at all. Just ask the right questions with your touchtone pad and the repeater can give you voltage and power output measurements and also the temperature at the site. It will even give you the time of day!

This only begins to describe the features of this particular repeater. Whose repeater is it? It could very easily be yours, just by interfacing your present repeater with the RC-850 repeater controller being manufactured by Advanced Computer Controls of Cupertino, California. And please, don't be put off by the word "interfacing," because in this case you can access most of the features of the controller just by feeding a carrier-operated switch (or relay) logic signal and audio from your receiver into it and by letting the controller feed audio into your transmitter along with a push-to-talk logic signal. Plug the controller's modular jack into a telephone line at your repeater site, supply it with 12 volts dc, adjust one or two audio levels, and you will be able to put much of the power of the controller to work for you right away.

Naturally, other connections need to be made between the controller and the repeater station in order for it to provide received signal reports and other voice response telemetry (VRT) information about the repeater itself. You can even connect the controller's logic outputs to a synthesized transceiver and operate a remote base station, complete with frequency selection, through your repeater. This makes it simple to link up with another repeater for nets or public-service activities.

### Software-Based

The controller itself, even without the synthesized voice capability, offers features which to my knowledge are not available in any other commercially-manufactured controller or repeater/controller combination. The key to the power of this unit, and the thing that enables ACC to expand the controller's features on a continuing basis, is that it is software-based (or, to be technical, firmware-based in the form of several EPROMs). New releases of the operating system software can enhance the capabilities of your machine, in many cases without any additional wiring or work on your part beyond changing out the EPROMs. It also makes it possible for the manufacturer to incorporate into the controller some additional feature which may be very important to you.

The Blue Knob Repeater Association, which sponsors the highest amateur repeater in Pennsylvania (147.75/15 MHz), had a special problem which ACC was able to solve through a small amount of

Photos by David Beightol

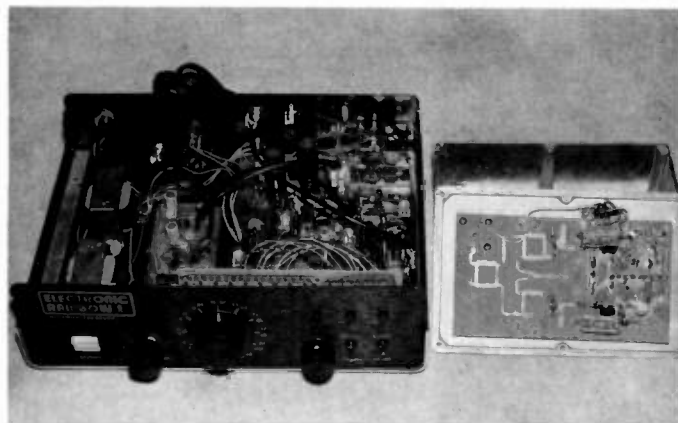

The completed Electronic Rainbow satellite TV receiver. At right is the downconverter unit, which is mounted at the antenna.

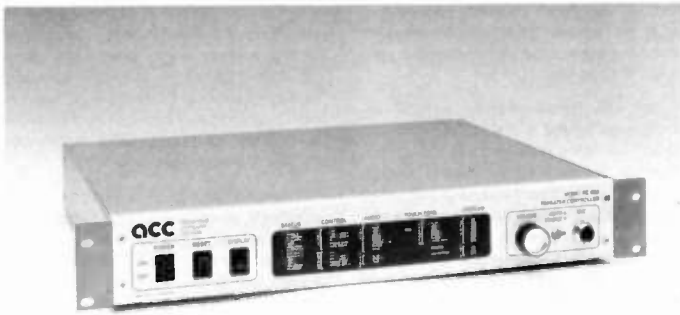

The RC-850 repeater controller from Advanced Computer Controls.

additional programming (which then became available to every user of the controller through an upgraded release of the software). Most of us are familiar with just dialing (or pressing) the number "1" to access the nationwide long-distance telephone network. However, there is a fairly rural telephone system operating at our site on Blue Knob Mountain, and it requires entering "1121" to make a long-distance call. Couple this with the fact that most of our members live outside the local calling area from the exchange at the site and you've got a cumbersome number of digits to enter when operating mobile, a number which can rise to 14 digits in order to place a call outside our own area code. What made this even worse was the fact that while the controller has the capability to store up to 90 telephone numbers in its user autodialer and 10 numbers in its emergency autodialer (these numbers can then be called just by entering an access prefix plus two digits), the storage locations are limited to 11-digit numbers at most. This would present no problem for the typical long-distance number, but it would have severely limited the usefulness of the autodialers in our system. Ed Ingber WA6AXX, who founded ACC, solved the problem just by programming the controller to "see" a leading "1" and substitute an alternate sequence when the number is dialed out (in our case, "1121"). This small change, which was relatively easy to handle by modifying software, would have been far more difficult, if not impossible, in a hardware-based system.

The controller's autopatch, which is logically separated into three different components (basic autopatch, user autodialer, and emergency autodialer) is extremely advanced in design. Phone numbers are read back to the user for confirmation (in voice with the voice-response option installed, and otherwise in CW) before a call is placed. The controller itself enters the number into the landline system in your choice of ten pulses per second, twenty pulses per second, or standard touchtones. This greatly increases the reliability of the autopatch, since tones are not being passed from many different user's touchtone pads directly into the telephone system.

The user autodialer codes can be programmed by the members themselves, or the user autodialer can be "locked" so that only control operators can load and change the telephone numbers to be stored. The access prefix for the autodialer can also be changed if and when necessary.

The emergency autodialer provides for the storage of 10 public-service telephone numbers and associated response messages for each agency (such as "Fire").

With the voice-response option, the reverse autopatch (which requires entering a code sequence after calling the repeater

on the telephone) can actually call a repeater user *by call sign*. Forty call signs can be stored in the controller's memory for use with these directed reverse autopatch calls (or as part of a demonstration message).

Separate timers can be set for each type of autopatch call, and the three functions can be enabled or disabled separately. This can be used as a way of allowing emergency calls to be placed at night, while the other autopatch functions might be turned off. A programmable activity timer functions with all autopatch calls to drop the patch if no activity (or constant keying) comes from the repeater user for the designated period of time.

It's also possible to place a full duplex autopatch call (for simultaneous receiving and transmitting) and a semi-private patch where the repeater-user side of the conversation is not fed through to the transmitter, but instead is replaced with a "cover tone" to alert other users that a call is in progress. If your repeater suffers the misfortune of having someone maliciously dropping the autopatch on legitimate users, you can program the controller to allow *each user* to define his or her own custom hang-up code just before placing a call. Then, only that code or the control operator's override code will terminate the call.

Long-distance calls can be prohibited on the main autopatch, which then allows the entry of a 7-digit number only, which cannot begin with "1" or "0." There is even an "autodialer," which can be loaded with up to five telephone numbers which may *not* be called on the autopatch (such as a local pizza parlor?).

One convenience which anyone who has ever used an autopatch will appreciate is that the controller will give the time and date for you automatically upon completion of a call. This is also very helpful to the repeater owner for the proper logging of autopatch calls.

#### Identification, Please

The controller handles repeater identification requirements in a similarly sophisticated manner. An "intelligent" ID algorithm directs the unit's handling of several different ID messages in accordance with the activity on the machine. For example, if the repeater has been dormant and is then keyed up, an initial ID (typically a voice greeting) is given. As time progresses from the initial keying of the repeater and with a QSO in progress, the controller will wait for an opportunity to ID again when a user lets the repeater carrier drop. If this opportunity doesn't occur, then the unit becomes anxious to ID, but will still try to avoid IDing over the top of a user transmission. But, if ten minutes pass without even a break in the QSO, then the controller will do a forced CW ID over the top of the user, but at a fast, unobtrusive level.

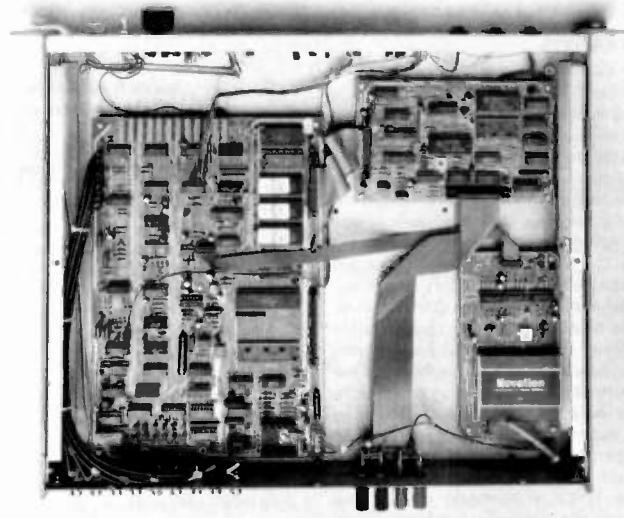

Interior view of the RC-850.

With the voice-response option, you can use the built-in message editor, either on site or remotely, to program the messages you want for IDs and other responses. The controller has a vocabulary of over 200 letters, numbers, words, and sound effects. You can even have custom words, such as your group's name or location, merged into your controller's software, but these words are not cheap at \$200 each!

Probably the second most remarkable feature of the RC-850 (I'll save the first one for later) is that all of your repeater's operating parameters, including timers, courtesy tones (you can select from eight sets that you program yourself), messages, autodial numbers, control operator and user codes, and even an initial power-up configuration (in case power to the unit is temporarily lost), can be changed *remotely*.

#### Non-Volatile Memory

If you're like me, you're wondering now what happens to all of that information stored in the controller, including the 90 user autodialer numbers and 10 emergency autodialer numbers, if power to the controller does fail. Incredibly, absolutely none of this data is lost, because it has been stored in EEPROMs (Electrically Erasable Programmable Read Only Memory) by the controller's own built-in programmer/eraser. The controller will "awaken" according to the configuration you've programmed as soon as power returns. And, by the way, battery backup circuitry is included in the unit.

Other standard features include several modes of operation based upon a subaudible tone input, touchtone up/down access by users with programmable automatic timeout, logic outputs for remote control of other devices (complete with response messages to indicate their function in your system), provisions for a control receiver, a kerchunker filter that can be switched on or off, spare audio inputs, tone signalling, and a host of others literally too numerous to mention in this review.

One extremely clever feature of the controller is that it suppresses the squelch tails of user transmissions (which makes listening comfortable for users and control operators alike) and also, at your option, touchtones. It does this through the use of a 75-ms analog delay line which allows the controller to cut off audio to the transmitter when the carrier-operated

switch signal disappears or when touchtones are properly decoded by the state-of-the-art Mitel chip set. Without actually hearing it operate, it's hard to believe how effective this circuitry really is.

#### Construction

A review of a product such as this one wouldn't be complete without some description of how it's constructed. I can honestly sum it up with one word: impressive. Machine-contact IC sockets, fully sealed, are used throughout the controller. Signal connectors are gold on gold for long-term reliability. The circuit boards are computer-grade glass epoxy with through-plate holes. They are solder-masked and silk-screened with component designations. And, finally, low-current CMOS circuitry provides highly efficient operation.

#### Product Support

Another important plus is that the device is fully documented with a comprehensive owner's manual which includes a description of the unit, how to install it, how to operate it, service and maintenance information, and schematics and parts placement drawings. The manual makes liberal use of figures and tables. It's clearly written, but don't expect to skim through it once or twice and completely understand the operation of the controller. Careful reading is necessary due to the many advanced features of the unit.

From my own experience, however, by far the most impressive support for the product comes from the designer himself. Ed Ingber WA6AXX is an electronics engineer, and his background (which includes a Master's Degree) lies primarily in designing test equipment, programming microcomputers, and working with speech synthesis. I have been able to reach him by telephone (he provides owners with both his factory and home numbers) any time our group has needed information or assistance.

I mentioned earlier that I would save the most remarkable feature of the controller for last, which is that *it works just like the manual says it will* (the manual can be purchased by itself for \$30), and it sounds terrific on the air. The speech synthesis is so good that during the first few days that we had the controller on-line, we actually had people responding to the female "Good Morning" greeting with a complete rundown of their name, location, and other information, only to be tremendously sur-

prised to learn that they had been talking to a computer!

### Few Problems

In our controller, problems were hard to find, and I heard essentially the same thing from other owners before we made our decision to purchase one. Our unit was shipped with an interim version of the controller's operating system software designated as 1.4X, and this version did have a few bugs in it. One example was that giving the controller the code to disable the autopatch timer disabled the autopatch itself. Another bug caused two of the front-panel display LED indicators to be reversed. In a way, though, these problems actually point out the strengths of a software-based device, because the final release of this version of the software corrected both of these glitches.

If you haven't guessed by now that the price tag for one of these controllers is pretty hefty, then you might consider price alone to be a drawback. Actually, the RC-850 controller comes in a number of different configurations, ranging in price from \$1195 for an assembled and tested control circuit board only up to nearly \$2800 for the maximum system, which includes an FCC-registered telephone interface, voice-response telemetry option, and front-panel display option, all contained in a rack mount cabinet ready to install at your repeater site. There are also several versions between these two extremes. For example, you may want to provide your own telephone interface, which reduces the cost of the unit by \$349. Or, while you might want to have synthesized voice IDs and the time-of-day clock, you may not really need the 16-channel analog measurement and speech-readback capability provided by the complete VRT option. This would also reduce the cost of the controller. And, it's good to know that you can start out small and expand to a maximum system at a later time with very little difficulty, since the control board has been designed to be upward compatible.

If you want to significantly enhance your repeater's capabilities and at the same time infuse your organization with new enthusiasm and excitement, the RC-850 repeater controller may well be just what you're looking for!

For more information, contact *Advanced Computer Controls*, 10816 Northridge Square, Cupertino CA 95014; (408) 253-8085. Reader Service number 476.

Gerald R. Patton WA3VUP  
Duncansville PA

### LJM2RK STORM ALERT

My wife does not like ham radio. She despises the funny noises my radio makes, and she would really rather it didn't ride in the car with us. So, I find myself and my rig relegated (or maybe I should say "banished") to a remote corner of the basement.

Now, I don't mind being in the basement, but I'm an Army officer whose specialty is tanks. That means, after years of firing tank guns on various ranges in combat, I'm rather hard of hearing. Consequently, I can't hear when someone is calling me unless I'm right at the radio, and, while I'm a pretty avid ham (my wife thinks too avid), I do occasionally go upstairs to get a cup of coffee or take care of the effects of an earlier cup. So, I've been looking for months for a simple (and affordable) tone decoder I could put on the two-meter rig to alert me to calls. I needed to be able to set up a visible signal to alert me when I was copying CW traffic on the HF bands (since I wear headphones to muffle the sound of the "mill"), and an audible alarm to call me when I was elsewhere in the house. I also needed to mute the audio, since my wife does not have a hearing problem and would have fits on those occasions when the repeater was really busy.

It didn't take me long to find that a simple tone decoder, even if you elect to just buy the parts and home-brew it yourself, isn't all that cheap, while ready-made or kit decoders are downright unreasonable (\$50.00 plus is the normal range). I had finally decided the only way out was to home-brew one, with the attendant costs involved in making a circuit board and the costs in time to construct it, when I happened to stop at a hamfest in Lafayette, Indiana.

At one of the booths, a guy (whose name I never did get) was demonstrating something that caused alarms to sound

and strobe lights to flash. Intrigued, I stopped to watch what turned out to be a demonstration of exactly the thing I'd been looking for.

He was demonstrating a tone decoder—he called it the "LJM2RK Storm Alert"—in nine different configurations. Each of the nine circuit boards was attached to a big board and each was wired for a different option. All nine were essentially the same—only a few jumper wires were different. The same board, ICs, resistors, etc., were used in each one, and each was constructed exactly the same, except for the jumpers. When the guy running the show told me they cost only \$15.00, I picked up two. I had already proven that parts alone would cost that (not counting the cost of constructing a circuit board and my time to find all the parts).

Once I got home, it took me about 45 minutes to build the first one, most of that time spent locating the parts on the board. The second one took about 20 minutes. For such a little company, the kit is a real joy to build. The written instructions, while not elaborate, are more than adequate, and the circuit board is beautifully silk-screened with both a drawing of the component and its reference number (R1, C3, etc.). Orientation of every polarized part is shown on the board and referenced in the instructions.

In only one case are the instructions a little remiss. Two of the LEDs have to be mounted with nylon spacers (if you use the company enclosure). The instructions mention that in passing, but when you go down the list of parts to install, as the instructions suggest, the spacers are listed well after the LEDs. It would be wise to write in "spacer" next to the LED listing, although it won't damage the operation of the device even if you forget the spacer. It just won't fit as neatly in the enclosure.

Once the boards are finished, aligning them is even simpler than building them. First, apply an audio source to the decoder. If you use one of the Metheny enclosure kits, that simply means plugging the thing into the speaker jack. Then attach a power lead and have someone generate a tone. I did mine by hooking my HT into a dummy load and the decoder into my Wil-

son WE-800. If that is not sufficient attenuation of the signal, leave the antenna off the receiving unit or attach it to a dummy load. At any rate, that hookup attenuated my 100-mW signal enough to allow me to align the decoder. A buddy at the other end of the repeater can do the same for you, if you'd rather.

Transmit the tones you want (I used the number 9, since the local RACES net uses that as an alert signal) and adjust a simple pot for tone B (it's well marked on the board) until an LED on the board lights. (They have thoughtfully provided this LED just for alignment.) Then, still applying the tone, adjust the pot for tone A until another LED comes on (you'll be able to see this LED even after you put the device in the enclosure). The decoder is now aligned and all you have left to set is the delay. Another little pot allows you to set in a delay so the decoder will not do its thing until the tones you choose have been applied for whatever time you want. I use one second, but you can go from instant on to a very long delay.

Electronically, the device is equally simple. It uses two 567 tone decoder ICs, one to control each tone, and then feeds them to an LM7402N quad 2-input NOR gate. Each 567 is adjusted to one of the required tones by varying a single potentiometer (you could easily change the frequency range by modifying the value of the capacitor on the circuit, but since the thing already operates on all the touch-tone™ and likely PL® frequencies, you will need to do that only if you use really exotic tones). When the first 567 is triggered, it lights an LED and signals one of the LM7402 gates, which waits for the next 567 to decode the other tone (when using the two-tone option). Once the second tone appears, the gate opens, lights a second LED (labeled "decoding" on the Metheny enclosure), and provides the logic state that causes the LM7402 to activate the delay and, finally, the relay. If either tone is removed too soon, the delay resets. Once activated, the relay does whatever you wired it to do, the usual task being to connect the speaker to the audio line. All the components, save the circuit board, are generally available at well-stocked Radio Shack stores, so repairs should be especially easy. The Metheny enclosure also has a couple of well-placed mounting holes in it to allow attachment of the power source and an external relay, driven by the on-board relay.

Now, let's see what else this thing will do. It has an on-board relay, so the control possibilities are almost unlimited. You can have it take two tones (standard touchtones) to open the audio on your transceiver so the thing stays quiet until you are called. Or you can have the relay sound an alarm or turn something on or off (great possibilities for a repeater system). Metheny even provides a suggestion for a simple timing circuit that will automatically reset your decoder after a preset delay. You can also set it up so one tone turns it on and another turns it off, or one tone turns it on and leaves it on. Delays can be worked on both ends. It can also be set up to turn on with a subaudible tone and off when the tone is removed. And, by changing a single resistor, you can use 12-V-dc, 9-V-dc, or 6-V-dc power sources. All the required controls mount right on the board and are included in the kit.

You can also do a number of other things not mentioned in the Metheny instructions—your imagination will be your only real limitation. With two boards, you can use one dual tone to turn a device on and another to turn it off (retaining all the

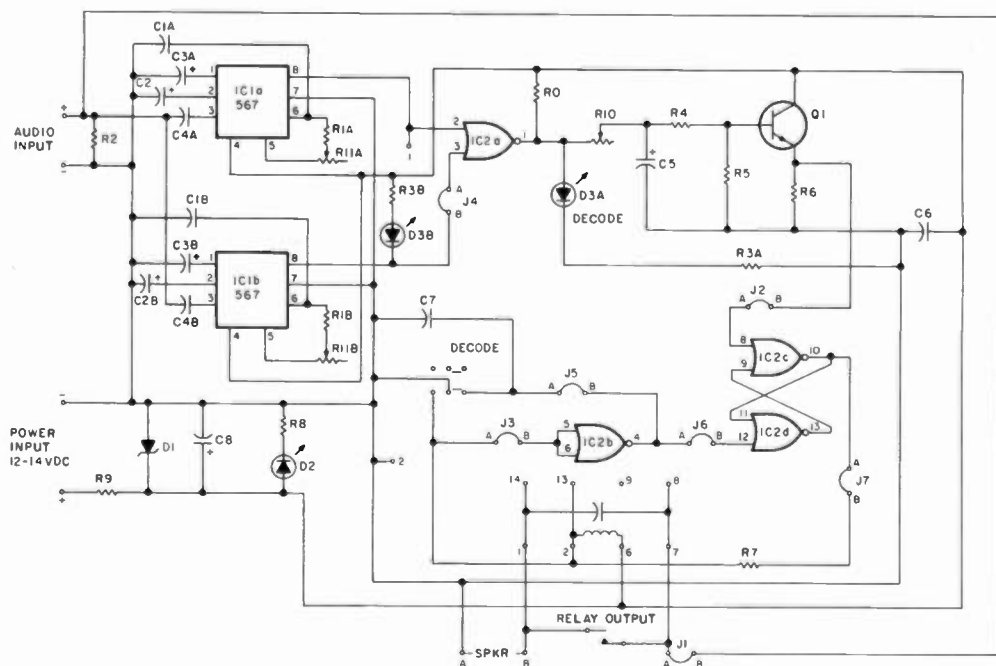

Fig. 1. Schematic.



# Westland Electronics

## Microprocessor & Interface

1771	24.50	6845	12.95	DAC0800	3.99
1791	34.95	6850	4.49	INS8250	14.90
21102	1.49	8085A	8.95	MM58167	12.75
2112	1.65	8212	2.75	TMS9900	29.95
2516	4.75	8214	3.95	TR16028	2.49
2532	7.95	8216	2.75	SC-01	55.00
2651	12.95	8224	3.29	Z80A-CPU	7.95
4044L-2	2.49	8226	2.79	Z80ACTC	7.49
6502	8.99	8228	4.49	Z80ADart	19.95
6800	6.99	8251	6.95	Z80APIO	7.49
6802	11.95	8255	6.49	Z80ASIO	17.95
6809	19.95	AY5-1013A	4.95	Z8603	74.95
6821	4.95	AY5-2376	12.39	Z8671	29.95

## 1 Amp TO-220 Voltage Regulators

PART #	1-24	25-99	100-499
7805 (LM340T-5)	.75	.68	.56
7812 (LM340T-12)	.75	.68	.56
7815 (LM340T-15)	.75	.68	.56
7818 (LM340T-18)	.75	.68	.56

## Linear Integrated Circuits

8038	3.95	LM393	.97	MC3302	.90
LF351	.75	LM733	.99	MC1458	.59
LF353	1.29	LM741-8	.35	MC1514	1.39
LF357	1.39	LM741-14	.35	NE555	.45
LM301	.45	LM747	.77	NE566	.98
LM307	.49	LM748	.49	NE565	1.25
LM311	.95	LM1310	1.69	NE5534	1.99
LM318	1.75	LM1458	.69	NE5538	2.25
LM324	.90	LM1800	2.49	SSM2010	7.50
LM339	.79	LM1818	3.49	SSM2020	7.50
LM358	.90	LM1889	2.99	SSM2030	7.50
LM377	2.49	LM2900	.69	SSM2040	7.50
LM380N-14	1.25	LM3900	.89	SSM2044	5.75
LM381	1.89	LM3905	1.49	SSM2055	6.50
LM383	3.29	LM3914	3.79	KR2206	5.19
LM384	1.95	LM3915	3.79	KR4136	.99
LM386	.99	LM3916	3.79	KR4741	1.95
LM387	1.49	LM4500	3.29	KR558	1.99

## 5% Carbon Film Resistors

We stock all 5% standard values between 1 Ohm and 1 Meg Ohm.

1/4 Watt	
Package of 5	20
Package of 100 (one value)	1.50
Package of 1000 (one value)	9.75
1/2 Watt	
Package of 5	25
Package of 100 (one value)	1.75
Package of 1000 (one value)	15.00

Sampler box consisting of 5 each of all 169 standard 5% values between 1 Ohm and 10 Meg Ohm (845 pieces total).

1/4 Watt Sampler Box	25.00
1/2 Watt Sampler Box	28.00

We Also Stock 1/4 Watt Resistors

## 1% 1/4 Watt Metal Film Resistors

We now stock all 481 Standard EIA values between 10 Ohms and 1 Meg Ohm.

Package of 5	45
Package of 100 (one value)	5.50
Box of 1000 (one value)	28.00

Send for our full line catalog of IC's, Resistors, Capacitors, Diodes, Regulators, Crystals, Trim Pots, Switches, Sockets, Connectors, RF Chokes, and more.

Minimum Order \$10.00

Shipping

10-24.99	3.00	Above 50.00	FREE
25-49.99	1.50	C.O.D.	Add 1.50

## WESTLAND ELECTRONICS

37387 Ford Rd. • Westland, MI 48185  
Order Line - 1-800-521-0664  
In Michigan - 313-728-0650 ✓154

Announcing

## NEW AUTOPATCH



### PRIVATE PATCH

Introducing Private Patch. A giant step forward in non-sampling Autopatch/Interconnect technology, capability and standard features. Our revolutionary new techniques of audio and digital signal processing offer several advantages over conventional sampling/scanning type Autopatches: 1. The annoyance of continuous squelch tails is *totally* eliminated. Makes conversation much more natural and enjoyable. 2. In addition to superb simplex capability, operation through repeaters is made possible. 3. The only connections made to your base transceiver are to microphone and speaker jacks. **NO INTERNAL CONNECTIONS OR MODIFICATIONS NECESSARY!** Use Private Patch simplex for local operation, through a repeater for extended range. CW ID makes your Autopatch legal, and alerts you to incoming calls when ringback is turned on. Channel monitor logic precludes ringback transmission if channel is in prior use. Eliminates accidental interference. Five digit owner programmable access code and operator/long distance inhibit switch assure security and protect your phone bill. Positive control is assured by Private Patch logic functions. A fully digital timing approach eliminates all Timing adjustments. Three/six minute timer shuts down Private Patch if you drive out of range. Resettable with reset code for additional talk time as required. Self contained AC supply. Modular phone jack and modular phone cord provided. All electronics contained on one high quality glass circuit card. Private Patch contains 42 integrated circuits and 16 transistors. Send for additional information. Compare our features. (State callsign when ordering.)

Special Factory Direct  
Introductory Price

**1 YEAR WARRANTY**



\$489



Postage Paid

PHONE: (213) 540-1053

# AUTOCONNECT

P.O. BOX 4155  
TORRANCE, CA 90510

DEALERSHIPS INVITED ✓130

# MFJ 24 HOUR CLOCKS

Your choice: dual 24 hour LCD display, or 24/12 hour with ID timer, or 12 inch quartz analog.



**\$39.95** DUAL 24 HOUR LCD  
MFJ-104

Two independent 24 hour LCD displays! Read both GMT and local times at a glance.

Six digit main display has seconds readout. Four digit auxiliary. Switch reverses main/aux.

Alarm plays 4 selectable melodies. Alarm "ON" indicator. Snooze button.

Quartz timing. Synchronizable to WWV.

Flip-top cover serves as stand.

Night light. Forward/reverse. fast/slow set buttons. Lock function prevents mis-setting.

Display main time only. main/auxiliary or main/ alarm time. Includes battery. 4x2x1/2 inches.



24/12 HOUR, ID TIMER **\$32.95**  
MFJ-102

Switchable 24 hour GMT or 12 hour format. ID timer sounds every 9 minutes after reset.

Switchable seconds readout.

Observed timer. Just start clock from zero and note time of event up to 24 hours.

Bright blue 0.6" vacuum fluorescent digits. Alarm with snooze function. Synchronizable with WWV. Fast/slow set buttons. Lock function prevents mis-setting. Power out, alarm "ON" indicators. 110 VAC, 60 Hz (50 Hz with simple modification). UL approved.

Black, brushed aluminum top/front. 6x2x3".

True 24 hour quartz wall clock has huge 12 inch diameter face. Gives excellent visibility across computer /radio room.

Fifteen seconds per month accuracy.

Single "AA" battery provides over one year operation. Immunity from power line failure and eliminates power cord.

Sweep second hand. Brown hi-impact case. Glass front. 24 hour military time format.

Order from MFJ and try it. If not delighted, return within 30 days for refund (less shipping).

One year unconditional guarantee.

Order yours today. Call toll free 800-647-1800. Charge VISA, MC. Or mail check, money order. Add \$4.00 each for shipping and handling.

CALL TOLL FREE 800-647-1800

Call 601-323-5869 in Miss., outside continental USA, tech/repair info. Telex 53-4590 MFJ STKV

**MFJ ENTERPRISES, INCORPORATED**

Box 494, Mississippi State, MS 39762 ✓47

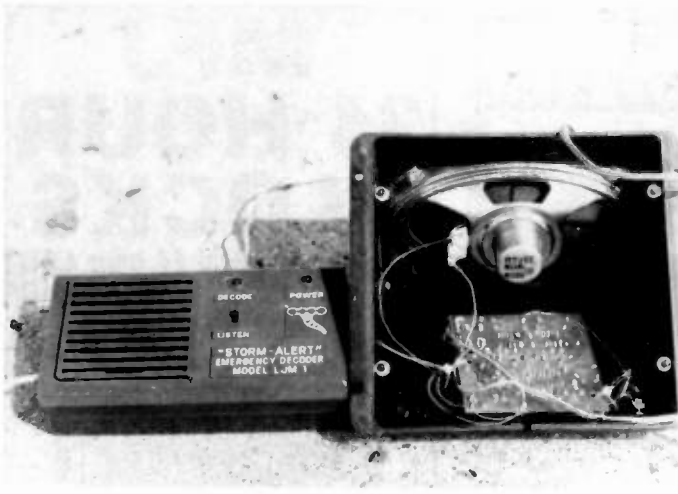

The front side of the Metheny enclosure, next to the speaker case.

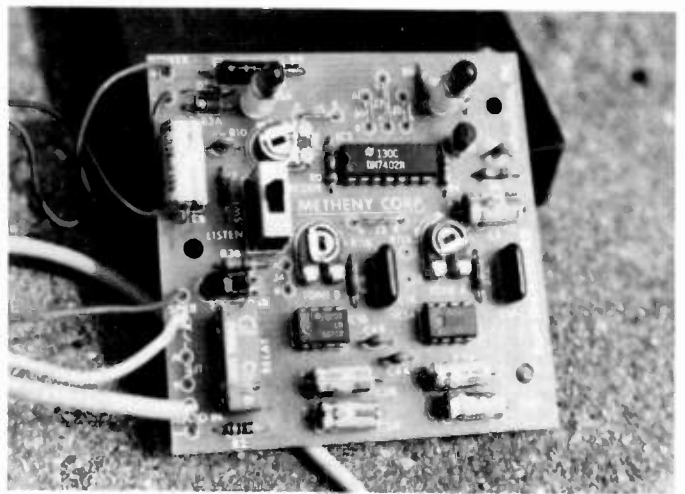

The decoder itself. Note that while it does not leave a lot of wasted space on the board, there is sufficient room to work comfortably.

usual options for each tone). With one board, you can even use sequential single tones with a delay. In this case, a single pot would establish the delay so that, in effect, the device will require that you input both tones within two seconds, or three, or whatever period you program. Using multiple boards, you could do the same thing, but with variable delays be-

tween selected digits to safeguard your autopatch from the guy who breaks your code (he's not likely to catch on to the variable delay idea). And if you use the Metheny enclosure, it is easy to add a battery pack, hang it on your belt, and have an inexpensive tone-accessed HT. Or you could forego the speaker and package it in an even smaller enclosure.

It is really nice to see a little outfit like Metheny offer a really useful and inexpensive device like this. If only we had more such little companies in ham radio.

The LJM2KR (I have no idea what those letters mean) is sold for \$15.00 plus shipping. The "Storm Alert" enclosure is avail-

able for \$5.00 plus shipping and includes speaker and patch cable. For more information, contact the Metheny Corporation, 204 Sunrise Dr., Madison IN 47250. Reader Service number 478.

David Boyd K9MX  
Fort Sheridan IL

## RTTY LOOP

Marc I. Leavey, M.D. WA3AJR  
4006 Winlee Road  
Randallstown MD 21133

Happy New Year! I do hope the winter is going well for all of the readership, with projects underway and the like. One such project we have been dealing with in this column has been the design of a computer-based RTTY terminal. This month, another installment: character input and control mechanisms.

It should be obvious that in any complex system there is a need for suitable control mechanisms. Now, while we are not talking about Three-Mile Island here, with a computer-based RTTY terminal there is a need to direct the data flow, fill or empty buffers, change speed, etc. If the terminal being designed operated only on Murray, the job would be relatively easy. The ASCII character set, which most computers use, supports many more characters than could ever be sent on Murray. It would be easy, therefore, to use any or all of those codes, such as control codes, special punctuation, or even lower case, to implement some of these special functions. In fact, an earlier terminal I designed did just that.

However, when designing a terminal which will be able to operate on any of the several modes, including Murray, ASCII, or even Morse, using these extra or control characters becomes difficult, if not impossible. A glance at some of the specialized RTTY terminals on the market reveals the presence of several function switches on the keyboard. These function switches do not send out one ASCII character, but a sequence of characters which can command a task to be carried out.

Such a sequence of codes is normally preceded by the ASCII "ESCAPE" character. Normally abbreviated ESC, this character is 27 in decimal, \$1B in hex, or

00011011 in binary. As defined in the ASCII standards, the ESC character is used to shift into another character set, or code grouping. We can use it, as many terminals do, to indicate to the program that the character(s) which follows is not to be sent, but to be treated as a special command.

Once such a protocol is adopted, an essentially infinite number of command sequences become possible. For example, ESC-F might be used to fill a buffer and ESC-S to send it. Numbers appended to the command could denote one of a series of buffers, such as ESC-F-7 to fill buffer number seven. As we have been looking at the design of an "ideal" RTTY terminal, such a technique would appear to fill the bill nicely.

Implementing this scheme is not as hard as it might sound. Fig. 1 is a flowchart of the way a character, once received from the keyboard, might be screened for a command sequence. By use of a flag, input which follows an ESC character can be diverted to initiate the appropriate command sequence. I will add here, for the smarties among you who are worried that you won't be able to send an ESC out over the air even if the distant station requires it because it would be trapped in this sequence, that the command ESC-ESC is normally configured to send the ESC code out. Does that make you happy?

Combining this command input routine with the receive and screen display routines presented in previous months begins to suggest just what this terminal will be able to do. Additional modules will be presented in the months to come, don't worry.

I have a panic note here from Roy E. Denney N5DQX of Roswell, New Mexico. Roy bought a "Transcillator," Mod ZUH II, at a hamfest, and despite being told that it was in fine working order, it isn't. Now, I don't know what this beast is, and Roy notes that

the manufacturer, Prossen Industries of Westminster, California, is apparently out of business. I presume it has something to do with RTTY, and so does Roy, and we both address the readers of this column to scrounge around and see if something can't be turned up. If so, send it to me and I will see that Roy gets it.

Thanks to Winston Yancey WA4TFB who relates that RTTY Loop is the first thing he looks for in 73. He notes being upset if we miss a month and wonders why that happens. For those of you not fully acquainted with the schedule a magazine such as 73 must follow, there is a two- to three-month delay between when I write a column and when you read it. Since I try to delay until just before deadline to keep the material as topical as possible, it becomes very sensitive to unscheduled delays, such as demands from my work (I am a physician in active practice here in the Baltimore area) or family. Hopefully, that's not too often, but it will occasionally happen.

Winston also relates trying to interface his Texas Instruments TI-99/4s computer for RTTY. Apparently little in this vein is available through the users group. I must say that I have noticed TI-99/4s being widely marketed, from computer stores to discount outlets to toy stores. I'm sure somebody out there is writing software that would be useful to the RTTYer, if only we can find it. Hopefully we can collect some here and display it for all to see in a future column. Are you listening, Tiers?

Greetings to Kevin A. Muench, Ph.D., a RTTY buff working in the Philippines. He is attempting to interface a Flesner TU-170 to a Teletype Model 33 and is looking for help. I am afraid that the TU-170 is another piece of equipment I have very little information about, but it is widely used and I am sure someone out there has already accomplished such a mating. If so, let me know so that I can send the details along to Kevin. I am sending Kevin some other material on the 6800 programs detailed here in the past. I am sure that with his 6800/6809 system, Kevin will be interested in following the current "super-terminal" series as it develops.

From one end of the world to another, I have a letter here from John M. Clarke VO1EE, Newfoundland, who is having problems of a different sort. John has been working on the LNW-80 computer and, after building the boards, apparently has trouble getting the thing to work right. He's unable to obtain a good display and thinks that the onboard regulators are running too warm.

Well, John, I will offer two words of advice. First of all, regulators usually run warmer than you think they should, but rarely are they hot. If they are too warm to touch comfortably, something may well be drawing too much current. Which brings me to my second bit of wisdom.

Projects which come on printed circuit boards, especially widely-marketed and complex ones like computers, are usually well designed if they come from reputable manufacturers. In the case of the LNW-80,

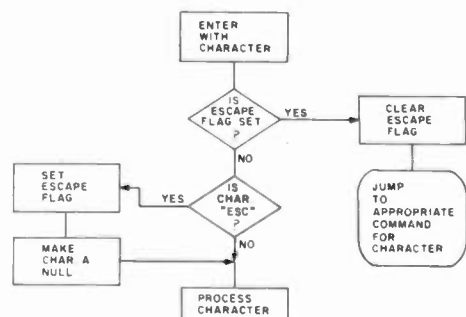

Fig. 1. ESCAPE code processor flowchart.

# THE AUTEK "QRM ELIMINATOR"



**Model QF-1A  
For SSB & CW  
\$69.00 (+ \$4)**

115 VAC supply built-in. Filter by-passed when off.

Auxiliary Notch rejects 80 to 11,000 Hz! Covers signals other notches can't touch.

Four main filter modes for any QRM situation.

Continuously variable main selectivity (to an incredible 20 Hz!)

Continuously variable main frequency. (250 to 2500 Hz)

AUTEK pioneered the ACTIVE AUDIO FILTER back in 1972. Today, we're still the engineering leader. Our new QF-1A is the latest example. It's INFINITELY VARIABLE. You vary selectivity 100:1 and frequency over the entire usable audio range. This lets you reject whistles with dual notches (to 70 dB), or reject SSB hiss and splatter with a fully adjustable lowpass plus aux. notch. Imagine what the NARROWEST CW FILTER MADE will do to QRM! HP rejects low frequencies. Skirts exceed 80 dB. 1 watt speaker amp.

Built-in 115 VAC supply. 6 1/2 x 5 x 2 1/2. Two-tone grey styling. Even latest rigs include only a fraction of the QF-1A selectivity. Yet it hooks up in minutes to ANY rig: Yaesu, Kenwood, Drake, Swan, Atlas, Tempo, Heath, Collins, Ten-Tec, etc. Just plug it into your phone jack and connect spkr. or phones to the output. Join the thousands of owners who now hear stations they couldn't copy without a QF-1A! It really works!

## WORLDS RECORD KEYS. OVER 4000 DX QSO'S IN 2 DAYS!



**\$100.50 (+ \$4)**

Model MK-1 Keyer

Probably the most popular "professional" contest keyer in use, yet most owners are casual CW operators or novices. After a few minutes, you'll see how memory revolutionizes your CW operation! Just start sending and record your CQ, name, QTH, etc. In seconds. 1024 bits stores about 100 characters (letters, numbers). Playback at any speed. Dot/dash memories, triggered clock, repeat, combine, 5 to 50+ WPM, built-in monitor and 115 VAC supply. Works with any paddle. Sit back and relax while your MK-1 calls CQ and handles standard exchanges!

Optional memory expander (ME-1) expands any MK-1 to 400 characters. ME-1 factory installed \$35. Owner installed, only \$21 (+ \$4). Add more memory now or later!

### NO LONG DELAYS. WE SHIP 95% OF ORDERS FROM STOCK

We sell only factory direct. No dealer markup in our price. Order with check, M.O., VISA, MC. Add \$4 postage and handling in 48 states. (\$7 for UPS air). Add \$7 to Canada, HI., Ak. Add \$22 elsewhere (shipped air). Add 5% tax in Fla.

*Autek Research*

BOX 302 DEPT. S

ODESSA, FLORIDA 33556 • (813) 920-4349

# LEARNING THE MORSE CODE?

Try the All New  
**AEA BT-1 —  
Basic Trainer For  
Morse Code**



AEA, in conjunction with ETS (Educational Technology and Services)\*, has developed the BT-1 Code Trainer. ETS methodology, based upon research by a prominent mid-west university, has demonstrated that a typical student using this system and the BT-1 can learn Morse code to speeds of 20 WPM in four weeks based upon two 20 minute daily training sessions.

The pre-programmed BT-1 computerized trainer will allow you to achieve proficiency in Morse code faster than any other known method.

No prior knowledge of Morse code is required to use the BT-1. There are no tapes to purchase or wear out. The BT-1 operates from a 12 VDC source or from the AEA 117 Vac wall adapter unit, AC-2. For portable use the BT-1P is available with Nicad batteries and comes with a charger that operates from 117 Vac. The unit can also be used in mobile settings via the 12 VDC system.

\*Education Technology & Services, see page 81 October 1981 issue of Ham Radio Magazine.

**Prices and Specifications  
Subject To Change Without  
Notice Or Obligation.**

**AEA**  
Brings you the  
Breakthrough!

See the BT-1 at your dealers or write:  
**Advanced Electronic Applications, Inc.**  
P.O. Box C2160  
Lynnwood, Washington 98036  
(206) 775-7373 Telex: 152571 AEA INTL

# Hear Police / Fire Weather

on 2 Meter Handhelds with  
this MFJ VHF Converter.

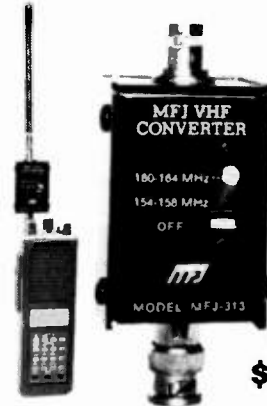

**Scanning  
Handhelds  
become  
Police/Fire  
Scanners**

**MFJ-313  
\$39.95**

New MFJ VHF converter turns your synthesized scanning 2 meter handheld into a hot Police/Fire/Weather band scanner.

144-148 MHz handhelds receive Police/Fire on 154-158 MHz with direct frequency readout. Hear NOAA weather, maritime coastal plus more on 160-164 MHz.

Mounts between handheld and rubber ducky. Feedthru allows simultaneous scanning of both 2 meters and Police/Fire bands. No missed calls.

Highpass input filter and 2.5 GHz transistor gives excellent uniform sensitivity over both bands. Crystal controlled.

Bypass/OFF switch allows transmitting. Won't burn out if you transmit (up to 5 watts) with converter on. Low insertion SWR. Uses AAA battery. 2 1/4 x 1 1/2 x 1 1/2 in. BNC connectors.

Enjoy scanning, memory, digital readout, etc. as provided by your handheld on Police/Fire band.

### 220 MHz Converter for 2 M Handheld

**MFJ-314 \$59.95** MFJ-314, like MFJ-313 but lets you receive 221-225 MHz on your 2 meter handheld.

### Police/Fire/Weather Band Converter for 2 Meter Mobile Rigs.

**MFJ-312 \$59.95**

MFJ-312, like MFJ-313 but for mobile 2 meter rigs. Transmit up to 40 watts thru converter without damage. SO-239 connectors. Mobile mounting brackets. Rugged. "ON" LED. Use 12 VDC or AAA battery. 3x4x1 in.

Order from MFJ and try it-no obligation. If not delighted, return it within 30 days for refund (less shipping). One year unconditional guarantee.

Order today. Call toll free 800-647-1800. Charge VISA, MC or mail check, money order for amount indicated plus \$4.00 each shipping. Hear police/fire/weather. Order now. ✓47

**CALL TOLL FREE ... 800-647-1800**

Call 601-323-5869 in Miss. outside continental USA, tech/order/repair info. Telex 53-4590.

**MFJ ENTERPRISES, INCORPORATED**

Box 494, Mississippi State, MS 39762

This is a widely-marketed piece of equipment which has received good reviews. Problems such as you describe can be traced to anything from an integrated circuit installed backwards (that is, 180 degrees out of phase—don't tell me it can't happen, I've done it!) to a solder bridge between two printed circuit tracings (ditto!). The critical thing about this is that if something "happened," the result may be remedied easily by reversing the integrated circuit or clearing the bridged conductors. But circuit damage could be temporary or permanent. If the former, fine, but if the latter, you are in for a lot of headaches unless you really know your way around a circuit.

The moral of this story, if there is one, is to check all the work out *very carefully* for integrated-circuit placement, solder

bridges, unsoldered pins, or misplaced plugs *before* you apply power. If something is not working right after power is applied, *stop right there!* Cut the power to the circuit and check again. If you find an error and correct it and the unit still does not function or if you are unable to locate any mistakes at all, seek expert guidance. This may be a friend who has a similar device or the expertise and equipment to troubleshoot complex digital electronics. If all else fails, write a clear description of your problem to the manufacturer, including the model and serial number of your unit. After all, changes in printed circuits or designs may make an early production run and a late one two different animals, and in order to help you, the manufacturer needs to know what you have, what the problem is, and any

information such as measurements or the like which will aid in diagnosis. Do not just bundle up the unit and ship it back without the manufacturer's consent unless their book tells you that you can. Doing so will only prompt the string of letters that should have preceded and may have prevented the shipment.

While we are up north, regards to another newcomer, Irvin F. Haworth VE7CVL from West Vancouver, B.C. Irv has a rather complete Apple II setup which he wants to try on RTTY, and he wonders how to proceed. Well, by now I hope Irv has read last month's column with its raft of sources for Apple (and other computer) interfaces. You might ask around in your area to get a feel for what others are using, then visit their

shack to see how the various units operate. Let me hear from you when you get on the air, OK?

My Atari 400 is coming along, for those of you who have asked, although it's not yet "on-line." I will be looking into various interfaces and the like in the coming months and will pass along any tips on what I find. I have also been looking into buying eight-inch disk drives and have been having a rather interesting time with a dealer. No details right now, just a caveat to be sure that what you order by mail is really in stock and shipped. It appears that the back-order is a way of life for some mail-order houses. I will pass along more information if the situation warrants it. Stay tuned to this magazine and don't miss next month's RTTY Loop!

# FUN!

*John Edwards K12U*  
78-56 86th Street  
Glendale NY 11385

## THE YEAR IN REVIEW—1982

Like most years, 1982 was a year of turmoil. In ham radio and the rest of the world change was in the wind. Proposed massive FCC rule changes and the advent of micro-computers were just two areas that may mark 1982 as the year ham radio embarked on a new era.

This month's FUN! takes its annual look at the year just gone. How much can you remember?

### ELEMENT 1—CROSSWORD PUZZLE (Illustration 1)

**Across**

- |  |                           |
|--|---------------------------|
| 1) Craft announced last year as a 1983 DXpedition site (2 words) | 13) Satellite TV (abbr.)  |
| 7) CW salutation (abbr.)   | 15) Least-crowded DX time |
| 8) Critical sunspot point (abbr.)                                | 17) Prosign               |
| 9) Prompt or pool stick  | 19) Half a headset        |
| 10) Harvest  | 20) Slang for FCC rule    |
| 11) Pacific prefix   | 22) Interference (abbr.)  |
| 12) Problem  | 23) Whatever number       |
|  | 24) Your residence        |

- |  |  |
|--|--|
| 25) What a jammer usually gets on his face | 6) Earthquake, fire, etc.                  |
| 28) Former ARRL president (2 words)        | 7) ARRL listener (abbr.)                   |
| <b>Down</b>                                | 11) Standby                                |
| 1) Not ordinary                            | 14) Peru prefix                            |
| 2) Popular 1982 ham accessory              | 16) In the airmobile (abbr.)               |
| 3) New ARRL General Manager                | 18) Man who signed new communications bill |
| 4) Above VHF (abbr.)                       | 21) Avarice                                |
| 5) Potential no-code license class         | 25) Listening organ                        |
|  | 27) Summer contest (abbr.)                 |

### ELEMENT 2—MULTIPLE CHOICE

- 1) The year 1982 witnessed one of the greatest turnovers in ARRL upper-level personnel in quite some time. By now, we all know that Vic Clark is the League's new president and Dave Sumner the new General Manager. What, however, was the fate of Richard Baldwin, the old General Manager?
  - 1) The job of ARRL International Affairs Vice President
  - 2) The job of ARRL Secretary
  - 3) The job of ARRL TVI Task Force Chairman
  - 4) No job
- 2) What was last year's big news from the Heath Company?
  - 1) Heath's withdrawal from the amateur radio marketplace
  - 2) The introduction of Heath's first non-kit amateur transceiver
  - 3) The introduction of Heath's first solar-powered radio
  - 4) None of the above
- 3) Last year's amendment to the Communications Act of 1934 will permit the FCC to perform which of the following actions:
  - 1) Complete elimination of all code requirements
  - 2) The addition of a new satellite band
  - 3) The delegation of amateur testing to local radio clubs
  - 4) Last year's amendment gave the FCC no new powers

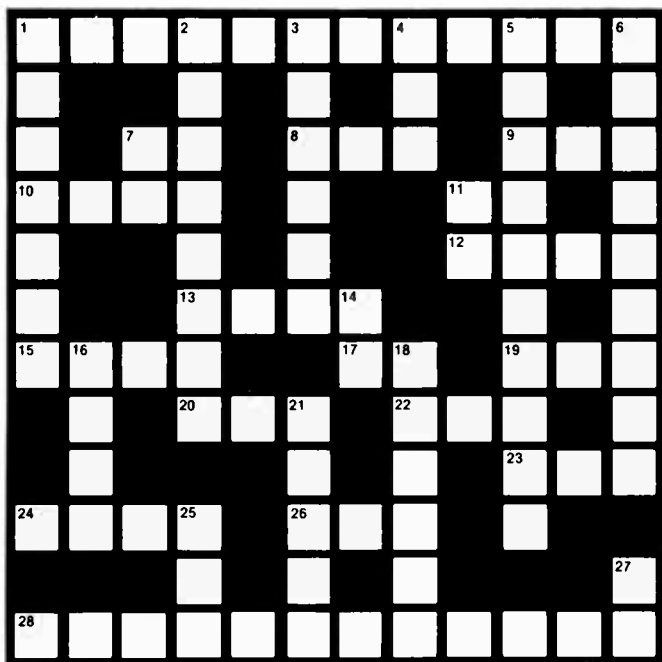

Illustration 1.

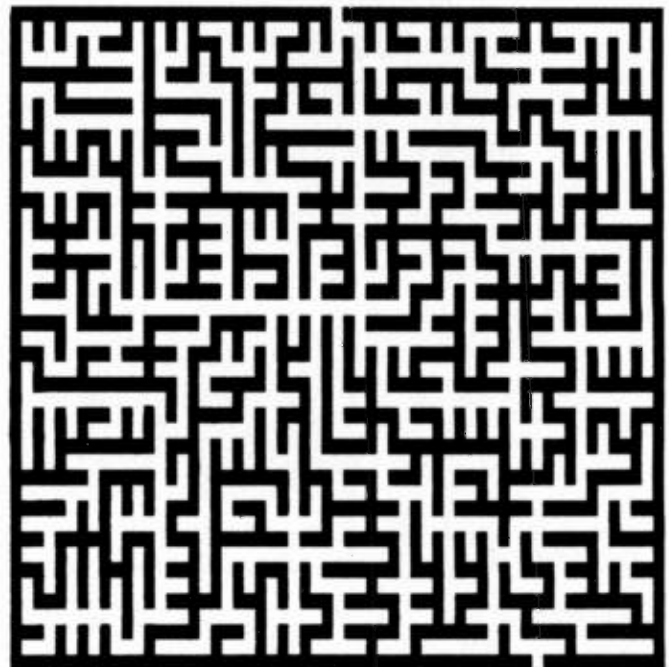
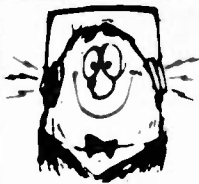

Illustration 2.



# The HAM SHACK

808 N. Main  
Evansville, IN 47711  
✓449

<b>AEA</b>	
MBA RO Reader	\$269.00
MBA RC Rcv/Code Conv. Xmt	395.00
MM-2 MorseMatic Ultimate Keyer	150.00
CK-2 Contest Memory Keyer	125.00
KT-2 Keyer/Trainer	99.00
BT-1 Trainer	72.00
Isopole 144/220 MHz	40.00
<b>ARRL</b>	
83 Handbook	\$12.00
Antenna Book	8.00
License Manual	4.00
Large Assortment of Publications	call
<b>ASTRON</b>	
RS7A 5-7 Amp Power Supply	\$49.00
RS12A 9-12 Amp Power Supply	69.00
RS20A 16-20 Amp Power Supply	89.00
RS20M 16-20 Amp w/meter	109.00
RS35A 25-35 Amp	135.00
RS35M 25-35 Amp w/meter	149.00
RS50A 37-50 Amp	199.00
RS50M 37-50 Amp w/meter	225.00
<b>AZDEN</b>	
PCS 4000 2M Xcvr	call
PCS 300 Handheld	\$285.00
Most Accessories in Stock	
<b>BASH</b>	
Code Tapes/Study Guides	\$9.95
<b>BENCHER</b>	
BY-1 Paddle	\$36.00
BY-2 Chrome Paddle	45.00
<b>CALLBOOK</b>	
U.S.	\$19.95
DX	18.95
Map Library	4.50
<b>DAIWA</b>	
CNA-1001 0.5KW Antenna Tuner	\$299.00
CN 520 1 8-60 MHz SWR/Pwr Mtr	63.00
CN-620B 1 8-150 MHz SWR/Pwr Mtr	110.00
<b>DENTRON</b>	
<b>DRAKE</b>	
TR7A Xcvr	\$1,439.00
R7A Receiver	1,399.00
TR5 Xcvr	695.00
RV75 VFO	269.00
<b>ENCOMM (SANTEC)</b>	
ST-144/P	\$285.00
ST-440/P	309.00
Base Charger	29.95
All Accessories in Stock	
<b>HAL DAY</b>	
Saturday, January 22nd very special pricing.	
Call for details.	
<b>ICOM</b>	
R70 General Coverage Receiver	call
720A General Coverage Xcvr	\$1,140.00
730 Xcvr	669.00
740 Xcvr	call
251A 2 Meter All Mode	575.00
505 6 Meter Xcvr	395.00
25A 2 Meter	299.00
290H 2 Meter All Mode	475.00
35A 220 MHz Mobile	call
45A 440 MHz Mobile	call
2AT/3AT/4AT Handhelds	235.00
<b>KANTRONICS</b>	
Interface	\$165.00
Mini-Reader Pkg	225.00
Mini-Terminal	249.00
<b>MFJ</b>	
941C Tuner	\$81.00
496 Super Keyboard	279.00
313 VHF Conv. for 2 M HTs	36.00
104 New 24 hr Dual Clock	36.00
Large Assortment	call
<b>MIRAGE</b>	
B1016	\$239.00
B3016	205.00
MP1/MP2 Watt Meters	100.00
<b>ROBOT</b>	
400 SSTV Converter	call
800 ASCII/Baudot/CW Terminal	call
<b>SHURE</b>	
444D Desk Mic	\$50.00
414A Hand Mic	36.00
<b>TEN TEC</b>	
New Transceiver. Call about this one!	
<b>TOKYO HY-POWER</b>	
HL32V 25W Amp	\$75.00
HL82V 80W Amp	155.00
HL160V 160W Amp	285.00
HL200 440 MHz Amp	105.00
HC 150 Tuner	90.00
HC2000 Tuner	285.00
<b>VOCOM</b>	
Amplifiers/Ants	call

Prices and availability subject to change.

**812-422-0231**  
MON-FRI 9AM-6PM • SAT 9AM-3PM

Send SASE for our new & used equipment list.

# MFJ/Bencher Keyer Combo

Deluxe MFJ Keyer fits on Bencher Paddle. Curtis 8044 IC. Iambic. Adjustable weight, tone, volume, speed. Semi and automatic modes. Solid state keying. RF proof.



**MFJ-422 Combo** **\$99<sup>95</sup>**

The best of all CW worlds - a deluxe MFJ Keyer in a compact configuration that fits right on the Bencher iambic paddle! You can buy the combination or just the keyer for your Bencher.

**New MFJ Keyer**—small in size, big in features. Curtis 8044 IC, adjustable weight and tone, front panel volume and speed controls (8-50 wpm). Built-in dot-dash memories. Speaker, sidetone, and push button selection of semi-automatic/tune or automatic modes.

**Ultra-reliable solid state keying:** grid-block, cathode and solid state transmitters (-300 V, 10 mA max., +300 V, 100 mA max.). Fully shielded. Uses 9 V battery or 110 VAC with optional adapter, MFJ 1312, \$9.95.

**Beautiful functional engineering.** The keyer mounts on the paddle base to form a small (4 1/8 x 2 5/8 x 5 1/2") attractive combination that is a pleasure to look at and use. ✓47



**MFJ-422X Keyer only** **\$69<sup>95</sup>**

The Bencher Paddle is a best seller. Fully adjustable gold-plated silver contacts, lucite paddles, chrome plated brass, heavy steel base with non-skid feet.

**Order from MFJ and try it - no obligation.** If not delighted, return it within 30 days for refund (less shipping). One year unconditional guarantee.

**Order today.** Call toll free 800-647-1800. Charge VISA, MC or mail check, money order for amount indicated plus \$4.00 each shipping and handling. Enjoy CW. See dealer or call MFJ now.

**CALL TOLL FREE ... 800-647-1800**

Call 601-323-5869 in Miss., outside continental USA or for technical info., order/repair status.

**MFJ ENTERPRISES, INCORPORATED**

Box 494, Mississippi State, MS 39762

We stock:  
**RADIOS**

- Azden
- Icom
- KDK
- Kenwood
- Santec
- Ten-Tec
- Yaesu

**ANTENNAS**

- AEA Isopoles
- Antenna Specialists
- Avanti
- Butternut
- Cushcraft
- Hustler
- Hy-Gain
- KLM
- Larsen
- Mini-Products
- Mosley
- VoCom

**ACCESSORIES**

- AEA Keyers, Code Readers
- Alliance Rotors
- Ameritron Amplifiers
- ARRL Publications
- Astron Power Supplies
- B & W
- Bencher Paddles
- Callbooks
- CDE (Telex) Rotors
- Daiwa/MCM/J.W. Miller
- Kantronics
- MFJ
- Benjamin Michael Clocks
- Microlog
- Mirage Amplifiers & Meters
- Saxon Cable
- Telex Headsets
- Tokyo Hy-Power Amplifiers
- VoCom Amplifiers

**ege, inc.**

13646 Jefferson Davis Highway  
Woodbridge, Virginia 22191  
Store Hours: M-W-F 12 noon-8 p.m.  
T-Th-S 10 a.m.-4 p.m.  
Information and Virginia Orders:  
(703) 643-1063  
**Call for Quotes**  
Dealer Inquiries Invited

Your SWL & Marine Communications Dealer

**ORDER TOLL FREE 1-800-336-4799** (Orders Only, Please)

Order Hours: M-F 11 a.m. to 7 p.m.;  
Saturday 10 a.m. to 4 p.m.  
Bonus: 2% Discount  
for Prepaid Mail Orders  
(Cashiers Check or Money Order)

Send stamp for a flyer.  
Terms: Prices do not include shipping. VISA and Master Charge accepted. 2% discount for prepaid orders (cashier's check or money order). COD fee \$2.00 per order. Prices subject to change without notice or obligation. No personal checks accepted. Returns subject to 10% restocking fee.





Illustration 1A.

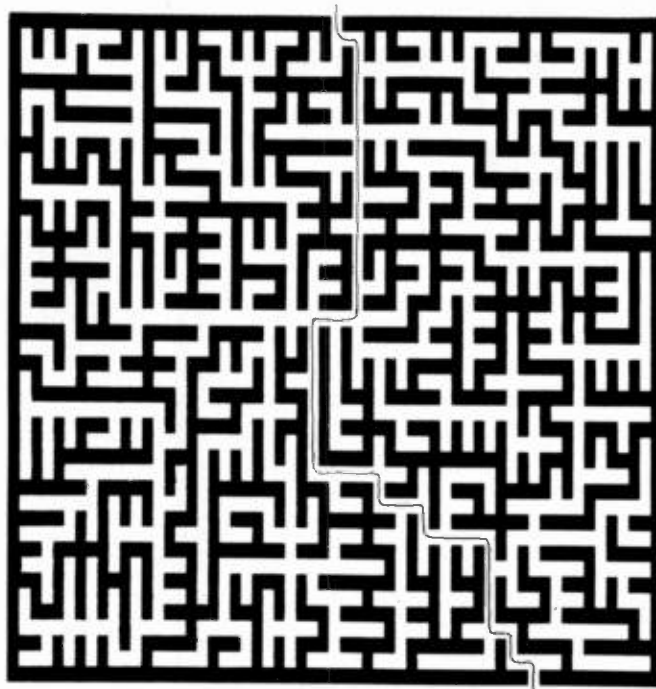

Illustration 2A.

- 4) Which of the following countries reached a third-party agreement with the US during 1982:
- 1) Spain
  - 2) Austria
  - 3) Sweden
  - 4) Australia
- 5) What did the FCC plan to do to our phone bands in 1982?
- 1) Expand them
  - 2) Contract them
  - 3) Eliminate them
  - 4) Leave them alone

**ELEMENT 3—CRYPTIC PUZZLE**

By using a standard substitution code, decipher this message: YMUDV CEQ YMJV OHCK QCO KFH MO M JMZKW SWKUDVJ DMOC LVMW.

**ELEMENT 4—MAZE  
(Illustration 2)**

Did 1982 leave you confused? Join the club. This maze certainly won't make you any less dizzy, but at least it isn't very difficult.

# CORRECTIONS

In the "Automatic Beam Almer," which appeared in the November issue, there was an error in the schematic on p. 23. The diodes across K1, K2, and K3 were drawn in the opposite direction from what they should be. In the parts list on the same page, Radio Shack part number 271-1715 refers to a 25k pot. Actually, part 271-1715 is a 10k pot, but it will work equally as well in the circuit.

Avery Jenkins WB8JLG  
73 Staff

Our apologies to Steven Katz WB2WIK, author of "Build Yourself A Paralyzed Beam" (December). Readers might better view the photo of the relay box on page 24 by turning the page upside down.

Avery Jenkins WB8JLG  
73 Staff

Several errors crept into the "Circuits" feature in recent months. In the September,

1982, issue on p. 92, there were two errors. The first occurred in the description of the "Visual Adjust for Gamma Match," with the sentence beginning, "Even if you use an swr meter at the transmitter end of the scale. . . ." It should read, "Even if you use an swr meter at the transmitter end of the cable. . . ." And in the description of the "Electronic Phone Bell," "heat-sink tubing" should be heat-shrink tubing.

On p. 109 of November's Issue, there were two errors in "Substitute Transformer for Heath Gear." Circuit author Terry Martin points out that the circuit is a voltage tripler, not a voltage doubler as stated in the text. He also adds that it supplies 950 V, not 450 V.

On p. 112 of the same issue, in "Modification to the Kenwood TS-520S for AFSK," Fig. 3 was incorrectly labeled. Fig. 3 shows the i-f filters of the 530S, not the 520S as implied by the text.

Avery Jenkins WB8JLG  
73 Staff

**THE ANSWERS**

- Element 1:*  
See Illustration 1A.
- Element 2:*  
1—1 The man's too young for retirement.  
2—2 The SS-9000 computer-controllable rig.  
3—3 Soon, perhaps, no more trips to the Federal Building.  
4—4 Down Under was the place.  
5—1 Much to the irritation of most foreign hams.

*Element 3:*  
Coded as follows—  
A B C D E F G H I J K L M N O P Q R S T U V W X Y Z  
M U Y B V P A X Q Z I D J H K S R W O C N E F T L G

"CABLE TVI CAME INTO ITS OWN AS A MAJOR PROBLEM LAST YEAR."

*Element 4:*  
See Illustration 2A.

**SCORING**

- Element 1:*  
Twenty-five points for the completed puzzle, or one-half point for each question correctly answered.
- Element 2:*  
Five points for each correct answer.
- Element 3:*  
Twenty-five points for the completed puzzle.
- Element 4:*  
Twenty-five points for the completed puzzle.

How well did you remember '82?

1-20 points—Skipped the year  
21-40 points—Not very well  
41-60 points—Blts and pieces  
61-80 points—Very well  
81-100+ points—Total recall, proceed to '83

**FUN! MAILBOX**

I just got to the June issue of 73 and began your logic puzzles. Element 3, DXX Couples, is incorrect by your solution as Diane has 206. You say Diane is Stan's wife, but that Frank's wife has more countries than Stan's wife. Therefore, Stan's wife cannot have the highest total. It was given that Diane had 206. The correct solution is:

Stan 198, Wilma 202—Total 400  
Frank 194, Diane 206—Total 400  
Joe 196, Susan 200—Total 396  
Stan has 198  
Joe has 196

Bob Gingras WB4JMH  
Cocoa Beach FL

Very good, Bob. Don't you like the way I mess up answers just to keep my readers on their toes?—J. E.

# Better by the dozen.

- 1. NEVER SAY DIE**—If you want controversy, Wayne Green W2NSD/1 will give it to you. His popular column ranges from travelogue to tirade and is guaranteed to entertain, inspire and enlighten you.
- 2. DX**—This globe-trotting column keeps you informed about the news of the DX world from Kingman Reef to Bahrain.
- 3. CONTESTS**—You get all the news on the contest world from Robert Baker WB2GFE. He'll give you information on upcoming events and results from recent contests.
- 4. FUN**—Just for fun, John Edwards K12U provides you with wacky puzzles, quizzes, and games that test your ham mettle.
- 5. FCC**—If you're looking to the future, these outtakes from the Federal Register chronicle changes in policy and regulations that relate to amateur radio.
- 6. RTTY LOOP**—To keep you abreast of radioteletype developments, Marc Leavey WA3AJR explains the new RTTY equipment, the increasing role of computers in RTTY, and other matters of interest to digital communications fans.
- 7. REVIEWS**—Before you buy, save yourself some money... check 73's in-depth evaluation of the latest gear.
- 8. HAM HELP**—As a service to you, 73 prints your questions in our magazine. This helps you to obtain hard-to-get parts, schematics, and owner's manuals.
- 9. SATELLITES**—From Phase III to TVRO, 73 Magazine covers the news of the satellite world like no other radio amateur magazine.
- 10. NEW PRODUCTS**—This brief look at the latest ham equipment on the market keeps you on top of new developments in amateur radio.
- 11. AWARDS**—To find out what certificates are available where, read Bill Gosney KE7C's coverage of all the ham radio awards.
- 12. CONSTRUCTION**—The builder's magazine... that's 73. You get the best projects from the best authors every month.

Send me a dozen issues of  
**73** MAGAZINE  
for the dozen reasons listed!

Check enclosed for 1 year for only \$19.97

Bill:  MC  VISA  AMEX  ME

Card# \_\_\_\_\_ Interbank# \_\_\_\_\_

Exp. date \_\_\_\_\_ Sig. \_\_\_\_\_

Name \_\_\_\_\_

Address \_\_\_\_\_

City \_\_\_\_\_ State \_\_\_\_\_ Zip \_\_\_\_\_

Canada & Mexico \$22.97 1 year U.S. funds.

Foreign surface \$39.97 1 year U.S. funds drawn on US bank only  
Foreign airmail—please inquire.

73 Magazine • PO Box 931 • Farmingdale, NY • 11737

Please allow 6-8 weeks for delivery

331R6

**73**  
MAGAZINE  
FOR RADIO AMATEURS

Subscription Department  
P.O. Box 931  
Farmingdale, NY 11737

**1-800-258-5473**

For orders only please.  
Foreign air mail, please inquire.



# THE SELECTRIC™ INTERFACE

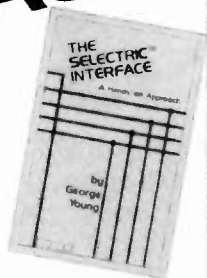

## Daisy wheel quality without daisy wheel expense.

You need the quality print that a daisy wheel printer provides but the thought of buying one makes your wallet wilt. *Selectric™ Interface*, a step-by-step guide to interfacing an IBM Selectric I/O Writer to your microcomputer, will give you that quality at a fraction of the price. George Young, co-author of *Microcomputing* magazine's popular "Kilobaud Classroom" series, offers a low-cost alternative to buying a daisy wheel printer.

*Selectric Interface* includes:

- ◆ step-by-step instructions
- ◆ tips on purchasing a used Selectric
- ◆ information on various Selectric models, including the 2740, 2980, and Dura 1041
- ◆ driver software for Z80, 8080, and 6502 chips
- ◆ tips on interfacing techniques

With *Selectric Interface* and some background in electronics, you can have a high-quality, low-cost, letter-quality printer. *Petals* not included.

Credit card orders call TOLL-FREE 1-800-258-5473. Or mail your order with payment plus \$1.50 shipping and handling to: Wayne Green Inc. Attn: Retail Book Sales, Peterborough, NH 03458. Dealer inquiries invited.

ISBN 0-88006-051-4

128 pages

**\$12.97**

Yes, I want **Selectric Interface** (BK7388). Enclosed is \$12.97 per copy plus \$1.50 for shipping and handling.

MASTER

VISA

AMEX

Card # \_\_\_\_\_ Expires \_\_\_\_\_

Signature \_\_\_\_\_

Name \_\_\_\_\_

Address \_\_\_\_\_

City \_\_\_\_\_

State and Zip \_\_\_\_\_

All orders shipped UPS if complete street address is given.

SS01

## YOU MISSED IT!



But you still need that issue of *73 Magazine*. Well, it's not too late to get it. Send for your free Back Issue Catalog. A complete listing, including editorial highlights.

You still need it.  
And we've still got it.

YES, I want my free Back Issue Catalog for *73 Magazine*.

Name \_\_\_\_\_

Address \_\_\_\_\_

City \_\_\_\_\_ State \_\_\_\_\_ Zip \_\_\_\_\_

73 Magazine, Mail Order, 80 Pine St., Peterborough, NH 03458

## MOVING?

Let us know 8 weeks in advance so that you won't miss a single issue of *73 Magazine*.

Attach old label where indicated and print new address in space provided. Also include your mailing label whenever you write concerning your subscription. It helps us serve you promptly. Write to:

**73 magazine**

Subscription Department  
P.O. Box 931  
Farmingdale NY 11737

- Extend my subscription one additional year for only \$19.97  
 Payment enclosed  Bill me

Canada and Mexico \$22.97, US funds, Foreign Surface \$39.97, US funds, drawn on US banks

If you have no label handy print OLD address here.

NAME \_\_\_\_\_ Call \_\_\_\_\_

Address \_\_\_\_\_

City \_\_\_\_\_ State \_\_\_\_\_ Zip \_\_\_\_\_

print NEW address here:

Name \_\_\_\_\_ Call \_\_\_\_\_

Address \_\_\_\_\_

City \_\_\_\_\_ State \_\_\_\_\_ Zip \_\_\_\_\_

331R6M

AFFIX LABEL



**ASSOCIATED RADIO**

**913-381-5900**

8012 CONSER BOX 4327  
OVERLAND PARK, KANSAS 66204

# BUY—SELL—TRADE

## All Brands New & Reconditioned



**YOU WANT A DEAL — WE WANT TO DEAL  
CALL NOW!!!**



# SAVE—SAVE—SAVE



**NOTE: SEND \$1.00 FOR OUR CURRENT CATALOG OF NEW AND RECONDITIONED EQUIPMENT  
SEND \$1.00 FOR OUR WHOLESALE LIST OF UNSERVICED & OVERSTOCK ITEMS.  
SEND \$2.00 FOR BOTH. THEY WILL BE MAILED SEPARATELY.**

## Take your favorite H.T. out for a drive tonight.

VISA or MASTERCARD for  
same day shipment.

For \$69.95 you get the most efficient,  
dependable, fully guaranteed 35W 2 meter  
amp kit for your handy talkie money can buy.  
Now you can save your batteries by operating  
your H.T. on low power and still get out like a  
mobile rig. The model 335A produces 35 watts  
out with an input of 3 watts, and 15 watts out with  
only 1 watt in. Compatible with IC-2AT, TR-2400,  
Yaesu, Wilson & Tempo! Other 2 meter models are avail-  
able with outputs of 25W and 75W, in addition to a 100W  
amplifier kit for 430MHZ. 382



**Communication Concepts Inc.** 2548 N. Aragon Ave., Dayton, OH 45420  
(513) 296-1411

**NEW**  
**WINDSTREAM**

**ELECTRICITY FOR HAM RADIO**

**ONLY \$359**  
plus \$15 shipping

**LET WIND POWER YOUR RADIO EQUIPMENT**  
Windstream charges 6, 12 or 24 volt batteries. Ideal for daily radio operation, emergencies and field days — Easy to mount and operate.

**QUIET, EFFICIENT AND RELIABLE**  
Strong sitka spruce blades drive a special TC25G low rpm generator. Delivers up to 100 watts.

**SAFETY FEATURE** — Rotor automatically tilts back in high winds then returns to operating position.

New technology for clean, natural power.  
**REPLY TODAY FOR FREE INFORMATION**

**Thermax**

**THERMAX CORPORATION, DEPT. ST2**  
One Mill St., Burlington VT 05401  
Phone 800-451-3402

OVER 70 BRANDS IN STOCK

LAND-MOBILE RADIO

Full Service Shop • Spectrum Analysis • Antennas  
New and Used Equipment • CW-SSB-FM, Etc. • Towers  
FCC Study Guides • Code Tapes • Books • Accessories

**AMATEUR RADIO**

**SHORTWAVE**

**SCANNERS**

**SPECTRONICS**

Specialists in Amateur Radio,  
Short-Wave Listening  
And Contemporary  
Electronic Gear.

HOURS  
MON, TUES, WED.: 9:30-6:00 PM  
THURS, FRI.: 9:30-8:00 PM  
SAT.: 9:30-3:00 PM

DRAKE, ICOM, TEN-TEC, BIRDO, HYGAIN, ARRL, BEARCAT, MORGAIN, MANY MORE...

CLOSED SUNDAYS, HOLIDAYS

**SPECTRONICS INC.** (312) 848-6777  
1009 GARFIELD ST. OAK PARK, IL. 60304

# DX

Chod Harris VP2ML  
Box 4881  
Santa Rosa CA 95402

## NEW YEAR'S RESOLUTIONS

The new year always provides a good time to review operating practices and perhaps improve techniques on the air. Here is my list of New Year's DX resolutions; why don't you come up with your own list and post it next to your rig!

1. I will not tune up on the air without checking the frequency. Instead, I will use a dummy load, mark the controls for each band, or search for a clear frequency before tuning up.

2. I will listen carefully before I call. No more "Who did I just work?" or calling out of turn when the DX station is working by call areas.

3. I will keep well informed, so that I don't have to ask "What's his QSL address?" in the middle of a DX pileup.

4. I will not be a "DX hog." I won't flaunt my (multi-)kilowatts in pileups and then ask the rare DX station to run a few tests with different antennas, etc.

5. I will not be a self-appointed policeman on the DX bands, nor will I talk back to one. The bands are crowded enough without this nonsense.

6. I will keep my transmissions short and listen often, to reduce QRM.

7. I will be courteous at all times to my fellow DXers, no matter what they do.

8. I will QSL promptly, with the card carefully filled out.

9. I will check out my rig to ensure that my signal is clean and not causing QRM.

10. I will try other bands and modes and not sit on 20 SSB.

If we all follow these resolutions, we will have an easier and more pleasant DX experience in 1983. And we'll need every advantage we can get for the big pileups around Heard Island early this year.

## HEARD UPDATE

The race is on to Heard Island. One of the most difficult and expensive DXpeditions continues its relentless drive towards this isolated rock (see this column, September, 1982), as the members of the VK6 DX Chasers Club nail down many of the details of the trip.

At the same time that the VK6 DX Chasers are organizing their trip to Heard, the well-known South Pacific DXer, Jim Smith VK9NS, has chartered his own transportation to Heard. Jim sports an impressive record of successful DXpeditions throughout the region and is as knowledgeable and experienced as any DXpeditioner. Jim aims to arrive at Heard a month before the mountaineering group. So after years with absolutely no activity, it looks like Heard might be the subject of not one but two DXpeditions.

As of press time, the operators on the VK6 DX Chasers DXpedition are slated to be: Alan Fisher N8CW, Charles Brady N4BQW, and David Shaw VK3DHF. Alan is a mechanical engineer, which is likely to be a very useful talent on icy, wind-swept Heard. N4BQW is a physician when not DXing, and one hopes his specialty will not be needed on this DXpedition. The Australian on the DXpedition team has worked with the Australian meteorology department as an electronics technician. Both meteorology and electronics will certainly be needed on Heard Island.

The vessel taking the hams and mountaineers to Heard is as impressive as the list of operators. The *Anaconda II* is 84' long, 20' wide, and sports a 98' main mast. *Anaconda II* has Antarctic experience, having just completed the Rio De Janeiro Race through the "Roaring Forties" and around Cape Horn. The yacht comes fully equipped with the latest in navigational and electronic systems, including radar, satellite and terrestrial navigation, depth sounder, and access to remote computers. (It's probably too much to hope that they could keep the radio log in their computer...) The hams and mountaineers will use inflatable surf rescue boats to get to the rocky shore of Heard.

The choice of rigs and antennas for the Antarctic DXpedition presents a difficult problem. Sturdy, dependable, easy-to-repair radios are the order of the day. Another key to dependable operation involves taking several of the same radio. Then a malfunctioning radio can be cannibalized for parts if another fails.

The antennas and outside gear will take an even worse beating than the radios. The combination of freezing rains and high winds can destroy most antennas, so specially reinforced antennas are required of the day. Finding lubricants that won't freeze up for the antenna's rotors represents another necessity.

After the hams collect their equipment they must practice its assembly and repair. Each antenna and support system must be put together and taken apart again and again. What tools are needed? Can they be handled with gloves and mittens on? Exactly what hardware is needed for each operation? How many extra nuts and bolts should be taken? What do they do if piece X breaks? The size of the yacht limits the number of spare parts the DXpedition crew can take, so which are the most essential? These are the kinds of decisions which go into a well-planned DXpedition.

But even more important than the hardware is the "software"—the radio skills of the amateur operators. There are definite skills necessary for handling pileups, keeping the contact rate high, and giving everyone a fair chance at a contact. Weather conditions are going to be rough on Heard, and radio conditions might not be much better. Heard is a long, long way from any sizeable collection of amateurs. That means that Heard's signals will be relatively weak, and European, stateside, and Japanese signals will also be weak at Heard. It will take highly-skilled amateurs to keep the pileups under control.

We hope that the Heard Island DXpeditioners will avoid the kind of poor operation shown at the St. Peter and Paul Rocks (PY0) this fall. There is simply no excuse for spreading out the callers over 100 kilohertz of the 20-meter phone band. Even the Clipperton Island DXpedition used only 75 kHz! There are many ways to spread out the callers without disrupting the entire 20-meter phone band. Non-DXers think poorly enough of the DX fraternity without this kind of bad manners. Perhaps it's time for a standard of DX conduct for DXpeditions. We'll have more to say about this in a future issue.

Meanwhile, the question of money continues. The mountaineering Heard Island trip may well cost \$150,000 or more. Donations of equipment, supplies (including warm underwear), and cash have started the ball rolling. The expedition is taking firm

of the entire trip, to recoup some of their costs. An artist on the expedition team intends to sell paintings of the Heard Island landscape and penguins.

One major source of expedition funds is the amateur community. Both the Northern California DX Foundation (PO Box 2368, Stanford University CA 94305) and the International DX Foundation (PO Box 117, Manahawkin NJ 08050) have pledged \$10,000 to the program. And both DX foundations are looking for new members and contributions to assist their work. The Australians organizing the amateur part of the trip are inviting amateurs and others to become associate members of the "Antarctic Adventure," at \$30 (Australian). The VK6 DX Chasers are also selling DXpedition T-shirts at \$9.50 (Australian). Contact them at Box 10, Perth 6005, Western Australia.

Meanwhile, Jim Smith continues to solicit funds and operators for his assault on Heard. You can send your contributions to Box 103, Norfolk Island, Australia.

Your contributions will help with the Heard Island DXpeditions and future trips to other rare spots.

Who will get to Heard first? Will there be anyone left to work for the second DXpedition? The best way to find out is to turn on your receiver and listen.

## MAILING YOUR QSL CARD

If you do work Heard Island this winter, either VK0HI or VK0JS, you will want to get a QSL card confirming the contact. In the last two months we discussed how to design and fill out your QSL. This month we'll look at ways to get your card to the right place. I'll discuss these methods roughly in order from slowest to fastest.

### The Bureaus

By far the easiest way to send your QSL to another amateur in another country is via the QSL bureau system. Every civilized country (and some that are not) has an incoming QSL bureau for the benefit of its amateurs. Incoming cards are sorted every so often and distributed to local amateurs.

Some of the bureaus are excellent. The Japanese and West Germans have especially top-notch bureaus. The smaller countries have less formal systems; in some cases, they are essentially nonexistent.

Sending your card to a DX station via the bureau is simply a matter of writing the DX station's call in the upper right corner of the back of the QSL and sending it to the address listed in the IARU information or the *Callbook*. If you have any number of cards going to the same country, the cost is a few cents a card.

An even easier system for ARRL members is the League's on-going DX QSL bureau. A membership label off QST and \$1.00 per pound of QSLs (about 150) gets the cards off to the DX bureaus for less money (and probably faster) than any other service. Contact the ARRL for more information.

The chief complaint about the bureau method is speed. There isn't any. Three to four months is about as fast a turnaround as anyone can expect. A year or two is not unusual. With Russian QSLs (through the famous Box 88, Moscow), delays of 3-5 years are common and I have seen 10-15-year-old QSLs in packages direct from Box 88. Small wonder that it takes twenty years to get on the honor roll; it can take that long for a bureau card!

### Commercial QSL Forwarding Services

There are other outfits which provide the same service as the League's outgoing QSL bureau, plus the added benefit of searching out QSL managers and faster QSL methods. These services advertise in most amateur-radio magazines.

The price per card runs about \$0.10-20,

but service depends on the volume of cards and the expertise of the amateur running the operation. W3KT's service used to be the best, before Jesse passed away last year (see this column, September, 1982).

If you want to go this route, contact the operator and find out the number of cards per week he handles, how long the cards sit in his hands, how he arranges for return QSLs, and the calls of some hams who have used the service. Then follow up on this information before depending on the QSL forwarding service.

The same problem applies to this kind of service as to the League bureau system: It can take a long time. A well-run forwarding service can get cards to stateside QSL managers and back quite cheaply and rapidly. But DX QSLs usually go by sea mail and can be months in transit. There is another potential problem with the QSL forwarding services: Their success depends heavily on the skills of the manager. His knowledge of DX and QSLing can make the difference between cards on the wall and wasting your money.

### Direct QSLs

Since DXers are an impatient lot, the preferred method involves sending a QSL of an important DX contact directly to the person handling the QSL chores. This person might be the actual DX operator himself or a QSL manager.

To send the card, you need the correct address. Obtaining this accurate address is one of the fine arts of DXing. The first place you look for this information is on the air. Listen to the DX station. Where does he say you should send the QSL? The horse's mouth is by far your best source of QSL information.

Next best are second-hand sources, such as DX nets, repeaters, and bulletins. Pulling information out of the bulletins is a time-consuming task, and errors abound. DX nets are a little better, but it helps to know who is providing the information, to help judge its reliability. DX repeaters offer the chance to talk to someone who has already received a card back from that DX station. Whatever method was successful once is worth another try.

If you don't want to spend your DXing time reading every bulletin and monitoring every DX net, you might consider subscribing to one of the DX QSL lists. Look for their ads in the magazines and bulletins. W6GO and K6HHD publish a QSL Manager List with more than 5000 calls. This list is updated monthly and costs \$15.00 per year in the US. The address is PO Box 700, Rio Linda CA 95673.

Another possible source of DX address information is the *Callbook*. Some amateurs say they are "OK in any *Callbook*." The *Callbook* also lists QSL bureaus in the various DX countries. The *Callbook* is available at your local radio store or by mail.

### Addressing the Envelope

You have finally located what you are sure is the "latest word," the "up-to-the-minute" QSL address. You could just write the address on the back of your card and mail it, but you would get an answer via the incoming QSL bureau or not at all. You probably want to send the card in an envelope, with a self-addressed, stamped envelope (SASE) enclosed.

Avoid the temptation of putting more than one card in an envelope. Say you worked Eric SM0AGD from several of his Pacific locations this past fall (see this column, August, 1982). Please don't put all the cards for SM3CXS (Eric's QSL Manager) in one envelope. Use a separate envelope for each QSL card. Or if you really can't afford to do that, at least send cards for each separate call sign in a separate envelope.

# FREE! Brand New Catalog With Over 150 Programs

Best  
Software  
Under The  
Sun

Instant Software's new catalog is free and it offers 150 of the finest programs you can find. At reasonable prices...and a variety you've never seen before in one catalog. And they're all contained in the new 16 page 1983 Instant Software catalog. You'll find:

**ASSEM/ZSIM**—2 great utilities in one super package. Assembly language programmers, this package solves all your programming problems from ASSEM to ZSIM.

**Super Utility Plus**—the most powerful program of its kind. A must for every serious TRS-80\* disk installation.

**Geography Explorer Series**—the exciting, attention-holding series that teaches your children essential geographical facts.

**Phaser Blast**—phaser-armed robots, enemy Hovertanks...prepare for a journey into the war of the future.

**Space Shuttle**—experience the ultimate flight as you pilot America's

Columbia through launch, orbit, re-entry and landing.

Plus dozens of other practical, mind-boggling or spine-tingling programs.

And now you can get the new 1983 Instant Software Catalog absolutely free. You don't even have to pay for the phone call. Just dial toll free:

**1-800-258-5473**

and ask for your free copy of Instant Software's 1983 Catalog. It could be the smartest call you'll make all year.

**Instant Software. The best software under the sun.**



## Instant Software™

(a subsidiary of Wayne Green Inc.)

Route 101 & Elm St.

Peterborough, NH 03458

\*TRS-80 is a registered trademark of the Radio Shack division of Tandy Corp.

Yes, I want a free catalog!  
Please send my free copy to:

Name \_\_\_\_\_

Address \_\_\_\_\_

City \_\_\_\_\_ State \_\_\_\_\_ Zip \_\_\_\_\_

I have a \_\_\_\_\_ computer

**Instant Software™**

Peterborough, N.H. 03458 USA A subsidiary of Wayne Green Inc.

The best software under the sun.

NC016

Mixing the calls or cards will only delay the response. Often, different people in different locations handle the cards for different calls, even though the QSL address is the same, as is the case with SM3CX. If you mix several callsigns, the cards and your return envelope will go to one QSL manager, back to SM3CX, and so on. Anywhere along the line your cards might get lost or separated from the return envelope. Make everyone's life easier, and speed your return QSL by sending each card in a separate outer envelope.

Should you put the callsign of the DX station on the outer envelope? An excellent question. If the card is going to an address in the States, Western Europe, or Japan, by all means do so. The first callsign on the address should be that of the DX station you worked, the second the call of the QSL manager: VP2ML via K1RH. This allows the QSL manager to sort the cards quickly.

On the other hand, I recommend leaving off the callsign on the envelope if the card

is going to an African country, Eastern Europe, Turkey, or any other country where amateur radio is illegal or frowned upon. The reason is theft or danger to the DX amateur. Callsigns on the outer envelope may indicate money inside, so many of these envelopes never reach their intended destinations. In the case of Turkey, the DX amateur can run afoul of local authorities by receiving mail with a callsign on the envelope.

The best rule of thumb is, when in doubt, leave it off. And if you ever send personal mail to an active QSL manager, write in large letters. "Not a QSL" on the envelope! Otherwise, it may get thrown in with the QSLs to be answered "tomorrow."

#### When to Mail

We are all anxious to get our return QSL card, especially one confirming a rare QSO. So many of us rush right out the day we work the DX station and mail off the card. This is fine when the card is going directly to a DX resident in another country. But it is

not necessarily the best time to send a QSL card for a DXpedition contact or to a QSL manager.

Many DXpeditioners handle their own QSLing. If you can still read them on the radio, they can't be home answering your QSL. Wait a while. In fact, most DXpeditions don't print the QSLs until they get home and know how many they need. It will often be a month or more before they even have any cards to fill out.

If you really jump the gun and send the card out while the DXpeditioner is still away from home, you can create some unneeded friction between the DXer and his local post office. When I returned from 10 days in the Galapagos, there were 6 bags of QSLs waiting for me. On one day I received more mail than the rest of the local residents combined! The post office personnel thought I was running some sort of mail scheme and threatened to charge me a commercial rate and storage fees. And somewhere, buried in that tome of mail, were personal letters,

and checks. It took a solid day just to pull my personal mail out of the QSLs!

So give the DXer some time to get home, get some cards printed, and catch his breath, before overflowing his PO box.

The same problem can happen when QSL managers get their log information via the mail. The logs might take weeks or months to get to the QSL manager, before he can look up the contact and answer your QSL.

Some QSL managers get around this by having regular schedules with the DX station. The manager reads the contact information, the DX station checks his log, and the QSO is confirmed. This system worked so well for me at VP2ML that one amateur received his QSL card less than 48 hours after the contact!

Enough about how to get your QSL card to the right place. It's the next step that's the important one anyway: getting the DX station's QSL card back! Hang on until next month!

## AWARDS

Bill Gosney KE7C  
Micro-80, Inc.  
2665 North Busby Road  
Oak Harbor WA 98277

### LABRE AWARD

The Worked All American Award has been instituted by LABRE (Liga de Amadores Brasileiros de Radio Emissao) to promote interest in the American area.

The WAA award will be issued to any licensed amateur station presenting proof of contact with forty-five (45) or more countries in the American area.

All applications should be sent to the Awards Manager, LABRE, PO Box 07/0004, Brasilia, Distrito Federal, Brasil, CEP 70.000.

Confirmations must be accompanied by a list of claimed countries to aid in checking. A log verified by the awards manager of the applicant's country league or association will be accepted instead of QSL cards. Logs may also be verified by two amateurs in the applicant's area.

All contacts must be made with licensed amateur stations operating in authorized amateur bands. Contacts must be made only with licensed and based amateur stations. Contacts with ships and aircraft cannot be counted.

All stations must be contacted from the same call areas where such areas exist, or from the same country in cases where there are no call areas. One exception is allowed to this rule. If a station moves from one call area to another, or from one country to another, all contacts must be made from within a radius of 150 miles from the initial location.

Contacts may be made over any period of years since November of 1945. Contacts may have been made under different call letters in the same call area (or country) if the license for all was the same.

Any altered or forged confirmations will result in permanent disqualification if observed by the WAA award advisory committee. A minimum readability of 3 (R3) must be recorded for phone and a minimum signal tone of 5 (S5) must be recorded for CW.

All applications must be forwarded with

ten IRCs or equivalent for handling and postage and return of QSL cards by registered air mail.

All certificates will be consecutively numbered and an honor roll showing all those issued will be kept by the awards manager of LABRE.

The following list of countries in the American area (North and South America) is presented as a guide. Deleted countries will not be valid.

#### WAA Countries List

CE	Chile
CE	Easter Island
CE	Juan Fernandez
CE	San Felix
CM-CO	Cuba
CX	Uruguay
FG	Guadeloupe
FM	Martinique
FOB	French Polynesia
FOBX	Clipperton Island
FP	St. Pierre & Miquelon Islands
FS	Saint Martin
FY	French Guiana
HC	Ecuador
HC8	Galapagos Island
HH	Haiti
HI	Dominican Republic
HK	Colombia
HK0	Bajo Nuevo
HK0	Malpelos Island
HK0	San Andres & Providencia
HP	Panama
HR	Honduras
J3	Grenada
J6	St. Lucia
J7	Dominica
K-W	USA
KC4	Navassa
KG4	Guantanamo Bay
KP7	Alaska
KP4	Puerto Rico
KP4/D	Desecheo Island
KS4	Swan Is. (now HR)
KS4	Serrana Bank (now uses HK0)
KV4	Virgin Islands
KZ5	Canal Zone (until March 24, 1978)
LU	Argentina
OX	Greenland
PJ	Neth. Antilles
PJ	Saint Maarten
OA	Peru
PP, P2, PR, PS, PT, PU, PW, PY	Brazil

PY0	Fernando Noronha
PY0	St. Peter's & St. Paul's
PY0	Trindade & Martim Vaz Islands
PY0	Abrilhos Island
PZ	Surinam
TG	Guatemala
TI	Costa Rica
TI9	Cocos Island
VE	Canada
VP1	British Honduras
VP2A	Antigua and Barbuda
VP2E	Anguilla
VP2K	St. Kitts
VP2M	Montserrat
VP2S	St. Vincent
VP2V	British Virgin Islands
VP5	Turks & Caicos Islands
VP7	Bahama Island (Now C6)
VP8	Antarctica
VP8/LU	Falkland Island
VP8/LU	Georgia Island
VP8/LU	So. Orkney Island
VP8/LU	So. Sandwich Island
VP8/LU	So. Shetland Island
VP9	Bermuda
XE	Mexico
XF4	Revilla Gigedo
YN	Nicaragua
YS	El Salvador
YV	Venezuela
YV	Aves Island
ZF1	Cayman Island
ZP	Paraguay
6Y	Jamaica
8P	Barbados
8R	Guyana
9V	Trinidad & Tobago Islands

Box 152, 97202 Fort de France Cedex, Martinique.

### W. VIRGINIA QSO PARTY

The West Virginia QSO Party, sponsored by the West Virginia State Amateur Radio Council, will be from 1700Z January 22 until 1700Z January 23. Single operator only. Exchange signal report, serial number, county (WV only), state, or country. WV stations multiply total by sum of WV counties, states, and countries worked. Others multiply QSO totals by WV counties worked. Multiply score by 1.5 if you run 200 Watts or less. Suggested frequencies: Phone—10 kHz from lower edge of General subbands; CW—35 kHz from low ends; Novice—35 kHz from low ends. Repeater contacts permissible. Mail logs by February 11 to K8BS, 950 Gordon Road, Charleston WV 25303.

### WISCONSIN SPECIAL EVENT

The Eau Claire, Wisconsin, ARC will operate K9EC/9 during the National 70-Meter Ski Jumping and Nordic Combined Championship on January 29 and 30 from 1400Z to 2300Z. Frequencies: CW—52 kHz up from bottom edge. Phone—3980, 7277, 14282, 21382, and 28620. For an 8 1/2 x 11 certificate, send SASE to N9AIX, PO Box 201, Altoona WI 54720.

### GROUNDHOG DAY

The Punxsutawney (Pennsylvania) Amateur Radio Club will operate on 14.290 and 7.230 from 9 am to 5 pm, January 30, 1983, in commemoration of Groundhog Day 1983. We will operate also on 7.230 on February 2, 1983 (Groundhog Day). This special-event station will operate from Gobblers Knob, the home of the Groundhog. Certificate for SASE and QSL card to Art Sweeney K3HWJ, RD #1, Box 371, Punxsutawney PA 15767.

### GEORGIA'S 250TH BIRTHDAY

Savannah area amateurs will have a special-events operation in honor of the State of Georgia's and historical Savannah's 250th birthday. Operation will be February 12 and 13, 1500-2000Z on upper 25 kHz, all General phone, and 21.130 to 21.170 kHz Novice. QSOs on 2 meters 146.52 only. For special certificate, send QSL card with QSO number and large SASE to call of contact operator.

### GOLDEN SHEARS AWARD

In honor of the 1983 Golden Shears

### MARTINIQUE AWARD

The FM DX Group of Martinique is offering a certificate for QSOs with FM7 and FM0 stations. Three hundred points will earn the certificate, with scoring as follows: Contacts with an FM DX Group member count 10 points per QSO, FM0 contacts count 4 points each, and FM7 contacts count 2 points. A phone QSO is worth 1 point, RTTY or ASCII count for 2 points, and a CW contact is worth 3 points.

One point is given for a contact on 10, 15, or 20 meters, a contact on 160 or 80 meters is worth 2 points, and a QSO on any other frequency receives 3 points. One point also is added for each 3,000 miles distance from Martinique.

A minimum of 7 days is required between two QSOs with the same station, and 25 percent of the points must have been made in contact with an FM DX Group member.

Logs and a \$5.00 money order should be sent to Gerard Souqui FM7BX, PO

# WAYNE GREEN BOOKS

## KILOBAUD CLASSROOM

by George Young and Peter Stark

Makes learning electronics fun and easy. First published as a series in *Kilobaud Microcomputing*, the book combines the learning of essential theory with practical, hands-on experience. The course begins with basic electronic projects and culminates in the construction of your own programmable microcomputer. The direct instructional methods of authors Young & Stark make KILOBAUD CLASSROOM a simple way for you to acquire a solid background in digital electronics.

BK7386 (419 pages)..... \$14.95

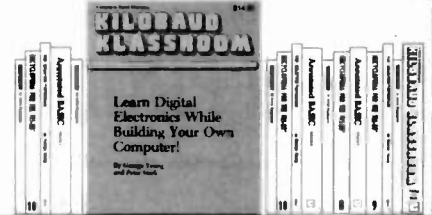

## THE SELECTRIC INTERFACE by George Young

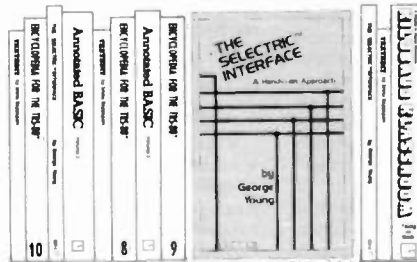

You need the quality print that a daisy wheel printer provides but the thought of buying one makes your wallet wilt. The SELECTRIC™ INTERFACE, a step-by-step guide to interfacing an IBM Selectric I/O Writer to your microcomputer, will give you that quality at a fraction of the price. George Young, co-author of *Kilobaud Microcomputing* magazine's popular "Kilobaud Klassroom" series, offers a low-cost alternative to buying a daisy wheel printer. The SELECTRIC INTERFACE includes: step-by-step instructions, tips on purchasing a used Selectric, information on various Selectric models, including the 2740, 2980, and Dura 1041, driver software for Z80, 8080, and 6502 chips, tips on interfacing techniques. With The SELECTRIC INTERFACE and some background in electronics, you can have a high-quality, low-cost, letter-quality printer. Petals not included.

BK7388 (125 pages)..... \$12.97

## GENERAL LICENSE STUDY GUIDE

By Timothy M. Daniel N8RK

This is the complete guide to the General License. Learning rather than memorizing is the secret. This is not a question-and-answer guide that will gather dust when the FCC issues a new test. Instead, this book will be a helpful reference, useful long after a ham upgrades to General. Includes up-to-date FCC rules and an application form. Order yours today and talk to the world.

SG7358 (87 pages)..... \$6.95

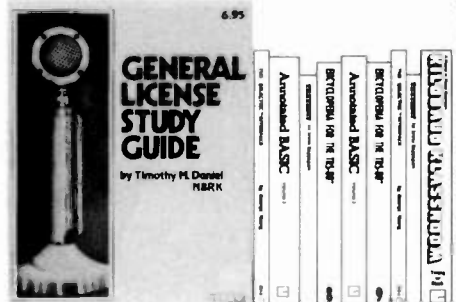

## NOVICE LICENSE STUDY GUIDE

By Timothy M. Daniel N8RK

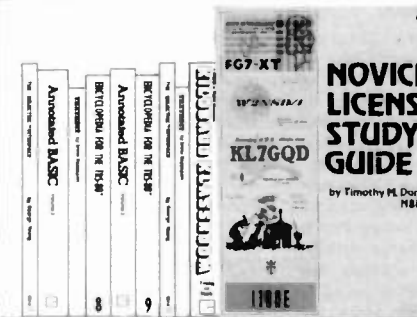

Here is the most up-to-date novice guide available. It is complete with information about learning Morse code, has the latest FCC amateur regulations and the current FCC application forms. This guide is *not* a question/answer memorization course but rather it emphasizes the practical side of getting a ham license and putting a station on the air. It reflects what the FCC expects a Novice to know without page after page of dull theory. The most current information still available at last year's price.

SG7357 (98 pages)..... \$4.95

## THE NEW WEATHER SATELLITE HANDBOOK by Dr. Ralph E. Taggart WB8DQT

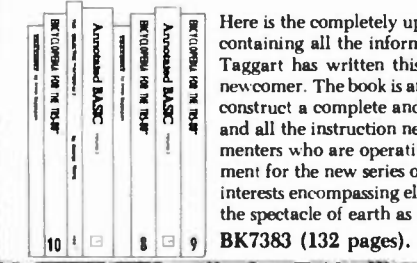

Here is the completely updated and revised edition of the best-selling *Weather Satellite Handbook*—containing all the information on the most sophisticated and effective spacecraft now in orbit. Dr. Taggart has written this book to serve both the experienced amateur satellite enthusiast and the newcomer. The book is an introduction to satellite watching, providing all the information required to construct a complete and highly effective ground station. Not just ideas, but solid hardware designs and all the instruction necessary to operate the equipment are included. For the thousands of experimenters who are operating stations, the book details all procedures necessary to modify their equipment for the new series of spacecraft. Amateur weather satellite activity represents a unique blend of interests encompassing electronics, meteorology and astronautics. Join the privileged few in watching the spectacle of earth as seen from space on your own monitoring equipment.

BK7383 (132 pages)..... \$8.95

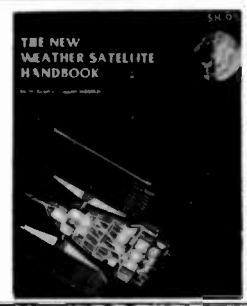

## FOR TOLL-FREE ORDERING CALL 1-800-258-5473 WAYNE GREEN BOOKS • PETERBOROUGH NH 03458

Itemize your order on a separate piece of paper and mail to Wayne Green Books, Attn: Sales, Peterborough, NH 03458. Be sure to include check or detailed credit card information. (Visa, MC or AMEX accepted.) No C.O.D. orders accepted. All orders add \$1.50 for the first book, postage and handling; \$1.00 each additional book; \$10.00 per book foreign air mail. Please allow 4-6 weeks after publication for delivery. Questions regarding your order? Please write to Customer Service at the above address.

Sheep Shearing Contest in March, 1983, the members of New Zealand's Branch 46 in Wairarapa are offering an award for contacts made that month with their members.

To be eligible for the award on HF bands, ZL stations must have 10 points, VK stations must have 7 points, and DX

stations need 5 points. Net contacts count toward the award.

On VHF, ZL2 stations need 15 points to qualify, other ZL stations have to get 7 points, and DX stations must have 3 points. Repeater QSOs count toward the award, but repeater/net contacts do not.

Scoring is as follows: Golden Shears President ZL2AHU is worth 3 points; club

station ZL2OA, a YL operator, farming branch member, or mobile station within Wairarapa are worth 2 points each, and any other member is worth 1 point.

Except for crossband operation, any band/mode combination is allowed. However, only one contact per member is permitted unless the member is operating the

club station or working mobile within Wairarapa. No QSLs are required for the award; send your application with \$2.00 (NZ) or an equivalent International Money Order to Awards Manager, PO Box 860, Masterton, New Zealand. Entries must be received before August 31, 1983. All proceeds will go toward funding for an operating room for emergency situations.

## NEW PRODUCTS

### APOLLO X10 ANTENNA

National Microtech, Inc., has just introduced its new Apollo X10 antenna, which utilizes a 10-foot, eight-segment, compression-molded fiberglass reflector. The reflector provides high strength-to-weight ratio and significantly reduces the size of the shipping container, thus providing savings in handling and shipping costs.

The X10 can be erected easily by two installers. The individual reflector segments are interchangeable and field-replaceable,

utilizing indexing tabs for position and self-alignment.

The Apollo X10 delivers 40.1 dB gain at 3.95 GHz. Its textured front surface diffuses sunlight and reduces solar heating at the focal point, and the high-quality fiberglass material is impervious to salt, pollutants, and contaminants that may be encountered in coastal and industrial areas.

The center-mounted "button hook" prime feed provides accurate alignment with the focal point without the use of cables and other supporting gear. The LNA is located at the focal point while the rotor

is placed at the rear of the dish, permitting rotation of the feed through 360 degrees of polarization by remote control.

For more information, contact *National Microtech, Inc., PO Drawer E, Grenada MS 38901*. Reader Service number 481.

### UNITED STATES FREQUENCY ALLOCATION CHART

An updated "Varian United States Frequency Allocation Chart" is now available free of charge from Varian Associates Electron Device Group. The four-color chart includes radio, television, point-to-point, microwave, satellite communications, and millimeter wave frequency allocations. This 15" by 21" foldout wall chart features a ledger guide and is both color- and line-coded for easy reference.

Frequency allocations from 3 kHz to 300 GHz are divided into eight one-order-of-magnitude divisions. These divisions are color-coded to illustrate frequency uses of government exclusive, non-government only, and government and non-government shared frequencies. Line coding is then used for the demarcation of 31 specific frequency categories such as fixed satellite, radio navigation, land mobile, broadcasting, and meteorological satellite.

For further information, contact *Varian Associates, Electron Device Group Marketing, 301 Industrial Way, San Carlos CA 94070*. Reader Service number 488.

### AZDEN INTRODUCES NEW PCS-4000

Japan Piezo Company, Ltd., and Amateur-Wholesale Electronics have announced their new PCS-4000 2-meter FM transceiver. Like its predecessors, the PCS-4000 utilizes keyboard frequency control, but many new features have been added, making this a truly unique radio.

Some of the features are 8-MHz coverage (142 to 149.995 MHz), extremely small size (2 inches high by 5 1/2 inches wide by 6 3/4 inches deep), two banks of eight memories which can be scanned separately or together, capability for up to eight nonstandard repeater splits, and two priority channels. Other features include a full 16-key touchtone™ pad built in, multicolored display for easy function recognition, discriminator scan centering, repeater reverse button, and free/vacant scan mode selection with auto-resume.

For more information, contact *Amateur-Wholesale Electronics, Inc., 8817 SW 129 Terrace, Miami FL 33176; (303)-233-3631*. Reader Service number 483.

### SIMPSON'S MODEL 467E LCD DMM

Simpson Electric Company has introduced a new hand-portable LCD digital multimeter. Model 467E joins the Simpson line of LCD hand-portable DMMs.

Features include peak hold to capture surge currents and voltages, a continuity mode to provide instant visual/audible checks for shorts and opens, and true rms capability for more significant measurements of non-sinusoidal waveforms over a wide frequency range. The 467E has 26

ranges to provide full ac/dc voltage, current, and resistance (including low-power Ohms) measurement capability.

Additional features include 0.1% dc V accuracy, high-voltage transient protection, a double fusing system, and color-coded front-panel graphics. Its size is a compact 2" x 5.6" x 4.6" and its weight is 1 1/2 lbs.

For further information, contact *Simpson Electric Company, 853 Dundee Avenue, Elgin IL 60120; (312)-697-2260*. Reader Service number 486.

### SUBMINIATURE CHANNEL SCANNER

Midian Electronics, Inc., has introduced a subminiature channel scanner. It features 6-channel capability on radios employing crystal high switching, 16-channel capability on radios using battery-line binary address, and 8-channel capability on radios using battery or ground switching. The scanner also has a priority channel scan capability as well as a three-second hold timer, manual advance, and an adjustable channel scan length.

For further information, contact *Midian Electronics, Inc., 5907 E. Pima Street, Tucson AZ 85712; (602)-885-6883*. Reader Service number 487.

### PLUG-IN DTMF DECODER

Palomar Engineers has announced a new single-digit decoder which is available for any of the 16 DTMF digits.

Replacing the firm's older model T2, the new P200 features improved temperature stability, high input impedance (200,000 Ohms), and a 1/2-Ampere SPDT output relay. It operates from 12 volts dc, signal levels from -25 to +5 dBm, and has a response time of 100 ms. The decoder plugs into a standard octal socket.

For further information, contact *Palomar Engineers, 1924F W. Mission Road, Escondido CA 92025; (714)-747-3343*.



National Microtech's Apollo X10 antenna.



Simpson's model 467E DMM.



Palomar Engineers' P200 DTMF decoder.



Icom's IC-290H transceiver.

### ICOM'S IC-290H

Icom has announced the release of a new 2-meter multimode mobile transceiver, the IC-290H, featuring a powerful 25-Watt output and a highly sunlight-readable green readout in the same compact package as the IC-290A. Other features and styling of the IC-290H are the same as the previous model—the IC-290A. These include: 5 memories for storing your most worked frequencies, a call channel to make your favorite frequency instantly available, 5-kHz FM tuning or 1-kHz/100-Hz tuning on SSB, FM/USB/LSB/CW modes, programmable offsets, a priority channel that monitors 2 frequencies, and scanning of memories or band.

For more information, contact *Icom America, Inc.*, 2112 116th Avenue NE, Bellevue WA 98004.

### ENCON PHOTOVOLTAIC PANELS

Encon, Inc., distributors of Solarex photovoltaic products for the Midwest, has introduced the new Solarex SX series of semicrystalline photovoltaic panels, using state-of-the-art technology.

Solarex semicrystalline cells offer unique advantages over earlier technology, including lower cost, increased packing efficiency, and higher power output compared with the traditional round single-crystal silicon cells. Semicrystalline cells are made by melting less-than-pure polycrystalline silicon, crystallizing it into rectangular "bricks," and then sawing the bricks into wafers to make rectangular cells. The cost reductions afforded by the new process promise to bring prices down from \$100 per Watt to under \$20 per Watt within the next few years.

Solarex supplied the photovoltaic cells for the UoSAT (University of Surrey)

OSCAR 9 satellite launched on October 6, 1981. OSCAR 9's four solar panels each contain 408 high-efficiency 2 cm x 2 cm cells. Each panel produces 27 Watts when fully illuminated. The Solarex system is designed to produce 18 Watts peak power and 8 Watts average power in orbit to charge the 14-volt nicad battery.

Encon, Inc., assembles complete photovoltaic power systems for emergency and primary communication applications, as well as residential and commercial packages. Interested amateurs are invited to contact *Encon, Inc.*, 27584 Schoolcraft, Livonia MI 48150. Reader Service number 479.

### ICOM'S IC-R70 GENERAL-COVERAGE RECEIVER

Icom has just announced its new professional general-coverage receiver, the IC-R70.

It is a full generation newer and features more functions than other less sophisticated general-coverage receivers on the market. Features include squelch on sideband, adjustable-width noise blanker, adjustable-speed agc, passband tuning as standard, and adjustable notch filter as standard.

Other convenient features are high-stability, synthesized tuning with tuning speeds, an optional AM/FM mode, variable CW-filter widths, dial lock, and two vfo's with data transfer. Also, the IC-R70 will operate transceive with the IC-720A, making an ideal combination for the serious DXer or CW buff.

For more information, contact *Icom America, Inc.*, 2112 116th Avenue NE, Bellevue WA 98004.



PolyPhaser's new impulse suppressor.

### POLYPHASER'S IMPULSE SUPPRESSORS

A new series of bulkhead-style impulse suppressors for coaxial lightning protection was recently introduced by PolyPhaser Corporation. This new IS-B50 series can easily replace older air-gap-type arrestors and can be mounted on up to 1 1/8" thick bulkhead panels. These weatherproofed gas tube protectors are designed for repeaters, base stations, and TVROs to 1 GHz, with typical (N) 0.1 dB loss and 1.1-to-1 vswr. Their hefty 20-kA multi-strike and 50-nanosecond turn-on time make protection against most direct strikes possible. They come complete with weather washer and stainless steel hardware in both N and UHF fittings. A tower mounting kit is also available.

For further information, contact *PolyPhaser Corporation*, 1500 West Wind Boulevard, Kissimmee FL 32741; (303) 396-1807. Reader Service number 485.

### DC POWER SUPPLY

Many mobile operators would like to be able to operate their mobile equipment at home on ac power mains. Tripp-Lite has just announced a product that meets that desire: a precision regulated dc supply that converts 120 V ac into 13.8 V dc. For example, CB radios, automobile tape players, tape recorders, high-power stereo systems, amateur radio equipment, linear amplifiers, and marine- or business-band radios can now be used at home.

The new low-cost power supply saves the user money, since it also eliminates the expense of having to buy ac equipment. It features a solid-state integrated circuit for precise regulation. A built-in

filter ensures low-noise operation, and current-limiting electronic "foldback" is provided for automatic overcurrent protection. Other features include a heavy-duty power transformer for complete line isolation, a maximum ripple voltage of only 0.1 volts from zero to full load, an on/off switch and Indicator light on the faceplate, and a UL-listed ac cord and plug (type SPT-2).

For more information, write *Tripp-Lite*, 500 N. Orleans, Chicago IL 60610. Reader Service number 484.

### W9AV MORSE CODE TRANSLATOR FOR TRS-80 COLOR COMPUTER

J. C. Sprott W9AV announced some time ago his Morse-code programs for the TRS-80 Mod I/Mod III computers. Now, he has announced the availability of a Morse program in 16K extended color Basic for the TRS-80 color computer. It is believed that this program is the only Morse-code program available for sending and receiving Morse code by way of the computer's cassette port.

With 9 programmable memories of 240 characters each and a random-character "practice" mode, the translator program allows you to send and receive the code by merely plugging the computer cassette plugs directly into the transmitter key jack and the receiver phone jack. Morse code may then be sent at speeds of up to 60 words per minute and received at speeds of up to 30 words per minute.

For more information, write *Professor J. C. Sprott W9AV*, 5002 Sheboygan, #207, Madison WI 53705. Reader Service number 480.



Icom's IC-R70 receiver.



Tripp-Lite's dc power supply.

## SLEP SPECIALS

<b>AEA</b>	
MBA-RO Reader Receive Only	\$269.00
MBA-RC Receive/Code Converter	395.00
MM-2 Morsematic Ultimate Keyer	135.00
CK-2 Contest Memory Keyer	99.00
Isopole 144 2M Antenna	35.00
Isopole 220 Antenna	35.00
<b>BARKER &amp; WILLIAMSON</b>	
370-15 Broad Band Dipole Antenna 3.5-30 MHz, 90 ft., 5 KW PEP	\$134.00
370-10 Portable Window Sill Apartment/Mobile-Home Whip Antenna covers 2, 6, 10, 15, 20, 40 Meters plus 27 MHz	39.50
331A Grid Dip Meter Solid State, Range 2 MHz thru 230 MHz, Takes 9V Transistor Battery	112.00
374 Dummy Load Wattmeter DC to 300 MHz, 1500 Watts Input	199.00
375 Coax Switch, 6 Position Rear SO-239	22.50
376 Coax Switch 5 Position Side SO-239	22.50
<b>COLLINS/ROCKWELL</b>	
55G-1 VLF Preselector for 51S-1 and KWM-380, Limited Supply	\$375.00
312B-5 Station Console/VFO, Limited Supply	550.00
<b>DRAKE</b>	
TR-7A XCVR	\$1,439.00
TR-5 XCVR	695.00
PS-7 P/S 25 Amp	269.00
PS-75 P/S 15 Amp/25 Amp Surge	179.00
RV-75 Synthesized VFO	269.00
R-7A Receiver 0-30 MHz Digital	1,399.00
<b>COM</b>	
C-720A XCVR	\$1,140.00
C-730 XCVR	690.00
C-740 XCVR	985.00
C-2AT Hand Held w/TTP 2M	235.00
C-25A 2M Mobile 25W	305.00
C-45A New Model 440-450 MHz Mobile, 10W, FM	call
C-290H New Model All-Mode 2M FM/USB/LSB/CW 25 Watt, Easy-To-Read Green LED Read-Out, Scans	489.00
C-R70 New Model Professional General-Coverage Receiver, Many Beautiful Features	685.00
<b>MIRAGE</b>	
B-23 2M 2/30W Amplifier	\$78.00
B-108 2M 10/80W Amplifier/Preamp	154.00
B-1016 2M 10/160W Amplifier/Preamp	239.00
B-3016 2M 30/160W Amplifier/Preamp	199.00
D-1010 440 10/100W Amplifier	279.00
RC-1 Remote Control Head, All Models w/18 ft. Cable	24.95

We accept M/C, Visa or Checks. Add shipping FOB Otto, N.C. Save money by ordering today at these Low Discount Prices. Mail or phone Bill Slep 704-524-7519.



**SLEP ELECTRONICS COMPANY**  
P.O. BOX 100, HWY. 441, DEPT. 73  
OTTO, NORTH CAROLINA 28763

✓367



# HAM HELP

I am looking for schematics for a Siltronics LA 550 bi-linear.

Arthur Lee  
Route 1, Box 329  
Centreville MD 21617

I need help troubleshooting my Spec-tronics digital readout DD-1C. The display has quit counting, and I need a schematic for it.

Dr. M. R. Klein WA4GUM  
201 East Arbor Ave.  
Pt. St. Lucie FL 33452

I am looking for a manual for the Tektronix 524D oscilloscope and a meter movement for a Bird model 43 wattmeter. I will pay any reasonable price and postage.

Don DeLung WB4LJE  
830 Pinecrest Ave.  
Bedford VA 24523

Can anyone help me eliminate the chirp and drift in my Heath HG-10B vfo?

Dave Artman N9CZJ  
599 Wheel Estates  
Greenwood IN 46142

## MULTI-BAND SLOPERS

160, 80, and 40 meters

Outstanding DX performance of slopers is well known. Now you can enjoy 2 or 3 band BIG-SIGNAL reports! Automatic bandswitching • Very low SWR • Coax feed • 2kw power • Compact • Ground or tower feed • Hang from any support 25 ft. high or higher • Easy to install • Very low profile • Complete instructions • Immediate shipment • Check ok

3 BAND SLOPER - 160, 80, & 40 Meters - 60 ft. long	\$ 43.00 frt. ppd
2 BAND SLOPER - 80 & 40 Meters - 41 ft. long	\$ 30.00 frt. ppd
3-BAND NO TRAP DIPOLE, 160, 80, & 40M - 113ft. long	\$ 66.00 frt. ppd
2-BAND NO TRAP DIPOLE, 80, & 40M - 84ft. long	\$ 49.00 frt. ppd

FOR ADD'L INFO on these and other unique antennas: send SASE

**W9INN ANTENNAS**  
BOX 393-S MT. PROSPECT, IL 60056

## 2 GHz Microwave Receiving Systems

The new Micro-System features a machined 18" parabolic reflector for maximum efficiency, a linear feed-point downconverter with ceramic high performance RF preamplifier transistor, a variable 12 to 18 volt regulated power supply and 50' of 75Ω coaxial downlead, including a 3' jumper and matching transformer. The Micro-System includes a full 6 month warranty.

Micro-System (MS-021)	\$159 <sup>99</sup>
Micro-System (MS-578)	\$169 <sup>99</sup>
Micro-System (MS-645)	\$179 <sup>99</sup>
Shipping & Handling: USA	\$4 <sup>00</sup>
AK, HI & PR	\$10 <sup>00</sup>

**Data Service Company** 612-636-9469  
✓346 3110 Evelyn Street  
Roseville, MN • 55113

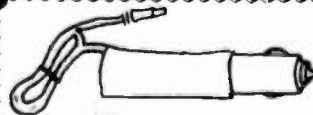

**MOBILE POWER**  
For Your H.T.

only \$21.95<sup>ppd</sup>

The new MOBILE ENERGIZER will provide operating power for your H.T. from any 12 volt source and charge it's nicads at the same time! Featuring a time-proven regulator circuit enclosed in a tough, rugged housing that plugs into the cigarette lighter jack of your car, it will work with any synthesized H.T. except Icom, Azden, and Tempo S-15. Specify H.T. model when ordering.

**CONTEMPORARY ELECTRONIC PRODUCTS**



P.O. BOX 570549  
MIAMI, FL 33157  
(305) 255-7660



✓184

# NEW!



## Introducing the POWER PACKET™ from VoCom

An innovative new product that you can combine with your VoCom Power Amplifier to obtain the functions of the famous VoCom Power Packet™ using any handheld radio.

**AF POWER** — 2 to 3 watts of road-noise-overcoming audio to your vehicle speaker or to external Packet Speaker™ (optional).

**EASY HOOK-UP** — Packet Bracket™ at bottom of Power Packet, provides place to clip almost any make or model handheld. Connects to handheld through pin jacks. Hooded light on Power Packet illuminates portable's front panel.

**CHARGE POWER** — 35 mA charge on receive, 400 mA when mic is keyed. Unless your handheld draws more than 400 mA,

you can talk as long as you wish and the batteries will be at least as charged as when you started.

**MIC PREAMP** — adjustable; tie in your handheld directly without changing its mic input. Also makes Power Packet compatible with most standard mobile mics. Optional Packet Mic™ available.

Suggested retail \$84.95. See your favorite amateur radio dealer.

# VoCom

**PRODUCTS CORPORATION**

65 E. Palatine Rd., Prospect Heights, IL 60070  
(312) 459-3680

✓90



# FREE CATALOG



**NEW!**  
CATALOG OF  
HARD-TO-FIND  
PRECISION TOOLS

✓ 354

Also contains test equipment  
plus wide selection of  
tool kits and cases

Jensen's new catalog is jam-packed with more than 2000 quality items. Your single source for hard-to-find precision tools and tool kits used by electronic technicians, scientists, engineers, instrument mechanics, schools, laboratories and government agencies. Send for your free copy today!



**JENSEN TOOLS INC.**

7815 S 46TH STREET PHOENIX AZ 85040

## C.B. SPECIAL

(Repeat of a sell out)  
CONVERT THESE TO  
10 METER FM

New Hi-Gain 40 channel printed circuit boards assembly (Squelch pot, volume control and channel switch not included). Boards sold as is. Dimension 6" X6"

1-9 pcs \$7.50 ea.

10-49 pcs \$6.50 ea.

(White quantities last)

### REMOTE 40 CHANNEL C.B.

Remotes have a metal frame Speaker plastic case, and control mic not included. Sold as is.

\$14.95 ea

### C.B. BARGAIN

C.B. boards missing parts or damaged. Can be used for spare parts. Buy several!

\$3.50 ea

Order information Please add \$4.00 for S/H via UPS. COD's accepted for orders totaling \$50.00 or more. Florida residents add 4% sales tax. Minimum order \$15.00. Foreign orders US funds only add 20% for S/H. MASTER CARD and VISA accepted.

### Surplus Electronics Corp.

7294 NW 54th St.  
Miami FL 33166  
P.H.# 305-887-8228

✓ 69

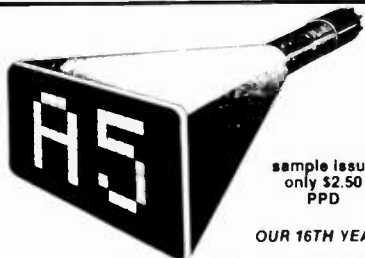

sample issue  
only \$2.50  
PPD

OUR 16TH YEAR!

## AMATEUR TELEVISION MAGAZINE

✓ 115

"FOR THE SPECIALIZED COMMUNICATION RADIO AMATEUR"

	Surface U.S./Canada	Surface Mexico	Surface All Foreign	Airmail Central S. America	Airmail All Other Foreign
1/2 year	\$ 10.00	\$ 13.00	\$ 20.00	\$ 23.00	
1 year	\$ 20.00	\$ 26.00	\$ 40.00	\$ 46.00	
2 year	\$ 38.00	\$ 50.00	\$ 78.00	\$ 90.00	
3 year	\$ 56.00	\$ 74.00	\$116.00	\$134.00	

ATV-SSTV-FAX-RTTY-Satellites-EME  
Microwave and Computers.

Published 12 times per year by Mike Stone WB0QCD  
P.O. Box H, Lowden, Iowa 52255 0408

## Microwave Field Disturbance Motion Detector Kit

- Range 100' unobstructed
- Safe low power 10mW output
- Detects motion from 0.1 to 20 MPH

Unlike ultrasonic motion detectors, the Microwave Field Disturbance Motion Detector, can see thru non-metallic walls. Output is N.O. or N.C. relay contacts which can operate alarms, lights, or electric doors. Output can be programmed from seconds to hours and will reset automatically.

Kit contains: 10.525 GHz transceiver module, 10 db diecast horn antenna, all components, PC board, and instructions. Requires 10-14 VDC, 70mA standby, 110mA activated.

Model MT2 \$89.95 PPD in U.S.  
COD add \$2. N.J. residents add  
5% sales tax.

MicroTek (201) 548-4321  
35 West Francis St.,  
Iselin, New Jersey 08830

✓ 196

## SYNTHESIZED SIGNAL GENERATOR

MADE IN  
USA



MODEL  
SG100D  
\$349.95  
plus shipping

- Covers 100 to 185 MHz in 1 kHz steps with thumb-wheel dial
- Accuracy 1 part per 10 million at all frequencies
- Internal FM adjustable from 0 to 100 kHz at a 1 kHz rate
- Spurs and noise at least 60 dB below carrier
- RF output adjustable from 5-500 mV at 50 ohms
- Operates on 12 Vdc @ 1/2 Amp
- Available for immediate delivery
- \$349.95 plus shipping
- Add-on Accessories available to extend freq. range, add infinite resolution, voice and sub-audible tones, AM, precision 120 dB calibrated attenuator
- Call for details • Dealers wanted worldwide.

### VANGUARD LABS

196-23 Jamaica Ave., Hollis, NY 11423  
Phone: (212) 468-2720

✓ 311

## "KEEP IN TUNE WITH THE WORLD"

\*\*TECHNICAL ASSISTANCE BY F.C.C.  
LICENSED TECHNICIANS:

- repairs
- alignments
- modifications
- installation of custom circuits

\*\*PRODUCTS AVAILABLE:

- QSK keying
- VOX
- Power supplies—[memory keep alive]

\*All above circuits for solid state equipment

manufactured by



12325 Madonna Dr. Lansing, Michigan 48917  
(517) 627-2650 or 627-2879

✓ 159

## QUALITY MICROWAVE TV SYSTEMS

### 1.9 to 2.5 GHz Antennas

Complete System (Rod Style as pictured) \$124.95

Complete System  
(Reflector Style as pictured) \$149.95

Down Converter, Assembled & Tested \$64.95

Power Supply (12 to 18V) \$49.95

Also Dish Style Antennas In Stock.

**Galaxy Electronics** ✓ 178  
6007 N. 61st Ave.  
Glendale, Az.

(602) 247-1151

COD's  
Quantity Pricing



90 DAY WARRANTY  
PARTS & LABOR

## COLLINS RECEIVER

R-388/COLLINS 51J3 RECEIVER - 0.5-30.5

Mhz AM-CW in 30 bands.  
1 Mhz per band. Bandwidth 0.2-6 KHz; 500 KHz IF. 5-step crystal selectivity, "S" meter, and 100 KHz calibration points. Requires 115/230 VAC 60 Hz; 10 1/2"x19"x13".

56 lbs. sh. Used-reparable: \$925. \$265.

Checked: \$400. \$330. Manual, partial repro: \$10.

RF TUNER

From 400watt transmitter; has Jennings UCSXF-1200 7.5 KV vacuum variable capacitor and 0.5-50 uH variable ribbon inductor. Selectable 50 ohm or whip antenna load and turns counters. 24 VDC required for capacitor and inductor drives; schematic included. 13 1/2"x10 1/4"x5 1/4". 24 lbs. sh. #RF1200/GRC14, used-excellent \$195.

Prices F.O.B. Lima, O. • VISA, MASTERCARD Accepted.  
Allow for Shipping • Write for our FREE CATALOG  
Address Dept. 73 • Phone: 419/227-6573

**FAIR RADIO SALES** ✓ 22  
1016 E. EUREKA • Box 1105 • LIMA, OHIO • 45802

**AMATEUR RADIO SOFTWARE FOR VIC**

THICE AS MUCH FOR YOUR MONEY. TWO PROGRAMS ON A SINGLE CASSETTE.

THE DIPOLE ANTENNA & ANTENNA FORMULAS.....\$8.95  
THREE ELEMENT YAGI & ANTENNA FORMULAS.....\$8.95  
BASIC & MORE ELECTRONIC FORMULAS.....\$8.95  
.....  
SINGLE PROGRAMS

MORSE CODE TUTOR.....\$8.95  
GIVES YOU PRACTICE AND TESTS YOU FROM 5-20 WPM, WITH TOTALLY RANDOM FIVE CHARACTER CODE GROUPS.

AMATEUR RADIO DATA SYSTEM.....\$14.95  
RECORD CALLSIGN, NAME, CITY, STATE, CONTACT #, DATE, TIME, FREQ. ON EACH CONTACT. 50 CONTACTS PER FILE. UNLIMITED NUMBER OF FILES. REQUIRES A MINIMUM OF 3K ADDITIONAL MEMORY. FREE C-60 CASSETTE SUPPLIED FOR DATA, OR BUY DISK VERSION AND STORE 1200 CONTACTS ON PROGRAM DISK.

ALL PROGRAMS AVAILABLE ON DISK—ADD \$3.00

VIRGINIA RESIDENTS ADD 4%, WE PAY POSTAGE. SEND CASH, CHECK OR MONEY ORDER TO:

**RUSS SOFTWARE LTD.**  
P.O. BOX 378 NORTHWEST STATION  
CHESAPEAKE, VA. 23322  
(804) 421-3914

✓ 207

**RELIABLE MICROWAVE TV ANTENNAS**

**2.1 to 2.6 GHz Frequency Range**

**34db System Gain (or Greater)**

- Complete System (as pictured) \$149.95
- Down Converter Probe Style (Assembled and Tested) \$ 64.95
- Power Supply (12V to 16V DC+) (Assembled and Tested) \$ 59.95



**1 YEAR WARRANTY PARTS & LABOR**

**PETERSON ELECTRONICS**

4558 Auburn Blvd.  
Sacramento, CA 95841  
(916) 486-9071

✓ 182

C.O.D.'s  
**SPECIAL QUANTITY PRICING**  
Dealers Wanted



**PACKET RADIO TREASURE TROVE**

MODEM BOARD		POWER SUPPLY
SINGLE BOARD COMPUTER		AND MORE!

- SURPLUS FINANCIAL TERMINAL CONTAINING:**
- 202 TYPE MODEM BOARD: 0-1800 baud, separate 600 ohm audio xfrms, TTL digital I/O, 5 x 5.5"
  - 8080A CPU BOARD: With sockets for 4ea 2708s. Also in sockets: 8251 Programmable Communications Interface (USART), 8253 Triple Programmable Interval Timer, 8228 System Controller/3-state Bus Driver, 256 bytes RAM, 29 other support ICs, intal. clock IC 7.5 x 10"
  - ENCLOSED POWER SUPPLY: With pw cord & switch +5V @ 2.5A, +12V @ 350ma, -5V @ 250ma, plus 2 unregulated voltages for display, 3 x 4 x 8"
  - DOCUMENTATION PACKAGE: Includes schematics & Technically Oriented User Manual
  - MISC.: 20 Key Decimal & Function Keyboard, 16 Digit Fluorescent Display, Mag Stripe Credit Card Reader, Speaker and MORE

Units are removed from service and in good working condition. High quality modern construction throughout. Each is given a full off-line test before shipment. Large quantity in stock. You'd have to buy a lot of turkeys before finding another gem like this.

PRICE, SURFACE UPS INCLUDED ..... \$55  
DOCUMENTATION PACKAGE ..... \$5

ELECTROVALUE INDUSTRIAL INC.  
P.O. BOX 157-W  
MORRIS PLAINS, NJ 07960  
Phone orders and questions welcome  
201-267-1117

**DIGITAL DISPLAY**

**30 DAY FREE TRIAL**



**YAESU  
HEATH  
DRAKE  
COLLINS  
KENWOOD**

NEW YAESU DIGITAL DISPLAYS CONVERTED FOR YAESU KENWOOD HEATH COLLINS AND DRAKE TRANSCEIVERS RECEIVERS AND TRANSMITTERS. 5 ACTIVE RED LED DIGITS READ DOWN TO 10 Hz. REAR PANEL 10 Hz DIGIT DEFEAT SWITCH. FROM COLD MAX. 100 Hz DRIFT IN 24 HRS. 1 3/8" HIGH, 4 1/2" WIDE & 6 1/2" DEEP. STEEL CASE IS BLACK. LOWER FRONT PANEL IS BRUSHED ALUMINUM. UNITS FOR MODEL NUMBERS UNDERLINED WORK WITHOUT ANY INSTALLATION BY PLUGGING INTO EXISTING JACKS ON THE RADIOS. MODELS WITH AN \* ASTERISK HAVE A POWER SUPPLY/TRANSFORMER AND OFF SWITCH. ALL POSTAGE PAID. IF YOUR EXTERNAL VFD JACK IS USED FOR A VFD, REC. OR TRANSMITTER) FOR A MALE/FEMALE PLUG/JACK ADD-----\$5.00

FT101 SERIES FT101 TS5205(4E) PLUG INTO REAR JACK FOR VFO SIGNAL AND POWER. NO INSTALLATION REQUIRED. ----- \$110.00  
TS520 TS820 TS900 TS600 8599 TS999 FR101 FL101 FR67  
F77(4B) HW104 ----- ALL PARTS & INFO. --- \$115.00

\*75S SERIES \*KVM SERIES \*32S SERIES \*R-4 SERIES FRDX RECEIVERS  
\*FT100 \*FT400 & 401 \*FT560 & 570 \*HW100-101 \*SB100-102  
\*SB300-303 \*MR1680 ----- ALL PARTS & INFO. --- \$125.00

YC221 FOR FT221(4R) w/D SERIAL. FT221 TS700. 7 DIG. --- \$75.00

SEND U.S. CASHIERS CHECK OR M.O. 30 DAY MONEY BACK. YOU PAY RETURN POSTAGE. WRITE WITH MOD. & SERIAL NO. FOR INFORMATION. WRITE IF YOUR RADIO IS NOT LISTED--WE'LL MAKE ONE YR WARRANTY.

**GRAND SYSTEMS**

P.O. Box 2171  
BLAINE WASH. ✓ 132 20352 40A AVE.  
U.S.A. 98230 (604) 530 4551 CANADA V3A2Y8  
LANGLEY B.C.

**YAESU FT-207R OWNERS**

**AUTO SCAN MODULE AND BATTERY SAVER KIT**



15 minutes to install; scan restarts when carrier drops off; busy switch controls automatic scan on-off; includes module and instructions.

**Model AS-1. \$25.00**

**FT-207R BATTERY SAVER KIT MODEL BS-1 \$14.95**

- \*No more dead batteries due to memory backup
- \*30% less power drain when squelched
- \*Simple to install; step-by-step instructions and parts included
- \*4 mA memory backup reduced to 500 uA.
- \*45 mA receiver drain reduced to 30 mA.
- \*Improved audio fidelity and loudness

**ENGINEERING CONSULTING**

P.O. Box 3966 ✓ 400  
**ANAHEIM, CALIFORNIA 92803**

WRITE FOR CLUB DISCOUNTS



**GO MOBILE WITH YOUR H.T.!**



Model I—Icom IC-2A/T, Etc.  
Model K-1 for TR-2500  
—slides on bottom of radio

**Guaranteed!**



Model K—TR-2400;  
—powered thru battery plug  
Model N—FT-208R  
Model T—Simple mod for Tempo

**NOW FOR FT-208R & TR-2500**



Model Y—FT-207R;  
—fits into battery compartment  
"A unique battery eliminator"  
HANDI-TEK Regulator allows constant hand-held operation from auto DC or base supply with no nicad drain and WITHOUT RADIO MODIFICATION! \$24.95 PPD in USA. CA add \$1.50 Sales Tax.  
✓ 460

**HANDI-TEK**  
P.O. BOX 2205, LA PUENTE, CA 91748

**THE BEST PLACE To Look For New & Used Equipment Buy-Sell-Trade Our 4th Year**

**NUTS & VOLTS MAGAZINE**

PO BOX 1111-G • PLACENTIA, CA 92670  
(714) 632-7721 ✓ 137

JOIN THOUSANDS OF READERS NATIONWIDE, EVERY MONTH

U.S.A. SUBSCRIPTIONS

\$ 7.00 - 1 YR. 3RD CLASS MAIL

\$12.50 - 1 YR. 1ST CLASS MAIL

\$25.00 - LIFETIME - 3RD CLASS

With Free Classified Ad



**CB TO TEN METER CONVERSION KITS**

**10 METER FM**—Limiter discriminator board with specific instructions to fit over 80 different AM & SSB chassis

**SSB-AM KITS**—Now in stock kits for most CB models—23 or 40 channels

**NEW & USED**—FM—SSB—AM converted C.B.'s in stock

**ANEXTER MARK ANTENNAS**—You saw them at Dayton. Now in stock the HW-3 three band whip that covers 10—15—20 meters with no traps

**FREE CATALOG**—Write or call today

INDEPENDENT

**CRYSTAL SUPPLY COMPANY**

141 Rt. 6A, Box 183  
Sandwich, Ma. 02563-0183  
(617) 888-4302

✓ 78

**FREE! FREE! FREE! FREE! FREE!**

**SEND FOR OUR NEW 1982/1983 PARTS CATALOG**  
THOUSANDS OF SURPLUS ELECTRONIC PARTS, SUPPLIES AND DEVICES.  
**ALL ELECTRONICS CORP**  
905 S. Vermont Ave.  
P.O. Box 20406  
Los Angeles, Cal. 90006

✓ 20

We now have available a bunch of goodies too good to bypass. Items are limited so order today

Call your Phone Order in Today. TERMS: Satisfaction guaranteed or money refunded. C.O.D. add \$2.50. Minimum order \$6.00. Orders under \$10.00 add \$1.50. Add 6% for postage, insurance, handling. Overseas add 15%. N.Y. residents add 7% tax.

**MINI KITS - YOU HAVE SEEN THESE BEFORE NOW HERE ARE OLD FAVORITE AND NEW ONES TOO. GREAT FOR THAT AFTERNOON HOBBY.**

<p><b>FM MINI MIKE</b></p>  <p>A super high performance FM wireless mike kit! Transmits a stable signal up to 300 yards with exceptional audio quality by means of its built in electret mike. Kit includes case, mike, on-off switch, antenna, battery and super instructions. This is the finest unit available.</p> <p>FM-3 Kit <b>\$14.95</b> FM-3 Wired and Tested <b>19.95</b></p>	<p><b>Color Organ</b></p> <p>See music come alive! 3 different lights flicker with music. One light each for high, mid-range and lows. Each individually adjustable and drives up to 300 W runs on 110 VAC.</p> <p>Complete kit, ML-1 <b>\$8.95</b></p>	<p><b>Video Modulator Kit</b></p> <p>Converts any TV to video monitor. Super stable, tunable over ch. 4-6. Runs on 5-15V. accepts std video signal. Best unit on the market! Complete kit, VO-1 <b>\$7.95</b></p>	<p><b>Super Sleuth</b></p> <p>A super sensitive amplifier which will pick up a pin drop at 15 feet! Great for monitoring baby's room or as general purpose amplifier. Full 2 W rms output, runs on 6 to 15 volts, uses 8-45 ohm speaker. Complete kit, BN-9 <b>\$5.95</b></p>
	<p><b>Whisper Light Kit</b></p> <p>An interesting kit, small mike picks up sounds and converts them to light. The louder the sound, the brighter the light. Includes mike, controls up to 300 W, runs on 110 VAC. Complete kit, WL-1 <b>\$6.95</b></p>	<p><b>Tone Decoder</b></p> <p>A complete tone decoder on a single PC board. Features 400-5000 Hz adjustable range via 20 turn pot, voltage regulation, 567 IC. Useful for touch-tone burst detection. FSK etc. Can also be used as a stable tone encoder. Runs on 5 to 12 volts. Complete kit, TD-1 <b>\$5.95</b></p>	<p><b>Siren Kit</b></p> <p>Produces upward and downward wall characteristic of a police siren. 5 W peak audio output, runs on 3-15 volts, uses 3-45 ohm speaker. Complete kit, SM-3 <b>\$2.95</b></p>
<p><b>FM Wireless Mike Kit</b></p> <p>Transmits up to 300' to any FM broadcast radio, uses any type of mike. Runs on 3 to 9V. Type FM-2 has added sensitive mike preamp stage.</p> <p>FM-1 kit <b>\$3.95</b> FM-2 kit <b>\$4.95</b></p>	<p><b>Universal Timer Kit</b></p> <p>Provides the basic parts and PC board required to provide a source of precision timing and pulse generation. Uses 555 timer IC and includes a range of parts for most timing needs.</p> <p>UT-5 Kit <b>\$5.95</b></p>	<p><b>Mad Blaster Kit</b></p> <p>Produces LOUD ear shattering and attention getting siren like sound. Can supply up to 15 watts of obnoxious audio. Runs on 6-15 VDC.</p> <p>MB-1 Kit <b>\$4.95</b></p>	

**CLOCK KITS**

Your old favorites are here again. Over 7,000 Sold to Date. Be one of the gang and order yours today!

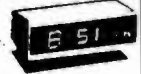

Try your hand at building the finest looking clock on the market. Its satin finish anodized aluminum case looks great anywhere, while six 4" LED digits provide a highly readable display. This is a complete kit, no extras needed, and it only takes 1-2 hours to assemble. Your choice of case colors: silver, gold, black (specify).

Clock kit, 12/24 hour, DC-5 **\$24.95**  
Clock with 10 min. ID timer, 12/24 hour, DC-10 **\$29.95**  
Alarm clock, 12 hour only, DC-8 **\$29.95**  
12V DC car clock, DC-7 **\$29.95**

For wired and tested clocks add \$10.00 to kit price SPECIFY 12 OR 24 HOUR FORMAT

**PARTS PARADE**

<p><b>IC SPECIALS</b></p>		<p><b>Resistor Ass't</b></p> <p>Assortment of Popular values - 1/4 watt. Cut lead for PC mounting, 1/2" center, 1/8" leads, bag of 300 or more <b>\$1.50</b></p>	<p><b>Crystals</b></p> <p>3 579545 MHZ <b>\$1.50</b> 10 00000 MHZ <b>\$5.00</b> 5 248800 MHZ <b>\$5.00</b></p>
<p><b>LINEAR</b></p> <p>301 <b>\$1.35</b> 324 <b>\$1.50</b> 380 <b>\$1.50</b> 555 <b>\$1.45</b> 556 <b>\$1.00</b> 565 <b>\$1.00</b> 566 <b>\$1.00</b> 567 <b>\$1.25</b> 741 <b>10/\$2.00</b> 1458 <b>\$1.50</b> 3900 <b>\$1.50</b> 3914 <b>\$2.95</b> 8038 <b>\$2.95</b></p>	<p><b>TTL</b></p> <p>74500 <b>\$1.40</b> 7447 <b>\$1.65</b> 7475 <b>\$1.50</b> 7490 <b>\$1.50</b> 74196 <b>\$1.35</b></p>	<p><b>Switches</b></p> <p>Mini toggle SPDT <b>\$1.00</b> Red Pushbuttons N O <b>3/\$1.00</b></p>	<p><b>AC Adapters</b></p> <p>Good for clocks, nicad chargers, all 110 VAC plug one end.</p> <p>8.5 vdc @ 20 mA <b>\$1.00</b> 16 vac @ 160mA <b>\$2.50</b> 12 vac @ 250mA <b>\$3.00</b></p>
<p><b>CMOS</b></p> <p>4011 <b>50</b> 4013 <b>50</b> 4046 <b>\$1.85</b> 4049 <b>50</b> 4059 <b>\$9.00</b> 4511 <b>\$2.00</b> 4518 <b>\$1.35</b> 5639 <b>\$1.75</b></p>	<p><b>SPECIAL</b></p> <p>11C90 <b>\$15.00</b> 10116 <b>\$1.25</b> 7208 <b>\$17.50</b> 7207 A <b>\$1.50</b> 7216D <b>\$21.00</b> 7107C <b>\$12.50</b> 5314 <b>\$2.95</b> 5375A/B/G <b>\$2.95</b> 7001 <b>\$6.50</b></p>	<p><b>Earphones</b></p> <p>3' leads, 8 ohm, good for small tone speakers, alarm clocks, etc. <b>5 for \$1.00</b></p>	<p><b>Solid State Buzzers</b></p> <p>small buzzer 450 Hz, 86 dB, sound output on 5-12 vdc at 10-30 mA, 1/2" compatible <b>\$1.50</b></p>
<p><b>READOUTS</b></p> <p>FND 359 4" C.C. <b>\$1.00</b> FND 507 5" 5" C.A. <b>1.00</b> MAN 72/HP730 33" C.A. <b>1.00</b> HP 7651 43" C.A. <b>2.00</b></p>	<p><b>FERRITE BEADS</b></p> <p>With info and specs <b>15/\$1.00</b> 6 Hole Bead Bars <b>3/\$1.00</b></p>	<p><b>Slugs Tuned Coils</b></p> <p>Small 3/16" Hex Slugs turned coil, 3 turns <b>10 for \$1.00</b></p>	<p><b>AC Outlet</b></p> <p>Panel Mount with Leads <b>4/\$1.00</b></p>
<p><b>TRANSISTORS</b></p> <p>2N3904 NPN C-F <b>15/\$1.00</b> 2N3906 PNP C-F <b>15/\$1.00</b> 2N405 PNP C-F <b>15/\$1.00</b> 2N4401 NPN C-F <b>15/\$1.00</b> 2N4516 FET C-F <b>4/\$1.00</b> 2N5401 PNP C-F <b>\$1.00</b> 2N6028 C-F <b>4/\$1.00</b> 2N3771 NPN Silicon <b>\$1.50</b> 2N5179 UHF NPN <b>3/\$2.00</b> Power Tab PNP 40W <b>\$1.00</b> Power Tab PNP 40W <b>3/\$1.00</b> MPE 102/2N5484 <b>8.50</b> NPN 3804 Type T-R <b>50/\$2.50</b> PNP 3806 Type T-R <b>50/\$2.50</b> 2N3055 <b>8.80</b> 2N2646 UJT <b>3/\$2.00</b></p>	<p><b>Diodes</b></p> <p>5 1 V Zener <b>20/\$1.00</b> 1N914 Type <b>50/\$1.00</b> 1KV 2Amp <b>8/\$1.00</b> 100V 1Amp <b>15/\$1.00</b></p>	<p><b>DC-DC Converter</b></p> <p>+5 vdc input prod. -9 vdc @ 30ma -9 vdc produces -15 vdc @ 35ma <b>\$1.25</b></p>	<p><b>Ceramic IF Filter</b></p> <p>Mini <b>10/\$1.50</b> B.W. <b>SOLD OUT</b> <b>\$1.50 ea.</b></p>
<p><b>25 AMP 100V Bridge \$1.50 each</b></p>	<p><b>Coax Connector</b></p> <p>Chassis mount <b>\$1.00</b> BNC type <b>\$1.00</b></p>	<p><b>Crystal Microphone</b></p> <p>Small 1" diameter 1/2" thick crystal mike cartridge <b>\$1.75</b></p>	<p><b>9 Volt Battery Clips</b></p> <p>Nice quality clips <b>5 for \$1.00</b> 1/2" Rubber Grommets <b>10 for \$1.00</b></p>
<p><b>Mini-Bridge 50V 1 AMP 2 for \$1.00</b></p>	<p><b>Parts Bag</b></p> <p>Ass't of chokes, disc caps, tant resistors, transistors, diodes, MICA caps etc. sm. bag (100 pc) <b>\$1.00</b> lg. bag (300 pc) <b>\$2.50</b></p>	<p><b>Trimmer Caps</b></p> <p>Sprague - 3-40 pf Stable Polypropylene <b>50 ea.</b></p>	<p><b>Shrink Tubing Nubs</b></p> <p>Nice pre-cut pces of shrink size 1" x 1/4" shrink to 1/8" Great for splices <b>50/\$1.00</b></p>
	<p><b>LEDs - your choice, please specify</b></p> <p>Mini Red, Jumbo Red, High Intensity Red, Illuminator Red <b>8/\$1</b> Mini Yellow, Jumbo Yellow, Jumbo Green <b>6/\$1</b></p>	<p><b>Connectors</b></p> <p>6 pin type gold contacts for mA-1003 car clock module price <b>.75 ea.</b></p>	<p><b>Regulators</b></p> <p>78M <b>\$1.25</b> 79M <b>\$1.25</b> 723 <b>\$1.50</b> 309K <b>\$1.15</b> 7805 <b>\$1.00</b></p>
	<p><b>Varactors</b></p> <p>Motorola MV 2209 30 PF Nominal cap 20-80 PF - Tunable range - .50 each or 3/\$1.00</p>	<p><b>Mini RG-174 Coax</b></p> <p>10 ft. for <b>\$1.00</b></p>	<p><b>Mini TO-92 Heat Sinks</b></p> <p>Thermalloy Brand <b>3 for \$1.00</b> To-220 Heat Sinks <b>3 for \$1.00</b></p>

**SATELLITE TV KIT**



image rejection, fully tunable audio to recover 'hidden' subcarriers, divide by two PLL demodulator for excellent threshold performance, light tracking AFC to assure drift free reception, and of course, full 24 channel tunable coverage.

Build your satellite TV system around the R2B, close to ten thousand others already have and now it's available in kit form at a new low price. Order yours today.

**THE POPULAR SAT-TEC RECEIVER IN KIT FORM**

Featured in a Radio Electronics magazine cover story (May 82), the reliable R2B Sat-tec TV receiver is now operating in thousands of locations. The R2B is easy to build, pre-etched, plated boards with screened component layout assures accurate component placement and the critical IF section and local oscillator are pre-assembled and aligned! All parts are included for the R2B, attractive case, power supply, descriptive operating manual as well as complete assembly instructions. Features of the receiver include: dual conversion design for best

A complete Satellite TV System requires a dish antenna, LNA (low noise amplifier), Receiver and Modulator.

R2B Receiver Kit **\$359.00**  
R2B Receiver, Wired and Tested **\$595.00**  
120" K AvanteK LNA **\$495.00**  
RM3 RF Modulator **\$49.95**

Prices include domestic UPS shipping and insurance.

**Audio Prescaler**

Make high resolution audio measurements, great for musical instrument tuning, PL tones, etc. Multiplies audio UP in frequency, selectable x10 or x100, gives 01 Hz resolution with 1 sec. gate time! High sensitivity of 25 mv, 1 meg input z and built-in filtering gives great performance. Runs on 9V battery, all CMOS.

PS-2 kit **\$29.95**  
PS-2 wired **\$39.95**

**600 MHz PRESCALER**



Extend the range of your counter to 600 MHz. Works with all counters. Less than 150 mv sensitivity, specify -10 or -100

Wired, tested, PS-1B **\$59.95**  
Kit, PS-1B **\$44.95**

**30 Watt 2 mtr PWR AMP**

Simple Class C power amp features 8 times power gain. 1 W in for 8 out, 2 W in for 15 out, 4 W in for 30 out. Max output of 35 W, incredible value, complete with all parts, less case and T-R relay.

PA-1, 30 W pwr amp kit **\$22.95**  
TR-1, RF sensed T-R relay kit **6.95**

**Power Supply Kit**

Complete triple regulated power supply provides variable 6 to 18 volts at 200 ma and +5 at 1 Amp. Excellent load regulation, good filtering and small size. Less transformers, requires 6.3 V 1 A and 24 VCT. Complete kit, PS-3LT **\$6.95**

**RF actuated relay senses RF (1W) and closes DPDT relay**

For RF sensed T-R relay TR-1 Kit **\$6.95**

**OP-AMP Special**

BI-FET LF 13741 - Direct pin for pin 74, compatible, but 500,000 MEG input z, super low 50 pF power drain

50 for only **\$9.00** **SOLD OUT** 10 for **\$2.00**

**Opto Isolators - 4N28 type \$1.00 ea.**

**Opto Reflectors - Photo diode + LED \$1.00 ea.**

**Molex Pins**

Molex already precut in length of 7. Perfect for 14 pin sockets **20 strips for \$1.00**

**CDS Photocells**

Resistance varies with light. 250 ohms to over 3 meg **3 for \$1.00**

FACIT 4555 SERIAL PAGE PRINTER

The Facit 4555 alphanumerical serial printer is complete. Equipped with RS232C Interface, printing mechanism, control electronics, drive electronics, power supply and character generator. The adaptation electronics can be modified in four versions: Bit-parallel data transfer, CCITT (EIA, RS232C) for bit-serial data transfer and the current loop (TTY) interface also for bit serial data transfer. The Facit 4555 prints on ordinary paper and is adjustable for different paper widths and formats, 9.5" paper width with 66 lines per page or DIN A4 with 70 lines per page.

SPECIFICATIONS

Print speed	up to 60ch.s.	Char. spacing	2.54mm/1/10" 80ch/line
Printing mode	Incremental.		1.55mm/0.06" 132ch/line
Max. # of ch/line	80 alt. 132.	Char. Code	ECMA-6 7-bit coded char. set
Matrix	7 X 5 dot matrix.	Char. Set	63 Char. various national versions.
Char. Size Height	2.7mm/1/8"	Feed mechanism	Sprocket feed.
Char. Size Width	1.3mm/0.05" 132ch/line		
	2.1mm/0.083" 80ch/line		

THESE UNITS WERE PULLED OUT OF SERVICE IN GOOD WORKING CONDITION. WE CHECK EACH UNIT ON A RADIO SHACK TRS-80 COLOR COMPUTER.



PRINTER ONLY \$129.99

Printer with linecord, box of paper, inter-connect cable for TRS-80 COLOR COMPUTER. \$149.99

GENEVA CALCULATOR WATCH

This attractive watch has the following modes:  
 Normal Time Setting,  
 Calendar Setting,  
 Daily Alarm Time Setting,  
 Weekly Alarm Time Setting,  
 Chronograph,  
 Calculator.



Featured in Black Plastic \$24.99 or Featured in Stainless Steel \$29.99

SILICON DIODES

MR751	100vdc	6Amps	10/\$5.00	100/\$38.00
MR510	1000vdc	3Amps	10/\$3.75	100/\$24.00
HEP170	1000vdc	2Amps	20/\$2.00	100/\$15.00
1N3209	100vdc	15Amps	\$2.00	10/ \$15.00
BYX21/200	200vdc	25Amps	\$2.00	10/ \$15.00
1N2138A	600vdc	60Amps	\$5.00	10/ \$40.00
DS85-04C	400vdc	80Amps	\$10.00	10/ \$80.00
1N3269	600vdc	160Amps	\$15.00	10/\$120.00
275241	300vdc	250Amps	\$20.00	10/\$175.00
7-5754	300vdc	400Amps	\$30.00	10/\$250.00
RCD-15	15KVDC	20ma.	\$3.00	10/ \$20.00
SMFR20K	20KVDC	20ma.	\$4.00	10/ \$30.00
1N4148	signal		30/\$1.00	100/ \$3.00

FEED THRU SOLDER RF CAPACTORS

470pf +-20%
5/\$1.00 or 100/\$15.00 or 1000/\$100.00
1000pf/.001uf +-10%
4/\$1.00 or 100/\$20.00 or 1000/\$150.00

E PROMS

2708 1024x1	\$2.00 each
2716 2048x8	\$4.00 each
27L32/25L32	\$10.00 each

FAIRCHILD 4116 16K DYNAMIC RAMS 200ns. Part # 16K75

25 For \$25.00 or 100 For \$90.00 or 1000 For \$750.00

HEWLETT PACKARD MICROWAVE DIODES

1N5711	(5082-2800)	Schottky Barrier Diodes	\$1.00 or 10 for \$ 8.50
1N5712	(5082-2810)	" " "	\$1.50 or 10 for \$10.00
1N6263	(HSCH-1001)	" " "	\$ .75 or 10 for \$ 5.00
5082-2835		" " "	\$1.50 or 10 for \$10.00
5082-2805	Quad Matched	" " "	per set \$5.00 or 10 for \$40.00

**Toll Free Number  
 800-528-0180  
 (For orders only)**

**MHz electronics**

PRICES SUBJECT TO CHANGE WITHOUT NOTICE

# "MIXERS"

## WATKINS JOHNSON WJ-M6 Double Balanced Mixer

LO and RF 0.2 to 300MHz	IF DC to 300MHz	\$21.00
Conversion Loss (SSB)	6.5dB Max. 1 to 50MHz	
	8.5dB Max. .2 to 300MHz	WITH DATA SHEET
Noise Figure (SSB)	same as above	
Conversion Compression	8.5dB Max. 50 to 300MHz	
	.3dB Typ.	

## NEC (NIPPON ELECTRIC CO. LTD. NE57835/2SC2150 Microwave Transistor

NF Min F=2GHz	dB 2.4 Typ.	MAG F=2GHz	dB 12 Typ.	\$5.30
F=3GHz	dB 3.4 Typ.	F=3GHz	dB 9 Typ.	
F=4GHz	dB 4.3 Typ.	F=4GHz	dB 6.5 Typ.	

Ft Gain Bandwidth Product at Vce=8v, Ic=10ma. GHz 4 Min. 6 Typ.  
 Vcbo 25v Vceo 11v Vebo 3v Ic 50ma. Pt. 250mw

## UNELCO RF Power and Linear Amplifier Capacitors

These are the famous capacitors used by all the RF Power and Linear Amplifier manufacturers, and described in the RF Data Book.

5pf	10pf	18pf	30pf	43pf	100pf	200pf	1 to 10pcs.	\$1.00 ea
5.1pf	12pf	22pf	32pf	51pf	110pf	220pf	11 to 50pcs.	\$ .90 ea
6.8pf	13pf	25pf	33pf	60pf	120pf	470pf	51 up	pcs. \$ .80 ea
7pf	14pf	27pf	34pf	80pf	130pf	500pf		
8.2pf	15pf	27.5pf	40pf	82pf	140pf	1000pf		

## NIPPON ELECTRIC COMPANY TUNNEL DIODES

		MODEL 1S2199	1S2200	\$7.50
Peak Pt. Current ma.	Ip	9min. 10Typ. 11max.	9min. 10Typ. 11max.	
Valley Pt. Current ma.	Iv	1.2Typ. 1.5max.	1.2Typ. 1.5max.	
Peak Pt. Voltage mv.	Vp	95Typ. 120max.	75Typ. 90max.	
Projected Peak Pt. Voltage mv.	Vpp Vf=Ip	480min. 550Typ. 630max.	440min. 520Typ. 600max.	
Series Res. Ohms	rS	2.5Typ. 4max.	2Typ. 3max.	
Terminal Cap. pf.	Ct	1.7Typ. 2max.	5Typ. 8max.	
Valley Pt. Voltage mv.	VV	370Typ.	350Typ.	

## FAIRCHILD / DUMONT Oscilloscope Probes Model 4290B

Input Impedance 10 meg., Input Capacity 6.5 to 12pf., Division Ration (Volts/Div Factor) 10:1, Cable Length 4Ft., Frequency Range Over 100MHz.

These Probes will work on all Tektronix, Hewlett Packard, and other Oscilloscopes.

PRICE \$45.00

## MOTOROLA RF DATA BOOK

Lists all Motorola RF Transistors / RF Power Amplifiers, Varactor Diodes and much much more.

PRICE \$7.50

**Toll Free Number**  
**800-528-0180**  
**(For orders only)**

**MHz electronics**

PRICES SUBJECT TO CHANGE WITHOUT NOTICE

# RF TRANSISTORS, MICROWAVE DIODES

PART	PRICE	PART	PRICE	PART	PRICE
1S2199	\$ 7.50	2N6083	\$ 13.25	CA2612 (TRW)	\$ 25.00
1S2200	7.50	2N6084	15.00	CA2674 (TRW)	25.00
2N1561	25.00	2N6094 /M9622	11.00	CA2881-1 (TRW)	25.00
2N1562	25.00	2N6095 /M9623	12.00	CA4101 (TRW)	25.00
2N2857	1.55	2N6096 /M9624	15.50	CA4201 (TRW)	25.00
2N2857JAN	2.55	2N6097	17.25	CA4600 (TRW)	25.00
2N2876	11.00	2N6136	21.85	CD1889	20.00
2N2947	18.35	2N6166	40.25	CD2545	20.00
2N2948	15.50	2N6201	50.00	CMD514AB	20.00
2N2949	3.90	2N6459	18.00	D4959	10.00
2N2950	4.60	2N6603	12.00	D4987M	20.00
2N3375	8.00	2N6680	80.00	D5147D	10.00
2N3553	1.57	2SC756A	7.50	D5506	10.00
2N3632	13.80	2SC781	2.80	D5827AM	20.00
2N3818	5.00	2SC1018	1.00	DMD6022	30.00
2N3866	1.30	2SC1042	12.00	DMS-2A-250	40.00
2N3924	3.35	2SC1070	2.50	HEP76	4.95
2N3927	17.75	2SC1239	2.50	HEPS3002	11.30
2N3950	25.00	2SC1251	12.00	HEPS3003	30.00
2N4072	1.80	2SC1306	2.90	HEPS3005	10.00
2N4127	21.00	2SC1307	5.50	HEPS3006	19.90
2N4427	1.30	2SC1760	1.50	HEPS3007	25.00
2N4428	1.85	2SC1970	2.50	HEPS3010	11.34
2N4957	3.45	2SC2166	5.50	HTEF2204 H.P.	112.00
2N4958	2.90	8B1087 (M.A.)	25.00	5082-0112 H.P.	14.20
2N4959	2.30	A50-12	20.00	5082-0253 H.P.	105.00
2N5090	13.90	A283B	5.00	5082-0320 H.P.	58.00
2N5108	4.00	ALD4200N (AVANTEK)	395.00	5082-0386 H.P.	POR
2N5109	1.70	AM123	97.35	5082-0401 H.P.	POR
2N5160	3.45	AM688	100.00	5082-0438 H.P.	POR
2N5177	21.62	BB105B	.52	5082-1028 H.P.	POR
2N5179	1.00	BD4/4JFBD4 (G.E.)	10.00	5082-2711 H.P.	23.15
2N5583	4.00	BFQ85	1.50	5082-3080 H.P.	2.00
2N5589	8.65	BFR90	1.30	5082-3188 H.P.	1.00
2N5590	10.35	BFR91	1.65	5082-6459 H.P.	POR
2N5591	13.80	BFW92	1.50	5082-8323 H.P.	POR
2N5635	10.95	BFX89	1.00	35826E H.P.	POR
2N5637	15.50	BFY90	1.00	35831E H.P.	29.99
2N5641	9.20	BGY54	25.00	35853E H.P.	71.50
2N5642	10.95	BGY55	25.00	35854E H.P.	75.00
2N5643	15.50	BGY74	25.00	HPA0241 H.P.	75.60
2N5645	13.80	BGY75	25.00	HXTR3101 H.P.	7.00
2N5646	20.70	BL161	10.00	HXTR3102 H.P.	8.75
2N5691	18.00	BLX67	11.00	HXTR6101/2N6617 H.P.	55.00
2N5764	27.00	BLY568CF	25.00	HXTR6104 H.P.	68.00
2N5836	5.45	BLY87	13.00	HXTR6105 H.P.	31.00
2N5842	8.00	BLY88	14.00	HXTR6106 H.P.	33.00
2N5849	20.00	BLY89	15.00	QSCH1995 H.P.	POR
2N5913	3.25	BLY90	20.00	JO2000 TRW	10.00
2N5922	10.00	BLY351	10.00	JO2001 TRW	25.00
2N5923	25.00	C4005	20.00	JO4045 TRW	25.00
2N5941	23.00	CA402 (TRW)	25.00	K3A	10.00
2N5942	40.00	CA405 (TRW)	25.00	MA450A	10.00
2N5944	9.20	CA612B (TRW)	25.00	MA41487	POR
2N5945	11.50	CA2100 (TRW)	25.00	MA41765	POR
2N5946	19.00	CA2113 (TRW)	25.00	MA43589	POR
2N6080	9.20	CA2200 (TRW)	25.00	MA43636	POR
2N6081	10.35	CA2213 (TRW)	25.00	MA47044	POR
2N6082	11.50	CA2418 (TRW)	25.00	MA47651	25.50

**Toll Free Number**  
**800-528-0180**  
**(For orders only)**

PRICES SUBJECT TO CHANGE WITHOUT NOTICE

**MHz electronics**

# GaAs, TUNNEL DIODES, ETC.

PART	PRICE	PART	PRICE	PART	PRICE
MA47100	\$ 3.05	MRF503	\$ 6.00	PT4186B	\$ POR
MA47202	30.80	MRF504	7.00	PT4209	POR
MA47771	POR	MRF509	5.00	PT4209C	POR
MA47852	POR	MRF511	8.65	PT4566	POR
MA49558	POR	MRF605	20.00	PT4570	POR
MB4021	POR	MRF629	3.47	PT4571	POR
MBD101	1.00	MRF644	23.00	PT4571A	POR
MDO513	POR	MRF816	15.00	PT4577	POR
MHW1171	42.50	MRF823	20.00	PT4590	POR
MHW1182	48.60	MRF901	3.00	PT4612	POR
MHW4171	49.35	MRF8004	2.10	PT4628	POR
MHW4172	51.90	MS261F	POR	PT4640	POR
MHW4342	68.75	MT4150 Fair.	POR	PT4642	POR
MLP102	25.00	MT5126 Fair.	POR	PT5632	POR
MM1500	32.32	MT5481 Fair.	POR	PT5749	POR
MM1550	POR	MT5482 Fair.	POR	PT6612	POR
MM1552	50.00	MT5483 Fair.	POR	PT6626	POR
MM1553	50.00	MT5596 Fair.	POR	PT6709	POR
MM1614	10.00	MT5764 Fair.	POR	PT6720	POR
MM2608	5.00	MT8762 Fair.	POR	PT8510	POR
MM3375A	11.50	MV109	.77	PT8524	POR
MM4429	10.00	MV1401	8.75	PT8609	POR
MM8000	1.15	MV1624	1.42	PT8633	POR
MM8006	2.30	MV1805	15.00	PT8639	POR
MO277L	POR	MV1808	10.00	PT8659	POR
MO283L	POR	MV1817B	10.00	PT8679	POR
MO3757	POR	MV1863B	10.00	PT8708	POR
MP102	POR	MV1864A	10.00	PT8709	POR
MPN3202	10.00	MV1864B	10.00	PT8727	POR
MPN3401	.52	MV1864D	10.00	PT8731	POR
MPN3412	1.00	MV1868D	10.00	PT8742	POR
MPSU31	1.01	MV2101	.90	PT8787	POR
MRA2023-1.5 TRW	42.50	MV2111	.90	PT9790	41.70
MRF212/208	16.10	MV2115	1.55	PT31962	POR
MRF223	13.25	MV2201	.53	PT31963	POR
MRF224	15.50	MV2203	.53	PT31983	POR
MRF237	3.15	MV2209	2.00	PTX6680	POR
MRF238	12.65	MV2215	2.00	RAY-3	24.99
MRF243	25.00	MWA110	7.45	40081	POR
MRF245	34.50	MWA120	7.80	40281	POR
MRF247	34.50	MWA130	8.25	40282	POR
MRF304	43.45	MWA210	7.80	40290	POR
MRF315	23.00	MWA220	8.25	RF110	25.00
MRF420	20.00	MWA230	8.65	SCA3522	POR
MRF421	36.80	MWA310	8.25	SCA3523	POR
MRF422	41.40	MWA320	8.65	SD1065	POR
MRF427	16.10	MWA330	9.50	SS43	POR
MRF428	46.00	NEC57835	5.30	TP1014	POR
MRF450/A	13.80	ON382	5.00	TP1028	POR
MRF453/A	17.25	PPT515-20-3	POR	TRW-3	POR
MRF454/A	19.90	PRT8637	POR	UT0504 Avantek	70.00
MRF455/A	16.00	PSCQ2-160	POR	UT0511 Avantek	75.00
MRF458	19.90	PT3190	POR	V15	4.00
MRF463	25.00	PT3194	POR	V33B	4.00
MRF472	1.00	PT3195	POR	V100B	4.00
MRF475	2.90	PT3537	POR	VAB801EC	25.00
MRF477	11.50	PT4166E	POR	VAB804EC	25.00
MRF502	1.04	PT4176D	POR	VAS21AN20	25.00

**Toll Free Number**  
**800-528-0180**  
**(For orders only)**

## MHz electronics

PRICES SUBJECT TO CHANGE WITHOUT NOTICE

COAXIAL RELAY SWITCHES SPDT

Electronic Specialty Co./Raven Electronics FSN 5985-556-9683 \$49.00  
 Part # 25N28 Part # SU-01  
 26Vdc Type N Connector, DC to 1 GHz.

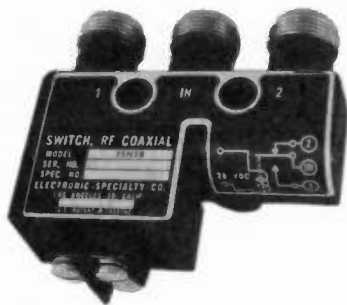

Amphenol  
 Part # 316-10102-8  
 115Vac Type BNC DC to 3 GHz.

FXR  
 Part # 300-11182  
 120Vac Type BNC DC to 4 GHz.  
 FSN 5985-543-1225

FXR  
 Part # 300-11173  
 120Vac Type BNC Same  
 FSN 5985-543-1850

\$29.99

\$39.99

\$39.99

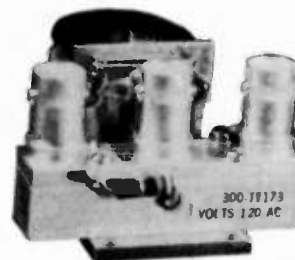
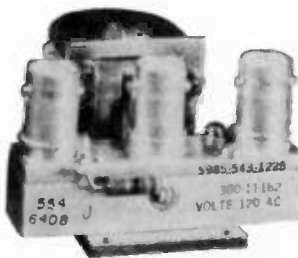
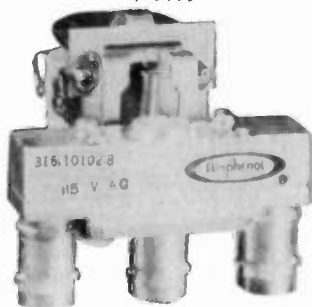

BNC To Banana Plug Coax Cable RG-58 36 inch or BNC to N Coax Cable RG-58 36 inch.

\$7.99 or 2 For \$13.99 or 10 For \$50.00

\$8.99 or 2 For \$15.99 or 10 For \$60.00



SOLID STATE RELAYS

P&B Model ECT1DB72 5vdc turn on  
 PRICE EACH \$5.00

Digisig, Inc. Model ECS-215 5vdc turn on  
 PRICE EACH \$7.50

Grigsby/Barton Model GB7400 5vdc turn on  
 PRICE EACH \$7.50

120vac contact at 7amps or 20amps on a 10"x 10"x .124 aluminum. Heatsink with silicon grease.

240vac contact 14amps or 40amps on a 10"x 10"x .124 aluminum. Heatsink with silicon grease.

240vac contact at 15amps or 40amps on a 10"x 10"x .124 aluminum. Heatsink with silicon grease.

NOTE: \*\*\* Items may be substituted with other brands or equivalent model numbers. \*\*\*

**MHz** electronics

Toll Free Number  
 800-528-0180  
 (For orders only)

PRICES SUBJECT TO CHANGE WITHOUT NOTICE



RECALL PHONE MEMORY TELEPHONE WITH 24 NUMBER AUTO DIALER

The Recall Phone Telephone employs the latest state of art communications technology. It is a combination telephone and automatic dialer that uses premium-quality, solid-state circuitry to assure high-reliability performance in personal or business applications. \$49.99



ARON ALPHA RAPID BONDING GLUE

Super Glue #CE-486 high strength rapid bonding adhesive. Alpha Cyanoacrylate. Set-Time 20 to 40 sec., 0.7fl.oz. (20gm.) \$2.00



TOUCH TONE PAD

This pad contains all the electronics to produce standard touch-tone tones. New with data.

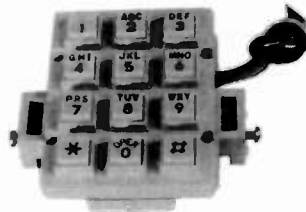

\$9.99 or 10/\$89.99

MITSUMI UHF/VHF VARACTOR TUNER MODEL UVE1A

Perfect for those unscrambler projects. New with data.

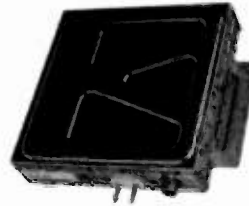

\$19.99 or 10/\$149.99

INTEGRATED CIRCUIT.

		1 to 10	11up
MC1372P	Color TV Video Modulator Circuit.	\$ 4.42	\$2.95
MC1358P	IF Amp., Limiter, FM Detector, Audio Driver, Electronic Attenuator.	5.00	4.00
MC1350P	IF Amplifier	1.50	1.25
MC1330A1P	Low Level Video Detector	1.50	1.15
MC1310P	FM Stereo Demodulator	4.29	3.30
MC1496P	Balanced Modulator/Demodulator	1.50	1.25
LM565N	Phase Locked Loop	2.50	2.00
LM380N14	2Watt Audio Power Amplifier	1.56	1.25
LM1889N	TV Video Modulator	5.00	4.00
NE564N	Phase Locked Loop	10.00	8.00
NE561N	Phase Locked Loop	10.00	8.00

FERRANTI ELECTRONICS AM RADIO RECEIVER MODEL ZN414 INTEGRATED CIRCUIT.

Features:

1.2 to 1.6 volt operating range., Less than 0.5ma current consumption. 150KHz to 3MHz Frequency range., Easy to assemble, no alignment necessary. Effective and variable AGC action., Will drive an earphone direct. Excellent audio quality., Typical power gain of 72dB., TO-18 package. With data. \$2.99 or 10 For \$24.99

NI CAD RECHARGEABLE BATTERIES

AA Battery Pack of 6 These are Factory New. \$5.00

SUB C Pack of 10 2.5Amp/Hr. \$10.00

Gates Rechargeable Battery Packs

12vdc at 2.5Amp/Hr. \$11.99

12vdc at 5Amp/Hr. \$15.99



**MHz electronics**



Toll Free Number  
800-528-0180  
(For orders only)

PRICES SUBJECT TO CHANGE WITHOUT NOTICE

# "SOCKETS AND CHIMNEYS"

## EIMAC TUBE SOCKETS AND CHIMNEYS

		SPOR
SK110	Socket	\$520.00
SK300A	Socket For 4CX5000A,R,J, 4CX10,000D, 4CX15,000A,J	260.00
SK400	Socket For 4-125A,250A,400A,400C,4PR125A,400A,4-500A,5-500A	74.00
SK406	Chimney For 4-250A,400A,400C,4PR400A	36.00
SK416	Chimney For 3-400Z	390.00
SK500	Socket For 4-1000A/4PR1000A/B	51.00
SK600	Socket For 4CX250B,BC,FG,R,4CX350A,F,FJ	73.00
SK602	Socket For 4CX250B,BC,FG,R,4CX350A,F,FJ	11.00
SK606	Chimney For 4CX250B,BC,FG,R,4CX350A,F,FJ	60.00
SK607	Socket For 4CX600J,JA	60.00
SK610	Socket For 4CX600J,JA	66.00
SK620	Socket For 4CX600J,JA	10.00
SK626	Chimney For 4CX600J,JA	66.00
SK630	Socket For 4CX600J,JA	34.00
SK636B	Chimney For 4CX600J,JA	36.00
SK640	Socket For 4CX600J,JA	71.00
SK646	Chimney For 4CX600J,JA	225.00
SK700	Socket For 4CX300A,Y,4CX125C,F	225.00
SK711A	Socket For 4CX300A,Y,4CX125C,F	86.00
SK740	Socket For 4CX300A,Y,4CX125C,F	86.00
SK770	Socket For 4CX300A,Y,4CX125C,F	225.00
SK800A	Socket For 4CX1000A,4CX1500B	40.00
SK806	Chimney For 4CX1000A,4CX1500B	225.00
SK810	Socket For 4CX1000A,4CX1500B	300.00
SK900	Socket For 4X500A	57.00
SK906	Chimney For 4X500A	650.00
SK1420	Socket For 5CX3000A	585.00
SK1490	Socket For 4CV8000A	

## JOHNSON TUBE SOCKETS AND CHIMNEYS

124-111/SK606	Chimney For 4CX250B,BC,FG,R, 4CX350A,F,FJ	\$ 10.00
122-0275-001	Socket For 3-500Z, 4-125A, 250A, 400A, 4-500A, 5-500A	(pair)15.00
124-0113-00	Capacitor Ring	15.00
124-116/SK630A	Socket For 4CX250B,BC,FG,R, /4CX350A,F,FJ	55.00
124-115-2/SK620A	Socket For 4CX250B,BC,FG,R, /4CX350A,F,FJ	55.00
	813 Tube Socket	20.00

## CHIP CAPACITORS

.8pf	10pf	100pf*	430pf
1pf	12pf	110pf	470pf
1.1pf	15pf	120pf	510pf
1.4pf	18pf	130pf	560pf
1.5pf	20pf	150pf	620pf
1.8pf	22pf	160pf	680pf
2.2pf	24pf	180pf	820pf
2.7pf	27pf	200pf	1000pf/.001uf*
3.3pf	33pf	220pf*	1800pf/.0018uf
3.6pf	39pf	240pf	2700pf/.0027uf
3.9pf	47pf	270pf	10,000pf/.01uf
4.7pf	51pf	300pf	12,000pf/.012uf
5.6pf	56pf	330pf	15,000pf/.015uf
6.8pf	68pf	360pf	18,000pf/.018uf
8.2pf	82pf	390pf	

PRICES: 1 to 10 - .99¢ 101 to 1000 .60¢ \* IS A SPECIAL PRICE: 10 for \$7.50  
 11 to 50 - .90¢ 1001 & UP .35¢ 100 for \$65.00  
 51 to 100 - .80¢ 1000 for \$350.00

## WATKINS JOHNSON WJ-V907: Voltage Controlled Microwave Oscillator \$110.00

Frequency range 3.6 to 4.2GHz, Power output, Min. 10dBm typical, 8dBm Guaranteed.  
 Spurious output suppression Harmonic (nf<sub>0</sub>), min. 20dB typical, In-Band Non-Harmonic, min. 60dB typical, Residual FM, pk to pk, Max. 5KHz, pushing factor, Max. 8KHz/V, Pulling figure (1.5:1 VSWR), Max. 60MHz, Tuning voltage range +1 to +15volts, Tuning current, Max. -0.1mA, modulation sensitivity range, Max. 120 to 30MHz/V, Input capacitance, Max. 100pf, Oscillator Bias +15 +/-0.05 volts @ 55mA, Max.

**Toll Free Number**  
**800-528-0180**  
**(For orders only)**

**MHz electronics**

PRICES SUBJECT TO CHANGE WITHOUT NOTICE

# TUBES

<u>TYPE</u>	<u>PRICE</u>	<u>TYPE</u>	<u>PRICE</u>	<u>TYPE</u>	<u>PRICE</u>
2E26	\$ 5.69	KT88	\$ 20.00	6562/6974A	\$ 50.00
2K28	100.00	DX362	50.00	6832	22.00
2X1000A	300.00	DX415	50.00	6883/8032A/8552	7.00
3B22	19.75	572B/T160L	49.00	6897	110.00
3B28/866A	7.50	592/3-200A3	144.00	6907A	75.00
3-500Z	102.00	807	7.50	6939	15.00
3-1000Z	400.00	811	10.00	7094	125.00
3CX1000A/8283	428.00	811A	15.00	7117	17.00
3CX1500A7/887	533.00	812A	35.00	7211	60.00
3X2500A3	200.00	813	50.00	7289/3CX100A5	34.00
3CX3000A7	490.00	829B	38.00	7360	11.00
4-65A/8165	45.00	832A	28.00	7377	67.00
4-125A/4D21	58.00	4624	310.00	7408	4.00
4-250A/5D22	75.00	4662	80.00	7650	250.00
4-400A/8432	90.00	4665	585.00	7695	8.00
4-400C/6775	95.00	5675/A	25.00	7843	58.00
4-1000A/8166	300.00	5721	200.00	7854	83.00
4B32	22.00	5768	85.00	7868	5.00
4E27A/5-125B	155.00	5836	100.00	7894	12.00
4CS250R	146.00	5837	100.00	8072	65.00
4X150A/7034	30.00	5861/EC55	110.00	8117A	130.00
4X150D/7035	40.00	5876A	25.00	8121	60.00
4X150G/8172	100.00	5881/6L6W	6.00	8122	100.00
4X250B	30.00	5893	45.00	8236	30.00
4CX250B/7203	45.00	5894/A	50.00	8295/PL172	506.00
4CX250F/G/8621	55.00	5894/B	60.00	8462	100.00
4CX250K/8245	100.00	5946	258.00	8505A	73.50
4CX250R/7580W	69.00	6080	10.00	8533W	92.00
4CX300A/8167	140.00	6083/AX9909	89.00	8560/A	65.00
4CX350A/8321	83.00	6098/6AK6	14.00	8560AS	90.00
4CX350F/J/8904	95.00	6115/A	110.00	8608	34.00
4X500A	282.00	6146	7.00	8637	38.00
4CX600J/8809	607.00	6146A	7.50	8643	100.00
4CW800F	625.00	6146B/8298A	8.50	8647	123.00
4CX1000A/8168	340.00	6146W	14.00	8737/5894B	60.00
4CX1500B/8660	397.00	6156	66.00	8873	260.00
4CX5000A/8170	932.00	6159	15.00	8874	260.00
4CX10000D/8171	990.00	6161	233.00	8875	260.00
4CX15000A/8281	1260.00	6291	125.00	8877	533.00
4PR60A	100.00	6293	12.00	8908	12.00
4PR60B/8252	175.00	6360	5.00	8930/651Z	71.00
4PR400A/8188	192.00	6524	53.00	8950	12.00
5CX1500A	569.00	6550	10.00		
6BK4C	6.00	6JM6	6.00	6LQ6 (Sylvania)	7.50
6DQ5	5.00	6JN6	6.00	6LU8	6.00
6FW5	6.00	6JS6B	6.00	6LX6	6.00
6GE5	6.00	6KG6/EL505	6.00	6ME6	6.00
6GJ5	6.00	6KM6	6.00	12BY7A	4.00
6HS5	6.00	6KN6	6.00	12JB6A	6.00
6JB5/6HE5	6.00	6LF6	6.00	6KD6	6.00
6JB6A	6.00	6LQ6 (GE)	6.00	6JT6A	6.00
				6KD6	6.00

NOTICE ALL PRICES ARE SUBJECT TO CHANGE WITHOUT NOTICE !!!  
TUBES MAY EITHER BE NEW OR SURPLUS CONDITION !!!

**Toll Free Number**  
**800-528-0180**  
**(For orders only)**

**MHz electronics**

PRICES SUBJECT TO CHANGE WITHOUT NOTICE

# "TVRO BOARD LIST"

**70 MHZ IF BOARD:** This circuit provides about 43dB gain with 50 ohm input and output impedance. It is designed to drive the Demodulator. The on-board bypass filter can be tuned to bandwidths between 20 and 35 MHz with a passband ripple of less than 1/2 dB. Hybrid IC's are used for the gain stages.

**SINGLE AUDIO BOARD:** This circuit recovers the audio signals from the 6.8 MHz frequency. The Miller 9051 coils are tuned to pass the 6.8MHz subcarrier and the 9052 coil tunes for recovery of the audio.

**DUAL AUDIO BOARD:** Duplicate of the single audio but also covers the 6.2 range.

**DC CONTROL BOARD:** No description.

<u>DUAL AUDIO BOARD</u>	<u>PRICE EACH</u>
Printed Circuit Board	\$ 25.00
2 3pf sm	1.00
2 12pf sm	1.00
2 50pf sm	1.00
2 68pf sm	1.00
4 91pf sm	1.00
5 .001mfd	.35
6 .01mfd	.35
2 .047mfd	.35
1 .47mfd 25vdc	.35
2 1mfd 10vdc	.59
4 4.7mfd 35vdc	.59
1 470mfd 25vdc	1.29
2 220K 1/4w	.15
2 150K 1/4w	.15
2 6.8K 1/4w	.15
2 3.3K 1/4w	.15
2 2.2K 1/4w	.15
4 1K 1/4w	.15
2 10 ohm 1/4w	.15
2 50K pots	1.00
1 5K pot	1.00
2 CA3065	2.16
1 LM380	1.56
1 7812 Voltage Reg.	1.17
5 2N2222	.50
4 Miller 9051	5.99
2 Miller 9052	5.99
<b>TOTAL KIT PRICE</b>	<b>97.62</b>

<u>DC CONTROL BOARD</u>	<u>PRICE EACH</u>
Printed Circuit Board	15.00
2 470mfd 25vdc	1.29
2 4.7mfd 25vdc	.59
1 imeg 1/4w	.15

3 10K 1/4w	.15
1 3.3K 1/4w	.15
3 2.2K 1/4w	.15
1 1K 1/4w	.15
2 5K 10 turn trimpot	1.00
4 10K 10 turn trimpot	1.00
1 10K 10 turn with dial	10.00
1 7815 Voltage Reg.	1.17
1 LM324	2.50
1 5 pole rotary switch	2.50
1 SPDT switch	1.00
1 DPDT swich	1.00
1 0-1ma meter	5.00
1 18 to 24vdc at 1 amp power supply	24.99
<b>TOTAL KIT PRICE</b>	<b>74.27</b>

<u>DEMODULATOR BOARD</u>	<u>PRICE EACH</u>
Printed Circuit Board	\$ 40.00
1 1mfd 35vdc	.59
13 .01mfd 50vdc disc	.35
1 470mfd 25vdc	1.29
2 100mfd 16vdc	.69
2 22mfd 35vdc	.59
3 4.7mfd 35vdc	.59
1 4300pf sm	2.00
1 330pf sm	1.00
1 100pf sm	1.00
1 91pf sm	1.00
2 3pf sm	1.00
1 2 to 8pf ceramic trimmer	1.00
1 100uh choke	1.50
1 4.7uh choke	1.50
1 2.7uh choke	1.50

4 100K 1/4w	.15
1 51 ohm 1/4w	.15
1 27K 1/4w	.15
5 10K 1/4w	.15
1 8.2K 1/4w	.15
2 4.7K 1/4w	.15
1 2.2K 1/4w	.15
1 1.2K 1/4w	.15
3 1K 1/4w	2.50
3 560 ohm 1/4w	.15
1 470 ohm 1/4w	.15
1 390 ohm 1/4w	.15
1 300 ohm 1/4w	.15
1 270 ohm 1/4w	.15
1 150 ohm 1/4w	.15
1 41 ohm 1/4w	.15
1 10K pot	1.00
1 NE592/LM733N	2.50
1 NE564	5.00
1 MWA120 (Motorola)	7.80
1 7812 Voltage Reg.	1.17
1 7815 Voltage Reg.	1.17
3 2N2222	.50
2 1N34/38	.50
1 HP5082-2800	2.20
1 5 to 7 volt Zenner	1.00
<b>TOTAL KIT PRICE</b>	<b>92.25</b>

COMPLETE KIT WITH DUAL AUDIO \$923.23  
COMPLETE KIT WITH SINGLE AUDIO 880.77

LESS 10% ON ALL COMPLETE KIT ORDERS

BOARDS AND PARTS MAY BE PURCHASED SEPERATELY AT THE PRICES LISTED ABOVE.

ALL PRICES ARE SUBJECT TO CHANGE WITHOUT NOTICE!!!!!!!!!!!!!!!!!!!!!!!!!!!!!!!!!!!!

TVRO BOARD DESCRIPTION AND PARTS LIST

**DUAL CONVERSION BOARD:** This board provides conversion from the 3.7-4.2 band first to 900 MHz where gain and bandpass filtering are provided and, second, to 70 MHz. The board contains both local oscillators, one fixed and the other variable, and the second mixer. Construction is greatly simplified by the use of Hybrid IC amplifiers for the gain stages.

**DEMODULATOR BOARD:** This circuit takes the 70 MHz center frequency satellite TV signal in the 10 to 200 millivolt range, detects them using a phase lock loop, de-emphasizes and filters the result to produce standard NTSC video. Other outputs include the audio subcarrier, a DC voltage proportional to the strength of the 70 MHz signal, and APC voltage centered at about 2 volts DC.

<u>DUAL CONVERSION BOARD</u>	<u>PRICE EACH</u>
Printed Circuit Board	\$ 25.00
6 47pf chip caps	1.00
2 4.7mfd 35vdc	.59
2 .01mfd 50vdc disc cap	.35
4 1.5 to 8pf piston trimmer cap	5.99
2 470 ohm 1/4w	.15
2 MWA320 (Motorola)	8.65
1 7815 Voltage Reg.	1.17
1 VTO8090	150.00
1 VTO8240	156.25
2 1N4005	.39
1 DBM500/1100 (Varil)	125.00
1 MLP102 (Engleman)	25.00
8 SMA Male Connector	5.00
<b>TOTAL KIT PRICE</b>	<b>572.64</b>

<u>70 MHZ IF BOARD</u>	<u>PRICE EACH</u>
Printed Circuit Board	25.00

3 MWA120	7.80
7 .01mfd 50vdc	.35
2 4.7mfd 35vdc	.59
1 10pf sm	1.00
5 22pf sm	1.00
1 18pf sm	1.00
1 33pf sm	1.00
2 330 ohm 1/4w	.15
5 J.W. Miller 4500-4	4.99
1 7815 Voltage Reg.	1.17
<b>TOTAL KIT PRICE</b>	<b>86.45</b>

<u>SINGLE AUDIO BOARD</u>	<u>PRICE EACH</u>
Printed Circuit Board	\$ 15.00
1 3pf sm	1.00
1 12pf sm	1.00
1 50pf sm	1.00
1 68pf sm	1.00
2 91pf sm	1.00
3 .001mfd	.35
3 .01mfd	.35

1 .047mfd	.35
1 .47mfd	.35
1 1mfd 10vdc	.59
3 4.7mfd 35vdc	.59
1 470mfd 25vdc	1.29
1 220K 1/4w	.15
1 150K 1/4w	.15
1 6.8K 1/4w	.15
1 3.3K 1/4w	.15
1 2.2K 1/4w	.15
3 1K 1/4w	.15
1 10 ohm 1/4w	.15
1 50K pot	1.00
1 5K pot	1.00
1 CA3065/MC1358P	2.16
1 LM380	1.56
1 7812 Voltage Reg.	1.17
3 2N2222	.50
2 Miller 9051	5.99
1 Miller 9052	5.99
<b>TOTAL KIT PRICE</b>	<b>55.16</b>

Toll Free Number  
800-528-0180

(For orders only) PRICES SUBJECT TO CHANGE WITHOUT NOTICE

**MHz electronics**

# "CHIPS"

FAIRCHILD VHF AND UHF PRESCALER CHIPS		PRICE
95H90DC	350MC Prescaler divide by 10/11	\$ 8.50
95H91DC	350MC Prescaler divide by 5/6	8.50
11C90DC	650MC Prescaler divide by 10/11	15.50
11C91DC	650MC Prescaler divide by 5/6	15.50
11C06DC	UHF Prescaler 750MC D Type Flip Flop	12.30
11C05DC	1GHz Counter Divide by 4 (Regular price \$75.00)	50.00
11C01FC	High Speed Dual 5/4 Input NO/NOR Gate	15.40
82S90	Presetable High Speed Decade/Binary Counter used with the 11C90/91 or the 95H90/91 Prescaler can divide by 100. (Signetics)	5.00
11C24DC	This chip is the same as a Motorola MC4024/4324 Dual TTL Voltage Control Multivibrator.	3.37
11C44DC	This chip is the same as a Motorola MC4044/4344 Phase Frequency Detector.	3.37

**GENERAL ELECTRIC CO. GUNN DIODE MODEL Y-2187**  
 Freq. Gap (GHZ) 12 to 18, Output (Min.) 100mW, Duty (%) CW, Typ. Bias (Vdc) 8.0, Type. Oper. (MAdc) 550, Max. Thres. (mAdc) 1000, Max. Bias (Vdc) 10.0. **\$39.99**

**VARIAN GALLIUM ARSENIDE GUNN DIODES MODEL VSX-9201S5**  
 Freq. Coverage 8 to 12.4GHz, Output (Min.) 100mW, Bias Voltage (Max.) 14vdc, Bias current (mAdc) Operating 550 Typ. 750 Max., Threshold 850 Typ. 1000 Max. **\$39.99**

**VARI-L Co. Inc. MODEL SS-43 AM MODULATOR**  
 Freq. Range 60 to 150MC, Insertion Loss 13dB Nominal, Signal Port Imp. 50ohms Nominal, Signal Port RF Power + 10dBm Max., Modulation Port BW DC to 1KHZ, Modulation Port Bias 1ma. Nominal. **\$24.99**

AVANTEK CASCADABLE MODULAR AMPLIFIERS			
Frequency Range	Model UTO-504	UTO-511	
Gain	5 to 500 MHz	5 to 500 MHz	
Noise Figure	6dB	15dB	
Power Output	11dB	2.3dB to 3dB	
	+ 17dB	- 2dB to - 3dB	
Gain Flatness	1dB	1dB	
Input Power Vdc	+ 24	+ 15	
mA	100	10	
	PRICE \$70.00	PRICE \$75.00	

#### ORDERING INSTRUCTIONS

**DEFECTIVE MATERIAL:** All claims for defective material must be made within sixty (60) days after receipt of parcel. All claims must include the defective material (for testing purposes), our invoice number, and the date of purchase. All returns must be packed properly or it will void all warranties.

**DELIVERY:** Orders are normally shipped within 48 hours after receipt of customer's order. If a part has to be backordered the customer is notified. Our normal shipping method is via First Class Mail or UPS depending on size and weight of the package. On test equipment it is by Air only. FOB shipping point.

**FOREIGN ORDERS:** All foreign orders must be prepaid with cashiers check or money order made out in U.S. Funds. We are sorry but C.O.D. is not available to foreign countries and Letters of Credit are not an acceptable form of payment either. Further information is available on request.

**HOURS:** Monday thru Saturday: 8:30 a.m. to 5:00 p.m.

**INSURANCE:** Please include 25¢ for each additional \$100.00 over \$100.00, United Parcel only.

**ORDER FORMS:** New order forms are included with each order for your convenience. Additional forms are available on request.

**POSTAGE:** Minimum shipping and handling in the US, Canada, and Mexico is \$2.50 all other countries is \$5.00. On foreign orders include 20% shipping and handling.

**PREPAID ORDERS:** Order must be accompanied by a check.

**PRICES:** Prices are subject to change without notice.

**RESTOCK CHARGE:** If parts are returned to MHZ Electronics due to customer error, customer will be held responsible for all extra fees, will be charged a 15% restocking fee, with the remainder in credit only. All returns must have approval.

**SALES TAX:** Arizona must add 5% sales tax, unless a signed Arizona resale tax card is currently on file with MHZ Electronics. All orders placed by persons outside of Arizona, but delivered to persons in Arizona are subject to the 5% sales tax.

**SHORTAGE OR DAMAGE:** All claims for shortages or damages must be made within 5 days after receipt of parcel. Claims must include our invoice number and the date of purchase. Customers which do not notify us within this time period will be held responsible for the entire order as we will consider the order complete.

OUR 800 NUMBER IS STRICTLY FOR ORDERS ONLY  
 NO INFORMATION WILL BE GIVEN. 1-800-528-0180.

HEWLETT PACKARD MIXERS MODELS		
Frequency Range	10514A	10514B
	2MHz to 500MC	2MHz to 500MC
Input/Output Frequency L & R	200KHz to 500MC	200KHz to 500MC
	X DC to 500MC	DC to 500MC
Mixer Conversion Loss (A)	7dB	7dB
(B)	9dB	9dB
Noise Performance (SSB) (A)	7dB	7dB
(B)	9dB	9dB
PRICE	\$49.99	PRICE \$39.99

#### FREQUENCY SOURCES, INC MODEL MS-74X MICROWAVE SIGNAL SOURCE

MS-74X: Mechanically Tunable Frequency Range (MHz) 10630 to 11230 (10.63 to 11.23GHz) Minimum Output Power (mW) 10, Overall Multiplier Ratio 108, Internal Crystal Oscillator Frequency Range (MHz) 98.4 to 104.0, Maximum Input Current (mA) 400.

The signal source are designed for applications where high stability and low noise are of prime concern, these sources utilize fundamental transistor oscillators with high Q coaxial cavities, followed by broadband stable step recovery diode multipliers. This design allows single screw mechanical adjustment of frequency over standard communications bands. Broadband sampling circuits are used to phase lock the oscillator to a high stability reference which may be either an internal self-contained crystal oscillator, external primary standard or VHF synthesizer. This unique technique allows for optimization of both FM noise and long term stability. List Price is \$1158.00 (THESE ARE NEW) **Our Price—\$289.**

#### HEWLETT PACKARD 1N5712 MICROWAVE DIODE

This diode will replace the MBD101, 1N5711, 5082-2800, 5082-2835 ect. This will work like a champ in all those Down Converter projects **\$1.50 or 10/\$10.00**

#### MOTOROLA MHW1172R LOW DISTORTION WIDEBAND AMPLIFIER MODULE.

Frequency Range: 40 to 300 MHz., Power Gain at 50MHz 16.6min. to 17.4max., Gain Flatness ± 0.1 Typ. ± 0.2 Max. dB., DC Supply Voltage - 28vdc, RF Voltage Input + 70dBmV **PRICE \$29.99**

#### GENERAL ELECTRIC AA NICADS

Model #41B905HD11-G1  
 Pack of 6 for \$5.00 or 60 Cells, 10 Packs for \$45.00  
 These may be broken down to individual cells.

**TERMS: DOMESTIC:** Prepaid, C.O.D. or Credit Card  
**FOREIGN:** Prepaid only, U.S. Funds—money order or cashier's check only.  
**C.O.D.:** Acceptable by telephone or mail. Payment from customer will be by cash, money order or cashier's check. We are sorry but we cannot accept personal checks for C.O.D.'s  
**CONFIRMING ORDERS:** We would prefer that confirming orders not be sent after a telephone order has been placed. If company policy necessitates a confirming order, please mark "CONFIRMING" boldly on the order. If problems or duplicate shipments occur due to an order which is not properly marked, customers will be held responsible for any charges incurred, plus a 15% restock charge on returned parts.  
**CREDIT CARDS:** WE ACCEPT MASTERCARD VISA AND AMERICAN EXPRESS.  
**DATA SHEETS:** When we have data sheets in stock on devices we do supply them with the order.



**MHZ electronics**

✓ 48

(602) 242-3037  
 (602) 242-8916  
 2111 W. CAMELBACK ROAD  
 PHOENIX, ARIZONA 85015

Toll Free Number  
 800-528-0180  
 (For orders only)

# NEW LOW-NOISE PREAMPS RECEIVING CONVERTERS TRANSMIT CONVERTERS

New low-noise microwave transistors make preamps in the 0.9 to 1.0 dB noise figure range possible without the fragility and power supply problems of gas-fet's. Units furnished wired and tuned to ham band. Can be easily retuned to nearby freq.



Models LNA( ), P30, and P432 shown

Model	Tunable Freq Range	Noise Figure	Gain	Price
LNA 28	20-40	0.9 dB	20 dB	\$39.95
LNA 50	40-70	0.9 dB	20 dB	\$39.95
LNA 144	120-180	1.0 dB	18 dB	\$39.95
LNA 220	180-250	1.0 dB	17 dB	\$39.95
LNA 432	380-470	1.0 dB	18 dB	\$44.95

## ECONOMY PREAMPS

Our traditional preamps, proven in years of service. Over 20,000 in use throughout the world. Tuneable over narrow range. Specify exact freq. band needed. Gain 16-20 dB. NF = 2 dB or less. VHF units available 27 to 300 MHz. UHF units available 300 to 650 MHz.

- P30K, VHF Kit less case \$14.95
- P30C, VHF Kit with case \$20.95
- P30W, VHF Wired/Tested \$29.95
- P432K, UHF Kit less case \$18.95
- P432C, UHF Kit with case \$24.95
- P432W, UHF Wired/Tested \$33.95

P432 also available in broadband version to cover 20-650 MHz without tuning. Same price as P432; add "B" to model #.

## HELICAL RESONATOR PREAMPS

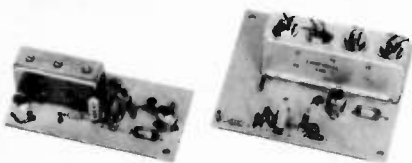

Our lab has developed a new line of low-noise receiver preamps with helical resonator filters built in. The combination of a low noise amplifier similar to the LNA series and the sharp selectivity of a 3 or 4 section helical resonator provides increased sensitivity while reducing intermod and cross-band interference in critical applications. See selectivity curves at right. Noise figure = 1 to 1.2 dB. Gain = 12 to 15 dB.

Model	Tuning Range	Price
HRA-144	143-150 MHz	\$49.95
HRA-220	213-233 MHz	\$49.95
HRA-432	420-450 MHz	\$59.95



Models to cover every practical rf & if range to listen to SSB, FM, ATV, etc. NF = 2 dB or less.

	Antenna Input Range	Receiver Output
<b>VHF MODELS</b>	28-32	144-148
	50-52	28-30
Kit \$44.95	50-54	144-148
Less Case \$39.95	144-146	28-30
Wired \$59.95	145-147	28-30
	146-148	28-30
	144-144.4	27-27.4
	144-148	50-54
	220-222	28-30
	220-224	144-148
	222-226	144-148
	220-224	50-54
	222-224	28-30

	Antenna Input Range	Receiver Output
<b>UHF MODELS</b>	432-434	28-30
Kit \$54.95	435-437	28-30
Less Case \$49.95	432-436	144-148
Wired \$74.95	432-436	50-54
	439.25	61.25

**SCANNER CONVERTERS** Copy 72-76, 135-144, 240-270, 400-420, or 806-894 MHz bands on any scanner. Wired/tested Only \$79.95.

**SPECIAL FREQUENCY CONVERTERS** made to custom order \$119.95. Call for details.

## SAVE A BUNDLE ON VHF FM TRANSCEIVERS!

FM-5 PC Board Kit - ONLY \$159.95 complete with controls, heatsink, etc. 10 Watts, 5 Channels, for 6M, 2M, or 220



Cabinet Kit, complete with speaker, knobs, connectors, hardware. Only \$59.95

**REPEAT OF A SELLOUT!**

While supply lasts, get \$59.95 cabinet kit free when you buy an FM-5 Transceiver kit. Where else can you get a complete transceiver for only \$159.95?

For SSB, CW, ATV, FM, etc. Why pay big bucks for a multi mode rig for each band? Can be linked with receive converters for transceive. 2 watts output.

	Exciter Input Range	Antenna Output
For VHF,	28-30	144-146
Model XV2	28-29	145-146
Kit \$79.95	28-30	50-52
Wired \$119.95	27-27.4	144-144.4
(Specify band)	28-30	220-222
	50-54	220-224
	144-146	50-52
	50-54	144-148
	144-146	28-30

	Exciter Input Range	Antenna Output
For UHF,	28-30	432-434
Model XV4	28-30	435-437
Kit \$99.95	50-54	432-436
Wired \$149.95	61.25	439.25
	144-148	432-436*

\*Add \$35 for 2M input

**FREE OFFER**

For limited time, buy a transmit converter above with 40-45W PA (\$129.95) and get \$39.95 cabinet FREE.



## LOOK AT THESE ATTRACTIVE CURVES!

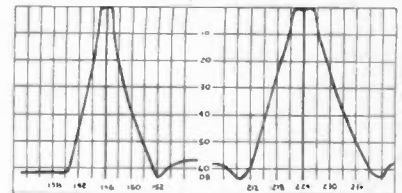

R144 & R220 Front Ends. HRA 144/220, & HRF-144/220

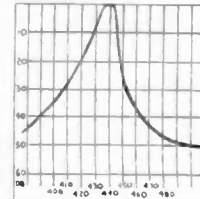

R451 Receiver Front End

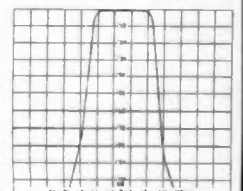

Rcvr I-F Selectivity

Typical Selectivity Curves of Receivers and Helical Resonators.

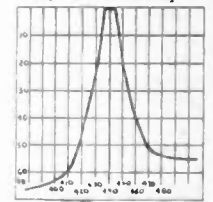

HRA-432, HRF-432

- Call or Write for **FREE CATALOG** (Send \$1.00 or 4 IRC's for overseas mailing)
- Order by phone or mail • Add \$2 S & H per order (Electronic answering service evenings & weekends)
- Use VISA, MASTERCARD, Check, or UPS COD.

**hamtronics, inc.**

65-W MOUL RD. • HILTON NY 14468  
Phone: 716-392-9430

Hamtronics® is a registered trademark ✓ 33

**AT LAST —  
A REPEATER  
YOU CAN AFFORD!**

For years, Hamtronics® Modules have been used by individual hams and manufacturers to make repeaters. Now, in the Hamtronics tradition of top quality and superb value, we are proud to offer a complete repeater package.



**JUST LOOK AT THESE PRICES!**

Band	Kit	Wired/Tested
6M,2M,220	\$595	\$745
440	\$645	\$795

Both kit and wired units are complete with all parts, modules, hardware, and crystals.

**CALL OR WRITE FOR COMPLETE DETAILS.**

Also available for remote site linking/crossband & 10M.

**FEATURES:**

- SENSITIVITY SECOND TO NONE; TYPICALLY 0.15 uV ON VHF, 0.2 uV ON UHF.
- SELECTIVITY THAT CAN'T BE BEAT! BOTH 8 POLE CRYSTAL FILTER & CERAMIC FILTER FOR GREATER THAN 100 dB AT ± 12KHZ. HELICAL RESONATOR FRONT ENDS. SEE R144, R220, AND R451 SPECS IN RECEIVER AD BELOW.
- OTHER GREAT RECEIVER FEATURES: FLUTTER-PROOF SQUELCH, AFC TO COMPENSATE FOR OFF-FREQ TRANSMITTERS, SEPARATE LOCAL SPEAKER AMPLIFIER & CONTROL.
- CLEAN, EASY-TUNE TRANSMITTER; UP TO 20 WATTS OUT.

**HIGH QUALITY MODULES FOR  
REPEATERS, LINKS, TELEMETRY, ETC.**

**INTRODUCING —  
NEW 1983 RECEIVERS**

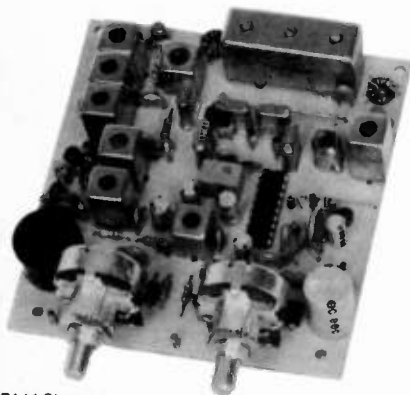

R144 Shown

- **R144/R220 FM RCVRs** for 2M or 220 MHz. 0.15uV sens.; 8 pole xtal filter & ceramic filter in i-f, helical resonator front end for exceptional selectivity (curves at left). AFC incl., xtal oven avail. Kit only \$119.95
- **R451 FM RCVR** Same but for uhf. Tuned line front end, 0.2 uV sens. Kit only \$119.95.
- **R76 FM RCVR** for 10M, 6M, 2M, 220, or commercial bands. As above, but w/o AFC or hel. res. Kits only \$109.95. Also avail w/4 pole filter, only \$94.95/ kit.
- **R110 VHF AM RECEIVER** kit for VHF aircraft band or ham bands. Only \$84.95.
- **R110 UHF AM RECEIVER** for UHF uses, including special 296 MHz model to hear SPACE SHUTTLE. Kit \$94.95.

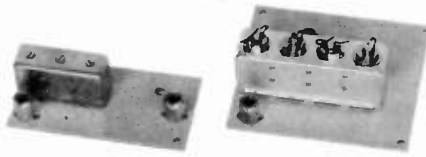

- **HELICAL RESONATOR FILTERS** available separately on pcb w/connectors.  
 HRF-144 for 143-150 MHz \$34.95  
 HRF-220 for 213-233 MHz \$34.95  
 HRF-432 for 420-450 MHz \$44.95  
 (See selectivity curves at left)

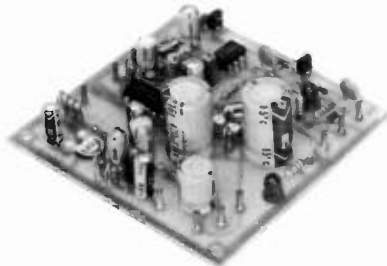

- **COR KITS** With audio mixer and speaker amplifier. Only \$29.95.
- **CWID KITS** 158 bits, field programmable, clean audio. Only \$59.95.

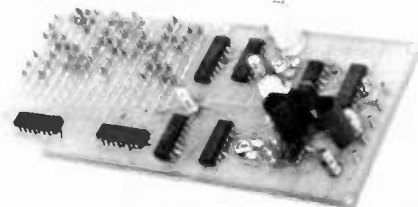

- **A16 RF TIGHT BOX** Deep drawn alum. case with tight cover and no seams. 7 x 8 x 2 inches. Only \$18.00.

**TRANSMITTERS AND  
ACCESSORIES**



- **T51 VHF FM EXCITER** for 10M, 6M, 2M, 220 MHz or adjacent bands. 2 Watts continuous. Kits only \$59.95



- **T451 UHF FM EXCITER** 2 to 3 Watts on 450 ham band or adjacent. Kits only \$69.95.
- **VHF & UHF LINEAR AMPLIFIERS.** Use on either FM or SSB. Power levels from 10 to 45 Watts to go with exciters & xmtg converters. Kits from \$69.95.

# INTRODUCING SONY'S NEW DIGITAL DIRECT ACCESS RECEIVER!

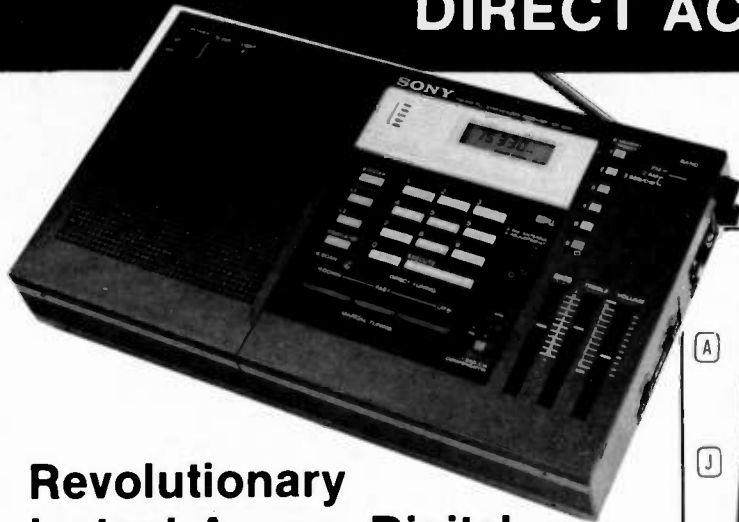

only **\$199<sup>95</sup>** plus \$5.00 shipping  
**(NOW IN STOCK)**

## Revolutionary Instant Access Digital Shortwave Scanner

- Continuous Scanning of LW, MW, SW, & FM Bands
- Instant Fingertip Tuning—No More Knobs!
- 6 Memories for Any Mode (AM,SSB/CW, & FM)
- Dual PLL Frequency Synthesized—No Drift!

**A WHOLE NEW BREED OF RADIO IS HERE NOW!** No other short wave receiver combines so many advanced features for both operating convenience and high performance as does the new Sony ICF-2001. Once you have operated this exciting new radio, you'll be spoiled forever! Direct access tuning eliminates conventional tuning knobs and dials with a convenient digital keyboard and Liquid Crystal Display (LCD) for accurate frequency readout to within 1 KHz. Instant fingertip tuning, up to 8 memory presets, and continuous scanning features make the ICF-2001 the ultimate in convenience.

Compare the following features against any receiver currently available and you will have to agree that the Sony ICF 2001 is the best value in shortwave receivers today:

**DUAL PLL SYNTHESIZER CIRCUITRY** covers entire 150 KHz to 29.999 MHz band. PLL<sub>1</sub> circuit has 100 KHz step while PLL<sub>2</sub> handles 1 KHz step, both of which are controlled by separate quartz crystal oscillators for precise, no-drift tuning. **DUAL CONVERSION SUPERHETERODYNE** circuitry assures superior AM reception and high image rejection characteristics. The 10.7 MHz IF of the FM band is utilized as the 2nd IF of the AM band. A new type of crystal filter made especially for this purpose realizes clearer reception than commonly used ceramic filters. **ALL FET FRONT END** for high sensitivity and interference rejection. Intermodulation, cross modulation, and spurious interference are effectively rejected. **FET RF AMP** contributes to superior image rejection, high sensitivity, and good signal to noise ratio. Both strong and weak stations are received with minimal distortion.

### EXTENDED SPECTRUM CONTINUOUS TUNING

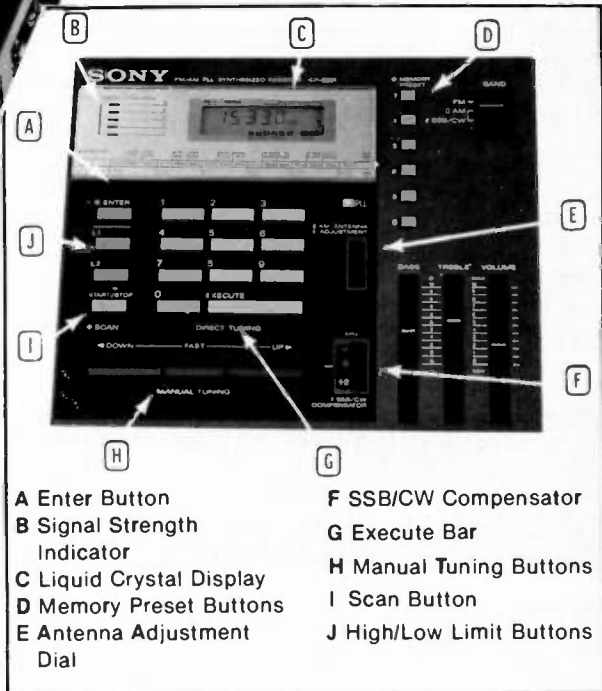

### OPERATIONAL FEATURES

**INSTANT FINGERTIP TUNING** with the calculator-type key board enables the operator to have instant access to any frequency in the LW, MW, SW, and FM bands. And the LCD digital frequency display confirms the exact, drift-free signal being received. **AUTOMATIC SCANNING** of the above bands. Continuous scanning of any desired portion of the band is achieved by setting the "L<sub>1</sub>" and "L<sub>2</sub>" keys to define the range to be scanned. The scanner can stop automatically on strong signals, or it can be done manually. **MANUAL SEARCH** is similar to the manual scan mode and is useful for quick signal searching. The "UP" and "DOWN" keys let the tuner search for you. The "FAST" key increases the search rate for faster signal detection. **MEMORY PRESETS.** Six memory keys hold desired stations for instant one-key tuning in any mode (AM, SSB/CW, and FM), and also, the "L<sub>1</sub>" and "L<sub>2</sub>" keys can give you two more memory slots when not used for scanning. **OTHER FEATURES:** Local, normal, DX sensitivity selector for AM; SSB/CW compensator; 90 min. sleep timer; AM Ant. Adjust.

### SPECIFICATIONS

**CIRCUIT SYSTEM:** Fm Superheterodyne; AM Dual conversion superheterodyne. **SIGNAL CIRCUITRY:** 4 IC's, 11 FET's, 23 Transistors, 16 Diodes. **AUXILIARY CIRCUITRY:** 5 IC's, 1 LSI, 5 LED's, 25 Transistors, 9 Diodes. **FREQUENCY RANGE:** FM 76-108 MHz; AM 150-29,999 KHz. **INTERMEDIATE FREQUENCY:** FM 10.7 MHz; AM 1st 66.35 MHz, 2nd 10.7 MHz. **ANTENNAS:** FM telescopic, ext. ant. terminal; AM telescopic, built-in ferrite bar, ext. ant. terminal. **POWER:** 4.5 VDC/120 VAC **DIMENSIONS:** 12 1/4 (W) X 2 1/4 (H) X 6 3/4 (D). **WEIGHT:** 3 lb. 15 oz. (1.8 kg)



**SPECTRONICS, INC.**  
 1009 GARFIELD ST. OAK PARK, IL. 60304

PHONE  
**(312) 848-6777**





ramsey

# the first name in Counters!



## 9 DIGITS 600 MHz \$129<sup>95</sup> WIRED

**PRICES:**

CT-90 wired, 1 year warranty	\$129.95
CT-90 Kit, 90 day parts war- ranty	109.95
AC-1 AC adapter	3.95
BP-1 Nicad pack + AC Adapter/Charger	12.95
OV-1, Micro-power Oven time base	49.95
External time base input	14.95

The CT-90 is the most versatile, feature packed counter available for less than \$300.00! Advanced design features include: three selectable gate times, nine digits, gate indicator and a unique display hold function which holds the displayed count after the input signal is removed! Also, a 10MHz TCXO time base is used which enables easy zero beat calibration checks against WWV. Optionally, an internal nicad battery pack, external time base input and Micro-power high stability crystal oven time base are available. The CT-90, performance you can count on!

**SPECIFICATIONS:**

Range:	20 Hz to 600 MHz
Sensitivity:	Less than 10 MV to 150 MHz Less than 50 MV to 500 MHz
Resolution:	0.1 Hz (10 MHz range) 1.0 Hz (60 MHz range) 10.0 Hz (600 MHz range)
Display:	9 digits 0.4" LED
Time base:	Standard-10,000 mHz, 1.0 ppm 20-40°C Optional Micro-power oven-0.1 ppm 20-40°C
Power:	8-15 VAC @ 250 ma

## 7 DIGITS 525 MHz \$99<sup>95</sup> WIRED



**SPECIFICATIONS:**

Range:	20 Hz to 525 MHz
Sensitivity:	Less than 50 MV to 150 MHz Less than 150 MV to 500 MHz
Resolution:	1.0 Hz (5 MHz range) 10.0 Hz (50 MHz range) 100.0 Hz (500 MHz range)
Display:	7 digits 0.4" LED
Time base:	1.0 ppm TCXO 20-40°C
Power:	12 VAC @ 250 ma

The CT-70 breaks the price barrier on lab quality frequency counters. Deluxe features such as: three frequency ranges - each with pre-amplification, dual selectable gate times, and gate activity indication make measurements a snap. The wide frequency range enables you to accurately measure signals from audio thru UHF with 1.0 ppm accuracy - that's .0001%! The CT-70 is the answer to all your measurement needs, in the field, lab or ham shack.

**PRICES:**

CT-70 wired, 1 year warranty	\$99.95
CT-70 Kit, 90 day parts war- ranty	84.95
AC-1 AC adapter	3.95
BP-1 Nicad pack + AC adapter/charger	12.95

## 7 DIGITS 500 MHz \$79<sup>95</sup> WIRED



**PRICES:**

MINI-100 wired, 1 year warranty	\$79.95
AC-Z Ac adapter for MINI- 100	3.95
BP-Z Nicad pack and AC adapter/charger	12.95

Here's a handy, general purpose counter that provides most counter functions at an unbelievable price. The MINI-100 doesn't have the full frequency range or input impedance qualities found in higher price units, but for basic RF signal measurements, it can't be beat! Accurate measurements can be made from 1 MHz all the way up to 500 MHz with excellent sensitivity throughout the range, and the two gate times let you select the resolution desired. Add the nicad pack option and the MINI-100 makes an ideal addition to your tool box for "in-the-field" frequency checks and repairs.

**SPECIFICATIONS:**

Range:	1 MHz to 500 MHz
Sensitivity:	Less than 25 MV
Resolution:	100 Hz (slow gate) 1.0 KHz (fast gate)
Display:	7 digits, 0.4" LED
Time base:	2.0 ppm 20-40°C
Power:	5 VDC @ 200 ma

## 8 DIGITS 600 MHz \$159<sup>95</sup> WIRED



NEW  
READ  
RECEIVER  
FREQUENCY

**SPECIFICATIONS:**

Range:	20 Hz to 600 MHz
Sensitivity:	Less than 25 mv to 150 MHz Less than 150 mv to 600 MHz
Resolution:	1.0 Hz (60 MHz range) 10.0 Hz (600 MHz range)
Display:	8 digits 0.4" LED
Time base:	2.0 ppm 20-40°C
Power:	110 VAC or 12 VDC

The CT-50 is a versatile lab bench counter that will measure up to 600 MHz with 8 digit precision. And, one of its best features is the Receive Frequency Adapter, which turns the CT-50 into a digital readout for any receiver. The adapter is easily programmed for any receiver and a simple connection to the receiver's VFO is all that is required for use. Adding the receiver adapter in no way limits the operation of the CT-50, the adapter can be conveniently switched on or off. The CT-50, a counter that can work double duty!

**PRICES:**

CT-50 wired, 1 year warranty	\$159.95
CT-50 Kit, 90 day parts warranty	119.95
RA-1, receiver adapter kit	14.95
RA-1 wired and pre-program- med (send copy of receiver schematic)	29.95

## DIGITAL MULTIMETER \$99<sup>95</sup> WIRED



**PRICES:**

DM-700 wired, 1 year warranty	\$99.95
DM-700 Kit, 90 day parts warranty	79.95
AC-1, AC adaptor	3.95
BP-3, Nicad pack + AC adapter/charger	19.95
MP-1, Probe kit	2.95

The DM-700 offers professional quality performance at a hobbyist price. Features include: 26 different ranges and 5 functions, all arranged in a convenient, easy to use format. Measurements are displayed on a large 3 1/2 digit, 1/2 inch LED readout with automatic decimal placement, automatic polarity, overrange indication and overload protection up to 1250 volts on all ranges, making it virtually proof-proof! The DM-700 looks great, a handsome, jet black, rugged ABS case with convenient retractable tilt bail makes it an ideal addition to any shop.

**SPECIFICATIONS:**

DC/AC volts:	100µV to 1 KV, 5 ranges
DC/AC current:	0.1µA to 2.0 Amps, 5 ranges
Resistance:	0.1 ohms to 20 Megohms, 6 ranges
Input impedance:	10 Megohms, DC/AC volts
Accuracy:	0.1% basic DC volts
Power:	4 °C cells

### AUDIO SCALER

For high resolution audio measurements, multiplies UP in frequency.

- Great for PL tones
- Multiplies by 10 or 100
- 0.01 Hz resolution!

\$29.95 Kit \$39.95 Wired

### ACCESSORIES

Telescopic whip antenna - BNC plug	\$ 7.95
High impedance probe, light loading	15.95
Low pass probe, for audio measurements	15.95
Direct probe, general purpose usage	12.95
Tilt bail, for CT 70, 90, MINI-100	3.95
Color burst calibration unit, calibrates counter against color TV signal.	14.95

### COUNTER PREAMP

For measuring extremely weak signals from 10 to 1,000 MHz. Small size, powered by plug transformer-Included.

- Flat 25 db gain
- BNC Connectors
- Great for sniffing RF with pick-up loop

\$34.95 Kit \$44.95 Wired

ramsey electronic's, inc.



2575 Baird Rd. Penfield, NY 14526

PHONE ORDERS  
CALL 716-586-3950

TERMS

Satisfaction guaranteed - examine for 10 days, if not pleased, return in original form for refund. Add 5% for shipping insurance to a maximum of \$10. Overseas add 15%. COD add \$2. Orders under \$10, add \$1.50. NY residents, add 7% tax.

# DEALER DIRECTORY

## Culver City CA

Jun's Electronics, 3918 Sepulveda Blvd., Culver City CA 90230, 390-8003. Trades 463-1886 San Diego. 827-5732 (Reno NV).

## Fontana CA

Complete lines ICOM, DenTron, Ten-Tec, Mirage, Cubic, Lunar, over 4000 electronic products for hobbyist, technician, experimenter. Also CB radio, landmobile. Fontana Electronics, 8628 Sierra Ave., Fontana CA 92335, 822-7710.

## New Castle DE

Factory Authorized Dealer! Yaesu, ICOM, Ten-Tec, KDK, Azden, AEA, Kantronics, Santee. Full Line of Accessories. No Sales Tax in Delaware. One mile off I-95, Delaware Amateur Supply, 71 Meadow Road, New Castle DE 19720, 328-7728.

## San Jose CA

Bay area's newest Amateur Radio store. New & used Amateur Radio sales & service. We feature Kenwood, ICOM, Azden, Yaesu, Ten-Tec, Santee & many more. Shaver Radio, Inc., 1378 So. Bascom Ave., San Jose CA 95128, 998-1103.

## Smyrna GA

For your Kenwood, Yaesu, ICOM, Drake and other amateur needs, come to see us. Britt's Two-Way Radio, 2506 N. Atlanta Rd., Smyrna GA 30080, 432-8006.

## Preston ID

Ross WB7BYZ has the Largest Stock of Amateur Gear In the Intermountain West and the Best Prices. Call me for all your ham needs. Ross Distributing, 78 So. State, Preston ID 83263, 852-0830.

## Bloomington, IL

ROHN TOWERS—Large stock plus all UNARCO ROHN items available for fast drop shipments. Wholesale prices to all users. Also wholesale distributor for Antenna Specialists, Regency, and Wilson. Hill Radio 2503 G.E. Road Box 1405, Bloomington, IL 61701 663-2141

## Terre Haute IN

Your ham headquarters located in the heart of the midwest. Hoosier Electronics, Inc., #9 Meadows Center, P.O. Box 3300, Terre Haute IN 478003, 238-1456.

## Littleton MA

The Reliable Ham Store Serving N.E. Full line of ICOM & Kenwood. Yaesu HTs, Drake, Daiwa, B&W accessories. Curtis & Trac keys. Larsen, Hustler, Telex/Hy-Gain products. Mirage amps., Astron P.S., Alpha Delta protectors, ARRL & Kantronics instruction aids. Whistler radar detectors. Full line of coax fittings. TEL-COM Electronic Communications 675 Great Rd. (Rt. 119), Littleton MA 01460, 617-486-3400/3040.

## Ann Arbor MI

See us for products like Ten-Tec, R. L. Drake, DenTron and many more. Open Monday through Saturday, 0830 to 1730. WBBVGR, WB8UXO, WD8OKN and WB8RP behind the counter. Purchase Radio Supply, 327 E. Hoover Ave., Ann Arbor MI 48104, 666-8686.

## Hudson NH

New England's Distributor and Authorized Service Center for all Major Amateur Lines. Tufts Radio Electronics, Inc., 61 Lowell Road, Hudson NH 03051, 883-5005.

## Somerset NJ

New Jersey's only factory-authorized ICOM and Yaesu distributor. Large inventory of new and used specials. Most major brands in stock. Complete service and facilities. Radios Unlimited, 1760 Easton Avenue, P.O. Box 347, Somerset NJ 08873, 469-4599.

## Buffalo NY WESTERN NEW YORK

Niagara Frontier's only full stocking Amateur dealer. Also Shortwave, CB, Scanners, Marine, Commercial. Operating displays featuring Kenwood and others. Towers, Antennas, Sales and Service. DX Communications, 3214 Transit Road, West Seneca NY, 668-8873.

## Amsterdam NY UPSTATE NEW YORK

Kenwood, ICOM, Drake, plus many other lines. Amateur Dealer for over 35 years. Adirondack Radio Supply, Inc., 185 West Main Street, Amsterdam NY 12010, 842-8350.

## Syracuse-Rome-Utica NY

Featuring: Kenwood, Yaesu, ICOM, Drake, Ten-Tec, Swan, DenTron, Alpha, Robot, MFJ, Tem-go, Astron, K1AM, Hy-Gain, Mosley, Larsen, Cushcraft, Hustler, Mini Products. You won't be disappointed with equipment/service. Radio World, Oneida County Airport-Terminal Building, Oriskany NY 13424, 736-0184.

## Columbus OH

The biggest and best Ham Store in the midwest featuring quality Kenwood products with working displays. We sell only the best. Authorized Kenwood Service. Universal Amateur Radio Inc., 1280 Aida Dr., Reynoldsburg (Columbus) OH 43068, 866-4267.

## Bend OR

Satellite TV. Known brands. Call today for more information and inquire about our dealer program. WESPERCOM, P.O. Box 7226, Bend OR 97708, 389-0986.

## Philadelphia PA/ Camden NJ

Waveguide & Coaxial Microwave Components & Equipment. Laboratory Grade Test Instruments, Power Supplies, Buy, Sell & Trade all popular makes—HP, GR, FXR, ESI, Sorensen, Singer, etc. Electronic Research Labs, 1423 Ferry Ave., Camden NJ 08104, 541-4200.

## Scranton PA

ICOM, Bird, Cushcraft, Beckman, Fluke, Larsen, Hustler, Antenna Specialists, Astron, Avanti, Belden, W2AU/W2VS, CDE, AEA, Vibroplex, Ham-Key, CES, Amphionel, Sony, Fanon/Courier, B&W, Ameco, Shure. LaRue Electronics, 1112 Grandview St., Scranton PA 18509, 343-2124.

## San Antonio TX

Amateur, Commercial 2-way. Selling Antenna Specialists, Avanti, Azden, Bird, Hy-Gain, Standard, Vibroplex, Midland, Henry, Cushcraft, Dielectric, Hustler, ICOM, MFJ, Nye, Shure, Cubic, Tempo, Ten-Tec and others. Appliance & Equipment Co., Inc. 2317 Vance Jackson Road, San Antonio TX 78213, 734-7793.

## DEALERS

Your company name and message can contain up to 25 words for as little as \$150 yearly (prepaid), or \$15 per month (prepaid quarterly). No mention of mail-order business or area code permitted. Directory text and payment must reach us 60 days in advance of publication. For example, advertising for the March. '83 issue must be in our hands by Jan. 1st. Mail to 73 Magazine, Peterborough NH 03458. ATTN: Nancy Ciampa.

# DEALER DIRECTORY

# PROPAGATION

J. H. Nelson  
4 Plymouth Dr.  
Whiting NJ 08759

## EASTERN UNITED STATES TO:

GMT:	00	02	04	06	08	10	12	14	16	18	20	22
ALASKA	14A	7A	7	7	3A	3A	3A	7B	7B	14	21A	21A
ARGENTINA	21	14	7B	7B	7B	7	14	21A	21A	21A	21A	21
AUSTRALIA	21	14	7B	7B	7B	7B	14B	14	14	21	21A	
CANAL ZONE	14A	7	7	7	7	7	14	21	21A	21A	21A	21
ENGLAND	7	7	7	3A	3A	7	14	21A	21A	14	7	7
HAWAII	21	14	7B	7	7	7	3A	3B	7A	21A	21A	21A
INDIA	7	7	7B	7B	7B	7B	14	14	14B	7B	7B	7B
JAPAN	21A	7B	7B	7B	7	7	7	7B	7B	7B	14	14
MEXICO	21	7A	7	7	7	7	7	14A	21A	21A	21A	21A
PHILIPPINES	14A	14B	7B	7B	7B	7B	7	7B	7B	7B	7B	14
PUERTO RICO	14	7	7	7	7	7	14	21	21A	21A	21A	21
SOUTH AFRICA	14	7	7	7	7B	14	21	21A	21A	21A	21	14A
U. S. S. R.	7	7	7	3A	3A	7B	14	21	14	14B	7B	7
WEST COAST	21	14	7	7	7	3A	3A	14	21A	21A	21A	21A

## CENTRAL UNITED STATES TO:

ALASKA	14A	14	7	7	3A	3A	7	7	14	21A	21A	
ARGENTINA	21	14	7B	7B	7B	7	14	21	21A	21A	21A	21A
AUSTRALIA	21A	14	14B	7B	7B	7B	7B	14	14	14	21	21A
CANAL ZONE	21	14	7	7	7	7	7	14A	21A	21A	21A	21A
ENGLAND	7	7	7	3A	3A	7	14	21A	14	7B	7	
HAWAII	21A	14	7B	7	7	7	7	3A	7B	21A	21A	
INDIA	7B	14	7B	7B	7B	7B	7B	14B	14B	7B	7B	7B
JAPAN	21A	14B	7B	7B	7	7	7	7	7B	7B	14	21
MEXICO	21	14	7	7	7	7	7	14A	21A	21A	21A	21A
PHILIPPINES	21	14	7B	7B	7B	7B	7	7B	7B	7B	14	14
PUERTO RICO	14	7A	7	7	7	7	14	21	21A	21A	21A	21
SOUTH AFRICA	14	7	7	7	7B	7B	14	21A	21A	21A	21	14A
U. S. S. R.	7	7	7	3A	3A	7B	7B	14	14	14B	7B	7B

## WESTERN UNITED STATES TO:

ALASKA	21	14	7	7	3A	3A	3A	7	7	14	21A	21A
ARGENTINA	21	14	7B	7B	7B	7	7B	14	21	21A	21A	21A
AUSTRALIA	21A	21	14	14B	7B	7B	7B	14	14	14	21	21A
CANAL ZONE	21A	14	7	7	7	7	7	14	21A	21A	21A	21A
ENGLAND	7B	7	7	3A	3A	3B	7B	14B	21	14	7B	7B
HAWAII	21A	14A	14	7	7	7	7	3A	7A	21A	21A	21A
INDIA	7B	14A	7B	7B	7B	7B	7B	14B	7B	7B	7B	7B
JAPAN	21A	21	7B	7	7	7	7	7	7	7B	14	21A
MEXICO	21	14	7	7	7	7	7	14A	21A	21A	21A	21A
PHILIPPINES	21A	14	14F	7B	7B	7	7	7	7B	7B	14A	
PUERTO RICO	14A	14	7	7	7	7	7	14	21A	21A	21A	21A
SOUTH AFRICA	14	7	7	7	7B	7B	7B	14	21A	21A	21	14A
U. S. S. R.	7B	7	7	3A	3A	7B	7B	14B	14B	14B	7B	7B
EAST COAST	21	14	7	7	7	3A	3A	14	21A	21A	21A	21A

A = Next higher frequency may also be useful.

B = Difficult circuit this period.

First letter = night waves. Second = day waves.

G = Good, F = Fair, P = Poor. \* = Chance of solar flares.

# = Chance of aurora.

NOTE THAT NIGHT WAVE LETTER NOW COMES FIRST.

JANUARY						
SUN	MON	TUE	WED	THU	FRI	SAT
						1 F/G
2 G/G	3 G/G	4 G/G	5 F/G	6 F/F	7 G/G	8 G/G
9 G/G	10 F/F	11 F/F	12 F/G	13 G/G	14 G/G	15 F/G
16 F/F	17 P/F	18 F/F	19 F/G	20 G/G	21 G/G	22 F/G
23 F/F	24 F/G	25 G/G	26 G/G	27 G/G*	28 F/F*	29 P/F
30 F/G	31 G/G					

# FT-230R: QUITE A SIGHT! (AND EASY TO SEE, TOO!!)

Spotting an all-new Liquid Crystal Display, the FT-230R is Yaesu's high-performance answer to your call for a very affordable 2 meter mobile rig with an easy-to-read frequency display! The FT-230R combines microprocessor convenience, a sensitive receiver, a powerful yet clean transmitter strip, and the new dimension of LCD frequency readout. See your Authorized Yaesu Dealer today — and go home with your new FT-230R!

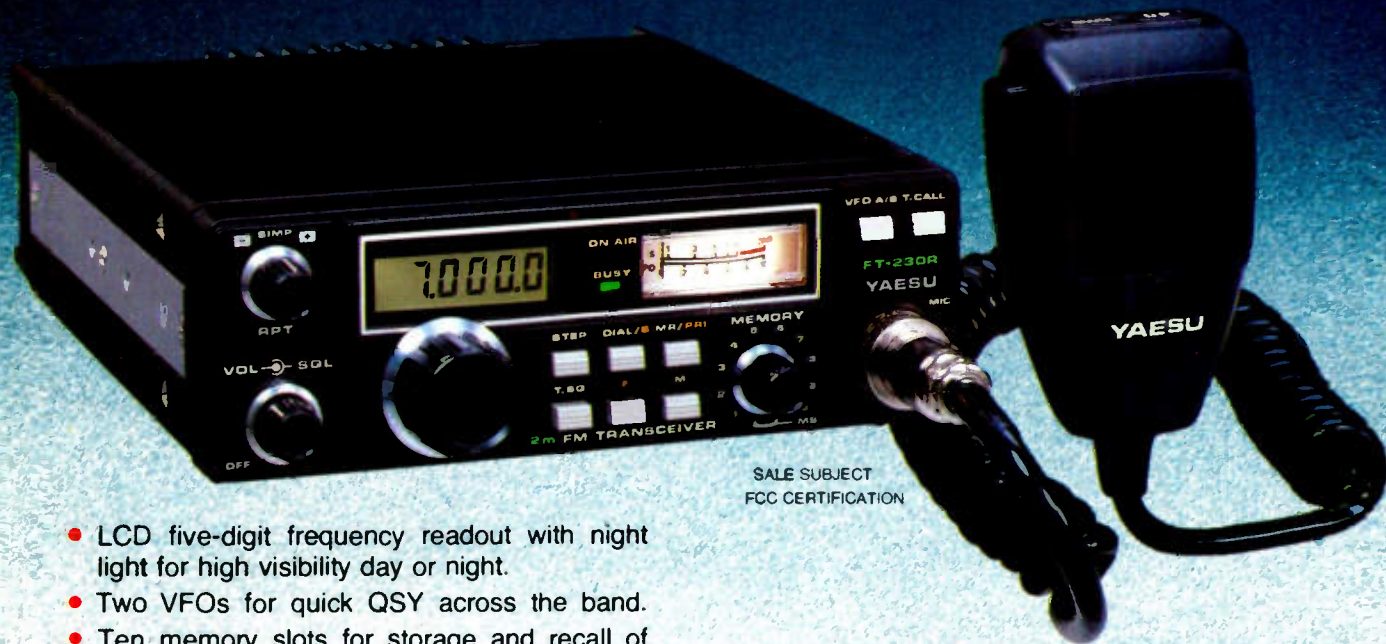

SALE SUBJECT  
FCC CERTIFICATION

- LCD five-digit frequency readout with night light for high visibility day or night.
- Two VFOs for quick QSY across the band.
- Ten memory slots for storage and recall of favorite channels.
- Selectable synthesizer steps (5 kHz or 10 kHz) in dial or scanning mode.
- Priority channel for checking a favorite frequency for activity while monitoring another.
- Unique VFO/Memory Split mode for covering unusual repeater splits.
- Up/Down band scan plus memory scan for busy or clear channel. Scanning microphone included in purchase price.

- Full 25 watts of RF power output from extremely compact package.
- Built-in automatic or manual tone burst.
- Optional synthesized CTCSS Encode and Decode boards available.
- Lithium memory backup battery with estimated lifetime of five years.
- Optional YM-49 Speaker/Microphone and YM-50 DTMF Encoding Microphone provide maximum operating versatility.

**And don't forget! Yaesu has a complete line of VHF and UHF handheld and battery portable transceivers using LCD display!!!**



FT-208R  
FM Handheld  
2 Meters



FT-708R  
FM Handheld  
70 cm



FT-290R - 2 Meters  
SSB/CW/FM Portable

FT-690R - 6 Meters  
USB/CW/AM/FM Portable

**YAESU**  
*The radio.*



Price and Specifications Subject To  
Change Without Notice or Obligation

482

YAESU ELECTRONICS CORP. 6851 Walthall Way, Paramount, CA 90723 • (213) 633-4007  
Eastern Service Ctr., 9812 Princeton-Glendale Rd., Cincinnati, OH 45246 • (513) 874-3100

# NEW

# Digital DX-terity...



**General coverage, Superior dynamic range, 2 VFO's, 8 memories, Scan, Notch... COMPACT!**

## TS-430S

The TS-430S combines the ultimate in compact styling with advanced circuit design and performance. An all solid-state SSB, CW, and AM transceiver, with FM optional, covering the 160-10 meter Amateur bands, it also incorporates a 150 kHz-30 MHz general coverage receiver having a superior dynamic range, dual digital VFO's, 8 memories, memory scan, programmable band scan, IF shift, notch filter, all-mode squelch, and built-in speech processor.

### TS-430S FEATURES:

- **160-10 meter operation, with general coverage receiver**  
With 160-10 meter Amateur band coverage, including WARC 30, 17, and 12 meter bands, it also features a 150 kHz-30 MHz general coverage receiver. Innovative UP-conversion digital PLL circuit, for superior frequency stability and accuracy. UP/DOWN band switches for Amateur bands or 1-MHz steps across entire 150 kHz-30 MHz range. Two digital VFO's continuously tuneable from band to band. Band information output on rear panel.
- **USB, LSB, CW, AM, with optional FM**  
Operates on USB, LSB, CW, and AM, with optional FM. Internally installed. AGC time constant automatically selected by mode.
- **Compact, lightweight design**  
Measures only 10-5/8 (270) W x 3-3/4 (96) H x 10-7/8 (275) D. inches (mm), weighs only 14.3 lbs. (6.5 kg.).
- **Superior receiver dynamic range**  
Use of 2SK125 junction-type FET's in the Dyna-Mix high sensitivity, balanced, direct mixer circuit provides superior dynamic range.
- **10-Hz step dual digital VFO's**  
10-Hz step dual digital VFO's operate independently, include band and mode information. Different band and mode cross-operation possible. Dial torque adjustable. STEP switch for tuning in 10-Hz or 100-Hz steps. A-B switch quickly shifts "B" VFO

to the same frequency and mode as "A" VFO, or vice-versa. VFO LOCK switch provided. RIT control tunes VFO or memory. UP/DOWN manual scan possible using optional microphone.

- **Eight memories store frequency, mode, and band data**  
Memories store frequency, mode, and band data. Eighth memory stores receive and transmit frequencies independently. M.CH switch for operation of memory as independent VFO, or fixed frequency.
- **Lithium battery memory back-up**  
Estimated five-year life.
- **Memory scan**  
Scans memories in which data is stored.
- **Programmable automatic band scan**  
Scans programmed band width. Scan speed adjustable. HOLD switch interrupts band or memory scan.
- **IF shift circuit for minimum QRM.**  
IF passband may be moved to place interfering signals outside the passband, for best interference rejection.
- **Tuneable notch filter built-in**  
Deep, sharp, tuneable, audio notch filter.
- **Narrow-wide filter selection**  
NAR-WIDE switch for IF filter selection on SSB, CW, or AM, when optional filters are installed. (2.4 kHz IF filter built-in.)
- **Speech processor built-in**  
Improves intelligibility, increases average "talk-power".
- **Fluorescent tube digital display**  
Indicates frequency to 100 Hz (10 Hz modifiable).

- **All solid-state technology**  
Input rated 250 W PEP on SSB, 200 W DC on CW, 120 W on FM (optional), 60 W on AM. Built-in cooling fan, multi-circuit final protection. Operates on 12 VDC, or 120 VAC, or 220/240 VAC with optional PS-430 AC power supply.

- **All-mode squelch circuit, built-in**
- **Noise blanker, built-in**
- **RF attenuator (20 dB)**
- **Vox circuit, plus semi break-in with side-tone**

### Optional accessories:

- PS-430 compact AC power supply.
- PS-30 or KPS-21 AC power supplies.
- SP-430 external speaker.
- MB-430 mobile mounting bracket.
- AT-130 compact antenna tuner, 80-10 m incl. WARC.
- AT-230 base antenna tuner, 160-10 m incl. WARC.
- FM-430 FM unit.
- YK-88C (500 Hz) or YK-88CN (270 Hz) CW filters.
- YK-88SN (1.8 kHz) narrow SSB filter.
- YK-88A (6 kHz) AM filter.
- MC-42S UP/DOWN hand microphone, UP/DOWN switch.
- MC-60A deluxe desk microphone, UP/DOWN switch.

More information on the TS-430S is available from all authorized dealers of Trio-Kenwood Communications, 1111 West Walnut Street, Compton, California 90220.

# KENWOOD

...pacesetter in amateur radio



Specifications and prices are subject to change without notice or obligation.