

November 1980 \$2.95

73 MAGAZINE

FOR RADIO AMATEURS

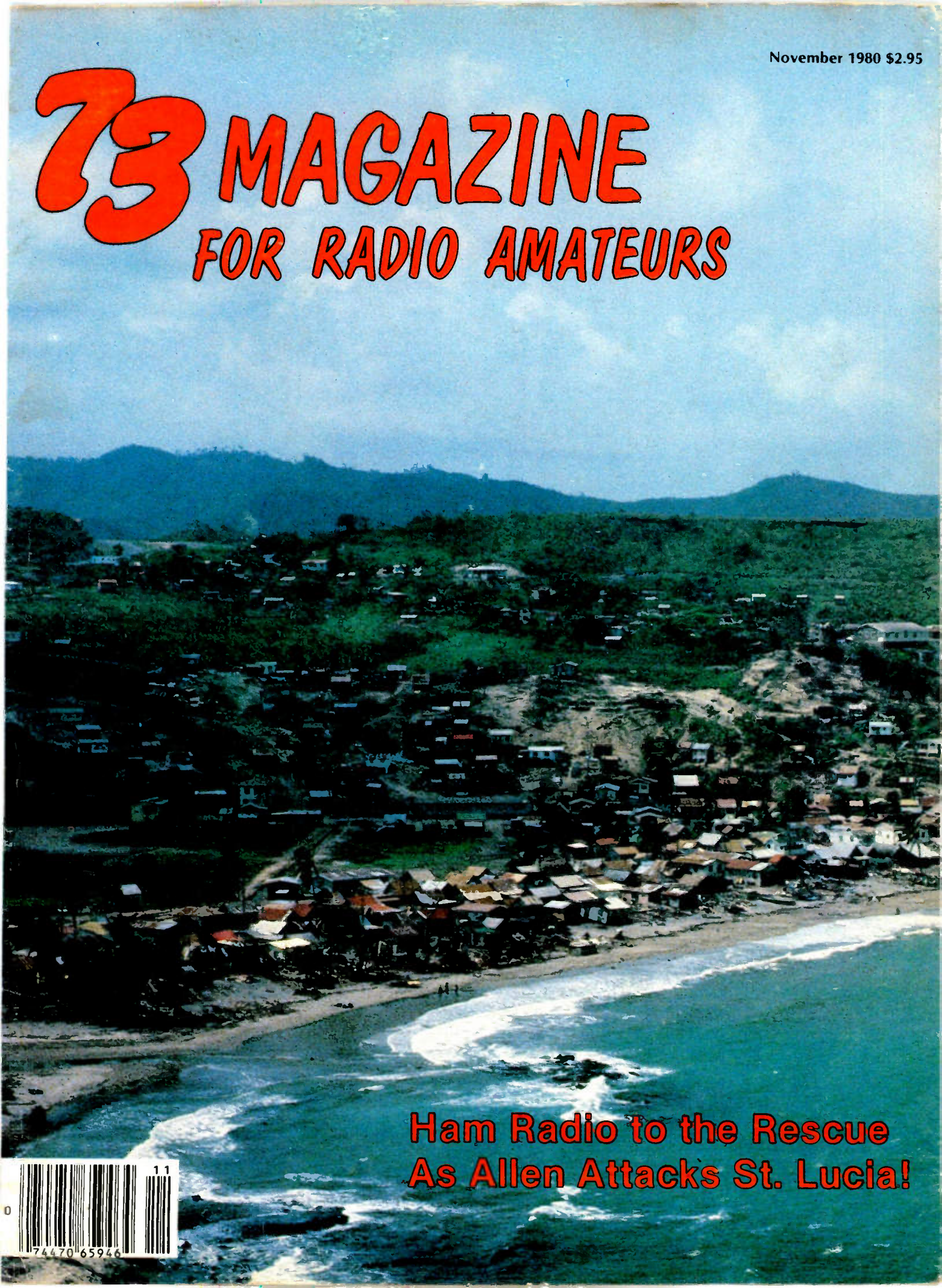

**Ham Radio to the Rescue
As Allen Attacks St. Lucia!**





Shown with optional touch tone pad

The new improved Tempo S-1

- The first and most thoroughly field tested hand-held synthesized radio available. 800 channels in the palm of your hand.
- Simple to operate. (You don't need a degree in computer programming)
- Heavy duty battery pack allows more operating time between charges.
- External microphone capability
- The lowest price ever...\$259.00
- The S-1T (With touch tone pad installed)...\$289.00

Now available is the expanded line of Tempo commercial hand helds... "big name" quality at affordable prices. The FMH-12 & FMH-15 operate in the 135 to 174 MHz range and the FMH-40 & FMH-44 in the 440 to 480 MHz range. Tempo also offers the FMT-2 & FMT-42. They provide excellent VHF or UHF mobile communications and feature a remote control head for hide-away mounting. Also available is the superb MR-3 pocket receiver... a miniature, 2 channel VHF high band monitor or paging receiver. Please call or write for complete information. Also available from Tempo dealers throughout the U.S. and abroad.



TOLL FREE ORDER NUMBER: (800) 421-0631

For all states except California. Calif. residents please call collect on our regular numbers.

11240 W. Olympic Blvd., Los Angeles, Calif. 90064 213/477-6701
 931 N. Euclid, Anaheim, Calif. 92801 714/772-9200
 Butler, Missouri 64730 816/679-3127

tempo...

the first in synthesized portables gives you the broadest choice at the lowest price

...the new S-5

- * The only synthesized hand-held offering 5 watts output. (Switchable for 1 or 5 watt operation)
- * The same dependability as the time proven S-1. Circuitry that has been proven in more than a million hours of operation.
- * Heavy duty battery pack.
- * External microphone capability.
- * The S-5's exciting low price...only \$299.00
- * With touch tone pad \$339.00

SPECIFICATIONS

Frequency Coverage: 144 to 148 MHz
 Channel Spacing: Receive every 5 kHz. transmit Simplex or ± 600 kHz
 Power Requirements: 9.6 VDC
 Current Drain: 17 ma-standby 900 ma-transmit
 Antenna Impedance: 50 ohms
 Dimensions: 40 mm x 62 mm x 170 mm (1.6" x 2.5" x 6.7")
 Weight: 17 oz.
 Sensitivity: Better than .5 microvolts nominal for 20 db

SUPPLIED ACCESSORIES

Telescoping whip antenna, ni-cad battery pack, charger.

OPTIONAL ACCESSORIES

12 Button touch tone pad (not installed): \$39 • 16 Button touch tone pad (not installed): \$48 • Tone burst generator: \$29.95 • CTCSS sub-audible tone control: \$29.95 • Rubber flex antenna: \$8 • Leather holster: \$16 • Cigarette lighter plug mobile charging unit: \$6 • Matching 30 watt output 13.8 VDC power amplifier (S30): \$89 • Matching 80 watt output power amplifier (S80): \$149

The Tempo S-2

Tempo is first again. This time with a superior quality synthesized 220 MHz hand held transceiver. With an S-2 in your car or pocket you can use 220 MHz repeaters throughout the U.S. It offers all the advanced engineering, premium quality components and exciting features of the S-1. The S-2 offers 1000 channels in an extremely lightweight but rugged case.

If you're not on 220 this is the perfect way to get started. With the addition of the S-25 (25W output) or S-75 (75W output) Tempo solid state amplifier it becomes a powerful mobile or base station. If you have a 220 MHz rig, the S-2 will add tremendous versatility. Its low price includes an external microphone capability, heavy duty ni-cad battery pack, charger, and telescoping whip antenna. Price...\$349.00 With touch tone pad...\$399.00

TEMPO VHF & UHF SOLID STATE POWER AMPLIFIERS

Boost your signal... give it the range and clarity of a high powered base station. VHF (135 to 175 MHz)

Drive Power	Output	Model No.	Price
2W	130W	130A02	\$209
10W	130W	130A10	\$189
30W	130W	130A30	\$199
2W	80W	80A02	\$169
10W	80W	80A10	\$149
30W	80W	80A30	\$159
2W	50W	50A02	\$129
2W	30W	30A02	\$ 89

UHF (400 to 512 MHz) models, lower power and FCC type accepted models also available.

Henry Radio

Prices subject to change without notice.

Announcing the Heathkit VF-7401

2-meter FM Digital Scanning Transceiver



LED indicates 5 kHz position.

The 0 kHz/5 kHz Switch gives you an effective choice of 800/2-meter channels in 5 kHz steps.

Dim/Bright Switch for bright illumination of frequency read-out and meter for daytime, and lower intensity for safe mobile operation at night.

The Manual/Scan Switch lets you choose your frequency manually, or have the VF-7401 find an active channel for you.

Lock/Latch Switch. In Scan Latch mode a channel latch-up signal inhibits scan circuits when signals detected, and the 7401 stays on that frequency. If it detects a 4-8 second break in received signal scanning resumes. In the Scan-Lock mode, once the receiver scans to a signal, it remains on that channel until reset.

Optional Micoder II Microphone/ Auto Patch Encoder lets you phone through repeaters with auto patch input. Draws power from the 7401, so no mike battery is necessary.

The Squelch Control also functions as the receiver's sensitivity control to stop scanning only upon reception of "full-quieting" signals, skipping the weak ones.

The 100 kHz Selector button controls the VF-7401's tuning in 100 kHz increments. The 7401's 1 MHz Selector button lets you choose any 1 MHz segment of the 2-meter band.

The 10 kHz Selector advances in 10 kHz steps. In Scan, as it cycles from "9" to "0," it also causes the 100 kHz readout to advance by one digit. Depress once to resume scan function.

More features that make the VF-7401 the 2-meter rig that belongs in your shack and vehicle

No more searching through repeater guides while mobiling in unfamiliar territory - your new Heathkit VF-7401 will find the active channels for you. It will even alert you to band openings. You're going to enjoy building your VF-7401... and you're going to love using it. The VF-7401, the ultimate 2-meter rig... from the more than 200 Hams at Heath.

- Adjustable, 15-watt (nominal), solid-state, narrow-band FM Transceiver. Fully synthesized digital circuitry provides full-band coverage without need for added crystals.

- All-new, state-of-the-art circuits provide the exciting, exclusive features of 1 MHz bandwidth scanning, and Scan Lock/Latch capability on 2-meters.
- A receiver hotter than Heath's HW-2036A features dual-gate MOSFET front-end to minimize overload and adjacent-channel interference.
- "Power-up" on a pre-programmed frequency of your own choice, such as your favorite repeater.
- Convenient detachable mike using 4-pin connector.

- Power to the Micoder II Microphone (if used) eliminates need for a battery.
- Sturdy SO-239 rear-panel antenna jack.
- Chassis-mounted power and external speaker plugs.
- Improved synthesizer, eliminating need for panel mounted sync lock light.
- Tuning for Power Amplifier and output power level adjustment is accessible without removing case.
- Capability of mobile or base operation (with Model VFA-7401-1 AC Power Supply -13.8 V at 4A nominal, transmit).

SEND FOR FREE CATALOG OR VISIT YOUR HEATHKIT ELECTRONIC CENTER



The new VF-7401 is featured in the latest Heathkit Catalog. For a free copy write: Heath Company, Dept. 011-714, Benton Harbor, MI 49022. Or visit the nearest Heathkit Electronic Center in the U.S. or Canada where Heathkit products are displayed, sold and serviced. See the white pages of your phone book for location. In the U.S., Heathkit Electronic Centers are units of Veritechnology Electronics Corporation.

Heathkit®

✓ 303

INFO

Manuscripts

Contributions in the form of manuscripts with drawings and/or photographs are welcome and will be considered for possible publication. We can assume no responsibility for loss or damage to any material. Please enclose a stamped, self-addressed envelope with each submission. Payment for the use of any unsolicited material will be made upon acceptance. All contributions should be directed to the 73 editorial offices. "How to Write for 73" guidelines are available upon request.

Editorial Offices:

Pine Street
Peterborough NH 03458
Phone: 603-924-3873, 924-3874

Advertising Offices:

Elm Street
Peterborough NH 03458
Phone: 603-924-7138

Circulation Offices:

Elm Street
Peterborough NH 03458
Phone: 603-924-7296

Subscription Rates

In the United States and Possessions:
One Year (12 Issues) \$25.00
Two Years (24 Issues) \$38.00
Three Years (36 Issues) \$53.00

Elsewhere:

Canada—\$27.00/1 year only, U.S. funds. Foreign surface mail—\$35.00/1 year only, U.S. funds. Foreign air mail—\$62.00/1 year only, U.S. funds.

To subscribe, renew or change an address:

Write to 73 Magazine, Subscription Department, PO Box 931, Farmingdale NY 11737. For renewals and changes of address, include the address label from your most recent issue of 73. For gift subscriptions, include your name and address as well as those of gift recipients. Postmaster: Send form #3579 to 73 Magazine, Subscription Services, P.O. Box 931, Farmingdale, NY 11737.

Subscription problem or question:

Write to 73 Magazine, Subscription Department, PO Box 931, Farmingdale NY 11737. Please include an address label.

73 Magazine (ISSN 0098-9010) is published monthly by 73, Inc., 80 Pine Street, Peterborough NH 03458. Second class postage paid at Peterborough NH 03458 and at additional mailing offices. Copyright (c) 1980 by 73, Inc. All rights reserved. No part of this publication may be reprinted or otherwise reproduced without written permission from the publisher. Microfilm Edition—University Microfilm, Ann Arbor MI 48106.

Code reading Gets even better.

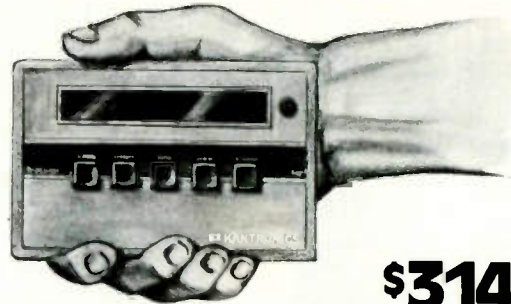

\$314.95

Introducing the versatile Kantronics Mini-Reader™

At last, you can have the code-reading functions for Morse, RTTY and ASCII combined in a miniature package price at just over \$300. The Kantronics **Mini-Reader** has all the functions of its larger counterpart, the **Field Day 2**, including code-speed display, automatic Morse speed tracking, demodulator output, a tuning eye, code-editing programs and a 24-hour clock.

But the **Mini-Reader** measures only 5.74" by 3.5" by 1" and runs on 12 volts! Its calculator size still leaves room for a 10-character, vacuum-tube fluorescent display.

Compare the features and price of the Mini-Reader to any similar device, and you'll find what a breakthrough in code-reading it is!

Both have full features! See them at your Kantronics dealer.

- * Morse copying ability
- * 3 to 80 WPM Morse range
- * Computer programs for improving sloppy Morse
- * Radioteletype copying ability
- * 60, 67, 75 and 100 WPM Baudot
- * ASCII copying ability
- * 110 and 300 WPM baud (300 baud readable only at operator typing speed)
- * Copies any shift of RTTY or ASCII
- * 24-hour clock
- * Entire unit in single package

- * Automatic code-speed tracking
- * Morse-code speed display
- * Tuning eye
- * Full-year limited warranty
- * Demodulator output
- * Internal 200 Hz bandwidth filter
- * All letters, numbers and punctuation with special characters for Morse, RTTY and ASCII
- * 15-day trial period (if purchased from factory)
- * Self-test mode



Field Day 2[®]
\$449.95

115/230 volt AC
Internal speaker
Large, 14-segment
displays
10" by 9" by 3.5"

Kantronics (913) 842-7745
1202 E. 23rd Street
Lawrence, Kansas 66044

VSWR . . . Automatically!

—simplify antenna matching with this tune-up aid.....WB0GWP 42

Welcome Back, Barry!

—the Scottsdale RC's most famous member.....K7NZA 52

Return to Shangri-la

—a visit with 9N1MM.....W1QMS 58

Breadboard Signal Generator

—sell your H-P stock once you build this project.....K3QKO 100

The Odd Couple

 —CASEY/1 tackles OSCAR's telemetry.....WA9LRI 110

PL Tones from a KIM-1

 —a real time wasting project.....WD8CHH 112

Super Duper for Field Day

 —system keeps the computer in a safe place.....WB5KVZ 114

A/D Converters Explained!

 —another enigma unraveled.....WB4UHY 122

73 MAGAZINE

nov. 80



Hurricane

Direct Conversion Lives!

—excitingly simple receiver project.....ZS6UP 64

Hams vs. Hurricane Allen

—73 aids St. Lucia relief efforts.....N8RK 70

Tune In the Wind

—a do-it-yourself hot-wire anemometer.....VE7DKR 80

Direct Printing FAX

—get photographic-quality reproduction for 6¢ a copy.....WB8DQT 90

A Computer-Controlled Talking Repeater

 —part II: microcomputer details.....WA6AXX 132

The Radio Spectrum at a Glance

—from VLF to UHF, SWLing is fun.....WA4PYQ 142

Be Prepared!

—30 meters for the FT-101B.....KB8NO 156

Automated Operating Comes of Age

—Microlog's ATR-6800.....K3CMY 170

New Weather Eye in the Sky

—a primer on NOAA's TIROS...WB8DQT 176

Never Say Die—6, Looking West—12, DX—14, Contests—16, RTTY Loop—18, Awards—20, Leaky Lines—23, Ham Help—23, 188, 198, 200, Letters—26, OSCAR Orbits—28, Fun!—30, New Products—32, Social Events—184, FCC—200, Review—200, Dealer Directory—225, Propagation—225

W2NSD/1 NEVER SAY DIE

editorial by Wayne Green



CRFI

There are two ways of going about getting into RTTY these days...one via the old noisy Teletype™ machines and the other via a simple connection to any of the microcomputers. With some 35,000 active hams already having computers, the latter approach is the obvious one. Also, those hams not yet having computers need the extra push to get aboard this part of the electronics hobby.

The main drawback to using a microcomputer for RTTY is the hellish noise it generates at radio frequencies...and I mean right up into the VHF ranges. The problem here stems from the need for a clock frequency for synchronizing the signals traveling through the computer, which is usually in the 2-4 MHz range. That isn't so bad in itself, but all of your computer signals are digital (I hope that is not news) and this means square waves...and a square wave is made up of an almost infinite number of odd harmonics. The resultant of all that is rf hash which will boggle any radio in the vicinity of a computer.

The FCC, reacting with characteristic speed, took almost five years to discover that home computers were being built which were generating RFI. They sometimes remind me of the dinosaurs, whose nervous system was so slow that it took minutes for word to get to the brain when the tail had been stepped on. The FCC is not that fast. Eventually the news did reach the "brains" of the FCC...and I use that term in quotation marks for obvious reasons...and word came down on tablets for the microcomputer in-

dustry to start shielding their computers.

What this means to amateurs is this: If you want to wait until next January, you may find an assortment of relatively quiet computers being offered for sale. If you are impatient or have already made your investment, you'll want to know how to put a damper on all that racket.

First, I'm sure that the readers of 73 are, for the most part, as interested as I am in getting reports on the noise-proofing accomplished by the industry. If you get a new computer, you might make some noise measurements and let us know how successful you are in using the system in your ham shack...and how noisy or quiet it is on the various bands. Second, if you are going to tackle the shielding and bypassing of your computer, please make notes and pass along word of your success...or failure. That bypassing may be ticklish, since the rounding off of signals on data lines is not likely to enhance the operation of the computer, and some of the microcomputers are right on the edge of disaster in this department to start with. You'll have to be careful and check each move you make for a lessening of the noise and continued operation of the system. More is called for than putting in some aluminum foil around the bottom of the case.

This is a call for articles on the subject so our brethren can get their systems RTTYfied. We'll also want to know what you are using in the way of interfaces...and any other developments. Keep writing.

Can we expect much help

from the major villain—Radio Shack? Nothing encouraging on that front as yet. I've a copy of some correspondence one ham has had with Radio Shack and the degree of obtuseness is almost unbelievable. The ham asked about curing interference to his receiver and asked it quite clearly. The answer had to do with reducing TV interference...which, by the way, is not inconsiderable. My TRS-80 in my office wipes out the TV set in that room plus three upstairs...and I'm using cable!

The interference with most microcomputers is two-way, with the transmitter screwing up the computer as much as the computer wipes out the shack receiver. Even an HT can recycle many computers since the signal wires inside are unshielded for most systems. These wires run all over the place and act as very efficient antennas for both transmitting and receiving.

The newer Radio Shack systems are much quieter, so I know the industry will be able to meet the FCC specs in January. But that doesn't stop our need for ways to fix the systems we already have.

LETTER TO ADVERTISERS

It's time that I wrote a bit in the magazine aimed at advertisers and prospective advertisers...with some words which may also be of interest to the regular reader. The topic in particular has to do with those Reader Service cards which we put into the back of each issue of the magazine.

Readers should recognize that we spend a bundle on this service...and it is a service for both the advertiser and the read-

er. With a magazine the size of 73, we are talking about a couple thousand dollars for the cards to be printed and put in the magazine, a couple thousand more in postage to get them from you, and three or four thousand for the Neilsen Company to put the requests on a computer and send the labels to the advertisers. That's per month!

We used to be trying to do the computer part on our Prime, but with the breakdowns in the system, the service got a couple months behind and it was just one more disaster. We're hoping to get a microcomputer set up to handle the requests and thus be able to save a thousand or two dollars a month...a little here, a little there...it mounts up and the first thing you know we may have enough to print another 32-page section of the magazine.

One might think that the average full-page advertiser who is spending about \$80 of his ad money for this service would use it as productively as possible. Unfortunately, this is not always the case. Those firms which are making full use of the labels received tell us that the service is fantastic. Mail-order firms often get over 50% of their total sales from a particular ad from these labels. This means that firms which throw out the labels or who do not make effective use of them are essentially throwing out about 50% of the sales they might have gotten from their ad.

A full-page ad runs around \$1,500 these days and the rule of thumb is that this should bring in about \$15,000 in sales, minimum. Can you imagine firms being so disorganized that they knowingly throw out around \$10,000 in business each month? Perhaps this will explain to you why so many firms manage to go out of business, even when they have good products.

I'm sure you have had the same experience I have had...circling a number for a response on a product which interests me. When I do that there is a darned good chance that I will buy the product. But this can only happen if the firm gets information to me quickly, the information is well done, and the price is right. Then, if they make it simple for me to buy, they get my order on the spot.

Firms have discovered a num-

New 2-meter direction.



A compact transceiver with FM/SSB/CW plus...

TR-9000

Kenwood's done it again! Now, it's the exciting TR-9000 2-meter all-mode transceiver... complete with a host of new features. Combining the convenience of FM with long-distance SSB and CW in a very compact, very affordable package, the TR-9000 is the answer for any serious Amateur Operator! Versatile? You bet! Because of its compactness, the TR-9000 is ideal for mobile installation. Add on its fixed-station accessories and it becomes the obvious choice for your ham shack!

TR-9000 FEATURES:

- FM, USB, LSB, and CW... all popular modes
- Compact size... only 6 11/16 inches wide X 2 21/32 inches high X 9 7/32 inches deep
- Digital dual VFOs... with selectable tuning steps of 100 Hz, 5 kHz, and 10 kHz, convenient for each mode of operation
- Digital frequency display... five, four or three digits, depending on selected tuning step

- Extended frequency coverage... 143.9000 - 148.9999 MHz
- Five memories:
 - M1 - M4... for simplex or ± 600 kHz repeater offset
 - M5... for nonstandard offset (memorizes transmit and receive frequency independently)
- Scan of entire band... automatic busy stop and free scan
- SSB/CW search... sweeps over selectable 9.9-kHz bandwidth segments, for easy monitoring
- UP/DOWN microphone (standard)... "beep" sounds with each frequency step
- Noise blanker... eliminates pulse-type noise on SSB and CW
- Low-noise, dual-gate MOSFET and two-stage monolithic crystal filter for improved receiver front-end characteristics
- RIT (receiver incremental tuning) for SSB and CW... effective even on memory channels
- RF gain control

- CW sidetone
- Automatic selection of AGC time constant with MODE switch (slow for SSB and fast for CW)
- Improved power module for reliable and stable linear RF output
- Selectable power outputs... 10 W (HI)/1 W (LOW)
- Mobile mounting bracket... easy to mount, with quick-release levers
- LED indicators... ON AIR, BUSY, and VFO
- Accessory terminals on rear panel... KEY, BACKUP DC, STBY, EXT SP. DC, TONE INPUT, and ANT

See your Authorized Kenwood Dealer now for details on the TR-9000... the new direction in 2-meter all-mode transceivers!

NOTE: Price, specifications subject to change without notice and obligation.

MATCHING ACCESSORIES FOR FIXED-STATION OPERATION:

- PS-20 power supply
- SP-120 external speaker
- BO-9 System Base... with power switch, SEND/RECEIVE switch for CW operation, backup power supply for memory retention (BC-1 backup power adaptor may also be used for this application), and headphone jack



STAFF

PUBLISHER/EDITOR
Wayne Green W2NSD/1

ASSISTANT PUBLISHER/EDITOR
Jeff DeTray WB8BT/H

**ASSOCIATE PUBLISHER/DIRECTOR
OF PUBLICATIONS**
Edward Ferman WA1UFY

MANAGING EDITOR
John Burnett

ASST. MANAGING EDITOR
Susan Philbrick

NEWS EDITOR
Gene Smarte WB6TOV

EDITORIAL ASSISTANTS
Nancy Noyd
Richard Phenix

CONTRIBUTING EDITOR
Chris Brown N1AUI

ADMINISTRATIVE ASSISTANTS
Suzy Clyne
Pat Graham

ASSOCIATES
Robert Baker WB2GFE
Jim Cain K1TN
Bill Gosney WB7BFF
Sanger Green
Dave Ingram K4TWW
Larry Kahaner WB2NEL
Joe Kasser G3ZCZ
Dr. Marc Leavey WA3AJR
Dave Mann K2AGZ
Bill Pasternak WA6ITF
John Schultz W4FA
Peter Stark K2OAW

MANUFACTURING MANAGER
Noel Sell WB1ARP

**PRODUCTION MANAGER/
PUBLICATIONS**
Nancy Salmon

**ASST. PRODUCTION
MANAGER/PUBLICATIONS**
Michael Murphy

ART DIRECTOR
Diana Shonk

PRODUCTION
William Anderson III
Steve Baldwin
Tedd Cluff
Linda Drew
Robert Drew
Bruce Hedin
Kenneth Jackson
Ross Kenyon
Maryann Metevler
Dion Owens
Robert Sawyer
Patrice Scribner
Susan Symonds
John White

PHOTOGRAPHY
William Heydolph
Terrie Anderson

TYPESETTING
Barbara Latti
Sara Bedell
Mary Kinzell
Linda Locke

EXECUTIVE VICE PRESIDENT
Sherry Smythe

CORPORATE CONTROLLER
Alan Thulander

EXECUTIVE ASSISTANT
Leatrice O'Neil

ACCOUNTING MANAGER
Knud Keller KV4GG/1

CIRCULATION MANAGER
Debra Boudrieau

CIRCULATION
Doris Day
603-924-7296
Pauline Johnstone

BULK SALES MANAGER
Ginnie Boudrieau

ADVERTISING
603-924-7138
Jim Gray W1XU, Mgr.
Nancy Ciampa, Asst. Mgr.

ber of ways to discourage me from buying. Those firms who care so little about my business that they merely send me a copy of their ad... which I obviously had in the first place... are not going to get money from me. Firms which care so little that they don't include the prices of the product are wasting their postage and printing costs on me for their brochures go in the wastebasket. I have no intention of writing twice for information. I want to know about the product and the price is a key element for me... and for anyone else. The day is long off when I will buy something without even asking what the price is.

When I ask for information, I want to be sold. I do not want to get some silly little mimeo sheet or a small blah folder. I want to know what the product is going to do for me... why I should buy it... how much it costs... how I can get it quickly... things like that. The easier the firm makes it for me to buy, the more likely they are to get my money.

I also want to have confidence in the firm. A mimeo sheet tells me that this is just a couple of kids pretending to be in business. I want to deal with serious people who are more likely to have a good product and are going to stand behind it. A good businessman realizes that the image his firm projects is of great importance. His ads will be well done... professional. His literature will be professional. I figure, like most folks, that if a firm doesn't take care with their ads and literature, I really can't expect them to do better with their products and service.

Jim Gray, our advertising manager, mentioned the other day that several of the firms advertising in 73 were not following up on Reader Service requests. Well, I can understand some skepticism about the labels which might be left over from one of the other magazines in the field. They apparently just printed out labels from a large part of their subscriber list each month and sent these to the advertisers. The result was enormous piles of labels... and heavy literature and postage expenses for the advertisers... but with hardly anything to show for it in sales. Rather than suspecting foul play, many firms just got the idea that Reader Service labels are a waste of

time and money.

It's a pity that one magazine should screw things up for some of the others... and in the process get a number of firms used to virtually throwing away \$50,000 to \$200,000 in sales per year which they might have otherwise made.

From the ham viewpoint, it is a lot of fun to buy a new piece of equipment, but most of us want more information than appears in the ad before we are going to spend our money. Far too few advertisers tell the whole story, including price and how to order, all in their ad. So we have to go about buying in two steps... or more. If the product is sold through a dealer, I'm much in favor of that because that gives me a place to get service and someone I can have confidence in to back up the product. Even the best of products break down... and it can happen during the first hours of use. To have to send it (at my expense) all the way back to Seattle or someplace for repairs takes weeks and money, so I like to have a dealer taking care of this for me.

If you have found some of our advertisers to be doing a first-rate job of responding to your requests for information, please drop me a line and let me know who they are. If you have trouble with some, I'd like to know that, too.

It is difficult for a magazine publisher to keep his hands clean in working with Reader Service requests. Many advertisers use these labels as the main indicator of the success of their ad (rather than making an effort to count sales). This sort of thinking forces some publishers to start cheating on the labels and adding some extra circles as the cards arrive to make sure that a particular advertiser gets lots of response. Even when we did all of our processing at the magazine, we were scrupulous about being honest with Reader Service requests... often watching advertisers go away to the other magazine which was cheating. That hurts.

I hope that every reader will use the card we bind into each issue. It's not only a way of getting information about products you are interested in buying, but it is also a sort of vote for the magazine which gets sent along to the advertisers... and it is

their ads which pay for the pages you read.

SIXTH ANNUAL INDUSTRY MEETING

The annual meeting of ham manufacturers, dealers, and publishers will take place, as usual, in Colorado during the second week of January. This comes right after the Winter CES show in Las Vegas. The meeting this year will be in Vail, running from Saturday to Saturday.

In addition to the usual feature of lots of skiing, there will be the usual symposiums on selling the ham market, aimed at helping dealers cope with the problems of 1981 such as shoppers using the 800 WATS lines, coping with manufacturer service and credit policies, and a look at the most profitable ham equipment for dealers to handle.

Manufacturers will be interested in sessions discussing needs for new techniques and circuits which should dominate ham sales in the next few years. Evaluations of the viability of equipment for satellite use, slow scan, RTTY, and other special modes will be explored. Why pay \$1,000 for a bogus industry report on hamming in the 80s when you can get one which is just as bogus at the Annual Industry Meeting and enjoy the \$1,000 while you ski. You might even have some money left over, if you can keep your wife out of the boutiques.

The emphasis is on bringing the industry together... friendship, eating, skiing... with some serious business discussions. Everyone will have HTs for keeping in touch while skiing or shopping around town, so don't forget to bring one or two of those.

You'll have to make your own reservations (good luck), but Vail is small.

Speaking of boutiques, I got to thinking about the shopping in Vail and Aspen (about 100 miles further from Denver), and it brought to mind a recent visit to San Marino, that small enclave in Italy (M1). Sherry and I were driving around Italy setting up sales for Instant Software and we decided to add one more country to my list of countries visited. San Marino, for those of you who have not taken the time to visit it, is a large mass

Continued on page 190

6 Meters + ICOM + Sunspots = The best DX



ICOM's 551D is Essential to the 6 mtr DX Formula.

The IC-551D is the high powered brother to the ICOM IC-551. With an 80+ watt output, you have all the punch you need for that really good DX when the Sunspots are working for you. The 551D has the same no-backlash, no-delay dual VFO light chopper system, coupled to the microprocessor for split frequency as well as completely variable offsets.

For quick access to DX excitement, three memories are provided for programmed beacon watching, which can be scanned and programmed to stop on the first one heard. A room full

of white noise is no longer a problem with ICOM. Pass band tuning and VOX are included at no extra cost.

SPECIFICATIONS

Frequency Coverage: 50~54MHz

Power Supply Requirements:

13.8V DC±15%, negative ground
Current drain 18A max.
(at 200W input). AC power supply speaker console is available for AC operation.

Emission Modes:

A3J SSB (USB/LSB)
A1 CW
A3H AM
F3* FM

Dimensions: 111mm (H)×
241mm (W)×311mm (D)

Weight: 6.6kg

Sensitivity: SSB/CW/AM

Less than 0.5μV for 10dB S+N/N
FM* More than
30dB S+N+D/N+D at 1μV

Squelch Sensitivity: SSB/CW/AM 1μV
FM* 0.4μV

Selectivity: SSB/CW/AM

More than ±1.1 KHz at -6dB
Less than ±2.2KHz at -60dB
Adjustable to 1KHz at -6dB
FM*

More than ±7.5KHz at -6dB
Less than ±15KHz at -60dB

*Only when FM Unit is installed.

HF/VHF/UHF AMATEUR AND MARINE COMMUNICATION EQUIPMENT



ICOM

ICOM AMERICA, INCORPORATED

Sales Service Centers located at:

2112 116th Avenue NE
Bellevue, WA 98004
Phone (206) 454-8155

3331 Towerwood Dr., Suite 307
Dallas, TX 75234
Phone (214) 620-2780

ICOM INFORMATION SERVICE

2112 116th Ave., N.E.
Bellevue, WA 98004

Q H

Z S

Please send me: IC-551D specifications sheet; full color ICOM Product Line Catalog; List of Authorized ICOM Dealers.

NAME _____ CALL _____

ADDRESS _____

CITY _____ STATE _____ ZIP _____

You may send a machine copy of this form



1 4.8	2000	118.8	2100
1 0.9	841	123.0	2150
1 07.2	852	127.2	2200
1 03.6	1850	131.4	2250
1 00.0	770	136.5	2300
94.8	1850	141.3	2350
91.5	1800	145.2	2400
88.5	897	151.4	1209
85.4	1750	156.7	2450
82.5	1700	162.2	2500
79.7	1650	167.9	2550
77.0	1600	173.8	1338
74.4	1500	179.8	2175
71.8	1000	186.2	1477
67.0	800	192.8	1831
	OFF	203.5	2804

Communications Specialists TE-64

Food for thought.

Our new Universal Tone Encoder lends it's versatility to all tastes. The menu includes all CTCSS, as well as Burst Tones, Touch Tones, and Test Tones. No counter or test equipment required to set frequency-just dial it in. While traveling, use it on your Amateur transceiver to access tone operated systems, or in your service van to check out your customers repeaters; also, as a piece of test equipment to modulate your Service Monitor or signal generator. It can even operate off an internal nine volt battery, and is available for one day delivery, backed by our one year warranty.

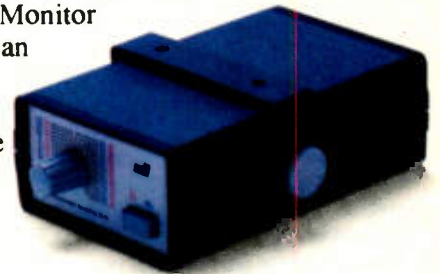

- All tones in Group A and Group B are included.
- Output level flat to within 1.5db over entire range selected.
- Separate level adjust pots and output connections for each tone Group.
- Immune to RF
- Powered by 6-30vdc, unregulated at 8 ma.
- Low impedance, low distortion, adjustable sinewave output, 5v peak-to-peak.
- Instant start-up.
- Off position for no tone output.
- Reverse polarity protection built-in.

Group A

67.0 XZ	91.5 ZZ	118.8 2B	156.7 5A
71.9 XA	94.8 ZA	123.0 3Z	162.2 5B
74.4 WA	97.4 ZB	127.3 3A	167.9 6Z
77.0 XB	100.0 1Z	131.8 3B	173.8 6A
79.7 SP	103.5 1A	136.5 4Z	179.9 6B
82.5 YZ	107.2 1B	141.3 4A	186.2 7Z
85.4 YA	110.9 2Z	146.2 4B	192.8 7A
88.5 YB	114.8 2A	151.4 5Z	203.5 M1

- Frequency accuracy, $\pm .1$ Hz maximum - 40°C to + 85°C
- Frequencies to 250 Hz available on special order
- Continuous tone

Group B

TEST-TONES:	TOUCH-TONES:	BURST TONES:			
600	697 1209	1600	1850	2150	2400
1000	770 1336	1650	1900	2200	2450
1500	852 1477	1700	1950	2250	2500
2175	941 1633	1750	2000	2300	2550
2805		1800	2100	2350	

- Frequency accuracy, ± 1 Hz maximum - 40°C to + 85°C
- Tone length approximately 300 ms. May be lengthened, shortened or eliminated by changing value of resistor

Wired and tested: \$79.95



COMMUNICATIONS SPECIALISTS ✓ 15

426 West Taft Avenue, Orange, California 92667
(800) 854-0547/ California: (714) 998-3021

LOOKING WEST

*Bill Pasternak WA6ITF
24854-C Newhall Ave.
Newhall CA 91321*

A few months ago we reported that TASMA, southern California's 2-meter coordination council, was faring poorly in comparison to its 220-MHz counterpart. Having to report this hurt on a personal level in that I had spent many years working with the SCRA prior to the 1979 split that led to the formation of both TASMA and 220-SMA. I am happy to report that things are getting a lot better for TASMA. Interest in the organization is again growing and so is its overall membership. In fact, the only things missing are the old-line repeater owners. These are the people who formed the original SCRA and decided to boycott the TASMA organization when the new structure permitted non-repeater owners a voting voice.

According to my friend Bob Thornburg WB6JPI, who still serves with TASMA, the turn-about began when the current chairman, Tom Polley WA6GEV, decided to hold regularly scheduled Technical Committee meetings which were open to the general amateur public. Attendance at these meetings has grown to the point where more amateurs show up for Technical Committee meetings than usually come out to general membership meetings. Bob told me that having 40 or 50 amateurs show up at a Tech Committee meeting is not uncommon. Moreover, those attending show a definite interest in what's happening. Some are the new-generation repeater owners, while others are simply spectrum users. Note I said "spectrum" rather than "repeater" users. This is because the new open format in TASMA is pulling a total cross-section of the southern California 2-meter community—not just FM people.

I doubt if TASMA will ever get the old-liners back in the fold. They seem to live in their own world. Many have openly called the "user" an unnecessary by-product of a repeater ownership and have made themselves totally unavailable to TASMA,

their users, or anyone else. I guess they still see themselves as the gods of the mountain-tops, but the days of repeater gods are gone. For a while, there were rumors abounding that the old-liners were about to make a comeback of their own with a totally new organization to challenge the viability of TASMA and 220-SMA, but this has not happened and I doubt if it ever will. Under its current leadership, TASMA has weathered the worst of the storm and is now on the road to becoming a national leadership organization in the field of voluntary spectrum management.

SEANARC '80

This year's ARRL National Convention, dubbed SEANARC '80 by its sponsors, was held at a beautiful motor hotel known as the SEA-TAC Airport Red Lion Motor Inn. Arrival and departure were a snap. Within 30 minutes of deplaning, we were at the convention site, baggage in hand. In fact, the Red Lion sent over a courtesy car to pick me up and drive me over. Now, that's service.

I did not attend last year's conclave in Baton Rouge, but I have heard the disaster reports first-hand, especially from disgruntled dealers and manufacturers who were unhappy with the way things went. I think that Newington must have listened to the complaints, because none were heard this year. I tape-recorded interviews with at least half of the manufacturers, manufacturer reps, and dealers, and to a man they were ecstatic about the facilities and crowd turnout at SEANARC '80. Both DSI and Opto just about sold out all their merchandise, and new products at the manufacturers' booths drew day-long crowds. There was even a very novel grand prize: a year's lease on a VW Rabbit equipped with a two-meter radio.

There were seminars galore, running right through to the close of the show on Sunday. In fact, that was the reason I was in attendance. I had been asked by the planners of two seminar sessions to appear on their pan-

els, and I spent most of Saturday morning and part of the afternoon on the dual session repeater-FM panel. I had to excuse myself around 2:30 in order to make it to the media seminar. Both were well attended. I'll get into more detail about these two seminars later on, but for the moment let me continue with the convention overview.

Saturday night's banquet was a total sellout even before I arrived. In fact, I did not get to the banquet and wound up having dinner with two friends at a restaurant. I can give you a simple reason for the banquet sellout: Its featured speaker was my friend Roy Neal K6DUE of NBC News. Roy is probably one of the best public speakers around these days. His stories of the early days of amateur radio and covering the early days of the space race, combined with his personal projections for the future of amateur communications, make for a truly awe-inspiring evening. I know this for a fact, as I was at his talk in St. Louis at ARCH '80 when he left his audience spellbound. I was able to obtain an audio tape of his talk this time and spent a good part of the next morning pulling out bits and pieces of it and fitting them into a Westlink newscast that would air that evening, even before I returned to Los Angeles. At about 10:00 am Sunday morning, I cornered Gordon West WB6NOA and conned him into playing reporter for this story. We went off for half an hour and recorded the anchor script on cassette. An hour later, the tape cassette of Roy's talk, another with Gordon's report, and a copy of the script were en route back to Westlink's Production Coordinator, Bill Orenstein KH6IAF, in Los Angeles.

Every convention has a certain air about it. A topic that's on just about everyone's lips. This one was no different, and the topic of the day seemed to be combatting the problem of willful and malicious interference caused to amateur communications by other amateurs who chronically violate the amateur regulations. Maybe the presence at the convention of Joe Merdler N6AHU (who has been leading the cleanup campaign) and the head of the League's Ad-Hoc Committee on Malicious Interference, Carl Smith W0BWJ, along with Southwest-

ern Division Director Jay Holladay W6EJJ (also an activist in this area) had something to do with this. I cannot say. I will tell you that the problem itself and finding solutions to it were on just about everyone's lips. An example of this was at the Repeater and FM Forum, at which the topic dominated at least half of the morning session and came up again at the afternoon session. It was at this forum that I first learned that the League had announced the formation of a new task force to work at combatting the problem on all levels. The exact make-up of this task force was not announced, though it will have as members those who are considered experts in the problem and finding solutions to it. Carl did remark that a good deal of the effort will be made at the local level through existing radio clubs, repeater councils, and T-hunt groups. Exactly how the task force will perform its appointed duties was not made clear.

As long as we are talking about the Repeater-FM Forum, let me continue for a moment. This session was hosted by the Western Washington Amateur Relay Association, or WWARA for short. The panel consisted of WWARA President John Marcinko W7FHZ, Secretary Clay Freinwald K7CR, and members Dale Justice K7WWR and Bob St. Andre WA7NAN. Others included ARRL Vice President Carl Smith W0BWJ, Hudson Division Vice Director and VRAC board liaison George Diehl W2IHA, Oregon Regional Relay Council UHF Coordinator Neil McKie WA6KLA, and yours truly. I should note that I was not a directed representative of TASMA, 220-SMA, or SCRRBA. I was asked by Ray Clark K5ZMS of SMIRK to represent 6-meter weak-signal interests at the meeting, but in actuality I was invited based on my experience in frequency coordination matters rather than as a representative of any one specific group. I must say that being in this position made me feel more at ease than when I have had to represent someone else's views as has happened in the past on occasion. I kind of like being able to be myself and speak my own mind. This seminar put me in that very position and I felt very

Continued on page 189

enter the new world of TEN-TEC

OMNI-Series C



new features, new performance + all 9 hf bands

NEW — ALL 9 HF BANDS. Full coverage from 160 through 10 Meters. Ready to go, with crystals supplied for seven bands (crystals for 18 and 24.5 MHz bands available when bands are ready for use).
ALL SOLID-STATE. From the pioneer.
BROADBANDED. From the pioneer.
NEW 3-MODE, 2-RANGE OFFSET TUNING. Another TEN-TEC first... (1) Offset Receiver Tuning, (2) Offset Transmitter Tuning and (3) Offset Transceiver Tuning. None other has it. For complete flexibility, to meet all needs, fine tuning or DX. 2-ranges: ± 500 Hz or ± 4 kHz.
OPTIMIZED RECEIVER SENSITIVITY. For an ideal balance between dynamic range and sensitivity... from $2 \mu\text{V}$ on 160 to $0.3 \mu\text{V}$ on 10 Meters.
NEW OPTIMIZED BANDWIDTH. Seven response curves—four for SSB, three for CW. Standard i-f filter is an 8-pole 2.4 kHz crystal ladder type. Options include a 1.8 kHz 8-pole crystal ladder type, a 500 Hz 8-pole CW filter and a 250 Hz 6-pole CW filter. Switch an optional filter from the front panel to put it in series for up to 16 poles of filtering. And the standard CW active audio filter has 450 and 150 Hz bandwidths for added attenuation. New toggle switches select i-f and audio filtering. Selectivity for any situation.
BUILT-IN NOTCH FILTER. Variable null eliminates unwanted signals and carriers in a pass band from 200 Hz to 3.5 kHz with a notch depth of more than 50 dB.
NEW BUILT-IN NOISE BLANKER. Standard equipment. New 2-pole monolithic crystal filter handles big signals easily, makes impossible locations usable.
GREATER DYNAMIC RANGE. Better than 90 dB, typically. Reduces front-end overload and distortion. Plus a PIN diode switchable 18 dB attenuator on the RF gain control.

NEW "HANG" AGC. Smoother operation.
2-SPEED BREAK-IN. "Fast" or "Slow" speeds. "Fast" for instant, full break-in. "Slow" has a longer mute time before receiver is actuated for working crowded bands with heavy QRM and for mobile.
WWV RECEPTION. On the 10 MHz band.
DIGITAL READOUT. 6 shielded 0.43" LEDs with 5 in red, the 6th (100 Hz) in green.
SEPARATE RECEIVING ANTENNA CAPABILITY. Use with separate components, instant break-in linears, or transverters.
"S"/SWR METER. Easy-to-read. Electronically switched.
200 WATTS INPUT. On all bands, when used with 50 ohm load. Proven, conservatively rated design. Fully warranted for first year, pro-rata warranty for five extra years!
100% DUTY CYCLE. Full power hour after hour without fail. Ideal for RTTY, SSTV or any hard usage.
BUILT-IN VOX AND PTT. Smooth VOX with 3 front panel controls. And PTT control at both front and rear panel jacks.
BUILT-IN PHONE PATCH JACKS. Easy interface to speaker and microphone signals.
BUILT-IN CW ZERO-BEAT SWITCH. Puts you on exact frequency of a station being worked without being on the air.
BUILT-IN ADJUSTABLE SIDETONE. Vary pitch and volume for easy listening.
ADJUSTABLE THRESHOLD AUTOMATIC LEVEL CONTROL. From low power to full output with full ALC control.
FRONT PANEL CONTROL OF LINEAR OR ANTENNA. Auxiliary bandwidth terminals on rear panel permit simultaneous control of external relays or circuits.

AUTOMATIC SIDEBAND SELECTION. And you can reverse it with the mode switch.

SUPER AUDIO. A TEN-TEC trademark. Proper shaping plus low distortion.
IMPECCABLE SIGNAL. Clean. Easily exceeding FCC requirements, thanks to meticulous design, fine components, and conservative ratings.
HIGH STABILITY. Deviation is no more than 15 cycles per degree temperature change after warm-up.
HIGH ARTICULATION KEYING. 2½ msec rise and decay time for sharp, clean keying.
BUILT-IN SPEAKER. Built into the bottom of the cabinet shell. Compression-loaded for better quality and higher efficiency. External speaker connections on rear panel.
PLUG-IN CIRCUIT BOARDS. For easy removal if needed.
FUNCTIONAL STYLING. Dark front panel, convenient control groupings, "clamshell" cabinet, full shielding, and easier-to-use size: 5¼" h x 14¼" w x 14" d.
POWER. Operates on 12-14 VDC for mobile or storage battery use. For 117 VAC use, an external supply is required.
FULL ACCESSORY LINE. Model 217 500 Hz CW filter \$55, Model 219 250 Hz CW filter \$60, Model 218 1.8 kHz SSB filter \$55, Model 243 Remote VFO \$139, Model 255 Power Supply/Speaker \$169, Model 280 Power Supply \$139, Model 645 Dual Paddle Keyer \$85, Model 670 Single Paddle Keyer \$34.50, Model 234/214 Speech Processor & Condenser Microphone \$163, Model 247 Antenna Tuner \$69. All in matching color.

Model 546 OMNI-Series C \$1189

See your TEN-TEC dealer, or write for full details.

TEN-TEC, INC.
 SEVIERVILLE, TENNESSEE 37862
 EXPORT 5715 LINCOLN AVE., CHICAGO, ILL. 60644

DX



Jim Cain K1TN
306 Vernon Avenue
Vernon CT 06066

Last night I dreamed it was the peak of the sunspot cycle, all the new HF bands were in place, and I was sitting at the radios with five minutes to go before the big DX contest. I had antennas for all nine bands on 160-10 meters and was ready for a big effort. With four minutes to go, I programmed the memory keyer, sharpened all the number three pencils, and made certain I had a "dupe" sheet for every band; it took three cut up grocery cartons to provide backing for nine sheets and they were strewn here and there.

With three minutes to go, I checked 160, often open at 0000 UTC this time of year; yep, some Caribbean DXpeditions were warming up for their skeds at contest beginning. 80 was open to Europe pretty well, ditto on 40. The new 10-MHz band sounded like 40, only with stronger signals. Good old 20 meters was going to be open all forty-eight hours of the activity. Two minutes to go as I checked 18 MHz;

Japanese contesters warming up there, as on 21 and 24 MHz. Heard deep Russian Asians on 10 meters. What band to do first?

A minute left now, with commercial amplifier warmed up, homemade linear for the three new bands cooking away, transceiver with its 15-position band-switch ready. I reached for the 10-position antenna selector knob but it started spinning by itself—160, 80, 40, 30, 20, 18, 15, 12, 10, dummy, dummy, dummy. The automatic digital selector which puts the transceiver on the appropriate amplifier began clacking away in unison but out of sync with the antenna switch. Then dupe sheets began flying around the room in a paper hurricane but there was no wind anywhere and...

I put the headphones on to hear what was happening to cause this (nuclear war, maybe?) while the receiver switched itself from band to band and mode to mode. It was JA stations on 160, static on 10 meters, the Woodpecker, or was it just my ears? Then the clock struck. Everything went back to normal electronically and I had a nervous breakdown.

Of course it was only a dream, but this is no joke. Mel Farrer of KLM Electronics gave a talk last month at one of the conventions on the coming new bands and hinted that log periodic antennas just may be a necessity to the operator who wants to have

capabilities everywhere he is allowed in the HF spectrum. DXers have always been ready for any contingency: The Caribbean DXpedition which falls prey to extremely poor conditions and can only make contacts on 3.5 MHz CW, for example.

It has been just a year since word began sneaking out of WARC that some new allocations were in store for amateurs. Of course, we don't have them yet, but another year might see at least one band open. The ARRL Board of Directors has already made recommendations on the 10-MHz band, and the others will be undoubtedly treated in upcoming meetings. Some manufacturers already had radios that could be crystallized for a certain number of new bands and others have come out with brand new rigs that can work on the three new slots. Pretty soon the rest will have caught up and certainly the antenna manufacturers only have to change a few cutting fixtures to make new lengths of booms, elements, quad spiders, and matching devices. We in the industrialized countries will be ready. Amateurs in areas where home brew is still the norm will have more work cut out for them but we wager that come opening gun, the Russians and others will be there with us.

Remember November, 1968, when the new Extra class segments on 80- and 15-meter phone opened up? Both were packed at 0000 UTC, although there had been some doubt as to if the FCC had meant November 23 local time or UTC. What the heck, hams use UTC and who could wait? That was an ex-

citing evening, but when an entirely new *band* opens, the Extra segments will pale by comparison. It will be the biggest happening since the opening of 15 meters 25 years ago.

We are currently struggling with an antenna dilemma which hints at the nature of the upcoming situation. Our old dilapidated tower will support one antenna and one human being at the top—no more. Our 6-element tribander is coming down to make way for a homemade 7-element 10-meter beam in honor of 1980, probably the last truly good year of this sunspot cycle. That will mean no beam on 15 or 20 meters, but it is nice to be really competitive on at least one band! If a new country comes on but avoids 10 meters, we can probably work them with the vertical on one of the other bands. The tribander works OK on all three bands but is just not a *real* beam, in our eyes. It is time to get used to that sort of thing because the new bands are going to require a bunch of compromises by most of us. There will be a lot of dipoles in use on the new bands that first season, which might not be a bad thing as it will allow more people to use the bands, signals not being so overpowering. Much of the activity will be sans amplifier, too, also not a bad thing.

And don't forget the race for 7-band DXCC, 7-band WAZ, and 7-band WAS!

As for this year, in early September 10 meters was already open to Japan from the East Coast. As the peak of the current sunspot cycle is generally accepted to have taken place in November, 1979, it would seem



Anne DF3KX/FR0ACB and husband Hans DK9KX, working CW from Glorioso.



These were the antennas near the operating site of last April's Glorioso Island operation by a six-member German team.

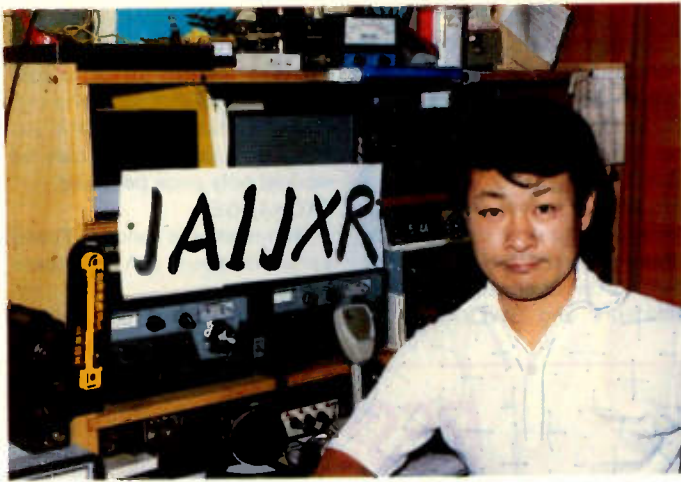

Active Japanese DXer JA1JXR proudly displays his American-made ham gear!



FH8YL (above) and husband FH8OM are the two active amateurs on Mayotte Island.

reasonable to assume that 1980 will be about the same propagation-wise as 1978, and thus far that is holding true. K1RM set an all-time record in the CQ Worldwide Phone Contest last year on 15 meters, the highest single-band score ever on any band, and he is out after 10 meters this year. His record, if not broken in 1980, will surely stand until the next sunspot peak. VP2KC made an incredible 38 million points in the multi-transmitter category which may also stand for a few years.

In some ways, it might have been fun to get the new HF bands now, at the peak, but that also might have diluted their impact. Actually, they will be most handy when sunspots are down, as we will all have more choices of where to effect our communications. And we are being given time to gear up for them (pun intended) by having a few years. Now, if the deal doesn't fall through (you know politicians), we will be ready.

ROCKS AND REEFS UNLIMITED

About two dozen entities on the DXCC countries list have no permanent population; some have weather stations with rotating crews and some just have zero people always, except for a boatload of visiting hams every decade or so. With some regularity, the "should these count for DXCC?" question comes up. The arguments are well-worn but bear repeating here.

On the pro side of the argument, the justification goes like this. Although uninhabited rocks and reefs are certainly not "countries" in the average person's eyes, and even though

DXers refer to them as "entities," not countries, they are legitimate for DXCC because DXCC is merely a game which the rocks and reefs make more interesting and fun to play.

And besides, the R and Rs are not as rare on the radio as some countries. Furthermore, world politics actually plays little part in DXCCing, thus no attempt need be made to have DXCC re-

fect the world at large, i.e., real countries.

The con side of the argument points out that it is nearly im-

Continued on page 187

Call	Via	OH0SUF	OH1PA
A4X1H	G4GIR	OH2VY/OH0	Callbook address
A7XA	DJ9ZB	OH0XZ	OH2KI
A7XD	PO Box 4747, Doha, Qatar	OJ0MA	8/80 OH0NA
CO7RCB	Box 52, Camaguey (No IRCs)	PJ2FR	K2TJ
CS1BI	CT1XK	P29LB	WB2FLB
CT2CE	AG1K	DJ1US/ST3	DF2RG
CT2DE	WB3IFD	SV0AO	KA2FRP
C31MJ	EA3NE	SV0AT	AF4B
C31MK	EA3WZ	TL8JM	W5RU
C31MS	EA3MS	TU2IJ	Box 520, Abidjan
C31TD	WA3OMQ	TU4AT	HB9BTQ
C31UB	DL7HZ	TU4AW	K5TC
C31UI	K7VAY	T3AT	G3XZF
C31UN	DF3HN	UA1PAL	UA1OSM Box 47, Archangel
C31UZ	WB7VDN	VK9CCT	VK5QX
C5ABK	G3LQP	VK9ZG	VK3OT
C5ACC	KB4GQ	VP2KC	W4HR
C5ACO	W2TK	VP2MM	W1CDC
DX3UB/1	JA3UB	VP2VGA	WA3UBN
WA2UUK/DU	WB9MFC	VP8PP	W6TKV
D68AP	WB2OHD	VQ9CY	K5HK
EA9GJ	Box 544, Cueta	VU2RAK	WB0TNY
EL6A	K4SE	YJ8DH	JA3ARY
FB8XY	F6CIU	YJ8IND	Box 39, Port Villa, Vanuatu
FB8ZO	F6EYB	ZB2GK	Box 292
FM7BW	WB4IWW	ZK1CF	ZL2AQF
FM7WW	WB4AXN	ZK2YY	K5YY
FM0FJE	F5VU	ZL3MA/C	WB8WMS
FP0FOM	FP0FON W1IHN	3B8BD	K5BDX
FR0FLO	Box 200, Tampon via 97430 France	3B8ZV	ZL1BIL
DJ2BW/HB0	Callbook address	3B9ZV	ZL1BIL
DF4GU/HB0	Callbook address	3D2EI	W5RBO
HK0BKX	WB4QFH PO Box 1139, West Palm Beach FL 33402	3D6BS	N7RO
HS1AMI	VE3DPB	4S7EA	WB9OQU
H44PD	Box 350, Hanlari, Solomons	5H3AA	Box 83, Bagamoyo, Tanzania
H44SH	AD1S	5N0KUY	J11MD
I212C/IA5	I2USR	5Z4YV	JA2AJA
J28AZ	I8JN	6O0DX	I2YAE
KG4KK	N6AWD	8Q7AZ	Four Winds, Male, Maldives
KG4WM	WB1COR	9G1RF	WA1ZFS
KC6DC	AD1S. G. Adkins, PO Box 32735, Oklahoma City OK 73123	9G1RI	Box 76, Ghana
W6SOT/LX	KA5CCD	9M8PW	Bureau
		9Z7CSJ	9Y4BW

QSL Managers—Lists of QSLing information are available everywhere, and we do mean everywhere. We have tried to make this list useful in a special way by listing stations actively worked on the bands during the month of August. This is a regular part of this DX column in 73. You will note some listings which are the same as they have been for years. The idea is to provide you with useful information for your recent DXing.

CONTESTS



Robert Baker WB2GFE
15 Windsor Dr.
Atco NJ 08004

DELAWARE VALLEY RADIO ASSOC. QSO PARTY

Starts: 0000 GMT November 1
Ends: 2400 GMT November 2

The Delaware Valley Radio Association is celebrating its 50th year of operation with this first annual QSO party. Contestants must work a total of five DVRA members on 80 through 10 meters during the 48-hour period. Use the lower portion of each General class phone and CW band.

Log sheets are to be submitted to: William Cunnane KA2BBZ, Apt. 18, Princeton Arms East, Cranbury NJ 08512. Please include an SASE. All participants with the required number of QSOs will receive a formal printed award.

DELAWARE QSO PARTY

Starts: 1700 GMT November 8
Ends: 2300 GMT November 9

Sponsored by the Delaware ARC. Stations may be worked

once per band and mode for QSO and multiplier credits.

EXCHANGE:

QSO number, RS(T), and DEL county, ARRL section, or country.

FREQUENCIES:

CW—1805, 3560, 7060, 14060, 21060, 28160.

SSB—1815, 3975, 7275, 14325, 21425, 28650.

Novice—3710, 7120, 21120, 28120.

SCORING:

DEL stations score 1 point per QSO. Multiply total by the number of ARRL sections and DX countries worked.

Others score 5 points per DEL station worked. Multiply total by the number of DEL counties worked on each band and each mode (maximum of 36 multipliers possible). Three DEL counties are Kent, New Castle, and Sussex.

ENTRIES & AWARDS:

Appropriate awards will be given to the top scorers. In addition, a certificate will be awarded to all stations working all three Delaware counties. If you work all three counties and want the WDEL Award, send two 15-cent stamps and an address label. Mail logs by December 15th to: Charlie Sculley AE3H, 103 E. Van Buren Avenue, New Castle DE 19720. Send an SASE for a copy of the results.

CALENDAR

Nov 1-2	ARRL Sweepstakes—CW
Nov 1-2	Delaware Valley Radio Assoc. QSO Party
Nov 8-9	European DX Contest—RTTY
Nov 8-9	IPA Contest
Nov 8-9	Delaware QSO Party
Nov 9	International OK DX Contest
Nov 15	DARC Corona 10-Meter RTTY Contest
Nov 15-16	ARRL Sweepstakes—Phone
Nov 29-30	CQ Worldwide DX Contest—CW
Dec 6-7	ARRL 160-Meter Contest
Dec 6-8	Connecticut QSO Party
Dec 13-14	ARRL 10-Meter Contest
Jan 10-11	Hunting Lions in the Air
Jan 17-18	73's International 160-Meter Phone Contest
Jan 18	FRACAP Worldwide Contest
Mar 7-8	1981 SSTV Contest

IPA CONTEST

Contest periods are: 0700 to 1000 and 1400 to 1800 GMT on both days, November 8 & 9

The International Police Association Radio Club (IPARC) British Section is sponsoring this year's contest. Participants are eligible to work the Sherlock Holmes Award (SHA) and the contest is open to all radio amateurs and SWLs. Use all

bands on CW and SSB. No cross-band or cross-mode contacts are permitted. For a contact to be valid, one of the two stations must be an IPA RC member. Each station can be worked only once per band.

EXCHANGE:

Non-members send RS(T) and serial number. IPA members

Continued on page 199

RESULTS

1980 MASSACHUSETTS QSO PARTY

<i>Bristol County</i>		<i>Colorado</i>	
K1KJT	91,576	KA0CLS	104
N1AS	15,150	<i>Delaware</i>	
W1FJI	14,112	N3AHA	388
<i>Essex County</i>		<i>Georgia</i>	
WA1UZH	10,802	K4VN	326
<i>Franklin County</i>		<i>Kentucky</i>	
K1UR	554	WA4QMQ	146
<i>Hampden County</i>		AB4Y	140
K1UR	6	<i>Montana</i>	
<i>Hampshire County</i>		K7PGL	182
K1NWE	90,530	KA1EA	58
K1UR	342	<i>Nebraska</i>	
<i>Plymouth County</i>		W0OLL	74
WB1ANT	165,330	<i>New Mexico</i>	
KA1GG	70,710	KB5DQ	140
K1VUT	18,142	<i>New Jersey</i>	
<i>Berkshire County</i>		K9CW	168
WB1HIH	104,576	WA2WJL	156
K1UR	9,230	W2CC	8
<i>Middlesex County</i>		KA2EGO	8
KA1CLV	4,500	<i>New York</i>	
K1UR	176	WB2THN	196
<i>Norfolk County</i>		W2WSS	150
N1ADY	10,878	<i>N. Dakota</i>	
K1MEM	7,602	KC0W	112
K1UR	170	<i>Oklahoma</i>	
<i>Suffolk County</i>		WD5ICO	170
N1EE	68,262	KA5FVJ	8
K1UR	24	<i>Oregon</i>	
<i>Worcester County</i>		KA7EOG	74
K1UR	156	<i>Pennsylvania</i>	
		WA3JXW	24
<i>STATES</i>		<i>Washington</i>	
<i>Arizona</i>		WD0OCL	372
AK7J	58	K7NW	66
<i>California</i>		<i>Wisconsin</i>	
W6TPC	582	K9GTQ	324
W6OUL	120	K9GDF	210

High Novice Score KA1CLV with 4,500 points
High Score in 1980 Mass. QSO Party—

WB1ANT with 165,330 points

High Club Yankee Clipper Contest Club with 244,394 points
K1UR worked 8 counties mobile—

1st in 3, 2nd in 4, and 3rd in 1.

LU6EF 1st Argentina
PA3AIC 1st Netherlands

SPONSORS

K1KJT, N1AS, W1FJI

A LIFETIME GUARANTEE AND 11 OTHER REASONS TO BUY AN "OPTOELECTRONICS" FREQUENCY COUNTER

- 1. SENSITIVITY:** Superb amplifier circuitry with performance that can't be matched at twice the price. Average sensitivity of better than 15 mV from 10 Hz to 500 MHz on every model and better than 30 mV from 500 MHz to 1.1 GHz on the Series 8010A and 8013.
- 2. RESOLUTION:** 0.1 Hz to 12 MHz, 1 Hz to 50 MHz; 10 Hz over 50 MHz.
- 3. ALL METAL CASES:** Not only are the heavy gauge aluminum cases rugged and attractive, they provide the RF shielding and minimize RFI so necessary in many user environments.
- 4. EXTERNAL CLOCK INPUT/OUTPUT:** Standard on the 8010/8013 series and optional on the 7010 series is a buffered 10 MHz clock time base input/output port on the rear panel. Numerous uses include phase comparison of counter time base with WWVB (U.S. National Bureau of Standards). Standardize calibration of all counters at a facility with a common 10 MHz external clock signal, calibrate scopes and other test equipment with the output from precision time base in counter, etc., etc.
- 5. ACCURACY:** A choice of precision to ultra precision time base oscillators. Our ± 1 PPM TCXO (temperature compensated xtal oscillator) and ± 0.1 PPM TCXO are sealed units tested over 20-40°C. They contain voltage regulation circuitry for immunity to power variations in main instrument power supply, a 10 turn (50 PPM) calibration adjustment for easy, accurate setability and a heavily buffered output prevents circuit loads from affecting oscillator. Available in the 8010 and 8013 series is our new ultra precision micro power proportional oven oscillator. With $\pm .05$ PPM typical stability over 10-45°C, this new time base incorporates all of the advantages of our TCXO's and virtually none of the disadvantages of the traditional ovenized oscillator: Requires less than 4 minutes warm-up time, small physical size and has a peak current drain of less than 100 ma.
- 6. RAPID DISPLAY UPDATE:** Internal housekeeping functions require only .2 seconds between any gate or sample time

MODEL 7010A 600 MHz

- period. At a 1 second gate time the counter will display a new count every 1.2 seconds, on a 10 second gate time a new count is displayed every 10.2 seconds. (10.2 seconds is the maximum time required between display updates for any resolution on any model listed).
- 7. PORTABILITY:** All models are delivered with a 115 VAC adapter, a 12 VDC cord with plug and may be equipped with an optional ni-cad rechargeable battery pack installed within its case. The optional Ni-Cad pack may be recharged with 12 VDC or the AC adapter provided.
 - 8. COMPACT SIZES:** State-of-the-Art circuitry and external AC adapters allowed design of compact easy to use and transport instruments.
Series 8010/8013: 3" H x 7-1/2" W x 6-1/2" D
Series 7010: 1-3/4" H x 4-1/4" W x 5-1/4" D
 - 9. MADE IN U.S.A.:** All models are designed and manufactured at our modern 13,000 square foot facility at Ft. Lauderdale, Florida.
 - 10. CERTIFIED CALIBRATION:** All models meet FCC specs for frequency measurement and provided with each model is a certificate of NBS traceable calibration.
 - 11. LIFE TIME GUARANTEE:** Using the latest State-of-the-Art LSI circuitry, parts count is kept to a minimum and internal case temperature is only a few degrees above ambient resulting in long component life and reliable operation. (No custom IC's are used.) To demonstrate our confidence in these designs, all parts (excluding batteries) and service labor are 100% guaranteed for life to the original purchaser. (Transportation expense not covered).
 - 12. PRICE:** Whether you choose a series 7010 600 MHz counter or a series 8013 1.3 GHz instrument it will compete at twice its price for comparable quality and performance.

MODEL 8010A/8013 1.1GHz/1.3 GHz



MODEL	RANGE (From 10 Hz)	10 MHz TIME BASE			AVG. SENSITIVITY		GATE TIMES	RESOLUTION			EXT. CLOCK INPUT/OUTPUT	SENSITIVITY CONTROL	NI-CAD BATTERY PACK
		STABILITY	AGING	DESIGN	10 Hz to 500 MHz	500 MHz to 1.1 GHz		12 MHz	60 MHz	Max. Freq.			
7010A	600 MHz	± 1 PPM	<1 PPM/YR	TCXO*	15 mV	N/A	(3) 1, 1, 10 sec.	1 Hz	1 Hz	10 Hz (600 MHz)	YES OPTIONAL	NO	YES OPTIONAL
7010.1A		± 0.1 PPM											
8010A	1.1 GHz	± 1 PPM	1 PPM/YR	TCXO*	15 mV	30 mV	(4) .01, .1, 1, 10 sec.	1 Hz	1 Hz	10 Hz (1.1 GHz)	YES STANDARD	YES	YES OPTIONAL
8010.1A		± 0.1 PPM											
8010.05A		$\pm .05$ PPM											
8013.1		$\pm .05$ PPM											
8013.1	1.3 GHz	± 1 PPM	<1 PPM/YR	TCXO*	15 mV	30 mV	(4) .01, .1, 1, 10 sec.	1 Hz	1 Hz	10 Hz (1.3 GHz)	YES STANDARD	YES	YES OPTIONAL
8013.05		$\pm .05$ PPM											

TCXO = Temperature Compensated Xtal Oscillator **OCXO = Proportional Oven Controlled Xtal Oscillator

- SERIES 7010A**
- #7010A 600 MHz Counter - 1 PPM TCXO \$199.95
 - #7010.1A 600 MHz Counter - 0.1 PPM TCXO \$249.95
- OPTIONS:**
- #70-H Handle/Tilt Bail (not shown) \$2.95
 - #Ni-Cad-701 Ni-Cad Battery Pack & Charging Circuitry Installed Inside Unit \$19.95
 - #EC-70 External Clock Input/Output \$35.00
 - #CC-70 Carry Case - Padded Black Vinyl \$9.95

- SERIES 8010A/8013**
- #8010A 1.1 GHz Counter - 1 PPM TCXO \$399.00
 - #8010.1A 1.1 GHz Counter - 0.1 PPM TCXO \$450.00
 - #8010.05A 1.3 GHz Counter - .05 PPM Oven \$499.00
 - #8013.1 1.3 GHz Counter - 0.1 PPM TCXO \$550.00
 - #8013.05 1.3 GHz Counter - .05 PPM Oven \$599.00
- OPTIONS**
- #Ni-Cad-801 Ni-Cad Battery Pack & Charging Circuitry Installed Inside Unit \$49.95
 - #CC-80 Carry Case - Padded Black Vinyl \$ 9.95

- ACCESSORIES**
- #TA-100 Telescope antenna with right angle BNC \$ 9.95
 - #P-100 Probe, 50 Ohm, 1X \$13.95
 - #P-101 Probe, Lo-Pass \$16.95
 - #P-102 Audio Usage Probe, Hi-Z \$16.95
 - #LFM:1110 Low Frequency Multiplier X 10, X 100, X1000 For High Resolution of Audio Freq. \$119.95

Optoelectronics inc
5821 N.E. 14th Avenue, Fort Lauderdale, Florida 33334

1-800-327-5912
FROM FLORIDA (305) 771-2051/2

TERMS: Orders to U.S. and Canada, add 5% for shipping, handling and insurance to a maximum of \$10.00. All other orders add 15%. C.O.D. collection fee \$2.00. Florida orders add 4% state tax. Personal checks must clear before goods are shipped.

RTTY LOOP

Marc I. Leavey, M.D. WA3AJR
4006 Winlee Road
Randallstown MD 21133

November—the month of Thanksgiving! And what does a columnist have to be thankful for if not his readership. Let's take a look into the mailbag and see what some of you have had to say.

We start off this month with a note from Frank Salerno III in Weirton, West Virginia, who writes that he recently read 73's *Introduction to RTTY* (available from 73's Radio Bookshop at \$2.00) and was impressed by RTTY art. Frank wonders if there are any current sources of RTTY pictures.

Sorry to say, Frank, I know of none. A company representing itself as a purveyor of RTTY art popped up in these pages a number of months back, but no one had seen any products. It would seem as though some demand exists for this service, though, and perhaps someone will step into the void in the near future. Until then, though, the best way to get pictures is off the air, either in contacts or just by monitoring. Especially at this time of year, with the Christmas season approaching, the airwaves are full of sleighs, rein-

deer, and scantily clad girls. If you do not have facilities to receive, perhaps another ham in the area can help you out. Ask around.

Chaplain Paul E. Phelps WA8ZLJ/6, a major in the U.S. Army stationed in California, writes about his 6800 computer system, based on the Motorola MEK-D2. With 40K of RAM, a Percom LFD-400 disk, and a HAL DS-3000 terminal, Paul has more than a minimal system! He would like to use his ASCII printer, type unspecified, to copy off the air. His stumbling block is getting the five-level Baudot code into the computer for translation to ASCII.

Well, Paul, there is no way that I know of to input five-level Baudot at machine speed into an ACIA. Although the ACIA is basically a UART, it uses programmable registers to set up the bit pattern, speed, parity, etc. Five bits just ain't one of the choices! Now, you can, if you need to input through a serial port, use a conventional UART, such as the 1013, to input five bits onto an eight-bit bus, and just tie the extra bits down. The technique I use in my RTTY program, also written for the 6800, is to use one bit of a PIA as a software UART, much as Motor-

ola did when they created the (in)famous MIKBUG. Since you do not need the whole PIA for input, just one bit, you might look closely at your existing I/O slots to see if there is not one lone bit hanging around that you could use. The program published here about two years ago would make an easy job of receiving with such an input.

Another military man, Capt. S. C. Anderson W2GFN, USN RET, drops a line about a machine I have not heard much about. He has a Teletype Corporation Model 35 and believes that the loop current should be 500 mA. He notes that this is no real problem, as he has the 500-mA selector magnet driver card. He wonders, however, whether the magnets should be in series or parallel. Tell you the truth, Captain, I don't know. But I am sure one of our readers does, and I will pass along the information as soon as I get it.

A letter from Cary, North Carolina, brings news of a new RTTY repeater. Howard Cochran W4PPN relates that a group has formed to put a RTTY repeater on the air in the Raleigh, North Carolina, area. The frequency pair to be used will probably be 144.75/145.35 MHz, in the new lower subband. Apparently, the more widely used 146.10/146.70 pair was already in use in the area as a voice repeater. Howard makes a plea for groups in other areas to consider RTTY when laying out bandplans, as well as other non-voice users.

Of the continuing saga of getting this piece of equipment or that one onto RTTY, there is never an end. Charles Dykes K4CUU of Florence, Alabama, has been trying to key the FSK circuit on his Kenwood TS-180S with an Info-Tech M-150. While Info-Tech advised him that the keyboard should work just peachy, he has had problems. With FSK, he is reported as having hum or ac on his signal, with a fuzzy mark. No problems are noted with AFSK input or SSB, just on FSK. Grounds and all have been checked, and Charles even plugged a dummy plug into the jack and got the hum without the Info-Tech or cable attached. Kenwood drew a blank. Any of y'all (he is from Alabama!) have an idea? If so, drop me a note, and I will be sure to pass it along to Charles and the rest of us.

Storage of messages, pic-

tures, etc., is always a headache, especially if you have to contend with miles of punched paper tape. Some years back I tinkered with recording AFSK on tape as a storage medium; that was B.K.C. (Before Kansas City), don't 'cha know, but it worked, after a fashion. Now comes word from Stan Henderson N6BHT/DU2, a.k.a. NNNØIDR on Navy MARS, that he is doing just that, and doing it well. Fig. 1 is a diagram of just how he does it, too.

Stan uses a HAL DS-2000KSR terminal and HAL ST-5000 demodulator. The ST-5000 regenerates audio input as new AFSK output tones. Recording these clean tones solves many of the problems I used to have with recording off-the-air signals. He uses it to record many of the transmissions passing through his station, which otherwise would require paper tape. Since he uses common audio cassettes, he has many of the same advantages users of computer cassette interfaces enjoy, such as long recording times in a small package and easy availability of media.

The heartbreak Stan notes is when you record a picture at the beginning of the tape, thus on the leader. While Stan advises us to check the cassette carefully to wind the leader past the heads, he could also use the short leaderless tape now marketed for computer use.

A small audio transformer is used to match the speaker output to the 500-Ohm line; this would not be necessary if a 500-Ohm output were available from the receiver. Any small, cheap transformer of the appropriate impedance should suffice.

Stan has a viable system here, which should appeal to those who cannot get paper tape, or who need an auxiliary storage system. Incidentally, the RTTY Loop in the April, 1978, 73 Magazine covered various kinds of storage media, including audio tapes.

More on the boards for next month—"Something for Everyone," as the song goes. Have something you would like to share with other RTTY or computer freaks? Drop it along to me, at the above address, for inclusion in the Loop. Please remember, though, if you want a personal reply, to include a self-addressed, stamped envelope.

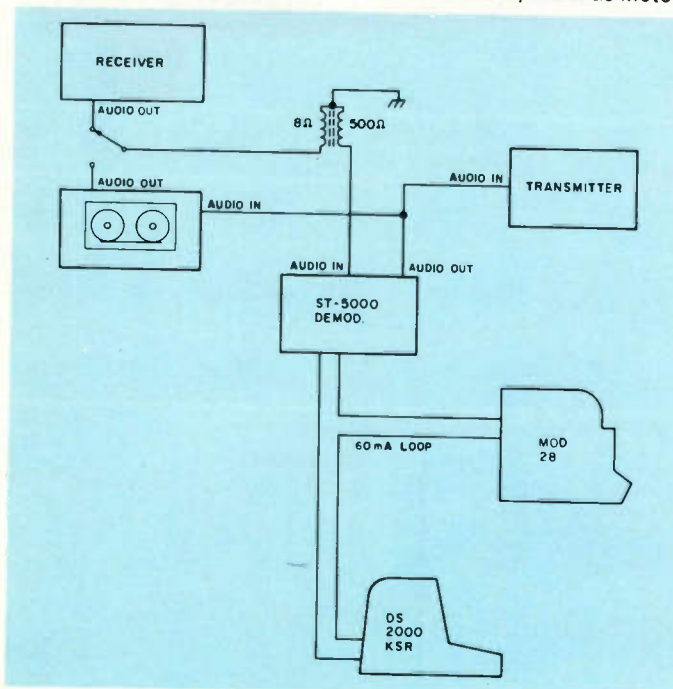

Fig. 1.

SOMETIMES THE BEST COSTS A LITTLE MORE...

**BUT you get a LOT more
for your money.
For instance:**

- Full length 72 character line and 24 line screen
- True "ASR" operation—type into 50 line on-screen buffer *while* receiving
- 150 line receive buffer and power off EAROM storage
- Ten HERE IS messages plus CW ID, WRU, and SEL-CAL
- Original split-screen plus bright/dim display of RX/TX text
- Control Functions *clearly marked* on the keytops
- On screen status indicators and time
- P31 eye-ease green screen phosphor (white also available)
- All three modes—CW, Baudot RTTY, and ASCII Computer code
- Upper/lower case ASCII with all control characters; 110-9600 baud
- ST6000 multiple active filters and detectors for super reception
- Crystal controlled TX tones matched to RX filters for true transceive
- Interface LOOP, RS232, MIL 188 and CMOS with no extra options to buy
- Full RS232 Modem connector and full or half-duplex for computer use
- HAL one year warranty and ten years' experience with RTTY

...AND THEN SOMETIMES IT DOESN'T!

**COMPARE with other similarly
priced systems—note these
extra features and better
performance for fewer dollars:**

- Full length 72 character lines and 24 line screen
- "Semi-ASR" operation by typing into 255 character buffer *while* receiving
- Pretype the entire 1728 character screen
- Two programmable HERE IS messages plus CW ID
- Keyboard Operated Switch (KOS) for automatic TX/RX control
- Bright/dim display of RX/TX text
- Labeled controlled keys plus on-screen status line for easy operation
- All three modes—CW, Baudot RTTY, and ASCII Computer code
- 1-175 wpm CW; 60, 66, 75, 100, 133 wpm Baudot; 110, 300 baud ASCII
- Word wrap-around, Unshift On Space, Synchronous Idle
- Edit as you type with Word Mode
- High performance external demodulator rather than built-in compromise
- Internal Loop Supply and Motor control for full TTY machine compatibility
- Solid state RTTY Loop interface; both cathode and grid-block CW outputs
- HAL one year warranty and ten years' experience in RTTY



DS3100 & ST6000 . . . \$2550*



DS2000, MR2000
ESM914, ST5000 . . . \$1029*

LOOK FOR THE BEST or THE MOST ECONOMICAL . . . WE HAVE BOTH!

* Prices for U.S. customers purchasing complete systems as specified in our catalog. Write for our complete catalog for detailed specifications and other system combinations. Prices and specifications subject to change without notice.



HAL COMMUNICATIONS CORP.
Box 365
Urbana, Illinois 61801 ✓ 345
217-367-7373

For our European customers, contact: Richter & Co. D3000
Hannover 1 • Transradio SA, 6816 Bissone/Lugano • Radio
Shack Ltd., London NW6 3AY • Erik Torpdahl Telecom, DK 3660
Stenlose Denmark

AWARDS

Bill Gosney WB7BFK
2665 North 1250 East
Whidbey Island
Oak Harbor WA 98277

Over the past year, it has been my pleasure to work with a very knowledgeable friend, Mr. Chuck Ellis W0YBV, founder, editor, and publisher of the *New DX Awards Guide*. Determined to consolidate a single source of information for would-be DXers, Chuck has compiled what I feel is probably the most comprehensive awards manual in existence today.

I believe one of the features particularly original is that Chuck has provided application forms for the many incentives offered. Though these applications are not a specified format of the sponsor, they can be appreciated as a great aid to the many volunteers who have to validate applications as they are received.

Packed within the covers of this 164-page manual, you will find award programs featured from all parts of the world. What's even greater, the manual is assembled in a loose-leaf format so changes, additions, and deletions easily can be made as they occur.

A lot of hard work and countless hours burning the midnight oil went into the editing of this publication. Conservatively priced at \$14.95 prepaid (\$14.95

+ 16 oz. postage charge for overseas), I consider this manual a must buy for the serious award hunter. Be sure to inform Chuck that you read about his *Awards Guide* right here in the Awards Column of 73. And most important, should you learn of additional awards which either Chuck or myself can utilize for either of our awards publications, be sure to submit them at your earliest convenience.

Order your *New DX Awards Guide* by enclosing your payment to Charles Ellis, Box 1136 Welch Station, Ames IA 50010.

Traveling south of the border, this month we learn of three very popular awards from the country of Brazil.

PACW AWARD

The PACW Award is issued by the Para CW Group, our South American friends in Brazil. To qualify for this award, amateurs must have worked at least two of the PACW members via CW on or after January 1, 1980.

To apply for this award, state the callsign, date and time in GMT, and signal report. Applicants are requested not to send QSL cards! Have your list of contacts verified by two amateurs, a club secretary, or by a notary public. Award fee is 10 IRCs. Send your applications to: PACW, PO Box 203, 66.000 Belem, Para, Brasil, South America.

I might add that this award is available to shortwave listeners as well. The same award rules apply.

PACW members who qualify for contacts are: PY8AA, PY8ACR, PY8ACS, PY8AFH, PY8BI, PY8DP, PY8EL, PY8FI, PY8HP, PY8JS, and PY8ZIC.

My special thanks to Fred Van Aalst WR4RAD for providing this award information for our column.

CWSP AWARD

The CWSP Award is issued by the "Sao Paulo Group of CW" for all radio amateurs who have worked five different members of the organization on CW only. To be valid, all contacts must be made after October 15, 1976.

Do not send QSL cards when making application. Merely list all five QSOs by stating the call of the station worked, the date and time in GMT, the band, and signal report. Enclose your application along with an awards fee of 10 IRCs. Be sure to have your list of contacts verified by at least two amateurs, a radio club secretary, or by a notary public. SWL endorsements also will be granted utilizing the same rule requirements. Special endorsements will be given for 10, 20, 30, and additional multiples of 10 stations worked.

Mail your application to: CWSP, PO Box No. 15.098, 01000 —Sao Paulo, Brasil, South America.

CWSP members are: PY2 AA, AAI, ACH, ADI, AEO, AES, APE, ARX, ASI, ATL, AVB, AWL, BTR, BW, BWD, BZD, CJW, CPU, CQM, CZX, DCP, HDP, DJE, DML, DY, EM, EMM, ESY, FFA, FWR, FWT, GPA, GVV, GXC, GWF, GWO, GYB, JM, JN, JX, KN, OE, RG, SI, TR, WD, WSS, XB, YP, ZA, and PY1DG/2.

BRYLA AWARD

The YLs of Brazil offer a special award incentive for working the many YLs of their own country and countries around the world.

Known as the BRYLA Award, the applicant must make contact with YLs of 12 countries on 3 continents plus 8 YLs in Brazil.

List the usual logbook information and have your contacts verified by at least two amateurs, a local club secretary, or by a notary public. Submit your application along with an award fee of 10 IRCs to: Therezinha Cardoso PT2TF, SQN 102, Bloco

E Apto 604, Brasilia DF CEP 70.000 Brasil, South America.

And while speaking of YL Awards, we have a couple I'd like to mention that are being offered stateside.

DX-YL CERTIFICATE

Known as the DX-YL AWARD, applicants may only be YL operators. They are required to work 25 other YLs outside their own country. All contacts must have been made on or after April 1, 1958, to qualify.

All QSOs have to be made from the same QTH, or within a 25-mile radius. Contacts do not have to be with 25 separate countries but contacts with 25 DX-YLs are required.

Do not send QSL cards! Have your logs verified by at least two amateurs or a local radio club official. Submit your log to the Award Custodian: Emma Berg W0JUV, RFD 2 Box 171, Lawrence KS 66044. Stickers will be awarded for each group of 10 YLs contacted outside your own country.

Even though there is no charge for the DX-YL Award, applicants may donate stamps or small amounts of cash to defray costs.

DX-YLCC AWARD

Looking over the rules of the DX-YLCC Award, I would have to say that this is probably one of the toughest awards on the DX scene. To qualify, two-way communications must be made on any amateur band with 100 different licensed DX YLs, with not more than two YL contacts from any one country.

All contacts must be made from the same QTH and not to exceed a 25-mile radius if a change of QTH is necessary. Any band or mode may be utilized, but crossmode contacts do not count.

YLs contacted must be located in countries listed on the ARRL DX Countries List. The QSL confirmation must clearly state the station contacted was operated by a duly licensed woman amateur operator.

QSLs are to accompany all award applications. Include a list of contacts in prefix order. Include the callsign, operator's first name, the band and mode of operation, and the date and time in GMT.

Though the award is issued at



1234-240 p.—21 Custom Speaker Enclosure Projects You Can Build (\$12.95)

1066-882 p.—The Illustrated Dictionary of Electronics (\$19.95)

1113-182 p.—Understanding Electronics (\$8.95)

1167-168 p.—Electronic Music Synthesizers (\$9.95)

1222-266 p.—Advanced Radio Control, including Rockets & Robots—2nd Edition (\$12.95)

An Extraordinary Offer to introduce you to the benefits of Membership in

ELECTRONICS BOOK CLUB

take any **6** of these 24 unique electronics books (values to \$101⁷⁰) for only **\$2⁹⁵** for **ALL SIX**

with a Trial Membership in the Book Club that guarantees to save you 25% to 75% on a wide selection of electronics books



Facts About Club Membership

- The 6 introductory books of your choice carry publisher's retail prices of up to \$101.70. They are yours for only \$2.95 for all 6 (plus postage/handling) with your Trial Membership.
- You will receive the Club News, describing the current Selections, Alternates, and other books, every 4 weeks (13x a year).
- If you want the Selection, do nothing, it will be sent to you automatically. If you do not wish to receive the Selection, or if you want to order one of the many Alternates offered, you simply give instructions on the reply form (and in the envelope) provided, and return it to us by the date specified. This date allows you at least 10 days in which to return the form. If, because of late mail delivery, you do not have 10 days to make a decision and so receive an unwanted Selection, you may return it at Club expense.
- To complete your Trial Membership, you need buy only four additional monthly Selections or Alternates during the next 12 months. You may cancel your Membership any time after you purchase these four books.
- All books—including the Introductory Offer—are fully returnable after 10 days if you're not completely satisfied.
- All books are offered at low Member prices, plus a small postage and handling charge.
- Continuing Bonus: If you continue after this Trial Membership, you will earn a Dividend Certificate for every book you purchase. Three Certificates plus payment of the nominal sum of \$1.99 will entitle you to a valuable Book Dividend of your choice which you may choose from a list provided Members.

May we send you your choice of 6 of these practical time-and-money-saving books as part of an unusual offer of a Trial Membership in Electronics Book Club?

Here are quality hardbound volumes, each especially designed to help you increase your know-how, earning power, and enjoyment of electronics. Whatever your interest in electronics, you'll find Electronics Book Club offers practical, quality books that you can put to immediate use and benefit.

This extraordinary offer is intended to prove to you through your own experience, that these very real advantages can be yours... that it is possible to keep up with the literature published in your areas of interest, and to save substantially while so doing. As part of your Trial Membership, you need purchase as few as four books during the coming 12 months. You would probably buy at least this many anyway, without the substantial savings offered through Club Membership.

To start your Membership on these attractive terms, simply fill out and mail the coupon today. You will receive the 6 books of your choice for 10-day inspection. YOU NEED SEND NO MONEY. If you're not delighted, return the books within 10 days and your Trial Membership will be cancelled without cost or obligation.

ELECTRONICS BOOK CLUB, Blue Ridge Summit, Pa. 17214

ELECTRONICS BOOK CLUB ✓321

Blue Ridge Summit, Pa. 17214

Please open my Trial Membership in ELECTRONICS BOOK CLUB and send me the 6 books circled below. I understand the cost of the books I have selected is only \$2.95 for all 6, plus a small shipping charge. If not delighted, I may return the books within 10 days and owe nothing, and have my Trial Membership cancelled. I agree to purchase at least four additional books during the next 12 months after which I may cancel my membership at any time.

800 806 861 887 971 1006 1059 1066
1097 1113 1119 1136 1146 1167 1168 1169
1196 1199 1212 1222 1225 1234 1255 8224

Name _____ Phone _____

Address _____

City _____

State _____ Zip _____

(Valid for new Members only. Foreign and Canada add 15%.) ST-1180

THE GIANT **AZDEN** COMPANY

REVOLUTIONIZES THE STATE OF THE ART

AWE AND AZDEN. INTRODUCE THE BRILLIANT NEW PCS-2000

MICROCOMPUTER CONTROLLED

SUPERIOR COMMERCIAL GRADE 2 METER FM TRANSCEIVER

NOT \$550.00

NOT \$550.00

FALL SALE

FALL SALE

\$259⁰⁰

\$259⁰⁰

REG. \$369.00

REG. \$369.00



COMPARE THESE FEATURES WITH ANY UNIT AT ANY PRICE

- **FREQUENCY RANGE:** Receive and transmit: 144.00 to 147.995 MHz, 5KHz steps + MARS-CAP CAPABILITY BUILT IN (142-149.995 MHz).
- **ALL SOLID STATE-CMOS PL DIGITAL SYNTHESIZED.**
- **SIZE: UNBELIEVABLE! ONLY 6 3/4" x 2 3/8" x 9 3/4". COMPARE!**
- **MICROCOMPUTER CONTROLLED:** All scanning and frequency-control functions are performed by microcomputer.
- **DETACHABLE HEAD:** The control head may be separated from the radio for use in limited spaces and for security purposes.
- **SIX-CHANNEL MEMORY:** Each memory is re-programmable. Memory is retained even when the unit is turned off.
- **MEMORY SCAN:** The six channels may be scanned in either the "busy" or "vacant" modes for quick, easy location of an occupied or unoccupied frequency. **AUTO RESUME. COMPARE!**
- **FULL-BAND SCAN:** All channels may be scanned in either "busy" or "vacant" mode. This is especially useful for locating repeater frequencies in an unfamiliar area. **AUTO RESUME. COMPARE!**
- **INSTANT MEMORY-1 RECALL:** By pressing a button on the microphone or front panel, memory channel 1 may be recalled for immediate use.
- **MIC-CONTROLLED VOLUME AND SQUELCH:** Volume and squelch can be adjusted from the microphone for convenience in mobile operation.
- **ADDITIONAL OFFSETS:** Provides three additional offset values: +0.4 MHz, +1 MHz and +1.6 MHz. Other offsets may also be obtained.
- **25 WATTS OUTPUT:** Also 5 watts low power for short-distance communication.
- **DIGITAL S/RF METER:** LEDs indicate signal strength and power output. No more mechanical meter movements to fall apart!
- **LARGE 1/2-INCH LED DISPLAY:** Easy-to-read frequency display minimizes "eyes-off-the-road" time.
- **PUSHBUTTON FREQUENCY CONTROL FROM MIC OR FRONT PANEL:** Any frequency may be selected by pressing a microphone or front-panel switch.
- **SUPERIOR RECEIVER SENSITIVITY:** 0.28 uV for 20-dB quieting. The squelch sensitivity is superb requiring less than 0.1 uV to open. The receiver radio circuits are designed and built to exacting specifications, resulting in unsurpassed received-signal intelligibility.
- **TRUE FM, NOT PHASE MODULATION:** Transmitted audio quality is optimized by the same high standard of design and construction as is found in the receiver. The microphone amplifier and compression circuits offer intelligibility second to none.
- **OTHER FEATURES:** Dynamic Microphone, built in speaker, mobile mounting bracket, external remote speaker jack (head and radio) and much, much more. All cords, plugs, fuses, microphone hanger, etc. included. Weight: 6 lbs.
- **ACCESSORIES:** 15' REMOTE CABLE.....\$29.95. CS-6R A/C POWER SUPPLY.....\$49.95. TOUCHTONE MIC. KIT.....\$39.95. EXTERNAL SPEAKER.....\$18.00.

AMATEUR-WHOLESALE ELECTRONICS ORDER NOW TOLL FREE

8817 S.W. 129th Terrace, Miami, Florida 33176
Telephone (305) 233-3631 • Telex: 80-3356

Hours: 9-5 Mon.-Fri.

✓5

U.S. DISTRIBUTOR
DEALER INQUIRIES INVITED

1-800-327-3102

LEAKY LINES

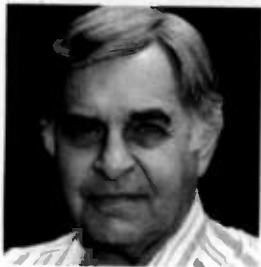

Dave Mann K2AGZ
3 Daniel Lane
Kinnelon NJ 07405

As long-time readers of Leaky Lines may know, my real line of work is a bit off the beaten track. I've been a professional songwriter for years, having been lucky enough to have produced several pretty important songs. This can lead to complications when you want to get on the air for a few contacts. Word has a way of getting around and it can be a real problem.

One thing I duck immediately is any query concerning the titles of my songs. Then comes the inevitable question: "Have you written anything that I might know?"

"Sure!" I answer, making a joke out of it. "The Star Spangled Banner," "Happy Birthday to You" and "Hail, Hail, the Gang's All Here." This usually will discourage any further questions—but not always. There's always that persistent cuss who gets an idea in his teeth and hangs on like a bulldog. I generally tell him to go to his local library's reference section and look me up in the *ASCAP Biographical Dictionary*, where he can find the information. But even that doesn't satisfy some of these people. . . they simply won't take no for an answer. But I want no part of it, for good and ample reasons.

I was once in contact with a ham who was interested in my writing credits. Some days afterward, I got a piece of mail and for some reason failed to deal with it in my customary fashion. (I generally mark it "REFUSED" in big red letters and give it back to the postman.) I opened the envelope inadvertently and regretted it immediately, for there were some song lyrics inside. I glanced at them quickly and threw them right into the basket.

Apparently one was called "I Remember September."

About two years later, I wrote a song called "November Memories," a totally undistinguished song that was unsuccessful. It wasn't even my title, but that of my co-writer. But, evidently the guy who had sent me the unsolicited manuscripts had a son who had recently completed law school, and he must have convinced the joker that he ought to file an action claiming plagiarism or infringement.

I had to get an attorney, he had to file briefs, and there were all sorts of other costs involved, not to mention the enormous loss of time. Despite the notorious tone deafness of judges and juries, the case was thrown out. The guy didn't get a penny.

Why was he unsuccessful? Simply because there was nothing even remotely similar in the two songs. Only the titles were somewhat related because of the use of a month and the concept of memory. But titles are not protected by copyright. That is why they write thousands of "I Love Your . . ." songs. There's no possibility of doing anything truly original any more. All songs are variations of other songs.

Notwithstanding the unvarnished truth that professional songwriters have no intention of becoming involved with amateurs, these characters (and there must be millions of them) insist upon imagining that the world is just waiting breathlessly for their "masterpieces." It's ridiculous.

That's why I detest it when hams insist on talking about songs. How do you suppose a physician would feel about discussing medicine on the air? How would a professional athlete feel about arguing with some dummy who'd never gone beyond sandlot, pickup ball games? I'm not looking for collaborators. . . I have more than a sufficiency of them. What makes some amateur think that a professional would be even remotely interested in collaborating with him?

I wasn't exaggerating about enormous throngs of would-be

songwriters. I've been stopped on highways by state troopers who, when they found out what I do for a living, immediately pulled some scruffy song poems out of their tunic pockets, and tried to pressure me to write melodies for them. I demurred, preferring to take the summons instead. I've been approached by elevator operators, waiters, busboys, dentists, service technicians and mechanics, school teachers, grocery clerks, mailmen, barbers (they're just about the worst), painters, plumbers, golf caddies, and God alone knows how many others. And all of them seem to believe that if only they can get one little break, they will replace Irving Berlin and Burt Bacharach!

On the way into the Brill Building some years ago (this building was known as Tin Pan Alley, for most music publishers were located there), I was accosted by some guy who was always hanging around. I had heard that he was in the button business, but he was song-struck. He had it in his mind to be a writer but had no talent, only nerve. He handed me a piece of lined copybook paper on which there was a scrawled lyric. I got no further than the title. It repelled and disgusted me. In big block letters, it stretched across the top of the page: "THE SUICIDE SONG." I handed it back to him without a word, continuing toward the elevators in the rear of the lobby. When he pressed me for my reasons, I told him that I regarded it as a revolting song idea, not worth the time to look at seriously. He slunk away, his face as dark as a thundercloud, muttering imprecations and curses under his breath.

I promptly forgot all about the incident, but some weeks afterward, when I arrived home one evening, my wife greeted me with an implausible story. It seemed that the phone had rung. . . it was another writer, Lee Kuhn, a close friend.

"Hello, Bobby? Are you all right?"

"Of course, Lee. What's up?"

"Are you sure you're all right?"

"I don't understand you, Lee. What's the matter?"

"When. . . when are the services?"

"What are you talking about, Lee?"

"Well, I was listening to Martin Bloch on the Make Believe Ballroom on WNEW, and he halted the show for a news bulletin. It seemed that David Mann, the songwriter, had taken his own life. Bloch commented that he could not understand this, as he knew David Mann, and he just wasn't the type to do such a thing."

"Listen, Lee. I just got off the phone with David about ten minutes ago. He called from the garage to tell me he was on his way home. I expect him any minute."

I didn't know what to make of it. Then all at once it hit me. The jerk in the Brill Building, angry and frustrated about my unceremonious rejection of his rotten song, had dreamed this up as a sort of just retribution.

I hesitate to speculate on what he might have done if the song had involved murder instead of suicide!

So there you have it. . . a small glimpse into the trials and tribulations of the songwriter. Perhaps it will give you some understanding of the problem and will explain why I don't like to talk about popular songs on the air.

I simply want to avoid getting inundated with unsolicited song material from guys who are looking to capitalize on the slightest connection. I have no objection to their writing of songs. But I just don't want to be a party to it, that's all.

Editor's Note: Among Dave's many songwriting credits are, "There, I've Said It Again," "Wee Small Hours," "Don't Go To Strangers," and "Dearie (You're Much Older Than I)."

HAM HELP

I need a copy of a complete schematic or a manual for an RME 4350 receiver. I will pay postage and copying costs, but

I'd rather copy at my end.

Will George W4LHJ
1731 Country Club Drive
Tullahoma TN 37388



DRAKE 7-Line Family



A pacesetter since 1943, Drake led in 1963 with 9 MHz i-f transceivers, and now with 48 MHz i-f "Up Conversion" ... Drake brings you tomorrow's state of the art today.



Model 1336

TR7

**solid state
continuous coverage
synthesized hf system**

Continuous Frequency Coverage—The TR7 provides continuous coverage in receive from 1.5 to 30 MHz. Transmit coverage is provided for all amateur bands from 160 through 10 meters. The optional AUX7 Range Program Board allows out-of-band transmit coverage for MARS, Embassy, Government and Commercial services as well as future band expansions in the 1.8 through 30 MHz range.* The AUX7 Board also provides 0 through 1.5 MHz receive coverage and crystal-controlled fixed-channel operation for Government, Amateur or Commercial applications anywhere in the 1.8 to 30 MHz range.

Synthesized/PTO Frequency Control—A Drake exclusive: carefully engineered high-performance synthesizer, combined with the famous Drake PTO, provides smooth, linear tuning with 1 kHz dial and 100 Hz digital readout resolution. 500 kHz up/down range switching is pushbutton controlled.

Advanced, High-Performance Receiver Design—The receiver section of the Drake TR7 is an advanced, up-conversion design. The first intermediate frequency of 48.05 MHz places the image frequency well outside the receiver input passband, and provides for true general coverage operation without i-f gaps or crossovers. In addition, the receiver section features a high-level double balanced mixer in the front end for superior spurious and dynamic range performance.

True Passband Tuning—The TR7 employs the famous Drake full passband tuning instead of the limited range "i-f shift" found in some other units. The Drake system allows the receiver passband to be varied from the top edge of one sideband, through center, to the bottom edge of the opposite sideband. In fact, the range is even wider to accommodate RTTY. This system greatly improves receiving performance in heavy QRM by

allowing the operator to move interfering signals out of the passband, and it is so flexible that you can even transmit on one sideband and listen on the other.

Unique Independent Receiver Selectivity—Space is provided in the TR7 for up to 3 optional crystal filters. These filters are selected, along with the standard 2.3 kHz filter, by front panel pushbutton control, independent of the mode control. This permits the receive response to be optimized for various operating conditions in any operational situation. Optional filter bandwidths include 6 kHz for a-m, 1.8 kHz for narrow ssb or RTTY, and 500 Hz and 300 Hz for cw.

Broadband, Solid State Design—100% solid state throughout. All circuits are broadbanded, eliminating the need for tuning adjustments of any kind. Merely select the correct band, dial up the desired frequency, and you're ready to operate.

Rugged, Solid State Power Amplifier—The power amplifier is internally mounted, with nothing outboard subject to physical damage. A Drake designed custom heat sink makes this possible. The unique air ducting design of this heat sink allows an optional rear-mounted fan, the FA7, to provide continuous, full power transmit on SSTV/RTTY. The fan is not required for ssb/cw operation, since normal convection cooling allows continuous transmit in these modes.

Effective Noise Blanker—The optional NB7 Noise Blanker plugs into the TR7 to provide true impulse-type noise blanking performance. This unit is carefully designed to maximize both blanking and dynamic range in order to preserve the excellent strong-signal handling characteristics of the TR7.

* NOTE: Transmitter coverage for MARS, Government, and future WARC bands is available only in ranges authorized by the FCC, Military, or other government agency for a specific service. Proof of license for that service must be submitted to the R. L. Drake Company, including the 500 kHz range to be covered. Upon approval, and at the discretion of the R. L. Drake Company, a special range IC will be supplied for use with the Aux7 Range Program Board. Prices quoted from the factory. See Operator's Manual for details. (Not available for services requiring type acceptance.)

TR7

ACCESSORIES

**Aux7 must be used with either Model 1546 RRM-7 Range Receive Module, or Model 1547 RTM-7 Range Transceiver Module. Use one module per 500 kHz range. Modules plug directly into Aux7.

Model 1336	Drake TR7 General Coverage Digital R/O Transceiver
Model 1338	Drake RV7 Remote VFO
Model 1502	Drake PS7 120/240V Ac Supply for continuous duty operation (25 amps)
Model 1570	Drake PS75 120/240V Ac supply for intermittent duty (15 amps continuous, 25 amps intermittent)
Model 1553	Drake SP75 Speech Processor
Model 1230	Drake LA7 Line Amplifier
Model 1533	Drake CS7 Coax Switch
Model 7077	Drake Desk Microphone
Model 1520	Drake P75 Phone Patch
Model 1536	Drake Aux7 Range Program Board **
Model 1531	Drake MS7 Matching Speaker
Model 1537	Drake NB7 Noise Blanker
Model 1529	Drake FA7 Fan
Model 7021	Drake SL-300 Cw Filter, 300 Hz
Model 7022	Drake SL-500 Cw Filter, 500 Hz
Model 7023	Drake SL-1800 Ssb/RTTY Filter, 1.8 kHz
Model 7024	Drake SL-6000 A-m Filter, 6.0 kHz
Model 1335	Drake MMK-7 Mobile Mounting Kit
Model 7037	Drake TR7 Service Kit/Extender Board Set
Model 385-0004	Drake TR7 Service/Schematic Book

TR7 SPECIFICATIONS

GENERAL

Receive

Without Aux7	1.5 to 30 MHz, continuous, no gaps.
With Aux7	Same, plus 0 to 1.5 MHz at reduced performance.

Transmit

Without Aux7	1.8-2.0, 3.5-4.0, 7.0-7.5, 14.0-14.5, 21.0-21.5, 28.0-30.0 MHz.
With Aux7*	Above ranges, plus any eight 500 kHz segments from 1.8 to 30 MHz.

Modes of Operation

Usb, Lsb, Cw, RTTY, A-m equiv. (A-3H).

Frequency Stability

Less than 1 kHz first hour. Less than 150 Hz per hour after 1 hour warm up. Less than 100 Hz for $\pm 10\%$ line voltage change.

Frequency Readout Accuracy

Analog	Better than ± 1 kHz when calibrated at the nearest marker point.
Digital	15 ppm \pm 100 Hz.

External Counter Mode

Maximum Input Freq.	150 MHz.
Input Level Range	50 mV to 2 V, rms.

Power Supply Requirements

11-16 V-dc (13.6 V-dc nominal), 3A receive, 25A transmit.

Dimensions

Depth	12.5 in. (31.75 cm), excluding knobs and connectors.
Width	13.6 in. (34.6 cm).
Height	4.6 in. (11.6 cm) excluding feet.
Weight	17.1 lb. (7.75 kg).

RECEIVER

Sensitivity

Ssb, Cw	Less than $0.5 \mu\text{V}$ for 10 dB (S+N)/N.
A-m (30% Mod.)	Less than $2.0 \mu\text{V}$ for 10 dB (S+N)/N.

Selectivity

2.3 kHz at -6 dB and 4.4 kHz at -60 dB (1.8:1 shape factor).

Ultimate Selectivity

Greater than 100 dB.

Agc

Less than 4 dB output variation for 100 dB input signal change, referenced to agc threshold.

Intermodulation

Intercept Point, +20 dBm. Two-tone Dynamic Range, 99 dB (at spacings of 100 kHz and greater).

I-f Frequency

First i-f—48.05 MHz.
Second i-f—5.645 MHz.

Image and I-f Rejection

Greater than 80 dB.

Spurious Response

Greater than 60 dB down.

Internally Generated Spurious

Less than $1 \mu\text{V}$ equivalent, except $3 \mu\text{V}$ equivalent from 5 to 6 MHz (reduced specs on internal osc frequencies).

Audio Output

2.0 watts @ less than 10% THD (4 ohm load).

TRANSMITTER

Power Input (Nominal)

Ssb	250 watts PEP.
Cw	250 watts.
A-m equiv.	80 watts (carrier), plus upper sideband.

Load Impedance

50 ohms, nominal.

Spurious Output

Greater than 50 dB down.

Harmonic Output

Greater than 45 dB down.

Intermodulation Distortion

30 dB below PEP (24 dB below one of two tones).

Undesired Sideband Suppression

Greater than 60 dB @ 1 kHz.

Duty Cycle

Ssb, Cw	100%.
Tune, SSTV, RTTY, A-m	1529 FA7 Fan—33%, 5 min. transmit, max.
	with 1529 FA7 Fan—100%.

Wattmeter Accuracy

$\pm 5\%$ @ 100 watts (50 ohm load).

Carrier Suppression

Greater than 50 dB.

Microphone Input

High Impedance.

Specifications, availability and prices subject to change without notice or obligation.

R. L. DRAKE COMPANY



540 Richard St. Miamisburg, Ohio 45342, USA
Phone: (513) 866-2421 • Telex: 288-017

LETTERS

BASHED

Our article on Dick Bash in the September issue elicited quite a response from our readers. Letters fell into three categories: those in favor of Bash, those against, and those requesting his address. Considering reader requests for Mr. Bash's address as evidence of at least tacit approval of his activities, the mail ran approximately 2 to 1 in his favor. Below is a cross section of the many letters we received.

I do not, as a rule, write letters to publications, or anything... but after reading your article on Dick Bash, I felt that at last someone feels as I do and I had to say so.

Anthony D. Tartaglia
Titusville FL

I enjoyed your article on Dick Bash and would like to order one of his books. Search as I did, however, I could not find his address in the September issue of 73. Was it purposely left out?

Paul Powell, M.D.
Borger TX

Yes.—Ed.

I say hooray for Dick Bash! I'm trying to find a copy of *The Final Exam* for my General. I worked and got my Novice and now I want to use phone privileges.

I really don't want to go back to illegal CB, but if the hams and FCC don't make it easier, I will, cause I just want to shoot the bull.

Harlan Steffen KA9GDF
Appleton WI

I read your interesting article about Dick Bash and his license manual, *The Final Exam*. I am interested in the Advanced manual.

In June, 1977, I passed my 13 wpm code but failed the Advanced for the second time. It seemed as though I was doing well in my licensing progression and then all of a sudden I didn't seem to be able to answer the questions right. It happened

twice, so I thought that anything I can do to pass on the third try would be worth the effort. I am seventy-two years old—got a late start in ham radio.

Wilbur T. Reed WB9KDB
Marion IN

I've just finished your excellent article on Dick Bash. More power to the guy. He's doing just what he should—make it as easy as possible to get a ham license.

I'm sure that its the old-guard hams who don't want changes who are against Dick. I love ham radio as a hobby. It has added a lot to the quality of my life and I would do anything to help someone get on the air.

Alan D. Kline WB1FOD
Swampscott MA

If your article is not a complete put on, please send info on where to send for the Dick Bash manuals. I know several people who are interested.

T. J. Ward
Weymouth MA

I enjoyed your article in September's issue on Dick Bash KL7IHP.

While being new to ham radio, I have much experience with the "Feds." I hold FAA single and multi-engine instrument and commercial ratings, instructor for single engine and instrument, and flight engineer, turbojet, as well as a Boeing 707/720 type rating. I now work for a major air carrier. It is virtually impossible to pass the FAA's written tests from just the regulations and tech orders. You must literally learn the test!

I just completed a course at a local radio club on the Novice license. The electronics section was first baffling but now is intriguing. I can handle the circuits for the General test. Given a few years' study, I may be able to handle the Advanced or Extra. I agree with Mr. Bash in most areas. More emphasis should be placed on how to use equipment than why it works. I intend to use Kenwood equipment; I couldn't modify those circuits if I wanted to.

Ham radio is a fascinating hobby. Teach me how to communicate legally—not build a replacement for WWV!

David R. Remont
Covington LA

I enjoyed your recent article about Dick Bash KL7IHP and I agree about all the FCC "trick" questions.

C. D. Isenburg WD4LTM
Stone Mountain GA

Congratulations on the fine profile on Dick Bash KL7IHP in the September issue. The word "malaise" hardly describes the illness which is pervading the Amateur Radio Service. The arrival of one Dick Bash and the acceptance of his views and justifications by a growing segment of the prospective amateurs signal the galloping decline of what was a proud fraternity.

The FCC is understandably in a quandary about how to promote the high ideals of our service, with Dick Bash selling the test answers. In that regard, I have a suggestion.

The Commission could herald the arrival of Dick Bash as a Special Event. Then, relaxing the current ban on Special Events call signs, they could unblock the computer and recycle Bash's name for assignment of a Special Events call sign befitting the occasion. If the computer then selected the call sign W6ASS, Bash would be very appropriately honored. The call sign is not currently assigned, and I can think of few who deserve it more.

Robert G. Wheaton W5XW
San Antonio TX

I won't bore you with the details of how hard I had to work to pass the FCC license tests, but I know that since I did have to put out a little effort I have a much greater respect for the Amateur Radio Service and the privileges (and they are privileges) it provides.

When it finally gets to the point that anyone who can afford to buy the answers to the FCC tests and be practically guaranteed of passing, when the only real knowledge required is the ability to read and plug the transmitter into the wall, and when the bands become so crowded with unknowledgeable and immature opera-

tors who are concerned only with getting everything they want the easy way, amateur radio as we know it today will be a thing of the past.

When that happens, I will say a little prayer over it and go on to something else.

George Hogue KB5OU
Bridgeport TX

I read Chris Brown's profile on Dick Bash KL7IHP with amused interest. I think Mr. Bash can best be described as a businessman, and a good one at that!

The author spoke of a malaise affecting ham radio, which apparently afflicts this society, too—that is, the shift in people's attitude and priorities. There are definitely people who would like to get things done the easiest way, irrespective of reason, and they do not care one bit as to how this will be attained. Mr. Bash certainly serves these people well.

So, just like the oldest profession, for as long as there are people buyin', they will come sellin'.

Frederico Po DU1FP
Berkeley CA

"Who am I to judge morality?"

Who else, Dick Bash? You, I, Wayne Green, and, in this case, a lot of other hams—not Jerry Brown and Melvin Belli.

Those of us who have call signs, Dick, we and no other will judge the morality, will establish the morality. You seem to have forgotten us altogether.

What you and your high-priced legal talent really need to think about are the little, forgotten things, like pride, dignity, and common decency.

Sadly, I am reasonably sure that nothing can be done about this sort of thing and you'll sell lots of your books.

John B. Stolp KA6BRT
Oakland CA

Wayne, after reading Mr. Bash's article in your magazine, I was both shocked and disgusted by the irresponsible behavior of you two. It is very apparent that neither of you deserve the trust given you as amateur radio operators.

I have a question for both of you. I want to get my FAA pilot's license but I don't want to learn

Continued on page 194



"BRAND NEW"
**CHAMPION MESSAGE
 MEMORY KEYER**
 Model TE-292
\$125.95

Features:

- State-of-the-Art-CMOS Circuitry
- Choice of Message Storage
 - A. Six 50 character messages
 - B. Twelve 25 character messages
 - C. 27 combinations of message C. programming.
- Records at any speed—plays at any speed.
- Memory operating LED
- Use for daily QSO or contests

PLUS:

- Self-completing dots and dashes
- Both dot and dash memory
- Iambic Keying with any squeeze paddle
- 5-50 w.p.m.
- Speed, volume, tone, tune and weight controls
- Sidetone and speaker
- Low current drain CMOS battery operation—portable
- Rear panel Jack for auxiliary power
- Deluxe quarter-inch jacks for keying and output
- Keys grid block and solid rigs
- WIRED AND TESTED FULLY GUARANTEED—LESS BATTERY

\$89.95

Features: Model TE-284

- State-of-the-Art CMOS Circuitry
- Three choices of Message Storage
 - A. Two (50 character each) message storage
 - B. Four (25 character each) message storage
 - C. One 50 character and two 25 character message storage
- Records at any speed—plays at any speed
- Memory operating LED
- Use for daily QSO or contests



PLUS:

- Self-completing dots and dashes
- Both dot and dash memory
- Iambic Keying with any squeeze paddle
- 5-50 w.p.m.
- Speed, volume, tone, tune and weight controls
- Sidetone and speaker
- Low current drain CMOS battery operation—portable
- Deluxe quarter-inch jacks for keying and output
- Keys grid block and solid rigs
- WIRED AND TESTED FULLY GUARANTEED—LESS BATTERY



**MESSAGE
 MEMORY KEYER**

Features:

- Advanced CMOS message memory
- Two (50 char each) message storage
- Repeat function
- Records at any speed—plays back at any speed
- Longer message capacity
 Example: send CQ CQ CQ Dx de WB2YJM WB2YJM K—then play second message on contact—de WB2YJM QSL NY NY 579 579 Paul K
- Use for daily QSOs or contests

Model # TE201

\$69.95

PLUS:

- State-of-the-art-CMOS keyer
- Self-completing dots and dashes
- Both dot and dash memory
- Iambic keying with any squeeze paddle
- 5-50 wpm
- Speed, volume, tone, tune and weight controls
- Sidetone and speaker
- Low current drain CMOS battery operation—portable
- Deluxe quarter-inch jacks for keying and output
- Keys grid block and solid state rigs
- WIRED AND TESTED FULLY GUARANTEED—LESS BATTERY



Model # TE144

\$59.95

**Features: Deluxe CMOS
 Electronic Keyer**

- State-of-the-art CMOS circuitry
- Self-completing dots and dashes
- Both dot and dash memory
- IAMBIC keying with any squeeze paddle 5-50 wpm

- Speed, weight, tone, volume tune controls & sidetone and speaker
- Semi-automatic "bug" operation & straight keying—rear panel switch
- Low current drain CMOS battery operation—portable
- Deluxe quarter inch jacks for keying and output
- Keys grid block and solid state rigs
- Wired and tested—fully guaranteed—less battery

MODEL TE133—same as TE144 with wgt and tone control internal, less semi-auto keying. **\$49.95**

MODEL TE122—same as TE133 less wgt, tune, solid state keying **\$36.50**

AT YOUR DEALER OR SEND CHECK OR MONEY ORDER.
 Plus \$2.00 S/H NY Res add tax

TRAC

ELECTRONICS, INC
1106 RAND BLDG.
BUFFALO NY 14203

Toroid Cores



- All the popular sizes and mixes.
- Fast Service. Same day shipment via first class mail or air.
- No minimum order.

IRON POWDER TOROIDS:

CORE SIZE	MIX 2 5-30 MHz u = 10	MIX 6 10-90 MHz u = 8.5	MIX 12 60-200 MHz u = 4	SIZE OD (in.)	PRICE USA \$
T-200	120			2.00	3.25
T-106	135			1.06	1.50
T-80	55	45		.80	.80
T-68	57	47	21	.68	.65
T-50	51	40	18	.50	.55
T-37	42	30	15	.25	.45
T-25	34	27	12	.37	.40

RF FERRITE TOROIDS:

CORE SIZE	MIX Q1 u = 125 1-70 MHz	MIX Q2 u = 40 10-150 MHz	SIZE OD (in.)	PRICE USA \$
F-240	1300	400	2.40	6.00
F-125	900	300	1.25	3.00
F-87	600	190	.87	2.05
F-50	500	190	.50	1.25
F-37	400	140	.37	1.25
F-23	190	60	.23	1.10

Chart shows uH per 100 turns.

Ferrite Beads slip over 18 ga. wire
 FB-1 for 50-200 MHz **\$2/dozen**
 FB-2 for 50 MHz & below **\$2/dozen**
 Jumbo Beads slip over #12 wire
 FB-3 for 50 MHz & below **\$3/dozen**

**EXPERIMENTERS KITS
 Iron Powder Toroids**

Includes:

- 1 ea. T25-12, T80-2, T106-2.
- 2 ea. T25-6, T37-6, T50-2, T50-6.
- 3 ea. T68-2

Price \$7.50

RF Ferrite Toroids

Includes:

- 1 ea. F23-Q1, F23-Q2, F87-Q1.
- 2 ea. F37-Q1, F37-Q2, F50-Q1.

Price \$10.00

TO ORDER: Specify both core size and mix for toroids. Packing and shipping 50 cents per order USA and Canada. Californians add 6% sales tax.

Fast service: Free brochure and winding chart on request.

**Palomar
 Engineers**

Box 455, Escondido, CA. 92025
 Phone: [714] 747-3343

OSCAR ORBITS

Courtesy of AMSAT

The OSCAR satellites are subject to atmospheric drag, of course, and the present period of intense solar activity has accentuated the problem. During this period, our sun has been expelling huge numbers of charged particles, some of which find their way into the Earth's upper atmosphere, increasing the density (and thus the drag) there. It is through this region that the OSCARs must pass. OSCAR 8, in a lower orbit than OSCAR 7, is the more seriously affected of the two.

If the drag factor is not considered when OSCAR calculations are performed, long-range orbital projections will be in error. For example, by the end of 1979, OSCAR 8 was more than 20 minutes ahead of some published schedules. The nature of orbital mechanics is such that extra drag on a satellite causes it to move into a lower orbit, resulting in a shorter orbital period. Thus, the satellite arrives above a given Earthbound location earlier than predicted.

Using data supplied to us by Dr. Thomas A. Clark W3WJL of AMSAT, the equatorial crossing tables shown here were generated with the aid of a TRS-80™ microcomputer. The tables take into account the effects of atmospheric drag and should be in error by a few seconds at most.

The listed data tells you the time and place that OSCAR 7 and OSCAR 8 cross the equator in an ascending orbit for the first time each day. To calculate successive OSCAR 7 orbits, make a list of the first orbit number and the next twelve orbits for that day. List the time of the first orbit. Each successive orbit is 115 minutes later (two hours less five minutes). The chart gives the longitude of the day's first ascending (northbound) equatorial crossing. Add 29° for each succeeding orbit. When OSCAR is ascending on the other side of the world from you, it will descend over you. To find the

equatorial descending longitude, subtract 166° from the ascending longitude. To find the time OSCAR 7 passes the North Pole, add 29 minutes to the time it passes the equator. You should be able to hear OSCAR 7 when it is within 45 degrees of you. The easiest way to determine if OSCAR is above the horizon (and thus within range) at your location is to take a globe and draw a circle with a radius of 2450 miles (4000 kilometers) from your QTH. If OSCAR passes above that circle, you should be able to hear it. If it passes right overhead, you should hear it for about 24 minutes total. OSCAR 7 will pass an imaginary line drawn from San Francisco to Norfolk about 12 minutes after passing the equator. Add about a minute for each 200 miles that you live north of this line. If OSCAR passes 15° east or west of you, add another minute; at 30°, three minutes; at 45°, ten minutes. Mode A: 145.85-.95 MHz uplink, 29.4-29.5 MHz downlink, beacon at 29.502 MHz. Mode B: 432.125-.175 MHz uplink, 145.975-.925 MHz downlink, beacon at 145.972 MHz.

At press time, OSCAR 7 was scheduled to be in Mode A on odd numbered days of the year and in Mode B on even numbered days. Monday is QRP day on OSCAR 7, while Wednesdays are set aside for experiments and are not available for use.

OSCAR 8 calculations are similar to those for OSCAR 7, with some important exceptions. Instead of making 13 orbits each day, OSCAR 8 makes 14 orbits during each 24-hour period. The orbital period of OSCAR 8 is therefore somewhat shorter: 103 minutes.

To calculate successive OSCAR 8 orbits, make a list of the first orbit number (from the OSCAR 8 chart) and the next thirteen orbits for that day. List the time of the first orbit. Each successive orbit is then 103 minutes later. The chart gives the longitude of the day's first ascending equatorial crossing. Add 26° for each succeeding orbit. To find the time OSCAR 8 passes the North Pole, add 26 minutes to the time it crosses the equator. OSCAR 8 will cross the imaginary San Francisco-to-Norfolk line about 11 minutes after crossing the equator. Mode A: 145.85-.95 MHz uplink, 29.4-29.50 MHz downlink, beacon at 29.400 MHz. Mode J: 145.90-146.00 MHz uplink, 435.20-435.10 MHz downlink, beacon on 435.090 MHz.

OSCAR 8 is in Mode A on Mondays and Thursdays, Mode J on Saturdays and Sundays, and both modes simultaneously on Tuesdays and Fridays. As with OSCAR 7, Wednesdays are reserved for experiments.

OSCAR 7 ORBITAL INFORMATION FOR NOVEMBER

ORBIT #	DATE	TIME (GMT)	EQ. CROSSING (DEGREES WEST)
27277	1	0008:45	74.5
27299	2	0054:59	89.1
27303	3	0149:14	101.7
27315	4	0048:32	86.6
27328	5	0142:46	100.2
27349	6	0042:04	85.8
27353	7	0136:19	98.6
27365	8	0035:37	83.4
27378	9	0129:52	97.8
27398	10	0029:10	81.9
27403	11	0123:24	95.5
27415	12	0022:42	80.3
27428	13	0116:57	93.9
27440	14	0016:15	78.7
27453	15	0110:29	92.3
27465	16	0009:47	77.2
27478	17	0104:02	90.8
27490	18	0003:20	75.6
27503	19	0057:34	89.2
27516	20	0151:49	102.8
27528	21	0051:07	87.6
27541	22	0145:21	101.2
27553	23	0044:39	86.1
27566	24	0138:54	99.7
27578	25	0038:12	84.5
27591	26	0132:26	98.1
27603	27	0031:44	82.9
27616	28	0125:59	96.5
27628	29	0025:17	81.4
27641	30	0119:31	95.0

OSCAR 8 ORBITAL INFORMATION FOR NOVEMBER

ORBIT #	DATE	TIME (GMT)	EQ. CROSSING (DEGREES WEST)
13551	1	0116:47	74.7
13565	2	0121:34	75.9
13579	3	0126:21	77.2
13593	4	0131:08	78.4
13607	5	0135:55	79.6
13621	6	0140:41	80.8
13634	7	0002:16	56.2
13648	8	0007:03	57.5
13662	9	0011:50	58.7
13676	10	0016:36	59.9
13690	11	0021:23	61.1
13704	12	0026:09	62.4
13718	13	0030:56	63.6
13732	14	0035:42	64.8
13746	15	0040:28	66.0
13760	16	0045:15	67.2
13774	17	0050:01	68.5
13788	18	0054:47	69.7
13802	19	0059:34	70.9
13816	20	0104:20	72.1
13830	21	0109:06	73.3
13844	22	0113:52	74.5
13858	23	0118:38	75.8
13872	24	0123:24	77.0
13886	25	0128:10	78.2
13900	26	0132:56	79.4
13914	27	0137:42	80.6
13928	28	0142:28	81.9
13942	29	0044:02	57.3
13955	30	0008:48	50.5

OSCAR 7 ORBITAL INFORMATION FOR DECEMBER

ORBIT #	DATE	TIME (GMT)	EQ. CROSSING (DEGREES WEST)
27653	1	0018:49	79.8
27666	2	0113:04	93.4
27678	3	0012:22	78.2
27691	4	0106:36	91.8
27703	5	0005:54	76.7
27716	6	0100:09	90.3
27729	7	0154:23	103.9
27741	8	0053:41	80.7
27754	9	0147:56	102.3
27766	10	0047:14	87.1
27779	11	0141:28	100.7
27791	12	0040:46	85.6
27804	13	0135:00	99.2
27816	14	0034:18	84.0
27829	15	0128:33	97.6
27841	16	0027:51	82.4
27854	17	0122:05	96.0
27866	18	0021:23	80.9
27879	19	0115:37	94.5
27891	20	0014:55	79.3
27904	21	0109:10	92.9
27916	22	0008:27	77.7
27929	23	0102:42	91.3
27941	24	0001:59	76.2
27954	25	0056:14	89.8
27967	26	0150:29	103.4
27979	27	0049:46	88.2
27992	28	0144:01	101.8
28004	29	0043:19	86.6
28017	30	0137:33	100.2
28029	31	0036:51	85.1

OSCAR 8 ORBITAL INFORMATION FOR DECEMBER

ORBIT #	DATE	TIME (GMT)	EQ. CROSSING (DEGREES WEST)
13969	1	0013:34	59.7
13983	2	0018:20	60.9
13997	3	0023:06	62.1
14011	4	0027:51	63.4
14025	5	0032:37	64.6
14039	6	0037:23	65.8
14053	7	0042:08	67.0
14067	8	0046:54	68.2
14081	9	0051:39	69.5
14095	10	0056:25	70.7
14109	11	0101:10	71.9
14123	12	0105:56	73.1
14137	13	0110:41	74.3
14151	14	0115:26	75.5
14165	15	0120:12	76.8
14179	16	0124:57	78.0
14193	17	0129:42	79.2
14207	18	0134:27	80.4
14221	19	0139:13	81.6
14234	20	0008:46	57.0
14248	21	0005:31	50.2
14262	22	0010:16	59.5
14276	23	0015:01	60.7
14290	24	0019:46	61.9
14304	25	0024:31	63.1
14318	26	0029:16	64.3
14332	27	0034:01	65.5
14346	28	0038:46	66.8
14360	29	0043:30	68.0
14374	30	0048:15	69.2
14388	31	0053:00	70.4



**10% DISCOUNT
Off List**

64K I Drive \$3499.00

No Taxes an Out of State Shipments

Immediate Shipment From Stock

AUTHORIZED TRS-80® DEALER A301

COMPUTER SPECIALISTS

Popular 16K Level II System with Keypad \$670.00

26-1145 RS-232 Board	84.00
26-1140 "O" K Interface	249.00
26-1160 Mini Disk	424.00
26-1171 Telephone Modem	169.00
Fast 100 CPS Centronics 730 Printer	675.00
Text Quality Centronics 737 Printer	850.00

**1-800-841-0860 Toll Free Order Entry
MICRO MANAGEMENT SYSTEMS, INC. ✓ 313**

DOWNTOWN PLAZA SHOPPING CENTER
115 C SECOND AVE. S.W.
CAIRO, GEORGIA 31728
GA. PHONE NO. (912) 377-7120



**15% DISCOUNT
Off List**

4K Level II \$552.00

Full Factory Warranty on All Items Sold

Largest Inventory in S.E. U.S.A.

Count on DSI Frequency Counters to deliver.

1.2 GHz for only **\$189.95**

- Accuracy Sensitivity High Resolution and Reliability
- Meeting All FCC Regulations

Checking a 960 MHz transmitter, Servicing a TV tuner, VTR, Calibrating Instrumentation; Measuring PLL signals; Reading a PL or audio signal to 1/1000th of a Hz (Models C1200, 5700 only) — Whatever your needs — DSI's 1.2 GHz Models 5700, C1200 or 1 GHz Model 5510 or 512 MHz Model 5500 are sure to provide the accuracy, sensitivity and flexibility required to meet your most stringent criteria. All C1200 counters include 1/1000th Hz capability and a variable sensitivity control. (Resolve 1/1000th of a Hz with your 5700 by adding option AM57 - Audio Multiplier.) The 5500 series are compact and portable and use a TCXO time base, while the 5700 and C1200 offer laboratory standard oven time base oscillators. Portability is improved on all models with the addition of the rechargeable NiCad battery pack which includes AC batt eliminator/AC9. All DSI models will operate on 8 to 14.5 VDC, and include 50 ohm and 1 Meg BNC inputs. Join the growing ranks of tens of thousands of satisfied customers who have discovered that DSI offers the best price to quality features ratio in the industry.



MODEL C1200 \$269.95
BUILT-IN AUDIO MULTIPLIER
1/1000 HZ RESOLUTION ON AUDIO
50 Hz - 1.2 GHz

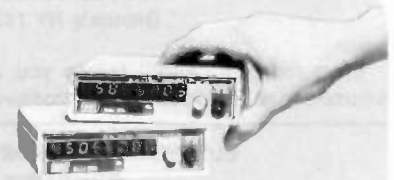

MODEL 5500
50 Hz — 512 MHz
\$119.95

MODEL 5510
50 Hz to 1.0 GHz
\$139.95



MODEL 5700
50 Hz - 1.2 GHz 189.95

MODEL	FREQ. RANGE	TYP OF OSC.	ACCURACY OVER TEMPERATURE			SENSITIVITY TYP.			NO OF DIGITS	RESOLUTION		
			20° - 28° C		0° - 40° C	100 Hz	26 MHz	260 MHz		AUDIO FREQ. USING SCALER	50 Hz	10 MHz
			± 1 ppm	± 3 ppm	25 Mv	15 Mv	20 Mv	to 1 Hz			to 10 Hz	
5500	50 Hz to 512 MHz	TCXO	± 1 ppm	± 3 ppm	25 Mv	15 Mv	20 Mv	8	N/A	1 Hz	10 Hz	
5700	50 Hz to 1.2 GHz	oven	± 2 ppm	± 1 ppm	10 Mv	10 Mv	15 Mv	9	SAME AS C1200 WITH OPT AM57	1 Hz	10 Hz	
C1200	50 Hz to 1.2 GHz	oven	± 1 ppm	± 5 ppm	10 Mv	10 Mv	15 Mv	9	.001 Hz Std	1 Hz	10 Hz	

NOTE: 9th Digit-Overflow 1 NOTE: Prices and/or specifications are subject to change without notice or obligation by DSI Instruments, Inc. Please add 10% to a maximum of \$10.00 for shipping, handling and insurance. Orders outside of U.S.A. & Canada, please add an additional \$20.00 to cover air shipment. California residents add 6% sales tax.

To Order Call

Toll Free **800-854-2049** DSI INSTRUMENTS INC. 9550 Chesapeake Dr. San Diego, CA 92123 • (714) 565-8402



5500 BAC	139.95	AM57	34.95
5500	119.95	BA/NI CAD-W/A e9	34.95
5700	189.95	BA-57	8.95
C1200	269.95	A C-9	8.95
		T-600	8.95

See Your Local Authorized DSI Dealer

- Alabama**
 - Amtronics, Route 1, Box 1039, Milledgeville, AL 36550
 - Ack Radio Supply, 3101 4th Ave. South, Birmingham, AL 35233
 - Arizona Radio Comm, 2245 N. 7th St, Phoenix, AZ 85006
 - Basco Station, 2101 Pacheco, Concord, CA 94520
 - Cai-Pine Elec, 1950 Lake Tahoe Blvd, South Lake Tahoe, CA 95731
 - Center Comm, 455 Auzenas, San Jose, CA 95126
 - Cut Rate Elec, 1074 S. Brawley, Fresno, CA 93706
 - Jun's Elec, 11655 E. Pico Blvd, West Los Angeles, CA 90064
 - University Ave, San Diego, CA 92121
 - Omega Radio Elec, 7094 Miramar Rd, San Diego, CA 92121
 - Henry Radio, 11240 W. Olympic Blvd, Los Angeles, CA 90081
 - Henry Radio, 931 N. Euclid Ave, Anaheim, CA 92801
 - Hobbytronics, 1378 S. Bascom Ave, San Jose, CA 95128
 - C & A Roberts, Inc, 2559 East 220th St, Long Beach, CA 90810
 - Estero Comm, 573 Manhatta St, Los Osos, CA 93402
 - Tele Com, 15460 Union Ave, San Jose, CA 95124
- California**
 - Cherokee Elect. & Comm, 6119 Graystone, Citrus Heights, CA 95610
 - 916-969-1339 Sacramento
 - Radio-1, 2155 Central Expressway, San Jose, CA 95128
 - Delaware
 - Amateur Adv. Comm, 3208 Conrd Pk, RR 202, Wilmington, DE 19803
 - Delaware Ama Sup, 71 Meadow Road, New Castle, DE 19720
 - Florida
 - Amateur Elec. Sup, 621 Commonwealth Ave, Orlando, FL 32803
 - A.G.L. Electronics, 1898 Dine St, Clearwater, FL 33515
 - Hialeah Comm, 612 East 9th Street, Hialeah, FL 33010
 - Hollister & Clayton, 1747-1749 Pearl St, Jacksonville, FL 32206
 - Lakeland Spec. Elec, 37424 Smindell Road, Lakeland, FL 33801
 - N & G Distributing, 7285 NW 12th Street, Miami, FL 33126
 - Quad Electronics, 2251 North "E" St, Pinecastle, FL 32501
 - Ray's Amat Radio, 1590 US 19 South, Clearwater, FL 33516
 - Tymms Elec. Ser, 14714 NW 7th Ave, Miami, FL 33168
 - Amat Radio Center, 2805 NE 2nd Ave, Miami, FL 33137
 - AB Comm, 1660 West 32nd St, Place, Hialeah, FL 33012
 - Colorado**
 - Com-Tec Assoc, 215 Hopkins Ave, (US1), Tusuville, FL 32780
 - Georgia
 - Britt's 2-Way, 2508 Atlanta Street, Smyrna, GA 30080
 - Ack Radio Supply, 354 Deering Rd, NW Atlanta, GA 30309
 - Florida
 - Van's CB Radio Supply, 1352 D So Beretania St, Honolulu, HI 96814
 - Ideho
 - Ross Distributing, 78 S. State, Preston, ID 83263
 - Indiana
 - Gardner Electronics, 204 Wesley St, Orleans, Indiana 47452
 - Illinois
 - Erickson Comm, 5456 N. Milwaukee Av, Chicago, IL 60630
 - Floyd Electronics, 2213 Vandana St, Collinsville, IL 62234
 - Spectronics, Inc, 1009 Garfield St, Oak Park, IL 60304
 - Kansas
 - Audas Amat Radio Electronics, 1590 US 19 South, Clearwater, FL 33516
 - Kansas City, KS
 - Coohan Ama Supply, 307 McLean Ave, Hopkinsville, KY 42240
 - P.J. Burks Company, 842 South 7th Street, Louisville, KY 40203
 - Maine
 - Downeast Hamshack, 206 Northeast Rd, Auburn, ME 04210
 - Michigan**
 - Com Center, 24 Fort Mead Road, Laurel, MD 20610
 - Elect. Int. Svc. Corp, 11305 Elkin St, Wheaton, MD 20902
 - Mississippi
 - Hooon Elec. Sup, 495 Rodenburg Ave, Biloxi, MS 39531
 - Michigan
 - Pal Electronics, 3452 Fremont Ave, N, Minneapolis, MN 55412
 - Minnesota
 - P.T.I., 10201 103rd St, No Stillwater, MN 55082
 - Missouri
 - Mid-Com, 2506 S. Brentlan St, Louis, MO 63144
 - Missouri Comm. Systems Inc, 9807 View Cove Dr, Parkville, MO 64152
 - Roberts Rz Elec, 405 E 19th Ave, N. Kansas City, MO 64116
 - Saturn Elec, #9 Country Lane, Florissant, MO 63033
 - Massachusetts
 - Norbills' Elec, 2097 Riverside St, W Springfield, MA 01089
 - Tuff's Radio & Elec, 209 Myrick Ave, Bedford, MA 01215
 - TL-Comm, 875 Great Rd, Littleton, MA 01460
 - New Jersey
 - Summit Radio Sup, 1008 Traneck Rd, Teaneck, NJ 07866
 - New York
 - Barry Electronics, 512 Broadway, New York, NY 10012
 - Comm. Tech. Group, 488 Merrick Rd, Oceanside, NY 11572
 - Cavaliere Elec, 2336 14th Street, Astoria, NY 11102
 - Grand Cen. Radio, 124 E. 44th St, New York, NY 10016
 - JRS Amat Radio, 1185 Scottsville Rd, Rochester, NY 14624
 - Radio World, 605 Beech Street, Rome, NY 13440
 - North Carolina
 - George Town Comm, 1074 Patton Ave, Asheville, NC 28806
 - Vicker's Elec, 500 East Main Street, Durham, NC 27701
 - Ohio
 - Amateur Elect. Sup, 28940 Euclid Ave, Wickliffe, OH 44092
 - Queen City Elec, 7404 Hamilton Ave, Cincinnati, OH 45231
 - Universal Amateur, 1280 Acadia Drive, Reynoldsburg, OH 43068
 - Marietta Radio & TV, 5022 Marietta, OH 45750
 - Srapco Elect, 314 Lep St, Dayton, OH 45404
 - Oklahoma
 - Brodie Elec, 2537 Edgewood Dr, Moore, OK 73160
 - Derrick Elec, 714 W. Renoah, Broken Arrow, OK 74012
 - Nebraska
 - Omaha Amat Center, 2565 Dodge Street, Omaha, NE 68131
 - Nevada
 - Amateur Elec. Sup, 401 W. 1st Ave, Las Vegas, NV 89106
 - Evans' Radio, Inc, Rt. 3A Box 893, Bowling Green, NV 89301
 - Oregon
 - Sixpou Radio, 586 N. Main, Astland, OR 97520
 - Oregon Ham Sales, 401 W. 1st Ave, Albany, OR 97321
 - Pennsylvania
 - Ham-Burger, 68 North York Road, Willow Grove, PA 19090
 - Hamtronics, 4033 Brownsville Rd, Trevose, PA 19047
 - Rhode Island
 - D & N Communications, 1854 Smith St, No Providence, RI 041-231-6653
 - South Carolina
 - A & G Electronics, Route 3 Ayrstaek Dr, Taylors, SC 29687
 - Radio Com-Charles, 100 B Farm Road, Goose Creek, SC 29445
 - Gismo Comm, 2305 Cherry Rd, Rock Hill, SC 29730
 - Tennessee
 - A.R.S.O.N., 615 S. Gallatin D, Madison TN 37115
 - Rush Electronics, 1315 Bluff City Hwy, Bristol, TN 37620
 - Texas
 - Amateur & Comm. Elec, 5691 W. Creek Dr, Ft. Worth, TX 76133
 - Kennedy Assoc, 2618 Rignby, San Antonio, TX 78222
 - Leak Proof Seal, Red Bird Airport #8, Dallas, TX 75232
 - Madison Elec, 17508 McKinley, Houston, TX 77002
 - Omega Electronics, Rt. 1-10 Clumer Dr, Amarillo, TX 79106
 - Alpha Tronics, 3713 Cranston Ct East, Irving, TX 75062
 - B & T Electronics, 10457 Seawood, El Paso, TX 79925
 - Virginia
 - Eqc Equip. Bank, 516 Mill St, Vienna, VA 22180
 - Radio Comm, 311 Sherandoah Av, NW, Roanoke, VA 24016
 - The Tuned Circuit, 789 E. Market St, Harrisburg, VA 22801
 - Virginia Elec. Com, 702 E. Nine Mile Rd, Highland Spring, VA 23075
 - Washington
 - ABC Communications, 17550 15th St, NE, Seattle, WA 98154
 - Amateur Elec. Sup, 4828 W. Ford Du Lac Ave, Milwaukee, WI 53261
 - Ranger Elec, La Crosse, WI 608-452-3230
 - Wisconsin**
 - Amateur Elec. Sup, 4828 W. Ford Du Lac Ave, Milwaukee, WI 53261
 - Ranger Elec, La Crosse, WI 608-452-3230
 - Foreign Dealers**
 - Argentina
 - Centro Instrumental Electronico SA, AvDA Independencia 1956, 1225 Buenos Aires, Argentina
 - Puerto Rico
 - Radio Comm, P.O. Box 1832, San Juan, P.R. 00903
 - Canada
 - Dollard, 810 SW Marine Dr, Vancouver, Canada BC 6P6E3
 - New Zealand & Australia
 - Southern Cross El, 26 Southern Cross Rd, Kohmara Auckland NZ
 - West Germany
 - Kethley Instruments, 8000 Munchen 70, Heigol Str. 5, West Germany (089) 7144065
 - Dynatrade, Schimmelbusch Str. 25, 4005 Erkrath 2, West Germany
 - Belgium
 - MCR Electronics, Chaussee De Nivelles 100, 1420 Braine l'Alleud, Belgium

FUN!

John Edwards WB2IBE
78-56 86th Street
Glendale NY 11385

Each month's "Fun!" brings you all manner of delights and amusements. Included will be crossword puzzles, matching ques-

tions, scrambled words, and ham acrostics, all designed to help you pass the idle hours while waiting for the DX list to work toward your call.

We'll have trivial questions, important questions, questions that will amaze, confound, and perplex you. And why do we do it? So you can have an alternative to boring FCC tests, a way to learn about our hobby that will make the learning fun. You may not get a new license when you pass a Fun! ham test, but you won't have to travel to the Federal Building, either.

To get the ball rolling, this month's test will concentrate on that most challenging and complex mode of amateur communications—repeater operation! Answers appear on page 193.

ELEMENT 1—CROSSWORD PUZZLE (Illustration 1)

- | Across | Down |
|---|---|
| 1 G.E. FM surplus rig | 1 Most popular repeater modulation |
| 10 Multi-skip | 2 Some machines have these memories (abbr.) |
| 11 Element (abbr.) | 4 Repeater task |
| 12 IC feature | 5 Liberian prefix |
| 13 Pre-FM mode (abbr.) | 6 A repeater halved pair |
| 14 Like full-quieting (abbr.) | 7 Long Island (abbr.) |
| 15 "Secret" tone (abbr.) | 8 Repeater noise |
| 16 High end of band | 9 Effective radiated power (abbr.) |
| 17 Phone sigs on 2-meter's bottom (abbr.) | 19 To apply power |
| 18 Author's suffix | 21 Backwards integrated circuit (abbr.) |
| 19 RTTY repeater test string | 22 Amateur Radio op |
| 20 Radio control (abbr.) | 23 Hard-line (abbr.) |
| 22 W1AF's QTH (abbr.) | 25 A ham rock |
| 24 Microphone (abbr.) | 26 Unfriendly machine |
| 26 FM frequencies | 27 FCC special permission (abbr.) |
| 28 Anxious repeater owner's air-date | 29 Repeater scheme |
| 30 Original repeater source | 31 To employ a frequency |
| 33 Repeater antenna calculation (abbr.) | 32 Legal threat |
| 35 Morse "and" | 33 Can I _____ that machine from here? |
| 36 E = | 34 Amateur Radio Association (abbr.) |
| 37 Repeater hearing problem | |
| 38 Squelch appendage | |

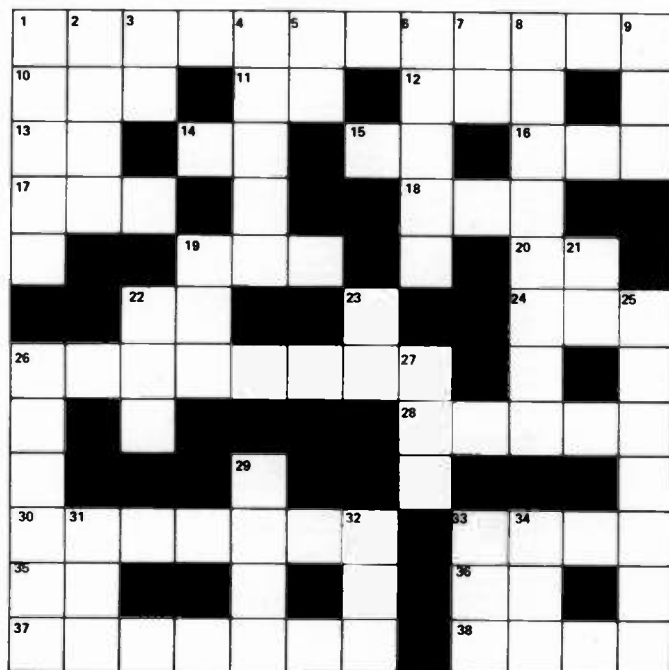

Illustration 1.

ELEMENT 2—MULTIPLE CHOICE

1) What many believe to be the first VHF repeater was installed near Springfield, Massachusetts, in the early 1930s. The callsign of this 5-meter machine closely resembled that of a noted station of today. It was...

- 1) KCBS
- 2) W1AWW
- 3) W1MK/R
- 4) W6RO/1

2) Back in the early 1970s, when repeaters were just coming into their own, one way of bringing up a tone-accessed machine was by using a little device known as a "Captain Crunch" whistle. How did this item get its name?

- 1) From its English inventor, Captain Sir Joseph Crunch.
- 2) The prototype whistles were modeled after toys that came in cereal boxes.
- 3) From the "crunchy" sound the whistles made.
- 4) From a ham who thought he was being funny.

3) Before synthesized HTs became popular, one particular rock-bound HT was the desire of every 2-meter FMer. Although the units were originally designed for commercial use, possession of this HT by an amateur marked its owner as a man of taste, distinction, and wealth. What was the name of this fabled HT?

- 1) The RCA PortaTalk
- 2) The G.E. TR-50
- 3) The Kenwood TS-520
- 4) The Motorola HT-220

4) We all know that WR-prefixed repeater callsigns are currently being phased out in favor of the station operator's primary call. However, before the first WR calls were issued by the FCC in 1972, what system was used for repeater identification?

- 1) Basically, that same system that is coming back today.
- 2) KN-prefixed calls.
- 3) KR-prefixed calls.
- 4) WC—RACES—calls.

5) In what year did the FCC open the 2-meter band to amateurs?

- 1) 1914
- 2) 1954
- 3) 1945
- 4) 1968

ELEMENT 3—SCRAMBLED WORDS

Unscramble these familiar repeater terms:

- | | | | |
|-----------|----------|---------|-------------|
| vondiaet | xelpud | mmajre | resranimttt |
| tchupaoat | tnlorco | hwpi | hcquest |
| retmi | tesl | emcanih | uspr |
| nevo | bmolie | tsam | pamflieri |
| orc | ortpblea | ttanois | notireecj |

Continued on page 193

November

Specials

11C05 1 GHz, pre.
Special \$59.95



ATF 417 pre-amp net Special \$19.95
MRF 901 UHF transistors, 1 GHz Special \$ 3.95

COMPLETE KITS: CONSISTING OF EVERY ESSENTIAL PART NEEDED TO MAKE YOUR COUNTER COMPLETE. **HAL-600A** 7-DIGIT COUNTER WITH FREQUENCY RANGE OF ZERO TO 600 MHZ. FEATURES TWO INPUTS, ONE FOR LOW FREQUENCY AND ONE FOR HIGH FREQUENCY, AUTOMATIC ZERO SUPPRESSION, TIME BASE IS 1.0 SEC OR .1 SEC GATE WITH OPTIONAL 10 SEC GATE AVAILABLE. ACCURACY ± .001%. UTILIZES 10-MHZ CRYSTAL 5 PPM.

COMPLETE KIT.....\$129

HAL-300A 7-DIGIT COUNTER WITH FREQUENCY RANGE OF ZERO TO 300 MHZ. FEATURES TWO INPUTS, ONE FOR LOW FREQUENCY AND ONE FOR HIGH FREQUENCY, AUTOMATIC ZERO SUPPRESSION, TIME BASE IS 1.0 SEC OR .1 SEC GATE WITH OPTIONAL 10 SEC GATE AVAILABLE. ACCURACY ± .001%. UTILIZES 10-MHZ CRYSTAL 5 PPM.

COMPLETE KIT.....\$109

HAL-50A 8-DIGIT COUNTER WITH FREQUENCY RANGE OF ZERO TO 50 MHZ OR BETTER. AUTOMATIC DECIMAL POINT, ZERO SUPPRESSION UPON DEMAND, FEATURES TWO INPUTS, ONE FOR LOW FREQUENCY INPUT, AND ONE ON PANEL FOR USE WITH AN INTERNALLY MOUNTED HALTRONIX PRE-SCALER FOR WHICH PROVISIONS HAVE ALREADY BEEN MADE. 1.0 SEC AND .1 SEC TIME GATES. ACCURACY ± .001% UTILIZES 10-MHZ CRYSTAL 5 PPM

COMPLETE KIT.....\$109

PRE-SCALER KITS

HAL 300 PRE.....\$14.95

(Pre-drilled G10 board and all components)

HAL 300 A/PRE.....\$24.95

(Same as above with preamp)

HAL 600 PRE.....\$29.95

(Pre-drilled G10 board and all components)

HAL 600 A/PRE.....\$39.95

(Same as above but with preamp)

TOUCH TONE DECODER KIT

HIGHLY STABLE DECODER KIT. COMES WITH 2 SIDED, PLATED THRU AND SOLDER FLOWED G-10 PC BOARD, 7-567's, 2-7402, AND ALL ELECTRONIC COMPONENTS. BOARD MEASURES 3 1/2 x 5 1/2 INCHES. HAS 12 LINES OUT. ONLY \$39.95

DELUXE 12-BUTTON TOUCHTONE ENCODER KIT utilizing the new ICM 7206 chip. Provides both VISUAL AND AUDIO indications! Comes with its own two-tone anodized aluminum cabinet. Measures only 2 3/4 x 3 3/4" Complete with Touch-Tone pad, board, crystal, chip and all necessary components to finish the kit.

PRICED AT.....\$29.95

For those who wish to mount the encoder in a hand-held unit, the PC board measures only 9/16" x 1 3/4". This partial kit with PC board, crystal, chip and components.

PRICED AT.....\$14.95

ACCUKEYER—MEMORY OPTION KIT THIS ACCUKEYER MEMORY KIT PROVIDES A SIMPLE, LOW COST METHOD OF ADDING MEMORY CAPABILITY TO THE WB4VVF ACCUKEYER, WHILE DESIGNED FOR DIRECT ATTACHMENT TO THE ABOVE ACCUKEYER, IT CAN ALSO BE ATTACHED TO ANY STANDARD ACCUKEYER BOARD WITH LITTLE DIFFICULTY. \$16.95

ACCUKEYER (KIT) THIS ACCUKEYER IS A REVISED VERSION OF THE VERY POPULAR WB4VVF ACCUKEYER ORIGINALLY DESCRIBED BY JAMES GARRETT, IN QST MAGAZINE AND THE 1975 RADIO AMATEURS HANDBOOK. \$16.95

ACCUKEYER—MEMORY OPTION KIT—TOGETHER ONLY \$32.00

6-DIGIT CLOCK • 12/24 HOUR

COMPLETE KIT CONSISTING OF 2 PC G10 PRE-DRILLED PC BOARDS, 1 CLOCK CHIP, 6 FND 359 READOUTS, 13 TRANSISTORS, 3 CAPS, 9 RESISTORS, 5 DIODES, 3 PUSH-BUTTON SWITCHES, POWER TRANSFORMER AND INSTRUCTIONS. DON'T BE FOOLED BY PARTIAL KITS WHERE YOU HAVE TO BUY EVERYTHING EXTRA.

PRICED AT.....\$12.95

CLOCK CASE Available and will fit any one of the above clocks. Regular Price... \$6.50 But Only \$4.50 when bought with clock

SIX-DIGIT ALARM CLOCK KIT for home, camper, RV, or field-day use. Operates on 12-volt AC or DC, and has its own 60-Hz time base on the board. Complete with all electronic components and two piece, pre-drilled PC boards. Board size 4" x 3". Complete with speaker and switches. If operated on DC, there is nothing more to buy.

PRICED AT.....\$16.95

Twelve-volt AC line cord for those who wish to operate the clock from 110-volt AC. \$2.95

SHIPPING INFORMATION

ORDERS OVER \$20.00 WILL BE SHIPPED POSTPAID EXCEPT ON ITEMS WHERE ADDITIONAL CHARGES ARE REQUESTED. ON ORDERS LESS THAN \$20.00 PLEASE INCLUDE ADDITIONAL \$1.50 FOR HANDLING AND MAILING CHARGES. SEND SASE FOR FREE FLYER.



"HAL" HAROLD C. NOWLAND
W8ZXH

HAL-TRONIX ✓31

P. O. BOX 1101
SOUTHGATE, MICH. 48195
PHONE (313) 285-1782



Shortwave Listener?

SEND FOR FREE CATALOG!

Scanner Buff?

Increase Your
Listening Power!

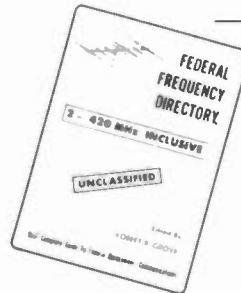

**FEDERAL
FREQUENCY
DIRECTORY** \$14.95
(Plus \$2.00 del.chg.)

OVER 100,000 UNCLASSIFIED FREQUENCIES, AGENCIES, AND LOCATIONS OF US FEDERAL GOVERNMENT COMMUNICATIONS STATIONS, 2-420 MHZ. MILITARY, JUSTICE, TREASURY, AIRCRAFT TOWERS, NASA, DOZENS MORE!



**SOUNDS OF
SHORTWAVE** \$5.95
(Plus .50 del.chg.)

A 60-MINUTE CASSETTE IDENTIFIES THOSE STRANGE SOUNDS: TELEMETRY, MULTI-PLEX JAMMING, SPY TRANSMISSIONS, SWEEPERS, TELETYPE, MANY MORE. EXPLAINS IN EASY-TO-LISTEN TERMS: HOW TO BUY A RECEIVER, PLANNING THE PROPER ANTENNA, COPING WITH INTERFERENCE, WHEN AND HOW TO LISTEN, CHOOSING ACCESSORIES.

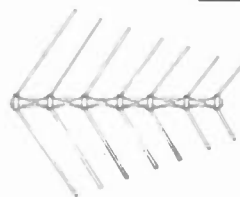

SCANNER BEAM

\$39.95
(Plus \$2.00 del.chg.)

FINALLY, A DIRECTIONAL ANTENNA MADE ESPECIALLY FOR SCANNERS. PICK UP THOSE WEAK DISTANT STATIONS WITH EASE. OPTIMIZED FOR 108 - 174 AND 406 - 512 MHZ AIRCRAFT, LAND MOBILE, AND AMATEUR SERVICES. ALSO RECEIVES 30 - 50 MHZ (non-directional). MATCHING TRANSFORMER AND MOUNTING HARDWARE INCLUDED.

SEARCHING FOR THE SOUNDS OF TOMORROW
GROVE ENTERPRISES

ROUTE 1 BOX 156 K BRASSTOWN, NC 28902

• DEALER INQUIRY INVITED • ✓352

NEW PRODUCTS

DRAKE R7 GENERAL COVERAGE COMMUNICATIONS RECEIVER

While a good number of imported general coverage receivers are now available, the emergence of a competitive domestic product is worthy of special note. The new R7 receiver from Drake is an example of a quality product for serious listening applications. Early problems of power supply harmonics in the VLF tuning range have been resolved.

An accurate 6-digit LED display is presented through a divided bezel which separates the megahertz window from the kilohertz window, affording a slight psychological cognitive advantage when quickly glancing at the frequency display. The sixth digit indicates tenths of a kilohertz (100 Hz), assuring great tuning accuracy.

An internal 25-kHz crystal calibrator seems an unnecessary luxury.

Selectivity of the R7 is factory-supplied with a 2.3-kHz 8-pole crystal filter; optional switch-selectable filters of 4.0-, 1.8-, 0.5-, and 0.3-kHz filters are available from the factory at \$55 each. The same filters are used on both AM and SSB/CW detection modes. Image and I-f rejections are at least 80 dB.

One of the major drawing cards of the R7 is its passband tuning feature. By slightly shift-

ing the intermediate frequency of the receiver, an interfering signal may be substantially reduced or even eliminated. This is nice, and on the R7 it works well.

A high-level double-balanced mixer is used in an up-conversion scheme to create the first i-f (48.05 MHz). Both front-end overload and intermodulation are kept to a minimum with this approach. A second i-f of 5645 kHz and a third i-f of 50 kHz help maintain the receiver's 100-dB ultimate selectivity.

Apparent receiver sensitivity is good; undoubtedly, careful attention to filter matching and input losses has helped preserve its 0.5-microvolt shortwave sensitivity on SSB and CW reception. AM sensitivity is better than 2.0 microvolts.

On the standard broadcast band and below, sensitivity is better than 1.0 microvolt on SSB/CW and 4.0 microvolts on AM.

Sensitivity of the receiver may be enhanced somewhat through the utilization of an integral pre-amplifier which boosts gain some 10 dB. Since noise is also boosted somewhat, the effective net improvement in receiver sensitivity using the preamp is actually around 5 or 6 dB.

The R7 exhibits high thermal and mechanical stability. At power-on, bfo adjusted to a low heterodyne on an incoming signal, no detectable drift occurred

on our sample. A substantial rap on the cabinet also failed to produce a warble in pitch. That's good stability!

Receiver incremental tuning (RIT) allows ± 3 -kHz independent frequency adjustment when used in a transceive mode with a matching transmitter. The frequency display moves with the RIT adjustment.

A "store" control permits the operator to lock the display on its present receive frequency and then tune up and down without the display changing. This feature is a "visual scratch pad" useful for net operation.

Frequency bands are selected both by rotating a band-switch and by pressing appropriate "up" or "down" keys to jump in 500-kHz increments.

An auxiliary program board (AUX-7) may be purchased (\$45 plus modules and crystals) to permit crystal-controlled operation of the R7. No preselection is required in any tuning mode.

An i-f notch filter is useful in reducing adjacent-frequency heterodyne interference some 40 dB, and is variable over several kilohertz of passband.

AGC attack time is one millisecond, and release times may be selected from 4 choices, 0 through 2 seconds. An optional noise blanker may be purchased separately and controlled from the front panel.

A highly-flexible antenna switching provision allows a variety of converters and antennas to be used with the R7, attachable through a row of RCA phono plugs on the rear apron. Although purists may scoff at the use of phono connectors for antenna jacks on an expensive

receiver, such devices perform perfectly well at these frequencies.

An rf gain control is useful for reducing background interference on loud signals. The af gain control, for some reason, does not allow complete reduction of audio. While the internal speaker is capable of good audio, rear-apron provision for an external speaker, and front-panel provision for headphones, are both made.

Power requirements for the R7 may be selected from 120 or 240 V ac, 50/60 Hz, or 12 V dc at 3 Amps.

While a few spurious signals were noted, especially in the VLF range, we were generally impressed with the performance of the R7 receiver, and feel that it affords a great deal of flexibility for the array of imaginative requirements of most amateurs and listening hobbyists. The R7 receiver is listed at \$1449. R. L. Drake Co., 540 Richard Street, Miamisburg OH 45342. Reader Service number 476.

Robert Grove WA4PYQ
Brasstown NC

RADIO SHACK DX-302 GENERAL COVERAGE RECEIVER

It has been a couple of years since Radio Shack released their DX-300 digital-display general coverage receiver. Reports from users varied from praise to eternal damnation, but one thing was certain: It had problems.

The DX-300 was plagued with horrendous spurious signals, largely due to self-oscillation. Frequency drift, lack of i-f selectivity, and cumbersome two-step peaking were others.

It was evident that redesigning would be necessary, and the new DX-302 (why not 301?) was the result. Is it any better? Yes. Is it a lot better? Well... in order to answer the question of just how good a receiver is, we have to view the product from the perspective of the market for whom it is manufactured.

The DX-302 is intended for a broad consumer audience not sophisticated in electronics. The bulk of these listeners will apply their listening time to AM international broadcast, using the bfo provision less often. This is just as well, as the DX-302 still exhibits frequency drift.

Some AGC pumping with strong CW and SSB signals



Drake's R7 general coverage receiver.

SUPER RIG



NEW TEN-TEC

OMNI-C 9 Band Transceiver + HERCULES Solid-State kW Linear

TEN-TEC SUPER RIG IS READY. For every band, every band condition. With the latest in solid-state hf technology, the latest in features. To make communications easier, more reliable — super.

OMNI-C

The new model in this famous series. With new coverage and new features to make it better than ever!

All 9 HF Bands. From 160 through 10 meters, including the new 10, 18 and 24.5 MHz bands. Coverage you can live with—for years and years.

3-Mode, 2-Range Offset Tuning. Offset the receiver section or the transmitter section or the entire transceiver! In 2 ranges: ± 500 Hz or ± 4 kHz. For complete flexibility in fine tuning, a DX work, or net operations.

Seven Response Curves. Four for SSB, three for CW. With new switching to select the standard 2.4 kHz filter, optional 1.8 kHz SSB filter, 500 Hz or 250 Hz CW filters, and standard 450 and 150 Hz CW active audio filters. Up to 16 poles of i-f filtering plus audio filtering to handle any situation.

Built-In Notch Filter and Noise Blanker. Notch is variable from 200 Hz to 3.5 kHz with a depth of more than 50 dB. New noise blanker reduces ignition and line noise. Both standard equipment.

"Hang" AGC. New, smoother operation.

Super Specs. Optimized sensitivity—a balance between dynamic range and sensitivity ($2 \mu\text{V}$ on 160 to $0.3 \mu\text{V}$ on 10 meters) Greater dynamic range: better than 90 dB. And a PIN diode switchable 18 dB attenuator. 200 watts input on all bands! 100% duty cycle on all bands for up to 20 minutes.

Super Convenient. Built-In VOX with 3 up-front controls. Built-In PTT control at front and rear jacks. Built-In Zero-Beat switch puts you on exact frequency. Built-In Adjustable Sidetone with variable pitch and level. Adjustable ALC for full control from low power to full output. 2-Speed Break-In, fast or slow speeds to fit operating conditions. Built-In Speaker eliminates desk clutter. Automatic Sideband Selection—reversible.

Super Design. All Solid-State and Broadbanded—from the pioneer, Ten-Tec. Modular plug-in circuit boards. Functional Styling with convenient controls, full shielding, easy-to-use size ($5\frac{3}{4}$ "h x $14\frac{1}{4}$ "w x 14"d).

Super Hercules Companion. Styled to match, plus separate receiving antenna capability, plus transceiver front panel control of linear's bandswitching (one knob does it all).

Full Accessory Line including filters, remote VFO, power supplies, keys, microphones, speech processors, antenna tuners—all in matching color.

Model 546 OMNI-Series C . . . \$1189.

HERCULES

Amateur Radio's first full break-in solid-state kW linear amplifier. With the reliability you'd expect from the pioneer in high-power solid-state technology—TEN-TEC.

All Solid-State. No tubes. Instead, HERCULES uses two 500-watt push-pull solid-state amplifier modules with an output combiner. Super solid.

Broadband Design. No knobs, no tuning. From the pioneer, TEN-TEC. For fast, effortless changing of bands. Super easy.

Automatic Bandswitching when used with OMNI (the OMNI bandswitch also controls HERCULES bandswitching through a motor driven stepping switch). Super convenient.

Full Break-In. HERCULES puts the conversation back into high power CW operation—you can hear between every character you send.

Full Coverage. 160 through 15 meters plus four "AUX" positions for 10-meter conversion by owner and future band additions.

Full Gallon. 1000 watts input on all bands, 600 watts output, typical. Built-in forced-air cooling. Driving power: 50 watts, typical. Adjustable negative ALC voltage. 100% duty cycle for SSB voice modulation; 50% duty cycle for CW/RTTY (keydown time: 5 minutes max.) Continuous carrier operation at reduced output.

Full Protection. Six LED status indicators continuously monitor operating conditions and shut down the amplifier whenever any one exceeds set limits (the exciter automatically bypasses the amplifier under amplifier shut-down for barefoot operation). The six parameters monitored are: 1) overdrive; 2) improper control switch setting; 3) heat sink temp.; 4) SWR; 5) overvoltage/overcurrent; 6) rf output balance. Two meters monitor collector current, voltage, and forward/reverse power. And a highly efficient automatic line voltage correction circuit (patent applied for) eliminates the need for selecting transformer taps, prevents applying too high a voltage to final amplifier devices, becomes operative under low line conditions.

Super Power Supply. Provides approximately 45 VDC @ 24 amperes, operates on 105/125 VAC or 210/250 VAC. Tape wound transformer and choke reduce weight (50 lbs.) and size ($7\frac{1}{2}$ "h x $15\frac{3}{4}$ "w x $13\frac{1}{2}$ "d). Separate enclosure.

Super Styling. Designed to match OMNI, the HERCULES has the same height as OMNI, plus matching bail and matching colors. The front panel is simplicity in itself with two push-button switches (power and mode) plus two knobs (meter and bandswitch), and a "black-out" monitor panel (when unit is off, meters are unobtrusive). Amplifier size is $5\frac{3}{4}$ "h x 16 "w x $15\frac{1}{2}$ "d.

Model 444, HERCULES amplifier & power supply . . . \$1575.

Experience SUPER RIG at your TEN-TEC dealer, or write for full details.

TEN-TEC, INC.
SEVIERVILLE, TENNESSEE 37852
EXPORT 5715 LINCOLN AVE., CHICAGO, ILL. 60646

NEW PRODUCTS

exciting new ideas from the world's leading manufacturer of amateur radio accessories

NEW MFJ/BENCHER Keyer-Paddle Combo — "The Pacesetter"



MFJ-422
Combo
\$99⁹⁵ (+\$4)

The best of all CW worlds — a deluxe MFJ keyer in a compact configuration that fits right on the BENCHER iambic paddle! And you can buy the combination or just the keyer to fit on your BENCHER.

New MFJ keyer — small in size, big in features. Curtis 8044 IC, adjustable weight and tone, front panel volume and speed controls (8-50 wpm), built-in dot-dash memories, speaker, sidetone, and push-button selection of semi-automatic/tune or automatic modes.

Ultra-reliable solid-state keying: grid-block, cathode and solid-state transmitters (-300 V, 10 mA max; +300 V, 100 mA max). Fully shielded. Uses 9 V battery or optional AC adapter (\$7.95 +\$2)

Beautiful functional engineering. The keyer mounts on the paddle base to form a small (4 1/8" x 2 1/8" x 5 1/2" L) attractive combination that's a pleasure to look at and use. The BENCHER paddle is a best seller. Fully adjustable; gold-plated silver contacts; lucite paddles; chrome plated brass; heavy steel base with non-skid feet.

MFJ-422X Keyer only
\$69⁹⁵ (+\$4)

NEW MFJ 4 & 8-Band Mobile Shortwave Converters



MFJ-304 \$59⁹⁵ (+\$4)



MFJ-308 \$79⁹⁵ (+\$4)

Another MFJ "first," these low cost mobile SWL converters provide new excitement and variety for your driving/listening pleasure.

Two models to choose from. The 4-band "World Explorer I" (MFJ-304) offers complete 19, 25, 31 and 49 meter coverage (the most popular HF bands due to their distance capabilities at various times of the day and year). Hear countries from Europe, Africa, Middle East, Asia, the Islands, North and South America. The 8-band "World Explorer II" (MFJ-308 adds 13, 16, 41, and 60 meter bands) for even greater listening variety.

Compact and sensitive. The 4-band model

measures just 5 1/4" x 1 1/4" x 4" D to fit anywhere in your vehicle (the 8-band version is just 1" wider and 1" deeper). Two dual-gate MOSFETS give these converters excellent sensitivity and selectivity when combined with your automotive receiver.

Easy to use, easy to install. Push a converter button to choose the band, tune in stations with your regular car radio. To install, just plug the car antenna into the converter and insert the converter cable into your car radio antenna jack; connect the power lead to 12 VDC.

Listen to the world on the road. Get the new MFJ mobile SWL converters — "World Explorers I & II."

NEW MFJ Active CW/SSB/Notch Filters



MFJ-722
\$69⁹⁵ (+\$4)

MFJ-723
\$49⁹⁵ (+\$4)

Two new super-selective filters. The new MFJ-722 "Optimizer" offers razor sharp, no-ring CW filtering with switch-selectable bandwidths (80, 110, 150, 180 Hz centered on 750 Hz), steep-skirted SSB filtering, and a 300-3000 Hz tunable 70 dB notch filter.

The 8-pole (4-stage) active IC filter gives CW performance no tunable filter can match. (80 Hz bandwidth gives -60 dB response one octave from center and up to 15 dB noise reduction). The 8-pole SSB audio bandwidth

is optimized for reduced sideband splatter and less QRM (375 Hz highpass cutoff plus selectable lowpass cutoffs at 2.5, 2.0, and 1.5 kHz, 36 dB/octave rolloff). Size: 5x2x6".

New model MFJ-723 is similar to the 722 but is for CW only, has a 60 dB notch tunable from 300-1200 Hz, and measures 2x4x6". Other models: MFJ-721, \$59.95, like 722 but less notch; MFJ-720, \$39.95, like 723 but less notch.

Versatile, all models plug into the phone jack, provide 2 watts for speaker or can be used with headphones. All require 9-18 VDC, 300 mA max (or 110 VAC with optional AC adapter at \$7.95 +\$2).

Enjoy pleasant listening and improved readability with one of these new MFJ filters.

NEW MFJ "Dry" 300W & 1KW Dummy Loads

MFJ-262
\$49⁹⁵ (+\$4)

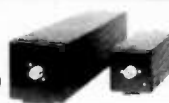

MFJ-260
\$26⁹⁵ (+\$4)

Air Cooled, non-inductive 50-ohm resistors in perforated metal housings with SO-239

connectors; both rated to full load for 30 seconds; de-rating curves to 5 minutes included. Just right for tests and fast tune up.

Low VSWR. 300W: 1.1:1 max to 30 MHz, 1.5:1 max. 30-160 MHz. 1 kW: 1.5:1 max to 30 MHz. MFJ-260 (300W) is just 2 1/2 x 2 1/2 x 7"; MFJ-262 (1 kW) is 3 x 3 x 13".

NEW MFJ Shortwave Accessories



MFJ-1040
\$99⁹⁵ (+\$4)

MFJ-1020
\$79⁹⁵ (+\$4)



MFJ-1040 Receiver Preselector

Boosts weak signals, rejects out of band signals, reduces images. Covers 1.8-54 MHz with up to 20 dB gain from low noise MOSFET circuitry. Works with 2 antennas and 2 receivers (even XCVRS to 350W input).

Built-in 20 dB attenuator prevents receiver overload. Also includes auto-bypass, delay control, PTT jack. Operates on 9 V battery,

9-18 VDC, or 110 VAC with optional AC adapter, \$7.95 +\$2.

Model MFJ-1045, \$69.95, is the same less attenuator, bypass, delay, PTT, 1 antenna & 1 receiver.

MFJ-1020 Indoor Active Antenna

"World grabber," rivaling or exceeding reception of outside long wires.

Unique tuned circuitry with amplification minimizes intermod distortion, improves selectivity, reduces noise outside the tuned band, even functions as a preselector with an external antenna. Covers 0.3-30 MHz in 5 bands. Telescoping ant.; tune, band, gain, on-off-bypass. Uses 9 V battery, 9-18 VDC, or 110 VAC, with optional AC adapter at \$7.95 +\$2. 5x2x6".

TO ORDER PRODUCTS, CALL TOLL FREE



800-647-1800

VISA

For tech. info., order or repair status, or calls outside continental U.S. and inside Miss., call 601-323-5869.

- All MFJ products unconditionally guaranteed for one year (except as noted)
- Products ordered from MFJ are returnable within 30 days for full refund (less shipping)
- Add shipping & handling charges in amounts shown in parentheses

Write for FREE catalog, over 60 products

MFJ ENTERPRISES
INCORPORATED

Box 494; Mississippi State, MS 39762

MFJ 941C Versa Tuner II



MFJ-941C
\$84⁹⁵ (+\$4)

Fastest selling MFJ tuner . . . because it has the most wanted features at the best price.
SWR + dual range wattmeter (300 & 30 watts full scale, forward and reflected power). *Sensitive meter* measures SWR down to 5 watts output.
More flexible antenna switch selects 2 coax lines, direct or through tuner, random wire/balanced line, or tuner bypass for dummy load.
12 position efficient airwound inductor for lower losses, more watts out.

Built-in 4:1 balun for balanced lines. 1000v capacitor spacing.
Matches everything from 160-10 meters: dipoles, inverted vees, random wires, verticals, mobile whips, beams, balanced and coax lines.
Easy to use, anywhere. Measures 8x2x6", has SO-239 connectors, 5-way binding posts, finished in eggshell white with walnut-grained sides.
MFJ-945, \$74.95, like model 941C but less ant. switch. Optional mobile bracket for either model is \$3.

MFJ 484 "Grandmaster" Memory Keyer

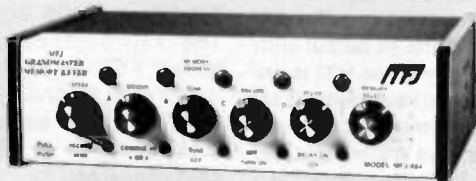

MFJ-484
\$139⁹⁵ (+\$4)

Up to twelve 25 character messages plus 100, 75, 50 or 25 ch. messages (4096 bits). **Repeat any message continuously or with pauses** of up to 2 min. LEDs show use. **Record, playback, or change messages instantly** at touch of a button. Memories are resettable with button or touch of the paddle. **Built-in memory saver** — 9 V battery takes over when power is lost.
Iambic operation with squeeze key. Dot-dash insertion. Optional BENCHER paddle \$42.95 + \$4.
Dot-Dash memories, self-completing, jam-proof spacing, instant start.

Panel controls: Speed (8-50wpm)/Record; Weight/Memories Combined; Tone/Tune; Delay (0-2 min.)/Repeat; rotary Vol/On-Off; Memory Select; Message Buttons select desired 25 ch. messages; Memory Reset button.
Ultra reliable solid state keying: grid block, cathode, solid state transmitters (-300 V, 10 mA max; +300 V, 100 mA max). Operates 12-15 VDC or 110 VAC with optional adapter. \$7.95 + \$2. Size 8x2x6". **MFJ-482, \$99.95**, four 25 or 50 + two 25 ch. messages; **MFJ-481, \$89.95**, two 50 ch. messages. Get the best seller keyers—MFJ "Grandmasters."

MFJ 410 "Professor Morse" Code Generator/Keyer



NEW LOW PRICE Save \$20
MFJ-410 Now Only \$129⁹⁵ (+\$4)

Use it to learn, use it to operate. It sends *unlimited random code* in random groups for practice; *never repeats* sequences. And when you're on the air, it's a *full feature keyer*. **Vary speed from 5-50 wpm;** meter readout. **Vary spacing;** give fast sound to low speed. **Alpha or alphanumeric** with punctuation. **Built-in speaker** and phone jack; tone and vol. Ideal for classroom or private use.
Full feature keyer includes vol., speed, tone and weight controls, tune switch, dot-dash memories, keys grid block, cathode, solid-state rigs. Optional BENCHER paddle \$42.95 + \$4. Operates on 9-18 VDC, two 9 V batteries or 110 VAC with optional adapter \$7.95 + \$2. Size 7x2x6". Get "Professor Morse" — you'll never outgrow it.

MFJ Dual Tunable SSB/CW Filter "Signal Enhancer"



MFJ-752B **\$84⁹⁵** (+\$4)

Dual filters give unmatched performance. **The primary filter** lets you *peak, notch, low pass or high pass* with extra steep skirts. **Auxiliary filter;** 70 dB notch, 40 Hz peak. **Both filters tune from 300 to 3000 Hz** with variable *bandwidth from 40 Hz to nearly flat*. **Constant output** as bandwidth is varied; linear frequency control.
Switchable noise limiter for impulse noise. **Simulated stereo sound** for CW lets ears and mind reject QRM.
Inputs for 2 rigs, switch selectable. Plugs into phone jack. Two watts for speaker. OFF bypasses filter. 9-18 VDC, 300 mA or 110 VAC with optional adapter \$7.95 + \$2. 10x2x6". **MFJ 751, \$59.95**, similar, primary filter only, less high pass & noise limiter.



favorite products from the world's leading manufacturer of amateur radio accessories

GMT Clock/ID Timer



MFJ-101
\$29⁹⁵ (+\$4)

24 hour, solid-state, blue 0.6" digits. ID timer sounds every 9 min (also a snooze alarm), regular alarm for skeds or to awaken, power-out/alarm-on indicators, ready to use on 110VAC, 50-60Hz, 6x2x3".

KW Dummy Load With Oil



MFJ-250
\$29⁹⁵ (+\$4)

Rated at 1 kW CW or 2 kW PEP for 10 min., half that for 20 min., cont. at 200 W CW, 400 W PEP, non-inductive 50 ohm resistor, quality transformer oil (no PCB), VSWR under 1.2:1 to 30 MHz, 1.5:1, 30-300 MHz, 2:1, 300-400 MHz. Coax conn., vent cap., 7 1/2" h x 6 1/2" diam.

300 Watt Antenna Tuner



MFJ-949B
\$129⁹⁵ (+\$4)

Does it all! Built-in dummy load, SWR, forward and reflected power meter, antenna switch, balun, matches everything from 1.8-30 MHz (coax, random wires, balanced lines), coax conn., binding post, 10x3x7".

TO ORDER PRODUCTS, CALL TOLL FREE



800-647-1800



For tech. info., order or repair status, or calls outside continental U.S. and inside Miss., call 601-323-5869.

- All MFJ products unconditionally guaranteed for one year (except as noted)
- Products ordered from MFJ are returnable within 30 days for full refund (less shipping)
- Add shipping & handling charges in amounts shown in parentheses

Write for FREE catalog, over 60 products

MFJ ENTERPRISES INCORPORATED ✓47
 Box 494; Mississippi State, MS 39762



Radio Shack's DX-302 general coverage receiver.

might be objectionable, showing a need for slower decay time.

The i-f selectivity problem has been improved considerably in the DX-302; the -6 dB and -60 dB points are at 3.5 kHz and 6.0 kHz in the wide position and at 2.5 kHz and 4.0 kHz in the narrow position. The spurs which were evident in the DX-300 are now extinct. Two-step peaking is still necessary.

Sensitivity of the DX-302 is excellent, averaging 0.3 microvolts throughout the shortwave spectrum. Image rejection is 60-70 dB down. Upper or lower sideband selection adds to the receiver's flexibility.

Frequency coverage is another plus, permitting continuous-coverage reception from 10 kHz through 30 MHz. Frequency display is provided by a five-digit LED readout—and it's accurate. A drop of oil behind the spindle

of the spinner knob did wonders for our sample, loosening the stiff turning feel.

The receiver is relatively straightforward, reflecting design philosophies incorporated into the new breed of synthesized receivers. Incoming signals are up-converted to 55 MHz where they are tuned in 1-MHz increments into a 3-2 MHz tunable i-f. Triple conversion finally results in a conventional 455-kHz 3rd i-f which is also the bfo frequency (± 1.5 kHz).

Power requirements may be selected from 120 V ac at 60 Hz (220-volt, 50-Hz models available for Europe and Australia), 12 V dc for mobile operation, or 8 internal C cells for fully portable operation.

While the DX-302 would not be recommended for primary reception, it would make a good standby receiver. And, most important, it would be a good intro-

ductory receiver for a newcomer to the fascinating world of shortwave listening. The DX-302's self-contained code practice oscillator just might encourage that newcomer to go one step further!

The Radio Shack DX-302 general coverage receiver lists for \$379.95. For further information, contact *Radio Shack, a division of Tandy Corporation, 1300 One Tandy Center, Ft. Worth TX 76102*. Reader Service number 490.

**Robert Grove WA4PYQ
Brasstown NC**

MIRAGE'S MODEL B23 2M AMP

Mirage has announced the latest member in its line of quality amateur equipment, the B23 2-meter all-mode low-power amplifier. The B23 is designed to be used with all available HT and low-power SSB transmitters.

Mirage's newest amplifier will provide 30 Watts of output with 2 Watts of drive. The B23 is linear and may be keyed with as little as 100 mW and up to as much as 5 Watts. Five Watts input will give 40 to 45 Watts output.

The B23 is packaged in a rugged, compact enclosure that may be mounted anywhere or left unmounted for maximum portability.

For more information, contact Everett Gracey WA6CBA or Ken Holladay K6HCP at *Mirage Communications Equipment, Inc., PO Box 1393, Gilroy CA 95020; (408)-847-1857*. Reader Service number 482.

JE610 ASCII-ENCODED KEYBOARD KIT ANNOUNCED BY JAMECO

Jameco Electronics has

developed the JE610 ASCII-Encoded Keyboard Kit which can be interfaced into almost any computer system.

The kit comes complete with a 62-key industrial grade keyboard switch assembly, integrated circuits, sockets, connector, electronic components and a double-sided printed circuit board. Complete, easy-to-follow step-by-step wiring instructions and circuit diagram are also included.

The keyboard switches are SPST mechanical action and 60 keys generate the full 128 characters, upper and lower case, of the ASCII set. Two user defined keys are provided for custom applications. This unit is fully buffered and there is a caps lock for upper case alpha characters.

The heart of the system is a 40-pin ROM (AY5-2376) with outputs directly compatible with TTL/DTL or MOS logic arrays. The keyboard assembly requires +5 V dc at 150 mA and -12 V dc at 10 mA for operation. Interfacing is accomplished by a 16-pin DIP or an 18-pin edge card connector.

For more information, write to *Jameco Electronics, 1355 Shoreway Road, Belmont CA 94002*. Reader Service number 488.

BROADBAND VHF/UHF BEAM ANTENNA ANNOUNCED BY GROVE ENTERPRISES

Intended primarily for the hobby scanner radio market, the new Scanner Beam from Grove Enterprises is designed to work over the continuous frequency range of 18 through 512 MHz. A seven-element, log-periodic di-



Mirage's Model B23 2m amp.



Jameco's JE610 ASCII-encoded keyboard.

pole array, the Scanner Beam is said to offer gain approaching 8 dB above a dipole on high band and UHF. An additional 15-dB front-to-back ratio makes the Scanner Beam particularly suitable for long distance, weak-signal directional reception. Average vswr is 1.92:1.

On low band (30-50 MHz), the antenna resembles an omnidirectional vertical dipole.

Constructed of heavy-duty aluminum tubing, the Scanner Beam features unbreakable ABS Cyclocac insulators and 4-foot baked enamel painted boom, and includes a 4:1 matching balun transformer for either 50- or 75-Ohm coaxial feedline.

A universal offset mount permits the Scanner Beam to be attached to a metal mast with a minimum of interaction, and additionally allows the antenna to be tilted in a vertical plane for satellite reception. Hams will find the Scanner Beam also useful for transmitting in the 144-, 220-, and 420-MHz bands.

A matching coaxial cable assembly is also available. Constructed of 65 feet of low-loss, foam-dielectric, copper-braided shield, the cable assembly comes with factory installed F connector, Motorola connector, and weather boot.

For further information, contact *Grove Enterprises, Inc., Route 1, Box 156K, Brasstown NC 28902*. Reader Service number 486.

HEATH INTRODUCES NEW LINE OF FREQUENCY COUNTERS

Heath Company has introduced two new digital frequency counter kits. The IM-2400, Heath's first hand-held counter, features a 50 Hz-512 MHz frequency range—while the portable IM-2410 offers a single input for its entire 10 Hz-255 MHz frequency range.

Weighing just 4/5 of a pound, the Heathkit IM-2400 hand-held frequency counter can be used anywhere in the field—or on the test bench. Large-scale integration and CMOS technology allow the IM-2400 to fit into a cabinet measuring only 1-5/8" H x 3-3/8" W x 8-3/8" L.

The IM-2400's crystal-controlled 10-MHz time base provides improved accuracy and 10-ppm temperature stability, according to a Heath spokesperson. With a typical sensitivity of 10 millivolts, the IM-2400

hy-gain[®]

DX'ER, CONTESTER, or RAG-CHEWER

With the sunspot cycle nearing its peak, and traffic on 10, 15 and 20 meters at an all-time high, you need a tri-band beam that really delivers. You'll find that there are more Hy-Gain Tri-Banders on the air than any other brand, and that says a lot! All of Hy-Gain's Tri-Banders feature separate High-Q, high-efficiency traps that ensure maximum F/B ratio and gain and minimum VSWR on ALL THREE bands. Hy-Gain's "no-compromise" construction features; taper-swaged 6063-T832 thick-wall aluminum tubing for maximum strength and minimum wind resistance; a rugged boom-to-mast bracket that adjusts from 1 1/4" to 2 1/2"; heavy gauge, machine formed, element-to-boom brackets that won't allow the elements to twist on the boom; and improved element compression clamps that allow greater tightening ability and easier readjustment. Hy-Gain's unique Beta-Match is factory pre-tuned to ensure minimum VSWR and maximum gain on all three bands. All Hy-Gain beams are fed with 52 ohm coaxial cable and deliver less than 1.5:1 VSWR at resonance. Write for full details today!

Hy-Gain has the right Tri-Bander for you!

Antenna shown is:
TH6DXX
6-Element
Tri-Band Beam

Other Tri-Banders in the Hy-Gain line:
TH5DX
5-Element
Tri-Band Beam

TH3MK3
3-Element
Tri-Band Beam

Tower shown is
The NEW Hy-Gain
HG-52SS
Self Supporting
Crank-Up Tower

TELEX hy-gain

TELEX COMMUNICATIONS, INC.

8800 Alton Ave. St. Minnesota, MN 55420 U.S.A.
Euron. P. 094 de la Legion d'Honneur 73201 St. Denis, France



Heathkit's IM-2400 hand-held frequency counter.

can read weaker signals. And the 7-digit LED display is 3/8" high, for more legible readings.

True hand-held portability is achieved by placing the five rechargeable nickel-cadmium batteries inside the housing of the IM-2400.

The IM-2410 portable frequency counter measures input signals between 10 Hz and 225 MHz, with good accuracy and



Heathkit's new IM-2410 portable frequency counter.

10-ppm temperature stability. A durable metal cabinet, improved RFI shielding, and complete voltage protection help ensure proper operation.

A pivoting stand and locking swing-down bail place the 8-digit LED display at a convenient viewing angle.

Both the IM-2400 and IM-2410 counters may be connected directly to the component under measurement. Or, for counting without any connections, the optional SMA-2400-1 swiveling telescopic antenna may be used. This right-angle antenna with BNC connector may also be used on many 2-meter transceivers. The chrome-plated SMA-2400-1 is frequency-tunable, by extending or retracting the telescoping sections.

For more information, contact Heath Company, Dept. 350-500, Benton Harbor MI 49022. Reader Service number 485.

INTERNATIONAL INTRODUCES THE TV-4300 SATELLITE RECEIVER

A new 24-channel satellite re-

ceiver is now available from International Crystal Manufacturing Co.

The high-performance receiver tunes all channels within the 3.7-4.2-GHz band. Standard dual audio output is provided at 6.2 and 6.8 MHz. Others are available.

The TV-4300 is a fully packaged and assembled receiver complete with a built-in LNA power supply, built-in AFC, tuner, control circuitry, and power cable. All output levels are compatible with video monitor and VTR input.

ICM offers several options including a remote tuning control and selectable audio with stereo output. For complete information, write *International Crystal Manufacturing Co., Inc.*, 10 North Lee, Oklahoma City OK 73102. Reader Service number 483.

RTTY89

COMMSOFT, a software company located in Palo Alto, California, has introduced RTTY89 for the Heath H89 or H8/H17/H19 computer. By taking advantage of the disk and dynamic video graphics capabilities of either computer, this program adds a new dimension to amateur radio communications. Version 3.0 of the W6LLO program provides exclusive 3-level split screen to allow pretyping messages while copying incoming data. Other features include: disk-based autostart (record incoming/outgoing data on disk); disk load into pretype buffer; sophisticated on-screen graphics displaying complete system status including time; automatic CW identification; and ASCII or Baudot operation. These and many other features

are described in a free brochure.

For further information, contact COMMSOFT, 665 Maybell Avenue, Palo Alto CA 94306; (415)-493-2184. Reader Service number 481.

DTMF DECODER

The Teltone M-917 is a DTMF decoder and rotary dial pulse counter in a modular package. It accepts touchtone™ (dual tone-multifrequency) signals from telephone, radio, pre-recorded tape and other sources. Output is logic level binary with strobe, and other options. It can be used to drive a low-power TTL gate or transistor, CMOS, or MOS devices. The low-cost, sealed modular unit (3.5 x 2.5 x .65 inches) meets or exceeds all telephone industry standards for use in central office equipment. It contains a proprietary LSI, high-impedance input buffer, dial-tone filter, high- and low-bandpass filter, and a crystal-controlled, digital frequency detector that can recognize all 16 DTMF digits.

For further information, contact Teltone Corporation, 10801-120th Avenue NE, Kirkland WA 98033; (206)-827-9626. Reader Service number 484.

KANTRONICS' FIELD DAY 2 SWL MODEL

There was time not too long ago when the thought of copying radioteletype would conjure up a mental image of cumbersome, noisy teleprinters. The venerable Model 15 has been in the shacks of countless thousands of stalwart experimenters, clacking away and spewing out rolls of paper.

The RTTY scene has changed dramatically. No longer are the mechanical monsters necessary for the registration of RTTY copy, nor are the touchy demodulators with their bevy of controls.

Digital technology has come to the rescue with several self-contained readers, displaying their copy faultlessly via an LED readout.

One of the most popular of these automatic RTTY readers is the Field Day 2 from Kantronics. For use with general coverage receivers, a specially-shielded SWL model is available at a slight additional cost.

Far more flexible than any of the mechanical teleprinters, the Field Day 2 has provision for automatic Morse code display, on-



International Crystal's TV-4300 satellite receiver.

ly a dream when the mechanical teleprinter was king. The Field Day 2 will track any Morse speed, from 3 to 80 words per minute.

On RTTY, speeds of 60, 67, 75, and 100 wpm are selectable, with the additional compatibility with 110 and 300 wpm ASCII. An internal 24-hour clock is also included.

The Field Day recognizes virtually all of the conventional characters, numerals, and pro-signs on all three modes. Presentation of readout is on ten 14-segment, alphanumeric, half-inch LEDs. The message moves from right to left, Times-Square style, and is quite easy to read after a moment's practice.

In actual operation, an audio cable (not included) is simply plugged into the earphone jack or external speaker jack of the receiver. The receiver dial is adjusted until the audio frequency falls into the sharp audio pass-band of the Kantronics active filter (750 Hz, ± 100 Hz). On CW, the dots and dashes are processed by their relative timing. On RTTY, only the mark signal is copied and processed.

The audio input impedance will adequately match 8-100 Ohms.

The Field Day 2 is operable from ac only (117 V ac @ 60 Hz; a 220 V ac @ 50 Hz export model is available on special order at no extra cost).

A built-in speaker assists the operator in centering in on the desired signal. The speaker may be defeated by plugging an unwired miniature phone plug into the appropriate jack on the rear apron. This simple move will prevent a RTTY enthusiast from coming unwired after a few minutes of listening to the incessant "diddly-diddly-diddly" from his favorite RTTY station, and could conceivably save his marriage as well.

Additional jacks are provided to accommodate a key for Morse code practice (the display reads your fist) and TTL-compatible demodulator output (if desired for ancillary equipment).

In Actual Use

We found the Field Day 2 complicated at first, but a little familiarization session changed the complication into push-button flexibility.

A row of 5 push-buttons provides full control of the unit. Let's examine them in order.

desk & hand microphones

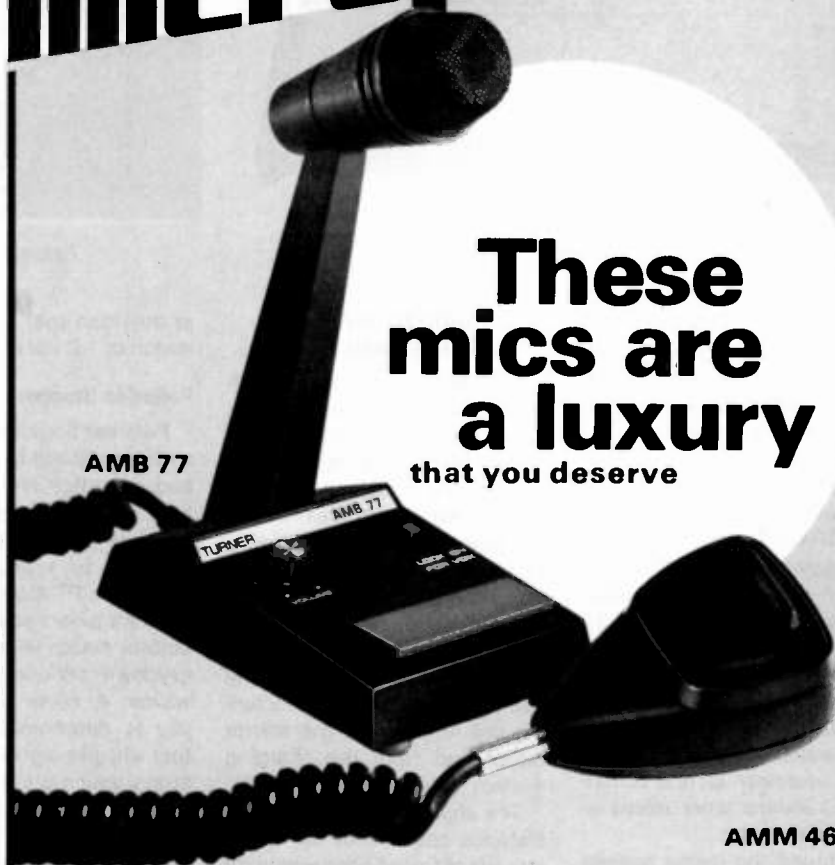

These mics are a luxury that you deserve

AMB 77

AMM 46

Serious amateurs deserve the very best equipment they can afford and one person's luxury may be another's necessity. These mics are a little like that. If you deserve a microphone with extra high output, a frequency response carefully tailored to the voice range, and made of high quality materials, then here are three new desk mics and three new hand mics from which to choose. The desk mics are heavy die cast metal with an attractive black, textured finish and a lock lever on the push-to-talk bar for VOX operation. The hand mics are high impact resistant Cylolac® with extra long, high quality, neoprene coil cords. Most models are dual impedance.

| ELEMENT TYPE | DESK MICROPHONES | | | HAND MICROPHONES | | |
|-----------------------|------------------|------------------|---------------------|------------------|------------------|---------------------|
| | AMB 75 | AMB 76 | AMB 77 | AMM 45 | AMM 46 | AMM 47 |
| | DYNAMIC | DYNAMIC | DYNAMIC (AMPLIFIED) | DYNAMIC | DYNAMIC | DYNAMIC (AMPLIFIED) |
| POLAR PATTERN | OMNI | CARDIOID | CARDIOID | OMNI | NOISE CANC. | OMNI |
| IMPEDANCE (HIGH Z) | 50K ohms | 50K ohms | 4000 ohms | 50K ohms | 50K ohms | |
| IMPEDANCE (LOW Z) | 200 ohms | 200 ohms | | 470 ohms | 470 ohms | 200 ohms |
| OUTPUT LEVEL (HIGH Z) | 55 dB | 58 dB | ADJUSTABLE TO 20 dB | 54 dB | 54 dB | |
| OUTPUT LEVEL (LOW Z) | 75 dB | 80 dB | | 75 dB | 75 dB | 45 dB |
| FREQUENCY RESPONSE | 200-8000 Hz | 100-13000 Hz | 150-5000 Hz | 200-4000 Hz | 200-4000 Hz | 200-5000 Hz |
| CABLE | 5 cond. 1 shield | 5 cond. 1 shield | 5 cond. 1 shield | 6 cond. 2 shield | 6 cond. 2 shield | 5 cond. 1 shield |
| POWER SOURCE | | | BATTERY PROVIDED | | | EXTERNAL DC |

OUTPUT LEVEL MEASURED (0 dB = 1 Volt Per Microbar)

TELEX *hy-gain*

TELEX COMMUNICATIONS, INC.

9600 Aldrich Ave. So., Minneapolis, MN 55420 U.S.A.
Europe: 22, rue de la Légion-d'Honneur, 93200 St. Denis, France.



Kantronics' Field Day 2 SWL model.

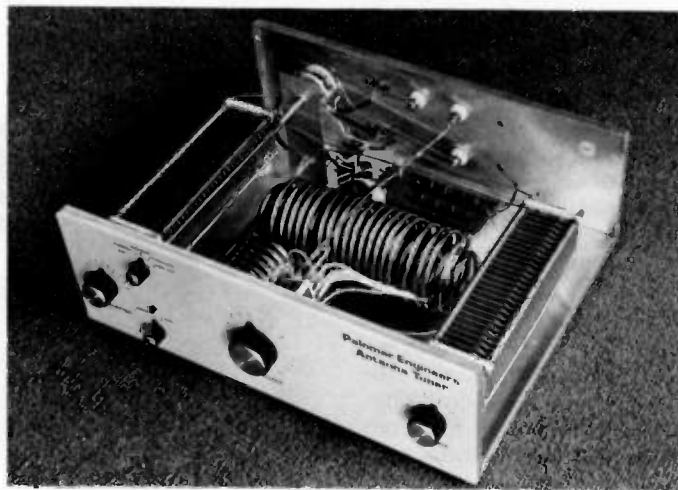

Palomar Engineers' PT-3000 antenna tuner.

1. RESET clears the display of its last-received information as well as permits the internal computer to adjust to a dramatic change in code speed.

2. SPEED calls up a numeric display of received Morse or RTTY speed.

3. EDITOR assists in the copy of sloppy or weighted code. (SPEED and EDITOR are also used to set the 24-hour clock.)

4. MODE chooses between the reception of Morse or RTTY/ASCII.

5. POWER is, of course, the on/off switch. The clock begins at zero at power-up, and continues as a 24-hour timer unless reset to time of day.

We found the reader easiest to use by audibly tuning in a signal with the receiver speaker, then plugging the Field Day cord into the receiver phone jack. We had previously disabled the Kantronics speaker by plugging the disabling jack with an open connector.

Our silent copy was a pleasure. Bright, large-digit characters danced across the display faithfully reproducing the messages being sent on the other end of the circuit.

Not having to worry about hard-copy printers, demodulators, video displays, or other complex accessories was both financially and cosmetically reassuring.

For the receive-only short-wave enthusiast, the Kantronics Field Day 2 is hard to beat.

The Kantronics Field Day 2 SWL model lists at \$464.95. For further information, contact Kantronics, 1202 E. 23rd Street, Lawrence KS 66044.

Robert Grove WA4PYQ
Brasstown NC

CURRENT SHUNTS FOR DMM'S

An inexpensive one-milliohm shunt extends the current measuring capability of digital multimeters to hundreds of Amperes. Each millivolt of voltage drop across the shunt means that one Ampere of current is flowing through the shunt. A DMM can thus read all the currents, both ac and dc, found in the home, laboratory, or shop when used with this shunt. In addition, the current in an automobile, including the Amperes to the starter motor and from the charging system, can be read by a DMM.

The shunt is a special low-resistance cable made up of 105 strands of tinned copper wire for flexibility. Solid copper clamps, rated at 75 Amperes and capable of handling much larger intermittent currents, connect the shunt into a circuit. Meter connections are made to the shunt cable through combination jacks that accept tip plugs, banana plugs, or alligator clips. For further information, contact R. H. Johns-Scientific Instruments, 3379 Papermill Road, Huntingdon Valley PA 19006. Reader Service number 479.

PALOMAR ENGINEERS' PT-2500 AND PT-3000 ANTENNA TUNERS

It is hard to get excited about antenna tuners. They are just one of those accessories you take for granted. In fact, the name "antenna tuner" is often not correct since many times these matching devices are located far from the actual antenna. Regardless of their name, tuners seem to be a popular way to make your skywire meet the approval of a new rig that balks

at any load that causes a mismatch of 1.5:1 or more. Big deal.

Pollution Stopper

Palomar Engineers has taken a new approach to tuner design and operation and in so doing has made this review easier to write and more interesting for you to read. Now, with Palomar's PT-2500 and PT-3000 antenna tuners you can get that perfect match without hours of keydown pollution of the airwaves. A noise bridge allows you to determine the settings that will give a good swr and not strain your rig's final tubes or transistors in the process. You merely flip the front panel switch from operate to tune and then adjust the controls until the introduced noise on your receiver is at a minimum, indicating a match close to 50 Ohms.

Aside from the noise bridge, several other design features set the Palomar products apart from typical tuners. The PT-2500 and PT-3000 adhere to the popular T-type network and use a tapped inductor that is connected to an 18-position switch. When a balanced line is used, the step-down balun is placed at the transmitter terminals; most other tuners put the balun at the antenna input. Palomar claims the relocated balun adds to efficiency.

On the Air

The built-in bridge does not greatly reduce the amount of knob twisting required. However, the noise bridge and its external 9-volt battery do the work, rather than those expensive finals. There is no magic way to find the correct combination of settings. However, once you

find them, a quick fine tuning with your transmitter and swr meter is all that is needed to minimize the swr. Jot down the settings so you won't forget them.

The noise bridge cannot be switched in line when you are transmitting. A fuse acts as a means of idiot-proofing. However, if you are like me it won't be long before the fuse is "accidentally" blown. Often the bridge will continue to work after the fuse is blown, but the nulls it gives may be false. The solution, of course, is a new fuse. But where do you buy 1/200-Ampere fuses? This inconvenience emphasizes the need to switch from "tune" to "operate" before you transmit.

These tuners are designed so that you can match balanced lines, random length wires, and coaxial feedlines. In addition, the transmitted signal can be switched to a dummy load via an auxiliary position on the front panel. Our on-the-air tests confirmed the usefulness of the PT-2500's noise bridge and the tuner's ability to match most of the loads we tried. When using high power on 40 meters with the tuner matching a balanced line feeding a tuned doublet, the amount of rf in the shack caused problems with the IC-701 transmitter's solid-state circuitry. This can be partly blamed on the PT-2500's two-piece cabinet which gives less than ideal shielding.

This reviewer has always believed that antenna tuners are one of the few things that today's hams can home-brew easily. A look at advertising shows that many amateurs don't agree and are buying their

tuners. Palomar offers a product that goes beyond the typical matchbox. The PT-2500 and PT-3000 each cost \$349.95. More details are available from Palomar Engineers, Box 455, Escondido CA 92025.

Tim Daniel N8RK
73 Magazine Staff

ETCO CATALOG

The ETCO Idea Book contains more than 4,000 electronic items, many of them hard-to-find special purchases and factory buyouts. The 96-page catalog is designed for hams, hobbyists, teachers, students, experimenters, and anyone else involved in electronics.

The ETCO Idea Book is free upon request from ETCO Electronics, Dept. 166, Box 796, Plattsburgh NY 12901. Reader Service number 489.

RADIO SHACK'S SPACE-SAVER DESK

If you've been looking for a compact, sturdy table for your radio gear, you know by now that most of the presentable alternatives require you to part with a substantial amount of hard-earned cash. Surprise! Radio Shack has come to the rescue with a \$49.95 table that is attractive enough to hold a place of honor in your living room.

The Radio Shack Space-Saver Desk is designed for use with the TRS-80 computer system, but it makes an ideal operating position for a ham with a modest amount of radio equipment. The walnut-veneer-covered tabletop looks good and measures 23-3/4 x 37-1/2 inches. On the back of the top surface is a 9 1/2-inch deep shelf with plenty of room for a transceiver, power supply, rotor control, keyer, and other accessories. Underneath the shelf is just enough space for logs, callbooks, and all the usual small paraphernalia that accumulates in a ham station. The shelf is about eight inches shorter than the tabletop, allowing ideal placement of a key or paddle.

The tabletop is supported by two nicely-finished black metal I-shaped legs, which are equipped with screw-in levelers.

In short, if you need a place to put your R390 receiver, 32S-1 transmitter and Alpha 77DX am-

Continued on page 196

hy-gain®

NEW VHF and UHF Mobiles

Hy-Gain's new HyCom series of UHF and VHF mobile antennas have been tested in actual use by amateurs across the U.S. for nearly two years with excellent results. The antennas have weathered the salt spray of the coast, the freezing rain and snow of the northlands, and the blazing sun of the desert southwest. HyCom's materials and workmanship have taken the worst that Mother Nature could dish out, and they still perform as if they were installed yesterday. If you want the finest mobile antenna that you can buy - with proven reliability - try a Hy-Gain HyCom.

HC-144-TLM (for 2-meters)

A 5/8 wave, trunk lip mobile antenna with less than 1.5:1 SWR across the 144-148 MHz band. Maximum power capability is a full 200 watts. Hy-Gain's exclusive screw-in antenna connector eliminates all installation soldering. Includes 18 ft. (5.5m) coax and connector.

HC-144-MAG (for 2-meters)

The same antenna as above except with a powerful 90 lb. (40.8kg) direct pull magnet mount with a neoprene gasket to protect your vehicle's finish.

HC-440-TLM (for 440-450 MHz)

This is a, trunk lip mount antenna featuring two 5/8 wave collinear radiators coupled with a moisture resistant phasing coil. SWR is less than 1.5:1 and maximum power capability is 200 watts. Antenna comes with Hy-Gain's exclusive screw-in antenna connector that eliminates all installation soldering and 18 ft. (5.5m) of coax and connector.

HC-440-MAG (for 440-450 MHz)

The same antenna as above except with a powerful 90 lb. (40.8kg) direct pull magnet mount with neoprene gasket to protect your vehicle's finish.

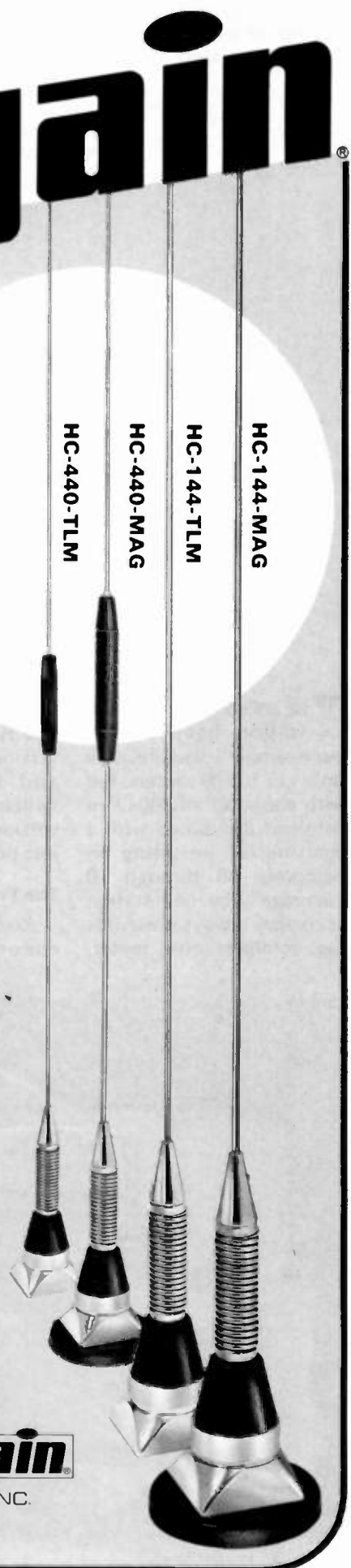

TELEX hy-gain

TELEX COMMUNICATIONS, INC.

9600 Aldrich Ave. So., Minneapolis, MN 55420 U.S.A.
Europe: 22, rue de la Légion d'Honneur, 93200 St. Denis, France

VSWR . . . Automatically!

— simplify antenna matching with this self-calibrating tune-up aid

The antennas used at my station have always been simple—usually a dipole cut for 80 meters, fed with about 52' of 300-Ohm twinlead and tuned with a transmatch, resulting in complete 80 through 10 coverage. The one station accessory always present is the common vswr meter.

Over the years, I have used two types, the single-meter version, with the adjust pot and forward-reflected switch, and the dual-meter version, with only the adjust pot.

The Problem

Assuming you have used one or both of the above ex-

amples, you know the frustration of trying a new antenna, changing bands, or even just moving within a band. There are at least a half-dozen adjustments to make to get tuned up: grid, plate, and loading on the rig, assuming tube finals which most of us have, full-scale forward set, and

forward-reflected switch on the vswr meter, and, finally, two or three adjustments on the transmatch. This can be quite a juggling act.

There are times when vswr decreases and so does forward power, and times when forward power increases as well as vswr. During tune-up, the transmitter power level constantly changes due to a changing load and so does the vswr. Indications change so drastically that, in some cases, quite a bit of time is used hunting for resonance. This can result in lost contacts and some worry to those who own rigs with solid-state finals. This all occurs because the standard vswr meter is also sensitive to power level and this condition helps mask what we are really trying to correct—the source-to-load mismatch.

The Solution

What is needed is a vswr meter which does not react to power levels, but displays only the mismatch. Tune-up would then only require: (1) nulling the vswr

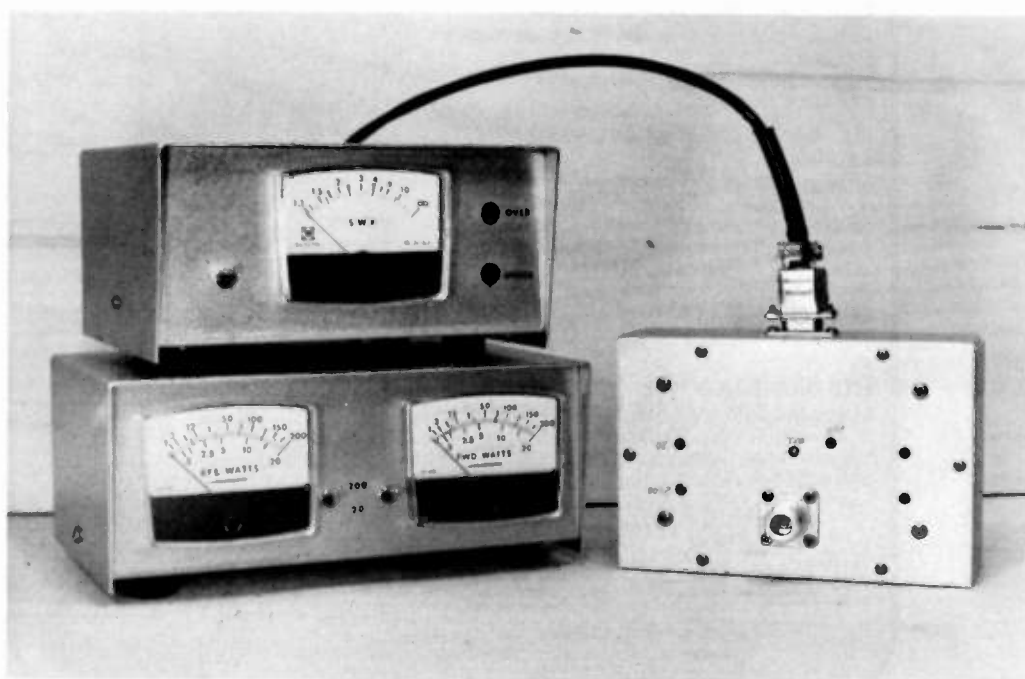

Photo A. Finished design of power sensor, dual wattmeter, and automatic vswr meter.

at the transmatch and (2) peaking the transmitter. This would be the end of tune-up. With solid-state finals, step two is omitted and tune-up becomes a real breeze. Photo A shows the finished design, which consists of a power sensor, dual wattmeter, and automatic vswr meter.

I know of another project article on an automatic vswr meter and I credit this one for getting me interested in this idea.¹ However, there were some things that I felt needed to be changed.

First of all, I have always had trouble in the past constructing a power sensor with a flat enough frequency response to cover 80 through 10 meters. Instead of building one from scratch, I used some circuit boards which were purchased from a popular kit manufacturer and which have worked out great.

Second, the earlier design incorporated a dual wattmeter into the solid-state circuitry. If you do not have 115 V ac, you do not have any way to measure power for mobile or battery operation. My design separates the wattmeter and the vswr meter and treats the latter as an attachment to be used when 115 V ac is available.

Third, the earlier design has five calibration adjustments in the vswr meter portion of the circuit. After some work, I got that down to one. Calibration of my vswr meter is very easy and accurate.

Finally, the wattmeter scales in the earlier design were obtained through calibration and the vswr scale through theoretical computations. Unfortunately, they do not match very well: 25 percent reflected power is a 3:1 vswr and not 2.5:1. My vswr meter scale was derived from the wattmeter scale data which pro-

vides for a much more accurate indication.

Power Sensor and Dual Wattmeter

Fig. 1 shows the schematic of the power sensor and dual wattmeter. The power sensor was designed around two circuit boards and their associated parts purchased from the Heath Company. The circuit board comes from Heath's vswr/wattmeter kit. The 200-Watt adjustment is the same as the original Heath design, but the line used for forward vswr set is now used for the 20-Watt position with the addition of a 50k-Ohm pot. There is also an adjustment provided for 2000-Watt capability, if desired. The lines going to the null position of the calibration switches in the dual wattmeter were originally used for the reflected vswr position in Heath's vswr/wattmeter and are now used for calibration of the power sensor that will be discussed later. Ferrite beads (not shown) are used on each internal and external lead at the power sensor to reduce rf currents.

The dual wattmeter uses two 0-50-uA meter movements from Radio Shack. The 1.54k-Ohm resistors let the meters appear to have the same impedance as Heath's. The 4.22k-Ohm resistors in series with the power meters raise the voltage that will drive the automatic vswr meter such that a full-scale deflection on a power meter will be equivalent to 500 mV dc at the vswr meter. The 0.1-uF bypass capacitors were added to minimize rf pick-up on the forward and reflected lines and across the meters.

Automatic Vswr Meter

The circuit of Fig. 2 does nothing but compute the ratio of two dc voltages. If the meter scale were left at 0-1 mA, then it would read the ratio of V dc-reflected/V

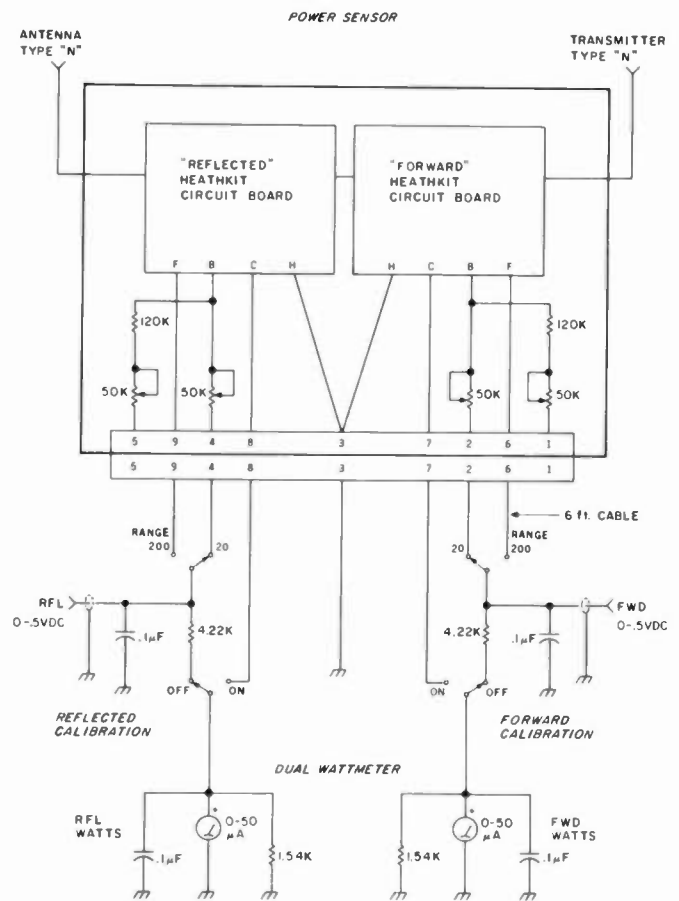

Fig. 1. Schematic of power sensor and dual wattmeter.

dc-forward directly. First of all, the two dc voltages are filtered to keep out rf and then amplified by a gain of about 20 in the LM108As. Note the relatively large values, 0.001 uF, of frequency compensation capacitors on pins 1 and 8 of the LM108As. This also helps in keeping rf from causing erratic operation of the circuit. Next, these two amplified dc voltages are compared against a ramp generated by the digital-to-analog converter as implemented by the 4040 counter IC and the R/2R ladder network. This comparison takes place at the LF356Hs (note the positive feedback for hysteresis). The output of the LF356Hs is a square wave, going from about +11 V dc to -11 V dc since bipolar op amps do not conduct to the supply rail. The negative portion of the square wave is clipped off by the 15k-Ohm resistor and

1N4454 diode combination.

From here, the signals go to digital circuitry. The reflected side gets buffered by two sections of a 4049 hex inverter IC, then drives the meter directly through a calibration pot—that's right, a square wave drives the meter. The forward side generates a reset pulse with the 4013 flip-flop IC which clears the 4040 and starts the ramp all over again. The end result of all this is a meter driven by a square wave whose duty cycle is directly proportional to the ratio of the two voltages V dc-reflected/V dc-forward.

Fig. 3 shows that as the forward component changes in amplitude, the maximum amplitude of the ramp changes also, since it is this comparison which ultimately generates the reset pulse. Consequently, the frequency of the square wave driving the meter also changes, but since the meter is not sensitive to fre-

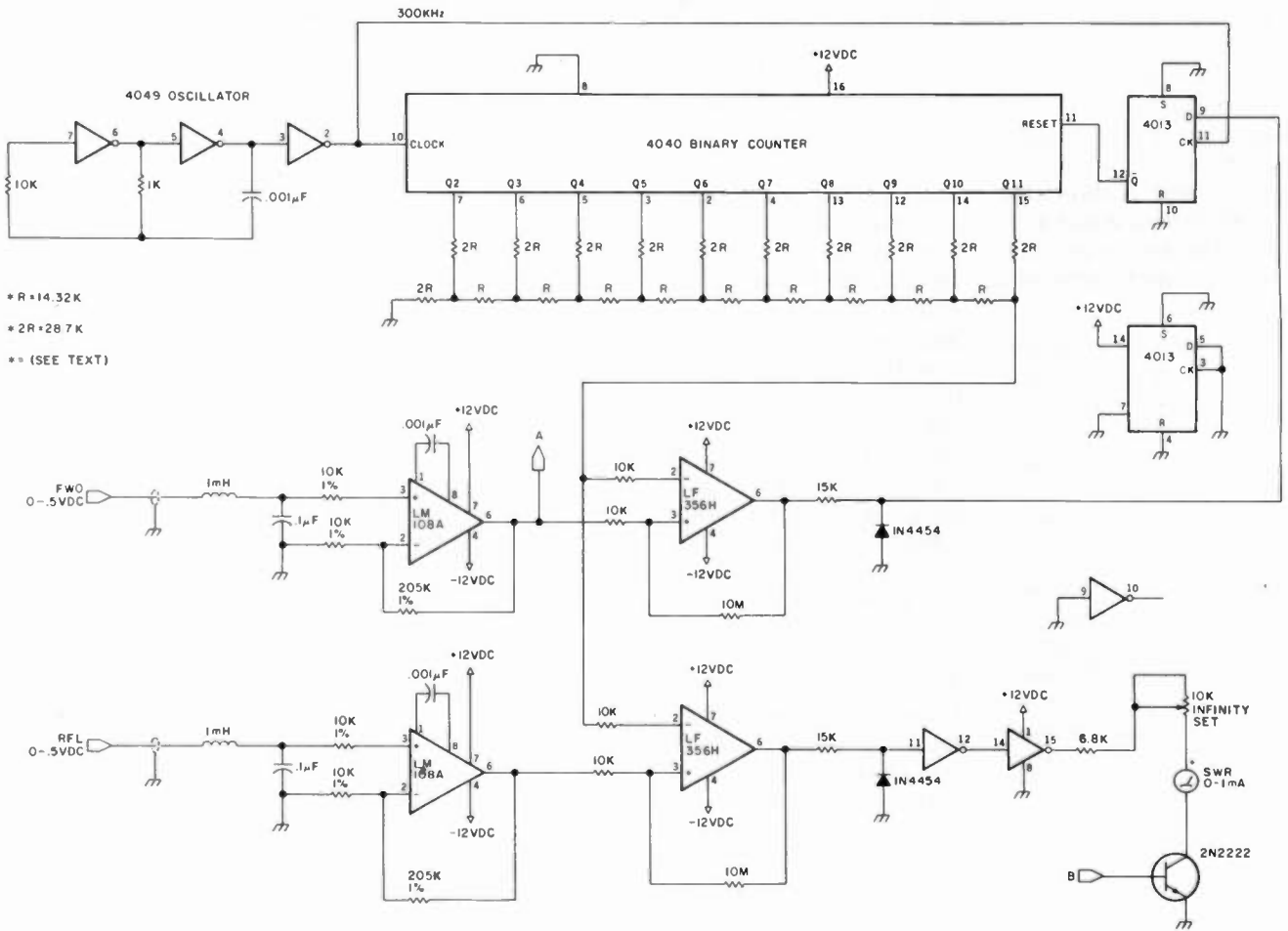

Fig. 2. Schematic of computing portion of automatic vswr meter.

quency, only duty cycle, this is of no importance.

Also, note the absence of a filter cap across the

meter. The square wave is at a fast enough frequency such that no meter jitter is observed. The frequency of

the 4049 oscillator is approximately 300 kHz. The frequency of the square wave driving the meter will vary from approximately 2000 Hz at a low forward-power reading to 175 Hz for a full-scale forward power reading. The exact frequency is not critical, so no adjustment of the oscillator

was provided. The oscillator also clocks the 4013 flip-flop IC to generate a clean reset pulse which starts the ramp over again.

The reason for buffering the square wave with the 4049 inverter IC was to add stability to the amplitude of this signal driving the meter. CMOS logic con-

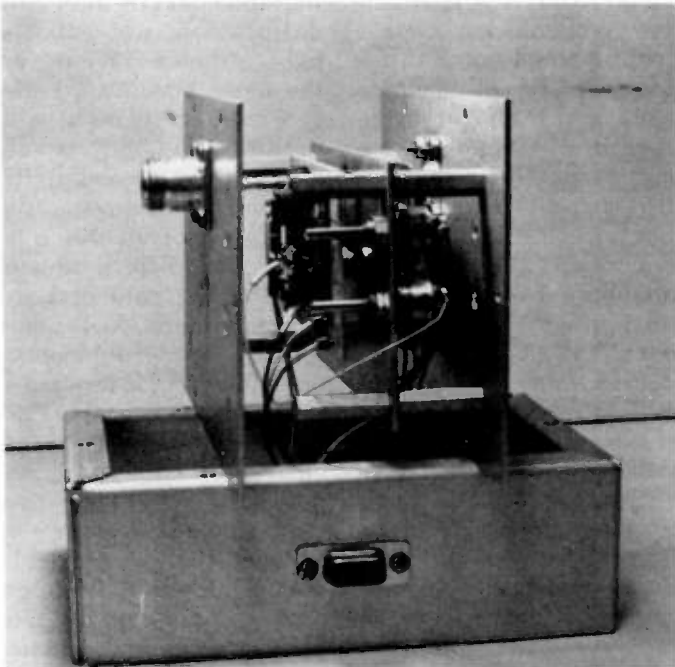

Photo B. Inside view of power sensor sandwich. Note removable side plate.

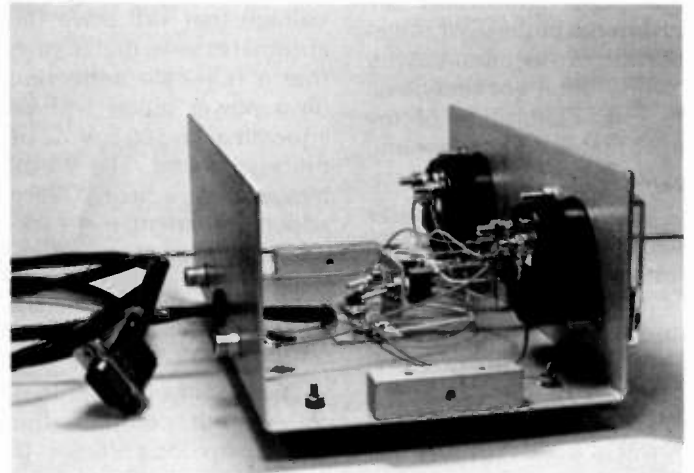

Photo C. Inside view of dual wattmeter. Calibration switches were mounted internally.

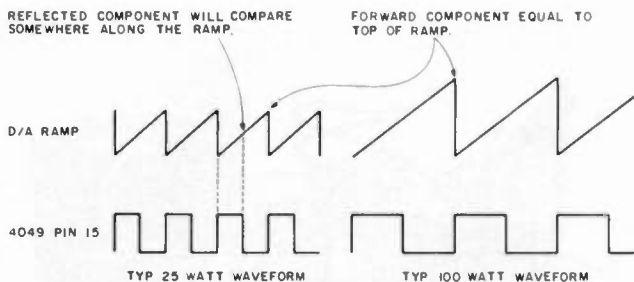

Fig. 3. Waveforms showing change in frequency of the square wave driving the meter with change in power level. A 50% duty cycle, as shown here, equals a 3:1 vswr in both cases (25 and 100 Watts).

ducts to the supply rail and the +12 V dc supply is regulated. The result is a nice, amplitude-stable square wave.

The value of R in the ladder network (Fig. 2) is not that critical. I would stay between 10k Ohms and 15k. The important thing here is that the value of 2R must be exactly double. These resistors must also be 1% in tolerance for a smooth ramp.

A Few Problems

1. During times of no forward or reflected power, as during receive, the vswr computer tries to generate a square wave whose characteristics would indicate a vswr of infinity—this is unacceptable.

2. At low forward-power levels for the range selected, the resolution of the circuit becomes degraded. Consider that the maximum count of the D/A converter is 1,024. A reflected component would then have one of 1,024 counts to compare against if the forward component was high enough to cause a count of 1,024. However, if the forward component caused a count of only 10, that would mean that the reflected component would have only 10 counts to compare against, resulting in a visibly-stepped meter response.

3. An over-range forward component causes erroneously high vswr readings. When watching the vswr meter during tune-up, you

may not be aware of the forward power level. Example: Let's say both forward and reflected range switches are in the 20-Watt position, but you are putting out much more than 20 Watts forward, let's say 100 Watts. The LM108A op amp that amplifies the forward dc component will have peaked out at slightly over 20 Watts and will remain saturated at 100 Watts. Now let's say the reflected power is around 5 Watts. The meter will display around a 3:1 vswr when, in fact, it is around 1.5:1.

The Fixes

For problems 1 and 2, I chose to disable the 0-1-mA

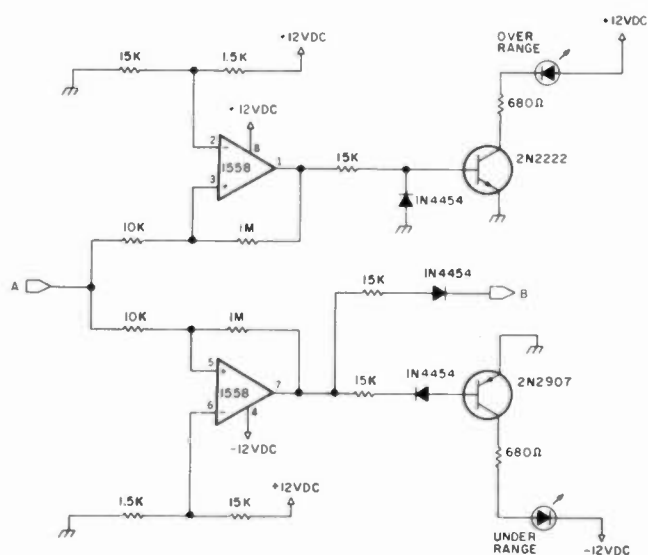

Fig. 4.

meter when the forward power was at the low end of the range. I picked a point at about 3 Watts on the 200-Watt range and 0.5 Watts on the 20-Watt range.

As shown in Fig. 4, this was implemented by one section of a 1558 dual op amp IC in a comparator configuration. When the forward component gets too low, the base drive is removed from the 2N2222 that provides the ground for the 0-1-mA meter movement. At the same time, the

under-range light-emitting diode is turned on giving you a solid indication that the meter is turned off and not indicating a 1:1 vswr.

For problem 3, I chose to provide an over-range indication to aid the operator. This was implemented by the other half of the 1558 op amp, also in a comparator configuration. The only difference is that the trip point is at the high end of the range instead of at the low end.

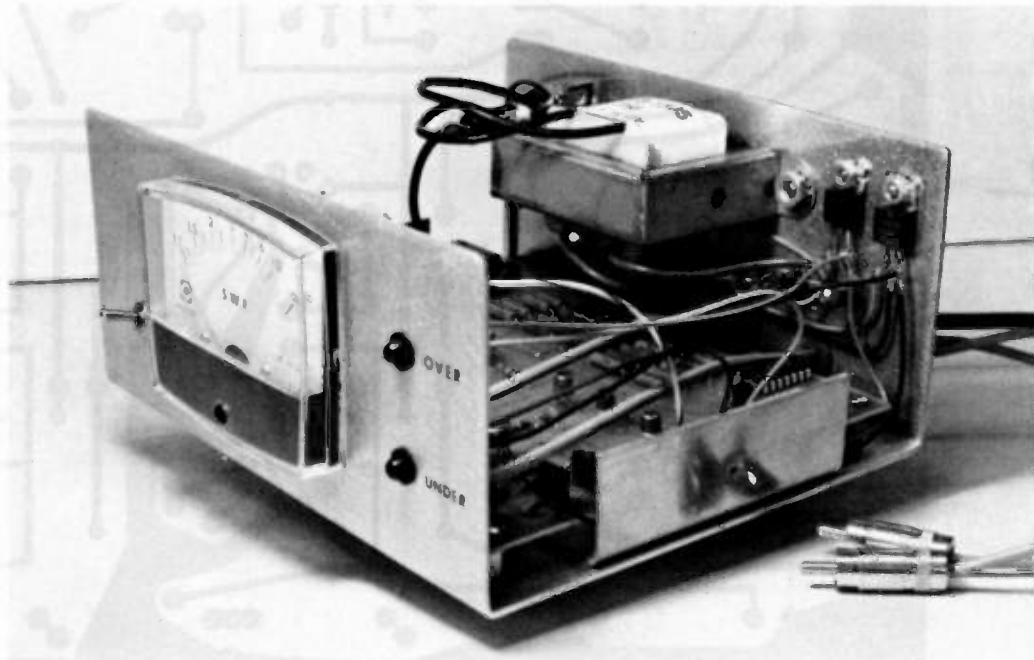

Photo D. Automatic vswr meter. Note that one of the three-terminal regulators is insulated from the chassis.

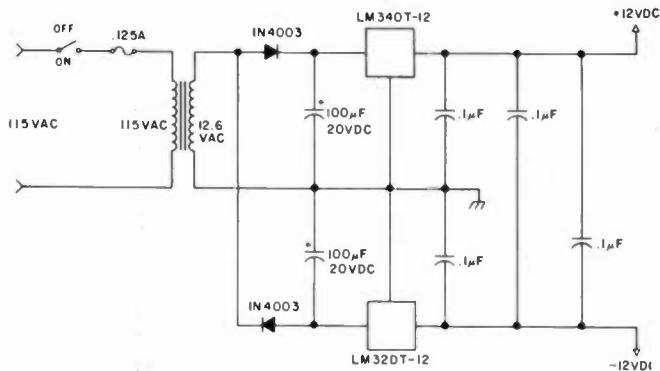

Fig. 5. Power Supply.

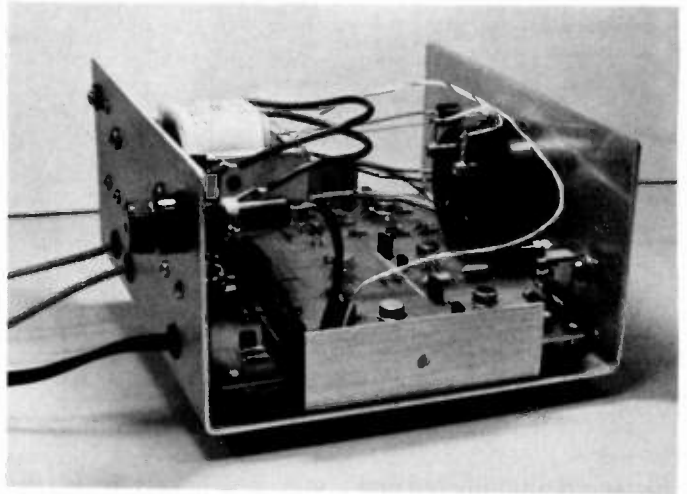

Photo E. Automatic vswr meter, rear side view.

The power supply in Fig. 5 is as simple as I could make it: a voltage-doubler configuration with the capacitors center-tapped to obtain both polarities, a pair of three-terminal regulators, and then some 0.1- μ F bypass capacitors. The current consumption is relatively small, about 30 mA for the negative supply and 50 mA for the positive supply. No power-on in-

dicator was included because the under-range light-emitting diode effectively fulfills this function.

Construction Notes

Power Sensor. Photo B shows the wattmeter head "sandwich." Keep in mind that in order for one circuit board to be used for forward Watts and the other for reflected Watts, they must be mounted back to

back. One of the sides is removable by modifying one of the type "N" connectors. There are retaining rings holding the center pin in place. Remove the ring from the front of the connector so the pin can slide out the back. Solder the pin to the piece of heavy-gauge

bus wire which goes through the toroids of the circuit boards. Do not forget to insulate the bus wire as it goes through the eyelet holding the toroid. A list of the parts needed for the circuit boards can be obtained by ordering the manual from the Heath Company

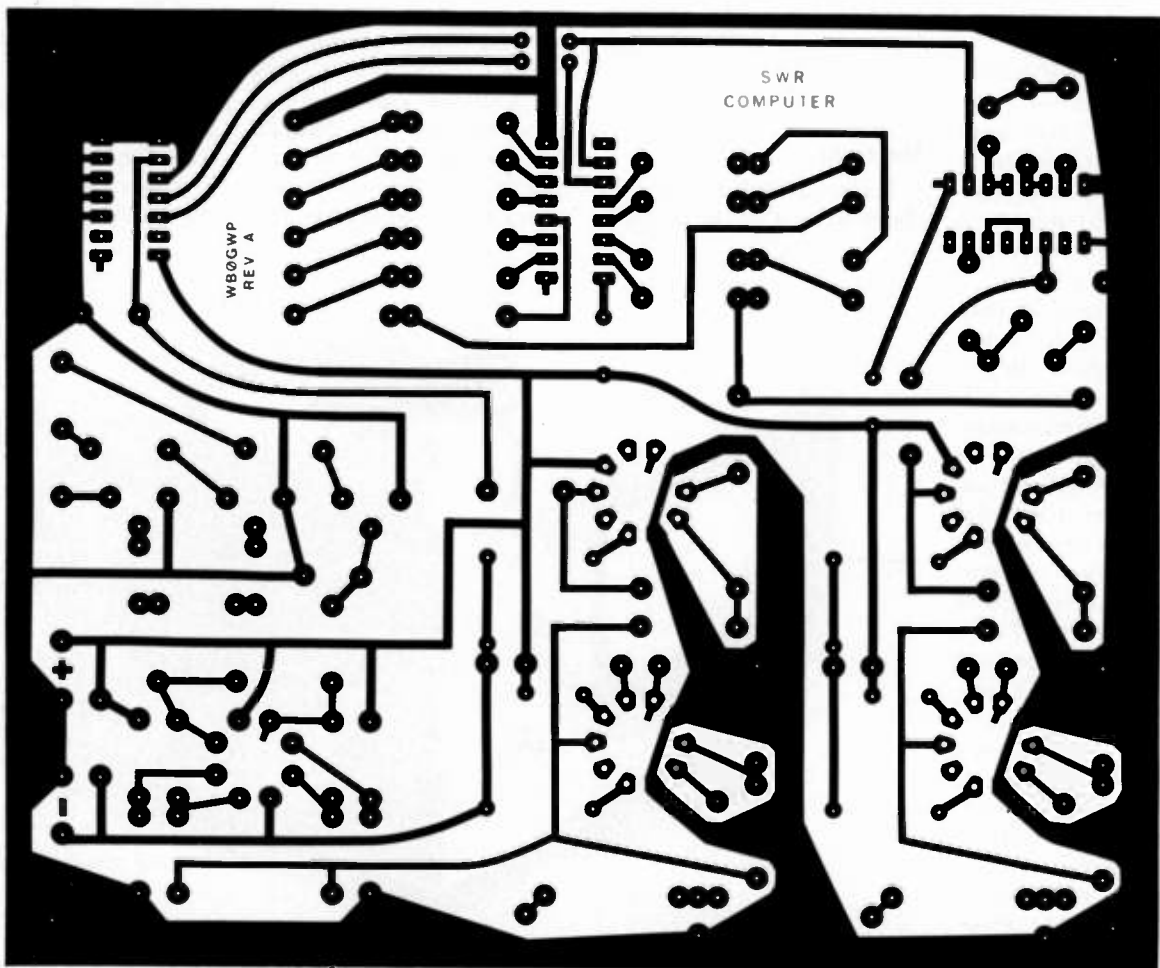

Fig. 6. PC board layout for automatic vswr meter.

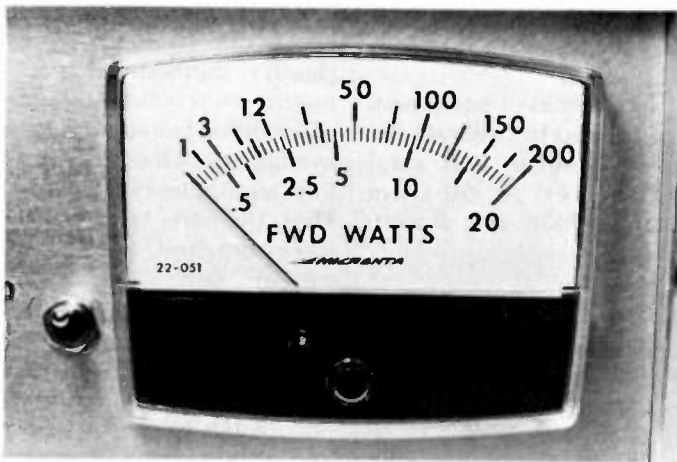

Photo F. Forward power wattmeter scale. Reflected power wattmeter scale is identical.



Photo G. Vswr meter scale.

for the HM-102 HF Wattmeter/SWR Bridge.

Dual Wattmeter. Photo C shows the enclosure holding the dual wattmeter. The enclosure was homemade out of aluminum and measures 8" x 3" x 5". The two null-calibration switches were mounted inside the wattmeter enclosure to keep them out of the way. I decided to use two separate SPDT switches for the wattmeter ranges instead of one DPDT switch. I like the added flexibility of being able to look at low levels of reflected power while on the 200-Watt forward power range. Keep in mind that when the two range switches are not in the same position, the vswr meter will not give totally accurate readings.

Vswr Meter. Photos D and E show the vswr meter

enclosure which measures 6 1/2" x 3" x 5 1/2". An important point to remember is to insulate the tab of the LM320T-12 from the chassis because the tab is not at ground potential. The circuit board measures 5" x 6" and was mounted on 3/8" standoffs. The circuit board foil pattern and component layout are shown in Figs. 6 and 7, respectively.

Meter Scales. Photo F shows the forward Watts meter scale. The reflected Watts meter scale is identical. The data was obtained by using the equipment in the calibration lab at work. From 80 through 15 meters, the accuracy is within 5% and on 10 meters, it is within 8%.

I removed the existing nomenclature on the 0-50-uA meter scales with the use of an electric eraser.

Parts List

Power Sensor

- 1 2" x 4" x 6" chassis
- 2 Type "N" female chassis connectors
- 2 Heathkit® #85-393-4 circuit board, plus associated parts (see text)
- 4 50k pot
- 2 120k, 1/2-W, 10% resistors
- 1 9-pin connector
- 10 rf beads
- Misc. hardware as needed

Dual Wattmeter

- 1 3" x 5" x 8" chassis
- 1 9-pin connector
- 2 RCA phono jacks
- 4 0.1-uF capacitors
- 2 1.54k, 1/2-W, 1% resistors
- 2 4.22k, 1/2-W, 1% resistors
- 2 0-50-uA meter movements
- 4 SPDT switches
- 4 Rubber feet
- 7 rf beads
- Misc. hardware as needed

Vswr Meter

- 1 3" x 5 1/2" x 6 1/2" chassis
- 1 SPST switch
- 1 Power cord
- 1 Fuse holder
- 1 .125 ASB Fuse
- 1 115-V-to-12.6-V transformer, 1.2-A secondary
- 4 Rubber feet
- 2 RCA phono plugs
- 1 0-1-mA meter movement
- 2 1N4003 diodes
- 2 Light-emitting diodes
- 5 1N4454 diodes
- 2 2N2222 transistors
- 1 2N2907 transistor
- 1 LM340T-12, +12-V voltage regulator
- 1 LM320T-12, -12-V voltage regulator
- 1 1558 dual op amp IC
- 2 LM108A op amp IC
- 2 LF356H op amp IC
- 1 4049 CMOS IC
- 1 4040 CMOS IC
- 1 4013 CMOS IC
- 2 1-mH coil
- Capacitors
 - 2 100-uF, 20-V capacitors
 - 6 0.1-uF capacitors
 - 3 0.001-uF capacitors
- Resistors
 - 2 680-Ohm, 1/4-W, 10%
 - 1 1k, 1/4-W, 10%
 - 1 6.8k, 1/4-W, 10%
 - 7 10k, 1/4-W, 10%
 - 7 15k, 1/4-W, 10%
 - 2 1M, 1/4-W, 10%
 - 2 10M, 1/4-W, 10%
 - 2 1.5k, 1/4-W, 10%
 - 1 10k pot (circuit board mount)
 - 4 10k, 1/4-W, 1%
 - 9 14.32k, 1/4-W, 1% (see text)
 - 11 27.8k, 1/4-W, 1% (see text)
 - 2 205k, 1/4-W, 1%
- Misc. hardware as needed.

Use great care, when using this method, not to go through the paint to bare metal. All of the lettering was done by using rub-on letters.

The data for the vswr meter scale as shown in

Photo G was obtained from the 200-Watt range data and the formula: $vswr = (1 + \sqrt{P_{ref}/P_{fwd}})/(1 - \sqrt{P_{ref}/P_{fwd}})$. The 20-Watt range data did not quite match the 200-Watt range data, so some error will ex-

ist when using the 20-Watt range to measure vswr.

Two pieces of equipment are needed to calibrate the power sensor and dual wattmeter: a 50-Ohm resistive load and a watt-

meter of known accuracy. I chose not to incorporate Heath's method for calibrating their wattmeter circuit boards because of the availability of the rf calibration equipment at work. Thus, the parts Heath used were omitted from the power sensor circuit boards.

The forward-power wattmeter is calibrated first. Place the forward calibration switch to the on position. With enough rf power applied to give a meter deflection, adjust the trimmer cap on the forward Watts circuit board for a null on the FWD WATTS meter. Keep increasing the rf power and maintain the null.

Place the forward calibration switch to the off position and the forward range switch to the 20-Watt position. Apply 20 Watts as measured by the wattmeter of known accuracy and adjust the 20-Watt potentiometer for a full-scale deflection.

The 200-Watt scale was determined using a 200-Watt source, but one is not necessary to calibrate this range. Since most rigs will put out 100 Watts, I will use this as an example. Apply 100 Watts as measured by the wattmeter of known accuracy and adjust the 200-Watt potentiometer mounted on the circuit board for a 100-Watt indication. A 2000-Watt adjustment was incorporated in the wattmeter head in case I decide to add it on later.

Now reverse the wattmeter head in the line and adjust the reflected side exactly as the forward side. I found the most accurate results were obtained by calibrating the wattmeter at either 7 or 14 MHz.

Calibrate the vswr meter by using the circuit of Fig. 8. Apply 470 mV dc to both the forward and reflected inputs, which simulates a vswr of infinity. Then adjust the Infinity Set poten-

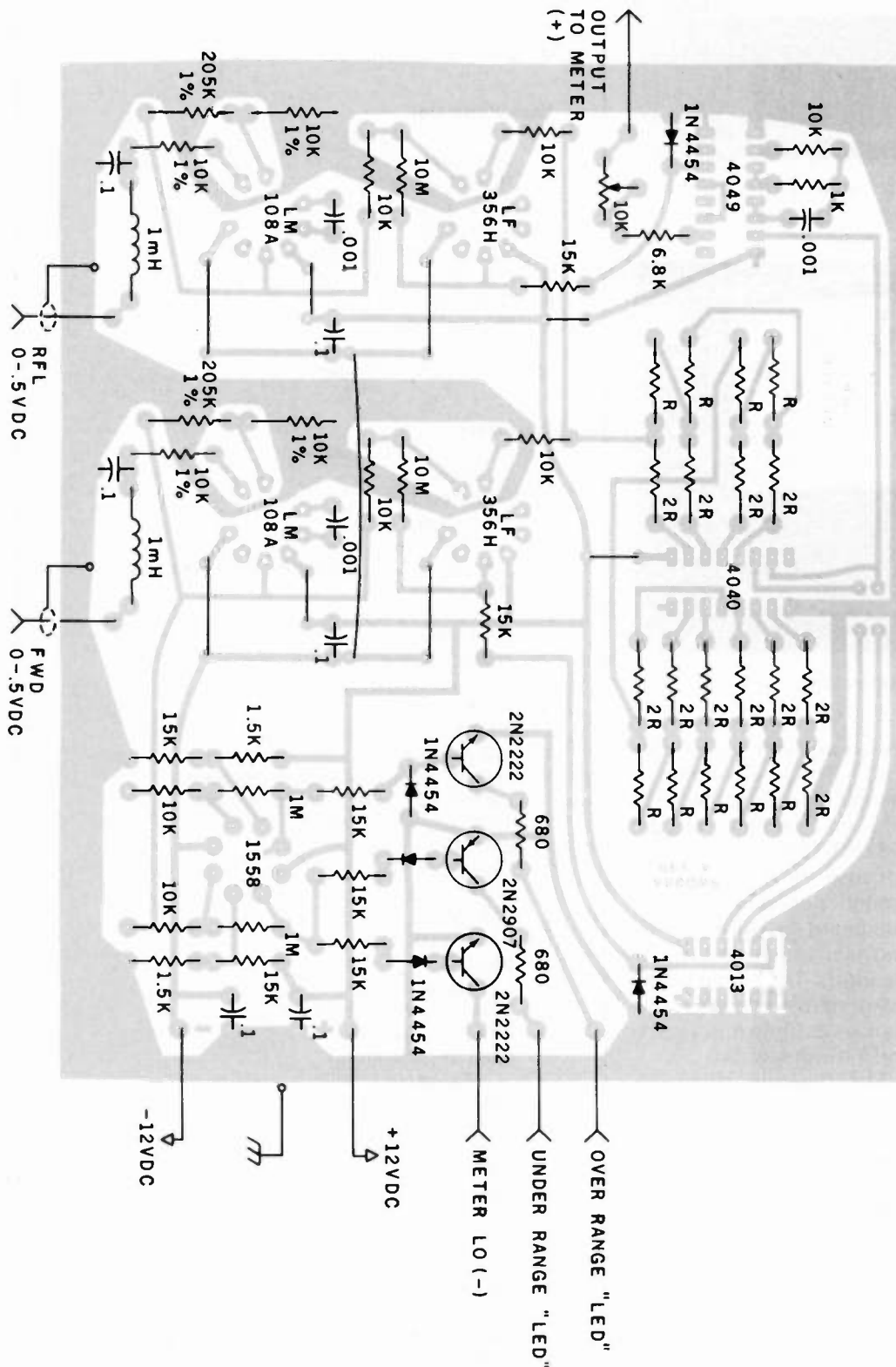

Fig. 7. Component layout of automatic vswr meter. All pin 1s of the integrated circuits have a tab etched to facilitate orientation.

tiometer in series with the vswr meter for full scale.

Operation Field Day

The dual wattmeter-automatic vswr meter combination was extensively tested during Field Day, 1979. The tent it was used in had a longwire and dipole for its antennas and a transmatch for tune-up. Changing frequencies was a snap. While applying low rf power, all the operator had to do was null the vswr with the transmatch and then peak the finals of the rig. Needless to say, the total number of contacts this time was higher than last. You really have no idea how easy tune-up can be until you have tried an automatic vswr meter.

Circuit boards for the automatic vswr meter are obtainable from me for \$10 a copy. Also, any correspondence must include an SASE for a reply. Special thanks go to my brother,

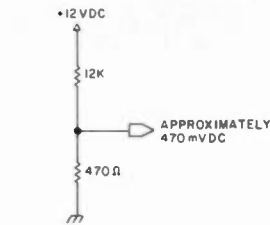

Fig. 8. Vswr meter calibration source.

Carl WBØDFH, for getting me interested in amateur radio back in 1972, Ray WAØPMY, who took the photos, Dave, who helped calibrate the wattmeter ranges at work, and the Field Day gang of NØ11/Ø who let me use one of the tents at the site for the acid test. ■

References

1. David L. Fayman, "A Simple Computing SWR Meter," *QST*, July, 1973.
2. Hank Perras, "Broadband Power-Tracking VSWR Bridge," *Ham Radio*, August, 1979.
3. Staff, "Impedance and Other Ogres," *73*, February, 1979.

CAN 20% BE WRONG?

A recent survey showed that 20% of the 73 subscribers also read Kilobaud MICROCOMPUTING magazine . . . and enjoy it. This is the best way to learn and keep up with the rapidly developing world of microcomputers. There's nothing to be afraid of, you just have to read an interesting magazine and you'll learn. Try a subscription to Kilobaud MICROCOMPUTING and see for yourself.

New subscription Renewal 12 issues for \$25.00
 Payment enclosed \$ _____ 24 issues for \$38.00
 VISA MC AE Bill me 36 issues for \$53.00

Card # _____ Interbank # _____
 Signature _____ Exp. date _____
 Name _____
 Address _____
 City _____ State _____ Zip _____

— for even faster ordering service call toll free (800) 256-5473

Canadian: \$27, one year only, U.S. funds. Other foreign: 30NB7
 \$35, one year only, U.S. funds. Please allow 6-8 weeks for delivery.

MICROCOMPUTING • POB 997 • Farmingdale NY 11737

FAST DELIVERY GET

1-800-325-3609

MO. RESIDENTS CALL (314) 961-9990

We have it!
 And we'll get it to you fast.

To our extensive list of major brands; we proudly announce the addition of:
 Bearcat scanners
 Regency scanners
 Vibroplex

One call will let you know why we're "The Direct Connection" for delivery too.

MIDCOM ELECTRONICS, INC.

✓ 52

2506 S. BRENTWOOD BOULEVARD
 ST. LOUIS, MISSOURI 63144
 Hours: 9-7 Mon.-Fri. 9-5 Sat.

B & W NOW OFFERS A COMPLETE

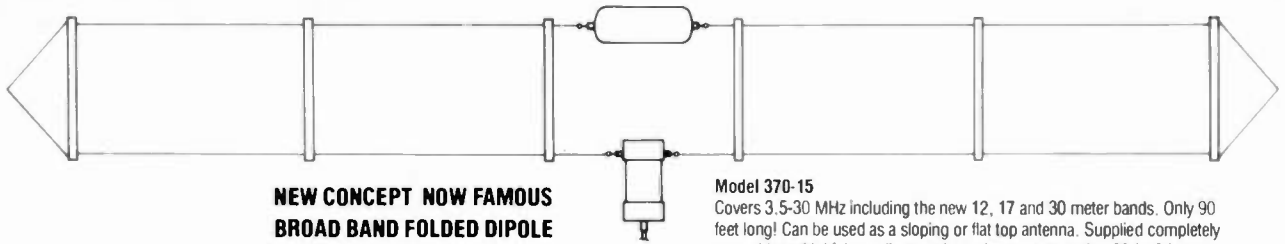

**NEW CONCEPT NOW FAMOUS
BROAD BAND FOLDED DIPOLE**

Model 370-15

Covers 3.5-30 MHz including the new 12, 17 and 30 meter bands. Only 90 feet long! Can be used as a sloping or flat top antenna. Supplied completely assembled with high tensile strength steel copper clad wire, 50 ft. RG-8 coax cable and PL259 connector. Will handle 2.5 KW-5 KW PEP.

New

**HEAVY DUTY
4-ELEMENT
TRI-BAND
BEAM**

Model 370-16

Four working elements on each band in 10, 15 and 20 meters. The 24 foot boom permits optimum spacing for maximum forward gain and front-to-back ratio. All traps are precision tuned. Rugged reliability assures ability to withstand winds up to hurricane strength.



Model 370-11

FIVE BAND TRAP ANTENNA
80, 40, 20, 15 and 10 meters
1,000 Watts
2,000 Watts PEP
All Band Antenna
One Feed Line

Model 370-12

Same as above, in kit form.

Model 370-13

FOUR BAND ANTENNA
40, 20, 15 and 10 meters
1,000 Watts
2,000 Watts PEP

Model 370-14

Same as above, in kit form.

New

**HEAVY DUTY
3-ELEMENT
TRI-BAND
BEAM**

Model 370-17

Three working elements on each band in 10, 15 and 20 meters. The 16 foot boom can be handled by a lighter duty rotor and tower than the TB4HA but still provides excellent performance characteristics. Precision tuned traps are combined with rugged construction.

ANTENNA TRAPS

Weatherproof. Strain test over 600 lbs. Power-1000 watts-2000 watts PEP. Supplied with complete instructions for antenna wire lengths.

Model 370-1

5 Band Antenna Traps for coverage of 80, 40, 20, 15 and 10 meters in one antenna.

Model 370-2

4 Band Antenna Traps for coverage of 40, 20, 15 and 10 meters in one antenna.

Model 370-5

- END INSULATOR**
- Space Age Glass Polymer Material
 - 1000 lb. Pull Test
 - Size 4"L x 1-1/4"D

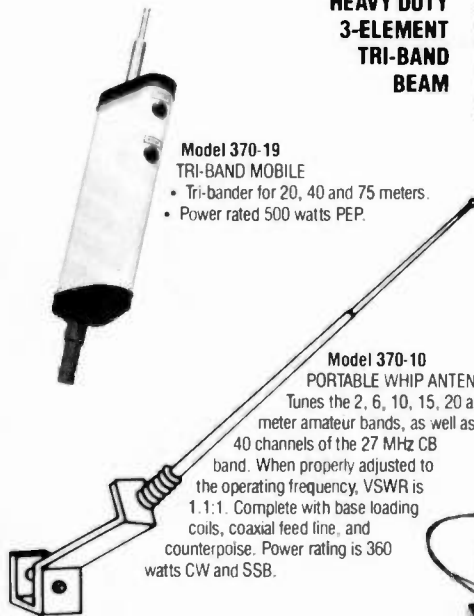

Model 370-19
TRI-BAND MOBILE

- Tri-bander for 20, 40 and 75 meters.
- Power rated 500 watts PEP.

Model 370-10

PORTABLE WHIP ANTENNA
Tunes the 2, 6, 10, 15, 20 and 40-meter amateur bands, as well as all 40 channels of the 27 MHz CB band. When properly adjusted to the operating frequency, VSWR is 1:1:1. Complete with base loading coils, coaxial feed line, and counterpoise. Power rating is 360 watts CW and SSB.

COAXIAL ANTENNA CHANGEOVER RELAY

Model 377

Power Rating 1000 watts CW (2000 watts SSB)

VSWR Less than 1.15:1 DC to 150 MHz

Power Requirements 0.015 Ampere 48 to 130 volts AC

Connectors UHF Type SO-239



ANTENNA TUNERS

AT-140

Matches auto antenna to your C.B. rig.

Model AT-200

Matches auto antenna to your 2m Rig.

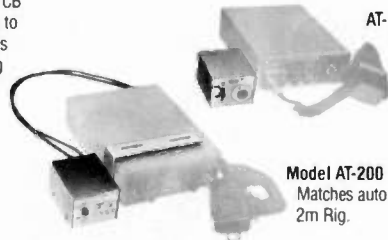

Model 370-9

PL-259 Connector for use with RG-8 Coax Cable. Mates with SO-239 Connectors. UHF Type.



Model 370-8

50 ft. RG 8 Type coax cable.



Models 370-6, 370-7

ANTENNA WIRE
No. 14 AWG (17/22)
370-6, 70' coil—370-7, 140' coil



**DIPOLE
CENTER
CONNECTORS**

Model CC50
Standard

Model CC51
Military Type

FOR COAXIAL-CABLE FEED

Waterproof, mechanically strong connection between a coaxial feed line and the center of a dipole antenna.

ANTENNA PRODUCT LINE



RADIO FREQUENCY FILTERS

| Model Number | Intended Use | Power Capacity (Watts) | Impedance (Ohms) |
|--------------|---------------------------------|------------------------|------------------|
| 423 | 6 Meter | 100 | 50 |
| 427 | Amateur Radio | 1000 | 50 |
| 424 | Amateur Radio | 100 | 50 |
| 425 | TVI Filter | 1000 | 50 |
| 426 | | 1000 | 50 |
| 422-15 | Amateur 15 Meter | 100 | 50 |
| 431-15 | Radio Harmonic | 1000 | 50 |
| 421-20 | Amateur 20 Meter | 100 | 50 |
| 430-20 | Radio Harmonic | 1000 | 50 |
| 420-40 | Amateur 40 meter | 100 | 50 |
| 429-40 | Radio Harmonic | 1000 | 50 |
| 419-80 | Amateur 80 Meter | 100 | 50 |
| 428-80 | Radio Harmonic | 1000 | 50 |
| 422-2 | Amateur 2 Meter Bandpass Filter | 350 | 50 |

ECONOMICAL 2-ELEMENT TRI-BAND BEAM

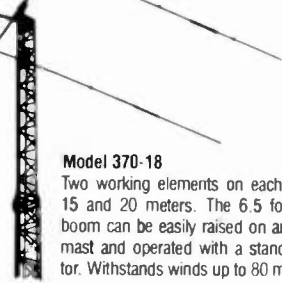

Model 370-18
Two working elements on each band in 10, 15 and 20 meters. The 6.5 foot aluminum boom can be easily raised on an inexpensive mast and operated with a standard TV rotator. Withstands winds up to 80 mph.

New

VERTICAL ANTENNAS

Model 370-30
Four band trap vertical for operation 40, 20, 15 and 10 meter band. 2000 PEP. Does not require counterpoise radials when using a standard eight foot ground rod (not supplied). VSWR not more than 1.5:1 at resonance. Includes slimline traps for use as a "flag pole". Overall length is 21 feet.

Model 370-31
RADIAL KIT-ACCESSORY
For 370-30 and 370-32 Verticals on 10-80 meters. All necessary wire and hardware is included for two ground-plane radials for 10-80 meter band.

Model 370-32
Outstanding performance with this omnidirectional, low radiation angle, trap vertical antenna. Requires small installation space for either roof or ground-level. Hardware is included. Traps are precision set at the factory for maximum radiation efficiency on each band with low VSWR. Heavy duty construction withstands winds up to 100 mph.

Models 370-33 & 370-34
75 Meter ADD-ON Kit for models 370-30 and 370-32 antennas.

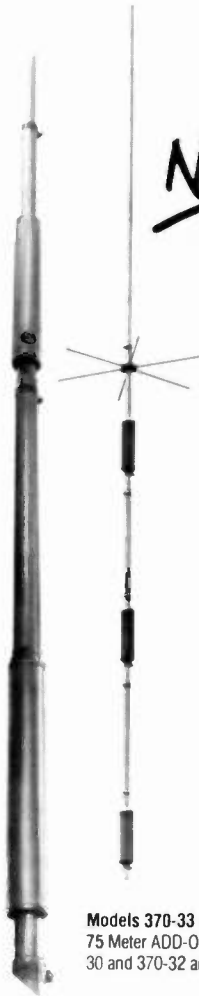

COAX SWITCHES

- | | |
|-----------|---------------------|
| Power | 1 KW-2 KW PEP |
| Impedance | 50-75 ohms |
| VSWR | 1.2:1 up to 150 MHz |
- Model 593** Single Pole 3 Position with grounding of all unused positions
Dimensions 1-3/4" high, 5" wide, 3" deep
Mount Wall or desk
 - Model 594** 2 Pole 2 Position
Dimensions 1-3/4" high, 5" wide, 3" deep
Mount Wall or desk
 - Model 595** Single Pole 6 Position with grounding of all unused positions
Dimensions 8-1/2" x 3-1/2" x 2"
Mount Wall or desk
 - Model 375** Single Pole 6 position with grounding of all unused positions
Axial mounted connectors.
 - Model 590** Single pole 5 position, non-grounding type switch. Axial mounted connectors
 - Model 590G** Single Pole 5 position with grounding of all unused positions. Axial mounted connectors.
 - Model 592** Single Pole 2 position switch, non-grounding. Axial mounted connectors.

- Model 376** Single Pole 5 position with grounding of all unused positions. Sixth switch position grounds all outputs. Radial mounted connectors.
- Model 550A** Single Pole 5 position switch. Radial mounted connector.
- Model 551A** 2 Pole 2 position. Radial mounted connectors
- Model 550A-2** Single Pole 2 position switch. Radial mounted connectors

R. F. COAXIAL SWITCHES WITH BNC CONNECTORS

- Model 596** Single Pole 3 position with grounding of all unused positions
Dimensions 1-3/4" high, 5" wide, 3" deep
Mount Wall or desk
- Model 597** Single Pole 6 position with grounding of all unused positions
Dimensions 8-1/2" x 3-1/2" x 2"
Mount Wall or desk



RECEIVING BALUNS

| Type | STANDARD IMPEDANCE RATIOS | Freq. Range |
|--------|-------------------------------|-------------|
| RC-780 | 50 ohms bal to 50 ohms unbal | 3.5-30 MHz |
| RC-781 | 70 ohms bal to 50 ohms unbal | 3.5-30 MHz |
| RC-782 | 150 ohms bal to 50 ohms unbal | 3.5-30 MHz |
| RC-783 | 200 ohms bal to 50 ohms unbal | 3.5-30 MHz |
| RC-784 | 300 ohms bal to 50 ohms unbal | 3.5-30 MHz |
| RC-785 | 600 ohms bal to 50 ohms unbal | 3.5-30 MHz |
| RC-790 | 50 ohms bal to 70 ohms unbal | 3.5-30 MHz |
| RC-791 | 70 ohms bal to 70 ohms unbal | 3.5-30 MHz |
| RC-792 | 150 ohms bal to 70 ohms unbal | 3.5-30 MHz |
| RC-793 | 200 ohms bal to 70 ohms unbal | 3.5-30 MHz |
| RC-794 | 300 ohms bal to 70 ohms unbal | 3.5-30 MHz |
| RC-796 | 600 ohms bal to 70 ohms unbal | 3.5-30 MHz |



TRANSMITTING BALUNS

Power 2.5KW-5KW PEP
Connectors SO-239

| Type | Standard Impedance Ratios | Freq. Range |
|------|-------------------------------|-------------|
| RC-1 | 50 ohms bal to 50 ohms unbal | 1.8-30 MHz |
| RC-2 | 50 ohms bal to 700 ohms unbal | 1.8-30 MHz |
| RC-3 | 50 ohms bal to 300 ohms unbal | 3.5-30 MHz |
| RC-4 | 50 ohms bal to 600 ohms unbal | 3.5-30 MHz |



BALUNS

Commercial & Industrial Types

MODELS AVAILABLE

| B&W MODEL NO | INPUT IMPEDANCE (unbalanced) | OUTPUT IMPEDANCE (balanced) | POWER CAPACITY |
|---------------------|------------------------------|-----------------------------|----------------------|
| HFT-1K 50U 700B | 50 ohms | 700 ohms | 11KW Average 2KW PEP |
| HFT-1K 50U 600B | | 600 ohms | |
| HFT-1K 50U 300B | | 300 ohms | |
| HFT-1K 50U 200B | | 200 ohms | |
| HFT-1K 70U As Above | 70 ohms | as above | 5KW Average 10KW PEP |
| HFT-5K 50U 700B | | 700 ohms | |
| HFT-5K 50U 600B | 50 ohms | 600 ohms | 5KW Average 10KW PEP |
| HFT-5K 50U 300B | | 300 ohms | |
| HFT-5K 50U 200B | | 200 ohms | |
| HFT-5K 70U As Above | | 70 ohms | |

BARKER & WILLIAMSON
10 CANAL STREET
BRISTOL, PA 19007



PROFESSIONAL QUALITY SINCE 1932

Welcome Back, Barry!

— the Scottsdale RC's most famous member



Photo A. When you work in Washington, it's pretty hard to attend meetings in Scottsdale. That's what Barry Goldwater K7UGA tells the Scottsdale Radio Club when attending his first meeting since the club was formed in 1958. In a stroke of good humor, the club had already decided that the Senator should be an honorary member, so they had made him one.

*Martin W. Krey K7NZA
7037 E. Chaparral Rd.
Scottsdale AZ 85253*

When Thomas Wolfe said, "You can't go home again," he wasn't talking about ham radio operators. Barry Goldwater proved that when he hit home base at the Scottsdale Radio Club for the first time in twenty years. Old-timers with plenty of white around the ears couldn't remember the last time they saw K7UGA there in the flesh. But he's paid his dues and he's tossed in a portable power unit and other goodies whenever word of a club need leaked up to Ben-Nun-I-Kin (Navajo for "house on the hill"), which is where Barry hangs his hat when he's in town.

When word got around that ol' Barry Sun Dust (Navajo) would be at a meeting and would talk, well over a hundred club members and their guests from around the country packed the clubhouse to welcome him back. For his part, Senator Goldwater chipped in an off-the-cuff talk on a number of ham things that made his listeners hope for an encore somewhere down the line.

Speaking without notes,

the Senator delivered a solid half hour of pertinent and zingy ham palaver that left no doubt in anyone's mind why he's been the number one speaker on college campuses for many years. His crackling and witty editorializing won repeated bursts of applause and two standing ovations from the Scottsdale hams before the evening was over.

Club vice president Dennis Reiley WB7PXP introduced Goldwater, and the Senator strode to the dais nattily dressed in gray striped pants and a gray tweed sports jacket. White hair curled gently down over his collar. A true westerner, he wore sleek tan cowboy boots. Over seventy, he's still as trim as he was a few years ago when he slipped into cockpits to fly Air Force jets, and only a slight limp bares evidence of his recent hip reconstruction surgery. And that famous one-sided Goldwater smile was still there.

K7UGA thanked the audience for its warm welcome and apologized for being "such a lousy club member."

"But I think I've got some pretty good excuses," he

added, "which is more than people can say."

Barry waxed nostalgic for a time, much to the delight of the club. He told of getting into radio when a "wireless store" opened down on the old town ditch in Phoenix, and 6ABH, a mechanic at the Chevrolet garage, let him hold soldering lugs "so that he could pour solder on my fingers instead of his own."

About 1922, Barry became 6BPI and pounded brass on a crystal set.

"With a good crystal and a set of earphones, you could hear Los Angeles in Phoenix—if the wind was right," Barry said.

Goldwater laid claim to being one of the first of the disc jockeys, playing phonograph records late at night over the ham rig belonging to 6ABH, the auto mechanic.

"With just a loop of number 14 insulated wire around the oscillator transformer, we got a call from Mesa (15 miles away) saying they had heard the music," Barry said.

Goldwater said that he had helped build KXAD, the first broadcasting station in Arizona (now KTAR), which first went on the air with a home-brew 250-Watt transmitter. Garage mechanics were resourceful and imaginative in the twenties, so it was only natural that KXAD was constructed in, and first went on the air from, the old Dodge Garage on Phoenix's Jackson Street, now one of the old parts of that booming city.

Barry just missed being in on the development of air-ground communications when he became interested in flying in 1928.

"When you wanted to take off in an airplane in those days, you just took off," he said, "and when you wanted to land, you just landed. There weren't many more regulations than that."

There were inconveniences and possible dangers to such a flying arrangement, even though there weren't today's swarms of airplanes flying. The need for air-ground radio was obvious.

"I thought maybe I could figure out a way that you could talk out of an airplane to the ground," Barry said, "but a young fella named Herbert Hoover, Jr., kinda beat me to it, and I think his family still owns most of the basic patents on air-to-ground and ground-to-air radio."

Senator Goldwater said that he has continued his interest in radio without interruption since the 1920s, although he could not always be as active as he would have liked. Family business obligations and then the pressing demands of political involvement took their toll, and there were times when other hams didn't hear K7UGA's call on the air very much.

Goldwater noted that after twenty years in the Senate, he has finally been put on the Communications Subcommittee.

"That's quite an honor," Barry said, and he pointed out that it took him nine years to get on the Armed Services Committee and still another nine years before somebody asked him a question about it.

"That's the way your Congress is run," he said. "You can go to Washington with all the experience in the world, and the last thing you're going to be asked to do is use that experience."

He pointed out that he was the only member of the Armed Services Committee of either the Senate or the House who had flown a military aircraft.

"If I sound a little disheartening at times," he said, "I'm not trying to lead you on. I'm just trying to tell you the truth." Goldwater pointed out that one

of his best friends from Tucson was appointed to the Federal Aviation Agency and the Civil Aeronautics Board, "and he wasn't quite sure which end of the airplane took off first. But he had some idea," Barry said, "and within two weeks he was chairman of that important group."

Senator Goldwater had high praise for Senator Ernest Hollings of South Carolina, who, he says, is a very, very fine Democrat. That's important to hams because Senator Hollings is head of the Communications Subcommittee.

"Senator Hollings is a very easy man for me to work with," Barry said. "He understands that I know a little bit about communications, and consequently he and I usually come to full agreement before anything comes up on the floor that we're going to act on."

This bodes well for the ham fraternity because, as Barry put it, "You don't find many people around with a background in communications. Consequently, you wind up with people who did something nice in a certain election sometime, and they become staff members."

At first glance, it would seem logical that someone as knowledgeable and as persuasive as Barry Goldwater might have considerable success in preserving, protecting, and perhaps even in gaining privileges for hams, but the job is not going to be easy.

"The major problem in communications as far as you are concerned and as far as every user of frequencies is concerned, except television and commercial radio, is that nobody believes there is any other frequency use than television and commercial radio," Barry said. "Consequently, when you get to talking about spectrum, they don't know what you're talking

about, and when you get to talking about frequency usages, they can't quite understand you. One of the major problems that we have is finding people on this rule-making board who understand problems that you and I are running into as communicators."

The first problem the Senator chose to discuss was CB.

"You think maybe we have that whipped," he said. "Don't you believe it. There are 15 million CB users that we know about, and within two years every car that is sold will have a CB hooked into the stereo system. We'll someday be seeing 50 to 100 million Citizens Band radios, or, as they like to call it, family or business communicators, using the spectrums that we are not even thinking of now."

Goldwater went on to say that he didn't believe that this increase in number is going to cause any more trouble than it already has and that he is very interested and happy about the number of CB operators that are beginning to move over into the ham frequencies, "especially since they're beginning to make the ham examinations in some categories a little less difficult."

"That little problem that we run into with CB, like using one to five kilowatts in the basement and heard all over the world on two Watts, is something we can't control," Goldwater said, obviously disappointed.

Barry next brought up the problem of the deterioration of communications on the forty-meter band.

"That's a very fine frequency for long-range broadcast purposes," he said. "We are watching the almost complete domination of the band by foreign broadcasters, and more and more of our own broad-

casters want to get in on the forty-meter frequencies."

The Senator said the problem would be dealt with at WARC where we would see how many friends the amateur fraternity has around the world.

Barry struck a hopeful note when he pointed out that there are some good possibilities for frequencies that we haven't been able to get into yet.

"There are some frequencies that have been reserved for military and State Department use and foreign country use that are really not being used. Those frequencies are going to be explored," he said, "to the end that we may be able to come up with something more to offer the world amateur than it now looks like we might."

Barry's next concern was TVI, and he said that unless manufacturers of any equipment that puts out signals or emissions put equipment on it to clean it up, he and his staff are going to reintroduce a bill to require the FCC to force manufacturers to clean up their products. He pointed out it is very inexpensive to do so, costing only from fifty cents to five dollars per unit.

The Senator left no doubt that he hoped the manufacturers would see fit to end the TVI problem without being forced to. "Being a free enterpriser basically, I don't like to see the Federal Government telling anybody else in this country what they have to do," he said.

Goldwater's mood changed when he recalled what focussed attention on the TVI problem, and he couldn't help chuckling.

"That all came about by garage doors suddenly opening in Detroit," he said. "Nobody could figure it out, but one day somebody got smart and checked the

harmonics on the Air National Guard, and sure enough, about the eighth harmonic would run the garage doors."

The Senator pointed out that Pan American Airways did emissions studies and "can tell you the frequency of damn near everything that goes into your home." He noted that the studies were done below Ajo and Gila Bend, Arizona, which he calls the largest frequency-free place in the United States.

Barry discussed briefly the rewriting of the Communications Act, a process that is presently causing concern among television and radio broadcasting station owners across the land. The House panel charged with redrafting the 1934 Communications Act is chaired by Rep. Lionel Van Deerlin, D-California, who hopes the job will be completed by the end of 1980. One major concern to broadcasters is the proposal by Senator Hollings to raise \$80 million dollars by charging a broadcasting fee. Senator Hollings has said the fee will not apply to CB, ham radio, or other noncommercial operators, and as long as Barry Goldwater is working with Senator Hollings, it probably won't.

One of the problems that really irks Barry, although at seventy he's learned to accept human nature, is discourtesy on the amateur frequencies.

"We'll continue to have our problems with unsolicited interference by amateurs who do not violate regulations but just violate the common laws of decency," he said, "and there's not much we can do about it. I get mail stacked up to my ears on that."

The Senator then chose to elaborate on amateur testing, which he had touched on earlier. "I think

we're going to see some rather drastic changes for some of us who have been in this service for so long," he said. "We'll have no code examinations with limitations on the use, we'll have no technical examinations where no technical knowledge is needed, and there is a very growing feeling that a person who wants to become an amateur radio operator doesn't necessarily have to be able to follow a schematic, particularly those damn things they have today. I can lay you out a Hartley circuit and do it blindfolded," Barry snapped, "but you throw a package of transistors in front of me and you're going to wind up with a new hair dryer or something."

The last thing Barry chose to discuss with his club members before giving them a chance to question him was the growing problem of non-ham citizens across the nation referring to what they call the "antenna blight" and urging planning and zoning commissions to help to limit or ban amateur radio and television antennas.

Barry has had his share of problems with the Paradise Valley zoning board over two of his antennas. One of them, which his AFA6BG (formerly AFA7UGA) station operators use for servicemen's phone patches on calls from Southeast Asia, tops out at eighty feet with a Collins 237B log periodic. Now designated a gateway station, Barry's station uses this same antenna for teleprinter traffic between the States and the Pacific islands, handling health and welfare messages. The other "problem" antenna is a Hy-Gain log periodic ninety feet up, used as a backup antenna.

"The California courts have ruled," Barry said, "that in effect, an amateur radio operator having an

antenna is not misusing his property any more than is a person having a tennis court or a swimming pool. Those are things that are not needed for everyday living. I don't believe that they [the governing bodies] should be permitted to pass laws that can control the blue skies above your property.

"I'll never forget my answer at putting up those two monsters over at my house," said Barry. "The building inspector in Paradise Valley said, 'Do you have a building permit for those?' and I said, 'No.' He said, 'They're gonna have to come down.' 'Well,' I said, 'You take 'em down. Each one of them's sitting in thirty-five tons of concrete, and you just have at it.' He's never come around."

With that, Senator Goldwater concluded his talk, but he stayed right up there at the dais, all seventy years of him, game leg and all, until every club member and guest had had his chance to ask questions and get pleasant, definitive answers. It was easy to see why William F. Buckley called Barry "the friendliest man in the history of the world."

One listener wanted to know about a microwave television signal coming off South Mountain, the source of all other television signals aimed at the Valley of the Sun.

"They've been saying things in the paper that anybody that receives their signals without paying for them is stealing their signals. Now, I was wondering how in the world you can steal something that they are putting out for anybody to pick up," said the man, who obviously enjoyed watching full-length movies with no commercial breaks and at no cost.

"Well, I don't think they can make that stand," said

Barry. "I pay a monthly charge for that stuff, and it's not bad. If you have Channel 4 frequency open, I don't know how they can stop you. How could they know you are using it?"

"We had one guy write to them for their monthly program guide," said the man, to the delight of the audience.

The Senator laughed. "You write to me and I'll send you one," he said. "We're very lucky here," he noted. "That's a very fine television company. They have good movies. There are some places back east that put out X-rated movies and all that junk."

Arturo Acquafondata WB7ATA stood up to thank Barry for having supported, in 1974, Senate Bill 93-505, "American Radio Operators, Aliens in U.S." Arturo had emigrated from near Rome, Italy, in 1970, but although skilled in electronics and radio, was unable to get an amateur license. When the Goldwater bill was passed, Arturo was able to get his Novice license after declaring his intention to become a U.S. citizen. He now has his amateur Extra class license.

"Well, that's very interesting, and I appreciate it," Barry said, and he went on to tell about how the bill for reciprocal licensing had come about. "I had a friend in Mexico City who wanted to put his son in the University of Arizona, so he drove his Cadillac up to Nogales. I don't know what he had in that car, but I can tell you it was a station and a half, and they wouldn't let him into the United States unless he took all the radio equipment out. He said, 'The hell with you. I'll go back to Mexico City.' He called me, and I introduced the bill for reciprocal licensing. We've got forty-nine or fifty countries who have agreed with us to have

reciprocity—if we go to their countries, we get a license, and if they come to our country, they get a license. But we've never been able to get Mexico to sign up."

A California ham, obviously upset, complained about constant harassment on 7255 kHz and asked if there were anything that could be done about it.

Barry was familiar with the problem. "I've gotten letter after letter on that," he said. "I even have tapes, and I've listened to them myself. The problem is that there's no regulation that says you or I can control any frequency. So a man has a privilege. Even though you say, 'Keep this frequency clear. We're having an overseas phone patch,' he can keep on yakking and yakking as long as he doesn't use foul language or advertise a product or do anything that's contrary to established rules."

"There is one other Six that works around fourteen three hundred, and he gives us fits," continued Goldwater. "Fellas have even gone out and chopped off his antenna leads and it didn't stop him.

"All we have is sort of a gentlemanly rule-of-the-road not to interfere, and I swear it's getting so bad," Barry said, "that I'm even going back on CW to get a QSO going."

Another ham asked who the audience is on the foreign broadcast band and how large an audience it is. The Senator told him that his personal opinion was that the audience could not be large because of the \$300 to \$3000 cost of the equipment involved. He identified the audience as shortwave listeners and those who want to listen to Russian and Cuban broadcasts. He noted that some programs are aimed at building up trade in the

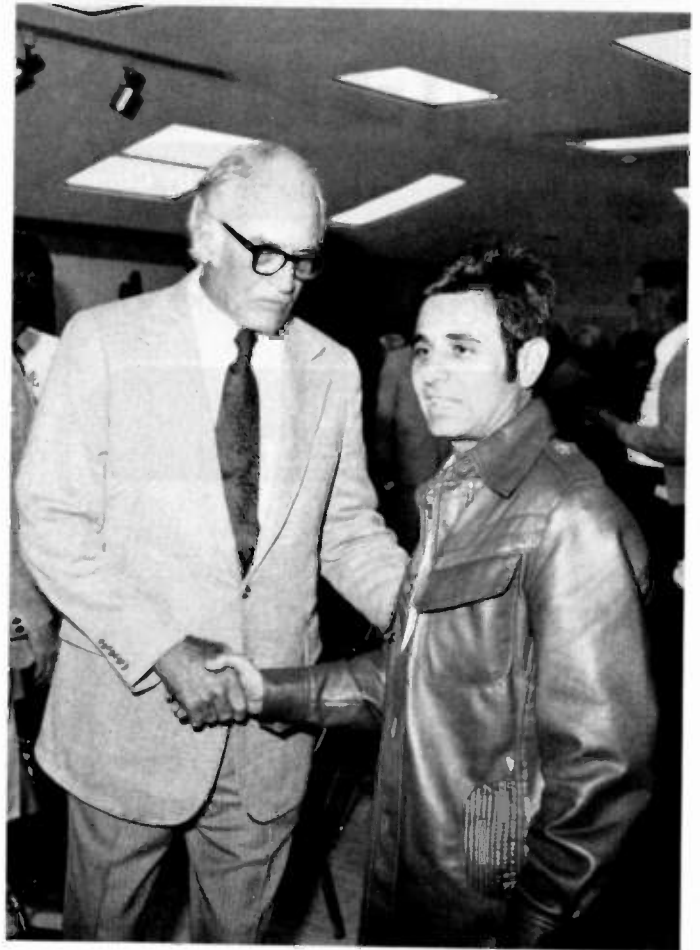

Photo B. Barry Goldwater congratulates Italian immigrant Arturo Acquafondata on his having worked his way up from Novice to Extra in just four years. Arturo had come to the United States in 1970, unable to speak English. He thanks K7UGA for having worked for the necessary reciprocal licensing legislation to make it possible for him to get a license before becoming a citizen.

broadcaster's own or other countries.

A ham observed that he hadn't talked to anybody who had heard Barry on frequency lately and wondered if he was still active. Barry said he was hooked up in an apartment house in Washington and didn't have much of an antenna, but he has a Swan 200 and makes quite a few contacts.

"I'm a member of several repeater clubs back east," Barry said, "and I've got an antenna on top of the Senate Office Building and I work Pennsylvania on repeater frequencies. I had a rig in the car until some jerk stole it," he said.

Somebody wanted to know if Senator Gold-

water's celebrity status caused any difficulty, and he said he usually has a pileup every time he gets on the air, but he enjoys it.

"Another fella and I wanted to see how many QSOs we could have on one frequency one day, and we got eighteen hundred in eight hours, really just one-second QSOs," Goldwater said. He noted that the pileups have caused Arthur Godfrey and Curt Lemay to quit, and King Hussein had a fit because he can't talk to anybody without a pile-up.

Somebody wanted to know if Barry had calls stack up on him when he was working CW, and Barry said it even happened

TIME TRAC

By Comus

the microcomputer-controlled
appointment clock

NEW
First Time Offer

— NOT A KIT —

Limited Offer by
HAL-TRONIX
only \$49.95
plus \$2.00



Shipping & handling charge

FEATURES:

- Sleek modern styling to complement any home or office decor.
- Tells the time.
- Tells the date and year.
- Up-timer to 60 minutes, 59 seconds with pause.
- Alarm to ring at the same time everyday.
- Daily appointment sets appointments for the next 23 hours, 59 minutes.
- Future appointments up to one year.
- Dimmer switch for display.
- Memory will hold up to 30 appointments.
- Lithium power cell to retain memory during power outage.
- Appointments entered out of chronological order will be stored in chronological order.
- Colon flashes once each second.
- A.M./P.M. indicator.
- Plugs into any wall outlet.
- Easy to read vacuum fluorescent display.
- Extremely accurate quartz crystal clock.

EFFICIENT. REMARKABLE.

TimeTrac sold and distributed by HAL-TRONIX. Dealers welcome.

Send 15¢ stamp or S.A.S.E. for information and flyer on other HAL-TRONIX products. To order by phone: 1-313-285-1782.



"HAL" HAROLD C. NOWLAND
WBZXH

HAL-TRONIX ✓31
P.O. Box 1101
Southgate, MI 48195

SHIPPING
INFORMATION:

ORDERS OVER \$20.00 WILL BE SHIPPED POSTPAID EXCEPT ON ITEMS WHERE ADDITIONAL CHARGES ARE REQUESTED. ON ORDERS LESS THAN \$20.00 PLEASE INCLUDE ADDITIONAL \$1.50 FOR HANDLING AND MAILING CHARGES.

there. "I get some jam-ups from overseas," he said. "I call CQ, and those Russians really come back. One sent me a QSL card asking for a picture of me and my family. I think the government wants it, not him."

No more hands shot up, so Barry invited the whole club out to Ben-Nun-I-Kin for a swim and a barbecue. "We can drink a little beer or booze and work the station," he said.

The whole club responded by standing and clapping, but it was more for the man than for the invitation, though they valued that very much, too.

Special punch and a lot of nifty little sweet things were served by Carol Reiley WB7UZK and her helpers, and this gave the club members second wind and a chance to bend the Senator's ear with a whole lot more ham radio questions. Barry One Salt (another In-

dian name) hung right in there until every last ham had been recognized and every question answered. Only then did he slip out the door and head for the home shack, leaving a lot of friends who hoped this would be the year he decided to quit working for the government in Washington and that he would get back to Arizona permanently so they could see him and hear him on the air a little more often.

But Barry's club members weren't through yet. They got in the last word at Arizona's Fort Tuthill Hamfest by joining with all the other hams of the Arizona Amateur Radio Council and naming Senator Goldwater Arizona's Ham of the Year. Barry accepted the award personally at Flagstaff, in August, and the big smile on his face let everyone know that he was home again and loved it. ■

FAST SCAN ATV

WHY GET ON FAST SCAN ATV?

- You can send broadcast quality video of home movies, video tapes, computer games, etc. at a cost that is less than sloscan.
- Really improves public service communications for parades, RACES, CAP searches, weather watch, etc.
- DX is about the same as 2 meter simplex -- 15 to 100 miles.

ALL IN ONE BOX



TC-1 Transmitter/Converter Plug in camera, ant., mic, and TV and you are on the air. Contains AC supply, T/R sw, 4 Modules below \$399 ppd

PUT YOUR OWN SYSTEM TOGETHER

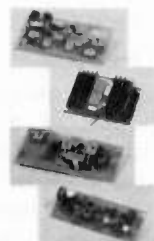

TXA5 ATV Exciter contains video modulator and xtal on 434 or 439.25 MHz. All modules wired and tested \$85 ppd
PA5 10 Watt Linear matches exciter for good color and sound. This and all modules run on 13.8 vdc. \$79 ppd
TVC-1B Downconverter tunes 420 to 450 MHz. Outputs TV ch 2 or 3. Contains low noise MRF901 preamp. \$49.50 ppd

PACKAGE SPECIAL all four modules \$225 ppd

FMA5 Audio Subcarrier adds standard TV sound to the picture \$25 ppd

SEND FOR OUR CATALOG, WE HAVE IT ALL

Modules for the builder, complete units for the operator, antennas, color cameras, repeaters, preamps, linears, video ider and clock, video monitors, computer interface, and more. 19 years in ATV.

Credit card orders call (213) 447-4565. Check, Money Order or Credit Card by mail.



Maryann
WB6YSS

P.C. ELECTRONICS ✓57

2522 PAXSON
ARCADIA, CA 91006

Tom
W6ORG



FT-707 is shown with optional FV-707DM VFO & Scanning Microphone



THE FT-707 "WAYFARER"

The introduction of the "WAYFARER" by Yaesu is the beginning of a new era in compact solid state transceivers. The FT-707 "WAYFARER" offers you a full 100 watts output on 80-10 meters and operates SSB, CW, and AM modes. Don't let the small size fool you! Though it is not much larger than a book, this is a full-featured transceiver which is ideally suited for your home station or as a traveling companion for mobile or portable operation.

The receiver offers sensitivity of .25 μ V/10 dB SN as well as a degree of selectivity previously unavailable in a package this small. The "WAYFARER" comes equipped with 16 poles of IF filtering, variable bandwidth and optional crystal filters for 600 Hz or 350 Hz. Just look at these additional features:

FT-707 with Standard Features

- Fast/slow AGC selection
- Advanced noise blanker
- Built-in calibrator
- WWV/JJY Band
- Bright Digital Readout
- Fixed crystal position
- 2 auxiliary bands for future expansion
- Unique multi-color bar metering—monitors signal strength, power output, and ALC voltage.

FT-707 with Optional FV-707DM & Scanning Microphone

- Choice of 2 rates of scan
- Remote scanning from microphone
- Scans in 10 cycle steps
- Synthesized VFO
- Selection of receiver/transmitter functions from either front panel or external VFO
- "DMS" (Digital Memory Shift)

Impressive as the "WAYFARER" is its versatility can be greatly increased by the addition of the FV-707DM (optional). The FV-707DM, though only one inch high, allows the storage of 13 discrete frequencies and with the use of "DMS" (Digital Memory Shift) each memory can be band-spread 500 KHz. These 500 KHz bands may be remotely scanned from the microphone at the very smooth rate of 10 Hz steps.

The FT-707 "WAYFARER" is a truly unique rig. See it today at your authorized Yaesu Dealer.

YAESU ⁸³
The radio.



YAESU ELECTRONICS CORP., 6851 Walthall Way, Paramount, CA 90723 ● (213) 633-4007
YAESU ELECTRONICS Eastern Service Ctr., 9812 Princeton-Glendale Rd., Cincinnati, OH 45246

80

Return to Shangri-la

— a visit with 9N1MM

After a QSO in 1968, I was invited to drop in to see 9N1MM. It took 10 years to make it, when a trip to India just happened to allow a long weekend in Nepal. The Himalayas were covered with a heavy cloud

layer, but DX was great.

It was not as long before my second visit to Shangri-la in the Kathmandu Valley of Nepal. In January of 1980, the second trip was another rewarding experience with worldwide

DX—the easy way—from the “top of the world.”

We really should know a little more about Nepal. It is a small kingdom situated between India and China, bordered by Pakistan to the west and Sikkim to the east.

These border countries are equally rare prefixes. Kathmandu is the ancient capital with 2000-year-old wooden temples. The site is the fabled Shangri-la, a rich green valley sheltered by the Himalayan mountain range.

Political rumblings in nearby countries of access pointed to a wise decision not to take in gear. Father Moran, furthermore, remarked that his linear was once again in good shape and his own station would be at my disposal. Security checks at most airports are now more rigid than in bygone years. There was the possibility that a transceiver could be impounded by some eager-beaver customs clerk, despite proper documentation.

To get to Nepal, you need a visa from the royal government, obtained from the consulate in Washington DC or New York, and a round-trip ticket. The air approach can be via Bangkok, Thailand, or Delhi, India. Royal Nepalese Airlines



Photo A. Administration building of the Xavier School.

IF YOU'RE READY FOR A MOVE TO THE ROCKY MOUNTAIN SOUTHWEST, CONSIDER A POSITION IN ELECTRONICS AT THE LOS ALAMOS SCIENTIFIC LABORATORY

Los Alamos Scientific Laboratory, a world leader in linear accelerator technology, has positions available for qualified electronics technicians to participate in the maintenance and design of complex electronic equipment at the Los Alamos Meson Physics Facility. Successful candidates will troubleshoot and maintain high voltage, rf, and control systems for the accelerator. Salary range for these positions is from \$16,000 to \$24,000 per annum. Our Laboratory is a multi-faceted national R & D facility operated for the Department of Energy by the University of California. We provide stable employment; promotion and advancement based on individual merit; and excellent benefits, which includes 24 days annual vacation. Our location in the Rocky Mountains of Northern New Mexico offers an aesthetically pleasing lifestyle; superb climate; and abundant recreational opportunities in the pine and aspen covered mountains that surround Los Alamos.

QUALIFICATIONS:

- A technical institute graduate in electronics or an equivalent combination of education and experience.
- Demonstrated technical competence in the development or maintenance of general electronics systems. High voltage, rf, and control system experience is particularly desirable.
- Ability to effectively interact and communicate with other technical and professional team members.

Send complete resume, in confidence, to:

Elmer Salazar, DIV 80-B1
Los Alamos Scientific Laboratory
P.O. Box 1663
Los Alamos, New Mexico 87545

An Affirmative Action/Equal Opportunity Employer. Women, Minorities, the Handicapped, and Veterans are Urged to Apply. U.S. Citizenship Required.

LOS ALAMOS SCIENTIFIC LABORATORY



HI-Q BALUN

- For dipoles, yagis, inverted vees & doublets
- Replaces center insulator
- Puts power in antenna
- Broadbanded 3-40 MHz
- Small, lightweight and weatherproof
- 1:1 Impedance ratio
- For full legal power and more
- Helps eliminate TVI
- With SO 239 connector



\$10.95

HI-Q ANTENNA CENTER INSULATOR



Small rugged lightweight, weatherproof
Replaces center insulator
Handles full legal power and more

\$5.95 With SO 239 connector

HI-Q ANTENNA END INSULATORS



Rugged light-weight injection molded of top quality material with high dielectric qualities and excellent weatherability. End-insulators are constructed in a spiral unending fashion to permit winding of loading coils or partial winding for tuner traps.

- May be used for
- Guy wire strain insulators
- End or center insulators for antennas

\$4.95 • Construction of antenna loading coils or multiband traps

Patent No. 4,091,350

DIPOLES

| MODEL | BANDS | LENGTH | PRICE WITH HI-Q BALUN | WITH HI-Q CENTER INSULATOR |
|--|----------------|--------|-----------------------|----------------------------|
| Dipoles | | | | |
| D 80 | 80 75 | 130 | \$28.95 | \$24.95 |
| D 40 | 40 15 | 66 | 25.95 | 21.95 |
| D 20 | 20 15 | 33 | 24.95 | 20.95 |
| D 15 | 15 | 22 | 23.95 | 19.95 |
| D 10 | 10 | 16 | 22.95 | 18.95 |
| Shortened dipoles | | | | |
| SD 80 | 80 75 | 90 | 31.95 | 27.95 |
| SD 40 | 40 | 45 | 28.95 | 24.95 |
| Parallel dipoles | | | | |
| PD 8010 | 80 40 20 10 15 | 130 | 39.95 | 35.95 |
| PD 4010 | 40 20 10 15 | 66 | 33.95 | 29.95 |
| PD 8040 | 80 40 15 | 130 | 35.95 | 31.95 |
| PD 4020 | 40 20 15 | 66 | 29.95 | 25.95 |
| Dipole shorteners - only, same as included in SD models | | | | |
| S 80 | 80 75 | | \$11.95 pr | |
| S 40 | 40 | | \$10.95 pr | |

All antennas are complete with a HI-Q Balun or HI-Q Antenna Center Insulator. No 14 antenna wire, ceramic insulators, 100 nylon antenna support rope. (SD) models only 50' rated for full legal power. Antennas may be used as an inverted V and may also be used by MARS or SWL's.

Antenna accessories - available with antenna orders:
Nylon guy rope 450e test 100' length \$3.49
Ceramic (Dugstone Type) antenna insulators 70 pr
SO 239 coax connectors 55

All prices are postpaid USA 48
Available at your favorite dealer or direct from:

Van Gorden Engineering ✓ 373
BOX 21308, B. 14CL10, OHIO 44121 Dealer Inquiries Invited

For your TRS-80 send & receive CW/RTTY



FEATURES

- Auto Send & Receive RTTY & CW
- Connects to TRS 80 User Port & Key head phone jacks
- 10 message memories 255 char ea
- Uses builtin PLL or external TU
- Includes hardware, cassette & manual
- Morse tutorial 10 lessons corrects mistakes simplest fastest way to learn the code
- Morse practice random 5 letter words
- Auto numbering contest keyer
- Interactive graphics custom PIX
- Auto/transmitter control PTT
- Requires Level II Basic & 16K RAM
- M80 Software, PC Board, Manual \$149
- CM80 As above in Cabinet \$279
- TM80 As above plus demodulator & AFSK \$499
- M800 Adds advanced RTTY to M80 CM80 TM80 \$99

NEW! M8000 DISK BASED RTTY for the TRS-80

- ★ DISK BASED "MAILBOX" - Any station on frequency can:
 - Leave a message in a mailbox (on disk)
 - Playback any message from disk
 - Echo a message
 - Play the system instructions
 - List current calls in mailbox
 - And much much more!
- ★ Customized with your Name & Callsign

ONLY \$150
(\$100 with M800 Trade-in)
Write or call for ordering information. Requires M800 CM80 or TM80 plus 32K (8500) Disk System.

Write or call
for complete catalog

MACROTRONICS, inc.®

1125 N. Golden State Blvd. / Suite G
Turlock, CA 95380 (S)

✓ 44 (209) 667-2888 / 634-8888



We are experiencing telephone difficulties, please keep trying. California residents add 6% tax

See Pages 221-224

Literally Looking for Books!

See pages 221-224

provides jet service and flies along either the Himalaya range or the Annapurna range, depending upon the approach, east or west. Both provide spectacular views. The Bangkok routing allows a 100-mile view with Mt. Everest in dead center as you approach the airport at Kathmandu. The landings are never without some turbulence.

After some brief customs formalities, Father Moran was there to greet me. Upon this, my second arrival in his country, he put out his hand and said, "Welcome back!" After registering at the hotel in the city, we drove the 8 miles to the Xavier School at Godawari.

The road is through ancient villages that reflect a biblical civilization. The houses are of mud-brick, animals are free to roam, women gather at wells, and chickens scatter in all directions; the clock seems to be set back 2000 years. The people are a happy lot and are all smiles.

Arriving at the school administration building (Photo A), a three-story brick structure where 9N1MM's QTH is located, the first thing that hits your eyes is a Thunderbird TH6-DXX on the roof, flanked by a triband vertical and 40- and 80-meter dipoles. Behind the building, you see the foothills of the Himalayas, and a closer examination reveals that the school is surrounded by hills on three sides; the opening of this horseshoe-shaped area points north towards the US.

The shack (Photo B) is on the second floor, and the main gear consists of Drake twins and a Drake linear. The linear is used only on 20 when conditions require it. Since the electric current is 230 volts ac, 50 Hz, it is stepped down and controlled by a monstrous



Photo B. Father Moran's QTH.

variac. Generally, the line voltage reaching the twins is only 95 volts nominal, and drastic excursions force Father Moran to keep one eye on his ac voltmeter and his right hand on the variac. Sometimes he loses electricity for a few hours and can turn to a 4-kW generator.

A Hammarlund SP6JX Super Pro is used for general listening. To the left of the main gear is a very elaborate tape library, tape recorders, and players of all descriptions. The shack is an old-fashioned ham shack, for it has one wall dedicated to QSL cards protected by cellophane holders. Many distinguished awards, plaques, and autographed photos of government leaders decorate another wall.

The moment has come... we sit at the operating table, warm up the gear, and get ready for high adventure... to be DX from a very rare DX location!

So, what is it like to operate from the roof of the world? What are the conditions on the bands? What

can you hear? Let's tune the Super Pro—a receiver with a long wire—and note some readings.

- 160—noise, static, no signals, no LORAN, and, in fact, 160 is not available in Nepal... so scratch 160!

- 80—is used for local QSOs and you can hear Indian and Pakistani stations through the QRN.

- 40—is good for 800-1000 miles; it is limited to stations on the subcontinent of India or Siberia.

- 20—is active, brings in worldwide signals, and is, of course, the only worthwhile band.

- 15—is spotty and the receiver brings in reasonably long skip; it takes monitoring and plotting to pursue the operators specializing on 15.

- 10—has infrequent openings to Europe and to the US. Despite the peak of the 11-year cycle, it cannot be relied upon for definite schedules.

That brings us to the topic at hand: DX on 20! The modus operandi of Father Moran in a typical morning or evening session of DXing is a very careful

monitoring of 20 from the low end in; he starts on 14,203 kHz. His morning session is between 8:00 and 9:00 am. There is dead silence for awhile and then a few Siberian stations are calling CQ. The beam is now heading towards the North Pole. This direction allows coverage of most of the US, and the band begins to liven up with the W4s. The boys from Florida are in first, and usually W4RHE breaks the barrier. Several W4s are worked and the W3s poke through. A powerful W3 that always thunders in is W3BL. After a few minutes of this "warmup," the W2s and W1s come in. Those with monstrous arrays together with full power stand out and lay in a solid signal.

K1GZL of New Hampshire is a steady entrant, and his 6-element quad simply pours his signal into the Kathmandu Valley. Another strong one is W1ZLG of Massachusetts. The barefoot transceiver boys with tribanders make it, too, but do get clobbered by the big guns. The big boys exchange their greetings and

CALL TOLL FREE
1-800-228-4097

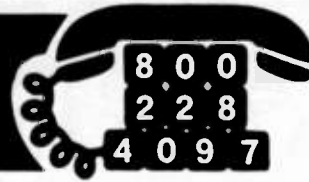

Another Great Buy!

FEATURES

- No Crystals to buy
- Lo Band 32-50 MHZ
- Ham Band 146-148 MHZ
- High Band 148-174 MHZ
- UHF Band 450-470 MHZ
- "T" Band 470-512 MHZ
- Auto Search
- Delay Scan
- Automatic Lock Out
- AC/DC Operation
- Simple Programming
- Scan Rate 20 ch./sec.
- Ext. Antenna Jack
- Ext. Speaker Jack
- Big 3" Front Mounted Speaker
- UL Listed / FCC Certified

Bearcat® 210
 PROGRAMMABLE SCANNER

**LIMITED SPECIAL
 ONLY
 \$199.95**



PANASONIC RF-2900

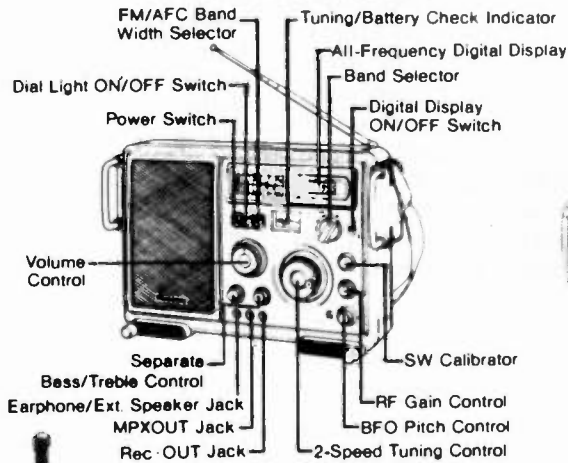

**Suggested List \$329.95
 SPECIAL \$219.95**



PANASONIC RF-4900
 General Coverage Receiver
 List \$549.95
 Ours \$399.95



NEW SHURE 444D
 Dual Impedance
 Normal/Vox Slide Switch
 Adjustable Height
 Mfg. List \$90.00
SAVE AT ONLY \$49.95

KENWOOD TR-7800
 2 Mtr. Transceiver
CALL for Discount Price



KENWOOD TR-2400
 2 Mtr. Hand Held
 144-148 MHZ
 List \$395.00
CALL FOR PRICE



Call for **LOWEST PRICES** on Antennas and Towers

New QTH

We Export

PRICES SUBJECT TO CHANGE AND AVAILABILITY

Communications Center

1840 "O" STREET LINCOLN, NEBRASKA 68508
 In Nebraska Call 402/476-7331





Photo C. Father Moran accepts the SOB (Sons of Boston) certificate from W1QMS.

then kindly move off frequency to give the others a break. There is a mixture-phenomenon of long and short path openings, and now the fun begins. More US districts come in: 8s and 9s and a few 6s plus HKs and YVs. The band is now wide open and the Siberians come in from the north (plus the woodpecker). Pandemonium breaks loose; "bedlam" is mild as a single-word description.

The S-meter now reaches 3—a healthy sign that 20 is alive and that we now can work all that we can hear. There is no pinning of the S-meter. Father Moran says only "Mickey Mouse" and copies the last letters of outstanding callers. There is a quick succession of perhaps 25 such log entries when the band suddenly shifts. Neither he nor I has ignored any callers or pretended not to hear; we

peeled the clear signals off the top and attempted to reach the callers at the bottom of the layer (which never is exhausted). There are interruptions from many friends from all over the world, especially the Sea Net.

There are two distinct DX windows to the US in the day. They are 12 hours apart, and as many stations as possible are worked in these two brief openings. Once the last letters are distinctly copied, that station will be acknowledged. When in a pileup the copy is impossible, it becomes necessary to "up five." The first one to come through clearly is answered. This will continue until the band deteriorates... and this happens after an hour or so. The telltale signs of failing conditions are evidenced and the window begins to close. The path will reopen

in 12 hours. With this assurance and a little patience, 9N1MM can be worked again.

True enough, we now know that with some perseverance and a good antenna system, all DXers can add 9N1MM to their worked list. A log copy is sent to QSL Manager N7BE once a week, and shortly thereafter the treasured QSLs are dispensed.

The "between hours" do provide DX possibilities to other areas of the world. There seems to be a permanent path to G-land. During one of the "between sessions," WA1EYK was heard working a W8. We called him frantically with no luck. He was the only W on at 2:15 pm, Nepal time. Later we discovered that we had forgotten to switch back to upper sideband!

I was by no means the first ham to visit 9N1MM. Gus Browning W4BPD, Armin Meyer W3ACE, and Wayne Green W2NSD/1, among others, have been there, as well as Lowell Thomas and a host of diplomats and movie stars. My host is an unusual man.

Marshall Moran was born in Chicago in 1906, and, as a boy, "played with spark gaps," like so many others. He built many an "oatmeal box" type of receiver, but, regretfully, did not become a licensed W9. He graduated from Loyola University and never lost sight of the wonders of wireless. He constructed various items of radio gear in the roaring twenties, in the evolutionary period of KDKA. He earned tuition money with these construction projects, in this golden era of radio constantly sparked by Hugo Gernsback, the dynamic radio publisher of *Short-Wave Craft*, *Radio-Craft*, and *Radio and Television*.

After graduation, he sailed to the East as Rev. Marshall Moran, SJ, to

begin a lifetime career in education/administration on the vast subcontinent of India. He taught at Patna University, and in India became VU2SX in the days of AM. His first Nepal journey was to visit Tribhuvan University. He saw the needs of this northern land, and when Nepal opened its doors in 1951, he traded in the VU call to become 9N1MM. He founded the Xavier School for boys, as well as clinics which later turned into hospitals. Many institutions have him as an active member on their boards of directors. He is the communications link to and from Mt. Everest climbers and their outside world. One evening, SP6ABA, at base camp, relayed a report from the 1980 Polish Mt. Everest climbers. We were both on 75 lower sideband and then switched to 10 meters for a contact with SP5PWK in Warsaw. Fortunately, 10 meters was open to Europe.

On the last day of my visit, a special certificate (Photo C) was presented to Father Moran—a new certificate created by Dick K1RAW and Peter WB1DQC. It is the SOB certificate awarded to those who work members of the "Sons of Boston." Fr. Moran went right to his fellow priests and, flashing the new award, said, "Guess what? I'm now an official SOB!"

So there you have it... a rare prefix and unique propagation. The prefix is being supplied to the ham fraternity by the most famous mouse in the world—9N1 Mickey Mouse, the sole dispenser of Nepal QSLs.

If you need 9N1MM, listen patiently near 14,225 kHz during the DX windows. You will hear the activity... get in there and call... and after your QSO, may you also hear his closing words, "God Bless!" ■

ASTRO-LOGICAL

From Swan to Cubic

102BXA — \$1195.00

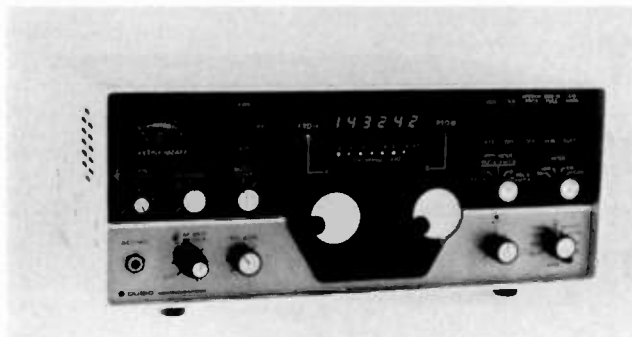

Dual PTO's, 235 Watts PEP & CW on all Frequencies, IF Passband Tuning, with LED Position Indicators and Full Break-In

150A — \$925.00

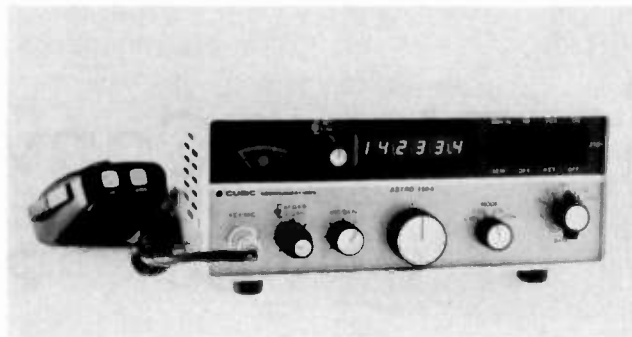

HF SSB Transceiver Featuring "VRS™" a Knob with a New Twist, and Over 100,000 Fully Microprocessor-Controlled Frequencies on Present or Envisioned "Ham" Bands.

Please note that CUBIC COMMUNICATIONS, INC. is screened on the front panel. The Swan "bug" is on the meter face.

Cubic Corporation is a multi-million, diversified, 29-year old American Stock Exchange listed company, with Divisions and Subsidiaries world-wide. We feel the Amateur should know the strength and longevity of the company he is dealing with to know that when he needs service the company will still be around! The combined technical skills and resources now available are light years away from the "old Swan." We intend to slowly let the Swan name disappear from the scene.

From glowing user reports being received daily, there is no question that the PERFORMANCE of the new ASTRO LINE FROM Cubic Communications, Inc. is superb!

All prices remain the same. The ASTRO-102BXA, however, will be supplied LESS THE OLD MARGINAL CWN CRYSTAL FILTER. A superior CWN 400 Hz 6 pole filter to operate with the Passband tuning is available as an option and is priced at \$82.50 list.

ACCESSORIES AVAILABLE
SEND FOR COMPLETE BROCHURE
CALL FOR QUOTES

MADISON

Electronics Supply, Inc.

1508 McKinney • Houston, Texas 77002 • 713/658-0268

Direct Conversion Lives!

— excitingly simple receiver project

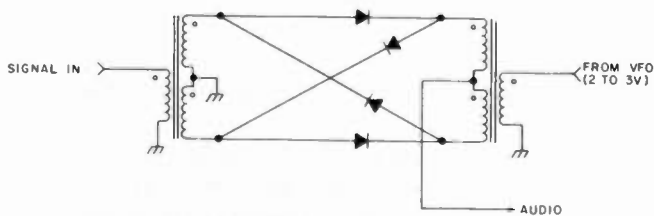

Mike van der Westhuizen ZS6UP
 PO Box 13947
 Sinoville
 Pretoria 0129
 South Africa

Fig. 1. Passive double-balanced mixer. Transformers are trifilar wound on toroids. Diodes are 1N914, 1N4148, etc.

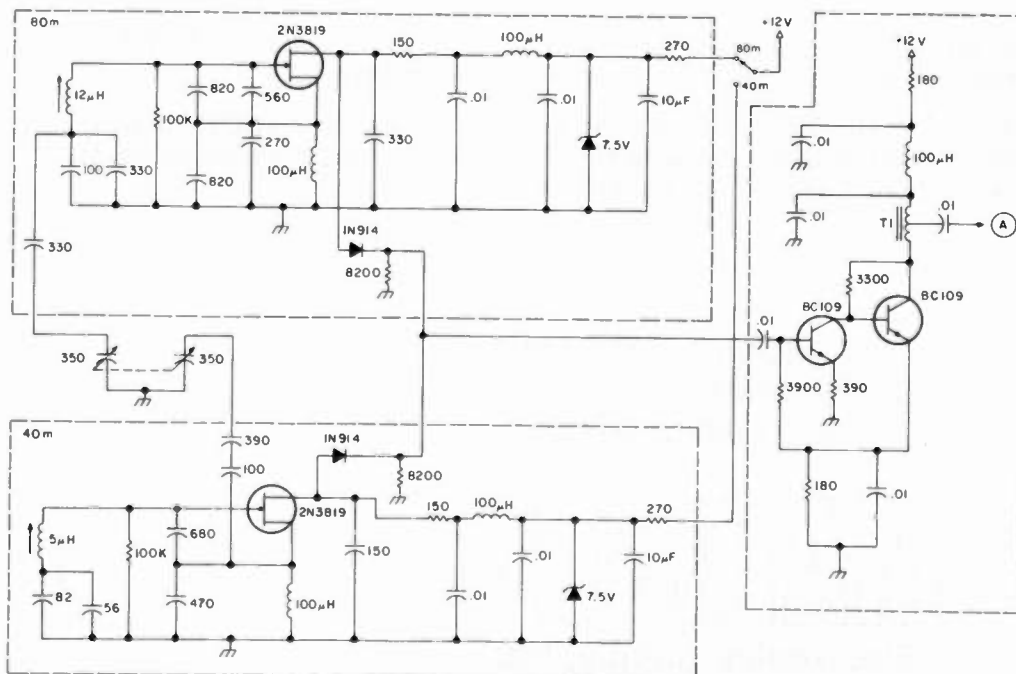

Fig. 2. 80m and 40m oscillators and buffer. The output parts of the oscillators and the buffer are the same as that of Rollema.³ For T1, see text.

Ever since the Japanese started building receivers and transmitters for us, we hams who like to do something with our hands in the evenings were left with building accessories for the shack, QRP transmitters for CW, simple receivers, power supplies, etc. Even power supplies in the high-current range are nowadays probably cheaper to buy than to build.

One of the most interesting of the simple receivers is the D-C (Direct-Conversion) receiver in which the rf signal is converted directly to audio without any intermediate-frequency (i-f) amplification. Through the years, I have built quite a number of versions of the

TET[®]

ANTENNA SYSTEMS 1-800-654-3231

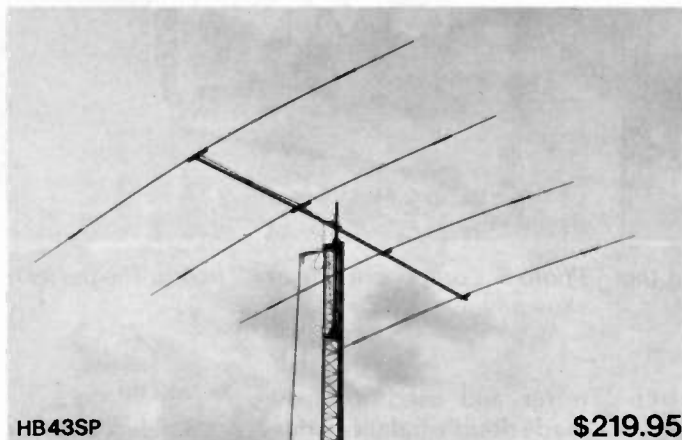

HB43SP

\$219.95

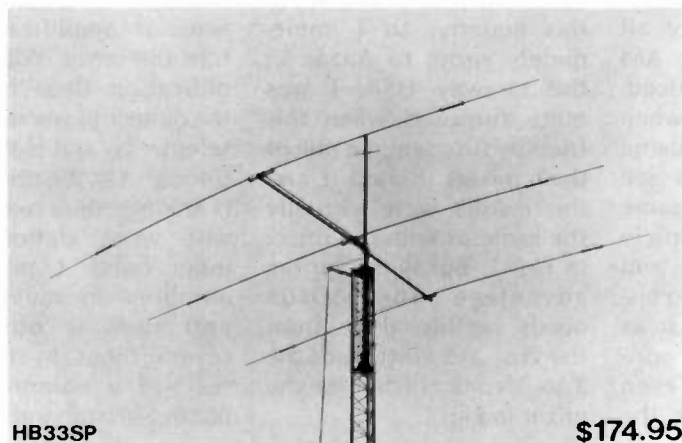

HB33SP

\$174.95

TET, THE LEADER IN WIDEBAND ANTENNA DESIGN, introduces another new triband antenna to provide unmatched wideband performance on the 10, 15 and 20 meter amateur bands. This radical departure from conventional triband antenna design employs TWO DRIVEN ELEMENTS with a rigid phasing line to couple power from the radiator element to the reflector. Phase relationships have been carefully engineered to provide extremely high gain figures without neglecting the need for high front to back ratio. The two element drive system is coupled to one parasitic director on the model HB33SP; two parasitic directors on a longer boom with the model HB43SP.

FULL BAND COVERAGE is possible without the need for antenna tuners or separate CW and phone antenna adjustments. The 1.5:1 VSWR bandwidth covers the entire 20 and 15 meter amateur bands, with a little extra for MARS operation. On 10 meters, coverage is in excess of 1 MHz.

QUALITY CONSTRUCTION and repeatable performance permit TET to deliver an antenna package without need for any tuning adjustments. All tubing is cut and pre-drilled to precision tolerances. The phasing harness and feed assembly for the two driven elements are pre-assembled to insure ease of construction and reliable performance.

MOVE UP with the performance oriented leader in antenna technology. Order your new high performance wideband triband antenna system from TET today.

| MODEL | BANDS | ELE-
MENTS | ELE-
MENTS
PER
BAND | MAX
PWR | VSWR | IMPEDANCE | MAX
ELEMENT
LGTH | BOOM
LGTH | TURN-
ING
RADIUS | WIND
SURFACE
AREA | WIND
LOAD
@80 mph | BOOM
DIA-
METER | MAST
SIZE | WT |
|--------|----------|---------------|------------------------------|------------|-----------|-----------|------------------------|--------------|------------------------|-------------------------|-------------------------|-----------------------|--------------|--------|
| HB43SP | 14/21/28 | 4 | 4 | 2KW | BELOW 1.5 | 50 Ohm | 27' | 19'8" | 16'9" | 6.62 sq.ft. | 131.3 lb. | 2" | 1 1/2"-2" | 38 lb. |
| HB33SP | 14/21/28 | 3 | 3 | 2KW | BELOW 1.5 | 50 Ohm | 27' | 13'2" | 15' | 4.73 sq.ft. | 102 lb. | 1 9/16" | 1 1/2"-2" | 27 lb. |

Call Factory for ANTENNA GAIN dBd and FRONT TO BACK RATIO.

TET FACTORY DIRECT PRICE

HB43SP \$219.95

HB33SP \$174.95

Call Toll FREE 1-800-654-3231



TET U.S.A., INC.



425 HIGHLAND PARKWAY, NORMAN, OKLAHOMA 73069 TEL: 405-360-6410

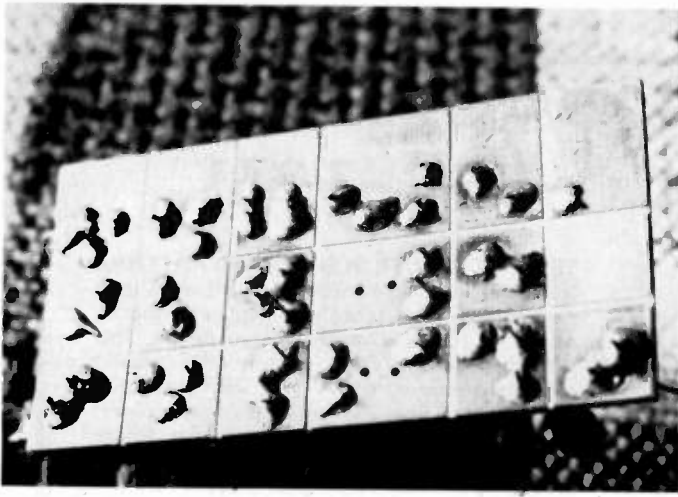

Photo A. Copper side of PC board. The grooves cut in the copper foil are made by an ordinary hacksaw.

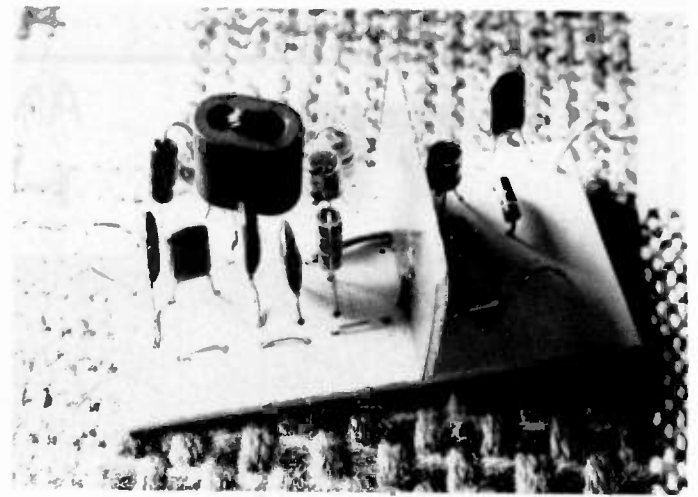

Photo B. Component side of PC board. The buffer module is shown here.

D-C receiver and in this article, I want to present my latest version, which I modestly think is not far from the ultimate, keeping in mind that simplicity is the key word. First, I shall give a few short notes about some parts of the D-C receiver and, thereafter, the complete circuit.

Mixer

The mixer is the most important part of the D-C receiver. My first experiments were all with single active mixers. The 6 dB of conversion gain was always very attractive to me, but with this kind of mixer, you nearly always get AM breakthrough from nearby commercial broadcast stations. This is particularly true of the 40m band, which in South Africa is from 7000 kHz to 7150 kHz; just above the latter figure, there are some strong AM stations.

I then moved to active balanced mixers, more or less like the one used by Rusgrove W1VD.¹ This cured most but not all of the AM breakthrough—you could still hear a little background music between the ham stations! My next move was to try double-balanced mixers using passive elements (4 diodes) approximately like the ones used by O'Grady WA5WWN² in

a QRP transmitter (represented in Fig. 1).

In my experience, this mixer was the best of all that I tested, and no AM breakthrough was noticed. I was very pleased, when the article of Dick Rollema PAØSE³ appeared, to see that he came to the same conclusion. PAØSE's article is an excellent one and must surely go down in history as a classic as far as D-C receivers are concerned. PAØSE went even one step further with the

mixer and used a ready-made double-balanced mixer, the Anzac MD108. This mixer was unavailable in this country, so I immediately wrote to Anzac in the faraway USA; I was quite surprised when this friendly firm sent me one of their mixers. I tried it and the results were virtually the same as with the mixer in Fig. 1, but with one big advantage: The MD108 needs far less drive from the vfo—0.5 volts—not the 2 to 3 volts needed for the mixer in Fig. 1.

Front End

Builders of D-C receivers are always in doubt as to whether they must use some rf amplification before the mixer. With rf amplification, there is always the danger of worsening the selectivity and AM breakthrough. On the other hand, rf amplification really helps with weak stations in a quiet band. I put an rf amplifier in my receiver and took it out again several times. In the end, I reached a compromise: I put in a broadband rf ampli-

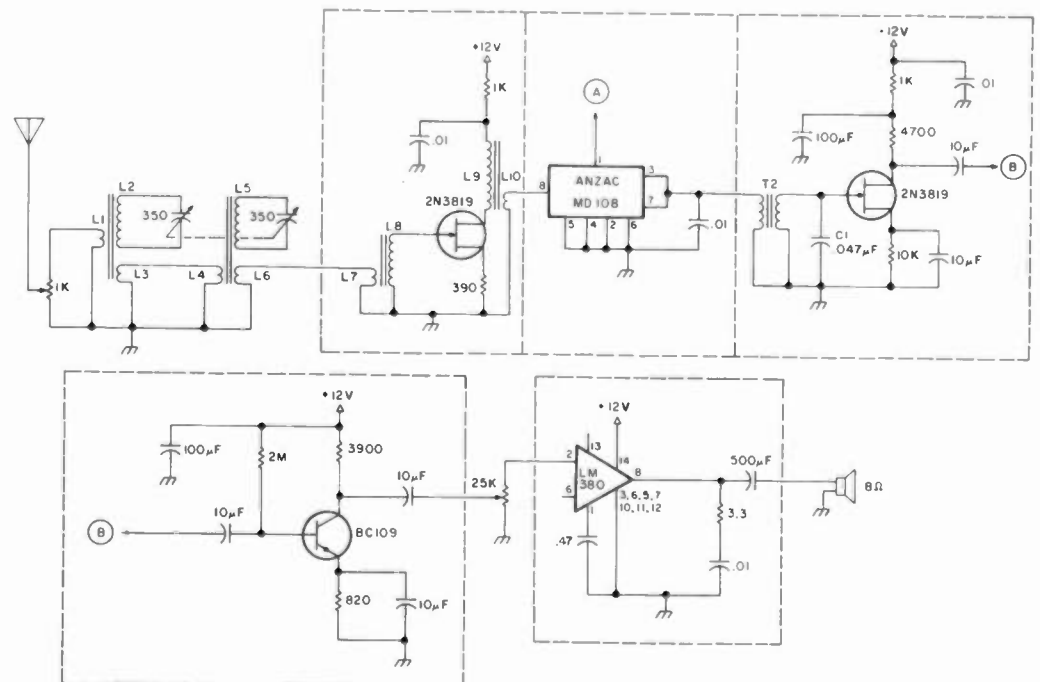

Fig. 3. Input, mixer, and audio parts of the D-C receiver. For L1 to L10 and T2, see text.

FORMULA FOR 2 METER FM ENJOYMENT

4
x RELIABILITY
=



CLEGG FM-88

LIMITED TIME SPECIAL
\$279.00

143-149 MHz

.25 uv sensitivity

mobile mount & microphone included
25 Watts (variable)

Provisions for non-standard splits
(CAP, MARS, etc.)

Optional AC power supply available

Holiday Special

THAT'S CORRECT!!!

We are convinced that the FM-88 is four times more reliable than the other 2 meter rigs being offered. To prove it to you, we are supplying the FM-88 with *four times* more warranty than supplied with other models—One full year instead of the normally expected 90 days.

While there are radios on the market that offer lots of "gadgets"—our past experience

Phone 1 (800) 233-0250 today to order your FM-88 or to request a detailed brochure describing this fantastic transceiver & related accessories.

has been that simplicity of operation & elimination of unnecessary "Bells & Whistles" actually removes the causes of many failures being experienced with such transceivers.

If you are shopping for a new 2 meter transceiver, don't you owe it to yourself to go with a radio that has proven itself with thousands of hours of reliable, "On the Air" operation?

The FM-88 is also available with an 800 channel, programmable scanner—order model FM-88S—\$379.00



Clegg

✓13
Communications Corp.
1911 Old Homestead Lane
Greenfield Industrial Park East
Lancaster, PA 17601
(717) 299-7221

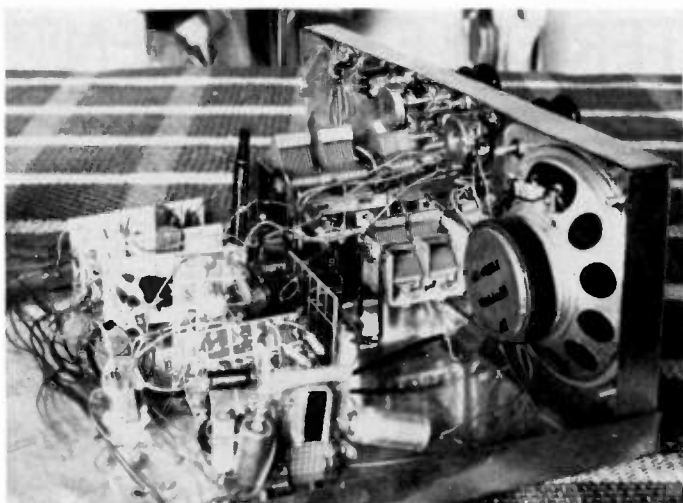

Photo C. Inside of the receiver. The modules are mounted vertically by means of Terry clamps.



Photo D. Front part of the receiver. The extra switches and sockets are for interfacing with a 5-Watt DSB transmitter.

fier with low amplification, but with a DPDT switch to disable the amplifier if I so wished. To avoid confusion, this switch is not shown in the circuit diagrams.

The complete circuit diagram of my 80m/40m receiver is shown in Figs. 2 and 3. Here are some notes about the circuit.

Audio Filters?

Purists will immediately ask: Where is the audio filter? I tried several audio filters and found out one thing very quickly: The input impedance of the filter must exactly match the output impedance of the preceding stage; the same applies for the output of the filter and the input of the succeeding stage. The other problem was that no cheap 88-mH inductances are available in this country. The best filter that I used had more or less the same effect as capacitor C1 in Fig. 3. So I chucked out the filter and used only this capacitor. I use my receiver only for SSB—perhaps if you want to use it mainly for CW, a filter is necessary.

Construction

My experience is that no two hams use the same construction methods, so here are a few sentences on my own construction method—which is far from ideal.

May I say, first, that I am no sucker for miniaturization; with my construction method, you can't put the receiver in a cigarette box, etc.

I divided the receiver into eight parts as shown by dotted lines in Figs. 2 and 3 and built each part as a separate module. For each module, I used the square block method, which means cutting the copper side of a piece of PC board into squares and mounting the components on the squares. For later modules, I drilled holes through the board, mounted the components on the bare side, and soldered the leads on the copper side. This is illustrated in Photos A and B. Each module was mounted vertically with Terry clamps on the bottom of a homemade cabinet. Photo C shows the inside of the cabinet. The module method has the great advantage that you can change a component on a module or replace a module with another one with the greatest of ease.

A form of slow-motion drive for the tuning capacitor is essential. Lady Luck sometimes, just sometimes, smiles toward the building ham. Here it was my turn, and from the deepest part of my junk box, I dug up a very old slow-motion drive—but a beauty! You can't

buy such things in South Africa. With this slow-motion drive, I cover the 80m band (3500-3800 kHz in South Africa) with 25 turns of the knob. It works out at 12 kHz per turn, which is just about ideal. If no slow-motion drive is available, a 20-pF variable capacitor can be put in parallel with the main one and used to fine-tune an SSB signal.

Photo D shows the front part of the receiver. The few extra switches and sockets are for interfacing with a small 5-Watt DSB transmitter.

Inductances L2 and L5 are wound on toroids. I shall give no details on the number of turns as I have no idea of the characteristics of the toroids I used—they are unmarked and came out of an unmarked cardboard box in the corner of a local radio shop. As always, it is best to use a gdo to determine resonance. Links L1, L3, L4, L6, L7, and L10 can be 5 or 10 turns to start with. L8 and L9 also are wound on toroids and can have an inductance of, say, 50 to 100 mH. Transformer T1 is described fully by Rollema. I won't repeat it here, except to say that it has a step-down voltage ratio of 3 to 1 and the secondary impedance is 50 Ohms. An ordinary toroid with the right

turns ratio will probably work just as well.

Results

I was genuinely surprised with the performance of this receiver. To quote the words of Rusgrove, "A well-designed D-C receiver will provide a certain, pleasing clarity and depth of sound... signals seem to stand out against a nearly noiseless background." Also, the words of Rollema: "It is a real pleasure to operate the D-C receiver."

I did not have a calibrated signal generator to measure the sensitivity of this receiver, but it compared very well with my FT-301. Selectivity is just a little bit worse than that of the FT-301.

In conclusion, I have used my D-C receiver now for over a year and it still gives me a deep sense of satisfaction to tell the chap on the other side, "Equipment on this side is home-built, old man." ■

References

1. J. Rusgrove W1VD, "A 20-meter High-Performance Direct-conversion Receiver," *QST*, April, 1978.
2. C. O'Grady WA5WWN, "Quazar QRP 40-meter DSB Transmitter," *73 Magazine*, January, 1970.
3. D. Rollema PA0SE, "Second Thoughts on the Direct-Conversion Receiver," *Ham Radio*, November, 1977.

Save on Scanners! NEW Rebates!

Communications Electronics,™ the world's largest distributor of radio scanners, celebrates Christmas early with big savings on Bearcat synthesized scanners. Electra Company, the manufacturers of Bearcat brand scanners is offering consumer rebates on their fantastic line of crystalless scanners purchased between September 15 and November 15, 1980.

We give you excellent service because CE distributes more scanners worldwide than anyone else. Our warehouse facilities are equipped to process thousands of scanner orders every week. We also export scanners to over 300 countries and military installations. Most items are in stock for quick shipment. Do your Christmas scanner shopping early and order today from CE!

Bearcat® 300

The Ultimate Synthesized Scanner!

List price \$519.95/CE price \$329.00/\$20.00 rebate
Your final cost is a low \$309.00

4-Band, 50 Channel • Service Search • No-crystal scanner • AM Aircraft and Public Service bands. • Priority Channel • AC/DC Bands: 32-50, 118-136 AM, 144-174, 421-512 MHz. The new Bearcat 300 is the most advanced automatic scanning radio that has ever been offered to the public. The Bearcat 300 uses a bright green fluorescent digital display, so it's ideal for mobile applications. The Bearcat 300 now has these added features: Service Search, Display Intensity Control, Hold Search and Resume Search keys, Separate Band keys to permit lock-in/lock-out of any band for more efficient service search.

Bearcat® 250

List price \$419.95/CE price \$259.00/\$20.00 rebate
Your final cost is a low \$239.00

50 Channels • Crystalless • Searches Stores • Recalls • Digital clock • AC/DC Priority Channel • 3-Band • Count Feature. Frequency range 32-50, 146-174, 420-512 MHz. The Bearcat 250 performs any scanning function you could possibly want. With push button ease you can program up to 50 channels for automatic monitoring. Overseas customers should order the Bearcat 250FB at \$349.00 each. This model is like a Bearcat 250, but designed for international operation with 220V AC/12V DC power supply and 66-88 MHz low band coverage instead of 32-50 MHz.

Bearcat® 220

List price \$419.95/CE price \$259.00/\$20.00 rebate
Your final cost is a low \$239.00

Aircraft and public service monitor. Frequency range 32-50, 118-136 AM, 144-174, 420-512 MHz. The Bearcat 220 is one scanner which can monitor all public service bands plus the exciting AM aircraft band channels. Up to twenty frequencies may be scanned at the same time. Overseas customers should order the Bearcat 220FB at \$349.00 each. This model is like a Bearcat 220, but designed for international operation with 220 V AC/12 V DC power supply and 66-88 MHz low band coverage instead of 32-50 MHz.

NEW! Bearcat® 210XL

List price \$319.95/CE price \$209.00/\$20.00 rebate
Your final cost is a low \$189.00

18 Channels • 3 Bands • Crystalless • AC/DC Frequency range: 32-50, 144-174, 421-512 MHz. The Bearcat 210XL scanning radio is the second generation scanner that replaces the popular Bearcat 210 and 211. It has almost twice the scanning capacity of the Bearcat 210 with 18 channels plus dual scanning speeds and a bright green fluorescent display.



NEW! 50-Channel Bearcat 300

FREE Bearcat® Rebate Offer

Get a coupon good for a \$20 rebate when you purchase a Bearcat 300, 250, 220 or 210XL. \$10 rebate on models 211, 210 and 160. To get your rebate, mail this coupon with your original dated sales receipt and the Bearcat model number from the carton to Electra. You'll receive your rebate in four to six weeks. Offer valid only on purchases made between September 15, 1980 and November 15, 1980. All requests must be postmarked by November 29, 1980. Limit of one rebate per household. Coupon must accompany all rebate requests and may not be reproduced. Offer good only in the U.S.A. Void where taxed or prohibited by law. Resellers, companies, clubs and organizations—both profit and non-profit—are not eligible for rebates. Employees of Electra Company, their advertising agencies, distributors and retailers of Bearcat Scanners are also not eligible for rebates. Please be sure to send in the correct amount for your scanner. Pay the listed CE price in this ad. Do not deduct the rebate amount since your rebate will be sent directly to you from Electra. Orders received with insufficient payments will not be processed and will be returned.

NEW! Bearcat® 160

List price \$279.95/CE price \$189.00/\$10.00 rebate
Your final cost is a low \$179.00

16 Channels • 3 Bands • AC only • Priority Dual Scan Speeds • Direct Channel Access Frequency range: 32-40, 144-174, 440-512 MHz. The Bearcat 160 presents a new dimension in scanning form and function. The keyboard is smooth. No buttons to punch. No knobs to turn. Instead, finger-tip pads provide control of all scanning operations, including On/Off, Volume and Squelch. Green easy to read fluorescent display.

NEW! Bearcat® 5/800 MHz

The world's first 800 MHz scanner!
This is a new model. Shipments will begin in November, 1980.

List price \$179.95/CE price \$129.00
8 Crystal Channels • 4 Bands • AC only Frequency range: 33-50, 144-174, 440-512, 806-870 MHz. The Bearcat 5/800 MHz is the only scanner on the market today that offers coverage of the 800 MHz public service band and the other public service bands. Individual channel lockout. Scan Delay. Manual Scan.

Bearcat® 5

List price \$129.95/CE price \$94.00

8 Crystal Channels • 3 Bands • AC only Frequency range: 33-50, 146-174, 450-508 MHz. The Bearcat 5 is a value-packed crystal scanner built for the scanning professional — at a price the first-time buyer can afford. Individual lockout switches.

Bearcat® Four-Six ThinScan™

List price \$179.95/CE price \$114.00

Frequency range: 33-47, 152-164, 450-508 MHz. The incredible, new Bearcat Four-Six Thin Scan™ is like having an information center in your pocket. This three band, 6 channel crystal controlled scanner has patented Track Tuning on UHF. Scan Delay and Channel Lockout. Measures 2 3/4 x 6 1/4 x 1 1/2". Includes rubber ducky antenna. Order crystals for each channel. Made in Japan.

NEW! Fanon Slimline 6-HLU

List price \$169.95/CE price \$109.00

Low cost 6-channel, 3-band scanner!
The new Fanon Slimline 6-HLU gives you six channels of crystal controlled excitement. Unique Automatic Peak Tuning Circuit adjusts the receiver front end for maximum sensitivity across the entire UHF band. Individual channel lockout switches. Frequency range 30-50, 146-175 and 450-512 MHz. Size 2 3/4 x 6 1/4 x 1 1/2". Includes rubber ducky antenna. Order crystal certificates for each channel. Made in Japan.

NEW! Fanon Slimline 6-HL

List price \$149.95/CE price \$99.00

6-Channel performance at 4-channel cost! Frequency range: 30-50, 146-175 MHz. If you don't need the UHF band, get this model and save money. Same high performance and features as the model HLU without the UHF band. Order crystal certificates for each channel. Made in Japan.

FANON SCANNER ACCESSORIES

CHB-6 AC Adapter/Battery Charger \$15.00
CAT-6 Carrying case for Fanon w/Belt Clip \$15.00
AUC-3 Auto lighter adaptor/Battery Charger \$15.00

OTHER SCANNER ACCESSORIES

SP50 AC Adapter \$12.00
SP51 Battery Charger \$12.00
SP58 Carrying Case for Bearcat 4-6 ThinScan™ \$15.00
FB-E Frequency Directory for Eastern U.S.A. \$15.00
FB-W Frequency Directory for Western U.S.A. \$15.00
FFD Federal Frequency Directory for U.S.A. \$18.00
B-4 1.2 V AAA Ni-Cad's for ThinScan™ and Fanon \$15.00
A-135cc Crystal certificate \$4.00
Add \$3.00 shipping for all accessories ordered at the same time.

INCREASED PERFORMANCE ANTENNAS

If you want the utmost in performance from your scanner, it is essential that you use an external antenna. We have six base and mobile antennas specifically designed for receiving all bands. Order #A60 is a magnet mount mobile antenna. Order #A61 is a gutter clip mobile antenna. Order #A62 is a trunk-clip mobile antenna. Order #A63 is a 1/4 inch hole mount. Order #A64 is a 3/8 inch snap-in mount, and #A70 is an all band base station antenna. All antennas are \$30.00 and \$3.00 for UPS shipping in the continental United States.

TEST ANY SCANNER

Test any scanner purchased from Communications Electronics™ for 31 days before you decide to keep it. If for any reason you are not completely satisfied, return it in original condition with all parts in 31 days, for a prompt refund (less shipping/handling charges and rebate credits).

NEW! Regency® M400

List price \$379.95/CE price \$259.00
30 Channel • Synthesized • Service Search Digital clock • Digital timer • M100 styling Search/Store • Priority Channel • AC/DC Frequency range: 30-50, 144-174, 440-512 MHz. The new Regency M400 is a compact programmable FM monitor receiver for use at home or on the road.

OTHER REGENCY SCANNERS

Touch K100 \$199.00
Touch M100 \$199.00

NEW! Telephone Products

Electra's cordless Freedom Phone does everything an ordinary phone does and more. Because it is cordless, you can take it anywhere, inside or outside—on the patio, by the pool, in the garage, in the workshop...even next door at the neighbor's.

Model FF-500 has pushbutton dialing. Rechargeable ni-cad batteries included. Battery low light. Secure feature. Telescopic antenna. Your cost is \$179.00. Model FF-1500 has the same features as the FF-500 but also includes a charger/cradle that allows the phone's handset to be recharged away from the base station. Your cost for this cordless phone is \$199.00. The model FF-3000 has all the standard features (except charger/cradle) plus interchangeable telescopic and rubber ducky antenna. Redial feature. Belt clip. Carrying case. Greater range. Your cost is \$229.00.

World Scanner Association™

The WORLD SCANNER ASSOCIATION is sponsored as a public service by Communications Electronics.™ When you join, you'll receive a one-year membership and our quarterly newsletter with scanner news and features. You'll also get a wallet I.D. card, an Official WSA Membership Certificate, and more. FREE classified ads for members so you can contact other scanner owners when you want to sell or buy a scanner. FREE membership in the WSA Buyer's Co-op. Your Co-op membership will allow you to get special discounts on scanners and scanner related products. Since the WSA Buyer's Co-op gives you group purchasing power, you can easily pay for your membership dues the first time you make a Co-op purchase. To join, send \$12.00 (\$20.00 outside U.S.A.) for your membership materials.

BUY WITH CONFIDENCE

To get the fastest delivery from CE of any scanner, send or phone your order directly to our Scanner Distribution Center.™ Be sure to calculate your price using the CE prices in this ad. Michigan residents please add 4% sales tax. Written purchase orders are accepted from approved government agencies and most well rated firms at a 10% surcharge for net 30 billing. All sales are subject to availability. All sales on accessories are final. Prices, terms and specifications are subject to change without notice. Out of stock items will be placed on backorder automatically unless CE is instructed differently. Most products that we sell have a manufacturer's warranty. Free copies of warranties on these products are available prior to purchase by writing to CE. International orders are invited with a \$20.00 surcharge for special handling in addition to shipping charges. All shipments are F.O.B. Ann Arbor, Michigan. No COD's please. Non-certified and foreign checks require five weeks bank clearance.

Mail orders to: Communications Electronics,™ Box 1002, Ann Arbor, Michigan 48106 U.S.A. Add \$6.00 per scanner or phone product for U.P.S. ground shipping, or \$12.00 for faster U.P.S. air shipping to some locations. If you have a Master Charge or Visa card, you may call anytime and place a credit card order. Order toll free in the U.S.A. 800-521-4414. If you are outside the U.S. or in Michigan, dial 313-994-4444. Dealer inquiries invited. All order lines at Communications Electronics™ are staffed 24 hours.

WSA™ Scanner Distribution Center™ and CE logos are trademarks of Communications Electronics.™

† Bearcat and Freedom Phone are federally registered trademarks of Electra Company, a Division of Masco Corporation of Indiana.

‡ Regency is a federally registered trademark of Regency Electronics Inc.

Copyright © 1980 Communications Electronics™



COMMUNICATIONS ELECTRONICS™

854 Phoenix □ Box 1002 □ Ann Arbor, Michigan 48106 U.S.A.
Call TOLL FREE (800) 521-4414 or outside U.S.A. (313) 994-4444

We're first with the best.™

Hams vs. Hurricane Allen

— 73 aids St. Lucia relief efforts

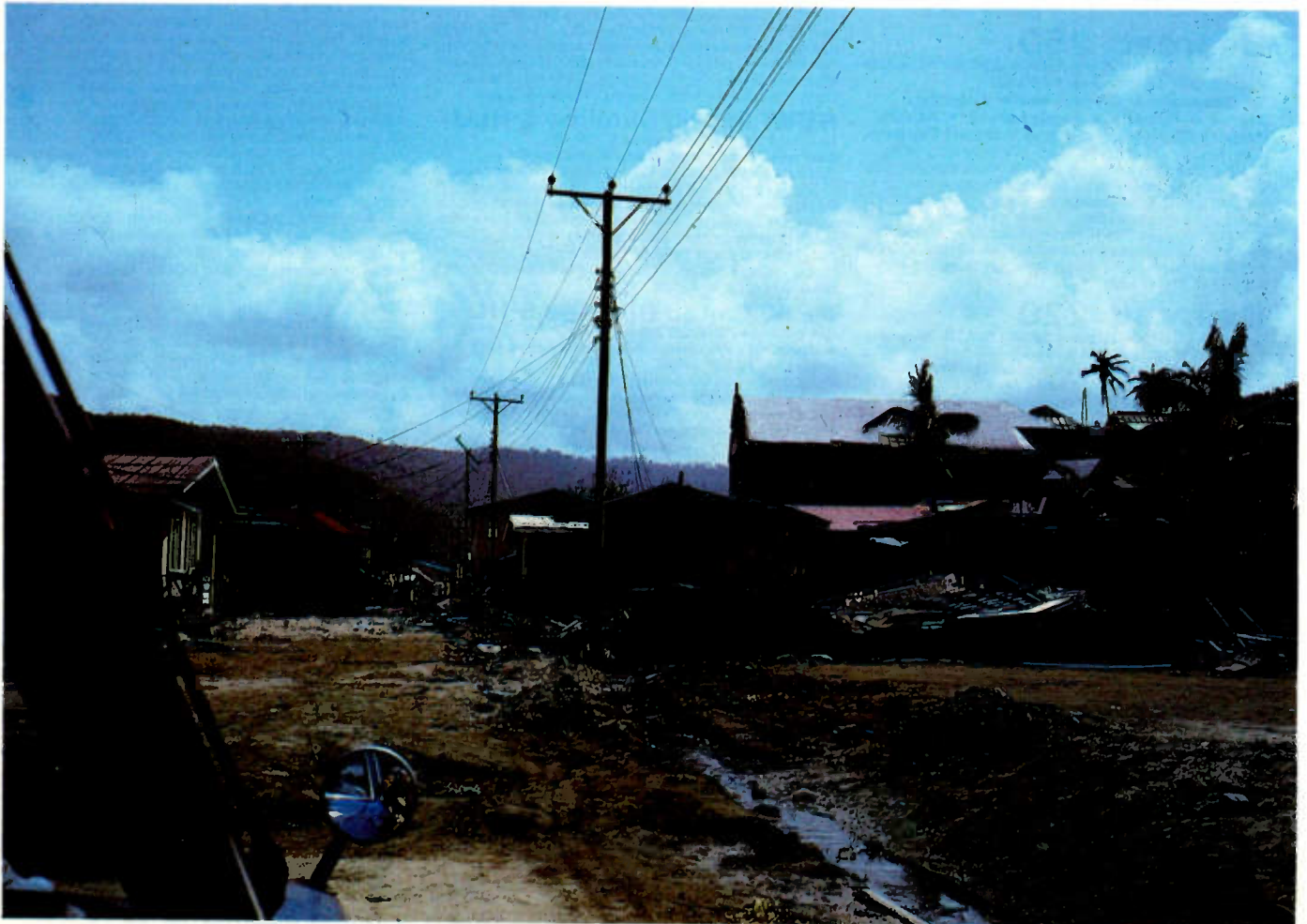

Hurricane Allen: Weather scientists labeled it as the second worst storm ever recorded in the Atlantic. Television and newspaper reports kept everyone from South America to Canada fascinated and sometimes terrified as Allen weaved and bobbed across the Caribbean, leaving death and destruction in its wake. This story is a testament to the awesome force of a tropical storm as well as to the heroic role played by ham radio. While based on my first-hand experiences during an eight-day visit to the Caribbean island of Saint Lucia, this article belongs to hams everywhere.

Thanks to weather satellites and other space-age technology, Saint Lucia had plenty of warning that its 238-square-mile island was the first land in the storm's projected path. Preparations were made, and as darkness approached on Sunday, August 3, 1980, the 80-meter band was busy with chatter between Saint Lucia amateurs and hams on nearby islands. Shortly before 11:00 pm local time, the prime ministers on the islands closest to the hurricane's center issued final words urging calm. Then the power went off and a terrifying night began.

Saint Lucia — Before

Prior to Hurricane Allen's strike, the people of Saint Lucia were quietly developing an island paradise. Banana and coconut production was on the increase and the government was starting to encourage light industry and commerce. Saint Lucia's spectacular mountain terrain and sandy beaches had long attracted thousands of tourists from Europe.

Although originally settled by the French, Saint Lucia spent 165 years as a

British colony. On February 22, 1979, the 130,000 citizens of Saint Lucia formed an independent nation. Incidentally, on that day, amateur radio call signs changed from a VP2L prefix to J6L. Another day that will be long remembered is August 4, 1980, when the fledgling nation assessed the results of Allen's fury.

Saint Lucia — After

Words alone cannot adequately describe the damage suffered by Saint Lucia. Hurricane Allen did not discriminate—homes of the rich and the poor were flattened. Of three buildings standing side by side, two would be left unmarred while the one in the middle would be missing its roof

and windows. Everywhere you looked, trees were down and most if not all of the delicate banana crop was wiped out. Miles of power and telephone lines were left lying on the ground, leaving Saint Lucia in the dark with no way to communicate internally or with the rest of the world.

Perhaps the first voice to

UNITED STATES INTERNATIONAL DEVELOPMENT COOPERATION AGENCY
AGENCY FOR INTERNATIONAL DEVELOPMENT
WASHINGTON D C 20523

AUG 27 1980

Mr. Wayne Green, Publisher
73 Magazine
Peterborough, New Hampshire 03458

Dear Mr. Green:

Our office is returning to normal after responding to the emergency needs of the Caribbean victims of Hurricane Allen. The U.S. Government through this office and the U.S. Embassy in Barbados has so far provided over \$200,000 in emergency food, shelter materials and relief supplies. The U.S. Government has also committed an additional \$400,000 to repair critical public buildings such as schools, and health facilities. I am enclosing our most recent situation report on St. Lucia so that you can see the type and amount of assistance provided by the U.S. Government and private sources.

One of the critical links in the U.S. Government's response to this disaster was the amateur radio network between St. Lucia and Barbados and between Miami and St. Lucia. My staff relied on the Ham radio reports for news of the situation and for information on current needs. Tim Daniel's efforts in support of the St. Lucian Ham operators was a major contribution and his observations upon his return provided us with valuable insights into the situation in St. Lucia. Your support of his efforts is commendable.

I am attaching a copy of my letter to George Naftzinger (W4 PPC) net control in Miami whose assistance in this disaster response effort was invaluable. Please convey our appreciation to all those on your staff and to the many amateur radio operators who participated in this important effort.

Sincerely yours,



Joseph A. Mitchell
Director
Office of U.S. Foreign Disaster
Assistance

Attachment: a/s

cc: George Naftzinger, Net Manager
International Assistance Net
11260 SW 176 Street
Miami, Florida 33157

Brian Cordray, Ham Club
COM/CPS, 705E, SA-18

Tim Daniel, 73 Magazine
Peterborough, N.H. 03458

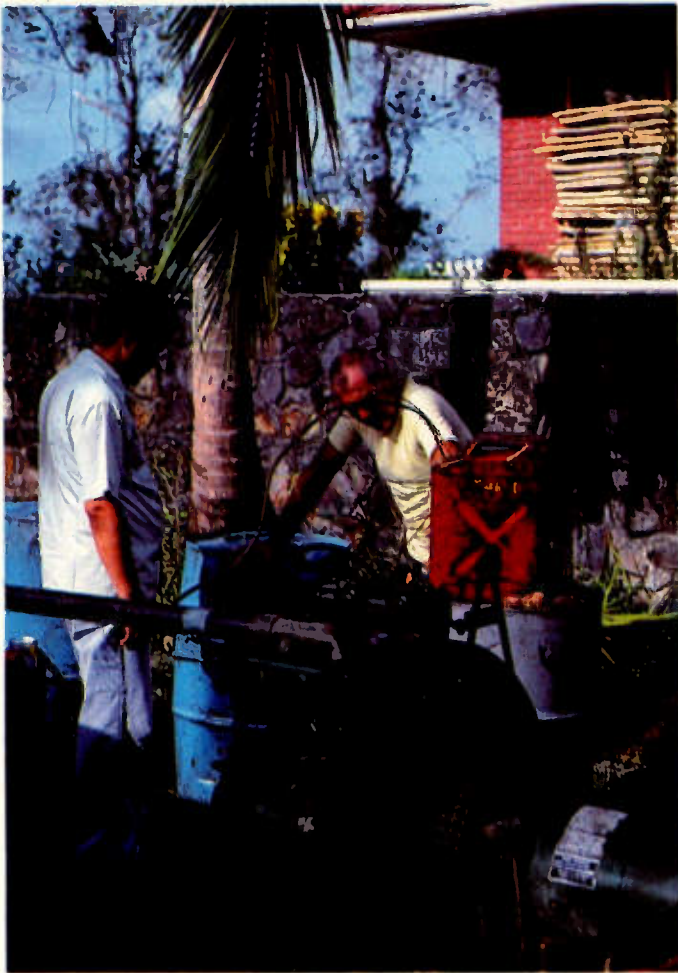

Generators provided by Hess Oil Company helped to keep Don J6LJS on the air. St. Lucia Amateur Radio Club President Vic J6LDJ watched the refueling operation.

announce Saint Lucia's plight was amateur radio station J6LJS. Operated by an American, Don Johnson, J6LJS used battery power to describe the situation on the 14.325-MHz Hurricane Information Net. While Don's house survived, the mast for his Cushcraft tri-band beam was pushed askew. Miraculously, the antenna was unscathed by the 160-mile-per-hour winds.

Wildly fluctuating line voltage had knocked Don's Kenwood TS-820 out of commission a few hours before the storm struck. Luckily, he was able to get back on the air after repairing the 820 with parts cannibalized from another rig. Disaster conditions demand the most of equipment; the

ability to make emergency repairs is essential when the nearest service facility is thousands of miles away.

While J6LJS's terse reports alerted the rest of the world, other members of the Saint Lucia Amateur Radio club swung into action to provide internal communications.

Because of Saint Lucia's mountainous terrain, hams there were already experienced at operating a local network of 40 meters in the daytime, shifting to 80 meters at night. Stations would be needed at the various relief control points, the two airports, and eventually in the outlying cities and towns. This meant assembling gear, antennas, and batteries or generators

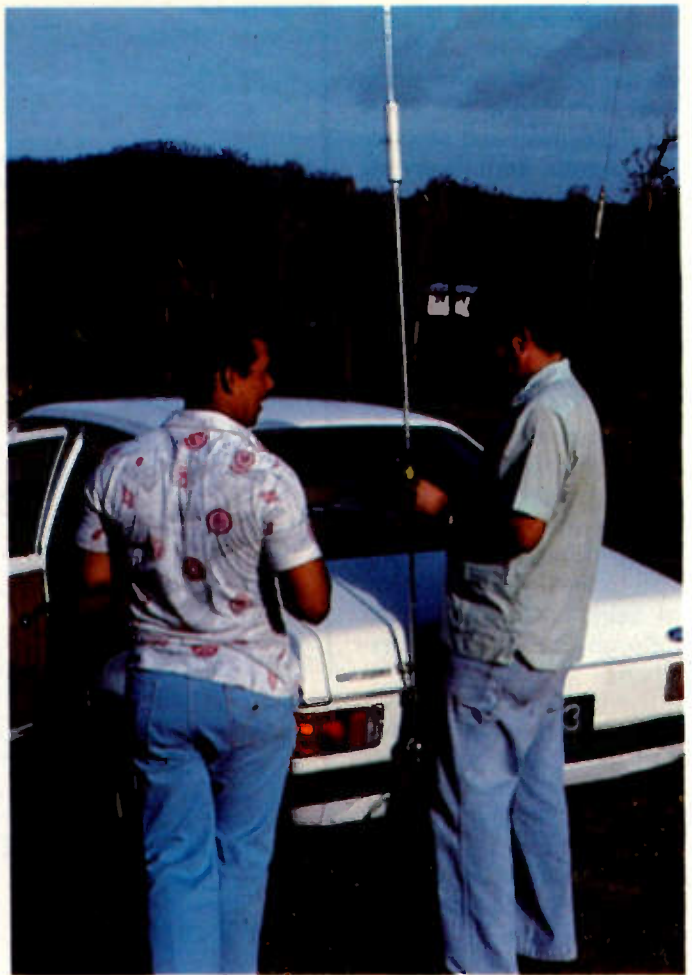

A roadside stop was necessary for J6LDJ (right) to change the antenna from 40 to 80 meters. The frequency switch was made every evening when the QRM rendered 40 meters useless.

while the roads were being cleared and damage assessed.

Enter 73 Magazine

Jeff DeTray, WB8BTH, 73 Magazine's assistant publisher, had been following the progress of Hurricane Allen. Shortly after hearing the reports coming from Saint Lucia, he offered 73's assistance in the form of HF gear and VHF commercial hand-held units. This announcement went out on the 14.325-MHz Hurricane Information Net on Monday morning. Among the Saint Lucians who were in the U.S. when Allen struck was Tim James J6LT, a government information officer. Through Ham Robinson W4ZR, Tim kept abreast of the situation prior to Sun-

day night. Following the hurricane, J6LT began organizing equipment and a way to return to Saint Lucia.

When Tim and Ham contacted 73 on Tuesday, August 5, plans moved into high gear. Initially, we hoped to pack two complete HF stations and 10 hand-holds with chargers, sending them to J6LT in Miami on an afternoon flight from Boston. The appointed time to leave passed without the necessary confirmation from Miami. The gear was still in Peterborough, with several anxious staffers waiting by the phone. Shortly before 4:00 pm, 73 publisher Wayne Green W2NSD/1 decided the gear should be

hand carried to Saint Lucia and manpower assistance provided to the Saint Lucian operators. This left only a few hectic hours to plan and pack before I had to leave on a night flight to Miami.

After deplaning in Miami, I waited eagerly for the luggage to appear. Without those four metal suitcases marked "Emergency Communications Equipment," my trip would be in vain. Not to worry: Delta Airlines soon had all four cases in my hands. Next I had to find Tim J6LT. Later, Tim and I discussed the situation; he was tired and anxious to return home, but after some hurried arrangements, I had a ticket for a flight to Barbados, just a few miles short of Saint Lucia. While flying south, we both stole a few hours of sleep; neither of us knew what to expect when we arrived at our destination.

Arrival in Barbados meant another anxious wait for the luggage. One, two, three . . . four—safe and sound. Now on to Saint Lucia. It was Wednesday, August 6, two days after Allen had passed and the first commercial flights were going to the island on an irregular basis. While we waited as standby passengers on an island-hopping flight, I noticed that life proceeded "as usual" on Barbados. I was carrying radio gear in one hand and a small pack with food and fresh water in the other; the other passengers were headed for a different island paradise with tennis racquets and beach togs.

When the small prop plane taxied down the runway towards Saint Lucia, Martinique, and other islands to the north, Tim and I found ourselves lucky enough to be aboard. At the end of the half-hour flight, we got a bird's-eye view of

Saint Lucia's western coastline. The broken trees, wrecked homes, and ravaged shoreline evidenced Allen's visit two days earlier.

The Vigie airport in Castries, Saint Lucia, was a beehive of activity as tourists struggled to go home and islanders returned, hoping to find their loved ones safe. We were waved through customs and I found myself on the sidewalk shaking hands with Vic J6LDJ, President of the Saint Lucia Amateur Radio Club.

Prisoners and Dipoles

The next few hours were busy as Vic and I visited different communications posts around Castries and discussed the best way to utilize my time and the 73 equipment. We visited the central police station, where a torrent of information was being processed. A makeshift HF station had been set up. To expand its capability, we replaced the 40-meter dipole with an all-band model I had brought along with the rigs. Since none of the hams present were avid tree climbers, an acrobatic prisoner from the jail was requested. He somewhat reluctantly climbed a nearby palm tree under the watchful eyes of his amateur jailers who sincerely hoped that no escape attempts would be made. The urgency of the situation somehow dissolved into humor as our unorthodox antenna party went about its business. The resulting aerial violated a number of the laws of dipole installation, but nonetheless it put out a good signal and was fondly named the "J6L Special."

The next stop was J6LJS's QTH. Located on a hill overlooking the airport and Castries harbor, there was plenty to observe as Don's home rivaled Grand Central Station at rush hour. In ad-

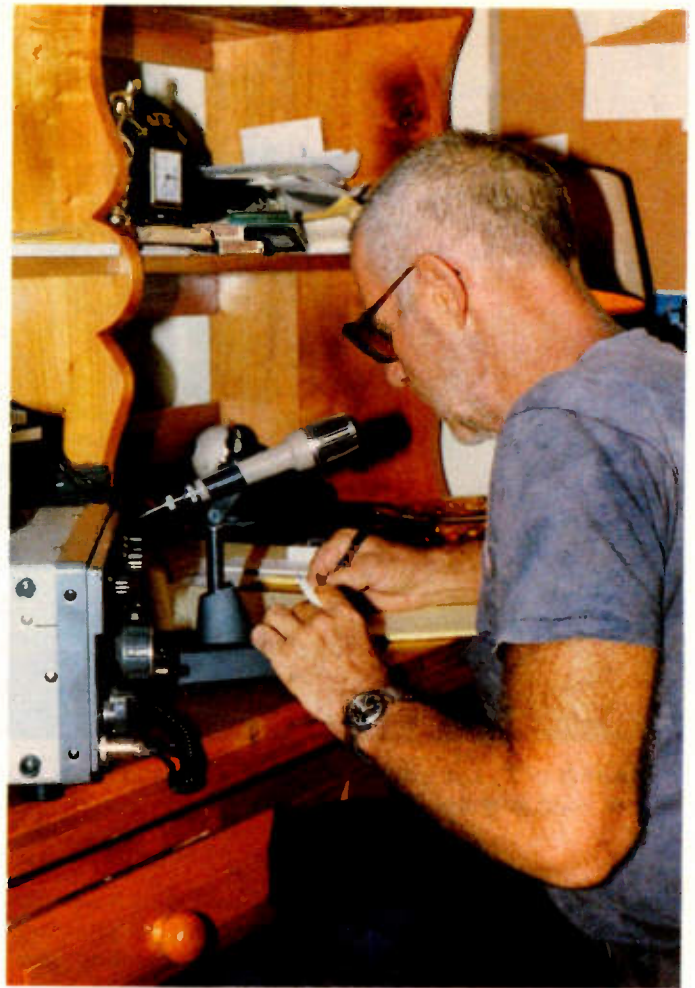

Don J6LJS handled hundreds of pieces of traffic. In one week's time more than forty hours were logged on the International Assistance Net alone.

dition to amateur operation on 20 and 40, the newly-arrived U.S. Navy had chosen this spot as its communications post for shore parties. Amid the confusion, I met Don and his wife Mary J6LKT. They were busy trying to pass on health and welfare inquiries and keep track of the generators which kept the radios on the air as well as powered a refrigerator and lights.

I got my first good look at the Caribbean landscape on an hour-long drive to Saint Lucia's other principle city, Vieux Fort. Located at the southern end of the island, Vieux Fort and the surrounding towns were clobbered by the full force of the storm. The accompanying photographs better illustrate the destruction

than I can describe with words.

Vieux Fort's Hewanorra airport was of great interest to us since it would be the location where most of the relief supplies would eventually land. Joe J6LHV had set up a station there prior to Sunday. When emergency generators were running, he was able to provide the only link between the south and the rest of Saint Lucia. Two of the VHF rigs were left at the airfield so that Joe could keep in touch with the control tower when air traffic resumed. This link would prove to be vital in a few days.

Darkness caught up with Vic and me as we made a final stop at St. Jude's Hospital. Normally, Sister Mary Mark J6LBR would have been there. Instead, she was

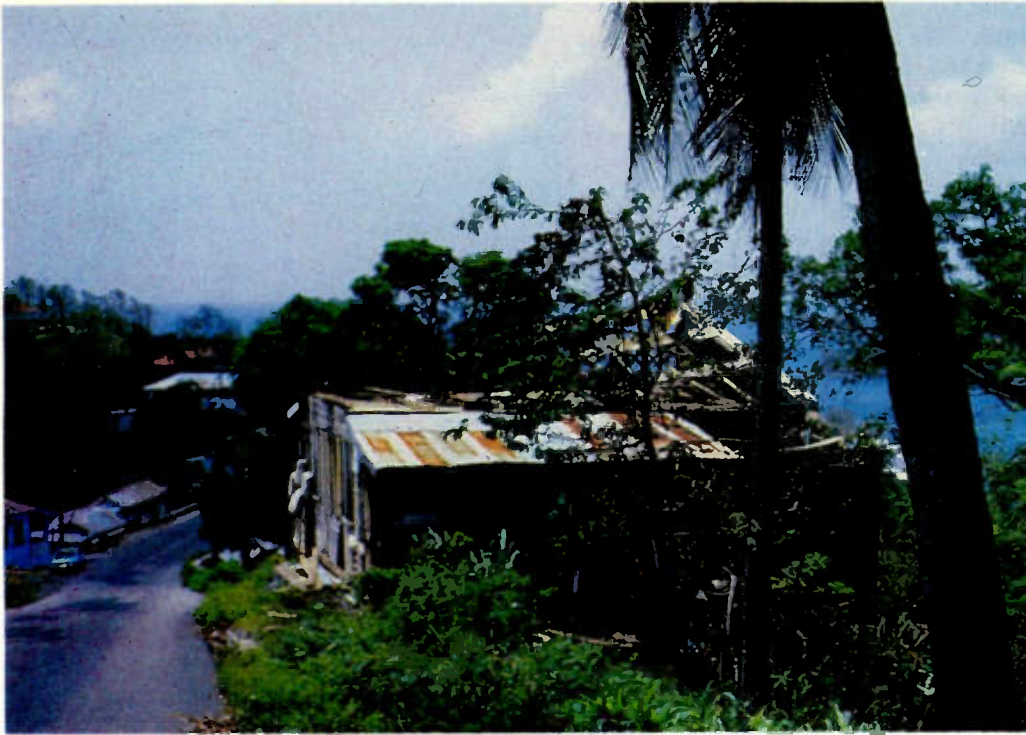

Thousands of St. Lucians were left homeless and many moved in with friends or relatives. Others lived in temporary shelters.

in the U.S., making plans for a hurried return with medical supplies. In her place was Hogarth J6LCU. Later I was to see the remains of his home. Luckily he was able to get on the air with Sister Mark's station. A VHF link was established between the hospital and airport in hopes of relieving some of the traffic on the HF net.

The drive back to Castries was eerie as we passed through small towns lit only by a few candles and lanterns. Vic's TS-120 gave us company while we monitored the 80-meter net. Stations from up and down the Windward and Leeward Islands were checking in, helping to relay the heavy flow of health and welfare traffic. Vic and I listened closely as urgent traffic was passed to Barbados requesting a charter plane to evacuate a severely injured man. Questions flowed back and forth—would a stretcher fit in the plane, when would it arrive, and so forth. The amateurs involved did what they were

best at, providing a communications link, which in turn allowed cooperating governments to save a man's life.

Vic dropped me off at J6LJS's QTH where I would spend the night. Don had just finished a three-hour stretch on the 14.303-MHz International Assistance Net, passing a long list of medical supplies requested by the Saint Lucian government. In exchange, he received a handful of health and welfare inquiries. The large gathering of Navy personnel, hams, and neighbors had begun to dissipate, and I had my first chance to sit and talk with someone who had been involved in the disaster from the start. The roar of two generators and a cool Caribbean breeze were our companions as we looked down on the pitch-black city of Castries. It seemed that conditions had worsened after the hurricane, perhaps as a result of the confusion and untamed efforts to organize relief. I had no objections when the time

came to turn in; it was my first chance to go horizontal in 40 hours.

USS Patterson and Friends

No alarm clock was needed to wake me Thursday morning. Promptly at 6:00 am, Don was outside starting up the generator that powered his shack. Don's employer, Hess Oil Company, was providing the generators and fuel needed to run them 18 hours a day. Hess's construction site for a super-tanker off-loading facility suffered severe damage, yet the company did not hesitate to let Don and other employees participate in the island's cleanup—with pay.

Another source of valuable aid was the United States Navy. The *USS Patterson*, out of Jacksonville, Florida, was near the affected area prior to the storm; early on Wednesday, it dropped anchor a few miles outside of Castries harbor. Originally, liberty shore leave was scheduled, but it

was soon obvious that the sailors would not find their usual leisure pursuits available on the stricken island. Instead of enjoying R and R, the crew of the *Patterson* spent two days speeding Saint Lucia's recovery. Miles of broken water lines were fixed and electrical power was returned to parts of Castries days before it was expected.

Among the *Patterson's* crew was Vince WA4CDK. He was an invaluable aid at the J6LJS communications post. Vince was there to act as a relief operator when net sessions stretched on and on. He helped to troubleshoot various rigs that were brought to Don's QTH when the word went out that technical help was available. Vince's skilled operating style, the product of years of maritime mobile phone patching, was immensely helpful; everyone was sorry to see him and the *Patterson* head for home on Friday morning.

Another naval ship, under the British flag, was in the harbor near Vieux Fort. The *SS Glasgow* provided the island's only helicopter and helped to put the airport in Vieux Fort back into shape. Ham radio operators and naval operators worked together so that the ship's representative at relief central could communicate back to the harbor. Forty meters saved the day again, allowing the ship's resources to be put to the best use.

W4PPC and the 14.303 Net

By midday Thursday, the hams had basic intra-island communications established. Traffic to and from the U.S. was passed on the well-run International Assistance Net at 14.303 MHz. In contrast with other net operations on 20 meters, the Assistance Net Control, George W4PPC, ran things with a firm hand. Jamming and other forms of trouble

were practically nonexistent. A lot of credit is due W4PPC and his assistants. They made the thrice daily sessions bearable and very beneficial.

Turnaround time was often incredible. Traffic passed to the Office of Foreign Disaster Assistance in Washington via the 14.303 relay would be quickly evaluated and replies or inquiries could then be heard coming back to Saint Lucia via the American embassy in Barbados, only an hour or two after the request originated in Saint Lucia. The 40- and 80-meter nets allowed the U.S. AID officials in Saint Lucia to communicate with their headquarters in Barbados. When conditions permitted, a Barbados amateur would provide a phone patch, but we usually relied on verbal relays. Regardless of where they were, hams went out of their way to help.

The Health and Welfare Dilemma

Despite the good intentions of everyone involved, hundreds of health and welfare inquiries went unanswered. Perhaps the originating station failed to give enough information. A name with the address "Saint Lucia" is a bit hopeless when you consider the size of the island. Even those inquiries that had telephone numbers were not likely to receive quick replies. Until a week after the disaster, telephone service was almost nonexistent, and then it was restored only for a few areas around Castries. This meant that most welfare replies would have to be obtained by a personal visit. With gas being pumped by hand and the roads in disrepair, messages were piling up faster than they could ever be delivered.

In many disaster situations, health and welfare in-



The delicate banana crop, a mainstay of the local economy, was wiped out by the storm's wind.

quiries are processed by organizations such as the Red Cross. On Saint Lucia, individual radio operators did their best, with little official assistance available. The problem was further aggravated by the lack of any official channel for public in-

formation. Since the U.S. had no full-time representatives available, the State Department was unable to handle part of the flood of inquiries.

Even though official results were discouraging, hundreds of families did re-

ceive some comfort from informal replies provided by hams who had visited stricken areas. In an attempt to reach individuals in outlying areas, messages were broadcast on Radio Saint Lucia, the island's commercial AM station.



Allen left a peculiar pattern of destruction on St. Lucia's countryside.



The fishing village of Dennerly, on the island's east coast, was battered by both winds and waves.

Stateside amateurs can be helpful when it comes time to pass health and welfare traffic if a few guidelines are remembered. First have the concerned party try official government and relief channels. If you want

to pass an inquiry via an emergency net, do so only after all other traffic has been handled and follow the net control station's instructions to the letter. Be sure to have a complete name and address. Don't

ask for property damage reports; those can be passed along later. Finally, be patient. The hams on the scene are probably spending every waking moment trying to aid the relief effort; they cannot provide in-

dividual replies without help. Asking the net to check the status of your inquiry or reoriginating it only consumes valuable time and creates an even larger backlog. Again, be patient; as noble as health and welfare traffic is, its only value is to those individuals who are far removed from the disaster.

All in a Day's Work

The frustrations encountered with health and welfare traffic were overshadowed by more immediate results involving aircraft. As the weekend of August 8-10 approached, Saint Lucia prepared for large shipments of supplies, some of them coming on C-130 transport planes originating in the United States. Before leaving the U.S., charters needed to know the status of airport communications, availability of fuel, and so forth. Questions and answers buzzed back and forth on 20 meters. Hams played a dramatic role by keeping the two airports in touch. At one point, air traffic was being passed from the Hewanorra tower to a station in the terminal via VHF. The message was then relayed to the airport on 40 meters. From the Vigie airport control tower, operators contacted a plane on the ground that had the frequencies needed to talk to a plane landing at Hewanorra airport.

Politics

The amateur radio operators on Saint Lucia knew how disaster communications were supposed to be run. They had done their homework, holding a Simulated Emergency Test and informing the government of their capabilities. This preparation and planning soon became a distant memory when the real disaster called. The young government of Saint Lucia



This British naval officer from the Glasgow used ham radio to keep in touch with his ship. St. Lucia's hilly terrain made a VHF link impossible, so 40 meters was used.

AMATEUR RADIO OPERATIONS AT NATIONAL HURRICANE CENTER

By Julio Ripoll WD4JNS

On Sunday, August 3, 1980, Miami was having a nice, sunny, clear day, but elsewhere in the Caribbean a tropical storm named Allen had turned into a hurricane destined to kill over 90 people and cause heavy damage to the islands of St. Lucia, Haiti, and Jamaica, and end up in Texas.

Shortly after Allen had become a hurricane, the official Amateur Radio Station at the National Hurricane Center was activated by Dade County E. C. Andy Clark W4IYT. The equipment that was provided by the University of Miami Amateur Radio Society was promptly in place and operating, sending the latest hurricane advisories to the affected areas on the hurricane net, "14.325 MHz," and receiving weather reports from the islands for use by the forecasters.

The station was in operation approximately 130 manned hours. During those hours, many messages were logged. For example, when Hurricane Allen passed over St. Lucia Island, we were the only link between NHC and their weather bureau. Throughout that night, Ham Robinson W4ZR relayed important weather information from 80 meters to NHC over 2 meters. Also, the first reports of the damage caused by Allen, which gave NHC forecasters first-hand information on the strength of Allen, were received at NHC.

Weather information was also received from remote locations in the affected area, such as Jamaica, Haiti, Cuba, Caymans, Cozumel, Cancun, Yucatan, and many marine mobiles. In all, we handled 90 radiograms and logged 20 pages of NHC from the affected area.

One important QSO happened when the Brownsville Weather Center lost all power and had communications problems with NHC. At that time, Dr. Joseph Pelissier, hurricane forecaster for the NHC, spoke with Dr. Richard Hagen, director of the Brownsville Weather Center, who also had a ham radio station on emergency power. They discussed the strange behavior of Allen's eye and why it had stalled 2 hours just off the Texas coast. Many other important QSOs occurred, too numerous to mention.

The operation of this station was not only necessary for the Caribbean Islands to be able to get the latest information, but it also helped here at home by bringing the local ham community together behind a purpose, getting more PR than ever before, acknowledging the value of ham radio, and giving us a good reputation.

Some of the PR we got was from TV channels 4, 6, 7, 10, and 51, NBC National, *Time* magazine, *Miami Herald*, *Miami News*, WPLN, WLRN, WNWNS, WGBS, and others.

All of the forecasters expressed their gratitude to us for our

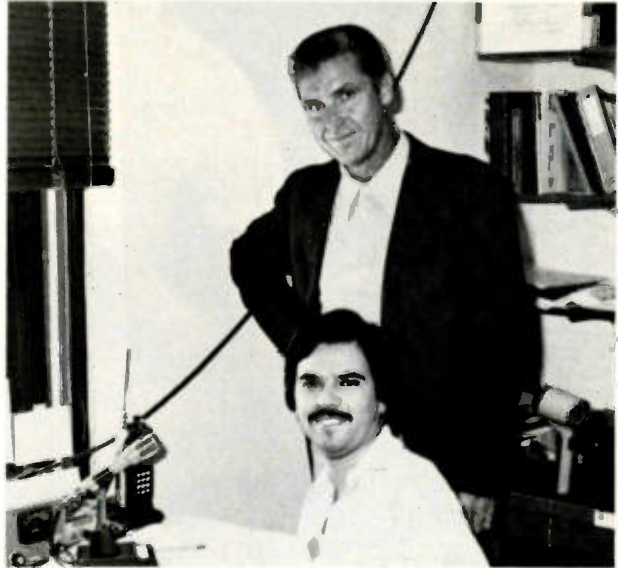

Recently Dade County ARPSC Planning Committee reached an agreement to provide Emergency Communications to and from the NOAA Hq. in Miami. Here Julio Ripoll WD4JNS, NOAA Station Coordinator, poses with Dr. Neil Frank, Director of the National Hurricane Center during a lull in Hurricane Allen. The NOAA station will be active during all future hurricanes with Dr. Frank's blessings.

operations, which they rated A+. Dr. Neil Frank, Director of NCH sent this message:

"ATTENTION ALL HAMS WHO WORKED DURING HURRICANE ALLEN:

Thanks for a great job. Without your help many people in the islands would not have received our warnings. We look forward to working with you during future hurricanes.

73 Dr. Neil Frank"

I would personally like to extend my sincere thanks to those who operated or helped with the Amateur Radio Operations at the National Hurricane Center, the APRSC, Dr. Frank Merceret WB4BBH, Andy Clark W4IYT, Rick Silverston WD4JJI, Ham Robinson W4ZR, and the FM Association 16/76RPT—without all of their help, this operation would have been impossible.

Reprinted from *Florida Skip*.

desperately needed the help of amateur radio, but was not always able to recognize its limitations. The resulting confusion emphasized the need for individual hams to be patient and flexible.

For the most part, hams acted as communicators. Our job was to relay messages. The decisions about what supplies were needed and where they were to go was the responsibility of relief officials; we merely

passed the word on. The head-over-heels drive to revive the island resulted in some hasty judgments. As amateurs, we had to insist that official traffic was separated from rumor and that whenever possible, messages were signed with a name and title.

Despite the rumors, political conflict, and intrigue, amateur radio served as a responsible and reliable medium.

People

Slowly, Saint Lucia dug itself out. A multi-national effort provided tons of food and supplies while individuals did their best to rebuild damaged homes and return to work. Of course, there were a few opportunists who played on the hurricane's visit to make some quick money, but they stood apart from the vast majority that quietly endured carrying water, eat-

ing canned food, and watching out for friends and neighbors.

Each night, a few more lights shone in Castries, and in a week's time, ham radio operators found themselves serving as a backup while regular lines of communication were restored. It will be a long time before Saint Lucia returns to normal. The expensive task of rebuilding homes, schools, and industry was secondary



It was like Christmas in August when a shipment of ham gear held in customs before the storm was released. Some of the equipment was damaged by rain that flooded the customs storage shed. 73's Tim Daniel N8RK is at right.

to the possibility of food shortages and the threat of typhoid and cholera, not to mention the hurricane's long-term effects on Saint Lucia's agrarian economy.

Coming Home

One morning I woke up missing the usual chugging sound of the generator starting. Commercial power had been restored to J6LJS's home. Later that day, the International Assistance Net was reduced to one session and local amateurs began to return to work. It was time for me to return to my job at 73's office in Peterborough. My departure was not without complications, but when Wednesday, August 12, came, I was headed for home.

For me, the Saint Lucia

operation was an education as effective as any classroom course. The exposure to the unique Caribbean lifestyle was an experience in itself. Occasional angry outbursts, personality conflicts, and bureaucratic frustrations, while fresh in my mind, are of minimal importance. Hindsight, of course, offers many lessons for next time, but let's not be too hasty about forgetting the unqualified success that amateur radio had this time.

As I said in the beginning, this article belongs to hams everywhere. As much as I would like to give individual recognition and thanks, I'm afraid I would miss someone. Hurricane Allen was the season's first major tropical storm. Are you ready for what is ahead? ■

RAPID MOBILE CHARGER

The DEB-TED Rapid Mobile Charger is a constant voltage charger that will charge your batteries off a 12 Volt source in 4-6 hours. You may use the charger at all times, this includes transmit and receive periods. It is equipped with a cigarette lighter plug on the input side and the appropriate charging plug on the output side. Models available now for the Kenwood TR2400, Yaesu 207R, Tempo S1, S2, S5 and the Wilson Mark II and IV. Other models available also please call or write for info..... \$34.95.



COMING SOON THE NEW AC VERSION

VEHICLE INTRUSION ALARM

An easy to assemble and install kit that offers options not normally found in other alarm systems. Hidden switch mounts under the dash. Kit has provisions for sensors and remote control switch. Programmable time delays for exit, entry and alarm periods. Basic hook-up utilizes dome light circuit activating when doors are opened. The alarm will drive a siren or pulse horn at a 1HZ rate. Not prone to false alarm do to reliable CMOS circuitry. No external switch required! Complete kit with easy to follow instructions and diagrams..... \$12.95
Wired and Tested..... \$19.95

"SEE THE WORKS" CLOCK

OUR EASIEST CLOCK TO ASSEMBLE!

6 Digits 12 or 24 Hour Format Clock rests between two pieces of clear plexiglas A GREAT CONVERSATION PIECE! Kit is complete including top quality PC board, all componets, pre-cut and drilled plexiglas and all hardware..... \$29.95
Wired and Tested..... \$39.95

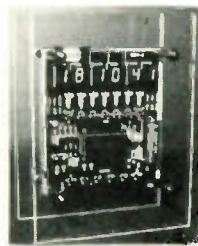

SPECIAL



SPECIAL

MODEL 5314 CLOCK KIT 12 or 24 hour format 6 large "5 Digits. Kit is complete with all parts, pc board and custom designed cabinet. (Specify Whit or Black) \$29.95



DEBCO ELECTRONICS
P.O. BOX 9169
CINCINNATI, OHIO 45209

✓330

Phone: (513) 731-7220

- Add 5% Shipping for U.S. & Canada
- All foreign orders add 10%
- COD orders add \$1.25
- Master Charge and Visa Welcome
- Orders under \$20.00 add \$1.00 handling
- Ohio residents add 4½% Tax

CALL OR WRITE FOR CATALOG

**UNIVERSAL CONVERTER
ASCII - BAUDOT - MORSE
ABM-200**

+5v

MORSE



ASCII

BAUDOT

The ABM-200 is a universal code converter for translating between ASCII and Baudot, or between Morse and ASCII (or Baudot). Also used as TTY* speed and line length converter. Inserts directly between TU and TTY*. RS232 & current plus 40 char FIFO buffer. Write for details \$189.



OEM Inquiries invited.



XITEX Corporation ✓82
9861 Chartwell Dr.
Dallas, Texas 75243
214-349-2490

C.O.D.

Check

**NOISE AND FLASHES
CAN'T STOP THEFT!!!**

**BUT AutoPage CAN
UNIT PAGES YOU**



**129.95
POST PAID**



YOU CALL POLICE

CAR - HOME - OFFICE

CHECK OR MONEY ORDER
CAL. RES. ADD 6 PERCENT TAX
ADD 2.50 FOR C.O.D.

SK ELECTRONICS ✓374

10672 WOODBURY ROAD
GARDEN GROVE, CA 92643

G133 HF RECEIVER



0.2 to 30 Mhz SSB, AM, CW in thirty continuously tuneable bands. Set is Collins 51S1 repackaged by LTV-Temco for military with added AM BFO, extra filtering, and jack for 14-600 KHz tuner. 50 ohm input impedance; 600 or 4 ohm audio output. 16 tubes. Requires 115/230 VAC 50-400 Hz; 24 VDC for AM BFO. 6 1/4 x 18 1/4 x 13"; 40 lbs. sh. More info upon request. Used, repairable: **\$695**. Checked: **\$850**. Collins 51S1 manual, **\$15** when purchased with G133

STACO 4 AMP POWER SUPPLIES

Solid state, new. #FPS-4, filtered 12 VDC; 5x3x5 1/2". 5 lbs. sh. **\$12.95 2/\$22**. #RPS-4, filtered, regulated 13.8 VDC, 5x3x6 3/4", 6 lbs. sh. **\$18.95 2/\$35**.



Prices F.O.B. Lima, O. • VISA, MASTERCARD Accepted. Allow for Shipping • Send for New FREE CATALOG! Address Dept. 73 • Phone: 419/227-6573

FAIR RADIO SALES ✓22

1016 E. EUREKA • Box 1105 • LIMA, OHIO • 45802

**Kreco CO-AXIAL
ANTENNA**

All Aluminum

LIGHT • STRONG • EFFICIENT

SPECIAL SALE

Model CO-2A

2 Meters

\$19.95 Delivered

Herb Kreckman Co.
Cresco, PA. 18326

✓375

MICROWAVE

DOWN CONVERTER POWER SUPPLY KIT \$39.95
All Parts included, Quality Case, 250 ma regulated, very detailed instructions, two models- works with all down converters
TU-8 8-12 VDC
TU-12 12-16 VDC

Introduction to 2 GHz Study Course, includes a quality down converter kit, detailed step-by-step instructions. Requires 8-12V
FREE BONUS: Microwave Antenna Cookbook

MICROWAVE ANTENNA COOKBOOK \$10.00
Information on SMP products \$ASE
\$2.00 handling charge, Maryland residents add sales tax
VISA and Master Charge accepted.

SMP ✓376

Post Office Box 2050
Gaithersburg, Maryland 20760
(301) 258-5150

Radio Amateurs!

Tempo Handheld!

| | | |
|------|----------|----------------|
| S-1 | \$232.80 | 2 Meter |
| S-1T | \$260.90 | With Tone Pad |
| S-2 | \$315.00 | 220 MHz |
| S-2T | \$359.00 | With Tone Pad |
| S-5 | \$264.50 | 2 Meter 5 Watt |
| S-5A | \$299.95 | With Tone Pad |

AZDEN PCS 2000

2 Meter \$259.95 MARS CAPABILITY WITH MOD.

AZDEN PCS 2800

10 Meter \$259.95

SWAN ASTRO 102BX

160/10 Meters \$995.00

Astro 150 \$785.00

100 MX \$589.00

TEN-TEC OMNI C new \$998.00

TEN-TEC OMNI D \$795.00

Six others lower priced Limited Quantities.



Amateur equipment accessories & antennas.

COD: USA. Export Anywhere.

Amateur & commercial repair service.

2317 Vance Jackson Rd. San Antonio, TX 78213

(512) 734-7793 ✓301

Now with courtesy
beep and beacon
capability

144

REPEATERS

220

New and Improved
Receiver
and Transmitter

(Included in All Repeaters)

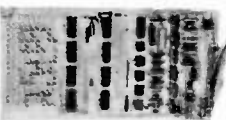

COR Identifier: All on one band, programmable, Fully adjustable, time out (.5-7 min.), hang time (0-1 min.), identifier (1-10 min.), tone, speed, volume, L.E.D. outputs, low current drain, CMOS logic, plugs for easy installation and removal plus much more \$99.95.

Basic Repeater \$649.95

2M 130-175 MH/Basic Repeater for 2 meters with all the features of the Hi Pro Mk I less the power supply and front panel controls and accessories.

Maggiore Electronic Laboratory ✓46

845 Westtown Rd.
West Chester, PA 19380 Phone (215) 436-6051

OPTIONS

- Duplexers
- Basic auto patch
- Matching cabinet
- .0005% High stability crystals

Hi Pro Mk I

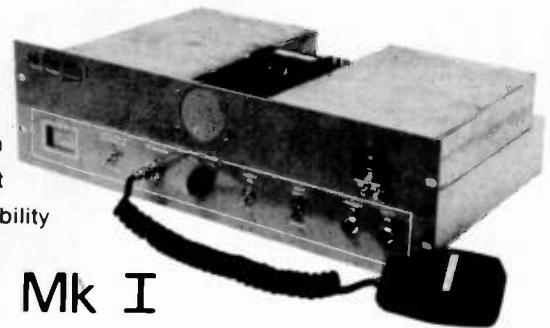

144 or 220 MHz \$849.95

PLUS SHIPPING
PA Res. add 6% tax

Tune In the Wind

— a do-it-yourself hot-wire anemometer

The force of the wind is a constant threat to many amateur radio station antenna installations. When amateurs are alerted in advance to the forces of nature outside of the shack, however, they can crank down towers or feather beam elements into the

wind and save many hours of labor and expensive antenna repair.

An easily-constructed wind-measuring instrument with no moving parts is the hot-wire anemometer, which continuously provides a visual indication of wind speed and, therefore,

can give early warning of threatening increases in wind speed. An alarm circuit may be incorporated easily.

There are a number of different anemometer types, including the commonly-seen cup anemometer and the pendulum type

first developed in the 17th century. The hot-wire anemometer is known scientifically as the cooling-power anemometer; it utilizes the principle that a heated wire is cooled as a function of the air speed past it. In commercially made instruments, a thin platinum wire is heated to approximately 1000 degrees Celsius so that its temperature is independent of ambient thermal fluctuations. Two different methods of indication can be employed. Either the current necessary to maintain the given hot-wire temperature or the resistance variation of the wire is measured. Extremely low wind speeds can be measured with this instrument and it can be constructed with wide parameters of sensitivity, response time, and physical complexity.

Details of Construction

A simple, balanced-bridge circuit comprises the electronic portion of the amateur station hot-wire anemometer, with a physical shroud over the sensing

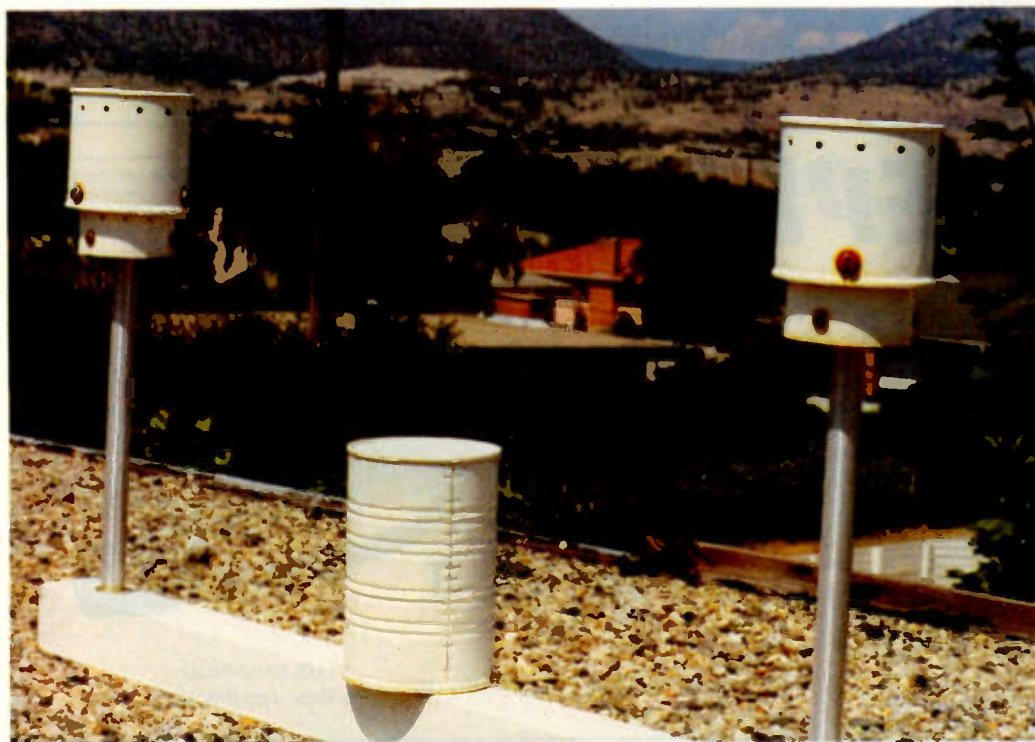

elements to reduce the sensitivity of the instrument for outdoor wind-speed measurement. As shown in Fig. 1, the two halves of the balanced bridge that form the sensing elements are made from two identical rf chokes. My version, shown here, utilized two 2.5-mH rf chokes wound with copper wire on paper tubes, the type used in vacuum-tube circuitry. (The wire must be one of the pure metals.) They measured 45-Ohms dc resistance and were rated at a current of 250 mA, although only 100 mA flow in each choke. The rf chokes were constructed of two pi-wound sections.

The power supply need not be filtered; it delivers between 8.6- and 9.0-volts full-wave direct current. A transformer rated at 12 volts, 300 mA is sufficient. The voltage across each 45-Ohm choke is 4.5 volts; the current, therefore, is 100 mA in each choke.

Certainly, other values of rf chokes or other coils could be used and different voltages applied. A current through each coil of 100 mA is optimum for the physical shroud dimensions described. Care should be taken to keep current ratings about half of the maximum specified for the coil selected since they will remain heated indefinitely. The instrument should not be turned on and off for the taking of readings since a long warm-up time is necessary before the entire rooftop sensing units reach thermal equilibrium and permit accurate indications.

The device is constructed in two parts, with an interconnecting three-wire cable for the rooftop sensing units which house the two rf chokes and the remote (inside the shack) meter display and power supply which are housed in a small metal box. Screw-driver-type potentiometers are mounted in the metal

box since they can be set at the time of calibration and will not be changed except for recalibration at quite long intervals.

Care must be taken in connecting the three-wire cable (22 gauge is adequate) to the rooftop sensing unit so that symmetry is maintained between the two halves of the bridge inside the cans and down to the roofline. A center tin can be seen in the photographs, in the middle of the sensing unit assembly, where electrical connections are made to the three-wire cable. The wire connections must be soldered since a socket doesn't withstand weather very long without becoming a poor connection.

The sensing elements should be mounted about 60 cm apart (see the photograph and Fig. 1). The assembly must be well into the open, away from chimneys, tree branches, and other wind-interference objects, if reliable wind-speed readings are to be obtained.

Four tin cans serve as wind shrouds for the two halves of the sensing unit, each pair of cans fixed to a round wooden disk atop the end of a 30-cm length of 2-cm aluminum tubing. I had a lathe for the con-

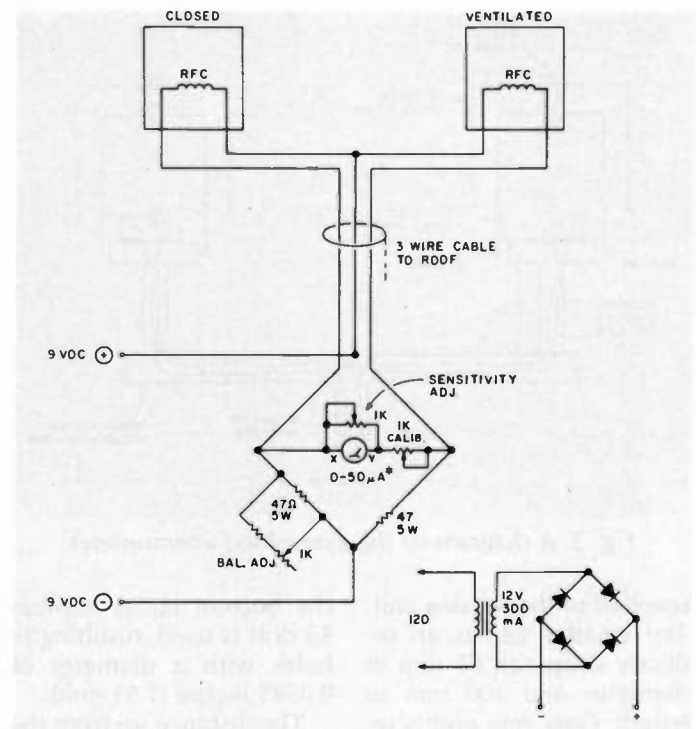

Fig. 1. Some pots can be replaced by fixed resistors once testing and calibration are done. *Other meter movements could be used. A zero-to-50- μ A movement was selected for a 50-mph, full-scale reading.

struction work, but this was more a convenience, making the job neater; it is not necessary. Availability of materials may dictate sizes of cans and spacing between the two halves of the sensing assembly, but the critical matter is to ensure that the two halves of the sensing unit assembly are exactly the same—except for the ventilation of the in-

ner can on one side of the bridge. Additionally, all wiring about the roofline must be the same with respect to the two halves of the bridge circuit, including wire sizes, lengths, and solder connections. (Obviously, the three-wire cable obviates such concerns since symmetry is already accomplished with the cable itself.)

Looking for a moment at

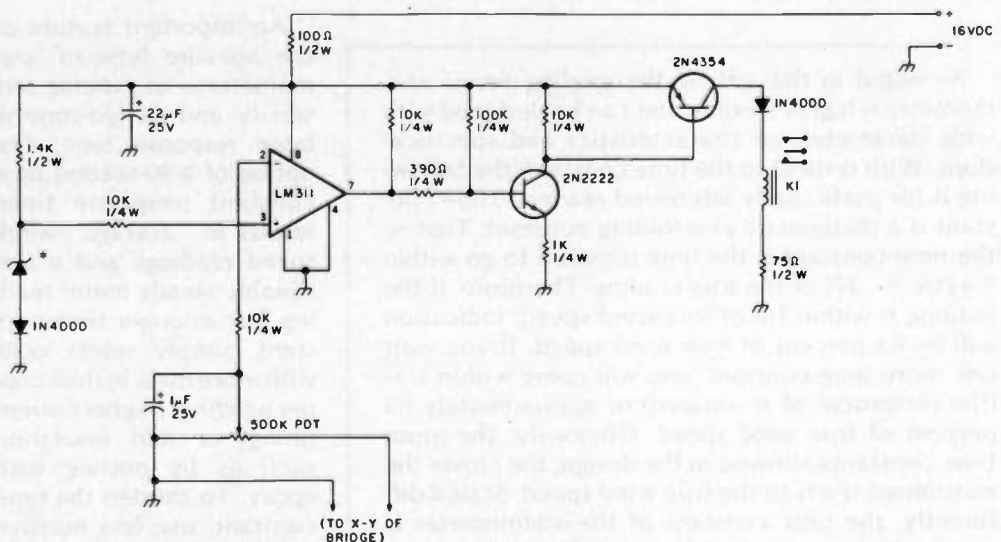

Fig. 2. For reverse relay action on sensed X-Y voltage, reverse pins 2 and 3 of LM311. *The zener was selected as suitable for reference.

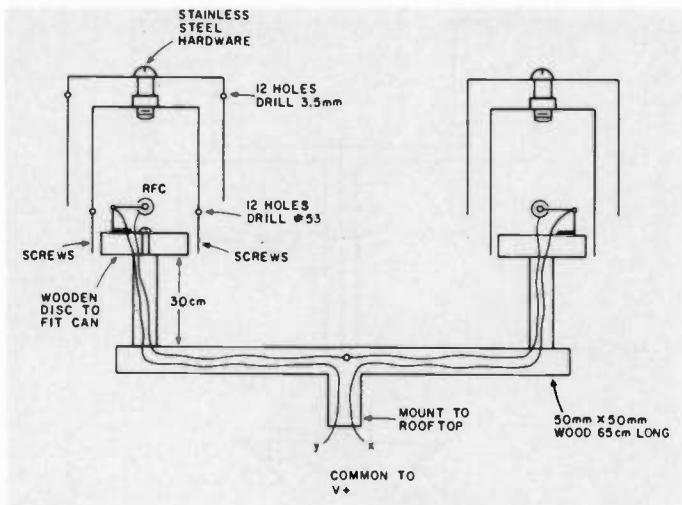

Fig. 3. A diagram of the assembled anemometer.

one half of the sensing unit. The smaller can is an ordinary soup can 65 mm in diameter and 100 mm in length. Only one end is removed, and that end faces down and is mounted onto a wooden disk made to fit snugly into it. A larger tin can with a diameter about 12 mm greater and about 20 to 35 mm shorter is mounted over the soup can and coupled to it with stainless steel bolts so as to provide about 7 or 8 mm of air space between the walls and top end of the soup can.

The ventilated soup can has 12 holes drilled into it around the lower portion, with holes equally spaced at 30-degree intervals and about 30 to 35 mm up from

the bottom lip. A number 53 drill is used, resulting in holes with a diameter of 0.0595 inches (1.51 mm).

The distance up from the lower lip of the inside can may need to be adjusted to accommodate placement of the rf choke; the holes are opposite the centerline of the rf choke which is mounted in a horizontal position with a fiber, standoff solder terminal. The larger can has 12 holes in it also, but only 15 mm from the upper end—the one with the end still intact. Both of the outer cans are vented, unlike the inner cans of which only the can on one side is vented. These holes are drilled in the outer can at 30-degree intervals, with a 3.5- to 4.0-mm

As noted in the article, the cooling-power anemometer is highly flexible and can be designed with wide parameters of characteristics and specifications. With respect to the time constant, the following is for particularly interested readers: Time constant is a mathematical e folding constant. That is, the time constant is the time required to go within $1/e$ ($1/e = .37$) of the true reading. Therefore, if the reading is within $1/e$ of true wind speed, indication will be 63 percent of true wind speed. If you wait one more time constant, you will come within $1/e^2$ (the reciprocal of e squared) or approximately 85 percent of true wind speed. Obviously, the more time constants allowed in the design, the closer the instrument reads to the true wind speed. Stated differently, the time constant of the anemometer is simply the time required for the voltage to move to $1 - 1/e$ of the true wind speed.

drill. These larger holes in the outer can are not quite as critical as the small #53-drill holes in the inner can. The outer can shields the inner rf-choke-containing can from heating as a result of solar radiation.

All surfaces of the tin cans, inside and out, are painted with two coats of glossy white paint, as is the wooden and aluminum structure forming the remainder of the rooftop assembly. Both sets of holes in the tin cans affect the instrument's sensitivity, the #53 holes being the most important in this regard. The outer can's edge extends down to no more than 7 or 8 mm above the #53 holes in the inner can so as not to obstruct airflow into the small holes and across the rf choke.

Response Time and Sensitivity

Copper and other pure metals have a high temperature coefficient of resistance and are cooled by the wind, thus effecting an upset of the bridge's balance. The temperature coefficient of resistance is the ratio of the change of resistance in a wire due to a change of temperature of one degree Celsius to its resistance at zero degrees Celsius. (See Table 1.)

An important feature of the hot-wire type of anemometer is its *extreme* sensitivity and design-controllable response time. The option of a 90-second time constant (response time) results in "average" wind-speed readings and a reasonably steady meter reading. For a longer time constant, simply select coils with more mass in their copper windings (higher current rating) or add insulation such as by potting with epoxy. To shorten the time constant, use less massive and less compactly-wound coils, producing more exposure to air.

For a change in the sensitivity, change the hole sizes in the inner can—make larger holes for more sensitivity and smaller ones for less sensitivity. Alternatively, increase the temperature at which the rf chokes are balanced for greater sensitivity. The easiest way to do this is to increase the voltage—provided the current rating of the selected coils is not exceeded.

Other Design Possibilities

Instead of using rf chokes for the sensing elements, it would be possible to build a faster-time-constant version by utilizing the base and filament structure from inside a 25- or 60-Watt, 120-volt incandescent bulb (using two identical such units) by merely removing the glass envelope carefully and preserving the delicate integrity of the innards. As can be seen from the table of temperature coefficients of metals, tungsten has the largest value of temperature coefficient. This is not to imply that there is any problem getting enough sensitivity; actually, the biggest problem, using the two rf chokes, is reducing the sensitivity to a reasonable level. The eventual choice of #53 drill holes in the ventilated can came as quite a surprise to me, after beginning the experimental work with 6-mm holes.

An audible or flashing-light alarm could be obtained by incorporating a voltage comparator to respond to the differential between points X and Y in the bridge circuit. An appropriate circuit utilizing the LM311 is shown in Fig. 2. (This same circuit works well as an automatic battery-charging sensing circuit for storage cells (or gel/cells) with a relay shutting off the charging circuit when a preset level is reached on the charged cells.)

Have you ever wondered why the best ham bargains are advertised in 73?

You'll find a wider selection of ham bargains . . . and lower prices in 73, because 73's readers buy far more than readers of other ham magazines.



Wayne Green

THE LEADING EDGE

That shouldn't come as a surprise to you . . . For twenty years we've been publishing more construction projects and articles than any other ham magazine, so it is natural for the active hams to read 73 . . . and buy from the ads.

The readers of 73 catch the leading edge, through side-band in the early 60's, then solid state in the mid-60's, FM and repeaters in the early 70's . . . SSTV, ATV, RTTY and all other special modes have received more coverage in 73 than all other ham magazines combined.

NEXT YEAR WE'LL BE PUSHING . . .

In the next year or so, we'll be pushing for amateur experimentation and pioneering with new modes of communications, via computer, automatic identification, satellite, wideband techniques, synchronous detectors, time slicing. Never before was a point in time so exciting to contemplate, and with 73 you can keep up with the new ideas and changes.

We'll also be pushing for increased pressure on the FCC for better and more responsive rules, for a return to a national growth and for amateur radio development in as many of the emerging nations as possible.

ALL OF THIS IS MADE POSSIBLE BY YOU

All of this is made possible by you reading 73 and getting your friends and club members to subscribe to 73. I admit

that we're not really pushing the radio relay of messages, since that is more geared to the 1920's than the 1980's and is more likely than other activities to cause troubles with foreign governments nervous about potential lost telephone revenues. We're looking toward the 1990's, with over one million hams in our country using state of the art communications techniques to keep in touch with hams worldwide.

I will appreciate your help in getting word of 73 out to more prospective subscribers. You might even express your friendship at Christmas with gift subscriptions to 73 . . . 2300 pages of a real ham encyclopedia during the last twelve months. That's about two and a half times as many articles and pages of articles as the next largest ham magazine!

YEAR 2000?

What will amateur radio be like in the year 2000? We can't really even imagine, except that we know it will be different from 1980 . . . probably as different as amateur radio is today from what it was in 1960, when FM and repeaters were all but unknown, and AM was still going strong on our phone bands. A frequency synthesizer required over a hundred tubes and radioteletype circuits were larger than the printers. You can be sure that 73 will be in the vanguard of the developments to come . . . reporting on them and giving you the information so you can participate.

73 Magazine's
20th Anniversary.....

73 Magazine's
20th Anniversary.....

73 Magazine's
20th Anniversary.....

73 Magazine's
20th Anniversary.....

Bill me for one year of 73 at \$20.00

New Subscription

Renewal

Name _____

Address _____

City _____

State _____ Zip _____

Canadian \$22.00/1 year only, US funds Foreign \$30.00/1 year only, US funds

Please allow 4-6 weeks for delivery.

73 Magazine • PO Box 931 • Farmingdale NY 11737

30NT6



Let us know 8 weeks in advance so that you won't miss a single issue of 73 Magazine.

Attach old label where indicated and print new address in space provided. Also include your mailing label whenever you write concerning your subscription. It helps us to serve you promptly. Write to:

**73 Magazine Subscription Dept.
P.O. Box 931, Farmingdale NY 11737**

- | | |
|---|---|
| <input type="checkbox"/> Address change only | <input type="checkbox"/> 1 year \$25.00 |
| <input type="checkbox"/> Extend subscription | <input type="checkbox"/> Payment enclosed |
| <input type="checkbox"/> Enter new subscription | <input type="checkbox"/> Bill me later |

If you have no label handy, print OLD address here.

Name _____ Call _____

Address _____

City _____ State _____ Zip _____

print NEW address here:

Name _____ Call _____

Address _____

City _____ State _____ Zip _____

Alignment and Adjustment

The two sensors of the rooftop assembly should be oriented so that the predominant wind direction passes between the two sensors. My version of the device was calibrated and adjusted by strapping it onto the roof of an automobile which was then driven over a circular course so as to cancel out variations in wind direction with respect to the sensor assembly. This bridge circuit is balanced with 45-Ohm rf chokes and 47-Ohm resistors since only the adjacent legs of the bridge (rf chokes with themselves and resistors with themselves) have to match. Quad matching of bridge components is not necessary in this particular configuration.

Wind-proof antennas are difficult to build and maintain as many amateurs, including the author,² can testify. The hot-wire anemom-

| | |
|--------------------------|---------|
| Platinum..... | 0.003 |
| Gold..... | 0.0034 |
| Silver..... | 0.0038 |
| Copper (hard drawn)..... | 0.00382 |
| Aluminum..... | 0.0039 |
| Copper (annealed)..... | 0.00393 |
| Tungsten (drawn)..... | 0.0045 |

Table 1. Temperature coefficients for various metals at 20 degrees Celsius.¹

eter is a helpful and easily-constructed instrument which can increase your chances of avoiding wind-damaged antenna installations.

I wish to thank Edward Argyle, formerly VE7AAV, for his original idea and his early experimental work developing this amateur application of the cooling-power anemometer. ■

References:

1. *Handbook of Chemistry and Physics*, 55th edition, 1975, C.R.C. Press, Inc.
2. "A Wind-Proof 20m Beam," D. Hembling VE7DKR, *73 Magazine*, November, 1974.

H.F. Transceiver Bonanza

YAESU FT-101 ZD

(With New WARC Bands)



List Price
\$942.00



\$769⁰⁰

(Add \$15.00 Shipping & Handling U. S. A. Continental 48 States)

Supply Limited

* 160-80-40-30*-20-17*-15-12*-10 meter coverage. (*Proposed WARC Bands).

* Built-in A.C. Power Supply.

* Digital plus Analog Freq. Display

* 180 Watts D.C. Input

* Variable Receive I.F. Bandwidth.

* 6146B Final Amp. Tubes.

* Built-in VOX, NB & R.F. Speech Processor.

Optional Accessories: 600 Hz CW Filter - \$40.00, 350 Hz. CW Filter - \$45.00, Cooling Fan - \$20.00, FV-10Z Remote VFO - \$157.00

Call toll-free

1-800-325-3636

HAM RADIO CENTER

8340-42 Olive Blvd. P.O. Box 28271 St. Louis, MO 63132

Call toll-free

1-800-325-3636



WILSON SYSTEMS, INC.

CHRISTMAS SPECIAL SALE

SYSTEM 36

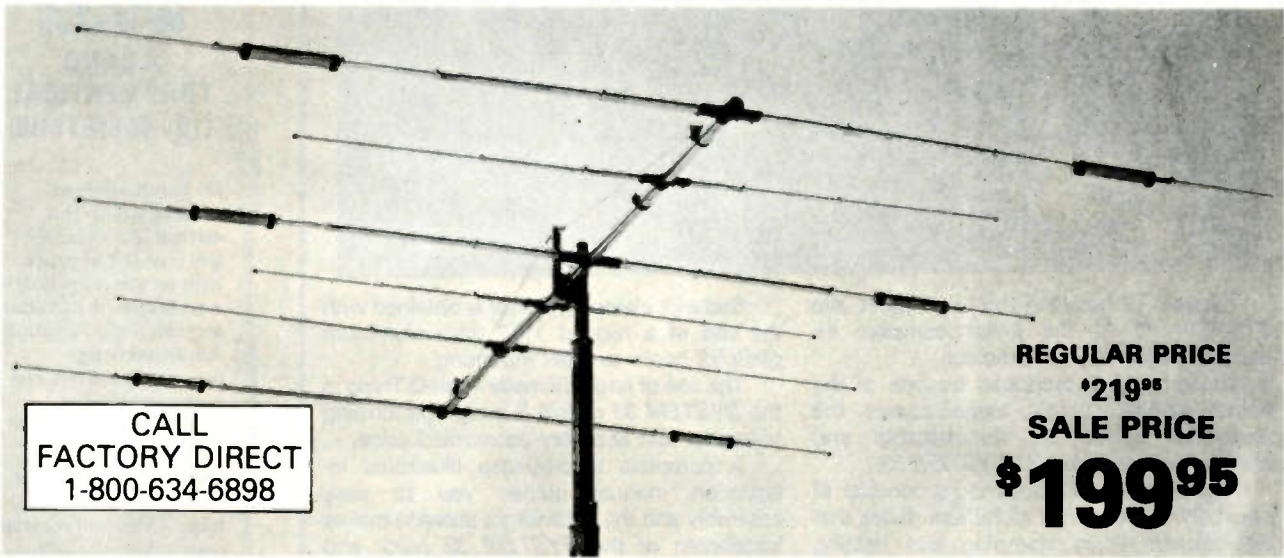

CALL
FACTORY DIRECT
1-800-634-6898

REGULAR PRICE
\$219⁹⁵
SALE PRICE
\$199⁹⁵

A trap loaded antenna that performs like a mono-bander! That's the characteristic of this six element three band beam. Through the use of wide spacing and interlacing of elements, the following is possible: three active elements on 20, three active elements on 15, and four active elements on 10 meters. No need to run separate coax feed lines for each band, as the bandswitching is automatically made via the High-Q Wilson traps. Designed to handle the maximum legal power, the traps are capped at each end to provide a weather-proof seal against rain and dust. The special High-Q traps are the strongest available in the industry today.

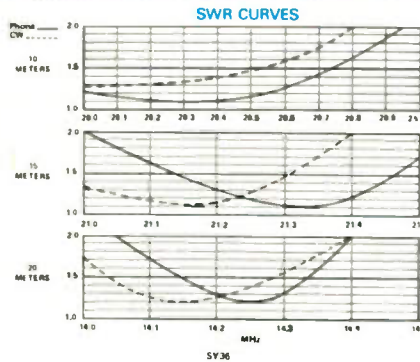

SPECIFICATIONS

- Band MHz 14-21-28
- Maximum power input Legal Limit
- Gain (dbd) 9 db
- VSWR @ resonance 1.2:1
- Impedance 50 ohm
- F/B Ratio 20 db or Better
- Boom (O.D. x Length) 2" x 24' 2 1/2"
- No. of Elements 6
- Longest Element 28' 2 1/2"
- Turning Radius 18' 6"
- Maximum Mast Diameter 2"
- Surface Area 8.6 sq. ft.
- Matching Method Beta
- Wind Loading @ 80 mph 215 lbs.
- Maximum Wind Survival 100 mph
- Feed Method Balun (Supplied)
- Assembled Weight (approx.) 53 lbs.
- Shipping Weight (approx.) 62 lbs.

Compare the SY-36 & SY-33 with others...

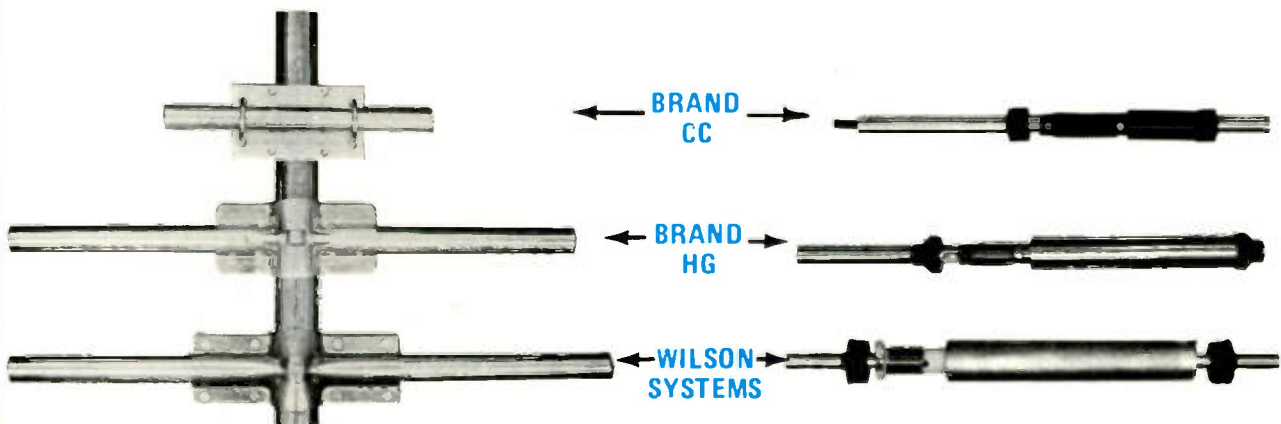

Compare the size and strength of the boom to element clamps. See who offers the largest and heaviest duty. Which would you prefer?

Wilson Systems traps offer a larger diameter trap coil and a larger outside housing, giving excellent Q and power capabilities.

For
Christmas
Special

CALL
FACTORY DIRECT
1-800-634-6898

W S I WILSON SYSTEMS, INC.

4286 S. Polaris Ave., Las Vegas, Nevada 89103

Prices and specifications subject to change without notice.

WILSON SYSTEMS INC.

SYSTEM 33

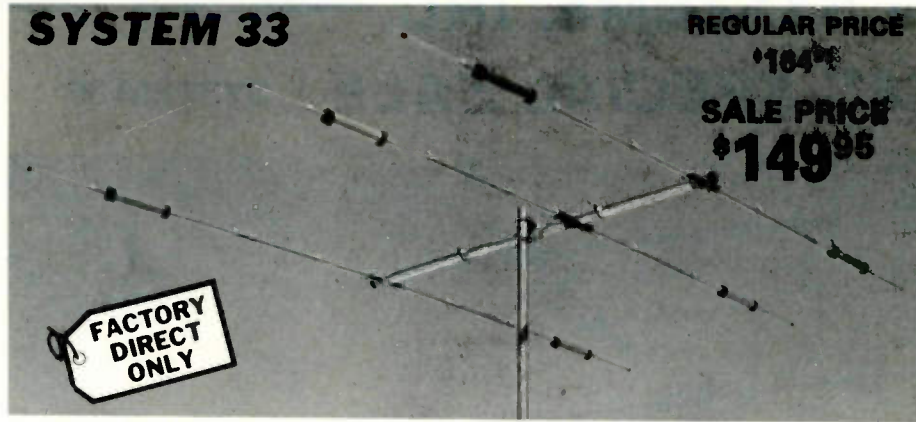

REGULAR PRICE

~~\$104~~

SALE PRICE
\$149⁹⁵

**FACTORY
DIRECT
ONLY**

Capable of handling the Legal Limit, the **SYSTEM 33** is the finest compact tri-bander available to the amateur.

Designed and produced by one of the world's largest antenna manufacturers, the traditional quality of workmanship and materials excels with the **SYSTEM 33**.

The boom-to-element mount consists of two 1/8" thick formed aluminum plates that will provide more clamping and holding strength to prevent element misalignment.

Superior clamping power is obtained with the use of a rugged 1/4" thick aluminum plate for boom to mast mounting.

The use of large diameter High-Q Traps in the **SYSTEM 33** makes it a high performing tri-bander and at a very economical price.

A complete step-by-step illustrated instruction manual guides you to easy assembly and the lightweight antenna makes installation of the **SYSTEM 33** quick and simple.

SPECIFICATIONS

Band MHz..... 14-21-28
Max. power input ... Legal limit
Gain (dbd)..... 8
VSWR at resonance..... 1.2:1
Impedance..... 50 ohms
F/B ratio..... up to 20

Boom (O.D. x length) 2" x 14'4"
No. elements..... 3
Longest element..... 27'4"
Turning radius..... 15'9"
Max. mast diameter... 2" O.D.
Surface area..... 5.7 sq. ft.

Wind load @ 80 mph .. 114 lbs
Assembled Wt..... 37 lbs
Shipping Wt..... 42 lbs
Direct 52 ohm feed
no balun required
Max wind survival ... 100 mph

ACTUAL SWR CURVES

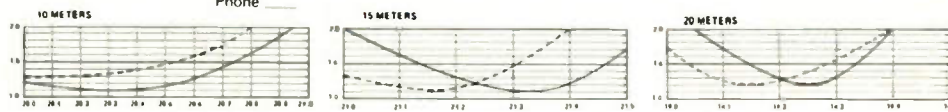

COMPARE
THE SY33
WITH OTHERS...

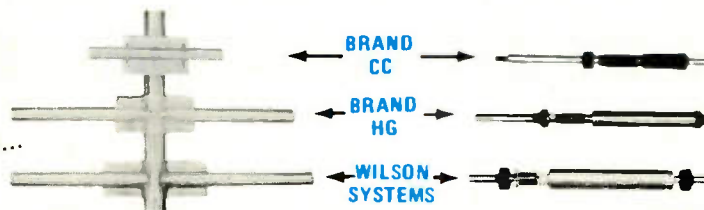

Compare the size and strength of the boom to element clamps. See who offers the largest and heaviest duty. Which would you prefer?

Wilson Systems traps offer a larger diameter trap coil and a larger outside housing, giving excellent Q and power capabilities.

ADD 40 METERS TO YOUR TRI-BAND WITH THE 33-6 MK

— IN STOCK —

Now you can have the capabilities of 40-meter operation on the **SYSTEM 36** and **SYSTEM 33**. Using the same type high quality traps, the 40-meter addition will offer 150 KHZ of bandwidth. The 33-6 MK will fit your present SY36, SY33, or SY3 and use the same single feed line.

The 33-6 MK adds approximately 15' to the driven element of your tri-bander, increasing the tuning radius by 5 to 6 feet. This addition will offer a rotatable dipole at the same height of your beam.

W S I WILSON SYSTEMS, INC.

4286 S. Polaris Ave., Las Vegas, Nevada 89103

Prices and specifications subject to change without notice.

Prices Effective 11-1-80 thru 12-31-80

For Christmas Special
Sale — Call
FACTORY DIRECT
1-800-634-6898

REGULAR PRICE

~~\$85⁹⁵~~

SALE PRICE
\$59⁹⁵

WV-1A

4 BAND
TRAP VERTICAL
(10 - 40 METERS)

No bandswitching necessary with this vertical. An excellent low cost DX antenna with an electrical quarter wavelength on each band and low angle radiation. Advanced design provides low SWR and exceptionally flat response across the full width of each band.

Featured is the Wilson large diameter High-Q traps which will maintain resonant points with varying temperatures and humidity.

Easily assembled, the WV-1A is supplied with a base mount bracket to attach to vent pipe or to a mast driven in the ground.

NOTE:

Radials are required for peak operation or above ground mounting. (See GR-1 below)

SPECIFICATIONS

- 19' total height
- Self supporting — no guys required
- Weight — 14 lbs.
- Input impedance: 50 Ω
- Powerhandling capability: Legal Limit
- Two High-Q traps with large diameter coils
- Low angle radiation
- Omnidirectional performance
- Taper swaged aluminum tubing
- Automatic bandswitching
- Mast bracket furnished
- SWR: 1.1:1 or less on all bands

GR-1

REGULAR PRICE

~~\$14⁹⁵~~

GROUND
RADIAL KIT

SALE PRICE
\$12⁹⁵

The GR-1 is the complete ground radial kit for the WV 1A. It consists of 150' of 7/14 aluminum wire, heavy duty egg insulators and instructions. The GR-1 will increase the efficiency of the WV-1 by providing the correct counterpoise.

WILSON SYSTEMS TOWERS

— FACTORY CHRISTMAS SALE —

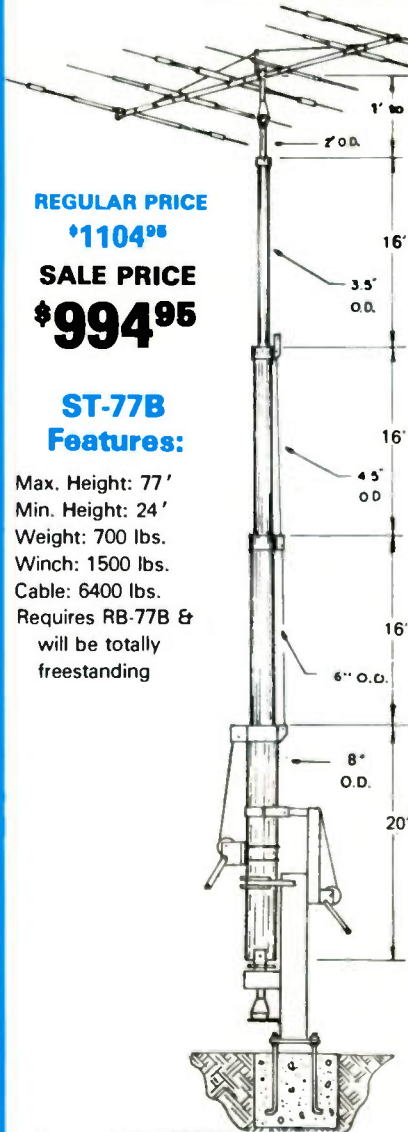

REGULAR PRICE
***1104⁹⁵**
SALE PRICE
\$994⁹⁵

ST-77B Features:

Max. Height: 77'
Min. Height: 24'
Weight: 700 lbs.
Winch: 1500 lbs.
Cable: 6400 lbs.
Requires RB-77B & will be totally freestanding

REGULAR PRICE
***619⁹⁵**
SALE PRICE
\$579⁹⁵

MT-61B Features:

Max. Height: 61'
Min. Height: 23'
Weight: 450 lbs.
Winch: 1200 lbs.
Cable: 4200 lbs.
No Guys required when mounting against house.
For completely freestanding installation, use RB-61B or FB-61B below.

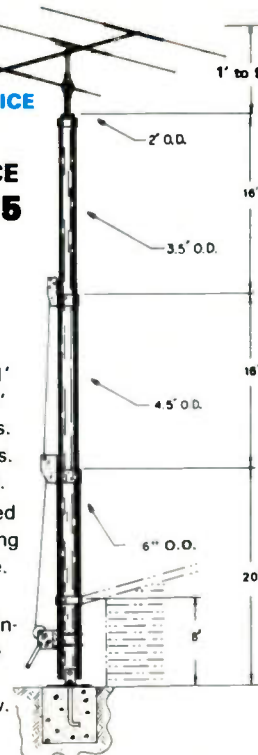

REGULAR PRICE
***395⁹⁵**
SALE PRICE
\$349⁹⁵
TT-45B Features:

Max Height: 45'
Min. Height: 22'
Weight: 250 lbs.
Winch: 1200 lbs.
Cable: 4200 lbs.
No Guys required when mounting against eve of house.
For completely freestanding installation, use RB-45B or FB-45B below.

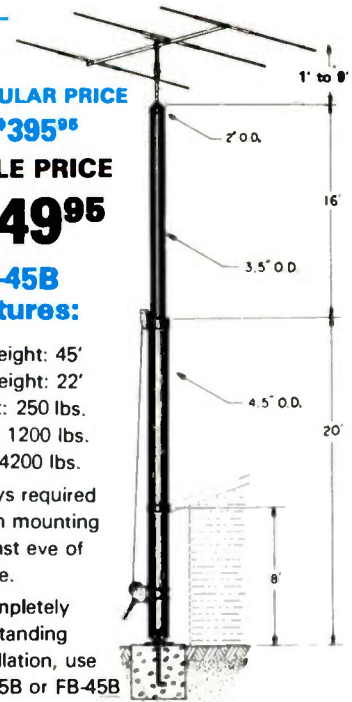

NEW! Wilson Electric Winch



Now you can raise and lower your Wilson Tower electrically. The electric winch will replace the hand operated winch. Available for use on the TT-45, MT-61 and ST-77 towers.

EW-45 (TT-45) ***249⁹⁵**
EW-61 (MT-61)
EW-77 (ST-77)
Remote Switch . . . *24⁹⁵

| BASE CHART | | |
|------------|-----------------|--------|
| TOWER | WIDTH | DEPTH |
| TT-45B | 12" x 12" | 30" |
| FB-45B | 30" x 30" | 4 1/2' |
| RB-45B | 30" x 30" | 4 1/2' |
| MT-61B | 18" x 18" | 4' |
| FB-61B | 3' x 3' | 5 1/2' |
| RB-61B | 3' x 3' | 5 1/2' |
| ST-77B | See Below | |
| RB-77B | 3 1/2' x 3 1/2' | 6' |

| Tower | WIND LOADING | | Square Footage Based on 50 MPH Wind |
|--------|--------------|---------|-------------------------------------|
| | Height | Sq. Ft. | |
| ST 77B | 69 | 18 | |
| | 77 | 10 | |
| MT 61B | 53 | 18 | |
| | 61 | 12 | |
| TT 45B | 37 | 18 | |
| | 45 | 12 | |

Wilson Systems uses a high strength carbon steel tube manufactured especially for Wilson Systems. It is 25% stronger than conventional pipe or tubing. The tubing size used is: 2" & 3 1/2"-.095; 4 1/2" & 6"-.125; 8"-.134. All tubing is hot dip galvanized. Top section is 2" O.D. for proper rotor and antenna mounting.

The TT-45B and MT 61B come complete with house bracket and hinged base plate for against-house mounting. For totally freestanding installation, use either of the tilt-over bases shown below.

The ST-77B cannot be mounted against the house and must be used with the rotating tilt-over base RB-77B shown below.

TILT-OVER BASES FOR TOWERS

FIXED BASE

The FB Series was designed to provide an economical method of moving the tower away from the house. It will support the tower in a completely free-standing vertical position, while also having the capabilities of tilting the tower over to provide an easy access to the antenna. The rotor mounts at the top of the tower in the conventional manner, and will not rotate the complete tower.

FB-45B...112 lbs...*169⁹⁵
FB-61B...169 lbs...*244⁹⁵



ROTATING BASE

The RB Series was designed for the Amateur who wants the added convenience of being able to work on the rotor from the ground position. This series of bases will give that ease plus rotate the complete tower and antenna system by the use of a heavy duty thrust bearing at the base of the tower mounting position, while still being able to tilt the tower over when desiring to make changes on the antenna system.

RB-45B...144 lbs...*234⁹⁵
RB-61B...229 lbs...*309⁹⁵
RB-77B...300 lbs...*463⁹⁵



Tilting the tower over is a one-man task with the Wilson bases. (Shown above is the RB-61B. Rotor is not included.)

CHRISTMAS SPECIAL SALE
Call Factory Direct
1-800-634-6898

Order the CHRISTMAS SPECIAL!

Prices Effective 11-1-80 thru 12-31-80

W S I WILSON SYSTEMS, INC.

4286 S. Polaris Ave. • Las Vegas, Nevada 89103

WILSON SYSTEMS, INC. PRESENTS

CHRISTMAS SPECIAL THE SYSTEM 40 TRIBANDER

3 MONOBAND ANTENNAS IN ONE — EACH WITH FULL MONOBAND PERFORMANCE

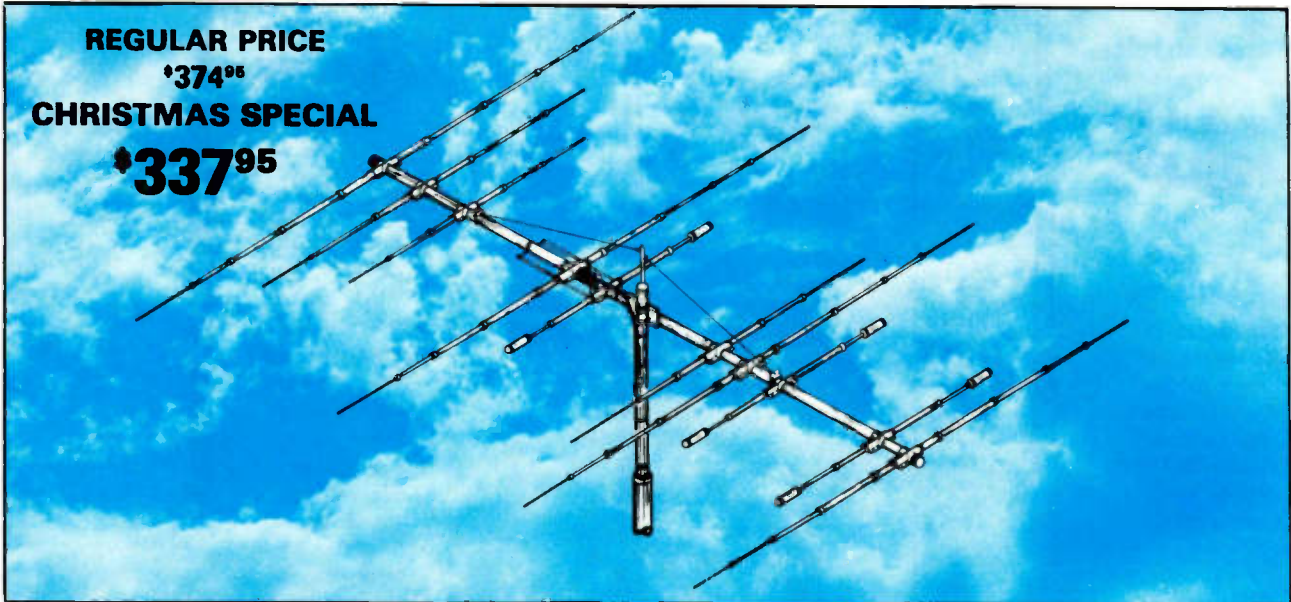

REGULAR PRICE

\$374⁰⁰

CHRISTMAS SPECIAL

\$337⁹⁵

- FOR THE SERIOUS DXer WHO WANTS MONOBANDERS ON 10-15-20
- FOUR FULL SIZE 20 MTR ELEMENTS WITH 10 dbd GAIN AND 25 db F/B
- FOUR WIDE SPACED 15 MTR ELEMENTS WITH 10 dbd GAIN AND 20 db F/B
- FIVE WIDE SPACED 10 MTR ELEMENTS WITH 11.5 dbd GAIN AND 20 db F/B
- ONLY ONE FEED LINE REQUIRED
- HEAVY DUTY BALUN INCLUDED
- DESIGNED WITH NO INTERACTIONS BETWEEN ELEMENTS
- ALL DRIVEN AND DIRECTOR ELEMENTS ARE INSULATED FROM BOOM
- SAME QUALITY HARDWARE AS USED IN ALL WILSON ANTENNAS

—SPECIFICATIONS—

| | | | |
|----------------------|---------------------|----------------------------|--------------|
| Max. Pwr. Input..... | Legal Limit..... | Longest Element..... | 36' |
| VSWR @ Res..... | 1.2:1..... | Turning Radius..... | 22' 6" |
| Impedance..... | 50 ohm..... | Boom..... | 26' |
| Feed Method..... | Balun Supplied..... | Surface Area..... | 12.1 sq. ft. |
| Matching Method..... | Modified Beta..... | Wind Loading @ 80 mph..... | 309 lbs. |
| F/B Ratio..... | See Above..... | Assem. Weight..... | 75 lbs. |
| Gain..... | See Above..... | Shipping Weight..... | 99 lbs. |

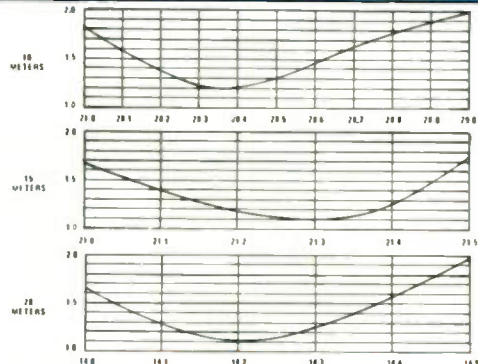

WILSON SYSTEMS, INC. — 4286 S. Polaris
Las Vegas, NV 89103 — (702) 739-7401

FACTORY DIRECT ORDER BLANK

Toll-Free Order Number

CHRISTMAS SPECIAL SALE

1-800-634-6898

| Qty. | Model | Description | Shipping | Price | Qty. | Model | Description | Shipping | Price |
|------|---------|--|----------|---------|------|--------|--|----------|--------|
| | SY40 | 10 Ele. Tribander for 10, 15, 20 Mtrs. | UPS | 337.95 | | RM-1 | Remote Switch for EW | UPS | 24.95 |
| | SY36 | 6 Ele. Tribander for 10, 15, 20 Mtrs. | UPS | 199.95 | | TT-45B | Freestanding 45' Tubular Tower | TRUCK | 349.95 |
| | SY33 | 3 Ele. Tribander for 10, 15, 20 Mtrs. | UPS | 149.95 | | RB-45B | Rotating Base for TT-45B w/tilt over feature | TRUCK | 234.95 |
| | 33-6 MK | 40 Mtr. Mod Kit for SY33 & SY36 | UPS | 59.95 | | FB-45B | Fixed Base for TT-45B w/tilt over feature | TRUCK | 169.95 |
| | WV-1A | Trap Vertical for 10, 15, 20, 40 Mtrs. | UPS | 59.95 | | MT-61B | Freestanding 61' Tubular Tower | TRUCK | 579.95 |
| | GR-1 | Ground Radials for WV-1A | UPS | 12.95 | | RB-61B | Rotating Base for MT-61B w/tilt over feature | TRUCK | 309.95 |
| | M-420A | 4 Elements on 20 Mtrs. | UPS | 174.95 | | FB-61B | Fixed Base for MT-61B w/tilt over feature | TRUCK | 244.95 |
| | M-515A | 5 Elements on 15 Mtrs. | UPS | 139.95 | | ST-77B | Freestanding 77' Tubular Tower | TRUCK | 994.95 |
| | M-520A | 5 Elements on 20 Mtrs. | TRUCK | 224.95 | | RB-77B | Rotating Base for ST-77B w/tilt over feature | TRUCK | 463.95 |
| | M-410A | 4 Elements on 10 Mtrs. | UPS | 74.95 | | GK-46 | Guying Kit for GT-46 | UPS-TRK | 74.95 |
| | | ACCESSORIES | | | | GK-45B | Guying Kit for TT-45B | UPS-TRK | 69.95 |
| | T'X | Tail Twister Rotor | UPS | 274.95 | | GK-61B | Guying Kit for MT-61B | UPS-TRK | 79.95 |
| | HD-73 | Alliance Heavy Duty Rotor | UPS | 109.95 | | GK-77B | Guying Kit for ST-77B | UPS-TRK | 99.95 |
| | RC-8C | B/C Rotor Cable | UPS | 18¢/ft. | | WTB-1 | Thrust Bearing for Top of Rotating Towers | UPS-TRK | 59.95 |
| | RG-8U | RG-8U Foam Coaxial Cable — Ultra Flex center conductor, 11 gauge | UPS | 28¢/ft. | | | | | |
| | EW-45 | Wilson Electric Winch for TT-45B | UPS | 249.95 | | | | | |
| | EW-61 | Wilson Electric Winch for MT-61 | UPS | 249.95 | | | | | |
| | EW-77 | Wilson Electric Winch for ST-77 | UPS | 249.95 | | | | | |

NOTE:

On Coaxial and Rotor Cable, minimum order is 100' and 50' multiples.
Prices and specifications subject to change without notice.
Ninety (90) Day Limited Warranty—Shipping Not Included in Above

Christmas Prices Effective Nov. 1-Dec. 31, 1980 Nevada Residents add Sales Tax

Ship C.O.D. Check enclosed Charge to VISA MasterCharge

Card No. _____ Expires _____

Bank No. _____ Signature _____

Name _____ Phone _____

Street _____

City _____ State _____ Zip _____

Prices and specifications subject to change without notice.

**Signalcrafters Presents
The Most Advanced
Automatic Computing
Power Meters
In Amateur Radio!**

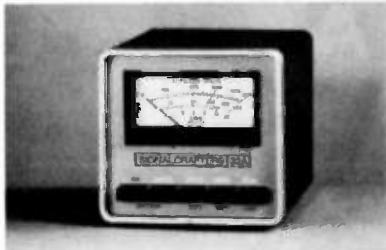

MODELS 31 and 32*

Our portable Models 31 and 32 feature the same state-of-the-art technology that is incorporated in their Big Brother, the Model 30. Never again will you have to bother with SWR "calibrate" controls and switches! Signalcrafters' custom integrated circuit makes power and SWR measurement a "hands-off" operation by automatically computing SWR. The result is unparalleled accuracy and ease of operation.

FEATURES:

- **CUSTOM IC**—Computes SWR from the level sensed on the transmission line independent of the power level. This analog computer operates over a range of only one watt to the full scale of the meter with unequalled accuracy.
- **RUGGED TAUT-BAND METERS**—Provide accuracy and readability that must be seen to be appreciated.
- **HEAVY DUTY CABINETS**—Handsome heavy duty metal cabinets complement virtually every transceiver on the market today.
- **TWO MODES—PEAK OR AVERAGE**—The amateur may choose between either peak or average power readings.
- **POWER REQUIREMENTS**—Due to the advanced low current design, battery life is truly outstanding, making this meter a natural for portable or field day operation. Uses standard 9 volt battery or 120V AC with optional AC adaptor.
- **ATTRACTIVE AFFORDABLE PRICING**
*Model 31A (0 to 200w)
31B (0 to 20w)
..... only \$149.00
Model 32A (0 to 200w, 0 to 2000w)
32B (0 to 20w,
0 to 200w)
..... only \$169.00

SIGNALCRAFTERS, INC.
5460 BUENA VISTA DRIVE
SHAWNEE MISSION, KANSAS 66205
913/262-6565; TELEX 42-4171

All Signalcrafters products are designed, engineered, and produced in the U.S.A. Prices include shipping to all U.S.A. VISA and Master Charge accepted. Kansas Residents please add 3% percent.

Conley Radio

**CONLEY RADIO SUPPLY OFFERS YOU
SENSATIONAL PRICES WITH EXCEPTIONAL
SERVICE. THE NUMBER ONE OUTLET IN THE
NORTHWEST** Red Hot Prices From Conley Radio



TS-120S \$699.95

**ORDER YOUR NEW...
KENWOOD TR-2400**

**2 METER PROGRAMMABLE
H.T. WITH NICADS, CHARGER
AND RUBBER ANTENNA**

\$395.00

***TS-180/W DFC.
\$1149.95**

***Special sale, limited offer.
call for quote**

Other Kenwood gear we stock...

| Model | List Price | | |
|-------------|------------|--------------------|---------|
| TS-180S/DFC | \$1149.95 | TS-820 TRANSCEIVER | 869.00 |
| TS-520 SE | \$629.95 | R-1000 RECEIVER | 495.00 |
| TS-120S | \$699.95 | TR-8300 450 Mhz. | |
| PS-30 | \$139.00 | TRANSCEIVER | 369.00 |
| R-1000 | \$495.00 | R-820 RECEIVER | 1099.00 |
| TR-2400 | \$395.00 | TS-600 6 M. TRANS | 799.00 |
| TR-7800 | \$399.95 | SM-220 MON SCOPE | 349.00 |
| TR-9000 | \$499.95 | BS-5 PAN ADAPTER | 75.00 |
| TL-922A | \$1199.00 | BS-8 PAN ADAPTER | 75.00 |
| | | DG-5 DIG DISPLAY | 199.00 |

CALL FOR OUR
LOW QUOTE

***We will meet or
beat any reasonable offer**

**OVER 50 MAJOR LINES OF
EQUIPMENT AND
AMATEUR ACCESSORIES**

**No Sales Tax in Montana.
Write or Call for Catalog**

ALL ITEMS F.O.B. BILLINGS, MONTANA
CERTIFIED CHECK, M.O. OR SHIPPED COD UPS.

**NO SALES TAX
CALL TODAY
406-259-9554**

318 N. 16th Street Billings, Mt 59101



IC-251A LIST PRICE \$699.00
CASH PRICE \$599.00



IC-255A
*** LIST PRICE \$389.00**

Other ICOM gear we handle.

| Model | List Price | Cash Price |
|----------|------------|------------|
| IC-255 | \$389.00 | \$329.00 |
| IC-211 | \$870.00 | \$659.00 |
| IC-701/S | \$1375.00 | \$1195.00 |
| IC-551 | \$449.00 | \$399.00 |
| IC-551D | \$849.00 | \$769.00 |
| IC-260A | \$489.00 | \$439.00 |
| IC-251A | \$699.00 | \$599.00 |
| IC-2AT | \$249.50 | ----- |
| IC-2A | \$229.50 | ----- |
| IC-2A | \$199.50 | ----- |

With Alkaline Batteries

**The FT-707
has the new WARC bands**



**List Price \$810.00
Cash Price \$729.00**

Other Yaesu gear we carry

| MODEL | LIST PRICE | CASH PRICE |
|-----------|------------|------------|
| FT-101ZD | \$942.00 | \$849.95 |
| FT-901 DM | \$1535.00 | \$1379.00 |
| FT-107 | \$1045.00 | \$939.00 |
| FP-107E | \$145.00 | ----- |
| FP-107 | \$139.00 | ----- |
| DMS-107 | \$125.00 | ----- |
| FT-707 | \$810.00 | 729.00 |
| FV-707 DM | \$279.00 | \$249.00 |
| FP-707 | \$162.00 | \$145.00 |
| FV-101Z | \$175.00 | \$157.50 |
| FT-207 | \$399.00 | \$375.00 |
| FRG-7 | \$370.00 | \$329.00 |

Direct Printing FAX

— get photographic-quality reproduction
for 6¢ a copy

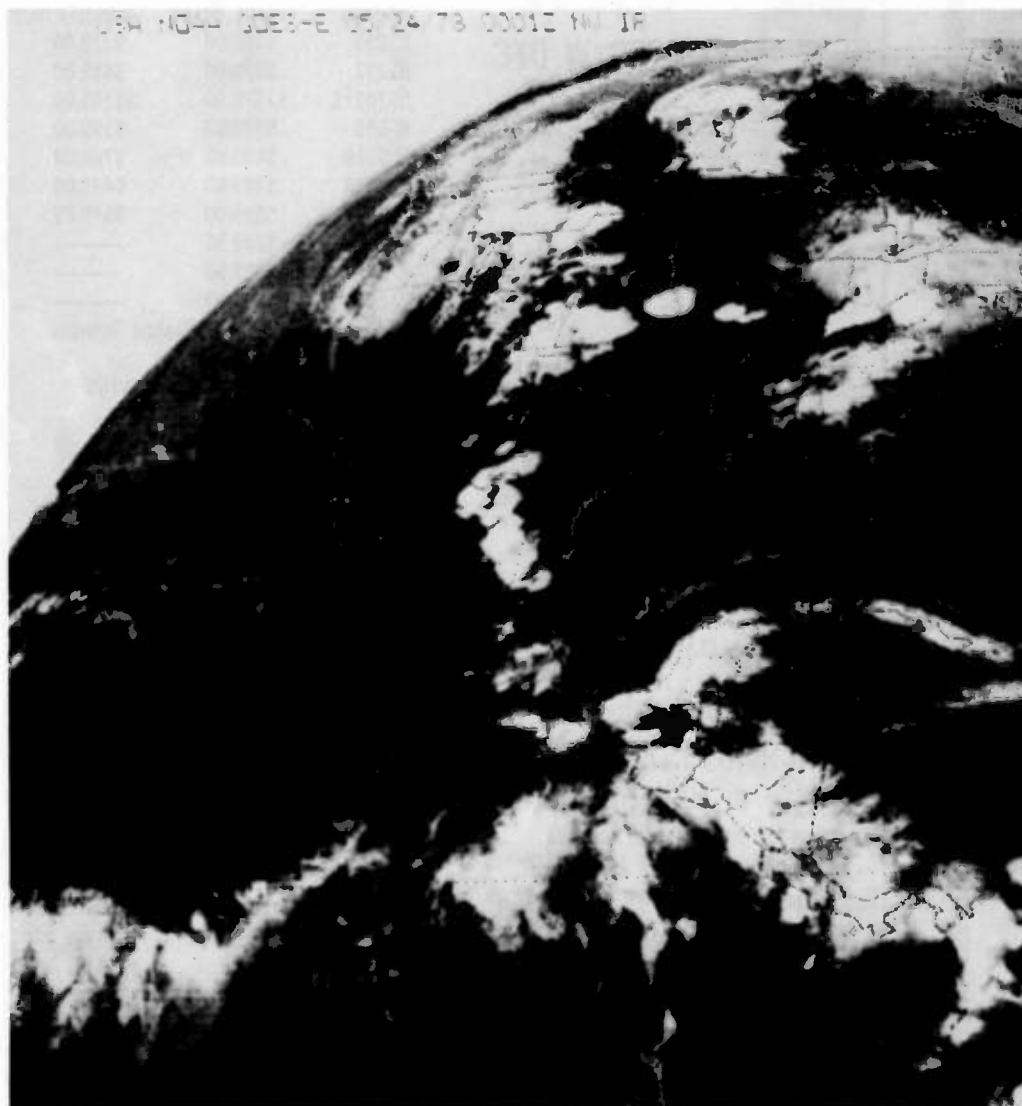

Fig. 1. A single GOES frame as reproduced on the FX-1P photographic facsimile recorder. This frame, representing evening infrared imagery, covers most of North America.

Dr. Ralph E. Taggart WB8DQT
602 South Jefferson
Mason MI 48854

There are two major approaches to displaying weather satellite pictures—CRT systems where the image is read out slowly on the face of a television-like picture tube and recorded on Polaroid™ or roll film, and facsimile (fax) systems where the image is printed directly onto some sort of recording paper. CRT systems lend themselves to multi-mode service and present few mechanical problems in construction but have the disadvantage of either using expensive Polaroid film with its small print format or, if roll film is used, a time delay involved in film processing and printing. Fax systems require some considerable mechanical work to get them working right, but they can provide a good-sized image at comparatively low cost.

Perhaps the best approach in terms of quality is the photographic facsimile recorder in which the image is printed directly on a

piece of paper using a modulated light source. Picture quality can be very high with this option but you pay for the quality with some operational problems. The paper must be loaded and printed under darkroom safelight conditions and one must maintain a stock of processing chemicals to handle the exposed photographic paper.

My first photographic facsimile system (described in the September and October, 1975, issues of 73 and in the first edition of the *Weather Satellite Handbook*), was a hybrid unit using both tubes and solid-state devices with the mechanics constructed of readily available hardware items. This unit worked very well and I have lost track of the number of times it has been duplicated by various operators.

In preparing for the second edition of the satellite handbook, I undertook the redesign of the photofax system to convert it completely to solid-state technology with an updated and improved set of mechanics. It was desired to make the unit compatible with GOES WEFAX transmissions while at the same time permitting modifications for the new series of TIROS/NOAA polar orbiting weather satellites. The project was completely successful, as shown in Fig. 1 where a typical GOES WEFAX frame is represented.

For some time, however, I have been looking for suitable alternatives to photographic paper as a recording medium. What was needed was a direct-print-out medium that would produce a print directly without the need for paper processing or darkroom operations.

One promising avenue involved various kinds of electrosensitive papers of

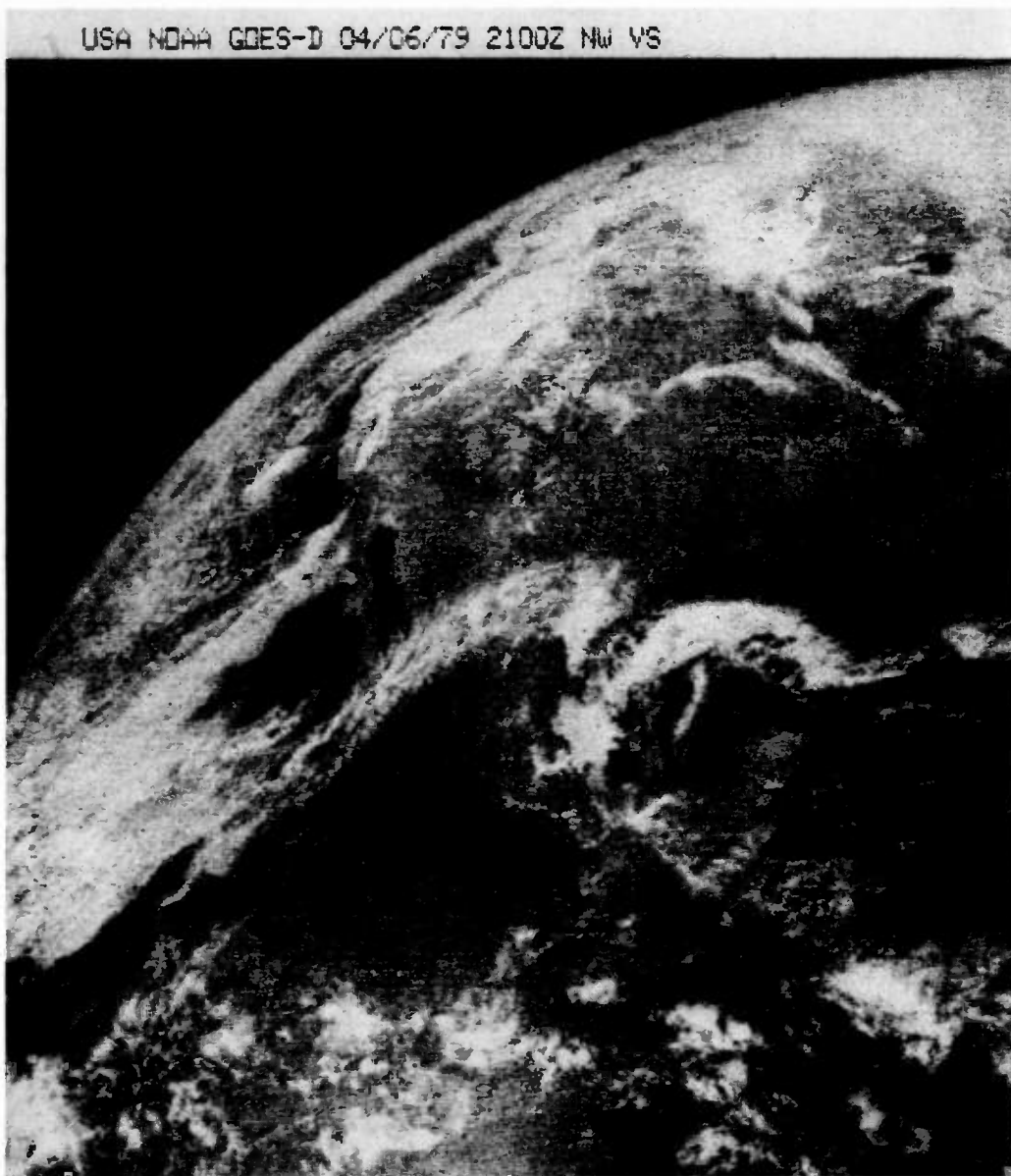

Fig. 2. An example of visible light imagery (GOES D, a replacement for GOES E) printed on the FX-2E direct-printing fax recorder. GOES D had drifted several degrees north of the equator when this picture was acquired and the downlink signal was noticeably noisy. Despite this, the machine printed a quite acceptable picture.

the type used in the ubiquitous Western Union Deskfax machines. These papers incorporate a black base layer with a white surface coating. A printing voltage is applied to the paper surface by a wire stylus, and beyond a certain threshold voltage (usually 35-40 V) the white surface coating begins to burn away. The higher the voltage, the more the white layer is removed, producing a darker and darker trace. At about 240 V, all of the surface will burn away, leaving a completely black trace.

Although many satellite experimenters have used the Deskfax approach, the results usually leave something to be desired. The original Deskfax units are designed to transmit printed messages, and the video circuits will not produce a reasonable gray scale without meticulous adjustment. The papers that are commonly sold with the machines also leave something to be desired in terms of gray-scale fidelity. Considerable progress has been made, however, in the formulation of such electro-

sensitive papers, and after spending considerable time on the test bench, a modified version of the photofax circuit was developed that will print pictures of photographic quality on a paper marketed by XeroxTM for use with their TelecopierTM phone-line office fax systems.

Fig. 2 shows the results obtained with the new paper. Comparing the picture with that of Fig. 1 indicates that indeed it is possible to obtain photographic quality with a direct-printing paper.



Fig. 3. FX-2E direct printout of a near-overhead pass in the Great Lakes area. This TIROS N visible-light imagery was acquired on 16 March 1979 (orbit #2177), and shows the Great Lakes, southern Canada, and most of the eastern US. A line of snow from a recent storm angles across the lower peninsula of Michigan while the ice breakup has already begun in Lake Superior. The lower Great Lakes are essentially ice-free. Lake Nippagon, directly north of Lake Superior, is still frozen and snow-covered, as is James Bay at the upper margin just right of center. This pass was received using the omni-directional VHF antenna described in chapter 2 of the Weather Satellite Handbook.

The advantages of this kind of system are many. The paper, unlike direct printing papers used in electrolytic fax recorders, is dry and requires no special storage conditions—you treat it simply like ordinary office bond. The paper is not light-sensitive, so it can be handled under normal room lighting conditions, thus simplifying satellite station operations. The picture prints out directly, and

the image is available immediately without the need for any sort of processing. The image is a true black and white rendition—as opposed to the sepia tones commonly achieved with electrolytic papers—and the image will not fade or discolor when displayed or stored. All in all, a most satisfactory system for GOES WEFAX image display!

As an added bonus, it is quite possible to use the

basic fax system with minor modification for display of the new TIROS N polar orbiting satellite imagery as shown in Fig. 3.

The direct printing fax recorder, designated as model FX-2E, will be described here, and in parts II and III of this article, the mechanical and electronics assembly details will be presented, along with complete alignment and operation instructions. All of the

information needed to reproduce the unit will be included, as will details on use with the TIROS satellites. As an added bonus, if you want a photographic rather than direct-printing recorder, modifications in that direction also will be described. The FX-2E is marketed commercially by METSAT Products so that circuit boards and fax mechanics sets are available for those desiring to bypass that part of the project. For those who don't want to build at all, wired and tested FX-2E units also are available.

Video Format

I have described the GOES WEFAX video format in an earlier article in 73 (November, 1978), so I will not go into extensive detail. Basically, we are dealing with an amplitude-modulated video tone in which minimum amplitude (approximately 4%) corresponds to black and full amplitude (98-100%) corresponds to white. Video is transmitted at the rate of 4 lines/second (240 lines/minute) for 200 seconds, resulting in an 800-line picture. The FX-2E is capable of fully resolving this picture detail with a 6.75-inch-square picture format.

The TIROS video standards are similar with regard to the subcarrier modulation and compatible in terms of line rate. In the TIROS format, however, we are dealing with a 240-line/minute format involving alternate lines of visible and infrared (IR) data. IR subcarrier levels tend to stay so close to 100% that if daylight displays are printed, you do not need to blank the unwanted data lines. If you print a daylight pass, you will get simply the visible light display.

Two different transmission modes are used at night. In one of these, the visible channel is black and

it is necessary to blank out the alternate lines of visible data to display the IR. In the other mode, the visible channel segment is filled with IR data, and in such a case, the IR can be displayed without line blanking. More on this subject later.

Principles of Operation

Fig. 4 shows a simplified diagram of a drum-type facsimile system. The recording paper is wrapped around a drum which is rotated at 240 rpm to provide the line scanning. This 240-rpm rate must be controlled precisely if the picture is to stay in sync, so a synchronous motor is used for the drum drive with the motor drive signal locked to the satellite subcarrier using a phase-locked loop IC with digital frequency dividers. The printing voltage is applied to the paper by a wire stylus. Vertical scanning is provided by moving the stylus carriage assembly along the length of the drum at a controlled rate using a threaded rod driven by another synchronous motor. The traverse rate is dependent on the drum diameter and the drive rod thread pitch. With the system to be described, a 40-rpm motor is used for WEFAX display while a 20-rpm motor is used for TIROS pictures. The speed requirements of the traverse drive are not nearly as critical as those for the drum, so the traverse motor may be driven from ac mains.

Circuit Functions

Figs. 5-9 comprise the schematic for the active circuits for the FX-2E. Most of the active components are on the large, main control circuit board and carry part designations below 100 (R15, C26, U10, etc.). Main-frame components carry part designations from 200 to 299 (T201, etc.).

Video circuits. Incoming video enters at J201 (VIDEO IN) and is applied across the WHITE SET control (R201). This functions as the video gain control, setting peak signal levels in the video chain. U1 functions as an active bandpass filter centered on the 2400-Hz subcarrier frequency with unity gain and a bandwidth of about 1600 Hz. Despite its simplicity, the circuit does a very good job of reducing the effect of noise located outside of the video passband. U2 is an audio power amplifier which provides a power boost for the video detector. T101 is an output transformer driven through the 8-Ohm winding by U2 and provides a voltage step-up to drive the full-wave video detector consisting of D1-D4. The video detector drives the print control transistor, Q1.

To understand the operation of the printing circuit, keep in mind that stylus voltages below 35 V will not affect the paper, producing white, while a voltage of about 240 V (at our drum speed) will burn away all of the surface coating to produce black. Intermediate voltages in the range of 40-240 V will produce in-

termediate gray-scale tones. The collector load resistors and zener diodes for Q1 establish this voltage range. With minimum subcarrier amplitude (black), there is little drive for Q1 from the detector so that the voltage at the junction of R10 and R9 is limited to 240 V by D5 and D6, two series-connected 120-V

zener diodes. With full subcarrier amplitude, Q1 is driven hard by the detector and is essentially fully "on." The voltage at the junction of R9 and R10 is then a function of the values chosen for the resistors. They have been chosen so that with full drive we get about 30 V. It is impractical to derive the printing voltage

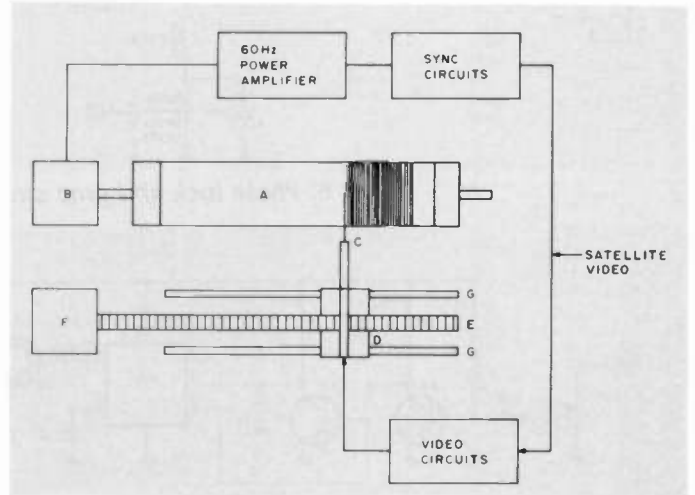

Fig. 4. Diagrammatic representation of the direct-readout fax system. The electrosensitive paper (A) is wrapped around a drum which is rotated at the 240-rpm line rate by a synchronous motor (B). Sync circuits, driven by the video signal, provide a precision 60-Hz reference to the power amplifier which provides the operating voltage for the drum motor. The video circuits provide a stylus (C) with the proper marking voltage. The stylus is supported by a carriage (D) that moves along the drum at a controlled rate established by a threaded drive rod (E) and a traverse motor (F). The carriage is supported in a track (G) to provide smooth scanning for the stylus.

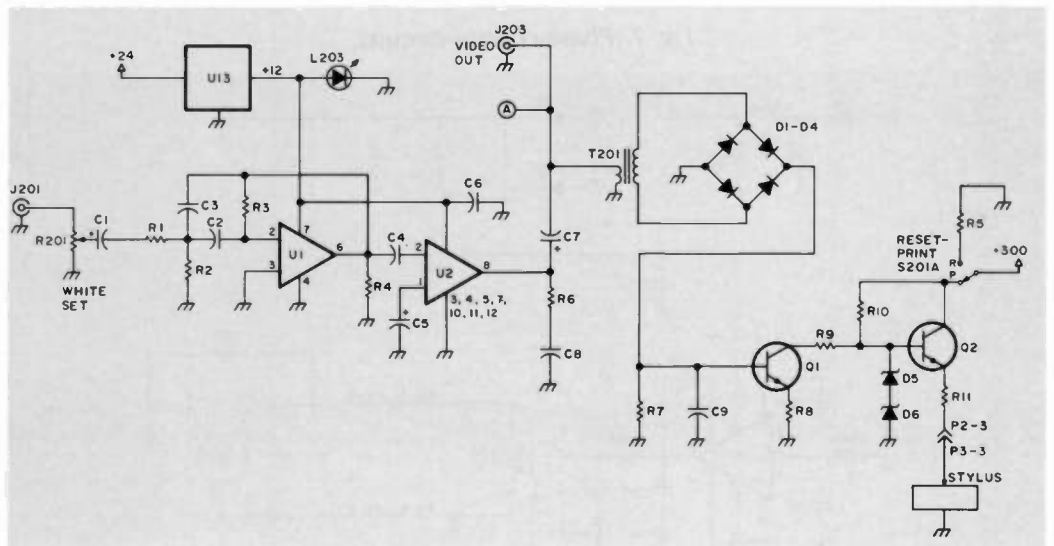

Fig. 5. Video circuits. Parts values for Figs. 5 through 9 can be found at the end of the article. Parts numbered 1-99 are on the main circuit board, 101-199 are on the drum amplifier board, 201-299 are on the mainframe, and 301-399 are on the recorder mechanics assembly.

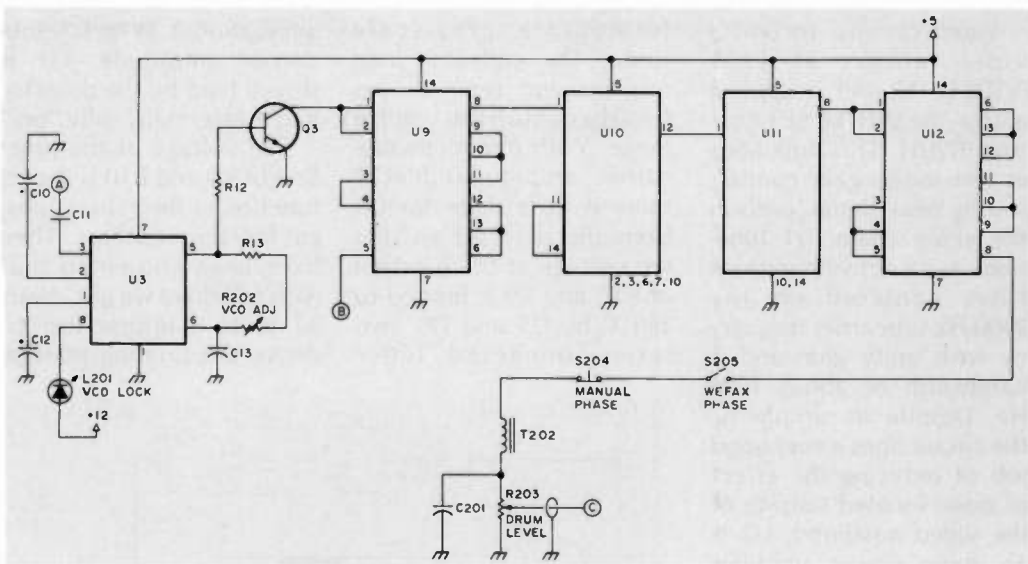

Fig. 6. Phase lock and sync circuits.

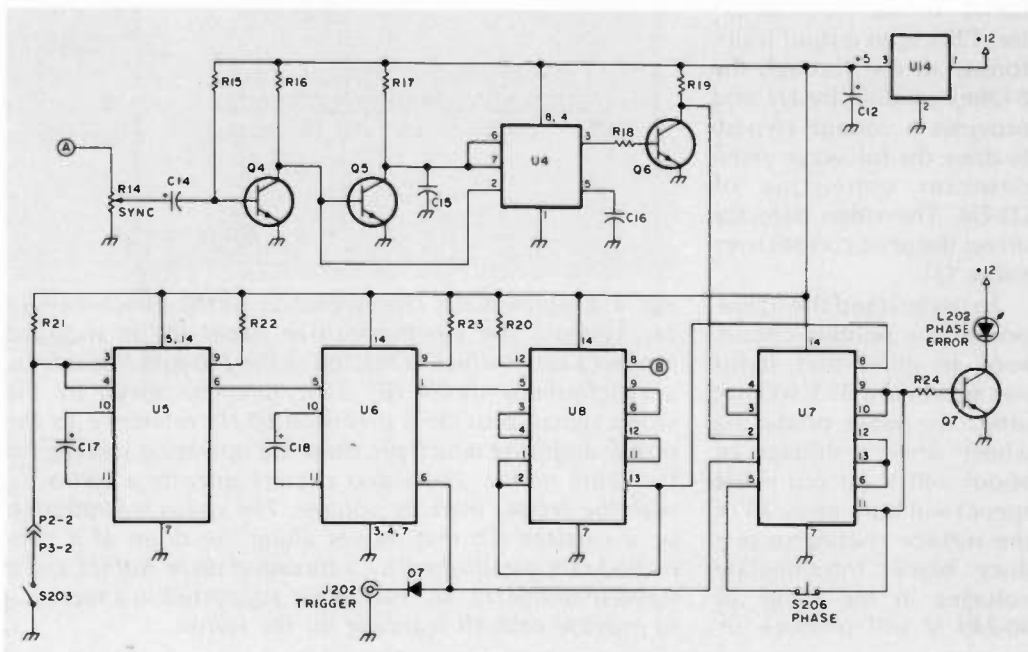

Fig. 7. Phase-control circuits.

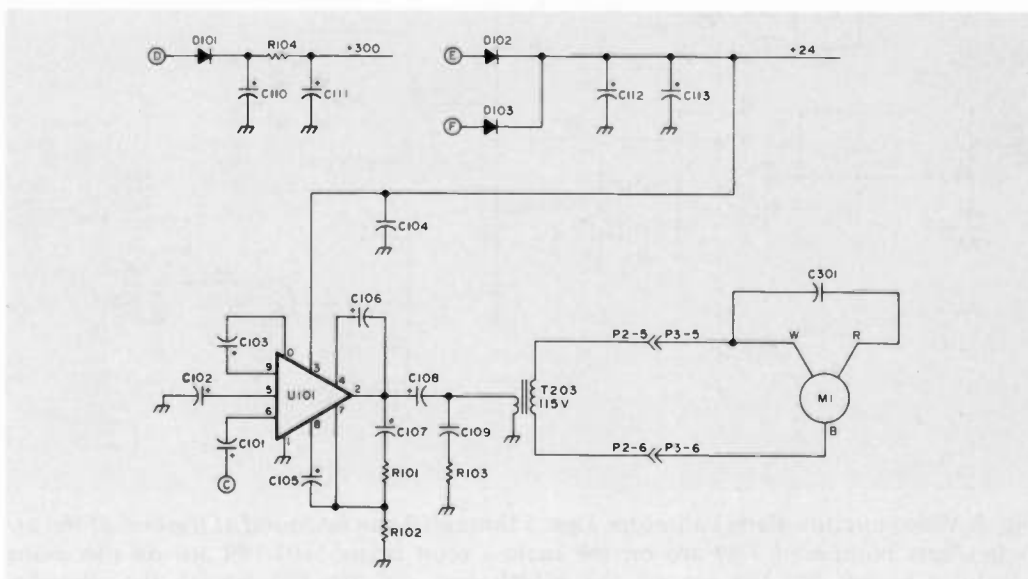

Fig. 8. Drum Amplifier circuit.

directly from the collector circuit of Q1 since the print voltage would be affected by the voltage drop induced by the stylus current—up to 40-45 mA. We get around this by applying the control voltage developed at the junction of R9 and R10 to the base of Q2. Q2 is effectively functioning as a pass transistor regulator, tracking the voltage variations at its base. The voltage at the emitter of Q2 is essentially the same as that at the base (less the small collector-emitter voltage drop), but with the advantage that the print voltage is no longer current-dependent. S201 is a DPDT switch to energize both the traverse motor and stylus when printing or just the traverse motor when resetting the system.

Sync circuits. The basis of the sync system is a phase-locked loop circuit locked to the 2400-Hz subcarrier. This permits the 60-Hz drum drive signal to be derived via digital frequency division. This approach has the advantage that the recorder will handle the speed variations in tape-recorded signals as effectively as it does "live" signals directly from the satellite. An NE567 tone decoder IC is used to provide the phase-locked function. This chip has an advantage over the more commonly used 565 chip in that a control transistor in the 567 can be used to provide an unambiguous indication that the chip is locked to the subcarrier. The internal vco of the 567 is set to free-run at 2400 Hz using the VCO ADJ control (R202). A sample of the subcarrier signal is routed to the 567 (U3) via C11 and the internal vco locks to and tracks the subcarrier signal. The 567 was not designed to provide direct interfacing with the vco, but this is achieved using Q3 as a buffer.

When the vco locks to the subcarrier, an internal control transistor pulls low and lights the vco lock lamp (L201). If L201 fails to light—due, for example, to using someone else's tape that is considerably off the correct speed—R202 can be adjusted until a lock is indicated by L201. The 2400-Hz signal from Q3 is routed through a series of phase-control gates, U9, to be discussed shortly, and on to the frequency dividers, U10 and U11. U10 provides a division of 10, while U11 divides by 4; this results in a 60-Hz output from U11. This 60-Hz signal is buffered by a series of NAND gates (U12) and then sent through the motor control switches (S204 and S205) to an LC filter consisting of T202 and C201. This combination is resonant at 60 Hz and shapes the square-wave signal from U12 to an approximation of a sine wave needed for the motor amplifier (U13).

| T202 (H) | C201 (μF) |
|----------|-----------|
| 5 | 1.41 |
| 6 | 1.17 |
| 7 | 1.00 |
| 8 | 0.88 |
| 9 | 0.78 |
| 10 | 0.70 |
| 11 | 0.64 |
| 12 | 0.59 |
| 13 | 0.54 |
| 14 | 0.50 |
| 15 | 0.47 |

Table 1.

put from T203 to precisely 115-V ac under load. This is not particularly critical, as the motor will usually hold sync over a 100-140-V range. This motor amplifier circuit is superior to most others which have been described in that it is quite efficient and thus produces little heat. The chip does not require a heat sink or cooling fan for proper operation.

Phasing circuits. Although the sync circuits ensure that the drum operates at the correct speed, they

T3 can be any small choke between about 5 and 15 H. Its resistance is not important as it does not handle any significant power. The value of C201 is dependent upon the choke value you obtain. Table 1 lists several small choke values and the corresponding values for C201 to resonate the combination at 60 Hz. Standard value mylar™ capacitors can be paralleled to yield non-standard values where required.

The 60-Hz waveform is then applied across the DRUM LEVEL control, R203, and on to the drum amplifier, U101. U101 is a 10-Watt hybrid power amplifier module which drives the 6.3-volt windings of a 6.3-V/1.2-A filament transformer, T203. T203 provides the step-up to 115 V required for operation of the drum motor. R203 provides a means of setting the out-

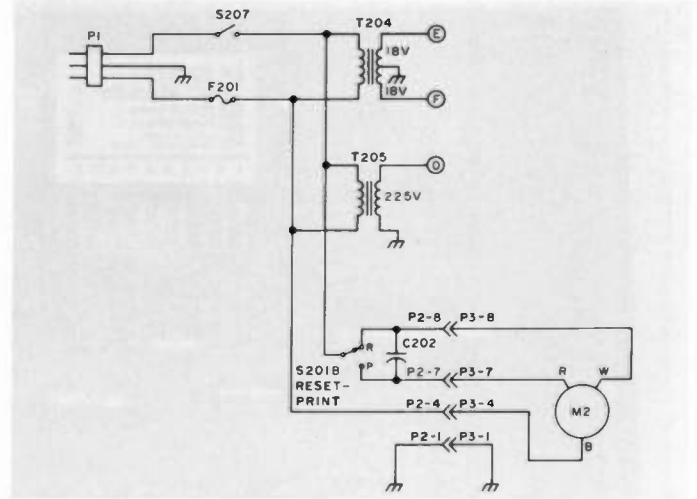

Fig. 9. Miscellaneous mainframe wiring.

are not sufficient to ensure that the start of a video line corresponds to the point where the printing stylus crosses the left edge of the paper. When these two factors do not coincide, the picture is said to be "out of phase" and would have to be cut and reassembled. To properly phase the picture, we need to do several things:

- 1) Detect the start of a line of video;
- 2) Detect the point in time where the stylus passes the paper edge;
- 3) Throw the drum slightly out of sync, wait until 1) and 2) coincide, and, finally, when they do, snap the drum back into sync.

Detecting the start of a video line is relatively easy, as a phasing interval pre-

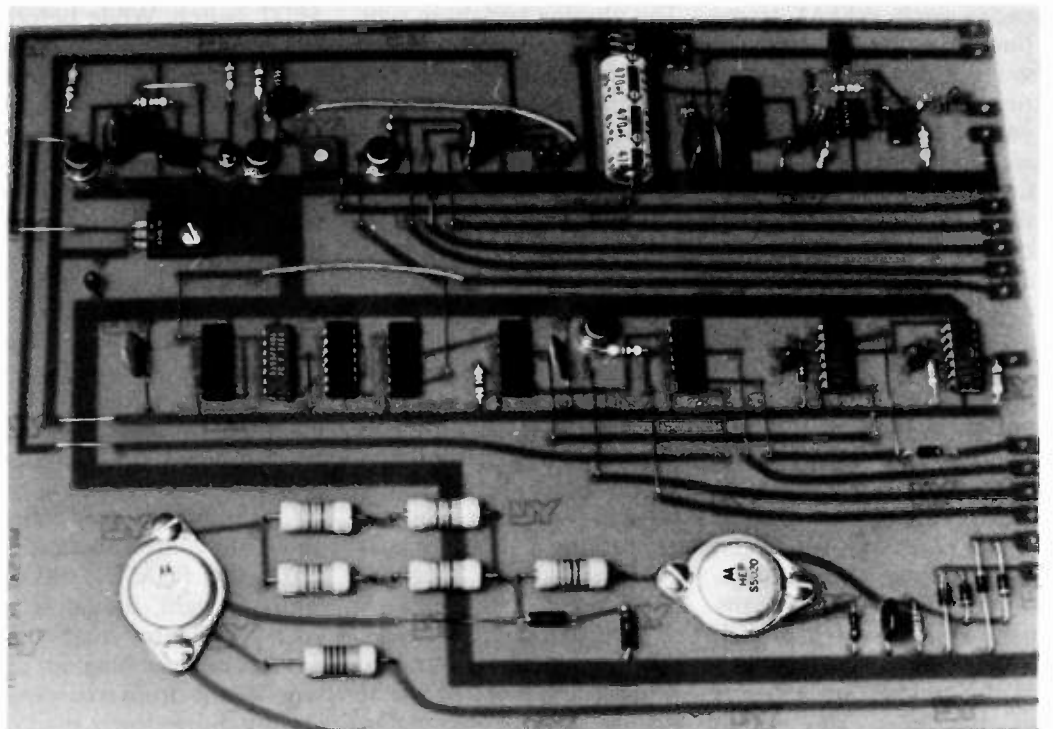

Fig. 10. A photograph of the main video circuit board in the METSAT version of the fax system. Parts located on this board carry parts designations below 100 on all schematics. The upper group of components, from left to right, includes the sync detector circuits with the 5-V regulator below, the NE567 phase-locked loop, the LM380 power amplifier, and the 741 video input filter. The center row of components includes the drum-trigger monostables, the various control gates, and the frequency-divider chips. The lower group of components includes the high-voltage transistors and the video detector diodes.

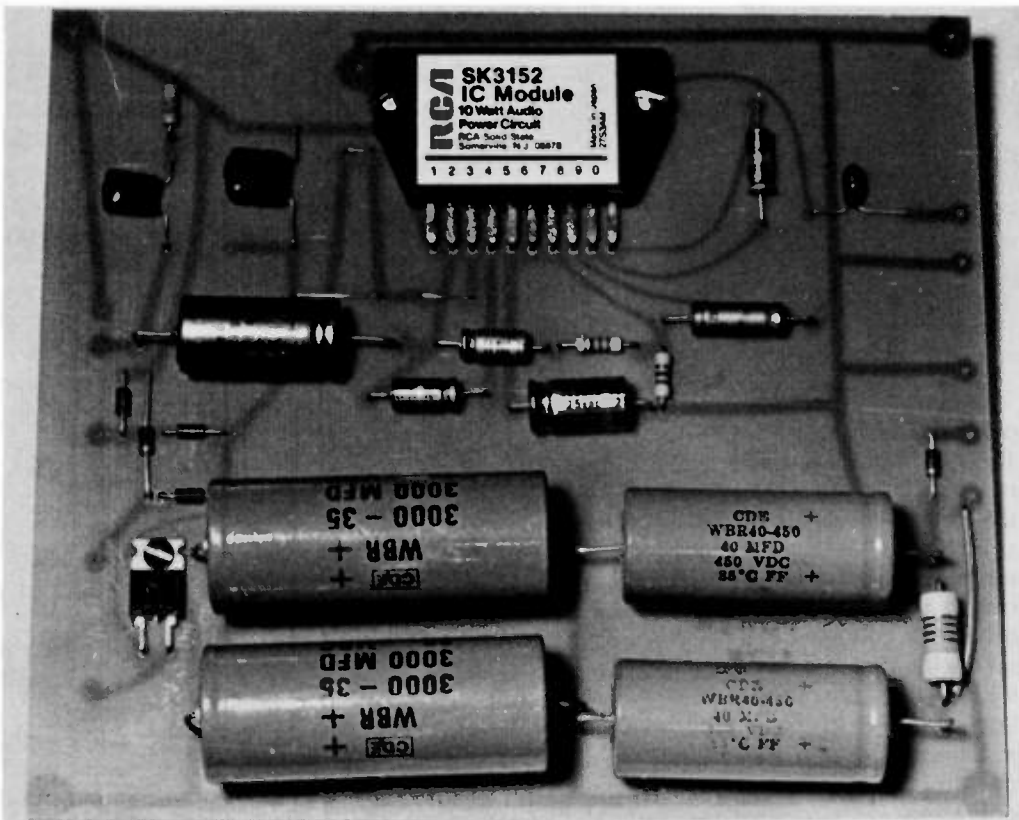

Fig. 11. The power supply and drum amplifier board in the METSAT version of the fax circuit. The upper half of the board contains the circuits associated with the RCA SK3152 drum amplifier, while the lower half contains the LV and HV power supply components. Components on this board carry parts designations from 100 through 199.

cedes each WEFAX frame during which white-level video is transmitted, interrupted by black-level intervals of 10-12 ms which correspond to the start of each line of video. Detection of these phasing pulses is accomplished by Q4, Q5, U4, and Q6. They comprise a missing pulse detector that generates a logic high at the collector of Q6 for the duration of the phasing pulse.

The drum position indication is provided by a small magnet on the drum which passes a reed switch once during each revolution. The position of the magnet and switch is such that the switch closes just as the stylus starts its scan of the paper. This switch closure is debounced by a long-period (over 100-ms) single-shot (U5) which, when triggered, also triggers a short-period (10-ms) single-shot (U6) which provides the drum sync pulse.

The phasing and drum sync pulses are monitored by U7A, which produces a logic low whenever the drum- and line-sync pulses coincide.

The previous discussion has shown how the phase-sensing circuits work—now let's look at the matter of control. If you think back to the sync discussion, you will remember that the 2400-Hz vco signal was routed through U9 prior to entering the frequency-divider network. U9B is the critical point, for whether or not the 2400-Hz signal gets through U9 is dependent upon the state of pin 5 of U9B. If that pin is high, the signal is gated through, while if it is low, the signal flow is stopped. Normally, U8 will hold that pin high, but if the PHASE switch (S206) is pressed for a moment, gates U7B and C lock up so that a low appears at the output of U7D. This toggles U8 which is wired as an

SPDT switch. While before a high was gated through U8 to control U9B, we now gate through the \bar{Q} output of the trigger single shot (U6). This signal is high except for the 10-ms drum trigger interval when it goes low.

This 10-ms low is applied to U9B through U8 and introduces a 10-ms counting error in the gating of the 2400-Hz vco signal, throwing the drum slightly out of sync (it slows down). Note also that the logic state of U7 which initiated this chain of events also causes L202, the PHASE ERROR lamp, to light, providing a visual indicator that the drum is now running out of sync. As the drum is running slightly more slowly than it should, the drum and phase pulses should begin to occur closer and closer together. When they coincide, as determined by a low at the output of U7A, U7B and C snap back to

their original state, turning off the PHASE ERROR lamp and producing a high at the output of U7D. This high toggles U8 so that a continuous high is now applied to pin 5 of U9B and the drum returns to proper sync, this time with the drum in the proper phase relationship.

As can be seen, drum phasing with WEFAX signals is essentially automatic—you press the PHASE switch once and the circuits take care of the details. This automatic feature will not work with TIROS imagery since there is no phasing interval with simple black-level pulses for the phase pulse detector to operate on. It would have been possible to design a second pulse detector for TIROS—to detect 7 pulses of 832-Hz modulation for the start of IR lines or 7 pulses of 1040 Hz for visible lines—that could be switched in in place of the WEFAX detector, but this would have increased the complexity of the circuit.

Still another detector would have been required for 240-line transmissions from the Soviet METEOR polar orbiters. Instead, it was decided to use another approach for phasing with polar orbiters. For these spacecraft, an oscilloscope (or even a CRT satellite monitor) is triggered by the drum trigger pulse at J202, with subcarrier video at J203 applied to the vertical input. The display is initiated by the drum trigger pulse and the position of the line sync pulse is easily noted on the scope. Phasing is accomplished by repeatedly pressing S204 for short intervals while observing the display. When the position of the satellite sync pulse matches the left edge of the display, the picture is properly phased.

Power supplies. Only two basic supplies are required. One provides +24 V for the

Parts List

Semiconductors

| | |
|--------------|--------------|
| U1 | LM741CN |
| U2 | LM380N |
| U3 | NE567 |
| U4 | NE555 |
| U5,U6 | SN74121N |
| U7,U8,U9,U12 | SN7400N |
| U10 | SN7490N |
| U11 | SN7493N |
| U13 | LM340T-12 |
| U14 | LM340T-5 |
| U101 | SK3152 (RCA) |
| Q1,Q2 | S5020 (MOT) |
| Q3,Q4,Q6,Q7 | 2N2219 |
| Q5 | 2N2907A |

| | |
|-------------------|-----------------------|
| D1,D2,D3,D4,D101, | |
| D102,D103,D7 | 1N4007 |
| D5,D6 | 120-V, 5-W, 10% zener |

Resistors (1/4-W, 5% unless noted)

| | |
|--------------------|---|
| R1,R4 | 10k |
| R2 | 2200 |
| R3,R17 | 20k |
| R5 | not used |
| R6,R103 | 4.7 |
| R7,R16,R19,R20,R21 | 1000 |
| R8 | 100 |
| R9 | 3300 2-W, 10% |
| R10 | 47k 4-W, 10% (four 47k 2-W, 10% in series/parallel) |
| R11,R104 | 2200 2-W, 10% |
| R12,R18,R24 | 470 |
| R13,R23 | 1500 |
| R14 | 10k linear taper PC pot (SYNC LEVEL) |
| R15 | 470k |
| R22 | 15k |
| R101 | 3000 |
| R102 | 47 |
| R201 | 10k audio taper pot (WHITE SET) |
| E202 | 5k linear taper pot (VCO ADJ) |
| R203 | 10k audio taper pot (DRUM LEVEL) |

Capacitors (D = disc ceramic, M = dipped mylar™, T = tantalum, A = aluminum)

| | |
|----------------|------------------|
| C1,C5,C14 | 1-μF, 35-V T |
| C2,C3,C4,C13 | 0.01-μF, 50-V M |
| C6,C8,C16,C104 | 0.1-μF, 50-V D |
| C7 | 470-μF, 16-V A |
| C9,C15,C109 | 0.047-μF, 50-V M |
| C10,C11 | 2.2-μF, 35-V T |
| C12,C101 | 4.7-μF, 35-V T |
| C17,C18 | 10-μF, 25-V T |
| C102 | 220-μF, 25-V A |

drum amplifier, and with IC regulators, provides the +12 V and +5 V required by the other circuits. The 24-V supply need not be regulated, and if an 18-V transformer is used, the unregulated output can be used, eliminating the 24-V regulator components. If your unregulated output is greater than 25-28 V, however, the circuit should be included to protect the amplifier module and to ease the strain on the other IC

regulators. The second supply is for the unregulated 300-350 V required for the printing circuit.

Parts. A complete parts list for the electronic components is included. The large mail-order supply houses are your best bet for everything except the RCA power module (U101) and the two high-voltage transistors. Substitutions for the latter two items are limited—we want a collector voltage limit of 400 V or more

| | |
|-----------|---|
| C103 | 10-μF, 25-V A |
| C105 | 47-μF, 25-V A |
| C106,C107 | 22-μF, 25-V A |
| C108 | 1000-μF, 25-V A |
| C110,C111 | 40-μF, 450-V A |
| C112,C113 | 3300-μF, 35-V A |
| C201 | see text |
| C202 | Starting capacitor supplied with CA motor |
| C301 | Starting capacitor supplied with GA motor |

Transformers

| | |
|------|-----------------------------------|
| T201 | Output transformer (1-4k:8 Ohm) |
| T202 | 5-15-H choke (see text) |
| T203 | 6.3-V, 1.2-A filament transformer |
| T204 | 18-V, 2-A power transformer |
| T205 | 225-V, 50-mA power transformer |

Indicator Lamps (12-V-15-V LED or incandescent panel lamps)

| | |
|------|-------------|
| L201 | VCO LOCK |
| L202 | PHASE ERROR |
| L203 | POWER |

Switches

| | |
|------|---|
| S201 | DPDT toggle (RESET/PRINT)(must have center "off") |
| S203 | NO magnetic reed switch (drum phase sensor) |
| S204 | NC push-button (MANUAL PHASE) |
| S205 | SPST toggle (DRUM) |
| S206 | NC push-button (WEFAX PHASE) |
| S207 | SPST (POWER) |

Miscellaneous

| | |
|----------------|---|
| J201,J202,J203 | Switchcraft 3501FR phono jacks |
| P1 | 3-wire ac power cord and plug |
| P2 | Cinch-Jones S-308-AB |
| P3 | Cinch-Jones P-308-CCT |
| M1 | Type GA synchronous motor, 240 rpm (HURST) |
| M2 | Type CA synchronous motor, 40 rpm for WEFAX, 20 rpm for TIROS (HURST) |
| F201 | 1/2-A, type 3AG fuse and holder. |

As an aid to those who want to save some time on the project, METSAT Products, Box 142, Mason MI 48854, has the following parts available: (1) FX-2E board set—a set of two drilled and plated circuit boards, \$70.00; (2) FX-2E minikit—the drilled and plated boards, plus a complete set of machined fax mechanics, including the drum and fax motors. The unit is partially assembled and requires about 15 minutes of additional assembly time, \$500.00; and (3) Wired and tested FX-2E units—contact METSAT for current prices.

and at least 50 W of dissipation to keep things cool and stable. The transistors specified are rated to 125 Watts! No real high-frequency response is required. GE manufactures a plug-in replacement for the RCA module if the latter cannot be obtained locally. It should do just as well, although I have never used it. The 2N2219 transistors can be replaced by any general-purpose NPN silicon device.

Electronics Assembly

The schematic diagrams are based on the METSAT Products version of the FX-2E in which the electronic circuits are contained on two main circuit boards. These boards, which come with the kit version of the fax mechanics, greatly simplify assembly. The two boards are shown in Figs. 10 and 11 and may provide you with some ideas for circuit layout. The circuits can

New Improved Adhesive Mount for the 2 Meter Avanti Mobile Antenna.

Mounts on glass — no holes!

- Receives and transmits through glass.
- Superior performance equivalent to 5/8 wave.
- Superior radiation full Omni-Directional.

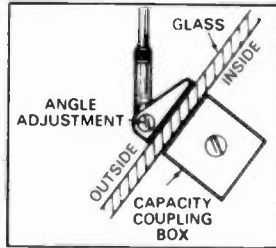

It's easy to install — No holes to drill, no magnet to scratch the paint, no clamps. Uses an especially developed silicone adhesive that secures antenna to window. The capacity coupling box is simply attached with a special adhesive tape to inside of window. Worried about crimping or corroding coaxial cables? It's all inside and out of sight.

Models also available for 220 MHz and 450 MHz.

See Avanti's other new mobile and base antennas. Write for new catalog today. Send 50¢ for handling and postage.

avanti® antennas

Avanti Research and Development, Inc.
340 Stewart Ave., Addison, IL 60101 (312) 628-9350
In Canada: Lenbrook Ind., Scarborough, Ontario MIH IH5

be combined on a single large board or can be further subdivided into a series of smaller boards. The latter approach was used in the prototype and greatly facilitated its evolution from a strictly photographic fax system to its present form, as new circuit ideas could be tested readily and easily. You can develop your own PC layouts, wire the circuits on perfboard, or even purchase the boards separately if you so desire. In all cases, layout is not critical, but you should place the high-voltage components so that you are unlikely to come into contact with them while taking readings or making adjustments on the low-voltage circuits. The use of sockets is suggested. As you wire up the circuits, do not insert the 8- or 14-pin ICs at this time.

Packaging. An instrument enclosure houses all of the

electronics components in the METSAT version and you can use any cabinet that will house your particular circuit layout. All of the controls and indicators, with the exception of the drum-level control, should be located on the front panel. The drum-level control is located internally wherever space is available. The rear apron contains the ac cable, fuse, video input, and the sockets for the drum, traverse, and control cables. If you are building a version for TIROS/NOAA or METEOR, the trigger and video out jacks also should be located on the rear apron. Needless to say, all wiring should be checked several times prior to powering up. In part II, we'll tackle the mechanical aspect of construction, probably the most difficult part of the system. Meanwhile, get started on the electronics. ■

From: **DIGITREX**
ELECTRONICS COMPANY

PA-19 Wideband Preamplifier

- 2 to 200 MHz Bandwidth (-3dB Points)
- 19dB Gain!
- 50 Ohms Input & Output Impedance
- Tiny PC Board Size (7/8" x 1-5/8")
- Absolutely No Tuning Required
- Extremely Stable
- Draws only 20MA @ 12VDC
- Great Way to Increase Sensitivity of Receivers, Counter, etc.
- Fully Assembled and Tested
- Instructions Provided, Full Warranty



only
\$8.95
+ 50 Shipping/Handling

PS-600 600 MHz Prescaler

- Provides ±10 and ±100 TTL Level Output
- 75 MV RMS Input Sensitivity
- Built in 5 Volt Regulator Allows Use at 8-12 VDC @ 90-110 MA.
- Tiny PC Board Size (1-1/4" x 1-3/8")
- Fully Assembled and Tested
- Instructions Provided, Full Warranty



only
\$28.95
ppd

New PS-1250 1.25 GHz Prescaler
complete **\$79.95** ppd

COD Orders Accepted
4412 Fernlee

Royal Oak, Michigan 48073
Phone 313-651-9247

JAN CRYSTALS
HOLD THE FREQUENCY

- CB
- CB standard
- 2 meter
- Scanners
- Amateur Bands
- General Communication
- Industry
- Marine VHF
- Micro processor crystals

Send 10¢ for our latest catalog. Write or phone for more details.



P.O. Box 06017
Ft. Myers, Florida 33906
ALL PHONES (813) 936-2397

easy to charge
✓39



Organize your shack with a
CLUTTERFREE MODULAR CONSOLE \$179.95

- Large, 42" H x 57" W x 29"D
- Strong groove-construction
- Mar-resistant wood grain finish
- Options, drawers & face plate
- For ham or home computer
- Visa and Master Charge

CLUTTERFREE MODULAR CONSOLES

P.O. Box 5103 Tacoma, WA 98405
(206) 759-1611 ✓89

KLM Amplifiers beat the heat



OVERHEATING . . . one of the leading causes of amplifier failure, UNLESS YOU OWN A KLM!

Here are a few basic facts: Overheating is easy! Poor air circulation, overdriving, high VSWR, and low operating efficiency can all cause amp temperatures to skyrocket, damaging performance and expensive components.

KLM takes the heat off, beginning with **HIGH EFFICIENCY DESIGNS** that make every watt count.

Each amplifier is wrapped in a **MASSIVE CUSTOM HEATSINK** that's the envy of the industry.

The ultimate protection is KLM's unique "on the board" **THERMAL SENSOR** that bypasses the amplifier at the approach of unsafe temperatures (a yellow L.E.D. on the front panel alerts you to check your installation). When things cool down, your KLM amp jumps back on-line with clean full-rated power.

To keep you cool, KLM backs each amplifier with a full **ONE YEAR WARRANTY** that includes the **output transistors**. Compare! Only KLM amplifiers can offer you all these features.

When you're ready for a new power amplifier . . . and don't want to get burned, COME TO KLM. ✓40

P. O. BOX 816, MORGAN HILL, CA 95037

MORE POWER TO YOU . . .
No increase in price!



**KLM's NEW PA10-170BL
Power Amplifier**
(Now with FM/SSB selector)

KLM, P. O. BOX 816, Morgan Hill, CA 95037

ROM-116

THE COMPLETE AMATEUR RTTY OPERATING SYSTEM

TRS-80*/RTTY

THE CROWNING TOUCH

 **CROWN
MicroProducts**

P. O. Box 892
Marysville, Washington 98270

206-659-4279 ✓16

* a trademark of Tandy Corporation

Breadboard Signal Generator

— sell your H-P stock once you build this project

This signal generator will not start a panic selling of Hewlett-Packard stock on the New York Exchange, but it will give the operator excellent stability and signal purity, with convenient operation and versatility comparable to commercial test equipment. It has a continuously adjustable

frequency range of 6.2 through 12.1 MHz. The dial resolution at center range is 30 degrees per 100 kHz, and its power output is 30 mW (1.5 V across 75 Ohms). It is equipped with front-panel quartz-crystal sockets that will accept FT-243 and HC/6U holders. These crystals can be made to oscil-

late separately or in conjunction with the vfo, creating sum and difference frequencies at its output. The input power requirement is very low (12 V dc regulated), with a current drain of 30 mA.

The circuit has three transistor stages. Q1, a MOS-

FET, is in a series-tuned Colpitts oscillator circuit. Q2, another MOSFET, is in the buffer that also doubles as a Pierce crystal oscillator. Q3, a bipolar, is in the emitter-follower output circuit. Using MOSFET transistors, with their very high input impedances, makes it easy to isolate the tuned-circuit elements from the generator's output. They did not have to be dual-gate types, but the many low-cost deals offered by Poly Paks inspired this action.

I have not heard anyone describe (in plain English) how the series-tuned Colpitts oscillator works since I left the US Navy Radio School. What I learned there has been a great help to me through the years. I believe that what the ancient mariner taught me was correct, for transistors as well as for tubes. This information should be passed along to others. So, if you will refer to the schematic (Fig. 1), I will start the story.

When the range switch is in the 6.2-6.6 MHz position, just after the power switch

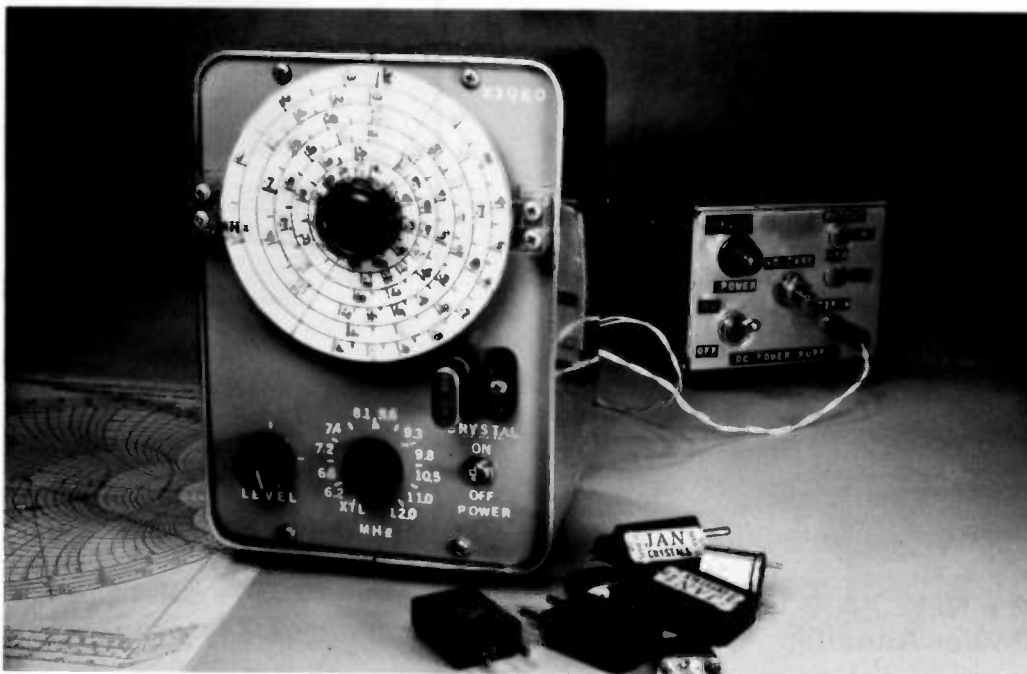

The wideband signal generator.

is closed, Q1 begins to conduct. The current, flowing through its channel from drain to source, causes a large voltage drop across L7 and R3 (positive at the Q1 end of L7). This potential will cause a current flow that will divide, charging C3 to ground, C2 through L1, and the parallel combination of C4/C5. This path causes L1 to have an expanding magnetic field, and there is a positive potential at its C2 end. This potential charges C1 through R1, and the voltage drop across it will increase in the positive direction. R1 is connected to the gates of Q1, so this positive voltage will open its channel wider, and the increased conduction makes the voltage drop across L7 and R3 rise. This process continues at a time rate controlled by the LC time constant of the circuit elements, until Q1 reaches the conduction limit set by the R3 bias. At this time, all the capacitors are fully charged and no more current flows through L1. The magnetic field around L1 will collapse, and the flux lines cutting the turns will develop a potential opposite to the charging one. All of the capacitors begin to discharge at the LC time-constant rate, storing the energy to be released by L1's flux. This will mean that the current through R1 has reversed, and at a magnitude great enough to pinch off Q1. This process continues until all the field has collapsed, after which Q1 returns to the conducting state. The current is now increased by the oppositely charged capacitors of the tank circuit, L1/C2/C3/C4/C5. The amount is directly proportional to the circuit Q and will add more energy to L1's field. This means that when the field collapse cycle begins again, Q1 will quickly be pinched off and oscillations will continue, with

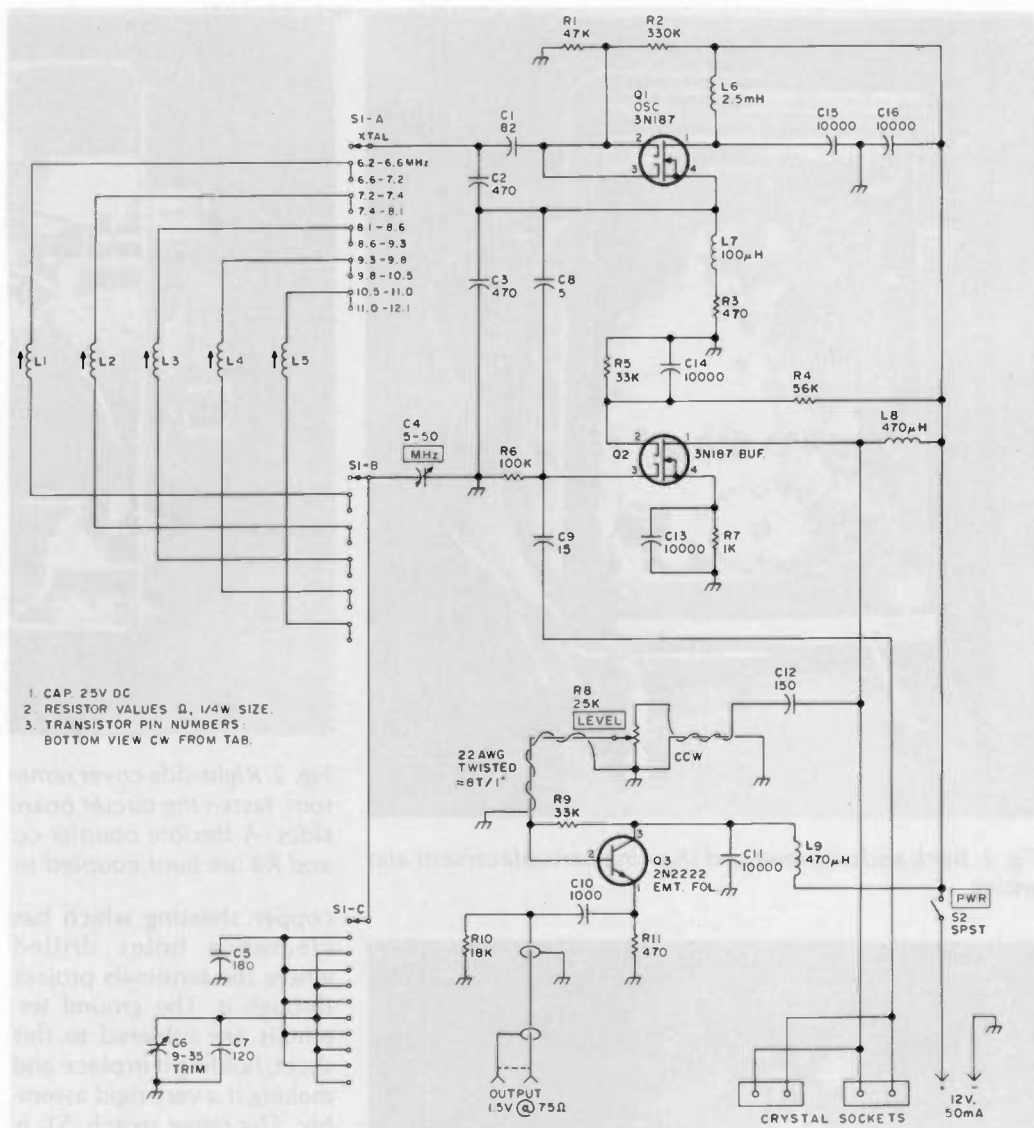

Table 1. Coil data.

| Coil | Turns | Wire Size (AWG, Enam.) | Freq. (MHz) |
|------|-------|------------------------|-------------|
| L1 | 40 | 28 | 6.2-7.2 |
| L2 | 35 | 28 | 7.2-8.1 |
| L3 | 27 | 28 | 8.1-9.3 |
| L4 | 26 | 24 | 9.3-10.5 |
| L5 | 18 | 24 | 10.5-12.1 |

Forms $\frac{1}{4} \times \frac{1}{4}$ (63 x 190 mm) ceramic slug-tuned

Fig. 1. Schematic of the signal generator.

only spurts of energy being supplied by the transistor. The ac tank circuit signal across C3 is tapped for a useful output.

The MOSFET buffer, Q2, is a class A amplifier that is lightly coupled to the oscillator by C8. It also has leads connecting the drain and gate to a pair of quartz-crystal sockets. When the range switch, S1, is in the XTAL position and a crystal is in one of the sockets, Q2 becomes a Pierce oscillator. The LEVEL control, R8, should be fully CW in this mode so that an ideal impedance match is present for oscillations to begin. The oscillator will operate when the crystals are within the range of 2 to 15 MHz. When the range switch is in

any other position, the signals of the two oscillators mix and the output of the signal generator will contain the vfo, the crystal, their sum, and their difference frequencies.

The buffer output is fed to the bipolar emitter-follower, Q3, through potentiometer LEVEL control, R8. A homemade transmission line of twisted 22 AWG insulated wire carries the signal into and away

from this control. This type of level control will reduce the generator output to almost zero, eliminating the need for a complicated attenuator for most test work.

To allow for versatile experiments and changes, all of the electronic circuits are constructed on a piece of perforated board containing .064" diameter holes spaced .25" apart. It measures 4" x 5.5" (9.8 x 13.5 cm), and all

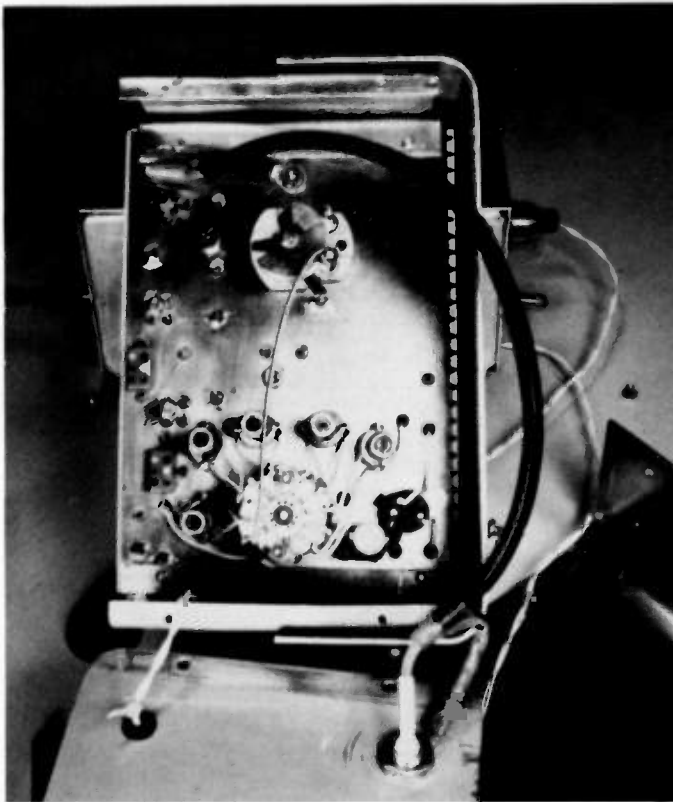

Fig. 2. Back and side removed showing parts placement and wiring.

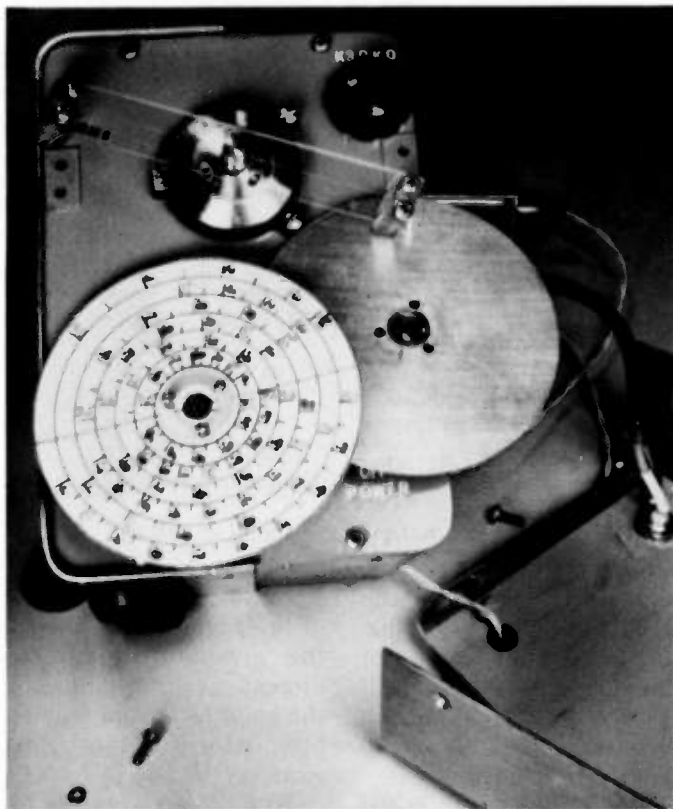

Fig. 4. Aluminum disc, scale, and index separated from the 36mm vernier dial.

the components are soldered to push-in terminals. As can be seen in Fig. 2, the

back side of the board is covered with a piece of .032" (.8mm) thick brass or

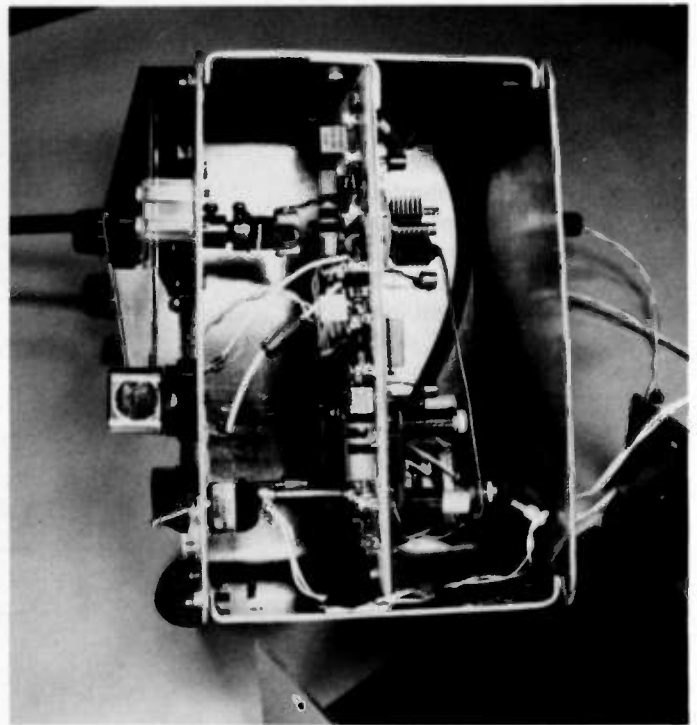

Fig. 3. Right-side cover removed. "U" channels, top and bottom, fasten the circuit board to the cabinet front, back, and sides. A flexible coupler connects the C4 shaft to dial. S1 and R8 are hard coupled to knobs.

copper sheeting which has clearance holes drilled where the terminals project through it. The ground terminals are soldered to this sheet, holding it in place and making it a very rigid assembly. The range switch, S1, is located near the bottom center with the coils (L1-L5 described in Table 1) soldered to terminals around it. Q1 is just above the coils to the left, and the trim capacitor (C6) is next to the level potentiometer (R8) on the right. To the left, the next transistor up is Q2, followed by Q3. Centered near the top is the tuning capacitor, C4. Fig. 3 shows how the crystal sockets are connected to the circuit board and the details of the aluminum case built around the breadboard-type electronic assembly. Fig. 4 shows how a large scale is fastened to the 36mm vernier dial. An aluminum disc, 3.4" (8.6 cm) in diameter, backs up a lacquered, heavy paper dial which has six concentric circles and a center line inked on it. An index of plastic, scribed through the

center, extends across the whole dial. This will allow 12 scales to be marked on the dial, 6 on each half. The disc and paper scales are fastened to the vernier dial with the same screws used to hold the original scale in place. When soldering the MOSFET transistors into place, be sure to short all the leads to the case with a piece of foil or you will zap the gates. It would be better to use sockets and then plug the MOSFETs safely into them.

After the unit is wired and power applied, you should check for an output. If none is present or it is at an unexpected frequency, troubleshoot the problem using Table 2 in order to isolate the malfunction. When the output is found to be normal, set the range switch to the 8.1-8.6 MHz position, rotate the dial fully CCW (C4 plates open), and adjust L3 until the signal measures 8.6 MHz. Reset the switch to the 8.6-9.3 MHz position, rotate the

| Range
Switch
Position | Q1 (V dc @ pin) | | | | Q2 (V dc @ pin) | | | | Q3 (V dc @ pin) | | | Output
(V RMS)
75Ω |
|-----------------------------|-----------------|--------|--------|-------|-----------------|--------|--------|-------|-----------------|-------|-------|--------------------------|
| | 1 (D) | 2 (G2) | 3 (G1) | 4 (S) | 1 (D) | 2 (G2) | 3 (G1) | 4 (S) | 1 (E) | 2 (B) | 3 (C) | |
| Xtal
(no xtal) | 12.0 | 1.5 | 1.5 | 1.7 | 12.0 | 6.0 | 1.4 | 4.4 | 3.8 | 4.2 | 12 | -- |
| Xtal
(8.3 MHz
FT-243) | 12.0 | 1.5 | 1.5 | 1.7 | 12.0 | 6.0 | 3.3 | 6.4 | 5.9 | 4.0 | 12 | 1.3 |
| 8.1-8.6 MHz
(No xtal) | 12.0 | 1.4 | 1.4 | 3.3 | 12.0 | 6.6 | 3.6 | 7.0 | 5.4 | 4.2 | 12 | 1.6 |

Table 2. Pin voltage data measured with 10 megohm input VTVM to ground.

dial fully CW (C4 plates closed), and adjust the trimmer (C6) until the signal measures 5 kHz less

than 8.6 MHz. Set the range switch to all the other positions and adjust the coils (L1-L5) until there

is a continuous overlap of frequency. The calibration marks are now inked on the scale circles, having lo-

cated them by using a 100-kHz crystal oscillator and a receiver or a frequency counter. ■

BETTER QUALITY TOUCH-TONE® DECODING

With this Touch-Tone® Decoder in your radio network, you can turn on transmitters, control antennae direction, and signal over public and private telephone networks.

The Teltone M-917 accepts push-button DTMF signals from a radio, telephone, or prerecorded tape.

Pin selectable, logic level, binary output can drive a Schottkey TTL gate, a low power transistor, a CMOS or MOS device.

It's compact, complete, field tested, and proven.



✓ 363

The I-CAN Company
P.O. Box 1417
Orange Park, Florida 32073

Adirondack Radio...

Your Rockwell-Collins dealer for the northeast and Upstate New York--has the fabulous KWM-380 on display for your inspection.

For the amateur who is only satisfied with the finest, Adirondack Radio Supply will be happy to give you quotations for early delivery for a truly professional amateur station.

Adirondack Radio Supply, Inc.

185 WEST MAIN STREET
AMSTERDAM, NEW YORK 12010
TELEPHONE (518)842-8350 ✓1

new--useful--clear--colorful--complete

Chart of UNITED STATES AMATEUR RADIO PRIVILEGES

by class of license, emission type, and frequency from 160 thru 2 meters, including provision for the new 30, 17, and 12 meter bands. This 22 x 28 in, twelve-color chart is the first of its kind to be both informative and decorative. Enhance your shack.

Regular price \$3.00. SPECIAL INTRODUCTORY PRICE \$2.50. Includes postage and handling.

Larry Dennison—KB6KG
5002 Marion Avenue
Torrance, California 90505

✓ 365

name _____

address _____

city _____

state _____ zip _____

Handie

MORE POWER TO YOU!



✓ 40

KLM's NEW MA-35BL Power Amplifier

35W out, Preamp, Nicad Charger!

KLM, P. O. Box 816, Morgan Hill, CA 95037

Microcraft's New Morse-A-Word!

- Eight character moving display.
- Built-in code practice oscillator.
- Excellent for learning Morse Code.
- Complete — no CRT or expensive extras needed.
- Decodes audio CW signals from your receiver's speaker and displays letters, numbers, punctuation and special Morse characters as the code is received.



MORSE-A-WORD Kit with 4 character readout MAWK-4 \$149.95
MORSE-A-WORD Kit with 8 character readout MAWK-8 \$169.95
MORSE-A-WORD wired & tested with 8 character readout . . . MAWF \$249.95

Send check or money order. Use your VISA or Master Charge. Add \$3.50 shipping and handling for continental U.S. Wisconsin residents add 4% State Sales Tax.

Microcraft Corporation Telephone: (414) 241-8144
P. O. Box 513G, Thiensville, Wisconsin 53092

TS-830S

"Top-notch"... VBT, notch, IF shift, wide dynamic range

The TS-830S has every conceivable operating feature built-in for 160-10 meters (including the three new bands). It combines a high dynamic range with variable bandwidth tuning (VBT), IF shift, and an IF notch filter, as well as very sharp filters in the 455-kHz second IF. Its optional VFO-230 remote digital VFO provides five memories.

TS-830S FEATURES:

- LSB, USB, and CW on 160-10 meters, including the new 10, 18, and 24-MHz bands. Receives WWV.
- Wide receiver dynamic range. Junction FETs in the balanced mixer, MOSFET RF amplifier at low level, and dual resonator for each band.
- Variable bandwidth tuning (VBT). Varies IF filter pass-band width.
- Notch filter (high-Q active circuit in 455-kHz second IF)
- IF shift (passband tuning).
- Built-in digital display (six digits, fluorescent tubes), analog subdial, and display hold (DH) switch
- Noise-blanker threshold level control.
- 6146B final with RF negative feedback. Runs 220 W PEP (SSB)/180 W DC (CW) input on all bands
- Built-in RF speech processor.
- Narrow/wide filter selection on CW
- SSB monitor circuit to check transmitted audio quality.
- RIT (receiver incremental tuning) and XIT (transmitter incremental tuning).

OPTIONAL ACCESSORIES:

- SP-230 external speaker with selectable audio filters.
- VFO-230 external digital VFO with 20-Hz steps, five memories, digital display.
- AT-230 antenna tuner/SWR and power meter/antenna switch; 160-10 meters, including three new bands.
- YG-455C (500-Hz) and YG-455CN (250-Hz) CW filters for 455-kHz IF.
- YK-88C (500-Hz) and YK-88CN (270-Hz) CW filters for 8.83-MHz IF. (VFOs for TS-830S, TS-130 Series, and TS-120S are compatible with all three series of transceivers.)



SP-230

TS-830S

VFO-230

AT-230

TS-130S/V

"Small wonder"... processor, N/W switch, IF shift, DFC option

The compact, all solid-state HF SSB/CW mobile or fixed station TS-130 Series transceiver covers 3.5 to 29.7 MHz, including the three new bands.

TS-130 SERIES FEATURES:

- 80-10 meters, including the new 10, 18, and 24-MHz bands. Receives WWV.
- TS-130S runs 200 W PEP/160 W DC input on 80-15 meters and 160 W PEP/140 W DC on 12 and 10 meters. TS-130V runs 25 W PEP/20 W DC input on all bands.
- Built-in speech processor.
- Narrow/wide filter selection on both CW (500 Hz or 270 Hz) and SSB (1.8 kHz) with optional filters.

- Automatic selection of side-band mode (LSB on 40 meters and below, and USB on 30 meters and above). SSB REVERSE switch provided.
- Built-in digital display.
- Built-in RF attenuator.
- IF shift (passband tuning).
- Effective noise blanker.

OPTIONAL ACCESSORIES:

- PS-30 base-station power supply.
- YK-88C (500 Hz) and YK-88CN (270 Hz) CW filters.
- YK-88SN (1.8 kHz) narrow SSB filter.
- AT-130 compact antenna tuner (80-10 meters, including three new bands).

- SP-120 external speaker.
- VFO-120 remote VFO.
- MB-100 mobile mounting bracket.
- PS-20 base-station power supply for TS-130V.



Optional DFC-230 Digital Frequency Controller

Frequency control in 20-Hz steps with UP/DOWN microphone (supplied with DFC-230). Four memories and digital display. (Also operates with TS-120 and TS-830S.)



PS-30

SP-120

TS-130S

VFO-120

TS-180S with DFC

High quality...top performance,
with optimum features

The top-of-the-line TS-180S all solid-state HF SSB/CW/FSK transceiver with DFC (Digital Frequency Control) provides maximum performance and efficiency for every amateur.

TS-180S FEATURES:

- All solid-state, 200 W PEP/160 W DC input on 160-15 meters, and 160 W PEP/140 W DC on 10 meters. Adaptable to three new bands.

- Dual SSB filter (optional) to improve selectivity, reduce noise, and improve RF-speech-processor operation.
- Digital Frequency Control (DFC), including four memories with digital up/down paddle-switch tuning in 20-Hz steps. Memories operate in transceiver or split modes. (Also available without DFC.)
- IF shift (passband tuning).

- Built-in digital display with differential function. Shows actual VFO frequency and difference between VFO and "M1" memory (or "hold" without DFC) frequencies.
- Selectable wide and narrow CW bandwidth.

- Tunable noise blanker.
- RF AGC.

- Automatic selection of upper and lower sideband (with SSB NORMAL/REVERSE switch).
- Dual RIT (VFO, memory/fix).

OPTIONAL ACCESSORIES:

- PS-30 base-station power supply.
- SP-180 external speaker with selectable audio filters.
- VFO-180 remote VFO.
- AT-180 antenna tuner/SWR and power meter/antenna switch.
- DF-180 digital frequency control (for TS-180S without DFC).
- YK-88C (500 Hz) and YK-88CN (270 Hz) CW filters.
- YK-88S SSB filter for dual F filter system.



PS-30

SP-180

TS-180S

VFO-180

TS-520SE

"Cents-ability" in a quality 160-10 meter
SSB/CW rig

The TS-520SE is an economical, full-featured 160-10 meter transceiver, found in more ham shacks than any other rig.

TS-520SE FEATURES:

- 160-10 meters... and receives WWV on 15 MHz.
- 200 W PEP (SSB)/160 W DC (CW) input on all bands.

- CW WIDE/NARROW bandwidth switch for use with optional 500-Hz CW filter.
- Speech processor for extra audio punch.
- Effective noise blanker.
- 20-dB RF attenuator.
- RIT (receiver incremental tuning) control.

- Digital display with optional DG-5, showing actual operating frequency while transmitting and receiving.
- Eight-pole crystal filter for excellent selectivity.
- Built-in 25-kHz calibrator, adjustable to WWV.
- VOX and semi-break-in CW with sidetone.
- Built-in speaker.
- Solid-state, with tube driver and final.

- Amplified-type AGC circuit.
- Amplified-type ALC.
- Front-panel carrier level control.

OPTIONAL ACCESSORIES:

- SP-520 external speaker.
- DG-5 digital frequency display and 40-MHz counter.
- VFO-520S remote VFO.
- CW-520 500-Hz CW filter.
- AT-200 antenna tuner/SWR and RF power meter/antenna switch.



SP-520

TS-520SE

VFO-520S



TR-7800

"Easy selection"...15 memories/offset recall, scan, priority, DTMF (Touch-Tone®)

Frequency selection with the TR-7800 2-meter FM mobile transceiver is easier than ever. The rig incorporates new memory developments for repeater shift, priority, and scan, and includes a built-in autopatch Touch-Tone® encoder.

TR-7800 FEATURES:

- 15 multifunction memory channels, selected with a

rotary switch. M1-M13 ... memorize frequency and offset (± 600 kHz or simplex). M14 ... memorize transmit and receive frequencies independently for nonstandard offset. M0 ... priority channel, with simplex, ± 600 kHz, or nonstandard offset.

- Internal backup for all memories, by installing four AA NiCd batteries (not Kenwood-

supplied) in battery holder.

- Priority channel (memory "0") and priority alert.
- Covers 143.900-148.995 MHz, in 5-kHz or 10-kHz steps.
- Built-in autopatch DTMF (Touch-Tone®) encoder.
- Front-panel keyboard for selecting frequency, transmit offset, and autopatch encoder tones, programming memories, and controlling scan.
- Automatic scan of entire band (5-kHz or 10-kHz steps) and memories.
- Manual scan of band and memories, with UP/DOWN microphone (standard).

SP-40

Compact, high-quality mobile speaker

- Matches all HF, VHF, and UHF radios for mobile operation.
- Only 2-11/16 inches wide by 2-1/2 inches high by 2-1/8 inches deep.
- 4-ohm input impedance.
- Handles 3 watts of audio.
- Mounting bracket with ferrite magnet. Adhesive-backed steel plate supplied for mounting virtually anywhere.



- Repeater REVERSE switch.
- Selectable power output. 25 W (HI)/5 W (LOW).
- LED S/R/F bar meter.
- TONE switch to actuate subaudible tone module (not Kenwood-supplied).

OPTIONAL ACCESSORIES:

- KPS-7 fixed-station power supply.

TR-8400

"Go synthesized on 440 MHz FM"... 5 memories, memory/band scan

The TR-8400 synthesized 70-cm UHF FM mobile transceiver covers 440-450 MHz in 25-kHz steps and includes five memories, automatic memory and band scan, UP/DOWN manual scan, and two VFOs.

TR-8400 FEATURES:

- Synthesized coverage of 440-450 MHz in 25-kHz steps.

- Five memories and memory backup terminal on rear panel.
- Two VFOs.
- Offset switch for ± 5 MHz transmit offset and simplex operation. Fifth memory allows any other offset by memorizing receive and transmit frequencies independently.

- Automatic scan of memories and of 440-450 MHz band (in 25-kHz steps). Locks on busy channel and resumes when signal disappears. HOLD or mic PTT button cancels scan.
- Up/down manual band scan in 25-kHz steps with UP/DOWN microphone supplied with TR-8400.
- Only 5-3/4 inches wide, 2 inches high, and 7-5/8 inches deep. Weighs only 3.75 pounds.

- TONE switch to activate sub-tone device (not Kenwood-supplied). DTMF (Touch-Tone™) terminal on rear panel.
- Four-digit frequency display and S/R/F bar meter. Other LEDs indicate BUSY, ON AIR, and REPEATER operation.
- HI/LOW (10 W/1 W) RF-output power switch.

OPTIONAL ACCESSORIES:

- KPS-7 fixed-station power supply.
- SP-40 compact mobile speaker.



TR-9000

"New 2-meter direction"... compact rig with FM/SSB/CW, scan, five memories

The TR-9000 combines the convenience of FM with long distance SSB and CW. It is extremely compact... perfect for mobile operation. Matching accessories are available for optimum fixed-station operation.

TR-9000 FEATURES:

- FM, USB, LSB, and CW.
- Only 6-11/16 inches wide, 2-21/32 inches high, 9-7/32 inches deep.

- Two digital VFOs, with selectable tuning steps of 100 Hz, 5 kHz, and 10 kHz.
- Digital frequency display. Five, four, or three digits, depending on selected tuning step.
- Covers 143.9000-148.9999 MHz.
- Band scan... automatic busy stop and free scan.
- SSB/CW search of selectable 9.9-kHz bandwidth segments.

- Five memories... four for simplex or ± 600 kHz repeater offsets and the fifth for a non-standard offset (memorizes transmit and receive frequency independently).
- UP/DOWN microphone (standard) for manual band scan.
- Noise blanker for SSB and CW.
- RIT (receiver incremental tuning) for SSB and CW.
- RF gain control.
- CW sidetone.
- Selectable RF power outputs... 10 W (HI)/1 W (LO).
- Mobile mounting bracket with quick-release levers.
- LED indicators... ON AIR, BUSY, and VFO.

OPTIONAL ACCESSORIES:

- PS-20 fixed-station power supply.
- SP-120 fixed-station external speaker.
- BO-9 System Base... with power switch, SEND/RECEIVE switch (for CW), memory-backup power supply, and headphone jack.



PS-20

TR-9000

BO-9

SP-120

TR-2400

"Hand-shack"... synthesized, big LCD, scan, 10 memories, DTMF (Touch-Tone®)



CONVENIENT TOP CONTROLS

The TR-2400 has the most convenient operating features desired in a 2-meter FM hand-held transceiver.

TR-2400 FEATURES:

- Large LCD digital readout. Readable in direct sunlight (virtually no current drain) and in the dark (lamp switch). Shows receive and transmit frequencies and memory channel. "Arrow" indicators show "ON AIR," "MR" (memory recall), "BATT" (battery status), and "LAMP" switch on.

- Keyboard selection of 144.000-147.995 MHz in 5-kHz increments. No "5-UP" switch needed.
- UP/DOWN manual scan in 5-kHz steps from 143.900 to 148.495 MHz.
- 10 memories. Retained with battery backup. "M0" memory may be used to shift transmitter to any frequency for nonstandard-split repeaters.
- Built-in autopatch DTMF (Touch-Tone®) encoder, using all 16 keyboard buttons.
- Automatic memory scan.
- Repeater or simplex operation. Transmit frequency shifts ± 600 kHz or to "M0" memory frequency.
- Reverse switch. Transposes receive and transmit frequencies.
- Subtone switch (tone encoder not Kenwood-supplied).
- Two lock switches to prevent accidental frequency change and accidental transmission.

- External PTT microphone and earphone connectors.
- Rubberized antenna with BNC connector, NiCd battery pack, AC charger, PTT and mic plugs, handstrap, and earphone included.
- Extended operating time with LCD and overall low-current circuit design. Only draws about 28 mA squelched receive and 500 mA transmit (at 1.5 W RF output).
- High-impact case and zinc die-cast frame.
- Compact and lightweight. Only 2-13/16 inches wide, 7-9/16 inches high, and 1-7/8 inches deep. Weighs only 1.62 pounds (including antenna, battery, and hand strap).

OPTIONAL ACCESSORIES:

- ST-1 Base Stand (provides 1.5-hour-quick, trickle, and floating charges, 4-pin microphone connector, and SO-239 antenna connector).
- BC-5 DC quick charger.
- LH-1 leather case.
- BH-1 belt hook.
- PB-24 extra NiCd battery pack.
- SMC-24 speaker/microphone.



R-1000

"Hear there and everywhere"...
easy tuning, digital display

The R-1000 is an amazingly easy-to-operate, high-performance, communications receiver, covering 200 kHz to 30 MHz in 30 bands. This PLL synthesized receiver features a digital frequency display and analog dial, plus a quartz digital clock and timer.

R-1000 FEATURES:

- Covers 200 kHz to 30 MHz continuously.

- 30 bands, each 1 MHz wide.
- Five-digit frequency display with 1-kHz resolution and analog dial with precise gear dial mechanism.
- Built-in 12-hour quartz digital clock with timer to turn on radio for scheduled listening or control a recorder through remote terminal.
- Step attenuator to prevent overload.
- Three IF filters for optimum AM, SSB, CW, 12-kHz and 6-kHz (adaptable to 6-kHz and 2.7-kHz) for AM wide and narrow, and 2.7-kHz filter for high-quality SSB (USB and LSB) and CW reception.
- Effective noise blanker.
- Terminal for external tape recorder.
- Tone control.
- Built-in 4-inch speaker.
- Dimmer switch to control intensity of S-meter and other panel lights and digital display.

- Wire antenna terminals for 200 kHz to 2 MHz and 2 MHz to 30 MHz. Coax terminal for 2 MHz to 30 MHz.
- Voltage selector for 100, 120, 220, and 240 VAC. Also adaptable to operate on 13.8 VDC with optional DCK-1 kit.

OPTIONAL ACCESSORIES:

- SP-100 matching external speaker.
- HS-5 and HS-4 headphones.
- DCK-1 modification kit for 12-VDC operation.



SP-100

R-1000

HS-5



HC-10

Digital world clock with two 24-hour displays, quartz time base

The HC-10 digital world clock with dual 24-hour display shows local time and the time in 10 preprogrammed plus two programmable time zones.

HC-10 FEATURES:

- Two 24-hour displays with quartz time base. Right display shows local (or UTC) hour, minute, second, day. Left display shows month, date, world time in various cities, memory time (QSO starting time), and time difference (in hours from UTC).
- Preprogrammed time in 10 cities around the world, plus two programmable time zones.
- "TOMORROW" and "YESTERDAY" indicators.
- Memorization of present time. Can be recalled later, for logging purposes.
- High accuracy (± 10 seconds/month).



DM-81

Dip meter performs many RF measurements

The DM-81 dip meter is highly accurate and features, in addition to the traditional inductive-coupling technique, capacitive coupling for measuring metal-enclosed coils and toroidal coils.

DM-81 FEATURES:

- Measuring range of 700 kHz-250 MHz in seven bands.
- Built-in storage compartment for all seven coils, capacitive probe, earphone, and ground clip lead.
- All solid-state and built-in battery.
- HC-25U and FT-243 sockets for checking crystals and marker-generator function.
- Amplitude modulation.
- FET for good sensitivity.
- Absorption frequency meter function.
- Earphone for monitoring transmitted signals.
- Capacitance probe for measuring resonant frequencies without removing coil shields, and also for measuring resonant frequencies of toroidal coils.



TL-922-A

Maximum legal power on 160-15 meters

The TL-922A linear amplifier provides maximum legal power on the 160-15 meter Amateur bands.

TL-922A FEATURES:

- 2000 W PEP (SSB)/1000 W DC (CW, RTTY) input power on 160, 80, 40, 20, and 15 meters, with 80 W drive.
- Excellent IMD characteristics.
- Pair of EIMAC 3-500Z high-

performance transmitting tubes.

- Safety protection.
- Blower with automatic turnoff-delay circuit.
- Variable threshold level type ALC.
- Two meters, one indicating plate current, and the other indicating grid current, relative RF output, and high voltage.



SM-220

High-performance oscilloscope for various monitoring functions

The SM-220 Station Monitor provides a variety of waveform-observing capabilities, and an optional pan display.

SM-220 FEATURES:

- Monitors transmitted SSB and CW waveforms from 1.8 to 150 MHz.
- Monitors signal waveforms in receiver's IF stage.
- Functions as high-sensitivity, wide-frequency-range (up to 10 MHz) oscilloscope.
- Tests linearity of linear amplifiers (provides trapezoid pattern).

- Allows observation of RTTY tuning points (cross pattern).
- Built-in two-tone (1000-Hz and 1575-Hz) generator.
- Expandable to pan-display capability for observing the number and amplitude of stations within a switchable ± 20 kHz/ ± 100 kHz bandwidth.

OPTIONAL ACCESSORIES:

- BS-8 pan-display module for TS-180S, TS-830S, and TS-820 Series.
- BS-5 pan-display module for TS-520 Series.



SP-70

TS-600 W/VOX-3

TS-600

All-mode, all solid-state 6-meter transceiver

The TS-600 is a 6-meter, all-mode, all solid-state transceiver with VFO (and crystal-controlled) coverage of the entire band.

TS-600 FEATURES:

- SSB (20 W PEP input), FM and CW (10 W output), and AM (5 W output).
- Operates on 120/220 VAC, 50/60 Hz or 13.8 VDC.
- VFO coverage of 50-54 MHz in four bands, with two-speed dial mechanism. Favorite frequencies may be crystal-controlled.
- Effective noise blanker.
- VOX operation with VOX-3

accessory (standard).

TS-700SP 2-meter, all-mode, all solid-state transceiver is also available... with similar features, plus:

- Digital frequency display, with 100-Hz resolution.
- VFO coverage of 144-148 MHz in four bands.
- Simplex and repeater operation, including all repeater subbands. REVERSE switch.

OPTIONAL ACCESSORIES:

- VFO-700S remote VFO (for TS-700S/SP).
- SP-70 external speaker.

ACCESSORIES

A wide selection of optional accessories is offered for optimum operating flexibility. In addition to the optional items listed with each piece of equipment described in this catalog, the following accessories are also available:



MC-50 dynamic dual-impedance (50 k Ω /500 Ω) desk microphone.

MC-30S (500 Ω) and **MC-35S** (50 k Ω) dynamic noise-canceling hand microphones.

HS-5 deluxe 8 Ω headphone set.

HS-4 8 Ω headphone set.



PC-1 phone patch with hybrid circuit and VU meter for null and audio gain measurements.



MC-45 Touch-Tone[®] (with automatic transmit) microphone.

NOTE: Prices and specifications of all Trio-Kenwood products are subject to change without prior notice or obligation.

The Odd Couple

—CASEY/1 tackles OSCAR's telemetry

I was one of those reactionary hams—you know the type: writing to 73 Magazine complaining about those damn computer articles in an amateur radio publication. But computer madness finally caught up with me, and a TRS-80 named CASEY/1 is now in the den, its luminescent READY a constant

taunt to the neophyte programmer.

After three weeks of working with the excellent instruction manual that comes with the machine and several nights of concerted game playing, I started looking for a way to put CASEY/1 to work, and copying OSCAR 8's telem-

etry one night gave me an idea.

This program decodes the satellite's telemetry channel readings, giving the user information on how OSCAR 8 is doing. Although Radio Shack Level I BASIC is used, the program will run on any BASIC machine with minor modifications as needed; 1,187 bytes of memory are required. Channel one calculations are straightforward. A no-current reading is registered if the count is 100, 101, or 102. If the count is in the 90s, the satellite is approaching sunlight, and counts less than 90 indicate that OSCAR 8 is out of the Earth's shadow.

The calculations for channels two and three are self-explanatory. For channels four and five, I have added a Fahrenheit conversion for those of us who have yet to jump onto the metric bandwagon.

For channel six, when OSCAR 8 is in Mode J, the program calculates power output. In Mode A, input to the power amplifier stages can be derived whenever the satellite is in the Earth's shadow by multiplying current (channel 2) and voltage (channel 3). Three Watts are then subtracted for resting power consumption. With the satellite in the sunlight, current can flow directly

from the solar panels to the transponder, and a faulty reading can result.

OSCAR newcomers should note that the first number of each telemetry frame is the channel number, so a 101 becomes an 01 when you are entering it into the program.

Copying OSCAR 8 telemetry is a lot more interesting with this program since it converts those frames into current, usable information. But don't forget to pass those readings on to the ARRL, which has assumed day-to-day responsibility over OSCAR 8, so that AMSAT could concentrate on the upcoming Phase III series. It is only through this constant monitoring that the amateur satellites consistently have outperformed commercial satellites launched with them.

Information needed for this program was gleaned from a pre-launch article by W3PK and G3ZCZ in the AMSAT Newsletter¹ and an excellent article in a recent QST.■

References

1. "The AMSAT-OSCAR D Spacecraft," W3PK and G3ZCZ, AMSAT Newsletter, December, 1977.
2. "OSCAR 8 Has A Message For You," W9KDR and WB2CHO, QST, July, 1978.

```
5 REM AMSAT OSCAR 8 TELEMETRY PROGRAM
6 REM DE WA9LRI RICH CASEY 7809.04
9 CLS
10 P." AMSAT QSCAR 8 TELEMETRY PROGRAM"
20P.:P.:P."ENTER TELEMETRY READINGS AS REQUESTED:"
30 IN."1";A
40 IN."2";B
50 IN."3";C
60 IN."4";D
70 IN."5";E
80 IN."6";F
99 CLS

100 REM CHANNEL ONE CALCULATIONS
110 G=7.15*(101-A)
120 P."THE TOTAL SOLAR ARRAY CURRENT IS ";G;" MA."
130 IF (G=0)+(A>89)P."THE SATELLITE IS IN THE EARTH'S SHADOW.":G.200
150 P."THE SATELLITE IS CURRENTLY IN THE SUNLIGHT."

200 REM CHANNEL TWO CALCULATIONS
210 H=57*(B-50)
230 P.:P."THE BATTERY CURRENT IS ";H;" MA."
250 IF B>50 P."THE BATTERY ABOARD A08 IS CHARGING."
260 IF B<50 P."THE BATTERY ABOARD A08 IS DISCHARGING"

300 REM CHANNEL THREE CALCULATIONS
310 I=(.1*A*C)+8.25
330 P.:P."THE BATTERY VOLTAGE IS ";I;" VOLTS."

400 REM CHANNEL FOUR CALCULATIONS
405 J=95.8-1.48*A*D
410 M=(9/5)*J+32
415 P.
420 P."THE BASEPLATE TEMPERATURE IN DEGREES IS ";J;" C, ";M;" F."

500 REM CHANNEL FIVE CALCULATIONS
505 K=95.8-(1.48*A*E)
510 N=(9/5)*K+32
520 P.:P."THE BATTERY TEMPERATURE IN DEGREES IS ";K;" C, ";N;" F."

600 REM CHANNEL SIX CALCULATIONS
605 IF F<3 THEN F=0
608 P.
610 IF F=0 GOSUB 1000
630 IF F>0 P."THE POWER OUTPUT IN MODE J IS ";L;" MW."
999 END

1000 REM MODE A POWER CALCULATIONS
1001 P=((0.001*H)*I)-3
1003 IF (G=0)+(A>89) THEN 1010
1005 P."POWER READING CANNOT BE TAKEN WHILE A08 IS IN SUNLIGHT."
1010 P."THE MODE A TRANSMITTER INPUT POWER IS ";ABS(P);" WATTS."
1020 RETURN
```

Program listing.

Orbit



ORBIT is the Official Journal for the Radio Amateur Satellite Corporation (AMSAT), P.O. Box 27, Washington, DC 20047. Please write for application.

For a **FREE SAMPLE COPY** please send \$1 to cover First Class Postage and handling to: Orbit, 221 Long Swamp Road, Wolcott, CT 06716.

Dear Subscriber:

73 Magazine does not keep the subscription records on the premises, therefore, calling the Peterborough offices doesn't solve your subscription problem.

To quickly solve your problem please send your most recent address label and a description of the problem to:

73 Magazine
Subscription Department
PO Box 931
Farmingdale, NY 11737

Please allow the subscription department at least two weeks for an answer or a solution to your problem.

Thank you and enjoy your subscription.

Sincerely,

Debra L. Boudrieau
Circulation Manager

BW-2630 Battery Tool

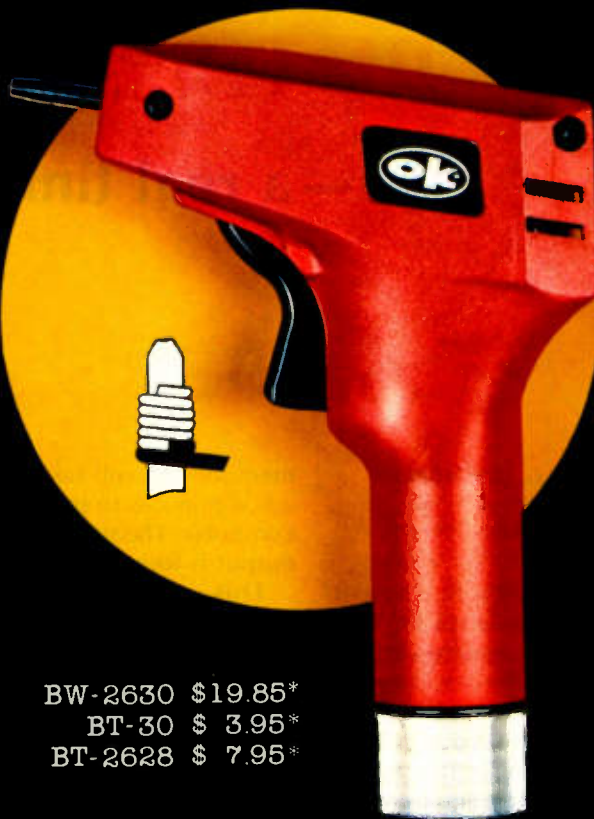

BW-2630 \$19.85*
BT-30 \$ 3.95*
BT-2628 \$ 7.95*

BW-2630 BATTERY TOOL

The new BW-2630 is a revolutionary battery powered wire-wrapping tool. The tool operates on 2 standard "C" size NiCad batteries (not included) and accepts either of two specially designed bits. Bit model BT-30 is for wrapping 30 AWG wire onto .025" square pins; BT-2628 wraps 26-28 AWG wire. Both produce the preferred "modified" wrap.

Designed for the serious amateur, BW-2630 even includes both positive indexing and anti-overwrapping mechanisms — features usually found only in industrial tools costing five times as much. Pistol grip design and rugged ABS construction assure performance and durability. In stock at local electronic retailers or directly from

OK Machine & Tool Corporation
3455 Conner St., Bronx, N.Y. 10475 U.S.A.
Tel. (212) 994-6600 Telex 125091

Minimum billings \$25.00, add shipping charge \$2.00
New York State residents add applicable tax

PL Tones from a KIM-1

— a real time wasting project

Steven G. Erdei WD8CHH
16005 Ramage Avenue
Maple Heights OH 44137

If you need a PL encoder for your base station VHF or UHF FM transceiver and own a KIM-1 microcomputer, then you need look no further than your KIM-1. The program in this article will generate a square-wave tone anywhere in the range of 191 Hz to 66 Hz. This program resides in page 0 of

memory and will take only a few minutes to put in the computer. The square-wave output is found on PA0.

This program simply wastes the precise amount of time necessary for tone generation by executing a large number of machine cycles before toggling the PA0 output. The precise frequency being generated is determined by the values in the locations labeled X1 and X2. These locations can

range in value from 00 to FF in hexadecimal notation.

To generate a tone in the range of 191 Hz to 98 Hz, use formula 1 as shown in Table 1. To generate a tone in the range of 98 Hz to 66 Hz, use formula 2. The values calculated should be used for X1 or X2, depending on the formula used. These values are approximations only and should be fine tuned on the air or with a very good fre-

quency counter.

The circuit shown in the figure is used to clean up and attenuate the audio tone generated at PA0. R2 should be adjusted in value to provide the proper amount of deviation of the transmitter. The connection from R2 should be made at the deviation control and not in the microphone circuit.

You will find that this encoder program works quite well, especially when considering the capability of changing tones just by changing two numbers in the program. I hope you have as much fun using this program as I have had in writing it. ■

```

0000 A9 01 LDA #01 SET UP PA0 FOR OUTPUT
0002 8D 01 17 STA 1701
0005 A9 FF LDA #FF FIRST DELAY LOOP
0007 85 D0 STA 00D0
0009 C6 D0 DEC 00D0
000B F0 03 BEQ 0010
000D 4C 09 00 JMP 0009
0010 A9 00 LDA #00 SECOND DELAY LOOP (VARIABLE X1)
0012 85 D0 STA 00D0
0014 C6 D0 DEC 00D0
0016 F0 03 BEQ 001B
0018 4C 14 00 JMP 0014
001B A9 01 LDA #01 THIRD DELAY LOOP (VARIABLE X2)
001D 85 D0 STA 00D0
001F C6 D0 DEC 00D0
0021 F0 03 BEQ 0026
0023 4C 1F 00 JMP 001F
0026 EE 00 17 INC 1700 TOGGLE PA0
0029 4C 05 00 JMP 0005 RETURN TO FIRST DELAY LOOP
    
```

Note: The program with variables X1 and X2 set as shown will generate a 110.9-Hz tone.

Program listing.

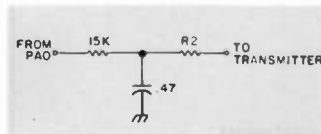

Fig. 1. PL interface.

1. First calculate the number of machine cycles required to generate the tone by the following formula: N (number of machine cycles) = $10^6/f$ (freq. of tone in Hz).
2. If the frequency is between 191 Hz and 98 Hz, then $X2 = 01$; calculate the value of $X1$ using formula 1: $X1 = N - 5174/20$. Convert the result obtained for $X1$ to hexadecimal notation and insert the values for $X1$ and $X2$ in memory.
3. If the frequency is between 98 Hz and 66 Hz, then $X1 = FF$; calculate the value of $X2$ using formula 2: $X2 = N - 10274/20$. Convert the result obtained for $X2$ to hexadecimal notation and insert the values for $X1$ and $X2$ in memory.

Table 1. Calculating tone frequency.

**MAKE
MONEY...
SELL
73 MAGAZINE**

Selling 73 Magazine, the ham radio magazine that offers quality and quantity, brings the ham into your store. Once through the door you can sell him anything.

Our dealers are telling us that "73" outsells them all... so call today and join the dealers who make money with 73 Magazine.

For information on selling 73 Magazine call 603-924-7296 and speak with Ginnie Boudrieau, our Bulk Sales Manager. Or write to her at:

73 MAGAZINE
80 PINE STREET
PETERBOROUGH NH 03458

ok



Wire Wrapping Kit

Model WK-6 is a unique new Wire Wrapping Kit that contains a complete range of tools and parts for prototype and hobby applications, all conveniently packaged in a handy, durable plastic carrying case.

The kit includes Model BW-630 battery wire wrapping tool complete with bit and sleeve; Model WSU-30, a remarkable new hand wire-wrapping/unwrapping/stripping tool; a universal PC board; an edge connector with wire-wrapping terminals; a set of PC card guides and brackets; a mini-shear with safety clip; industrial quality 14, 16, 24 and 40 pin DIP sockets; an assortment of wire-wrapping terminals; a DIP inserter; a DIP extractor and a unique 3-color wire dispenser complete with 60 feet each of red, white and blue Kynar® insulated, silver plated solid AWG 30 copper wire.

\$74.95*

OK Machine & Tool Corporation ✓ 54
3455 Conner St., Bronx, N.Y. 10475 U.S.A.
Tel. (212) 994-6600 Telex 125091

* Minimum billings \$25.00, add shipping charge \$2.00
New York State residents add applicable tax

 Pennwalt

Super Duper for Field Day

— system keeps the computer in a safe place

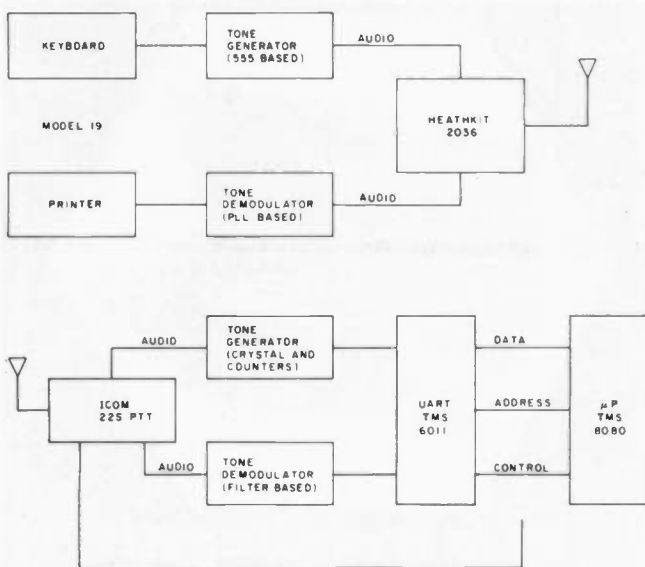

Fig. 1. Block diagram, equipment used.

David Hein WB5KVZ
2821 Chariot Lane
Garland TX 75042

Did you have enough of those dupe sheets last Field Day? Want to know a way to never have a dupe sheet bother you again, no matter how many new prefixes the FCC adds? Got someone in the club who has an 8080-based processor that keeps asking for some way to help? If you get resounding yeses to such questions at your Field Day reviews, then read on! Here is a stepping-stone towards automating the

drudgery of Field Day.

Described here is a remote automatic (except for IDing) dupe checker that was used recently for Field Day at K5OJI, Texins ARC. The trial system consisted of a Model 19 teleprinter on the FD site, a two-meter RTTY simplex radio link, and an 8080-based processor with 20K of RAM at the other end. With no modifications, this is enough for about 2000 contacts. Although the search-and-store routines are somewhat of a brute force approach, this setup will say GO/NO-GO before your regular dupe operator can find the right square to look in!

All commands are a single letter followed by the call in question and are terminated by a carriage return. The commands are:

- 1) C—check list for previous occurrence of call; report back GO/NO-GO for contact.
- 2) L—log call; report successful entry into table or prior presence.
- 3) R—remove call (oops, we didn't get him), report removal complete, or nothing by that call to remove.
- 4) B—band change; confirm band table now in use.



5) D—dummy; no return. Since all data sent to and received from the FD site is copied on the processor console, this command allows the FD crew to leave messages at the computer (see detailed description of program).

Look at the block diagram. Except for the interfacing around the processor, it is a standard simplex RTTY link. Any working RTTY equipment will do just fine.

System Requirements

Before describing the end result, it is worth reviewing the constraints such a typical system must operate under.

1) Remote intelligence. This system has a radio link because of one of the common components of Field Day—generators. Questions such as: Would you plug your Altair and precious floppies into an ac line that swings between 90 and 150 V ac and between 50 and 70 Hz?, or Where is your data when the lights go out?, point towards remoting the smarts. The ideal FD terminal is, however, a processor-driven video display operating from PROM. A Model 19 is too noisy for CW operators.

2) Data speed and format. As of this writing, the only mode to transmit data is half duplex Baudot code at its various slow speeds. No ASCII and no speeds above 100 wpm.

3) Speed. Since the data-link speed is slow, any foot-dragging in table lookup is unacceptable. The worked call signs must be speedily accessed, i.e., kept in main memory or maybe in floppy files. This program uses main memory.

Hardware Discussion

The interface to the computer is done through four output ports and two input ports. At output port 0F0H,

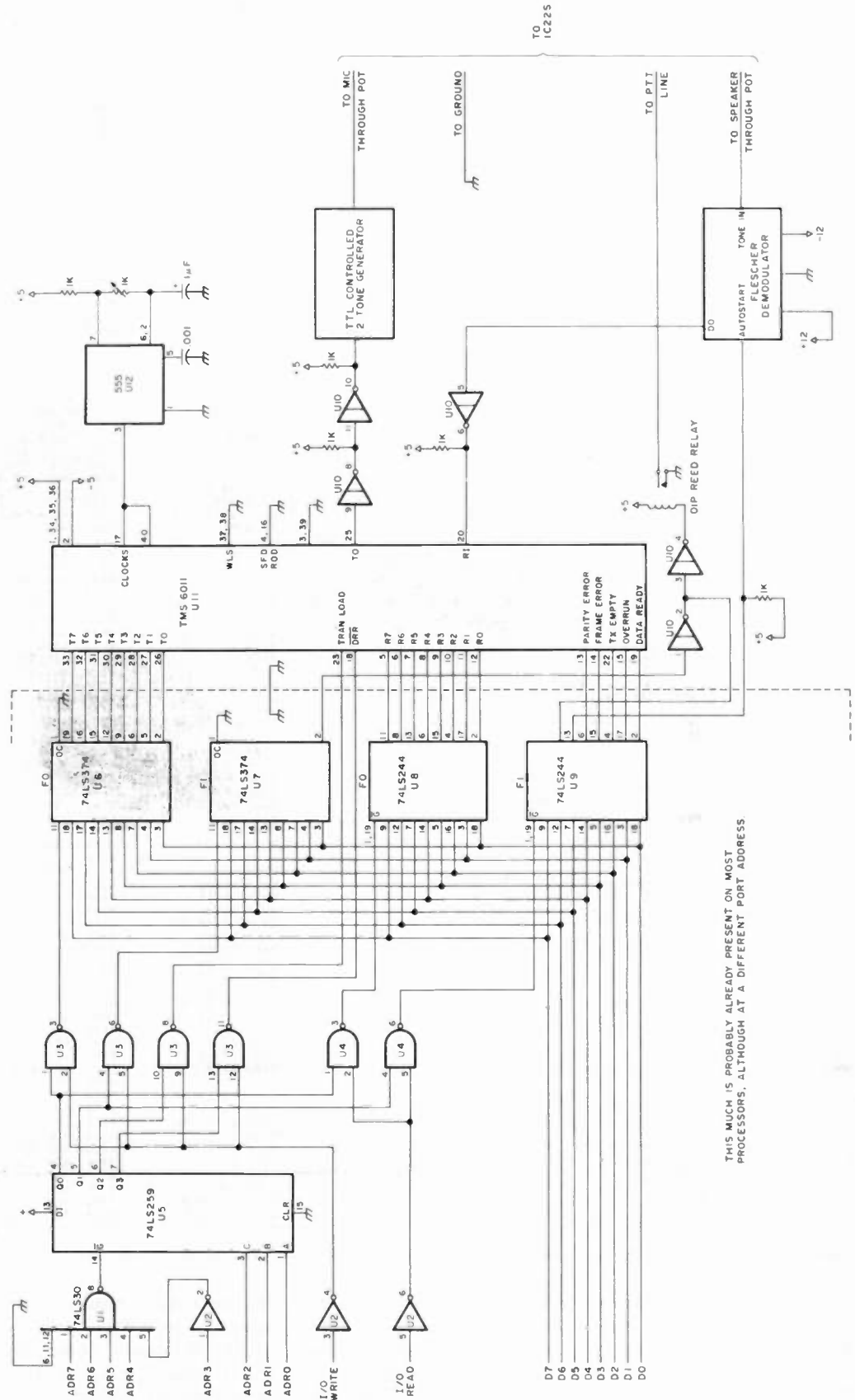

Fig. 2. Schematic: dupe checker tie-in to processor.

the computer transmits data to the UART. The data is 5-level Baudot code. One bit of output port 0F1H is used to control the reed

relay that turns on the transmitter. On output ports 0F2H and 0F3H, only the decoded strobes are used to pulse the UART for the

data-ready reset and for loading the transmitter buffer register.

Input port 0F0H is used to input the data from the

Program listing.

ASSM 0100 7000

```

0100      0001 *
0100      0002 * FIELD DAY LOGGING SYSTEM;
0100      0003 * PART I - DUPLICATE CHECKING
0100      0004 *
0100      0005 * 24 JUN 1978, BY DAVE HEIN
0100      0006 *
0100      0007 *
0100      0008 * USES A BAUDO CONVERSION ROUTINE BY
0100      0009 * JIM SZOT
0100      0010 *
0100      0011 * PORTS:
0100      0012 * F0=BAUDO DATA (IN AND OUT)
0100      0013 * F1=BAUDO STATUS (IN)
0100      0014 * F1=TRANSMIT CONTROL (OUT)
0100      0015 * F2=STR=UART LOAD
0100      0016 * F3=STR=UART DRR-
0100      0017 * JMP STARTI
0100      0018 *
0100      0019 * EQUATES
0100      0020 CONST EQU 01H
0100      0021 RTYST EQU 0F1H
0100      0022 RTYLA EQU 0F0H
0100      0023 TRAMP EQU 0F1H
0100      0024 SPCE EQU 20H
0100      0025 CR EQU 0DH
0100      0026 LF EQU 0AH
0100      0027 ERR EQU 00H
0100      0028 FOUR EQU 04H
0100      0029 TTYDA EQU 00H
0100      0030 TTYST EQU 01H
0100      0031 AUTO EQU 20H
0100      0032 LISEH EQU 4CH LIST END HIGH
0100      0033 LISEL EQU 00H LIST END LOW
0100      0034 *
0100      0035 *
0100      0036 * SUBROUTINES FIRST;
0100      0037 *
0100      0038 * SUBROUTINES BORROWED FROM MONITOR
0100      0039 * INCLUDED TO MAKE PGM SELF SUFFICIENT
0100      0040 *
0100      0041 * MOVEC=UTILITY TABLE MOVE ROUTINE
0100      0042 * DE=SOURCE BEGIN, BC=SOURCE END
0100      0043 * HL=DESTINATION START
0100      0044 MOVEC PUSH DE
0100      0045 PUSH BC
0100      0046 PUSH HL
0100      0047 DCX HL
0100      0048 CALL HILO CARRY=1 IF HL>DE
0100      0049 JC MOVEU IF SO, MOVE UP
0100      0050 MOVED POP BC IF NOT MOVE DOWN
0100      0051 POP DE
0100      0052 POP HL
0100      0053 MV0 MOV A,M GET A BYTE
0100      0054 STAX BC MOV TO NEW AREA
0100      0055 INX BC
0100      0056 CALL HILO DONE?
0100      0057 JNC MV0
0100      0058 RET
0100      0059 MOVEU POP BC
0100      0060 POP DE
0100      0061 POP HL
0100      0062 PUSH HL
0100      0063 DCX HL
0100      0064 CALL HILO CREATE LENGTH
0100      0065 LHLD FOUR
0100      0066 DAD BC END OF MOVED TABLE
0100      0067 PUSH HL
0100      0068 POP BC XCHG TO BC
0100      0069 POP HL
0100      0070 XCHG
0100      0071 MVI MOV A,M
0100      0072 STAX BC
0100      0073 DCX BC
0100      0074 DCX HL
0100      0075 DCX HL HL BUMPED IN HILO
0100      0076 CALL HILO
0100      0077 JC MVI
0100      0078 MOV A,M HL=DE
0100      0079 STAX BC
0100      0080 RET
0100      0081 *
0100      0082 HILO INX HL COMPARE HL,DE
0100      0083 MOV A,M IS HL=0?
0100      0084 ORA L
0100      0085 STC
0100      0086 RZ
0100      0087 MOV A,E
0100      0088 SUB L DE-HL
013F 32 04 00
0142 7A
0143 9C
0144 32 05 00
0147 C9
0148
0148 C5
0149 0E 0D
014B CD 55 01
014E 0E 0A
0150 CD 55 01
0153 C1
0154 C9
0155
0155 DB 01
0157 E6 04
0159 CA 55 01
015C 79
015D D3 00
015F C9
0160
0160 C5
0161 06 54
0163 05
0164 C2 63 01
0167 C1
0168 C9
0169
0169
0169
0169 FE 1B
016B CA 9A 01
016E FE 1F
0170 CA 92 01
0173 57
0174 3A B1 02
0177 B2
0178 21 39 02
017B 06 00
017D 4F
017E 09
017F 4E
0180 79
0181 FE 0A
0183 CA BE 01
0186 FE 0D
0188 CC 48 01
018B CD 55 01
018E 79
018F FE 20
0191 C0
0192 57
0193 3E 00
0195 32 B1 02
0198 7A
0199 C9
019A 57
019B 3E 20
019D 32 B1 02
01A0 7A
01A1 C9
01A2
01A2
01A2 5F
01A3 FE 07
01A5 CA F8 01
01A8 FE 0A
01AA CA 00 02
01AD FE 0D
01AF CA 05 02
01B2 FE 20
01B4 CA 0A 02
01B7 FE 00
01B9 CA 0F 02
01BC FE 5B
01BE D0
01BF FE 41
01C1 D2 D8 01
01C4 FE 21
01C6 D8
01C7 CD 1A 02
01CA 7B
01CB 21 92 02
01CE D6 21
01D0 06 00
01D2 4F
01D3 09
01D4 4E
01D5 C3 16 02
01D8 3A B2 02
01DB FE 20
0089 STA FOUR SAVE RESULT
0090 MOV A,D
0091 SBB H
0092 STA FOUR+1
0093 RET
0094 *
0095 CRLF PUSH BC CONSOLE CRLF
0096 MVI C,CR
0097 CALL C
0098 MVI C,LF
0099 CALL C
0100 POP BC
0101 RET
0102 *
0103 CO IN TTYST CONSOLE OUTPUT
0104 ANI 04H
0105 JZ C0
0106 MOV A,C
0107 OUT TTYDA
0108 RET
0109 *
0110 DELAY PUSH BC
0111 MVI B,54H
0112 DL0 DCR B
0113 JNZ DL0
0114 POP BC
0115 RET
0116 *
0117 * SUBROUTINES PARTICULAR TO THIS TASK
0118 *
0119 * TOASC: BAUDO TO ASCII TO CONSOLE
0120 TOASC CPI 1BH
0121 JZ FIG5
0122 CPI 1FH
0123 JZ LTRSH
0124 MOV D,A SAVE A
0125 LDA LTRF GET LETTER FLAG
0126 ORA 0 OR TOGETHER
0127 LXI HL,CV5T7
0128 MVI B,0
0129 MOV C,A
0130 DAD BC
0131 MOV C,M
0132 MOV A,C
0133 CPI LF
0134 JZ SKIP
0135 CPI CR
0136 CZ CRLF
0137 CALL C
0138 SKIP MOV A,C LTR SHFT ON SPCE
0139 CPI SPCE
0140 RNZ
0141 LTRSH MOV D,A SAVE A
0142 MVI A,0
0143 STA LTRF SET SHFT FOR LTRS
0144 MOV A,D RESTORE A
0145 RET
0146 FIG5 MOV D,A SAVE BAUDO
0147 MVI A,20H SET FIG5 FLAG
0148 STA LTRF
0149 MOV A,D RESTORE FOR ASCII IGNORE
0150 RET
0151 *
0152 * TOBAO: ASCII TO BAUDO TO RADIO
0153 *
0154 TOBAO MOV E,A SAVE ASCII
0155 CPI 07H
0156 JZ SBELL
0157 CPI 0AH
0158 JZ SLF
0159 CPI CR
0160 JZ SCR
0161 CPI SPCE SPECIAL ASCII
0162 JZ SSP
0163 CPI 00H
0164 JZ SNUL
0165 CPI 5BH CHECK FOR INVALIDS
0166 RNC
0167 CPI 41H
0168 JNC SALPH
0169 CPI 21H
0170 RC
0171 SFIGS CALL FIGST MAKE SURE IN FIGS
0172 MOV A,E
0173 LXI HL,C7T5F LOOK UP BAUDO CODE
0174 SUI 21H
0175 MVI B,0
0176 MOV C,A
0177 DAD BC TABLE LOOKUP
0178 MOV C,M
0179 JMP FINBO XMIT IT
0180 SALPH LDA LTRSF CHECK SHFT FLAG
0181 CPI 20H

```

UART that's coming in from the radio. The system status, including the autostart indicator, comes in on port 0F1H. Other more dedicated hookup methods surely are as viable, but this accessory is currently plugged into the general I/O board of the target processor.

The schematic provided will not work directly on an

S-100-based processor. The target machine is a homebrew 8080-based machine with an 8228 system controller for decoding the status signals. The main purpose of the schematic is to back up the listing, i.e., to show what the program was working with.

Program Explanation

Lines 019-033: These are

the necessary equates of names to numbers. Included are I/O ports, common ASCII characters, buffer areas (FOUR), and the end of the call table area (in two parts to make end checks easier). The call table area starts at the end of the object for the program and ends at LISEH, LISEL.

Lines 041-093: MOVEC is

the callable part of the move monitor command used in the target processor. It opens or closes holes in the call table to add or remove calls from the table. When moving up the rest of the table to create a hole in the list, the move is done from the end to the beginning to avoid filling the memory with the same callsign. When squeezing a

```

01DD CA EA 01      0182 JZ NSM2
01E0 3E 20      0183 MVI A,20H
01E2 32 B2 02    0184 STA LTRSF SET TO LETTERS
01E5 0E 1F      0185 MVI C,1FH AND XMIT LTRS CODE
01E7 CD 2C 02    0186 CALL IOOUT
01EA 7B          0187 NSM2 MOV A,E RESTORE ASCII IN A
01EB 21 78 02    0188 LXI HL,C7T5L TABLE LOOKUP
01EE D6 41      0189 SUI 41H LOW GROUP
01F0 06 00      0190 MVI B,0
01F2 4F          0191 MOV C,A
01F3 09          0192 DAD BC
01F4 4E          0193 MOV C,M GET CODE
01F5 C3 16 02    0194 JMP FINBO XMIT IT
01F8 CD 1A 02    0195 SBELL CALL FIGST IN FIGS?
01FB 0E 05      0196 MVI C,5 BAUDO BELL
01FD C3 16 02    0197 JMP FINBO
0200 0E 02      0198 SLF MVI C,2 BLF
0202 C3 16 02    0199 JMP FINBO
0205 0E 08      0200 SCR MVI C,8 BCR
0207 C3 16 02    0201 JMP FINBO
020A 0E 04      0202 SSP MVI C,4 BSPCE
020C C3 16 02    0203 JMP FINBO
020F 0E 00      0204 SNUL MVI C,0
0211 CD 2C 02    0205 SHOUT CALL IOOUT SEND IT THEN
0214 0E 1F      0206 MVI C,1FH LTRS CODE
0216 CD 2C 02    0207 FINBO CALL IOOUT SEND IT THEN
0219 C9          0208 RET
021A 3A B2 02    0209 FIGST LDA LTRSF FIGS MODE?
021D FE 00      0210 CPI 00H
021F C8          0211 RZ
0220 3E 00      0212 MVI A,0
0222 32 B2 02    0213 STA LTRSF ZERO FLAG
0225 0E 1B      0214 MVI C,1BH AND XMIT FIGS
0227 CD 2C 02    0215 CALL IOOUT
022A 7B          0216 MOV A,E RESTORE ASCII
022B C9          0217 RET
022C DB F1      0218 IOOUT IN RTYST
022E E6 04      0219 ANI 00H
0230 CA 2C 02    0220 JZ IOOUT
0233 79          0221 MOV A,C
0234 D3 F0      0222 OUT RTYDA
0236 D3 F2      0223 OUT 0F2H STROBE TBRL
0238 C9          0224 RET
0239             0225 *
0239             0226 * LOOKUP TABLES
0239             0227 *
0239             0228 CVST7 EQU $ ASCII TO BAUDO
0239 00          0229 DB 00
023A 45          0230 DB 'E'
023B 0A          0231 DB LF
023C 41          0232 DB 'A'
023D 20          0233 DB SPCE
023E 53 49      0234 DW 'IS'
0240 55          0235 DB 'U'
0241 0D          0236 DB CR
0242 44 52      0237 DW 'RD'
0244 4A 4E      0238 DW 'NJ'
0246 46 43      0239 DW 'CF'
0248 4B 54      0240 DW 'TK'
024A 5A 4C      0241 DW 'LZ'
024C 57 48      0242 DW 'HW'
024E 59 50      0243 DW 'PY'
0250 51 4F      0244 DW 'OQ'
0252 42 47      0245 DW 'GB'
0254 00          0246 DB ERR
0255 4D 58      0247 DW 'XM'
0257 56          0248 DB 'V'
0258 00          0249 DB ERR
0259 00          0250 DB 0
025A 33          0251 DB '3'
025B 0A          0252 DB LF
025C 2D 20      0253 DW ' '
025E 07          0254 DB 07H BELL
025F 38 37      0255 DW '78'
0261 0D          0256 DB CR
0262 24 34      0257 DW '45'
0264 27          0258 DB 27H
0265 2C 21      0259 DW '1.'
0267 3A 28      0260 DW '1.'
0269 35 22      0261 DW '5.'
026B 29 32      0262 DW '2.'
026D 23 36      0263 DW '6.'
026F 30 31      0264 DW '10'
0271 39 3F      0265 DW '79'
0273 26          0266 DB 'A'
0274 00          0267 DB ERR
0275 2E 3B      0268 DW '1.'
0277 00          0269 DB ERR
0278             0270 C7T5L EQU $ ASCII TO BAUDO (LETTERS)
0278 03          0271 DB 3 A
0279 19          0272 DB 25
027A 0E          0273 DB 14
027B 09          0274 DB 9
027C 01          0275 DB 1
027D 0D          0276 DB 13
027E 1A          0277 DB 26
027F 14          0278 DB 20
0280 06          0279 DB 6
0281 0B          0280 DB 11
0282 0F          0281 DB 15
0283 12          0282 DB 18
0284 1C          0283 DB 28
0285 0C          0284 DB 12
0286 18          0285 DB 24
0287 16          0286 DB 22
0288 17          0287 DB 23
0289 0A          0288 DB 10
028A 05          0289 DB 5
028B 10          0290 DB 16
028C 07          0291 DB 7
028D 1E          0292 DB 30
028E 13          0293 DB 19
028F 1D          0294 DB 29
0290 15          0295 DB 21
0291 11          0296 DB 17 Z
0292             0297 C7T5F EQU $ ASCII TO BAUDO (FIGS)
0292 0D          0298 DB 13 I
0293 11          0299 DB 17 "
0294 14          0300 DB 20 #
0295 09          0301 DB 9 $
0296 00          0302 DB 00 %-NULL
0297 1A          0303 DB 26 &
0298 0B          0304 DB 11 '
0299 0F          0305 DB 15 (
029A 12          0306 DB 18 )
029B 00          0307 DB 00 *-NUL
029C 00          0308 DB 00 *-NULL
029D 0C          0309 DB 12 ,
029E 03          0310 DB 3 -
029F 1C          0311 DB 28 .
02A0 1D          0312 DB 29 /
02A1 16          0313 DB 22 0
02A2 17          0314 DB 23 1
02A3 13          0315 DB 19 2
02A4 01          0316 DB 1 3
02A5 0A          0317 DB 10 4
02A6 10          0318 DB 16 5
02A7 15          0319 DB 21 6
02A8 07          0320 DB 7 7
02A9 06          0321 DB 6 8
02AA 18          0322 DB 24 9
02AB 0E          0323 DB 14 ;
02AC 1E          0324 DB 30 :
02AD 00          0325 DB 00 <-NULL
02AE 00          0326 DB 00 >-NULL
02AF 00          0327 DB 00 >>-NULL
02B0 19          0328 DB 25 ?
02B1 00          0329 LTRF DB 00 INIT TO LTRS
02B2 00          0330 LTRSF DB 00 INIT TO LTRS
02B3             0331 *
02B3 3E FF      0332 TOFF MVI A,0FFH
02B5 D3 F1      0333 OUT TRANP
02B7 C9          0334 RET
02B8             0335 *
02B8 DB F1      0336 TON IN RTYST
02BA E6 40      0337 ANI 00H
02BC C0          0338 RNZ ALREADY ON
02BD 3E FE      0339 MVI A,0FEH
02BF D3 F1      0340 OUT TRANP
02C1 CD C5 02   0341 CALL DLY2
02C4 C9          0342 RET
02C5             0343 *
02C5 C5          0344 DLY2 PUSH BC 4 X .25 SEC
02C6 06 04      0345 MVI B,4
02C8 C5          0346 DLY2L PUSH BC
02C9 CD D3 02   0347 CALL DLY1
02CC C1          0348 POP BC
02CD 05          0349 DCR B
02CE C2 C8 02   0350 JNZ DLY2L
02D1 C1          0351 POP BC RESTORE ORIG BC
02D2 C9          0352 RET
02D3             0353 *
02D3 06 FA      0354 DLY1 MVI B,250 .25 SEC
02D5 CD 00 01   0355 DLY1L CALL DELAY
02D8 05          0356 DCR B
02D9 C2 D5 02   0357 JNZ DLY1L
02DC C9          0358 RET
02DD             0359 *
02DD 00          0360 BI NOP
02DE 00          0361 NOP
02DF 00          0362 NOP PATCH JUMP
02E0 DB F1      0363 IN RTYST
02E2 E6 20      0364 ANI AUTO
02E4 C2 0A 04   0365 JNZ STARI

```

call out of the buffer, the move starts at the beginning of the table. HILO is a subroutine used to compare register pairs HL and DE to see if the move is over. In performing the comparison, HILO computes the difference (saved at FOUR), a feature useful in calculating where to start on a move up, or to end a move down.

Lines 095-108: These two routines are used to put a CRLF on the target machine's console device between commands. All data sent on the radio channel is echoed to the console device through the CO routine for monitoring purposes.

Lines 110-115: DELAY is used to hold up the answer

for a specified time after the RTTY tones leave the air. This gives the operator (or machine) at the FD site time to throw the T-R switch.

Lines 119-150: TOASC is the Baudot-to-ASCII character converter. This uses a table lookup (CV5T7, 228-269) with a LTRS-FIGS flag called LTRF. The

Baudot code and the flag value are added to the table start address to indirectly get the ASCII code. This routine unshifts on space automatically.

Lines 154-224: TOBAO converts ASCII to Baudot and sends the character out to the UART. Because any character converted has no use if not transmitted, this

| | | | |
|---------------|--|---------------|---|
| 02E7 DB F1 | 0366 BII IN RTYST | 037E | 0458 * |
| 02E9 E6 01 | 0367 ANI 0IH | 037E 21 B6 03 | 0459 FBUF LXI HL,CBUF HANDLES CALL BUFFER |
| 02EB CA DD 02 | 0368 JZ BI | 0381 06 06 | 0460 MVI B,6 |
| 02EE DB F1 | 0369 IN RTYST | 0383 E5 | 0461 CHK3 PUSH HL |
| 02F0 E6 20 | 0370 ANI AUTO STILL THERE | 0384 C5 | 0462 PUSH BC |
| 02F2 C2 0A 04 | 0371 JNZ STARI | 0385 CD DD 02 | 0463 CALL BI QUILTS IF AUTO LEAVES |
| 02F5 DB F0 | 0372 IN RTYDA | 0388 C1 | 0464 POP BC |
| 02F7 D3 F3 | 0373 OUT 0F3H STROBE DRR- | 0389 E1 | 0465 POP HL |
| 02F9 E6 1F | 0374 ANI IFH | 038A FE 2E | 0466 CPI ',' RUBOUT CHAR |
| 02FB CD 69 01 | 0375 CALL TOASC RETURNED IN A | 038C C2 9A 03 | 0467 JNZ CHK8 |
| 02FE FE 1F | 0376 CPI IFH DO NOT RTN FIGS | 038F 2B | 0468 DCX HL |
| 0300 CA DD 02 | 0377 JZ BI BUT TOASC NEEDS IT | 0390 04 | 0469 INR B BACK UP ONE CHAR |
| 0303 FE 1B | 0378 CPI 1BH | 0391 78 | 0470 MOV A,B |
| 0305 CA DD 02 | 0379 JZ BI FIGS NEITHER | 0392 FE 07 | 0471 CPI 07H WIPE OUT COMMAND T007 |
| 0308 C9 | 0380 RET | 0394 CA 0A 04 | 0472 JZ STARI CLEAN OFF STACK |
| 0309 | 0381 * | 0397 C3 83 03 | 0473 JMP CHK3 |
| 0309 DB F1 | 0382 BMESS IN RTYST B=CHARS,HL=START | 039A FE 0D | 0474 CHK8 CPI CR |
| 030B E6 20 | 0383 ANI AUTO | 039C C2 A6 03 | 0475 JNZ CHK5 NOT CR |
| 030D CA 09 03 | 0384 JZ BMESS | 039F 78 | 0476 MOV A,B IS IT CR AT 1ST CHAR |
| 0310 CD B8 02 | 0385 CALL TON | 03A0 FE 06 | 0477 CPI 06H IF SO RETURN |
| 0313 7E | 0386 BLP MOV A,M | 03A2 C8 | 0478 RZ BUFFER UNTOUCHED |
| 0314 E5 | 0387 PUSH HL | 03A3 C3 AD 03 | 0479 JMP CHK1 |
| 0315 C5 | 0388 PUSH BC | 03A6 77 | 0480 CHK5 MOV M,A |
| 0316 4F | 0389 MOV C,A | 03A7 23 | 0481 INX HL |
| 0317 CD 55 01 | 0390 CALL CO | 03A8 05 | 0482 DCR B |
| 031A 79 | 0391 MOV A,C | 03A9 C8 | 0483 RZ |
| 031B CD A2 01 | 0392 CALL TOBAO CONVERT AND SEND | 03AA C3 83 03 | 0484 JMP CHK3 |
| 031E C1 | 0393 POP BC | 03AD 3E 20 | 0485 CHK1 MVI A,' ' |
| 031F E1 | 0394 POP HL | 03AF 77 | 0486 MOV M,A ON CR FILL REST OF BUFFER |
| 0320 05 | 0395 DCR B | 03B0 23 | 0487 INX HL |
| 0321 C8 | 0396 RZ REMEMBER TO TOFF | 03B1 05 | 0488 DCR B |
| 0322 23 | 0397 INX HL | 03B2 C8 | 0489 RZ |
| 0323 C3 13 03 | 0398 JMP BLP | 03B3 C3 AD 03 | 0490 JMP CHK1 |
| 0326 | 0399 * | 03B6 | 0491 * |
| 0326 7E | 0400 COMP MOV A,M B LONG,HL MASTER,DE COPY | 03B6 | 0492 * DATA WORDS |
| 0327 FE 00 | 0401 CPI 0 NOT EQ, AND ZEROS COUNTED | 03B6 | 0493 * |
| 0329 CC 38 03 | 0402 CZ INRZ | 03B8 5A 5A | 0494 CBUF DW 'ZZ' INITIALIZE CHARACTER BUFFER |
| 032C 1A | 0403 LDAX DE | 03BA 5A 5A | 0495 DW 'ZZ' |
| 032D BE | 0404 CMP M | 03BC 06 05 | 0496 DW 'ZZ' |
| 032E C4 41 03 | 0405 CNZ INRNE | 03BE 0D | 0497 CLIST DW DTAB*6 INITIALIZE TO BAND=A |
| 0331 13 | 0406 INX DE | 03BF 00 | 0498 ASTR DB CR |
| 0332 23 | 0407 INX HL | 03C0 0A | 0499 DB 0 FOR TTY |
| 0333 05 | 0408 DCR B | 03C1 0D | 0500 DB LF |
| 0334 C2 26 03 | 0409 JNZ COMP | 03C2 20 44 | 0501 DB CR |
| 0337 C8 | 0410 RZ | 03C4 55 50 | 0502 DW 'D' |
| 0338 3A 40 03 | 0411 INRZ LDA ZEROS | 03C6 20 | 0503 DW 'PU' |
| 033B 3C | 0412 INR A | 03C7 0D | 0504 DB ' ' |
| 033C 32 40 03 | 0413 STA ZEROS | 03C8 00 | 0505 BSTR DB CR |
| 033F C9 | 0414 RET | 03C9 0A | 0506 DB 0 FOR TTY |
| 0340 00 | 0415 ZEROS DB 0 | 03CA 0D | 0507 DB LF |
| 0341 3A 49 03 | 0416 INRNE LDA NOTEQ | 03CB 20 4F | 0508 DB CR |
| 0344 3C | 0417 INR A | 03CD 4B 20 | 0509 DW 'O' |
| 0345 32 49 03 | 0418 STA NOTEQ | 03CF 0D | 0510 DW 'K' |
| 0348 C9 | 0419 RET | 03D0 00 | 0511 CSTR DB CR |
| 0349 00 | 0420 NOTEQ DB 0 | 03D1 0A | 0512 DB 0 FOR TTY |
| 034A | 0421 * | 03D2 0D | 0513 DB LF |
| 034A 3E 00 | 0422 SRCH MVI A,0 | 03D3 20 4E | 0514 DB CR |
| 034C 32 40 03 | 0423 STA ZEROS | 03D5 4F 54 | 0515 DW 'N' |
| 034F 32 49 03 | 0424 STA NOTEQ | 03D7 20 49 | 0516 DW 'TO' |
| 0352 C5 | 0425 PUSH BC B=STRING LENGTH | 03D9 4E 20 | 0517 DW 'I' |
| 0353 CD 26 03 | 0426 CALL COMP HL=LIST OF STRINGS | 03DB 4C 49 | 0518 DW 'N' |
| 0356 C1 | 0427 POP BC DE=FIXED STRING | 03DD 53 54 | 0519 DW 'IL' |
| 0357 2B | 0428 DCX HL RETURNS CY IF GOT TO NEXT BOUNDARY | 03DF 2E 20 | 0520 DW 'TS' |
| 0358 2B | 0429 DCX HL RETURNS Z IF STRING FOUND | 03E1 0D | 0521 DW ' ' |
| 0359 2B | 0430 DCX HL REGS POINT TO BEGIN | 03E2 00 | 0522 DSTR DB CR |
| 035A 2B | 0431 DCX HL OF LAST COMPARE | 03E3 0A | 0523 DB 0 FOR TTY |
| 035B 2B | 0432 DCX HL | 03E4 0D | 0524 DB LF |
| 035C 2B | 0433 DCX HL | 03E5 20 42 | 0525 DB CR |
| 035D 1B | 0434 DCX DE | 03E7 41 4E | 0526 DW 'B' |
| 035E 1B | 0435 DCX DE | 03E9 44 3D | 0527 DW 'NA' |
| 035F 1B | 0436 DCX DE | 03EB 0D | 0528 DW 'D' |
| 0360 1B | 0437 DCX DE | 03EC 00 | 0529 ESTR DB CR |
| 0361 1B | 0438 DCX DE | 03ED 0A | 0530 DB 0 FOR TTY |
| 0362 1B | 0439 DCX DE | 03EF 20 4E | 0531 DB LF |
| 0363 3A 40 03 | 0440 LDA ZEROS | 03F1 4F 20 | 0532 DB CR |
| 0366 B7 | 0441 ORA A | 03F3 42 41 | 0533 DW 'N' |
| 0367 CA 6C 03 | 0442 JZ SRCHI NO ZEROS ON HL STRING | 03F5 4E 44 | 0534 DW 'O' |
| 036A 37 | 0443 STC YES THERE ARE | 03F7 3D | 0535 DW 'AB' |
| 036B C9 | 0444 RET | 03F8 0D | 0536 DW 'DN' |
| 036C 3A 49 03 | 0445 SRCHI LDA NOTEQ | 03F9 00 | 0537 DB ' ' |
| 036F B7 | 0446 ORA A | 03FA 0A | 0538 FSTR DB CR |
| 0370 C8 | 0447 RZ RET IF ALL 6 CHARS EQ | 03FB 0D | 0539 DB 0 FOR TTY |
| 0371 CD 77 03 | 0448 CALL AD6HL | 03FC 41 4C | 0540 DB LF |
| 0374 C3 4A 03 | 0449 JMP SRCH | 03FE 52 45 | 0541 DB CR |
| 0377 | 0450 * | 0400 41 44 | 0542 DW 'LA' |
| 0377 23 | 0451 AD6HL INX HL | 0402 59 20 | 0543 DW 'ER' |
| 0378 23 | 0452 INX HL | 0404 54 48 | 0544 DW 'DA' |
| 0379 23 | 0453 INX HL | 0406 45 52 | 0545 DW 'Y' |
| 037A 23 | 0454 INX HL | 0408 45 20 | 0546 DW 'HT' |
| 037B 23 | 0455 INX HL | 040A | 0547 DW 'RE' |
| 037C 23 | 0456 INX HL | | 0548 DW 'E' |
| 037D C9 | 0457 RET | | 0549 GSTR EQU 5 |

routine assumes the radio is in transmit and proceeds to send the characters as they are converted. The conversion uses a separate two-part table, half for FIGS (C7T5F) and half for LTRS (C7T5L). There also is a separate shift flag for this conversion called LTRSF.

Using two tables is admittedly not memory-efficient, but the tables are not

that big and the program runs faster with a direct lookup each way. Running fast makes it easier later to add more tasks or features without incurring timing conflicts.

Lines 228-330: These are the tables themselves, requiring 78H words. At the end are the two flags for LTRS and FIGS for conversion each way.

Lines 332-334: TOFF sends all ones to the port controlling the transmitter. A one turns the transmitter off (see schematic).

Lines 336-342: TON sends a low to the bit of the port that turns the transmitter on, then calls a delay routine that causes one second of tone before any text is sent. This is only to ensure

that the receiving end has time to set up. If your receiving end is manual, you may want to lengthen it by changing the MVI B,X in line 345 to four times the number of seconds necessary.

Lines 354-358: These are nested delay routines that tie up the processor for certain periods of time decre-

```

040A      0550 *
040A      0551 *
040A      0552 * MAIN PARSER--LOGER
040A      0553 *
040A      0554 *
040A 31 00 01 0555 STARI LXI SP,0100H RESTART STACK
040D 3E 00 0556 MVI A,00H
040F 32 B1 02 0557 STA LTRF START IN LETTERS
0412 32 B2 02 0558 STA LTRSF
0415 CD B3 02 0559 START CALL TOFF
0418 CD DD 02 0560 CALL BI
041B FE 43 0561 CPI 'C'
041D CA 37 04 0562 JZ CHECK
0420 FE 4C 0563 CPI 'L'
0422 CA 6F 04 0564 JZ LOG
0425 FE 42 0565 CPI 'B'
0427 CA A9 04 0566 JZ BAND
042A FE 44 0567 CPI 'D'
042C CA E7 04 0568 JZ DUMMY
042F FE 52 0569 CPI 'R'
0431 CA ED 04 0570 JZ REMOV
0434 C3 15 04 0571 JMP START
0437      0572 *
0437 CD 7E 03 0573 CHECK CALL FBUF
043A 21 B6 03 0574 LXI HL,CBUF
043D EB      0575 XCHG TO DE
043E 2A BC 03 0576 LHLD CLIST
0441 06 06 0577 MVI B,6
0443 CD 4A 03 0578 CALL SRCH
0446 DA 54 04 0579 JC RPOK NOT HERE
0449 21 BE 03 0580 LXI HL,ASTR HERE
044C 06 09 0581 MVI B,BSTR-ASTR
044E CD 09 03 0582 CALL BMESS
0451 C3 5C 04 0583 JMP CHK4
0454 21 C7 03 0584 RPOK LXI HL,BSTR
0457 06 08 0585 MVI B,CSTR-BSTR
0459 CD 09 03 0586 CALL BMESS
045C 21 B6 03 0587 CHK4 LXI HL,CBUF
045F 06 06 0588 MVI B,6
0461 CD 13 03 0589 CALL BLP AUTO WILL BE ON FROM XMIT
0464 21 BE 03 0590 LXI HL,ASTR
0467 06 04 0591 MVI B,4 **PARTING CHAR-CR,0,LF,CR**
0469 CD 13 03 0592 CALL BLP AUTO AGAIN
046C C3 15 04 0593 JMP START
046F      0594 *
046F CD 7E 03 0595 LOG CALL FBUF
0472 21 B6 03 0596 LXI HL,CBUF
0475 EB      0597 XCHG
0476 2A BC 03 0598 LHLD CLIST
0479 06 06 0599 MVI B,6
047B CD 4A 03 0600 CALL SRCH FIND HOLE
047E CA 9E 04 0601 JZ LOG1
0481 E5      0602 PUSH HL
0482 5D      0603 MOV E,L
0483 54      0604 MOV D,H DE-BEGIN
0484 06 4C 0605 MVI B,LISEH BC-END
0486 0E 00 0606 MVI C,LISEL
0488 CD 77 03 0607 CALL AD6HL
048B CD 03 01 0608 CALL MOVEC
048E 21 BB 03 0609 LXI HL,CBUF+5
0491 44      0610 MOV B,H
0492 4D      0611 MOV C,L
0493 21 B6 03 0612 LXI HL,CBUF
0496 EB      0613 XCHG
0497 E1      0614 POP HL SAVED AFTER SEARCH
0498 CD 03 01 0615 CALL MOVEC
049B C3 54 04 0616 JMP RPOK
049E 21 F8 03 0617 LOG1 LXI HL,FSTR
04A1 06 12 0618 MVI B,GSTR-FSTR
04A3 CD 09 03 0619 CALL BMESS
04A6 C3 5C 04 0620 JMP CHK4
04A9      0621 *
04A9 CD 7E 03 0622 BAND CALL FBUF
04AC 21 15 04 0623 LXI HL,START NO WAY TO MATCH
04AF EB      0624 XCHG
04B0 21 5A 05 0625 LXI HL,DTAB LOOKING FOR BOUNDARIES
04B3 06 06 0626 BAND2 MVI B,6
04B5 CD 4A 03 0627 CALL SRCH
04B8 3A B6 03 0628 LDA CBUF MUST COME BACK W/ CARRY
04BB BE      0629 CMP M CHAR OF BOUNDARY
04BC CA CB 04 0630 JZ BAND1 NEW BAND
04BF 7E      0631 MOV A,M ALL THRU
04C0 FE 00 0632 CPI 0
04C2 CA DC 04 0633 JZ BAND3
04C5 CD 77 03 0634 CALL AD6HL
04C8 C3 B3 04 0635 JMP BAND2
04CB CD 77 03 0636 BAND1 CALL AD6HL
04CE 22 BC 03 0637 SHLD CLIST
04D1 21 E1 03 0638 LXI HL,DSTR
04D4 06 0A 0639 MVI B,ESTR-DSTR
04D6 CD 09 03 0640 CALL BMESS
04D9 C3 5C 04 0641 JMP CHK4

04DC 21 EB 03 0642 BAND3 LXI HL,ESTR
04DF 06 0D 0643 MVI B,FSTR-ESTR
04E1 CD 09 03 0644 CALL BMESS
04E4 C3 5C 04 0645 JMP CHK4
04E7      0646 *
04E7 CD DD 02 0647 DUMMY CALL BI
04EA C3 E7 04 0648 JMP DUMMY
04ED      0649 *
04ED CD 7E 03 0650 REMOV CALL FBUF
04F0 21 B6 03 0651 LXI HL,CBUF
04F3 EB      0652 XCHG
04F4 2A BC 03 0653 LHLD CLIST
04F7 06 06 0654 MVI B,6
04F9 CD 4A 03 0655 CALL SRCH
04FC DA 0F 05 0656 JC REMO1 NOT THERE
04FF E5      0657 PUSH HL
0500 CD 77 03 0658 CALL AD6HL
0503 EB      0659 XCHG
0504 06 4C 0660 MVI B,LISEH BC-END
0506 0E 00 0661 MVI C,LISEL
0508 E1      0662 POP HL
0509 CD 03 01 0663 CALL MOVEC
050C C3 54 04 0664 JMP RPOK
050F 21 CF 03 0665 REMO1 LXI HL,CSTR
0512 06 12 0666 MVI B,DSTR-CSTR
0514 CD 09 03 0667 CALL BMESS
0517 C3 5C 04 0668 JMP CHK4
051A      0669 *
051A      0670 DS 64 PATCH AREA
051A      0671 *
051A      0672 *
051A      0673 *
051A      0674 * DATA TABLE STARTS HERE
051A      0675 *
051A      0676 *
051A 41      0677 DTAB DB 'A'
055B 00      0678 NOP
055C 00 00 0679 DW 0
055E 00 00 0680 DW 0
0560 42      0681 DB 'B'
0561 00      0682 NOP
0562 00 00 0683 DW 0
0564 00 00 0684 DW 0
0566 43      0685 DB 'C'
0567 00      0686 NOP
0568 00 00 0687 DW 0
056A 00 00 0688 DW 0
056C 44      0689 DB 'D'
056D 00      0690 NOP
056E 00 00 0691 DW 0
0570 00 00 0692 DW 0
0572 45      0693 DB 'E'
0573 00      0694 NOP
0574 00 00 0695 DW 0
0576 00 00 0696 DW 0
0578 46      0697 DB 'F'
0579 00      0698 NOP
057A 00 00 0699 DW 0
057C 00 00 0700 DW 0
057E 47      0701 DB 'G'
057F 00      0702 NOP
0580 00 00 0703 DW 0
0582 00 00 0704 DW 0
0584 48      0705 DB 'H'
0585 00      0706 NOP
0586 00 00 0707 DW 0
0588 00 00 0708 DW 0
058A 49      0709 DB 'I'
058B 00      0710 NOP
058C 00 00 0711 DW 0
058E 00 00 0712 DW 0
0590 4A      0713 DB 'J'
0591 00      0714 NOP
0592 00 00 0715 DW 0
0594 00 00 0716 DW 0
0596 4B      0717 DB 'K'
0597 00      0718 NOP
0598 00 00 0719 DW 0
059A 00 00 0720 DW 0
059C 4C      0721 DB 'L'
059D 00      0722 NOP
059E 00 00 0723 DW 0
05A0 00 00 0724 DW 0
05A2 4D      0725 DB 'M'
05A3 00      0726 NOP
05A4 00 00 0727 DW 0
05A6 00 00 0728 DW 0
05A8      0729 * END RECORD
05A8 00 00 0730 DW 0
05AA 00 00 0731 DW 0
05AC 00 00 0732 DW 0
NEWP

```

menting registers. They use the B register several times by pushing and popping it.

Lines 360-380: The BI routine is a single character in routine for Baudot from the radio circuits. At the front is a three-byte patch space for putting in a jump to another temporary data source, intended for checkout. Then follows a strong check for

the presence of the auto-start. If at any time this routine senses that the tones have left the air, it causes dupe checker to abandon whatever command it was executing. It keeps the current band and table pointers, but it goes back to the main parser (command decode) and resets the stack pointer. With this feature, if the user gets con-

fused about what's happening, before he enters a (CR) to activate a command, he can inactivate it by just dropping off the air. BI calls TOASC so that it returns ASCII to the calling routine in register A.

Lines 382-398: BMESS is a routine for sending ASCII characters from a buffer out on the air. HL must point to the buffer to be

sent, and register B must contain the number of characters to be sent. Just before the first character is sent through BMESS, TON is called, turning on the transmitter. Since there most likely will be multiple uses of BMESS for each total message, BMESS does not turn off the transmitter; the calling routine must do so.

```

LIST
0100
0110
0120
0130
0140
0150
0160
0170
0180
0190
0200
0210
0220
0230
0240
0250
0260
0270
0280
0290
0300
0310
0320
0330
0340
0350
0360
0370
0380
0390
0400
0410
0420
0430
0440
0450
0460
0470
0480
0490
0500
0510
0520
0530
0540
0550
0560
0570
0580
0590
0600
HERE IS SOME SIMULATED OUTPUT OF THE PROGRAM AS IT
WOULD APPEAR ON THE CONSOLE OF THE TARGET PROCESSOR.
THE LEFT JUSTIFIED LINES COME FROM THE FIELD, THE
INDENTED LINES ARE PROCESSOR ANSWERS.
THE COMMENTS, OF COURSE, ARE ADDED HERE
FOR EXPLANATION.
BA
BAND=A      ESTABLISH BAND
CWB5ABC     CHECK TABLE FOR THIS CALL
OK WB5ABC   THIS CALL OK
LWB5ABC     LOG IT
CWB5ABC     LOGGED
OK WB5ABC   TRY IT AGAIN
DUP WB5ABC  ALREADY THERE
RWB5ABC     REMOVE IT
OK WB5ABC   REMOVE
CWB5ABC     NOW CHECK IT AGAIN
OK WB5ABC   NOW OK TO WORK AGAIN
LWB5ABC     LOG IT AGAIN
OK WB5ABC   LOGGED
R           REMOVE IT (SHORTHAND FORM)
OK WB5ABC   REMOVE AGAIN
C           CHECK IT AGAIN, WB5ABC STILL IN CALL BUFFER
OK WB5ABC   OK TO WORK AGAIN
BD
BAND=D
LWIAEL     OK WIAEL
LWBLT     OK WBLT
*****NOW HERE ARE EXAMPLES OF COMMON ERRORS
WBLT       L=LOG PICKED OUT OF CALL
OK T
R           REMOVE THAT GARBAGE (T)
OK T       B=BAND CHANGE PICKED OUT OF PREFIX
WB5KUZ     NO BAND=SKUZ
WASROF     R=REMOVE CALL OF
NUT IN LIST. OF
WAZALA     L=LOG THE CALL A
OK A
R           REMOVE CONTENTS OF CALL BUFFER (A)
OK A
*****HERE IS AN EXAMPLE OF THE COMMAND D
D WE NEED SOME FRESH CW OPERATORS.

```

Simulated printout.

Lines 400-420: COMP is used to check for matching text in the call buffer and a table entry. As written, COMP will check variable length strings, but in dupe checker, the strings are always six characters long. If respective characters don't match, data word NOTEQ is incremented. Boundary strings in the call table are found by detecting zeros in the call table string.

Since the call buffer is filled out to six characters with blanks, only the boundary strings will have zeros.

Lines 422-449: SRCH uses COMP to do a search for a match to the text string in the call buffer. Between unsuccessful comparisons, it initializes ZEROS and NOTEQ (the counters for COMP), sets up the HL register to the next string in the call table, and sets DE back to the beginning of the call buffer. A search can end only at the boundary in the call table of the next band (carry set) or with a match to the call buffer (equal bit set).

Lines 459-490: FBUFF handles the filling of the call buffer. It calls BI to get characters, handles the rub-out (here defined to be a period, "."), and even terminates the task in progress if the user elects to rub out the command letter. If the call being entered has less than six characters on the terminating (CR), FBUFF fills out the buffer with blanks so that the boundary strings remain the only ones with zeros. If the first character entered is a (CR), the buffer is left untouched, allowing the user to execute a second command with the same buffer contents, such as logging it after checking for it.

Lines 494-549: These are the text strings sent routinely as responses. They are referred to by the label at the beginning of the string and the length is fixed by the assembler by subtracting the addresses of the enclosing labels. This makes the strings easy to change during re-assembly.

Lines 555-571: Here is the main command decoding

string. All commands are single letter for speed of use. Any additional commands need only a CPI-JZ pair to jump out and execute the new command. In this setup, each execution module is responsible for calling FBUFF if it needs text in the call buffer.

Lines 573-593: CHECK is used to find out if a particular call has been entered previously on this band. It primarily calls SRCH to do this, but it also provides the proper messages and a standard return to START which echoes the call buffer. This standard return is also used by the rest of the commands.

Lines 595-620: LOG will put a call into the call table at the end of the current band segment if it is not there already. If it is already there, it issues a message to that effect and does not double-entry. It could be used in lieu of CHECK to save time as it also calls SRCH.

Lines 622-645: BAND is in charge of band changes. It has to find the proper starting point for each section of the table corresponding to each band. Bands are identified here by single letters. A band boundary is a six-word string carrying the ASCII for its letter identifier in the first word and zeros in the other five. To find them in the call table as they move up, before calling SRCH, the DE register is set to point where no match can occur. Here it points to executable code that cannot be interpreted as ASCII. Each time SRCH returns with carry set, the first word of the string is checked for the first character in the call buffer. When the correct starting place is found, HL is incremented to the first location beyond the boundary and then stored at CLIST as the place to

begin searching for calls entered.

Lines 647-648: Since all traffic through the processor is echoed to the console device, this call prints text there until the auto-start drops out. This command was included so that operators in the field can leave messages to the computer operator without leaving the keyboard, i.e., send more beer, round up more recruits, etc.

Lines 650-668: REMOVE will attempt to remove a text string corresponding to the call buffer from the call table. Note the use of the term "text string." This command is not only for those loggers who log the contact that wasn't completed, but also for the Model 19 users who forget the shift key and for those who forget the single-letter command before the call (and have one picked out of the call itself). These last two were found to be the two most common operator errors at K5OJ1. Note again that R(CR) will take that garbage in the call buffer that the user just logged and remove it without having to recreate that garbage.

Line 670: This area is saved for fixes, updates, and the like. The task assumes the stack is at 0100H and the table extends out to very near the end of memory. Therefore, a safe patch area was included here inside the object code.

Lines 677-732: This table shows the initialized state of the call table, containing at this stage only the band boundary markers.

So there you have it. Maybe this will help put some of the fun back into Field Day that the FCC seems determined to take out with all the new prefixes. ■

SWISS QUAD Series • PORTABLE TOWER

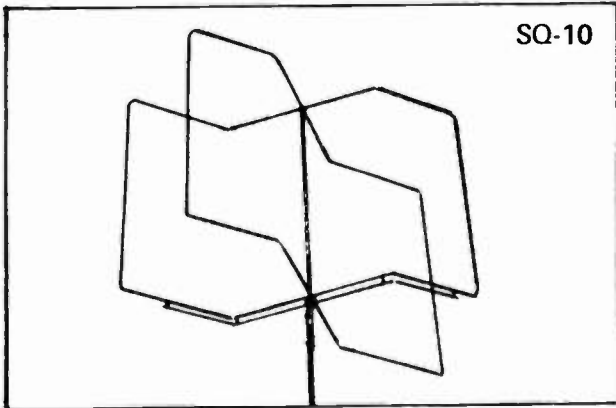
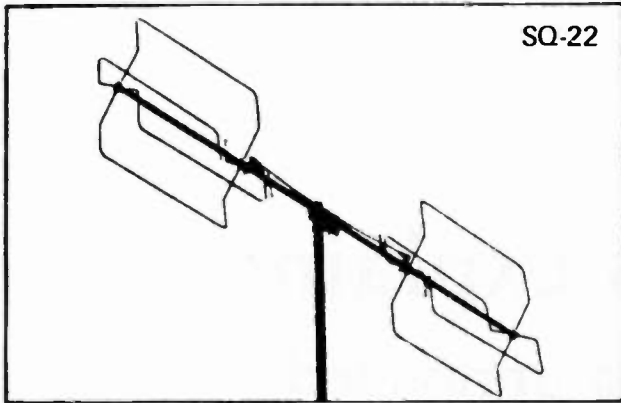

ANTENNA GAIN AND FRONT-TO-BACK RATIO ARE WELL IMPROVED WHEN TWO ELEMENTS ARE DRIVEN AT ONE TIME WITH PHASED DIFFERENCE COMPARED TO A SINGLE DRIVEN ELEMENT SUCH AS A CONVENTIONAL QUAD OR YAGI. THE SQ-22 AND SQ-10 PROVIDE THE OWNER WITH SUCH FEATURES AS SIMPLE ASSEMBLY AND LIGHT WEIGHT.

PORTABLE TOWER—
EASY TO ERECT ANYWHERE!!

GOOD DX HUNTING

- Light Weight
- High Stability
- High Quality Aluminum Alloy
- 3 Sizes Available
- Inc 2½" thrust Bearing
- SQ22 \$45.95
- SQ10 \$59.95
- TE35A 11.6' tower \$149.95
- TE55B 18' tower \$214.95
- TE75C 25' tower \$279.95

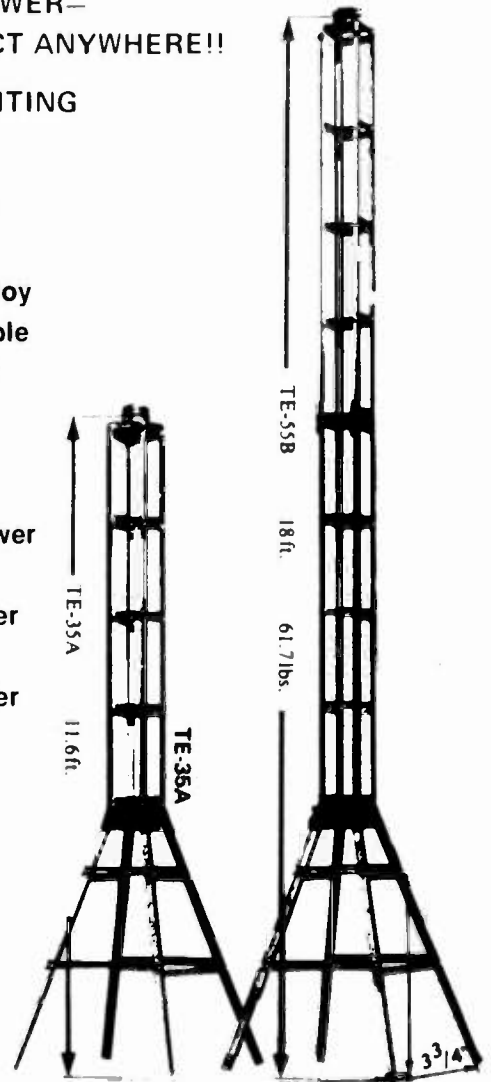

\$249.95



\$139.95



\$84.95

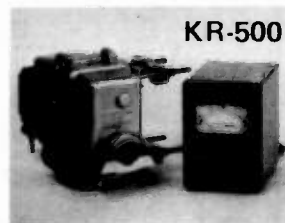

\$169.95



\$29.95

TOLL FREE # 1-800-654-3231



✓ 73

TET U.S.A., INC.



425 HIGHLAND PARKWAY, NORMAN, OKLAHOMA 73069 TEL: 405-360-6410

A/D Converters Explained!

— another enigma unraveled

It's my bet that the overwhelming majority of you computer enthusiasts out there don't really know what an analog-to-digital converter is, much less how it is used. Well, this is your chance! After all, contrary to what most of you believe, the majority of the world is analog. So, if you can't beat 'em...

What is an A/D?

Radio Shack's *Dictionary of Electronics* defines the

analog-to-digital converter as "A circuit that changes a continuously varying voltage or current into a digital output. The input may be ac or dc, and the output may be serial or parallel..." This is quite a broad definition and doesn't really tell us too much, so maybe I should expound upon it a little bit.

The input voltage to an A/D could be from almost anything imaginable. One possible example could be

that of a voltage across a thermistor. A thermistor is a solid-state device which changes its electrical resistance with temperature. Therefore, the A/D "sees" the temperature (an analog level) of the thermistor and changes it to a digital word which our computer would be able to understand. Another example would be that of looking at the voltage across a strain gauge. A strain gauge is a resistive device which has an electrical output proportional to the amount it is deformed under strain. Again, this is an analog level and must be changed into something which our computer can understand. The input voltage levels to most A/Ds must be limited to some finite value, and that value is generally something in the range of ± 20 V, ± 10 V, ± 5 V, or ± 2.5 V.

The output of an A/D converter is usually a 4-, 6-, 8-, 10-, or 12-bit digital word that is proportional to the analog voltage level at its input. This digital word can be in binary, binary coded decimal (BCD), or two's complement form. (I will assume that these terms are familiar to you and will not

explain them.) It is this digital word, then, which is available to our computers for manipulation. But let's slow down a bit and take a look at a sample A/D to clarify things.

Suppose we have just purchased an A/D with an allowed input voltage range of 0 to 10 volts and an output which takes the form of an 8-bit binary word. Well, we all know (don't we?) that a binary word with n bits has 2^n different binary levels. Therefore, with an 8-bit output for our A/D, we have 2^8 or 256 different states which we can use to represent the 0 to 10 volts present on the input. With our grade school education, we can deduce that the least significant bit (LSB) of our 8-bit word would then have a value of $10 \text{ volts} / 256 = .039$ volts, or 39 millivolts. Therefore, as the input voltage to our A/D varies, voltage changes as small as 39 millivolts may be detected (see Fig. 1).

The binary output for corresponding input voltage levels can be seen in Table 1. Notice that the all ones in the binary coding

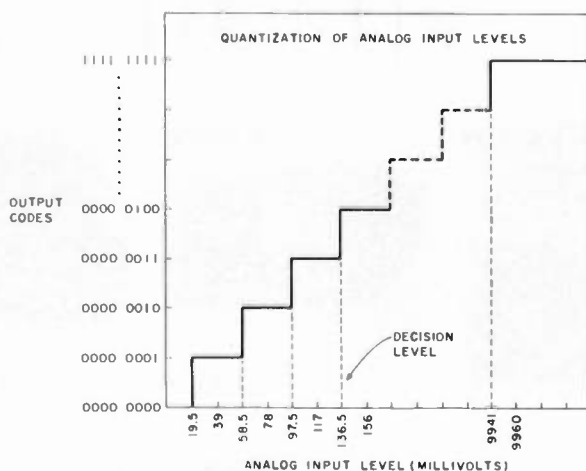

Fig. 1. This graph indicates how an analog signal is quantized through a decision-making process inside of the A/D. When the analog voltage to the A/D reaches 19.5 millivolts, the decision is reached to call this level binary 00000001. Similar decision levels can be seen at 58.5 mV, 97.5 mV, and so on throughout the 0- to 10-volt input range.

column do not correspond to the full-scale voltage of 10 V, but to 10 volts - 39 mV = 9.96 volts. I might add here that the higher the number of bits on the output of an A/D, the higher is its resolution. Therefore, with a 12-bit A/D, the 0- to 10-volt input could be represented in 2^{12} (4096) different increments. The LSB would then have a value of 10 volts/4096, or 2.44 millivolts. We could, therefore, recognize a voltage change on the input as small as 2.44 millivolts.

How Does the A/D Work?

To truly know all there is to know about an A/D, we really should study things like quantizing theory, sampling theory, digital coding theory, filter theory, and a lot of other forbidding subjects in which I'm sure none of you is really interested. Pages and pages of information could be written on these subjects, but the purpose of this article is not to make engineers out of you, but to introduce you to something which, if used correctly, could open up a whole new field for you.

A lot of different methods have evolved over the years to obtain A/D conversion, but all of them produce the same end result. The result is, of course, a digital word which is proportional to an analog voltage level present at the input to the device. Some methods are slower than others, some are more expensive, and some even have a higher conversion error than others. The one you choose to utilize in your system is up to you. We will look at only two of the many ways in which A/D conversion is obtained, the two methods which I feel are the easiest to understand.

The Counter type of A/D is one of the simplest and cheapest to implement (see

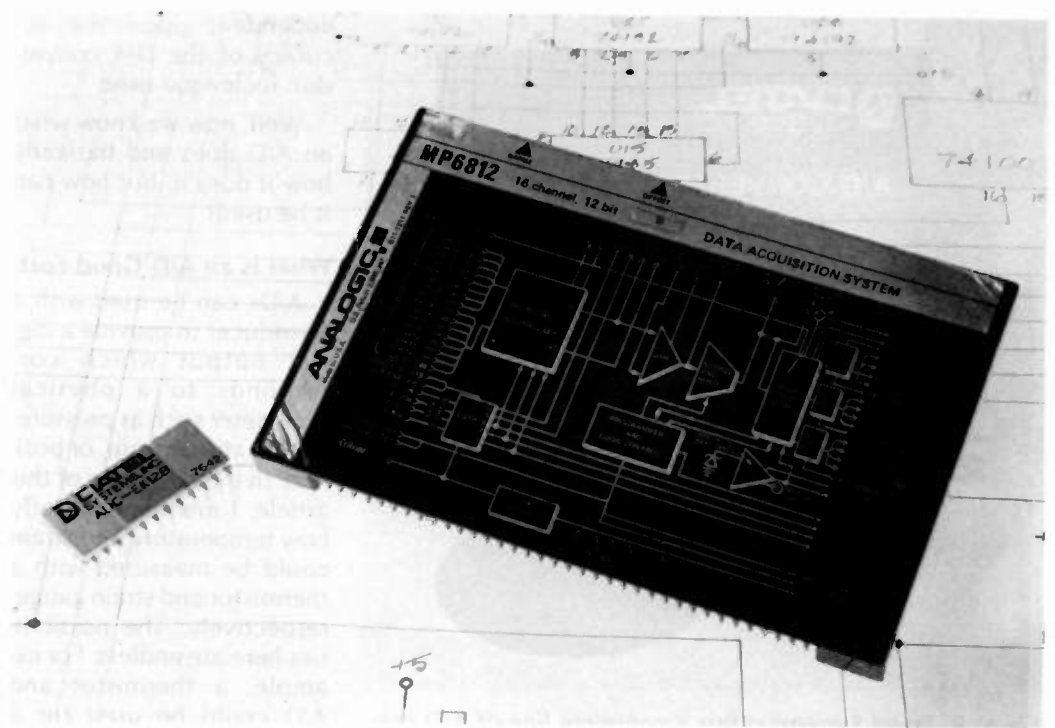

Photo A. Photo by Vernon Brady and Mike Sinclair.

Fig. 2). Here's how it works. When conversion begins, a clock is gated to a binary counter. With each clock pulse, the output of the counter changes its binary state. This binary output of the counter is the input to a digital-to-analog converter (D/A). As the binary count increases, the voltage, V_x , at the output of the D/A increases. When V_x compares equally to the analog input voltage, the clock is gated off and the conversion process ceases. The output of the binary counter is then proportional to the analog input voltage.

This converter is simple to implement, cheap, and

accurate, but it can be really slow. Its conversion time is proportional to the input voltage, so the greater the input voltage, the longer it takes to produce the binary word at the output. This can tend to be a problem in applications where time is a constraint. In some applications, using an up-down counter will speed things up a bit because then the counter can count either up or down from its previous value rather than having to be reset at the beginning of conversion and counting up.

The other method of A/D conversion to be examined here is called *Successive*

Approximation (see Fig. 3). This is the method which is generally used in practice because of its high speed. Here's how it works. At the start of the conversion cycle, the MSB of the D/A is set to 1. This corresponds to an output voltage from the D/A of $\frac{1}{2}$ of full scale. This D/A output voltage is compared to the analog input voltage. If it is smaller than the input voltage, then the next LSB of the D/A is set to 1. Now the D/A's output is

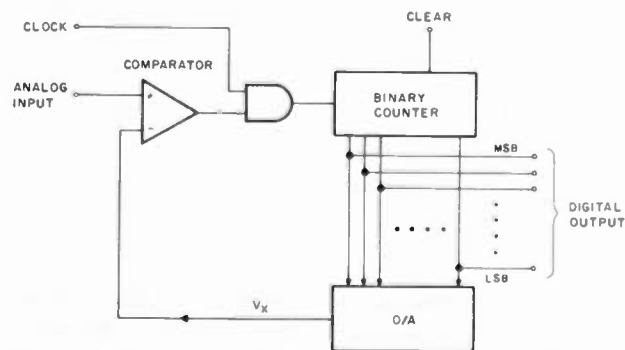

Fig. 2. The counter-type A/D in simplified form can be seen here. See the text for explanation. MSB = most significant bit. LSB = least significant bit.

| Input Voltage Level | Binary Coding |
|---------------------|---------------|
| 0.000 | 00000000 |
| 0.039 | 00000001 |
| 0.078 | 00000010 |
| 0.156 | 00000100 |
| 0.313 | 00001000 |
| 0.625 | 00010000 |
| 1.250 | 00100000 |
| 2.500 | 01000000 |
| 5.000 | 10000000 |
| 7.500 | 11000000 |
| 9.960 | 11111111 |

Table 1. The binary coding for a few different values of input voltage to the A/D can be seen above. Remember, there are 255 additional values of voltage that can be represented with the 8 bits of binary data available to us.

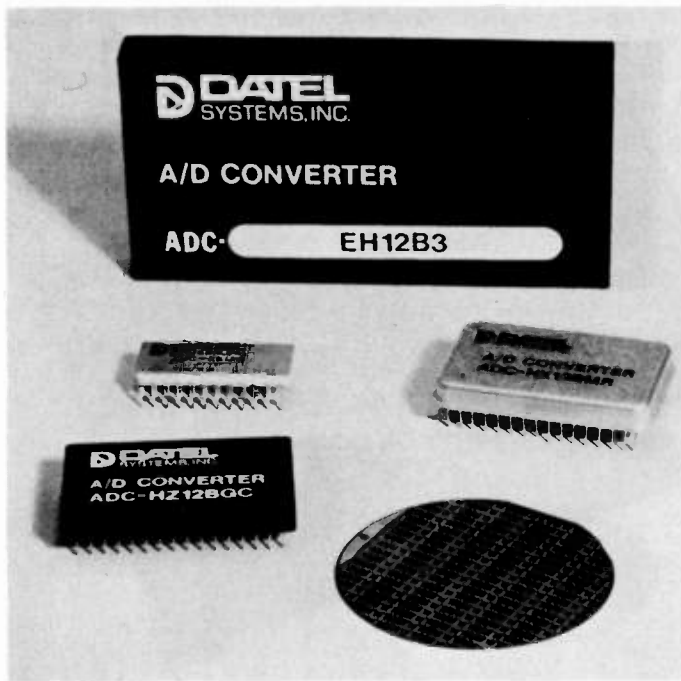

Photo B. Datel Systems offers a complete line of A/D converter products. Here are just a few. (Courtesy of Datel Systems, Inc.)

again compared with the input voltage. If the input voltage is still larger than the D/A's output voltage, the process continues. If, however, the D/A's output exceeds the input voltage, then the bit which was just set to 1 on the D/A is now set to zero (0), the next LSB is set to 1, and the process continues all the way down to the very least significant bit. The output register then contains the complete digi-

tal number representing the input. A sample of the successive-approximation analog-to-digital conversion process can be seen in Fig. 4, which might help to explain things a bit.

The successive-approximation type of A/D operates with a fixed conversion time per bit and, therefore, no matter what the input voltage is, the conversion time is the same. The accuracy of this technique is

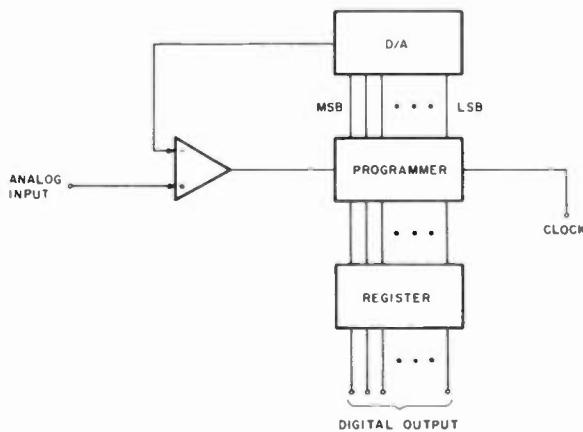

Fig. 3. A simplified schematic of the successive-approximation technique for A/D conversion. In this technique, the programmer in the diagram simply makes an educated guess as to the value of the analog input voltage and then compares this guess with the actual value. In this manner, each guess is closer and closer to the actual input value.

dependent upon the accuracy of the D/A conversion technique used.

Well, now we know what an A/D does and basically how it does it, but how can it be used?

What is an A/D Good For?

A/Ds can be used with a transducer to provide a digital output which corresponds to a physical parameter such as pressure, temperature, strain, or position. In the beginning of this article, I mentioned briefly how temperature and strain could be measured with a thermistor and strain gauge, respectively. The possibilities here are endless. For example, a thermistor and A/D could be used for a digital thermometer, a temperature control system for cooking, a temperature control system for heating the home, or a fire alarm system. A strain gauge and A/D could be used to detect illegal entry through locked doors or windows and for many other strain-related uses.

Pressure and position transducers can be put to good use in much the same way: detecting and correcting gas pressures or detecting the position of a joy stick for computer games.

All of these analog inputs can be detected and corrected through "feedback" networks with the use of A/D converters.

Fig. 5 is a block diagram of a basic control system utilizing an A/D. In this system, the input signal is applied to the A/D which converts the signal to digital form. The microprocessor takes this digital information and conducts some kind of decision-making process. Once a decision is reached, the processor feeds this information back into the system to compensate for any discrepancies.

I am speaking in generalities here because I do not want to limit myself to one or two applications. The field is extremely wide open, and a little imagination will take you far. For example, couldn't we use the A/D and microprocessor combination as a simple, direct-readout, smart, digital voltmeter?

What's Available?

Table 2 is a brief listing of some commonly-available A/Ds. While it is possible to find A/Ds for less than \$15, it also is possible to find them for as much as \$900. I don't mean to scare you

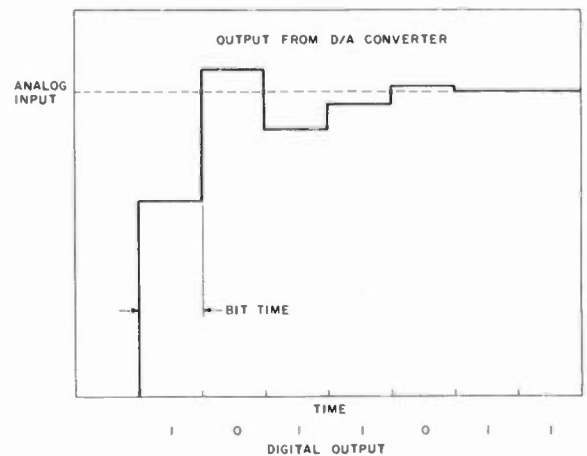

Fig. 4. This depicts the guessing process which the programmer goes through while closing in on the actual input-voltage level. If the programmer's guess is too high, the bit which was just set to 1 is reset to 0, and the next LSB is set to 1. This process continues until the least significant bit is assigned its final value.

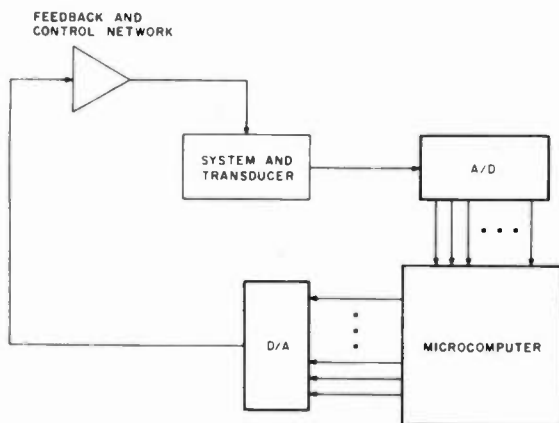

Fig. 5. One of the many uses for A/Ds is in the area of feedback and control systems. An analog voltage level representing position, temperature, strain, pressure, speed, or practically anything you wish is converted to digital form with the A/D. The microprocessor then reads this information and makes some decision in response to a question such as: Is the temperature correct? Is the pressure too high? How fast is the electric train going? Is the printer near the end of the page? When a decision is reached, the processor outputs a digital word to correct or change the present situation. The D/A converts this word to analog form and the feedback network makes the necessary changes.

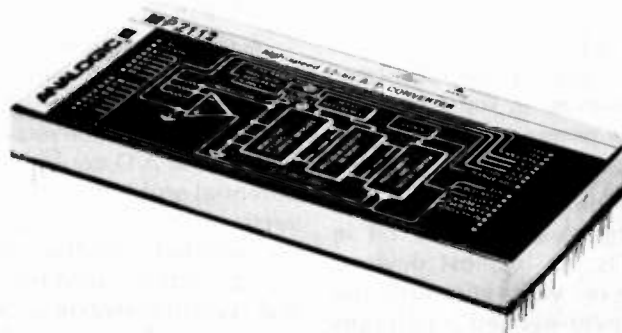

Photo C. Analogic Corporation is another large manufacturer of A/Ds. Pictured above is one of their more expensive units. (Courtesy of Analogic Corporation)

away, but as with anything else, you can pay as much for an A/D as you want. The higher the performance, the more the cost to you.

Choosing the Right A/D

The A/D selection process can be quite mind-boggling if you don't know what you are looking for! There are all kinds of specifications listed which, for the hobbyist, aren't all that important. So now we will

wade through the specifications which normally are listed and dip out those which I feel are most important for the average hobbyist.

One of the first things we need to decide on when choosing an A/D is its resolution. The resolution of an A/D is a measure of the degree to which it can distinguish changes in voltage on its input and is determined by the number of

bits on the A/D's output. For example, a 12-bit A/D has more resolution than an 8-bit A/D, and therefore can detect smaller voltage changes on its input. If an analog voltage variation is to be digitized and stored in memory for later reproduction through a digital-to-analog conversion process and the output signal has to

be a faithful reproduction, then we would need as much resolution as possible. If less accuracy is dictated, however, the number of bits could be reduced.

The coding of the output of an A/D also is very important. Coding merely defines whether the output of the A/D is in binary, BCD, or two's complement form. If

| Manufacturer | Item | Resolution # Bits | Coding | Power | Input Voltage or Current Range | Conversion Time | Price (1978) |
|----------------|-----------|-------------------|--------|---------------|--|-----------------|--------------|
| Datel | ADC-MC8BC | 8 | Binary | +5 | 0 to +5, +10 V | 500 μ s | \$ 8.00 |
| Datel | ADC-EK8B | 8 | Binary | ± 5 | 0 to 10, ± 5 V | 1.8 ms | \$ 11.50 |
| Datel | ADC-EK10B | 10 | Binary | ± 5 | 0 to 10, ± 5 V | 5.0 ms | \$ 26.00 |
| Datel | ADC-EK12B | 12 | Binary | ± 5 | 0 to 10, ± 5 V | 20 ms | \$ 34.00 |
| Datel | ADC-ECONO | 6 | Binary | ± 15 , +5 | +5, +10, ± 2.5 , ± 5 V | 50 μ s | \$ 29.95 |
| Datel | ADC-89A8B | 8 | Binary | ± 15 , +5 | 0 to 10, ± 5 V | 200 μ s | \$ 69.00 |
| Teledyne | 8700CJ | 8 | Binary | Vdd 3 to 7 | ± 10 mA | 1.25 ms | \$ 11.95 |
| Teledyne | 8703CJ | 8 | Binary | Vss -3 to -7 | ± 10 mA | 1.25 ms | \$ 13.75 |
| Teledyne | 8704CJ | 10 | Binary | Vss -3 to -7 | ± 10 mA | 5.0 ms | \$ 17.25 |
| Teledyne | 8701CN | 10 | Binary | Vss -3 to -7 | ± 10 mA | 5.0 ms | \$ 23.50 |
| Teledyne | 8702CN | 12 | Binary | Vss -3 to -7 | ± 10 mA | 20 ms | \$ 29.75 |
| Teledyne | 8705CN | 12 | Binary | Vss -3 to -7 | ± 10 mA | 20 ms | \$ 35.00 |
| Analogic | MN2301 | 3½ digits | BCD | ± 15 | ± 2 V | 100 ms | \$ 24.00 |
| Analogic | MP2410 | 10 | Binary | +5, ± 15 | ± 10 , ± 5 , 0 to +10, 0 to +5 V | 30 μ s | \$ 95.00 |
| Analogic | MP2112 | 12 | Binary | +5, ± 15 | ± 10 , ± 5 , 0 to +10, 0 to +5 V | 7 μ s | \$219.00 |
| Hybrid Systems | ADC586-8 | 8 | Binary | ± 5 | 0 to 10 V | 1.8 ms | \$ 19.00 |
| Hybrid Systems | ADC586-10 | 10 | Binary | ± 5 | 0 to 10 V | 6.0 ms | \$ 33.50 |
| Hybrid Systems | ADC586-12 | 12 | Binary | ± 5 | 0 to 10 V | 24 ms | \$ 45.00 |

Table 2. A listing of some of the commonly-available A/Ds on the market today. If you would like more information about any particular product, consult the manufacturer. A listing is provided for your convenience at the end of this article.

you don't know how the data is represented, it probably can't be very meaningful.

The *power requirement* of most A/Ds is on the order of ± 15 V, ± 5 V, or some combination thereof. It would be to your advantage, of course, to choose an A/D that fits your present supply capabilities. However, in some cases, a new power supply might be necessary.

Analog input voltage ranges vary quite a bit in A/Ds. As in most devices, these voltages are the "never-exceed" voltages and care must be taken to adhere to the limits. These voltages therefore represent the range of input levels which the A/D can convert to digital form. In some of the more expensive A/Ds, the input-voltage range can be programmed into the device through a

simple pin connection. This is usually a choice between two ranges such as either 0 to 10 volts or ± 5 volts and not some arbitrary voltage set by the designer. The less expensive units are not so flexible and must be purchased with a specified input range.

In some analog interfacing applications, time is an important factor. In these cases then, the *conversion time* of the A/D could be a potential problem. The conversion time is defined as the time between the commands "start conversion" and "end of conversion." As was stated previously, some A/Ds are faster than others. If time is no problem, then a cheaper and slower A/D would seem to be indicated.

There are quite a few more specifications listed by most manufacturers, but it is my feeling that for our

purposes those listed in the above paragraphs should be sufficient to at least make preliminary selections as to the correct A/D for the job.

Conclusion

The analog-to-digital converter is quite a powerful tool and, as such, can greatly increase the power of our home-computer systems. Just think of the control problems that can be solved by you consultant types with the use of this device.

This article is by no means complete in itself. It was meant as a general introduction to the world of analog-to-digital interfacing to your computer, and I hope that it has brought you one step closer to conquering the analog world. ■

References

1. Millman and Halkias, *Integrated Electronics: Analog and Digital Circuits and Systems*, McGraw-Hill Book Co., New York, 1972.
2. *Electronic Design's Gold Book*, vol. 3, Datel Systems, Inc., 1976-1977.

List of Manufacturers

1. Datel Systems, Inc., 1020G Turnpike St., Canton MA 02021; (617)-828-8000.
2. Hybrid Systems Corp., Dept. G, Crosby Drive, Bedford Research Park, Bedford MA 01730; (617)-275-1570.
3. Analog Devices, Inc., Dept. G, Box 280, Norwood MA 02062; (617)-329-4700.
4. Analogic Corp., 1G Audubon Rd., Wakefield MA 01880; (617)-246-0300.
5. Burr Brown Research Corp., Dept. G, 6730 S. Tucson Blvd., Tucson AZ 85734; (602)-294-1431.
6. Teledyne Semiconductor, 1300 Terra Bella Avenue, Mountain View CA 94043; (415)-967-9241.

the direct connection

AEA ★ AVANTI ★ ASTRON ★ ALLIANCE ★ ALPHA ★ BEARCAT ★ BENCHER ★ BIRD ★ CUSHCRAFT ★ COLLINS ★ CDE ★ DRAKE ★ DENTRON ★ HY-GAIN ★ HUSTLER ★ ICOM ★ KANTRONICS ★ KLM ★ KENWOOD ★ MICRO-LOG ★ MINI-PROD ★ MOR-GAIN ★ MIRAGE ★ MFJ ★ PALOMAR ENG. ★ REGENCY ★ SWAN ★ TEN-TEC ★ UNIVERSAL ★ UNARCO ★ ROHN ★ VO COM.....ALL THESE AND MORE

MIDCOM ⁵²

ELECTRONICS, INC.

2506 S BRENTWOOD BOULEVARD
ST LOUIS MISSOURI 63144



1-800-325-3609

MO. RESIDENTS CALL COLLECT 314-961-9990

SOMETHING DIFFERENT

The FT-107 Series with "DMS"*

"It's A Cut Above The Rest"

* OPTIONAL DIGITAL MEMORY SHIFT ("DMS")
12 discrete memories. Stores individual frequencies
or use as 12 full coverage VFOs (500 kHz each)

- Solid State
- 240 watts DC SSB/CW
- 160-10 meters, WWV
(2 auxiliary band positions are available for future expansion)
- RF Speech Processor
- SSB, CW, AM, FSK
- Built-in SWR Meter
- Excellent Dynamic Range
- Audio Peak/Notch Filter
- Variable Bandwidth
- Full Line of Accessories



The FT-107 has been created as a result of a blending of technologies — computer, solid state and RF design. By careful utilization of these disciplines and the experience gained from our FT-301 series, YAESU has achieved an HF transceiver which offers unique features (e. g. "Digital Memory Shift"), efficient operation and a level of performance that has been previously unattainable.

(Receiver Section) FT-107 TRANSCEIVER SPECIFICATIONS (Transmitter Section)

Sensitivity: 0.25 μ V for 10dB S/N, CW/SSB, FSK
1.0 μ V for 10dB S/N, AM

Image Rejection: 60dB except 10 meters (50dB)

IF Rejection: 70dB

Selectivity: SSB 2.4 kHz at -6dB, 4.0 kHz at -60dB.
*CW 0.6 kHz at -6dB, 1.2 kHz at -60dB.
*AM 6 kHz at -6dB, 12 kHz at -60dB
Variable IF Bandwidth

20dB RF Attenuator

Peak/Notch Audio Filter

Audio Output: 3 watts (4-16 ohms)

Accessories: FV-107 VFO (standard not synthesized)
FTV-107 VHF (UHF Transverter)
FC-107 Antenna Tuner
SP-107 Matching Speaker
FP-107 AC Power Supply

*CW/AM Filters Optional

Power Input: 240W DC (SSB/CW) 80W DC (AM/FSK)

Opposite Sideband Suppression: Better than 50dB

Spurious Radiation: -50dB.

Transmitter Bandwidth 350-2700 hz (-6dB)

Transmitter: 3rd IMD -31dB neg feedback 6dB

Transmitter Stability: 300 hz after 10 min. warmup
less than 100 hz after 30 min.

Antenna Input Impedance: 50 ohms

Microphone Impedance: 500 ohms

Power Required: 13.5V DC at 20 amps

** 100/110/117/200/220/234V AC at 650 VA

**FP-107 or FP-107E Optional

YAESU ✓83
The radio.



1179RR

Price And Specifications Subject To
Change Without Notice Or Obligation

YAESU ELECTRONICS CORP., 6851 Walthall Way, Paramount, CA 90723 • (213) 633-4007
YAESU ELECTRONICS Eastern Service Ctr., 9812 Princeton-Glendale Rd., Cincinnati, OH 45246

APPLE Owners send & receive CW/RTTY

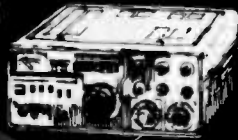

FEATURES

- Send & Receive MORSE BAUDOT ASCII
- Connects to APPLE game I/O port
- Split Screen - edit while receiving
- Uses builtin PLL or external TU

- Includes hardware, cassettes & manual
- Word Oriented Editor
- Instant Break operation - preserve type ahead buffer
- Eight message memories - 255 characters
- Auto transmitter control - PTT
- Diddle, Replay, Cassette Save, CWID (RTTY only)
- Random Practice, Beacon, change spacing (Morse only)
- CA650 in cabinet as illustrated \$259
- TA650 FSD 1 active filter RTTY demodulator
- XTLE 1 star controlled AFSK and AC power supply installed in CA650 (assembled tested) \$499
- A6500 adds disk based RTTY to CA650/TA650 \$50

Write or call for complete catalog

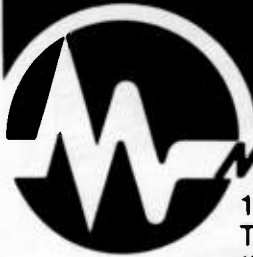

MACROTRONICS, inc. ^{✓44}

1125 N. Golden State Blvd. / Suite G
Turlock, CA 95380 (S)
(209) 667-2888 / 634-8888

*We are experiencing telephone difficulties,
please keep trying.*

California residents add 6% tax



SLOTTED ARRAY ANTENNA ^{✓378}



- 2100 +/- 100 MHz
- 16 dBi gain
- 14 x 98 degree beamwidth
- H or V polarization
- Type N connector
- Low wind loading
- Alodined
- 24" x 5" x 1"
- Mast mount
- Superior to 20" dish
- Commercial grade
- Mast mount

Postpaid.....\$35

Optional small corner reflector narrows beam width to 14 x 14 degrees; increases gain 4 dBi. FREE PLAN.

HVB 1508 Ports O'Call
Plano, Texas 75075

Satellite TV

FOR THE HOME

Sick of Network TV?

Our receiver lets you get over 75 channels of television directly from earth-orbiting cable TV satellites! HBO, Showtime, super stations, sports and movies from around the world.



**We don't just sell information!
We Manufacture Hardware!**

Our 94-page catalog and information book tell the whole story! Inexpensive dishes, high pro-feeds, computer aiming software! Specs, kits and more! Send \$7.95 today!

24-hour C.O.D. Hotline
(305) 339-7600



SPACECOAST RESEARCH ^{✓309}
Dept. S, P.O. Box 442, Altamonte Springs, FL 32701

ASTRON POWER SUPPLIES

● HEAVY DUTY ● HIGH QUALITY ● RUGGED ● RELIABLE ●

SPECIAL FEATURES

- SOLID STATE ELECTRONICALLY REGULATED
- FOLD-BACK CURRENT LIMITING Protects Power Supply from excessive current & continuous shorted output.
- CROWBAR OVER VOLTAGE PROTECTION on Models RS-7A, RS-12A, RS-20A, RS-35A, RS-20M & RS-35M
- MAINTAIN REGULATION & LOW RIPPLE at low line input Voltage.
- HEAVY DUTY HEAT SINK ● CHASSIS MOUNT FUSE
- THREE CONDUCTOR POWER CORD
- ONE YEAR WARRANTY ● MADE IN U.S.A.
- VOLT & AMP METER ON MODELS RS-20M & RS-35M

PERFORMANCE SPECIFICATIONS

- INPUT VOLTAGE: 105 - 125 VAC
- OUTPUT VOLTAGE: 13.8 VDC ±0.05 volts (Internally Adjustable: 11-15 VDC)
- RIPPLE: Less than 5mv peak to peak (full load & low line)
- REGULATION: ±.05 volts no load to full load & low line to high line



ASTRON 20 AMP REGULATED POWER SUPPLY Model RS-20M

16 Amps continuous
20 Amps ICS*
5" (H) x 9" (W) x 10.5" (D)
Shipping Weight 20 lbs.
Price \$117.95

Other popular POWER SUPPLIES also available: (Same features and specifications as above)

| Model | Continuous Duty (amps) | ICS* (amps) | Size (in.) H X W X D | Shipping Wt. (lbs.) | Price |
|--------|------------------------|-------------|----------------------|---------------------|----------|
| RS-35M | 25 | 35 | 5 X 11 X 11 | 29 | \$167.95 |
| RS-35A | 25 | 35 | 5 X 11 X 11 | 29 | \$149.95 |
| RS-20A | 16 | 20 | 5 X 9 X 10½ | 20 | \$99.95 |
| RS-12A | 9 | 12 | 4½ X 8 X 9 | 13 | \$74.95 |
| RS-7A | 5 | 7 | 3¾ X 6½ X 9 | 8 | \$54.95 |
| RS-4A | 3 | 4 | 3¾ X 6½ X 9 | 5 | \$39.95 |

*ICS - Intermittent Communication Service (50% Duty Cycle)
If not available at your local dealer, please contact us directly.



Inside View - RS-12A

ASTRON CORPORATION

1971 South Ritchey Street
Santa Ana, CA 92705
(714) 835-0682 ^{✓358}

MICROWAVE ANTENNAS & KITS

- MICROWAVE TRANSISTORS
- AZ-EL OPTION KITS
- MICROWAVE DIODES
- PARABOLIC REFLECTORS
- ALUMINUM FEED-HORNS

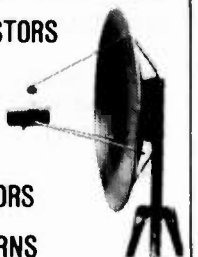

Your source of supplies for the fastest growing field of communications. Here is a low cost entry into the fascinating area of microwave technology. We offer a complete line of antennas, receivers, pre-amps, power supplies, etc..... Call or write for details.



DATA SERVICE COMPANY ^{✓346}
3110 Evelyn Street
Roseville, MN 55113
612-636-9469

**YOU ARE LOOKING AT
EVERYTHING
THAT IS NOT ON SALE
THIS MONTH
AT HAM RADIO CENTER**

**FOR BEST PRICE – FAST DELIVERY
CALL TOLL - FREE**

1-800-325-3636

HAM RADIO CENTER ✓ 32
8340-42 Olive Blvd. • P.O. Box 28271 • St. Louis, MO 63132



SCANNERS:

KENWOOD TR7400A, TR7600, & TR7625, TEMPO (discontinued), KDK 2015R, KDK 2016A, ICOM IC22S, MIDLAND 13-510, 13-513, CLEGG FM-28, COMTRONIX, YAESU FT227R

- AED continues to expand its line of quality scanners.
- All of AED's scanners are custom designed to install completely inside of their respective rigs.
- Installation is simple. Unlike other competitive products all AED scanners are designed so that it is totally unnecessary to cut any wires inside your rig during installation.
- All P.C.B.s are silk-screened and tin plated for easier and more effective soldering.
- The kit comes complete with all parts and a detailed instruction manual including schematics.
- In the scanner OFF mode the rig operates normally. In the scanner ON mode the scanner locks on an occupied frequency, pauses for a preset time (about 5 sec.) and then resumes scanning (except 22S).
- The frequency being scanned is displayed on the digital readout (except 22S and Tempo).
- This gives you the ability to eavesdrop all over the band without lifting a finger. When you hear something interesting, you flip the switch to the LOCK mode and the rig is ready to transmit.

KIT PRICE..... 39.95
PREASSEMBLED, REG. .. 59.95
SPECIAL, NOW..... 49.95

10 METER FM —THE NEW FRONTIER

The AED FM ADAPTER is now available

- The AED adapter converts existing HF transceivers to transmit on 10 meter FM.
- To use the adapter you are required to have an HF SSB transceiver and a 2 M FM transceiver or receiver.
- The AED kit consists of 2 P.C. boards. Both boards are designed to fit entirely inside your HF rig. (Each board measures 1" x 2")
- One board serves as the modulator which FM's your existing HF transceiver's VFO.
- The second board is a receiver adapter which converts your HF transceiver's IF to a 2M frequency. This will allow you to receive noise free 10M FM on your 2M transceiver.
- This modification can be disabled with the on-off switch supplied with the kit.
- The kit comes complete with all parts and a detailed instruction manual (crystal not included).

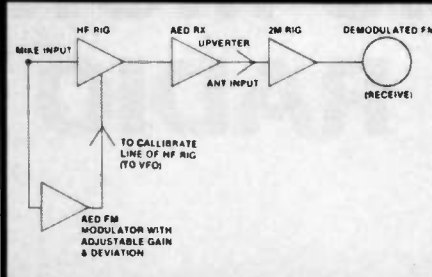

KIT PRICE..... 39.95
PREASSEMBLED, REG.... 59.95
SPECIAL, NOW..... 49.95

AED ELECTRONICS

750 LUCERNE RD., SUITE 120 DEPT. A
 MONTREAL, QUEBEC, CANADA H3R 2H6
 TEL. 514-737-7293

✓3 INCLUDE \$1.50 FOR
 POSTAGE AND HANDLING PER ITEM



Compact, economical, & easy RTTY



We speak your language

\$169.95 buys the most economical terminal unit available today – not the cheapest, but the best for the price. The TU-170 is a single unit that connects your rig, printer, and computer at an economical price. That's a language anyone can understand.

Flesher Corporation

P.O. Box 976 Topeka, KS 66601 913•234•0198
 Distributors in Canada and Australia

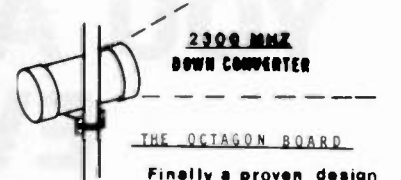

THE OCTAGON BOARD

Finally a proven design with a small size. PC board mounts on back of coffee can. PC board contains a Rf amp, Mixer, Lo, and an If amp.



Kit supplied with a 5 page brochure, PC board, Diodes, Chip Caps, Transistors, and all parts to complete a working board.

power supply kits available \$38.50

Money Order or Check
 mail or phone

UNIVERSAL COMMUNICATIONS
 P.O. BOX 6302, ARLINGTON, TEX. 76011
 817-265 0391

CB to 10 METER

10 METER CONVERSION KITS FOR CB RADIOS AM-FM & SSB

- Kits for over 300 Models of CB Radios
- Low Cost from \$10.00
 Easy to Install with All Instructions
 Tune-Up Procedure Alignment
- KITS FOR MOST POPULAR UNITS
 Over 5,000 Satisfied Customers
- Write or Call Today for Our Free
 1980 Catalogue

AMERICAN CRYSTAL SUPPLY COMPANY

PO Box 638
 W Yarmouth, MA 02673
 (617) 771-4634 ✓7

AUXILIARY POWER for Emergency or Portable Operation



Light wt. Portable Alternator. Stand-by power for Ham Equipment, household needs during power outages or operation in remote areas. Operates lighting, refrigerators, heating systems or other appliances including freq. sensitive loads such as TV sets, induction motors and fluorescent lights. Solid-state voltage regulation. 25% surge capacity. B&S engine. Alternator draws just enough engine output to meet load resulting in up to 25% fuel savings. Low interference. Advanced design. Drip-proof construction protects windings from rain and dirt assuring long life. One year warranty by manufacturer.

Models available with 1350 to 7000 watt ratings. Write for our quote and additional information. Mastercharge or VISA accepted

OUTDOOR OUTFITTERS ✓325
 705 Elm St. • Waukesha, WI 53187

Good-bye RFI

With the compact ATR-6800, you can forget about RFI . . . Add silent RTTY/CW/SSTV capability to your station with equipment that's **designed** to be ham gear! Unlike plastic-cased home computers, your ATR-6800 will sit right next to your kilowatt and ignore it! (And your receiver won't know it's there either!) By combining everything in one rugged aluminum enclosure, we have eliminated another source of RFI — all those boxes and assorted cables. The ATR-6800 is really complete; the AFSK-terminal unit, keying circuits, video drive, computer . . . everything's inside for direct connection and control of your transceiver. To get the full story, write for our ten page brochure or pick one up at your local dealer. Microlog Corporation, 4 Professional Drive, Suite 119, Gaithersburg, MD 20760. Telephone (301) 948-5307.



MICROLOG ✓ 51

Innovators in Digital Communications

A Computer-Controlled Talking Repeater

— part II: microcomputer details

The first part of this article provided a description of the principal features of the control system, the design approach, and overviews of the hardware and software. This part describes details of the microcomputer hardware and the software nucleus.

The microcomputer block diagram is shown in Fig. 1. The Pragmatic Designs CPU-1A single

board microcomputer provides the 8085A CPU, six programmable I/O ports, two programmable counter/timers, two blocks of 256 bytes of RAM, and sockets and decoding for two EPROMs. The breadboard area of the CPU-1A was wired to contain one additional ROM socket, an eight-bit latch as an additional output port, an eight-input multiplexer as addi-

tional inputs, a watchdog timer, an A/D converter, a binary divider, and edge connectors for the Telesensory speech synthesizer boards and a small CMOS RAM board.

Program Memory

The software was designed to be ROM resident, unlike many traditional real time control programs which execute from RAM. RAM resident software must be loaded from a disk or communications line, increasing the complexity and cost of the system. ROM resident software is ready to execute immediately upon powerup. It allows the use of a small, low cost, single board computer and results in a highly reliable system.

It was hoped originally that the computer program would fit in the 4K of ROM provided directly on the CPU-1A. As the programming progressed, it became clear that restricting program size to 4K would have required leaving out features. A third ROM socket was added in the breadboard area to allow up to

6K of program ROM using 2716s. Address decoding for the ROM was obtained from a spare output of the existing decoder IC on the CPU-1A. The final program used 5½K of the available 6K of ROM.

I/O Assignments

At first glance, it would seem that an enormous amount of I/O would be required to interface the computer to the repeater, making it impractical to use a single board computer. Careful sharing and multiplexing of available ports reduced the amount of I/O hardware required with just a small amount of extra software. The entire I/O is accommodated by the two programmable I/O chips on the single board computer plus an octal latch and an eight-input multiplexer. Several spare bits remain for future use. Since the entire computer bus is available on a separate connector on the CPU-1A, virtually unlimited expansion capability remains with the addition of more hardware.

The functions of the I/O ports are shown in Fig. 3. The DACPORT output port

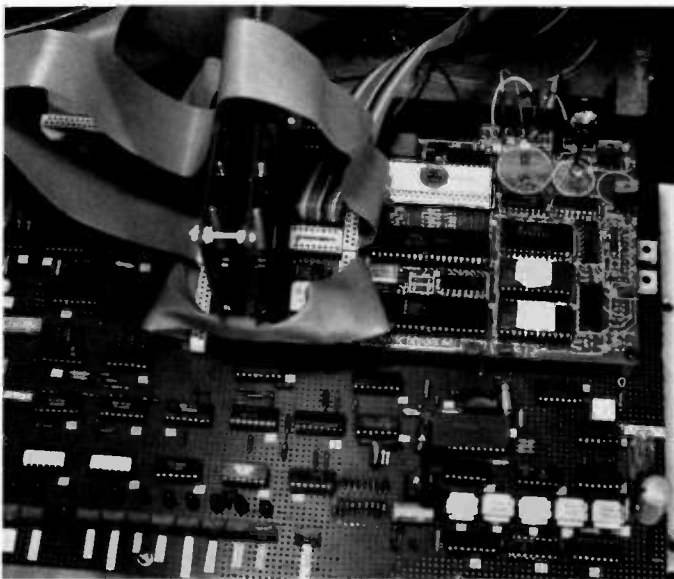

Photo A. CPU-1A microcomputer mounted on main control board. I/O signals interconnect through A P Products Great Jumper™ cables.

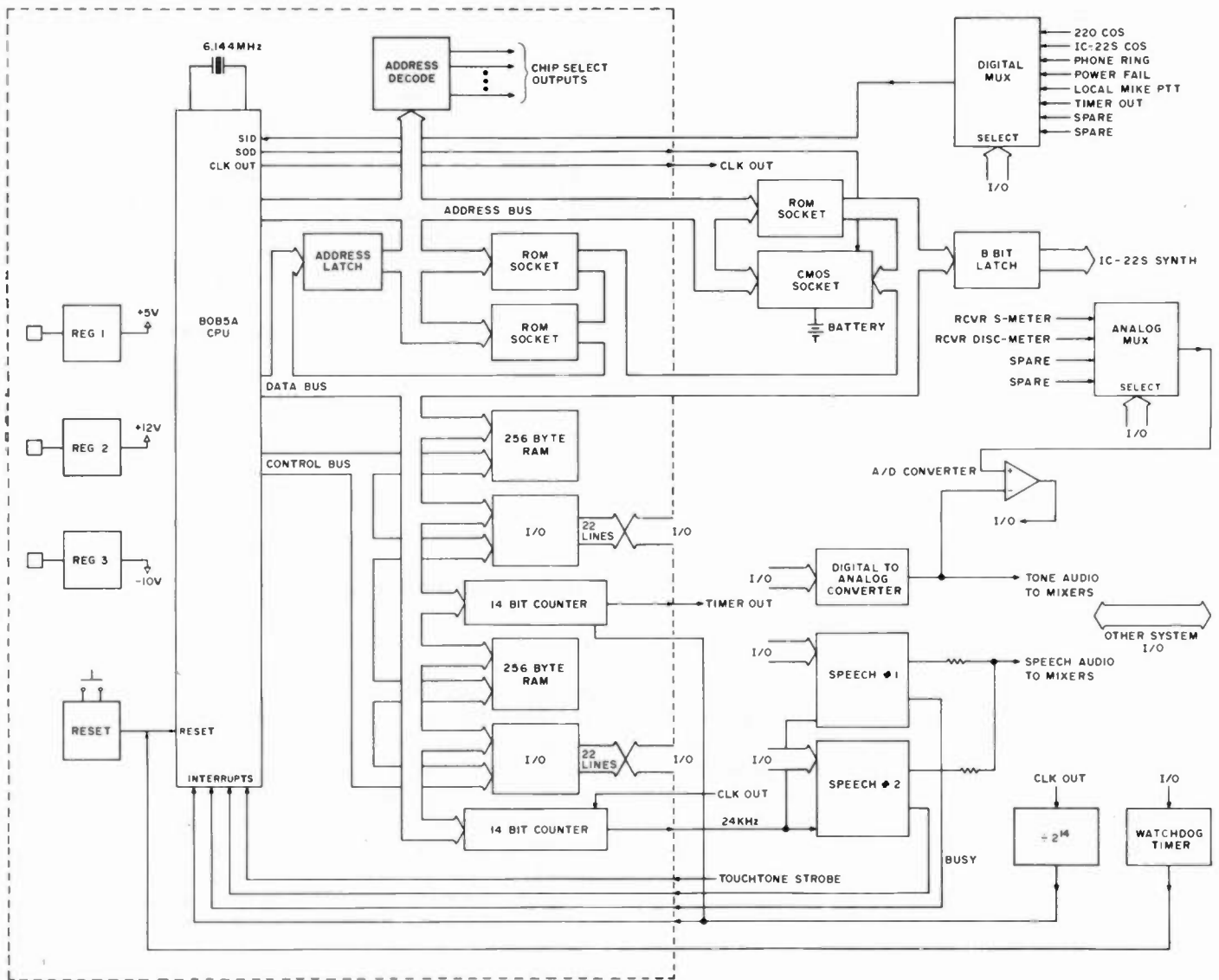

Fig. 1. Microcomputer hardware block diagram. CPU-1A provides portion enclosed in dotted lines. Remainder of hardware shown is wired in CPU-1A's breadboard area.

serves several functions, including driving the eight-bit DAC for tone generation and A/D conversion, providing the six-bit word select for the two speech synthesizers, and selecting the input to the expansion multiplexer which drives the CPU's serial input line.

XPORT output port provides eight single-bit oriented control lines. Active low was chosen for several of the control lines since during processor reset the I/O chip port lines float high. Active low ensures that the transmitters and phone line are not activated when pressing reset.

CHPORT output port selects the A/D analog channel to be measured and the

proper input to the touch-tone™ receiver. The watchdog timer pulse is generated by this port.

RPORT input port receives the touchtone receiver data bits, the A/D converter comparator output for the software-controlled A/D conversion, and other status inputs.

AUD1 and AUD2 output ports select the audio inputs to the transmitter and phone audio mixers. One or more audio sources may be connected to either or both mixers. AUD2 port also controls the IC-22S two-meter remote base transmit frequency offset.

IC22PORT is a hardwired memory mapped output port which drives the

IC-22S remote base frequency synthesizer.

The 8085A CPU contains a single-bit input and a single-bit output line. The output line (SOD) enables the CMOS autodialer RAM. The input line (SID) is multiplexed between several status signals, with the select to the SID multiplexer derived from DACPORT.

Two of the 8085A's vectored interrupt inputs are used as additional single bit inputs to accommodate the speech synthesizer busy signals. The Interrupt 5.5 and 6.5 inputs on the 8085A are normally used as maskable level-sensitive interrupt inputs. If they aren't needed as interrupt inputs, though, they can be used

like an input port since their level can be read by executing the RIM instruction and testing the "interrupt pending" bits. Just be sure that the interrupt masks remain set when using the SIM instruction so that a high level does not cause an interrupt to occur.

Interrupts

Two interrupts are used in the system. The 3.072-MHz clock-out signal from the 8085A is divided by a 14-bit CMOS binary ripple counter down to a 5.33-ms period square wave. This signal drives the rising-edge-sensitive Interrupt 7.5 input to cause the Background module interrupt routine to be executed

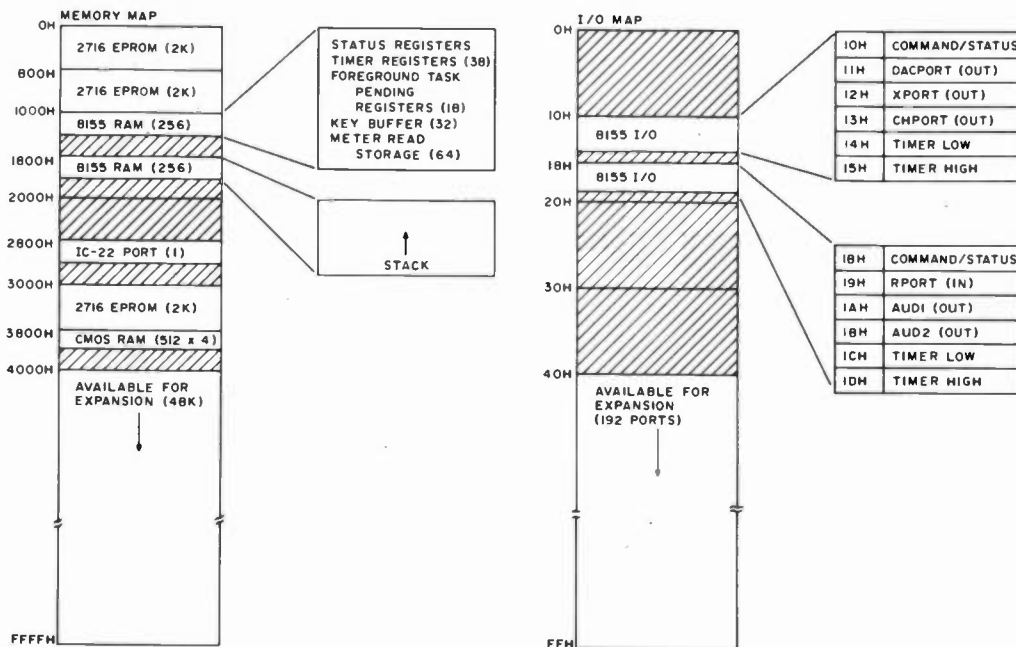

Fig. 2. Memory and I/O maps. Three quarters of the 8085A's memory and I/O capacity remain for expansion if needed.

every 5.33 ms. This interrupt is maskable by software.

The second interrupt in the system is generated by the touchtone receiver's data-ready strobe output driving the TRAP input. The TRAP interrupt is rising-edge sensitive and non-maskable, and requires cer-

tain cautions in its use which will be described later. The TRAP interrupt causes the TRAP Interrupt module to be executed, placing the received touchtone data into a RAM buffer.

Timers

Two 14-bit program-

mable counter/timers are provided by the CPU-1A. Each counts its timer input pulses and can be programmed to produce a square wave or pulse output when the counter's terminal count is reached.

In the repeater control system, one counter/timer divides the 8085's 3.072-

MHz clock signal to 24 kHz to supply the Telesensory Systems' speech synthesizer boards with a crystal-derived clock frequency. The second counter/timer divides the 5.33-ms interrupt signal to a one-minute period, which is further divided in software to time the tape voice ID.

CMOS RAM

Autodialer phone numbers are stored in RAM so that users can load and change the phone numbers over the air at any time. The RAM is battery backed up so that the numbers aren't lost when the repeater is taken down for maintenance.

CMOS RAM is best for battery backup since it draws only a few microamps when powered down. A separate small board was built which plugs into the CPU-1A microcomputer, containing the CMOS RAM, batteries and power switching (Fig. 4). The board can be removed so that the rest of the computer can be worked on without the pos-

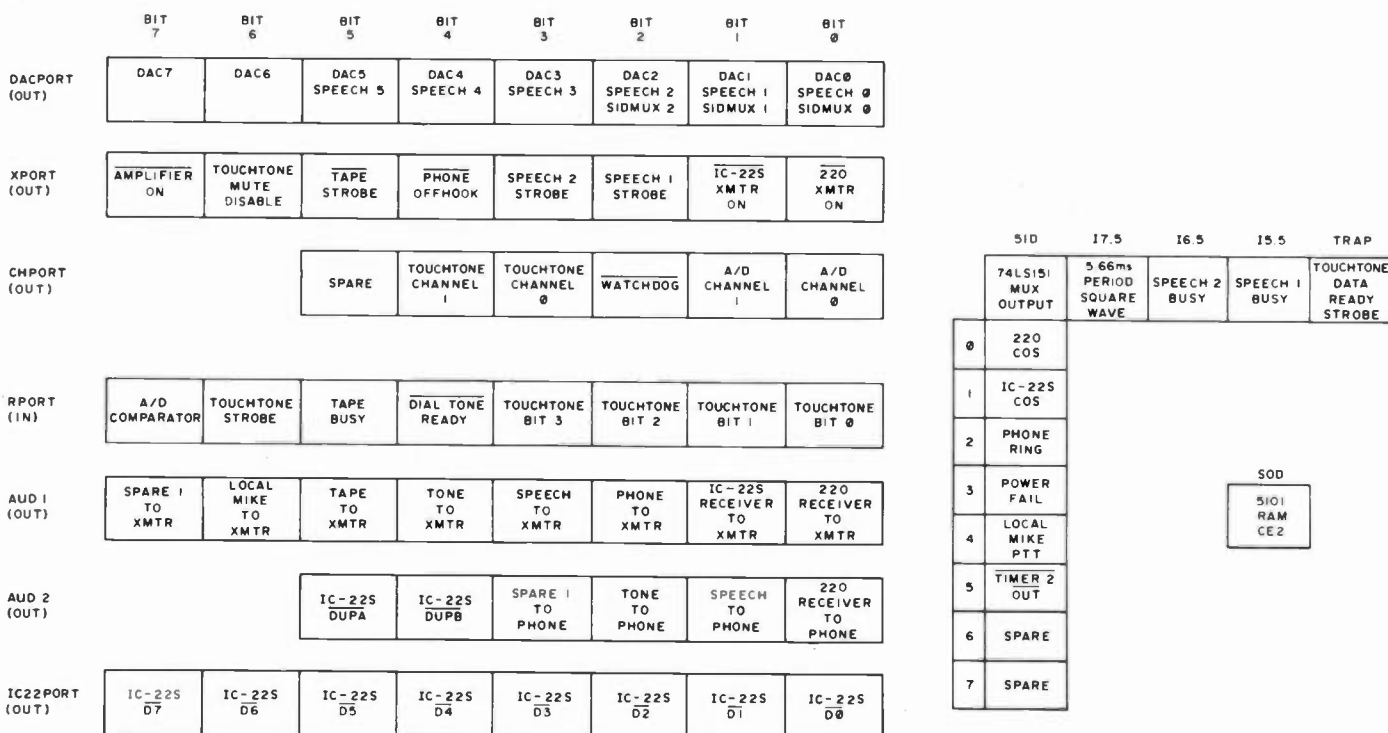

Fig. 3. I/O port definition. CHPORT and AUD2 ports are six bits wide. 8085A serial input (SID) is multiplexed between several status signals, selected by DACPORT bits 0-2.

sibility of destroying the data in RAM.

The RAM is organized as 512 words by 4 bits for convenient storage of BCD numbers. Two 5101L-1 RAMs are used. These parts can draw up to 27 mA each when operating, but only 10 μ A when in standby, where standby for the chip is defined as $CE2 < .2$ volts. Data also is retained with supply voltage as low as 2.0 volts when in standby. Unlike other CMOS RAMs, no special precautions are required to ensure that the 5101's inputs are defined as highs or lows during power-down, as with many other CMOS RAMs. Note that in an application such as this, the L-1 suffix part should be used for 450-ns access time and low-voltage data retention.

The 8085A CPU SOD serial output line drives the RAM CE2 input. The SOD line normally is held low by the software except when the RAM is to be accessed for autodialer activities, so the RAM is normally in the low-current standby mode. It's also ready in case primary power is lost, so no special power-fail software routines are required to save the data. Finally, if the CPU should ever go berserk and write over existing data in RAM, the CMOS RAM would not be written into when address-selected by CE1/ because its other chip enable (CE2) would be inactive. To play it really safe, a switch in the CE2 line can be opened when intentionally powering down the computer.

Power switching from primary to battery backup for the RAM can be done in one of several ways, but diode switching is probably the simplest. The primary supply normally powers the RAM. A 5-volt regulator is biased up to about 5.7-volts output by placing a diode in its common lead and supplies the RAM through a

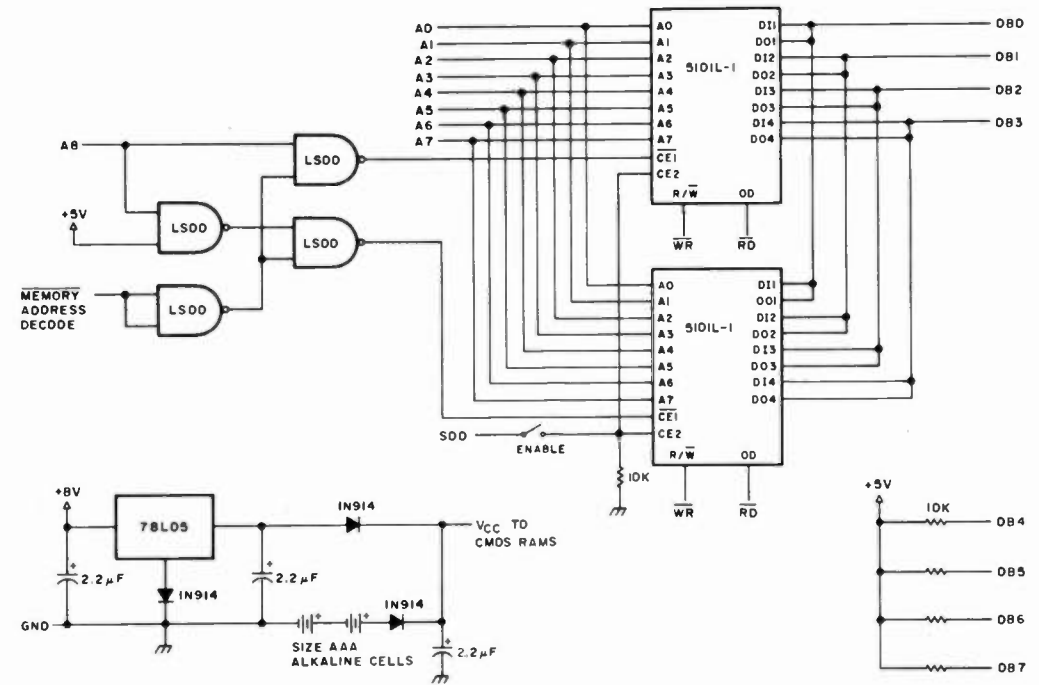

Fig. 4. CMOS autodialer RAM board schematic.

diode so that the RAM sees a 5-volt supply. The diode to the battery is reversed biased and no current flows from the battery. If the primary supply goes away, the 3-volt batteries forward bias their diode and reverse bias the other to supply approximately 2.3 volts to the CMOS RAM.

Since the batteries normally supply no current, and only around 10 μ A when in service, their life essentially is equal to their shelf life. Good silver oxide watch batteries or the AAA alkaline batteries used here are appropriate. Alternatively, nicad batteries could be used and trickle charged, so that they would never need to be replaced.

Watchdog Timer

Most microcomputer systems have reset buttons, allowing them to be cleared in case they hang up as the result of a noise glitch, hardware intermittent, or software bus. Since the repeater is located miles away on a hilltop, provisions should be included for either a remote reset or an automatic reset. An approach considered, but not used, was to decode touch-

tone A, B, C, or D for a reset function, but only one user has a 16-key touchtone pad. Instead, built into the microcomputer is an automatic reset circuit, or watchdog timer, that requires no user interaction if the computer gets hung up. A 555 timer and a transistor are wired as a "missing pulse detector" (Fig. 5). The pulse is provided by an output port of the microcomputer.

The software routine which provides the pulse is deep in the Foreground module program, so that if the software is not functioning properly the watch-

dog timer times out and generates a reset pulse to the CPU. The routine was placed in the foreground program rather than the background program because the foreground execution could be out of control but the background interrupt program, forced by the hardware interrupt request, could still execute normally. The computer pulses the watchdog timer every ten seconds, and the timer is set to time out at about thirty seconds.

The watchdog timer isn't foolproof—it activates only if the foreground is not

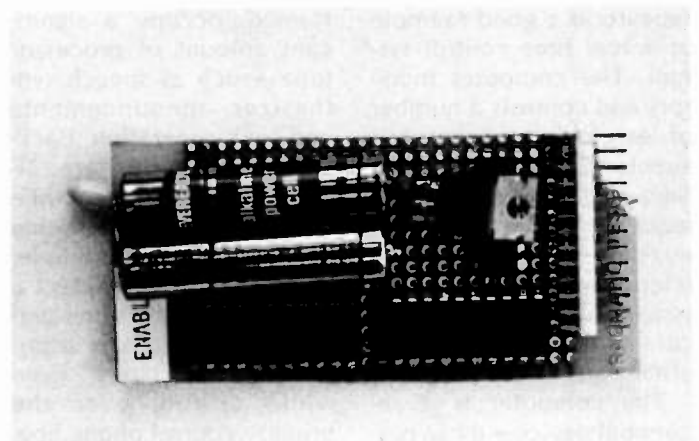

Photo B. CMOS autodialer RAM plug-in board, with battery backup.

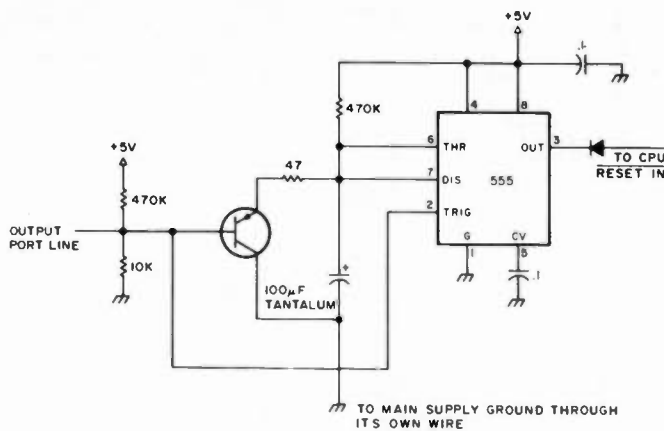

Fig. 5. Watchdog timer (missing pulse detector) schematic. A reset signal is generated if the software "misses a pulse."

executing properly. This usually means that control over the air or primary control has been lost. Since the sequence detection is performed in the foreground, control should be retained if the watchdog timer doesn't activate in response to a failure.

A second error recovery technique used is a "Jump to 0" instruction placed at address 38H ("An 8080 Repeater Control System," 73 Magazine, April, 1979). In case the program should ever find itself executing instructions where no memory is present, the floating bus appears as instruction RST 7 (all ones), which calls location 38H, causing the program to jump to location zero for initialization.

Software

A computer-controlled repeater is a good example of a real time control system. The computer monitors and controls a number of external, asynchronous events which occur in real time. The program must react to and control the events based on their relative priorities. It must synchronize the events and communicate with I/O and other parts of the program.

The computer is a sequential device—it can perform only one operation at a time. However, since it executes its operations ex-

tremely fast relative to a human's perception (hundreds of thousands of operations per second), it is possible to program the machine in a way that causes it to appear to be doing a number of things simultaneously.

Several approaches are possible to multi-tasking real time programming. The approach used here is a relatively simple foreground/background mode of operation. Background activities occur on a regular, periodic basis and include monitoring of receiver squelches and phone ring, and control of transmitters and phone off/on hook. Timing in the system also is managed by the background.

Foreground activities, or tasks, are those infrequent events which, when performed, occupy a significant amount of processor time—such as speech synthesizer announcements and tone generation. Background activities are allowed to continue while foreground tasks are being performed. For example, the computer will detect a receiver squelch open and turn on the repeater transmitter immediately, even while talking over the primary control phone line.

Another important element of the software is a highest priority activity

(TRAP interrupt) initiated by the data-ready strobe of the touchtone receiver, which loads the touchtone data into a RAM buffer as the data is received. Because of its highest priority, touchtone data can be received and stored at any time, regardless of the operation in progress, without interfering with that operation.

The various elements of the program communicate with each other by leaving information in memory registers, or "mailboxes." Repeater status, timing information, and task requests are deposited and read from the memory mailboxes by the program.

Simplified flowcharts of the principal modules are shown in Fig. 6, and a description of each follows.

Initialization Module

The Initialization module is executed after power-up or other processor reset. After I/O is initialized, the autodialer RAM contents are checked for valid data and the RAM is cleared if the contents are not valid, as in initial autodialer RAM powerup. Main RAM registers are cleared, then initialized, and control is transferred to the Foreground module.

Background Module

The Background module is an interrupt-driven routine initiated every 5.6 ms by the edge-sensitive Interrupt 7.5 input to the 8085A CPU. The activities which occur during the background occupy a significant period of time relative to the interrupt tick period. A slower interrupt tick would be preferred to allow all activities to be performed without the possibility of missing an interrupt tick. However, since an available signal (3.072 MHz) and a cheap 14-stage binary divider (4020) yield a 5.66-ms period, a simple hardware/software trade-

off can be made—the background routine is divided up five ways. During every fifth background interrupt tick (we'll call it the primary background interrupt tick), the background sample, decision, and timer routines are executed. The background meter-read routine executes during the other four out of five interrupt ticks, measuring one of the four analog channels at each tick and storing the measured value in RAM.

Background Sample

During the primary background interrupt tick (every 26.6 ms), several status inputs are sampled, including 220 receiver squelch, remote base squelch, ac power fail, phone ring, and local mike. Status bits are set and timers are loaded (mail delivered) based on the results of the samples.

Background Decisions

Several questions decided by the computer at every primary background interrupt tick include: should the 220 transmitter be on, should the remote base transmitter be on, and should the phone be off hook? To simplify the decisions, status information for each question is stored in registers (Fig. 7)—the 220 Transmitter On Register (TTOR), Remote Base Transmitter On Register (RBOR), and Phone Off-hook Register (POHR).

The bits of the registers are set and cleared by foreground and background routines and are tested at the decision times (the mail is checked). For example, the TTOR 220 hang timer bit is set by the background sample program when a receiver squelch open is detected, at which time the 220 hang timer is also loaded. The bit is cleared by the 220 hang timer timeout routine. The TTOR repeater enabled bit is set by the Initialization module, and then may be set or cleared

by primary control commands. The 220 transmitter is turned on if repeater is not timed out, is enabled, and local mike is active or autopatch is on or function is in progress or the 220 hang timer is not timed out. Otherwise, the 220 transmitter is turned off by the background decision routine.

Background Timer Structure

In the repeater controller, as in most real time control systems, a need exists for implementing a number of timers. Some events must occur at peri-

odic intervals and other events must occur at fixed time periods after the occurrence of other events. A general-purpose software scheme was used which allows virtually any number of independent timers to be implemented. Just think of each timer implemented this way as one less 555 timer in the system! With timers so easy to add, the tendency is to refine the operation of the system by using timers where they normally wouldn't be used because of cost or complexity.

Each timer is assigned a two-byte RAM location

where the timer's current value is stored. The RAM locations are used as 16-bit presetable dead-end down counters. If non-zero, the value is decremented by one by the Background module during the primary interrupt tick (every 26.6 ms). The resolution of the timers is therefore 26.6 ms, with a maximum period of 29.1 minutes.

When a timer value dead-ends or is decremented from one to zero, the routine associated with the timer is executed. Typically, the timeout routine loads other timers and/or sets status bits used by

other parts of the Background and Foreground modules (leaves mail in mailboxes).

Any timer that has a non-zero value or is counting can be forced to zero by any part of the program to inhibit execution of its timeout routine. Also, at any point the timer's value can be read by any part of the program to determine when the initiating event occurred or when timeout will occur.

The timer software executes with the remainder of the primary background software every 26.6 ms. Since the next background

Table 1. Timer program listing.

```

;SOFTWARE TIMER LOAD VALUE DEFINITIONS (EQUATES).
; VALUE = (TIME/26.66 MS)
;
34BC = TID EQU 13500 ;TID TIMER=6 MIN
1A5E = TAID EQU 6750 ;*ANXIOUS ID TIMER=3 MIN
08CA = TFCWID EQU 2250 ;FORCED CW ID TIMER=1 MIN
0177 = TTHT EQU 375 ;220 HANG TIMER=10 SEC
0026 = STTHT EQU 38 ;220 SHORT HANG TIMER=.75 SEC
0013 = TRBHT EQU 19 ;REMOTE BASE HANG TIMER=.5 SEC
1A5E = TPPTW EQU 6750 ;PHONE PATCH TO WARN TIMER=3 MIN
0465 = TPPT EQU 1125 ;PHONE PATCH TIMER=30 SEC
1A5E = TMT EQU 6750 ;MONOLOGUE TIMER=3 MIN
0071 = TSEDDT EQU 113 ;SED DET INTERDIGIT TIMER=3 SLC
08CA = TREVP EQU 2250 ;REVERSE PATCH TIMER=1 MIN
0177 = TSREVP EQU 375 ;SHORT REVERSE PATCH TIMER=10 SEC
0017 = TBEEP EQU 23 ;BEEP TIMER=.62 SEC
0177 = TSFCWID EQU 375 ;SHORT FORCED CW ID TIMER=10 SEC
0071 = TPNAD EQU 113 ;PHONE ANSWER DELAY=3 SEC
0230 = TICYT EQU 560 ;TAPE CYCLE TIME=15 SEC
0011 = TTTCOVER EQU 17 ;TT COVER TIMER=.45 SEC
0177 = TWATCH EQU 375 ;WATCHDOG TIMER=10 SEC

;TIMER REGISTER RAM ALLOCATION (DEFINE STORAGE)
;
1017 = TIMLOC EQU $
1017 = LID: DS 2 ;ID TIMER
1019 = LAID: DS 2 ;ANXIOUS ID TIMER
101B = LFCWID: DS 2 ;FORCED CW ID TIMER
101D = LTHT: DS 2 ;220 HANG TIMER
101F = LRBHT: DS 2 ;REMOTE BASE HANG TIMER
1021 = LPPTW: DS 2 ;PHONE PATCH TO WARN TIMER
1023 = LPPT: DS 2 ;PHONE PATCH TIMER
1025 = LMT: DS 2 ;MONOLOGUE TIMER
1027 = LSEDDT: DS 2 ;SED DETECTOR INTERDIGIT TIMER
1029 = LREVP: DS 2 ;REVERSE PATCH TIMER
102B = LBEEP: DS 2 ;BEEP TIMER
102D = LTTBEEP: DS 2 ;220 SEQUENCE ACKNOWLEDGE TIMER
102F = LGPT: DS 2 ;GENERAL PURPOSE FOREGROUND TIMER
1031 = LPHAD: DS 2 ;PHONE ANSWER DELAY TIMER
1033 = LTICYT: DS 2 ;TAPE CYCLE TIMER
1035 = LFIP: DS 2 ;FUNCTION IN PROGRESS HANG TIMER
1037 = LTTCOVER: DS 2 ;TOUCH TONE COVER HANG TIMER
1039 = LFDL: DS 2 ;RINGBACK RING DELAY TIMER
103B = LWATCH: DS 2 ;WATCHDOG TIMER
103D = FINTIMLOC EQU $

;TIMERS ARE DEADEND DOWN COUNTERS, AND COUNTERS WHICH
;DECREMENT FROM 1 TO 0 (DEADEND) CAUSE APPROPRIATE ROUTINE
;TO BE EXECUTED.
;
01C4 = RES75CON1 EQU $
01C4 211610 LXI H,TIMLOC-1 ;POINT TO FIRST TIMER LOCATION
;
01C7 = R75T EQU $
01C7 CD4103 CALL DECR ;DOWNCOUNT AND JMP TO ROUTINE IF DEADEND
01CA 7D MOV A,L ;DONE ALL TIMERS?
01CB FE3C CPI LOW FINTIMLOC-1
01CD C2C701 JNZ R75T ;NO, LOOP
;
;FINISHED RESTART 7.5 ACTIVITIES. RETURN FROM INTERRUPT ROUTINE.
;
01D0 C3D900 JMP FIN75 ;YES, RETURN

;COUNTER DECREMENT ROUTINE. (HL)->COUNTER LS LOCATION -1, THE 16
;BIT COUNTER IS TESTED FOR ZERO, AND IF NOT IS DECREMENTED, IF
;DECREMENTED FROM ONE TO ZERO, DROPS THRU TO APPROPRIATE
;CONTROL ROUTINE, RETURNS WITH (HL)->COUNTER MS LOCATION.
;INR L AND DCR L SHOULD BE INX H AND DCX H IF TIMER
;RAM IS AT START OF OR CROSSES PAGE BOUNDARY.
;
0341 = DECR EQU $
;
0341 2C INR L ;(HL)->COUNTER LS LOCATION
0342 5E MOV E,M ;GET LS COUNTER VALUE
0343 2C INR L ;(HL)->COUNTER MS LOCATION
0344 7E MOV A,M
0345 R3 ORA E ;IS COUNTER ZERO?
0346 C8 RZ ;RETURN IF ALREADY ZERO
0347 5A MOV D,M ;DE-COUNTER VALUE
0348 1B DCX D ;INCREMENT IT
0349 72 MOV M,D ;PUT IT BACK IN MEMORY
034A 2D DCR L
034B 73 MOV H,E
034C 2C INR L ;(HL)->COUNTER MS LOCATION

```

```

034D 7B MOV A,E
034E B2 ORA D ;IS COUNTER ZERO NOW?
034F C0 RNZ ;RETURN IF NO
;
;(HL)->COUNTER MS LOCATION. THIS ROUTINE FINDS THE ADDRESS OF
;THE TIMEOUT ROUTINE FROM THE COUNTER TIMEOUT ROUTINE TABLE,
;AND TRANSFERS EXECUTION TO THAT ROUTINE. SUBROUTINE RETURN
;FROM DECR OCCURS FROM THE TIMEOUT ROUTINE. HL IS SAVE!
;TO POINT TO NEXT TIMER REGISTER.
;
0350 = DOTIME EQU $
;
0350 E5 PUSH H ;SAVE HL
0351 113FF3 LXI D,TIMROUTAR-TIMLOC-1
0354 C34531 JMP JMP1AB2 ;COMPUTE ROUTINE ADDRESS AND JUMP
;
;TIMEDOUT ROUTINE ADDRESS TABLE. ENTRIES MUST BE IN SAME ORDER AS
;IN TIMER RAM REGISTER TABLE.
;
0357 = TIMROUTAR EQU $
;
0357 7B03 DW RID ;ID TIMEOUT
0359 9003 DW RAID ;ANXIOUS ID TIMEOUT
035B AD03 DW RFCWID ;FORCED CW ID TIMEOUT
035D B303 DW RTHT ;220 HANG TIME TIMEOUT
035F B003 DW RRBHT ;REMOTE BASE HANG TIME TIMEOUT
0361 C703 DW RPPTW ;PHONE PATCH TO WARN TIMEOUT
0363 FF03 DW RPPT ;PHONE PATCH TIMEOUT
0365 EF03 DW RMT ;MONOLOGUE TIMEOUT
0367 F503 DW RSEDDT ;SED DETECTOR INTERDIGIT TIMEOUT
0369 FF03 DW RREVP ;REVERSE PATCH TIMEOUT
036B 0504 DW RBEEP ;BEEP TIMEOUT
036D 2704 DW RTTBEEP ;220 ONLY BEEP TIMEOUT
036F 4404 DW RGPT ;GENERAL PURPOSE TIMER TIMEOUT
0371 4604 DW RPNAD ;PHONE ANSWER DELAY TIMEOUT
0373 4404 DW RTCYC ;TAPE CYCLE TIMEOUT
0375 9C03 DW RFIP ;FUNCTION IN PROGRESS HANG TIME TIMEOUT
0377 AC04 DW RTTCOVER ;TT COVER TIMEOUT
0379 4404 DW RFDL ;RINGBACK INTERRUPT DELAY
037B A603 DW RWATCH ;WATCHDOG TIMER TIMEOUT

; *** SAMPLE TIMEOUT ROUTINES ***
;
;ID TIMER TIMEOUT ROUTINE. THE ID FOREGROUND TASK
;PENDING REGISTER BIT IS SET AND THE ANXIOUS ID
;TIMER IS LOADED.
;
037D = RID EQU $
;
037D 3A4F10 LDA IDREQ ;ID REQUIRED?
0380 0F RRC
0381 D2B0E3 JNC FINRID ;DO NOTHING IF NO
;YES, SET ID PENDING BIT
0384 214110 LXI H,PID
0387 4711 MOV M,C
038B 215E1A LXI H,TAID ;ANXIOUS ID TIMER VALUE
038D 221910 SHLD LAID ;LOAD TIMER REGISTER
;
038E = FINRID EQU $
038E E1 POP H
038F C9 RET
;
;ANXIOUS ID TIMER TIMEOUT ROUTINE. THE ANXIOUS ID
;FOREGROUND TASK PENDING REGISTER BIT IS SET
;AND THE FORCED CW ID TIMER IS LOADED.
;
0390 = RAID EQU $
;
0390 214210 SETF AID ;SET ANXIOUS ID PENDING BIT
0393 4711 LXI H,AID
0394 21CA08 MOV M,C
0397 221B10 SHLD LFCWID ;FORCED CW ID TIMER VALUE
039A E1 POP H
039B C9 RET

;FORCED CW ID TIMER TIMEOUT ROUTINE. THE FORCED CW
;ID FOREGROUND TASK PENDING REGISTER BIT IS SET.
;
03AD = RFCWID EQU $
;
03AD 213E10 SETF FCWID ;SET FORCED CW ID PENDING BIT
03B0 4711 LXI H,FCWID
03B1 E1 POP H
03B2 C9 RET

```

Fig. 6. Software nucleus flowchart. Nucleus consists of Initialization, Background, Foreground, and TRAP Interrupt Modules.

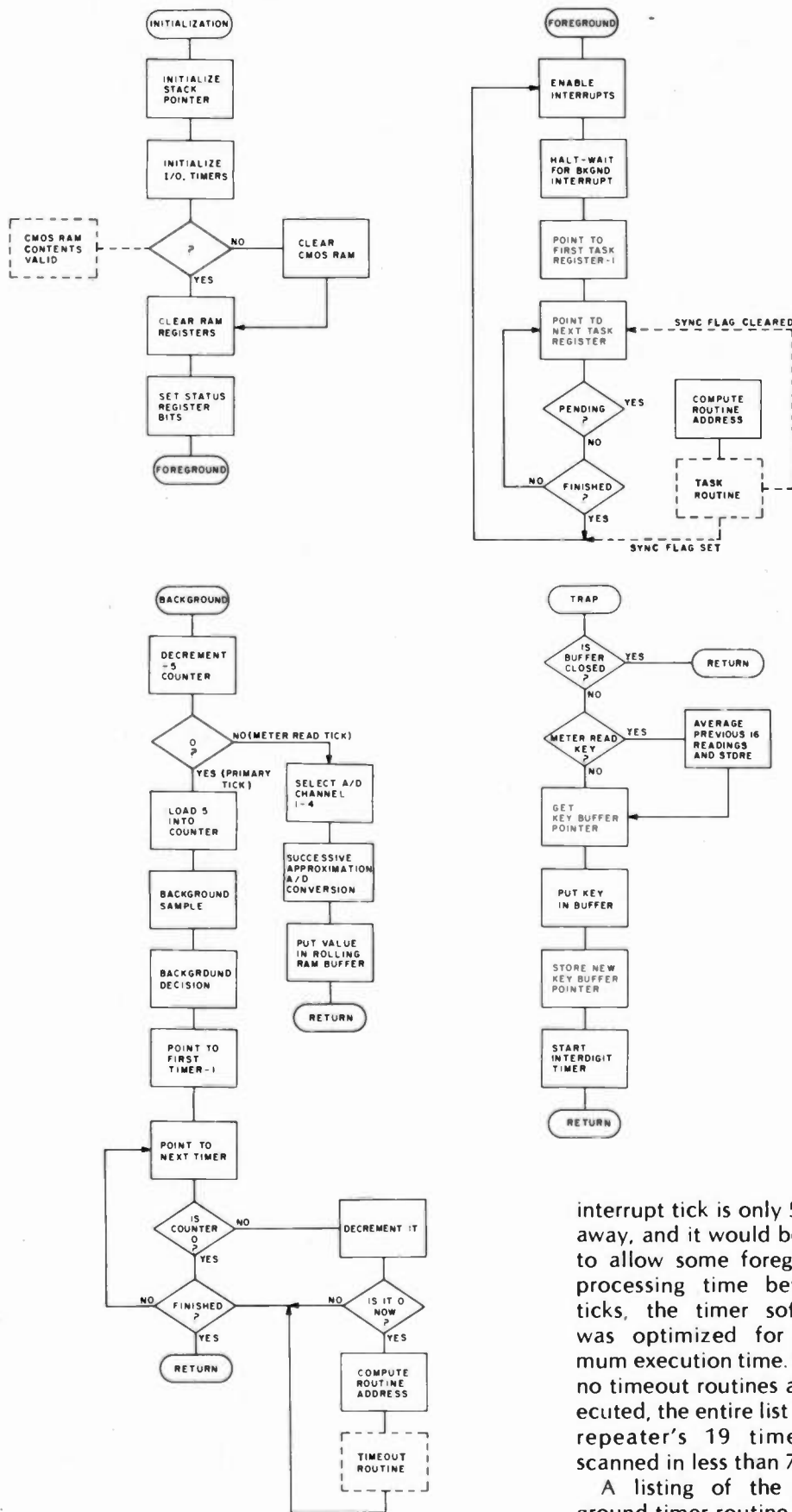

the timer load values are given names so that they may be referred to symbolically in the program. Memory locations are allocated for the timer registers in RAM, along with the allocation for other buffers and temporary storage registers. The main timer program is executed at the end of the primary background routine, and control is allowed to drop through to a timeout routine when its timer dead-ends. A table of addresses is used to find the appropriate routine address for each timer.

Three sample timeout routines are shown. Six minutes after the last ID occurred, the ID timer times out, causing the RID routine to execute. The "pending ID" foreground task-pending register is set. The anxious ID timer is also loaded, so that if the pending ID is not performed in the next three minutes (after a hang timer timeout), the anxious ID timeout routine sets the "anxious ID" task register and loads the forced CW ID timer. Finally, if the forced CW ID timer times out because an anxious ID hasn't worked its way in before a beep (because someone has continued to talk), the "forced CW ID" task bit is set and the foreground routine sends a CW ID. The SETF and CLRF macros simply set or clear foreground task-pending registers by loading register B or C into the proper memory location. B and C were previously loaded with values zero and one.

Background Meter Read

During four out of every five background interrupt ticks, one of the four analog input channels is measured using a successive approximation A/D conversion routine controlled by the software. The measured value is stored in RAM along with the last fifteen measured values for that

interrupt tick is only 5.6 ms away, and it would be nice to allow some foreground processing time between ticks, the timer software was optimized for minimum execution time. When no timeout routines are executed, the entire list of the repeater's 19 timers is scanned in less than 700 μ s.

A listing of the background timer routine is given in Table 1. At the beginning of the main program,

channel. The newest value is written over the oldest, so that the latest sixteen values are available at any time to the TRAP Interrupt module to be averaged and read out by the Foreground module.

Foreground Module

The Foreground module is normally executed following each background interrupt tick (Fig. 8). Each foreground task-pending register is tested starting at the first entry of the list. If no tasks are found to be pending, the processor returns to the start of the module, entering a HALT state waiting for the next interrupt tick. When a task is found pending, the program branches to the task routine, then returns either to check the next task register down the list, or to the beginning of the module to resynchronize to the background interrupt tick. If a task is pending but not all conditions required for its complete execution are present, the execution may be postponed temporarily until the required conditions are met. For example, if an ID task is pending but the hang timer has not yet timed out, the ID will not be performed. The ID task routine will quickly return allowing continuing scanning down the table. Eventually, the task routine may find that the hang timer has timed out. The ID is then performed and the task-pending register is cleared.

The ID task routine returns control with the synchronize flag cleared to continue checking the next registers down the list while waiting for the hang timer timeout. When the task is finally performed, during which time background interrupts are allowed to occur, the task routine returns with the synchronize flag set so that the return is to the beginning of the Foreground module, and further

table scanning will be re-synchronized to the background interrupt tick.

Foreground task-pending registers are frequently set by the Background module. Synchronizing the Foreground module to the Background module by use of the HALT instruction ensures that the foreground tasks are performed according to the desired priority. Without the HALT, the background interrupt would normally occur in the middle of the foreground's continuous scanning of the table. When control was returned to the foreground, new pending tasks could possibly be performed out of the desired sequence or priority.

When the foreground is not tied up executing a task, the computer actually spends about 80% of its time in the HALT state—sleeping! This has at least two small system benefits. When asleep, the computer is not sensitive to noise which may appear on its bus, and thus the system's noise immunity is improved. Also, the 2716 EPROMs remain deselected during the HALT state, lowering their power dissipation and total power supply current by about 50 mA.

The apparent simplicity of the Foreground module is deceiving, since most of

the repeater's features are implemented as foreground tasks. The largest foreground task is the sequence detector with its function decodes. Its task-pending register bit is set by the timeout of the 220 beep timer. The sequence detector task examines the RAM key buffer after every 220 transmission for a valid command sequence. Efficient command decoding is important to a multi-feature, expandable, easily modifiable repeater. Because of the sequence detector's importance, it will be described in detail in part III of this article.

The listing of the Foreground module nucleus and three sample task routines are given in Table 2. RAM is allocated at the beginning of the program for the task registers. The main program loop is followed by a table of task routine addresses, followed by the task routines themselves. The pending ID routine (FPID) causes a speech ID (or CW ID when remote base is on) to occur when the 220 hang timer times out. The anxious ID routine causes the same if the beep timer times out (occurs just before the beep). The forced CW ID routine sends the Morse code ID over any conversation in progress if the repeater wasn't given

the opportunity to ID at a convenient time.

TRAP Interrupt Module

The leading edge of the touchtone receiver's data-ready strobe initiates execution of the TRAP Interrupt module. The module reads the touchtone key in the binary format presented by the touchtone receiver and stores the data at the next position in the key buffer in RAM.

The TRAP input to the 8085A CPU is a rising-edge sensitive, non-maskable interrupt input. Because the interrupt cannot be disabled by software, its use requires certain cautions.

Often in interrupt driven systems, an entire group of instructions must be allowed to execute without being interrupted. Interrupts could allow certain parameters to be modified during a critical operation. For example, a single bit in a status register in memory may be modified by reading the memory location, ANDing or ORing the contents with a value, and then writing the modified value back to RAM. If between the time the RAM contents are read and rewritten an interrupt occurs which changes the contents of the status register in RAM, the value rewritten by the interrupted routine is obsolete—the in-

220 TRANSMITTER ON REGISTER (TTOR)

| | | | | | | | |
|----------------------|--------------------------------|-------|-----------------------|-------|---------------------------|----------------------------------|----------------------------|
| TIMED OUT
(TTTIM) | REPEATER
ENABLED
(RPTEN) | _____ | LOCAL
MIKE
(LM) | _____ | AUTOPATCH
ON
(APON) | FUNCTION
IN PROGRESS
(FIP) | 220 HANG
TIMER
(THT) |
|----------------------|--------------------------------|-------|-----------------------|-------|---------------------------|----------------------------------|----------------------------|

220 TRANSMITTER ON = TTTIM · RPTEN · (LM · APON · FIP · THT)

REMOTE BASE TRANSMITTER ON REGISTER (RBOR)

| | | | | | | | |
|----------------------|--------------------------------|-------------------------------------|-------|--|-------|---|--|
| TIMED OUT
(RBTIM) | REPEATER
ENABLED
(RPTEN) | REMOTE
BASE
ENABLED
(RBEN) | _____ | REMOTE
BASE
RECEIVER
ENABLED
(RBREN) | _____ | REMOTE
BASE
TRANSMITTER
ENABLED
(RBXEN) | REMOTE
BASE
HANG TIMER
(RBHT) |
|----------------------|--------------------------------|-------------------------------------|-------|--|-------|---|--|

REMOTE BASE TRANSMITTER ON = RBTIM · RPTEN · RBEN · RBREN · RBXEN · RBHT

PHONE OFFHOOK REGISTER (POHR)

| | | | | | | | |
|-------|-------|-------|-------|-------|-----------------------------|-------------------------|---------------------------|
| _____ | _____ | _____ | _____ | _____ | PATCH
PENDING
(PPEND) | PRIMARY
ON
(PRIM) | AUTOPATCH
ON
(APON) |
|-------|-------|-------|-------|-------|-----------------------------|-------------------------|---------------------------|

PHONE OFFHOOK = PPEND · PRIM · APON

Fig. 7. Background decision registers. Each register is a RAM memory location.

Table 2. Foreground nucleus program listing.

```

;FOREGROUND TASK PENDING REGISTER RAM
; ALLOCATION (DEFINE STORAGE).
;
1030 = FTFR EQU %
103D PITSED: DS 1 ;PENDING TT SEQUENCE
103E FCFWID: DS 1 ;FORCED CW ID
103F PVID: DS 1 ;PENDING VOICE ID
1040 AVID: DS 1 ;ANXIOUS VOICE ID
1041 PID: DS 1 ;PENDING ID
1042 AID: DS 1 ;ANXIOUS ID
1043 SAYCALL: DS 1 ;DIRECTED RINGBACK SAY CALL
1044 HWARN: DS 1 ;MONOLOGUE WARNING
1045 PFWARN: DS 1 ;PHONE PATCH TIMEOUT WARNING
1046 PBEEP: DS 1 ;BEEP
1047 P73HANG: DS 1 ;SAY 73 AND HANG UP PHONE
1048 RINGBACK: DS 1 ;RING BACK RING
1049 PRIM: DS 1 ;PRIMARY ANSWER
104A TIMEOUTANNC: DS 1 ;TIME OUT RESET ANNOUNCE
104B CLRANNC: DS 1 ;INITIALIZE ANNOUNCEMENT
104C WATCH: DS 1 ;WATCHDOG TIMER INITIALIZE
104D PCOVER: DS 1 ;COVER TONE
104E TTCOVER: DS 1 ;TT COVER TONE
104F = FINFTFR EQU %

;*****
; FOREGROUND ROUTINE
;*****
;
; THE FOREGROUND ROUTINE EXAMINES THE FOREGROUND
; TASK PENDING REGISTERS, AND IF A TASK IS PENDING THE
; APPROPRIATE ROUTINE IS CALLED. THE HALT INSTRUCTION
; SYNCHRONIZES THE FOREGROUND ROUTINE TO THE RST7.5
; INTERRUPT, ENSURING THE FOREGROUND TASKS ARE PERFORMED
; ACCORDING TO PRIORITY.

0523 = FOREGROUND EQU %
;
; EI ;ENABLE RST7.5 INTERRUPT
0524 31EF18 LXI SP,102*256+0EFH ;DON'T PRESS YOUR LUCK
0527 213C10 LXI H,FTFR-1 ;POINT TO FIRST REGISTER LOCATION
052A 76 HLT ;WAIT FOR NEXT INTERRUPT TO CONTINUE

; FORE1 EQU %
052B C13A05 CALL DFCR ;SEE IF TASK PENDING
052E DA2305 JC FOREGROUND ;START OVER IF CY=1
0531 7D MOV A,L ;OTHERWISE CONTINUE, DONE?
0532 FE4E CPI LOW FINFTFR-1
0534 C2B05 JNZ FORE1
0537 C32305 JMP FOREGROUND ;DONE, START OVER

; DFCR EQU %
053A =
;
053A 23 INX H ;NEXT
053B 7E MOV A,H
053C 0F RRC ;TASK PENDING?
053D D0 RNC ;RETURN IF NOT

; DOFORE EQU %
053E =
;
053E E5 PUSH H ;YES, (HL)-> FTFR LOCATION
053F 7D MOV A,L
0540 D63D SUI LOW FTFR ;SAVE ADD VALUE
0542 110CF5 LXI D,FROUTAR-FTFR
0545 19 DAD D ;CALCULATE ROUTINE ADDRESS
0546 C34231 JMP JMPTAB1 ; AND JUMP TO ROUTINE

;FOREGROUND TASK ROUTINE ADDRESS TABLE. ENTRIES MUST BE IN SAME
;ORDER AS IN FOREGROUND TASK PENDING RAM REGISTER TABLE. PRIORITY
;IS DEPENDANT ON POSITION IN TABLE.
;
0549 = FROUTAR EQU %
;
0549 1008 DW FPPTSED ;SEQUENCE DETECTOR BUFFER READY
054B C105 DW FFCWID ;FORCED CW ID
054D D605 DW FPID ;PENDING VOICE ID ROUTINE
054F 6D06 DW FAVID ;ANXIOUS VOICE ID ROUTINE
0551 9205 DW FPID ;PENDING ID
0553 BB05 DW FAID ;ANXIOUS ID
0555 6D05 DW FSAYCALL ;DIRECTED RINGBACK SAY CALL
0557 1007 DW FHWARN ;MONOLOGUE WARNING

0559 BE06 DW FPPTWARN ;PHONE PATCH TIMEOUT WARNING
055B 7306 DW FPBEEP ;PENDING BEEP
055D FA06 DW F73HANG ;PRIMARY HANGUP
055F B207 DW FRINGBACK ;RINGBACK RING
0561 5F07 DW FFPRIH ;PRIMARY PHONE ANSWER
0563 3A07 DW FTIMERANNC ;TIMED OUT RESET ANNOUNCEMENT
0565 9F07 DW FCLRANNC ;INITIALIZE ANNOUNCEMENT
0567 D906 DW FWATCH ;WATCHDOG TIMER RESET
0569 9207 DW FPCOVER ;PENDING COVER TONE
056B 9207 DW FTTCOVER ;PENDING TT COVER TONE

; *** SAMPLE FOREGROUND TASK ROUTINES ***
;
;PENDING ID. IF 220 HANG TIMER TIMED OUT AND AUTOPATCH
;OFF, THEN ID.
0592 = FPID EQU %
;
0592 2A1D10 LHL LTTHT ;220 HANG TIMER
;
0595 = FPID1 EQU %
0595 7D MOV A,L ;IS TIMER ZERO?
0596 B4 ORA H
0597 C2B905 JNZ FINFPID ;IF NOT DONT ID, CY=0
059A 3A0010 LDA TIOR ;YES, PATCH ON?
059D E604 ANI SAPON
059F C2B905 JNZ FINFPID ;IF YES DONT ID, CY=0
05A2 3A0110 LDA RBOR ;RB RCVR ON?
05A5 E628 ANI SRBRN OR SRBRON
05A7 FE28 CPI SRBRN OR SRBRON
05A9 CAC105 JZ FFCWID ;IF YES, DO CW ID

; FPID2 EQU %
05AC =
05AC 210000 LXI H,VIDENT ;POINT TO MESSAGE
05AF C3C333 CALL TALKR ; AND TALK
05B2 DAB905 JC FINFPID ;ABORT IF SQUELCH OPENED, TOP OF FTFR

; FPID3 EQU %
05B5 =
05B5 CD7231 CALL CLEARID ;CLEAR ID REQUIRED, TIMERS, ETC
05B8 37 SIC ;SO RETURN TO TOP OF FTFR

; FINFPID EQU %
05B9 =
05B9 E1 POP H ;RESTORE HL
05BA C9 RET

; FAID EQU %
05BB =
05BB 2A2B10 LHL LBEEP ;BEEP TIMER
05BE C39505 JMP FPID1

; FFCWID EQU %
05C1 =
;
05C1 CDB333 CALL CONNTONER ;CONNECT TONE GENERATOR TO RADIO
05C4 010080 LXI B,8000H ;DELAY
05C7 C9A34 CALL DEL2
05CA 210000 LXI H,VIDENT ;POINT TO MORSE CODE MESSAGE
05CD CD1432 CALL MORSE ;SEND ID
05D0 CDD733 CALL XCONN ;DISCONNECT
05D3 C3B505 JMP FPII3 ;FINISH

;JUMP TO ADDRESS IN TABLE. A=ENTRY IN WORD TABLE. (HL)-> TOP OF
;TABLE.
;
3141 = JMPTAB EQU %
3141 07 RLC ;AX2
;
3142 = JMPTAB1 EQU %
3142 5F MOV E,A
3143 1600 MVI B,0 ;DE-OFFSET VALUE
;
3145 = JMPTAB2 EQU %
3145 19 DAD D ;(HL)-> ADDRESS IN TABLE
3146 5E MOV E,H
3147 23 INX H
3148 56 MOV D,H
3149 ER XCHG ;HL=JUMP ADDRESS
314A E9 PCHI ;JUMP

```

interrupted routine failed to correctly perform its job.

Although the probability of an occurrence at exactly the wrong time of an interrupt which modifies the memory location is extremely low, when a com-

puter executes hundreds of thousands of operations per second, twenty-four hours per day, year after year, the "highly improbable" will happen. This type of problem may appear only once every few months, but it is a

source of software unreliability and is extremely difficult to test for. The goal must be 100% reliability; aiming for anything less will probably leave room for software failures. A critical section of code such as that

described must be protected by disabling interrupts around it so that the operation may be completed before an interrupt is allowed to occur. The solution is simple—it's just necessary to be careful in the design of interrupt driven software. When using the TRAP interrupt, which cannot be disabled by software, care must be taken to ensure that no conflicts such as those described can exist.

A second potential problem using the TRAP interrupt input is that if a TRAP interrupt can be generated before the computer is completely initialized after reset, the system may not

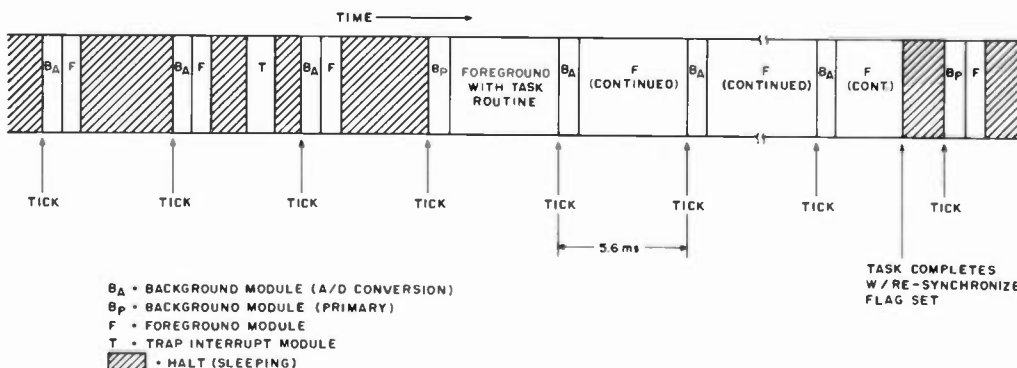

Fig. 8. Typical software module execution interaction.

be able to process the interrupt correctly, since the stack pointer may not yet be set, data memory may not yet be initialized, etc. Because of these two potential problems, the TRAP interrupt must be used with care. The hardware and software were designed here so that these restrictions were not a problem.

Following the TRAP interrupt, the previous interrupt enable status can be found by executing a RIM instruction. For example, at the end of the TRAP routine before the return, the RIM instruction can be used to enable interrupts if they were previously enabled, or to leave them disabled if they were disabled at the time the TRAP interrupt occurred. The RIM instruction and the conditional enable interrupt should be placed before the POP PSW instruction, however, since

the RIM modifies the contents of the accumulator.

In retrospect, the touchtone data read routine could have been accommodated in the background. The touchtone data-ready strobe could be checked either at every background interrupt tick or at every fifth (primary) tick. The extra complexity of a second interrupt would have been avoided and it would have been a lower risk approach.

Next Time

The conclusion of this article will discuss hardware and software interfacing of peripheral circuits including the speech synthesizer, remote base, audio mixers, and audio delay line.

A single-density, eight-inch CP/M-compatible diskette containing a source listing of the repeater software is available from the author. ■

NEW!! **ATTENTION MOBILE HAMS**
15 METER MOBILE TRANSCEIVER
CW & USB
NCG 15SB



THE QRP RIG WITH THE **BIG RIG SOUND** ACTIVE NOISE BLANKER—RF GAIN—CW SWITCH—SQUELCH—MIC GAIN—DIGITAL FREQUENCY DISPLAY—HI/LO POWER SWITCH—13.8 VDC 5A POSITIVE OR NEGATIVE GROUND.

See your dealer for a demonstration.
 DEALER INQUIRY INVITED.

NCG Co. **NEW** 438 to 450 MHz
 PLL mobile
 Memory-Scan
 318
 1275 N. GROVE ST.
 ANAHEIM, CALIF. 92806 (714) 630-4541

Hustler: The First Family of fixed station two meter gain antennas.

Whatever your requirement, Hustler provides outstanding performance. Precision engineered antennas manufactured with finest materials available.

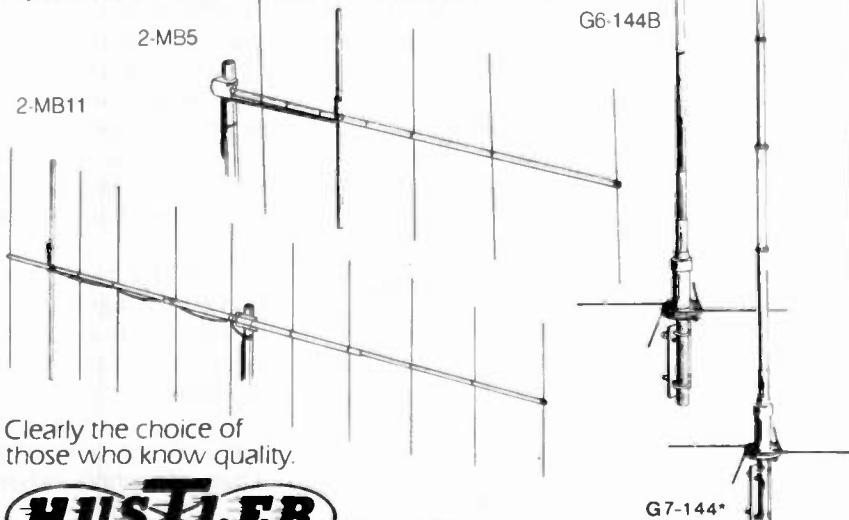

Clearly the choice of those who know quality.



3275 North B. Ave. • Kissimmee, Florida 32741

*Also available in 1-1/4 meter



DEALERS

Electronics, Inc.
 227 No. Santa Fe
 Salina, KS 67401
 (913) 827-7377

Ferris Radio
 21738 John Rd.
 Hazel Park, MI 48030
 (313) 398-6645

"Ham" Buerger, Inc.
 68 North York Rd.
 Willow Grove, PA 19090
 (215) 659-5900

Ham Radio Outlet
 2620 West LaPalma
 Anaheim, CA 92801
 (714) 761-3033

Radio Communications
 of Charleston, Inc.
 102 Farm Rd.
 Goose Creek, SC 29445
 (803) 553-4104

Sandro's Electronics, Inc.
 1559 Brentwood Rd.
 Bayshore, NY 11706
 (516) 666-4434

The Radio Spectrum at a Glance

— from VLF to UHF, SWLing is fun

Spies, smugglers, military missions, rescue operations, foreign broadcasts, undercover surveillances, medical relief messages, and space and satellite communications are but a tiny fraction of the communications networks humming throughout the most concentrated portion of the radio spectrum: 2-420 MHz.

To keep these millions of radio operations worldwide from landing on top of each other, nations of the Earth, developed and developing, have established depart-

ments to regulate the users of the radio spectrum.

On an international level, the United Nations provides a cooperative effort known as the International Telecommunications Union. Entirely voluntary, it was the ITU which conducted the World Radio Administrative Radio Conference last fall at its Geneva, Switzerland, headquarters. The ramifications of agreements made at WARC '79 will not be fully appreciated until further meetings are held for ratification. But

there will be some changes in the next few years.

In the United States, two government agencies provide for regulation of the users of the radio spectrum. We are familiar with the agency closest to amateur radio, the Federal Communications Commission. It is the primary purpose of the FCC to draft rules and regulations pertaining to the non-federal government users of the spectrum. Police and fire, trucking, business and industry, amateur and CB, common car-

rier services, ship to shore, and many other conventional services are regulated by rules proposed and maintained by the FCC.

At the federal level, it is the Interdepartment Radio Advisory Committee, now a function of the Department of Commerce, which regulates government radio assignments. Interestingly enough, although the FCC regulates non-government communicators, they are a government entity and their communications thus are regulated by IRAC!

Call sign blocks for both government and non-government operations are issued by the FCC. Table 1 shows the basic band plan as allocated in the United States.

With this brief introduction to the agencies which cooperatively do their best to prevent chaos on the radio bands, let's have a closer look at the spectrum itself and see who is doing what with whom, where!

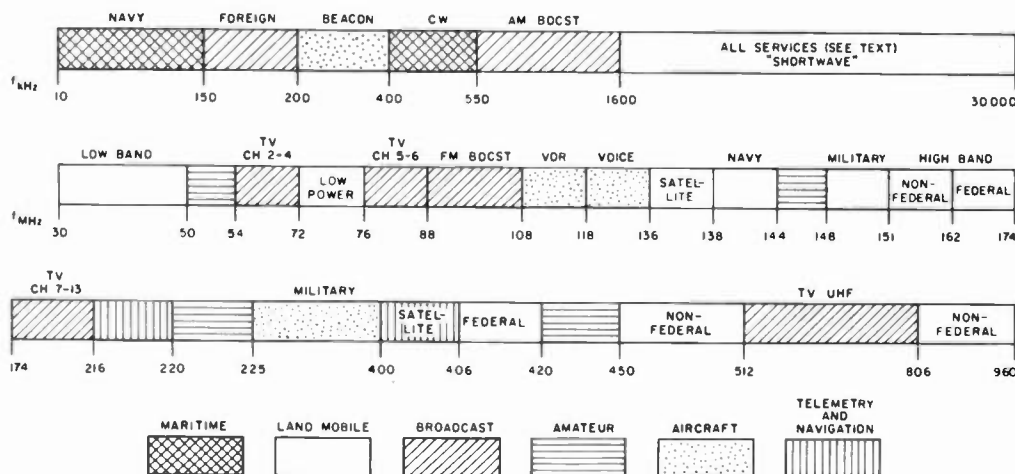

Table 1. Frequency band allocations.

Below the Broadcast Band

Because of reliable ground wave coverage, the

spectrum below the standard broadcast band, 10-535 kHz, is utilized primarily by long-distance point-to-point and ship-to-shore communications. The lowest portion (10-15 kHz) is occupied extensively by navigational signals such as Omega.

Some high-speed Morse and a great deal of narrow-shift radioteletype is encountered by listeners while monitoring this base-band of radio. There is no voice below 150 kHz, although 150-285 kHz is used for broadcasting in parts of Europe. The venerable 200-400-kHz range has been used for aeronautical navigational beacons since before World War II and still is filled with tone-modulated Morse identifiers for airports all over the world. From 400-535 kHz, CW transmissions from government and non-government ocean-going vessels communicate with their land stations.

Above the broadcast band, from 1.6 to 30 MHz, we encounter the best-known region of the radio spectrum. Classically called "shortwave" because the wavelengths of emissions are shorter than those first encountered in the early low-frequency days of radio, this frequency range is absolutely polluted with virtually every imaginable electromagnetic emanation! AM and sideband, CW and RTTY, telemetry and multiplex, tone paging and FM, broadcasters and broadcast jammers, facsimile and data—the high-frequency range is a veritable polyglot of activity.

In the United States, frequency allocations are made on an alternating basis; that is, the same service will be assigned at intervals throughout the spectrum. For example, international broadcasters are assigned

discrete frequencies in the ranges 5950-6200, 9500-9775, 11700-11975, 15100-15450, 17700-17900, 21450-21750, and 25600-26100 kHz.

This same alternating allocation procedure is used for aeronautical, maritime, fixed and mobile, and mobile services. We see this procedure in our own hobby, with amateur bands spaced at intervals as the 160-, 80/75-, 40-, 20-, 15-, and 10-meter bands, with others added at WARC '79.

For convenience of discussion, all radio operations are divided into two basic categories: broadcasting and "utilities." The broadcasters don't listen; they radiate signals for reception by anyone who is interested in listening. All two-way communications are classified as utilities.

Are there some "hot spots" of listening intrigue? Yes, there certainly are. The most interesting portion of the shortwave spectrum is between 3 and 18 MHz, outside of the foreign broadcast bands and ham bands. They center around the most-used military bands and include spies, embassy communications, tactical maneuvers, smuggling operations, undercover agencies, and other drama.

To avoid monitoring, clandestine operations frequently change operating frequencies, but because of propagation, antennas, or equipment limitations, they generally will occupy certain key portions of the spectrum. These include 50-100 kHz or so up or down from the following center frequencies (kHz): 4725, 5700, 6700, 7400, 9000, 11250, 13300, 15050, and 18000.

VHF/UHF

As communications congestion becomes increasingly worse, frequencies used by communicators be-

Frequency Lists

A listener without a frequency directory is like a hunter without a gun. Fortunately, there are a number of useful guides on the market. The new *Federal Frequency Directory* features more than 100,000 frequencies, agencies, and locations of US Government radio communicators using the spectrum 2-420 MHz, inclusive. Unlike many smaller volumes, this exhaustive directory is taken directly from the unclassified IRAC computer file. It is available for \$14.95 postpaid from Grove Enterprises, Rt. 1, Box 156K, Brass-town NC 28902.

The popular *Confidential Frequency List* is now in its 4th edition. It is geared toward the shortwave listener, confining its listings to 4-25 MHz. It may be purchased from Gilfer Associates, PO Box 239, Park Ridge NJ 07656.

The *Radio Communications Guide* features hundreds of commonly reported frequencies in the shortwave and VHF/UHF range. A copy is available for \$6.95 plus \$1.00 postage from Handler Enterprises, PO Box 48, Deerfield IL 60015.

For the scanner listener, two directories are outstanding. The *Police Call Directory* has become a classic for public safety monitoring. It is regionalized and available from Radio Shack outlets.

A new scanner frequency directory has been released from Electra, manufacturer of the famous Bearcat scanner line. Featuring a variety of VHF/UHF services, it may be obtained for \$12.95 from Better Bearcat, Electra Co., Cumberland IN 46229.

come increasingly higher (Grove's Law of Proportionate Pollution!). So it has been with shortwave and higher frequencies for years.

The sunspot cycle has contributed a great deal to motivating users to new frequencies, and worldwide skip now can be heard up through 50 MHz.

The 30-50-MHz spectrum peaks in the afternoon, with worldwide land mobile users of every language (including profane) populating "low band," as this block of spectrum is commonly referred to.

In the United States, the most common users of low band are military bases, paging systems, and state public safety agencies. FM mode dominates, although occasional AM is encountered.

Above 54 MHz, TV broadcast (channels 2 through 6) dominates through 88 MHz, with a short break between 72-76 MHz. A variety of low-power industrial and public

safety communications may be found there, especially in larger cities. The familiar FM broadcast band is 88-108 MHz (with low-cost "bugs" popularly used between 86-90 MHz—listen in on your neighbors!).

Aeronautical services share the exclusive use of the 108-136-MHz band. Aeronavigational beacons (VOR) dominate 108-118 MHz; this is why most aircraft scanners include only 118-136 MHz, the active air-to-ground band. Emission in this range is always AM voice. Commercial carriers chat with their home offices in the 129-132-MHz portion of this range, and when pilots get bored (!), they get together on 123.45 MHz.

There still is some satellite activity in the 136-138-MHz region, with ATS-3 commonly reported on 135.575 MHz with voice relays from scientific users all over the hemisphere.

Military agencies use land mobile on their bases on each side of the two-

meter band: 138-144 and 148-150.8 MHz.

VHF high band is divided into two distinct halves: 150.8-162 non-government and 162-174 federal government. There are very few exceptions within this range. Mobile telephone may be found from 152.51-152.81 MHz (30-kHz channel separation); police and fire are most commonly assigned in the 154-156-MHz portion; ship-to-shore is in the 156-158-MHz range (with some telephone traffic from boats to shore clustered near 162 MHz).

High band is the most populated mobile band in the spectrum, with government services from every agency represented in the upper portion. Military, agriculture, FBI, Secret Service, VA hospitals, Indian Affairs... everybody is up there. While some sensitive intelligence is openly conducted, most of those voice

communications are encoded or even encrypted beyond recognition.

TV channels 7-13 occupy 174-216 MHz, and a few navigational and control signals may be found from 216-220 MHz, but no voice has ever been reported.

Above the 220-225-MHz ham band, military aeronautical communications dominate nearly 200 MHz of spectrum! AM tactical and air-to-ground voice is heard from 225-400 MHz, usually channelized at 100-kHz intervals. The space shuttle *Columbia* (*Enterprise* will no longer fly) will use 259.7 and 296.8 MHz as UHF backup while in flight. Air Force, Navy, Coast Guard, and Navy aircraft use this band constantly.

While AM is the operating mode almost exclusively, the new FLEETSATCOM military satellites may be heard using FM in the

240-270-MHz portion, shared with air-to-ground AM.

If you like beeps and whistles, you'll love 400-406 MHz. It is used for satellite telecommand and environmental/meteorological telemetry, such as radiosonde balloons. You're welcome to listen, but polar-bear tracking satellites rarely QSL!

We won't discuss the 406-420 MHz band because there is a lot of sensitive federal government stuff in there. Don't listen, or you may hear all manner of fascinating things. Naturally, I never listen due to a keen sense of patriotic duty.

The 420-450-MHz band is shared by hams and navigational beacons. Some Navy ships are equipped with long-distance radar in that region that would wipe out everything in range if it were used near land; fortunately, it isn't.

The 450-470-MHz band has been extended through 512 MHz (called "T-band" because it was taken from the lower UHF TV channels allocations). It is also becoming congested in major metropolitan areas, forcing the FCC to consider adding even more UHF space.

512-806 MHz still is claimed by UHF-TV broadcasting, with 806-960 MHz the new land mobile frontier. A few assignments have been made in the large metropolitan areas with varying degrees of success. As costs come down, users will move up.

Conclusion

The radio spectrum is a precious natural resource. A full understanding of its uses will make us all better equipped to understand the struggles which users outside the ham bands face for effective and often vital communications. ■

Solid-State H.F. Kilowatt Amplifier

NO TUNING !

"FCC TYPE ACCEPTED"

All new, all nine hf bands

160 thru 10* meters including the new 10, 18 and 24 MHz bands.



| | | |
|----------------|---------------------------|-----------|
| MODEL: A1000 | 115/230VAC, 50-100W Input | \$1395.00 |
| *MODEL: A1000X | 115/230VAC, 15-35W Input | \$1395.00 |



*Export Model

Use your Master Charge or BankAmericard/VISA when you order.



DEALER INQUIRIES INVITED ✓₆₃
RF POWER LABS, INC.

21820 87th S.E., Maltby Industrial Village,
Woodinville, WA 98072, (206) 481-8833
Telex No. 32-1042

HAMS... with TRS-80* Computers
GET ON RADIOTELETYPE



with **BIT-BYTER**

Complete system includes BIT-BYTER interface and the RTY-80 computer program.

Great Features: split screen, level 1 and 2 4K computers, transmit buffer and countless others... all at this terrific price:

Only **\$129.00**

Order today... or for more information write to:

Vic Frump, KBEXJ
UHF SALES & SERVICE COMPANY
Rt. 1, Box 52A
Evans, West Virginia 25241 ✓ 361
(304) 372-2047

* TRADEMARK of The Tandy Corporation

MILITARY SURPLUS WANTED

Highest prices ever on recent U.S. Military surplus, especially on Collins equipment or parts. We Pay freight. Call collect for high offer. (201) 440-8787. 35 Ruta Court, S. Hackensack, N.J. 07606

✓ 317
SPACE ELECTRONICS CO.

THE LITTLE GIANT

BRAKE BEND & FORM .060 ALUM. & STL.



CLEAN
SMOOTH
BENDS TO
90°

18" CAPACITY

**EASY
TO USE**

BUILD CUSTOM
CABINETS YOU'LL BE
PROUD OF! COMMERCIAL
QUALITY AT 1/10 THE COST!

GUARANTEED! 19⁹⁵

Z ASSOCIATES
P.O. BOX 757
3050 NE 55 TH AVE. ✓ 336
SILVER SPRINGS, FLA. 32688

+150 SHIPPING
**SORRY!
NO CODA**

The UDT 170



**SPECIAL
CW Ident Prom
included!**

The SMART TU for RTTY & MORSE

The UDT 170 Universal Data Transceiver will instantly convert any ASCII or Baudot teletype or video terminal into a multiple baud rate data transceiver for ASCII, Baudot or Morse operation. It features...

- 170/850 HZ Shift
- Dual 6 pole active filters for weak signal operation
- ASCII/Baudot Regeneration with multiple baud rates
- CW Auto Ident (optional)
- 1-150 WPM Morse with Auto-track
- Computes & Displays WPM copy rate & Buffer Status
- Selectable line length from 40 to 80 characters
- Metal Enclosure 12"x7 1/4"x3 1/2"

For more information write or phone

Price, Complete and Assembled \$549

XXITEX CORP.
9861 Chartwell Drive
Dallas, Texas 75243
(214) 349-2490

Price subject to change without notice

Poly Paks[®] INC. Quality Electronics

For Less!



\$1888

100%
Factory
Guaranteed!

SELECTABLE VOLTAGE SOLAR PANEL UNIQUE!

- Snap-On Reflectors
- 1st Multiple Voltage Solar Power Supply!
- Excellent Battery Substitute 3, 6, or 9 VDC @ 50 mA!

Cat. No. 92CU6413

Attractive 4 1/2 x 5 1/2 x 1 1/2" black plastic case houses 24 crescent shaped silicon slivers, arranged under a plastic faceplate consisting of 100s of bubble magnifiers which enhance the light and insure optimum cell performance. In addition, two 4 x 5" reflector panels fit on either side of the case (similar to a tanning mirror) thus providing maximum light collection and panel efficiency. Three miniature mm jacks are top mounted and labeled 3V, 6V, and 9V. Just plug into the voltage you need! Delivers 50 mA @ all voltages. (under full sun). Excellent battery substitute in transistor radios, small motors & lamps, etc. Comes w/mini plug with 18" insulated wire leads. For Less! Wt. 5 oz.

COMPLETE COUPON AND MAIL TO.....

Send For Our **FREE** Catalog Today!

Featuring the Largest Selection and the Lowest Prices on a wide variety of quality electronic products, including: Computer Peripherals, Solar Devices, Speakers, Audio Equipment, and much much more! Take advantage of our 25 years as America's foremost supplier of discount electronics.

**For Faster Service
Order By Phone
1-617-245-3828**

Poly Paks /
P.O. Box 942, 73 11 SOUTH LYNNFIELD, MA. 01940
Send me _____ Solar Panels @ \$18.88 ea.
Plus \$3 each for Postage & Handling

NAME _____
ADDRESS _____
CITY _____
STATE _____ ZIP _____
Enclosed is CHECK, MONEY ORDER
Charge my MASTERCARD VISA
ACCT. # _____ EXP. DATE _____
 Send me your **FREE** catalog



G.I.S.M.O. ✓27

**2305 CHERRY ROAD
ROCK HILL, S.C. 29730**

Featuring



ICOM



YAESU



Cushcraft



Wilson

BIRD



Larsen

TEMPO

Henry Radio

Dentron



KENWOOD



DRAKE

IN ADDITION TO THE PRODUCTS LISTED ABOVE, WE ARE ALSO FACTORY AUTHORIZED DEALERS OR DISTRIBUTORS FOR B & W, UNIVERSAL TOWERS, BERK-TEK CABLES, BENCHER PADDLES, THE NEW CES DIALER AND MANY OTHER ACCESSORIES. OUR SERVICE SHOP, STAFFED BY FIRST PHONE, EXTRA CLASS TECHNICIANS, OFFERS EXPERT SERVICE ON ALL MAKES AND MODELS AND FACTORY AUTHORIZED SERVICE ON SWAN, YAESU AND KENWOOD PRODUCTS.

SERVICE DEPARTMENT CALL 803-366-7158

**73, THE
GISMO
GANG**

**ORDER TOLL FREE!
800-845-6183**

new

Looking For a VHF/UHF FM Link System? With or Without Autopatch?

- For Remote Autopatch Hookup
- To Link 2 Repeaters. (W/or W/O Autopatch).
- To Reach a Remote Station
- Other Special Purpose Application!

Spectrum is proud to announce that we are now supplying a wide line of VHF & UHF Link equipment such as Full Duplex or Half Duplex/Simplex link transceivers and rack mount Link Receivers, etc. These units are typically made up from our SCR1000/4000 Repeater Mainframes, but they are specially modified for Link Transceiver use.



SCR1000 Link Transceiver

The link units typically operate "cross band", e.g. 2M to 200 MHz. or 2M to 450MHz, or vice versa, etc. We normally supply complete systems, including rack mount Link Transceivers, possibly a main Repeater, plus any duplexers, antennas, cable, cabinets, etc. However, we can also supply shielded receiver & transmitter subassemblies (w/ or w/o rack mount panel), as well as COR, ID and Touch Tone Control Boards, etc.

These systems are often used to link a very remote mountain-top Repeater (which has no access to a phone line), to a site in the valley where there is access to a phone line. The Autopatch unit is then located at the valley site, and is "linked" to the mountain-top repeater which has "tremendous coverage", thereby providing wide area Autopatch service! There are also many other applications for Link Systems. Call or write us today to discuss your particular requirements!

SCR200L Link Receiver



COMMERCIAL MOBILE & BASE TRANSCEIVERS - For U.S. or Export Markets

"Professional Communications Line"

(225-240 MHz Commercial Export)

- Very attractive woodgrain housing.



PCL250 30W.
Min. Mobile Unit

- 136-174 MHz & 220-240 MHz (450 soon).
- 6 channels.
- 0.35 uV Rcvr.
- 8 Pole Crystal Filtr.
- Beautiful Audio—RX & TX.
- Very Reasonable Price!
- "Super Rugged" Housing. Solid 1/8" Thk. Aircraft Aluminum!



PCL300 30W. Base Station

- Built-in AC Power Supply.
- Front Panel Status Indicator Lights. ("Busy," Xmit, & AC Power.)
- Optional Rcvr. Scanning Function Available.

FCC TYPE ACCEPTED - PARTS 21, 81, 90

Any interest in 10M FM Repeaters?



SPECTRUM COMMUNICATIONS

Commercial Business Radio
Dealer Inquiries Invited

Write or call for Data Sheets, prices, etc. • Export orders—Contact our International Dept.
1055 W. Germantown Pk., Dept. S11 • Norristown PA 19401 • (215) 631-1710

68

RTTY Demodulators

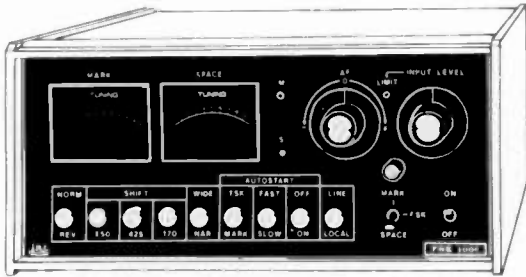

\$449.00 Ham net

FSK-1000 T.M.

Here is no compromise design and construction:

- Unparalleled selectivity achieved with sophisticated limiterless design utilizing ultrasharp active filters and decision level correction circuits
- The most flexible interface system available to computers and high voltage loops
- Built in 170 volt loop supply
- Selectable bandwidths of 55 and 100 Hz. (copies 110 Baud ASCII)
- Continuously tunable shift coverage
- Rugged construction - commercial quality throughout
- Full complement of rear panel connectors for easy interface
- Keyboard activated switch for break in operation
- Individual tuning meters and LED's for quick, accurate tuning



\$197.00 until Nov. 1, \$229.00 after

FSK-500 T.M.

This RTTY demodulator is designed for computer interface but is a fine stand alone unit:

- Easy computer interface with RS-232 or 5 volt logic signals
- Three shift coverage without straddle tuning
- Selectable bandwidths give you optimal Baudot or 110 Baud ASCII copy
- Input bandpass preselector using active filters
- High voltage loop keyer output
- Autostart built in
- Three shift AFSK keyer plus narrow shift CW ID
- Fully wired and tested: ready to copy!
- The FSK-500 is the best demodulator available for under \$500.00 (Except for our FSK-1000!)
- Positive tuning with meter and LED's



Order direct on Visa or MC
700 Taylor Road
Columbus, Ohio 43230
T.M. Call (614) 864-2464



SIMPLY THE BEST! FOX TANGO FILTERS YAESU-KENWOOD-DRAKE-COLLINS-HEATH

Whether your SSB rig is old or new, there is no easier or essentially less expensive way to significantly upgrade its performance than by improving its IF passband filtering.

FOX-TANGO filters are made of specially-treated high-Q quartz crystals, affording excellent shape factors and ultimate rejection exceeding 80 dB. They are custom made for drop-in installation, matching perfectly, both physically and electronically. Our Diode Switching Boards make possible (now or in the future) the addition of a variety of switch-selectable filters affording superior variable bandwidth without the need to buy an expensive new model. If you want the best for less, you'll buy FOX-TANGO. Just tell us the bandwidth(s) desired for your make and model.

*DIODE SWITCHING BOARDS available to permit 1, 2 or more filters than those for which manufacturer provides room. SPECIFY make and model.

Single-filter type: \$12 Airmail postpaid worldwide.
Dual-filter type: \$21 Airmail postpaid worldwide.
Florida residents add 4% (sales tax) (FOREIGN ADD \$5 per filter)

Dealer Inquiries Welcomed

Visa/MC welcomed. Money back if not satisfied.

BROCHURE ON REQUEST

GIFT CERTIFICATES AVAILABLE



8-POLE FILTER BANDWIDTHS IN STOCK

| CRYSTAL FILTER | CW (Hz) | | | | | SSB-AM (kHz) | | | | |
|-------------------|--|-----|-----|-----|-----|--------------|-----|-----|-----|-----|
| | 125 | 250 | 400 | 500 | 600 | 1.8 | 2.1 | 2.4 | 6.0 | 8.0 |
| YAESU | \$55 EACH | | | | | | | | | |
| *FT-101/F/FR-101 | ✓ | ✓ | ✓ | ✓ | ✓ | ✓ | ✓ | ✓ | ✓ | ✓ |
| *FT-301/FT-7B/620 | ✓ | ✓ | ✓ | ✓ | ✓ | ✓ | ✓ | ✓ | ✓ | ✓ |
| *FT-901/101ZD/107 | ✓ | ✓ | ✓ | ✓ | ✓ | ✓ | ✓ | ✓ | ✓ | ✓ |
| FT-401/560/570 | ✓ | ✓ | ✓ | ✓ | ✓ | ✓ | ✓ | ✓ | ✓ | ✓ |
| FT-200/TEMPO I | ✓ | ✓ | ✓ | ✓ | ✓ | ✓ | ✓ | ✓ | ✓ | ✓ |
| KENWOOD | \$55 EACH | | | | | | | | | |
| *TS-520/R-599 | ✓ | ✓ | ✓ | ✓ | ✓ | ✓ | ✓ | ✓ | ✓ | ✓ |
| *TS-820/R-820 | ✓ | ✓ | ✓ | ✓ | ✓ | ✓ | ✓ | ✓ | ✓ | ✓ |
| HEATH | \$55 EACH | | | | | | | | | |
| ALL HF | ✓ | ✓ | ✓ | ✓ | ✓ | ✓ | ✓ | ✓ | ✓ | ✓ |
| DRAKE | FOR PRICES SEE NOTES | | | | | | | | | |
| R-4C | GUF-1 Broad 1st IF Superior Shape Factor/Ult Rej \$65 ✓ ✓ | | | | | | | | | |
| | GUF-2 Narrow 1st IF ✓ ✓ + pcb w sw relays \$90 | | | | | | | | | |
| | 2nd IF ✓ ✓ Plug in type ✓ \$55 | | | | | | | | | |
| | GUD Product Detector pcb w relay double balanced type \$30 | | | | | | | | | |
| COLLINS | SPECIAL \$125 EACH | | | | | | | | | |
| 75S-3B/C | ✓ | ✓ | ✓ | ✓ | ✓ | ✓ | ✓ | ✓ | ✓ | ✓ |

FOX-TANGO CORP.

Box 15944S, West Palm Beach, FL 33406

323

... at last ...
your shack organized!
 A beautiful piece of furniture — your XYL will love it!

\$16450 S-F RADIO DESK
 Deluxe - Ready to Assemble

Designed with angled rear shelf for your viewing comfort and ease of operation.

FINISHES: Walnut or Teak Stain.
 Floor Space: 39" Wide by 30" Deep

Additional Information on Request.
 Checks, Money Orders, BankAmericard and Master Charge Accepted.

F.O.B. Culver City. (In Calif. Add 6% Sales Tax.)
 DEALER INQUIRIES INVITED

\$9 65

S-f Amateur Radio Services

4384 KEYSTONE AVENUE • CULVER CITY, CALIF. 90230 — PHONE (213) 837-4870

You can't tell the players without a scorecard!

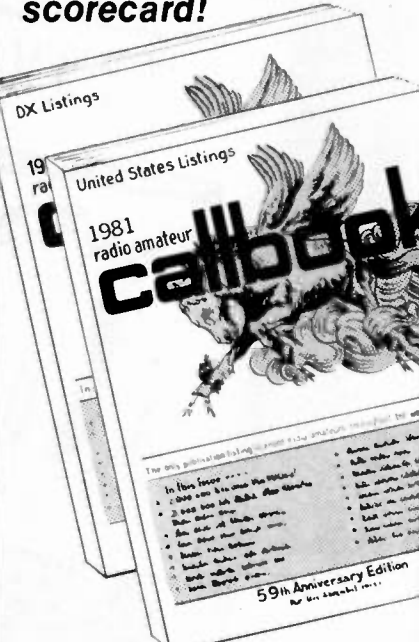

DX Listings
 1981 United States Listings
Callbook
 59th Anniversary Edition

Radio World

CENTRAL NEW YORK'S MOST COMPLETE HAM DEALER

ROBOT 800 ICOM IC-720 KENWOOD TS830S DRAKE TR7-DR7 YAESU FT707

Featuring Kenwood, Yaesu, Icom, Drake, Ten-Tec, Swan, Dentron, Alpha, Robot, MFJ, Tempo, Astron, KLM, Hy Gain, Mosley, Larsen, Cushcraft, Hustler, Mini Products, Bird, Mirage, Vibroplex, Bencher, Info-Tech, Universal Towers, Callbook, ARRL, Astatic, Shure. *We service everything we sell!*

Write or call for quote. **You Won't Be Disappointed.**
 We are just a few minutes off the NYS Thruway (I-90) Exit 32

OUT OF STATE ONEIDA COUNTY AIRPORT TERMINAL BUILDING
 CALL TOLL FREE ORISKANY, NEW YORK 13424
800-448-9338 Warren - K21XN
 N.Y. Res. Call (315) 337-0203 Bob - WA2MSH

Order today!
NEW 1981 RADIO AMATEUR CALLBOOKS
READY DECEMBER 1st!

The latest editions will be published soon! World-famous Radio Amateur Callbooks, the most respected and complete listing of radio amateurs. Lists calls, license classes, address information. Loaded with special features such as call changes, prefixes of the world, standard time charts, world-wide QSL bureaus, and more. The U.S. Edition features over 400,000 listings, with over 100,000 changes from last year. The Foreign Edition has over 300,000 listings, over 90,000 changes. The new 1981 Callbooks will be available on December 1, 1980. Place your order now.

| | Each | Shipping | Total |
|---|---------|----------|---------|
| <input type="checkbox"/> US Callbook | \$17.95 | \$2.55 | \$20.50 |
| <input type="checkbox"/> Foreign Callbook | \$16.95 | \$2.55 | \$19.50 |

Order both books at the same time for \$37.45 including shipping.

Order from your dealer or directly from the publisher. All direct orders add \$2.55 for shipping. Illinois residents add 5% sales tax.

Microcraft's New Morse-A-Word

Eight character moving display.
 Built-in code practice oscillator.
 Excellent for learning Morse Code.
 Complete — no CRT or expensive extras needed.
 Decodes audio CW signals from your receiver's speaker and displays letters, numbers, punctuation and special Morse characters as the code is received.



MORSE-A-WORD Kit with 4 character readout MAWK-4 \$149.95
 MORSE-A-WORD Kit with 8 character readout MAWK-8 \$169.95
 MORSE-A-WORD wired & tested with 8 character readout . . . MAWF \$249.95

Send check or money order. Use your VISA or Master Charge. Add \$3.50 shipping and handling for continental U.S. Wisconsin residents add 4% State Sales Tax.

Microcraft Corporation Telephone: (414) 241-8144
 P. O. Box 513G, Thiensville, Wisconsin 53092

ALL BAND TRAP ANTENNAS!

PRETUNED - COMPLETELY ASSEMBLED - ONLY ONE NEAT SMALL ANTENNA FOR UP TO 7 BANDS! EXCELLENT FOR CONGESTED HOUSING AREAS - APARTMENTS LIGHT - STRONG - ALMOST INVISIBLE!

FOR ALL MAKES & MODELS OF AMATEUR TRANSCEIVERS - TRANSMITTERS - GUARANTEED FOR 2000 WATTS SSB 1000 WATTS CW. INPUT FOR NOVICE AND ALL CLASS AMATEURS!

COMPLETE AS SHOWN with 90 ft. RG58U-52 ohm feedline, and PL259 connector, insulators, 30 ft. 300 lb. test dacron end supports, center connector with built in lightning arrester and static discharge - molded, sealed, weatherproof, resonant traps 1" X 6" - you just switch to band desired for excellent worldwide operation - transmitting and receiving! Low SWR over all bands. - Tuners usually NOT NEEDED! Can be used as inverted V's - slopers - in attics, on building tops or narrow lots. THE ONLY ANTENNA YOU WILL EVER NEED FOR ALL DESIRED BANDS - WITH ANY TRANSCEIVER - NEW - EXCLUSIVE! NO BALUNS NEEDED!

80-40-20-15-10-6 meter - 2 trap --- 104 ft. with 90 ft. RG58U - connector - Model 998BUA . . . \$69.95
 40-20-15-10 meter --- 2 trap --- 54 ft. with 90 ft. RG58U - connector - Model 1001BUA . . . \$68.95
 20-15-10 meter --- 2 trap --- 26ft. with 90 ft. RG58U - connector - Model 1007BUA . . . \$67.95

SEND FULL PRICE FOR POSTPAID INSURED. DEL. IN USA. (Canada is \$5.00 extra for postage - clerical-customs etc) or order using VISA - MASTER CHARGE - CARD - AMER. EXPRESS. Give number and ex. date. Ph 1-308-236-5333 9AM - 6PM week days. We ship in 2-3 days. ALL PRICES WILL INCREASE . . . SAVE - ORDER NOW! All antennas guaranteed for 1 year. 10 day money back trial if returned in new condition! Made in USA FREE INFO, AVAILABLE ONLY FROM WESTERN ELECTRONICS

Dept. A7-11 80 Kearney, Nebraska, 68847

SPECIAL LIMITED OFFER!
Amateur Radio Emblem Patch
only \$2.50 postpaid



Pegasus on blue field, red lettering. 3" wide x 3" high. Great on jackets and caps. Sorry, no call letters.

ORDER TODAY!

61
RADIO AMATEUR callbook INC.
 Dept. B
 925 Sherwood Drive
 Lake Bluff, IL 60044, USA

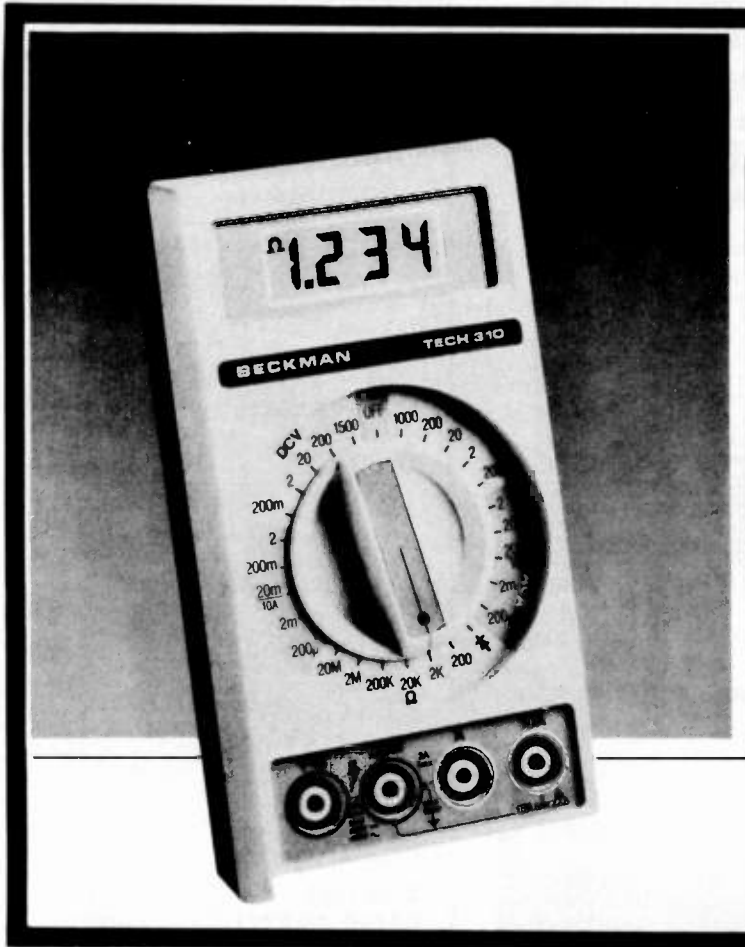

BECKMAN 3 1/2-DIGIT MULTIMETER MODEL TECH 310

COMPLETE MULTIMETER CAPABILITY:

DC VOLTS: 100 μ V TO 1500 V
 AC VOLTS: 100 μ V TO 1000 V rms
 RESISTANCE: 0.1 OHMS TO 20 MEGOHMS
 DC CURRENT: 100 nA TO 10 A
 AC CURRENT: 100 nA TO 10 A
 DIODE/SEMICONDUCTOR TEST FUNCTION.
 CONTINUITY FUNCTION - INSTA-OHMS [TM].
 COMPLETE OVERVOLTAGE PROTECTION.
 LOW-POWER OHMS IN ALL RESISTANCE RANGES.

FULLY EQUIPPED WITH THE FOLLOWING:
 9-VOLT BATTERY, A SPARE FUSE, SAFETY-DESIGNED TEST LEAD SET, OPERATOR'S MANUAL AND BECKMAN'S FULL ONE-YEAR WARRANTY.

OPTIONAL ACCESSORIES AND PRICES:

TECH 310 DIGITAL MULTIMETER \$140.00
 DC-202 DELUXE CASE 24.00
 VC-201 VINYL CASE 10.00
 DL-241 DELUXE TEST LEAD KIT 10.00
 TL-242 TEST LEAD SET [AS SUPPLIED] ... 6.00
 RF-221 RF PROBE 35.00

LaRUE ELECTRONICS
 1112 GRANDVIEW STREET
 SCRANTON, PENNSYLVANIA 18509
 PHONE [717]343-2124



The new GaAs FET preamps improve dynamic range up to 10 times over standard FET's, and up to 1000 times over bi-polar amps!

✓ 43

Introducing the new

LUNAR PAG PREAMP SERIES

Designed especially by Louis N. Anciaux WB6NMT, for repeater operators and those working low noise, weak signal.

INCREDIBLE LOW NF .5 dB TYPICAL

By replacing your present front end preamp unit with a new Lunar PAG preamp, noise generated by your equipment is reduced so your main limitation is the external world!

Now, you can get 100% copy of signals you were barely able to hear before!

1000 TIMES IMPROVEMENT IN SIGNAL HANDLING LEVELS

In addition to reducing noise figure, the new Lunar PAG preamps provide high dynamic range, thus a high overload capability ... up to 1000 times improvement in signal handling levels over bi-polar preamps. No longer can your sig-

nal get crunched by external signals.

PROVEN PERFORMANCE!

At the August '80 Central States VHF conference at Colorado Springs, our new PAG 144 and 220 preamps won the NF contest with the amazing low NF figure of .2 dB. No other preamps came close!

INSTALL A NEW PAG PREAMP IN YOUR REPEATER

to increase your sensitivity and dynamic range and to reduce intermodulation problems.



TYPICAL PERFORMANCE PA COMPARISONS

| | dB
G | dB
NF | dBm
1 dB Comparison |
|----------|---------|----------|------------------------|
| PA144 | 10 dB | 1.3 dB | +1 dBm |
| PAD144 | 22 dB | 1.3 dB | +1 dBm |
| PAG144 | 26 dB | 0.2 dB | +12 dBm |
| PA220 | 9 dB | 1.9 dB | +1 dBm |
| PAD220 | 19 dB | 1.9 dB | +1 dBm |
| PAG220 | 24 dB | 0.2 dB | +11 dBm |
| PA432-2 | 16 dB | 1.5 dB | -20 dBm |
| PAE432-5 | 18 dB | 0.95 dB | -20 dBm |
| PAG432 | 18 dB | 0.50 dB | +11 dBm |

Other special and commercial preamps also available.



2785 Kurtz Street, Suite 10
 San Diego, CA 92110
 Telephone: (714) 299-9740
 Telex: 181747
 Louis N. Anciaux, WB6NMT



Germantown Amateur Supply, Inc.

MEMPHIS, TENNESSEE

NO MONKEY BUSINESS!

- (A) Complete Service Facilities
- (B) Good Deals on most Brands
- (C) Shipping within 24 Hours
- (D) All inquiries handled by Active Hams with over 20 years experience in ham radio

CALL TOLL FREE
1-800-238-6168

IN TENNESSEE, CALL 901-452-4276
MONDAY - SATURDAY 8:30-5:30
FOR YOUR SPECIAL.

Write: 3202 Summer Ave., Memphis, Tennessee 38112

INTIMIDATED BY MORSE CODE?



\$99.95

INTRODUCTORY PRICE

**THE NEW AEA
MODEL MT-1
COMPUTERIZED
MORSE TRAINER
MAKES MORSE
CODE EASY AND
FUN TO LEARN.**

- Automatic Speed Increase, User May Program: Starting Speed, Ending Speed, Practice Duration; 5 Letter code Groups or Random Space; Common or All Characters.
- Precise Speed Control 1 to 99 WPM (Tailor to Your Exact Requirements).
- 24,000 Character Answer Book Available (\$2.00) For 10 Starting Positions.
- Random Mode For Practice (No Answers).

KT-1 Computerized Keyer With All Features of Above Trainer Is Also Available in Same Package For \$129.95.

Advanced Electronic Applications, Inc., P.O. Box 2160, Lynnwood, WA 98036. Call 206/775-7373.

AEA Brings you the
Breakthrough!

RF POWER

ONE BILLION WATTS IN STOCK

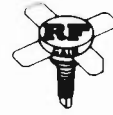

Your One Stop Source for RF Power Tubes and Transistors

CHRISTMAS SPECIALS

| | | | |
|---------|----------|-------|----------|
| 3-400Z | \$ 95.00 | 811A | \$ 10.00 |
| 3-500Z | 95.00 | 6146B | 6.00 |
| 3-1000Z | 260.00 | 6146W | 14.00 |
| 4CX250B | 45.00 | 8122 | 76.00 |
| 4CX350F | 78.00 | 8236 | 22.00 |
| 6MJ6 | 4.50 | 8877 | 300.00 |
| 12BY7 | 1.75 | 8908 | 9.95 |
| 572B | 32.00 | 8950 | 6.50 |

RF TRANSISTORS

2-30 Mhz

| | | |
|---|-------|--------------|
| RF23,RF13 (RFG) 50W | 12.5V | 13.00 |
| (Premium Replacements for MRF450 & MRF450A) | | |
| RF43,RF33 (RFG) 70W | 12.5V | 15.00 |
| (Premium Replacements for MRF455 & MRF455A) | | |
| CD2545 (CTC) 50W | 12.5V | Flange 13.50 |
| CD3424 (CTC) 60W | 12.5V | Flange 14.00 |
| SD1451 (SSM) 60W | 12.5V | Flange 14.00 |
| SD1076 (SSM) 80W | 12.5V | Flange 18.50 |
| RF85 (RFG) 80W | 12.5V | Flange 17.50 |
| MRF458 (MOTO) 80W | 12.5V | Flange 19.88 |

VHF

150-175 Mhz

| | | | |
|---------------------------------------|-------|--------|-------|
| B40-12 (CTC) 40W | 12.5V | Stud | 13.75 |
| 2N5591 (SSM) 25W | 12.5V | Stud | 8.50 |
| 2N6083 (SSM) 25W | 12.5V | Stud | 9.95 |
| 2N6097 (SSM) 40WPNP | 12.5V | Flange | 15.50 |
| MRF247 (MOTO) 75W | 12.5V | Flange | 33.00 |
| SD1416 (SSM) 70W | 12.5V | Flange | 24.25 |
| RF13,RF23 also replaces 2N6084-MRF224 | | | 13.00 |

UHF

450-512MHZ

| | | | |
|---------------------|-------|-------------------|-------|
| 2N5946 (SSM) 10W | 12.5V | Stud | 11.95 |
| MHW710-2 (MOTO) 13W | 12.5V | Module 19 db Gain | 54.00 |
| CM60-12A (CTC) 60W | 12.5V | Flange | 42.95 |

MINIMUM ORDER \$30.00

CALL TOLL-FREE 800-845-2322 (N.Y. State 516-536-8868)



RF Gain, Ltd.

100 Merrick Road

Rockville Centre, New York 11570

✓ 342

TRS 80* OWNERS ARISE!

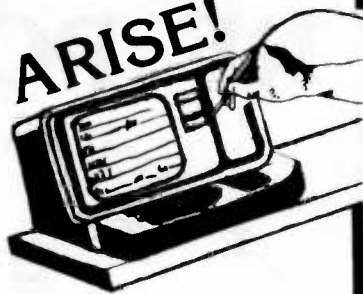

Arise and subscribe to 80 MICROCOMPUTING, the newest and fastest growing microcomputer magazine. This is full of news about programs, accessories and theory on the world's largest selling computer, the TRS-80*. Definitely beginner level and includes lots of program listings. Find out what all the fuss is about.

- New subscription Renewal 12 issues for \$18
 Payment enclosed \$ _____ 24 issues for \$30
 VISA MC AE Bill me 36 issues for \$45

Card # _____

Interbank # _____ Exp. date _____

Signature _____

Name _____

Address _____

City _____ State _____ Zip _____

Please allow 6 to 8 weeks for delivery
 Canadian: 1 yr. only/\$20 in U.S. Funds
 Foreign: 1 yr. only/\$28 in U.S. Funds

80 microcomputing

• P.O.B. 981 • Farmingdale N.Y. 11737

*TRS-80 is a trademark of Tandy Corporation.

30NB6



Handful of POWER

Give your low power 2-meter rig real punch by delivering a potent 25-watt signal with only two watts of drive (also available set up for 200 milliwatts drive). Compact and convenient to mount, VoCom's Model 2C025 is ideal for car, boat or anywhere you've got a 12 VDC source. At only \$84.95 (\$99.95 for 200 mW drive), it's the perfect companion for your Drake, Encomm, Henry, Icom, Kenwood, Motorola, Standard, Wilson, Yaesu or other 2-meter FM portable!

- 2 or 2 watt nominal drive (specify)
- 2 watt model delivers 15-20 watts with only one watt of drive
- 10 MHz bandwidth for CAP or MARS
- Harmonic and spurious down more than 70 dB
- 200 mW drive model permits operating Icom IC-2A or Yaesu FT-207R on their battery-saving low-power mode
- Only \$84.95 (\$99.95 for 200 mW drive)

Ask about our 50 and 100 watt amplifiers for use with low-power hand-held radios!

Available now from your local amateur radio dealer or order direct.

✓ 90

VoCom Box 219, Prospect Heights, IL 60070
 PRODUCTS CORPORATION (312) 870-8060



close encounter



Dateline Dayton Hamvention . . .

To demonstrate the selectivity of our Mark 3CR repeater we keyed a transmitter 15 KHz off frequency and set it directly against the receiver input. Our Mark 3CR didn't even notice the close encounter.

Sure the Mark 3CR can withstand severe interference. . . it uses both crystal filtering and double conversion. And that's just the beginning. Its performance continues with a transmitter that meets commercial specs plus a microprocessor controller that gives you 39 functions and 13 Morse messages. For peak performance have your own close encounter with a Mark 3CR / Repeater or Mark 3C Controller.



call or write for specifications ✓ 49

MICRO CONTROL SPECIALTIES
 23 Elm Park, Groveland, Ma. 01834
 (617) 372-3442

CALL TOLL FREE
1-800-228-4097



Win the contest with an Alpha!!



ALPHA 374

With "No Tune Up" convenience
 Instantaneous band switching
 2+K.W. PEP
 Two 8874 Tubes
 1000 watt DC "No Time Limit" Power Supply



ALPHA 78

The new Alpha 78 combines the best features of all previous ALPHA's: More quiet brut power than the original Alpha 77--- A new "no tune up" system even better than the 374A --- and the same superb QSK system used in the Alpha 77DX.



ALPHA 76A

Two 8874 Tubes
 1.5 KVA Heavy Duty Transformer
 2.5 K.W. PEP, 1 K.W. CCS Average
 Efficiency better than 60%

Call for discount prices.

ANTENNAS

CUSHCRAFT

| | | |
|-----------|--------------------------------|-----------|
| ATB-34 | 4 Element Triband Beam | \$ 219.95 |
| ATV-4 | 40' 10' mtr Trap Vertical | 84.95 |
| ATV-5 | 80' 10' mtr Trap Vertical | 89.95 |
| ARX-2 | 2 mtr "Ringo Ranger" | 32.95 |
| A-3219 | 19 Element 2 mtr "Boomer" | 74.95 |
| A-214B | 14 Element 2 mtr "Boomer" | 56.95 |
| A-214FB | 14 Element 2 mtr FM "Boomer" | 56.95 |
| A-228FB | 28 Element 2 mtr FM Power Pack | 179.95 |
| A-147-11 | 11 Element 2 mtr FM Beam | 32.95 |
| A-147-22 | 22 Element 2 mtr FM Power Pack | 95.95 |
| ARX-450 | 450 MHz "Ringo Ranger" | 32.95 |
| A-144-10T | 10 Element 2 mtr "Oscar" ant | 39.95 |
| A-144-20T | 20 Element 2 mtr "Oscar" ant | 56.95 |
| A-432-20T | 20 Element 432 MHz "Oscar" ant | 49.95 |

LOWEST PRICES IN THE COUNTRY ON ANTENNAS
 HY-GAIN - CUSHCRAFT - MOSLEY - HUSTLER

HY-GAIN

| | | Regular | Special |
|----------|------------------------------|----------|----------|
| TH80XX | Super Thunderbird | \$329.95 | \$239.95 |
| TH3MK3 | 3 el. 10-15-20M beam | 222.95 | 160.95 |
| TH3JR | 3 el. 10-15-20M beam | 169.95 | 129.95 |
| Hy-Quad | 2 el. 10-15-20M Quad | 274.95 | 206.95 |
| 205BA | 5 el. "Long John" 20M beam | 329.95 | 239.95 |
| 155BA | 5 el. "Long John" 15M beam | 199.95 | 149.95 |
| 105BA | 5 el. "Long John" 10M beam | 129.95 | 99.95 |
| 204BA | 4 el. 20M beam | 249.95 | 189.95 |
| 204MK5 | 5 el. conversion kit | 99.95 | 79.95 |
| 153BA | 3 el. 15M beam | 89.95 | 79.95 |
| 103BA | 3 el. 10M beam | 74.95 | 59.95 |
| 402BA | 2 el. 40M beam | 239.95 | 189.95 |
| BN-95 | Beam for beam antennas | 15.95 | 15.95 |
| TH2MK3 | 2 el. 10-15-20M beam | 149.95 | 119.95 |
| 18HT | Hy-Tower 80-10M vertical | \$359.95 | \$289.95 |
| 18AVT/WB | 80-10M Trap vertical | 105.95 | 84.95 |
| 14AVD/WB | 40-10M Trap vertical | 69.95 | 57.00 |
| 12AVD | 20-10M Trap Vertical | 42.95 | 34.95 |
| 14RMO | Roof Mounting kit (vertical) | 33.95 | 29.95 |
| 58DQ | 80-10M Trap doublet | 109.95 | 89.95 |
| 28DQ | 80-40M Trap doublet | 59.95 | 49.95 |
| 64B | 6 el. 6M beam | 119.95 | 99.95 |
| 203 | 3 el. 2M beam | 15.95 | |
| 205 | 5 el. 2M beam | 21.95 | |
| 208 | 8 el. 2M beam | 29.95 | |
| 214 | 14 el. 2M beam | 34.95 | |
| LA-1 | Deluxe lightning arrester | 59.95 | 49.95 |
| TH5DX | 5 el. 10-15-20 M Beam | 269.95 | 199.95 |

We Export

PRICES SUBJECT TO CHANGE AND AVAILABILITY

Communications Center

1840 "O" STREET LINCOLN, NEBRASKA 68508
 In Nebraska Call 402/476-7331

✓ 14



MEMORY KEYS BREAKTHROUGH!



The remarkable AEA Morsematic memory keyer has 33 fantastic features including two AEA designed microcomputers, up to 2,000 character memory, automatic serial number and four different modes.

Get the Facts.

Learn the other 30 features simply by contacting Advanced Electronic Applications, Inc., P.O. Box 2160, Lynnwood, WA 98036. Call 206/775-7373.

AEA Brings you the Breakthrough!

New Improved Adhesive Mount for the 2 Meter Avanti Mobile Antenna.

Mounts on glass — no holes!

- Receives and transmits through glass.
- Superior performance equivalent to 5/8 wave.
- Superior radiation full Omni-Directional.

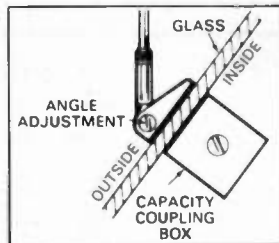

It's easy to install — No holes to drill, no magnet to scratch the paint, no clamps. Uses an especially developed silicone adhesive that secures antenna to window. The capacity coupling box is simply attached with a special adhesive tape to inside of window. Worried about crimping or corroding coaxial cables? It's all inside and out of sight.

Models also available for 220 MHz and 450 MHz.

See Avanti's other new mobile and base antennas. Write for new catalog today. Send 50¢ for handling and postage.

avanti® antennas

Avanti Research and Development, Inc.
340 Stewart Ave., Addison, IL 60101 (312) 628-9350
In Canada: Lenbrook Ind., Scarborough, Ontario M1H 1H5

MODEL TR70A

ATV RECEIVING CONVERTER, 420-450 MHz



- TUNABLE—vernier tuned, 420 to 450 MHz
- HIGH PERFORMANCE—low noise RF preamp., mosfet mixer, mosfet IF amp. [Ch2 or 3 out]
- SELF-CONTAINED—including power supply
- 1 YEAR WARRANTY
- PRICE: \$ 88.00 [includes shipping. Add \$ 1.15 for COD shipment]

To order, or receive detailed information, write us or call us at 1-812-336-4775

APTRON LABORATORIES
PO BOX 323, BLOOMINGTON, INDIANA, 47402

S-100 S-100 S-100 S-100

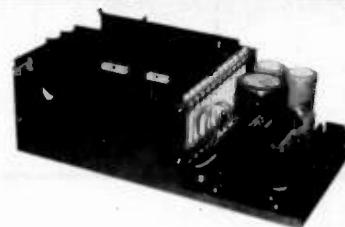

***\$249.00**

IN STOCK NOW
INTRODUCTORY OFFER

PLACE QUANTITY ORDERS NOW, SAVE!

*Less Boards and Fans, Assembled Add \$45.00,
6 Slots Populated with Connectors

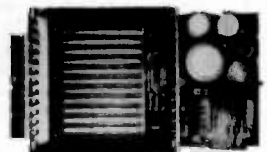
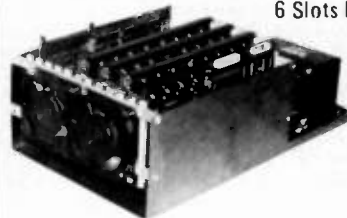

COMPLETE S-100 SYSTEM ALL NECESSARY POWER SUPPLIES

*12 Slot Motherboard Fully Terminated

*30A of +8V
6A of ±16V

*Disc Power Supply
6A of +24V
5A of +5V
1A of -5V

*All Steel Frame

*220VAC or 110VAC
50 or 60 Cycle Operation

*Low Voltage Tap

*Nylon Card Guides

*Connectors Supplied for up to 4 Drives

*Optional Fans Mount Neatly on One Side

DELTA PRODUCTS
15392 Assembly Lane, Huntington Beach, CA 92649
(714) 898-1492

“HARD”

COPY



.....on inexpensive paper too. Our latest addition, the MICROLOG companion printer for the ATR-6800, plugs in directly for easy 'hard copy' of your QSO's, messages, programs, etc. When the tape interface isn't enough, our printer is ready on keyboard command. Complete system for CW/RTTY: ATR-6800, video and printer \$2,445, without printer \$1995, printer alone \$495. We're always up to something new here at MICROLOG CORPORATION, 4 Professional Drive, Suite 119, Gaithersburg, Maryland 20760. Telephone (301) 948-5307.

MICROLOG

Innovators in Digital Communications

✓ 51

Be Prepared!

— 30 meters for the FT-101B

Mark H. Monson KB8NO
1640 Sunnyside Avenue
Lansing MI 48910

If you were as excited as I was to find out about the new amateur allocations at WARC, you probably wanted to be the first ham on the block to operate the new frequencies. Unfortunately, the 24.890-24.990-MHz and

the 18.068-18.168-MHz bands won't be available for five to ten years. However, the 10.100-10.150-MHz 30-meter band probably will be usable in two years or thereabouts.

When I saw 10 MHz, it rang a bell; that is the same as the WWV band on my Yaesu FT-101B! By studying the bandswitch and schematic, you will note that

there is a WWV position from front to back on the bandswitch. WWV has its own heterodyne oscillator and crystal, but the receiver front end and driver grid tuned circuits are borrowed from 20 meters to save space and money. The driver plate and final amplifier tuned circuits are left out to prevent transmission on an unauthorized band. By adding separate tuned circuits (i.e., trimmer and capacitor) to the receiver front end and driver grid circuits, adding a new tuned circuit to the driver plate circuit, and rewiring the final amplifier, the FT-101B can be modified to operate on the 30-meter band.

Fig. 1 is a very important aid in making the modification and locating the bandswitch wafers. All parts were purchased at an average local electronics store

at premium prices for about \$15.00. The bottom and case must be completely removed first. You should work with the rig on its top with the bottom up for the best view.

TC13', TC3', and TC8' all can be mounted wherever you can find space for them. I mounted them on their respective circuit boards (PB1188, PB1187A, and PB1092) by finding an open spot on the boards and judiciously drilling the appropriate holes. Drill the holes with the rig on its side so borings don't fall into the works. Use the modifier's trick of drilling holes on the edge or through the circuit board foil. When you mount the trimmers, you can then build a solder bridge to the lug of the trimmer for electrical contact and mechanical stability. Be careful not to ding up the existing trimmers.



Photo A. The WWV position on the bandswitch is used to cover 10.0 to 10.5 MHz, which includes the 30-meter band. The 11-meter position on the bandswitch can easily be modified to cover 24.0 to 24.5 MHz, which includes the 13-meter band, at a later date. Likewise, the 160-meter position could be sacrificed to cover 18.0 to 18.5 MHz, which includes the 17-meter band.

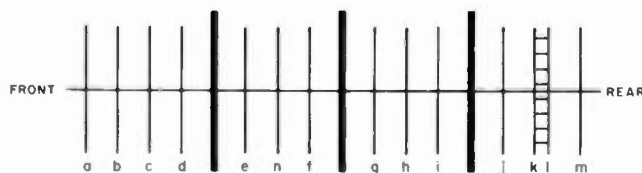

Fig. 1. Bottom view of the S1 wafer physical arrangement.

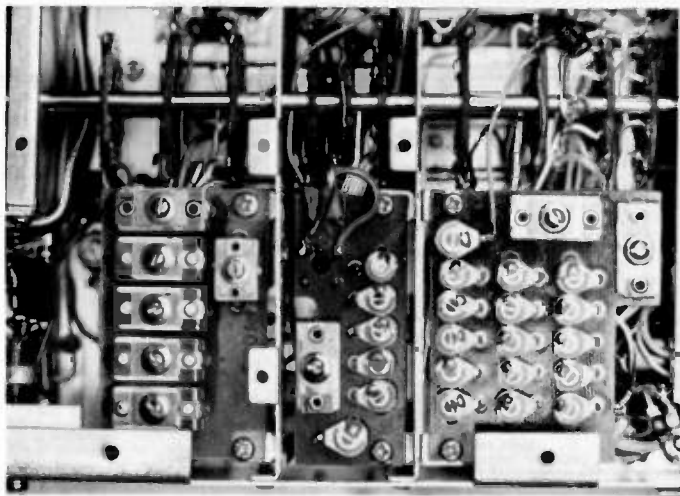

Photo B. Wafers a through i and n, and PB1188, PB1187A, and PB1092 are shown in this photo. Note my positioning of TC13', TC3', and TC8' on their respective boards.

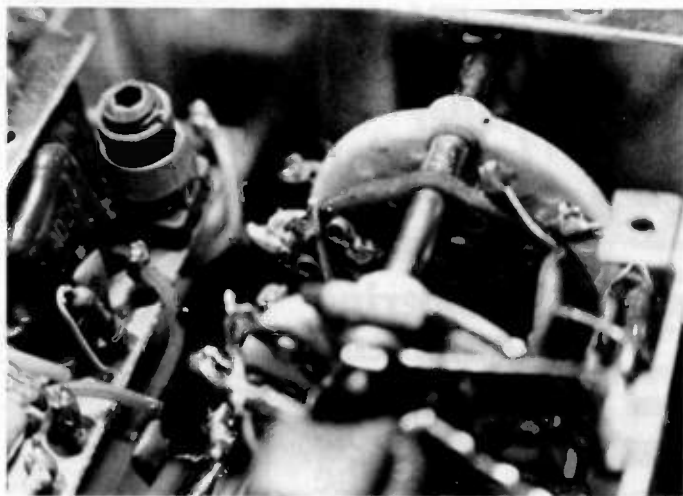

Photo C. Wafers j, k, l, and m are shown in this photo. Note the added tab in the center of the photo on S1l, held in place by the rivet and Super Glue.

Likewise, C43', C6', and C10' all can be mounted under their respective circuit boards.

The receiver front end tuned circuit is separated from 20 meters by removing the jumper between the WWV and 20-meter tabs on S1c. TC13' and C43' are then placed in the circuit by a wire to the WWV tab.

The driver grid tuned circuit is separated from 20 meters by removing the jumper between the 20-meter and WWV tabs from the 20-meter tab *only* on S1e. This is because the WWV tab is very difficult to reach—so lengthen the jumper by soldering on an extra piece of wire and attach this to TC3' and C6'.

The driver plate tuned circuit is not tied to 20 meters and WWV has a blank tab on S1g. Simply solder a wire from the blank tab to TC8' and C10'. This tab is deep, but if you are careful, it can be accessed readily with a soldering gun.

All that is left to do is to modify the final amplifier tuned circuit. This required the most ingenuity. S1l adds extra load capacitance on 160, 80, 40, and 20 meters by ganging the two parts of the load capacitor, VC2, together. 30 meters also should be ganged together,

and all that is necessary is to add a jumper from the WWV to the 160-meter tab.

The only problem is that there is no WWV tab! Where the tab should be on the S1l, there is a lonely hole on the wafer board. What you do is make a tab! Go to your junk box and find an old wafer switch. Look for a tab that matches the 160-meter tab. Then break the wafer along the axis of the tab through the rivet hole, freeing the rivet and the tab without damaging them. Then take a good wire cutter and carefully nip the lip off the end of the rivet that was under the wafer until it fits freely through the hole on S1l. Place the tab and the rivet appropriately in the hole and check to make sure that there is good contact when the bandswitch is rotated. Then glue the rivet and tab onto the wafer with Super Glue. Then jump the WWV and 160-meter tabs.

Finally, add a 30-meter tap on the tuned circuit coil and connect it to the WWV tap on S1m. L9, C133, and C136 are temporarily unsoldered from their tabs on S1m and lifted out of the way to facilitate soldering. The 30-meter tap should fall about halfway between the 40- and 20-meter taps (i.e., just below the nut

holding the last wafer on the bandswitch).

If you study the coil, you will note that the turns just beside the other taps are bent down into the crack in the ceramic form. You can also do this by placing a small screwdriver over the adjacent turn and tapping the screwdriver with a small block of wood. Then solder the tap to the coil. Make sure you don't leave a solder bridge to the adjacent turns. Then reattach L9, C133, and C136 to their tabs.

Your Yaesu will now be a seven-band rig. All that is necessary is to peak TC13', TC3', and TC8' according to the manual. The preselector should be set around 4. Don't be fooled by the noise in the receiver at about 9 on the preselector. If you try to tune and transmit here, the driver will go into uncontrolled oscillation. Again, make your adjustments at 4 where the receiver will peak to the calibrator signal. Use a dummy load to prevent illegal operation. Performance seems as good as the other bands. I drilled holes in the shield plate over TC13' and TC3' to facilitate tuning. If operation is restricted to Extras, then you have two years to upgrade!

For future reference, the 11-meter band will be easily modifiable to the 24-MHz band. Probably all that will be necessary will be the addition of a different crystal and adjustment of the heterodyne oscillator. To enable the 11-meter transmit section, all that needs to be done is to (1) remove the jumper from the 11-meter tab on S1g that goes to S1h and (2) remove the jumper from the 11-meter tab on S1i that goes to ground.

If you want to get onto the 18-MHz band, remember that the 160-meter band used to be an auxiliary position on the bandswitch. If you can sacrifice the 160-meter band and you understand and have completed the previous modifications, then with appropriate changes and substitutions you can get on 18 MHz also. You now have an eight-band rig! ■

Parts List

| | |
|-------|--|
| TC13' | 79-pF trimmer, 250 |
| TC3' | volts dc (Sprague "Q line" #QTI-31 or similar) |
| TC8' | 40-pF trimmer, 500 volts dc (Calectro AI-246 or similar) |
| C43' | 50-pF silver mica, 250 volts dc |
| C6' | 68-pF silver mica, 250 volts dc |
| C10' | 68-pF silver mica, 500 volts dc |

TUFTS Electronic Department Store TUFTS

Weller Industrial & Service Equipment, Soldering Equipment, Accessories, & Other Tools for the Professional or Hobbyist



Model D550 Heavy-Duty Gun (260/200 Watts) \$24.65

Highest output gun with 2-position trigger selection of dual heats. Heavy gauge, high efficiency, pre-tinned copper tip comes up to temperature in 6 seconds. Balanced pistol-grip design with twin lights to illuminate work. Complete with "Soldering Hints" booklet. 120V, 60Hz. 2-wire cord. UL listed. Boxed.



Model 8200W All-Purpose Gun (140/100 Watts) \$18.13

Finger-tip trigger selection of high or low output from this instant-heat gun that's ready to solder in 6 seconds. High efficiency tip of pre-tinned pure copper. Light illuminates work. Compact, balanced pistol-grip design. "Soldering Hints" booklet included. 120V, 60Hz. 2-wire cord. UL listed.



Model 250K Electronic Tool Kit \$35.58

Ideal 12-piece kit for the budding technician or for general use in countless electronic jobs. UL-listed. Housed in a compact convenient plastic carrying case/storage tray and contains the following professional quality Weller and Xcelite tools:

- WP25 Soldering Iron with 1/16" screwdriver tip. 750°F
- ST2 Extra tip. 1/32" screwdriver
- Soldering Aid Tool
- Rosin-Core Solder
- #8 1/4" Nutdriver
- #R184 1/4" Blade driver for slotted screws
- #X101 No. 1 Phillips-type Screwdriver
- #41CG 4" Short Chain-Nose Pliers with cushion-grip
- #54CG 4" Diagonal Cutting Pliers with cushion-grip
- #100 Wire Stripper/Cutter with cushion-grip

Replacement and extra soldering tips Same as for Model WP25 iron.



Model WTCPN, Controlled-Output Soldering Station \$70.80

Exclusive Weller closed loop, low-voltage circuit automatically controls output and temperature in three ranges: 600°F, 700°F, and 800°F. Temperature selected simply by changing the grounded, heat-sensing tip with knurled thumbscrew. Safe for IC soldering. Comfortable, lightweight pencil iron has heat shield, non-burnable silicone rubber cord, and locking design for easy interchangeability. Power unit, with contemporary impact-resistant case, has unitized on/off toggle switch and neon indicator light, non-heat-sinking iron holder, storage tray for extra tips, and tip-cleaning sponge with receptacle. 3-wire 6 ft. long cord. 120V, 60Hz, 60W. Furnished with 1/16" screwdriver tip. 700°F. PT A7. UL listed.

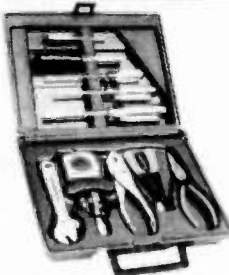

TKX-11 Multi-Purpose Tool Kit \$36.70

The versatile kit contains 11 quality tools, perfect for all types of routine repair and simple do-it-yourself projects. Everything comes neatly packaged in an attractive, easy to store case.

Tool Kit includes:

- R144 1/4" x 4" Round Blade Screwdriver
- R184 1/8" x 4" Round Blade Screwdriver
- X101 #1 Phillips x 3" Screwdriver
- 8 1/4" Hex Nutdriver
- P125 #0 Phillips x 2" Screwdriver
- 51CG 6" Long Nose Plier w Side Cutter
- 46CG 6" Adjustable Wrench
- S-141 1/4" x 1 1/4" Stubby Square Blade Screwdriver
- 100-X Wire Stripper & Cut Adj. Screw Stop
- TM120 1/2" x 10" Metric English Tape Rule
- 76C 6" Combination Plier. Chrome Plated



Models WP25 and WP40 Professional Soldering Irons

Top quality industrial grade tools develop 750°F temperature. Rugged stainless steel barrel construction. Long life double coated tips. High efficiency. Popular pencil styling. Light blue handle with black heat shield. Only 7 1/4" long. 1 1/4 oz. 120V, 50/60 Hz. 4 Ft. Cord. UL-listed.

| Model | Description | Tip | Price |
|--------|-----------------|-----------------------|---------|
| WP25 | 2-Wire Cord 25W | ST1 1/16" screwdriver | \$13.35 |
| WP25-3 | 3-Wire Cord | | |
| WP40 | 40W | ST3 1/16" screwdriver | \$16.40 |
| WP40-3 | 3-Wire Cord | | |

Replacement and extra soldering tips

Top quality iron plated tips with anti-wetting chrome coating. All tips are pre-tinned.

| Cat. No. | Tip Size | Description |
|----------|----------|--------------------|
| ST1 | 1/16" | Screwdriver |
| ST2 | 1/32" | Screwdriver |
| ST3 | 1/16" | Screwdriver |
| ST4 | 3/16" | Screwdriver |
| ST5 | 1/32" | Single Flat |
| ST6 | 1/32" | Screwdriver |
| ST7 | 1/32" | Conical |
| ST8 | 1/16" | Narrow Screwdriver |

Xcelite Versatile Series 99

Series 99 Service Kits and Sets Series 99 service kits and sets are made up primarily of various screwdriver, nutdriver, and other blades which can be used interchangeably in Series 99 handles. This saves space offers utmost economy.

All blades are high carbon steel with highly polished nickel chrome finish except Bristol and Allen Hex types which are precision-formed of alloy steel. Hex head sockets are precision-formed, cold drawn, case hardened steel. Plastic handles have a unique spring device that holds blades firmly, yet permits quick, easy insertion and removal. All handles accommodate all blades.



99SMW Service Kit \$84.24

Plastic-coated cover holds 26-piece set of handles and interchangeable screwdriver, nutdriver and other blades plus wire stripper and cutter and Weller's soldering iron.

Contents:

- WP25 — Soldering Iron
- ST3 — Tip
- 100-X — Wire Stripper and cutter
- 52CG — 6" Long Nose Cushion Grip Plier
- 55CG — 5" Diagonal Cushion Grip Plier

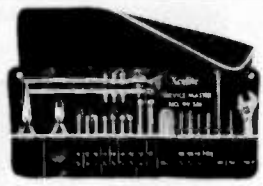

99SM Service Kit \$64.71

This versatile 23-piece set of quality tools in a durable roll-up plastic coated canvas case weighs only 2 1/2 pounds. Provides a variety of quick-change tools and tool combinations to speed up assembly and service work. Set includes:

- 52CG — 6" Long Nose Cushion Grip Plier
- 55CG — 5" Diagonal Cushion Grip Plier
- 46CG — 6" Thin-pattern Cushion Grip Adjustable Wrench
- 99-1 — Regular Handle
- 99-3 — Stubby Handle
- 99-6 thru 99-16 — Regular Nutdrivers (9)
- 99-58, 99-510, 99-517 — Stubby Nutdrivers
- 99-821, 822 — Phillips Screwdrivers
- 99-811, 99-250 — Slotted Screwdrivers
- 99-38 — Reamer
- 99-X10 — Extension Blade
- 99SMK — Canvas Case



46CG — 6" Thin-pattern Cushion Grip Adjustable Wrench

- 99-1 — Regular Handle
- 99-3 — Stubby Handle
- 99-6 thru 99-16 — Regular Nutdrivers (9)
- 99-821, 99-822 — Phillips Screwdrivers
- 99-58, 99-510, 99-517 — Stubby Nutdrivers
- 99-811, 99-250 — Slotted Screwdrivers
- 99-38 — Reamer
- 99-X10 — Extension Blade
- 99SMK — Canvas Case



Model D550PK Kit \$28.68

8-piece heavy-duty soldering kit featuring the versatile Weller Model D550 soldering gun with pre-tinned heavy copper tip. Kit also includes 2 spare un-tinned tips, tip-changing wrench, flux brush, soldering aid tool, coil of 60/40 rosin-core solder, and sturdy plastic carrying case, plus "Soldering Hints" booklet. UL-listed.



Model 8200 PK Kit \$21.15

8-piece kit includes Weller Model 8200 dual-heat soldering gun with pre-tinned copper tip, 2 extra un-tinned copper tips, tip-changing wrench, flux brush, soldering aid tool, coil of 60/40 rosin-core solder, and sturdy plastic carrying case, plus "Soldering Hints" booklet. UL-listed.



MP Series Miniature Controlled-Output Soldering Stations \$47.22

Especially designed for printed circuit electronic work. The famous Weller closed-loop temperature control circuit and grounded tip protect sensitive components from heat damage. Tip temperature of 650°F or 750°F is selected by changing the plug-in iron, which operates at low voltage and has non-burnable silicone rubber cord for added safety and longer life. High impact-resistant housing has non-heat-sinking iron holder plus tip cleaning sponge and receptacle. Variety of tips available for special applications. 3-wire cord. 120V, 60/40Hz, 22W. Furnished with .020" conical tip. MP131 UL-listed. Power Cord 6 Ft. Iron Cord 4 Ft.





Model 230K Hobby Kit \$14.58

Complete kit for hobbyists contains SP23 Soldering Iron in carrying case and tool tray, with 6 tips; cone soldering, screwdriver, chisel, smoothing hot knife, and cone burning. Work sponge. Hot iron rest. Soldering aid tool. Rosin core solder. Instruction Booklet. UL-listed. Canon weight 8 1/2 lbs. Canon quantity 6.

Tools, Parts, Accessories

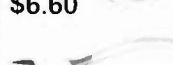
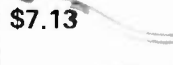
Diagonal Pliers

-  **\$6.60**
Midget 4" size for close quarter work
-  **\$7.13**
5" Plier for most cutting needs
-  **\$8.87**
4" long, for fast, clean, easy tip cutting of fine wires in close quarters
-  **\$7.48**
6" all-purpose diagonal plier
-  **\$7.33**
7" diagonal pliers for heavy duty cutting

Needle-Nose Pliers

-  **\$8.37**
*56CG
6" size: Long, slim serrated jaws permit entry inaccessible to regular long nose plier
-  **\$8.27**
*57CG
5 1/2" size with fine serrated jaws and coil spring for firm gripping and looping of wire
-  **\$6.85**
*41CG
Midget 4" pliers serrated jaws without side cutters
-  **\$7.92**
*51CG
6" long-nose pliers with side cutters
-  **\$6.37**
*52CG
6" long-nose pliers without side cutters

Long-Nose Pliers

Xcelite® XST-5 — Super-Tru Tip (Phillips type) Screwdriver Set

Contains 5 pieces — all Phillips

\$13.97

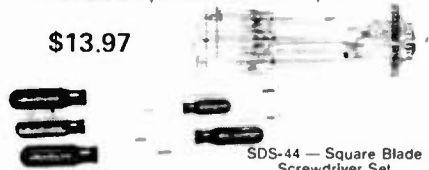

SDS-44 — Square Blade Screwdriver Set

\$14.76

Contains 5 Square Blade Screwdrivers for slotted screws. Catalog Nos: S-141 S-3164 S-144 S-5166 S-388

Adjustable Wrenches

Xcelite's exclusive thin-pattern design permits access where regular adjustables will not fit. Rugged construction, chrome-plated, polished heads, with quick one-hand adjustment and Cushion-Grip (CG)

- *44CG — 4" length, 1/2" opening **\$6.38**
- *46CG — 6" length, 3/4" opening **\$6.45**
- *48CG — 8" length, 1 1/4" opening **\$7.28**

Wire Strippers & Cutters

With Cushion Grip Handles

- *100-X **\$2.63**
Has adjustable screw stop for different wire sizes, and cushion grips. Cuts and strips both solid and stranded wire cleanly, neatly. Hardened with ground blades
- *101-S **\$3.32**
Specifications same as 100, except with spring-equipped self-opening handles
- *103-S **\$4.12**
Has unique cam stop adjustment for different wire sizes. Cam adjustment stays put, won't move, even with screw loose. Fine for industrial use
- 104CG Wire Stripper and Cutter **\$10.08**
Cutter, stripper and crimper for all types and sizes of wire, with a wide-size-range bolt cutter. Features scissor action-up front wire cutting and wire stripping, bolt cutters, cushion grip plier nose, hardened pivot joint bushing and crimp stations

Quality Coaxial Cable for All Applications

- LOW LOSS CABLE • NON TARNISHING CONNECTORS
- FACTORY ASSEMBLED, TESTED FOR 100% RELIABILITY

RG58/U Type

| PART NUMBER | DESCRIPTION | APPLICATIONS |
|----------------|--|---|
| 581-58018 * | 18' length with UHF CB plugs on both ends | Used as patch cords for mobile & base station SWR & power meters, antenna switches, and SWR matchers |
| \$3.20 | | |
| 581-583 * | 3' length with UHF CB plugs on both ends | Used to connect mobile CB sets to trunk, mirror gutter or bumper mount antennas using spade lug terminations to the antenna. |
| \$3.70 | | |
| 581-585 * | 5' length with UHF CB plug & spade lugs | Used to connect mobile CB sets to trunk, mirror gutter or bumper mount antennas requiring a UHF CB plug termination to the antenna. |
| \$4.10 | | |
| 581-5812L * | 12' length with UHF CB plug & spade lugs | Used to connect base station CB sets with base antennas. Where loss is critical, these cables will out perform RG 58/U cables of the same length. |
| \$4.10 | | |
| 581-5820L * | 20' length with UHF CB plug & spade lugs | Used to connect base station CB sets with base antennas. Where loss is critical, these cables will out perform RG 58/U cables of the same length. |
| \$4.99 | | |
| 581-5812 * | 12' length with UHF CB plugs on both ends | Used to connect base station CB sets with base antennas. Where loss is critical, these cables will out perform RG 58/U cables of the same length. |
| \$4.99 | | |
| 581-5820-259 * | 20' length with UHF CB plugs on both ends | Used to connect base station CB sets with base antennas. Where loss is critical, these cables will out perform RG 58/U cables of the same length. |
| \$5.49 | | |
| 581-5850-420 | 50' length with UHF CB plugs on both ends | Used to connect base station CB sets with base antennas. Where loss is critical, these cables will out perform RG 58/U cables of the same length. |
| \$7.25 | | |
| 581-5875-420 | 75' length with UHF CB plugs on both ends | Used to connect base station CB sets with base antennas. Where loss is critical, these cables will out perform RG 58/U cables of the same length. |
| \$9.29 | | |
| 581-58100-420 | 100' length with UHF CB plugs on both ends | |
| \$10.99 | | |



RG 58/U Type RG 8/U Low Loss Type

RG 8/U Low Loss Type

| PART NUMBER | DESCRIPTION | APPLICATIONS |
|----------------|--|---|
| 581-83 * | 3' lengths with UHF CB plugs on both ends | Used as patch cords for mobile and base station SWR and power meters, antenna switches & SWR matchers |
| \$4.10 | | |
| 581-820 | 20' length with UHF CB plugs on both ends | Used to connect mobile or base stations with antennas requiring a UHF CB plug termination at the antenna |
| \$8.50 | | |
| 581-850-420 | 50' length with UHF CB plugs on both ends | Used to connect base station CB sets with base antennas. Where loss is critical, these cables will out perform RG 58/U cables of the same length. |
| \$14.99 | | |
| 581-875-420 | 75' length with UHF CB plugs on both ends | Used to connect base station CB sets with base antennas. Where loss is critical, these cables will out perform RG 58/U cables of the same length. |
| \$22.50 | | |
| 581-8100-420 | 100' length with UHF CB plugs on both ends | |
| \$26.50 | | |



LAB QUALITY CABLES

BNC Test Voltage

1500 vac; Frequency: 0-4 GHz; Impedance: 50 Ohms nominal; Cable Retention Force: 60 lbs. minimum (RG-58C/U)

UHF Test Voltage

1500 vac; Frequency: 0-500 MHz; Impedance: Non Constant; Cable Retention Force: 60 lbs. minimum (RG-58C/U)

| | | | | | |
|---|---------|------------------------------------|---------|---------|---------|
|  | | 50 ohm UHF Plug to UHF Plug | | | |
|  | | 50 ohm BNC Plug to UHF Plug | | | |
|  | | 50 ohm BNC Plug to BNC Plug | | | |
| No. 651 | 3 feet | \$ 6.52 | No. 651 | 3 feet | \$ 6.52 |
| No. 652 | 5 feet | \$ 7.05 | No. 652 | 5 feet | \$ 7.05 |
| No. 653 | 10 feet | \$ 8.34 | No. 653 | 10 feet | \$ 8.34 |
| No. 657 | 1 foot | \$ 7.20 | No. 657 | 1 foot | \$ 7.20 |
| No. 658 | 3 feet | \$ 7.72 | No. 658 | 3 feet | \$ 7.72 |
| No. 656 | 5 feet | \$ 8.24 | No. 656 | 5 feet | \$ 8.24 |
| No. 668 | 3 feet | \$ 8.91 | No. 668 | 3 feet | \$ 8.91 |
| No. 662 | 5 feet | \$ 9.43 | No. 662 | 5 feet | \$ 9.43 |
| No. 666 | 10 feet | \$10.73 | No. 666 | 10 feet | \$10.73 |

TUFTS Electronic Department Store TUFTS

FINCO STINGER VHF/UHF Antennas



\$62.95

10 meter

STINGER A 10 1/4 DESCRIPTION

The model Stinger A 10 1/4 is a wide spread, full size, high gain four element 10 meter monopole designed for optimum DX performance. Utilizing the exclusive Stinger Square boom construction, the A 10 1/4 is light enough to be easily stacked for an additional 3 dB gain yet strong enough to withstand the most adverse weather conditions. The highly efficient gamma match system easily withstands 2,000 watts P.E.P. of power and maintains a relatively low V.S.W.R. across the entire 10 meter amateur band.

SPECIFICATIONS - A 10 1/4

| ELECTRICAL- | | MECHANICAL- | |
|-------------------------|------------------|----------------------|-------------|
| Forward Gain | 10dB | Boom Length | 16 ft. |
| Front to Back Ratio | 25dB | Longest Element | 18 1/2 ft. |
| V.S.W.R. (at resonance) | 1.1 | Turning Radius | 7 1/4 ft. |
| Half Power Beam Width | 55° | Maximum Surface Area | 4.4 sq. ft. |
| Bandwidth | 78 to 30 MHz | Wind Load at 80 MPH | 118 lbs. |
| Impedance | 50 Ohms | Weight | 12 1/2 lbs. |
| Matching System | Adjustable Gamma | | |

6 meter

STINGER A 6 DESCRIPTION

The model Stinger A 6 is a highly directional 6 meter five element beam specifically designed for maximum forward gain with the compromise front to back ratio. The elements are constructed of high tensile strength aluminum of uniform tubing plus the exclusive Stinger square boom and bracket assemblies. For maximum power transfer and low V.S.W.R., a carefully designed gamma matching assembly capable of withstanding 2,000 watts P.E.P. is incorporated. Wide element spacing assures optimum D.S. performance and good operating efficiency across the entire 50 to 54 MHz 6 meter band. The square boom at low optional vertical mounting for accessing 6 meter operations.

SPECIFICATIONS - A 6

| ELECTRICAL- | | MECHANICAL- | |
|-------------------------|------------------|----------------------|--------------|
| Forward Gain | 13dB | Boom Length | 13 ft. |
| Front to Back Ratio | 30dB | Longest Element | 10 1/2 ft. |
| V.S.W.R. (at resonance) | 1.1 | Turning Radius | 8 3/8 ft. |
| Half Power Beam Width | 50° | Maximum Surface Area | 3.23 sq. ft. |
| Bandwidth | 50 to 54 MHz | Wind Load at 80 MPH | 160 2 lbs. |
| Impedance | 50 Ohms | Weight | 11 1/2 lbs. |
| Matching System | Adjustable Gamma | | |

STINGER A 6 1/2 DESCRIPTION

The model Stinger A 6 1/2 is a 3 element light gain 6 meter beam. Like the A 6 but especially designed for the casual 6 meter enthusiast. It offers the same excellent performance for portable use as is suggested in the package. Due to the unit's light weight and minimum wind load, it is ideal for double stacked and quad stacked arrays.

SPECIFICATIONS - A 6 1/2

| ELECTRICAL- | | MECHANICAL- | |
|-------------------------|------------------|----------------------|--------------|
| Forward Gain | 9.5dB | Boom Length | 6.9 ft. |
| Front to Back Ratio | 25dB | Longest Element | 6.8 ft. |
| V.S.W.R. (at resonance) | 1.1 | Turning Radius | 5.4 ft. |
| Half Power Beam Width | 50° | Maximum Surface Area | 1.76 sq. ft. |
| Bandwidth | 50 Ohms | Wind Load at 80 MPH | 17 1/2 lbs. |
| Impedance | 50 Ohms | Weight | 7.8 lbs. |
| Matching System | Adjustable Gamma | | |

6 and 2 meter

STINGER A 6-2 DESCRIPTION

The model Stinger A 6-2 is a truly remarkable combination 6 and 2 meter beam designed for optimum performance on both bands yet only requiring ONE transmission line. This is accomplished through the use of selective phasing elements to accomplish dual band operation with no sacrifice in either band. NO SWITCHING REQUIRED!

SPECIFICATIONS - A 6-2

| ELECTRICAL- | | MECHANICAL- | |
|------------------------|-------------------------|----------------------|--------------|
| Forward Gain | 6 meters 9.5dB | Boom Length | 10.1 ft. |
| | 2 meters 12.0dB | Longest Element | 10 ft. |
| Front to Back Ratio | 6 meters 19dB | Turning Radius | 9.7 ft. |
| | 2 meters 25dB | Maximum Surface Area | 4.48 sq. ft. |
| V.S.W.R. (6 & 2 meter) | 1.1 | Wind Load at 80 MPH | 83 lbs. |
| Half Power Beam Width | 40° to 55° | Weight | 13 lbs. |
| Bandwidth | 6 meters 50 to 54 MHz | | |
| | 2 meters 144 to 148 MHz | | |
| Impedance | 50 ohms | | |
| Matching System | Adjustable Gamma | | |

2 meter

STINGER A 2 10 DESCRIPTION

The model Stinger A 2 10 is a high performance wide spaced ten element 2 meter yagi designed for the amateur VHF operator. Utilizing the Stinger construction features, the A 2 10 is almost indestructible no matter what weather conditions are encountered. Complete coverage of the 2 meter band and low V.S.W.R. is assured through the use of non-linear spaced elements thus also achieving maximum forward gain. Power rating - 2,000 watts P.E.P. The A 2 10 can be mounted for vertical polarization, there by making the antenna quite useful in repeater operation or mounted for horizontal polarization for station to station VHF DX work. Additional legs of the A 2 10 can be easily stacked for even greater gain and front to back ratio.

SPECIFICATIONS - A 2 10

| ELECTRICAL- | | MECHANICAL- | |
|-------------------------|------------------|----------------------|--------------|
| Forward Gain | 13.8dB | Boom Length | 10 ft. |
| Front to Back Ratio | 25dB | Longest Element | 42 in. |
| V.S.W.R. (at resonance) | 1.1 | Turning Radius | 7 1/4 ft. |
| Half Power Beam Width | 40° | Maximum Surface Area | 2.36 sq. ft. |
| Bandwidth | 144 to 148 MHz | Wind Load at 80 MPH | 76 2 lbs. |
| Impedance | 50 Ohms | Weight | 9.8 lbs. |
| Matching System | Adjustable Gamma | | |

\$44.95

STINGER A 2 6 DESCRIPTION

The model Stinger A 2 6 is a five element high gain antenna similar to the A 2 10 but having physically less of a profile. The A 2 6 finds excellent application in portable operation as it disassembles into a very compact package. Like the A 2 10, the antenna can be mounted for vertical or horizontal polarization for repeater or general coverage work. Constructed of the Stinger heavy duty materials, the A 2 6 is ideal for local areas encountering severe weather conditions. Power rating 2,000 watts P.E.P.

SPECIFICATIONS - A 2 6

| ELECTRICAL- | | MECHANICAL- | |
|-------------------------|------------------|----------------------|----------|
| Forward Gain | 9.5dB | Boom Length | 6.5 ft. |
| Front to Back Ratio | 22dB | Longest Element | 43 in. |
| V.S.W.R. (at resonance) | 1.1 | Turning Radius | 42 in. |
| Half Power Beam Width | 50° | Maximum Surface Area | 3.3 lbs. |
| Bandwidth | 144 to 148 MHz | Wind Load at 80 MPH | 63 lbs. |
| Impedance | 50 Ohms | Weight | 6.5 lbs. |
| Matching System | Adjustable Gamma | | |

\$27.95

STINGER A 2 1/4 DESCRIPTION

The model Stinger A 2 1/4 is a dual polarization 2 meter antenna designed for portable operation. It is constructed from horizontal to vertical polarization. The A 2 1/4 can even be stacked to operate on the horizontal polarization of the same time. This is not only useful but gives your station versatility for ground communication.

SPECIFICATIONS - A 2 1/4

| ELECTRICAL- | | MECHANICAL- | |
|---------------------|------------------|----------------------|--------------|
| Forward Gain | 9.5dB | Boom Length | 6 ft. |
| Front to Back Ratio | 10.5dB | Longest Element | 41 in. |
| Circle Polarization | 58° | Center Mount | 5.8 ft. |
| V-plane | 52° | Maximum Surface Area | 1.81 sq. ft. |
| H-plane | 52° | Wind Load at 80 MPH | 13.4 lbs. |
| Circle Polarization | 52° | Weight | 11 lbs. |
| H-plane | 52° | | |
| Bandwidth | 144 to 148 MHz | | |
| Impedance | 50 Ohms | | |
| Matching System | Adjustable Gamma | | |

\$46.50

STINGER A 2 2 DESCRIPTION

The Stinger construction features make the A 2 2 extremely heavy duty. Provisions are made for mounting the antenna at the end of the boom - for much control - or at the middle of the boom for normal applications.

SPECIFICATIONS - A 2 2

| ELECTRICAL- | | MECHANICAL- | |
|-----------------------|------------------|----------------------|--------------|
| Forward Gain | 9.5dB | Boom Length | 6 ft. |
| Front to Back Ratio | 10.5dB | Longest Element | 41 in. |
| Circle Polarization | 58° | Center Mount | 5.8 ft. |
| H-plane | 52° | Maximum Surface Area | 1.81 sq. ft. |
| Vertical Polarization | 52° | Wind Load at 80 MPH | 13.4 lbs. |
| Circle Polarization | 52° | Weight | 11 lbs. |
| H-plane | 52° | | |
| Bandwidth | 144 to 148 MHz | | |
| Impedance | 50 Ohms | | |
| Matching System | Adjustable Gamma | | |

STINGER A 1 1/4 DESCRIPTION

The model Stinger A 1 1/4 is a ten element 1 1/4 meter (120 MHz) high performance yagi designed for all 220 MHz communication needs. Designed to be mounted in either the vertical or horizontal plane, the A 1 1/4 is suitable for OSCAR, repeater, or general communication work. Incorporating the Stinger heavy duty elements, boom and boom to support construction, the antenna easily withstands 170 mph wind loads under 1/4" ice conditions. A low loss gamma matching system assures a low V.S.W.R. is maintained at 1,000 watts.

SPECIFICATIONS - A 1 1/4

| ELECTRICAL- | | MECHANICAL- | |
|-------------------------|------------------|----------------------|--------------|
| Forward Gain | 13.8dB | Boom Length | 8 ft. |
| Front to Back Ratio | 25dB | Longest Element | 28 in. |
| V.S.W.R. (at resonance) | 1.2 | Turning Radius | 4.3 ft. |
| Half Power Beam Width | 40° | Maximum Surface Area | 1.32 sq. ft. |
| Bandwidth | 220 to 276 MHz | Wind Load at 80 MPH | 17 9 lbs. |
| Impedance | 50 Ohms | Weight | 8 lbs. |
| Matching System | Adjustable Gamma | | |

\$32.95

slinky

\$39.95

SLINKY! \$43.95 Kit A LOT of antenna in a LITTLE space New Slinky® dipole with helical loading radiates a good signal at 1/10 wavelength long!

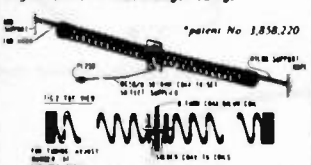

Patent No. 1,858,270
Deluxe straight key
Flip-top bracket, Can't tip
Heavy base, No need to attach to desk
CC 3P shielded cable & plug for HK-3M \$2.48
Model A T B anti-top bracket only. Add \$5.50 Shipping & Handling
\$2.99

This electrically small 80/75, 40 & 20 meter antenna operates at any length from 24 to 70 ft. • no extra balun or transmatch needed • portable - erects & stores in minutes • small enough to fit in attic or apt. • full legal power • low SWR over complete 80/75, 40 & 20 meter bands • much lower atmospheric noise pick-up than a vertical & needs no radials • kit incl. a pr. of specially-made 4" dia. by 4" long coils, containing 335 ft. of radiating conductor, balun, 50 ft. RG58/U coax, PL259 connector, nylon rope & manual.

HAM-KEY

Model HK-3M



\$19.95

Deluxe straight key
Flip-top bracket, Can't tip
Heavy base, No need to attach to desk
CC 3P shielded cable & plug for HK-3M \$2.48
Model A T B anti-top bracket only. Add \$5.50 Shipping & Handling
\$2.99

Model HK-4



\$44.95

Combination HK-1 & HK-3 on same base
Straight key may be used conventionally or as a switch to trigger a camera
CC-1P Shielded cable with plug for HK-4 \$5.95

RADIO TELEGRAPH SENDING DEVICES

Model HK-1



\$29.95

OC 1P shielded cable & plug for HK-1 \$3.75
Model HK-2, same as HK-1 but has base for incorporation in your own keyer \$19.95

Model HK-5A
Electronic Keyer

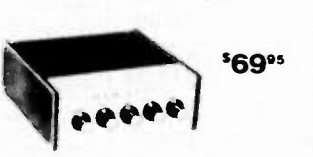

\$69.95

• Simple circuit for squeeze keying
• Soft completing dots & dashes
• Dot & dash memory
• Built-in sidetone
• Battery operated with provision for external power
• Uses Curtis B04A keyer chip
• Grid block as direct keying
• Speed, volume, tone & weight controls on front panel
• Use with HK-1 or HK-4

DATONG



MODEL FL1 \$219.95

Frequency - Agile Audio Filter
The Datong Frequency-Agile Audio Filter is intended primarily for post-detector signal filtering in RF and LF communications receivers for SSB and CW. It offers an unusually versatile combination of benefits to the user including:
For the SSB operator:
• Fast automatic suppression of interfering heterodyne whistles in the range 280-3000 Hz by a unique search-lock-and-track notch filter. The tracking notch can be left in circuit with no audible effect until a whistle appears in which case the whistle will 'disappear' within typically one second.
• A continuously adjustable audio 'window' or a variable-width notch to improve reception in the presence of other off-tune SSB, RTTY or SSTV signals.
For the CW operator:
• Continuously variable center-frequency (280-3000 Hz) and bandwidth (25-1000 Hz) for perfect matching of receiver passband to changing band conditions, sending speeds, and personal preference.
• Flat-topped, steep-skirted response shape for optimum ease of tuning combined with excellent noise rejection.
• Linear tuning law with bandwidth independent of frequency and gain independent of bandwidth for natural 'feel'.



OSCAR

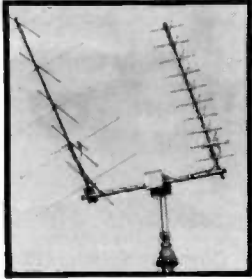

OSCAR Satellite Communications

Cushcraft offers complete antenna systems for OSCAR satellite communications on 2m and 70 cm. On 145 MHz the 10-element twist antenna (5 vertical elements, 5 horizontal) yields up to 10 dB dBS gain; the 20-element 4.35 MHz twist (10 vertical elements plus 10 horizontal) provides up to 13.8 dB gain. For greater performance on 2m, choose the 20-element 145 MHz twist which offers 13.8 dB gain. The half-power beamwidth of these antennas has been optimized for reliable satellite communications with maximum tracking requirements. All twist antennas come complete with coaxial matching harness for selectable horizontal, vertical, or circular polarization. Match 50 ohm feedlines.

ATV-5



ATV-5

This trapped vertical antenna system has been designed for five-band operation on 80m-10m. The high Q traps are carefully optimized for wide operating bandwidth; 2:1 SWR bandwidth with 50 ohm feeding is approximately 1 MHz on 10m; more than 800 kHz on 15m and 20m; 160 kHz on 40m and 78 kHz on 80m. Instructions are provided for adjusting resonance to your preferred part of the band, CW or SSB. Built-in coaxial connector takes PL 250. Nominal height, 283 inches. Rated at 2000 watts PEP on all bands.

Two Meter Boomers

Whether you have the space for the 3 1/2 x 32-19 or the compact 2 1/2 x models, 2m Boomers are your best choice. They offer the maximum gain available for their boom length (See NBS no. 688). They feature trigon reflectors for additional front to back ratio and clean patterns. All stainless steel hardware and heavy gauge heat treated aluminum are used throughout. Whatever your choice of 2m activity, the Boomer will fit your needs. For FM use the 228FB or 214FB. For CW/SSB on the low end use 32-19 or 214B, in EME, DX or just reliable QSO, Boomer will perform for you.

Six Meter Boomers

The new 6m Yag offers more boom, more gain and fewer elements. Designed for the low end of the band, the 6m Boomer has Cushcraft's typical attention to detail: the Boomer's balanced feed with balun, and extra heavy duty mechanics in construction. The secret behind its super performance and light weight is special element spacing and boom lengths.

Specifications

| Model number | 32-19 | 214B | 214FB | 228FB | 617-4B |
|--------------------------------------|---------|---------|---------|---------|--------|
| Frequency range (MHz) | 144-148 | 144-148 | 144-148 | 144-148 | 50-54 |
| Forward gain (dBd) | 16.2 | 15.2 | 15.2 | 18.2 | 18 |
| Front to back ratio (dB) | 28 | 28 | 28 | 28 | 30 |
| Element (deg) | 2x18 | 2x17 | 2x17 | 2x17 | 2x19 |
| Element Breadth (deg) | 2x17 | 2x18 | 2x18 | 2x8 | NA |
| Side lobe attenuation (dB) | -80 | -80 | 80 | 80 | -80 |
| SWR less than (dB) | 1.2:1 | 1.2:1 | 1.2:1 | 1.2:1 | 1.2:1 |
| Impedance (ohms) | 50 | 50 | 50 | 50 | 50 |
| Recommended element spacing distance | 14 | 10 | 10 | 10 | NA |
| Element (ft) | 12 | 10 | 10 | 10 | 22.5 |
| Weight (lbs) | 12 | 8 | 8 | 22 | 28 |
| Length (ft) | 22 | 15 | 15 | 15 | 35 |
| Longest element (ft) | 40L | 40L | 30L | 30L | 113L |
| Turning radius (ft) | 11 | 7.5 | 7.5 | 9.5 | 11.7 |
| Windload (lb/ft) | 3.5 | 1.7 | 1.7 | 4.0 | 4.8 |

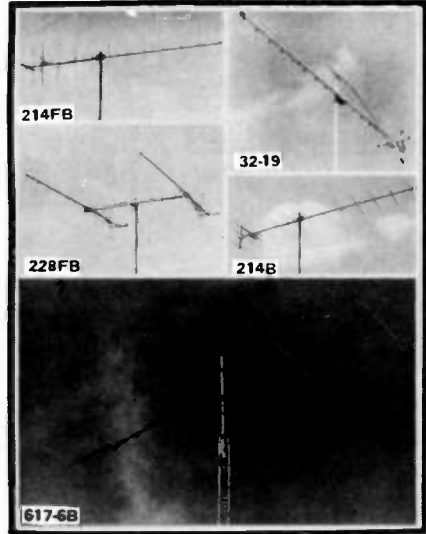

ALL PRICES SHOWN ARE LIST PRICES! CALL FOR SPECIAL PACKAGE PRICING!



PRICE LIST

AMATEUR FM ANTENNAS

| | |
|----------|----------|
| A147-4 | \$ 29.95 |
| A147-11 | 44.95 |
| A147-20T | 74.95 |
| A147-22 | 129.95 |
| A220-7 | 32.95 |
| A220-11 | 42.95 |
| A449-6 | 29.95 |
| A449-11 | 42.95 |
| AFM-40 | 79.85 |
| AFM-24D | 72.95 |
| AFM-44D | 67.95 |
| AR-2 | 27.95 |
| AR-6 | 44.95 |
| AR-10 | 44.95 |
| AR-20 | 28.95 |
| AR-40 | 28.95 |
| ARX-2B | 44.95 |
| ARX-2A | 21.95 |
| ARX-2Z0 | 44.95 |
| ARX-450 | 39.95 |

FM STACKING KITS

| | |
|--------------------------|----------|
| A14-SK | \$ 22.95 |
| A14-VPK | 32.95 |
| A21-SK | 22.95 |
| A220-VPK | 22.95 |
| A147-SK | 49.95 |
| A449-SK | 22.95 |
| A449-VPK | 32.95 |
| BLITZ BUGS | |
| LAC-3 | \$ 5.95 |
| DX ARRAYS-20 ELEMENT | |
| DX-120 | \$ 67.95 |
| DX-150 | 34.95 |
| DX-420 | 44.95 |
| DX ARRAY BALUNS | \$ 18.95 |
| DX-18N | 18.95 |
| DX-28N | 18.95 |
| DX-88N | 18.95 |
| DX ARRAY | |
| 40 ELEMENT STACKING KITS | |
| DKK-140 | \$179.95 |
| DKK-440 | 74.95 |
| DX ARRAY | |
| 80 ELEMENT STACKING KITS | |
| DKR-180 | \$329.95 |
| DKR-480 | 149.95 |
| DKR-110 | 22.95 |
| MULTI BAND HF ANTENNAS | |
| A-3 | \$219.95 |
| ATB-34 | 319.95 |
| ATV-3 | 34.35 |
| ATV-4 | 112.95 |
| ATV-5 | 119.95 |
| R-3 | 299.95 |
| A-35K | 39.95 |

TWIST ANTENNAS

| | |
|------------------------|----------|
| A147-MB | \$ 24.95 |
| A144-10T | 54.95 |
| A144-20T | 74.95 |
| A435-21T | 64.95 |
| AT-413 | 129.95 |
| VMP/JMHF BEAMS | |
| A50-3 | \$ 54.95 |
| A50-5 | 74.95 |
| A50-6 | 99.95 |
| A144-7 | 32.95 |
| A144-11 | 44.95 |
| A430-11 | 42.95 |
| VMP/JMHF STACKING KITS | |
| A11-SK | \$ 22.95 |
| A17-SK | 22.95 |
| A51-SK | 22.95 |
| A535-SK | 22.95 |
| A551-SK | 24.95 |
| AQK-144 | 159.95 |
| AQK-244 | 119.95 |

MIDDLE ANTENNAS

| | |
|----------------------|----------|
| AMS-147 | \$ 32.95 |
| ATS-147 | 32.95 |
| AMS-220 | 32.95 |
| ATS-220 | 32.95 |
| BDDMER ANTENNAS | |
| 32-19 | \$ 99.95 |
| 214B | 79.95 |
| 214FB | 79.95 |
| 220B | 89.95 |
| 228FB | 249.95 |
| 617-4B | 229.95 |
| BDDMER STACKING KITS | |
| 22-SK | \$ 39.95 |
| 32-SK | 44.95 |
| 220-SK | 44.95 |
| 220-QK | 279.95 |
| 224-QK | 279.95 |
| 228-VPK | 22.95 |
| PD-2 | 22.95 |
| PD-4 | 32.95 |
| PD-222 | 22.95 |
| PD-224 | 22.95 |
| SKYWALKER BEAMS | |
| 20-4CD | \$319.95 |
| 20-3CD | 219.95 |
| 18-4CD | 129.95 |
| 15-3CD | 109.95 |
| 10-4CD | 99.95 |
| 10-3CD | 79.95 |



Skywalker

Skywalker

3 and 4 Element Single Band Yagis

Skywalker

More contacts, less waiting, less interference, and a better signal at the other end are yours with the Skywalker series of single band Yagis. The 10dBd forward gain of the 4 element model will put you first in line. See the chart for all the details. Heavy wall heat treated 6063-T832 aluminum tubing, ruggedly plated steel fasteners, and carefully formed aluminum brackets. Assembly is simple with the new Cushcraft Boom Assembly Marking System.

Specifications

| Model Number | 30-4000 | 300-10 | 400-15 | 15-300 | 10-400 | 10-300 |
|--------------------------------------|------------|------------|------------|------------|-----------|-----------|
| Frequency range (MHz) | 14.0-14.35 | 14.0-14.35 | 21.0-21.45 | 21.0-21.45 | 28.0-29.7 | 28.0-29.7 |
| Forward gain (dBd) | 10.0 | 8.0 | 10.0 | 8.0 | 10.0 | 8.0 |
| Front to back ratio (dB) | 30 | 30 | 30 | 30 | 30 | 30 |
| Element (deg) | 32 | 18 | 20 | 14 | 17 | 12 |
| Element Breadth (deg) | 35-10 | 35-4 | 23-4 | 23-2 | 17-10 | 17-8 |
| Side lobe attenuation (dB) | 60 | 56 | 57 | 56 | 57 | 56 |
| SWR less than (dB) | 1.2 | 1.2 | 1.2 | 1.2 | 1.2 | 1.2 |
| Impedance (ohms) | 50 | 50 | 50 | 50 | 50 | 50 |
| Recommended element spacing distance | 44 | 40 | 33 | 30 1/4 | 30 | 27 |
| Element (ft) | 20 | 25 | 15 1/4 | 13 1/4 | 14 | 10 |
| Turning radius (ft) | 16 | 10 | 21 | 20 | 16 | 11 |
| Windload (lb/ft) | 8.1 | 5.5 | 4.5 | 2.4 | 3 | 2.1 |

ATB-34

ATB-34 - 10-15-20 Meters

The Cushcraft ATB 34 3-band antenna offers the maximum performance of a single band Yagi on 10m, 15m, and 20m, and represents the best in state-of-the-art antenna design. The antenna's rugged construction, broad bandwidth, and four active elements give superb performance. Quality workmanship and the use of the best available materials give an estimated wind survival rating of 90 mph. Forward gain is 7.8 dBd on all bands; front to back ratio is nominally 30 dB on 20m; 22 dB on 15m, and 18 dB on 10m. Nominal input impedance is 50 ohms; VSWR is 1.8:1 or less at resonance.



ATB-34

A3

The full power, full performance 20-15-10m beam.

Enjoy the thrill of working rare DX. Increase the pleasure of your daily contacts with A3 interference reducing front-to-back ratio. Use your linear amplifier with confidence with our new high power traps.

6 METER BEAMS

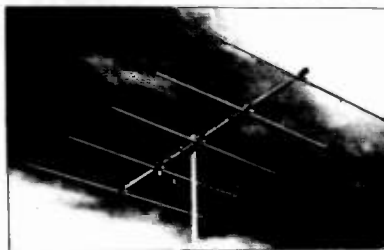

3 - 5 - 6 - 10 ELEMENTS

| Description | 3 element | 5 element | 6 element | 10 element |
|-------------|-----------|-----------|-----------|------------|
| Model No. | A50 3 | A50 5 | A50 6 | A50 10 |
| Boom Length | 6' | 12' | 20' | 24' |
| Longest El | 117" | 117" | 117" | 117" |
| Turn Radius | 6' | 7' 6" | 11' | 13' |
| Fwd. Gain | 7.5 dB | 9.5 dB | 11.5 dB | 13 dB |
| F/B Ratio | 20 dB | 24 dB | 26 dB | 28 dB |
| Weight | 7 lbs. | 11 lbs. | 18 lbs. | 25 lbs. |

3/4, 1-1/4, 2 METER BEAMS

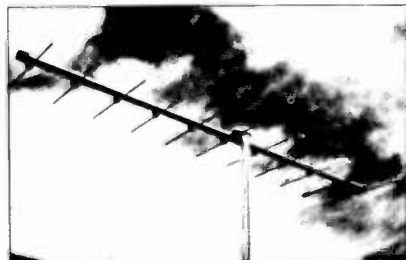

| Model No | A144 7 | A144 11 | A220 11 | A430 11 |
|---------------------|--------|---------|---------|---------|
| Description | 2m | 2m | 1 1/4m | 1/4m |
| Elements | 7 | 11 | 11 | 11 |
| Boom Length | 98" | 143" | 102" | 57" |
| Weight | 4 | 6 | 4 | 3 |
| Fwd Gain | 11 dB | 13 dB | 13 dB | 13 dB |
| F/B Ratio | 26 dB | 26 dB | 28 dB | 28 dB |
| Fwd Lobe @ 1/2wr pt | 46 | 42 | 42 | 42 |
| SWR @ Freq | 1 to 1 | 1 to 1 | 1 to 1 | 1 to 1 |

TUFTS Electronic Department Store TUFTS

Panasonic



\$179.00
Panasonic RF-2200
International Band

Eight-band worldwide shortwave radio. AC or battery power. Includes AM, FM and six shortwave bands. Combination 2-stage selectivity and AFC switch. RF gain control. Separate bass, treble, and volume controls. FM/SW telescoping antennas. Four "D" batteries, AC power cord, and earphone included.



\$239.00
Command Series RF-2600

Six-band portable shortwave radio with all-band, five-digit fluorescent frequency display. SW frequencies from 3.9-28 MHz. FM/AM radio. Battery/signal strength meter. AFC on FM. RF gain control. 4" dynamic speaker. Comes with AC power cord, shoulder belt and earphone. Operates on 6 "D" batteries (not included).



\$249.00
Command Series RF-2900

Portable 5-band shortwave radio. Five-digit fluorescent display. SW from 3.2 to 30 MHz. RF gain control. BFO pitch control. Comes with AC power cord, shoulder belt, dial hood and earphone. Operates on 6 "D" batteries (not included).



\$399.00
Command Series RF-4900

Ten-band communications receiver with 5-digit, all-band fluorescent display. SW from 1.6 to 30 MHz. FM and AM frequencies. FET RF amplifier. BFO pitch control. RF gain control. Comes with earphone, AC power cord and headphone converter. Operates on 6 "D" batteries (not included).

Kantronics

Our smart machine reads sloppy copy.



NEW! INCLUDES 24-hour UTC Clock
110 and 300 baud ASCII, & tuning eye!

kantronics
Field Day® \$399.00

If someone tells you they offer the same features we do, check them out with the list below.

- Morse copying ability
- 3 to 80 WPM Morse range
- Computer programs for improving sloppy Morse
- Radioteletype copying ability - 60, 67.75 and 100 WPM Baudot
- ASCII radioteletype ability - 110 and 300 WPM baud
- Copies any shift of RTTY
- 24-hour UTC clock available in any mode
- Entire unit contained in one package
- Automatic code-speed tracking
- Full 10-character, large-size display
- Displays code speed
- Tuning eye for faster tuning
- Full year limited warranty
- Internal speaker
- Requires no TV set for use
- Advanced demodulator circuits
- Internal 200 Hz bandwidth filter
- All letters, numbers and punctuation plus special Morse characters and 5 special RTTY characters

DRAKE

See back cover for specials!

Drake R-7 / DR-7

Synthesized, General Coverage Receiver

- Fully synthesized with a permeability tuned oscillator (PTO) for smooth, continuous tuning.
- Covers complete range 0-30 MHz. Both digital and analog readout.
- Special low distortion "synchro-phase" AM detector provides superior International shortwave broadcast reception.
- Tunable IF notch filter effectively reduces heterodyne interference from nearby stations.
- Multi-function antenna selector/50 Ohm splitter is switch-selected from the front



\$1299.00

- panel. Provides simultaneous dual receive with the TR-7, making possible the reception of two different frequencies at the same time.
- Built-in power supply operates from 100, 120, 200, 140 Vac, 50/60 Hz, or nominal 13.8 Vdc.
- Much more!

See back cover for specials!

YAesu



FRG-7000 \$655.00
Digital Display Communications Receiver with CPU Digital Clock and Timer

- 0.25 Thru 29.9 MHz Coverage with 1 kHz Readout
- Computer technology and convenience features are brought together in the FRG-7000, a digital-display general coverage receiver for the discriminating SWL. The digital clock and timer, controlled by a CPU (Central Processing Unit) chip, will read out both local and GMT time, and will control peripheral station equipment such as a tape recorder.



FRG-7 \$370.00

- General Coverage Receiver
- 0.5-29.9 MHz Coverage with 10 kHz Readout
- The FRG-7 is a precision-built all-purpose communications receiver, featuring all solid state construction for long life and high performance. Utilizing the Wadley Loop drift cancellation system, in conjunction with a triple conversion superheterodyne circuit, the FRG-7 boasts high sensitivity along with excellent stability.

KENWOOD

...presetter in amateur radio

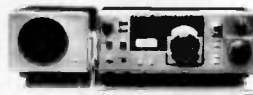

Kenwood R-1000 \$499.00

The R-1000 is a highly advanced communications receiver. Up-conversion, PLL circuitry and other new technology provide optimum sensitivity, selectivity, and stability from 200 kHz to 30 MHz. Featuring easy-to-operate single-knob tuning and digital frequency display, it's perfect for listening to shortwave, medium wave, and long-wave bands. Even SSB signals are received perfectly. Included is a quartz digital clock and timer.

R-1000 FEATURES:

- Continuous frequency coverage from 200 kHz to 30 MHz.
- 30 bands, each 1 MHz wide.
- Five-digit frequency display and illuminated analog dial.
- Quartz digital clock and ON/OFF timer.
- Multi-modes... AM (wide and narrow), SSB (USB and LSB), and CW.
- Three IF filters... 2.7 kHz for SSB and CW, 6.0 kHz for AM narrow, and 12 kHz for AM wide.
- Effective noise blanker, built-in speaker, three antenna terminals, rf step attenuator, tone control, recording terminal.
- Remote terminal, for access to timer relay ON/OFF circuit and muting circuit.
- SSB sensitivity of 0.5 µV from 2 to 30 MHz.
- More than 60 dB IF image ratio.
- More than 70 dB IF rejection.



THE IAMBIC KEYER PADDLE. Features include: adjustable jeweled bearings ("Deluxe" only); tension and contact spacing fully adjustable; large, solid, coin silver contact points; 2 1/2 lb. chrome plated steel base rests on non-skid feet; lifetime guarantee against manufacturing defects. "Standard" model with textured gray base. \$49.50. "Deluxe" model with chrome plated base. \$65.00

THE IMPROVED "ORIGINAL" VIBROPLEX. Suitable for All Classes of Transmitting Work Where Speed and Perfect Morse Are Prime Essentials. This great new Vibroplex is a smooth and easy working BUG. It has won fame on land and sea for its clarity, precision and ease of manipulation. Can be slowed down to 10 words per minute or less or geared to as high rate of speed as desired. Maintains the same high quality signal at whatever speed, insuring easy reception under all conditions. Weight 3 lbs. 8 oz. Standard \$56.95. DeLuxe - Chromium base and top parts, with jeweled movement. \$69.95



THE "LIGHTNING BUG" VIBROPLEX High Quality Signals at All Speeds. Flat pendulum model. Weight 3 lbs. 8 oz. Standard - Polished Chromium top parts, grey base. \$69.95. Standard \$56.95



THE "CHAMPION" VIBROPLEX. Weight 3 lbs. 8 oz. Without circuit closer. Standard finish only. Chromium finished top parts, with grey crystal base. \$56.95



VIBRO-KEYER
Over the years, we have had many requests for Vibroplex parts to be used for construction of a keying mechanism for an electronic transmitting unit. This beautiful and most efficient "Vibro Keyer" is ideal for this job.

FEATURES OF THE "VIBRO-KEYER"

- Beautiful beige colored base, size 3 1/2" x 4 1/2", weight 2 1/2 pounds
- Same large size contacts as furnished on Deluxe Vibroplex.
- Same main frame and super finished parts as Deluxe Vibroplex

Standard - \$49.50; Deluxe Finish \$65.00



No. SSK-1 \$23.95
No. SSK-1CP Chrome - \$29.95

NYE VIKING SQUEEZE KEY
Extra-long, finger-fitting molded paddles with adjustable spring tension, adjustable contact spacing. Knife-edge bearings and extra large, gold plated silver contacts! Nickel plated brass hardware and heavy, die cast base with non-skid feet. Base and dust cover black crackle finished. SSK-1 - \$23.45. SSK-1CP has heavily chrome-plated base and dust cover. Price - \$32.95

CODE PRACTICE SET

You get a sure, smooth, Speed-X model 310-001 transmitting key, linear circuit oscillator and amplifier, with a built-in 2" speaker, all mounted on a heavy duty aluminum base with non-skid feet. Operates on standard 9V transistor type battery (not included). Price - \$20.75

PHONE PATCH Model No. 250-46-1 measures 6-1/2" wide, 2-1/4" high and 2-7/8" deep. List price, \$36.50. Model 250-46-3, designed for use with transceivers having a built-in speaker, has its own built-in 2" x 6" 2 watt speaker. Measures 6-1/2" wide, 2-1/4" high and 2-7/8" deep. Price - \$46.50



No. 114-320-003 - \$31.70
No. 114-327-001 - \$32.10
No. 114-320-001 - \$9.70
No. 114-327-001 - \$16.15
No. 114-310-002 - \$9.85
No. 114-317-003 - \$16.25

NYE VIKING SPEED-X KEYS

NYE VIKING Standard Speed-X keys feature smooth, adjustable bearings, heavy-duty silver contacts, and are mounted on a heavy oval die cast base with black wrinkle finish. Available with standard, or Navy knob, with, or without switch, and with nickel or brass plated key arm and hardware.

Pamper yourself with a Gold-Plated NYE VIKING KEY! Model No. 114-31C-004GP has all the smooth action features of NYE Speed-X keys in a special "presentation" model. All hardware is heavily gold plated and it is mounted on onyx-like jet black plastic sub-base. Price \$50.00

ALL BAND PREAMPLIFIERS



- 6 THRU 160 METERS
- TWO MODELS AVAILABLE
- RECOMMENDED FOR RECEIVER USE ONLY
- INCLUDES POWER SUPPLY

MODEL PLF employs a dual gate FET providing noise figures of 1.5 to 3.4 db., depending upon the band. The weak signal performance of most receivers as well as image and spurious rejection are greatly improved. Overall gain is in excess of 20 db. Panel contains switching that transfers the antenna directly to the receiver or to the Preamp. Model PLF 117V AC, 60 Hz. Wired & Tested \$49.95

Now you can receive the weak signals with the Ameco PT-2 pre-amplifier!

Model PT-2 is a continuous tuning 6-160 meter Pre-Amp specifically designed for use with a transceiver. The PT-2 combines the features of the well-known PT with new sophisticated control circuitry that permits it to be added to virtually any transceiver with no modification. No serious ham can be without one. Price: \$74.95.

- Improves sensitivity and signal-to-noise ratio.
- Boosts signals up to 26 db.
- For AM or SSB.
- Bypasses itself automatically when the transceiver is transmitting.
- FET amplifier gives superior cross modulation protection.
- Simple to install.
- Improves immunity to transceiver front-end overload by use of its built-in attenuator.
- Provides master power control for station equipment.



- Handle full 200 watts ● low loss V.S.W.R.
- Deliver 3 dB gain and more!
- Pick the one that best fits your needs:

MAGNETIC MOUNT

stays put even at 100 mph!

MM-JM-150 for 144 MHz use } Only \$42.00 complete
MM-JM-220 for 220 MHz use }
MM-JM-440 for 440 MHz use }



TRUNK LID MOUNT

No holes and low silhouette too!

TLM-JM-150 for 144 MHz use } Only \$42.00 complete
TLM-JM-220 for 220 MHz use }
TLM-JM-440 for 440 MHz use }

And 1/4 wave antenna for trunk and magnetic mount - \$18.50



ROOF or FENDER MOUNT

Goes on quick and easy in 3/8" or 3/4" with fewest parts.

JM-150-K for 144 MHz use } Only \$34.50 complete
JM-220-K for 220 MHz use }
JM-440-K for 440 MHz use }

And 1/4 wave antenna for roof and fender mounts \$11.50



TRAC \$89.95 "BRAND NEW"

DELUXE MESSAGE MEMORY KEYER

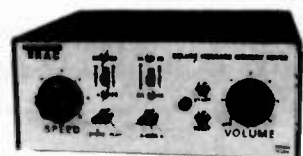

- Features: Model TE-784**
- Special low drift CMOS Circuitry
 - Three choices of message storage
 - 1. Four 20 character dash message storage
 - 2. One 20 character and two 7 character message storage
 - Records at any speed up to 55 wpm
 - Memory switching LED
 - Up for duty QSO or COMBAT
- PLUS:**
- Self-examining dots and dashes
 - Built-in and dash memory
 - Sensitive keying with any message length
 - 150 mhz
 - Speed, volume, tone, tune and weight controls
 - Sidelone, tone, tune and weight controls
 - Low current drain CMOS battery operation - portable
 - Deluxe quarter inch jacks for keying and output
 - Keys grid block and solid state rigs
 - WIRE DASH AND TESTED FULLY GUARANTEED - LESS BATTERY

MESSAGE MEMORY KEYER

Model # TE201 \$69.95



- Features:**
- Advanced CMOS message memory
 - Two (50 char each) message storage
 - Repeat function
 - Records at any speed - plays back at any speed
 - Long message capacity
 - 550 wpm
 - Speed, volume, tone, tune and weight controls
 - Sidelone and speaker
 - Low current drain CMOS battery operation - portable
 - Deluxe quarter inch jacks for keying and output
 - Keys grid block and solid state rigs
 - WIRE DASH AND TESTED FULLY GUARANTEED - LESS BATTERY

"BRAND NEW" Model # TE144 \$59.95



- Features: Deluxe CMOS Electronic Keyer**
- State-of-the-art CMOS Circuitry
Self-completing dots and dashes
Both dot and dash memory
IAMBIC keying with any squeeze paddle 550 wpm
Speed, weight, tone, volume tune controls & sidetone and speaker
Semi-automatic "bug" operation & straight keying - rear panel switch
Low current drain CMOS battery operation - portable
Deluxe quarter inch jacks for keying and output
Keys grid block and solid state rigs
Wired and tested - fully guaranteed - less battery

MODEL TE133 - same as TE144 with wgt and tone control internal, less semi-auto keying. \$49.95

MODEL TE122 - same as TE133 less wgt, tune, solid state keying. \$36.50

ASTATIC MICROPHONES

- T-UP9-D104 transistorized w/push bar base \$67.50
- T-UG8-D 104 transistorized. \$55.50
- T-UG9-D 104 "Silver Eagle" transistorized. \$74.40
- UG-D 104 ceramic or crystal . . . \$49.50



TUFTS Electronic Department Store TUFTS

PALOMAR ENGINEERS



\$299.95

ANTENNA TUNER

Here is a new tuner that puts more power into your antenna, works from 160m-10m, handles full legal power and then some, and works with coax, single wire and balanced lines. And it lets you tune up without going on the air.

All tuners lose some rf power, mostly in the inductance coil and the balun core. To avoid this we switched from No. 12 wire for the main inductor to 1/4" copper tubing. It can carry ten times the rf current. And we've moved the balun from the output, where it almost never sees its design impedance, to the input where it always does. Thus more power to your antenna.

The biggest problem with tuners is getting them tuned up. With three knobs to tune on your transceiver and three on the tuner and ten seconds to do it (see the warning in your transceiver manual) that's 1 1/2 seconds per knob. We have a better way; a built-in 50 Ohm noise bridge that lets you set the tuner controls without transmitting. And a switch that lets you tune your transmitter into a dummy load. So you can do the whole tuneup without going on the air. Saves that final cut's ORM.



TEMPO
the first in synthesized portables gives you the broadest choice at the lowest price

... the new S-5

- ★ The only synthesized hand-held offering 5 watts output. (Switchable for 1 or 5 watt operation)
- ★ The same dependability as the time proven S-1. Circuitry that has been proven in more than a million hours of operation.
- ★ Heavy duty battery pack.
- ★ Telescoping whip antenna.
- ★ Ni-cad battery pack, charger.
- ★ External microphone capability.

the Tempo S-2

- ★ Tempo is first again. This time with a superior quality synthesized 220 MHz hand-held transceiver. With an S-2 in your car or pocket you can use 220 MHz repeaters throughout the U.S. It offers all the advanced engineering, premium quality components and exciting features of the S-1. The S-2 offers 1000 channels in an extremely lightweight but rugged case.

TEMPO

PRICE LIST

| | |
|--|----------|
| Tempo S-5 | \$299.00 |
| Tempo S-5 with touch tone pad | 339.00 |
| 12 Button touch tone pad (not installed) | 39.00 |
| 16 Button touch tone pad (not installed) | 48.00 |
| Tone burst generator | 29.95 |
| CTCSS sub-audible tone control | 29.95 |
| Rubber flex antenna | 8.00 |
| Leather holster | 16.00 |
| Cigarette lighter plug mobile charging unit | 6.00 |
| Matching 30 watt output 13.8 VDC power amplifier (S30) | 89.00 |
| Matching 80 watt output power amplifier (S80) | 149.00 |
| Tempo S-2 | 349.00 |
| Tempo S-2 with touch tone pad | 399.00 |
| Tempo S-1 | 259.00 |
| Tempo S-1 with touch tone pad | 289.00 |

If you're not on 220 this is the perfect way to get started. With the addition of the S-25 (25W output) or S-75 (75W output) Tempo solid state amplifier it becomes a powerful mobile or base station. If you have a 220 MHz rig, the S-2 will add tremendous versatility. Its low price includes an external microphone capability, heavy duty ni-cad battery pack, charger, and telescoping whip antenna.

Tempo S-1

- ★ The first and most thoroughly field tested hand-held synthesized radio available. 800 channels in the palm of your hand.
- ★ Simple to operate. (You don't need a degree in computer programming).
- ★ Heavy duty battery pack allows more operating time between charges.
- ★ External microphone capability.

R-X NOISE BRIDGE \$55.00



- Learn the truth about your antenna.
- Find its resonant frequency.
- Find R and X off-resonance.
- Broadband 1-100 MHz.
- Simple to use. — Self contained.

VLF CONVERTER \$59.95



- New device opens up the world of VLF radio.
- Converts VLF to 80 meters. For use with any software receiver covering 3.5-4 MHz.
- Advanced design for simple operation, high performance.
- Gives reception of the 1750 meter band.
- Also covers navigation radiobeacons, WWVB, ship-to-shore, and LF broadcast band.

LOOP ANTENNA Loop Amplifier \$67.50 Plug-in loops \$47.50 ea.

- Plug-in loops available for:
1600-5000 KHz (160/80 meter amateur bands)
550-1600 KHz (Broadcast Band)
150-500 KHz (VLF, 1750 meter band)
40-150 KHz (WWVB, Loran)
10-40 KHz (Omega)
- Nulls out interference



IC KEYER \$97.50



- Sends Manual, Semi-Automatic, Full Automatic, Dot Memory, Dash Memory, Squeeze and Iambic.
- More Features than any other keyer. Built-in sidetone, speaker, speed and volume controls.
- Fully Adjustable contact spacing and paddle tension. The perfect paddle touch will Amaze you.
- Battery Operated. Heavy shielded die-cast metal case. 3-lb. steel base.
- By the World's oldest manufacturer of electronic keys.

FREQUENCY STANDARD \$42.50

- 100, 50, 25, 10 and 5 KHz. Markers selectable by panel switch.
- Crystal controlled.
- A true secondary frequency standard.
- Square Wave Signal. Rich harmonics usable from 5 kHz to 50 MHz.
- Sharp Clear Output. Exclusive circuit suppresses unwanted markers.
- Battery Operated. No line cord. Self contained battery.



RF TRANSFORMER \$42.50



- Full 2000 watt CW (5-Kw PEP).
- Matches 32, 28, 22, 18, 12, 8, 5 ohm antennas.
- For all verticals and mobile whip antennas.
- Smaller size. Higher efficiency.
- RF ferrite toroid core.

500 W. RF TRANSFORMER \$35.00



- Full 500 watt CW capability. No time limit.
- Convenient switch selection of impedance taps.
- Small size. High efficiency.
- RF ferrite toroid core.

CW FILTER \$39.95



- Steep skirts. No ringing.
- Simulated stereo technique filters QRM, improves copyability of CW signals.
- 80 Hz bandwidth.
- Eight pole K filter.

ALL BANDS PREAMPLIFIER \$89.50



- Tunes 1.8 to 54 MHz. Covers ALL amateur bands 160 to 6 meters. ALL shortwave broadcast bands.
- For receivers AND transceivers.
- Up to 20 db gain.
- Peps up that tired receiver.
- Reduces image and spurious response.

BEAM BALUN \$47.50



- 3 Kw CW, 6 Kw PEP input power.
- U bolt for 2" boom.
- 1.7 - 30 MHz.
- 1:1 or 4:1 ratio available.
- All stainless steel hardware.

MODEL 2K BALUN \$42.50



- 3 Kw CW, 6 Kw PEP input power.
- Replaces center insulator.
- 1.7 - 30 MHz.
- 1:1 or 4:1 ratio available.

MODEL 1K BALUN \$22.50



- 1.5 Kw CW, 3 Kw PEP input power.
- Replaces center insulator.
- 1.7 - 30 MHz.
- 1:1 or 4:1 ratio available.

PALOMAR ENGINEERS

BIRO Electronic Corporation

\$99 VHF model 4362 (140-180 MHz)
\$99 HF model 4360 (18-30 MHz)

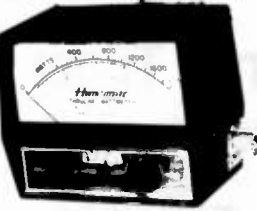

the indispensable BIRO 43 THRU-LINE WATTMETER



The 4360, 4362 HAM-MATE Directional Wattmeters are insertion type instruments for measuring forward or reflected power in 50-ohm coaxial transmission lines. They are direct descendants of the model 43 THRU-LINE® Wattmeter—the professional standard of the industry—and will accurately measure RF power flow under any load condition. Each wattmeter is made up of a precisely machined section of 50-ohm line, a rotatable sensing element and meter calibrated in watts, all mounted in a high-impact plastic housing. It is this type of solid construction and the directional THRU-LINE coupling circuit, without toroids, that account for the superiority of the HAM-MATE Wattmeters.

| Power Range | Frequency Bands (MHz) | | | | |
|-------------|-----------------------|--------|---------|---------|----------|
| | 2-30 | 25-60 | 100-250 | 200-500 | 500-1000 |
| 5 watts | — | 5A | 5C | 5D | 5E |
| 10 watts | — | 10A | 10C | 10D | 10E |
| 25 watts | — | 25A | 25C | 25D | 25E |
| 50 watts | 50H | 50A | 50C | 50D | 50E |
| 100 watts | 100H | 100A | 100C | 100D | 100E |
| 250 watts | 250H | 250A | 250C | 250D | 250E |
| 500 watts | 500H | 500A | 500C | 500D | 500E |
| 5000 watts | 5000H | 5000A | 5000C | 5000D | 5000E |
| 50000 watts | 50000H | 50000A | 50000C | 50000D | 50000E |

MODEL 43

Elements (Table 1) 2-30 MHz \$135.00
Elements (Table 1) 25-1000 MHz 50.00
Carrying case for Model 43 & 6 elements 42.00
Carrying case for 12 elements 28.00
Carrying case for 12 elements 17.00

READ RF WATTS DIRECTLY! (Specify Type N or SO239 connectors) 0.45 - 2300 MHz, 1-10,000 Watts ±5%, low insertion VSWR - 1.05. Unequaled economy and flexibility. Buy only the element(s) covering your present frequency and power needs, add extra ranges later if your requirements expand.

AMPHENOL BLANKET BRAND

SPRINGS 31 - BNC CONNECTORS
Amphenol's BNC connectors are small, lightweight, weatherproof connectors with bayonet action for quick disconnect applications.

Shells, coupling rings and male contacts are accurately machined from brass. Springs are made of beryllium copper. All parts in turn are ASTRO-plater® to give you connectors that can take constant handling, high temperatures and resist abrasion.

BNC BULKHEAD RECEPTACLE 31-221-385 UG-1094
Mates with any BNC plug. Receptacle can be mounted into panels up to 1/4" thick. \$1.25

UG-1094

BNC (M) TO UHF (F) ADAPTER 309-2900-385 UG-255
Adapts any BNC jack to any UHF plug. \$3.63

UG-255

DOUBLE MATE ADAPTER R3-877-385 Both coupling rings are free turning. Connects 2 female components. \$2.72

R3-877-385

JACK ADAPTER R3-15P-385 Adapts 1/8" SP-385 to Motorola type auto antenna jack or pin jack. \$1.17

R3-15P-385

PANEL RECEPTACLE 31-219-385 UG-914 Mounts with 4 fasteners in 21/32" diameter hole. \$1.17

UG-914

BNC (F) TO UHF (M) ADAPTER 31-028-385 UG-273 Adapts any BNC plug to any UHF jack. \$2.39

UG-273

PUSH-ON R3-55P-385 Features an unthreaded, springy shell to push fit on female connectors. \$2.27

R3-55P-385

LIGHTNING ARRESTOR 575-105-385 Eliminates static build-up from antenna. Protects your valuable equipment against lightning damage. \$4.80

575-105-385

BNC PLUG 31-002-385 UG-88 Commonly used for communications antennas. Lead cables. For RG 55/U & RG 58/U cables. \$1.59

UG-88

BNC STRAIGHT ADAPTER 31-219-385 UG-914 1 9/32" long, allows length of cables to be joined. Mates with BNC plugs. \$2.12

UG-914

BNC PANEL RECEPTACLE 31-003-385 UG-290 Mounts with 4 fasteners in 29/64" diameter hole. \$1.74

UG-290

R3-878-385 SO239SH Mounts in single 21/32" diameter hole. Knurled lock nuts prevent turning. \$1.59

SO239SH

BNC ANGLE ADAPTER 31-009-385 UG-306 Adapts any BNC plug for right angle use. \$4.23

UG-306

BNC TEE ADAPTER 31-008-385 UG-274 2 BNC plugs to 31-003-385 or other female BNC type receptacle. \$4.56

UG-274



First is the Fox XK. It reads all bands and tucks away on the visor.



Our remote (RW) unit is "out-of-sight" when installed. Out-of-sight in performance, too.



And now there's Superfox!

The first remote, superheterodyne radar warning system. Superfox has 10 times the sensitivity capability of any conventional radar detector. It is ideal for custom installations.

PRICE LIST

| Order No. | Description | Price |
|-----------|---|----------|
| 80 | Fox XK
All band detector w/self contained aural/visual alarm | \$109.00 |
| 80-2 | Fox XK (RW)
All band detector w/remote control, waterproof | \$139.00 |
| 80-3 | Super Fox
Super-Heterodyne remote radar warning system | \$299.95 |

HITACHI OSCILLOSCOPES

SPECIAL!
15% OFF ALL
HITACHI SCOPES

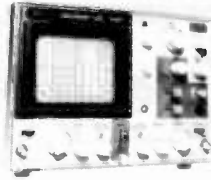

Single and dual trace, 15 and 30 MHz. All four high sensitivity Hitachi oscilloscopes are built to demanding Hitachi quality standards and are backed by a 2-year warranty. They're able to measure signals as low as 1mV/division (with X5 vertical magnifier). It's a specification you won't find on any other 15 or 30 MHz scope. Plus: Z-axis modulation, trace rotation, front panel X-Y operation for all four scope models, and X10 sweep magnification. And, both 30 MHz oscilloscopes offer internal signal delay lines. For ease of operation, functionally related controls are grouped into three blocks on the color coded front panel.

- V-302 30 MHz Dual Trace \$850.50
- V-301 30 MHz Single Trace \$670.50
- V-152 15 MHz Dual Trace \$625.25
- V-151 15 MHz Single Trace \$490.50

ALLIANCE

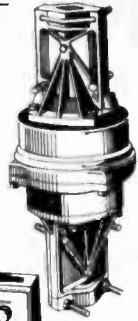

\$99.00

HD-73 HEAVY-DUTY ROTATOR

with exclusive Dual-Speed Control!
For antennas up to 10.7 sq. ft. of wind load area. Mast support bracket design permits easy centering and offers a positive drive no-slip option. Automatic brake action cushions stops to reduce inertia stresses. Unique control unit features DUAL-SPEED rotation with one five-position switch. SPECIFICATIONS: Max. wind load bending moment - 10,000 in.-lbs. (side-thrust over-torque); Starting torque - 400 in.-lbs.; Hardened steel drive gears; Bearings - 100-3/8" diameter (hardened); Meter - D'Arsonval, taut band (back-lighted). There's much, much more.



Two NEW Rotors from Cornell-Dubilier

TAIL TWISTER™



HAM IV



- For the New Super Communications Antennas
 - New Thickwall Casting
 - New Steel Ring Gear
 - New Metal Pinion Gear
 - New Motor Prebrake
 - New Super Wedge Brake
 - New L.E.D. Control Box
 - Safe 26 Volt Operation
- Designed for the newest of the king-size communications antennas, the TAIL TWISTER™ is the ultimate in antenna rotational devices. The TAIL TWISTER™ starts with a deluxe control box featuring snap action controls for brake and directional controls; L.E.D. indicators signal rotation and brake operation, while the illuminated meter provides direction readout. This new control box couples to the newest bell rotor. Using the time tested bell rotor principle, the TAIL TWISTER™ is a brand new design with thickwall castings and six bolt assembly. A brand new motor with prebrake action brings the antenna system to an easy stop, while the massive square front brake wedge locks the assembly in place. A new stainless steel spur gear system provides final drive

into a new steel ring gear for total reliability. Triple race, 138 ball bearing assembly carries dead weight and maintains horizontal stability. An optional heavy duty lower mast adaptor is available for lighter loads with mast mounting. Price: \$279.00

The HAM IV sets new levels of performance. Snap action switched wedge brake and rotational controls brings pinpoint accuracy to large directional arrays popular in communications. A new motor provides pre-brake action to assist in slowing down rotational mass, and the new thicker wedge brake offers far stronger lock-in phase action. To take full advantage of this new design, the HAM III is designed for in-tower mounting. A new optional heavy duty lower mast adaptor is available when the HAM III is to be mast mounted with smaller arrays. A stainless steel spur gear system multiplies the torque into the dual race 98 ball bearing support assembly assuring years of trouble free performance. Price: \$189.00

TUFTS Electronic Department Store TUFTS

MFJ INTRODUCES THE NEW! GRANDMASTER MEMORY KEYS

At \$139.95 this MFJ-484 GRANDMASTER memory keyer gives you more features per dollar than any other memory keyer available — and Here's Why . . .

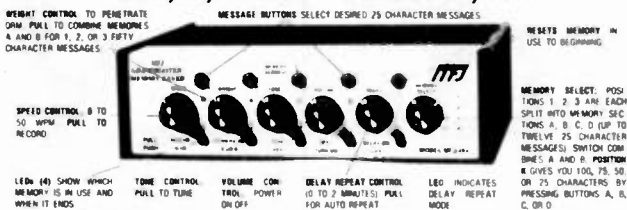

- WEIGHT CONTROL TO PENETRATE**
SLOW PULL TO COMBINE MESSAGES
A AND B FOR 1, 2, OR 3 FIFTY CHARACTER MESSAGES
- MESSAGE BUTTONS SELECT DESIRED 25 CHARACTER MESSAGES**
- REPEATS MEMORY IN USE TO BEGINNING**
- SPEED CONTROL** 0 TO 50 WPM PULL TO RECORD
- LED'S (4) SHOW WHICH MEMORY IS IN USE AND WHEN IT ENDS**
- MEMORY KEYS**
- MFJ-484 Grandmaster Memory Keyer. Up to twelve 25 character messages plus a 100, 75, 50, or 25 character message. 139.95
 - MFJ-482 Grandmaster Memory Keyer. Four 25 or a 50 and two 25 character messages. 99.95
 - MFJ-481 Grandmaster Memory Keyer. Two 50 character messages. 79.95
 - HK-1 Optional Squeeze Key. 29.95
- PROFESSOR MORSE**
- MFJ-410 Professor Morse, Random code generator/keyer. Morse code teaching computer. Sends alpha only or alphanumeric, full feature Curtis keyer, speed readout, delay for spacing letters up to three seconds. 149.95
- TELEPHONE PATCHES**
- MFJ-624 Crisp clear professional sounding audio, Vu meter for monitoring line level and for nulling for maximum separation of transmitter and receiver, easy patch in patch out connections. 59.95
 - MFJ-620 Same as MFJ-624 except without meter. 49.95



- MISCELLANEOUS**
- MFJ-202 RF Noise Bridge. 59.95
 - MFJ-1030BX Receiver Preselector. 49.95
 - MFJ-200BX Frequency Standard. 29.95
 - MFJ-40T QRP Transmitter. 29.95
 - MFJ-40V Companion QRP VFO for 40T. 29.95
 - CPO-555 Code Practice Oscillator. 17.95
 - TK-555 Optional Telegraph Key. 1.95

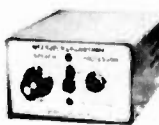

- LSP-520BX**
- SPEECH PROCESSOR**
- MFJ-525 RF Speech Processor. Plugs between microphone and rig. Powerful natural sounding speech. Vu meter for adjustment of processing, 4 pin mic jack, 6 dB more average SSB power, use with any rig and any mic, push button on-off/bypass. 119.95
 - LSP-520BX II Logarithmic Speech Processor, Deluxe model. 59.95
 - LSP-520BX Logarithmic Speech Processor. 49.95



- CMOS-8043 Electronic Keyer**
State of the art design uses CURTIS-8043 Keyer-on-a-chip.
- Built-in Key • Dot memory • Lambic operation with external squeeze key • 0 to 50 WPM • Sidetone and speaker • Speed/volume tone weight controls • Ultra-reliable solid state keying - 300 volts max • 4 position switch for TUNE OFF ON SIDETONE OFF • Uses 4 penlight cells • 2-3 16" x 3-1/4" x 4 inches
- ELECTRONIC KEYS**
- MFJ-B044IC Deluxe Keyer. Dot and dash memory. 69.95
 - MFJ-404 Econo Keyer. Built-in paddle, plus extras. 59.95
 - MFJ-402 Econo Keyer. Built-in paddle. 44.95
 - MFJ-400 Econo Keyer. External Key. 49.95
 - MFJ-408 New Deluxe Electronic II, speed readout meter, socket for: Memory, random code generator, keyboard. 8044IC keyer chip dot and dash memory. Up to 50 WPM. 79.95
 - BY-1 Bencher Deluxe Lambic Paddles. Heavy steel base, non-skid feet. 39.95

MFJ ENTERPRISES DELUXE Versa Tuner II



BRAND NEW

- MFJ-984 Deluxe 3kW Versa Tuner IV. SWR, forward-reflected wattmeter, rf ammeter, dummy load, antenna switch, balun, 3kW PEP. 299.95
- MFJ-982 3kW Versa Tuner IV. 7 position antenna switch, balun, 3kW PEP. 199.95
- MFJ-981 3kW Versa Tuner IV. SWR, forward-reflected wattmeter, balun, 3kW PEP. 199.95
- MFJ-980 3kW Versa Tuner IV. Built-in balun, 3kW PEP. 169.95
- MFJ-962 1.5 kW Versa Tuner III. SWR, forward-reflected wattmeter, 6 position antenna switch, balun, 1.5kW PEP. 169.95
- MFJ-961 1.5kW Versa Tuner III. 6 position antenna switch, balun for balanced lines, 1.5kW PEP. 149.95
- MFJ-949 Deluxe Versa Tuner II. Ultimate in antenna tuners: SWR, dummy load, forward-reflected wattmeter, front panel antenna switch, balun, 300W output. 129.95
- MFJ-941B Versa Tuner II. Improved model with SWR/wattmeter, antenna switch, balun, mobile mounting bracket, 300W output. 79.95
- MFJ-940 Versa Tuner II. SWR/wattmeter, antenna switch, no balun, no mobile mount, 300W. 69.95
- 700-0014 Mobile mount for MFJ-940. 3.00
- MFJ-945 Versa Tuner II. With SWR/wattmeter and mobile mounting bracket, less 6 position antenna switch, 300W. 69.95
- MFJ-944 Versa Tuner II. With antenna switch and mobile mounting bracket, less SWR/wattmeter, 300W output. 69.95
- MFJ-943 Versa Tuner II. Less SWR/wattmeter, antenna switch mounting bracket, 300W output. 59.95
- MFJ-901 Versa Tuner. Matches anything. Coax, random wires, balance lines, 200W output. 49.95
- MFJ-900 Econo Tuner. Matches coax and random wires. 200W. 39.95
- MFJ-16010 Random Wire Tuner. For random and long wires, 200W. 29.95

24-HOUR DIGITAL CLOCK SOLID-STATE



\$29.95

- 24 HOUR DIGITAL CLOCK
- MFJ-101 24 hour digital clock, totally solid state, 6" blue display (like TS-B20S), ID time, lock function (prevents accidental missetting of time). 29.95

These MFJ active filters are the most copied in industry.



- SSB/CW FILTERS**
- MFJ-752 Dual tunable SSB/CW active filter Signal Enhancer II. 2 noise limiters, inputs for 2 rigs, 110VAC or 12 VDC Tunable SSB/CW active filter Signal Enhancer. 79.95
 - MFJ-751 Tunable SSB/CW active filter Signal Enhancer. 110VAC or 12 VDC. 59.95
 - MFJ-721 Super CW/SSB Filter. 2W amplifier, noise limiters, inputs for 2 rigs. 12VDC or 110VAC with optional AC adapter. 59.95
 - MFJ-720 Deluxe Super CW Filter. 2W amplifier, 12VDC or 110VAC with optional AC adapter. 44.95
 - CWF-2BX Super CW Filter. 29.95
 - SBF-2BX Single Sideband Filter. 29.95
 - AC Adapter 12 VDC, 200 mA. 7.95
 - CWF-2PC Same wired and tested PC board as in CWF-2BX with 4 position switch. 19.95
 - SBF-2PC Same wired and tested PC board as in SBF-2BX with 4 position switch. 19.95
 - AC Adapter 6 VDC, 300 mA. 7.95

KENWOOD



TR7600: 2m FM XCVR. 10 watts, LED readout, 144-147.995. Fully synthesized, any repeater offset possible, memory channel.

TR7600 VHF XCVR **\$375.00**
 BLC 10/70 VHF Power Amplifier **149.95**



TOTAL REGULAR PRICE **\$524.95**
 SALE PRICE **\$424.95**

Vhf engineering

SAVE \$100.00

TEMPO KLM YAESU



Syncom S1 with TTP: From Tempo — the world's first synthesized 800 channel handheld transceiver. Includes battery pack, charger, telescoping antenna — and 800 channels!

FT207R: From YAESU — 2m FM XCVR. Handheld completely synthesized, digital readout, keyboard access, 2 watts, 4 memories and much more.



KLM PA2-25B Power Amplifier: 2 watts in, 25 watts out.

PACKAGE 1

Tempo S1 w/TTP **\$339.00**
 KLM PA2-25B Power Amplifier **92.95**

Total Regular Price **\$431.95**
 SALE PRICE **\$396.95**

SAVE \$35.00

PACKAGE 2

FT207R Synthesized 2m handheld **\$399.00**
 KLM PA2-25B Power Amplifier **92.95**

Total Regular Price **\$491.95**
 SALE PRICE **\$441.95**

SAVE \$50.00

Unarco-Rohn

COMPLETE 25G TOWER PACKAGES

50' Guyed Tower: Includes top section, 4 regular sections, base plate, rotor plate, 50' guy wire, 2 guy assemblies with torque bars, 3 concrete guy anchors and other miscellaneous hardware.

TOTAL REGULAR PRICE **\$594.02**
 SALE PRICE **464.02**

SAVE \$130.00

50' Bracketed Tower: Includes top section, 4 regular sections, base plate, rotor plate and universal house bracket.

TOTAL REGULAR PRICE **\$366.15**
 SALE PRICE **266.15**

SAVE \$100.00



KENWOOD

...pacesetter in amateur radio



TS520SE

TS520SE: 160-10 meters, 200 watts P.E.P., speech processor, noise blanker, excellent sensitivity and minimum cross-mod.

5BTV

TS520SE **\$629.95**
 Hustler 5BTV Vertical **139.95**

TOTAL REGULAR PRICE **\$769.90**
 SALE PRICE **\$649.90**

SAVE \$120.00

or

ATB34



TS520SE **\$629.95**
 ATB34 Cushcraft TriBander **\$329.95**

TOTAL REGULAR PRICE **\$959.90**
 SALE PRICE **\$793.90**

SAVE \$166.00

BECKMAN



If you've ever been troubled by a faulty multimeter — or had one that wasn't quite up to the toughest jobs — your troubles are over

Choice of Models
 The TECH 310 has all above features, 7 functions, 29 ranges, plus 0.25% Vdc accuracy.
 The TECH 300 has a 0.5% Vdc accuracy and all the above features, but without Insta-Ohm™ continuity function or the 10 amp current ranges.

Complete Multimeter Capability
 DC volts: 100 μ V to 1500V
 AC volts: 100 μ V to 1000V rms
 Resistance: 0.1 Ω to 20M Ω
 DC current: 100nA to 10A (TECH 310)
 100nA to 2A (TECH 300)
 AC current: 100nA to 10A (TECH 310)
 100nA to 2A (TECH 300)
 Diode/Semiconductor test function
 Continuity function (TECH 310)

TECH 300 — \$110
 TECH 310 — \$140

TEN-TEC



574



570

TUFTS NOVICE EXCLUSIVE

Purchase your Century 21 (570 or 574) from us and have up to one year to apply the full purchase price towards a new HF transceiver when you upgrade your station.

NOVICE SPECIAL



KENWOOD



TL922A: 2kW P.E.P., 160-15 meters, 3-500Z tubes.

TL922A: **\$1199.00**
 MBII Tuner **295.00**

Total Regular Price **\$1494.00**
 Sale Price **\$1294.00**

SAVE \$200.00



Model 43



MBII TUNER: 3kW, 160-10 meters.

TL922A: **\$1199.00**

Bird Model 43 with 2500H element and carrying case **201.00**

Total Regular Price **\$1400.00**
 Sale Price **\$1200.00**

SAVE \$200.00

CALL AND CHECK OUR GREAT DEALS ON ALL YOUR AMATEUR RADIO NEEDS.
 DIAL: 1-617-391-3200

Stock items shipped within 24 hours. Prices subject to change. Limited quantity on some items.

TUFTS Electronic Department Store TUFTS

TUFTS Electronic Department Store TUFTS

JANEL LABORATORIES

CLASSIC 2 METER PREAMP

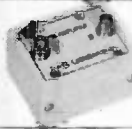

This widely used 2 meter preamp is probably the most sensitive available today. One model provides a uniformly low noise figure across the full band. Equally applicable for DX, AM, SSB, FM and OSCAR. 18 dB gain. 2 dB noise figure. 12 vdc power (5mA) BNC connectors. Aluminum box is 1 1/2 x 2 1/2 x 2 1/2".
Model 144PB 144-148MHz

| MODEL | DESCRIPTION | PRICE |
|---------------------------|---|-------------------|
| PREAMPS | | |
| 30PB | 28-30 MHz (BNC) | \$ 21.95 |
| 50PB | 50-52 MHz (BNC) | 21.95 |
| 53PB | 52-54 MHz (BNC) | 21.95 |
| 137PB | 135-139 MHz (BNC) | 21.95 |
| 144PB | 144-148 MHz (BNC) | 21.95 |
| PM-1 | 2m Preamp Module (Solder Terminals) | 16.95 |
| QSA 5 | 144-148 MHz for Transceivers (50-239) | 41.95 |
| QSA 6 | 50-52 MHz (50-239) | 43.95 |
| 220PB | 220-225 MHz (BNC) | 21.95 |
| 432PA | 420-450 MHz (BNC) 3.5 dB maximum NF | 33.00 |
| 432PC | 420-450 MHz (BNC) 2.0 dB maximum NF | 54.95 |
| 432PE | 1.0 dB typical NF | 90.00 |
| PB | Any single frequency between 30 and 50, or 148-174 MHz (BNC) | 27.00 |
| CONVERTERS | | |
| 144CF | 144-146 MHz IN, 28-30 MHz OUT (BNC)
2nd crystal for 144CF (146-148 IN, 28-30 OUT) | \$ 79.95
12.00 |
| 432CF | 432-434 MHz IN, 28-30 MHz OUT (BNC)
2nd crystal for 432CF (434-436 IN, 28-30 OUT)
Also available with 434-436 MHz IN and 28-30 MHz OUT. (Oscar 8, Mode J) | 79.95
10.00 |
| OSCILLATORS | | |
| 01-A | Precision, Specify 4 or 10 MHz | \$ 79.95 |
| D1-A | 10 to 1 Digital Divider | 11.95 |
| D8-A | Eight, 10 to 1 Dividers | 27.95 |
| USEFUL ACCESSORIES | | |
| 17013 | BNC to BNC, 36" RG-58C/U Cable | \$ 6.00 |
| 17010 | BNC to UHF, 36" RG-58C/U Cable | 6.00 |
| 17014 | BNC to RCA Phono, 36" RG-58C/U Cable | 6.00 |
| 03005 | Adaptor, BNC Plug to UHF Jack | 4.00 |
| 03006 | BNC Connector, UG-88/U for RG-58 size cable | 1.25 |
| MISCELLANEOUS | | |
| ISOLINE | Antenna Isolator, 144-174 MHz (50-239) | \$ 14.95 |
| 432FA | Cavity Filter, .5 dB loss | 105.00 |
| 432FA-2 | Cavity Filter, 2 dB maximum loss | 115.00 |



UHF PREAMPS \$33.00
Low Cost All Around Favorite

This two stage amplifier provides high sensitivity across the full 420 to 450 MHz band. A low 3.5 dB noise figure makes this preamp ideal for most amateur applications. Can be used for all modes. 17dB gain, 12vdc power (10mA) BNC connectors (50 ohms), aluminum box 1 1/2 x 2 1/2 x 2 1/2".
Model 432PA 420-450MHz

Extremely Sensitive \$54.95

This preamp provides a low noise figure required for demanding applications. A premium state-of-the-art transistor is used to provide extremely high sensitivity. Two stages, 20 dB gain, 2 dB maximum noise figure (1.7 dB typical), 12 volt dc power BNC connectors.
Model 432PC 420-450MHz

QSA5 PREAMP For Transceivers

The QSA 5 preamp is a high performance, low noise preamp for improving the receiving sensitivity of 2 Meter transceivers. This preamp features easy installation with no modification to the transceiver required. This preamp can be used with virtually all 2 meter transceivers and on all modes — FM, SSB, CW or AM. Relays in the QSA 5 automatically bypass the preamp when transmit power is sensed. A LED indicator shows the status of the QSA 5. A front panel switch allows the preamp to be bypassed while receiving. The low noise figure of the QSA 5 provides for exceptional sensitivity. The gain has been set to optimize the performance with 2 meter transceivers.

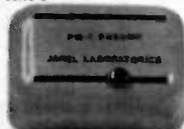

Model PM-1

PREAMP MODULE

This low noise preamp is designed to be easily incorporated into new or existing 2 meter equipment. Solder pins are provided for mounting to a PC board or for connection to wire or coax. Use low noise JANEL MOSFET circuitry. Each unit is fully tested for gain and noise figure. Quantity prices are available for OEM's.



For 6 Meter Transceivers \$43.95

All of the features of our popular QSA-5 but for 6 meters. Fully compatible with transceivers running 30 watts or less. All mode use. Noise Figure: 2dB Gain: 15dB VSWR (transmit) 1:2. Available for 50-52 or 52-54MHz (specify when ordering) UHF connectors. Model QSA-6.

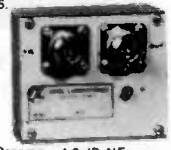

\$90.00

Our Finest UHF Preamp—1.0 dB NF
This outstanding 432 MHz preamp provides the lowest practical noise figure. The finest transistors available today are combined with the ultimate in construction and alignment. Single stage. Gain 15dB (min) Noise Figure 1.2dB (max including measurement uncertainty). 0.8 to 1.0dB typical. Bandwidth 100MHz. 12 volts at about 7 mA. Type N connectors. Size 1 1/2 x 3 1/2 inches. Center Frequency 400 to 512 MHz (specify when ordering). Model 432PE



10 METER PREAMP Oscar Special

Ideal for pulling weak satellite signals out of the noise. This preamp has been responsible for producing many "impossible" OSCAR QSO's. 18 dB gain. 2 dB noise figure. 12vdc power (5mA) BNC connectors. Aluminum box is 1 1/2 x 2 1/2 x 2 1/2".
Model 30 PB 28-30MHz.

6 METER PREAMP \$21.95
Ideal for DX

This low noise preamp significantly improves the sensitivity of most 6 meter receivers. Available in two frequency versions to cover DX and FM portions of the band. 18 dB gain. 2 dB noise figure. 12 vdc power. BNC connectors.
Model 50PB 50-52MHz, Model 53PB 52-54MHz.

220 MHz \$21.95

Low Noise Preamp
1 1/2 Meters-Covers full 220-225 MHz range with 15 dB gain. 3 dB noise figure. 12 volt power and BNC connectors. Model 290PB.

\$65.95

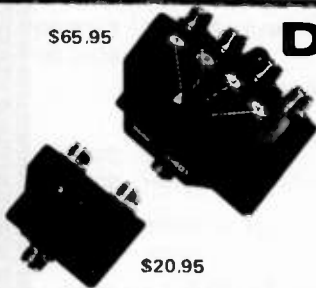

DAIWA

\$105.00 RF-660

\$20.95

Coaxial Switches
2 Position/Model CS-201
4 Position/Model CS-401

SWR & Power Meters

Models CN-720, CN-620 and CN-630
Professionally engineered cavity construction.
Power Rating: 2.5kW PEP, 1kW CW
Impedance: 50 Ohms
Connectors: SO-239
Insertion Loss: Less than 2 dB
VSWR: 1:1.2
Maximum Frequency: 500 MHz
Isolation: Better than 50 dB at 300 MHz; better than 45 dB at 450 MHz; adjacent terminal.
Unused Terminals grounded.



CN-720 \$166.95



\$135.95 RF-440

RF Speech Processor Models RF-400 & RF-660

Increases talk power with splatter free operation. RF clipping assures low distortion. Simply install between microphone and transmitter.

Talk Power: Better than 6 dB.
Frequency Response: 300-3000 Hz at 12 dB down.
Distortion: Less than 3% at 1 kHz, 20 dB clipping.
Power Requirement: RF-440 self contained. AC power supply: RF-660 13.5Vdc external supply.

CN-720 and CN-620

Frequency Range: 1 B-150 MHz
SWR Detection Sensitivity: 5W min.
Power: 3 Ranges (Forward, 20/200/100W) (Reflected, 4/40/200W)



\$140.50 CN-620

Interference Filters from J. W. Miller

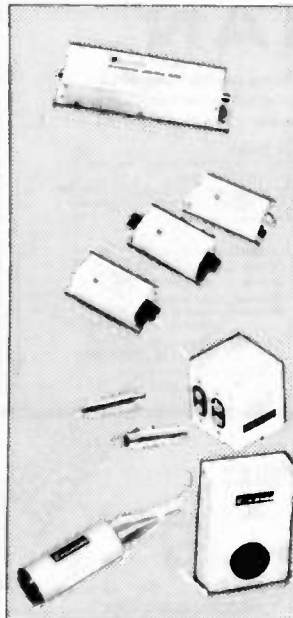

Low Pass Filters

Eliminate or greatly reduce interference to TV receivers by radio amateur stations when installed in antenna lines of those transmitters. Input and output impedance 50 ohms. Insertion loss: 3 dB max. VSWR: 1.2:1. Attenuation greater than 75 dB above 41 MHz.
C-511-T: 75 W AM 50 W PEP SSB \$19.50
C-514-T: 1000 W AM 2000 W PEP SSB \$26.80

High Pass Filters

When installed in the antenna, eliminate or greatly reduce front end overload interference to TV or FM receivers caused by amateur radio transmitters and other high frequency radio services. Filter attenuates signals below 40 MHz by a power factor greater than 1,000,000:1. Impedance C-513-T: 75/300 ohm
C-513-T2: 75/75 ohm; C-513-T3: 300/300 ohm

Audio Interference Filters

Eliminate interference caused in your audio equipment by radio amateur transmitters and other radio services. C-505-R installs in the input lines of audio equipment. Consists of 1 pair C-506-R installs in speaker lines. Unit will take care of stereo speaker system.
\$5.07
\$6.67

AC Power Line Filters

Eliminate or reduce interference to radio amateur receivers, TV's and radios, and prevent radio signals from entering power line.
C-508-L: 3-section LC filter, 3 A max. \$ 8.33
C-509-L: 5-section LC filter (for more severe interference), 5 A max. \$18.35

CN-630
Frequency Range: 140-450 MHz
Power: 2 Ranges (Forward 20/200W) (Reflected 4/40W)

CN-630 \$139.00



TUFTS

Electronic Department Store

OPEN DAILY 9-9
SATURDAY 9-6



ORDER BLANK



Prices FOB Medford,
Mass. Mass. residents
add 5% sales tax.

Minimum \$3.50 for
shipping and handling
on all orders.

P. O. Box 27, Medford, Mass., 02155, Tel. 1-617-391-3200

| CAT. NO. | PAGE NO. | DESCRIPTION | QUANTITY ORDERED | UNIT PRICE | TOTAL PRICE |
|----------|----------|-------------|------------------|------------|-------------|
| | | | | | |
| | | | | | |
| | | | | | |
| | | | | | |
| | | | | | |
| | | | | | |
| | | | | | |
| | | | | | |
| | | | | | |
| | | | | | |
| | | | | | |
| | | | | | |
| | | | | | |
| | | | | | |
| | | | | | |
| | | | | | |
| | | | | | |
| | | | | | |
| | | | | | |
| | | | | | |
| | | | | | |
| | | | | | |
| | | | | | |

Name _____ Call _____

Address _____

City _____ State _____ Zip _____

Check Enclosed Visa Master Charge \$1 Enclosed for Catalog
(S1 refundable with first purchase)

PRICES SUBJECT TO CHANGE WITHOUT NOTICE

Card no. _____ Card exp. date _____

Signature _____

5% Sales Tax
(Mass. Residents)

Shipping and Handling **\$3.50**
Min.

Amount Enclosed

SPECIAL PRICING NOTICE

Many of the major items, such as transceivers, are available at special discount prices. A complete list of these special discount prices may be obtained by writing or calling our mail order department. If your order contains one of the items on the current discount list our sales staff will make sure that you receive the lower prices.

BANDPASS-REJECT DUPLEXER
DPLA-144 FOR 144-174 MHz
Also available for
54, 220, 450 MHz.

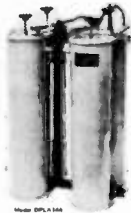

WACOM \$479

These Band Pass Band Reject Circuit duplexers include the use of an exclusive circuit developed for WACOM, which provides superior suppression of spurious sideband noise between and adjacent to the duplex frequencies. When used with a high Q filter, the Band Pass Band Reject Circuit provides frequency response curves with bandpass cavity characteristics at the frequency to be passed and band-reject cavity characteristics at the frequency to be attenuated.

SPECIAL!
15% OFF ALL
HITACHI SCOPES

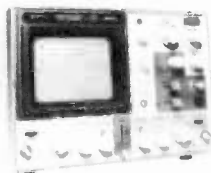

HITACHI OSCILLOSCOPES

Single and dual trace, 15 and 30 MHz. All four high sensitivity Hitachi oscilloscopes are built to demanding Hitachi quality standards and are backed by a 2-year warranty. They're able to measure signals as low as 1mV/division (with X5 vertical magnifier). It's a specification you won't find on any other 15 or 30 MHz scope. Plus: Z-axis modulation, trace rotation, front panel X-Y operation for all four scope models, and X10 sweep magnification. And, both 30 MHz oscilloscopes offer internal signal delay lines.

- V-302 30 MHz Dual Trace \$850.50
- V-301 30 MHz Single Trace \$670.50
- V-152 15 MHz Dual Trace \$625.25
- V-151 15 MHz Single Trace \$490.57

Mosley

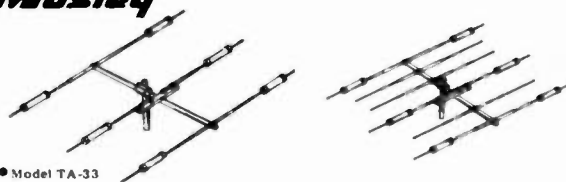

• Model TA-33

- Model TA-33, 3 elements, 10.1 dB forward gain (over isotropic source) — \$264.00
- Model MPK-3, 7500 Watts AM/CW and 2000 Watts P.E.P. SSB — \$67.75
- Model TA-36, 6 elements — \$392.75
- AK-60 mast plate adapter — \$14.50
- Model CL-33, 3 elements — \$304.75
- Model CL-36, 6 elements — \$392.75
- Model CL-203, 3 elements — \$290.00
- Model TA-40 KR — 40 meter conversion kit — \$119.50

SPECIAL! 25% OFF ALL MOSLEY ANTENNAS.

TUFTS Electronic Department Store TUFTS

P. O. Box 27, Medford, Massachusetts, 02155 — TEL. 1-617-391-3200

Automated Operating Comes of Age

— Microlog's ATR-6800

Back in October of 1978, *73 Magazine* published an article of mine entitled "Triple Threat." It was about a then new CW/RTTY/ASCII system manufactured by the Microlog Corporation. Recently, Microlog introduced a new and very innovative system called the ATR-6800, and that is what we now are going to take a

very close look at.

The Microlog ATR-6800 is not the run-of-the-mill CW/RTTY/ASCII system—in fact, there is no other unit available from one manufacturer offering all of the features to be found in the ATR-6800. From the expected CW/RTTY/ASCII modes, the ATR expands the horizons to include full functioning as a "smart" termi-

nal and a stand-alone microcomputer with 4K of on-board RAM. Its price, when all things are considered, is better than competitive.

When I bought my first Microlog system, I was impressed with the attitude of the company, the quality of their equipment, the enhanced operational capabilities of their system over

others, and the full one-year warranty. Now that I have the new ATR system, I find that the features and performance of the earlier system(s) were just the tip of the proverbial iceberg! Not only have they maintained their impressive attitude and high quality, but in the ATR-6800 they have produced a product that is just short of being miraculous. As their ad says, "For additional performance specs, just use your imagination..." With the addition of a printer and a floppy drive or two, your computing powers are virtually unlimited.

The Stage Is Set

Look at this little scenario to gain some insight into the capability of the ATR-6800: You are having breakfast with the family while also trying to work an expected band opening into the South Pacific on 20-meter RTTY. There you are, sitting at the breakfast table casually sipping your coffee while scanning the morning paper and ducking the biscuit fight the kids are having. Suddenly, you hear *beep, beep*—not too loud, of course (after all, you don't want Rover scared out of his wits)—and you stroll into the shack to see that a 3D2 is calling you!

Nonchalantly, you head back to the kitchen, pour

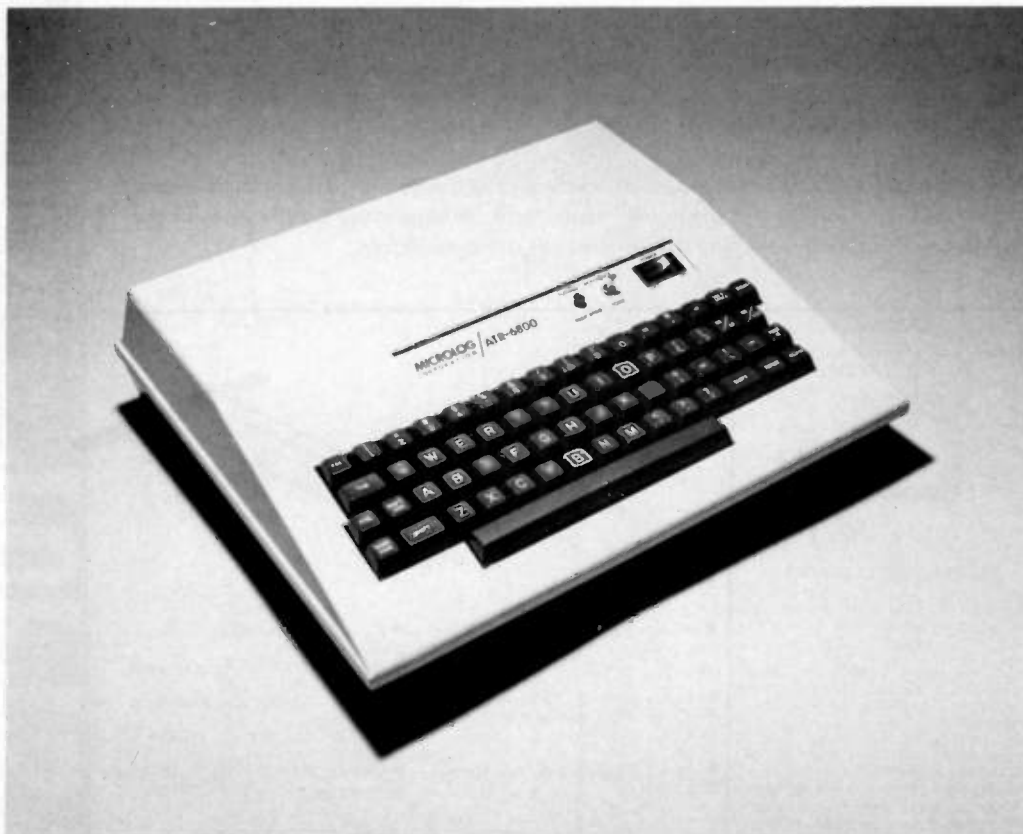

Photo A. The Microlog ATR-6800. On the recessed strip above the keys are (r to l) power switch with integral indicator, reference tone switch, and LED indicator.

yourself another cup of coffee, and wend your way back to the solitude of your shack. Now settled in properly, you can *continue* your QSO with the 3D2 in complete comfort. Yup! I sure did say *continue*. You see, while you were having that quiet breakfast with the family, your ATR-6800 was hard at work. Having been programmed by you, it was diligently calling CQ every ten minutes, then listening for a return call, and repeating this ritual tirelessly. Finally, when the 3D2 called, the ATR went into high gear. It responded to the 3D2 while also beginning your log entry.

Oh, yes, it took a moment out to trigger an I/O line which set off the little beeper to advise you that your presence was desired in the shack to *continue* the QSO. Now in the shack and comfortable, you see on the monitor that the 3D2 is Henry and that he is on holiday. Now, as soon as the ATR-6800 finishes giving your name, QTH, and the run-down on your shack, you can take over the QSO *live!*

If the foregoing sounds like something from an old Buck Rogers comic strip, let me assure you that it is not science fiction! That was just a sample of what the system is capable of providing.

Another feature (and perhaps a big selling point with the little lady) is that the ATR is also a smart terminal. You can subscribe to a service offered all small-computer users called The Source. As an ATR owner and a subscriber, you open up an incredible new vista to yourself and your family. Through The Source, you can have instant access to such features as classified ads, consumer information, dining-out information, energy saving news and tips, games, home entertainment, a *New York Times*

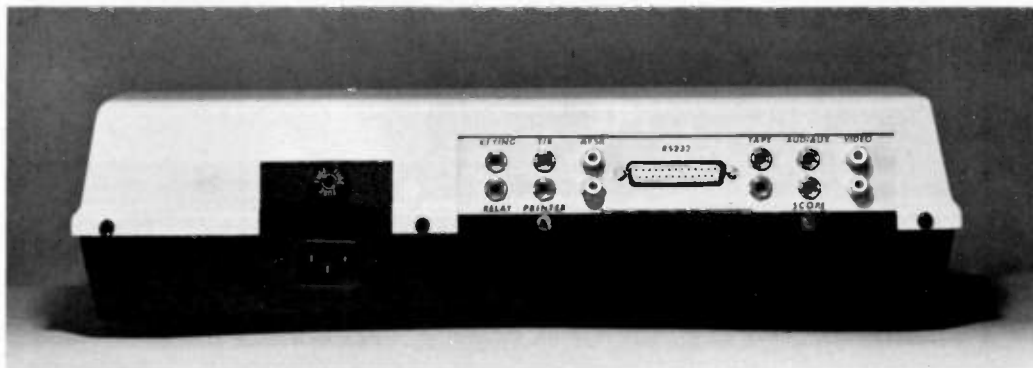

"The ATR Connection"—A look at the business end of the ATR from whence it is possible to interface with the world!

news summary, personal finance guidance, UPI (United Press International) news wire service, educational subjects, and (the ultimate bribe) discount shopping via computer! All this is available via a local number and a nominal charge of \$2.75 per hour of on-line time, provided, of course, that you have paid the one-time \$100.00 subscriber fee. (For further information on The Source, contact Doug Eddy at The Comm Center, Laurel Plaza, Laurel MD 20810.)

Quality Control—From Beginning to End

With the Microlog factory and engineering facilities so close to my home, I decided to do more checking on the ATR-6800 than I had done while writing about the earlier system. During the course of several trips to the factory, I was to find many reasons for Microlog's acceptance by the ham community. Unlike too many other companies in the amateur radio marketplace, Microlog does *not* hold to a "you bought it, it's your problem now" attitude. While they may not respond overnight to your letters, they do respond and usually by telephone. Their feeling is that while it may be slightly cheaper to respond with a letter, it is not always best. As they explained it to me, a letter may answer a customer's question, but it also may leave him with new or

additional questions—to be answered. By using the telephone, they feel that they can better assist a customer with his needs and assure final resolution of any problem or question without undue delay.

Production of the ATR-6800 is a closely supervised affair, with intense quality-control inspection throughout. Incoming parts shipments are checked and double checked. Circuit boards are inspected before, during, and after assembly. Keyboard contacts are tri-redundant and fully gold-plated to ensure long-term reliability.

By far the most fascinating part of the production of the ATR is the final test and alignment procedure. After undergoing initial testing and basic alignment, each ATR-6800 is subjected to a full twenty-four-hour "burn-in"; then it is sent for final test and alignment. This, by the way, is a much more positive method than that used by many manufacturers who usually perform a final test and alignment and *then* follow with a burn-in and a last minute function check.

Check procedures include the final alignment of the demodulator to the *geometric* mean for both the high and the low tone groups. Every key of the keyboard is individually tested for both mechanical and electrical operation. A complete functional test is made of all I/O ports. A

failure at any point in the checklist results in return of the unit to production with the test cycle begun again from scratch, including another burn-in period.

Now, after all of the preliminary final tests and adjustments have been completed, the ATR under test is connected to a "master" ATR-6800 and to a very special tape via the Tape I/O port, and at this point, *the ATR-6800 begins testing itself!* A very thorough and complete test is conducted of every operation of the ATR, and should any problem crop up, the ATR tells you not only what the problem is, but also where it is located! I had this procedure demonstrated for me by one of Microlog's top design engineers, Bob Bugash WA3VPE. Bob let the full test program run on a unit to ensure that in fact it was operating properly, then he removed a RAM chip from one socket and replaced it with a defective chip. After restarting the diagnostic program, it was just a matter of seconds until the ATR-6800 discovered something amiss and stopped the test automatically; it then displayed on the monitor what was wrong and the location of the problem. If only I could figure out a way to get it to do that with my rig!

No Strong Signals From Home

Many fellow RTTY enthusiasts that I have talked

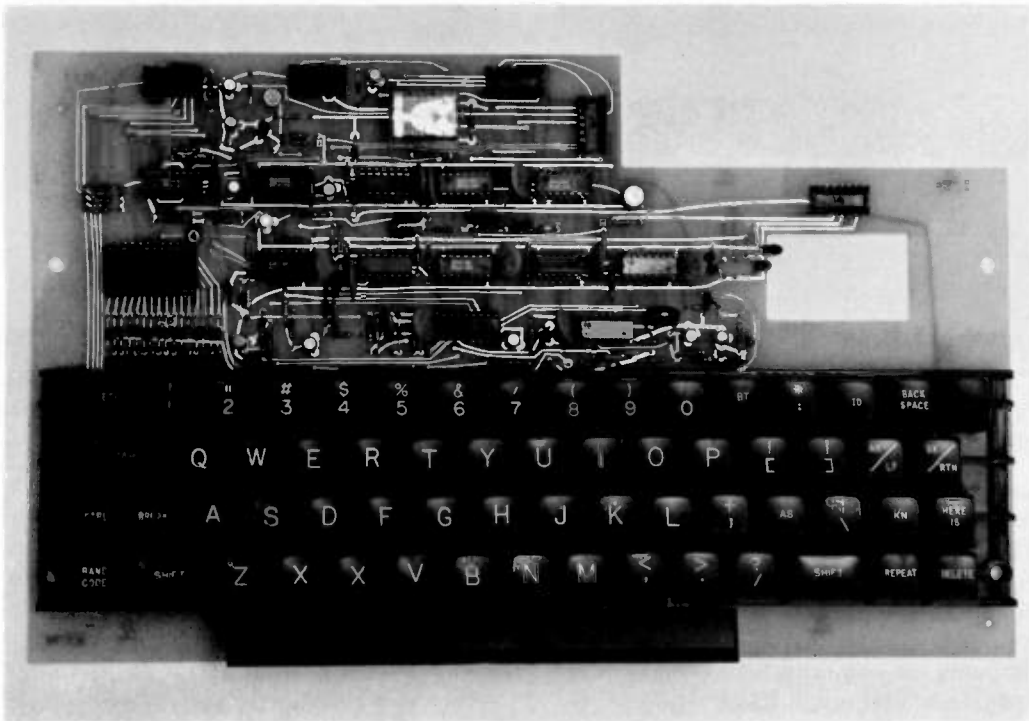

Photo C. A close-up look at the ATR-6800 keyboard and its associated circuitry. All keycaps are double-injection molded and cover four gold-plated, leaf contacts which ensure positive contact on every keystroke. Debouncing of the contacts is ensured via an integral part of the ATR's sophisticated firmware program.

with about the ATR-6800 have asked the same two questions: "But what does it do to your receiver?", and "Yeah, but can it stand being in an rf environment?"

If you have read "Microcomputers and Radio Interference" by Paul E. Cooper N6EY, *QST*, March, 1980, then you have some idea of what a horror story a makeshift, "not-designed-for-that-use" lash-up can create. For those of you who have not read this article, I heartily suggest that you do so, especially if you are contemplating going the route of the corner computer store and mail-order interfacing. I am not by any means knocking the many fine microcomputers on the market, but beware of the fact that these units were *not* designed with amateur radio in mind; they were not designed to operate in an rf environment.

Too many of us have seen what plastic cabinets and profit motives have given us in consumer electronics—RFI, and more RFI—all for the saving of a few

bypass capacitors and for a pretty injection-molded cabinet. Microcomputers, some produced by those same folks who keep us busy fighting RFI problems, are produced the same way. If you like the idea of having calibration markers every 10 kHz and really enjoy redesigning and repackaging factory-built equipment, microcomputers are the way to go. If, however, your time is of some value to you and the unknown expenses of redoing someone else's work is unattractive, then it is time to look for a piece of equipment designed for the uses at hand.

Now to those two questions: First, there is no measurable RFI emanating from the ATR-6800 cabinet (not measurable or even detectable with a Drake TR-7). Second, the ATR-6800 has no susceptibility to strong rf fields—at least those which would be encountered in any legally operated shack! The major factor responsible for this is that the ATR is housed in a heavy-duty,

heli-arc-welded, aluminum enclosure which provides a fully-shielded cabinet when coupled with the shielded keyboard and the Corcom "brute-force" ac line filter/connector in the ATR-6800. In addition, all sensitive lines are either bypassed or filtered against RFI. So those strong signals from home that are emitted by the average home computer and wreak havoc with your receiver, and the stray rf from your transmitter which causes unplanned program "dumps" on microcomputers, are non-existent with the ATR-6800.

Meanwhile, Back in the Shack...

I have had the pleasure of giving the ATR-6800 a real shakedown with several of the latest state-of-the-art offerings in ham rigs. Of course, my first on-the-air test had to be with my own TR-7. The first contact was with an old friend, Bill K8TBW. He was amazed that I finally had learned how to type *and* spell. What Bill didn't know

was that the ATR and I had him fooled; I was typing with all the speed of both index fingers into the two-kilocharacter buffer, where I was able to see and correct what I was typing *before* it was transmitted. With the incredible buffer and the split-screen feature of the ATR, your response to the other station can begin the moment he asks the first question. More about this later.

The interface with the TR-7 is a little bit more of a pain than it is with the Icom IC-701. This is because Drake did not provide rear-panel access for RTTY interconnections. This results in having to change connectors on the microphone jack every time you want to go from SSB to RTTY or vice versa. You could, of course, build a little mini-box switching arrangement to solve this problem.

With the IC-701, interfacing was a breeze! With two connections (one to the molex® connector and one to the keyjack), the interface is complete.

The last rig that I tried was the new Swan Astro 150. The Astro, like the TR-7, is not fully RTTY-oriented; however, at least with a rear-panel audio-input jack, speaker jack, and PTT control, interfacing was reasonably easy.

Ignoring the differences in operating style of the various rigs, there is virtually no detectable difference in performance of the ATR among the several rigs tried, and this includes the use of receiver bandwidths from 500 Hz to 2.7 kHz.

Operating convenience with the ATR-6800 is an understatement! In RTTY operation as well as CW, computer software handles signal conditioning and enhancement, resulting in extremely clean copy. The AFSK generator, which is digitally controlled via the keyboard, has an output that varies only ± 3 dBm

from center frequency over the range from 500 Hz to 3 kHz (measured on an H-P 3551 transmission test set). The running buffer will accommodate almost 2,000 characters and this, combined with the variable split-screen feature which allows selection of up to 20 lines of buffer text as well as simultaneous display of received text, eliminates the need for note-taking during a QSO.

Character, word, or line modes of transmission are easily keyboard-selected, with the back-space key allowing error correction prior to transmission. The back-space key also has another unique function when combined with the shift key: It permits continuous loop transmission of whatever has been loaded into the running buffer. This can be a handy feature for making tests and adjustments to equipment. Operating speeds are more than plentiful in each mode, and they also are keyboard-selectable.

These are only a few of the many features of the ATR; I will try to cover all of them in a review of the specifications accompanying this article.

On the receive end, the ATR-6800 is no slouch, either. The video monitor (a Sanyo VM-4209, 9-inch unit is supplied with every ATR) displays a T or R indicating either transmit or receive mode, or the word "computer" when in that mode. Along this top line of the display, the operating speed also is indicated (in the case of CW, both the transmitted and the received speeds are displayed), and a real-time, six-digit clock with zone display also is included. There also is room to program the ATR to display your call or any other short message on this top line. Via keyboard command, you may select either

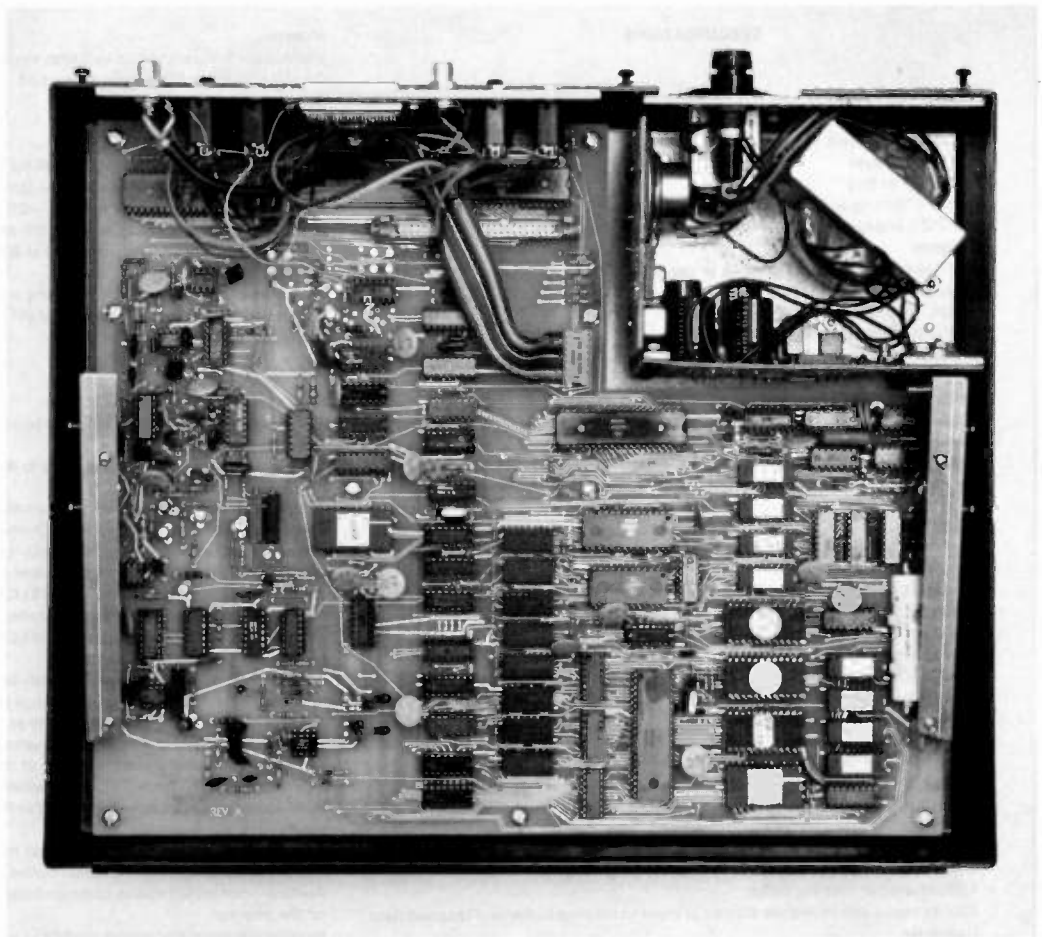

The main chassis of the ATR-6800. Partially hidden from view under the ribbon cable, slightly left of top center, is one of the two connector blocks which provide expansion interfacing (the other connector is hidden from view). Near the lower right can be seen what appears to be a large capacitor. This is the battery back-up which is responsible for non-volatile storage of user-programming.

white-on-black or black-on-white display, and, for group viewing or for those of you who, like me, don't wear glasses when you should, another keyboard command will allow selection of either standard characters which are 3/16" or "zoom" characters which are 3/8".

Going from your rig to and from the ATR should not pose any major obstacle. As I mentioned earlier, most, if not all, rig deficiencies can be made up for by the simple addition of a switching box. As for the ATR itself, cables are provided for connection to both the monitor and ac mains. In addition, cables also are provided with ATR-compatible connectors already attached to one end. Several extra connec-

tors are provided which mate with the special, high quality, military-style jacks of the ATR. All that you must provide are the mating connectors for your particular rig.

To get on the air right after receiving the ATR-6800 requires the following connections be made to the rig: key line (for CW), PTT line (for T/R switching), microphone line (for AFSK output), and the rig's speaker (to drive the ATR).

During all of the on-the-air tests and in everyday operation, the ATR has performed flawlessly. At one point, I was able to borrow a friend's Alpha 374 amplifier (I never run over 250-Watts input on any mode) to test the immunity of the ATR to high levels of

nearby rf. I placed the ATR on top of the amplifier while running the amp at full-bore... and, as I had fully expected, the ATR proved to be immune to the effects of stray rf even that close to the source! Even if there were absolutely no leakage from the amplifier itself, my shack is only about 15 feet from one antenna and directly under another.

A rather unusual and also enjoyable feature of the ATR is the freedom of movement that it gives you. For instance, sitting back in the recliner in my shack, I was able to comfortably hold the ATR in my lap and carry on a QSO with the rig about 6 feet away, and with the previously-mentioned zoom display of the moni-

SPECIFICATIONS

Inputs

Audio—800 Hz nominal (CW)
Digital—TTL levels
Electronic keyer
Hand key or bug
AFSK—from rig audio output or other source
RS-232—voltage levels

Outputs

CW—solid-state keying, positive or negative polarity
Mercury-relay keying
AFSK—any tone pair, 500 Hz to 3 kHz
FSK—solid-state transistor switching
RS-232—voltage levels
RTTY loop—isolated mercury relay
RS-232—printer-compatible
TTL—printer-compatible

Codes

Morse—Including all punctuation, foreign letters, and special CW signals
Baudot—with auto carriage return/line feed and letters/figures coding user-selectable

ASCII

Random—5-character, alphanumeric groups

Data Rates

Morse—5 to 199 words per minute, in one-word-per-minute increments
Baudot—60, 66, 75, 100, and 132 words per minute
ASCII—110, 300, 600, 1200, 2400, 4800, and 9600 baud

Video Display

40 characters per line (normal), 3/16" high
24 lines per page (normal)
20 characters per line (zoom), 3/8" high
12 lines per page (zoom)
Black on white display
White on black display

Operating Modes

Character
Word (outputs only when spacebar is depressed)
Line (outputs and the end of preset line length)
1,800-character running buffer
Split screen—simultaneous display of input to running buffer and received data

Computer

4K RAM (Random Access Memory)
Built-in monitor for debugging
Built-in monitor for execution of user-developed (M-6802) programs
May be used for user-defined action in response to digital selective calls
Terminal mode—full or half duplex at standard ASCII rates from 300 to 9600 baud with the RS-232 interface

Modem

Mark/space frequencies up to 3 kHz, keyboard-selectable
Crystal-controlled frequency generation
Computer-enhanced demodulation
Dual-tone shift to 850 Hz
Normal or inverted operation
Input bandpass filter provided for 170-Hz shift
Low tone group, nominal frequency—900 Hz
High tone group, nominal frequency—2.2 kHz
Computer-enhanced Morse (correlation detector)
100-Hz active filter for CW, centered at 800 Hz

Tuning Indicator

LED indicator for RTTY and CW tuning and mark/space indication
Scope output—rear-panel connector (RTTY tuning)
Audio reference—800-Hz tone

Audio Tape Interface

Off-the-air recording
Brag tape functions
Computer program storage and preservation

Other Features

Up to 10 independent messages of up to 80 characters may be user-programmed into non-volatile memory
Special ID feature allows user programming of callsign for transmission in the operating mode or autoshift to CW ID when in the RTTY mode
Reception of a WRU (Who aRe yoU) character string will trigger up to a 16-character message which can be user-programmed into non-volatile memory
Up to four separate selective call (SELCAL) character sequences of up to 16 characters each may be user-programmed into non-volatile memory. User may define the specific function of each SELCAL, such as activating relay contacts, etc.

Keyboard-selectable automatic unshift-on-space

Keyboard-selectable automatic carriage return/line feed

Internal 24-hour clock, synchronized to ac line frequency, displayed in the upper right-hand corner of the monitor, including time zone

Keyboard command allows insertion of the time into the transmission

24 independent I/O lines (TTL) are available for user-defined functions

ROM-based test messages—RYRYRY in Baudot; U*U*U* in ASCII; and VVVVVV in CW

ROM-based "Quick brown fox ..." test message

Full keyboard control of transmit/receive switching

Keyboard-controlled status command displays all system operating parameters on the monitor

Keyboard selection of printer mode and speed, both ASCII and Baudot, for hard-copy output of all received data

Solid State Components

82 integrated circuits

24 Transistors

50 Diodes

6 Other solid-state devices

tor there was no need to move it away from the rig. All this is possible because all transmit/receive switching is controlled by the ATR. For seriously disabled of bedridden hams, this capability may well enable them to expand their horizons and add a little more variety to their operating.

As I stated in my earlier article, neither this system nor any other is intended to replace the human brain for copying CW. The ATR can cope with human inconsistencies only to a limited degree. It will copy exactly what is being received; if someone is sending "— — — — —" and intends this to be a CQ, don't be surprised if the ATR doesn't exactly see it that way. It will

read out "NN MA," which is what was sent even though that was not what was intended. As for the guys who are so ashamed of their calls that they send them 30 times faster than they send anything else, the ATR can't copy them either.

All that the ATR does, it does very well. If you want to perfect your fist, the ATR will be quite accommodating; merely plug your hand key into your rig and, using the sidetone, you can key the ATR. Please remember to do this either into a dummy load or with the rig out of the transmit position! (By the way, the ATR is also a great aid for setting up a bug properly, as it will search for the correct dot/dash ratio, thus enabling you to properly set

the weighting and spacing of the bug.)

I would be one of the last to advocate the demise of CW, but there are a few "left-footed fists" out there that would certainly benefit from the use of the ATR-6800 on CW. The very light touch of the ATR's keyboard may also make it less painful for those afflicted with arthritis to continue using the time-honored mode of CW. And, while on the subject of CW, the ATR-6800 also can be used to improve copying ability, as it has a random code key which can generate code groups (random alphanumerics) from 5 to 199 wpm. For the ham who wants to improve himself or provide a service to others, this feature is hard to beat.

No Hidden Expenses

With the ATR-6800 there are no hidden expenses for added extras that other systems must have before they can really be put on the air. The folks at Microlog are not infallible, however. They did goof very early on with the very first decoder, the AVR-1. Due to the design, this unit was not readily adaptable to new features that followed. This was corrected after a very few units had been manufactured.

The AVR-1 was replaced by the AVR-2, which opened the door to the concept of the ATR-6800. The ATR-6800 is a cornerstone, and while it requires no additional "hidden" extras, this is not to say that it has

no future. Quite the opposite is true. According to the folks at Microlog, the ATR is intended to be the heart of a limitless system. By the time you read this, a special program for generating SSTV graphics may be available.

On the ATR-6800, the RTTY terminal unit is built right and is fully controllable from the keyboard, even to the selection of shift frequency groups. In other systems, the absence of this feature can add anywhere from about \$300 to well over \$1,000 to the final cost. For CW reception, a rig with a CW filter would produce slightly improved reception, but it is not absolutely necessary, for the ATR is able to copy even weak signals quite well.

With the ATR-6800, all you need to do to get on the air is unpack it, provide two ac outlets (one for the monitor and one for the ATR), spend a few minutes with your soldering iron installing the connectors for your rig, and apply the power. (However, I would strongly recommend that you spend a little time with the instruction manual before actually jumping in with both feet and going on the air!)

During my visits to Microlog, I spent quite a bit of time with Joe Lynn N3JL, president of the company. Joe and I discussed the overall concept of the ATR and some of the philosophy behind the design. With rigs constantly being downsized yet packed with more and more features (such as the IC-701), it was only natural for Microlog to take this concept into the terminal field. Another very important consideration, according to Joe was to design and produce a unit that would be *expandable* rather than replaceable. Since, as he says, "We have no intention of stopping our research," they also wanted a unit that would not pre-

sent the average ham with an expensive piece of equipment that would be outdated in a few years.

The ATR-6800 seems to fill these requirements and much more as well. It is a piece of gear that is both complete as well as expandable, and is compact to the point of "briefcase" portability, which should be of interest to the traveling ham, vacationer, and DX-peditioner. Oh, yes, the ATR can be ordered for use in foreign countries with ac mains different from those here in the United States.

On The Technical Side

A word of warning... this section is by no means complete in terms of details, nor is it the story of all of the capabilities of the ATR, since those are almost without limit.

The only functions of the ATR that are not controlled by keyboard commands are: turning power on and off to the ATR and to the video monitor, and turning the audio reference tone on and off. Virtually everything else is controlled either automatically or by keyboard-input commands. Basically, there are three sets of controls. There are primary controls which require only one keystroke to accomplish. There are those major functions which require access via the use of the control key and another key. Finally, there are secondary commands which also require the use of two keystrokes.

The computer functions of the ATR are directly compatible with standard audio tape recorders through the tape I/O port on the rear panel of the ATR. In this computer mode, the ATR-6800 is a stand-alone Motorola 6800 microprocessor-based microcomputer with 4K of user-accessible, on-board RAM. Expansion of the computing capabilities of

PUNCH THROUGH WITH THE STRONGEST, CLEAREST SIGNAL POSSIBLE!

BOOST YOUR VOICE POWER!

NEW from SOUNDPOWER



INSTANT BY-PASS SWITCH

SP 100 SPEECH PROCESSOR

Uses new technique in speech processing. Multiplies effective voice power over 10 times. Features easy installation. Switch for normal or processor operation. Adjustments for gain and output level. One year manufacturer warranty. Patent Pending.

UP TO 10X TIMES MORE EFFECTIVE! THAN OTHER SPEECH PROCESSORS

NEW HI-POWER MODEL SP-100 79⁹⁵

complete with MIC and POWER CONNECTORS

PS9 Optional AC Power Supply 5.95

Add 3.00 Shipping & Handling

ORDER DIRECT FROM

SOUNDPOWER

360 17 CLINTON PARK DRIVE BERGENFIELD, N.J. 07621

the ATR is made both feasible and accessible between the combination of the RS-232 rear-panel port and a special opening on the rear connector panel intended to accommodate two ribbon cables to be attached to internal connectors which will permit full expansion interfacing of the ATR.

Look at the specifications. You can see that this little (14.75" X 12.25" X 4") package packs a lot of wallop! It probably is the most versatile 10-pound package ever offered to amateur radio operators. Both units come well packed and are shipped via United Parcel Service in the United States. Foreign shipments are sent via the best available method.

The one-year warranty should also be pleasing to those of us who have grown weary of manufacturers claiming to have the best

products while willing to guarantee them for only 60 to 90 days. The entire system, consisting of the ATR-6800 and its companion Sanyo VM-4209 video monitor, with all necessary cabling, is \$1,995.

Those of you who would like further information or assistance should write Charlie Talbot K3ICH at Microlog Corporation, 4 Professional Drive, Gaithersburg MD 20760, or call him at (301)-948-5307. Charlie is in charge of amateur sales and customer service. Also, remember to tell him that you read about the ATR in 73!

One final comment. In answer to the many inquiries after my last article, I am in no way connected with Microlog, other than being a very satisfied customer who is willing to praise a product, a company, and its people when they deserve it. ■

New Weather Eye in the Sky

— a primer on NOAA's TIROS

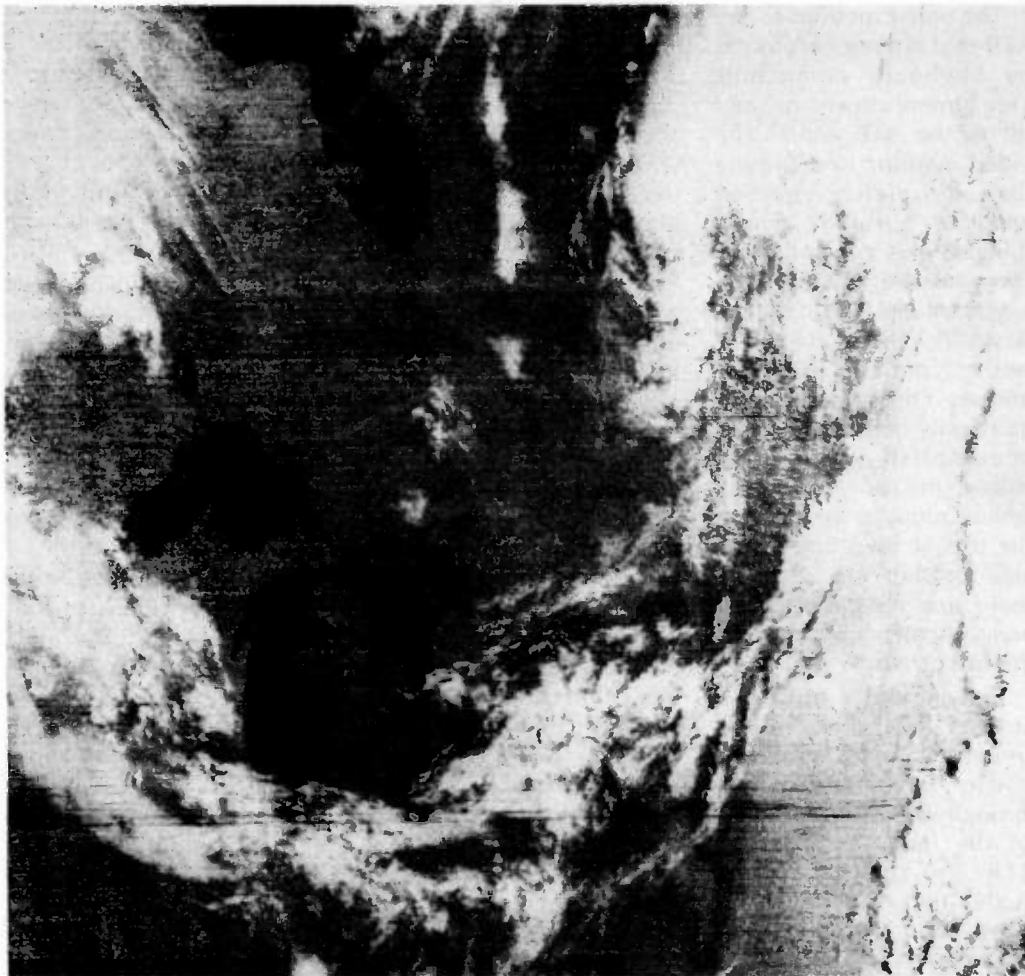

Fig. 1. An NOAA 6 visible light picture recorded during orbit #567 on 6 August 1979. Hudson and James Bays show to the north (top) of the picture, while almost all the Great Lakes are visible in the center of the display.

Over the past few years, the amateur weather satellite community has been concentrating on the GOES geostationary weather satellites.¹ In part, this has been due to the technical challenge of setting up receiving gear on the 1691-MHz GOES S-band frequency, coupled with the declining performance of the last of the US ITOS/NOAA satellites in polar orbit (NOAA 5).

Technical challenge aside, the GOES spacecraft do have a number of factors in their favor including fixed antenna bearings (no tracking), predictable signal levels, and scheduled image transmissions. Of course, the S-band converter and antenna do increase the cost of the ground station as compared to the relatively simple VHF receiving requirements for polar-orbiting spacecraft.

A number of other developments, including omnidirectional receiving antennas that can eliminate the need for tracking in many polar-orbiting installations² and the increasing use of

| Minutes After Crossing | Subpoint Latitude | Subpoint Longitude | | | |
|------------------------|-------------------|--------------------|----|------|-------|
| 0 | 0 | 0 | 24 | 79.8 | 64.5 |
| 1 | 3.5 | .8 | 25 | 81.1 | 84.7 |
| 2 | 7 | 1.6 | 26 | 81.1 | 108 |
| 3 | 10.5 | 2.4 | 27 | 79.8 | 128.2 |
| 4 | 14 | 3.2 | 28 | 77.6 | 142.7 |
| 5 | 17.4 | 4 | 29 | 74.9 | 152.6 |
| 6 | 20.9 | 4.9 | 30 | 71.9 | 159.5 |
| 7 | 24.4 | 5.7 | 31 | 68.8 | 164.5 |
| 8 | 27.9 | 6.6 | 32 | 65.5 | 168.3 |
| 9 | 31.4 | 7.6 | 33 | 62.2 | 171.4 |
| 10 | 34.3 | 8.6 | 34 | 58.9 | 173.8 |
| 11 | 38.3 | 9.7 | 35 | 55.5 | 175.9 |
| 12 | 41.8 | 10.9 | 36 | 52.1 | 177.9 |
| 13 | 45.2 | 12.1 | 37 | 48.6 | 179.2 |
| 14 | 48.6 | 13.5 | 38 | 45.2 | 180.6 |
| 15 | 52.1 | 15.1 | 39 | 41.8 | 181.9 |
| 16 | 55.5 | 16.9 | 40 | 38.3 | 183.1 |
| 17 | 58.9 | 18.9 | 41 | 34.8 | 184.1 |
| 18 | 62.2 | 21.4 | 42 | 31.8 | 185.1 |
| 19 | 65.5 | 24.4 | 43 | 27.9 | 186.1 |
| 20 | 68.8 | 28.2 | 44 | 24.4 | 187 |
| 21 | 71.9 | 33.2 | 45 | 20.9 | 187.9 |
| 22 | 74.9 | 40.1 | 46 | 17.4 | 188.7 |
| 23 | 77.6 | 50 | 47 | 14 | 189.6 |
| | | | 48 | 10.5 | 190.4 |
| | | | 49 | 7 | 191.2 |
| | | | 50 | 3.5 | 192 |
| | | | 51 | 0 | 192.8 |

Table 1(a). Satellite subpoint data for the Northern-Hemisphere half of the reference orbit based on a nominal period of 102 minutes. Note: These data replace Table 1, reference 3, and Table 2 in reference 4 (Ch. 6).

microcomputers to ease the burden of orbital and antenna tracking calculations,⁸ have made polar-orbiting spacecraft a more attractive proposition than was the case only a few years ago, so it was with some interest that the weather satellite community awaited the launch of the first of a new series of TIROS weather satellites. The prototype spacecraft went up in October of 1978 (TIROS N), followed in June of 1979 by the second operational spacecraft in the series (NOAA 6). Most of the promises of improved polar-orbit service have been borne out in our early experience with these new spacecraft, and it will be the purpose of this article to acquaint you with some of the details of the new TIROS/NOAA system so that you can get in on the fun!

Orbital Characteristics

The older ESSA and ITOS/NOAA polar orbiters operated in near polar orbits at altitudes of approximately 1400 km. The orbits were

such as to yield daylight passes in the morning hours and night-side passes in the early evening. In order to get improved resolution in the new TIROS series, they are placed in lower orbits—approximately 825 km, with periods of about 102 minutes instead of the nominal 115 minutes characteristic of ESSA and the early NOAA (NOAA 2-NOAA 5) spacecraft. The 115-minute orbital data could be used with techniques specifically tailored for weather satellite work^{3,4} or the various OSCAR tracking articles and devices could be used. The latter approach was made possible by the fact that the OSCAR satellites were launched piggyback with NOAA spacecraft and thus had essentially identical orbits.

The 102-minute orbits of TIROS call for new tracking data although you can still use the tracking techniques cited above. The new data you will need are a reference orbital track (provided in Table 1) and the data for plotting antenna elevation circles around your loca-

| Minutes After Crossing | Subpoint Latitude | Subpoint Longitude | | | |
|------------------------|-------------------|--------------------|-----|-------|-------|
| 52 | -3.5 | 193.5 | 76 | -91.1 | 277.5 |
| 53 | -7 | 194.3 | 77 | -81.1 | 300.8 |
| 54 | -10.5 | 195.1 | 78 | -79.8 | 321 |
| 55 | -14 | 195.9 | 79 | -77.6 | 335.5 |
| 56 | -17.5 | 196.8 | 80 | -74.9 | 345.4 |
| 57 | -20.9 | 197.6 | 81 | -71.9 | 352.3 |
| 58 | -24.4 | 198.5 | 82 | -68.8 | 357.3 |
| 59 | -27.9 | 199.4 | 83 | -65.5 | 1.1 |
| 60 | -31.4 | 200.4 | 84 | -62.2 | 4.1 |
| 61 | -34.8 | 201.4 | 85 | -58.9 | 6.6 |
| 62 | -38.3 | 202.4 | 86 | -55.5 | 8.6 |
| 63 | -41.8 | 203.6 | 87 | -52.1 | 10.4 |
| 64 | -45.2 | 204.9 | 88 | -48.6 | 12 |
| 65 | -48.6 | 206.3 | 89 | -45.2 | 13.4 |
| 66 | -52.1 | 207.8 | 90 | -41.8 | 14.6 |
| 67 | -55.5 | 209.6 | 91 | -38.3 | 15.8 |
| 68 | -58.9 | 211.7 | 92 | -34.8 | 16.9 |
| 69 | -62.2 | 214.1 | 93 | -31.4 | 17.9 |
| 70 | -65.5 | 217.2 | 94 | -27.9 | 18.9 |
| 71 | -68.8 | 221 | 95 | -24.4 | 19.8 |
| 72 | -71.9 | 226 | 96 | -20.9 | 20.6 |
| 73 | -74.9 | 232.9 | 97 | -17.4 | 21.5 |
| 74 | -77.6 | 242.8 | 98 | -14 | 22.3 |
| 75 | -79.8 | 257.3 | 99 | -10.5 | 23.1 |
| | | | 100 | -7 | 23.9 |
| | | | 101 | -3.5 | 24.7 |
| | | | 102 | 0 | 25.5 |

Table 1(b). Satellite subpoint data for the Southern-Hemisphere half of the reference orbit, again based on a period of 102 minutes. Note: These data replace Table 1 in reference 3 and Table 2 in reference 4 (Ch. 6).

tion (provided in Table 2). If you replace the original 115-minute orbital data with the material from the new tables, you can proceed with tracking as before. TIROS equatorial

crossing data are included in the W1AW bulletins, so you should be able to keep up with the new birds just as you did the older ones. The primary effects of the new orbits on station opera-

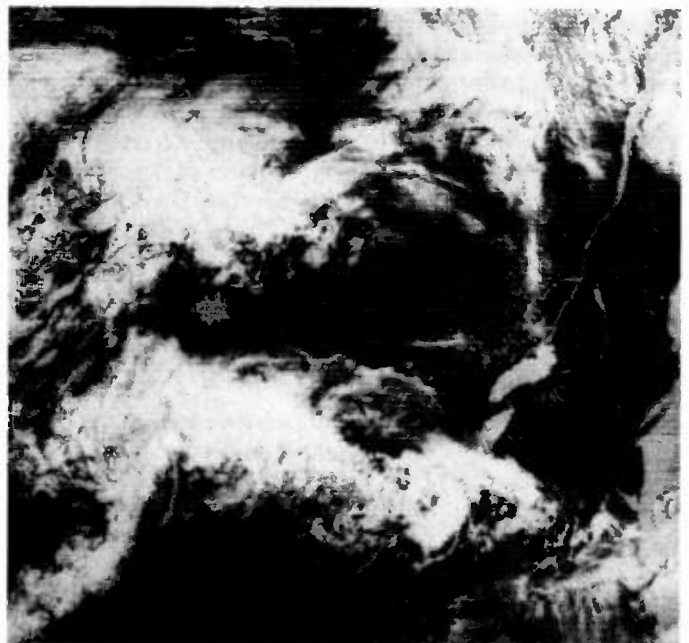

Fig. 2. An NOAA 6 pass (orbit #610) on 9 August 1979. Water in the eastern U.S. and Canada is highlighted due to sun glint, making the eastern seacoast highly visible along the right edge of the picture. Interior lakes and large rivers also are visible, including the Finger Lakes in upper New York.



Fig. 3. Another NOAA 6 pass showing a major storm system centered in the northeastern States. The coastline from Chesapeake Bay south through the Carolinas also is visible.

tions are threefold:

1. Passes are shorter. Instead of the 20+ minutes for a NOAA 2-5 overhead pass, you will get about 14 minutes of coverage from the new satellites.

2. The spacecraft come across much faster as a result of the shorter pass length and thus you have to pay more attention to tracking than you did with

the older satellites. For this reason, data in Table 1 are provided at one-minute intervals instead of the two minutes employed in the earlier tables.

3. Reduced geographic coverage. The older NOAA spacecraft would produce a strip of picture coverage extending from central Greenland to Yucatan with an overhead pass over the

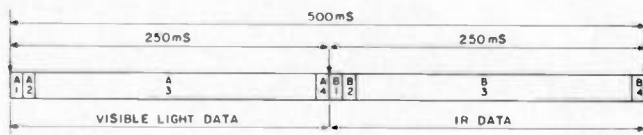

Fig. 4. TIROS/NOAA video line format.

Channel A (normally visible light data.)

A1—Sync pulse (9.37 ms); 7 cycles of 1040-Hz square-wave modulation.

A2—Pre-Earth space scan and minute markers (11.30 ms); normally black.

A3—Channel A Earth scan (218.50 ms).

A4—Telemetry data (10.82 ms).

Channel B (normally infrared data.)

B1—Sync pulse (9.37 ms); 7 cycles of 832-Hz square-wave modulation.

B2—Pre-Earth space scan and minute markers (11.30 ms); normally white.

B3—Channel B Earth scan.

B4—Telemetry data (10.82 ms).

east coast. The new TIROS satellites will produce useful pictures from central Hudson Bay to the central Gulf of Mexico.

Although one may look at the reduced coverage as a disadvantage, most operators feel that you get ample compensation by the contribution of the lower altitude to increased picture resolution.

Another major improvement, inaugurated when both TIROS N and NOAA 6 became operational, was the fact that the TIROS polar-orbit system is designed to have two fully operational spacecraft in orbit at any time. One of the spacecraft (currently NOAA 6) provides early morning visible light and IR (infrared) coverage, followed by IR coverage in the early evening hours. The second spacecraft (currently TIROS N) provides early afternoon visible and IR imagery, followed by IR coverage in the early morning hours.

Orbital decay is a factor in TIROS orbits that could effectively be ignored with the older ESSA and NOAA spacecraft at 1400 km. The TIROS spacecraft, at an orbital altitude of about 825 km, experiences significant atmospheric drag, which has the effect of slowing the spacecraft. This causes it to drop slightly with each orbit, and thus the period decreases by a measurable amount with each orbit. Most microcomputer programs that carry out orbital calculations over a period of several weeks or more incorporate a decay factor that is subtracted from the period for each orbit of the Earth. Computing a decay factor is quite complicated, but WA7MOV, working from ground track corrections determined from spacecraft imagery, has arrived at a factor of 1.7873×10^{-5} minutes/orbit. While not precise, this factor will result in long-term predic-

tions of greater accuracy than if no correction is applied. If you are working from crossing data only a few days old, you can pretty much ignore decay correction.

Rf Characteristics

Rf characteristics of the TIROS/NOAA system are covered in Table 3. The operating frequencies for the older polar-orbiting spacecraft were 137.5 and 137.62 MHz. The 137.5 frequency was the primary operating frequency for the NOAA 2-5 spacecraft, with 137.62 being used as a backup in case of conflicting passes. In the present system, both frequencies can be expected to see equal use, so a two-channel system is recommended. At present, the "morning" spacecraft (NOAA 6) uses 137.5 while the "afternoon" spacecraft (TIROS N) uses 137.62. Some juggling of these two frequencies is to be expected every time a new spacecraft is launched and checked out prior to the deactivation of the previous operational satellite.

| Antenna Elevation (Degrees) | Great-circle Radius (Degrees) |
|-----------------------------|-------------------------------|
| 90 | 0 |
| 80 | 1.2 |
| 70 | 2.4 |
| 60 | 3.8 |
| 50 | 5.4 |
| 40 | 7.5 |
| 30 | 10.2 |
| 20 | 14.0 |
| 10 | 19.7 |
| 0 | 28.1 |

Table 2. Great Circle arc radius (in degrees) corresponding to antenna elevation angles. Because of the crowding in the center of the overlay, you may want to put in the circles for elevation angles of 0-60 degrees, leaving out 70 and 80 degrees. The point marking the station location corresponds to 90 degrees. Note: These data replace Table 2 in reference 3 and Table 3 in reference 4.

Ground Signal Levels

The power output of the TIROS/NOAA spacecraft is roughly equivalent to that (about 5 W) of the older polar orbiters, but significant increases in ground signal level—an increase of 3-6 dB—can be expected due to reduced path loss brought about by the lower altitude. This prediction appears to be consistent with actual ground signal levels.

Antenna Factors

The older polar-orbiting spacecraft employed antennas radiating a linearly polarized signal. Since the attitude of the spacecraft relative to the ground antenna shifts during a pass, it was necessary to use a circularly polarized antenna. The two most common antenna types used for reception were the helix and the crossed yagi beam.⁴ My omnidirectional "Satellite Zapper" was also designed for circular polarization.

The TIROS/NOAA spacecraft now use a quadrifilar helix as the transmitting antenna, producing a radiated signal with right-hand circular polarization. It should thus be possible to use a linearly polarized ground station antenna (simple dipole, conventional yagi, etc.) with a worst-case drop of 3 dB compared to the use of an antenna of the same gain with matched circular polarization. Unfortunately, my observations indicate that this is not the case. Linear antennas seem to produce deep fades characteristic of the polarization mismatches noted with the use of linear antennas with the older NOAA spacecraft. Optimum results appear to be obtained with the use of circular polarization at the ground station antenna. You should therefore continue to use your existing polar-orbit antenna array, or plan to build a circularly polarized system if you are just getting started.

Receiver Bandwidth Requirements

With the older NOAA spacecraft, most stations employed a receiver with a 30-kHz bandwidth set by a crystal filter in the 10.7-MHz i-f portion of the receiver.^{4, 5} Such a filter would neatly accommodate the ± 9 kHz of Doppler shift. The new spacecraft employ ± 17 -kHz deviation so that modulation alone would require at least 34 kHz of i-f bandwidth. If an allowance is made for Doppler and other sources of frequency error, you end up with a recommended bandwidth of 50 kHz.⁶ This is a most inconvenient value!

Standard crystal filters are readily available for 30 kHz, but the more complex filters required for 50 kHz must be custom-built and are quite expensive. Two alternatives exist. The first, which I have successfully employed, is to stay with the 30-kHz i-f filter. There are a number of factors which make this approach possible.

First, the simple and inexpensive crystal filters which are plug-in replacements for the standard 15-kHz units used in many wired-and-tested and kit receivers have a relatively mild roll-off at the edge of the nominal passband, providing useful response out somewhat beyond ± 15 kHz.

Second, satellite video

| | |
|---------------------------|--|
| Frequency: | 137.5 and 137.62 MHz ($\pm 2 \times 10^{-5}$) |
| Transmitter Power: | 5.5 Watts (5 Watts end-of-life) |
| Antenna: | Type—quadrifilar helix
Gain—From +3.7 dBi (nadir) to -0.3 dBi (horizon)
Polarization—right circular
Transmitter-Antenna Losses—2.1 dB |
| Modulation: | Type—analog FM
Modulation Index— 17 ± 0.85 kHz (peak)
Subcarrier Frequency—2400 Hz
Subcarrier Modulation—92% AM
Baseband Video Bandwidth—1600 Hz |

Table 3. TIROS/NOAA rf characteristics.

excursions rarely approach the deviation limits with visible light data, although they do so in the case of IR data. If you have a good strong signal, you can usually punch through the 30-kHz filter with only minor effects on the dynamic range of white level data. The biggest problems will be at low signal levels (close to the horizon) with maximum Doppler shift. In such cases, you probably will squelch out on white level peaks with the IR data although visible light data should still be obtainable.

Several cautions are required, however. The first is to use a relatively inexpensive—and hence sloppy—30-kHz filter. A good multipole filter will have sharp shoulders on the passband and you will have problems. Second, if your receiver is a double-conversion unit in which the 10.7-MHz i-f is converted to 455 kHz, watch the tuning of the 455 stages. If you align the receiver for maximum gain, you will proba-

bly have a tighter system due to 455-kHz Q. The 455 stages should always be stagger-tuned to minimize their contribution to system bandwidth, even if this results in lower i-f gain.

If you want a receiver with sufficient bandwidth to avoid any of these problems, there probably is no simple off-the-shelf solution; you may have to build your own. The best approach would be to ignore the conventional 10.7-to-455 i-f approach and use a 4.5-MHz i-f. This is relatively easy due to the large selection of i-f components designed for TV sound systems. If you use enough tuned stages at 4.5 MHz, you ought to be able to attain a 50-kHz bandwidth with careful tuning. With a given front-end design, you will lose something in terms of signal-to-noise ratio, but usually there is enough signal available to handle the tradeoff.

Such a receiver would have one drawback, however. Most satellite opera-

| | Channel 1 | Channel 2 | Channel 3 | Channel 4 | Channel 5 |
|--|-----------|-----------|-------------------|---------------------------|---------------------------|
| Spectral Range (μm) | 0.55-0.90 | 0.725-1.0 | 3.55-3.93 | 10.5-11.5 | 11.5-12.5 |
| Detector | Silicon | Silicon | Indium Antimonide | Mercury Cadmium Telluride | Mercury Cadmium Telluride |
| Resolution | 1.1 km | 1.1 km | 1.1 km | 1.1 km | 1.1 km |

Fig. 5. TIROS AVHRR image sensor channels. The TIROS/NOAA imaging system is designed as a five-channel instrument with two channels in the visible light range (1 and 2) and three channels in the infrared ranges (3, 4, and 5). The early spacecraft in the series will have only channels 1-4, with the channel 5 slot filled with a repeat of the channel 1 data. On the high resolution S-band frequency, all channel data are transmitted at full 1.1 km resolution (the instantaneous field of view directly below the spacecraft). The APT data link on VHF can handle any two of these channels at reduced resolution (4 km). Normally, APT Channel A will carry either channel 1 or 2 data while Channel B will carry data from IR channels 3 or 4.

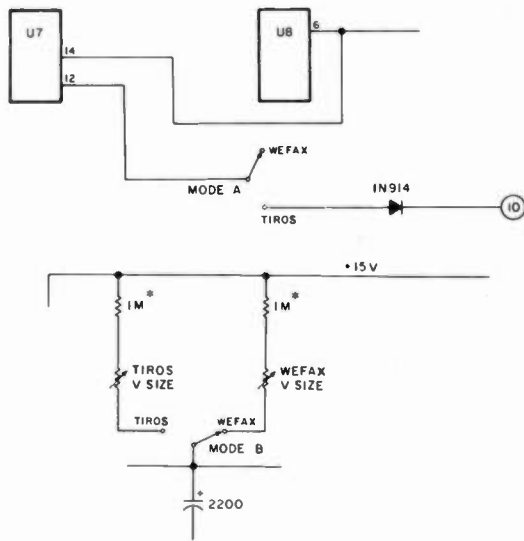

Fig. 6. Modifications to the WB8DQT GOES monitor to provide switch selection of either TIROS or GOES image display.

tors like to use the VHF satellite receiver as an i-f in conjunction with a suitable S-band downconverter for reception of GOES signals at 1691 MHz. In the case of a 50-kHz i-f bandwidth, the S/N loss with the GOES signal may be prohibitive with small antenna systems (3- to 4-foot parabolic antennas). Unless you want to run two different VHF receivers—not a bad idea if you can spare the bucks—I would recommend the “sloppy 30” approach as being the best compromise between TIROS/NOAA and GOES receiver requirements.

As an editorial comment, I think that the decision to go with the wider deviation for TIROS/NOAA was a bad call. Extensive experience with the old ESSA polar orbiters (± 9 -kHz deviation) and the superb pictures from the Soviet METEOR satellites (± 10 -kHz deviation) would indicate that we probably would have had no observable drop in resolution with a ± 10 -kHz system, and receiver compatibility would have been preserved!

Video Modulation

The TIROS/NOAA spacecraft retain the same basic

video modulation system that has served well in all previous polar orbiters and in the GOES WEFAX format. Basically, the video information is transmitted via amplitude modulation of a 2400-Hz audio subcarrier. Minimum subcarrier modulation (4%) represents black, maximum subcarrier level (90+%) represents white, and intermediate gray-scale values are transmitted as intermediate subcarrier levels. As in previous spacecraft, white in the IR channel represents cold objects while black represents warm objects. No changes in display equipment are required to accommodate this modulation format.

Video Format

Like the older NOAA polar orbiters, the TIROS/NOAA data format included both visible light and infrared (IR) data. In the older designs, two separate scanning radiometers were used to generate data. One was a very high-resolution instrument that generated both visible and IR data for real-time S-band transmission (wide bandwidth modulation), while the second generated the low-resolution IR and visible light data for transmission at VHF. The

new spacecraft have gone to a single high-resolution instrument for all data—the Advanced Very High Resolution Radiometer, or AVHRR. The high-resolution data are transmitted directly on S-band and the data are selectively sampled via on-board micro-computer hardware for transmission at lower resolution on the VHF frequencies. The sampling process follows an algorithm designed to eliminate almost entirely the panoramic distortion that was characteristic of NOAA 2-5 scanning radiometer data, producing images that look very much like the much-prized pictures from the old ESSA spacecraft.

Figs. 1-3 show some representative visible light output from NOAA 6. The AVHRR instrument scans at 360 rpm with the VHF data formatted for 120 line-per-minute transmission. The first half of each line (channel A) consists of visible light data, while the second half (channel B) carries IR scan data (Fig. 4). The most effective way to display the pictures is to use a 240 line/minute display, producing alternate lines of visible and IR data. One or the other set of data lines can be selectively blanked so that only visible light or IR data are shown.

The Earth scan data are split into five bandwidth (light) windows using a beam splitter and filters and then passed on to five separate detectors (Fig. 5). Two of these—channels 1 and 2—are visible light sensors, while the other three cover various IR windows. Ground command determines which sensor is online for generating the visible light data in channel A and the IR data for channel B. One of the visible light sensors is quite good at discriminating fine cloud structure, but relatively poor in terms of differ-

entiating land-water boundaries. The other performs somewhat less well on cloud features, but yields a beautiful distinction in picking out geographic features. The fact that the CDA control station may switch from one sensor to the other, coupled with daily and seasonal light variations, explains why it is possible to see a beautiful coastline one day and miss it the next!

Picture Display

The simplest approach to picture display is to handle the signal in a 240 line/minute (4 line/second) format with provisions to blank the unwanted data lines (IR or visible). The approach is particularly attractive in that this is the line rate used for GOES WEFAX transmission on S-band, and, if we handle things right, we can get double the mileage from our display system.

Let's look first at CRT displays, as they are the easiest to modify. Conceptually, we want to provide a sync divider/trigger circuit that will give us the proper 4-Hz trigger rate while providing a means to blank the unwanted data lines. Two examples from my previously published circuits will show one approach to doing this and should set you on the right track if you are working with another circuit. The video monitor described in chapter IV of the *Weather Satellite Handbook* has been widely duplicated and is easy to modify for TIROS/NOAA display. Most of the relevant circuits are shown in Figures 4.1 on page 23 and 4.2 on page 24.

1. Remove the connection between pin 9 of IC8 and the SR lug on S3A.

2. Connect a jumper between the SR and APT lugs of S3A.

3. Remove R2 from the circuit board and connect a jumper from the SR to the APT lugs on S3C.

4. Switch S3 (mode) to SR and adjust R4 for a vertical sweep time of 400 seconds.

This completes the required changes. GOES WEFAX images are copied in the APT mode position, while TIROS/NOAA pictures can be displayed in the SR position. The PHASE switch is used to properly align either the visible light or IR data when displaying TIROS/NOAA imagery.

The solid-state monitor for GOES picture display is another easy conversion.⁷ Four new components, a 1-meg fixed resistor, a 1-meg pc pot, any general-purpose silicon diode, and a DPDT toggle switch (for MODE selection), will be required. The changes are summarized in Fig. 6:

1. Connect a jumper between pin 6 of U8 and pin 14 of U7 on the main circuit board.

2. Connect a wire from pin 12 of U7 and the common lug on one set of contacts on the new mode switch. Solder the cathode of the diode to lug 10 on the main circuit board and connect a wire from the anode to the TIROS lug on the same side of the switch where you wired into the common lug.

3. Make the following connections to the remaining set of lugs on the MODE switch:

(A) Break the connection between the vertical deflection amplifier. Connect the amplifier input bus to the common lug of the switch.

(B) Connect the old size pot to the WEFAX lug of the mode switch.

(C) Take the new size pot and connect one side and the wiper to the TIROS lug of the switch. Connect the other side of the pot to the +15-V bus through a 1-meg resistor

The original size pot is now your WEFAX size pot and should be properly set already. The new pot will be your TIROS vertical size pot. Set the mode switch to TIROS and adjust the pot for a 400-second vertical sweep. You now can switch select for either GOES WEFAX or TIROS.

If you would like to build the monitor just for TIROS display, the job is even simpler. In this case, you will not need a mode switch and you would proceed as follows:

1. Install the jumper between pin 6 of U8 and pin 14 of U7.

2. Solder the anode of the diode to pin 12 of U7 and connect the cathode to pin 10 of the main board connector strip.

3. Adjust the vertical size pot on the main board for a 400-second vertical sweep.

4. Adjust the horizontal size pot as described.

The amount of work required to modify a facsimile machine depends upon a variety of factors, including the line and feed rates for which the machine was designed and whether or not you want the capability for IR display as well as visible light data. Any machine that will handle GOES WEFAX display will do a job of sorts with TIROS visible data during daylight passes.

An example of one such machine is a direct printing recorder for GOES pictures. Minimal requirements include some means to check the phasing of the TIROS/NOAA signal, as the WEFAX automatic phasing circuits will not operate properly with the TIROS video format. The simplest means of phasing is the use of a triggered oscilloscope as a phasing indicator. Connections should be made as follows:

1. Connect a lead from board connector K to a



Fig. 7. An NOAA pass displayed on the WB8DQT direct-printing GOES facsimile recorder without changing the 40-rpm carriage drive motor. Note the vertical "stretching" of the display. The use of a 20-rpm motor will provide the proper aspect ratio with this machine (see Fig. 1).

new phono jack (TRIGGER) on the rear apron of the FAX control unit. Use a shielded lead to connect the TRIGGER jack to the trigger input of the oscilloscope.

2. Connect a lead from board lug E to another new phono jack (VIDEO) on the rear apron of the control unit. Use a shielded lead to connect the VIDEO jack to the vertical input of the oscilloscope.

Start the drum of the FAX machine and verify that the oscilloscope is being triggered by the drum. The horizontal sweep frequency should be set to about 4 Hz for optimum results. With a TIROS signal at the FAX input, adjust the scope vertical gain for a usable display of the video waveform. The 832- or 1040-Hz square-wave modulation of the sync pulses will be evident if you study the display on the scope. Press the FAX PHASE switch and hold it until either sync waveform

is lined up with the origin (left edge) of the scope trace. At this point, release the PHASE switch and switch the RESET/PRINT switch to print.

What you will get is a picture with the characteristics of Fig. 7. It probably will be low in contrast and may look about right unless you compare Fig. 7 with Fig. 1—both are taken from the same TIROS (actually NOAA 6) pass. If you compare the two, you will note that the Great Lakes appear stretched vertically in Fig. 7, while they have the proper proportions in Fig. 1. This is due to the fact that the 40-rpm carriage motor in the GOES version of the machine moves the carriage too rapidly for proper aspect ratio display of TIROS/NOAA pictures. If you want to do the job right, you should substitute a 20-rpm type CA motor for the carriage drive. This will yield an excellent aspect ratio for TIROS pictures

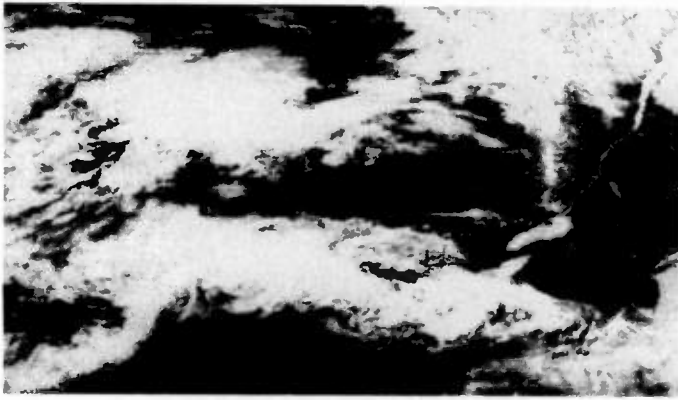

Fig. 8. An NOAA 6 pass (orbit #610 on 9 August 1979) showing a picture as it would be displayed on a modified version of the Weather Satellite Handbook (first edition) FAX machine, using the original carriage drive motor. The vertical compression is plainly obvious if this frame is compared with Fig. 2, displayed with a carriage motor of twice the speed of the original.

and is precisely what was used to generate Fig. 1.

If you built the FAX machine described in chapter V of the *Weather Satellite Handbook*, you will have a few modifications to make of a somewhat different sort. First, the sync divider section will have to be changed to provide 60-Hz motor drive. The easiest way to do this is to change the reference crystal from 4.8 to 6.0 MHz. The frequency of the 565 PLL will then have to be shifted from 4800 Hz to 6000 Hz. The next step is the substitution of a Hurst type CA 240-rpm motor for the 120-rpm unit used for

the old NOAA satellites. If you have built this machine, you already have provision for phasing the picture, so nothing else is needed there. You will have to change the value of C1 in the motor amplifier input circuit to resonate at 60 Hz. If you used the 15-H choke specified, simply replace C1 with a .47-mF, 50-V mylar™ capacitor and you are now in business. If you retain the old carriage drive motor and print pictures, you will get something that looks like Fig. 8. The relatively slow carriage speed will let you fit all of the pass on a single piece of paper, but the ver-

tical rate of travel is too slow, resulting in a "squashed" vertical display. If you add a new traverse motor of twice the speed as the old one, you will get the proper aspect ratio shown in Fig. 2—the same pass shown in Fig. 8.

One of the major disadvantages of either of these machines in their present form is the need for an external scope to phase the pictures. I am presently at work on an autophase circuit for TIROS that can be switched in to provide autophasing for either GOES or TIROS pictures along with switch selection of the proper carriage motor speed using a dual-speed motor for the carriage drive.

If one wishes to display IR imagery on the direct-printing machine, some means must be provided to blank out the visible data. The problem is that with the required printing polarity, normal visible data or the dark visible channel at night will simply override any IR data. The latter is typically very near white level and the darker visible data simply covers it up.

The hybrid FAX system from the first edition of the *Weather Satellite Handbook* already incorporates line-blanking circuits so that this unit will print out both visible and IR data. Fig. 9 shows a line-blanking circuit for the direct-printing WEFAX facsimile machine. A sample of the trigger pulse is used to toggle a 7476 flip-flop. A switch selects one of the complementary outputs which drives a small switching transistor. Assuming that the signal is properly phased, the collector of the transistor will be high on every other video line. The collector voltage is coupled to the printing transistor through a diode, driving the transistor to white cutoff for

the duration of the line. On alternate lines, the collector of the transistor is low and the base of the print control transistor is controlled by the signal from the video detector, permitting the video data to be printed. This particular circuit will have to be added only if you plan to copy IR imagery. Visible light imagery will print quite well without any attention to line blanking.

Summary

Hopefully, this represents most of the essential information required to introduce you to this new satellite series. Conversion of an existing satellite system is quite easy, and it is equally straightforward to incorporate TIROS/NOAA capability into new equipment as it is constructed. Polar-orbiting spacecraft represent the simplest and least costly introduction to weather satellites. Why not tune in and see what's happening? ■

References

1. Taggart, R. E. "Be a Weather Genius—eavesdrop on GOES," *73 Magazine*, November, 1978.
2. Taggart, R. E. "Satellite Zapper—effective antenna for weather birds," *73 Magazine*, May, 1977.
3. Taggart, R. E. "How To Find the Satellite," *73 Magazine*, January, 1975.
4. Taggart, R. E. *The Weather Satellite Handbook*, 73 Publications, Peterborough NH, 1976.
5. Taggart, R. E. "Predict the Weather!—a complete satellite receiver," *73 Magazine*, May, 1977.
6. Schneider, J. R. "Guide For Designing Rf Ground Receiving Stations for TIROS N," NOAA Technical Report NESS 75, U.S. Department of Commerce, Washington DC, 1976.
7. Taggart, R. E. "Attention, Satellite Watchers!—a solid-state monitor for GOES," *73 Magazine*, February, 1979.
8. Taggart, R. E. "Microcomputers and Your Satellite—part 1: calculating orbital crossing data; part II—ground station antenna bearings," *73 Magazine*, January, February, 1980.

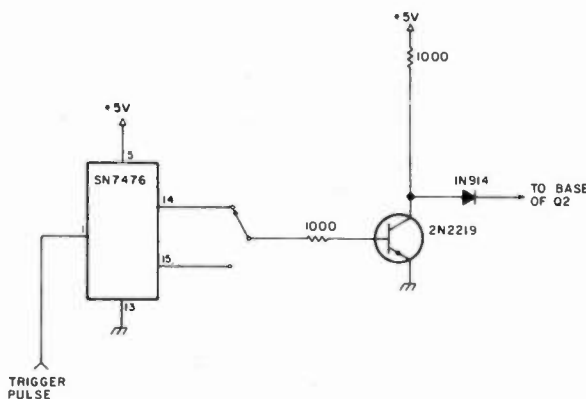
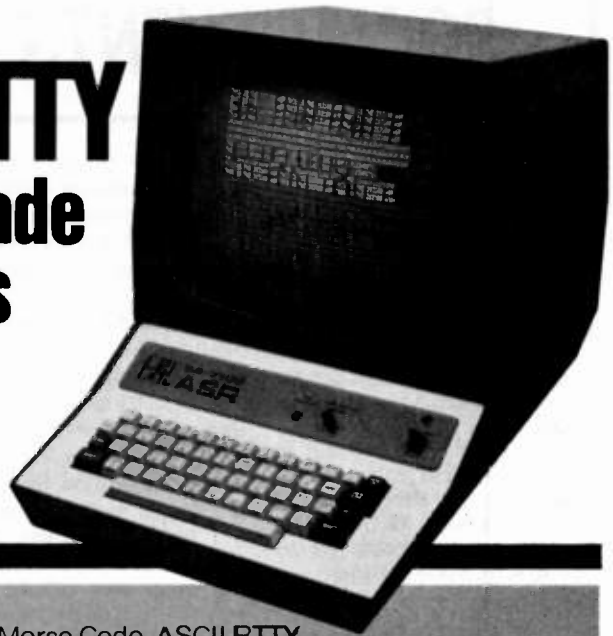

Fig. 9. A video line-blanking circuit for the WB8DQT direct-printing facsimile recorder. Such a circuit is a requirement for printing IR data, but is not needed for visible light display.

UNSURPASSED RTTY

No other RTTY terminal made gives you ALL the features of our new DS3100 ASR:



- TX/RX operation with 3 codes: Baudot RTTY, Morse Code, ASCII RTTY
- Storage buffers for 150 lines of RX storage and 50 lines of TX storage
- The HAL "original" split screen shows both RX and TX buffers or whole screen for RX
- Ten programmable "Here Is" messages can be chained from one to next
- The EAROM allows power-off storage of 2 "Here Is" messages and terminal operating conditions
- Programmable WRU answer-back and selective-call features
- Separate CW identification key for RTTY operations
- Automatic TX/RX control with KOS plus 4 keyboard controlled accessory switches
- Internal real time clock keeps 24 hour time plus date
- Newly developed CW receive circuitry and programs give superior CW reception
- New green, P31 phosphor display screen gives clear, eye-easing viewing
- On-screen status indicators give continuous display of terminal operating conditions
- Word-Wrap-Around prevents splitting of words at end of display line
- Continuous, line, and word modes offer flexibility in editing transmit text
- Attractive streamlined metal cabinet gives effective RFI shielding from transmitters

Here Are More DS3100 ASR Specifications that Give You State-of-the-Art RTTY Operation:

QBF and RY test messages ■ Loop and RS 232 RTTY I/O ■ Plus or minus CW key output ■ 25 pin EIA modem connector ■ Half or full duplex ■ Upper-lower case ASCII ■ All ASCII control codes ■ Optional line printer for all codes ■ Selectable ASCII parity ■ 110 to 9600 baud ASCII ■ 45 to 100 baud Baudot ■ 1 to 175 WPM Morse receive and transmit ■ UnShift on space for Baudot ■ SYNC idle for RTTY and Morse ■ Break key for RTTY ■ Tune key for Morse ■ Automatic CR-LF ■ 120/240 v, 50/60 Hz power ■ Custom labeled key tops show control operation ■ Copy receive text into transmit buffer ■ TX flags allow segmenting of TX buffer ■ One year warranty

PRICE: \$1995.00



HAL COMMUNICATIONS CORP.
Box 365
Urbana, Illinois 61801
217-367-7373

For our European Customers Contact:
Richter & Co., D3000 Hannover 1
I.E.C. Interelco, 6816 Bissone/Lugano

*Write or give us a call.
We'll be glad to send you our
new RTTY catalog.*

SOCIAL EVENTS

Listings in this column are provided free of charge on a space-available basis. The following information should be included in every announcement: sponsor, event, date, time, place, city, state, admission charge (if any), features, talk-in frequencies, and the name of whom to contact for further information. Announcements must be received two months prior to the month in which the event takes place. They should be sent directly to Editorial Offices, 73 Magazine, Pine Street, Peterborough NH 03458, Attn: Social Events.

MORRISTOWN TN NOV 1

The Lakeway Amateur Radio Club will operate from the David Crockett Tavern, Morristown TN, on Saturday, November 1, 1980, from 1300 UTC until 2200 UTC. SSB-only operation will be on the following frequencies, plus or minus QRM: 28.560, 21.360, 14.280, and 7.235 MHz. Amateurs and the general public are invited to visit the tavern and site, which is the boyhood home of Davy Crockett, during regular operating hours (weekdays, 9:00 am to 5:00 pm, and Sundays, 2:00 pm to 5:00 pm). For a certificate commemorating the event, send \$1.00 plus a legal-size SASE or 3 IRCs and an SASE to Davy Crockett DXpedition, Rte. 11, Box 28, Morristown TN 37814.

ST. PETERSBURG FL NOV 1-2

The Florida Gulf Coast Ama-

teur Radio Council, Inc., will hold the Suncoast Amateur Radio Convention on November 1-2, 1980, at the Bayfront Concourse Hotel, downtown St. Petersburg FL. Close by are the Albert Whitted Airport, the St. Petersburg Marina, bus depots, and many parking lots. Registration is \$3.00 each and children under 12 are admitted free. Two award tickets are free with advance registration. Swap tables are \$10.00 each for both days (no one-day tables). Double booth space is available and all the swap area will be inside. Featured will be dealer displays, forums, a Saturday luncheon and banquet, and a Sunday luncheon and fashion show. FCC exams will be given. Send to the Tampa office for 610s. Talk-in on 147.96/.36, 147.66/.06, and 146.52. For more information, write FGARC, PO Box 157, Clearwater FL 33517, or phone (813)-461-4267.

HICKSVILLE OH NOV 2

The Defiance County Amateur Radio Club is sponsoring its 3rd annual hamfest on Sunday, November 2, 1980, from 8:00 am until 4:00 pm at the Defiance County Fairgrounds at Hicksville OH. Tickets are \$1.50 in advance and \$2.00 at the gate. Table space is free on a first-come-first-served basis, inside or outside. Hourly drawings will be held, with the main event at 3:00 pm. Talk-in on 147.69/.09 and .52. For more information,

write Ed Ballard, Jr., RFD #1, Roland Road, Sherwood OH 43556.

SOUTH FALLSBURG NY NOV 7-9

On November 7, 8, and 9, 1980, the Hudson Amateur Radio Council will sponsor the ARRL Hudson Division Convention to be held at the Pines Hotel, South Fallsburg NY. The theme is "Good Times at the Pines," with emphasis on a mini-vacation type convention for both families and solo attendees. A full range of forums is planned along with an exhibit hall and flea market. Contact Mike Evans WB2RDD for flea market info at Box 143, White Sulphur Springs NY 12787, or call at night (914)-292-8630.

NEWMARKET ONT CANADA NOV 8

The York North Amateur Radio Club will hold its annual flea market on Saturday, November 8, 1980, at the Newmarket Community Centre, Newmarket, Ontario. General admission will be \$1.50, which includes a door prize ticket. Admission for exhibitors will be \$4, which includes a door prize ticket and one table. Additional tables will cost \$2. The flea market will run from 0800 to 1400 EST, but doors will be open earlier for exhibitors. The talk-in frequency will be 146.52 MHz simplex; the club call is VE3YNA.

SO GREENSBURG PA NOV 8

The Foothills ARC will hold its annual Swap & Shop on Saturday, November 8, 1980, at the St. Bruno's Church in South Greensburg PA. Doors will be open from 9:00 am until 5:00 pm. Dealers are welcome. The main prize is a complete HF antenna system, including a tri-band beam, a 40-foot tower, a rotor, thrust bearing, and cable. Second prize is an Icom IC-2A handheld. Talk-in on 146.07/.67 and .52. For advance table reservations, phone Jim Yex WB3CQA at (412)-256-3531. For more information, phone Chuck Hamman WB3HZM at (412)-837-9194.

WEST MONROE LA NOV 9

The Twin City Ham Club of Monroe/West Monroe will hold

its annual "Hamfest" on Sunday, November 9, 1980, at the West Monroe Civic Center, 910 Ridge Avenue, West Monroe LA. The \$1.00 admission includes a chance for the grand prize. Talk-in on .25/.85 and .52/.52. For more information, contact WB5MHU, 94 Birchwood Drive, Monroe LA 71203.

FRAMINGHAM MA NOV 9

The Framingham Amateur Radio Association will hold its annual fall flea market on Sunday, November 9, 1980, at the Framingham Police Station Drill Shed, Framingham MA. Admission is \$1.00 and sellers' tables are \$6.00. Sellers are advised to pre-register. Doors will open at 9:00 am. Talk-in on .75/.15 and .52. For more information or to register, contact Ron Egalka K1YHM, FARA, PO Box 3005, Saxonville MA 01701, or phone (617)-877-4520.

SELLERSVILLE PA NOV 9

The RF Hill Amateur Radio Club will hold its fourth annual hamfest on November 9, 1980, in the Sellersville National Guard Armory, Sellersville PA. Doors will open to sellers at 7:00 am and a \$2.00 donation will admit buyers after 8:00 am. Tickets are on sale for the grand prize, a complete low-band station from key to antenna. The radio is the new 9-band Ten-Tec Model 580 DELTA with a 110-volt power supply and filters. The antenna is a model AP-3 from W6TIK. Talk-in on 146.28/.88 and 146.52. For further information, contact the RF Hill ARC, PO Box 29, Colmar PA, or Robert Bentley WB3EWP, RF Hill Hamfest, 334 Railroad Avenue, Souderton PA 18964, or phone (215)-723-8303.

MASSILLON OH NOV 16

The 23rd annual auction, Auctionfest '80, sponsored by the Massillon ARC will be held on Sunday, November 16, 1980, from 8:00 am until 5:00 pm at the Massillon Knights of Columbus Hall, Massillon OH. The flea market opens at 8:00 am with auction action to start at 11:00 am. Auctionfest '80 will feature three major prizes, plus a long list of door prizes to be given away hourly. Tickets are \$2.50 in advance and \$3.00 at the door.

LINEAR 2 to 400 MHz PLANBOOK

15 to
1000 WATT
13 Different Models, 96 pgs
A.P. Systems \$11.95

Box 263 sm.

Newport, RI 02840 (401) 846-5627

362

AWARDS

from page 20

no charge, it is necessary for the applicant to enclose sufficient postage fees for the safe return of your cards.

Once your initial award is received, applicants may earn a Silver Sticker for any 25 different DX YL contacts within five countries. The same application and postage requirements apply.

North American applicants may submit their cards and applications to Phyllis Shanks W2GLB, 7 Lake Circle Drive, Vicksburg MS 39180, or one of two DX stations may be utilized: 18KDB or DL3LS.

This week I received a very nice letter from Doris Kinney who represents the Green Mountain Awards.

GREEN MOUNTAIN AWARD

The Green Mountain Award is made available to licensed amateurs the world over. To qualify, the applicant must make two-way contact with other amateurs of the State of Vermont. A Bronze Award will be issued for 25 contacts, a Silver Award for 50 contacts, and for 100 contacts with Vermont stations, a Gold Award will be made. Repeater contacts are not valid.

Each applicant must list all contacts made, showing call-sign, date and time in GMT, the band and mode, and the signal report. To be valid, all contacts must be made on or after Janu-

ary 1, 1971. Submit your verified list of contacts and award fee of \$5.00 to: Green Mountain Awards, Doris Kinney, RFD #2, Brandon VT 05733.

Paralleling the Green Mountain Award is an achievement known as the Worked All Bands Award. This award also is sponsored by Doris Kinney.

WORKED ALL BANDS AWARD

The Worked All Bands Award requires the applicant to work a minimum of 50 Vermont contacts on each band, 10 through 80 meters. There are no mode limitations, but specific modes will be recognized if requested.

List all log entries by band and submit this application with a \$5.00 award fee to Green Mountain Awards, c/o Doris Kinney, RFD #2, Brandon VT 05733.

WORKED ALL MAINE AWARD

While we are in the 1st Call District, let's take a look at the Worked All Maine Award.

The requirements are simple and straight to the point. Applicants must work an amateur operator in each of the sixteen counties of Maine. There are no band or mode requirements, but specific recognition can be made if so stated at the time application is made.

Submit your log entries and award fee of \$2.00 to: John Blinick K1JB, c/o Portland Amateur Wireless Association, Box 1605, Portland ME 04104.

WORKED TRUMBULL COUNTY AWARD

The Warren County Amateur Association of Ohio announces its Worked Trumbull County Award (WTC), a program designed to promote increased amateur radio activity among and with Trumbull County amateur radio operators.

To qualify for this award, applicants must make 10 contacts with Trumbull County amateur operators. DX stations outside the United States and Canada must log a minimum of five Trumbull County amateurs. All contacts must be made January 1, 1959, and after to be valid.

To apply, list call-sign of the stations worked, the date and time in GMT, and the mode and band of operation for each contact made. Have this list verified by at least two fellow amateurs or a radio club official. Enclose this application and a \$1.00 award fee or 13 IRCs to Don Lovett K8BXT, Awards Chairman, WARA, PO Box 809, Warren OH 44401.

NH WAC AWARD

An award is available to those who successfully contact each of the ten New Hampshire counties. There are no band, mode, or time restrictions.

Include an SASE with date, time, frequency, mode, call of station contacted, and county. New Hampshire counties are Belknap, Carroll, Cheshire, Coos, Grafton, Hillsborough, Merrimack, Rockingham, Strafford, and Sullivan.

Submit your request for this award to Basil Cutting W1JB, RFD, Suncook NH 03275.

Before concluding this column for another month, I would like to remind our readers to make reference to the September and October, 1980, editions of *73*. Packed within its pages, I have detailed 19 individual awards which constitute the fabulous new *73 Magazine* Awards Program. Each offering its own degree of challenge, there is something in it for everyone!

FINAL RESULTS FIRST ANNUAL 160-METER PHONE CONTEST

For all these years, they said it couldn't be done, so nobody ever tried it—not until January, 1980, when a group of dedicated top-band operators convinced

73 Magazine to sponsor the First Annual 160-Meter Phone Contest! We believe the comments noted in Feedback tell it all.

The entire program idea took many months of planning from early spring, 1979, right up to the golden hour the contest began. During this preliminary period, over 25 top-band operators from all parts of the United States, Canada, and the Caribbean were drawn together to coordinate their ideas on what was to be a "first" for 160 meters. Many on-the-air schedules were conducted by the group to refine the rules and set the stage for the event. Countless hours were spent by the contest chairman and his dedicated committee to get things set up and conclude any last minute details. We now can see the product of their hard work: probably one of the most promising events in 160-meter history, the results of the First Annual 160-Meter Phone Contest.

From the logs of those entries submitted, over 500 individual stations were found to be on the air for the weekend event. Unfortunately, only 74 of these operators forwarded their scores to the contest chairman. It was a weekend of achievement, however, with over 60 DX stations activated on the band: CO2FA, G3SZA, GD4BEG, HP3FL, KH6CC, KH6ILA, KL7GIH, KL7GKY, KL7JEF, KV4FVS, KV4FZ, PA0HIP, PJ9EE, PY1RO, VP2ML, XE2EJ, YV4TI, ZL1BIL, ZL2BT, ZL3GQ, plus 45 Canadian stations. Hopefully, next year more entries will be submitted from these ever-popular DX stations; they, too, may be eligible for an award. As Chod Harris VP2ML stated, "Chances are I may take high score for Montserrat!"

The race for the championship was a dead heat. Top honors went to K8NG with a total of 139,240 points, followed by only 1240 points by second-place finisher K0GVB with 138,000 total points. WA9EYY managed to capture third place overall with a finishing tally of 131,670 points. For the United States, W4PZV tallied the most multiplier points by establishing contact with 41 states and 12 DX countries, which earned him 77 multiplier points. For DX stations, VE3OCU took top honors with 68,640 points overall. In order of their respective calls,



the following single-operator stations led their region: N1AAR, W2MPK, K3LGC, W4PZV, AE5H, AE6U, N7DF,

K8NG, WA9EYY, K0GVB. Multi-operator stations: A12K, WA3GMS, WA4UNZ, WB7BFK, WD9GGY, and WB0IBT. For the

multi-ops, WB0IBT took top contest honors by a margin of less than 50 contacts!

As most of us know, one doesn't pursue a contest without some motive in mind. Maybe it is to add a few states or countries to our totals or just to hand

FINAL RESULTS

FIRST ANNUAL 160-METER PHONE CONTEST

Final results listed in order by total score. Shown are call sign, state or DX, QSOs, QSO points, multiplier points, and total score. (*) State winner in their class. (**) Multi-operator stations.

| | | | | | |
|------------|----|-----|------|----|---------|
| * K8NG | MI | 472 | 2360 | 59 | 139,240 |
| * K0GVB | IA | 400 | 2000 | 69 | 138,000 |
| * WA9EYY | IL | 418 | 2090 | 63 | 131,670 |
| * W8EPT | MI | 355 | 1775 | 63 | 111,825 |
| * N1AAR | CT | 369 | 1845 | 54 | 99,630 |
| * WB0IBT** | NE | 375 | 1875 | 53 | 99,375 |
| * W4PZV | FL | 258 | 1290 | 77 | 99,330 |
| * K3LGC | DE | 354 | 1770 | 51 | 90,270 |
| * WD0BNC** | KS | 328 | 1640 | 54 | 88,560 |
| * N9GT | IN | 314 | 1570 | 54 | 84,780 |
| * K9QLL | IL | 338 | 1690 | 49 | 82,810 |
| * KB8EZ | OH | 242 | 1210 | 63 | 76,230 |
| * VE3OCU | DX | 286 | 1430 | 48 | 68,640 |
| * WA3GMS | PA | 315 | 1575 | 43 | 67,725 |
| * W2MPK | NY | 271 | 1355 | 46 | 62,330 |
| * W1WCR | NH | 249 | 1245 | 50 | 62,250 |
| * AE5H | MS | 203 | 1015 | 55 | 55,825 |
| * WA0DXZ/5 | MS | 237 | 1185 | 45 | 53,325 |
| * N7DF | UT | 229 | 1145 | 46 | 52,670 |
| * AA1K | CT | 181 | 905 | 53 | 47,965 |
| * WD4EPX | TN | 246 | 1230 | 38 | 46,740 |
| * WB8HCV | MI | 221 | 1105 | 40 | 44,200 |
| * WB2QLO | NJ | 169 | 845 | 49 | 41,405 |
| * K8ES | OH | 176 | 880 | 47 | 41,360 |
| * W3YOZ | MD | 156 | 780 | 53 | 41,340 |
| * A12K** | NJ | 172 | 860 | 44 | 37,840 |
| * N7AM | WA | 157 | 785 | 46 | 36,110 |
| * N4CMU | TN | 170 | 850 | 42 | 35,700 |
| * VE4WR | DX | 172 | 860 | 41 | 35,260 |
| * K2HPN | NY | 162 | 810 | 43 | 34,830 |
| * WB4ASY | AL | 145 | 725 | 48 | 34,800 |
| * W8QBF | OH | 169 | 845 | 41 | 34,645 |
| * K3IXD | MD | 150 | 750 | 44 | 33,800 |
| * W4WWD | VA | 157 | 785 | 42 | 32,970 |
| * AE6U | CA | 135 | 675 | 47 | 31,725 |
| * WD9GGY** | IL | 172 | 860 | 33 | 29,240 |
| * WB1HIH | MA | 173 | 865 | 33 | 28,545 |
| * W7AVD | MT | 126 | 630 | 45 | 28,350 |
| * W4YZX | NC | 124 | 620 | 44 | 27,280 |
| * K1NBN | ME | 146 | 730 | 37 | 27,010 |
| * WD9HX | IL | 150 | 750 | 34 | 25,500 |
| * WD5DUD | LA | 114 | 570 | 44 | 25,080 |
| * WA7OFH | WA | 106 | 530 | 45 | 23,850 |
| * WD6EQG | CA | 135 | 675 | 35 | 23,625 |
| * A17K | WA | 133 | 665 | 35 | 23,275 |
| * W4WWQ | VA | 96 | 480 | 47 | 22,560 |
| * N9RC | IN | 114 | 570 | 39 | 22,230 |
| * WA4JWS | SC | 113 | 565 | 33 | 18,645 |
| * K8SIA | MI | 111 | 555 | 33 | 18,315 |
| * W7ULC | OR | 96 | 480 | 36 | 17,280 |
| * K5MAT | NM | 74 | 370 | 44 | 16,280 |
| * W4VKK | GA | 66 | 330 | 44 | 14,520 |
| * WA9FTU | IL | 85 | 425 | 33 | 14,025 |
| * K0BF | CO | 79 | 395 | 33 | 13,035 |
| * W1BB | MA | 79 | 395 | 32 | 12,640 |
| * WA4UNZ** | SC | 72 | 360 | 31 | 11,160 |
| * WA2GZB | NJ | 58 | 290 | 35 | 10,150 |
| * WB7BFK** | WA | 76 | 380 | 24 | 9,120 |
| * N7AKU | NV | 72 | 360 | 24 | 8,640 |
| * K2DWI | NY | 65 | 325 | 23 | 7,475 |
| * W7TO | WY | 59 | 295 | 23 | 6,785 |
| * WB4ZPF | VA | 43 | 215 | 30 | 6,450 |
| * W2CC | NJ | 50 | 250 | 25 | 6,250 |
| * AK7H | WA | 50 | 250 | 24 | 6,000 |
| * WA4JWC | SC | 60 | 300 | 19 | 5,780 |
| * N8BJU | OH | 40 | 200 | 23 | 4,600 |
| * VE5JQ | DX | 41 | 205 | 21 | 4,305 |
| * N8ACQ | WV | 41 | 205 | 20 | 4,100 |
| * WA6EKJ | CA | 50 | 250 | 16 | 4,000 |
| * KA8CQI | OH | 27 | 135 | 20 | 2,700 |
| * W5VGC | NM | 31 | 155 | 17 | 2,635 |
| * AK2E | NY | 19 | 95 | 18 | 1,710 |
| * AK7H | WA | 26 | 130 | 12 | 1,560 |
| * VP2ML | DX | 17 | 85 | 18 | 1,530 |

Contest Feedback

"A well-planned, interesting, and fun contest. Only lacked better DX propagation and more respect for the DX window. Congratulations to WB7BFK of 73 Magazine and the many volunteers who made it all possible!"—W1BB.

"Had a ball in this contest; lots of stations on. Let's do it again as I think it is the best contest on 160—a great bunch of gentlemen and darn good operators—K2DWI.

"Glad to work the contest as I really enjoyed the entire operation. Thanks to 73 Magazine for the sponsorship."—K2HPN.

"My first contest that I operated from start to finish. Please have it again next year; I'll try to do better."—W2MPK.

"A great contest! Let's have it again next year."—W3YOZ.

"Great that someone finally sponsored a 160 phone event. Enjoyed it very much and sounded like a big success. Hope to do it again next year."—WD4EPX.

"I didn't do terribly well but thought I would submit an entry anyway to help support the contest. Great fun!"—W4YZX.

"Your contest was 59+ and I had a super lot of fun. You can definitely count on me next year, too!"—WD5DUD.

"Fantastic contest. Two great nights for propagation. Worked KL7GKY Friday for #48, KH6CC for #49, and N7GA in Idaho for my 50th state on Saturday evening. Good signals; great fun—but too little sleep."—AE5H.

"Thank you for your first 160 contest. Wish it had been published in all the magazines as many more would have been on. I almost missed it myself."—WA6EKJ.

"Used a Coast Guard 310-foot Ioran antenna. Was super for transmitting but a bit noisy for receiving. Could only operate the second night and this hurt my score. Was a great experience anyway. Looking forward to next year now."—AE6U.

"This could be a big contest if proper advertising can be realized. Your rules are vague on Canada. Should be separate multipliers for each province. Had a great time."—N7AM.

"My antenna tuner had ice on the capacitor and would arc over if I ran over 25 Watts. Very pleased with my first 160-meter contest."—N7DF.

"Used a 120' longwire out the window, hooked to a transmatch. Very surprised at the result. Hope to do better next year."—AK7F.

"Hard for us in Washington to work DX. My sight is only 1/10 normal vision so had to log each contact on cassette first. Lots of activity—seemed like everyone was having a good time and voiced nothing but praise for 73's sponsoring of this event."—WA7OFH.

"Enjoyed every minute."—N8BJU.

"Tnx, 73, for a nice 160 contest. Fantastic turnout on SSB. Had a great time and will be back next year."—KA8CQI.

"QRP contacts were rough at times, but still managed to work all those I heard, I think. Had a great time and will try again next year."—WD8HCV.

"Seems funny that during a CW contest the operators flood the entire 160-meter band, but when a phone test comes about, a few soreheads claim we are out of line operating below 1810. Let's count Canadian provinces for multipliers next year. Had a great time and will see you again next year."—K8NG.

"Really pleased with all the activity your contest produced. I'm sure it will set the stage for an even greater event next year. Only negative comment is that I believe Canadian provinces should be separate multipliers."—K8SIA.

"I really enjoyed the contest, more than any other 160-meter event. I hope to see it happen again next year. You might consider including Canadian provinces for multipliers."—WA9EYY.

"Had a fun time on 160 phone and hope I can do it again next year."—WD9HX.

"This was a great contest. Hope it continues from year to year as it is a good counterpart to the ARRL and CQ CW events."—N9GT.

"My first contest. Had rain and lightning the first night. Met some very nice people on 160. Thanks to 73 Magazine for a fun time."—WD0BNC.

"The rules were unclear on VEs. Didn't know if they should be counted for DX or not. Was a great contest and I hope to compete again next year."—K0GT.

"Very surprised at the high level of activity. Conditions were very good and some surprising DX was heard here, including HP and VP2M. I was appalled, however, at the level of activity in the DX window by American SSB stations. Thanks for a very enjoyable contest and I'll be back again next year."—VE3OCU.

"Thanks to 73 for creating this fun time. There was an area of confusion throughout the contest which I hope is cleared up before next year's event. The subject: Should the Canadian provinces be separate multipliers?"—VE5JQ.

"Didn't hear about the contest until it was happening. Anyway, here is my log. It's bound to be top score for Montserrat! Had a good time, as it seemed everyone did."—VP2ML.

Feedback From Non-Contestants

"This is probably the stupidest idea for a contest I have ever seen. Whoever thought this one up needs a dunce hat."—WB1J. (Tom, do you have one in size 7 1/4 that I can borrow?)—WB7BFK)

"... listening during the weekend of the new 160 phone contest organized by Wayne Green... I found that it generated quite a bit of SSB activity. There was one disturbing factor, however, the malicious QRM from a few CW diehards who resented the invasion of SSB signals in that portion of the band usually occupied by CW operation. I had expected a retaliation by the phone boys the following weekend during our CW contest but it did not materialize; they were real gentlemen."—W1WY. (Quotation from CQ, May, 1980, p. 80)

out a few contacts to those who need them. Special congratulations go out to the following stations who each achieved results above the norm: N1AAR worked G3ZSA; K3LGC contacted 5 countries; W4PZV worked 41 states and 12 countries; AE6U worked 6 countries including New Zealand; AK7H worked ZL2BIL and ZL2BT; WB8HCV was the only QRP entry; W8EPT worked all 50 states plus 5 countries; K8NG worked 47 states and 4 countries; KB8EZ worked 47 states and 6 countries; K9QLL worked 46 states and 4 countries; WA9EYY worked 49 states and 4 countries; K0GVB worked all 50 states and 4 countries; and WB0IBT worked 47 states and 2 countries.

The 1980 rules were quite vague in regard to the status of Canadian contacts. Over 45 Canadian stations supported this first annual event and everyone will be pleased to learn that the 1981 rules will reflect a change in which each Canadian province will count as a separate multiplier. Our apologies and most assuredly our heartfelt thanks to the following VE stations who were in support of this year's contest: VE1IC, VE1OC, VE1UM, VE1UW, VO1FN,

VE2DC, VE2EV, VE3ABG, VE3BBN, VE3CV, VE3EYK, VE3GPU, VE3HP, VE3IDU, VE3IDW, VE3KH, VE3KQD, VE3KQN, VE3OCW, VE3QA, K8AMJ/VE3, VE4AED, VE4MP, VE4VV, VE4WR, VE5AZG, VE5DNG, VE5DX, VE5JQ, VE5JS, VE5XU, VE5ZZ, VE6TL, VE7CMK, VE7CNY, VE7JUP, VE7KE, VE7SZ, VE7VP, VE7YQ, VE7ZG, 3D6AC/VE7, and G4HBE/VE7.

One of the advantages of gathering contest results is the opportunity to survey the actual equipment and antennas being utilized. For years, one of the restrictive elements which kept many amateurs from operating 160 meters was the availability of equipment. As you'll witness in the survey to follow, it would seem that 160 meters could be considered a "born-again band." We hope you'll find this analysis as interesting as we did. Here's the breakdown of equipment used by contestants in our first annual event:

Yaesu: (36)
 FT-101 series (24)
 FT-901 series (6)
 FT-301 series (3)
 FL-101/FR-101 (3)
 FT-101/FR-101S (1)

Drake: (17)
 T-4XC/R-4XC (6)
 T-4XB/R-4B (6)
 T-4XR/4B (3)
 TR-7 (2)
 Kenwood: (14)
 TS-820S (6)
 TS-520S (6)
 TS-180S (2)
 Ten-Tec: (3)
 540/240 (1)
 Omni A (1)
 Omni B (1)
 Icom: (2)
 IC-701
 Atlas: (2)
 350XL (1)
 215X (1)

Talking with many amateurs, there are those who'd never try 160, as they felt you had to own acres of real estate to erect an antenna. Surveying our contestants, you'll find a variety of antennas being used, most installed on small city lots:

Vertical (20)
 (excluding Hy-Towers)
 Inverted L (13)
 Dipole (11)
 Beverage (8)
 Longwire (7)
 Sloper (5)
 Hy-Tower vertical (2)
 Horizontal Quad (2)
 80-Meter Dipole (2)

Double Zepp (1)
 2-el. fixed horizontal beam (1)
 3-el. fixed vertical beam (1)
 10-80-meter trap dipole (1)
 40-meter dipole (1)
 Discage (1)

We cannot tie the ribbon on the 1980 event without mentioning some very dedicated individuals who made it all possible. Special recognition should be paid to Dan Murphy WA2GZB who was this year's contest chairman and who has accepted the position for next year. Assisting Dan were fellow top-band operators John Fried W4WWD, Vic Misesek W1WCR, Ed Steeble K3IXD, Paul Engle K9QLL, Bill MacDonald W8EPT, and members of both the Top Band SSB Net and the Worked All States Net on 160.

It was a great experience and we all met many new friends as a result. So it is onward and upward, the second annual event is just around the corner. Every effort is being utilized to advertise in all publications. Hopefully, things will see a new beginning and more will join our efforts to make the 160 phone event one of the best on the band! I'll be there, will you join us?

DX

from page 15

possible to explain to a non-amateur about DXing because of the nature of the DXCC entities. In addition, expeditions to the R and Rs accomplish nothing positive except enabling everyone who is interested to advance one notch toward the Honor Roll. R and Rs don't enable visiting amateurs to introduce amateur radio to interested Third-World citizens and they don't produce good public relations. They are simply expensive and unnecessary, a product of affluent societies. R and R expeditions merely make expensive playthings for Itinerant DXers.

In the past year or two, attitudes toward the question of R and Rs have subtly swung from the majority being on the pro side to being on the con side.

Suddenly, straw polls at conventions are producing more and more hands raised in favor of making DXCC counters *only* countries having a separate government all their own.

This really has nothing to do with how "rare" and entity is for DXers. Kingman Reef, for example, is an uninhabited reef, yet the demand for contacts is satisfied by an expedition every few years. China is the most sought after country, yet it has more people than all of Europe. Those who suggest that China should be struck from DXCC because there has not been amateur activity there for two decades are always hooted off the stage; those who suggest deleting the R and Rs are getting more and more support. Why not ask the question at the next convention or DX meeting you attend? The results may surprise you!

AUGUST HAPPENINGS

Speaking of rocks and reefs, several were on at summer's end. The Radio Club of Bogota, Colombia, mounted a two-part expedition to Bajo Nuevo HK0AB and then Serrana Bank HK0AA in early September. Seventeen Colombian operators participated in the operation, which included all bands 160-10 meters, both phone and CW. QSLs to Edilberto Rojas, HK3DDD, PO Box 584, Bogota, Colombia.

In early September, DXers were awaiting an operation from Juan Fernandez Island, to sign CE0CJA, by the Radio Club of Chile. Their plans for a mid-August operation were foiled by transportation problems—the Chilean Navy is the only way to get to Juan Fernandez.

Dave Gardner K6LPL took a short trip to Tonga in August and signed A35LP for a few days. He will be part of an expedition to Abu Ail, to sign J20AA/A for about five days, beginning December 5. Franz Langer DJ9ZB and Pierre Reis-

sian J28AZ are the other operators definitely slated for the operation.

K6LPL is also part of the Heard Island team, which will sign VK0JS beginning about January 15, 1981, if all falls into place. P29JS is heading planning for this very complex and expensive undertaking.

We are pleased to have photos this month of last April's Glorioso Island operation by a group of German amateurs (see story in 73, September, page 154). This same group was ready to leave in early September for Juan de Nova, to sign FR0RXJ and FR0CIW/J beginning September 14. They also planned some operating from the Comoros as D68AS and D68AT, with another short stop on Glorioso also possible. QSL and logistics manager for the April and September operations, DK9KD, calculates a total cost for the two at nearly \$50,000!

Two problem countries in Africa were in August's news: Burundi 9U5 and United Arab Emirates A6. Stations on are 9U5AC and 9U5DS, but their op-

erations are in question at the DXCC desk in Newington. Also, several bootleggers have signed 9U5DS on CW, compounding problems. Several Polish amateurs are presently in Burundi as technical advisors and stand the best chance of anyone of getting actual operating permission.

Several stations also are operating from A6 but their QSLs are not being accepted for DXCC. Amateur radio was banned in the U.A.E. In February, 1979, and the DXCC desk has received inadequate documentation from several A6 operators since that time. The League's policy of requiring documentation from operators that they were actually where they claimed to be and that they had official operating permission is a policy we highly agree with. It may make a few of your QSL cards worthless for DXCC purposes but the value in preventing ill will that can be generated by visiting hams justifies

the position ARRL has taken.

N6ZV, AA6AA, and KA6S left California for the Indian Ocean area late in August. They first operated from Mauritius as 3B8ZV and 3B9ZV and then from the Comoros as D68GA and D68XX. Plans called for permission for a Tromelin Island operation. Permission for Tromelin, as well as for Juan de Nova and Glorioso, is obtained at Reunion Island, from which the others are administered. QSLs for all stops by this group are to ZL1BIL, one envelope per operation/callsign please.

Roger Ulsky KB7JX continued his boat trip in the Pacific with August setups on the South Cooks ZK1CF and Samoa 5W1. They aimed for the Fiji Islands 3D2 and New Zealand in September, with a very outside chance for a landing on Kermadec. All QSLs for their operations are to ZL2AQF.

ZL1AMO and ZL1AZV operated from the Pacific in August

and early September, first as A35EA and A35TW, then from Niue using ZK2EA and ZK2TW. They followed these with some time on Western Samoa 5W1 and another stop on Tonga. QSLs for CW contacts to ZL1AMO, phone contacts to ZL1AZV.

Corsica was ably represented by a German group the first two weeks of September, seven of them signing FC0FOC. QSLs to DJ3TF. Their location a thousand feet from the beach allowed some serious low band operations, including 160 meters.

Watch for an operation November 2-7 from Fernando de Noronha, with Morris Johnson KB4IT signing PY0ZDX and Carlos Albuquerque as PY0OD. Johnson is a member of the Latin American Committee of the Southern Association of Colleges and Schools and is in Brazil again this year as part of an accreditation program for

American schools in Latin America.

Anthony Green VS6EZ should be operating from Muscat, Oman, signing A4XGR. Look for him around 28.550 and 21.300 from 0930 to 2000 UTC. QSLs to PO Box 981, Muscat, Oman, with 5 IRCs or a greenback for airmail return.

A QRP DXpedition to South Point, Island of Hawaii, will be active between 1800 UTC November 29 and 2400 UTC November 30. The Big Island Amateur Radio Club will be operating from the southern most area of the 50 states. Tentative frequencies include 7.115, 21.115, and 28.115 CW; 7.275, 21.375, and 28.750 SSB. A special QSL will be available from the Big Island Amateur Radio Club, Russell R. Roberts, Jr. KH6JRM, PO Box 363, Honokaa HI 96727.

Most of the information in this column comes from *The DX Bulletin*. Thanks for sending the photos, and please keep them coming. Good DX!

HAM HELP

Wanted: Operating and service manuals for the Atlas RX-110 receiver, PS-110H power supply/amp, and service manual only for the TX-110 transmitter module. I will gladly pay postage and copying cost.

Charles Y. Mooney KA5IWF
4905 Walker Drive
Box 92814
The Colony TX 75056

I am a ham and railroad fan interested in starting a radio rail-fan net. Any interested radio rail-fans can contact me by mail or phone call.

Bill Anderson, Jr. KA6BXS
650 Leo Dr.
Foster City CA 94494

I am looking for a Venus C1 fast/slow scan camera to complement my Venus 552 monitor. These units are no longer being produced by Venus Scientific. Also, I need a good circuit diagram for converting the output of a conventional TV camera to slow scan.

Ira Linderman WB2RXR
89 Dovecote Lane
Commack NY 11725

I need a schematic and instructions for a Valtec Model VS-11 speech integrator made by Valley Technics, Kalamazoo MI (now out of business). Will pay.

Merle Israelson W4NEJ
1425 SW Egret Way
Palm City FL 33490

I need schematics and manuals for a Lafayette HA-90 vfo, Lafayette HA-800 receiver, Sylva model 216 signal generator, Knight T-60 transmitter, Heath VF-1 vfo, and Elmac PRM6-A receiver. I'll be glad to pay any expenses involved.

Frank Lev WA2LPX
327 Adirondack Drive
Farmingville NY 11738

Needed: Modification data for converting a Hallicrafters SR-42 AM modulated exciter to FM.

Neil Johnson WA4ZTN
PO Box 154
Glenwood FL 32722

I need a schematic for a National HRO-60 receiver and Central Electronics sideband slicer/Q multiplier. I will copy

and return promptly. I also need "AC" (15 meter bandspread), "E", "F", and "G" coil sets and dial scales.

M. Crestohi VE2BDM
PO Box 642
Victoria Station
Montreal
Quebec, Canada H3Z 2Y7

I am disabled and find I have a lot of spare time, so if anyone needs a QSL manager, I'm available!

Karl Rietz WB7FAT
4346 S. Boxwood Ave.
Tucson AZ 85730

Can anyone supply me with a used video head for an Ampex VR 5100?

Al Cikas KA9GDL
2112 Stonehenge
Springfield IL 62708

African ham needs 3-kHz (500B-31) and/or 6-kHz (500B-60) mechanical filters for 51J4.

Rod Hallen KB7NK/5T5RH
State Department—Accra
Washington DC 20520

I am looking for schematics, manuals, or information about a Hallicrafters SR-46 and a Hickok model 295X.

Bill Smith K3LF
RD #2
Cold Spring Creamery Rd.
Doylestown PA 18901

Please contact me if you have instruction manuals and/or a schematic for the Allied Knight-kit T-150 transmitter (early 1960s vintage). I would appreciate any assistance in locating same.

R. E. Langford WA4ARK
1320G Scully Road
Aberdeen Proving Ground MD
21010

I need a service manual or schematic for a Collins 310B-1. I also need knobs for a Halli-crafters S-76 or SX-101 receiver.

H. F. Schnur
115 Intercept Ave. North
Charleston SC 29405

We need the manual for a National NCX-3. Or our second choice would be to get just the schematic. We'll happily pay postage both ways and photocopy it or pay postage and copying costs for a good-quality photocopy of same. Thank you.

C.G. Sakowski KA9FIJ
R.J. Sakowski KA9FIJ
Rt. 1, Box 50
Barneveld WI 53507

I need a schematic diagram for a National HRO-500 receiver. My manual is missing the fold-outs. I'll be happy to pay for postage and duplicating costs.

Robert McLeod N4CKP
Rt. 4, Lot 6, Creekside
Moncks Corner SC 29461

LOOKING WEST

from page 12

relaxed to say the least.

Aside from the malicious interference problem, other matters that were discussed included the viability of national repeater directories, 10-meter CTCSS plans, and what to do about 15-kHz tertiary channels. Also explained was the alternative 20-kHz plan adopted in the Pacific Northwest and the overwhelming success it has had. Other than the malicious interference problem, most of the time was spent on the topic of what to do about the 15-kHz tertiaries. I'll share my own ideas with you on this later.

As for repeater directories, it was noted that such volumes cause problems for coordinators because amateurs tend to look upon such books as being akin to bibles depicting all activity. As one panel member pointed out, for his area the things were totally useless because they were at least 75% inaccurate. The problem lies in two places. First, those wishing to put up repeaters many times consult a national repeater directory rather than their local coordinator, coordination council, or fellow amateurs. This then leads to conflicts when a system shows up on the air on a supposedly vacant channel pair and finds that a repeater is already using said channel pair. In fact, the latter may have been in operation for some time, but because of the time lag in the publication and update of national repeater guidebooks, the listing had not appeared.

Then there is the opposite problem: the paper repeater. Since the ARRL, 73, and all publishers of national listings take input from all sources, they have no way to ascertain whether a system really exists. They can only go by input provided to them by all sources and hope for the best. If some joker decides to send in a listing for a non-existent repeater, there is no way for a publisher to check the validity of the listing. The cost and paperwork involved would be overwhelming. For the coordinator, this poses the problem of

convincing the prospective repeater putter-upper that a given channel pair is indeed clear, regardless of what the national book says.

Some repeater councils have petitioned the ARRL's VRAC to only accept input from recognized coordinators and coordination councils. It was pointed out that should this occur, many closed, private and membership-only (this was a new term to me, and it was never defined) systems might go to great lengths to see that a listing of their existence was deleted from all publications. Again, this could lead to coordination problems and confrontation. In the end, the panel seemed to agree that it should be stressed that all such national publications be used only as general guides to possible area activity and that those seeking more accurate information send a self-addressed, stamped envelope to the area coordinator or coordination council for a given geographic area and request a local repeater list. In making this suggestion, Neil McKie suggested that the word "stamped" be underlined. I agree.

What to do about 15-kHz tertiaries between 146 and 148 MHz? First, I think we have to agree that there is no such thing as a 15-kHz tertiary channel. That's a term left over from the mid-'70s that's still haunting us for some unknown reason. A better term for today would be 15-kHz "standard pairs," for indeed that's what they are. Keep in mind that once an area starts coordinating on 15-kHz centers, the 30-kHz standard has gone out the window. 15 kHz has become the standard automatically, regardless of whether you go upright or inverted. So, the first step in solving the 15-kHz question is to start thinking in terms of 15 kHz and totally forget 30 kHz, the same as we did when we went from 60-kHz to 30-kHz separation more than 12 years ago. Once you start thinking in this more positive light, you can also look toward more positive solutions.

The initial solution presented to the ARRL Board of Directors

by the VRAC was this: All systems east of the Continental Divide would operate upright on 15-kHz centers, while those west of it would invert except for the Pacific Northwest (which would retain its own 20-kHz plan). Some suggestion. This is one of the few times I find myself in complete agreement with the ARRL Board of Directors. If I were sitting on that august body, I would have vetoed it as well. Why? Because it only endorses the status quo, but does nothing for those caught in a now developing squeeze play in middle America. As I understand it, it was pressure from those in the central area of this nation that brought about the veto. I am with them 100%. They should not be left holding the bag, with inverted systems crawling toward them from the west and upright systems approaching from the east. Eventually, a day will come when somewhere a giant lock-up will occur and you will witness the biggest repeater confrontation in history. Endorsing the status quo solves nothing.

As early as 1975, Bob Thornburg WB6JPI had the answer. He prepared a paper discussing the merits of both upright and inverted 15-kHz centers. He used mathematical extrapolation to explain what would work best where, and supplied this material to all the publishers of amateur magazines. It was never printed. When I was preparing my own book on repeaters and FM, I received permission from Bob to include this work in one of the book's appendices. It's there. Every bit of information needed by any coordinator, council, the VRAC, or the ARRL. Since it is now copyrighted by TAB, I cannot reprint it here, but those of you who need this information can find it in TAB book #1212, pages 527 through 535. Immediately following this is a description of the alternative being utilized in the Pacific Northwest of 20-kHz centers. Again, the information is there, and in both cases is based on solid technological research rather than political consideration.

The answer to the 15-kHz problem lies simply in adopting one of the two 15-kHz standards or opting for total recoordination nationally on 20-kHz centers. The latter would be ideal on technological grounds but impossible to implement in many

areas. This is due to already overcrowded conditions. This leaves us with the two 15-kHz alternatives and I urge all to read Bob Thornburg's work on the subject before reaching any conclusions. One thing is for certain: With the current growth patterns on two meters, the current status quo won't last much longer. A solution must be found.

The afternoon session was a User's Forum in which repeater and non-FM users posed questions to the panel; we tried our best to provide intelligent answers. I think we succeeded and feel the hours spent on this particular panel were constructive. There are some top minds in the world of FM relay technology to be found in the Pacific Northwest. I was proud to have been able to spend this time with them. By far, they are some of the most dedicated amateurs I have ever met.

The next forum I was part of was the Media Relations Forum chaired by John Brown W7CKZ. Many of you have heard of John in regard to the Mt. St. Helens disaster. He is the Washington State ARES Public Information Officer who was interviewed by many news services. John had put together a top-notch panel which featured representatives of the local print and broadcast media, network radio and television, and even the amateur media. On this one, the panel consisted of John as moderator, Roy Neal K6DUE, Milt Furness K7JKH of KOMO-TV News, Kerry Webster WB7AKE of the Tacoma *News-Tribune*, George Garrett AC7X, News Director of KPMS AM/FM radio, Ted McGee of National Cable Television, and again yours truly.

Matters covered were simple in appearance but very complex in actuality. What makes an amateur radio story newsworthy? To what type of news outlet? How do you obtain news coverage? How should you plan for it? These things were covered in depth at the discussion. I have a complete audio tape of the session, and if you are a club public relations director or an ARRL Public Information Assistant and need a copy of the seminar itself, just mail me a high-quality (Scotch AVM Studio Master or equivalent) C-120 cassette with a self-addressed, stamped mailer and I will duplicate my tape and re-

turn yours to you. A C-120 will cover most of what was discussed without you missing much. All I ask is that you pay the return postage and be patient. The duplication can only be done when the equipment is not in use for producing the weekly Westlink newscasts.

SEANARC '80 was a good convention by all standards. It was not a Dayton in size or scope nor did it have the totally fun atmosphere I found rampant at ARCH '80. SEANARC '80 was, however, a good show that provided yours truly with a rather fun-filled though busy weekend. By the way, the final highlight came about 15 minutes after we departed on the return leg of the trip to Los Angeles. As we were climbing to altitude in our 727, the captain came on the intercom to announce that off the right side of the aircraft was the now infamous Mt. St. Helens. We were at about 25,000 feet and 60 miles east of the volcano, yet from my window seat I could clearly see the steam billowing forth and the devastation on what had once been the north slope. It was both chilling and awe-inspiring in its grotesque beauty. As I raised my camera to photograph it, I could not help but remember that a number of my fellow amateurs had given their lives on that mountain.

On Tuesday, July 22nd, Lou was tuning across the DX portion of the 432-MHz band when he noted the KH6HME beacon transmitter. For those of you who are not familiar with what beacons are, I will digress for a moment to say that they are automated transmitters placed in-

to operation by individuals or groups worldwide for the purpose of propagation study. Another friend of mine in North Hollywood operates such a device from his home on 10 meters. Perhaps some of you have heard the W6IRT 10-meter beacon. In recent years, it's become one of the popular ways for DXers to see if 10 meters is open. The KH6HME operation in Hawaii is a similar undertaking on the 432-MHz band.

It was about 8:45 pm Pacific Time when Lou first spotted the beacon, but having heard it on numerous occasions from his San Diego QTH, Lou was not overly excited by the happening. To quote Lou: "I had heard this happen on many occasions, but usually it didn't hold in for very long." This time it did, and by Wednesday afternoon others were hearing it as well. This was mainly because Lou had alerted other VHF/UHF DXers that the beacon was audible in southern California. Also alerted that the UHF path was open between Hawaii and the mainland was Al Pachicko KH6IAA in the Island State. Unfortunately, Al was suffering from a severe cold at the time and was unable to make the trek to the top of 8000-foot Mauna Loa. Al did try to make the path to Lou on Wednesday evening from his home in Hilo, but he had no luck.

HAWAII ON 220

In 1959, K6NLZ worked KH6UK on 220 MHz CW for a few fleeting moments. Considering the equipment of the era, it was a true triumph of technology and just plain human persever-

ance. In late July of this year, Hawaii was again finally worked on 220 MHz, but this time it was a phone contact on 220 MHz FM. Here is the story from one of those who took part in this monumental achievement.

I doubt if the name Lou Ancaux or the callsign WB6NMT requires very much of an introduction. Many know Lou from his fine line of VHF and UHF equipment marketed under the name Lunar Electronics. Others know Lou as a member of the League's VHF/UHF Advisory Committee or as one of the nicest people you can meet or talk with on the air. You might say that Lou typifies the devoted amateur of today, and one of his most avid interests is VHF/UHF weak-signal DXing. The details of this story came to me from Lou, but there were other amateurs involved who all deserve credit. As this story progresses, you will see who they are and, moreover, witness something not found very much elsewhere in amateur radio these days, a willingness to cooperate regardless of who might be the one whose name goes down in the record books. I am firmly convinced that the last true vestige of old-time amateur spirit is found among the VHF/UHF DX crowd. You will soon see why.

Al was feeling better on the 24th, and agreed to drive up the mountain if Lou could be home around noon Pacific Time to try the path. Al went up the mountain, but no contact was made until about 5:30, when Lou and Al made the path on 432-MHz SSB. Among those alerted to the

opening had been Dr. Wayne Overbeck N6NB. You might remember that Wayne was recently named "Ham of the Year" by the Dayton Amateur Radio Association. Wayne had made a trek of his own to a hilltop in Orange County and was also able to work Al on the 432-MHz path.

Shortly after 6:00 pm, Lou heard Al come onto 220-MHz FM, and was able to QSO him on 223.5 MHz. Lou's contact was followed by one between Al and Wayne, and then Wil Anderson AA6DD also was able to make the 220-MHz FM path. At this time, both sides of the path were running horizontal polarization. Al then switched to vertical and, although he was heard in Santa Barbara, California, no QSO could be made. At 8:00 pm Al showed up on 2 meters SSB and again Lou was able to QSO him. At times, he was peaking S-9 into San Diego. The next hour was spent in trying to get KH6IAA in contact with as many mainland stations as possible, but few could hear him. At 9:00 pm the operation was secured, but in its wake a new record had been set: Hawaii to the mainland on three bands, one of them 220-MHz FM for the first time.

I have related this story as told to me on the phone by Lou. It's ironic that more amateurs do not recognize what can be done with a bit of time, patience, and cooperation. Above all, these were the ingredients that made this event possible. I think that even the most avid HF DXer can learn a lot from the VHF weak-signal enthusiast.

W2NSD/1

NEVER SAY DIE

editorial by Wayne Green

from page 8

of souvenir shops clustered around an old castle on top of a hill. I don't think I've ever seen so many virtually identical souvenir stands all in one tiny area...and that includes the tourist meccas of Mexico, Pisa, and the peak of Mt. Washington.

The tourist areas which attract the more affluent travelers tend to have boutiques rather than souvenir shops. These start out with leather belts, belt buckles, leather handbags, and get into designer clothes and furs on the high end. Vail and Aspen are packed with these more expensive stores.

The restaurants tend to reflect the income levels of the visitors, too, with the busload and souvenir shop areas featuring hot dog stands and Aspen about one hundred restaurants, most of them in the \$10 to \$20 per dinner bracket. Sherry and I have learned how to deal with that situation...as well as the overloaded plate syndrome. We normally order one meal and two plates and find that we have no problem getting more than enough to eat...and at considerably lower cost. You have to watch out for us tight Yankees.

I've often wondered who buys all those souvenirs. I've bought a few coffee mugs with place names on 'em, but that's about

the extent of my souvenir purchases. There are tens of thousands of such stores, so obviously there are millions of people buying stuff. Not that boutiques do any better with me... I'm just not a spender.

Yes, I know that I can't take it with me...so I'm not going.

I hope that many of the industry people will come to the Vail meeting this January 10-17th and help to make our industry grow.

MILLER MAKES FORTUNE

Old-timers in the DXing game will tell you stories about the legendary Don Miller who, some 15 years ago, was moving around the world to one rare

spot after another, in the greatest DXpedition of all time. Oh, there were some spoilsports who were claiming that Don wasn't perhaps always exactly where he claimed to be, but then a country worked was a country earned, and it was better not to look too closely at things like that.

Besides, if Don was cheating a bit, he wasn't the first, by any means. More than a few well-aimed questions had been asked of Dick McKircher W0MLY and his North African DXpedition as well as of good old Gus Browning W4BPD, the immediate predecessors of Don... and perhaps his mentors, in a way.

Miller got a bit careless in his work and was exposed in *73 Magazine*, for which he brought a \$650,000 suit, claiming that *73* had deprived him of his means of making a livelihood as a DXpeditioner. Never mind that it is illegal to make money this way. Miller was proven a liar about one expedition and more than serious questions were raised about many of his other operations, so he dropped out of sight for a while.

The next I heard he was a very successful doctor and was opening up clinics in California to reap the Medicare funds... and was worth millions. Having known Miller pretty well, this seemed likely.

Miller recently made the news for several things, with a nice piece in *Fortune* magazine (August 25th issue, page 28). First, it seems that he had brought suit against a hospital for refusing to accept him on its staff and the Jerry Brown majority of the California Supreme Court had ordered the hospital to reconsider his application, feeling that just because Miller was known to be abrasive, hypercritical, outspoken, controversial, litigious, and personally offensive to some of his colleagues was no real reason to blackball him.

On the same day that the Supreme Court story broke in one paper, another headlined a story about Miller being sentenced to 25 years in prison for conspiring to murder his wife, with another trial pending on charges that he had burned down his own clinic for insurance fraud. Presumably the Supreme Court of California will back down, liberally minded

though they are.

The Miller DXpedition story was a wonderful one. Miller wanted to write a series about it for *73 Magazine* at one time, but after looking into it, I begged off and CQ went along with the story for many, many months. During the time when Miller was on speaking terms with me, he called one day to ask if I would be interested in accompanying him on a forthcoming trip to the Indian Ocean. That sounded like fun, so I listened a bit more. His plan, as he outlined it, was to operate from a number of rare spots. The only klicker was that he would always sign the call of the last place he had operated... thus never signing the call of the actual operating spot. I lost interest.

Miller blamed the ARRL for his weird plots. He had cooked up a DXpedition to some place not far from Japan while he was in the Army there. He asked the ARRL whether this would be considered a new country or not. They said they thought so, but would make the final decision later. He kept pushing them and they finally gave him a verbal okay. He went to the spot, put on a great DX operation, and later found that the League had decided it was not a new country, but had neglected to tell him about this. The news, he claimed, arrived via a letter sent by sea mail.

From then on, Miller was bent on getting even with the League. He set out to destroy their DXCC Honor Roll. He charged the higher up listees \$25 a country to work him... or else lose out and forever be one down from their lifelong won spot on THE LIST. Many famous DXers got fed up with this and quit the fight rather than have to pay for every Miller operation.

Questions as to the authenticity of more and more Miller operations arose. Bearings were taken of operations from islands and reefs which showed him to be thousands of miles from where he claimed. I got word that he had visited Canberra and swiped some pictures of Heard Island from the archives. These were later published in *CQ* as proof that he had been there. Never mind that he was known to be half a world away a couple days before he went on the air signing the Heard Island call. Gus claimed that Miller had called him and

asked if he would like to work with him on the Heard Island operation... to actually take place not far from Vancouver, Canada.

I went to Burma and checked to see how he had managed to operate from there. The officials and local hams said "no way." It appeared that he had probably set up in Thailand and signed the Burma, Cambodia, Laos, and Spratly Island calls. Thousands of us got nice QSL cards from these operations and ARRL dutifully counted them just as if they were authentic... so everyone was happy.

Things began to go wrong in bunches for Miller. He claimed that he was making over \$50,000 a year... tax free... in donations from DXers. After talking with a lot of the top men in the hobby, I don't think Miller was exaggerating. But his falsified credentials, vagueness about documentation, and a growing list of countries refusing to allow him entry began to catch up with him. Miller set back U.S.-Indian ham relations years when he apparently forged a letter giving him permission to operate from their ultra-rare Laccadive Islands. He went on the air, claiming to be there and to have a license. India investigated and said the license was a fraud and that he had not even been near the islands.

The Colvins, who have gone out of their way to put on the cleanest DXpeditions on record, also put the lie to some of Miller's claimed operations. They provided a good deal of hard-to-get documentation which showed several Miller DXpeditions to be fakes.

73 Magazine reported this at the time and suffered a protracted law suit by Miller as a result. This cost thousands of dollars, though much of the expense was covered by insurance. One of the results of that is our having a whole box full of old Miller logs taken as an exhibit in the case. Miller was a wonderful operator.

I don't know how long a 25-year sentence takes to do, but judging from a ham murderer who got a similar conviction, Miller may be out again in a few years. The medical profession may not want him practicing again, so perhaps Miller will take up DXing in the late 80s. He certainly knows how to make it pay off handsomely.

YOU CAN'T FIGHT CITY HALL

Yes, you can! And the time seems to be here for a bit of a tussle if we want to preserve some of our long-accepted privileges. We are so used to our "right" to own an all-band receiver that we tend to forget that amateurs in many other countries are forbidden to even own equipment which is capable of tuning in many non-ham frequencies.

We've had frequent efforts by city and state governments to make laws prohibiting the use of radio receivers and, in each case, when the matter was fought, the FCC's posture has been to protect the Communications Act of 1934 wherein anyone is permitted to tune in *any* radio channels. Section 605 does prohibit the divulging or using for commercial benefit the information contained in radio signals, but there are and have been no restrictions on receiving.

Unless we permit our government to start setting up limitations on reception, we will continue to be free to buy or build and use receivers for any of the radio channels. If we let our city, state, or even the federal government pass laws restricting reception, we will be on the road to ever more restrictions. Laws prohibiting the personal use of receivers in cars capable of receiving police channels are not valid laws. The prohibition of receivers for 10 GHz (radar) is clearly illegal.

Now comes Representative Richard Preyer (D-N.C.) with a bill to change the Communications Act of 1934 so as to prohibit the reception of certain radio communications. The bill says it is "to protect the privacy" of some telecommunications users. The bill seems to have been written by the pay TV people for the benefit of the pay TV companies, and to hell with the interests of over 30,000 hams and thousands more experimenters.

We have already seen the HBO crowd using their lawyers to harass amateurs who dare to write and have articles published which describe microwave receivers for a ham band near the HBO channels. A current suit is costing amateurs tens of thousands of dollars... with the result that the fear of more such frivolous harassment suits has stopped the writing

and publishing of information on several of our microwave ham bands.

This group also tried to get the FCC to take away the amateur licenses of writers of articles on equipment which even *could* be used to intercept their signals... even though there is no law prohibiting such reception. They also tried to get the FCC to further punish both the authors and the magazine editors and publisher by asking that they be fined by the Commission for the publication. The FCC turned all these demands down... reiterating their policy

that all radio channels are open to the public and are not owned by corporations.

But, with the pay TV people all pushing hard through every means at their disposal and with billions of dollars riding on the development of this market, you may be sure that these firms will not spare any expense in legal harassment or intimidation. Unless amateurs make a concerted effort to fight back every try at taking away our rights, we will lose them.

If you live in any of the following states where a congressman is on either the Interstate and

Foreign Commerce Committee or the Judiciary Committee, then start putting on the screws. Make sure you call them when they are at their home office and tell them you don't want more freedoms given up for the sake of protecting the profits of the pay TV people. Write them, at the House of Representatives, Washington DC 20510.

| | |
|----------------------|------------------|
| Gudger (D-NC) | Railsback (R-IL) |
| Volkmer (D-MO) | Fish (R-NY) |
| Harris (D-VA) | Butler (R-VA) |
| Synar (D-OK) | Moorhead (R-CA) |
| Matsui (D-CA) | Ashbrook (R-OH) |
| Mikva (D-IL) | Hyde (R-IL) |
| Barnes (D-MD) | Kindness (R-OH) |
| Shelby (D-AL) | Sawyer (R-MI) |
| McClory (R-IL) | Lungren (R-CA) |
| Sensenbrenner (R-WI) | |

HOUSE COMMITTEE ON INTERSTATE AND FOREIGN COMMERCE

| | |
|--------------------|-----------------|
| Staggers (D-WV) | Ottinger (D-NY) |
| Dingell (D-MI) | Waxman (D-CA) |
| Van Deerlin (D-CA) | Wirth (D-CO) |
| Murphy (D-NY) | Sharp (D-IN) |
| Satterfield (D-VA) | Florio (D-NJ) |
| Eckhardt (D-TX) | Moffett (D-CT) |
| Preyer (D-NC) | Santini (D-NV) |
| Scheuer (D-NY) | Maguire (D-NJ) |

HOUSE COMMITTEE ON THE JUDICIARY

| | |
|--------------------|------------------|
| Rodino (D-NJ) | Danielson (D-CA) |
| Brooks (D-TX) | Drinan (D-MA) |
| Kastenmeier (D-WI) | Holtzman (D-NY) |
| Edwards (D-CA) | Mazzoli (D-KY) |
| Conyers (D-MI) | Hughes (D-NJ) |
| Seiberling (D-OH) | Hall (D-TX) |

96TH CONGRESS
2d Session

H. R. 7747

To amend the Communications Act of 1934 to prohibit the unauthorized interception and use of subscription telecommunications and to protect the privacy of the users of such telecommunications.

IN THE HOUSE OF REPRESENTATIVES

JULY 2, 1980

Mr. PETER introduced the following bill, which was referred jointly to the Committees on Interstate and Foreign Commerce and the Judiciary

A BILL

To amend the Communications Act of 1934 to prohibit the unauthorized interception and use of subscription telecommunications and to protect the privacy of the users of such telecommunications.

Be it enacted by the Senate and House of Representatives of the United States of America in Congress assembled,
That the Communications Act of 1934 (47 U.S.C. 15 et seq.) is amended by inserting after section 5 the following new section:

"UNAUTHORIZED INTERCEPTION AND USE OF SUBSCRIPTION TELECOMMUNICATIONS

"Sec. 6. (a)(1) Except as provided in paragraph (4), a person who—

"(A) knowingly carries out an unauthorized interception of a subscription telecommunication; or

"(B) knowingly attempts to carry out, or conspires to carry out, an unauthorized interception;

shall be liable for civil penalties under subsection (b) and shall be subject to criminal penalties under subsection (c)(1).

"(2) Except as provided in paragraph (4), a person who—

"(A) knowingly carries out an unauthorized interception of a subscription telecommunication; and

"(B) knowingly uses the subscription telecommunication for his own commercial advantage or financial gain, or for the commercial advantage or financial gain of any other person;

shall be liable for civil penalties under subsection (b) and shall be subject to criminal penalties under subsection (c)(2).

"(3) For purposes of this subsection, the interception of a subscription telecommunication by any person shall not be considered an unauthorized interception if—

"(A) such person is the originator of the subscription telecommunication, or his agent;

"(B) such person has agreed to pay a fee or charge to the person originating the subscription telecommunication, or his agent, for the use of the subscription telecommunication;

"(C) such person has entered into any other contractual arrangement or any other agreement under which such person is entitled to receive the subscription telecommunication from the person originating the subscription telecommunication, or his agent; or

"(D) such person has reasonable cause to believe that such person is entitled to receive the subscription telecommunication from the person originating the subscription telecommunication, or his agent.

"(4) The provisions of paragraph (1) and paragraph (2) shall not apply to any interception which is authorized under chapter 119 of title 18, United States Code.

"(b)(1)(A) Except as provided in subparagraph (B), any person who is aggrieved by any violation of subsection (a) may commence a civil action for actual damages, for damages under paragraph (2), and for equitable relief against the person who is alleged to have committed the violation.

"(B) No civil action may be commenced under subparagraph (A) after the end of the 2-year period following the date of the discovery of the alleged violation, or the 7-year period following the date of the occurrence of the alleged violation, whichever occurs first.

"(2) Any person who violates subsection (a) shall be liable to any aggrieved person for damages in the amount of \$100 per day for each day in which the violation occurs, except that any damages awarded under this paragraph shall not be more than \$1,000.

"(3) In any civil action under this subsection in which the court determines that the plaintiff has substantially prevailed, the court may assess against the defendant reasonable attorney fees and other costs of litigation reasonably incurred, and the court may award, for a violation of subsection (a)(2), such punitive damages as it considers appropriate. Any punitive damages awarded by a court under this paragraph shall be in addition to any other damages or equitable relief awarded by the court under this subsection.

"(4) Any civil action under this subsection may be com-

menced in any United States district court of competent jurisdiction, without regard to the amount in controversy, or in any other court of competent jurisdiction.

"(c)(1) Any person who violates subsection (a)(1) shall be fined not more than \$25,000, or imprisoned for not more than 1 year, or both.

"(2) Any person (other than an individual) who violates subsection (a)(2) shall be fined not more than \$1,000,000. Any individual who violates subsection (a)(2) shall be fined not more than \$250,000, or imprisoned for not more than eighteen months, or both. If the conviction is for a violation committed after the first conviction of the individual under this paragraph, the individual shall be fined not more than \$250,000, or imprisoned for not more than forty months, or both.

"(d) The penalties established in this section shall be in lieu of any penalties established in any other provision of this Act.

"(e) For purposes of this section:

"(1) The term 'basic telecommunications service' means that basic two-way switched voice telephone service which is provided as an interstate telecommunications service on the effective date of this section and which is provided on a universal basis to the general public. Such term includes any other interstate telecommunications service which the Commission, from time to time, determines by rule is recognized as an essential part of an efficient nationwide system of basic telecommunications.

"(2) The term 'interception' means the receipt of any subscription telecommunication.

"(3) The term 'subscription telecommunication' means any telecommunication, other than basic telecommunications service, which is intended for receipt in intelligible form only by a person who has agreed to pay a fee or charge to the person originating the telecommunication, or his agent, and any other telecommunication incident to such telecommunication.

"(4) The term 'telecommunication' means any transmission, emission, or reception of signs, signals, writings, images, and sound or intelligence of any nature by wire, radio, optical, or other electromagnetic systems."

- | | |
|-----------------|-------------------|
| Russo (D-IL) | Carter (R-KY) |
| Markey (D-MA) | Brown (R-OH) |
| Luken (D-OH) | Collins (R-TX) |
| Walgren (D-PA) | Lent (R-NY) |
| Gore (D-TX) | Madigan (R-IL) |
| Mikulski (D-MD) | Moorhead (R-CA) |
| Mottl (D-OH) | Rinaldo (R-NJ) |
| Gramm (D-TX) | Stockman (R-MI) |
| Swift (D-WA) | Marks (R-PA) |
| Leland (D-TX) | Corcoran (R-IL) |
| Shelby (D-AL) | Lee (R-NY) |
| Devine (R-OH) | Loeffler (R-TX) |
| Broyhill (R-NC) | Dannemeyer (R-CA) |

Big Brother looking into our ham shacks to make sure we are not breaking the law.

Remember that first comes the small restriction...then comes the police to make it stick with the enforcement. With each step of the way along this path, we lose freedom. Next come further exceptions to the things which can or cannot be listened to...and since the precedent is there, this step is simple compared to the first one. This will bring further policing of the laws and more intrusion into our lives and hobby.

The mess with the ten-meter linears should serve as an example of what can happen when we don't make an effort to protect ourselves.

EGO REPORT

Someone apparently commissioned a report on the "ego count" in the 1979 ARRL Annual Report. This is a count of the use of the words "I" and "my" by the various people reporting. At first the analysis seemed as if it must have been contrived, but no, it turned out to be reasonably accurate.

The top ego award goes where all who know him would expect: Harry Dannals won hands down with a score of 30 in his modest report. He was followed by Stan Zak, who managed to cram 22 "I" and "my" references into his one-page report...possibly an all-time record. Harry Thurston was close

on his heels with 18 in his one-pager, which will be no surprise to hams in the Northwest where his ego is legend.

On the positive side of the ledger is one single use of "I" by Baldwin in 27 pages. That shows what *can* be done.

In general, the ARRL report, which is worth the buck, grumbled about a downturn in membership, was excessive in applause for winning everything single-handedly at WARC (a position not shared by other national amateur radio societies), and a unanimity of concern over the long-range pursuit of amateur interests both nationally and internationally, which many directors seem to feel is inadequate.

FUN!

from page 30

ELEMENT 4—MATCHING

Match the past and present 2-meter rigs in Column A with the manufacturers in Column B.

- | Column A | Column B |
|--------------------------|----------------------|
| 1) 13-510A | A) Tempo |
| 2) FM144-10SXRII | B) VHF Engineering |
| 3) Carfone | C) Drake |
| 4) FT-221 | D) Yaesu |
| 5) 1402 SM | E) Satan Electronics |
| 6) Voice Commander III | F) Heathkit |
| 7) HR-2A | G) Kenwood |
| 8) TRX 144 | H) Azden |
| 9) VHF-1 | I) RCA |
| 10) FM-2X | J) Motorola |
| 11) FM-DX | K) Midland |
| 12) GTX-202 | L) General Electric |
| 13) Brimstone 144 | M) Icom |
| 14) Multi 11 | N) Collins |
| 15) IC-22 | O) Swan |
| 16) TR-2200 | P) KLM |
| 17) HW-2036 | Q) Wilson |
| 18) Metrum II | R) Genave |
| 19) Marker-Luxury (ML-2) | S) Regency |
| 20) PCS-2000 | T) Clegg |
| | U) KDK |

- 6) "Duplexer" and "cavity resonator" are different words for the same unit. _____
- 7) The 220-MHz National Simplex Frequency is 222.50. _____
- 8) On crystal-controlled rigs, channel 9 is reserved for emergencies. _____
- 9) You may not use a vfo-equipped rig on a repeater. _____
- 10) The standard ATV repeater split is 439.25/427.25. _____
- 11) An "alligator repeater" is a nickname for a machine that transmits over a further distance than it can receive. _____
- 12) Another name for a COR is "squelch relay." _____
- 13) The term "autopatch" originally got its name from the fact that you used it from an automobile. _____
- 14) Hard-line is cheaper than coax. _____
- 15) PL-259s are called "UHF connectors" because they work well above 400 MHz. _____
- 16) If King Kong were to climb the Empire State Building today, he would find a repeater antenna on the way up. _____
- 17) The standard 220-MHz repeater split is 1.6 MHz. _____
- 18) AM repeaters are illegal. _____
- 19) Frequency coordinator appointments are subject to approval by the local FCC Field Office. _____
- 20) No repeaters are allowed on 6 meters due to TVI problems. _____

ELEMENT 5—TRUE-FALSE

- | | True | False |
|---|-------|-------|
| 1) Facsimile (F4) transmissions are legal on 2-meter repeaters. | _____ | _____ |
| 2) F-layer propagation is common on 220 MHz. | _____ | _____ |
| 3) "Rubber Duckies" are a type of HT antenna. | _____ | _____ |
| 4) Most repeater antennas are horizontally polarized. | _____ | _____ |
| 5) Ham jargon for a fluttery mobile signal is "picket fencing." | _____ | _____ |

THE ANSWERS



Element 1:

See illustration.

Element 2:

1-2 Transmitting on the old 5-meter band, W1AWW (no connection to W1AW) relayed AM transmissions over distances as far as Boston and New York.

2-3 As the name implies, the original "Captain Crunch" whistles were found in Cap'n Crunch cereal boxes.

3-4 Still faithfully serving many "unsynthesized" FMers, the Motorola HT-220 was once known as "The Collins of 2 meters."

4-1 Although you had to file a separate (and very complicated) application with the Commission, you still used the trustee's call. Within a decade, knowing the FCC, we'll probably be back using WR calls.

5-3 As a part of the FCC's postwar amateur band realignments, the old 2½-meter band (112-118 MHz) was shifted to today's familiar 144-148-MHz position in 1945.

Element 3:

(Reading from left to right) deviation, duplex, jammer, transmitter; autopatch, control, whip, squelch; timer, site, machine, spur; oven, mobile, mast, amplifier, cor, portable, station, rejection.

Element 4:

1-K, 2-U, 3-I, 4-D, 5-Q, 6-L, 7-S, 8-B, 9-A, 10-O, 11-T, 12-R, 13-E, 14-P, 15-M, 16-G, 17-F, 18-J, 19-C, 20-H.

Element 5:

- 1) False—FM FAX is not allowed on 2 meters, but AM FAX is.
- 2) False—F-layer propagation rarely even makes it to 6 meters.
- 3) True—They're those little black antennas that often end up poking other hams in the eyes.
- 4) False—Vertically polarized.
- 5) True—Sounds like you're talking while running past a picket fence.
- 6) True—A duplexer by any other name would still cost a bundle.
- 7) False—It's 223.50.
- 8) False—What do you think this is, CB?
- 9) False—Why not?

- 10) True—Wide split for a wide mode.
- 11) True—And the opposite is a "rabbit-repeater."
- 12) True—Obsolete.
- 13) False—Means an automatic phone patch.
- 14) False—And a KWM-380 is cheaper than an HW-101.
- 15) False—Back when 50 MHz was UHF perhaps; today you better get some BNCs.
- 16) True—WB2IMT/R, 222.66/224.26.
- 17) True—Nice, wide spacing. Helps lessen desense.
- 18) False—Not at all.
- 19) False—No way.
- 20) False—Tell that to your local 6-meter repeater group.

SCORING

Element 1:

See illustration. Twenty points for complete puzzle, or ½ point for each question you got.

Element 2:

Each correct answer nets you four points.

Element 3:

One point for each word successfully unscrambled.

Element 4:

Give yourself one point for each rig you correctly matched to its manufacturer.

Element 5:

One point for each correct answer.

Total up your points and see how you rank in the repeater pecking order:

- 0-20 points—Jammer
- 21-40 points—Kerchunker
- 41-60 points—Mail-order Tech
- 61-80 points—Control operator
- 81-100 points—Repeater trustee

Next month: Specialized Modes

LETTERS

from page 26

anything about aircraft mechanics, how to read instruments, how to navigate, or any of the rules and regulations of the sky. Will you be publishing a manual on FAA tests soon? If so, I do not want to hear you scream when my Piper Cub accidentally flies through your house because I don't know anything about it—I just want to fly.

**John F. Hauser KA4DLC
Pensacola FL**

MORE 10 FM

The 29-MHz FM Club has gained another member with my new Comtronix FM-80 operating off an OMNI-D or battery pack.

Your magazine has wisely pushed this mode on ten, suggesting channel 29.6 MHz as a DX listening/calling frequency.

Puget Sound has quite a number using this frequency for a variety of purposes, including transfer of computer programming data as well as rag chewing. As activity congests it, we will want to police things, leaving 29.6 for initial contacts, shifting to the generous handful of alternate channels nearby.

I would appreciate hearing from other users of FM on ten, particularly from FM-80 owners. An alternate listening/DX channel to 29.6 could possibly be 29.2—the FM-80 allows an instant switch from one to the other by pressing the Band A to Band B push-button. It's just a thought.

Using our Daiwa CN-620 power meter, we get 11 Watts into the antenna (whether longwire or whip) with 1:1 swr. The rig can be shoulder-strap supported with Gel-cell battery pack feeding a 53" ETCO Electronics

99¢ surplus whip through a miniaturized outboard-mounted transmatch network secured to the right side of the clamshell case, making an ideal spot to anchor the whip base.

**F. W. Anderson W7AR
Seattle WA**

NEW DX REPEATER

The first European 10-meter FM repeater started operation under the callsign DB0QK in Mainz, FGR, 20 miles southwest of Frankfurt (Main), in August, 1980.

The callsign is transmitted automatically every 45 seconds on an output frequency of 29.670 MHz for identification purposes. The station is intended for local and DX traffic use. Power output is currently 3 W, but will be increased to 15 W very soon. Antennas include two separate ground planes for receiver and transmitter.

Daily operating hours are from 6:00 am to 8:00 pm. The repeater is activated by a 1750-Hz tone burst on an input frequency of 29.570 MHz. Peak

deviation should be less than 3 kHz. Repeater specifications are similar to US standards.

Interested amateurs are invited to try the FM repeater during band openings. Correspondence should be directed to address given below.

**Amateur Radio DB0QK
Postbox 4040
D-6500 Mainz
Federal German Republic**

AUTOMATED DX

I am firmly opposed to your idea of automating DX contacts. By putting this type of operation into use, the whole concept of DXing will be totally destroyed. The human element would be removed for the sake of expediency—radio will be conversing with radio. All of the emotional highs and lows associated with DXing would be totally eliminated; operator skill would be unnecessary.

I am curious as to how you reached the conclusion that most rare DX operators QRT rather than face the DX hunters? Did you take any type of survey

or poll to support these conclusions? If this is the case, I wonder why DXing itself has lasted so long as an integral part of our hobby. In my opinion, most DX station operators are quite skilled and capable of holding a rag-chew if they so desire. True, there are some lads who will resort to low operating ethics to bust a rag-chew and work the DX station, but the majority of the DX hunters I have heard in operation are not of that nature. Also, by using a firm hand when dealing with lads, this idiotic type of operation will ultimately be ended.

DXing is one of the most interesting and exciting facets of amateur radio. To me, watching an automated radio work DX would be about as exciting as watching a lawn sprinkler.

Charles E. Daum WA4YZF
Lutz FL

TAKE A BROMO

I just had to write and tell you how much I enjoyed both the old-time broadcasting articles and the feature stories on some of the older ham gear. It is sort of a break in the writing and was very enjoyable. I would like to see more of it. The articles from the August issue are "Notes from Big Sky Country" and "Those Fabulous Fifties."

Incidentally, Wayne, I read your editorials, take a bromo, and go to bed (hi), but I do like the magazine in spite of that.

Jack Golden WA2YPW
Portville NY

HAVE SOME FUN

I would like to encourage all radio amateurs to stop for a moment and think about their hobby. In particular, reflect a bit on your use of the spectrum.

Do you operate 2m FM from dawn until midnight, mostly on, say, .22/.82? Maybe you park your 6m SSB rig on 50.110 and never move. Perhaps you live on 14.205 MHz or even 3.850 and your bandswitch has not been touched since you last renewed your license.

Why not try something new? If 75m phone is where you usually are, why not work up a 15m dipole some afternoon and pound a little brass? It is easy to go slow, and fairly easy to find a clear spot in the band!

Don't forget about 10 meters, either. Besides being good for DX, it is good for some local groundwave, too. It can be a solution to some awkward problems. For example, a bunch of guys wanted a local channel at a lake to use as an intercom between cabins, the boats, and a few vehicles. It was too expensive to buy 2m FM rigs that would be left in the cabins, so converted CB rigs were used, providing the desired service at a fraction of the cost of a 2m system. One fellow even home-brewed a crystal-controlled rig for 29.335 MHz. Hooray for him! So, in a few years when sun-spots are rare, keep up the activity on 10 meters via this mode.

If you find 2m FM boring, consider getting on 6m, 1 1/4m, or even 0.7m with some home-built transmitters and converters for your present 2m rig. All are good bands for local work, so do some exploring, even if it means QRP operation on one channel for a while. It can even have some good points. Suppose you and some buddies like to work DX on 20 CW most every evening. You can trade tips on who is where on the band on some UHF gear. Cook up something on 425 MHz. The band is big at 0.7 meters.

There are plenty of opportunities to build or modify rigs when expanding your horizons. As a club project, your group may acquire four or five of the toy-type 49-MHz HTs and put them somewhere on 6 meters. The club members could borrow them as needed to save lung power when doing antenna work requiring ground coordination. It takes only a few milliwatts to do the job. Start with a pair and add units as required by popular demand.

We have the spectrum; let's have some fun.

Jim Swaters WB0IXI
Kansas City MO

GETTING STARTED

Do you really mean everything that you write about? I wonder. You bemoan the need for more amateurs and the slow growth of the hobby in nearly every issue. Yet you have increased the price of 73 by 67%, which will probably scare off more people who might have been attracted to the hobby. Of course, I rushed to extend my subscrip-

tion at the old price and crossed my fingers that the computer will not mess up.

Even though I am not yet a ham, I find 73 interesting, but it is poorly lacking in articles directed toward the beginning ham or those of us who have yet to get started. Why not start a major effort in this direction? If the hobby is to grow, something must be done now.

One last complaint: Please, if you need to hire more staff, I would like you to search quietly, rather than tell of your need in 73. As one of your neighbors in a nearby town, I would rather that the world did not learn about our area.

Frederick Breton
Surry NH

WINNERS

The Foundation for Amateur Radio announces the 1980 winners of the seven scholarships which it administers.

John W. Gore Memorial Scholarship (\$900)

Darryl F. Mihalek WB4JZT
Charleston SC

Richard G. Chichester Memorial Scholarship (\$900)

Katherine Hevener WB8TDA
Franklin WV

QCWA Silent Key Memorial Scholarship (\$900)

Maureen Porter KA0BSR
Denver CO

Radio Club of America, Inc.,
Scholarship (\$500)

Brian D. Miller KA0DGT
Englewood CO

Edmund B. Redington Memorial Scholarship (\$500)

Gregory Polanchyck N3GP
Frackville PA

Edwin S. Van Deusen Memorial Scholarship (\$350)

Nicholas A. Ferro, Jr. WA2SFS
Lake Placid NY

Young Ladies Radio League
(YLRL) Scholarship (\$300)

Ann Waines KA8CSM
Shelby OH

These scholarships were open to all radio amateurs holding at least a General class license or equivalent. This year's applications were received from 31 states and Denmark. The Foundation is a nonprofit organization representing fifty-one clubs in Maryland, the District of Columbia, and northern Virginia. It is devoted exclusively to promoting the interests

of amateur radio and to the scientific, literary, and educational pursuits that advance the purposes of the Amateur Radio Service.

Hugh A. Turnbull W3ABC
College Park MD

RESPONSIBILITY

I'm writing about your little column in the August issue of 73 pertaining to the NARA.

Frankly, I'm surprised that you have not heard about its formation. I hope the skunk you refer to as a rip-off specialist is not the guy listed as national director—he seemed pretty sincere and honest. That's only an observation, not a fact. Apparently, you have several facts relating to this individual. I hope if it's bad you can blow his cover and I hope if it's OK you will support it. But either way, I'm sure you will find out.

I responded to an article that was in *HR Report* in April, but if this guy is a bad egg, I'd like to see him fry. From what Bob Stankus said in a letter to me, he was getting 50 letters a day and you can realize what this brings to the surface. Why don't *HR Report*, 73, *QST* and all the other magazines investigate or qualify the sincerity and integrity of an advertiser other than simply accepting a check? Other than the profit gained for the magazine by taking an ad, where does the responsibility lie in recognizing a rip-off from a sincere advertiser with integrity? Does it lie with the magazine for not screening a company or does it lie with the magazine's subscriber who is simply supporting the advertisers in the magazine and he is the one who takes the beating and loss?

Personally, I don't think it's fair, and although the magazines claim that they're not responsible for the companies that advertise, maybe they should be totally responsible since they have taken the ad and been paid first. That proves that they are responsible for themselves—maybe they should be responsible for their subscribers not getting ripped off.

Examine the number of quick-buck schemes that come up. Most of them come from advertisements in magazines. If the magazine was stringent in accepting ads, most quick-buck

schemes would never reach the amateur community.

The above is a thought you may or may not agree with, but think of it for a moment and eliminate *blame* from your thought.

**Tony Musero K3UKW
Philadelphia PA**

Well, Tony, some of the magazines (one, at least) go to a lot of trouble to try to protect readers from rip-offs. I do write about this every now and then, explaining the situation, but it is not a happy one. There are known rip-off firms and some of the ham magazines are running their ads . . . knowingly.

One of the several strains between HR and 73 has to do with some of the advertising they accept and by inference endorse. When a firm is trying to sell a lousy product or is providing unforgivable service, I cut them off and refuse to run their ads. It is frustrating to see their ads in HR and CQ . . . and even in QST. Right now, we are passing up several thousand dollars a month in advertising revenue by trying to be good guys and I see no sign that anyone really gives a damn. I see the ads for these rip-off firms in the other magazines and though they are not able to screw as many people as they could if I permitted them to advertise in 73, they are doing well enough to stay in business, at least for a while.

Now, when a new firm comes out of the woodwork with no history, that presents some problems which are difficult to surmount. Let's say some chap in Seattle sends in a quarter-page ad. How can I find out if he is straight or a rip-off? This is complicated by one other factor . . . the inadvertent rip-off. I can't jump on a plane and zip out to Seattle and see what is happening. What we do is request bank and other financial references. We try to follow up on these as best we can. We also demand prepayment for the first ads, having found that rip-offs usually try to rip off the magazines, too, and this gets many of them out of our hair.

But let me give a horrible example. We had a firm advertising in Kilobaud Microcomputing a couple of years ago . . . World Power. We went through all the regular procedures, with bank references and prepayment for the first ads. Their bank refused to give us any information at all, good or bad. I called a chap I knew in Tucson and asked him to trot on over and check 'em out. He called back a couple of days later and said they looked legit. He had a friend of his check, too . . . another positive report.

The World Power ads ran in all of the computer magazines and looked awfully good. The firm ripped off the industry for over half a million dollars. The chap

who pulled it off is in prison now, but he not only fooled the magazines and the local computerists, but even the people working for his firm. This disaster has made the industry jumpy and brought out the Captain Queeg in at least one industry leader who got wind of the problem early.

On the other hand, there are the rip-offs which are not intended. I can't even complain about that because 73 has been a terrible offender in the past. It is exceedingly frustrating to try to run a business and find that employees are lying and covering up their own bad performance. Right now, we are getting QSL card orders out within a few days of receipt, but at one time they were months behind, with everyone responsible shrugging their shoulders and passing the buck.

Even worse were the subscription problems we had as a result of our Prime computer problems. Thousands of readers had their subscriptions screwed up, with virtually no help whether they called in or wrote. The chap who managed the customer service response to the computer disaster is now with another magazine, bless him. I was assured that all was okay and not to worry, while the complaints went from dozens to hundreds to thousands.

There still has been no solution to the Prime computer sit-

uation, despite promises by Prime of cooperation. Well, I'll see them at NCC again next year and see what they say. Their plant is almost an hour's drive from the 73 headquarters so I can see why they might not be able to get to see me for a couple of years or so. After three years of regular complaints at the NCC shows and many letters, they are beginning to recognize me and blanch when they see me coming.

Getting back to advertiser rip-offs, again I want to say that I plead with all readers to let me know as soon as possible of any spotted. If you run into bum products or lousy service, I want to know about that, too, but in a different form. Here, I want you to write to the offending firm and give the details, with a copy marked to me. I'll see that we follow up on it. We usually get results.

I don't know how to let you know when a firm is under suspension of ads. So far, my lawyers refuse to let me publish our list of blackballed firms and there are a few companies not advertising in 73 out of choice, usually because they hate my editorials more than they like the sales they would get by advertising. That doesn't influence me in the slightest and it makes them pay dearly in lost sales, so I'm not sure what they think they are proving.—Wayne.

NEW PRODUCTS

from page 41

plifier, keep looking! If what you need is an attractive, inexpensive table to fit into a small space and hold a reasonable amount of compact gear, check out the Radio Shack Space-Saver Desk!

For further information, contact *Radio Shack*, a division of *Tandy Corporation*, 1300 One Tandy Center, Ft. Worth TX 76102. Reader Service number 487.

**Paul Grupp KB0NV/1
73 Magazine Staff**

MFJ ACTIVE ANTENNA

With the new resurgence in in-

terest and equipment for shortwave listening, new accessories for the SWL are popping up as well. Hopefully, this is a positive growth sign for the industry.

Because modern shortwave receivers boast incredible sensitivity when compared with their tube-type forebears, small antennas are now just as effective as the skywires of decades ago.

One outstanding innovation in shortwave reception is the active antenna. A small signal-collecting "voltage probe" dipole or whip, usually only a few feet in length, delivers its tiny signal to a matched amplifier which, in turn, presents a whopping signal to a receiver. The system is

as effective—often more so—as a hundred-foot longwire!

While several manufacturers are now advertising active antennas, one of the most compact and effective is the new model 1020 from MFJ.

Designed to cover all received signals from 300 kHz through 30 MHz, the 1020 is a very compact handful (5 × 2 × 6 inches) and may be powered by an internal 9-volt battery (clip provided), external 12 volts dc, or an ac adapter (provided).

Advantages of such a receiving system are obvious: It is tiny and unobtrusive with its 22" whip extended; it is not lightning-prone as would be an outside antenna; no cumbersome, insulated, wind-prone, corrodable eyesore need be erected with its vulnerable down-lead. And the 1020 is tunable, providing a measure of preselection as well.

Naturally, if the listener already has an outside antenna which works well, resistance to purchasing an active antenna is understandable. However, even a ham will find benefit with such a receiving system. For one thing, the antenna may be swiveled to optimize the incoming signal. For another, the 1020 has an rf gain control which controls receiver overload to help reduce intermod and images. And for yet another, the high-Q preselection can get rid of unwanted noise which often overpowers even high-quality receiving equipment.

The common drawback for any indoor receiving antenna is its vulnerability to ac line-radiated electrical noise. Housing wiring surrounds the listener and his antenna, and noisy appliances can raise the background level of interference while receiving. But the swivel

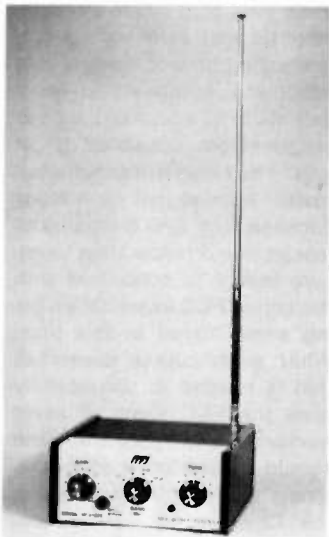

The MFJ-1020 active antenna.

antenna may take care of that; experimentally try manipulating it through its various planes until a noise null reduces the interference and you have now turned a disadvantage into an advantage: You can't rotate that skywire for minimum noise pick-up!

The 1020 has a bright LED which alerts the user that it is on. A push-button functions dually as a power switch and antenna bypass so that the 1020 may be used alternately as an active antenna or controlled-amplification preselector.

Five bands comprise the continuous tuning; calibration is close, although the loading effect of a large external antenna will reduce dial accuracy. Since tuning is done more with the S-meter and ear than by dial readings, the calibration error is insignificant.

The Innards

As often happens with modern solid-state equipment, the inside of the 1020 is mostly empty space. A small 2-3/4"-square circuit board occupies a front corner of the Ten-Tec cabinet, while the remainder of the box provides rigid support for the extended whip and fat fingers which must manipulate the controls. Rubber feet cushion the cabinet on a desk or radio.

The circuitry is very straightforward: Two series 2N5486 FETs drive a bipolar 2N5179 for the preamplifier circuitry. Gain is controlled by a potentiometer between the second FET and the base input of the output transistor.

A 320-pF variable tuning capacitor is alternately switched between five different inductances for the bands of coverage.

Our Test

The MFJ-1020 active antenna was extremely simple to use. There is a natural inclination to ignore reading the instructions and just plug it in and use it. Resist the temptation; all owner's manuals contain *something* worth reading!

We found that although the 1020 did raise the noise floor of our receiver, signal strength improvement more than compensated for the increased background hiss.

The active antenna was compared with a 135-foot Windom dipole elevated some 30 feet above ground. In more than 90% of the discrete frequencies compared from 2-30 MHz, the MFJ-1020 active antenna equalled or exceeded the reception on the mammoth dipole! And even on the remaining few percent where the Windom provided slightly higher signal levels, signals on the 1020 were perfectly readable. At night, when high-level shortwave signals can be a nightmare, the 1020 consistently outperformed the Windom, especially at the higher frequencies, due to excessive signal voltages at all frequencies coming from the Windom.

We found the 1020 to be useful as a preselector as well. While modern communications receivers have high i-f selectivity and rf sensitivity, they are often vulnerable to spurious signals resulting from front-end overload. The sharp high-Q tuning of the 1020 sharply reduced strong images from shortwave powerhouses. Some juggling of the 1020's gain control and the receiver's rf gain or attenuator will optimize the desired signal.

If you are debating the possibility of improving your receiving antenna, you might wish to give serious consideration to an effective active antenna like the 1020 from MFJ. The MFJ-1020 active antenna/preselector/pre-amplifier lists for \$79.95. For information, write *MFJ Enterprises, PO Box 494, Mississippi State MS 39762*. Reader Service number 478.

**Robert Grove WA4PYQ
Brasstown NC**

NEW SHURE MODEL 444D FIXED-STATION MICROPHONE

Serious amateur radio operators, who have long regarded the Shure Model 444 as the "standard" among fixed-station microphones, now have a new candidate upon which they may bestow the title.

It is the new Shure Model 444D, which retains all the performance characteristics that made the Model 444 popular, but also offers added features amateurs will find especially appealing.

For one, the Model 444D has a new impedance selector switch located on the bottom of the base, which allows selecting either high or low impedance operation.

A second easy-to-use slide switch is provided for switching between normal or VOX operation. These new convenience features join the unit's easy-to-use, momentary or locking, push-to-talk switch bar, which

actuates the microphone and an external relay or control circuit with fingertip action.

Other added features of the Model 444D are a coiled cable, the availability of a free, personalized nameplate imprinted with an amateur's station call letters, and a new wiring guide with instructions for wiring the microphone to major brands of ham equipment.

Field-proven features retained in the design of the new Model 444D include a rugged, Controlled Magnetic[®] microphone element, speech response tailored for maximum intelligibility, height adjustment for operator comfort, and a tough, Armo-Dur[®] case that is impervious to rust and deterioration.

For more information, write: *Shure Brothers, Inc., 222 Hartrey Avenue, Evanston IL 60204*. Reader Service number 480.

NEW 1981 AMATEUR RADIO THEORY REVIEW

Micro-80 Incorporated, a cas-



Shure's Model 444D fixed-station microphone.

sette and computer software manufacturer, has designed an excellent computerized Amateur Radio Theory Review for each operator class. The entire program package for each license class consists of over 95,000 bytes. It is split up in 12 "byte-size" pieces so it will load into the TRS-80 Level II (16K) computer system, the only system for which it has been developed.

The first portion of each program is an introduction to Micro-80 Incorporated, telling the purchaser more about the firm, where it is located, who the owners are, and what their goals appear to be.

The second part of the program is a table of contents and a brief outline telling you what to expect from the program and how to use it. All instructions are placed in the program itself. It was felt that instruction booklets which accompany most software programs usually get thrown out with the newspaper when it's clean-up time.

Each course covers 10 general subjects:

Part 1 Rules and Regulations

- Part 2 Signals and Emisions
- Part 3 Electrical Principles I
- Part 4 Electrical Principles II
- Part 5 Circuit Components
- Part 6 Practical Circuits
- Part 7 Operating Procedures
- Part 8 Antennas and Feedlines
- Part 9 Radio Wave Propagation
- Part 10 Amateur Radio Practice

Once each program is up and running, there is no need to utilize the ENTER key as the INKEY\$ function is used throughout the course. Personally, I have always felt this particular routine belongs in almost every program for the convenience of operation.

Since this course was designed to simulate the actual FCC exam, you are cautioned to read all questions and answers very closely! Quite a few of the questions are just plain tricky; the answers are not much easier. Some are nearly right, but not close enough, as the instruc-

tions very explicitly tell you to select the "most correct answer" or it will be counted wrong. All very nasty of course, but it keeps you on your toes when it comes time for the actual examination.

If you choose to cycle through the program once again, you can't help but notice that the format has been shuffled each time. This feature should keep you from memorizing the answer locations and/or corresponding letter.

I loaded all the theory programs several times, not only to get the information for this review, but to also see how well I could do the test! Absolutely no load difficulties or drop-outs were encountered at all. I attribute this fact to the excellent brand of tape utilized. Micro-80 markets its own line of professional data cassettes which are wholesale priced and have proven to be 100% error-free.

When I first acquired the course, I talked with the founder of Micro-80, Bill Gosney WB7BKF. Bill is an Associate Editor of 73 Magazine and an avid contest and DX operator. Bill indicated that all software creations from Micro-80 were

the efforts of in-house programmers as well as associate programmers the world over. I was especially surprised to learn that Micro-80's staff of in-house programmers consisted of at least a half dozen licensed amateurs. I learned that each study package took over 6 months of research and preparation to ensure that it is consistent with the actual FCC examination being administered at this time. While each course covers all that is needed to successfully pass the FCC exam, it never hurts to over-prepare. One should consult other study materials such as those found in the 73 Magazine Radio Bookshop and through the various advertisers in 73.

According to Bill at Micro-80, his corporation will soon have a Morse Code Training Course that will be useful to the beginner as well as the expert. Additional information about Micro-80 products and services may be obtained by writing *Micro-80 Incorporated, S-2665DF North Busby Road, Oak Harbor WA 98277*. Reader Service number 477.

Dave Fisher KA0BYS
Bettendorf IA

HAM HELP

I would like to get in touch with anyone who has made the SSB squelch mod to the IC-211. This modification was de-

scribed in the June, 1980, issue on p. 69. I completed the two wiring changes shown in the article and could not detect any change in the operation of the radio. Help!

Robert Parker
1226 May Street
Shelton WA 98584

I need help finding information to connect an IBM Selectric typewriter to a Radio Shack 64K computer. This will include the interface and mechanical connections to the typewriter.

Irwin M. Schmuckler
Box 244
Graterford PA 19426

this publication
is available in
microform



University Microfilms International

300 North Zeeb Road
Dept. P.R.
Ann Arbor, MI 48106
U.S.A.

18 Bedford Row
Dept. P.R.
London, WC1R 4EJ
England

SYNTHESIZED SIGNAL GENERATOR



- Covers 100 to 179.999 MHz in 1 kHz steps with thumb-wheel dial
- Accuracy .0001% at all frequencies
- Internal frequency modulation from 0 to over 100 kHz at a 1 kHz rate
- Spurs and noise at least 60dB below carrier
- RF output adjustable from 50 to 500mv across 50 ohms
- Operates on 12vdc @ 1/2 amp
- Price \$299.95 plus shipping.

In stock for immediate shipping. Overnight delivery available at extra cost. Phone: (212) 468-2720.

VANGUARD LABS
196-23 Jamacia Ave. Hollis, NY 11423

Scanners

BEARCAT | REGENCY

| | | | |
|---------|-------|------------------|-------|
| 210XL | \$229 | R804 | \$ 89 |
| 300 | 360 | R106 | 105 |
| 220 | 290 | M100 | 209 |
| 250 | 290 | M400 | 279 |
| T/S 4-6 | 129 | N.J. RESIDENTS | |
| 160 | 199 | ADD 5% SALES TAX | |

NO COD'S. CHECKS, MONEY ORDERS VISA OR MASTERCHARGE ARE ACCEPTABLE. ADD \$3.50 EACH ITEM FOR SHIPPING AND HANDLING.

PAUL DAVIS ELECTRONICS
PEDDLERS VILLAGE
MANASQUAN, NJ 08736

TEL: 201-223-9298 WEEKENDS
201-493-4511 EVE'S

CONTESTS

from page 16

send "IPA," 2-letter state abbreviation, RS(T), and serial number.

FREQUENCIES:

CW—3575, 7025, 14075, 21075, 28075.

SSB—3650, 3775-3800 (European DX), 7075, 14295, 21295, 28650.

SCORING:

Every completed QSO counts 2 points on 80 and 40 meters, 8 points if DX on 80 or 40 meters, and 4 points for all contacts on 20/15/10 meters. The multiplier is the total number of IPA countries and states worked per band.

For IPA members only, an IPA country and each US IPA state will be counted for multiplier and QSO only if an IPA station in that country/state has been worked. QSOs with DXCC countries or US states which are not listed in the IPARC membership list count only 1 point and do not count as a multiplier.

ENTRIES & AWARDS:

Each IPA member, non-member, and SWL with the highest score will receive a certificate and will be honored in the Award Chronicle of the International Police Association Radio Club. Entries must be postmarked no later than December 31st and sent to: IPARC Secretary, Richard A. Ridley G3UTX/G4IPA, 23 Greenacre, Worlebury, Weston-Sup-Mare, BS22-9SL, Great Britain.

For US hams, contest logs along with SHA rules, IPARC world membership list, and SHA application sheets are available from: Vince Gambino WB4QJO, 7606 Kingsbury Road, Alexandria VA 22310. Please include a large envelope with \$.28 postage.

EUROPEAN DX CONTEST —RTTY

Starts: 0000 GMT November 8
Ends: 2400 GMT November 9

Sponsored by the Deutscher Amateur Radio Club (DARC). Only 36 hours of operation out of the 48-hour period are permitted for single-operator stations. The 12 hours of non-operation may be taken in one, but not

more than three periods at any time during the contest. Operating classes include single operator, all band, and multi-operator, single transmitter. Multi-operator, single-transmitter stations are only allowed to change band one time within a 15-minute period, except for making a new multiplier. Use all amateur bands from 3.5 through 28 MHz. A contest QSO can be established between all continents and also one's own continent. Each station can be worked only once per band.

EXCHANGE:

Exchange the usual six-digit number consisting of RST and progressive QSO number starting with 001.

SCORING:

Each QSO counts 1 point. Each QTC (given or received) counts 1 point. Multipliers will be counted according to the European and ARRL countries list. The multiplier on 3.5 MHz may be multiplied by 4, on 7 MHz by 3, and on 14 through 28 MHz by 2. The final score is the total QSO points plus QTC points multiplied by the sum total multipliers.

QTC TRAFFIC:

Additional point credit can be realized by making use of the QTC traffic feature. A QTC is a report of a confirmed QSO that has taken place earlier in the contest and later sent back to another station, the general idea being that after a number of stations have been worked, a list of these stations can be reported back during a QSO with another station. An additional 1 point credit can be claimed for each station reported.

A QTC contains the time, call, and QSO number of the station being reported, i.e., 1300/DA1AA/134. This means that at 1300 GMT you worked DA1AA and received number 134. A QSO can be reported only once and not back to the originating station. Only 10 QTCs to a station are permitted. You may work the same station several times to complete this quota, but only the original contact has QSO point value. Keep a uniform list of QTCs sent. QTC 3/7 indi-

cates that this is the 3rd series of QTCs sent and that 7 QSOs are reported.

AWARDS:

Certificates to the highest scorer in each classification in each country, reasonable score provided. Continental leaders will be honored with plaques. Certificates will also be given stations with at least half the score of the continental leader or with at least 250,000 points. The minimum requirements for a certificate or a trophy are 100 QSOs or 10,000 points.

ENTRIES:

Violation of the rules, unsportsmanlike conduct, or taking credit for excessive duplicate contacts will be deemed sufficient cause for disqualification. The decisions of the Contest Committee are final. It is suggested that the log sheets of the DARC or equivalent be used. Send a large SASE to get the wanted number of logs and summary sheets (40 QSOs or QTCs per sheet). SWLs apply the rules accordingly. Entries should be sent no later than December 15th. North American residents may send their applications and logs to: Hartwin E. Weiss W3OG, PO Box 440, Halifax PA 17032 USA.

EUROPEAN COUNTRY LIST:

C31, CT1, CT2, DL, DM, EA, EA6, EI, F, FC, G, GC Guer, GC Jer, GD, GI, GM, GM Shetland, GW, HA, HB9, HB0, HV, I, IS, IT, JW Bear, JW, JX, LA, LX, LZ, M1, OE, OH, OH0, OJ0, OK, ON, OY, OZ, PA, SM, S, SV, SV Crete, SV Rhodes, SV Athos, TA1, UA1346, UA2, UB5, UC2, UN1, UO5, UP2, UQ2, UR2, UA Franz Josef Land, YO, YU, ZA, AB2, 3A, 4U1, 9H1.

INTERNATIONAL OK DX CONTEST

Starts: 0000 GMT November 9
Ends: 2400 GMT November 9

Participating stations work stations of other countries according to the official DXCC country list. Contacts between stations of the same country count for multipliers, but have no QSO point value. Each station may be worked once on each band. Use all bands, 160 through 10 meters, on phone or CW. Cross-band or cross-mode contacts are not valid. Operating categories include: A—single operator, all bands; B—single operator, one band; C—multi-operator, all bands. Any stations operated by a single person obtaining assistance,

such as in keeping the log, monitoring other bands, tuning the transmitter, etc., is considered a multi-operator station. Club stations may work in category C (multi-op) only.

EXCHANGE:

RS(T) and 2-digit number indicating the ITU zone. Please note the ITU zones are quite different from the ARRL zones! For a list and map of the ITU zones, send 2 IRCs to the entry address listed below.

SCORING:

Each QSO counts one point, or 3 points if with an OK station. Final score is QSO points times the total number of ITU zones worked on each band.

ENTRIES:

A separate log must be kept for each band and must contain the full data. The log must contain in its heading the category of the station (A,B,C), name, callsign, address, and band(s) used. Also show the total number of contacts, QSO points, multipliers, and total score. Each log must be accompanied by the following declaration: "I hereby state that my station was operated in accordance with the rules of the contest as well as all regulations established for amateur radio in my country, and that my report is correct and true to the best of my belief."

A certificate will be awarded to the top-scoring operators in each country and each category. The "100 OK" Award may be issued to stations for contests with 100 OK stations, and the "S 6 S" Award or endorsements for individual bands may be issued to a station for contacts with all continents. Both awards will be issued upon a written application in the log and no QSLs are required. Logs must be postmarked no later than December 31st and sent to: The Central Radio Club, PO Box 69, 113 27 Praha 1, Czechoslovakia.

DARC CORONA 10-METER RTTY CONTEST

**Contest Period: 1100 to
1700 GMT November 15**

This is the last of four tests during the year sponsored by the DARC eV to promote RTTY activity on the 10-meter band. Use the recommended portions of the 10-meter band.

EXCHANGE:

RST, QSO number, and name.
SCORING:

Each station can be contacted only once. Each completed 2-way RTTY QSO is worth 1 point. Multipliers include the WAE and DXCC lists and each district in WIK, VE/VO, and VK. Also count each different prefix

as a multiplier. The final score is the total number of QSOs times the total multiplier.

AWARDS:

Plaques will be awarded to the leading stations in each class with a reasonable score

present. Operating classes include: Class A for single or multi-op, and Class B for SWLs.

ENTRIES:

Logs must contain name, call, and full address of participant. Also show class, times in GMT,

exchange, and final score. SWLs apply the rules accordingly. Logs must be received within 30 days after the test. Send all entries to: Klaus K. Zielski DF7FB, PO Box 1147, D-6455 Erlensee, West Germany.

FCC

FCC BEGINS PHASE II OF FEE REFUND PROGRAM

Millions of Americans are eligible to apply for approximately \$31 million in fees to be refunded by the Federal Communications Commission under Phase II of its refund program, according to an announcement by the Commission.

Individuals who paid to the Commission fees of more than \$4 but \$20 and less between August 1, 1970, and February 28,

1975, may be eligible for a partial refund.

However, the Commission emphasized that the CB (Citizens Band) licenses that cost \$4—granted March 1, 1975, or later—do not qualify for a refund.

Since June 1979—under Phase I of this program—the FCC has refunded more than \$49 million in fees collected from broadcasters, common carriers, electronic equipment manufacturers, aviation and

marine radio users, and certain amateurs.

Fees to be refunded in Phase II include those collected for amateur radio, aviation radio, land mobile, maritime radio microwave and CATV systems, restricted radio telephone permits, type certification requests for equipment operating under Part 18 of the Commission's rules, and cable television notifications under Section 74.1105.

The refund program was developed in response to four decisions by the U.S. Court of Appeals for the District of Columbia Circuit in December, 1976. The court held that fees collected by the FCC between August 1, 1970, and December 31, 1976, were not valid. The FCC was

directed to recalculate those fees and make refunds.

To request a refund under Phase II, licensees must obtain a copy of the Fee Refund Program request form and instructions (Phase II). It is available at FCC Field Offices or by mail from the FCC Refund Program Office, PO Box 19209, Washington DC 20036.

Licensees should be certain they are due refunds before filing for them. Complete information is contained in the request form and instructions.

For specific details about the fee refund program, licensees may call the toll-free number: 800-424-2901. This number is not to be used for other FCC business or complaints.

REVIEW

Vertical Users: Novice to Extra
by Charles "Doc" Schwartzbard
AF2Y

Danrick Enterprises, Clifton NJ

"What actual advantage, if any, does height above ground of a vertical play in working DX? Can rf obstacles be overcome to allow success with a vertical under crowded city conditions? Can a low ground-plane installation with a few radials surpass a grounded installation using twice as many radials?" It is

these kind of questions that AF2Y's book, *Vertical Users: Novice to Extra*, tries to answer.

You won't find impedance charts or directional plots in this thin 35-page volume. The author presents the results of the hundreds of on-the-air tests for you to analyze and then decide what kind of vertical setup is best. "Doc" AF2Y makes no claim that his methods or results are scientific. Instead, he bases his conclusions on the comparative

signal reports given by operators on the other end of a QSO.

Vertical Users: Novice to Extra contains three separate reports. One compares the performance of roof-mounted verticals versus a ground-mounted vertical with and without radials as well as a pole-mounted Hustler 5BTV with radials. A second study looks at the differences between two ground-mounted verticals, one with radials, the other without. The final report compares pole- versus ground-mounted verticals.

Each set of conclusions is based on at least 100 QSOs, and every band, 80 through 10 meters, is covered. Don't forget that the data is based on anten-

nas at one particular location and you may or may not be able to apply the findings to your requirements. The results, in some cases, are startling and there is no way to generalize them for all bands and distances.

It wouldn't be fair for this review to divulge the conclusions reached in *Vertical Users: Novice to Extra*. Suffice it to say that a trap vertical needn't always have the reputation of being a compromise antenna. *Vertical Users: Novice to Extra* is available for \$3.95 from more than 20 dealers nationwide or from Danrick Enterprises, 213 Dayton Ave., Clifton NJ 07011.

Tim Daniel N8RK
Terre Haute IN

HAM HELP

I am looking for a power supply transformer for a Globe King transmitter, model 500-A.

R. Keys W0DDF
1525 Roslyn Street
Denver CO 80220

schematic of the external wiring to a Texas Instruments TMS 1952 clock chip.

Rex D. Taulkva KA3FTN/4
3413 Covington Drive
Augusta GA 30904

I am trying to convert a clock to 24-hour format and need a

I need an antenna changeover relay for a G. E. pre-Progress FM

rig. I also need a schematic or manual for an AN/ART-13 transmitter.

B. Carling AF4K
5131 Raywood Lane
Nashville TN 37211
(615)-331-8461

Thanks to all those who sent copies of the *Handbook* article I needed to rebuild the "5 Band 50 Watter" I first built long ago.

Bill Graham N8BNK
Paris KY

I have a Flexowrite paper tape recorder and reproducer Model

FL which I would like to use for RTTY with my TRS-80. If anyone can give me information about how I should interface this unit, I would be very pleased.

Bro. Nicholas Lorson WB3HDJ
St. Anthony-on-Hudson
Rensselaer NY 12144

Wanted: Diagram or instruction book for a Premier Signal Generator. You find it, I'll copy it!

Louis Albizati
8312 SE Skylark Ave.
Hobe Sound FL 33455

BULLET ELECTRONICS

P.O. Box 401244-E Garland, TX. 75040 (214) 278-3553

Special Buy!



RF POWER TRANSISTORS

2N5591 25 W @ 13.6 VDC
to 240 mhz. minimum
gain 4.4 db.
6.95

Limited Qty.
Limit 5 of
each type
per customer

2N6081 / MRF221
15W @ 13.6 VDC to 240 mhz.
Minimum gain 6.3 db.
4.95

Units are marked with special mfg's. part number, however, all are new and guaranteed.

TO-3 P.C. BOARD HEATSINK

Perfect for power transistors, or 309 and 340K series voltage regulators.

3/1.10



Thermoloy H6014
Black Anodized

LM395 High gain power transistor with built in current limiting, power limiting and thermal overload making it virtually impossible to destroy with overload. V_{CEO} = 36V IC = 2A H_{FE} 3000. Will drive directly off TTL and CMOS. **1.65**

TRANSFORMER

A good transformer for TTL, linear, and smaller computer systems.
Primary 117VAC Sec #1 15V@1A
Sec #2 15V@1A Sec #3 8V@2A
Size: 2x3x2.25 Wt. 1.5 lbs
Construction: Open Frm w/Mt flang; wire leads
Order: BET-0005
\$2.95

200V 4A SCR

Sensitive Gate
7/\$1.00

Special Purchase
Order BES-0025

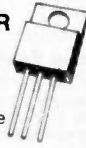

THE PERFECT TRANSFORMER

117VAC primary, 12VAC secondary @ 200ma
Great for all you CMOS, or low power TTL projects. PC board mount.

99c ea. 3/\$2.50

Size: 1.5" W x 1.25" D x 1.25" H

AY3-8910 PROGRAMMABLE SOUND GENERATOR

The AY3-8910 is a 40 pin LSI chip with three oscillators, three amplitude controls, programmable noise generator, three mixers, an envelope generator, and three D/A converters that are controlled by 8 BIT WORDS. No external pots or caps required. This chip hooked to an 8 bit microprocessor chip or Buss (8080, Z80, 6800 etc.) can be software controlled to produce almost any sound. It will play three note chords, make bangs, whistles, sirens, gunshots, explosions, bleets, whines, or grunts. In addition, it has provisions to control its own memory chips with two IO ports. The chip requires +5V @ 75ma and a standard TTL clock oscillator. A truly incredible circuit.

\$14.95 w/Basic Spec Sheet (4 pages)

60 page manual with S-100 interface instructions and several programming examples, **\$3.00** extra

OVP-2 OVER VOLTAGE PROTECTOR **6.95**

Provides cheap insurance for your expensive equipment. Trip voltage is adjustable from 3 to 30 volts. Overvoltage instantly fires a 25A SCR and shorts the output to protect equipment. Should be used on units that are fused. Directly compatible with the PS-12 and PS-14. All electronics supplied. Drilled and plated PC board.

ULTRASONIC RELAY KIT

Invisible Beam Works Like A Photo Electric Eye. **COMPLETE KIT**. All Parts & PC Board. Use Up To 25 Ft. Apart.
\$21.50

Optional entry delay and Alarm Timeout Circuit will source or sink up to 200 MA DC.

\$3.95

AUTO/VAN CLOCK KIT

- 12 Hr. Format
- 6 Digit 1/2" LED Readouts
- Quartz XTAL Timebase
- Alarm & Snooze Options
- Noise Filtering
- Easy Assembly • 12 VDC
- 4 5/8" x 3" x 1 1/2"
- All Parts!

\$16.95

X-RATED! ZULU II CLOCK KIT

X-TRA VALUE: All the components and high quality plated G-10 PC Boards are provided.

X-TRA CARE IN DESIGN: Easy Assembly! Large open layout.

X-CELLENCE IN IDEAS: 5 years of designed products for the amateur radio market

X-CELLENCE IN INSTRUCTIONS: Clear step-by-step instructions with quality illustrations and schematic.

X-TRA FEATURES: There has never been a clock kit with so many features — at any price!

- Unit operates on either 12 VAC or 12 VDC.
- On board **QUARTZ XTAL TIMEBASE** or 60Hz AC line freq. can be used.
- Automatic **BATTERY BACKUP!**
- Reads true **24 HOUR TIME** and **31 DAY CALENDAR**.
- **Unique NOX™ CIRCUIT** activates readouts with a handclap followed by the date for 4 seconds. Or they can be turned on constantly.
- When used mobile readouts blank when ignition is off.
- Special **NOISE SUPPRESSION** and battery reversal circuits.
- Bright 1/2" LED's show hours, minute and seconds.

WITH CALENDAR
AND NOX™ CIRCUIT

19.95

LESS CASE
ACCESSORIES

Custom High Impact Molded Case with Ruby Lens. Available in Blue or Tan.

\$6.50

117 VAC to 12 VAC Transformer.

\$1.35

*9V Battery Not Included

Sound Effects Kit **\$18.50**

The SE-01 Sound Effects Kit is a complete kit. All you need to build a programmable sound effects machine except a battery and speaker. Our kit is designed to really ring out the **TI 76477** Sound Chip. Only the SE-01 provides you with additional circuitry that includes a **PULSE GENERATOR, MUX OSCILLATOR and COMPARTOR** to make more complex sounds a snap. We help you in building the kit with a clear, easy-to-follow construction manual and we show you how to easily program the unit. Other dealers will sell you the chip or a "kit" of parts but you are on your own to do the most difficult part...make neat sounds! Within a short time after you build the SE-01 you can easily create **Gunshots, Explosions, Space Sounds, Steam Trains** and much more. We think the Bullet SE-01 is the best deal on the market but don't ask us — ask the 15,000 happy SE-01 owners!

Complete Kit With Quality Plated PC Board **\$18.50**

(Less battery & speaker)

Users Group Notes: Includes additional programming charts plus quarterly updates **\$5.00**

7 WATT AUDIO AMP KIT

SMALL SINGLE HYBRID IC AND COMPONENTS FIT ON A 2" x 3" PC BOARD (INCLUDED) RUNS ON 12VDC GREAT FOR ANY PROJECT THAT NEEDS AN INEXPENSIVE AMP LESS THAN 3% THD @ 5 WATTS. COMPATIBLE WITH SE-01 SOUND KIT \$5.95

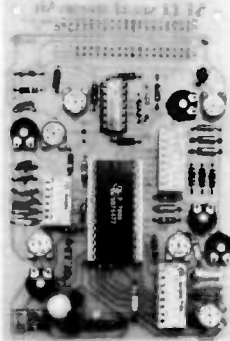

PARTS

| | | |
|-----------|--|--------|
| LM3046 | (CA3046) Xistor Array | .75 |
| RCA 40430 | 400V 6A TRIAC TO-66 | .75 |
| LM567 | Tone Decoder | .75 |
| CO4046 | PULL CMOS | .99 |
| LM3302 | Quad Comparator | .89 |
| 25C 1849 | High Freq. NPN TO-92 | 6/1.00 |
| MPS A 20 | NPN General Purpose | 8/1.00 |
| TL490 | Bar/Graph Driver w/specs | 2.50 |
| 7812 | 12V 1A Regulator | .99 |
| 7805 | 5V 1A Regulator | .99 |
| 78M05 | 5V 1/2A Reg. TO-5 (Hse #) | .60 |
| LM3911 | Temp. Transducer w/specs | 1.10 |
| 555 | Timer IC | .49 |
| 2N6028 | P.U.T. w/specs | .50 |
| IL-1 | Opto Isolator w/specs | .60 |
| LM380 | 2W Audio IC w/specs | .50 |
| LM377 | Dual LM380 w/specs | 1.09 |
| TIP-30 | PNP Power TO-220 | 3/1.00 |
| SCR | Sensitive Gate 200V 4A | 7/1.00 |
| SCR | Sensitive Gate 600V | |
| | 4A RCA | 3/1.00 |
| LM317 | Variable Reg. 3-35V 1A w/specs | 1.69 |
| | Trigger diode for triacs in AC phase control operation | .29 |
| OIAC | | |

NEW!

MUSIC FOR YOUR EARS

Bullet's Electronic Music Machine™ Kit has a single 28 Pin Microprocessor Chip with ROM that has been programmed to play the first 6 to 10 notes of the 25 popular tunes listed below. Each tune can easily be addressed individually or played sequentially at the push of a button. The 3 chime sequences are activated at any time by separate switch closures so when used as a doorbell, one door can play songs while two others will play different chimes. The unit has a **5 watt audio Amp** and will run on either 12VAC or 12VDC. Optional 117VAC transformer is available. Construction is very simple, works with any 8 or 16 ohm speaker, or horn speaker. (Not Included) Tunes can be remotely programmed using a single rotary switch. (not included), if desired.

Complete Kit **\$16.95** Transformer **\$1.35**
For Operation on 117VAC

Tunes: Toreador • William Tell • Hallelujah Chorus • Star Spangled Banner • Yankee Doodle • America, America • Deutschland Leid • Wedding March • Beethoven's 5th and 9th • Hell's Bells • La Vien En Rose • Star Wars Theme • Clementine • Augustline • Jingle Bells • God Save The Queen • Colonel Bogey • Marseillaise • O Sole Mio • Santa Lucia • The End • Blue Danube • Brahms Lullaby • Westminster Chime • Simple Chime • Descending Octave Chime.

★ CALL OR WRITE TODAY FOR FREE CATALOG ★

- ★ NO C.O.D.
- ★ SEND CHECK, M.O., OR CREDIT CARD #
- ★ PHONE ORDERS ACCEPTED ON VISA/MASTER CHARGE ONLY (214) 278-3553

P
O
L
I
C
I
E
S

- ★ ADD 5% FOR SHIPPING
- ★ ORDERS UNDER \$10 ADD .75 HANDLING
- ★ TEX. RES. ADD 5% TAX
- ★ FOREIGN ORDERS (EXCEPT CANADA) ADD 10% (20% FOR AIRMAIL).

STEREO SOUND EFFECTS

How about an S-100 board that has **six Oscillators, two Noise Generators, six Amplitude Controls, two Envelope Controls, six D to A Converters, four 8 BIT parallel I/O's** and a price so low it should have only a fraction of those features?

IT'S HERE! THE S-100 SOUND COMPUTER BOARD

| | |
|--|--|
| COMPLETE KIT!
\$84.85
(With Data Manual) | BLANK PC BOARD
W/DATA
\$31.00 |
|--|--|

Compatible with both 2 and 4 mhz CPU's. All Sockets, parts and hardware are included in this kit. Both Basic and Assembly Language programming examples are included.

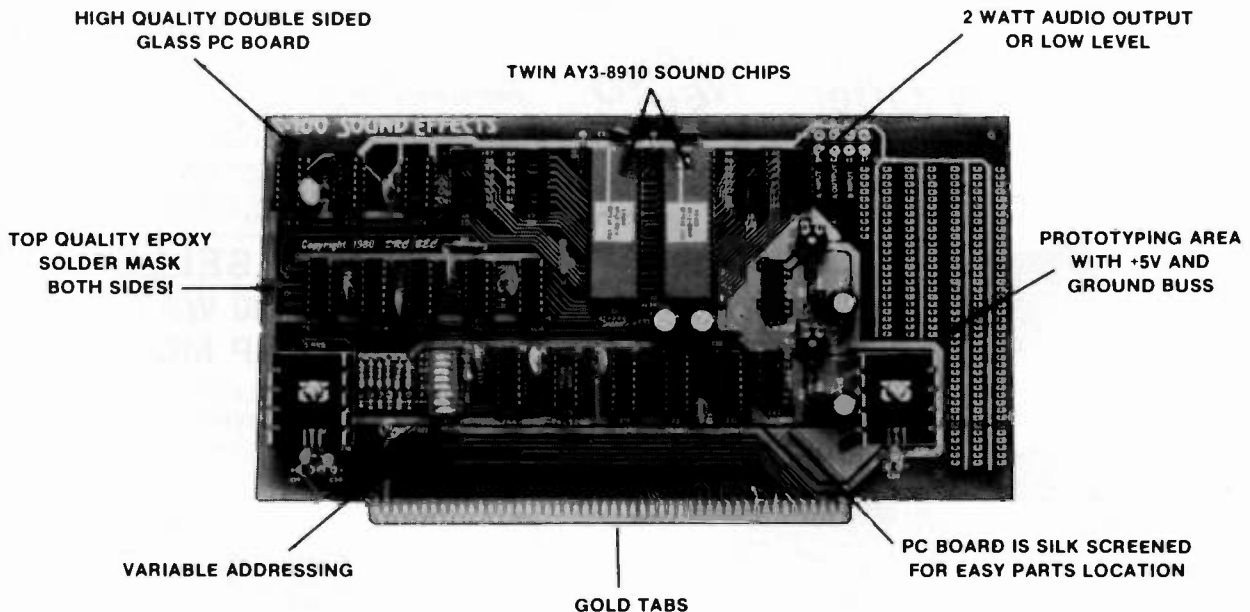

The S-100 Sound Board is the ultimate in computer sound effects. It allows you under total computer control to generate an infinite number of special sound effects . . . all in stereo! Unlike other designs the computer is not tied down to **JUST** making sounds so that programs in **Basic, Assembly Language or other languages** can be run and tied to the Sound Board. Imagine how much more fun all your game programs would be with **realistic sound effects!** Want music? The S-100 Sound Board will play chords, notes or beat the drums!

SOFTWARE

SCL™ is now available! Our Sound Command Language makes writing Sound Effects programs a snap! Allows you to examine/modify the sound chip registers and/or memory. Will play programs or read programs stored in ROM library. Available on CP/M* compatible diskette or 2708 or 2716 EPROMS. Diskette \$24.95 - 2708 \$19.95 - 2716 \$29.95. Diskette includes source.

ANOTHER GREAT DEAL!

We are compiling a **library of sounds** to be released soon. Written in SCL™ they will allow even greater flexibility. **WE NEED YOUR HELP!** Any sound effect submitted to us earns a **30% discount** on the Library ROM's or Diskettes. Sounds selected for inclusion in the library earn a **\$50.00 merchandise certificate**. Send us your sounds!

Digital Research Computers
(OF TEXAS)

P.O. BOX 401565 • GARLAND, TEXAS 75040 • (214) 271-3538

TERMS: Add \$1.25 postage. We pay balance. Orders under \$15 add 75¢ handling. No C.O.D. We accept Visa and MasterCard. Tex. Res. add 5% Tax. Foreign orders (except Canada) add 20% P & H. 90 Day Money Back Guarantee on all items. Orders over \$50. add 85¢ for insurance.

*TRADEMARK OF DIGITAL RESEARCH.

NOT ASSOCIATED WITH DIGITAL RESEARCH OF CALIFORNIA. THE SUPPLIERS OF CPM SOFTWARE.

THREE NEW RADAR DETECTOR BOARDS

- #1 - Includes 3 - 741 op amps, 1NE555 Timer, and 1 - LM311 \$ 2/1.00
 - #2 - Includes 1 - NE567 PLL, 1NE555 Timer, 1 - 5634 Low Noise op amp for high quality audio, 2 - 741 op amps, and 1 - 78M08 voltage Regulator: 8V. 500MA. \$.75 Each or 3/2.00
 - #3 - Audio Board - Emits Sonalert™ Sound - 4½ to 15V with Volume Control. \$1.25 Each
- Each of these boards contain many other parts too numerous to list.

MICRO MINI TOGGLE SWITCHES
6 for \$5 with hardware.



99¢ EACH

***** **CABLE TIES** *****
MAKE YOUR PROJECTS "NEAT & TIDY." 4" CABLE TIES AT A FANTASTIC PRICE. GET THIS BARGAIN AND "TIE" IT DOWN. \$2.00 for 100 or better yet \$15.00 for 1000

A Full Color* TV Game For The Family

Six exciting TV Games — Hockey, Tennis and Handball with one or two player capability for each game. Ball velocity doubles after the fourth player hit for an increasingly competitive game.

Adjustable paddle size for each player allows for handicapped play if desired. Paddles can give automatic ball spin with seven possible angles of ball deflection.

Automatic digital scoring appears after each point is scored. Game ceases automatically after one player scores 15 points. Serving is from the paddle of player who scored the last point, thus server can "place" his shot.

Video-Volley is designed to be installed, with a minimum of effort, to any standard television receiver, either color or black and white. Batteries are not required.

Small hand-held player modules with 15 foot cord length provides more comfort and versatility for players.

The compact command module sits atop the television receiver and has front panel control allowing effortless change from normal television reception to game play. Easy disconnection of the player hand-held modules facilitates easy set-up and take-down for storage.

Video-Volley™

BRAND NEW!

Introductory Offer

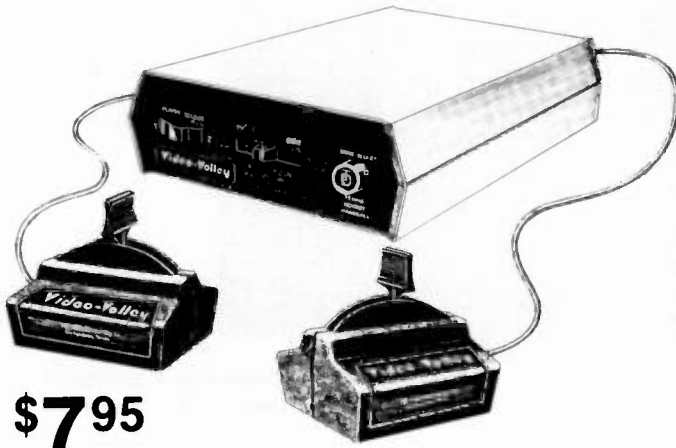

\$795

REPEAT OF SELLOUT #2
SONY 30 WATT
AUDIO AMP MODULE

#STK-056. 30 WATTS SUPER CLEAN AUDIO. 20 HZ to 100 KHZ ±2DB. HYBRID, SILICON, SELF-CONTAINED MODULE. ONLY 1½x2½ IN. WITH DATA. COMPARE AT UP TO TWICE OUR PRICE!

LIMITED QUANTITY

\$850

Each

LAB-BENCH VARIABLE POWER SUPPLY KIT \$12.00 KIT SUPER SALE
5 to 20 VDC at 1 AMP. Short circuit protected by current limit. Uses IC regulator and 10 AMP Power Darlington. Very good regulation and low ripple. Kit includes PC Board, all parts, large heatsink and shielded transformer. 50 MV. TYP. Regulation.

RCA SENSITIVE GATE TRIAC
TO-5 CASE. HOUSE #40531
ALSO SAME AS T2300D.
2.5 AMPS 400 PIV

5/\$1.19

Perfect for Dimmers, Color Organs, etc. PC LEADS



60 Hz CRYSTAL TIME BASE \$4.95 (Complete Kit)
Uses MM5369 CMOS divider IC with high accuracy 3.579545 MHZ Crystal. Use with all MOS Clock Chips or Modules. Draws only 1.5 MA. All parts, data and PC Board included. 100 Hz. same as above, except \$5.95

D.C. HORN
VERY LOUD!
6-12 VDC
Like Used In Smoke Alarms.
FANTASTIC SAVINGS.
Compare this true value.
.60 ea. 4 For \$2.00

NATIONAL SEMICONDUCTOR "COLOSSUS JR." JUMBO CLOCK MODULE



\$8.50

- Bright 4 digit 0.7" LED Display
- Complete-Add only Transformer and Switches
- 24 Hour Alarm Signal Output
- 12 Hour Real Time Format
- 50 or 60 Hz Operation
- Power Failure Indication
- LED Brightness Control
- Sleep and Snooze Timers
- Alarm "on" and PM Indicators
- Direct Drive - No RFI
- Direct Replacement for MA1012
- Comes with Full Data

ASSEMBLED! NOT A KIT!
MANUFACTURER'S CLOSEOUT!

PERFECT FOR USE WITH A TIMEBASE

MA1013 BRAND NEW!

PMD-11K-60
60 Volts. HFE 800-20K
12 Amps. PNP TO-3
150 Watts. By Lambda.
\$1.50

BRAND NEW!

Crystal Super Savings
4.433618 MHZ
2/\$1.10

REPEAT OF A SELL-OUT!

VECO PRECISION THERMISTOR. GLASS TYPE. VECO #41A72. 8.2K OHMS at ROOM TEMP. VERY SENSITIVE. INDIVIDUALLY PACKAGED IN PLASTIC VIALS. \$3.00 VALUE

\$1.00 each or 3 FOR \$2.50

Digital Research: Parts
(OF TEXAS)

P.O. BOX 401247 • GARLAND, TEXAS 75040 • (214) 271-2461

TERMS: Add 50¢ postage, we pay balance. Orders under \$15 add 75¢ handling. No C.O.D. We accept Visa, MasterCard and American Express cards. Tex. Res. add 5% Tax. Foreign orders (except Canada) add 20% P&H. 90 Day Money Back Guarantee on all items.

SEND FOR CATALOG WITH SUPER SAVINGS!!

These Low Cost SSB TRANSMITTING CONVERTERS

Let you use inexpensive recycled 10M or 2M SSB exciters on UHF & VHF!

- Linear Converters for SSB, CW, FM, etc.
- A fraction of the price of other units; no need to spend \$300 - \$400!
- Use with any exciter; works with input levels as low as 1 mW.
- Use low power tap on exciter or simple resistor attenuator pad (Instructions included).
- Link osc with RX converter for transceive.

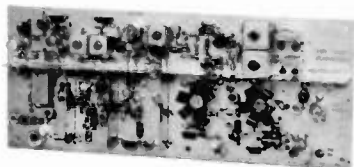

XV4 UHF KIT — ONLY \$99.95

28-30 MHz in, 435-437 MHz out; 1W p.e.p. on ssb, up to 1½W on CW or FM. Has second oscillator for other ranges. Atten. supplied for 1 to 500 mW input, use external attenuator for higher levels.

Extra crystal for 432-434 MHz range \$5.95
XV4 Wired and tested \$149.95

XV2 VHF KIT - ONLY \$69.95

2W p.e.p. output with as little as 1mW input. Use simple external attenuator. Many freq. ranges available.

| MODEL | INPUT (MHz) | OUTPUT (MHz) |
|-------------------------------------|--------------------|---------------------|
| XV2-1 | 28-30 | 50-52 |
| XV2-2 | 28-30 | 220-222 |
| XV2-4 | 28-30 | 144-146 |
| XV2-5 | 28-29 (27-27.4 CB) | 145-146 (144-144.4) |
| XV2-7 | 144-146 | 50-52 |
| XV2 Wired and tested \$109.95 | | |

XV28 2M ADAPTER KIT - \$24.95

Converts any 2M exciter to provide the 10M signal required to drive above 220 or 435 MHz units.



NEW! COMPLETE TRANSMITTING CONVERTER AND PA IN ATTRACTIVE CABINET

Far less than the cost of many 10W units!

Now, the popular Hamtronics® Transmitting Converters and heavy duty Linear Power Amplifiers are available as complete units in attractive, shielded cabinets with BNC receptacles for exciter and antenna connections. Perfect setup for versatile terrestrial and OSCAR operations! Just right for phase 3! You save \$30 when you buy complete unit with cabinet under cost of individual items. Run 40-45 Watts on VHF or 30-40 Watts on UHF with one integrated unit! Call for more details.

| MODEL | KIT | WIRED and TESTED |
|-----------------------------|----------|------------------|
| XV2/LPA2-45/Cabt (6M or 2M) | \$199.95 | \$299.95 |
| XV4/LPA4-30/Cabt (for UHF) | \$229.95 | \$349.95 |

Easy to Build FET RECEIVING CONVERTERS

Let you receive OSCAR and other exciting VHF and UHF signals on your present HF or 2M receiver



- NEW LOW-NOISE DESIGN
- ATTRACTIVE WOODGRAIN CASE
- Less than 2dB noise figure, 20dB gain

| MODEL | RF RANGE | OUTPUT RANGE |
|---------|---------------------------|-----------------------|
| CA28 | 28-32 MHz | 144-148 MHz |
| CA50 | 50-52 | 28-30 |
| CA50-2 | 50-54 | 144-148 |
| CA144 | 144-146 | 28-30 |
| CA145 | 145-147-or-144-144.4 | 28-30
27-27.4 (CB) |
| CA146 | 146-148 | 28-30 |
| CA220 | 220-222 | 28-30 |
| CA220-2 | 220-224 | 144-148 |
| CA110 | Any 2MHz of Aircraft Band | 26-28 or 28-30 |
| CA432-2 | 432-434 | 28-30 |
| CA432-5 | 435-437 | 28-30 |
| CA432-4 | 432-436 | 144-148 |

Easily modified for other rf and if ranges.

| STYLE | VHF | UHF |
|----------------------|---------|---------|
| Kit less case | \$34.95 | \$49.95 |
| Kit with case | \$39.95 | \$54.95 |
| Wired/Tested in case | \$54.95 | \$64.95 |

Professional Quality VHF/UHF FM/CW EXCITERS

- Fully shielded designs
- Double tuned circuits for spurious suppression
- Easy to align with built-in test aids



| | | |
|---------|------------------------------|---------|
| T50-50 | 6-chan, 6M, 2W Kit..... | \$44.95 |
| T50-150 | 6-chan, 2M, 2W Kit..... | \$44.95 |
| T50-220 | 6-chan, 220 MHz, 2W Kit..... | \$44.95 |
| T450 | 1-chan, 450 MHz, ¼W Kit..... | \$44.95 |

See our Complete Line of VHF & UHF Linear PA's

- Use as linear or class C PA
- For use with SSB Xmitg Converters, FM Exciters, etc.

| | | |
|---------|------------------------|----------|
| LPA2-15 | 6M, 2M, 220; 15 to 20W | \$59.95 |
| LPA2-30 | 6M, 2m; 25 to 30W | \$89.95 |
| LPA2-40 | 220 MHz; 30 to 40W | \$119.95 |
| LPA2-45 | 6M, 2M; 40 to 45W | \$119.95 |
| LPA4-10 | 430MHz; 10 to 14W | \$79.95 |
| LPA4-30 | 430MHz; 30-40W | \$119.95 |

See catalog for complete specifications

FAMOUS HAMTRONICS PREAMPS

Let you hear the weak ones too!
Great for OSCAR, SSB, FM, ATV. Over 14,000 in use throughout the world on all types of receivers.



- NEW LOW-NOISE DESIGN
- Less than 2 dB noise figure, 20 dB gain
- Case only 2 inches square
- Specify operating frequency when ordering

MODEL P-30 VHF PREAMP, available in many versions to cover bands 18-300 MHz.

MODEL P432 UHF PREAMP, available in versions to cover bands 300-650 MHz.

| STYLE | VHF | UHF |
|----------------------|---------|---------|
| Kit less case | \$12.95 | \$18.95 |
| Kit with case | \$18.95 | \$26.95 |
| Wired/Tested in Case | \$27.95 | \$32.95 |

NEW VHF/UHF FM RCVRs Offer Unprecedented Range of Selectivity Options

- New generation
- More sensitive
- More selective
- Low cross mod
- Uses crystal filters
- Smaller
- Easy to align

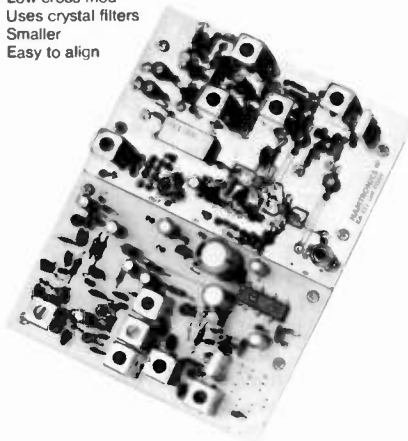

R75A* VHF Kit for monitor or weather satellite service. Uses wide L-C filter. -60dB at ± 30 kHz..... \$69.95

R75B* VHF Kit for normal nbfm service. Equivalent to most transceivers. -60dB at ± 17 kHz, -80dB at ± 25 kHz.... \$74.95

R75C* VHF Kit for repeater service or high rf density area. -60dB at ± 14kHz, -80dB ± 22kHz, -100dB ± 30kHz.... \$84.95

R75D* VHF Kit for split channel operation or repeater in high density area. Uses 8-pole crystal filter. -60dB at ± 9 kHz, -100dB at ± 15 kHz. The ultimate receiver!... \$99.95

*Specify band: 10M, 6M, 2M, or 220 MHz. May also be used for adjacent commercial bands. Use 2M version for 137 MHz WX satellites.

R450 () UHF FM Receiver Kits, similar to R75, but for UHF band. New low-noise front end. Add \$10 to above prices. (Add selectivity letter to model number as on R75.)

A14 5 Channel Adapter for Receivers..... \$9.95

NEW R110 VHF AM RCVR

AM monitor receiver kit similar to R75A, but AM. Available for 10-11M, 6M, 2M, 220 MHz, and 110-130 MHz aircraft band \$74.95. (Also available in UHF version.)

IT'S EASY TO ORDER!

- Write or phone 716-392-9430 (Electronic answering service evenings & weekends)
- Use Credit Card, UPS COD, Check, Money Order
- Add \$2.00 shipping & handling per order

Call or Write to get FREE CATALOG With Complete Details (Send 4 IRC's for overseas mailing)

HAMTRONICS® IS A REGISTERED TRADEMARK

hamtronics, inc.

65J MOUL RD · HILTON, NY 14468

SEMICONDUCTORS SURPLUS

2822 North 32nd Street/Unit -1 Phoenix, Arizona 85008 (602) 956-8423

We accept checks, MasterCharge, and Visa

Prices subject to change without notice

(800)528-3611 (No C.O.D.)



HAM MICROWAVE RECEIVERS

2100-2400 MHz
28 dB Gain
2.5 to 3 dB Noise

Assembled and tested with 90 day guarantee \$ 209.99
\$5.00 shipping with charge card or money order.

RECEIVER KIT \$149.95; Includes Yagi antenna, power supply box, P.C.B. and parts, down converter P.C.B. and parts, and complete instructions.

MISCELLANEOUS PARTS FOR HMR

| | |
|--|----------|
| Yagi antenna | |
| Power supply box | \$ 49.95 |
| Power supply P.C.B. | 12.95 |
| Power supply transformer | 4.99 |
| Power supply kit | 3.99 |
| Power supply assembled and tested | 39.95 |
| Down converter P.C.B. | 49.95 |
| Down converter kit | 19.95 |
| Down converter assembled and tested | 79.95 |
| Complete Instructions | 114.95 |
| MRF901 | 10.00 |
| MRF902 | 3.99 |
| MRF911 | 12.50 |
| 7812 | 4.29 |
| MBD101 | 1.99 |
| MB1101 | 1.99 |
| 2835/1N5711 | 4.99 |
| 1 K Pot | 1.99 |
| Matching transformers, 75 Ohm - 300 Ohm | 3.00 |
| Two-way splitters | 1.99 |
| Chassis type F connectors | 2.99 |
| Cable type F connectors | 4.99 |
| Barrel type F connectors | .76 |
| One 6 foot RG59 with connectors and one 50 foot RG59 with connectors | 18.99 |

TUBES

| | | | |
|------------|---------|------------|---------|
| 2E26 | \$ 5.00 | 12BY7A | \$ 4.50 |
| 3-500Z | 100.00 | 811A | 12.95 |
| 3B2B | 7.00 | 6146 | 5.00 |
| 3X2500A3 | 125.00 | 6146A | 5.25 |
| 3X3000F1 | 200.00 | 6146B | 7.95 |
| 4-65A | 30.00 | 6146W | 12.95 |
| 4-125A | 40.00 | 6360 | 7.95 |
| 4-250A | 60.00 | 6939 | 8.00 |
| 4-400A | 80.00 | 8072 | 45.00 |
| 4-1000A | 200.00 | 8295/PL172 | 300.00 |
| 4CX250B | 43.00 | 8950 | 10.00 |
| 4CX250R | 45.00 | 8877 OUT | 300.00 |
| 4CX350A | 50.00 | 7289 | 6.99 |
| 4CX1000A | 150.00 | 6KD6 | 6.00 |
| 4X150A | 20.00 | 6LF6 | 6.00 |
| 4X150G | 30.00 | 6LQ6/6JE6 | 6.00 |
| 572B/T160L | 39.00 | 8908 | 13.00 |
| | | 6550A | 8.00 |

Other numbers on request

NEW ELECTRICAL POWER STRIP
9 OUTLETS WITH BUILT IN CIRCUIT
BREAKER AND INDICATOR LAMP
\$21.95 each

QUANTITY PRICES AVAILABLE FOR 10 AND UP

Check, money order, or credit cards. (MasterCharge and VISA only) NO C.O.D.'s. No personal checks or certified personal checks for foreign countrys accepted. Money order or cashier's check in U.S. funds only. Letters of credit are not acceptable. Minimum shipping by UPS is \$2.00 plus 35¢ insurance per \$100.00. Please allow extra shipping charges for heavy items. All parts returned due to customer error will be subject to a 15% restock charge.

If we are out of an item ordered we will try to replace it with an equal or better part unless you specify not to, or we will back order the item. PRICES ARE SUBJECT TO CHANGE WITHOUT NOTICE. Prices superseade all previously published. Some items offered are limited to small quantities and are subject to prior sale. FOR OUT OF STATE USE OUR NEW 800 NUMBER FOR PHONE ORDERS. 800 528-3611 (For charge orders only, NO C.O.D.)

SEMICONDUCTORS SURPLUS

2822 North 32nd Street/Unit -1 Phoenix, Arizona 85008 (602) 956-9423

We accept checks, MasterCharge, and Visa

Prices subject to change without notice



FOR OUT OF STATE USE OUR NEW 800 NUMBER FOR PHONE ORDERS (800)528-3611

NO ORDERS WILL BE ACCEPTED UNDER \$10.00, NOT INCLUDING SHIPPING!

NO C.O.D.'s. PHONE IN YOUR ORDER

NEW PRIME RF POWER TRANSISTORS

| | | | | | |
|----------------|---------|------------------|---------|------------------------|---------|
| 2N2270 | \$ 1.00 | 2N6094 | \$ 7.15 | MRF901 | \$ 3.99 |
| 2N2857 | 1.57 | 2N6095 | 11.77 | MRF902 | 12.55 |
| 2N2857JAN | 2.54 | 2N6097 | 29.54 | MRF904 | 3.00 |
| 2N2947 | 17.25 | 2N6166 | 38.60 | MRF911 | 4.29 |
| 2N3227 | 3.25 | 2N6368 | 26.52 | MRF5177 | 21.62 |
| 2N3261 | 2.32 | MRF6439 | 45.77 | MRF8004 | 1.60 |
| 2N3375/MM3375 | 9.32 | 40280 | 3.00 | CD3495 | 19.99 |
| 2N3553 | 1.80 | 40281 | 11.90 | CD3435 | 29.95 |
| 2N3818 | 8.00 | 40282 | 12.90 | A50-12 | 29.95 |
| 2N3866 | 1.20 | 40894 | 1.20 | BFR96 | 2.00 |
| 2N3866JAN | 2.80 | PT3551C/2N6082NS | 5.00 | MWA110 | 6.92 |
| 2N3866JANTX | 4.49 | (no stud) | | MWA120 | 7.38 |
| 2N3925/M9477 | 8.00 | PT3563 | 5.00 | MWA130 | 8.08 |
| 2N3948 | 2.00 | PT4571A | 1.50 | MWA210 | 7.46 |
| 2N3950 | 26.86 | PT3607 | 5.00 | MWA220 | 8.08 |
| 2N3959 | 3.88 | PT3123E | 5.00 | MWA230 | 8.62 |
| 2N4072 | 2.00 | MRF216 | 22.46 | MWA310 | 8.08 |
| 2N4427 | 1.20 | MRF221 | 10.08 | MWA320 | 8.62 |
| 2N4429 | 9.00 | MRF227 | 3.00 | MWA330 | 9.23 |
| 2N4877 | 1.00 | MRF238 | 10.00 | | |
| 2N4959 | 2.23 | MRF240 | 14.62 | MICROWAVE DIODES | |
| 2N5108 | 4.03 | MRF245 | 33.30 | 1N21 | \$ 2.85 |
| 2N5109 | 1.66 | MRF247 | 33.30 | 1N21B | 3.85 |
| 2N5179 | 1.05 | MRF314 | 14.08 | 1N21D | 3.85 |
| 2N5177/MRF5177 | 21.62 | MRF412 | 23.83 | 1N21WE | 2.85 |
| 2N5214 | 20.00 | MRF421 | 31.38 | 1N23CR | 4.85 |
| 2N5583 | 4.55 | MRF422A | 44.14 | 1N23F | 5.50 |
| 2N5589 | 6.83 | MRF426A | 10.24 | 1N23WE | 4.00 |
| 2N5590 | 8.15 | MRF432 | 11.23 | 1N23FMR | 6.95 |
| 2N5591 | 11.85 | MRF449A | 10.61 | 1N25 | 6.50 |
| 2N5635 | 6.86 | MRF450 | 11.77 | 1N78 | 8.63 |
| 2N5636 | 13.38 | MRF450A | 11.77 | 1N446 | 12.00 |
| 2N5637 | 22.15 | MRF452 | 15.00 | 1N3655A | 3.85 |
| 2N5641/PT4132D | 6.00 | MRF452A | 15.00 | 1N5711/2835 | 1.99 |
| 2N5642 | 12.38 | MRF454 | 21.83 | MBD101 | 1.99 |
| 2N5643 | 15.82 | MRF454A | 21.83 | MB1101 | 4.99 |
| 2N5645 | 12.38 | MRF455 | 14.08 | 1S1544A | 3.00 |
| 2N5842/MM1607 | 8.78 | MRF455A | 14.08 | P40075 | 3.85 |
| 2N5847 | 11.15 | MRF474 | 3.00 | 1N41SEMR | 7.85 |
| 2N5919 | 30.00 | MRF475 | 3.25 | MA41482 | 3.00 |
| 2N5946 | 14.69 | MRF476 | 2.25 | MA41482R | 5.00 |
| 2N5849/MM1620 | 21.29 | MRF477 | 10.06 | | |
| 2N5862 | 51.91 | MRF479 | 4.68 | MOTOROLA RF MODULES | |
| 2N6080 | 7.74 | MRF485 | 3.50 | MHW602 | |
| 2N6082 | 11.30 | MRF502 | 1.08 | 20 W output at 174 MHz | |
| 2N6083 | 13.23 | MRF604 | 2.00 | 12.5 VDC 20.6 dB Gain | |
| 2N6084 | 14.66 | MRF629 | 3.00 | \$42.00 | |

ramsey

the first name in Counters!

9 DIGITS 600 MHz \$129⁹⁵ WIRED



PRICES:

| | |
|--------------------------------------|----------|
| CT-90 wired, 1 year warranty | \$129.95 |
| CT-90 Kit, 90 day parts war | ranty |
| AC-1 AC adapter | 109.95 |
| BP-1 Nicad pack + AC Adapter/Charger | 3.95 |
| OW-1, Micro-power Oven time base | 12.95 |
| External time base input | 49.95 |
| | 14.95 |

The CT-90 is the most versatile, feature packed counter available for less than \$300.00! Advanced design features include: three selectable gate times, nine digits, gate indicator and a unique display hold function which holds the displayed count after the input signal is removed. Also, a 10MHz TCXO time base is used which enables easy zero beat calibration checks against WWV. Optionally, an internal nicad battery pack, external time base input and Micro-power high stability crystal oven time base are available. The CT-90, performance you can count on!

SPECIFICATIONS:

| | |
|--------------|--|
| Range: | 20 Hz to 600 MHz |
| Sensitivity: | Less than 10 MV to 150 MHz
Less than 50 MV to 500 MHz |
| Resolution: | 0.1 Hz (10 MHz range)
1.0 Hz (60 MHz range)
10.0 Hz (600 MHz range) |
| Display: | 9 digits 0.4" LED |
| Time base: | Standard 10.000 mHz, 1.0 ppm 20-40°C.
Optional Micro-power oven-0.1 ppm 20-40°C |
| Power: | 8-15 VAC @ 250 ma |

7 DIGITS 525 MHz \$99⁹⁵ WIRED



SPECIFICATIONS:

| | |
|--------------|--|
| Range: | 20 Hz to 525 MHz |
| Sensitivity: | Less than 50 MV to 150 MHz
Less than 150 MV to 500 MHz |
| Resolution: | 1.0 Hz (5 MHz range)
10.0 Hz (50 MHz range)
100.0 Hz (500 MHz range) |
| Display: | 7 digits 0.4" LED |
| Time base: | 1.0 ppm TCXO 20-40°C |
| Power: | 12 VAC @ 250 ma |

The CT-70 breaks the price barrier on lab quality frequency counters. Deluxe features such as: three frequency ranges - each with pre-amplification, dual selectable gate times, and gate activity indication make measurements a snap. The wide frequency range enables you to accurately measure signals from audio thru UHF with 1.0 ppm accuracy - that's .0001%! The CT-70 is the answer to all your measurement needs. In the field, lab or ham shack.

PRICES:

| | |
|--------------------------------------|---------|
| CT-70 wired, 1 year warranty | \$99.95 |
| CT-70 Kit, 90 day parts war- | ranty |
| AC-1 AC adapter | 84.95 |
| BP-1 Nicad pack + AC adapter/charger | 3.95 |
| | 12.95 |

7 DIGITS 500 MHz \$79⁹⁵ WIRED



PRICES:

| | |
|--|---------|
| MINI-100 wired, 1 year warranty | \$79.95 |
| MINI-100 Kit, 90 day part warranty | \$9.95 |
| AC-Z Ac adapter for MINI-100 | 3.95 |
| BP-Z Nicad pack and AC adapter/charger | 12.95 |

Here's a handy, general purpose counter that provides most counter functions at an unbelievable price. The MINI-100 doesn't have the full frequency range or input impedance qualities found in higher price units, but for basic RF signal measurements, it can't be beat! Accurate measurements can be made from 1 MHz all the way up to 500 MHz with excellent sensitivity throughout the range, and the two gate times let you select the resolution desired. Add the nicad pack option and the MINI-100 makes an ideal addition to your tool box for "in-the-field" frequency checks and repairs.

SPECIFICATIONS:

| | |
|--------------|---|
| Range: | 1 MHz to 500 MHz |
| Sensitivity: | Less than 25 MV |
| Resolution: | 100 Hz (slow gate)
1.0 KHz (fast gate) |
| Display: | 7 digits, 0.4" LED |
| Time base: | 2.0 ppm 20-40°C |
| Power: | 5 VDC @ 200 ma |

8 DIGITS 600 MHz \$159⁹⁵ WIRED



SPECIFICATIONS:

| | |
|--------------|---|
| Range: | 20 Hz to 600 MHz |
| Sensitivity: | Less than 25 mv to 150 MHz
Less than 150 mv to 600 MHz |
| Resolution: | 1.0 Hz (60 MHz range)
10.0 Hz (600 MHz range) |
| Display: | 8 digits 0.4" LED |
| Time base: | 2.0 ppm 20-40°C |
| Power: | 110 VAC or 12 VDC |

The CT-50 is a versatile lab bench counter that will measure up to 600 MHz with 8 digit precision. And, one of its best features is the Receive Frequency Adapter, which turns the CT-50 into a digital readout for any receiver. The adapter is easily programmed for any receiver and a simple connection to the receiver's VFO is all that is required for use. Adding the receiver adapter in no way limits the operation of the CT-50, the adapter can be conveniently switched on or off. The CT-50, a counter that can work double-duty!

PRICES:

| | |
|---|----------|
| CT-50 wired, 1 year warranty | \$159.95 |
| CT-50 Kit, 90 day parts warranty | 119.95 |
| RA-1, receiver adapter kit | 14.95 |
| RA-1 wired and pre-programmed (send copy of receiver schematic) | 29.95 |

DIGITAL MULTIMETER \$99⁹⁵ WIRED



PRICES:

| | |
|---------------------------------------|---------|
| DM-700 wired, 1 year warranty | \$99.95 |
| DM-700 Kit, 90 day parts warranty | 79.95 |
| AC-1, AC adaptor | 3.95 |
| BP-3, Nicad pack + AC adapter/charger | 19.95 |
| MP-1, Probe kit | 2.95 |

The DM-700 offers professional quality performance at a hobbyist price. Features include: 26 different ranges and 5 functions, all arranged in a convenient, easy to use format. Measurements are displayed on a large 3 1/2 digit, 1/2 inch LED readout with automatic decimal placement, automatic polarity, overrange indication and overload protection up to 1250 volts on all ranges, making it virtually goof-proof! The DM-700 looks great, a handsome, jet black, rugged ABS case with convenient retractable tilt ball makes it an ideal addition to any shop.

SPECIFICATIONS:

| | |
|------------------|----------------------------------|
| DC/AC volts: | 100uV to 1 KV, 5 ranges |
| DC/AC current: | 0.1uA to 2.0 Amps, 5 ranges |
| Resistance: | 0.1 ohms to 20 Megohms, 6 ranges |
| Input impedance: | 10 Megohms, DC/AC volts |
| Accuracy: | 10.1% basic DC volts |
| Power: | 4 'C' cells |

AUDIO SCALER

For high resolution audio measurements, multiplies UP in frequency.

- Great for PL tones
- Multiplies by 10 or 100
- 0.01 Hz resolution!

\$29.95 Kit \$39.95 Wired

ACCESSORIES

| | |
|--|---------|
| Telescopic whip antenna - BNC plug | \$ 7.95 |
| High impedance probe, light loading | 15.95 |
| Low pass probe, for audio measurements | 15.95 |
| Direct probe, general purpose usage | 12.95 |
| Tilt ball, for CT 70, 90, MINI-100 | 3.95 |
| Color burst calibration unit, calibrates counter against color TV signal | 14.95 |

COUNTER PREAMP

For measuring extremely weak signals from 10 to 1,000 MHz. Small size, powered by plug transformer-included.

- Flat 25 db gain
 - BNC Connectors
 - Great for sniffing RF with pick-up loop
- \$34.95 Kit \$44.95 Wired

ramsey electronic's, inc.

BOX 4072 • ROCHESTER, NY 14610



PHONE ORDERS
CALL 716-586-3950

TERMS

Satisfaction guaranteed - examine for 10 days - if not pleased return in original form for refund. Add 5% for shipping insurance to a maximum of \$10. Overseas add 15%. COD add \$2. Orders under \$10 add \$1.50. NY residents add 7% tax.

The Question we seem to get most often from our customers:

"WHEN IS ICOM COMING OUT WITH A HAND-HELD?"

ICOM IC-2A SYNTHESIZED 2 METER HAND HELD

FEATURES YOU'VE WANTED

- 800 T/R Channels. Synthesized.
- 1.5 Watt Output High/Low Power Battery Saving Switch to .15 Watt.
- Separate built in Speaker & Mic. Excellent audio quality.
- Compact. About the size of a dollar bill.
- Variable size Nicad Power Pack, 3 sizes available to suit your needs. (250 MA standard). Makes the IC-2A the most compact on the market.
- ICOM level Receiver Performance-ICOM Quality Receiver in a compact package (.2uv/20db typical)
- Optional Tone Pad, Desk Charger, Speaker/Mic available.
- With slip on/slip off Bottom Nicad Pack, you can vary the size from about 116 mm high to 175 mm high. Easy to carry extra Snap-on packs with you for extended trips.

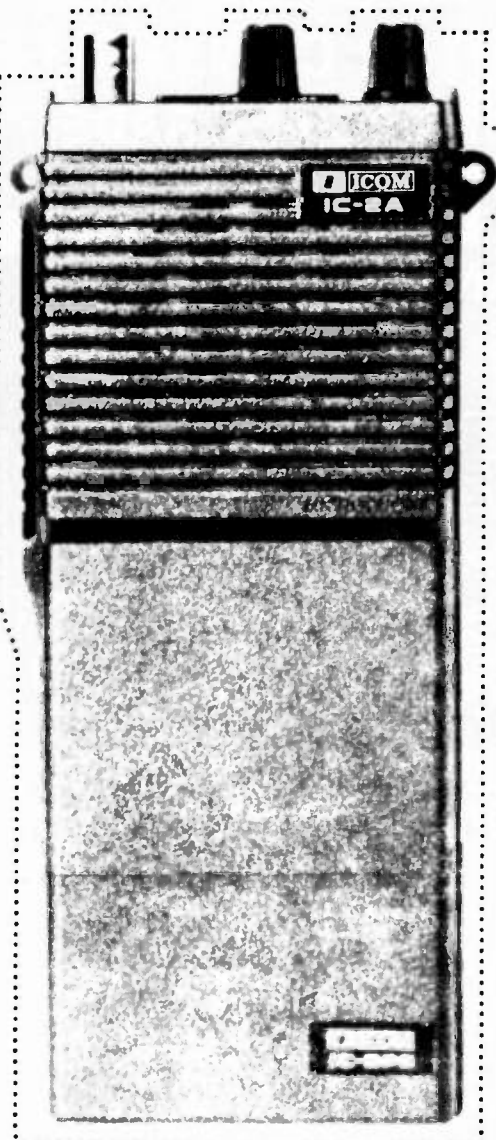

BACK VIEW

±600 khz offset
simplex/duplex
Hi/lo power

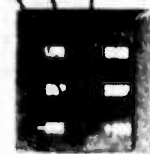

TOP VIEW

BNC antenna connector
"Rubber Duckie" standard
transmit indicator
squelch
volume control
on/off
5 khz channel selection
10 khz channel selection
speaker/mic jack

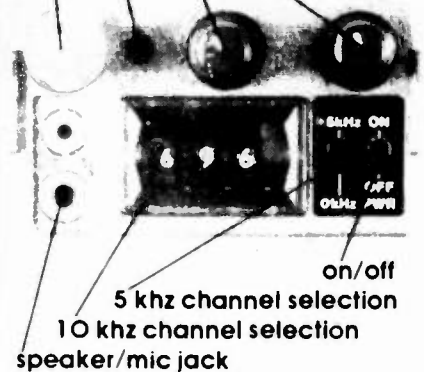

THE ANSWER IS: NOW!

All 800 channels of it!

PHONE: (312) 848-6777



SPECTRONICS, INC. — 1009 GARFIELD ST., OAK PARK, ILL. 60304

AZDEN ★ NEW! ★ AZDEN ★ NEW! ★ AZDEN ★ NEW! ★ AZDEN

THE GIANT **AZDEN** COMPANY
REVOLUTIONIZES THE STATE OF THE ART
AWE AND AZDEN. INTRODUCE THE BRILLIANT NEW PCS-2800
MICROCOMPUTER CONTROLLED
SUPERIOR COMMERCIAL GRADE
10 METER
FM TRANSCEIVER

FALL
SALE
239.00



COMPARE THESE FEATURES
WITH ANY UNIT AT ANY PRICE

- **FREQUENCY RANGE:** Receive and transmit: 28.000 to 29.995 MHz, 10KHz steps with built-in +100 KHz repeater offset.
- **ALL SOLID STATE-CMOS PL DIGITAL SYNTHESIZED.**
- **SIZE: UNBELIEVABLE! ONLY 6 3/4" x 2 3/8" x 9 3/4". COMPARE!**
- **MICROCOMPUTER CONTROLLED:** All scanning and frequency-control functions are performed by microcomputer.
- **DETACHABLE HEAD:** The control head may be separated from the radio for use in limited spaces and for security purposes.
- **SIX-CHANNEL MEMORY:** Each memory is re-programmable. Memory is retained even when the unit is turned off.
- **MEMORY SCAN:** The six channels may be scanned in either the "busy" or "vacant" modes for quick, easy location of an occupied or unoccupied frequency. **AUTO RESUME. COMPARE!**
- **FULL-BAND SCAN:** All channels may be scanned in either "busy" or "vacant" mode. This is especially useful for locating repeater frequencies in an unfamiliar area. **AUTO RESUME. COMPARE!**
- **INSTANT MEMORY-1 RECALL:** By pressing a button on the microphone or front panel, memory channel 1 may be recalled for immediate use.
- **MIC-CONTROLLED VOLUME AND SQUELCH:** Volume and squelch can be adjusted from the microphone for convenience in mobile operation.
- **DIRECT FREQUENCY READOUT:** LED display shows operating frequency, NOT channel number. **COMPARE!**
- **TEN (10) WATTS OUTPUT:** Also 1 watt low power for shorter distance communications. LED readout displays power selection when transmitting.
- **DIGITAL S/R/F METER:** LEDs indicate signal strength and power output. No more mechanical meter movements to fall apart!
- **LARGE 1/2-INCH LED DISPLAY:** Easy-to-read frequency display minimizes "eyes-off-the-road" time.
- **PUSHBUTTON FREQUENCY CONTROL FROM MIC OR FRONT PANEL:** Any frequency may be selected by pressing a microphone or front-panel switch.
- **SUPERIOR RECEIVER SENSITIVITY:** 0.28 uV for 20-dB quieting. The squelch sensitivity is superb, requiring less than 0.1 uV to open. The receiver audio circuits are designed and built to exacting specifications, resulting in unsurpassed received-signal intelligibility.
- **TRUE FM, NOT PHASE MODULATION:** Transmitted audio quality is optimized by the same high standard of design and construction as is found in the receiver. The microphone amplifier and compression circuits offer intelligibility second to none.
- **OTHER FEATURES:** Dynamic Microphone, built in speaker, mobile mounting bracket, external remote speaker jack (head and radio) and much, much more. All cords, plugs, fuses, microphone hanger, etc. Included. Weight 6 lbs.
- **ACCESSORIES:** 15' REMOTE CABLE...\$29.95. FMPS-4R A/C POWER SUPPLY...\$39.95. TOUCHTONE MIC. KIT...\$39.95. EXTERNAL SPEAKER...\$18.00.

AMATEUR-WHOLESALE ELECTRONICS ORDER NOW TOLL FREE

8B17 S.W. 129th Terrace, Miami, Florida 33176
Telephone (305) 233-3631 • Telex: 80-3356

Hours: 9:5 Mon.-Fri.

U.S. DISTRIBUTOR
DEALER INQUIRIES INVITED

1-800-327-3102

CREDIT CARD HOLDERS MAY USE OUR TOLL FREE ORDERING NUMBER.

We now have available a bunch of goodies too good to bypass. Items are limited so order today

Call Your Phone Order in Today

TERMS: Satisfaction guaranteed or money refunded. C.O.D. add \$2.00. Minimum order \$6.00. Orders under \$10.00 add \$1.50. Add 5% for postage, insurance, handling. Overseas add 15%. N.Y. residents add 7% tax.

MINI KITS - YOU HAVE SEEN THESE BEFORE NOW HERE ARE OLD FAVORITE AND NEW ONES TOO. GREAT FOR THAT AFTERNOON HOBBY.

FM MINI MIKE



A super high performance FM wireless mike kit! Transmits a stable signal up to 300 yards with exceptional audio quality by means of its built in electret mike. Kit includes case, mike, on-off switch, antenna, battery and super instructions. This is the finest unit available.

Complete kit, ML-1 **\$8.95**
ML-1 **\$8.95**

Color Organ

See music come alive! 3 different lights flicker with music. One light each for, high, mid-range and lows. Each individually adjustable and drives up to 300 W runs on 110 VAC.

Complete kit, CPO-1
Runs on 3-12 Vdc 1 wall out, 1 KHZ good for CPO, Alarm, Audio Oscillator. Complete kit **\$2.95**

Video Modulator Kit

Converts any TV to video monitor. Super stable, tunable over ch 4-6. Runs on 5-15V. Complete std video signal. Best unit on the market! Complete kit, VD-1 **\$7.95**

Super Sleuth

A super sensitive amplifier which will pick up a pin drop at 15 feet! Great for monitoring baby's room or as general purpose amplifier. Full 2 W rms output, runs on 6 to 15 volts, uses 8-45 ohm speaker. Complete kit, BN-9 **\$5.95**

CLOCK KITS

Your old favorites are here again. Over 7,000 Sold to Date. Be one of the gang and order yours today!

Try your hand at building the finest looking clock on the market. Its satin finish anodized aluminum case looks great anywhere, while six 4" LED digits provide a highly readable display. This is a complete kit, no extras needed, and it only takes 1-2 hours to assemble. Your choice of case colors: silver, gold, black (specify).

Clock kit, 12/24 hour, DC-5 **\$24.95**
Clock with 10 min. ID timer, 12/24 hour, DC-10 **\$29.95**
Alarm clock, 12 hour only, DC-8 **\$29.95**
12V DC car clock, DC-7 **\$29.95**

For wired and tested clocks add \$10.00 to kit price. SPECIFY 12 OR 24 HOUR FORMAT

FM Wireless Mike Kit



Transmits up to 300' to any FM broadcast radio, uses any type of mike. Runs on 3 to 9V. Type FM-2 includes added sensitive mike preamp stage.

FM-1 kit **\$3.95** FM-2 kit **\$4.95**

Whisper Light Kit

An interesting kit, small mike picks up sounds and converts them to light. The louder the sound, the brighter the light. Includes mike, controls up to 300 W, runs on 110 VAC. Complete kit, WL-1 **\$6.95**

Car Clock

The UN-KIT, only 5 solder connections

Here's a super looking, rugged and accurate auto clock, which is a snap to build and install. Clock movement is completely assembled, 100% tested, 3 wires and 2 switches, takes about 15 minutes! Display is bright green with automatic brightness control photocell - assures you of a highly readable display day or night. Comes in a satin finish anodized aluminum case which can be attached 5 different ways using 2 sided tape. Choice of silver black or gold case (specify)

DC-3 kit, 12 hour format **\$22.95**
DC-3 wired and tested **\$29.95**

Universal Timer Kit

Provides the basic parts and PC board required to provide a source of precision timing and pulse generation. Uses 555 timer IC and includes a range of parts for most timing needs.

UT-5 Kit **\$5.95**

Mad Blaster Kit

Produces LOUD ear shattering and attention getting siren like sound. Can supply up to 15 watts of obnoxious audio. Runs on 6-15 VDC

MB-1 Kit **\$4.95**

Siren Kit

Produces upward and downward wail characteristic of a police siren. 5 W peak audio output, runs on 3-15 volts, uses 3-45 ohm speaker. Complete kit, SM-3 **\$2.95**

Calendar Alarm Clock

The clock that's got it all: 6-5" LEDs, 12/24 hour, snooze, 24 hour alarm, 4 year calendar, battery backup, and lots more. The super 7001 chip is used. Size 5x4x2 inches. Complete kit, less case (not available) **\$34.95**

Under Dash Car Clock

12/24 hour clock in a beautiful plastic case features 6 jumbo RED LEDs high accuracy (.001%), easy 3 wire hookup display blanks with ignition and super-instructions. Optional dimmer automatically adjusts display to ambient light level. QC-11 clock with mtg bracket **\$27.95 kit**
DM-1 dimmer adapter **\$2.50**
Add \$10.00 Assy and Test

PARTS PARADE

IC SPECIALS

LINEAR

| | |
|------|---------|
| 301 | \$.35 |
| 324 | \$1.50 |
| 380 | \$1.50 |
| 555 | \$.45 |
| 525 | \$1.00 |
| 566 | \$1.00 |
| 567 | \$1.25 |
| 741 | \$10.00 |
| 1458 | \$.50 |
| 3900 | \$.50 |
| 3914 | \$2.95 |
| 8038 | \$2.95 |

TTL

| | |
|-------|---------|
| 74500 | \$ 4.40 |
| 7447 | \$.65 |
| 7475 | \$.50 |
| 7490 | \$.50 |
| 74196 | \$1.35 |

Resistor Ass't

Assortment of Popular values - 1/4 watt, Cut lead for PC mounting, 1/8" center, 1/2" leads, bag of 300 or more **\$1.50**

Switches **\$1.00**
Mini toggle SPDT
Red Pushbuttons N/O **3/\$1.00**

Earpieces **\$1.00**
3" leads, 8 ohm, good for small tone speakers, alarm clocks, etc. 5 for \$1.00

Mini 8 ohm Speaker **\$1.00**
Approx 2 1/2" diam round type for radios, mice etc. 3 for \$2.00

Slugs Tuned Coils **\$1.00**
Small 3/16" Hex Slugs turned coil, 3 turns. 10 for \$1.00

CAPACITORS

| TANTALUM | ALUMINUM | DISK CERAMIC |
|---------------------|----------------------------|-----------------------|
| Dipped Epoxy | Electrolytic | 01 16V disc 20/\$1.00 |
| 1.5 uF 25V 3/\$1.00 | 1000 uF 16V Radial \$.50 | 1 16V 15/\$1.00 |
| 1.8 uF 25V 3/\$1.00 | 500 uF 20V Axial \$.50 | 100 16V 20/\$1.00 |
| 22 uF 25V 3/\$1.00 | 150 uF 16V Axial 5/\$1.00 | 100 pf 20/\$1.00 |
| | 10 uF 15V Radial 10/\$1.00 | 047 16V 20/\$1.00 |

CMOS

| | |
|------|--------|
| 4011 | \$.50 |
| 4013 | \$.50 |
| 4046 | \$1.85 |
| 4049 | \$.50 |
| 4059 | \$9.00 |
| 4511 | \$2.00 |
| 4518 | \$1.35 |
| 5639 | \$1.75 |

SPECIAL

| | |
|----------|---------|
| 11C90 | \$15.00 |
| 10116 | \$ 1.25 |
| 7208 | \$17.50 |
| 7207A | \$ 5.50 |
| 7216D | \$21.50 |
| 7107C | \$2.50 |
| 5314 | \$ 2.95 |
| 5375AB/G | \$ 2.95 |
| 7001 | \$ 6.50 |

AC Adapters

Good for clocks, nicad chargers, all 110 VAC plug one end

| | |
|-----------------|--------|
| R 5 vdc @ 20 mA | \$1.00 |
| 16 vac @ 160mA | \$2.50 |
| 12 vac @ 250mA | \$3.00 |

FERRITE BEADS

With info and specs **\$181.00**
6 Hole Baton Beads **\$1.00**

DC-DC Converter

+5 vdc input prod -9 vdc @ 30ma
-9 vdc produces -15 vdc @ 35ma **\$1.25**

25K 20 Turn Trim Pot **\$1.00**
1K 20 Turn Trim Pot **\$.50**

Crystal Microphone

Small 1" diameter 1/8" thick crystal mike cartridge **\$.75**

Coax Connector **\$1.00**
Chassis mount
BNC type

Crystal IF Filters

Mini ceramic filters 7 kHz B.W. 455 kHz **\$1.50 ea.**

Trimmer Caps Sprague - 3-40 pf Stable Polypropylene **50 ea.**

9 Volt Battery Clips **\$ for \$1.00**
Nice quality clips **5 for \$1.00**
1/2" Rubber Grommets **10 for \$1.00**

Connectors
6 pin type gold contacts for mA-1003 car clock module **.75 ea.**

Audio Prescaler

Make high resolution audio measurements, great for musical instrument tuning, PL tones, etc. Multiplies audio UP in frequency, selectable x10 or x100, gives .01 HZ resolution with 1 sec. gate time! High sensitivity of 25 mv, 1 meg input z and built-in filtering gives great performance. Runs on 9V battery, all CMOS

PS-2 kit **\$29.95**
PS-2 wired **\$39.95**

30 Watt 2 mtr PWR AMP

Simple Class C power amp features 8 times power gain, 1 W in for 8 out, 2 W in for 15 out, 4W in for 30 out. Max output of 35 W, incredible value, complete with all parts, less case and T-R relay.

PA-1, 30 W pwr amp kit **\$22.95**
TR-1, RF sensed T-R relay kit **6.95**

RF actuated relay senses RF (1W) and closes DPDT relay.

For RF sensed T-R relay TR-1 Kit **\$6.95**

OP-AMP Special

BI-FET LF 13741 - Direct pin for pin 741 compatible, but 500,000 MEG Input z, super low 50 pa input current, low power drain

50 for only **\$9.00** 10 for **\$2.00**

| | | | |
|------|--------|------|--------|
| 78MG | \$1.25 | 7812 | \$1.00 |
| 79MG | \$1.25 | 7815 | \$1.00 |
| 723 | \$.50 | 7905 | \$1.25 |
| 309K | \$1.15 | 7912 | \$1.25 |
| 7805 | \$1.00 | 7915 | \$1.25 |

Shrink Tubing Nubs **\$0/\$1.00**
Nice precut pcs of shrink size 1" x 1/2" shrink to 1/4". Great for splices.

Mini TO-92 Heat Sinks **5 for \$1.00**
Thermalloy Brand
TO-220 Heat Sinks **3 for \$1.00**

Opto Isolators - 4N28 type **\$.50 ea.**
Opto Reflectors - Photo diode + LED **\$1.00 ea.**

Molex Pins **\$0/\$1.00**
Molex already precut in length of 7. Perfect for 14 pin sockets, 20 stripe for \$1.00

CDS Photocells **250 ohms to 3 for \$1.00**
Resistance varies with light.

THESE PRICES ARE NOT MISPRINTS

Here is a chance to stock up your lab at unprecedented prices... we've got to move these out to make room for our ever-expanding CompuPro™ division. Limited quantities - first come, first served. Sorry, at these low prices we cannot include spec sheets or accept COD/telephone orders. Part numbers must include the special -S suffix or you will be charged our regular prices. Parts may be house numbered or have dual markings. This is your chance to save!

TTL

| | | |
|---------|-------------------------------|--------|
| 7403-S | Quad 2 input OC | 21/\$2 |
| 7410-S | Triple 3 input NAND | 21/\$2 |
| 7413-S | 4 to 16 line decoder/demux | 6/\$2 |
| 7438-S | Quad 2 input NAND OC | 21/\$2 |
| 7444-S | Gray to decimal decoder | 8/\$2 |
| 7450-S | And-or-invert | 21/\$2 |
| 7472-S | JK M-S flip flop | 21/\$2 |
| 7493-S | 4 bit binary counter | 10/\$2 |
| 7496-S | 5 bit shift register | 12/\$2 |
| 74122-S | Retriggerable one-shot | 18/\$2 |
| 74151-S | 8 channel mux | 8/\$2 |
| 74155-S | Dual 2/4 demux | 8/\$2 |
| 74159-S | 4 to 16 line decoder/demux OC | 4/\$2 |
| 74161-S | Synchro 4 bit binary counter | 8/\$2 |
| 74163-S | Synchro 4 bit binary counter | 8/\$2 |
| 74164-S | 8 bit shift register | 6/\$2 |
| 74190-S | Up/down decade counter | 4/\$2 |
| 74192-S | Up/down binary counter | 4/\$2 |
| 74194-S | 4 bit bidirectional shift reg | 4/\$2 |
| 74195-S | 4 bit parallel shift register | 6/\$2 |
| 74198-S | 8 bit shift register | 4/\$2 |

CMOS

| | | |
|--------|-----------------------------|--------|
| 4012-S | Dual 4 input NAND | 12/\$2 |
| 4020-S | 14 stage counter | 4/\$2 |
| 4023-S | Triple 3 input NAND | 12/\$2 |
| 4044-S | Quad R-S latch | 4/\$2 |
| 4046-S | Phase locked loop | 2/\$2 |
| 4071-S | Quad 2 input OR | 12/\$2 |
| 4093-S | Quad 2 in NAND Schmitt trig | 4/\$2 |
| 4507-S | Quad EX-OR | 4/\$2 |
| 4510-S | BCD up/down counter | 2/\$2 |

LINEARS

(package type: H = TO99, M = minidip, D = dip, TK = TO66)

| | | |
|----------|---------------------------|--------|
| 201H-S | Improved 301 op amp | 10/\$2 |
| 308H-S | Micropower op amp | 6/\$2 |
| 703H-S | RF/IF amp | 6/\$2 |
| 723D-S | Voltage regulator | 6/\$2 |
| 741M-S | Compensated op amp | 15/\$2 |
| 1458M-S | Dual 741 | 10/\$2 |
| 4558M-S | Dual 741 | 12/\$2 |
| 4195TK-S | Dual track 15V reg w/data | 2/\$2 |

TO-220 NEGATIVE VOLTAGE REGULATORS

| | | |
|---------|----------------|-------|
| 7906-S | -6V regulator | 2/\$2 |
| 7908-S | -8V regulator | 2/\$2 |
| 7912-S | -12V regulator | 2/\$2 |
| 79M15-S | -15V regulator | 2/\$2 |
| 7918-S | -18V regulator | 2/\$2 |
| 7924-S | -24V regulator | 2/\$2 |

OTHER SEMICONDUCTORS

| | |
|--|------------|
| • General purpose silicon signal diodes | 50/\$2 |
| • GT5306 NPN darlington, min gain | |
| 17000, 25V 200 mA, T092 package | 100/\$8.95 |
| • NPN transistor similar 2N3904 | 100/\$7.95 |
| • PNP transistor similar 2N3906 | 100/\$8.95 |
| • 4N28-S opto-coupler 6 pin minidip, MCT-2/IL-1 pinout | 5/\$2 |
| • SN76477-S complex sound generator | 1/\$2.50 |
| • Opto-Isolator Grab Bag - 50 mixed opto-isolators from a major manufacturer. Unmarked 6 and 8 lead minidips include single and dual types with diode, transistor, and darlington outputs. Test them yourself and save! Not recommended for beginners. | 50/\$4 |

SOLDERTAIL SOCKET SPECIAL

Now that you've got the ICs, get some sockets at a fantastic price!

| | | | |
|---------|-----------|---------|-----------|
| 14 pin: | 50/\$4.95 | 20 pin: | 40/\$4.95 |
| 16 pin: | 50/\$4.95 | 24 pin: | 30/\$4.95 |
| 18 pin: | 50/\$4.95 | 28 pin: | 30/\$4.95 |
| | | 40 pin: | 20/\$4.95 |

74LS TTL

| | | | |
|---------|--------|---------|------|
| 74LS00 | \$0.34 | 74LS154 | 2.10 |
| 74LS01 | 0.34 | 74LS155 | 1.87 |
| 74LS02 | 0.34 | 74LS157 | 1.57 |
| 74LS04 | 0.38 | 74LS160 | 2.20 |
| 74LS05 | 0.44 | 74LS161 | 2.18 |
| 74LS08 | 0.34 | 74LS162 | 2.20 |
| 74LS10 | 0.34 | 74LS163 | 2.18 |
| 74LS11 | 0.40 | 74LS168 | 3.75 |
| 74LS12 | 0.34 | 74LS169 | 3.75 |
| 74LS14 | 2.20 | 74LS173 | 2.08 |
| 74LS15 | 0.40 | 74LS174 | 2.05 |
| 74LS20 | 0.34 | 74LS175 | 1.95 |
| 74LS21 | 0.40 | 74LS181 | 3.50 |
| 74LS22 | 0.40 | 74LS192 | 3.05 |
| 74LS26 | 0.48 | 74LS195 | 1.87 |
| 74LS27 | 0.42 | 74LS221 | 1.70 |
| 74LS30 | 0.34 | 74LS240 | 2.50 |
| 74LS32 | 0.46 | 74LS241 | 2.50 |
| 74LS33 | 0.60 | 74LS244 | 2.50 |
| 74LS37 | 0.48 | 74LS257 | 1.95 |
| 74LS38 | 0.48 | 74LS258 | 2.02 |
| 74LS42 | 1.56 | 74LS266 | 0.69 |
| 74LS47 | 1.68 | 74LS273 | 2.91 |
| 74LS48 | 1.68 | 74LS283 | 2.02 |
| 74LS74 | 0.54 | 74LS365 | 0.88 |
| 74LS75 | 0.82 | 74LS366 | 0.88 |
| 74LS76 | 0.50 | 74LS367 | 0.88 |
| 74LS86 | 0.58 | 74LS368 | 0.88 |
| 74LS109 | 0.62 | 74LS386 | 0.69 |
| 74LS123 | 1.70 | 80LS95 | 0.88 |
| 74LS125 | 0.87 | 80LS96 | 0.88 |
| 74LS126 | 0.87 | 80LS97 | 0.88 |
| 74LS132 | 1.50 | 80LS98 | 0.88 |
| 74LS136 | 0.69 | 81LS95 | 2.10 |
| 74LS138 | 1.87 | 81LS96 | 2.10 |
| 74LS139 | 1.87 | 81LS97 | 2.10 |
| 74LS151 | 1.66 | 81LS98 | 2.10 |

MORE TRANSISTORS AND FETS

| | | |
|---------|-----------------------------------|----------|
| 2N2221 | NPN TO-18 unmarked | 7/\$1.00 |
| 2N2222 | PNP TO-18 unmarked | 5/\$1.00 |
| 2N2907A | PNP plastic house # | 5/\$1.00 |
| 2N3055 | NPN TO-3 house # | 1/\$0.75 |
| 2N3904 | NPN TO-105 house # | 5/\$1.00 |
| 2N3906 | PNP TO-105 house # | 5/\$1.00 |
| 2N4124 | 30V/350 mW TO-92 | 3/\$1.00 |
| 2N4304 | TO-18 plastic N-JFET gen purp | 2/\$1.00 |
| 2N4400 | NPN plastic house # | 5/\$1.00 |
| 2N4917 | PNP TO-106 | 5/\$1.00 |
| 2N4946 | NPN TO-106 | 6/\$1.00 |
| 2N5227 | PNP TO-92 30V | 6/\$1.00 |
| 2N5306 | NPN TO-92 darlington | 3/\$1.00 |
| 2N5449 | NPN | 6/\$1.00 |
| 2N5484 | RF N-JFET | 3/\$1.00 |
| D41D1 | PNP TO-202 1A max | 1/\$0.50 |
| D44C4 | NPN TO-220 4A/55V | 1/\$0.75 |
| D45C4 | PNP TO-220 4A/55V | 1/\$0.75 |
| D45H8 | PNP TO-220 10A/60V | 3/\$2.00 |
| MPS3694 | NPN gen purp | 4/\$1.00 |
| FPT100 | Phototransistor | 1/\$0.50 |
| FET-2 | Dual N-JFET TO-18 sim 2N4416 | 3/\$1.00 |
| FET-3 | Dual N-JFET lo noise audio | 2/\$1.00 |
| FET-6 | Gen purp dual gate MOSFET house # | 3/\$2.00 |

CLOSEOUT H8 MEMORY 32K for \$549!

Limited quantity: 32K of static memory in kit (not unkit) form. Includes all parts, sockets for all ICs, documentation, mounting bracket, etc. With solder-masked, double-sided, fully legended board for easy assembly. If you own an H8, this is your chance to obtain top-notch memory — without paying top-notch prices.

16K DYNAMIC RAMS NEW LOW PRICE! LOW - 8/\$39!!

Lowest price ever on one of our most popular items. Expands memory in TRS-80* -I and -II, as well as machines made by Apple, Exidy, Heath H89, newer PETs, etc. Low power, speed (4 MHz). Add \$3 for dip shunts plus TRS-80* conversion instructions. Limited quantity — first come, first served. *TRS-80 is a trademark of the Tandy Corporation

MA1003 CLOCK MODULE - \$14.95

Our very best clock module operates from 12V DC and includes an Internal timebase accurate to 0.01%, making it ideal for mobile applications in your car, van, or boat. Blue-green fluorescent readouts don't wash out during the day, and look great at night. Easy to build; just hook up power, add two time-setting switches, and you've got one of the best clock modules on the road. With application note that shows you how to get the most out of your MA1003.

Also available: clock/case combination. For \$19.95, we'll include a matching case, with mounting hardware and optical filter, along with the MA1003.

DC ROBOT MOTOR SPECIAL

DC fractional horsepower motor runs on about 1 to 5V. Not a servo motor by any means, but good for experimenting with robots, toys, games, etc. 10/\$2.95

TERMS: Cal res add tax. Allow 5% for shipping; excess refunded. Orders under \$15 add \$1 handling. VISA®/Mastercard® orders (\$25 min) call our 24 hour order desk at (415) 562-0636. COD OK with street address for UPS. PLEASE NOTE: TELEPHONE ORDERS AND CDS ARE NOT ALLOWED ON SPECIALS LISTED ABOVE. Sale prices good through cover month of magazine; other prices subject to change without notice.

GODBOUT

GODBOUT ELECTRONICS
Bldg. 725, Oakland Airport, CA 94614

AND THERE'S MORE

FREE FLYER: This ad is only the tip of the iceberg; our catalog tells the rest of the story. Add 41 cents in stamps for 1st class delivery. Outside USA, include \$2 to cover postage (refundable with order). Thank you for your business!

SAVE! SAVE! SAVE!

28

| 7400 | | 74LS | | 74S | |
|---------|------|----------|------|-------|------|
| SN7400N | .25 | SN74156N | .75 | 74S00 | .50 |
| SN7401N | .20 | SN74157N | .69 | 74S01 | .50 |
| SN7402N | .25 | SN74158N | .89 | 74S02 | .29 |
| SN7403N | .25 | SN74159N | .89 | 74S03 | .29 |
| SN7404N | .29 | SN74160N | 1.25 | 74S04 | .50 |
| SN7405N | .29 | SN74161N | .89 | 74S05 | .29 |
| SN7406N | .35 | SN74162N | .89 | 74S06 | 1.15 |
| SN7407N | .35 | SN74163N | .89 | 74S07 | .29 |
| SN7408N | .29 | SN74164N | 1.25 | 74S08 | .29 |
| SN7409N | .29 | SN74165N | 1.25 | 74S09 | .29 |
| SN7410N | .25 | SN74166N | 1.25 | 74S10 | .29 |
| SN7411N | .25 | SN74167N | 1.25 | 74S11 | .29 |
| SN7412N | .35 | SN74168N | 1.25 | 74S12 | .29 |
| SN7413N | .40 | SN74169N | 1.25 | 74S13 | .29 |
| SN7414N | .69 | SN74170N | 1.25 | 74S14 | .29 |
| SN7415N | .29 | SN74171N | 1.25 | 74S15 | .29 |
| SN7416N | .29 | SN74172N | 1.25 | 74S16 | .29 |
| SN7417N | .29 | SN74173N | 1.25 | 74S17 | .29 |
| SN7418N | .29 | SN74174N | 1.25 | 74S18 | .29 |
| SN7419N | .29 | SN74175N | 1.25 | 74S19 | .29 |
| SN7420N | .29 | SN74176N | 1.25 | 74S20 | .29 |
| SN7421N | .29 | SN74177N | 1.25 | 74S21 | .29 |
| SN7422N | .29 | SN74178N | 1.25 | 74S22 | .29 |
| SN7423N | .29 | SN74179N | 1.25 | 74S23 | .29 |
| SN7424N | .29 | SN74180N | 1.25 | 74S24 | .29 |
| SN7425N | .29 | SN74181N | 1.25 | 74S25 | .29 |
| SN7426N | .29 | SN74182N | 1.25 | 74S26 | .29 |
| SN7427N | .29 | SN74183N | 1.25 | 74S27 | .29 |
| SN7428N | .29 | SN74184N | 1.25 | 74S28 | .29 |
| SN7429N | .29 | SN74185N | 1.25 | 74S29 | .29 |
| SN7430N | .29 | SN74186N | 1.25 | 74S30 | .29 |
| SN7431N | .29 | SN74187N | 1.25 | 74S31 | .29 |
| SN7432N | .29 | SN74188N | 1.25 | 74S32 | .29 |
| SN7433N | .29 | SN74189N | 1.25 | 74S33 | .29 |
| SN7434N | .29 | SN74190N | 1.25 | 74S34 | .29 |
| SN7435N | .29 | SN74191N | 1.25 | 74S35 | .29 |
| SN7436N | .29 | SN74192N | 1.25 | 74S36 | .29 |
| SN7437N | .29 | SN74193N | 1.25 | 74S37 | .29 |
| SN7438N | .40 | SN74194N | 1.25 | 74S38 | .29 |
| SN7439N | .25 | SN74195N | 1.25 | 74S39 | .29 |
| SN7440N | .20 | SN74196N | 1.25 | 74S40 | .29 |
| SN7441N | .20 | SN74197N | 1.25 | 74S41 | .29 |
| SN7442N | .20 | SN74198N | 1.25 | 74S42 | .29 |
| SN7443N | 1.10 | SN74199N | 1.25 | 74S43 | .29 |
| SN7444N | 1.10 | SN74200N | 1.25 | 74S44 | .29 |
| SN7445N | 1.10 | SN74201N | 1.25 | 74S45 | .29 |
| SN7446N | .79 | SN74202N | 1.25 | 74S46 | .29 |
| SN7447N | .69 | SN74203N | 1.25 | 74S47 | .29 |
| SN7448N | .79 | SN74204N | 1.25 | 74S48 | .29 |
| SN7449N | .20 | SN74205N | 1.25 | 74S49 | .29 |
| SN7450N | .20 | SN74206N | 1.25 | 74S50 | .29 |
| SN7451N | .20 | SN74207N | 1.25 | 74S51 | .29 |
| SN7452N | .20 | SN74208N | 1.25 | 74S52 | .29 |
| SN7453N | .20 | SN74209N | 1.25 | 74S53 | .29 |
| SN7454N | .20 | SN74210N | 1.25 | 74S54 | .29 |
| SN7455N | .20 | SN74211N | 1.25 | 74S55 | .29 |
| SN7456N | .20 | SN74212N | 1.25 | 74S56 | .29 |
| SN7457N | .20 | SN74213N | 1.25 | 74S57 | .29 |
| SN7458N | .20 | SN74214N | 1.25 | 74S58 | .29 |
| SN7459N | .20 | SN74215N | 1.25 | 74S59 | .29 |
| SN7460N | .20 | SN74216N | 1.25 | 74S60 | .29 |
| SN7461N | .20 | SN74217N | 1.25 | 74S61 | .29 |
| SN7462N | .20 | SN74218N | 1.25 | 74S62 | .29 |
| SN7463N | .20 | SN74219N | 1.25 | 74S63 | .29 |
| SN7464N | .20 | SN74220N | 1.25 | 74S64 | .29 |
| SN7465N | .20 | SN74221N | 1.25 | 74S65 | .29 |
| SN7466N | .20 | SN74222N | 1.25 | 74S66 | .29 |
| SN7467N | .20 | SN74223N | 1.25 | 74S67 | .29 |
| SN7468N | .20 | SN74224N | 1.25 | 74S68 | .29 |
| SN7469N | .20 | SN74225N | 1.25 | 74S69 | .29 |
| SN7470N | .20 | SN74226N | 1.25 | 74S70 | .29 |
| SN7471N | .20 | SN74227N | 1.25 | 74S71 | .29 |
| SN7472N | .20 | SN74228N | 1.25 | 74S72 | .29 |
| SN7473N | .20 | SN74229N | 1.25 | 74S73 | .29 |
| SN7474N | .20 | SN74230N | 1.25 | 74S74 | .29 |
| SN7475N | .20 | SN74231N | 1.25 | 74S75 | .29 |
| SN7476N | .20 | SN74232N | 1.25 | 74S76 | .29 |
| SN7477N | .20 | SN74233N | 1.25 | 74S77 | .29 |
| SN7478N | .20 | SN74234N | 1.25 | 74S78 | .29 |
| SN7479N | .20 | SN74235N | 1.25 | 74S79 | .29 |
| SN7480N | .20 | SN74236N | 1.25 | 74S80 | .29 |
| SN7481N | .20 | SN74237N | 1.25 | 74S81 | .29 |
| SN7482N | .20 | SN74238N | 1.25 | 74S82 | .29 |
| SN7483N | .20 | SN74239N | 1.25 | 74S83 | .29 |
| SN7484N | .20 | SN74240N | 1.25 | 74S84 | .29 |
| SN7485N | .20 | SN74241N | 1.25 | 74S85 | .29 |
| SN7486N | .20 | SN74242N | 1.25 | 74S86 | .29 |
| SN7487N | .20 | SN74243N | 1.25 | 74S87 | .29 |
| SN7488N | .20 | SN74244N | 1.25 | 74S88 | .29 |
| SN7489N | .20 | SN74245N | 1.25 | 74S89 | .29 |
| SN7490N | .20 | SN74246N | 1.25 | 74S90 | .29 |
| SN7491N | .20 | SN74247N | 1.25 | 74S91 | .29 |
| SN7492N | .20 | SN74248N | 1.25 | 74S92 | .29 |
| SN7493N | .20 | SN74249N | 1.25 | 74S93 | .29 |
| SN7494N | .20 | SN74250N | 1.25 | 74S94 | .29 |
| SN7495N | .20 | SN74251N | 1.25 | 74S95 | .29 |
| SN7496N | .20 | SN74252N | 1.25 | 74S96 | .29 |
| SN7497N | .20 | SN74253N | 1.25 | 74S97 | .29 |
| SN7498N | .20 | SN74254N | 1.25 | 74S98 | .29 |
| SN7499N | .20 | SN74255N | 1.25 | 74S99 | .29 |
| SN7500N | .20 | SN74256N | 1.25 | 74S00 | .29 |

J608 PROGRAMMER

2708 EPROM PROGRAMMER

3 8-bit Data Registers • **8** LED's for Hex Key entries, **10** LED's (D¹)² for Address Register and **8** LED's for Data Memory Register (The Data Memory Register displays the contents of the RAM from the EPROM Chip).
4 Development of microprogram memory by means of a ribbon cable from the programmer panel interface to the EPROM socket on the microprocessor board.
4 Check of microprogram memory contents.
4 Allow manual stepping microprogram (up and down) at any address location.
4 Stand alone EPROM Programmer consisting of:
 • A green microprogram memory, Programmer Board assembly with a green register and a LED/Status Socket Panel Board assembly. The Top Socket Panel Board multi-pin type. Power consumption: 115W/500mA/115V.
4 Compact 60 pin ribbon cable connected through a cable with light blue panel and multi-pin cable in each end. Size: 2 1/2" x 1 1/2" x 1 1/2" D³ 1/8".

The J608 EPROM Programmer is a completely self contained unit which is independent of computer control and requires no additional systems or peripherals. The EPROM can be programmed from the Hexadecimal Keyboard or from a pre-programmed EPROM. The J608 Programmer can simulate a program EPROM by the use of its internal RAM. This will allow the user to test or correct a program, test a system, prior to programming a chip. Any changes on the program can be entered directly into the memory device with the Hexadecimal Keyboard so that rewriting the program EPROM will not be necessary. The J608 Programmer contains a Programmer Board with 25 IC's and including power supplies of -5V, -5V, +12V and +5V. The Hexadecimal Keyboard and LED/Status Socket Panel Board are separate assemblies within the system.

J608A KIT

J608K Assembled and tested

\$399.95
\$499.95

DISCRETE LEDS

| Type | Color | Polarity | Ht. | Price |
|--------|--------------|----------|------|-------|
| CX556R | .000" red | 5/81 | .270 | 2.95 |
| CX556G | .000" green | 4/81 | .300 | 4.95 |
| CX556Y | .000" yellow | 4/81 | .300 | 4.95 |
| CX556C | .000" clear | 4/81 | .300 | 4.95 |
| CX22R | .000" red | 5/81 | .300 | 4.95 |
| CX22G | .000" green | 4/81 | .300 | 4.95 |
| CX22Y | .000" yellow | 4/81 | .300 | 4.95 |
| MV10B | .100" red | 4/81 | .300 | 4.95 |
| MV50 | .085" red | 6/81 | .300 | 4.95 |
| CX209R | .125" red | 5/81 | .300 | 4.95 |
| CX209G | .125" green | 4/81 | .300 | 4.95 |
| CX209Y | .125" yellow | 4/81 | .300 | 4.95 |
| CX256R | .185" red | 5/81 | .300 | 4.95 |
| CX256G | .185" green | 4/81 | .300 | 4.95 |
| CX256Y | .185" yellow | 4/81 | .300 | 4.95 |
| CX256C | .185" clear | 4/81 | .300 | 4.95 |

INFRA-RED LED Flat
 4 1/4" x 1/8" Flat
 1RL - 5/81

DISPLAY LEDS

| Type | Polarity | Ht. | Price |
|---------|--------------|------|-------|
| MAN 1 | C.A.-red | .270 | 2.95 |
| MAN 2 | SXT.D.M.-red | .300 | 4.95 |
| MAN 3 | C.C.-red | .125 | .75 |
| MAN 4 | C.C.-green | .300 | 1.25 |
| MAN 5 | C.C.-red | .300 | 1.25 |
| MAN 6 | C.C.-yellow | .300 | .49 |
| MAN 7 | C.C.-orange | .300 | .49 |
| MAN 8 | C.C.-red | .300 | .49 |
| MAN 9 | C.C.-red | .300 | .49 |
| MAN 10 | C.C.-red | .300 | .49 |
| MAN 11 | C.C.-red | .300 | .49 |
| MAN 12 | C.C.-red | .300 | .49 |
| MAN 13 | C.C.-red | .300 | .49 |
| MAN 14 | C.C.-red | .300 | .49 |
| MAN 15 | C.C.-red | .300 | .49 |
| MAN 16 | C.C.-red | .300 | .49 |
| MAN 17 | C.C.-red | .300 | .49 |
| MAN 18 | C.C.-red | .300 | .49 |
| MAN 19 | C.C.-red | .300 | .49 |
| MAN 20 | C.C.-red | .300 | .49 |
| MAN 21 | C.C.-red | .300 | .49 |
| MAN 22 | C.C.-red | .300 | .49 |
| MAN 23 | C.C.-red | .300 | .49 |
| MAN 24 | C.C.-red | .300 | .49 |
| MAN 25 | C.C.-red | .300 | .49 |
| MAN 26 | C.C.-red | .300 | .49 |
| MAN 27 | C.C.-red | .300 | .49 |
| MAN 28 | C.C.-red | .300 | .49 |
| MAN 29 | C.C.-red | .300 | .49 |
| MAN 30 | C.C.-red | .300 | .49 |
| MAN 31 | C.C.-red | .300 | .49 |
| MAN 32 | C.C.-red | .300 | .49 |
| MAN 33 | C.C.-red | .300 | .49 |
| MAN 34 | C.C.-red | .300 | .49 |
| MAN 35 | C.C.-red | .300 | .49 |
| MAN 36 | C.C.-red | .300 | .49 |
| MAN 37 | C.C.-red | .300 | .49 |
| MAN 38 | C.C.-red | .300 | .49 |
| MAN 39 | C.C.-red | .300 | .49 |
| MAN 40 | C.C.-red | .300 | .49 |
| MAN 41 | C.C.-red | .300 | .49 |
| MAN 42 | C.C.-red | .300 | .49 |
| MAN 43 | C.C.-red | .300 | .49 |
| MAN 44 | C.C.-red | .300 | .49 |
| MAN 45 | C.C.-red | .300 | .49 |
| MAN 46 | C.C.-red | .300 | .49 |
| MAN 47 | C.C.-red | .300 | .49 |
| MAN 48 | C.C.-red | .300 | .49 |
| MAN 49 | C.C.-red | .300 | .49 |
| MAN 50 | C.C.-red | .300 | .49 |
| MAN 51 | C.C.-red | .300 | .49 |
| MAN 52 | C.C.-red | .300 | .49 |
| MAN 53 | C.C.-red | .300 | .49 |
| MAN 54 | C.C.-red | .300 | .49 |
| MAN 55 | C.C.-red | .300 | .49 |
| MAN 56 | C.C.-red | .300 | .49 |
| MAN 57 | C.C.-red | .300 | .49 |
| MAN 58 | C.C.-red | .300 | .49 |
| MAN 59 | C.C.-red | .300 | .49 |
| MAN 60 | C.C.-red | .300 | .49 |
| MAN 61 | C.C.-red | .300 | .49 |
| MAN 62 | C.C.-red | .300 | .49 |
| MAN 63 | C.C.-red | .300 | .49 |
| MAN 64 | C.C.-red | .300 | .49 |
| MAN 65 | C.C.-red | .300 | .49 |
| MAN 66 | C.C.-red | .300 | .49 |
| MAN 67 | C.C.-red | .300 | .49 |
| MAN 68 | C.C.-red | .300 | .49 |
| MAN 69 | C.C.-red | .300 | .49 |
| MAN 70 | C.C.-red | .300 | .49 |
| MAN 71 | C.C.-red | .300 | .49 |
| MAN 72 | C.C.-red | .300 | .49 |
| MAN 73 | C.C.-red | .300 | .49 |
| MAN 74 | C.C.-red | .300 | .49 |
| MAN 75 | C.C.-red | .300 | .49 |
| MAN 76 | C.C.-red | .300 | .49 |
| MAN 77 | C.C.-red | .300 | .49 |
| MAN 78 | C.C.-red | .300 | .49 |
| MAN 79 | C.C.-red | .300 | .49 |
| MAN 80 | C.C.-red | .300 | .49 |
| MAN 81 | C.C.-red | .300 | .49 |
| MAN 82 | C.C.-red | .300 | .49 |
| MAN 83 | C.C.-red | .300 | .49 |
| MAN 84 | C.C.-red | .300 | .49 |
| MAN 85 | C.C.-red | .300 | .49 |
| MAN 86 | C.C.-red | .300 | .49 |
| MAN 87 | C.C.-red | .300 | .49 |
| MAN 88 | C.C.-red | .300 | .49 |
| MAN 89 | C.C.-red | .300 | .49 |
| MAN 90 | C.C.-red | .300 | .49 |
| MAN 91 | C.C.-red | .300 | .49 |
| MAN 92 | C.C.-red | .300 | .49 |
| MAN 93 | C.C.-red | .300 | .49 |
| MAN 94 | C.C.-red | .300 | .49 |
| MAN 95 | C.C.-red | .300 | .49 |
| MAN 96 | C.C.-red | .300 | .49 |
| MAN 97 | C.C.-red | .300 | .49 |
| MAN 98 | C.C.-red | .300 | .49 |
| MAN 99 | C.C.-red | .300 | .49 |
| MAN 100 | C.C.-red | .300 | .49 |

RADIO CONTROL CIRCUITS

Ideal for remote control systems which use pulse amplitude modulation (toy cars, boats, tanks, etc.) Features: 1/2 function control, adjustable steering angle, suitable for 27 and 42MHz bands and low power consumption.

KB-4428 TRANSMITTER \$4.25
 Abs. max. rating (TA₂₅°C): Supply volt.: V_{cc} 12VDC. Power Dissip.: P_D 300mW; Temp. range: Oper. 0-+50°C. Power Source: 1.5V. Power Output: 100mW; Range: Oper. 0-300' C. or Oscillation circuits acceptable.

KB-4429 RECEIVER \$5.95
 Abs. max. rating (TA₂₅°C): Supply volt.: V_{cc} 11V; V_{ce2}: 7.5V. Power Output: 100mW; Range: Oper. 0-300' C. Rec. oper. volt.: VOPI 7-11V - VOPI 2-3V.

| LOW PROFILE (TIN) SOCKETS | | SOLDERTAIL STANDARD (TIN) | |
|---------------------------|-----|---------------------------|-----|
| 8 pin LP | .17 | 14 pin ST | .27 |
| 14 pin LP | .20 | 16 pin ST | .30 |
| 16 pin LP | .22 | 18 pin ST | .35 |
| 20 pin LP | .34 | 24 pin ST | .45 |
| 22 pin LP | .37 | 28 pin ST | .55 |
| 24 pin LP | .40 | 36 pin ST | .65 |
| 28 pin LP | .45 | 40 pin ST | .75 |

ASSOCIATED RADIO

913-381-5900

8012 CONSER BOX 4327
OVERLAND PARK, KANSAS 66204



CALL US WITH YOUR REQUIREMENTS
AMERICA'S NO. 1 Real Amateur Radio Store



"ASSOCIATED" IS THE BEST PLACE TO BUY.

***NOTE: WE BUY EQUIPMENT, AS WELL AS
SELL AND TRADE.**



WE'LL DO IT YOUR WAY!



**NOTE: SEND \$1.00 FOR OUR CURRENT CATALOG
OF NEW AND RECONDITIONED EQUIPMENT.**

***ALSO WE PERIODICALLY PUBLISH A LIST OF UNSERV-
ICED EQUIPMENT AT GREAT SAVINGS. A BONANZA
FOR THE EXPERIENCED OPERATOR. TO OBTAIN THE
NEXT UNSERVICED BARGAIN LIST, SEND A SELF
ADDRESSED STAMPED ENVELOPE.**

NEW!



Tunable 420 MHz Fast Scan TV Converter

Receive Fast Scan Amateur TV in the 420 to 450 MHz Band with any TV set. Low noise, high gain rf Amp with Varactor Tuned input and outputs. Built in AC supply. Comes in two tone walnut & beige cabinet measuring 1-7/8" x 4-1/4" x 4-1/8". Factory wired with 2-year guarantee. ATVC-10 \$59.95

Basic Varactor Tuner & PS Kit w/instructions
ATVC-10K \$39.95

ALDELCO ELECTRONIC COMPANY

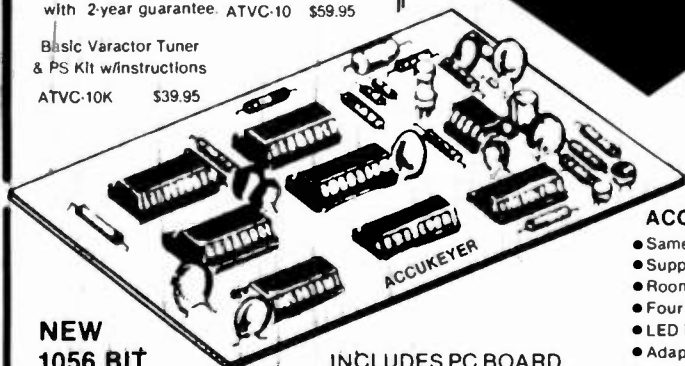

NEW 1056 BIT EXPANDABLE MEMORY KIT

INCLUDES PC BOARD AND PARTS STILL ONLY \$21.95

ACCUKEYER MEMORY KIT

- Same size PC Board as Accukeyer
- Supplied with one 2102 Memory Chlp
- Room on the board for three more
- Four chips will total 4224 BITS
- LED indicator for Programming
- Adaptable to other keyers
- Requires 5 volts DC

THE VERY POPULAR

TOPE ACCUKEYER KIT

- Self Completing Dots & Dashes
- Iambic Operation
- Single Dot & Dash Memories
- Provision for Attachment of Memory for DX or Contest Work

Revised version of the Accukeyer featured in the ARRL Handbook. Has more logical IC Layout and ON Board sidetone Oscillator. Includes PC Board, TTL ICs, 555 Timer, IC Sockets, Switch, Speaker, Transistors, capacitors and resistors. Requires 5 VDC. **\$21.95**
Use our PS-5 Power supply kit to power keyer & Memory only \$8.95

MEMORY ADD ON KIT

Four Position Switch
3-2102s, sockets, and resistors \$5.00

OV-12 Crow Bar
Overvoltage Protection
Circuit. Triggers App.
16 to 18 volts \$8.95
5 to 8 volts 9.95

SEVEN DIGIT HAND HELD FREQUENCY COUNTER KIT

Accuracy: $\pm 0.0002\%$
Gate Times: 1 or 0.1 Seconds
Frequency: Typical to 148 Mhz
Sensitivity: 5.5 mv @ 27 Mhz
5 mv @ 50 Mhz
12 mv @ 135 Mhz
Power Required: 5 VDC (4 AA nicads)
Has input for batt. charger diode protected.
P.C. board measures 2 3/4" x 4"
Aldelco supplies:
ICs, sockets, P.C. board crystal capacitors, resistors, battery holder nat. A 1188A readouts 0.100" and instructions.
(case & batteries not included)
\$49.00

| RF TRANSISTORS | | | | | | | | | |
|----------------|------|-------|--------|---------|-------|--------|-------|--------------|-------|
| SD1018-4 | 40W | 4.5db | 450MHz | 380-4FL | 15.25 | 2N3375 | 3.0W | 400 MHz TO60 | 5.60 |
| SD1074 | 50W | 11db | 30MHz | 500-6FL | 21.15 | 2N3553 | 2.5W | 175 MHz TO39 | 1.40 |
| SD1076 | 75W | 13 | 50 | 500-6FL | 24.00 | 2N3866 | 1.0W | 400 MHz TO39 | 1.25 |
| SD1088 | 25W | 6 | 450 | 500-6FL | 23.25 | 2N4427 | 1.0W | 175 MHz TO39 | 1.35 |
| SD1089 | 40W | 5 | 450 | 500-6FL | 27.15 | 2N5589 | 3.0W | 175 MHz MT71 | 4.75 |
| SD1143 | 10W | 10 | 200 | MT72 | 10.95 | 2N5590 | 10W | 175 MHz MT72 | 7.80 |
| SD1158 | 12W | 5.3 | 200 | TO117 | 12.30 | 2N5591 | 25W | 175 MHz MT72 | 10.25 |
| SD1272 | 30W | 6 | 220 | MT72 | 9.60 | 2N5913 | 1.75W | 175 MHz TO39 | 1.70 |
| SD1278 | 50W | 10 | 50 | MT72 | 16.30 | 2N6080 | 4.0W | 175 MHz MT72 | 5.40 |
| SD1416 | 70W | 6.7 | 175 | 500-6FL | 26.80 | 2N6081 | 15W | 175 MHz MT72 | 8.45 |
| SD1428 | 45W | 6.5 | 175 | 500-6FL | 22.65 | 2N6082 | 25W | 175 MHz MT72 | 9.75 |
| SD1433 | 8W | 7.5 | 450 | MT90 | 9.50 | 2N6083 | 30W | 175 MHz MT72 | 11.75 |
| SD1434 | 50W | 5 | 450 | 500-6FL | 34.00 | 2N6084 | 40W | 175 MHz MT72 | 12.95 |
| SD1451 | 50 | 14 | 50 | 500-6FL | 18.10 | 2N6094 | 4.0W | 175 MHz X106 | 6.60 |
| SD1477 | 100W | 6 | 175 | 500-6FL | 52.85 | 2N6095 | 15W | 175 MHz X106 | 8.50 |
| 2N5945 | 4W | 8 | 450 | MT90 | 10.75 | 2N6096 | 30W | 175 MHz X106 | 10.35 |
| 2N5946 | 10W | 6 | 450 | MT90 | 13.00 | 2N6097 | 40W | 175 MHz X106 | 20.00 |

ALDELCO JOINS - THE GLOBAL SPECIALTIES FAMILY (formerly Continental Specialties)



3.579545 MHz Crystal Oscillator. Size 1.75" x 7.38" x 5.63". Requires 7.5 to 10 VDC. Operates on AA nicads or alkaline's (not supplied). \$134.95

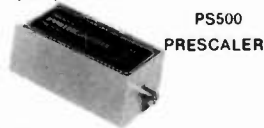

Extends range 10 times compatible with most counters. Requires 7.5 - 10 VDC \$70.00.

ACCESSORIES
Charger adaptor 110V mod. 100 CA1 \$12.45
Mobile charger adaptor mod. 100 CLA \$5.95.

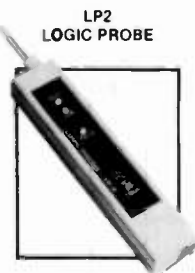

Use to 300 nsec 1.5 MHz. Shows logic state at a glance. Easy to use. Only \$24.95

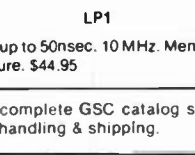

Use up to 50nsec. 10 MHz. Memory feature. \$44.95

For complete GSC catalog send 50¢ handling & shipping.

PROTO CLIPS

14 pin
PC 14
\$4.50

16 pin
PC 16
\$4.75

24 pin
PC 24
\$10.00

EXPRIMENTOR SERIES BREAD BOARDS

EXP 600
\$10.95

EXP 300
\$9.95

EXP 4B
\$4.00

EXP 650
\$6.25

EXP 350
\$5.50

TWO METER TELESCOPING WHIP ANTENNA

with BNC male \$8.95 angle whip with BNC male \$9.50 (also good for freq. counters)

MODEL 951 ADAPTER \$2.95

UG255U BNC male to VHF female

12 or 24 HOUR DIGITAL CLOCK KIT

Uses 0.5 Display LED. 5314 Clock Chip. Freeze feature for accurate set. Fits our standard cabinet. ONLY \$19.95

CLOCK CABINETS

Woodgrain or black leather

ea \$4.95

CRYSTAL TIME BASE KIT

Includes PC Board, Crystal, all parts and instructions \$4.95

BASIC 600 MHZ PRESCALER KIT

Includes: PC board 11C90, capacitors, diodes and instructions requires 5VDC \$29.95
12VDC option \$1.75

ALDELCO KITS

DUAL DIGITAL 12/24 HOUR CLOCK KIT NOW WITH A NEW WALNUT GRAIN WOOD CABINET

ONLY \$49.95



MODEL ALD 5-W 0.5 LEDES

Features:
12 or 24 Hour Operation on either clock
Each Clock separately controlled
Freeze feature for time set
Easy assembly for clock and cabinet

ADJUSTABLE POWER SUPPLY KITS

5-15 Volts 500 MA Model PS5..... \$8.95
12-20 Volts 500 MA Model PS12..... 8.95

ALDELCO

✓ 300

2789A MILBURN AVE, BALDWIN, N.Y. 11510
516-378-4555

Add 6% shipping. Add \$1.00 for orders under \$10.00. Out of U.S.A. add 15% shipping and certified check or money order in U.S. funds.

✓ Reader Service—see page 226

73 Magazine • November, 1980 215

MHz electronics

**Toll Free Number
800-528-0180
(For orders only)**

1900 MHz to 2500 MHz DOWN CONVERTER

This receiver is tunable a range of 1900 to 2500 mc and is intended for amateur radio use. The local oscillator is voltage controlled (i.e) making the i-f range approximately 54 to 88 mc (Channels 2 to 7).

| | |
|---|----------|
| PC BOARD WITH DATA | \$19.99 |
| PC BOARD WITH CHIP CAPACITORS 13 | \$44.99 |
| PC BOARD WITH ALL PARTS FOR ASSEMBLY | \$69.99 |
| PC BOARD WITH ALL PARTS FOR ASSEMBLY PLUS 2N6603 | \$89.00 |
| PC BOARD ASSEMBLED AND TESTED | \$99.99 |
| PC BOARD WITH ALL PARTS FOR ASSEMBLY, POWER SUPPLY AND ANTENNA | \$159.99 |
| POWER SUPPLY ASSEMBLED AND TESTED | \$49.99 |
| YAGI ANTENNA 4' LONG APPROX. 20 TO 23 dB GAIN | \$49.99 |
| YAGI ANTENNA 4' WITH TYPE (N, BNC, SMA Connector) | \$64.99 |
| 2 FOOT DISH WITH FEED AND MOUNT | \$59.99 |
| 2300 MHz DOWN CONVERTER | |
| Includes converter mounted in antenna, power supply, Plus 90 DAY WARRANTY | \$259.99 |
| OPTION #1 MRF902 in front end. (7 dB noise figure) | \$299.99 |
| OPTION #2 2N6603 in front end. (5 dB noise figure) | \$359.99 |
| 2300 MHz DOWN CONVERTER ONLY | |
| 10 dB Noise Figure 23 dB gain in box with N conn. Input F conn. Output | \$149.99 |
| 7 dB Noise Figure 23 dB gain in box with N conn. Input F conn. Output | \$169.99 |
| 5 dB Noise Figure 23 dB gain in box with SMA conn. Input F conn. Output | \$189.99 |
| DATA IS INCLUDED WITH KITS OR MAY BE PURCHASED SEPARATELY | \$15.00 |

Shipping and Handling Cost:

Receiver Kits and \$1.50. Power Supply add \$2.00. Antenna add \$5.00. Option 1/2 add \$3.00. For complete system add \$7.50.

Replacement Parts:

| | | | |
|--------|---------|----------------|-------------------|
| MRF901 | \$5.00 | MBD101 | \$2.00 |
| 2N6603 | \$12.00 | .001 chip caps | \$2.00 |
| | | PC Board only | \$25.00 with data |

HOWARD/COLEMAN TVRO CIRCUIT BOARDS

| | |
|---|---------|
| DUAL CONVERSION BOARD | \$25.00 |
| This board provides conversion from the 3.7-4.2 band first to 900 MHz where gain and bandpass filtering are provided and, second, to 70 MHz. The board contains both local oscillators, one fixed and the other variable, and the second mixer. Construction is greatly simplified by the use of Hybrid IC amplifiers for the gain stages. Bare boards cost \$25 and it is estimated that parts for construction will cost \$270. (Note: The two AvanteK VTO's account for \$225 of this cost.) | |
| 47 pF CHIP CAPACITORS | \$6.00 |
| For use with dual conversion board. Consists of 6-47 pF. | |
| 70 MHz IF BOARD | \$25.00 |
| This circuit provides about 43 dB gain with 50 ohm input and output Impedance. It is designed to drive the HOWARD/COLEMAN TVRO Demodulator. The on-board band pass filter can be tuned for bandwidths between 20 and 35 MHz with a passband ripple of less than 1/2 dB. Hybrid ICs are used for the gain stages. Bare boards cost \$25. It is estimated that parts for construction will cost less than \$40. | |
| .01 pF CHIP CAPACITORS | \$7.00 |
| For use with 70 MHz IF Board. Consists of 7-.01 pF. | |
| DEMODULATOR BOARD | \$40.00 |
| This circuit takes the 70 MHz center frequency satellite TV signals in the 10 to 200 millivolt range, detects them using a phase locked loop, deemphasizes and filters the result and amplifies the result to produce standard NTSC video. Other outputs include the audio subcarrier, a DC voltage proportional to the strength of the 70 MHz signal, and AFC voltage centered at about 2 volts DC. The bare board cost \$40 and total parts cost less than \$30. | |
| SINGLE AUDIO | \$15.00 |
| This circuit recovers the audio signals from the 6.8 MHz frequency. The Miller 9051 coils are tuned to pass the 6.8 MHz subcarrier and the Miller 9052 coil tunes for recovery of the audio. | |
| DUAL AUDIO | \$25.00 |
| Duplicate of the single audio but also covers the 6.2 range. | |
| DC CONTROL | \$15.00 |
| This circuit controls the VTO's, AFC and the S Meter. | |
| TOTAL COSTS | |
| Using the HOWARD/COLEMAN boards and the recommended parts, it is easily possible to build the complete receiver (excluding LNA) for less than \$600. Construction time is a few evenings and the tune up is minimal. | |

TERMS:

WE REGRET WE NO LONGER ACCEPT BANK CARDS.

PLEASE SEND POSTAL MONEY ORDER, CERTIFIED CHECK, CASHIER'S CHECK OR MONEY ORDER.
PRICES SUBJECT TO CHANGE WITHOUT NOTICE. WE CHARGE 15% FOR RESTOCKING ON ANY ORDER.

ALL CHECKS AND MONEY ORDERS IN US FUNDS ONLY.

ALL ORDERS SENT FIRST CLASS OR UPS.

ALL PARTS PRIME AND GUARANTEED.

WE WILL ACCEPT COD ORDERS FOR \$25.00 OR OVER. ADD \$1.50 FOR COD CHARGE.

PLEASE INCLUDE \$1.50 MINIMUM FOR SHIPPING OR CALL FOR CHARGES.

WE ALSO ARE LOOKING FOR NEW AND USED TUBES,
TEST EQUIPMENT, COMPONENTS ETC.

WE ALSO SWAP OR TRADE.

FOR CATALOG SEE JANUARY, 1980, 73 Magazine, 10 Pages.

**(602) 242-3037
(602) 242-8916**

**2111 W. Camelback
Phoenix, Arizona 85015**

FAIRCHILD VHF AND UHF PRESCALER CHIPS

| | | |
|----------------|--|--------|
| 95H90DC | 350 MHz Prescaler Divide by 10/11 | \$9.50 |
| 95H91DC | 350 MHz Prescaler Divide by 5/6 | 9.50 |
| 11C90DC | 650 MHz Prescaler Divide by 10/11 | 16.50 |
| 11C91DC | 650 MHz Prescaler Divide by 5/6 | 16.50 |
| 11C83DC | 1 GHz Divide by 248/256 Prescaler | 29.90 |
| 11C70DC | 600 MHz Filp/Flop with reset | 12.30 |
| 11C58DC | ECL VCM | 4.53 |
| 11C44DC/MC4044 | Phase Frequency Detector | 3.82 |
| 11C24DC/MC4024 | Dual TTL VCM | 3.82 |
| 11C06DC | UHF Prescaler 750 MHz D Type Filp/Flop | 12.30 |
| 11C05DC | 1 GHz Counter Divide by 4 | 74.35 |
| 11C01FC | High Speed Dual 5-4 Input NO/NOR Gate | 15.40 |

WISPER FANS

This fan is super quiet, efficient cooling where low acoustical disturbance is a must. Size 4.68" x 4.68" x 1.50", Impedance protected, 50/60 Hz. 120 Vac.

\$9.99

TRW BROADBAND AMPLIFIER MODEL CA615B

Frequency response 40 MHz to 300 MHz
Gain: 300 MHz 16 dB Min., 17.5 dB Max.
50 MHz 0 to -1 dB from 300 MHz
Voltage: 24 volts dc at 220 ma max.

\$19.99

CARBIDE — CIRCUIT BOARD DRILL BITS FOR PC BOARDS

| | |
|--|--------|
| Size: 35, 42, 47, 49, 51, 52 | \$2.15 |
| Size: 53, 54, 55, 56, 57, 58, 59, 61, 63, 64, 65 | 1.85 |
| Size: 66 | 1.90 |
| Size: 1.25 mm, 1.45 mm | 2.00 |
| Size: 3.20 mm | 3.58 |

CRYSTAL FILTERS: TYCO 001-19880 same as 2194F

10.7 MHz Narrow Band Crystal Filter
3 dB bandwidth 15 kHz min. 20 dB bandwidth 60 kHz min. 40 dB bandwidth 150 kHz min.
Ultimate 50 dB: Insertion loss 1.0 dB max. Ripple 1.0 dB max. Ct. 0 + / - 5 pf 3600 ohms.

\$5.95

MURATA CERAMIC FILTERS

| | |
|--------------------------|--------|
| Models: SFD-455D 455 kHz | \$3.00 |
| SFB-455D 455 kHz | 2.00 |
| CFM-455E 455 kHz | 7.95 |
| SFE-10.7 10.7 MHz | 5.95 |

TEST EQUIPMENT — HEWLETT PACKARD — TEKTRONIX — ETC.

| | | |
|---|-----------|--|
| Hewlett Packard: | | |
| 491C TWT Amplifier 2 to 4 Gc 1 watt 30 dB gain | \$1150.00 | |
| 608C 10 mc to 480 mc .1 uV to .5V into 50 ohms Signal Generator | 500.00 | |
| 608D 10 to 420 mc .1 uV to .5V into 50 ohms Signal Generator | 500.00 | |
| 612A 450 to 1230 mc .1 uV to .5V into 50 ohms Signal Generator | 750.00 | |
| 614A 900 to 2100 mc. Signal Generator | 500.00 | |
| 616A 1.8 to 4.2 Gc Signal Generator | 400.00 | |
| 616B 1.8 to 4.2 Gc Signal Generator | 500.00 | |
| 618A 3.8 to 7.2 Gc Signal Generator | 400.00 | |
| 618B 3.8 to 7.2 Gc Signal Generator | 500.00 | |
| 620A 7 to 11 Gc Signal Generator | 500.00 | |
| 623B Microwave Test Set | 900.00 | |
| 626A 10 Gc to 15 Gc Signal Generator | 2500.00 | |
| 695A 12.4 to 18 Gc Sweep Generator | 900.00 | |

Alltech:
473 225 to 400 mc AM/FM Signal Generator 750.00

Singer:
MF5/VR-4 Universal Spectrum Analyzer with 1 kHz to 27.5 mc Plug In 1200.00

Kaitek:
XR630-100 TWT Amplifier 8 to 12.4 Gc 100 watts 40 dB gain 9200.00

Polarad:
2038/2436/1102A
Calibrated Display with an SSB Analysis Module and a 10 to 40 mc Single Tone Synthesizer 1500.00

HAMLIN SOLID STATE RELAYS:

120vac at 40 Amps.
Input Voltage 3 to 32vdc.
240 vac at 40 Amps.
Input Voltage 3 to 32 vdc.

YOUR CHOICE \$4.99

RF TRANSISTORS

| TYPE | PRICE | TYPE | PRICE | TYPE | PRICE |
|-------------|---------|---------------|--------|----------------|---------|
| 2N1561 | \$15.00 | 2N5590 | \$8.15 | MM1550 | \$10.00 |
| 2N1562 | 15.00 | 2N5591 | 11.85 | MM1552 | 50.00 |
| 2N1692 | 15.00 | 2N5637 | 22.15 | MM1553 | 56.50 |
| 2N1693 | 15.00 | 2N5641 | 6.00 | MM1601 | 5.50 |
| 2N2632 | 45.00 | 2N5642 | 10.05 | MM1602/2N5842 | 7.50 |
| 2N2857JAN | 2.52 | 2N5643 | 15.82 | MM1607 | 8.65 |
| 2N2876 | 12.35 | 2N5645 | 12.38 | MM1661 | 15.00 |
| 2N2880 | 25.00 | 2N5764 | 27.00 | MM1669 | 17.50 |
| 2N2927 | 7.00 | 2N5842 | 8.78 | MM1943 | 3.00 |
| 2N2947 | 18.35 | 2N5849 | 21.29 | MM2605 | 3.00 |
| 2N2948 | 15.50 | 2N5862 | 51.91 | MM2608 | 5.00 |
| 2N2949 | 3.90 | 2N5913 | 3.25 | MM8006 | 2.23 |
| 2N2950 | 5.00 | 2N5922 | 10.00 | MMCM918 | 20.00 |
| 2N3287 | 4.30 | 2N5942 | 46.00 | MMT72 | 1.17 |
| 2N3294 | 1.15 | 2N5944 | 8.92 | MMT74 | 1.17 |
| 2N3301 | 1.04 | 2N5945 | 12.38 | MMT2857 | 2.63 |
| 2N3302 | 1.05 | 2N5946 | 14.69 | MRF245 | 33.30 |
| 2N3304 | 1.48 | 2N6080 | 7.74 | MRF247 | 33.30 |
| 2N3307 | 12.60 | 2N6081 | 10.05 | MRF304 | 43.45 |
| 2N3309 | 3.90 | 2N6082 | 11.30 | MRF420 | 20.00 |
| 2N3375 | 9.32 | 2N6083 | 13.23 | MRF450 | 11.85 |
| 2N3553 | 1.57 | 2N6084 | 14.66 | MRF450A | 11.85 |
| 2N3755 | 7.20 | 2N6094 | 7.15 | MRF454 | 21.83 |
| 2N3818 | 6.00 | 2N6095 | 11.77 | MRF458 | 20.68 |
| 2N3866 | 1.09 | 2N6096 | 20.77 | MRF475 | 5.00 |
| 2N3866JAN | 2.80 | 2N6097 | 29.54 | MRF476 | 5.00 |
| 2N3866JANTX | 4.49 | 2N6136 | 20.15 | MRF502 | 1.08 |
| 2N3924 | 3.34 | 2N6166 | 38.60 | MRF504 | 6.95 |
| 2N3927 | 12.10 | 2N6265 | 75.00 | MRF509 | 4.90 |
| 2N3950 | 26.86 | 2N6266 | 100.00 | MRF511 | 8.15 |
| 2N4072 | 1.80 | 2N6439 | 45.77 | MRF901 | 3.00 |
| 2N4135 | 2.00 | 2N6459/PT9795 | 18.00 | MRF5177 | 21.62 |
| 2N4261 | 14.60 | 2N6603 | 12.00 | MRF8004 | 1.60 |
| 2N4427 | 1.20 | 2N6604 | 12.00 | PT4186B | 3.00 |
| 2N4957 | 3.62 | A50-12 | 25.00 | PT4571A | 1.50 |
| 2N4958 | 2.92 | BFR90 | 5.00 | PT4612 | 5.00 |
| 2N4959 | 2.23 | BLY568C | 25.00 | PT4628 | 5.00 |
| 2N4976 | 19.00 | BLY568CF | 25.00 | PT4640 | 5.00 |
| 2N5090 | 12.31 | CD3495 | 15.00 | PT8659 | 10.72 |
| 2N5108 | 4.03 | HEP76/S3014 | 4.95 | PT9784 | 24.30 |
| 2N5109 | 1.66 | HEPS3002 | 11.30 | PT9790 | 41.70 |
| 2N5160 | 3.49 | HEPS3003 | 29.88 | SD1043 | 5.00 |
| 2N5179 | 1.05 | HEPS3005 | 9.95 | SD1116 | 3.00 |
| 2N5184 | 2.00 | HEPS3006 | 19.90 | SD1118 | 5.00 |
| 2N5216 | 47.50 | HEPS3007 | 24.95 | SD1119 | 3.00 |
| 2N5583 | 4.55 | HEPS3010 | 11.34 | TA7993 | 75.00 |
| 2N5589 | 6.82 | HEPS5026 | 2.56 | TA7994 | 100.00 |
| | | HP35831E/ | | TRWMRA2023-1.5 | 42.50 |
| | | HXTR5104 | 50.00 | 40281 | 10.90 |
| | | MM1500 | 32.20 | 40282 | 11.90 |
| | | | | 40290 | 2.48 |

CHIP CAPACITORS

| | | | |
|-------|-------|--------|--------|
| 1pf | 27pf | 220pf | 1200pf |
| 1.5pf | 33pf | 240pf | 1500pf |
| 2.2pf | 39pf | 270pf | 1800pf |
| 2.7pf | 47pf | 300pf | 2200pf |
| 3.3pf | 56pf | 330pf | 2700pf |
| 3.9pf | 68pf | 360pf | 3300pf |
| 4.7pf | 82pf | 390pf | 3900pf |
| 5.6pf | 100pf | 430pf | 4700pf |
| 6.8pf | 110pf | 470pf | 5600pf |
| 8.2pf | 120pf | 510pf | 6800pf |
| 10pf | 130pf | 560pf | 8200pf |
| 12pf | 150pf | 620pf | .010mf |
| 15pf | 160pf | 680pf | .012mf |
| 18pf | 180pf | 820pf | .015mf |
| 22pf | 200pf | 1000pf | .018mf |

We can supply any value chip capacitors you may need.

PRICES

| | |
|-------------|--------|
| 1 to 10 | \$1.99 |
| 11 - 50 | 1.49 |
| 51 - 100 | 1.00 |
| 101 - 1,000 | .75 |
| 1,001 up | .50 |

ATLAS CRYSTAL FILTERS FOR ATLAS HAM GEAR

5.52-2.7/8
5.595-2.7/8/U
5.595-500/4/CW
5.595-2.7LSB
5.595-2.7USB
5.645-2.7/8
9.0USB/CW

YOUR CHOICE \$24.95

MOTOROLA Semiconductor

The RF Line

MRF454 \$21.83

NPN SILICON RF POWER TRANSISTORS

... designed for power amplifier applications in industrial, commercial and amateur radio equipment to 30 MHz.

- Specified 12.5 Volt, 30 MHz Characteristics -
Output Power = 80 Watts
Minimum Gain = 12 dB
Efficiency = 50%



MRF458 \$20.68

NPN SILICON RF POWER TRANSISTOR

... designed for power amplifier applications in industrial, commercial and amateur radio equipment to 30 MHz.

- Specified 12.5 Volt, 30 MHz Characteristics -
Output Power = 80 Watts
Minimum Gain = 12 dB
Efficiency = 50%
- Capable of Withstanding 30:1 Load VSWR @ Rated P_{out} and V_{CC}

NPN SILICON RF POWER TRANSISTOR

... designed primarily for use in large-signal output amplifier stages. Intended for use in Citizen-Band communications equipment operating at 27 MHz. High breakdown voltages allow a high percentage of up-modulation in AM circuits.

- Specified 12.5 V, 27 MHz Characteristics -
Power Output = 4.0 Watts
Power Gain = 10 dB Minimum
Efficiency = 65% Typical

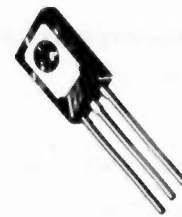

MRF472

\$2.50

MRF475

NPN SILICON RF POWER TRANSISTOR

... designed primarily for use in single sideband linear amplifier output applications in citizens band and other communications equipment operating to 30 MHz.

- Characterized for Single Sideband and Large-Signal Amplifier Applications Utilizing Low-Level Modulation.
- Specified 13.6 V, 30 MHz Characteristics -
Output Power = 12 W (PEP)
Minimum Efficiency = 40% (SSB)
Output Power = 4.0 W (CW)
Minimum Efficiency = 50% (CW)
Minimum Power Gain = 10 dB (PEP & CW)
- Common Collector Characterization



\$5.00

MHW710 - 2

\$46.45

440 to 470MC

UHF POWER AMPLIFIER MODULE

... designed for 12.5 volt UHF power amplifier applications in industrial and commercial FM equipment operating from 400 to 512 MHz.

- Specified 12.5 Volt, UHF Characteristics -
Output Power = 13 Watts
Minimum Gain = 19.4 dB
Harmonics = 40 dB
- 50 Ω Input/Output Impedance
- Guaranteed Stability and Ruggedness
- Gain Control Pin for Manual or Automatic Output Level Control
- Thin Film Hybrid Construction Gives Consistent Performance and Reliability



Tektronix Test Equipment

| | | |
|--------|---|----------|
| B | Wideband High Gain Plug In | \$ 51.00 |
| CA | Dual Trace Plug In | 150.00 |
| K | Fast Rise DC Plug In | 63.00 |
| N | Sampling Plug In | 200.00 |
| R | Transistor Rise/Time Plug In | 116.00 |
| W | High Gain Differential Comparator Plug In | 283.00 |
| TU-2 | Test Load Plug In for 530/540/550 Main Frames | 50.00 |
| 1A2 | Wideband Dual Trace Plug In | 216.00 |
| 151 | Sampling Unit With 350PS Rise/Time DC to 1GHz | 730.00 |
| 2A61 | AC Differential Plug In | 133.00 |
| 353 | Dual Trace Sampling DC to 1GHz Plug In | 250.00 |
| 3576 | Dual Trace Sampling DC to 875MHz Plug In | 250.00 |
| 3777A | Sampling Sweep Plug In | 250.00 |
| 3L10 | Spectrum Analyzer 1 to 36MHz Plug In | 1000.00 |
| 50 | Amplifier Plug In | 50.00 |
| 51 | Sweep Plug In | 50.00 |
| 53B | Wideband High Gain Plug In | 25.00 |
| 53/54B | Wideband High Gain Plug In | 45.00 |
| 53/54C | Dual Trace Plug In | 112.50 |
| 53/54D | High Gain DC Differential Plug In | 38.00 |
| 53/54G | Wideband DC Differential Plug In | 68.00 |
| 53/54L | Fast Rise High Gain Plug In | 68.00 |
| 84 | Test Plug In For 580/581 Main Frames | 75.00 |
| 107 | Square Wave Generator .4 to 1MHz | 48.00 |
| RM122 | Preamplifier 2Hz to 40MHz | 63.00 |
| 123 | AC Coupled Preamplifier | 25.00 |
| 127 | Power Supply For 2 Plug In's | 148.00 |
| 131 | Current Probe Amplifier | 50.00 |
| 184 | Time Mark Generator | 363.00 |
| R240 | Program Control Unit | 150.00 |
| 280 | Trigger Countdown Unit | 84.00 |
| 455 | Portable Dual Trace 50MHz Scope | 2000.00 |
| 465 | Portable Dual Trace 100MHz Scope | 2500.00 |
| 503 | DC to 450KHz Scope Rack Mount | 250.00 |
| 535A | DC to 15MHz Scope Rack Mount | 263.00 |
| 543 | DC to 3MHz Scope Rack Mount | 300.00 |
| 561 | DC to 10MHz Scope Rack Mount | 350.00 |
| 561A | DC to 10MHz Scope Rack Mount | 200.00 |

Scopes with Plug-ins

| | | |
|------|--|--------|
| 561A | DC to 10MHz Scope with a 3576 Dual Trace DC to 875MHz Sampling Plug In and a 3777A Sweep Plug In. Rack Mount | 600.00 |
| 565 | DC to 10MHz Dual Beam Scope with a 2A63 Diff. and a 2A61 Diff. Plug In's | 900.00 |
| 581 | DC to 80MHz Scope with a 82 Dual Trace High Gain Plug In | 650.00 |

Tubes

| | | | | | |
|-----------|---------|-------------|----------|------------|--------|
| 2E26 | \$ 5.00 | 4CX350FJ | \$116.00 | 6146W | 12.00 |
| 3-5002 | 102.00 | 4CX1000A | 300.00 | 6159 | 10.60 |
| 3-1000Z | 268.00 | 4CX1500R | 350.00 | 6161 | 75.00 |
| 3B2B/866A | 5.00 | 4CX15000R | 750.00 | 6293 | 18.50 |
| 3A2500A3 | 150.00 | 4E27 | 50.00 | 6360 | 6.95 |
| 4-65A | 45.00 | 4R150A | 41.00 | 6907 | 40.00 |
| 4-125A | 58.50 | 4R150D | 52.00 | 6939 | 14.75 |
| 4-250A | 68.50 | 4R150G | 74.00 | 7360 | 12.00 |
| 4-400A | 71.00 | 572B/T160L | 39.00 | 7984 | 10.40 |
| 4-1000A | 184.00 | 6A6 | 5.00 | 8072 | 49.00 |
| 5-500A | 145.00 | 6A6 | 5.00 | 8106 | 2.00 |
| 4CX250R | 65.00 | 6A6 | 12.95 | 8156 | 7.85 |
| 4CX250F/G | 55.00 | 813 | 29.00 | 8226 | 127.70 |
| 4CX250R | 113.00 | 5894JA | 42.00 | 8295/PL172 | 328.00 |
| 4CX250R | 92.00 | 6146 | 5.00 | 9458 | 25.75 |
| 4CX300A | 147.00 | 6146A | 6.00 | 8560A/AS | 50.00 |
| 4CX350A | 107.00 | 6146B/8298A | 7.00 | 890R | 9.00 |
| | | | | 8950 | 9.00 |

MICROWAVE COMPONENTS

ARRA

| | | |
|----------|------------------------------------|----------|
| 2416 | Variable Attenuator | \$ 50.00 |
| 3614-60 | Variable Attenuator 0 to 60dB | 75.00 |
| KU520A | Variable Attenuator 18 to 26.5 GHz | 100.00 |
| 4684-20C | Variable Attenuator 0 to 180dB | 100.00 |
| 6684-20F | Variable Attenuator 0 to 180dB | 100.00 |

General Microwave

| | |
|---|-------|
| Directional Coupler 2 to 4GHz 20dB Type N | 75.00 |
|---|-------|

Hewlett Packard

| | | |
|-------|---------------------------------------|--------|
| H487B | 100 ohms Neg. Thermistor Mount (NEW) | 150.00 |
| H487B | 100 ohms Neg. Thermistor Mount (USED) | 100.00 |
| 477B | 200 ohms Neg. Thermistor Mount (USED) | 100.00 |
| X487A | 100 ohms Neg. Thermistor Mount (USED) | 100.00 |
| X487B | 100 ohms Neg. Thermistor Mount (USED) | 125.00 |

| | | |
|-------|--|--------|
| J468A | 100 ohms Neg. Thermistor Mount (USED) | 150.00 |
| 478A | 200 ohms Neg. Thermistor Mount (USED) | 150.00 |
| 8478A | 200 ohms Balanced Neg. Thermistor Mount (USED) | 175.00 |
| J382 | 5.85 to 8.2 GHz Variable Attenuator 0 to 50dB | 250.00 |
| X382A | 8.2 to 12.4 GHz Variable Attenuator 0 to 50dB | 250.00 |

| | | |
|--------|---|--------|
| X885A | 8.2 to 12.4 GHz Phase Shifter +/- 360° | 250.00 |
| 394A | 1 to 2 GHz Variable Attenuator 6 to 120dB | 250.00 |
| NK292A | Waveguide Adapter | 65.00 |
| K422A | 18 to 26.5 GHz Crystal Detector | 250.00 |
| K375A | 18 to 26.5 GHz Variable Attenuator | 300.00 |
| 8436A | Bandpass Filter 8 to 12.4 GHz | 75.00 |

| | | |
|-------|----------------------------------|--------|
| 8439A | 2 GHz Notch Filter | 75.00 |
| 8471A | RF Detector | 50.00 |
| X347A | 8.2 to 12.4 GHz Noise Source | 250.00 |
| H532A | 7.05 to 10 GHz Frequency Meter | 300.00 |
| G532A | 3.95 to 5.85 GHz Frequency Meter | 300.00 |
| J532A | 5.85 to 8.2 GHz Frequency Meter | 300.00 |

| | | |
|------|---|--------|
| 809A | Carriage with a 444A Slotted Line Untuned Detector Probe and 809B Coaxial Slotted Section 2.6 to 18 GHz | 175.00 |
| 809B | Carriage with a 442B Broadband Probe 2.6 to 12.4 GHz and a X810B Slotted Section | 200.00 |

Merrimac

| | | |
|---------|----------------------------|--------|
| AU-25A/ | 801115 Variable Attenuator | 100.00 |
| AU-26A/ | 801162 Variable Attenuator | 100.00 |

Microlab/FXR

| | | |
|---------|----------------------------------|--------|
| Y410A | Frequency Meter 12400 - 18000 MC | 250.00 |
| X638S | Horn 8.2 - 12.4 GHz | 60.00 |
| 601-B18 | X to N Adapter 8.2 - 12.4 GHz | 35.00 |
| Y6100 | Coupler | 75.00 |

Narda

| | | |
|-----------|---|--------|
| 3095/ | 22909 Directional Coupler 7 to 12.4 GHz 10dB Type N | 250.00 |
| 4013C-10/ | 22540A Directional Coupler 2 to 4 GHz 10dB Type SMA | 90.00 |
| 4014-10/ | 22538 Directional Coupler 3.85 to 8 GHz 10dB Type SMA | 90.00 |
| 4014C-6/ | 22876 Directional Coupler 3.85 to 8 GHz 6dB Type SMA | 90.00 |
| 4015C-10/ | 22539 Directional Coupler 7.4 to 12 GHz 10dB Type SMA | 95.00 |
| 4015C-30/ | 23105 Directional Coupler 7 to 12.4 GHz 30dB Type SMA | 95.00 |
| 3044-20 | Directional Coupler 4 to 8 GHz 20dB Type N | 125.00 |
| 3040-20 | Directional Coupler 240 to 500 MC 20dB Type N | 125.00 |
| 3041-20 | Directional Coupler 500 to 1000 MC 20dB Type N | 125.00 |
| 3043-20/ | 22006 Directional Coupler 1.7 to 4 GHz 20dB Type N | 125.00 |
| 3003-10/ | 22011 Directional Coupler 2 to 4 GHz 10dB Type N | 75.00 |
| 3003-30/ | 22012 Directional Coupler 2 to 4 GHz 30dB Type N | 75.00 |
| 3042-20 | Directional Coupler 950 to 2 GHz 20dB Type N | 125.00 |
| 3043-30/ | 22007 Directional Coupler 1.7 to 3.5 GHz 30dB Type N | 125.00 |
| 22574 | Directional Coupler 2 to 4 GHz 10dB Type N | 125.00 |
| 3033 | Coaxial Hybrid 2 to 4 GHz 3dB Type N | 125.00 |
| 3032 | Coaxial Hybrid 950 to 2 GHz 3 dB Type N | 125.00 |
| 784/ | 22380 Variable Attenuator 1 to 90dB 2 to 2.5 GHz Type SMA | 550.00 |
| 22377 | Waveguide to Type N Adapter | 35.00 |
| 720-6 | Fixed Attenuator 8.2 to 14.4 GHz 6 dB | 50.00 |
| 3503 | Waveguide | 25.00 |

PRD

| | | |
|----------------|--|--------|
| U101 | 12.4 to 18 GHz Variable Attenuator 0 to 60dB | 300.00 |
| X101 | 8.2 to 12.4 GHz Variable Attenuator 0 to 60dB | 200.00 |
| C101 | Variable Attenuator 0 to 60dB | 200.00 |
| 205A/367 | Slotted Line with Type N Adapter | 100.00 |
| 195B | 8.2 to 12.4 GHz Variable Attenuator 0 to 50dB | 100.00 |
| 185B51 | 7.05 to 10 GHz Variable Attenuator 0 to 40dB | 100.00 |
| 196C | 8.2 to 12.4 GHz Variable Attenuator 0 to 45dB | 100.00 |
| 173B | 3.95 to 5.85 GHz Variable Attenuator 0 to 45dB | 100.00 |
| 588A | Frequency Meter 5.3 to 6.7 GHz | 100.00 |
| 140A,C,D,E | Fixed Attenuators | 25.00 |
| 109J,I | Fixed Attenuators | 25.00 |
| WEINSCHEL ENG. | 2692 Variable Attenuator +30 to 60dB | 100.00 |

COMPUTER I.C. SPECIALS

| MEMORY | DESCRIPTION | PRICE |
|--------------|----------------------------------|---------|
| 2708 | 1K x 8 EPROM | \$ 7.99 |
| 2716/2516 | 2K x 8 EPROM 5Volt Single Supply | 20.00 |
| 2114/9114 | 1K x 4 Static RAM 450ns | 6.99 |
| 2114L2 | 1K x 4 Static RAM 250ns | 8.99 |
| 2114L3 | 1K x 4 Static RAM 350ns | 7.99 |
| 4027 | 4K x 1 Dynamic RAM | 3.99 |
| 4060/2107 | 4K x 1 Dynamic RAM | 3.99 |
| 4050/9050 | 4K x 1 Dynamic RAM | 3.99 |
| 2111A-2/8111 | 256 x 4 Static RAM | 3.99 |
| 2112A-2 | 256 x 4 Static RAM | 3.99 |
| 2115AL-2 | 1K x 1 Static RAM 55ns | 4.99 |
| 6104-3/4104 | 4K x 1 Static RAM 320ns | 14.99 |
| 7141-2 | 4K x 1 Static RAM 200ns | 14.99 |
| MCM6641L20 | 4K x 2 Static RAM 200ns | 14.99 |
| 9131 | 1K x 1 Static RAM 300ns | 10.99 |

C.P.U.'s ECT.

| | | |
|--------------|--------------------------------------|-------|
| MC6800L | Microprocessor | 13.80 |
| MCM6810AP | 128 x 8 Static RAM 450ns | 3.99 |
| MCM68A10P | 128 x 8 Static RAM 360ns | 4.99 |
| MCM68B10P | 128 x 8 Static RAM 250ns | 5.99 |
| MC6820P | PIA | 8.99 |
| MC6820L | PIA | 9.99 |
| MC6821P | PIA | 8.99 |
| MC68B21P | PIA | 9.99 |
| MC68B30L7 | Mikbug | 14.99 |
| MC6840P | PTM | 8.99 |
| MC6845P | CRT Controller | 29.50 |
| MC6845L | CRT Controller | 33.00 |
| MC6850L | ACIA | 10.99 |
| MC6850P | ACIA | 4.99 |
| MC6852P | SSOA | 5.99 |
| MC6852L | SSOA | 11.99 |
| MC6854P | ADLC | 22.00 |
| MC6860CJCS | 0-600 BPS Modem | 29.00 |
| MC6862L | 2400 BPS Modem | 14.99 |
| MK3850N-3 | FB Microprocessor | 9.99 |
| MK3852P | FB Memory Interface | 16.99 |
| MK3852N | FB Memory Interface | 9.99 |
| MK3854N | FB Direct Memory Access | 9.99 |
| 8008-1 | Microprocessor | 4.99 |
| 8080A | Microprocessor | 8.99 |
| Z80CPU | Microprocessor | 14.99 |
| 6520 | PIA | 7.99 |
| 6530 | Support For 6500 series | 15.99 |
| 2650 | Microprocessor | 10.99 |
| TMS1000NL | Four Bit Microprocessor | 9.99 |
| TMS4024NC | 9 x 64 Digital Storage Buffer (FIFO) | 9.99 |
| TMS6011NC | UART | 9.99 |
| MC14411 | Bit Rate Generator | 11.99 |
| AY5-4007D | Four Digit Counter/Display Drivers | 8.99 |
| AY5-9200 | Repertory Dialler | 9.99 |
| AY5-9100 | Push Button Telephone Diallers | 7.99 |
| AY5-2376 | Keyboard Encoder | 19.99 |
| AY2-8500 | TV Game Chip | 5.99 |
| TR1402A | UART | 9.99 |
| PR1472B | UART | 9.99 |
| PT1482B | UART | 9.99 |
| 8257 | UMA Controller | 9.99 |
| 8251 | Communication Interface | 9.99 |
| 8228 | System Controller & Bus Driver | 5.00 |
| 8212 | 8 Bit Input/Output Port | 5.00 |
| MC14410CP | 2 of 8 Tone Encoder | 9.99 |
| MC14412 | Low Speed Modem | 14.99 |
| MC14408 | Binary to Phone Pulse Converter | 12.99 |
| MC14409 | Binary to Phone Pulse Converter | 12.99 |
| MC1488L | RS232 Driver | 1.00 |
| MC1489L | RS232 Receiver | 1.00 |
| MC1405L | A/D Converter Subsystem | 9.00 |
| MC1406L | 6 Bit D/A Converter | 7.50 |
| MC1408/6/7/8 | 8 Bit D/A Converter | 4.50 |
| MC1330P | Low Level Video Detector | 1.50 |
| MC1349/50 | Video IF Amplifier | 1.17 |
| MC1733L | LM733 OP Amplifier | 2.40 |
| LM565 | Phase Lock Loop | 2.50 |

MHz ⁴⁸ electronics

Toll Free Number
800-528-0180
(For orders only)

(602) 242-3037
(602) 242-8916

2111 W. Camelback
Phoenix, Arizona 85015

7294 N.W. 54 STREET
MIAMI, FLORIDA 33166

SEEC SURPLUS ELECTRONICS CORP.

PHONE: (305) 887-8228
TWX: 810-848-6085
WHOLESALE - RETAIL

| <p>SO239
10/\$5.00 100/\$35.00
50/\$20.00 1000/\$300.00</p> | <p>CB SPECIAL
Brand new printed circuit board assembly. Used in all HyGain 40 Channel CB transceivers. Fits many other manufacturers' units also. Squelch pot/volume control/channel selector switch not included. Board Dimensions 6" x 6 1/2"
1-9 - 7.50 ea. 50-99 - 6.00 ea. 100-up - 5.50 ea.</p> | | <p>TRIMMER CAPS
Can fit in your watch
3.5-20 pF & 5-30 pF
\$.75 ea., 2/\$1.25
5/\$3.00</p> | | | | | | | | | | | | | | | | | | | | | | | | | | | | | | | | | | | | | | | | | | | | | | | | | | | | | | | | | | | | | | | | | | | | | | |
|--|--|---|---|---------|-------------------|-------------|-------------|-------------|--------------|--------------|----------|-------------------|------------|-------------|-------------|------------|------------|--------|-------------------|-------------|--------------|--------------|-------------|---|---------|---------|-----|--------|----------|---------|----------|-----|----|------|---------|----------|-----|--------|------|---------|---------|-----|--------|----------|---------|----------|-----|----|----------|---------|-------|-----|--------|----------|---------|-------|------|--------|----------|---------|-------|------|--------|----------|---------|------|------|--------|------|---------|---|--|---|
| <p>PL259 Amphenol .60¢ ea.</p> | <p>CB SPECIAL W/40 ch SW same as above
1-9 \$10.50 ea. 50-99 \$9.00 ea.
10-49 \$9.50 ea. 100-up \$8.50 ea.</p> | | <p>POLY FOAM COAX 50 Ohm
Low Loss = to RG174
\$4.95/100' \$3.00/50'</p> | | | | | | | | | | | | | | | | | | | | | | | | | | | | | | | | | | | | | | | | | | | | | | | | | | | | | | | | | | | | | | | | | | | | | | |
| <p>E. F. Johnson S Meter
Edge Meter 250 UA. Fits in 5/8" x 1-3/8" hole. MTG holes on each end 1-1/4" behind panel. Black scale 0-5 bottom 1-20 top
\$1.25 ea. 5/\$5.00</p> | <p>Serviceman Special
New Hy-Gain 40ch CB Less Case. Speaker & Knobs (as is) \$14.95 ea</p> | | <p>ULTRASONIC TRANSDUCER
Detects sound above the range of human hearing! Transmits & receives
\$2.50 ea. 5/\$10.00</p> | | | | | | | | | | | | | | | | | | | | | | | | | | | | | | | | | | | | | | | | | | | | | | | | | | | | | | | | | | | | | | | | | | | | | | |
| <p>E. F. Johnson Signal Strength Meter 200 UA 2 1/2" x 2 1/2" Sq. mounts in 1 1/4" hole 1" behind panel. Scale 1-30 db top 0-5 bottom.
\$4.95 ea 5/\$20.00</p> | <p>NEW Hy-Gain Remote 40ch CB Less Case. Speaker & Control Mic (as is) \$14.95 ea</p> | <p>NEW E.F. Johnson Power Mic/Less Cord. Desktop Style \$19.95 ea</p> | <p>MAGNETIC PICK UP TRANSDUCER
Converts motion to ac voltage without mechanical linkage
1/2" x 2" w/6" shielded cable
\$4.95 ea.</p> | | | | | | | | | | | | | | | | | | | | | | | | | | | | | | | | | | | | | | | | | | | | | | | | | | | | | | | | | | | | | | | | | | | | | | |
| <p>PANEL METERS
\$4.00 ea 2 for \$7.00
25-0-25 dc Volts } 2 1/4" x 3"
0-25 dc Volts } 2 1/4" x 2 1/4"
0-50 ac Volts }
-Shunt Required-</p> | <p>ASTATIC T-UG8-D104
PREAMP Desktop microphone w/crystal element 3 Pin Plug \$35 ea.</p> | <p>CERAMIC IF FILTERS
EFC L455K
\$3.50 ea.</p> | <p>SOLDERLESS TEST PROD (BLACK)
Threaded type, molded handle
\$.40 ea. 10/\$3.50</p> | | | | | | | | | | | | | | | | | | | | | | | | | | | | | | | | | | | | | | | | | | | | | | | | | | | | | | | | | | | | | | | | | | | | | | |
| <p>Double Row/Wire Wrap .100
25 pins \$3.49 ea 10/\$30.00
30 pins \$3.96 ea 10/\$32.00
50 pins \$5.43 ea 10/\$45.00</p> | <p>ILEX COPY LENS F:5.6,6.1
Focal Length (155MM) 1 1/4" D.
2 1/16" L, 1 1/16" Fixed Iris.
\$7.50 ea.</p> | <p>15' MODEM CABLES
10#22ga wire w/shield, DB25P conn & DB51226-1 cover on one end \$5.50 ea. 10/\$50.00</p> | <p>25' MODEM CABLES
13#22ga wire w/shield, DB25P conn & DB51226-1 cover on one end \$6.50 ea. 10/\$60.00</p> | | | | | | | | | | | | | | | | | | | | | | | | | | | | | | | | | | | | | | | | | | | | | | | | | | | | | | | | | | | | | | | | | | | | | | |
| <p>Double Row/Solder Eyelet .156
6 pins \$1.10 ea 10/\$ 9.00
15 pins \$1.55 ea 10/\$12.50
22 pins \$2.08 ea 10/\$17.00
43 pins \$3.66 ea 10/\$30.00</p> | <p>8 Position Dip Switches
16 pin (AMP) \$1.50 ea.
10/\$13.50</p> | <p>12 Vdc RELAY SPST 35 Amp Contacts
Open Frame
Rugged, great for mobile use
\$4.50 ea 5/\$20.00</p> | <p>12 Vdc RELAY
SPST Open Frame
5 Amp Contacts
Mfg-Magnecraft
\$1.50 ea 4/\$5.00</p> | | | | | | | | | | | | | | | | | | | | | | | | | | | | | | | | | | | | | | | | | | | | | | | | | | | | | | | | | | | | | | | | | | | | | | |
| <p>C & K SWITCHES
PART # MOVEMENT
7101 ON/NONE/ON SPST
7103 ON/OFF/ON SPST
7108 ON/NONE/(ON) SPST
7201 ON/NONE/ON DPDT
\$1.00 EA 6 FOR \$5.00</p> | <p>22 pins/Double Row/Dipped Solder
.156 \$2.08 ea 10/\$17.00</p> | <p>12 V DC Horn
2" diameter x 1 1/4" deep
.75 each
3/\$2.00</p> | <p>100 ASSORTED DISC CAPS (FULL LEADS) 20 EA OF 5 DIFFERENT VALUES \$2.00 PER PACK</p> | | | | | | | | | | | | | | | | | | | | | | | | | | | | | | | | | | | | | | | | | | | | | | | | | | | | | | | | | | | | | | | | | | | | | | |
| <p>6 TV GAMES ON (1) CHIP
Gen Instr AY-3-8500-1
28 Pin Plastic Case
EVERYDAY LOW PRICE \$7.50 ea</p> | <p>Autronic Elect Auto Alarm
Easy installation independent circuits solid state 12V neg ground
\$5.00 ea.</p> | <p>White Porcelain Egg Insulator
1 1/2" x 1" 50¢ ea. 3 for \$1.25</p> | <p>CAPS RADIAL LEADS
2200 uF @ 16V
.25 ea. 10/\$2.00</p> | | | | | | | | | | | | | | | | | | | | | | | | | | | | | | | | | | | | | | | | | | | | | | | | | | | | | | | | | | | | | | | | | | | | | | |
| <p>ASSORTED ELECTROLYTICS</p> <table border="1"> <thead> <tr> <th>VALUE/MFD</th> <th>VOLTS</th> <th>DIA</th> <th>LENGTH</th> <th>PRICE</th> </tr> </thead> <tbody> <tr><td>63,000 @</td><td>15V</td><td>3"</td><td>x 5 1/2"</td><td>4.00 ea</td></tr> <tr><td>10,000 @</td><td>20V</td><td>1 1/2"</td><td>x 5 3/4"</td><td>3.00 ea</td></tr> <tr><td>2,700 @</td><td>25V</td><td>1 1/4"</td><td>x 2 1/4"</td><td>2.00 ea</td></tr> <tr><td>2,900 @</td><td>25V</td><td>1 1/4"</td><td>x 2"</td><td>2.00 ea</td></tr> <tr><td>3,000 @</td><td>25V</td><td>1 1/2"</td><td>x 4 1/2"</td><td>2.00 ea</td></tr> <tr><td>18,000 @</td><td>25V</td><td>2"</td><td>x 4"</td><td>3.00 ea</td></tr> <tr><td>21,000 @</td><td>25V</td><td>2 1/2"</td><td>x 3"</td><td>3.00 ea</td></tr> <tr><td>1,000 @</td><td>50V</td><td>1 1/4"</td><td>x 3 1/4"</td><td>2.50 ea</td></tr> <tr><td>34,800 @</td><td>50V</td><td>3"</td><td>x 5 1/2"</td><td>3.00 ea</td></tr> <tr><td>450 @</td><td>75V</td><td>1 1/4"</td><td>x 2 1/4"</td><td>2.00 ea</td></tr> <tr><td>500 @</td><td>100V</td><td>1 1/2"</td><td>x 3 1/2"</td><td>2.00 ea</td></tr> <tr><td>240 @</td><td>300V</td><td>1 1/4"</td><td>x 3 1/4"</td><td>2.00 ea</td></tr> <tr><td>50 @</td><td>450V</td><td>1 1/4"</td><td>x 2"</td><td>2.00 ea</td></tr> </tbody> </table> | VALUE/MFD | VOLTS | DIA | LENGTH | PRICE | 63,000 @ | 15V | 3" | x 5 1/2" | 4.00 ea | 10,000 @ | 20V | 1 1/2" | x 5 3/4" | 3.00 ea | 2,700 @ | 25V | 1 1/4" | x 2 1/4" | 2.00 ea | 2,900 @ | 25V | 1 1/4" | x 2" | 2.00 ea | 3,000 @ | 25V | 1 1/2" | x 4 1/2" | 2.00 ea | 18,000 @ | 25V | 2" | x 4" | 3.00 ea | 21,000 @ | 25V | 2 1/2" | x 3" | 3.00 ea | 1,000 @ | 50V | 1 1/4" | x 3 1/4" | 2.50 ea | 34,800 @ | 50V | 3" | x 5 1/2" | 3.00 ea | 450 @ | 75V | 1 1/4" | x 2 1/4" | 2.00 ea | 500 @ | 100V | 1 1/2" | x 3 1/2" | 2.00 ea | 240 @ | 300V | 1 1/4" | x 3 1/4" | 2.00 ea | 50 @ | 450V | 1 1/4" | x 2" | 2.00 ea | <p>15' MODEM CABLES
14#22ga wire w/shield, DB25P conn & DB51226-1 cover on one end \$6.00 ea. 10/\$55.00</p> | <p>SOLDER LUG-TYPE CAPS
50 uF @ 350V 1" D x 3" L
50 uF @ 450V 1" D x 2 1/2" L
50 uF @ 450V 1" D x 3" L
60¢ EA. 5 FOR \$2.50</p> | <p>EFJ CRYSTAL OVENS
6V/12V 75°
\$5.00 ea.</p> |
| VALUE/MFD | VOLTS | DIA | LENGTH | PRICE | | | | | | | | | | | | | | | | | | | | | | | | | | | | | | | | | | | | | | | | | | | | | | | | | | | | | | | | | | | | | | | | | | | | | |
| 63,000 @ | 15V | 3" | x 5 1/2" | 4.00 ea | | | | | | | | | | | | | | | | | | | | | | | | | | | | | | | | | | | | | | | | | | | | | | | | | | | | | | | | | | | | | | | | | | | | | |
| 10,000 @ | 20V | 1 1/2" | x 5 3/4" | 3.00 ea | | | | | | | | | | | | | | | | | | | | | | | | | | | | | | | | | | | | | | | | | | | | | | | | | | | | | | | | | | | | | | | | | | | | | |
| 2,700 @ | 25V | 1 1/4" | x 2 1/4" | 2.00 ea | | | | | | | | | | | | | | | | | | | | | | | | | | | | | | | | | | | | | | | | | | | | | | | | | | | | | | | | | | | | | | | | | | | | | |
| 2,900 @ | 25V | 1 1/4" | x 2" | 2.00 ea | | | | | | | | | | | | | | | | | | | | | | | | | | | | | | | | | | | | | | | | | | | | | | | | | | | | | | | | | | | | | | | | | | | | | |
| 3,000 @ | 25V | 1 1/2" | x 4 1/2" | 2.00 ea | | | | | | | | | | | | | | | | | | | | | | | | | | | | | | | | | | | | | | | | | | | | | | | | | | | | | | | | | | | | | | | | | | | | | |
| 18,000 @ | 25V | 2" | x 4" | 3.00 ea | | | | | | | | | | | | | | | | | | | | | | | | | | | | | | | | | | | | | | | | | | | | | | | | | | | | | | | | | | | | | | | | | | | | | |
| 21,000 @ | 25V | 2 1/2" | x 3" | 3.00 ea | | | | | | | | | | | | | | | | | | | | | | | | | | | | | | | | | | | | | | | | | | | | | | | | | | | | | | | | | | | | | | | | | | | | | |
| 1,000 @ | 50V | 1 1/4" | x 3 1/4" | 2.50 ea | | | | | | | | | | | | | | | | | | | | | | | | | | | | | | | | | | | | | | | | | | | | | | | | | | | | | | | | | | | | | | | | | | | | | |
| 34,800 @ | 50V | 3" | x 5 1/2" | 3.00 ea | | | | | | | | | | | | | | | | | | | | | | | | | | | | | | | | | | | | | | | | | | | | | | | | | | | | | | | | | | | | | | | | | | | | | |
| 450 @ | 75V | 1 1/4" | x 2 1/4" | 2.00 ea | | | | | | | | | | | | | | | | | | | | | | | | | | | | | | | | | | | | | | | | | | | | | | | | | | | | | | | | | | | | | | | | | | | | | |
| 500 @ | 100V | 1 1/2" | x 3 1/2" | 2.00 ea | | | | | | | | | | | | | | | | | | | | | | | | | | | | | | | | | | | | | | | | | | | | | | | | | | | | | | | | | | | | | | | | | | | | | |
| 240 @ | 300V | 1 1/4" | x 3 1/4" | 2.00 ea | | | | | | | | | | | | | | | | | | | | | | | | | | | | | | | | | | | | | | | | | | | | | | | | | | | | | | | | | | | | | | | | | | | | | |
| 50 @ | 450V | 1 1/4" | x 2" | 2.00 ea | | | | | | | | | | | | | | | | | | | | | | | | | | | | | | | | | | | | | | | | | | | | | | | | | | | | | | | | | | | | | | | | | | | | | |
| <p>TERMS: All material guaranteed • If for any reason you are not satisfied, our products may be returned within 10 days for a full refund (less shipping) Please add \$3 for shipping and handling on all orders. Additional 5% charge for shipping any item over 5 lbs COD's accepted for orders totaling \$50.00 or more. All orders shipped UPS unless otherwise specified. Florida residents please add 4% sales tax Minimum order \$15.00</p> | <p>10#22ga wire w/shield, DB25S conn & DB51226-1 cover on one end \$6.50 ea. 10/\$60.00</p> | <p>IC SOCKETS
Cambion
Gold Plated Wire Wrap
14 pin .35 ea 10/\$3.00
16 pin .38 ea 10/\$3.30</p> | <p>COMCO XTAL FILTER
23#8" x 1" x 1/4"
13KC BW \$10.00 ea.</p> | | | | | | | | | | | | | | | | | | | | | | | | | | | | | | | | | | | | | | | | | | | | | | | | | | | | | | | | | | | | | | | | | | | | | | |
| <p>EQUIPMENT / COMPONENTS / WIRE & CABLE / ACCESSORIES</p> | <p>Coax Connectors
UG-273/U BNC-F/UHF-M 2.50
UG-255/U BNC-M/UHF-F 3.00
UG-146A/U N-M/UHF-F 4.50
UG-83B/U N-F/UHF-M 4.50
UG-175 RG-58 Adapt. .20
UG-176 RG-59 Adapt. .20</p> | <p>AXIAL LEAD ELECTROLYTIC CAPACITORS</p> <table border="1"> <tbody> <tr><td>2 uF @ 15V</td><td rowspan="5">}</td><td rowspan="5">12 ea. for \$1.00</td></tr> <tr><td>10 uF @ 15V</td></tr> <tr><td>20 uF @ 15V</td></tr> <tr><td>50 uF @ 15V</td></tr> <tr><td>2.2 uF @ 25V</td></tr> <tr><td>3.3 uF @ 25V</td><td rowspan="5">}</td><td rowspan="5">15 ea. for \$2.00</td></tr> <tr><td>1 uF @ 35V</td></tr> <tr><td>2 uF @ 150V</td></tr> <tr><td>25 uF @ 25V</td></tr> <tr><td>3 uF @ 50V</td></tr> <tr><td>5 uF @ 50V</td><td rowspan="5">}</td><td rowspan="5">10 ea. for \$2.00</td></tr> <tr><td>10 uF @ 50V</td></tr> <tr><td>250 uF @ 25V</td></tr> <tr><td>100 uF @ 50V</td></tr> <tr><td>50 uF @ 75V</td></tr> </tbody> </table> | 2 uF @ 15V | } | 12 ea. for \$1.00 | 10 uF @ 15V | 20 uF @ 15V | 50 uF @ 15V | 2.2 uF @ 25V | 3.3 uF @ 25V | } | 15 ea. for \$2.00 | 1 uF @ 35V | 2 uF @ 150V | 25 uF @ 25V | 3 uF @ 50V | 5 uF @ 50V | } | 10 ea. for \$2.00 | 10 uF @ 50V | 250 uF @ 25V | 100 uF @ 50V | 50 uF @ 75V | <p>RED SEVEN SEGMENT DISPLAY
TIL 322P \$1.00 ea.</p> <p>BOURNS' EDGE MOUNTING
5K pot single turn
3345W series \$1.50 ea.</p> <p>12 VOLTS @ 1/2 AMP
Filament transformer
1 1/2" x 2" x 1" \$1.50 ea.</p> <p>CTS DP6P ROT SWITCH
.50 ea. 5/\$2.00</p> | | | | | | | | | | | | | | | | | | | | | | | | | | | | | | | | | | | | | | | | | | | | | | | | | |
| 2 uF @ 15V | } | 12 ea. for \$1.00 | | | | | | | | | | | | | | | | | | | | | | | | | | | | | | | | | | | | | | | | | | | | | | | | | | | | | | | | | | | | | | | | | | | | | | | |
| 10 uF @ 15V | | | | | | | | | | | | | | | | | | | | | | | | | | | | | | | | | | | | | | | | | | | | | | | | | | | | | | | | | | | | | | | | | | | | | | | | | |
| 20 uF @ 15V | | | | | | | | | | | | | | | | | | | | | | | | | | | | | | | | | | | | | | | | | | | | | | | | | | | | | | | | | | | | | | | | | | | | | | | | | |
| 50 uF @ 15V | | | | | | | | | | | | | | | | | | | | | | | | | | | | | | | | | | | | | | | | | | | | | | | | | | | | | | | | | | | | | | | | | | | | | | | | | |
| 2.2 uF @ 25V | | | | | | | | | | | | | | | | | | | | | | | | | | | | | | | | | | | | | | | | | | | | | | | | | | | | | | | | | | | | | | | | | | | | | | | | | |
| 3.3 uF @ 25V | } | 15 ea. for \$2.00 | | | | | | | | | | | | | | | | | | | | | | | | | | | | | | | | | | | | | | | | | | | | | | | | | | | | | | | | | | | | | | | | | | | | | | | |
| 1 uF @ 35V | | | | | | | | | | | | | | | | | | | | | | | | | | | | | | | | | | | | | | | | | | | | | | | | | | | | | | | | | | | | | | | | | | | | | | | | | |
| 2 uF @ 150V | | | | | | | | | | | | | | | | | | | | | | | | | | | | | | | | | | | | | | | | | | | | | | | | | | | | | | | | | | | | | | | | | | | | | | | | | |
| 25 uF @ 25V | | | | | | | | | | | | | | | | | | | | | | | | | | | | | | | | | | | | | | | | | | | | | | | | | | | | | | | | | | | | | | | | | | | | | | | | | |
| 3 uF @ 50V | | | | | | | | | | | | | | | | | | | | | | | | | | | | | | | | | | | | | | | | | | | | | | | | | | | | | | | | | | | | | | | | | | | | | | | | | |
| 5 uF @ 50V | } | 10 ea. for \$2.00 | | | | | | | | | | | | | | | | | | | | | | | | | | | | | | | | | | | | | | | | | | | | | | | | | | | | | | | | | | | | | | | | | | | | | | | |
| 10 uF @ 50V | | | | | | | | | | | | | | | | | | | | | | | | | | | | | | | | | | | | | | | | | | | | | | | | | | | | | | | | | | | | | | | | | | | | | | | | | |
| 250 uF @ 25V | | | | | | | | | | | | | | | | | | | | | | | | | | | | | | | | | | | | | | | | | | | | | | | | | | | | | | | | | | | | | | | | | | | | | | | | | |
| 100 uF @ 50V | | | | | | | | | | | | | | | | | | | | | | | | | | | | | | | | | | | | | | | | | | | | | | | | | | | | | | | | | | | | | | | | | | | | | | | | | |
| 50 uF @ 75V | | | | | | | | | | | | | | | | | | | | | | | | | | | | | | | | | | | | | | | | | | | | | | | | | | | | | | | | | | | | | | | | | | | | | | | | | |

Radio Bookshop

License Study Guides & Tapes

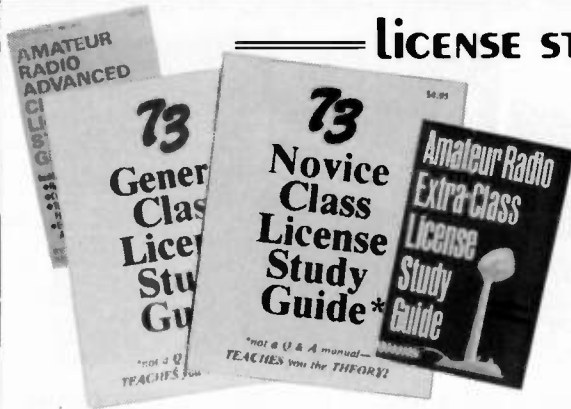

• **NOVICE STUDY GUIDE—SG7357**—Here is a completely new study guide and reference book for the potential ham. This is not a question/answer memorization course. Electronic and radio fundamentals are presented and explained in an easy-to-understand fashion, preparing the beginner for the Novice exam. Includes the latest FCC amateur regulations, as well as application forms. Easily the best path into the exciting world of ham radio! \$4.95.*

• **GENERAL CLASS STUDY GUIDE—SG7358**—A complete theory course for the prospective General or Technician. This reference explains transistor, amplifier, and general radio theory, while preparing the Novice for the "big" ticket. After getting your ticket, you'll use this guide again and again as an electronics reference source. Not a question/answer guide that becomes dated when the FCC updates the amateur exams. Under revision, expected availability is December 1980. \$5.95*

• **ADVANCED CLASS LICENSE STUDY GUIDE—SG1081**—Ready to upgrade your license? To prevent retaking the FCC theory exam, you need the 73 Advanced theory guide. SSB, antenna theory, transmitters, and electronics measuring techniques are covered in detail in this easy-to-follow study guide. Special modes and techniques, such as RTTY, are also treated. An engineering degree is *not* necessary to master the Advanced theory—try this book before visiting the examiner's office! \$6.95.* (Published by TAB Books previous to recent changes in FCC exam material.)

• **EXTRA CLASS LICENSE STUDY GUIDE—SG1080**—Before going for your 1 x 2 call, it pays to be a master of the Extra class electronics theory. This study guide is the logical extension of the 73 theory course. All the theory necessary to pass the exam is presented. Antennas, transmission lines, swr are discussed, as well as noise, propagation, and specialized communication techniques. This book is not a classroom lecture or memorization guide, but rather a logical presentation of the material that must be *understood* before attempting the Extra exam. Save yourself a return trip to the FCC and try the 73 method first! \$5.95.*



NOVICE THEORY TAPES Startling Learning Breakthrough



• **NOVICE THEORY TAPES—CT7300**—Startling Learning Breakthrough. You'll be astounded at how really simple the theory is when you hear it explained on these tapes. Three tapes of theory and one of questions and answers from the latest Novice exams give you the edge you need to breeze through your exam. 73 is interested in helping get more amateurs, so we're giving you the complete set of our tapes for the incredibly low price of **ONLY \$15.95.***

Scientists have proven that you learn faster by listening than by reading because you can play a cassette tape over and over in your spare time—even while you're driving! You get more and more info each time you hear it. You can't progress without solid fundamentals. These four hour-long tapes give you all the basics you'll need to pass the Novice exam easily. You'll have an understanding of the basics which will be invaluable to you for the rest of your life! Can you afford to take your Novice exam without first listening to these tapes? Set of 4—\$15.95.*

These tapes were made previous to recent changes in FCC rules. These minor changes do not affect the *theory* involved. A new set of tapes reflecting these rule changes is being developed. Expected availability is December 1980.



SSTV

• **SLOW SCAN TELEVISION TAPE—CT7350**—Prize-winning programs from the 73 SSTV contest. Excellent for Demo! \$5.95.*



73 CODE TAPES

"GENESIS"

5 WPM—CT7305—This is the beginning tape for people who do not know the code at all. It takes them through the 26 letters, 10 numbers and necessary punctuation, complete with practice every step of the way using the newest blitz teaching techniques. It is almost miraculous! In one hour many people—including kids of ten—are able to master the code. The ease of learning gives confidence to beginners who might otherwise drop out.

"THE STICKLER"

6+ WPM—CT7306—This is the practice tape for the Novice and Technician licenses. It is made up of one solid hour of code, sent at the official FCC standard (no other tape we've heard uses these standards, so many people flunk the code when they are suddenly—under pressure—faced with characters sent at 13 wpm and spaced for 5 wpm). This tape is not memorizable, unlike the zany 5 wpm tape, since the code groups are entirely random characters sent in groups of five.

Any Four Tapes For \$15.95! *
\$4.95 Each! *

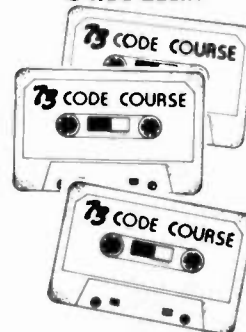

"BACK BREAKER"

13+ WPM—CT7313—Code groups again, at a brisk 13 per so you will be at ease when you sit down in front of the steely-eyed government inspector and he starts sending you plain language at only 13 per. You need this extra margin to overcome the panic which is universal in the test situations. When you've spent your money and time to take the test, you'll thank heavens you had this back-breaking tape.

"COURAGEOUS"

20+ WPM—CT7320—Code is what gets you when you go for the Extra class license. It is so embarrassing to panic out just because you didn't prepare yourself with this tape. Though this is only one word faster, the code groups are so difficult that you'll almost fall asleep copying the FCC stuff by comparison. Users report that they can't believe how easy 20 per really is with this fantastic one hour tape.

"OUTRAGEOUS"

25+ WPM—CT7325—This is the tape for that small group of overachieving hams who wouldn't be content to simply satisfy the code requirements of the Extra Class license. It's the toughest tape we've got and we keep a permanent file of hams who have mastered it. Let us know when you're up to speed and we'll inscribe your name in 73's CW "Hall of Fame."

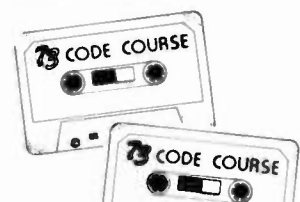

*Use the order card in the back of this magazine or itemize your order on a separate piece of paper and mail to: 73 Radio Bookshop • Peterborough NH 03458. Be sure to include check or detailed credit card information. No C.O.D. orders accepted. *Add \$1.00 handling charge. Note: Prices subject to change on books not published by 73 Magazine. Questions regarding your order? Please write to Customer Service at the above address. Please allow 4-6 weeks for delivery.

FOR TOLL FREE ORDERING CALL 1-800-258-5473

Radio Bookshop

73 TECHNICAL LIBRARY

● **BEHIND THE DIAL**—BK7307—By Bob Grove. Get more fun out of shortwave listening with this interesting guide to receivers, antennas, frequencies and interference. \$4.95.*

● **THE CHALLENGE OF 160**—BK7309—is the newest book in the 73 technical library, dedicated to 160 meter operating. Si Dunn provides all necessary information to get started on this unique band. The all-important antenna and ground systems are described in detail. The introduction contains interesting photos of Stew Perry's (the King of 160) shack. This reference is a must for new and experienced "Top Band" operators. Price: \$4.95.*

● **IC OP-AMP COOKBOOK**—BK 1028—by Walter G. Jung. Covers not only the basic theory of the IC op amp in great detail, but also includes over 250 practical circuit applications, liberally illustrated. 592 pages, 5½ x 8½, softbound. \$12.95.*

● **THE POWER SUPPLY HANDBOOK**—BK7305—Need a power supply for a gadget you're building? In the **POWER SUPPLY HANDBOOK** there are dozens ready-to-build, plus detailed steps for designing your own. There are circuits and parts lists for all kinds of supplies, ranging from simple DC types to highly stable regulated versions. If you need a circuit to convert a DC voltage to a higher or lower voltage, turn DC into AC, or AC to DC—then this is the book you need. With more than 400 pages, you should be able to find just the circuit you need. Without a doubt one of the best power supply source books available, compiled by the editors of 73. \$9.95.*

● **WEATHER SATELLITE HANDBOOK**—BK7370—Simple equipment and methods for getting good pictures from the weather satellite. Antennas, receivers, monitors, facsimile you can build, tracking, automatic control (you don't even have to be home). Dr. Taggart WB8DQT. \$4.95.*

● **THE NEW RTTY HANDBOOK**—BK7347—is a new edition and the only up-to-date RTTY book available. The state of the art has been changing radically and has made all previous RTTY books obsolete. It has the latest circuits, great for the newcomer and expert alike. \$5.95.*

● **PROPAGATION WIZARD'S HANDBOOK**—BK7302—by J. H. Nelson. When sunspots riddled the worldwide communications networks of the 1940's, John Henry Nelson looked to the planets for an answer. The result was a theory of propagation forecasting based upon interplanetary alignment that made the author the most reliable forecaster in America today. The book provides an enlightened look at communications past, present, and future, as well as teaching the art of propagation forecasting. \$6.95.*

● **SSB . . . THE MISUNDERSTOOD MODE**—BK7351—by James B. Wilson. Single Sideband Transmission . . . thousands of us use it every day, yet it remains one of the least understood facets of amateur radio. J. B. Wilson presents several methods of sideband generation, amply illustrated with charts and schematics, which will enable the ambitious reader to construct his own sideband generator. A must for the technically-serious ham. \$5.50.*

● **MASTER HANDBOOK OF HAM RADIO CIRCUITS**—BK1033—This is an encyclopedia of amateur radio circuits, gleaned from past issues of 73 Magazine and carefully selected according to application. You'll find many you've never seen before, some new twists on the tried and true, and several that have been long forgotten but are well worth remembering. Where your interest ranges from ragchewing to EME, from CW to slow-scan TV, from DX to county nets, this handbook will be a welcome addition to your shack. \$8.95.*

● **OWNER REPAIR OF RADIO EQUIPMENT**—BK7310—Frank Glass K6RQ shares over 40 years of operating, servicing, and design experience in this book which ranges from the elementary to the highly technical written for the top engineers in the field. It is written in narrative style on the subjects of electronic servicing, how components work, and how they are combined to provide communication equipment. This book will help you understand the concepts required to service your own station equipment. \$7.95.*

● **TOOLS & TECHNIQUES FOR ELECTRONICS**—BK7348—is an easy-to-understand book written for the beginning kit builder as well as the experienced hobbyist. It has numerous pictures and descriptions of the safe and correct ways to use basic and specialized tools for electronic projects as well as specialized metal working tools and the chemical aids which are used in repair shops. \$4.95*

● **THE CONTEST COOKBOOK**—BK7308—reveals the secrets of the contest winners (Domestic, DX and specialty contests), complete with photos and diagrams of equipment used by the top scorers. Find out how to make 150 contacts in one hour. \$5.95*

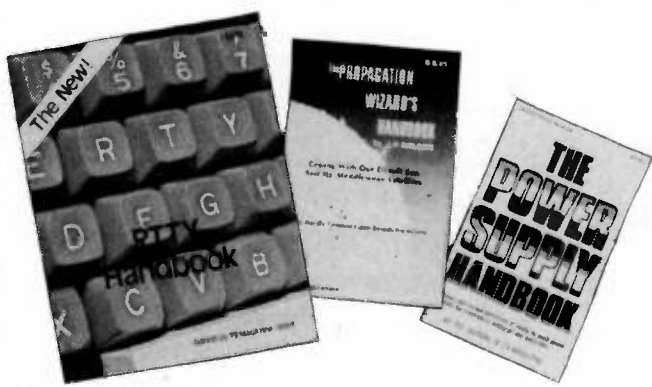

*Use the order card in the back of this magazine or itemize your order on a separate piece of paper and mail to: 73 Radio Bookshop • Peterborough NH 03458. Be sure to include check or detailed credit card information. No C.O.D. orders accepted. *Add \$1.00 handling charge. Note: Prices subject to change on books not published by 73 Magazine. Questions regarding your order? Please write to Customer Service at the above address. Please allow 4-6 weeks for delivery.

FOR TOLL FREE ORDERING CALL 1-800-258-5473

Radio Bookshop

TEST EQUIPMENT

● **RF AND DIGITAL TEST EQUIPMENT YOU CAN BUILD**—BK1044—Rf burst, function, square wave generators, variable length pulse generators—100 kHz marker, i-f and rf sweep generators, audio osc, af/rf signal injector, 146 MHz synthesizer, digital readouts for counters, several counters, prescaler, microwave meter, etc. 252 pages. \$5.95.*

● **VOL. I COMPONENT TESTERS**—LB7359—... how to build transistor testers (8), diode testers (3), IC testers (3), voltmeters and VTVMs (9), ohmmeters (8 different kinds), inductance (3), capacity (9), Q measurement, crystal checking (6), temperature (2), aural meters for the blind (3) and all sorts of miscellaneous data on meters... using them, making them more versatile, making standards. Invaluable book. \$4.95.*

● **VOL. II AUDIO FREQUENCY TESTERS**—LB7360—... jam packed with all kinds of audio frequency test equipment. If you're into SSB, RTTY, SSTV, etc., this book is a must for you... a good book for hi-fi addicts and experimenters, too! \$4.95.*

● **VOL. III RADIO FREQUENCY TESTERS**—LB7361—Radio frequency waves, the common denominator of Amateur Radio. Such items as SWR, antenna impedance, line impedance, rf output and field strength; detailed instructions on testing these items includes sections on signal generators, crystal calibrators, grid dip oscillators, noise generators, dummy loads and much more. \$4.95.*

● **VOL. IV IC TEST EQUIPMENT**—LB7362—Become a troubleshooting wizard! In this fourth volume of the 73 TEST EQUIPMENT LIBRARY are 42 home construction projects for building test equipment to work with your ham station and in servicing digital equipment. Plus a cumulative index for all four volumes of the 73 TEST EQUIPMENT LIBRARY. \$4.95.*



The well-equipped ham shack

● **THE MAGIC OF HAM RADIO**—BK7312—by Jerrold Swank, WB8XR begins with a brief history of amateur radio and of Jerry's involvement in it. Part 2 details many of ham radio's heroic moments. Hamdom's close ties with the continent of Antarctica are the subject of Part 3. In Part 4 the strange and humorous sides of ham life get their due. And what of the future? Part 5 peers into the crystal ball. \$4.95.*

● **A GUIDE TO HAM RADIO**—BK7321—by Larry Kahaner WB2NEL. What's Amateur Radio all about? You can learn the basics of this fascinating hobby with this excellent beginner's guide. It answers the most frequently asked questions in an easy-going manner, and it shows the best way to go about getting an FCC license. A Guide to Ham Radio is an ideal introduction to a hobby enjoyed by people around the world. \$4.95.*

● **HOW TO BUILD A MICROCOMPUTER—AND REALLY UNDERSTAND IT**—BK7325—by Sam Creason. The electronics hobbyist who wants to build his own microcomputer system now has a practical "How-To" guidebook. This book is a combination technical manual and programming guide that takes the hobbyist step-by-step through the design, construction, testing and debugging of a complete microcomputer system. Must reading for anyone desiring a true understanding of small computer systems. \$9.95.*

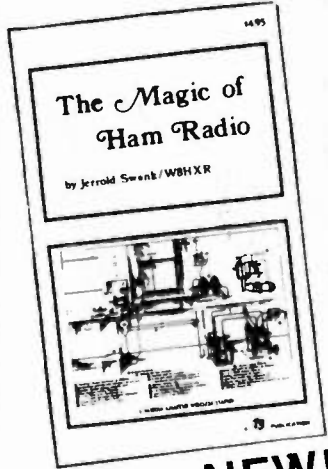
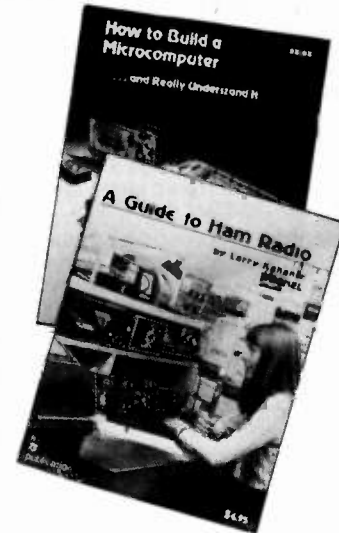

NEW!

● **LIBRARY SHELF BOXES**—These sturdy white, corrugated, dirt-resistant boxes each hold a full year of 73, *Kilobaud Microcomputing* or *80 Microcomputing*. With your order, request self-sticking labels for any of the following: 73, *Kilobaud Microcomputing*, *80 Microcomputing*, *CQ*, *QST*, *Ham Radio*, *Personal Computing*, *Radio Electronics*, *Interface Age*, and *Byte*. Order 1—BX1000—for \$2.00*; order 2-7—BX2002—for \$1.50 each*; order 8 or more—BX1002—for \$1.25 each*.

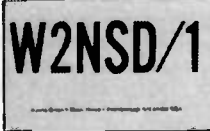

Style Y



Style W

● **QSL CARDS**—73 turns out a fantastic series of QSL cards at about half the cost of having them done elsewhere because they are run as a fill-in between printing books and other items in the 73 Print Shop. 250 Style W—QW0250—for \$8.95*; 500 Style W—QW0500—for \$13.95*; 250 Style X—QX0250—for \$8.95*; 500 Style X—QX0500—for \$13.95*; 250 Style Y—QY0250—for \$8.95*; 500 Style Y—QY0500—for \$13.95.* Allow 6-12 wks. for delivery.



Style X

● **BACK ISSUES**—Complete your collection; many are prime collectables now, classics in the field! A full collection is an invaluable compendium of radio and electronics knowledge!

Single back issue—ST0000—

\$3.00*;

25 our choice—ST2500—\$12.00*;

25 your choice—ST2501—\$25.00*;

5 your choice—ST0500—\$8.75*;

10 your choice—ST1000—\$14.00.*

● **FREE BACK ISSUE CATALOGS** are yours for the asking... specify 73 Magazine and/or *Kilobaud Microcomputing* back issue catalog when you send your name and address to us on a postcard.

73 MAGAZINE BINDERS

● Preserve and protect your collection for a lifetime! Order these handsome red binders with gold lettering. \$7.50 for 1, 3 for \$21.75, 6 for \$42.00. (Postpaid within USA, please add \$2.50 per order outside USA.) Check or money orders only, no phone or C.O.D. orders. 73 Binders, P.O. Box 5120, Philadelphia, PA 19141.

*Use the order card in the back of this magazine or itemize your order on a separate piece of paper and mail to: 73 Radio Bookshop • Peterborough NH 03458. Be sure to include check or detailed credit card information. No C.O.D. orders accepted. *Add \$1.00 handling charge. Note: Prices subject to change on books not published by 73 Magazine. Questions regarding your order? Please write to Customer Service at the above address. Please allow 4-6 weeks for delivery.

FOR TOLL FREE ORDERING CALL 1-800-258-5473

Radio Bookshop

● **73 DIPOLE AND LONG-WIRE ANTENNAS**—BK1016—by Edward M. Noll W3FQJ. This is the first collection of virtually every type of wire antenna used by amateurs. Includes dimensions, configurations, and detailed construction data for 73 different antenna types. Appendices describe the construction of noise bridges, line tuners, and data on measuring resonant frequency, velocity factor, and swr. \$5.50.*

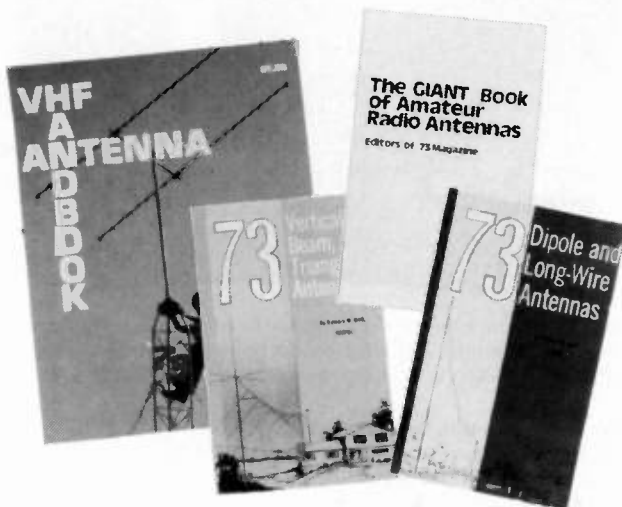

● **THE GIANT BOOK OF AMATEUR RADIO ANTENNAS**—With the **GIANT Book of Amateur Radio Antennas**—BK1104—by your side, antennas will become the least of your worries. Over 450 pages of design ideas, theory and reference data make this book live up to its title. The 7 chapters cover everything from basic antenna theory through designs for DIY accessories, as well as dozens of antenna designs. Whether planning to build or buy, design or admire, test or enjoy a ham antenna—this is the book for you. From the editors of 73; published by Tab Books. Hardcover \$12.95.*

● **73 VERTICAL, BEAM AND TRIANGLE ANTENNAS**—BK1069—by Edward M. Noll W3FQJ. Describes 73 different antennas for amateurs. Each design is the result of the author's own experiments covering the construction of noise bridges and antenna line tuners, as well as methods for measuring resonant frequency, velocity factor, and standing-wave ratios. 160 pages. \$5.50.*

● **VHF ANTENNA HANDBOOK**—BK7368—The **NEW VHF Antenna Handbook** details the theory, design and construction of hundreds of different VHF and UHF antennas... A practical book written for the average amateur who takes joy in building, not full of complex formulas for the design engineer. Packed with fabulous antenna projects you can build. \$5.95.*

● **PRACTICAL ANTENNAS FOR THE RADIO AMATEUR**—BK1015—A manual describing how to equip a ham station with a suitable antenna. A wide range of antenna topics, systems, and accessories are presented giving the reader some food for thought and practical data for construction. Designed to aid the experienced ham and novice as well. Only \$9.95.*

● **TTL COOKBOOK**—BK1063—by Donald Lancaster. Explains what TTL is, how it works, and how to use it. Discusses practical applications, such as a digital counter and display system, events counter, electronic stopwatch, digital voltmeter and a digital tachometer. \$9.50.

● **CMOS COOKBOOK**—BK1011—by Don Lancaster. Details the application of CMOS, the low power logic family suitable for most applications presently dominated by TTL. Required reading for every serious digital experimenter! \$10.50.*

● **TVT COOKBOOK**—BK1064—by Don Lancaster. Describes the use of a standard television receiver as a microprocessor CRT terminal. Explains and describes character generation, cursor control and interface information in typical, easy-to-understand Lancaster style. \$9.95.*

● **RTL COOKBOOK**—BK1059—by Donald Lancaster. Explains the how and why of RTL (Resistor-Transistor Logic) and gives design information that can be put to practical use. Gives a multitude of digital applications ranging from the basic switch to the sophisticated counter. 240 pages; \$6.50.*



● **40 COMPUTER GAMES FROM KILOBAUD MICROCOMPUTING**—BK7381—Forty games in nine different categories. Games for large and small systems, and a section on calculator games. Many versions of BASIC used and a wide variety of systems represented. A must for the serious computer gamesman. \$7.95*

● **UNDERSTANDING AND PROGRAMMING MICROCOMPUTERS**—BK7382—A valuable addition to your computing library. This two part text includes the best articles that have appeared in 73 and Kilobaud Microcomputing magazines on the hardware and software aspects of microcomputing. Well known authors and well structured text helps the reader get involved. \$10.95*

● **HOBBY COMPUTERS ARE HERE!**—BK7322—If you want to come up to speed on how computers work... hardware and software... this is an excellent book. It starts with fundamentals and explains the circuits, and the basics of programming, along with a couple of TVT construction projects, ASCII-Baudot, etc. This book has the highest recommendations as a teaching aid. \$4.95.*

● **SOME OF THE BEST FROM KILOBAUD/MICROCOMPUTING**—BK7311—A collection of the best articles that have recently appeared in Kilobaud/MICROCOMPUTING. Included is material on the TRS-80 and PET systems, CP/M, the 8080/8085/Z80 chips, the ASR-33 terminal. Data base management, word processing, text editors and file structures are covered too. Programming techniques and hardcore hardware construction projects for modems, high speed cassette interfaces and TVTs are also included in this large format, 200 plus page edition. \$10.95.*



NEW BOOKS FROM 73!

*Use the order card in the back of this magazine or itemize your order on a separate piece of paper and mail to: 73 Radio Bookshop • Peterborough NH 03308. Be sure to include check or detailed credit card information. No C.O.D. orders accepted. *Add \$1.00 handling charge. Note: Prices subject to change on books not published by 73 Magazine. Questions regarding your order? Please write to Customer Service at the above address. Please allow 4-6 weeks for delivery.

FOR TOLL FREE ORDERING CALL 1-800-258-5473

DEALER DIRECTORY

San Jose CA

Bay area's newest Amateur Radio store. New & used Amateur Radio sales & service. We feature Kenwood, ICOM, KDK, Yaesu, Ten-Tec, VHF Engineering & many more. Slaver Radio, Inc., 1378 So. Bascom Ave., San Jose CA 95128. 998-1103.

San Leandro CA

Specializing in Amateur Radio Test Guides. We publish the most accurate F.C.C. exam preparation material in the country according to letters on file from hams nationwide. General, Advanced, and Extra Class manuals available. Bash Educational Services, 519 Estudillo Avenue, P.O. Box 2115, San Leandro, CA 94577. 352-5420.

Denver CO

Experimenter's paradise! Electronic and mechanical components for computer people, audio people, hams, robot builders, experimenters. Open six days a week. Gateway Electronics Corp., 2839 W. 44th Ave., Denver CO 80211. 458-5444.

Columbus GA

KENWOOD—YAESU—DRAKE
The world's most fantastic amateur showroom! You gotta see it to believe it! Radio Wholesale, 2012 Ashburn Avenue, Columbus GA 31906. 561-7000.

Boise ID

Adzen, Amidon, Ameco, ARRL, B&W, Callbook, Collins, CushCraft, Dentrone, Hustler, ICOM, Jim-Pak, KDK, MFJ, NPC, Nye, Sams, SST, Swan, Ten-Tec, Wanzer, Wilson, Custom Electronics, 1209 Broadway, Boise ID 83706. Bob W7SC 344-5084.

Preston ID

Ross WB7BZ, has the Largest Stock of Amateur Gear in the Intermountain West and the Best Prices. Call me for all your ham needs. Ross Distributing, 78 So. State, Preston ID 83263. 852-0830.

Terre Haute IN

Your ham headquarters located in the heart of the midwest. Hoosier Electronics, Inc., 43B Meadows Shopping Center, P.O. Box 2001, Terre Haute IN 47802. 238-1456.

Littleton MA

The ham store of N.E. you can rely on. Kenwood, ICOM, Wilson, Yaesu, DenTron, KLM amps, B&W switches & wattmeters, Whistler radar detectors, Bearcat, Regency, antennas by Larsen, Wilson, Hustler, GAM, TEL-COM Inc. Communications & Electronics, 675 Great Rd., Rt. 119, Littleton MA 01460. 486-3040.

Laurel MD

Kenwood, Drake, ICOM, Ten-Tec, Swan, Dentrone, Tempo and many ham accessories. Also computers by Apple and Exidy. The Comm Center, Inc., Laurel Plaza—Rt. 198, Laurel MD 20810, 792-0600.

St. Louis MO

Experimenter's paradise! Electronic and mechanical components for computer people, audio people, hams, robot builders, experimenters. Open six days a week. Gateway Electronics Corp., 8123-25 Page Blvd., St. Louis MO 63130. 427-6116.

Syracuse-Rome-Utica NY

Featuring: Yaesu, ICOM, Drake, Atlas, DenTron, Ten-Tec, Swan, Tempo, KLM, Hy-Gain, Mosley, Wilson, Larsen, Midland Southwest Technical Products. You won't be disappointed with equipment/service. Radio World, Oneida County Airport-Terminal Building, Oriskany NY 13424. 337-2622.

Phila. PA/Camden NJ

Waveguide & coaxial microwave components & equipment. Laboratory grade test instruments, power supplies. Buy, sell & trade all popular makes, HP, GR, FXR, ESJ, Sorensen, Singer, etc. Electronic Research Labs., 1423 Ferry Ave., Camden NJ 08104. 541-4200.

Columbus OH

All major brands featured in the biggest and best ham store for miles around. Come in and twist the knobs before you buy. Universal Amateur Radio, Inc., 1280 Aida Dr., Reynoldsburg (Columbus) OH 43068. 866-4267.

Houston TX

Experimenter's paradise! Electronic and mechanical components for computer people, audio people, hams, robot builders, experimenters. Open six days a week. Gateway Electronics Inc., 8932 Clarkcrest, Houston TX 77063. 978-6575.

San Antonio TX

Complete 2 way service shop. Call Dee, W5FSP. Selling Antenna Specialists, Avanti, Azden, Bird, Hy-gain, Standard communications, Genave, Henry, CushCraft, Dielectric, Hustler, ICOM, MFJ, Nye, Shure, Swan, Tempo, Ten-Tec and others. Appliance & Equipment Co., Inc., 2317 Vance Jackson Road, San Antonio TX 78213. 734-7783.

DEALERS

Your company name and message can contain up to 25 words for as little as \$150 yearly (prepaid), or \$15 per month (prepaid quarterly). No mention of mail-order business or area code permitted. Directory text and payment must reach us 60 days in advance of publication. For example, advertising for the January issue must be in our hands by November 1st. Mail to 73 Magazine, Peterborough NH 03458. ATTN: Nancy Ciampa.

PROPAGATION

J. H. Nelson
4 Plymouth Dr.
Whiting NJ 08759

EASTERN UNITED STATES TO:

| | GMT: | 00 | 02 | 04 | 06 | 08 | 10 | 12 | 14 | 16 | 18 | 20 | 22 |
|--------------|------|----|----|----|----|----|-----|-----|-----|-----|-----|-----|----|
| ALASKA | 14 | 14 | 7 | 7 | 7 | 7 | 7 | 7 | 7A | 14 | 21A | 21 | |
| ARGENTINA | 14 | 7A | 7 | 7B | 7B | 7 | 14 | 21A | 21A | 21A | 21A | 21A | |
| AUSTRALIA | 21 | 14 | 7B | 7B | 7B | 7B | 7B | 14B | 21 | 21 | 21A | 21A | |
| CANAL ZONE | 14 | 14 | 7 | 7 | 7 | 7 | 14 | 21A | 21A | 21A | 21A | 21 | |
| ENGLAND | 7 | 7 | 7 | 7 | 7 | 7A | 14 | 21A | 21A | 21 | 14 | 7A | |
| HAWAII | 21A | 14 | 7B | 7 | 7 | 7 | 7 | 7B | 14 | 21A | 21A | 21A | |
| INDIA | 7 | 7B | 7B | 7B | 7B | 7B | 14 | 21 | 14 | 14B | 7B | 7B | |
| JAPAN | 14 | 14 | 7B | 7B | 7 | 7 | 7 | 7B | 7B | 7B | 7A | 21 | |
| MEXICO | 14A | 14 | 7 | 7 | 7 | 7 | 7 | 14A | 21A | 21A | 21A | 21 | |
| PHILIPPINES | 14A | 14 | 7B | 7B | 7B | 7B | 7B | 14B | 14 | 14 | 14B | 14 | |
| PUERTO RICO | 14 | 7 | 7 | 7 | 7 | 7 | 14 | 21 | 21A | 21A | 21 | 14A | |
| SOUTH AFRICA | 14 | 14 | 7 | 7B | 7B | 14 | 21A | 21A | 21A | 21A | 21A | 21 | |
| U. S. S. R. | 7 | 7 | 7 | 7 | 7B | 7B | 14 | 21A | 21 | 14B | 7B | 7 | |
| WEST COAST | 21 | 14 | 7 | 7 | 7 | 7 | 7 | 14 | 21A | 21A | 21A | 21A | |

CENTRAL UNITED STATES TO:

| | GMT: | 00 | 02 | 04 | 06 | 08 | 10 | 12 | 14 | 16 | 18 | 20 | 22 |
|--------------|------|-----|----|----|----|----|-----|-----|-----|-----|-----|-----|----|
| ALASKA | 21A | 14 | 7 | 7 | 7 | 7 | 7 | 7 | 7A | 14 | 21A | 21 | |
| ARGENTINA | 21 | 14 | 7 | 7B | 7B | 7 | 7 | 7 | 21A | 21A | 21A | 21A | |
| AUSTRALIA | 21A | 14A | 7B | 7B | 7B | 7B | 14B | 21 | 21 | 21A | 21A | | |
| CANAL ZONE | 21 | 14 | 7 | 7 | 7 | 7 | 14 | 21A | 21A | 21A | 21A | | |
| ENGLAND | 7 | 7 | 7 | 7 | 7 | 7 | 14 | 21 | 21A | 21 | 14 | 7 | |
| HAWAII | 21A | 14A | 14 | 7 | 7 | 7 | 7 | 7 | 14 | 21A | 21A | 21A | |
| INDIA | 14 | 14 | 7B | 7B | 7B | 7B | 14 | 14 | 14B | 7B | 7B | | |
| JAPAN | 21A | 14 | 7B | 7B | 7 | 7 | 7 | 7 | 7B | 7B | 14 | 21A | |
| MEXICO | 14 | 7 | 7 | 7 | 7 | 7 | 7 | 14 | 21A | 21A | 21 | 14 | |
| PHILIPPINES | 21A | 14 | 7B | 7B | 7B | 7B | 7 | 14 | 14 | 14B | 21 | | |
| PUERTO RICO | 14 | 14 | 7 | 7 | 7 | 7 | 14 | 21 | 21A | 21A | 21 | 21 | |
| SOUTH AFRICA | 14 | 14 | 7 | 7B | 7B | 7B | 14 | 21A | 21A | 21A | 21A | 21 | |
| U. S. S. R. | 7 | 7 | 7 | 7 | 7B | 7B | 7B | 14 | 21 | 14B | 7B | 7B | |

WESTERN UNITED STATES TO:

| | GMT: | 00 | 02 | 04 | 06 | 08 | 10 | 12 | 14 | 16 | 18 | 20 | 22 |
|--------------|------|-----|-----|----|----|----|----|-----|-----|-----|-----|-----|----|
| ALASKA | 21A | 14 | 7 | 7 | 7 | 7 | 7 | 3A | 7 | 14 | 21 | 21A | |
| ARGENTINA | 21A | 14 | 14 | 7B | 7B | 7 | 7A | 21 | 21A | 21A | 21A | 21A | |
| AUSTRALIA | 21A | 21 | 14 | 14 | 7 | 7 | 7B | 7 | 14 | 21 | 21A | 21A | |
| CANAL ZONE | 21A | 14 | 7A | 7 | 7 | 7 | 7 | 21 | 21A | 21A | 21A | 21A | |
| ENGLAND | 7B | 7 | 7 | 7 | 7 | 7 | 7B | 14 | 21A | 21 | 14 | 7B | |
| HAWAII | 21A | 21A | 14 | 14 | 7 | 7 | 7 | 7 | 14 | 21A | 21A | 21A | |
| INDIA | 14 | 14A | 14B | 7B | 7B | 7B | 7B | 7B | 14 | 14B | 7B | 7B | |
| JAPAN | 21A | 21 | 14 | 7 | 7 | 7 | 7 | 7 | 7 | 7B | 14 | 21A | |
| MEXICO | 21 | 14 | 7 | 7 | 7 | 7 | 7 | 14 | 21A | 21A | 21A | 21 | |
| PHILIPPINES | 21A | 21A | 14 | 7B | 7B | 7B | 7 | 7 | 14 | 14 | 14B | 21A | |
| PUERTO RICO | 21 | 14 | 7A | 7 | 7 | 7 | 7 | 14A | 21A | 21A | 21A | 21 | |
| SOUTH AFRICA | 14A | 14 | 7 | 7B | 7B | 7B | 7B | 14 | 21A | 21A | 21A | 21 | |
| U. S. S. R. | 7B | 7 | 7 | 7 | 7B | 7B | 7B | 14 | 21B | 14B | 7B | 7B | |
| EAST COAST | 21 | 14 | 7 | 7 | 7 | 7 | 7 | 14 | 21A | 21A | 21A | 21A | |

- A = Next higher frequency may also be useful
- B = Difficult circuit this period
- F = Fair
- G = Good
- P = Poor
- SF = Chance of solar flares

november

| sun | mon | tue | wed | thu | fri | sat |
|-----------------|-----------|---------|---------|---------|---------|---------|
| | | | | | | 1
G |
| 2
F/SF | 3
P/SF | 4
P | 5
F | 6
G | 7
G | 8
G |
| 9
G | 10
G | 11
F | 12
F | 13
F | 14
G | 15
G |
| 16
G | 17
G | 18
G | 19
G | 20
G | 21
G | 22
G |
| 23
30
G/G | 24
F | 25
G | 26
G | 27
G | 28
G | 29
G |

List of AdvertisERS

*Please contact these advertisers directly.

To receive full information from our advertisers please complete the following postage-paid card.

| R.S. No. | Page | R.S. No. | Page | R.S. No. | Page | R.S. No. | Page |
|--|----------|---|---------------------|--|------------|---------------------------------|-------------------|
| * AEA/Advanced Electr. Applca., Inc..... | 151, 154 | 25 Germantown Amat. Supply..... | 151 | 49 Micro Control Specialties..... | 152 | 484 Teltone..... | 38 |
| 3 AED Electronics..... | 130 | 28 Godbout Electronics..... | 212 | 313 Micro Management Systems..... | 28 | * Ten-Tec, Inc..... | 13, 33 |
| 362 A.P. Systems..... | 184 | 352 Grove Enterprises..... | 31 | 50 Microcraft Corp..... | 103, 149 | 76 Trac Electronics..... | 27 |
| 1 Adirondack Radio Supply, Inc..... | 103 | 486 Grove Enterprises..... | 36 | 477 Micro-80, Inc..... | 197 | 77 Tufts Radio Electronics..... | 158-169 |
| 300 Aldelco..... | 215 | 345 Hal Comm..... | 19, 183 | 51 Microlog Corp..... | 131, 155 | 361 UHF Sales & Service..... | 145 |
| 5 Amateur-Wholesale Elect..... | 22, 210 | 31 Hal-Tronix..... | 31, 56 | 52 MidCom Electronics, Inc..... | 49, 126 | * Universal Communications..... | 130 |
| 7 American Crystal Supply..... | 130 | 32 Ham Radio Center..... | 129 | 482 Mirage Communications Equip-ment, Inc..... | 36 | 311 Vanguard Labs..... | 198 |
| 301 Applf. & Equip. Co., Inc..... | 79 | 353 Ham Radio Center..... | 84 | 318 National Comm. Group Co..... | 141 | 373 Van Gorden Engineering..... | 59 |
| 8 Apron Laboratories..... | 154 | 33 Hamtronics, NY..... | 205 | 54 OK Machine & Tool..... | 111, 113 | 90 VoCom Products Corp..... | 152 |
| * Associated Radio..... | 214 | 303 Heath Co..... | 3 | 55 Optoelectronics, Inc..... | 17 | * Western Electronics..... | 149 |
| 358 Astron Corporation..... | 128 | 485 Heath Co..... | 37 | * Orbit Magazine..... | 111 | * Wilson Systems, Inc..... | 85-88 |
| 10 Avanti Research & Develop..... | 98, 154 | 34 Henry Radio..... | Cov. II | 325 Outdoor Outfitters..... | 130 | 82 Xltek Corp..... | 79 |
| 11 Barker + Williamson..... | 50, 51 | 305 Hustler, Inc..... | 141 | 57 P.C. Electronics..... | 56 | 83 Yaesu Elect. Corp..... | Cov. III, 57, 127 |
| 12 Bullet Electronics..... | 202 | 378 HVB..... | 128 | * Palomar Engineers..... | 27 | 336 Z Associates..... | 145 |
| 13 Clegg..... | 67 | 316 Hy-Gain Div. of Telex Comm., Inc..... | 37, 39, 41 | * Palomar Engineers..... | 40 | | |
| 89 Clutterfree Modular Consoles..... | 98 | 363 I-Can Company..... | 103 | 58 Poly Paks..... | 145 | | |
| 481 COMMSOFT..... | 38 | * IRL..... | 148 | 60 Quest Electronics..... | 201 | | |
| 14 Comm. Center, NE..... | 61, 153 | * ICOM..... | 9 | 342 RF Gain, Ltd..... | 151 | | |
| 377 Communications Electronics..... | 69 | 483 International Crystal Mfg..... | 38 | 63 RF Power Labs, Inc..... | 144 | | |
| 15 Comm. Specialists..... | 10, 11 | 38 Jameco Electronics..... | 213 | 61 Radio Amateur Callbook, Inc..... | 149 | | |
| 367 Conley Radio Supply..... | 89 | 488 Jameco Electronics..... | 36 | 487 Radio Shack..... | 41 | | |
| 16 Crown Micro Products..... | 99 | 39 Jan Crystals..... | 98 | 490 Radio Shack..... | 32 | | |
| 20 DSI Instruments..... | 29 | 479 R.H. Johns Scientific Instruments | | * Radio World..... | 149 | | |
| 30 Debco Electronics..... | 78 | | 40 | 62 Ramsey Electronics..... | 208, 211 | | |
| * Paul Davis Electronics..... | 198 | 40 KLM Electronics..... | 99, 103 | 65 S-F Amateur Radio Services..... | 149 | | |
| 346 Data Service..... | 128 | * Kantronics..... | 4 | 374 SK Electronics..... | 79 | | |
| 357 Delta Products..... | 154 | * Kantronics..... | 38 | 376 SMP..... | 79 | | |
| 365 Larry Dennison..... | 103 | * KB Microcomputing..... | 49 | 64 Semiconductors Surplus..... | 206, 207 | | |
| 379 Digital Research Computers..... | 203 | * Kenwood..... | Cov. IV, 7, 104-109 | * 73 Magazine | | | |
| * Digital Research Parts..... | 204 | 375 Herb Kreckman Co..... | 79 | 83, 111, 113, 198, 221-224, 226 | | | |
| 18 Digitrex Electronics..... | 98 | * LaRue Electronics..... | 150 | 480 Shure Brothers..... | 197 | | |
| 19 R.L. Drake Co..... | 24, 25 | * Los Alamos Scientific Laboratory | | 66 Signalcrafters..... | 89 | | |
| 476 R.L. Drake Co..... | 32 | | 59 | 360 Soundpower..... | 175 | | |
| 489 ETCO Electronics..... | 41 | 43 Luñar Electronics..... | 150 | 317 Space Electronics..... | 145 | | |
| * 80 Microcomputing..... | 152 | 47 MFJ Enterprises..... | 34, 35 | 309 Spacecoast Research..... | 128 | | |
| 321 Electronics Book Club..... | 21 | 47 MFJ Enterprises..... | 196 | 67 Spectronics..... | 209 | | |
| 22 Fair Radio Sales..... | 79 | 48 MHz Electronics..... | 216-219 | 68 Spectrum Comm..... | 147 | | |
| 23 Flesher Corp..... | 130 | 44 Macrotronics..... | 59, 128 | 69 Surplus Electronics..... | 220 | | |
| 323 Fox-Tango Corp..... | 148 | 45 Madison Electronics..... | 63 | 73 TET, USA..... | 65, 121 | | |
| 27 G.I.S.M.O..... | 146 | 46 Magglore Electronic Lab..... | 79 | 316 Telex Comm, Inc..... | 37, 39, 41 | | |

73 MAGAZINE

Books, ETC.

To order, complete the following postage-paid card, or itemize your order including detailed credit card information or check and mail to:
73 Magazine/Mail Order Dept./Peterborough NH 03458.

| Catalog # | Item | Price | Catalog # | Item | Price | Catalog # | Item | Price |
|-----------|---|---------|-----------|--|-------------|-----------|--|---------|
| BK1016 | 73 DIPOLE & LONG WIRE ANTENNAS | \$ 5.50 | BK1033 | MASTER HANDBOOK OF HAM RADIO CIR-
CUITS | \$ 8.95 | SG1080 | STUDY GUIDE—EXTRA CLASS..... | \$ 5.95 |
| ST0000 | 73 BACK ISSUE..... | \$ 3.00 | BK7340 | THE NEW HOBBY COMPUTERS..... | \$ 4.95 | SG7358 | STUDY GUIDE—GENERAL CLASS...\$ 5.95 | |
| ST2500 | 73 BACK ISSUES—25 OUR CHOICE..... | \$12.00 | CT7300 | NOVICE THEORY TAPES..... | \$15.95 | SG7357 | STUDY GUIDE—NOVICE CLASS..... | \$ 4.95 |
| ST0500 | 73 BACK ISSUES—5 YOUR CHOICE..... | \$ 8.75 | BK7310 | OWNER REPAIR OF RADIO EQUIPMENT | | LB7359 | TEST EQUIP LIB V1—COMPONENT
TESTERS..... | \$ 4.95 |
| ST1000 | 73 BACK ISSUES—10 YOUR CHOICE | \$14.00 | BK7305 | POWER SUPPLY HANDBOOK..... | \$ 7.95 | LB7360 | TEST EQUIP LIB V2—AUDIO TESTERS | \$ 4.95 |
| ST2501 | 73 BACK ISSUES—25 YOUR CHOICE | \$25.00 | BK1015 | PRACTICAL ANTENNAS FOR THE RADIO
AMATEUR..... | \$ 9.95 | LB7361 | TEST EQUIP LIB V3—RADIO EQUIP..\$ 4.95 | |
| BK7307 | BEHIND THE DIAL..... | \$ 4.95 | BK7302 | PROPAGATION WIZARD'S HANDBOOK | \$ 6.95 | LB7362 | TEST EQUIP LIB V4—IC TEST EQ...\$ 4.95 | |
| BK7309 | CHALLENGE OF 160..... | \$ 4.95 | QW0250 | QSL CARDS—STYLE W—250..... | \$ 8.95 | BK7348 | TOOLS & TECHNIQUES..... | \$ 4.95 |
| CT7305 | CODE TAPE—5 WPM..... | \$ 4.95 | QW0500 | QSL CARDS—STYLE W—500..... | \$13.95 | BK1063 | TTL COOKBOOK..... | \$ 9.50 |
| CT7306 | CODE TAPE—6 + WPM..... | \$ 4.95 | QX0250 | QSL CARDS—STYLE X—250..... | \$ 8.95 | BK1064 | TVT COOKBOOK..... | \$ 9.95 |
| CT7313 | CODE TAPE—13 + WPM..... | \$ 4.95 | QX0500 | QSL CARDS—STYLE X—500..... | \$13.95 | BK7382 | UNDERSTANDING & PROGRAMMING
MICROCOMPUTERS..... | \$10.95 |
| CT7320 | CODE TAPE—20 + WPM..... | \$ 4.95 | QY0250 | QSL CARDS—STYLE Y—250..... | \$ 8.95 | BK1069 | VERTICAL BEAM & TRIANGLE ANTNS | \$ 5.50 |
| CT7325 | CODE TAPE—25 + WPM..... | \$ 4.95 | QY0500 | QSL CARDS—STYLE Y—500..... | \$13.95 | BK7368 | VHF ANTENNA HANDBOOK..... | \$ 5.95 |
| CT7394 | CODE TAPES (ANY FOUR ABOVE)..... | \$15.95 | BK1044 | RF & DIGITAL TEST EQUIPMENT..... | \$ 5.95 | BK7370 | WEATHER SATELLITE HANDBOOK..\$ 4.95 | |
| BK7308 | THE CONTEST COOKBOOK..... | \$ 5.95 | BK7347 | RTTY HANDBOOK..... | \$ 5.95 | | | |
| BK7381 | 40 COMPUTER GAMES..... | \$ 7.95 | BK1059 | RTL COOKBOOK..... | \$ 6.50 | | | |
| BK7304 | GIANT BOOK OF AMATEUR RADIO
ANTENNAS..... | \$12.95 | BX1000 | SHELF BOX—1..... | \$ 2.00 | | | |
| BK7322 | HOBBY COMPUTERS ARE HERE..... | \$ 4.95 | BX1001 | SHELF BOXES—2-7..... | \$1.50 each | | | |
| BK7325 | HOW TO BUILD A MICROCOMPUTER &
REALLY UNDERSTAND IT..... | \$ 9.95 | BX1002 | SHELF BOXES—8 AND UP..... | \$1.25 each | | | |
| BK1028 | IC OP AMP COOKBOOK..... | \$12.95 | BK7351 | SSB THE MISUNDERSTOOD MODE..\$ 5.50 | | | | |
| BK7312 | MAGIC OF HAM RADIO..... | \$ 4.95 | CT7350 | SSTV TAPE..... | \$ 5.95 | | | |
| | | | SG1081 | STUDY GUIDE—ADV. CLASS..... | \$ 6.95 | | | |

73 magazine

peterborough, n.h. 03458

READER SERVICE

73 Magazine, P.O.B. 2739, Clinton, IA 52735

This card is valid until February 28, 1981.
Please help us to bring you a better magazine—by answering these questions:

I. What is your age?

- A. under 18
- B. 18-22
- C. 23-40
- D. 41-60
- E. over 60

II. ARRL

- 1. Love it
- 2. Don't care
- 3. Hate it

III. If you are not a subscriber please circle number 500.

Reader Service: Return this card to receive full information on the products advertised in this issue. Refer to the ad. You will find numbers near the logo of each advertiser. Each represents the advertiser's individual Reader Service Number. Circle the corresponding numbers on one of the cards on this page, include your name, address & zip, and drop in a mailbox. In 4-6 weeks you'll hear from the advertiser directly.

| | | | | | | | | | | | | | | | | | | | |
|-----|-----|-----|-----|-----|-----|-----|-----|-----|-----|-----|-----|-----|-----|-----|-----|-----|-----|-----|-----|
| 1 | 6 | 11 | 16 | 21 | 126 | 131 | 136 | 141 | 146 | 251 | 256 | 261 | 266 | 271 | 376 | 381 | 386 | 391 | 396 |
| 2 | 7 | 12 | 17 | 22 | 127 | 132 | 137 | 142 | 147 | 252 | 257 | 262 | 267 | 272 | 377 | 382 | 387 | 392 | 397 |
| 3 | 8 | 13 | 18 | 23 | 128 | 133 | 138 | 143 | 148 | 253 | 258 | 263 | 268 | 273 | 378 | 383 | 388 | 393 | 398 |
| 4 | 9 | 14 | 19 | 24 | 129 | 134 | 139 | 144 | 149 | 254 | 259 | 264 | 269 | 274 | 379 | 384 | 389 | 394 | 399 |
| 5 | 10 | 15 | 20 | 25 | 130 | 135 | 140 | 145 | 150 | 255 | 260 | 265 | 270 | 275 | 380 | 385 | 390 | 395 | 400 |
| 26 | 31 | 36 | 41 | 46 | 151 | 156 | 161 | 166 | 171 | 276 | 281 | 286 | 291 | 296 | 401 | 406 | 411 | 416 | 421 |
| 27 | 32 | 37 | 42 | 47 | 152 | 157 | 162 | 167 | 172 | 277 | 282 | 287 | 292 | 297 | 402 | 407 | 412 | 417 | 422 |
| 28 | 33 | 38 | 43 | 48 | 153 | 158 | 163 | 168 | 173 | 278 | 283 | 288 | 293 | 298 | 403 | 408 | 413 | 418 | 423 |
| 29 | 34 | 39 | 44 | 49 | 154 | 159 | 164 | 169 | 174 | 279 | 284 | 289 | 294 | 299 | 404 | 409 | 414 | 419 | 424 |
| 30 | 35 | 40 | 45 | 50 | 155 | 160 | 165 | 170 | 175 | 280 | 285 | 290 | 295 | 300 | 405 | 410 | 415 | 420 | 425 |
| 51 | 56 | 61 | 66 | 71 | 176 | 181 | 186 | 191 | 196 | 301 | 306 | 311 | 316 | 321 | 426 | 431 | 436 | 441 | 446 |
| 52 | 57 | 62 | 67 | 72 | 177 | 182 | 187 | 192 | 197 | 302 | 307 | 312 | 317 | 322 | 427 | 432 | 437 | 442 | 447 |
| 53 | 58 | 63 | 68 | 73 | 178 | 183 | 188 | 193 | 198 | 303 | 308 | 313 | 318 | 323 | 428 | 433 | 438 | 443 | 448 |
| 54 | 59 | 64 | 69 | 74 | 179 | 184 | 189 | 194 | 199 | 304 | 309 | 314 | 319 | 324 | 429 | 434 | 439 | 444 | 449 |
| 55 | 60 | 65 | 70 | 75 | 180 | 185 | 190 | 195 | 200 | 305 | 310 | 315 | 320 | 325 | 430 | 435 | 440 | 445 | 450 |
| 76 | 81 | 86 | 91 | 96 | 201 | 206 | 211 | 216 | 221 | 326 | 331 | 336 | 341 | 346 | 451 | 456 | 461 | 466 | 471 |
| 77 | 82 | 87 | 92 | 97 | 202 | 207 | 212 | 217 | 222 | 327 | 332 | 337 | 342 | 347 | 452 | 457 | 462 | 467 | 472 |
| 78 | 83 | 88 | 93 | 98 | 203 | 208 | 213 | 218 | 223 | 328 | 333 | 338 | 343 | 348 | 453 | 458 | 463 | 468 | 473 |
| 79 | 84 | 89 | 94 | 99 | 204 | 209 | 214 | 219 | 224 | 329 | 334 | 339 | 344 | 349 | 454 | 459 | 464 | 469 | 474 |
| 80 | 85 | 90 | 95 | 100 | 205 | 210 | 215 | 220 | 225 | 330 | 335 | 340 | 345 | 350 | 455 | 460 | 465 | 470 | 475 |
| 101 | 106 | 111 | 116 | 121 | 226 | 231 | 236 | 241 | 246 | 351 | 356 | 361 | 366 | 371 | 476 | 481 | 486 | 491 | 496 |
| 102 | 107 | 112 | 117 | 122 | 227 | 232 | 237 | 242 | 247 | 352 | 357 | 362 | 367 | 372 | 477 | 482 | 487 | 492 | 497 |
| 103 | 108 | 113 | 118 | 123 | 228 | 233 | 238 | 243 | 248 | 353 | 358 | 363 | 368 | 373 | 478 | 483 | 488 | 493 | 498 |
| 104 | 109 | 114 | 119 | 124 | 229 | 234 | 239 | 244 | 249 | 354 | 359 | 364 | 369 | 374 | 479 | 484 | 489 | 494 | 499 |
| 105 | 110 | 115 | 120 | 125 | 230 | 235 | 240 | 245 | 250 | 355 | 360 | 365 | 370 | 375 | 480 | 485 | 490 | 495 | 500 |

Name _____
Address _____
City _____ State _____ Zip _____

73 Magazine • November 1980

BOOKS

73 Magazine, Pine Street, Peterborough, N.H. 03458

Please send me the following 73 products:

| Qty. | Catalog # | Title | Unit Price | Total |
|------|-----------|-------|------------|-------|
| | | | | |
| | | | | |
| | | | | |
| | | | | |
| | | | | |
| | | | | |
| | | | | |
| | | | | |
| | | | | |
| | | | | |
| | | | | |
| | | | | |
| | | | | |
| | | | | |
| | | | | |
| | | | | |
| | | | | |
| | | | | |
| | | | | |
| | | | | |
| | | | | |

Add \$1 shipping/handling _____
Total _____

Please allow 4-6 weeks for delivery.
No C.O.D. orders accepted.
Enclosed \$ _____ Check M.O.
Bill: AE MC Visa

Card # _____ Exp. date _____
Signature _____ Interbank # _____
Name _____
Address _____
City _____
State _____ Zip _____ 11/80

SUBSCRIPTION

73 Magazine P.O. Box 931 Farmingdale, N.Y. 11737

73 subscribers
CELEBRATE 73's 20th ANNIVERSARY WITH A YEAR FOR \$20.

- New subscription
- Renewal
- 1 year—\$20
- Enclosed \$ _____ Check M.O.
- Bill: MC Visa AE me

Card # _____ Exp. date _____
Signature _____ Interbank # _____
Name _____
Address _____
City _____ State _____ Zip _____
Canada—\$22. 1 year only. US funds.
Other foreign—\$30. 1 year only. US funds.

This card expires 11/15/80

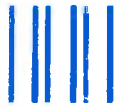

NO POSTAGE
NECESSARY
IF MAILED
IN THE
UNITED STATES

BUSINESS REPLY CARD

FIRST CLASS PERMIT NO. 73 PETERBOROUGH NH 03458

POSTAGE WILL BE PAID BY ADDRESSEE

73 MAGAZINE
Subscription Dept.
POB 931
Farmingdale NY 11737

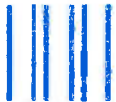

NO POSTAGE
NECESSARY
IF MAILED
IN THE
UNITED STATES

BUSINESS REPLY CARD

FIRST CLASS PERMIT NO. 73 PETERBOROUGH NH 03458

POSTAGE WILL BE PAID BY ADDRESSEE

73 MAGAZINE
Peterborough
NH 03458



BUSINESS REPLY CARD

FIRST CLASS PERMIT NO. 217 CLINTON IA 52735

POSTAGE WILL BE PAID BY ADDRESSEE

73 MAGAZINE
POB 2739
Clinton IA 52735

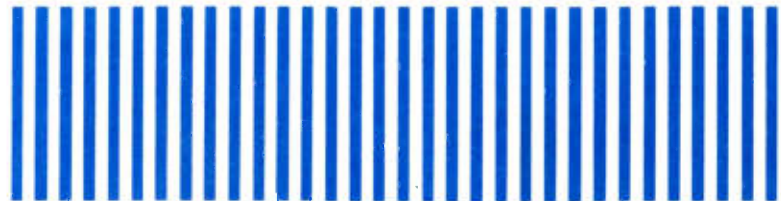

NO POSTAGE
NECESSARY
IF MAILED
IN THE
UNITED STATES

Att. Mail Order

DOUBLE YOUR PLEASURE



Versatility Plus . . . Work Both 2 and 3/4 Meters With Yaesu's New FT-720R

The FT-720R series is a compact VHF/UHF mobile transceiver that harnesses the incredible power of the microprocessor to bring you top-operating flexibility. Start with the FT-720R Control Head, then add either the 10 watt FT-720RU 440 MHz or 25 watt FT-720RVH 2 meter RF Deck. You can clamp the Control and RF Deck together or use an optional remote cable to hide the RF Deck. The best news is still to come! By using the optional S-72 Switching Box and two remote cables, you can use a single Control Head for operation with both the 440 MHz and 2 meter decks, giving you a high-performance two band FM station for your car or home. Compare the features below, then ask your dealer for a demonstration of the fabulous FT-720R series. . . another winner from the performance leader . . . Yaesu.

- Four simplex/repeater memory channels, plus receive-only memory channel.
- Scanning controls on microphone with search for busy or clear channel.
- Optional 32 tone CTCSS module for accessing private repeaters.
- Colorful, easy-to-read LED power output/S meter.
- Built-in 1800 Hz tone generator.
- Priority channel with search-back feature.
- Pause feature that holds, then restarts scan, on busy or clear channels.
- Digital display of last four digits of operating frequency.
- Single Control Head may be used for operation on both 440 MHz and 2 meters via optional switching box and remote cables.
- Extremely compact size, light weight.

| FT-720RVH | Specifications | FT-720RU |
|------------------------------|--------------------|------------------------------|
| 144.00-147.99 MHz | Frequency Coverage | 440.00-449.975 MHz |
| 10 kHz | Synthesizer Steps | 25 kHz |
| 25 watts | Power Output | 10 watts |
| .32 uV for 20 dB
quieting | Sensitivity | 0.5 uV for 20 dB
quieting |
| ±6 kHz (-6dB) | Selectivity | ±12 kHz (-6dB) |
| ±12 kHz (-60 dB) | | ±24 kHz (-60 dB) |

YAESU ✓83
The radio.



480

Price And Specifications Subject To
Change Without Notice Or Obligation

YAESU ELECTRONICS CORP., 6851 Walthall Way, Paramount, CA 90723 ● (213) 633-4007
YAESU ELECTRONICS Eastern Service Ctr., 9812 Princeton-Glendale Rd., Cincinnati, OH 45246

Top-Notch.

VBT, notch, IF shift, wide dynamic range

TS-830S

Now most Amateurs can afford a high-performance SSB/CW transceiver with every conceivable operating feature built in for 160 through 10 meters (including the three new bands). The TS-830S combines a high dynamic range with variable bandwidth tuning (VBT), IF shift, and an IF notch filter, as well as very sharp filters in the 455-kHz second IF. Its optional VFO-230 remote digital VFO provides five memories.

MC-50

SP-230

TS-830S

VFO-230

AT-230



Ask your Authorized Kenwood Dealer about the many operating features offered by the TS-830S...at a very reasonable price!

NOTE: Price, specifications subject to change without notice and obligation.



KENWOOD

...pacesetter in amateur radio

TRIO-KENWOOD COMMUNICATIONS INC.
1111 WEST WALNUT / COMPTON, CA 90220