

# 73 Magazine

## for Radio Amateurs

- 30 **NBVM: Dawn of an Era or Promotional Hype?**  
— the performance and politics of Narrow Band Voice Modulation  
..... N8RK
- 36 **Frequency Counter Survival Course**  
— use that gadget wisely  
..... McClellan
- 40 **DX with a Difference: the Utility Stations**  
— when the ham bands get frustrating, give SWLing a try..... WA3EOP
- 46 **IO How to Write a RTTY Program**  
— machine language is easier than you think..... WA4FMZ
- 53 **IO The Perfect Morse Machine**  
— send and receive CW with a dedicated micro..... WA5VQK
- 63 **IO Microcomputers and Your Satellite Station**  
— part 1: calculating orbital crossing data..... WB8DQT
- 76 **A Brasspounder Improves Heath's HR-1680**  
— add a crystal CW filter, bfo, noise blanker, and more..... KA5N
- 83 **The Dollar-Saver DVM**  
— 3½-digit unit features autopolarity, auto-zero, and a \$30 price tag  
..... McClellan
- 92 **Personalize Your Repeater with a Voice ID**  
— low-cost design uses 8-track decks  
..... K9EID
- 96 **The Nearly Perfect WE-800**  
— add an on-board charger, a TT pad, and ...  
..... K1OTW
- 98 **How to Make Your Own Crystal Filters**  
— requires considerable patience, but very few bucks..... Staff
- 106 **The Procrastinator's Special: A Simple Six-Band Antenna**  
— this 10-160 endfed vee goes up in a jiffy..... W6TKA/Q
- 108 **They Don't Make 'Em Like They Used To**  
— home-brewing a hard-to-find neutralizing cap..... W2OLU
- 110 **The Europa-B Two Meter Transverter**  
— work OSCAR and 2m SSB with this British import..... G3ZCZ
- 112 **Zero In on Zero Beat**  
— an easy-to-make vernier for your tube-type oscillator..... W2OLU
- 117 **CB-to-10 FM**  
— best conversion yet?  
..... K1DCS, N1XN, W1WRO/N2XN
- 131 **Home-Brew Holders for Icom Portables**  
— keeps your IC-502, -202, or -215 on the level..... KH6IAA
- 132 **Catch You on the Flip-Flop**  
— add a handy repeater reverse switch to your Memorizer... K7ACN
- 136 **Personality Plus for your Repeater**  
— this low-budget voice IDer will really wow 'em..... K9EID
- 140 **A Better Overvoltage Protection Circuit**  
— the original was good... this version is better..... W7RXV

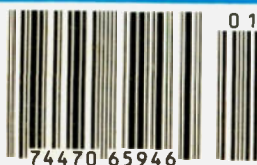

Never Say Die—4, Looking West—8, Faces, Places—12, Ham Help—12, 21, 152, 157, 159, 172, RTTY Loop—14, DX—16, Awards—18, Microcomputer Interfacing—21, Leaky Lines—22, Contests—24, New Products—26, Letters—28, Corrections—146, OSCAR Orbits—152, FCC—154, Social Events—170, Propagation—193



Shown with accessory touch tone pad

# PROVEN DEPENDABILITY

## ...THE TEMPO S-1 GREET'S THE NEW YEAR WITH A SPECIAL LOW PRICE

The **TEMPO S-2**... the world's first synthesized 220 MHz hand held transceiver. With an S-2 in your car or pocket you can use any 220 MHz repeater in the United States. It offers all of the advanced engineering, premium quality components and exciting features of the S-1. It is completely synthesized, offering 1000 channels in an extremely lightweight but rugged case. If you're not on 220 it's about time you try it and this is the perfect way to get started. With the addition of a matching Tempo solid state amplifier you can use your S-2 as a powerful mobile or base station as well. It's all you really need. And if you already have a 220 MHz rig, the S-2 will add versatility you never dreamed possible.

Also... the price is right. The ni-cad battery pack, charger, and telescoping whip antenna are included. Although not a necessary option, the touch tone pad shown in the illustration adds greatly to its convenience at a low price.

The time has never been better to expand your horizons... there has never been a better little rig for 220 than the S-2.

Price...\$349.00

With touch tone pad...\$399.00

The Tempo line also features a fine line of extremely compact UHF and VHF pocket receivers. They're low priced, dependable, and available with CTCSS and 2-tone decoders. The Tempo FMT-2 & FMT-42 (UHF) provide excellent mobile communication and features a remote control head for hide-away mounting. The Tempo FMH-42 (UHF) and the *NEW* FMH-12 and FMH-15 (VHF) micro hand held transceivers provide 6 channel capability, dependability plus many worthwhile features at a low price. FCC type accepted models also available.

Please call or write for complete information. Also available from Tempo dealers throughout the U.S. and abroad.

**B**y now most of you have heard the same words of praise on the air that we (gratefully) receive over and over. The quality that is built into the S-1 has been attested to by the outstanding performance and dependability of the thousands of units in daily use. It's simple to operate and the high level of innovative engineering that brought forth the Amateur world's first hand held synthesized radio also designed into this compact beauty exciting performance and features at a very affordable price. A price that also includes a ni-cad battery pack, charger, and a telescoping whip antenna. The optional touchtone pad shown in the illustration adds greatly to its convenience. In addition we offer superior quality 30 and 80 watt solid state matching power amplifiers that give the S-1 the flexibility of operating as a portable, mobile, or base station rig.

**Remember...the Tempo S-1 is the original and proven 800 channel synthesized hand held transceiver. Don't be fooled by substitutes.**

#### SPECIFICATIONS

Frequency Coverage: 144 to 148 MHz  
 Channel Spacing: Receive every 5 kHz, transmit Simplex or  $\pm$ 600 kHz  
 Power Requirements: 9.6 VDC  
 Current Drain: 17 ma-standby  
 Batteries: 500 ma-transmit  
 8 cell ni-cad pack included  
 Antenna Impedance: 50 ohms  
 Dimensions: 40 mm x 62 mm x 165 mm (1.6" x 2.5" x 6.5")  
 RF Output: Better than 1.5 watts  
 Sensitivity: Better than 5 microvolts

Price... ~~\$349.00~~ Reduced to \$299.00

With touch tone pad... ~~\$399.00~~ Reduced to \$339.00

#### SUPPLIED ACCESSORIES

Telescoping whip antenna, ni-cad battery pack, charger.

#### OPTIONAL ACCESSORIES

Touch tone pad (not installed): \$39 •  
 Tone burst generator: \$29.95 •  
 CTCSS sub-audible tone control: \$29.95 •  
 Rubber flex antenna: \$8 •  
 Leather holster: \$16 •  
 Cigarette lighter plug mobile charging unit: \$6 •  
 Matching 30 watt output 13.8 VDC power amplifier (S30): \$89 •  
 Matching 80 watt output power amplifier (S80): \$149



NEW TOLL FREE ORDER NUMBER: (800) 421-6631

For all states except California. Calif. residents please call collect on our regular numbers.

✓ H3

11240 W. Olympic Blvd., Los Angeles, Calif. 90064 213/477-6701  
 931 N. Euclid, Anaheim, Calif. 92801 714/772-9200  
 Butler, Missouri 64730 816/679-3127

# Henry Radio

Prices subject to change without notice.

# Wilson...

## has your needs well in hand.

Today's Amateur demands rugged, rapid and accurate communications between Hams in the know. That's why they choose the Wilson Mark Series of hand-held radios. With exceptional qualities like these . . . why not choose the most popular radio available for yourself?

### FEATURES

Advantages such as solid state circuitry, rugged Lexan® case, removable rear panel (enabling easy access to battery compartment) and compact mini-size enhance the Mark Series portable radio's versatility. In addition, Wilson carries a full line of accessories to satisfy almost any of your requirements.

### SPECIFICATIONS

The Mark radios offer: • 144-148 MHz range • 6 Channel operation • Individual trimmers on TX and RX xtals • Rugged Lexan® outer case • Current drain: RX; 15 mA, TX; Mark II: 500 mA, Mark IV: 900 mA • A power saving Hi/Lo Switch • 12 KHz ceramic filter and 10.7 monolithic filter included • 10.7 MHz and 455 KHz IF • Spurious and harmonics, more than 50 dB below quieting • Uses special rechargeable Ni-Cad battery pack • LED battery condition indicator • Rubber duck and one pair Xtals 52/52 included • Weight: 19 oz. including batteries • Size: 6" x 1.770" x 2.440".

### OPTIONS

Options available, include Touch Tone Pad, CTCSS, Leather Case, Chargers for Desk Top, Travel or Automobile, Speaker Mike and large capacity, small size batteries.

For more details and/or the name of your nearest dealer, contact: Consumer Products Division, Wilson Electronics Incorporated, 4288 So. Polaris Ave., P. O. Box 19000, Las Vegas, Nevada 89119. Phone 702/739-1931.

 **Wilson Electronics** ✓ W2  
**Incorporated**

A Subsidiary of REGENCY ELECTRONICS, INC.

**ACTUAL  
SIZE!!!**



Prices and specifications subject to change without notice.

# Info

## Manuscripts

Contributions in the form of manuscripts with drawings and/or photographs are welcome and will be considered for possible publication. We can assume no responsibility for loss or damage to any material. Please enclose a stamped, self-addressed envelope with each submission. Payment for the use of any unsolicited material will be made upon acceptance. All contributions should be directed to the 73 editorial offices. "How to Write for 73" guidelines are available upon request.

## Editorial Offices:

Pine Street  
Peterborough NH 03458  
Phone: 603-924-3873, 924-3874

## Advertising Offices:

Pine Street  
Peterborough NH 03458  
Phone: 603-924-7138, 924-7139

## Circulation Offices:

Pine Street  
Peterborough NH 03458  
Phone: 603-924-7296

## Subscription Rates

In the United States and Possessions:  
One Year (12 Issues) \$18.00  
Two Years (24 Issues) \$30.00  
Three Years (36 Issues) \$45.00  
Lifetime subscription \$240.00

## Elsewhere:

Canada—add \$2.00 per year unless paid with U.S. currency.

All other foreign—one year only—\$26.00 payable in U.S. currency through a U.S. bank. (Surface mail).

## To subscribe, renew or change an address:

Write to 73 Magazine, Subscription Department, PO Box 931, Farmingdale NY 11737. For renewals and changes of address, include the address label from your most recent issue of 73. For gift subscriptions, include your name and address as well as those of gift recipients. Postmaster: Send form #3579 to 73 Magazine, Subscription Services, P.O. Box 931, Farmingdale NY 11737.

## Subscription problem or question:

Write to 73 Magazine, Subscription Department, PO Box 931, Farmingdale NY 11737. Please include an address label.

73 Magazine (ISSN 0098-9010) is published monthly by 73, Inc., Pine Street, Peterborough NH 03458. Second class postage is paid at Peterborough NH 03458 and at additional mailing offices. Copyright (c) 1979 by 73, Inc. All rights reserved. No part of this publication may be reprinted or otherwise reproduced without written permission from the publisher. Microfilm Edition—University Microfilm, Ann Arbor MI 48106.

# W2NSD/1 NEVER SAY DIE

editorial by Wayne Green



## GETTING ORIENTED

A trip to Korea, Taiwan, Hong Kong, Guam, and Japan in October helped put things into sobering perspective as far as the US leadership in technology is concerned. Oh, the evidence was there without the trip—on my wrist in the form of a digital watch with built-in calculator from Japan, two or three more Casio calculators always at hand, a Sansui hi-fi system at home, Icom, Kenwood, Tempo, and Yaesu ham gear at every turn, Hitachi and Sanyo televisions, VTR systems made in Japan, etc. Even my new rechargeable pencil sharpener says Sansui.

While traveling through the Orient visiting consumer electronic shows in Seoul, Osaka, Taipei, and Hong Kong, I got the full brunt of the competition the US faces from this area. It is no wonder that these countries have taken over 80-90% of the production of high technology electronics equipment being sold in our country... they're ahead of us in just about every field except computers and microwaves.

Can anything be done to reverse this worsening situation? I think it can, and I think that you, the readers of 73 Magazine, can have a profound effect on the position of the US in electronics over the next few years. I don't think this is a situation which can be helped by setting up trade barriers. I do think it is high time the US did get vigorously to work to break down the one-way Japanese trade barriers... in essence, forcing them to fight us on more equal terms.

My visits to the electronic shows and Japanese electronic firms had me in contact with Asian amateurs at every turn. While this was no surprise, it did back up what I have been writing in my editorials for many years. Byron Kretzman W2JTP recently dropped me a letter reminding me of an editorial I published in the June, 1969,

issue of 73, pointing out that if our ham clubs did not get busy and get the amateur radio ranks growing again (growth had stopped for a six-year period at that time as a result of the FCC handling of the so-called "incentive licensing" proposals), the US dominance of the electronic industry worldwide could be lost within twenty years. I missed my guess; we lost it within ten years.

If amateur radio had been permitted to continue to grow at the rate it had established during the years after WWII until 1963, at which time it was proposed that we go back to the pre-war Class A and Class B licensing system and all growth stopped, we would today have well over 1,500,000 licensed amateurs and I sincerely believe that the US would be making 80% of the electronic equipment instead of Japan and their off-shore workshops in Hong Kong, etc.

Let's look at the situation carefully and think about it. Statistics (ARRL) show that about 50% of the new licensees are either 14 or 15 years old. We also know that about 80% of these newcomers to amateur radio get involved enough with electronics so they choose it for their career. This means that if our ham growth had not been brought to a halt in 1963 by the FCC failure to immediately dismiss the "incentive licensing" proposals, we might expect to have 166,000 new hams just in 1980. This would also result in about 133,000 of these new people entering the electronics industry within about five years.

Now, look here, don't come whining to me about how crowded the ham bands would be with 2,000,000 or more hams trying to use them. We have so damned many UHF and microwave bands that we aren't even using and so many techniques for getting more use out of the low bands that I don't think a big ham population would be any-

thing but a big plus which would force more inventing and pioneering on us.

If you, the readers of 73 Magazine, make it your business to see that your ham club gets busy and starts filling up those Novice classes with high school kids, we'll start having some good technicians and engineers flowing into our electronics industry within ten years. We want to get the kids at this time of their lives and infect them with one of the most virulent of viruses... amateur radio. If you get their attention at 14 and 15 years of age, you'll have most of them for life.

But we need a 20% growth rate or better, not a puny 11% that we had for the years prior to 1963 and the licensing debacle. We have to catch up so we can eventually get back our high technology industries. This means that your club must find some way to get into the nearby high schools and put on demonstrations of the wonders of amateur radio... repeaters, satellite communications, DXing, emergency service... the dozens of facets of our hobby which have made it one of the most important in the world.

With only about 30% of the licensed amateurs belonging to clubs, we need to have some vigorous club promotions. It's been some time since I have run articles in 73 on how to build up clubs, so perhaps it is time for you to write about this aspect of the hobby. There are some relatively simple rules for promoting club growth which I can pass on... such as making sure that your club meetings are fun to attend. That may sound too simple an idea, but unfortunately, I have been to far too many club meetings which were anything but fun. Long battles over buying paint to spruce up the clubhouse will not bring the membership back to the next meeting.

Let me provide some basic rules for getting clubs to grow. I

# TS-180S with DFC\*



## Digital Frequency Control\* ...a Kenwood innovation for maximum HF operating enjoyment!

Kenwood's TS-180S with DFC is an all solid-state HF transceiver designed for the DXer, the contest operator, and all other Amateurs who enjoy the 160 through 10-meter bands. The following features prove, beyond doubt, that the TS-180S is the classiest rig available!

- Digital Frequency Control (DFC), including four memories and manual scanning. Memories are usable in transmit and/or receive modes. Memory-shift paddle switches allow any of the memory frequencies to be tuned in 20-Hz steps up or down, slow or fast, with recall of the original stored frequency. It's almost like having four remote VFOs!
- All solid-state... including the final. No dipping or loading. Just dial up the frequency, peak the drive, and operate!
- High power... 200 W PEP/160 W DC input on 160-15 meters, and 160 W PEP/140 W DC on 10 meters (entire band provided). Also covers more than 50 kHz above and below each band (MARS, WARC, etc.) and receives WWV on 10 MHz.
- Improved dynamic range.
- Adaptable to all three proposed (WARC) bands.
- Single-conversion system with highly advanced PLL circuit, using only one crystal with improved stability and spurious characteristics.
- Built-in microprocessor-controlled large digital display. Shows actual VFO frequency and difference between VFO and "M1" memory frequency. Blinking decimal points indicate "out of band." Monoscale dial, too.
- IF shift... Kenwood's famous passband tuning that reduces QRM.
- Selectable wide and narrow CW bandwidth on receive (500-Hz CW filter is optional).
- Automatic selection of upper and lower sideband (SSB NORM/SSB REV switch).
- Tunable noise blanker (adjustable noise-sampling frequency).
- RF AGC ("RGC"), which activates automatically to prevent overload from strong, local signals.
- AGC (selectable fast/slow/off).
- Dual RIT (VFO and memory/fix).
- Three operating modes... SSB, CW, and FSK.
- Improved RF speech processor.
- Dual SSB filter (optional), with very steep shape factor to reduce out-of-passband noise on receive and to improve operation of RF speech processor on transmit.
- 13.8 VDC operation.
- Also available is the TS-180S without DFC, which still shows VFO frequency and difference between VFO and "hold" frequencies on the digital display.

- Full line of matching accessories, including PS-30 base-station power supply, SP-180 external speaker with selectable audio filters, VFO-180 remote VFO, AT-180 antenna tuner/SWR and power meter, DF-180 digital frequency control, YK-88 CW filter, and YK-88 SSB filter.

All of these advanced features can be yours... and at an attractive price! Visit your local Authorized Kenwood Dealer and inquire about the exciting TS-180S with DFC!



Still available...  
Kenwood's TS-820S HF transceiver.



**KENWOOD**

...pacesetter in amateur radio

TRIO-KENWOOD COMMUNICATIONS INC.  
1111 WEST WALNUT / COMPTON, CA 90220

# Staff

## EDITOR/PUBLISHER

Wayne Green W2NSD/1

## EXECUTIVE VICE PRESIDENT

Sherry Smythe

## CORPORATE CONTROLLER

O. Alan Thulander

## ASSISTANT PUBLISHER

Jeffrey D. DeTray WB8BTH

## ADMINISTRATIVE ASSISTANT

Dotty Gibson

## MANAGING EDITOR

John C. Burnett

## ASSISTANT MANAGING EDITOR

Susan G. Philbrick

## NEWS EDITOR

Gene Smarte WB6TOV/1

## EDITORIAL ASSISTANTS

Elisabeth Blackmore

Richard Phenix

## PRODUCTION MANAGER

Noel R. Self WB1ARP

## ASSISTANT PRODUCTION MANAGER

Robin M. Sloan

## ART DEPARTMENT

Steve Baldwin

Bob Drew

Bruce Hedin

Kenneth A. Jackson

Dion Owens

Nancy Salmon

Patrice Scribner

John W. White

## BOOK PUBLICATIONS

Jim Perry

## BOOK PRODUCTION

Peter Perin

Emily A. Gibbs

Chris Brown N1AUI

## PRINTING

Gary Steinbach, Mgr.

## PHOTOGRAPHY

Bill Heydolph

Tedd Cluff

Terrie Anderson

## TYPESETTING

Barbara J. Latti

Sara Bedell

Rhonda Clapper

Sandie Gunseth

## BOOKKEEPER

Knud E. M. Keller KV4GG/1

## DATA ENTRY

Cathy DeSilva

## SUBSCRIPTION SALES MANAGER

Debra Boudrieau

## CIRCULATION MANAGER

Harold L. Stephens

## ASSISTANT CIRCULATION MANAGERS

Donna Taylor

Judy Waterman

## CIRCULATION

Pauline Johnstone

## BULK SALES MANAGER

Ginnie Boudrieau

## SHIPPING

Mark Dendy

Bill Barry

## RECEPTIONIST

Doni Jarvis

## ASSOCIATES

Robert Baker WB2GFE

W. Sanger Green

Dave Ingram K4TWJ

Larry Kahner WB2NEL

Joe Kasser G3CZC

Bill Pasternak WA6ITF

John Schultz W4FA

Peter Stark K2OAW

## COMPUTER PROGRAMMING

Richard J. Dykema

## ADVERTISING

Aline Coutu, Mgr.

Kevin Rushalko

Nancy Ciampa

Marcia Stone

Louise Holdsworth

Jerry Merrifield

Lori Mugford

Rita Rivard

mentioned that meetings should be fun... that means keeping the business part of the meeting mercifully short. The business aspect of a club should be handled almost 100% by an executive committee, with merely brief reports to the membership. There is a tendency on the part of some nitpickers to try to get long bitter battles going over obscure matters. Somehow the whole club then joins in and the meeting goes on endlessly with everyone deeply involved in the discussion. It seems like this amount of participation and interest must be a good thing. Not true. The fact is that many of these battlers will find something more enjoyable to do instead of the next meeting... like watching television.

Think of the club meeting as show biz. Look for some interesting people to bring in and talk to the group. If you have any ham manufacturers in the area, draw on them. Arrange shows of RTTY, SSTV, and other new or unusual developments. Microcomputers are also a big draw. Get some of your experts to talk about DXing, satellite communications... maybe a short QSL show-and-tell during each meeting for the DX gang to brag about their accomplishments. New equipment is always of interest. If someone has built a piece of gear, have show and tell about that.

Don't forget the refreshments. I'm not the only one who will drive miles for a coffee and doughnut break... or, better yet, cider and doughnuts.

Club projects are a plus... Novice and higher class license classes will interest many amateurs and help the club to grow. If you don't have at least 50% youngsters in your club, then you may find that it is in the hands of some old-timers who are keeping out the newcomers. Novices are disruptive, and old-timers try to avoid them... kids get bored easily and make noise. When the noise starts, that means that the meeting really is getting boring and that should be fixed rather than dump on the kids.

Club activities for contests can help provide fun... VHF contests, DX contests, Field Day... all can bring excitement to the club members and increase their enjoyment of amateur radio. Providing communications for civic events is a wonderful way to help the club and also promote amateur radio. The recent ham communications provided at Colorado Springs for the National Sports Festival was a great demonstration of what a club can do to provide a valuable service and promote amateur radio.

But the key to changing the

increasing loss of high technology industries to Asia is, I feel, in the growth of amateur radio here. We have to get busy and work as we never have before to build up our club Novice classes... to get high school students involved with amateur radio and moving up the ladder of ham licenses. This means we have to be visible. We have to provide service and make sure that everyone knows about it. We have to acquaint every high school student with the wonders of amateur radio and then fan the flames of interest which result.

Even with a 25% growth in amateurs, it will be several years before we are able to catch up with where we would have been in amateurs today if our growth had not stopped in 1963. By 1986, we could be caught up with where we would have been in 1979. If we are able to manage a 25% growth from now on, we would catch up with our previous 11% growth by 1991.

Until we have more amateurs than they have in Japan... and they are way ahead of us today... I don't think we have a serious prayer of catching up with them technologically. Hams just have too much of an influence on industry and even government. Heck, when I met the Mayor of Osaka as a representative of the visiting IEEE tour group, one of the chief aides of the mayor was a ham (JE3DTA).

When you consider that we have double the population of Japan, their passing us in the number of hams is doubly distressing. Of course, one advantage they do have over us is their no-code license. This does not seem to have seriously hurt their quality of amateurs, while it certainly has contributed much to the quantity. Perhaps it is getting time for us to start putting pressure on the FCC to get this rule change into effect. We might find it easier to attract newcomers to amateur radio if we only had to worry about the technical and rule tests. You and I know how easy it really is to learn the code, but a large percentage of the newcomers are so panic-stricken by the thought that they are not able to react reasonably. For some reason, the code seems to present a terrible threat to many people... despite proof that kids of four are able to surmount the obstacle.

Now that the pay rates are fairly equal between Japan and the US, the big difference in technical consumer goods lies in development and production. This is a situation that I think we could surmount if we had the technical people we need.

Even if we give up on the

presently lost fields, we could still hold on to the microwave and computer fields if we had enough engineers, technicians, and technically-educated businessmen. The key to this lies with you. If you get things moving with classes in your club, it could make a substantial difference over the next generation. Take delight in bringing the fun of amateur radio to the kids... they need it... you need it... and, for sure, our country needs it.

## CB IMPORTS REALLY DOWN

The government figures on CB imports show that they are down from a year ago... substantially. During the first nine months of 1979, there were only 341,503 CB sets imported as compared with over two million during the same period in 1978.

While I don't particularly feel sorry for the Japanese firms and people inconvenienced by this radical change in the market, still, it is a bit unfair to them from the aspect that they apparently had very little to do with bringing this state of affairs about. Of course, perhaps we could fault them for trying to take over every one of our high technology industries... and doing it so successfully. But we can't honestly fault them for being smart enough to understand that their firms and country will do best if they export high-priced goods instead of shoes and shirts, nor can we really fault them for the help the American government has given them in their enterprise... making it almost unable to fail.

By taxing risk capital which succeeds and offering no help for risk capital which fails to make a profit, a stupidity which none of the successful countries has been foolish enough to enact, we have virtually thrown most of our major high technology industries out of our country. We could start bringing them back by abolishing the capital gains tax.

Getting back to the CB disaster, for those of you who have missed my comments on that some time ago: It was the greed of a couple American businesses which screwed up the entire CB industry. It was with perhaps some amusement I watched Hy-Gain go bankrupt since it was my understanding that the president, Andy Andros, was one of the people behind much of the EIA plan to "sell all the CBers another radio." This was the 50-channel plan. Andy was, I believe, also one of the main people behind the EIA push to take 220 MHz away from amateurs. If I'm wrong, I'd sure like to hear from anyone with better information.

Continued on page 148

# COMPACT RTW

## TU-170

\$159.95 buys a terminal unit kit with capabilities beyond your expectations for the price. And

the Flesher Corp TU-170 won't devour your precious space. Wired units are available at \$234.95. Call or write today for our free 1980 catalog of affordable kits, wired units and accessories.



**FLESHER CORP** ✓FS

P.O. Box 976 • Topeka, Kansas 66601 • 913 • 234 • 0198

## SCANNERS:

**KDK 2015R, KDK 2016A  
MIDLAND 13-510, 13-513, CLEGG FM-28  
YAESU FT227R, ICOM IC22S,  
KENWOOD TR7400A, TR7600, & TR7625**

- AED continues to expand its line of quality scanners. All of the above scanners are custom designed for their respective rigs.
- All scanners install completely inside the rig. No obtrusive external connections.
- All are easy to assemble and come complete with a detailed instruction manual.
- Scanned frequency displayed on digital readout (except IC22S).
- In the scanner OFF mode the rig operates normally. In the scanner ON mode the scanner locks on an occupied frequency, pauses for a preset time (about 5 secs.) and then resumes scanning.
- This gives you the ability to eavesdrop all over the band without lifting a finger. When you hear something interesting, you flip the switch to the LOCK mode and the rig is ready to transmit.

### AED SCANNER SPECIFICATIONS

	KDK 2015R	KDK 2016A	KENWOOD TR7600 TR7625	KENWOOD TR7400A	YAESU FT227R	MIDLAND 13-510 13-513	CLEGG FM-28	ICOM IC22S
SCANNING RATE	Adjustable 100kHz/sec-1MHz/sec		50kHz/sec	50kHz/sec	200kHz/sec	100kHz/sec	100kHz/sec	100kHz/sec
SWEEP WIDTH	144-148 or only the mHz segment you select on mHz switch	142-149.995	complete band or mHz you want	complete band or mHz you want	adjustable eg. 146-148 144-146 146-147	scans the mHz seg. selected by the mHz switch	same as Midland	145.35-147.99
SCANNING CONTROLS	2 mini toggle switches mounted on rig — LOCK switch may be mounted on mic.		2 mini toggle switches mounted on rig.	2 mini toggle switches mounted on rig.	1 mini toggle switch mounted on mic or rig.	2 mini toggle switches mounted on rig.	same as Midland	1 mini toggle switch mounted on mic or rig.
PRICE FOR KIT	\$39.95							
PRICE PRE-ASSEMBLED	\$59.95							

DEALER INQUIRIES INVITED

✓A60

**AED ELECTRONICS**

750 LUCERNE RD., SUITE 120  
MONTREAL, QUEBEC, CANADA H3R 2H6  
TEL. 514-737-7293

Add \$1.50 for postage & handling

## R-X Noise Bridge



- Learn the truth about your antenna.
- Find its resonant frequency.
- Adjust it to your operating frequency quickly and easily.

If there is one place in your station where you cannot risk uncertain results it is in your antenna.

The Palomar Engineers R-X Noise Bridge tells you if your antenna is resonant or not and, if it is not, whether it is too long or too short. All this in one measurement reading. And it works just as well with ham-band-only receivers as with general coverage equipment because it gives perfect null readings even when the antenna is not resonant. It gives resistance and reactance readings on dipoles, inverted Vees, quads, beams, multiband trap dipoles and verticals. No station is complete without this up-to-date instrument.

Why work in the dark? Your SWR meter or your resistance noise bridge tells only half the story. Get the instrument that really works, the Palomar Engineers R-X Noise Bridge. Use it to check your antennas from 1 to 100 MHz. And use it in your shack to adjust resonant frequencies of both series and parallel tuned circuits. Works better than a dip meter and costs a lot less. Send for our free brochure.



The price is \$55.00 in the U.S. and Canada. Add \$3.00 shipping/handling. California residents add sales tax.

Fully guaranteed by the originator of the R-X Noise Bridge.

**ORDER YOURS NOW!**

# Palomar Engineers

Box 455, Escondido, CA. 92025

Phone: [714] 747-3343

# Looking West

Bill Pasternak WA6ITF  
24854-C Newhall Ave.  
Newhall CA 91321

Letters from all you videotape enthusiasts tell me you want more, so here goes. At the outset, let me state that I am no expert on the subject. I do service U-Matic, Beta, and VHS-type machines. In fact, I cut my teeth on the Sony V0-1600 U-Matic series, but that's it, except for a stint working on the now deceased Cartravision units. I'm probably one of the few people who ever was actually schooled on them, but that's long ago, one of those things best left forgotten. Anyhow, my postal person's complaints about the volume of mail on this subject seem to indicate that there is a good deal of interest in the topic, so let's go a bit further than last time.

Between Bill Orenstein KH6IAF and myself, we possess three videocassette machines. They are a 3/4" U-Matic format Panasonic, an RCA Selectavision VHS, and my Sony SL-7200 Beta machine. The RCA and Panasonic are at the Westlink facilities in Hollywood and the Beta is at my home. All perform the same function: They record and play back a television picture, either color or monochrome, and the audio that goes with the picture. Without getting super technical, the 3/4" machine reproduces a better picture than either of the 1/2" machines, but this is to be expected. However, to people like you and me, cost is a very important factor, and most people cannot afford the \$35/hour price of U-Matic tape cassettes. When Bill and I decided we were going to get home-type machines, we fought about which format was best. Bill opted for VHS and I chose Beta. Neither of us has been disappointed in his choice. I will venture to say that Bill and I represent two average consumers, even though our backgrounds are in the electronics/broadcast businesses.

Recently, we had an opportunity to utilize our equipment in a manner directly related to amateur radio. The Valley Good Guys Radio Club offered to procure for Westlink a suite at the Anaheim Sheraton Hotel during the 1979 ARRL Southwestern Division Convention. The room would be called the "Westlink Radio Network VHF/UHF/FM Hospitality Suite," and part of the agreement was that we supply some form of program for amateurs with those particular interests. We were puzzled as to

how to do this without bringing in live speakers. The convention program itself had gobbled up most of the top-notch local personalities, including two members of the Westlink staff—anchorman Jim Davis KA8BWZ/6 for the Public Relations seminar and legal correspondent Joe Merdler N6AHU to host a forum titled "The Legal Considerations of Amateur Radio." More about Joe's talk later on.

We had a problem. The Westlink Radio Network is a free service by amateurs for amateurs, currently funded out-of-pocket by Bill and myself. There are no paid employees and no excess funds with which to cover the cost of bringing in out-of-town speakers. One Sunday, during a break in one of our editing sessions, the idea hit us simultaneously. There in the corner sat a possible solution to our problem: If we couldn't bring the speakers to the convention live, how about "live on tape"? An announcement was added to that and the next week's Westlink news soliciting 30- to 60-minute presentations on VHF/UHF/FM-related topics.

Within two weeks, tapes and films started pouring in. A fellow 73 writer, Bob Heil K9EID, supplied a tape of Wayne Green's talk to the Marissa (Illinois) Radio Club dealing with WARC preparations and a synched audio/slide presentation about the WD9GOE Marissa multi-band/multi-mode repeater. Wayne himself prepared a 20-minute talk dealing with microwaves, microwave communication, and how he obtained his world's microwave record. From Washington DC came a tape about AMRAD and the Metrovision ATV Repeater. The JPL Radio Club provided tapes about the *Voyager* commemorative operation—thanks to Dr. Norm Chalfin K6PGX. Hank Feinberg K2SSQ sent a print of a film he directed at Bell Labs titled *I-C A Shrinking World* (a must for any radio club program) and Dave Bell W6AQ permitted our use of his new film, *The World of Amateur Radio*.

Our decision was to edit all of this material onto three VHS format cartridges, thereby having to tote only the RCA machine to the convention with us, where we would use the hotel's TV as a playback monitor. We also prepared an 8-track audio cartridge with a number of Westlink newscasts thereon, to be played at low level whenever the room was open.

The 220-SMA of Southern California and TASMA provided

literature about their activities, and the Southern California ATV Club supplied additional taped video material. Except for changing tapes every four hours, the room was literally automated, thus allowing Bill and myself to enjoy other convention festivities and do other things.

Results? The place was loaded from the moment it opened until it closed. The crowds glued themselves around the TV watching Wayne complain about the size of the rocks on Mt. Monadnock or Roy Neal explain the "World of Amateur Radio" time and again. The Valley Good Guys, who were also running a video-equipped hospitality suite, reported similar results. They were also using VHS format cassettes which told the story of their club and repeater, but they had done us one better by bringing along a Panasonic 6' projection TV.

I mentioned earlier that automating the hospitality suite left us free to do other things. This is not to say that we were not ever present. Quite the contrary. Usually Bill, myself, or some other Westlink staff member was there to oversee operations and answer questions pertaining to Westlink operation. However, when things came up that we wanted to do, we could do them without having to shut down operations.

For instance, there were three seminars we planned to record, all three on audio and one of them both audio and video. Of these, the one we deemed most important was that of Attorney Joseph Merdler N6AHU. As mentioned, his talk was titled "Legal Considerations in Amateur Radio," but with Joe being a staff member, we were well aware that his talk would be going well beyond simple (or complex) tower ordinance cases and the like. We knew that most of Joe's talk would deal with the handling of willful and malicious interference problems to amateur communications and that it would be a no-holds-barred presentation. The Valley Good Guys group stepped in here and provided a JVC EJ camera and portable Panasonic EJ recorder (VHS), along with Wayne Rankin WA6MPG and Paul Strauss WD6EBY as an EJ crew. If the new cassette had not been a damaged one, everything would have gone smoothly. As it was, about 45 minutes into Joe's talk, the cartridge went bad, but we did not realize that it had an oxide flaking problem until playback. We were most concerned with the first 30 minutes anyway; only part of the question and answer session was lost videowise. We have since transferred what we had to 3/4"

U-Matic and have sent the bad cartridge back to its manufacturer with a rather "explicit" note. An interesting aside to the foregoing: Joe's presentation became a prime attention-getter in our suite later on. People who arrived late and missed it found that they really had not missed it at all. It was played at least a half dozen times to a packed room.

You have just read a quick account of an actual test using recorded video as a prime attention-getter in an amateur radio hospitality suite at a major convention. Production costs involved just the raw tape and return postage on supplied material and one sleepless night crash-editing it all together. The results were very positive, and we intend to expand our pre-recorded library to do an even better job next time. A few months ago, I suggested that someone give this idea a try. We took our own advice and are very gratified with the results.

## THE RETURN OF NATIONTIE 80

Due to other important news, we dropped the national open intertie concept for a month. As it was, this turned out to be a good idea, in that it has given readers time to start voicing their opinions on the concept. Thus far, all mail received has been supportive, and this makes me think that there may be some merit to my madness. Of particular interest are two wide area open intertie systems now under construction, one in Texas and the other in Baja California, Mexico. I will begin by telling you about the Baja intertie and Ron Johnson WA5RON will explain a bit about TIRS, the Texas Intercity Relay System.

I learned about the Baja project only this past weekend when I ran into Alex Hodayan XE2IO at the ARRL convention mentioned earlier. I've known Alex for about five of the nine years I have lived in the southwest, and the highest compliment I can think of to pay him is to say that he has become to Baja what people such as Art Gentry and Burt Weiner have been to the US. He is a true pioneer in FM and FM repeater technology. He is currently involved in a truly humanitarian project.

The Baja peninsula is truly rugged territory, yet each year thousands of tourists, mainly Americans, visit it because of its overall natural beauty. Many come in "off-road vehicles" such as dune buggies or motorcycles. Most heed the warnings given them by both US and Mexican tourist bureaus as to how

Continued on page 157



**THE OMNI SYSTEM — tools of the trade for serious DX operators, contesters, traffic, nets, or just rag chewing — designed to give you the operating edge.**

**Simply Super.** The keynote of a Ten-Tec OMNI is simplicity of operation combined with super performance. No tricky controls, no distracting readings, no fussy adjustments. Your operating is pure enjoyment, unhampered by complexity, enhanced by features that are meaningful, advanced by options that are realistic.

**Instant Band Change**—to catch the openings. Just flip the bandswitch, no tuning the transmitter. A convenience originated by Ten-Tec in modern transceivers.

**Full Break-In**—for CW with perfect timing, for a real conversation in code. And slow break-in at the flip of a switch to suit band conditions or quiet mobile operation.

**Ultra Selectivity**—to fit any band condition. Standard 2.4 kHz 8-pole crystal ladder filter for normal reception; optional 1.8 kHz filter (\$55) operates in series with the 2.4 kHz filter to transform an unreadable signal in heavy QRM into one that gets the message through; optional 0.5 kHz 8-pole filter (\$55) provides steep, deep skirts to the CW passband window to cut out even those strong adjacent signals; standard 150 Hz CW active audio filters have three ranges (450, 300, 150 Hz) for further attenuation of adjacent signals and band noise.

**Variable Notch Filter**—to eliminate interfering carriers and CW signals. Attenuation is more than 8 "S" units (over 50 dB).

**Six-Function Separate VFO**—for complete versatility in working DX. Independent transmit and receive frequencies with OMNI; reversible at the touch of a button for full monitoring of the action. Even allows simultaneous reception on both VFO and OMNI with transmission on either. LEDs show status. An optional operating bargain at \$139.

**Speech Processor and Microphone**—to extend your operating range under adverse conditions by increasing average envelope power without derating the OMNI power limits and with minimum distortion. Model 234 is a true RF processor, model 214 is a peak-free condenser microphone. An optional system for optimum speech energy; 234 is \$124, 214 is \$39.

**Electronic Keyer**—key to perfect CW. Styled to match OMNI; self-completing; dit and dah memories with individual defeat switches; automatic variable weighting; adjustable magnetic paddle return; and more for just \$85.

**Matching Power Supply**—to completely power the OMNI system. Regulated, over-current protected, switched from OMNI or front panel, and only \$139.

**Plus All These Famous Standard Features of OMNI**—All Solid-State, 160-10 Meters, Built-in VOX and PTT, Dual-Range Receiver Offset Tuning, Wide Overload Capabilities, Adjustable Sidetone Tone and Level, Exceptional Sensitivity, 200 Watts Input, Adjustable ALC, 100% Duty Cycle, Phone Patch Interface Jacks, Zero-Beat Switch, "S"/SWR Meter, Dual Speakers, Plug-In Circuit Boards, Complete Shielding, Rigid Light-Weight Aluminum Construction, Comfortable Operating Size (5¾" h x 14¼" w x 14" d).

**Model 545 Series B OMNI-A** (analog transceiver) \$ 949

**Model 546 Series B OMNI-D** (digital transceiver) \$1119

**Get The Operating Edge — Get The OMNI System.** See your Ten-Tec dealer or write for full details.



TEN-TEC, HF equipment supplier to  
Winter Olympics Radio Amateur Network (WORAN)

# THE OPERATING EDGE



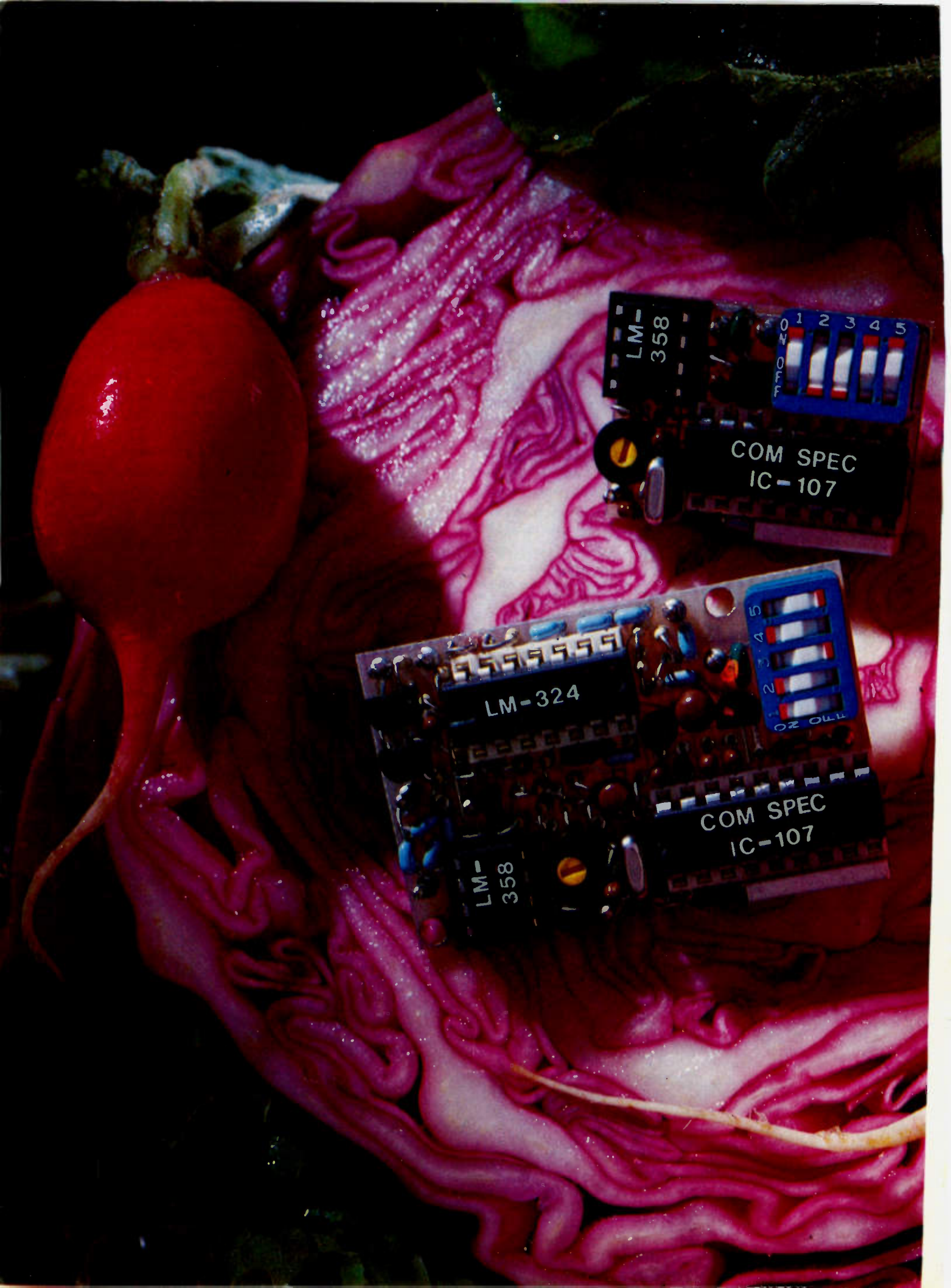

LM-358

COM SPEC  
IC-107

LM-324

LM-358

COM SPEC  
IC-107

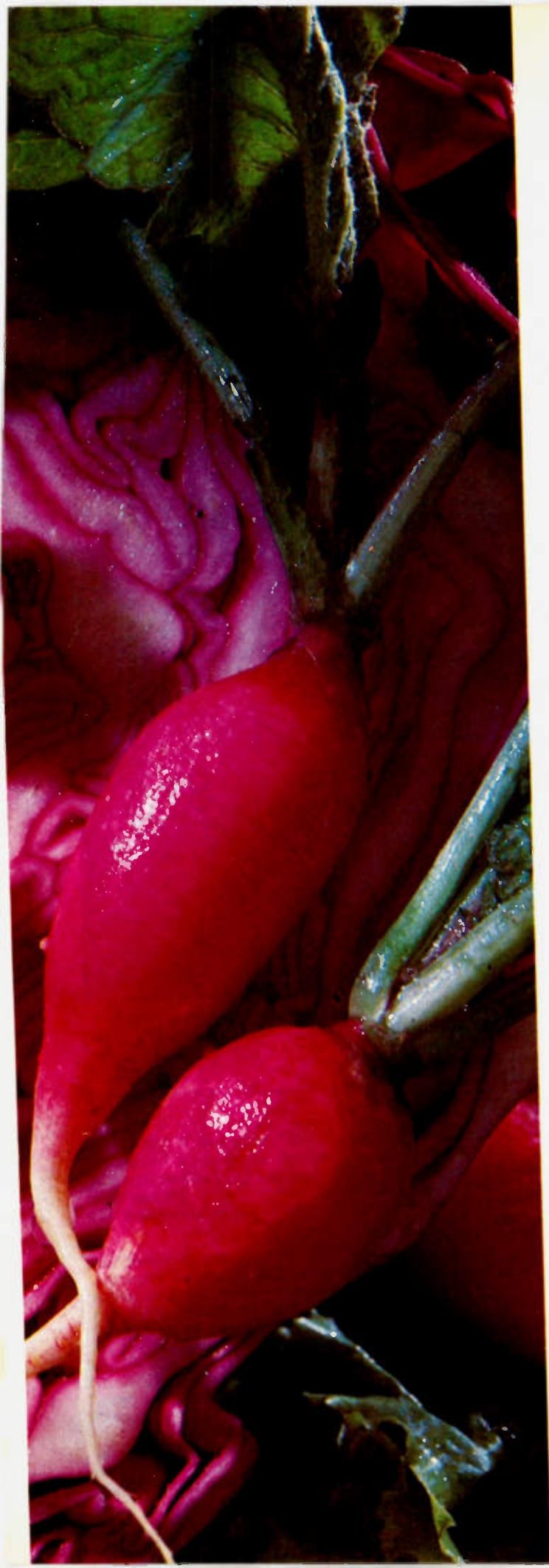

# A fresh idea!

Our new crop of tone equipment is the freshest thing growing in the encoder/decoder field today. All tones are instantly programmable by setting a dip switch; no counter is required. Frequency accuracy is an astonishing  $\pm .1$  Hz over all temperature extremes. Multiple tone frequency operation is a snap since the dip switch may be removed. Our SS-32 encode only model is programmed for all 32 CTCSS tones or all test tones, touch-tones and burst-tones. And, of course, there's no need to mention our 1 day delivery and 1 year warranty.

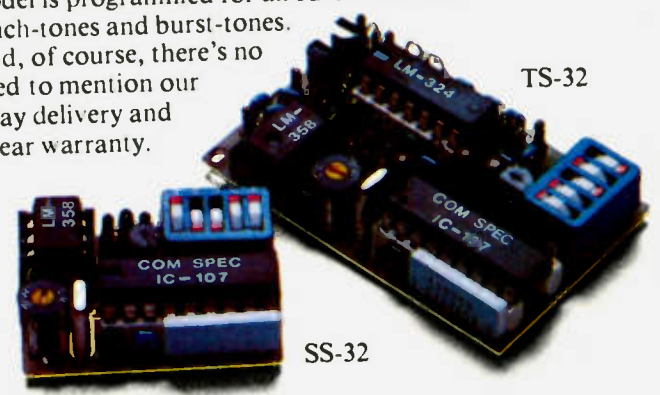

### TS-32 Encoder-Decoder

- Size: 1.25" x 2.0" x .40"
- High-pass tone filter included that may be muted
- Meets all new RS-220-A specifications
- Available in all 32 EIA standard CTCSS tones

### SS-32 Encoder

- Size: .9" x 1.3" x .40"
- Available with either Group A or Group B tones

### Frequencies Available:

Group A			
67.0 XZ	91.5 ZZ	118.8 2B	156.7 5A
71.9 XA	94.8 ZA	123.0 3Z	162.2 5B
74.4 WA	97.4 ZB	127.3 3A	167.9 6Z
77.0 XB	100.0 1Z	131.8 3B	173.8 6A
79.7 SP	103.5 1A	136.5 4Z	179.9 6B
82.5 YZ	107.2 1B	141.3 4A	186.2 7Z
85.4 YA	110.9 2Z	146.2 4B	192.8 7A
88.5 YB	114.8 2A	151.4 5Z	203.5 M1

- Frequency accuracy,  $\pm .1$  Hz maximum - 40°C to + 85°C
- Frequencies to 250 Hz available on special order
- Continuous tone

Group B			
<b>TEST-TONES:</b>	<b>TOUCH-TONES:</b>	<b>BURST-TONES:</b>	
600	697 1209	1600	1850 2150 2400
1000	770 1336	1650	1900 2200 2450
1500	852 1477	1700	1950 2250 2500
2175	941 1633	1750	2000 2300 2550
2805		1800	2100 2350

- Frequency accuracy,  $\pm 1$  Hz maximum - 40°C to + 85°C
- Tone length approximately 300 ms. May be lengthened, shortened or eliminated by changing value of resistor

Wired and tested: TS-32 \$59.95, SS-32 \$29.95



426 West Taft Avenue, Orange, California 92667  
 (800) 854-0547 / California: (714) 998-3021

# Faces, Places

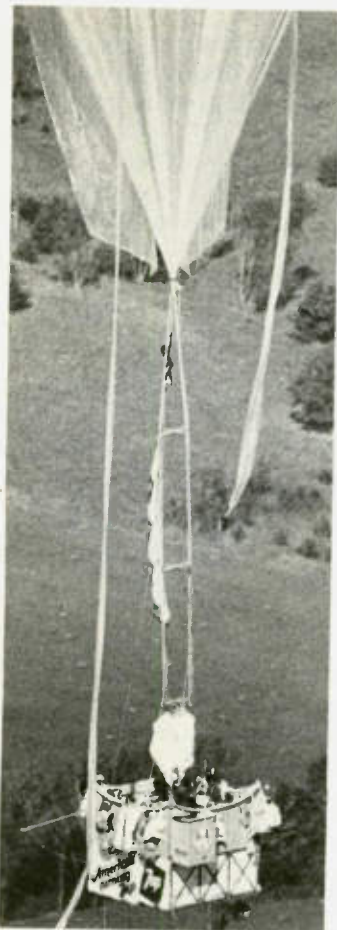

Say hello to the new Avanti Amateur Radio Club (Addison IL) and you'll receive their attractive QSL card. Members (left to right) are: Howard Valzah WB9IPG, Joe Krusa WB9PIT, Dale Parfitt WA2YPY, Herb Blaese WB9PXD, Bob Steinhofer KA9FPB, Louis Martino W9DSG, Marty Linke WD9ABG, and Jack Pickering KA9FNR.

Alice Fishburn of Rochester MN presented her OM, Joe KØTS, with a 12-by-25-foot 35th birthday card in August.



John Shideler WAØNEV piloted the plane from which Dale Monaghan WØHSK photographed the DaVinci trans-american balloon on September 30, 1979. While they circled at 2500 feet about 30 miles north-west of Topeka, they used 2m to speak with the craft.

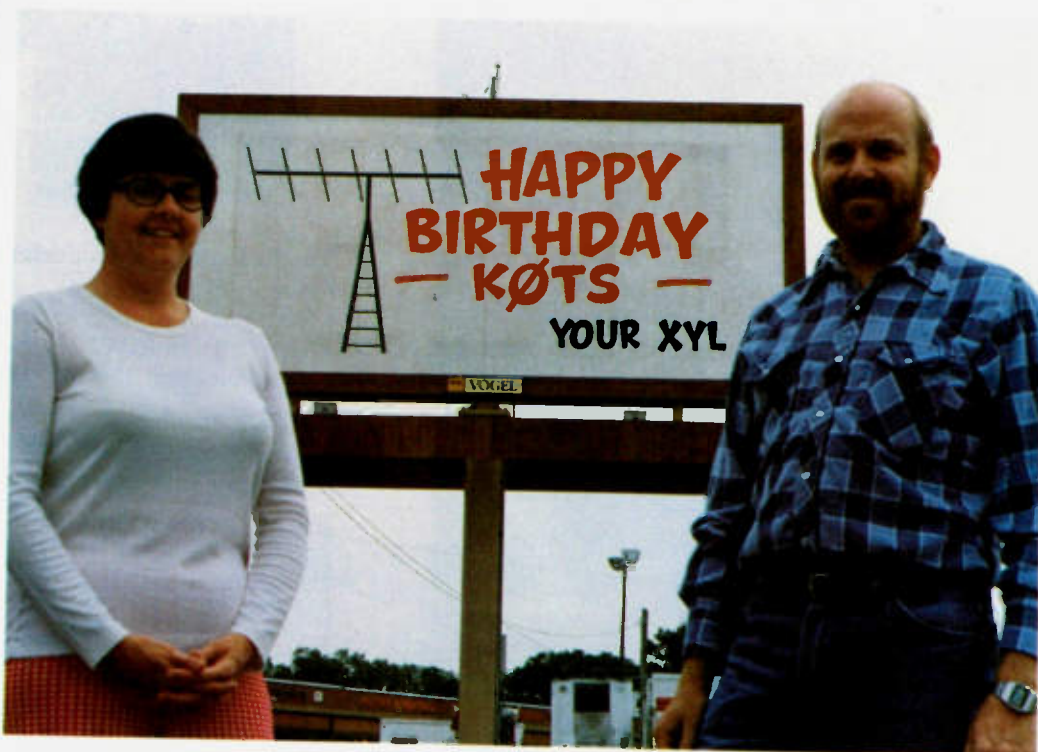

Bill Allsopp W5TJI and his XYL, Mary WB5DVA, headed up the CAREN radio club (Little Rock AR) team at the annual Arkansas State Fair in October. (Photo by Paul J. Kirsch WA8ASQ/5)

## Ham Help

I need help in obtaining a repair/service manual with schematics for a Micro Match swr wattmeter, model NBR 263.11. The meter was manufactured by M. C. Jones Electronics Co., Bristol CT.

I will pay for the manual or copies of the manual and any shipping.

**Nick Marsala AB5M**  
5339 East 97th Street South  
Tulsa OK 74136

I need a manual for an Eico model 324 signal generator. I will pay for copies.

**Bill Morehouse**  
PO Box 214  
Waukesha WI 53187

I'm interested in contacting anyone who owns a TRS-80.

**Sam Martinez N3SM/HK1CWB**  
PO Box 8814  
Baltimore MD 21224

I have just purchased an older-type dc supply manufactured by Universal Electronics of Santa Monica, California. It is a Transistorized Power Supply, Model LQ35, 15 Amps, 0 to 35 volts.

If anyone has a schematic or service manual to sell or copy, please contact me. Any help will be greatly appreciated.

**John Pisarski**  
114 Evans Rd.  
Norristown PA 19403

(616) 982-3296

WA8ZVO



# Heathkit<sup>®</sup> service is at the other end

Heathkit Service Techs know their stuff and you can count on them for answers on any Heathkit HAM gear. Most problems can be solved right over the phone. Those that require hands-on service can be brought to one of the 55 Heathkit Electronic Centers throughout the U.S. or sent in to the Heath factory. Either way, you'll find reliable, experienced people who know what they're doing. And that's a very good reason to consider Heath when you're considering amateur radio gear.



## Free catalog

For all the newest in Heathkit Amateur Radio, send for the latest, free Heathkit Catalog. It's loaded with nearly 400 exciting kits for your home, work or pleasure. Send for

yours today or pick one up at your Heathkit Electronic Center.

# Heathkit<sup>®</sup> ✓ H50

Heath Company, Dept. 011-614, Benton Harbor, MI 49022  
Heathkit Electronic Centers (Units of Veritechnology Electronics Corporation)  
are located in major cities throughout the U.S.  
See your white pages.

# RTTY Loop

Marc I. Leavey, M.D. WA3AJR  
4006 Winlee Road  
Randallstown MD 21133

With the new year, it is time to consider the new readership this column has picked up in the three years it has been running. One of the most frequent questions received by this column is typified by a letter written by Robert Bunn WA0LKE, who writes, "... I am seriously considering getting into RTTY, (and) the confusing mass of hardware and software approaches are about to 'boggle my mind'..."

The approaches that Robert describes in his letter are rather typical of the options facing anyone interested in getting on RTTY. Typically, these options include:

1. Purchasing a microcomputer with requisite software to run RTTY.
  2. Purchasing an ASCII-encoded Teletype™ machine and hard-wiring an ASCII-Baudot converter.
  3. Purchasing or acquiring an old Baudot machine and using it directly.
- In terms of cost, the Baudot

machine may well be available at a minimal expense. What the beast lacks in "bells and whistles," i.e., noise factor, off-line use as a computer, or automatic functions, it may make up in the convenience of immediate use. Now don't forget, except for some of the computer software packages, you still will need a converter (demodulator) to decode the RTTY off the receiver audio and feed the printer. Depending on what you choose there, that could be \$35 or so on up to your yearly net!

Now, I have not yet answered your question, and I know that I must, so here it goes. I cannot see buying a microcomputer if all you want it for is RTTY. There are several video-based RTTY terminals on the market, any of which should do a fine job of getting you on RTTY effortlessly and quickly. If you want to use the computer for other purposes (as I do mine, and as most everyone I know does), then your choice of a computer should be governed by considerations of the system as a computer, not a teleprinter. Adequate software is available for

just about any system to turn it into a RTTY machine. Certainly, the articles mentioned in this column over the past few months show that 6800s, 8080s, KIMs, TRS-80s, and even SC/MPs are useful on RTTY. As you may know, commercial modules are even available for the PET and TRS-80, among others, to allow direct use on RTTY. However (you knew that was coming), if you want hard copy, the game changes. The cheapest, simplest path to hard copy is with a Baudot-encoded Teletype machine, such as a Model 15 or 28, hung onto a demodulator off the receiver. If you plan to use the computer for things needing hard copy, then you will probably want something a bit nicer than a Model 33 Teletype, but that is your choice.

I don't know if all this cleared things up or only served to "boggle" you a bit more, but I would urge you to ask around your area, at clubs and such, to see if you can take a look at any of the options we have discussed. That is probably the surest way to help make up your mind.

By the way, on this never-ending (it seems) topic of "silent RTTY," add another few articles to the queue. The July, 1979, issue of 73 featured two articles dealing with interfacing com-

puters to RTTY. Albert S. Woodhall N1AW wrote "Microcomputer RTTY... a Software TU," which details interfacing to an 8080 system. A few pages later, Garry Caudell K4HBG shows how to hook a Teletype to an SWTPC 6800 system in his article, "Baudot Hard Copy For Your SWTPC." Also, the November, 1979, issue of *Popular Electronics* features a "Radio-teletype Reader for Shortwave Receivers" as its lead article. This is a device which accepts Baudot RTTY at all commonly sent speeds, or ASCII at 110 baud, and displays eight characters on a moving LED display. Written by George Steber WB9LVI, the circuit has a self-contained demodulator that may be worth building on its own for computer interfacing.

For those of you who delight in covering the cracks in the shack wall with "ham wallpaper," the staff at 73 may have just the thing for you. The Specialty Communications Achievement Award is dedicated to amateurs worldwide who take pride in the field of specialty communications, and that includes RTTY!

To be eligible for this award, contacts must have been made on or after January 1, 1979. And

Continued on page 156

# HAM RADIO CENTER

for the famous **HAM-KEY\*** and **KEYER!**

\*TM trade-mark

**NEW!**



## Model **HK-3M**

With anti-tip bracket even a heavy-handed key pounder cannot tip. All the features of the HK-3.

- Deluxe straight key
- Heavy base — no need to attach to desk
- Navy type knob

**\$19<sup>95</sup>**

CC-3 shielded cable w/plug for HK-3M **\$3.95**



## Model **HK-1**

- Dual-lever squeeze paddle

**\$29<sup>95</sup>**

CC-1 shielded cable w/plug for HK-1 **\$4.49**



## Model **HK-2**

- Same as HK-1, less base for incorporation in own keyer

**\$19<sup>95</sup>**



## Model **HK-5A** Electronic Keyer

- New Cabinet Colored-Keyed to match most modern radio equipment
- Iambic Circuit for squeeze keying
- Self-completing dots and dashes
- Curtis 8044 I.C. Keyer Chip

**\$69<sup>95</sup>**

## **NEW!** Model **AT-B** Anti-Tip Bracket

Converts any HK-3 to HK-3M

**\$2<sup>99</sup>**

Prepaid



## Model **HK-4**

- Combination of HK-1 and HK-3

**\$44<sup>95</sup>**

CC-1/3 shielded cable w/plugs for HK-4 **\$7.95**

Order today direct or from your favorite dealer • Add \$2.00 shipping & handling per unit (USA) Same day shipment ...



**JUST DIAL**  
8340 OLIVE BLVD  
P.O. BOX 28271

**1-800-325-3636**

**TOLL FREE**  
ST. LOUIS, MO.  
63132

✓ H2



# Even WEAK SIGNALS print clearly with a HAL Demodulator.

ST-6000 Demodulator \$595.00



ST-5000 Demodulator \$225.00



Pulling in weak or distorted signals with a HAL Demodulator is no problem. Even if the band is crowded.

With high-gain, wide-bandwidth limiters and extremely linear active detector circuits, both the ST-6000 and ST-5000 Demodulators convert RTTY tones into strong, readable signals that display bright and clear.

Tones necessary for transmitting RTTY are conveniently generated and receive filters and transmit tones are accurately set and matched to assure on-the-money transceive operation.

**BUY NOW AND SAVE**  
**PRICE INCREASE COMING**  
Effective 2/1/80

**Both the ST-6000 & ST-5000 offer these features:**

- Internal Loop Supply
- Internal AFSK Generator with CW ID Tone
- Internal Tuning Indicator
- Autostart Motor Control
- Line/Local Loop Control
- TTY Machine Compatibility
- RS-232 type DATA Interface
- "High" or "Low" Tones
- 120/240, 50/60 Hz Power
- Normal/Reverse Switch
- 170 and 850 Shift
- Active Discriminator
- Metal Cabinets for RF Shielding.

**Special Features of the ST-6000:**

- Mark-Hold
- Antispace
- Automatic Threshold Control (ATC)
- Decision Threshold Hysteresis (DTH)
- Keyboard Operated Switch (KOS)
- MIL-188 and CMOS Data Interface
- Optional Oscilloscope Tuning Indicator
- Crystal Controlled AFSK Tones
- Active Input Bandpass Filter
- Pre-Limiter AGC
- Three Shifts (170 - 425 - 850)

*Write or give us a call. We'll be glad to send you our new RTTY catalog.*



**HAL COMMUNICATIONS CORP.**  
Box 365  
Urbana, Illinois 61801  
217-367-7373

For our European Customers Contact:  
Richter & Co., D3000 Hannover 1  
I.E.C. Interelco, 6816 Bissone/Lugano

# DX

The new month, new year, and new decade get off to a rousing start if all goes as planned: one major DXpedition in progress and one commencing the first week of January.

David Schoen N2KK should presently be operating from the Indian Ocean, on Juan de Nova, through about January 8; then he's on to Mauritius, an unnamed (at this time) island in the 3B group, the Malagasy Republic 5R8 on the 20th, and the pièce de resistance, the Somali Republic, around January 30. Dave is mainly interested in operation on the "low bands," but he plans to be wherever the demand is, 160-10 meters. N2KK is a professional photographer on assignment and should have an incredible slide show to present when he returns.

Since "becoming a country" in 1974, Kingman Reef has hosted two operations: the first in 1974 and another in June, 1977. At today's rates of amateur population growth, three years is enough time for a country to pass from not-needed status by most DXers into a slot on the "most-needed" lists again. In the case of Kingman, this may be rectified in the next couple of weeks, with Palmyra as a bonus.

January 4, 1980, is the starting date for operation from Kingman and Palmyra by WA2FIJ, W2TDQ, WA6YQW, K6LPL, and K2HFX. The operations will be simultaneous, with one group signing a KH5 callsign from Palmyra and another using a KH5K callsign from Kingman. Five days of operation are planned.

October, 1979, was a wild 31 days of DX by several well-known individuals and groups. Expeditions were mounted to

FP8, 3D2, YJ8, FO8, FC, TF, HB0, KC6, 3C1, and CQ Zone 23. Here's a rundown of this extravaganza of a month.

DK6XR and DK7XN operated from the New Hebrides as YJ8XR the first week of October, then activated Tahiti for four more days. They were joined in the Pacific by Darrell Bevan N6DX, who finished a venture begun in September operating from the Fiji Islands. Darrell treated many DXers to contacts from the various islands on 6 meters.

In North America, K2RW and W2BHM vacationed on St. Pierre Island and put FP8AA and FP0VI on all bands. Meanwhile, during the first week of October, Lloyd and Iris Colvin, W6KG and W6QL, were plotting the next YASME Foundation jaunt through the Caribbean, with help deciding provided by attendees of the Houston Com-Con convention.

Boston hosted the annual New England DXCC meeting, featuring K1MM, KP4AM (of Desecheo fame), and former *West Coast DX Bulletin* editor WA6AUD. About 80 DXers showed up for this event.

In Europe, while HB9NL was accommodating 40- and 80-meter country chasers looking for Liechtenstein (HB0), DL1RK operated CW on all bands from Corsica (FC). Meanwhile, a large group of Ukrainian operators were en route to Siberia, to Tana Tuva, which is in CQ Zone 23. They appeared on the bands mid-October for a one-month stay, and, by putting that zone on for the CQ Worldwide Phone Contest, made it possible for contestants to work all 40 zones during the contest. Zone 23 turned out to be a snap; the toughies were 34 and 37.

As if all this wasn't enough to

make DXers happy, although busy, the two most important operations were yet to come. At mid-month, the long-awaited operation from the West Carolines group came to pass: JE1JKL and JA7FFN stayed four days on Yap Island and made 5278 contacts... 3738 were on CW on HF, with another 1540 on 6 meters! They must have had a 50-MHz pipeline home to Japan. JE1JKL has his QSL-handling chores cut out for him.

Finally, after weeks of rumors and counter-rumors, Equatorial Guinea came on the air to the delight of many. A Spanish DX contingent opened up with 3C1AA on October 13 and operated for several days. Their plans to proceed to Annobon Island ran into some snags, but persistence prevailed. After a fly-over the island, during which the pilot ruled out landing on the overgrown runway, the operators regrouped on the continent, hired a boat, and took the waterway to 3C0.

Annobon finally showed up on the bands on Saturday, October 27, during the CQ Phone Contest. The operators wisely stuck close to CW during the weekend. A full two weeks had passed between opening gun from 3C1 and starting mark for 3C0. Never say die! QSLs for 3C1AA to EA4MY, and for 3C0AB to EA4LH.

Politics often rears its head in the world of DX, especially on the continents of Africa and Asia. Last spring's expedition to Spratly Island (1S1DX) satisfied much of the demand for that country and may have been the last hamming to be done from there for some time. In its September 25 issue, *The DX Bulletin* out of Vernon, Connecticut, presented material demonstrating the tensions surrounding Spratly and the South China Sea area in general. Late last winter, the Philippines quietly annexed the major parts of

the Spratly group, contrary to claims on the islands already made by Vietnam, China, and Taiwan. The main Spratly island is occupied by Vietnamese troops, while Taiwan uses three of the islands and the Philippines six.

Those who have attended a convention and seen the slide presentation by one of last year's 1S1DX operators can vouch for the uninviting nature of this "country." If you worked it, be glad. If not, you are in good company.

Franz Josef Land of the USSR is a much-needed DXCC country, and activity there has picked up. Look for UK1PAA, UK1PGO, and UA1PAL on 20 meters, both phone and CW.

Other than the Japanese, who regularly make business trips into China, the best bet for someone's foot getting in the BY door for amateur radio appears to be Thomas Wong VE7BC. He was in China in October for his twice-yearly business visit and stopped off to see JA6HOZ en route. JA6HOZ, you may recall, put BY on the air for an hour in August as part of a demonstration to city officials. VE7BC is scouting the territory and testing the waters, but the word from Chinese officials and from JA6HOZ is that it will "be a long time" before amateur radio comes to fruition in China.

Jim Bullington N4HX may be active from Chad (TT) by the time you read this. Jim works for the US government. Don Riebhoff of XV5AC, XU1DX, and CT4AT fame has his bags packed for Czechoslovakia. He visited Prague in October, showed some slides to the DX crowd at OK1ADM, and hopes for an OK8 callsign.

Bangladesh came back on the air in early autumn, after a short hiatus; S2BTF was found on 20 meters at various times

*Continued on page 156*



JR1AIB.

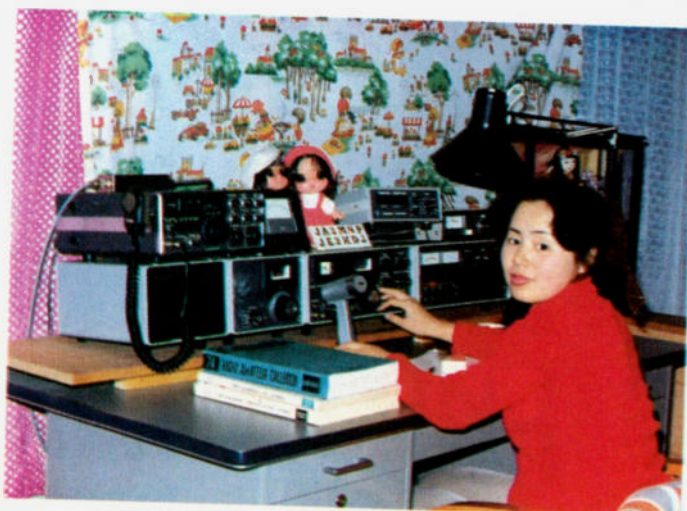

JA3MNP.



# When quality counts

Do not be fooled by the low prices, these brand new lab quality frequency counters have important advantages over instruments costing much more. The models 7010 and 8010 are not old counters repackaged but 100% new designs using the latest LSI state-of-the-art circuitry. With only 4 IC's, our new 7010 offers a host of features including 10 Hz to 600 MHz operation, 9 digit display, 3 gate times and more. This outperforms units using 10-15 IC's at several times the size and power consumption. The older designs using many more parts increase the possibility of failure and complexity of troubleshooting. Look closely at our impressive specifications and note you can buy these lab quality counters for similar or less money than hobby quality units with TV xtal time bases and plastic cases!

Both the new 7010 and 8010 have new amplifier circuits with amazingly flat frequency response and improved dynamic range. Sensitivity is excellent and charted below for all frequencies covered by the instruments.

Both counters use a modern, no warm up, 10 MHz TCXO [temperature compensated xtal oscillator] time base with external clock capability - no economical 3.579545 MHz TV xtal.

Quality metal cases with machine screws and heavy gauge black anodized aluminum provide RF shielding, light weight and are rugged and attractive - not economical plastic.

For improved resolution there are 3 gate times on the 7010 and 8 gate times on the 8010 with rapid display update. For example, the 10 second gate time on either model will update the continuous display every 10.2 seconds. Some competitive counters offering a 10 second gate time may require 20 seconds between display updates.

The 7010 and 8010 carry a 100% parts and labor guarantee for a full year. No "limited" guarantee here! Fast service when you need it too, 90% of all serviced instruments are on the way back to the user within two business days.

We have earned a reputation for state-of-the-art designs, quality products, fast service and honest advertising. All of our products are manufactured and shipped from our modern 13,000 square foot facility in Ft. Lauderdale, Florida.

When quality counts...count on Optoelectronics.



MODEL 7010 600 MHz

MODEL 8010 1 GHz

- 100% U.S.A. FACTORY ASSEMBLED
  - 100% PARTS & LABOR YEAR GUARANTEE
  - CERTIFIED NBS TRACEABLE CALIBRATION
  - EXTERNAL CLOCK INPUT
  - DISPLAY HOLD FUNCTION
  - 9 RED LED DIGITS, 4" HIGH
  - .1 Hz RESOLUTION
  - 0.1 PPM 10 MHz TCXO TIME BASE
  - LAB/PORTABLE-AC ADAPTER INCLUDED
  - 1 MEGOHM & 50 OHM INPUTS
  - STATE-OF-THE-ART LSI DESIGNS
  - COMPREHENSIVE USER MANUAL PROVIDED
- COMPACT SIZES—7010- 1-3/4" Hx4-1/2" Wx5-1/4" D 8010- 3" Hx7-1/2" Wx6-1/2" D

MODEL	\$ PRICE	RANGE 10Hz to	LED DIGITS	SENSITIVITY			HI-Z INPUT 10Hz - 60 MHz	GATE TIMES	RESOLUTION			TCXO TIME BASE		EXT CLOCK INPUT	NI-CAD BATT PACK
				25-250 MHz	250-450 MHz	450 MHz-1GHz			12 MHz	60 MHz	MAX. FREQ.	20°-40° C	FREQ.		
7010	145.00	600 MHz	9	5-20 mV	10-30 mV	20-40 mV to 600 MHz	1-10 mV	3 .1 1.10 SEC	.1Hz	1 Hz	10 Hz 600 MHz	1 PPM 0.1 PPM	10 MHz	YES OPTION \$25.	YES OPTION \$15.
7010.1	225.00	600 MHz	9	5-20 mV	10-30 mV	20-40 mV to 600 MHz	1-10 mV	3 .1 1.10 SEC	.1Hz	1 Hz	10 Hz 600 MHz	1 PPM 0.1 PPM	10 MHz	YES OPTION \$25.	YES OPTION \$15.
8010	325.00	1 GHz	9	1-10 mV	5-20 mV	10-25 mV	1-10 mV	8 .01-20 SEC	.1 Hz	1 Hz	10 Hz 1 GHz	1 PPM 0.1 PPM	10 MHz	YES STD	YES OPTION \$39.
8010.1	405.00	1 GHz	9	1-10 mV	5-20 mV	10-25 mV	1-10 mV	8 .01-20 SEC	.1 Hz	1 Hz	10 Hz 1 GHz	1 PPM 0.1 PPM	10 MHz	YES STD	YES OPTION \$39.

\* Has precision 0.1 PPM TCXO time base.

#### MODEL 7010

- #7010 600 MHz Counter - 1 PPM TCXO \$145.00
- #7010.1 600 MHz Counter - 0.1 PPM TCXO \$225.00

#### OPTIONS

- #NI-Cad-701 Ni-Cad Battery Pack & charging circuitry installs inside unit \$ 15.00
- #EC-70 External Clock Input, 10 MHz \$ 25.00
- #CC-70 Carry Case, Padded Black Vinyl \$ 8.95

#### MODEL 8010

- #8010 1 GHz Counter - 1 PPM TCXO \$325.00
- #8010.1 1 GHz Counter - 0.1 PPM TCXO \$405.00
- #8010.1-13 1.3 GHz Counter - 0.1 PPM TCXO \$495.00

#### OPTIONS

- #NI-Cad-801 Ni-Cad Battery Pack & charging circuitry installs inside unit \$ 39.00
- #CC-80 Carry Case, Padded Black Vinyl \$ 9.95

#### ACCESSORIES

- #TA-100 Telescope Ant with Right Angle BNC \$ 9.95
- #P-100 Probe, 50 ohm 1x \$13.95
- #P-101 Probe, Lo-Pass, Audio Usage \$16.95
- #P-102 Probe, HI-Z, General Purpose \$16.95



ORDER FACTORY DIRECT • CALL TOLL FREE



**Optoelectronics inc**

5821 N.E. 14th Avenue, Fort Lauderdale, Florida 33334

**1-800-327-5912**

FROM FLORIDA (305) 771-2051/2

TERMS: Orders to U.S. and Canada, add 5% for shipping, handling and insurance to a maximum of \$10.00. All other orders add 10%. C.O.D. collection fee \$1.00. Orders under \$15.00 add extra \$1.00 handling. Regular checks must clear before order is shipped. Florida residents add 4% sales tax.

# Awards

Bill Gosney WB7BFK  
2665 North 1250 East  
Whidbey Island  
Oak Harbor WA 98277

The holiday season has come again. Now that you found that new radio or antenna packed under the Christmas tree, it's about time you got it out and gave it the old smoke test. How about a contact or two with our Middle Eastern friends where some booming signals have been originating lately?

Just this week I received a letter from Bruce Blackburn JY9BB, who is the Communications Advisor for His Majesty King Hussein of Jordan. As maybe you know, King Hussein and the Royal Jordanian Family are avid amateur radio operators. Perhaps you have heard their calls on the air, JY1 and JY2.

Mr. Blackburn writes to share three very spectacular awards being sponsored personally by King Hussein and the Arab Radio Amateur League. Of course, upon receipt of this letter, the very first thing I did was go through my own card file to see if I qualified. Much to my disappointment, I still need one more contact, that being with either JY1 or JY2. Perhaps, just perhaps, if they read my column this month, they'll sympathize with my need and arrange a future sked.

As you can see by the requirements of the three Jordanian awards, none was meant to be accomplished in one sitting. Naturally, that creates an even greater incentive for those of us wishing to pursue their goals.

## THE ARABIAN KNIGHTS AWARD

This award is issued by the Arab Radio Amateur League (ARAL) members and presented by His Majesty King Hussein (JY1) of Jordan.

To qualify for this recognition of achievement, amateurs must have proof of having contacted at least ten (10) Arab countries, and one contact must be with either JY1 or JY2. All contacts must be made on or after January 1, 1971, on any authorized mode of communications. There are no special endorsements.

JY1	King Hussein
JY2	Royal Jordanian Family
A4X	Oman
A6X	United Arab Emirates
A7X	Qatar
A9X	Bahrain
CN	Morocco
HZ, 7Z	Saudi Arabia
J2	Djibouti
JY	Jordan
OD5	Lebanon
ST	Sudan
SU	Egypt
YK	Syria
YI	Iraq
3V8	Tunisia
4W	Yemen
5A	Libya
5T5	Mauritania
6O	Somali
7O	South Yemen
7X	Algeria
9K2	Kuwait

To apply for the Arabian Knights Award, the applicant must prepare a list of claimed contacts in prefix order. Each entry must also include the date and time in GMT, the band and mode of operation, and the

and station worked.

Do not send QSL cards, as photocopies will be accepted. As an alternative, you may have your list verified by two local amateurs, a local radio club secretary, or a notary public.

Enclose this list along with an award fee of ten IRCs and send to the attention of: JY1 Award Manager, PO Box 1055, Amman, Jordan.

## THE ROYAL JORDANIAN AWARDS

To amateurs throughout the world who qualify, JY1, His Majesty King Hussein I of Jordan, will issue a very elegant award of achievement to recognize one of two levels of accomplishment.

First, the Silver Award is offered in recognition of having worked six different JY prefixes. There are no band or mode restrictions; however, all contacts must be on or after January 1, 1971, to count.

The second and probably the

toughest award of all to obtain is the Coral Award, which is issued to amateurs who visit Jordan and make a QSO from Aqaba. Simple, huh? Anyone for a charter trip this winter?

As with all awards sponsored by our Jordanian friends, applicants must prepare a list of claimed contacts made citing the usual logbook information including RS(T).

Forward this list, stating which award it is you are applying for, along with an award fee of ten (10) IRCs to: JY1 Award Manager, PO Box 1055, Amman, Jordan.

While you have your beam in that direction, why not turn it a few more degrees and see if perhaps propagation doesn't allow a few contacts with our friends in Switzerland. Here would be your chance to qualify for the very attractive award being offered by the union of Swiss Short Wave Amateurs

*Continued on page 145*



An Extraordinary Offer to introduce you to the benefits of Membership in  
**ELECTRONICS BOOK CLUB**

invites you to take this 854-p. amateur radio library for only

**49¢**

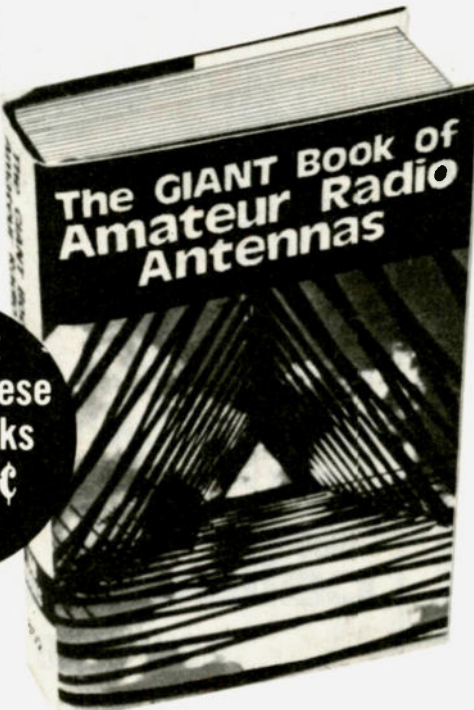
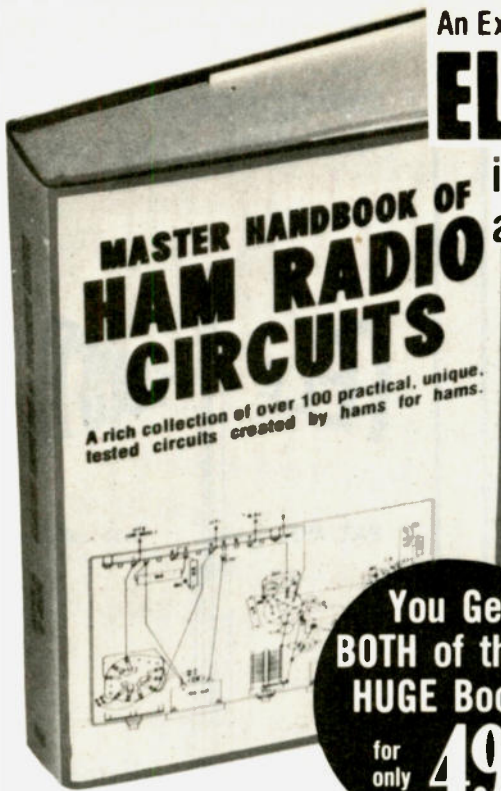

You Get **BOTH** of these **HUGE** Books for only **49¢**

- ✓ Only 49¢ for BOTH HUGE volumes!
- ✓ Regular List Price \$25.90
- ✓ Top-Quality Hardbinding
- ✓ Over 550 illustrations
- ✓ Contains over 250,000 words
- ✓ 854 data-packed pages

**Master Handbook of Ham Radio Circuits**

Here's a rich collection of over 100 practical, unique, tested circuits created by hams for hams! It's a super collection—an encyclopedic collection—of some of the most usable, most ingenious ham radio circuits around; a book written by hams for hams—hams who are into ragchewing or EME or CW or slow-scan TV or DX or whatever. If you've been scraping your mind lately trying to come up with that perfectly functional circuit for that perfectly fantastic application, you've got it now... right here in this giant book of carefully selected amateur radio circuits! All the circuits included have been built and tested by hams—and they tell you step-by-step how to build 'em, how to modify 'em, and how to combine 'em into your own personal homebrew creations. And, best of all, you can build most of these devices with commonplace components you probably already have in your shack. Some of these circuits are brand new, some are old—as but goodies that have been long forgotten but are well worth remembering, and some are souped-up versions of the tried and true—but they're all useful... to the novice operator and to the extra-class licensee. There are circuits for voice communications, for CW, for radioteletype, for SSTV... for just about anything and everything you want. 392 pps., 301 illus. List \$12.95

**The GIANT Book of Amateur Radio Antennas**

462 pages with complete build-it descriptions and how-to-install details for over 50 tested ham antennas. Whether your interest lies in mobile operations, DX, VHF, UHF... or anything else... there's something in this huge volume that will fit your needs. It's a complete guide to amateur radio antennas of all types—for all modes—for all operators under all types of operating conditions. Every practical fact packed into this manual is based on actual experience, because all these antennas have been prebuilt and pretested for top results by hams. Is limited space your problem? This book has the answers, along with complete info on all types of regular antennas, from mobile to highly directional DX jobs. You'll find non-directional vertical and multi-band antennas, indoor and limited space antennas, quads, beams, triangular loops, and antennas for both VHF and UHF... plus a wealth of detail and information on accessories and tuning. The latest info on the latest equipment is all right here, but you'll also find an assortment of older units which are useful in certain modern applications. Literally dozens of antennas are covered, including the "California cross," the "double-duty boom," the "indoor Sterba curtain," the "suspended long yagi," etc. There's even a special Chapter on "novelty" antennas! You get simple, easy-to-understand explanations of each antenna project, plus over-sized drawings and schematics to make construction easy, and understanding simple. In clear and precise terms, you'll learn how to build, install, set up, and operate any type of ham radio antenna you can think of. 462 pps., 255 illus. List \$12.95

Let us send you this 2-volume, 854-page Amateur Radio Library as part of an unusual offer of a Trial Membership in Electronics Book Club.

Here are quality hardbound volumes, each especially designed to help you increase your know-how and enjoyment of electronics and ham radio. Whatever your interest, you'll find Electronics Book Club offers practical, quality books that you can put to immediate use and benefit. Among upcoming selections, for example, are *OSCAR: The Ham Radio Satellites*; *Antenna Data Reference Manual, including dimension tables*; *How to Troubleshoot & Repair Amateur Radio Equipment*; *The Practical Handbook of Amateur Radio FM & Repeaters*; *Radio Propagation Handbook*, *The Master IC Cookbook*, etc.

This extraordinary offer is intended to prove to

you, through your own experience, that these very real advantages can be yours... that it is possible to keep up with the literature published in your areas of interest, and to save substantially while so doing. As part of your Trial Membership, you need purchase as few as four books during the coming 12 months. You would probably buy at least this many anyway, without the substantial savings offered through Club Membership.

To start your Membership on these attractive terms, simply fill out and mail the coupon today. You will receive the 2-volume Amateur Radio for 10-day inspection. YOU NEED SEND NO MONEY. If you're not delighted, return the books within 10 days and your Trial Membership will be cancelled without cost or obligation.

ELECTRONICS BOOK CLUB, Blue Ridge Summit, Pa. 17214

**Facts About Club Membership**

- The 2 introductory books carry a publisher's retail price of \$25.90. They are yours for only 49¢ for both (plus postage/handling) with your Trial Membership.
- You will receive the Club News, describing the current Selection, Alternates, and other books, every 4 weeks (13x a year).
- If you want the Selection, do nothing; it will be sent to you automatically. If you do not wish to receive the Selection, or if you want to order one of the many Alternates offered, you simply give instructions on the reply form (and in the envelope) provided, and return it to us by the date specified. This date allows you at least 10 days in which to return the form. If, because of late mail delivery, you do not have 10 days to make a decision and so receive an unwanted Selection, you may return it at Club expense.
- To complete your Trial Membership you need buy only four additional monthly Selections or Alternates during the next 12 months. You may cancel your Membership any time after you purchase these four books.
- All books—including the Introductory Offer—are fully returnable after 10 days if you're not completely satisfied.
- All books are offered at low Member prices, plus a small postage and handling charge.
- Continuing Bonus: If you continue after this Trial Membership, you will earn a Dividend Certificate for every book you purchase. Three Certificates plus payment of the nominal sum of \$1.99 will entitle you to a valuable Book Dividend of your choice which you may choose from a list provided Members.

**ELECTRONICS BOOK CLUB**

Blue Ridge Summit, Pa. 17214

Please open my Trial Membership in ELECTRONICS BOOK CLUB and send my 2-volume Amateur Radio Library, invoicing me for only 49¢ plus shipping. If not delighted, I may return the books within 10 days and owe nothing, and have my Trial Membership cancelled. I agree to purchase at least four additional books during the next 12 months after which I may cancel my membership at any time.

Name \_\_\_\_\_ Phone \_\_\_\_\_

Address \_\_\_\_\_

City \_\_\_\_\_

State \_\_\_\_\_ Zip \_\_\_\_\_

(Valid for new Members only. Foreign and Canada add 15%.) QS-180

# Signalcrafters Presents The Most Advanced Automatic Computing Power Meters In Amateur Radio!

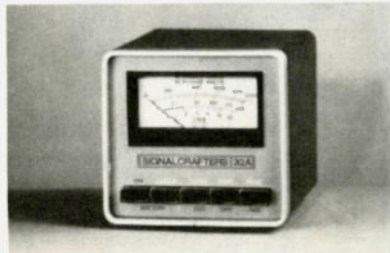

## MODELS 31 and 32\*

Our portable Models 31 and 32 feature the same state-of-the-art technology that is incorporated in their Big Brother, the Model 30. Never again will you have to bother with SWR "calibrate" controls and switches! Signalcrafters' custom integrated circuit makes power and SWR measurement a "handsoff" operation by automatically computing SWR. The result is unparalleled accuracy and ease of operation.

### FEATURES:

- **CUSTOM IC**—Computes SWR from the level sensed on the transmission line independent of the power level. This analog computer operates over a range of only one watt to the full scale of the meter with unequaled accuracy.
- **RUGGED TAUT-BAND METERS**—Provide accuracy and readability that must be seen to be appreciated.
- **HEAVY DUTY CABINETS**—Handsome heavy duty metal cabinets complement virtually every transceiver on the market today.
- **TWO MODES—PEAK OR AVERAGE**—The amateur may choose between either peak or average power readings.
- **POWER REQUIREMENTS**—Due to the advanced low current design, battery life is truly outstanding, making this meter a natural for portable or field day operation. Uses standard 9 volt battery or 120V AC with optional AC adaptor.
- **ATTRACTIVE AFFORDABLE PRICING**  
\*Model 31A (0 to 200w)  
31B (0 to 20w)  
..... only **\$149.00**  
Model 32A (0 to 200w, 0 to 2000w)  
32B (0 to 20w,  
0 to 200w)  
✓ \$130 ..... only **\$169.00**

**SIGNALCRAFTERS, INC.**  
5460 BUENA VISTA DRIVE  
SHAWNEE MISSION, KANSAS 66205  
913/262-6565; TELEX 42-4171

All Signalcrafters products are designed, engineered, and produced in the U.S.A. Prices include shipping to all U.S.A. VISA and Master Charge accepted. Kansas Residents please add 3% percent.

## When it comes to **AMATEUR RADIO QSL's...**

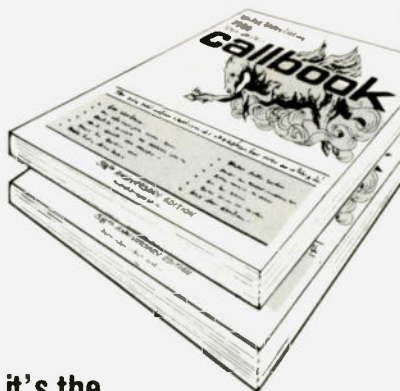

it's the  
**ONLY BOOK!**  
US or DX Listings

## 1980 callbooks NOW READY!

Here they are! The latest editions. World-famous Radio Amateur Callbooks, the most respected and complete listing of radio amateurs. Lists calls, license classes, address information. Loaded with special features such as call changes, prefixes of the world, standard time charts, world-wide QSL bureaus and more. The new 1980 Radio Amateur Callbooks are available now. The U.S. Edition features over 400,000 listings, over 120,000 changes from last year. The Foreign Edition, over 315,000 listings, over 90,000 call changes. Place your order now.

	Each	Shipping	Total
<input type="checkbox"/> US Callbook	\$16.95	\$1.75	\$18.70
<input type="checkbox"/> Foreign Callbook	\$15.95	\$1.75	\$17.70

Order both books at the same time for \$34.65, includes shipping.

Order from your favorite electronics dealer or direct from the publisher. All direct orders add \$1.75 for shipping. Illinois residents add 5% Sales Tax.



**SPECIAL LIMITED OFFER!**  
Amateur Radio  
Emblem Patch  
only **\$2.50** postpaid

Pegasus on blue field, red lettering. 3" wide x 3" high. Great on jackets and caps. Sorry, no call letters.

**ORDER TODAY!**

✓ R1

**RADIO AMATEUR  
callbook INC.**  
Dept. 731  
925 Sherwood Drive  
Lake Bluff, IL 60044



## Completely Free Standing Towers



PAT. NO.

4,151,534

**40' MODEL**  
Model 40 (extends  
from 21' to 40')  
List \$259.10

**55' MODEL**  
Model 55 (extends  
from 21' to 55')  
List \$473.97

**Breakover Model  
40** (extends from  
23' to 40' with  
breakover at  
ground level)  
List \$440.62

**Breakover Model  
55** (extends from  
23' to 55' with  
breakover at  
ground level)  
List \$661.75

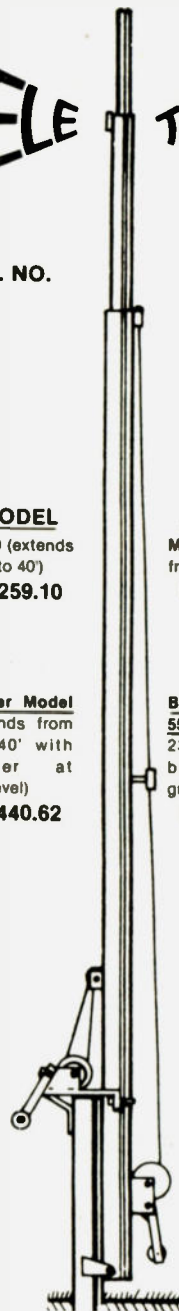

All steel constructed.

Concrete sleeve available for all models.

**TELE-TOW'R MFG. CO., INC.**  
P.O. Box 3412 • Enid, OK 73701  
405-233-4412

✓ T52

# Microcomputer Interfacing

Peter R. Rony  
Jonathan A. Titus  
Christopher A. Titus  
David G. Larsen

Most eight-bit microprocessors such as the 8080A, Z-80, 6800, 6502, and F-8 can add and subtract only eight-bit numbers, which can represent only decimal quantities between 0 and 255. This is not enough resolution or dynamic range for many applications. Consequently, *multiple-precision* and *floating-point numbers* are used.

The term multiple precision refers to the use of two or more computer words to represent a numeric quantity. In the above-mentioned microprocessor chips, a computer word is called a *byte*, and is eight bits long. A double precision number, therefore, contains two bytes, or 16 bits, and can represent any unsigned integer number between 0 and 16,777,216. Despite this ability to represent very large numbers, multiple-precision numbers do have their limitations, especially when units such as picograms, liters/second, and kilograms all appear in a single equation.

Floating-point numbers are frequently used for scientific and engineering calculations

because they can represent quantities that vary greatly in magnitude. The term floating-point number refers to a computer quantity that is usually composed of two parts, a *mantissa* and an *exponent*. For eight-bit microprocessors, a floating-point number is often represented by a 16-bit mantissa and an eight-bit exponent. Since the exponent and mantissa may be either positive or negative, one bit in each is used as a *sign bit*. This means that the three-byte floating-point number (15-bit mantissa plus sign bit, 7-bit exponent plus sign bit) can represent numbers between  $32,767 \times 2^{-127}$  and  $32,767 \times 2^{+127}$ , which correspond to the decimal number range,  $1.93 \times 10^{-127}$  to  $5.58 \times 10^{+42}$ . It is quite common for the mantissa to contain an implied binary decimal point, and thus to represent binary numbers between 0 and 1.000 or between 0.500 and 1.000.<sup>1</sup>

Unfortunately, a *floating-point package*, which is a collection of subroutines that perform the addition, subtraction, multiplication, and division of floating-point numbers, is a complex program. The Intel 8080 floating-point package,<sup>1</sup> which was written by O. C. Jelich and had its origin in an

earlier 8008 floating-point package written by C. E. Ohme, requires 865 bytes of read-only memory (ROM) and 24 bytes of read/write memory. Few programmers write floating-point packages because they are available from computer manufacturers of their respective users' groups.

Integer, or *fixed-point*, mathematical programs are relatively easy to write. For 8080A-based microcomputers, the add (ADD) and add-with-carry (ADC) instructions are used to write integer addition subroutines and programs. These instructions are used not only to add eight-bit numbers, but also 16-bit, 24-bit, and larger numbers. The add-with-carry instructions are particularly useful in this regard, since they add the content of the *carry bit* to the sum of two eight-bit bytes. The carry bit is also either set or cleared as a result of this addition.

A typical triple-precision integer-addition subroutine for an 8080A microcomputer is shown in Fig. 1. The subroutine adds two three-byte (24-bit) numbers that are stored in memory and returns the sum back to memory. When subroutine ADD3 is called, register pair D must contain the memory address where the least significant byte (LSBy) of one of the numbers is stored in memory. The more significant bytes of the three-byte number must be stored in consecutive memory locations at the next two higher memory addresses. At location ADD3, the C register is loaded with the number of bytes that are to be added, in this case, three. Register pair H is then loaded with the memory address where the other 24-bit number is stored. The first of the three memory locations used for this storage is assigned the symbolic address IACC (Integer ACCumulator). It should be noted that it is always possible to use a group of consecutive bytes in memory to create a multi-byte accumulator, which contains one of the operands and in which the final result of an arithmetic or logical operation is stored.

The next instruction that the 8080A executes, XRAA, clears the carry to a logic zero. This instruction must be included in the subroutine because you have no way of knowing what

the state of the carry is when the subroutine is called. You do not want to add the carry from some previous operation into the 24-bit result.

At ADDAGN (ADD AGain), a single byte is moved to the A register from the memory location addressed by register pair D. The content of the memory location addressed by register pair H is then added to the content of the A register, and the result of this addition is copied into the memory location addressed by register pair H. Both register pairs, D and H, are then incremented by one with the aid of the INXC and INXH instructions, respectively. The *byte count*, which is contained in the C register, is then decremented by one.

When the content of the C register is decremented to zero, the 8080A returns from the subroutine. If the content of the C register is not zero, the 8080A jumps back to ADDAGN and adds the next two bytes in sequence. Note that the XRAA instruction is used to clear the carry to a logic zero only when the subroutine is first called.

Subroutine ADD3 can be easily modified to add a four, seven, or even a 200-byte number simply by changing the immediate data byte of the MVIC instruction. Of course, if four-byte numbers are to be added, you must provide a four-byte integer accumulator to store the *accumulated* result.

A triple-precision integer-subtraction subroutine for an 8080A microcomputer is shown in Fig. 2. The program is almost identical to the integer addition program given in Fig. 1; the instruction ADCM in Fig. 1 is replaced by SBBM in Fig. 2. Note that the content of the integer accumulator is subtracted from the content of memory addressed by register pair D, with the result of the subtraction stored in the integer accumulator.

In the next column, we shall discuss integer multiplication and division subroutines. A subsequent column will describe the application of these subroutines to the *smoothing* or *filtering* of data acquired from an analog-to-digital converter (ADC).



```
ADD3,  MVIC    /LOAD THE C REGISTER WITH THE
      003    /NUMBER OF 8-BIT BYTES TO BE ADDED.
      LXIH   /LOAD REGISTER PAIR H WITH THE
      IACC   /MEMORY ADDRESS WHERE ONE OF THE
      0      /ARGUMENTS IS STORED.
      XRAA   /CLEAR THE A REGISTER AND CARRY
ADDAGN, LDAXD /GET ONE ARGUMENT INTO A
      ADCM  /ADD THE OTHER ARGUMENT TO IT
      MOVMA /SAVE THE RESULT BACK IN MEMORY
      INXD  /INCREMENT ONE MEMORY ADDRESS AND
      INXH  /THEN INCREMENT THE OTHER.
      DCRC  /DECREMENT THE BYTE COUNT IN C
      JNZ   /IF THE COUNT IS NON-ZERO,
      ADDAGN /PERFORM THE ADDITION AGAIN
      0
      RET   /OTHERWISE, RETURN FROM THE SUBROUTINE
```

Fig. 1.

```
SUB3,  MVIC    /LOAD THE C REGISTER WITH THE
      003    /NUMBER OF 8-BIT BYTES TO BE SUBTRACTED
      LXIH   /LOAD REGISTER PAIR H WITH THE
      IACC   /MEMORY ADDRESS WHERE ONE OF THE
      0      /ARGUMENTS IS STORED.
      XRAA   /CLEAR THE A REGISTER AND CARRY
SUBAGN, LDAXD /GET ONE ARGUMENT INTO A
      SBBM  /SUBTRACT THE OTHER ARGUMENT FROM IT
      MOVMA /SAVE THE RESULT BACK IN MEMORY
      INXD  /INCREMENT ONE MEMORY ADDRESS AND
      INXH  /THEN INCREMENT THE OTHER.
      DCRC  /DECREMENT THE BYTE COUNT IN C
      JNZ   /IF THE COUNT IS NON-ZERO,
      SUBAGN /PERFORM THE SUBTRACTION AGAIN
      0
      RET   /OTHERWISE, RETURN FROM THE SUBROUTINE
```

Fig. 2.

## Ham Help

I would like to get in touch with anyone who had had experience getting a computer (OSI C1P, 4K) set up and running on the ham bands sending and re-

ceiving RTTY and Morse code. Thank you.

Larry Herbert WB3HEX  
2315A 14th Street  
Ft. Eustis VA 23604

# Leaky Lines

Dave Mann K2AGZ  
3 Daniel Lane  
Kinnelon NJ 07405

Phlukey phonetics are back with us again. For a brief while it appeared that the forces of Alfa, Bravo, Charlie, and Delta had prevailed; one heard the preferred phonetics and only occasionally ran into those of the humorous (or not so humorous) variety. But now they are all over the place. The bands are full of Hot Water Bottles, Soggy Tennis Sneakers, Aunt Maggie's Drawers, Jersey's Ugliest Quad, Mississippi Pea Picker, and Always Going Zigzag (you see, I'm in there, too).

I must confess that I like this sort of thing. Granted, such frivolities shouldn't be used on MARS or RACES, where a certain decorum and protocol must be observed, but what's wrong with injecting a bit of informality where it isn't out of place?

Some callsigns defy all efforts, however. As a wordsmith of somewhat lengthy experience, especially in the pop song field, I think that I'm pretty good at devising fairly clever phonetics. But when somebody hits me with those Qs, Zs, and Xs, I generally shrug my shoulders and give up. Good ones seem to come spontaneously. The very first time I ever worked Tony W2IOO, it didn't take five seconds for me to bestow upon him the sobriquet, Italy's Oiliest Olive. Whether he approved or not is an entirely different matter. I never promised him a rose garden! But it's a heckuva lot easier to remember than India Oscar Oscar, isn't it? And as for Ida Oboe Oboe, forget it!

On Christmas Day of 1964 or 1965, I've forgotten which, and I'm far too lazy to pull the appropriate logbook from the disreputable looking pile of rubble in the bottom of the shack closet to find out, I hooked up with a guy who signed We Broke 4 Plate Glass Windows. QSB was closing in fast, and we lost each other very quickly. I haven't heard him since, but I guarantee that I'll know him at once if ever I hook up with him again. How in the world could anyone ever forget We Broke 4 Plate Glass Windows? But I don't think I'd be able to remember Whiskey Bravo 4 Papa Golf Whiskey.

I'll admit that there are times when it can get confusing. I used to work a certain Horses, Ponies, & Zebras. I am now acquainted with Horses, Zebras, & Ponies. The latter happens to be a musician, and I've decided to

suggest that he use Hungarian Zither Player. It doesn't matter that he's not of Magyar descent. You can't have everything.

Quarters, Dimes, & Nickels . . . Pints, Quarts, & Gallons . . . April, May, & June . . . Jacks, Queens, & Kings — all friends of mine, all instantly recognizable on the ham bands. So are Ugly Lover, Hot Little Hands, and Red Hot Electrons, not to mention one of the most well known of all, Never Say Die, who, I'm told, has something to do with this magazine.

We not only apply phonetics to our callsigns, but to many things. Who has not heard a thousand guys calling, "CQ, CQ, CQ Dog X-Ray," and what ham is not familiar with Heathkit's Hot Water series of equipment? Sometimes it's not very flattering; some AM enthusiasts still refer to sideband as Slop Bucket. And who among us has not sometimes said of another service, Criminal Band, Chicken Band, or Children's Band?

Once in a while you will hear someone use trick phonetics to clarify his name. I suppose that almost all the Floyds have used Funny Little Old Yellow Dog, and all the Bobs spell out Broken Old Bottles.

Please, I beg you, don't infer that just because I've done a little bragging here about my facility with phonetics, I'm ready, willing, and able to dig one up for you. Don't ask me to assume the burden . . . I've got enough troubles of my own. I once had the temerity (and stupidity) to offer to help someone select a name for a forthcoming blessed event, and I got into the middle of a horrendous family argument that is still going on. The mother's family is sore because they think the kid should have been named after a maternal grandfather, and the father's family is sore because he was named after a wealthy uncle who promptly changed his will in favor of the kid, thus cutting them out of their anticipated bequests . . . the kid got it all! In point of fact, he isn't even known by the name I helped to select. Everybody calls him Red, since his hair is the color of a ripe tomato.

But I resolved that I would never get inveigled into such a situation again, and I am just as adamantly determined to avoid helping with callsign phonetics. So please don't ask me for any help . . . as I say, I've got enough troubles of my own.

\*\*\*

A serious note: Some weeks ago, while sitting in the living room, I became aware of a faint-

ly acrid odor which seemed to be wafting in from the radio shack, about thirty feet down the hall. I went to investigate and found the room blanketed in a vast, impenetrable cloud of yellowish smoke.

The first thing I did was reach for the convenient circuit-breaker switch, just inside the doorway. Then I slammed the door shut, went into the bathroom, saturated a towel in cold water, and draped it over my mouth and nose. I took a very deep breath, opened the door, ran over to the windows and threw them open (it was a chilly night and they had been closed), and turned on the exhaust fan. I then reclosed the door and waited for about two hours before venturing back into the shack.

The surface of my operating desk was covered with an ugly, dark brown film of goop, vile-smelling and extremely viscous, like molten tar. Evidently, all the potting compound of a transformer had melted and run out through the apertures in the bottom of my prop pitch rotator control. But the worst of it had been due to the burn-up of some selenium diodes. The gas generated from these is noxious enough to be used in the California lethal death chamber!

I had been under the distinct impression that this device was adequately protected against short-circuit damage. It was designed with a power main fuse and with the appropriate interlocks and so forth. It ran on 110 V ac and its sole function was to provide 36 V dc to run the motor and to switch from clockwise to counterclockwise rotation . . . a very simple device indeed. But its power supply contained selenium diodes, and these are not to be taken lightly.

A tragedy was averted. But I am chilled by the realization that I frequently used to leave all my gear running on standby overnight, and if this malfunction had occurred while the family was asleep, we might all have been asphyxiated in our beds!

At nine o'clock on the very next morning, I drove over to my handy-dandy local hardware store and purchased a number of smoke detector alarms. One of them was promptly installed in the radio room, and others are placed in strategic locations all over the house. I do not intend to run the risk of a recurrence.

Every radio shack should be equipped with certain basic items. We have been aware of the necessity of a dependable fire extinguisher, a dummy load, certain test equipment, and so forth. But every ham should make sure that he adds to this list of fundamental necessities

a good smoke detector alarm. Don't put it off . . . it may save your life and the lives of your loved ones.

\*\*\*

If you have a strong stomach and can withstand disgusting things, go down to 14.195 when a rare DX operation is working split. I always thought that this frequency was off limits for us, but I was amazed to learn that it is a gathering place, not only for a flock of self-appointed monitors, but for one of the foulest-mouthed groups of morons and idiots I've ever had the displeasure of running into.

The usual procedure followed when DXpeditions operate split frequency is for the operator to announce his listening frequencies. He will invariably do this, and for people to insist upon calling him on his transmit frequency is bad enough, but for fifteen or twenty big mouths to feel that it is their prerogative not only to inform others that they are out of the US phone band, but to call them vile names in the bargain, is really too much. This generally occasions a retort by either the offending station or by the other filth peddler and the result is pretty chaotic.

The DX station is not bothered by the carrier throwers, the tuner-uppers, and the occasional excitable QSO seeker who forgets to flip his band-switch . . . he is listening up the band for callers. All these guys do is make it impossible for the station being recognized by the DX operator.

Most of their voices are recognizable by their friends and associates. In all good conscience, they should be told to knock it off. And their friends need not take the trouble to be tactful or diplomatic about telling them. They are perfectly aware of the trouble they cause, and if they persist in these sorts of carryings-on, they ought to have their heads handed to them.

There's absolutely no excuse for it, and the sooner they are exposed and given what they deserve, the better. Imbeciles who do this sort of thing deserve no consideration, because they give none to others, and the very last thing their friends should provide them with is anonymity. This only enables them to continue the misbehavior.

I had occasion, even though I did not need it, to listen to the most recent operation on Mount Athos, and despite the fact that I am a guy who's been around and who's been exposed to some pretty filthy talk in my day, I was appalled at the foul talk that I heard. It's an intolerable

*Continued on page 156*

AZDEN ★ NEW! ★ AZDEN ★ NEW! ★ AZDEN ★ NEW! ★ AZDEN

# AZDEN®

## REVOLUTIONIZES THE STATE OF THE ART AWE AND AZDEN. INTRODUCE THE BRILLIANT NEW PCS-2000 MICROCOMPUTER CONTROLLED

**NEW!**

2 METER FM TRANSCEIVER

NOT \$550.00  
WINTER  
SPECIAL  
**\$339<sup>00</sup>**

ALSO PCS 2800 10 METER  
VERSION WITH THE SAME  
BASIC FEATURES COMING IN  
NOVEMBER. PRICE TBA.



### COMPARE THESE FEATURES WITH ANY UNIT AT ANY PRICE

- **FREQUENCY RANGE:** Receive and transmit 144.00 to 147.995 MHz, 5Khz steps + MARS-CAP\* and MULTIPLE OFFSET BUILT IN
- **ALL SOLID STATE-CMOS PL DIGITAL SYNTHESIZED.**
- **SIZE:** UNBELIEVABLE! ONLY 6 1/4" x 2 1/2" x 9 1/4" COMPARE!
- **MICROCOMPUTER CONTROLLED:** All scanning and frequency control functions are performed by microcomputer
- **DETACHABLE HEAD:** The control head may be separated from the radio for use in limited spaces and for security purposes
- **SIX-CHANNEL MEMORY:** Each memory is re programmable. Memory is retained even when the unit is turned off
- **MEMORY SCAN:** The six channels may be scanned in either the "busy" or "vacant" modes for quick, easy location of an occupied or unoccupied frequency
- **FULL-BAND SCAN** All channels may be scanned in either "busy" or "vacant" mode This is especially useful for locating repeater frequencies in an unfamiliar area
- **INSTANT MEMORY-1 RECALL:** By pressing a button on the microphone or front panel, memory channel 1 may be recalled for immediate use
- **MIC-CONTROLLED VOLUME AND SQUELCH:** Volume and squelch can be adjusted from the microphone for convenience in mobile operation
- **ACCESSORY OFFSET:** Provides three additional offset values: +0.4 MHz, +1 MHz and +1.6 MHz. Other offsets may also be obtained.
- **25 WATTS OUTPUT:** Also 5 watts low power for short distance communication
- **DIGITAL S/R/F METER:** LEDS indicate signal strength and power output No more mechanical meter movements to fall apart!
- **LARGE 1/2-INCH LED DISPLAY:** Easy-to-read frequency display minimizes "eyes off the road" time
- **PUSHBUTTON FREQUENCY CONTROL FROM MIC OR FRONT PANEL:** Any frequency may be selected by pressing a microphone or front-panel switch
- **SUPERIOR RECEIVER SENSITIVITY:** 0.28 uV for 20-dB quieting The squelch sensitivity is superb, requiring less than 0.1 uV to open The receiver audio circuits are designed and built to exacting specifications, resulting in unsurpassed received-signal intelligibility
- **TRUE FM, NOT PHASE MODULATION:** Transmitted audio quality is optimized by the same high standard of design and construction as is found in the receiver The microphone amplifier and compression circuits offer intelligibility second to none
- **OTHER FEATURES:** Dynamic Microphone, built in speaker, mobile mounting bracket, external remote speaker jack (head and radio) and much, much more. All cords, plugs, fuses, microphone hanger, etc. included Weight 6 lbs.
- **ACCESSORIES:** 15' REMOTE CABLE \$29.95 \*MARS-CAP KIT TBA. PCS-6R A/C POWER SUPPLY. \$49.95. TOUCHTONE MIC. KIT... \$39.95.



## AMATEUR-WHOLESALE ELECTRONICS

8817 S.W. 129th Terrace, Miami, Florida 33176

Telephone (305) 233-3631 • Telex: 80-3356

U.S. DISTRIBUTOR DEALER INQUIRIES INVITED

ORDER NOW TOLL-FREE

Credit card holders may use

our toll free ordering number

Ask for operator 701

(800) 824-7888

In California (800) 852 7777

Alaska and Hawaii (800) 824 7919

✓ A21



800 800

# Contests

Robert Baker WB2GFE  
15 Windsor Dr.  
Atco NJ 08004

## QSL EXCHANGE CONTEST

Starts: 0000 GMT January 5  
Ends: 2359 GMT January 6

While there are many efficient, inexpensive ways by which QSL cards can be exchanged with DX stations, exchanging QSLs within the US is an expensive proposition. This contest was proposed to eliminate the high cost of QSLing and to provide an opportunity to work those rare states, counties, etc., knowing that you will actually receive a QSL card for each contact. In making a contact in this contest, you agree that you are actually filling out the other station's QSL card as the contact is being made. The objective is to receive as many QSLs as possible for contacts in the contest period.

The contest is open to all single-operator stations. Contacts may be made with the same station more than once, provided that they are made only once on each band on each mode. All modes are permitted.

### EXCHANGE:

The contest exchange is an exchange of call signs and signal reports, accompanied by the statement "I have completed your QSL card" (or "QSL DONE" on CW), or its equivalent. I suggest on phone that you actually read the time, date, band, etc., as you fill in the blanks on your QSL as a part of the exchange, but that is optional. On CW, a QRX can be used to free the hand to write the card, followed by the "QSL DONE," but again that is optional. The QSO should, in any event, be completed only when both stations

have completed their QSL cards. Make sure the other station is actually in the QSL Exchange Contest and is filling out your card at the same time. Only one QSO per QSL card should be used to provide easier counting by the contest committee.

### SCORING:

Scoring is the count of QSL cards which are received for you at the contest address by February 6th. Cards will be sorted and mailed to their new owners by March 6th. For each call district and for foreign countries with sufficient entrants, a trophy will be awarded the highest scorer. For each state, province, or country, the highest-scoring station will also receive a certificate.

### ENTRIES

All QSL cards must be mailed as described below to: H. W. Barry Merrill W5GN, 10717 Cromwell Drive, Dallas TX 75229. The mailing must include an SASE which is at least as large as your outgoing envelope. You can use your own outgoing mailing to determine the amount of postage on the return envelope, being careful if your QSL cards are thin to add enough postage. You must sort your QSL cards in the same order that is used by the *Callbook*—by call district, then by suffix, and then by prefix. Use the station call sign, disregarding any portable call signs for this sort. Finally, you must accompany your entry with \$1.00 for every 100 QSL cards, preferably by check.

## INTERNATIONAL ISLAND DX CONTEST

Starts: 0000 GMT January 12  
Ends: 2400 GMT January 13

The object of this contest is to work as many stations worldwide with special emphasis on DXCC countries which are designated IDX Islands. A complete list of IDX Islands is available from the contest committee. Maximum operating time is 36 hours for single operators and 48 hours for multi-op stations. No crossmode contacts are allowed. Operating categories include phone only, CW only, or mixed mode. Entry classes include single operator/single transmitter, multi-operator/single transmitter, or multi-operator/multi-transmitter.

### EXCHANGE:

All stations give RS(T) and consecutive contact number. DXCC countries which are designated IDX Islands must also give their island name.

### SCORING:

Score 1 point for contacts within your own DXCC country, 2 points for contacts outside your own DXCC country. Score 1 bonus point for contacts with stations located in a DXCC country which is a designated IDX Island. Hawaii and Alaska are considered separate DXCC countries from the continental US. A station may be worked only once in the contest for point value, but may be worked on a new band for multiplier credits. The multiplier is the number of DXCC countries worked on each band. Final score is total QSO points times the total multiplier.

### FREQUENCIES:

Lower 50 kHz of each phone and CW segment of the US amateur bands on 6 through 160 meters.

### AWARDS:

Contestants must operate a minimum of 12 hours to be eligi-

ble for awards. Awards will be issued to those qualifying high-score entries for each operator class and mode in each US state, each DXCC country, and each IDX Island.

### ENTRIES:

All entries must be post-marked no later than February 15th and must include a log-sheet(s) for each band and indicate stations worked, date and time in GMT, frequency, mode, and points per QSO. Each entry must include a multiplier list for each band, a dupe sheet for contacts of 100 or more, and a summary sheet which is available from the contest committee. All entries or inquiries concerning the IDX Contest must enclose a business-size SASE or 3 IRCs and be sent to: Gary Pierson WA7GVM, Box C, LaConner WA 98257.

## HUNTING LIONS IN THE AIR CONTEST

Starts: 1200 GMT January 12  
Ends: 1200 GMT January 13

The contest is sponsored by Lions Clubs International and is coordinated by Lions Club Rio de Janeiro ARPOADOR, Brazil. Participation in the contest is open to all duly licensed radio operators, Lion and non-Lion, except members of the Contest Committee of the Lions Club Rio de Janeiro. There are two operating modes: phone and CW. Participation in both modes is allowed, but points are counted separately. All participating stations must operate within their licensing regulations. Categories include single operator and radio clubs (multi-op). Points of radio clubs and radio societies will be

Continued on page 144

# Calendar

Jan 1	ARRL Straight Key Night
Jan 5-6	QSL Exchange Contest
Jan 12-13	International Island DX Contest ARRL VHF Sweepstakes Hunting Lions In The Air Contest
Jan 19-20	North and South America RTTY Flash
Jan 26-27	French Contest - CW
Jan 27-28	Classic Radio Exchange
Feb 1-10	ARRL Novice Roundup
Feb 2-3	South Carolina QSO Party
Feb 9-10	QCWA QSO Party - CW
Feb 16-17	ARRL DX Competition - CW
Feb 23-24	French Contest - Phone
Mar 1-2	ARRL DX Competition - Phone
Mar 8-9	QCWA QSO Party - Phone
Mar 9-10	Europe and Africa RTTY Giant Flash
Mar 22-24	BARTG Spring RTTY Contest
Mar 29-30	YL International SSBers QSO Party - CW
Apr 19-20	YL International SSBers QSO Party - Phone

# Results

## RESULTS OF THE 1979 RHODE ISLAND QSO PARTY COUNTY AWARD WINNERS

County	Call	QSOs	Points	Mult.	Score
Bris	KA1BBY	201	434	42	18,228
Kent	W1GOG	39	99	24	2,328
Newport	WA1OSL	82	180	33	5,940
Providence	WA1TAQ	268	536	51	27,336
Washington	K1QFD	52	120	24	2,880

## SECTION AWARD WINNERS

State	Call	QSOs	Points	Mult.	Score
Conn.	WA1HYN	5	10	3	30
Maine	WA1WRI	9	40	4	160
Penn.	WA3ZGL	12	32	4	128
Georgia	AI4X	7	22	2	44
Ken.	KA4AZT	33	99	5	495
Tenn.	WB4WHE	4	8	2	16
Calif.	WA6JGB	10	28	3	84
Idaho	WB7URE	14	39	5	195
Oregon	KA7EOG/N	1	10	1	10
Wash.	WB7QEL	17	53	5	265
WV	WB8BMX	5	18	3	54
Ill.	W9QWM	14	28	5	140
Colo.	KA0CLS	4	16	2	32



# Tomorrow's Technology—Here Today!

## THE YAESU FT-207R

The "horse-and-buggy" days of crystal-controlled handies are gone! Yaesu's engineers have harnessed the power of the microprocessor, bringing you 800 channels, digital display, memory, and scanning from a hand-held package. Only with Yaesu can you get these big performance features in such a compact package.

- 4 bit CPU chip for frequency control.
- Keyboard entry of all frequencies
- Digital frequency display.
- 800 channels across 144-148 MHz.
- Up/Down manual scan, or auto scan for busy/clear channels. 10 kHz scanning steps.
- Five channels of memory
- Priority channel with search-back feature.
- Keyboard lock to prevent accidental frequency change.
- Memory backup
- $\pm$  600 kHz or odd repeater splits.
- Display ON/OFF switch for battery conservation.
- Equipped with rubber flex antenna, wallmount battery charger, earphone, shoulder strap, and belt clip.
- Switchable RF output 2.5 watts (minimum) or 200 mW
- Earphone for private listening
- 2 Tone (Touchtone<sup>®</sup>) Input from Keyboard
- Highly reliable LED frequency display (works in cold temperatures and does not fade with age)

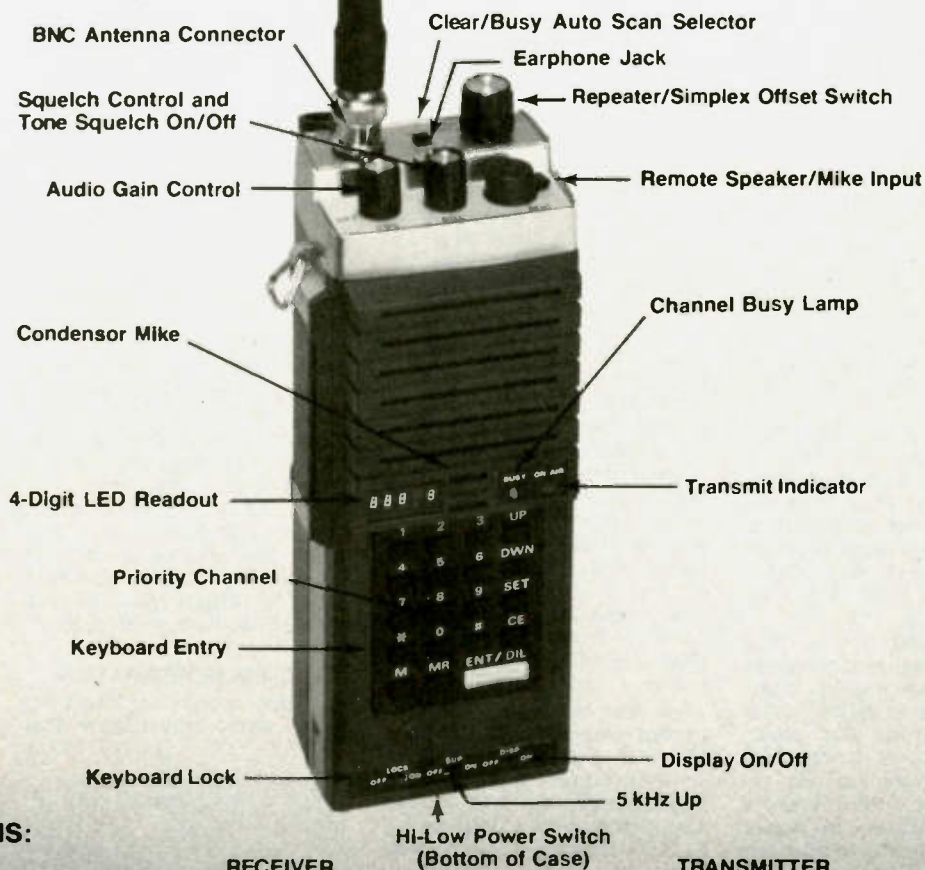

### SPECIFICATIONS:

#### GENERAL

**Frequency coverage:** 144-148 MHz  
**Number of channels:** 800  
**Emission type:** F3  
**Batteries:** NiCd battery pack  
**Voltage requirement:** 10.8 VDC  
 $\pm$  10%, maximum  
**Current consumption:**  
 Receive: 35 mA squelched (150 mA unsquelched with maximum audio)  
 Transmit: 800 mA (full power)  
**Case dimensions:** 68x181x54 mm (HWD)  
**Weight (with batteries):** 680 grams

#### RECEIVER

**Circuit type:** Double conversion superheterodyne intermediate frequencies.  
 1st IF = 10.7 MHz  
 2nd IF = 455 kHz  
**Sensitivity:** 0.32  $\mu$ V for 20 dB quieting  
**Selectivity:**  $\pm$  7.5 kHz at 60 dB down  
**Audio Output:** 200 mW at 10% THD

Price And Specifications Subject To Change Without Notice Or Obligation

#### Hi-Low Power Switch (Bottom of Case)

#### TRANSMITTER

**Power Output:** 2.5 watts minimum /200mW  
**Deviation:**  $\pm$  5 kHz  
**Spurious radiation:** -60 dB or better  
**Microphone:** Condenser type (2000 ohms)

#### OPTIONS

LC-C7 Leather Carrying Case  
 YM-24 Remote Speaker/Microphone  
 Tone Squelch Unit  
 NB-P9 Battery Pack  
 NC-2 Quick Charger

**YAESU**  
*The radio.*



180

# New Products

## THE AZDEN PCS-2000

Amateur-Wholesale Electronics is proud to announce its superior new Azden PCS-2000 2-meter FM transceiver. The PCS-2000 covers 144-148 MHz in 5-kHz steps (800 channels). It features six memory channels and scanning of memory or the full band in "free," "busy," and "vacant" modes. All frequency control functions are performed by a microcomputer.

Upon inspection, the most striking feature is the absence of a large knob for frequency control. In place of a knob, there is a 12-button microcomputer control keyboard. The desired frequency is programmed into the radio digit by digit. Simplex, -600-kHz, or +600-kHz operation is selected by pushing a keyboard button. Using a front-panel rotary switch, three additional offsets become available: +400 kHz, +1 MHz, and +1.6 MHz.

It won't take an observer long to notice that the unit comes apart into two pieces: the control head and the main unit. With an optional connecting cable, the two units can be located as much as 15 feet apart. This allows great flexibility for mobile and portable operation.

The microphone contains a volume and squelch control, two frequency control buttons, and a button for instant recall of memory channel 1. By using these controls, the necessity of reaching down to the control panel while driving is greatly minimized.

The PCS-2000 has a huge 1/2-inch LED display that makes frequency determination easy. The S-rf meter is digital, using LEDs instead of the usual, often-troublesome mechanical movement. There are two selectable power output levels: 5 Watts and 25 Watts. Low power is internally adjustable from 3 to

7 Watts. Frequency deviation is  $\pm 5$  kHz maximum. Azden units significantly exceed FCC regulations limiting spurious emissions.

An external speaker jack is provided on both the control head and the main unit. Optional accessories include external speaker, remote cable, desk microphone, and touchtone™ microphone kit. Both the desk microphone and the touchtone kit provide the same remote-control functions. For additional details, contact *Amateur-Wholesale Electronics*, 8817 SW 129 Terrace, Miami FL 33176. Reader Service number A21.

## 50 HZ-550 MHZ 9-DIGIT FREQUENCY COUNTER

DSI Instruments, Inc., of San Diego, has announced its new Model 5600A frequency counter. Its large-character, bright-contrast, 0.5-inch-high 9-digit LED array—with automatic zero blanking—provides enhanced readability at a distance and at wide viewing angles, even under high ambient light conditions.

Two input channels are provided. One covers the 50 Hz-to-50 MHz range while the other is for the 50 MHz-to-550 MHz frequency spectrum. High-visibility indicator lights for "Standby," "Oven-Ready," and "Gate-Time" status are included as standards rather than extra-charge options. The user can quickly select a desired resolution from 0.1 Hz to 1.0 kHz with convenient push-button ease. Additional features include an rf preamplifier and a 550-MHz prescaler.

Housed in a compact, high-impact-resistant portable cabinet with a coordinated multi-position combination carrying handle-easel, the 5600A operates directly from an internal 8.2-to-14.5 V dc battery or a 115 V ac

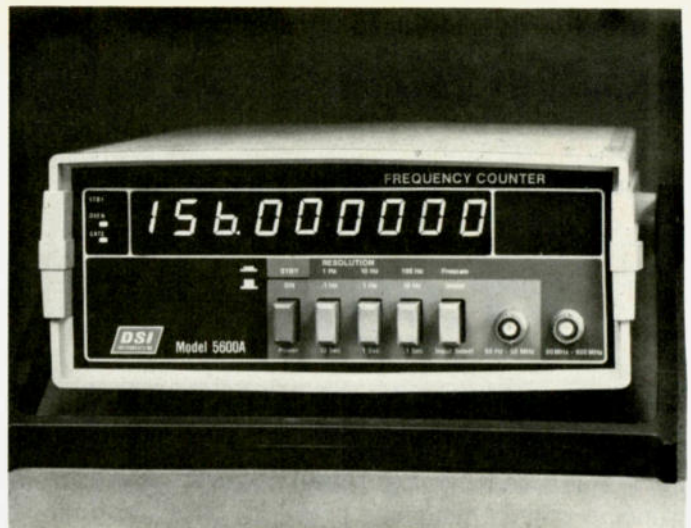

DSI's Model 5600A counter.

adaptor. It measures 3.25 inches high by 9.5 inches wide by 9.0 inches deep, including a self-contained battery holder compartment, facilitating convenient and quick adaptation to field or bench usage.

Cost-effectively priced options include a 10-hour rechargeable battery pack, as well as an audio multiplier that allows up to 0.001-Hz resolution, and a 25-dB preamplifier with a variable sensitivity control.

The 5600's low-cost to high-performance quotient and convenient portability make it ideally suited for measuring, troubleshooting, calibration, and servicing applications—on the bench or out in the field.

For additional information, contact *DSI Instruments, Inc.*, 9550 Chesapeake Drive, San Diego CA 92123; (800)-854-2049, (800)-542-6253 (California). Reader Service number D25.

## THE AEA MORSEMATICTM

At last, a computerized electronic keyer is available that

combines virtually all the features of all the other keyers in the marketplace. The AEA MorseMatic utilizes two custom state-of-the-art microcomputer chips to perform functions that were previously only a CW operator's fantasy.

For serious contest enthusiasts, the MorseMatic offers the most flexible automatic serial number generator on the market. For VHF DXers, it offers the exclusive automatic beacon mode for precise moonbounce, scatter, or tropospheric DX scheduling. To utilize the beacon mode, the MorseMatic can be instructed as to how long to transmit any selected message and how long to pause before the message is automatically transmitted again. The computers will automatically set the message code speed to fit the desired transmit window. The beacon mode can also be used for contest operating and for VHF beacon transmissions.

The MorseMatic keyer is the

*Continued on page 147*



The Azden PCS-2000.

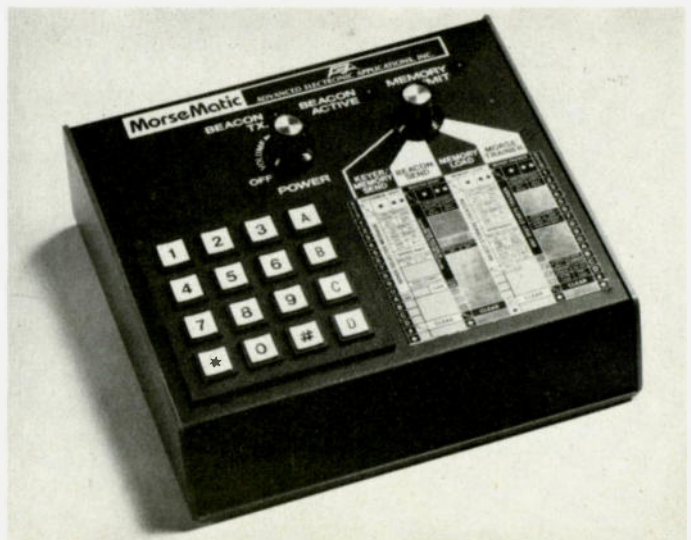

The MorseMatic™.

# SIGNALCRAFTER INTRODUCES

## The Most Advanced Automatic Computing RF Measuring Instrument in Amateur Radio!



### MODEL 30

This new Signalcrafters SWR/Power Meter is in a class by itself. Signalcrafters custom-designed integrated circuits compute SWR automatically, thus eliminating need for "set" or "sensitivity" controls. The built-in analog computer operates over the power range of only one watt to several kilowatts with unparalleled accuracy. Our auto-ranging feature automatically selects the proper range of 0 to 20, 0 to 200, or 0 to 2,000 watts according to the RF level detected on the transmission line and indicates the proper range on one of three front panel LED's. The operator can assume manual control of this feature by selecting one of the three basic ranges on the front panel switches. Two large taut-band meters indicate forward power and SWR. Complete hands-off operation! The amateur may also choose between either average or peak RF power. Self-indicating push buttons allow selection of any of three antennas or a dummy load when used with external 12-volt coaxial relays or our Model 50 Antenna Relay/Dummy Load. The 1.5 to 30 mhz coupler is plug-in mounted on the rear apron and can be unplugged and remote-mounted for convenience. The attractive, heavy-duty, low profile metal cabinet complements the latest transceiver designs. DC output receptacles supply analog voltages that track the meter readings. These outputs can be used to control many different accessories, such as analog to digital converters, remote meters, control and alarm devices, as well as the Signalcrafter Model 40 Audio-Tuner for the blind amateur. Operates from 110 volt 60 hz AC. Width: 8½" (216 mm), Height: 4½" (108 mm), Depth: 6" (152 mm)..... \$225.00

## SIGNALCRAFTERS, INC. ✓ S130

5460 Buena Vista Drive

Shawnee Mission, Kansas 66205

913/262-6565; Telex: 42-4171

All Signalcrafters products are designed, engineered and produced in the U.S.A.

Prices include shipping to all U.S.A. — VISA and Master Charge accepted.

Kansas residents please add 3½ percent.



ou moons don't ever profit  
lousy manuscripts from the  
burh  
you li  
I insist that you print ev  
tell Ma bell that she shou

### DO SOMETHING

I have just subscribed to 73 Magazine, but I only did so in order to obtain some fine technical and operating articles which I have had the pleasure to read in the past. The editorials are, however, another item.

Now, I realize that our government has its problems, but it is ours. We elect its representatives and it is our civil right to improve it. The ARRL is our national amateur organization and it is the right of its members to improve it. My observations have shown that when it comes to ARRL decision making, 73 is quick to criticize, but lacks either the ability or the capability to do something about it. Mr. Green, if you are intelligent enough to discover a problem, gather your band of followers and run for League president! Hams should not point fingers if they are incapable of trying to correct the problem. The ARRL is *our* organization and we should do our best to improve it rather than belittle it. For myself, I am proud to be an ARRL member.

My second point of friction concerns a segment of your September, 1979, editorial concerning "Spreading the Word." Mr. Green, this nation has had enough economists and Ralph Naders to keep our heads spinning for the next century. Tatling on grocery store chains is not our normal form of amateur activity. Besides, many factors go into the price of differing items, such as wholesale prices, middleman prices, operating and maintenance costs, taxes, wages, and, of course, a profit which is usually less than 10% of the store's actual income. If we are to develop a strong picture of amateur radio to the public, let us continue to do so as we have in the past: teaching classes, speaking to groups, giving school demonstrations, appearing at local fairs, monitoring track events, passing traffic, and, of course, working to *save lives* in the event of natural disasters, and allowing the media to know of it. *This* will continue to develop the public relations we need. Saving lives will always be more important than saving pennies!

Finally, I would like to comment on the "ARRL Line" which

also appeared in the September issue. I have only been licensed three years, and I am currently an Advanced. I was not around when the ARRL pushed for this dividing line at 14.275 MHz, but I would have supported it, even as a General. What would be the use of upgrading if I would have had the chance to operate on the elite part of 20 meters? This line keeps SSTV for those who have adequate knowledge of it (i.e., Advanced and Extra). Using call signs as the only means of incentive is all too foolish. You mentioned that this line was also the cause of losing the old manufacturers of amateur radio such as Hallicrafters, National, and Hammarlund. These companies died because of a lack of distributors, not the dividing line. Local radio dealers of the 1960s could not continue to cut their prices in order to beat the dealer down the street. Profits were lost, and the local dealer was among a vanishing breed. The manufacturers therefore lost their distributors, which caused their collapse. Another piece of evidence: The dividing line is still with us, yet names like Kenwood, Swan, Icom, Den-Tron, Yaesu, Drake, and Ten-Tec have prospered.

In closing, Mr. Green, please get your facts straight, do something rather than nothing, and keep up the great technical and operating articles. I assure you that I'll never say die.

Edward Middlebrook WD5BCI  
West TX

### NOT FOR SALE

The FCC column in the October, 1979, issue (p. 29) clarified a most irritating point for me. Apparently the struggle between freedom of reception and greedy commercialism was bent towards commercialism in Section 605 of the Communications Act of 1934. It is hard to believe that in this supposedly free country, artificial (fiat) restrictions would be legislated against citizens entirely for the purpose of creating a commercial market for a minority.

In order to correct the situation, I believe that a statement of the ideal for a reception law in a free country should be made and then possibly adopted as a new Constitutional amendment. I propose the fol-

lowing:

1. There shall be no law passed or action taken to abridge the citizen's right to receive transmissions of communications or entertainment material which are broadcast, by any means, through the citizen's private property or through public property.

2. No means of reception shall cause interference with any other reception.

3. Any broadcast material shall, during the real-time broadcast, become public domain to be disposed of at the discretion of the citizen receiving the broadcast. No copyright shall exist for material which has been broadcast.

In the foregoing, I would define broadcast to mean transmission by any means which are not shielded from radiating.

The proposal would affect zoning, mobile scanner, satellite, MDS, unscrambler, and Fuzzbuster™ restrictions, along with any other attempts to conceal from the public, deceive the public, or profit from fiat restriction of the public. It would allow all present forms of commerce to continue, except without the protection afforded by artificial law.

In my opinion, transmission must be regulated to maintain order, but reception must remain uncompromised.

I presently hold a commercial operator's license which would allow me to profit from the restrictions of the public's right to receive, but I am appalled to think that a citizen could be arrested and fined or jailed for receiving transmissions which are broadcast through his own private property. Compromise of the right to receive opens the door to all forms of censorship, greed, and tyranny. By any reasonable sense of ethics, Section 605 is out of line and MDS is out of business. The airwaves are not for sale!

Carl B. Rayman WA0RLY  
Austin TX

### WINDMILLS

The conversations, editorials, letters, strong words, and anger about CBers on 11 meters all seem a little fruitless to me. The false premise is that something significant can be done about it.

The FCC choices really are: Shall we waste \$100,000 trying to enforce present regulations or shall we legalize the 11-meter facts of life?

Isn't it perfectly obvious that nothing of value is being gained through present levels of enforcement? And isn't it equally obvious that Congress isn't going to fund a vastly increased enforcement effort? Besides, 11

meters will be dead in a couple of years anyway. It seems, to me, more productive to worry about unlicensed operators on the bands that will be open.

I have no statistics to support my belief that 7, 14, and 21 are loaded with Novice operators who can't master code or who haven't the engineering background to upgrade. Nor do I have any statistics to support my guess that as 11 meters dies, thousands of CBers will convert their ham rigs back to the ham bands. It's either that or junk some very expensive equipment.

Of course, ham ranks have grown greatly as CBers upgraded. I would expect this to continue, but not to the exclusion of unlicensed operators.

Hams now operating on 11 meters—some think it's more fun than the typical signal report—will go back to legal operation, but the amateur bands will never be the same.

I would expect the next step to be, as ham frequencies become vastly overloaded, hams going outside the bands. Won't that be embarrassing?

Old hams will battle against the new boys. Amateur radio will never be the same—whether that's for the better (vastly increased use by citizens of their airwaves) or for the worse (pollution of those airwaves).

It's a matter of opinion, but one thing is for sure: It *will* be different! And tilting at windmills is just as fruitless today as it was in the days of Don Quixote.

Name withheld  
by request

### NITPICKING

This letter is about the comments in 73 Letters concerning the ARRL.

It is likely that the things they say are true, but I have yet to hear of any of these characters recommending an outstanding ham for election to the ARRL Board of Directors. Criticism without constructive countermeasures accomplishes nothing. Seems more like the writers are just jackals on an ego trip.

I'd sort of like to see a good "Bismarck" in ARRL headquarters. They tell me the only good time to live in Europe was when he ruled with an iron fist.

The mass of hams in the US are too diversified a group to be governed in such a manner that all hands will be content with everything. I have doubts that a good Bismarck will ever be found, so I guess hams will have to depend on the Board of Directors.

How many more years are

Continued on page 154

# TET ANTENNA SYSTEMS Powerful Rotors

Inside Tower Installation

Mast-Top Installation



**KR-2000**  
WT. 25.5 LBS

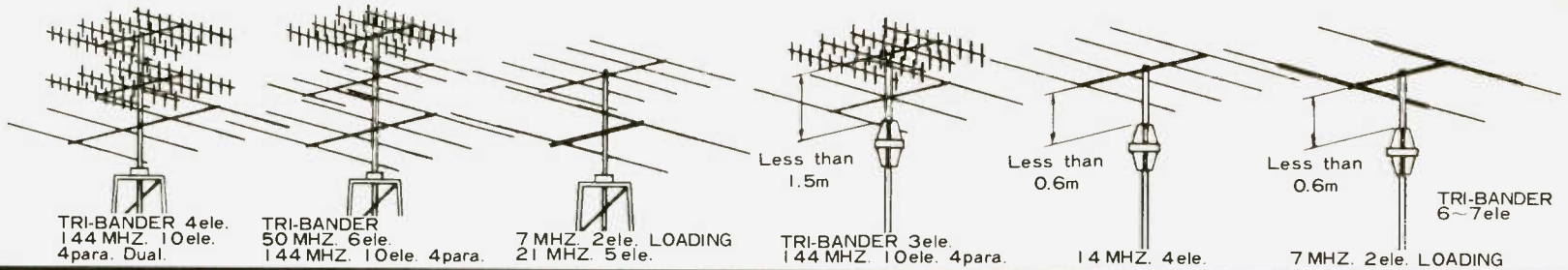

**KR-600**  
WT. 15.5 LBS

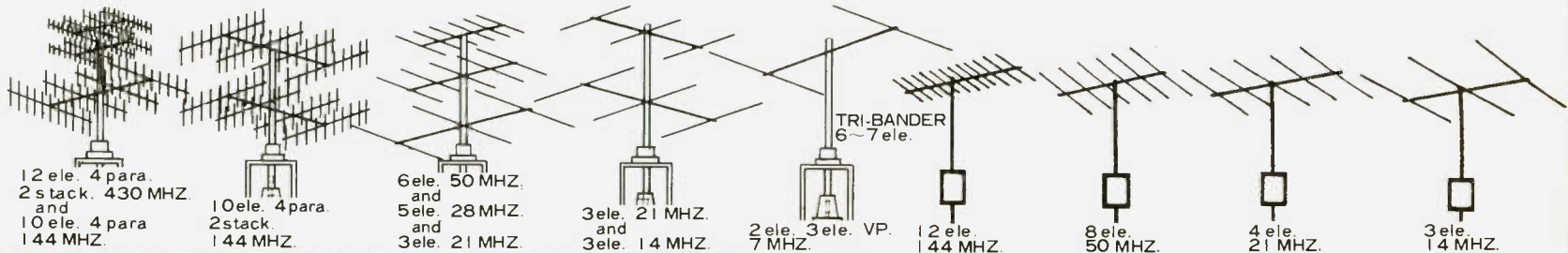

**KR-400**  
WT. 15.5 LBS

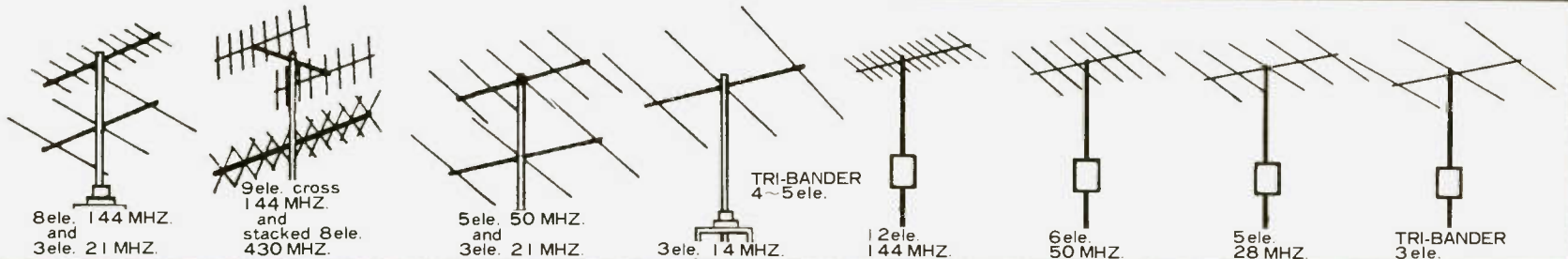

**KR-500**  
WT. 11.0 LBS



**KS-065**



**KS-050**



Call or Write for your super quote today!

**TET U.S.A., INC.**

425 Highland Parkway, Norman, Oklahoma 73069 Tel. (405) 360-6410

# NBVM: Dawn of an Era or Promotional Hype?

— the performance and politics of  
Narrow Band Voice Modulation

In December, 1977, a well-known radio organization announced the development of "Narrow Band Voice Modulation," a breakthrough that would "revolutionize" voice communications. In the months that followed, two feature articles in *QST* and a chapter in the *Radio Amateur's Handbook* were devoted to NBVM. A prototype was developed and tested, and now a commercially-produced version of the system is in the hands of approximately 300 amateurs. If you are curious about the future in store for one of amateur radio's most publicized developments, read on.

At first glance, NBVM proponents have presented a number of highly beneficial reasons for adopting the system. Among those listed are:

1) Savings in spectrum. This is accomplished by reducing the bandwidth of your SSB signal to one-half its original size.

2) Significant improvement in the signal-to-noise ratio as a result of reducing bandwidth.

3) Better adjacent-channel rejection. This means cutting down on QRM.

In an age where our frequency allocations are threatened and the number of hams is growing, it is hard to criticize any proposal that would reduce congestion in the "overcrowded voice segments of the high-frequency amateur bands"—as one editor put it.

As a bonus, NBVM is supposed to increase your capability per Watt and reduce the bother of QRM! However, it is important to remember that performance, not promotional tactics, will be the deciding factor for the acceptance by the amateur radio community of any new communication system.

This article discusses the theory behind NBVM, evaluates the only commercial unit available, and offers

some insight into the politics surrounding amateur radio's newest mode. Readers who are not technically inclined may want to skip the "How It Works" section and go directly to the later material on the performance and politics of NBVM.

## How It Works

Narrow Band Voice Modulation is based on two methods of audio processing. The amplitude-compressor portion of the system compresses the amplitude of the signal. Expansion of the audio takes place at the receiving end. The concept of amplitude compressing has been around for many years but did not become economically feasible until the development of large scale integrated circuits. The signal's bandwidth is compressed by using a frequency compander. NBVM pioneer Dr. Richard W. Harris claims that this is a newly developed technique of audio processing.

The concept behind the amplitude compander is a familiar one to many SSB operators. More efficient use of the transmitter power is obtained when the audio signal is compressed before it reaches the modulation stage. Compression and clipper circuitry have been the mainstay for most amateur speech processors. The problem of a noisy waveform arises when compression goes beyond the first few decibels of improvement. Characteristically, most hams using processors keep the level of compression low enough to avoid this problem. The NBVM system allows a greater level of compression since the receive station has an expander that reduces the noise level during the quiet part of the voice passage.

Many of the NBVM benefits rely on a reduction in bandwidth. Normal single sideband techniques use the voice information between 350 and 2400 Hz. The

lower and upper responses are determined by the characteristics of the microphone and the filters built into your transmitter. The resulting carrier contains about 2100 Hz of usable audio.

I doubt if most audiophiles would praise the fidelity of a typical SSB signal, but the quality is more than adequate for everyday amateur use. Since SSB is the most effective method of rf modulation for voice communication presently in use, any conservation of bandwidth must take place in the audio frequency range. Accordingly, NBVM is known as a "baseband communications system." This allows any required processing scheme to be interfaced to the microphone and speaker lines of your rig, a much more pleasant concept than the alteration needed for rf processing.

Analysis of speech has shown that there are several parts of the audio spectrum that carry the information needed for acceptable intelligibility. Three such formants lie below 2500 Hz. It is important to remember that these formants are separated with noncritical spectrum between them. By removing these gaps, the frequency compandor portion of an NBVM unit is able to reduce the required audio bandwidth. The vocal chord sounds between the 400-Hz system rolloff and 600 Hz are passed through unaltered. The second and third formants are composed of voice sounds between 1000 and 2500 Hz. By mixing this audio with a 3100-Hz sine wave and filtering the output, the 1000- and 2500-Hz segments are folded into the 600-to-2100-Hz spectrum.

A further savings in bandwidth can be achieved by inverting and translating only the 1500-to-500-Hz segment. This means the output will fall between 600

and 1600 Hz. Fig. 1 shows a block diagram for a 1600 Hz frequency compandor.

The frequency compandor theory may look fine on paper, but the ability to translate it into a working model is what counts. The most important element of the design is the need for extremely sharp filters. Dr. Harris chose to use active-type filters for his prototype. Filter theory has been thoroughly discussed in previous amateur articles, so I will mention only the most important characteristics.

With the exception of a 700-Hz high-pass device, the filters in the commercial model are of the low-pass variety. The *QST* "construction" article states that they are based on 0.1-dB Chebyshev prototypes. They must exhibit a very small delay yet remain selective. The crucial 1600- and 2100-Hz filters have 16 poles each, while the remaining three use either 6 or 8 poles.

The resulting circuitry involves approximately 20 operational amplifiers. In order to ensure low noise and uniform gain, high quality TI074 bi-FET quad op amps are used. The resistors and capacitors used in the filters should have no more than one percent tolerance for best results. A great deal of attention must be paid to eliminating potential audio and rf feedback as well as troublesome ground loops.

Due to the complexity of the frequency compandor and the problems associated with discrete layouts, Dr. Harris and the VBC corporation developed six hybrid chips that contain most of the necessary circuitry. In addition to the filters, the VBC chips contain the 3100-Hz oscillator, balanced mixer, preamplifier, and buffers. Because the filters become saturated if the audio level gets too high, the voice signals

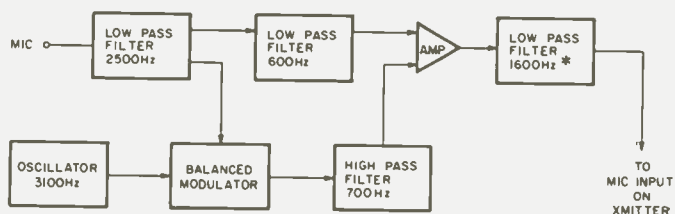

Fig. 1(a). 1600-Hz frequency compandor used to transmit narrow band voice modulation. \*2100-Hz low-pass filter is used in the wider frequency expander mode.

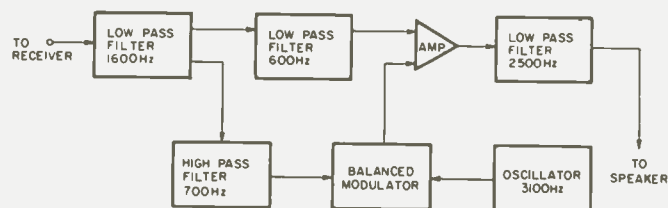

Fig. 1(b). 1600-Hz frequency compandor used to receive narrow band voice modulation.

are kept at around -10 dBm.

Several standard ICs are incorporated in the VBC design. These include an LM380 that gives one Watt of audio output during receive and an NE571 for the amplitude compandor. The power supply uses two garden-variety regulator chips. All of the system's active components reside on a 4.5" x 5.5" circuit board. A 44-pin edge connector provides connection to the inputs and outputs as well as to the switches and gain controls.

### Theoretical and Test Performance

The *QST* articles on NBVM stressed the idea of ham experimentation to evaluate and improve the NBVM system. Prior to the availability of the VBC-3000 unit, very few high-frequency tests were conducted. Most of the performance data resulted from a study by the FCC's Land Communications Office. Their tests were oriented towards channelized SSB applications in the VHF commercial radio bands. The Commission's findings give some numerical indications of the effectiveness of NBVM.

When a 1600-Hz method (1300-Hz bandwidth) is

used, the bandwidth of a normal SSB signal is cut in half. The broader 2100-Hz method (1800-Hz bandwidth) gives only a 33% savings. The smaller bandwidth can be interpreted as an improvement in the signal-to-noise ratio. The log (base ten) of the bandwidth in kilohertz is multiplied by 10 to obtain a comparative value. An unaltered SSB signal is computed to be  $10 \times \log 3.2 = 5.05$  dB.

Calculating the bandwidth factor for the 2100-Hz system gives 3.22 dB, and when the 1600-Hz setup is used, the value is reduced to 2.04 dB. The NBVM numbers are subtracted from the SSB value to give the improvement resulting from frequency companding. With the 1600-Hz filter, a theoretical improvement of 3 dB is achieved. Dr. Harris's description of the FCC results states only that a net improvement in the SNR was found. No numerical figure was given.

FCC tests also showed a 12- to 15-dB increase when only the amplitude compandor is used. Unlike the frequency compandor mode, improvement occurred when the received signal was measured straight through, without

expansion. The *Radio Amateur's Handbook* states that amplitude companding becomes effective when the signal is several decibels above the noise level. Apparently, the expander requires a signal that is strong enough to act as a reference.

### The VBC Model 3000

There were a number of comments in the early NBVM write-ups which suggested that many amateurs could get involved in NBVM tests by building their own baseband unit. Unfortunately, the detailed technical information dealt only with a system based on the VBC hybrid chips. Since most hams lack the ability or initiative to design and build a project of this magnitude, the only practical way to get involved was by purchasing a commercial NBVM transceiver. Only one model is available, the VBC Model 3000 Baseband Transceiver.

The 3000 is manufactured by Dr. Harris's company, VBC, and is marketed to amateurs by Henry Radio. One of the first units available (serial number 12) was acquired by 73 early last spring. Since then several cosmetic changes have been made in the 3000's design, but our unit functions identically to the newer ones.

The 6.5"W x 2"H x 9.5"D size is slightly smaller than a typical two-meter rig, and the Model 3000 weighs approximately two pounds. The two-piece grey cabinet contains the circuit board described previously plus the necessary controls and jacks that interface it to the real world. The user must supply 12.5-20 volts dc. VBC offers an optional wall-plug transformer that will meet this need. A 40-page operator's manual gives a thorough functional description and hookup information. The manual provides a number of tips for

the NBVM, but it appears to be written hastily and includes a number of spelling mistakes.

There are two receive inputs, three receive audio outputs, two microphone inputs, and two transmit audio output lines. It is very important that the 3000 be properly matched to the microphone, speaker, and transmit/receive apparatus in your station. I found out the hard way! Attention must be paid to impedance matching if you want decent results. The amateur compatible microphone input can be varied to match a 500-50k-Ohm microphone by clipping two jumpers inside the cabinet. The stereo phone jack was factory wired to be used with a 600-Ohm rig. By swapping the 600-Ohm line with the high impedance output at the circuit board connector, I was able to hook the VBC system to a Kenwood TS-820 microphone input. An Astatic D104 microphone was used during the 73 tests.

Care must be taken to avoid applying dc to the Model 3000's audio connections. For example, the Icom IC-701 transceiver microphone line has a nine-volt potential used to power a preamp in the microphone. If you were not aware of this, serious damage might result to the baseband transceiver's protective capacitors when the 701 was turned on.

### On the Air

The operator's manual suggests that a Model 3000 owner familiarize himself with the NBVM functions by using a tape recorder, before going on the air. Frequency-companded speech sounds far different than normal SSB when it has not been expanded at the receiving end. I found the tape recorder practice to be well worth the time. Once I was familiar with the unit and was ready to go on the

air, I had to find another station with NBVM capabilities. Since there were no widely publicized NBVM nets or frequencies, I resorted to using the telephone to set up the first few contacts. Needless to say, NBVM is not in wide use.

The initial QSOs were very unsatisfying since the transmitter was not getting enough drive from the NBVM transceiver. This problem was solved by checking for and finding an impedance mismatch. When the gain controls on the 3000 and the transmitter are properly adjusted, there should be plenty of drive. This can be checked on most rigs by using the alc meter. I found that these adjustments were somewhat critical, and it was easy to overdrive the system, causing distortion.

When receiving NBVM signals, it is important to experiment with different rf and af gain settings on the receiver as well as the volume control on the Model 3000. The best copy was achieved when the rf gain was substantially reduced, although there was then degradation of the agc action. If good performance is desired, it is necessary to re-adjust the three receive and two transmit audio controls constantly. This is not a "set it and forget it" system.

Early narrow band publicity stressed that the frequency-companded signals could be copied by a station not equipped with NBVM. Since the second and third formants of the voice are inverted, they will be on the opposite sideband compared to the conventional signal. If the NBVM is transmitted on lower sideband, these formants can be understood by tuning in the signal on upper sideband. A more complete explanation is given in the "Listening to NBVM" box.

It is important to note

that this is a very compromised situation. The level of intelligibility is low, and the advantages of NBVM aren't being used. It would be extremely awkward to conduct a QSO between an NBVM and non-NBVM station due to the need to change sidebands and turn the frequency compander on and off. The ability to listen to NBVM without having a compander is of little practical consequence.

The 73 tests were carried out under a variety of actual operating conditions. Although we did not perform a laboratory-style evaluation, several NBVM claims were confirmed. The amplitude compander provides at least 12 dB of improvement, as long as the signal-to-noise ratio is positive. The amplitude compressor offers a number of advantages for everyday use. Simple tests on bandwidth savings showed that the 1600-Hz mode (1300-Hz bandwidth) provided no noticeable improvement. This result was confirmed by several other NBVM users, and the general consensus is that the 1600-Hz mode is the only beneficial one in terms of spectrum savings.

The most obvious benefit occurs during QSOs with stations which are weak and where adjacent channel interference (QRM) is causing problems. Provided the other station has NBVM, it may be possible to conduct a QSO when it would not be possible using conventional sideband. For day-to-day strong signal amateur activity, the VBC Model 3000 does not offer much in the way of improvement.

### Bells and Whistles

One of the selling points of the 3000 is its multipurpose nature. A number of uses besides NBVM are suggested. These include having the unit serve as an



audio amplifier or perhaps as the filter-power amplifier for a simple receiver. At one time, VBC was investigating the possibility of providing hybrid chips for such a receiver. If you experiment with digitally-based voice communications, the frequency compandor might offer some interesting possibilities. Commercial owners are using the 3000 to combine voice and data information on the same telephone line.

A more practical ham use of the 3000 could be as an auxiliary filter. Front-panel switches allow the user to select this option for receive only. The high quality of the filters make them useful for non-NBVM use. However, they are not specifically meant for this, and provide a compromise in this respect. The alternate functions do enhance the Model 3000's value, but they should not be considered when evaluating NBVM.

Pound for pound, the VBC Baseband Transceiver is probably not one of the better electronic buys available. The Model 3000 costs \$349.00. A circuit board configuration is available for \$279.00. The early model tested at 73 has poor quality switches which do not enhance the unit's value. The later version uses better parts, and as a result, it looks and handles better. The amplitude compandor is centered around an NE571 IC which has a single unit price of about \$5.00. The major reason for the \$349.00 price tag lies in the frequency-compandor circuitry. The overall dollar value of the 3000 is a subjective matter. I don't think the price is right to encourage widespread amateur use.

Another subjective area is the evaluation of the NBVM sound. I am certainly not a high-fidelity freak, but the frequency-companded speech does not

have nearly as pleasing a quality as traditional sideband modes. As a result, I found it more difficult to fully comprehend the other stations. Any NBVM test should consider the factors of operator fatigue and enjoyment. Like any new system, it takes time to adjust to NBVM.

### A Commercial Gold Mine?

Technological breakthroughs are not an everyday occurrence in amateur radio. No matter what the result is for the art of communications, politics is sure to be involved. NBVM is no exception. The circumstances surrounding its role in the amateur world has both current and historical implications.

Long before the first amateur test of NBVM, the system received careful scrutiny by the FCC. VBC, in cooperation with Stanford University and the FCC, tested NBVM as a possible means to reduce the size of channels needed for commercial VHF communication. In this scenario, the present FM land mobile systems would be replaced by SSB using narrow band voice modulation. This would allow between three and six times the current number of users.

Conflicting reports were presented to the Commissioners. The one referred to in the *QST* articles supported the NBVM claims and suggested further study. A second report raised a number of questions about the effectiveness of SSB/NBVM. It said there was a need for far greater frequency stability and that many intermod problems may occur if a narrow channel scheme is used. Although the report did not totally dismiss the idea of SSB/NBVM, it raised a number of objections. The industry reaction to NBVM has been cool, at best.

The current NBVM sys-

### Listening to NBVM

If you do not own a frequency compandor, it still is possible to listen to the gang on NBVM. The results will depend on the receiver you use and your ability to comprehend less than ideal audio. The two formants of speech lying between 1000 and 2500 Hz are inverted into the spectrum lying between 600 and 2100 Hz. In the case of the narrow frequency compression, usable speech will be found between 600 and 1600 Hz. By tuning your receiver to the opposite sideband, it is possible to listen to these two translated formants. Tune slowly; a 20-Hz difference in frequency can be enough to make the signal unintelligible. If your receiver has a tunable passband filter, it may be possible to eliminate the first formant, below 600 Hz. It is in the other sideband and acts as QRM when you are trying to tune in the 600-to-2100-Hz segment. The 2100-Hz mode is not too difficult to eavesdrop on. The 1600-Hz mode requires you to have a good receiver and sharp ears. Remember, use the opposite sideband.

The best results for receiving NBVM obviously occur when you have a frequency compandor. If possible, establish contact on conventional sideband first. Carefully tune your receiver for the most natural sounding audio. If the transmitting station is using an amplitude compandor and you have an expander, adjust the receiver af gain (volume) so that no difference in the audio output level is heard when you switch the expander in and out. Then set the volume on your NBVM unit to a pleasant level. If the signal seems to blank out the expander, reduce the drive.

Now go to the frequency-companded mode. It will be possible to copy a compressed signal using either the 1600- or 2100-Hz filter in your expander, but the best results occur when your mode matches the transmitted signal. It may be necessary to make slight adjustments in frequency. This is best accomplished using RIT, a separate vfo, or a receiver/transmitter pair. It is essential to be able to tune within 20 or 30 Hz of the other station's frequency. Older receivers and some of the new synthesized rigs may present problems.

Readjust the rf and af gain controls on your receiver to obtain the best sounding audio. It may be necessary to turn off the agc if there is a strong signal on an adjacent channel. The i-f filtering in different rigs can influence the quality of the NBVM. Remember that a frequency-companded system will not offer the same intelligibility found on conventional SSB. Experimentation is the name of the game.

Following are some frequencies where NBVM activity is centered. The number of users is very small, so don't be surprised if there isn't much activity.

#### 80 meters

3.850 MHz, Wednesdays at 0000 UTC (Tuesday night). This net meets prior to the East Coast AMSAT net on the same frequency.

#### 40 meters

7.175 MHz, Saturdays at 0030 UTC (Friday night). This is an informal net of eastern stations.

#### 20 meters

14.210 MHz—International calling frequency for NBVM.  
14.235–14.242 MHz—Stateside NBVM QSOs can sometimes be found between these frequencies.

#### 15 meters

21.302 MHz—Several DX NBVM stations have reported using this frequency.

tem is not the final version. VBC is developing a pilot carrier system that will automatically take care of frequency and gain control.

It should be stressed that this is a substantial improvement over what is available now, but it is not readily applicable to HF

amateur use.

Careful readers will remember that VBC has a system patent for parts of the NBVM system. At least one major corporation disputed the claim that Harris's frequency compander design was original. It is easy to sympathize with VBC in its David vs. Goliath battle with the FCC and the big corporations, but the stakes are high. An FCC follow-up grant totalled \$54,000, while production of 25 units a week for amateur use means a gross of \$455,000 a year if all the units are sold. The private land mobile industry represents a potential market on the order of \$12 billion if the FM gear currently in use is replaced. Obviously, VBC is very interested in being the sole supplier of NBVM hardware.

#### **NBVM Is Dead and the ARRL Slew It?**

It is easy to see how NBVM differs from earlier amateur radio developments like SSB and FM repeaters. The American Radio Relay League's involvement (or lack of it!) in these previous breakthroughs provides an interesting comparison to their NBVM affiliation. It was clear in the beginning that the ARRL would be the major backer of NBVM. Early publicity stressed that this was an experimental system that could be built and tested by amateurs. The much awaited *QST* "technical" information tarnished those claims. Since then, the Newington-based spokesmen for ham radio have quietly dropped NBVM.

Rumors abound concerning the League's involvement. It is clear that the initial support was based on a VBC demonstration tape which was not necessarily the most unbiased source. The *QST* articles and the *Handbook* chapter were published before the

League staff had seen or tested a prototype. When tests were finally conducted, the inability to achieve the claimed benefits apparently left the ARRL in a corner. No W1AW tests have been conducted for the membership, and the League has turned its attention to other spectrum-saving techniques.

Despite the lack of independent supporting evidence, ads are appearing which claim that NBVM is the "most important innovation in amateur radio since SSB." Even though no concrete numbers showing the actual benefits to an HF amateur user are available, we are assured that the system is bound to succeed. Conflicting reports are given about the number of Model 3000s owned by hams. It is clear that many of the units are being tested by non-amateur users. The approach by those people commercially involved with NBVM is characterized by a lack of organization, poor technical documentation, and, in some cases, evasion.

Although early NBVM publicity urged us to exercise the ham tradition of experimentation, Model 3000 owners are cautioned by VBC not to "attach improvised circuitry anywhere on the printed wiring board." Despite the appliance operator's approach taken by VBC, there is amateur involvement in baseband communications experimentation. At least one ham has built an NBVM unit based on digital filters, and there are several designs being tested that don't rely on single-source chips.

#### **Conclusions**

During our on-the-air testing with other amateur stations equipped with the VBC Model 3000, we did not encounter a single situation in which NBVM was superior to ordinary SSB, although a few of the op-

erators we contacted said they had found an advantage to using NBVM under certain conditions. Another point to remember is that the spectrum-saving frequency-companded mode is useful only when the stations at both ends of the QSO are equipped for NBVM.

Reception of frequency-companded signals on an ordinary receiver is possible, as outlined in the accompanying "Listening to NBVM" box, but the process is cumbersome and the fidelity is quite poor. A successful contact between an NBVM station and a non-NBVM station is an extremely unwieldy method of communication. It's doubtful that amateurs without NBVM will have much interest in participating in NBVM testing. Although such participation was suggested in the September, 1978, issue of *QST*, there is little useful information which non-NBVM stations can gather by listening to frequency-companded signals.

It would be shortsighted simply to dismiss a technology that promises more efficient use of the amateur bands. However, it is equally shortsighted to jump at the first new technique to come along and begin promoting it as the most important innovation since single sideband. This tends to discourage exploration of other promising methods such as digitalized speech, time multiplexing, and synchronous detection.

Regardless of the methods used to achieve a savings in spectrum, the advantages of reduced bandwidth, power savings, and signal-to-noise ratio improvement must be weighed against the increased complexity, loss in fidelity, and higher cost. When SSB was introduced, most amateurs were skeptical of the new mode, much as they are now skeptical of NBVM. In

the case of SSB, though, its clear superiority over AM convinced the skeptics; the benefits obviously outweighed the costs. After our tests, we at 73 do not believe that NBVM, as applied in the VBC Model 3000, offers that same clear superiority over our present modes of communication.

More experimentation with reduced-bandwidth techniques is needed. Also, it's important that ideas be shared among experimenters. If you are having success with any reduced-bandwidth system, including VBC's Model 3000, be sure to document your work, write it up, and send it to us for publication in 73. Let's all work together to develop a viable system. ■

#### **References**

- Baldwin, "Dawn of a New Era?"—*QST*, September, 1978.
- Harris and Cleveland, "A Baseband Communications System, Part I," *QST*, November, 1978.
- DeMaw, "Narrow Band Voice Modulation," *The Radio Amateur's Handbook*, 1979 edition.
- Operators Manual*, NBVM Baseband Transceiver VBC Model 3000, VBC Inc.
- Wilmotte and Lusignan, "Spectrum-Efficient Technology for Voice Communications," *UHF Task Force Report*, Federal Communications Commission, February, 1978.
- Spence and Higginbotham, "UHF Task Force Presentation on Spectrum Efficient Technology for Voice Communications," *Memorandum to the Commissioners*, Federal Communications Commission, February, 1978.
- Tall, "Spectrum-Efficient Technology," *Industrial Communications*, February 3, 1978.
- Harris and Cleveland, "Efficient Bandwidth Communication Using Audio Signal Processing," *Modern Design & Concepts for RF Communications, MF through Microwaves*, 1979 Electro Professional Program, April, 1979.
- Baldwin, "Another Opportunity for the Amateur Radio Service," *QST*, March, 1978.

# M & M For Quality Ham Products at Discount Prices!

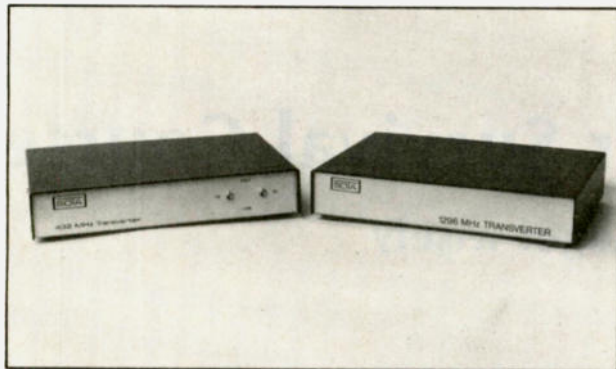

## LINEAR TRANSVERTERS

M&M has been appointed the exclusive U.S. distributor for these new products from SOTA Communications Systems Ltd. These units are produced by SOTA under a license agreement from UKW, and are the commercial versions of some products previously in issues of VHF Communications.

### 1296 TRANSVERTER

- Receive NF under 3 dB
- Image Rejection 20 dB or better
- Output Power 2½ W min
- Covers 1296-1298 with 28-30 MHz input.
- 144 MHz available soon.

### 1296 CONVERTER

- Receive portion of transverter only with same specs

### 1296 POWER AMPLIFIER

- 50W output
- Built-in AC Supply
- Compatible with transverter

M&M has the items listed below for immediate delivery. Call for quote now before prices go up at first of year.

### TRANSVERTERS

SOTA	23 cm 2W out	28 MHz in	\$499.95
SOTA	23 cm 2W out	144MHz in	\$499.95
SOTA	70 cm 15W out	28 MHz in	\$424.95

### CONVERTERS

SOTA	23 cm	28 MHz IF	3 dB NF	\$149.95
SOTA	23 cm	144 MHz IF	3 dB NF	\$149.95
SOTA	70 cm	28 MHz IF	2 dB NF	\$124.95
LUNAR	70 cm	OSCARBOX 'J'		\$124.95

### POWER AMPLIFIERS

SOTA	23 cm	50W output AC Supply	\$699.95
SOTA	70 cm	50W output AC Supply	\$499.95
MMW	70 cm	50W out 12.5V (MML 432/50)	\$369.95
LUNAR	220 & 144 MHz	power amps also - call for quote	

### ANTENNAE

SI	23 cm	28 el Loop Yagi	\$59.95
RIW	70 cm	19 el Yagi	\$59.95
NMT	1.3 m	11 el Yagi (220 & 223 models)	\$54.95
NMT	2 m	11 el Yagi (144 & 146 models)	\$59.95

Year end close out KR-500 elevation rotors - \$150.00

**RIW ANTENNAS  
SPECIAL YEAR END  
CLOSE-OUT PRICES!**

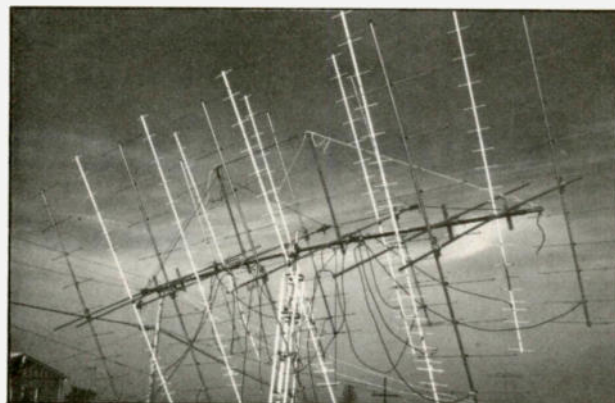

## YAGI ANTENNAS

Announcing the new NMT-11 series of 144 & 220 MHz Yagis. Originally developed by WB6NMT for his pioneering 220 MHz work, these modern designs meet the demanding criteria required by all serious VHFers. High gain with high efficiency; good mechanical strength without additional boom structures; vertical or horizontal mounting; all elements ¼" thru the boom, insulated mounting; driven element ½" brass tubing with tunable insert (may be silver plated); integral 50 ohm 4:1 balun included; SO239 or type N connector options; models for each sub-band for optimum performance where you want it. EME proven on 144 and 220 bands.

### General Specs:

	144 MHz Model	220 MHz Model
Boom Diameter	1 ¾"	1 ¾"
Active boom length	17.4 ft	11.5 ft
Mast clamp accepts	to 2½" diam	to 2½" diam
Parasitic elements	¼" aluminum	¼" aluminum
Driven element	¼" brass w/ insert	¼" brass w/ insert
Beamwidths	31° E 34° H	31° E 34° H
Stacking (-20 dB lobes)	9.9' E 8.8' H	6.5' E 5.8' H
Stacking (max gain)	12.9' E 11.9' H	8.4' E 7.8' H
SWR (at resonance)	less 1.1:1	less 1.1:1
Relative gain	-0.5 dB ref 3.2 NBS	-0.5 dB ref 3.2 NBS
Bandwidth NMT-11/144	144-146 MHz	
Bandwidth NMT-11/147	145.5-148 MHz	
Bandwidth NMT-11/220	220-222.5 MHz	
Bandwidth NMT-11/223	222-225 MHz	



**KEN PRO KR 500  
ROTATORS  
SPECIAL YEAR END  
CLOSE-OUT PRICES!**

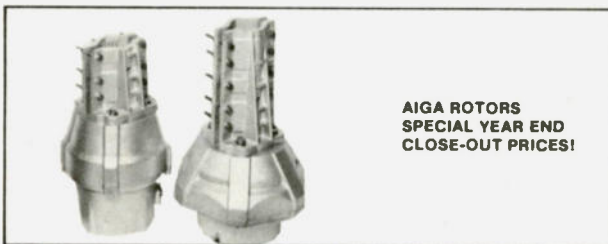

**AIGA ROTORS  
SPECIAL YEAR END  
CLOSE-OUT PRICES!**

# M&M RF DISTRIBUTORS

2785 Kurtz Street, Suite 4, San Diego, CA 92110  
P.O. Box 82183, San Diego, CA 92138

**CALL (714) 299-9741**

✓ M76

# Frequency Counter Survival Course

## — use that gadget wisely

**M**y article in 73, "DMM Survival Course," (May, 1978, page 62), was so well received that I thought a continuation of the articles on test equipment would be helpful to the public. I was (and still am) surprised at how much ignorance there is in using modern test equipment;

however, that may not be the fault of anyone but the people who write the equipment operating manuals! This is true in the industry where test-equipment manufacturers assume that the user already knows how to use, at least basically, a DMM, counter, scope, or what-

ever. So the manuals are usually very general, and that doesn't help out the average ham-radio user, an occasional test-equipment user, very much! Anyhow, that's my impression of some manuals I have seen on new test equipment, plus the general consensus of a lot of input from hobbyist users. Since those new test instruments cost so much more than in the old days, but do so much more for the money, it pays you to learn about your equipment! And that is what this article is about. We will primarily deal with the pitfalls seldom discussed in operating manuals and learn how to get the most in performance out of our frequency counter.

manufacturer. Counters are pretty easy to use on the surface; just connect power, a signal to be measured, and read off the frequency. Great! That is where your troubles can begin. First, let's look at your power supply. If the unit is battery-powered, a slight error can be introduced by weak or over-charged batteries. Usually, this is on the order of a few parts per million (ppm) or, say, 1-2 Hz out of 1 MHz. The counters using the Intersil chip set, widely used in ham counters, are stable to within 1 ppm, but I have evaluated other counters with errors of 10 ppm (10 Hz/1 MHz) and worse. This is especially apparent with weak batteries. Also, your input sensitivity (sensitivity to the input signal being measured) may drop with weak batteries. This can cause errors in your measurement if you are measuring a weak signal. The input picks up only *part* of the signal being measured; your frequency reading will be *low*. Play it safe and always keep your batteries fully charged! Or use the charger to power your counter. Ac-powered units are less prone to power problems, but there is one type of counter that is sen-



The shape of things to come... a pocket-sized 135-MHz counter.

sitive to the line frequency. You don't see many of these counters anymore; they are cheapies, but, for a time, Hewlett-Packard and several surplus dealers offered units that derived their clock timebase (determines the accuracy of your counter) from the power line. These units are only about  $\pm 0.033\%$  accurate when powered from a wall outlet, and accuracy is zilch if the unit is powered from a generator or inverter in the field. Needless to say, if you have one of these units, power it off the ac line or build a crystal-controlled clock generator for it.

The signal you apply to your counter is important, too. In fact, I could write a book on the subject. But I'll cover only the most important areas that will affect you in this article.

The type of signal is very important. If you feed your counter a signal that is varying in amplitude, or contains some FM, you will get a changing, often inaccurate reading. That is because your counter measures or counts the number of cycles in your unknown signal in a given length of time. The time is called "gate time" and is usually 1 second, 0.1 second, and so on. Some counters even have a 10-second gate time for audio signal measurement.

*The point is, your accuracy depends upon the stability of your signal to be measured!* If you are measuring the frequency of a transmitter, you must use the CW position. No AM, FM, or SSB allowed. Modulation causes changes in the signal and a shifty reading on your counter. Also, play it safe and use a dummy load on your transmitter to prevent QRM. I might add that there are special counters with phase locked loops that will track FM signals, but

they are still too costly for home use. If you are experimenting with circuitry on the bench, such as with an oscillator circuit, you may find the counter causes drift when it is connected directly to the circuit. In this case, couple your counter to the output of the circuit with a small value capacitor/resistor combination (I found that a 5-pF/100-Ohm combination is okay at VHF frequencies). Or, if your frequency is below about 60 MHz and your counter has a 1-meg input impedance, use a x10 oscilloscope probe. You'll lose sensitivity, but you'll make a big gain in stability. The idea here is to couple your circuit as loosely as possible to the counter (a dummy load) to reduce drift readings. Coax cable becomes a load as the frequency goes up, so try to avoid using cable between your oscillator and the counter. Instead, put the coupling cap/resistor between the circuit and your counter's input cable. Luckily, this type of stability problem doesn't come up often, but you should be aware of it.

The amplitude of your signal is important, too. It must not be too low or your counter will count only part of it, or worse, noise on it, and give a false reading. At the same time, the signal must not be too great or you'll run the risk of damaging the input of your counter. Since a sick counter generally must be sent to the factory, fixed, and returned, you'll be saving yourself a lot of trouble if you pay attention to the level of the signal you apply to your counter!

Weak signal can be quite a problem, first in the fact that you must be aware of it. Most counters will display a frequency *higher* than the true frequency—if they read at all. This is due to noise spikes that

ride on top of the signal. Needless to say, a weak signal can fool you.

The secret of success is to be sure you have enough signal! On most counters, this is a level above 50 to 100 mV rms. If you aren't sure, increase the signal level to the counter by coupling better to the source. If you are measuring a transmitter and using a whip antenna on your counter, move the whip closer to the feedline or transmitter antenna. If you are experimenting with a circuit, try another pickup point and compare readings. You will find that increasing the signal beyond a certain point determined by the counter will cause no further change in your readings.

I can't emphasize too strongly how important your minimum signal level is; it plays a big factor in the accuracy of your measurements! The signal level must not be too great or you will damage the front-end circuitry in your counter. This is very easy to do around transmitters (more to follow).

Ideally, the owner's manual will spell out the maximum signal voltage to apply to your counter. You should find that it is related to frequency; 120 volts ac, 60 Hz, and on down to 20 volts at 30 MHz is a typical spec. If you aren't sure how much the maximum level is, use 10 volts rms as a rule of thumb. Also, any dc offset in that signal must be tolerated; most counters are limited to about 100 volts dc plus the signal peak value. Check your manual for any info on dc offsets; if there is no mention that the counter will take dc voltages, put a 0.1 uF capacitor in series with the input lead whenever you measure signals at the collector of a transistor, or anyplace else dc-plus

signal would be present. If you don't block out the dc component, the counter input stage may be biased on so hard that it won't count your signal. This is especially important as most service/hobby grade (the ones in the plastic cases) counters are affected by dc offset.

An area that must be explored is the relation between counters and radio transmitters. Usually, the operating frequency is measured by sampling off a signal in a low-powered stage in the transmitter, which is run in the CW (tune-up) mode. Since it usually isn't practical to do this with existing transmitters, you must do the next best thing and use a whip antenna on the counter. This works well, but noise pickup can be a problem with high-impedance inputs. This problem shows as random counting with no signal, and the cure is to tie a 1-mH rf choke across the input. With low-impedance inputs, this is no problem, however. In operation, the counter/whip is placed near the transmitter or its antenna, if possible, and the frequency is read off the counter display when the transmitter is keyed. This is easy and convenient to do. However, someone is sure to connect the counter directly to the transmitter. Don't!

Let me illustrate what happens: Several years ago I was an NCO in an instrument shop at an Army post. One of the troops connected a counter to a 1 kW linear and transceiver under repair. When he pressed the mike button, both the linear and the counter went up in a big cloud of smoke. Needless to say, that was a very expensive accident! And the Fort Huachuca instrument lab lost a budding (but misguided) technician!

Never make the costly mistake this guy did. And one more thing: Use a dummy load whenever possible.

After you have power and a signal to be measured, you are set to read the frequency off the display. To get the most accurate reading, you must take full advantage of all digits you have. Try to fill up as much of the display as possible; a readout of, say, 60.0000 MHz is much more accurate than 0060.00 MHz. Remember that the larger the number, the more accurate your reading will be. This is because you will have several forms of error in the two right-most digits; there is a  $\pm 1$  count error (or  $\pm 1$ ) in the right-most digit, and any errors in your timebase will show up in this and the next digit. So, if you refer to the frequency illustration just made, the errors would show up in the 1k and 100 Hz positions, and that is better than having your errors show up in the 100k and 10k positions. To fill up the display, just set

your timebase switch for longer gate time, which gives you more numbers. Generally, a 1-second gate time will provide optimum accuracy in your measurements. Also, most non-switchable counters have this gate time built in, so you are all set. However, this holds true only for rf signals. If you are measuring audio or other low-frequency signals, you will run into trouble with a 1-second gate time. Why? Suppose you are measuring 100 Hz. With a 1-second gate time, you will measure "100". In reality, you will see readings like "099", "100", "101", "100", and so on. This is the result of the  $\pm 1$  count error mentioned earlier. That is a  $\pm 1\%$  error! If you can live with 1%, fine! But if you are fussy like me, you'll switch your counter to the 10-second timebase position and read "100.0" Hz and get an error of only 0.1%. Of course, if you don't have a 10-second timebase position, you are stuck. But more counters

have them, and better yet, many have a method for even greater accuracy — *period measurement*. In this mode, you measure frequency in terms of period, then convert from time back to frequency. If your frequency is stable, you can push out your accuracy at least to 0.001%. If you have a counter-timer with period measurement, use it for speedy, accurate measurements of frequencies below 10 kHz.

As an interesting sidelight, I worked with an interesting application of time-period counters several years ago. Digital watches must be calibrated after they are assembled. The watch is placed over an electrostatic pickup and energized. The "noise" from the LED display (LCD watch in my case) is picked up and counted. It is then measured on a period counter and converted to numbers showing % deviation from the correct frequency. The operator adjusts the watch so that the reading is 00. And the result is a very accurate watch! This idea isn't new; I believe it was used with analog watches, but it is still simple and clever. And fast, too. We built a unit like this in 1973 thinking the idea was original, but it wasn't.

Now that you have a good idea of how to get the most accuracy out of your counter and have read about the pitfalls most counters have, let's concentrate on other areas that affect the performance of your counter.

First, the operating temperature your counter is used in affects accuracy. Ideally, that counter should be used as close to the temperature it was calibrated at as possible. Why? The crystal used to generate the clock or timebase is temperature sen-

sitive. Also, the oscillator circuit used in conjunction with it is, as well. If you use the counter at a different temperature than what is calibrated at (hopefully 25° C.), error will creep into your readings. The amount of error can be as high as 20 ppm, enough to affect your readings. And the effects of the error really show up when you are measuring low frequencies. Also, at VHF frequencies, the error can throw you off. So the best thing for you to do is operate your counter as close to 25° C. as possible. I might add that the more expensive counters have temperature-compensated oscillators (medium-cost units) or temperature-controlled ovens (high-priced units). The oven-controlled counters are normally left plugged in with the oven and oscillator left running at all times, so accuracy is optimized. Regardless of what type of counter you own, it should be turned on for at least a half hour before use. This will allow the internal temperature to rise and stabilize, allowing the best accuracy. If you own a battery counter, this isn't possible, of course, but using it at room temperature will still give you the best accuracy.

You should know that the crystal in your counter is also subject to aging. That means that with time and use its frequency will drift. Also, changes in the oscillator components will probably result in the same effect, in even greater magnitude. So, if you are going to be making a highly-accurate measurement, calibrate the counter on a frequency standard first, then use it as soon as possible (hopefully without turning it off if the counter is ac-powered). This one step can often "buy" you an extra 20 Hz of accuracy or so. It's an important step! This mag-

#### Square-Wave Input Signals and Your Counter

This is one section that deserves special mention and that is why it is in a section of its own. Sooner or later, most counter users try to measure square-wave signals with a counter. The result is error in the readings, with a display of double the correct frequency being typical. There are several reasons for this, the most important being the fact that most counters will trigger on both the positive and negative edge of each half cycle of the waveform, effectively giving a reading of double the correct value.

Also, the harmonic-rich signal can cause ringing in your cables and, in some cases ringing in your input circuitry. The counter may trigger on these "rings" and give you a completely false reading.

The solutions to these problems are fairly simple and straightforward. If your problem is cable ringing, connect (terminate) the *counter end* of the cable with a 50-75-Ohm resistor. The value is to match the characteristic impedance of the cable. Or use the low-impedance input (often VHF prescaler input) on your counter for best results. If the resistor drags down your signal too much, eliminate or sharply reduce the size of the cable; longer cables aggravate ringing. If your counter front end is at fault, and at HF frequencies this will often be the case, try to "soften" the *edges* of the waveform you are measuring by using a x10 scope probe between the counter input and your signal. This simple step will often work with high-impedance counter inputs and TTL level signals. Try it!

NEW MFJ-410 "Professor Morse" lets you . . .

# COPY CW FASTER AND UPGRADE QUICKER

NEW MFJ Random Code Generator/Keyer sends unlimited random code in random groups for practice. Never repeats same sequence. Tailor level to your ability. Vary speed 5 to 50 WPM. Vary spacing between characters. Speed Meter. Full Feature Keyer.



**BRAND NEW**

*Sends unlimited random code. Never repeats same sequence. Tailor level to your ability. Vary speed 5-50 WPM.*

**\$149<sup>95</sup>** ✓M52

Copy code faster and upgrade quicker. Now you can tailor the level of code practice to your exact needs. Practice copying code anywhere and anytime you have a spare moment. Practice at home, in bed, driving to work, during lunch, etc.

The new MFJ-410 "Professor Morse" is a computer-like random code generator and keyer that sends an unlimited supply of precision Morse Code in random groups.

It never repeats the same sequence so you can't memorize it like code tapes.

Vary speed 5-50 WPM and read on speed meter.

Vary spacing between characters and character groups (for example, copy 5 WPM with 13 WPM characters) to give proper character sound at low speed.

Select alphabetic only or alphanumeric plus punc-

tuation (period, comma, question, slash, double dash.)

**Tone control.** Room filling volume. Built-in speaker. **Ideal for classroom teaching.** Earphone jack (2.5 mm) for private listening.

**Uses 110 VAC, or 9-18 VDC, or 4-C cells** (for portable use). Optional cable for car cigarette lighter (\$3.00). 6x2x6 inches.

**Built-in full feature keyer.** Volume, speed, internal tone and weight controls. **Weight control** adjusts dot-dash space ratio; makes your signal distinctive to penetrate QRM. Speed meter works for keyer, too. Tune switch keys transmitter for tuning. Reliable solid-state keying: grid block, cathode, solid state rigs. **OPTIONAL BENCHER IAMBIC PADDLE.** Dot and dash paddles have fully adjustable ten-

sion and spacing. Heavy base with non-slip rubber feet eliminates "walking". \$39.95.

**Order from MFJ and try it — no obligation.** If not delighted, return it within 30 days for refund (less shipping). One year unconditional guarantee.

**Order today.** Call toll free 800-647-1800. Charge VISA, MC or mail check, money order for \$149.95 plus \$3.00 shipping for MFJ-410 and/or \$39.95 plus \$3.00 shipping for Bencher paddle.

**CALL TOLL FREE ... 800-647-1800**

Call 601-323-5869 for technical information, order/repair status. Also call 601-323-5869 outside continental USA and in Mississippi.

**MFJ ENTERPRISES, INC.**  
BOX 494, MISSISSIPPI STATE, MS 39762



## Where's the WHEATON HAMFEST / 9 ?

WE MOVED TO THE ARLINGTON PARK RACETRACK EXPO CENTER  
Arlington Heights, Illinois

WHEN??

JANUARY 27, 1980 • 8 AM to 6 PM

146.94

HOW MUCH ARE THE TICKETS?

\$2.00 By Mail

Talk in

\$3.00 At The Door

SEND CHECKS TO WCRA\*

Acres of Parking — Hundreds of Free Tables  
Hourly Prizes

WHAT'S SO GOOD ABOUT THAT?

MAIN PRIZE Kenwood 180S Station

DETAILS? Call WB9TTE (312) 766-1684

\*WHEATON COMMUNITY RADIO AMATEURS : BOX QSL : WHEATON, ILLINOIS 60187

azine has described several methods of calibrating counters using the TV chroma subcarrier ("In Search of the Ultimate Counter Calibrator," R. Bloom, April, 1978, 73), and I can't think of a better use for a TV. Pick a show you hate for best accuracy. Note that it must be a *live* network show!

Surprisingly, the place in which you keep your counter can affect ac-

curacy. Most hams love to stack their equipment, and that may mean the counter goes on top of a hot receiver or transmitter. The result is a slow drift in the displayed frequency as the counter case warms up. Try not to do this!

There are a number of miscellaneous hints for you to remember in using your counter. First, place the counter in a place where it can easily be seen,

and yet is not likely to fall on you or into a live piece of equipment. If the counter is dropped, always recheck its accuracy, as shock changes the crystal-frequency and oscillator-trimmer settings. Use a x10 probe, or set the counter's attenuator for x10 if it has one, when measuring large signals over a few volts. And keep the counter display away from sensitive pieces of equipment.

Modern counters have multiplexed displays and the noise they generate can drive a receiver up the wall!

Let me sum this up by saying it is always worth your time to use the suggestions I have made and to avoid the pitfalls I have mentioned. By doing so, you should be able to get longer life and better accuracy from your counter. ■

# DX with a Difference: the Utility Stations

— when the ham bands get frustrating, give SWLing a try

W. Page Pyne WA3EOP  
PO Box 1062  
Hagerstown MD 21740

With the recent emergence of general frequency coverage added to high quality ham transceivers, we hams may find ourselves drifting the dials beyond our band edges. In fact, our ability to listen and our right to listen to anything we please may bring us to stop the dial on what are known as utility stations.

A utility station is any station (excluding ham radio) which does not beam its transmissions for the general public. These broadcasts are limited to specific audiences and may be run by worldwide government or commercial enterprises.

By now, we all know of public service broadcasts of fire, police, and ambulance services which, by nature, are best trapped in the VHF and UHF world, where mostly they have migrated. However, there is a world of interest and ex-

citement hiding between the ham bands on the commercial and military channels, available on any general-coverage transceiver or receiver.

One note of warning: Although you are allowed to listen as you please, Secrecy of Communication laws generally prevent you from revealing what you have heard.

What can you hear? There are at least four distinct types of services which make up the utility stations. These are time-

and frequency-standard stations, aeronautical and weather stations, coastal stations, and fixed point-to-point stations.

## Time- and Frequency-Standard Stations

Most of you are familiar with the transmissions from WWV and CHU. These are the main North American time and frequency stations. In the case of WWV, propagation and weather information to a degree is included with the regular time information. There are, however, other stations, near and far, which operate like "clock-work." A list of some of the more interesting ones (some easy, some hard to hear) is included with this article (see Table 1).

## The Aeronauticals

The aeronautical stations, especially the weather stations, utilize announced frequencies on a time-shared basis. It is quite possible, given the right propagation condi-

Call and Location	Frequency	Air Schedule (GMT)
BPV Shanghai, China P.R.	9368	5 min. before 0600, 1100, 1300, 1500, 1700, 2100, 2300
CCV Valparaiso, Chile	8558	5 min. before 2000, 0100
CHU Ottawa, Canada	3330, 7335, 14670	24 hours French & English
FTK77 Pontoise, France	10775	5 min. before 0800, 2000
DAM Elmshorn, Germany F.R.	8638.5, 16980.4	1155-1206
NPN Mariana, Guam	4955, 8150, 13380	5 min. before 0600, 1200, 1800, 2400
PLC Jakarta, Indonesia	11440	5 min. before 0100
VWC Calcutta, India	4286 12745	5 min. before 1630 5 min. before 0830
NSS Annapolis, Maryland	5870, 8090, 12135	5 min. before 0500, 1100, 1700, 2300

Table 1. Interesting time stations.



## CUSTOM TRANSFORMERS

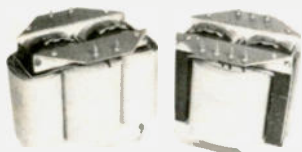

### HEAVY-DUTY REPLACEMENT TRANSFORMERS

BTLK-2000 Plate	\$135	HEATH HA-10 Plate	\$115
COLLINS 305-1 Power	\$215	HEATH HX-10 Power	\$95
COLLINS KWS-1 Plate	\$135	HEATH SB-220 Plate	\$125
COLLINS S16F-2 Power	\$95	HENRY 2K Plate	\$150
DENTRON 160-10L Power	\$125	HENRY 2K-2 Power	\$155
DRAKE L4B Plate	\$165	HENRY 2K-4 Power	\$165
GONSET GSB-100 Power	\$95	HENRY 3K-A Plate	\$165
GONSET GSB-201 Power	\$135	HENRY 3K-A DC Choke	\$85
H-CRAFTERS HT-32 Power	\$95	EFJ T-BOLT Plate	\$125
H-CRAFTERS HT-37 Power	\$95	EFJ 500 Modulation	\$95
HEATH DX-100 LV Power	\$95	EFJ 500 DC Choke	\$75
HEATH DX-100 Modl	\$95	NATL NCL-2000 Plate	\$125

### OFF-THE-SHELF SPECIALS

PLATE XFMR:	3000 VAC @ 3.0A CCS 230 PRI-120LB	\$450
PLATE XFMR:	2400 VAC @ 1.5A ICAS 220/240 PRI-41LB	\$150
PLATE XFMR:	3000 VAC @ 1.5A CCS 230 PRI-60LB	\$195
PLATE XFMR:	3000 VAC @ 0.7A ICAS 115/230 PRI-27LB	\$115
PLATE XFMR:	3500 VAC @ 1.0A ICAS 115/230 PRI-41LB	\$150
PLATE XFMR:	4000/4600 VAC @ 1.5A ICAS 230 PRI-60LB	\$195
PLATE XFMR:	6000 VCT @ 0.8A CCS 115/230 PRI-41LB	\$150
FILMT XFMR:	5.0 VCT @ 30A 117 PRI-9.5LB	\$30
FILMT XFMR:	7.5 VCT @ 21A 117 PRI-9.5LB	\$30
FILMT XFMR:	7.5 VCT @ 55A 115/230 PRI-14.6LB	\$65
FILMT XFMR:	7.5 VCT @ 75A 115/230 PRI-20.2LB	\$95
FIL CHOKE:	30 AMP Bifilar Wound on 1/2" x 7" rod	\$9
DC CHOKE:	8.0 Henries @ 1.5 AMP DC 4 1LB	\$150
SWG CHOKE:	5-30 Henries @ 1.0 AMP DC 23LB	\$100

ALL TRANSFORMERS & CHOKES GUARANTEED FOR 24 MONTHS

Many others also available. Write for free list or quote on any custom transformer, choke, or saturable reactor.

## Peter W. Dahl Co.

4007 Fort Blvd. - El Paso, Texas 79930

Telephone (915) 566-5365

✓ D6



### MODEL TR70A

ATV RECEIVING CONVERTER, 420-450 MHz



- TUNABLE—vernier tuned, 420 to 450 MHz
- HIGH PERFORMANCE—low noise RF preamp., mosfet mixer, mosfet IF amp. [Ch 2 or 3 out]
- SELF-CONTAINED—including power supply
- 1 YEAR WARRANTY
- PRICE: \$ 88.00 [includes shipping. Add \$ 1.15 for COD shipment]

To order, or receive detailed information, write us or call us at 1-812-336-4775

**APTRON  
LABORATORIES**  
PO BOX 373, BLOOMINGTON, INDIANA, 47402

✓ A6

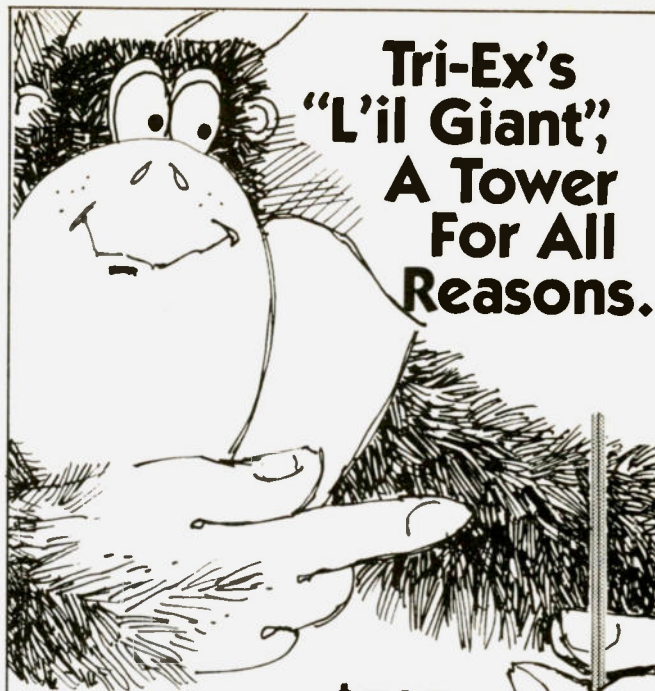

## Tri-Ex's "L'il Giant", A Tower For All Reasons.

MODEL NO. ED40 **\$595**

Like a legendary character of yesteryear, the new TRI-EX "L'IL GIANT" is destined to become a modern-day Superstar . . . among crank-up towers that is. It's strong, durable, yet lightweight.

Four 12 foot (3.6m) sections, each with a solid 2 1/2 foot (.76m) telescoping overlap for added strength. Cranks up securely and effortlessly to heights of up to 40 feet (12m).

Now available from your TRI-EX dealer, the "L'IL GIANT" is truly versatile. Use it for 2-way radio, Ham radio, CB, TV, FM, etc.

Here are some of the reasons why "L'IL GIANT" is headed for stardom:

- Compact — Only 13' (4m) when nested.
- Made of TRIEXIUM™ — TRI-EX Tower's exclusive space-age metal alloy . . . it's non-corroding and maintenance-free (never needs painting).
- Lightweight — Only 77 lbs. (35kg) including winch.
- Strong — Holds 6 sq. ft. (.56m<sup>2</sup>) antenna load in 50 mph (80kph) wind. Carries 50 lbs. (23kg) dead load.
- Square Tubing Design—Minimizes tower twisting, stabilizes antenna direction.
- Easily Erected — Usually can be put up by one person in 1/2 hour or less.
- Hinged Base — Allows easy push up to vertical position.
- Safety Winch — Will not free spin. When retracting, tower must be cranked down.
- Stainless Steel Hoisting Cable.
- Will conform to Electronic Industries Association Standards.
- Price Is Complete: Includes Guying Kit. Guys required only at first level, 12 feet (3.6m), and at top.



**Tri-Ex**  
TOWER CORPORATION

7182 Rasmussen Ave.  
Visalia, CA 93277

✓ T76

See your dealer or call  
TRI-EX for name of  
nearest dealer 209-625-9400.

tions, to hear several different aviation weather stations on a single shared frequency within an hour's time. Gander, Newfoundland, and New York aeroradio share four common frequencies. Each signs on immediately after the other signs off. (See Table 2.)

In addition to the easy catches, some African broadcasts may be heard on 8896 and 11279 kHz—and try listening on 5561, 8819, or 10017 for a broadcast from Asia. These are by no means all the frequencies used, but if fate is kind, you may hear Singapore or Beirut and a host of others.

One other fact is that most of these stations will QSL if approached politely and return postage is included with your report. Sometimes it is advisable to include a prepared form QSL so that someone at the station can simply fill in a few blanks, sign the card, and drop it in the mail.

It may be helpful to include return postage from the country heard back to you. US stamps are not valid for this purpose in most countries. All is not lost for the QSL hunters, however. George Robertson is a gentleman who conducts a DX stamp service for hams and SWLs. For an SASE, George will send you a listing of prices and countries for which he stocks stamps. His address is DX Stamp Service, 7661 Roder Parkway, Ontario, New York 14519. Tell him that *73 Magazine* sent you.

While on the subject of weather broadcasts, I might mention that the US Coast Guard also transmits broadcasts of about 10 minutes duration several times daily. The station at Portsmouth, Virginia, has been known to use 6505, 8765, and 13113 kHz (approximate), and you should listen around 0400, 1130, 1600, 1730, and 2200 GMT.

Call and Location	Frequencies (kHz)	Time Past the Hour (mins.)
WSY70 New York, N.Y.	3001, 5652, 8868, 13272	00-20 & 30-50
VFG Gander, NFD, Canada	3001, 5652, 8868, 13272	20-30 & 50-60
KSF70 Oakland, Calif.	2980, 5519, 8903, 13344	05-10 & 35-40
JMA Tokyo, Japan	2980, 5519, 8903, 13344	10-15 & 40-45
-- Hong Kong	2980, 5519, 8903, 13344	15-20 & 45-50
KVM70 Honolulu, Hawaii	2980, 5519, 8903, 13344	20-25 & 50-55
KIS70 Anchorage, Alaska	2980, 5519, 8903, 13344	25-30 & 55-60

Table 2. Aviation weather for Atlantic and Pacific areas.

Again, these are just some of their broadcasts, but if you stay tuned, you may hear others at different times.

Getting back to strictly aeronautical stations, we find that most long-haul international air traffic is still conducted on the high frequencies. Airports, aircraft, and beacons all can be heard within certain bands. Some of these stations, such as San Juan on 8945 and Piarco Trinidad on 8847, have been known to QSL usually by the pre-paid-form card method. Listen especially in the bands 6525-6765 and 8815-9040 kHz for this air traffic.

### The Coastal Stations

Coastal stations also are either commercial or military. The commercial stations may relay telephone communications, telegrams, weather, or other information for the ships in the merchant fleets, or even to pleasure vessels still in harbor. Whereas many stations of an aeronautical nature use phone only, the coastal stations use phone and CW fairly equally. Like us hams, their bands have been divided into separate CW and phone segments. The phone usage may be either AM or SSB. For CW, expect speeds of 15 wpm and up. Try listening in the bands 6345-6495, 8459-8705, and 12690-13070 kHz. For phone transmissions, the best bets are 6515-6525, 8725-8815, and 13170-13200 kHz.

The entire world is represented by coastal sta-

tions. Some of the more readily heard are CUL, Lisbon, Portugal; DAN, German Federal Republic; WSL, New York; IAR, Rome, Italy; WCC, Chatham, Mass; GKE, Great Britain; and VCS, Halifax, N.S., Canada.

The CW band on 8 MHz is perhaps the most active. Sometimes these stations will send marker transmissions. These markers take two or three recognizable forms.

Look first for the V marker. A typical exchange might give 3 Vs followed by the call of the station. Sometimes a chain of calls might be heard. In this case, several stations are hooked electronically to a master operator, human or otherwise, and several transmitters are being keyed at once, on different frequencies. Usually, each frequency is licensed with a different assigned call. It is done this way so that stations with traffic may tune into the best signal receivable for band conditions. Often a V marker by the same basic station may be heard on several bands at once. This also makes for more use of our radio spectrum and is one of the reasons that commercial interests will be attempting to secure more and more frequencies at future World Administrative Radio Conferences. Many of the coastal commercial stations will QSL if the prepared-form card method is used.

The military also has its share of the coastal stations. In the United States, the Coast Guard handles

the military coastal traffic. The Guard regularly schedules broadcasts on 2670 kHz. Depending on location, you may hear weather advisories, including ice conditions. Sometimes vessel operators are told of naval operations in specific geographical areas. (Listen then for the Navy on 6723 kHz.)

Some of the popular Coast Guard frequencies are 6506, 8710, 8765, and 13113 kHz. Other types of coastal station markers include the popular CQ when actually looking for a call and the simple DE identification marker. The DE marker is used for transmitter adjustments and sometimes is used interchangeably as a V marker. Often the CQ marker will say QSX and give reference to the band being tuned by the station for responding calls. Some of the popular coastals like WSL generate so much QRM on the return calls that you would sometimes think they are rare DX in a contest!

### FPTP or Else

Our final category of stations are those in the fixed point-to-point service. These stations offer a real variety of listening and are sometimes challenging because it may be difficult just to be able to copy such a feed. These utility stations, as the name implies, are directing their transmissions to one particular receiving site.

These stations are operated by commercial, aeronautical, or military sources. (Even spies, I guess!) The vast majority

**AUXILIARY POWER**  
for Emergency or Portable Operation

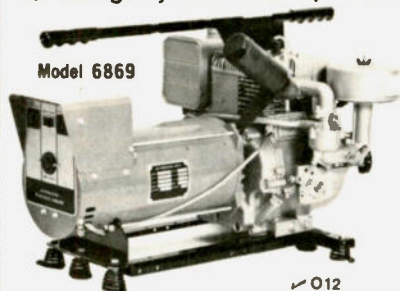

Model 6869  
O12

Light wt. Portable Alternator. Stand-by power for Ham Equipment, household needs during power outages or operation in remote areas. Operates lighting, refrigerators, heating systems or other appliances including freq. sensitive loads such as TV sets, induction motors and fluorescent lights. Solid-State voltage regulation. 3750W rating; 25% surge capacity. 120/240V at 31.3/15.6A. 8 HP/3600 RPM B&S engine. Alternator draws just enough engine output to meet load resulting in up to 25% fuel savings. Low interference. Advanced design. Drip-proof construction protects windings from rain and dirt assuring long life. One year warranty by manufacturer. 30"L x 18"W x 19"H. 128 lbs. Shipped via Truck

**PREPAID (No extra charges) . . \$725.00**  
Electric Start. . . . . 121.00  
Battery Charging. . . . . 12.00  
Spark Arrest Muffler. . . . . 23.00

Models available with 1350 to 7000 watt ratings. Write for our quote and additional information.

**Mastercharge or VISA accepted**

**OUTDOOR OUTFITTERS**  
705 Elm Ct. Waukesha, WI 53186  
Ph. 1-414-542-7772 • Ken, N9KS - Mgr.

**new COAX SWITCHES**  
from Barker & Williamson

**Model 593**

- **Single Pole 3** Position with grounding of all unused positions
- **Crosstalk** (measured at 30 MHz) is -45db between adjacent outlets and 60 db between alternate outlets



**Model 594**

- **2 Pole 2 Position**
- **Crosstalk** 45db (measured at 30 MHz)



**Specifications for both switches**

- **Power** 1 KW-2 KW PEP
- **Impedance** 50-75 ohms
- **VSWR** 1.2:1 up to 150 MHz
- **Dimensions** 1 3/4" high, 5" wide, 3" deep
- **Weight** 1 lb.
- **Mount** Wall or desk

✓ B23 Available at your B&W dealer



Barker & Williamson, Inc.  
10 Canal St. Bristol, Pa. 19007  
Telephone: (215) 788-5581

**NEW MFJ SOLID STATE 24 HOUR DIGITAL CLOCK**

Eliminate converting to GMT. Pleasant BLUE easy-on-eyes display. Bright .6 inch digits. ID timer. Alarm, snooze, lock functions. Power out, alarm on indicators. Assembled.



**Pleasant Blue Display is easy-on-eyes.**  
Bright .6 inch digits.  
Built-in ID timer.

**\$29<sup>95</sup>**

The MFJ-101 is a new all solid state 24 hour digital clock. Just set it to GMT and forget about converting to GMT.

Pleasant blue .6 inch digits (like TS-820S) are easy-on-eyes and bright enough to see clear across your room.

ID timer alerts you every 9 minutes after you tap ID/doze button.

Set alarm to remind you of SKED or simply to wake you up in morning. Has alarm on indicator.

Fast/slow set buttons make setting time and alarm simple.

Lock function prevents missetting time/alarm. Digits flash if power is interrupted. Rugged black plastic case. Brush aluminum front/top panel.

UL approved. 110 VAC. 50/60 HZ switch for USA, Europe, Japan and other countries. Use

220/240 VAC with optional AC adapter. 6x2x3 in. Order from MFJ and try it — no obligation. If not delighted, return it within 30 days for refund (less shipping). One year limited warranty by MFJ.

Order today. Call toll free 800-647-1800. Charge VISA, MC or mail check, money order for \$29.95 plus \$3.00 shipping/handling for MFJ-101.

Don't wait any longer to enjoy the convenience of reading GMT time directly.

**CALL TOLL FREE . . . 800-647-1800**

Call 601-323-5869 for technical information, order/repair status. Also call 601-323-5869 outside continental USA and in Mississippi. ✓ M52

**MFJ ENTERPRISES, INC.**  
BOX 494, MISSISSIPPI STATE, MS 39762

**Station ID Timer and Code Practice Oscillator**

**ONLY \$19<sup>95</sup>**  
IN KIT FORM  
**\$26<sup>95</sup>**  
ASSEMBLED PLUS \$2.00 SHIPPING



**NEW!**

**NOW! EAGLE ELECTRONICS INTRODUCES** a practical accessory to every amateur station: The TM-1000™ 10 minute ID timer and code practice oscillator will remind you with a loud clear tone when it is time to identify. No longer is it necessary to keep an eye on the clock to be sure you identify in time; **the TM-1000™ keeps track of the time for you.** And, when you're not on the air, you can use it to improve your code speed because it **doubles as a code practice oscillator.**

**THE TM-1000™ HAS FULLY ADJUSTABLE** volume and tone and its timer is adjustable from 45 seconds to 10 minutes. It comes in an attractive walnut-grain cabinet and is powered by one 9v battery (not included).

**THERE'S NO NEED TO WORRY ABOUT** missed ID's during roundtables and QSO's anymore. **With the TM-1000™ in your station, you are assured of identifying in time.**

**THE TM-1000™ AUTOMATICALLY RESETS** after alerting you and can be reset any time by pressing the reset button.

**TRADITIONALLY, AMATEURS HAVE** endeavored to obey all regulations as closely as possible. **The TM-1000™ is an important aid to help amateurs** maintain that tradition by assuring that identification is accomplished at the proper intervals.

**THE TM-1000™ COMES WITH A 1 YEAR** guarantee and a 10 day, money back (less shipping) guarantee.

**SO ORDER YOUR TM-1000™ STATION ID TIMER/CODE PRACTICE OSCILLATOR TODAY FROM:**

**EAGLE ELECTRONICS®**

BOX 426C, PORTAGE, MI 49081  
or call 1-616-375-7469 to order COD or by bank card.  
Mich. res. add 4% sales tax.  
Optional AC adapter \$7.95 extra.

Selected Air Bases	kHz
Andrews—Forrestville, Maryland	6756, 13247
Clark—Manila, Philippines	8993, 11226
MacDill—Florida	8989, 8993
Yokota—Tokyo, Japan	8967, 11236

(Note: Above frequencies mostly SSB, but some AM may be used yet on all frequencies. Some other USAF frequencies in general worldwide use include 6738, 6753, 11179, 13201, and 18019.)

Table 3. Aeronautical calling frequencies, USAF.

of them don't appreciate our reception reports, but legally they can't stop you from listening.

Some of the international shortwave broadcasters use point-to-point feeders to give programming to their relay stations around the world. Some communist nations may refuse to admit they are on the air on feeder frequencies, yet they want the world to hear it all as relayed. (The games people play!) Although there must be 30 specific bands allocated to the point-to-point service, these bands are spread out over the HF radio spectrum. I have had

a fair amount of fun listening for these stations in the range of 10-13 MHz.

#### Help Is Nearby

If I have got you to the point of being interested in doing a little tuning between the ham bands, good!—as I'm sure you will find it great listening. There is more information available for the person who wants to get into the serious side of utility listening.

At least 3 US radio clubs give fair coverage in their bulletins to the utility stations. The oldest of these clubs is the Newark News Radio Club, P.O. Box 539,

Newark, New Jersey 07101, which was founded over 50 years ago and currently devotes four of its 36 pages monthly exclusively to utility DXing. The *NNRC Bulletin* often contains information on other utility reference works and identifies many of the popularly-heard utility stations by frequency, mode, type, call, and, when available, station location.

Another organization with an excellent utility section is SPEEDX, P.O. Box E, Lake Elsinore CA 92330. Utility coverage could run as high as eight pages monthly with military station information, publication notes, QSL reports, and station loggings. It should be noted that SPEEDX is shortwave broadcast and utility coverage only, while the *NNRC Bulletin* covers all major shortwave listening interests, including ham radio and TV/FM.

One other club with utility station coverage is the American Shortwave Listener's Club, 16182 Ballard Lane, Huntington Beach, California 92649. ASWLC's coverage may run to four pages monthly. Any of these clubs will be happy to send you a sample bulletin for one dollar shipping and handling charge. All of these clubs are accredited through the Association of North America Radio Clubs (ANARC), 557 North Madison Ave., Pasadena CA 91101. For an SASE, ANARC will send a listing of all clubs in the association along with a list of publications offered by the various clubs.

#### Books and Things

The main reference book for utility DXers has to be the *SPEEDX Utility Guide*. This book has 239 pages of detailed utility station information, including 40 pages devoted to the US Coast Guard and listings of high frequency

beacon stations, and, perhaps most important for the serious utility DXer, station addresses. Present cost is about \$7.00 shipped prepaid.

Another reference aid (for those who can afford it) is the ITU's International Frequency List. The list is in several volumes and the cost is a modest \$1500.00, or more by the time you read this. These rather large books are divided into frequency spectrum groupings, and the first four volumes take you from 10 kHz all the way through 28 MHz.

The ITU has many other publications for sale at substantially lower prices. Some of these include lists of coastal stations, lists of ship stations, *The Telecommunication Journal*, and more. If interested in further information on these, write directly to ITU, Place de Nations, Geneva 20, Switzerland, asking for their *List of Publications* catalog.

The Superintendent of Documents, Government Printing Office, Washington D.C. 20402 also publishes several books listing beacons and US Coast Guard radio stations. These are divided into US geographical areas and may be purchased separately. Write the GOP for availability and prices before ordering.

*Communications World Magazine*, Davis Publications, 229 Park Ave. South, New York NY 10017, often has valuable information for the utility DXer.

#### Finale

It doesn't take a great receiver or a super antenna to cash in on the fun of utility DXing. And when the ham bands are phooey from too many stations, it might be just the ideal time to spin the receiver dial and discover for yourself what lies beyond. You might be glad you did. ■

**DADE RADIO CLUB presents**



**1980**  
Southeastern Division Convention  
& 20th Annual  
**TROPICAL HAMBOREE**



**Flagler Dog Track  
Miami, Florida**

**January 26-27, 1980**

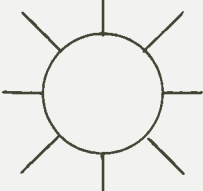
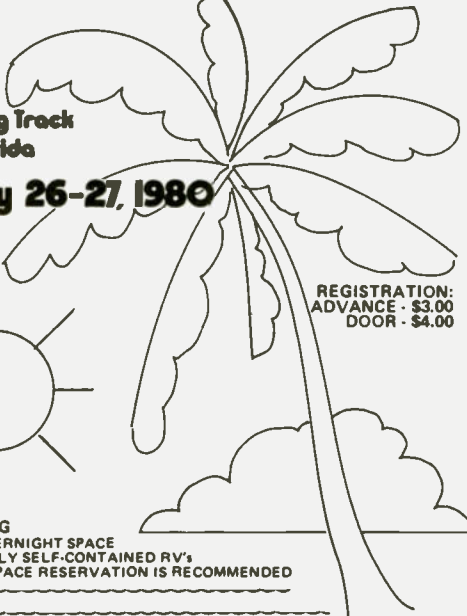
REGISTRATION:  
ADVANCE - \$3.00  
DOOR - \$4.00

FREE PARKING  
INCLUDING OVERNIGHT SPACE  
FOR COMPLETELY SELF-CONTAINED RV'S  
ADVANCE RV SPACE RESERVATION IS RECOMMENDED

For Additional Information Write:  
DADE RADIO CLUB, INC.  
P.O. Box 350045 - Riverside Station  
Miami, Florida 33135

NEW FROM CLEGG



FM-88S with SCANNER (optional)

## THE FM-88 & 88S

25 watts/143.0-149.0 MHz

In the tradition of the famous FM-DX and the FM-28 Clegg proudly announces the 2 Meter FM Transceiver of the next decade.

We've retained all the features and performance of the popular FM-28. And we've added CAP and MARS frequency coverage. And we've added an optional SCANNER. You'll have continuous control of output power from 1 to 25 watts right from the panel.

As with the FM-28 we give a full 1 YEAR limited warranty. And when you purchase an FM-88 or 88S we will refund your purchase price if for any reason you elect to return it within the first 10 days.

Because the FM-88 is available ONLY DIRECTLY from CLEGG and there is no "MIDDLEMAN" involved, we are able to deliver to you much more RADIO for your hard earned dollar. You are virtually buying WHOLESALe!

Whether you elect the FM-88S at \$439.00 or the FM-88 (without SCANNER) at only \$345.00, we are certain you'll be delighted with your selection. (These introductory prices won't last long).

Each unit is supplied complete with Mobile Mounting Bracket; Base Station Bale; Microphone; Mobile Power Cable; Base Station Power Cable and many many hours of OPERATING ENJOYMENT.

A detailed SPECIFICATION sheet describing the new transceivers and Clegg's coordinated accessories and antennas is yours for the asking. Phone 1 (800)-233-0250 today for your copy or to order either one of these super TRANSCeIVERS!

**Clegg** Communications Corp.  
1911 Old Homestead Lane  
Greenfield Industrial Park East  
Lancaster, PA 17601

✓ C3

(717) 299-7221



## MFJ SUPER CW/SSB FILTERS



✓ M52  
**\$59<sup>95</sup>**  
MFJ-721

**MFJ-721 SUPER SELECTOR CW/SSB FILTER** gives 80 Hz BW, steep SSB skirts, noise limiting.

**CW Filter** gives 80 Hz BW. No ringing. 8 poles give super steep skirts (60 dB down one octave from center freq. of 750 Hz). No tunable filter can match performance. BW: 80, 110, 150, 180 Hz. Reduces noise up to 15 dB.

**SSB Filter** improves readability. Reduces splatter, hiss, static, noise, hum. IC active filter has 375 Hz highpass cutoff; 2.5, 2.0, 1.5 KHz (36 dB/octave) lowpass cutoffs.

**Works with any rig.** AM, SSB, CW. Plugs into phone jack. 2 watts for speaker. Inputs for 2 rigs. Speaker and phone jacks. Phones disable speaker. OFF bypasses filter. 9-18 VDC, 300 ma. 5x2x6 inches. Optional AC adapter, \$7.95.

**Switchable noise limiter** for impulse noise; trough clipper removes background noise.

**Simulated stereo for CW** lets ears, brain reject QRM. Yet, hear off frequency calls.

## Tunable Filter

Instantly zero in SSB/CW signals with tunable peak, notch, lowpass filter.



**\$59<sup>95</sup>**  
MFJ-751

**MFJ-751. Peak, notch or lowpass signals, zero in with freq. control, adjust bandwidth for minimum QRM. Double tuned for extra steep skirts.**

**Linear freq. control** tunes 300 to 3000 Hz. Output is constant as bandwidth is varied flat to 40 Hz. Tight notch to 70 db. 5x2x6 in.

**Hear off frequency calls with simulated stereo.**

**Works with any rig.** Plugs in phone jack. 2 watts for speaker. 110 VAC or 9-18 VDC, 300 ma. One year unconditional guarantee.

**MFJ-721** has 4 CW stages for super steep skirts. Best for CW. **MFJ-751** is best for general use when versatility is more important.

**Order from MFJ and try it.** If not delighted return within 30 days for refund (less shipping). One year unconditional guarantee. **Order today.** Call toll-free 800-647-1800, charge VISA, MC. Or mail check, money order. Add \$3.00 shipping.

**CALL TOLL FREE ... 800-647-1800**

Call 601-323-5869 for technical information, order/repair status. Also call 601-323-5869 out side continental USA and in Mississippi.

**MFJ ENTERPRISES, INC.**  
BOX 494, MISSISSIPPI STATE, MS 39762

# How to Write a RTTY Program

— machine language is easier than you think

As a result of my article published in the April, 1977, issue of 73 ("CW for the 6800"), one of the letters I received assumed

that I was into ham RTTY. This caused me to wonder if I was missing something. I was. A large percentage of the RTTY operators are

running micros or discrete logic gear for the generation and reception of Baudot. Furthermore, very few of these operators are totally dedicated to signal reports and QSL cards. Most of them are hacking away at the frontiers of microcomputer applications in general. So you could learn quite a bit with a RTTY receiving setup, even if you do not have a ham license.

Machine-language programming is not as difficult as it looks! In fact, if you can program in BASIC, you can program in machine language. There are two major attributes of machine language that make it immediately worthwhile:

1. It is more efficient in its usage of memory space because it doesn't have to go through a series of lookup tables just to determine what you have commanded it to do.
2. Because of reason #1, it can execute programs with fantastic speed and accuracy.

No, I am not suggesting that interpreter basics should be junked. In fact, at my place of employment, I have installed a microcomputer as a plant

demand monitor/controller (millions of Watts) and have it running a BASIC program.

In writing any program, M/L, BASIC, or whatever, I think it necessary as a first step to write out the programming objectives, or a general description of what the program is to accomplish. From the description, a flowchart should be drawn next. From the flowchart, a program can be written. The program must, of course, address specific items of hardware for input/output (I/O), so a brief description of my setup follows:

1. Old model SWTPC M6800 mainframe.
2. 16K of 21L02 memory.
3. One parallel interface card (PIA) at location 8000.
4. One serial interface card (ACIA) at location 8004.
5. MIKBUG has been replaced by SWTBUG.
6. A C-30 cassette interface.
7. CT-1024 terminal system, 16 lines, 32 characters.
8. 12-inch black and white Zenith, modified for composite video entry.
9. HAL ST-6 RTTY terminal unit (MOD/

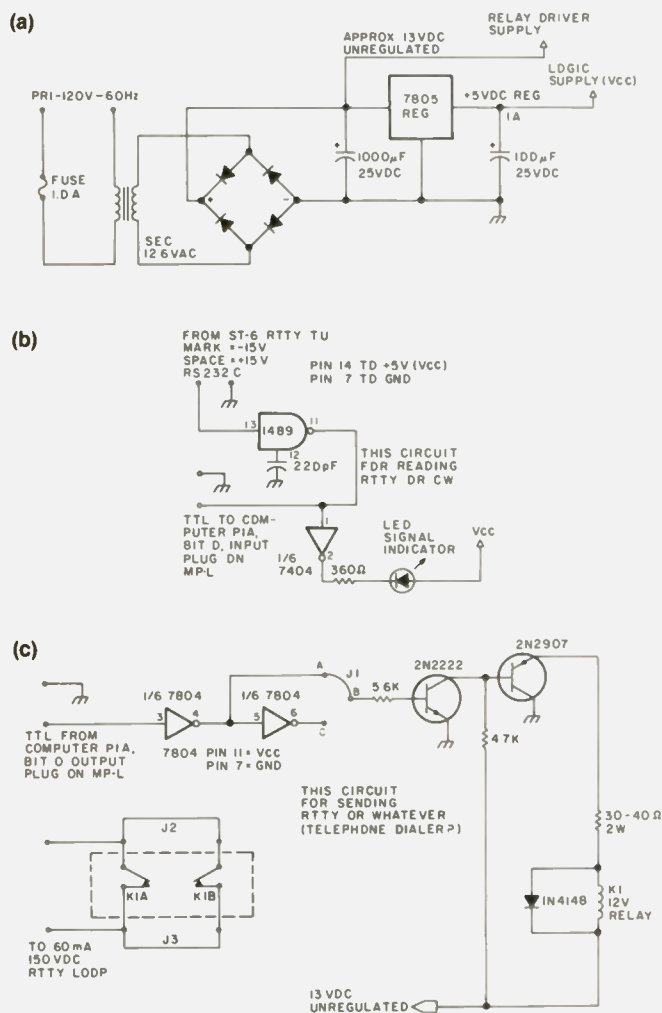

Fig. 1. Interface box with power supply. (a) Power supply. (b) Input switching. (c) Output switching.

DEMODO).

10. Small interface box, RS232-C to TTL for input to computer, also contains a computer-driven relay with two paralleled sets of NC contacts in series with the 60-mA RTTY local loop for output. (See Fig. 1.)

11. Ancient Model 19 Teletype™.

12. Drake TR4-C transceiver (with a muffin fan positioned directly over the finals).

Now let's define what we want to do:

1. The program is to accept interrupt from the ASCII keyboard via the ACIA interface.

2. Convert the incoming ASCII character to Baudot and store it in a "circular buffer," that is, a page of memory from XX00 through XXFF. By doing this, when a character is eventually stored at XXFF and the storage pointer is incremented, the storage pointer then contains 00, and we are back at the start of the buffer area.

3. Get the Baudot character pointed to by "Print next pointer" and send it out via the PIA.

4. Utilize the Baudot stop bit as a delay between characters by making it much longer than normal.

5. Enable IRQ only during the stop bit, allowing the delay to be interrupted, the incoming ASCII character stored, and then the delay finished.

6. Print something at the end of each delay period. If no characters remain to be printed, print a Baudot blank.

7. Keep count of the characters stored in the buffer. After (decimal) 67 characters, look for the next incoming space character, then store a carriage return line feed immediately following the space in the buffer.

There are any number of other goodies we could have this program do, but beyond this it would tend to get lengthy. You will note that we don't use any of the computer's resident monitor routines. This means the program should run on any 6800-based machine, possibly requiring a bit of adjustment on the delays in the "bit timer" and maybe relocating the IRQ vector.

This brings up another point: You might have to adjust the delays in any case, because the loop-keying relay requires a small, but finite, time for armature travel. Your relay armature might be heavier or lighter than mine, the contact gap might be more or less, etc. No problem; change the delay constants up until the printer garbles, then down until it garbles, and then set the number between these two values.

I have installed a switch that allows my CT-1024 to be switched to either 300 or 1200 baud. This program runs equally well on either baud rate. If you want your keyboard input to be displayed on your video display, you should enable your data terminal's internal "echo," as this program does not contain routines to accomplish this.

Now let's do a flowchart to accomplish all the things we have described, not necessarily in the order they were enumerated.

A few words about Fig. 1: Since I am not an engineer, these circuits are probably somewhat unorthodox, but they are working in my

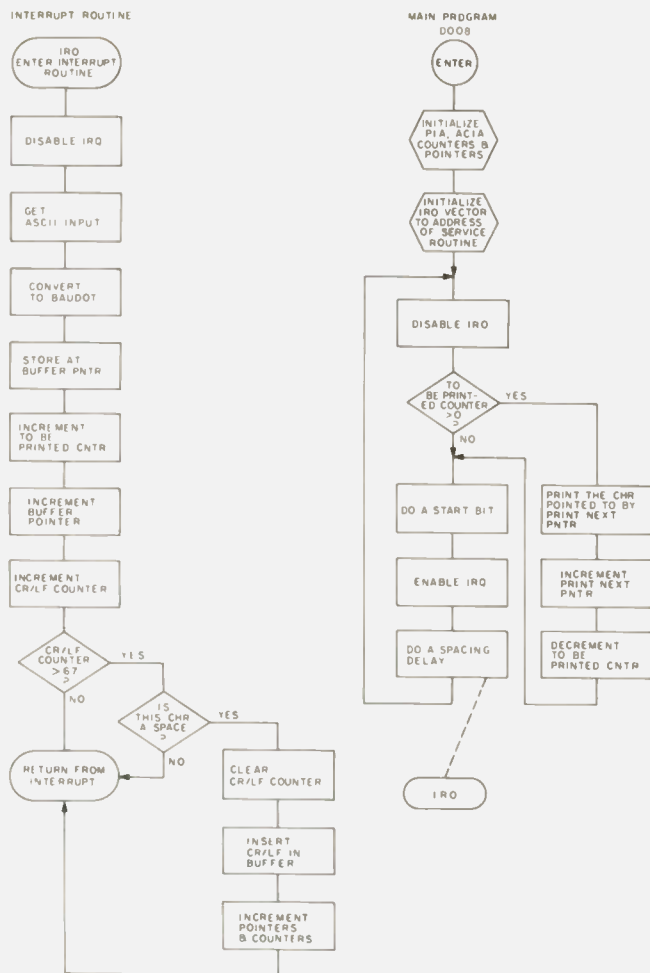

Fig. 2. Flowchart.

gear. Unless I have let a drawing error slip by, they will work in yours.

If you can't find a small 12-volt relay that will stand interrupting 150 V dc at 60 mils, try one with a higher coil voltage. In most cases, 12 or 13 volts will operate a 24-volt relay. If you have a 6-volt relay with sufficient contact rating, all you need change in this circuit is the power transformer. Change to a 6.3-V ac secondary, and you will have approximately 9 volts dc unregulated. Use a heat sink on the voltage regulator. The transistor pair is a circuit that I have used quite a bit; I feed them with supply voltages that have ranged from +5 to +15 volts. They are quite inexpensive, 5/\$1.00 at James Electronics.

Paralleling the two normally-closed sections of K-1 has the apparent effect

of reducing contact bounce, in addition to increasing current capacity.

I do not recommend connecting either of the RTTY loop lines to interface board common, the goal being to keep that 150 volts out of my computer!

My interface is assembled on perfboard and housed in a small Radio Shack cabinet. Don't forget a fuse in the transformer primary. I always use sockets for all ICs, even on perfboard.

### Machine Code

The M6800 CPU, like other CPU chips, has what is called an instruction set. This is simply a list of commands that the chip will recognize and execute. For most microprocessors, these are one-byte (8-bit) numbers. These commands are sometimes called op codes, and the instruction



PROGRAM LISTING, RTTY OUT.

ADDR.	OP-CODE	DATA	MNEMONIC	REMARKS
Program entry point: 0008				
0000	00		RMB	Buffer storage pointer.
0001	00		RMB	To be printed counter.
0002	00			Not used.
0003	00		RMB	CR/LF counter.
****	**	** **	***	*****
0008	86	FF	LDA-A	Initialize PIA for output
000A	B7	80 00	STA-A	to model 19.
000D	86	04	LDA-A	
000F	B7	80 01	STA-A	
0012	86	95	LDA-A	Initialize ACIA to
0014	B7	80 04	STA-A	generate IRQ.
0017	CE	03 00	LDX	Set up IRQ vector to
001A	FF	A0 00	STX	service routine.
001D	7F	00 36	CLR	Print next pointer.
0020	7F	00 01	CLR	To be printed counter.
0023	01	01 01	NOP	No operation, not used.
0026	7F	00 03	CLR	CR/LF counter.
0029	7F	00 00	CLR	Buffer storage pointer.
*****				
START PRINT				
002C	0F		SEI	Disable IRQ.
002D	B6	00 01	LDA-A	Get to be printed counter.
0030	27	05	BEQ	If zero, branch to 0037.
0032	CE	02 00	LDX	Set index reg. to start of buffer.
0035	A6	00	LDA-A	Get chr. at index plus prnt. nxt ptr.
0037	36		PSH-A	Save A reg.
0038	7E	03 20	JMP	Do a start bit.
003B	36		PSH-A	Save A again.
003C	7E	00 6D	JMP	To bit timer.
003F	7C	00 63	INC	Increment bit counter.
0042	44		LSR-A	Shift lab out of A reg.

0043	24	07	BCC	If lab=0, BRA to out a space.
0045	C6	01	LDA-B	Else out a mark.
0047	F7	80 00	STA-B	
004A	20	05	BRA	To bit count check.
004C	C6	00	LDA-B	Out a space.
004E	F7	80 00	STA-B	
0051	F6	00 63	LDA-B	With bit counter.
0054	C1	06	CMP-B	To hex 06.
0056	26	E3	BNE	Back to 003B if not zero.
0058	7F	00 63	CLR	Finished, clr bit counter.
005B	B6	00 01	LDA-A	More chrs. to print?
005E	27	25	BNE	
0060	7E	00 7F	JMP	To stop bit timer and spacer.
0063	00		RMB	Bit counter.

BIT TIMER				
ADDR.	OP-CODE	DATA	MNEMONIC	REMARKS
0064	01	01	NOP	
0066	01	01 01	NOP	
0069	01	01	NOP	
006B	3C			Timer constants.
006C	35			
006D	B6	00 6B	LDA-A	Timer
0070	F6	00 6C	LDA-B	
0073	5A		DEC-B	
0074	26	FD	BNE	
0076	4A		DEC-A	
0077	26	F7	BNE	
0079	32		PUL-A	
007A	7E	00 3F	JMP	Go finish this chr.
*****				
STOP BIT TIMER AND SPACER				
007D	01		NOP	
007E	01		NOP	
007F	7A	00 01	DEC	Dec. to be printed counter.

Program listing.

set for an M6800 chip will not produce the same results when input to an 8080 chip. However, a chip called the Z-80 will properly execute all of the 8080 instruction set, plus several more instructions that the 8080 cannot execute.

When writing machine code for my SWTPC 6800, I make frequent use of two reference listings, the *Motorola M6800 Microprocessor Programming Manual*, pages A-1 through A-69, and an article from

73 by T. H. Hunter called "Backward Branch the Easy Way" (Holiday, 1976, page 90).

Machine code, when deposited by hand, commonly utilizes one of two methods, depending on the configuration of the computer. Computers similar to the older model Imsai 8080 having a complete front panel permit data entry in binary format by manipulation of a row of toggle switches located on the front panel. By means

of these switches you can examine (display contents of) any memory address, change the contents thereof, start program execution from the displayed address, examine the next sequential address, etc.

Computers similar to the SWTPC 6800 have no switches for data entry. Their front panels usually contain only a power on-off switch and a system reset button. This type of computer has what is called a "system monitor" program stored in permanent memory (ROM). When the power is turned on or the reset button depressed, the CPU's program counter is automatically initialized to the beginning of this program and the program be-

gins running. This means that in addition to the computer, you must also have a terminal unit consisting of a keyboard that produces ASCII characters and a display. If you have a video display, you must also have a display refresh memory consisting of a memory byte (usually less than 8 bits) for each position on the screen that is to be printed into, plus logic circuitry to generate the necessary timing, decoding, and synchronizing signals. This display refresh could be accomplished inside the computer, but it would use up a good bit of the computer's time and memory.

The system monitor program establishes communi-

	ASCII "A" =	0100 0001	(41 in hex)
		0100 0001	(ASCII "A")
Plus	0000 0001	0000 0000	(hex 0100, start of decode table)
Equals	0000 0001	0100 0001	(hex 0141)

Fig. 3.



0082	7C	00 36	INC	Inc. print next pointer.	0328	35			
0085	C6	01	LDA-B	Out a stop bit.	0329	B6	03 27	LDA-A	Timer.
0087	F7	80 00	STA-B		032C	F6	03 28	LDA-B	
008A	0E		CLI	Enable interrupt request.	032F	5A		DEC-B	
008B	86	AF	LDA-A	Timer constants	0330	26	FD	BNE	
008D	C6	FF	LDA-B		0332	4A		DEC-A	
008F	5A		DEC-B	Timer	0333	26	F7	BNE	
0090	26	FD	BNE	To 008F if not zero.	0335	32		PUL-A	
0092	4A		DEC-A		0336	7E	00 3F	JMP	Go finish this chr.
0093	26	F8	BNE	Count B down again if not zero.					*****
0095	7E	00 2C	JMP	Finished, print another one.					CR/LF ROUTINE
				*****	0339	01	01 01	NOF	
0100	XX	XX XX	XXX	Insert DECODING TABLE beginning here.	033C	7C	00 03	INC	Increment CR/LF counter.
				*****	033F	C6	43	LDA-B	With decimal 67.
0200	XX	XX XX	XXX	Reserved for operating buffer,	0341	F1	00 03	CMF-B	To CR/LF counter.
02FF	XX	XX XX	XXX	no initial data necessary.	0344	22	2B	BHI	To 0371 if CR/LF less than 67.
				*****	0346	C6	04	LDA-B	Load B with Baudot space.
				SERVICE IRQ	0348	11		CRA	Compare B to A; is space?
				LOAD, DECODE, AND STORE	0349	01	01	NOF	
0300	B6	80 05	LDA-A	Get data from ACIA	034B	26	24	BNE	To 0371 if not space.
0303	B7	03 0A	STA-A	In decode table index.	034D	CE	02 00	LDX	With buffer start.
0306	CE	01 00	LDX	With decode table start.	0350	D6	00	LDA-B	With contents of buffer sto. ptr.
0309	A6	00	LDA-A	Indexed by contents of 030A.	0352	F7	03 58	STA-B	In temporary.
030B	CE	02 00	LDX	Buffer start.	0355	C6	08	LDA-B	With Baudot CR
030E	D6	00	LDA-B	From loc.0000 (Storage pointer)	0357	E7	00	STA-B	Indexed by temporary.
0310	F7	03 14	STA-B	In buffer index.	0359	7C	00 00	INC	Increment buffer sto. ptr.
0313	A7	00	STA-A	Indexed by contents of 0314.	035C	7C	00 01	INC	Increment to be printed counter.
0315	7C	00 00	INC	Increment storage pointer.	035F	D6	00	LDA-B	With buffer storage pointer.
0318	7C	00 01	INC	Increment to be printed counter.	0361	F7	03 67	STA-B	In another temporary.
031B	7E	03 3C	JMP	To CR/LF routine.	0364	C6	02	LDA-B	With Baudot LF.
				*****	0366	E7	00	STA-B	Indexed by temporary.
				DO A START BIT	0368	7C	00 00	INC	Increment buffer sto. ptr.
0320	C6	00	LDA-B	Out a start bit.	036B	7C	00 01	INC	Increment to be printed counter.
0322	F7	80 00	STA-B		036E	7F	00 03	CLR	Clear CR/LF counter.
0325	20	02	BRA	Around constants.	0371	3B		RTI	Return from interrupt.
0327	3C			Timer constants.					END

cation between you and your computer via the keyboard and display. Input is in hexadecimal notation, which is a condensed cousin of binary. Two hex digits can express any number that you can write with eight binary digits.

A system monitor program contains several small programs (routines) that the designer thinks will be useful, such as:

Examine (display) a specified memory location.

Change the contents of the displayed location, then display the next sequential location.

Jump to a specified location and start execution.

Display contents of the stack.

Load cassette data through the control port.

Record data on cassette from specified memory, etc.

Several companies now offer system monitor boards for S-100 systems, which greatly simplifies the task of establishing communication with a computer of the front panel type.

### The RTTY Program

Looking at the program listing, you will see that the first few memory locations contain zeros. These locations are used by other parts of the program as temporary data storage lo-

cations. Out in the main program at their point of use, you will also see several NO-OPS which, if executed, cause only the program counter to be incremented. These were put there to replace unnecessary code and could be used as jump-points to other routines if you want to expand the program. We start the program by typing J 0008 (with SWTBUG system monitor; all numbers in hex unless otherwise stated). Remember that I spoke of an instruction set or op code? At 0008, the op code 86 means load accumulator A with the next byte. The program counter is incremented as each byte is processed, thereby keeping track of what location

comes next.

How does the computer know the difference between op codes and data? It doesn't! So, to avoid a spectacular program wipe-out, the first byte in your program had better be a valid op code followed by the number of bytes of data that that particular op code requires. All subsequent lines of code must follow the same general pattern—op code followed by enough data to satisfy the op code you have used. The first few lines of code are used as the flowchart says, to clear all pointers and counters, to set the PIA for output, and to set the ACIA for generate an interrupt request when new data comes in

# The Ultimate QRM Killer

DATONG MODEL FL-1



FREQUENCY-AGILE  
AUDIO FILTER  
**\$199.<sup>95</sup>**

Including Pre-Paid  
Shipping & Full Insurance

- Made in England
- 90 Day Warranty
- Reviewed in QST Aug. 1979
- VISA-MASTERCHARGE accepted

Model FL 1 is a versatile add-on audio filter for communications receivers. It gives great flexibility in helping to extract the desired signal (SSB, CW, RTTY, etc.) from background interference and yet simply connects between loudspeaker and receiver output.

- Fully automatic search/lock/track operation for notching out unwanted heterodynes.
- Selectable bandpass or band-reject modes.
- Bandwidth smoothly variable from 20 Hz to 1000 Hz.
- Center frequency smoothly variable from 280 to 3000 Hz.
- Built-in 2 watt power output stage.
- Uses internal 9-volt battery or external source of 6 to 12 volts DC.

#### Application to CW

Model FL 1 is superb for CW reception. As an extra refinement automatic frequency control can be switched, which enables the filter to tune itself onto a CW station over a 100 Hz range. This way the 20 Hz minimum bandwidth becomes as easy to tune in as if it were 100 Hz.

#### Application to SSB and RTTY

For SSB or RTTY reception Model FL 1 can be used to give either a fully adjustable audio "window" to pass the wanted signal and to reject others, or as a variable notch to remove unwanted narrow band signals. Tuning in the notch mode can be fully automatic or manual. Auto-notching allows routine "hands off" use of a notch only 20 Hz wide so that the wanted signal is completely unaffected.

Dedicated to Excellence (Exclusive importers of DATONG ASP's)

**AR** Technical Products Corp. Box 62  
Birmingham, Michigan 48010  
Telephone 313/644-5698

## Order Your Collins KWM-380 NOW! and receive FREE

(+ old pricing, deposit only required)

- 1) Noise Blanker — \$195.00
- 2) 2 Filters, your choice — \$96.00 ea.
- 3) Blower Kit — \$195.00



Get on with the Best!

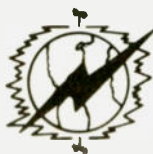

# MADISON

Electronics Supply, Inc. ✓ M35

1508 McKinney • Houston, Texas 77002 • (713) 658-0268

ADDR.	DATA	ADDR.	DATA	ADDR.	DATA
0100	00	0132	13	014C	12
****	**	0133	01	014D	1C
0107	05	0134	0A	014E	0C
****	**	0135	10	014F	18
010A	02	0136	15	0150	16
****	**	0137	07	0151	17
010D	08	0138	06	0152	0A
****	**	0139	18	0153	05
0120	04	013A	0E	0154	10
0121	0D	013B	1E	0155	07
0122	11	013C	1F	0156	1E
0123	14	013D	00	0157	13
0124	09	013E	1B	0158	1D
0125	00	013F	19	0159	15
0126	1A	0140	00	015A	11
0127	0B	0141	03	015B	00
0128	0F	0142	19	015C	1F
0129	12	0143	0E	015D	00
012A	00	0144	09	015E	1B
012B	00	0145	01	*****	*****
012C	0C	0146	0D	• Subtract 0100 from any •	•
012D	03	0147	1A	• of these addresses, and •	•
012E	1C	0148	14	• you get an ASCII chr. •	•
012F	1D	0149	06	• The data there is the •	•
0130	16	014A	0B	• Baudot equivalent. •	•
0131	17	014B	0F	*****	*****

Decoding table.

from the keyboard. We also store the address of the interrupt service routine at location A000-A001 (0300). At 0300, the service routine reads the incoming character, converts it to Baudot, and stores it in the buffer. It increments the proper pointers and counters, then checks to see if you have stored enough characters to need a CR/LR. If so, it adds them to the buffer after the next space and avoids hacked or hyphenated words this way.

The Baudot conversion works in the following manner: The binary value of the ASCII character, plus the binary value of the start of the decoding table, produces addresses where we have stored Baudot translations. See example in Fig. 3.

Hex 0141 is the address at which this program contains the Baudot equivalent of the letter "A", 000 0011. And so it goes for the entire Baudot-printable sequence, with the numerical value of each ASCII character serving as a pointer

to a memory location where we have stored the Baudot equivalent. This method is much faster than trying to do a character-by-character comparison through alphanumeric tables.

The ltrs/figs shift is set up to decode a less than (<) as figs and a greater than (>) as ltrs. This seems a trifle unhandy, since to get these characters one must also depress the shift bar. My date entry keyboard has ^ and \ as the two topmost right-hand keys, so these are also decoded as figs/ltrs, respectively. My keyboard prints these without shifting.

At this point, I won't bore you further with a line-by-line explanation of the program. You should get into machine-language programming; it's great fun and unlimited in its applications. If I can be of any help in your implementation of this program, drop me a line (with an SASE, please) and I'll do what I can to help. ■

# THE SMALL COMPUTER MAGAZINE AT 1/2 PRICE

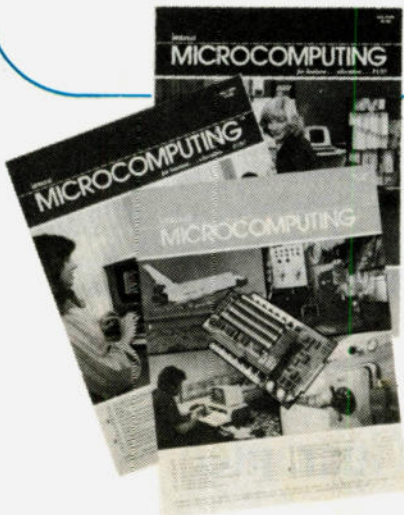

Broaden your knowledge of microcomputing by subscribing to this small-computer magazine. *Kilobaud Microcomputing* is aimed at the computer hobbyist and small businessman who wants to learn the fundamentals of computers. This encyclopedia of microcomputing will contain such information as:

- Programs to help you with your system
- Reviews of the latest software and hardware
- Evaluations of new hardware you may want to acquire
- Thought-provoking articles
- How to have fun with your computer, and save money
- Information exchanges for hobbyists and more . . .

*Kilobaud Microcomputing* believes that hobby computing is the forerunner of small-business computing, home computing and educational computing. To stay in touch with what's happening day to day in the world of computing, or if you are just getting interested, *Kilobaud Microcomputing* is for you. It's written to be *understandable* for beginners, yet interesting for experts. Find out what's happening in the world of microcomputers by filling out the handy coupon below, or send in the attached postage-paid card today!

kilobaud

**MICROCOMPUTING** T.M.

**SUBSCRIBE NOW AND SAVE \$15  
OFF THE \$30 NEWSSTAND PRICE  
FOR ONE YEAR**

PLEASE RUSH MY SUBSCRIPTION TO KILOBAUD MICROCOMPUTING  
AND START MY ENCYCLOPEDIA OF MICROCOMPUTING TODAY!

- 1 year \$15.00 \*  
 3 years \$45.00 \*

Bill my

Visa

Master Charge

- Bill me  
 Cash or M.O. Enclosed

Card # \_\_\_\_\_ Exp. date \_\_\_\_\_

Signature \_\_\_\_\_

Name \_\_\_\_\_

Street \_\_\_\_\_

City \_\_\_\_\_ State \_\_\_\_\_ Zip \_\_\_\_\_

\*Canada \$15 per year, US funds. Other foreign: \$23 one year only, US funds.

501H36

kilobaud

**MICROCOMPUTING** T.M.

Box 997 • Farmingdale NY 11737

# Buy One Of These Transceivers From Ham Radio Center & Be Guaranteed That You Will Get The Best Price!



**DRAKE**®



**KENWOOD**®



**TEN-TEC**®



**SWAN**®  
ELECTRONICS



**YAESU**®

## Ham Radio Center's Best Price Guarantee

1. Shop any or all the ham dealers with a TOLL-FREE (WATS) Line.
2. Then call HAM RADIO CENTER.
3. HAM RADIO CENTER guarantees to meet or beat any legitimate price\* quoted by a factory authorized ham dealer with a TOLL-FREE (WATS) Line on the following equipment:
 

DRAKE	KENWOOD	TEN-TEC	SWAN	YAESU
TR-7/DR-7	TS-120S	509 (Argonaut)	100-MX	FT-101Z
R-7/DR-7	TS-180S/DFC	570 (Century/21)	Astro-150	FT-101ZD
	TS-520SE	545B (Omni-A)		FT-901DM
	TR-7600	546B (Omni-D)		FT-227RB
				CPU-2500RK
4. This guarantee on the above transceivers expires January 31, 1980.

\*NOTE: HAM RADIO CENTER limits legitimate price to current dealer cost plus mark-up!

CALL TOLL-FREE

# 1-800-325-3636

FOR BEST PRICE GUARANTEE

**HAM RADIO CENTER**  
8340-42 Olive Blvd. • P.O. Box 28271 • St. Louis, MO 63132



# The Perfect Morse Machine

— send and receive CW with a dedicated micro

**Author's note:** I will supply a photocopy of the PC board artwork for \$4.00. I will also program reader-supplied 2708s for \$6.00. Both are payable by money order or certified check. I also wish to thank Mike Hadley WA7NLM for his audio filter design.

**H**ave you seen all of the ads coming out for "automatic" Morse keyboards and readers with one big alphanumeric "eye" that gives you a readout as someone is sending code? Then there are the "complete" sta-

tions which will do both on a TV screen for only \$600. The item I am about to describe can do all of this and more, with many possible options, for less than \$100.

About three years ago at the Dayton Hamvention, I picked up a program for

a computer-controlled Morse code station. This program was written with the MC6800 computer in mind and was fathered by Don Jackson W7GKU and Jim Bainter WA7VKZ. The computer and the program in our story have changed

significantly, but still are based on their algorithms. The original program was designed for use with the old Mikbug® evaluation module, and used the on-board ACIA (Asynchronous Communications Interface Adapter) serial port for communications with a TTY or CRT terminal.

Well, after I finally got to the point where I had a little knowledge of the 6800, I decided to try to make this thing work. Keep in mind that a little knowledge is dangerous! I had to do some work, but after a while, a wire-wrapped version appeared on a card within my computer. I didn't believe it, but it really worked. The only problem I had with it was the way it copied code. It was so perfect that all of those with sorry fists would really mess it up. With all of the means available to generate decent code, whether keyer or keyboard, there is really no excuse for a poor fist.

Well, enough of my soapbox. With this gizmo, everybody can have perfect CW capabilities. After the original version, wire-

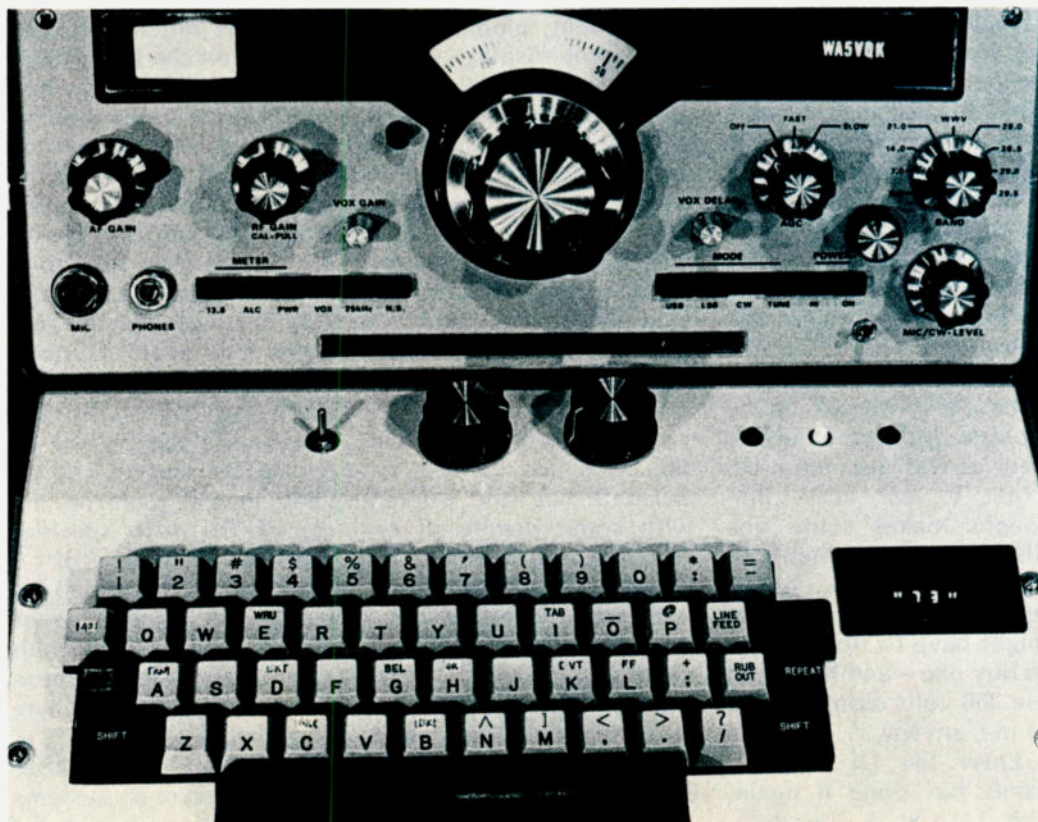

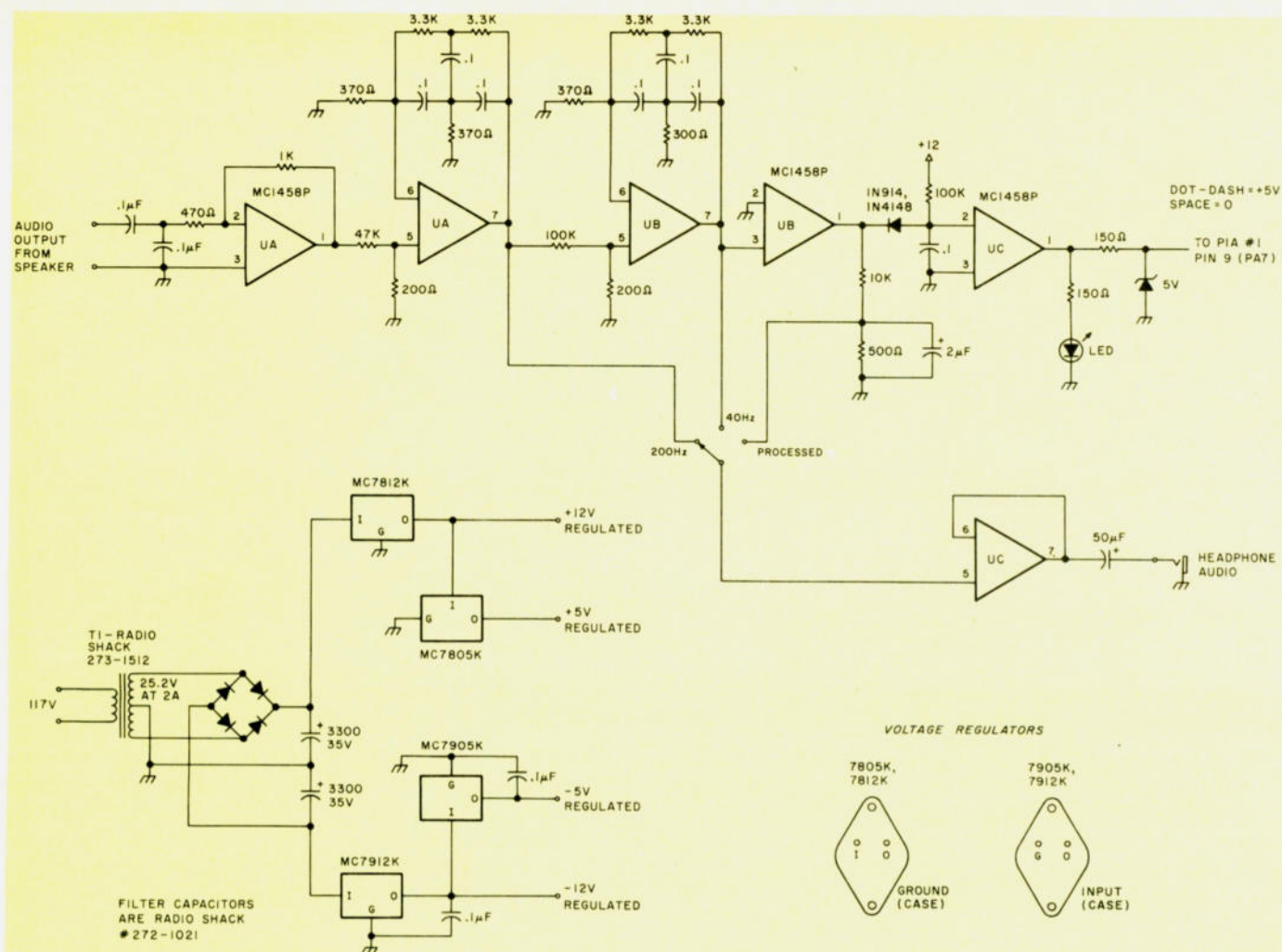

Fig. 1. This is the audio filter and recommended power supply. The input audio is filtered by the op amps and turned into dc to be fed into the PIA.  $V_{cc}$  = pin 8 (+12);  $V_{ee}$  = pin 4 (-12).

wrapped deep within the bowels of my mainframe, worked, the next thought was to make it a fully self-contained system with a dedicated CPU to work with. The most logical choice was to use the MC6802—son of 6800. With clock and RAM all on silicon, at least three packages could be saved over the original 6800 design. The age of the small dedicated system has arrived.

The following evening was spent on wire-wrapping a small board with the system. The program was, of course, stored in an EPROM for automatic "boot" and for more additions later. The two biggest drawbacks that I could find were that it still required a terminal which was both large and expen-

sive, and it had a switch to go from receive to transmit, and so forth. The last time I saw one of those things was as a Novice with my Globe Scout and S100!

So, these little things had to be fixed. OK, the switch could be replaced with a different polling routine within the software. No sweat, but what about the terminal? Well, plugging in a keyboard would be no trouble, but something to peer at was also required. What to do? Well, Burroughs makes some fine display panels which can display about 30 characters on a line, but you might have to float a loan to buy one—and having to use 250 volts didn't appeal to me, anyway.

Enter the DL-1416. Litronix has done it again. The 1416 is a four-digit,

16-segment, alphanumeric intelligent display, which, when fed parallel ASCII, will display the most-used 64 characters of the ASCII set. It is a five-volt-only device, and by placing it directly on the CPU bus, will appear as "write-only RAM." Unfortunately, the slow setup times and the need to have data valid before Read/Write comes out present a few problems. The first version had the LEDs just hanging on the data bus and worked with some degree of reliability. But when Rs started coming out as Ps, I knew that the timing specifications were being violated.

After much manipulation of the clock and stretching of the E pulse, I determined that too much glue (peripheral hardware)

would be required to just leave it on the bus. Then I remembered that only half of PIA 2 was being used, so the most logical choice was to put the 1416 on the peripheral data bus. By setting the control register within the PIA first to a \$34 and then to a \$3C, the CB2 line would go low and come high again, all done while the data was latched onto the output lines. Great—use this for the  $\overline{W}$  (write) line, and tie it to  $\overline{CE}$  (chip enable), too! The timing of the 1416 specifies that the falling edge of  $\overline{CE}$  must be at least 500 ns before the rising edge of  $\overline{W}$ . So having them both come in at the same time is permissible. See the timing diagrams.

According to Appnote 9A from Litronix, systems which use only a 6-bit

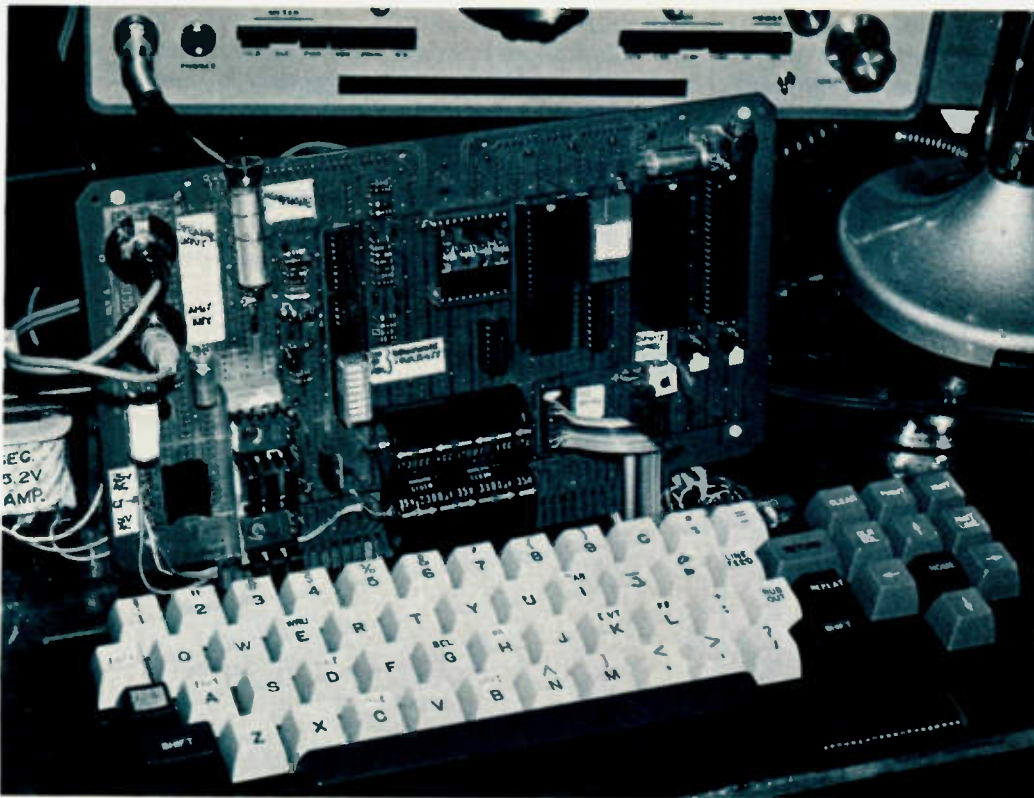

ASCII code can still utilize the 1416 by inverting D5 and feeding it into D6. By doing it this way, two "spare" data lines on the PIA are saved. These two lines are used for addressing either of the four digits to be written to. All of the work writing to the LEDs is now being accomplished in software.

The clock within the 6802 is really a strange beast. It can accept any parallel-resonant crystal from 1 to 4 MHz. Of course, the crystal is divided by four, so remember this when selecting your crystal. In this program, the CPU will work fine even when running at its minimum frequency (100-kHz bus speed, 400-kHz crystal frequency).

A funny thing happened

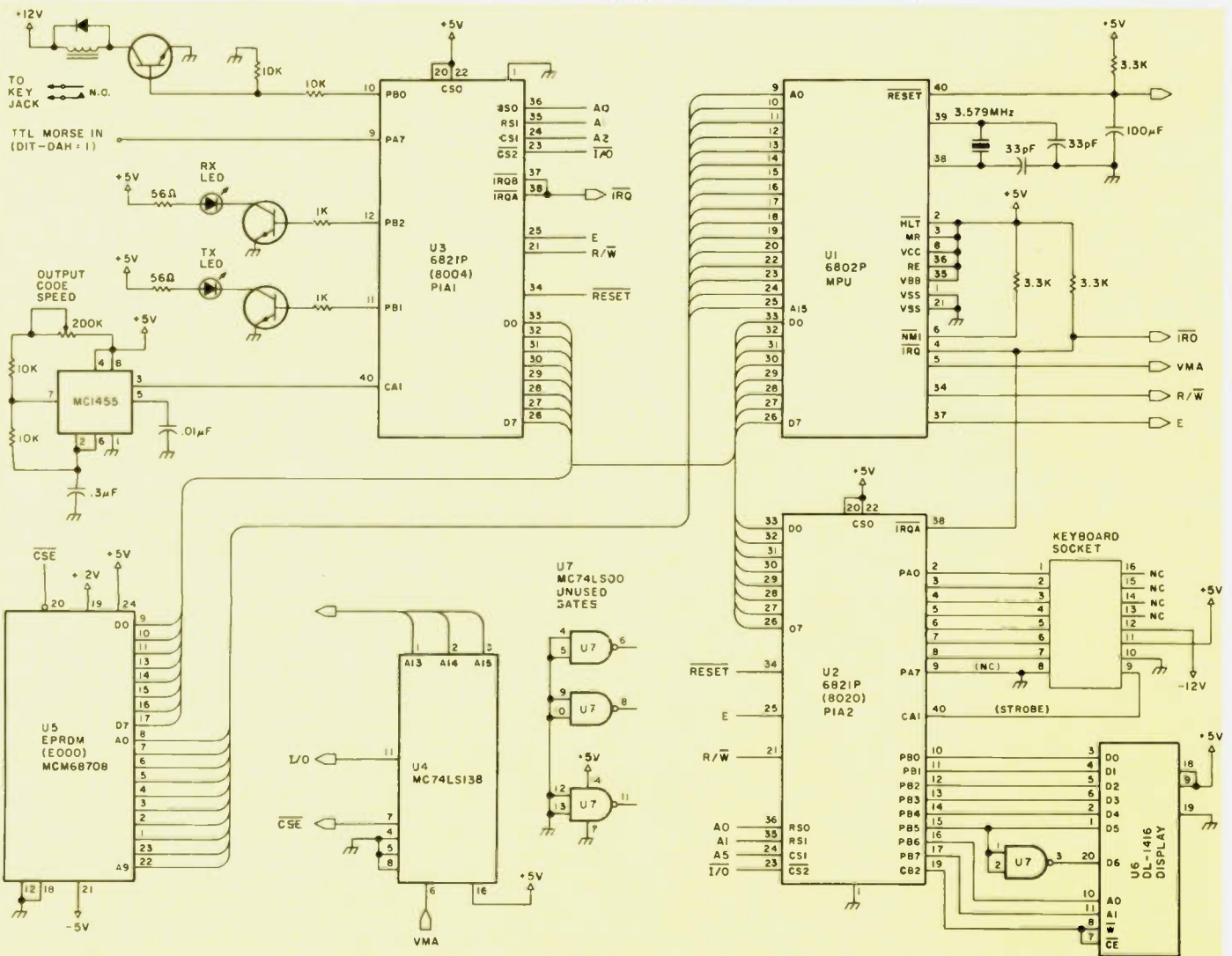

Fig. 2. The main processor, composed of the MC6802 MPU, two PIAs, and an EPROM.

while experimenting with different crystal types; the thing oscillated even without a crystal! The frequency was really slow and

quite unstable, but it worked. Even after power down and up, it continued to oscillate. Since the 6802 is not specified for use

without a crystal, Motorola won't guarantee it to work without one, but, just for fun, why not try it out on yours when you build it?

You might think that having only four digits a little bigger than a calculator display would be a real

hassle to use. Not so! The program takes the incoming data or keyboard data and puts it in the right-hand display. As the next character comes in, it is shifted left one digit. Instant "Times Square" display. I was a bit hesitant to use on-

### POWER SUPPLY NOTES

The total current requirements for the reader/talker are given below. These figures are the absolute maximums for the individual components, so don't expect them to be that high, but, just in case, go ahead and plan for it.

Current requirements for the reader/talker. All values are in milliamps and are absolute maximums.

	+ 5 V	+ 12 V	- 12 V	- 5 V
MC6802	240	—	—	—
MC6821	110	—	—	—
MC6821	110	—	—	—
MCM68708	10	65	—	65
MC74LS138	6.4	—	—	—
MC74LS00	15	—	—	—
DL1416	100	—	—	—
MC1458	—	8	8	—
MC1458	—	8	8	—
MC1458	—	8	8	—
3 LEDs	30	—	—	—
Average Keyboard	225	—	45	—
Maximum Totals	846.4	89	69	45

As can be seen in the totals, all currents can be handled with the three-terminal-style regulators. The following calculations are to determine what the power dissipation for each device is. For the three-terminal regulators, the power dissipation can be expressed by the following equation:

$P_D = (\Delta E_{IN}) I_{OUT} + E_{IN} (I_Q)$ , where:  $P_D$  = Power dissipation,  $E_{IN}$  = In-Out voltage,  $I_{OUT}$  = output current, and  $I_Q$  = current through ground lug.

For the positive voltage regulators, the following schematic is used, and the voltages are labeled. These were typical, using the values of transformers and capacitors specified in Fig. 1.

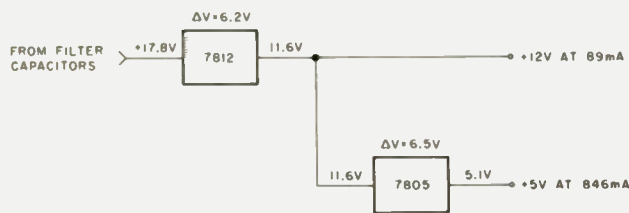

$$7812 P_D = (6.2 \text{ V}) (.935 \text{ A}) + 17.8 (.008) = 5.94 \text{ W}$$

(Note: .935 A = .846 A + .089 A)

$$7805 P_D = (6.5 \text{ V}) (.846 \text{ A}) + 11.6 (.008) = 5.34 \text{ W}$$

In the same light, the minus voltage regulators can be also calculated:

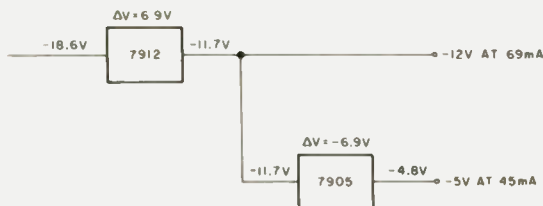

$$7912 P_D = (6.9 \text{ V}) (.114 \text{ A}) + (18.6) (.008) = .935 \text{ W}$$

$$7905 P_D = (6.9 \text{ V}) (.045 \text{ A}) + 11.7 (.008) = .404 \text{ W}$$

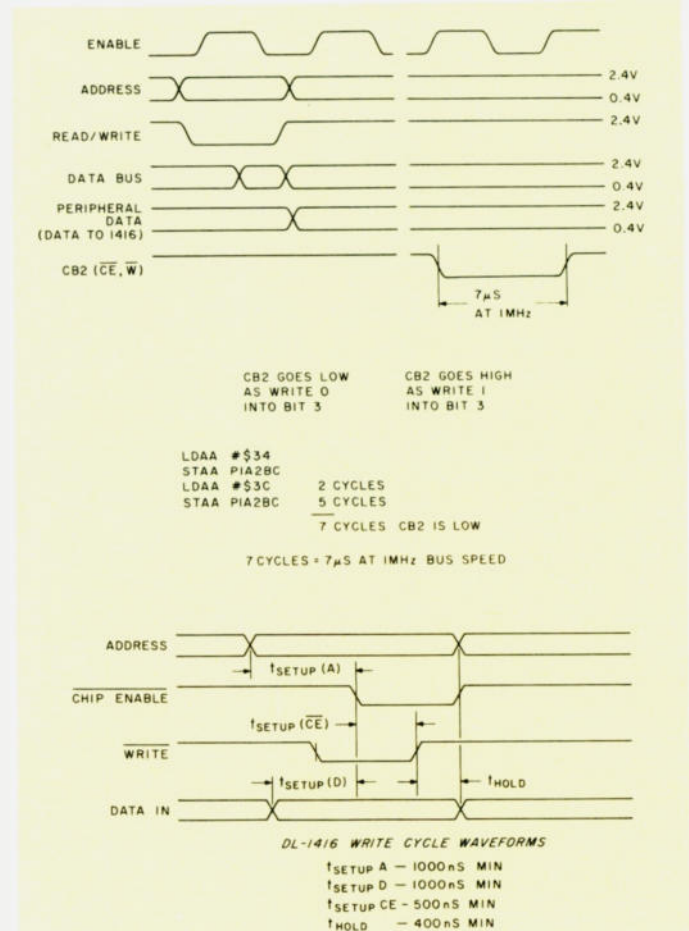

Fig. 3. PIA write-timing to displays, and Litronix-recommended write-cycles for the DL-1416.

By taking the input of the 7805 from the output of the 7812, the power dissipation of the 7812 was raised from about 1/2 Watt to almost 6 Watts. But by taking the 7805 input directly at the capacitor output, its  $P_D$  would have been 10.75 Watts! This would be very difficult to heat sink, so by doing it as shown, the total power dissipation is about the same, only divided between two parts.

According to the *Motorola Linear IC Data Book*, to dissipate the required power (5.9 and 5.3 W), a heat sink which can dissipate 15°C/Watt will be required. The minus voltage regulators are not as critical, as they have a lesser current demand on them. I recommend the use of the -K suffix regulators (TO-3 case), because their thermal resistance (junction-to-case vs. junction-to-air in the plastic package) is so much better. Heat sink them with an appropriate sink, preferably to a metal case, and no problems should be encountered. The negative regulators' requirements can be satisfied by simply bolting them to the chassis. (Be sure to insulate their cases!)

The voltage regulators shown in the pictures are of the plastic style and get quite hot even with the heat sinking shown. When the project is put into an enclosure, TO-3-style regulators will replace them.



ly four digits, but after using it, I find that 4 is really not too few, and the faster the code is sent, the easier it is to read. The new design now automatically

transfers from receive to transmit and back again after all characters have been sent. The algorithm used in the code conversion is set up so that

it automatically senses speed changes and adjusts itself for the correct speed. This can be anywhere between about one-half wpm to 300 wpm. Changing speed

requires only about 2 characters to be lost, so it is quite efficient. Neat, eh?

Back before I built the keyboard/reader, I thought that it would be "cheating" to use one; it had been done manually for such a long time, who was I to change any preconceived ideas? Anyway, I have found just the opposite to be true! Number 1, the computer is not foolproof. It can be messed up by zero-beat QRM, sloppy fists, or high noise levels. So, when you start your QSO, try not to get carried away and go too fast, because if one of these should happen, you might be stranded by sending faster than you can receive. Another thing is that you are seeing a character appear on the display at the same time you are hearing it. No better way for associative learning than to get the code into your eyes and ears simultaneously. I've found my speed to be dramatically increasing following the use of it for a couple of weeks. Also, you have a tendency to follow the conversation along in your head—the only way to do it for above 15 or 20 wpm. The final plus is that you hear perfect code being sent by your keyboard, and it makes you wish that everyone had one of these things! So, it's not really cheating, but only another progressive learning device provided by the computer.

As this design recognizes a single input to determine a character and a single output for code, why couldn't it also be used for Baudot or ASCII teletype™? This is just a bug in your ear—look for some further programs in later articles. Wouldn't it be nice to have a truly portable TTY "machine"?

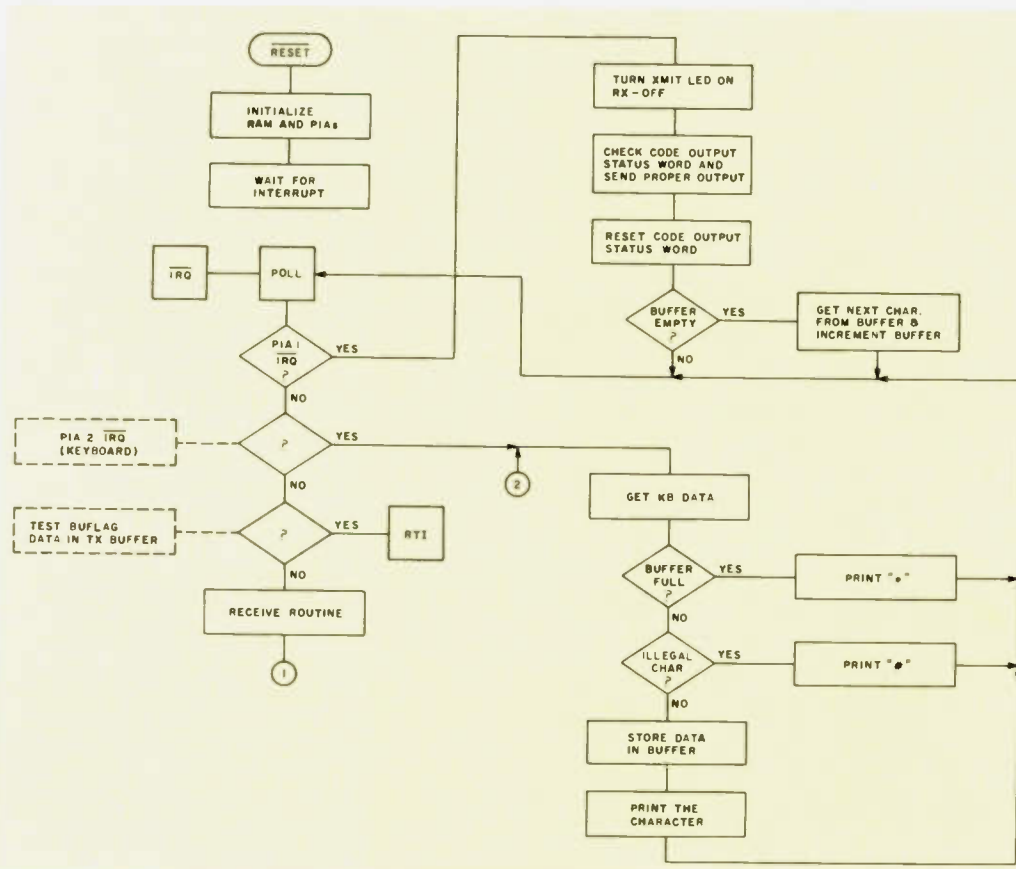

Fig. 4. Flowchart, part 1.

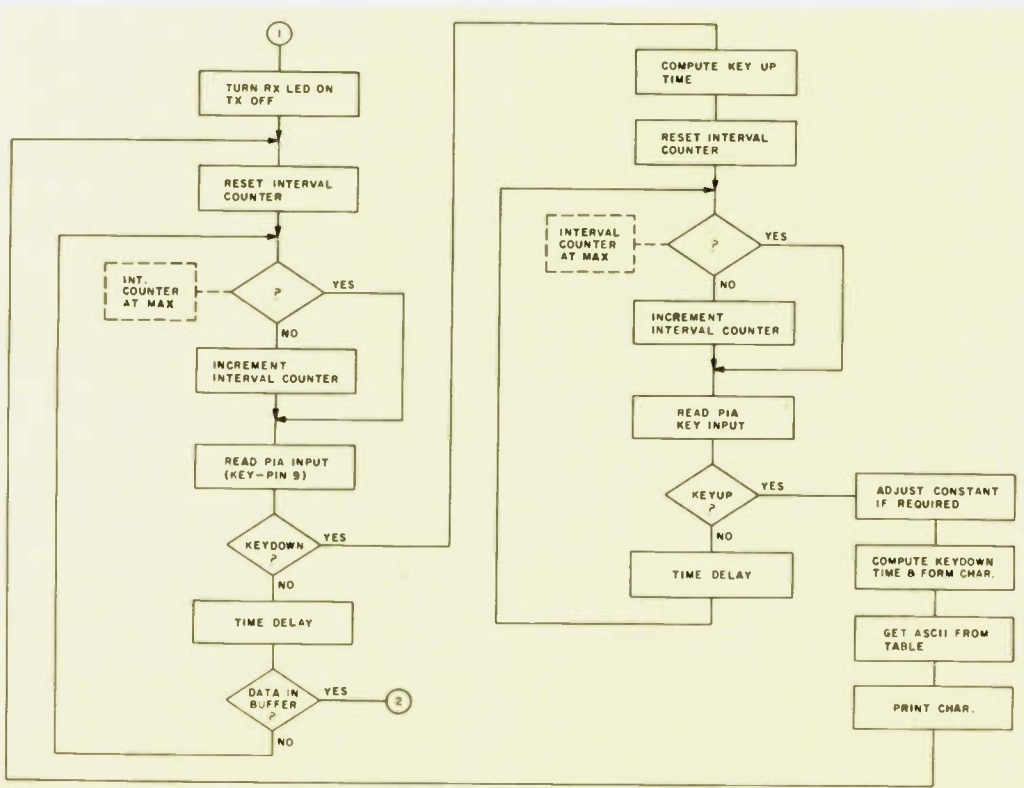

Fig. 5. Flowchart, part 2.

### Construction

As you can see in Fig. 1,

the audio from a headphone jack or speaker tie-in goes into a filter-processor where it is converted from audio tones to TTL-compatible levels.

This audio input is fed into an op amp preamplifier, so not a whole lot of audio is required. You might want to pad it if your receiver overdrives the device. You

also can plug your headphones into the jack on the board and use it for a filter. The first switch position provides selectivity down to about 200 Hz, the sec-

ond to 40 Hz, and the third to processed audio—this is a really fun feature. After it is tuned in correctly, all you hear is a tone. No QRM, no static, no garbage, only a pure representation of the sent character. This is a really weird feeling, especially if you have never used it before. If you don't want to build the computer, at least build the filter—it works great for CW by itself.

After this processed audio is converted to a voltage level, it is fed into a single bit of a PIA (Peripheral Interface Adapter) parallel port. Two of these PIAs are used on the board, one for Morse in and out, transmit speed timing, and indicator LEDs. The second PIA is for the keyboard and LED display unit. The 555 circuit is set for the desired speed at which you wish to transmit. In this design, a relay is provided for Morse code output. Although my HW-104 uses positive voltage keying and worked great with just a single keying transistor, a reed relay provides a more versatile interface for use with any type of keying, from grid-block to cathode.

The EPROM in the circuit is used to hold the pro-

CHARACTER SET										
				D0	L	H	L	H	L	H
				D1	L	L	H	H	L	L
				D2	L	L	L	L	H	H
D6	D5	D4	D3							
L	H	L	L	-	0	1	2	3	4	5
L	H	L	H	<	>	*	+	/	--	-
L	H	H	L	0	1	2	3	4	5	6
L	H	H	H	8	9	-	-	/	--	\
H	L	L	L	a	A	B	C	D	E	F
H	L	L	H	H	I	J	K	L	M	N
H	L	H	L	P	Q	R	S	T	U	V
H	L	H	H	X	Y	Z	[	\	]	^

**LOADING DATA**

ADDRESS					DATA INPUT							DIGIT	DIGIT	DIGIT	DIGIT
$\overline{CE}$	$\overline{CU}$	$\overline{W}$	A <sub>1</sub>	A <sub>0</sub>	D6	D5	D4	D3	D2	D1	D0	3	2	1	0
H	X	X	X	X	X	X	X	X	X	X	X	N/C	N/C	N/C	N/C
L	H	L	L	L	H	L	L	L	L	L	H	N/C	N/C	N/C	A
L	H	L	L	H	H	L	L	L	L	H	L	N/C	N/C	B	A
L	H	L	H	H	H	L	L	L	L	H	L	N/C	C	B	A
L	H	L	L	L	H	L	L	L	H	L	H	D	C	B	A
L	H	L	H	L	H	L	L	H	L	H	H	D	C	B	E
L	H	L	-	-	-	-	-	-	-	-	-	D	K	R	E

SEE CHARACTER SET

**LOADING CURSOR**

ADDRESS					DATA INPUT							DIGIT	DIGIT	DIGIT	DIGIT
$\overline{CE}$	$\overline{CU}$	$\overline{W}$	A <sub>1</sub>	A <sub>0</sub>	D6	D5	D4	D3	D2	D1	D0	3	2	1	0
H	X	X	X	X	X	X	X	X	X	X	X	D	K	B	E
L	L	L	X	X	X	X	X	L	L	L	H	D	K	B	.
L	L	L	X	X	X	X	X	L	L	L	L	D	K	.	E
L	L	L	X	X	X	X	X	L	H	L	L	D	.	B	E
L	L	L	X	X	X	X	X	H	L	L	L	.	K	B	E
L	L	L	X	X	X	X	X	H	H	H	H	.	.	.	.
L	L	L	X	X	X	X	X	L	L	L	L	D	K	B	E

Fig. 6. Litronix DL-1416 character set and truth table. X = don't care; N/C = no change.

# 6 Meters + ICOM + Sunspots = The best DX



## ICOM's 551D is Essential to the 6 mtr DX Formula.

The IC-551D is the high power brother to the ICOM IC-551. With an 80+ watt output, you have all the punch you need for that really good DX when the Sunspots are working for you. The 551D has the same no-backlash, no-delay dual VFO light chopper system, coupled to the microprocessor for split frequency as well as completely variable offsets.

For quick access to DX excitement, three memories are provided for programmed beacon watching, which can be scanned and programmed to stop on the first one heard. A room full

of white noise is no longer a problem with ICOM. Pass band tuning and VOX are included at no extra cost.

### SPECIFICATIONS

**Frequency Coverage:** 50~54MHz

### Power Supply Requirements:

13.8V DC $\pm$ 15%, negative ground  
Current drain 18A max.  
(at 200W input). AC power supply speaker console is available for AC operation.

### Emission Modes:

A3J SSB (USB/LSB)  
A1 CW  
A3H AM  
F3\* FM

**Dimensions:** 111mm (H) $\times$   
241mm (W) $\times$ 311mm (D)

**Weight:** 0.6kg

### Sensitivity: SSB/CW/AM

Less than 0.5 $\mu$ V for 10dB S+N/N  
FM\* More than  
30dB S+N+D/N+D at 1 $\mu$ V

**Squelch Sensitivity: SSB/CW/AM 1 $\mu$ V**  
FM\* C.4 $\mu$ V

### Selectivity: SSB/CW/AM

More than  $\pm$ 1.1 KHz at -6dB  
Less than  $\pm$ 2.2KHz at -60dB  
Adjustable to 1KHz at -6dB  
FM\*

More than  $\pm$ 7.5KHz at -6dB  
Less than  $\pm$ 15KHz at -60dB

\*Only when FM Unit is installed.

HF/VHF/UHF AMATEUR AND MARINE COMMUNICATION EQUIPMENT



# ICOM

## ICOM AMERICA, INCORPORATED

Sales Service Centers located at:

2112 116th Avenue NE  
Bellevue, WA 98004  
Phone (206) 454-8155

3331 Towerwood Dr., Suite 307  
Dallas, TX 75234  
Phone (214) 620-2780

### ICOM INFORMATION SERVICE

2112 116th Ave., N.E.  
Bellevue, WA 98004

Q H

Z S

Please send me:  IC-551D specifications sheet;  full color ICOM Product Line Catalog;  List of Authorized ICOM Dealers.

NAME \_\_\_\_\_ CALL \_\_\_\_\_

ADDRESS \_\_\_\_\_

CITY \_\_\_\_\_ STATE \_\_\_\_\_ ZIP \_\_\_\_\_

You may send a machine copy of this form

Program listing. Software for reader in 6800 assembler source code.

```

00001          NAM MORSEMAX (LED VERSION)
00002A 0000    ORG      S0000
00003          *****
00004          * MORSE CODE/ASCII SEND/RECEIVE PROGRAM
00005          * FOR THE MOTOROLA 6802 MICROPROCESSOR
00006          * FROM AUSTIN, TEXAS
00007          * MICROPROCESSOR CAPITOL OF THE WORLD!
00008          *****
00009          * I/O HARDWARE CONFIGURATION:
00010          * PIA1 ADDRESS - $8004
00011          * CA1 - INTERRUPT TIMING FOR XMIT CODE,
00012          * 2-50 HZ.
00013          * PA7 - RECEIVE CODE INPUT
00014          * PB0 - CODE OUT
00015          * PB1 - TRANSMIT LED
00016          * PB2 - RECEIVE LED
00017          * PIA2 ADDRESS (KBD) - $8020
00018          * LITRONIX DISPLAY DL-1416 4 DIGIT LED - $C000
00019          * MCM2708L EPROM - $E000
00020          *****
00021          * ALL COMMONLY USED MORSE CHARACTERS
00022          * ARE AVAILABLE:
00023          *
00024          * SPACE - SPACE
00025          * ESC - AS
00026          * = - BT
00027          * CNTRL A - KN
00028          * B - BK
00029          * C - AR
00030          * D - SK
00031          * F - SN
00032          * H - ERROR ( 8 DOTS )
00033          *****
00034          *
00035          *****
00036          *
00037          *****
00038A 0000    0002 A CVCX RMB 2 INDEX REG CONVERT STORE
00039A 0002    0002 A SAVEX RMB 2 X-REG TEMP STORAGE
00040A 0004    0001 A COUNT RMB 1
00041A 0005    0001 A RESMSK RMB 1 COSTA RESET MASK
00042A 0006    0001 A BFLAG RMB 1 B7=1 DATA IN BUFFER
00043A 0007    0003 A TMPVSE RMB 3 TEMP SAVE AREA FOR LED DIS
00044A 000A    0001 A COSTA RMB 1 CODE OUTPUT STATUS
00045          * *B7 DIT FLAG,B6 DAH FLAG,B5 ELEMENT SPACE FLAG
00046          * *B4 WORD SPACE FLAG,B3 CHAR. SPACE FLAG
00047A 000B    0001 A LETYPE RMB 1 LAST ELEM TYPE DOT=0 DASH
00048A 000C    0001 A HLETTM RMB 1 HALF LAST ELEM TIME
00049A 000D    0001 A TLETTM RMB 1 TWICE LAST ELEM TIME
00050A 000E    0001 A SPEEDK RMB 1 SPEED CONSTANT
00051A 000F    0001 A RCHAR RMB 1 CHAR BEING RECEIVED
00052A 0010    0001 A LDATM RMB 1 LAST DASH TIME
00053A 0011    0001 A TQDATM RMB 1 3/4 LAST DASH TIME
00054A 0012    0001 A TLDATM RMB 1 TWICE LAST DASH TIME
00055A 0013    0001 A KDTIM RMB 1 KEYDOWN INTERVAL TIME
00056A 0014    0001 A KUTIM RMB 1 KEYUP INTERVAL TIME
00057A 0015    0001 A KCTRM RMB 1 REC. CHARACTER COUNTER
00058A 0016    0002 A RECX RMB 2 REC. INDEX REG. TO ACCA.
00059A 0018    0055 A BUFBOT RMB 85 XMIT BUFFER BOTTOM
00060A 001D    0001 A BUFTOP RMB 1 XMIT BUFFER TOP

00062          * PIA USED FOR I/O OF CW AND LED STATUS
00063A 8004    ORG      $8004
00064A 8004    0001 A PIA1AD RMB 1
00065A 8005    0001 A PIA1AC RMB 1
00066A 8006    0001 A PIA1BD RMB 1
00067A 8007    0001 A PIA1BC RMB 1

00069          * PIA USED FOR KEYBOARD INPUT AND LED DISPLAY OUT
00070A 8020    ORG      $8020
00071A 8020    0001 A PIA2AD RMB 1 *KEYBOARD
00072A 8021    0001 A PIA2AC RMB 1
00073A 8022    0001 A PIA2BD RMB 1 *DISPLAY
00074A 8023    0001 A PIA2BC RMB 1

00076          007F A STACK EQU $007F
00077          FFF8 A IRQVEC EQU $FFF8
00078          *
00079A E000    * ORG      $F000
00080          * KN BK AR SK ACK
00081A E000    00 A CODE FCB 0,$B4,$8B,$54,$16,0,$14,0
00082          * ERR SP
00083A E008    01 A FCB 1,0,0,0,0,$21,0,0
00084A E010    00 A FCB 0,0,0,0,0,0,0,0
00085          * AS
00086A E018    00 A FCB 0,0,0,$44,0,0,0,0
00087          * SP

```

```

00088A E020    21 A RTAB FCB $21,0,$4A,0,0,0,0,$7A
00089          *
00090A E028    B6 A FCB $B6,$B2,0,0,0,$CE,$86,$56,$94
00091          * 0 1 2 3 4 5 6 7
00092A E030    FC A FCB $FC,$7C,$3C,$1C,$0C,4,$84,$C4
00093          * 8 9 : ; BT(=) ?
00094A E038    E4 A FCB $E4,$F4,$E2,$AA,0,$8C,0,$32
00095          * A B C D E F G
00096A E040    00 A FCB 0,$60,$8B,$A8,$90,$40,$28,$D0
00097          * H I J K L M N O
00098A E048    08 A FCB $08,$20,$78,$B0,$48,$F0,$A0,$F0
00099          * P Q R S T U V W
00100A E050    68 A FCB $68,$D8,$50,$10,$C0,$30,$18,$70
00101          * X Y Z
00102A E058    98 A FCB $98,$B8,$C8

00104          *****RESTART ROUTINE*****
00105A E05B CE 007F A RESRT LDX $57F CLR RAM 0-7F
00106A E05E 6F 00 A LI CLR 0,X
00107A E060 09 DEX
00108A E061 26 FB E05E BNE L1
00109A E063 CE 2020 A LDX $52020
00110A E066 DF 07 A STX TMPVSE 'CLEARS TMPVSE'
00111A E068 DF 08 A STX TMPVSE+1
00112A E06A CE 0F01 A LDX $50F01
00113A E06D DF 0E A STX SPEEDK INZ SPEED CONS & RCHAR
00114A E06F 86 80 A LDAA $580
00115A E071 97 6D A STAA BUFTOP INZ BUFTOP
00116A E073 09 DEX
00117A E074 CE E000 A LDX #CODE
00118A E077 DF 00 A STX CVCX INZ CVCX
00119A E079 CE 006D A LDX #BUFTOP
00120A E07C DF 02 A STX SAVEX
00121A E07E CE E0B4 A LDX #POLL INZ IRQ VECTOR
00122A E081 FF FFF8 A STX IRQVEC
00123A E084 CE 8004 A LDX #PIA1AD
00124A E087 6F 01 A CLR 1,X CLR PIA1AC
00125A E089 6F 03 A CLR 3,X CLR PIA1BC
00126A E08B 8E 0007 A LDS $50007 (PIA1A & ALLOWED
00127A E08E AF 00 A STS 0,X (PIA1A & PIA1AC)
00128A E090 8E FF34 A LDS $5FF34
00129A E093 AF 02 A STS 2,X (PIA1B & PIA1BC)
00130A E095 A6 00 A LDAA 0,X CLR IRQA FLAGS
00131A E097 A6 02 A LDAA 2,X CLR IRQB FLAGS
00132A E099 86 00 A LDAA $500
00133A E09B 87 8020 A STAA PIA2AD
00134A E09E 86 07 A LDAA $507 CA1 NEG INPUT
00135A E0A0 87 8021 A STAA PIA2AC
00136A E0A3 86 FF A LDAA $5FF
00137A E0A5 87 8022 A STAA PIA2BD SETS PIA2B FOR OUTPUTS
00138A E0A8 86 04 A LDAA $504
00139A E0AA 87 8023 A STAA PIA2BC SETS DDR
00140A E0AD 8E 007F A LDS #STACK INZ STACK POINTER
00141A E0B0 0E A CLI CLEAR INTERRUPT FLAG
00142A E0B1 3E EXEC WAI
00143A E0B2 20 FD E0B1 BRA EXEC
00144          *
00145          *****JUMP FROM IRQ VECTOR*****
00146A E0B4 7D 8005 A POLL TST PIA1AC
00147A E0B7 2B 0E E0C7 BMI POLL2 (MC1455 IRQ)
00148A E0B9 7B 8021 A TST PIA2AC
00149A E0BC 2B 6A E128 BMI COMMR1 (KEYBOARD IRQ)
00150A E0BE 7B 0006 A TST BUFLAG
00151A E0C1 2B 03 E0C6 BMI NOTRCV (DATA IN BUFFER)
00152A E0C3 7E E1E9 A JMP REC
00153A E0C6 3B NOTRCV RTI

00155          *****TRANSMIT ROUTINE*****
00156A E0C7 F6 8004 A POLL2 LDAB PIA1AD
00157A E0CA F6 8006 A LDAB PIA1BD
00158A E0CD CA 02 A ORAB #2 XMIT LED ON
00159A E0CF C4 FB A ANDB $5FB REC LED OFF
00160A E0D1 F7 8006 A STAB PIA1BD
00161A E0D4 96 0A A LDAA COSTA GET CODE OUTPUT STATUS
00162A E0D6 2A 07 E0DF BPL CFDAH CHECK FOR DAH
00163A E0D8 C6 7F A LDAB $57F
00164A E0DA D7 05 A STAB RESMSK DIT BEING
00165A E0DC 5F CES1 CLRB TST
00166A E0DD 20 29 E108 BRA CKCNT TEST COUNT
00167A E0DF 48 CFDAH ASLA TEST FOR DAH
00168A E0E0 2A 08 E0EA BPL CFES CHECK FOR ELEMENT SPACE
00169A E0E2 C6 BF A LDAB $5BF
00170A E0E4 D7 05 A STAB RESMSK DAH RESET
00171A E0E6 C6 04 A LDAB #4 DAH BEING SENT
00172A E0E8 20 1E E108 BRA CKCNT

00174A E0EA 4B CFES ASLA TEST FOR ELEMENT SPACE
00175A E0EB 2A 0A E0F7 BPL CFWS CHECK FOR WORD SPACE
00176A E0ED C6 DF A LDAB $5DF
00177A E0EF D7 05 A STAB RESMSK ELEMENT SPACE *RESET
00178A E0F1 8D 2C E11F BSR SOZERO
00179A E0F3 C6 01 A LDAB #1
00180A E0F5 20 11 E108 BRA CKCNT

```

gram permanently until it is desired to erase it. For a one-time shot, specify the plastic version. Much less expensive, but good only once. On the ceramic types, be sure to keep the adhesive paper over the quartz lid, as it might start to forget if exposed to ultraviolet light. The MC6802 processor contains an on-board clock generation circuit and 128

bytes of RAM. This RAM is used by the processor for temporary storage and for the 85-character keyboard buffer. You can type in up to 85 characters, sit back, and drink your coffee while the code dribbles out. Additional memory could be added—up to 65 thousand characters, and that's what I call a big buffer. With only a little more memory, canned messages

could be inserted and held for a later call-up (before power is turned off)—CQs, tests, QTHs, for example. As the program is right now, only what is typed will be sent out.

Almost any crystal between 1 and 4 MHz can be used, so the old junk box can be used for some of the components. Look in an old color TV set—the 3.58-MHz crystal works

well, too. Reset is provided by the resistor-capacitor combination automatically upon power-up conditions. If for any reason the computer does something strange or just quits, turn the power off and back on again. This will reset everything and start over. A note about the keyboard: The program is set up to recognize any keyboard that provides the ASCII code

```

00182A E0F7 48 CFWS ASLA
00183A E0F8 2A 08 E102 BPL CFCFS
00184A E0FA C6 EF A LDAB $SEF CHECK FOR SPACE
00185A E0FC D7 05 A STAB RESMSK
00186A E0FE C6 08 A LDAB $8 WORD SPACE RESET
00187A E100 20 06 E108 BRA CKCNT WORD SPACE BEING SENT

00189A E102 C6 F7 A CFCFS LDAB $SF7
00190A E104 D7 05 A STAB RESMSK
00191A E106 C6 04 A LDAB $8
00192A E108 D1 04 A CKCNT CMPB COUNT
00193A E10A 27 06 E112 BEQ CK1
00194A E10C 7C 0004 A INC COUNT
00195A E10F 7E E0B4 A RETRN JMP POLL

00197A E112 7F 0004 A CK1 CLR COUNT
00198A E115 96 0A A LDAA COSTA
00199A E117 94 05 A ANDA ANDA RESMSK
00200A E119 97 0A A STAA COSTA
00201A E11B 26 F2 E10F BNE RETRN
00202A E11D 20 14 E133 BRA GNEL

00204 ***SEND OUT A ZERO***
00205A E11F B6 8006 A SOZERO LDAA PIA1BD
00206A E122 84 FE A ANDA $SFE
00207A E124 87 8006 A STAA PIA1BD
00208A E127 39 RTS
00209A E128 20 64 E1B8 COMMRI BRA COMMRR

00211 ***SEND OUT A ONE***
00212A E12A B6 8006 A SOONE LDAA PIA1BD
00213A E12D 8A 01 A ORAA $1 SET BIT ZERO
00214A E12F B7 8006 A STAA PIA1BD
00215A E132 39 RTS

00217 ***GET NEW ELEMENT FOR OUTPUT***
00218A E133 96 6D A GNEL LDAA BUFTOP
00219A E135 81 80 A CMPA $S80 TEST FOR CHAR END
00220A E137 26 26 E15F BNE GNEL1
00221A E139 86 08 A LDAA $S08 SEND OUT CHAR. SPACE
00222A E13B 97 0A A STAA COSTA
00223A E13D 8D E0 E11F BSR SOZERO
00224A E13F DE 02 A LDX SAVEX
00225A E141 8C 006D A CPX $BUFTOP
00226A E144 26 09 E14F BNE GNELR
00227A E146 96 06 A LDAA BUFLAG BUFFER EMPTY
00228A E148 84 7F A ANDA $S7F
00229A E14A 97 06 A STAA BUFLAG RESET FLAG
00230A E14C 7E E0B4 A JMP POLL
00231
00232A E14P 8D 2D E17E GNELR BSR MOVUP
00233A E151 96 6D A LDAA BUFTOP
00234A E153 81 21 A CMPA $S21 LOOK FOR SPACE
00235A E155 27 1A E171 BEQ SWS
00236A E157 7D 000A A TST COSTA
00237A E15A 27 03 E15P BEQ GNEL1
00238A E15C 7E E0B4 A JMP POLL
00239
00240A E15F 78 006D A GNEL1 ASL BUFTOP
00241A E162 25 04 E168 BCS SODAH SEND OUT DAH
00242A E164 86 A0 A LDAA $SA0 SEND OUT DIT & ELEMENT SPA
00243A E166 20 02 E16A BRA SOEL
00244
00245A E168 86 60 A SODAH LDAA $S60 SEND OUT DAH & ELEMENT SPAC
00246A E16A 97 0A A SOEL STAA SET STATUS
00247A E16C 8D BC E12A BSR SOONE
00248A E16E 7E E0B4 A JMP POLL
00249
00250A E171 86 80 A SWS LDAA $S80
00251A E173 97 6D A STAA BUFTOP
00252A E175 86 10 A LDAA $S10
00253A E177 97 0A A STAA COSTA SEND OUT WORD SPACE
00254A E179 8D A4 E11F BSR SOZERO
00255A E17B 7E E0B4 A JMP POLL
00256
00257A E17E CE 0055 A MOVUP LDX $BUFTOP-BUFBOT
00258A E181 A6 17 A MOV1 LDAA BUFBOT-1,X
00259A E183 A7 18 A STAA STAA BUFBOT,X
00260A E185 09 DEX
00261A E186 26 F9 E181 BNE MOV1
00262A E188 DE 02 A LDX SAVEX UPDATE INPUT POINTER
00263A E18A 08 INX
00264A E18B DF 02 A STX SAVEX
00265A E18D 39 RTS

00267 ***COMM REC INTERRUPT ROUTINE***
00268A E18E DE 02 A COMMRR LDX SAVEX
00269A E190 B6 8020 A LDAA PIA2AD GET KB DATA
00270A E193 8C 0018 A CPX $BUFBOT
00271A E196 27 49 E1E1 BEQ BUFPUL MEMORY BUFFER FULL
00272A E198 81 5A A CMPA $S5A
00273A E19A 22 49 E1E5 BHI BADCH ILLEGAL CHAR
00274A E19C 97 01 A STM STAA CVCX+1

00275A E19E DE 00 A LDX CVCX
00276A E1A0 E6 00 A LDAB 0,X DATA CONVERTED TO MORSE CO
00277A E1A2 27 41 E1E5 BEQ BADCH KICK OUT BAD CHAR'S
00278A E1A4 DE 02 A LDX SAVEX
00279A E1A6 09 DEX
00280A E1A7 E7 00 A STAB 0,X STORE DATA IN BUFFER
00281A E1A9 DF 02 A STX SAVEX MOVE POINTER DOWN
00282A E1AB D6 06 A LDAB BUFLAG
00283A E1AD CA 80 A ORAB $S80 SET FLAG BIT 7
00284A E1AF D7 06 A STAB BUFLAG
00285A E1B1 8D 03 E1B6 PRNT BSR OUTCH PRINT CHARACTER
00286A E1B3 7E E0B4 A BSR POLL
00287 ***PRINT CHARACTER ROUTINE***
00288A E1B6 36 OUTCH PSHA SAVE LSB CHARACTER
00289A E1B7 C6 C0 A LDAB $S00
00290A E1B9 CE 0009 A LDX $TMPSVE+2
00291A E1BC A6 00 A LDAA 0,X
00292A E1BE 8D 10 E1D0 OUTCH1 BSR STROBE
00293A E1C0 09 DEX
00294A E1C1 A6 00 A LDAA 0,X
00295A E1C3 A7 01 A STAA 1,X
00296A E1C5 C0 40 A SUBB $S40
00297A E1C7 26 F5 E1BE BNE OUTCH1
00298A E1C9 32 PULA
00299A E1CA 84 3F A ANDA $S3F STRIPS BIT 6 AND 7
00300A E1CC 97 07 A STAA TMPSVE
00301A E1CE 20 00 E1D0 BRA STROBE
00302A E1D0 1B STROBE ABA
00303A E1D1 B7 8022 A STAA PIA2BD WRITE INTO APPROPRIATE DIG
00304A E1D4 86 34 A LDAA BIT 3 = 0
00305A E1D6 B7 8023 A STAA PIA2BC PULSES CR2 LOW
00306A E1D9 86 3C A LDAA $S3C BIT 3 = 1
00307A E1DB B7 8023 A STAA PIA2BC AND BACK AGAIN FOR
00308A E1DE 39 RTS WRITF PULSE
00309A E1DF 20 AD E1BE COMMRR2 BRA COMMRR
00310
00311A E1E1 86 2A A RUFFUL LDAA $' PRINT '*' FOR RUFFER FULL
00312A E1E3 20 CC E1B1 PRNT
00313
00314
00315A E1E5 86 23 A BADCH LDAA $S23 PRINT '*' FOR BAD CHAR
00316A E1E7 20 C8 E1B1 BRA

00318 ***START OF RECEIVE ROUTINE***
00319A E1E9 B6 8006 A REC LDAA PIA1BD
00320A E1EC 8A 04 A ORAA $8 REC LED ON
00321A E1EE 84 FD A ANDA $SFD XMIT LED OFF
00322A E1F0 B7 8006 A STAA PIA1BD
00323A E1F3 86 FF A KEYUP LDAA $SFF RESET INTERVAL COUNTER
00324A E1F5 81 FE A KULOOP CMPA $SFE INTERVAL COUNTER AT MAX?
00325A E1F7 27 03 E1FC BEQ NOINC DO NOT INCR IF MAX
00326A E1F9 4C INCA INCREMENT INTERVAL COUNTER
00327A E1FA 20 0A E206 BRA KUCONT

00329A E1FC 97 14 A NOINC STAA KUTIM SAVE KU INTERVAL TIME
00330A E1FE D6 0F A LDAB RCHAR GET RCVD CHAR
00331A E200 C1 01 A CMPB $1 ANYTHING THERE?
00332A E202 27 02 E206 BEQ KUCONT
00333A E204 8D 4C E252 BSR COMPKU
00334A E206 F6 8004 A KUCONT LDAB PIALAD CHECK INPUT
00335A E208 2B 09 E214 BHI KD BRANCH IF KEYDOWN
00336A E20B 8D 36 E243 BSR TIMER TIME DELAY

00338A E20D 7D 8021 A TST PIA2AC TESTS BIT 7 TO SEF IF DATA
00339A E210 2B CD E1DF BHI COMMRR2 IF DATA THN XMIT
00340A E212 20 E1 E1F5 BRA KULOOP
00341A E214 97 14 A KD STAA KUTIM
00342A E216 8D 3A E252 BSR COMPKU
00343A E218 86 FF A KEYDOWN LDAA $SFF RESET INTERVAL TIMER
00344A E21A 81 FE A RDLOOP CMPA $SFE INTERVAL COUNTER AT MAX?
00345A E21C 27 01 E21F BEQ MAXKD DO NOT INCR IF MAX
00346A E21E 4C INCA INCREMENT INTERVAL COUNTER
00347A E21F F6 8004 A MAXKD LDAB PIALAD CHECK INPUT
00348A E222 2A 04 E228 BPL KU BRANCH IF KEYUP
00349A E224 8D 1D E243 BSR TIMER
00350A E226 20 F2 E21A BRA KULOOP

00352A E228 97 13 A KU STAA KDTIM SAVE KD INTERVAL TIME
00353A E22A 81 04 A CMPA $S4 KD INTERVAL TIME TOO LOW?
00354A E22C 24 05 E233 BCC CKHI BRANCH IF NOT TOO LOW
00355A E22E 96 0E A LDAA SPEEDR
00356A E230 44 LSR DIVIDE SPEED CONSTANT BY 2
00357A E231 20 07 E23A BRA UNZERO

00359A E233 81 7F A CKHI CMPA $S7F KD INTERVAL TIME TOO HIGH?
00360A E235 25 07 E23E BCS BRANCH IF OK
00361A E237 96 0E A LDAA SPEEDK
00362A E239 48 ASLA MULTIPLY SPEED CONSTANT BY

```

Continued

set and a negative-going strobe. There are many available from wholesale houses for \$20.00 and up.

### Key Characters Available

The computer will generate all of the Morse characters plus some special function keys which can be generated by the use of the CNTRL key. A list of them follows:

Control A — KN  
 B — BK  
 C — AR  
 D — SK  
 F — SN  
 H — ERROR  
           (8 dots)  
 = — BT  
 ESC — AS  
 SPACE — SPACE

A "space" will insert a space in the buffer to be transmitted along with the code, thereby making per-

fect Morse every time. While typing, if you should reach the top of the buffer, the character you try to enter will be displayed as an \*, meaning that it did not get entered and you should reenter it after one character has been sent.

Any illegal character typed will appear as a # and will not get sent. Any received character which the computer cannot

figure out—like run-together characters—will be displayed as an \_\_, and an error (8 dots) will be an @.

### Parts Procurement

All parts (with the exception of the DL-1416) can be obtained from your local Motorola distributor, and the 1416 comes from a Litronix distributor. All of the parts should tally to

```

00363A E23A 8A 01 A UNZERO ORAA #1 ASCERTAIN SPEED CONSTANT I
00364A E23C 97 0E A A STAA SPEEDK NOT SET TO ZERO
00365A E23E 8D 31 E271 CMPTKD BSR COMPKD
00366A E240 7E E1F3 A JMP KEYUP

00368 ***SUBROUTINE TO CREATE TIME DELAY***
00369A E243 37 TIMER PSHB SAVE B
00370A E244 36 PSHA SAVE A
00371A E245 D6 0E A LDAB SPEEDR
00372A E247 86 40 A DELOOP LDAA #540
00373A E249 4A DELOOP DECA
00374A E24A 26 FD E249 BNE DELOOP
00375A E24C 5A DECB
00376A E24D 26 FB E247 BNE DELOP2
00377A E24F 32 PULA RESTORE A
00378A E250 33 PULB RESTORE B
00379A E251 39 RTS

00381 ***SUBROUTINE TO COMPUTE KU***
00382A E252 91 11 A COMPKU CMPA TOLDAT
00383A E254 25 1A E270 BCS MOREL BRANCH IF KUTIM ~ TOLDAT
00384A E256 96 0F A LDAA RCHAR GET CHAR BEING RECEIVED
00385A E258 01 01 A CMPA #1
00386A E25A 27 09 E265 BBO CKFSP
00387A E25C 8D 4A E2A8 BSR GAFT GET ASCII FROM TABLE
00388A E25E 8D E1B6 A JSR OUTCH PRINT CHARACTER IN ACCA
00389A E261 86 01 A LDAA #1
00390A E263 97 0F A STAA RCHAR READY FOR NEW CHAR
00391A E265 96 12 A CKFSP LDAA TLDAT GET TWICE LAST DASH TIME
00392A E267 91 14 A CMPA KUTIM COMPARE WITH KU INTERVAL
00393A E269 24 05 E270 BCC MOREL BRANCH IF TLDAT == KU INTR
00394A E26B 86 20 A LDAA #S20 ASCII SPACE
00395A E26D 8D E1B6 A JSR OUTCH PRINT SPACE
00396A E270 39 MOREL RTS

00398 ***SUBROUTINE TO COMPUTE KD***
00399A E271 96 0D A COMPKD LDAA TLETIM GET TWICE LAST ELEM TIME
00400A E273 91 13 A CMPA KDTIM COMPARE WITH KD INTERVAL
00401A E275 25 10 E287 BCS DASHEL BRANCH IF TLETIM ~ KD INTR
00402A E277 96 0C A LDAA HLETIM GET HALF LAST ELEM TIME
00403A E279 91 13 A CMPA KDTIM COMPARE WITH KD INTERVAL
00404A E27B 24 04 E281 BCC DOTEL BRANCH IF HLETIM == KD INT
00405A E27D 96 0B A LDAA LETYPE CHECK LAST ELEMENT TYPE
00406A E27F 26 06 E287 BNE DASHEL BRANCH IF LAST ELEM WBS DA
00407A E281 7F 000B A DOTEL CLR LETYPE MAKE LAST ELEM TYPE=00=DOT
00408A E284 0C CLC
00409A E285 20 14 E29B BRA ADDEL
00410A E287 7C 000B A DASHEL INC LETYPE MAKE LAST ELEM TYPE=DASH
00411A E28A 96 13 A LDAA KDTIM GET KD INTERVAL
00412A E28C 97 10 A STAA LDATIM STORE IN LAST DASH TIME
00413A E28E 16 TAB SAVE IN ACCUM B
00414A E28F 44 LSRA DIVIDE KD INTERVAL BY 2
00415A E290 97 11 A STAA TOLDAT SAVE 1/2 KD
00416A E292 44 LSRA DIVIDE 1/2 KD BY 2
00417A E293 9B 11 A ADDA TOLDAT ADD 1/2 TO 1/4 KD INTERVAL
00418A E295 97 11 A STAA TOLDAT STORE RESULT
00419A E297 58 ASLB MULTIPLY KD INTERVAL BY 2
00420A E298 D7 12 A STAB TLDAT STORE RESULT
00421A E29A 0D SEC
00422A E29B 79 000F A ADDEL ROL RCHAR ADD NEW ELEM TO CHARACTER
00423A E29E 96 13 A LDAA KDTIM GET KD INTERVAL
00424A E2A0 16 TAB SAVE IN ACCUM B
00425A E2A1 44 LSRA DIVIDE KD BY 2
00426A E2A2 97 0C A STAA HLETIM STORE 1/2 KD INTERVAL
00427A E2A4 58 ASLB MULTIPLY KD BY 2
00428A E2A5 D7 0D A STAB TLETIM STORE TWICE KD INTERVAL
00429A E2A7 39 RTS

00431 ***SUBR. TO GET ASCII CHAR FROM CODE TABLE***
00432A E2AB 0D GAFT SEC CHANGE FORMAT OF RCHAR.
00433A E2A9 49 ROLA
00434A E2AA 48 GAFT1 ASLA
00435A E2AB 24 FD E2AA BCC GAFT1
00436A E2AD CE E05A A LDX #RESRT-1
00437A E2B0 A1 00 A STAB1 CMPA 0,X
00438A E2B2 27 09 E2BD BEQ TABM FOUND MATCH
00439A E2B4 09 DEX
00440A E2B5 8C E021 A CPX #RTAB+1 END OF TABLE?
00441A E2B8 26 F6 E2B0 BNE STAB1 NO!
00442A E2BA 86 5P A LDAA # _ RETURN " _ " FOR NO MATCH
00443A E2BC 39 RTS
*
00444A E2BD DF 16 A TABM STX RECX
00446A E2BP 96 17 A LDAA RECX+1 X(LOW) TO ACCA.
00447A E2C1 39 RTS

00449 ***INITIALIZATION AND RESTART VECTORS***
00451A E3F8 ORG CODE+S3F8
00452A E3F8 E0B4 A FDB POLL IRO
00453A E3FA E05B A FDB RESRT SWI
00454A E3FC E05B A FDB RESRT NMI
00455A E3FE E05B A FDB RESRT RESET
00456 END
TOTAL ERRORS 00000

E29B ADDEL 00409 00422*
E1E5 BADCH 00273 00277 00315*
0018 BUFBOT 00059*00257 00258 00259 00270
E1E1 BUFFUL 00271 00311*
0006 BUFLAG 00042*00150 00227 00229 00282 00284
006D BUFTOP 00060*00115 00119 00218 00225 00233 00240 00251 00257
E0DC CES1 0165*
E102 CFCS 00183 00189*
E0DF CFDAH 00162 00167*
E0EA CFES 00168 00174*
E0F7 CFWS 00175 00182*
0015 CHCTR 00057*
E112 CK1 00193 00197*
E108 KCKNT 00166 00172 00180 00187 00192*
E265 CKFSP 00386 00391*
E233 CKHI 00354 00359*
E23E CMPTKD 00360 00365*
E000 CODE 00081*00117 00451
E18E COMMR 00209 00268*00309
E128 COMMR1 00149 00209*
E1DF COMMR2 00309*00339
E271 COMPKD 00365 00399*
E252 COMPKU 00333 00342 00382*
000A COSTA 00044*00161 00198 00200 00222 00236 00246 00253
0004 COUNT 00040*00192 00194 00197
0000 CVCX 00038*00118 00274 00275
E287 DASHEL 00401 00406 00410*
E249 DELOOP 00373*00374
E247 DELOP2 00372*00376
E281 DOTEL 00404 00407*
E0B1 EXEC 00142*00143
E2A8 GAFT 00387 00432*
E2AA GAFT1 00434*00435
E133 GNEL 00202 00218*
E15F GNEL1 00220 00237 00240*
E14F GNELR 00226 00232*
000C HLETIM 00048*00402 00426
FFF8 IRQVEC 00077*00122
E214 KD 00335 00341*
E21A KDLOOP 00344*00350
0013 KDTIM 00055*00352 00400 00403 00411 00423
E218 KEYDWN 00343*
E1F3 KEYUP 00323*00366
E228 KU 00348 00352*
E206 KUCONT 00327 00332 00334*
E1F5 KULoop 00324*00340
0014 KUTIM 00056*00329 00341 00392
E05E L1 00106*00108
0010 LDATIM 00052*00412
000B LETYPE 00047*00405 00407 00410
E21F MAXKD 00345 00347*
E270 MOREL 00383 00393 00396*
E181 MOV1 00258*00261
E18D MOVRT 00265*
E17E MOVUP 00232 00257*
E1FC NOINC 00325 00329*
E0C6 NOTRCV 00151 00153*
E1B6 OUTCH 00285 00288*00388 00395
E1BE OUTCH1 00292*00297
8005 PIA1AC 00065*00146
8004 PIA1AD 00064*00123 00156 00334 00347
8007 PIA1BC 00067*
8006 PIA1BD 00066*00157 00160 00205 00207 00212 00214 00319 00322
8021 PIA2AC 00072*00135 00148 00338
8020 PIA2AD 00071*00133 00269
8023 PIA2BC 00074*00139 00305 00307
8022 PIA2BD 00073*00137 00303
E0B4 POLL 00121 00146*00195 00230 00238 00248 00255 00286 00452
E0C7 POLL2 00147 00156*
E1B1 PRNT 00285*00312 00316
000F RCHAR 00051*00330 00384 00390 00422
E1E9 REC 00152 00319*
0016 RECX 00058*00445 00446
0005 RESMSK 00041*00164 00170 00177 00185 00190 00199
E05B RESRT 00105*00436 00453 00454 00455
E10F RETRN 00195*00201
E020 RTAB 00088*00440
0002 SAVEX 00039*00120 00224 00262 00264 00268 00278 00281
E168 SODAH 00241 00245*
E16A SOEL 00243 00246*
E12A SOONE 00212*00247
E11F SOZERR 00178 00205*00223 00254
000E SPEEDK 00050*00113 00355 00361 00364 00371
E2B0 STAB1 00437*00441
E07F STACK 00076*00140
E19C STM 00274*
E1D0 STROBE 00292 00301 00302*
E171 SWS 00235 00250*
E2BD TABM 00438 00445*
E243 TIMER 00336 00349 00369*
0012 TLDAT 00054*00391 00420
000D TLETIM 00049*00399 00428
0007 TMPSTV 00043*00110 00111 00290 00300
0011 TOLDAT 00053*00382 00415 00417 00418
E23A UNZERO 00357 00363*

```

less than \$80-\$90, including the display, which is \$30 in quantities of one.

### Operation

Operation of the reader-talker is quite simple. Hook up the required power supplies, the cords to the speaker and key jacks, and go to town. The easiest way to tune in a signal is to use the on-board headphone

jack and set the selectivity to 40 Hz. When you hear the signal, watch the LED, and when it starts to blink at the incoming CW rate, switch the filter to the processed mode and tune for the cleanest signal. An RIT control is almost a must as the input tuning is quite sharp, and if you tune the other guy for the best signal each time he gives it

back to you, you could walk right up or down the band!

The only drawback I have found is that when copying at fast speeds, the display will run words together, since most operators do not leave enough space between them. I understand that most of the keyboard keyers do not have a space key on them,

and this will explain some of the problems. The others are self-explanatory. As I said earlier, the lack of more digits on the board is not a hindrance, and after you use it a while, you'll agree. Whether you use a PC board or wire-wrap this project, it will be a great addition to any ham shack and do a lot for cleaning up the airways. ■

# Microcomputers and Your Satellite Station

## — part 1: calculating orbital crossing data

*Dr. Ralph E. Taggart WB8DQT  
602 S. Jefferson  
Mason MI 48854*

**I**n case you haven't noticed, microcomputers have really begun to come of age. Units such as the Radio Shack TRS-80 are available with built-in BASIC language (in ROM) and a reasonable amount of RAM workspace. The availability of such machines, with capability for later expansion, has shifted the emphasis from small computers as an engaging hobby to their real utility as data processing terminals in science, business, and a number of other areas of application. I purchased a TRS-80 computer to handle a number of important jobs in my research lab, with an eye toward its possibilities in my weather satellite operation as well. I have been completely happy with the

computer and have been working up innumerable programs, some of which involve the satellite operation.

There is little doubt that one of the most tedious tasks facing satellite station operators is keeping track of equatorial crossing data for polar orbiting spacecraft. Such information is absolutely essential in generating tracking data for the OSCAR communications satellites and the various polar orbiting weather satellites. There are several ways to keep track of this information. The most direct procedure is to monitor the W1AW bulletins on a daily basis to get reference orbit data for the next day. This is time-consuming and still requires that you calculate crossing dates for passes not covered with the reference orbit data. You can get similar reference orbit data

from the various magazines, AMSAT bulletins, and other sources, but again you often are faced with calculating crossings for additional passes, since most of these sources list only one or two reference crossings for a given day.

My usual situation is that I will decide on short notice that I want to copy a few weather satellite passes. I then will root around looking for some old crossing data, usually finding something up to several weeks old written on the back of a matchbook cover or something equally pretentious! I then sit down and quickly project the data with the pocket calculator (something that usually is anything but quick), only to discover that I have just missed the best pass or that I have made an error and none of the carefully-generated numbers means anything for that particular day.

One of my first program-

ming tasks when I had the TRS-80 on line, was to develop a program to provide orbital crossing data, given information on any single reference crossing. This program is shown in Fig. 1. The program is written in Radio Shack Level I BASIC and incorporates the various abbreviations that are possible with that dialect—P for PRINT, for example. With minimal work, the program could be modified to run in almost any of the small BASIC dialects. As written, the program occupies 2062 bytes of memory and fits comfortably within the 4K capacity of the most inexpensive member of the TRS-80 family. Even with modifications to run on another system, it is safe to say that the program easily could be accommodated in 4K of memory and thus be usable on virtually all small systems.

Let's look at the use of

the program, and then we can consider some highlights of the program structure for those of you who can't resist making modifications.

### Using the Program

You can load the program at the keyboard using Fig. 1 and then save it on cassette for later use after debugging the inevitable typos! Once the program is loaded, simply enter RUN (R), and the display should show the program ID header (ah, vanity!) and request the name of the spacecraft. Here, you simply enter the name of the bird you are tracking. Let's take a fictitious example and enter NOAA 6. It then will request the orbital

period in minutes. You should use the most accurate figure you can obtain for the period as this and the number of significant figures the machine can handle are the primary limitations in the accuracy of long-term predictions. For the sake of example, let's enter a period of 115.16 minutes.

The computer then will print:

```
ENTER MONTH, DAY,
YEAR OF REFERENCE
CROSSING:
```

?

Each part of this data must be entered separately. For example, if the date of the reference crossing is 1/23/78, you would perform the following input operations:

1 ENTER

23 ENTER

78 ENTER

The machine will ask for the reference orbit number. This tells us the number of orbits since initial insertion and is handy for making long-distance OSCAR schedules (both stations can be assured that they are using the satellite during the proper pass) and for cataloging satellite pictures in the case of the weather birds. If you don't care about orbit numbers, simply enter 0. If you use them, then simply enter the number of your reference orbit. Let's say, for the sake of our example, that the reference orbit number is 7248—we would enter that number

when requested.

The computer now will request the hours, minutes, and seconds of the reference crossing. Like the date, these items are entered separately and in sequence. If the crossing is at 20:15:48, we would enter 20, enter 15, and enter 48. A note here: If the reference data are GMT times and dates, the printout will be so referenced. If you want printout in local times and date, make the appropriate conversions in the reference data prior to entry.

The computer now will ask for the crossing point in degrees W. If your reference data has a crossing in degrees E longitude, convert this to degrees W using the formula:

```

1 CLS
10 P."ORBITAL CROSSING PROGRAM"
15 P."BY DR. RALPH E. TAGGART"
20 P.
25 IN."WHAT IS THE NAME OF THE SPACECRAFT";A$
30 CLS:IN."ENTER THE ORBITAL PERIOD (IN MINUTES)";P:CLS
35 P."ENTER MONTH, DAY, AND YEAR OF REFERENCE CROSSING"
40 IN.L:IN.J:IN.K:GOSUB 900:D=W:Z=W:CLS
45 IN."REFERENCE ORBIT NUMBER";N:X=N:CLS
50 P."ENTER HR., MIN., SEC. OF REFERENCE CROSSING"
55 IN.H:IN.M:IN.S:A=(60*H)+M+(S/60):G=A:CLS
60 IN."REFERENCE CROSSING POINT (DEG W)";C:Y=C:CLS
65 P."ENTER MONTH, DAY, YEAR FOR DISPLAY"
70 IN.L:IN.J:IN.Q:GOSUB 900:T=W:CLS
75 IF (Q<K)+(T<D) THEN GOSUB 930:GOTO 65
80 IF Q=K+1 THEN T=365+T
85 IF T>D+5 THEN 500
90 GOSUB 940
100 A=A+P:N=N+1
110 IF A>1440 THEN A=A-1440
120 C=((P/1440)*360)+C
130 IF C>360 THEN C=C-360
140 IF D=T THEN 200
150 IF D>T THEN 300
160 GOTO 100
200 H=INT(A/60)
210 M=INT(A-(H*60))
220 S=A-((H*60)+M):S=INT(S*60)
230 E=C+.05:E=INT(E*10)/10
240 P.N,H;"":M;"":S,E
250 GOTO 100
300 IN."DO YOU WANT ANOTHER DAY'S DATA (Y=1 N=0)";R
310 IF R=0 THEN 400
320 P."ENTER MONTH, DAY, YEAR FOR DISPLAY"
330 IN.L:IN.J:IN.Q:GOSUB 900:T=W:CLS
340 IF (Q<K)+(T<Z) THEN GOSUB 930:GOTO 300
350 IF Q=K+1 THEN T=356+T
360 IF T=D-1 THEN GOSUB 950:GOTO 300
370 IF T=D THEN GOSUB 940:GOTO 200
380 IF T>D+5 THEN 500
385 IF D>T THEN D=Z:A=G:C=Y:N=X:GOTO 75
390 GOSUB 940:GOTO 100
400 CLS:IN."ANOTHER SPACECRAFT";R
410 IF R=1 THEN CLS:GOTO 25
420 END
500 D=Z:A=G:C=Y:N=X
505 B=(T-1)-D:I=1440*B:B=INT(I/P)+1
510 A=(B*P)-I
520 V=B*((P/1440)*360):U=INT(V/360):C=V-(U*360)
530 D=T-1:N=N+B
540 GOSUB 940:GOTO 100
899 END
900 W=0
901 IF L=1 THEN W=J:RET.
902 IF L=2 THEN W=31+J:RET.
903 IF L=3 THEN W=59+J:RET.
904 IF L=4 THEN W=90+J:RET.
905 IF L=5 THEN W=120+J:RET.
906 IF L=6 THEN W=151+J:RET.
907 IF L=7 THEN W=181+J:RET.
908 IF L=8 THEN W=212+J:RET.
909 IF L=9 THEN W=243+J:RET.
910 IF L=10 THEN W=273+J:RET.
911 IF L=11 THEN W=304+J:RET.
912 IF L=12 THEN W=334+J:RET.
930 P."SORRY - PROGRAM DOES NOT COMPUTE DATA"
931 P."PRIOR TO REFERENCE CROSSING":RET.
940 CLS:P."DATE ";L:"/";J:"/";Q;" ";A$
941 P."ORBIT","TIME","DEGREES W":RET.
950 CLS:P."YOU JUST PRINTED DATA FOR ";L:"/";J:"/";Q
951 RET.
999 END

```

Fig. 1. TRS-80 program for computation of satellite equatorial crossings. Given a single reference crossing, the program permits the computer to display crossings for any subsequent day for a period of up to two years from the date of the reference crossing.



```

DATE: 1/24/78 NOAA 6
ORBIT TIME DEGREES W
7250 0:6:7 157.8
7251 2:1:16 186.6
7252 3:56:26 215.4
7253 5:51:35 244.2
7254 7:46:45 273
7255 9:41:55 301.8
7256 11:37:4 330.5
7257 13:32:14 359.3
7258 15:27:23 28.1
7259 17:22:33 56.9
7260 19:17:43 85.7
7261 21:12:52 114.5
7262 23:8:2 143.3
DO YOU WANT ANOTHER DAYS DATA (Y=1 N=0)?

```

Fig. 2. Sample printout for 1/24/78, given a reference crossing for NOAA 6 on 1/23/78 at 20:15:48, crossing the equator at 100.23° W (assuming a period of 115.16 minutes).

#### Numeric Variables

- A The current crossing time in minutes.
- B Scratchpad variable in the 500 block routines.
- C The current crossing point (degrees W).
- D The current numerical day.
- E Rounded value for the crossing point used for display.
- F Not used.
- G Not used.
- H Hours—used for input and display.
- I Scratchpad variable in the 500 block routines.
- J Day of the month (used for input).
- K Year of the reference crossing date.
- L Month of the year (used for input).
- M Minutes—used for input and display.
- N Current orbit number.
- O Not used.
- P The orbital period.
- Q The year of the display date.
- R Interactive question replies.
- S Seconds—used for input and display.
- T Display day number.
- U Scratchpad variable in the 500 block routines.
- V Scratchpad variable in the 500 block routines.
- W Output value from the date conversion subroutine.
- X Orbit number for the reference crossing.
- Y Reference orbit crossing point (degrees W).
- Z Day number of the reference crossing.

#### String Variables

- A\$ The name of the spacecraft.
- B\$ Not used.

Fig. 3. Variable assignments in the orbital crossing program.

Longitude (°W) = 360 – (Longitude °E).

Let us assume a crossing point of 100.23° W and enter it. The computer will ask for the month, day, and year for display. This is entered in three parts, as before. Let's take the next day—1/24/78—and enter 1, then 24, and then 78. Quick as a wink the computer will

print out the display shown in Fig. 2, showing all of the passes for 1/24/78.

It certainly beats messing with the calculator, doesn't it? Note that you are not necessarily finished, for at the bottom of the listing you are asked if you want another day's printout. If you do, simply enter 1 and the computer will request

the new date. Just for the fun of it, enter 12/31/78—a projection of almost a year! Notice that for all intents and purposes you get the readout right away, regardless of the length of the projection. The program will handle dates up to one full year beyond the year of the reference crossing, to handle the cross-year transition. You can demonstrate this by requesting a printout for any date in 1979. Remember, however, that although the machine will crunch the numbers for you, the period must be known with some precision for long-term projections!

The program also permits you to back up in time. Try entering a date of 1/23/78 for example. The computer will print out the single orbit (number 7249) that will start on the day of the reference crossing. For the sake of your own edification, you might type in a date prior to the reference crossing. The computer will politely inform you that it won't respond to that and will give you a chance to request another date!

OK—enough with imaginary data. Enter 0 when you are asked if you want another day's data (NO=0). The computer will ask if you want another spacecraft. Enter 1 (YES) and plug in some actual crossing information as requested, and you will be off and running with real data.

#### Program Notes

The following is not an exhaustive analysis of the program structure, but does provide sufficient information for you to dive into the program—in company with your Level I BASIC user's manual—if you are interested in how it works.

With a few exceptions, lines 1-65 are devoted to interactive data input. A few mathematical operations are included here to convert data from a convenient-form-for-user input to

a convenient-form-for-machine processing. One example is line 50, where you input data on the hour (H), minute (M), and seconds (S) for the reference crossing. It is most convenient in terms of orbital calculations to keep track of the current crossing time in total minutes (A). The mathematical routines in the remainder of line 50 simply convert the time to total minutes.

A similar situation is encountered in line 35, where you input the month (L), day (J), and year (K) of the reference crossing. The month and day are converted to the day of the year using the subroutine that runs from line 900 to 912. A numerical day of the year is far more convenient than attempting to keep track of days of a certain month. A similar situation exists in line 70, where the identical conversion is made for the desired day for printout.

Line 75 checks to ensure that the requested date is actually on or after the date of the reference crossing, while line 80 updates the desired display day number (T) if the year of the display date (Q) is the year following the year for the reference crossing date (K).

Line 85 requires some additional explanation. The basic approach to computing orbital data is iterative, in that the orbital period is simply added to the time of the last orbit to determine the time of the next crossing, with a similar approach taken for the crossing point. If we are projecting forward in time beyond a few days, this requires an increasingly greater interval for the computer to repeat these calculations again and again until it arrives at the day for printout. If the desired day for printout is more than 5 days beyond the reference cross-

ing day, line 85 bypasses the iterative mode (which begins with line 100) and jumps to a moderately-complicated mathematical routine in lines 500 through 540 that will quickly derive data for an arbitrary single orbit on the day prior to the day requested. Once this has been done, the machine jumps back to line 100 to begin the iterative calculations leading up to the first orbit of the desired day.

You could leave out 85 and the routines in the 500 block, but if you did, you would require lots of time for long-term projections. With the program as written, for example, a one-month projection requires just two seconds to start cranking out data. This two-second delay is all that is required for any projection beyond reference day +5. If we eliminate 85 so that we don't use the routines in the 500 block, a one-month projection would require about 30 seconds to initiate printout, and a one-year projection would require six *minutes* to initiate printout. The iterative approach is the surest way to avoid missing an orbit, but does take time over a long haul.

The iterative sequence is fairly straightforward. Line 100 adds the period to the previous time to get the new time and also updates the orbit number by 1. Line 110 checks the new time against 1440—the total minutes in a day—and, if required, corrects the time to the new day and updates the current day number (D). Line 120 computes the increment of longitude for a single orbit and adds this to the last crossing point to derive the crossing point for the new orbit.

Line 130 compares this value with 360 degrees and corrects it if required. Lines 100 through 130 thus generate the data for a new orbit; lines 140 through 160 simply compare the current or-

bit day (D) with the day for display (T). If D is smaller than T, we haven't arrived yet, and the computer shuffles back to 100 to compute data for the next orbit. If D is larger than T, we have gone through all the orbits of interest and we are shuffled off to 300 for additional display options. If, however, D=T, we want to display the data and thus move along to the display routines in the 200 block.

Lines 200 through 220 convert the orbital crossing time in minutes back to hours (H), minutes (M), and seconds (S) for display. Line 230 rounds out the crossing point to one decimal place (to make a more pleasing display), and then 240 prints out the data. Line 250 then sends the computer back to the iterative routine to compute the next orbit. These display routines will be repeated as long as the orbits fall on the target day, after which it quits and goes to the 300 block to give you the option of another day. If you take the option, the date for the new day is processed and checked, just as it was at the beginning.

There are a few new wrinkles, however. Line 370 is a special routing designed to avoid missing the first orbit when the new day is the one immediately following the day for which you have displayed data. Line 360 takes care of the situation in which you inadvertently ask for a new day which is identical with the day for which you have just received data, and 385 catches situations where we must backtrack. If D is larger than the new day you request (T), it means that we must backtrack in our calculations—a clumsy process. The easiest approach is simply to reassign the reference crossing values to the orbit number (N), time (A), crossing point (C), and day (D), and start over again—something accom-

```

21  IN. "REFERENCE ORBIT DATA ON FILE (Y=1 N=0)"; R
22  CLS: IF R=1 THEN 600
600  A$=... insert name of spacecraft
610  P=... insert orbital period in minutes
620  L=... insert reference month
621  J=... insert reference day
622  K=... insert reference year
623  GOSUB 900: D=W: Z=W:
630  N=... insert reference orbit number
640  H=... insert reference orbit hour
641  M=... insert reference orbit minute
642  S=... insert reference orbit seconds
643  A=(60*H)+M+(S/60): G=A
650  C=... insert reference crossing point (degrees W)
651  Y=C
660  GOTO 65

```

Fig. 4. Program modifications for repeated use of data for a single reference crossing. Depending upon the accuracy of the period (P), the data in lines 620-622, 630-642, and 650 should be updated every few weeks or months with new crossing data to maintain accuracy. If you update for a new satellite, you should then change the data in lines 600 and 610 as well. Be sure to save the modified program on cassette so that you don't lose the reference data.

plished in 385.

The 900 block is devoted to subroutines, including conversions of dates to numerical days of the year and various printing routines. As a guide to understanding the program or making creative modifications, Fig. 3 is provided to summarize the variable assignments used in the program. 🐾

#### Program Modifications

Aside from inspirations that may come to you, there are two major modifications that you may find desirable to make at one time or another. The program as written does not accommodate leap years (29 days in February as opposed to the normal 28). For use during a leap year, each number in lines 903 through 912 should be increased by 1. Thus, for example, line 906 would read:

```
906 IF L=6 THEN W=152+J: RET.
```

Another modification is useful if you will be working primarily with just a single satellite. If you know the period with some precision, you may want to work with a single reference crossing over a period of weeks or months and avoid

the hassle of inputting reference data at the start of a run. Fig. 4 shows the additions required to accomplish this. Be sure, however, to dump the modified version back on to cassette so that you don't lose the reference data.

#### Summary

Over a period of years, I have tended to concentrate on the geostationary weather satellites primarily, to avoid the orbit-computation hassle associated with polar orbiters. This program was developed to minimize the strain of dealing with the new TIROS N satellite that became operational in 1978. The program is so useful that I could probably justify the purchase of the TRS-80 for that alone. The beauty of a computer, of course, is that it is a general-purpose problem-solving machine, and need not be limited to any one task.

Part II of this mini-series will demonstrate how to use the TRS-80 to calculate antenna bearings for geostationary spacecraft. Why not try a microcomputer? Even if you hate computers, you soon will wonder how you ever got along without one! ■

# LAST CHANCE

to be a Charter Subscriber  
to 80 MICROCOMPUTING

Subscribe today and take advantage of this super charter member offer . . . 12 months of 80 MICROCOMPUTING for \$12 . . . that's half the newsstand price . . . PLUS, if you subscribe now, we will send you FREE OF CHARGE a giant book of 80 PROGRAMS for the TRS-80\*.



## AN ALL NEW PUBLICATION FOR THE TRS-80

80 MICROCOMPUTING is the only major publication that addresses your TRS-80 directly. This magazine contains a wealth of information designed to appeal to every owner of the TRS-80 . . . from business, personal, and educational software to upgrading your system . . . from reviews of new products to new languages . . . from text editing to music and more! You'll stay on top with this encyclopedia of information as the market—and the world—opens to the TRS-80.

## ARTICLES AND FEATURES

Each month, 80 MICROCOMPUTING's editorial will bring you the latest in the TRS-80 world. 80 will introduce you to virtually every new event, product, or book pertaining to your microcomputer. 80 is written for the relative newcomer to microcomputing. The articles within are a good diet of programs, ideas on programming applications for the system, and reviews of both hardware and software available for the TRS-80. As you build up your encyclopedia of 80 MICROCOMPUTING, you will develop an invaluable reference for your microcomputer.

## LAST CHANCE . . .

Utilize your TRS-80 to its fullest potential . . . subscribe today by sending in the attached postage-paid card and enjoy a Charter Subscription to this unique and informative magazine. 80 PROGRAMS will be sent to you upon the payment of your subscription. This offer expires January 31, 1980.

- 12 issues—\$12
- 36 issues—\$36
- Payment enclosed
- Master Charge
- American Express
- Visa
- Please bill me

Canada: \$12 per year US funds.  
Other foreign: \$20 one year only,  
US funds.

\*TRS-80 is a trademark of the Tandy Corp.)

- Yes! I want to take advantage of this last chance offer. Sign me on as a charter subscriber to 80 Microcomputing for only \$12 (half the newsstand price) and send me your giant book of 80 Programs—FREE!

Card # \_\_\_\_\_ Expires \_\_\_\_\_

Signature \_\_\_\_\_

Name \_\_\_\_\_

Street \_\_\_\_\_

City \_\_\_\_\_ State \_\_\_\_\_ Zip \_\_\_\_\_

501K35

If you enjoy driving, you're going to get a **COMPUCRUISE**. Once you see what it can do, you just won't be able to live without it.

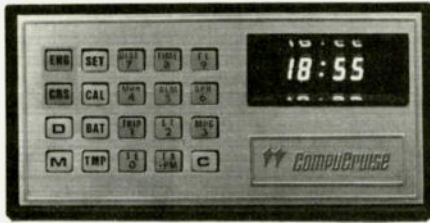

This gadget fits into most dashboards... no strain even in a tiny sports car like the Mazda RX-7... and once you have it, every trip is like flying a 747. The darned thing tells you the time, how fast you're going, how far you've been on this trip or since the last regassing, how many miles per gallon you're getting, either at the instant or the average on the trip... or gallons per hour at the moment or for the trip... temperature outside... Inside (or coolant temperature, if you prefer)... oh, it has an elapsed time for the trip, a stop watch, lap time, an alarm... how much further for your trip, how many gallons more the trip will take, how much longer for the trip at your present average speed... yes, it gives you your average speed for the trip. You prefer it in metric, no strain... liters remaining, etc. Did we mention that it also has cruise control either at a speed set on the control board or at whatever speed you are travelling? The Compucruise will keep you busy and entertained during any trip... telling you more than you will ever want to know.

The Compucruise is not difficult to install... though it does connect to everything except the cigarette lighter. Until you've tried computerized travel, you haven't found out how much fun driving can be. It will work on any car not having fuel injection... and there is a front-wheel drive accessory gadget available for only \$4.40-#P001 (regularly \$5.50).

The price for the Compucruise is regularly \$199.95... and a bargain at that price. We'll sell you one of these fantastic gadgets for \$159.95 with cruise control (Model 44-#P002), and \$127.95 without (Model 41-#P003). Send money... and start having fun!

# MOM'S

**MAIL ORDER MICROS** ✓M128  
**PO Box 427 • Marlboro NH 03455**



**A CAR IS STOLEN EVERY 32 SECONDS. Will yours be next?**

Do you want to drive a car thief completely batty? Put one of these little buggers in your car and watch the fun. You can even leave your keys in the ignition and the best of thieves won't be able to get your car started. Hot wiring? No way, not from the passenger compartment.

To start your car, you must punch in the correct four digit code... it's a digital combination lock. Not bad for \$49.95... and even better for our special price of \$39.95 (#P004) (that's 20% less than the manufacturer's suggested retail). We're in business for the fun of it, not to make money, so we're able to pass this gadget along to you at a real bargain price. Buy one now, before we come to our senses!

## 20% OFF Inventory Clearance SALE

3 Parallel Keyboard (can be used with Poly-88) —Good condition. #S001-\$50 each. **SPECIAL PRICE.**

1 PolyMorphic System 88 Software on 5 1/4" —This is system software that requires a PolyMorphic Disk Controller in a System 88 Cabinet. #D002-\$100.

1 Electric Pencil for Poly 88—Word Processor. #D003-\$80.

4 Processor Tech. SOL Computers—8K Memory, S-100, excellent condition. #D004-\$980 each.  
 19 TREK-80 on cassette for SOL—This is one of the best real time space games available today; needs 8K. #D005-\$11 each.

9 Electric Pencil on cassette for SOL—Word processor, needs 8K. #D006-\$80 each.

1 Processor Tech ROM/RAM card—Contains 1K RAM, empty slots for 12K ROM, S-100, excellent condition. #D007-\$76.

3 Processor Tech 3P + S I/O card—Three parallel ports, one serial port, S-100, excellent condition. #D008-\$116 each.

2 Processor Tech 16K Static RAM card—450 nano-seconds, S-100, excellent condition. #D010-\$199 each.

4 Processor Tech 2K ROM card (kit)—Empty board, S-100, new. #D011-\$17.20 each.

4 Processor Tech 2K ROM card—Empty board, S-100, excellent condition. #D012-\$25.20 each.

19 BASIC 5 from Processor Tech—This is a simple BASIC for a SOLOS, CUTTER, or CONSOL Monitor and 8K of RAM. #D013-\$11.60 each.

4 Processor Tech GAMEPAC for above BASIC—Various simple games. #D014-\$11.60 each

9 Processor Tech Video Display Module—Memory mapped video for S-100, excellent condition. #D009-\$144 each.

2 Processor Tech Extended Disk BASIC—This is full disk BASIC on 8" disk for HELIOS II disk controllers with PTDOS and greater than 16K. #D015-\$80 each.

1 Extended Disk BASIC on cassette—This is the same as previously mentioned for the Disk BASIC from Processor Tech. Needs more than 16K. #D017-\$72.

8 Extended Cassette BASIC from ProTech—This includes all file operations, advanced functions for doing more than playing games; for SOLOS, CUTTER, and CONSOL Monitors. #D016-\$22 each.

8 PolyMorphic Video Terminal Interface—Memory mapped video for S-100 bus, good to excellent condition. #S044-\$150 each. **SPECIAL PRICE.**

1 PolyMorphic Video Terminal Interface (used)—As above. #S045-\$100.00. **SPECIAL PRICE.**

3 PolyMorphic CPU—8080 CPU for S-100 with Poly monitor in ROM, excellent condition. #S046-\$100 each. **SPECIAL PRICE.**

4 PolyMorphic Cassette Interface—Plugs into Poly CPU only, new. #D047-\$29.60 each.

4 PolyMorphic Printer Interface—Plugs into Poly CPU only, new. #D048-\$29.60 each.

4 PolyMorphic S-100 Cabinets—Nice 5 slot S-100 mainframe, good to excellent condition. #D049-\$248 each.

17 Tech Design Consultants Income Tax Manager—This requires the above BASIC and is for the year 1977. #D019-\$11.60 each.

1 IASIS COMPUTER-IN-A-BOOK Computer Trainer —8080 Microcomputer, comes built into training manual, excellent condition. #D020-\$240

6 Novation Modem #3102A—Connects to any phone, originate only, good condition. #S021-\$165 each. **SPECIAL PRICE.**

2 Novation Modem #3103A—Connects to any phone, answer/originate, good condition. #S022-\$200 each. **SPECIAL PRICE.**

1 Novation Modem #43—Connects to any phone, originate only, good condition. #S023-\$165. **SPECIAL PRICE.**

2 Compucolor Computer 8001 (use as computer or 75 MHZ Color Monitor)—8K RAM, BASIC and DOS in ROM, good condition. #S025-\$1500 each. **SPECIAL PRICE.**

2 Compucolor MiniFloppy—5 1/4 inch, good condition. #S026-\$525 each. **SPECIAL PRICE.**

4 Compucolor 8K RAM card—Static RAM, good condition. #S027-\$200 each. **SPECIAL PRICE.**

3 Compucolor Floppy Tape Drive—Uses eight track cartridges, good condition. #S028-\$70 each. **SPECIAL PRICE.**

14 ALS-80 Operating system—This system requires 12K RAM from D000 to FFFF; as well as either the SOLOS or CUTTER monitor; it includes an Assembler/Editor. #D018-\$11.60 each.

1 Heuristics Speech Lab—S-100, used, fair condition. #S042-\$100 as is. **SPECIAL PRICE.**

4 Heuristics Speech Labs—S-100, new. #D043-\$151 each.

2 MicroTerm ACT Terminal—Need a video monitor, up to 600 Baud, good condition. #S035-\$200 each. **SPECIAL PRICE.**

1 Shugart MiniDisk Drives—With case and power supply, includes cable for North Star, good condition. #S036-\$320. **SPECIAL PRICE.**

4 Shugart MiniDisk Drives—No cabinet, good condition. #S037-\$300 each. **SPECIAL PRICE.**

4 Power Supplies for above—good condition. #S038-\$30 each. **SPECIAL PRICE.**

7 Mountain Hardware AC Controller—Remote AC outlet control, S-100, new. #D040-\$100 each.

4 Mountain Hardware remote outlet—Remote module for above, two channels, new. #D041-\$72 each.

3 Vector Graphic ROM/RAM card—12K empty ROM sockets, 1K RAM, excellent condition. #D0078-\$119.60.

5 Vector Graphic Analog interface—Allows hobbyist to interface analog experiments, S-100, new. #D0079-\$79.20.

1 Vector Graphic Analog Interface (kit)—As above, S-100, new. #D0080-\$55.60.

1 ICOM Dual Disk Drive—Single density, 512K storage, S-100 controller, includes CP/M ROM, good condition. #S030-\$1500. **SPECIAL PRICE.**

1 ICOM PROM and 8" Disk for SOL FDOS—This disk requires an ICOM S-100 Disk Controller installed in an S-100. #D031-\$180.

1 ICOM CP/M on 8" Disk for S-100—Requires an ICOM S-100 controller in an S-100 cabinet. #D032-\$100.

2 ICOM FDOS-II on 8" Disk for S-100—Requires an ICOM S-100 controller in an S-100 cabinet, no documentation. #D033-\$180 each.

1 ICOM FDOS-II on 5 1/4" Disk for S-100—Requires an ICOM S-100 Mini-Floppy Controller in an S-100 cabinet. #D034-\$168.

112 Abacus Paperweight—Hefty, brass, excellent condition. #S024-\$3 **SPECIAL PRICE.**

**MORE FROM MOM'S**



# X-RATED

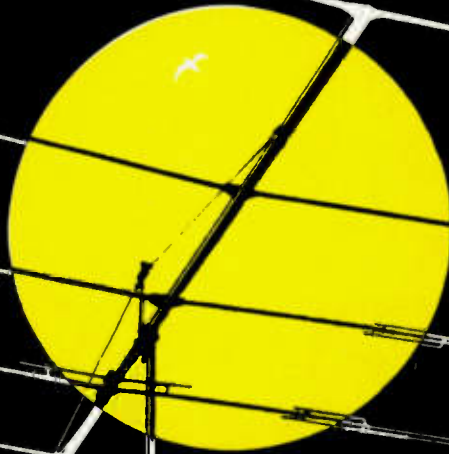

**OUTPERFORMS  
ALL commercially  
available tribanders  
AND many monoband  
systems, too!**

KT-34 UPGRADE KITS AVAILABLE  
WRITE FOR COMPLETE DETAILS OR  
SEE YOUR LOCAL KLM DEALER

## KLM's KT-34X

20, 15, & 10M — FOR THE MATURE HAM ONLY

KLM 17025 LAUREL RD., MORGAN HILL, CA 95037, (408) 779-7363

✓ K4

# MOM'S

MAIL ORDER MICROS  
PO Box 427 • Marlboro NH 03455

## 20% OFF

Inventory  
Clearance

# SALE

- 2 TDL ZPU Z-80 CPU—S-100 CPU with adjustable clock 0.4 MHz, good condition. #D0062-\$159.
- 1 TDL Systems Monitor Board—Contains system software including monitor, S-100, good condition. #D0063-\$140.
- 1 TDL FDOS & SuperBASIC on 8" Disk—This requires an ICOM Disk Controller and at least 20K of memory, plus a ZAPPLE Monitor in an S-100 Cabinet (Altair, IMSAI, etc.). #D0065-\$137.
- 1 TDL System Software on 5 1/4" disk—This set of system software requires a North Star Disk Controller, a TDL Systems Monitor Board I, and consists of 12K BASIC, Relocator/Linking Loader, Z-80 Editor, and Text Processor. #D0066-\$183.
- 1 TDL System Software on 5 1/4" disk—This is the same as above, but does not require the Systems Monitor Board I. #D0067-\$200.
- 1 TDL System Software on 5 1/4" disk—Again, as above, but requires a HELIOS Disk Controller and the TDL Systems Monitor Board II (not I). #D0068-\$183.
- 1 TDL 12K BASIC V2.1 on cassette—Same as disk version. #D0069-\$22.
- 1 TDL System Pack—This is the same as the Disk Pack. #D0070-\$136.
- 2 TDL Z 80 8K BASIC—This is for a Z-80 system with a ZAPPLE Monitor. #D0071-\$30.
- 1 TDL ZAPPLE 2K Monitor—Nice monitor to start a system with. #D0072-\$16.
- 3 TDL ZAP 1K Monitor—Simple monitor. #D0073-\$12.
- 2 TDL Text Output Processor—Text processor. #D0074-\$16.
- 1 TDL Text editor—Nice editor. #D0075-\$12.
- 1 TDL Memory Test—Simple utility. #D0076-\$4.

- 2 IMSAI IMDOS V2.02 on 8" Disk for S-100—No documentation, but this is apparently IMSAI's version of CP/M for S-100 systems with an IMSAI Disk Controller. #D0056-\$96 each.
- 2 IMSAI BASIC 9A—This BASIC is for an S-100 system with a TARBELL cassette interface. #D0057-\$22.
- 1 TARBELL Cassette Interface (kit)—Kansas City Interface, Tarbell Phase encoding, S-100, new. #D0064-\$96.
- 1 IMSAI 8800 Mainframe S-100—Excellent condition. #D0047-\$839.
- 1 IMSAI 80/15 S-100 Development System—Partially assembled, needs a CPU card, excellent condition. #S0048-\$525 as is. **SPECIAL PRICE**
- 1 IMSAI 80/15 S-100 Development System—Kit, mainframe cover missing, needs a CPU card, excellent condition. #S0049-\$500 as is. **SPECIAL PRICE**
- 1 IMSAI Serial I/O card 2-2—Two serial ports, full RS-232 control, S-100, good condition. #D0050-\$188.
- 5 IMSAI Serial I/O card 2-2 (kit)—Two serial ports, full RS-232 control, S-100, new. #D0051-\$124.
- 2 IMSAI Serial I/O card 2-1 (kit)—One serial port, full control RS-232 control, S-100, new. #D0052-\$100.
- 2 Bally VideoCode Cassettes—We received only four of these; they consist of two games: Speed Math and Bingo Math. #D029-\$16 each.

- 2 Software Technology S-100 Music system on cassette—This is an S-100 Music system: contains the proper hardware. #D0058-\$19.60 each.
- 1 North Star Floating Point BASIC card—With special BASIC, new. #D0059-\$287.
- 2 North Star Floating Point BASIC card (kit)—With special BASIC, S-100, new. #D0060-\$207.
- 8 North Star Floppy Disk Controller card—Single density, S-100, new. #D0061-\$248.
- 120 S-100 Edge Connector—Gold Contacts, new. #D0050 \$20 each.
- 6 Extender Card for S-100 (kit)—New. #D051-\$24 each.
- 1 IMSAI Parallel I/O card 4-4—Four parallel ports, S-100, excellent condition. #D0053-\$186.
- 1 IMSAI Parallel I/O card 4-1 (kit)—One parallel port, S-100, new. #D0054-\$74.40.
- 2 IMSAI 4K RAM card—S-100, good condition. #D0055-\$89.60.

Prices include 20% discount. **SPECIAL PRICE** includes more than 20% discount.

Quantities are limited, immediate refund if ordered item is no longer available.

Please read terms below.

**TERMS:** FOB Marlboro, NH USA. Limited stock; everything guaranteed as described; you pay postage on returns. PRINT orders clearly. Minimum order \$10 plus \$2.50 shipping and handling charge in USA only. DOUBLE THAT ELSEWHERE. Orders over \$50 add 5% for shipping in USA; 10% elsewhere (we will refund excess). Orders shipped UPS or insured mail only. Send US funds by check or money order. For credit card purchases, add 4%, list AE, MC or VISA, number, and expiration date. Mail to MOM'S, Department J73, PO Box 427, Marlboro NH 03455.

Please specify catalog number and name of item when ordering.

Condition of Inventory:

New = original container    Excellent = new, but not in original container    Good = tested or used in store

# ARE YOU A BIG GUN CONTESTER?

The small number of elite operators at the top of the list when the results are published know what it takes to win a major contest . . . do you?

Now the winners reveal their secrets in **THE CONTEST COOKBOOK** by Bill Zachary N6OP. It contains detailed suggestions for the first-time contestant as well as tips for the advanced operator.

Domestic, DX and specialty contests are all discussed . . . complete with photographs and diagrams showing the equipment and operating aids used by the top scorers.

Can you make 150 contacts . . . in one hour? Find out how in 73's latest publication, **THE CONTEST COOKBOOK**. Whether you take contests seriously or just enjoy a few hours of skilled operating, this 170-page book is sure to make your participation more pleasurable . . . and increase your score.

Winning a contest means more than having a kilowatt and beam—it takes a good operator with lots of determination. Don't settle for being a little gun . . . **THE CONTEST COOKBOOK (BK7308)** is available from the Radio Bookshop.

**MAIL THE COUPON  
BELOW OR FILL OUT THE  
POSTAGE PAID CARD AT  
THE BACK OF THIS ISSUE.  
ORDER TODAY!**

**\$5.95**

## THE CONTEST COOKBOOK

By Bill Zachary N6OP

Basic and Advanced Techniques  
Domestic, DX and Specialty Contests  
Station Engineering for Higher Scores  
Winners Reveal Their Operating Secrets

A 73 PUBLICATION

Yes! Please rush me \_\_\_\_\_ copies of **THE CONTEST COOKBOOK (BK7308)** at \$5.95 each.

Bill me

Visa     Mastercharge     American Express

Card # \_\_\_\_\_ Exp. date \_\_\_\_\_ Signature \_\_\_\_\_

Name \_\_\_\_\_

Street \_\_\_\_\_

City \_\_\_\_\_

State \_\_\_\_\_ Zip \_\_\_\_\_

# WILSON SYSTEMS INC. MULTI-BAND ANTENNAS

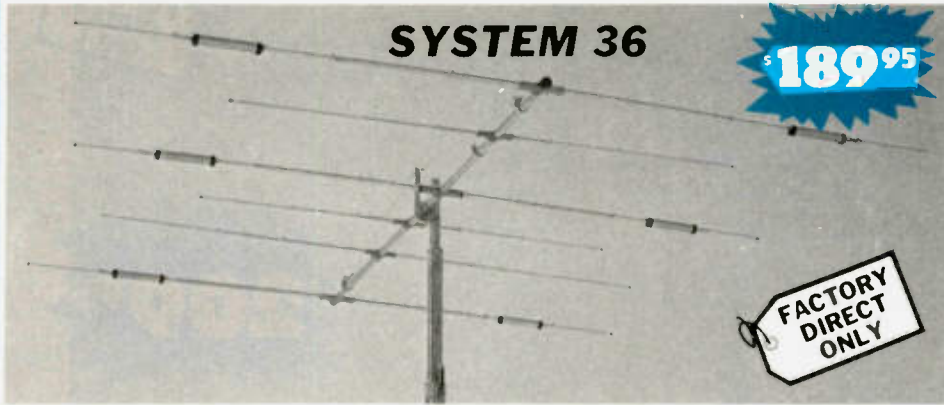

## SYSTEM 36

\$189<sup>95</sup>

FACTORY DIRECT ONLY

A trap loaded antenna that performs like a monobander! That's the characteristic of this six element three band beam. Through the use of wide spacing and interlacing of elements, the following is possible: three active elements on 20, three active elements on 15 and four active elements on 10 meters. No need to run separate coax feed lines for each band, as the bandswitching is automatically made via the High-Q Wilson traps. Designed to handle the maximum legal power, the traps are capped at each end to provide a weather-proof seal against rain and dust. The special High-Q traps are the strongest available in the industry today.

### SPECIFICATIONS

Band MHz	14-21-28	Boom (O.D. x Length)	2" x 24' 2 1/2"	Wind Loading @ 80 mph	215 lbs.
Maximum power input	Legal Limit	No. of Elements	6	Maximum wind survival	100 mph
Gain (dBd)	Up to 9 dB	Longest Element	28' 2 1/4"	Feed method	Coaxial Balun (supplied)
VSWR @ resonance	1.3:1	Turning Radius	18' 6"	Assembled weight (approx)	53 lbs.
Impedance	50 ohm	Maximum mast diameter	2"	Shipping weight (approx)	62 lbs.
F/B Ratio	20 dB or better	Surface area	8.6 sq. ft.		

COMPARE THE SY36 WITH OTHERS...

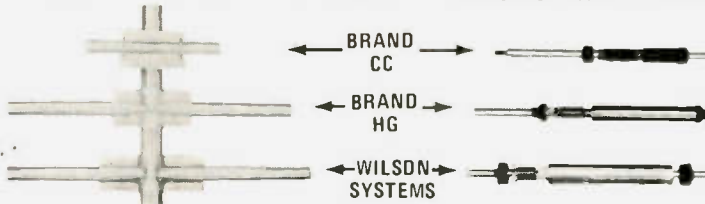

Compare the size and strength of the boom to element clamps. See who offers the largest and heaviest duty. Which would you prefer?

Wilson Systems traps offer a larger diameter trap coil and a larger outside housing, giving excellent Q and power capabilities.

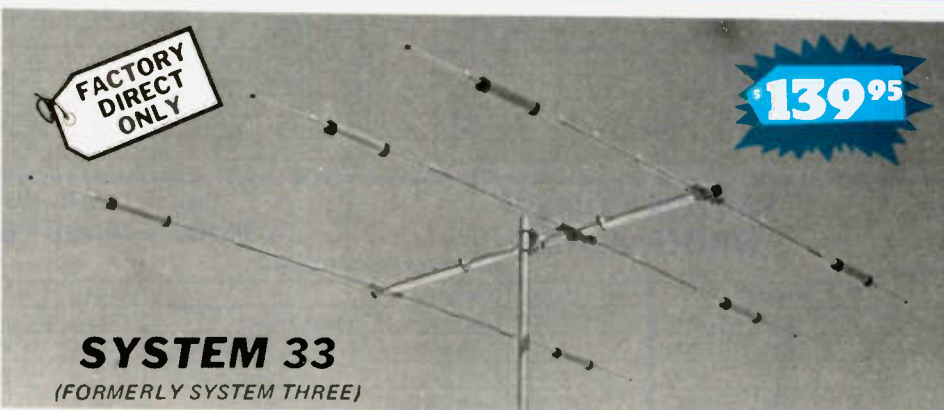

## SYSTEM 33

(FORMERLY SYSTEM THREE)

\$139<sup>95</sup>

Capable of handling the Legal Limit, the "SYSTEM 33" is the finest compact tri-bander available to the amateur. Designed and produced by one of the world's largest antenna manufacturers, the traditional quality of workmanship and materials excels with the "SYSTEM 33". New boom-to-element mount consists of two 1/8" thick formed aluminum plates that will provide more clamping and holding strength to prevent element misalignment. Superior clamping power is obtained with the use of a rugged 1/4" thick aluminum plate for boom to mast mounting. The use of large diameter High-Q traps in the "SYSTEM 33" makes it a high performing tri-bander and at a very economical price. A complete step-by-step illustrated instruction manual guides you to easy assembly and the lightweight antenna makes installation of the "SYSTEM 33" quick and simple.

### SPECIFICATIONS

Band MHz	14-21-28	Boom (O.D. x length)	2" x 14' 4"	Wind loading at 80 mph	114 lbs.
Maximum power input	Legal Limit	No. of elements	3	Assembled weight (approx)	37 lbs.
Gain (dbd)	Up to 8 dB	Longest element	27' 4"	Shipping weight (approx)	42 lbs.
VSWR at resonance	1.3:1	Turning radius	15' 9"	Direct 52 ohm feed — no balun required	
Impedance	50 ohms	Maximum mast diameter	2" O.D.	Maximum wind survival	100 mph
F/B Ratio	20 dB or better	Surface area	5.7 sq. ft.		

**W S I WILSON SYSTEMS, INC.**

W33

4286 S. Polaris Ave., Las Vegas, Nevada 89103

Prices and specifications subject to change without notice

ORDER FACTORY DIRECT  
1-800-634-6898

\$44<sup>95</sup>

## WV-1A

4 BAND TRAP VERTICAL (10 - 40 METERS)

No bandswitching necessary with this vertical. An excellent low cost DX antenna with an electrical quarter wavelength on each band and low angle radiation. Advanced design provides low SWR and exceptionally flat response across the full width of each band.

Featured is the Wilson large diameter High-Q traps which will maintain resonant points with varying temperatures and humidity.

Easily assembled, the WV-1A is supplied with a hot dipped galvanized base mount bracket to attach to vent pipe or to a mast driven in the ground.

Note: Radials are required for peak operation. (See GR-1 below)

### SPECIFICATIONS

- 19' total height
- Self supporting — no guys required
- Weight — 14 lbs.
- Input impedance: 50 Ω
- Powerhandling capability: Legal Limit
- Two High-Q traps with large diameter coils
- Low angle radiation
- Omnidirectional performance
- Taper swaged aluminum tubing
- Automatic bandswitching
- Mast bracket furnished
- SWR: 1.1:1 or less on all bands

## GR-1

\$9<sup>95</sup>

The GR-1 is the complete ground radial kit for the WV-1A. It consists of: 150' of 7/14 stranded copper wire and heavy duty egg insulators, instructions. The GR-1 will increase the efficiency of the GR-1 by providing the correct counterpoise.

# WILSON MONO-BAND BEAMS

**FACTORY DIRECT ONLY**

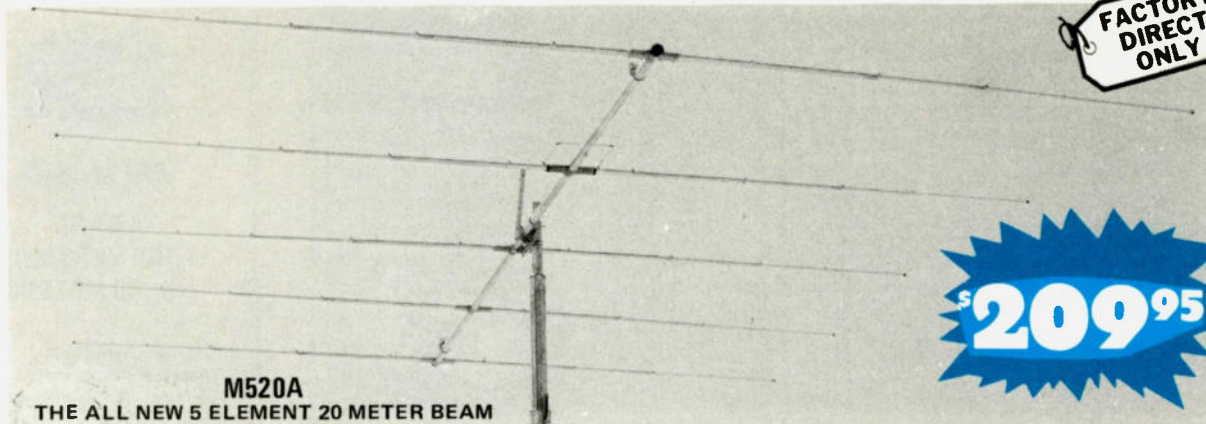

**M520A**  
THE ALL NEW 5 ELEMENT 20 METER BEAM

At last, the antennas that you have been waiting for are here! The top quality, optimum spaced, and newest designed monobanders. The Wilson System's new Monoband beams are the latest in modern design and incorporate the latest in design principles utilizing some of the strongest materials available. Through the select use of the current production of aluminum and the new boom-to-element plates, the Wilson Systems' antennas will stay up when others are falling down due to heavy ice loading or strong winds. Note the following features:

- 1. Taper Swaged Elements** — The taper swaged elements provide strength where it counts and lowers the wind loading more efficiently than the conventional method of telescoping elements of different sizes.
- 2. Mounting Plates — Element to Boom** — The new formed aluminum plates provide the strongest method of mounting the elements to the boom that is available in the entire market today. No longer will the elements tilt out of line if a bird should land on one end of the element.
- 3. Mounting Plates — Boom to Mast** — Rugged 1/4" thick aluminum plates are used in combination with sturdy U-bolts and saddles for superior clamping power.
- 4. Holes** — There are no holes drilled in the elements of the Wilson HF Monobanders. The careful attention given to the design has made it possible to eliminate this requirement as the use of holes adds an unnecessary weak point to the antenna boom.

With the Wilson Beta-match method, it is a "set it and forget it" process. You can now assemble the antenna on the ground, and using the guide-lines from the detailed instruction manual, adjust the tuning of the Beta-match so that it will remain set when raised to the top of the tower.

The Wilson Beta-match offers the ability to adjust the terminating impedance that is far superior to the other matching methods including the Gamma match and other Beta matches. As this method of matching requires a balanced line it will be necessary to use a 1:1 balun, or RF choke, for the most efficient use of the HF Monobanders.

The Wilson Monobanders are the perfect answer to the Ham who wants to stack antennas for maximum utilization of space and gain. They offer the most economical method to have more antenna for less money with better gain and maximum strength. Order yours today and see why the serious DXers are running up that impressive score in contests and number of countries worked.

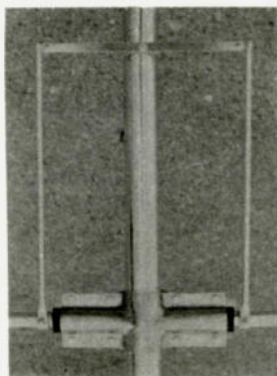

Wilson's Beta match offers maximum power transfer.

## SPECIFICATIONS

Model	Band Meters	Gain dBd	F/B Ratio	Element Frequency (KHz)	VSWR @ Resonance	Impedance	Matching	Elements	Longest Element	Boom O.D.	Boom Length	Turning Radius	Surface Area (sq. Ft.)	Windload @ 60 mph (Lbs. Ft.)	Maximum Mast	Assembled Weight (Lbs.)
M520A	20	11.5	25 dB	500 KHz	1.1:1	50 Ω	Beta	5	36'6"	2"	34'2 1/2"	25'1"	8.9	227	2"	68
M420A	20	10.0	25 dB	500 KHz	1.1:1	50 Ω	Beta	4	36'6"	2"	26'0"	22'6"	7.6	189	2"	50
M515A	15	12.0	25 dB	400 KHz	1.1:1	50 Ω	Beta	5	26'3"	2"	26'0"	17'6"	4.2	107	2"	41
M415A	15	10.0	25 dB	400 KHz	1.1:1	50 Ω	Beta	4	24'2 1/2"	2"	17'0"	14'11"	3.1	54	2"	25
M510A	10	12.0	25 dB	1.5 MHz	1.1:1	50 Ω	Beta	5	18'6"	2"	26'0"	16'0"	2.8	72	2"	36
M410A	10	10.0	25 dB	1.5 MHz	1.1:1	50 Ω	Beta	4	18'3"	2"	12'11"	11'3"	1.4	36	2"	20

WILSON SYSTEMS, INC. — 4286 S. Polaris  
Las Vegas, NV 89103 — (702) 739-7401

**FACTORY DIRECT ORDER BLANK**

Toll-Free Order Number  
**1-800-634-6898**

### WILSON SYSTEMS ANTENNAS

Qty	Model	Description	Shipping	Price
	SY33	3 Ele. Tribander for 10, 15, 20 Mtrs.	UPS	\$139.95
	SY36	6 Ele. Tribander for 10, 15, 20 Mtrs.	UPS	189.95
	WV-1A	Trap Vertical for 10, 15, 20, 40 Mtrs.	UPS	44.95
	GR-1	Ground Radials for WV-1A	UPS	9.95
	M-520A	5 Elements on 20 Mtrs.	TRUCK	209.95
	M-420A	4 Elements on 20 Mtrs.	UPS	139.95
	M-515A	5 Elements on 15 Mtrs.	UPS	119.95
	M-415A	4 Elements on 15 Mtrs.	UPS	79.95
	M-510A	5 Elements on 10 Mtrs.	UPS	84.95
	M-410A	4 Elements on 10 Mtrs.	UPS	64.95
	WM-62A	Mobile Antenna: 5/8 λ on 2, 1/4 λ on 6	UPS	19.95
	M-86	8 Elements on 6 Mtrs.	UPS	84.95
	M-66A	6 Elements on 6 Mtrs.	UPS	54.95
	M-46	4 Elements on 6 Mtrs.	UPS	27.95
	M-112	11 Elements on 2 Mtrs.	UPS	29.95
	M-92	9 Elements on 2 Mtrs.	UPS	24.95
	M-72	7 Elements on 2 Mtrs.	UPS	19.95
	<b>ACCESSORIES</b>			
	HD-73	Alliance Heavy Duty Rotor	UPS	109.95
	RC-8C	8/C Rotor Cable	UPS	.12/ft.
	RG-8U	RG-8U Foam-Ultra Flexible Coaxial Cable. 38 strand center conductor, 11 gauge	UPS	.21/ft.

### WILSON SYSTEMS TOWERS

Qty.	Model	Description	Shipping	Price
	TT-45A	Freestanding 45' Tubular Tower	TRUCK	\$249.95
	RB-45A	Rotating Base for TT-45A w/tilt over feature	TRUCK	159.95
	FB-45A	Fixed Base for TT-45A w/tilt over feature	TRUCK	109.95
	MT-61A	Freestanding 61' Tubular Tower	TRUCK	449.95
	RB-61A	Rotating Base for MT-61A w/tilt over feature	TRUCK	219.95
	FB-61A	Fixed Base for MT-61A w/tilt over feature	TRUCK	149.95

**NOTE:**  
On Coaxial and Rotor Cable, minimum order is 100 ft. and in 50' multiples.  
Prices and specifications subject to change without notice.  
Ninety Day Limited Warranty, All Products FOB Las Vegas, Nevada

PRICES EFFECTIVE JANUARY 1, 1980

Nevada Residents Add Sales Tax  
Ship C.O.D.  Check enclosed  Charge to Visa  M/C

Card # \_\_\_\_\_ Expires \_\_\_\_\_  
Bank # \_\_\_\_\_ Signature \_\_\_\_\_

*Please Print*  
Name \_\_\_\_\_ Phone \_\_\_\_\_  
Street \_\_\_\_\_  
City \_\_\_\_\_ State \_\_\_\_\_ Zip \_\_\_\_\_

Prices and specifications subject to change without notice.



# New, Improved Wilson Towers



Hinged Base Plate - Concrete Pad, Heavy Duty Winch



Mounting the House Bracket



The Hinged Base Plate allows tower to be tilted over for access to antenna and rotor from the ground.

FACTORY DIRECT  
**\$249<sup>95</sup>**

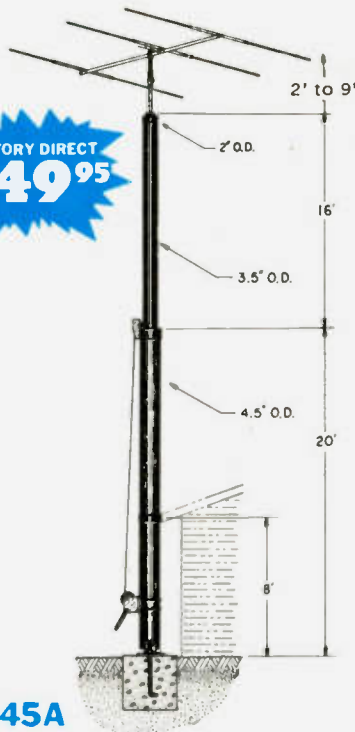

## TT-45A

### FEATURES:

- Maximum Height 45' (will handle 12 sq. ft. at 38') @ 50 mph
- 1200 lb. winch
- Totally freestanding with proper base
- Total Weight, 243 lbs.

The TT-45A is a freestanding tower, ideal for installations where guys cannot be used. If the tower is not being supported against the house, the proper base fixture accessory must be selected. (Requires 12"x12"x36" of concrete.)

### GENERAL FEATURES

All towers use high strength heavy galvanized steel tubing that conforms to ASTM specifications for years of maintenance-free service. The large diameters provide unexcelled strength. All welding is performed with state-of-the-art equipment. Top sections are 2" O.D. for proper antenna/rotor mounting. A 10' push-up mast is included in the top section of each tower. Hinge-over base plates are standard with each tower. The high loads of today's antennas make Wilson crank-ups a logical choice. Prices and specifications subject to change without notice.

FACTORY DIRECT  
**\$449<sup>95</sup>**

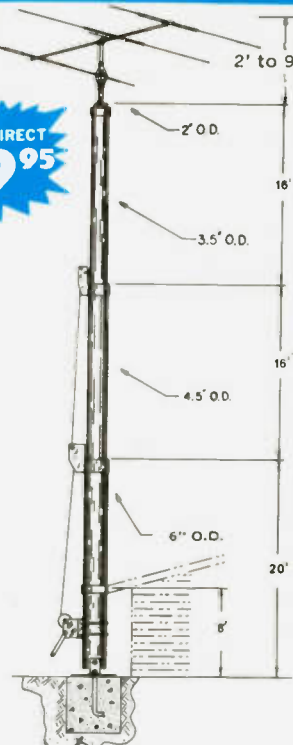

## NEW IMPROVED FEATURE

Heavier wall tubing greatly increases the stress capabilities over the older TT-45 and MT-61.

## MT-61A

### FEATURES:

- Is freestanding with use of proper base
  - Maximum Height is 61' (will handle 12 sq. ft. at 53') @ 50 mph
  - 1200 lb. brake winch
  - 4200 lb. raising cable
  - Total Weight, 400 lbs.
- Recommended base accessory: RB-61A, FB-61A.

The MT-61A is our largest and tallest freestanding tower. By using the RB-61A rotating base fixture the MT-61A is ideally suited for the SY33 or SY-36. If you plan to mount the tower to your house, caution should be taken to make certain the eave is properly reinforced to handle the tower. If not, one of the base accessory fixtures should be used. (Requires 18"x18"x48" concrete.)

# TILT-OVER BASES FOR TOWERS

## FIXED BASE

The FB Series was designed to provide an economical method of moving the tower away from the house. It will support the tower in a completely free-standing vertical position, while also having the capabilities of tilting the tower over to provide an easy access to the antenna. The rotor mounts at the top of the tower in the conventional manner, and will not rotate the complete tower. (Requires 3'x3'x5½" of concrete.)

FB-45A ... \$109.95  
FB-61A ... 149.95



## ROTATING BASE

The RB Series was designed for the Amateur who wants the added convenience of being able to work on the rotor from the ground position. This series of bases will give that ease plus rotate the complete tower and antenna system by the use of a heavy duty thrust bearing at the base of the tower mounting position, while still being able to tilt the tower over when desiring to make changes on the antenna system. (Requires 3'x3'x6" of concrete.)

RB-45A ... \$159.95  
RB-61A ... 219.95



Tilting the tower over is a one-man task with the Wilson bases. (Shown above is the RB-61A. Rotor is not included.)

ORDER  
FACTORY DIRECT  
1-800-634-6898

**W S I WILSON**  
SYSTEMS, INC.

4286 S. Polaris Ave., Las Vegas, Nevada 89103

\*\*\*WILSON SPECIAL\*\*\*  
**TRISTAO TWS 771 TOWER**  
Sold in 1978 at \$7,500. Have one only.  
All new cables.  
only \$4,000.

# A Knob with a new twist "VRS™"

Swan Astro 150 Exclusive Microprocessor Control w/memory gives you over 100,000 fully synthesized frequencies, and more!

- VRS — Variable Rate Scanning, a dramatic new technique for unprecedented tuning ease and accuracy
- POWER — 235 watts PEP and CW on all bands for that DX punch
- Advanced microcomputer technology developed and manufactured in the U.S.A.
- Price? See your authorized SWAN dealer for a pleasant surprise!



**Dual Meter**  
Reads PEP output in watts and receive "S" units.

**Full Break-in CW**  
(or semi, switch selected)

### Wide Frequency Coverage

- 10M — 28.0-30.0 MHz
  - 15M — 20.8-23.0 MHz
  - 20M — 13.8-16.0 MHz
  - 40M — 6.0-8.3 MHz
  - 80M — 3.0-4.5 MHz
  - 160M — 1.8-2.4 MHz\*
- \*in lieu of 10M band on Model Astro 151

**Mike Tuning**  
For accurate 100 Hz steps or fixed rate scan.

PSU-5 Power Supply with Speaker



ASTRO 150 Transceiver

ST-3 Antenna Tuner

THE MOST ADVANCED HF SSB TRANSCEIVER AVAILABLE.

FULLY SOLID-STATE **SWAN ASTRO 150**



**SWAN**  
ELECTRONICS

A member of the Cubic Corporation family of companies.

305 Airport Road / Oceanside, CA 92054 / 714-757-7525

# Discover the unrivaled ASTRO 102BX with Dual PTO's

Plus IF Passband Tuning/Full Band Coverage, Speech Processing, 235 Watts PEP All Bands and Much More.

**4-Function Meter**  
reads "S" units in receive, and selects forward power, reflected power, or ALC in transmit.

**Visual Display of Passband Tuning**  
A series of 8 LED's indicate the equivalent band width and position of the passband from 0.6 to 2.7 KHz as the passband tuning knob is rotated.

**300Hz Crystal CW Filter**  
Cascaded with the passband filters and tunable through the passband. Combined with notch filter yields unrivaled CW performance.

**Full or Semi CW Break-in**  
A must for the avid CW operator!

**2 Position CW Wave Shaping**  
Your choice of soft or hard CW rise and decay time!



**Variable AGC Decay**  
Continuously variable to suit your preference.

**Passband Tuning with 16 Pole Filters**  
Two 8-pole crystal filters in cascade provides a 1.4:1 shape factor at -100dB! The ultimate in selectivity.

**Tunable Notch Filter**  
Provides the ability to "notch out" QRM. When used in conjunction with the passband tuning, provides the ultimate in removing interference.

**Dual PTO's**  
Two independent high stability PTO's provide true split band operation. The digital counter reads the PTO selected, or in split band reads the PTO used for receive, then switches to the transmit frequency selected when the mic is keyed.

**All Band Coverage using PLL and Synthesizer for Band Selection**  
Full coverage of 160 meters through all of 10 meters in 9 ranges . . . diode matrix programmed for now — or for the future!



The ASTRO 102BX with it's companion PSU-6 Power Supply, 1500Z Linear Amplifier and ST-2A Antenna Tuner provides a matched and highly efficient 1500 watt PEP or 1000 watt CW complete station to be complemented by a great Swan antenna.

S44

All Solid State Quality American Construction

# ASTRO 102BX

**SWAN**  
ELECTRONICS

A member of the Cubic Corporation family of companies

305 Airport Road / Oceanside, CA 92054 / 714-757-7525

## A Brasspounder Improves Heath's HR-1680

— add a crystal CW filter, bfo, noise blanker, and more

**T**he Heathkit® HR-1680 is a distinct rarity: a ham-bands-only receiver in kit form for a tad more than \$200. It is a fine piece of equipment and is almost the answer for a low-budget station. Why almost? Low budget usually means CW using a homebrew or swap-meet-special

transmitter and low power at that. The SSB capabilities of the HR-1680 are good, but CW is sort of tacked on. What the HR-1680 needs is a narrow CW filter, and a bfo placed correctly for CW operation, and maybe even a noise blanker. It so happens that Heath makes these items

for other products in their line, and for a reasonable price.

I hate modifications that wreck the appearance of a piece of gear and reduce its resale value to zero. Many modifications not only prove to be far less useful than the author promises, but unfortunately, irreversible. This article describes how to add a crystal CW filter, bfo, noise blanker, and a couple of other worthwhile modifications to your HR-1680 without having to attack the set with drills, saws, and other sharp instruments. All modifications are reversible, require a minimum of rewiring, and the drilling of one little hole on one circuit board. Purists can attach the bfo board to the AUD/REG board with silastic rubber.

### Modifications

The modifications will be presented in the following order:

- 1) changing the dial lamps to reduce voltage regulator heating; and to a type more readily available.
- 2) modification of the spinner knob for 1-kHz resolution;
- 3) addition of an SBA-301-2,

- 4) 400-Hz crystal filter;
- 4) addition of a separate bfo for CW; and
- 5) addition of an SB-104-1, noise blanker.

The crystal filter and noise blanker are housed in a small utility cabinet (Radio Shack 270-253 is an ideal size), or they could be fitted into the HR-1681 speaker cabinet if desired. The bfo board is attached to the HR-1680's AUD/REG PCB. Total cost of all mods should be about \$75.

### Pilot Lamps

At this writing, I have been using my HR-1680 for over two years without any component failures, and this mod may be due in part to something that annoyed me no end when I discovered it. The pilot lamps in the HR-1680 operate from the regulated supply. This represents two Watts of unnecessary power for the regulator series pass transistor (Q201) to handle, and causes its heat sink to reach to over 100°C after only a few minutes of operation. Besides, nobody seems to stock type 1813 bulbs.

The solution is simple: Disconnect the red wire supplying 13.8 volts to the

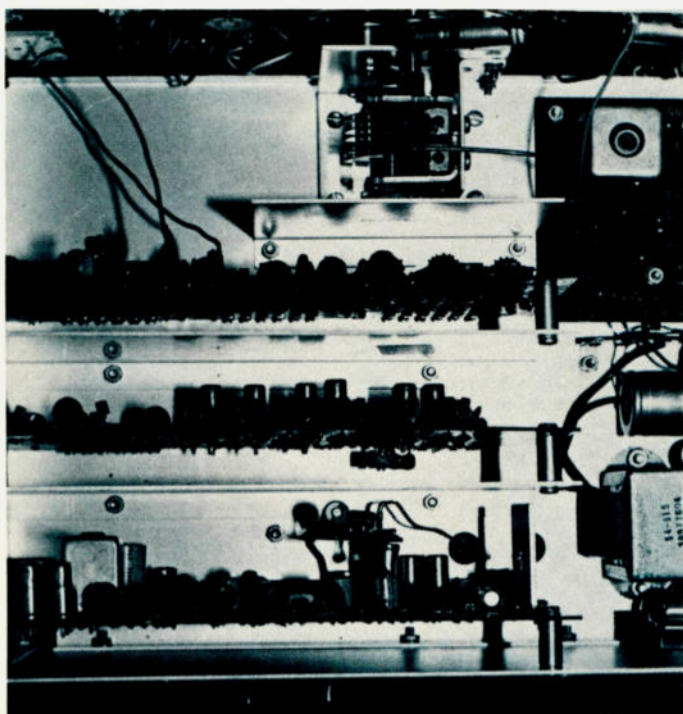

Photo A. Top interior view of the HR-1680 shows the new bfo board (near middle of bottom board) and new connecting wire to pilot lamps (upper right).

pilot lamps. Run a new wire across the top of the chassis and connect it to the junction of D1, D2, and C2 at one end and the lamp sockets at the other. Arch the wire up and over and avoid getting it too close to the vfo (see Photo A). Remove the two type 1813 bulbs and replace them with type 1819 bulbs (28 volts, 40 mA). The new lamps will provide just about the same amount of light, you will save 120 mA of total current, and the regulator will now operate at a reasonable temperature even when we borrow 50 mA to operate the crystal filter amplifier and the noise blanker.

A small drawback exists with this modification: The lamps won't light when external power is used. If you use external power very often, you might want to install some sort of switching arrangement. My feeling is that if you are really on emergency power, can you afford those wasted Watts? Buy a flashlight.

### Spinner Dial

Another thing that bothered me about the HR-1680 was the dial calibration. When the vfo is

properly adjusted, the HR-1680's dial is reasonably linear, but there are calibration marks only at every five kHz. It seemed that the spinner knob could be inscribed to give at least one-kHz markers. I spent about a week of fooling around and gluing pieces of cardboard to the spinner. To spare you the cussin', I found that each revolution of the spinner was equivalent to 15.625 kHz or 23.04 degrees of arc per kHz. It does not take a mathematician to see that there is no way to calibrate the spinner in a whole number of one-kHz increments. After spending all that time, I was not about to give up. I removed the skirt from the spinner and glued a thin flat plate (a 3½-inch diameter dial plate from an old stereo receiver) to the back side of the spinner knob. I then scribed lines on the plate to make pies of 23.04 degrees, and when I ran out of plate, I stopped. I then filled the scribed lines with black ink and coated the plate with clear nail polish (acrylic spray made the ink run). Now the spinner is calibrated in one kHz in-

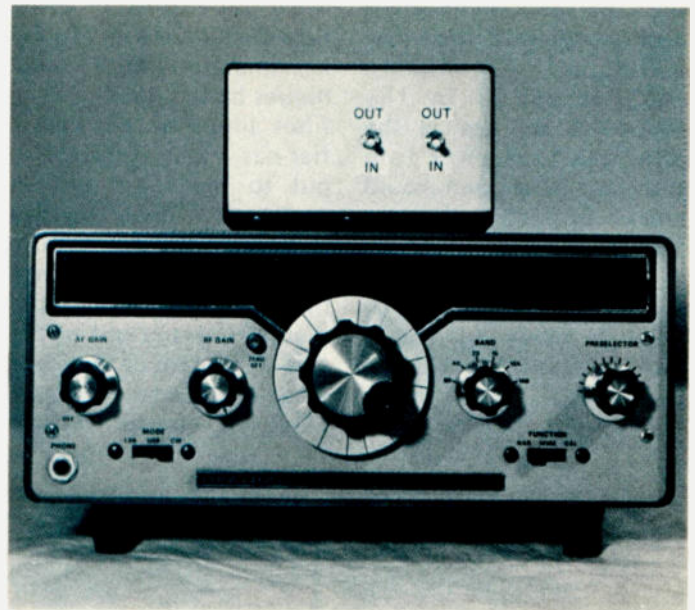

Photo B. Front view of modified HR-1680 (with completed filter-blanker on top) shows details of modified spinner knob.

crements with one .625-kHz increment left over. The construction sounds terrible, but it works fine. See Photo B.

### Crystal Filter and Amplifier

Anyone who has ever operated CW must surely have desired "single-signal reception." The audio filter of the HR-1680 does not have anything like the needed selectivity. I feel sure that the people at Heath know this, but they

had to keep the price down. Heath makes two 400-Hz filters, the SBA-301-2 and the newer SBA-401-1. As far as I can determine, the filters are

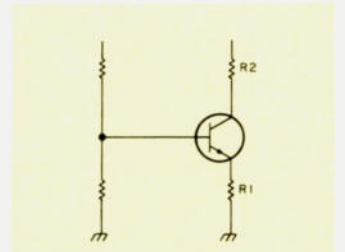

Fig. 2. In a common-emitter bipolar amplifier, the voltage gain of a stage with an un-bypassed emitter resistor is approximately the ratio of the collector resistor to the emitter resistor:  $\text{Gain} \approx R2/R1$ . This relationship holds over one or two decades (sometimes more) assuming that the gain of the transistor is adequate for the bandwidth of interest. As an example, consider a phase-splitter circuit where  $R1 = R2$  and the gain is unity. In the amplifier used in this article,  $R1 = 470$  Ohms and  $R2 = 2200/470 = 4.68$  or  $4.68 \times 20 \log 10 = .670 \times 20 = 13.4$  dB. Naturally, when 10% components are used the approximation suffers.

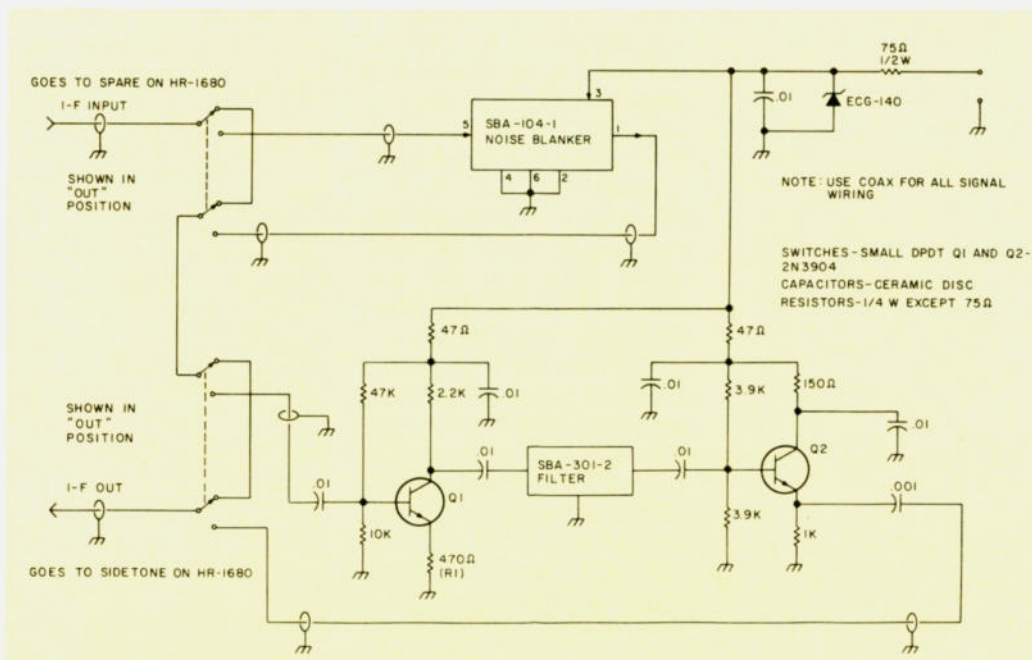

Fig. 1. Filter-blanker interface schematic diagram.

the same, and the different part numbers reflect the additional coils, diodes, etc., included in the SBA-401-1 for use in the SBA-104A transceiver. I am sure that either one would work. Buy the cheaper SBA-301-2.

The crystal filter has some insertion loss which must be made up, and it must be presented with the correct (2k Ohms) input and output impedance in

order to perform correctly. I used a circuit that I found in *Amateur Radio Techniques* by the RSGB for the filter amplifier. The amplifier has a gain stage for input to the filter and an emitter-follower output (see Fig. 1). It does not use any inductive components, but it allows for a proper match into and out of the filter. The gain of the input stage is set by selecting the value of emitter resistor

R1. Details on gain calculation are shown in Fig. 2. With the values indicated, the first stage gain is approximately 13.4 dB (voltage) and this results in unity gain through the filter-amplifier combination. The nice thing about this circuit is that there is nothing to tune. The filter and its amplifier are mounted on a piece of copper-clad board using the board fabrication method outlined in the bfo section.

### Bfo

To obtain maximum benefit from the crystal filter, the bfo needs to provide a beat note of about 750 Hz to be within the bandpass of the HR-1680's audio filter. The frequency of the bfo should be 3395.4 kHz (filter center frequency), plus or minus 750 Hz. Several solutions suggested themselves, but I wanted to retain full SSB capabilities; so, fooling with one of the existing bfos was out. I built a new bfo using a 3395.7-kHz crystal (Heath part number 404-549, about \$5.70) in a slightly modified copy of the HR-1680 bfo circuit (See Fig. 3). The trimmer (C2) allows the crystal to be pulled upwards in frequency by as much as 700 Hz, so you can place the bfo signal for the most pleasing tone or to fit the peak of the audio filter. The injection level is the same as the original bfo's and the new bfo works as well as the original. If you don't care about SSB, you can just pad the USB-CW bfo down to the correct frequency.

The new bfo is built on a piece of single-sided copper-clad board. The foil pattern shown (Fig. 4) should be followed rather closely so the finished board will fit properly onto the AUD/REG board. For small one-of-a-kind PC boards, I find that it is faster and easier to grind off the unwanted foil with a Dremel

Moto-Tool® or to score the foil with an X-acto® knife and peel off the unwanted foil, rather than to do all the things involved with etching. I used a Moto-Tool on the board that I built and it took less than an hour to produce a completed bfo.

The crystal and the FET are on the component side of the board (Fig. 5) and holes are drilled for their leads. All other components are on the foil side and no holes are required. Use a leftover PCB pin (Heath part 432-121) for the 13.8-volt connection.

The completed bfo board is mounted to the AUD/REG board using 4-40 hardware and one ¼-inch standoff. A small clearance hole must be drilled in the AUD/REG board just to the right of the connector sockets (viewing component side) that are below the existing bfo crystals (see Photo C). The exact location of the hole depends on your board, but the main idea is to have the new crystal snug against Y205 (and upsidedown) so as to create a compact piggyback fit.

Solder a small piece of bare wire from the new crystal to Y205 in the same fashion as was done for

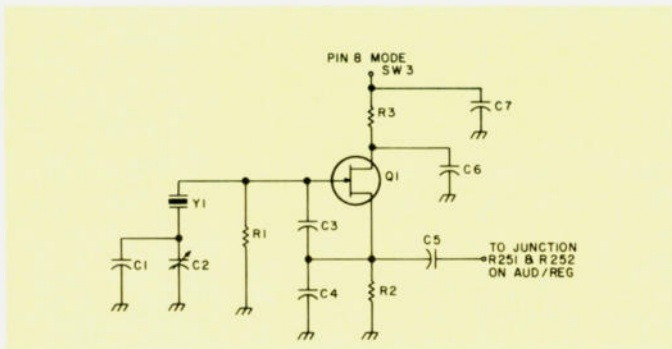

Fig. 3. Bfo schematic diagram.

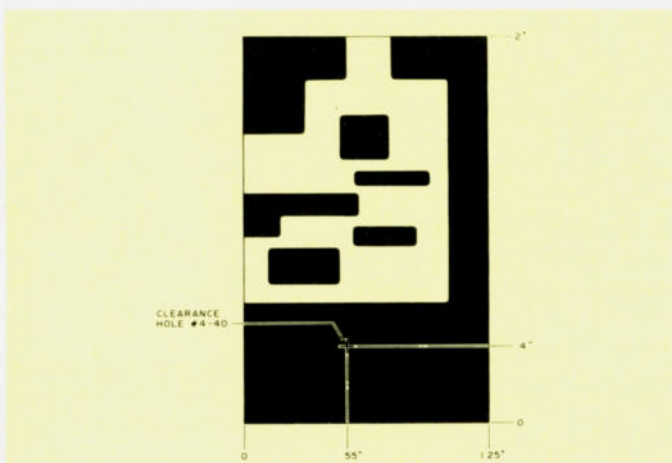

Fig. 4. PCB layout.

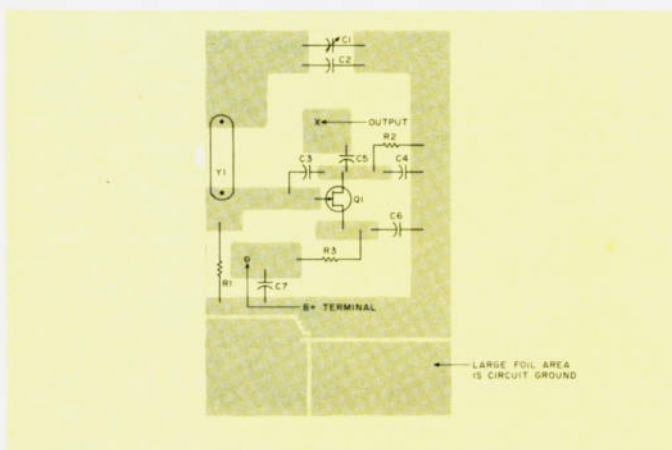

Fig. 5. Component location. Note: crystal and FET are mounted on the component side. All remaining components are mounted on the foil side.

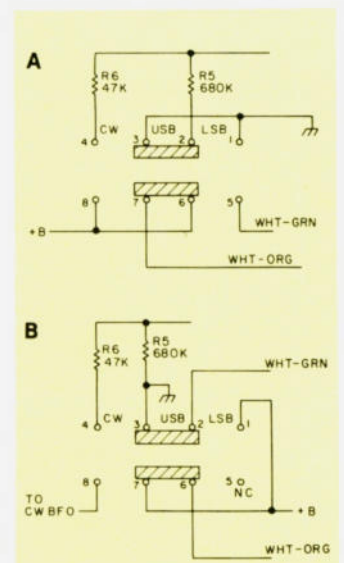

Fig. 6. MODE switch arrangement. (a) Original wiring. (b) After modifications.

The engineering  
breakthrough by

**DRAKE**

brings an entirely new state of the art  
to worldwide radio communications...

**solid state**

**TR7**

**synthesized hf  
transceiving system**

**continuous coverage**

**0-30** MHz

continuous coverage reception — no gaps —  
no range crystals required

**160-10** Meters

Amateur Band transmission, including  
capability for MARS, Embassy, Government,  
and future band expansions



- ★ Sophisticated System Concept
- ★ Innovative Design Features
- ★ Straightforward Simplified Operation
- ★ State of the art performance now a pleasure

#### 7 Line Accessories

- RV7 Remote VFO • PS7 120/240V Ac Supply • Aux7 Range Program Board
- MS7 Matching Speaker • NB7 Noise Blanker • FA7 Fan • SL300 Cw Filter, 300 Hz • SL500 Cw Filter, 500 Hz
- SL1800 Ssb/RTTY Filter, 1.8 kHz • SL6000 A-m Filter, 6.0 kHz • MMK7 Mobile Mounting Kit • TR7 Service Kit/Extender Board Set • TR7 Service/Schematic Book.

- Broadband, 100% Solid State Design.
- Exclusive Synthesized/PTO Frequency Control — 1 kHz dial, 100 Hz digital readout. 500 kHz range pushbuttons.
- Continuous, Wide Range Frequency Coverage — 1.5 thru 30 MHz (zero thru 30 MHz with optional Aux7).
- State of the Art "Up-Conversion" Receiver Design — with high level double balanced mixer.
- True Full-Passband Tuning improves reception in heavy QRM.
- Unique Independent Receive Selectivity — Optional front panel pushbutton-selected filters.
- Effective Noise Blanker — true impulse-type performance.
- Special High Power Solid State Power Amplifier — diagonal heat sink allows internal mounting. Continuous duty on SSTV/RTTY with optional fan.
- TR7 Internal Test Facilities — "S" meter and built-in rf Wattmeter/VSWR Bridge.
- Receiver Incremental Tuning (RIT)

Specifications and prices subject to change without notice or obligation.

**R. L. DRAKE COMPANY**



540 Richard St., Miamisburg, Ohio 45342  
Phone: (513) 866-2421 • Telex: 288-017

For a FREE Drake Full Line Catalog contact your favorite Drake Dealer.

Y203 and Y204 during the original assembly of the HR-1680. Connect an insulated wire between the ground foil on the new board to connector socket pin 13 of the AUD/REG board. Make sure that you do not get solder in the spring clips. Solder an insulated wire to the junction of R251 and R252 and solder the other end to the output land of C5 of the bfo board.

### Mode Switch Wiring Changes

The MODE switch must be rewired so that the new bfo will be energized when the switch is placed into the CW position. Fig. 6 shows the original and modified connections.

Remove all connections to the MODE switch except for R6 (pin 4). Solder the end of R5 which was connected to pin 2 to the adjacent ground lug. Solder the red wire (originally connected to pins 6 and 8) to pin 7 and connect a short insulated jumper from pin 7 to pin 1. Solder the white-orange wire to pin 6. Solder the white-green wire to pin 2.

Secure a piece of #20 or #22 stranded insulated wire about two feet long. Solder one end of the wire to pin 8 of the MODE switch and dress the wire along the harness branch which contains the white-orange and the white-green wires to the AUD/REG board. Pull the free end of the wire through the ventilation hole which is almost directly under Q201. This wire is the 13.8-volt source for the CW bfo. Cut the free end to leave about three inches above the chassis, and install a leftover PCB connector (Heath part 432-120) or a pin removed from an old miniature tube socket at the free end of the wire.

### Breaking the I-f Signal Path

The normal i-f signal

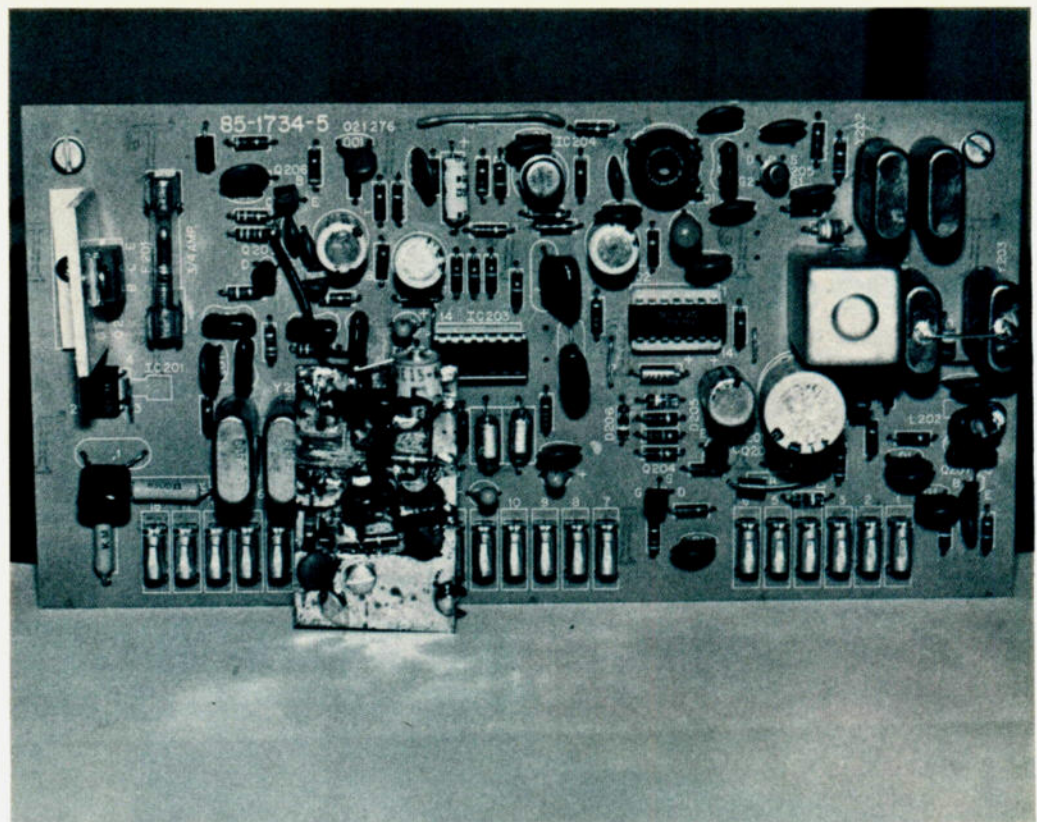

Photo C. Component-side view of AUD/REG board with new CW bfo board attached.

path in the receiver must be broken in order to insert the crystal filter and the noise blanker. The best and most convenient place to break the path is between the output of the FRONT END board and the AUD/REG board's input.

Disconnect the shielded cable with violet color coding from pins D1 and D2 of the AUD/REG board chassis socket. Dress the cable to the SPARE phono-type connector at the rear of the receiver. Solder the inner conductor to the inside terminal of the phono connector and the shield to the ground terminal.

Disconnect the 10k resistor from the SIDETONE phono connector and either remove it altogether or secure it so that it does not short to anything. Cut a piece of the shielded cable supplied with the blanker kit (or RG-174/U) long enough to reach from D1 and D2 of the AUD/REG board to the

SIDETONE jack. Solder the inner conductor to the inside terminal and the shield to the ground terminal of the SIDETONE jack.

The SPARE jack is now i-f out and the SIDETONE jack is i-f input. This change disables the sidetone feature of the receiver. If you want to retain the sidetone capability, you will have to install another connector somewhere. My sidetone comes from my keyer and the loss did not bother me. I assure you that the filter is worth a little trouble.

### Noise Blanker

The SBA-104-1 noise blanker is very effective for some types of noise, notably automotive ignition noise and other types of short duration impulse noise. It does not do much good with long-term "grinding" noise like summer static and some types of power line noise. Since the HR-1680 does not have any noise limiter at all, the SBA-104-1 is a worthwhile improvement.

Build the noise blanker according to Heath's instructions, except change the value of R3 from 33

### Parts List

- C1—47-pF silver mica
- C2—15—60-pF ceramic trimmer (Erie 528 type)
- C3—33-pF silver mica
- C4—330-pF silver mica
- C5—10-pF silver mica or ceramic
- C6,7—.01 ceramic disc, 100 volts
- R1—47k, ¼ Watt
- R2—330 Ohms, ¼ Watt
- R3—1.5k, ¼ Watt
- Q1—2N3819 or similar junction FET
- Y1—3395.7-kHz Heath part 404-549



# ATR-6800



Truly a new dimension in digital communications, the ATR-6800 is more than a superb CW and RTTY machine. It includes a user programmable microprocessor designed to fully automate your station.

Your ATR-6800 is ready to run in a "real world" environment. A shielded metal box and extensive RFI filtering allow side by side operation with your kilowatt, and there is no need for extra attachments or cumbersome program loading.

Direct connection to your transceiver provides total capability on CW and all Baudot and ASCII speeds, both present and future.

For additional performance specs, just use your imagination . . . ATR-6800 with 9" monitor amateur net. . . . . \$1,995.

Ask your dealer for a full demo, or drop by. MICROLOG CORPORATION, 4 Professional Drive, Suite 119, Gaithersburg, MD. 20760. telephone (301)-948-5307.

## MICROLOG

INNOVATORS IN DIGITAL COMMUNICATIONS

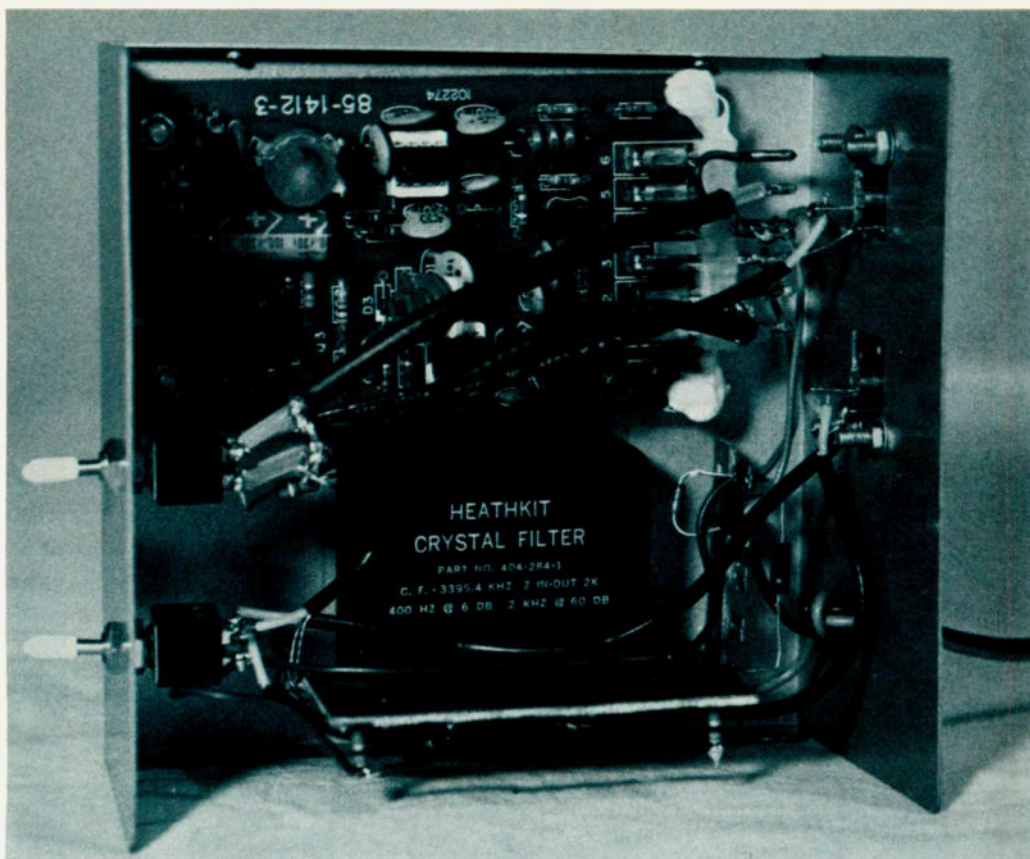

Photo D. Interior view of filter-blanker cabinet. Note globs of silastic rubber used to secure connector to PCB.

Ohms to 390 Ohms. The 390-Ohm resistor is included in the kit for use in the SB-104A and is not needed in the HR-1680. I could not see that the 560-Ohm resistor and the 2.2-uH coil were needed in the HR-1680, so I left them out.

The Heath manual discusses the increase in the IMD (intermodulation distortion) when the blanker is installed, and I noticed that a whole flock of "birdies" fly across the dial when the blanker is in the signal path. When you really need the blanker, all this does not matter, but it is not to be lived with when there is no noise. The best solution is to switch the blanker completely out of the circuit when it is not being used. The circuit diagram reflects this switching.

#### Filter-Blanker Power

13.8 volts is available at the external power connec-

tor at the rear of the set. This connector goes directly to series pass transistor Q201, and care should be exercised when using it because the fuse is ahead of the regulator. The blanker is normally connected to 11 volts, so I used one of several ECG-140s (10-volt) zeners that I had as a simple shunt regulator. The blanker and crystal filter work well with a 10-volt supply.

#### Checkout

Connect the filter-blanker combination to the HR-1680 using RG-58 coax with phono-type connectors at each end. The length of the cables is not critical, but they should not be too long. My cables are about 20 inches each and I could not measure any loss through the cables and switching arrangement.

Use Heath's instructions for checking and adjusting the blanker, except just

switch the blanker out for "initial" readings.

To check out the crystal filter, switch out the blanker, switch the MODE switch to USB, and switch the FUNCTION switch to CAL. Find one of the 100-kHz calibration signals (any band) and switch to CW to see if the new bfo is operating. The beat note will change pitch when the new bfo is switched in. Switch in the crystal filter and verify that it is working. Switch to WIDE and USB and find a strong CW signal or use the spot function on your transmitter. Switch to NAR and peak the signal on the audio filter of the HR-1680. Switch in the crystal filter and switch to CW and adjust the bfo trimmer for a beat note which is peaked at the audio filter center frequency. You should now be able to switch the filter and blanker in and out without changing the S-meter reading.

With the crystal filter switched out and the receiver in the WIDE position, an S-9 signal can be heard over three or four kHz. With the crystal filter switched in, the same signal can be heard over less than one kHz and the signal falls off sharply outside the passband of the filter. The audio filter is helpful in eliminating some of the higher frequency noise that the crystal filter passes.

The normal SSB filter is always in the signal path and this helps improve the overall shape of the passband of the receiver. With the circuit shown, the crystal filter is properly terminated and does not have the "ringing" often associated with sharp filters. In fact, at first I did not think that it was working correctly because the audio was so natural sounding. I purposely mismatched the filter and the typical "ringing" was there. With the new bfo and using only the wider SSB filter, you can now actually zero-beat a signal. This is extremely handy at times.

#### Conclusion

With the modifications that I have outlined, the HR-1680 becomes a superb CW receiver which out-classes almost every secondhand set and is equal to many new and much more expensive sets. ■

#### Bibliography

Hawker, Pat, *Amateur Radio Techniques*, Radio Society of Great Britain, Letchworth, Hertfordshire, G.B., page 63, 1978.  
Waters, Mort W2NZ, "Improving CW Reception on the SB-303," *QST*, July, 1972.  
Frankel, S. Henry WB2DQP, "A New-Look Noise Blanker That Works," *QST*, January, 1977.  
Davis, Al WA2KOC, "Still More on the SBA-104-1 Noise Blanker," *QST*, August, 1977.  
Clarke, C.P. EI3CP, "Variable-Bandwidth Filters—Irish Style," *Technical Correspondence*, *QST*, March, 1978.

# The Dollar-Saver DVM

— 3½-digit unit features autopolarity,  
auto-zero, and a \$30 price tag

Thanks to a new integrated circuit, there has been a dramatic drop in the cost of the digital voltmeter. If you have held off buying or building a simple digital voltmeter because the parts cost too

much, you are in for a pleasant surprise with this one! The parts will cost about \$30.00 or less, and a kit is available to save you the effort of rounding up all of the components. Needless to say, the price is

right! The voltmeter is easy to build, too. The bulk of the components are on a 24-pin IC from Motorola. All you have to add to this chip is a display circuit, a voltage reference, and power supplies. The circuit

is, as a result, quite simple. And PC board layouts are included to make this project as easy to build as a simple kit!

So how about the features? This voltmeter has at least all the features of digital panel meters on the market, and, in fact, more features than several meters that sell for at least twice the price! You get features such as auto-zero (no more zero-adjust—Hooray!), auto-polarity with minus sign display, and overrange indication. You have your choice of a 0 to 199.9 mV range or 0 to 1.999 V range by simply changing one resistor. As you just might have guessed, this meter has a 3½-digit display of 0.33" LEDs, and backing the display up is a voltmeter chip with  $\pm 0.05\%$  accuracy. Of course, the accuracy you get depends upon how well you calibrate your instrument, but it can be darn good! Input impedance is greater than 1000 megohms, minimizing circuit loading and making the design of input at-

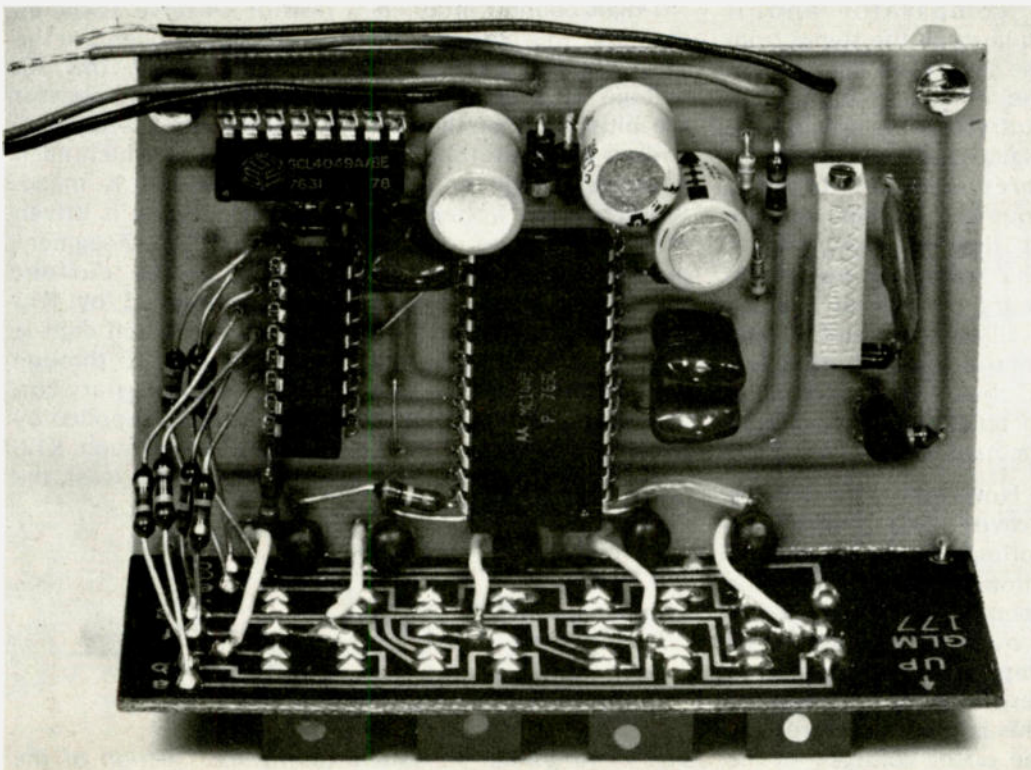

The completed DVM.

tenuators much easier. In short, this voltmeter is built around a terrific IC chip, and one that represents a major breakthrough in features and price.

This article will show you how to build a simple, super low-cost voltmeter. It's so cheap you can permanently install one in such equipment as power supplies, etc. Perhaps in a future article, we can show you how to add ac volts, Ohms, and current ranges to your existing instrument. None of these additions are especially expensive, but they will dramatically increase the versatility of your voltmeter.

### How It Works

The heart of this digital voltmeter project is a single CMOS IC made by Motorola. It contains all the critical circuitry necessary for a simple digital voltmeter. Fig. 1 shows a block diagram of the basics. All you have to add to it is a dc-to-dc inverter, which converts the positive 5-volt power to minus 5 volts, a 2-volt reference supply, a display driver, and a display. This sounds like a lot of parts, but in reality there aren't that many. And they are cheap, anyhow. Note that this voltmeter will measure dc volts only. Other functions require a few more parts which must be added to this basic voltmeter, and that must wait for another article.

The Motorola IC is what is known as a dual-ramp A/D converter. This is a technique of converting analog signals to digital logic and is probably the most widely used method of A/D conversion. Dual-ramp (or dual-slope, if you prefer) voltmeters feature high accuracy (0.1% to 0.05% is common) and high resistance to noise which might be on the voltage you are trying to

measure. Noise read on inferior meters causes jitter in the readings. The dual-ramp technique has been taken one step further by Motorola in that there is an auto-zero step before each measurement, eliminating the zero-adjust control forever!

Let's look at some of the circuitry inside the DVM IC. Fig. 2 shows a simplified version of the A/D converter. There are three CMOS op amps, as you can see, and they function as follows: Dc signals are applied to the input of the first op amp, which serves as a buffer, isolating the influences of the outside world from the sensitive A/D converter. It has a gain of one. The second op amp serves as a ramp generator. It generates linear sweeps upon command. The signal applied at the noninverting input (+ input) and the position of the switch across the capacitor determine the size of the ramp. This is the part of the circuit that does the actual bulk of the A/D conversion. The third op amp serves as a comparator and it squares up the signal from the second op amp so that the remaining digital circuitry can be driven. The digital section consists of three decades of BCD counters, latches, and the "1" digit/polarity-sign logic. The remaining digital circuitry consists of a clock oscillator, multiplex, and control logic. Quite a few IC chips would be required to build this DVM circuit the hard way!

Now let's turn on the power and trace the voltage to be measured through the IC chip. The complete analog-to-digital conversion is done in six steps. The first step is to zero the A/D converter. This is done by correcting the offset voltages on the first two op amps of Fig. 2, or in other words, by set-

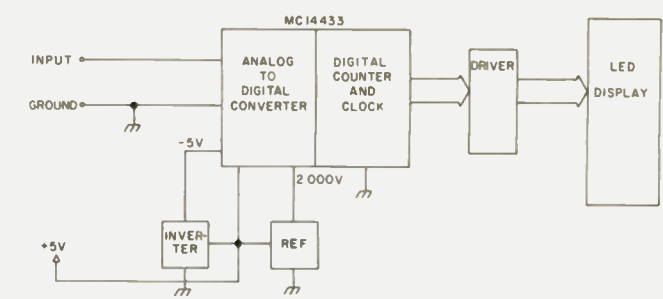

Fig. 1. Block diagram of the DVM.

ting their output voltages to zero. The capacitor across op amp number two is also shorted. The second step stores the number of counts equivalent to the input offset voltage (corrected by step 1) for later use in the auto-zero process. Step 3 uses the information to again re-zero the A/D converter. Then in step 4, the switch across the capacitor of the second IC opens, the plus input is grounded, and a positive ramp results. This ramp is for measuring positive voltages. The ramp starts at the voltage being measured, and then goes to its limit. This generates a series of pulses which are squared by the third op amp and go on to drive a 3½-digit counter array, indicating the voltage. In step 5, the reference voltage is substituted at the plus input of the second op amp, resulting in a negative ramp for measuring negative voltages. It works the same as the positive ramp. Finally, in the sixth step, the signals are squared up by the third IC and counted by the digital section. This process takes place about four times a second.

Let's take a look at the

rest of the DVM circuit (Fig. 3), now that the Motorola IC has been discussed. Looking at the input, resistor R1 and diodes D1 and D2 serve as input protection, saving your DVM chip in the event of a gross overload. The hex inverter, IC1, is wired as an oscillator/buffer. It produces a 900 Hz square-wave signal, which is voltage-doubled by D3-D4 and C2-C3, and that provides the minus 5 volts required by the DVM chip. There is a 2.000-volt reference voltage source consisting of C5, D6, Q1, R5, and R6. FET Q1 serves as a constant-current source, making the reference voltage more stable. Capacitor C4 and resistor R4 serve as the integrator components in the A/D section of the IC. Capacitor C6 and resistor R7 set the clock frequency, or the rate at which each A/D conversion is made. The LED display is driven by IC3, a BCD-to-7-segment decoder, with current limiting supplied by R13 through R19. Each digit is switched by Q2 through Q5, and the necessary current limiting is supplied by resistors R8 through R12. And last, but not least, the

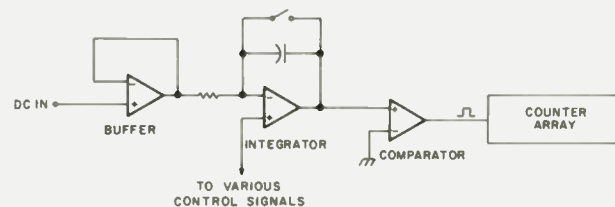
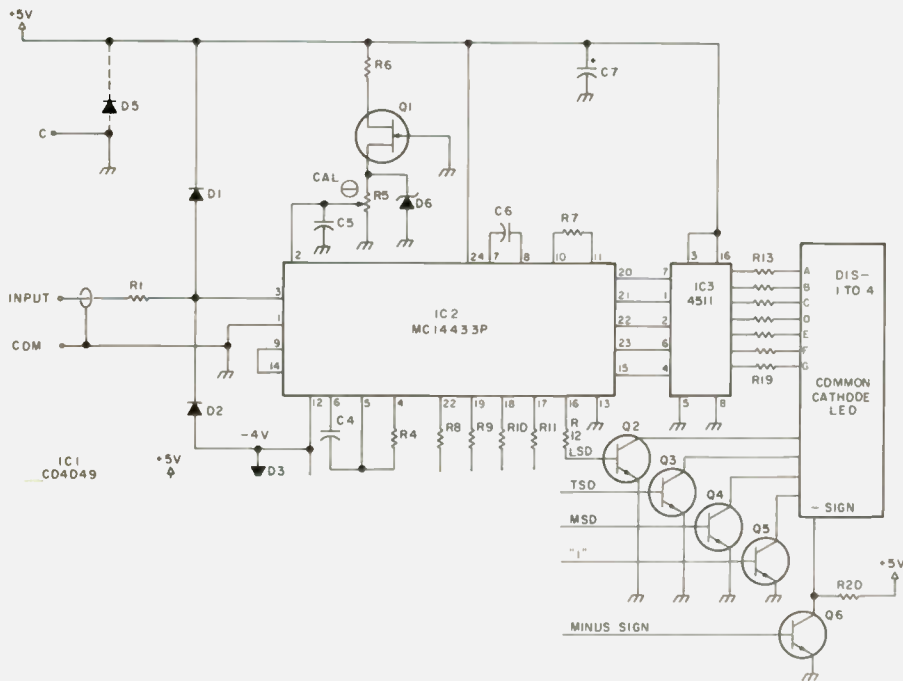

Fig. 2. Simplified schematic of the A/D section of the Motorola chip. The digital counter array is a standard 3½-digit configuration.



the three jumpers below the displays. Check this board for properly soldered connections, solder bridges, etc., and set it aside.

Now you can start on the main board. Cut up Molex Soldercons® into strips of four 8-pin, and two 12-pin. You can use ordinary 16-pin sockets for the two small ICs, but you *must* use Molex for the 24-pin IC because parts run underneath this IC! Insert the strips into the proper holes as shown in Fig. 5. Be sure that the board is oriented properly. The "c", "5V", and "in" markings on the foil side should be closest to you. Solder the pins in place, but do not remove the tab from each row of pins. Next, add the four jumpers. You can use bare wire but be careful to allow a little clearance on the jumper that goes under IC1. You don't want this wire to touch any IC pins. Install trimmer pot R5 on the board. Follow suit with the rest of the resistors, but temporarily leave off R13 through R19. They go on when you add the display board. As you install R12 and R8, you may want to put spaghetti tubing on these resistor leads to prevent them from shorting against the pins of IC2. When you finish with the resistors, install the five diodes. Diode D5 is optional—it provides reverse polarity protection for the DVM. It kills the power supply if the DVM is improperly powered, saving the \$15 DVM chip. If you want this feature, mount the diode on the foil

f DVM.

an sensitive as this one. A poor layout will result in noise pickup and, thus, diminished accuracy. If you are reasonably well-versed in DVM construction, fine! You can design your own layout as long as you are careful of what you connect to the analog ground (pin 1, IC2). If you are not so knowledgeable in DVM construction, play it safe. Either copy your boards from our illustrations, or buy the kit from the author.

A good place to start is with the display board. Fig. 4 shows the front view of this board, which you can wire directly from this illustration. Just place the board in front of you so that the row of 8 holes along the edge is to your left, then stick in each of the displays, solder, and trim the wires. Next, add

**73 MAGAZINE**  
 Subscription Department • Box 931  
 Farmingdale NY 11737

POSTAGE WILL BE PAID BY ADDRESSEE

**BUSINESS REPLY CARD**  
 FIRST CLASS PERMIT NO. 17 PETERBOROUGH NH 03458

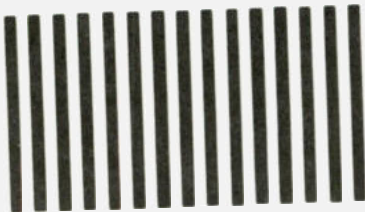
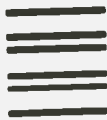

NO POSTAGE  
 NECESSARY  
 IF MAILED  
 IN THE  
 UNITED STATES

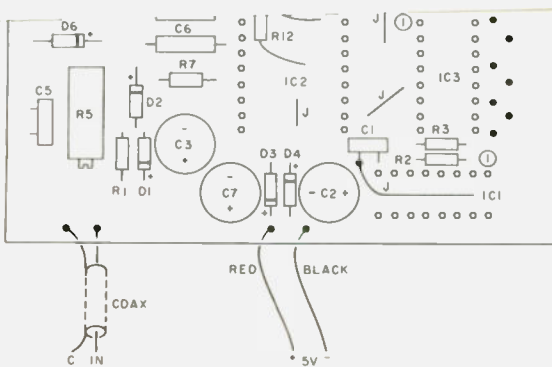

Fig. 5. Top of main board.

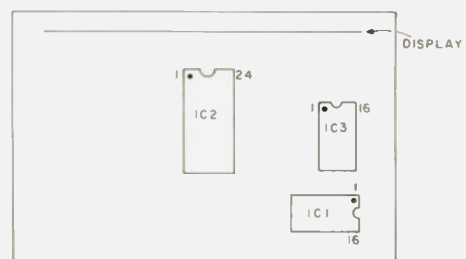

Fig. 6. IC location diagram.

side of the board between the "c" terminal and the "5V" terminal. Do not run the leads through these holes, as wires will later be connected here. Instead, solder directly to the foil. Make sure that the diode polarities are correct and then go on to the capacitors. When you are done, be sure to check the polarity of C2, C3, and C7. Add the FET, Q1. Notice how it is mounted in the illustration. If you have trouble finding a TIS-75, you may get it from S.D. Sales of Dallas, Texas. They call them "FETS" by Texas Instruments" and they have sold at 5 for a \$1.00. Add transistors Q2 through Q6, orienting them as shown. Notice that the emitter leads of these transistors are bussed together. Finish up the board by cutting up a piece of hookup wire into five one-inch pieces. Strip and tin each end, then solder one each to the collector pads of Q2 through Q6.

Now it's time to install the display board and clean up a few odds and ends. The display board mounts flush against transistors Q2 through Q6. You can mount it with two homemade "L" brackets, or just epoxy it. We did the latter after wiring up the display. If you want to do the same, start by wiring the drivers first. Simply solder the free end of the wire coming from Q2 to the cathode of the display *directly* above it. Follow with the other transistors. Note that the minus sign driver, Q6, lead goes to the pad marked "-" on the edge of the board. When you are done with the drivers, turn to the segments. Seven 180 Ohm resistors serve as the leads here, so no more wire is necessary. You will notice that there are pads around IC3 marked "a" through "g". These are the segment letters, and they are

duplicated on the display board. Install the resistors in this order: c, d, e, a, b, f, and g. Leave extra lead length on each of these resistors so they can be positioned without touching. Add short lengths of hookup wire to the holes marked "c" and "5V". These are the power supply leads. Then add a short length of shielded cable between the "c" and "In" holes. This is the signal lead. Finish up by breaking the tabs off the IC sockets and inserting the ICs. Fig. 6 shows IC placement. Be patient with IC2! It may take several tries to get all the pins in the socket.

### Calibration

After you have checked over your wiring, and have corrected any problems, you are all set to test your meter. Connect the supply leads to a source of regulated 5 volts dc. If you don't have a power supply handy, or expect to be needing one with this meter, build the simple one of Fig. 7. Apply power and you should see a flash of light from the display and then it should blank. This is normal with open-circuited input leads. Then short the

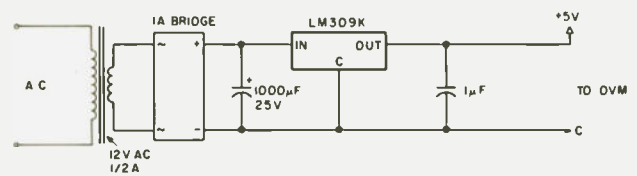

Fig. 7. DVM power supply.

input leads together and the display should light and read "000" with the minus sign flashing slowly. These two tests tell you that your overrange feature (blanked display) and auto-zero feature, as well as the rest of the unit are working properly.

Now you can calibrate your meter. There are several ways to do this and one is shown in Fig. 8. The best way is to use a commercial meter calibrator, such as the Dattel, Fluke, and other "low-cost" units. But these are commercial units and the cheapest is about \$300.00! If you have access to one of these, fine! Just be sure that the calibrator is at least 5 times more accurate than your meter is, or  $\pm 0.01\%$ . Nearly all commercial calibrators are better than this. However, don't despair. There are other ways to calibrate your meter. If you can get a hold of a good 3½-digit, or better, voltmeter you can cali-

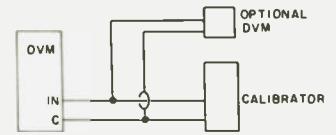
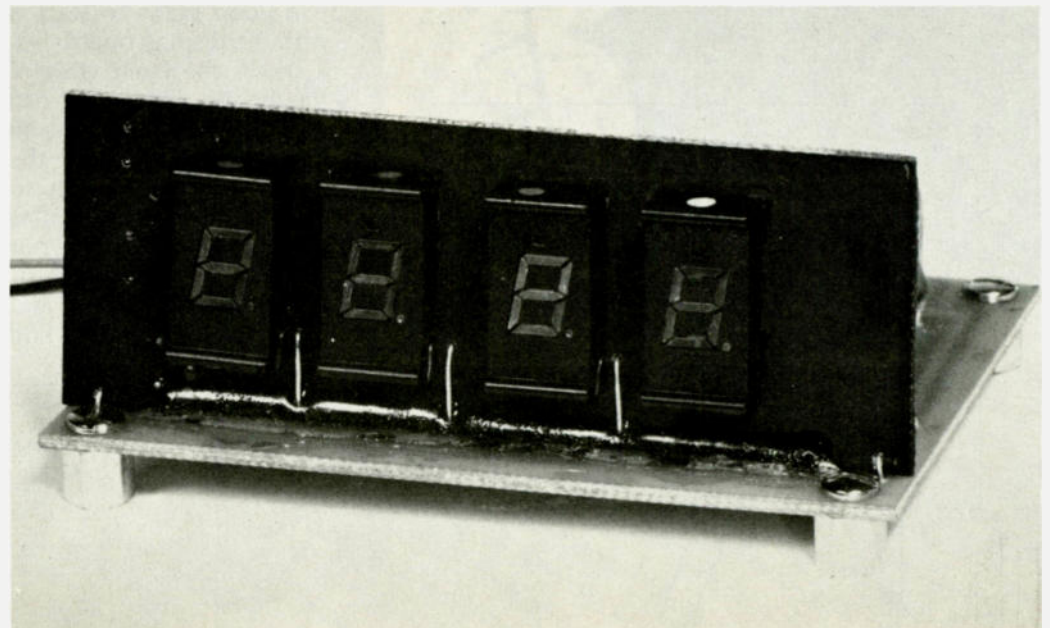

Fig. 8. Calibration setup.

brate your meter against it. Of course the accuracy you get from your meter will be reflected by the unit you calibrate against. Do not calibrate against any analog meter, even the best, if you expect accuracy better than 1 to 5%. The last method is to calibrate it against a mercury battery. If you build our kit, you can return it to us and we'll calibrate it for a fee. So one way or another, you can get your meter calibrated!

The actual calibration procedure is quite simple. Remember, there is only one adjustment! If you are using a commercial calibrator, set it to 1.99900 volts, and adjust R5 for a reading of 1.999 volts. If you are calibrating against another digital meter, ad-



The display board may be held in place with epoxy.

## Parts List

C1, C4, C6—0.1 uF, 50-volt miniature mylar capacitors  
 C2, C3—50 uF, 16-volt electrolytic capacitors  
 C5—0.1 uF to 0.2 uF, 10-volt disc capacitor  
 C7—100 uF, 16-volt electrolytic capacitor  
 D1, D2—1N4148 switching diodes  
 D3, D4, D5 (optional)—1N4002 diodes  
 D6—1N703 zener diode  
 DIS 1 to DIS 4—Litronix DL-704 LED displays  
 IC1—CD 4049 hex inverter IC  
 IC2—Motorola MC-14433P DVM IC  
 IC3—Motorola MC-14511CP display decoder IC  
 Q1—TIS-75 FET or equivalent  
 Q2 to Q6—2N2222 transistors or equivalent  
 R1—100k, ¼-Watt, carbon-film resistor  
 R2, R4—470k, ¼-Watt resistors  
 R3—4.7k, ¼-Watt resistor  
 R5—10k, multi-turn trimmer potentiometer  
 R6, R13 to R19—180 Ohm, ¼-Watt resistors  
 R7—270k, ¼-Watt resistor  
 R8 to R12—10k, ¼-Watt resistors  
 R20 270 Ohm, ¼-Watt resistor  
 Misc.: PC boards, wire, solder, etc.

A kit of all the above parts is available from: Beckman Instruments, 2500 N. Harbor Blvd., Fullerton CA 92638, for \$29.95. California residents include \$1.80 sales tax. All orders include \$2.00 postage and handling. A set of PC boards and construction manual are also available for \$4.50, postpaid.

just R5 until the meters read the same. You can use a flashlight battery here for the voltage source and it works fine. And finally, if

you are calibrating against a mercury battery, adjust R5 to read 1.340 volts and you will be in the ballpark. After tweaking R5 in any of

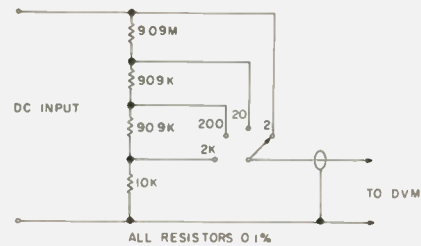

Fig. 9. Voltage divider for additional voltage ranges.

these methods, reverse your meter's input leads. The minus sign will light and you will get the same reading, plus or minus a millivolt.

## Operation

There are many uses for this meter and it's up to you to find them. Do you have a regulated power supply? Why not add a DVM to it. Fig. 9 shows a simple voltage divider you can use in this or other applications. Of course, you can incorporate it into a bench voltmeter. Or, power it with a set of nicad

batteries and make your meter portable. The possibilities are endless!

One last thing: You will probably want a decimal point and perhaps a 0 to 199.9 mV range. To get that decimal point, it is recommended that you place a series combination of any small LED lamp and a 2.2k resistor between the appropriate readouts. Attach the leads to the 5-volt power supply. This addition will give superior performance to the built-in decimal points. Need a 200 mV range? Just change R4 to 27k and recalibrate. That's it! ■

**NEW!**

# PS-1.0 GHz

- 1.00 GHz pre-scaler ÷ by 1000
- Broadband operation 10HZ to 1.25 GHz
- High sensitivity
- Standard T2L or ECL power supply
- Dual mode operation—VHF/UHF
- Independent VHF and UHF inputs
- Divide by 1000 so it can be used with any counter having seven digits or more.
- Circuit uses only four chips.
- Fully assembled and tested.

**\$79.95**

# HAL

HAL HAROLD C. NOWLAND  
W8ZXM

## HAL-TRONIX

P.O. Box 1101  
Southgate, MI 48195  
(313) 285-1782

# PA-19

### WIDEBAND PREAMPLIFIER

- 2 to 200 MHz band width (– 3db points)
- 19 db gain
- 50 ohms input & output impedance
- Tiny PC Board size (7/8" × 1-5/8")
- Absolutely no tuning required
- Extremely stable
- Draws only 20MA at 12 v dc
- Great way to increase sensitivity of receivers, counter, etc.
- Fully assembled and tested
- Instructions provided, full warranty.

**\$8.95**

SHIPPING INFORMATION ORDERS OVER \$15.00 WILL BE SHIPPED POSTPAID EXCEPT ON ITEMS WHERE ADDITIONAL CHARGES ARE REQUESTED. ON ORDERS LESS THAN \$15.00 PLEASE INCLUDE ADDITIONAL \$1.00 FOR HANDLING AND MAILING CHARGES. SEND SASE FOR FREE FLYER.

Tempo, Ten-Tec, Texas RF, Tonna Antennas, TPL, Tri-EX, Van Gorden, Vibroplex, Vidaire, Vista, VHF Engineering, VOMAX, Wilson, YAESU?

# KENWOOD

...pacesetter in amateur radio



**TR7600:** 2m FM XCVR. 25 watts, LED readout, 144-147.995. Fully synthesized, any repeater offset possible, memory channel.

TR7600 VHF XCVR	\$375.00
BLC 10/70 VHF Power Amplifier	149.95
<b>TOTAL REGULAR PRICE</b>	<b>\$524.95</b>
<b>SALE PRICE</b>	<b>\$424.95</b>
<b>SAVE \$100.00</b>	

# Unarco-Rohn

## COMPLETE 25G TOWER PACKAGES

**50' Guyed Tower:** Includes top section, 4 regular sections, base plate, rotor plate, 50' guy wire, 2 guy assemblies with torque bars, 3 concrete guy anchors and other miscellaneous hardware.

TOTAL REGULAR PRICE	\$594.02
SALE PRICE	464.02

**SAVE \$130.00**

**50' Bracketed Tower:** Includes top section, 4 regular sections, base plate, rotor plate and universal house bracket.

TOTAL REGULAR PRICE	\$366.15
SALE PRICE	266.15

**SAVE \$100.00**



# BECKMAN



... Beckman Multimeters keep going

If you've ever been troubled by a faulty multimeter — or had one that wasn't quite up to the tougher jobs — your troubles are over

**Choice of Models**  
The TECH 310 has all above features + functions 29 ranges plus 0.2% Vdc accuracy.  
The TECH 300 has a 0.5% Vdc accuracy and all the above features, but without Insta Ohms™ continuity function or the 10 amp current ranges

**Complete Multimeter Capability**  
DC volts 100μV to 1500V  
AC volts 100μV to 1000V rms  
Resistance 0.1Ω to 20MΩ  
DC current 100nA to 10A (TECH 310)  
100nA to 2A (TECH 300)  
AC current 100nA to 10A (TECH 310)  
100nA to 2A (TECH 300)  
Diode/Semiconductor test function  
Continuity function (TECH 310)

**TECH — \$100**  
**TECH — \$130**

# TEN-TEC



574



570

## TUFTS NOVICE EXCLUSIVE

Purchase your Century 21 (570 or 574) from us and have up to one year to apply the full purchase price towards a model 540, 544, 545, or 546 when you upgrade your station.

**NOVICE SPECIAL**

# TEMPO

# YAESU



**Syncom S1 with TTP:**  
From Tempo — the world's first synthesized 800 channel handheld transceiver. Includes battery pack, charger, telescoping antenna — and 800 channels!

**FT207R:**  
From YAESU — 2m FM XCVR. Handheld completely synthesized, digital readout, keyboard access, 2 watts, 4 memories and much more.



**KLM PA2-25B Power Amplifier:** 2 watts in, 25 watts out.

Tempo Syncom S1 with TTP	}	\$399.00
or FT207R Synthesized 2m handheld		
KLM PA2-25B Power Amplifier		92.95
<b>TOTAL REGULAR PRICE</b>		<b>\$491.95</b>
<b>SALE PRICE</b>		<b>\$441.95</b>
<b>SAVE \$50.00</b>		

# KENWOOD

...pacesetter in amateur radio



TS520SE

**TS520SE:** 160-10 meters, 200 watts P.E.P., speech processor, noise blanker, excellent sensitivity and minimum cross-mod.

5BTV

TS520SE	\$629.95
Hustler 5BTV Vertical	139.95

<b>TOTAL REGULAR PRICE</b>	<b>\$769.90</b>
<b>SALE PRICE</b>	<b>\$649.90</b>

**SAVE \$120.00**

or



ATB34

TS520SE	\$629.95
ATB34 Cushcraft TriBander	\$289.95

<b>TOTAL REGULAR PRICE</b>	<b>\$919.90</b>
<b>SALE PRICE</b>	<b>\$769.90</b>

**SAVE \$150.00**



# KENWOOD



**TL922A:** 2kW P.E.P., 160-15 meters, 3-500Z tubes.



Model 43



MBII TUNER:

3kW, 160-10 meters.

TL922A:	\$1199.00	TL922A:	\$1199.00
MBII Tuner	295.00	Bird Model 43	201.00
<b>Total Regular Price</b>	<b>\$1494.00</b>	with 2500H element and carrying case	<b>\$1400.00</b>
<b>Sale Price</b>	<b>\$1294.00</b>	<b>Sale Price</b>	<b>\$1200.00</b>
<b>SAVE \$200.00</b>		<b>SAVE \$200.00</b>	

**CALL AND CHECK OUR GREAT DEALS ON ALL YOUR AMATEUR RADIO NEEDS.**  
DIAL: (617) 395-8280

Stock items shipped within 24 hours. Prices subject to change. Limited quantity on some items.



QUESTION: Who has Advanced Electronics, Alpha, AMECO, Amphenol, Antenna Specialists, Astatic,

☆☆☆☆☆☆☆☆ PALOMAR ENGINEERS ☆☆☆☆☆☆☆

R-X NOISE BRIDGE \$55.00



- Learn the truth about your antenna.
- Find its resonant frequency.
- Find R and X off-resonance.
- Broadband 1-100 MHz.
- Simple to use. — Self contained.

VLF CONVERTER \$59.95



- New device opens up the world of VLF radio.
- Converts VLF to 80 meters. For use with any shortwave receiver covering 3.5-4 MHz.
- Advanced design for simple operation, high performance.
- Gives reception of the 1750 meter band.
- Also covers navigation radiobeacons, WWVB, ship-to-shore, and LF broadcast band.

LOOP ANTENNA

Loop Amplifier \$67.50  
Plug-in loops \$47.50 ea.

- Plug-in loops available for:  
1600-5000 KHz (160/80 meter amateur bands)  
550-1600 KHz (Broadcast Band)  
150-550 KHz (VLF, 1750 meter band)  
40-150 KHz (WWVB, Loran)  
10-40 KHz (Omega)  
• Nulls out interference



ALL BANDS PREAMPLIFIER \$89.50



- Tunes 1.8 to 54 MHz. Covers ALL amateur bands 160 to 6 meters. ALL shortwave broadcast bands.
- For receivers AND transceivers.
- Up to 20 db gain.
- Pegs up that tired receiver.
- Reduces image and spurious response.



Model MB II \$295  
(with Balun) \$325

MB II provides:  
\* Constant SWR monitoring \* Precision tuning of final amp \* Harmonic suppression  
\* Receiver input impedance-matching \* Maximum power transfer to antenna \* Continuous frequency coverage 1.6 to 30 MHz \* Precision tuning of any wire wavelength or longer, with SWR of 1:1

MB II features:  
\* Finest quality, made-in-USA components \* Large, precision, easy-to-read dials with 360 readout \* Optional 3000 watt Balun for twin lead antennas



\$94 VHF model 4362 (140-180 MHz)  
\$94 HF model 4360 (18-30 MHz)



The 4360, 4362 HAM-MATE Directional Wattmeters are insertion type instruments for measuring forward or reflected power in 50-ohm coaxial transmission lines. They are direct descendants of the model 43 THURLINE® Wattmeter — the professional standard of the industry — and will accurately measure RF power flow under any load condition. Each wattmeter is made up of a precisely machined section of 50-ohm line, a rotatable sensing element and meter calibrated in watts, all mounted in a high impact plastic housing. It is this type of solid construction and the directional THURLINE coupling circuit, without toroids, that account for the superiority of the HAM-MATE Wattmeters.

the indispensable  
**BIRD 43**  
THRULINE  
WATTMETER



Power Range	Frequency Bands (MHz)					
	2-30	25-100	100-250	250-500	500-1000	1000-3000
5 watts	—	5A	5C	5D	5E	—
10 watts	—	10A	10C	10D	10E	—
25 watts	—	25A	25C	25D	25E	—
50 watts	50M	50A	50C	50D	50E	—
100 watts	100M	100A	100C	100D	100E	—
250 watts	250M	250A	250C	250D	250E	—
500 watts	500M	500A	500C	500D	500E	—
1000 watts	1000M	1000A	1000C	1000D	1000E	—
2500 watts	2500M	—	—	—	—	—
5000 watts	5000M	—	—	—	—	—

MODEL 43  
Elements (Table 1) 2-30 MHz \$130.00  
Elements (Table 1) 25-1000 MHz 45.00  
Carrying case for Model 43 & 6 elements 38.00  
Carrying case for 12 elements 27.50  
Carrying case for 12 elements 17.00

READ RF WATTS DIRECTLY! (Specify Type N or SO239 connectors) 0.45 - 2300 MHz, 1-10,000 Watts ±5%, low insertion VSWR - 1.05. Unequaled economy and flexibility. Buy only the element(s) covering your present frequency and power needs, add extra ranges later if your requirements expand.

**BW**  
5-BAND TRAP DIPOLE  
(80 thru 10 Meters)

Barker & Williamson

Power rated 2k WPEP, approx. 110 ft. span



Complete with: wire, traps, end insulators, 50 ft. RG-8/U, PL-259 connector, heavy-duty cast aluminum and seatite center connector. 4-Band (40 thru 10M) 55 ft.

Pre-assembled:  
Model 370-11 — \$64.95  
Kit (illustrated):  
Model 370-12 — \$54.95



Hy-Gain REEL TAPE PORTABLE DIPOLE  
for 10 thru 80 Meters Model 18TD  
The most portable high performance dipole ever...

The Model 18TD is unquestionably the most foolproof high performance portable doublet antenna system ever developed. It has proven invaluable in providing reliable communications in vital military and commercial applications throughout the world. Two stainless steel tapes, calibrated in meters, extend from either side of the main housing up to a total distance of 132 feet for 3.5 mc operation. 25 ft. lengths of polypropylene rope attached to each tape permits installation to poles, trees, buildings — whatever is available for forming a doublet antenna system. Integrated in the high impact housing is a frequency to length conversion chart calibrated to meter measurements on the tapes — makes installation foolproof. Feeds with 52 ohm coax. Delivers outstanding performance as a portable or permanent installation. Measures 10x5 1/2 x 2 inches retracted. Wt. 4.1 lbs. Order No. 228 Price \$94.95



hy-gain

BANDPASS-REJECT DUPLEXER  
DPLA-144 FOR 144-174 MHz  
Also available for  
54, 220, 450 MHz.

THESE BAND PASS BAND REJECT CRYSTAL FILTERS provide the use of an extremely developed VHF-ENG which provides superior suppression of your most unwanted spurious signals and also offers the most frequencies when used as a high Q filter. The Band Pass Band Reject Crystal provides frequency response curves with bandwidths down to 100 kHz and the frequency to be passed and band edges clearly, sharp, and steep. The quality of the filter is the ultimate. Performance characteristics are printed in the frequency specification in the manual. Frequency stability of the Band Pass Band Reject Crystal is superior to any other type of crystal available. An important feature of the Band Pass Band Reject Crystal is its ruggedness. Each module will survive through the power of 1000 watts and all modules are sealed with impervious glass hermetic and mounting frame.



\$479.00

Name \_\_\_\_\_ Call \_\_\_\_\_  
Address \_\_\_\_\_  
City \_\_\_\_\_ State \_\_\_\_\_ Zip \_\_\_\_\_  
Order: \_\_\_\_\_

Prices FOB Medford, MA. MA residents add 5% sales tax.  
Minimum \$3.00 for shipping and handling on ALL ORDERS.  
 Check Enclosed  Visa  Master Charge  Send for Free Catalog  
PRICES SUBJECT TO CHANGE WITHOUT NOTICE  
Card no. \_\_\_\_\_ Card exp. date \_\_\_\_\_  
Signature \_\_\_\_\_



Radio Electronics  
OPEN DAILY 9-9  
SATURDAY 9-5

206 Mystic Avenue, Medford, Mass. 02155, Tel: 1-617-395-8280

Atlas, Bencher, Bird, Bomar, B&W, CDE, CES, CSC, Cushcraft, Daiwa, Datong, DGM, Drake, ETO, F9FT, Finco, Ham Key, Henry Hustler, Hygain,

JMR, KLM, Kenwood, Larsen, MFJ, Microwave Filter, Morgain, Mosley, Newtronics, NPC, Nye Viking,

# Lunar's new 2M 4-40P Linearized Amplifier makes your hand-held synthesized transceiver a GIANT!



## 1 to 4 WATTS IN— 10 to 40 WATTS OUT.

- Can be used with any 1-5 watt radio.
- Linearized so it's compatible with SSB.
- Has pre-amp for receiver portion to increase power and clarity of incoming signals.
- Amp and pre-amp functions independently controllable.
- Remote control capability.
- Regulated voltage output as required by the FT 207R and TR2400 to conserve battery pack.
- Turns your 1-4 watt transceiver into a higher powered base or mobile station.
- Made with the quality and care that has made Lunar the leader in linearized amps.

**SEE IT AT SAROC!**

2785 Kurtz Street, Suite 10, San Diego, CA 92110  
 Telephone 714 299-9740      Louis N. Anciaux  
 Telex 181747                      WB6NMT



## ALL-MODE VHF amplifiers

FOR BASE STATION & REPEATER USE

MODEL: V350



- ☆ Built-in 115/230 VAC Supply
- ☆ AM-FM-CW-SSB-RTTY
- ☆ 60dB Harmonics
- ☆ 60dB Spurious
- ☆ Heavy Duty Design

MODEL: V180



- ☆ Illuminated Panel Meter
- ☆ Automatic T/R Switching
- ☆ VSWR Protected
- ☆ + 13V/3A Accessory Socket
- ☆ U.S. Manufactured

**All Solid-State!**

MODEL	FREQUENCY	INPUT	OUTPUT	SIZE WxDxH	WEIGHT	FAN KIT REQUIRED	PRICE
V76	50-54MHz	8-15W	100-120W	216x330x178mm	11.7 kg (26 lbs)	No	\$339.00
V360	50-54MHz	2-10W	400-450W	432x330x178mm	23.4 kg (52 lbs)	Yes	\$895.00
V70	144-148MHz	10-15W	75-90W	216x330x178mm	11.7 kg (26 lbs)	No	\$315.00
V71	144-148MHz	1-3W	75-90W	216x330x178mm	11.7 kg (26 lbs)	No	\$349.00
V180	144-148MHz	5-15W	170-200W	216x330x178mm	13.5 kg (30 lbs)	CW & FM	\$539.00
V350	144-148MHz	10-20W	350-400W	432x330x178mm	23.4 kg (52 lbs)	Yes	\$895.00
V130B	220-225MHz	10-15W	70-85W	216x330x178mm	11.7 kg (26 lbs)	No	\$329.00
V135B	220-225MHz	25-35W	140-160W	216x330x178mm	11.7 kg (26 lbs)	CW & FM	\$469.00
F110		Fan Kit, 115VAC		135x135x50mm	1 kg (2.2 lbs)		\$ 33.00
F220		Fan Kit, 230VAC		135x135x50mm	1 kg (2.2 lbs)		\$ 33.00
*F135		Fan Kit, 115VAC		381x140x89mm	3.2 kg ( 7 lbs)		\$ 59.00
*F235		Fan Kit, 230VAC		381x140x89mm	3.2 kg ( 7 lbs)		\$ 59.00
RM 1		19 Inch Rack Adaptor		483x3x178mm	1 kg (2.2 lbs)		\$ 25.00
*RM 2		19 Inch Rack Adaptor		197x32x28mm	.5 kg (1.1 lbs)		\$ 12.00

\* Used with the V360 & V350 Amplifiers

Other Frequencies Available on Request

Dealer Inquiries Invited

Meeting all applicable FCC Requirements.



POWER  
LABS

**RF POWER LABS, INC.**

✓ R27



11013-118th Place N.E. • Kirkland, Washington 98033 Telephone: (206) 822-1251 • TELEX No. 32-1042

**DELUXE MESSAGE MEMORY KEYS**

**"BRAND NEW"**  
**\$89.95**



**Features: Model TE-284**

- State-of-the-Art CMOS Circuitry
- Three choices of Message Storage
  - A. Two (50 character each) message storage
  - B. Four (25 character each) message storage
  - C. One 50 character and two 25 character message storage
- Records at any speed—plays at any speed
- Memory operating LED
- Use for daily QSO or contests

- PLUS:**
- Self-completing dots and dashes
  - Both dot and dash memory
  - Iambic Keying with any squeeze paddle
  - 5-50 w.p.m.
  - Speed, volume, tone, tune and weight controls
  - Sidetone and speaker
  - Low current drain CMOS battery operation—portable
  - Deluxe quarter-inch jacks for keying and output
  - Keys grid block and solid state rigs
  - **WIRED AND TESTED FULLY GUARANTEED—LESS BATTERY**

**MESSAGE MEMORY KEYS**



**Features:**

- Advanced CMOS message memory
- Two (50 char each) message storage
- Repeat function
- Records at any speed—plays back at any speed
- Longer message capacity  
Example send CQ CQ CQ DX de WB2YJM WB2YJM K—then play second message on contact—de WB2YJM QSL NY NY 579 579 Paul Paul K
- Use for daily QSOs or contests

**Model # TE201**

**\$69.95**

**PLUS:**

- State-of-the-art-CMOS keyer
- Self completing dots and dashes
- Both dot and dash memory
- Iambic keying with any squeeze paddle
- 5-50 wpm
- Speed, volume, tone, tune and weight controls
- Sidetone and speaker
- Low current drain CMOS battery operation—portable
- Deluxe quarter-inch jacks for keying and output
- Keys grid block and solid state rigs
- **WIRED AND TESTED FULLY GUARANTEED—LESS BATTERY**

**"BRAND NEW"**



**Model # TE144**  
**59.95**

**Features: Deluxe CMOS Electronic Keyer**

- State-of-the-art CMOS circuitry
- Self completing dots and dashes
- Both dot and dash memory
- IAMBIC keying with any squeeze paddle 5-50 wpm
- Speed, weight, tone, volume tune controls & sidetone and speaker
- Semi-automatic "bug" operation & straight keying—rear panel switch
- Low current drain CMOS battery operation—portable
- Deluxe quarter inch jacks for keying and output
- Keys grid block and solid state rigs
- Wired and tested—fully guaranteed—less battery



**Model # TE133**

**\$49.95**

**Features CMOS ELECTRONIC KEYS**

- State-of-the-art-CMOS circuitry
- Self completing dots and dashes
- Dot and dash memory
- Iambic keying with any squeeze paddle
- 5-50 WPM
- Speed, volume, tone, weight & tune controls, sidetone and speaker
- Low current drain CMOS battery operation
- Deluxe quarter inch jacks for keying and output
- Handsome eggshell white base—woodgrain top
- Compact and portable 1-7/8 x 4-1/4 x 6-1/4
- Grid block & solid state keying
- Wired and rested—fully guaranteed — less battery

**MODEL TE122**—same as TE133 less wgt, tune, solid state keying \$36.50

**AT YOUR DEALER OR SEND CHECK OR MONEY ORDER.**

(plus \$2.00 S/P NY res add tax)

**TRAC ELECTRONICS, INC**  
**1106 RAND BLDG.**  
**BUFFALO NY 14203**

**MFJ 25W ANTENNA TUNERS**

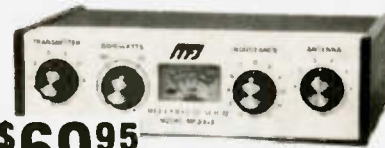

**\$69.95**

**NEW MFJ-940 VERSA TUNER II** matches coax and random wire 1.8 to 30 MHz.

Up to **300 watts RF OUTPUT**. SWR, dual range wattmeter (300 and 30 watts full scale).

Six position antenna switch on rear. Select 2 coax lines direct or thru tuner, random wire, and tuner bypass for dummy load.

New efficient airwound inductor (12 positions) gives you less losses than tapped toroid for more watts out. 8x2x6 inches. SO-239 coax connectors. 208 pf, 1000 volt capacitors.

Optional mobile mounting bracket, add \$3.00. Beware of imitators. When you buy MFJ you buy proven MFJ quality and a one year unconditional guarantee.



**\$39.95**

**MFJ-900 ECONO TUNER** matches coax, random wires. Full band coverage 1.8 to 30 MHz.

Up to **200 watts RF OUTPUT**. Efficient airwound inductor gives more watts out than tapped toroid.

SO-239 coax connectors. 5x2x6 inches. One year unconditional guarantee.

**MFJ-901 Versa Tuner** available. Same as MFJ-900 but has 4:1 balun for balanced lines. \$49.95.

Beware of imitators. Some are still copying our earlier models. MFJ has made improvements.

For example, a new efficient airwound inductor gives you less losses than a tapped toroid for more watts out and plenty of inductance for full band coverage 1.8 to 30 MHz.

**\$29.95**



**MFJ-16010 RANDOM WIRE TUNER** lets you operate 1.8 to 30 MHz with random wire. Up to **200 watts RF OUTPUT**. Small enough to carry in your hip pocket. Ultra compact 2x3x4 inches.

Match low and high impedances by interchanging input and output. SO-239 coax connectors.

One year unconditional guarantee.

Order from MFJ and try it. If not delighted, return within 30 days for refund (less shipping).

Order yours today. Call toll free 800-647-1800. Charge VISA, MC. Or mail check, money order. Add \$3.00 each for shipping.

**CALL TOLL FREE ... 800-647-1800**

For technical information, order/repair status, in Miss., outside continental USA, call 601-323-5869.

**MFJ ENTERPRISES, INC.**  
BOX 494, MISSISSIPPI STATE, MS 39762

# Personalize Your Repeater with a Voice ID

— low-cost design uses 8-track decks

Bob Heil K9EID  
411 S. Main  
Marissa IL 62257

With the great increases of repeater systems on the air today have come all kinds of ideas for hardware to personalize each system and projects offering ideas for clubs to get new members

involved with the building and maintaining of these systems.

Here is a voice identification system using easy-to-obtain parts, simple straightforward circuitry, and such easy construction practices that any repeater group can build it with a minimum of problems.

## Circuit Description and Planning

The system consists of a

16-digit function decoder feeding an address field of gates which, in turn, drive five relays that simply turn on or off an 8-track tape-

player deck.

The function decoder used here is the Data Signal TTD-226, but any function decoder will



This is the M.A.R.C. voice ID system. Two of the four tape decks are shown, mounting into one chassis with access to the tapes from the front. The underneath view of the electronics shows the function decoder board on the right and the address field-motor switching on the left. The audio patch is on the extreme right of the picture.

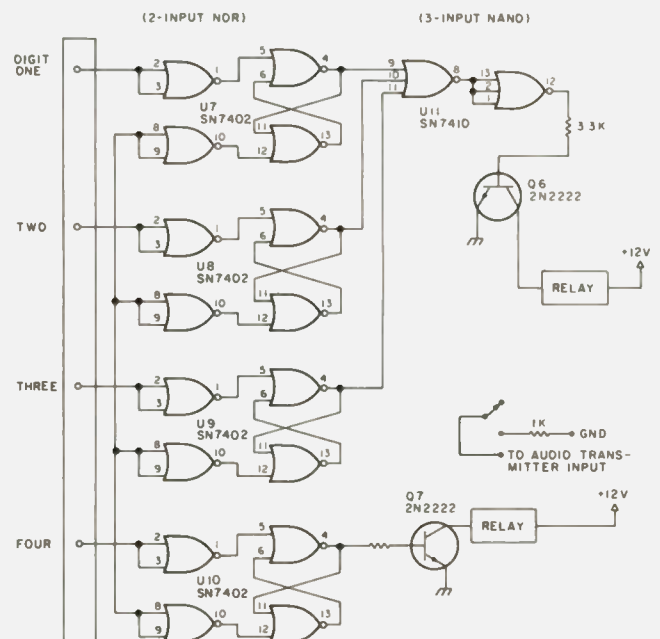

Fig. 1. A multi-digit access board is incorporated, and can be used whenever you desire more than one or two entries. The circuit described here is a 4-digit input, with an audio clamp circuit that will turn off the audio fed to the transmitter. During the digit-accessing, no audio is fed out over the air. When the fourth digit is accessed, the audio clamp circuit is released and the transmitter is again fed audio.

### HOW IT WORKS

Audio from the receiver is fed to the function decoder. An agc circuit is used to feed the eight 567 tone decoders. Their outputs feed various gates to give a total output of each digit corresponding to a 16-digit pad. As a digit is sent, a low signal appears at the corresponding pin of S1. This signal is sent to the input of the address field board, which contains five SN7402 QUAD NOR gates wired as flip-flops. Applied low signals to the two inputs will cause the circuit to turn on and drive Q1 into conduction, which then turns the relay on. Proper connection of low signals from the tone decoder to the address field board will give you all kinds of variety with respect to access codes and types of operation.

The relays turn 110 volts on and off to the series of 8-track stereo tape-player decks which feed the repeater audio system. The relays can be used to control any number of functions needed for your particular repeater control.

work. (The repeater handbook has an excellent function decoder described which will work well, also.) The number of digits is up to your group. Great thought has to be put into your input access codes, unless you desire a completely "open" system accessible with one digit.

If your repeater has an autopatch, it will be very important to disable the tape ID decoder system so that dialing phone numbers will not access any tape messages. This can be accomplished very easily by shorting the audio input signal feeding those decoders. At the same time the patch is brought back "down," this audio short is lifted and audio is allowed to feed the decoders once again.

This system uses a three-digit input and a single-digit cancel, or an automatic cancel fed by the tape deck.

### Operation

The signal path starts at the repeater receiver speaker. This audio line feeds the repeater transmitter, and we bridge it to feed the function decoder audio input. An agc (automatic gain control) amplifier is used to limit the audio coming into the decoder ICs, so that the audio signals do not distort and overload the circuit.

The function decoder then uses 567 PLL chips to decode two-tone audio tones and gives a low or high signal to drive the address field.

The address field board can be thought of as a very simple memory storage board, using 7402 TTL chips. The decision was made to use this method so that one can use inexpensive chips (usually less than 50¢ each) which do not require any special handling or give serious voltage problems.

### 7402 R-S Flip-Flops

The 7402 is a two-input quad NOR gate. It can be connected as a set-reset flip-flop. A high to pin 5 will cause pin 4, the output, to latch high. Sending a low to pin 3 will reset pin 4 to a low state. We actually have a storage for recall of information at any time. This has to be addressed with another 7402 so that the clocking is uniform.

### Alternative IC

As with any electronic circuit, there are many ways to achieve the same function. A 7472, 7407, or 7476 J-K flip-flop latch IC could replace the 7402. Our decision, however, favored simplicity; it allows use of the same chip throughout the entire project, making parts replacement for servicing easier,

should any problems arise.

The outputs of the flip-flops drive an NPN transistor, which buffers the 7402 output to control a 12-volt relay. This relay switches the 110 V to the 8-track tape-deck motors. The message tape has silver foil applied at the end of each message. This foil comes in contact with two metal fingers which are connected to the off pin of the flip-flop, thereby latching the 7402 off, which releases the relay and turns the tape-deck motor off. One set of contacts is used to key the PTT line of the transmitter, also.

### Time Machine

One feature some of our members really wanted was a voice time machine that could be punched up to give the time of day. Our rural telephone system does not have the usual time-and-temperature public service number. However, in checking out the available time machines, it was found that the lowest-priced unit was over \$2,000!

In checking around, a Panasonic "Talking Clock Radio" was found, however. This product was built over five years ago. It uses a series of magnetic discs that change position every minute and hour. A remote keying jack and audio output are already installed, so interface was very easy. The biggest problem was the addition of a timer to hold the PTT

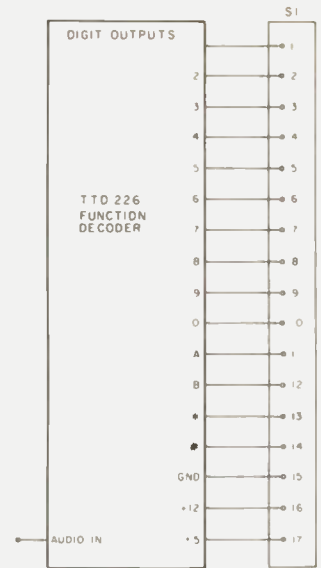

Fig. 2. Interface for the TTD-226. Connect pins of S1-P1 to correspond with the particular access code you desire. Program 1 needs two digits to turn the program on. The tape sensor will turn it off. Select the digits you prefer from S1, to correspond with P1. Example: Connect terminals 3 and 4 of S1 (TTD-226) to terminals 1 and 2 of P1 (address field board). Connect terminal 3 of P1 to the tape-deck sensor switch. When digits 3 and 4 are sent in sequence, U1 turns the program 1 tape deck on. When the message is finished, the aluminum tape sensor on the tape cartridge activates the tape sensor switch, turning off pin 3 of P1, which reverses the U1 flip-flop.

line on so that the transmitter remained keyed during the six seconds that it takes for the voice tape to announce the time. This was accomplished with a 555

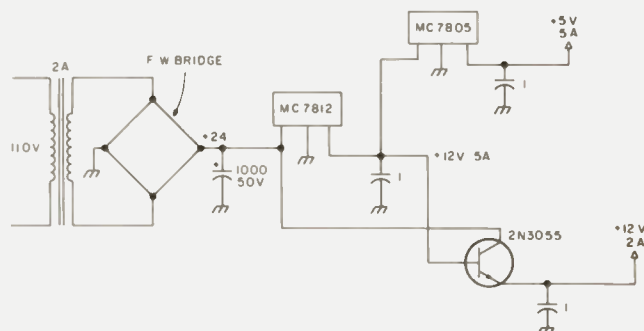

Fig. 3. Power supply.

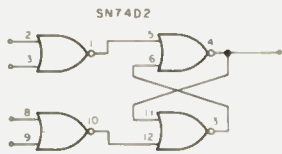

Fig. 4.

timer IC turning on a reed relay to ground the PTT line.

### Tape-Player Hardware

As with all repeater groups, our cash was in short supply, so the acquisition of tape decks got to be expensive in the planning stages. We ran across an ad from Poly Paks, however, for 8-track players for \$9.00! They worked out great! It was inconceivable to use one of those players, with that head jumping up and down, to select the various programs, so we used two players and removed all of that solenoid nonsense.

We mounted the playback head solid and eliminated many problems.

One player is programmed for ID announcements. The other player can be used for club messages, announcements, and so on. We have a third player that comes on every tenth time the CW identifier is called upon. This produces a low level voice ID automatically. The other tapes are accessed by touchtone™ pads only. Each message is about 6 to 8 seconds, average, with a piece of silver foil sensing tape 1/2" long at the end of each message. Most of our tapes contain 15 different messages on a continuous loop. The sensing foil stops the machine at the end of each. This ensures greater tape life and gives you much more program source.

### Chassis Work

The entire unit is built into two aluminum chassis. One, 17" x 6" x 3", houses the electronic keying board, regulated supplies, and relays. The other, 17" x 12" x 3", contains the tape players and associated 110-volt switching. Nineteen-inch standard-rack front panels are mounted on the front of each chassis. The clock radio can be mounted on a shelf inside the repeater cabinet. Proper shielding and single point rf grounding should, of course, be done to prevent any interference. LED indicators are mounted on the front panel to show which program is on the left side of the panel, for the regulated power supply.

### PCB

The main address field board, a double-sided

board, includes all of the 7402 devices, four tape-player relays, the 6-second timer, and the keying relay for the time machine. A 20-pin edge connector interfaces the board to the output terminal strip mounted on the chassis and connects to the output of the TTD-226 date signal decoder board. A lot of point-to-point wiring is done on the circuit board, so that should you want different access codes at any time, you can simply unsolder the various wire jumpers and re-connect at the desired spots. The relay contacts are hard-wired to the edge connectors so that 18-gauge wire can be used to carry the current. The relays are mounted right on the PC board and use the encased-type relays to keep contacts free of dirt. This point-to-point wiring very versatile as to how your interface gets connected to the output of the function decoder.

### Power Supplies

Two regulated supplies are necessary for the system. A single transformer feeds both of them. Straightforward practice in filtering and grounding has to be observed.

### Tape-Deck Modification

The tape decks used were built by RCA and were purchased from Poly Paks. They are of excellent quality and have held up without any problems. They contain an audio preamp that interfaced very well with our audio system, and the on-air quality is remarkable. The track-selection solenoid was removed from the entire unit. Mount the head bar solid to the tape-deck chassis. This ensures almost foolproof operation and cures that terrible "tape-eater" problem that so many 8-track players seem to have. The wiring of

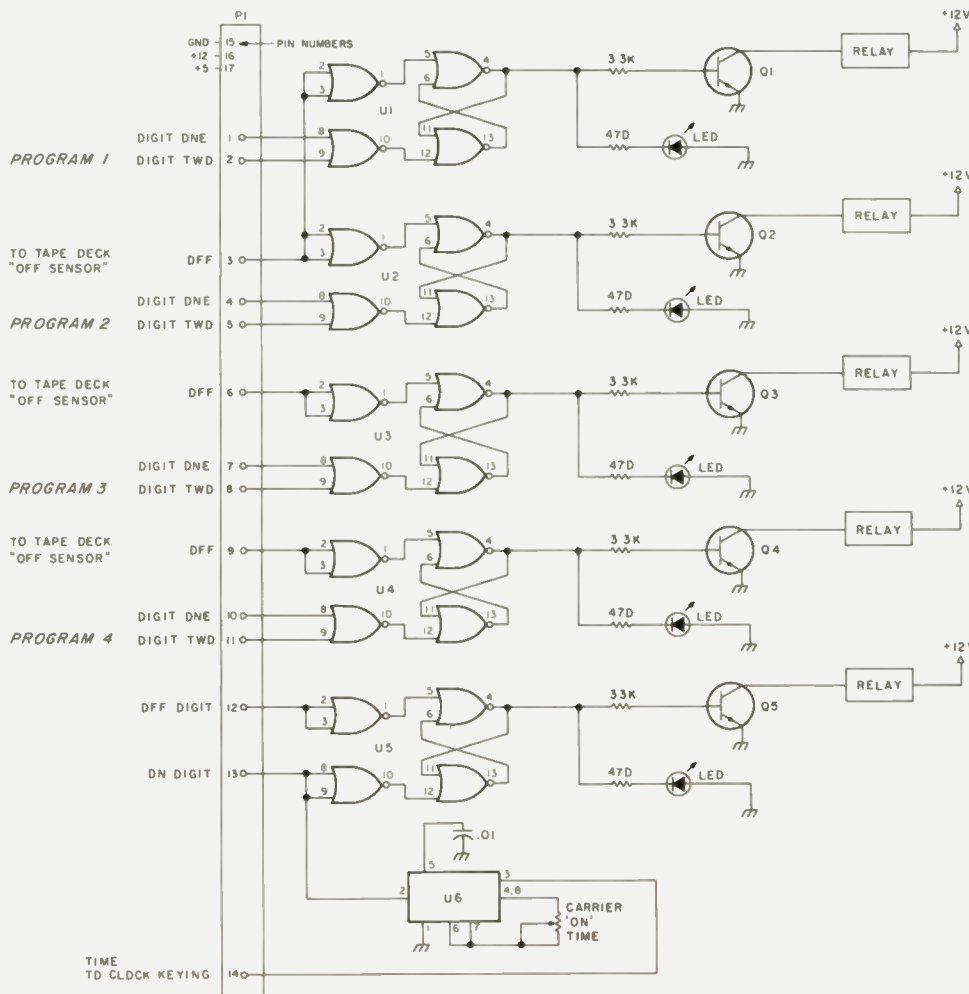

Fig. 5. Address field board.

# NEW MFJ-525 RF SPEECH PROCESSOR

**True RF Speech Processing. Gives you up to 4 times (6db) more average SSB power on all bands. Powerful natural sounding speech punches thru QRM. Works with any rig. Plugs between mic and rig. VU meter. Uses advanced digital and analog techniques.**



**BRAND NEW**

**Powerful natural sounding processed speech punches thru QRM. Plugs between mic and rig. No internal connections to rig.**

**\$119<sup>95</sup>** ✓ M52

The MFJ-525 gives you up to four times (6db) more average SSB power on all bands with true RF Speech Processing.

Powerful natural sounding speech punches thru QRM and DX pile ups.

Used with your rig, the MFJ-525 gives you more average SSB power increase per dollar than a linear or beam.

Combined with a linear and a beam, you have the ultimate with up to four times more average SSB power.

Ideal for mobile and QRP. Vastly improves phone patching. Eliminates flat-topping, splatter.

The MFJ-525 is a closed SSB transmitter-receiver system. Using high performance digital and analog techniques, microphone audio is converted to SSB, clipped and filtered and then converted back down to audio for your rig's mic input.

Use any rig and microphone. Plugs between your mic and rig. No internal connections needed.

Two color VU meter aids in setting clipping level. Clipping level control sets amount of processing.

Output level control adjusts level to transmitter and eliminates readjusting rig's mic gain control when processor is bypassed.

Push button ON-OFF/BYPASS switch bypasses processor in OFF position. LED indicates power on. 4 pin mic jack. Shielded output cable has push-talk line. Uncommitted 4 pin mic plug supplied. Easily adapted for any rig.

RFI protected with double sided PC board ground plane, input, output RFI filtering, ferrite beads, careful layout, RFI coating on side panels.

110 VAC or 12 to 18 VDC. Eggshell white with

walnut grain sides. 6x2x6 inches.

Order from MFJ and try it — no obligation. If not delighted, return it within 30 days for refund (less shipping). One year unconditional guarantee.

Order today. Call toll free 800-647-1800. Charge VISA, MC or mail check, money order for \$119.95 plus \$3.00 shipping for MFJ-525.

Don't wait to punch thru QRM with powerful natural sounding processed speech, order today.

**CALL TOLL FREE ... 800-647-1800**

Call 601-323-5869 for technical information, order/repair status. Also call 601-323-5869 outside continental USA and in Mississippi.

**MFJ ENTERPRISES, INC.**  
BOX 494, MISSISSIPPI STATE, MS 39762

the tape decks is a very simple process of elimination after all of the unused parts are removed. The motors are 110-volt and are wired with regular 18-gauge lamp cord. Proper bypass capacitors are used to minimize any spikes or hash injected into the power lines. The pre-amp assemblies remain where they were originally and are wired with +12 volts dc for proper operations. Two holes may be drilled on the chassis bottom to give access to the audio level controls of the preamp cards.

## Message Content

The system described here has been in use since November, 1977, on the Marissa (southwestern Illinois) 147.81/147.21 repeater. Ed Bolton WA3PUN cut most of the voice tapes with some of his best imitations of Amos 'n Andy, John Wayne, Henry Kissinger,

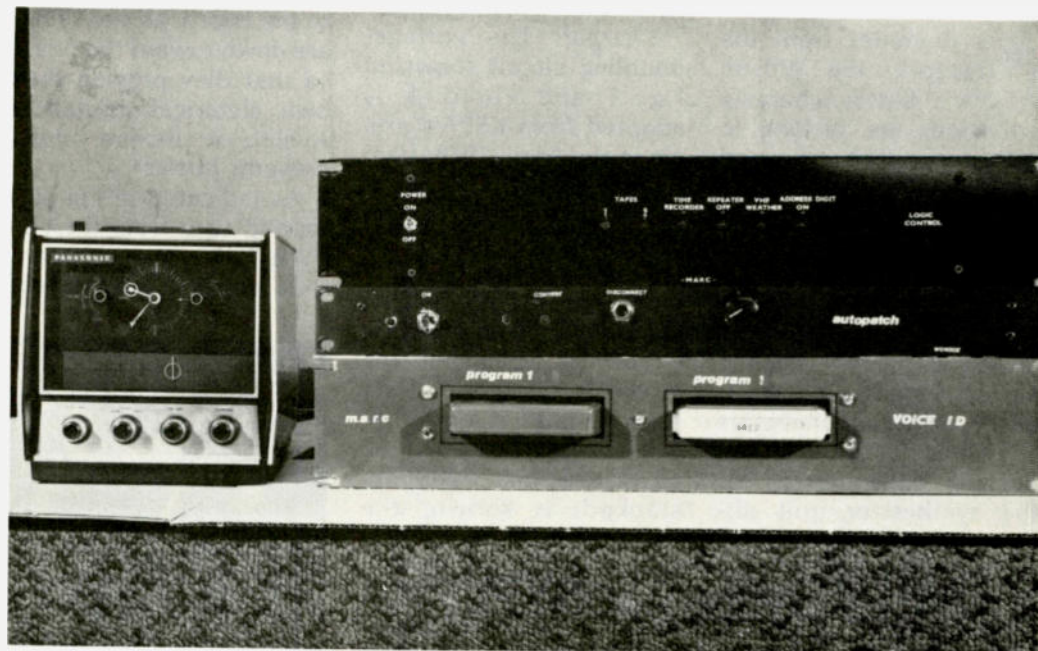

The front view before rack-mounting shows the Panasonic RC 6800 Talking Clock Radio used as the time machine. The stack on the right consists of the logic control, autpatch, and two of the four tape machines.

and a host of others, giving travel, club affiliation, frequency, and other informative messages. A lovely-voiced lady from a St. Louis

radio station did several station ID tapes, also.

Needless to say, the system makes the Marissa Machine (the double M) a

very popular system and allows visiting operators to acquire useful information as well as great enjoyment as they use it. ■

# The Nearly Perfect WE-800

## —add an on-board charger, a TT pad, and . . .

H. R. Worthington K1OTW  
17 Fremont St.  
Oxford MA 01540

As it comes from the factory, the Wilson WE-800's battery-charging provisions are lacking in that it cannot be used while its nicads are being charged. My solution is an on-board charger with no switching or holes required. A shutoff switch could be added by believers in deeply cycling nicads; there is space at the 9-volt battery connectors at the rear panel. With the current consumption of the synthesizer, full dis-

charge occurs often enough without trying. The Wilson can still be charged as the designer intended, if desired.

**Charger:** The voltage-doubling circuit shown in Fig. 1 and Photo A is adapted from K5PA's article in the April, 1978, *Ham Radio*, p. 36. It charges at 45 mA anytime the rig is on external power. The 555 is in the standard astable mode and the 7805 is the standard current-limiting circuit as found in the *Motorola Linear I.C. Data Book*. I built it on 1" × 1-3/4" vectorboard. If the transistors and 7805 are stacked as shown, the

assembly is 5/8" high and fits neatly into the space next to the diode matrix board as in Photo B. I epoxied the stack together and to the board; all heat sinks are down toward the board so that they provide their own electrical insulation. A blob of silicone rubber prevents rattles.

As indicated in Fig. 2, I tapped 12 V from the EXT PWR jack so that, in the INT position, the nicads

don't try to charge themselves. I grounded the charger by soldered it to a nearby shield partition. Charging current is put into an unused terminal of the EXT-INT-CHG switch. This terminal is at the top—viewing the terminals with the chassis upright. When road tested, I found that the original 1400-Hz note was getting into the low-level audio circuits on receive and transmit, so I

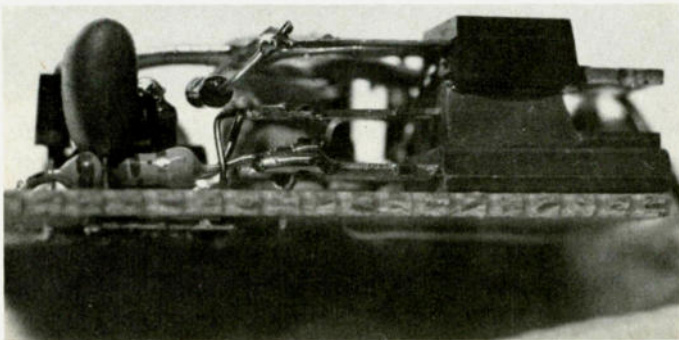

Photo A.

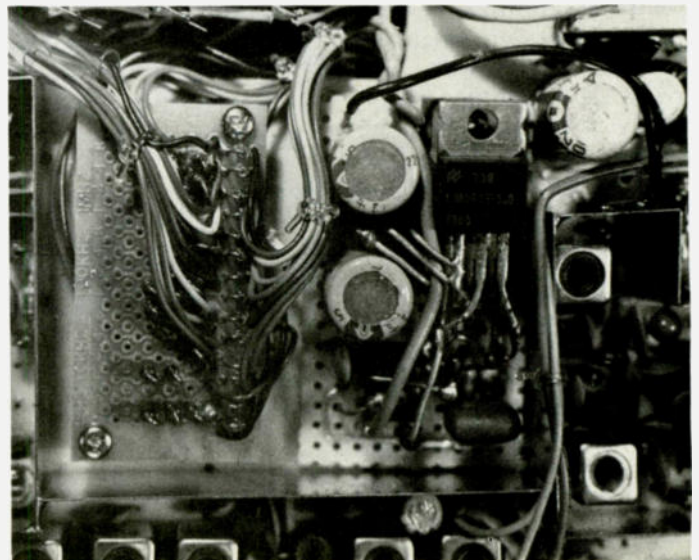

Photo B.



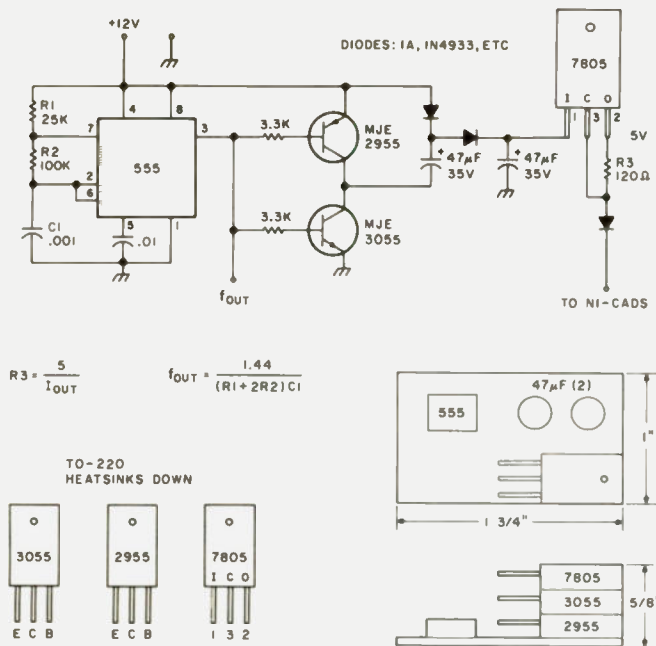

Fig. 1.

changed R1 and R2 to 25k and 100k respectively to increase the 555's frequency to about 6400 Hz. That cured this problem by being above the audio frequency response of the rig (just my theory). R3 of 120 Ohms produced 45-mA charging current. Tolerances of components account for this discrepancy from the formula. The charger draws 130 mA, which produces some heat, but evidently this is not detrimental.

TTP: There is no factory-installed Touchtone™ pad available so I decided upon the Data Signal SME circuitry with the reliable Digitran™ keyboard (type "F" from Data Signal).

Since this rig is used sitting on a bench or transmission hump, the keyboard was mounted on top of the case symmetrically with the dummy speaker grille per Photo C. This location is above the battery compartment, so a friendly machinist milled a 1/4" through slot for the 8-pin terminals and a .030" deep × 1/4" slot inside the case to guide the eight leads off the side of the battery compartment. I drilled and countersunk 1/32" on the inside four holes for the plastic mounting pins and melted and filed them flush. I cut the 8-pin terminals flush, soldered the eight leads and secured them into their slot with



Photo C.

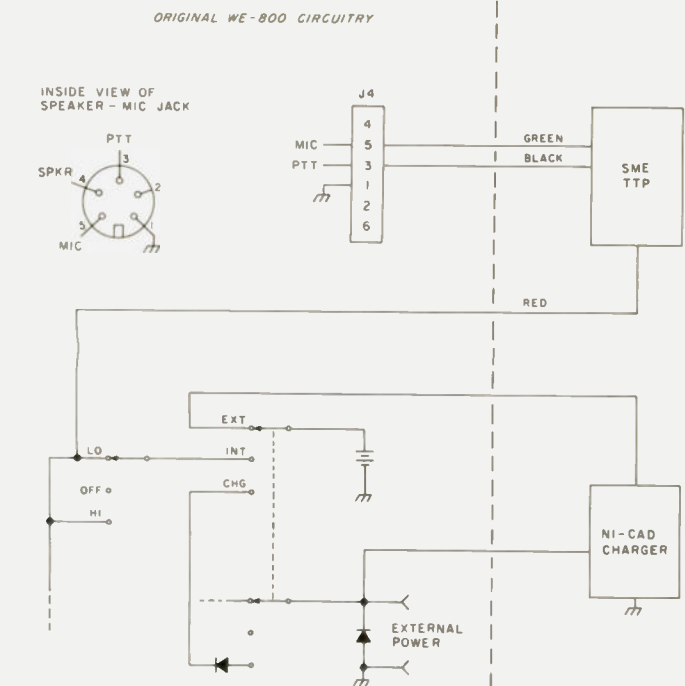

Fig. 2.

electricians' tape. I stuck the circuit board onto the side of the case with thin foam tape so that it neatly rests beside the battery enclosure.

I ran the 12-volt, ground, and audio-out leads thru a .062" 3-pin Molex connector so that the case can be removed easily. As shown in Fig. 2, I took 12 V from the HI-OFF-LO switch, soldered the ground lead to pin 3, and soldered the audio lead to pin 5 of the MIC/SPKR jack.

The Data Signal factory-set audio level turned on the local 99/39 autopatch first shot. An unexpected side benefit is that the tones can be monitored in the MIC/SPKR.

As shown in Photo D, I epoxied two automotive distributor cap tower nipples to the bottom surface of the case toward the front to jack it up for a convenient operating angle. They also prevent slippage on a desk. These are for sale at \$10 per pair installed, but no clients so far; hi!

Why just "nearly" perfect? The thumbwheel switches should be lighted, but I can't think of anything that doesn't resemble a plumber's nightmare.

Appreciation is due to K11CU for his photography, WA1VVS for his machining, and WA1WPX for use of her Wilson as the guinea pig. ■



Photo D.

# How to Make Your Own Crystal Filters

— requires considerable patience, but very few bucks

73 Magazine Staff

Everyone knows that good, high-frequency (3-9 Mhz) crystal filters for use in SSB exciters or accessory CW filters for transceivers are expensive. However, if one has a bit of test equipment and is short on cash but long on patience, it is possible to home-brew very good crystal filters using relatively simple circuitry and without the need for com-

plicated coupling networks.

The crystal filter circuit of Fig. 1 has a number of advantages. First of all, no tuned circuits are involved. The crystals are simply paralleled, and from one to six crystals can be used, depending upon whether one wants to construct a simple CW filter with a very sharp response or an SSB filter with a specific bandwidth. The frequency spacing of the individual crystals used is critical; this will be covered later in detail. The

crystals are driven from a low-impedance source by the first-stage emitter-follower. At the series-resonant frequency of the crystals, the signal voltage will be developed across the .001-uF capacitor and drive the output amplifier. At frequencies other than those where the crystals exhibit series resonance, the capacitor serves as a bypassing element and helps sharpen the skirts of the filter response. Some signal leak-through will occur because of stray capacitance across the crystals; this is compensated for by coupling some signal from the collector of the first amplifier around the crystals via the 100-pF variable capacitor. A number of general-purpose transistors can be used in the circuit. With those shown, the circuit will have about 10-dB gain.

To make the circuit work properly, the series resonance of the crystals used must be carefully con-

trolled. The only exception might be if one decides to use only a single crystal to form a simple CW filter. However, even for CW reception, the bandwidth provided by one crystal is too sharp and provides uncomfortable reception. Therefore, a controlled bandwidth of 200 to 500 Hz should be used. Such a filter can be constructed using at least two crystals spaced in frequency by the desired bandwidth and centered on the i-f frequency desired. For an SSB filter, at least six crystals should be used. This is because the individual crystal series-resonant frequencies should not differ by more than about 300 Hz. Otherwise, the passband of the filter will not be smooth, as it is just a composite of the highly selective passband of each individual crystal.

The type of overall response one might expect from this type of filter is

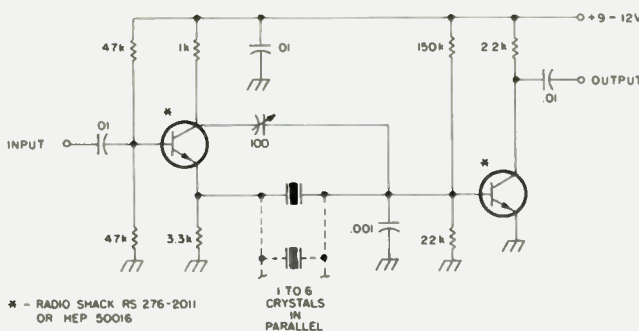

Fig. 1. Simple crystal filter circuit does not require any tuned circuits.

shown in Fig. 2. The ultimate rejection that one can achieve with the circuit depends on how carefully the circuit is constructed to prevent stray coupling around the crystals, and on how carefully the 100-pF variable is adjusted. Values of 40 dB can be achieved before the skirts of the filter response start to flare out. Admittedly, this is nothing like the 80-dB out-of-passband rejection of an expensive 8-pole commercial crystal filter. It is sufficient, however, for a simple SSB exciter, and more than adequate for an accessory CW filter in a transceiver when the SSB filter is also left in operation to sharpen the skirts of the overall i-f response.

One may ask how there can be anything inexpensive about a circuit which might require up to six crystals. The answer is to use the old-style FT-243 crystals. These crystals are available for \$1.00 or less each from various suppliers (JAN Crystals, for instance), and they allow easy disassembly and access to the crystal itself. The latter is important since there is no easy way of specifying the series-resonant frequency for the crystals to be used in the circuit. So, one has to obtain crystals which are marked approximately for the i-f frequencies of interest, disassemble them, and grind them to the exact frequencies needed. This operation, particularly the "grind" part, is not as terrible as it sounds. In fact, the whole operation is relatively simple.

The circuit of Fig. 3 is used to find the series-resonant frequency of a crystal. A signal is applied from a signal generator or vfo. The voltage across the crystal is monitored by any high-impedance instrument which will respond at the frequency being used.

Usually an oscilloscope is the most suitable instrument. The "bandwidth" of the oscilloscope may be far below that of the test frequency being used, since only an indication of the voltage change across the crystal is necessary. A "5-MHz oscilloscope," for instance, will easily respond to signals up to 10 MHz or more in frequency (although, of course, it cannot be used to analyze the waveform of 10-MHz signals).

As the test frequency is varied, there will be a sharp drop in the voltage across the crystal when its series-resonant frequency is reached, producing a short circuit. The voltage drop is very sudden, and one must vary the test frequency slowly. The series-resonant frequency should be within a few kHz of the frequency stamped on the crystal holder. The FT-243 crystals are easy to disassemble, and the rest of the job now consists of taking the crystal apart, grinding it slowly to raise its frequency, and then testing it back in its holder until one collects the desired number of crystals with the proper series-resonant frequencies.

Although acids can be used to "grind" crystals, it is usually better to use a very slightly abrasive material such as 3M "Trimit" silicon carbide paper (with a fineness of 400 or greater). This paper is obtainable at large hardware stores and comes in 9" x 11" sheets. The paper is taped to any flat surface, and the crystal held flat with a finger and rubbed on the paper with a circular motion. The grinding should be done "wet." That is, the crystal should be kept moistened with water. After grinding, the crystal is carefully cleaned with rubbing alcohol and, avoiding any finger marks, put back in its holder.

To go back for a moment, it should be mentioned that although the FT-243 holders are easy to disassemble with just a screwdriver, the operation should be done carefully. The contact plates and spring should be kept in the same order for reassembly. Also, the crystal should be marked on one corner so that it is set back in the holder in its original orientation.

The amount of grinding a crystal needs to change its frequency depends on the pressure used while grinding, the number of passes while grinding, and so on. However, it takes very little practice to get some "feel" for the changes which take place in the crystal frequency as one grinds it. For instance, with an 8-MHz crystal, one circular pass on the abrasive paper might change the crystal frequency by 150 Hz. One hundred passes might change it as much as 20 kHz. For lower-frequency crystals, more passes will be required for a given frequency change. A 4-MHz crystal might change 60 Hz in one pass and 7 kHz in 100 passes.

Obviously, as one approaches the desired crystal frequencies, the grind-

ing has to be done slowly and patiently. If one goes slightly too far in the grinding process, the crystal frequency can be lowered slightly with a very soft lead pencil. Lightly rub the surface of the crystal with the pencil and then use a soft cloth and a drop of rubbing alcohol to distribute the coating. With a bit of patience between grinding times and possible corrections, one can easily come "right on" with regard to frequency.

Although the acid approach is not really recommended, those amateurs who have access to the chemicals required and who can be careful in their application may want to try it. If so, one should use an ammonium bifluoride solution diluted with two parts of water. The crystal is simply placed in the solution (using a small pair of tweezers) for 30 to 60 seconds at a time, removed and rinsed with water, and dried. The crystal frequency is checked and the process repeated as many times as necessary. The whole process is quite easy, but it must be emphasized that the chemical solution is very corrosive and must be used and disposed of carefully. ■

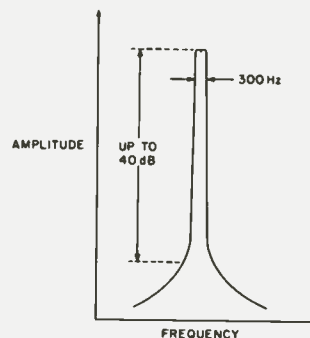

Fig. 2. A typical response one could expect from the crystal filter circuit shown in Fig. 1. In this case, it would be for a two-crystal circuit with the crystals' frequencies (series-resonant frequencies) separated by about 300 Hz.

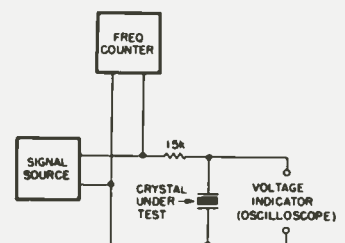
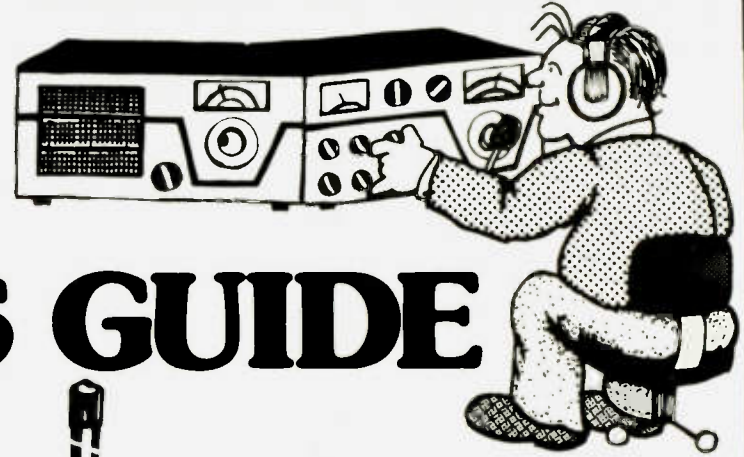

Fig. 3. A test setup for measuring the series-resonant frequency of a crystal. Capacitance effects across the crystal must be avoided, so short leads which go directly to the plates of the oscilloscope must be used. A suitable low-capacitance probe may also be used with the oscilloscope or a suitable VTVM.

CALL LONG'S TOLL FREE

1-800-633-3410 TODAY!

# LONG'S HAM BUYERS GUIDE



Prices in this catalog subject to change without notice. Prices good only while supply lasts.



## KENWOOD TR-2400 synthesized 2m hand-held transceiver

Featuring: 143.900-148.495 MHz, operates on MARS, 10 memories, automatic memory scanning and up/down manual scanning for busy or open channel, mode switch for standard repeater  $\pm$  600 KHz offset, simplex and non-standard repeater splits, LCD digital readout, built-in touch tone generator with 16 button keyboard, and 1.5 watts RF output, includes flex antenna with BNC connector, NiCad battery pack and wall charger.

**395.00** List. Call for quote.



**ORDER NOW!**

## ACCESSORIES FOR THE KENWOOD TR-2400

- 244 NiCad extra battery
  - ST-1 Base stand/quick trickle charger with mic connector
  - BC-5 Mobile quick charger
  - 2400 Leather carrying case
- Prices to be announced.



## 200 WATTS PEP KENWOOD TS-180S All solid state HF transceiver with Digital Frequency Control

With 4 memories, manual scanning, tuning in 20 Hz steps with recall of stored frequency, 160 to 10 meters. Modes: USB, LSB, CW and WWV. Needs no tune up. Built-in microprocessor, digital display, IF shift, selectable bandwidth, tunable noise blanker, RF AGC, dual RIT, improved speech processor, 13.8 VDC operation. Adaptable to proposed bands.

**1149.00** List. Call for quote.



## 200 WATTS PEP KENWOOD TS-120S All solid state HF SSB transceiver

No tune up! Miniaturized circuits, built-in digital display, IF shift, final transistor protection, VOX, noise blanker, 25 KHz marker. Frequency range: 80-10 meters and WWV. Modes: SSB and CW. Power requirements: RX-0.7A 13.8 VDC, TX-18A 13.8 VDC, 3 1/2" H x 9 1/4" W x 13 1/4" L. Weight: 11.7 lbs.

**699.95** List. Call for quote.



# Long's Electronics



# CALL LONG'S TODAY!

1-800-633-3410 TOLL FREE

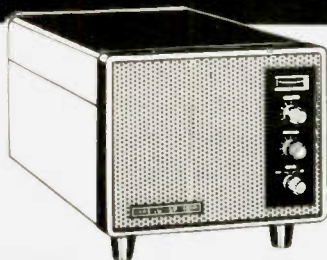

### SP-901P speaker/patch

A speaker/phone patch to match the FT-901 series. The unit has full metering and level controls.

**74.00** Call today.

### YAESU FT-101Z high performance HF transceiver

**DON'T WAIT**

Covers 160 thru 10 meters plus WWV, modes are: LSB, USB, and CW, built-in power supply, built-in RF speech processor, built-in noise blanker, variable IF bandwidth, analog frequency readout, 6146 final tubes with RF negative feedback, heater switch, VOX, attenuator 10 dB or 20 dB selectable. Power requirements: 100/110/117/200/220/234 volts AC 50/60 Hz.



**749.00** List. Call for quote.



### YAESU FC-901 antenna tuner

Designed as part of the FT-901 series, freq. coverage is 160 to 10 meters. 500W PEP. It has 3 coaxial outputs & 1 longwire, built-in wattmeter & SWR bridge with 25, 250 & 500W scale.

**199.00** List. Call for quote.

### YAESU FT-901DM All mode HF transceiver

**ORDER NOW!**

Covers 160 thru 10 meters. variable IF bandwidth, rejection tuning, CW audio peak filter, built-in Curtis keyer, RF speech processor, 10 second tune mode timer, 6146 finals, auto. mic gain control, 25 KHz crystal calibrator and  $\pm 5$  KHz clarifier, VOX, built-in power supply, 180W DC input for SSB/CW, 80W AM/FSK/FM. DC-DC converter built-in.

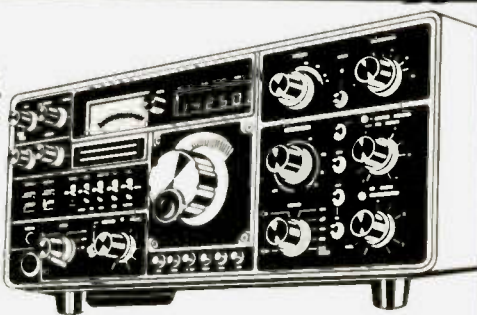

**1459.00** List. Call for quote.



### YAESU QTR-24 world clock

A great addition to your ham shack! Tell world time at a glance, battery powered, automatically retains the correct time.

**35.00** Call today.

## YAESU

### YAESU CPU-2500RK 2m FM transceiver

With 800 PLL channels, automatic scan over entire 2m band, 4 memories, toneburst, 25W Hi/3W Lo, 13.6 VDC at 8A continuous. Freq. coverage: 144-148 MHz. Comes with a keyboard mic that allows remote input of memory or dial freqs. up/down scanning, aux repeater selection to 4 MHz, 2 tone input for auto-patch.



**585.00** List. Call for quote.

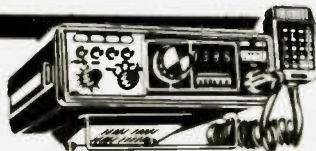

### YAESU FT-227RB 2m FM transceiver

4 memory channels, a remote scan for mic, select to scan clear or busy channel, freq. coverage of 144 to 148 MHz, 800 channels, power requirements: 13.8 VDC @ 2.5 amps continuous, RF output: 10W hi/1W lo, toneburst  $\pm 600$  KHz repeater offset. Complete with YM-22 touch tone mic.

**425.00** List. Call for quote.

## YAESU

### YAESU FT-207R synthesized Handi-Talkie

Covers 144-148 MHz, in 5 KHz steps, output: 2.5 watts hi/200 milliwatts low, 4 memories plus programmable offset, priority channel, memory band and auto scan, keyboard encoder frequency entry, 2 tone input from keyboard, keyboard lock, odd splits can be programmed from keyboard, auto battery saver feature for LED, rubber flex antenna and 15 hr. wall charger.

**ORDER NOW!**

**399.00** List. Call for quote.



VISA

# Long's Electronics



# & MAPS CALL TOLL

FOR YOUR BOOKS, TAPES



## ARRL Publications

**1980 ARRL Radio Amateur's Handbook** - Newly revised & packed with everything from basics to latest developments. I.N. 10035. **10.00**

**ARRL Radio Amateur's License Manual** The most up to date compilation of rules & regulations. Covers from Novice to Extra Class I.N. 10012 **4.00**

**ARRL Novice Q and A Book.** A new pocket sized study guide with 223 sample question and answers and a sample novice exam. 96 pages. I.N. 10008. **2.00**



**ARRL Antenna Handbook** Complete instructions for building antennas of all types I.N. 10026 **5.00**

**ARRL World Map** I.N. 10099 **3.50**

**LCF Calculator** Slide rule type calculator to compute resonant frequency, etc. A great aid! I.N. 10062 **3.00**

**Electronic Data Book** All you need to know about Filter design, RF circuit data, antennas and feedline info & more I.N. 10027 **4.00**

**Learning to Work With Integrated Circuits** Build a digital voltmeter/freq. counter while learning about IC's I.N. 10060 **2.00**

**Single Sideband for the Radio Amateur** Covers theory and practical how-to-built ideas I.N. 10017 **3.00**

**FM and Repeaters for the Radio Amateur** Learn all about FM and repeaters from this handy book I.N. 10014 **5.00**

**Solid State Design for the Radio Amateur** Packed with information for practical use of solid state devices I.N. 10061 **7.00**

**Solid State Basics** Pure solid state information and practical basics for today's ham I.N. 10037 **5.00**

**ARRL Repeater Directory** By Stan Horzepa, WATLOU. Handy sized booklet with room for your own notations. I.N. 10047 **1.00**

**ARRL Radiogram Message Pads** I.N. 10007 **.75 ea.**

**ARRL Special Operating Kit** Consists of ARRL Ham Radio Guide, full color U.S. area call map ARRL log book, 70 ARRL radiograms I.N. 10063 **6.50**

**ARRL Ham Radio Operating Guide** Brush up on good operating practices with this ready reference source I.N. 10025 **4.00**

**ARRL Satellite Communications** Includes Getting to Know OSCAR, info on the "RS" satellites, maps, locators and more! I.N. 10064 **4.75**

**80 meter DXing Handbook.** Contains 4 sections on propagation, antennas, station equipment, and operating practices. It's filled with solid practical experience I.N. 26307 **4.50**

**The Amateur Radio Vertical Antenna Handbook** The first book for amateurs solely about vertical antennas, it is full of information I.N. 26316 **5.00**

**The Challenge of 160** The unique operating characteristics are explained and there are tips on building simple equipment I.N. 26312 **4.95**

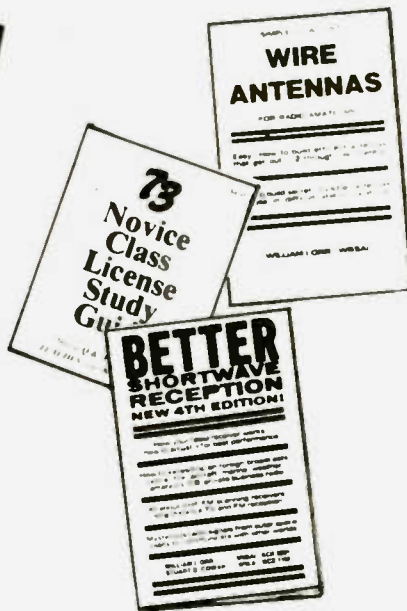

## WIRE ANTENNAS

## 73 Novice Class License Study Guide

## BETTER SHORT WAVE RECEPTION



**Hints and Kinks** New ideas written by hams themselves. This is full of practical ideas and tips that they have used successfully. I.N. 10029 **4.00**

**Radio Frequency Interference** A new book to help everyone understand RFI. It covers all from good neighbor relations to simple technical cures for RFI. Helps identify and solve problems. I.N. 10083 **3.00**



**ARRL Code Kit** Upgrade your Novice or Tech License with these 2 60 min. cassettes with speeds of 5, 7, 10, & 13 wpm. Instruction book included I.N. 10046 **8.00**

**ARRL Log Books** spiral bound books Large I.N. 10015 **1.75** Small I.N. 10020 **.75**

**Tune in the World with Ham Radio** Learn all about amateur radio with a text and a morse code cassette. For the beginner studying for the Novice exam I.N. 10031 **7.00**

**Understanding Amateur Radio** A must guide for the newcomer, it explains in simple language elementary principles of electronics & tells how to build low cost equipment I.N. 10016 **5.00**

## Radio Publications, Inc.

- Beam Antennas Handbook by Wm Orr W6SAI I.N. 26200 **4.95**
- Wire Antennas by Wm Orr W6SAI I.N. 10058 **5.95**
- All About Cubical Quad by Wm Orr, W6SAI I.N. 26201 **4.75**
- The Truth About CB Antennas by Wm Orr, W6SAI I.N. 26202 **5.95**
- EIMAC's Care and Feeding of Power Grid Tubes I.N. 26205 **5.95**
- The Antenna Handbook I.N. 26207 **6.95**
- VHF Handbook by Wm Orr, W6SAI I.N. 26203 **5.95**
- Better Short Wave Reception by Wm Orr, W6SAI I.N. 26204 **4.95**



## Ameco Books

- Communicate with the World with Ham Radio NP-1 I.N. 24825 **6.95**
- Ameco 7-01 Question and Answer Guide for the Novice Exam I.N. 24828 **1.00**
- Ameco 12-01 General Class Question and Answer Guide. I.N. 24829 **1.50**
- Question & Answer for Advanced Class Exam 16-1 I.N. 24809 **1.50**
- Question & Answer for Extra Class Exam 17-1 I.N. 24810 **1.50**
- Radio Amateur Theory Course 102-01 I.N. 24812 **5.95**
- Radio Electronics Made Simple I.N. 24800 **2.50**
- Logbook I.N. 24807 **1.50**
- Commercial Radio Operator Theory Course 15-01 I.N. 24808 **6.95**
- Commercial Q&A License Guide Ele. 4 I.N. 24805 **1.95**
- Commercial Q&A License Guide Ele. 3 I.N. 24804 **2.95**
- Commercial Q&A License Guide Ele. 1, 2, & 8-01. I.N. 24803 **1.50**



## Other Great Books

- Practical Antennas for the Radio Amateur by Robert Myers, W1XT. A new basic antenna book to tell you every thing about making and using antennas. Ills. with pictures and line drawings. I.N. 32407 **9.95**
- Collins Radio Co. SSB Amateur Single Sideband I.N. 10092 **4.95**
- 73 Magazine VHF Antenna Handbook I.N. 26303 **4.95**
- 73 Magazine Novice Class Study Guide. I.N. 26300 **4.95**
- 73 Magazine General Class Study Guide I.N. 26301 **5.95**
- The Beverage Antenna Handbook. I.N. 26208 **5.00**
- K3CHP DX QSL Guide I.N. 26313 **3.95**
- Amateur TV in a Nutshell I.N. 26322 **5.00**
- How to Make Better QSL's. I.N. 26304 **4.95**
- The Complete Handbook of Slow Scan TV. I.N. 30518 **9.95**

Remember, you can Call Toll Free: 1-800-633-3410 in the U.S.A. or call 1-800-292-8668 in Alabama for our low price quote. Store hours: 9:00 AM til 5:30 PM, Monday thru Friday.



# Long's Electronics



MAIL ORDERS: P.O. BOX 11347 BIRMINGHAM, AL 35202 • STREET ADDRESS: 2808 7TH AVENUE SOUTH BIRMINGHAM, ALABAMA 35233

# FREE 1-800-633-3410 OR

# ORDER BY MAIL TODAY

## Tab Books

- Novice Class Study Guide I N 30517 5.95
- General Class Study Guide I N 30519 7.95
- Advanced Class Study Guide I N 30522 5.95
- Extra Class Study Guide I N 26302 5.95
- A Beginners Guide to Microprocessors I N 30502 5.95
- 57 Programs and Games in Basic I N 30501 7.95
- The "Compuator" Book I N 30509 7.95
- Ham Radio Incentive Licensing Guide I N 30503 4.95
- Programming Microprocessors I N 30508 6.95



- Third Class FCC License Study Guide I N 30514 6.95
- First Class FCC License Study Guide I N 30542 7.95
- Electronics Data Handbook I N 30549 5.95
- Impedance I N 30520 5.95
- Basic Digital Electronics I N 30527 4.95
- Basic Electronic Problems Solved I N 30545 4.95
- Tower's International FET Selector I N 30500 6.95
- Second Class FCC Encyclopedia I N 30535 7.95
- How to Use AF and RF Signal Generators I N 30512 5.95
- Electronics Unraveled I N 30531 5.95
- Master Transistor/IC Substitution Handbook I N 30510 7.95
- RF and Digital Test Equipment You Can Build I N 30521 5.95
- Commercial FCC License Handbook I N 30542 7.95
- IC Projects for the Amateur and Experimenter I N 30543 5.94
- How to Read Electronic Circuit Diagrams I N 30546 6.95

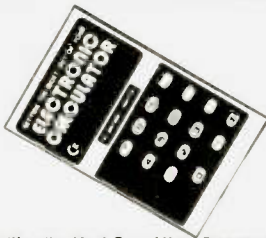

- Getting the Most Out of Your Electronic Calculator I N 30528 4.95
- How to Install Everything Electronic I N 30552 7.95
- The 2 Meter FM Repeater Circuit Handbook I N 30537 6.95
- Modern Applications of Linear IC's I N 30530 9.95
- Mobile Radio Handbook I N 30534 4.95
- Basic Electricity and Beginning Electronics I N 30536 5.95
- Practical Solid State DC Power Supplies I N 30515 6.95
- Electronic Conversions, Symbols, and Formulas I N 30524 5.95
- Tower's International Transistor Selector I N 30507 6.95
- Electronic Test Equipment and How to Use It I N 30526 4.95

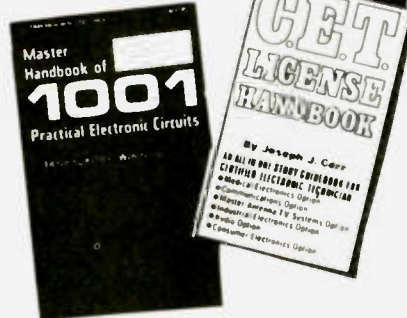

- Master Handbook of 1001 Practical Electronic Circuits I N 30523 9.95
- Master Handbook of Ham Radio Circuits I N 30506 8.95
- Complete Short Wave Listeners handbook I n 30532 6.95
- Master OP-AMP Applications Handbook I N 30505 9.95
- C.E.T. License Handbook I N 30513 8.95
- Effective Trouble Shooting with EVM and Scope I N 30525 5.95
- Handbook of Electronic Tables I N 30548 4.95
- Homebrew HF/VHF Antenna Handbook I N 30504 5.95
- How to Be a Ham I N 30533 3.95

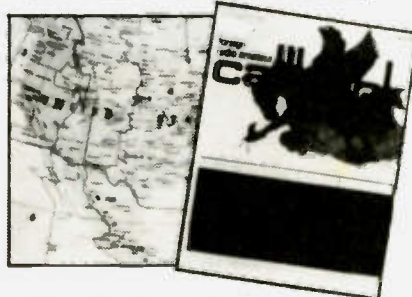

## Radio Amateur Callbook

- Map Library A complete set of maps, prefix world map, great circle chart, map of N. America and world atlas I N 10005 3.75
- Callbook binders
  - U.S. callbook red I N 10054 6.00
  - DX callbook blue I N 10055 6.00
  - 1980 DX Callbooks I.N. 10034 15.95
  - 1980 US Callbooks I.N. 10033 16.95
  - Prefix map of North America I N 10004 1.25
  - Zone prefix map of the World I N 10022 1.25
  - Great circle chart of the World I N 10003 1.25
- ARRL US Call Area Map I.N. 10030 3.00
- ARRL World Prefix Map I.N. 10006 3.50

## RSGB Books

- Oscar - Amateur Radio Satellites The comprehensive book on amateur satellites illustrated with pictures and charts I N 10059 8.50
- VHF-UHF Manual If you have any interest above 30 MHz, then get this book. It covers everything in this field I N 26208 13.95

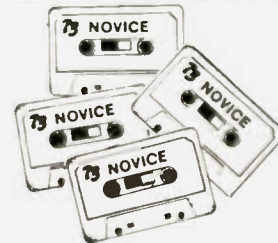

## TRAINING PACKAGES TAPES

Crack the code and ace your exam by studying the new way with our selection of cassettes! Just drop them into a cassette player and study anywhere easily and quickly! You'll have great results!

### 73 cassettes

- Novice Theory Tapes prepare you for the FCC novice exam. Clearly presented material can be reviewed many times I N 26306 15.95

### Code Tapes

- 5 word per min. Blitz Tape I N 26308 4.95
- 6 word per min. Blitz Tape I N 26309 4.95
- 13 word per min. Blitz Tape I N 26310 4.95
- 20 word per min. Blitz Tape I N 26311 4.95



Teco Code Practice Tape are guaranteed for life.

- Novice tape I N 31461 3.95
- 5 wpm tape I N 31450 3.95
- 7 1/2 wpm tape I N 31451 3.95
- 10 wpm tape I N 31452 3.95
- 13 wpm tape I N 31460 3.95
- 15 wpm tape I N 31454 3.95
- 17 wpm tape I N 31455 3.95
- 20 wpm tape I N 31456 3.95
- 22 wpm tape I N 31457 3.95
- 25/30 wpm tape I N 31458 3.95
- 35/40 wpm tape I N 31459 3.95

### Ameco Code Tapes

- Junior Code Course #100-T Covers start to 8 wpm I N 24819 4.95
- Advanced Code Course #103-T From 8 1/2 to 18 wpm I N 24821 4.95
- Senior Code Course #101-T Double length covering the Junior and Advanced Courses start to 18 wpm I N 24820 8.95
- Extra Class Code Course #104-T Covers from 13 wpm to 22 wpm includes FCC type exam I N 24822 4.95
- General Class QSO tapes #105-QT 12, 13, 14, & 15 wpm I N 24827 4.95
- Extra Class QSO tape #106QT 19, 20, 21, & 22 wpm I N 24826 4.95

### Kantronics

- QSO Code Tapes Covers 7 1/2, 10, 13, & 15 wpm. Be ready for the new FCC exams! I N 28906 4.95
- Super QSO 13 A 13 wpm cassette tape. An excellent study guide. I N 28921 4.95
- Novice Combo A kit that includes a novice License Manual, Novice theory cassette, 5 wpm cassette, and 7 1/2, 10, 13, 15 wpm QSO tape. I N 28922 14.95
- General Class Theory Course A set of two cassettes I N 28920 8.95
- Novice Theory Cassette Theory for the novice on 1 cassette I N 28920 4.95

Remember, you can Call Toll Free: 1-800-633-3410 in the U.S.A. or call 1-800-292-8668 in Alabama for our low price quote. Store hours: 9:00 AM til 5:30 PM, Monday thru Friday.



# Long's Electronics



MAIL ORDERS: P.O. BOX 11347 BIRMINGHAM, AL 35202 • STREET ADDRESS: 2808 7TH AVENUE SOUTH BIRMINGHAM, ALABAMA 35233

# 1-800-633-3410 TODAY!



**DENTRON MT-3000A antenna tuner**

Dentron's ultimate tuner! For coax, random wire, and balanced feed systems, built-in antenna selector switch for 5 different antennas, power handling in excess of 3 KW PEP, built-in 50 ohm 250W dummy load, dual watt meters, 3 core heavy duty balun, continuous tuning: 160 to 10 meters.

**349.50** List. Call for quote.

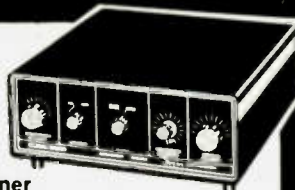

**DENTRON MT-2000A antenna tuner**

A full power tuner with continuous tuning 1.8 to 30 MHz, front panel grounding switch, handles a full 3KW PEP, Inputs: unbalanced coax (SO-239 connectors), random wire, balanced line, built-in heavy duty balun (3 cores), capacitor spacing 6000V, transforms load imp. to 50-75 ohms.

**199.50** List. Call for quote.



**DENTRON Super Tuner Plus antenna tuner**

Matches any feedline, built-in heavy duty 2 core balun, selectable antenna functions (4 antennas) alternate output, relative output meter, 1000W CW and 1200W PEP SSB, continuous tuning 1.8-30 MHz.

**149.50** List. Call for quote.

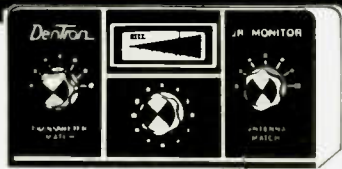

**DENTRON Jr. Monitor**

Featuring: continuous tuning 1.8-30 MHz, forward reading relative output power meter, 300W power capability, built-in balun, mobile mounting bracket, ceramic rotary switch 23 position, capacitor spacing 1000V, antenna inputs: unbalanced coax, random wire, balanced feed line.

**79.50** Call today.

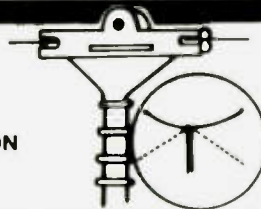

**DENTRON All band doublet antenna**

Covers 160 thru 10 meters and has a total length of 130' (14 ga. stranded copper). It may be made shorter. It is center fed through 100' of 470 ohm PVC covered balanced transmission line. Assembly is complete. Antenna tuner required. Tunes 160 thru 10 with 1 antenna.

**24.50** Call today.



**DENTRON Big Dummy load**

Now you can tune-up off the air with the Big Dummy! It has a flat SWR, full freq. coverage from 1.8 to 300 MHz and a high grade of industrial cooling oil furnished with the unit. Fully assembled. Cut out the QRM factor now!

**29.50** Call today!



**DENTRON Clipperton L linear amplifier**

Hi/Lo Power switching, covers 160 thru 15 meters, 2000W PEP SSB, 1000W DC on CW, RTTY, SSTV, continuous duty power supply 2500V idle SSB, 1800V Idle CW, covers most MARS frequencies, easily changed 117V or 234V AC 50/60 Hz. Final tubes: 4-572B.

**699.50** List. Call for quote.

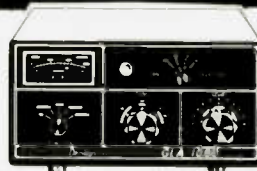

**DENTRON GLA-1000 linear amplifier**

Freq. coverage 80-15 meters, covers most MARS freq., RF drive: Max. 125, power consumption: 117 VAC 50/60 Hz 12.5 Amps, factory fused at 15 Amps. 234 VAC 50/60 Hz 7 Amps, DC input: 1 KW CW and 1200W PEP SSB. Final tubes 4 D-50A tubes (6LQ6).

**379.50** List. Call for quote.

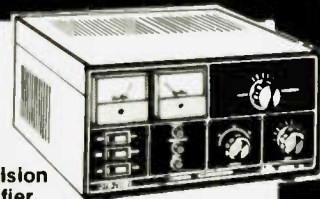

**DENTRON DTR-2000L 2000W precision linear amplifier**

Features a Broadcast proven 8877 tube, freq. coverage 160 thru 15 meters, covers most MARS freq., modes: USB, LSB, CW, RTTY, SSTV, power requirements: 234/117 VAC 50/60 Mz. RF drive power 125W max and 65W RMS min for 1 KW DC input. 1.8-21 MHz 2000W PEP.

**1199.50** List. Call for quote.



**DENTRON MLA-2500B linear amplifier**

The MLA-2500B features Hi/Lo power switching, covers 160 thru 15 meters, 2000W PEP on SSB, 1000W DC on CW, RTTY, or SSTV continuous duty, final tubes: 2 EIMAC 8875, self contained continuous duty power supply, covers MARS, built-in ALC, built-in RF wattmeter, 117/234 VAC 50/60 Hz, 65W min. drive 1 KW DC Input.

**899.50** List. Call for quote.

**ORDER NOW!**



**BIRD Model 43 Thruline® watt meter**

50 ohms nominal impedance, permits direct reading of full scale power from 100 Mw to 10,000 W. Shock mounted.

**130.00** Call for yours today.

**BIRD plug-in elements**

Frequency Bands in MHz

Power range:	2-30	25-60	100-250	200-500	400-1000
5W		5A	5C	5D	5E
10W		10A	10C	10D	10E
25W		25A	25C	25D	25E
50W	50H	50A	50C	50D	50E
100W	100H	100A	100C	100D	100E
250W	250H	250A	250C	250D	250E
500W	500H	500A	500C	500D	500E
1000W	1000H	1000A	1000C	1000D	1000E
2500W	2500H				
5000W	5000H				

H-Elements (2-30 MHz) ..... 47.00 ea.  
A-C-D-E Elements (25-1000MHz) . 39.00 ea.

CALL LONG'S TOLL FREE



# Long's Electronics





# CALL LONG'S TODAY!

1-800-633-3410 TOLL FREE



### MFJ-408 deluxe electronic keyer II with speed readout

Speed readout meter lets you read to 50 wpm. Socket for external Curtis memory, random code generator, keyboard. Uses Curtis 8044 IC. Gives you dot-dash memories, weight, speed, volume, tone controls, speaker. Sends iambic, automatic, semi-automatic, & manual. Reliable solid state keying, RF proof.

**79.95** Call today.

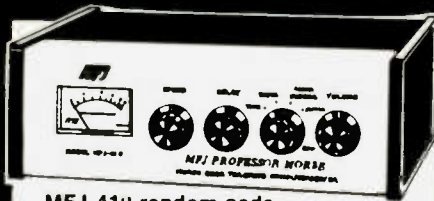

### MFJ-410 random code generator/keyer

Sends unlimited random code in random groups for practice. Never repeats the same sequence. Varies the speed from 5 to 50 wpm so you work at your level. Vary spacing between characters. Speed meter. Full feature keyer.

**149.95** Call for quote.



### MFJ 484 Grandmaster Memory keyer

Stores up to 12,25 character messages plus another one with up to 100 characters! Also speed control, 4 LEDs to show memory in use, record and playback, iambic operation, repeats messages, memory saver, weight, tone, volume controls, tune function, solid state keying. 110 VAC or 12-15 VDC.

**139.95** List. Call for quote.



### MFJ-624 deluxe hybrid phone patch

This new feature packed unit has VU meter for line and null, receiver gain, transmitter gain, null controls and bypass switch. Hum free audio, RF filtered, VOX or push to talk, and works with any rig. Simple patch-in patch-cut installation.

**59.95** List. Call today.



### MFJ-101 solid state 24 hour digital clock

Eliminate converting to GMT. Pleasant blue, easy on the eyes display with bright .6 inch digits. ID timer. Alarm, snooze, lock functions. Power out, alarm on indicators.

**29.95** Call today.



### MFJ 949 Deluxe Versa Tuner II

A 300 watt antenna tuner with features like dummy load, SWR, forward and reflected power meters, antenna switch and balun. It matches every thing from 1.8 thru 30 MHz, coax, random wires and balanced lines.

**119.95** List. Call for quote.



### MFJ-941B Versa tuner II

This accurate unit has SWR and dual range wattmeter, antenna switch, built-in balun, 300W RF output. Matches everything from 1.8 thru 30 MHz. You can use just one antenna and increase the useable bandwidth. Has SO-239 connectors. Mobile mounting bracket.

**79.95** List. Call today.

### MFJ-901 Versa tuner

Featuring: efficient 12 position air inductor for more watts out! 200 watts RF, 1:4 balun built-in and has SO-239 connectors. Matches coax, balanced lines, and random wires.

**49.95** Call today.

### MFJ-900 EcnO Tuner

This antenna tuner matches coax and random wires. It has full band coverage: 1.8 to 30 MHz, up to 200 watts RF output, SO-239 connectors and an efficient air-wound inductor.

**39.95** Call today.



### MFJ-752 dual tunable SSB/CW filter

Now you can zero in SSB/CW signals and notch out the interfering signal at the same time. The primary filter lets you peak, notch, lowpass, or highpass signals. Works with any rig, switchable noise limiter, power requirements: 110 VAC or 9-18 VDC.

**79.95** Call today.

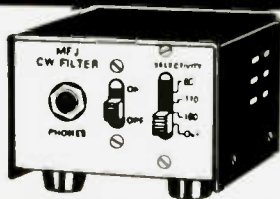

### MFJ CWF-2BX super CW filter

This unit features an 8 pole filter, a 70 Hz bandwidth, a selectable bandwidth, center frequency: 750 Hz. Requires 9 volt battery. 2" x 3" x 4". Compact, lightweight unit.

**29.95** Call today.

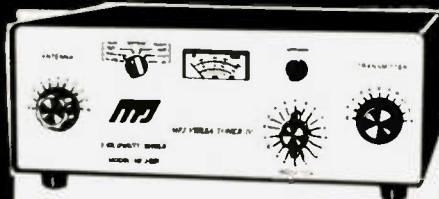

### MFJ-981 Versa Tuner IV

3 KW PEP, matches everything from 1.8 thru 30 MHz, coax, balanced lines, and random wires. It has a built-in balun, SWR, dual range forward and reflected power meter.

**199.95** List. Call for quote.



### MFJ

### LSP-520-BX II super logarithmic speech processor

Plugs between your mic and transmitter to give you 400% more RF power. Strengthens weak valleys, reduces peaks of speech. Active filter concentrates power, gives clean audio for maximum punch. RF filtered. 9V battery. With deluxe cabinet.

**59.95** Call today.

VISA

# Long's Electronics



# The Procrastinator's Special: A Simple Six-Band Antenna

— this 10-160 endfed vee goes up in a jiffy

There is really nothing new about this type of antenna, but I'm using it as an inverted vee. Many years ago it was called a Fuchs antenna (pronounced "Fooks"), but it's easy to see why that name didn't stick. Later on, it was (and is) variously called an endfed Hertz, a directly-fed, self-fed, voltage-fed, straight-wire, or random-length antenna. That last name is applicable only when you really don't know or care what length it is.

Pre-TV, some of the more daring hams would simply clip one end of the antenna to the hot end of the final amplifier tank coil at a point where the final loaded up reasonably

well, and they were on the air—never mind the harmonics and parasitics. Using a capacitor at the tank circuit, in series with the aerial, kept anyone who might touch the wire from getting fatally zapped with dc, so the more prudent operators opted for that approach.

Later on, things became more sophisticated and, in the late 1930s, something known as the Universal Antenna Coupler was developed. This enabled link-coupling of an antenna to the amplifier, thus eliminating the dc shock hazard and minimizing spurious radiations.

The ARRL *Antenna Manual*, in its 1949 Fifth

Edition, called antennas without feedlines "... the simplest and probably least effective multiband antenna." Untrue. Simple, yes. Ineffective, no.

Those graybeards among you who can remember back to over 20 years ago may recall an article written by me and published in the February, 1956, issue of CQ under the title, "The Drooping Doublet." To the best of my knowledge and research, that was the first article to appear in an amateur publication pertaining to what we call today the inverted vee. That antenna, as was the one I am about to describe, evolved out of necessity.

After many years of using the inverted vee—usually fed, in my operations, with open-wire feeders (or tuned, as many call them)—I found myself in a situation where it just was not too convenient to bring the feedline from a centerfed antenna into the radio room. Having moved from California to Missouri, I now had more land but the shape of my God's Little Half Acre meant that the optimum means of feeding the inverted vee

was at one end. What to do? No problem. The ham shack was now in the basement, so I planted my 40-foot telescoping TV pole out in the middle of the backyard, attached an insulator to the top, ran approximately 130 feet of wire through the insulator, hoisted up the mast, and guyed it.

I then extended half of the wire out to a 10-foot pole (which I no longer needed for not-touching-things-with) which was located at the rear fence and attached it with a large insulator. The other end of the wire drooped nicely down to the eaves of the house, where I anchored it with another insulator and then brought it in through an access hole in the wood just above the concrete basement wall. Inside it was attached to a transmatch with, of course, coaxial cable running from there to my transceiver or amplifier.

Having gotten you thoroughly enthused about this miracle of modern science, I must inject a note of caution: A good ground system is most helpful when using

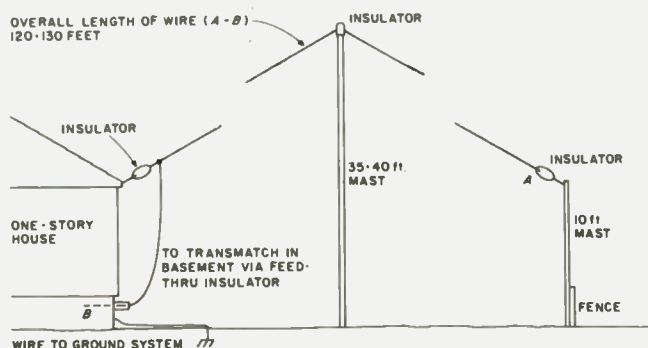

Fig. 1. Directly-fed inverted vee antenna, as installed at W6TKA/Ø. Layout and dimensions can be varied somewhat to suit individual installation requirements.

this antenna. Even if you have only a small backyard, the antenna and ground system are still feasible. Among other things, I used a large quantity of #18 copper wire (copperclad steel or aluminum electric-fence wire is cheap and comes in rolls ranging from small to huge) and simply sliced the lawn with—now, don't laugh—a pizza-cutting wheel, poked the wire about an inch into the soil with a large screwdriver, then stomped the grass back in place. No one could tell where I had buried wires.

Somewhat like a ground-plane antenna, the ground system forms a reflecting, conductive plane—the other half of the antenna system, as it were. This is especially important on 160 meters, where the directly-fed inverted vee functions as a quarter-wave or slightly longer radiator.

A good ground helps on all bands to prevent "rf from floating around the shack," as the old expression goes. And it makes quite a difference in the kind of signal others, at distant places, hear from your station. Here in this part of Missouri, soil conductivity is pretty good, according to a soil conductivity map issued by the FCC for use by broadcast stations. To make sure I had the best possible ground, I got a half dozen five-foot ground rods (they really should have been eight feet long), spotted them at various places around the 100- x 100-foot backyard, and wired them together with #12 copper wire. Tied to all of this is the #18 wire I mentioned earlier and the radial system employed for my all-band vertical (that antenna is yet another story). From this conglomeration, a couple of stout copper wires run to a chain-link fence which borders the back of my lot (plus several other lots) and is about 600 feet

in total length. All ground rod and wire connections were carefully spliced and soldered. (See Fig. 2.)

This antenna was put up in something of a hurry in the fall of 1977, just before the weather turned nasty. My main concern was to have an allband radiator up for the winter; a classy, super-efficient installation was secondary to me at that time. But, to my surprise, the thing seems to radiate as well as any inverted vee I have ever used and is still in use with only minor modifications.

I have three home-built transmatches, so I use one on 160 meters, another on 80/75, and the third on 40 through 10. (See Fig. 3.) One transmatch might work as well if you don't mind retuning it each time you change bands. The transmatches are separated from the radio room by a wall and are located in the unfinished furnace area of the basement. A remote meter on the swr meter and a remote transmitter keying circuit enable me to adjust the transmatches from the furnace room without having to be in two places at once.

Just in case you happen to be curious about the resonant frequency of your directly-fed inverted vee, here's a hint that may help you. Just on a hunch, I connected the center conductor of the RG-8/A coax running from my Kenwood TS-820S to the end of the vee and the shield to the ground system. Switching the transceiver to 160 meters and placing it in the "tune" mode (about 10 Watts of output), I carefully tuned the band for a dip in reflected power. Minimum swr occurred at 1.810 MHz. The swr was about 2.0:1, but it was a pronounced dip, so I knew the antenna was quarter-wave resonant at that frequency. Some simple calculations ( $234/f$ ) told me

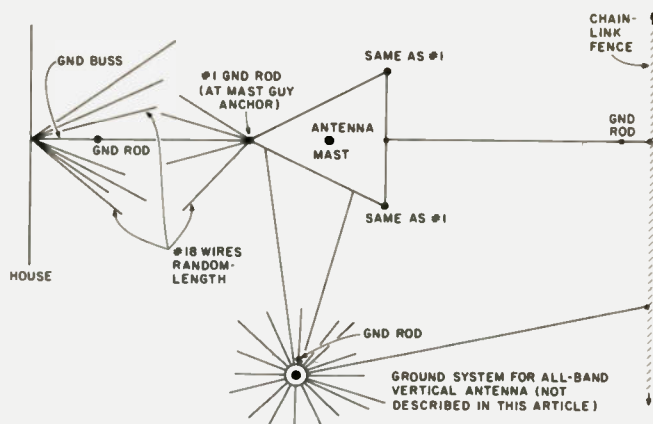

Fig. 2. Ground system in use with directly-fed inverted vee at W6TKA/0, shown only as an example of how an efficient ground system can be installed. Many variations are possible and acceptable. (The vertical antenna shown is not described in the article—it is included only to illustrate the total ground system being used.) Both hot and cold water pipes in the basement also are included in the ground system.

that the antenna was—electrically, anyway—just over 129 feet long—a quarter wavelength at 1.810 MHz. It is a bit long for 75 meters, representing a half wavelength at 3.610 MHz. It is a full wavelength at 7.220 MHz, two wavelengths at 14.440, three wavelengths at 21.660, and four wavelengths at 28.880 MHz. It provides some gain in those bands over the basic half-wave antenna. Obviously, the antenna presents a variety of input impedances, and hence the need for an antenna tuner (or transmatch) to match the transmitter to the antenna.

I've been very pleased with the results this antenna has provided on all bands, especially 160, 75, and 40 meters. I feel that it is a much more versatile system than a conventional single band, coaxial-fed inverted vee. Advantages include the convenience of allband operation, no cost for feedline, and no worry about where to run the feedline to keep it from getting too close to the antenna or other structures. It seems to work as well as any inverted vee I have used in the past twenty-five years. It is inexpensive, and you can put it up in a few hours. ■

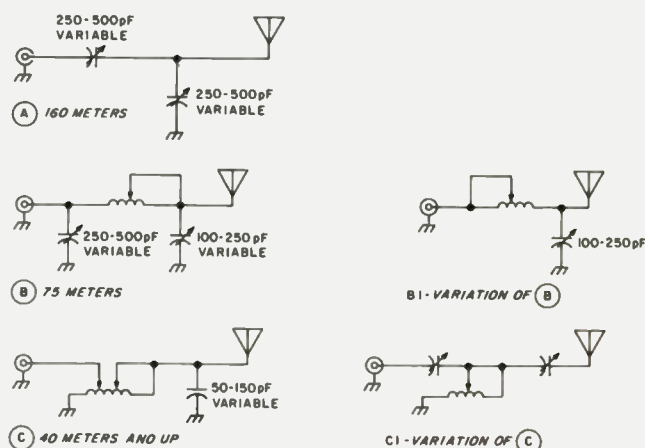

Fig. 3. These transmatch circuits, or other variations of  $\pi$ ,  $L$ ,  $T$ , et cetera, can be used with the directly-fed inverted vee antenna.

# They Don't Make 'Em Like They Used To

— home-brewing a hard-to-find neutralizing cap

*Neil Johnson W2OLU  
30 Harwich Road  
South Orleans MA 02662*

**M**y old amplifier was getting tired; it had a bad case of flat feet, low

emission... or something. So I accumulated all the parts for a new PA. Parts were all ready to go, except for the neutralizing capacitor. So, down to the big city. Big Apple, maybe, but big parts supplier, no.

The first clerk just did not understand what a neutralizing capacitor was. The next guy looked at me as if I had been recently turned loose from the funny farm. Finally, I made it to a shop where

they once sold such items... only they hadn't seen any for years. I refused to be insulted for a fourth time and returned home to reconsider.

Why not roll my own? I pondered this. Old-timers used to do it... but now? As you know, there are two main classes of so-called neutralizing capacitors. The first type has half-round plates, the same as an ordinary variable capacitor, and the second utilizes a plunger-type of mechanism. Some of the older handbooks show examples of the first type, but I have yet to see home-brew examples of the in-and-out style.

Even so, I chose the second type. This construction roughly follows the capacitors developed by Millen, except that solid dielectric is used. This makes for a more compact design. A second advantage lies in the fact that the screw-in type of construction allows for easier calibration, if such be desired. Finally, the procurement problem

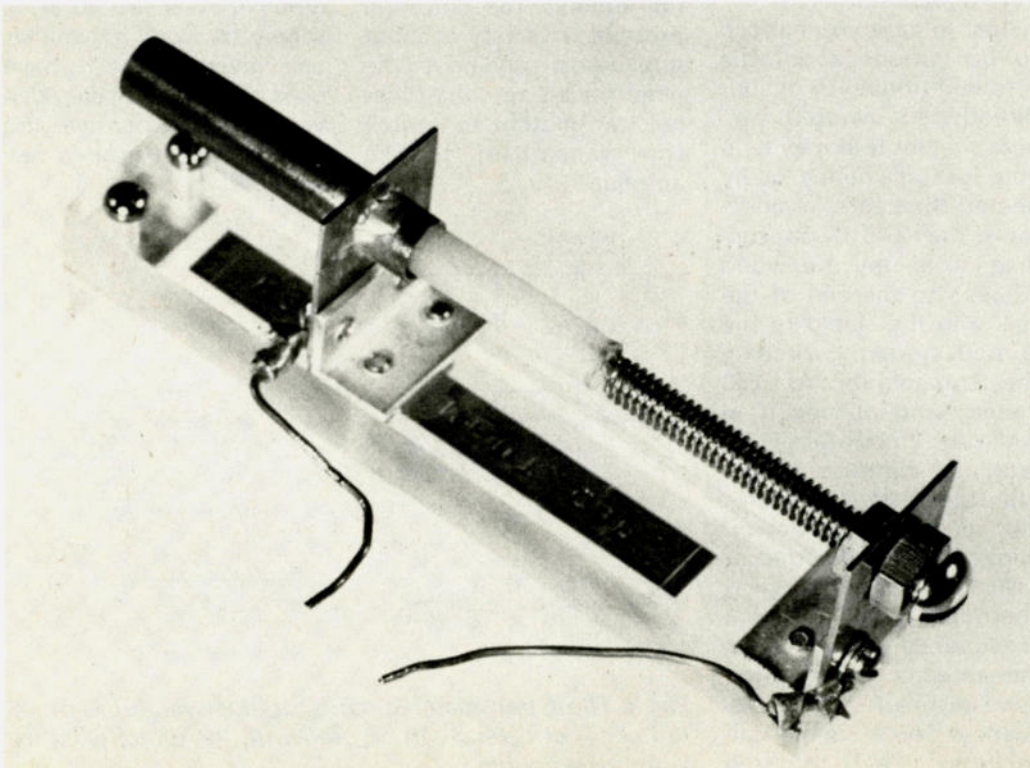

is easily overcome. Please don't laugh at that last item. The final design allows for anyone, anywhere, to make such a capacitor—even those hams in far-off lands. All that is needed are a brass nut and bolt, a few pieces of scrap metal, and a small piece of lucite or similar insulation approximately 5 inches long.

The materials list for the prototype follows:

1 base or plastic support form, 1" x 1/2" x 5";

3 pieces, right-angle dural or brass, 1/2" x 1/2" x 1/16", 1 inch long;

6 5/8" 6-32 nickel-plated brass screws, with copper lox;

4 1/4" 6-32 nickel-plated brass screws, with copper lox;

1 brass bolt 2" long (US 1/4-20 thread or similar);

2 brass nuts, to match above screw;

2 pieces of brass (or copper) 1" x 1" x .050" thick;

1 piece of copper tubing, 2" long x 1/4" inside diameter.

You can see that all the conductive parts should be made from brass, copper, or aluminum. Certain parts should be made only from brass or copper, since they require soldering. Oh, yes—I almost forgot! You will require a short piece of RG-8/U coaxial cable, about 3 inches long, for the rotor.

It is well to remember that all of the soldered pieces must be finished before assembly to the plastic base, which melts easily. You will be best served if you stick to the following schedule of assembly:

(1) Cut the base section to size—5 inches, suggested minimum.

(2) Cut the 2 pieces of right-angle material to size, then drill and tap to meet with the base and the brass 1" x 1" pieces.

(3) Drill holes through

the plastic base to allow 3 right-angle brackets to be mounted.

(4) Drill 3 holes in the brass 1" x 1" pieces: two holes to meet with the holes in the right-angle pieces, and one hole to accept inserts (which are soldered in later).

(5) Carefully enlarge one hole to accept copper tubing. Solder it in (at right angles) with about 5/16 inch protruding from one end.

(6) Solder one brass nut to the proper spot on the other 1" x 1" piece of brass.

(7) Remove 1/4 inch of insulation from a 3-inch piece of inner section of RG-8/U coaxial cable.

(8) Drill a small hole in the center of the brass screw, 1/4" deep at most.

(9) Join the brass bolt and the brass nut to one brass 1" x 1" plate.

(10) Carefully insert and solder the exposed copper wire from RG-8/U cable into the small hole in the brass screw.

(11) The balance of construction follows. Just use common sense.

Your finished capacitor will have a capacity of 3.65 pF minimum up to 6.9 pF, a difference of 3.27 pF. These are actual figures. Capacity changes, per turn, are essentially linear. This may suggest its use as a tuning capacitor with very small changes in capacity for each complete turn of the feed screw. Capacity change was 0.103 pF for

each turn.

Voltage breakdown? Forget it. A pal of mine fanned back the braid one foot from each end of a sample of RG-8 cable and then applied a test voltage of 100 kV with no ill effects. Personally, I helped to install a section of RG-8 cable between the power supply and the visual amplifier of a commercial TV rig. It's still working OK

10 years later, without a whimper, at 6500 volts.

So, try your hand at making such a capacitor, whether it be for neutralizing or for some other purpose, perhaps as a high-precision vernier capacitor having a small change of capacitance for each turn—approximately 0.103 pF. And please remember: All metal should be non-ferrous. ■

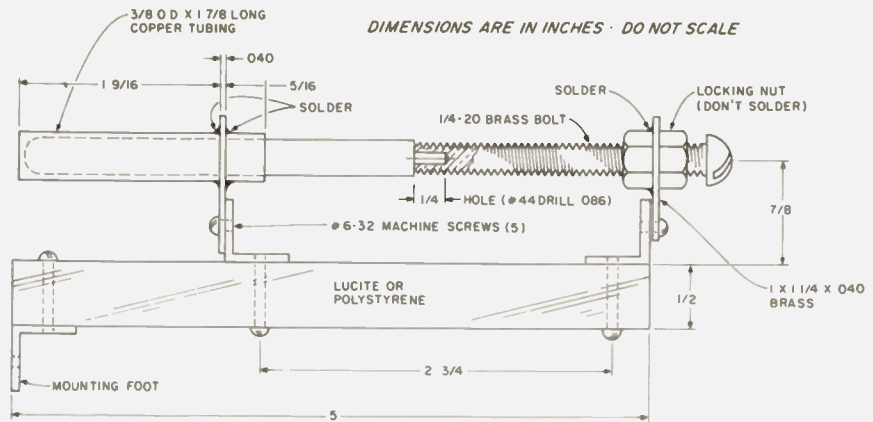

Fig. 1. Neutralizing capacitor.

## NO MONKEY BUSINESS!

- (A) Complete Service Facilities
- (B) Good Deals on most Brands
- (C) Shipping within 24 Hours
- (D) All inquiries handled by Active Hams with over 20 years experience in ham radio

CALL TOLL FREE  
1-800-238-6168

IN TENNESSEE, CALL 901-452-4276  
MONDAY - SATURDAY 8:30-5:30  
FOR YOUR SPECIAL.

Write: 3202 Summer Ave., Memphis, Tennessee 38112

# The Europa-B Two Meter Transverter

— work OSCAR and 2m SSB with this British import

*Joe Kasser G3ZCZ  
11532 Stewart Lane  
Silver Spring MD 20910*

**W**hat is smaller than a six pack, will put you on two meter sideband or on OSCAR, and is not made in the USA? The an-

swer is, of course, the British-made Europa-B two meter transverter. This unit converts both received and transmitted signals on ten meters to the two meter band, with enough power to work both OSCAR 7 and OSCAR 8. You can also use it to work up to about 200 miles or so direct, using

FM, AM, SSB, RTTY, CW, or any mode that you have an exciter for on ten meters.

The Europa-B comes in a package only nine inches wide, four and three-quarters inches high, and four and a half inches deep. It comes complete with a power cable for the Yaesu FT-101, FT-200, FT-277, or

FT-250. It can be used with any rig having a 12-volt heater chain. A transformer is available for rigs with a 6.3-volt heater chain. In fact, a whole power supply in a package the same size as the Europa-B is also available, but it is not included in this review.

## Construction

The receive side of the Europa-B is all solid state. There is a dual-gate MOSFET rf stage followed by a dual-gate MOSFET mixer. The converter is specified as having a noise figure of 2 dB and a gain of 30 dB.

The transmit side uses tubes. A maximum of 200 mW of ten meter drive is applied to a 6360 mixer. The resultant two meter energy is amplified by a second 6360 used as a driver for the final (which is a 5894). The final amplifier runs at about 200 Watts input and is specified as being at least 50% efficient. This is more than enough signal output to work through both the OSCAR spacecraft.



*The Europa-B two meter transverter.*

The selectivity of the tuned circuits is such that both the mixer and the driver plate circuits need tuning when a change of frequency of more than about 100 kHz takes place. The whole tuning operation takes about five seconds and is no bother to do. The narrow passband also acts to suppress unwanted mixer products.

The unit is well built. A double-sided printed circuit board is used as a chassis for both the transmit and receive converters, keeping the rig nice and small.

The ON/OFF switch is wired such that when the switch is in the ON position, the unit is powered and the heater chain to the exciter finals is broken. Putting the switch in the OFF position removes the 12 volts from the Europa and reconnects the heater chain to the finals of the exciter. This feature allows the exciter to be used on both HF and VHF without having to remove the power cord to the transmitter. An accessory socket is provided on the rear of the Europa-B to supply voltages for a preamp or an rf relay for automatic switching of the rf input to the exciter between HF and VHF.

The manual supplied with the Europa explains the operation of the unit and is well written in a straightforward manner. It is also written in English. A schematic is supplied, as are operating voltages, in the event that troubleshooting is required. In fact, the operation of the unit is so straightforward that it can and was put on the air without reference to the manual.

#### Bad Points

The only undesirable features that I have found with the unit are that it gets very hot in use, and there is no way of removing power

from the tube filaments when I want to use it in the receive-only mode. These features can and will be cured by fitting a fan to the top of the unit. A suitable one is that supplied by Yaesu for the FT-101. A small toggle switch can also be fitted to disconnect the tube heaters when required.

#### Results In Use

On opening the package that arrived by mail, I found that although the Europa is advertised as coming with all cables necessary to put it on the air with an FT-101, that only applies to dc power. There were no rf cables included in the package. The Europa-B uses British television-type coax connectors for the receiver output and transmitter input cables. These are commonly known as Belling-Lee connectors after a well-known manufacturer. As I didn't have any of these connectors, I was stuck. As luck would have it, a local friend did have some of them. Two nights later, the Europa-B was on the air driven by my FT-101.

I worked a couple of stations via OSCAR 6 and OSCAR 7 using a dipole mounted on my balcony. Then, after that, I tuned down to the low end of two to see what was doing there. At about 144.1 MHz, I heard a weak station in QSO. Choosing my moment, I gave him a quick call. He acknowledged my break (the G3 gets them every time) and told me that I was "lots of dB over nine." I could hardly hear him.

Further investigations showed that I was copying signals even though I had a dead MOSFET in the rf stage of the converter. I replaced it with a ubiquitous 40673. Now received signals were much louder and I was able to give out

reports of the same order as I was getting. I compared the converter to my "Rochester" one and found that signals were slightly better on the Europa-B. The OSCAR 7B downlink is also pretty good. Later that evening, using only the dipole on the balcony, I worked SSB stations in New Jersey, Maryland, and Pennsylvania, receiving excellent audio reports.

#### How To Get One

The Europa-B is not readily available over the counter in the USA. It may be ordered by mail from the manufacturer in England and paid for by means of your VISA card, just as if you were ordering the unit by mail from a dealer in the USA. I ordered my unit in this manner and it came within ten days.

The price of the Europa-B is £87.50 complete or £75.00 without the tubes.

It is sold without the tubes to let long-time VHF nuts who already have a supply of these tubes (6360s and 5894s, or QQV-03-10s and QQV-06-40s as they are called over there) to upgrade to the Europa-B at a minimum of expense. At the time of this writing, the British pound is worth about \$2.00 and is rising. The cost for air parcel post is £7, and US customs will want a few dollars. The postman will collect their share COD.

The Europa-B may be ordered from Solid State Modules, 63 Woodland Road, Solid, Lockwood, Huddersfield, England.

The Europa-B is in use all over the world. In some places, the receive section is never used because there is only one active station on two meters and he is working OSCAR. It is about time that this fine piece of equipment was available and used in the USA. ■

## PREAMP

### FOR 2 METER TRANSCEIVERS



**MODEL QSA 5**  
Only \$41.95

The QSA 5 preamp is a high performance, low noise preamp for improving the receiving sensitivity of 2 Meter transceivers. This preamp features easy installation with no modification to the transceiver required. Can be used with virtually all 2 Meter transceivers and on all modes — FM, SSB, CW or AM. Relays in the QSA 5 automatically bypass the preamp when transmit power is sensed. Available with BNC or SO-239 connectors.



## JANEL

### LABORATORIES

All prices fob Houston, except where indicated. Prices subject to change without notice, all items guaranteed. Some items subject prior sale. Send letterhead for Dealer price list. Texas residents add 6% tax. please add postage estimate. \$1.00 minimum. W5GJ, W5MBB, K5AAD, N5JJ, AG5K, W5VVM, WD5EDE, K5ZD, WA5TGU, WB5AYF, K5RC, K5BGB, WB5USV

**MASTERCHARGE • VISA**

## MADISON

↖ M35

## ELECTRONICS SUPPLY, INC.

1508 MCKINNEY • HOUSTON, TEXAS 77002  
713/658-0268

# Zero In on Zero Beat

## — an easy-to-make vernier for your tube-type oscillator

The recent article<sup>1</sup> in 73, with respect to high-accuracy frequency measurements, brought to mind a method developed at W2OLU which is mechanical and somewhat simpler than the CRO technique. While the frequency standard described here is a

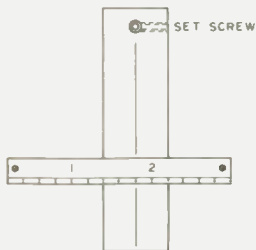

Fig. 1. Actual size of plastic arm in prototype is 5/8" wide, 1/4" thick, and 4" long.

tube-type affair, the precepts to be outlined apply equally well to all configurations, whether vacuum tubes, transistors, or integrated circuitry.

A relatively small trimmer capacitor with a shaft is used for the purpose of "zeroing in" the local crystal-controlled oscillator with respect to the WWV emissions. Since the human ear is unable to respond to audio tones lower than 30 Hertz, we must conclude that there is a no-man's-land, so to speak, of some 60 Hertz. To obtain higher accuracy with respect to true zero beat, some method must be employed to attain this end. Most methods to obtain

this require additional apparatus.

The relatively simple solution outlined will not completely satisfy all purists, but it should enable any home brew artist to improve frequency measurements by several orders of accuracy. Furthermore, it does not require any additions or modifications to existing circuitry.

The shaft of the variable capacitor, having to do with shifting the crystal oscillator frequency, is fitted with a fairly long arm made from some kind of clear plastic. Near one end, a small hole is drilled. In our particular case, this was 1/4 inch in diameter in order to fit the shaft of the trimmer condenser involved. Adjacent thereto, at right angles, a small hole is drilled so that a set screw may be installed. Kindly note that this hole must be drilled undersized, and subsequently threaded for the set screw. In our case, a 6/32 screw was used for this purpose.

Next, I scribed a straight line down the middle of the plastic arm. This may be lightly inked in order to form an indicator, or "cursor." This line should ap-

pear on the lower or "chassis" side of the plastic arm, next to the fixed indicator strip. This will help to avoid parallax and results in a higher order of accuracy. See Fig. 1.

Underneath the movable arm, I mounted a short piece of ruler which is graduated in fine divisions. General Hardware No. 616 is an ideal candidate for this role. It is relatively low in cost and graduated in fractions of an inch on one side and in hundredths on the reverse. There was insufficient space on the chassis for the entire 6-inch ruler, so I chose to use the upper end of the ruler, leaving the first part, zero to 3 inches, available for other uses.

Now to put the combination to work: With both the receiver and frequency standard suitably warmed up in the interests of stability, the coarse frequency adjustment to zero beat is made, preferably with the ruler-delineated capacitor at the midpoint of the high accuracy ruler. It then becomes a simple matter to move the marker arm slowly back and forth over the ruler. If the first audible tone appears at 16 markers on one side of

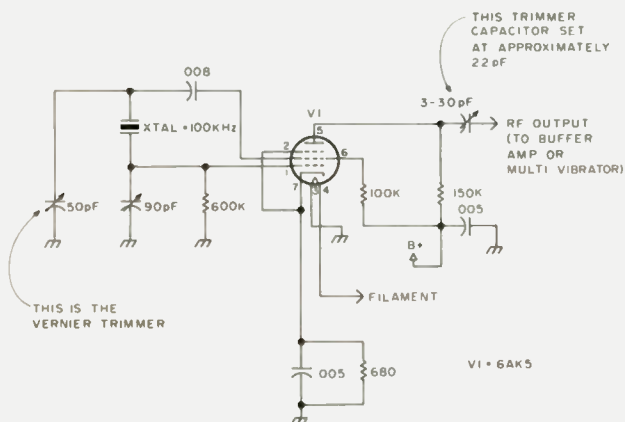

Fig. 2. Circuit of W2OLU, a crystal oscillator with vernier control for frequency variation.



# New 2 Meter Avanti Mobile Antenna

Mounts on glass — no holes!

- Receives and transmits through glass.
- Superior performance equivalent to 5/8 wave.
- Superior radiation full Omni-Directional.

It's easy to install — No holes to drill, no magnet to scratch the paint, no clamps. Uses an especially developed epoxy adhesive that secures antenna to window like a 1/4" bolt. The capacity coupling box is simply attached with a special adhesive tape to inside of window. Worried about crimping or corroding coaxial cables? It's all inside and out of sight.

Models also available for 220 MHz and 450 MHz.

#### AH 151.3G SPECIFICATIONS

Gain	Equivalent to 5/8 wave
2 meter V S W R Band Width	Better than 1.5:1
Maximum power	150 watts
Nominal impedance	50 Ohms
Chrome plated casting. Stainless Steel hardware. Swivel whip holder	33"
Height	
Performance and Mechanical Patents Pending	

Buy one from your nearest AVANTI dealer. If your dealer does not have one in stock, have him call the following toll free number and we will ship him one within 24 hours:

(800) 323-9429

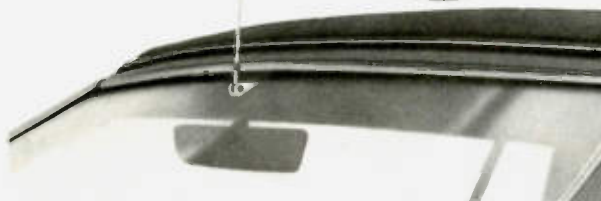
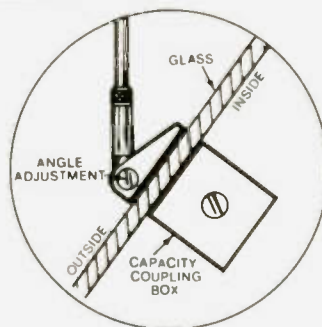

See Avanti's other new amateur mobile and base antennas. Write for new catalog today.

Send 50¢ for handling and postage

✓ A93

**avanti antennas**

Avanti Research and Development, Inc.,  
340 Stewart Ave., Addison, IL 60101  
1979 In Canada: Lenbrook Ind., Scarborough, Ontario M1H 1H5



Radio equipment  
not included

Also Available . . .  
Floor Space: 51" Wide by 30" Deep  
\$192.50

## ... at last ... your shack organized!

A beautiful piece of furniture — your XYL will love it!

### \$16450 S-F RADIO DESK Deluxe - Ready to Assemble

Designed with angled rear shelf for your viewing comfort and ease of operation.

FINISHES: Walnut or Teak Stain.

Floor Space: 39" Wide by 30" Deep

Additional Information on Request.

Checks, Money Orders, BankAmericard  
and Master Charge Accepted.

F.O.B. Culver City. (In Calif. Add 6% Sales Tax.)

— DEALER INQUIRIES INVITED —

✓ S33

# SF

**S-F Amateur Radio Services**

4384 KEYSTONE AVENUE • CULVER CITY, CALIF. 90230 — PHONE (213) 837-487

what appears to be center frequency, and the opposite direction of the swing arm shows first audibility to come in at 18 units on the ruler, then by averaging the two, e.g., 16 plus 18 equals 34, which divided by two, results in 17, a very close indication of absolute zero beat is obtained. A small plastic magnifying glass, costing about half a dollar, can be mounted over the plastic arm if

desired. This will enable these measurements to obtain even greater accuracy.

Several amateurs have asked me where to obtain the plastic strip which is used for the indicator arm. A thorough search of catalogs generally available to amateurs and experimenters showed nothing. The best all-around answer probably will be found in the yellow pages of your telephone directory, under

the heading "Plastics—Rods, Tubes, and Sheets." Other sources might be found in the local hobby shop. Possibly the plastic might be salvaged from various items found around the home, some of them broken.

And finally, it is possible to come up with a bare-bones type of indicator arm. This can be made from a piece of wood. Addi-

tional components are simple. A 6-32 nut and bolt, a small piece of brass (or two solder lugs), and a small nail or brad, which is used for the pointer. This alternate design can be put together anywhere in the boon-docks, so I have named it "The Robinson Crusoe Special." ■

#### Reference

1. "A WWV Primer," Thurber, 73, August, 1978, p. 84.



There's a new, eighth OSCAR satellite in orbit, and the AMSAT team helped put it there! Your help is needed for future satellites. Join AMSAT and support the new, advanced Phase III series of OSCARs, engineered to provide communications over transcontinental distances for hours at a time.

Send \$10 membership dues to AMSAT, P.O. Box 27, Washington, D.C. 20044. Life membership is available for a tax-deductible donation of \$100 or more, payable in quarterly installments if you wish.

Phase III satellite solar cells may be sponsored for \$10 each, and we'll send you a certificate specifying the cells you are sponsoring.

For a tax-deductible contribution of \$1,000 or more, we'll even inscribe your name on a plaque to be placed in orbit aboard the Phase III spacecraft for posterity, and we'll send you a replica honoring your contribution.

Dues and contributions may be charged to VISA or Master Charge. Phone us at (202) 488-8649.

Radio Amateur Satellite Corporation  
P.O. BOX 27, WASHINGTON, D.C. 20044  
**AMSAT**  
AMSAT MEMBER

# the direct connection

AVANTI • ASTRON • ALLIANCE • ATLAS • ALPHA • BIRD • CUSHCRAFT • COLLINS • COE • DRAKE • DENTRON • HY-GAIN • HUSTLER • ICOM • KLM • KENWOOD • MOSLEY • MICRO-LOG • MOR-GAIN • MIRAGE • MFJ • PALOMAR ENG. • SWAN • TEN-TEC • TAYLOR • TRI-EX • TELE-TOW'R • UNIVERSAL • UNARCO-ROHN ... ALL THESE AND MORE

**MIDCOM ELECTRONICS, INC.**

2506 S. BRENTWOOD BOULEVARD  
ST. LOUIS, MISSOURI 63144

✓ M62



# 800-325-3609

MO RESIDENTS CALL COLLECT 314-961-9990

# 2 FOR 1!!



Subscribe to 73 Magazine this month and you will have the unprecedented opportunity to renew your subscription for half-price . . . for the rest of your life. Simply fill out the special subscription form attached, and you will begin receiving 73 Magazine each month at 2 issues for the price of 1 . . . half the cover price for life.

Keep in touch with this dynamic field of amateur radio . . . with more than 100 pages of articles each month to fill you in on the latest techniques and equipment. 73 Magazine will guide you into new areas that will make amateur radio as fresh and exciting for you as the day you keyed your first transmission.

Take advantage of this incredible offer today. No need to send money now; we'll bill you if you prefer.

YES! Enroll me as a "2 for 1" subscriber, which makes me eligible for half the newsstand price for life.

- New subscription       Renewal
- 1 year —\$15 (saves \$15 off current cover price)
- 3 years—\$45 (saves \$45 off current cover price)
- Payment enclosed       Bill me

Name \_\_\_\_\_  
Address \_\_\_\_\_  
City \_\_\_\_\_ State \_\_\_\_\_ Zip \_\_\_\_\_

Canada: \$15 per year, US funds.  
Other foreign: \$26 one year only, US funds.

501H33

**73** magazine  
POB 931 Farmingdale NY 11737

**FOR EVEN FASTER SERVICE CALL TOLL-FREE (800) 258-5473.**

# New OMNI/SERIES B Filters The Crowd

The new OMNI/SERIES B makes today's bands seem less crowded. By offering a new i-f selection that provides up to 16 poles of filtering for superior selectivity. And a new Notch Filter to remove QRM. No other amateur transceiver we know of out-performs it.

**NEW I-F RESPONSE SELECTION.** OMNI comes equipped with an excellent 8-pole 2.4 kHz crystal ladder i-f filter which is highly satisfactory in normal conditions. But when the going gets rough, the new OMNI/SERIES B, with optional filters installed, provides two additional special purpose i-f responses.

The 1.8 kHz crystal ladder filter transforms an unreadable SSB signal in heavy QRM into one that gets the message through. The 0.5 kHz 8-pole filter provides extremely steep and deep skirts to the CW passband window which effectively blocks out even the very strong adjacent signals.

Both of these filters can be front-panel switched in series with the standard filter to provide up to 16 poles of filtering for near-ultimate selectivity. In addition, the standard CW active audio filters have three bandwidths (450, 300, and 150 Hz) to give even further attenuation to adjacent signals. In effect, OMNI/SERIES B has six selectivity curves—three for SSB and three for CW. That's true state-of-the-art selectivity.

**NEW NOTCH FILTER.** A variable frequency notch filter in OMNI/SERIES B is placed inside the AGC loop to eliminate interfering carriers and CW signals without affecting received signals. Attenuation is more than 8 "S" units (over 50 db) for any frequency between 0.2 kHz and 3.5 kHz.

**OMNI/SERIES B RETAINS ALL THE FEATURES THAT MADE IT FAMOUS.**

All solid-state; 160-10 meters plus convertible 10 MHz and AUX band positions; Broadband design for band changing without tuneup, without danger;

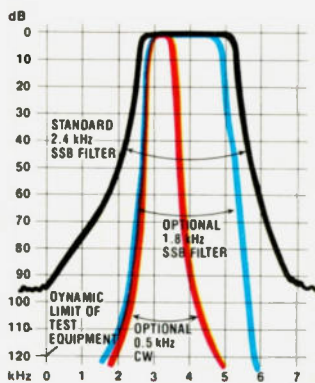

**OMNI/SERIES B I-F RESPONSES WITH STANDARD AND OPTIONAL FILTERS.**

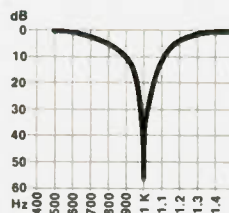

**NOTCH FILTER PERFORMANCE ADJUSTED TO 1 kHz POINT.**

**TEN-TEC, INC.**  
SEVIERVILLE, TENNESSEE 37862  
EXPORT: 5715 LINCOLN AVE., CHICAGO, ILL. 60646

Choice of readouts —OMNI-A for analog dial or OMNI-D for digital dial; Built-in VOX and PTT facilities; Selectable Break-in, instant or delayed receiver muting; Dual-Range Receiver Offset Tuning,  $\pm 5$  kHz or  $\pm 0.5$  kHz; Wide Overload Capabilities, dynamic range typically exceeds 90 dB and a PIN diode switched 18 dB attenuator is also included; Phone Patch Interface Jacks; Adjustable ALC; Adjustable Sidetone; Exceptional Sensitivity; 200 Watts input to final with full warranty on final transistors for first year, pro-rata for 5 years; 100% Duty Cycle for RTTY, SSTV or sustained hard usage; 12 VDC Circuitry for mobile use, external supplies for 117/220 VAC operation; Front Panel Microphone and Key Jacks; Built-in 25 kHz Calibrator in analog dial model; Zero-Beat Switch; "S"/SWR Meter; Dual Speakers; Plug-In Circuit Boards; Functional Styling, black textured vinyl over aluminum "clamshell" case, complementary nonreflective warm dark metal front panel; Complete Shielding; Easier-to-use size:  $5\frac{1}{4}''$ h x  $14\frac{1}{4}''$ w x 14"d; Full Options: Model 645 Keyer \$85; Model 243 Remote VFO \$139; Model 252MO matching AC power supply \$139; Model 248 Noise Blanker \$49; Model 217 500 Hz 8-pole Crystal Ladder CW Filter \$55; Model 218 1.8 kHz 8-pole Crystal Ladder SSB Filter \$55;

**OMNI owners note:** Your OMNI can be converted to a SERIES B model at the factory for just \$50 (plus \$5 for packing and shipping). The notch filter replaces your present squelch control and provision is made for the two additional optional filters; a partial panel with new nomenclature is provided. Contact us for details.

Model 545 Series B OMNI-A \$949  
Model 546 Series B OMNI-D \$1119

Experience the uncrowded world of OMNI/SERIES B. See your TEN-TEC dealer or write for full details.



Howard Knickerbocker K1DCS  
92 Sparrowbush Rd.  
East Hartford CT 06108

Andrew Weise N1XN  
64 Old Andover Rd.  
Hebron CT 06248

Robert Stielau W1WRO/N2XN  
20 Hillcrest Ave.  
Middletown CT 06457

# CB-to-10 FM

## — best conversion yet?

**W**hile in the final stages of writing this article, we could just hear the moans: "Not another CB-to-10 conversion! When will it end?"

But look again; this is CB-to-10 FM. Why not try something different as suggested by Steve Herman WA7WYF in his article, "Try FM on 29.6 MHz?"<sup>1</sup> A chan-

nelized band complete with repeaters, a national calling frequency, beacons, and long-distance skip exists less than a megahertz above the proposed 10-meter CB-to-10 band.

But what about equipment for 10 FM? The Yaesu FT-901D and the newly-introduced Comtronix FM-80 are the only radios available from amateur

manufacturers, so the FM portion of the 10-meter band from 29.0 to 29.7 MHz has long been occupied by a few hearty individuals specializing in surplus commercial 2-way FM conversions.

Many wideband, tube-type boat anchors still live on. Within the last few years, repeaters, remote bases, and beacons have appeared as band occupancy has increased. Unfortunately, 95% of this activity has fallen on the national calling frequency at 29.6 MHz. Recently, a band plan has been generally accepted by those operating on the 10-meter FM band. The national calling frequency at 29.6 MHz is the pivotal simplex frequency. Another simplex channel at 29.5 MHz is included as a secondary direct channel, and four repeater inputs fall at 29.52, .54, .56, and .58 MHz. Their respective outputs are 100 kHz higher at 29.62, .64, .66, and .68 MHz.

You say, "Enough! I'm convinced to try 10 FM, but how do I get on the air?" Until now, the conversion of CB radios to 10-meter FM

has been entirely overlooked in the haste to make rapid conversions of amplitude-modulated radios to 28.965 MHz. This article will present a simple method of converting a phase-locked loop Citizens Band radio to a state-of-the-art frequency-programmable narrowband FM transceiver having a 0.5 uV/20 dB quieting receiver and 5-Watt output power transmitter.

The units chosen for this conversion are available from several manufacturers but share the same printed circuit board. Fortunately, these radios are the \$30 to \$40 "loss leaders" at many discount houses. Recently, large quantities of Hy-Gain PC boards for these transceivers have come on the surplus market<sup>2,3</sup>. They offer all the electronics for this conversion minus front-panel controls, enclosure, microphone, and speaker. They are available in the \$5-to-\$15 range. A listing of the manufacturers and model numbers are included in Table 1.

Many CB conversion articles apply to early, unobtainable 23-channel



Front view of converted Lafayette rig. The CB channel switch has been replaced with a 10-position rotary. A pair of 7-segment LEDs have been added for direct frequency read-out. Three toggle switches provide display on/off, simplex/repeat, and add 10-kHz to operating frequency.

models. An advantage of this conversion is the large number of radios found available. The conversion is basically the same as described by Clay Walsh W1PI<sup>4</sup>. He gives an excellent set of instructions for converting these radios to AM operation. The addition of an FM discriminator and movement of a few wires to frequency-modulate the PLL oscillator are all that is needed to FM the radio.

### Phase-Locked Loop Frequency Synthesizer

The following is a description for the existing Citizens Band programming. Understanding this operation is not necessary to accomplish the conversion, but may be helpful during tune-up or trouble-shooting. The heart of the CB transceiver, shown in a block diagram in Fig. 1, is the phase-locked loop frequency synthesizer or PLL. It enables precise, multiple-frequency generation and can be audio-modulated to produce high-quality FM.

The control integrated circuit (IC101) provides three functions. It contains the frequency divider for the reference oscillator, a programmable frequency divider, and the phase-sensitive detector. The three functions of the chip operate as follows. The 10.24-MHz signal from oscillator #3, the reference oscillator, is divided by 1024, providing a 10-kHz reference signal to the phase detector. The programmable divide-by-N counter is programmed (in binary) by nine control lines from the front-panel channel-selector switch. Programming is accomplished by applying positive 5 V dc to the appropriate pin on IC101 through the programming switch. Pull-down resistors are provided internally in the IC to hold the inputs at a logic low level when a line from the programming switch is in an

open position. The phase detector compares the outputs of the two counter channels and provides a dc output which is proportional to the phase difference of the digital input signals. The phase detector is analogous to a frequency discriminator in an analog circuit.

During start-up operation of the PLL Q101, the voltage-controlled oscillator (vco), is running at some non-phase-locked frequency in the 40-MHz region. This signal is mixed with the 37.955-MHz from oscillator #1 at Q102 (mixer #1). The difference frequency (approximately 2 MHz) is low-pass filtered and amplified to logic levels by the Q103 stage. The 2-MHz signal is applied to the input of the divide-by-N counter at pin 6 of PLL02A (IC101). The frequency is counted down by the programmed divide-by-N ratio, and the output of this counter is fed to the internal phase detector. This counted-down signal is compared in frequency and phase with the 10-kHz reference signal. If the two signals are not coincident, a dc error signal is generated at pin 5 of IC101 by the phase detector. This error signal will force the vco to

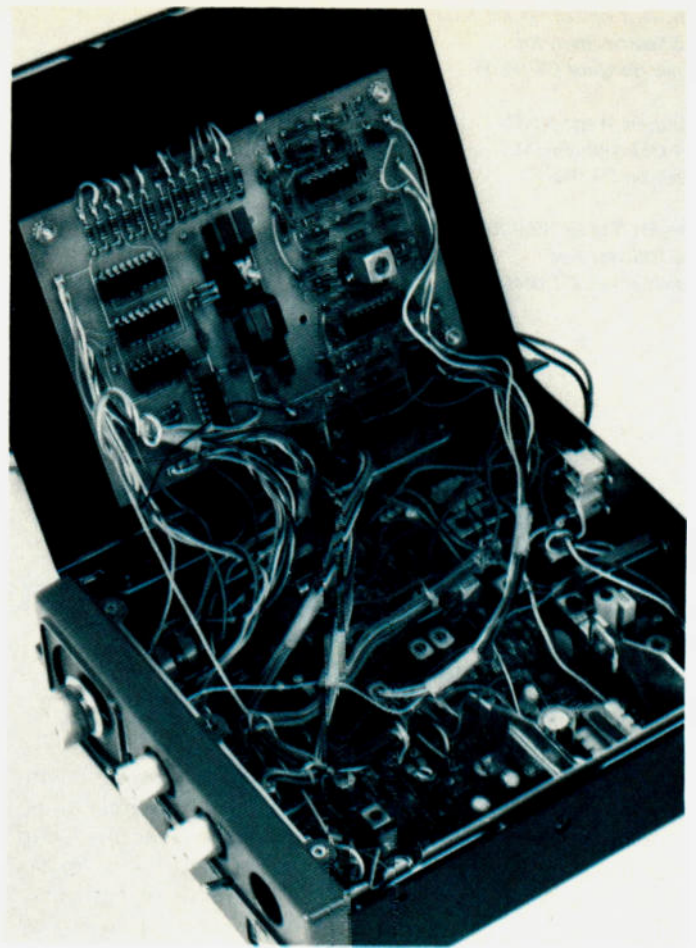

Lafayette rig with bottom cover removed to show printed circuit board mounted. The speaker has been removed to make room.

the correct frequency. The dc signal is filtered by a passive, low-pass filter section to remove the 10-kHz component on the output of the phase detector. Any rf leakage on the dc control

voltage would show up as sidebands on the carrier. This dc error, plus an offset voltage, is applied as reverse bias to the varactor diode, D101, which is the frequency-control element

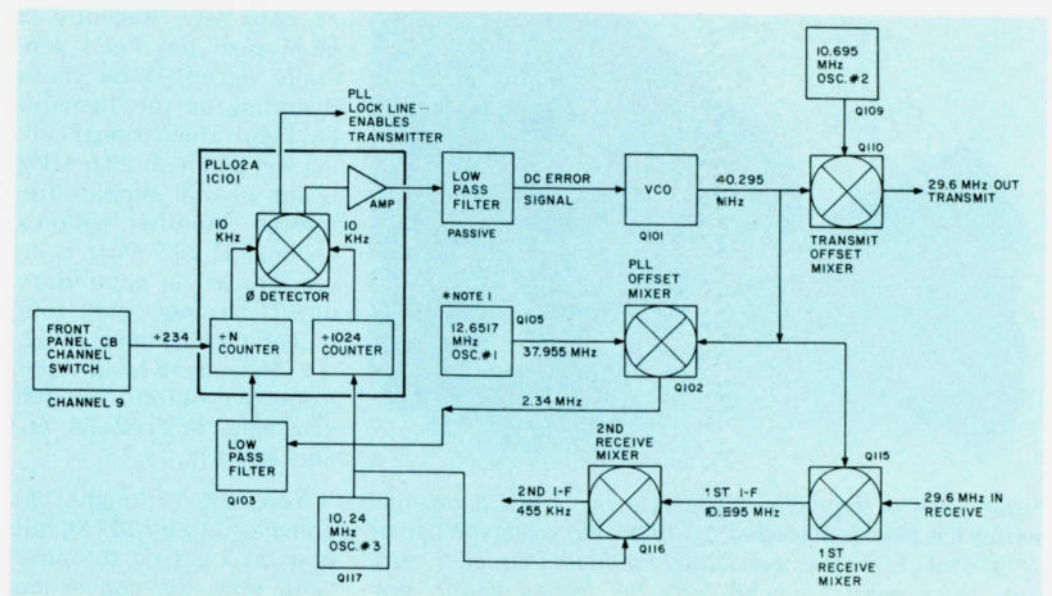

Fig. 1. FM frequency generation block diagram.



# Christmas in January at DSI!

We are repeating our outstanding Christmas offer because many of Santa's helpers didn't know the right DSI product to send. Now you can use that check or money order you received for that special present.

*My choices for Christmas in January are:* (check one or more)

- |  |  |
|--|--|
| <input type="checkbox"/> Model 500HH (wired) ... \$149.95  | <input type="checkbox"/> Model 5500 (wired) ..... \$ 99.95 |
| <input type="checkbox"/> Model 100HH (wired) ... \$149.95  | <input type="checkbox"/> Model LC 5000 ..... \$149.95 *    |
| <input type="checkbox"/> Model 5600A-W (wired) .. \$179.95 | <input type="checkbox"/> 5600A-K (kit) ..... \$149.95      |

• **These items are stocked for Immediate delivery .**

See your dealers or call our toll free number.

**DSI INSTRUMENTS, INC. • 9550 Chesapeake Drive • San Diego, Ca. 92123 • (714) 565-8402**

Call toll free

**(800) 854-2049**



California residents call toll free

**(800) 542-6253**

TERMS: MC VISA AE Check M.O. COD in U.S. Funds. Please add 10% to a maximum of \$10.00 for shipping, handling and insurance. Orders outside of USA & Canada, please add \$20.00 additional to cover air shipment. California residents add 6% Sales Tax.

\*Available end of January.

of the voltage-controlled oscillator. Transformer T101 makes up the inductive part of the vco parallel-resonant circuit and provides coupling of the vco signal to the rest of the transceiver. T101 is adjusted to keep the tuning voltage on the varactor diode, as measured at TP8, in the 1.5-to-3.5-volt range across the operating band of interest. If the voltage swings beyond these limits, the vco

will latch, causing the PLL to lose lock, which also disables the transmitter to prevent out-of-band transmissions.

#### Transceiver Description

The transceiver has been designed to obtain maximum performance at minimum cost. Fig. 1 shows the frequency-generation schemes for the transmitter and the two receiver local oscillators. An operating

frequency of 29.6 MHz is shown for the example. The existing 11.8066-MHz crystal at oscillator #1 has been replaced with one at 12.65167 MHz. The front-panel channel selector switch is set at channel 9. The output of the voltage-controlled oscillator in the PLL is at 40.295 MHz. The programming switch has a divide-by ratio of 234 entered to the PLL control, IC101. During transmit, the

output of the synthesizer is mixed with a 10.695-MHz signal from oscillator #2 (Q109). The difference frequency is 29.6 MHz. The transmitter is enabled by the PLL "locked" output and keyed by a switch on the microphone. High-level amplitude modulation is applied from the integrated circuit audio amplifier to the driver and final transmitter transistors. The transmitter has four gain stages and is capable of a power output in excess of 5 Watts into a 50-Ohm load.

The receiver is a dual-conversion superheterodyne with intermediate frequencies of 10.695 MHz and 455 kHz. The received signal at 29.6 MHz is mixed with the frequency-synthesizer output of 40.295 MHz at Q115, the first mixer, to give a difference frequency of 10.695 MHz, the first i-f. The output of this stage is filtered to remove the unwanted sideband and applied to mixer #2, Q116, along with the 10.24-MHz signal from oscillator #3 which was previously mentioned in the phase-locked loop description. The difference frequency is 455 kHz, the second i-f, which is amplified and diode-detected. The detected output is fed to the same audio amplifier used for transmitter modulation, but now the output is coupled to a loudspeaker.

There are many accessory functions in these transceivers, such as squelch, noise limiter, noise blanker, rf gain controls, delta tune, and others. All units, no matter who the manufacturer or what the level of sophistication is, can be updated to include these functions. All the printed circuit boards are identical, so the added functions can be wired into existing holes on the boards and interfaced to the appropriate switches and potentiometers on the front panel. In FM operation, the only two controls

#### Parts List—Synthesizer Programmer

Item	Description
C1	0.01-uF disc ceramic
C2, 3	15-uF, 35 V dc tantalum, Mallory TDC156MO35GL or equivalent
D1	1N270 germanium diode
Dis. 1, 2	7-segment common-cathode LED readout
IC1	74LS147 TTL 10-line-to-BCD decoder
IC2	74LS04 TTL hex inverter
IC3	74185 TTL binary-to-BCD decoder
IC4	74LS48 TTL BCD-to-7-segment decoder
IC5	7805 3-pin monolithic, 5-V dc voltage regulator with small heat sink
R1-13	470-Ohm, 1/4-Watt composition resistor
R14	10-Ohm, 1-Watt composition resistor
R15	1k-Ohm, 1/4-Watt composition resistor
R16	1.5k-Ohm, 1/4-Watt composition resistor
S1	2-pole, 2-deck, 10-position rotary switch, Grayhill 44D36-02-2-AJN or equivalent (Rotate rear deck to facilitate wiring.)
S2-5	Miniature SPDT toggle switch, Alco MST-105D or equivalent

#### Parts List—455-kHz FM i-f strip

Item	Description
C1	15-uF, 35 V dc tantalum, Mallory TDC156MO35GL or equivalent
C2-5	0.47-uF monolithic, Centralab CY20C474M or equivalent
C6	0.01-0.02 uF disc ceramic, selected for proper squelch action
C7	As required to resonate T1 to 455 kHz
C8	22-pF disc ceramic
C9, 10	0.001-uF ceramic
C11	0.005-uF disc ceramic
C12-19	0.01-uF disc ceramic
C20	0.02-uF disc ceramic
C21	0.1-uF disc ceramic
D1, 2	1N270 germanium signal diode
IC1	LM3065 (National) limiter/discriminator, or MC1358P (Motorola) limiter/discriminator, or C6063 (HEP) limiter/discriminator
IC2	MC3403 (Motorola) quad op amp, or SK3594 (RCA) quad op amp, or C6129P (HEP) quad op amp
Q1	2N3904 transistor or equivalent NPN switching type
R1	51-Ohm, 1/2-Watt composition
R2, 3	560-Ohm, 1/4-Watt composition
R4	1.8k-Ohm, 1/4-Watt composition
R5-8	2.2k-Ohm, 1/4-Watt composition
R9	4.7k-Ohm, 1/4-Watt composition
R10	8.2k-Ohm, 1/4-Watt composition
R11, 12	12k-Ohm, 1/4-Watt composition
R13	15k-Ohm, 1/4-Watt composition
R14	39k-Ohm, 1/4-Watt composition
R15	100k-Ohm, 1/4-Watt composition
R16	1 megohm, 1/4-Watt composition
T1	455-kHz miniature i-f transformer



# DSI STOPS BRANDS A thru Z with more counter for less money

FACTORY WIRED 500 MHz • 1 PPM TCXO • 8 DIGITS

**99<sup>95</sup>**

Without Battery Capability

**119<sup>95</sup>**

Includes Rechargeable Battery Pack and AC-9



- Two BNC Inputs
- 1 Meg and 50 Ohm Input
- Factory Wired and Tested
- Made in USA
- 50 Hz to 512 MHz

## Compare These Features and You Will Buy DSI

- 8 Digits *Not* 6 or 7 Digits
- 1 PPM TCXO *Not* 1.5 PPM - 10 PPM
- Resolution 1 Hz @ 50 MHz *Not* 10 Hz
- Resolution 10 Hz @ 450 MHz *Not* 100 Hz

## FREQUENCY COUNTER STRAIGHT TALK

There are only three functional requirements for a frequency counter: 1. Good accuracy over temperature 2. Resolution 3. Sensitivity

**Good accuracy over temperature.** Crystal oscillators drift with temperature changes. This change is specified in parts per million (PPM). The 5500 TCXO (temperature compensated crystal oscillator) holds an accuracy of 1 PPM from 17° to 40°C. This corresponds to ± 450 Hz at 450 MHz. Counters with 2 PPM accuracy would read to ± 900 Hz at 450 MHz. Counters with 10 PPM accuracy would read to ± 4500 Hz and so on.

**Resolution.** What is the value of the least significant digit displayed? A counter with 10 Hz resolution would display 146.52000 MHz as 146.52000 i.e. with the last digit left off. A counter with 100 Hz resolution would display 146.5200. The 5500 with 8 Digits is capable of resolving 1 Hz from 50 Hz to 50 MHz and 10 Hz from 50 MHz to 500 MHz. Counters with only 7 digits usually can only resolve 10 Hz to 50 MHz and 100 Hz to 500 MHz. The above effects, accuracy and resolution are cumulative. Example: a seven-digit counter with 1.5 PPM accuracy reading 450 MHz would only be accurate to ± 675 Hz ± 100 Hz (last digit error) or ± 775 Hz. The 5500 with eight full digits and 1 PPM accuracy would be accurate to ± 450 Hz ± 10 Hz (last digit error) or ± 460 Hz maximum. Not bad for \$99.95. You really need that eighth digit to achieve real accuracy.

**Sensitivity.** The 5500 requires only 10-15 mv of signal to stabilize and achieve an accurate reading. A one watt hand-held can be read with accuracy at a distance of 15-20 ft. from the counter using the T600 antenna. Counters with 150 mv sensitivity will only stabilize at distances of less than a foot.

The outstanding sensitivity of the 5500, the result of its unique engineering design, and built-in preamp assures stable, accurate readings every time you key up your transmitter.

If you are tired of receiving a plastic bag of sometimes surplus, sometimes defective material only to spend all night trying to solder both sides of the PC Board because the manufacturer chose to use low cost PC Boards without plated-thru holes; if you chose a kit because you only budgeted a hundred dollars for a frequency counter, then the DSI 5500 Counter is the answer. It is 100% factory assembled and tested. DSI strives to purchase the highest quality, prime materials imposing the most rigorous quality requirements possible. Every PC Board that DSI manufactures is plated-thru solder re-flowed, and 100% factory assembled, tested and burned-in in the USA, assuring years of trouble-free service. DSI has worked hard to achieve our worldwide reputation for the best price to quality features ratio in the industry. DSI's 5500 now makes it possible to buy a 100% factory assembled accurate 8-digit frequency counter for under \$100.00. Buy quality — Buy performance — Buy cost effectiveness — Buy DSI.

FOR INFORMATION — DEALER LOCATION — ORDERS — OEM  
CALL 800-854-2049 CALIFORNIA RESIDENTS CALL 800-542-6253

Model	Price	Frequency Range	Accuracy Over Temperature	SENSITIVITY			Number of Readouts	Power Requirements	Size		
				@ 100 Hz - 25 MHz	@ 50 - 250 MHz	@ 250 - 450 MHz			H	W	D
5500	\$99.95	50 Hz - 512 MHz	TCXO 1 PPM 17° - 40°C	10 - 15 MV	10 - 15 MV	15 - 50 MV	8	*115 VAC or 8.2 - 14.5 VDC	1 1/2"	5"	5 1/2"

\*With AC-9 Adaptor.

5500 wired factory burned-in 1 year limited warranty. Prices and/or specifications subject to change without notice.

**TERMS:** MC - VISA - AE - Check - M.O. - C.O.D. in U.S. Funds. Please add 10% to a maximum of \$10.00 for shipping, handling and insurance. Orders outside of USA & Canada, please add \$20.00 additional to cover air shipment. California residents add 6% Sales Tax.



**DSI INSTRUMENTS, INC.**  
9550 Chesapeake Drive  
San Diego, California 92123  
(714) 565-8402

- 5500 Wired ..... \$99.95
- 5500/W 55BA ..... 119.95
- Includes Rechargeable NiCad Battery Pack and AC Adapter.
- T600 BNC Antenna ..... 7.95
- AC-9 AC Adapter ..... 7.95

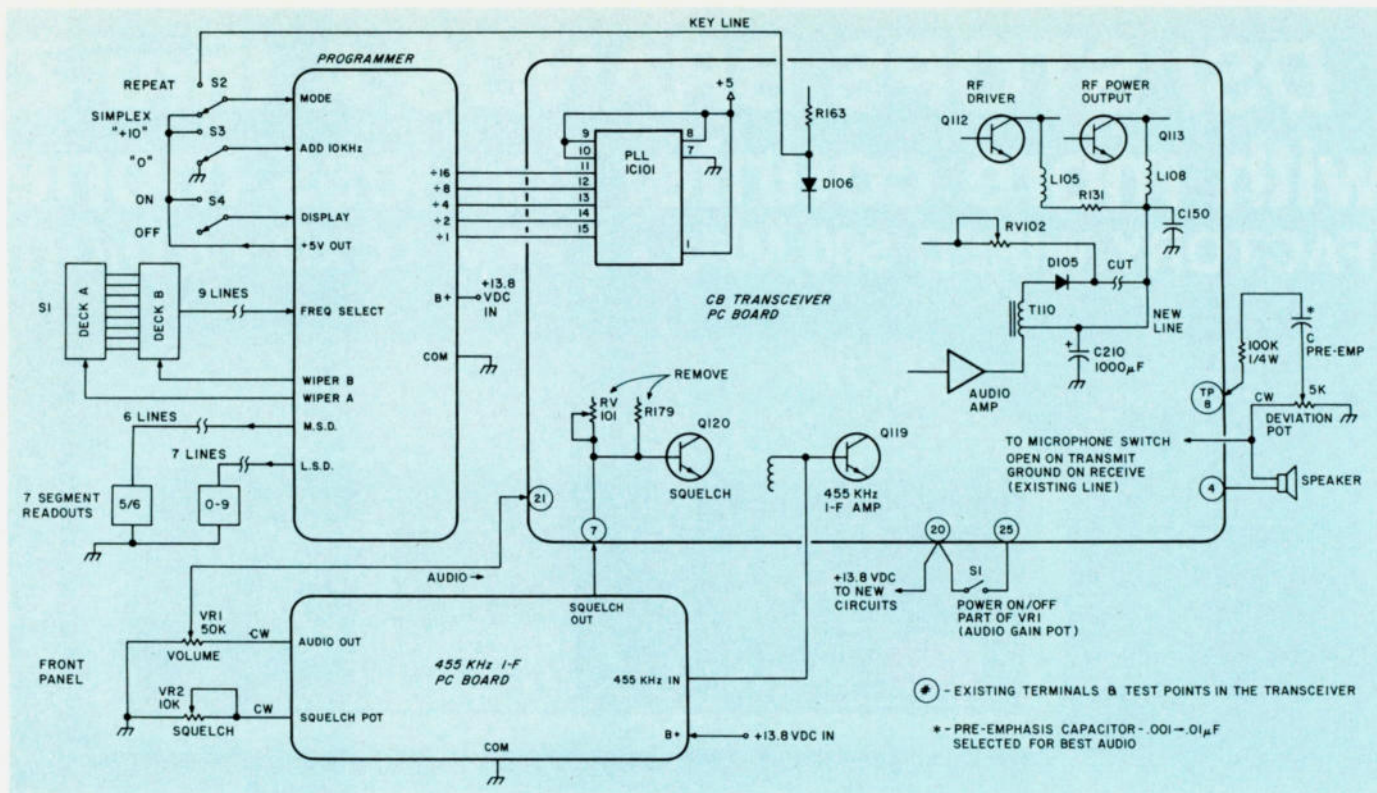

Fig. 2 Interconnection diagram.

which are useful are a noise blander in the wide-bandwidth section of the receiver and the squelch. Unfortunately, the existing squelch is level activated. This is changed to a noise-activated circuit later in the conversion. The wisest course is to buy the cheapest models since extra features are wasted in the FM conversion.

### Transceiver Conversion

The CB-to-10-meter FM conversion is only slightly more difficult than converting a CB for 10-meter AM operation and can range in complexity from a simple bare-bones modification to a deluxe treatment with digital readout and repeater capability. The conversion can be done in stages starting with the basic modification to whet your appetite and adding the additional features as time permits. A warning should be given here. As soon as you have one of these radios converted and operating on 10 FM, you may not be able to turn it off and add the remaining mod-

ifications.

Below is a list of four conversion steps with possible options. The steps will be described in detail later in the text. It should be noted that all four steps must be completed, but only one option per step is required.

### Conversion Steps and Options

- 1) Change the vco offset crystal, X101, and retune the transceiver to 10 meters.
- 2) Modify the transmitter for FM.
- 3) Modify the receiver for FM.
  - (a) Slope detect and use the existing level-activated squelch.
  - (b) Add the 455-kHz FM detector/squelch board.
- 4.) Select the frequency programming scheme
  - (a) Use the existing CB channel-selector switch.
  - (b) Install thumbwheel BCD programming switches.
  - (c) Construct the frequency-programming board without the 7-

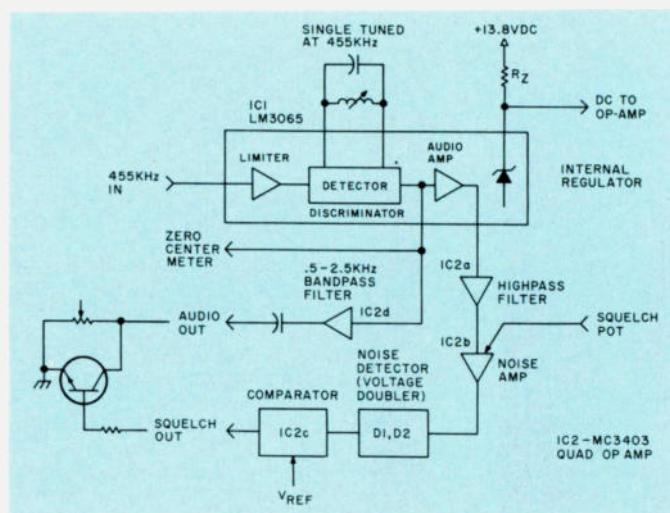

Fig. 3. Block diagram, 455 kHz limiter, discriminator, and squelch PC board.

segment LED readouts. (d) Construct the frequency-programming board with LED readouts.

The above steps are listed in the order in which the first conversion was accomplished. The transceiver was first converted to the high end of 10 meters and tuned for AM operation. The vco was then audio-modulated to produce FM in transmit. The receiver was operated with

Model	Manufacturer
2310B	Kraco
4010B	Kraco
2320B	Kraco
4020B	Kraco
Micro 223	Lafayette
HB 650	Lafayette
HB 750	Lafayette
HB 950	Lafayette
#1	Hy-Gain
#2	Hy-Gain
#9	Hy-Gain
Tiger 40A	Pierce Simpson
13-888B	Midland
13-882C	Midland

Table 1. CB transceivers suitable for this conversion.

# DSI GOES LCD

TRUE RMS - 3½ DIGITS - DMM - .1% BASIC ACCURACY

**149<sup>95</sup>**

**LC 5000**

**FACTORY WIRED**

**AVAILABLE  
JANUARY 1980**



## RANGES

- AC TRUE RMS TO 1000V — 200mv, 2v, 20v, 200v, 1000v
- DC VOLTAGE TO 1000V — 200mv, 2v, 20v, 200v, 1000v
- DC CURRENT TO 2 Amps — 200μa, 2ma, 20ma, 200ma, 2A
- RESISTANCE TO 20 Megohms — 200, 2k, 20k, 200k, 2mg, 20mg

## AN UNPRECEDENTED DSI VALUE . . . .

in a high quality, LSI Design, .1% basic accuracy, 3½ digit DMM and because it's a DSI innovation, you know it obsoletes all competitive makes, both in price and performance.

No longer do you have to settle for small readouts, short battery life, a kit with a bag of parts, a black box with 20 Resistors that need adjustment every time you need to recalibrate, because you only budgeted \$100.00 or \$150.00 for a DMM.

The Model LC 5000 is factory assembled and tested in the USA. DSI has designed in Precision Laser Trimmed

Resistor Networks to provide maximum accuracy, resulting in long time periods between recalibration and a simple two adjustment calibration procedure. The LC 5000 incorporates a fused input circuit to help prevent damage to the DMM. The large .5 inch LCD Readouts are easy to read even in the brightest sunlight and allows for very low battery drain, normally only two battery changes a year is required. The LC 5000 is the perfect lab quality instrument on the bench or in the field — you can depend on DSI LC 5000 to meet all your needs. Buy Quality — Buy Performance — Buy Reliability — Buy DSI.

**FOR INFORMATION — DEALER LOCATION — ORDERS — OEM  
CALL 800-854-2049 CALIFORNIA RESIDENTS CALL 800-542-6253**

LC 5000 wired factory burned-in 1 year limited warranty. Prices and/or specifications subject to change without notice or obligation.  
**TERMS:** MC - VISA - AE - Check — M.O. - C.O.D. in U.S. Funds. Please add 10% to a maximum of \$10.00 for shipping, handling and insurance. Orders outside of USA & Canada, please add \$20.00 additional to cover air shipment. California residents add 6% Sales Tax.



**DSI INSTRUMENTS, INC.**

9550 Chesapeake Drive  
San Diego, California 92123  
(714) 565-8402

**Model LC 5000 . . . . \$149.95**

**LCBA - Rechargeable  
Battery Pack Includes  
AC Battery Charger . \$24.95**

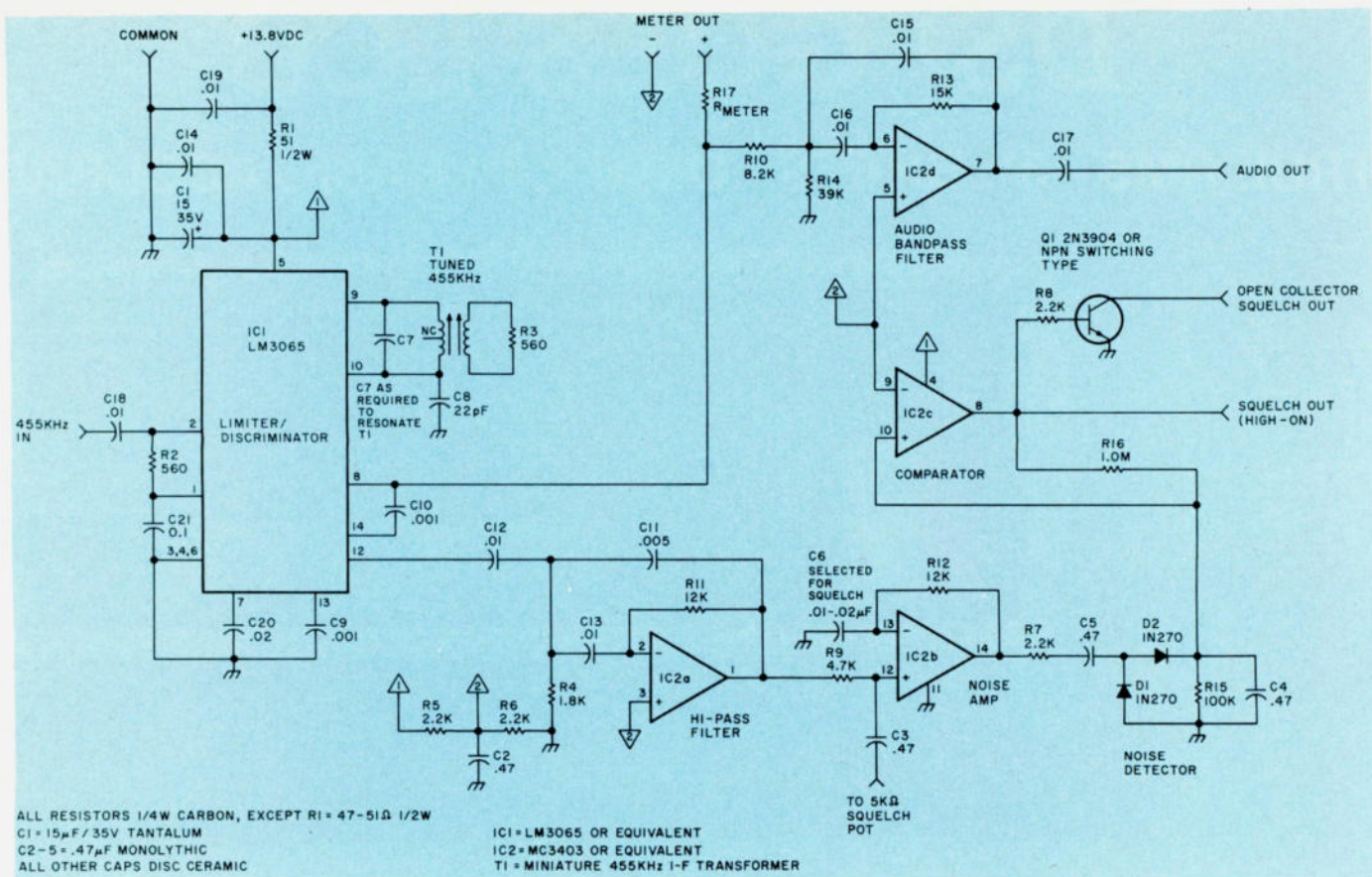

Fig. 4. 455 kHz FM i-f strip.

slope detection on receive; however, this proved to be unsatisfactory. A PC board with limiting amplifiers, FM detection, and noise-activated squelch was developed to provide improved FM reception. The final step was the evolution of frequency-programming techniques.

### Step 1. Change the Vco Offset Crystal

#### Crystal Selection

The offset-crystal frequency is tripled and subtracted from the vco frequency. Thus, to raise the vco operating frequency, one can simply raise the offset-crystal frequency by 1/3 of the vco frequency increase desired. Looking ahead to step 4, one can see that selecting the correct offset crystal is important. If a crystal is special-ordered, 12.65167 MHz is recommended. This will permit later modifications to be made without purchasing another crystal. This crystal

puts CB channel 1 on 29.5 MHz. For example, 29.5 MHz is 2.535 MHz higher than channel 1 (26.965 MHz). Thus, X101 is increased from 11.8066 MHz by 2.535 MHz divided by 3, or .845 MHz, to 12.65167 MHz. The transceiver can be operated from 29.5 (channel 1) to 29.690 (channel 16) with 29.6 MHz on channel 9 without changing the CB programming switch.

A crystal in the 37.9-MHz range can also be used for the offset crystal. A source of such crystals is older, crystal-synthesized, 23-channel CB sets. Many of them contain six crystals in the 37.6-to-37.9-MHz range. This is an inexpensive source for conversions using the existing CB channel switch.

#### Tune-Up

Install the new frequency-offset crystal in place of the 11.8066-MHz crystal at X101. The transceiver tune-up follows.

#### Vco Alignment

- Set the frequency programmer to 29.5 MHz, or channel 1.
- Monitor the voltage between TP8 and ground at the junction of R114 and R115.
- Adjust T101 to obtain 1.5 volts.
- Set the frequency programmer to 29.69 MHz (channel 16). The voltage should be approximately 3 volts.

#### Transmitter Alignment

- Set the transmit frequency to 29.6 MHz.
- Connect the output to a 5-Watt, 50-Ohm dummy load.
- Connect an oscilloscope or receiver tuned to 29.6 MHz to the junction of T102 and C141.
- Adjust L103, L104, and T102 for maximum signal at 29.6 MHz.
- Monitor the signal on the base of Q112 and adjust T102 and T103 for maximum amplitude.
- Monitor the output

power for the remaining steps.

- Adjust L106, L109, and L110 for maximum output.
- Repeat the above, tuning for maximum power out.
- Check output frequency and power out at 29.5 MHz and 29.69 MHz (channels 1 and 16).
- Set the exact operating frequency by adjusting CT101, a trimmer capacitor in the offset-oscillator circuit.

#### Receiver Alignment

- Set the receiver frequency to 29.6 MHz.
- Connect a 29.6-MHz signal source to the input.
- Adjust T104 and T105 for maximum signal.

#### Alignment Hints

Care should be taken in tuning these miniature transformers. Make sure you have the correct size non-metallic tuning tool and don't force them. All slugs will tune as you turn counter-clockwise out of the can. Less inductance is

# DSI HAS DONE IT AGAIN QUIK-KIT II®

## WITH 10 MHz PROPORTIONAL OVEN TIME BASE

- DC-BATT-AC (W-AC9)
- 95% Factory Assembled
- External 10 MHz Input
- External 10 MHz Output
- 100% Factory Tested
- .2 PPM 10° to 40° C Accuracy Proportional Oven
- 9 Digits .5 Inch LED's
- 0.1 Hz Resolution to 50 MHz
- Auto Zero Blanking



**\$149<sup>95</sup>**

MODEL 5600A KIT

**WHY BUY A 5600A:** Because 95% of the assembly is completed by DSI and you are only one hour away from solving all those difficult bench problems, from setting the frequency of an audio signal to within 1/10 of a HZ, to checking the frequency of a 486 MHz mobile radio. Whether you are servicing a VTR, trouble shooting a PLL circuit, the 5600A is the right counter with accuracy that will meet any FCC land mobile, broadcast, or telecommunications requirements. On the bench or in the field the 5600A will do the job you need. The 5600A includes a self contained battery holder providing instant portability or we offer a 10 hour rechargeable battery pack option. Other options include an audio multiplier which allows you to resolve a 1/1000 of a HZ signal and finally a 25db preamplifier with an adjustable attenuator making the 5600A perfect for communications, TV servicing, industrial testing or meeting your QSO on the correct frequency every time.

**FACTS ARE FACTS:** With the introduction of the 5600A. The sun has set on the competition. This may sound like a bold statement on the part of DSI BUT FACTS ARE FACTS. No counter manufacturer except DSI offers a Full Range 50 HZ to 512 MHZ counter with — 9 Digits — 0.1 HZ resolution — .2 PPM 10° to 40° C proportional oven — RF pre-amp — 600 MHZ prescaler — three selectable gate times — oven ready, standby and gate time indicator lights as standard features — For only \$149.95 kit and \$179.95 factory wired. In fact the competition doesn't even come close unless you consider \$200.00 to \$800.00 close. With DSI having the best price to quality features ratio in the industry, no wonder we've become one of the world's largest manufacturers of high quality frequency counter instrumentation.

**FOR INFORMATION — DEALER LOCATION — ORDERS — OEM  
CALL 800-854-2049 CALIFORNIA RESIDENTS CALL 800-542-6253**

Model	Price	Frequency Range Typ	Accuracy Over Temperature	Sensitivity Typ			Number of Readouts	Power Requirements	Size H W D
				@ 100Hz-25MHz	@ 50-250MHz	@ 250-450MHz			
5600A-K	\$149.95	50Hz-550MHz	Proportional Oven	5-10MV	5-10MV	5-50MV	9	*115 VAC or 8.2-14.5 VDC	3 1/4" x 9 1/2" x 9"
5600A-W	\$179.95		2 PPM 10° - 40° C						
5500 Wired	99.95	50Hz-550MHz	TCXO	10-15MV	10-15MV	15-50MV	8	*115 VAC or 8.2-14.5 VDC	1 1/2" x 5" x 5 1/2"
500HH Wired	\$149.95	50Hz-550MHz	TCXO	25MV	20MV	75MV	8	*115 VAC or 8.2-14.5 VDC or NICAD PAK.	1" x 3 1/2" x 5 3/4"

5600A wired factory burned in 1 year limited warranty. 5600A kit 90 day limited warranty. Prices and/or specifications subject to change without notice or obligation.

- \*With AC-9 Adaptor
- 5600A Kit ..... **\$149.95**
- 5600A Wired ..... **179.95**
- AC-9 AC Adaptor..... **7.95**
- T600 BNC Ant. .... **7.95**

**BUILT-IN OPTIONS**

- BA56 Rechargeable 10 Hr. Bat. Pack ..... **29.95**
- AM56 Audio Multiplier .001Hz Resolution ..... **34.95**
- PA56 25dB Preamplifier with Attenuator ..... **59.95**

**3550 OWNERS**  
You can add the 35P.2 .22 PPM 10° to 40° C proportional oven to your existing 3550

35P.2 ..... **29.95**  
Factory Installed ..... **49.95**

**AMERICAN EXPRESS** **Master Charge** **VISA**

**DSI INSTRUMENTS, INC.**  
9550 Chesapeake Drive  
San Diego, California 92123  
(714) 565-8402

**TERMS:** MC - VISA - AE - Check - M.O. - COD in U.S. Funds. Please add 10% to a maximum of \$10.00 for shipping, handling and Insurance. Orders outside of USA & Canada, please add \$20.00 additional to cover air shipment. California residents add 6% Sales Tax.

needed at the higher frequencies. If a slug is broken and unremovable, the i-f transformer can be unsoldered from the board and the slug removed from the bottom of the can.

### Step 2. Modifying the Transmitter for FM

a) Disable the amplitude-modulated power-supply line that feeds the driver and rf power amplifier. This originates at D105 on the high end of the audio output transformer. Cut the circuit board conductor connecting the cathode of D105 to the junction of C150 and R131. Next, connect the junction of C150 and R131 to the positive side of C210, a 1000- $\mu$ F electrolytic, to obtain pure dc for the transmitter.

b) Introduce FM to the phase-locked loop. Wire the transmit audio circuits as shown in Fig. 2, and drive TP8 which will FM the vco and likewise the output transmit frequency.

### Step 3. Modifying the Receiver for FM

a) Slope detection can be accomplished by using the existing receiver delta tune which offsets the receiver frequency. The existing level squelch can also be used, but neither of these techniques can be recommended since all of the reasons for operating on FM are lost if no limiters and noise-activated squelch circuits are employed. The limiter will improve the signal-to-noise ratio and maintain constant volume. The noise-activated squelch will operate only on real signals, muting the receiver for any noise bursts which do exist on 10 meters.

b) The 455-kHz FM detector/squelch board replaces the level-activated squelch and slope detection which were not adequate for useful FM communication. To complete the FM conversion, a PC board consisting

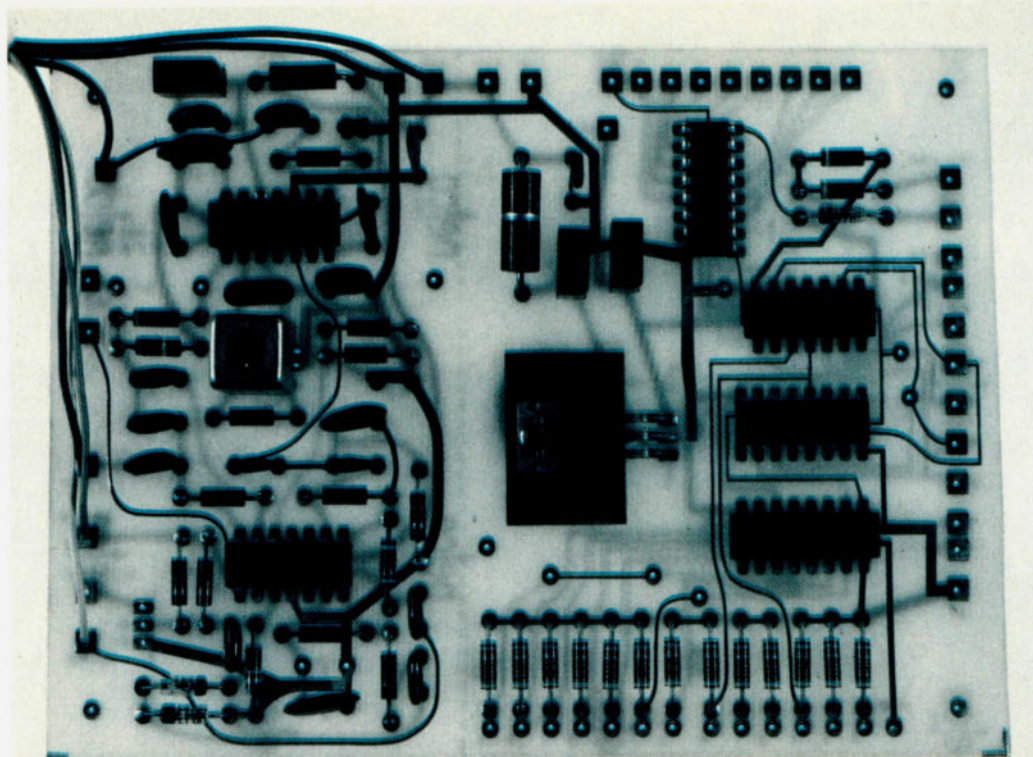

Top view of combination printed circuit board. The i-f strip is to the left and the frequency programmer is to the right. The board can be divided near the middle to separate functions or to make use of just one. The finished boards now have silk-screened component and lead identification.

of two integrated circuits and 40 discrete components was designed to provide i-f limiting, FM discrimination, receive audio shaping, and a noise-activated squelch control output.

A National LM3065 integrated circuit was used for the limiter/discriminator section of the circuit.<sup>5</sup> This IC was designed for 4.5-MHz TV sound service, but works well at 455 kHz for NBFM. The IC has an internal temperature-compensated voltage regulator which also is used to provide regulated dc to the remaining portions of the circuit. A Motorola MC3403 quad op amp is the second integrated circuit on the board. It is an excellent choice for this type of service since it is designed to operate from a single-ended power supply. The op amps are functionally equivalent to the standard 741 types.

The block diagram of the circuit board, Fig. 3, shows

the major functions of the FM i-f strip. The schematic diagram of the circuit is Fig. 4. The 455-kHz bandpass-filtered signal from the last i-f amplifier in the receiver is applied to the input of IC1. The signal is amplified by three differential limiter stages. The 3-dB limiting point is about 200 microvolts. The FM signal is detected by the internal differential peak detector which is set to the i-f frequency by a single-tuned 455-kHz LC parallel network. Standard miniature i-f transformers were used. The secondary was resistively loaded. We obtained a bagful of transformers from Poly Paks<sup>®</sup> which were unmarked.<sup>3</sup> Two types were usable. The LF-115 resonates with 100 pF across the primary and the LF-116 with 220 pF. Silver-mica capacitors are recommended for temperature stability in the tuned network.

An output can be taken from this stage to drive a

zero-center "frequency" meter. This is useful for netting off-frequency stations. Resistor R17 connects to the positive side of the meter. Resistors R5 and R6 provide a reference voltage at one-half the supply voltage. This point biases the negative side of the meter. The zero-frequency output of the discriminator is nominally at this potential. The meter should be a 100-0-100  $\mu$ A movement. Potentiometers can be used in place of the fixed resistors to provide for gain and zero-adjust in the meter circuits.

The output of the detector is fed to section 2d of the quad op amp. This is an active bandpass filter with minus 3-dB points of 500 Hz and 2.5 kHz. The audio level at this section's output was sufficient to drive the existing audio amplifier in the CB set to full output. The output of the detector also is fed to an internal audio amplifier with 20 dB

Channel #	+ N Ratio	Frequency (MHz)
1	224	26.965
2	225	.975
3	226	.985
4	228	27.005
5	229	.015
6	230	.025
7	231	.035
8	233	.055
9	234	.065
10	235	.075
11	236	.085
12	238	.105
13	239	.115
14	240	.125
15	241	.135
16	243	.155
17	244	.165
18	245	.175
19	246	.185
20	248	.205
21	249	.215
22	250	.225
23	253	.255
24	251	.235
25	252	.245
26	254	.265
27	255	.275
28	256	.285
29	257	.295
30	258	.305
31	259	.315
32	260	.325
33	261	.335
34	262	.345
35	263	.355
36	264	.365
37	265	.375
38	266	.385
39	267	.395
40	268	.405

Table 2. Channel number, PLL divide-by-N ratio, and original CB operating frequency using the CB programming switch. For both 23- and 40-channel models.

of gain. The output of this stage is high-pass filtered by section 2a of the quad op amp. This signal path is

used to amplify the noise component of the input signal. The output of section 2a is fed to section 2b which

is a noise amplifier. The input to this stage is attenuated by the squelch-level potentiometer on the front panel to provide the proper squelch level for the receiver.

The output of section 2b is fed to the noise detector consisting of diodes D1 and D2. The detector is configured as a voltage-doubler whose output is filtered by R15 and C4 which also provides a time constant to discriminate against nuisance tripping of the squelch circuit. The detected and filtered noise signal is fed to section 2c of the quad op amp to be compared with the fixed reference voltage developed across the R5-R6 voltage divider. As the receiver is quieted by an input signal, the detected-noise components level falls below the comparison level and the output of section 2d falls to ground level. The output of 2d is at nearly supply voltage when the squelch is on. The squelch action is adjusted by varying the value of C6 so a 2- to 3-microvolt signal cannot be squelched out with the squelch control pot set fully clockwise. A typical value of C6 is 0.01 uF.

The existing squelch transistor can be keyed by the new squelch line or a transistor can be switched to ground potential at the

volume-control potentiometer as shown in the block diagram, Fig. 3. Individual preferences determine the placement of the squelch switch in the circuit for the best listening comfort.

To convert the receiver to FM detection, install the FM i-f strip and run 13.8 volts and common to the board. Run a lead from the base of Q119 on the main transceiver to the "IF-IN" connection on the new i-f strip. Disconnect the squelch pot from TP7 and run it to "SQ-POT" on the new pc board. Run a lead from "SQ-OUT" to TP7 on the main board. Remove the lead from the top of the volume control pot to TP19 and run the lead to the "AO" (audio out) port on the new i-f board. A zero-center microammeter can be connected between M-Plus and M-Minus on the new board to monitor the discriminator.

#### Step 4. Select Frequency Programmer

a) Use the existing CB channel-selection switch with no changes to the transceiver. This requires no effort at all, but has some limitations since the CB switch skips certain frequencies which may be desired. For example, if the 12.65167-MHz offset crystal were to be installed, 29.68 MHz would not be obtainable directly with the CB switch. Since no effort was required for this step, why not look to the other options for more capability.

b) Install thumbwheel, octal, or BCD programming switches. This option requires some additional construction, but permits complete frequency coverage and, with the addition of a second set of programming switches, allows multiplexing transmit and receive frequencies for repeater operation. The switches can be BCD, octal, or individual toggle switches. Fig. 5

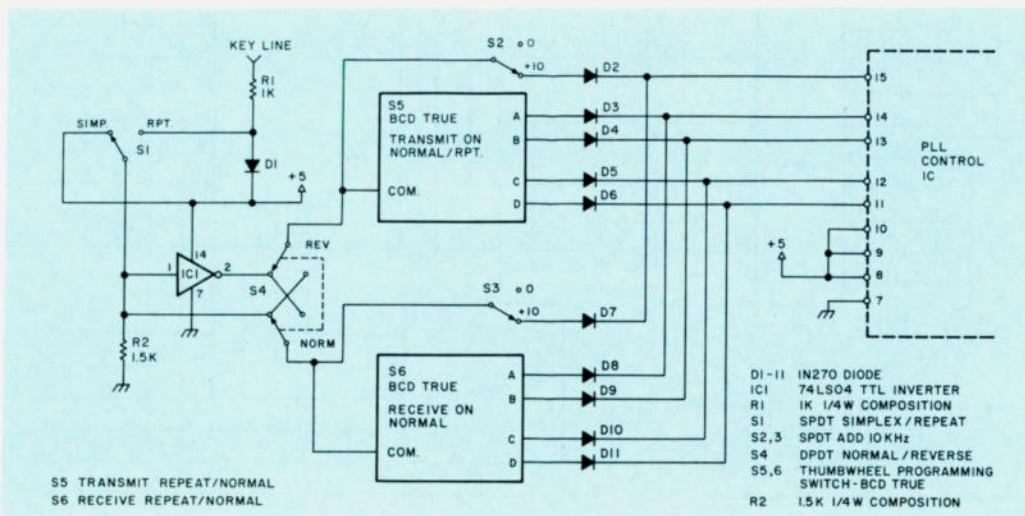

Fig. 5. BCD switch frequency programmer.

shows a programming scheme consisting of separate BCD-coded switches for receive and transmit. A toggle switch is included to add 10 kHz to either frequency. Steering diodes are used to logically OR the outputs of the switches to the PLL input. A key line in the transceiver is sensed to alternate between receive and transmit while in the repeat mode. It will be described in more detail in the following section. This is the simplest complete frequency-coverage scheme, but has a few problems. The non-direct frequency-reading switches, with each BCD digit equaling 20 kHz, leads to confusion. Repeater operation is not automatic. Both switches have to be set.

c) Construct the frequency programming board without LED readout. This step can be accomplished by omitting the readouts and 7-segment decoder chips from step 4d.

d) Construct the frequency-programming board with LED readouts. We finally bit the bullet after going through several generations of simple programmers, and designed a digital encoder that included 10-kHz steps from 29.5 to 29.7 MHz, automatic coverage of all the 100-kHz repeater splits and their reverses, one-switch frequency selection, and a 7-segment LED readout of the operating frequency.

The circuit in Fig. 6 was designed with low-power Schottky TTL. Five integrated circuits, a 10-position, 2-deck rotary switch, and 3 miniature SPDT toggle switches are needed for the design. To make use of this programmer, a 37.955-MHz crystal is used in the offset oscillator ( $12.65167 \text{ MHz} \times 3$ ). The 5 least-significant divide-by lines are digitally programmed to the PLL control IC. The divide-

by-32, -64, and -128 lines are fixed-programmed by connecting them to plus 5 V dc. The divide-by-256 line is disabled by leaving it open or grounding it. A divide-by ratio of 224 is entered to the PLL chip with no input from the programmer. The transceiver operates at 29.5 MHz at this no-input setting.

S1 is the front-panel programming switch. It is a 2-deck, 10-position rotary switch which was modified by rotating the rear deck by 180 degrees. This was done to make the wiring easier. Two single-deck switches could be used if repeater splits of other than 100 kHz are desired. S2 is the simplex/repeat switch. In the simplex position, 5 volts is applied to section F of IC2. This inverts the 5-volt signal to a TTL logic low and applies it to the selected input of IC1 through deck A of S1. This 74LS147 is a 10-line-to-BCD decoder which responds to a low-level signal on one of its inputs. A zero condition is decoded when the 9-input lines are high.

No pull-up resistors are needed on the disconnected inputs since they will bias themselves to a high (off) state.

With S2 in the repeat position, the 9-volt transmitter key line in the transceiver is monitored at the junction of R163 and D106. This point is clamped to the 5-volt supply through R1 and D1 to make the signal TTL-compatible. The signal is a logic high in receive and a low in transmit. The logic low signal to IC1 will now toggle between the two wipers of S1, deck A on receive, and deck B on transmit. Each switch position adds 20 kHz, therefore a 100-kHz change is introduced with the 5-position switching in the repeater mode. 100 kHz is subtracted on transmit while receiving above 29.6 MHz and added on transmit while listening below 29.6 MHz. The output of IC1 is inverted from the true high logic needed to program the PLL IC. The 4 output lines are run through 4 sections of

the 74LS04 inverter (IC2) to get the signal back to the true form. These 4 lines program the divide-by-2, -4, -8, and -16 inputs to the PLL IC. S3 will add 10 kHz to the operating frequency. It programs the least-significant digit (pin 15) of the control IC.

The plus 10-kHz line from the wiper of S3 and the four inverted outputs of IC1 are run to IC3 and IC4. These are the 7-segment display decoders. IC3 is a binary to BCD decoder. Its most-significant digit appears on pin 4. This output, when in the high state, is equal to an entered count of 100 kHz or more from the programmer, or 29.6 MHz and above. Only two segments of the most-significant digit 7-segment readout need to be changed to go from a 5 to 6. These are segments a and e. The switching to accomplish this change is done by section E of IC2. The least-significant digit (0-9) is decoded by the 74LS48, a BCD-to-7-line decoder.

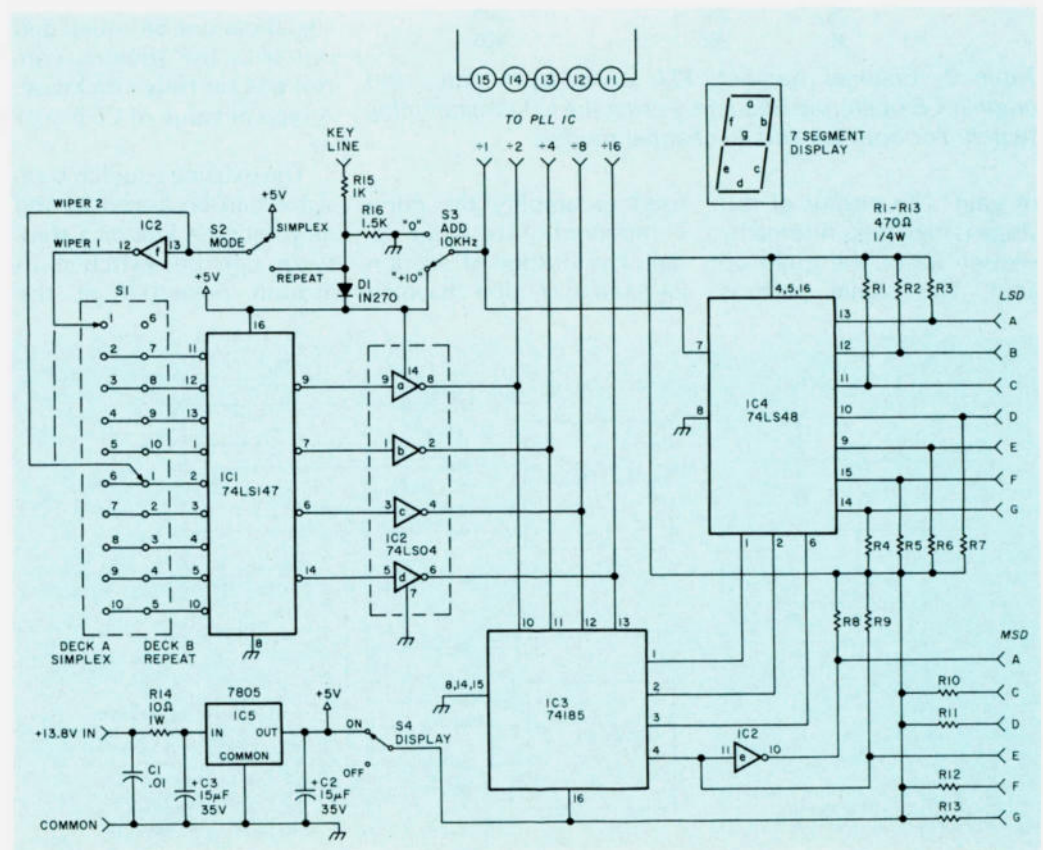

Fig. 6. Frequency programmer.



Since common-cathode 7-segment readouts were used, pull-up resistors are needed on each segment drive line to the displays. A DIP resistor package containing 13 resistors, with one side of each internally connected, could be used to save space on a printed circuit board. All of the logic is static, so there is no digital noise pickup in the receiver. Switch S4 will disable the display electronics as a power-saving measure.

IC5 is the monolithic 3-pin, 5-volt voltage regulator which powers this circuitry. It should be mounted on a small heat sink. Resistor R2 is used for dropping the unregulated voltage to the regulator to keep its power dissipation down. The internal speaker in the transceiver was removed to make space for the two added printed circuit boards. The internal

speaker was unusable for mobile work anyway, due to its directionality.

### Antennas, Amplifiers, and Such

We placed many of these transceivers in mobile service, so vertical polarization is a necessity in our local operating area. Any of the CB antennas can be used on 10 with some judicious pruning. A favorite of ours is the Antenna Specialists' "Star Duster" series. It is a ¼-wave vertical ground-plane type that resonates across the entire 10-meter band by chopping 6 inches from the vertical radiator and each of the ground-plane elements. Standard 8-foot whips are used in the mobile installations.

Five Watts of power was not adequate for mobile operation with our New England hills, so we put many CB "trucker special" 50- and 100-Watt, solid-

state linear amplifiers to good use in mobile service before the FCC took a dim view of the goings-on at 11 meters. These amplifiers were all of excellent quality, and with the addition of a low-pass section on the output, met all the relevant spurious and harmonic specs.

### A Few Closing Comments

Since the spring of 1977, approximately 40 of these rigs have been completed, and we are just scratching the surface of conversion possibilities. This is the first time a modern solid-state, synthesized transceiver has been available for pennies. We hope this article will force a few dormant soldering irons out of retirement.

Let's get some club projects going using these rigs for emergency communications. A split-site portable repeater using a microwave link looks like duck soup.

How about a CW Novice rig using the printed circuit boards? A zero-to-30-MHz general coverage receiver, anyone?

Many thanks to Denny Dittrich WA1VKS<sup>6</sup> for the printed circuit layouts. Denny has combined the iF strip and the programmer on one PC board to save space and cost. The board is available for \$7.00, which includes the postage. See you on 29.6 FM! ■

### References

1. Steve Herman WA7WYF, "Try FM on 29.6 MHz," *73 Magazine*, November, 1978, p. 184.
2. Surplus Electronics Corp., 7294 NW 54 St., Miami FL 33166.
3. Poly Paks, PO Box 942, South Lynnfield MA 01940.
4. Clay Walsh W1PI, "CB to 10, Part XII," *73 Magazine*, October, 1978, pp. 254-255.
5. National Semiconductor Corp., *Linear Data Book*, 1976, pp. 10-138 and 10-139.
6. Dennis Dittrich WA1VKS, RFD #3, Box 88, Willimantic CT 06226.

NOTE to

73

Subscribers

From time to time 73 Magazine makes its subscriber lists available to carefully-screened companies and organizations whose products, services or information may be of interest to you. In every case, we must approve all organizations wishing to mail to our subscribers. In every case they receive a list of names and addresses only—no other information we may have is divulged. Each organization may use the list only once and agrees never to make any personal or telephone solicitations from it.

The overwhelming majority of our subscribers appreciate this controlled use of our mailing lists—it helps them shop conveniently by mail for products and services they need, often at substantial savings. A few people prefer their names not be used. It is to them we address this message.

If you do *not* wish to be a part of this service, please complete the form below . . . your name will not be used in this manner for any reason.

(If you asked us in the past to remove your name from our lists, there is no need to repeat the request.) Please allow about six weeks for your request to take effect.

\*\*\*\*\*

I wish to have my name removed from the list of subscribers receiving mail other than the regular subscription to 73 Magazine.

\*\*\*\*\*

Mr. \_\_\_\_\_  
Mrs. \_\_\_\_\_  
Ms. \_\_\_\_\_

Please Print

Address \_\_\_\_\_  
City \_\_\_\_\_ State \_\_\_\_\_ Zip \_\_\_\_\_

Mail this form with your mailing label from the latest issue (or fill out the information as it appears on the label) to:

73 Magazine  
Subscription Services Dept.  
P.O. Box 931  
Farmingdale NY 11737

## 10-METER FM THE EASY WAY

This page of 73 contains the final part of a superb article on CB-to-10-meter FM by Nick K1DCS, Andy N1XN, and Bob N2XN. Their well-written and easy-to-follow instructions assure you of quick and trouble-free conversion. Since 10-meter conversions are our specialty, we are quite pleased to be working with them to provide the parts for a low-cost 10-meter FM kit.

Now in stock! We presently have a limited quantity of these kits on hand and will restock according to your requests. We have plenty of PC boards and plan to offer several optional kits for various chassis. Requests for custom designs are welcome.

---

For the latest facts on these FM kits and our free 1980 10-meter catalog containing AM/SSB kits for over 300 CB models (as well as dozens of other unique items for the kit builder), call or drop us a card today.

AMERICAN CRYSTAL SUPPLY CO.

PO BOX 638

W YARMOUTH, MA 02673

(617) 771-4634

AS8



# INEXPENSIVELY SUPERIOR

## The DS2000 KSR is the lowest priced RTTY terminal available with these advanced features:

- TX/RX operation on Baudot and ASCII RTTY plus Morse Code (Morse RX optional)
- Integrated keyboard and video generator allows editing of transmit text
- Full 24 line by 72 characters per line display
- Bright/dim display of characters differentiates between TX and RX display
- Morse receive option may be added at any time
- Separate CW identification key for RTTY operation
- Status line on top of screen shows terminal operating conditions
- Pretype transmit message into 255 character buffer; edit before transmitting
- 2 programmable "Here Is" messages
- Word-wrap-around prevents word splitting at end of display line
- Word mode allows editing of text to be transmitted
- Quick Brown Fox and RYRY test message keys
- Small size metal cabinet gives effective RFI shielding from transmitters
- Loop compatible RTTY connections and plus or minus CW key connections
- 110 and 300 baud ASCII
- 45,50,57,74,100 baud Baudot
- 1-175 wpm Morse transmit
- 1-175 wpm optional Morse receive
- 120/240 v, 50/60 Hz power
- Internal CW side-tone
- UnShift On Space for Baudot
- Keyboard Operated Switch
- SYNC idle for RTTY
- One year warranty

BUY NOW AND SAVE  
 PRICE INCREASE COMING  
 Effective 2/1/80

*Write or give us a call. We'll be glad to send you our new RTTY catalog.*



**HAL COMMUNICATIONS CORP.**  
 Box 365  
 Urbana, Illinois 61801  
 217-367-7373

For our European Customers Contact:  
 Richter & Co., D3000 Hannover 1  
 I.E.C. Intereico, 6816 Bissone/Lugano

DS2000 KSR.....	\$449.00
ESM-914 Video Monitor...	\$150.00
MR2000	
Morse receive option....	\$149.00

# Home-Brew Holders for Icom Portables

— keeps your IC-502, -202, or -215  
on the level

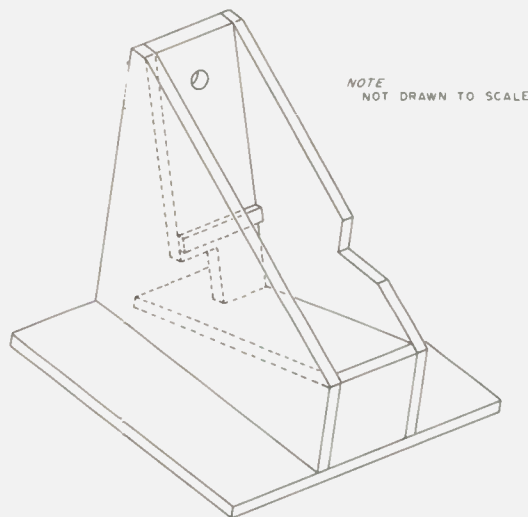

NOTE  
NOT DRAWN TO SCALE

*Alfred Pacheco KH6IAA  
20 Mokuhonua Lane  
Hilo HI 96720*

The Icom IC-502, IC-202, and IC-215 are popular transceivers. Although they were designed mostly to hang on a strap, many are in use as base station units or portable units on desks, car seats, etc. Operating them as such is difficult enough without having them topple over on their sides at times due

to their narrow base width (less than 2-1/2 inches).

A wooden holder (such as shown in Fig. 1) made out of 3/8" pine plyboard makes the units convenient to operate from a desk or car seat because of its wide base width and slanted position. Anyone with even a very little knowledge of woodworking can construct one. Make and put a mike holder on the right side if you care to. Finish the holder with varnish or perhaps flat black enamel paint to match the units.

If desired, one can go further with modifications, moving the holder part to one side of the base board and building a slanted external speaker box alongside to match the holder. Another idea is to build a holder extending further to the right or left to accommodate mounting a key for those units with CW operation capability. ■

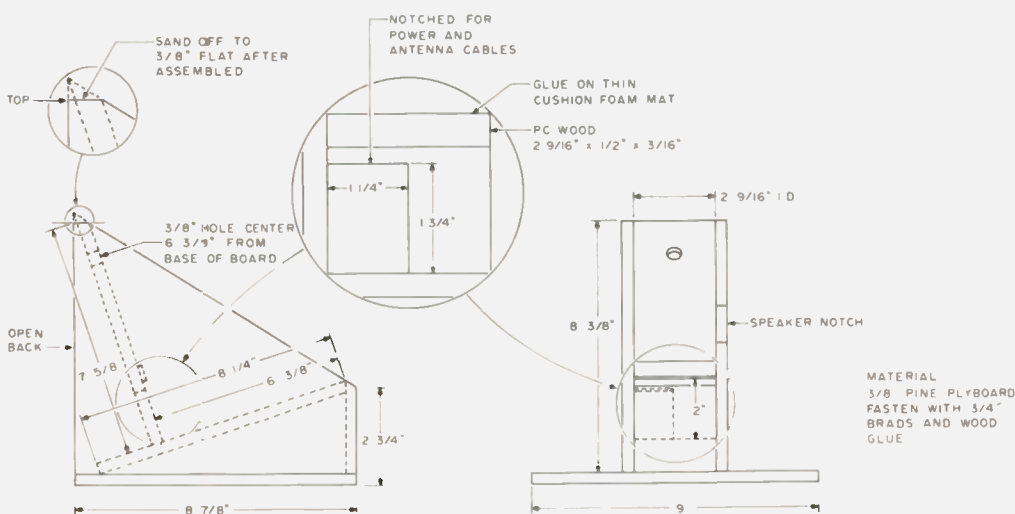

Fig. 1.

# Catch You on the Flip-Flop

— add a handy repeater reverse switch to your Memorizer

The Yaesu FT-227R Memorizer two-meter transceiver is fast becoming one of the more popular rigs heard on the band these days. Like many of its predecessors, it lends itself to many modifications. This modification, the repeater

reverse switch, is very simple to install, requiring only a DPDT switch and some wire, yet it greatly enhances the operational capabilities of the rig.

Let me start by explaining what the repeater reverse switch does: It

simply reverses the transmit and receive frequencies of the rig when used in repeater operation. For example, when you are using the local .34/.94 machine, you are transmitting on 146.34 MHz and receiving on 146.94 MHz. By throwing the repeater reverse switch, the rig would then transmit on 146.94 MHz and receive on 146.34 MHz.

Imagine the following situation: You are mobile and have just contacted a friend on a long-range repeater, but wish to go to a different simplex frequency to continue the QSO so as not to tie up the machine. Your friend is also mobile, so you throw the reverse switch momentarily to check his input (direct) signal to see if simplex operation is possible. You find that he has a good signal, but before you can get back to him, your long-winded buddy times out the repeater. So you again use your reverse switch and listen direct to the rest of his transmission, never missing a word. Then, for some unex-

plained reason, the repeater fails to come back on so you leave the switch in the reverse position and transmit back to him direct on his listening frequency and arrange to QSY. He acknowledges, never realizing the machine is out. As you can see, the repeater reverse switch can be a great help to your everyday operation.

But wait a minute, you say; why not just use the memory function of the Memorizer to work repeater reverse? You can, of course, and this would be fine if you use only one repeater. If you use several repeaters as most of us do, you must reprogram the memory each time you change frequencies. This is not only time consuming, it is very difficult, if not dangerous, when working mobile. With the repeater reverse switch installed, you can change to any frequency and switch instantly to the reverse mode. Also, you have the added bonus that the rig's memory is now free to remember your favorite channel.

The electrical operation

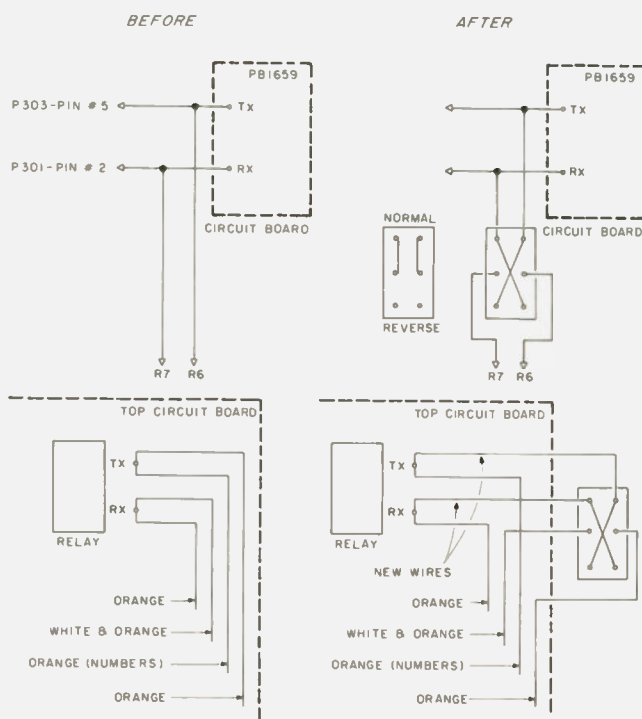

Fig. 1. The top shows how to change your rig schematic to conform to the modification, and the bottom shows wiring.

# SOMETHING DIFFERENT

## The FT-107 Series with "DMS"\*

*"It's A Cut Above The Rest"*

\* **OPTIONAL DIGITAL MEMORY SHIFT ("DMS")**  
 12 discrete memories. Stores individual frequencies  
 or use as 12 full coverage VFOs (500 kHz each)

- Solid State
- 240 watts DC SSB/CW
- 160-10 meters, WWV  
 (2 auxiliary band positions are available for future expansion)
- RF Speech Processor
- SSB, CW, AM, FSK
- Built-in SWR Meter
- Excellent Dynamic Range
- Audio Peak/Notch Filter
- Variable Bandwidth
- Full Line of Accessories



The FT-107 has been created as a result of a blending of technologies — computer, solid state and RF design. By careful utilization of these disciplines and the experience gained from our FT-50 series, YAESU has achieved an HF transceiver which offers unique features (e. g. "Digital Memory Shift"), efficient operation and a level of performance that has been previously unattainable.

### (Receiver Section) FT-107 TRANSCEIVER SPECIFICATIONS (Transmitter Section)

**Sensitivity:** 0.25 uV for 10dB S/N, CW/SSB, FSK  
 1.0 uV for 10dB S/N, AM

**Image Rejection:** 60dB except 10 meters (50dB)

**IF Rejection:** 70dB

**Selectivity:** SSB 2.4 kHz at -6dB, 4.0 kHz at -60dB.  
 CW 0.6 kHz at -6dB, 1.2 kHz at -60dB.  
 AM 6 kHz at -6dB, 12 kHz at -50dB  
 Variable IF Bandwidth

**20dB RF Attenuator**

**Peak/Notch Audio Filter**

**Audio Output:** 3 watts (4-16 ohms)

**Accessories:** FV-107 VFO (standard not synthesized)

FTV-107 VHF (UHF Transverter)

FC-107 Antenna Tuner

SP-107 Matching Speaker

FP-107 AC Power Supply

**Power Input:** 240 watts DC SSB/CW  
 80 watts DC AM/FSK

**Opposite Sideband Suppression:** Better than 50dB

**Spurious Radiation:** -50dB

**Transmitter Bandwidth:** 350-2700 hz (-6dB)

**Transmitter:** 3rd IMD -31dB neg feedback 6dB

**Transmitter Stability:** 30 hz after 10 min. warmup  
 less than 100 hz after 30 min.

**Antenna Input Impedance:** 50 ohms

**Microphone Impedance:** 500 ohms

**Power Required:** 13.5V DC at 20 amps

100/110/117/200/220/234V AC at 650 VA

**YAESU** Y1   
**The radio.**

Price And Specifications Subject To  
 Change Without Notice Or Obligation

1179R

**YAESU ELECTRONICS CORP., 6851 Walthall Way, Paramount, CA 90723 • (213) 633-4007**  
**YAESU ELECTRONICS Eastern Service Ctr., 9812 Princeton-Glendale Rd., Cincinnati, OH 45246**

of the switch is very simple. The Memorizer's phase lock loop is controlled by a crystal that is selected electrically from six crystals (X301-X306) depending on the position of the 5 UP switch, the function switch, and the T-R relay. This modification simply reverses the crystals selected for transmit and receive. It therefore reverses all frequency combinations that can be selected, including any non-standard repeater pair that is programmed into the memory. Simplex operation remains unaffected.

Prior to wiring up the modification, you should decide where to locate the switch. I mounted mine on the bottom cover just to the right of the meter. In this location it is out of sight and easy to operate. The modification is in dc level, so switch and wire placement should present no problems.

Start by wiring up the switch: Connect two short jumper wires from the terminals at one end to the terminals at the other end—making sure to cross them as shown in Fig. 1—and solder the terminals at one end only. Next, cut a pair of wires approximately 10 inches in length and solder one each to the terminals at the unsoldered end. Now set the switch aside for a moment, and locate the relay on the right rear of the top printed circuit board. Just to the right of the relay are several pins, two of which are marked Rx and Tx. Each has two wires attached: Rx has an orange and orange/white wire while Tx has two orange wires, one marked with printed numbers and one without. Unsolder the orange/white wire from Rx and the plain orange wire (no numbers) from Tx. Pull these two wires out of the

cable harness, working toward the front of the printed circuit board, until you have four or five inches of loose wire. Shorten these wires, if necessary, depending on where you have decided to locate the switch, and solder the orange wire to one center terminal of the switch. Likewise, solder the orange/white wire to the other center terminal. It makes no difference which wire goes to which center terminal. Now take the unused ends of the two new wires previously soldered to the switch, cut them to the correct lengths, and solder one to Rx and one to Tx. Again, either wire to either pin. The wiring is now complete.

Next, you must determine which switch position is normal and which is reverse. After briefly checking your wiring, turn the rig on and leave it in

the receive mode. Put the reverse switch in either position and leave it. Put the function switch to simplex. Program one frequency of your choice into the memory, and then manually dial up any different frequency, leaving the second frequency showing on the readout. Now, turn the function switch from simplex to MEM. If the readout remains the same, the reverse switch is in the normal position, but if the readout changes to the memory frequency, the switch is in the reverse position.

Now you can correctly label the switch. If you wish to reverse positions, simply reverse the switch center terminal wires, or, if you are using a toggle switch, simply turn it around.

The modification is now complete. I think you will find, as I have, that it makes a good rig even better. ■

<p><b>THOMAS LOVES YAESU SPECIALS!</b></p>  <p><b>YAESU FT-207R</b> 144 148 MHz FM Synthesized Hand-Held. Four memories plus offset, Auto Scan, Keyboard entry, 3 watts output, automatic battery saver, LED Display, BNC Antenna Connector, condenser mike, and MUCH MORE! List \$399 • Call for Quote!</p>  <p><b>YAESU FT-1012D High performance HF Transceiver</b> Covers 160 thru 10 meters plus WWV modes. USB, LSB, CW, and CW built-in power supply, input power 120 WDC, digital and analog frequency readout, 8146 final tubes, HF speech processor, variable IF bandwidth (300 Hz to 2.4 kHz), noise blanker, VFO, attenuator 10 dB or 20 dB, 100-234V operation, TX/RX freq offset. Call for Quote 8666 Hot.</p>  <p><b>YAESU CPU 2500RK 2 Meter FM Transceiver</b> With 800 PLL channels, automatic scan over entire 2m band, 4 memories, toneburst, 25W H20W Lo, 13.6 VDC at 8A continuous, Freq Coverage 144-148 MHz. Comes with a key-board mic that allows remote input of memory or dist. fr. auto scanning, au. repeater selection to 4 MHz, 2 tone input for auto-tune. 866.00 Hot. Call for quote.</p>	<p><b>THOMAS LOVES DENTRON SPECIALS! Dentron</b></p>  <p><b>MT-2000 3KW Antenna Tuner 1.8 — 30 MHZ SUPER DEAL</b> Closeout Price \$155... Reg. \$199</p>  <p><b>Dentron QLA-1000 LINEAR AMPLIFIER</b> Freq. 80 to 15 meters, covers most Mars frequencies. RF drive max 125 power consumption 117 VAC 50/60 Hz 12.5 Amps, factory tested at 15 Amps, 234 VAC 50/60 Hz 7 Amps. DC input 1 KW CW and 1200W PEP SSB. Final tubes: 4 Q-50A tubes (8L06). \$379.00 Call for Quote.</p>  <p><b>DENTRON Clipperton L</b> 160 thru 15 meters, 200 watts PEP on SSB, 1000 watts DC on CW, RTTY or SSV, covers most MARS frequencies just outside Ham bands, and easily changed 117V or 234V AC 50-60 Hz. 8669.00 Call for Quote.</p>	<p><b>SPECIALS! ICOM</b></p>  <p><b>ICOM IC-701 All Mode HF Transceiver</b> All solid state, 100W continuous duty on all bands, all modes 160 thru 10 meters, dual built-in digital VFO's for split freq. operation, VDR, semi-brain-in-CW, RIT, AGC, noise blanker and built speech processor, AC 120 VPS needed for AC operation. Power supply requirements: DC 13.6V negative ground. \$1,332 LIST—Call for quote!</p>  <p><b>DRAKE TR7/DR7 Solid State synthesized HF transceiver</b> Covers 160 thru 10 meters, reception from 1.5-30 continuous, 6-30 kHz with optional AUX 7, modes USB, LSB, CW, RTTY, AM. True dissipation tuning, RIT, built-in RF wattmeter/SWR bridge, SSB 250 watts PEP, CW 250 watts, AM 30 watts. Power supply required for AC operation: PS 7 120/240V power supply available. \$1995.00 List. Call for quote!</p>  <p><b>TEN-TEC OMNI D HF Transceiver</b> Totally solid state, 200W all bands. Covers 160 thru 10 meters, digital readout, built-in VDR and PTT, adjustable squelch, 4 position CW, SSB filter, 8 pole crystal SSB filter, 2 range offset tuning, crystal calibrator, zero beat switch, SWR bridge and more 12 VDC for mobile use, external power supply needed for fixed use. \$1099.00 List. Call for quote.</p>	<p><b>CHECK THESE PRICES ALLIANCE</b></p> <p>HD-73 Heavy duty rotor ..... \$119.95</p> <p><b>ATLAS</b></p> <p>TX-110H Transmitter ..... \$199 TX-110L Transmitter ..... \$129 RX-110 Receiver ..... \$199 RX-110S Receiver ..... \$209</p> <p><b>TEN TEC</b></p> <p>KR-20A Keyer/Paddle ..... \$55</p> <p><b>CDE</b></p> <p>CDE-44 Rotor ..... \$95</p> <p><b>DENTRON</b></p> <p>Big Dummy-1kw ..... \$27.50</p> <p><b>KDK</b></p> <p>AWE-800UP Scan Converter ..... \$88 CES 800K Scan Converter ..... \$88 CES 600YS Scan Converter ..... \$88</p> <p><b>KLM</b></p> <p>15-160BL 2M Amplifier (15 watts in, 160 watts out) linear ..... \$229</p> <p><b>TELEX</b></p> <p>HTC-2 Twin Lightweight Headphones \$23 SWL-610 Earphones, 2000 ohms ..... \$11.50</p> <p><b>SWAN</b></p> <p>FS-1 Field Strength Meter ..... \$15.50 FS-2 Field Strength Meter ..... \$16.50 SWR-3 SWR Meter ..... \$15.50</p> <p><b>YAESU</b></p> <p>FV-901 VFO ..... \$339 SP-101 Speaker ..... \$22 FT-101OC Converter ..... \$42 YC-601B Digital Display ..... \$185 YC-500S Frequency Counter ..... \$265 FT-101 Speech Processor ..... \$62 YC-221 Digital Display ..... \$99 YC-150 Dummyload/Wattmeter ..... \$75 YC-500J Freq. Counter ..... \$195 YQ-101 Monitor Scope ..... \$259</p> <p><b>THOMAS COMMUNICATIONS</b></p> <p>Master Charge, VISA, COD</p> <p>✓ T34</p> <p>95 KITTS LANE • NEWINGTON, Connecticut 06111 OPEN: 10:00-5:30 MON.-FRI. • THURS. till 8:00 p.m. • SAT. 10:00-4:00 Easy Directions: Rt. 15 South • 2 Blocks Past MacDonalds (Berlin Tpke.)</p>																																															
<p><b>Got Big Problems? Mail Order Repair Service</b></p> <ul style="list-style-type: none"> <li>• Fast Efficient Service</li> <li>• We Repair All Brands</li> <li>• Most Repairs Done and Shipped Within 14 Days</li> <li>• Amateur Extra/First Class Licenses</li> <li>• Send Equipment UPS Prepaid Shipping</li> <li>• Include Manuals and Power Supply</li> <li>• All Work Guaranteed</li> <li>• Our Fine Reputation Speaks For Itself</li> <li>• ALSO... Warranty Work On All Major Brands</li> </ul>		<p><b>We Sell and Service the Following New and Used Equipment</b></p> <table border="0"> <tr> <td>Alda</td> <td>ETD Alpha</td> <td>Rohn</td> </tr> <tr> <td>Alliance</td> <td>Ham Key</td> <td>Saxton Wire</td> </tr> <tr> <td>Ameco</td> <td>Hustler</td> <td>Shure</td> </tr> <tr> <td>ARRL</td> <td>Hy-Gain</td> <td>SST Electronics</td> </tr> <tr> <td>Atlas</td> <td>ICOM</td> <td>Swan</td> </tr> <tr> <td>Bencher</td> <td>JW Miller</td> <td>Telex</td> </tr> <tr> <td>Bird</td> <td>KDK</td> <td>Ten Tec</td> </tr> <tr> <td>B &amp; W</td> <td>KLM</td> <td>TET Antennas</td> </tr> <tr> <td>Callbook</td> <td>Larsen</td> <td>Trac</td> </tr> <tr> <td>CDE</td> <td>MFJ</td> <td>Unadilla</td> </tr> <tr> <td>CES</td> <td>Microlog</td> <td>VHF Engineering</td> </tr> <tr> <td>Covercraft</td> <td>Mirage</td> <td>Vibroplex</td> </tr> <tr> <td>Cushcraft</td> <td>Mosley</td> <td>Wilson</td> </tr> <tr> <td>Dentron</td> <td>Murch</td> <td>Wilson</td> </tr> <tr> <td>Drake</td> <td>PIPO</td> <td>Commercial</td> </tr> <tr> <td>DSI</td> <td>Robot</td> <td>Yaesu</td> </tr> </table> <p><b>GET A SUPER DEAL AND GREAT SERVICE CALL (203) 667-0811</b></p>	Alda	ETD Alpha	Rohn	Alliance	Ham Key	Saxton Wire	Ameco	Hustler	Shure	ARRL	Hy-Gain	SST Electronics	Atlas	ICOM	Swan	Bencher	JW Miller	Telex	Bird	KDK	Ten Tec	B & W	KLM	TET Antennas	Callbook	Larsen	Trac	CDE	MFJ	Unadilla	CES	Microlog	VHF Engineering	Covercraft	Mirage	Vibroplex	Cushcraft	Mosley	Wilson	Dentron	Murch	Wilson	Drake	PIPO	Commercial	DSI	Robot	Yaesu
Alda	ETD Alpha	Rohn																																																
Alliance	Ham Key	Saxton Wire																																																
Ameco	Hustler	Shure																																																
ARRL	Hy-Gain	SST Electronics																																																
Atlas	ICOM	Swan																																																
Bencher	JW Miller	Telex																																																
Bird	KDK	Ten Tec																																																
B & W	KLM	TET Antennas																																																
Callbook	Larsen	Trac																																																
CDE	MFJ	Unadilla																																																
CES	Microlog	VHF Engineering																																																
Covercraft	Mirage	Vibroplex																																																
Cushcraft	Mosley	Wilson																																																
Dentron	Murch	Wilson																																																
Drake	PIPO	Commercial																																																
DSI	Robot	Yaesu																																																

# 1-800-228-4097

## CALL TOLL FREE

### Hy-Gain 3806 2-Meter Hand-Held Amateur Transceiver



**SPECIAL PRICE**  
**\$109.95**

- Low cost, 6-channel hand-held provides superb voice transmission over short to medium distances
- Sharply tuned on-frequency selectivity in the RF amplifier stages plus FETs in the 1st and 2nd mixers for virtual immunity to out-of-band signals intermodulation distortion and cross-modulation
- Separate microphone and speaker elements for enhanced audio
- Internally adjustable mic preamp—a Hy-Gain exclusive
- Specially gasketed case seals out water, dirt and corrosive salt air
- Watertight, high-impact ABS plastic case—ribbed for non-slip grip
- Top-mounted controls for instant access

**Accessories:**

Model No.	Description	Price
3807	Nical Battery Pack	\$31.95
1104	Touring Tone Pan	\$44.95
1106	AC Battery Charger	\$9.95
1107	Cigarette Lighter Adaptor Cord	\$ 9.95
1108	Antenna Adaptor Cord	\$ 9.95
1110	Carrying Case (Leather)	\$17.95
1111	Carrying Case (Vinyl)	\$ 9.95
269	Rubber Duck Antenna	\$ 5.95
	Crystal Certificates	\$ 1.95

PLEASE ENCLOSE \$2.50 FOR SHIPPING AND HANDLING PER UNIT

CALL TOLL FREE

# 1-800-228-4097

for Quality Ham Radio Products at Discount Prices

- |           |           |         |                 |
|-----------|-----------|---------|-----------------|
| KENWOOD   | DENTRON   | MIRAGE  | E.T.O. ALPHA    |
| YAESU     | HY-GAIN   | SWAN    | VHF ENGINEERING |
| DRAKE     | MOSLEY    | TEMPO   | BERK-TEK CABLE  |
| ICOM      | CUSHCRAFT | TEN-TEC | ROBOT-SSTV      |
| AEA       | WILSON    | MIDLAND | SAY             |
| PANASONIC | HUSTLER   | CDE     | SHURE           |
| BENCHER   | LARSEN    | AUTEK   | TELEX           |

Our Mail Order Hours (CST)

M-F 8 am to 10 pm  
Saturday 8 am to 5 pm  
Sunday Noon to 8 pm

Call and Talk to

Don WBØYEZ  
Denny WØQR Blaine WBØQLH  
Bill WBØYHJ Bob WBØRQZ  
Joe WAØWRI Jim KAØCRK



**Communications Center**

443 N. 48th, Lincoln, Nebraska 68504 In Nebraska Call (402)466-8402



CALL TOLL FREE

# 1-800-228-4097

## Communications Center

443 N 48th Street  
Lincoln, Nebraska 68504  
In Nebraska Call (402)466-8402



# Antenna Sale!

**HY-GAIN**

	Regular	Special		Regular	Special
TH6DXX Super Thunderbird	\$329.95	\$259.95	18HT Hy-Tower 80-10M vertical	\$359.95	\$289.95
TH3MK3 3 el. 10-15-20M beam	222.95	179.95	18AVT/WB 80-10M Trap vertical	105.95	84.95
TH3JR 3 el. 10-15-20M beam	169.95	139.95	14AVQ/WB 40-10M Trap vertical	69.95	57.00
Hy-Quad 2 el. 10-15-20M Quad	274.95	219.95	12AVQ 20-10M Trap Vertical	42.95	34.95
205BA 5 el. "Long John" 20M beam	329.95	259.95	14RMQ Roof Mounting kit (verticals)	33.95	29.95
155BA 5 el. "Long John" 15M beam	199.95	159.95	5BDQ 80-10M Trap doublet	109.95	89.95
105BA 5 el. "Long John" 10M beam	129.95	109.95	2BDQ 80-40M Trap doublet	59.95	49.95
204BA 4 el. 20M beam	249.95	199.95	66B 6 el. 6M beam	119.95	99.95
204MK5 5 el. conversion kit	99.95	79.95	203 3 el. 2M beam	15.95	14.95
153BA 3 el. 15M beam	89.95	79.95	205 5 el. 2M beam	21.95	19.95
103BA 3 el. 10M beam	74.95	59.95	208 8 el. 2M beam	29.95	26.95
402BA 2 el. 40M beam	239.95	189.95	214 14 el. 2M beam	34.95	29.95
BN 86 Balun for beam antennas	15.95	15.95	LA-1 Deluxe lightning arrester	59.95	49.95
TH2MK3 2 el. 10-15-20M beam	149.95	119.95	TH5DX 5 el. 10-15-20M beam	269.95	209.95

**MOSLEY**

	Regular	Special
Classic 33 3 el. 10, 15, 20 Mtr. beam	304.75	209.95
Classic 36 6 el. 10, 15, 20 Mtr. beam	392.75	249.95
TA-33 3 el. 10, 15, 20 Mtr. beam	264.00	189.95
TA-36 6 el. 10, 15, 20 Mtr. beam	392.75	249.95
TA-33 Jr. 3 el. 10, 15, 20 Mtr. beam	197.00	149.95
TA-40K R 40 Mtr. Add On	119.95	89.95

**CUSHCRAFT**

ATB-34 4 ele. 10, 15, 20 Mtr. beam	289.95	229.95	A147-11 11 ele. 146-148 Mhz. beam	39.95	32.95
ATV-4 10, 15, 20, 40 Mtr. Vertical	99.95	84.95	A147-22 22 ele. Power Pack	119.95	95.95
ATV-5 10, 15, 20, 40, 80 Mtr. Vertical	109.95	89.95	A144-10T 2 Mtr. "Twist" 10 ele.	49.95	39.95
ARX-2 2 Mtr. Ringo Ranger	39.95	32.95	A144-20T 2 Mtr. "Twist" 20 ele.	69.95	56.95
AR 6 6 Mtr. Ringo	39.95	32.95	A147-20T 2 Mtr. beam	67.95	54.95
ARX-220 220 Mhz. Ringo Ranger	39.95	32.95	A430-11 432 Mhz. 11 ele. beam	37.95	31.95
ARX-450 435 Mhz. Ringo Ranger	39.95	32.95	A432-20T 430-436 Mhz. Beam	59.95	49.95
A144-11 11 ele. 144-146 Mhz. beam	39.95	32.95			

**HUSTLER**

3-TBA 3 ele. 10, 15, 20 Mtr. beam	259.95	189.95
4-BTV 10-40 Mtr. Vertical	109.95	79.95
5-BTV 10-80 Mtr. Vertical	139.95	99.95
RM-75 75 Meter Resonator	18.95	15.95
RM-75S 75 Meter Super Resonator	38.95	29.95
G6-144B 2 Mtr. Base Colinear	89.95	69.95
G7-144 2 Mtr. Base Colinear	139.95	99.95
G7-220 220 MHZ Base Colinear	129.95	89.95

**ROTORS**

HAM 4 \$159.95 T2X Tailtwister \$219.95 Alliance HD 73 \$109.95  
Call for prices on rotor cable, Coax, Towers, and Accessories. All prices do not include shipping.

18HT

**We carry all major brands of ham radios AT DISCOUNT PRICES**

Kenwood — Yaesu — Drake — ICOM — Dentron —  
Ten-Tec — Swan — Tempo — Midland — E.T.O. — Wilson



# Personality Plus for your Repeater

— this low-budget voice IDer will  
really wow 'em

Bob Heil K9EID  
#2 Heil Industrial Blvd.  
Marissa IL 62257

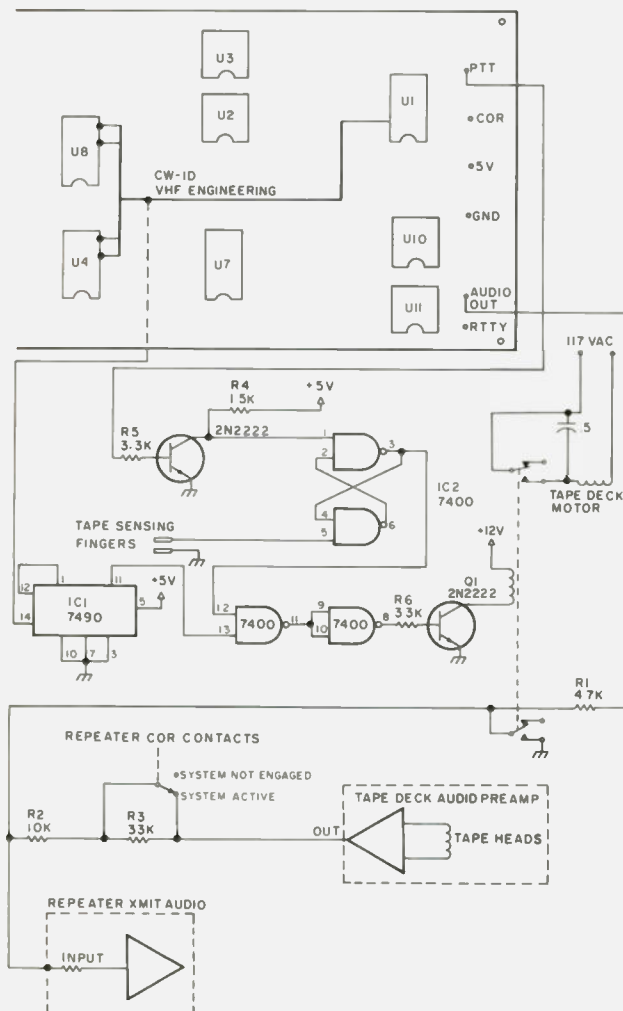

Fig. 1.

All repeater systems in use today are compelled to have some type of identification every three minutes during operation to satisfy the FCC. 99% of these systems use CW idents, generated very easily by CMOS or TTL packages.

Some of the more progressive technical groups are going to great pains to have voice identification instead of the CW, but in many cases there have been disasters in efforts to get the tape machine synchronized and reliable.

This article describes a simple, one-night project that will give a new dimension to your repeater system. It can be built to add on to the VHF Engineering, or similar, CW generation board.

The VHF Engineering

CW identifier board produces a "high" pulse every three minutes (or thereabouts, as set by R6). This pulse is picked off at pin 13, output of the U1 flip-flop, and fed to IC1, a 7490 decade counter. If the repeater remains in use for 30 minutes, the U1 flip-flop will have sent 10 pulses to the 7490. On the tenth pulse, gate IC2 will receive proper information to turn on Q1 and turn RLY1 on, which switches OFF the CW audio to the transmitter, turns on the motor of the tape player, and also keeps the PTT line grounded during the duration of the tape message.

At the end of the message, a short piece of metal sensing tape is used to short the two sensing fingers of the tape player to ground, reversing the flip-



Well known 10 and 2 meter DX'er Gordon West, WB6NOA, comments: "Since I switched from the gray loading coil system to the Metz, my mobile range has been substantially improved. I run a half gallon on both 10 and 2 SSB mobile, and after an hour of operation the Metz coil is barely warm! With the 'gray loading coil' antennas, they would be hot. Whether it's less I<sup>2</sup>R losses or just plain good construction, the Metz out-talks them all!"

Check 73's New Product Review (July 79)

Julie Metz

2 Meter and 70CM come pretuned.

**Lifetime Coil Guarantee!!**

No cutting required and needs no ground plane.

**MOBILE 10**

- 17-7 PH Stainless Steel Tapered 54" Whip—Deflects easily when struck—Minimum wind deflection—cut in field to match ground plane variables.
- 150 Watt capacity
- Unique dual-angle radiation pattern is ideal for groundwave communications as well as skip propagation.
- Minimum SWR at Band Edges
- Frequency Range 28-29.7mc

**MOBILE 2**

- 17-7 PH Stainless Steel Tapered 42" Whip—Deflects easily when struck—Minimum wind deflection.
- No ground plane required.
- 200 Watt capacity
- Low angle of radiation for repeater and Simplex operations.
- Low SWR across entire 2-Meter Band—Excellent for existing and new repeater channel operation
- Frequency Range 144-174mc

**MOBILE 70CM**

- 17-7 PH Stainless Steel 14" Whip
- 200 Watt capacity
- No ground plane required.
- Low Angle of radiation maximizes performance to hilltop remote base stations
- Designed for uplink and direct communications.
- Frequency Range 430-470mc



**METZ COMMUNICATION CORP.**

Corner Route 11 & 11C  
Laconia, New Hampshire 03246  
Tel.: 603-524-8806

✓ M100

**PRICING (Any frequency)**

- Coil with 90 lb. pull Mag Base \_\_\_\_\_ \$49.95
- Coil with Thru-Vehicle Mount \_\_\_\_\_ 39.95
- Coil with Right Angle Bracket \_\_\_\_\_ 34.95

Enclosed \$ \_\_\_\_\_  Check  Money Order  
 Master Charge  VISA  
 Credit card # \_\_\_\_\_ Exp. date \_\_\_\_\_  
 Name \_\_\_\_\_  
 Address \_\_\_\_\_  
 City \_\_\_\_\_ State \_\_\_\_\_ Zip \_\_\_\_\_  
 Signature \_\_\_\_\_



flop of IC1, which turns off the RLY1, causing the entire tape system to stop and begin counting those ten pulses produced by the CW identifier.

This gives you a voice identification once every 30 minutes, if the repeater remains in use. The length of the message is left up to you, since we use the sensing foil to shut the tape system off.

### COR Controls Audio Level

One of the unique aspects of this voice id system is that the audio fed from the tape heads is fed through R2 and R3. A set of contacts of the COR are connected in such a manner that should someone be using the repeater (meaning the COR would be activated), both resistors are in series with the tape head. If the repeater is not in use (COR de-activated), the COR contacts

short out R3.

What this accomplishes is that if someone is talking through the system and the logic brings up the tape message, the audio level of the tape will be 30 dB below the user's own audio. If someone releases the system allowing the COR to de-activate, the tape message will come through the system at full deviation.

### Construction

A simple method to properly house the voice id system is to mount the tape player mechanism and the small PC logic board in a 17" x 3" x 9" chassis. Mount a 19" x 3" rack panel on the front of the chassis. You have the option of making a cutout in the front panel so that the tape cartridge can be changed easily without removing the unit from the rack. (In some systems, the

technical crew may want everything totally enclosed, without access to any functions or the tapes.)

### Tape Machine

The tape deck used here was purchased from Poly Paks for \$12.95. These are excellent units, built by Motorola, which work very well. They have their own preamp audio boards with level controls.

I elected to remove all of that head switching solenoid business and mounted the playback head solid to the chassis. This ensures trouble-free service and more reliable head alignment.

The tape can be a 3- or 4-minute loop with many different 5-second messages. Use a piece of sensing foil at the end of each message. This will shut the system down as the foil passes over the sense fingers. If you had only one

message on the 8-track loop, tape wear would be excessive. By using several minutes of tape, a variety of messages can be used and the tape wear will be greatly reduced.

The system has been in use since the spring on the massive Marissa, Illinois, 81/21 system and has been trouble free. The voices used to give the short idents were imitations of John Wayne, Amos and Andy, Henry Kissinger, and many others. These voices were done for the club by Ed Bolton WA8PUN, host of 3920 kHz each evening.

The voice idents add a lot of versatility to the repeater system and take some of the boredom out of its operation. If you or your club are interested, send a #10 SASE for information on a complete kit of parts available from Melco, PO Box 26, Marissa IL 62257. ■

**MONITOR \$149. 12" B&W**



Offer expires January 1st.

## Stand Alone Video Terminal

αβγδ εθϋμνξζφψωρστζσ ρσ±÷×|←→↑↓  
!"#\$%&'()\* ++, -./012456789:;<=>?  
@ABCDEFGHIJKLMN O PQRSTU VWXYZ[\]^\_`  
'`abcdefghijklmnopqrstuvwxyz{|}~

**SCT-100 VIDEO BOARD FEATURES**

- 64x16 line format with 128 displayable characters
- Serial ASCII or BAUDOT with multiple Baud rates
- \$197 Assembled or \$167 Kit (Partial Kit \$45.00)
- Full cursor control with scrolling and paging
- On board power supply
- Serial interface RS232 or current loop
- Purchase SCT-100 alone or complete terminal

**COMPLETE KEYBOARD TERMINAL \$375**

Full Kit \$325 (includes SCT-100)

**XITEX CORP** 8681 Chartwell Drive  
Dallas, Texas 75243 (214) 349-2490

ORDER BY PHONE/Overseas orders & dealers welcome

---

**MRS100 FEATURES:**

- Connects directly with any ASCII or Baudot Teletype®/Terminal
- Operates from 1 to 150 WPM with Auto-Sync.
- Displays WPM rate of copied signal plus FIFO buffer status.
- Contains a built-in 80 Hz bandpass filter and sidetone oscillator.

\$299 Assembled & Tested • \$225 Complete Kit • \$45 Partial Kit

**XITEX MORSE TRANSCIVER**

mastercharge

VISA

**Xmas Special**



Full Kit \$179.  
Assembled \$236.

**NEW FROM XITEX...ABM-100**

Universal Converter ASCII • Baudot • Morse

The ABM-100 is a universal code converter for translating between ASCII and Baudot, or between Morse and ASCII (or Baudot). Also used as a TTY® speed converter. Assembled and tested the ABM will operate from a single +5V supply and sells for \$129. Write for complete details .....

138

# NEW!

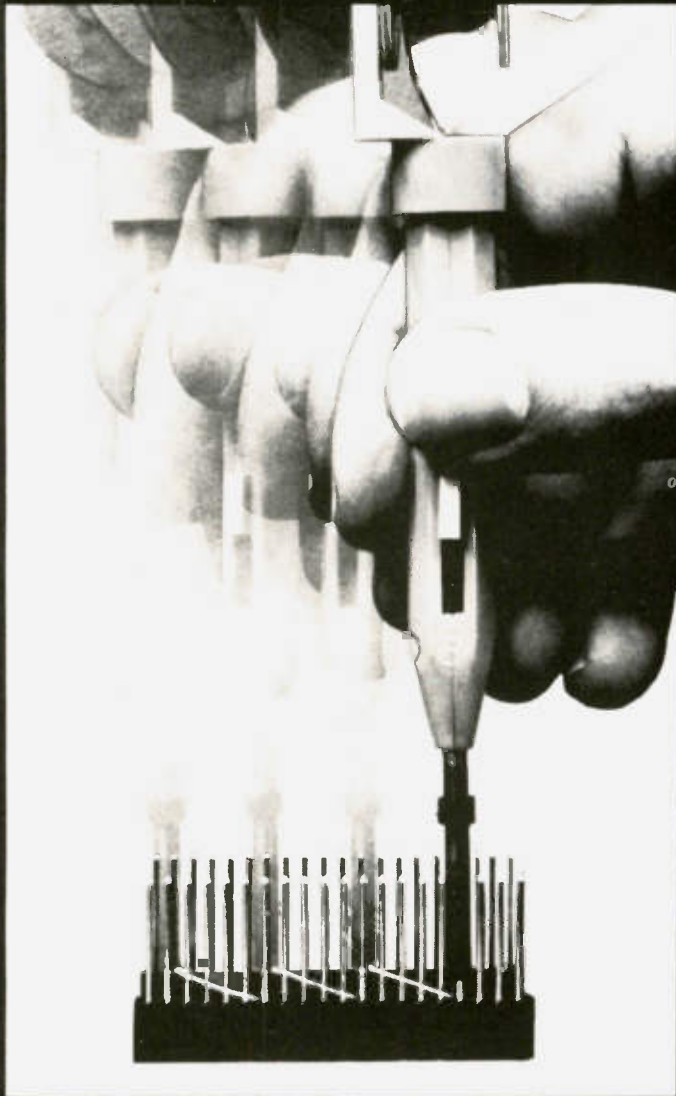

**WHY CUT?  
WHY STRIP?  
WHY SLIT?**

**WHY NOT...**

# JUST WRAP™



U.S.A.  
FOREIGN  
PATENTS  
PENDING

- AWG 30 Wire
- .025" Square Posts
- Daisy Chain or Point To Point
- No Stripping or Slitting Required
- ....JUST WRAP™....
- Built In Cut Off
- Easy Loading of Wire
- Available Wire Colors:  
Blue, White, Red & Yellow

**\$14<sup>95</sup>\***

JUST WRAP TOOL WITH ONE 50 FT. ROLL OF WIRE		
COLOR	PART NO.	U.S. LIST PRICE
BLUE	JW-1-B	\$14.95
WHITE	JW-1-W	14.95
YELLOW	JW-1-Y	14.95
RED	JW-1-R	14.95
REPLACEMENT ROLL OF WIRE 50 FT.		
BLUE	R-JW-B	2.98
WHITE	R-JW-W	2.98
YELLOW	R-JW-Y	2.98
RED	R-JW-R	2.98

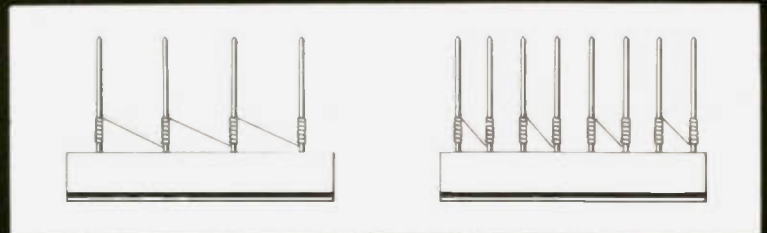

DAISY CHAIN

POINT TO POINT



OK MACHINE & TOOL CORPORATION 3455 CONNER ST., BRONX, N.Y. 10475 (212) 994-6600/TELEX 125091

✓ O5 \*MINIMUM BILLING \$25.00 / ADD SHIPPING CHARGE \$2.00 / NEW YORK CITY / STATE RESIDENTS ADD APPLICABLE TAX.

# A Better Overvoltage Protection Circuit

— the original was good . . . this version is better

Evert Fruitman W7RXV  
2808 W. Rancho Dr.  
Phoenix AZ 85017

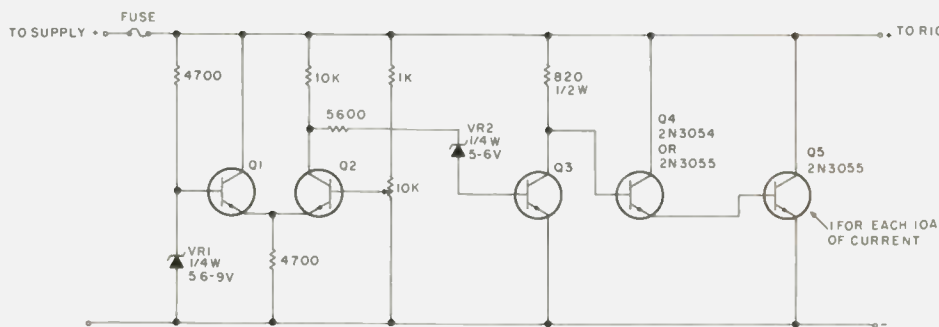

Fig. 1. The original overvoltage protection circuit.

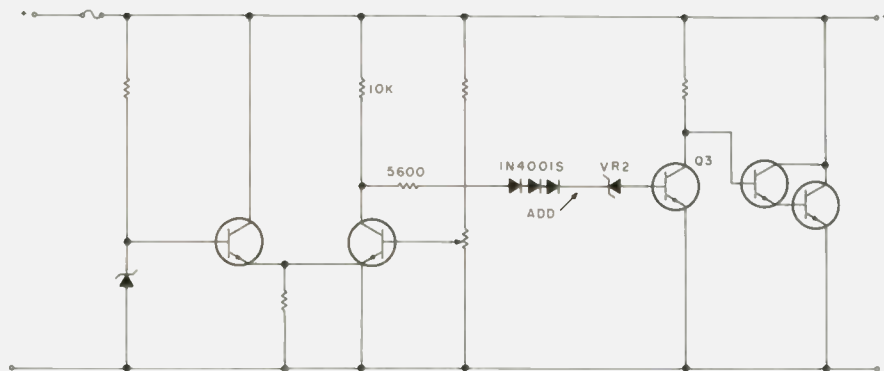

Fig. 2. Improved overvoltage protection circuit.

The following is in response to the requests for more information about the overvoltage protection circuit which appeared in the March, 1978, issue of 73.

Let me begin by stating that the system was carefully tested *before* it was written up and submitted for publication. Since that time, it has come to my attention that one component could prove troublesome and somewhat improved performance can be obtained by making two rather minor changes.

VR<sub>2</sub> is listed as 5-6 volts and noncritical. However, it is the basis of the abrupt turn-on/turn-off characteristic found in this system. VR<sub>2</sub> suppresses the 5- to 6-volt offset voltage at the collector of Q<sub>2</sub>.

At the low current level found in this circuit, the zener diode may not show a sharp enough turn-off



# Quality Kits

SWITCHES CRYSTALS CONNECTORS HEAT SINKS FUSEHOLDERS TEST CLIPS BOOKS KITS DIP JUMPERS CABLE ASSEMBLIES SWITCHES CRYSTALS CONNECTORS HEAT SINKS

SWITCHES CRYSTALS CONNECTORS HEAT SINKS FUSEHOLDERS TEST CLIPS BOOKS KITS DIP JUMPERS CABLE ASSEMBLIES SWITCHES CRYSTALS CONNECTORS HEAT SINKS

## Function Generator Kit

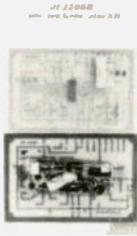

Provides three basic waveforms: sine, triangle and square wave. Frequency range from 1 Hz to 100K Hz. Output amplitude from 0 volts to over 6 volts (peak to peak). Uses a 12V supply or a ±6V split supply. Includes chip, P.C. Board, components & instructions.

**JE2206B ..... \$19.95**

## Digital Thermometer Kit



Dual sensors — switching control for indoor/outdoor or dual monitoring. Continuous LED .8" ht. display. Range: -40°F to 199°F / -40°C to 100°C. Accuracy ±1° nominal. Set for Fahrenheit or Celsius. Simulated walnut case. AC wall adapter included. Size: 3¼" h x 6-5/8" w x 1-3/8" d.

**JE300 ..... \$39.95**

## Digital Stopwatch Kit



Use Intersil 7205 Chip. Plated thru double-sided P.C. Board. Red LED display. Times to 59 minutes, 59.99 seconds with auto reset. Quartz crystal controlled. Three stopwatches in one: single event, split (cumulative) and taylor (sequential timing). Uses 3 penlite batteries.

Size: 4.5" x 2.15" x .90"

**JE900 ..... \$39.95**

## 4-Digit Clock Kit

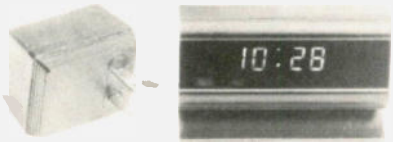

Bright .357" ht. red display. Sequential flashing colon. 12 or 24 hour operation. Black extruded aluminum case. Pressure switches for hours, minutes and hold functions. Includes all components, case and wall transformer. Size: 3¼" x 1¼" x 1¼"

**JE730 ..... \$14.95**

## 6-Digit Clock Kit



Bright .300 ht. common cathode display. Uses MM-5314 clock chip. Switches for hours, minutes and hold functions. Hours easily viewable to 20 ft. Simulated walnut case. 115VAC operation. 12 or 24 hour operation. Includes all components, case and wall transformer. Size: 6¾" x 3-1/8" x 1¼"

**JE701 ..... \$19.95**

## Jumbo 6-Digit Clock Kit



Four .630" ht. and two .300" ht. comm. anode displays. Uses MM5314 clock chip. Switches for hrs., mins., and hold functions. Hours viewable to 30 ft. Sim. walnut case. 115VAC operation. 12 or 24 hour operation. Incl. all components, case and wall transformer. Size: 6¾" x 3-1/8" x 1¼"

**JE747 ..... \$29.95**

## Regulated Power Supply Kit

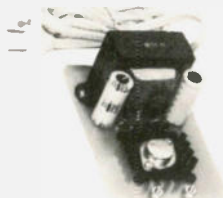

Uses LM309K. Heat sink provided. PC board construction. Provides solid 1 amp @ 5 volts. Includes components, hardware & instructions. Size: 3½" x 5" x 2" h

**JE200 ..... \$14.95**

## Multi-Voltage Board Kit



ADAPTS TO JE200 SUPPLIES ±5V, ±9V and ±12V Independent load rating at single terminal. ±12V:160mA, ±9V:200 mA, -5V:250mA. DC/DC converter with +5V input. Toroidal hi-speed switching XMFR. Short circuit protection. PC board construction. Piggy-back to JE200 board. Size: 3½" x 2" x 9/16" h

**JE205 ..... \$12.95**

## Variable Power Supply Kit



Full 1.5 amp @ 5-10V output. Up to .5 amp @ 15V output. Heavy duty transformer. Three-terminal I.C. voltage regulator. Heat sink provided for cooling efficiency. PC board construction. 120VAC input. Size: 3½" x 5" x 2" h

**JE210 ..... \$19.95**

## 62-Key ASCII Encoded Keyboard Kit



The JE610 ASCII KEYBOARD KIT can be interfaced into most any computer system. The JE610 kit comes complete with an industrial grade keyboard switch assembly (62-keys), IC's, sockets, connector, electronic components and a double-sided printed wiring board. The keyboard assembly requires +5V @ 150mA and -12V @ 10mA for operation. Features: 60 keys generate the full 128 characters, upper and lower case ASCII set. Fully buffered. Two user-define keys provided for custom applications. Caps lock for upper case-only alpha characters. Utilizes a 2376 (40-pin) encoder read-only memory chip. Outputs directly compatible with TTL/DTL or MOS logic arrays. Easy interfacing with a 16-pin dip or 18-pin edge connector.

**JE610 ..... \$79.95**

## Hexadecimal Encoder Kit

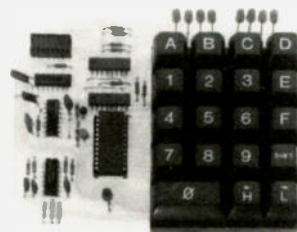

FULL 8-BIT LATCHED OUTPUT — 19-KEY KEYBOARD  
The JE600 ENCODER KEYBOARD provides two separate hexadecimal digits produced from sequential key entries to allow direct programming for 8-bit microprocessor or 8-bit memory circuits. Three (3) additional keys are provided for user operations with one having a bistable output available. The outputs are latched and monitored with 9 LED readouts. Also included is a key entry strobe. Features: Full 8-bit latched output for microprocessor use. Three user-define keys with one being bistable operation. Debounce circuit provided for all 19 keys. 9 LED readouts to verify entries. Easy interfacing with standard 16-pin IC connector. Only +5VDC required for operation.

**JE600 ..... \$59.95**

(Prices Subject To Change)

For Distributor Information, write or phone JIM-PAK®, 1355 Shoreway Road, Belmont, CA 94002 (415)592-8097  
**AVAILABLE AT YOUR JIM-PAK® DISTRIBUTOR TODAY!**

characteristic. This property will be helped along in the right direction by connecting 2 or 3 1N4001s (or other cheap silicon diodes) in series with VR<sub>2</sub> as shown in Fig. 2. An alternative solution would be to use a 6.8- to 8.2-volt zener for VR<sub>2</sub>.

If voltage is applied to this circuit and *slowly* increased from about 5 volts to whatever level was intended, the system will malfunction. The voltage set/trip control will exhibit some unusual properties. This malfunction will happen only under the above stated conditions. It may be prevented by making the following simple changes:

1. Disconnect the 10k and 5600-Ohm resistors from Q<sub>2</sub> collector.
2. Disconnect Q<sub>1</sub> collector from B+.
3. Connect Q<sub>2</sub> collector to B+.

4. Connect Q<sub>1</sub> collector to the junction of the 10k and 5600-Ohm resistors that used to be tied to Q<sub>2</sub> collector. See Fig. 2.

At this point you are almost there. As it stands, after completing the above operation, the fuse will clear if the input voltage is *below* the intended set point. In order to correct that malady and finish the project, it is necessary (and highly desirable) to make the final modification.

Disconnect the zener di-

ode, VR<sub>2</sub>, from the base of Q<sub>3</sub>, and connect it to the base of Q<sub>6</sub> (another 2N3414, etc.). Connect one end of a 1500-Ohm, ¼-Watt resistor to B+, and the other end of it to the collector of Q<sub>6</sub> and the base of Q<sub>3</sub>. Connect the Q<sub>6</sub> emitter to ground. That's it! See Fig. 3.

The initial adjustment is done in the same manner as in the original, and it is very smooth and very resettable. This modification was checked out using a

power supply that went from 5-25 volts with excellent results. The trip point could be set anywhere from 8 volts to 25 volts and it would consistently fire at the trip point  $\pm 0.25$  volt.

I do regret any difficulties that may have been encountered in the construction and testing of the circuit. Either version (original or modified) should prove to be a reliable means of protecting your equipment. ■

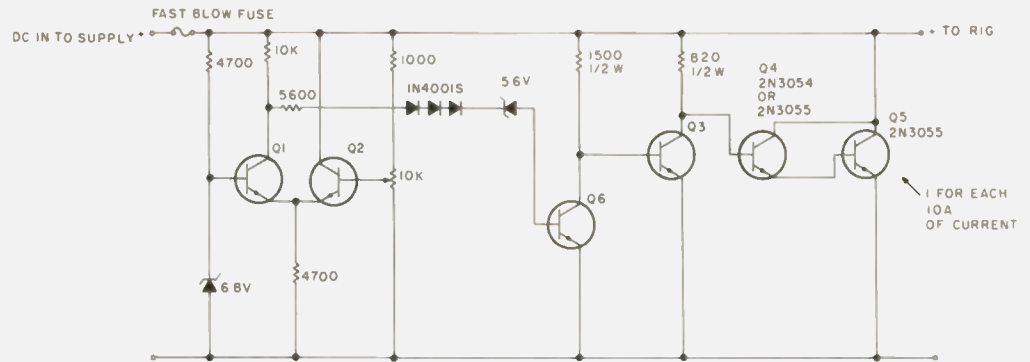

Fig. 3. The final modification.



**DID WE GET YOUR ATTENTION? WE HOPE SO. WE WANT TO BE YOUR AMATEUR RADIO DEALER. (WE DON'T SELL ANYTHING ELSE.) WE OFFER FULL SERVICE (WHETHER IT CAME FROM US OR NOT). WE CARRY ALL MAJOR LINES - KENWOOD, YAESU, DENTRON, DRAKE, ALPHA. WHAT CAN I SAY!! CALL US!!!**

**ORDER TOLL FREE!  
800-845-6183**

**G** **G.I.S.M.O.**  
**2305 CHERRY ROAD**  
**ROCK HILL, S.C. 29730**

**73,** **THE GISMO GANG**

✓ G22

**new**

# SCR 4000

## The Super-Deluxe 450MHz Repeater!

### Features

- 30W. Output
- Low Noise/Wide Dynamic Range 8 Pole Filtr. Front End for Excellent Sensitivity & Rejection of IM's & Spurious Responses.
- Sensitivity: 0.35uV Typ.
- 8 Pole First IF Crystal Filter for Super Selectivity & Image Rejection, + 4 Pole Ceramic 2nd IF Filtr.!
- Receiver Discriminator & Deviation Meter Functions!
- Ultra-High Stability Transmitter Crystal Oscillator/Oven.
- Plus—All of the Many Other Features Found in the SCR1000 VHF Repeater—Full Metering, Lighted Status Indicators/Control Push-buttons, Btry. Pwr. Input, AC Pwr. Supply, CW IDer, etc., etc.!



180 Day Warranty!

Shown in optional cabinet

Spec Comm is proud to announce the new SCR4000 UHF FM Repeater! This unit incorporates all of the many desirable repeater control, test and operating features which have been requested by our customers over the past 2½ years. The SCR4000 includes completely new transmitter and receiver boards which were specifically designed for this new repeater. The rest of the unit is basically the same as our tried and proven SCR1000 VHF Repeater which has an excellent reputation for performance and reliability throughout the world!

Of course, the SCR1000 VHF unit is still available in 2 Mtr. and 220 MHz versions along with a complete line of options and accessories for all of our repeaters... such as: Full Autopatch/Reverse Patch/Land-Line Control; Touch-Tone Control of various repeater functions; "PL" - CTCSS; "Emergency Pwr. I.D."; various Courtesy Tone and Timer units, etc. PLUS—the finest Duplexers, Cabinets, Antennas, Cables, etc.

The SCR4000 and SCR1000 are sold factory direct only or through Foreign Sales Reps—at prices which are only about ½ that of the "big two" names in 2-way radio! Get your order in A.S.A.P.!

### Spec-Comm Repeater Boards & Sub-Assemblies

2M 220 MHz 450 MHz!

- FL-6 Preselector. Rcvr. Front-End Filter/Preamp. Exc. rejection of strong "out of band" sigs. -60dB @ ±6 MHz.
- SCR100 Receiver Board w/xtal & 8 Pole IF Filter.
- SCR450 UHF Receiver Bd. New Design, as above.
- SCR100 Receiver Assembly. SCR100 mounted in shielded housing.
- SCT110 Xmtr./Exciter Bd. 7 or 10 Wt. bd. w/xtal. BA-10 30 Wt. Amp. bd. & Ht. Sink.
- SCT410 NEW 10W. UHF Transmitter Bd.
- SCT110 Transmitter Assembly. SCT110 mounted in shielded housing. 7, 10, or 30 Wt. Unit.
- CTC100 COR/Timer/Control Bd
- ID250 CW ID/AF Mixer Bd. Programmed.
- SCAP Autopatch Bd.
- RPCM "Reverse Patch" & Control Bd.
- IH10 0/1 Inhibit Bd. (For SCAP)
- TTC100 Touch Tone Control Bd. 3 or 2 digit control, 1 or 2 functions.
- TRA-1 Timer Reset Annunciator Bd.
- TMR-1 Timer Bd.
- OS-18 TX Xtal Osc./oven. w/xtal

### new COMMERCIAL MOBILE & BASE TRANSCEIVERS

Spec Comm "Professional Communications Line"

- 136-174 MHz & 220-240 MHz (450 soon)
- 6 channels
- 0.35 uV Rcvr
- 6 or 8 Pole Crystal Filtr
- Beautiful Audio—RX & TX
- Very Reasonable Price!



PCL 250 25 wt. Mobile unit  
• Super Rugged Housing



PCL 300 25-30 wt. Base station  
• Built-in AC Power Supply  
• Front Panel Status Indicator Lights  
• Optional Rcvr Scanning Function Available



# SPECTRUM COMMUNICATIONS

Write or call for Data Sheets, prices, etc. • Export orders—Contact our International Dept.

1055 W. Germantown Pk., Dept. S1 • Norristown PA 19401 • (215) 631-1710

# Contests

from page 24

counted separately. Multi-operators may participate, but each prefix must be listed in the log. Use all bands 80 through 10 meters. The call should be made as "CQ TEST LIONS." Participating Lions or Leos should identify their club name. Only one QSO with the same station in each band will be counted. Phone and CW are counted separately as previously stated.

## SCORING:

Score 1 point for QSOs within the same continent, 3 points between different continents. Score 1 extra bonus point for a QSO with a member of a Lions Club or Leo Club and 5 extra bonus points for a QSO with a member of Rio de Janeiro ARPOADOR Lions Club. Contacts between Brazilian stations and members of the Lions Club Rio de Janeiro ARPOADOR will count only 2 extra points. Contacts between members of the ARPOADOR Club will not count any bonus points.

## ENTRIES:

One log should be kept for each mode. Each participant will note in his logs the callsign, report, and the sequential number of the QSO. When contacts are made with Lions or Leos, the name of the Lions Club or Leo Club contacted should be clearly identified in the log. Confirmation of contacts will be made by comparing the logs of the participants. Participants should send their log sheets, postmarked by air mail not later than 30 days after the contest, to: Lions Club of Rio de Janeiro ARPOADOR, Rua Souza Lima #310, Apt. 802, Rio de Janeiro 22081, Brazil, South America. Various medallions, trophies, and certificates will be awarded winners in each class, etc.

## FREEZE YOUR ARCTIC OFF EXPEDITION

On January 19th, the Ford Tin Lizzy Club, North Metro Chapter, will have the second annual Freeze Your Arctic Off Expedition. The club will be operating from the frozen wastes of Lake

St. Clair near the US-Canadian border. Operations will be from 2000 GMT January 19th to 1500 GMT January 20th using the callsign AD8R. Operating frequencies will principally be 7275 on SSB plus 21380 if propagation allows. Also, 2-meter operation will be on 146.52, .55, and .58.

All QSLs will be acknowledged with an 8 x 10 certificate commemorating this event. No SASE necessary; just QSL to Box 545, Sterling Heights MI 48078.

## NORTH AND SOUTH AMERICA RTTY FLASH CONTEST

Operating Periods:  
1800 GMT January 19 to  
0200 GMT January 20  
1200 GMT to 2400 GMT  
January 20

The contest is sponsored by the IATG Radiocommunications and is open to all RTTY stations operating on 80 through 10 meters. The DXCC list will be used for country status except that the VE/VO, W/K, VK, PY, LU, JA, and UA0/9 call areas will be considered as separate countries. Operating classes include single- or multi-operator stations using a single transmitter and SWLs.

## EXCHANGE:

Messages will consist of RST, QSO number, and the station's continent.

## SCORING:

Exchange points are as follows: 80 and 40 meters = 1 point per QSO, 20 meters = 2 points per QSO, 15 meters = 8 points per QSO, 10 meters = 12 points per QSO. No points or multipliers are counted for contacts with one's own country. Only two-way RTTY contacts are valid. Multipliers are given for countries and continents worked. A multiplier is given for each country worked on 20 through 10 meters, but no country multipliers are given for 80- and 40-meter contacts. A separate multiplier may be claimed for the same country if a different band is used (max. 3 times). Only countries which appear in at least 5 other contest logs will be valid as multipliers. The continents are also valid as multipliers. For contacts with North and South America, the sender and receiver will each be assigned 100 points as multipliers. 50 points will be assigned for each of the remaining continents as contacted. An additional 100 points will be given for each contact with North and South America on 15 or 10 meters. Final score is the total QSO points times the number of countries times the number of continent points plus the total points for North and South American stations worked. Example: 600 points for total x 10 countries worked x 100 continent points = 600,000 plus 20 stations of North and South America worked on 15 and 10 meters giving a great total of 602,000 points.

Two promotional periods are included in the contest: Saturday, January 19th, from 1900 to 2000 GMT, and Sunday, January 20th, from 2100 to 2200 GMT. Stations operating from Europe, Africa, Australia-Oceania, and Asia contacting North and South America during these hours will *double* their points for these periods.

RTTYers entering logs in this contest who have not participated in previous contests will receive an additional 5% of the final score as a handicap. The contest is open to RTTY SWLs using the same scoring rules.

## LOGS AND ENTRIES:

Use one log for each band. Logs must contain date and time in GMT, callsign, RST, number of QSO, continent sent and received, country and continent multipliers, points, and final score. Each station may be contacted only once on any band; additional contacts may be made with the same station if a different band is used. In order to qualify, all logs must be received no later than February

# Results

## RESULTS OF THE 1979 FRENCH CONTEST

CANADA - CW			USA - CW		
Call	Points	QSOs	Call	Points	QSOs
VE1MX	159,238	157	K1SA	343,360	245
VE1AIH	90,288	104	W1BWS	51,220	83
VE2WA	8,712	37	WA1FCN	29,798	65
VE3DAP	214,964	179	W1OPJ	2,040	17
VE3KZ	59,092	89	W1PWK	819	9
VE6LU	30,618	77	W1CFZ	490	7
VO1KO	189,635	167	K2SX	323,175	212
CANADA - PHONE			W2GKZ	41,528	73
VE2RV	1,542,752	737	K2MQ	31,878	78
VE2AFC	145,137	149	K2PF	22,770	52
VE2EML	30,078	61	W2NCG	22,386	54
VE3KZ	1,592,730	605	W3ARK	328,600	222
VE3BR	5,400	20	W3HDH	105,892	120
VE4SW	8,100	30	K3NR	29,100	61
VE7VP	35,345	68	N3RL	640	8
log: VE1AIH			WA4OML	104,960	128
CANADA - CW			WB4ENI	101,994	116
W4UNO	66,654	98	USA - PHONE		
WB4YGL	3,888	25	WB1CRG	25,080	57
N6AW	55,575	89	W1BWS	3,570	21
N6TW	2,002	15	F2YS/W2	501,835	304
N6OB	90	3	K2JFV	129,612	155
W8UVZ	284,994	210	KB2DE	41,440	74
N8DE	240,909	186	HI3DJP/W2	11,070	41
W8DSO	55,815	96	W2QKJ	7,752	33
W8VSK	8,060	31	W2UL	1,680	14
K8NMG	3,360	21	N4NX	75,190	103
W9OA	302,085	228	W4KMS	39,200	70
K9FD	56,792	93	WA4AXT	27,280	88
WB0GOB	54,780	83	WB5MSU	1,200	12
W0WDW	10,730	37	W6HX	68,884	102
USA - PHONE			N6TW	720	9
WB1CRG	25,080	57	N7DF	12,383	43
W1BWS	3,570	21	KA8BAC	52,780	91
F2YS/W2	501,835	304	WA9FZQ	109,736	129
K2JFV	129,612	155	W9OA	105,469	118
KB2DE	41,440	74	K9HDE	79,725	107
HI3DJP/W2	11,070	41	W9QWM	16,502	48
W2QKJ	7,752	33	W0CDC	13,200	40
W2UL	1,680	14	W0PKO	1,820	14
N4NX	75,190	103			
W4KMS	39,200	70			
WA4AXT	27,280	88			
WB5MSU	1,200	12			
W6HX	68,884	102			
N6TW	720	9			
N7DF	12,383	43			
KA8BAC	52,780	91			
WA9FZQ	109,736	129			
W9OA	105,469	118			
K9HDE	79,725	107			
W9QWM	16,502	48			
W0CDC	13,200	40			
W0PKO	1,820	14			



20th. Send logs to: Prof. Franco Fanti, Via A. Dallolio n 19, Bologna 40139, Italy. For SWLs only, the same station is valid only one time on all bands.

**AWARDS:**

Grand prizes are reserved for the four first place winners. Consolation prizes along with medals and certificates will also be awarded. Remember that this contest is valid towards the final standing of the 5 Continent World Championship.

**FRENCH CONTEST**

**CW**

**Starts: 0000 GMT January 26**

**Ends: 2400 GMT January 27**

**Phone**

**Starts: 0000 GMT February 23**

**Ends: 2400 GMT February 24**

This contest is open to single-operator stations only and all contacts must be made with French countries (see list below).

**EXCHANGE:**

RS(T) and sequential QSO number.

**SCORING:**

Score 3 points per QSO within the same continent and 10 points per QSO with another continent. Multiplier is the number of French units from the list below on each band. Final score is total QSO points times the total multiplier.

**ENTRIES:**

Logs must be sent with a recap sheet; all multipliers should be listed for checking on each band. Entries should be mailed to REF French Contest, sq. Trudaine 2, 75009 Paris, France.

**FRENCH UNITS:**

95 French departments (2 figures). DA1/2 station of F forces in DL. French overseas countries — Mayotte FH, Reunion FR, Europa FR/E, Juan de Nova FR/I, Glorieuses FR/G, Tromelin FR/T, Guyane FY, St. Pierre et Miquelon FP, Martinique FM, Guadeloupe FG, St. Martin FG, St. Barthelemy FG, Clipperton FO, New Caledonia FK, I. Loyaute FK, Chesterfield FK, Wallis FW, Futuna FW, New Hebrides YJ, I. du Vent FO, I. sous le Vent FO, I. Australes

FO, Rapa FO, Marguises FO, Gambier FO, Touamotou FO, Terre Adelie F/FB8Y, Kerguelen FB8X, St. Paul et Amsterdam FB8Z, I. Crozet FB8W.

**CLASSIC RADIO EXCHANGE**

**Starts: 2100 GMT Sunday,**

**January 27**

**Ends: 0400 GMT Monday,**

**January 28**

The contest is sponsored by the Southeast ARC of Cleveland, Ohio, and is open to all amateurs. The object is to restore, operate, and enjoy older equipment with like-minded hams. A classic radio is any equipment built since 1945 but at least 10 years old, an advantage but not required. The same station may be worked with different equipment combinations and on each mode on each band. General call is "CQ CX" on CW and "CQ Exchange" on phone. Non-contestants may be worked for credit.

**EXCHANGE:**

Name, RS(T), state/province/country, receiver and transmitter type, and other interesting

pleasantries.

**FREQUENCIES:**

CW — up 60 kHz from low band edges.

Phone — 3910, 7280, 14280, 21380, 28580.

Novice/Tech — 3720, 7120, 21120, 28120.

Listen on the half hour to 20 for coast-to-coast DX and on the three-quarter hour on 15.

**SCORING:**

Add the numbers of different transmitters, receivers, and states/provinces/countries worked on each band. Multiply by total number of QSOs on all bands. Multiply that total by the classic multiplier: the total years old of all transmitters and receivers used with 3 QSOs minimum per unit. For transceivers, multiply the years old by two.

**ENTRIES:**

Send logs, comments, anecdotes, etc., to: Stu Stephans K8SJ, 1407 Hollywood Rd., Sandusky OH 44870. Include a SASE for copies of the *Classic Radio Newsletter* and results.

# Awards

from page 18

(USKA).

Walter Blattner HB9ALF writes to present us with their awards program in more detail.

**HELVETIA 26 AWARD**

This award has been instituted by the Union of Swiss Short Wave Amateurs (USKA) with the object of furthering friendly relations and the competitive spirit between its members and radio amateurs abroad.

Foreign amateurs must submit QSL cards showing evidence of contacts with stations in each of the 26 cantons and half-cantons of the Swiss Confederation on any bands between 1.8 and 30 MHz.

All contacts claimed must be made on or after January 1, 1979. Crossmode contacts will not be valid. Awards will be offered for all phone, all CW, phone/CW mixed mode, radioteletype (RTTY), and slow-scan television (SSTV).

QSL cards submitted must clearly show the location (canton) of the Swiss station at the time of contact. Any QSL card from a Swiss station operating from a temporary or portable location at the time of the contact must show the canton of such location in order to be recognized as a valid contact.

In addition to QSL cards, applicant must submit a signed list of all contacts in alphabetical order by canton. Include

the station's callsign, date and time in GMT, band and mode of operation, and RS(T).

The 26 cantons are as follows:

- AG Aargau
- AI Appenzell Inner Rhoden
- AR Appenzell Outer Rhoden
- BE Berne
- BL Basle Country
- BS Basle City
- FR Fribourg
- GE Geneva
- GL Glarus
- GR Grisons
- JU Jura
- LU Lucerne
- NE Neuchatel
- NW Nidwalden
- OW Obwalden
- SG Saint Gall
- SH Schaffhausen
- SO Solothurn
- SZ Schwyz
- TG Thurgau
- TI Ticino
- UR Uri
- VD Vaud
- VS Valais
- ZG Zug
- ZH Zurich

Applications for the award must have sufficient postage enclosed in the form of IRCs to allow the safe return of your QSL cards.

Mail your application to the attention of: Walter Blattner HB9ALF, PO Box 450, 6601 Locarno, Switzerland.

The awards custodian for the Newark News Radio Club, WB2MRA, sent me information regarding their new State

Capitals Award. This award is not to be confused with the State Capitals Award being offered by the 3.905 Century Club Net.

**STATE CAPITALS AWARD**

The Newark News Radio Club of Newark, New Jersey, takes pleasure in announcing its sponsorship of the SCA — State Capitals Award — which is available to licensed amateurs throughout the world for working stations located in state capital cities of the United States on or after January 1, 1960. This award is also available to shortwave listeners on a "heard" basis.

The purpose of this award is to offer recognition for operating achievements and to offer still another worthwhile contribution to the field of competitive radio amateur operation.

It is hoped by the directors, officers, and members of NNRC that amateurs everywhere will accept the award as a gesture on the part of the sponsor to further promote and expand goodwill and better understanding among amateur operators and shortwave listeners.

The State Capitals Award is offered in three (3) classes. Class C — work 30 state capital cities; Class B — work 40 state capital cities; Class A — work 50 state capital cities.

There are no band or mode endorsements. Crossmode contacts will not be valid.

To apply, applicants should prepare a list of contacts claimed, listing them in alphabetical order by US state. Include the usual logbook information for each contact. Have this list verified locally by two amateurs, a local radio club



secretary, or a notary public. Do not send QSL cards. Have your verified list sent along with the \$1.00 award fee to: S. J. Knox WB2MRA, 212 North Jerome Avenue, Margate, New Jersey 08402.

Checking my files, I find that information about foreign DX award programs outnumbers that of the domestic type four to one. Stateside clubs, societies, and organizations are encour-

aged to utilize this no-cost service to publicize your awards program. As you know, thousands of amateurs join our ranks annually and most are not aware of the various operating incentives available to them. It is the intent of this column to share the many achievement programs the amateur community has to offer. Why not research your local area. Perhaps your club doesn't sponsor an award. Maybe this is an area

you might consider to bring worldwide recognition for your fraternity and help build your club's treasury.

As you know, January 1st marks a new year. Those pursuing the 73 Awards Program realize all contacts claimed for the 73 DX Country Club and the Worked All USA Award are based on a single calendar year. Get in on the ground floor and pursue these operating incen-

tives and be the first in your area to proudly possess the beautiful awards being sponsored by the editors of 73 Magazine.

We now have a supply of 73 Magazine Awards Program booklets on hand. Send for your copy today. Be sure to enclose a large SASE with your inquiry. See you next month. Continue to climb the ladder of recognition.

## Corrections

Please note the following corrections to "The MICROSIZER: Computerized Frequency Control," which appeared in the October, 1979, issue.

### Parts List:

- C35 was listed as C31—there is no C31.
- R46, R26, and R33 are missing; they should be 10k, 1/4 Watt.
- R40 was listed as 4.7k; it should be 1.5k, 1/4 Watt.
- CR10 was listed twice.
- U10, U11, U12, and U13 are

missing; they should be CD4510s. CD4029s can be used if power-up reset to 0000 is not required.

- C24 was listed as .47; it should be 47  $\mu$ F.
- The values for U17 and U18 were interchanged.

### Fig. 6:

- The unmarked IC in the lower right-hand corner is U14.
- The unmarked resistor between U16 and U15 is R34.
- The unmarked resistor be-

tween U7 and U15 is R32.

•R33 should be mounted in holes directly above pins 13 and 11 of U15. Note that the "Z"-wire placement in Fig. 7 shows "Z" wires here—this is incorrect.

•The heat-sink tabs on U17 and U18 are shown on wrong side. In and out leads are correct.

### Fig. 7:

•In addition to the above problem, nine "Z" wires were omitted. The correct layout is shown here.

### Additional notes:

•Jumper U16-4 to U10-12 on the back side.

•Connect the top and bottom sides of the PCB together with pieces of wire, using 4 pieces on each side.

•There are two unused pads: One is to the right of U12-16 and the other is just above the left pad for jumper 9.

•All drilled holes are #65. Some may need to be slightly enlarged to accommodate variations in certain component leads.

•Make sure there is a good ground between MICROSIZER and transceiver; otherwise, some roughness of the CW note may occur.

•R43 should be adjusted to give vfo injection at the same level as the internal vfo. Too much level will cause spurious response problems.

**Fred Studenberg W4BF  
Tampa FL**

I would like to point out some items that need correcting in my article "Yes, You Can Build This Synthesizer!", which appeared in the October, 1979, issue.

There are four parts on the PC board layout on page 61 which have the incorrect values marked on them. R8 (180 $\Omega$ ) is correctly listed in the schematic and parts list, but is incorrectly shown as 270 $\Omega$  on the parts layout. R22, located to the left of the 4059, is marked as a 2.2k; it should be a 1.8k. R19, located to the right of the 4001, is marked as a 270 $\Omega$ ; it should be 180 $\Omega$ . Finally, C42, located in the lower right-hand side of the board, is marked as a 33  $\mu$ F; it should be a 2.2  $\mu$ F.

Z4 is incorrectly drawn in the schematic as a quad NAND gate; in reality, it is a quad NOR. However, since all of the gates are used as inverters, a CD4011 will also work as a pin-for-pin substitute.

I have also received numerous inquiries concerning the availabilities of the PC board and Y3, the 26.667-kHz crystal. Both items are available through me for fifteen dollars apiece.

**Michael Di Julio WB2BWJ  
Maplewood NJ**

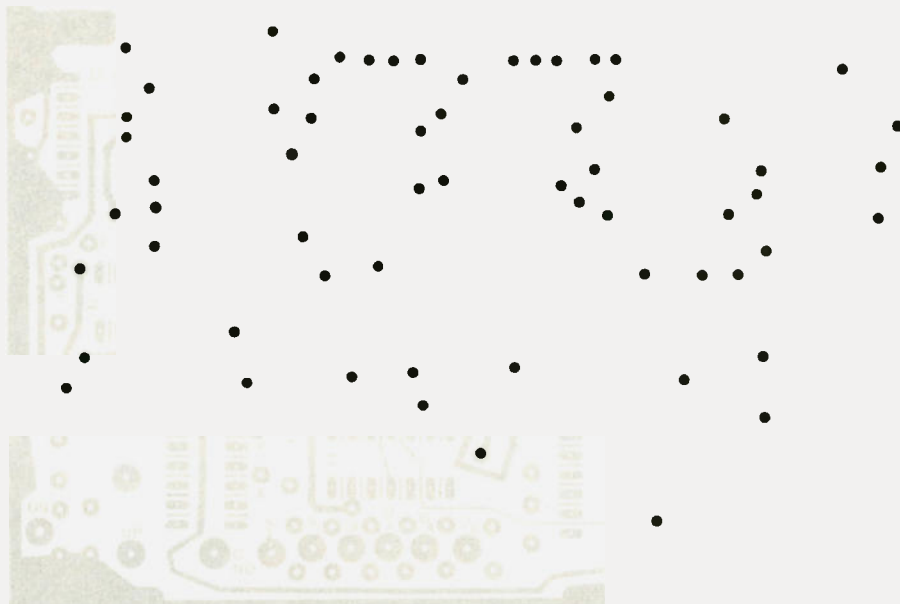

Revised Fig. 7, "The MICROSIZER."

# New Products

from page 26

first to offer "Soft Partitioning"™ of the memory unlike the "hard partitioning" utilized in all other keyers. "Soft Partitioning" means no wasted memory space. All of the memory can be allotted to one message location, or it can be divided up into as many as ten locations.

The memory can be loaded in automatic mode for perfect message formatting or it can be loaded in the real-time mode for individualizing a message. Memory can also be loaded in the automatic keyer mode (any dot and dash ratio) or in the semi-auto (bug) mode. Any message can be played back with any selected dot and dash ratio. Hence, the user can send a sloppily loaded bug mode message back with perfect 3-to-1 dash-to-dot ratio. Conversely, a perfectly loaded 3-to-1 dash-to-dot ratio message can be replayed later with as much as an 8-to-1 dash-to-dot ratio (sounding like a bug).

The MorseMatic can be used to key the transmitter for tuning

purposes. The operator need only hit any keypad button or the key paddle to defeat the tune mode.

Editing a memory loading mistake is a simple task. If you are near the end of loading a message into memory and a mistake is made, it only takes seconds to erase the mistake and then continue with an error-free message.

The MorseMatic includes a sophisticated Morse trainer. It is the only trainer that will automatically increase the speed of the practice characters so that your brain is "fooled" into thinking it is still copying the starting speed.

For further information, contact *Advanced Electronic Applications, PO Box 2160, Lynnwood WA 98036; (206)-775-7373.* Reader Service number A94.

## POCKET SHORTWAVE RECEIVER

Measuring only 45 mm W x 73 mm H x 25 mm D, the Model EP-8 is believed to be the smallest AM/SW 2-band receiver available in the US. In addition

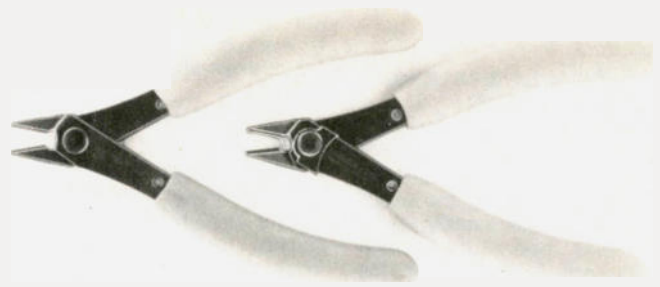

OK's new mini-shears.

to the standard "broadcast" band (AM), the Model EP-8 receives shortwave frequencies from 3.9 to 12 MHz (ideal for receiving WWV time signals on 5 and 10 MHz). Controls include a band-select switch, tunable dial for AM and SW, and volume control coupled with an ON-OFF switch. Audio output is via the supplied earphone only, and the receiver is powered by two hearing-aid type batteries (included).

The Model EP-8 has built-in ferrite rod antennas for both bands. While shortwave reception is satisfactory for powerful stations such as the BBC, Radio Canada International, Radio Nederland, Deutsche Welle, and others, better SW sensitivity can be obtained by placing the receiver near a telephone or ac line outlet. No direct antenna connections are necessary.

For further information, contact *Radios International, PO Box 6053, Richardson TX 75080; (214)-784-0862.* Reader Service number R39.

## MINI-SHEARS

OK Machine and Tool Corporation has introduced two new flush-cutting mini-shears. Model MS-20 features a handy safety clip which retains cut leads, preventing them from flying and injuring the operator or contaminating the work. Model MS-10 is identical except that it has no safety clip. Both will shear component leads up to 16 AWG as well as wires as small as 30 AWG. The shears feature

precision hardened and ground jaws for long life as well as comfortable cushioned grips to minimize operator fatigue. For further information, contact *OK Machine and Tool Corp., 3455 Conner Street, Bronx NY 10475.* Reader Service number O5.

## KEYER ADD-ON PROVIDES PRACTICE AND MEMORY

An add-on accessory provides both random code practice and message storage for the Curtis Electro Devices EK-480 series. Called IM-480, this device will automatically send Morse code in random groups at speeds from 6 to 50 wpm. It also allows variable extra spacing between letters and groups to allow slow-speed copy with letters being formed at a higher speed. This feature enhances learning in the 6-10 wpm beginners range. A meter display of code speed allows accurate speed settings.

The IM-480 also includes a message memory function yielding four messages of approximately 32 characters each with an automatic repeat function. The messages are programmable from the paddle key on an asynchronous basis.

The IM-480 is the same size as the EK-480 (7" x 4 1/2" x 2 1/2"); the two units attach via a short length of 14-pin-DIP plug-terminated ribbon cable. Use of the Curtis 8046 and 8047 LSI ICs allows the compact packaging.

For further information, contact *Curtis Electro Devices, Inc., Box 4090, Mountain View CA*



Radios International's EP-8 shortwave receiver.



Curtis Electro Devices' IM-480.

### THE MODEL 299 TALKING COUNTER

The Model 299 Talking Counter from Ten-Tec is a self-contained frequency counter, speech synthesizer, and audio amplifier/speaker system which enhances operating convenience and pleasure for the blind ham operating in the HF spectrum. It can be used with any HF transceiver, analog or digital, or with any VHF transceiver with an appropriate pre-scaler. Also, it can be used with any signal generator below 22 MHz as a test instrument. When used with Ten-Tec transceivers employing a 9-MHz i-f, special built-in presets allow proper megahertz readout of the operating frequency, even though the counter is reading vfo out-

put. The Model 299 will be available in February. For further information, contact *Ten-Tec, Inc.*, Sevierville TN 37862.

### TWO NEW HIGH-PERFORMANCE, LOW-COST FREQUENCY COUNTERS

Brand new from Optoelectronics, Inc., are the Model 7010 series miniature 600-MHz counters and the Model 8010 series 1 GHz/1.3 GHz counters. Both units include features such as rf-shielded, black anodized aluminum cases, 9-digit resolution, 1 ppm TCXO or (optional) 0.1 ppm precision TCXO 10-MHz timebases with external clock input, .4" red LED digits, and excellent sensitivity. 50-Ohm input sensitivity on the 7010 series is 5-40 mV from 25 MHz to 600 MHz; on the 8010 series it is 5-25 mV from 25 MHz to 1 GHz. Both units are offered

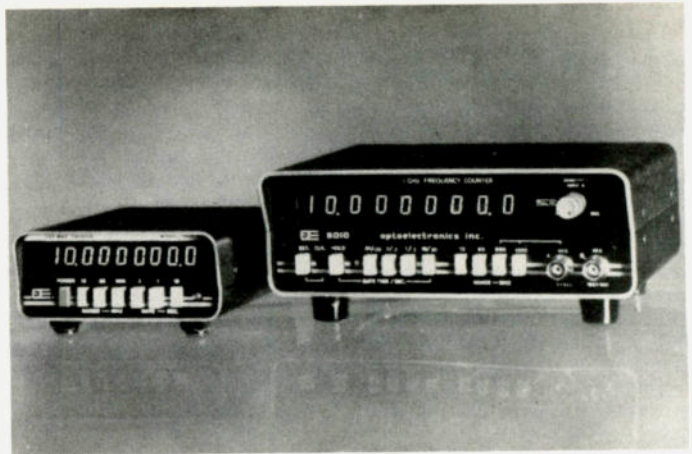

*Optoelectronics' new counters.*

with self-contained (optional) rechargeable nicad battery packs.

For additional information,

contact *Optoelectronics, Inc.*, 5821 NE 14th Avenue, Ft. Lauderdale FL 33334; (305)-771-2050/1, (800)-327-5912. Reader Service Number O3.

# W2NSD/1 NEVER SAY DIE

*editorial by Wayne Green*

*from page 6*

When I heard about the EIA plan to try to take the amateur 220-MHz band away and make it a CB band, I contacted Andy and talked with him about it. I told him I thought it was pretty crummy, him being an amateur and the head of one of the largest of the ham manufacturing firms, to bankroll the loss of a ham band. He said that business was business and that, after all, amateurs were not using the band, so if he didn't get it away for CB, some other service would grab it. He pointed out that we were weak because we had no lobby, such as the EIA, that money talked when it came to government, and that they had support from people at the highest level of the FCC for this move.

I countered, suggesting that we push for a code-free ham license for 220 MHz and thus keep it a ham band, rather than lose it permanently to CB. He felt that would be too restrictive, that they would settle for nothing less than CB for 220 MHz and thus be able to sell millions of people another radio. With the amateurs having virtually no clout in Washington, he felt it was just a matter of time before they got 220 MHz for CB.

There was no way to really write about this plot and name names, so I mulled it over and

decided to go about this obliquely. First I put together a petition for a code-free ham band at 220 MHz and filed that with the FCC. I figured that the firms behind the 220 CB push would at first reject this, but if I could bring enough pressure, perhaps they would support it and this would serve the dual purpose of saving the band for hams and also act as a nice entry level experience for new hams. And we certainly did need new hams at this time (1969).

Next, when the EIA proposal for 220 CB was filed, I got after my friends in Canada and Mexico and got them to put on the pressure for a rejection of the plan on the basis that it would interfere with their amateur operations across the border. This was a key approach because this band was designated as amateur with ITU and thus our government would have to be sensitive to the complaints from other governments if we were proposing a non-permitted use for the band.

Despite the high level support within the FCC claimed by Andy, the protests of Canada and Mexico did in fact cool the CB proposal... a bit.

The manufacturers who were involved with this situation were convinced that the EIA had it made. If you remember, Regency came out with a 220-MHz transceiver. Well, this was not

really for amateur radio; this was for CB. And ditto several others (Cobra, Midland, etc.) which appeared at that time. I was invited to visit Regency to preview the 220 rig and the president of the firm was willing to make a very substantial bet with me that the FCC was going to okay the 220 CB proposal soon. He already had the expense of the 220 ham rig on the line, so I decided not to venture any bets.

Things cooled a little bit more when the chairman of the FCC left and went onto the Nixon White House staff. Then we found pressure building up shortly after that via the White House Office of Telecommunications Policy. This obviously was pressuring the FCC, so I called the OTP and said I would start making a big stink over the White House connection if they didn't pull back. I don't know whether that did any good or not, but the pressure did seem to abate at that time.

Well, getting back to the CB screw-up. The manufacturers, via the Electronic Industries Association, were putting on the pressure for 50 CB channels. It looked as if they were going to get it through. Then someone got to worrying about possible interference to any radio equipment using a 455-kHz i-f if two CB rigs happened to be 455 kHz apart in frequency. Ooops. No one had considered that before.

The FCC ran some hasty tests and found two things. First, they verified that two CB rigs 455 kHz apart would indeed cause a mess with radios and other CB units. They also discovered, this apparently being the first time that they had ever tested the CB rigs being sold, that many were sending out all sorts of spurious emissions...

they were dirty. Anyone living near a CBER could have told them that... but apparently no one did.

This killed the 50-channel plan, but it was quickly replaced with a 40-channel CB plan which would not permit two CB channels to be 455 kHz apart. Then came the blow which the industry never counted on... and the one which brought down the multi-billion dollar industry in flames. The Commission, under great pressure from the EIA and the White House OTP, okayed the 40-channel plan... but put off the sale of the new rigs for six months... until January first.

Up until that time, CB was going strong. We had CB movies one after the other... CB television programs... a whole bunch of CB records... the country was being CB'ed at every turn and was responding by buying CB sets as fast as Japan could make them and ship them over. CBERs were getting on the air by the millions... asking about smokey and generally rag chewing. As one drove down the highway, just about every tenth car had sprouted a CB whip.

The announcement that there would be 40 channels, but that the new sets could not be purchased for six months, put an instant freeze on sales. Those shiploads of 23-channel sets were still coming in from Japan and the factories were turning them out by the hundreds of thousands. Within days, the shelves of dealers in the US became loaded and orders were frantically being cancelled. It took several months to shut down the flood of equipment being made in Japan and get the ships unloaded into warehouses all over our country. It was a disaster.

The bright side was that

come January, the industry would be allowed by the FCC to sell the new, cleaner 40-channel sets and then everything would be alright again. The manufacturers cheered each other up at meetings with plans for setting the prices high at first in order to make up for the losses. Other firms kept telling each other that it wasn't as bad as it looked. I went to some of these industry meetings and I have tapes of the self-delusion which was going on.

The manufacturers tried to get the FCC to move the deadline ahead so they could at least start selling their new sets during the Christmas rush, but the FCC was not to be moved... nor were the CB sets. You could now buy 23-channel sets for half their parts costs almost anywhere. I saw nice sets going for \$10 and \$20, and going begging. This was when I got started with the idea of hams buying them and converting them for 10m use. Unfortunately, only a few thousand were converted. Pity; I think hams missed out on a good and very inexpensive new band as a result. But this was at the bottom of the sunspot cycle and ten was stinko, so the 10m AM band did not catch on.

January finally arrived and suddenly the industry discovered that CB was no longer a fad. The movies were forgotten... the TV shows cancelled... even the hit CB songs were now oldies and CB joined the hula hoop in unpopularity. The great plans for making a killing on the new sets evaporated as prices skidded in a desperate effort to drum up sales. It didn't work and we then saw the major manufacturers folding up, one after the other. Pride collapsed. Johnson suffered terribly, but their commercial radio sales kept them in business. Hy-Gain disintegrated, with the ham end of things being picked up by Tel-ex... and doing quite well, thank you.

Like millions of others, I have a CB set in my car, but I don't use it very much. It's handy when there are traffic problems or I am going on a trip and want to know if there are radar checkpoints ahead, but other than that it is just there in case of need.

The greed of the industry brought about its collapse. Unfortunately, this has had some effects upon amateur radio... and I've written about them recently. The CB craze also supported the HF band sales of ham gear, making hams have to wait to get equipment. Then, when CB sales... and HF sales, too... faded away, hams bought a lot of HF equipment and this caused many ham dealers to expand their business. Our ham clubs had set up class-

es and these were fed by CBers and HFers, making recruitment of new hams easy. Then, when CB went away, so did the recruits, and the result is that today amateur radio newcomers are few and our population is again decreasing... and ham dealers are hurting.

Fortunately, I think there are some things which we can do to get newcomers coming into amateur radio again... and I think I have some ideas which will bring amateurs back into building gadgets and buying new equipment. I will be discussing my plans for reviving amateur radio at the January Aspen Ham Industry Conference. I'll go into more details on this in future issues of 73. I can't do this alone... but I can provide support for those who want to do something.

The FCC recently asked for comments on the proposed CB use of 900 MHz and I wrote up a lengthy proposal for that band. I do think that it will be possible to generate billions of dollars in sales of CB equipment for this band if it is established as I have proposed. I'll try to get my proposal for this into 73 in the near future for those interested in the concept. I have not proposed a service anything like the present CB eleven-meter mess. My idea is to provide a communications service more like the one originally intended by the FCC for CB. It would provide personal communications virtually anywhere at any time wanted. It would interface with the telephone, with computers, with beeper callers, etc.

Well, I'm sort of sorry about the drop in imports, but not too sorry. I do think that we should pester the hell out of our representatives in Washington to get rid of the capital gains tax so we will have investment money to rebuild our high technology industries. And we need to do this before we lose the last of them... microwaves and microcomputers.

#### THAT BANDWIDTH PROBLEM

An eon or two ago we suffered through a well-intentioned effort by the FCC to fix up our rules and permit some experimentation. But, as usual, there was more misery in the proposal than benefit, so amateurs overwhelmingly voted the proposal down.

We do have some ham frequencies where we have congestion. Ask any Novice about that. But, on the whole, we don't have any serious problems with finding frequencies to use for communications. We've built up something on the order of 4,000 or more repeaters for VHF communications... with a bit of a tight fit here and there, but accommodated overall. On the

low bands, we do run into more signal packing than we like on weekends and during contests, but if you are even slightly adventurous, you know that we have lots of open channels.

During much of the day and night, the 20-meter band—at least the Advanced portion of it—has room for more signals. The General part is often filled with bunches of nets and presents more of a problem in finding open channels. I defy you to find a time when 15 meters is open and you are unable to find an empty channel... ditto ten meters. Lots of 'em.

But when we start talking in terms of getting more hams, we have to start thinking in terms of eventually solving a crowded band situation. To a large degree, we can spread out our hamming, using the off-hours for more interference-free contacts. But if we are going to think in terms of doubling or tripling (or more) the ham population of our country, then we have to start thinking in other terms.

I do have some technical ideas which may forever change amateur radio. I'll be developing these in conjunction with the ham industry and I think you'll like what I have in mind. I think it may revolutionize much of our operation.

Before we get into serious technical developments, I think we can look more carefully at amateur radio and the frequencies it requires. Of course, the concept of frequency is deceptive since we are actually talking about a factor which might be considered to be frequency x time. If you look at amateur radio communications as using a resource which is the product of frequency channels and time... what in computer terms is called "throughput"... we can get a better grasp on what is happening and what we may be able to do to improve the situation.

There are sampling techniques which remove about 80% or more of speech and you can't tell the difference. We may eventually get into some sort of time multiplex system which would enable us to stack five to ten contacts all on one channel without serious interference between them.

Then there is the redundancy of the English language. There are many techniques for compacting English messages so they will take much less time to transmit. But, speaking of redundancy, how about the average ham contact? Think how much that could be compacted with little, if any, loss of intelligence.

We do have several different basic types of ham communications. Some are much more

adaptable to compacting than others. Take the average DX contact for the purpose of getting a new country... the call-sign, report, and a confirmation are all that is needed. Now, obviously, that could be made a good deal more efficient than it is at present, list operations notwithstanding.

It may be possible for future DXpeditions to conduct a two-way contact with eager DXers, all within two seconds per contact. The bandwidth might be a bit more than we are using today, but the goal is exchanging information efficiently, and in this we want to take advantage of every minute that the band is open to a certain area. We can afford to expend frequency spectrum to buy time. If we are transmitting our call-signs at a speed of, say, one hundred words per minute, then it will take about one one-hundredth of a minute to send a call-sign... that's about a half second.

By automating these DXpedition contacts and contacts with rare countries, we could salvage a good deal of the low end of 20 meters. This would provide more channels and time for hams to swap basic station information... which seems to take up a good deal of the ham spectrum. Again, this could easily be automated and most of the station data communicated within one second or two with some encoding standards.

But what about the rag chewers, you may ask. Well, if we are able to streamline the DX contacts, the hello-goodbye contacts, and contests, wouldn't that leave a lot more time and frequencies for rag chewing? But, you may argue... and I wouldn't blame you... rag chewers don't talk about anything much anyway. Well, maybe you don't, but I do. The fact is that I enjoy talking. I'm not quite so good on listening, but then neither are you. So I'll put up with you talking a lot as long as you'll put up with me doing the same.

Oh, I enjoy DX contacts, too, and I will get just as excited as you when the day comes and my printer occasionally prints out a line to let me know that my station has made another rare DX contact. Perhaps I would like to have a bell which would announce every ten new countries contacted.

Seriousness aside, I think we are going to be able to accommodate a lot more hams on our bands if we start thinking more in terms of throughput and automating those functions which can best stand the gaff.

#### OBJECTIVE RADAR REVIEW

Last May, Judge Nesbitt of Miami apparently got fed up with the police assurances that

radar evidence against a motorist was unimpeachable evidence of speeding. He called in both the proponents of radar and the opponents and heard nine days of testimony from engineers. This is the first known time when both sides of this field have had an opportunity to put their evidence on the line.

The judge's opinion was clear: Police radar, as now used, is unreliable and was not admissible in his court as evidence in speeding cases. He went into considerable detail about this, citing poor radar equipment and poor officer training as being the major problems. He found that certain types of radar could be dependable if used by knowledgeable officers under light traffic conditions.

Testimony on the cost of radar units surprised the judge (and me). He found that a \$2,395 list price unit could be had in quantity for \$375... with the manufacturer still making a good profit. That would mean a manufacturing cost of around \$100... which might explain why so many radar units are not dependable. It was found that perhaps 30% of the speeding tickets go to the wrong person, leading more and more people to have less and less enthusiasm for supporting our system of police and justice.

The judge suggested some changes which, if implemented, might make radar evidence of more value. He said that the width of the radar signal should be narrowed considerably. Present units run to as much as 24°, which means that officers often have to just guess which car they are trying to read. Engineers testified that beamwidths could be brought down to around 2° without great expense.

Next, the judge suggested it was time to get rid of the buzzers, which were very dependable, and use direct reading systems. All of the gadgets which have been added make the systems less reliable. He said police should stop using moving radar, phase locked loop detectors, automatic speed locks, and beam interrupters. With the moving radar, it was testified that no matter how well trained an officer is, a certain percentage of the tickets handed out will be incorrect.

He recommended that police departments set up their own training and not depend upon manufacturers for this... or hire a consultant. Officers should be trained to understand how the equipment works and its limitations.

The judge felt that our judicial system will only work when people are treated fairly... and

the present use of radar is defeating this concept.

My thanks to W2JTP for sending in this item.

### SATELLITE TV FANS — GOOD NEWS!

Though many experimenters were not bothering to get one, until recently the FCC required a license for receiving signals from the TV satellite. The Commission moved recently to eliminate this requirement, so the lid is off on receiving these signals.

Considering the popularity of this... we might call it a hobby... I suspect we will be seeing better and better receivers coming available for this service... and at lower and lower prices. I noticed an ad by International Crystal (ICM) for a satellite receiver priced at \$1995. It does take a fair-sized dish plus a low noise receiver to pull in these signals.

The receiver for the MDS signals we published in the August issue of 73 created quite a stir... and all sorts of attacks on us by the Common Carrier Association of Telecommunications (CCAT). They petitioned the FCC to take away the ham licenses of everyone involved in the publishing... plus asked the FCC to go for criminal action and assorted fines. I'll try to publish the public record on this in fine print for those who enjoy legal matters. The whole thing is nonsense.

CCAT backed up the petition to the FCC with a suit in a federal court, which is a big pain in the... er... neck. I sure hope that this attempt at what I think of as legal terrorism backfires and ends up with a clear statement by the courts that there are no restrictions on receiving satellite or MDS signals... which I know has to be the case. This might turn hundreds of firms loose with receivers for these signals and really give them trouble.

The FCC action on the satellite reception appears to open up the possibility for experimenters to not only receive the signals, but also to relay them via cable to friends on a non-profit basis.

### POLITICIANS... UGH!

The other night, while listening to a talk by New Hampshire's Senator Humphrey... one of those things one gets into as a member of the Chamber of Commerce... I got to thinking about politicians. Somewhere, in an article published recently, there was a description of the politicians we had back during the formative years of our country. It seems that in those days we did not have professional politicians... just people who were interested

enough in their country or state to offer their time... usually for one term.

One of the results of this was that politicians of those days were not faced, immediately upon being elected, with the goal of getting reelected. This meant that they could be a lot more objective and vote for things which seemed in the best interests of their constituents.

Humphrey brought this to mind when one of the people present asked him how he was able to vote the way he thought best rather than follow popular emotions the way most senators do. He said that he had run for office because he wanted to try to do something about the mess things were in and that since he didn't really care whether he was reelected or not, he was completely free to do what seemed best.

We get so swept up in the power of the vote that we tend to forget that we have not yet decided to put all matters of public interest to a vote... only the election of our representatives. Most of us are so busy with making a living, with problems of loving, and with all the other factors which make or break our day, that the rush of major events is reduced to news—entertainment on television or in the newspaper.

There is no practical way that all of us... or even most of us... can find out enough about what is going on—and recognize the myriad of contributing factors—to be sure of coming up with the best solution to these problems on every occasion. If we are realistic about this, it is a tough job even for the people we've chosen to look out after these interests. But what do we do? We elect someone to office and then we try to put on the pressure to get him (or her) to vote according to our emotions or according to our own far-from-well-informed understanding of what is going on.

Congressmen, ever vigilant to pressures from the voters who will reelect them, bend in the winds of public emotion, trying to shout each other to agree with the largest group. As a result, we are in one hell of a mess.

Heck, I see this to some extent even in the world of amateur radio. I've been around long enough and been in a position to know, probably better than anyone else, what has happened in the past to mold the way things are now... and to see how present emotions are molding the way things are turning. I've watched the great majority of amateurs take little interest in what is happening until something comes along which hits home... and then there is

a blast of emotion, usually in the wrong direction because they have not been paying attention.

Senator Humphrey spoke on SALT and oil company profits. In both cases, it was clear that he had done a good deal of research and had a very good understanding of the situations. It seems to me that this should be the purpose of paying a senator... to get the facts on situations and then represent us as an expert and vote appropriately. He should do that even if I am sending him telegrams to do the opposite. The time for my input is when I have facts for him... facts he has no way of getting elsewhere... and when it comes time for me to assess his ability to see through the baloney and vote in the best interests of those of us who elected him.

The media... and I include television in particular... are out selling their product. If you are able to get the facts through all that emeraldment, then you are a surprising person. When I see acts of terrorism, I also see money and power going to the media, for they play to our emotions with their coverage. Without television and the press, I doubt if there could be terrorism as we see it today. Terrorist groups have studied our media and know how to take advantage of it to get the maximum play.

Do you think that the Iranians would have taken US hostages if the whole thing would have been known only to our government? No, they knew that this would be on television all over the world... in special editions of the papers... in whole special issues of news magazines. We are in a time of the media and we are a prisoner of it. Oh, I'm watching the damned television news, too... cursing myself as I do it. I wonder if it is much different from going to the arena in Rome to watch the Christians get exercised by the lions.

No, I don't have any alternative to offer. I'm not in favor of censorship of the press, as much as I think their freedom is causing great changes in the world... and not necessarily for the better.

But perhaps, if we look at the TV news and recognize that each of the networks is battling for a tenth of a point increase in the ratings, we will better understand that we are being used by them to make money. They know exceedingly well how our emotions work and they are hard at it to produce the most reaction... and are succeeding. There is probably no way to keep us from turning on the news and watching in growing horror as they interview the relative of a victim, wondering if

we should give in to terrorism and do what they want . . . not realizing that it is the media which is making the terrorism work . . . and our watching which feeds the media. We are the ones who agree to be terrorized.

Getting back to our representatives and their obsession with getting reelected . . . I wonder what changes it would make if all senators and reps were allowed just one term in office. Sure, we might lose some good talent, but it would make a big change in the type of people running for office and it might free us from the entrenched interests which have been running things for so many years. We might even be able to cut down on government. The few good people who would be lost to us would be more than compensated for by the garbage which would get thrown out.

Senator Humphrey was perhaps a bit more candid than he should have been when he spoke so contemptuously of the great majority of congress . . . but he sure is in a spot to know.

#### WAYNE'S PICTURE ALBUM

Every now and then, I look through some of the piles of pictures I've taken down through the years and I suspect that some readers may be interested in seeing some of them. I'll try to put a few into the magazine now and then, covering events which are recent . . . or long ago.



This is a picture of Bill Godbout (Godbout Electronics) which I snapped at NCC in New York last year. I think they conned Bill into attending NCC by getting him to participate in a panel discussion on the future of personal computing. Unfortunately, the several important things that came through as a result of this panel seem to have been lost in the rush of wind from many other talks and discussions. I get the impression that revealing anything important at an NCC session is a sure way of keeping it a secret from the world. Yes, I know about the mighty volumes pub-

lished which contain the printed record of these talks, but I haven't seen any sign that these are ever opened by anyone.

The key here may be that these talks are for free and there is the concept that free things are not usually worth much. One of the same papers, published in a magazine as an article, would get maybe a thousand times the recognition. I suspect that a lot of talent and work has been virtually thrown away on papers for the technical talks at computer shows such as NCC and the Faires.

Well, getting back to Bill, take a good look at him here . . . before the telephone implant which is certain to be made. Bill spends about 26 hours a day on the phone. Well, I understand, is planning on dedicating the new wing of their Oakland office to Bill. But, if you want to know what is going on in the micro-computer field, ask Bill. He's better than any newsletter. And if you want any hard-to-find IC, you can bet that he either has a ton of them or knows where they are. He's been building up a dealer network handling his ICs by virtue of his infallibility in finding sources.

When Bill gets together with George Morrow and Tom Mullen, hold onto your intellectual stirrups. The ideas flow thick and fast . . . enough to supply a dozen companies with products.



The NCC panel was chaired by Portia Isaacson (left), now of Innovision and EDS. This may soon be the largest mail-order and direct mail firm in the microcomputing industry. Next to her is Richard Kuzmack, who did much of the work of organizing the personal computing aspect of NCC. Then we see Bill Godbout, opining. Next is Larry Stein, then Les Soloman of *Popular Electronics*, who came up with the Altair name for MITS . . . and for whom the Processor Tech SOL was named. And last, but not least, me, on the right.



Chuck Martin WA1KPS, here seen with Judy Waterman, our bulk sales manager, and Sherry Smythe, our executive vice president, is enjoying a massive amount of southern fried chicken, biscuits, gravy, Smithfield ham, and all the fixin's at Aunt Fanny's Cabin in Atlanta. This is a yearly pilgrimage during the Atlanta Hamfestival.



While Chuck is out eating, we see Eric Williams WA1HON hold down the Tufts Electronics exhibit at the Hamfestival. That's Eric pulling out a pair of crystals for an HT. Eric, by the way, is one of the regulars at the yearly Aspen ham industry conference.



Yep, there I am, speaking at the ARRL New England Convention! The announced topic was microcomputers, but this was a thinly disguised stratagem to thwart the general manager. There have been years when the manager had enough clout to prevent *73 Magazine* from even exhibiting at an ARRL convention . . . and for years there was no way that a convention committee would be permitted to put me on the speaking program.

In this case I am, in the picture, showing one of the 10-GHz transceivers which I used to make the contacts with Chuck Martin WA1KPS (of Tufts Electronics) with seven different states. The fact is that Chuck did most of the work . . . getting the rigs to work and repairing them every few days as they would break down. It does look as if it is going to be a while before we have dependable 10-GHz communications.

While I did manage to talk a good deal about microcomputers and the state of that hobby, I also was able to answer some questions about WARC and overcome, at least perhaps for the group present, some of the propaganda which has been painting me as a "purveyor of doom," as it says in so many director newsletters. I'm pragmatic about WARC, feeling that a prudent person would do everything possible to achieve success there, rather than just rely on luck.

#### SEPTEMBER WINNER

It pays to be honest! "Confessions of a Teenage HFer" was voted by our readers the most popular article in our September issue, so author Hans Peter will be receiving that month's \$100 bonus check.



Another regular at Aspen is Steve Murray K1KEC, here seen (with beard) taking a meal break during the VHF contest atop Pack Monadnock mountain, about three miles from downtown Peterborough.

# OSCAR Orbits

Courtesy of AMSAT

Any satellite placed into a near-Earth orbit suffers from the cumulative effects of atmospheric drag. The much publicized descent of the Skylab space station was a graphic demonstration of these effects.

The OSCAR satellites are subject to atmospheric drag, of course, and the present period of intense solar activity has accentuated the problem. During this period, our sun has been expelling huge numbers of charged particles, some of which find their way into the Earth's upper atmosphere, increasing the density (and thus the drag) there. It is through this region that the OSCARs must pass. OSCAR 8, in a lower orbit than OSCAR 7, is the more seriously affected of the two.

If the drag factor is not considered when OSCAR calculations are performed, long-range orbital projections will be in error. For example, by the end of 1979, OSCAR 8 was more than 20 minutes ahead of some published schedules. The nature of orbital mechanics is such that extra drag on a satellite causes it to move into a lower orbit, resulting in a shorter orbital period. Thus, the satellite arrives above a given Earthbound location earlier than predicted.

Using data supplied to us by Dr. Thomas A. Clark W3IWI of AMSAT, the equatorial crossing tables shown here were generated with the aid of a TRS-80™ microcomputer. The tables take into account the effects of atmospheric drag and should be in error by a few seconds at most.

The listed data tells you the time and place that OSCAR 7 and OSCAR 8 cross the equator in an ascending orbit for the first time each day. To calculate successive OSCAR 7 orbits, make a list of the first orbit number and the next twelve orbits for that day. List the time of the first orbit. Each successive orbit is 115 minutes later (two hours less five minutes). The chart gives the longitude of the day's first ascending (northbound) equatorial crossing. Add 29° for each succeeding orbit. When OSCAR is ascending on the other side of the world from you, it will descend over you. To find the

equatorial descending longitude, subtract 166° from the ascending longitude. To find the time OSCAR 7 passes the North Pole, add 29 minutes to the time it passes the equator. You should be able to hear OSCAR 7 when it is within 45 degrees of you. The easiest way to determine if OSCAR is above the horizon (and thus within range) at your location is to take a globe and draw a circle with a radius of 2450 miles (4000 kilometers) from your QTH. If OSCAR passes above that circle, you should be able to hear it. If it passes right overhead, you should hear it for about 24 minutes total. OSCAR 7 will pass an imaginary line drawn from San Francisco to Norfolk about 12 minutes after passing the equator. Add about a minute for each 200 miles that you live north of this line. If OSCAR passes 15° east or west of you, add another minute; at 30°, three minutes; at 45°, ten minutes. Mode A: 145.85-.95 MHz uplink, 29.4-29.5 MHz downlink, beacon at 29.502 MHz. Mode B: 432.125-.175 MHz uplink, 145.975-.925 MHz downlink, beacon at 145.972 MHz.

At press time, OSCAR 7 was scheduled to be in Mode A on odd numbered days of the year and in Mode B on even numbered days. Monday is QRP day on OSCAR 7, while Wednesdays are set aside for experiments and are not available for use.

OSCAR 8 calculations are similar to those for OSCAR 7, with some important exceptions. Instead of making 13 orbits each day, OSCAR 8 makes 14 orbits during each 24-hour period. The orbital period of OSCAR 8 is therefore somewhat shorter: 103 minutes.

To calculate successive OSCAR 8 orbits, make a list of the first orbit number (from the OSCAR 8 chart) and the next thirteen orbits for that day. List the time of the first orbit. Each successive orbit is then 103 minutes later. The chart gives the longitude of the day's first ascending equatorial crossing. Add 26° for each succeeding orbit. To find the time OSCAR 8 passes the North Pole, add 26 minutes to the time it crosses the equator. OSCAR 8 will cross the imaginary San Francisco-to-Norfolk line about 11 minutes after crossing the equator. Mode A: 145.85-.95 MHz uplink, 29.4-29.50 MHz downlink, beacon at 29.40 MHz. Mode J: 145.90-146.00 MHz uplink, 435.20-435.10 MHz downlink, beacon on 435.090 MHz.

OSCAR 8 is in Mode A on Mondays and Thursdays, Mode J on Saturdays and Sundays, and both modes simultaneously on Tuesdays and Fridays. As with OSCAR 7, Wednesdays are reserved for experiments.

OSCAR 7 ORBITAL INFORMATION FOR JANUARY

ORBIT #	DATE	TIME (GMT)	EQ. CROSSING (DEGREES WEST)
23456	1	0005:48	69.0
23469	2	0100:05	82.6
23482	3	0154:21	96.2
23494	4	0053:40	81.0
23507	5	0147:56	94.6
23519	6	0047:16	79.5
23532	7	0141:32	93.1
23544	8	0040:51	77.9
23557	9	0135:07	91.5
23569	10	0034:27	76.4
23582	11	0120:43	89.9
23594	12	0020:02	74.8
23607	13	0122:18	88.4
23619	14	0021:30	73.2
23632	15	0115:54	86.8
23644	16	0015:13	71.7
23657	17	0109:29	85.3
23669	18	0008:49	70.1
23682	19	0103:05	83.7
23694	20	0002:24	68.6
23707	21	0056:40	82.1
23720	22	0150:56	95.7
23732	23	0050:16	80.6
23745	24	0144:32	94.2
23757	25	0043:51	79.0
23770	26	0138:07	92.6
23782	27	0037:27	77.5
23795	28	0131:43	91.0
23807	29	0031:02	75.9
23820	30	0125:18	89.5
23832	31	0024:38	74.3

OSCAR 8 ORBITAL INFORMATION FOR JANUARY

ORBIT #	DATE	TIME (GMT)	EQ. CROSSING (DEGREES WEST)
9295	1	0035:54	57.6
9309	2	0040:54	58.0
9323	3	0045:54	69.1
9337	4	0050:54	61.4
9351	5	0055:54	62.6
9365	6	0100:54	63.9
9379	7	0105:54	65.2
9393	8	0110:54	66.4
9407	9	0115:54	67.7
9421	10	0120:54	69.0
9435	11	0125:54	70.3
9449	12	0130:54	71.5
9463	13	0135:54	72.8
9477	14	0140:54	74.1
9490	15	0002:41	49.5
9504	16	0007:40	50.8
9518	17	0012:40	52.1
9532	18	0017:40	53.3
9546	19	0022:39	54.6
9560	20	0027:39	55.9
9574	21	0032:38	57.1
9588	22	0037:38	58.4
9602	23	0042:37	59.7
9616	24	0047:37	61.0
9630	25	0052:36	62.2
9644	26	0057:36	63.5
9658	27	0102:35	64.8
9672	28	0107:35	66.0
9686	29	0112:34	67.3
9700	30	0117:33	68.6
9714	31	0122:33	69.8

OSCAR 7 ORBITAL INFORMATION FOR FEBRUARY

ORBIT #	DATE	TIME (GMT)	EQ. CROSSING (DEGREES WEST)
23845	1	0118:54	87.9
23857	2	0018:13	72.8
23870	3	0112:29	86.4
23882	4	0011:49	71.2
23895	5	0106:05	84.8
23907	6	0005:24	69.7
23920	7	0059:40	83.2
23933	8	0153:56	96.8
23945	9	0053:16	81.7
23958	10	0147:32	95.3
23970	11	0046:51	80.1
23983	12	0141:07	93.7
23995	13	0040:27	78.6
24008	14	0134:43	92.1
24020	15	0034:02	77.0
24033	16	0128:18	90.6
24045	17	0027:37	75.4
24058	18	0121:53	89.0
24070	19	0021:13	73.9
24083	20	0115:29	87.5
24095	21	0014:48	72.3
24108	22	0109:04	85.9
24120	23	0008:24	70.8
24133	24	0102:40	84.3
24145	25	0001:59	69.2
24158	26	0056:15	82.8
24171	27	0150:31	96.8
24183	28	0049:50	81.2
24196	29	0144:06	94.8

OSCAR 8 ORBITAL INFORMATION FOR FEBRUARY

ORBIT #	DATE	TIME (GMT)	EQ. CROSSING (DEGREES WEST)
9720	1	0127:32	71.1
9742	2	0132:31	72.4
9756	3	0137:30	73.6
9770	4	0142:29	74.9
9783	5	0004:16	50.4
9797	6	0009:15	51.6
9811	7	0014:14	52.9
9825	8	0019:13	54.2
9839	9	0024:12	55.4
9853	10	0029:11	56.7
9867	11	0034:10	58.0
9881	12	0039:09	59.2
9895	13	0044:08	60.5
9909	14	0049:06	61.8
9923	15	0054:05	63.0
9937	16	0059:04	64.3
9951	17	0104:03	65.6
9965	18	0109:01	66.8
9979	19	0114:00	68.1
9993	20	0118:59	69.4
10007	21	0123:57	70.6
10021	22	0128:56	71.9
10035	23	0133:55	73.2
10049	24	0138:53	74.4
10062	25	0000:39	49.9
10076	26	0005:37	51.1
10090	27	0010:36	52.4
10104	28	0015:34	53.7
10118	29	0020:33	54.9

## Ham Help

Several months ago, a letter was printed from Dick Jastrow, a blind would-be ham in California (August, 1979, p. 168). He asked for help in preparing for his exams in the code as well as theory. Apparently, there were a number of responses, but, in moving from one hospital to another, most of these letters got lost.

Dick recently answered my own letter and requested that I write to see if some hams in the Los Angeles area would reestablish contact. I am sure that contact with blind amateurs

would be especially valuable.

Although I am now inactive on the air, I am happy to help prospective hams if they ask me.

Dick's address is Richard Jastrow, Long Beach General Hospital, ward 800-A, 2597 Redondo Avenue, Long Beach CA 90806, (714)-427-9951, ext. 247.

**Bill Withrow W5BZY**  
211 N. 8th Avenue  
Teague TX 75860

I need the following states for my WAS award: Alaska, North

Dakota, Nevada, and Delaware. If anyone would like to exchange cards, it would be appreciated. I have a General class license and can operate on 10-40 meters, CW or SSB.

**Paul Gonicberg N1APW**  
265 Blackstone Blvd.  
Providence RI 02906

I need to borrow for a few days the operating manual and the maintenance manual for a Dumont scope, type 329. I will return it promptly with reimbursement for postage.

**Lloyd H. Yost K2YJP**  
Telecommunications  
Technology Center  
1 Research Drive  
Shelton CT 06484  
(203)-929-7341, Ext. 746

I need a schematic for a Heath general coverage receiver, the GR-91, with a 1961 copyright. The manual number is #595-492-01. I also need to know the specs on part #40-396, the band D antenna coil for the same rig, if at all possible.

I will be glad to pay copying expenses and postage. Thanks very much for any help.

**Dr. Richard Sanchez**  
1805 Adeline  
Hattiesburg MS 39401

I need a schematic or manual for a Hallicrafters model S-38. I will pay copying costs or copy myself.

**Chuck Bennett WB8GQW**  
5667 Nike Drive  
Hilliard OH 43026



# NEW DIGITAL READOUT



UPDATE YOUR  
HEATHKIT.  
PUT IT IN  
YOURSELF FOR

**\$89.95**

Low-cost digital frequency readout for Heath models listed below. Retains 1 kHz analog frequency readout and replaces top 100 kHz analog dial with digital frequency readout. Digital resolution to 100 Hz, covers all ham bands.

Easy step by step installation instructions: two wires, one small coax and band switch wafer. Unit installs with same two screws used for 100 kHz analog dial. To modify Heath models: HW-101 use DMK-101

SB-102 use DMK-102      SB-303 use DMK-303  
SB-300 use DMK-300      SB-400 use DMK-400  
SB-301 use DMK-301      SB-401 use DMK-401

Labor for DMK-SB units installed in your rig:

DMK-303 . . . \$19.95      DMK-all others . . . \$29.95

Includes installation, return shipping and insurance. Write for schedule form. Order by stock number. Send check or money order. We accept Master Charge and Visa. USA and Canada add \$3.50 shipping and handling. Washington residents add 5.1% tax. Open 24 hours—call code 206-829-0056 or 206-588-5804.

WB7WCE

Allow 6 weeks for delivery.

KA7AZM

73's      PROTRONICS, INC. P.O. BOX 778      BUCKLEY, WN. 98321      ✓ P80

## Computer **RTTY** Demodulator

**FSK-1000**  
**\$449.00**

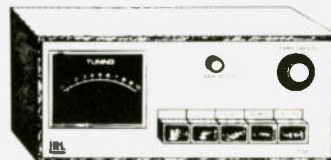

**FSK-500**  
**\$197.00**

✓ 127

iRL will now ship your FSK-1000 within 48 hours on Visa or MC. No need to wait for months to enjoy the finest RTTY demodulator. For those with the TRS-80 or other microcomputer, iRL has the FSK-500: the quality demodulator with no hassel interface and the low price tag. TRS-80 software is \$46.00 or \$20.00 with above units.

Call or write for full details or see our ad in the December, 1979 issue of 73 Magazine.

**iRL**  
T.M.

700 TAYLOR ROAD

COLUMBUS,

OHIO 43230

# Command Your Frequency

WITH A **DATONG** MODEL ASP



**\$249.95**

Including Pre-Paid  
Shipping &  
Full Insurance  
Dealer Inquiries Invited

**AUTOMATIC RF SPEECH PROCESSOR**

Made in England • 90 Day Warranty • Visa-Mastercharge Accepted

- Gives increased "punch" or "talk power" comparable to a times-ten increase in peak sideband power (SSB or AM) or peak deviation (FM).
- Instant push-button selection of 0, 6, 12, 18, 24 or 30dB of true r. f. Clipping for optimum talk-power enhancement under all conditions.
- No manual input level setting is required; it sets itself, automatically.
- Connects between microphone and transmitter - no internal connections required.
- Unique "TONE" button simplifies transmitter adjustment.
- LO/HI microphone impedance matching.
- Internal or external supply only 15mA at 6 and 16V.
- Eight ICs, eleven transistors, three LEDs.
- Elegantly styled to match any equipment.

Dedicated to Excellence (Exclusive Importers of DATONG FL-1's)

**AR** Technical  
Products  
Corp.      ✓ A105

Box 62  
Birmingham, Michigan 48010  
Telephone 313/644-5698

## FAST SCAN ATV

WHY GET ON FAST SCAN ATV?

- You can send broadcast quality video of home movies, video tapes, computer games, etc, at a cost that is less than slocan.
- Really improves public service communications for parades, RACES, CAP searches, weather watch, etc.
- DX is about the same as 2 meter simplex — 15 to 100 miles.



**ALL IN ONE BOX**

**TC-1 Transmitter/Conv**

Plug in camera, ant, mic and you are on the air . . . . . \$399 ppd



**HITACHI HV-62 TV CAMERA**

High performance closed circuit camera just right for atv. with lens . . . . . \$239 ppd

PUT YOUR OWN SYSTEM TOGETHER



**TVC-1B CONVERTER** tunes 420 mhz down to ch 2 or 3 . . \$49.50 ppd  
**TXA5 EXCITER** . . . . . \$69 ppd  
**PA5 10 WATT LINEAR** . . \$79 ppd  
**FMA5 Audio Subcarrier** . \$24.50 ppd

**SEND FOR OUR CATALOG, WE HAVE IT ALL**  
Modules for the builder, complete units for the operator antennas, color cameras, repeaters, preamps, linears, video ider and clock, and more. 19 years in ATV.

Call 213-447-4565 5-6 pm

✓ P41



Maryann  
WB6YSS

**P.C. ELECTRONICS**

2522 PAXSON  
ARCADIA, CA 91006

Tom  
W6ORG



## Eliminating Applicability From the Six Meter Frequency Band (50-54 MHz)

**AGENCY:** Federal Communications Commission.

**ACTION:** Notice of Proposed Rule Making.

**SUMMARY:** The Commission issues a Notice of Proposed Rule Making which proposes to allow frequency modulation telephony (F3) operation with more than 6 kHz over a greater segment of the 50 to 54 MHz (6 meter) amateur radio band. Deletion of the 6F3 limitation from the 6 meter band would offer much more flexibility for the amateur radio community.

**DATES:** Comments must be received on or before December 10, 1979 and Reply Comments must be received on or before December 28, 1979.

**ADDRESSES:** Federal Communications Commission, Washington, D.C. 20554.

**FOR FURTHER INFORMATION CONTACT:** Federal Communications Commission, Private Radio Bureau, Personal Radio Branch, Roy C. Howell (202) 254-6884.

In the matter of amendment of § 97.65(c) of the Commission's rules and regulations governing the Amateur Radio Service.

Adopted: October 25, 1979.

Released: October 31, 1979.

By the Commission:

1. On September 11, 1978, the Southern California Repeater and Remote Base Association (SCRRBA) petitioned for amendment of Part 97 in RM-3207 to allow frequency modulation telephony (F3) operation having an occupied bandwidth with more than 6 kHz over a greater segment of the 50 to 54 MHz (6 meter) amateur radio band. Subsequently, on January 18, 1979 the American Radio Relay League (ARRL) petitioned for a similar but not identical, rule change in RM-3313.

2. Frequency modulation is permitted now from 50.1 to 54 MHz (§ 97.61(a)), along with A1, A2, A3, A4, A5, F1, F2 and F5. However, § 97.65(c) requires "... between 50.1 and 52.5 MHz, the bandwidth of an F3 emission (frequency or phase modulation) shall not exceed that of A3 emission having the same audio characteristics. . . .". Since an A3 emission (amplitude modulation telephony), in this instance is normally considered to occupy a bandwidth of approximately 6 kHz, F3 operation between 50.1 and 52.5 MHz is limited to an occupied bandwidth of 6 kHz (6F3).

3. In support of its request, SCRRBA states that permitting occupied bandwidths greater than 6F3 would result in increased occupancy between 52 and 52.5 MHz by amateur stations using repeaters. Moreover, they claim it is possible some non-repeater operation using 16F3 (16 kHz occupied bandwidth standard) would occur between 51 and 52 MHz. SCRRBA requests the 6F3 limitation be stricken entirely from applicability to the 6 meter band.

4. Numerous comments were filed in support of SCRRBA's petition by various amateur radio groups. However, the Six Meter International Radio Club filed comments claiming the proponents of RM-3207 have overlooked the rapid expansion in single sideband operation (A3J) in the six meter band. They question the need for additional repeater operation.

5. In support of its request, ARRL also states that permitting occupied bandwidths greater than 6F3 would permit "... the fullest possible use . . . of the repeater subband 52.0-54.0 MHz . . .". ARRL requests the 6F3 lower limit be moved only from 52.5 MHz to 52.0 MHz. Comments from amateur radio groups were also filed in support of the ARRL petition, including comments from SCRRBA. However, SCRRBA takes exception to the ARRL's

proposed new lower limit of 52 MHz, stating they strongly believe 52 MHz is not appropriate. They argue that a more useful lower limit would be 51 MHz, and go on to reiterate their own proposal (RM-3207), for striking the 6F3 limitation from applicability to the 6 meter band. They state they "... seek the same flexibility for usage of this band as ARS (Amateur Radio Service) operators enjoy on the frequency bands above 144 MHz". The 6F3 limitations does not apply to these bands. SCRRBA also claims the ARRL petition would "... not facilitate the optimum utilization for this frequency band".

6. We believe that deletion of the 6F3 limitation from the 6 meter band would offer much more flexibility for the amateur radio community. As technology and interest in the many types of modulation schemes evolves, resolving sharing arrangements by the participants themselves would seem to be the most expeditious means for fulfilling the purposes of the service. Apparently, such has been the case on the 144 MHz, 220 MHz, and 420 MHz amateur radio frequency bands. This should also be the case for the 6 meter band. For the most part, 50 MHz has many of the characteristics of the higher frequency bands. For these reasons, the Commission proposes to amend § 97.65(c), as shown in the Appendix, to delete the 6F3 limitation from the 6 meter band. Comments on the amateur radio operators' ability to effectively resolve sharing arrangements, in this instance, are particularly invited. The Commission also proposes to delete the phrase "... and the purity of emissions shall comply with the requirements of § 97.73" in the interest of eliminating redundancy. The purity and stability requirements would remain in effect, as stated in § 97.73.

7. Authority for issuance of this Notice is contained in Sections 4(i) and 303(r) of the Communications Act of 1934, as amended, 47 U.S.C. 154(i) and 303(r). Pursuant to procedures set out in Section 1.415 of the Rules and Regulations, 47 CFR 1.415, interested persons may file comments on or before December 10, 1979, and reply comments

on or before December 28, 1979. All relevant and timely comments will be considered by the Commission before final action is taken in this proceeding. In reaching its decision, the Commission may take into consideration information and ideas not contained in the comments, provided that such information or a writing indicating the nature and source of such information is placed in the public file, and provided that the fact of the Commission's reliance on such information is noted in the Report and Order.

3. In accordance with the provisions of Section 1.419 of the Rules and Regulations, 47 CFR 1.419, formal participants shall file an original and 5 copies of their comments and other materials. Participants wishing each Commissioner to have a personal copy of their comments should file an original and 11 copies. Members of the general public who wish to express their interest by participating informally may do so by submitting one copy. All comments are given the same consideration, regardless of the number of copies submitted. All documents will be available for public inspection during regular business hours in the Commission's Public Reference Room at its headquarters in Washington, DC.

9. For further information concerning this rule making, contact Roy C. Howell, Rules Division, Private Radio Bureau, Federal Communications Commission, Washington, DC. 20554. (202) 254-6884.

Federal Communications Commission.  
William J. Tricarico,  
Secretary.

Part 97 of Chapter I of Title 47 of the Code of Federal Regulations is amended as follows:

In section 97.65, paragraph (c) is modified to read:

### § 97.65 Emission Limitations.

(c) On frequencies below 29.0 MHz the bandwidth of an F3 emission (frequency or phase modulation) shall not exceed that of an A3 emission having the same audio characteristics.

ou fools don't even profit  
lousy manuscripts from the  
burden the rock of  
you heard by  
I insist that you print ev  
tell Ma head that she shou

# LETTERS

from page 28

you going to harp on incentive licensing? After being a ham dropout for many years, I studied up a bit and got my Extra class back in 1963, long before the days of special call-signs. I did this mainly because I wanted to get permission to try out a couple of special modes of operation and thought I would have a better chance of getting permission from the FCC. Another reason for the Extra was to be able to operate in a portion of at least a few bands that would not be so full of signals. I guessed right in both cases.

So what's the big hassle about? Too many fellows wanting something for nothing, and quite willing to fight for just

that? Sounds like a labor union. Keep hounding the ARRL — they need it . . . even if a lot of it looks like nitpicking from out here in the boondocks.

Dave Hardacker W7TO  
Sheridan WY

### RADAR DEFENSE

I just read on page 171 of the October issue about illegal radar and hasten to write to caution all hams not to jump to conclusions. Radar principles have been well established, but the DC courts seem to base decisions on intrusion into the rights of private citizens rather than faulty radar. I do not think this is the best approach for a defense to a radar ticket.

For now, readers will be well informed to know the tests for law enforcement equipment, since it is up to the state to prepare a proper foundation for the evidence.

Some courts have found adequate foundations in various combinations of the following three means of testing radar speedometers:

1) A "run through" in which another police car closes on the site while holding a given speedometer reading (Query: How do we know the testing vehicle has been checked?);

2) Use of calibrated tuning forks intended to produce frequencies which will cause the machine, if accurate, to read particular speeds;

3) Use of a signal generator within the machine for the same purpose.

I know that in Massachusetts some foundation requirement is appropriate per a recent decision of the Supreme Judicial Court.

Duncan Kremer W1GAY  
Attorney at Law  
Vineyard Haven MA

### QSL STAMPS

This may be an old idea, but it has just occurred to me: Why not start a drive with the US Postal Service to come up with a 31c airmail stamp commemorating amateur radio?

This is the stamp that is used on most direct QSL mail and would be sent to every country in the world over a very short period of time. It could be themed, "Peace Over All The World Through Amateur Radio Fellowship."

Loren Carlberg WB5WDG  
Muskoogee OK

### UV-3 REVISITED

I had to comment on the review of the Drake UV-3, as printed in the October, 1979 (p. 31), issue.

The two features that the author noted as "could have been left out" are, in my opinion, most valuable. I think that any serious amateur who has these

Continued on page 159

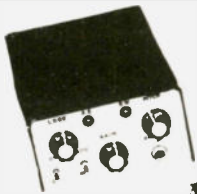

IT'S HERE!!

# THE AMCODER

4" x 2 3/8" x 6"

### A NEW ERA IN CW REGENERATION

- Select any CW signal that's 40 hz away from any other (Tune—400 to 1500 hz)
- Lock and switch to "auto" and you have tape quality audio. One and one only signal reception.
- Only 20 mv of audio above receiver noise required for acquisition.
- A 40 db over S9 signal, 50 hz away cannot come through.
- Reduce operator fatigue by not listening to any other band and/or signal noise except the one you want to work.
- Variable acquisition frequency—400 to 1500 hz.
- Variable output tone frequency—100 to 2000 hz.
- Variable output audio level (drives ear-phones or station speaker).

Kit includes all parts including cabinet, power supply and complete instructions. Epoxy glass boards, plated and pre-drilled.

Available—Factory wired and tested with 1 year warranty on parts and workmanship.

Kit—\$69.95 FWT—\$89.95

301-799-7741

VISA and Master Charge Accepted.

AMC ENGINEERING A106  
P. O. Box 427, Jessup, MD 20794

**JAN CRYSTALS**

**HOLD THE FREQUENCY**

- CB
- CB standard
- 2 meter
- Scanners
- Amateur Bands
- General Communication
- Industry
- Marine VHF
- Micro processor crystals

Send 10¢ for our latest catalog. Write or phone for more details.

**JAN CRYSTALS** **master charge** **BANK AMERICAN** **VISA** **easy to charge**

2400 Crystal Drive  
Ft. Myers, Florida 33907  
all phones (813) 936-2397

J2

# Now, upgrade faster!

## Here's 21 easy ways.

Satisfaction guaranteed or return in 10 days for full refund!

### THEORY

Interview-style discussion of the Novice-class theory for beginners.  
A two-tape set covering General theory with WØXI (set \$8.95).  
New! Advanced theory covered in interviews with KØRW, an Extra-class.  
New! Now study for your Extra exam with help from KØRW.

- Novice
- General
- Advanced
- Extra

**Novice** ■ An H. W. Sams book written in easy-to-understand style for beginners. \$3.95

**General** ■ Just published! Get the latest information for your FCC exam. \$6.50

### BOOKS

### MORSE CODE CASSETTES

Computer-generated to Morse specs in 7½, 10, 15 or 20 WPM (specify).  
Simulated on-the-air contacts with simulated exams - 7½, 10, 13, 15 WPM.  
Another hour of simulated contacts to bring you from 7½ WPM to 15 WPM with exam.  
An hour of QSO-style contacts at 13 WPM with simulated exam for self-testing.  
High-speed on-the-air contacts at 20, 23 and 26 WPM for Extra-class with simulated exam.  
Another hour QXX, high-speed, contacts at 20, 23 and 26 WPM.  
This super tape instructs "enhanced" code with wider spaces designed for beginners.  
On-the-air-style copy generated to "enhanced" specifications with spacing for 7½ to 15 WPM.  
Q-signals, short words and prosigns generated at 22, 33 and 40 WPM for recognition copy.  
Randomly-generated characters, numbers and punctuation at 7½ to 10 WPM.  
Random characters, numbers and punctuation at 13 and 15 WPM - no memorizing!

- Morse \_\_\_\_\_ WPM
- QSO
- QSO 2
- QSO 13
- QXX
- QXX 2
- Super 5
- Super QSO
- Q-signals
- Random I
- Random II

**Novice** ■ Novice Combo includes manual and Super 5, QSO and Novice Theory tapes - \$14.95

**General** ■ General Combo includes manual, QSO-2 tape and 2-tape General Theory - \$19.95

**Success** ■ Success Kit includes oscillator, key, your choice of manual and two tapes - \$29.95

**Speed** ■ Speed Kit includes oscillator, key and your choice of Kantronics tape - \$20.95

### COURSES

## Yes, I want to upgrade faster!

### ORDERS

Name \_\_\_\_\_

Address \_\_\_\_\_

City \_\_\_\_\_ State \_\_\_\_\_ Zip \_\_\_\_\_

Master Charge  Visa  Check

Card no. \_\_\_\_\_

Signature \_\_\_\_\_ Expiration date \_\_\_\_\_

Please include \$1 shipping/handling for each tape and \$2 for combination orders.

tapes

**\$4.95** each

**Kantronics**  
1202 E. 23rd Street (913) 842-7745  
Lawrence, Kansas 66044

# DX

from page 16

with help from several of the standard list-takers. A51PN and 9N1MM were welcome guests on both 20 and 15. Y11BGD still comes and goes and remains difficult for those strapped to a Monday-Friday work schedule.

New officers of the Iowa DX Association are: K0JSY, president; W0WP, vice president; K0LUZ, secretary-treasurer. The National Capitol DX Association also elected new leaders: N4MM, president; N4RA, vice president/activities manager; W3GG, secretary; and AA4M, treasurer.

The next team going to Macquarie will include VK0KH, to continue the work on the bands by VK0PK during 1979. P29JS has done yeoman service running the 14240 slot for these and others, around 0930Z.

More operations from Descecho appear doomed; KP4AM's try for a /D fire-up for the CQ Phone Contest in October was thwarted by the US government and the signs are that no one will be allowed on the rock for amateur radio purposes. YASME's hopes were similarly dashed in October.

5N0DOG is a good catch this winter on 40 and 80 meters, now that the Nigerian rainy season has passed. Dave's company, TICAS (Falls Church VA), purchased a ticket for Kunle 5N2NAS to attend WARC in Geneva last fall.

Rick Dorsch plans to move to the Galapagos (HC8) late in 1980 or early in 1981. He is just back from a visit there. Rick hails from Michigan but has been signing HC5EE from Ecuador for several years. The last American visitor to the Galapagos was Chod Harris VP2ML in early 1979.

KH6IJ continues to recover from a stroke suffered in early 1979; radio operating is still difficult for him. He has resumed his column in the Honolulu *Star-Bulletin*.

As this is written (early November), WARC continues with little news coming out of Geneva. A press gag by Secretary-General Mili has inspired the American representatives to keep the news to themselves, and the amateur radio press suffers accordingly, not only in the US, but around the world. The main item of interest has been Article 41, concerning in-

ternational Morse code requirements; apparently, CW will end up being a "recommendation" above 30 MHz, that is, each licensing authority (government) will have the option of requiring or not requiring CW proficiency above 30 MHz. Talk continues of an additional band at 24 MHz. 40 meters will probably not survive unscathed, with HF broadcast interests and their megabucks at work.

A reminder to contesters: Your CQ WW CW logs must be postmarked by January 15 and should be mailed to the new CQ address: CQ Publications, 76 North Broadway, Hicksville NY 11801. Do not enclose any correspondence, requests, etc., with your logs. This goes for sending contest logs to any organization.

HS1ABD out of Thailand operates on 40 and 80 meters; now is the time of the year to look for him, on 7005 and 3795 at 1300Z and 2200Z, respectively.

The East Germans begin using new prefixes this month; the callsign block is Y21A to Y99Z.

Careful about sending money overseas, please. Especially going to Africa and the Himalayan countries, your dollar bills may end up in some bureaucrat's pocket instead of in the pocket of the ham you just worked. FR7BP has mentioned this, as well as A51PN.

N6AR still collects old radio

books to send to deserving hams and hams-to-be around the world. 20 ARRL *Handbooks* have gone to 9J2TJ, another ten to Eastern Europe via W6YY, and N6DX and N6ZV each took a handful on DXpeditions. You can send your unneeded books to N6AR and help another amateur.

Finally, the ARRL International DX Competition takes place next month. As we write this, there is talk of changing the format of this long-running activity again. An editorial in *QST's* September "Operating News" column hinted at changes to come, and the administrators in Newington are toying with a new format more closely related to the CQ Worldwide style, i.e., everybody works everybody. This would drastically alter the ARRL competition from the standpoint of DX-ing, not to mention what it would do to the contest aspects of the activity. It hardly seems possible they could pull off a change this late, considering the time required to pass the word around the globe, but one would be well advised to watch closely for news before February.

Please send your input for this column to 73. Photos are especially welcome. The material for this column came from *The DX Bulletin*, Vernon CT.

## Leaky Lines

from page 22

situation, and that's the plain, unvarnished truth.

\*\*\*

Is there, I wonder, a possibility that the relatively recent techniques of voice printing might

be used to identify chronic malicious interferers? It is said that such prints are as dependable as fingerprints in establishing individual identity, and if some means were devised to extrapolate voice prints from audio signals, we could go a long way

toward ridding ourselves of these nuisances. The very realization that the possibility of positive identification exists might prove to be a deterrent, and perhaps this would cause them to think twice about exposing themselves to discovery.

I know very little about this branch of acoustical science, but I imagine that there are some amateurs who possess

the necessary expertise to come up with the answers. If so, I hope that they will consider investigating it and developing it to a practical level so that it can be used.

After all, forty years ago, who would have predicted the use of radar to detect violators of the highway speed laws? Why not voice prints to combat deliberate QRM?

## RTTY Loop

from page 14

what, you may ask, is "specialty communications"? Well, only contacts made on RTTY, SSTV, or via EME (moonbounce) or OSCAR paths will be recognized. Two levels of operating achievement will be recognized: Class A will require working all fifty US states; Class A-1 requires working ten DX countries from the 73 Magazine WTW list.

Application should be made by submitting a list containing date, time, band, and mode of each contact. Class A lists should be arranged in alphabetical order by state, and Class A-1 lists in order of callsign prefix. A signed declaration of

the type and description of your equipment and antenna should also be included. This entire package should then be verified by two other amateurs, a local radio club secretary, or a notary public, and sent with \$3.00 (or 8 IRCs) for each award to: Bill Gosney WB7BFB, Awards Editor, 73 Magazine, 2665 North 1250 East, Whidbey Island, Oak Harbor WA 98277.

The mail is continuing to come in on Teleprinter Art, Ltd., and one thing is for sure, the "didn'ts" far outnumber the "dids." So far, as of this writing, in October, 1979, about a dozen of you report sending orders to Urbana and receiving nothing. One individual received his

order as requested and notes he was pleased with the merchandise. I don't know if events subsequent to his order have changed things, but I am preparing all of the material I have been sent for forwarding to the proper authorities.

So as not to end this month on a sour note, let me take a moment to highlight one of 73's advertisers who appears to be doing a good job. Selectronics, in Philadelphia PA, has been running ads for years featuring component parts useful in the construction of video terminals and the like. A recent order from this QTH was filled promptly, with receipt of the merchandise via UPS in just a few days. One slight problem was handled quickly and efficiently by phone following receipt of the merchandise. A RTTY Loop-de-Loop to Selectronics.

Some more basics next month for those of you who have requested them, and remember to enclose that SASE if you wish a reply directly from me or any other 73 author.

**RIPPED OFF?**

If you have a serious problem with a ham firm, send them a letter with all the facts in detail, plainly and simply . . . and send a copy to Wayne Green W2NSD/1, c/o 73 MAGAZINE. 73 protects its readers more than any other magazine.

# Looking West

from page 8

to travel through Baja; most listen to the advice and have the time of their lives amid the splendor that is Baja California. Some people don't listen and are lost in the wilderness. Each year, the local LA newspapers and TV stations carry stories of vacationers who didn't follow the rules and found themselves lost in a territory they did not know. Many have died before would-be rescuers could find them.

Baja is not immune from the rampages of Mother Nature herself. Her annual rainfall equals or exceeds that of southern California, and in this type of area, it means that communities are easily cut off from one another. Overall communication in Baja is not the greatest. It is for these reasons and others that the amateur community of Baja has undertaken to tie the area together using many existing amateur repeaters.

Phase one of the intertie involves five existing northern Baja repeaters: .93/.33 in Tijuana, .34/.94 some 40 miles south of Tijuana, .31/.91 in Mexicali, 145.34/144.74 in Ensenada (remember that Mexican amateurs have an advantage in that they are not restricted by repeater subbands as we are in the USA), and .37/.97, which sits about 8,000' above average terrain and can be worked from as far north as Santa Barbara, California, even though it's better than 200 miles south of the US-Mexican border. What you are reading about is not a dream. It already exists, giving hand-held saturated coverage throughout northern Baja.

Phase two involves linking further south about 200 miles to XE2ERD on 145.5/144.9 and then to Cedros Island, where a new system will have to be established using some form of "nature power," i.e., wind, solar, etc. There is no place to just "plug in" a repeater at that location. Once accomplished, about ¾ of Baja will have linked coverage and it won't end there. Alex also informed us that long-range plans call for linking to the Mexican mainland from someplace near Mazatlan and that amateurs in Mexico City are already at work creating plans for a nationwide interlink. What's truly amazing about the Baja story is that what has thus far been accomplished has been the work of about six dedicated amateurs.

What about Americans using the interlink? Is it legal? Only if

you access it from the US side of the border or have obtained a Mexican amateur license to operate in Mexico. At present, no reciprocal licensing exists between the US and Mexico, although it is hoped by amateurs on both sides that someday it will. Meantime, to operate in Mexico, you must pass a Mexican amateur exam, and Mexican amateurs wishing to operate in the US must pass our exam. Exceptions are made during certain special events, such as off-road rallies, but remember that these are exceptions rather than the rule. As already stated, it is legal for US amateurs operating from US soil to talk with Mexican amateurs through Mexican-based repeaters. Many of the systems that lie near the US-Mexican border are accessible from a vast portion of southern California. If you are planning a visit to southern California, especially the San Diego area, you might try saying hello on one of the frequencies listed previously. I suspect you will find a warm welcome from our neighbors to the south.

Two final notes. Anyone interested in contacting Alex about the Baja intertie can do so through his *Callbook* address or through Looking West. Also, we will keep you posted on developments in this intertie as they occur.

Meanwhile, stateside, we received a letter from Ron Johnson WA5RON which reads as follows:

Dear Bill,

I always read your interesting columns in *73 Magazine*. I especially enjoyed the recent October issue where you suggest "growing" regional, and eventually national, VHF intertie systems by linking existing repeaters on UHF. I, too, am interested in intertie and am participating with others in a major UHF linking project in Texas. I would like very much to join in an information exchange program with other intertie builders around the country.

Since you quoted from the Texas VHF-FM Society *News* and W5OGZ, you may already be aware of our Texas Intercity Relay System project. TIRS will eventually link VHF simplex or repeater "dump" stations in major Texas cities. San Antonio and Austin are already connected. Equipment is being installed by local clubs in Dallas, Houston, and Beaumont at this time. Groups in other cities and towns have expressed interest in linking up. This intertie system is a grass-roots effort, local clubs or individuals providing

the necessary equipment in their own area, with coordination and technical support from the state society. TIRS is a wide-open system, carrier operated, and any ham is invited and encouraged to use it. TIRS had a disaster communications objective, and its readiness for emergency use is best demonstrated and practiced by frequent recreational use. Teletype signals, as well as voice, are welcomed on the TIRS frequency. It is not an "elite group" or by-subscription-only system.

I had not thought in the past that Texas was "west" enough to catch your interest, but since you asked for input on the intertie subject, I am sending you this info about TIRS. If you like, I'll be glad to keep you posted on future developments.

I would enjoy reading about other successful intertie efforts, either in your column or as articles in good ol' *73 Magazine*. Why don't you dig something up on the CACTUS network? I have enjoyed a QSO or two on that system during trips west of El Paso and have seen not one technical publication on CACTUS, except for their user's manual. An article describing the CACTUS hardware, control circuits, pictures of mountain-top sites, maps showing coverage, would be very good. Can't you goad those fellows into letting go of the soldering iron for a few minutes and sitting down to a typewriter? Surely the network isn't considered "secret" anymore. An article or just a short description in "Looking West" would be nice.

Those of us working on the Texas Intercity Relay System would like to find out about other systems being built in states surrounding Texas, particularly those who might be interested in linking to TIRS. If you hear about anything like that within range, please let me know or give them my address. Also note that we have a weekly meeting on 80 meters LSB for planning and discussion, 2130

local (Central) time at 3830 kHz every Sunday night.

I will be watching future issues of *73* for more on this subject. Thank you.

Ron Johnson WA5RON  
3524 Greystone #194  
Austin TX 78731

Well, we cannot fulfill Ron's request to make the little-known details about the famed CACTUS Radio Network public unless there comes a day when CACTUS wants to go public. They are a truly phenomenal organization, but they value their privacy and we will always respect that. Maybe some day, Ron...

TIRS, as you have already learned, is quite public. Write to Ron at the above address for more information.

That's it this month on the Nantontie project. If more input arrives before we write next month's column, we will include it. Meanwhile, it looks as if things are beginning to take shape.

Our closing story also comes from an out-of-area amateur, Jim Eagleson WB6JNN of Watsonville, California. Jim wrote to tell us about a new 23 cm linear translator now in service in northern California. Jim writes:

"Project OSCAR, the northern California group that put together the first OSCAR satellites, just put a linear translator into service on Mt. Umunuhm in the 23 cm band (1296). Additionally, the NBC (Narrow Band Communicators) two-meter translator is nearly completed with only integration of modules, site evaluations, duplexer tune-up, and related areas left to do. It is an embryo system (as is the 1296 system), but that's where we all have to start. Some on-the-air tests will be run in a few weeks for the two-meter system. The 23 cm system has been up for about three weeks."

More on this also as it develops. In the meantime, I hope that Santa brought you your dream rig.

## Ham Help

I am attempting to locate all Extra class husband and wife teams. Any Extra who had a late Extra class spouse is also eligible.

We now have a nucleus of names, so we can perhaps consider a name for the group, an occasional news bulletin, a net, a mini reunion in conjunction with other ham gatherings, and, perhaps, a charitable donation.

Those who are qualified should drop me a line with your thoughts regarding any activity that we should undertake. I will

summarize the ideas in a bulletin and mail it to those eligible.

Again, thanks to all, including Chris A16S, for helping me.

Betty Baldo KB6P  
3 Eton Court  
Berkeley CA 94705

I need a schematic for a Heathkit model GR-91 receiver for use with our junior high school amateur radio club.

W. G. Schuchman W7YS  
1400 N. Wakonda Street  
Flagstaff AZ 86001

### ALOELCO ELECTRONICS COMPANY

RF DEVICES

2N5913 1.7W 175 MHz	\$1.70	2N6080 4W 175 MHz	5.40
2N3866 1W 400 MHz	1.25	2N6081 15W 175 MHz	8.45
2N5589 3W 175 MHz	4.75	2N6082 25W 175 MHz	10.95
2N5590 10W 175 MHz	7.80	2N6083 30W 175 MHz	11.75
2N5591 25W 175 MHz	10.95	2N6084 40W 175 MHz	13.30

**OVERVOLTAGE PROTECTION OV-12** Provides protection from runaway Power Supply Voltage. Triggers @ 16V 25 Amp rated, 1 piece moulded unit for 12 Volt DC fused Power Supply \$8.95 OV-5 for 5 Volt PS Triggers at 7V \$9.95 Other Voltages \$11.95

**ACCUEYER KIT.** Similar to Handbook version. Includes PC Board, IC's, Sockets & all parts. Includes sidetone on board, Iambic operation dot dash memory. **Still Only \$19.95**

**NEW MEMORY KIT.** 1056 bit memory expandable to 4224 bits. 1 2102 supplied. Additional chips \$1.25 each. Led indicator. Adaptable to other keyers. Uses 5VDC. **Still Only \$19.95**

**Dual digital 12 or 24 HOUR CLOCK KIT.** NOW WITH A NEW WALNUT WOOD GRAIN CABINET Model ALO 5-W Six Big 0 5 Displays Only \$49.95 12 or 24 Hour Operation — Each Clock controlled separately Freeze Feature for Time Set — Easy assembly for clock and Cabinet  **\$4.95**

**5 Pin Din Accessory Cord and Plug.** Fits KDK **\$4.95**  
**60 Hz Crystal time Base Kit** **\$4.95**

**ALARM CLOCK KIT** Six 0 5 LED Display Readouts Elapsed Time indicator 12 Hour Format with 24 Hour Alarm Snooze feature AM/PM indicator Power Supply power failure indicator **Only \$21.95**  
12 or 24 Hour Clock Kit 0 5 Display LED's **\$19.95**  
Wood Grain Cabinet **\$4.95**

**TUNABLE AMATEUR TV CONVERTER** Receive Fast Scan ATV in the 420 MHz Band with any TV Set Low noise high gain Amplifier stage with Varactor Tuned input and output Built-in 110 VAC Supply Two Tone Walnut & Beige Cabinet measuring 1-7/8" x 4-1/4" x 4-1/8" Factory Wired & Tested 2 Year Warranty **Only \$59.95**

**Lunch Counter Kit (boards & front panel only)** **\$12.50**  
**11C90 Prescaler** \$19.95 1 MHz crystal **\$ 7.95**  
**74C925 Multiplex** \$15.95 10-60 PF trimmer **\$.60**  
**F9368 Drivers (2)** \$15.95 704 displays, each **\$ 1.25**  
**Resistor Kit** \$ 1.75 Capacitor Kit **\$ 6.00**

Add 6% for Shipping. Min. Order \$10.00. Out of USA send Certified Check or Money Order. Include Postage.

# ALDELCO

2789 Milburn Avenue, Baldwin, NY 11510  
(516) 378-4555

✓ A2 Send 1st class stamp for our catalog

### QUASAR VIDEO TAPE RECORDER SALE!

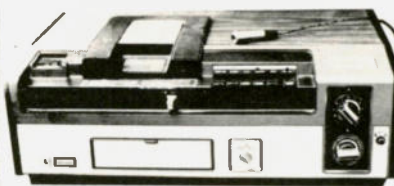

- ★ Records to two hours, color or black & white
  - ★ Records off the air—record one program while watching another
  - ★ Camera input to make your own tapes
  - ★ Can be used with optional timer while you are out
  - ★ Pause control for editing
  - ★ Limited supply—these \$1,000 VTRs were demonstrators & come with new warranty . . . \$499
- \$100 worth of new blank tape will be included at no extra charge!

Send for our new catalog!  
\$3 Shipping charge per order • NO C.O.D.'s!

Bill:  MC  Visa

Credit card # \_\_\_\_\_

Exp. date \_\_\_\_\_

Signature \_\_\_\_\_

Name \_\_\_\_\_

Address \_\_\_\_\_

City \_\_\_\_\_ State \_\_\_\_\_ Zip \_\_\_\_\_



206 Mystic Ave. ✓ T3  
Medford MA 02155  
(617) 395-8280

### New SATELLITE

For the TV home.



Supersharp Reception—Color Like Never Before

Get over 50 channels of television directly from the satellite! HBO, Showtime, the Superstations, and sports from around the world!

Works Anywhere!

Buy complete or build and save. Our book tells everything! Send \$7.95 today or call our 24 hr. C.O.D. Hotline!

(305) 869-4283

SPACECOAST RESEARCH ✓ S117

P.O. Box 442, Dept. G, Altamonte Springs, FL 32701

## DUPLER & CAVITY DIGEST

- ★ 6 Meters, 2 Meters, 220 MHz, 450 MHz
- ★ CONSTRUCTION DETAILS, OPERATION
- ★ CONFIGURATIONS, CHARACTERISTICS
- ★ COUPLING, CASCADING, ISOLATION
- ★ APPLICATIONS, MEASUREMENTS
- ★ NOISE, DESENSE, INTERMODULATION
- ★ PROBLEMS, SOLUTIONS, FIGURES

\$8.50 POST PAID

✓ C162

Castle Publishing



Box 17778 • Tucson • Az • 85731

## Radio World

CENTRAL NEW YORK'S FASTEST GROWING HAM DEALER



Featuring Yaesu, Icom, Drake, Atlas, Ten-Tec, Swan, Dentron, Pace, Palomar, Alda, Midland, Wilson, KDK, MFJ, Microwave Module, Standard, Tempo, Astron, KLM, Hy-Gain, Mosley, Larsen, Cushcraft, Hustler, Mini Products, Universal and Tristao Towers. We service everything we sell! Write or call for quote. You Won't be Disappointed. We are just a few minutes off the NYS Thruway (I-90) Exit 32

CALL TOLL-FREE ONEIDA COUNTY AIRPORT TERMINAL BUILDING Bob Warren  
1-800-448-7914 ORISKANY, NEW YORK 13424 WA2MSH K2IXN

NY STATE RESIDENTS CALL 315-337-2622 or 315-337-0203

### LARUE ELECTRONICS

### ICOM HEADQUARTERS

ICOM TRANSCEIVERS: IC-225, IC-202S, IC-211, IC-215, IC-255A, IC-280, IC-402, IC-502, IC-551, IC-551D AND IC-701AC. ICOM ACCESSORIES: IC-3PE POWER SUPPLY \$98.00. IC-3PS POWER SUPPLY \$98.00. IC-20L 2-METER LINEAR AMPLIFIER \$98.00. BC-15 NI-CAD BATTERY PACK AND AC WALL CHARGER FOR IC-202S AND IC-402 \$49.95. BC-20 NI-CAD BATTERY PACK AND DC/DC CHARGER FOR IC-202S, 215, 402 AND 502 \$49.95. IC-CF1 COOLING FAN FOR IC-701 POWER SUPPLY \$42.00. IC-CK28 5 FT. REMOTE KIT [CABLE AND BRACKETS] FOR IC-280 \$32.00. IC-280RC 15 FT. REMOTE CABLE FOR IC-280 \$20.00. IC-EX1 EXTENSION TERMINAL FOR IC-701 \$38.00. IC-EX106 FM UNIT FOR IC-551 \$136.00. IC-EX107 VOX UNIT FOR IC-551 \$59.00. IC-EX108 PASS BAND TUNING/RF SPEECH PROCESSING UNIT FOR IC-551 \$119.00. IC-HPI HEADPHONES FOR IC-211 AND IC-701 \$34.00. ICOM MOBILE MOUNTS: IC-202S, 215, 402 AND 502 \$16.95.; IC-225 AND IC-280 [W/EXTRA DC POWER CORD] \$19.95; IC-211, 551 AND 701 \$16.95. IC-RM2 REMOTE MICROPROCESSOR FOR IC-211, 245, 2455SB AND 701 \$169.00. IC-SM2 ELECTRET CONDENSER GOOSENECK BASE MICROPHONE FOR ANY ICOM 4-PIN MICROPHONE RADIO \$36.00. WC-215 AC WALL CHARGER FOR IC-202S, 215, 402 AND 502 [IF BC-20 IS USED] \$14.95. BIRD MODEL 43 AND 4431 WATTMETERS, TABLE-1 ELEMENTS AND CC-1/EC-1 CARRYING CASES. CUSHCRAFT ANTENNAS. ANTENNA SPECIALISTS 2-METER AND 450 MHZ. MOBILE AND FIXED STATION ANTENNAS. CDE ROTATORS: TX2 TAILTWISTER \$219.00, HAM-IV \$149.00, CD-45 \$109.00, AR-22-XL \$59.00. BELDEN COAX AND ROTOR CABLE. BARKER & WILLIAMSON COAX SWITCHES AND DIPOLE KITS. W2AU/W2VS ANTENNA PRODUCTS. VHF ENGINEERING 2-METER BLUE LINE AMPLIFIERS, POWER SUPPLIES AND MANY OTHER KITS AND W/T UNITS AVAILABLE. HAM-KEYS. CES 230A MICROPAD AND 235 MICRODIALER. SHURE 444 MICROPHONES. 1980 RADIO AMATEUR CALLBOOKS. ALL PRICES QUOTED IN THIS AD WILL INCLUDE UPS/INSURANCE CHARGES. 73, L. GENE LARUE K3JHAM. ✓ L28

LaRue Electronics, 1112 GRANDVIEW STREET, SCRANTON, PA. 18509 - Ph. [717]343-2124

## FREE CATALOG



**NEW!**  
CATALOG OF  
HARD-TO-FIND  
PRECISION TOOLS

Also contains test equipment plus wide selection of tool kits and cases

Jensen's new catalog is jam-packed with more than 2000 quality items. Your single source for hard-to-find precision tools and tool kits used by electronic technicians, scientists, engineers, instrument mechanics, schools, laboratories and government agencies. Send for your free copy today!



JENSEN TOOLS INC.  
1230 S PRIEST DR • TEMPE, AZ 85281

# LETTERS

from page 154

two features can, with little trouble, see that their value is one of the biggest features of the radio.

The scanning feature is great when applied to the situation of wanting to monitor another repeater for important DX news or an emergency channel. The ham listening to an active repeater for social reasons can be sure of not missing what might be of interest to him, or her, on another usually quiet repeater.

The second feature, programming capability, is a gift from the gods. Having owned the UV-3, I can vouch for the relative difficulty of changing bands or channels in the mobile mode. As the author explains, it is like a checklist in an aircraft. Being able to simply turn one knob and be in a specific channel, rather than having to set an offset frequency by removing one's eyes from the road, is a most valuable feature and adds to safe mobile operation with this radio.

The programming of the diode boards is quite prone to errors, but not impossible. As a matter of fact, Drake offers to send you a diode placement chart to use as a guide in placing the diodes in the proper spaces.

**Wallace B. Shapiro N2WS  
North Woodmere NY**

## TO THE HILT

I am writing to you about the constant attacks on the ARRL you levy almost every month in your Never Say Die column.

After reading many of these editorials, I have come to the basic conclusion that you are trying to help the League realize its mistakes. I personally do not think that you are trying to tear down the ARRL, although one must admit that you take some pretty good stabs at it.

Many times you make comments about the League publication, *QST*. I agree that eighteen dollars a year is a bit much for a magazine that has half the feature articles of *73*. Also, there are constant references to the subject of the top directors' salaries. I agree with your comments on this subject also.

One thing that I do not like

about your editorial is the constant reference to yourself. It seems that you are constantly making references to what you would do had you been offered the top job at the ARRL. If you have such good ideas, maybe you should try to get the proposed IRL formed.

In conclusion, I would like to say that I support your magazine to the hilt because it does provide more articles for the money than any other ham magazine.

**Mark L. Parrish WD0DXM  
Aurora CO**

## EME INFO

The following information may be of use to EME enthusiasts.

The *1980 Nautical Almanac* is now available and may be obtained by writing to: US Government, c/o Superintendent of Documents, Washington DC 20402. Ask for the *1980 Nautical Almanac*, #008-054-00079-7. The current price is \$8.75, which includes postage. Your check should be made payable to "Superintendent of Documents."

As you may know, "H.O. 214 - Tables of Computed Altitude & Azimuth" is no longer available. However, this series has been replaced with a newer version, "Pub. No. 229 - Sight Reduction Tables for Marine Navigation." Listed below are the volumes available and their current price.

Latitudes	Volume	Price
0-15	1	\$6.00
15-30	2	\$11.55
30-45	3	\$9.40
45-60	4	\$9.40
60-75	5	\$6.00
75-90	6	\$6.00

These volumes are available by writing to: Defense Mapping Agency, Office of Distribution Services, Attn: Code DDCP, 6101 McArthur Blvd., Washington DC 20315. Make your check payable to: "Treasurer of the United States." The volume prices also include postage.

**Brian M. Manns K3VGV  
Seven Valleys PA**

## OTHERS DWINDLE

The QRM Annihilator (October, 1979, p. 50) is well worth the price of a subscription to

Novice or old-timer alike. It is easy to build and a joy to use.

I breadboarded one immediately to try it out and was amazed at the results. Number two was built with variable resistances at R1 and R4 and two speakers; the one on the input monitors what is going in, while the output speaker delivers the message.

W5FOE built a demonstration model for the entire club's inspection and it was well received.

Two suggestions are well worth incorporating for the CW purist: 1) Change the output to sinusoidal rather than square wave for a more pleasant tone and less tiresome listening. 2) Input and output can be fed through a fader (one-knob control) to the speaker for ease of operation.

This article, like many others, is what makes *73* grow while others dwindle.

**Wayne O. Brewer W5KD  
Tow TX**

## THANK YOU

I thought that you might be interested to know that your magazine is one of the most important reasons I studied for and passed the test for my ham ticket.

After thinking about it for years—even to the extent of subscribing to *QST* several years ago—I had decided that the ARRL and ham radio were out.

Then I saw a copy of your magazine on the stand. I read it and I subscribed to it because it made the hobby look interesting.

On September 19th, I took and passed my Technician ex-

am. When my ticket comes, I should be ready to take the code test for General.

Once again, thank you.

**Ed Grubgeld  
Palo Alto CA**

## BIOFEEDBACK

"Blueprint for Biofeedback Experimentation" (September, 1979) is a nice rapid tour through brain-wave applications.

Please encourage experimenters to follow safety rules when they connect electrical devices to the body. Obtain a book on medical electronics from your library; *never* connect equipment to the ac line, *any* of it. If you want to see your name in lights, do it with LEDs! Thanks.

**Mitch Cohen WB4RXB  
Margate FL**

## DATONG UPDATE

In regard to the Datong FL1 filter review (October, 1979): Unfortunately, due to the weakening dollar in the world market, we were obliged to increase prices, effective July 16th, 1979, to \$199.95 from \$179.95. Also, Datong Electronics' address was shown in the review as the place to write for information. Readers who do write will, of course, receive responses or be directed to my office here at AR Technical Products. Anyone else seeking information should contact us directly.

**Roger L. Moss, President  
AR Technical Products Corp.  
PO Box 62  
Birmingham MI 48012  
(313)-588-2288**

## Ham Help

I am very interested in contacting hams who have used a VK2AOU-type antenna (*Ham Radio*, May, 1979), either home brew or commercially built. Any information would be gratefully appreciated.

**Gene Smarte WB6TOV/1  
Nubanusit Road  
Hancock NH 03449**

Raynet (Radio Amateurs' Emergency Network) in the United Kingdom—sponsored by the Radio Society of Great Britain—needs help. A Symposium to be held in April, 1980, near London will discuss emergencies of various kinds involving amateur participation. Can anyone lend any slide/tape lectures concerning such matters?

Offers of suitable materials should be made to me. Thank you.

**T. I. Lundegard G3GJW  
Raynet Committee  
c/o Tebrax Limited  
63 Borough High Street  
London SE1 1NG  
England**

Can anyone supply me with a schematic or tech manual for a Dage tube-type TV camera, model 101-AF?

I will gladly reimburse for photocopies, but I would prefer to borrow the original for a short period of time. I will pay postage. Thank you.

**Al Cikis  
2112 Stonehenge  
Springfield IL 62702**

# MHz electronics

2111 W. CAMELBACK

PHOENIX, ARIZONA 85015

(602) 242-3037

## TEST EQUIPMENT LIST

Manufacture	Model	Description	Price
AIL	74A	Automatic Noise Figure Meter 10mc to 40Gc	\$250.00
AIL	390A-3	Microwave Crystal Diode Test Set	25.00
AIL	07006/70	Noise Source 10-250mc	50.00
AIL	07049	Noise Generator	50.00
Ailtech	473	Swept RF Power Source 225 to 400mc AM/FM	900.00
Ballantine	303-06	AC Voltmeter	200.00
Ballantine	320	True RMS VTVM	50.00
Boonton	63M	Inductance Bridge	800.00
Boonton	71A	Capacitance Inductance Meter 1MC	800.00
Boonton	71AR	" " " " Rack Mount	800.00
Boonton	74C-S8	Capacitance Bridge .0002 to 11,000pf	800.00
Boonton	91C	RF Millivoltmeter 20Hz to 1.3GHz	100.00
Boonton	91CA	RF Millivoltmeter 10Hz to 600Mc	100.00
Boonton/H.P.	190A	Q Meter 20-260mc	300.00
Boonton/H.P.	207H	Univerter 100KHz to 55Mc	100.00
Boonton/H.P.	260A	Q Meter 50KHz to 50Mc	500.00
Boonton/H.P.	280A	Q Meter	300.00
Cobet	TP0-1	High Voltage Power Supply 0-500vdc @ 0-300ma.	50.00
Cohu	204AR	Galvanometer	50.00
Data Royal	F370A	Audio Sine Generator	150.00
Danna	5500/130	Digital Multimeter	300.00
E.H.	120D	Pulse Generator 100Hz to 20Mc	200.00
Empire	NF205	Noise & Field Intensity Meter	250.00
Empire	TA-NF105	Plug In 150KHz to 30Mc	100.00
Empire	TA-NF105/M126	Plug In 150KHz to 30Mc	150.00
Empire	TA-NF205	Plug In .15 to 30Mc	100.00
Empire	TX-NF105	Plug In 14KHz to 150KHz	100.00
Empire	TX-NF105/M126	Plug In 14KHz to 150KHz	150.00
Empire	T1-NF105	Plug In 20Mc to 200Mc	100.00
Empire	T1-MF105/M126	Plug In 20Mc to 200Mc	150.00
Empire	T2-MM120	Plug In 50 to 1000Mc	150.00
Empire	T2-NF105/M126	Plug In 200 to 400Mc	150.00
Empire	T2-NF112	Plug In 2 to 4Gc	150.00
Empire	T2-NF205	Plug In 200 to 400Mc	100.00
Empire	T3-NF105/M126	Plug In 400 to 1000MC	150.00
Empire	T3-NF112	Plug In 3.9 to 7.2Gc	150.00
Empire	T3-NF205	Plug In 400 to 700Mc	100.00
Fairchild	76-01A	Plug In For 766H and 767H Scope	100.00
FEL	133A	Microwave Synchronizer	400.00
Ferris	22-DS	Signal Generator 1Kc to 45Mc	100.00
Fluke	102	VAW Meter	150.00
General Microwave	454AR/N421	Microwave Power Meter with Mount	200.00
General Radio	546C	Audio Frequency Microvolter	50.00
General Radio	740B	Capacitance Test Bridge	100.00
General Radio	1203A	Unit Power Supply	50.00
General Radio	1208B	Unit Oscillator 65 to 500Mc	100.00
General Radio	1211C	Unit Oscillator 0.5 to 50Mc	100.00
General Radio	1214A	Unit Oscillator 400/1000Hz	50.00
General Radio	1214AS2	Unit Oscillator 400/1000Hz	50.00
General Radio	1214D	Unit Oscillator 400/1000Hz	50.00
General Radio	1215B	Unit Oscillator 50 to 250Mc	100.00
General Radio	1215C	Unit Oscillator 50 to 250Mc	100.00

2111 W. CAMELBACK

PHOENIX, ARIZONA 85015

(602) 242-3037



# MHz electronics

2111 W. CAMELBACK

PHOENIX, ARIZONA 85015

(602) 242-3037

Manufacture	Model	Description	Price
General Radio	1216A	Unit IF Amplifier	50.00
General Radio	1236	IF Amplifier	150.00
General Radio	1269A	Unit Power Supply	100.00
General Radio	1363	Unit Oscillator 50 to 500Mc	200.00
General Radio	1390A	Random Noise Generator	100.00
General Radio	1390B	Random Noise Generator	150.00
General Radio	1391B/1392P2	Pulse, Sweep and Time Delay Generator and P/S	350.00
General Radio	1570ALS15P1	Line Voltage Regulator Control Unit	75.00
General Radio	1570ALS15P2	Line Voltage Regulator Control Unit	75.00
General Radio	1581A	Automatic Voltage Regulator	250.00
General Radio	1605A	Impedance Comparator	250.00
General Radio	1607P3	Variable Capacitor For 1607A	50.00
General Radio	1652A	Resistance Limit Bridge	200.00
General Radio	1932A	Distortion Meter	125.00
Gertsch	SB-4C-4R	Synchro Bridge	100.00
Gertsch	ST-100	Transformer	25.00
Hewlett Packard	AC60	Matching Network	35.00
Hewlett Packard	120AR	Scope DC to 200KHz	150.00
Hewlett Packard	141A	Scope Main Frame Storage	500.00
Hewlett Packard	175A/1781B/1754A	Scope with Sweep Delay Plug In and Quad Trace	650.00
Hewlett Packard	175A/1780A/1752A	Scope with Singal Trace Plug In	400.00
Hewlett Packard	181A	Scope Main Frame Storage	1500.00
Hewlett Packard	200D	Audio Oscillator	50.00
Hewlett Packard	200TR	Audio Oscillator	50.00
Hewlett Packard	212A	Pulse Generator	50.00
Hewlett Packard	216A	Pulse Generator 100Mc	500.00
Hewlett Packard	222A	Pulse Generator 10Mc	200.00
Hewlett Packard	297A	Sweep Drive	100.00
Hewlett Packard	302A	Wave Analyzer	800.00
Hewlett Packard	330B	Distortion Analyzer 20Hz to 20KHz	150.00
Hewlett Packard	400DR	VTVM 10Hz to 4Mc	80.00
Hewlett Packard	403A	Solid State Voltmeter 1Hz to 1Mc	125.00
Hewlett Packard	412A	DC Meter	100.00
Hewlett Packard	412AR	DC Meter Rack Mount	100.00
Hewlett Packard	413AR	DC Null Voltmeter	100.00
Hewlett Packard	411AR	RF Millivoltmeter 500KHz to 1GHz	100.00
Hewlett Packard	416A	Ratio Meter	100.00
Hewlett Packard	417A	VHF Detector	200.00
Hewlett Packard	434A	Calorimetric Power Meter	450.00
Hewlett Packard	450A	Amplifier	50.00
Hewlett Packard	457A	AC DC Converter	100.00
Hewlett Packard	500BR	Frequency Meter	100.00
Hewlett Packard	508A	Motor	50.00
Hewlett Packard	540B	Transfer Oscillator 10Mc to 12.4Gc.	100.00
Hewlett Packard	606A	Signal Generator 50Kc to 65Mc	1000.00
Hewlett Packard	608D/TS510	Signal Generator 10 to 420Mc	300.00
Hewlett Packard	608D	Signal Generator 10 to 420Mc	400.00
Hewlett Packard	616A/B/TS403	Signal Generator 1.8 to 4.2Gc	300.00
Hewlett Packard	616A/B	Signal Generator 1.8 to 4.2Gc	400.00
Hewlett Packard	618A	Signal Generator 3.8 to 7.6Gc	200.00

2111 W. CAMELBACK

PHOENIX, ARIZONA 85015

(602) 242-3037

# MHz electronics

2111 W. CAMELBACK

PHOENIX, ARIZONA 85015

(602) 242-3037

Manufacture	Model	Description	Price
Hewlett Packard	618B	Signal Generator 3.8 to 7.6Gc	300.00
Hewlett Packard	620A	Signal Generator 7.0 to 11Gc	500.00
Hewlett Packard	623B	6.6 to 7.1Gc Test Set	500.00
Hewlett Packard	H03-624C	10.7 to 11.7Gc Test Set	800.00
Hewlett Packard	624-01	10.7 to 11.7Gc Test Set	800.00
Hewlett Packard	683C	2 to 4Gc Sweep Oscillator	200.00
Hewlett Packard	692C	2 to 4Gc Sweep Oscillator	500.00
Hewlett Packard	1105A	Pulse Generator	75.00
Hewlett Packard	1111A	AC Current Amplifier	100.00
Hewlett Packard	1400A	Differential Amplifier Plug In	100.00
Hewlett Packard	1401A	Dual Trace Plug In	125.00
Hewlett Packard	1411A	Sampling Vertical Plug In	400.00
Hewlett Packard	1415A	TDR Plug In	400.00
Hewlett Packard	1420A	Time Base Plug In	200.00
Hewlett Packard	1421A	Time Base and Delay Generator Plug In	250.00
Hewlett Packard	1425A	Sampling Time Base and Delay Generator Plug In	400.00
Hewlett Packard	1424A	Sampling Plug In	400.00
Hewlett Packard	1430A	DC to 12.4Gc Sampler	800.00
Hewlett Packard	1801A	Dual Channel Vertical Amp. Plug In	250.00
Hewlett Packard	1803A	Differential DC Offset Amp. Plug In	400.00
Hewlett Packard	1804A	Quad Channel Vertical Amp. Plug In	400.00
Hewlett Packard	1821A	Time Base and Delay Generator Plug In	300.00
Hewlett Packard	1825A	Time Base and Delay Generator Plug In	300.00
Hewlett Packard	1841A	Time Base and Delay Generator Plug In	500.00
Hewlett Packard	2650A	Oscillator Synchronizer	100.00
Hewlett Packard	3200B	10Mc to 500Mc Oscillator	500.00
Hewlett Packard	3301A	Auxiliary Plug In	25.00
Hewlett Packard	3441A	Range Selector Plug In	100.00
Hewlett Packard	3442A	Basic Plug In	100.00
Hewlett Packard	3443A	High Gain Auto Range Plug In	200.00
Hewlett Packard	3446A	AC DC Remote Plug In	200.00
Hewlett Packard	3450A	Digital Voltmeter	1000.00
Hewlett Packard	3521B		
Hewlett Packard	5382A	225Mc Frequency Meter	350.00
Hewlett Packard	5480A/5486A/5485A	Memory Display , Control , Two Channel	7000.00
Hewlett Packard	8005B	Pulse Generator	1000.00
Hewlett Packard	10407A	Plug In Extender	100.00
Hewlett Packard	10411A	Horizontal Gain Calibrator	100.00
Hickok	DP100	DC Voltmeter Plug In For DMS3200	25.00
Industrial Acoustics	SS-375	Audio Level Meter	100.00
ITT	74834SC	Distortion Measuring Equipment	175.00
Jerrold	H72A	Plug In 16 to 200Mc	35.00
Kay	P860	2 to 220Mc Plug In	100.00
Kay	570	Sweeper 10 to 80Mc	100.00
Keithley	200B	DC VTVM	50.00
Keithley	241	High Voltage Power Supply	100.00
Keithley	410C	Picoammeter	100.00
Keithley	600A	Electrometer	100.00
Keitel	202BR	DC Microvoltmeter	50.00
Krohn Hite	310ABR	Band Pass Filter 20cps to 200kc	150.00
Krohn Hite	350A	Ultra Low Frequency Rejection Filter .02hz to 2Khz	100.00
Krohn Hite	360ABR	Rejection Filter 20cps to 200kc	150.00

2111 W. CAMELBACK

PHOENIX, ARIZONA 85015

(602) 242-3037

# MHz electronics

2111 W. CAMELBACK

PHOENIX, ARIZONA 85015

(602) 242-3037

Manufacture	Model	Description	Price
Marconi	TF791C	Carrier Deviation Meter 4-270Mc	300.00
Marconi	TF791D	Carrier Deviation Meter 4-1024Mc	500.00
Measurements	80	VHF Signal Generator 2-400Mc	150.00
Measurements	800	VHF Signal Generator AM/FM 19-520MC and Deviation Meter	750.00
Millivac	RM28B	RF Voltmeter 20KHz to 1.2Gc	150.00
Millivac	828	RF Microvoltmeter solid state	150.00
Narda	438	Klystron Power Supply	50.00
Narda	440	Microwave Power Meter	100.00
Narda	3040-20	20db 240 to 500mc Coaxial Directional Coupler	100.00
Narda	3041-20	20db 500 to 1000mc " " "	100.00
Narda	3042-20	20db 950 to 2000mc " " "	100.00
Narda	3043-10	10db 2000 to 4000mc " " "	100.00
Narda	3043-20	20db 2000 to 4000mc " " "	100.00
Narda	3044-20	20db 4000 to 8000mc " " "	100.00
Narda	3045-20	20db 7000 to 11000mc " " "	100.00
Narda	22006	20db 1700 to 4000mc " " "	100.00
Narda	22007	30db 1700 to 4000mc " " "	100.00
Narda	22011	10db 2000 to 4000mc " " "	100.00
Narda	22012	30db 2000 to 4000mc " " "	100.00
Narda	22574	10.5db " " "	100.00
North Atlantic	VM204	Phase Angle Voltmeter	150.00
North Atlantic	RB503C	Ratio Box	100.00
Polarad	SD-1	Multi Pulse Spectrum Analyzer	100.00
Polarad	1001M4	Modulator	200.00
Polarad	1107	Signal Generator 3.8 to 8.2 Gc	500.00
Polarad	1108M4	Signal Generator 6.95 to 11 Gc	500.00
Polarad	1206	Signal Generator 1.95 to 4.20 Gc	500.00
PRD	680/X670	Calorimetric Power Meter with 8.2 to 14.4 Gc Dry Calorimeter	250.00
RFL	107A	Magnet Charger	500.00
RFL	531	Crystal Impedance Meter 10 to 140Mc	500.00
RFL	541A	Crystal Impedance Meter 10 to 1100Kc	400.00
RFL	541C	Crystal Impedance Meter 2.5 to 1100Kc	500.00
RFL	942A-8/HB7778	Magnet Charger with Transformer	1500.00
Stoddart	NM10A	RFI Receiver 10 to 250KHz	100.00
Stoddart	NM40A	RFI Receiver 30Hz to 15KHz	200.00
Stoddart	431-1A/431-1B	Remote Control Unit and Antenna Coupler 150Kc to 32Mc	300.00
Stoddart	90078-4	Remote Meter	30.00
Stoddart	91226-1	Power Supply	200.00
Stoddart	91923-2	Power Supply	200.00
Systron Donner	1017FEE	Frequency Counter	150.00
Systron Donner	1255A	300mc to 12.4Gc Plug In	200.00
Systron Donner	1948A	Video Amplifier Plug In	100.00
TIC	T10A	DME Pulse Generator	200.00
TIC	T10M	DME Speed Indicator Adapter	200.00
TIC	T17A	ATC/DME RF Adapter	200.00
Telonic	L-3M	SM2000 Plug In	100.00
Telonic	SM2000	Sweeper	250.00
Tektronix	B	Plug In	42.50
Tektronix	CA	Plug In Dual Trace	112.50
Tektronix	K	Plug In	47.50
Tektronix	L	Plug In	67.50

2111 W. CAMELBACK

PHOENIX, ARIZONA 85015

(602) 242-3037

# MHz electronics

2111 W. CAMELBACK

PHOENIX, ARIZONA 85015

(602) 242-3037

<u>Manufacture</u>	<u>Model</u>	<u>Description</u>	<u>Price</u>
Tektronix	M	Quad Trace Plug In	200.00
Tektronix	N	Sampling Plug In	200.00
Tektronix	R	Plug In	77.50
Tektronix	RM45A/545A	Scope DC to 30Mc	325.00
Tektronix	RM122	Amplifier	50.00
Tektronix	RM503	Scope DC to 450Khz	250.00
Tektronix	RM561	Scope DC to 10Mc	150.00
Tektronix	TU2	Plug In	37.50
Tektronix	W	Plug In	212.50
Tektronix	1L5	Spectrum Analyzer 10Hz to 1Mc	900.00
Tektronix	1M1	Plug In	77.50
Tektronix	1S1	Sampling Plug In	250.00
Tektronix	2A61	Plug In	100.00
Tektronix	2B67	Plug In	250.00
Tektronix	3A6	Plug In	247.50
Tektronix	3A75	Plug In	100.00
Tektronix	3S3	Plug In	150.00
Tektronix	3T77	Plug In	150.00
Tektronix	50	Plug In	100.00
Tektronix	51	Plug In	100.00
Tektronix	53B	Plug In	35.00
Tektronix	53/54B	Plug In	35.00
Tektronix	53/54C	Dual Trace Plug In	100.00
Tektronix	53/54K	Plug In	35.00
Tektronix	53/54L	Plug In	45.00
Tektronix	60	Plug In	45.00
Tektronix	81	Adapter Plug In	75.00
Tektronix	84	Plug In	100.00
Tektronix	105	Square Wave Generator	50.00
Tektronix	107	Square Wave Generator	50.00
Tektronix	123	AC Coupled Preamplifier	25.00
Tektronix	131	Current Probe Amplifier	100.00
Tektronix	180A	Time Mark Generator	100.00
Tektronix	181mod110	Time Mark Generator	75.00
Tektronix	280	Trigger Countdown Unit	100.00
Tektronix	067-508	50 Ohm Amplitude Calibrator	100.00
Tektronix	013-0034-00	Plug In Extender	25.00
Tektronix	531	Scope DC to 15Mc	225.00
Tektronix	535	Scope DC to 15Mc	262.50
Tektronix	543	Scope DC to 33Mc	300.00
Tektronix	543A	Scope DC to 33Mc	375.00
Tektronix	561	Scope DC to 10Mc	150.00
Tektronix	561A	Scope Dc to 10Mc	175.00
Tektronix	564	Scope Split Screen Storage	450.00
Tektronix	575	Transistor Curve Tracer	400.00
Tektronix	581	Scope DC to 80Mc	300.00
Tektronix	585A	Scope DC to 80Mc	500.00
Tektronix	661/5T3/4S2	Sampler Scope with Dual Trace Plug In	600.00
Tektronix	1791	NC Program Verfier	2000.00
Texscan	HS-85	400 to 1000mc Sweep Generator	250.00
Texscan	VS-73	400 to 450Mc Sweep Generator	175.00
Wandel U Goltermann	LDE2/LDS2	Measurins Set For Group Delay Attenuation Receiver and Attenuation Generator	10,000.00
Wayne Kerr	B221	Universal Bridge Rf	150.00

2111 W. CAMELBACK

PHOENIX, ARIZONA 85015

(602) 242-3037

# MHz electronics

2111 W. CAMELBACK

PHOENIX, ARIZONA 85015

(602) 242-3037

		R F Transistors			
2N1561	\$15.00	2N1562	\$15.00	MMCM918	\$ 1.00
2N1692	15.00	2N1693	15.00	MMT72	.61
2N2857	1.50	2N2857JAN	2.45	MMT74	.94
2N2876	12.35	2N2880	25.00	MMT2857	2.68
2N2927	7.00	2N2947	17.25	MMT3960	6.25
2N2948	15.50	2N2949	3.90	MRF245	31.50
2N2950	5.00	2N3287	4.30	MRF304	43.45
2N3294	1.15	2N3301	.75	MRF420A	20.00
2N3302	1.05	2N3304	1.48	MRF450A	10.35
2N3307	10.50	2N3309	3.90	MRF454A/BLY568	25.00
2N3375	7.00	2N3553	1.45	MRF502	.49
2N3818	6.00	2N3866	1.09	MRF504	6.95
2N3866 JAN	2.70	2N3866 JAN TX	4.43	MRF509	4.90
2N3924	3.20	2N3925	6.00	MRF511	8.60
2N3927	11.50	2N4072	1.70	MRF901	5.00
2N4135	2.00	2N4261	14.60	MRF8004	1.44
2N4427	1.09	2N4429	7.50	PT3539B	3.00
2N4430	20.00	2N4440	7.00	PT4186B	3.00
2N4957	3.50	2N4958	2.80	PT4571A	1.50
2N4859	2.12	2N4976	19.00	PT4612	5.00
2N5090	6.90	2N5108	3.90	PT4628	5.00
2N5109	1.55	2N5160	3.34	PT4640	5.00
2N5179	.49	2N5184	2.00	PT8659	10.72
2N5216	47.50	2N5583	4.43	PT9784	24.30
2N5589	4.60	2N5590	6.30	PT9790	41.70
2N5591	10.35	2N5637	20.70	PT9847	26.40
2N5641	4.90	2N5642	10.00	SD1043	5.00
2N5643	14.38	2N5645	11.00	SD1116	3.00
2N5764	27.00	2N5842	8.65	SD1118	5.00
2N5862	50.00	2N5913	3.25	SD1119	3.00
2N5922	10.00	2N5942	46.00	TA7993	75.00
2N5944	8.50	2N5945	11.90	TA7994	100.00
2N5946	14.20	2N6080	5.45	40281	10.90
2N6081	8.60	2N6082	9.90	40282	11.90
2N6083	11.80	2N6084	13.20	40290	2.48
2N6094	6.75	2N6095	11.50		
2N6096	20.35	2N6097	29.00		
2N6136	19.70	2N6166	36.80		
2N6265	75.00	2N6266	100.00		
2N6439	43.45	BFR90	3.00		
BLY568C/CF	25.00	HEP76/S3014	4.95		
HEPS3002	11.30	HEPS3003	29.88		
HEPS3005	9.95	HEPS3006	19.90		
HEPS3007	24.96	HEPS3010	11.34		
HEPS5026	2.56	MM1500	32.20		
MM1550	10.00	MM1552	50.00		
MM1553	56.50	MM1601	5.50		
MM1602	8.65	MM1607	8.65		
MM1661	15.00	MM1669	17.50		
MM1943	3.00	MM2605	3.00		
MM2608	5.00	MM8006	2.15		

We will try to replace any

RF Transistor not on our

list. We Can also order

many other RF Transistors

Not Listed On OUR LIST.

Please Let Us Know What

Your Needs Are.

2111 W. CAMELBACK

PHOENIX, ARIZONA 85015

(602) 242-3037

# MHz electronics

2111 W. CAMELBACK

PHOENIX, ARIZONA 85015

(602) 242-3037

## Solid Carbide Circuit Board Drill Bits

Drill Size	Decimal Size	Price
1.25mm	.0492	\$1.85
1.45mm	.0571	\$1.85
3.2mm	.1260	\$3.58
35	.1100	\$2.15
42	.0935	\$2.15
47	.0785	\$2.15
49	.0730	\$2.15
51	.0670	\$2.15
52	.0635	\$2.15
53	.0595	\$1.85
54	.0550	\$1.85
55	.0520	\$1.85
56	.0465	\$1.85
57	.0430	\$1.85
58	.0420	\$1.85
59	.0410	\$1.85
61	.0390	\$1.85
63	.0370	\$1.85
64	.0360	\$1.85
65	.0350	\$1.85
66	.0330	\$1.90

## Tyco Type 001-19880 Crystal Filter

10.7 Mc  
 3db Bandwidth 15 KHz Min.  
 20db Bandwidth 60 KHz Min.  
 40db Bandwidth 150 KHz Min.  
 Ultimate 50db; Insertion Loss  
 1.0db Max.  
 Ripple 1.0db Max  
 Ct. 0+/-5pf Rt. 3600 ohms \$5.95

## Tunnel Diodes And Back Diodes

1N2930	\$6.00
1N3716	6.00
1N4395	6.00
TD261A	10.00
TD263A	10.00
BD4/4JFBD4	7.00

## E F Johnson #122-0275-001 Tube Socket

These sockets are for the following tubes;  
 4-125A 4-250A 4-400A  
 3-400Z 3-500Z 5-500A  
 Ect. \$29.95/2

Murata	SFD455D	SFB455D
Center Freq.	455KHz+/- 2KHz	-----
3db Bandwidth	4.5KHz+/-1KHz	8KHz+/-2KHz
Selectivity	26db Min. at -10KHz	-----
	20db Min. at +10KHz	-----
Ripple	1.5db Max	-----
Insertion Loss	9db Max.	-----
	\$4.00	\$3.00

## Murata Type CFM455E Ceramic Filter

455 KHz  
 Insertion Loss 5db Max.  
 Spurious Response 45db Min.  
 50db Bandwidth +/-16KHz Max.  
 6db Bandwidth +/-8KHz Min.  
 3db Bandwidth +/-5.5KHz Min.  
 Ripple 3db max Bandwidth is 3db Max.  
 in 6db Bandwidth is 6db Max.  
 \$7.95

## Murata 10.7 Ceramic Filter SFE10.7

3db Bandwidth 230KHz+/-50  
 20db Bandwidth 650KHz Max.  
 Insertion Loss 6db  
 Spurious Response 40db Min.  
 Input/Output Impedance 330 Ohms  
 \$4.95

## TRW Broadband Amplifier CA602/CA2601BU

Frequency Range ; 15 to 270Mc  
 Gain ; 30db Max.  
 Supply Voltage ; 30vdc  
 \$14.99

## CA615BR

Frequency Range ; 40 to 300Mc  
 Gain ; 16db Min 17db Max.  
 50 Mc 0 to -1db From 300Mc  
 Supply Voltage ; 24vdc  
 \$19.99

## Wisper Fans

This fan is super quite , efficient cooling  
 where low acoustical disturbance is a must.  
 Size 4.68"x4.68"x1.50", Inpadance protected.  
 120vac 50/60cps  
 \$9.99 or 18.00 pair

2111 W. CAMELBACK

PHOENIX, ARIZONA 85015

(602) 242-3037

# MHz electronics

2111 W. CAMELBACK

PHOENIX, ARIZONA 85015

(602) 242-3037

## LASERS !!!!!!!!!!!!!

Coherent Radiation Model 80-2 Power Supply with 5 Milliwatt He Ne Laser	\$279.99
Coherent Radiation Model CR246 Power Supply with Model 138-02 5 Milliwatt He Ne Laser	\$249.99
Spectra Physics Model 236 Power Supply with 5 Milliwatt He Ne Laser	\$249.99
Spectra Physics Model 072 He Ne Laser with Power Supply Aprox. 5 Milliwatt	\$249.99
4 to 5 Milliwatt He Ne Laser Tubes	\$ 99.99

## 2 GC DOWN CONVERTERS !!!!!!!!!!!!!!!!!!!!!!!!!!!!!

Circuit Board With All Data	\$ 25.00
Circuit Board With 13 Chip Capacitors Assembled and Data	\$ 44.50
Circuit Board With All Parts And Data For Assembly	\$ 79.99
Power Supply Kit	\$ 44.99
Antenna 23dB Gain Yagi * Add \$5.00 For Shipping and Handling	\$ 59.99
Complete 2 GC Down Converter Assembled and Tested Comes with 6 connectors , 300 to 75 ohm Adapter , 2 Way Splitter , 100 Foot RG59 Cable * Add \$7.50 For Shipping and Handling. * Let Us Know What Your Polarization Is.	\$299.99

## TUBES SPECIAL PRICES

2E26	\$ 5.00	3-500Z	\$150.00 Pair
3B28	5.00	3X2500A3	150.00
4-65A	25.00	4-125A	34.50
4-250A	40.00	4-400A	50.00
4-1000A	150.00	5-500A	80.00
4CX250B	38.50	4CX250FG	53.50
4CX250K	72.00	4CX250R	48.00
4CX350A	60.00	4CX350FJ	70.00
4CX1000A	200.00	4CX1500B	200.00
4CX15000A	400.00	4X150A/G/D	30.00
572B	39.00	811A	12.95
813	29.00	5894	39.00
6146A	5.25	6146B/8298	6.25
6146W	10.00	6360	7.95
6907	35.00	6939	9.99
7360	15.00	7984	12.00
8072	45.00	8156	7.85
8226	127.50	8295/PL172	299.00
8458	25.75	8560/AS	25.00
8908	15.00	8950	10.00

2111 W. CAMELBACK

PHOENIX, ARIZONA 85015

(602) 242-3037

# MHz electronics

2111 W. CAMELBACK

PHOENIX, ARIZONA 85015

(602) 242-3037

## FAIRCHILD VHF AND UHF PRESCALER CHIPS

95H90DC	350MHZ Prescaler Divide By 10/11	\$ 9.50
95H91DC	350MHZ Prescaler Divide By 5/6	9.50
11C01FC	High Speed Dual 5-4 Input NO/NOR Gate	15.70
11C05DC	1GHZ Counter Divide By 4	74.35
11C06DC	UHF Prescaler 750MHZ D Type Flip/Flop	12.30
11C24DC/MC4024	Dual TTL VCM	3.82
11C44DC/MC4044	Phase Frequency Detector	3.82
11C58DC	ECL VCM	4.53
11C70DC	600MHZ Flip/Flop with Reset	12.30
11C83DC	1GHZ Divide By 248/256 Prescaler	29.90
11C90DC	650MHZ Prescaler Divide By 10/11	16.50
11C91DC	650MHZ Prescaler Divide By 5/6	16.50

## Fairchild 95H90DC Prescaler Kit 350MHz

95H90DC Prescaler Kit divides by 10 to 350MHz. This kit will take any 35MHz Counter to 350MHZ Kit Includes The Following;

1-95H90DC	1-2N5179	2-UG88 BNC Connectors	1-Circuit Board	\$29.95
-----------	----------	-----------------------	-----------------	---------

and all other parts for assembly

## Fairchild 11C90DC Prescaler Kit 650MHz

11C90DC Prescaler Kit divides by 10 to 650MHZ. This kit will take any 65MHz counter to 650MHZ Kit Includes The Following;

1-11C90DC	1-2N5179	2-uG88 BNC Connectors	1-7805	1-Circuit Board	\$59.95
-----------	----------	-----------------------	--------	-----------------	---------

and all other parts for assembly

with 82S90 option will take any 6.5MHz counter to 650MHZ \$69.95

## Motorola MC14410CP CMOS TONE GENERATOR KIT

CMOS Tone generator uses 1MHZ Crystal to produce standard dual frequency dialing signal.

Kit includes the following;

1-MC14410CP	1-1MHZ Crystal(HC6)	1-Circuit Board	\$20.65
-------------	---------------------	-----------------	---------

and all other parts for assembly(LESS TOUCH TONE PAD)

## MOTOROLA IC,S

MC1550G	RF IF Amplifier	1.50
MC1590G	Wide Band Amplifier with AGC	6.50
MC1648P	Voltage Controlled Oscillator	3.75
MC1648L	Voltage Controlled Oscillator	4.70
MC1658P	Voltage Controlled Multivibrator	4.42

## MICROWAVE DIODES

H.P. 2800-2835	Hot Carrier Diode	2.20
Motorola MBD101	Hot Carrier Diode	1.00
Motorola MBD102	Hot Carrier Diode	1.00
M.A. 1N831	Hot Carrier Diode	8.00
H.P. 1N5711	Hot Carrier Diode	2.20
H.P. 1N5712	Hot Carrier Diode	3.45

## Field Effect Transistors (FET,S)

RCA 40673	N Channel Dual Gate	1.39
RCA 3N128	N Channel Dual Gate	1.00
Motorola MPF102	N Channel	.45
G.I. MEM631	N Channel Dual Gate (40673)	.63
2N4416	N Channel	1.05

MOTOROLA	MJ7200/7201	60amp	300watts pd.	
Vceo 100	Vcb 120	Veb	6	\$25.00

2111 W. CAMELBACK

PHOENIX, ARIZONA 85015

(602) 242-3037



# MHz electronics

2111 W. CAMELBACK

PHOENIX, ARIZONA 85015

(602) 242-3037

Texas Instruments TIL311 Hexadecimal Display with logic.  
 0.270 inch High character High Brightness  
 Left and Right Hand Decimals Separate LED and Logic Power Supplies May Be Used  
 Easy System Interface Single Plane Wide Angle Visibility  
 Operates From 5 or 6 volts Internal TTL MSI Chip with Latch, Decoder, and Driver  
 Constant Current Drive For Hexadecimal Characters \$4.99

Hewlett Packard 5082-7300 Numerical Display with Logic  
 DTL TTL Compatible Includes Decoder/Driver with 5 Bit Memory 8421 Positive  
 Right Hand Decimal Logic Inputs  
 4 x 7 Dot Matrix Array Shaped Character , Excellent Readability  
 Standard .600 inch c .400 inch Dual in Line package including Contrast Filter  
 Categorizec for Luminous Intensity - Assures Uniformity of Light Output from unit to unit  
 within a single category Supply Voltage 4.5 to 5.5v \$4.99

Texas Instruments TIL305 5x7 Alpha Numeric Display  
 0.3 inch High Character High Brightness  
 Low Power Requiements Single Plane , Wide Angle Visibility  
 5 x 7 Array with X Y Select and Decimal  
 Comptable with USACII and EBCDIC Code Static Foward Voltage 1.5 min. 1.65 Typ. 2v max.  
 \$7.99

Teledyne Philbrick 4025 12Bit D/A Converters  
 Resolution 12Bits Output Voltage  
 Output Range 0 to -10v or +5v to -5V Unipolar or Bipolar Operation  
 12 Bit Linearity Internal or External Referance  
 200nanosec Setting Time \$19.99

General Electric PNP Power Transistors  
 GP-1600 will Replace the 2N1529 thru 2N1560  
 Cev/BVces 75v Cev/BVceo 60v Ebv/BVebo 40v  
 Collector Current /IC 15 Amps 150watts Power Dissipation @ 25°C Case \$4.95

AA NI CAD  
 1.25volt these were pulled out of units. Three per pack sold as is . 500mahr. or 600mahr  
 each pack may have one bad cell.  
 1 Pack \$2.37 10 Packs \$20.70 100 Packs \$147.00

Unelco RF Capacitors  
 10pf 13pf 14pf 20pf 22pf 43pf 62pf  
 180pf 650pf 820pf 1000pf \$1.00

We Buy All Types Of New And Used Tubes And Test Equipment And Also Take Trade Ins.  
 We Also Buy All Types Of GOLD SCRAP , Electronics , Rings ect.  
 Let Us Kncw What You Have For Sale.  
 WANTED ALL TYPES OF US GOLD COINS !!!!!!!!!!!!!!!!!!!!!!!!!!!!!!!

HAPPY NEW YEARS -----

2111 W. CAMELBACK

PHOENIX, ARIZONA 85015

(602) 242-3037

# Social Events

## SOUTH BEND IN JAN 6

A hamfest swap & shop will be held on January 6, 1980, at New Century Center, on US 31 by the river, South Bend, Indiana. Tables are \$3.00 each. Food service, automobile museum, and art center are in the same building as the hamfest. Talk-in on 146.52/.52, .13/.73, .34/.94, 147.99/.39, .87/.27, and .69/.09. For information, write the Repeater Valley Hamfest committee, Wayne Werts K9IXU, 1889 Riverside Drive, South Bend IN 46616, or phone (219)-233-5307.

## LANCASTER PA JAN 7

A 10-week Novice code and theory class course will be held at the Willow Street Vo-Tech, Lancaster, Pennsylvania, beginning the week of January 7th, 1980. For further information, call (717)-464-3359.

## OAK PARK MI JAN 13

The Oak Park Amateur Radio Club will hold its annual Swap

and Shop on January 13, 1980, at Oak Park High School, Oak Park Blvd., Oak Park, Michigan. Doors will open at 8:00 am.

## RICHMOND VA JAN 13

The Richmond Frostfest III, sponsored by the Richmond Amateur Telecommunications Society, will be held Sunday, January 13, 1980, at the Bon Air Community Center. There will be a home-brew contest with four awards: most original idea, best electrical work, best mechanical work, and most deserving work, and prizes. FCC exams start at 10:00 am and completed Form 610s must be received in the Norfolk Office of the FCC at 870 North Military Highway, Bank of Virginia Bldg., Norfolk VA 23502, no later than January 9th. Admission is \$3.00, indoor flea market tables are \$3.00, and tailgaters are \$2.00. Talk-in on .28/.88 and .34/.94. For further information, contact the Richmond Amateur Telecommunications Society, PO Box 1070, Richmond VA 23208.

## SHARON PA JAN 19

The third annual Mercer County Amateur Radio Club seminar will be held at the Holiday Inn, West Middlesex, Pennsylvania, off I-80, from 9:00 am to 5:00 pm. Come to hear speakers on your favorite amateur radio topics. Advance admission is \$2.00. There will be door prizes. For further details, write K3LA, PO Box 673, Sharon PA 16146.

## WAUKESHA WI JAN 19

The 8th annual Midwinter Swapfest presented by the West Allis Radio Amateur Club will be held on Saturday, January 19, 1980, beginning at 8:00 am at the Waukesha County Expo Center, Waukesha, Wisconsin. There will be food, refreshments, and cash prizes. Tickets are \$1.50 in advance, \$2.50 at door. Tables may be reserved at \$3.00 per four-foot table till January 11 or until half of the available tables are reserved. For information, write 1980 Swapfest, PO Box 1072, Milwaukee WI 53201.

## ARLINGTON HEIGHTS IL JAN 27

The Wheaton Community

Radio Amateur Club will hold its Wheaton Hamfest Portable Nine on Sunday, January 27, 1980, at the Arlington Park Expo Center, Arlington Heights Race Track, Arlington Heights, Illinois. Doors will open at 8:00 am sharp! 300 free flea market tables will be available, plus 100 commercial booths. There will also be hourly door prizes. Tickets are \$3.00 at the door and \$2.00 in advance. For information, send an SASE to WCRA, Box QSL, Wheaton IL 60187.

## MANSFIELD OH FEB 10

The Mansfield mid-winter hamfest and auction will be held on February 10, 1980, at the Richland County Fairgrounds, Mansfield, Ohio. Featured will be prizes, a flea market, and an auction to be held in large heated buildings. Doors will open to the public at 8:00 am. Tickets are \$1.50 in advance and \$2.00 at the door. Talk-in on 146.34/.94. For additional information or advance tickets, contact Harry Frietchen K8HF, 120 Homewood, Mansfield OH 44906, or phone (419)-529-2801 or (419)-524-1441.

## LIVONIA MI FEB 17

The Livonia Amateur Radio

# DEALER DIRECTORY

## Fontana CA

We carry the following: ICOM, Midland, Amcom, DenTron, K1M, Swan, Drake, Ten-Tec, Wilson, SST, MFJ, Hy-Gain, Lunar, Nye-Viking, B&W, Redi-kilowatt, CushCraft, Mosley, Big Signal, Pipco, etc. Full Service Store Fontana Electronics, 8628 Sierra Ave., Fontana CA 92335, 822-7710.

## Santa Clara CA

Bay area's newest Amateur Radio store. New & used Amateur Radio sales & service. We feature Kenwood, ICOM, Wilson, Yaesu, Atlas, Ten-Tec, VHF Engineering & many more. Shaver Radio, Inc., 1378 So. Bascom Ave., San Jose CA 95128, 998-1103.

## New Castle DE

ICOM, Ten-Tec, Swan, KDK, NDI, Tempo, Wilson; Authorized dealer: 1 mile off I-95. No sales tax. Delaware Amateur Supply, 71 Meadow Road, New Castle DE 19720, 328-7728.

## Columbus GA

**KENWOOD—YAESU—DRAKE**  
The world's most fantastic amateur showroom! You gotta see it to believe it! Radio Wholesale, 2012 Auburn Avenue, Columbus GA 31906, 561-7000.

## Preston ID

Ross WB7BYZ, has the Largest Stock of Amateur Gear in the Intermountain West and the Best Prices. Call me for all your ham needs. Ross Distributing, 78 So. State, Preston ID 83263, 852-0830.

## Terre Haute IN

Your ham headquarters located in the heart of the midwest. Hoosier Electronics, Inc., 43B Meadows Shopping Center, P.O. Box 2001, Terre Haute IN 47802, 238-1456.

## Littleton MA

The ham store of N.E. you can rely on. Kenwood, ICOM, Wilson, Yaesu, DenTron, K1M amps, B&W switches & wattmeters, Whistler radar detectors, Bearcat, Regency, antennas by Larsen, Wilson, Hustler, GAM, TEL-COM Inc. Communications & Electronics, 675 Great Rd., Rt. 119, Littleton MA 01460, 486-3040.

## St. Louis MO

Experimenter's paradise! Electronic and mechanical components for computer people, audio people, hams, robot builders, experimenters. Open six days a week. Gateway Electronics Corp., 8123-25 Page Blvd., St. Louis MO 63130, 427-6116.

## Camden NJ

X-band (& other frequencies) Microwave Components & Equipment. Laboratory Grade Test Instruments, Power Supplies, 1000's in stock at all times, BUY & SELL all popular makes—HP, GR, FXR, ESI, Sorensen, Singer, etc. Lectronic Research Labs, 1423 Ferry Ave., Camden NJ 08104, 541-4200.

## Syracuse—Central NY

We deal, we trade, we discount, we please! Yaesu, Ten-Tec, Cushcraft, Drake, DenTron, K1M, Midland, B&W, ICOM, Hygain, Swan, Amcom, Telco, Mirage, DSI etc. Complete 2-way service shop! Ham-Bone Radio (Div. Stereo Repair Shop) 3206 Erie Blvd. East, Syracuse NY 13214, 446-2266.

## Syracuse—Rome—Utica NY

Featuring: Yaesu, ICOM, Drake, Atlas, DenTron, Ten-Tec, Swan, Tempo, K1M, Hy-Gain, Mosley, Wilson, Larsen, Midland Southwest Technical Products. You won't be disappointed with equipment/service. Radio World, Oneida County Airport-Terminal Building, Oriskany NY 13424, 337-2622.

Tell them you saw their name in



## Phila. PA/Camden NJ

Waveguide & coaxial microwave components & equipment. Laboratory grade test instruments, power supplies. Buy, sell & trade all popular makes, HP, GR, FXR, ESI, Sorensen, Singer, etc. Lectronic Research Labs., 1423 Ferry Ave., Camden NJ 08104, 541-4200.

## Scranton PA

ICOM, Bird, CushCraft, VHF Engineering, Antenna Specialists, Barker & Williamson CDF Rotators, Ham-Keys, Belden, W2AU/W2VS, Shure, Regency, CES Touch-Tone pads, Radio Amateur Callbooks. LaRue Electronics, 1112 Grandview St., Scranton PA 18509, 343-2124.

## Houston TX

Experimenter's paradise! Electronic and mechanical components for computer people, audio people, hams, robot builders, experimenters. Open six days a week. Gateway Electronics Inc., 8932 Clarkcrest, Houston TX 77063, 978-6575.

## San Antonio TX

Complete 2 way service shop. Call Dec, WSFSP. Selling Atlas, Avanti, Bird, Hy-gain, Standard communications, Genave, Henry, CushCraft, Hustler, ICOM, KDK, Kenwood, MFJ, Nye, Shure, Swan, Tempo, Yaesu and others. Appliance & Equipment Co., Inc., 2317 Vance Jackson Road, San Antonio TX 78213, 734-7793.

## Port Angeles WA

Mobile RFI shielding for elimination of ignition and alternator noises. Bonding straps. Components for "do-it-yourself" projects. Plenty of free advice. Estes Engineering, 930 Marine Drive, Port Angeles WA 98362, 457-0904.

## DEALERS

Your company name and message can contain up to 25 words for as little as \$150 yearly (prepaid), or \$15 per month (prepaid quarterly). No mention of mail-order business or area code permitted. Directory text and payment must reach us 45 days in advance of publication. For example, advertising for the March issue must be in our hands by January 15th. Mail to 73 Magazine, Peterborough NH 03458. ATTN: Aline Coulu.

Club will hold its 10th anniversary Swap 'n Shop on Sunday, February 17, 1980, from 8:00 am to 4:00 pm, at the Churchill High School, Livonia, Michigan. There will be plenty of tables, door prizes, refreshments, and free parking available, plus reserved table space of 12-foot minimum. Talk-in on 146.52. For further information, send an SASE to Neil Coffin WA8GWL, c/o Livonia Amateur Radio Club, PO Box 2111, Livonia MI 48150.

**GLASGOW KY  
FEB 23**

The Mammoth Cave ARC will hold its annual Glasgow swapfest on Saturday, February 23, 1980, from 8:00 am to 5:00 pm at the Glasgow Flea Market, south of Glasgow on Highway 31E. There will be a large heated building with plenty of free parking. Spaces are available for \$3.00 each. There will be no meetings or forums, just door prizes, free coffee, and a large flea market. Admission is \$2.00. Talk-in on .34/.94. For additional information, contact WA4JZO, 121 Adairland Ct., Glasgow KY 42141.

**LANCASTER PA  
FEB 24**

The Lancaster Hamfest will be held on February 24, 1980, at the Guernsey Pavilion, located at the intersection of Rtes. 30 and 896, east of Lancaster, Pennsylvania. General admission is \$3.00, except children and XYLs. Doors will open at 8:00 am. All inside spaces are available by advance registration only and are \$3.00 each for an 8-foot space, which includes a table. There will be free tailgating in a specified area outside, if the weather permits. There will be a two-hour Dutch Country tour by an advance registration of \$4.00. Food will be served at the hamfest. Also, there are excellent restaurants and accommodations in the area. Talk-in on .01/.61. For information, write Sercom, Box 6082, Rohrerstown PA 17603.

**DAVENPORT IA  
FEB 24**

The Davenport Radio Amateur Club will hold its ninth annual hamfest on Sunday, February 24, 1980, from 8:00 am to 4:00 pm, at the Davenport Masonic Temple, Highway 61 (Brady Street) and 7th Street, Davenport, Iowa. Tickets are \$2.00 in advance; \$3.00 at the door. Tables are \$3.00 each, no limit, with a \$2.00 additional charge for ac electrical hook-up. Talk-in on 146.28/.88 W0BXR repeater. Advance tickets can be purchased by writing to club treasurer Clarence Wilson WA0OEW, 1357 W. 36th Street, Davenport IA 52806.

**MARLBORO MA  
FEB 24**

The Algonquin Amateur Radio Club will hold its 3rd annual ham radio flea market on Sunday, February 24, 1980, at the Marlboro Jr. High School Cafetorium, just off Rte. 85 North, Marlboro, Massachusetts. Admission will be 50¢. The event will be held rain, shine, or blizzard. Food will be available. Tables will be \$5.00 in advance or \$7.50 at the door. Talk-in on .01/.61 and .52. For more information or reservations, contact Charles D. McCarthy W1BK, 128 Forest Ave., Hudson MA 01749, or phone (617)-562-5622.

**BLACKSBURG VA  
MARCH**

Virginia Polytechnic Institute and State University Department of Chemistry will hold three short courses in March, 1980, at the Virginia Tech campus, Blacksburg, Virginia. The first workshop, entitled Digital Electronics for Instrumentation and Automation, will be held on

March 10-11, 1980. The second workshop, entitled 8080-8085-Z80 Microcomputer Interfacing, Design, and Software, will be held on March 12-14, 1980. The third workshop, entitled TRS-80 Interfacing and Programming for Instrumentation and Control, will be held on March 17-18, 1980. These programs will be directed by Dr. Jonathan A. Titus, Dr. Paul Field, Dr. Christopher Titus, and Mr. David G. Larsen. These are hands-on workshops with the participants having the opportunity to retain the equipment. For more information, contact Dr. Linda Leffel, CEC, Virginia Tech, Blacksburg VA 24061, or phone (703)-961-5241.

**CHRISTIANA DE  
MAR 2**

The Delaware Valley Amateur Radio Society will hold its Winter Fest and Computer Show on March 2, 1980, from 10:00 am to 4:30 pm at Christiana Memorial Hall, Rte. 273 and Old Baltimore Pike, Christiana, Delaware. Events include

a transmitter hunt (Freedom Foundation Fox Hunters Sanction Number 80-1) and a frost-bite tailgate section. Tables, food, and free parking will be available. Dealer inquiries are invited. Talk-in on 146.52, 223.36/224.96, and 146.355/.955. For information and advance tickets, write to DVARs, PO Box 426, New Castle DE 19720.

**STERLING IL  
MAR 9**

The Sterling-Rock Falls Amateur Radio Society will hold its 20th annual hamfest on Sunday, March 9, 1980, at the Sterling High School field house, 1608 4th Ave., Sterling, Illinois. Advance tickets are \$1.50; door tickets are \$2.00. Over \$2,000 worth of prizes will be given away. A large indoor flea market will be restricted to radio and electronic items only. There will be plenty of free parking, lots of bargains, and plenty of good food. Talk-in on .25/.85 (WR9AER). For tickets, write Don Van Sant WA9PBS, 1104 5th Avenue, Rock Falls IL 61071.

**AUTOMATIC CW  
COPIER**



Now you can copy the fast CW stations. The NEW professionally designed DE 150 plugs into a transceiver's earphone jack & automatically displays Morse code as it is being received. New characters are entered from the right and shift left giving a continuous easy to read display of the latest code received. \$425. One year warranty and 15 day return privilege. Add \$5 for shipping. VISA & MC cards welcome.

✓ D73

**Dynamic ELECTRONICS INC.**

(205) 773 2758 Box 896 Hartselle, AL 35640

**UNBEATEN SIX  
BAND ANTENNA**

**THE JOYSTICK VFA**

(Variable Freq. Antenna) claims unbeaten scoring over commercial and/or conventional antennae.  
 • Simple, rapid erection • Not only 6-band but CONTINUOUS 0.5 - 30 Mhz., incl. BC & MARS • Omnidirectional • Substantially Harmonic FREE • 1,000,000 miles per watt, unbeaten record! • Poor QTH's enhanced! CLIFFDWELLERS ANTENNA! • QUOTE from CQ Mag. - "If you are high enough the antenna will operate (esp. at 15-20) as well as the well-known 3-element beam with which we compared it. The tests were 'operational, not theoretical!' We find that if we can hear 'em we can work 'em ..."

**SYSTEM 'A' \$110.00**

150 W.P.E.P. &/or Receiving only

**SYSTEM 'J' \$130.00**

500 W.P.E.P. &/or Improved

Q Factor Receive

Rush Mastercharge/Visa no.

or check or request FREE literature.

**PARTRIDGE ELECTRONICS LTD**

8 Partridge House,

Broadstairs, Kent, England.

G3CED Tel: 011 44 0843 62535

G3VFA

Please send all reader inquiries directly

**50 144 REPEATERS 220 450 Mhz**

**BASIC AUTO PATCH**

\*Access, #Disable and adjustable Timer. COMPLETELY ASSEMBLED—\$75.00.

**EXTENSION BOARD**

Antialiasing, 3 digit sequential Touch Tone™ decoder with automatic reset, Antialiasing Ring detector, reverse auto patch capability for basic auto patch and two, two-watt audio amplifiers

COMPLETELY ASSEMBLED—\$140 00

New and Improved Receiver and Transmitter

Available Separately:

COR Identifier: All on one board, programmable, Fully adjustable, time out (1.5-7 min.), hang time (0-1 min.), identifier (1-10 min.), tone, speed, volume, L.E.D. outputs, low current drain CMOS logic, plugs for easy installation and removal plus much more. \$79.95 COMPLETELY ASSEMBLED

Basic Repeater 599.95 COMPLETELY ASSEMBLED

2M 130-175 MHz Basic Repeater for 2 meters with all the features of the Hi Pro MkI less the power supply and front panel controls and accessories.

PA Res. add 6% tax

PLUS SHIPPING

**Maggiore Electronic Laboratory**

845 WESTTOWN RD.

WEST CHESTER, PA. 19380 PHONE 215 436-6051

50 MHz \$889.95 450 MHz 899.95  
144 or 220 MHz 799.95

✓ M36

**Hi Pro Mk I  
REPEATERS**

# VIBROPLEX®

Vibroplex® has built for those who use electronic keyers, the finest keying mechanism available.

## the Vibro-Keyer

"deluxe"  
\$65<sup>00</sup>

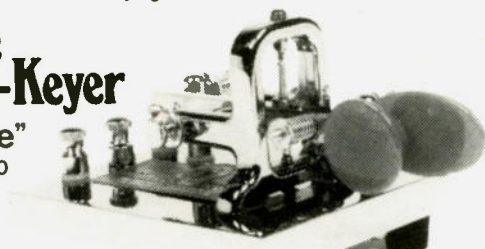

- Adjustable jeweled bearings.
- Tension and contact spacing fully adjustable.
- Large, solid, coin silver contact points.
- 2 1/2 lb. chrome plated steel base rests on non-skid feet.
- Top parts designed from our world famous Vibroplex® "Original."

- Lifetime guarantee against manufacturing defects.
- Registered serial number.
- Vibroplex® quality through-out.

"Standard" model with wrinkle finished cast iron base available for \$49.50.

Available at your dealers or through the factory. Send check, money order, or use your VISA or Master Charge. We pay all shipping charges except on orders outside the continental U.S.

See your dealer or write for literature on all our world famous line to:

The Vibroplex Company, Inc. ✓ V24  
P.O. Box 7230 476 Fore St. Portland, Maine 04112  
Or call: (207) 775-7710

"THE OLDEST NAME  
IN AMATEUR RADIO"

# Ham Help

I am wondering if anyone can help me beat the high cost of vacations. I have a three-bedroom home in Victoria BC and would like to visit the Disneyland area either at Easter break or in July/August. Easter would be preferred.

**Don Ankersen VE7DHG**  
4142 Hawkes Avenue  
Victoria BC V8Z 3Z1

I'm looking for the following manuals: NavShips 92175, MIL-R-12887, and documentation for the MD-141/GR and T-282D/GR units. Can anyone out there help me? I will gladly pay reasonable prices. Thanks.

**Charles T. Huth WB8NLM**  
146 Schonhardt Street  
Tiffin OH 44883

I desperately need manuals or schematic diagrams for the following equipment: Gonset G66B, Central Electronics 20A, and Knightkit tube tester, KG600B.

**Jimmie R. Hall**  
820 Robert Ct.  
Carlisle OH 45005

I'm looking for either an original manual or a copy for a Johnson model 240-122 vfo. The vfo was usable with many Johnson rigs and the manual for my Adventurer which I am using it on told how to get it hooked up, but I have no information on the vfo itself. Even a schematic would help.

I will pay a reasonable copying fee if required. Please advise by card first. Thanks.

**Dave Brown W9CGI**  
R5, Box 39  
Noblesville IN 46060

I need a schematic and parts list for an Ovenaire 1-MHz oscillator, type 15-10, used in Navy frequency counter AN/URM-207, circa 1963-64.

I also need a schematic for a Conar 223 tube checker and a Motorola D25 solid-state Dispatcher. I will copy and return.

**Marvin Moss W4UXJ**  
Box 28601  
Atlanta GA 30328

Does anyone have an instruction booklet for a Hallicrafters model TW 2000 (1952)? I will be happy to pay for a photocopy.

I would also like to know if any readers can suggest a source for spare parts and accessories for this same model. Thanks very much for any help.

**Bob Freedman**  
686 Cragmont Avenue  
Berkeley CA 94708

I am interested in building a "Morse-to-video" device that will sample the incoming CW signal from my rig, process it, and display it on a normal TV set.

**Chuck Bowers WA6GZZ**  
3326 Sawtelle Blvd., Apt. 31  
Los Angeles CA 90066

I would like to establish a ham radio club in my school. Our children are handicapped with language and hearing problems and we have very limited funds. Any useable equipment which could be donated will be greatly appreciated.

**Robert Boykin WA2HUY**  
Industrial Arts Department  
School for Language- and  
Hearing-Impaired Children  
421 East 88th Street  
New York NY 10028

A RTTY AMSAT information net is being started on Tuesday nights (Wednesday mornings, UTC) at 0230 UTC on 3620 MHz, 60 wpm, 170-Hz shift. I will be NCS.

**Charles E. Martin AB4Y**  
PO Box 3370  
Bowling Green KY 42101

I need a schematic of a high-serial-number Drake SC-6, 6-meter converter, or I will reproduce the manual and return.

You'll know the correct SC-6 by noting that it has 4 transistors. The rf stage is a pair of cascode J-FETs. Thanks.

**Jack Ross W2NXC**  
1244 Crim Road  
Bridgewater NJ 08807

For research purposes, I am interested in contacting anyone who has operated an amateur station from a "deleted country" as designated on the ARRL DXCC list.

**Gary Mitchell WA1GXE**  
Box 1003  
Fairfield CT 06430

I would like to get in touch with any amateurs interested in forming a net to learn the German language. We need some net members who are fluent in German to assist.

**Robert E. Bunn WA0LKE**  
Rt. 3, Box 565  
West Plains MO 65775

I would like to hear from anyone who has any modifications for a Swan 500. Thanks.

**Hal Hansen N1APE**  
8 Abenaki Trail  
Littleton MA 01460

## ALL BAND TRAP ANTENNAS!

PRE-TUNED - COMPLETELY ASSEMBLED - ONLY ONE HEAT SMALL ANTENNA FOR UP TO 6 BANDS! EXCELLENT FOR CONGESTED HOUSING AREAS - APARTMENTS - LIGHT - STRONG - ALMOST INVISIBLE!

FOR ALL MAKES & MODELS OF AMATEUR TRANSCEIVERS - TRANSMITTERS - GUARANTEED FOR 2000 WATTS SSB 1000 WATTS CW INPUT FOR NOVICE AND ALL CLASS AMATEURS!

COMPLETE AS SHOWN with 90 ft. RG58U-52 ohm feedline, and PL259 connector, insulators, 30 ft. 300 Ohm test dacron end supports, center connector with built in lightning arrester and static discharge - molded, sealed, weatherproof, resonant traps "X6" - you just switch to band desired for excellent worldwide operation - transmitting and receiving WT. LESS THAN 5 LBS.

160-80-40-20-15-10 bands 2 trap---209 ft. with 90 ft. RG58U - connector - Model 777BU .....\$64.95  
80-40-20-15-10 bands 2 trap ---102 ft. with 90 ft. RG58U - connector - Model 998BU .....\$59.95  
40-20-15-10 bands 2 trap ---54 ft. with 90 ft. RG58U coax - connector - Model 1001BU .....\$58.95  
20-15-10 bands 2 trap ---26 ft. with 90 ft. RG58U coax - connector - Model 1007BU .....\$57.95

SEND FULL PRICE FOR POST PAID INSURED DEL. IN USA. (Canada is \$5.00 extra for postage - clerical - customs - etc.) or order using VISA Bank Americard - MASTER CHARGE - AMER. EXPRESS Give number and exp. date. Ph 1-308-236-5333 9AM - 6PM week days. We ship in 2-3 days. ALL PRICES WILL INCREASE MAR 1-SAVE - ORDER NOW! All antennas guaranteed for 1 year. 10 day Money back trial! Made in USA. FREE INFO. AVAILABLE ONLY FROM

WESTERN ELECTRONICS Dept. A7-1 Kearney, Nebraska. 68847

## ALL BAND TRAP ANTENNAS!

## JUST GETTING ON THE AIR? See Adirondack for



- New Equipment
- Used Gear
- Friendly Advice

**ADIRONDACK** Radio Supply

185-191 West Main Street • P.O. Box 88  
Amsterdam, N.Y. 12010 Tel. (518) 842-8350  
Just 5 minutes from N.Y. Thruway - Exit 27

### HAM SCAN-1: YAESU MEMORIZER

\* Scans 145-148 MHz in 10 sec., stops 3 sec. on active channels, simple 7 wire installation.

ORDER HAM SCAN-1.....\$39.95

### HAM SCAN-2: K'WD 7625, 7600,

7400A, KDK 2015R, 2016A, CLEGG FM-28 MIDLAND 13-510, HW-2038, Others soon.

- \* Adds one channel of memory to any above rig
  - \* Scan range selectable by position of radio's MHz switch. Up to full 4 MHz width.
  - \* Scan rate 200 kHz/sec at 10 kHz steps with a 3 second pause on all active channels
  - \* Mike-mounted switch provides 3 functions: start/stop, remote freq. incrementing and xmit interlock while actively scanning
  - \* Scanner mounts inside radio, no external box
  - \* Assembled, tested and guaranteed \$59.95
- ORDER HAM SCAN-2 and specify type of radio

## Technical Clinic

P.O. BOX 636 T64  
STERLING HTS. MI 48078  
Phone Orders Call: (313) 286-4836

### 142-163 Mhz BANDPASS F-194/U BANDPASS FILTER

gold-plated twin tuned cavity designed for the 142 to 163 Mhz range. Has tuning controls and type N connections. Size: 6 1/2"x2 1/2"x1 1/2". 6 lbs. sh. wt. Unused \$17.95



We have similar filters (listed below) which can be converted to amateur usage according to conversions by W4FXE (Nov. '79 Ham Radio) used @ \$12.95 each or unused @ \$15.95: F-192/U or F-193/U, used only, conversion to 2-meters. F-195/U (163-184 Mhz) or F-196/U (185-205 Mhz), conversion to 220-225 Mhz. F-202/U (314-344 Mhz), conversion to 420-450 Mhz.

R-644/URR RECEIVER: 20-237 Mhz AM, FM, CW in seven continuously tunable bands. Same as R-220/URR but requires 24 VDC 10 amp power input. 10 1/2"x19x14 1/4". 96 lbs. net. Shipped in sealed gov't export crate with transit case, manuals, and spares — not checked. Crate sh. wt. 220 lbs. \$425.00

J-37 KEY: with adjustable contacts. 3x6 base, and cord, used \$7.95

All Prices F.O.B. Lima, Ohio. Please Allow for Shipping Use your VISA or MASTERCHARGE Card.

Write for our Big FREE CATALOG Address Dept. 73 • Phone 419/227-6573

FAIR RADIO SALES  
1016 E. EUREKA • Box 1105 • LIMA, OHIO • 45802

★ For Sale ★

**\$10,000,000**

INVENTORY

The *ultimate* source for electronic components and equipment.

PRODUCTION OVERRUNS SURPLUS MATERIALS

Send us your inquiries. Get on our exclusive mailing list. Inquire in writing or by Telex  
**TWX: 510-224-6539**

Serving domestic and overseas markets.

Ultima  
Electronics, Ltd.  
(516) 423-3770

U13

73 Sherwood Ct., Huntington, N.Y. 11743 U.S.A.

# URFI

(UNIVERSAL RECEIVED FREQUENCY INDICATOR)



Digitize your receiver's dial with the DIAL SPOTTER. Adapts to most Communication Receivers with simple connection to VFO. From \$149.95 Write for Data Sheet.

**GEMINI INSTRUMENTS INCORPORATED**  
Box 205, Larchmont, NY 10538 G27

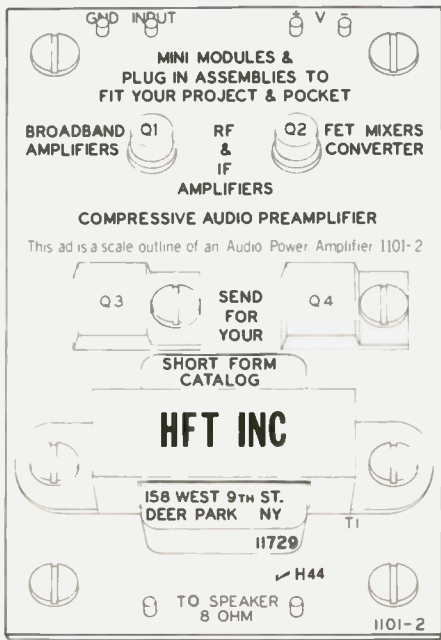

MILITARY SURPLUS WANTED

WE NEED: ARC-51BX, ARC-94, ARC-102, ARC-109, ARC-115, ARC-116, ARC-131, ARC-134, ARC-164, ARN-82, ARN-83, ARN-84, APN-59, APN-153, APN-141, APN-147, APN-171, APX-72, 618T, CU-1669A, 490T-1, CU-1658A, 51Y-4, 51R-8, 51RV-1, FM-622, 807A, URC-9, TOP DOLLAR PAID OR TRADE FOR NEW AMATEUR GEAR. WRITE OR PHONE BILL SLEP (704) 524-7519

S4

SLEP ELECTRONICS COMPANY  
P.O. BOX 100, DEPT. 73,  
OTTO, NORTH CAROLINA 28763.

## ANTENNA SYSTEMS/TOWER HARDWARE

HY-GAIN ANTENNAS		
TH5DX	New 5-Element Triband Beam	\$195
TH6DXX	6-Element Triband beam	\$225
TH3MK3	3-Element Triband beam	\$165
TH2MK3	2-Element Triband Beam	\$109
TH3JR	3-Element Triband Beam	\$119
205BA	5-Element 20-mtr "Long John"	\$235
155BA	5-Element 15-mtr "Long John"	\$145
105BA	5-Element 10-mtr "Long John"	\$94
203BA	3-Element 20-mtr beam	\$99
204BA	4-Element 20-mtr beam	\$175
153BA	3-Element 15-mtr beam	\$64
103BA	3-Element 10-mtr beam	\$54
402BA	2-Element 40-mtr beam	\$175
DB1015A	3-Element 10-/15-mtr beam	\$115
Hy-Quad	2-Element 10-/15-/20-mtr quad	\$199
64B	4-Element 6-mtr beam	\$42
66B	6-Element 6-mtr beam	\$89
18HT	Hy-Tower 80-10 mtr vertical	\$255
18AVT/WB	80-10 mtr trap vertical	\$75
14AVQ/WB	40-10 mtr trap vertical	\$55
208	8-Element 2-mtr beam	\$23
214	14-Element 2-mtr beam	\$26
28DQ	80/40 mtr trap dipole	\$44
58DQ	80-10 mtr trap dipole	\$79
BN86	kW balun	\$12

CUSHCRAFT ANTENNAS		
A3219	New 19-element 2-mtr 'Boomer'	\$66
214B	New 14-element 'Jr. Boomer'	\$53
214FB	New 14-el vertical 'Jr. Boomer'	\$53
228FB	New Jr. Boomer FM power pack	\$165
AT834	4-Element triband beam	\$209
ATV5	80-10 mtr vertical	\$85
ARX2	2-mtr 'Ringo-Ranger'	\$30
A147-11	11-Element 147-148 MHz beam	\$30
A147-22	22-Element 'Power-Pack'	\$90
A144-10T	10-Element 2-mtr Twist	\$37
A144-20T	20-Element 2-mtr Twist	\$53
A432-20T	20-element 432-MHz Twist	\$49
<b>Alliance HD73 Rotor Special \$99</b>		
CDE ROTORS		
CD45 (9 ft rating)		\$110
HAM 4 — (New model - 15 ft rating)		\$149
Tailtwister — (Now rated at 30 ft?)		\$209
8-Conductor Rotor Cable		\$0.15/ft

TEXAS TOWERS T77

1309 Summit Drive • Plano, Texas 75074  
Open 9 AM to 6 PM Monday thru Saturday  
**Telephone: (214) 423-2376**  
A Texas Communications Products Company (TEXCOM)

ROHN TOWERS		
20G/\$29.50	25G/\$37.50	45G/\$67.50
55G/\$104.50		
HDBX48	Free-standing 48-ft tower (18 ft ant)	\$305
HBX56	Free-standing 56-ft tower (10 ft ant)	\$335
FK2548	48-ft 25G foldover tower	\$595
FK2558	58-ft 25G foldover tower	\$660
FK2568	68-ft 25G foldover tower	\$725
FK4548	48-ft 45G foldover tower	\$835
FK4558	58-ft 45G foldover tower	\$920
FK4568	68-ft 45G foldover tower	\$999
GALVANIZED STEEL TOWER HARDWARE		
3/16" EHS (3990 lb rating)	... \$9.50/100 ft	\$90/1000 ft
1/4" EHS (6000 lb rating)	... \$12/100 ft	\$111/1000 ft
5/32" — 7 x 7 Aircraft cable(2700 lb)		\$8/100 ft
3/16 CCM cable clamps (3/16" or 5/32" cable)		\$0.30
1/4 CCM cable clamps(1/4" cable)		\$0.40
1/4 TH Thimble (fits all sizes)		\$0.25
3/8 EE (3/8" Eye and eye turnbuckle)		\$5.50
3/8 EJ (3/8" Eye and jaw turnbuckle)		\$6.00
1/2 EE (1/2" Eye and eye turnbuckle)		\$7.50
1/2 EJ (1/2" Eye and jaw turnbuckle)		\$8.00
3/16" Preformed guy deadend		\$1.45
1/4" Preformed guy deadend		\$1.65
6"-dia 4-ft long earth screw anchor		\$10.50
2"-dia 10-ft long heavy duty mast		\$30.00
Write or call for our SUPER PRICE on Hy-Gain and Towermaster crank-up towers!		



# DOES IT AGAIN!!

## THE ALL NEW **FM2025A** GIVES YOU MORE FEATURES FOR LESS MONEY THAN OTHER UNITS **MICROCOMPUTER CONTROLLED** 2 METER FM TRANSCEIVER

# NEW!



FMMC 1\* Microphone with Built-in Touch Tone Pad  
**WHY BUY LESS? THE FMMC-1 HAS IT ALL!**

- New! Auto key up
- Snap-Action Keyboard
- Adj level and tone balance
- Use with any transceiver
- Only 3 1/4" x 2"

\$44.95

## COMPARE THESE FEATURES

- **TEN-CHANNEL MEMORY WITH SCAN**  
Up to ten frequencies may be stored for frequent use. A NICAD battery retains the frequencies when power is removed. The ten channels may be scanned in the "busy" or "vacant" mode. AUTO RESUME — COMPARE!
- **TWO-SPEED, VFO-STYLE TUNING**  
Each increment of the single-knob dial changes the frequency by either 10 kHz or 100 kHz (front-panel selectable). A +5 kHz switch may be added. \*
- **HUGE 3/4-INCH LED DIGITAL READOUT**
- **FULL BAND SCAN**  
The entire 2-meter band can be scanned in 10-kHz steps in the "busy" or "vacant" mode. Locating a repeater in a remote or unfamiliar area is thus made easy.
- **PROGRAMMABLE SCAN LIMITS**  
If only a portion of the band is to be scanned, the lower and upper limits of the desired scan range can be programmed from the front panel.
- **MICROCOMPUTER CONTROLLED**  
All frequency control is done by a microcomputer, including memory and scanning. This results in a simple circuit with little chance for malfunction.
- **25 WATTS OUTPUT**  
A strong, clean signal minimizes "flutter" during mobile operation. A low-power function is included for short-range or battery-powered operation. The low-power level is adjustable from 3 to 25 watts.
- **RF ATTENUATOR**  
In certain areas with extraordinarily high signal levels, an rf attenuator provides improved reception with less chance for overload.
- **PROGRAMMABLE NON-STANDARD SPLITS**  
By using the memory channels in pairs, up to five sets of transmitting and receiving frequencies may be programmed. This allows up to five splits of any value, in addition to the usual -600 and +600 kHz offsets, which are switched in independently on all frequencies.
- **PL TONE OSCILLATOR**  
Tone level and frequency are adjustable for accessing closed repeaters.
- **VARIABLE TUNING OF RECEIVER FRONT END**  
The sensitive initial stages of the receiver contain varactor-controlled tuned circuits for narrow bandwidth at the front end. This greatly reduces the susceptibility of the circuit to overloading and intermodulation — A KDK EXCLUSIVE.
- **VCO OPERATES AT TRANSMITTED FREQUENCY**  
The result is a transmitter completely free of mixing products.
- **TRUE FM**  
Not phase modulation — for superb emphasized hi-fi audio second to none.
- **COMMERCIAL-GRADE CONSTRUCTION**  
The FM-2025A is built to the highest mechanical and electrical specifications. A neat layout makes servicing easy.
- **LED FUNCTION INDICATORS**  
Three LEDs indicate when a signal is being received, +600 kHz split operation and -600 kHz split operation.
- **MULTI-PURPOSE METER**  
The front-panel meter indicates relative received signal strength and relative rf power output.
- **FREQUENCY RANGE:** 144.000 - 148.990 MHz in 10-kHz steps.
- **RECEIVER SENSITIVITY:** Better than 0.28 uV for 20-dB quieting.
- **SIZE:** 65 x 186 x 242 mm HWD (2.55 x 7.32 x 9.53 in), including knobs and other protruding items.
- **OTHER FEATURES:** Mobile mounting bracket, 600-ohm dynamic microphone and dc power cord included.  
\* AVAILABLE UPON REQUEST AT NO CHARGE.



## AMATEUR-WHOLESALE ELECTRONICS

8817 S.W. 129th Terrace, Miami, Florida 33176

Telephone (305) 233-3631 • Telex: 80-3356

U.S. DISTRIBUTOR DEALER INQUIRIES INVITED

ORDER NOW TOLL-FREE

Credit card holders may use

our toll free ordering number

Ask for operator 701

(800) 824-7888

In California (800) 852-7777

Alaska and Hawaii (800) 824-7919

800 800





**NEW PRODUCTS!**

**Super Color S-100 Video Kit \$99.95**  
Expandable to 256 x 192 high resolution color graphics. 6847 with all display modes computer controlled. Memory mapped. 1K RAM expandable to 6K. S-100 bus 1802, 8080, 8085, Z80 etc.

**Gremlin Color Video Kit \$59.95**  
32 x 16 alpha/numerics and graphics, up to 8 colors with 6847 chip. 1K RAM at E000. Plugs into Super Elf 44 pin bus. Not expandable to high resolution graphics.

**Elf II Adapter Kit \$24.50**  
Plugs into Elf II providing Super Elf 44 and 50 pin bus plus S-100 bus expansion (With Super Expansion). High and low address displays, state and mode LED's optional \$18.00.

**1802/16K Dynamic RAM Kit \$149.00**  
1802/S-100 expandable to 32K, Hidden refresh w/clocks up to 4 MHz w/no wait states Addl. 16K RAM \$79.00.

**Quest Super Basic**

Quest, the leader in inexpensive 1802 systems announces another first. Quest is the first company worldwide to ship a full size Basic for 1802 systems. A complete function Super Basic by Ron Cenko including floating point capability with scientific notation (number range  $\pm 17E^9$ ), 32 bit integer  $\pm 2$  billion. Multi dim arrays. String arrays. String manipulation; Cassette I/O. Save and load data, Basic, Data and machine language programs; and over 75 Statements, Functions and Operators.

programs. Cassette version in stock now. ROM versions coming soon with exchange privilege allowing some credit for cassette version.

- Super Basic on Cassette \$40.00**
- Tom Pittman's 1802 Tiny Basic Source Listing now available. Find out how Tom Pittman wrote Tiny Basic and how to get the most out of it. Never offered before. \$19.00**
- S-100 4-Slot Expansion \$ 9.95**
- Super Monitor VI. I Source Listing \$15.00**  
Coming Soon: Assembler, Editor, Disassembler, DA/AD, Super Sound/Music, EPROM programmer.

Easily adaptable on most 1802 systems. Requires 12K RAM minimum for Basic and user

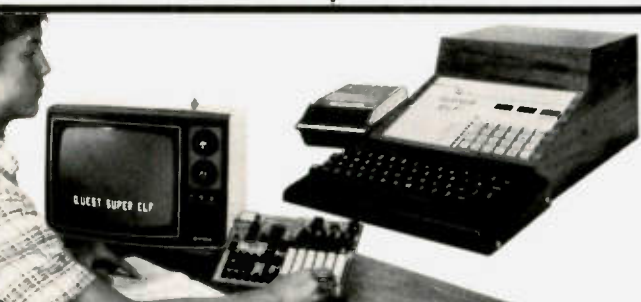

**RCA Cosmac Super Elf Computer \$106.95**

Compare features before you decide to buy any other computer. There is no other computer on the market today that has all the desirable benefits of the Super Elf for so little money. The Super Elf is a small single board computer that does many big things. It is an excellent computer for training and for learning programming with its machine language and yet it is easily expanded with additional memory, Full Basic, ASCII Keyboards, video character generation, etc.

A 24 key **HEX keyboard** includes 16 HEX keys plus load, reset, run, wait, input, memory protect, monitor select and single step. Large, on board displays provide output and optional high and low address. There is a 44 pin standard connector slot for PC cards and a 50 pin connector for the Quest Super Expansion Board. Power supply and sockets for all IC's are included in the price plus a detailed 127 pg. instruction manual which now includes over 40 pgs. of software info, including a series of lessons to help get you started and a music program and graphics target game.

Before you buy another small computer, see if it includes the following features: ROM monitor, State and Mode displays. Single step. Optional address displays; Power Supply, Audio Amplifier and Speaker, Fully socketed for all IC's; Real cost of in warranty repairs; Full documentation.

Many schools and universities are using the Super Elf as a course of study. OEM's use it for training and research and development. Remember, other computers only offer Super Elf features at additional cost or not at all. Compare before you buy. Super Elf Kit \$106.95, High address option \$8.95, Low address option \$9.95. Custom Cabinet with drilled and labelled plexiglass front panel \$24.95. Expansion Cabinet with room for 4 S-100 boards \$41.00. NiCad Battery Memory Saver Kit \$6.95. All kits and options also completely assembled and tested.

The Super Elf includes a ROM monitor for program loading, editing and execution with SINGLE STEP for program debugging which is not included in others at the same price. With SINGLE STEP you can see the microprocessor chip operating with the unique Quest address and data bus displays before, during and after executing instructions. Also, CPU mode and instruction cycle are decoded and displayed on 8 LED indicators.

Questdata, a 12 page monthly software publication for 1802 computer users is available by subscription for \$12.00 per year.

An RCA 1861 video graphics chip allows you to connect to your own TV with an inexpensive video modulator to do graphics and games. There is a speaker system included for writing your own music or using many music programs already written. The speaker amplifier may also be used to drive relays for control purposes.

Tiny Basic Cassette \$10.00, on ROM \$38.00, original Elf kit \$14.95, 1802 software; Mowes Video Graphics \$3.50. Games and Music \$3.00, Chip 8 Interpreter \$5.50.

**Super Expansion Board with Cassette Interface \$59.95**

This is truly an astounding value! This board has been designed to allow you to decide how you want it optioned. The Super Expansion Board comes with 4K of low power RAM fully addressable anywhere in 64K with built-in memory protect and a cassette interface. Provisions have been made for all other options on the same board and it fits neatly into the hardware cabinet alongside the Super Elf. The board includes slots for up to 6K of EPROM (2708, 2758, 2716 or TI 2716) and is fully socketed. EPROM can be used for the monitor and Tiny Basic or other purposes.

subroutines allowing users to take advantage of monitor functions simply by calling them up. Improvements and revisions are easily done with the monitor. If you have the Super Expansion Board and Super Monitor the monitor is up and running at the push of a button.

A 1K Super ROM Monitor \$19.95 is available as an on board option in 2708 EPROM which has been preprogrammed with a program loader/editor and error checking multi file cassette read/write software, (relocatable cassette file) another exclusive from Quest. It includes register save and readout, block move capability and video graphics driver with blinking cursor. Break points can be used with the register save feature to isolate program bugs quickly, then follow with single step. The Super Monitor is written with

Other on board options include Parallel Input and Output Ports with full handshake. They allow easy connection of an ASCII keyboard to the input port. RS 232 and 20 mA Current Loop for teletype or other device are on board and if you need more memory there are two S-100 slots for static RAM or video boards. Also a 1K Super Monitor version 2 with video driver for full capability display with Tiny Basic and a video interface board. Parallel I/O Ports \$9.85, RS 232 \$4.50, TTY 20 mA I/F \$1.95, S-100 \$4.50. A 50 pin connector set with ribbon cable is available at \$15.50 for easy connection between the Super Elf and the Super Expansion Board.

Power Supply Kit for the complete system (see Multi-volt Power Supply).

Same day shipment. First line parts only. Factory tested. Guaranteed money back. Quality IC's and other components at factory prices.

**INTEGRATED CIRCUITS**

7400T17	LM323E-5	5.95	CD4021	1.25
7400A	LM323E-1	1.50	CD4023	2.80
7400B	LM323E-1	1.50	CD4023	2.80
7400C	LM323E-1	1.50	CD4023	2.80
7400D	LM323E-1	1.50	CD4023	2.80
7400E	LM323E-1	1.50	CD4023	2.80
7400F	LM323E-1	1.50	CD4023	2.80
7400G	LM323E-1	1.50	CD4023	2.80
7400H	LM323E-1	1.50	CD4023	2.80
7400I	LM323E-1	1.50	CD4023	2.80
7400J	LM323E-1	1.50	CD4023	2.80
7400K	LM323E-1	1.50	CD4023	2.80
7400L	LM323E-1	1.50	CD4023	2.80
7400M	LM323E-1	1.50	CD4023	2.80
7400N	LM323E-1	1.50	CD4023	2.80
7400O	LM323E-1	1.50	CD4023	2.80
7400P	LM323E-1	1.50	CD4023	2.80
7400Q	LM323E-1	1.50	CD4023	2.80
7400R	LM323E-1	1.50	CD4023	2.80
7400S	LM323E-1	1.50	CD4023	2.80
7400T	LM323E-1	1.50	CD4023	2.80
7400U	LM323E-1	1.50	CD4023	2.80
7400V	LM323E-1	1.50	CD4023	2.80
7400W	LM323E-1	1.50	CD4023	2.80
7400X	LM323E-1	1.50	CD4023	2.80
7400Y	LM323E-1	1.50	CD4023	2.80
7400Z	LM323E-1	1.50	CD4023	2.80

**74LS00 TTL**

74LS00	LM3905	1.75	CD4019	3.00
74LS01	LM3905	1.75	CD4019	3.00
74LS02	LM3905	1.75	CD4019	3.00
74LS03	LM3905	1.75	CD4019	3.00
74LS04	LM3905	1.75	CD4019	3.00
74LS05	LM3905	1.75	CD4019	3.00
74LS06	LM3905	1.75	CD4019	3.00
74LS07	LM3905	1.75	CD4019	3.00
74LS08	LM3905	1.75	CD4019	3.00
74LS09	LM3905	1.75	CD4019	3.00
74LS10	LM3905	1.75	CD4019	3.00
74LS11	LM3905	1.75	CD4019	3.00
74LS12	LM3905	1.75	CD4019	3.00
74LS13	LM3905	1.75	CD4019	3.00
74LS14	LM3905	1.75	CD4019	3.00
74LS15	LM3905	1.75	CD4019	3.00
74LS16	LM3905	1.75	CD4019	3.00
74LS17	LM3905	1.75	CD4019	3.00
74LS18	LM3905	1.75	CD4019	3.00
74LS19	LM3905	1.75	CD4019	3.00
74LS20	LM3905	1.75	CD4019	3.00
74LS21	LM3905	1.75	CD4019	3.00
74LS22	LM3905	1.75	CD4019	3.00
74LS23	LM3905	1.75	CD4019	3.00
74LS24	LM3905	1.75	CD4019	3.00
74LS25	LM3905	1.75	CD4019	3.00
74LS26	LM3905	1.75	CD4019	3.00
74LS27	LM3905	1.75	CD4019	3.00
74LS28	LM3905	1.75	CD4019	3.00
74LS29	LM3905	1.75	CD4019	3.00
74LS30	LM3905	1.75	CD4019	3.00
74LS31	LM3905	1.75	CD4019	3.00
74LS32	LM3905	1.75	CD4019	3.00
74LS33	LM3905	1.75	CD4019	3.00
74LS34	LM3905	1.75	CD4019	3.00
74LS35	LM3905	1.75	CD4019	3.00
74LS36	LM3905	1.75	CD4019	3.00
74LS37	LM3905	1.75	CD4019	3.00
74LS38	LM3905	1.75	CD4019	3.00
74LS39	LM3905	1.75	CD4019	3.00
74LS40	LM3905	1.75	CD4019	3.00

**74LS00 TTL**

74LS00	LM3905	1.75	CD4019	3.00
74LS01	LM3905	1.75	CD4019	3.00
74LS02	LM3905	1.75	CD4019	3.00
74LS03	LM3905	1.75	CD4019	3.00
74LS04	LM3905	1.75	CD4019	3.00
74LS05	LM3905	1.75	CD4019	3.00
74LS06	LM3905	1.75	CD4019	3.00
74LS07	LM3905	1.75	CD4019	3.00
74LS08	LM3905	1.75	CD4019	3.00
74LS09	LM3905	1.75	CD4019	3.00
74LS10	LM3905	1.75	CD4019	3.00
74LS11	LM3905	1.75	CD4019	3.00
74LS12	LM3905	1.75	CD4019	3.00
74LS13	LM3905	1.75	CD4019	3.00
74LS14	LM3905	1.75	CD4019	3.00
74LS15	LM3905	1.75	CD4019	3.00
74LS16	LM3905	1.75	CD4019	3.00
74LS17	LM3905	1.75	CD4019	3.00
74LS18	LM3905	1.75	CD4019	3.00
74LS19	LM3905	1.75	CD4019	3.00
74LS20	LM3905	1.75	CD4019	3.00
74LS21	LM3905	1.75	CD4019	3.00
74LS22	LM3905	1.75	CD4019	3.00
74LS23	LM3905	1.75	CD4019	3.00
74LS24	LM3905	1.75	CD4019	3.00
74LS25	LM3905	1.75	CD4019	3.00
74LS26	LM3905	1.75	CD4019	3.00
74LS27	LM3905	1.75	CD4019	3.00
74LS28	LM3905	1.75	CD4019	3.00
74LS29	LM3905	1.75	CD4019	3.00
74LS30	LM3905	1.75	CD4019	3.00
74LS31	LM3905	1.75	CD4019	3.00
74LS32	LM3905	1.75	CD4019	3.00
74LS33	LM3905	1.75	CD4019	3.00
74LS34	LM3905	1.75	CD4019	3.00
74LS35	LM3905	1.75	CD4019	3.00
74LS36	LM3905	1.75	CD4019	3.00
74LS37	LM3905	1.75	CD4019	3.00
74LS38	LM3905	1.75	CD4019	3.00
74LS39	LM3905	1.75	CD4019	3.00
74LS40	LM3905	1.75	CD4019	3.00

**ROCKWELL AIM 65 Computer**

6502 based single board with full ASCII keyboard and 20 column thermal printer. 20 char alphanumeric display, ROM monitor, fully expandable. \$375.00. 4K version \$450.00. 4K Assembler \$85.00, 8K Basic Interpreter \$100.00.

Special small power supply for AIM 65 assem. In frame \$49.00. Complete AIM 65 in thin briefcase with power supply \$485.00. Molded plastic enclosure to fit AIM 65 plus power supply \$47.50.

AIM 65/KIM/VIM/Super Elf 44 pin expansion board; 3 female and 1 male bus. Board plus 3 connectors \$22.95.  
AIM 65/KIM/VIM I/O Expansion Kit; 4 parallel and 2 serial ports plus 2 internal timers \$39.00. PROM programmer for 2716 \$150.00.

**Multi-volt Computer Power Supply**

8v 5 amp,  $\pm 18v$  5 amp, 5v 1.5 amp,  $-5v$  .5 amp,  $\pm 12v$  .5 amp, 12v opt.  $\pm 5v$ ,  $\pm 12v$  are regulated. Kit \$29.95. Kit with punched frame \$37.40, \$4.00 shipping. Woodgrain case \$10.00, \$1.50 shipping.

**PROM Eraser**

Will erase 25 PROMs in 15 minutes. Ultra-violet, assembled \$37.50

**60 Hz Crystal Time Base Kit \$4.40**

Converts digital clocks from AC line frequency to crystal time base. Outstanding accuracy.

**79 IC Update Master Manual \$35.00**

Complete IC data selector, 2500 pg. master reference guide. Over 50,000 cross references. Free update service through 1979. Domestic postage \$3.50. No foreign orders.

**RESISTORS 1% 5% 10%**

100 per type 03	1000 per type 012
25 per type 025	350 price case
100 per type 015	5 per type 6.75
5 per type 05	

**KEYBOARDS**

50 key ASCII keyboard kit	\$67.50
Fully assembled	60.00
53 key ASCII keyboard kit	77.50
Fully assembled	70.00
Enclosure 14.95	

**CONNECTORS**

30 pin edge	2.50
44 pin edge	2.50
100 pin edge	4.50
100 pin edge WW	7.50

**IC SOCKETS**

40 pins	2.90
80 pins	3.50
140 pins	4.50
200 pins	5.50
276 pins	6.50
288 pins	7.50
360 pins	8.50
400 pins	9.50
480 pins	10.50
576 pins	11.50
640 pins	12.50
720 pins	13.50
800 pins	14.50
864 pins	15.50
960 pins	16.50
1024 pins	17.50
1152 pins	18.50
1280 pins	19.50
1408 pins	20.50
1536 pins	21.50
1664 pins	22.50
1792 pins	23.50
1920 pins	24.50
2048 pins	25.50
2176 pins	26.50
2304 pins	27.50
2432 pins	28.50
2560 pins	29.50
2688 pins	30.50
2816 pins	31.50
2944 pins	32.50
3072 pins	33.50
3200 pins	34.50
3328 pins	35.50
3456 pins	36.50
3584 pins	37.50
3712 pins	38.50
3840 pins	39.50
3968 pins	40.50
4096 pins	41.50
4224 pins	42.50
4352 pins	43.50
4480 pins	44.50
4608 pins	45.50
4736 pins	46.50
4864 pins	47.50
4992 pins	48.50
5120 pins	49.50
5248 pins	50.50
5376 pins	51.50
5504 pins	52.50
5632 pins	53.50
5760 pins	54.50
5888 pins	55.50
6016 pins	56.50
6144 pins	57.50
6272 pins	58.50
6400 pins	59.50
6528 pins	60.50
6656 pins	61.50
6784 pins	62.50
6912 pins	63.50
7040 pins	64.50
7168 pins	65.50
7296 pins	66.50
7424 pins	67.50
7552 pins	68.50
7680 pins	69.50
7808 pins	70.50
7936 pins	71.50

# GET ON PHASE THREE FOR MUCH LESS THAN YOU THINK!

## These Low Cost SSB TRANSMITTING CONVERTERS

Let you use inexpensive recycled 10M or 2M SSB exciters on UHF & VHF!

- Linear Converters for SSB, CW, FM, etc.
- A fraction of the price of other units; no need to spend \$300 - \$400!
- Use with any exciter, works with input levels as low as 1 mW.
- Use low power tap on exciter or simple resistor attenuator pad (instructions included).
- Link osc with RX converter for transceive.

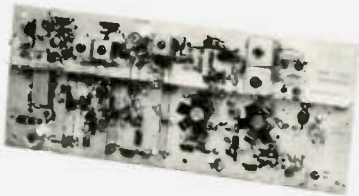

HAMTRONICS DOES IT AGAIN!

### NEW XV4 UHF KIT - ONLY \$99.95

28-30 MHz In, 435-437 MHz out; 1W p.e.p. on sssb, up to 1½W on CW or FM. Has second oscillator for other ranges. Atten. supplied for 1 to 500 mW input, use external attenuator for higher levels.

Extra crystal for 432-434 MHz range ..... \$5.95



### XV2 VHF KIT - ONLY \$69.95

2W p.e.p. output with as little as 1mW input. Use simple external attenuator. Many freq. ranges available.

MODEL	INPUT (MHz)	OUTPUT (MHz)
XV2-1	28-30	50-52
XV2-2	28-30	220-222
XV2-4	28-30	144-146
XV2-5	28-29 (27-27.4 CB)	145-146 (144-144.4)
XV2-7	144-146	50-52

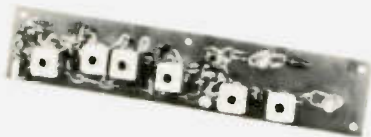

### XV28 2M ADAPTER KIT - \$24.95

Converts any 2M exciter to provide the 10M signal required to drive above 220 or 435 MHz units.

## Easy to Build FET RECEIVING CONVERTERS

Let you receive OSCAR and other exciting VHF and UHF signals on your present HF or 2M receiver

VHF KIT STILL ONLY \$34.95



MODEL	RF RANGE	OUTPUT RANGE
C28	28-32 MHz	144-148 MHz
C50	50-52	28-30
C50-2	50-54	144-148
C144	144-146	28-30
C145	145-147	28-30
or	144-144.4	27-27.4 (CB)
C146	146-148	28-30
C220	220-222	28-30
C220-2	220-224	144-148
C110 (less xtal)	Any 2MHz of Aircraft Band	26-28 or 28-30

UHF KIT ONLY \$34.95



MODEL	RF RANGE	OUTPUT RANGE
C432-2	432-434	28-30
C432-5	435-437	28-30
C432-4	432-436	144-148
C432-9	439.25	61.25

## Professional Quality VHF/UHF FM/CW EXCITERS

- Fully shielded designs
- Double tuned circuits for spurious suppression
- Easy to align with built-in test aids

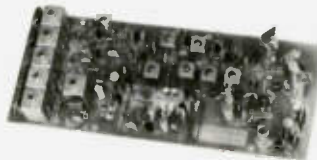

T50-50	6-chan, 6M, 2W Kit	\$49.95
T50-150	6-chan, 2M, 2W Kit	\$49.95
T50-220	6-chan, 220 MHz, 1½W Kit	\$49.95
T450	1-chan, 450 MHz, 1W Kit	\$49.95

## See our Complete Line of VHF & UHF Linear PA's

- Use as linear or class C PA
- For use with SSB Xmtg Converters, FM Exciters, etc.

LPA 2-15 VHF PA, 2W in/15-20W out. Solid-state 1/r switching. Kit	\$59.95
LPA 2-45 VHF PA, 2W in/40-45W out. Can also be used with 8-10W drive. Kit	\$109.95
LPA 4-10 UHF PA, ½W-1W in/8-10W out. Kit	\$79.95

## FAMOUS HAMTRONICS PREAMPS

Let you hear the weak ones too!  
Great for OSCAR, SSB, FM, ATV. Over 14,000 In use throughout the world on all types of receivers.

P9 Kit \$12.95  
P14 Wired \$24.95  
Specify band when ordering



- Deluxe vhf model for applications where space permits ● 1½" x 3" ● Models available to cover any 4MHz band in the 26 to 230 MHz range ● 12 Vdc ● 2 stages ● Ideal for OSCAR ● 20 dB gain

P8 Kit \$10.95  
Specify band when ordering



- Miniature vhf model for tight spaces—size only ½ x 2 ½ ● Models available to cover any 4MHz band in the range 20 to 230 MHz ● 20 dB gain ● 12 Vdc

P15 Kit \$18.95  
P35 Wired \$34.95

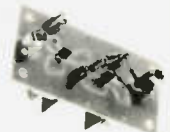

- Covers any 6 MHz band in UHF range of 380 to 520 MHz ● 20 dB gain ● 2 stages ● 12 Vdc

## NEW VHF/UHF FM RCVR'S

Offer Unprecedented Range of Selectivity Options

- New generation
- More sensitive
- More selective
- Low cross mod
- Uses crystal filters
- Smaller
- Easy to align

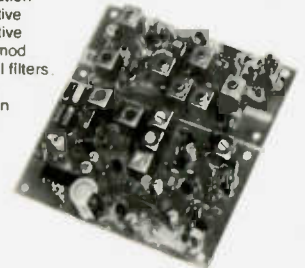

R75A\* VHF Kit for monitor or weather satellite service. Uses wide L-C filter. -60dB at ± 30 kHz. .... \$69.95

R75B\* VHF Kit for normal nbfm service. Equivalent to most transceivers. -60dB at ± 17 kHz, -80dB at ± 25 kHz. .... \$74.95

R75C\* VHF Kit for repeater service or high rf density area. -60dB at ± 14kHz, -80dB at ± 22kHz, -100dB at ± 30kHz. .... \$84.95

R75D\* VHF Kit for split channel operation or repeater in high density area. Uses 8-pole crystal filter. -60dB at ± 9 kHz, -100dB at ± 15 kHz. The ultimate receiver! ... \$99.95

\* Specify band: 10M, 6M, 2M, or 220 MHz. May also be used for adjacent commercial bands. Use 2M version for 137 MHz WX satellites.

R85( ) UHF FM Receiver Kits, triple conversion, include C432 UHF Front End Module. Add \$20 to above prices. (Add selectivity letter to model number.)

A13-45A 6-Channel Adapter for receivers ..... \$13.95

## IT'S EASY TO ORDER!

- Write or phone 716-392-9430 (Electronic answering service evenings & weekends)
- Use Credit Card, UPS COD, Check, Money Order
- Add \$2.00 shipping & handling per order

Call or Write to get FREE CATALOG With Complete Details

(Send 4 IRC's for overseas mailing)

# hamtronics, inc.

65C MOUL RD · HILTON, NY 14468



# SEMICONDUCTORS SURPLUS

S63

2822 North 32nd Street/Unit -1 Phoenix, Arizona 85008 (602) 956-9423

We accept checks, MasterCharge, and Visa

Prices subject to change without notice

## R.F. CONNECTORS

UG-1095A/U	\$3.99
UG-58/U	3.29
UG-30C/U	3.00
UG-27C/U	3.50
PL-259	.50
SO-239	.43
UG-175	.36
PL-258	2.99
UG-106	.69
UG-177	.69
UG-274/U	3.27
UG-447/U	1.50
UG-492	3.69
UG-306/U	3.00
UG-646/U	3.29
UG-260B/U	1.59
UG-1094/U	.90
UG-701/U	3.00
UG-212C/U	3.00

## TUBES

3-500Z	\$90.00
572B/T160L	34.00
6146	5.09
6146A	5.99
6-46W	7.95
811A	12.95
811	9.95
4CX250B	36.95
4CX250R	39.95
6KD6	4.99
6LF6	4.99
6LQ6/6JE6	6.25
8950	6.65
2E26	6.00
3B28	5.00
4X150A	15.00
6360/A	7.95
6939	5.95
7289/2C39	4.95
8072	45.00
4-400A	90.00
8877	300.00
PL172	250.00
4-1000A	160.00
4-250A	35.00

## FERRITE BEADS

12/\$.89 or  
100/\$4.00

## 1N914/1N4148

30/\$1.00 or  
120/\$3.00

## R.F. TRANSISTORS

2N2857	\$1.80
2N2857JAN	2.45
2N2947	17.00
2N3375	7.00
2N3553	1.80
2N3818	6.00
2N3866	1.09
2N3866JAN	2.70
2N2866JANTX	4.43
2N3925	6.00
2N3948	2.00
2N3950	26.25
2N3960	4.70
2N4072	1.70
2N4427	1.09
2N4877	2.57
2N4957	3.50
2N5108	3.90
2N5109	1.55
2N5179	.59
2N5589	4.60
2N5583	5.00
2N5590	6.30
2N5591	10.35
2N6080	5.45
2N6081	8.80
2N6082	10.75
2N6083	12.00
2N6084	13.20
2N6095	10.35
2N6097	19.35
MRF502	.69
MRF8004	.75
SS2548	.75
40280	3.50
40281	10.90
40282	11.90

## TRIMMERS 5-80pf

45¢ each or 10/3.50  
or 100/25.00

## CHOKE (U252) 2.5mh

150ma 30MHz  
2/\$1.00

## TRIMMER CAPS

small enough to  
fit in your watch  
3.5-11pf 75¢ each  
or 10/\$6.00

## PISTON CAPS 1.2-10pf

75¢ each or 10/\$5.50

## F.E.T.'s

MPF4391	\$ .75 or 10/ 6.50
MPF112	.69 or 10/ 5.50
MPF102	.43 or 10/ 3.50
40673	1.39 or 10/10.00
3N128	1.35 or 10/10.00
2N5248	.60 or 10/ 4.50
MPF131	.60 or 10/ 5.00
2N4303	.45 or 10/ 3.50
2N3958	2.95 each
MFE2000	.90 or 10/ 8.00
MFE2001	.99 or 10/ 8.00
MFE2008	4.20 or 10/36.00
MFE2009	4.80 or 10/39.00
MFE3002	3.35 each
MMF-5	5.00 each
MFE120	1.00 or 10/ 8.50
2N3436	2.25 each
2N4416	1.00 each
MFE131	1.05 each

## MICROWAVE DIODES

1N21D	\$ 1.40
1N21C	1.05
1N21WE	2.00
1N23B	1.05
1N23C	1.05
1N23CR	2.00
1N23E	2.00
1N23F	4.10
1N23WE	2.10
1N25	3.03
1N121WE	4.00
1N286	5.00
1N416E	5.00
1N446	8.00
1N3655A	4.00
1N5153	15.00
1N5711	1.20

## ADDITIONAL R.F. TRANSISTORS

40894	\$ 2.50
MRF454/568BLYCF	17.10

## BRIDGES 24 AMPS

500PIV \$2.99 each

## LM566V VCO/FUNCTION GENERATOR

\$.99 each

## LM340T-5 & LM340T-12

\$1.49 each

## VACUUM CAPACITORS

Amperex Model CVC  
10/1k-5KV405A 10 pf to 1000  
pf @5000 volts \$59.95

## MC4024P & MC4044P

\$3.25 each

## HEP 170 2.5 Amps

1000PIV 10/\$2.00 or 100/\$14.50

## POTTER & BRUMFIELD 12VDC RELAYS

SPDT 25 Amps \$5.95  
2PDT 3 Amps \$1.99

## KILOVAC H-8/54 VACUUM RELAY

26 volt coil \$29.95 each

## E. F. JOHNSON TUBE SOCKETS for 3-400Z and 3-5000Z tubes \$29.95 per pair

## TOROIDAL CORES

T-37-6 6/1.00  
25/4.00, 50/6.00  
100/10.00

## 4CX250B/R SOCKETS AND CHIMNEYS NEW

\$14.95 per set (1 socket, 1 chimney)

## B&W COILS

1206T \$3.99  
2006T \$7.99

## FAIRCHILD REGULATOR 78H05KC

\$6.99 each

## TUBES

6146B \$6.50

### MINIMUM ORDER \$5.00

Minimum Shipping \$1. Insurance 35¢ per \$100. COD charges 85¢ to street address only! We prefer street address as we ship UPS and P.O. Box #'s take up to 50% longer to deliver. We accept VISA or Mastercharge. Please list complete card number and expiration date. Allow 10% extra for shipping of heavy items. We reserve the right to change prices without notice. All items listed are in small quantities.



# SPECTRONICS, INC.

1009 Garfield St., Oak Park, Illinois • 60304

(312) 848-6777 ✓S81

## BARGAIN FAVORITES!

### OUR BEST-SELLING MULTI-BAND!



AS LOW AS  
**\$73<sup>75</sup>**

- One half the length of conventional half-wave dipoles
- Multi-band, Multi-frequency
- Maximum efficiency — no traps, loading coils, or stubs
- Fully assembled and pre-tuned — no measuring, no cutting
- All weather rated — 1 KW AM, 2.5 KW CW or PEP SSB
- Proven performance — more than 10,000 have been delivered
- Permit use of the full capabilities of today's 5-band xcvrs
- One feedline for operation on all bands.

40-10HD/A 40/20/15/10 Mtrs (36) . . . . .	\$73.75 c
80-40HD/A 80/40 Mtr bands (69) . . . . .	77.25 c
75/40HD/A 75/40 Mtr bands (66) . . . . .	73.75 c
75-10HD/A 75/40/20/15/10 Mtr (66) . . . . .	89.95 c
80-10HD/A 80/40/20/15/10 Mtr (69) . . . . .	94.95 c

### Famous "W2AU" Balun

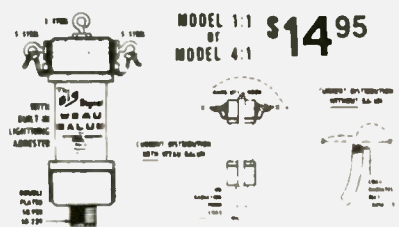

- HANDLES FULL 2 KW PEP AND THEN SOME. Broad Banded 3 to 40 Mc.
  - HELPS TVI PROBLEMS By Reducing Coax Line Radiation.
  - NOW ALL STAINLESS STEEL HARDWARE S0239 Double Silver Plated.
  - IMPROVES F/B RATIO By Reducing Coax Line Pick Up.
  - REPLACES CENTER INSULATOR. Withstands Antenna Pull of Over 600 Lbs.
  - BUILT IN LIGHTNING ARRESTER. Helps Protect Balun. Could Also Save Your Valuable Gear.
  - BUILT IN HANG UP HOOK. Ideal for Inverted Vees, Multi-Band Antennas, Dipoles, Beam and Quads.
- NOW BEING USED BY ALL BRANCHES OF THE U.S. ARMED FORCES, FAA, RCA, CIA, CANADIAN DEFENSE DEPT. PLUS THOUSANDS OF HAMS THE WORLD OVER.
- Model 1:1 . . . . . \$14.95      Model 4:1 . . . . . \$14.95

### 2 METER ANTENNAS at BARGAIN PRICES!!

hy-gain 3 db GAIN  
MAGNETIC MOUNT

NEW!

ONLY  
Model 287  
Wt. 2.5 lbs.      **\$19.<sup>95</sup>**

An economical alternative to drilling a hole. A magnetic antenna by a name you can trust at a low, low price.

Model 286 Same but trunk lid. . . . . \$15.95 b

### NEW! FINCO

2.8 dbd GAIN  
BASE ANTENNA

ONLY  
**\$9.<sup>95</sup>**

Model A2-GP  
Wt. 2 lbs.

At last! An inexpensive, omni directional, 144-148 MHz, 1/2 wave antenna. Fits 1 1/4" mast, 50 ohm imp. A good antenna at a very affordable price.

NEW!

FROM

avant! antennas

### ON GLASS MOBILE ANTENNAS

Modern technology lets you mount a mobile antenna right on the window. Ideal for tough installations. 3 models available

AH151.3G 144-174 MHz, 3 db gn . . . . .	\$33.95 b
AH220.3G 220 MHz, 3 db gn . . . . .	33.95 b
AH450.5G 406-512 MHz, 5 db gn . . . . .	36.95 b

### IMPROVE YOUR RECEPTION!

AN AMECO ALL-BAND PREAMP!  
• 6-160 Meters  
• 20+ dB Gain  
• Low Price

ONLY  
**\$49.<sup>95</sup>**



MODEL PLF-2 Improves weak signals as well as image and spurious rejection of most receivers. Direct switching to rec. or preamp. Includes pwr. supp. 117 VAC wired & tested. **\$49.95.**

### DIPOLE HEADQUARTERS

#### CABLE

8U FOAM, hi dens braid 50 ft . . . . .	\$12.95 c
8U FOAM, hi dens braid 100 ft . . . . .	24.00 e
RG58A/U stranded center 50 ft . . . . .	6.95 c
RG58A/U stranded center 100 ft . . . . .	9.95 d
RG58 3 ft w/PL259 each end . . . . .	3.35 b
RG58 5 ft w/PL259 each end . . . . .	4.39 b
RG58 50 ft w/PL259 each end . . . . .	9.95 c

#### COPPER WIRE

#14 stranded, 100 ft spool . . . . .	5.95 c
#14 solidcopper enameled 100' . . . . .	5.95 c

#### INSULATORS

Egg Ins, porcelain per pair . . . . .	.99 a
DOG BONE, porcelain set of 3 . . . . .	1.50 a
HY GAIN #155 center insulator . . . . .	5.95 b
HY GAIN Cyclocac end ins per pair . . . . .	3.95 b
MOSLEY dipole center insulator . . . . .	5.75 a

#### CONNECTORS

PL259 UHF male, 2 per pkg . . . . .	1.59 a
S0239 UHF female chassis mt . . . . .	.69 a
UG175 Adapts RG58 to PL259, pkg 2 . . . . .	.59 a
UG176 Adapts RG59 to PL259, pkg 2 . . . . .	.59 a
PL258 UHF double female . . . . .	.99 a
DM-SP UHF double male . . . . .	1.69 a
M359 90 deg UHF elbow conn . . . . .	2.10 a
UG88U BNC male for RG58 . . . . .	1.49 a
1094 BNC female . . . . .	1.49 a
M358 UHF "T" connector . . . . .	3.95 a
UG255 UHF female to BNC male . . . . .	3.49 a
UG273 BNC female to UHF male . . . . .	2.45 a

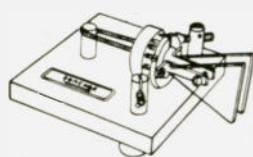

**BENCHER**

If it's the ultimate in paddles your looking for may we recommend the Bencher. It's simply the nicest one we've seen yet.

BY1 paddle w/black base. . . . .	\$39.95 c
BY1 Deluxe model w/chrome base. . . . .	49.95 c

## DSI

A 550 MHz  
COUNTER  
FOR UNDER  
\$100.00!  
**\$99.<sup>95</sup>**



- ONE HOUR easy assembly. • 1 YEAR warranty
- 8 DIGIT readout • 1 Hz resolution • 12 VDC
- operation • 1/2 INCH LED's • 95% assembled

Whether it's adjusting a 60 Hz. time base, or netting a UHF radio, here's one low cost counter to do it all! Ideal for all types of radios, TV and PLL repair, computer maintenance & construction, and audio amplifier & Receiver repair.

3550 Kit . . . . .	\$99.95	AC-9 AC Adapter . . . . .	\$7.95
T-101 Antenna . . . . .	3.95	Shipping & Handling . . . . .	2.50

**CATALOG SPECIAL —**  
T101 antenna free!  
A \$3.95 value!

### NEW from HY-GAIN!

A \$269.95 Value! **TH50XX 5 El.**  
ONLY **\$221.<sup>50</sup>** Beam — Rated  
Full Legal Power  
TRUCK SHIP ONLY Output

# HF & VHF BEAMS and VERTICALS



**SPECTRONICS, INC.**  
1009 Garfield St., Oak Park, Illinois • 60304  
**(312) 848-6777**

the antenna  
specialists



## 2 MTR DUCKIES

- Model HM-4.** Has 5/16" 32 thread Fits Motorola HT's ICOM IC215 and Standard 146A **\$7.00**
- Model HM-5.** Same as above, but with PL-259 connector **\$7.00**
- Model HM-226.** Same, with TNC connector for Wilson 1405 **\$18.50**
- Model HM-227.** Same, but with BNC connector termination **\$12.00**
- Model HM-228.** With F connector for Wilson 1402 & Tempo **\$11.50**

- HM180 2mtr, 3db trunk lip ant. .... **\$33.50 b**
- HM179 2mtr, 3db hole mount ant. .... **29.00 b**
- HM20 2mtr, 3db for marine use. .... **39.00 b**
- HM176 440MHz 5db trunk lip ant. .... **33.00 b**
- HM175 440MHz 5db hole mount ant. .... **29.00 b**
- HM224 220MHz 4db trunk lip ant. .... **33.50 b**



- AR2 2meter Ringo base ant. .... **\$24.95 b**
- ARX2 2mtr Ringo Ranger base ant. .... **39.95 c**
- AR220 220MHz Ringo base ant. .... **24.95 b**
- ARX220 220MHz Ringo Ranger. .... **39.95 c**
- AR450 UHF Ringo base ant. .... **24.95 b**
- ARX450 UHF Ringo Ranger base ant. .... **39.95 c**
- AR6 6 meter Ringo base ant. .... **36.95 c**
- ARX2K Adapts 2M Ringo to Ranger. .... **16.95 b**
- A147-4 4 ele 2M FM beam ant. .... **24.95 b**
- A147-11 11 ele 2M FM beam. .... **36.95 c**
- A147-20T 10 ele 2M vert/horz twist. .... **62.95 d**
- A144-7 7 ele 2M CW/SSB beam. .... **26.95 c**
- A144-11 11 ele 2M CW/SSB beam. .... **36.95 d**
- A144-10T 10 ele Twist OSCAR ant. .... **42.95 c**
- A144-20T 20 ele Twist OSCAR ant. .... **62.95 d**
- A220-7 7 ele 220MHz beam. .... **26.95 c**
- A220-11 11 ele 220MHz beam. .... **34.95 c**
- A449-6 6 ele UHF FM beam. .... **24.95 c**
- A449-11 11 ele UHF beam. .... **34.95 c**
- A432-11 11el 432MHz SSB/CW beam. .... **34.95 c**
- AFM4D 144-148MHz Four Pole. .... **69.95 c**
- AFM24D 220MHz Four Pole. .... **64.95 c**
- AFM44D 435-450MHz Four Pole. .... **64.95 c**
- ASQ-2 2M Squalo horiz ant. .... **19.95 b**
- LAC-1 Coax lightning arrester. .... **4.95 a**
- LAC2 Coax lightning arrester. .... **4.95 a**
- ATB34 ★ 4 ele 20-10mtr beam. .... **219.95 ★**
- ATV3 20-10mtr trap vertical. .... **49.95 e**
- ATV4 40-10mtr trap vertical. .... **69.95 e**
- ATV5 80-10mtr trap vertical. .... **89.95 e**
- A50-3 3 element 6 meter beam. .... **39.95 d**
- A50-5 5 element 6 meter beam. .... **59.95 e**
- A28-3 ★ 3 element 10 meter beam. .... **69.95 ★**
- A432-20T 432MHz 20 ele twist. .... **59.95 d**

## 2M BASE ANT. PACKAGE

Here's what you get:

- Cushcraft AR2 Ringo South River.
- PFM71 Roof mount.
- A125-5P 5' alum mast.
- Lag bolts.
- 50' 8U foam coax.
- PL259 coax conn.

**\$59<sup>95</sup>**

Wt. 16 lbs.



## FINCO

The most rugged 6 & 2 meter beams we've seen yet!!

- A 2-10 10 ele, 2M beam. .... **\$44.95 d**
- A 2-5 5 ele, 2M beam, 9.5db gain. .... **27.95 c**
- A 2-2 10 ele, 2M dual polarization. .... **46.50 e**
- A62 6&2M antenna on one boom. .... **74.95 e**
- A6-5 5 element 6M beam, 11db. .... **46.50 d**
- A6-3 3 ele 6M beam, 7db gain. .... **30.00 d**
- A 1 1/4 220MHz 10 ele, 13.8db. .... **32.95 d**



## \$9<sup>95</sup> "BUCK-BUSTER" SF-2 ANTENNA

Fits all Hustler deluxe mobile mounts 3/8"x24 base 5/8" wave two meters, 3 4 db gain SWR at resonance adj to 1 5 1 or better Bandwidth 6 MHz, 2 1 or better SWR 100 watts max

## \$7995 NEW 4-BTV VERTICAL

One setting covers 10, 15, 20, 40M. Space restricted or unlimited you get top signal reports, consistent contacts and complete coverage Add 5th band with a 75M resonator Use one feedline, any length Requires no switching or matching devices 15 lbs

SF-2

4-BTV

- MO1 Mobile mast. .... **\$22.95 c**
- MO2 Mobile mast. .... **22.95 c**
- RM10 10 Meter resonator. .... **6.95 b**
- RM15 15 meter resonator. .... **7.95 b**
- RM20 20 Meter resonator. .... **8.95 b**
- RM40 40 Meter resonator. .... **14.95 b**
- RM75 75 Meter resonator. .... **16.95 b**
- RM80 80 Meter resonator. .... **17.95 b**
- RM10S 10M resonator 2KW PEP. .... **11.95 b**
- RM15S 15M resonator 2KW PEP. .... **12.95 b**
- RM20S 20M resonator 2KW PEP. .... **13.95 b**
- RM40S 40M resonator 2KW PEP. .... **16.95 b**
- RM75S 75M resonator 2KW PEP. .... **31.95 b**
- RM80S 80M resonator 2KW PEP. .... **31.95 b**
- CG144 5.2db 2mtr ant 1/2" x 24 stud. .... **26.95 c**
- CGT144 Same but trunk lip mount. .... **42.95 c**
- SF2 3db 2mtr ant 1/2" x 24 stud. .... **9.95 b**
- SF220 3db 220MHz ant 1/2" x 24 stud. .... **11.95 b**
- 4BTV 40-10mtr vertical. .... **79.95 e**
- G6-144 2mtr base ant 6db. .... **79.95 d**
- BM1 Bumper mount 1/2" x 24 thread. .... **15.95 d**
- RSS2 Mobile resonator spring. .... **5.95 a**
- QD1 Quick disconnect 1/2" x 24. .... **16.95 a**

## hy-gain

### VERTICAL ANTENNAS

- Model 14AVQ/WB **SAVE \$10.00!**
- 40 thru 10 meters **List**
- Wide band performance **\$69.95**
- New Hy-Q traps

Self-supporting automatic band switching vertical antenna Omni-directional performance Favorable V/C ratio High Q True 1/4 wave resonance on all bands Low angle radiation pattern Taper swaged seamless aluminum construction 12 double-grip mast bracket Full circumference compression clamps at tubing joints Weight 8 2 lbs

Model 14AVQ/WB **59.95**

### Model 18AVT/WB **SAVE \$18.00**

- Automatic band switching **List**
- Completely Self-Supporting **\$105.00**
- Omni-Directional Performance

Three beefed-up Hy-Q traps permit automatic switching 5 band capability Favorable L/C ratio Top loading coil Across the band performance with one furnished setting for each band (10 thru 40) True 1/4 wave resonance on all bands SWR of 2 1 or less at band edges Low angle radiation pattern Extra heavy duty tapered swaged seamless aluminum tubing with full circumference, corrosion resistant compression clamps at tubing joints Antenna can be mounted without guide wires 25' high Weight 10 7 lbs

Model 18 AVT/WB **87.00**

- BN86 Ferrite balun for 80-10mtrs. .... **\$15.95 a**
- 155 Center insulator for doublet. .... **5.95 a**
- 156 End insul. for doublet (pair) .... **3.95 a**
- 18HT ★ HyTower 80-10M vertical. .... **289.95 ★**
- 18V Economy 80 tru 10M vertical. .... **29.95 c**
- 12AVQ 20-10mtr trap vertical. .... **39.95 c**
- 14AVQ 40-10mtr trap vertical. .... **59.95 d**
- 18AVT/WB 80-10mtr trap vertical. .... **87.00 d**
- 2BDQ Trap doublet for 80 & 40mtr. .... **49.95 d**
- 5BDQ Trap doublet for 80-10mtrs. .... **89.95 e**
- TH3 MkIII ★ 3 ele 20-10 tribander. .... **189.95 ★**
- TH6DX ★ 6 ele 20-10 tribander. .... **264.95 ★**
- TH3 Jr 3 ele tribander (750W PEP) . . . **149.95 e**
- HY QUAD ★ 2 ele quad 20-10 mtrs. . . **229.95 ★**
- 103BA 3 element 10Mtr beam. .... **64.95 e**
- 153BA ★ 3 element 15mtr beam. .... **79.95 e**
- 204BA ★ 4 element 20mtr beam. .... **214.95 ★**
- 402BA ★ 2 element 40 mtr beam. .... **204.95 ★**
- 64B ★ 4 element 6 meter beam. .... **49.95 b**
- 270 6db fiberglass 2M antenna. .... **49.95 b**
- 203 3 element 2 meter yagi. .... **21.95 b**
- 205 5 element 2 meter yagi. .... **17.95 c**
- 208 8 element 2 meter yagi. .... **29.95 c**
- 214 14 element 2 meter yagi. .... **34.95 d**

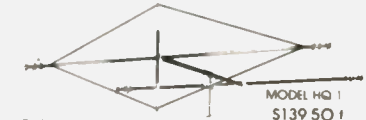

## CRAMPED FOR SPACE ?

MODEL HQ-1  
\$139.50 1



- Then you want the antenna that's known around the world for its small size and superior performance. The Multi-Band HYBRID QUAD FINAL for 6-10-15 & 20 meters.
- WING SPAN-11 FT.
- BOOM-54 INCHES LONG
- WIND AREA-1.5 SQ. FT.
- 1200 WATTS P.E.P. INPUT TO FINAL
- FEED LINE-50 OHMS

## MFJ

GIVE US A TRY ON YOUR MFJ NEEDS. MANY TIMES WE CAN GIVE QUICKER DELIVERY THAN WHEN YOU ORDER DIRECT.

### AVERAGE SHIPPING COST GUIDE

(Continental U.S.) Items sent UPS whenever possible.

Please estimate the shipping charges for your order. Any excess payment over 25c will be refunded or credited. Underpayment will be billed or sent collect. For insurance add 25c for each \$100.00 value over the first \$100.00

WR CALL AREA	ESTIMATED WEIGHT CODING			
WEIGHT 1,2,3,4,5	6,7	8,9	0	
1 lb.	.90	1.00	.90	.85
5 lbs.	1.50	2.00	1.35	1.20
10 lbs.	2.25	3.20	1.95	1.70
20 lbs.	3.80	5.60	3.20	2.60
30 lbs.	5.30	8.00	4.40	3.50
50 lbs.	8.40	12.90	6.90	5.35

After the price of each item you will find a letter, i.e., 19 95 a. To make it easier to figure shipping costs, these letters indicate the approximate weight of the item as follows:

a. Less than 1 lb	L 20-30 lbs
b 1-3 lbs	7-10 lbs
c 4-9 lbs	30-40 lbs
d 10-20 lbs	40-50 lbs

NOTE: INTERNATIONAL ORDERS write for Proforma Invoice. ITEMS MARKED ★ will be sent truck collect.

# IT'S... IT'S... A FLOTSAM AND JETSAM SALE!!!

(Jet•sam, noun. Goods thrown overboard to lighten a vessel in distress.)

In this case the vessel is our warehouse, which is filling up with stuff and threatens to engulf us all. We didn't worry about it at first, but now we hear rumors of mutant semiconductors living in unexplored parts of the building... and just last week, a desperate group of mylar capacitors tried to kidnap our head packer (but luckily, he put up some resistance and that short-circuited their plans). So you can see we're getting pretty desperate, which is a tip-off as to why the prices are so ridiculously low. Well, I must end this message; it sounds like the mutant semiconductors are hungry, and I'd just as soon not be around when it's feeding time... oh yes, all items below are limited quantity, first come, first served and all that... *Packer Bill*

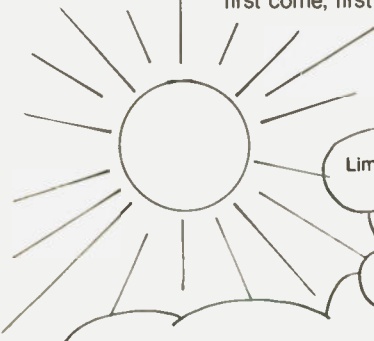

## SOCKET SPECIAL!

Limited quantities. **LESS THAN A DIME APIECE:**  
14, 16, 18, and 24 pin sockets are now only **20/\$1.95!**  
28 and 40 pin types are **10/\$1.50**, which is also quite a price.  
**If there was ever a time to stock your lab with sockets, this is it.**

## HOW ABOUT A NICE SET OF LEGS?

Hah! Had you going there for a second, didn't we? These are actually furniture legs, and we thought they were pretty much the most useless things in the world until some guy came in and said he wanted some. After determining for ourselves that this person was indeed mentally competent, we told him we'd give him the legs if he told us what he was using them for. "Why, to raise my speakers off the floor, of course," was his reply... and that's when we realized maybe they weren't so useless after all. These are finished, solid wood with a plastic tip at one end and a threaded steel stud at the other, and are about 6 1/2" to 7 1/2" long. Thanks, Marty Hoffert — wherever you are — for showing the world just one of the many things that can be done with surplus furniture legs.

Set of four legs: \$5.00    5 sets (20 legs total): \$20.00



## OUR FIRST X-RATED SPECIAL!

We have a whole bunch of surplus motors, little jobbies that run off 1 to 5V DC. Rumor has it that these were originally used as... well, we really can't say, that's the X-rated part. But they could have just as easily come from toy models, toothbrushes, window displays, or other applications where a small, battery operated motor is needed to vibrate something vigorously. At **10/\$2.95**, they are certainly inexpensive and we've got lots of 'em.



## YOU TOO CAN BE TRULY OBNOXIOUS.

While millions are made by authors of little books that purport to tell you how to be liked and popular, we dare to be different and offer a way for you to be truly obnoxious. The secret? Hook up one of our 110 dB Buzzers to a 6.3V AC supply, and you'll make such an obnoxious sound that people, small animals, and perhaps even insects will run for cover (or at least earplugs). On the other hand, it does have legitimate uses such as alarms, signals, etc. **\$8.95 each.**

## M61 CHERRY SWITCHES.

Alternate action, gold cross contacts, keyboard switch — but without keytop.  
**5/\$2.00**

**TERMS:** Cal res add tax. Add 5% shipping, excess refunded. VISA\* /Mastercharge\* call our 24 hour order desk at (415) 562-0636. COD OK with street address for UPS. Prices good through cover month of magazine or end of the world, whichever comes first. **Once again, quantities are limited!**

## FREE CATALOGUE:

Send for our free catalogue, you have nothing to lose and lots to gain.



# GODBOUT

GODBOUT ELECTRONICS

BLDG. 725, OAKLAND AIRPORT, CA 94614 (415) 562-0636

**7400 TTL**

SN7400N	16	SN7400N	29	SN74160N	89
SN7401N	16	SN7401N	29	SN74161N	89
SN7402N	18	SN7402N	35	SN74162N	89
SN7403N	18	SN7403N	35	SN74163N	89
SN7404N	18	SN7404N	35	SN74164N	89
SN7405N	20	SN7405N	35	SN74165N	89
SN7406N	20	SN7406N	35	SN74166N	1.25
SN7407N	20	SN7407N	35	SN74167N	1.95
SN7408N	20	SN7408N	35	SN74168N	1.95
SN7409N	20	SN7409N	35	SN74169N	1.95
SN7410N	18	SN7410N	35	SN74170N	1.95
SN7411N	18	SN7411N	35	SN74171N	1.95
SN7412N	20	SN7412N	35	SN74172N	6.00
SN7413N	40	SN7413N	43	SN74173N	1.25
SN7414N	40	SN7414N	43	SN74174N	89
SN7415N	25	SN7415N	65	SN74175N	79
SN7417N	25	SN7417N	65	SN74176N	79
SN7420N	20	SN7420N	35	SN74177N	79
SN7421N	20	SN7421N	35	SN74178N	1.95
SN7422N	39	SN7422N	89	SN74179N	1.95
SN7423N	39	SN7423N	89	SN74180N	79
SN7424N	39	SN7424N	89	SN74181N	1.95
SN7426N	29	SN7426N	35	SN74182N	79
SN7427N	25	SN7427N	35	SN74183N	1.95
SN7428N	20	SN7428N	39	SN74184N	1.95
SN7430N	20	SN7430N	39	SN74185N	1.95
SN7431N	25	SN7431N	35	SN74186N	9.95
SN7432N	25	SN7432N	35	SN74187N	1.95
SN7433N	25	SN7433N	35	SN74188N	1.95
SN7434N	25	SN7434N	35	SN74189N	1.25
SN7435N	25	SN7435N	35	SN74190N	1.25
SN7436N	25	SN7436N	35	SN74191N	1.25
SN7437N	25	SN7437N	35	SN74192N	79
SN7438N	25	SN7438N	35	SN74193N	1.95
SN7439N	25	SN7439N	35	SN74194N	89
SN7440N	25	SN7440N	35	SN74195N	69
SN7441N	89	SN7441N	2.95	SN74196N	89
SN7442N	49	SN7442N	2.95	SN74197N	1.49
SN7443N	75	SN7443N	2.95	SN74198N	4.95
SN7444N	75	SN7444N	2.95	SN74199N	89
SN7445N	75	SN7445N	2.95	SN74200N	99
SN7446N	69	SN7446N	1.29	SN74201N	2.25
SN7447N	59	SN7447N	1.49	SN74202N	3.95
SN7448N	79	SN7448N	3.95	SN74203N	3.95
SN7449N	79	SN7449N	3.95	SN74204N	69
SN7450N	79	SN7450N	3.95	SN74205N	69
SN7451N	20	SN7451N	59	SN74206N	69
SN7452N	20	SN7452N	59	SN74207N	69
SN7453N	20	SN7453N	59	SN74208N	69
SN7454N	20	SN7454N	59	SN74209N	69
SN7455N	20	SN7455N	59	SN74210N	69
SN7456N	20	SN7456N	59	SN74211N	69
SN7457N	20	SN7457N	59	SN74212N	69
SN7458N	20	SN7458N	59	SN74213N	69
SN7459N	20	SN7459N	59	SN74214N	69
SN7460N	20	SN7460N	59	SN74215N	69



**TU-ART Digital Interface**

Cromemco's TU-ART digital interface is a convenient interface for CRT terminals, line printers, modems, and other devices. Has 2 serial I/O ports, 2-bit parallel I/O ports, and 10 independent programmable interval timers. Baud rates are software-selectable from 10-8,000 baud. Has vectored interrupts so it is able to support the vectored interrupt structure of a 2-80 microprocessor. 10 interval timers w/real-time capability.

General Information: UART Type: 5001; Bus: 8 100; Power consumption: 1.8W @ 1.0A; I/O: 18V @ 10mA; Dimensions: 1.0 x 3.0 x 1.0.

Serial I/O Ports: 1 x 1000 baud; I/O levels: RS 232-C, A, or loop; I/O rate: 10-8000 baud; (software selectable); High speed range: 800 to 8000 baud; (software selectable).

Interval Timers: 10; Turn on: 0.16-32 msec; Turn off: 0.16-32 msec; Timer resolution: 80 micro-seconds.

Vectored Interrupts: No vectored interrupts (8080 model); No vectored interrupts (8080 model); No vectored interrupts (8080 model); No vectored interrupts (8080 model); No vectored interrupts (8080 model); No vectored interrupts (8080 model); No vectored interrupts (8080 model); No vectored interrupts (8080 model); No vectored interrupts (8080 model); No vectored interrupts (8080 model).

Parallel I/O Ports: 2; Input ports: 8 bits; Output ports: 8 bits; Input load: 20 TTL loads; Output Drive: 20 TTL loads.

**DISCRETE LEDS**

XC556G red	5/81	XC208R red	5/81
XC556G green	4/81	XC208R green	4/81
XC556G yellow	4/81	XC208R yellow	4/81
XC556G clear	4/81	XC208R clear	4/81

**TRT-W (Assembled) \$295.00**

**TIMEX T1001 LIQUID CRYSTAL DISPLAY CLASS II**

FIELD EFFECT



4 DIGIT 5 CHARACTERS  
THREE ENUNCIATORS  
2 00" x 1 20" PACKAGE  
INCLUDES CONNECTOR

T1001-Transmissive \$7.95  
T1001A-Reflective 0.25

**DISPLAY LEDS**

TYPE	POLARITY	MT	PRICE	TYPE	POLARITY	MT	PRICE
MAN 1	Common Anode-red	270	2.95	MAN 6730	Common Anode-red - 1	560	99
MAN 2	5 x 7 Dot Matrix-red	300	4.95	MAN 6740	Common Anode-red - D	560	99
MAN 3	Common Cathode-red	125	2.75	MAN 6750	Common Anode-red - 1	560	99
MAN 4	Common Cathode-orange	187	1.95	MAN 6760	Common Anode-red	560	99
MAN 7G	Common Anode-green	300	1.25	MAN 6780	Common Cathode-red	560	99
MAN 7Y	Common Anode-yellow	300	99	DL701	Common Anode-red - 1	300	99
MAN 7Z	Common Anode-yellow	300	1.25	DL702	Common Anode-red - 1	300	99
MAN 74	Common Cathode-red	300	1.25	DL707	Common Anode-red	300	99
MAN 82	Common Anode-yellow	300	49	DL728	Common Cathode-red	500	1.49
MAN 84	Common Cathode-yellow	300	99	DL741	Common Anode-red	600	1.25
MAN 3620	Common Cathode-orange	300	43	DL746	Common Anode-red - 1	630	1.49
MAN 3630	Common Anode-orange - 1	300	99	DL749	Common Cathode-red - 1	630	1.49
MAN 3640	Common Cathode-orange	300	99	DL750	Common Cathode-red	600	1.49
MAN 4610	Common Anode-orange	300	99	DL759	Common Cathode-red	110	35
MAN 4640	Common Cathode-orange	400	99	FHD170	Common Cathode	250	69
MAN 4650	Common Cathode-orange	400	99	FHD359	Common Cathode	357	75
MAN 4730	Common Anode-red - 1	400	99	FHD508	Common Cathode (FHD507)	500	99
MAN 4740	Common Cathode-red	400	99	FHD507	Common Cathode (FHD507)	500	99
MAN 4810	Common Cathode-yellow	400	99	FHD507	Common Cathode (FHD507)	500	99
MAN 5660	Common Cathode-orange	560	99	5082-7730	Common Anode-red	600	19.95
MAN 5610	Common Anode-orange-D	560	99	5082-7304	Overrange character (-1)	600	15.00
MAN 5630	Common Anode-orange - 1	560	99	HOSP-3400	Common Anode-red	800	15.00
MAN 5640	Common Cathode-orange-D	560	99	HOSP-3403	Common Cathode red	800	15.00
MAN 5650	Common Cathode-orange - 1	560	99	5082-7300	4 x 7 Sgl. Digit-RHDP	600	19.95
MAN 5660	Common Anode-orange	560	99	5082-7302	4 x 7 Sgl. Digit-LHDP	600	19.95
MAN 5680	Common Cathode-orange	560	99	5082-7304	Overrange character (-1)	600	15.00
MAN 6710	Common Anode-red-D	560	99	5082-7340	4 x 7 Sgl. Digit-Headnormal	600	22.50

**RCA LINEAR**

CA3013	2.15	CA3082N	2.00	M55300	\$4.95	MC1408L7	\$4.95
CA2023T	2.56	CA3083M	1.85	M55725	\$2.95	MC1408L8	5.75
CA3055T	2.48	CA3086M	85	M55735	82.95	MC1409	2.95
CA3089T	1.35	CA3089M	3.75	MC1512	4.95	MC3222P	2.95
CA3049N	1.30	CA3130T	1.39	MC15316	6.95	MC3081P	3.50
CA3059N	3.25	CA3140T	1.25	MC15318	9.95	MC4016(74416)	7.50
CA3069N	3.25	CA3160T	1.25	MC15359	2.95	MC4024P	3.95
CA3081T	85	CA3401M	58	MC15387/1998A	4.95	MC4040P	6.95
CA3081N	2.00	CA3500M	3.50	CT7001	2.95	MC4044P	4.50

**IC SOLDERTAILS - LOW PROFILE (TIN) SOCKETS**

8 pin LP	\$17	16	15	22 pin LP	\$ 37	36	35
14 pin LP	\$20	19	18	24 pin LP	\$ 45	44	43
18 pin LP	\$22	21	20	28 pin LP	\$ 65	64	63
20 pin LP	\$24	23	22	38 pin LP	\$ 95	94	93
14 pin ST	\$27	25	24	48 pin LP	\$ 135	134	133
16 pin ST	\$30	27	25	36 pin ST	\$ 99	126	115
18 pin ST	\$35	32	30	48 pin ST	\$ 150	145	130
24 pin ST	\$49	45	42				
14 pin SG	\$30	27	24				
16 pin SG	\$35	32	30				
18 pin SG	\$42	47	43				

**WIRE WRAP SOCKETS (GOLD) LEVEL 4 #3**

24 pin WW	\$ 95	85	75
28 pin WW	\$ 105	95	85
36 pin WW	\$ 140	125	110
48 pin WW	\$ 175	155	140

**1/4 WATT RESISTOR ASSORTMENTS - 5%**

ASST. 1	5 ea	2 OHM	13 OHM	15 OHM	18 OHM	22 OHM	27 OHM	33 OHM	39 OHM	47 OHM	56 OHM	68 OHM	82 OHM	100 OHM	150 OHM	200 OHM	300 OHM	470 OHM	680 OHM	1K OHM	1.5K OHM	2K OHM	3K OHM	4.7K OHM	6.8K OHM	10K OHM	15K OHM	22K OHM	33K OHM	47K OHM	68K OHM	100K OHM	150K OHM	220K OHM	330K OHM	470K OHM	680K OHM	1M OHM	1.5M OHM	2M OHM	3M OHM	4.7M OHM	6.8M OHM	10M OHM																																																																																																																																																																																																																																																																																					
ASST. 2	5 ea	180 OHM	20 OHM	220 OHM	240 OHM	270 OHM	300 OHM	330 OHM	360 OHM	390 OHM	430 OHM	470 OHM	510 OHM	560 OHM	620 OHM	680 OHM	750 OHM	820 OHM	910 OHM	1K OHM	1.1K OHM	1.2K OHM	1.3K OHM	1.5K OHM	1.6K OHM	1.8K OHM	2K OHM	2.2K OHM	2.4K OHM	2.7K OHM	3K OHM	3.3K OHM	3.6K OHM	3.9K OHM	4.3K OHM	4.7K OHM	5.1K OHM	5.6K OHM	6.2K OHM	6.8K OHM	7.5K OHM	8.2K OHM	9.1K OHM	10K OHM	11K OHM	12K OHM	13K OHM	15K OHM	16K OHM	18K OHM	20K OHM	22K OHM	24K OHM	27K OHM	30K OHM	33K OHM	36K OHM	39K OHM	43K OHM	47K OHM	51K OHM	56K OHM	62K OHM	68K OHM	75K OHM	82K OHM	91K OHM	100K OHM	110K OHM	120K OHM	130K OHM	150K OHM	160K OHM	180K OHM	200K OHM	220K OHM	240K OHM	270K OHM	300K OHM	330K OHM	360K OHM	390K OHM	430K OHM	470K OHM	510K OHM	560K OHM	620K OHM	680K OHM	750K OHM	820K OHM	910K OHM	1M OHM	1.1M OHM	1.2M OHM	1.3M OHM	1.5M OHM	1.6M OHM	1.8M OHM	2M OHM	2.2M OHM	2.4M OHM	2.7M OHM	3M OHM	3.3M OHM	3.6M OHM	3.9M OHM	4.3M OHM	4.7M OHM	5.1M OHM	5.6M OHM	6.2M OHM	6.8M OHM	7.5M OHM	8.2M OHM	9.1M OHM	10M OHM	11M OHM	12M OHM	13M OHM	15M OHM	16M OHM	18M OHM	20M OHM	22M OHM	24M OHM	27M OHM	30M OHM	33M OHM	36M OHM	39M OHM	43M OHM	47M OHM	51M OHM	56M OHM	62M OHM	68M OHM	75M OHM	82M OHM	91M OHM	100M OHM	110M OHM	120M OHM	130M OHM	150M OHM	160M OHM	180M OHM	200M OHM	220M OHM	240M OHM	270M OHM	300M OHM	330M OHM	360M OHM	390M OHM	430M OHM	470M OHM	510M OHM	560M OHM	620M OHM	680M OHM	750M OHM	820M OHM	910M OHM	1M OHM	1.1M OHM	1.2M OHM	1.3M OHM	1.5M OHM	1.6M OHM	1.8M OHM	2M OHM	2.2M OHM	2.4M OHM	2.7M OHM	3M OHM	3.3M OHM	3.6M OHM	3.9M OHM	4.3M OHM	4.7M OHM	5.1M OHM	5.6M OHM	6.2M OHM	6.8M OHM	7.5M OHM	8.2M OHM	9.1M OHM	10M OHM	11M OHM	12M OHM	13M OHM	15M OHM	16M OHM	18M OHM	20M OHM	22M OHM	24M OHM	27M OHM	30M OHM	33M OHM	36M OHM	39M OHM	43M OHM	47M OHM	51M OHM	56M OHM	62M OHM	68M OHM	75M OHM	82M OHM	91M OHM	100M OHM	110M OHM	120M OHM	130M OHM	150M OHM	160M OHM	180M OHM	200M OHM	220M OHM	240M OHM	270M OHM	300M OHM	330M OHM	360M OHM	390M OHM	430M OHM	470M OHM	510M OHM	560M OHM	620M OHM	680M OHM	750M OHM	820M OHM	910M OHM	1M OHM	1.1M OHM	1.2M OHM	1.3M OHM	1.5M OHM	1.6M OHM	1.8M OHM	2M OHM	2.2M OHM	2.4M OHM	2.7M OHM	3M OHM	3.3M OHM	3.6M OHM	3.9M OHM	4.3M OHM	4.7M OHM	5.1M OHM	5.6M OHM	6.2M OHM	6.8M OHM	7.5M OHM	8.2M OHM	9.1M OHM	10M OHM	11M OHM	12M OHM	13M OHM	15M OHM	16M OHM	18M OHM	20M OHM	22M OHM	24M OHM	27M OHM	30M OHM	33M OHM	36M OHM	39M OHM	43M OHM	47M OHM	51M OHM	56M OHM	62M OHM	68M OHM	75M OHM	82M OHM	91M OHM	100M OHM	110M OHM	120M OHM	130M OHM	150M OHM	160M OHM	180M OHM	200M OHM	220M OHM	240M OHM	270M OHM	300M OHM	330M OHM	360M OHM	390M OHM	430M OHM	470M OHM	510M OHM	560M OHM	620M OHM	680M OHM	750M OHM	820M OHM	910M OHM	1M OHM	1.1M OHM	1.2M OHM	1.3M OHM	1.5M OHM	1.6M OHM	1.8M OHM	2M OHM	2.2M OHM	2.4M OHM	2.7M OHM	3M OHM	3.3M OHM	3.6M OHM

# ASSOCIATED RADIO

913-381-5900

8012 CONSER BOX 4327

OVERLAND PARK, KANSAS 66204



CALL US WITH YOUR REQUIREMENTS  
**AMERICA'S NO. 1 Real Amateur Radio Store**



**(Associated Wants to TRADE - BUY - SELL  
GOT YOUR BEST DEAL? THEN CALL US AT  
913-381-5900 - NO TRADE? ASK FOR EXT. 12)**

**NOTE: SEND \$1.00 FOR OUR CURRENT CATALOG  
OF NEW AND RECONDITIONED EQUIPMENT.**

**\*ALSO WE PERIODICALLY PUBLISH A LIST OF  
UNSERVICED EQUIPMENT AT GREAT SAVINGS.  
A BONANZA FOR THE EXPERIENCED OPERATOR.  
TO OBTAIN THE NEXT UNSERVICED BARGAIN LIST,  
SEND A SELF ADDRESSED STAMPED ENVELOPE.**

POLY PAKS "SHOP BY MAIL" WITH ITS NEW INFLATION FIGHTIN'

# "ONE CENTERS"



**SALE** \*Buy any item on this page and get 2nd item of the same cat. no. for only one penny!

- |   |   |
|---|---|
| <ul style="list-style-type: none"> <li>1-LASCR OPTO COUPLER, type H11C3, mini dip. (#5700) 1.29 2 for 1.30</li> <li>3-LINE CORDS, 6 ft. 18 gauge, 2 cond. white w/plug. (#3787) 1.29 2 for 1.30</li> <li>15-SINGLE PIN MICRO RED LEADS, 100% material, 3 volts @ 10 mils. (#5896) 1.29 30 for 1.30</li> <li>40-FEEDTHRU CAPACITORS, used for hams, RF, UHF circuitry. (#5847) 1.29 80 for 1.30</li> <li>40-PLASTIC TRANSISTORS, asst'd untested and hobby. (#2604A) 1.29 80 for 1.30</li> <li>6-6V INDICATORS, w/leads, test lamp manufacturers excess. (#5893) 1.29 12 for 1.30</li> <li>40-METAL CAN TRANSISTORS, asst'd types, hobby, untested. (#2603A) 1.29 80 for 1.30</li> <li>10-UPRIGHT ELECTROS, 100% asst'd values and voltages. (#5900) 1.29 20 for 1.30</li> <li>40-SEMI-CON SUPPLIES: zeners, rectifiers, transistors, etc. U-test. (#2226) 1.29 80 for 1.30</li> <li>65-STABISOR: avail. for regulators &amp; computers. U-test. (#3140) 1.29 30 for 1.30</li> <li>40-SQUARE PC COILS, untested, assorted values, for PC applications. (#3188) 1.29 80 for 1.30</li> <li>50-1 WATT ZENERS, 3.3, 8.10, 12, 15V, etc., double plug, untested. (#1964) 1.29 100 for 1.30</li> <li>4-ROCKER SWITCHES, DPDT, solder eyelet terminals. (#3302) 1.29 8 for 1.30</li> <li>60-LONG LEAD DISCS, 100% prime, marked capacitors. (#5899) 1.29 120 for 1.30</li> <li>6-MINI TRANSFORMERS, asst'd outputs, interstage &amp; audio. 1" sq. (#3295) 1.29 12 for 1.30</li> <li>1-TV/AUDIO SHIELDED CABLE, 2 cond. 15 ft. w/RCA phone plugs. (#5812) 1.29 2 for 1.30</li> <li>2-GE 4 ENTRY KEYCAPS, 1/2" sq. &amp; 1/4" &amp; functions, asst. colors. (#4013) 1.29 50 for 1.30</li> <li>2-GE 4 ENTRY AMP, type PA-263 IC chip, mono. (#1522) 1.29 2 for 1.30</li> <li>1-MERCURY TILT SWITCH, N.C. rated 24VDC, 1/2" OSA, w/leads. (#5866) 1.29 2 for 1.30</li> <li>6-POWER TAB TRIACS, 100% prime, 100V, TO-220. (#5888) 1.29 12 for 1.30</li> <li>6-POWER TAB SCR'S, 100% prime, 100V, TO-220. (#5904) 1.29 12 for 1.30</li> <li>2-WATCH LCD'S, 3 1/2" digit, asst. types, size: 1" x 1 1/2" (Approx.) (#5066) 1.29 4 for 1.30</li> <li>4-TV INTERLOCK JACKS for TV/power mt. ctr. solder tabs terms. (#5519) 1.29 8 for 1.30</li> <li>4-MOS FETS, 3N128 by Fairchild &amp; RCA, TO-18, some duals. (#1686) 1.29 8 for 1.30</li> <li>4-PHOTODIODES, DARLINGTON TRANSISTORS, 2N5777. (#3276) 1.29 8 for 1.30</li> <li>6-AC "UTILITY" OUTLETS, for 1 1/2" mt. ctr., solder lugs. (#3582) 1.29 30 for 1.30</li> <li>15-NE-2 LAMPS, neon red, for 110VAC. less resistor. (#1435) 1.29 30 for 1.30</li> <li>20-1N4148 SWITCHING DIODES, 4N5, 100V, 10 mA, axial 100%. (#3000) 1.29 40 for 1.30</li> <li>2-4 AMP SILICON BRIDGE RECTIFIER, 200V, block style. (#5928) 1.29 4 for 1.30</li> <li>4-VARACTOR DIODES, var. tuner capacitance, 20-50 pf. (#5887) 1.29 8 for 1.30</li> <li>50-PRECISION RESISTORS, 1/4, 1/2 &amp; 2 watts, 1%, assorted types. (#363) 1.29 100 for 1.30</li> <li>60-CERAMIC CAPS, asst'd val. &amp; styles, incl: tubulars, NPO's, etc. (#590) 1.29 120 for 1.30</li> <li>25-PLASTIC SCR'S, incl: 200V, untested, high yield, TO-92. (#3192) 1.29 50 for 1.30</li> <li>40-MOLDED CAPACITORS, tubular, asst'd volt. to 1 mf. axial leads. (#348642) 1.29 80 for 1.30</li> <li>60-MICRO ZENER &amp; RECT. KIT, asst'd voltages, only 1/8" sq. U-test. (#1251) 1.29 30 for 1.30</li> <li>1-LINE CORD, 8 ft. 2 cond. 16 gauge, vinyl molded plug &amp; grommet. (#3661) 1.29 2 for 1.30</li> <li>6-SPDT MICRO SLIDE SWITCH, only 3/7" cube, for PC mount. (#3429) 1.29 12 for 1.30</li> <li>10-PR-RC PLUGS &amp; JACKS, for audio, speakers, etc. (#402) 1.29 20 for 1.30</li> <li>5-2N3055 HOBBY TRANSISTORS, 100%, TO-3. (#3771) 1.29 10 for 1.30</li> <li>10-ZENERS, 1 watt 9.1 volt axial leads 100%. (#5370A) 1.29 20 for 1.30</li> <li>40-1N4148, 4 NANO, SWITCHING DIODE, axial leads untested. (#5923) 1.29 80 for 1.30</li> <li>2-RELAYS, BUCKLE 6VDC, SPST, plastic case. (#5807) 1.29 4 for 1.30</li> <li>1-25 AMP BRIDGE RECTIFIER, 50 volts, 100. (#5948) 1.29 2 for 1.30</li> <li>2-QUADRACS, 10 amp 200V, TO-220 100%. (#5915) 1.29 2 for 1.30</li> <li>60-MINI RESISTORS, 30-1/2W, 30V-1/4 watt, axial, color coded. (#5922) 1.29 120 for 1.30</li> <li>12-SCRS-TRIAC-QUADRACS, asst. volts. TO-220 case. (#2087) 1.29 24 for 1.30</li> <li>10-BULLPLATES, asst. resistor/capacitor networks, various styles. (#5880) 1.29 20 for 1.30</li> <li>2-AIR TRIMMER CAPS, alum. plates, 1/2" shaft, panel mt. solder lugs. (#5658) 1.29 4 for 1.30</li> <li>30-MOLEX CONNECTORS, nylon, asst'd styles, colors, &amp; # of cond. (#5835) 1.29 60 for 1.30</li> <li>1-3 COND. LINE CORD, 8 ft. flat, w/ring terminals, 2 AC, 1 GND. (#5703) 1.29 2 for 1.30</li> <li>4-12 VOLT LAMPS, w/leads, popular voltage, 100's of uses. (#5942) 1.29 8 for 1.30</li> <li>25-TILIC's, untested, asst'd gates, flip flops, etc. 14-16 pin. (#5955) 1.29 50 for 1.30</li> <li>20-1000 PIV GLASS AMPS, micro-mini, axial, silicon, rated 1A. (#5903) 1.29 40 for 1.30</li> <li>1-12 VCT 200 mA TRANSFORMER, 115 V prim. PC mount. (#5914) 1.29 2 for 1.30</li> <li>20-400 mW 15V ZENERS, micro-style, asst. epoxy &amp; glass, 100%, axial. (#5914) 1.29 40 for 1.30</li> <li>100-UNMARKED CAPS, popular values, mylar &amp; polystyrene. (#5892) 1.29 200 for 1.30</li> <li>60-ONE WATT ZENERS, assorted voltages, glass cap, dbl plug, U-test. (#5947) 1.29 120 for 1.30</li> <li>50-MICRO ZENERS, 1 watt, 2-30V, DO-7 &amp; micro epoxy, axial, 100%. (#5905) 1.29 100 for 1.30</li> <li>5000-0-HARDWARE SUPPLIES, asst screws nuts &amp; washers. (#5891) 1.29 1000 for 1.30</li> <li>60-GLASS AMPS, up to 1KV, 1N4000 series, glass encased, untested. (#5942) 1.29 120 for 1.30</li> <li>200-PC BOARD PARTS, boards loaded w/100's parts, hobby bonanza. (#5946) 1.29 400 for 1.30</li> <li>6-RF NPN TRANSISTORS, type-2N1059, 8VbeCo, TO-22, 100%. (#5895) 1.29 12 for 1.30</li> <li>2-BRASS DOOR LOCKS, w/key, for doors windows, etc. 2-1/8" mt. cir. (#5949) 1.29 4 for 1.30</li> <li>1-PUSH-PUSH CB SWITCH, DPDT, 1 x 1 3/8", 100's of uses. (#3463) 1.29 2 for 1.30</li> <li>30-"CRIMP-ON" TERMINALS, rings and spades, for # 12-20 wire. (#3955) 1.29 60 for 1.30</li> <li>5-CALCULATOR KEYBOARDS, multi-function, 17 keys and up. (#3774) 1.29 10 for 1.30</li> <li>50-ONE-WATT RESISTORS, popular assort, some 5'sers, 100's of uses. (#3844) 1.29 100 for 1.30</li> <li>50-METALLIC FILMS, asst'd values, marked, axial leads. (#1605) 1.29 100 for 1.30</li> <li>4-RIBBON CABLE CONNECTOR, single-sided, 9 contacts, PC leads. (#5967) 1.29 8 for 1.30</li> <li>3-"SUPER" 2N2222's, NPN, ICBO-60V, hfe=100 IW @ 2A, TO-92, 100%. (#5952) 1.29 6 for 1.30</li> <li>1-12 VDC MINI BLOCK RECLAY, spdt, 1 x 3/4 x 5/8", 175 ohm, 1A. (#5937) 1.29 2 for 1.30</li> <li>10-1.5V GRANI-o-WHEAT LAMPS, 5/16", w/10" leads, lens: RED. (#6002) 1.29 20 for 1.30</li> <li>10-IF-FM OP AMPS, by RCA, FM-UHF circuitry, TO-5, 10 leads. (#5951) 1.29 20 for 1.30</li> <li>10-NPN SWITCHING TRANSISTORS, asst'd gen. audio &amp; switching. (#2595) 1.29 20 for 1.30</li> <li>1-12 VDC SOLENOID, similar to Guardian 16-P, w/plunger, 1/2" stroke. (#6015) 1.29 2 for 1.30</li> </ul> | <ul style="list-style-type: none"> <li>10-HUMBUCKER CONTROLS W/KNOB, for TV vertical, horiz., etc. (#5882) 1.29 20 for 1.30</li> <li>50-CAPACITOR SPECIAL, discs, mylar, and more. (#3775) 1.29 100 for 1.30</li> <li>4-HOBBY VOLTAGE REGULATORS, 1M-309, 320, 340's, TO-3. (#3330A) 1.29 8 for 1.30</li> <li>12-PANEL SWITCHES, assorted sizes, rotaries, modulars, etc. (#295) 1.29 24 for 1.30</li> <li>60-RESISTOR SPECIAL, 1/4 to 1 watt, carbon, carbon-films, etc. (#35896) 1.29 120 for 1.30</li> <li>65-HALF WATT RESISTORS, asst'd carbons, carbon-films, various values. (#454) 1.29 130 for 1.30</li> <li>6-LM340 VOLTAGE REGULATORS, 5 to 24 volts, TO-220. (#5897) 1.29 12 for 1.30</li> <li>40-POLYSTYRENE CAPACITORS, asst'd values and voltages. (#1052) 1.29 80 for 1.30</li> <li>15-THERMISTORS, resistors that change with the temperature. (#2048) 1.29 30 for 1.30</li> <li>65-1/4 WATT RESISTORS, asst'd values, metal film, marked. (#5797) 1.29 130 for 1.30</li> <li>1-12VDC SPOT RELAY, 180 ohm coil, 25 mA, 1st 18V. (#5937) 1.29 2 for 1.30</li> <li>15-VOLUME CONTROLS, asst. values, audio, and switch too! (#592) 1.29 30 for 1.30</li> <li>60-PREFORMED DISC CAPS, handy assortment of values, marked. (#1181) 1.29 120 for 1.30</li> <li>10-AXIAL ELECTROS, assorted values and capacitance. (#5901) 1.29 20 for 1.30</li> <li>60-GLASS ZENERS, 400mW, untested, better than 50% yield. (#5889) 1.29 120 for 1.30</li> <li>10-PC TRIMPOTS, screwdriver adjust, assorted values. (#3346) 1.29 20 for 1.30</li> <li>25-4" CABLE TIES, plastic, like Ty-wrap style. (#5217) 1.29 50 for 1.30</li> <li>5-CRYSTALS, may include, CB, ham various shapes and sizes. (#5716) 1.29 10 for 1.30</li> <li>40-POWER RESISTORS, assorted types, includes 2 to 10 watters. (#228) 1.29 80 for 1.30</li> <li>40-1 WATT RESISTORS, carbon, carbon-films, carbon, some 5'sers. (#454) 1.29 60 for 1.30</li> <li>50-TERMINAL STRIPS, asst'd solder and screw types, 2 lugs &amp; up. (#334) 1.29 100 for 1.30</li> <li>1-WATCH GUYS, LED, who knows how good, micro-digital bonanza. (#5115) 1.29 2 for 1.30</li> <li>10-1000V 1A RECTIFIERS, 1N4007, epoxy case, axial leads. (#5926) 1.29 20 for 1.30</li> <li>5-MULTI-DIGIT LED READOUTS, bubble magnifier, 2 to 6 digits. (#3624) 1.29 10 for 1.30</li> <li>10-POWER TAB TRANSISTORS, NPN, plastic, TO-220. (#5629) 1.29 20 for 1.30</li> <li>6-PRECISION TRIM POTS, asst'd singles and multi-turns, untested. (#3389) 1.29 12 for 1.30</li> <li>50-1N4000 RECTIFIERS, epoxy, axial leads, untested. (#2594) 1.29 100 for 1.30</li> <li>30P-CMCS ASST SIZES, Thermofit, useful asst. of sizes, shrinks 50%. (#5248) 1.29 60 for 1.30</li> <li>10-SLIDE SWITCHES, SPST, SPDT, etc. all shapes and sizes. (#5927) 1.29 20 for 1.30</li> <li>25-TILT, 100% prime, asst'd flip flops, etc., marked. (#3709) 1.29 50 for 1.30</li> <li>4-HOBBY OPTO COUPLERS, 1500 VOLT ISOLATION, U-test. (#2629A) 1.29 8 for 1.30</li> <li>8-TAPE RECORDER EARPHONE, for radios, recorders, 8 ohms. (#2946) 1.29 16 for 1.30</li> <li>5-MICRO-MINI JACKS, in a block, for 2mm sub-mini plugs. (#1437) 1.29 10 for 1.30</li> <li>5-PL-55 PHONE JACKS, standard bushing, for hams, communications. (#5868) 1.29 10 for 1.30</li> <li>40-RED DEVIL CAPACITORS, handy assort. of pop. values, axial leads. (#3823) 1.29 80 for 1.30</li> <li>10-MICA ASST SIZES, shapes, incl: "silvery" too! (#373) 1.29 100 for 1.30</li> <li>10-TRANSISTOR SOCKETS, for npn and pnp types. (#5944) 1.29 20 for 1.30</li> <li>12-LED DRIVER IC's, similar to 75491. (#5890) 1.29 24 for 1.30</li> <li>10-MODULAR SWITCHES, Centralab "push-on" type, up to 8PDT. (#3150) 1.29 20 for 1.30</li> <li>5-"MOTORS MOTORS", small, high speed, asst'd sizes, 3-6VDC. (#2551) 1.29 10 for 1.30</li> <li>2-HEAVY DUTY LINE CORDS, 8 ft., 2 cond., 16 gauge, black insulation. (#5803) 1.29 4 for 1.30</li> <li>10-LED SOCKETS, "snap-in" minis, for LEDs, and transistors, too! (#5745) 1.29 20 for 1.30</li> <li>10-WW-54 MICRO-MINI LEADS, flat top style, diffused red lens. (#1789) 1.29 20 for 1.30</li> <li>30-WIRE NUTS, twist-on's, for #20-24 gauge wire. (#3724) 1.29 60 for 1.30</li> <li>2-ALUM. HEAT SINKS, 2 1/2" x 3", for power tabs, innumerable uses. (#5338) 1.29 4 for 1.30</li> <li>1-"MICRO MINI" METER, 1/2" dia. 0-1 basic movement. (#5858) 1.29 2 for 1.30</li> <li>2-DOUBLE-SIDED PC BOARDS, 3" x 12", high quality G-10 glass. (#5694) 1.29 4 for 1.30</li> <li>60-TUBULAR CAPACITORS, asst'd 100mf to 1mf to 600 WVDC. (#35A219) 1.29 120 for 1.30</li> <li>6-MICRO MINI REED SWITCHES, 1" long, for alarms, relays, etc. (#1258) 1.29 12 for 1.30</li> <li>10-TANDEM ELECTROS, asst'd mini, axial, hermetically sealed. (#5848) 1.29 20 for 1.30</li> <li>50-DISC TYPE CAPS, incl: NPO, hi-Q, mylar, ceramics, asst'd values. (#437) 1.29 100 for 1.30</li> <li>60-COILS &amp; CHOKES, asst'd RF, OSC, IF, parasitic types. (#35A297) 1.29 120 for 1.30</li> <li>6-SWITCHCRAFT PHONO JACKS, hi-Q, chassis mount, telton base. (#5110) 1.29 12 for 1.30</li> <li>1-TO-3 HEAT SINK, heavy duty aluminum, prepunched for TO-3. (#4083) 1.29 2 for 1.30</li> <li>65-MOLEX SOCKETS, "on-a-strip", for multiple pin dips. (#1609) 1.29 130 for 1.30</li> <li>6-PAIRS 9V BATTERY CORDS, w/red &amp; black color-coded leads. (#2852) 1.29 12 for 1.30</li> <li>1-UHF TUNER, 3 gang, uh TV unit, 300 ohm, pos. direct drive. (#2927) 1.29 2 for 1.30</li> <li>15-HUMBUCKER CONTROLS, assorted values, manufacturers dump. (#3807) 1.29 30 for 1.30</li> <li>30-SUBMINI IF TRANSFORMERS, slug tuned, shielded. (#35A49) 1.29 60 for 1.30</li> <li>15-"POP" OPTICAL LENSES, plano-convex, 1" dia., plastic. (#5043) 1.29 30 for 1.30</li> <li>40-ADJUSTABLE FERRITE CORES, center cut for hex adjust. (#5701) 1.29 80 for 1.30</li> <li>3-1.5V MINI WAMP, only 3/32" dia., draws 15mA, w/1" wire leads. (#5693) 1.29 6 for 1.30</li> <li>30-FT. WIRE-LAMP WIRE, 30 gauge, insulated, continuous length. (#3803) 1.29 60 for 1.30</li> <li>4-MONO TAPE HEADS, may incl: cassette, 8-track, reel to reel too! (#5729) 1.29 8 for 1.30</li> <li>5-DUAL DIGIT "BUBBLE" READOUTS, HP5082 style, red, dbl type. (#5748) 1.29 10 for 1.30</li> <li>40-METAL &amp; PLASTIC TRANSISTORS, asst'd sizes. (#1965) 1.29 80 for 1.30</li> <li>2-HI PWR. TRANSISTORS, Motorola type, MJ3201, NPN 15W, TO-66. (#2797) 1.29 4 for 1.30</li> <li>60-GERM. GLASS DIODES, similar to 1N34, axial leads, untested. (#642) 1.29 120 for 1.30</li> <li>40-1N414 SWITCHING DIODES, silicon, 4N5, glass, untested. (#143) 1.29 80 for 1.30</li> <li>4-AM-FM VARIABLE COND., 2 bands, "poly" type. (#2924) 1.29 8 for 1.30</li> <li>3-MICRO SWITCHES, SPST, NO contacts, plunger style, solder tabs. (#5785) 1.29 6 for 1.30</li> <li>10-MULTI-GANG POTS, audio 2 gangs and up, asst'd types and values. (#5326) 1.29 20 for 1.30</li> <li>10-MAAN-3's, 7 segment, w/bubble magnifier, 100% material. (#3842) 1.29 20 for 1.30</li> <li>3-PL-259 COAX PLUG, mates to SO-239, Amphenol. (#5221) 1.29 6 for 1.30</li> <li>1-LITE SENSITIVE UNIJUNCTION TRANSISTOR, programmable. (#5719) 1.29 2 for 1.30</li> </ul> |
|---|---|

## FANTASTIC? YOU BET IT IS! LOOK WHAT YOU GET FOR 1c MORE!

**"TIE-PIN" CONDENSER MIKE**  
It's a little more than a sum of quality. Metal encased omnidirectional Frequency response 20-20,000 Hz. Less than 100 ohm input impedance. 15 VDC. Cat. No. 9730

Only **\$3.95**

**25 AMP BRIDGE RECTIFIERS**

PIV	SALE	2 FOR
25	1.28	1.26
50	1.98	1.96
100	2.28	2.26
200	2.98	2.96
400	3.80	3.81

Order by Cat. No. 2273  
Soffy, no choosing  
1/2" & voltage

**HOW TO ORDER**  
When ordering, always use catalog number, type no., the name of the magazine you are ordering from and the month

**POLY PAKS**  
CDD-MAY BK PHONED  
P.O. BOX 942, A1  
S.O. LYNNFIELD, MA  
01940

Terms: Add Postage  
Phone: (617) 245-3828  
Retail: 16 1/8 Del Carmine St  
**MINIMUM ORDER: \$8** Wakefield, MA

**HY-GAIN ONE ARM BANDIT MIKES**

Only **\$14.99**  
**2 FOR \$15**

**40 CHANNEL CB ON A BOARD**

**\$14.99 2 FOR \$15.00**

WITH SWITCH

**LEDS: LEDS: LEDS!**  
YOUR CHOICE 5 for \$1.39  
16 SALE 10 for \$1.30

Cat. No.	Type
1788	MICRO TOPHAT RED
1802	MICRO SINGLE PIN RED
1948	MICRO YELLOW
2135	JUMBO RED
2136	JUMBO TAPER RED
2137	MICRO RED
1944	Jumbo Yellow
2138	Jumbo Green

**ULTRASONIC TRANSDUCER**

Only **\$3.98**  
**2 for \$3.99**

Perfect for dozens of projects, including remote control devices, alarms, etc. Sends and Receives! 1" diameter, 1/2" deep, with standard RCA type phono jack. Wt 2 oz. Cat. No. 92CU5375

**"SKINNY-TRIMS" POTENTIOMETERS**

3 1/2" square Single turn axis screw driver adjust 20% tolerance 15 leads. ORDER BY CAT. NO. AMO VALUE

Value	Price
6	\$2.49
12	\$2.50

SINGLE TURN FLAT

Value	Price
10	10 10A 5R 25K 200K
20	20 200 2R 10M 50K 500K
50	500 2.5K 20R 100K 1Meg

Cat. No. 92CU5800  
Type 3

**1N4000 Epoxy Rectifiers**

Cat. No.	Type	Volts	Size	1c SALE
2377	1N4001	50	10 for \$7.50	7c 76
2378	1N4002	100	10 for \$8.25	8c 86
2379	1N4003	200	10 for \$9.00	9c 96
2380	1N4004	400	10 for \$1.20	1.20
2381	1N4005	600	10 for \$1.30	1.30
2382	1N4006	800	10 for \$1.40	1.40
2383	1N4007	1000	10 for \$1.50	1.50

**DIAL DESK TELEPHONE**

Only **\$14.99**  
**2 for \$15.00**

loss bell and control

7294 N.W. 54 STREET  
MIAMI, FLORIDA 33166

# SEEC SURPLUS ELECTRONICS CORP. ✓S43

PHONE: (305) 887-8228  
TWX: 810-848-6085  
WHOLESALE - RETAIL

<p><b>PL259 or SO239</b> Quality American Made 10/\$5.00      100/\$35.00 50/\$20.00      1000/\$300.00</p>	<p><b>CB SPECIAL</b> Brand new printed circuit board assembly. Used in all HyGain 40 Channel CB transceivers. Fits many other manufacturers' units also. Squelch pot/volume control/channel selector switch not included. 1-9 - 7.50 ea.      50-99 - 6.00 ea.      Board Dimensions 6" x 6 1/2" 10-49 - 6.50 ea.      100-up - 5.50 ea.</p>		<p><b>TRIMMER CAPS</b> Can fit in your watch 3.5-20 pF &amp; 5-30 pF \$.75 ea., 2/\$1.25 5/\$3.00</p>																																																																																																																													
<p><b>E. F. Johnson NICAD</b> 12.0 V. 1.2 AH @ 10 hr rate 4 1/2" x 1 7/8" x 1 3/4" \$1495ea.</p>	<p>CB SPECIAL W/40 ch SW same as above 1-9 \$10.50 ea.      50-99 \$9.00 ea. 10-49 \$9.50 ea.      100-up \$8.50 ea.</p>		<p><b>POLY FOAM COAX</b> 50 Ohm Low Loss = to RG174 \$.495/100' \$3.00/50'</p>																																																																																																																													
<p><b>E. F. Johnson S Meter</b> Edge Meter 250 UA. Fits in 5/8" x 1-3/8" hole. MTG holes on each end 1-1/4" behind panel. Black scale 0-5 bottom 1-20 top \$.125 ea.      5/\$5.00</p>	<p><b>Serviceman Special</b> New Hy-Gain 40ch CB Less Case. Speaker &amp; Knobs (as is) \$14.95 ea</p>		<p><b>ULTRASONIC TRANSDUCER</b> Detects sound above the range of human hearing! Transmits &amp; receives \$2.50 ea. 5/\$10.00</p>																																																																																																																													
<p><b>E. F. Johnson Signal Strength Meter</b> 200 UA 2 1/2" x 2 1/4" Sq mounts in 1 3/4" hole 1" behind panel Scale 1-30 db top 0-5 bottom \$.495ea      5/\$20.00</p>	<p><b>ASTATIC T-UG8-D104</b> PREAMP Desktop microphone w/crystal element 3 Pin Plug \$35 ea.</p>	<p><b>NEW E.F. Johnson Power Mic/Less Cord.</b> Desktop Style \$19.95 ea</p>	<p><b>MAGNETIC PICK UP TRANSDUCER</b> Converts motion to ac voltage without mechanical linkage 3/8" x 2" w/6' shielded cable \$.495 ea.</p>																																																																																																																													
<p><b>PANEL METERS</b> \$4.00 ea      2 for \$7.00  25-0-25 dc volts } 2 1/4" x 3" 0-20 dc volts } 0-25 dc volts } 2 1/4" x 2 1/4" 0-50 ac volts } -Shunt Required-</p>	<p><b>CRYSTAL FILTERS</b> 10.7 3/Lead Can Type \$3.00 ea.</p>	<p><b>CERAMIC IF FILTERS</b> EFC L455K \$3.50 ea.</p>	<p><b>SOLDERLESS TEST PROD (BLACK)</b> Threaded type, molded handle \$.40 ea. 5/\$3.50</p>																																																																																																																													
<p><b>Double Row/Wire Wrap .100</b> 25 pins \$3.49 ea      10/\$30.00 30 pins \$3.96 ea      10/\$32.00 50 pins \$5.43 ea      10/\$45.00</p>	<p><b>E. F. Johnson</b> 40ch. CB Selector Switch \$3.50 ea</p>	<p><b>2 SIDED</b> 062 Copper Clad Board 9" x 10 1/2" 3/\$5.00</p>	<p><b>Sony RK64A</b> 2 conductor mini phono plug w/patch cord 3' 6" long \$2.00 ea</p>																																																																																																																													
<p><b>Double Row/Solder Eyelet .156</b> 6 pins \$1.10 ea      10/\$ 9.00 15 pins \$1.55 ea      10/\$12.50 22 pins \$2.08 ea      10/\$17.00 43 pins \$3.66 ea      10/\$30.00</p>	<p><b>12 Vdc RELAY</b> SPST 35 Amp Contacts Open Frame Rugged, great for mobile use \$4.50 ea      5/\$20.00</p>	<p><b>12 Vdc RELAY</b> SPST Open Frame 5 Amp Contacts Mfg-Magnecraft \$1.50 ea      4/\$5.00</p>	<p><b>USED MUFFIN FANS</b> 3 blades, 110VAC, 4 1/2" sq. \$5.95</p>																																																																																																																													
<p><b>C &amp; K SWITCHES</b> PART # MOVEMENT 7101 ON/NONE/ON SPST 7103 ON/OFF/ON SPST 7107 ON/NONE/ON SPST 7108 ON/NONE(O)N SPST 7201 ON/NONE/ON DPDT \$1.00 EA      6 FOR \$5.00</p>	<p><b>RECEIVER FRONT ENDS</b> Made by EFJ 132-174 MHz \$12.00 ea.</p>	<p><b>100 ASSORTED DISC CAPS</b> (FULL LEADS) 20 EA OF 5 DIFFERENT VALUES \$2.00 PER PACK</p>	<p><b>CW MINI SLIDE SW</b> DPDT .15 ea. 10/\$1.25</p>																																																																																																																													
<p>6 TV GAMES ON (1) CHIP Gen Instr AY-3-8500-1 28 Pin Plastic Case EVERYDAY LOW PRICE \$7.50 ea</p>	<p><b>STANCOR TRANSFORMERS</b> STEP-DOWN AUTO (3) COND LINE CORD W/RECT GSD 200 (230V In/115V Out @ 200 Va) \$12.00 ea GSD 400 (230 In/115 V Out @ 400 Va) \$14.50 ea</p>	<p><b>White Porcelain Egg Insulator</b> 1 1/2" x 1" 50c ea.      3 for \$1.25</p>	<p><b>ALL STAR AIR VARIABLE</b> 24-275 pF .75 ea.</p>																																																																																																																													
<p><b>ASSORTED ELECTROLYTICS</b></p>	<p><b>MODEM CABLE</b> 50' cable contains 13 # 22 ga. wire DB-25p with DB-51226-1 cover on one end \$6.50 ea      10/\$50.00</p>	<p><b>White Porcelain Egg Insulator</b> 1 1/2" x 1" 50c ea.      3 for \$1.25</p>	<p><b>RED SEVEN SEGMENT DISPLAY</b> TIL 322P \$1.00 ea.</p>																																																																																																																													
<table border="1"> <thead> <tr> <th>VALUE/MFD</th> <th>@</th> <th>VOLTS</th> <th>DIA</th> <th>x</th> <th>LENGTH</th> <th>PRICE</th> </tr> </thead> <tbody> <tr><td>250,000</td><td>@</td><td>5V</td><td>3"</td><td>x</td><td>5 3/4"</td><td>\$4.00 ea</td></tr> <tr><td>30,000</td><td>@</td><td>15V</td><td>3"</td><td>x</td><td>4 1/2"</td><td>4.00 ea</td></tr> <tr><td>63,000</td><td>@</td><td>15V</td><td>3"</td><td>x</td><td>5 1/2"</td><td>4.00 ea</td></tr> <tr><td>10,000</td><td>@</td><td>20V</td><td>1 1/2"</td><td>x</td><td>5 3/4"</td><td>3.00 ea</td></tr> <tr><td>2,700</td><td>@</td><td>25V</td><td>1 1/4"</td><td>x</td><td>2 1/4"</td><td>2.00 ea</td></tr> <tr><td>2,900</td><td>@</td><td>25V</td><td>1 1/4"</td><td>x</td><td>2"</td><td>2.00 ea</td></tr> <tr><td>3,000</td><td>@</td><td>25V</td><td>1 1/2"</td><td>x</td><td>4 1/2"</td><td>2.00 ea</td></tr> <tr><td>18,000</td><td>@</td><td>25V</td><td>2"</td><td>x</td><td>4"</td><td>3.00 ea</td></tr> <tr><td>21,000</td><td>@</td><td>25V</td><td>2 1/2"</td><td>x</td><td>3"</td><td>3.00 ea</td></tr> <tr><td>39,000</td><td>@</td><td>45V</td><td>3"</td><td>x</td><td>5 3/4"</td><td>3.00 ea</td></tr> <tr><td>1,000</td><td>@</td><td>50V</td><td>1 1/4"</td><td>x</td><td>3 1/4"</td><td>2.50 ea</td></tr> <tr><td>34,800</td><td>@</td><td>50V</td><td>3"</td><td>x</td><td>5 1/2"</td><td>3.00 ea</td></tr> <tr><td>450</td><td>@</td><td>75V</td><td>1 1/4"</td><td>x</td><td>2 1/4"</td><td>2.00 ea</td></tr> <tr><td>500</td><td>@</td><td>100V</td><td>1 1/2"</td><td>x</td><td>3 1/2"</td><td>2.00 ea</td></tr> <tr><td>240</td><td>@</td><td>300V</td><td>1 1/4"</td><td>x</td><td>3 1/4"</td><td>2.00 ea</td></tr> <tr><td>50</td><td>@</td><td>450V</td><td>1 1/4"</td><td>x</td><td>2"</td><td>2.00 ea</td></tr> <tr><td>140</td><td>@</td><td>450V</td><td>1 1/4"</td><td>x</td><td>3"</td><td>2.00 ea</td></tr> </tbody> </table>	VALUE/MFD	@	VOLTS	DIA	x	LENGTH	PRICE	250,000	@	5V	3"	x	5 3/4"	\$4.00 ea	30,000	@	15V	3"	x	4 1/2"	4.00 ea	63,000	@	15V	3"	x	5 1/2"	4.00 ea	10,000	@	20V	1 1/2"	x	5 3/4"	3.00 ea	2,700	@	25V	1 1/4"	x	2 1/4"	2.00 ea	2,900	@	25V	1 1/4"	x	2"	2.00 ea	3,000	@	25V	1 1/2"	x	4 1/2"	2.00 ea	18,000	@	25V	2"	x	4"	3.00 ea	21,000	@	25V	2 1/2"	x	3"	3.00 ea	39,000	@	45V	3"	x	5 3/4"	3.00 ea	1,000	@	50V	1 1/4"	x	3 1/4"	2.50 ea	34,800	@	50V	3"	x	5 1/2"	3.00 ea	450	@	75V	1 1/4"	x	2 1/4"	2.00 ea	500	@	100V	1 1/2"	x	3 1/2"	2.00 ea	240	@	300V	1 1/4"	x	3 1/4"	2.00 ea	50	@	450V	1 1/4"	x	2"	2.00 ea	140	@	450V	1 1/4"	x	3"	2.00 ea	<p><b>IC SOCKETS</b> <b>Cambion</b> <b>Gold Plated Wire Wrap</b> 14 pin .35 ea      10/\$3.00 16 pin .38 ea      10/\$3.30  1N4148 SIGNAL DIODE \$.50 per 100 or 15 for \$1.00  <b>Coax Connectors</b> UG-273/U BNC-F/UHF-M 2.50 UG-255/U BNC-M/UHF-F 3.00 UG-146A/U N-M/UHF-F 4.50 UG-83B/U N-F/UHF-M 4.50 UG-175 RG-58 Adapt. .20 UG-176 RG-59 Adapt. .20</p>	<p><b>AXIAL LEAD ELECTROLYTIC CAPACITORS</b> 2 uF @ 15V } 10 uF @ 15V } 20 uF @ 15V } 12 ea. 50 uF @ 15V } for 2.2 uF @ 25V } \$1.00 3.3 uF @ 25V } 1 uF @ 35V } 2 uF @ 150V } 25 uF @ 25V } 3 uF @ 50V } 15 ea. 5 uF @ 50V } for 10 uF @ 50V } \$2.00 250 uF @ 25V } 100 uF @ 50V } 10 ea. 50 uF @ 75V } for \$2.00</p>
VALUE/MFD	@	VOLTS	DIA	x	LENGTH	PRICE																																																																																																																										
250,000	@	5V	3"	x	5 3/4"	\$4.00 ea																																																																																																																										
30,000	@	15V	3"	x	4 1/2"	4.00 ea																																																																																																																										
63,000	@	15V	3"	x	5 1/2"	4.00 ea																																																																																																																										
10,000	@	20V	1 1/2"	x	5 3/4"	3.00 ea																																																																																																																										
2,700	@	25V	1 1/4"	x	2 1/4"	2.00 ea																																																																																																																										
2,900	@	25V	1 1/4"	x	2"	2.00 ea																																																																																																																										
3,000	@	25V	1 1/2"	x	4 1/2"	2.00 ea																																																																																																																										
18,000	@	25V	2"	x	4"	3.00 ea																																																																																																																										
21,000	@	25V	2 1/2"	x	3"	3.00 ea																																																																																																																										
39,000	@	45V	3"	x	5 3/4"	3.00 ea																																																																																																																										
1,000	@	50V	1 1/4"	x	3 1/4"	2.50 ea																																																																																																																										
34,800	@	50V	3"	x	5 1/2"	3.00 ea																																																																																																																										
450	@	75V	1 1/4"	x	2 1/4"	2.00 ea																																																																																																																										
500	@	100V	1 1/2"	x	3 1/2"	2.00 ea																																																																																																																										
240	@	300V	1 1/4"	x	3 1/4"	2.00 ea																																																																																																																										
50	@	450V	1 1/4"	x	2"	2.00 ea																																																																																																																										
140	@	450V	1 1/4"	x	3"	2.00 ea																																																																																																																										

**TERMS:** All material guaranteed • If for any reason you are not satisfied, our products may be returned within 10 days for a full refund (less shipping). Please add \$3 for shipping and handling on all orders. Additional 5% charge for shipping any item over 5 lbs. COD's accepted for orders totaling \$50.00 or more. All orders shipped UPS unless otherwise specified. Florida residents please add 4% sales tax. Minimum order \$15.00



# Low Cost...High Performance

## DIGITAL MULTIMETER



**\$99.95 WIRED**

Low cost, high performance, that's the DM-700. Unlike some of the hobby grade DMMs available, the DM-700 offers professional quality performance and appearance at a hobbyist price. It features 26 different ranges and 5 functions, all arranged in a convenient, easy to use format. Measurements are displayed on a large 3 1/2 digit, 1/2 inch high LED display, with automatic decimal placement, automatic polarity, and overrange indication. You can depend upon the DM-700, state-of-the-art components such as a precision laser trimmed resistor array, semiconductor band gap reference, and reliable LSI circuitry insure lab quality performance for years to come. Basic DC volts and ohms accuracy is 0.1%, and you can measure voltage all the way from 100  $\mu$ V to 1000 volts, current from 0.1  $\mu$ A to 2.0 amps and resistance from 0.1 ohms to 20 megohms. Overload protection is inherent in the design of the DM-700, 1250 volts, AC or DC on all ranges, making it virtually goof proof. Power is supplied by four 'C' size cells, making the DM-700 portable, and, as options, a nicad battery pack and AC adapter are available. The DM-700 features a handsome, jet black, rugged ABS case with convenient retractable tilt bail. All factory wired units are covered by a one year limited warranty and kits have a 90 day parts warranty.

Order a DM-700, examine it for 10 days, and if you're not satisfied in every way, return it in original form for a prompt refund.

### Specifications

DC and AC volts: 100  $\mu$ V to 1000 Volts, 5 ranges  
 DC and AC current: 0.1  $\mu$ A to 2.0 Amps, 5 ranges  
 Resistance: 0.1  $\Omega$  to 20 megohms, 6 ranges  
 Input protection: 1250 volts AC/DC all ranges fuse protected for overcurrent  
 Input impedance: 10 megohms, DC/AC volts  
 Display: 3 1/2 digits, 0.5 inch LED  
 Accuracy: 0.1% basic DC volts  
 Power: 4 'C' cells, optional nicad pack, or AC adapter  
 Size: 6"W x 3"H x 6"D  
 Weight: 2 lbs with batteries

### Prices

DM-700 wired + tested	\$99.95
DM-700 kit form	79.95
AC adapter/charger	4.95
Nicad pack with AC adapter/charger	19.95
Probe kit	3.95

**TERMS:** Satisfaction guaranteed or money refunded, COD, add \$1.50. Minimum order \$6.00. Orders under \$10.00, add \$3.75. Add 5% for postage, insurance, handling. Overseas, add 15%. NY residents, add 7% tax.



## 600 mHz COUNTER



**\$99.95 WIRED**

The CT-70 breaks the price barrier on lab quality frequency counters. No longer do you have to settle for a kit, half-kit or poor performance, the CT-70 is completely wired and tested, features professional quality construction and specifications, plus is covered by a one year warranty. Power for the CT-70 is provided by four 'AA' size batteries or 12 volts, AC or DC, available as options are a nicad battery pack, and AC adapter. Three selectable frequency ranges, each with its own pre-amp, enable you to make accurate measurements from less than 10 Hz to greater than 600 mHz. All switches are conveniently located on the front panel for ease of operation, and a single input jack eliminates the need to change cables as different ranges are selected. Accurate readings are insured by the use of a large 0.4 inch seven digit LED display, a 1.0 ppm TCXO time base and a handy LED gate light indicator.

The CT-70 is the answer to all your measurement needs, in the field, in the lab, or in the ham shack. Order yours today, examine it for 10 days, if you're not completely satisfied, return the unit for a prompt and courteous refund.

### Specifications

Frequency range: 10 Hz to over 600 mHz  
 Sensitivity: less than 25 mv to 150 mHz  
 less than 150 mv to 600 mHz  
 Stability: 1.0 ppm, 20-40°C, 0.05 ppm/°C TCXO crystal time base  
 Display: 7 digits, LED, 0.4 inch height  
 Input protection: 50 VAC to 60 mHz, 10 VAC to 600 mHz  
 Input impedance: 1 megohm, 6 and 60 mHz ranges 50 ohms, 600 mHz range  
 Power: 4 'AA' cells, 12 V AC/DC  
 Gate: 0.1 sec and 1.0 sec LED gate light  
 Decimal point: Automatic, all ranges  
 Size: 5"W x 1 1/2"H x 5 1/2"D  
 Weight: 1 lb with batteries

### Prices

CT-70 wired + tested	\$99.95
CT-70 kit form	75.95
AC adapter	4.95
Nicad pack with AC adapter/charger	14.95
Telescopic whip antenna, BNC plug	7.95
Tilt bail assembly	3.95

## ramsey electronics

✓RB BOX 4072, ROCHESTER, N.Y. 14610  
 PHONE ORDERS CALL  
 (716) 271-6487

# ALARM CLOCK KITS: 4 Digit .5"

Here it is! The first of several quality kits we have been asked for: Here is what you get — unbelievable as it may sound...

- 1 National - 5375AA Clock Chip
- 1 Bowmar Clock Stick Readout (L.E.D.) 4 digit - 1/2"
- 13 Transistors
- 2 Push Buttons for time set
- 2 Toggle Switches for alarm
- 1 Filter cap
- 4 1N4000 series diodes
- 1 1N4148
- 2 Disc caps
- 29 Resistors
- 1 Transducer (Speaker) for Alarm
- 1 LED Lamp for alarm indicator

**NEW!**

**\$9.99**

ORDER  
KIT  
CK-100AC

P.C. Board \$2.25

Plug In

Transformer \$1.50

## D.C. MODEL

Same as above except it includes 60 Hz timebase.

This Kit Includes:

- 1 National 5375AA Clock Chip
- 1 Bowmar Clock Stick Readout - (L.E.D.) 4 digit - 1/2"
- 12 Transistors
- 2 Push Buttons for time set
- 2 Disc caps
- 27 Resistors
- 1 MOV
- 1 60 Hz time base

**NEW!**

**\$12.75**

ORDER  
KIT  
CK-100DC

P.C. Board \$2.25



We bought 350,000 LED's.  
And you get the savings.

Reds, greens, yellows, orange, small, medium, large Bags of 25 - mixed \$2.75. That's only 11¢ each Compare this bargain up to twice our price

**FACTORY PRIME**

BI - Polar LED 59¢ ea. or 10 for \$5

### LAB-BENCH VARIABLE POWER SUPPLY KIT

5 to 20 VDC at 1 AMP Short circuit protected by current limit. Uses IC regulator and 10 AMP Power Darlington Very good regulation and low ripple Kit includes PC Board, all parts, large heatsink and shielded transformer 50 MV TYP Regulation \$15.99 KIT

### LED BAR GRAPH AND ANALOG METER DRIVER

New from National Semi. #LM3914. Drives 10 LED directly for making bar graphs, audio power meters, analog meters, LED oscilloscopes, etc. Units can be stacked for more LED's. A super versatile and truly remarkable IC. Just out!

**SPECIAL PRICE: \$3.99 INCLUDES 12 Page Spec. Sheet**

### NATIONAL SEMICONDUCTOR

## "COLOSSUS JR." JUMBO CLOCK MODULE

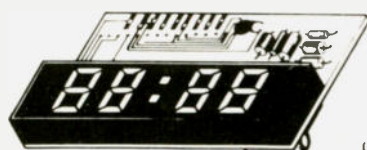

**\$8.50**

3 FOR \$15

(IAC XFMR \$1.95)

ASSEMBLED! NOT A KIT!

MANUFACTURER'S CLOSEOUT!

PERFECT FOR USE WITH A TIMEBASE

- Bright 4 digit 0.7" LED Display
- Complete-Add only Transformer and Switches
- 24 Hour Alarm Signal Output
- 12 Hour Real Time Format
- 50 or 60 Hz Operation
- Power Failure Indication
- LED Brightness Control
- Sleep and Snooze Timers
- Alarm "on" and PM Indicators
- Direct Drive - No RFI
- Direct Replacement for MA1012
- Comes with Full Data

### CLOCK MODULE OPTIONS MA1008 A and D MA1013

Switches and pot for all options

Includes:

- 5 push buttons
- 1 toggle
- 1 10K pot \$2.50
- Alarm Parts (including high impedance transducer) Much more efficient than a speaker \$1.50
- Transducer only (unbelievably loud!) \$1.10

### 16K DYNAMIC RAM CHIP WORKS IN TRS-80 OR APPLE II

16K X 1 Bits 16 Pin Package Same as Mostek 4116-4 250 NS access 410 NS cycle time Our best price yet for this state of the art RAM 32K and 64K RAM boards using this chip are readily available These are new fully guaranteed devices by a major mfg

**VERY LIMITED STOCK!**

"MAGAZINE SPECIAL" - 8/\$79.50

MA1013  
BRAND NEW!

MICRO MINI  
TOGGLE SWITCHES  
6 for \$5 with hardware.



**99¢**  
EACH

## VARO FULL WAVE BRIDGE

6 AMPS 200 PIV  
#VH248

3/4 IN. SQUARE **NEW!**

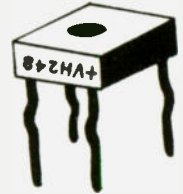

**89¢ ea. 4 For \$2.99**

## RCA SENSITIVE GATE TRIAC

TO-5 CASE. HOUSE #40531

ALSO SAME AS T2300D.

2.5 AMPS 400 PIV

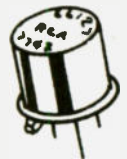

**5 FOR \$1.19**

Perfect for Dimmers, Color Organs, etc.  
PC LEADS

## Sonalert® on P.C. Board

Direct from a radar detector manufacturer! 4-741 on a board - plus 12 capacitors, trim pot and many useable components plus a Mallory Sonalert® - well worth the price of the board alone - while they last - **\$2.50 ea.**

### SONY 23 WATT AUDIO AMP MODULE

#STK-054. 23 WATTS SUPER CLEAN AUDIO. 20 HZ to 100 KHZ ± 2 DB. HYBRID, SILICON, SELF-CONTAINED MODULE. ONLY 1 1/4 x 2 1/2 IN. WITH DATA.

COMPARE AT UP TO TWICE OUR PRICE! **\$6.50 each**

### 60 Hz CRYSTAL TIME BASE \$4.95 (Complete Kit)

Uses MM5369 CMOS divider IC with high accuracy 3.579545 MHZ Crystal. Use with all MOS Clock Chips or Modules. Draws only 1.5 MA. All parts, data and PC Board included. 100 Hz, same as above, except \$5.95

### SILICON POWER SOLAR CELLS

2 Inch Dia Approx 5 VDC at 500 MA in sunlight Factory new units, not rejects as sold by others Series for higher voltage, parallel for higher current. Converts solar energy directly to electricity **LIMITED QUANTITY. \$5.99 ea**

### FAIRCHILD PNP

"SUPER TRANSISTOR"  
2N4402. TO-92 Plastic. Silicon PNP Driver. High Current. VCEO-40 HFE-50 to 150 at 150 MA FT-150 MHZ. A super "BEEFED-UP" Version of the 2N3906

**8 FOR \$1.19**

### SOUND ACTIVATED SWITCH

Not a kit Already assembled Clap your hands and turn on lights, music boxes, coffee pots, etc Full spec sheet with each unit

**69¢ 10 for \$5.50**

## TOSHIBA POWER AUDIO AMP

5.8 WATTS RMS Typical Output. 50 to 30,000 HZ ± 3 DB. For CB's, tape decks, PA's, etc. Works off of a single supply voltage from 10.5 to 18 VDC. 10 Pin plastic DIP with special built in heat sink tab. Perfect for use on 12VDC. **\$3.99 each** With Data.

# Digital Research: Parts (OF TEXAS)

P.O. BOX 401247 • GARLAND, TEXAS 75040 • (214) 271-2461

TERMS: Add 50¢ postage, we pay balance. Orders under \$15 add 75¢ handling. No C.O.D. We accept Visa, MasterCard and American Express cards. Tex. Res. add 5% Tax. Foreign orders (except Canada) add 20% P&H. 90 Day Money Back Guarantee on all items.

# M-M Electronic Sales

A division of **United Products Corporation**  
 Corp. Hdqts., 2300 1st Ave. — Seattle, WA 98121 • (206) 682-5025

# FREE

## FREE 5 FUNCTION L.C.D. MENS WATCH

SECONDS MINUTES HOURS DAY MONTH  
 If your order totals \$50.00 or more we will send you this national semiconductor L.C.D. Watch, valued at \$29.95

**FREE!**

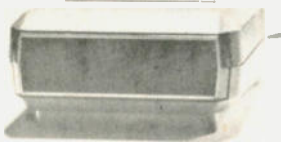

### INSTRUMENT CLOCK CASE KIT

A real jewel for those small projects. Hinged top door allows you to hide your control area. O.D. 4 1/2" x 4" x 1 3/4"  
**\$1.99 each.**

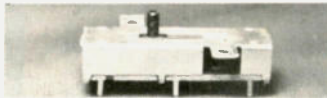

### ANTENNA SELECTING SWITCH D.P.D.T.

Long through slide switch providing correct isolation for 300 OHM Twin Lead  
 35¢ ea. 4 for ONLY \$1.00



### FERROX CUBE TORROID CORE

9/16" I.D. **95¢**

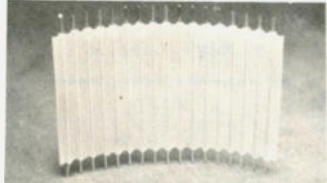

**DIP SPACED FLEX JUMPER** Pre-cut 1 1/2 L. and pre-stripped Pkg 20 **\$1.99**

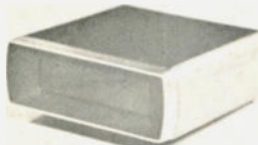

### INSTRUMENT/CLOCK CASE KIT

Perfect for your opto projects. Solid aluminum construction with real walnut sides. O.D. 5-3/8" by 5-3/8" by 2" **\$6.95 ea.**

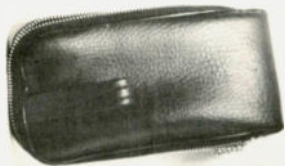

### NAUGAHYDE ZIPPER POUCH

O.D. Approx. 4" X 7". Brand new and of the finest quality. It even has a convenient belt loop. **95¢**



### TIP 121 (RCA121)

NPN Darlington **\$ .95 ea.**  
 60 Watt 8 Amp **2/\$1.50**  
 HFE 1000 TO 220

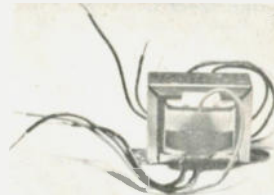

**TRANSFORMER** Pri 110 VAC Sec. 11 2 and 5 VCT (w) 1 amp **\$ .95 ea.**



**ROTRON WHISPER FAN #WR2H1**  
 75CFM, 115VAC Net \$17.00 Meas 4" diam NOTE These are not pull outs, these are new **YOUR PRICE \$9.95**

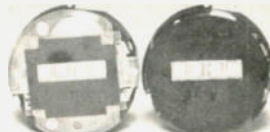

**L.E.D. WATCH GUTS** (untested)  
 All take 2, 1.5V Bat Mens size 75¢ ea. 2 for **\$1.00**



### CRYSTAL 3.579545 MHZ

This is the one you need for your time base. Reg Price \$4.95 **YOUR PRICE \$2.50** (while they last)



**SOLDERLESS CRIMP ON TERMINAL ASSORTMENT**  
 50 Pieces of the most popular sizes in a convenient plastic storage box (bulk available on request) **ONLY \$1.49**

### 1/4 WATT 5% DEPOSITED CARBON FILM RESISTOR ASSORTMENTS

ASST A	10 ea 1 OHM 1.5 OHM 2 OHM 2.7 OHM 3 OHM 3.6 OHM 4.7 OHM 5.6 OHM 6.8 OHM 8.2 OHM	100 pcs \$2.40
ASST B	10 ea 10 OHM 12 OHM 15 OHM 18 OHM 22 OHM 27 OHM 33 OHM 39 OHM 47 OHM 56 OHM	100 pcs \$2.40
ASST C	10 ea 68 OHM 82 OHM 100 OHM 120 OHM 150 OHM 180 OHM 220 OHM 270 OHM 330 OHM 390 OHM	100 pcs \$2.40
ASST D	10 ea 470 OHM 560 OHM 680 OHM 820 OHM 1K 1.2K 1.5K 1.8K 2.2K 2.7K	100 pcs \$2.40
ASST E	10 ea 3.3K 3.9K 4.7K 5.6K 6.8K 8.2K 10K 12K 15K 18K	100 pcs \$2.40
ASST F	10 ea 22K 27K 33K 39K 47K 56K 68K 82K 100K 120K	100 pcs \$2.40
ASST G	10 ea 150K 180K 220K 270K 330K 390K 470K 560K 680K 820K	100 pcs \$2.40
ASST H	10 ea 1M 1.2M 1.5M 1.8M 2.2M 2.7M 3.3M 3.9M 4.7M 5.6M	100 pcs \$2.40
ASST A-H	INCLUDES ALL RESISTOR ASSORTMENTS (800 pcs)	\$14.95 ea

### THE GOODIE BOX

1000 uf 25VDC P-C \$ .25  
 2000 uf 25VDC AXIAL .50  
 18 ga. LINE CORD 6' .25  
 Trimmer Cap 3-30pf VERT P-C .50  
 RCA Jack, Right Angle P-C .25  
 TIN-JAX 50¢ ea 3/1.00  
 TO-220 Clip on Heat Sink .20  
 #30 Kynar (any color) 100' Spool 1.00  
 Speaker Terms 15¢ ea 10/1.00  
 10K Lin. 2 watt Pot .50  
 AAA Rechargeable NI-CAD .95  
 Mini-Plug .50  
 S.P.D.T. min. Slide Switch 25¢ ea. 5/1.00



### SYNCHRONOUS STEPPING MOTOR

SLO-SYN #MO62 FD09  
 1.7V  
 200 steps per rev  
 65 oz in torque  
**Net Cost \$42.28 Your Cost \$29.95**



22VDC @ 140 MA Adapter \$1.95  
 4.5 VDC @ 265 MA Adapter \$1.95



### MM 5766 PROGRAMMER

- \* Dynamic Key Sequence Programmer
- \* Remembers any combination of key entries in the load mode
- \* Automatically plays them back in the run mode
- \* Stores up to 102 characters

Experimenters will have a lot of fun with this clip as it is possible to build many projects with it. We will supply pin outs and specs with your order.  
**Net Price \$20.00 Your Cost ONLY \$4.95 ea**



**PARTS BOARDS** A great way to buy parts on a budget. We guarantee your money's worth. **ONLY \$1.00 ea.**

### L.C.D. DISPLAYS

SMALL SIZE  
**45¢ EA. 3 FOR \$1.00**  
 (UNTESTED)



**MINIATURE D.P.D.T. 12VDC RELAY**  
 500 OHM Coil 1-1/8" X 3/4" X 3/8"  
 ARROW-M #NF2-12V **ONLY \$2.99 ea.**  
 P-C Mount



### XMAS STOCKING STUFFERS

National Semiconductor  
 L.C.D. Mens watches

- \* DEAWB05T
  - \* 5 Function Tritium Night Watch
  - \* Hours Minutes Month Day Seconds
  - \* Silver with Metal Band
- Your Price ONLY \$29.95**



- \* DABYBO4T
  - \* 5 Function Tritium Night Watch
  - \* Hours Minutes Seconds Calendar Date and Day of the Week Pointer
  - \* Gold with Metal Band
- Your Price ONLY \$29.95**

### TRITIUM WATCHES:

A Tritium Watch produces it's own night light. No more button pushing!

Terms: All orders shipped promptly. Minimum order \$5.00. Telephone orders accepted. All orders shipped UPS or PP. Add 5% extra for shipping & handling. Washington state residents add additional 5.3% sales tax. Master Charge & Visa cards accepted. Money orders & your personal or company check are welcome. Funds made payable in U.S. currency only. No C.O.D. orders. Your satisfaction guaranteed on all merchandise purchased. All merchandise subject to prior sale. Open account to govt. agencies & publicly funded schools.



Store Hours  
 M-F 9-6 • SAT 9-5

**O.E.M.'s WELCOME**

For Master Charge/Visa Orders use our **TOLL FREE HOT LINE: 1-800-426-0634** for areas outside Washington (incl. Alaska & Hawaii)

# BULLET ELECTRONICS

B8 P.O. Box 401244-E Garland, Texas 75040 (214) 278-3553

## AY3-8910 PROGRAMMABLE SOUND GENERATOR

The AY3-8910 is a 40 pin LSI chip with three oscillators, three amplitude controls, programmable noise generator, three mixers, an envelope generator, and three D/A converters that are controlled by 8 BIT WORDS. No external pots or caps required. This chip hooked to an 8 bit microprocessor chip or Buss (8080, Z80, 6800 etc.) can be software controlled to produce almost any sound. It will play three note chords, make bangs, whistles, sirens, gunshots, explosions, bleets, whines, or grunts. In addition, it has provisions to control its own memory chips with two IO ports. The chip requires +5V @ 75ma and a standard TTL clock oscillator. A truly incredible circuit.

**\$14.95** W/Basic Spec Sheet (4 pages) 60 page manual with S-100 interface instructions and several programming examples, **\$3.00 extra**

## SE-01 SOUND EFFECTS KIT

• 76477 CHIP IS INCLUDED. EXTRA CHIPS \$2.95 EACH

• **\$16.95** LESS SPEAKER & BATTERY

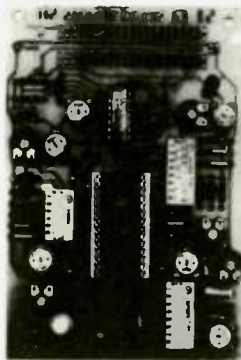

The SE-01 is a complete kit that contains all the parts to build a programmable sound effects generator. Designed around the new Texas Instruments SN76477 Sound Chip, the board provides banks of MINI DIP switches and pots to program the various combinations of the SLF Oscillator, VCO, Noise, One Shot, and Envelope Controls. A Quad Op Amp IC is used to implement an Adjustable Pulse Generator, Level Comparator and Multiplex Oscillator for even more versatility. The 3 1/2" x 5" PC Board features a prototype area to allow for user added circuitry. Easily programmed to duplicate Explosions, Phasor Guns, Steam Trains, or almost an infinite number of other sounds. The unit has a multiple of applications. The low price includes all parts,

assembly manual, programming charts, and detailed 76477 chip specifications. It runs on a 9V battery (not included). On board 100MW amp will drive a small speaker directly, or the unit can be connected to your stereo with incredible results! (Speaker not included)

ALLOW 3 WKS. FOR DELIVERY

## A RARE FIND! LAMBDA HIGH POWER REGULATOR 3205 MODULE

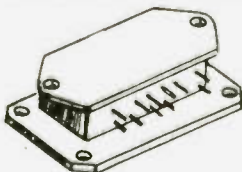

**\$12.95** W/SPECS  
LIMITED QTY.

- 5V @ 10A with 8-30VDC input.
- Current limiting, thermal shutdown and short protection.
- .2% Load regulation.
- Only 2 external components needed.

All you need to add is a transformer, rectifier, heatsink and filter cap to have a super regulated supply for 5 volts at 10 amps!

**SPECIAL BONUS!** Order the 3205 Module and get **FREE** a LAMBDA L-20-5 overvoltage protector that triggers at 6.6 volts up to 20 amps.

**LAS15U - 1.5A Four Terminal Adjustable Regulator.** 3-30V W/current limiting, short protection and thermal shutdown. TO-3 style. All units are prime. Spec sheets included. **\$2.50**

- \* NO C.O.D.'s
- \* SEND CHECK M.O. OR CHARGE CARD NO.
- \* PHONE ORDERS ACCEPTED ON VISA AND MASTERCARD ONLY.
- (214) 278-3553 9:00 AM - 6:00 PM CST
- \* ORDERS OVER 1 LB. SHIPPED VIA UPS

POLICIES

**4 DIGIT 1/2 INCH CHARACTER LED DISPLAY**  
Bowmar readout stick with colons. COMMON CATHODE ONLY. 100% Prime. All segments and colons brought out to edge pads. With pinout. LIMIT 5 PER CUSTOMER



**SPECIAL \$1.90**

From T.I.: **TL490 BAR/DOT DRIVER IC.** Drives 10 LED's with adjustable analog steps. Units are cascadable up to 10 (100 steps). Drives LED's directly. Great for voltage, current, or audio displays. Similar in features to LM3914 with specs and circuit notes.

**2.95**

**NEW!**



## XAN SUPER DIGITS

.6" JUMBO LED  
7 SEGMENT  
RED

**99¢**

6640 COMMON ANODE  
6920 COMMON CATHODE

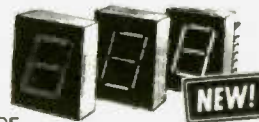

**NOW A SUPER READOUT AT A SUPER BUY!** These are factory fresh prime LED readouts, not seconds or rejects as sold by others. Compare our price and send for yours today, but hurry, the supply is limited!

**SPECIFY: COMMON ANODE OR COMMON CATHODE**

## NEW ITEMS

LM3046	(CA3046) Transistor Array	.75
LM3909	Led Flasher	.50
CA3086	RCA Transistor Array	.80
MC1438R	Power Op Amp/Driver	.50
1N4148	Prime, Full Lead	100/2.50
LM3302	Quad Comparator	.89
2SC1849	High Freq NPN TO-92	6/1.00

## POTENTIOMETER ASSORTMENT

A mix of new, panel mount 3/8" bushing pots in various values. Some dual, some with switches.

10/2.00

## 1/2W RESISTOR ASSORTMENT

A good mix of 5% and 10% values in both full lead and PC lead devices. All new, first quality.

(Asst.) 200 pieces/ 2.00

## SLIDE SWITCH ASSORTMENT

An outstanding bargain. Includes miniature and standard sizes and multiposition units. All new first quality, name brand switches. Try one pack and you'll reorder more: **SPECIAL - 12 for \$1.20** (Assortment)

- \* ADD 5% FOR SHIPPING
  - \* TX. RES. ADD 5% STATE SALES TAX
  - \* FOREIGN ORDERS ADD 10% (EXCEPT CANADA) (20% AIRMAIL) U.S. FUNDS ONLY.
  - \* SORRY WE CANNOT SHIP INSURED TO MEXICO
- PRICES SUBJECT TO CHANGE WITHOUT NOTICE

9500@75V Computer Grade Filter Cap 2"x5 1/2" **2.95**

## ZENER GRAB BAG

A very nice assortment of 1/4, 1/2 & 1W zeners. Voltage ranges are from 2.7 to 30 VDC. Most have house # but we provide a cross over list to standard numbers. A great buy for any shop. **12 different types.**

**.50 ea.**

## MC1469R POSITIVE VOLTAGE REGULATOR

AMP COMPLETE SPECS AND APPLICATIONS SHOW HOW TO BUILD FIXED OR VARIABLE POWER SUPPLIES FROM 3 TO 30VDC. DRIVE EXTERNAL SERIES PASS FOR CURRENT TO 20 AMPS!

1.25 EA. 10/10.00 HOUSE #



## QUAD MATCHED DIODES

4 1N914 type diodes that have been closely matched for use in bridge and balanced modulator circuits.

**50¢ ONE SET (4)**

## PARTS

301 OP AMP 8 LEAD CAN	3/1.00
723 VOLT REG 10 LEAD CAN	.50
*13741 FET INPUT 741 MINI DIP	3/1.10
30000 @ 15V COMPUTER GRADE	2.10
2N4400 NPN GEN. PURPOSE	8/1.00
2N4302 PNP COMPLEMENT	8/1.00
2N6028 P.U.T. W/SPECS	.50
LM380 2W AUDIO IC W/SPECS	1.09
LM377 DUAL LM380 W/SPECS	2.50
*7815 VOLT REG. 1A 15V	.69
*725 LOW NOISE OP AMP	.99
IL-1 OPTO ISOLATOR MINI DIP	.60
*MEM 631 DUAL GATE MOSFET. DIODE PROTECTED. SIMILAR TO 40673	.50
MV1624 VARICAP DIODE 10 PFO	.49
1N4003 1A 200V DIODE	15/1.00
TIP30 TAB PNP POWER	3/1.00
*MC1351P FM IF. OISC IC	.50

\*INDICATES ITEM IS "HOUSE NUMBERED"

## LED'S

JUMBO GREEN	4/.89
JUMBO RED	5/.89
MEDIUM RED (1/8")	.15
MEDIUM GRN OR YELLOW	.16

## 7 WATT AUDIO AMP KIT

SMALL, SINGLE HYBRID IC AND COMPONENTS FIT ON A 2" x 3" PC BOARD (INCLUDED) RUNS ON 12 VDC. GREAT FOR ANY PROJECT THAT NEEDS AN INEXPENSIVE AMP. LESS THAN 3% THD @ 5 WATTS. COMPATIBLE WITH SE-01 SOUND KIT. **\$5.95**

## 6 DIGIT AUTO/VAN CLOCK

- LARGE 1/2" CHARACTERS (LED)
- QUARTZ XTAL TIMEBASE
- ALARM & SNOOZE OPTIONS
- NOISE FILTERING
- EASY TO ASSEMBLE
- 4" x 3" x 1 1/2"
- DRILLED & PLATED PC BOARDS

COMPLETE KIT 12 VDC **\$16.95**

## ULTRASONIC RELAY KIT

INVISIBLE BEAM WORKS LIKE A PHOTO ELECTRIC EYE. USE UP TO 25 FT APART. COMPLETE KIT, ALL PARTS & PC BOARDS

**\$21.50**

# Radio Bookshop

## LICENSE STUDY GUIDES & TAPES

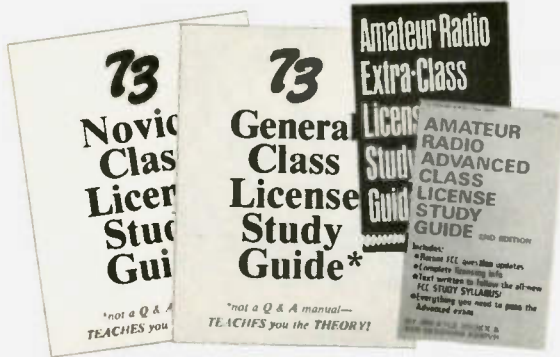

● **NOVICE STUDY GUIDE—SG7357**—Here is a completely new study guide and reference book for the potential ham. This is not a question/answer memorization course. Electronic and radio fundamentals are presented and explained in an easy-to-understand fashion, preparing the beginner for the Novice exam. Includes the latest FCC amateur regulations, as well as application forms. Easily the best path into the exciting world of ham radio! \$4.95.\*

● **GENERAL CLASS STUDY GUIDE—SG7358**—A complete theory course for the prospective General or Technician. This reference explains transistor, amplifier, and general radio theory, while preparing the Novice for the "big" ticket. After getting your ticket, you'll use this guide again and again as an electronic reference source. Not a question/answer guide that becomes dated when the FCC updates the amateur exams. \$5.95.\*

● **ADVANCED CLASS STUDY GUIDE—SG1081**—Ready to upgrade your license? To prevent retaking the FCC theory exam, you need the 73 Advanced theory guide. SSB, antenna theory, transmitters, and electronics measuring techniques are covered in detail in this easy-to-follow study guide. Special modes and techniques, such as RTTY, are also treated. An engineering degree is not necessary to master Advanced theory—try this book before visiting the examiner's office! \$5.95.\*

● **EXTRA CLASS LICENSE STUDY GUIDE—SG1080**—Before going for your 1 x 2 call, it pays to be a master of the Extra class electronic theory. This study guide is the logical extension of the 73 theory course. All the theory necessary to pass the exam is presented. Antennas, transmission lines, SWR are discussed, as well as noise, propagation, and specialized communication techniques. This book is not a classroom lecture or memorization guide, but rather a logical presentation of the material that must be understood before attempting the Extra exam. Save yourself a return trip to the FCC and try the 73 method first! \$6.95.\*



## NOVICE THEORY TAPES Startling Learning Breakthrough

● **NOVICE THEORY TAPES—CT7300**—Startling Learning Breakthrough. You'll be astounded at how really simple the theory is when you hear it explained on these tapes. Three tapes of theory and one of questions and answers from the latest Novice exams give you the edge you need to breeze through your exam. 73 is interested in helping get more amateurs, so we're giving you the complete set of our tapes for the incredibly low price of **ONLY \$15.95.\***

Scientists have proven that you learn faster by listening than by reading because you can play a cassette tape over and over in your spare time—even while you're driving! You get more and more info each time you hear it.

You can't progress without solid fundamentals. These four hour-long tapes give you all the basics you'll need to pass the Novice exam easily. You'll have an understanding of the basics which will be invaluable to you for the rest of your life! Can you afford to take your Novice exam without first listening to these tapes? Set of 4—\$15.95.\*



## SSTV

● **SLOW SCAN TELEVISION TAPE—CT7350**—Prize-winning programs from the 73 SSTV contest. Excellent for Demo! \$5.95.\*



### "GENESIS"

5 WPM—CT7305—This is the beginning tape for people who do not know the code at all. It takes them through the 26 letters, 10 numbers and necessary punctuation, complete with practice every step of the way using the newest blitz teaching techniques. It is almost miraculous! In one hour many people—including kids of ten—are able to master the code. The ease of learning gives confidence to beginners who might otherwise drop out.

### "THE STICKLER"

6+ WPM—CT7306—This is the practice tape for the Novice and Technician licenses. It is made up of one solid hour of code, sent at the official FCC standard (no other tape we've heard uses these standards, so many people flunk the code when they are suddenly—under pressure—faced with characters sent at 13 wpm and spaced for 5 wpm). This tape is not memorizable, unlike the zany 5 wpm tape, since the code groups are entirely random characters sent in groups of five.

## 73 CODE SYSTEM TAPES

Any Four Tapes For \$15.95! \*  
\$4.95 Each! \*

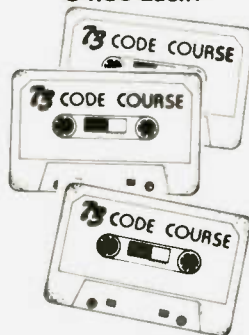

### "BACK BREAKER"

13+ WPM—CT7313—Code groups again, at a brisk 13 per so you will be at ease when you sit down in front of the steely-eyed government Inspector and he starts sending you plain language at only 13 per. You need this extra margin to overcome the panic which is universal in the test situations. When you've spent your money and time to take the test, you'll thank heavens you had this back-breaking tape.

### "COURAGEOUS"

20+ WPM—CT7320—Code is what gets you when you go for the Extra class license. It is so embarrassing to panic out just because you didn't prepare yourself with this tape. Though this is only one word faster, the code groups are so difficult that you'll almost fall asleep copying the FCC stuff by comparison. Users report that they can't believe how easy 20 per really is with this fantastic one hour tape.

### "OUTRAGEOUS"

25+ WPM—CT7325—This is the tape for that small group of overachieving hams who wouldn't be content to simply satisfy the code requirements of the Extra Class license. It's the toughest tape we've got and we keep a permanent file of hams who have mastered it. Let us know when you're up to speed and we'll inscribe your name in 73's CW "Hall of Fame."

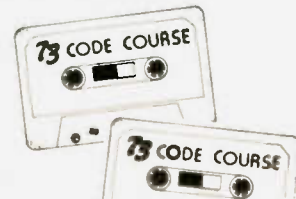

Use the order card in the back of this magazine or itemize your order on a separate piece of paper and mail to: 73 Radio Bookshop • Peterborough NH 03458. Be sure to include check or detailed credit card information.

\*Add \$1.00 handling charge. Note: Prices subject to change on books not published by 73 Magazine.

**FOR CUSTOMER SERVICE CALL (603) 924-7298**

# Radio Bookshop

## 73 TECHNICAL LIBRARY

● **BEHIND THE DIAL**—BK7307—By Bob Grove. Get more fun out of shortwave listening with this interesting guide to receivers, antennas, frequencies and interference. \$4.95.\*

● **THE CHALLENGE OF 160**—BK7309—is the newest book in the 73 technical library, dedicated to 160 meter operating. Si Dunn provides all necessary information to get started on this unique band. The all-important antenna and ground systems are described in detail. The introduction contains interesting photos of Stew Perry's (the King of 160) shack. This reference is a must for new and experienced "Top Band" operators. Price: \$4.95.\*

● **IC OP-AMP COOKBOOK**—BK1028—by Walter G. Jung. Covers not only the basic theory of the IC op amp in great detail, but also includes over 250 practical circuit applications, liberally illustrated. 592 pages, 5½ x 8½, softbound. \$12.95.\*

● **THE POWER SUPPLY HANDBOOK**—BK7305—Need a power supply for a gadget you're building? In the **POWER SUPPLY HANDBOOK** there are dozens ready-to-build, plus detailed steps for designing your own. There are circuits and parts lists for all kinds of supplies, ranging from simple DC types to highly stable regulated versions. If you need a circuit to convert a DC voltage to a higher or lower voltage, turn DC into AC, or AC to DC—then this is the book you need. With more than 400 pages, you should be able to find just the circuit you need. Without a doubt one of the best power supply source books available, compiled by the editors of 73. \$7.95.\*



● **INTRODUCTION TO RTTY**—BK7380—A beginner's guide to radioteletype including teletypewriter fundamentals, signals, distortion and RTTY art. You can be a RTTY artist! A 73 publication. \$2.00.\*

● **THE NEW RTTY HANDBOOK**—BK7347—is a new edition and the only up-to-date RTTY book available. The state of the art has been changing radically and has made all previous RTTY books obsolete. It has the latest circuits, great for the newcomer and expert alike. \$5.95.\*

● **PROPAGATION WIZARD'S HANDBOOK**—BK7302—by J. H. Nelson. When sunspots riddled the worldwide communications networks of the 1940's, John Henry Nelson looked to the planets for an answer. The result was a theory of propagation forecasting based upon interplanetary alignment that made the author the most reliable forecaster in America today. The book provides an enlightened look at communications past, present, and future, as well as teaching the art of propagation forecasting. \$6.95.\*



● **SSB... THE MISUNDERSTOOD MODE**—BK7351—by James B. Wilson. Single Sideband Transmission... thousands of us use it every day, yet it remains one of the least understood facets of amateur radio. J. B. Wilson presents several methods of sideband generation, amply illustrated with charts and schematics, which will enable the ambitious reader to construct his own sideband generator. A must for the technically-serious ham. \$5.50.\*

● **SSTV HANDBOOK**—BK7354(hardcover), BK7355(softcover)—This excellent book tells all about it, from its history and basics to the present state-of-the-art techniques. Contains chapters on circuits, monitors, cameras, color SSTV, test equipment and much more. Hardbound \$7.00, softbound \$5.00.\*

● **WEATHER SATELLITE HANDBOOK**—BK7370—Simple equipment and methods for getting good pictures from the weather satellite. Antennas, receivers, monitors, facsimile you can build, tracking, automatic control (you don't even have to be home). Dr. Taggart WB8DQT. \$4.95.\*

● **73 DIPOLE AND LONG-WIRE ANTENNAS**—BK1016—by Edward M. Noll W3FQJ. This is the first collection of virtually every type of wire antenna used by amateurs. Includes dimensions, configurations, and detailed construction data for 73 different antenna types. Appendices describe the construction of noise bridges, line tuners, and data on measuring resonant frequency, velocity factor, and swr. \$5.50.\*



● **THE GIANT BOOK OF AMATEUR RADIO ANTENNAS**—BK7304—With the **GIANT Book of Amateur Radio Antennas** by your side, antennas will become the least of your worries. Over 450 pages of design ideas, theory and reference data make this book live up to its title. The 7 chapters cover everything from basic antenna theory through designs for DIY accessories, as well as dozens of antenna designs. Whether planning to build or buy, design or admire, test or enjoy a ham antenna—this is the book for you. From the editors of 73; published by Tab Books. \$12.95 Hardback.\*

● **73 VERTICAL, BEAM AND TRIANGLE ANTENNAS**—BK1069—by Edward M. Noll W3FQJ. Describes 73 different antennas for amateurs. Each design is the result of the author's own experiments covering the construction of noise bridges and antenna line tuners, as well as methods for measuring resonant frequency, velocity factor, and standing-wave ratios. 160 pages. \$5.50.\*

● **VHF ANTENNA HANDBOOK**—BK7368—The **NEW VHF Antenna Handbook** details the theory, design and construction of hundreds of different VHF and UHF antennas... A practical book written for the average amateur who takes joy in building, not full of complex formulas for the design engineer. Packed with fabulous antenna projects you can build. \$4.95.\*



Use the order card in the back of this magazine or itemize your order on a separate piece of paper and mail to: 73 Radio Bookshop • Peterborough NH 03458. Be sure to include check or detailed credit card information.

\*Add \$1.00 handling charge. Note: Prices subject to change on books not published by 73 Magazine.

**FOR TOLL FREE ORDERING CALL 1-800-258-5473**

# Radio Bookshop

## TEST EQUIPMENT

● **RF AND DIGITAL TEST EQUIPMENT YOU CAN BUILD**—BK1044—Rf burst, function, square wave generators, variable length pulse generators—100 kHz marker, i-f and rf sweep generators, audio osc, a/rf signal injector, 146 MHz synthesizer, digital readouts for counters, several counters, prescaler, microwave meter, etc. 252 pages. \$5.95.\*

● **VOL. I COMPONENT TESTERS**—LB7359—... how to build transistor testers (8), diode testers (3), IC testers (3), voltmeters and VTVMs (9), ohmmeters (8 different kinds), inductance (3), capacity (9), Q measurement, crystal checking (6), temperature (2), aural meters for the blind (3) and all sorts of miscellaneous data on meters... using them, making them more versatile, making standards. Invaluable book. \$4.95.\*

● **VOL. II AUDIO FREQUENCY TESTERS**—LB7360—... jam packed with all kinds of audio frequency test equipment. If you're into SSB, RTTY, SSTV, etc., this book is a must for you... a good book for hi-fi addicts and experimenters, too! \$4.95.\*

● **VOL. III RADIO FREQUENCY TESTERS**—LB7361—Radio frequency waves, the common denominator of Amateur Radio. Such items as SWR, antenna impedance, line impedance, rf output and field strength; detailed instructions on testing these items includes sections on signal generators, crystal calibrators, grid dip oscillators, noise generators, dummy loads and much more. \$4.95.\*

● **VOL. IV IC TEST EQUIPMENT**—LB7362—Become a troubleshooting wizard! In this fourth volume of the 73 TEST EQUIPMENT LIBRARY are 42 home construction projects for building test equipment to work with your ham station and in servicing digital equipment. Plus a cumulative index for all four volumes of the 73 TEST EQUIPMENT LIBRARY. \$4.95.\*



## THE WELL-EQUIPPED HAM SHACK

● **73 MAGAZINE BINDERS**—Preserve and protect your collection for your lifetime! There's no excuse for lost issues when you have these handsome red binders with gold lettering. Order 1—BN1001—for \$6.50\*; 2 or more—BN1002—for \$6.00 each.\* (specify 1978 or 1979 binders)

● **QSL CARDS**—73 turns out a fantastic series of QSL cards at about half the cost of having them done elsewhere because they are run as a fill-in between printing books and other items in the 73 Print Shop. 250 Style W—QW0250—for \$8.95\*; 500 Style W—QW0500—for \$13.95\*; 250 Style X—QX0250—for \$8.95\*; 500 Style X—QX0500—for \$13.95\*; 250 Style Y—QY0250—for \$8.95\*; 500 Style Y—QY0500—for \$13.95.\* Allow 2-4 mos. for delivery.

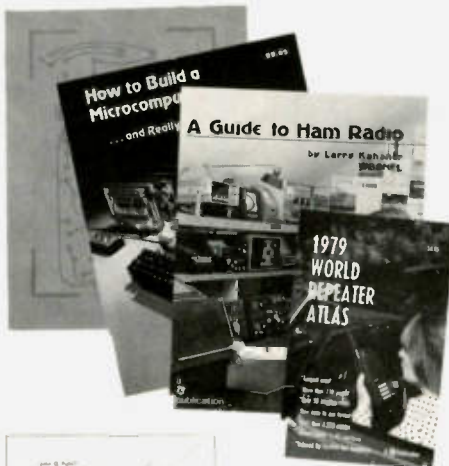

● **HOW TO BUILD A MICROCOMPUTER—AND REALLY UNDERSTAND IT**—BK7325—by Sam Creason. The electronics hobbyist who wants to build his own microcomputer system now has a practical "How-To" guidebook. Sam Creason's book is a combination technical manual and programming guide that takes the hobbyist step-by-step through the design, construction, testing and debugging of a complete microcomputer system. \$9.95.\*

● **1979 WORLD REPEATER ATLAS**—BK7346—With a new easy-to-use format, the 1979 World Repeater Atlas is the largest ever published by 73. More than 230 pages of repeaters, listed by both location and frequency, together with over 50 location maps—make this the best repeater atlas ever! Nearly 2000 separate repeater locations are shown on the maps, with greater accuracy than ever before. \$4.95.\*

● **BACK ISSUES**—Complete your collection; many are prime collectables now, classics in the field! A full collection is an invaluable compendium of radio and electronics knowledge!



Style X

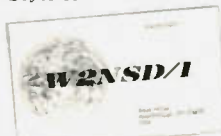

Style W



Style Y

Single back issue—ST0000—\$3.00\*;  
25 our choice—ST2500—\$12.00\*;  
25 your choice—ST2501—\$25.00\*;  
5 your choice—ST0500—\$8.75\*;  
10 your choice—ST1000—\$14.00.\*

● **OWNER REPAIR OF AMATEUR RADIO EQUIPMENT**—BK7310—Frank Glass shares over 40 years of operating, servicing, and design experience in this book. There are several books and numerous articles available on the subject of repairs to electronic equipment. The information within these books ranges from the elementary to the highly technical written for the top engineers in the field. But this book stands out from the rest in that it is written in narrative style aimed at conveying the concept of electronic servicing. A written discussion of how components work and how they are combined to provide communication equipment is used to help the reader understand the concepts required to service station equipment. \$7.95.\*

● **A GUIDE TO HAM RADIO**—BK7321—by Larry Kahaner WB2NEL. What's Amateur Radio all about? You can learn the basics of this fascinating hobby with this excellent beginner's guide. It answers the most frequently asked questions in an easy-going manner, and it shows the best way to go about getting an FCC license. A Guide to Ham Radio is an ideal introduction to a hobby enjoyed by people around the world. \$4.95.\*

● **LIBRARY SHELF BOXES**—These sturdy white, corrugated, dirt-resistant boxes each hold a full year of 73 or *Kilobaud Microcomputing*. With your order, request self-sticking labels for any of the following: 73, *Kilobaud Microcomputing*, *CQ*, *QST*, *Ham Radio*, *Personal Computing*, *Radio Electronics*, *Interface Age*, and *Byte*. Order 1—BX1000—for \$2.00\*; order 2-7—BX2002—for \$1.50 each\*; order 8 or more—BX1002—for \$1.25 each\*.

Use the order card in the back of this magazine or itemize your order on a separate piece of paper and mail to: 73 Radio Bookshop • Peterborough NH 03458. Be sure to include check or detailed credit card information.

\*Add \$1.00 handling charge. Note: Prices subject to change on books not published by 73 Magazine.

**FOR CUSTOMER SERVICE CALL (603) 924-7298**

# 19 years of 73 magazine

**The world's most  
comprehensive  
guide to the subject  
of ham radio.**



The back issues of 73 are a gold mine of interesting articles. Unlike the other magazines, which fill their pages with activity reports, there's little to go stale in 73. You'll find pioneering articles on SSTV, FM, repeaters, ICs, and computers. Even the editorials are fun as Wayne Green's dire predictions, like the debacle of incentive licensing, have come to pass.

Clip the coupon below and send for 73's new back issue catalogue. Treat yourself (or a friendly ham) to some fun, and a fantastic bargain to boot.

YES! Rush me 73's FREE Back Issue Catalogue!

Name \_\_\_\_\_

Address \_\_\_\_\_

City \_\_\_\_\_

State \_\_\_\_\_ Zip \_\_\_\_\_

73 Magazine • Peterborough NH 03458 • USA

## NEW FROM 73



Tools and Techniques for Electronics (BK7348) is a comprehensive guide to the tools and construction practices used by today's electronics hobbyist. This new 73 Magazine publication should be a part of the library of anyone who has ever built or fixed any electronic gear. The text and numerous pictures and illustrations provide an easy-to-understand description of the safe and correct way to use the basic and specialized tools needed for electronics work.

The first part of Tools and Techniques for Electronics covers the basic tools that will assist the amateur Novice, CB operator, or beginning computer kit builder. It is also an excellent review for more experienced hobbyists. The second portion of the text will be of interest to the advanced tool user. It explains specialized metal working tools as well as the chemical aids that are used in repair shops. The final chapters of Tools and Techniques for Electronics discuss the construction skills that result in a professional-looking project.

Handy reference data on English/metric conversions, machine screw data, and the like will be found in the appendices. The contents of basic and advanced tool kits are outlined, and the book includes a list of suppliers.

Whether you are interested in working with tubes or the latest wire-wrap techniques, a great deal of pride and satisfaction can be gained by building or repairing your own equipment. 73's Tools and Techniques for Electronics shows you the way.

**Order your copy today! Only \$4.95 from the Radio Bookshop. Use the handy order form on the Reader Service Card at the back of the magazine or phone toll free 1-800-258-5473.**



# PROPAGATION

by  
J. H. Nelson

**Practical Antennas for the Radio Amateur** is a manual which describes how to go about equipping an amateur station with a suitable antenna, with the goal of on-the-air operation. The scope of this work is designed to aid not only the experienced amateur operator but the newcomer as well. A wide range of antenna topics, systems, and accessories are presented, both to give the reader some food for thought and as practical data for construction. Just \$9.95, catalog number BK1015.

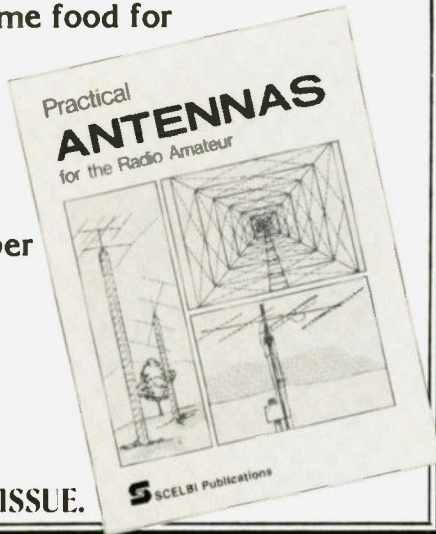

**ORDER TODAY!  
USE THE  
POSTAGE PAID  
CARD AT THE  
BACK OF THIS ISSUE.**

## EASTERN UNITED STATES TO:

	GMT:	00	02	04	06	08	10	12	14	16	18	20	22
ALASKA	21	14	7	7	7	7	7	7	14	21	21A	21A	21A
ARGENTINA	14A	14	7	7	7	7	14A	21A	21A	21A	21A	21A	21A
AUSTRALIA	21	14	7B	7B	7B	7B	7B	14	21	21	21A	21A	21A
CANAL ZONE	21	14	7	7	7	7	14	21A	21A	21A	21A	21A	21A
ENGLAND	7	7	7	7	7	7	14	21A	21A	21	14	14B	
HAWAII	21A	14	7B	7	7	7	7	7B	14	21A	21A	21A	21A
INDIA	7	7	7B	7B	7B	7B	14	14A	14	7B	7B	7B	7B
JAPAN	21	14	7B	7B	7B	7	7	7	7B	7B	7B	14	
MEXICO	21	14	7	7	7	7	7	21	21A	21A	21A	21A	21A
PHILIPPINES	21	14	7B	7B	7B	7B	7B	7	7	7	7B	14	
PUERTO RICO	14	7	7	7	7	7	14	21A	21A	21A	21	21	
SOUTH AFRICA	14	7	7	7B	7B	14	21A	21A	21A	21A	21	21	
U. S. S. R.	7	7	7	7	7	7B	14	21A	14A	7B	7B	7	
WEST COAST	21A	14	7	7	7	7	7	14	21A	21A	21A	21A	21A

## CENTRAL UNITED STATES TO:

	GMT:	00	02	04	06	08	10	12	14	16	18	20	22
ALASKA	21A	14	7	7	7	7	7	7	14	21	21A	21A	21A
ARGENTINA	21A	14	14	7	7	7	14	21A	21A	21A	21A	21A	21A
AUSTRALIA	21A	21	14	7B	7B	7B	7B	7B	21	21	21A	21A	21A
CANAL ZONE	21	14	7	7	7	7	14	21A	21A	21A	21A	21A	21A
ENGLAND	7B	7	7	7	7	7	7B	14	21A	21	14B	7B	
HAWAII	21A	21	14	7	7	7	7	7	14	21A	21A	21A	21A
INDIA	7B	14	7B	7B	7B	7B	7B	7B	14	7B	7B	7B	7B
JAPAN	21A	14	7B	7B	7	7	7	7	7	7B	7B	14	
MEXICO	14	14	7	7	7	7	7	14	21	21A	21A	21A	21A
PHILIPPINES	21A	14	7B	7B	7B	7B	7B	7	7	7	7B	14	
PUERTO RICO	21	14	7	7	7	7	14	21A	21A	21A	21A	21	
SOUTH AFRICA	14A	14	7	7B	7B	7B	14	21A	21A	21A	21	21	
U. S. S. R.	7	7	7	7	7	7B	7B	14	14	7B	7B	7B	7B

## WESTERN UNITED STATES TO:

	GMT:	00	02	04	06	08	10	12	14	16	18	20	22
ALASKA	21	14	7	7	7	7	7	7	14	21A	21A	21A	21A
ARGENTINA	21A	21	14	7	7	7	7B	14A	21A	21A	21A	21A	21A
AUSTRALIA	21A	21A	14A	14	7B	7B	7B	7B	14	21	21A	21A	21A
CANAL ZONE	21	14	14	7	7	7	7	14	21A	21A	21A	21A	21A
ENGLAND	7B	7	7	7	7	7	7B	7A	21A	21	14B	7B	
HAWAII	21A	21A	21	14	7	7	7	7	14	21A	21A	21A	21A
INDIA	14B	14	7B	7B	7B	7B	7B	7A	7B	7B	7B	7B	7B
JAPAN	21A	21	14	7B	7	7	7	7	7	7B	14	21	
MEXICO	21	14	14	7	7	7	7	14	21	21A	21A	21A	21A
PHILIPPINES	21A	21	14	7B	7B	7B	7B	7	7	7	7B	14A	
PUERTO RICO	21	14	14	7	7	7	7	14	21A	21A	21A	21	
SOUTH AFRICA	21	14	7	7B	7B	7B	7B	14	21	21A	21	21	
U. S. S. R.	7B	7	7	7	7	7B	7B	14	7B	14	7B	7B	7B
EAST COAST	21A	14	7	7	7	7	7	14	21A	21A	21A	21A	21A

- A = Next higher frequency may also be useful
- B = Difficult circuit this period
- F = Fair
- G = Good
- P = Poor
- SF = Chance of solar flares

## january

sun	mon	tue	wed	thu	fri	sat
		<b>1</b>	<b>2</b>	<b>3</b>	<b>4</b>	<b>5</b>
		G	G	G	G	G
<b>6</b>	<b>7</b>	<b>8</b>	<b>9</b>	<b>10</b>	<b>11</b>	<b>12</b>
G	G	F	G	G	G	G
<b>13</b>	<b>14</b>	<b>15</b>	<b>16</b>	<b>17</b>	<b>18</b>	<b>19</b>
G	G	G	G	F	F	G
<b>20</b>	<b>21</b>	<b>22</b>	<b>23</b>	<b>24</b>	<b>25</b>	<b>26</b>
G	G	G	G	G/SF	F/SF	F/SF
<b>27</b>	<b>28</b>	<b>29</b>	<b>30</b>	<b>31</b>		
P/SF	P	F	F	F		

# MOVING?

Let us know 8 weeks in advance so that you won't miss a single issue of 73 Magazine. Attach old label where indicated and print new address in space provided. Also include your mailing label whenever you write concerning your subscription. It helps us serve you promptly. Write to:

**73 magazine**

Subscription Department  
P.O. Box 931  
Farmingdale NY 11737

- Address change only
- Extend subscription
- Enter new subscription
- 1 year \$18.00
- Payment enclosed
- Bill me later

If you have no label handy, print OLD address here.

**AFFIX LABEL**

Name \_\_\_\_\_ Call \_\_\_\_\_

Address \_\_\_\_\_

City \_\_\_\_\_ State \_\_\_\_\_ Zip \_\_\_\_\_

print NEW address here:

Name \_\_\_\_\_ Call \_\_\_\_\_

Address \_\_\_\_\_

City \_\_\_\_\_ State \_\_\_\_\_ Zip \_\_\_\_\_ 301B55

# READER SERVICE

A1	Adirondack Radio Supply.....	172	G22	G.I.S.M.O.....	142	*	Partridge Electronics, Ltd.....	171	W33	Wilson Systems, Inc.....	71-73
A94	Advanced Electronic Applications.....	26	G4	Godbout Electronics.....	180	P41	P. C. Electronics.....	153	X3	Xitex Corp.....	138
A60	AED Electronics.....	7	H24	Hal Communications.....	15, 130	P2	Poly Paks.....	183	Y1	Yaesu Electronics Corp	
A2	Aldeico.....	158	H2	Hal-Tronix.....	87	P80	Protronics, Inc.....	153			CII, 25, 133
A21	Amateur-Wholesale Electronics.....	23, 26, 174	H16	Ham Radio Center.....	14, 52	Q3	Quest Electronics.....	175			From 73.....70, 115, 129, 189-194
A106	AMC Engineering.....	155	H50	Hamtronics, NY.....	176	R1	Radio Amateur Callbook.....	20			From 80 Microcomputing.....
A58	American Crystal Supply.....	129	H3	Heath Co.....	13	*	Radio World.....	158			
*	AMSAT.....	114	H44	Henry Radio.....	CII	R39	Radios International.....	147			
A6	Aptron Laboratories.....	41	I27	HFT, Inc.....	173	R8	Ramsey Electronics.....	185			
A105	AR Technical Products.....	50, 153	J1	ICOM.....	59	R27	RF Power Labs, Inc.....	90			
*	Associated Radio.....	182	J2	iRL.....	153	S63	Semiconductors Surplus.....	177			
A93	Avanti Research & Development.....	113	J7	Jameco Electronics.....	141, 181	S33	S-F Amateur Radio Services				
B23	Barker-Williamson.....	43	*	Jan Crystals.....	155	S130	Signalcrafters, Inc.....	20, 27			
B8	Bullet Electronics.....	188	*	Jensen Tools, Inc.....	158	S4	Slep Electronics Co.....	173			
C162	Castle Publishing.....	158	*	Kantronics.....	155	S117	Spacecoast Research.....	158			
C3	Clegg.....	45	*	KB Microcomputing.....	51	S81	Spectronics, Inc.....	178, 179			
C58	Communications Center, NE		K4	Kenwood.....	CIV, 5	S8	Spectrum Communications				
C6	Communications Specialists	10, 11	L28	KLM Electronics.....	69	S43	Surplus Electronics.....	184			
C90	Curtis Electro Devices.....	147	L9	LaRue Electronics.....	158	S44	Swan Electronics.....	74, 75			
*	Dade County Radio Club.....	44	L17	Long's Electronics.....	100-105	T64	Technical Clinic.....	173			
D6	Peter W. Dahl Company.....	41	M35	Lunar Electronics.....	90	T52	Tele-Tow'r Mfg. Co.....	20			
*	Digital Research Parts.....	186	M36	Madison Electronics Supply	50, 111	*	Ten-Tec, Inc.....	9, 116, 148			
D11	R. L. Drake Co.....	79	M100	Maggiore Electronic Lab.....	171	T55	TET, USA.....	29			
D25	DSI Instruments	26, 119, 121, 123, 125	M52	Metz Communication Corp	137	T77	Texas Towers.....	173			
D73	Dynamic Electronics, Inc.....	171	M52	MFJ Enterprises	39, 43, 45, 91, 95	T34	Thomas Communications.....	134			
*	Eagle Electronics.....	43	M8	MHZ Electronics.....	160-169	T18	Trac Electronics, Inc.....	91			
*	Electronics Book Club.....	19	M55	Microlog Corp.....	81	T76	Tri-Ex Tower Corp.....	41			
F1	Fair Radio Sales.....	173	M62	Mid Com Electronics, Inc.....	114	T3	Tufts Radio Electronics	88, 89, 158			
F5	Flesher Corporation.....	7	M76	M & M RF Distributors/Lunar	35	U13	Ultima Electronics, Ltd.....	173			
G27	Gemini Instrument Co.....	173	M128	MOM'S.....	68, 69	U8	United Products.....	187			
G12	Germantown Amateur Supply	109	O5	OK Machine & Tool.....	139, 147	V24	Vibroplex.....	172			
			O3	Optoelectronics, Inc.....	17, 148	W18	Western Electronics.....	172			
			O12	Outdoor Outfitters.....	43	*	Wheaton Community Radio				
			*	Palomar Engineers.....	7		Amateurs.....	39			
						W2	Wilson Electronics.....	3			

\*Reader Service inquiries not honored. Please contact advertiser directly.

# BOOKS, ETC.

BK1016	73 DIPOLE & LONG WIRE ANTENNAS.....	\$ 5.50	BK7305	POWER SUPPLY HANDBOOK.....	\$ 7.95
ST0000	73 BACK ISSUE.....	\$ 3.00	BK1015	PRACTICAL ANTENNAS FOR THE RADIO AMATEUR.....	\$ 9.95
ST2500	73 BACK ISSUES—25 OUR CHOICE.....	\$12.00	BK7302	PROPAGATION WIZARD'S HANDBOOK.....	\$ 6.95
ST0500	73 BACK ISSUES—5 YOUR CHOICE.....	\$ 8.75	QW0250	QSL CARDS—STYLE W—250.....	\$ 8.95
ST1000	73 BACK ISSUES—10 YOUR CHOICE.....	\$14.00	QW0500	QSL CARDS—STYLE W—500.....	\$13.95
ST2501	73 BACK ISSUES—25 YOUR CHOICE.....	\$25.00	QX0250	QSL CARDS—STYLE X—250.....	\$ 8.95
BK7307	BEHIND THE DIAL.....	\$ 4.95	QX0500	QSL CARDS—STYLE X—500.....	\$13.95
BN1001	BINDER—73—1.....	\$ 6.50	QY0250	QSL CARDS—STYLE Y—250.....	\$ 8.95
BN1002	BINDER—73—2 AND UP.....	\$ 6.00	QY0500	QSL CARDS—STYLE Y—500.....	\$13.95
BK7309	CHALLENGE OF 160.....	\$ 4.95	BK7346	1979 WORLD REPEATER ATLAS.....	\$ 4.95
CT7305	CODE TAPE—5 WPM.....	\$ 4.95	BK1044	RF DIGITAL TEST EQUIPMENT.....	\$ 5.95
CT7306	CODE TAPE—6+ WPM.....	\$ 4.95	BK7347	RTTY HANDBOOK.....	\$ 5.95
CT7310	CODE TAPE—10+ WPM.....	\$ 4.95	BX1000	SHELF BOX—1.....	\$ 2.00
CT7313	CODE TAPE—13+ WPM.....	\$ 4.95	BX1001	SHELF BOXES—2.....	\$1.50 each
CT7320	CODE TAPE—20+ WPM.....	\$ 4.95	BX1002	SHELF BOXES—8 AND UP.....	\$1.25 each
CT7325	CODE TAPE—25+ WPM.....	\$ 4.95	BK7351	SSB THE MISUNDERSTOOD MODE.....	\$ 5.50
CT7394	CODE TAPES (ANY FOUR ABOVE).....	\$15.95	BK7354	SSTV HANDBOOK (HARDCOVER).....	\$ 7.00
BK7308	THE CONTEST COOKBOOK.....	\$ 5.95	BK7355	SSTV HANDBOOK (SOFTCOVER).....	\$ 5.00
BK7321	GUIDE TO HAM RADIO.....	\$ 4.95	CT7350	SSTV TAPE.....	\$ 5.95
BK7304	GIANT BOOK OF AMATEUR RADIO ANTENNAS.....	\$12.95	SG1081	STUDY GUIDE—ADVANCED CLASS.....	\$ 6.95
BK7325	HOW TO BUILD A MICROCOMPUTER & REALLY UNDERSTAND IT.....	\$ 9.95	SG1080	STUDY GUIDE—EXTRA CLASS.....	\$ 5.95
BK1028	IC OP AMP COOKBOOK.....	\$12.95	SG7358	STUDY GUIDE—GENERAL CLASS.....	\$ 5.95
BK7380	INTRO TO RTTY.....	\$ 2.00	SG7357	STUDY GUIDE—NOVICE CLASS.....	\$ 4.95
CT7300	NOVICE THEORY TAPES.....	\$15.95	LB7359	TEST EQUIP LIB V1—COMP TESTERS.....	\$ 4.95
BK7310	OWNER REPAIR OF AMATEUR RADIO EQUIPMENT.....	\$ 7.95	LB7360	TEST EQUIP LIB V2—AUDIO TESTERS.....	\$ 4.95
			LB7361	TEST EQUIP LIB V3—RADIO EQUIP.....	\$ 4.95
			LB7362	TEST EQUIP LIB V4—IC TEST EQUIP.....	\$ 4.95
			BK7348	TOOLS & TECHNIQUES.....	\$ 4.95
			BK1069	VERTICAL BEAM & TRIANGLE ANTNS.....	\$ 5.50
			BK7368	VHF ANTENNA HANDBOOK.....	\$ 4.95
			BK7370	WEATHER SATELLITE HANDBOOK.....	\$ 4.95

### READER SERVICE REPLY CARD

Return this card to receive full information on the many products advertised in this issue. Limit: 25 requests.  Subscriber  Newsstand. This card is valid until March 31, 1980

A1	B23	F5	M52	P80	S44	T76
A2	C3	G4	M55	P86	S63	T77
A6	C6	G12	M62	Q3	S81	U8
A21	C58	G22	M76	R1	S117	U13
A58	C90	G27	M100	R8	S130	V24
A60	C162	H2	M128	R27	T3	W2
A93	D6	H3	O3	R39	T18	W18
A94	D11	H16	L28	O5	S4	T34
A105	D25	H24	M8	C12	S8	T52
A106	D73	H44	M35	P2	S33	T55
B8	F1	H50	M36	P41	S43	T64



This month's **ARTICLE WINNER** (title page number): \_\_\_\_\_

Name \_\_\_\_\_ (PLEASE TYPE OR PRINT CLEARLY)

Address \_\_\_\_\_

City \_\_\_\_\_ State \_\_\_\_\_ Zip \_\_\_\_\_

15

**READER SERVICE** To receive more information from any of the advertisers in this issue of 73, postage-paid return cards are provided here for your convenience. If you wish to hear from one or several advertisers, refer to the ad itself. You will find numbers near the logo of each advertiser. Each represents the advertiser's individual **Reader Service Number**. Circle the corresponding numbers on one of the cards on this page, include your name, address & zip, and drop in a mailbox. In 4-6 weeks you'll hear from the advertiser directly.

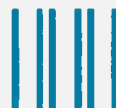

### BUSINESS REPLY CARD

FIRST CLASS PERMIT NO. PETERBOROUGH NH 03458

POSTAGE WILL BE PAID BY ADDRESSEE

**73 magazine**  
Peterborough NH 03458

NO POSTAGE  
NECESSARY  
IF MAILED  
IN THE  
UNITED STATES

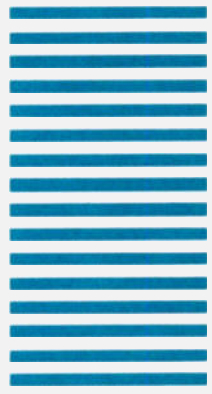

Att: Mail Order

### READER SERVICE REPLY CARD

Return this card to receive full information on the many products advertised in this issue. Limit: 25 requests.  Subscriber  Newsstand. This card is valid until March 31, 1980

A1	B23	F5	I27	M52	P80	S44	T76
A2	C3	G4	J1	M55	P86	S63	T77
A6	C6	G12	J2	M62	Q3	S81	U8
A21	C58	G22	J7	M76	R1	S117	U13
A58	C90	G27	K4	M100	R8	S130	V24
A60	C162	H2	L9	M128	R27	T3	W2
A93	D6	H3	L17	O3	R39	T18	W18
A94	D11	H16	L28	O5	S4	T34	W33
A105	D25	H24	M8	C12	S8	T52	X3
A106	D73	H44	M35	P2	S33	T55	Y1
B8	F1	H50	M36	P41	S43	T64	



This month's **ARTICLE WINNER** (title page number): \_\_\_\_\_

Name \_\_\_\_\_ (PLEASE TYPE OR PRINT CLEARLY)

Address \_\_\_\_\_

City \_\_\_\_\_ State \_\_\_\_\_ Zip \_\_\_\_\_

15

73 magazine



FT-707 is shown with optional FV-707DM VFO & Scanning Microphone



## THE FT-707 "WAYFARER"

The introduction of the "WAYFARER" by Yaesu is the beginning of a new era in compact solid state transceivers. The FT-707 "WAYFARER" offers you a full 100 watts output on 80-10 meters and operates SSB, CW, and AM modes. Don't let the small size fool you! Though it is not much larger than a book, this is a full-featured transceiver which is ideally suited for your home station or as a traveling companion for mobile or portable operation.

The receiver offers sensitivity of .25 uV/10 dB SN as well as a degree of selectivity previously unavailable in a package this small. The "WAYFARER" comes equipped with 16 poles of IF filtering, variable bandwidth and optional crystal filters for 600 Hz or 350 Hz. Just look at these additional features:

### FT-707 with Standard Features

- Fast/slow AGC selection
- Advanced noise blanker
- Built-in calibrator
- WWV/JJY Band
- Bright Digital Readout
- Fixed crystal position
- 2 auxiliary bands for future expansion
- Unique multi-color bar metering—monitors signal strength, power output, and ALC voltage.

### FT-707 with Optional FV-707DM & Scanning Microphone

- Choice of 2 rates of scan
- Remote scanning from microphone
- Scans in 10 cycle steps
- Synthesized VFO
- Selection of receiver/transmitter functions from either front panel or external VFO
- "DMS" (Digital Memory Shift)

Impressive as the "WAYFARER" is its versatility can be greatly increased by the addition of the FV-707DM (optional). The FV-707DM, though only one inch high, allows the storage of 13 discrete frequencies and with the use of "DMS" (Digital Memory Shift) each memory can be band-spread 500 KHz. These 500 KHz bands may be remotely scanned from the microphone at the very smooth rate of 10 Hz steps.

The FT-707 "WAYFARER" is a truly unique rig. See it today at your authorized Yaesu Dealer.

**YAESU**  
*The radio.*



YAESU ELECTRONICS CORP., 6851 Waltham Way, Paramount, CA 90723 ● (213) 633-4007  
YAESU ELECTRONICS Eastern Service Ctr., 9812 Princeton-Glendale Rd., Cincinnati, OH 45246

# TS-520SE



## "Cents-ability" in a quality HF Rig!

The TS-520SE is an economical new version of the TS-520S... the world's most popular 160-10 meter Amateur transceiver. Now anyone can easily afford a high quality HF transceiver, providing 200 watts PEP input on SSB and 160 watts DC on CW!

The TS-520SE is a high-quality 160-10 meter SSB/CW transceiver intended for ham-shack use. The following changes were made to produce the new "SE" model:

- Replaced the heater switch with a CW WIDE/NARROW bandwidth switch, for use with the optional CW-520 500-Hz CW filter. A big improvement for the CW operator!
- Removed DC converter terminals. Now it operates strictly on 120 VAC and is not intended for mobile use.
- Removed transverter terminals. Now it is strictly a 160-10 meter SSB/CW transceiver. (DG-5 Digital Display is optional).

Ask your Authorized Kenwood Dealer about the amazing TS-520SE...and its surprisingly affordable price!

 **KENWOOD**  
...pacesetter in amateur radio

TRIO-KENWOOD COMMUNICATIONS INC.  
1111 WEST WALNUT/COMPTON, CA 90220