

73 Magazine

for Radio Amateurs

- 28 **Five-Chip Auto IDer**
—in case you forget..... Bartholomew
- 29 **The Vacationer**
—B&W's portable antenna..... WA2ALT
- 30 **Tone Decoder Improvements**
—another step toward perfection..... WA1LMV
- 32 **The All-Wrong Power Supply**
—works in spite of itself..... WA3EEC
- 33 **The Hardhearted Rf Detector**
—insensitive to harmonics..... N4ES
- 34 **Custom-Designed Power Supplies**
—try the 723..... K2GEJ
- 39 **A Touch of Class**
—nifty \$35 operating console..... WA4CUD
- 40 **How To Bury Coax**
—the garden cultivator technique..... W4MEA
- 42 **Mobile Antenna Ingenuity**
—cheap HF radiators..... WA8ATE
- 46 **Impedance and Other Ogres**
—another look at swr..... Staff
- 50 **The Active Filter Cookbook**
—review of Lancaster's treatise..... VE2BVW
- 52 **A Rock-Solid AFSK Oscillator**
—hooray for stability!..... WB4MBL
- 54 **Pulser Plus**
—a one-shot with more..... VE2BVW
- 56 **Oh, My Poor Quad!**
—measuring wind speed..... K2CL
- 58 **A Self-Contained, Fully-Automated, Transistorized Fuse Tester**
—amaze your friends..... G3TAI
- 60 **Don't Get Burgled!**
—build this simple alarm..... Fletcher
- 61 **Power x 2**
—dual auto batteries..... Miller
- 62 **Experimenting with Tones**
—fun with functions..... W2FPP
- 64 **Synthesize Your Ash Tray**
—article for non-smokers..... WB9VWM
- 66 **Attention, Satellite Watchers!**
—a solid-state monitor for GOES..... WB8DQT
- 78 **Batteries Dead?**
—take preventative measures..... Staff
- 80 **How to Nab a Jammer**
—another use for 220..... WB0CMC
- 84 **This Station Plays Beautiful CW**
—with a Morse keyboard..... WB9WRE
- 92 **The Cure for Migraines**
—a low-pass CW filter..... Harper
- 94 ** An 8080 Repeater Control System**
—part I: an overview..... N3IC
- 106 ** The Cosmac Connection: Part 2**
—meeting Mr. Morse..... VE3CWY
- 110 ** Learning the Code**
—a better way..... Waldie
- 116 ** Books for Beginners**
—you have to start somewhere!..... WA7NEV
- 118 **The 2 Meter ECM Caper**
—James Bond, move over!..... W2JTP
- 120 **"I Love My Ten-Tec!"**
—a look at the 540/544..... WA0JIH
- 122 **A \$5 Phone Patch**
—the darn thing really works..... WA6RJK
- 136 **The Filcher Foiler Revisited**
—vehicular protection..... Davis
- 137 **Build An Economy Zener Checker**
—versatile test rig..... W4RBL
- 140 **Alaskan Adventure**
—stalking the elusive KL7..... WB5WDG
- 142 **The Last DXpedition**
—“QTH hr is Purgatory”..... K3FDL
- 144 **An Audio Morse Memory**
—got a tape recorder?..... WB6WQN
- 146 **The Amazing Active Attenuator**
—can you find a use for it?..... VE2BVW
- 148 **A Single IC Time Machine**
—amazing clock..... K6SK
- 156 **Car Battery Charger**
—junk-box special..... W1DWZ
- 160 **Immortality for Vacuum Tubes?**
—build a solid state tube saver..... K5KXM
- 163 **The Hot Mugger X1**
—coffee drinkers, rejoice..... WB9QZE
- 164 **Build the Mini-Probe**
—it's only logical..... Rister

PORTABLE... MOBILE... BASE STATION

the TEMPO SYNCOM S1

DOES IT ALL AND GIVES YOU

800 CHANNELS



*Shown with accessory touch tone pad

Top view
showing controls

TEMPO PRESENTS THE WORLD'S FIRST SYNTHESIZED 800 CHANNEL HAND HELD TRANSCEIVER

This amazing pocket sized radio represents the year's biggest breakthrough in 2-meter communications. Other units that are larger, heavier and are similarly priced can offer only 6 channels. The SYNCOM'S price includes the battery pack, charger, and a telescoping antenna. But, far more important is the 800 channels offered by the S1.

The optional touch tone pad adds greatly to its convenience and the addition of a Tempo solid state amplifier adds tremendously to its power.

SPECIFICATIONS

Frequency Coverage: 144 to 148 MHz
Channel Spacing: Receive every 5 kHz, transmit Simplex or +600 kHz

Power Requirements: 9.6 VDC
Current Drain: 17 ma-standby
500 ma-transmit
8 pieces ni-cad battery included

Batteries: 50 ohms
Antenna Impedance: 40 mm x 62 mm x 165 mm (1.6" x 2.5" x 6.5")

Dimensions: 40 mm x 62 mm x 165 mm (1.6" x 2.5" x 6.5")
RF Output: Better than 1.5 watts
Sensitivity: Better than .5 microvolts

Price... \$349.00 With touch tone pad... \$399.00

SUPPLIED ACCESSORIES

Telescoping whip antenna, ni-cad battery pack, charger.

OPTIONAL ACCESSORIES

Touch tone pad: \$55 • Tone burst generator: \$29.95 • CTCSS sub-audible tone control: \$29.95 • Rubber flex antenna: \$8 • Leather holster: \$16 • Cigarette lighter plug mobile charging unit: \$6 • Matching 30 watt output 13.8 VDC power amplifier (S30): \$89 • Matching 80 watt output power amplifier (S80): \$149

TEMPO VHF & UHF SOLID STATE POWER AMPLIFIERS

Boost your signal... give it the range and clarity of a high powered base station. VHF (135 to 175 MHz)

Drive Power	Output	Model No.	Price
2W	130W	130A02	\$209
10W	130W	130A10	\$189
30W	130W	130A30	\$199
2W	80W	80A02	\$169
10W	80W	80A10	\$149
30W	80W	80A30	\$159
2W	50W	50A02	\$129
2W	30W	30A02	\$ 89

UHF (400 to 512 MHz) models, lower power and FCC type accepted models also available.

The Tempo line also features a fine line of extremely compact UHF and VHF pocket receivers. They're low priced, dependable, and available with CTCSS and 2-tone decoders. The Tempo FMT-2 & FMT-42 (UHF) provides excellent mobile communications and features a remote control head for hide-away mounting.

The Tempo FMH-2, FMH-5 & FMH-42 (UHF) hand held transceivers provide 6 channel capability, dependability and many worthwhile features at a low price. FCC type accepted models also available.

Please call or write for complete information. Also available from Tempo dealers throughout the U.S. and abroad.

11240 W. Olympic Blvd., Los Angeles, Calif. 90064 213/477-6701
931 N. Euclid, Anaheim, Calif. 92801 714/772-9200
Butler, Missouri 64730 816/679-3127

Henry Radio

Prices subject to change without notice

THE SYSTEM THREE TRIBANDER ANTENNA . . .

Top Performance for 20 - 15 - 10 Meters!

NEW!

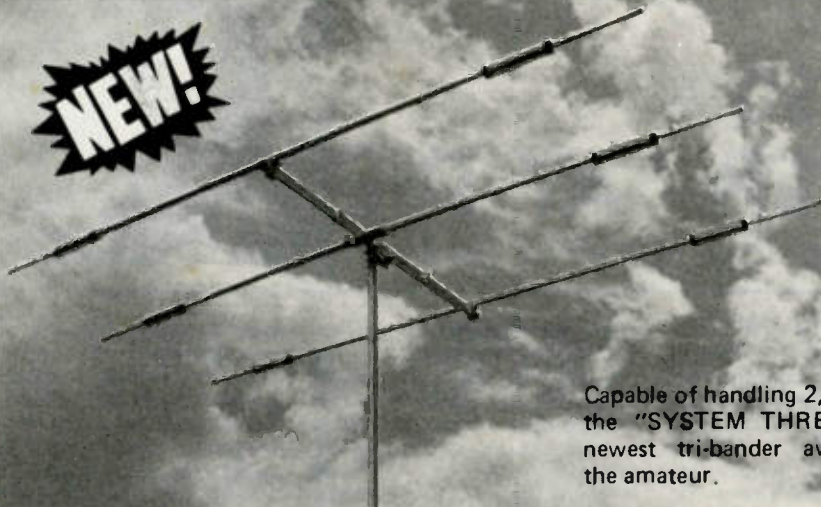

Wilson SY-3

SPECIFICATIONS

Band MHz	14-21-28
Maximum power input	Legal limit
Gain (dBd)	8 dB
VSWR at resonance	1.3:1
Impedance	50 ohms
F/B ratio	20 dB
Boom (O.D. x length)	2" x 14' 4"
No. of elements	3
Longest element	27' 4"
Turning radius	15' 9"
Maximum mast diameter	2" O.D.
Surface area	5.7 sq. ft.
Wind loading at 80 mph	114 lbs.
Assembled weight (approx.)	37 lbs.
Shipping weight (approx.)	42 lbs.
Direct 52 ohm feed or balun	
Maximum wind survival	100 mph

Capable of handling 2,000 watts, the "SYSTEM THREE" is the newest tri-bander available to the amateur.

Designed and produced by one of the world's largest antenna manufacturers, the traditional quality of workmanship and materials continues on with the "SYSTEM THREE". The special heavy-duty vise-like extruded aluminum clamps on the reflector and director are a key point in the design of strength and durability. Superior clamping power is obtained with the use of a rugged 1/4" thick aluminum plate for boom to mast mounting. The use of large diameter High-Q Traps in the "SYSTEM THREE" makes it a high performing tri-bander with a very economical price. A complete step-by-step illustrated instruction manual guides you to easy assembly and the lightweight antenna makes installation of the "SYSTEM THREE" quick and simple.

ACTUAL SWR CURVES

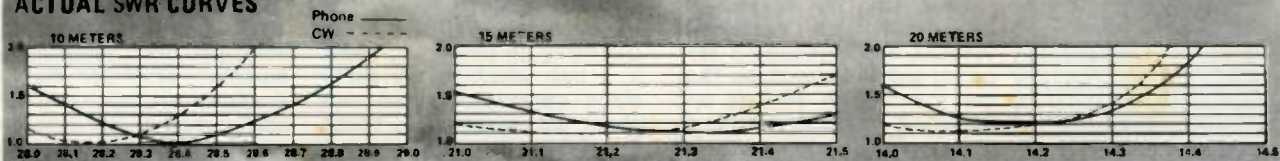

40 THRU 10 METERS VERTICAL TRAP

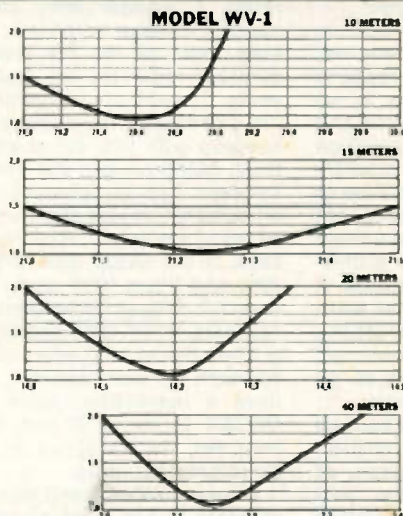

WV-1 WILSON VERTICAL TRAP ANTENNA

No bandswitching necessary with this vertical. An excellent low cost DX antenna with an electrical quarter wavelength on each band and low angle radiation. Advanced design provides low SWR and exceptionally flat response across full width of each band. Featured is the Wilson large diameter High-Q traps which will maintain resonant points with varying temperatures and humidity. Easily assembled, the WV-1 is supplied with base mount bracket to attach to vent pipe or to mast driven in the ground. The new WV-1 Antenna is value priced . . . and ships via UPS!

SPECIFICATIONS

Input Impedance: 50 ohms • Powerhandling capability: Legal Limit • Two High-Q Traps with large diameter coils • Low Angle Radiation Omnidirectional performance • Taper Swaged Aluminum Tubing • Automatic Bandswitching • Mast Bracket furnished • SWR: 1.1:1 on all Bands • 1 1/2" O.D. heavy wall aluminum tubing • Does not require guying • Overall length: 19' 8"

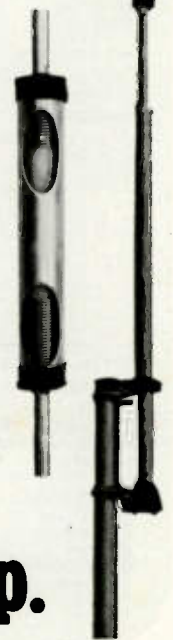

W2

Consumer Products Division



Wilson Electronics Corp.

P. O. Box 19000 • Las Vegas, Nevada 89119 • (702) 739-1931 • Telex 684-522

Prices and specifications subject to change without notice.

Staff

EDITOR/PUBLISHER
Wayne Green W2NSD/1

EXECUTIVE VICE PRESIDENT
Sherry Smythe

ASSISTANT PUBLISHER
Jeffrey D. DeTray WB8BTH/1

ADMINISTRATIVE ASSISTANT
Dotty Gibson

MANAGING EDITOR
John C. Burnett

ASSISTANT MANAGING EDITOR
Susan G. Philbrick

NEWS EDITOR
Gene Smarte WB6TOV/1

EDITORIAL ASSISTANTS
Elisabeth Blackmore
Cynthia Smith
Richard Phenix

BOOK PUBLICATIONS
Beth Weston

PRODUCTION MANAGER
Lynn Panciera-Fraser

ART DEPARTMENT
Craig Brown
Gayle Cabana
Bob Drew
Bruce Hedin
Dion Owens
Noel R. Self WB1ARP
Robin M. Sloan

PRINTING
Gary Steinbach
Dan Morgan
Dwight Perry

PHOTOGRAPHY
Bill Heydolph
Tedd Cluff

TYPESETTING
Barbara J. Latti
Mary Kinzel
Holly J. Walsh
Sara Bedell

BOOKKEEPER
Knud E. M. Keller KV4GG/1

CIRCULATION
Barbara Block
Laura Barnicle

DATA ENTRY
Mary Kinzel
Denise Loranger

DIRECTOR OF MARKETING
Robert R. LaPointe

BULK SALES MANAGER
Judy Waterman

SHIPPING
Ethan Perry
Bill Barry
Michelle Walsh

RECEPTIONIST
Maureen Smith

ASSOCIATES
Robert Baker WB2GFE
E. H. Barnett WB0IIX
Schley Cox WB9LHO
Tom DiBlase WB8KZD
Terry Fox WB4JFI
W. Sanger Green
Dave Ingram K4TWWJ
Larry Kahane WB2NEL
Joe Kasser G3ZCZ
Bill Pasternak WA6ITF
John Schultz W4FA
Waller Scott K8DIZ
Peter Stark K2QAW
Chuck Stuart N5KC
Bill Turner WA0ABI

COMPUTER PROGRAMMING
Richard J. Dykema

CUSTOMER SERVICE
Florence Goldman
Joyce Tarr
Ellen Blanchard

ADVERTISING
Aline Couto
Marcia Stone
Bill York
Nancy Ciampa
Rita Rivard

W2NSD/1 NEVER SAY DIE

editorial by Wayne Green



ATLANTA IN JUNE

Dayton is still the largest hamfest in the country, but Atlanta is undoubtedly the second largest—and closing in on Dayton. Atlanta has two major pluses and one minor plus which Dayton doesn't have. The biggest plus is the city of Atlanta, with its incredible variety of entertainment and restaurants. That in itself is worth the visit. The second big plus is the masterful planning and enthusiasm of Chaz Cone W4GKF, the magician who has put this show together.

Chaz, with the help of co-chairman Bob Verlander W4BCD, has organized a fast-paced and well-run show. They get the best in exhibits and somehow manage to bring in standing-room-only crowds for the forums. Perhaps it is the number and quality of the prizes that are responsible for keeping the place packed, even on Sunday. This is the *only* hamfest I've ever seen where it is even more packed on Sunday than on Saturday.

The minor plus, at least to some of us, is that I have an opportunity to speak in Atlanta... which I don't at Dayton. Last year at Atlanta, I held one session on current events in amateur radio and another on current events in microcomputing. I expect I'll be doing the same this year.

My ham session might be a good place for ARRL cultists to come to discover what many amateurs already know... that I don't hate the ARRL. It may be time to bring this out in the open and talk about it. You know, it's funny about that... when I'm critical of the FCC, everyone nods in agreement, and I don't hear any cries of anguish about me being anti-FCC. When I'm critical of our government, I

don't get anything but agreement. When I'm critical of the League, then I'm "slamming" them. Baloney. Why should the League be a sacred cow, with people having apoplexy at criticism? Is the ARRL a religion? Let's put these things into perspective and not let a cult mind rule out intelligent discussion of ham events.

Sure, I suppose I should be more political and not so direct. If you don't offend anyone, you have no enemies... but neither have you any share in the satisfaction of helping to improve the world a notch. When I see something wrong, I speak out and try to do something about it, a trait which makes politicians nervous. I speak out about the government, about the FCC, the ARRL, civil defense, and anything else where I see things going wrong. Yes, and I expect to get stoned for my trouble... though I don't enjoy it. Can you name one person who has spoken out who didn't make people angry?

One of the things I believe in is amateur radio. I believe that our hobby is one of the reasons why the United States is so outstanding in electronics and communications. Over a million of the people in this country have been hams at one time or another, and this personal spark of self-interest sets them aside from the strictly professional technician or engineer. A ham will usually go that extra distance to get something done, while the "professional" knocks off at 5:00 pm to go home and watch television.

Amateur radio has changed the lives of these million kids... and the course of events for our country. Just look at the amazing correlation between the development of foreign countries and the

number of their hams listed in the *Callbook*... do you really think that is a coincidence? We all know that hams discovered and pioneered most of the presently-used radio techniques... and would have worked out a lot more if they hadn't had the FCC fighting them at every turn for years.

Whether a amateur radio means rag chewing, building special projects, civil defense, emergency nets, contests, DXing, repeaters... whatever it means, I feel that amateurs are part of a special breed which is very important to the world. Before you put down the jerk who sits there clunking the repeater, remember that with the right motivation this fellow may suddenly get into some special interest in amateur radio and pioneer a whole new mode of communications. I try to provide as much of this spark as I can with the articles in 73.

When I hear or read that I'm trying to tear down amateur radio, I wonder who could possibly believe such bunk. I've built most of my life around amateur radio for the last 25 years... and that is most of my life. I've made it my business to keep up with just about everything going on and the people involved. I've participated with enthusiasm in just about every phase of the hobby, starting out back in the 1930s with CW on 40m and 2½m VHF work. I've been into DXing, DXpeditioning, contests, RTTY, SSB, and SSTV, got into FM and repeaters in the 60s with my own repeater, and have a reasonable score via OSCAR in mode B (the hard one). No, I'm not about to tear down amateur radio.

Come to Atlanta, and let's get together to see if we all aren't

Continued on page 166

Instant recall. (And 25 watts of power)



Kenwood's exciting 25-watt TR-7625 and optional RM-76 Microprocessor Control Unit...gives you the power you want plus outstanding channel memory and scanning capabilities.

... there's more! The TR-7625 has a lot of versatility for a 2-meter FM transceiver, and when teamed up with the RM-76 gives you a lot of rig. Check these features for both:

TR-7625 (only)

- Memory channel...with simplex or repeater (± 600 kHz transmitter offset) operation.
- Mode switch for operating simplex or for switching the transmit frequency up or down...or for switching the transmitter to the frequency you have stored in the TR-7625's memory (while the receiver remains on the frequency you have selected).
- Dual concentric knobs for fast, easy selection of any 2-meter frequency, in 100-kHz and 10-kHz steps.
- Full 4-MHz coverage (144.000–147.995) on 2-meters; 800 channels; 5-kHz offset switch, and MHz selector switch...for desired band (144, 145, 146, or 147 MHz).
- Digital frequency display (large, bright, orange LEDs).

- UNLOCK indicator...an LED that indicates transceiver protection when the frequency selector switches are improperly positioned or the PLL is not locked.

TR-7625 WITH RM-76

- Store frequencies in six memories (simplex/repeater).
- Scan all memory channels.
- Automatically scan up the band in 5-kHz steps.
- Manually scan up or down in 5-kHz steps (or fast tune).
- Set lower and upper scan frequency limits.
- Stop scan (with HOLD button).
- Clear scan (for transmitting).
- Adaptable to all MARS frequencies.
- Select repeater mode (simplex, transmit frequency offset (± 600 kHz or ± 1 MHz), or one memory transmit frequency).
- Scan for busy or open channel.
- Display indicates frequency (even while scanning) and functions (such



as auto-scan, lower scan frequency limit, upper scan limit, and error, i.e. transmitting out of band).

See the new TR-7625 and optional RM-76 now at any Authorized KENWOOD Dealer!



KENWOOD
...pacesetter in amateur radio

TRIO-KENWOOD COMMUNICATIONS INC.
1111 WEST WALNUT/COMPTON, CA 90220

GET MORE THAN YOU BARGAIN FOR

at a TEN-TEC franchised dealer

Buying amateur radio equipment is more than looking for the best price. It's all the extras you get from an involved, active dealer who has your best interests at heart—a TEN-TEC franchised dealer . . .

- **FREE HELP — GOOD ADVICE**

Investing in amateur radio equipment is a substantial move in personal finances, so it pays to get all the advice and help you can. Your TEN-TEC dealer has been franchised because he's the kind of expert we want to serve you—knowledgeable, honest, willing to spend the time you need to make the right decision.

- **FULL LINE DISPLAY**

There's no substitute for a first-hand look and trial when it's time to select your new gear. And your TEN-TEC dealer has our major models on display—even the manuals for each so you can check out every detail, every specification.

- **FAST DELIVERY**

Part of the joy of buying anything is taking it home with you. Once you've made up your mind, there's usually no need to wait for delivery with a TEN-TEC dealer. He will either have your model in stock (if it is an established one), or be among the first to receive new products.

- **FAIR PRICES**

Your TEN-TEC dealer is in business to make a living. His best price will be a fair price—one that is satisfactory to both of you. That way he will stay in business to provide all the services you want . . . new products, stores of needed items for emergencies, help for beginners, and just being there when you need him.

- **FREE WARRANTY SERVICE**

The TEN-TEC warranty is one of the most liberal in amateur radio, simple to understand, and fair. And your TEN-TEC dealer is ready to provide complete warranty service to your satisfaction—most of the time without your having to return anything to the factory.

- **AFTER WARRANTY SERVICE**

Your TEN-TEC dealer won't forget about you if trouble arises. He's right there with the facilities to get you back on the air quickly. And he does it all at reasonable cost.

You can count on your TEN-TEC dealer—he's franchised by the TEN-TEC factory because he's a man who is ready to help—to give you more than you bargain for.

There's a franchised TEN-TEC dealer near you . . .

Alabama

Long's Electronics, Birmingham
Younce Electronics, Mobile

Arizona

The Ham Shack, Phoenix

California

Ham Radio Outlet, Anaheim
Henry Radio, Anaheim
Ham Radio Outlet, Burlingame
The Base Station, Concord
Fontana Electronics, Fontana
Cohoon Amateur Supply West, Lompac
Loomis Electronics, Loomis
Henry Radio, Los Angeles
Dave's TV-CB & Stereo, Mentone
Vineyard Amateur Radio Sales, Oxnard
Electronics Emporium, San Diego
Ham Radio Outlet, San Diego
Quement Electronics, San Jose
Shaver Radio, Santa Clara
Ham Radio Outlet, Van Nuys

Colorado

Burstein-Applebee Company, Denver
CW Electronics, Denver

Connecticut

Hatry Electronics, Hartford
Thomas Communications, Newington

Delaware

Delaware Amateur Supply, New Castle

Florida

Ray's Amateur Radio, Clearwater
Sunrise Amateur Radio, Ft. Lauderdale
N & G Distributing Company, Miami
Amateur Electronic Supply, Orlando
Contemedia Communications Systems,
Tallahassee

Georgia

ZZZ Electronics Incorporated, Atlanta
Radio Wholesale, Columbus

Hawaii

Delcoms-Hawaii, Aiea

Idaho

Action Supply Company, Boise
Ross Distributing Company, Preston

Illinois

Magnus Electronics, Chicago
Organs & Electronics, Lockport
Spectronics Incorporated, Oak Park
Klaus Radio, Peoria

Indiana

Lakeland Electronic Supply, Angola
Kryder Electronics, Ft. Wayne
Graham Electronic Supply Inc., Indianapolis
Electrocom Industries, South Bend
Radio Distributing Company, South Bend
Hoosier Electronics, Terre Haute

Iowa

Hi Incorporated, Council Bluffs
Bob Smith Electronics, Ft. Dodge

Kansas

Associated Radio Communication,
Overland Park
Electronics Inc., Salina
Amateur Radio Equipment Co., Wichita

Kentucky

Cohoon's Amateur Service, Hopkinsville
Mobile Communications, Louisville

Maryland

The Comm Center, Laurel
Electronics Intl. Service Corp., Wheaton

Massachusetts

C. B. Wilkins Company, Greenfield
Tufts Radio Electronics, Medford

Michigan

Purchase Radio Supply, Ann Arbor
Radio Supply & Engineering Co., Detroit
Omar Electronics, Durand
Radio Parts Incorporated, Grand Rapids
Femis Radio, Hazel Park
H. R. Electronics, Muskegon

Minnesota

Electronic Center Incorporated, Minneapolis

Mississippi

Electronic World Incorporated, Pascagoula
Communication Services, Philadelphia

Missouri

Henry Radio Butler, Butler
Burstein-Applebee Company, Kansas City
Ham Radio Center Inc., St. Louis
Mid-Com Electronics, St. Louis

Montana

Conley Radio Supply, Billings

Nebraska

Communication Center, Lincoln
Omaha Amateur Center, Omaha

Nevada

Communications Center West, Las Vegas

New Hampshire

Evans Radio Incorporated, Concord
Evans Radio Inc., Nashua
Evans Radio Incorporated, Portsmouth

New Jersey

Atkinson & Smith, Eatontown
Radios Unlimited, Somerset

New York

Adirondack Radio Supply, Amsterdam
Caledonia Community Outfitters, Caledonia
Ham Bone, Dewitt
Grand Central Radio, New York
Jr's CB Radio Supply, Rochester
Radio World, Rome
Ham Shack Electronics, Watertown
Hirsh Sales Company, Williamsville

North Carolina

Georgetown Communications, Asheville
Bi-Comm, Greensboro
Sep Electronics, Otto
Bob's Amateur Radio Center, Salisbury

Ohio

Amateur Electronic Supply, Cleveland
Amateur Radio Sales & Service, Columbus
SREPCO Electronics, Dayton
Marietta Radio & TV Supply Inc., Marietta
Ken-Mar Industries, North Canton
Universal Amateur Radio Inc., Reynoldsburg
Richard Brock, Shaker Heights

Oklahoma

Oklahoma Ham Shack, Oklahoma City
Radio Store, Oklahoma City
Radio Incorporated, Tulsa

Oregon

Oregon Ham Sales, Albany
Portland Radio Supply, Portland

Pennsylvania

Supelco Inc., Bellefonte
Clegg Communications, Lancaster
Tydings Company, Pittsburg
Electronic Exchange, Souderton
Hamtronics, Treveose
Ham Buerger Inc., Willow Grove

Rhode Island

Budlong Marine, Cranston

South Carolina

ANR Electronics, Newberry

South Dakota

Burghardt Amateur Center, Watertown

Tennessee

John Franklin Enterprises, Chattanooga
Arson, Madison
Germantown Amateur Supply, Memphis
J-Tron, Springfield

Texas

AGL Electronics Incorporated, Dallas
Electronics Center Inc., Dallas
Electronic Service Company, Elemendorf
Hardin Electronics, Ft. Worth
Tracy's Electronics, Ft. Worth
Andy Electronics, Houston
Madison Electronics, Houston
Multi Communications, Houston
J-T Electronics, Plano
Jay Huckabee Company, Snyder
Jung & Perkins Corporation, Tyler

Virgin Islands

Electronics Unlimited Inc., St. Thomas

Virginia

Arcade Electronics Inc., Annandale
Priest Electronics, Norfolk
Radio Communications Company, Roanoke

Washington

Amateur Radio Supply Company, Seattle
Consumer Communications, Seattle

Wisconsin

Amateur Electronic Supply, Milwaukee

Canada

R & S Electronics, Dartmouth, Nova Scotia
Hamtraders Incorporated, Downsview, Ontario
WSI Sales Company, Kitchener, Ontario
C. M. Peterson Company Ltd., London, Ontario
Jac-Tenna Electronique, Tracy, P. Quebec

Franchised Dealer List as of December 1978.

RTTY Loop

Marc I. Leavey, M.D. WA3AJR
4006 Winlee Road
Randallstown MD 21133

Last month we started to investigate the design and construction of one type of RTTY "stunt box." Over the next few sessions, I hope to fully explain a solid-state way to generate any desired RTTY code sequence.

Fig. 1 is a reminder of what we are talking about. The desired data is encoded in some manner and passed in an intelligent manner to a device which puts it out in the standard format. Understanding how that data is encoded is this month's goal.

Consider the circuit in Fig. 2. Each light is connected to one vertical matrix conductor. Forming a grid with these three are an equal number of horizontal conductors. Each horizontal is connected to one, and only one, vertical member. It should

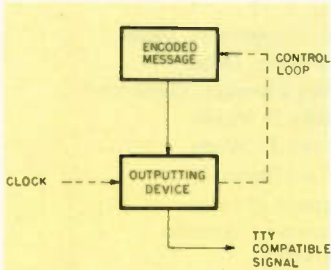

Fig. 1. Block diagram of "stunt box."

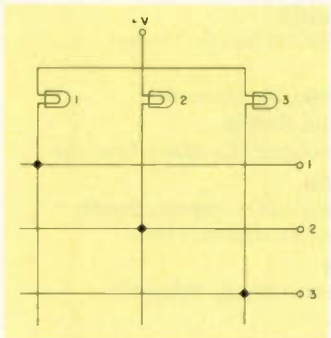

Fig. 2. One kind of matrix.

be fairly obvious that grounding any numbered horizontal conductor will cause the circuit of the corresponding bulb to be completed and the lamp to light. So far, so good, OK? Now, just suppose that I want both lights one and three to light, with one switch action. If I add another horizontal, as pictured in Fig. 3, then grounding that wire, number four, will certainly accomplish the required task. But the dotted arrow demonstrates the current path when wire number one is grounded alone. A path to light three still exists, through that extra wire, and it will continue to light. Clearly, what we need are little one-way valves at each junction which will let current flow one way but not the other.

After spending a few hours at the hardware store looking for such a valve and leaving empty-handed, I wandered into the Radio Shack next door. There I found just the ticket, little tiny chunks of silicon and germanium—*diodes*! Seriously, though, recall that one of the many uses of diodes is as switches. Also, note that conventional current flow, a la Benny Franklin, is from positive to negative and is represented in

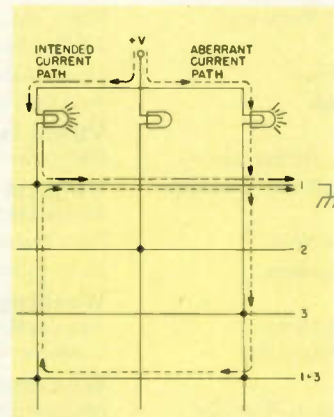

Fig. 3. A matrix with a problem.

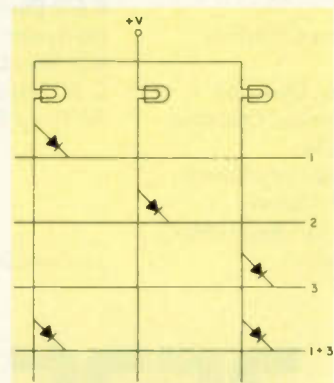

Fig. 4. The solution to the problem.

the diode symbol by the direction of the arrow.

Now let's replace each of the direct connections shown in Fig. 3 with a diode, oriented so that the "arrow" points to ground. Fig. 4 shows what I mean. Grounding wire one will now light only light bulb one, and wire four lights only one and three. The current path shown previously no longer exists; it is blocked by the diodes used as one-way valves at the matrix junctions. Take my word for it that in a properly-designed matrix, no other aberrant pathways will exist, either.

What we have constructed here is called a *diode matrix*, for what should by now be obvious reasons, and, although a three-by-four matrix is diagrammed, it is certainly not the most useful item in the world. I hope you can see, however, how one uses the matrix to individually select any of a set of possible outputs, encoded by strategically located diodes. By increasing the number of columns to five, the Baudot code can be represented. As many rows as needed may be provided for, one row per character. Encoding will place a diode in the matrix for each space bit in each character. The table in Fig. 5 shows where diodes go, represented by "X", for each character.

Now all you need to do is decide on a message, like "DE WA3AJR MARC," that you would like to encode, and construct a matrix as shown in Fig. 6. Note particularly the need for a FIGS and LTRS around the

"3". Since LTRS is all marks, no diodes are needed, and any blanks come out as LTRS. Neat, huh? Next month we will see what we can do with data encoded in this fashion.

While I won't say that I have been inundated with response to my question on what kind of RTTY gear you all are running out there, preliminary returns have been quite interesting. Model 15s, 28s, and 32s appear to be represented, along with a smattering of Kleinschmidts. Those of you who are into microcomputers are using everything from 8080s to 6800s, Altairs, SWTPCs, and Digital Groups. I am going to let the survey run a bit longer before trying to compile a meaningful list, but it looks good.

Several of you have sent little notes regarding RTTY art. While there are quite a few pictures and such on the air over the winter holiday season, newcomers who want to obtain a few, or those who want a particular one, may need an alternate source. Well, a few days ago, I received a catalog from a firm called Teleprinter Art, Ltd. Perusing it revealed listings for all kinds of RTTY art, everything from portraits (JFK, FDR, LBJ, Ike, or whoever), nudes, cartoon characters, and holidays. Prices are reasonable enough, with many items under a dollar, almost all under two. If you are interested, drop them a line at: Teleprinter Art, Ltd., 601 S. Dodson, Urbana, Illinois 61801. Tell them you saw it here, in RTTY Loop, OK?

Next month we will get into putting the data, as encoded by our matrix, out to the TTY loop. For this we will use a device known as a UART. If that word is totally foreign to you, you have one month to study! 'Til then, BCNU on RTTY!

LTRS	FIGS	1	2	3	4	5
A	-			X	X	X
B	?		X	X		
C	:	X				X
D	\$		X	X		X
E	3		X	X	X	X
F	!		X			X
G	&	X		X		
H	stop	X	X			X
I	8	X			X	X
J	'			X		X
K	(X
L)	X		X	X	
M	-	X	X			
N	,	X	X			X
O	9	X	X	X		
P	ø	X			X	
Q	1				X	X
R	4	X		X		X
S	bell		X		X	X
T	5	X	X	X	X	
U	7				X	X
V	;	X				
W	2			X	X	
X	/		X			
Y	6		X	X		
Z	"		X	X	X	
BLANK		X	X	X	X	X
LETTERS						
FIGURES			X			
CAR RET		X	X	X		X
LIN FEED		X	X	X	X	
SPACE		X	X	X	X	

Fig. 5. Diode encoding.

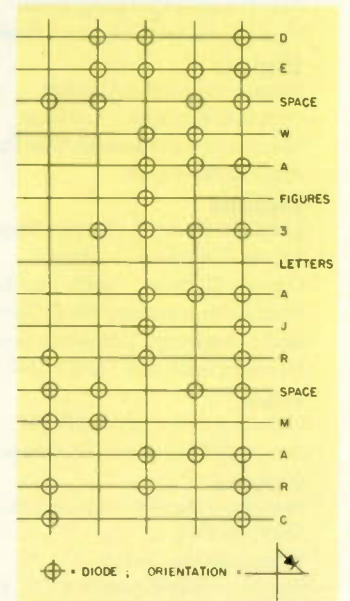

Fig. 6. A sample message.

73

Study Guides
and
Code Tapes —
The Best Available

see page 204

Super Terminals with Hidden Features

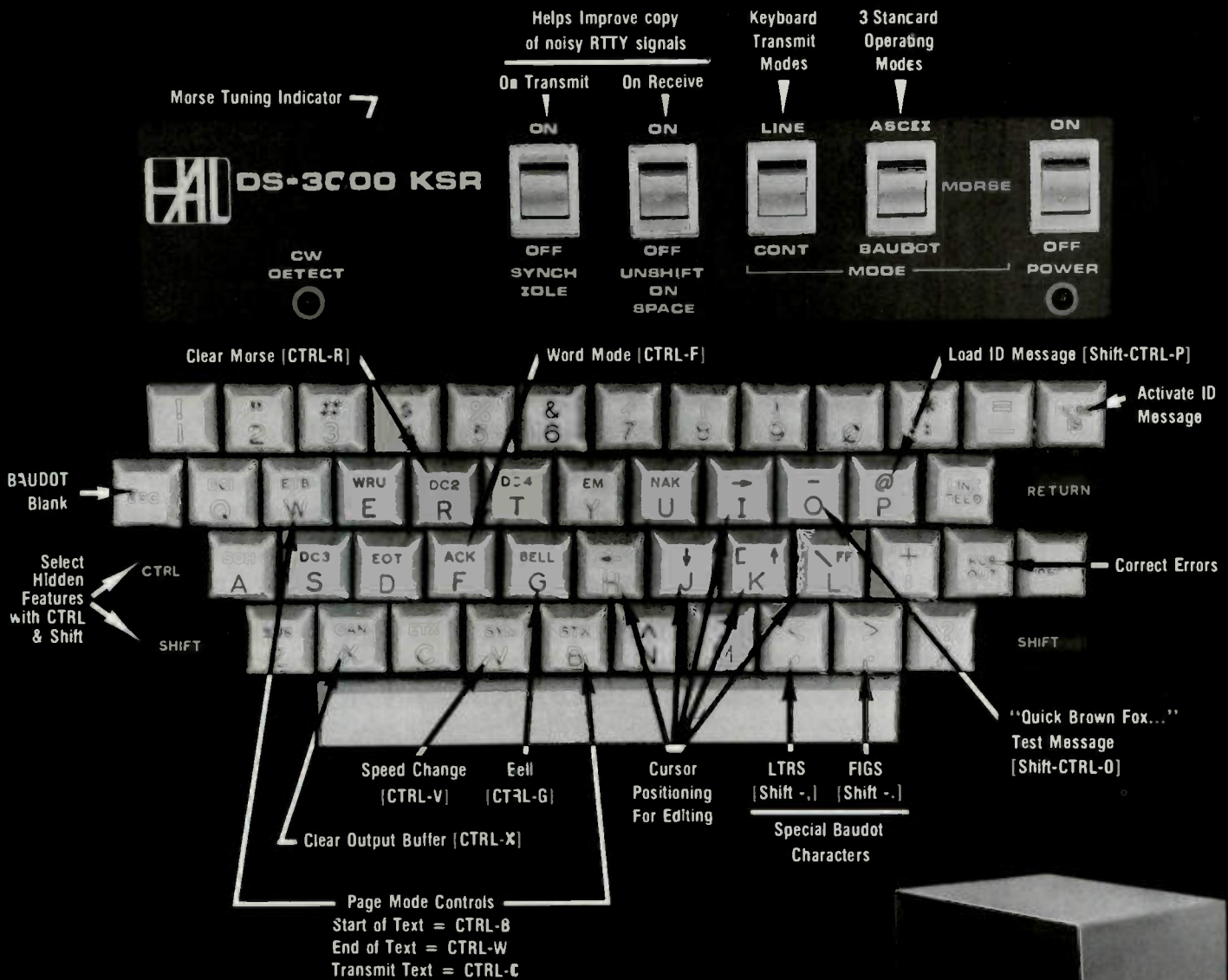

For super operator convenience, our keyboard works in MORSE, BAUDOT, and ASCII codes and controls the terminal, too. You can edit a message, program the HERE IS message, send the "QUICK BROWN FOX..." test message, change speeds, and change the terminal modes, all from the keyboard itself. In fact, the KOS (Keyboard Operated Switch) feature even turns the transmitter on and off from the keyboard. The DS-3000 KSR also features full-length 72 character lines (16 lines per screen), 5 speeds of BAUDOT and ASCII RTTY and Morse code from 1 to 175 wpm (Version 3), and word wrap-around to prevent splitting of words at the end of a line. When combined with the HAL ST-6000 Demodulator, you have the ULTIMATE in RTTY equipment.

- DS-3000 KSR Version 3 (MORSE, BAUDOT, ASCII)
- DS-3000 KSR Version 2 (BAUDOT & ASCII only)

Year End Special
~~\$1575.00~~
~~\$1095.00~~
\$1425.00

Write for our latest catalog & RTTY guide.



HAL COMMUNICATIONS CORP.
 Box 365
 Urbana, Illinois 61801
 217-367-7373



For our Overseas customers:
 see HAL equipment at:
 Richter & Co.; Hannover
 I.E.C. Interrelco; Bissone
 Vicom Imports; Auburn, Vic., Australia

ARE YOU ON FREQUENCY?

BE ON FREQUENCY WITH DSI



MODEL 3600A .5PPM 17° - 37°C

\$199⁹⁵

- AUTO ZERO BLANKING
- AUTO DECIMAL POINT
- INCLUDES ANTENNA

SAVE SHOP COSTS WHEN ADJUSTING XTALS
MEET YOUR QSO ON FREQUENCY EVERY TIME

The 3600A and 3550W Frequency Counters represent a significant new advancement, utilizing the latest LSI Design . . . which reflects DSI's ongoing dedication to excellence in instrumentation, for the professional service technician and amateur radio operator. Before you buy a DSI instrument you know what the specifications are. We publish complete and meaningful specifications which state accuracy over temperature and sensitivity at frequencies you need. And we guarantee those specifications in writing.

MODEL 3550W TCXO

\$149⁹⁵

- INCLUDES INTERNAL BATTERY HOLDER
- SAME AS 3600A LESS OVEN
- SEE SPECIFICATIONS BELOW

MODEL 3700 .2PPM 0° - 40°C

\$269⁹⁵

- AUTO ZERO BLANKING
- AUTO DECIMAL POINT
- INCLUDES ANTENNA

PORTABLE! TAKE IT TO THE MOUNTAINS OR
USE IT MOBILE — TAKE IT WITH YOU ON FIELD DAY

ALL NEW! ALL UNPARALLELED DSI QUALITY! The model 3700 700MHz frequency counter features2 PPM 0° to 40° C proportional oven time base . . . Built in battery trickle charger less batteries . . . Combined in a rugged (.125" thick) aluminum cabinet makes the 3700 ideal for the communications industry, professional service technicians, and sophisticated amateur radio operators.

3600A OWNERS: Update your 3600A frequency counter to a 3700 includes2 PPM proportional oven, rugged .125" thick aluminum cabinet, order 3600-A - 3700. Unit must be returned to DSI factory for modification.

DSI — GUARANTEED SPECIFICATIONS — MADE IN USA

Model	Frequency Range	Accuracy Over Temperature	@ 148MHz	@ 220MHz	@ 450MHz	Number of Readouts	Size of Readouts	Power Requirements	Size
3700	50Hz - 700MHz	Proportional Oven .2 PPM 0° - 40° C	10MV	10MV	50MV	8	.5 Inch	115 VAC or 8.2 - 14.5VDC	3"H x 8"W x 6"D
3600A	50Hz - 600MHz	Oven .5 PPM 17° - 37° C	10MV	10MV	50MV	8	.5 Inch	115VAC or 8.2 - 14.5VDC	2½"H x 8"W x 5"D
3550W	50Hz - 550MHz	1 PPM 65° - 85° F	25MV	25MV	75MV	8	.5 Inch	115VAC or 8.2 - 14.5VDC	2½"H x 8"W x 5"D

— ALL UNITS ARE FACTORY ASSEMBLED, TESTED AND CARRY A FULL 1 YEAR WARRANTY —

- NO EXTRA COSTS •

FREE Shipping anywhere in U.S.A. and Canada.
All other countries, add 10%.

*Strongest warranty in the counter field.
Satisfaction Guaranteed.*

See Your Dealer or

Call Toll Free: (800) 854-2049
DSI INSTRUMENTS, INC.

California Residents, Call Collect: (714) 565-8402

VISA • MC • AMERICAN EXPRESS • CHECK • MONEY ORDER • COD
7914 RONSON ROAD, #G, SAN DIEGO, CA 92111

Model 3700 \$269.95

3600A - 3700 Factory Update (3600A Only)
Includes Labor & Re-Calibration \$ 99.95

Model 3600A \$199.95

Model 3550W \$149.95

Option 03 20-Hr. Rechargeable
Battery Pack \$ 29.95

DSI COMMUNICATIONS SERIES

1.3GHz — 1GHz — 700MHz



MODEL C1000 10Hz to 1GHz

- INCLUDES BATTERY PACK
 - AUTO ZERO BLANKING
 - AUTO DECIMAL POINT
 - 10MHz TIME BASE
- \$499⁹⁵**

Accuracy . . . that's the operational key to this rugged advanced design Model C1000 1GHz frequency counter . . . a significant achievement from DSI. That's because you get1 PPM 0° to 40°C proportional oven time base . . . Built in 25DB preamplifier with a 60DB adjustable attenuator . . . x10 & x100 audio scaler which yields .01 Hz resolution from 10Hz to 10KHz equivalent to 10 sec. & 100 sec. Gate Time . . . Selectable .1 & 1 sec. time base and 50 ohms or 1 meg ohm input Impedance . . . Built-in battery charging circuit with a Rapid or Trickle Charge Selector . . . Color keyed high quality push button operation . . . All combined in a rugged black anodized (.125" thick) aluminum cabinet. The model C-1000 reflects DSI's on going dedication to excellence in instrumentation for the professional service technician, engineer, or the communication industry.

MODEL C700 50Hz to 700MHz

- INCLUDES BATTERY PACK
 - AUTO ZERO BLANKING
 - AUTO DECIMAL POINT
 - 10MHz TIME BASE
- \$369⁹⁵**

ALL NEW! All UNPARALLELED DSI QUALITY! The model C 700 700 MHz frequency counter features2 PPM 0° to 40° C proportional oven time base . . . 25db preamplifier with a 60db adjustable attenuator. Built in battery charger with a rapid or trickle charge selector . . . Combined in a rugged (.125" thick) aluminum cabinet makes the C700 ideal for the communication industry and professional service technician.

3600A OWNERS: Up date your 3600A frequency counter to a C 700 includes, new back board, .2PPM proportional oven, 25db preamplifier, rugged .125" thick aluminum cabinet, order 3600A-700. Unit must be returned to DSI factory for modification.

DSI — GUARANTEED SPECIFICATIONS — FACTORY ASSEMBLED — MADE IN USA

Model	Frequency Range	Proportional Oven Accuracy Over Temperature	50Hz To 75MHz	75MHz To 500MHz	500MHz To 1GHz	Number Of Digits	Size Of Digits	Power Requirements	Size
C700	50Hz to 700MHz	.2PPM 0° to 40° C	50MV	10MV	NA	8	.5 Inch	115 VAC-BATT 8 to 15VDC	3"H x 8"W x 6"D
C1000	10Hz to 1GHz	.1PPM 0° to 40° C	20MV	1MV	>50MV	9	.5 Inch	115VAC-BATT 8 to 15VDC	4"H x 10"W x 7½"D

— All Units Are Factory Assembled, Tested And Carry A Full 5 Year Limited Warranty —

FREE

*Strongest warranty in the counter field.
Satisfaction Guaranteed.*

FOR MORE INFORMATION

Call Toll Free: (800) 854-2049
DSI INSTRUMENTS, INC.

California Residents, Call Collect: (714) 565-8402
VISA • MC • AMERICAN EXPRESS • CHECK • MONEY ORDER • COD
7914 RONSON ROAD, #G, SAN DIEGO, CA 92111

- Model C 700 **\$369.95**
- 3600A-700 Factory Update (3600A only)
Includes Labor & Re-Calibration **\$199.95**
- Model C 1000 **\$499.95**
- Opt. 01 1.3 GHz (C1000 only) **\$ 99.95**
- Opt. 02 .05 PPM 10MHz Double Oven
0° to 50° C Time Base (C1000 only) **\$129.95**
- Ant. 210 Telescopic Ant./BNC Adapter **\$11.95**

Chuck Stuart N5KC
5115 Menefee Drive
Dallas TX 75227

DX PROFILE

Herb Lehmann WA6BJS of San Carlos, California, is best known to most of us as the gravel-voiced, no-nonsense MC of the fifteen meter Afrikaner Net.

Herb's first exposure to the mysteries of shortwave radio came in 1916 when, at the tender age of only eight years, a neighbor acquired a commercial crystal set which he shared with Herb. But before long, World War I came along and all antennas had to be removed.

In 1920, Herb's interest in radio was renewed when a friend asked Herb to accompany him to town to purchase some transmitter parts. Shortly thereafter, Herb acquired some #18 enameled wire, a Quaker Oats box, two square brass rods with two-inch sleeves which he cut into sliders, a

suspender clip swiped from his grandpa, a condenser, and a pair of headphones. All of this strange equipment was connected to about 400 feet of "aerial wire" and Herb was ready for some serious DXing.

His SWL hobby continued on and off for the next few years, and Herb began monitoring the ham bands more and more. In 1941, Herb moved to his present QTH in San Carlos and the roof was soon covered with dipoles. In 1956, by now completely addicted to the ham bands, Herb purchased a 40-foot tower, a TV rotator, and a TA-33 JR triband beam.

Forced into early retirement in 1964 due to a medical disability, Herb settled in for some first-class SWLing. He bird-dogged the DXpeditions for the local DXers and logged better than 300 countries for himself.

For some reason, during all these years of SWLing the ham bands, Herb never really considered getting his own ham

ticket until 1968 when some of the local youngsters began to encourage him. After several code lessons, Herb nervously took the Novice exam and shortly thereafter WN6BJS was licensed. In January of 1970, Herb passed his General exam and began DXing in earnest. His Advanced class license, his new Drake TR-4 transceiver, his 100th country, and his 63rd birthday arrived all in the same week.

FLASH!

The 73 Magazine 10 Meter DX Decade Award #1 goes to Bill Gosney WB7BFK. Watch for a profile on Bill in an upcoming column.

In 1972, a chance encounter on fifteen meters with several W2 stations on Long Island in a round table with several African stations resulted in the formation of the world famous Afrikaner Net which meets seven days a week on 21355 kHz at 1800Z. Stations from all over the world check in and give new country contacts to stateside stations.

Along with Cal W2PPG and Leo W0GX, Herb has been the guiding force of the net since its inception.

Herb says that one of the highlights of his hamming career was a trip through the midwest in 1976 when he got to meet personally with some of the many friends he has met on the air.

Much of Herb's time is devoted to amateur radio, but he also enjoys classical music and sports, especially tennis and baseball. WA6BJS, known affectionately to his many friends as "Herbie," is one of the class acts that makes amateur radio the great hobby that it is.

CARIBE 1978

The Caribe 1978 Dxpediton which took place this past July and August is now history. Operations took place from Dutch Sint Maarten using the call PJ8USA and from Montserrat using the call VP2MBC. Alex W1CDC and Mac WA1ZSW were highly successful in their efforts to put these two islands into many logbooks. Following an intense satellite and low-frequency operating schedule, the first contacts were made via the OSCAR 8 satellite, modes A and J. A number of contacts were also made via the OSCAR 7 satellite using modes A and B. Using high-speed CW, better than 105 satellite contacts were made with stations in North America, South America, Central America, and Europe.

In addition to the satellite and VHF operations, low-band activity netted 3200 plus contacts, with CW again being the primary mode. Bands used were 10, 15, 20, and 40 meters, with major target areas being the Far East and the Orient. The Caribbean is rare DX for those areas of the world.

The only regret they had is that due to bad weather and a tight travel schedule, they were unable to operate from Anguilla VP2E and Guadeloupe FG7 as planned, but there is always next year and Caribe 1979.

DX NOTEBOOK

Dodecanese SV

WA4ICK has been running weekly skeds with SV1JH there on Rhodes. It is also possible that SV1JH could show on the 14225 morning net. Those skeds with WA4ICK are on 14300 kHz at 1300Z on Saturdays and 1900Z on Sundays. Make every effort to work this one, as it isn't often available.

Seychelles S79

Recent word out of the Seychelles reports that no new amateur licenses will be issued. Also, any present licenses will not be renewed upon expiration. This action was taken after a raise in the license application fee to \$80.00 had no effect. Apparently S79 will become an endangered species. Better work one now while you still have the opportunity.

Qatar A7XAH

Ahmed has been showing recently on the long path on 14270 kHz after 1530Z, sometimes assisted in the pileups by a JY or 9K2. His QSL manager, DJ9ZB, says that 14270 kHz is indeed the frequency to watch. Ahmed is a Qatar ambassador and apparently the only A7 in existence.

Kerguelen Island FB8X

F6DZL arrived in December for a tour of duty on this rare French possession. Look for him in the usual DX alleys on ten, fifteen, and twenty.

South Sandwich LU3ZY

The operators at LU3ZY, Guillermo on SSB and Roberto on CW, left for Argentina last December. While on the island, they managed to rack up over 3,200 QSOs. The new crew on the island apparently will not be so productive, but it is heartening to note that there is at last a permanent station set up down there for any visiting operators to use. All QSLs for LU3ZY should be sent to the Radio Club at LU2CN.

Somalia 6O1

I2FGP should be showing from Somalia again soon. This time Giampaolo is planning on



Herb Lehmann WA6BJS. Those of us who have listened to Herbie run the Afrikaner Net for the past several years never thought he could look so serene.



Call for the famous
HAM·KEY

JUST DIAL TM Trade-Mark

1-800-325-3636

TOLL FREE



Model HK-1

- Dual-lever squeeze paddle
- Use with HK-5 A or any electronic keyer
- Heavy base with non-slip rubber feet
- Paddles reversible for wide- or close-finger spacing

\$29⁹⁵



Model HK-2

- Same as HK-1, less base for incorporation in own keyer

\$19⁹⁵



Model HK-3

- Deluxe straight key
- Heavy base...no need to attach to desk
- With navy type knob

\$16⁹⁵

Model HK-3A

- Same as above less base **\$9.95** Extra: navy type knob only **\$2.75**



Model HK-4

- Combination of HK-1 and HK-3 on same base

\$44⁹⁵

- Base only with rubber feet **\$12.00**
- Terminals, red or black. **\$.75** each



NEW DOT AND DASH MEMORY

Model HK-5A

Electronic Keyer

- New Cabinet Colored-Keyed to Match most modern radio equipment
 - Iambic Circuit for squeeze keying
 - Self-completing dots and dashes
 - Curtis 8044 I.C. Keyer Chip
 - Battery operated with provision for external power
 - Built-in side-tone monitor
 - Grid block or direct keying
- Speed, volume, tone and weight controls all mounted on front panel
- For use with external paddle, such as HK-1 or HK-4
- Can be used as Code practice oscillator with straight-key, such as HK-3

\$69⁹⁵

Same day shipment...PREPAID
So order today direct or from your favorite dealer

HAM RADIO CENTER

8340-42 Olive Blvd • P.O. Box 28271 • St. Louis, MO 63132

✓ H2

new FROM ALLIANCE!



HD-73 HEAVY-DUTY ROTATOR

with exclusive Dual-Speed Control!

For antennas up to 10.7 sq. ft. of wind load area. Mast support bracket design permits easy centering and offers a positive drive no-slip option. Automatic brake action cushions stops to reduce inertia stresses. Unique control unit features DUAL-SPEED rotation with one five-position switch. SPECIFICATIONS: Max. wind load bending moment—10,000 in.-lbs. (side-thrust overturning); Starting torque — 400 in.-lbs.; Hardened steel drive gears; Bearings — 100- $\frac{3}{8}$ " diameter (hardened); Meter — D'Arsonval, taut band (back-lighted). There's much, much more — so get the whole story!

Mail this coupon for complete details!

YES! Send me complete details on the new HD-73!
 Give me the name of my nearest dealer!

NAME _____

ADDRESS _____

CITY _____

STATE _____ ZIP _____

The **ALLIANCE** Manufacturing Co., Inc., Alliance, Ohio 44601
A NORTH AMERICAN PHILIPS COMPANY ✓ A57

Maker of the famous Antenna Rotator... Alliance Tenna-Rotor®... "TV's Better Color Getter!"

© 1978 The Alliance Mfg. Co., Inc.



some CW action and he will also be equipped for split-frequency operation. He has been one of the top European contesters for several years, so he is not afraid of pileups.

Franz Josef Land

UK1PAA was reported recently, so there does seem to be some activity. It has been reported that both UK1PAA and UK1PAD are on Franz Josef, UK1PAA on CW and UK1PAD on SSB. Regardless, work them first and worry later.

Saudi Arabia HZ1AB

This station is located at the US Military Training Mission at Dharan. No amateurs have been in the contingent for over a year now and any operating is done by visitors or by amateurs working in the Dharan area. Bill Gary K8CSG recently visited the area and found about 250 QSLs waiting to be answered. Most had been opened and everything but the QSL card had been removed. Bill says that the best way to QSL HZ1AB is to send the card along with an SASE to Leo Fry K8PYD, 5740 North Meadows, Columbus OH 43229. Copies of HZ1AB logs are sent to Leo and he takes care of the demand. If you need a card for a contact with HZ1AB, try Leo. If he has the logs, you will receive your card in short order.

Vatican City HV3SJ

W3US, who has operated

HV3SJ in the past, passes along some information on the possibility of a second Vatican station. This will be HV2VO, located at Castle Gondolfo south of Rome. The suffix "VO" stands for "Vatican Observatory." The operator for this second station holds the call LU9LAZ and previously operated from VU2SX. This one may pose an interesting question as to its DXCC status. Vatican City is a separate state, but Castle Gondolfo is located in the Italian countryside. HV3SJ is usually active on Saturday mornings around 21280 kHz or 21410 kHz. QSL to W6KNH.

Marcus Island KA1MI

This is Dick Kobylarz WB1GXU and he plans to be on regularly until next summer. Look on 21375 kHz on Monday, Wednesday, and Friday. KA1NC is also active from Marcus on ten meters around 28630 kHz. Best time to look for these stations is after 2100Z. This counts the same as JD1.

Niger 5U7AG

K1VSK has made arrangements for 5U7AG to be active on Sundays on 14265 kHz after 500Z. The station is looking especially for those needing Niger for a new country and ego contacts are discouraged.

"MOST NEEDED" LIST

It's always interesting to run

The Caribe 1978 DXpedition was blessed with overwhelming success on the satellites and low bands. Shown here on the island of Sint Maarten are Mac WA1ZSW and Alex W1CDC the day before making their departure for Montserrat, where they put VP2MBC on the air.



a "Most Needed" list because we can check and see how we stand compared to what others need. The following list is the result of a poll taken by the North Jersey DX Association. How many are on your list?

1. Okino-Torishima 7J1
2. Saudi-Iraq NZ8Z4
3. South Sandwich LU/VP8
4. Spratly 1S
5. Bouvet 3Y
6. China BY
7. Burma XZ2
8. Kamaran
9. Bhutan A5
10. Khmer XU
11. San Felix CE0X
12. Heard Island VK0
13. Laccadive Island VU
14. Mayotte FH0
15. Mellish VK9
16. Crozet FB8W
17. Glorioso FR7
18. Mt. Athos SV
19. Central African Empire TL8
20. Andam/Nicobar Island VU7

NOVICE CORNER

In reading through the mail this month, it seems that questions regarding the phenomenon of long-path DXing pop up the most often. First we will explain what it means to work a DX station via the long path, and then we will make an attempt at explaining the causes of long-path DX openings.

Generally speaking, working a station via the long path means working a station with your beam pointed the opposite direction from the shortest distance to the station. In other words, to work Europe and the Mideast from the United States via the long path requires pointing your

antenna southwest, toward New Zealand.

Long-path openings occur most often on twenty meters, with less frequent openings on fifteen and ten. If everyone else is giving a DX station 5 by 9 reports and you can barely hear him, rotate your antenna around 180 degrees. If there is a long-path opening, he will probably be booming in now. Long-path signals are usually much stronger than those received on the regular short path.

Radio waves, like everything else in electronics, follow the path of least resistance. During the winter months, the Northern Hemisphere is tilted away from the sun; this causes the sun's rays to strike the Northern Hemisphere at an angle. This results not only in colder weather, but also in less ionization of the atmosphere. Meanwhile, the Southern Hemisphere is tilted towards the sun and is receiving the sun's rays more directly. The result here is longer, warmer days and a more heavily ionized atmosphere. It is this ionization of the atmosphere that allows us to make DX contacts.

Long-path openings occur because the Southern Hemisphere is more heavily ionized than the Northern Hemisphere. Even though the distance is greater, the more heavily ionized atmosphere is the path of least resistance.

I would like to mention one more item concerning beam pointing. Directions are not what we were led to believe by the old Mercator projection maps which hung from the blackboard in school. I strongly recommend the purchase of a Great Circle map of the world. These maps show true direction from the center of the United States. If you live on the east or west coast, it would be better to purchase a map centered on your area. If you can't locate such a map, there are several companies which will sell you a list of beam headings based exactly on your QTH. Don't be surprised if you find out you have been pointing your antenna the wrong direction all this time.

THANKS, KENT!

The following letter is from Tom Waliiko K8NOQ to Kent Goddard, holder of the call ZD8KG. It chronicles the trials and tribulations of a quickie, unplanned DXpedition.

Kent Goddard
Pan American Airways
Patrick AFB FL 32925

Dear Kent,

Thanks very much for the use of your call, ZD8KG. To explain, our USAF C-135 was traveling

Continued on page 167

MADISON ELECTRONICS SUPPLY, INC.

1508-B MCKINNEY • HOUSTON, TEXAS 77002

713/658-0268

NEW! EXCITING! BREAKTHROUGH!

**YAESU FT 901DM
Transceiver & Accessories**



FT 901DM	\$1,459.00
Speaker/Patch	74.00
CW Filter	45.00
FV-901 VFO	415.00

CALL FOR QUOTES ON:

YAESU	KENWOOD
FT901 DM	TS820S
FT625	TS520S
FT225	TR7400A
ALDA, AMCOMM, ETO ALPHA	
TEMPO VHF ONE PLUS	



ANTENNAS

Model OJA-146

TWO METER AMATEUR BAND 146-148MHz

- NO GROUND PLANE REQUIRED
- USE FIXED, MOBILE, OR PORTABLE
- 5dB GAIN OVER ISOTROPIC IN MOST MOBILE APPLICATIONS
- OVERALL LENGTH: LESS THAN 64 INCHES
- COLLAPSIBLE TO 22 INCHES. MAY BE PACKED IN SUIT-CASE FOR THOSE OUT-OF-TOWN TRIPS
- STEEL WHIP AND ADAPTER INCLUDED FOR MOBILE AND FIXED APPLICATIONS
- VSWR: LESS THAN 1.2:1

PRICE \$39.95 UPS Prepaid

220 MHz — \$37.95 450 MHz — \$37.95

**CALL FOR FAST QUOTES
SPECIAL ORDERS WELCOME**

TERMS: All prices FOB Houston. Prices subject to change without notice. All items Guaranteed. Some items subject to prior sale. Send letterhead for Amateur dealers price list. Texas residents add 6% tax. Please add postage estimate.

W5GJ, W5MBB, K5AAD, N5JJ, W5IMJ, AG5K, W5VVM, WD5EDE, K5ZD, WD5ABR, WA5TGU, WD5BDX, WB5AYF, K5RC, K5BGB, WB5USV.

Have A Nice Day!
DLA

GROUNDHOG GOODIES

OMNI-J & heavy duty magnet mount complete	\$49.95
TRIEX W-51 FT Self Support Tower (Reg. \$825.00)	
Your Cost (F.O.B. California)	\$725.00
Tonna F9FT Antennas 144/16el	\$79.95
RIW 432/19el	\$59.95
KLITZING VHF-UHF Amplifiers	
2M 10W In — 100W Out	\$198.00
432 10W In — 50 W Out	\$198.00
BIRD 43 & Slugs. UPS Paid	Stock
Microwave Modules 432-28S. UPS Paid	\$329.00
Telrex TB5EM. In Stock	\$415.00
NEW Palomar Engr. Transceiver Preamp	\$89.50
Bencher Paddles . . . \$39.95; Chrome	\$49.95
ETO 76 Amplifiers	Stock
Lunar 6M-2M-220 In Line Preamps	\$49.95
Lunar 2M Amp 10-80 with Preamp. UPS Paid	\$189.95
Janel QSA-5	\$41.95
CDE HAM-3 . . . \$129.00; HAM-X	\$249.00
VHF Engrs. blue line amps	Stock
Cetron 572B	\$29.50
Amperex 6146B	\$7.95
Motorola HEP 170	\$0.29 ea.
Mallory 2.5A/1000 PIV Epoxy Diode	\$0.19 ea.
Aerovox 1000PF/500V Feed thru	\$1.95
GE 6146B or 8950	\$7.95
Technical books: AMECO, ARRL, Sams, TAB, Rider.	
Radio Pub., Callbook, Cowan, many others	Call
NEW BELDEN 9405 (2#16) (6#18) 8 wire Rotor Cable.	
heavy duty for long runs	\$0.26/ft.
8448. Std. 8-wire Rotor	\$0.16/ft.
9888. double shield RG8 Foam	\$0.39/ft.
8214. RG8 Foam	\$0.25/ft.
8237. RG-8	\$0.21/ft.
8267. RG-213	\$0.25/ft.
Amphonor Silver Plate PL259	\$0.59
TIMES 1/2" Foam Hardline \$0.60/ft	Connectors \$15.00 ea.
7/8" Hardline \$1.50/ft.	Connectors \$25.00 ea.
BERKTEK RG-8X. 52 ohm. KW	\$0.16/ft.
Consolidated HD-18 Ga. Galv. Tower, 10' Sec.	\$29.95
Robot "Slow Scan" Now In Stock	Call
Alliance HD73 Rotor	\$109.95
Teletower - self support - 55 ft/w breakover	\$499.00

Collins Repair — Factory Authorized Service/Sales. Many Years Experience. Call K5RRC, Tom 713-481-4586 for quote.

THIS MONTH'S SPECIAL

ICOM IC280 — \$395.00
DENTRON GLA1000 Amplifier — \$319.00
BEARCAT 250 — \$299.00



The 'Tonna' You've
been
hearing about

144/146 MHz	SWR 1.2:1
50 ohms	Horiz./Vert.
length 6.4 m.	Wt. 4.4 kg.
Side lobe attenuation — Superb	
Horizontal aperture	2 x 16° (-3 dB)
Vertical aperture	2 x 17° (-3 dB)

\$79.95

9 Element 144-146	\$39.95
4 Element 144-146	\$32.95

MADISON M35 ELECTRONICS SUPPLY, INC.

1508-B MCKINNEY • HOUSTON, TEXAS 77002

713/658-0268

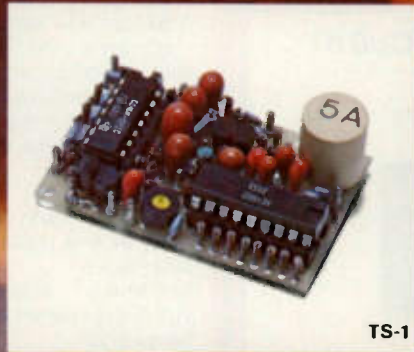

TS-1

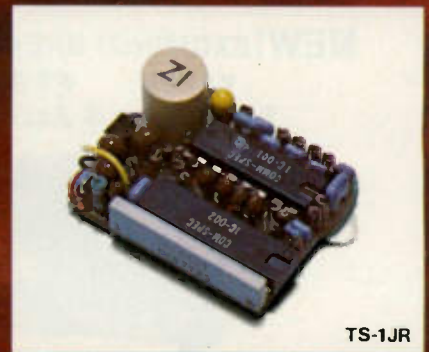

TS-1JR

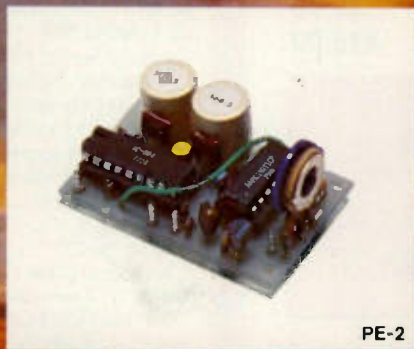

PE-2



SD-1

THE DAWNING

The age of tone control has come to Amateur Radio. What better way to utilize our ever diminishing resource of frequency spectrum? Sub-audible tone control allows several repeaters to share the same channel with minimal geographic separation. It allows protection from intermod and interference for repeaters, remote base stations, and autopatches. It even allows silent monitoring of our crowded simplex channels.

We make the most reliable and complete line of tone products available. All are totally immune to RF, use plug-in, field replaceable, frequency determining elements for low cost and the most accurate and stable frequency control possible. Our impeccable 1 day delivery is unmatched in the industry and you are protected by a full 1 year warranty when our products are returned to the factory for repair. Isn't it time for you to get into the New Age of tone control?

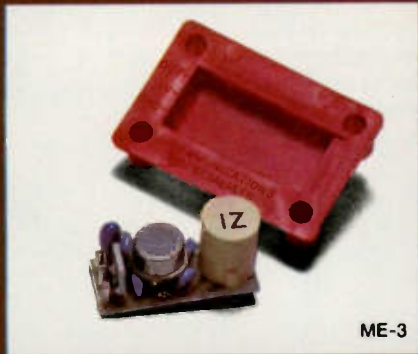

ME-3

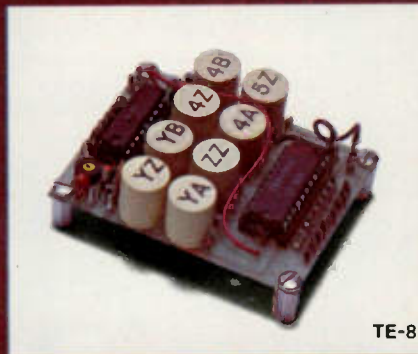

TE-8



TE-12

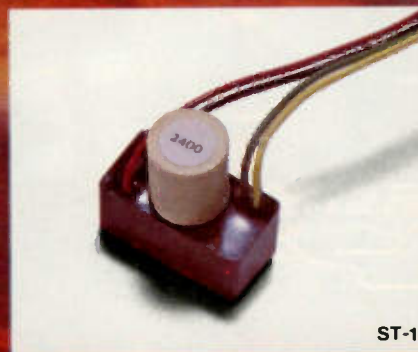

ST-1

OF A NEW AGE.

TS-1 Sub-Audible Encoder-Decoder • Microminiature in size, 1.25" x 2.0" x .65" • Encodes and decodes simultaneously • \$59.95 complete with K-1 element.

TS-1JR Sub-Audible Encoder-Decoder • Microminiature version of the TS-1 measuring just 1.0" x 1.25" x .65", for hand-held units • \$79.95 complete with K-1 element.

ME-3 Sub-Audible Encoder • Microminiature in size, measures .45" x 1.1" x .6" • Instant start-up • \$29.95 complete with K-1 element.

TE-8 Eight-Tone Sub-Audible Encoder • Measures 2.6" x 2.0" x .7" • Frequency selection made by either a pull to ground or to supply • \$69.95 with 8 K-1 elements.

PE-2 Two-Tone Sequential Encoder for paging • Two call unit • Measures 1.25" x 2.0" x .65" • \$49.95 with 2 K-2 elements.

SD-1 Two-Tone Sequential Decoder • Frequency range is 268.5 - 2109.4 Hz • Measures 1.2" x 1.67" x .65" • Momentary output for horn relay, latched output for call light and receiver muting built-in • \$59.95 with 2 K-2 elements.

TE-12 Twelve-Tone Sub-Audible or Burst-Tone Encoder • Frequency range is 67.0 - 263.0 Hz sub-audible or 1650 - 4200 Hz burst-tone • Measures 4.25" x 2.5" x 1.5" • \$79.95 with 12 K-1 elements.

ST-1 Burst-Tone Encoder • Measures .95" x .5" x .5" plus K-1 measurements • Frequency range is 1650 - 4200 Hz • \$29.95 with K-1 element.



COMMUNICATIONS SPECIALISTS

426 West Taft Avenue, Orange, CA 92667

(800) 854-0547, California residents use: (714) 998-3021



The parameters of the Palomar PTR-130k are the outer perimeters of logic technology.

Never before has any transceiver approached the capabilities of the Palomar PTR-130k!

It's the first completely multi-functional transceiver ever made available to the public!

The Palomar PTR-130k is a miniaturized mobile transceiver

capable of operating in 100 cycle resolution from 100 KHz to 30 MHz in all modes of transmission and reception. Instant frequency selection is available with the touch of a finger.

The Palomar PTR-130k.

technology is pure space age... the price is strictly down-to-earth. Send for our full color brochure to:

Palomar Electronics Corporation
665 Opper Street
Escondido, CA 92025
Telephone: (714) 746-2666



TECHNOLOGY AT THE SPEED OF SOUND

If you expect to invest in a new ham antenna in the next 90 days, invest 15¢ postage to get Antenna Specialists' brand new, complete ham catalog today.



FREE decal just for fun!

Name _____
Address _____
City _____ State _____ Zip _____



the antenna specialists co.

✓ A62 a member of The Allen Group Inc.
12435 Euclid Ave. Cleveland, Ohio 44106
Export: 2200 Shames Drive, Westbury, L.I., New York 11590
Canada: A. C. Simmonds & Sons, Ltd.

RTTY made easy

WITH THE NEW
TU-170
TERMINAL UNIT



Connect to your receiver speaker, transmitter microphone jack, and teletype machine and you're on the air. State of the art design features make the TU-170 ideal for HF and VHF autostat operation.

- Proved 170 Hz shift active filter demodulator
- Lighted tuning meter for easy tuning
- Current regulated loop keyer & power supply
- Autostat with threshold control and solid state relay
- Stable audio frequency shift oscillator produces phase coherent sine wave tones
- TTL compatible inputs and outputs for auxiliary equipment
- High level output for scope tuning

TU-170 Kit 149.95 TU-170 Wired 219.95

Flesher products... the critic's choice!



FLESHER CORP.



P.O. Box 976, Topeka, Kansas 66601 (913) 234-0198

(Cut on dotted line and keep next to your radio equipment)

(Cut on dotted line and keep next to your radio equipment)

Call our toll-free number first

... and it's the last call you'll have to make!

(NO CHARGE TO CALLING PARTY)

1-800-325-3636

CALL FOR THE BEST PRICE AND FAST DELIVERY

ON THE FOLLOWING LINES:

ATLAS
COLLINS
DENTRON
DRAKE
HY GAIN

ICOM
INFO-TECH
KENWOOD
MOSLEY
STANDARD

SWAN
TEMPO
TEN-TEC
WILSON
YAESU

... AND MANY OTHERS.

HAM RADIO CENTER

8340-42 Olive Blvd. P.O. Box 28271 St. Louis, MO 63132



ou rooms don't ever proof
lousy manuscripts from bat
burh...
you...
I insist that you print ev
tell Ma Bell that she shou

LETTERS

JONESTOWN

We believe that radio broadcasts were made from Guyana to San Francisco on the day before and the day that Congressman Leo Ryan was killed in Guyana.

Our office would appreciate your magazine printing a request for any ham radio operator who had contact with the People's Temple radio on November 17 and/or November 18, 1978, to contact the San Francisco District Attorney's Office at either (415)-553-1505 or (415)-553-1054 (call collect).

Thank you for your service.
Douglas N. Keener
Investigator
District Attorney's Office
San Francisco CA

AMMUNITION

As I was stuffing my husband's numerous magazines in the usual 99% of the closet (headache of wives of all hobbyists), I happened to drop your Aug., '77 issue of *Kilobaud*. It fell open to an article entitled, "Sooo, You Want To Be An Author." With nothing else to read in the house but medicine bottles and vegetable cans, I read it. I cannot possibly tell you of my utter amazement at having my husband so perfectly described. The excuses used by your aspiring authors(?) were classic—he's used every one of them, several times, in fact.

Believe me when I say that I am sick and tired of being used as a sounding board for ideas, criticisms, and comments perpetrated by your magazines (he's an avid *73/Kilobaud* reader). My question is this: Why discuss these subjects with a totally unwilling victim when there are people out there who would be happy to hear them? You must realize that I haven't the faintest idea what he's talking about.

I have tried tactful suggestions like "Why don't you get off your backside and write down your ideas and send them in?" Well, the answer, of course, is obvious. Just look at the list given in that article.

I finally drew the line when an article appeared in your magazine this month. The

author had the same ideas that my husband had four months ago. And you paid the man one hundred dollars for it.

Just this month, my husband was wishing that there was some way he could buy the computer he wanted so he could start sending in programs (he's a computer technician working for his BSEE). He has the knowledge and the intelligence, but he has no confidence in himself. So, like the dutiful and loving wife that I am, I exercised my right to nag him until he actually sat down and started to write. It's been two days since he started and it's almost finished. Though I am by far no expert, I think it's great.

So, Mr. Green, thank you for supplying the ammunition that was needed for a short but productive battle.

Be looking for a superb article written by a very proud WBØFGO.

Jean M. Johnson
Sioux City IA

WRONGLY POINTED?

I am an avid reader of *73 Magazine* and appreciate your many disclosures of vendors who do not live up to their claims. I do feel it my duty, however, to advise you when it appears the finger has been wrongly pointed. Reference the letter entitled "Skin Disease" on page 118 of the October issue: I sympathize strongly with Mr. Carver about his treatment from Kensco Communications. His accusations towards Southeastern Communications, while certainly understandable, are not warranted, however.

I have dealt with this firm three times in the last six months, each time with excellent service. Actually, this firm seems to go out of its way to please. Upon receipt of the first order of six crystals, which arrived one week after order, one crystal was bad (no one's perfect). It was mailed back on Thursday, and its replacement arrived the following Wednesday. The second order was back-ordered and then shipped special delivery at Southeastern's expense when they were advised of the urgent need. The third was requested

on a Thursday evening by phone and arrived the following Tuesday.

I don't know what more to say. Hopefully, it will not be long before service such as this is recognized. It seems unfair that a company should acquire the reputation of another just because they buy their stock.

Thanks for the chance to put in a good word for a good company. I hope you'll print this so others can see both sides of the story.

Keep up the good work, Wayne. You certainly help make an already interesting hobby more interesting.

Joe Bushel N4ARJ
Orange Park FL

SEEING THE LIGHT

After years of putting down "Chicken Banders," the light suddenly dawned that I might be missing something. My unfair speeding ticket for 50 mph in a country "30 mph zone" was the final clincher. I couldn't help but notice, as the polite but firm officer was writing my summons, that all cars with CB antennas were leisurely proceeding through the speed trap at a mere 29 mph.

I muttered all the way home: "I just gotta get me a CB." My XYL only shook her head—she's used to my muttering.

A short time later, while wandering through a local hamfest flea market, I encountered an enterprising CB dealer who was selling new (outlawed) 23-channel CB radios, sans mike, as "CB monitors" for only \$7.00 each. He assured me that there was no transmitter in the case, only the receiver. Hmm—perhaps he was "mistaken" about the "missing transmitter." My sporting blood said "buy," but my intuition does not always give me the best advice. For instance, the bumper sticker on my Edsel used to say "AM—YES, SSB—NO." You get the drift!

So I bought the \$7.00 wonder and after further searching and dickering bought a microphone for \$1.00 and a used Hustler mobile CB antenna for \$2.00.

Not wanting to wait until I arrived home to test the rig, I nervously connected power leads to fuse block and ground, plugged in the dollar mike, temporarily connected my 5/8-wave 2 meter FM antenna, and turned on the switch. Immediately my car was filled with rasping, squawking CB signals! At least the receiver section worked. Now for the acid test. I turned the channel selector to a relatively quiet channel, squeezed the push-to-talk switch, and timidly re-

quested a signal report. "Wall to wall and treetop tall" came back the report from a mobile station claiming to be eight miles from my location! Success! I had achieved "Good Buddy" status for only \$10.00. Could have had it for only \$8.00, if I hadn't bought the antenna! Say, wonder if the guy who sold me the \$2.00 Hustler will take it back at next year's Syracuse Hamfest?

Charles Willson K2GMZ
Palmyra NY

GOOD-BYE

I have received a notice that it is time to renew my long-standing subscription to *73 Magazine*. I have decided not to renew. Among the reasons for this decision, the following are the most pertinent.

The editorial policy of your magazine appears to promote unlawful activities and to encourage your readers to be scofflaws. I refer especially to your articles about radar jamming. Amateur radio does not need a spokesman who advocates this type of activity, and I certainly do not care to support the distribution of this type of material. Your proposal for the formation of a religious cult to further impede enforcement of the law borders on the ridiculous.

It would seem to me that if you would devote your talents to the enrichment of amateur radio instead of filling your editorial columns with attacks on the ARRL and the FCC, your magazine would benefit. One cannot build a desirable reputation by degrading others!

Your conduct is hurting not only amateur radio, but also your pocketbook, which, if I read between the lines correctly, is very near to your heart! It is my understanding that many others feel as I do and are not renewing their subscriptions. I was a charter subscriber to both *Byte* and *Kilobaud*, and when my *Kilobaud* subscription expires, it will not be renewed.

Mel Hart WØRV
St. Louis MO

MORE ON KM1CC

I was glad to read the article, "The KM1CC Story," in the October issue of *73 Magazine*. However, I should correct the statement made about the equipment loaned to KM1CC by RCA Global Communications, Inc. The reference to "a modern WCC inked-paper readout receiver" isn't quite correct.

First, the inked-paper re-

ceiver, more appropriately recorder, isn't a receiver as most of us would think of a receiver. Typically, when we speak of receivers in the amateur radio vernacular, we are talking about devices used to detect radio signals and convert them to a form of audio signal. The above-mentioned recorder does not detect radio signals; rather, it uses audio to control the deflection of a stylus, thus yielding an inked trace of the input audio.

Nelther would I describe the equipment as *modern*, because it dates back before World War II and hasn't been used at WCC since about that time. Incidentally, the receiver loaned with the recorder was an old Radlmarine AR-67, an LF and MF band receiver used at WCC quite a few years ago and hardly modern.

The equipment loaned by WCC was to enable the non-amateur to observe a visual display of CW signals. In this case, the recorder and the AR-67 receiver were used to monitor the WCC 500 kHz, A-2, CW signal.

I felt these points should be brought out so that the astute reader doesn't get the impression that we (WCC) are still using the *old* inked-paper recorder and calling it *modern*.

Wm. H. Farris, Jr. K1WF
Chatham MA

PAINT RIP-OFF

This note is to notify your readers of a new rip-off. It's called "Paint falling off your car due to rf." This BS is being passed around to auto dealerships and auto paint shops—that rf makes paint fall off cars in the area of the antenna. In my case, my new '78 car's trunk lid is discolored and the paint is chipping off. The dealer says that my radios are making it do that and that they are not going to fix it. I have talked to several other radio ops and they were told the same thing about the paint on their cars.

If this happens to anyone else, call the local Consumer Affairs Office and raise hell. I did, and it worked.

Jim Menefee WA4KKY
Jacksonville FL

CODE SUCCESS

Your long-standing theory on teaching Morse characters at high speed while spacing them out to make 5 wpm is working out well for a class of prospective Novices I'm teaching. I explained that I was doing this in order to have them learn letter sounds instead of having them

go through the double step of counting dots and dashes and then translating that to letters. They accepted the logic of this and seem to be having no trouble copying letters at 15 wpm, spaced to about 7.

Linc Thorner WD0CLB
Minot AFB ND

TOMBSTONE GAMBLING

"New Life for Old Transformers" in the January, 1978, issue was excellent, but one cringes when instructed to connect 110 volts to "what you suspect are the primary leads"! Gamble wrong and the author's address of Tombstone could become sadly appropriate.

A safe and constructive suggestion is offered: First, set the ac voltmeter to its highest range. Energize a separate 6.3-volt transformer and apply its low voltage to the unknown windings. When approximately 110 volts is measured across another winding, *that* is the primary, and the energized winding is a 6.3-volt winding. Now it is safe to apply 110 V ac to the primary and identify any remaining windings.

Gene Brizendine W4ATE
Hunsville AL

BOX-BUSTER

Well, Wayne, you have done it again!! Here I am looking at my nice new set of library shelf boxes and wondering how the heck I am going to get the December issue of 73 into one of them which already contains the first eleven issues! Leave it to Green to sell you a product and then have such a thick set of magazines that you can't possibly fit a whole year's worth of mags into it. I didn't have any problem fitting in some of the other mags! Oh well, I guess I'll just have to put the December issue alongside the box when I get it! Keep up the good work, and keep those RTTY articles coming.

Robert J. Farrell Jr. WB2COY
Poughkeepsie NY

THE WORD FROM JEDDAH

My friend W9MXU receives current copies of 73 Magazine here in Jeddah (costs \$5.05 US to mail the copies to him each month). I would say you have a devoted subscriber indeed!!

What is great is that he shares 73 with me and now I want to be a subscriber—enclosed is my subscription for 3 years. Please send 73 to my home QTH in the USA.

There are many hams here in

Jeddah from all over the world, as well as many from the U.S.A.—all we can do is listen to all those beautiful CQs on all the ham bands! I'm using a portable Toshiba RP-2000F receiver covering FM broadcast through 30 MHz; it also has a bfo for SSB and CW. It's a fine little receiver and I had not seen it in the U.S.A. before leaving for Arabia.

I hope when I arrive home I will have my first issue of 73—that would be great. The very best to you and your organization on the outstanding job you do for amateur radio.

David O. Finnell W5LCL
Jeddah, Saudi Arabia

COMMON SENSE

My hat is off to Wayne Green and his magazine as the finest amateur radio publication on the market. Contrary to Merrill Eidson's comments that Wayne should stop attacking the ARRL and stick to improving 73, I feel that Wayne is justified in his comments on the ARRL.

Merrill mentioned being a solid member of the ARRL for fifty years in his letter. This is indicative of quite a few members of the organization. Most are from the spark-gap era and the big guns running the organization operate it with this antiquated style.

I have been a ham for a number of years and feel that a magazine such as 73 is progressive and certainly represents the modern technology and operating practices of amateur radio. The only value I ever received from QST was who made DXCC, WAS, etc. As for technical articles of value,

Ham Help

We would like to swap club newsletters with other amateur radio clubs. If interested, contact:

Sterling-Rock Falls Amateur
Radio Society
c/o Donald Van Sant WA9PBS
1104 5th Ave.
Rock Falls IL 61071

In the last few years, I have been looking for a list of the frequency bands and power limitations of amateur stations in foreign countries. It is my opinion that such data would prove valuable to many amateurs, both foreign and domestic. Most of the information on the American amateur bands is widely published and well-known, but that of many foreign

QST never did impress me.

The ARRL certainly needs to work more for the interests of all hams instead of trying to promote measures that will benefit the elite group. A more down-to-earth approach by the ARRL would restore my faith in the organization.

Wayne, keep up the good work. You have my full support. Your common-sense approach to amateur radio is needed to keep things in their perspective.

Dick Sullivan K0DQG
Des Moines IA

PETTING

Thanks to Paul A. Lille for his fine article on the Commodore PET ("Look What Followed Me Home!", page 142, November, 1978). One of his "complaints" regarding the tape-handling system is the difficulty he experienced finding the end of program B on a tape when he wants to load a new program, A, on the same tape (he listens on an audio cassette deck for the end of the noise).

I have a better suggestion: Ask PET to VERIFY "B". PET will search for B, find it, compare it with A in memory and report a "VERIFY ERROR." No matter, you've found the end of B, which is what you need before asking PET to save "A". PET stops at the end of the VERIFY process.

The PET's implementation of the IEEE-488 bus makes it a truly professional machine, well beyond the mere "hobby video game" class.

How about some articles on the use of PET as a Morse/RTTY terminal?

Paul Birman WA2JJP
Flushing NY

countries is believed to be considerably restricted. Help in directing me to a source of this type of information would certainly be appreciated. Thanks for any information anyone may be able to provide.

Paul Wiegert W8TH
1205 East Franklin St.
Centerville OH 45459

I would appreciate (and pay reasonable expenses, if necessary) info on solid-stating (ICs?) a WWII-type BC-221-m frequency meter. If I build modular, why can't I use it for CW vfo? All responses acknowledged. Thanks.

Justin B. Snyder WA9MQO
403 North Ave
Lake Bluff IL 60044

Contests

Robert Baker WB2GFE
15 Windsor Dr.
Atco NJ 08004

THE WEST AUSTRALIAN 150TH YEAR CELEBRATION CONTEST

The aim of the contest is for amateurs on all continents to contact amateurs in Western Australia (VK6) on all bands using all modes, this being to commemorate the 150th year celebration of the foundation of Western Australia.

The contest will commence at 1600Z on 31 December, 1978, and end at 1600Z on 31 December, 1979.

All authorized amateur bands may be used between 1.8 MHz and 28 MHz using any of the modes appropriate to the regulations applying to the entrant. Operators are encouraged to operate both phone and CW.

The three highest scores from each continent for mixed and individual modes will receive a commemoration certificate. This contest is also open to SWLs.

For VK amateurs and SWLs, the three highest scores from each state will be eligible for a certificate, while VK6 partici-

pants who have more than 100 out-of-state QSOs will get an award.

SCORING:

One contact in each mode is allowed in each band every day with the same station, for which the following scores and multipliers will apply: CW—5 points per contact; phone—3 points per contact; RTTY—6 points per contact. Multipliers: One point per band used, provided that 30 QSOs are obtained on that band, except for 1.8 and 3.5 MHz, where 1 QSO will count. Final score = total points x total multipliers.

LOGS:

Contest logs should show date, time, call, band, mode, RST out, RST in, points scored, and include a running total. The log should bear a front cover sheet bearing the following: call, address, claimed score, and signature. Contest logs are to be forwarded to: The Contest Manager, 150th Celebration Contest, PO Box 6250, Hay Street East, Perth 6000, Western Australia.

NEW HAMPSHIRE QSO PARTY
2000 GMT February 3 to
0500 GMT February 4
1400 GMT February 4 to

0200 GMT February 5

The contest is sponsored by the Concord Brasspounders, Inc., W10C, to promote the Worked New Hampshire Award. Stations may be worked once per band per mode. NH stations may work each other.

EXCHANGE:

NH stations send RS(T) and country, others send RS(T) and ARRL section or country.

SCORING:

NH stations score 1 point per QSO times the number of ARRL sections plus countries plus NH counties. Others score 5 points per NH QSO times the number of NH counties.

FREQUENCIES:

CW—1810, 3555, 7055, 14055, 21055, 28130; Phone—1820, 3975, 7235, 14280, 21380, 28575; Novice—3730, 7130, 21130, 28130; VHF—50.115, 145.015, FM simplex (no repeaters!).

AWARDS:

Top scorer in each NH county and top scorer in each state,

province, and country (50 points min.). Additional certificates available for confirmation of all 10 NH counties. Send logs, summary, and checksheets to: Concord Brasspounders, Inc., C. Halloway, 9 Via Tranquilla, Concord NH 03301. Mailing deadline is March 12. Include a business size SASE for results and/or award.

TEN-TEN INTERNATIONAL NET WINTER QSO PARTY 0000 TO 2400 GMT on February 4 and February 11

The contest is open to all amateurs, but only members are eligible for awards. All contacts must be made on 10 meters. Classes of operation include: single-op, multi-op, and QRP (20 Watts PEP or less). A station may be counted only once; all logs must be in GMT. Stations with new calls must list old call sign. All QRP stations must list equipment used.

THE 73 MAGAZINE 10 METER AWARDS

The return of vigorous solar activity means that 10 meters is once again a band to be reckoned with. Ol' Sol's 11-year cycle of sunspot production is about to hit a peak, with the result that QRP 10 meter DX is possible.

Now's the perfect time to convert that old CB rig to 10. American Crystal Supply makes a variety of simple and inexpensive conversion kits, or you can do-it-yourself from the articles in 73. True appliance operators can purchase ready-made rigs from Bristol Electronics or Standard Communications. To give you an added incentive, 73 is offering two nifty Certificates of Achievement for 10 meter channelized communications.

For domestic types, there is the 10-40 Award. This one should be pretty easy—just work 40 of the 50 states. The DX Decade Award goes to DXers who work 10 or more foreign countries with a channelized 10 meter rig. We have endorsement stickers, too—the whole bit.

To give everyone an equal shot at award #1, only contacts made October 1, 1978, or after will be valid.

Well, don't just sit there. Get out your soldering iron, order some crystals, and put that CB rig on 10. This is going to be fun, so don't miss out!

RULES

1) All contacts must be made in the 10 meter amateur band using channelized AM equipment. Both converted Citizens Band equipment and commercially-produced units may be used.

2) To be eligible for award credit, all contacts must be made October 1, 1978, or after.

3) The 10-40 Award is available to applicants showing proof of contact with stations in at least 40 of the 50 United States. A special endorsement sticker will be available to those working all 50 states.

4) The DX Decade Award is available to applicants showing proof of contact with at least 10 foreign countries. Endorsement stickers will be awarded for 25, 50, 75, and 100 countries.

5) A log of stations worked, with the date, time, and type of equipment used for each contact, must be submitted when applying for each award or endorsement.

6) Each application for an award or endorsement must be accompanied by a signed statement that all claimed contacts are valid. No QSL cards need be sent, but they must be in the possession of the applicant.

7) To cover costs, a fee of \$5.00 must accompany each application for the 10-40 or DX Decade Award. The fee for endorsement stickers will be \$2.00 each.

8) All award applications should be mailed to: Chuck Stuart N5KC, 5115 Menefee Drive, Dallas TX 75227.

Calendar

Feb 2-11	ARRL Novice Roundup
Feb 3-5	NH QSO Party
Feb 4, 11	10-10 Net Winter QSO Party
Feb 10-11	QCWA QSO Contest—CW
Feb 17-19	Two-Land QSO Party
Feb 17-Mar 4	University of Cape Town Festival Station
Feb 24-25*	French Contest—Phone
Mar 3-4	ARRL DX Competition—Phone
Mar 10-11	QCWA QSO Contest—Phone
Mar 17-18	ARRL DX Competition—CW
Mar 24-26	BARTG Spring RTTY Contest
Mar 31-Apr 1	International 10-10 Net Canterbury Chapter QSO Party
Apr 7-8	North Dakota QSO Party ARRL Open CD Party—CW QRP QSO Party
Apr 21-22	ARRL Open CD Party—Phone ARRL EME Contest
May 19-20	ARRL EME Contest
June 9-10	ARRL VHF QSO Party
June 23-24	ARRL Field Day
July 4	ARRL Straight Key Night
July 14-15	ARRL IARU Radiosport Competition
Aug 4-5	ARRL UHF Contest
Sept 8-9	ARRL VHF QSO Party
Sept 15-16	Scandinavian Activity—CW
Sept 22-23	Scandinavian Activity—Phone
Oct 13-14	ARRL CD Party—CW
Oct 20-21	ARRL CD Party—Phone
Nov 3-4	ARRL Sweepstakes—CW
Nov 17-18	ARRL Sweepstakes—Phone
Dec 1-2	ARRL 160 Meter Contest
Dec 8-9	ARRL 10 Meter Contest

* = described in last issue.

Introducing the Tenham-153 two-meter FM radio.



Meet the Tenham-153. A brand new radio for American Amateurs featuring a brand new idea in flexibility: an outboard VFO for continuous coverage of the 144-148 MHz band.

Alone, the Tenham-153 is a 24-channel crystal-controlled (one crystal per channel) 10-watt 2-meter FM rig. A compact, rugged radio built in the solid-state-of-the-art design tradition of Fujitsu Ten, one of the world's most famous names in electronics for the past 40 years.

The Tenham-153 comes complete with 146.94 MHz crystals in place. Controls include a simplex/repeater (± 600 kHz splits) switch, plus a handy priority channel switch right on the MIC for instant access. A built-in regulator compensates for DC voltage variations. A high/low power switch makes long-range simplex or close-

range repeater operation convenient.

Add the optional VFO-32B outboard variable frequency oscillator and get complete coverage of the 144-148 MHz band. A large LED readout tells you exactly the frequency you dial up. It's the ultimate in flexibility. What's more, the VFO-32B acts as a handy frequency counter when you're netting crystals in the Tenham-153. A range check circuit prevents out-of-band operation. The oscillator disables itself and a warning light flashes on the front panel. There's even an RIT and fine tuning knob. Plus a built-in tuning meter for accurate tuning like you've never experienced before.

See the exciting Fujitsu Ten line-up of quality Amateur gear at your dealer's today. Or write us direct for complete information.



TEN FUJITSU TEN CORP. OF AMERICA
1135 East Janis St., Carson, CA 90746. Phone: (213) 537-8930

Stations can credit any chapter with their score as long as they hold a certificate from that

chapter.
EXCHANGE:
Call, 10X number, ARRL sec-

Results

RESULTS OF WASHINGTON STATE QSO PARTY FOR 1978 Sponsored by Boeing Employees' Amateur Radio Society (BEARS)

TOP SCORES, OUT-OF-STATE:

State	Call	QSOs	Mult.	Total
Alabama	K4ZGB	85	23	3910
Arizona	W7RIR	35	17	1190
California	N6PE	104	30	6240
Colorado	K0MT	62	28	3472
Connecticut	W1VH	50	19	1900
Delaware	N3AHA	2	2	8
Florida	K4DDB	68	19	2584
Georgia	N4NX	98	31	6076
Idaho	K7TAK	29	12	696
Illinois	K9BG	103	27	5562
Indiana	WB9BAI	70	18	2520
Iowa	WB0UIT	24	9	432
Kansas	K0FPC	22	9	396
Kentucky	WA4QMQ	28	14	784
Louisiana	W5WG	116	30	6960
Maine	W1DLC	46	13	1196
Maryland	W3PYZ	38	17	1292
Massachusetts	W1AQE	39	20	1560
Michigan	WA8VJE	44	12	1056
Minnesota	WB0LNO	39	14	1092
Missouri	K0RWL	15	10	300
Nevada	W7HI	32	14	896
New Jersey	WB2VFT	92	20	3680
New York	W2NRD	33	14	924
North Carolina	N4GF	9	6	108
Ohio	AD8J	41	14	1148
Oregon	K7DRD	5	4	40
Pennsylvania	WA3JXW	26	11	572
Rhode Island	WB1DET	20	10	400
South Carolina	K4BZD	37	12	888
South Dakota	WA0BZD	42	14	1176
Tennessee	WA4CMS	27	12	648
Texas	W5VGX	44	15	1320
Utah	W7LN	13	9	234
Virginia	W4KMS	33	11	726
Wisconsin	K9GTQ	41	18	1476
Ontario, Can.	VE3KK	52	20	2080
Nova Scotia, Can.	VE1BNN	5	4	40
Brazil	PY1BAR	16	9	288
Japan	JR1NRP	18	8	288
Sweden	SM3BCZ	15	10	300

TOP SCORES, WASHINGTON STATE:

County	Call	QSOs	Mult.	Total
Adams	W7GHT/M7	10	9	180
Asotin	W7GHT/M7	19	12	456
Chelan	N7RC	109	30	6540
Clark	N7ZZ	2090	114	476,520
Columbia	W7GHT/M7	18	12	432
Cowlitz	WA7PMW	466	62	57,784
Douglas	W7GHT/M7	28	13	728
Ferry	W7GHT/M7	20	10	400
Franklin	W7GHT/M7	25	17	850
Garfield	W7GHT/M7	25	16	800
Grant	W7WMO	393	53	41,658
Island	W7UMX	1053	90	189,540
King	K7GR	403	55	44,330
Kitsap	WA7UWE	620	56	69,440
Lincoln	W7GHT/M7	33	19	684
Okanogan	W7GHT/M7	14	11	308
Pend Orielle	W7GHT/M7	18	20	360
Skagit	WA7GVM	749	76	113,848
Snohomish	K7II	125	36	9000
Spokane	W7GHT/M7	29	16	928
Stevens	W7GHT/M7	38	21	1596
Thurston	N7RV	190	45	17,100
Wahkiakum	WB7OVA	46	19	1738
Whatcom	WA7YCZ	1430	71	203,060
Whitman	W7GHT/M7	19	13	494

tion, and name.

SCORING:

Continental USA contacts are 1 point, 2 points if 10X member. DX (outside continental USA) are 2 points or 3 points if 10X member. QRP contacts are 2 points or 4 points if 10X member.

ENTRIES:

Members only send logs to Robert C. Mugerini WA1AKS, PO Box 169, Randolph MA 02368. Logs must be received no later than March 11. Results will be published in the 10-10 Net spring bulletin.

AWARDS:

For each class, 1st place certificate to each US district, KL7, KH6, and other US Pacific Islands; each VE district, Central America, and Caribbean; So. America; Europe; Africa; and So. Atlantic, Asia, Australia, New Zealand, and So. Pacific.

QCWA MEMBERSHIP QSO CONTEST

CW:

0001 GMT Saturday,
February 10 to
2400 GMT Sunday,
February 11

Phone:

0001 GMT Saturday,
March 10 to
2400 GMT, Sunday,
March 11

Historically, the QCWA membership contest has been held on a single weekend for both modes of operation. For greater participation in 1979, the contest will be held on two weekends separated by one month. For additional interest and point-scoring purposes, three global areas have been established. Frequencies, confirmation texts, and related contest rules and guidelines are available in the QCWA News.

TWO-LAND QSO PARTY

2100 GMT Saturday,
February 17 to
0700 GMT Sunday,
February 18
1300 GMT Sunday,
February 18 to
0300 GMT Monday,
February 19

This is a new contest organized by the South Jersey Contest Coalition. There is no operating time limit within the contest periods, but there is a mandatory 6-hour rest period from 0700 to 1300 on Sunday. The same station may be worked once per band and mode, and mobiles and portables may be worked each time they change counties. The states of New Jersey and New York, with 83 counties, will try to work the world and vice versa!

EXCHANGE:

RS(T), county, and state for Two-Land stations. RS(T) and state, province, or country for

others.

FREQUENCIES:

CW—1805, 3560, 7060, 21060, 28060; SSB—1815, 3900, 7230, 14280, 21355, 28600; Novice—3725, 7125, 21125, 28125.

SCORING:

Each QSO counts 2 points. For Two-Land stations, the multiplier is the number of states, provinces, and DX countries (by DXCC) plus the number of Two-Land counties. For all others, the multiplier is only the number of Two-Land counties (83 max.).

AWARDS:

Certificates to the top scoring station in each Two-Land county, each state, province, and DX country. Second- and third-place awards will be issued where justified. Awards also for top mobile, portable, multi-operator, Novice, and club.

ENTRIES:

Logs with over 200 QSOs should include a dupe sheet. Indicate each new multiplier as worked. Also, include a summary sheet and usual declaration. For results, include a large SASE; DX stations include a large SAE. Send entries to: South Jersey Contest Coalition, c/o AB2E, Darrell Neron, 322 S. Cummings Avenue, Glassboro NJ 08028.

THE UNIVERSITY OF CAPE TOWN FESTIVAL AND AWARD, 1979

To commemorate the 150th anniversary of the University of Cape Town, Cape Town, Republic of South Africa, the Cape Town branch of the SARL will operate a special festival station with call ZS1UCT (ZS1-University of Cape Town) and issue an award.

The University of Cape Town Festival Station will operate Saturday, February 17, to Sunday, March 4, 1979, Saturdays and Sundays 0600 to 2000 GMT, and weekdays 0700 GMT to 1000 GMT, 1500 GMT to 2000 GMT.

FREQUENCIES:

Use for calling. Actual frequency will depend on QRM. 40 meters—7.050 MHz. 20 meters—14.210 MHz. 15 meters—21.200 MHz. 10 meters—28.580 MHz. 2 meters—145.500 MHz.

TRANSMISSION MODES:

SSB, CW, RTTY, and FM.
SARL Bureau, P.O. Box 3037, Cape Town 8000, Republic of South Africa.

RULES AND AWARDS:

The award is open to all licensed amateurs and short-wave listeners (SWLs). DX stations and SWLs must log ZS1UCT plus two (2) other ZS1 stations (ZS1 contacts to be logged between February 15 and March 15, 1979). ZS and ZR stations log ZS1UCT plus 5

Continued on page 172

This NEW MFJ Versa Tuner II . . .

has SWR and dual range wattmeter, antenna switch, efficient airwound inductor, built in balun. Up to 300 watts RF output. Matches everything from 1.8 thru 30 MHz: dipoles, inverted vees, random wires, verticals, mobile whips, beams, balanced lines, coax lines.

MFJ LOWER PRICES!

NEW, IMPROVED MFJ-941B HAS . . .

- More inductance for wider matching range
- More flexible antenna switch
- More sensitive meter for SWR measurements down to 5 watts output

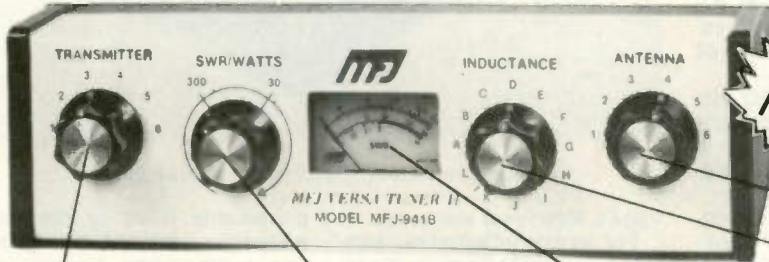

BRAND NEW

NEW LOWER PRICE

\$79⁹⁵

Transmitter matching capacitor. 208 pf. 1000 volt spacing.

Sets power range, 300 and 30 watts. Pull for SWR.

Meter reads SWR and RF watts in 2 ranges.

Efficient airwound inductor gives more watts out and less losses.

Antenna matching capacitor. 208 pf. 1000 volt spacing.

Only MFJ gives you this MFJ-941B Versa Tuner II with all these features at this price:

A **SWR and dual range wattmeter** (300 and 30 watts full scale) lets you measure RF power output for simplified tuning.

An **antenna switch** lets you select 2 coax lines direct or thru tuner, random wire/balanced line, and tuner bypass for dummy load.

A **new efficient airwound inductor** (12 positions) gives you less losses than a tapped toroid for more watts out.

A **1:4 balun** for balanced lines. 1000 volt capacitor spacing. Mounting brackets for mobile installations (not shown).

With the **NEW MFJ Versa Tuner II** you can run your full transceiver power output — up to 300 watts RF power output — and match your

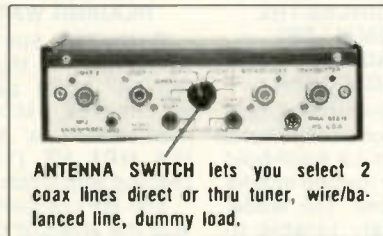

ANTENNA SWITCH lets you select 2 coax lines direct or thru tuner, wire/balanced line, dummy load.

transmitter to any feedline from 160 thru 10 Meters whether you have coax cable, balanced line, or random wire.

You can tune out the SWR on your dipole, inverted vee, random wire, vertical, mobile whip, beam, quad, or whatever you have.

You can even operate all bands with just

one existing antenna. No need to put up separate antennas for each band.

Increase the usable **bandwidth** of your mobile whip by tuning out the SWR from **inside your car**. Works great with all solid state rigs (like the Atlas) and with all tube type rigs.

It travels well, too. Its ultra compact size 8x2x6 inches fits easily in a small corner of your suitcase.

This beautiful little tuner is housed in a deluxe eggshell white Ten-Tec enclosure with walnut grain sides.

SO-239 coax connectors are provided for transmitter input and coax fed antennas. Quality five way binding posts are used for the balanced line inputs (2), random wire input (1), and ground (1).

NEW 300 WATT MFJ VERSA TUNER II'S: SELECT FEATURES YOU NEED.

NEW MFJ-945 HAS SWR AND DUAL RANGE WATTMETER. NEW LOWER PRICE

\$69⁹⁵

BRAND NEW



Same as MFJ-941B but less 6 position antenna switch.

NEW MFJ-944 HAS 6 POSITION ANTENNA SWITCH ON FRONT PANEL. NEW LOWER PRICE

\$69⁹⁵

BRAND NEW

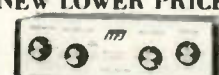

Same as MFJ-941B but less SWR/Wattmeter.

NEW MFJ-943 MATCHES ALMOST ANYTHING FROM 1.8 THRU 30 MHz. NEW LOWER PRICE

\$59⁹⁵

BRAND NEW



Same as MFJ-941B, less SWR/Wattmeter, antenna switch, mounting bracket. 7x2x6 in.

ULTRA COMPACT 200 WATT VERSA TUNERS FOR ALL YOUR NEEDS.

MFJ-901 VERSA TUNER MATCHES ANYTHING, 1.8 THRU 30 MHz. NEW LOWER PRICE

\$49⁹⁵

BRAND NEW



Efficient 12 position air inductor for more watts out. Matches dipoles, vees, random wires, verticals, mobile whips, beams, balanced lines, coax. 200 watts RF, 1:4 balun, 5x2x6 in.

MFJ-900 ECONO TUNER MATCHES COAX LINES/RANDOM WIRES. NEW LOWER PRICE

\$39⁹⁵

BRAND NEW

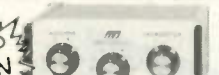

Same as MFJ-901 but less balun for balanced lines. Tunes coax lines and random lines.

MFJ-16010 RANDOM WIRE TUNER FOR LONG WIRES. NEW LOWER PRICE

\$29⁹⁵



1.8 thru 30 MHz. Up to 200 watts RF output. Matches high and low impedances. 12 position inductor. SO-239 connectors. 2x3x4 inches. Matches 25 to 200 ohms at 1.8 MHz. Does not tune coax lines.

For Orders **Call toll-free 800-647-1800**

Order any product from MFJ and try it. If not delighted, return within 30 days for a prompt refund (less shipping). Order today. Money back if not delighted. One year unconditional guarantee. Add \$2.00 shipping/handling. For technical information, order/repair status, in Mississippi, outside continental USA, call 601-323-5869.

Order By Mail or Call TOLL FREE 800-647-1800 and Charge It On

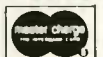

MFJ ENTERPRISES, INC. P. O. BOX 494 MISSISSIPPI STATE, MISSISSIPPI 39762

New Products

CSC INTRODUCES NEW SWEEPABLE FUNCTION GENERATOR, THE MODEL 2001

Continental Specialties Corporation is again broadening its line of inexpensive troubleshooting and design hardware with the introduction of its new Model 2001 four-waveform function generator, electronically sweepable over a 10:1 to 100:1 range.

The 2001 offers sine, triangle, square, and TTL square waves from 1 Hz to 100 kHz. In five push-button-selectable overlapping ranges, tuned with a 10:1 vernier dial featuring 50 increments and an accuracy of $\pm 5\%$ of the dial setting.

The TTL output will drive 10 TTL loads with rise and fall times of less than 25 nanoseconds.

Sine, square, and triangle waveform outputs are variable over a greater than 40 dB range. The high level output is rated at 0.1-10 V_{p-p} into an open circuit, and .05-5 V_{p-p} into a 600-Ohm load. A separate low level output, 40 dB down from the high level output, is rated at 1-100 mV into an open circuit, and .5-50 mV into a 600-Ohm load. The variable amplitude control, once set, holds the output signal to within less than ± 0.5 dB over the entire frequency range.

The sinusoidal waveform offers less than 2% distortion. The triangular waveform is within less than 1% of linearity error. The standard (not TTL, which is a separate output) square wave features rise and fall times of less than 100 nanoseconds, and a time symmetry error of less than $\pm 2\%$.

The voltage-controlled

sweeping oscillator (sweep vco) may be zero-referenced from any frequency setting. The banana jack input will accept any signal from 0 \pm 10 volts, and offers a 22k input impedance.

The 2001 is calibrated at 25° C. $\pm 5^\circ$ C., but operates over a 0-50° C. range. The 10" W x 3" H x 7" D package (25.4 x 7.6 x 17.8 cm) weighs in at 2.2 pounds (1.0 kg). Power requirements are 6 Watts at 105/125 V ac, 50/60 Hz.

A 220-240 V ac, 50/60 Hz-powered version is optionally available. Also available is a 20-dB banana jack adapter output attenuator.

For additional information, contact *Continental Specialties Corporation*, 70 Fulton Terrace, New Haven CT 06509, or 351 California Street, San Francisco CA 94104. Reader Service number C9.

VEGA ANNOUNCES THE WORLD'S SMALLEST TUNABLE SUBAUDIBLE TONE ENCODER-DECODER

Vega has introduced a new subminiature, subaudible tone encoder/decoder for hand-held radio as well as routine mobile radio applications. The Model 185 is completely tunable to any EIA CTCSS frequency without adding or changing any components. Measuring just 1.0" x 1.56" x 0.55", the unit includes a high-pass voice filter and adjustable output level. A unique self-squelching feature eliminates external squelch circuit connections in most applications, making installation simple and quick. The Model 185 exceeds all EIA specifications (including frequency stability) and comes with

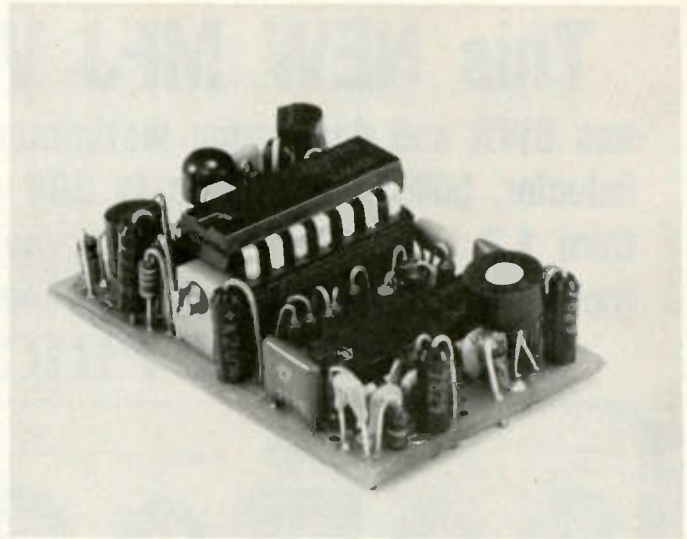

Vega's new Model 185 tone encoder/decoder.

Vega's three-year warranty.

For further information, contact Vega, 9900 Baldwin Place, El Monte CA 91731; (213)-442-0782. Reader Service number V21.

MIRAGE MP1 HF PEAK-READING WATTMETER

With the successful introduction of the MP2 VHF (50-200 MHz) peak-reading wattmeter, Mirage Communications is now offering the MP1 HF (1.8-30) peak-reading wattmeter.

The MP1 is designed to provide the amateur operator with

a versatile fixed or portable wattmeter, without having to use cumbersome plug-ins or add-ons.

It has three power ranges (25, 200, and 2000 Watts) which provide easy reading, whether in use for low-power QRP operation or with the biggest DX setup. The MP1 will read both forward and reverse power at the flip of a switch.

The MP1 has the same fine features as the MP2, namely, the ability to display either an average or a peak power read-

Continued on page 170

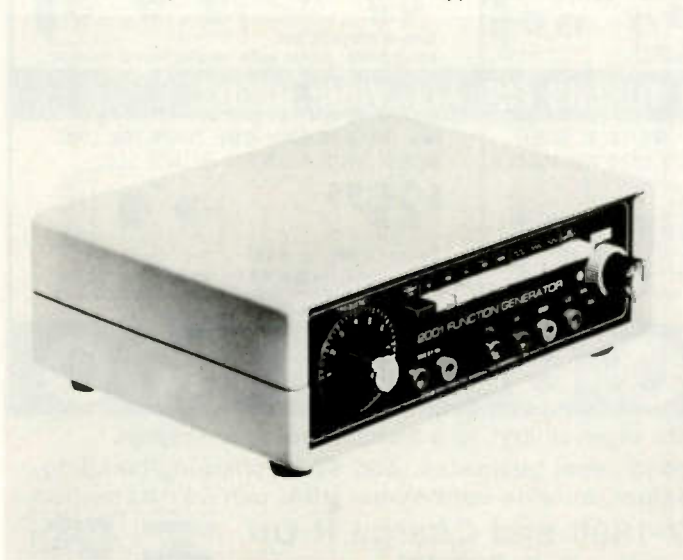

CSC's Model 2001 function generator.



The Mirage MP1 wattmeter.



If you can't hear them...



Dx'ing
Contesting • Ragchewing
Traffic Handling

There's a Telex Headphone that will let you do it better. Sure, sometimes you just can't hear them. But if there's a chance, it's easier with a Telex headphone. There's one for every discriminating choice. At better ham outlets everywhere, or write...

hy-gain electronics
DIVISION OF TELEX COMMUNICATIONS, INC.

8601 NORTHEAST HWY. 6, LINCOLN, NE 68505 U.S.A.
telephone: 402-467-5321, telex: 48-4324

Europe: 22, rue de la Legion d'Honneur, 93200 St. Denis, France,
telephone: 820 98-46, telex: 63-0013

TRANSISTORS, ETC.

type	case	VCE	Ic	PD	Ft	HEP#	each	ten	
MPSA10	NPN	T092	40V	.1A	.3W	50Mhz	72d	\$.40	\$3.50
MPSU52	PNP	T0202	40	1.5	1.0	150	S3031	.30	2.50
MPSU56	PNP	"	60	1.0	5.0	50	"	.35	3.00
MPSA55	PNP	T092	60	.5	.5	50	708	.25	2.00
2N2222	NPN	T092	30	.8	.5	250	736	.30	2.50
2N2322	SCR	T0-5	25V	1 AMP	.2ma	gate I	"	.30	2.50
2N2324	SCR	T0-5	100	1 AMP	.02ma	"	"	.40	3.50
2N2325	SCR	T0-5	150	1 AMP	.2ma	"	"	.45	4.00
2N2907	PNP	T018	40	.6	.4	200	52	.35	3.00
2N3440	NPN	T0-5*	250	1.0	10.0	50	S3021	.60	5.00
2N3565	NPN	T0106*	30	.2	.3	40	55	.15	1.00
2N3639	PNP	T092	12	.1	.2	350	57	.20	1.50
2N3640	PNP	T0106#	15	.2	.2	400	57	.15	1.00
2N3646	NPN	T0106#	15	.2	.2	400	50	.15	1.00
2N3704	NPN	T092	30	.8	.3	100	735	.40	3.50
2N3903	NPN	T092	40	.2	.3	300	736	.20	1.50
2N3904	NPN	T092	40	.2	.3	300	736	.20	1.50
2N4248	PNP	T092	40	.1	.2	40	715	.15	1.00
2N4250	PNP	T092	40	.1	.2	50	57	.25	2.00
2N4400	NPN	T092	40	.2	.3	200	736	.15	1.00
2N4437	NPN	T0106	30	.5	.2	250	736	.20	1.50
2N5138	PNP	T0106	30	.1	.2	30	52	.20	1.50
2N5172	NPN	T092	25	.1	.2	120	56	.25	2.00
2N5210	NPN	T092	50	.05	.3	80	728	.30	2.50
2N5910	PNP	T0106	20	.1	.3	700	52	.30	2.50
2N5964	NPN	T092	150	.1	.5	100	S0005	.25	2.00
D16P1	NPN	T098	12	(high gain lo-pwr DARL.)	"	"	"	.20	1.50
D40C1	NPN	T0220#	30	.5	6.	DARLINGTON	"	.30	2.50
D41D1	PNP	T0220	30	1.0	6.	150	S3027	.35	3.00
D44H8	PNP	T0220	60	10.0	50.	50	"	.50	4.50
RCA105	PNP	T0220	"	"	"	"	"	.35	3.00
MJE1091	"	T0220	60	5.0	70	PWR DARLINGTON	"	1.25	10.00
MJE1100	NPN	T0220	60	5.0	70	PWR DARLINGTON	"	1.25	10.00
TIP31A	NPN	T0220*	60	3.0	40W	"	"	.40	3.50
2N6101	NPN	T0220	80	10.0	75	"	"	.60	5.00
2N4304	N CHANNEL FET	T0106 CASE	sim.	HEP802	"	"	"	.35	3.00
40327	NPN	T0-5	300	1.A	5W	"	"	.40	3.50

* house number - we guarantee that the device sold is identical to the 2N number specified, HEP numbers from HEP T1ST.....
leads are cut and formed for PC mount



SUPER SAVER

- DIGITAL IC's**
- 2504T 1024 bit shift register TO-99 \$.80
 - 04025 CMOS 3 input NOR gate DIP .19
 - 04011 CMOS 2 input NAND gate .19
 - MC4015 TTL quad latch MOTO8084A .10
 - 75451 dual peripheral driver (8) .30
 - MM5058 1024 bit static shift reg. (8) 1.50
 - 7402N quad 2 input NOR TTL gate .12
 - 7430N 8 input NAND gate .13
 - 7492N decade by 12 TTL counter .10
 - 5P380 (DM836) NOR BUS receiver 1.00
 - DM8811 quad MOS interface IC .50
 - 8424 10/pwr dual SR flip flop .25
 - S270 pin compatible w/7400 .10
 - 74178 (8270) 4 bit shift reg. .30
 - LU321 dual JK flip flop SIG. .25
- LINEAR IC's**
- 747 dual 741 op-amp .50
 - 7708BPC 5W audio out w/heat sink 1.25
 - AD-1 (MC607) 1W out audio (8) .40
 - LM300 precision regulator TO-99 .50
 - LM307 op-amp (improved 741) .35
 - LM308AH micro/pwr op-amp 1.00
 - uA715 hi/speed 100V/us 60Mhz op/amp available in DIP(DIL) or TO99 2.00
 - MC1303 Motorola stereo amplifier DIP 2.00
 - uA776 programmable op/amp 1.00
 - LM309K +5V-1 AMP REGULATOR TO-3 .75
 - 7812K +12-1 AMP REGULATOR TO-3 .75
 - LS1412 1.4MBIA +12-3 AMP REGULATOR TO-3 (removed from sockets full specifications guaranteed) 3.95
 - CA3079 zero crossing switch DIL .60
 - uA703 VHF transistor array/epoxy TO99 .30
- MISC. IC's**
- 11C05 Fairchild 1.2GHz divide by 4 1MHz scaler 39.00
 - 95H90 Fairchild 300Mhz decade ctr. 7.95
 - 2706 1Kx8 bit EPROM 450NS 12.00
 - FC820 Fairchild opto/isolator DIL(6) .75
- DIODES**
- SIGNAL "pak" of 40 prime S1 or Ge signal diodes, leads are pre-trimmed for PCB board specify S1/Ge 40 min. each type \$2.00
 - 1N3810 15 AMP 200 PIV stud w/hdr. .70
 - 1N4581 6.4V .0058 reference diode .45
 - 18V Motorola 18V 5W zener .15

BISTABLE RELAY



SPOT 6VDC 200 ohm coils
1 amp 20 watt DC contacts
LONG LIFE 1x10⁹ operations
HIGH SPEED (500K)
HERMETICALLY SEALED

\$2.95 ea.

- SWITCHES -

RED PUSH BUTTON N.O. MOMENTARY CONTACT



40¢ each
\$3.75 ten
\$35-100

ONE AMP OP-AMP

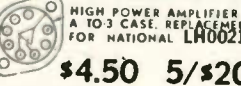

\$4.50 5/\$20

TRANSISTOR BONANZA

PRIME TO-92 PLASTIC TRANSISTORS FROM A RECOR SEMI CONDUCTOR MANUFACTURER. THESE ARE FIRST QUALITY DEVICES MADE FOR A COMPUTER FIRM. THE NPN'S HAVE CUT AND FORMED LEADS (TO-5 SHAPE), AND THE PNP ARE FULL LENGTH LEADS. SPECIFY NPN OR PNP. 50 PER TYPE MINIMUM.

\$6 for 100 \$50-k



600 MF 360V PHOTO FLASH
.90 ea.
10 \$7.50
100-\$65

DIP TRIMMER



12 TURN 1/4" x 1/4" x 1/4"
5K or 200K only
mfg. DALE
\$1.50 TEN FOR \$4

1/8 WATT RESISTORS

10 ea. -390, 1.8k, 3.9k, 6.8k, 11k, 43k, 68k, 240k - 5 percent tol.
80 FOR \$4

special

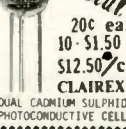

DIODE ARRAY
10 1N914's
20 PIN PACKAGE WITH SPINS SPACED .1" IN TWO STAGGERED ROWS
25¢ each
10 - \$2.25

VARO SEMICONDUCTOR

EPOXY BRIDGE RECTIFIERS
10 AMP 50V VJ048

90 ea. 10 for \$7.50 100-\$65

ZERO CROSSING SWITCH

A.C. powered 14 pin DIP IC used to trigger TRIAC devices... RCA CA3079

60¢ea \$5- ten

TRIACS - SCR's

TRIACS
RCA 8A 600V TO220 TAB
\$.99 each ten/\$9.50 \$89/c
RCA 8A 200V TO220 TAB
\$.69 each ten/\$6.50 \$60/c

SCR's
GE C122 8A 600V TO220 TAB (anode connected to tab)
\$.69ea. ten/\$6.50 \$60/c

10 pak of TO18 low voltage SCR's all marked and prime parts, 2N884, 2N896, etc.
10 for \$2.95

Numeric Display

1/4" Single Digit
GaAsP LED

COMMON CATHODE WITH RIGHT HAND DECIMAL. COMPACT-10 DIGITS IN 7.5cm PANEL WIDTH. HIGHLY LEGIBLE-BRIGHT RED W/ CHARACTER EASILY READ WITHIN 100° OVER A WIDE VIEWING ANGLE-125µm PER DIGIT AT TYPICAL BRIGHTNESS LEVELS.
65¢ each - 10 for \$5.95

PO BOX 41778
Sacramento, Ca.
95841 916 334 2161

Money back guarantee - \$5 minimum order. we pay post on orders for \$10 or more. All payment must be in U.S. funds Foreign orders must include post BAC & MC are not prepaid orders and shipping is added

BABYLON ELECTRONICS



Five-Chip Auto IDer

— in case you forget

You don't have to speak TV to use this one.

Richard Bartholomew
Box 300 Butler Terrace
Freeland PA 18224

Having seen several articles pertaining to automatic code identifica-

tion, all using diode matrices or one-shots, I thought I'd share a circuit I developed for TV translators requiring much the same thing. This particular circuit uses only five ICs, three TTLs (cheap), one 5-volt regulator, and one

256-bit ROM (read only memory). There are also four transistors performing housekeeping chores such as inversion and pulse generation.

Referring to Fig. 1, the circuit operation can be ex-

plained as follows: IC1, an LM556 dual timer uses half of its internal circuitry to provide a 30-minute timer. The output of this timer is normally high. After timing-out, it goes low which turns off Q1 and forces the reset pin on the second half of the timer to go high. This enables the astable oscillator, and a clock stream, at about 8 Hz, toggles IC2, a dual 4-bit binary counter. This counter performs two functions. First, it addresses IC4, an 8-line-to-1-line multiplexer, which causes IC4 to selectively scan its inputs for a signal. Going back to IC2 now, it also addresses IC3, a 32 word, 8 bit/word ROM. The output of the first counter also drives the clock input of the second counter at a speed 8 times slower than the first half. This causes the multiplexer to scan each of its 8 inputs before the ROM address changes once.

The ROM is programmed as shown in Table 1. I always allow the first three bits at address 00000 to be 0. This allows for any clearing operations of the counters to complete before data starts flowing. In the example, I

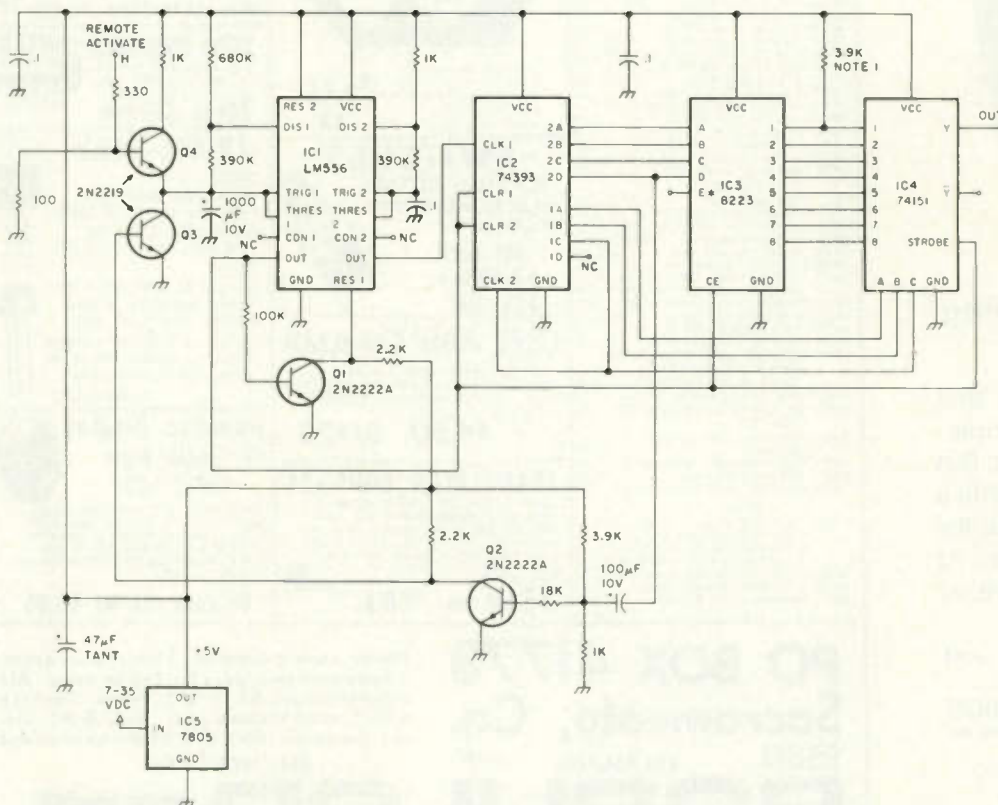

Fig. 1. Schematic diagram of automatic code ID circuit. *Tie high or low depending on message desired. See text for details. Note: tie all output to +5 volts through 3.9k resistor. All resistors are 1/4 W, 5%.

used the letters "DE W79QY7." I allowed 3 consecutive 1s for a dash and one 1 for a dot. Spacing between letters is three 0s and spacing between words is seven 0s. The table is read from address 00000, A through H, then address 00001, A through H, and continuing down through binary address 01111. As can be seen, the ROM outputs 8 bits at a time to the 8 inputs of the multiplexer. This is the reason for running the multiplexer 8 times faster than the ROM. As each 8 bits appear on the inputs to the multiplexer, the inputs are scanned and converted to serial data at the Y output.

At the completion of binary count 16, the negative-going edge on the 2D output of IC2 turns off Q2 for a period of about 100 ms. This causes its collector to go high. This high voltage on the base of Q3

forces it into heavy saturation, discharging the time-out capacitor at TRIG 2 on IC1. This causes the timer to reset to zero and start timing out 30 minutes, when the sequence will repeat. Q4 was added to allow remote triggering of the timer. This is accomplished by either a logic 1 at the remote activation input or tying this point to +5 volts.

IC5 is simply a 5-volt regulator which takes anywhere from 7 to 35 volts input and converts it to 5 volts for the rest of the circuitry.

This circuit can be programmed to provide two separate 128-bit messages, selectable at the flip of a switch. Input E on IC3, which is shown open on the schematic, can be tied to an SPDT switch which has one side grounded and the other tied to +5 volts. When switched to ground,

the address to the ROM will start with 00000 and when switched to +5 volts, it will start with 10000.

Being a computer freak and not a ham, I am not sure if this circuit will be an aid to anyone, but if so, I

would like to hear from you regarding your uses and any changes you might have made. (For amateur use, the 30-minute timer sequence would have to be shortened to 10 minutes. The sample call sounds like a rare one.—Ed.) ■

BCD count to ROM	Desired output of ROM							
	A	B	C	D	E	F	G	H
00000	0	0	0	1	1	1	0	0
00001	0	1	0	1	0	0	0	1
00010	0	0	0	0	0	0	0	1
00011	0	1	1	1	0	1	1	1
00100	0	0	0	1	1	1	0	1
00101	1	1	0	1	0	1	0	1
00110	1	1	0	1	1	1	0	1
00111	1	1	0	1	0	0	0	1
01000	1	1	0	1	1	1	0	1
01001	0	1	1	1	0	0	0	1
01010	1	1	0	1	0	1	1	1
01011	0	1	1	1	0	0	0	1
01100	1	1	0	1	1	1	0	1
01101	0	1	0	1	0	0	0	0
01110	0	0	0	0	0	0	0	0
01111	0	0	0	0	0	0	0	0
10000	0	0	0	0	0	0	0	0

Table 1. ROM programming sample. Sample indicated is W79QY7.

The Vacationer

— B&W's portable antenna

Steve Schwartz WA2ALT
2770 West 5 St. Apt. 18A
Brooklyn NY 11224

If you travel a lot or live in an apartment, there's a great little antenna for the low bands. B&W makes a low-band antenna covering 2-40 meters and it virtually takes up no space. The antenna is about 4½ feet long. When the antenna is disassembled, it can fit in a small suitcase with

all your clothes. This antenna is the Vacationer™.

The antenna comes with four coils and a shorting bar for 6 and 2 meters. The Vacationer also comes with coax, counterpoise, and all mounting hardware.

Changing coils is a breeze. To change a coil, all you have to do is loosen two screws and the coil slides right off. Tuning the antenna is just as easy. The whip itself does not have to ever be touched (except on

2 meters). Tuning is done by adjusting the length of the counterpoise. The counterpoise can hang out the window or lie along the floor in the room.

There's nothing else to buy for the antenna. The antenna mounts on the window via a vise-type mechanism. It's also great for you apartment-dwellers who can't put up antennas.

The only "tool" needed for assembly and disassembly is a flat screwdriver.

The Vacationer antenna

can be ordered from any store which stocks B&W parts. The number of the antenna is the Model 370-10. The antenna lists for approximately \$32.50.

There is a previous model, number 370, which is less in price and does not include 40 meters. If you would like the specifications, write to Barker and Williamson, Inc., 10 Canal St., Bristol PA 19007.

It's a great little antenna and the swr is adjustable to 1:1. ■

must have only one low tone and only one high tone.

The next section of the valid-digit recognizer is the delay circuit consisting of U3, U4, and U5. R1 and C1 determine the time delay. The output of the valid-digit recognizer circuitry is U3, pin 3. Pin 3 of U3 goes low only when one low tone AND only one high tone are present and they must remain uninterrupted for the time duration set by R1 and C1. Optimum setting of R1 is from 0.25 to 0.5 seconds. This setting may vary for your particular setup. As a rule of thumb, set R1 to be fast enough for your signaling requirements, but slow enough to reject erratic pulsing. Remember that a condition could exist where a certain voice may be decoded as two tones which happen to be two touchtone™ frequencies.

This would meet the requirements of only one low and only one high tone, but would not be decoded if R1 were set correctly.

Next, we use the output of the valid-digit recognizer to gate the outputs of the 567s into the eight-to-sixteen-line decoder. U5 and U6 are 7414 Schmitt triggers. They will further condition the outputs of the 567s and shape the out-

put waveform. U7 and U8 (7400 NAND gates) provide the gating of the 567s to the sixteen-line decoder. Thus, no tone decoding can take place without valid-digit recognition because the outputs of the 567s are not being applied to the sixteen-line decoder unless valid-digit recognition has occurred. The outputs of the sixteen-line decoder, U9-U12 (7402s), are normally low and go

high when the digit is decoded.

The system described here is in use at three repeaters in the Hartford CT area (WR1ABM: .28/.88 and 442.85-447.85 and WR1AFU: .75/.15) as autopatch and control decoders and are working well without any problems. With a 0.5-second response time, there has never been a false activation of any function. ■

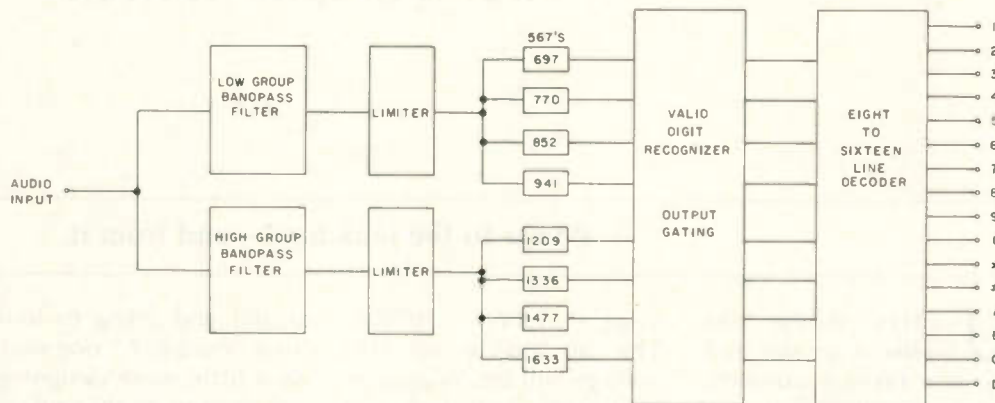

Fig. 2. Block diagram of decoding system.

POWERFUL KEN PRO ROTATORS

KR-2000



KR-600



KR-400



KR-500



« SWISS QUAD VHF SERIES »

Multi Band Beam Super DX Series

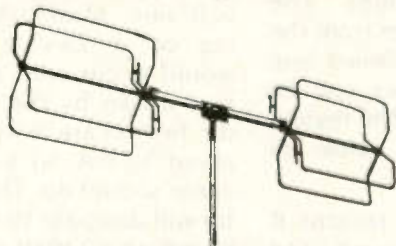

SQ-22 TWO METER DUAL QUAD

ANTENNA GAIN AND FRONT TO-BACK RATIO ARE WELL IMPROVED WHEN TWO ELEMENTS ARE DRIVEN AT ONE TIME WITH PHASE DIFFERENCE COMPARED TO A SINGLE DRIVEN ELEMENT SUCH AS A CONVENTIONAL QUAD OR YAGI. THE SQ-22 PROVIDES THE OWNER WITH SUCH FEATURES. SIMPLE ASSEMBLY AND LIGHT WEIGHT.

THE 3F35DX BEAM IS FOR USE IN THE 10, 15 AND 20 METER AMATEUR BANDS. THIS IS A HIGH PERFORMANCE BEAM THAT MAKES USE OF A COMBINATION OF PARALLEL FEED, FULL SIZE INDIVIDUAL DRIVEN ELEMENTS FOR EACH BAND. ALONG WITH THE USE OF HI-Q PARASITIC TRAPPED ELEMENTS. HIGH POWER RATING 3KW AND EXCELLENT VSWR ON EACH BAND.

WRITE OR CALL FOR PRICES AND INFORMATION.

DEALER INQUIRIES WELCOME

ALL ANTENNAS IN STOCK.
FOB OKLAHOMA CITY, OKLA.

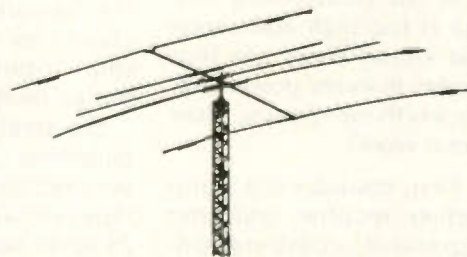

3F35DX MULTI BAND FIVE ELEMENT BEAM

BRODIE ELECTRONICS COMPANY

2537 Edgewood Drive
Moore, Oklahoma 73160
405-794-0406

✓ B42

The All-Wrong Power Supply

— works in spite of itself

Power to the junk box! — and from it.

Usually when one builds a power supply, one takes a currently vogue circuit and uses it verbatim. For solid-state rig advocates, the present norm is using a transformer, a diode-bridge rectifier, and a series pass transistor. While I have no qualms about this circuit, I know many hams who spend time and money looking for the "proper" parts when, in reality, they can use junk box parts in an equivalent circuit.

The circuit in Fig. 1 is the power supply I have been using for my Icom IC-230. It delivers about 3.5 Amps at 12 volts. When one looks at the schematic, however, the circuit *looks* wrong. First, the transformer voltage is too high and everyone *knows* there are four diodes in every power supply worth mentioning. How can it work?

First, consider the transformer, rectifier, and filter capacitor combination. The output voltage with transformer secondary voltage V_t , load current I_l , and capacitor C connected in a half-wave circuit is:

$V_{out} = 1.4V_t - I_l/120C$. The ac ripple on this voltage will be: $V_{ripple} = I_{out}/210C$. Inserting our values we find the following: $V_{out} = 1.4(28V) - 4 \text{ Amps}/(120 \times 4 \times 10^{-3} \text{ Farad}) = 30.87$ volts and $V_{ripple} = 4/(210 \times 4 \times 10^{-3}) = 4.76$ volts. Thus, the output is a dc level of 30.87 volts with a 4.76 volt ac voltage impressed upon top of it. Therefore, we have a varying voltage from 26 to 36 volts at the input to the regulator.

We have just shown why we are using a higher voltage transformer with a half-wave rectifier. The transformer chosen was a surplus one with a 28 V, 4 A secondary, bought for \$1.00. This is in contrast to the 18-volt types usually chosen for a similar supply, then operated with a bridge rectifier.

Practically, what these equations show is that if our regulator can follow an input voltage from roughly 25 to 36 volts, we can use this circuit to make a regulated power supply at a variety of voltages. Before slapping a three-terminal regulator on the

output and going to look for a "cold 807," one must do a little more designing.

Returning to the voltage output equation, we note that at zero current our voltage across the filter capacitor is 1.4×28 or 39.2 volts. This value is the maximum voltage across the capacitor. Then a capacitor with a working voltage of at least 60 volts should be used.

The standard three-terminal regulators have a maximum input voltage of about 35 volts. Therefore, one might damage or destroy the regulator if it were connected directly to the rectifier output. The zener diode (Z) and the resistor (R) in the schematic take this into account. The zener was chosen from the junk box and almost any power-type zener can be used as long as the regulating voltage is below 35 volts.

The value of resistor R can be easily found. The current through the regulator is roughly the base current of the transistor which is roughly the collector-emitter current divided by

the gain of the transistor. Since a typical power transistor has a gain of about 50 and our maximum output current is about 3.5 Amps, we see that the base current is about 70 mA. Since our lowest voltage across the capacitor is about 25 volts, we want something like an 8-volt drop with 70 mA or about 100 Ohms.

Although the drop across the resistor is constant, the actual voltage input to the regulator will vary from 17 to 27 volts. This can influence the choice of zeners since a 25-volt zener will only draw power when the voltage is above 25 volts and, therefore, has a smaller duty cycle than would a 20-volt one. Maximum heating on a 25-volt zener would occur with no current drawn by the regulator. In this case, it would be about 10 mA, so a 1-Watt zener should do. The resistor will dissipate 10 volts at 80 mA, so a 2-Watt one will be fine.

The final bit of analysis deals with the diode (D2) on the ground leg of the three-terminal regulator.

This is used to raise the regulator voltage up by 7 V so a "12-volt" regulator will give a 12-volt output.

No analysis will be given of the power transistor since my only suggestions are to heat-sink it well, choose one with a gain of about 50, and a power of about 75 Watts. A 2N3055 is an inexpensive and usually safe choice. The small capacitor across the output is used for protec-

- Parts List**
 D1 10A, 60 piv silicon diode
 D2 1A, 15 piv silicon diode
 U1 7812, 12-volt positive voltage regulator
 Q1 2N3055 transistor
 R,Z See text

tion from oscillation. Although I have never had a supply oscillate, the capacitor is cheap insurance.

The supply was constructed on a piece of particle board with plywood sides and a U-shaped cane

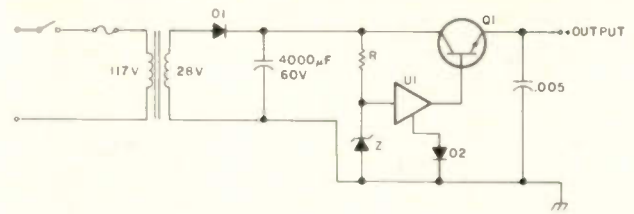

Fig. 1. Power supply schematic diagram.

metal cover for ventilation. A little decorative stain made the XYL joyfully approve of the supply for use in the den instead of being hidden away.

The design of this supply is neither unique nor innovative, but it shows that one can build a power supply from the junk box that really works. ■

Over the years, the thermal, or calorimetric, wattmeter has remained the standard for all measurements of radio frequency power. Unfortunately, calorimetric power meters are very expensive and, therefore, are found only in the laboratory. Almost without exception, the front panel "power" meter found on a radio transmitter is really a peak-reading voltmeter calibrated to approximate a reading in Watts. Any harmonic energy from the transmitter due to misalignment or component failure can cause this meter to soar to a reading much higher than the true rms power output. The obvious solution has been overlooked. Every radio transmitter can be equipped with a simple power metering circuit offering accuracy and insensitivity to harmonics approaching that of a thermal-type meter.

In place of the usual detector followed by a capacitor input filter, the improved circuit will employ a choke input filter. This circuit, prop-

erly designed, will develop an output equal to the average dc level of the half-wave pulsating dc from the detector (resemblance to the choke input power supply filter is not accidental). An average reading voltmeter may be calibrated to read the true average power dissipated by a load. The ratio of average power to rms power remains relatively constant for extreme distortions of the sine

wave, while the power, computed by the square of the peak voltage divided by twice the load resistance, may vary several decibels.

This simple high-accuracy circuit has but one special requirement. The input inductor must be chosen so that its effective inductance remains above the critical value required for voltage regulation to the average level over the frequency band of

interest. Therefore, a choke approaching self-resonance at the operating frequency would not be suitable. The critical value is computed by: $L_{min} = (0.060/F)R_L$ henrys.

A typical circuit for use at a 50-Ohm termination, where $X_{C1} \leq 5$ Ohms and $X_{C2} \leq R_L/10$, is shown in Fig. 1, and the results from low-frequency ($F = 40$ kHz) test circuits (Figs. 2 and 3) are shown in Table 1. ■

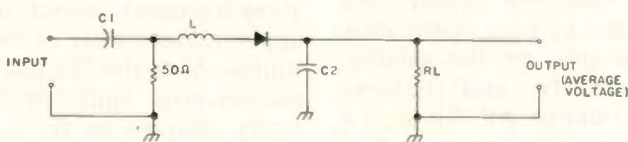

Fig. 1.

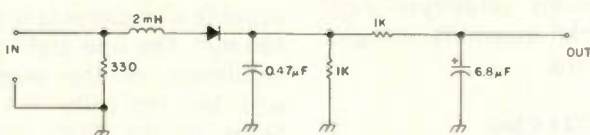

Fig. 2. Peak detector.

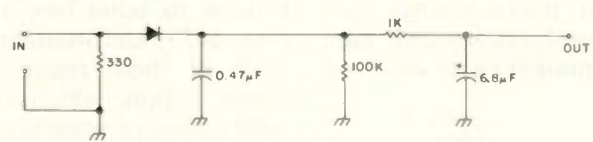

Fig. 3. Average detector.

Input	Calculated rms power	E _{Peak det.}	E _{Avg. det.}
8.0 V p-p triangle	0.016 W	3.5 V	1.0 V
6.5 V p-p sine	0.016 W	2.9 V	1.0 V
4.6 V p-p square	0.016 W	2.1 V	0.98 V

Table 1.

The Hardhearted Rf Detector

— insensitive to harmonics

William E. Coleman, Jr. N4ES
 Surface Equipment Engineering
 E-Systems, Inc./ECI Division
 1501 72nd Street North
 P.O. Box 12248
 St. Petersburg FL 33733

Custom-Designed Power Supplies

— try the 723

Bargain-basement fanatics will love this new approach.

Carl S. Griebno K2GEJ
R.D. #2 Kline Drive
Pennellville NY 13132

LSI, microcircuits, mass production, and high component costs are but a

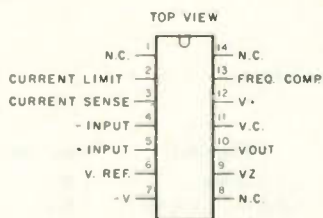

Fig. 1. Pin designation for the 723.

few of the many reasons that are leading to the demise of amateur radio home brewing. In spite of this, there are plenty of well-documented circuits for you to select from that will not wind up costing a fortune to build (see any issue of 73). Unfortunately, most of them require a power supply which can wind up with a price tag as large or larger than the rest of the project.

If you are considering bargain-basement electronics, you should also anticipate the problems associated with quality, reliability, and aesthetic appeal. There are precious

few units I would let adorn my operating table.

This article will show you how to custom-design your next supply, featuring the widely used 723 IC regulator. This will allow you to have the supply best suited to your application and provide the quality, reliability, and features you desire. All this is at a surprisingly low cost. You should find the design calculations relatively easy and the assembly straightforward.

The 723 Chip

There are many features of the 723 IC, one of which

is a temperature-compensated and amplified reference voltage output (Fig. 1, pin 6). This output voltage is typically 7.15 volts and capable of supplying up to 15 mA of current. Current-sense terminals (pins 2, 3) allow the user to select the upper current limit of the supply. Also, the 723 has a built-in error amplifier directly coupled to an "on-board" series pass transistor. This combination is capable of supplying up to 150 mA. The line and load regulation of the supply will be typically 0.1%. Some of the 723's other features are low current drain, low temperature

the Q1 and Q2 case temperatures below 100° C to achieve the best reliability.

There will be a special section on C1 later on in this article.

Overvoltage Protection (ovp)

The ovp circuit, an SCR crowbar-type, is optional in that it has no effect on the operation of the regulator. If, in fact, you opt for a variable supply, it can be a nuisance. But, if you have a nice new SSB rig, it can save you a bundle. The circuit consists of an SCR, C8, R10, C7, R6, D5, and R5. The only variable in the circuit is zener diode D5. The zener should be rated 2 to 3 volts higher than the regulated output voltage and have a 5% tolerance. The ovp circuit operates as follows: Any rise in the output voltage above the rating of D5 will fire the SCR. After firing, it will remain in the on state until fuse F2 blows, thereby protecting the load from a gross overvoltage. Choose a rating for F2 approximately 20% above the design current. Resistor R6 prevents any anode-gate leakage current from inadvertently firing the SCR. Capacitor C7,

along with R5, acts to prevent any power line switching transients from firing the SCR. This is especially true under no-load conditions. C8 and R10 form a dv/dt (voltage change to time change) network that prevents the SCR from turning itself on due to high rate-of-rise voltage excursions across the device. There are anode and gate pads for the SCR clearly marked on the board. Also, there is a hole drilled in the common foil, just below the SCR mounting hole, for the cathode connection. When mounting the SCR, use the insulating washer that usually comes with the device. The stud is the anode connection and, without the washer, the mounting nut will come in contact with the common foil. If there is no insulating washer with the SCR, one can be easily fabricated by peeling from a small piece of circuit board material. The unclad material may then be used as the washer.

Remote Voltage Sensing (rvs)

Rvs, a feature of this supply, is seldom discussed in literature. To better under-

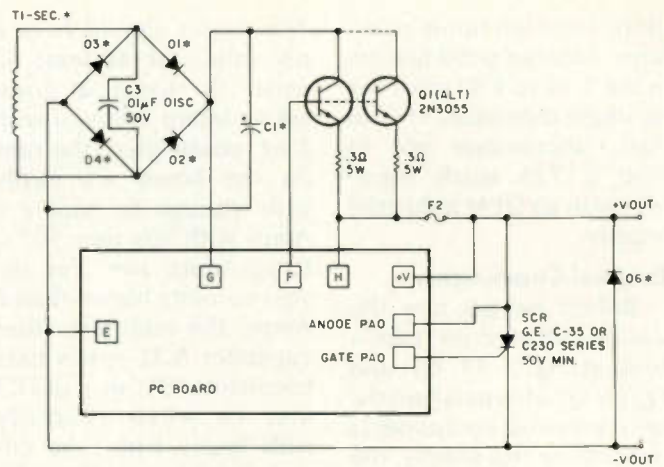

NOTES: □ - INDICATES MARKED FOIL CONNECTION

*SEE TEXT

Fig. 3. Wiring arrangement when the 723 is used as a control system for an external regulated supply. Run rvs wires from PC board. Do not use jumper (Fig. 4).

stand the value of rvs, let's take a look at what can happen when it isn't used. All electrical connections are imperfect, as they have some resistance associated with them. The same holds true for wire. Consider a connector resistance of 50 milliohms and a power lead resistance of the same magnitude. That is like putting a resistor with a value of 0.15 Ohms (two terminations and a conductor) in each lead of the power cable. This comes to a total resistance of 0.3 Ohms. That doesn't sound like

much, but, when multiplied by 10 Amps, the resultant voltage drop in the cable is 3 volts. Not good! Now, if we could sense voltage out at the load, the cable drop would still be there while the regulator is being "fooled" into putting out enough extra voltage to compensate for this drop. With this supply design, all that has to be done is to run two small wires in parallel with the power cable wires. Tie them together at the remote load location and you have rvs. (Connect the +S and the +V wires together, also the -S and the -V wires.) The reason you may use smaller wires is due to the fact that only a few milliamps of current are required to drive the error amplifier in the 723. Remember, the higher the current levels that you work with, the more important it becomes to use rvs. R3 and R4 are shown to be 3.9 Ohms. Any value you happen to have between 2 and 10 Ohms will be satisfactory here. If you do not wish to use remote sensing, a jumper may be installed in place of R3 and R4.

Let's Regulate

The regulator portion of this supply consists of C2, R8, R9, C6, the 723 IC, C4,

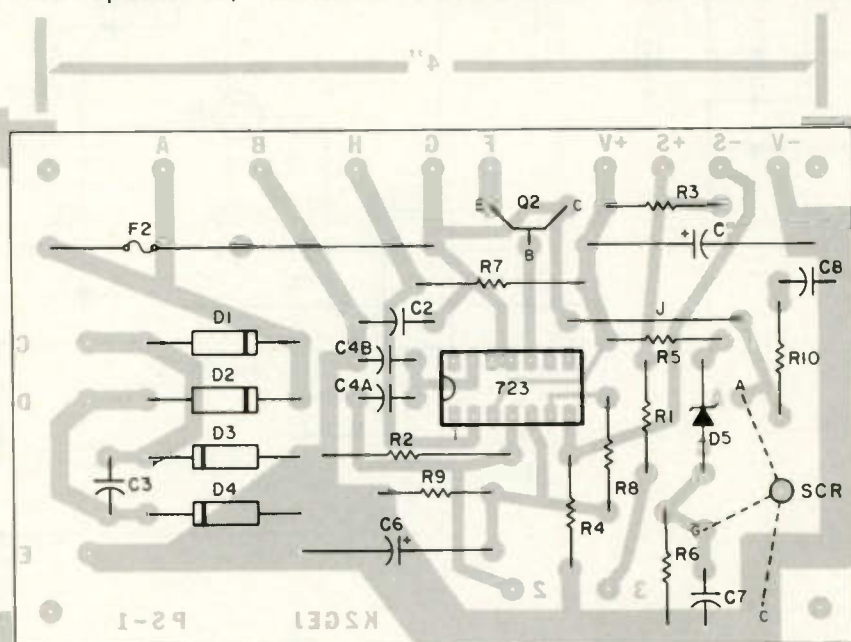

Fig. 4. Component layout.

Q2, Q1, R7, C5, R2 and R1 (Fig. 2). The circuit, when constructed with a jumper between pins 5 and 6 of the IC (in place of R8), is for output voltages of between 8 and 24 volts. Do not use R9 and C6 in this case. Remember our reference voltage (V_{ref}) output of 7.15 volts? In this connection, the reference voltage is applied directly to the (+) input of the error amplifier. Therefore, the (-) input of the error amplifier *must* be 7.15 volts in order for the 723 to be in a stable condition at V_{out} , pin 10. Let's go through a simple calculation and see how we can design for an output voltage of 13.5 V dc so that you can run your new 2 meter rig or maybe a mobile unit brought in for the winter. Looking at the schematic, we see that the voltage at pin 4 of the IC, the (-) input of the error amplifier, is derived from a voltage divider R3, R1, pads 2 and 3, and R2 and R4. R3 and R4 are very low value resistors that allow for rvs and, therefore, have no effect on our calculation. Pads 2 and 3 allow for an external voltage adjustment if desired. So now we're down to two resistors, R1 and R2. The value of R2 is not critical (somewhere between 1k and 3k is fine), but must be chosen first. Let's say a 2k resistor is handy for R2. The voltage across R2 must be equal to our reference supply, again 7.15 volts. Our supply is supposed to operate at 13.5 volts, so the voltage across R1 will be 13.5 volts minus the drop across R2 (7.15 volts). A proportion will give us the value for R1. The equation is as follows:

$$\frac{R1}{V R1} = \frac{R2}{V R2}$$

Solve:

$$\frac{R1}{13.5 - 7.15} = \frac{2k}{7.15}$$

$$7.15 \times R1 = 6.35 \times 2k$$

$$R1 = \frac{6.35 \times 2k}{7.15} =$$

$$1776 \text{ Ohms.}$$

Use 1800 Ohms, 5% tolerance, 1/4- or 1/2-Watt.

This will give you an output voltage very close to 13.5 volts. If you would like to trim V_{out} , use a 1300-Ohm resistor for R1 and wire a 1k variable resistor to pads 2 and 3. This will give you 13.5 volts output at approximately 50% of pot rotation, giving you plenty of trim range. Otherwise, don't forget to jumper pads 2 and 3 if you use a 1.8k resistor for R1. When using the 8-through-24-volt connection, place C4 at C4A, Fig. 4. C4 is the compensation capacitor and provides a high-frequency breakpoint in the error-amplifier circuitry, preventing unwanted oscillations.

In order to use the supply for voltages of less than 7 volts, only minor changes need be made. Resistor R2 will *not* be used. Place a jumper in pads 2 and 3 and also in place of R1. In doing this, the output voltage will be placed directly on the (-) input of the error amplifier. Let's say we want 5 volts output for some TTL circuit we have or maybe that new micro-computer the UPS man just delivered. All that has to be done is to divide the 7.15-volt reference supply down to 5 volts. This calculation will be the same as the previous one. Choose R9 (any value from 1k to 3k). Let R9 = 1k. This time the equation is:

$$\frac{R9}{V R9} = \frac{R8}{V R8}$$

Solve:

$$\frac{1k}{5} = \frac{R8}{7.15 - 5}$$

$$R8 \times 5 = 1k \times 2.15$$

$$R8 = \frac{1k \times 2.15}{5} =$$

$$430 \text{ Ohms.}$$

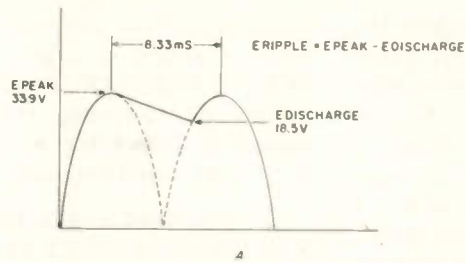

Fig. 5. C1 calculations.

CAPACITOR DISCHARGE TABLE	
% DISCHARGE	TIME
80	0.25 RC
60	0.50 RC
50	0.75 RC
37	1.00 RC

Use a 5% tolerance, 1/4- or 1/2-Watt resistor. Now we have the R8 and R9 values we need for our 5-volt supply. Capacitor C6 is used to filter out any "white noise" present in the V_{ref} output and in R8. Also, place C4 at C4B, Fig. 4.

For output current levels of 6 Amps or less, R7 must also be calculated. R7 is the current-sense resistor and its value will set the maximum output current of the supply. When the R7 voltage reaches 0.6 volts, the 723 will start reducing the output voltage in an attempt to keep the output current constant. This calculation is the Ohm's Law relationship $R = E/I$, where R is the value of R7, E is 0.6 volts (the specified CL - CS voltage), and I is the supply current limit. The calculation for R7 is as follows: $R = 0.6/2 \text{ Amps} = 0.3 \text{ Ohms}$. Don't forget the power dissipation in R7. That calculation is as follows: $P = E \times I = 0.6 \times 2 = 1.2 \text{ Watts}$. At the risk of not having current limiting, or waiting until you can procure this low value resistor, a jumper may be used in place of R7. As long as R7 is in place, the supply can even stand intermittent short-circuit conditions at the output terminals with no resulting damage.

If you've read this far, it's time to get a cup of coffee or maybe a nice cold 807. We still have a little more to go.

C1 Calculations

There are various ways

to find a value to be used for C1; most of them use higher mathematics. To me, that is an exercise in futility. What I will explain here is a simple method that works very well, and can be easily verified if you have access to an oscilloscope. Again, for the sake of numbers, let's work on a 13.5-volt, 2-Amp supply design. I will assume you have found in your junk-box a 24-volt center-tapped transformer. The first step is to add 5 volts to your design output voltage. The reason for this is to make absolutely sure that there is enough voltage to overcome the base-emitter drops (V_{be}) in the regulator transistors, and give the series pass transistors some "operating room." Adding 5 to 13.5 volts gives us 18.5 volts. This value is placed at the point labeled E DISCHARGE, Fig. 5. Now, suppose you would like to use the full-wave, center-tapped connection as previously mentioned. Divide the 24-volt rating by two. The reason this is done is that you are only using half the transformer winding by connecting the center tap to common. This will give you 12 volts, which is an rms value. To find E PEAK, the value C1 will charge to, multiply 12 volts by 1.414 ($E \text{ PEAK} = E \text{ RMS} \times 1.414$). This value, 16.97 volts, does not meet the minimum value of 18.5 volts required by the supply design. E PEAK should be a minimum of 5 volts higher than E DISCHARGE, or the filter capacitor (C1) will become very large (ex-

pensive). This dictates the use of the 24-volt transformer in a bridge rectifier configuration. It also means that you have to come up with two more diodes. The value for E PEAK will now be 24×1.414 or 33.9 volts. Now we have 15.4 volts before we're down to the E discharge value. The next step is to find out what percent 18.5 volts is of 33.9 volts. Divide E DISCHARGE by E PEAK. $18.5/33.9 = .5457$ or 54.57%.

Now go to the capacitor discharge table in Fig. 5 and find a percentage value closest to the above calculation, in this case 50%. Across from this you will find 0.75 RC. What this means is that in the 0.75 time constant, the capacitor will discharge to 50% of its initial value, E PEAK. Now $R \times C$ is a formula we can work with to find the value for C1. Remember $t = RC$? To find a value for t to be used in this formula, solve the equation $8.33 \text{ milliseconds} = 0.75t$. The time value, 8.33 milliseconds, does not change, as it is the period between the pulsating dc peaks that charge C1 (60 Hz line fre-

quency). 0.75 is the table value reached by the E PEAK, E DISCHARGE calculations. Solving the equation, we get: $t = 8.33/0.75 = 11.1$ milliseconds.

We now need a value for R to complete our C1 calculation. This value can be found from $R = E/I$ where E is the E PEAK value and I is the supply current design value, or 2 Amps. Solving this equation, we get $R = 33.9/2 = 17 \text{ Ohms}$.

To find the value of C1, use $t = RC$. Solving this, we get: $11.1 \text{ milliseconds} = 17 \text{ Ohms} \times C$. $C = 11.1/17 = 0.652$. To get uF, multiply $0.652 \times 1000 = 652 \text{ uF}$ for C1. Now 652 uF is the minimum value. Any capacitor of this value or larger is suitable. The voltage rating for C1 has to be greater than E PEAK. In this case, a 50 V dc unit should be used. This method is a bit arduous, but, nonetheless, it's a lot easier than some other methods.

Potpourri

I would like to make some more comments about T1 at this time. Transformers with secondary current ratings of two

to three Amperes are very reasonable. If you would like to design a 12-volt, 10-Amp supply, the transformer cost may become quite high. Remember the older tube-type TV sets? The power transformer used in these sets is good for 350 Watts continuous duty. In the *Radio Amateur's Handbook*, in the power supply section, there are excellent instructions on rewinding transformers. Also, in the section on construction practices, you can find a copper wire table that will guide you in selecting the right size wire for your new secondary winding. Rewinding is not difficult and your efforts will be well rewarded. Another advantage is that rewinding enables you to keep the Q1 power dissipation down by reducing the E PEAK (Fig. 5) value to a reasonable level for your supply design.

At no place in this article have I mentioned tying common (-V) to the chassis. Also, on the PC board artwork (Fig. 6) you will not find any mounting holes in the common foil. This is done for two good reasons. The first is safety!

Connect that third wire (green) in your power cord to the chassis. All of your equipment should be well grounded. The second reason is for convenience. With a floating supply, the positive and negative connections may be treated just like a battery. Remember that microprocessor the UPS man just delivered? Just found out you needed a negative supply for some PROMs? Build two of these supplies. Tie the positive output of one to the negative output of the other and you have a plus/minus supply. The applications are unending.

In Summary

I believe an outline of the steps you need to go through in designing this supply is in order. First, the regulated output voltage and rated current must be selected. If the voltage is above 8 volts, calculate the values for the R1 and R2 voltage divider. If the voltage is 7 volts or less, calculate the R8 and R9 voltage divider. If R7 is used, calculate that value. Select zener diode D5 in the ovp circuit if used. Select resistors R3 and R4 if rvs is to be used. Decide on the number of transistors to be used at Q1 or Q1 (alt.), and select the correct diodes for D1 through D4. Finally, run through the T1 and C1 calculations.

This sounds like a lot, but many of the above steps are quick and easy. The remainder of the components mounted on the PC board are common to all designs.

The 723 is a great IC. Give this supply your best shot and I'm sure you'll be very happy with the results. For those of you who wish, I can supply a high-quality predrilled circuit board for this article. The cost is \$4.50 postpaid. An SASE will bring an answer to any questions you may have. ■

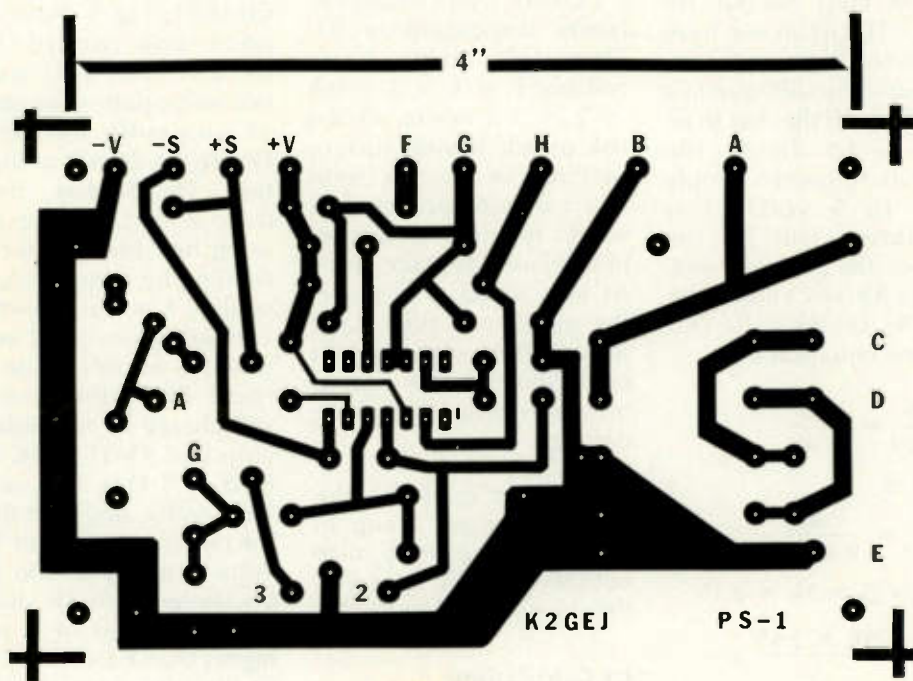

Fig. 6. PC board artwork.

A Touch of Class

— nifty \$35 operating console

For comfort and convenience, this bench can't be beat.

Horace M. Lewey, Sr. WA4CUD
2405 Cyprus Street
Greensboro NC 27405

Console design can make a world of difference in your enjoyment of ham radio. Comfort, convenience, and ease of operation were the criteria

set for the construction of this operating bench. The finished product provides all that and is very sturdy as well.

Figs. 1, 2, and 3 show how everything goes together. The parts list gives all the materials you will need.

You should countersink all holes for the bolts and screws, fill them with plastic wood, and sand them smooth before painting or staining. This will give you an attractive finish. Leave a one-inch overhang on the sides of the top shelf and the desk-

top, as you can see in the photo. ■

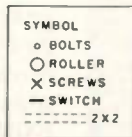
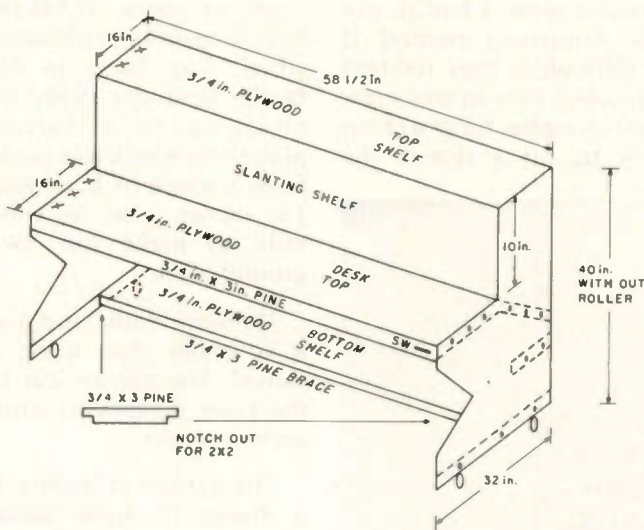

Fig. 1.

Parts List

- | | |
|-------|--|
| two | 3/4" x 4' x 8' plywood |
| four | 2" x 2" x 8' pine or oak |
| three | 3/4" x 3" x 6' pine (for front panel and shelf braces) |
| 24 | 1/4" x 2 1/2"-long bolts |
| 24 | flat washers |
| four | roller casters |
| | small can of plastic wood |

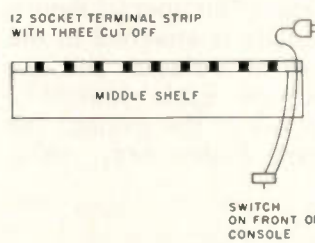

Fig. 2.

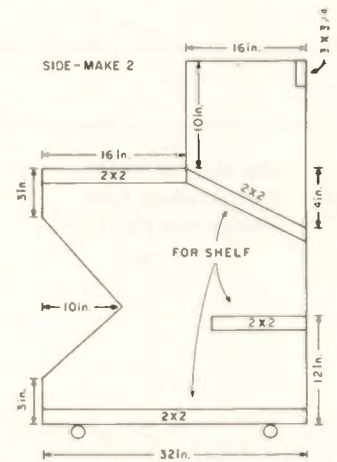
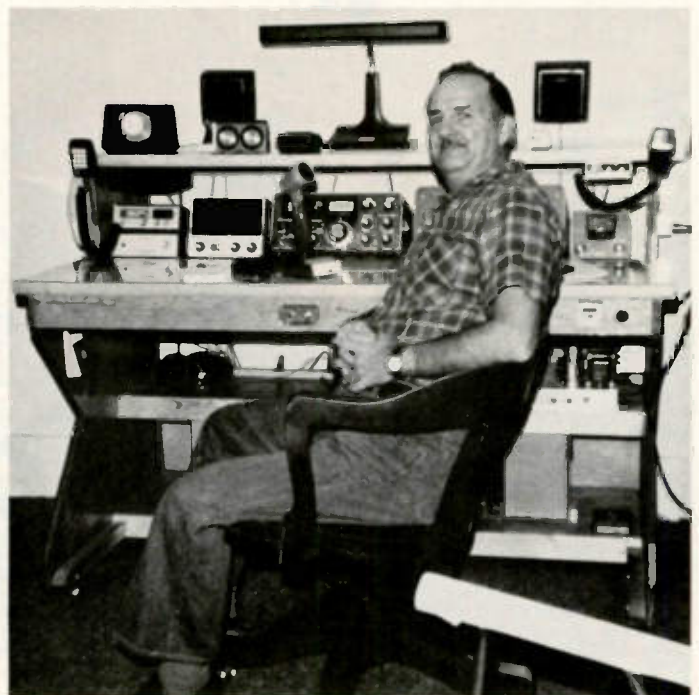

Fig. 3.



How To Bury Coax

— the garden cultivator technique

Ye keep what ye sow.

*Max Holland W4MEA
Rt. 3, Rawlings Lane
Madisonville TN 37354*

A ground plow is often used to bury coax cable. This special device usually is attached to the rear of a tractor and can put the cable down 8-12 inches in the ground. See *Ham Radio*, May, 1970,

page 66, for procedure.

Having no access to a ground plow, I had to use the Armstrong method. It is difficult to bury 100 feet of coax cable in this manner. Using the tip of a chain saw to cut a slot in the

ground is dangerous and is hard on the chain.

My neighbor, WA4KJA, has a garden cultivator which has been in his family since the 1930s. By changing to a narrow plowshare which was made from a piece of band iron 1½ inches wide, we were able to make our own ground plow.

The work is still hard, but it is easier than using a shovel. The narrow cut in the lawn disappears after several weeks.

The garden cultivator is a Planet Jr. made about 1935. Over the past 50 years of amateur radio, people have operated mobile from cars, airplanes, boats, bicycles, balloons, lawn mowers, go-carts, and tractors. To the best of my knowledge, this is the first time anyone has operated from a garden cultivator. The rig is a TR-22 with 1-Watt output. The antenna is a 5/8-wave whip. The antenna pattern will change depending on the depth of the cut. ■



FT-7 MOBILE/BASE HF TRANSCEIVER

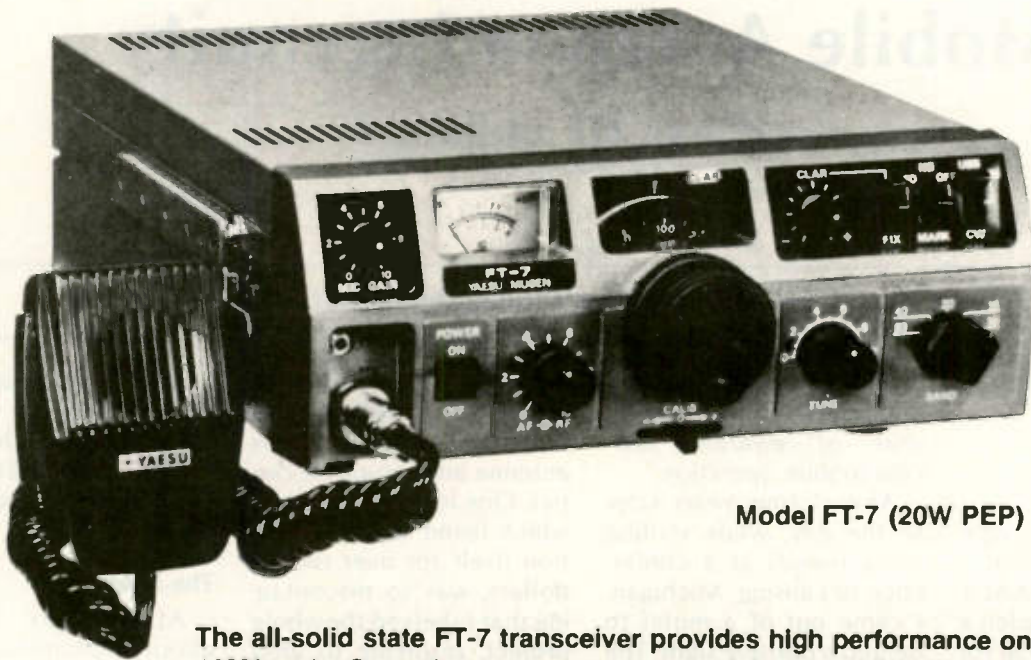

Model FT-7 (20W PEP)

The all-solid state FT-7 transceiver provides high performance on the 80M-10M bands. Operating on upper or lower sideband and CW, the compact package provides many features engineered for convenience while mobile. A single knob provides all transceiver tuning, and the state-of-the-art noise blanker minimizes impulse-type noise found in mobile applications. The FT-7 is designed for operation directly from your car's 12 volt battery or from its matching DC Power Supply.

- Single knob tune-up eliminates fumbling around panel searching for load and plate controls
- Extremely compact size for installation under dashboard
- 100 KHz calibrator is built in
- Semi-break-in with sidetone
- MOS FET receiver front end
- Receiver offset tuning
- Provision for crystal-controlled operation
- Choice of frequency control between internal VFO, fixed channel, or external VFO
- Power consumption 3A transmit, 0.4A receive (13.5VDC)

NEW . . . FT-202R HAND HELD

Tops for emergency work, tower and antenna adjustments, the Yaesu FT-202R is what you have been asking for! Small (67 x 49 x 171 mm) and light-weight (only 400g, less batteries), it has full 6 channel capability (3 supplied, 3 optional) wrapped in a tough impact-resistant ABS case. Complete with flexible helical whip antenna, S/power meter, squelch and tone burst, it's the affordable Handie you have been waiting for! At your dealer's now, ask for the Yaesu FT-202R—"THE HANDIE".



✓ Y1

Price And Specifications Subject To
Change Without Notice Or Obligation

YAESU
The radio.

YAESU ELECTRONICS CORP., 15954 Downey Ave., Paramount, CA 90723 ● (213) 633-4007
YAESU ELECTRONICS Eastern Service Ctr., 9812 Princeton-Glendale Rd., Cincinnati, OH 45246



Mobile Antenna Ingenuity

— cheap HF radiators

A Kool-Aid budget, a Champaign result.

George M. Ewing WA8WTE
P.O. Box 502
Cheboygan MI 49721

Four or five years ago, there was a terrific bargain at a northern Michigan hamfest. I unloaded a junky Hallicrafters S-38 for fifteen dollars, and spent the money immediately on a cardboard carton labeled "Mobile Stuff." Along with a lot of really useless junk, I found a Hustler mast, a bumper mount, three resonators for 80, 40, and 20, a desk mike, and twenty feet or so of good coax. The mobile antenna was bolted to the rear bumper of my trusty Barracuda right there in the hamfest parking lot, and, with an aging NCX-3 and a borrowed Heath HP-13 supply, I was

on the air almost immediately and enjoyed several years of rewarding low-cost mobile operation.

Almost four years later to the day, while visiting some friends at a conference in Lansing, Michigan, I came out of a motel to behold a horrible sight: The mast, mount, and the eighty meter resonator had been ripped off, leaving the chrome bumper itself twisted like a pretzel! Fortunately, the rig itself was safe, still tucked under my pillow in the motel room, and I had purchased a spare resonator for a couple of dollars the year before. For the rest, I headed straight for my (former) auto insurance company, Divestiture & Bombast Mutual.

Following lengthy nego-

tiations, I left the insurance office with ten measly dollars in search of a new antenna and insurance carrier. One look in a catalog, which listed the mast section itself for over twenty dollars, was so discouraging that I shelved the whole project, resolving to limit my mobiling to VHF until another hamfest bargain came along.

Several years more went by, and I replaced the venerable Barracuda with the bent bumper because I could no longer stand 10 miles per gallon on premium gas. A long Thanksgiving vacation trip to a science fiction conference in Champaign, Illinois, was coming, and, while I now had a good 2m FM rig, I would be out of range of repeaters for a good part of the journey. I decided to try and build a replacement for the missing Hustler. I had managed to come up with a spring similar to the one on the original bumper mount for a dollar from a CB friend.

This left about nine bucks in the fund, no machine shop facilities at hand, and a few days left before Thanksgiving. Could it be done? Of course!

The Mast

After some thought about aluminum or steel conduit, a helically-wound PVC pipe, and other substitutes, I decided to go with a rigid copper pipe for the mast. It was sturdy, not too expensive, and an excellent conductor. Two sizes were available at the local hardware store, 1/2" and 3/4". The trick would be to come up with fittings to match the 3/8" x 24 threads on the remaining resonators, using only simple hand tools and hardware available in a small-town corner store the Wednesday before Thanksgiving.

The 3/4" tubing was sturdier, heavier, and required two fittings less than the 1/2" size. It would also have a slightly lower resistance loss at rf frequencies. On



Changing resonators.

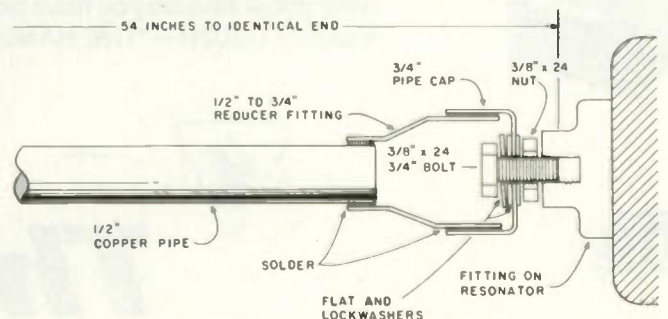

Fig. 1. 1/2"-pipe version. Mast-to-resonator fitting.

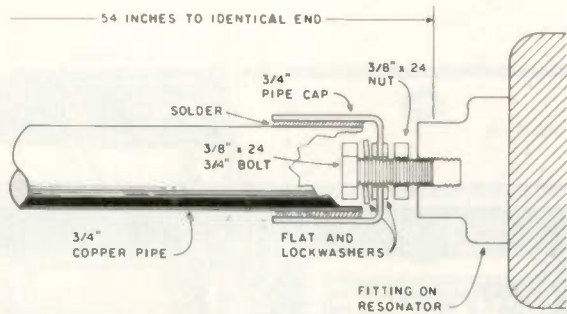

Fig. 2. 3/4"-pipe version. Mast-to-resonator fitting.

the other hand, its larger cross section and wind resistance might make it "whippier" in crosswinds on the freeway.

The 1/2" tubing was chosen because it was lighter, cheaper, and more closely matched the dimensions of the original Hustler chromed-brass mast. Cost was about 45 cents per foot, or close to \$2.50 for a 54-inch length. Had time allowed, used copper pipe could have been obtained for about half this amount, but it would have required extensive cleaning.

Mast-to-resonator and mast-to-spring adapters were made up using store-bought plumbing parts (see Fig. 1). The same design would work for a 3/4" mast, simply by omitting the 1/2"-to-3/4" reducer fittings (see Fig. 2). The 3/4"-diameter ends are needed for clearance for the hardware.

Making the Adapters

Clean the tubing and fittings carefully with a rag and automotive rubbing compound or some other mild abrasive. Salt and vinegar will also clean the copper chemically, but I found the rubbing compound much faster. Clean the residual abrasive, fingerprints, etc., off the parts with a solvent like alcohol, acetone, or carburetor cleaner. Do this outdoors or in a well-ventilated area, and keep the solvent away from sparks and flames. Handle the parts with gloves or a

clean rag, and you'll be able to solder them easily with ordinary rosin-core solder.

Center-punch the 3/4" end caps and drill them with 3/8" holes to assemble the bolts, nuts, and lockwashers before you do the soldering. Assemble the hardware as per the diagram, and then solder with a small propane torch, gas stove burner, or large (250 W+) iron.

After you have assembled the mast, clean it again with the rubbing compound and the solvent, especially the areas discolored by soldering, and then give it several coats of clear spray lacquer or urethane varnish to protect it from corrosion.

The total cost for the pipe, hardware, and fittings was just under five dollars, well within my cost goal.

The One-Dollar Bumper Mount

Refer to Figs. 3 and 4. The trusty Barracuda had been replaced with a '75 Chevy Monza hatchback which got better gas mileage but featured an odd rubber-covered bumper that made mounting difficult. The base for the mount was made from a piece of 1/2" marine scrap plywood, but almost anything will do if it's sturdy—sheet metal, Masonite, etc. The brackets were sawed off of the front panel from a TD-2 microwave bay that happened to be lying in the station junk

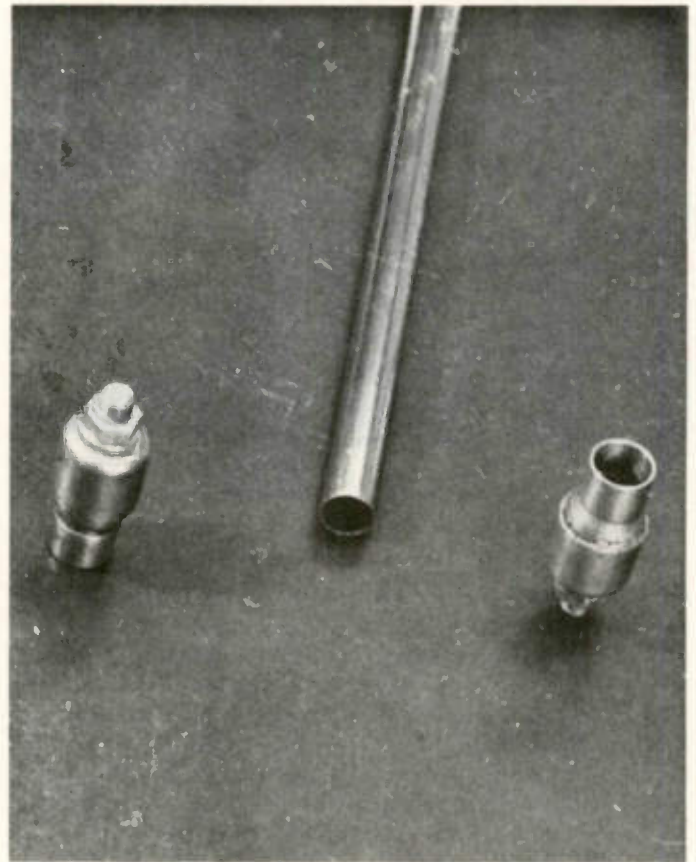

3/8" x 24 adapters for the 1/2" copper mast.

box. An aluminum channel from a busted storm door or more scrap plywood would be just as effective. The insulating plastic plate is the only tricky part, as it has to be very strong me-

chanically. I used a piece of heavy phenolic from the fur block in a piece of surplus equipment. A scrap of heavy Plexiglas™ or several pieces of scrap circuit board epoxied together

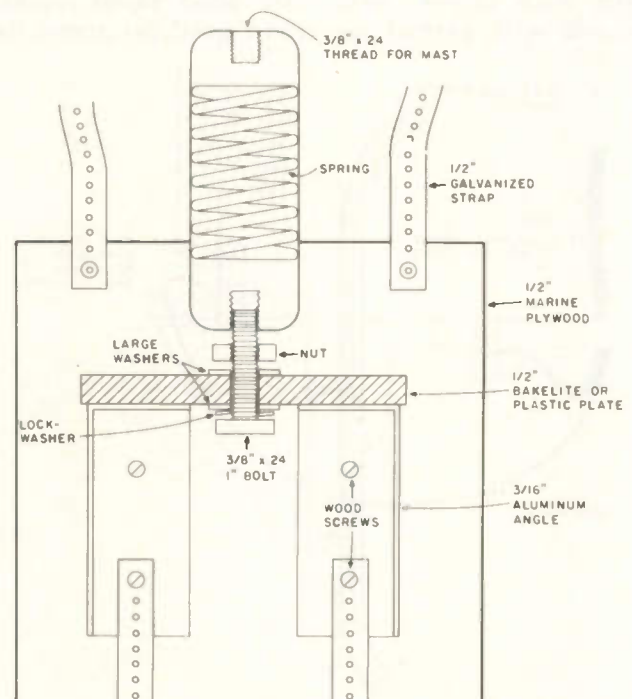
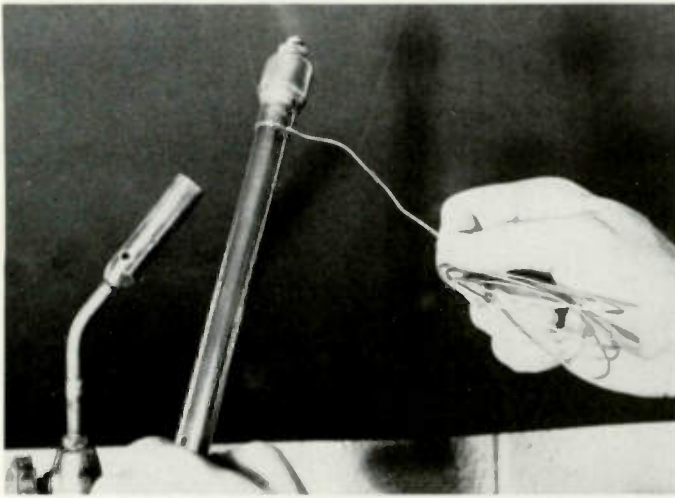

Fig. 3. \$1.00 bumper mount—rear view.



Soldering the adapters onto the mast with a propane torch.



The \$1.00 bumper mount attached to the Monza's rubber bumper. The coax braid must be securely grounded to the frame underneath.

er with the copper removed would work okay. If you can scrounge up an insulated 3/8" fitting like that used on commercial mounts, then the plate can be metal or wood.

The nails or wood screws that hold the bracket to the plywood base were allowed to extend through the wood for about an eighth of an inch, sticking into the rubber bumper covering and helping to secure the mount. The straps are cheap galvanized pipe hangers that are looped around the frame behind the bumper, pulled tight with pliers, and secured with screws or

nails to the plywood. Use large washers on both sides of the insulating plate to ease the strain. This hole takes the full force of the entire antenna and spring. Guys of nylon string from the resonator connection on the mast back to the car will help reduce "whipping" when the car is in motion. Make them light enough to break if the antenna hits an overhead object.

Conclusion: The Ham-burglar Strikes Again

The makeshift antenna worked beautifully, with very good signal reports and a good swr across the

middle thirty kHz or so of the phone band in each case. Retuning the resonators was a bit touchy, but only required a few minutes with an swr bridge in the line. Results on 40 phone were particularly good. Two meter operation with a Wilson 1402 running barefoot into a home-brew magnet mount was a blast, but, with only six crystal pairs, I was out of range of repeaters more often than not, and being back on the low bands again was a real pleasure.

Arriving at the conference in Champaign, the gear was all taken inside, leaving only the mast and bumper mount on the car. Upon leaving the hotel Sunday morning, it was found that some moron had grabbed the mast and bent it back and forth until it snapped, and then cheerfully pitched the top half into a nearby snowbank.

WB9MQY, also at the conference, was very consoling. "Nyahh, nyahh," he

said, "somebody stub-tuned yer copper mast for 5 meters!"

After five minutes work with a hacksaw, removing the bent ends and soldering the two pieces together with a 1/2" pipe coupling (17¢ at a nearby shopping center), the mast was back together. A slight retuning of the resonator, and I was back on the road!

Moral: Carry a wrench, and remove the mast and hide it inside the car, or use the Hustler quick-disconnect fittings.

Total cost for the project, including the repair, was well under the original goal of ten bucks, and with performance every bit as good as the original. The shiny copper mast looks as nice as the original, although it doesn't have the knurled chrome fittings. Best of all, it's completely compatible with original 3/8" x 24 threads which are also used in a lot of inexpensive CB mounts and hardware. ■

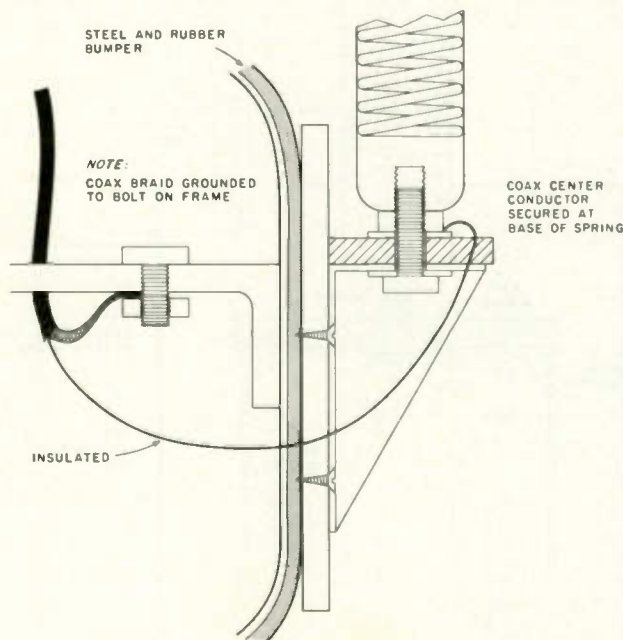
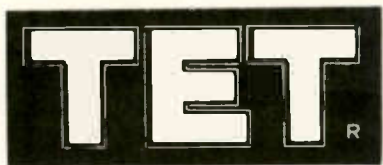

Fig. 4. \$1.00 bumper mount—side view (straps omitted).

Parts List

- two 3/8" x 24 (fine thread) bolts 3/4" long
- two lockwashers
- four flat washers
- two matching hex nuts
- *two 3/4" to 1/2" copper pipe reducers
- two 3/4" copper pipe caps, drilled and reamed with 3/8" holes
- 54 to 60 inches of 1/2" copper pipe
- cleaning compound and solder
- *The 3/4" version is the same, except that the two reducers aren't needed, thereby just about making up for the greater cost of the pipe (Fig. 2).



ANTENNA SYSTEMS

T55

now here in the U.S. from Japan with

HI-PERFORMANCE ANTENNAS, PORTABLE TOWER, AND KENPRO ROTATORS

3F35DX

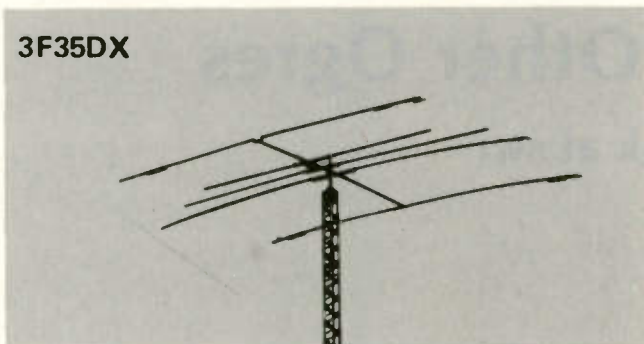

3F37DX

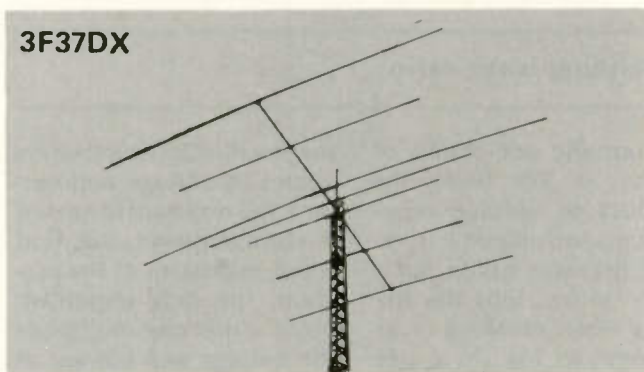

SQ-22

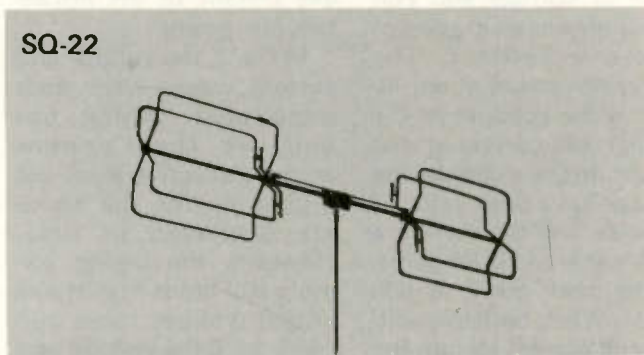

PORTABLE TOWER—
EASY TO ERECT ANYWHERE!!

GOOD DX HUNTING

- Light Weight
- High Stability
- High Quality Aluminum Alloy
- 3 Sizes Available

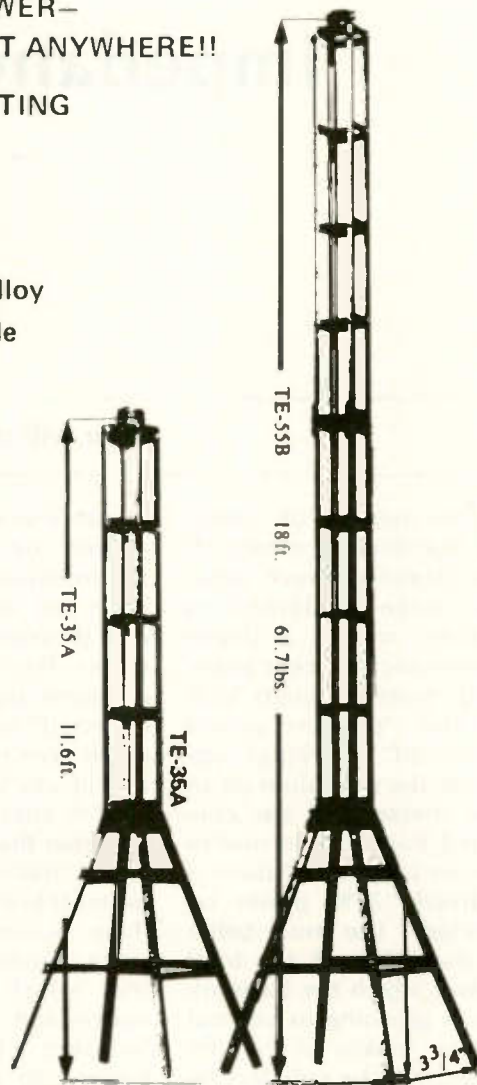

KR-2000



KR-600



KR-400



KR-500



KS-065

425 Highland Parkway, Norman, Oklahoma 73069

TET U.S.A.

enquire of **BRODIE ELECTRONICS CO.**

Tel: (405) 794-0406 2537 Edgewood Dr., Moore, Oklahoma 73160

Impedance and Other Ogres

— another look at swr

You will now understand standing wave ratio.

The subject of understanding the effects of swr (standing wave ratio) has been explained in various articles a dozen times over in recent years. Still, many amateurs look at the "percent power reflected" markings opposite the swr values on an swr meter and are confused. For instance, next to an swr value of 3:1 there is marked "25% power reflected." The usual belief is that 25% of the total power which the transmitter is groaning to put out never makes it to the antenna to be radiated. Instead, it is rejected (reflected at the transmission line/antenna junction) and goes bouncing endlessly back and forth between the transmission line/antenna and transmission line/transmitter junctions.

In other words, it is consumed or lost in the transmission line and/or plays all sorts of havoc with the transmitter output stages. This is not the case, of course, but the "percent reflected" scale of an swr meter does produce an image in one's mind that is hard to alter.

Rather than start talking about transmission lines, mismatched loads, etc., there is something much more fundamental than that which one should understand to have swr become clear. It has nothing to do with electronics and just goes back to basic ac electrical circuits. Understanding it (and not just skimming over the idea) will make the whole subject of swr and its effects in radio applications clearer.

Normally one thinks of power as just being the product of voltage times current, and indeed it is, except that one has to put a little "extra" into the formula when speaking of ac circuits. In Fig. 1, a sine wave of voltage and current is shown as it appears across a resistor. The power dissipated at any *instant* is the product of the voltage and current at that *instant*. In the example, the voltage has a peak value of 30 volts, and the current a peak value of 20 Amperes, so the peak power is 600 Watts. When both the voltage and current go into the negative half of their cycles, you have -30×-20 (at the peak negative excursion), so the peak power is still a positive number. By going back to the ac textbooks, one can confirm

that by multiplying the rms values of voltage and current, the resultant obtained is average power. But, that is not important at the moment; the only important point is that one multiplies the voltage and current at any instant to get instantaneous power.

In Fig. 2, the voltage and current waves have their same peak values, but because they appear across a reactive load, not a pure resistor, the waves are displaced in time. However, the power formula still holds true at any *instant* (voltage times current). So, if the voltage and current are multiplied at every instant, the dotted peak power line shown will result. The interesting thing about this power wave is that it goes negative. So, the actual overall power

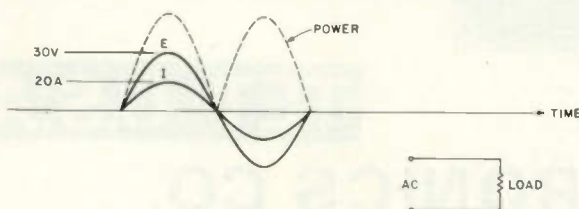

Fig. 1.

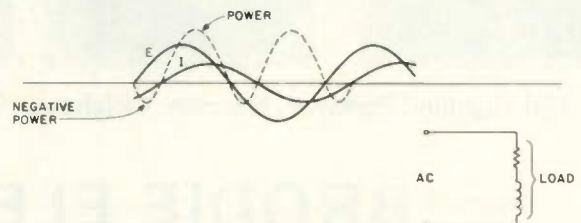

Fig. 2.

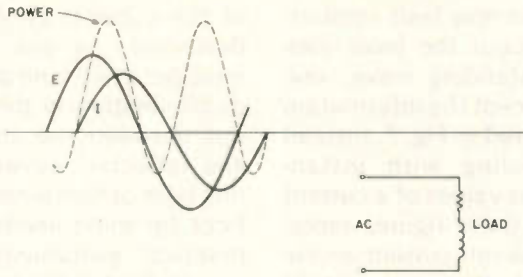

Fig. 3.

absorbed by the circuit is the net "positive" power minus the net "negative" power. This idea of negative power is where our little gremlin comes into play. The concept is that this negative or imaginary power represents power which the load will not accept. Therefore, although the source of power is able to supply power to the load as shown in Fig. 1, when the load is not purely resistive it cannot accept all of the power the source is capable of supplying. Said another way, during the portions of the voltage and current waves when they are both positive, the source is delivering power to the load. During the portions of the voltage and current waves when either one of them is negative, the load is returning power to the source that it could not absorb. Where is this power in between the time it is "offered" and then "rejected"? It's in the electromagnetic or electrostatic fields associated with reactive elements—inductors or capacitors. It doesn't bounce around like a Ping-Pong™ ball between the source and the load.

To obtain the net average power a load takes, one has to take into consideration not only the voltage and current values, but also the time displacement between the voltage and current waves. In basic ac circuits, the power formula then becomes $P_{AV} = E_{RMS} \times \cos \phi$. $\cos \phi$ is, of course, what electrical power people refer to as the "power factor."

There are three simple things one can learn from the simple ac circuit before going on to the radio applications of the idea presented. Note in Fig. 1 that the resistor absorbs a certain amount of power. Remember that only resistors can absorb and dissipate power. Now, if we have the load of Fig. 2 and we want the resistor part of the load to absorb the same amount of power as the resistor in Fig. 1, we have to do something. One thing we can do, so that the net power in Fig. 2 comes out the same as the net power in Fig. 1, is raise the voltage across the load and hence the power "offered" to the load. The load will reject the same proportion of the total power as before, but if we "pump" enough power into the load, we can get the resistive element of the load on Fig. 2 to absorb the same power as the load of Fig. 1. This means increased input power and greater voltages and currents in the circuit as shown in Fig. 3.

The other approach is to "match" the load. That is, if we cancel the inductive reactance in the load of Fig. 2 by a series capacitance reactance of the same value as shown in Fig. 4, the voltage and current wave across the combined resistor/capacitor/inductor load will again become as shown in Fig. 1. Since the reactive elements cannot dissipate power, the circuit becomes the equivalent of Fig. 1, and no extra power need be pumped into the

load to have the resistor dissipate the same power as in Fig. 1. This is all true, however, only at one frequency.

The loads in Figs. 1-4 are shown as being connected directly to a source of power. However, what if the load is connected to the power source over a long pair of wires, each side of which has some resistance, as shown in Fig. 5? If the load is a resistor, it doesn't take too much exercise of Ohm's Law to see that the power available from the source will be divided between the resistance of the load and the resistance of the wire pair in a manner depending on the relative value of the resistances. Let's assume that the resistance of the wire pair is a small fraction of the resistance in the load. If the load now becomes a combination of resistance and reactance and the power source is increased to maintain the same power in the load resistor, the power lost in the wire resistance will also increase. But, this is only because more current must flow in the entire circuit as per Fig. 3. The wire resistances will absorb *slightly* more power, but they do not absorb the rejected or reflected power because of the combined resistive/reactive load. Again, only resistances can dissipate power. So, even if the load becomes reactive, as long as the resistance in the load is large in value compared to the resistance of the wire pair, the power lost in the wire pair is not going to become significant.

When the foregoing simple circuits are "elevated" to radio frequencies, none

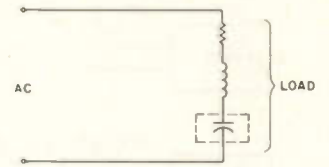

Fig. 4.

of the fundamentals described really changes. Some new elements are introduced, of course. The wire pair is now a transmission line with a characteristic called impedance, and a *time* element is introduced. That is, power cannot instantaneously go from the source (now a transmitter) to the load (the antenna). This time factor, of course, is very short, but, nonetheless, it does exist. That is why transmission lines have, besides impedance, a characteristic called velocity of propagation. So, one has to speak about power traveling along a transmission line. For instance, in Fig. 6(a) we will assume that we have a "matched" system. That is, the transmitter is designed for 50 Ohms output, the transmission line has 50 Ohms impedance, and the line is terminated in a 50-Ohm antenna. The transmitter is turned on only long enough to generate one cycle of sine wave current, which we'll call the incident, or forward, wave. Since everything is matched, the load completely accepts the power. If we leave the transmitter on continuously, we will have a continuous string of current waves traveling down the line and delivering power to the antenna. Note that although the current waves pass current down the line, when there is a continuing series of waves they will appear to stand still along the trans-

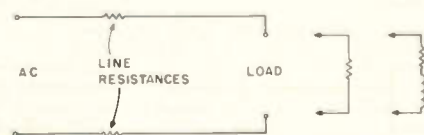

Fig. 5.

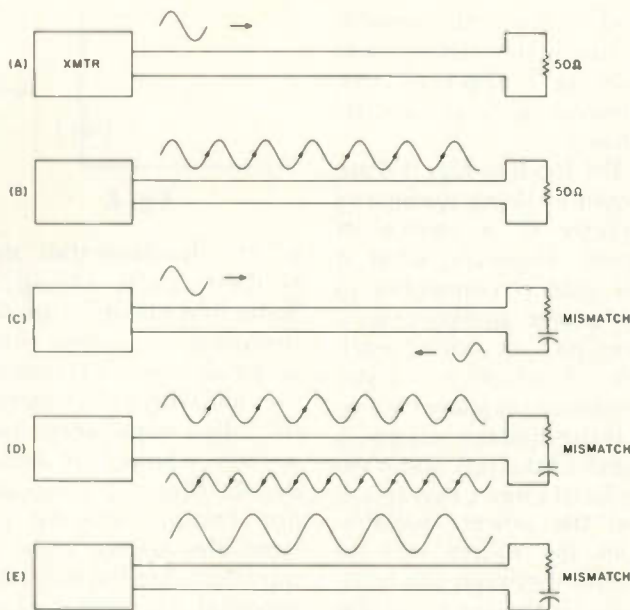

Fig. 6.

mission line.

If in Fig. 6(c) we have a mismatched load and again send a single current wave down the line, we are going to get back from the load a reflected wave. If continuous power is applied to the line, there will be continuous strings of incident and reflected waves. Since the strings are continuous, some incidental waves will always be present at any given point along the line. Therefore, at any given point and at any given instant, the resultant wave will be formed from the combination of the values of the two waves. At some points they will reinforce each other, and at some points they will subtract from each other. One probably thinks of various optical effects where two light sources interact to produce a seemingly stationary light interference pattern. Much the same thing happens on a transmission line. The

result of the traveling incident and reflected wave is a resultant stationary wave. Stationary, that is, in respect to its position along the transmission line. Since the resultant stationary wave stands still, it is referred to as a "standing" wave. For example, the resultant of the wave shown in Fig. 6(d) might look something like the standing wave of current shown in Fig. 6(e).

If one can grasp this basic concept of a standing wave, the rest of the ideas surrounding standing waves, what to do about them, how to interpret swr meter readings, etc., will not be difficult. If the ideas presented so far seem a bit unclear, one might go back over them a few times. Particularly, one should understand the simple ac circuit mentioned at the start of the article and be sure that one understands what rms values mean for voltage or current values.

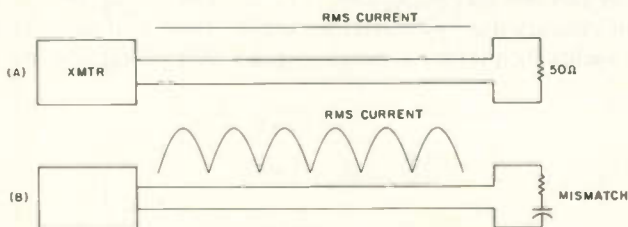

Fig. 7.

If one now feels comfortable about the basic idea of a standing wave, one can accept the information presented in Fig. 7. Instead of dealing with instantaneous values of a current wave, these figures represent the rms current, or the current that one would read along the line with a regular rf ammeter. In the case of Fig. 7(a), the current is the same at any point along the line since the system is matched throughout and there is no reflected current wave. In Fig. 7(b), where a mismatch exists, the current will be found to have different values at different points along the line. Depending on how bad the mismatch is, the current variation will be relatively small or the current variation pattern can approach the half sine wave shown. The swr on the line is defined as the ratio of the maximum current value to the minimum current value. In the case of Fig. 7(a), the ratio is 1:1 and the line is referred to as being "flat." In Fig. 7(b), if the maximum current were 3 Amperes and the minimum current 1 Ampere, the swr on the line would be 3:1.

One can actually measure the current along a line to determine swr. It is done this way in some high-power transmission lines. However, it is usually more convenient to measure voltages proportional to the value of the incident wave and to the value of the reflected wave. A directional coupler is used for this purpose, usually of the type shown in Fig. 8 (for a coaxial line). Two pickup wires are placed near the center conductor. One has a voltage induced in proportion to the value of the incident wave, and the other a voltage proportional to the value of the reflected wave. The ratio of the two voltages is the swr, the same as the ratio

of the currents previously described. As one might imagine, there is no perfect discrimination in the pickups between the incident and reflected waves. But, this type of instrument suffices for most needs. In a practical instrument, one usually "sets" the forward or incident voltage reading for full-scale deflection on a meter. Since the attenuation used remains in the circuit when the meter is switched to measure reflected voltage, the ratio of the two voltages is not upset. Therefore, the meter scale when reading reflected voltage can be calibrated in swr.

Since an swr greater than 1:1 indicates the load is taking less power than it could if it were matched, there is, as one might imagine, a mathematical relationship between swr and the percentage of power the load cannot accept. This formula is used to derive the "percent reflected power" one often sees marked along the swr scale on a meter.

How bad is it to have an swr of greater than unity on a line? What can one do about it? Part of the answer to the first question can be answered by going back to the simple ac circuit, and part of that answer requires a more careful look at the effects of a transmission line at radio frequencies. If the load is not matched to the line, maximum power will not be transferred to its resistive component, as in the case of the simple ac circuit. We can try to get more power out of the source (transmitter). This, of course, means loading the transmitter more heavily, with consequent heat dissipation problems, etc. But, it can be done if the transmitter can take it and if one is willing to waste input power. So, if the swr meter reads 3:1 (25% reflected power), it means that the

load could accept 25% more power if the system were matched. One could make up, approximately, for the swr by putting 25% more power into the system.

When dealing with a real transmission line, there are also a few other factors to be kept in mind, although their significance is usually a bit overstated for the normal HF installation. Any transmission line has an inherent loss due to its ohmic losses, and also rf losses, because of the dielectric material between the conductors. For instance, RG-58 coax might have a loss of about 1.2 dB for a 100-foot run on 20 meters. So, this means that even if the transmission line system were perfectly matched, a 100-Watt output from the transmitter would end up as about 78 Watts at the antenna. There is nothing that one can do about this except use a cable with a lower inherent loss at the frequency—such as RG-8. If the RG-58 line were now not “flat” but had an swr of 3:1, there would be some additional loss in this line. This is only because the reflected current wave travels along the line as well as the incident current wave. So, one suffers line losses coming and going. These losses can be obtained from a number of graphs in antenna manuals, but they are not as surprising as one might imagine. For instance, in the example given, the swr of 3:1 causes the total line loss to increase only to about 1.6 dB. Therefore, if we can still get 100 Watts into the line, the total loss would rise to about 31 Watts instead of the 22 Watts lost under matched conditions. Consequently, the swr has not caused any tremendous increase in the power lost in the transmission line. We are not burning up the transmission line

because of the swr, but neither are we getting the available power where we would like to get it dissipated—in the antenna load. But, under some circumstances, one might accept the situation since even if a total of half the transmitter output power were not utilized due to a combination of line losses and inability of the load to accept a portion of the power, the radiated signal would only be 3 dB, or about one half an “S”-unit down. With a view toward doing something to overcome the effects of swr on a line, getting the power into the load may or may not involve doing anything about the swr. The cause of the swr on the line is the mismatch between the load and transmission line impedances. For instance, in Fig. 9(a) we have a 50-Ohm load and a 50-Ohm transmission line. No matter how long the line is, a transmitter is going to see 50 Ohms at the transmitter end of the line. In Fig. 9(b), we have a complex load on the transmission line. At the junction of the line and the load there will be a mismatch. One cure for this problem is to do something at this juncture—insert an impedance matching device. This would eliminate the swr on the line, and the line would be “flat,” with no more than its inherent losses.

This is usually the preferred solution, but not always a practical one. So, in lieu of this, we can tackle things from the transmitter output terminals. At this end of the transmission line there are two things we can do. One is to experiment with the length of the transmission line when it is not terminated in its characteristic impedance will present a complex impedance at its feed terminals. Depending on the frequency and

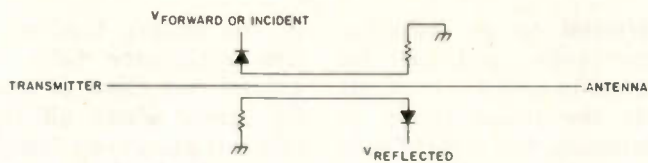

Fig. 8.

length of the line, this complex impedance can be capacitive or inductive. So, by experimenting with the line or by doing some calculations, we can find a line length where a situation similar to Fig. 4 exists. The transmission line/load considered as a whole is matched. The only price we pay is the bit of increased loss on the line due to the swr. Of course, this sort of solution is only practical on one frequency. As the frequency changes, the antenna load impedance changes, the electrical length of the transmission line changes, etc. Therefore, the more common solution is to insert a tuning device at the transmitter end of the transmission line. The tuning device can handle the various complex impedances found at the end of the line on various frequencies and match the transmission line/load considered as a whole. It presents a constant 50-Ohm impedance to the transmitter output when properly adjusted. We haven't cured the cause of the swr, because the basic mismatch at the antenna terminals still exists. But, we will be able to get more power into the antenna and pay only a small price

in terms of increased line loss due to the swr.

The foregoing was concerned with swr, its effects, and what may be done about it. But, to really “close the loop,” we might consider if we are really getting anyplace by matching. That is, say we have the setup of Fig. 9(c). Our “super” tuning device is effective enough so that with the same antenna and transmission line on 80 through 10 meters, it presents a 50-Ohm impedance to the transmitter. The transmitter loads easily to produce a 100-Watt output, and an swr meter between the transmitter and tuner reads 1:1. The answer to whether we are getting anyplace depends upon whether we are trying to do something reasonable or not. Remember, in the discussion of the simple ac circuit it was mentioned that only resistances can dissipate power. So, if the resistance part of the antenna load is significantly higher than the rest of the resistive losses in the system (transmission line and tuner), we may be getting someplace. Most of the power will be dissipated in the higher value resistance. The resistance part of the antenna impedance is

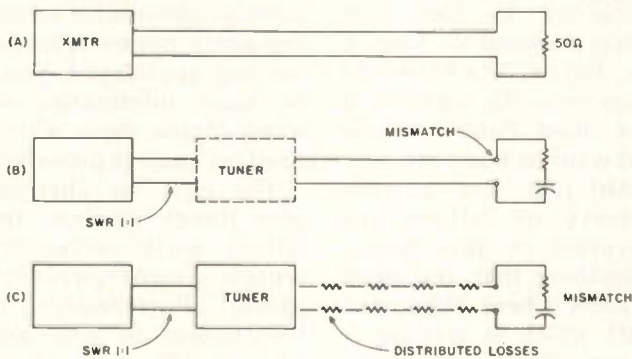

Fig. 9.

referred to as radiation resistance and can be found in antenna manuals for the usual types of antennas. For a $\frac{1}{2}\lambda$ dipole antenna, it might be on the order of 60 Ohms. So if the resistance losses in our matching system are just a few Ohms, essentially all of the power will be dissipated in the radiation resistance. Now, if we take that 10 meter $\frac{1}{2}\lambda$ dipole and try to operate it on 80

or 160 meters, the radiation resistance falls to around one Ohm or less. So, guess where all the power is going even though everything loads fine and the swr meter reading looks great? The use of tuning devices certainly has advantages in many applications. It provides more uniform loading to the transmitter across a band where the actual transmission line/antenna junction

swr is changing. They also allow many amateurs to operate on bands they do not have proper antennas for by at least getting some power into the antenna for radiation. But, you can't beat the basics of power distribution in simple ac circuits, even when operating at rf!

This article has not tried to deal with every nuance of the swr question. Math has been completely

avoided and a number of propositions have simply been presented without discussion, although they can be verified from antenna manuals. I feel, though, that if you try to relate the transfer of power in an rf application back, within reason, to the transfer of power in simple ac circuits, you will be able to feel more comfortable and understand more when looking at that swr meter. ■

The Active Filter Cookbook

— review of Lancaster's treatise

Canadian confirms composition's class.

*Michael Black VE2BVW
16 Anwoth Road
Montreal, Quebec
Canada H3Y 2E7*

In the September, 1977, issue of 73, there was an interesting article by Peter Stark using active filters. I was glad to see this because I feel that active filters have been rather neglected. *The Active Filter Cookbook* by Don Lancaster (Howard W. Sams & Co., 240 pp., \$14.95) would seem to be the next step if you liked Peter's article and want to know more.

Although not a wide variety of filters are covered in this book, everything that you need to know is here. The sort of stuff which is missing is about the more exotic types, and most people

would not have any use for them. Don starts the book off with some filter basics and some definitions of filter terms. He talks about active filter advantages and disadvantages and continues with a description of the rest of the book.

In chapter two, information on op amps, which form the backbone of active filters, is given. Described are integrators, summing blocks, and basic amplifiers. Also, there are some guidelines for selecting which device is useful for your application. Finally, basic information on some of the more widely used op amps is provided.

The next six chapters give theory on how the filters work, selecting which configuration (Bessel, Butterworth, or Chebyshev) to use, and what makes up each of these three types. Informa-

tion on component tolerance is given here also. Don goes on further to discuss scaling, which is an easy way of taking the normalized filters given in this book from their regular frequency of 1 kHz and placing them at the frequency which you desire.

Chapter 9 is miscellany. It gives information on selecting resistors and capacitors. It talks about manual wide-range tuning along with some thoughts on voltage control. This chapter ends with the description of elliptical filters, which are somewhat unusual.

The tenth and final chapter, like all of Don's other cookbooks, goes into some applications for active filters, such as tone decoding, modems, quadrature art, and color organs. Finally, he hints at some uses which the reader

can pursue himself.

Throughout this book, math is kept simple and is used sparingly. Instead, emphasis is placed on graphs and tables, which help the reader to better visualize what is going on. Examples of selecting a filter and putting it to use are given throughout the text. There are numerous pages on active filter theory, complete with math, but this is separate from the main text and can be completely ignored by those not interested.

While some may scoff at the idea of paying so much for a book on audio filters, I would recommend this book to those who have a lot of filtering needs. At audio frequencies, active filters are far better than coil and capacitor combinations and this book will open the door to their use. ■

Clegg is FM Headquarters!

No one else offers the wide selection of VHF FM Transceivers that you'll find at Clegg.



Clegg FM-DX
40+ Watts—
Synthesized
Made in USA
"THE BEST"

Clegg FM-28
25 Watts—
Synthesized
"Second only to
the FM-DX"

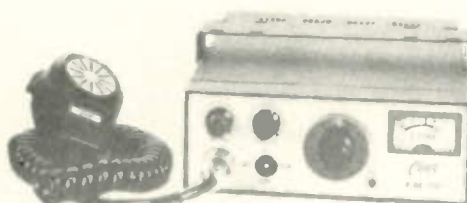
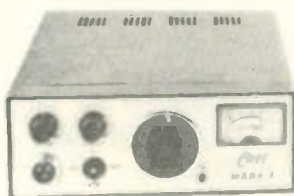

Clegg MARK 3 and FM-76
12 Channel coverage.
Select 144 or 220 MHz
"For the budget minded"

But if you have another brand in mind we can supply any of the other fine FM or Multi-Mode Transceivers and Hand Helds manufactured by YAESU, ICOM, WILSON, DRAKE—and at very competitive prices. And we service them all!



Yaesu CPU-2500R



Yaesu FT-625RD & FT-225RD



WILSON Mark II



ICOM IC-211

Whatever your needs in FM or Multimode Transceivers, Hand Helds, Antennas, etc., call your friends at Clegg, using our new departmentalized telephone system.

ORDERS AND QUOTES: TOLL FREE 1-800-233-0250

SERVICE DEPARTMENT: TOLL FREE 1-800-233-0337

ENGINEERING, PURCHASING, ADMINISTRATION AND ACCOUNTING: 1-717-299-7221

And—let us fill your antenna requirements:

- Towers, Masts & Hardware
- Rotators & Cables
- Coax & Connectors
- HF, VHF, UHF Beams & Mobile Antennas
- Multi-Band Dipoles
- Traps & Baluns

Clegg

Communications Corp.
1911 Old Homestead Lane
Greenfield Industrial Park East
Lancaster, PA 17601

✓ C3

A Rock-Solid AFSK Oscillator

— hooray for stability!

Economy and performance go digital.

*Winford Rister WB4MBL
402 Alicia Street
Albertville AL 35950*

After fighting the temperature drift problem with a 555-based audio frequency shift keyer, I decided to try crystal control. The design had three basic requirements: high performance, economy, and digital circuitry.

Making a few quick calculations, I found that I could obtain a 2125 Hz tone from an 8500 kHz military surplus crystal I had on hand by dividing by 4000. Likewise, the 2295 Hz tone would require a 9180 kHz crystal. Frequency tolerance is not critical in this application because a Hertz or two off in frequency is barely noticeable (I wish some of the guys could get within 10 or so), and the crystal would have to be off 8 kHz in order for the tone to be off by 2

Hertz.

The 8500 kHz crystal I used is a small type in an HC18-type holder, which is about 1/8 by 1/2 by 5/8 inches. The 9180 kHz crystal is in an FT-243-type holder and was originally at 8970 kHz. Fortunately, this type of holder is easily opened, and, also, the crystal can be etched rather easily.¹

Circuit Details

The circuit uses eight inexpensive ICs, all of which can be purchased from several sources for less than four dollars. Each oscillator is free running. The oscillator circuit is the simplest one available,² but works well for crystals in the range from about 2 to 15 MHz of almost any type. Some higher frequency crystals of the overtone type will oscillate at the fundamental frequency with this circuit.

The output of each oscillator is fed into separate divide-by-ten counters

(SN7490) to ensure isolation. Referring to Fig. 1, the output of each divider, now 850 and 918 kHz, respectively, is fed into a NAND gate, U7A-U7D (SN7400). The four gates in this chip are wired so that only one of the frequencies is passed at a time, depending upon whether the switching input is low or high. The signal is taken from the last section of the 7400 and divided by 10 twice more with U3 and U4 and then divided by 2 twice by U8, the SN7473 dual flip-flop. This results in a total division by 4000, which yields square waves of 2125 and 2295 Hz. The signal must consequently be passed through a low-pass filter in order to change it to a sine wave. I used a circuit similar to that in the AK-1³ for the filter. Active low-pass filters could be designed for this job, but the main advantage to them is space savings, since no amplification is needed. The passive

filter won out in my case for simplicity and eliminated the need for another power supply connection on the board. Some adjustment in the divider network may be necessary to suit individual transmitter requirements. Finally, this sine wave is fed into the microphone input of an SSB transmitter.

The keying circuit shown is designed to operate from the series loop in the printer and keyboard. The keying input is taken from the top of the emitter resistor of the loop switching transistor (27-Ohm resistor in my TU). If plus 5 volts is used for the switching input, resistor R_s should be increased to 15k Ohms. If separate keyboard and printer circuits are used, the input should be modified accordingly. If it's more convenient to have the mark condition low instead of high, the two crystals could be switched or another transistor configuration could

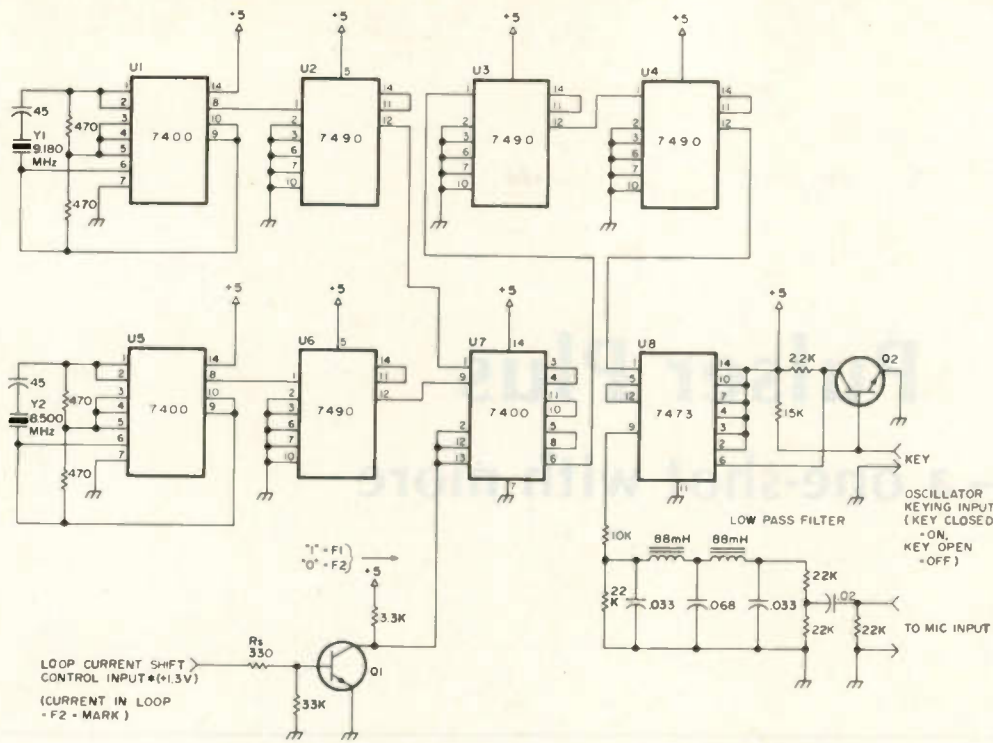

- † DENOTES CONNECTION TO +5V
 ⚡ DENOTES CONNECTION TO COMMON
 * IF +5V IS USED FOR SHIFT INPUT CHANGE R₅ TO 15K
- PARTS LIST**
 U1, U5, U7 - SN7400
 U2-U4, U6 - SN7490
 U8 - SN7473
 Q1, Q2 - GENERAL PURPOSE S-NPN
 Y1 - 9180 KHZ XTAL
 Y2 - 8500 KHZ XTAL
 ALL RESISTORS 1/4 WATT
 ALL CAPACITORS 50V DISC CERAMIC
 COILS - 88mH TOROIDS

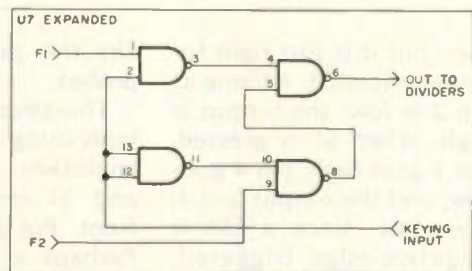

Fig. 1. TTL crystal AFSK oscillator.

be used (see Fig. 2). For CW ID, on-off keying is used instead of narrow shift. The key thus also acts as a transmit-receive switch when using VOX with the transmitter.

Construction Details

The complete circuit, except for the power supply

and the 88 mH toroids, is on a 2- by 4-inch circuit board using the layout shown in Fig. 3. Bypassing of all plus 5-volt leads with a .1 uF capacitor is recommended. Leads should be kept as short as possible, and all leads which leave the chassis should be bypassed to ground to pre-

vent rf from activating the switching chip. Good filtering of the power supply is necessary for a clean output from the transmitter. The circuit draws about 180 mA.

Conclusion

While not having the advantages of a single crystal

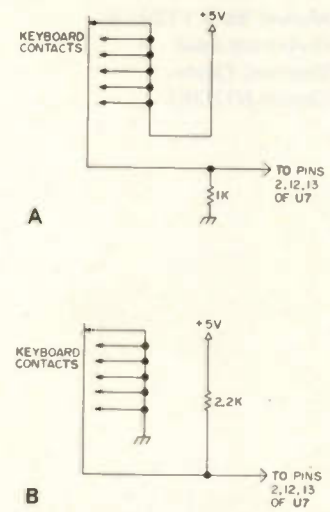

Fig. 2.(a) Separate keyboard normally high; (b) separate keyboard normally low (requires reversing crystals).

synthesized unit, this one does have rock-solid stability, is relatively inexpensive, and is readily compatible with computer or TTL circuits. Several QSOs were made using this unit, and only favorable comments have been received.

Acknowledgements

I wish to express thanks to all the authors mentioned in the references and many others from whom I got ideas and circuit information before deciding to design and build this circuit. Also, I am grateful for much assistance from Jimmie Straughn K4COV who did the layout and helped with making the board.

I will be glad to answer any questions of design, availability, performance, etc., if inquiries are accompanied by an SASE. ■

References

1. Newland, "A Safe Method for Etching Crystals," *Single Sideband for the Radio Amateur*, ARRL.
2. "A TTL Crystal Oscillator," *QST*, Feb., 1974, p. 34.
3. "Audio Frequency-Shift Keying for RTTY," *Specialized Communications Techniques for the Radio Amateur*, ARRL.

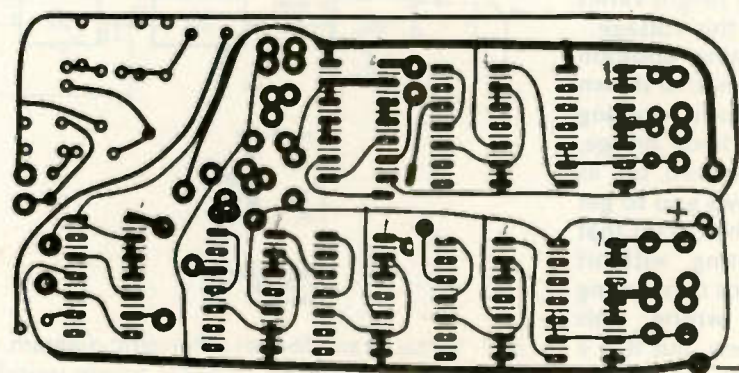

Fig. 3. PC board layout, foil side.

Pulser Plus

— a one-shot with more

This circuitry turns your single-shot multivibrator into a useful piece of test equipment.

This gadget is a combination of circuits from two previous articles. The first, in the October, 1974, issue of 73,¹ described a wide-range repeating pulse generator using three 555s. The second article was in 73 for February, 1975,² and described a variable pulse width, single-shot generator using TTL devices. Both of these circuits were interesting and I hope that the circuit discussed here has kept all the good features of both.

The circuit of the pulser is shown in Fig. 1. Here, again, the circuit consists mainly of three 555s. Every time S1 is pressed, there is a pulse at the output, the length of which is variable over a wide range. Both positive- and negative-going pulses are available. The unit operates over a supply voltage range of 4.5 to 16 volts, which makes it usable with both TTL and CMOS, and even linear circuitry under certain conditions.

Here's how it works: U1 is connected as an RS flip-flop. I have not seen much on using the 555 in this

way, but it is just right for our application. As long as pin 2 is low, the output is high. When S1 is pressed, pin 2 goes high, pin 4 goes low, and the output (pin 3) goes low. Since a 555 is negative-edge triggered, U2 will be triggered when pin 3 of U1 goes low. As U2 is connected as a single-shot multivibrator, there will be a pulse on pin 3 for a length of time determined by the equation $T = 1.1(R1 + R2)C1$. A positive-going pulse is available from pin 3 of U2. U3, connected as an inverter, provides a negative-going pulse. Note that the output pulse is somewhat less than the supply voltage and the pulse height varies directly with this voltage.

An interesting addition to this circuit is also shown in Fig. 1. This is nothing more than a diode bridge, but, when hooked up as shown, it allows you to get power from the circuit that you are testing without worrying about connecting the polarity wrong. This trick is not new, but it is a great addition to simple pieces of test equipment

like this pulser and logic probes.

This circuit can easily be built using a minibox as an enclosure. Have R1, S2, and S1 mounted on the front. Put J1 in the back. Perhaps a rough calibration of R1 would be useful. In some applications, both output polarities may be required, in which case S2, the polarity selector, could be eliminated, and two output jacks used. Be sure to locate S1 so that it can be used without hitting any of the other controls.

This unit can be used anywhere that a variable width, single-pulse multivibrator is needed. While it is not very different from the average one-shot, the little extras make it a valuable addition to your lab. ■

References

1. Christer Falkenstrom SM4DZR, "A Simple Pulse Generator Using the Signetics 555 Timer," 73 Magazine, October, 1974, p. 141.
2. Hank Olson W6GXN, "Further Adventures of the Bounceless Switch," 73 Magazine, February, 1975, p. 111.

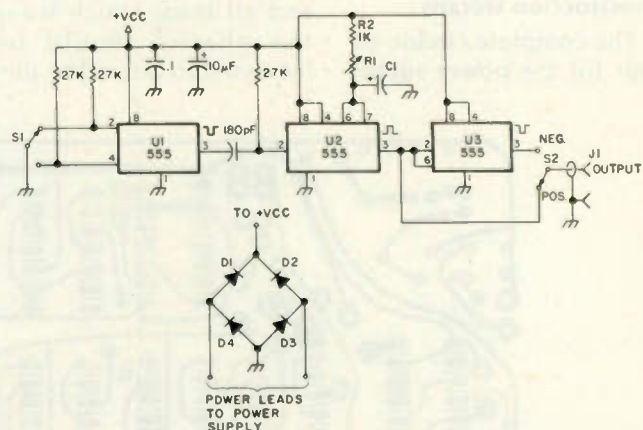

Fig. 1. Versatile single-shot schematic diagram. S1 = SPDT momentary contact. S2 = SPDT toggle switch. D1-D4 = 1N914 silicon diodes. J1 = phone jack or similar.

CALL TOLL FREE

1-800-228-4097

Communications Center

443 N 48th Street ✓CSB

Lincoln, Nebraska 68504

In Nebraska Call (402)466-8402

1-800-634-6227

Communications Center West

1072 N. Rancho Drive

Las Vegas, Nevada 89106

In Nevada Call (702)647-3114

Antenna Sale!

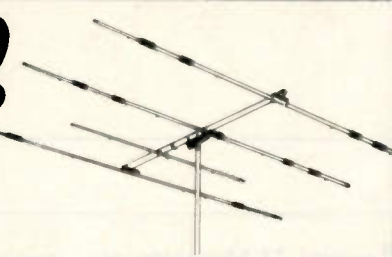

18HT

	HY-GAIN	Regular	Special
TH6-DXX	Super Thunderbird	\$296.95	\$ 209.95
TH3-MK3	3 ele. 10, 15, 20 Mtr. beam	219.95	179.95
Hy-Quad	2 ele. Quad 10, 15, 20 Mtr.	229.95	199.95
TH3-Jr.	3 ele. 10, 15, 20 Mtr. beam	144.50	129.95
18 HT	Hy-Tower 10-80 Mtr. Vertical	299.95	259.95
14AVQ/WB	10-40 Mtr. Trap Vertical	67.00	57.00
18AVT/WB	10-80 Mtr. Trap Vertical	97.00	84.95
205 BA	5 ele. "Long John" 20 mtr.beam	289.95	249.95
203	3 ele. 2 Mtr. beam	14.95	
205	5 ele. 2 Mtr. beam	16.95	
208	8 ele. 2 Mtr. beam	24.95	
214	14 ele. 2 Mtr. beam	31.95	

MOSLEY

Classic 33	3 ele. 10, 15, 20 Mtr. beam	304.75	219.95
Classic 36	6 ele. 10, 15, 20 Mtr. beam	392.75	289.95
TA-33	3 ele. 10, 15, 20 Mtr. beam	264.00	199.95
TA-36	6 ele. 10, 15, 20 Mtr. beam	392.75	289.95
TA-33 Jr.	3 ele. 10, 15, 20 Mtr. beam	197.00	149.95
TA-40KR	40 Mtr. add on	119.50	89.95

CUSHCRAFT

ATB-34	4 ele. 10, 15, 20 Mtr. beam	259.95	209.95
ARX-2	2 Mtr. Ringo Ranger	36.95	32.95
A147-20T	2 Mtr. Twist	59.95	52.95
A144-10T	10 ele. Twist 2 Mtr.	39.95	32.95
A144-20T	20 ele. Twist 2 Mtr.	59.95	52.95
A147-11	11ele. 146-148 MH2	34.95	30.95
A147-22	Power Pack 22 ele.146-148 MH2	99.95	88.95
A432-20T	430 -436 MH2 20 ele. TWIST	54.95	49.95
ATV-4	10,15,20,40 MTR Vertical	89.95	79.95
ATV-5	10,15,20,40 MTR Vertical	109.95	94.95

HUSTLER

4BTV	10-40 Mtr. Trap Vertical	99.95	82.95
RM-75	75 Meter Resonator	16.95	14.50
RM-75s	75 Meter Super Resonator	31.95	27.50
G6-144-A	6 db. 2 Mtr. Base Colinear	79.95	64.95
G6-144B	7 db. 2 Mtr. Base Colinear	119.95	99.95

WILSON

System One	5 ele. 10, 15, 20 Mtr. beam	274.95	239.95
System Two	4 ele. 10, 15, 20 Mtr. beam	219.95	189.95
System Three	3 ele. 10,15,20 MTR beam	179.95	159.95
WV-1 Vertical	10-40 MTR Vertical	79.95	69.95

CDE ROTORS

Ham III	\$125.00	T2X Tail Twister	\$225.00
---------	----------	------------------	----------

CUSHCRAFT
ATB-34

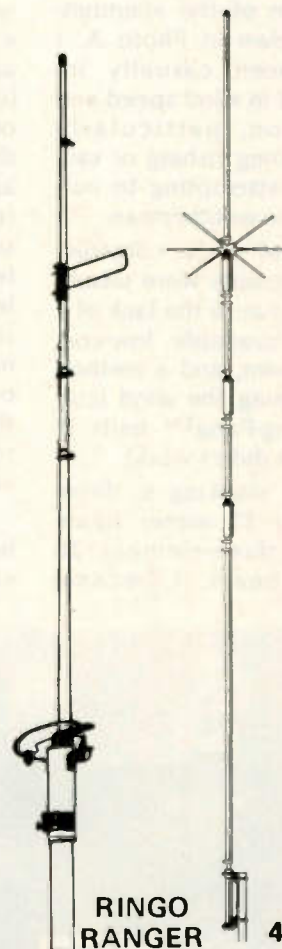

RINGO
RANGER 4BTV

**We carry all major brands of ham radios
AT DISCOUNT PRICES**

Yaesu — Kenwood — Drake — ICOM — Dentron —
Ten-Tec — Swan — Tempo — Midland — E.T.O. — Wilson



Oh, My Poor Quad!

— measuring wind speed

L'Eggs are the legs.

Several 73 Magazine articles on anemometers and weather indicating devices by W2A00^{1,2} and W9CG1³ caught my interest and led to the construction of the anemometer shown in Photo A. I have been casually interested in wind speed and direction, particularly when going fishing or sailing or attempting to out-guess the weatherman.

Several early construction attempts were unsuccessful due to the lack of a readily available, low-cost pivot point, and a method of trapping the wind (cutting Ping-PongTM balls in half just didn't work).

After stacking a three-element 15 meter beam and a three-element 20 meter beam, I became

even more interested in wind direction and wind speed. The wind surface area and resultant torque vary considerably depending on whether the wind blows against the elements broadside or against the boom length (element tips facing the observer). In my instance, the antenna surface area is approximately 9.5 square feet when viewed broadside and less than 5 square feet when facing the boom lengths. When you consider the combined antenna torque and wind loading on the antenna and tower, the resultant load on the rotor and tower is considerable.

Pointing the antenna boom lengths into the wind significantly reduces the

wind loading and lengthens rotor life. If high winds should develop, an indicating device in a high-traffic area such as the kitchen would indicate wind speed and gusts. A wind vane mounted on the tower would serve to indicate the wind direction.

The major items required to construct the anemometer are a bicycle front axle, three L'EggsTM stocking containers, a slot-car motor or other permanent magnet dc motor (which will serve as a dc generator), a 0-50 micro-ampere meter, a pipe or length of tubing, and the top from a spray paint can (Photo B).

The problem of finding a low resistance pivot point was solved by cutting in half the front axle of a discarded bicycle and using it as the pivot point. Most bicycle axles may have to be annealed before drilling a hole to accept the motor shaft. This shaft can

be held in place with epoxy glue or setscrews (Photo C). I used setscrews to secure the motor shaft to the axle so that the motor could easily be changed, although this hasn't been necessary during two years of operation. Be sure the slot-car motor readily drives the 0-50 micro-ampere meter when spun by hand.

A piece of tubing or pipe is selected so that the lip of the bicycle axle rests on the outside diameter of the tubing as shown in Photo D. An aluminum retainer bracket secures the axle to the tubing, and a piece of Romex insulation taped around the dc generator will prevent it from rotating inside the tubing.

In Photo E, three 1/8-inch diameter aluminum rods are cut into 7 1/4-inch lengths and threaded. The L'Eggs stocking containers are secured with nuts. Each rod is then threaded into a 1 1/4-inch diameter by 1/4-inch thick aluminum disk. The threaded holes are spaced 120 degrees apart. The center of the disk should be drilled so that it will pass through the bicycle axle.

Locate a plastic aerosol spray can top which will be used as a rain shield. Cut, or burn out with a soldering iron, the internal

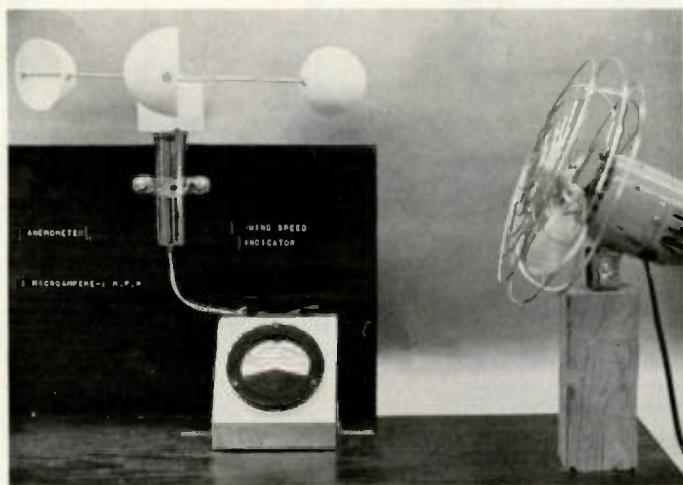

Photo A. Complete anemometer system.

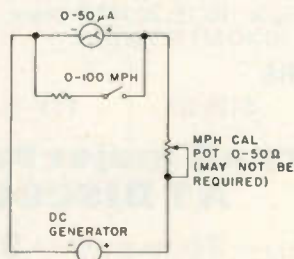

Fig. 1. Anemometer schematic.

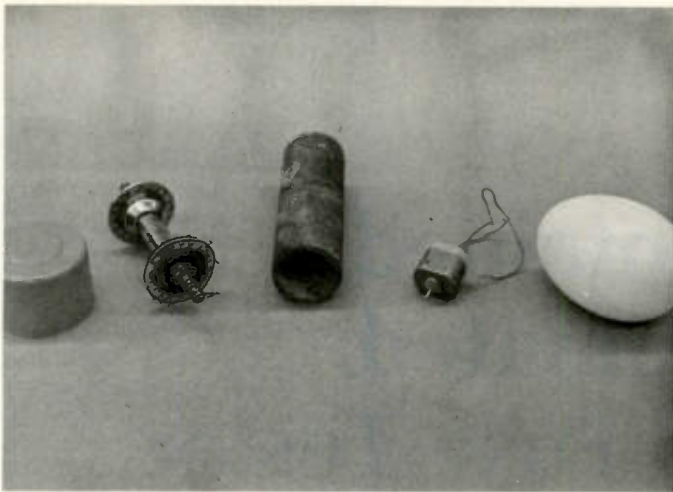

Photo B. Component parts of anemometer.

plastic wall which is used to lock the cap on the can. A hole should be drilled in the center of the cap so that it will fit over the axle. The unit is assembled by placing the cap over the bicycle bearing nut, followed by the cup assembly (which is secured with the remaining axle nut). (Photo E.) A wooden plug may be inserted in the other end where the two wires come through.

It just so happened that three of the constructed anemometers indicated approximately one microampere per mph on the 0-50 microampere meter readout device. Depending on various motor/dc generator outputs, a small value of variable resistance (0-50 Ohms) may

have to be inserted in series to calibrate the mph reading. A switchable shunt resistor should be installed across the meter movement. This will enable the meter to read 0-50 mph or 0-100 mph full scale. Refer to Fig. 1.

The internal resistance of the meter and the shunt value can easily be determined by using the formula or circuits found in the *ARRL Handbook*. In most cases, the shunt value will be the same as the meter's internal resistance. A typical shunt value would be 5 Ohms. I used common carbon resistors since extreme accuracy was not as important as the relative readings.

Frequent monitoring of a NOAA weather station in-

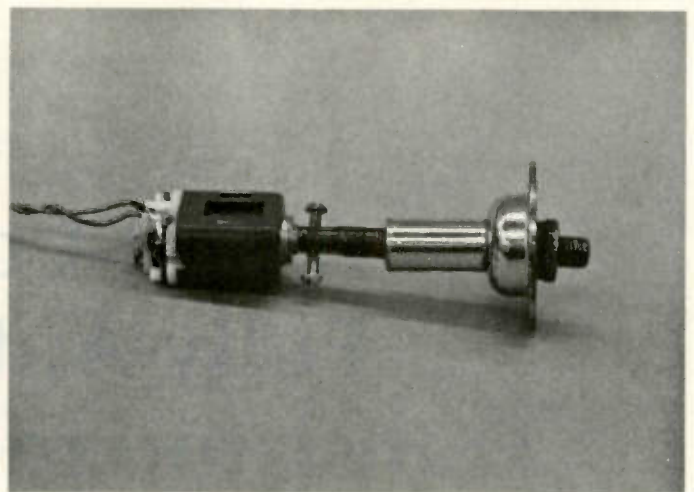

Photo C. Slot-car motor attached to bicycle axle by means of two setscrews.

dicated that the observed meter measurements were very close to local mph readings. Since I was only concerned with relative readings, no actual calibrating resistance was required.

If you are a purist, the easiest way to calibrate the anemometer is to compare the readings with an anemometer of known accuracy. An alternate method would be to mount the anemometer on the front of a car and adjust the calibration pot. An open field or vacant parking lot should be selected and all safety precautions and speed limits observed. A 10 mph reading should be sufficient for adequate calibration. The air-foiling effect of the car chassis

will affect the readings if it is held outside a window. Also, be sure the wind is not blowing.

One word of caution: Provide some means of disconnecting and grounding the lead-in wire from the anemometer to prevent damage from lightning.

Mount the anemometer in a clear, unobstructed area and pay attention to Mother Nature! ■

References

1. "Digital Wind Direction Indicator," Warren MacDowell W2A00, *73 Magazine*, November, 1974, pg. 40.
2. "Inherit the Wind," Warren MacDowell W2A00, *73 Magazine*, March, 1976, pg. 72.
3. "The Wind Counter," Dave Brown W9CGI, *73 Magazine*, November, 1976, pg. 84.

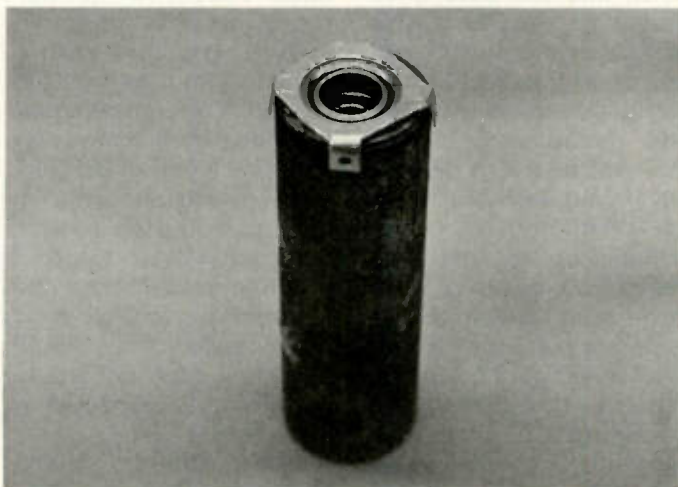

Photo D. Bicycle axle held in tubing by use of aluminum retainers.

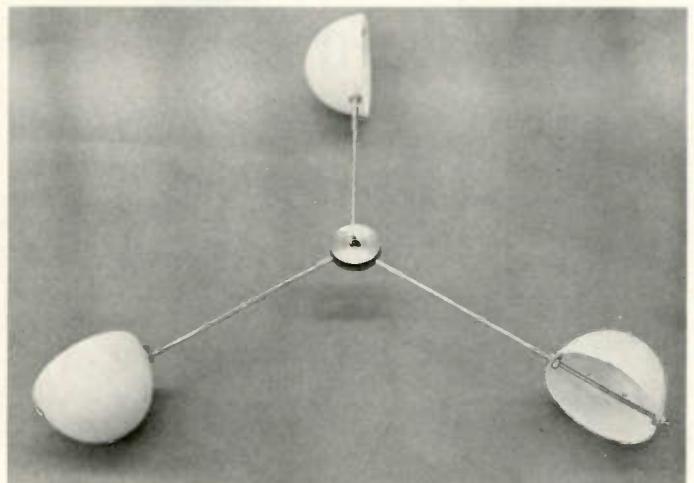

Photo E. Completed wind-catching assembly.

A Self-Contained, Fully-Automated, Transistorized Fuse Tester

— amaze your friends

Take a look at the English answer to the battery and bulb.

*C.F.J. Ward G3TAI
50 Lakeside
Bracknell, Berkshire
England RG12 2LE*

Here is a simple fuse tester for the shack

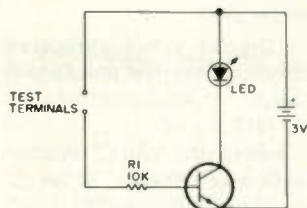

Fig. 1.

which is quick and easy to build and use. Although it is only one step better than a battery and bulb, it does have an advantage in that it will test those low-current fuses that appear here and there. (And it is bound to impress your nontechnical friends!)

The circuit is shown in Fig. 1, and operation is as follows:

1. With no fuse connected, there is no base current and, hence, no col-

lector current; the LED remains dark. Use of a silicon transistor ensures that the leakage current is negligible.

2. When a short circuit (good fuse) is placed across the test terminals, it completes the base drive line, and base current will flow. The resulting collector current will light the LED.

The base current will have a value of approximately 0.24 mA since the supply is 3 volts. The base-emitter drop is about 0.6 volts, and the base drive resistor is 10k Ohms. This will cause a collector current of HFE times 0.24 mA to flow, and, for a typical HFE spread of 50 to 150, this will be 12 to 36 mA, which will easily light the LED. With my unit, I used a low-gain transistor salvaged from a surplus computer board which gives a collector current of 16 mA. With a high-gain transistor, the collector current can be adjusted by increasing the value of the base drive resistor, but it is much better to use a low-gain transistor because leakage cur-

rent through the fingers when using the tester can cause the LED to light even if the fuse is blown! This effect is much worse with high-gain transistors.

Construction

The tester can be made up as shown in Fig. 2. The components are mounted on a small piece of Veroboard. This is fixed to the wooden base plate with screws and spacers made from ball-point pen cases cut into 3/4-inch-long tubes. The two AA-size batteries are tied together with lacing cord, which holds them against the spacers. The test terminals are made from some brass strip that I had in the junk box, but bits cut from an old can would do as well. The batteries are soldered into the circuit since no current flows unless a good fuse is tested. They should last a long time with the intermittent use expected of a fuse tester.

I have drilled a hole in the base of my tester so that it can be hung up when not in use. ■

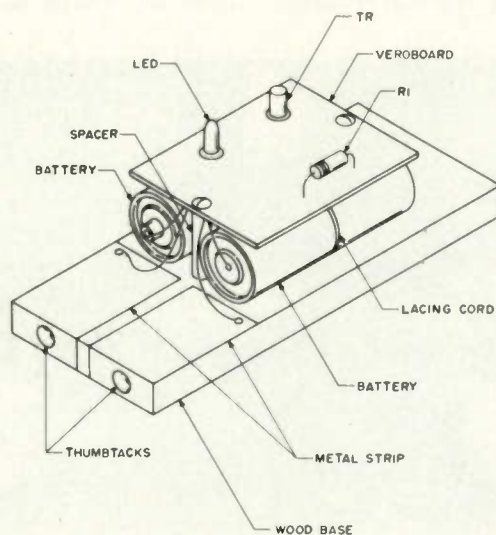

Fig. 2.

Call Toll Free 1-800-243-7765

FREE

• Retail Price Catalog • Monthly
Computerized Used Equipment List



WILSON
MARK IV



KENWOOD TS-820S



YAESU FT-901



ICOM IC-701



KDK 2015R



IC-701



TEN TEC OMNI-D



GLA-1000



CPU 2500 R/K

OVER 50 BRANDS IN STOCK

- KENWOOD • SWAN • KDK • DENTRON •
- MOSLEY • WILSON • YAESU • DRAKE •
- LARSEN • BENCHER • PIPO • BEARCAT •
- B & W • DATONG • ICOM • PANASONIC •
- ARRL PUBLICATIONS • ALLIANCE • MFJ •
- CUSHCRAFT • TRAC • MICROLOG • CDE •
- FINCO • DSI • DAYBURN INSULATORS •
- BIRD • ASTATIC • HAM KEY • REGENCY •
- HUSTLER • SAXTON • TEN TEC • AMECO •
- AMCOMM • CALL BOOK • KLM • TEMPO •
- ROHN • BUTTERNUT • Plus Many More!

★ NEW AND USED EQUIPMENT
"Get on our used equipment mailing list"

★ TRADES WELCOME
"The best allowances anywhere"
"We buy good used SSB gear"

★ FREE CATALOG
"Prices of all major manufacturers"

★ SAME DAY U.P.S. SHIPPING
"Just a phone call away"

★ COMPLETE RADIO SERVICE SHOP
"Mail Order Repair Service"

- Fast Efficient Service • We Repair All Brands
- All Work Guaranteed • Amateur Extra/First Class Licenses • Send Us Your Defective Equipment U.P.S. Collect • Free Shipping Both Ways If Work Is Done
- Most Repairs Done and Shipped Within 7 Days

OUR FINE REPUTATION SPEAKS FOR ITSELF

"YOU SHIP IT
WE FIX IT"

THOMAS COMMUNICATIONS

T34

**Call
or Write
for your
super quote
today!**

95 Kitts Lane, Newington, Conn. 06111

"Near ARRL Headquarters"

Connecticut Residents Call:

(203) 667-0811



OPEN MON.-FRI. 10-6 • THURS. 10-8 P.M. • SAT. 10-4

EASY DIRECTIONS: Rt. 15 South — 2 blocks past McDonald's
(Berlin Turnpike)

Don't Get Burgled!

— build this simple alarm

Isn't security worth \$10 or less?

William R. Fletcher, Jr.
2810 Riverview Drive
Fairbanks AK 99701

Here is a simple burglar alarm that makes an excellent one-evening project and can result in a safe car or shack. It is based on the fact that some thieves will not stop for anything

except a good reliable alarm such as this one. There are no critical parts to find or adjustments to make with this alarm as with others I've seen (Jeffrey Pawlan WA6KBL, "The Smart Alarm," 73 Magazine, June, 1975). The circuit allows safe exit and entry using a minimum of components. Most ham

operators with a small junk box could probably build it for almost nothing. Even if you had to buy all the parts new, it should cost less than \$10. Shopping in the back of 73 Magazine could put it closer to \$5. Not much for such a reliable source of protection.

Operational Description

All you have to do is park your car, open the door, set the alarm, and exit. Unlike other alarms I have read about, there is no minimum exit time on

this one. For example, you can't take as long as you want to unload groceries, kids, etc. This alarm is only activated and starts timing out the next time your door is opened, such as when you return or when a thief decides your car is next. You then have ten seconds to switch off the alarm. Once switched off, it will not sound the car horn.

Circuit Description

The circuit is inexpensive, reliable, and very easy to build. For active com-

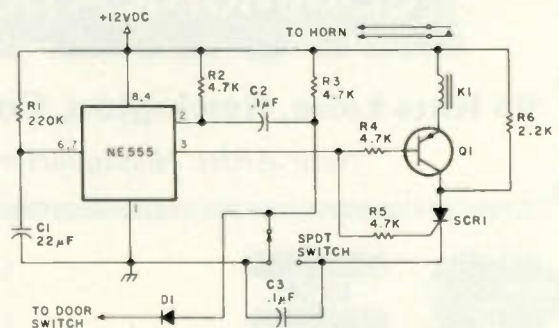
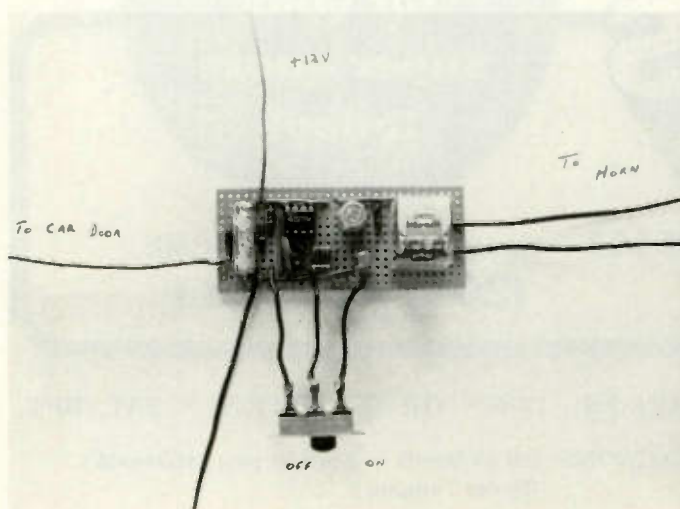

Fig. 1. Burglar alarm schematic diagram.

ponents, it uses a very common integrated circuit (NE555), one PNP transistor, and one SCR. See Fig. 1.

The timer circuit is designed to have 12 V dc applied at all times. If the circuit used a power switch, it would cause false triggering of the timer, and this would cause the horn to sound after time-out. It does, however, use a switch in the relay circuit. With the switch in the off position, it holds the input to pin 2 at ground, which also prevents false triggering of the timer. With the switch in the on position, it puts ground to the relay circuit so it can be switched in or out, to shut off the alarm, and removes the ground from the trigger input (pin 2). When pin 2 goes high (12 V dc), this arms the alarm.

When you open the door, the switch is in the

off position and ground is applied to the trigger input (pin 2). If the door opens, the door switch puts ground on the trigger input wire. Now you can switch to the on position. This arms the circuit and the trigger input still sees ground (via the door switch). You can now close the door and lock it if you wish. This puts pin 2 at 12 V dc. The next time the door is opened, pin 2 receives a negative-going pulse which starts the time-out. When pin 2 goes low, pin 3 (output) goes high (12 V dc) and turns on the SCR. After the circuit times out, pin 3 drops back low again, which turns on Q1, and K1 energizes which sounds the alarm. Relay K1 can be connected to a horn, bell, lights, or any combination thereof. The alarm will continue to sound until you shut off the switch and, by then, the would-be

thief should be long gone.

If for any reason you need to alter the entry time, it is easily accomplished by changing R1 or C1. Increasing either will lengthen entry time and decreasing either will decrease entry time. With the components shown, entry time is about 10 seconds. I find this to be just about right to comfortably enter and shut the alarm off.

If this alarm is to be used for shack protection, you must build an additional input circuit which is nothing more than a switch and resistor combination (Fig. 2). Also, if house current is preferred over a bat-

tery, Fig. 3 shows a power supply circuit that will work.

This alarm has already proven itself once for me! Since that one attempt on my car by a thief, I consider it to have paid for itself. If you value your possessions as I do, this alarm will give you peace of mind while away from your car or shack. ■

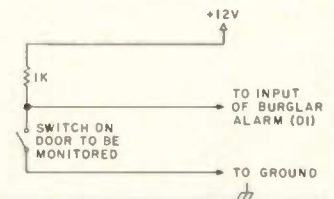

Fig. 2. Input circuit switch schematic diagram.

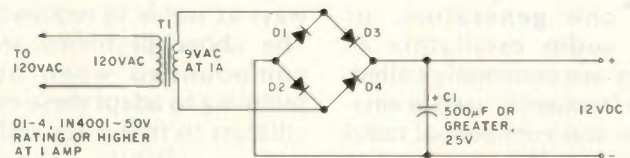

Fig. 3. Power supply schematic for burglar alarm.

Power x 2 — dual auto batteries

Your car will always start, and you can operate all you like.

Harry J. Miller
991 42nd Street
Sarasota FL 33580

If you'd like to install a second battery in your car to operate your radio, CB unit, ham setup, etc., and not worry about having enough current to operate your starter, use the device shown in Fig. 1.

Your car's alternator will charge both batteries, but operating your radio gear too long will only discharge one, leaving the regular vehicle battery fully charged for instant use.

D1 through D4 are stud-mounted silicon diodes rated at 60 piv and 25 Amps or more. Mount with the usual insulating washers on a heat sink. ■

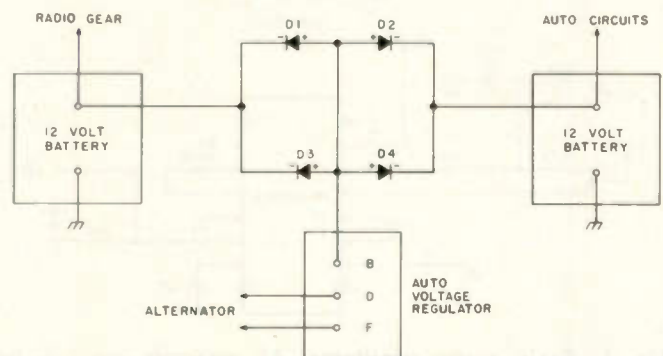

Fig. 1. Battery isolator schematic diagram.

Experimenting with Tones

— fun with functions

Tone generation the foolproof way.

Tone generators, or audio oscillators as they are commonly called, are frequently used in amateur and commercial radio systems. They are used in touchtone™ pads, tone-burst generators, sub-audible generators, AFSK oscillators, and in remote station control systems. They have also been widely used for years in test generators for testing AM, SSB, and telephone equipment. While there are many ways to generate tones for these and other uses, most of the traditional methods have drawbacks of one sort or another. LC circuit oscillators, for example, are difficult to tune up, twin-T oscillators sometimes are reluctant to oscillate, and multivibrators aren't al-

ways as stable as required. The above problems are compounded when attempting to adapt these oscillators to frequency shift keying. While these drawbacks aren't too serious to an experienced experimenter or engineer, they sometimes prove to be major frustrations and obstacles to the average experimenter who needs a good audio oscillator quickly.

An easy and almost foolproof way to generate audio tones for a large variety of purposes is to use one of the IC function generators, readily available from most electronic supply houses. These function generators and a minimum number of external components will pro-

vide stable, low-distortion sine wave audio outputs. This article describes the operation and application of these IC function generators, and gives simple examples and circuits using an EXAR XR2206 function generator IC. The experiments require no test equipment other than a pair of earphones and a VOM. The total cost of these experiments should be under \$10, provided that a source of 12V dc is available.

The EXAR XR2206 IC Function Generator

Fig. 1 shows a basic audio oscillator using an XR2206 IC. None of the components is critical, and the circuit should work the first time it is turned on. R and C are the frequency determining components. With the values given for R and C, the function generator will produce an audio output of 1 kHz. Connect the earphones to point A through a .1- μ F capacitor. A clean sine wave of about 1 kHz will be heard. The output impedance is 600 Ohms, and the IC will drive earphones of 600 Ohms or higher impedance. It will not drive a 4- or 8-Ohm speaker. The

rms audio output is about 1-2 V, which is more than enough for most purposes. For ease of construction, the circuit may be bread-boarded on a Continental Specialties or similar breadboard.

With the earphones still connected to point A, remove Rx from the circuit. The output should become slightly richer in harmonics as the sine wave is changed to a triangle wave. If an oscilloscope is available, the waveforms should appear as shown in Fig. 2.

Connect the earphones to point B, the square wave output, through a .1- μ F capacitor. A 1-kHz tone, rich in harmonics (square waves), should be heard. If an oscilloscope is available, the waveform should appear as shown in Fig. 3.

The output frequency of the function generator is determined by R and C, by the expression:

$$f = 1/RC.$$

Thus, in this case,
 $f = 1/[(1 \times 10^4)(1 \times 10^{-7})]$
 $= 1/10^{-3} = 10^3/1 = 1000$
 Hz

Component tolerances are an important consideration if a precise frequency is desired. With average, run-of-the-mill

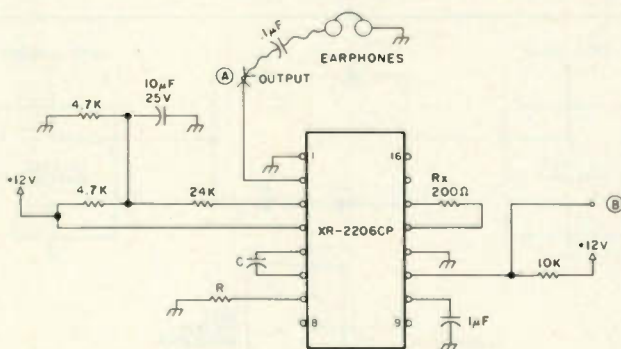

Fig. 1. Basic audio oscillator. All resistors are 1/4- or 1/8-Watt. For a frequency of 1 kHz, C = .1 μ F, R = 10k.

capacitors and resistors (20% tolerances), you can get near the desired frequency, but you won't get exactly on frequency. If a precise frequency is desired, then a trimming resistor should be inserted in the circuit as shown in Fig. 4.

Temperature Stability

The temperature stability of the XR2206 is about 15 parts per million per degree centigrade, or about .15% over the temperature range of 0 to 75 degrees C. This is very good temperature stability and probably better than needed for most purposes. Unfortunately, in practice, it is difficult to achieve this stability due to temperature tolerances of R and C, the frequency determining components. In the circuit given in Fig. 1, it is assumed that normal run-of-the-mill carbon composition resistors and disk ceramic capacitors will be used. Components of this variety exhibit very poor temperature stability, and will change in value from 10 to 20% from room temperature to freezing. This phenomenon can be verified by connecting the output of the tone generator to a counter, and then placing the tone generator in the refrigerator. A significant change in frequency will be noted.

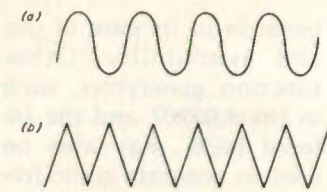

Fig. 2. (a) Waveform with R_x in circuit; (b) Waveform with R_x removed from circuit.

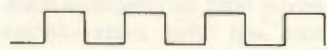

Fig. 3. Waveform at square wave output.

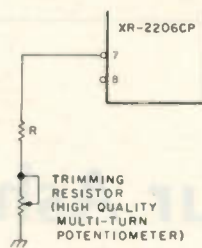
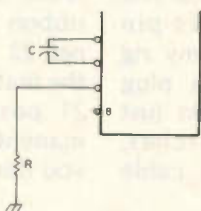

Fig. 4. Adding a trimming resistor to adjust frequency.

The temperature stability of the tone generator circuit can be improved considerably by using temperature-stable components for R and C. For C, mylar™ or silver mica capacitors should be used; for R, 1% resistors of the variety RN55 (an industry designation) should be used. These components exhibit good temperature stability, and are readily available from the supply houses listed at the end of the article. Fig. 5 shows a stable oscillator



Frequency	C	R
100 Hz	.01 mylar	1 meg
500 Hz	100 W V dc	200,000
1000 Hz		100,000
1500 Hz		66,500
2000 Hz		49,900
3000 Hz		33,200
5000 Hz		20,000

Fig. 5. Stable oscillator. Resistors are 1% tolerance MIL style, RN55D, RN55C, or RN55E. $f = 1/RC$.

with a table of components for various frequency ranges.

The XR2206 IC is a unique chip in that it is designed for two-frequency or AFSK operation. If the circuit in Fig. 6 is used, the frequency will change from 1000 to 1170 by grounding pin 9. By adding a relay, as shown in Fig. 6, this circuit may be used for AFSK keying. The output of the oscillator is continuous when changing frequency, as shown in Fig. 7, and thus the oscillator may be used to modulate an SSB transmitter to produce FSK.

Tone-Burst Oscillator

Fig. 8 shows a simple tone-burst oscillator. Point C is connected to the push-to-talk line in the transmitter. When the transmitter is keyed, a short tone burst is generated and fed to the audio circuit of the transmitter. R_T adjusts the time duration of the tone burst, and R_A controls the output tone level. Choose C and R according to the formula shown for the desired frequency.

Subaudible Oscillator

A simple subaudible tone oscillator may be con-

structed by using the circuit in Fig. 8. In this case, omit the NE555V and its associated components, and connect pin 4 of the XR2206 to +12 V. The output of the subaudible generator should be connected to the high side of the modulation or deviation control in order to bypass audio speech filters that pass speech in the 300-3000-Hz range. This type of oscillator is called

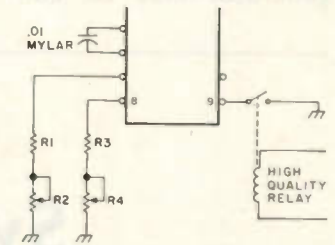

Fig. 6. AFSK oscillator. $R_1 = 90,900$ RN55, 1%; $R_3 = 75,000$ RN55, 1%; $R_2, R_4 =$ multiturn miniature 20k pot, such as Beckman or Spectrol, which are used to trim the frequencies to 1000 Hz and 1170 Hz, respectively.

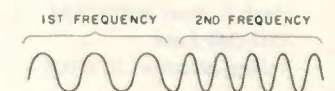

Fig. 7. Oscillator output when changing frequency.

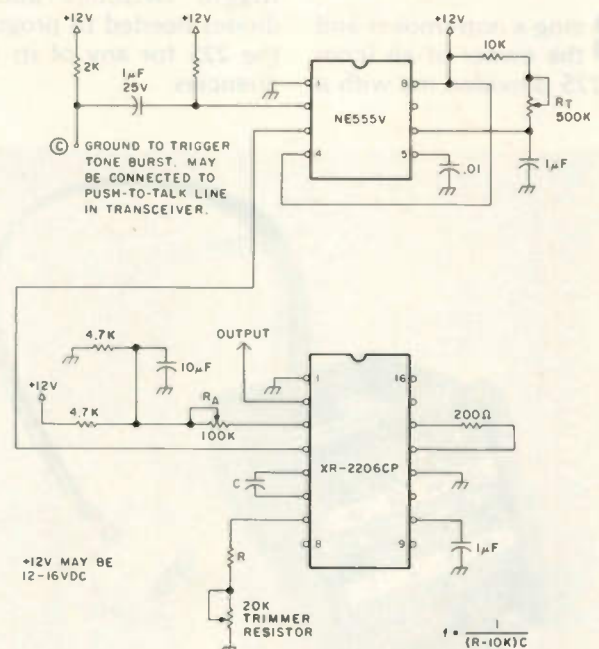

Fig. 8. Tone-burst oscillator.

subaudible since FM receivers with private line or tone squelch capability filter out frequencies below 300 Hz, and are not passed to the audio stages. Subaudible frequencies (frequencies below 300 Hz) are used to activate a private-access repeater or station.

Audio Test Generator/Code-Practice Oscillator

A simple audio test generator may be con-

structed by using the circuit in Fig. 4. If R is 10k and the potentiometer is a 500k pot, the frequency may be varied over the range of about 200 Hz to 10 kHz. This simple generator may also be used as a code-practice oscillator by placing a key between +12 V and pin 4 of the XR2206.

Other Function Generators

The circuits given in this article were based on the XR2206, which was chosen

because of its ease of use and availability. Other function generators, such as the XR2207 and the Intersil 8038, may also be used to generate audio frequencies. However, they

are not the same as the XR2206 and lack some of its capabilities. If these other chips are to be used, a set of application notes should be obtained from your distributor. ■

Sources for Parts

XR2206CP, NE555V, .01 mylar (mylar film), nonprecision resistors and other parts—James Electronics.
Resistors, capacitors, and multiturn trimming pots—Poly

Paks.
Precision 1% resistors—Harvy Electronics, Vestal Parkway E., Vestal NY 13850, or Cramer, Summitt, and other large distributors.

Synthesize Your Ashtray

— article for non-smokers

Let your dashboard do it for the 22S.

*Hugh S. Pearl WB9VWM
2502 Oak Lane
Rolling Meadows IL 60008*

Being a non-smoker and the owner of an Icom IC-22S provided me with a

simple way to have a programmer built permanently into my car. The cup in the front ashtray is removable and has enough room in it for 8 miniature toggle switches and 8 diodes needed to program the 22S for any of its frequencies.

An aluminum plate was cut to fit the ashtray opening and drilled out for the switches and mounting holes. The back of the ashtray has a hole and rubber grommet in it to protect the connecting cable. A 9-conductor ribbon cable (10 conductor with one wire removed) was used with the accessory plug connected to one end. The photo shows a 24-pin Molex plug which my rig uses, but the 9-pin plug Icom provided works just as well. The switches, diodes, and ribbon cable

were obtained from James Electronics.

I made a listing of the frequency conversion code and mounted it to my visor. When the ashtray cover is closed, the programmer is hidden in the dashboard. Best of all, now no one leaves old butts in my ashtray.

The connector in the radio is connected by the ribbon cable to the channel 22 switch position on the matrix board. The other 21 positions can be permanently programmed as you desire. ■

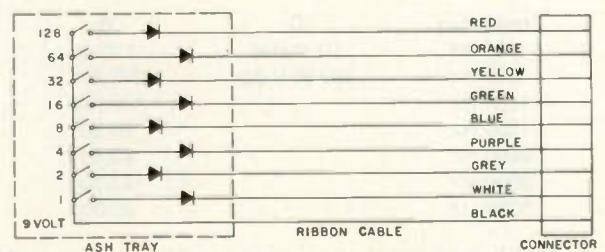
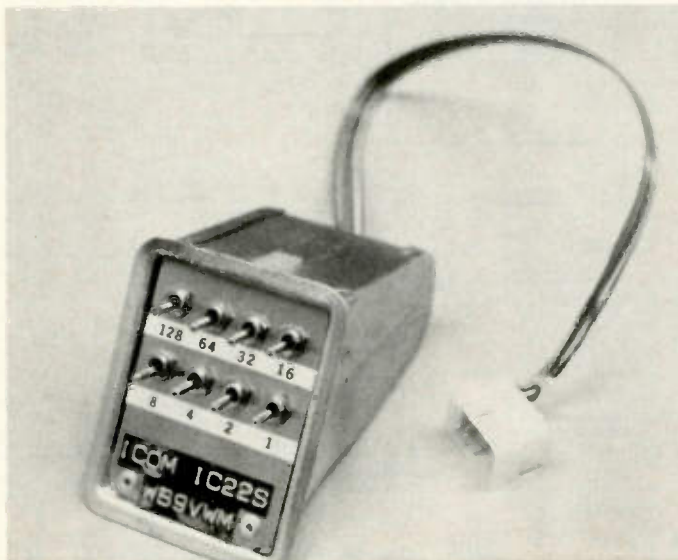

Fig. 1.

Midland's 13-510 Is One Great 2-Meter Mobile. Our 13-510A Is Even Better!



- NEW!** The 13-510A P.L.L. synthesizer delivers 1,200 frequencies between 143.00 and 149.00 MHz . . . the full 2-meter band, plus MARS.
- NEW!** The 13-510A will operate with up to a 6 MHz split between TX and RX frequencies.
- NEW!** The 13-510A microphone connector is pre-wired for your Touch-Tone® encoding microphone.
- NEW!** The 13-510A has a 7-pin accessory connector for your Touch-Tone® dial, tone-burst generator or discriminator meter. *Touch-Tone is a registered trademark of AT&T.
- NEW!** The 13-510A is compatible with available popular CTCSS continuous tone-coded squelch system accessories.
- NEW!** The 13-510A has 3 transmitter outputs: 1, 10 and 25 watts.

Midland's 13-510, with its commercial-type modular construction, earned its reputation as one tough 2-meter FM mobile. Now Midland has made the 13-510A an even more versatile performer!

The 13-510A P.L.L. synthesizer splits the 6 MHz spread between 143.00 and 149.00 into 600 discrete frequencies, and a 5 KHz up-shift delivers 600 more for a total of 1,200 . . . shown directly on the digital display. In addition, there's access to 4 available offsets for repeater operation on ± 600 Hz with crystals supplied or up to 6 MHz spread with your crystals installed. Inside the 13-510A, there's a highly sensitive (0.3 μ V), highly selective (-70 dB at ± 15 KHz) dual conversion receiver with

dual gate MOSFET RF and mixer stages, crystal filter in the 1st IF, ceramic filter in the 2nd IF, and helical resonators in the RF amplifier.

The transmitter is conservatively rated for 25 watts output, switchable to 1 or 10 watts for repeaters, and uses direct FM modulation to deliver natural sounding audio.

Other features making Midland's 13-510A the one to look at include automatic protection circuit for the output transistor, internal DC filtering and polarity protection, a deep-finned heat sink for the power transistors, and electronic switching that needs no mechanical maintenance. Mobile mounting bracket, base stand and push-to-talk microphone are included.

CHECK OUR SPECS:

RECEIVER. Type: dual conversion superheterodyne. 1st IF frequency: 16.9 MHz. 2nd IF frequency: 455 KHz. Sensitivity: Less than 0.5 μ V for 20 dB quieting (0.3 μ V for 12 dB SINAD). Spurious response: -60 dB. Squelch threshold: Less than 0.3 μ V. Modulation Acceptance: ± 7.5 KHz. Selectivity: -70 dB at ± 15 KHz. Audio output power: 1.5 watts at 8 ohms.

TRANSMITTER. Outputs: 1, 10, 25 watts. Frequency deviation: Adjustable 3 - 16 KHz (normal 5 KHz). Audio Input: 600 ohms. Modulation system: Direct FM. Spurious Radiation: Less than -60 dB below carrier.

GENERAL. Power: 13.8 volts DC, negative ground. Current drain: Transmit, 2 - 7 amps.; receive, 0.8 amps. average. Antenna impedance: 50 ohms. Unit size: 2-5/8" x 6-13/16" x 9-5/8". Unit weight: 6.6 lbs.

Want to know more? See your
Amateur Radio Dealer for Midland Quality

- P.L.L. "220" MOBILE
- CRYSTAL "220" MOBILE
- ANTENNAS & ACCESSORIES

... or write for free full-color brochures. ^{M41}

MIDLAND[®]
INTERNATIONAL

P.O. Box 1903, Kansas City, Missouri 64141

Attention, Satellite Watchers!

— a solid-state monitor for GOES

The satellite doctor strikes again.

In a previous article in 73 (November, 1978), I described various approaches for reception of GOES (geostationary operational meteorological satellite) picture signals on S-band (1691 MHz). For the experienced satellite fanatic, the S-band conversion is the big snag to implementing GOES operations, since

most have adequate display equipment to handle the APT mode pictures. For newcomers, however, the problem is more complex, particularly since many new converts to weather satellites have little experience in electronic construction. All things considered, the easiest approach for most is an integrated display monitor which permits photographs to be obtained from a TV-like display.

The 73 *Weather Satellite Handbook* contains one such display unit that will do a fine job. This monitor is a multimode unit, however, and is designed to handle both geostationary and polar orbiting satellites. If geostationary spacecraft such as GOES are the major objective, there are several design simplifications which are possible. In addition, since designing the original unit, several new circuit ideas have been tried with good results. It seemed a good idea to present a circuit incorporating many of these ideas while, at the same time, getting at a unit that

was designed strictly with GOES service in mind.

Before getting into a discussion of the unit, a short digression on design philosophy is in order. There is no single-circuit solution to any given problem. Some approaches are more complex than others, and each has its own unique trade-off between simplicity and performance. As is always the case in my published circuits, I have taken the simplest approach that will yield quality results. If you think you have a better solution at one point or the other, feel free to modify the beast. If worse comes to worst, you can always put it back in its original state with assurance that it will do a good job.

The second problem facing the home constructor these days is the matter of obtaining parts. It gets hard enough to obtain garden-variety components at times, without trying to duplicate a circuit where the author had access to a one-of-a-kind part left over from the construction of the last lunar module! In that regard,

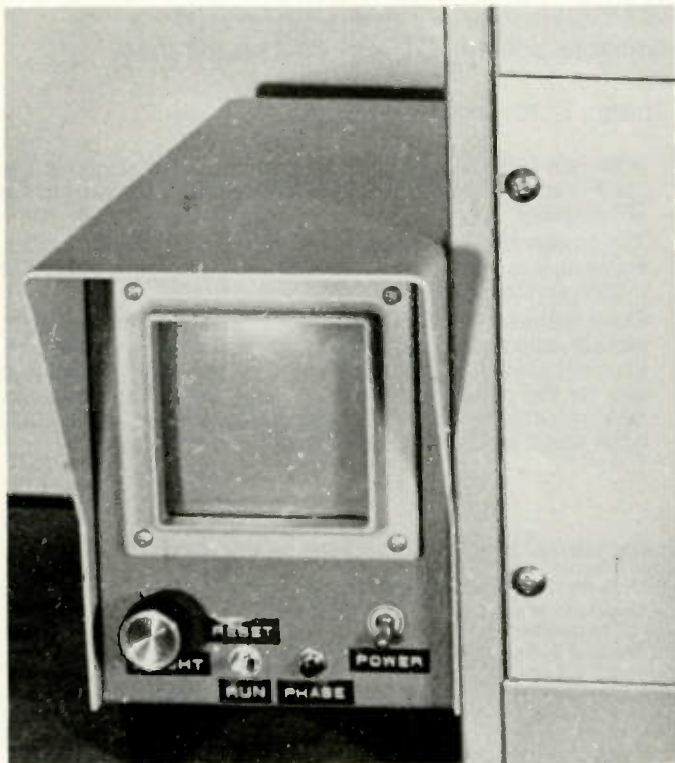

Photo A. The remote display terminal in the author's prototype. This used the cabinet, bezel, CRT, HV module, and yoke from a Robot fast-scan viewfinder. The cabinet contains these components and the relevant CRT circuits.

you can rest assured that all of the parts specified are widely available and a wide margin for substitution exists. In each case where this is possible, I will try to outline what you should look for in substitute parts. Virtually all of the specified components are available from local distributors, off the peg-board at your local Radio Shack, or from mail-order supply firms.

Finally, as an aid to those who are terrified of what looks like a complex project, virtually all of the active circuits for this monitor have been boiled down to single large plug-in circuit boards with only 14 connections to the outside world. For those without facilities for making PC boards, the boards are available, as I will note later.

Circuit Functions

In the broadest sense, the monitor has to take the satellite video signal and turn it into a meaningful image. To understand how it does this, we must first understand the satellite video format which is summarized in Fig. 1. GOES pictures are transmitted in the APT (automatic picture transmission) mode, and, for the sake of discussion, the overall circuit can be broken down into a number of fundamental sub-units, each with its own function.

(1) *Video circuits*—These circuits must filter the signal to remove any components outside of the video passband and must demodulate it in such a way that maximum subcarrier amplitude (white) results in a bright trace on the screen, while minimal amplitude (black) causes the trace to be extinguished.

(2) *Sync Circuits*—Here we must maintain a precise 4 Hz trigger rate in order to display the picture proper-

ly. Since it is possible to record the satellite pictures on standard audio tape, it is most useful if the sync circuits will function even with the speed variations resulting from the recording and playback process, in addition to handling satellite signals in real time.

(3) *Phase circuits*—Although the sync circuits maintain the proper trigger rate, they cannot assure that the line trigger pulse that starts each display line corresponds precisely with the start of each line of satellite video. Without special provisions for phasing the picture, you are likely to get a display where the left edge of the actual picture falls somewhere inside the display frame, forcing you to cut and paste the picture to get the proper display.

(4) *Horizontal deflection circuits*—In this case, we want to generate a linear, 250 ms line each time a line trigger pulse is produced by the sync circuits.

(5) *Vertical deflection circuits*—Here we want to produce a linear vertical scan which requires 200 seconds for the trace to move from the top to the bottom of the screen. If 8-second frames in slow scan (SSTV) are actually slow scan, then APT pictures with their 200-second frame intervals are very slow scan indeed!

The remaining functional description will center around Fig. 2 (a system block diagram) and the schematics in Figs. 3-8.

Video circuits (Fig. 3). The video signal from the receiver or tape recorder enters the unit at J1 across the 10k CONTRAST control (Fig. 7). Since the gain of all circuits after the CONTRAST control is fixed, it is this control that determines the amplitude of the final processed signal and, hence, the contrast of the displayed pic-

Subcarrier frequency	2400 Hz
Subcarrier modulation	FM
White level	maximum amplitude (@ 96%)
Black level	minimum amplitude (@ 4%)
Dynamic range	@ 14 dB
Line rate	4 Hz (240 lines/min.)
Direction of horizontal scan	left to right
Frame rate	200 seconds
Direction of vertical scan	top to bottom
Number of scanning lines/frame	800
Aspect ratio	1:1 (square)
Baseband video bandwidth	1600 Hz

Fig. 1. Characteristics of the APT satellite video format.

tures. From the CONTRAST control, the signal enters the main circuit board on pin 12 (Fig. 3) where it passes through an active filter (U1) set up for a center frequency of 2400 Hz, a bandwidth of 1600 Hz, and unity gain. The 2840-Ohm resistor in the input circuit sets the center frequency, and can be approximated closely enough by paralleling two 5600-Ohm resistors. From the filter, the signal is routed to U2, which is the video power amplifier. Here the signal gets a significant power boost. A part of the subcarrier signal is tapped off at "A" for the sync circuits which will be described shortly. The signal is also routed off the board at pin 15, where it goes to T1 to be stepped up in voltage in the high impedance secondary windings. Here it is detected by a bridge rectifier network. The output of the detector is a 4800 Hz waveform (positive going) whose amplitude is proportional to the instantaneous amplitude of the satellite subcarrier. This signal is applied to the CRT grid across a 10k load resistor (Fig. 7).

The CRT is biased by the BRIGHTNESS control in the cathode circuit so that the tube is just cut off (the trace is just extinguished when viewed in a dark room). Any positive excursions at the grid will cause the trace to brighten proportionally to the applied voltage which is precisely what APT display requires.

About 5 V swing on the grid is all that is required for useful display. To prevent transients or other inputs from blooming the trace, a conventional silicon diode and zener are used across the grid resistor to provide peak white limiting by holding voltage at the grid to a maximum of a little over 5 V. Q1, the blanking transistor, is driven by the line trigger pulse, pulling the grid to near ground potential and blanking the trace during horizontal retrace.

Sync circuits (Fig. 4). The operation of the sync circuits is based on the fact that the 2400 Hz satellite subcarrier is locked to the same master frequency source as the 4 Hz line trigger generator. If we can lock a stable frequency source to the subcarrier signal, it is possible to derive the 4 Hz line trigger rate by digital frequency division. Our reference source in this case is a 565 phase locked loop. The internal voltage controlled oscillator (vco) of the loop is adjusted to free run very close to 2400 Hz by the 1k vco pot. When a sample of the subcarrier signal from "A" is applied to one input of the phase comparator, the vco is pulled onto the subcarrier frequency with the vco output providing a stable source for frequency division. The loop will follow any reasonable frequency changes caused by speed changes in the tape recorder, thus providing

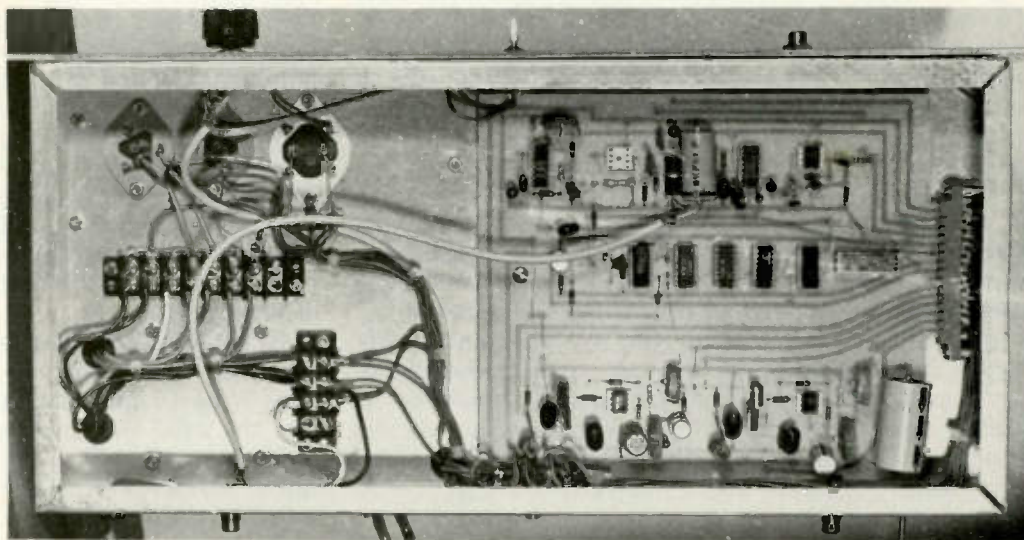
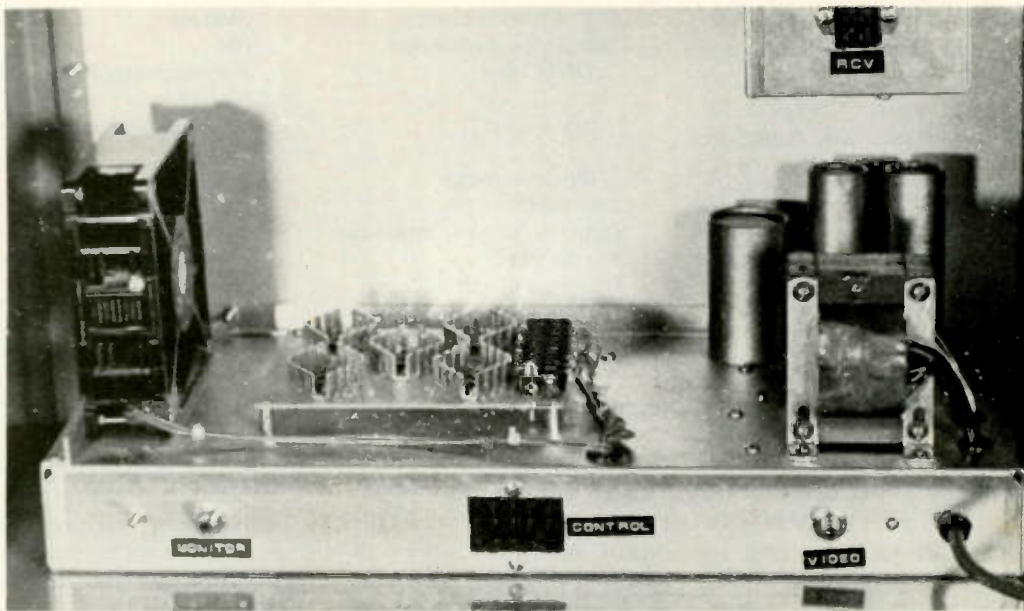

Photo B. Above chassis (top) and below chassis (bottom) views of the electronics assembly of the author's prototype. This unit contains the power supply and the main circuit board. A fan was required to compensate for inadequate heat sinking of the regulators (see text).

for display of recorded video as well. The vco signal from the PLL (U3) is routed through a series of gates in U4 to provide phasing, a function I will discuss shortly. The 2400 Hz output from U4 is then routed to a frequency divider chain composed of U5, U6, and U7, providing a total frequency division of 600. Since $2400/600 = 4$, we have derived the proper line trigger rate. This 4 Hz signal is routed to a 12 ms single-shot (U8) which generates the required trigger pulse. A sample of this pulse is routed to board pin

10 for blanking, while another sample, "B", is used to actually trigger the horizontal deflection system.

Phase circuits (Fig. 4). Although the phase locked sync system does maintain the proper line rate, it cannot assure that the line triggering in the display coincides with the start of a line of video data. When it does not, which is likely to be the case most of the time, you get a situation where the left edge of the satellite picture is actually inside the frame. This condition is corrected by the

phase circuits. To understand their function, it is necessary to redraw a portion of Fig. 4 to show the connections of the various gates. This is done in Fig. 4(a).

The PHASE switch, a normally-closed push-button, has one side grounded and the other connected to the phasing bus on the main board at pin 8. Since the phase bus is normally grounded, this low is inverted to a high by gate D, and this high is applied to one input of gate B with the other input to the 2400 Hz PLL signal that is

buffered by gate A. The 2400 Hz signal is thus gated through gate B and then through C without interruption on its way to the sync divider chain. When a phase error exists, however, the switch is pressed (opened), and the status of the phase bus is now determined by the state of the collector of the phasing transistor (Q2). This transistor is driven by the Q output of U8, which is high except during the 12 ms trigger interval when it goes low. This results in the collector of Q2 remaining low except for a 12 ms high that is coincident with the trigger pulse. This high is inverted to a low by gate D, and this low at one input of gate B stops the 2400 Hz signal for 12 ms. This interruption, occurring once each line, represents a 12 ms counting error in the sync chain so that the next trigger pulse is delayed for 12 ms, causing the beginning of the next satellite video line to appear closer to the left edge of the display. The PHASE switch is held down until the edge of the satellite video signal moves over to the left edge, at which point the switch is released. This restores proper sync, but, this time, the picture is properly phased.

A worst-case phase error, where the left edge of the picture was all the way at the right end of the 250 ms line, would require 20 line pulses to correct ($250/12$). Since the line pulses occur 4 times each second, the phase switch would have to be held closed for only 5 seconds ($20/4$). This is entirely ample since about 20 seconds is actually available for phasing at the start of each APT frame. The action of the phase circuits in stepping the picture into place is shown in Fig. 11.

Horizontal deflection (Fig. 5). The 12 ms trigger pulse at "B" turns on Q3 for the duration of the pulse,

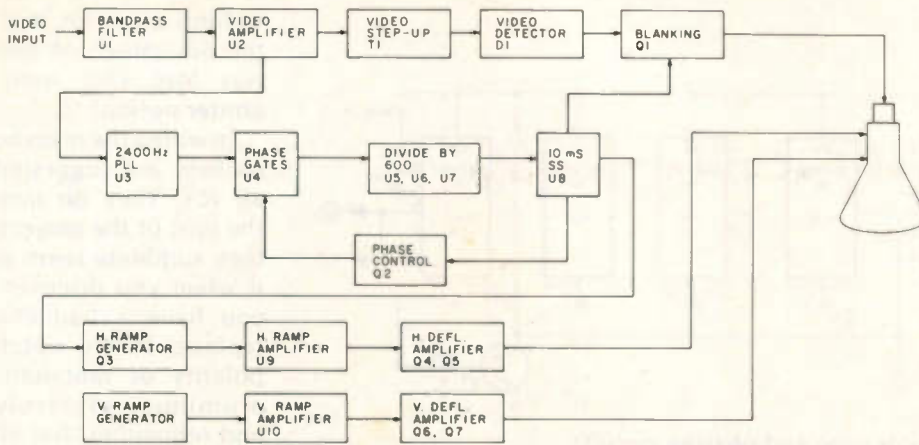

Fig. 2. A block diagram of the monitor signal processing circuits.

discharging the 4.7 uF capacitor in the collector circuit. When the trigger pulse is finished, this capacitor begins to charge through the HORIZONTAL SIZE control, producing a voltage ramp that is amplified by U9. The output of U9 drives the complementary output transistors (Q4 and Q5), which have the deflection windings in their emitter circuit (pins 5 and 6 of the main board). Feedback to the inverting input of U9 via the 100k resistors helps to linearize the deflection waveform. The HORIZONTAL CENTERING control feeds a voltage to the inverting input which provides centering of the trace.

Vertical deflection (Fig. 6). The vertical circuits, with a few exceptions,

function much like the horizontal circuits, with the vertical deflection windings connected to pins 3 and 4 of the main board. The differences involve the use of a much larger discharge capacitor (2200 uF) to accommodate the 200-second sweep interval and the fact that the capacitor is cycled by a switch (the sweep switch) rather than a transistor. In the RUN position of the DPDT center-off sweep switch, a reed relay (K1) on the main board is pulled in, causing its contact (K1A) to short out the capacitor and reset the sweep at the top of the screen. When cycled to the center-off position (RUN), the contacts of K1 open, permitting the capacitor to charge and initiating the sweep down

the screen. The other position of the switch (FOCUS) grounds the bases of Q6 and Q7, centering the trace on the screen. This position is used to focus the CRT or the film camera and also serves as a standby position when the monitor is not displaying pictures. The low-resistance vertical windings would cause one or the other of the deflection transistors to draw excessive current if left for long periods in the RESET or RUN positions. In the FOCUS position, neither transistor is drawing current, and they will sit indefinitely without overheating.

Mainframe wiring (Fig. 7). Much of the mainframe wiring has been covered in previous circuit descriptions. In order to eliminate the chance that power transformers would cause unwanted deflection of the scanning beam, it is suggested that the power supply be removed from the main cabinet. The mainframe does contain the +5, +15, and -15 V regulator ICs, driven from the unregulated voltage buses from the remote supply. If the regulators were mounted on the supply itself, you would get unwanted voltage drop in the connecting cable. In addition, the mainframe contains the high-voltage module for generating the +7-10 kV required for the CRT external anode. The

high voltage module will be discussed in detail in the construction section. Regardless of the approach taken, however, it is desirable to power the module from its own regulators to minimize interaction with other circuit components.

Power supply (Fig. 8). This supply is one possibility for generating the required voltages. A low-voltage transformer (T3) provides the unregulated voltages via a bridge rectifier and filter capacitor network. The +350 volts required for the internal anode and focus grid of the CRT as well as the BRIGHTNESS network is obtained via a conventional power transformer (T2) and a full-wave rectifier assembly. T2 also provides the 6.3 V ac required by the CRT filament. The mainframe and power supply circuits are shown with Cinch Jones P-808-AB and S-308-AB connectors, respectively. An 8-conductor cable with an S-308-CCT on one end and a P-308-CCT on the other is used to interconnect the monitor and its supply. The power supply is turned on via an ac lead actuated by an SPST switch (S3) on the mainframe.

Construction

Main Circuit Board

Fig. 9 shows the land layout for the main circuit board which carries most of the active circuits. If you do not have facilities for making boards, this particular board is available—a point that will be covered at the end of the article. The component layout is shown in Fig. 10 as viewed from the component side of the board. The main puzzle in wiring the board is the cluster of unused holes between the LM380 and the LM565. These holes mark the demise of an idea that was better on paper than it was in prac-

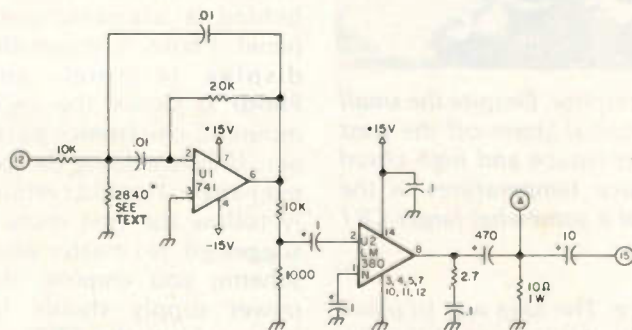

Fig. 3. Monitor video circuits. Unless otherwise noted in this and other schematics, all resistors are 1/4 W, 5% carbon film, all decimal value capacitors are 50 or 100 V dipped mylar, all capacitors between 1 and 10 uF are 16 to 35 V tantalums, and all higher value capacitors are aluminum electrolytics rated at 16 V. All unmarked diodes are general-purpose switching types (1N457, 1N914, etc.). Circled numbers refer to board pinouts, while circled letters refer to interface points on other schematics.

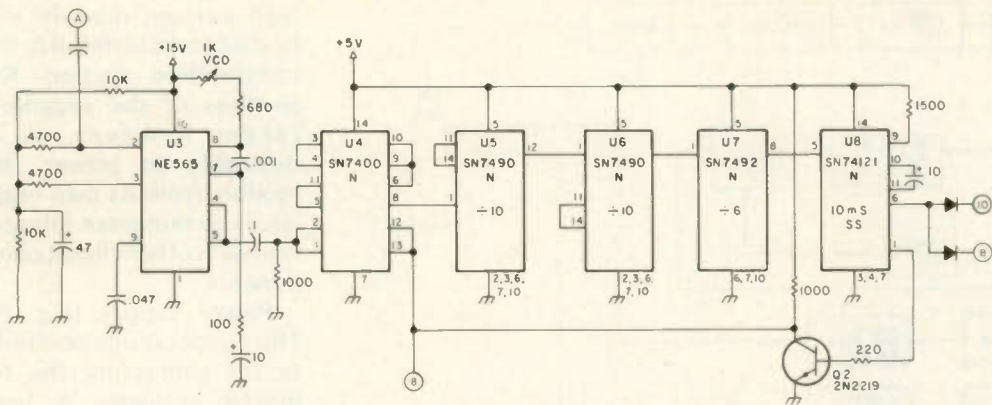

Fig. 4. Monitor sync and phasing circuits.

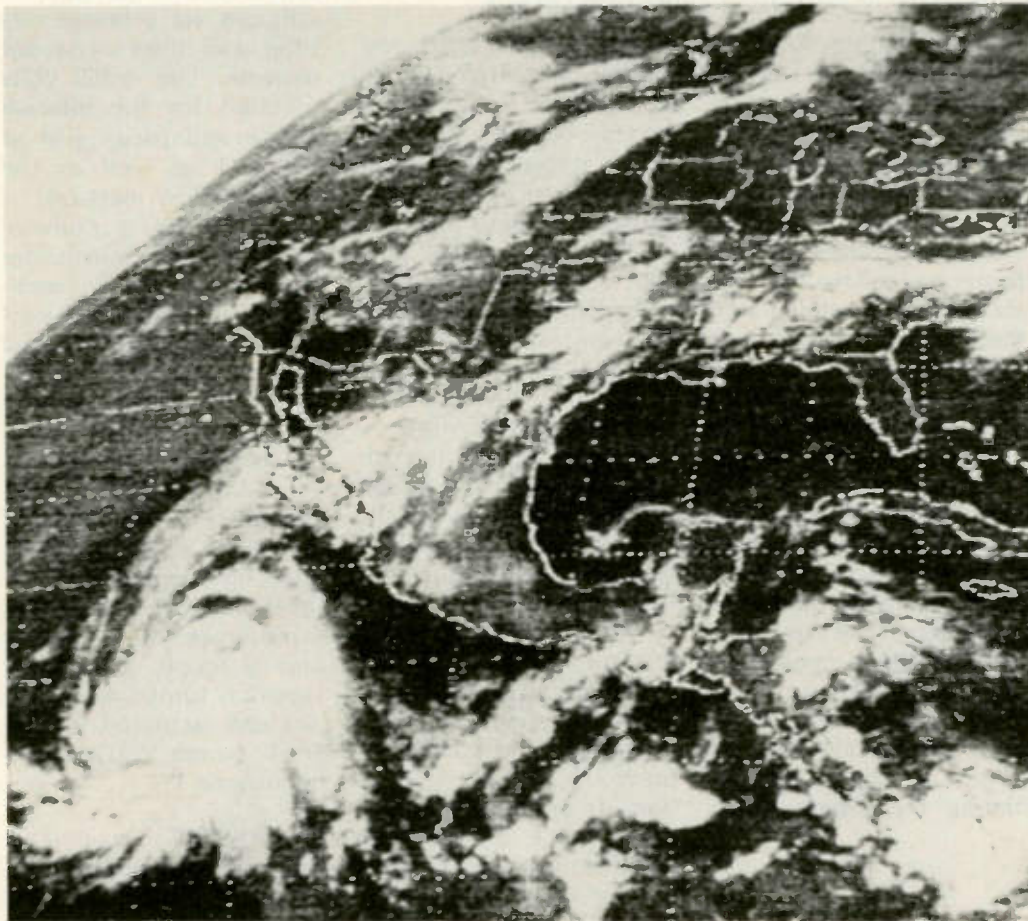

Photo C. An IR frame from GOES E displayed on the prototype monitor. Despite the small screen size, the picture is relatively clear, showing a major tropical storm off the west coast of Mexico. The IR format displays cold objects as white (space and high cloud tops), while warmer areas are darker. Note the warm surface temperatures in the southwestern US and northern Mexico in this frame. The use of a somewhat larger CRT would assure the full 800-line resolution in the APT pictures.

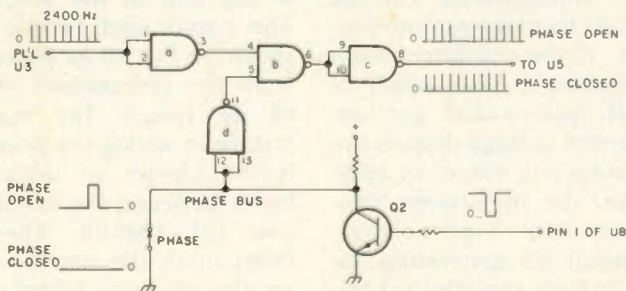

Fig. 4(a).

to limit on noise, much of the advantage of the PLL was lost. Out went the limiter notion!

In wiring the main board, sockets are suggested for all ICs. They do increase the cost of the project, but they suddenly seem worth it when you discover that you have a bad chip to replace! If you watch the polarity of tantalum and aluminum electrolytics and remember that all the ICs have the same orientation, you will not get into much trouble.

Mainframe

Once the board is finished, the remaining decisions revolve around the packaging style you want to use. The schematics of Figs. 7 and 8 assume that the monitor will go in one box with the power supply remoted on its own chassis. In terms of simplicity, this is probably the best approach to take. In the case of the prototype unit, I opted for a different scheme which got just a bit more complicated. I happened to have a Robot Research fast-scan viewfinder unit which had a suitable CRT, yoke, and HV module, so this was stripped and used as a remote display terminal. The power supplies and main circuit board assembly were mounted on a chassis behind a standard rack panel. Photo A shows the display terminal, and Photo B shows the rack-mounted electronics package. If I were doing the job over again, I would certainly follow the first route I suggested. No matter what scheme you employ, the power supply should be remote from the CRT circuits. It is virtually impossible to package everything in one cabinet and avoid unwanted deflection of the CRT trace by transformer fields. You can try if you want, but plan it so you can pull the transformers with minimal difficulty! When

tice. The idea was to place a limiter in front of the PLL to remove any AM variations in the signal, thus improving the ability of the loop to lock on the subcarrier. That part worked, but the unforeseen difficulty was that the limiter was quite sensitive to any noise, and, should it begin

you actually start to build the mainframe and power supply, you will run into situations where you may want to substitute, so let's look at some of those options.

CRT. The CRT used in the prototype was the original tube that came with the fast-scan viewfinder. It is a type 5M140P7M manufactured by Thomas Electronics, 100 Riverview Drive, Wayne NJ 07470. They made a larger tube for the Robot Model 70 SSTV monitor which is ideal for satellite display and has the same pinouts as the smaller tube used in the prototype. The latter measures only 4.25" X 3.25" (5 inches diagonally) and is really quite small for the display of an 800-line picture. Although the pictures are acceptable, you really can't get the full resolution unless you have a somewhat larger tube.

The one used in the Robot Model 70 is just about ideal. Both of these tubes have a P7 phosphor. This long-persistence phosphor is sufficient to let you see some aspects of the picture in real time in a dark room and therefore has some advantages. P4 phosphors of the type used in black and white TV sets will also work fine, although they do not have the long-persistence feature. If you have a Model 70 SSTV monitor on hand that is doing little these days with the advent of digital SSTV scan converters, you can use this as the basis for a conversion, as it will provide a cabinet, yoke, HV module, and a suitable power transformer. If you are building from scratch, I would suggest contacting Thomas and seeing what is available along the lines of the tubes they supplied to Robot. Their prices are quite reasonable compared to other sources. Failing this, you can check

out various small black and white TV picture tubes at your local distributor. Many of these will work fine if you change the socket wiring to accommodate the pinouts. Many of these will have a 12 V filament which can be powered from another LM340T-12 regulator tied to the +LV bus.

HV Module. As mentioned above, the HV module for the prototype came from the Robot fast-scan viewfinder. Other Robot display equipment will furnish similar units. There are many designs available for such modules, and several alternatives are shown in references 1 and 2 and the SSTV section of reference 3. All of these are similar in that a power transistor is hooked up as an oscillator operating into the primary of a standard TV flyback transformer with the HV rectifiers and capacitors in the secondary circuit. The main difficulty with most is that the suggested feedback circuits to run the oscillator are highly dependent on the specific flyback which is specified in each case. Another approach worth checking, if you like to play on the bench, is to use a 555 timer chip as an oscillator at about 20-25 kHz and use this to drive the power transistor as a switch in the flyback primary circuit as shown in Fig. 11. This approach should work with just about any flyback, and you simply choose your primary taps to achieve the desired output voltage.

Transformers. T1 in the video circuits (Fig. 7) is a standard audio output transformer with an 8-Ohm secondary winding (actually used as the primary in this application), and primary windings can be anything from about 1k to 16k. Calectro and others make quite a few that will work just fine—simply look for a "universal" out-

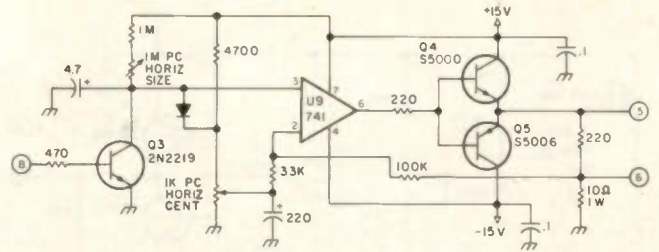

Fig. 5. Horizontal deflection circuits.

put transformer if you can find one that seems to be custom made for the application. Power transformers are comparatively noncritical as well. If you convert a Robot Model 70 monitor, the power transformer in that unit has all the proper windings in one package. If you go the route of separate transformers, as shown in Fig. 8, you can use the following guidelines in making substitutions.

The LV circuit requires that the voltage on both the + and - buses be at least 17-18 V for the 15 V regulators to operate properly. The regulators themselves will take up to 30 V when properly heat sunked, so any transformer that will deliver between those dc limits will work fine. It

should be capable of supplying at least 1 Amp, and 2 Amps is better yet. The HV supply is low current, and there are a variety of power transformers with 225 and 250 V c-t secondaries in the 25-50 mA range which will work fine. All of these have the required 6.3 V ac filament winding.

Deflection yokes. Any deflection yoke designed for a small solid-state black and white TV set will do the job here. If you have a choice, pick a yoke with higher resistance windings in preference to one with very low resistance.

Cabling. You can do anything you want in this area, from hardwiring the two units together to the use of exotic cable assemblies. Figs. 7 and 8 specify the use of a Cinch-Jones P-308-AB

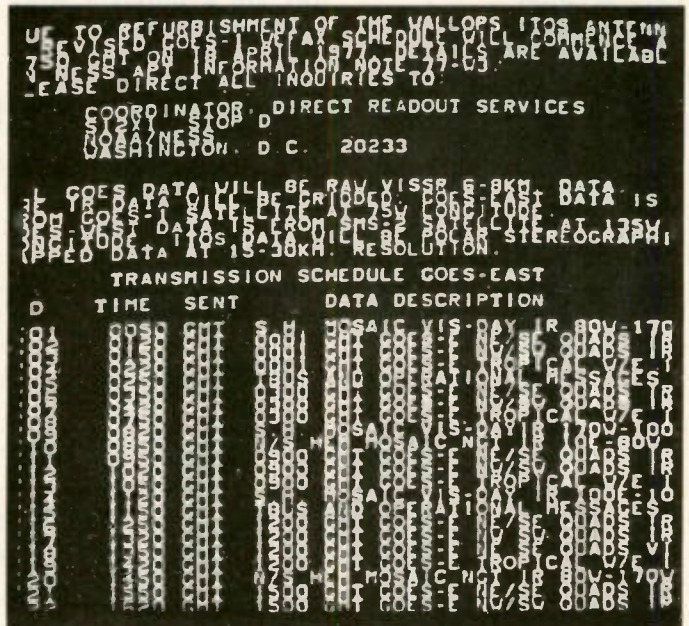

Photo D. An example of an operational message. In this case, it is a system status announcement and part of the transmission schedule for COES E. This example shows the old format with white letters on a black background. The current format uses black letters on white.

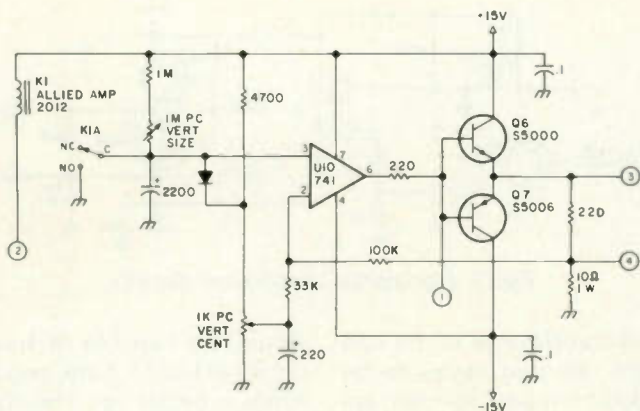

Fig. 6. Vertical deflection circuits.

on the mainframe and an S-308-AB on the power supply. An 8-conductor cable terminated with an S-308-CCT on one end and a P-308-CCT on the other connects the two units. These plugs and sockets are available from almost any distributor and are inexpensive compared to other options. Of course, octal plugs and sockets could be used if you can tolerate wiring the former—I can't! Just be sure to use a socket on the supply and a plug on the mainframe lest you electrocute yourself some evening while wrestling with cables!

General Notes

Only a few general

guidelines are necessary in actually wiring up the mainframe and power supply. The first is to adequately heat sink the IC regulators. Dinky sheet aluminum sinks were used in the prototype, and this required the use of a cooling fan to stop them from shutting down when they got too hot. Generous extruded aluminum units are a good investment and will keep the regulators cool. Note that the positive regulators (LM340T series) have their cases at ground potential, so no insulation is required in mounting them to a grounded heat sink. The negative regulators are a different story (the LM320T series). Either

use mica washers to isolate the cases from a grounded heat sink or mount them individually on smaller heat sinks, each of which is isolated from ground.

In hooking up the deflection yoke, first measure the resistance of the two windings. One is almost always higher than the other. Use the high resistance member of the pair for Y2 (vertical deflection) and the low resistance one for Y1 (horizontal deflection), and orient the yoke accordingly.

Ordinary hookup wire can be used in most interconnections, but you should use shielded wire in the CRT grid circuit and in the video input circuit to and from the CONTRAST control.

S3, the SPST POWER switch, is best incorporated on the BRIGHTNESS control, so choose a pot with a switch assembly. Wire the BRIGHTNESS pot so that, when the switch is off, the center arm of the pot is at ground potential. This will assure that CRT brightness is always minimum when the unit is first turned on.

The HV module should

be mounted quite close to the external anode of the CRT so that only a short length of HV cable is required for the anode connection. The HV module should operate off its own regulators (as in Fig. 7) to minimize its effect on other circuits.

Setup and Operation

Preliminary Setup

By all means, check and recheck all connections prior to powering up. In particular, the +15, +5, and -15 V lines should be checked for proper voltages. To start with, remove U9 and U10 from their sockets and connect the board to the ground, +15, and +5 V lines with the board on the bench.

(1) Connect a frequency counter to the junction of the .1 uF capacitor and 1k resistor at the output of the 565 circuit. Adjust the vco control for a reading of 2400 Hz.

(2) A counter or logic probe should show a 4 Hz signal on pin 8 of U8. A short pulse should be observable on pin 6 of U9 using a logic probe or scope. This pulse should occur at the 4 Hz line rate.

(3) Connect a scope or logic probe to pin 8 of U4. Gaps in the output of 12 ms at the 4 Hz rate should be noted. Use a test lead to ground pin 8 of the main board, and the gaps should disappear.

You can now plug the main board into the powered down monitor. Preset all controls as follows:

CONTRAST (panel)	minimum (max. CCW)
H SIZE (board)	midrange
H CENTERING (board)	midrange
V SIZE (board)	midrange
V CENTERING (board)	midrange
SWEEP (panel)	FOCUS
FOCUS (panel)	midrange

(1) Advance the BRIGHTNESS control to

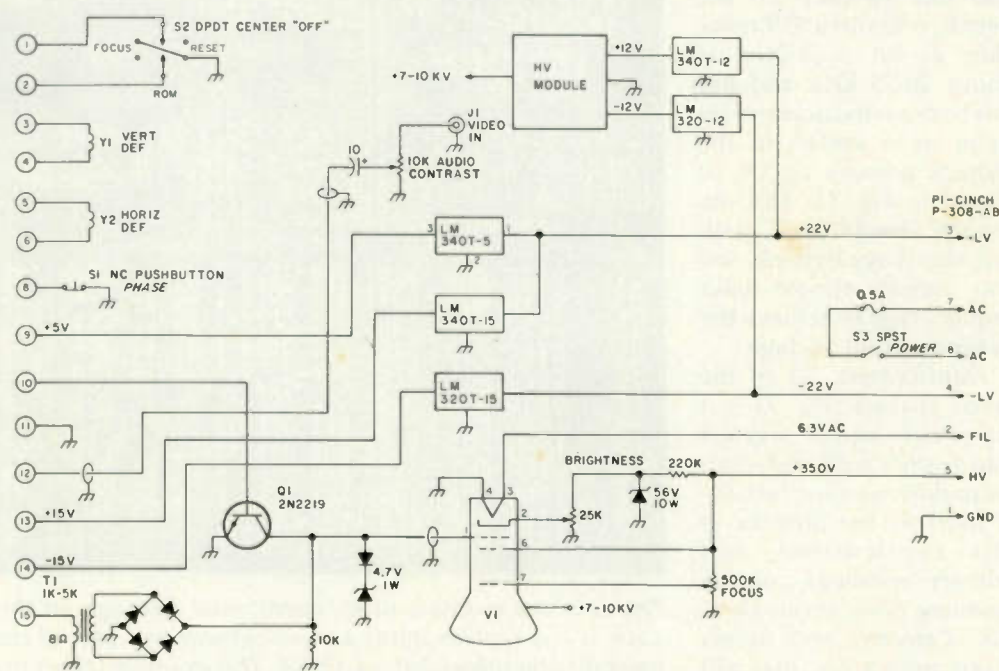

Fig. 7. Monitor mainframe wiring, assuming that all components, exclusive of power supplies, are in one cabinet.

contains a great deal of useful information about photography from CRT displays, and I won't repeat it here. In each case where the monitor is used, you should allow at least 5 minutes for warmup to get

reproducible results. Whenever the monitor is on but not displaying pictures, the SWEEP switch should be in the FOCUS position. When you are ready to display a frame, it can be cycled to RESET.

The picture will begin with a few seconds of start tone—300 Hz modulation of the subcarrier which results in a distinct bar pattern on the trace. When the tone terminates, you should observe a black

area somewhere along the trace. Press the PHASE switch to move this to the left edge of the viewing area. 20 seconds after the end of the start tone, cycle the SWEEP switch to RUN and the frame will begin to

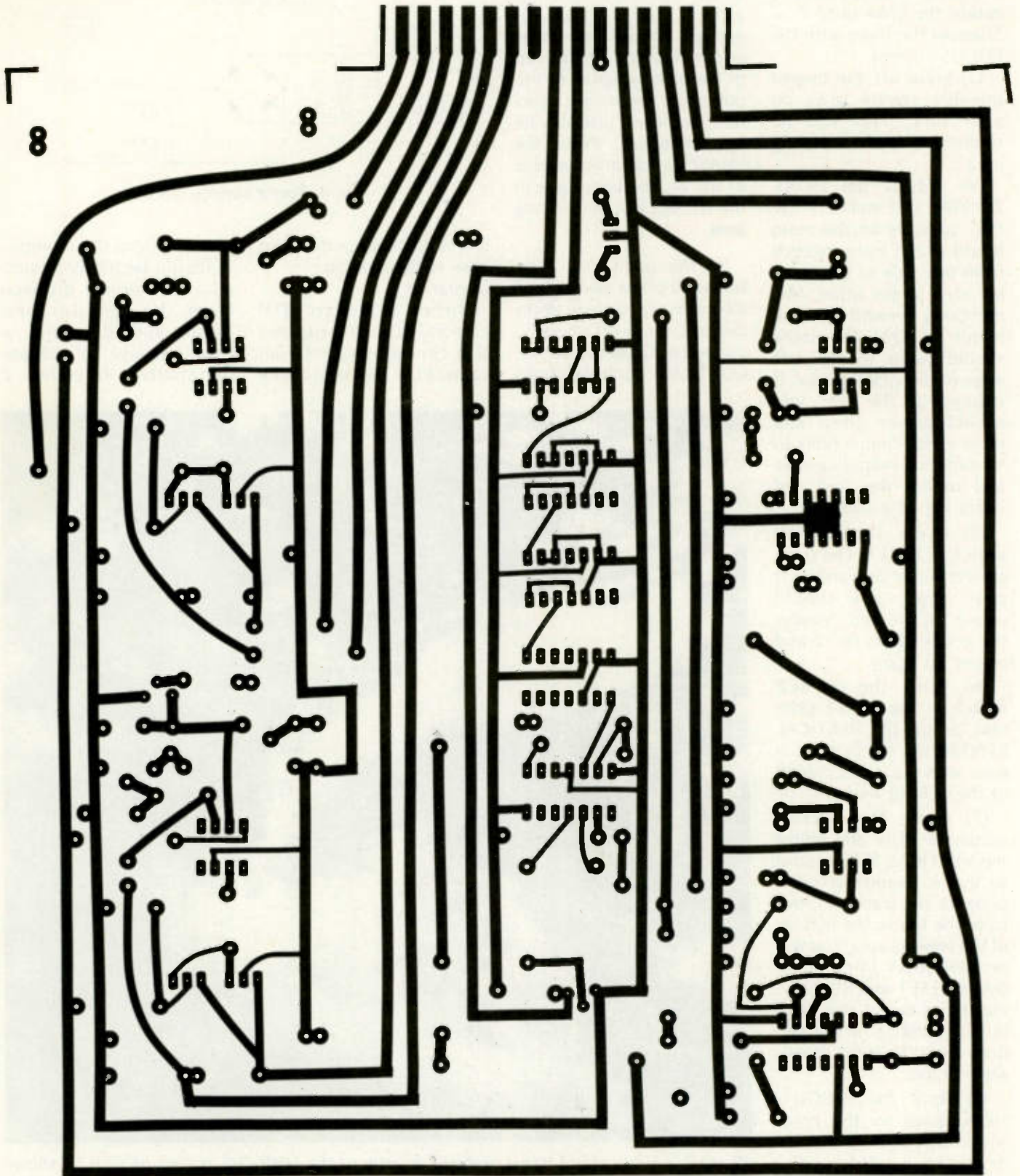

Fig. 9. PC board layout (foil side) for the main circuit board.

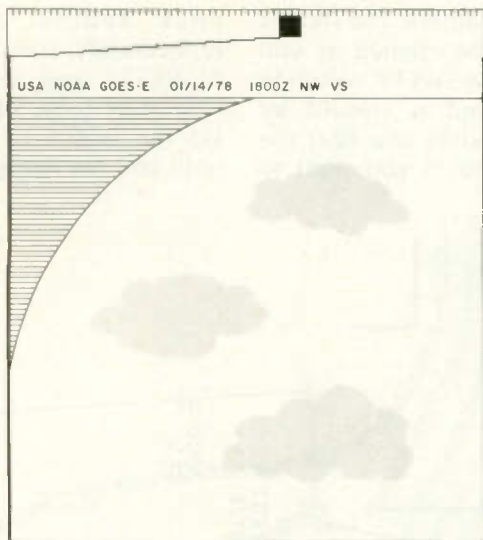

Fig. 11. Operation of the phasing circuits. The top of this segment is the start tone (300 Hz modulation of the subcarrier) where the PLL first locks on the signal. This is followed by a 25-second phasing interval. Note that the edge of the picture, marked by the black bar, is inside the viewing area. When the PHASE switch is pressed, the bar begins to move toward the left edge of the picture where it belongs. When it reaches the edge, the PHASE switch is released and the picture drops back into sync. Note that the last 5 seconds of the phasing interval is devoted to an ID header for the picture. Normally, phasing is done with the sweep switch in the RESET position and the switch is cycled to RUN about 20 seconds after the end of the start tone, permitting the ID header to be displayed.

next frame.

Summary

Photos C, D, and E show typical GOES APT frames displayed on the prototype monitor. Despite the small CRT size, the pictures are quite acceptable. The use of a larger CRT would sharpen them noticeably, however. With a larger

CRT, the display can come quite close to the results achieved with a good photographic fax system with considerably less fuss. Polaroid film will give you almost instant prints with little bother, or the use of roll film will let you prepare enlargements at any size you desire.

This is actually an easy

unit to build and operate and probably represents one of the easiest ways to get into GOES picture display. With a few modifications, the unit can also be used to display VHF pictures from the new series of polar orbiting satellites that became operational with the launch of TIROS N.

Circuit boards are available for this project from METSAT Products, Box 142, Mason MI 48854. The main circuit board, G-10

epoxy, drilled and plated, and a documentation pack costs \$50. If you want to go this route, ask for minikit GM-1. ■

References

1. Taggart, R.E., *The Weather Satellite Handbook*, 73, Inc., Peterborough N.H.
2. Miller, D. and R.E. Taggart, *The Slow-Scan Television Handbook*, 73, Inc., Peterborough NH.
3. ARRL, *Specialized Communications Techniques*, American Radio Relay League, Newington CT.

CUSTOM TRANSFORMERS



HEAVY DUTY REPLACEMENT TRANSFORMERS

ALPHA A77D Power	\$135	HEATHDX-100 Modl	\$ 95
BT1LK-2000 Plate	\$135	HEATHHX-10 Power	\$ 95
COLLIN5 30S-1 Power	\$215	HEATH5B-220 Plate	\$125
COLLIN5 KWS-1 Plate	\$135	HENRY 2K Plate	\$150
COLLIN5 51 6F-2 Power	\$ 95	HENRY2K-2 Power	\$155
DENTRON 160-10L Power	\$125	HENRY 2K-4 Power	\$165
DRAKE L4B Plate	\$165	HENRY 3K-A Plate	\$165
GONSET G5B-100 Power	\$ 95	HENRY 3K-A DC Choke	\$ 85
GONSET G5B-201 Power	\$135	EFJ T-BOLT Plate	\$125
H-CRAFTERS HT-32 Power	\$ 95	EFJ 500 Modulation	\$ 95
H-CRAFTERS HT-37 Power	\$ 95	EFJ 500 DC Choke	\$ 75
HEATHDX-100 LV Power	\$ 95	NATLNCL-2000 Plate	\$125

OFF-THE-SHELF SPECIALS

PLATE XFMR:	2400 VAC @ 1.5A ICAS 220/240 PRI-4 ILB	\$150
PLATE XFMR:	3000 VAC @ 1.5A CCS 230 PRI-60LB	\$195
PLATE XFMR:	3000 VAC @ 0.7A ICAS 115/230 PRI-27LB	\$115
PLATE XFMR:	3500 VAC @ 1.0A ICAS 115/230 PRI-4 ILB	\$150
PLATE XFMR:	4000/4600 VAC @ 1.5A ICAS 230 PRI-60LB	\$195
PLATE XFMR:	6000 VCT @ 0.8A CCS 115/230 PRI-4 ILB	\$150
FILMT XFMR:	5.0 VCT @ 30A 117 PRI-9.5LB	\$ 30
FILMT XFMR:	7.5 VCT @ 21A 117 PRI-9.5LB	\$ 30
FILMT XFMR:	7.5 VCT @ 55A 115/230 PRI-14.6LB	\$ 65
FILMT XFMR:	7.5 VCT @ 75A 115/230 PRI-20.2LB	\$ 95
FIL CHOKE:	30 AMP Billiar Wound on 1/2" x7" rod	\$ 9
DC CHOKE:	8.0 Henries @ 1.5 AMP DC 4 ILB	\$150
SWG CHOKE:	5-30 Henries @ 1.0 AMP DC 23LB	\$100

ALL TRANSFORMERS & CHOKES GUARANTEED FOR 24 MONTHS

Many others also available. Write for free list or quote on any custom transformer, choke, or saturable reactor.

Peter W. Dahl Co.

4007 Fort Blvd. • El Paso, Texas 79930

Telephone (915) 566-5365 or (915) 751-4856



Germantown Amateur Supply, Inc.

MEMPHIS, TENNESSEE

NO MONKEY BUSINESS!

- (A) Complete Service Facilities
- (B) Good Deals on most Brands
- (C) Shipping within 24 Hours
- (D) All inquiries handled by Active Hams with over 20 years experience in ham radio

CALL TOLL FREE
1-800-238-6168

IN TENNESSEE, CALL 901-452-4276
MONDAY - SATURDAY 8:30-5:30
FOR YOUR SPECIAL.

Write: 3202 Summer Ave., Memphis, Tennessee 38112

RADIO EQUIPMENT DOESN'T GROW ON TREES—

But C & A ELECTRONICS offers super values that will make you think it does—

SUPER VALUE NO. 1

Purchase the compact ICOM IC701 HF Synthesized Transceiver with matching Power Supply and Microphone for \$1,719.00

and receive a brand new, ICOM IC 215 15-channel FM Portable/Mobile Transceiver including accessories (\$250.00 value)

FREE



SUPER VALUE NO. 2

- Wilson Mark IV Hand Held\$259.95
1.5W & 4.5W (switchable)
- 2 Crystals—.52/.52no charge
- BP4 Battery Pack24.95
- WC14 Wall Charger15.95
- Rubber Duck Antennano charge

Amateur Net \$300.85

Super Value Price \$271.00

Optional TTP Touchtone Pad
(installed at time of purchase)61.95



This is a limited offer!

TO ORDER:

Super Value No. 1
Super Value No. 2

or

Quotes On All Your Amateur Needs

call

800-421-2258

FOR OUR TOLL FREE NUMBER
(Out of California)

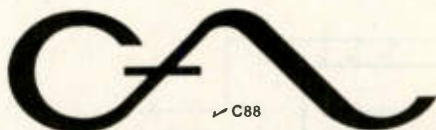

C&A Electronic Enterprises

Distributors of Commercial and Amateur Radio Equipment
22010 S. Wilmington Ave., Suite 105
Carson, CA 90745
(213) 834-5868 (California residents)

Batteries Dead?

— take preventative measures

Your worries are over if you use battery status indicators.

One of the problems associated with battery-operated equipment is knowing that the battery supply has been turned on and/or that the battery voltage is still within suitable limits. Suitable limits might mean the voltage range necessary for a circuit to perform properly, or the upper voltage limit that a rechargeable battery pack should have when it is properly charged and the lower voltage limit when discharged to the point where its usage should be discontinued before the battery pack is damaged by too deep a discharge.

Depending on the capacity of the battery used, one can "afford" only certain types of battery status indicating circuits. Obviously, for a small piece of test gear operated from a 9-volt transistor radio-type battery, even the use of an

LED or the smallest incandescent lamp available will take too much current (15 to 20 mA) compared to the milliampere hours (mAh) rating of the battery (62 mAh for an inexpensive 9-volt type). On the other end of the scale, using a higher capacity battery source, one can "afford" even elaborate battery status circuits that provide detailed information regarding battery condition.

This article explores several interesting battery status circuits including ones that will work with even the lowest capacity battery source to more elaborate alphabetic indicators. Some of the circuits use discrete devices although ICs are available to do the job. Discrete device circuits don't take significantly more current and use commonly available components, whereas the ICs may not be readily

available.

Before getting to the circuits, one might mention meters as battery status indicators. The availability of inexpensive, imported microampere meters might appear attractive to use because of the very low current drain. But, if one calculates the current change indicated by the meter as the battery voltage changes, it might not be very significant. The current change indicated depends on the internal resistance of the meter and any added series resistance. As an example, if a typical, inexpensive 500-microampere meter in series with a suitable resistor is placed across a 9-volt battery, the meter indication might only decrease by about 1/3 scale as the battery voltage sinks to 6 volts. This is not a very obvious indication that the

battery voltage has fallen to the point where it will significantly affect the performance of many 9-volt circuits. Of course, there are often small battery status meters available during parts sales, but a true indication is obtained only when the meter is used for its designed purpose.

After having left many 9-volt-powered transistor checkers, bridges, and even portable receivers turned "on" instead of "off" after usage, with resultant battery loss, the circuit of Fig. 1 was finally discovered. It uses an LED as a battery "on" indicator, but the LED is flashed at a low duty cycle so the average current drain is only about 1 mA. The 2N4870 unijunction transistor forms a simple pulsed oscillator circuit which in turn drives a 2N2222

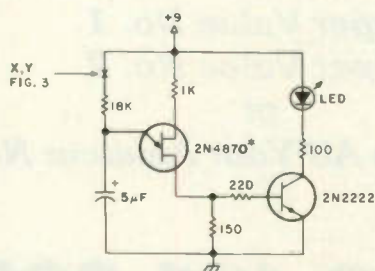

*RADIO SHACK
RS 276-2029
OR ANY TYPE UJT

Fig. 1. Due to the low duty cycle of this flashing LED circuit, the average current drain is 1 mA or less.

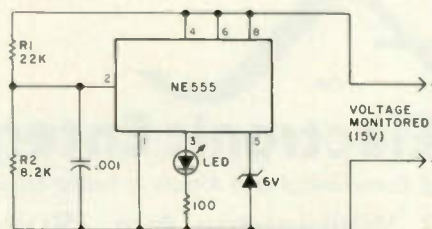

Fig. 2. The NE555 will trigger the LED on when the monitored voltage falls to 12 volts. The ratio of R1 to R2 only needs to be changed if it is desired to change the voltage point at which the LED is triggered.

switch that turns on the LED. The LED flashing rate and the battery voltage range which may be accommodated can vary over a wide range by the suitable choice of R1, R2, and C1. Flashing rates from 2 to 20 per second are the most attention-getting, while still keeping the average current consumption low. The battery voltage can be anything from 3 volts on up. The values in the circuit of Fig. 1 will produce a flashing rate of about 5 times a second from a 9-volt battery. A small amount of experimenting is necessary, particularly with R1 and R2, for other battery voltages. They should be raised in value for higher battery voltages and lowered in value for voltages below 9 volts, although their value is not at all critical. The cost of the batteries saved will rapidly repay the cost of the components for this circuit if you have any tendency at all to forget to turn off battery-powered equipment.

The circuit of Fig. 2 is an undervoltage indicator. It is particularly valuable when using nicad battery supplies since such batteries can be damaged if they are too deeply discharged. This circuit is useful only if there already is some sort of indicator on a piece of equipment informing the operator when it is turned "on," since this circuit will tell the operator when it is time to turn the equipment "off." As shown, the circuit is used to monitor a 15-volt battery source. The ratio of R1 to R2 is such that the LED will illuminate when the battery voltage falls to 12 volts, which is approximately 80 percent of the fully-charged voltage of the 15-volt nicad supply. The voltage value at which the circuit switches on can be controlled by changing the ratio of R1 to R2. The cir-

cuit can also be used on other supply voltages in approximately the 9- to 18-volt range. The circuit is quite sensitive and the turn-on of the LED when a low voltage condition is reached is distinct and sharp. If one wanted absolute protection, pin 3 of the IC can also be used to drive a small relay which would automatically turn off a piece of equipment. This might not be a bad idea for some operators who insist on a last transmission although their nicad battery packs are about to be damaged.

The circuit of Fig. 3 does not indicate when a supply is on, but it can indicate both an undervoltage and an overvoltage condition. This may be useful when charging certain types of battery packs where a fully-charged condition is indicated by a specific voltage level. The circuit can also be a warning device to indicate that the output of some device, such as a portable generator, is not within acceptable lower and upper voltage limits. The circuit can be set up for completely independent lower and upper voltage limits and the limits can be as far apart or as close together as desired. The critical components are the two zener

diodes: D1 to set the undervoltage indication value and D2 to set the overvoltage indication value. These diodes have to be fairly exact in value. For instance, if one wanted to set the upper voltage indication at 15 volts, one would have to use a 15-volt, 5% tolerance zener or test a bunch of 10 or 20% tolerance zeners until a suitable diode is found.

The circuit of Fig. 3 provides a steady LED display for low and high voltage. A more attention-getting display can be obtained by combining the circuits of Figs. 1 and 3 so a flashing LED display is obtained. In this case, the LEDs shown in Fig. 3 are not used and the points marked X and Y are connected to the similarly-noted points in Fig. 1. Note that two circuits of the type shown in Fig. 1 are necessary.

The circuit of Fig. 4 provides a battery status

display using a 7-segment LED readout. A low voltage state is indicated by display of "L", a high voltage state by display of "H", and when any in-between voltage is sensed, the display is a constant "F". One can arrange the connections to the readout to display differently depending upon one's fancy. For instance, one could have the display read "1" for high, "2" for in-between voltages, and "3" for low voltage. Another idea might be to have all segments on the readout active for a high voltage state and then progressively switch off segments for lower voltage states. By studying the diagram and the logic states to get the L, F, and H display, one can arrange other displays on the readout. The zener diodes are, again, critical in value if the circuit is to react when specific voltage levels are sensed. ■

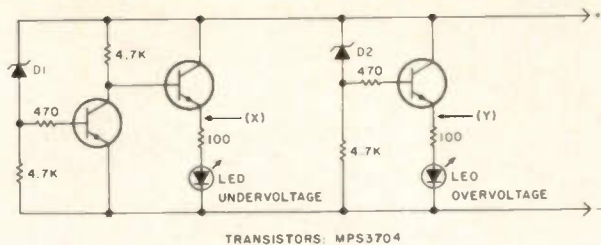

Fig. 3. This circuit will ignite the appropriate LED if the monitored voltage goes below or above the value determined by zener diodes D1 and D2.

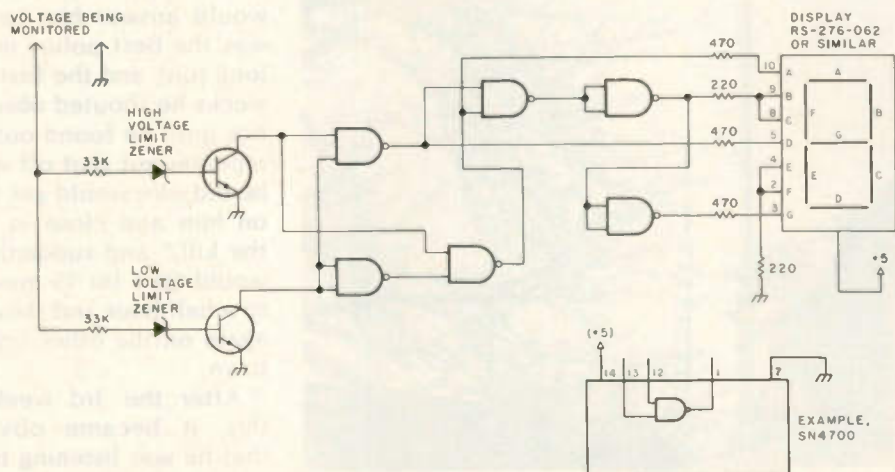
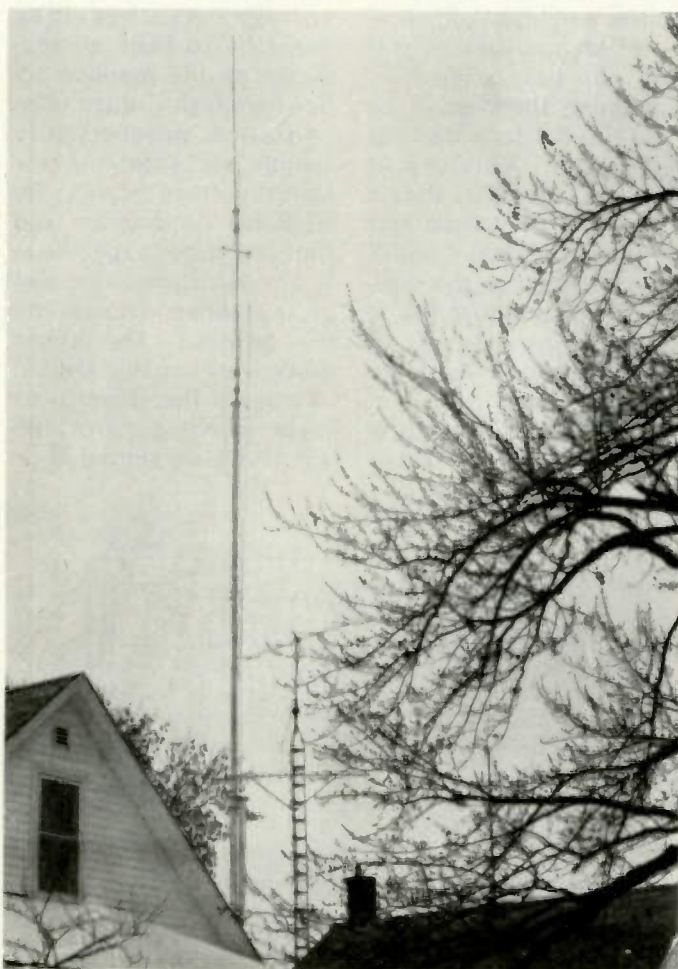

Fig. 4. This circuit uses an LED readout and displays an "L" when the monitored voltage is low, an "H" when the voltage is high, and an "F" when the voltage is between the low and high limits.

How to Nab a Jammer

— another use for 220

It's the Omaha VHF posse vs. the Red Rider.



This shows the 146.40/147 antenna with a 100' tip and, more difficult to see, the 222.34/223,44 repeater antenna with an 85' tip.

*John Gebuhr WB0CMC
2340 N. 64th St.
Omaha NE 68104*

It all started about a year ago when Omaha VHF was plagued by a character who went by the handle of "Red Rider." Every Saturday night without fail, for several weeks, he would come up on the 34-94 repeater: "Breaker one nine, this here's the Red Rider." Usually, no one would answer him (which was the best policy in the long run), and the first few weeks he shouted obscenities until he found out the repeater got shut off when he did. We would get fixes on him and close in "for the kill," and suddenly he would QRT for 15 minutes to a half hour and show up again on the other side of town.

After the 3rd week of this, it became obvious that he was listening to us on other 2m frequencies as we would track him. We used some very uncommon ones, but he obviously

had a synthesized receiver. His transmitters were identified as a PLL type of moderate power (10-30 W) and also a low-power crystal, probably hand-held, unit. (This was later verified.) The two transmitter fingerprints were watched for on legal transmissions, but never appeared until several months later.

One night, we used 5 or 6 ten meter mobiles and spotted his car, but he saw us about the same time and we didn't get a license number. We saw that evening that 10 meters would work, but to get enough 10 meter mobiles to do a good job proved a hassle, as did propagation.

A couple of days before, I had received a flyer from Clegg which offered ten 220 MHz radios for the price of eight. I asked the rest of the guys if they

would be interested in going together on this, and there seemed to be some interest. I took a chance and ordered ten. About ten days later they came, and, by nightfall, six had gone out the door. That was on Thursday night. By Saturday, the rest of them were in service and crystals were ordered for two repeater pairs and another simplex frequency. The following Monday, ten more Cleggs were on order, and two weeks later, there was a 220 repeater in Omaha with 19 users.

If one wonders what happened to the 20th radio, it is now the upper 34-94 repeater in north Omaha. The entire receiver lifted out of the case by loosening four screws and was put in a shielded box. The COR is a reed relay driven from the squelch circuit. R61 is removed from B+ and reconnected to the base of a PNP transistor, the emitter is connected to B+, and the collector goes through a relay coil to ground. A diode was hooked across the relay coil to reduce spikes (hysteresis diode). A 25 uF capacitor was later added to provide a short squelch tail. The LED was added as a cosmetic device.

Cavities were later made out of some 3" transmission line donated for the cause. A handful of "SMA" series connectors was used in the duplexer (because they were free) and a half pound of solder.

The repeater finished, we got permission from Motorola to put the thing up on the Woodmen Tower (300'+ above average terrain) for the weekend. The top of this building is a protected site and has what looks like a crewcut of top-quality commercial antennas — ATS, paging, business, railroad, and many others. I had managed to pack the entire repeater into a suitcase, duplexer and

all, and we carried it up to the top, climbed out on the roof 425 feet above the street, and clamped a Ringo Ranger to a lightning rod. We took the repeater out of the suitcase, set it up, and put it on the air in about 15 minutes. The duplexer didn't need any retuning, and we were off to hunt Red Rider.

We had some success that night, but, unfortunately, Red didn't stay on too long and we didn't get him. For about four months, 220 was probably the best-kept secret in Omaha. And in those four months, we compiled a nice fat file including names, addresses, vehicle descriptions, footprints, and real dog smelling prints, and sent it to the FCC in Kansas City. The night that we got a positive ID on the Red Rider, the comments heard on the 2m 34-94 were, "This is the first Saturday night I'm gonna sleep soundly for a long time," and "Bad guys 31, good guys 1; that kind of evens up the score, doesn't it?"

The only thing that got on people's nerves after that was that it took the FCC about three months to do anything about it. Since the FCC came to town, though, there has been almost no deliberate interference or other flagrant rule violation.

By this time, it was obvious that 220 was here to stay, and there is now a second repeater here cross-linked with the 2m 40-00 machine, making possible, for many people, full duplex operation.

The second repeater is a Midland 13-509, which turned out to be the exact same radio as the Clegg, except for the case and name, right down to the Japanese fingerprints on the PC board. As it turns out, the Cobra 200 is also identical to the above two radios and is the cheapest

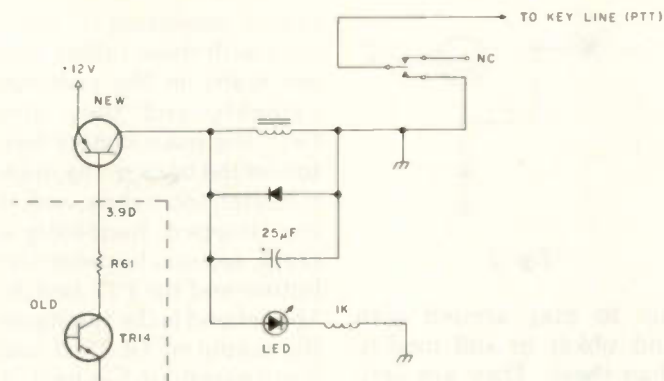

Fig. 1.

one on the market.

As with most ham gear, all three of these radios are imperfect and it is a lot of fun modifying them for various reasons.

Modification #1 eliminates the somewhat long squelch recovery time or reduces it to insignificance (with the squelch set near the edge of operation, it may take up to a full second for it to recover). By changing C89 and C91 from 4.7 uF each to 1 uF each, the recovery time is very fast without significantly impairing the operation.

Modification #2 removes the lamp behind the channel selector and replaces it with an LED. The LED is connected in series with R60 on the receiver board, and R60 is changed from 100 Ω, 1 W to 47 or 56 Ω, ½ Watt. The entire operation reduces receiver current from over 200 mA to about 140 mA. Modification #2(a) removes the meter lamp or puts a switch on it, reducing receiver current to around 60 mA, easily in the portable range.

Modification #3 removes the TX lamp and replaces it with an LED in series with the relay coil, reducing the low-power transmit current from 800 to 700 mA. The only degradation in performance this entails is that the transmitter must have 10.5 V minimum instead of 9.1 V to key properly. So, total low-power current

drain is 1.1 A stock minus meter lamp minus channel lamp minus key lamps = 700 mA, clearly a significant saving. A 12 V gel cell will run the radio for a couple of days and still have power to spare (1.5 Ah).

Modifications #4 and #5 change the SO-239 to a BNC for quick disconnect, lower loss at this frequency, and the capability to use a rubber ducky. The power leads are removed and a quick disconnect plug and socket are installed.

Modification #6: The zener, D6, next to the 56 Ω resistor (in Mod. #2) is disconnected from the 9 V line as is the 9 V side of the LED/56 Ω network. An NPN 1 W resistor is put in as a series regulator, and a 1k resistor is added as shown in Fig. 2. This modification further reduces receiver current by 5 to 10 mA, and, as the zener is a ±5% device, the performance of the receiver is completely unchanged. The 9.1 V line should now be about 8.5 to 8.7 V.

I might at this point say that the part numbers above mentioned are the same for all three makes of radio. The instruction book that comes with the Cobra is far more complete than that with either the Clegg or Midland. It is a service manual, whereas the other two have only a schematic and block diagram.

I don't know when I've seen a radio that is more

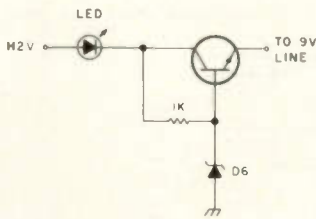

Fig. 2.

fun to play around with and tinker in and modify than these. They are very easy to work on, are laid out well, and come apart quickly.

The first two batches of Cleggs probably sparked the biggest antenna building boom Omaha has ever seen. The two amateur stores had nothing and the only antennas available for 220 were from the local Larsen rep, and they were for mobile only. For the base antennas, most built 5/8-wave or 1/4-wave antennas, and a few cut down Ringo Rangers to the proper dimensions.

There are only two

minor problems I have seen with these radios that are really in the problem category and they are: First, the mike hanger button on the back of the mike is riveted too tightly, and, if it is dropped, frequently a crack appears between the button and the PTT switch. The second is the tuning on the output of TR 21. If one is not careful in tuning it, it can create spurs due to oscillation of the stage. A simple verification can be made of this by keying the transmitter and pulling the crystal while keyed. If the power meter shows output, it's oscillating. If the meter goes instantly to zero, it's probably not and is set alright.

One might notice a much greater difference in antenna position compared to 2m; because of the shorter wavelength, moving the antenna 5 or 6 inches one way or the other may make as much dif-

ference as a 2/3-scale reading on the S-meter. Objects which only partially reflect and partially absorb on 2m become good reflectors on 220, and, consequently, the interference fringes are much more pronounced (see optical behavior in any general physics book).

Looking to the future, I see 220 as a band that will grow by leaps and bounds in the next 2 or 3 years. The 220 class E is dead, there is a vast empty space there now in most parts of the country, and, as 2 meters becomes more congested, 220 and 440 are the next logical places to go. I also think one of the reasons 440 is so much more popular than 220 is the availability of used VHF gear retired from commercial service at very low prices. But, as people are finding out, 220 seems to take the best of both 2m and 440 plus a few points

all its own and offers the individual a new playground to do as he wishes on VHF.

As a footnote to this, one of the 220 repeaters has become an administrative frequency for ARES and other such activities because of the large and ever-growing number of people who have 2m crystals in their scanners. 146.94 is a hot-selling rock in Omaha Radio Shack stores. People are finding out that, for weather watch information, 146.94 is where it's at. Inasmuch as we have stations at NWS and a 3rd weather wing at Offutt AFB during severe weather and tornado watches, there are a number of bits of information which should not be passed over 2m, so, rather than tie up telephones or take a chance on upsetting the nonamateur public on 2m, they go via 220 as there are no scanners made which will pick it up. ■

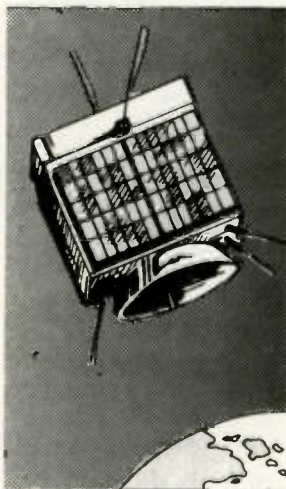

There's a new, eighth OSCAR satellite in orbit, and the AMSAT team helped put it there!

Your help is needed for future satellites. Join AMSAT and support the new, advanced Phase III series of OSCARs, engineered to provide communications over transcontinental distances for hours at a time.

Send \$10 membership dues to AMSAT, P.O. Box 27, Washington, D.C. 20044. Life membership is available for a tax-deductible donation of \$100 or more, payable in quarterly installments if you wish.

Phase III satellite solar cells may be sponsored for \$10 each, and we'll send you a certificate specifying the cells you are sponsoring.

For a tax-deductible contribution of \$1,000 or more, we'll even inscribe your name on a plaque to be placed in orbit aboard the Phase III spacecraft for posterity, and we'll send you a replica honoring your contribution.

Dues and contributions may be charged to VISA or Master Charge. Phone us at (202) 488-8649.

Radio Amateur Satellite Corporation
P.O. Box 27, Washington, D.C. 20044



free

Our famous value-packed mail order catalog filled with thousands of Amateur Radio items. Now ready to roll and yours for the asking... Call Tufts today for prompt delivery of your Amateur Radio needs from our tremendous inventory. Let us show you why Tufts is the leader in mail order sales.

Our crew of 100% hams, very competitive prices, and reliable modern service facilities ensure your complete satisfaction. Call toll free daily 9-9 and Saturday 9-6. 1-(800) 225-4428.

TUFTS
Radio Electronics

209 S Mystic Avenue
Medford MA 02155
1-(800)225-4428

1-(617)395-8280

TRY kilobaud MICROCOMPUTING... ON US!

Return the attached postage-free card, and we'll have your trial copy of **Kilobaud/Microcomputing** on the way to you within a few days. Wayne is willing to go to this expense because he feels that all hams can profit (and he means \$\$\$) from an understanding of the basics of microcomputing. The fact is, there's a revolution going on, even more important than the one that replaced vacuum tubes with solid state, and you'll want to be a part of it and join the fun. **Over 20,000 hams already have their own computers up and running and are having a ball.**

Kilobaud/Microcomputing is the only magazine in the field written specifically for newcomers to computers, and many of the articles are ham-oriented . . . after all, many of the pioneers of microcomputers are hams. Don't let this revolution pass you by. Return the subscription card and your trial issue will be on the way, along with a bill for a year's subscription at a special introductory rate of \$15. If you're not completely satisfied, just write "cancel" on the bill and return it to us within 30 days . . . and keep the trial copy.

Rush me my trial copy of **Kilobaud/Microcomputing** and enter my subscription at half the newsstand price (\$15). If I'm not completely satisfied, I'll return the bill marked "cancel" within 30 days and keep the trial copy.

Name _____

Address _____

City _____ State _____ Zip _____

Please allow 30 days for shipment of first copy.

50

S2C

kilobaud
MICROCOMPUTING
peterborough nh 03458

This Station Plays Beautiful CW

— with a Morse keyboard

Roll over, Beethoven!

The international Morse code (CW) is a digital musical language. If you happen to be a straight-key master, such as K9ZTH, you can make music to rival that of Mantovani. If you happen to be blind, a talented pianist, composer, piano tuner, and a ham, you can even write a concerto using this musical language. Ol' Rip Snorter John (W9ORS) is such a person and is presently

writing *The CQ Concerto*. The first few bars are great and I can hardly wait for the finished work, because it will include a CW message hidden within beautiful music.

Because timing is tricky, it is a challenge for a composer to work the unique rhythm of CW into conventional music. The dot is the basic unit of time in precise code. The syllable space between dots and

dashes also requires one time unit. A dash is exactly three time units long and matches the letter space. The interword space is the mystical number 7.

The digital aspect of CW makes ICs ideally suited for application in keyers, keyboards, and readers. In the CW language, spaces are as important as the dots and dashes. Often hams forget that spaces are important. At times, a ham will send, "my nag is . . ." It is easy to run the "m" and the "e" together so that instead of having a name, the ham is a nag. Even old-timers with bugs and weighted keyers have problems. With dots set for 40 words per minute and dashes at 20 words per minute, the sender speaks with an accent. He can communicate with his own kind who have the same accent, but others who prefer the musical rhythm of good code have difficulty copying 20 words per minute even though they are capable of handling 30

words per minute of perfect code.

The importance of spaces and the application of ICs has been recognized by others and many fine articles have been published (see references). The electronic keyer with its supervised dots and dashes has improved CW communications in recent years. However, proper operation of a keyer takes a certain amount of musical skill which many of us do not have. As a result, the average CW QSO is still well below 20 words per minute.

The keyboard encoder offers additional improvement in communications with the CW language. Good commercial equipment is available, but high prices discourage many potential users. Articles on home-brew projects are being published, and any ham who likes to solder (or wire-wrap) can have a keyboard.

My prototype keyboard used TTL and a 9-bit code. I



Photo A. Diode matrix (front) forms 8-bit binary code. The 13 ICs (back) provide logic to convert binary code to Morse code. Keying and VOX relays at lower right.

used a diode matrix to generate a binary code and digital logic to convert it into dots and dashes. The TTL scheme worked fine, but as I was putting on the finishing touches, a regulator in the power supply failed and fried a \$17.50 40 x 9 first-in, first-out (FIFO) memory chip. About the same time, K2BLA published a circuit that could be constructed using about \$30 worth of parts. Also, WB5IRY wrote about the possibility of TTL becoming obsolete. Both of these writers were generous in their praise for CMOS and emphasized how easy it is to construct a power supply for CMOS. With this motivation, I switched to CMOS and an 8-bit code.

After trying high-frequency keyboard scanning, such as is used by K2BLA and in calculator keyboards, I have decided that diodes are still beautiful (Photo A). They are rugged, cheap (\$2.84 for this circuit), and even though 142 diodes have 284 leads, the hookup is so simple that it can be made while the XYL is talking. There are no glitches, and troubleshooting is so easy that it can be done with a VOM.

Considering the possibility that some hams may not be any more advanced in the art of applying ICs than I am, some basic fundamentals about logic devices used in this circuit will be included for convenience. Being an electrical engineer specializing in power, I am more familiar with 500 MCM cables and 10,000 kV-A transformers than I am with the 14- and 16-legged bedbugs normally called ICs. If you happen to be a digital pro, skip a few paragraphs and go directly to the schematics. Before going into the details of how the circuit works, let's review a few basics concerning solid-state devices that are used in the system. Use Fig. 2 for

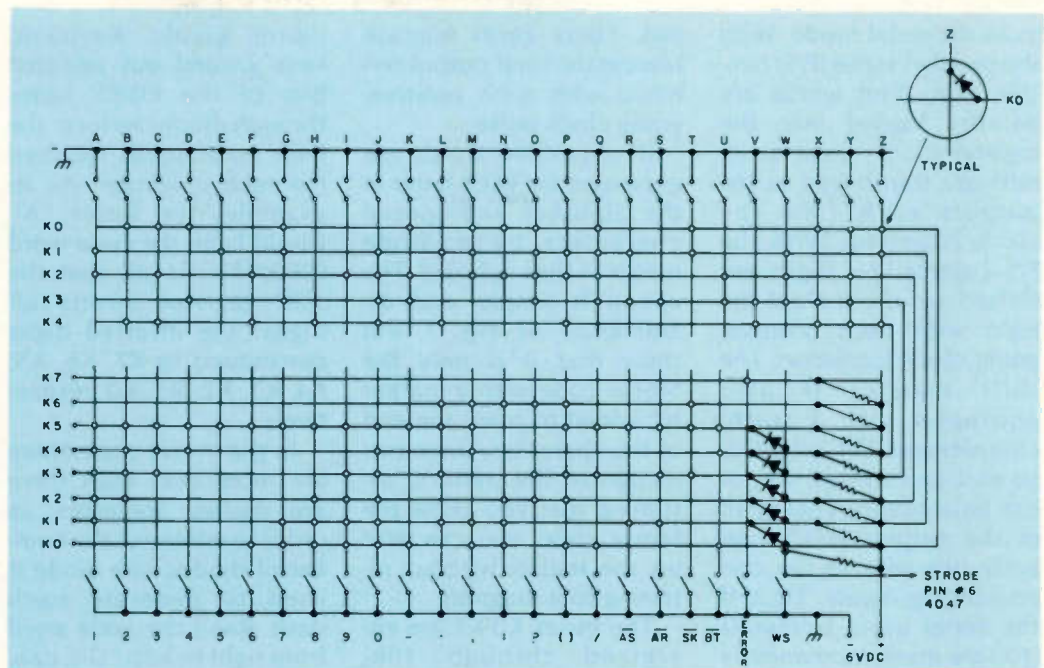

Fig. 1. Diode matrix for alphanumeric characters. All diodes are 1N4814 or equal. Resistors are 10k, 1/4 Watt. Switches—typewriter keyboard.

reference.

Flip-flops can be considered remotely controlled switches which have several input control lines. Two 4013 ICs are used. The 4013 is a dual type D flip-flop. Each section has 6 terminals: a data terminal marked D, a clock input marked C, an output marked Q, the complement of the output marked \bar{Q} (pronounced not Q), and set and reset terminals. Data is transferred from the input D to output Q on the positive transition of the clock, provided that both the set and reset pins are low. With a high on the reset pin, the Q output is zero, and the \bar{Q} output is high regardless of clock status.

Those of you who have constructed the "contest keyer" by WA4KUO will recognize the dot-dash generator used in this keyboard. The CMOS 4027 is a dual J-K flip-flop equivalent to the TTL 7473. The J-K flip-flop is similar to the type D flip-flop, except that it has two input terminals labeled J and K. The 4027 also flip-flops on the positive transition of the clock. The J-K flip-flop is

useful in this application because, with relatively simple connections, it can be made to toggle with clock transitions.

Logic gates OR, AND, NOR, and NAND behave just as their names would suggest. OR gates and AND gates have two or more inputs and normally have only one output. In the case of an OR gate, a high on any input terminal will produce a high at the output terminal. With the AND gate, all of the input terminals must be high in order to obtain an output. Then, with the NOR and the NAND, the operation is simply reversed.

The inverter is another useful logical device. It has one output and one input, and they always complement each other. The 4049 has six inverters in one chip.

Two 40105 4-bit chips are used to make up an 8-bit first-in, first-out (FIFO) memory. This provides 8 input data terminals and 8 output terminals. A binary code word of 8 digits is loaded into the FIFO each time that the strobe pin receives a positive pulse. The array will hold 16

words. Within a few nanoseconds after loading, code words bubble through the memory and queue up in order at the output terminals. When the output data is stable, a *data out ready* (DOR) flag goes high. Binary words can be clocked out of the memory by applying a negative-going pulse to the shift-out (SO) terminals. Loading is completely independent of the output. By using the FIFO as a buffer between the input keyboard and the reading logic, the operator is free to type at any speed. If he types below the output clock speed, the output will follow the hesitating typing strokes. If the operator types faster than the clock speed, output will be a smooth continuous stream. Of course, since the memory will only hold 16 binary words, the operator cannot go more than 16 letters ahead of the reading logic or some of the characters will be lost.

Two 4035 chips are used to make an 8-bit shift register which also has 8 input and 8 output terminals. The shift register operates in the parallel mode as well

as in the serial mode. With the parallel/series (P/S) control high, 8-bit words are parallel loaded into the register clock. Data at inputs are transferred to the outputs each time the clock is pulsed. With the P/S control low, digits are shifted serially toward the right with each positive-going clock transition. The shift register is also equipped with a truth/complement (T/C) control so that an inverted output can be obtained. That is, all of the outputs will be exactly opposite to the corresponding inputs. Thus, if the serial input terminals (J-K) are made permanently high, zeros will be clocked into the shift-register out-

put. These zeros migrate toward the final output terminal with each positive-going clock pulse.

Binary-coded words are generated for each letter in the alphabet and special characters by a diode matrix in the keyboard. The circuit is simple, and examination of Fig. 1 will show that it is only the Morse code with a marker bit added to mark the end of the character. Once you recognize the pattern, assuming that you know the Morse code, you can wire up the matrix without referring to a diagram.

The buses K0-K7 are energized through 10k, ¼-Watt resistors from the positive terminal of the

power supply. Keyboard keys ground out selected bits of the K0-K7 buses through diodes to form the 8-bit code words required for each character. As an example, the letter "A" would have the code word 00000110. Recall that the shift register inverts all digits. The inverted digits correspond to K7, K6, K5, K4, K3, K2, K1, K0, respectively.

In the Morse code, there are more dots than there are dashes; therefore, in order to minimize the number of diodes, one diode is used to generate each dash. Read the code word from right to left: "Dit, dah, marker." Meaningful digits are followed by a string of

filler zeros.

For a closer look at the system, refer to Figs. 2 and 3 which show the general schematic and its companion timing diagram. The diagram assumes that the operator has turned on power and set the master clock to operate at a selected speed. At some random time later, he has typed the letters "AE" followed by a word space, then the letter "T" at a speed greater than the corresponding clock speed. After power has been turned on, the master clock runs at a frequency set by the operator. The instant that a key is struck is a random event with respect to the clock output. The FIFO is very fast and responds within nano-seconds after the operator strikes a key on the keyboard. The code words (one 8-bit word for each character) bubble through to the output terminals of the FIFO, queuing up in order. As soon as data is stable, the data out ready (DOR) goes high. Since there are two FIFO chips involved, the two DOR signals are combined by AND gate U8D into a single signal. This high passes through OR gate U7C and on the next positive transition of the master clock output causes U12B to flip, thereby starting the dot generator in synchronism with the master clock. (I learned the hard way that this flip-flop 12B was needed. Without it, sometimes the first syllable of a letter would be cut short or missed completely. The addition of the 12th IC had a bonus. The "Q" of 12B gives a signal to provide automatic receive/transmit switching.)

The dot generator, U6A, is clocked by divide-by-2 flip-flop U12A, which runs at one-half clock frequency. The combination of U12A and U12B ensures that the dots will have the

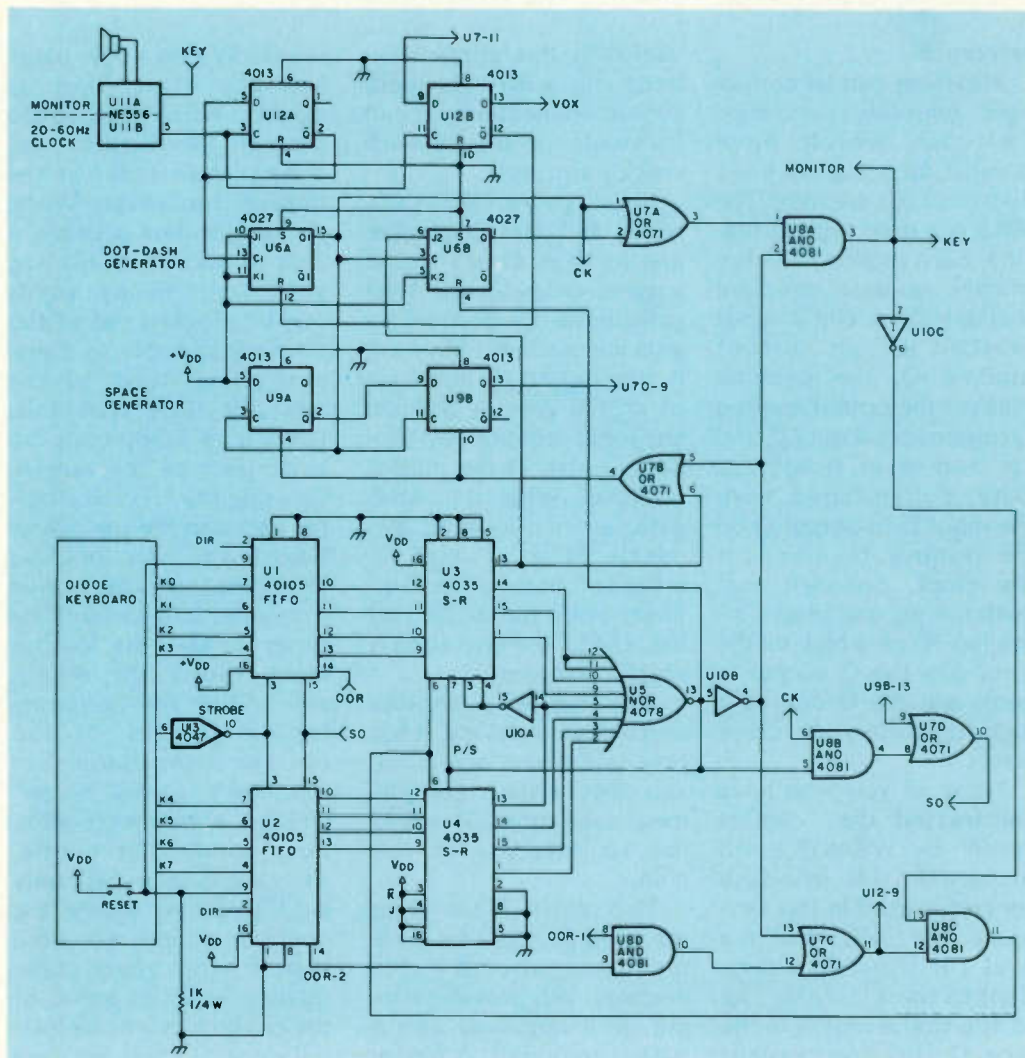

Fig. 2. CMOS Morse encoder schematic. U1, U2—40105 FIFO. U3, U4—4035 shift register. U5—4078 8-input NOR gate. U6—4027 dual J-K flip-flop. U7—4017 quad OR gate. U8—4081 quad AND gate. U9, U12—4013 dual type D flip-flop. U10—hex inverter. U11—NE555 dual timer. U13—4047 one-shot. Refer to spec sheets for power connections.

proper phase relationship with respect to the random loading of the FIFO.

Observe that the positive transition from DOR is passed through AND gate U8C to provide a positive-going clock pulse to clock the shift registers via pins 6-6. This causes the parallel-load feature to function because terminals 7-7 of the shift registers are already high (parallel mode) since at the time of starting, the outputs of the shift registers were all zero. Therefore, NOR gate U5 would have a high output.

Remember that the dot generator runs continuously once it is turned on by the synchronizer flip-flop. Each dot represents one time unit. This is also the fundamental time unit for dashes and spaces. The "CK" clock signal is generated by U6A, which is shown as line 6 of the timing diagram, Fig. 3. When required, U5 and U10B will silence the key by controlling pin 2 of AND gate U8A. Flip-flop U6B goes into operation any time that a dash is required. Examination of the timing diagram will show that both the dot generator and the dash generator are divide-by-2 counters. The OR gate, U7A, combines these outputs to produce a dash whenever U6B is active. Flip-flop U6B is turned off and on by commands from pin 13 of U3.

In the case of the letter "A", the first digit presented to terminal 13 is a zero. Consequently, the dash generator is restrained because there is a zero on the "J" input of U6B. Pin 2 of AND gate U8A is high because the signal from inverter U10B is the complement of NOR gate U5 output and all characters (except the word space) will have at least one "high" at the inputs of U5. The dot generated by U6A will be passed on to the keying circuit

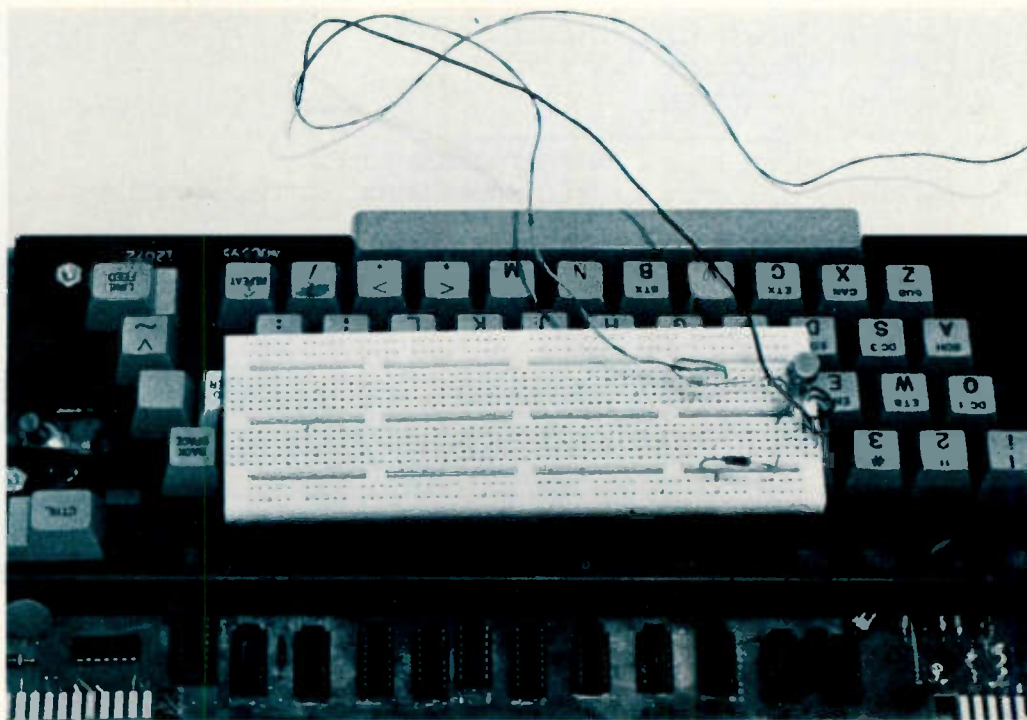

Photo B. A surplus NPN transistor, two current-limiting resistors, and an LED make a breadboard logic probe to debug circuit. Discrete components (lower right) are used for the clock and sidetone monitor.

through gates U7A and U8A. On the falling edge of the dot, the shift registers see a positive-going pulse on terminals 6-6 through AND gate U8C after it is inverted by U10C. This clocks the shift register one position to the right. Note that the shift register is in the serial mode because of the low on P/S. The next digit at terminal 13 of U3 is a one, representing the dash of the "A". This activates dash generator U6B, causing a dash to be dispatched. (See lines 6, 7, and 8 of Fig. 3.) On the falling edge of the dash, the shift register is pulsed again and another high moves to terminal 13 of U3. At this instant, all of the inputs to NOR gate 5 are low. This makes U5 output high and silences the key by causing pin 2 at U8A to be low. U5 output also resets dash generator U6B, changes the signal on P/S from high to low in preparation for a new character, and, at the same time, AND gate U8B is set up so that it will pass the next pulse from the dot generator.

The key is silent because of the low on pin 2 of U8A. The next pulse from the dot generator (see line 6, Fig. 3) is passed through U7D to shift out the next character. On the falling edge of the SO pulse, the FIFO dumps the old character and replaces it with a new one. During the dumping process, the DOR flag dips momentarily. This logic function is internal to the FIFO and the pulse is of only a few nanoseconds duration. (This is the only pulse in the system that is too short to be seen with a simple LED logic probe.) The short pulse is used to clock the shift register and parallel load the new character via gates U7C and U8C. This is more easily understood by referring to lines 13-15 of Fig. 3. This pulse is not to scale but illustrates the phase relationships. The process of dumping the old character and loading a new letter into the shift register has had the effect of silencing one dot. The dot requires one time unit; this, with the intervening spaces on either

side, makes a total of 3, as is required by exact code for the inter-letter space. Some keyboards silence a "T", but this is not precise code because the "T" is 3 time units long, which, when added to the two intervening space units, totals 5 time units.

To continue the example, the letter "E" is dispatched next. Action would be similar to that described for the "A". The main difference is that following the "E" there is a word space. The code word for a word space is 00000000. With this code word loaded into the shift register, the key is silenced, as was the case with the inter-letter space, but pin 13 of U3 is also zero and this drops the reset signal of the space generator on U9. This is a mini shift register which counts the word space. Refer to the timing diagram and note that it has the effect of silencing a total of three dots. These dots plus the four intervening spaces total 7, as Mr. Morse specified for the word space.

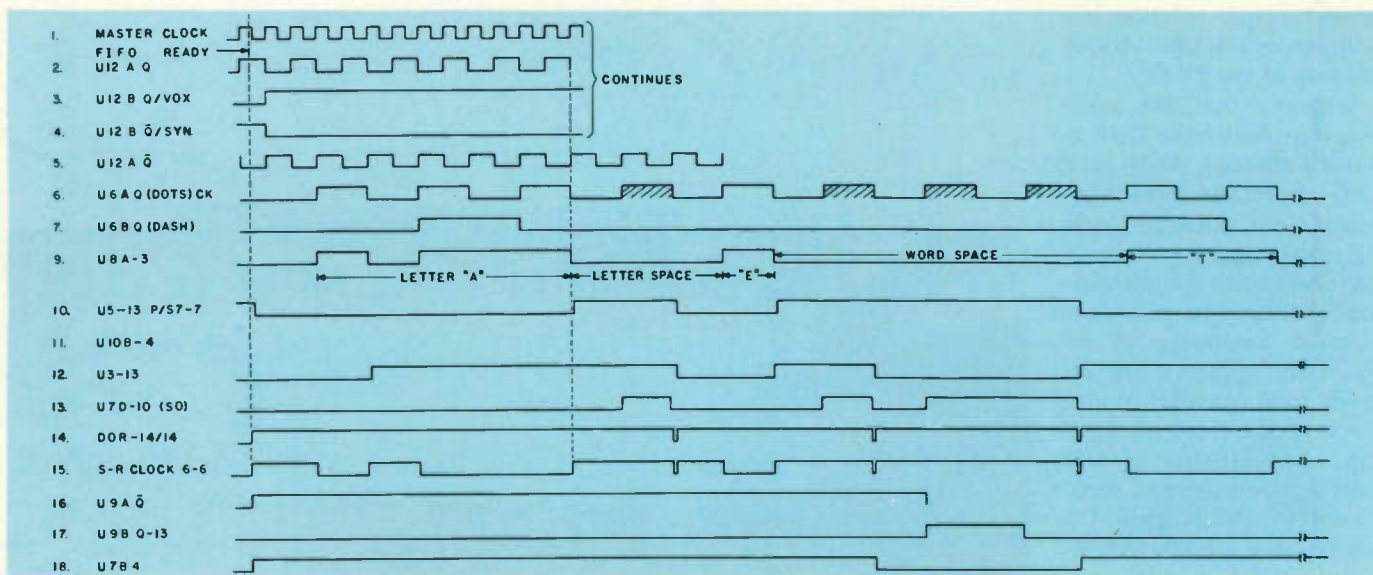

Fig. 3. Timing diagram.

The timing diagram shows the remaining letter "T" of the example. This is for illustration only and will not be described.

Circuit details for the sidetone oscillator, master clock, and the strobe have not been shown on the schematic because these are readily available from a number of existing publications. Manufacturers will supply chip specification sheets with this information.

The master clock and the sidetone oscillator (U11) are made from an NE556, which is simply two 555 timers in a single DIP package. A variety of capacitors and resistors are suitable. Just follow the graphs in the specification sheets. The master clock should have its frequency adjustable between 20 and 60 Hz for a speed range of about 5 to 50 wpm.

The sidetone oscillator can be made variable if desired. I used a fixed tone of about 440 Hz, which is the musical note "A". My rig has a sidetone oscillator, so I installed a switch to silence the monitor speaker while on the air. When not used for communications, the keyboard makes an excellent code teaching aid.

An additional switch can

be installed to have a "send-store" feature. By stopping the master clock, the FIFO can be preloaded. A storage of sixteen characters is too short for anything more than a CQ. However, for those who would choose to have a longer message, the Fairchild FIFO 3351 is an excellent choice and holds 40 characters. One 3351 can be substituted for the two 40105 4-bit chips. Additional 40105 chips can also be cascaded to provide more storage.

A master reset button is needed for the FIFOs. Just after power up, random noise is loaded into the FIFOs, and, unless the M-R button is used, you will have a hard time recognizing the language that will be dispatched.

The choice of power supplies is almost unlimited. The CMOS and the NE556 can use anything between 5 and 15 volts. On my keyboard, I used a 50¢ surplus 6-volt, 200 mA calculator adapter. In order to improve the tone of the monitor, I did add a 25¢ electrolytic capacitor and a couple of resistors to provide filtering. To my surprise, even unfiltered full-wave dc can be used for the CMOS and still work. It must be that some

of the claims about noise immunity by CMOS are valid.

As the numbering might suggest, U13 is an afterthought. At first I was determined to make a one-shot from the spare inverter gates in U10. According to RCA's ICAN 6267, three inverter gates will make a one-shot. The circuit worked most of the time, but occasionally a double pulse would be triggered, causing two letters to be loaded for one key stroke. I took the easy way out and cook-booked a 4047 one-shot and selected a capacitor/resistor combination to make a 2 millisecond pulse. This is a very versatile chip and does a good job of debouncing; it interlocks the keys so that only one letter will be dispatched even though two keys are struck simultaneously. This circuit will ignore all other strokes until keys are completely released.

The one-shot strobe (4047) is triggered by "wiring" through diodes. The lower right of Fig. 1 shows this circuit. Note that only buses K1, K2, K3, K4, and K5 are monitored. This is sufficient to cover all characters except the word space. A separate switch is used for the word space.

The 4047 is connected to fire on a negative-going pulse which is obtained through 2 diodes in series for the normal characters and through a switch for the word space.

Experience with my Swan 700 CX has taught me that it eats expensive PNP transistors like a feathered swan eats corn. I took the coward's approach and used relays for both the VOX and key functions. This works very well except that if someday I am to give the "bionic brass pounder," WB2ZDF, his 1000 wpm, I may be forced to use a transistor. Is he kidding about 1000 wpm? Maybe not, or at least something that will approach that figure. Although no one can type 1000 wpm, a RAM can be interfaced in between the keyboard and the FIFOs to provide burst sending. Then, with the video readers, very high speed should be possible. This raises an interesting question. If TTL is on the verge of obsolescence, how about the RTTY bandwidth hog?

Parts for the final circuit cost about \$40 (this does not include parts invested in the prototype which have been returned to the junk box). It does include

\$10 for a surplus computer keyboard. This keyboard had good quality reed switches and a fiberglass PC board. None of the circuits on the PC board were salvaged but were removed from the old fiberglass board by using a wide-flame burner on a propane torch and a wood chisel. Holes for the diodes and the ICs were quickly drilled by using a standard piece of perforated board as a template and a Dremel tool. Interconnections were made with point-to-point wiring using standard wire-wrap wire. I use solder-tail sockets rather than conventional wire-wrap sockets because the long pins give my bifocals fits. A wire-wrap tool conveniently fastens connections to the solder-tail pins of the sockets and these can be quickly secured with a small dab of solder. This approach was used for all chips except No. 13. I ran out of sockets, so I simply wired this rascal in place. It worked so well that on the next circuit I build, I will not waste time with the sockets except for the two FIFOs. These are needed to provide a quick disconnect to simplify wire checking.

With 13 ICs, one can expect to make a few wiring errors. These can be readily detected by using a simple homemade logic probe that will cost less than \$1.00. My breadboard probe is shown in Photo B parked on top of the keyboard. It is simply an LED driven by a small surplus NPN transistor with a length of No. 22 wire as a probe. By setting the clock at 5 wpm, the waveforms shown in Fig. 3 can be observed by simply watching the LED and counting flashes.

Should you decide to build a keyboard, be sure you understand the timing diagram. It is the key to troubleshooting. Also, re-

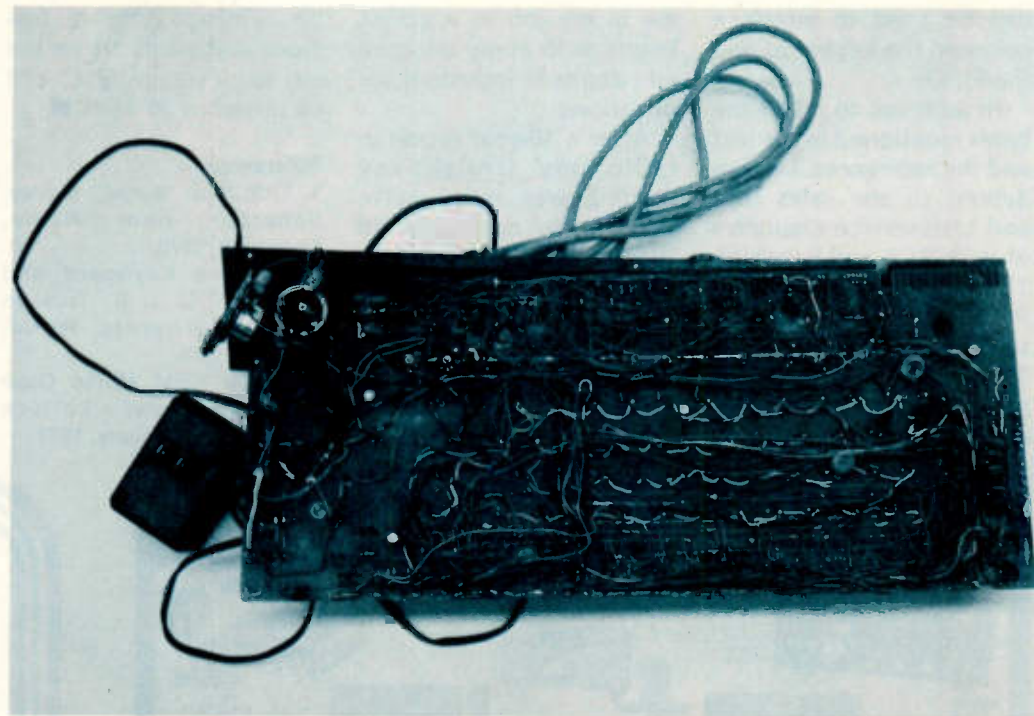

Photo C. This photo shows point-to-point wiring using wire-wrap wire for ICs and #22 telephone wire for keys and diode matrix buses.

check pin numbers against the IC manufacturer's specification sheet. Standardization is good, but there are some variations and it is possible that a typographical error exists. However, the diagram has been checked and rechecked to prevent the latter possibility.

The error signal has 8 time units; thus, it can be used as an aid in calibration: $wpm = 192/T$, where $T = \text{seconds (stopwatch)}$ required to send 10 error signals.

A case was constructed from standard heating and ventilating sheet metal. While this is not as beauti-

ful as some store-bought equipment, it is adequate.

If you are still not convinced that diodes are beautiful, you can use an ASCII keyboard, or, for that matter, any keyboard with an oddball code, as long as it does not exceed 8 bits. You can even use your home computer. An EPROM

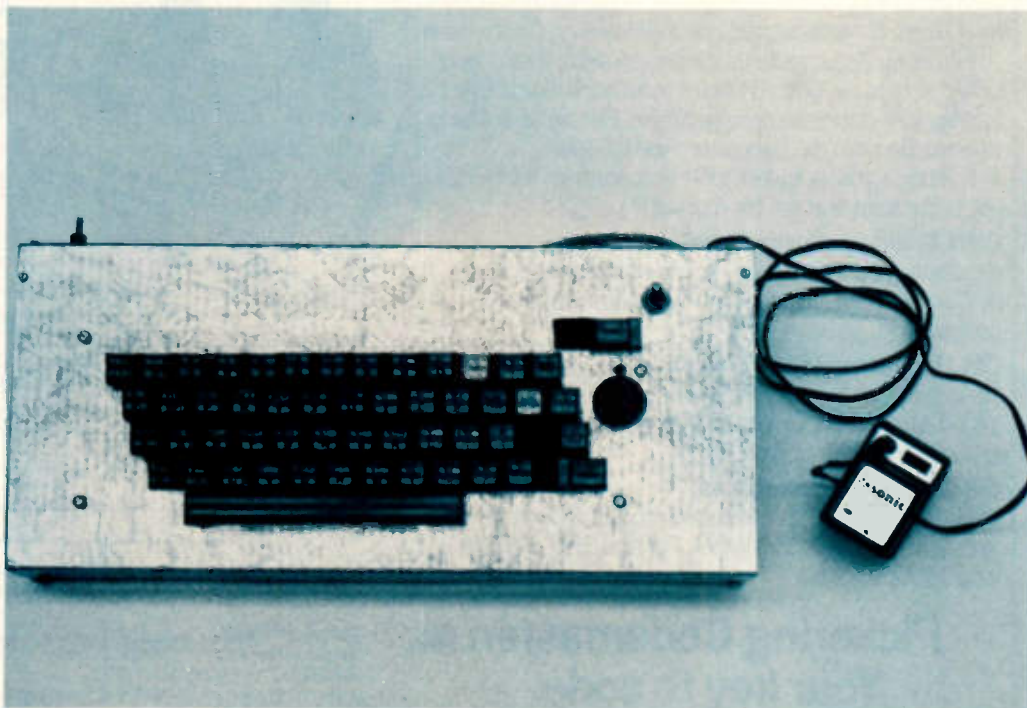

Photo D. Finished keyboard with surplus calculator power supply at right.

can be used to interface between the keyboard and the FIFOs.

In addition to all of the hams mentioned in the text and the references, I am indebted to the sales reps and tech-service engineers of both RCA and Fairchild. They patiently answered my numerous and sometimes frivolous questions. They not only made it possible for me to build a keyboard, but also helped

me in my job as a power engineer to apply integrated circuits to industrial applications.

After a 30-year recess in radio, my straight-key sending was even worse than it was during World War II when I frequently would be interrogated with "INT LF" (modern translation, QLF?). Now, with my keyboard, I, too, can make good CW music and the high-speed boys will talk to

me. Perhaps after a few more keyboards are on the air, the average QSO can be raised to 30 wpm. ■

References

1. "ASCII to Morse," Morley, Sharon, *Ham Radio*, December, 1976.
2. "Morse Keyboard and Memory," C. I. B. Trusson G3RVM, *Wireless World*, January, 1976.
3. "1000 WPM Morse Code Typer," James Pollock WB2DFA, 73, January, 1977.

4. "Contest Special Keyer," Henry Cross WA2KUO, 73, February, 1977.
5. "The Morse Clock," Robert Souza WA1MXV, 73, July, 1977.
6. "Decode Morse with an 8080," William Thomas WB9KPT, 73, December, 1977.
7. "An Inexpensive Morse Keyboard," Albert Helfrick K2BLA, QST, January, 1978.
8. "Is TTL Already Obsolete?," William Browning WB5IRY, 73, April, 1978.
9. *COS/MOS RCA Manual SSD-250*.



Radio World
CENTRAL NEW YORK'S FASTEST GROWING HAM DEALER



Featuring Yaesu, Icom, Drake, Atlas, Ten-Tec, Swan, Dentron, Pace, Palomar, Alda, Midland, Wilson, KDK, MFJ, Microwave Module, Standard, Tempo, Astron, KLM, Hy-Gain, Mosley, Larsen, Cushcraft, Hustler, Mini Products, Universal and Tristao Towers. We service everything we sell! Write or call for quote. You Won't be Disappointed. We are just a few minutes off the NYS Thruway (I-90) Exit 32

CALL TOLL-FREE ONEIDA COUNTY AIRPORT TERMINAL BUILDING Bob Warren
1-800-448-7914 ORISKANY, NEW YORK 13424 WA2MSH K2IXN
NY STATE RESIDENTS CALL 315-337-2622 or 315-337-0203



**Study Guides
and
Code Tapes —
The Best Available**

see page 204

Code Made Easy.

If you want to master code, get the Pickering Codemaster.

Pickering Codemaster is the proven set of instruction tapes. In fact, we've sold tens of thousands over the last 12 years. And the reasons are simple. Our tapes are easy to learn. Easy to use. Complete. And reliable.

But don't take our word for it. Ask any ham. Or better yet, order a set and see for yourself.

CM-1 Beginner (Novice Class)

A complete course in code is on the tape. Practice at 5, 7 and 9 WPM. The tape includes code groups and punctuation.

CM-1½ Intermediate (General)

No instruction, just practice. ½ hour at 11 WPM, 1 hour at 14 WPM, and ½ hour at 17 WPM. It includes both coded groups and straight text.

CM-2 Advanced (Extra-Class)

Mostly straight text, some coded groups. 1 hr. at 20 WPM, ½ hr. each at 25 and 30 WPM. For real QRQ, play this tape at twice speed!

Pickering Codemaster. ✓ P44
Your key to code.

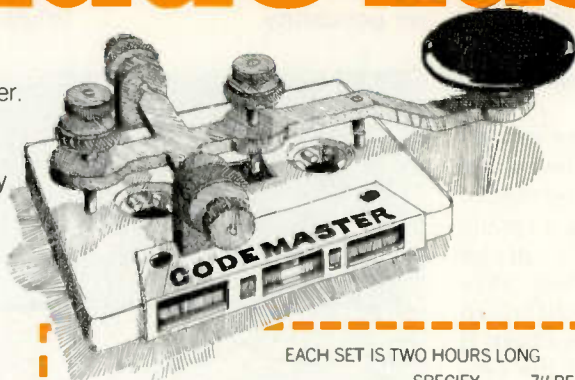

EACH SET IS TWO HOURS LONG

	SPECIFY	7" REEL (3¼ IPS)	CASSETTE (C-120)
Single tape price	\$ 7.95		
Any two; save \$1.90	\$14.00	<input type="checkbox"/> CM-1	<input type="checkbox"/>
All three; save \$4.85	\$19.00	<input type="checkbox"/> CM-1½	<input type="checkbox"/>
		<input type="checkbox"/> CM-2	<input type="checkbox"/>

Special rates to code classes on request, retail inquiries welcome.
Postage paid SP 4th class in USA
1st class and Canada, Mexico add \$1.00 per reel, 50¢ per cassette

Name _____ Call _____
Street or PO # _____
City _____ State _____ Zip _____
Total enclosed or charge to MASTER CHARGE or VISA Account: \$ _____
or C.O.D.
Charge card No. _____ expires _____
Clip out and send to: PICKERING CODEMASTER CO., PO BOX 396 D,
PORTSMOUTH, RI 02871
In a hurry? Call (401) 683-0575 R.I. residents add 6%.

New, Remotable 2meter Mobile!



ICOM's New IC-280

ICOM introduces its new 2 meter mobile radio with the detachable microprocessor control head, the **IC-280**. Bright, easy to read LED's and a new style meter grace the brushed aluminum "new look" front panel of the detachable control head, which provides memory and frequency control for the remotely mountable main section.

The **IC-280** comes as one radio to be mounted in the normal manner: but, as an option, the entire front one third of the radio detaches and mounts by its optional bracket and the main body tucks neatly away out of sight. Now you can mount your 2 meter mobile radio in places that seemed really tight before.

With the microprocessor head the **IC-280** can store three frequencies of your choice, which are selected by a four position front panel switch. These frequencies are retained in the **IC-280's** memory for as long as power is applied to the radio. Even

when power is turned off at the front panel switch, the **IC-280** retains its programmed memories; and when power is completely removed from the radio, the ± 600 KHz splits are still maintained!

Frequency coverage of the **IC-280** is in excess of the 2 meter band; and the new band plan (144.5-145.5 MHz repeaters) can easily be accommodated, since it was included in the **IC-280's** initial planning by the ICOM design team.

The main section of the **IC-280** puts you up to the minute with the latest state of the art engineering. The new **IC-280** includes the latest innovations in large signal handling FET front ends for excellent inter-modulation character and good sensitivity at the same time. The IF filters are crystal monolithics in the first IF and ceramic in the second, providing narrow band capacity for today and tomorrow's crowded operating conditions. Modular PA construction with broad band tuning provides full rated power across the full 2 meter band (plus a little).



All ICOM radios significantly exceed FCC specifications limiting spurious emissions.

Specifications subject to change without notice.

IC-280 Specifications: Frequency Coverage: 143.90—148.11 MHz Operating Conditions: Temperature: -10°C to 60°C (14°F to 140°F), Duty Factor: continuous Frequency Stability: ± 1.5 KHz Modulation Type: FM (F3) Antenna Impedance: 50 ohms unbalanced Power Requirement: DC 13.8V $\pm 15\%$ (negative ground) Current Drain: Transmitting: 2.5A Hi (10W), 1.2A Lo (1W), Receiving: 0.630A at max audio output, 0.450 at SQL ON with no signal Size: 58mm(h) x 156mm(w) x 228mm(d) Weight: approx. 2.2 Kg Power Output: 10W Hi, 1W Lo Modulation System: Phase Max. Frequency Deviation: ± 5 KHz Spurious Output: more than 60 dB below carrier Microphone Impedance: 600 ohms dynamic or electret condenser type, such as the SM-2 Receiving System: Double superheterodyne Intermediate Frequency: 1st: 10.695 MHz, 2nd: 455 KHz Sensitivity: 1 μV at S +N/N at 30 dB or better. Noise suppression sensitivity 20 dB, 0.6 μV or less Selectivity: less than ± 7.5 KHz at -6 dB, less than ± 15 KHz at -60 dB Audio Output: More than 1.5W Audio Output Impedance: 8 ohms

HF/VHF/UHF AMATEUR AND MARINE COMMUNICATION EQUIPMENT

DISTRIBUTED BY:



ICOM

ICOM WEST, INC.
Suite 3
13256 Northrup Way
Bellevue, Wash. 98005
11 (206) 747-9020

ICOM EAST, INC.
Suite 307
3331 Towerwood Drive
Dallas, Texas 75234
(214) 620-2780

ICOM CANADA
7087 Victoria Drive
Vancouver B.C. V5P 3Y9
Canada
(604) 321-1833

The Cure for Migraines

— a low-pass CW filter

In most receivers, the groundwork has already been laid.

Many hams copy CW by using an SSB receiver with an outboard CW filter consisting of 88-mH toroids or active filters, to obtain very narrow bandwidths and a beat note of about 1000 Hertz. Some have found that a couple of hours of this type of operating will bring on something resembling a migraine headache and a

strong desire to go work SSB up the band.

A lower beat note and a bandwidth of a few hundred Hertz appear to alleviate CW fatigue. The lower tone is softer to the ear and a somewhat wider bandwidth allows the signal to be moved around slightly in the passband, which helps to avoid monotony.

One advantage of this approach is that one side of the needed filter response is already there in most receivers. The low frequency side of a typical communications receiver might appear as in Fig. 1. The audio section is designed to attenuate the very low audio frequencies, usually with the 3-dB point around 300 Hertz.

This allows you to build a simple, low-pass filter to get the desired attenuation on the high-frequency side. The filter is shown in Fig. 2. The .176-H inductors are made from two 88-mH to-

roids connected in series. It plugs into the speaker output, requires no power, uses common components, and will fit easily inside a small minibox. Its response is shown in Fig. 3.

Combined response is shown in Fig. 4. Bandwidth is about 300 Hertz at the 3-dB points, allowing for some variation of tone (and drift). There appears to be less ringing with this approach, as compared with one narrow filter.

This filter may solve your headache. See you on the low end, OM. ■

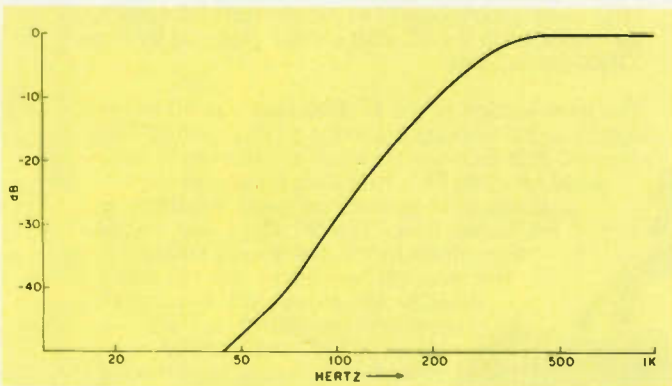

Fig. 1. Low frequency response of typical receiver.

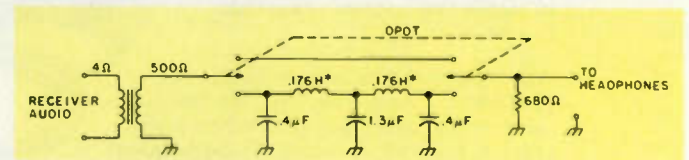

Fig. 2. Low-pass filter schematic diagram. * = 288 mH in series.

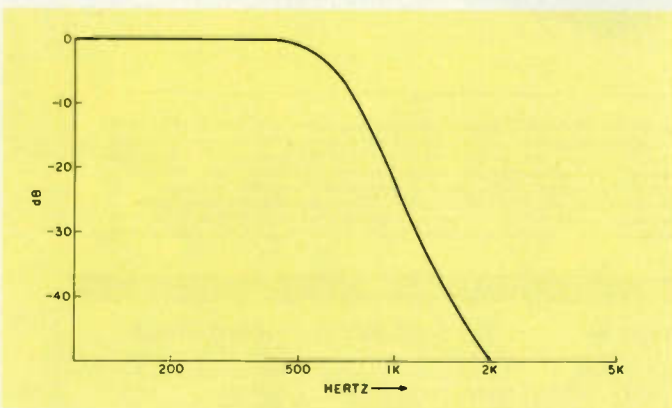

Fig. 3. Low-pass filter frequency response.

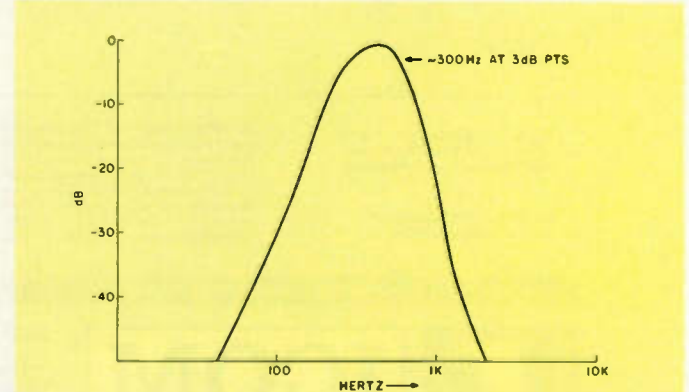

Fig. 4. Combined low-pass filter/receiver frequency response.

Flukemeter II.



Like the classic "Flukemeter" differential voltmeter of the fifties (inset), the new 8020A DMM offers a superb combination of performance and value for the seventies. Only \$169.*

You know Fluke for innovation in precision test and measurement instrumentation. For almost 30 years we've anticipated the measurement problems that come with fast-changing technology.

And we've done it again. Introducing the new 8020A digital multimeter.

The 8020A is built to the same high standards we've designed into its predecessors. The only difference is that the 8020A is smaller. And, of course, it costs a lot less.

You'll find the 8020A is the only DMM around with such impressive

features for only \$169,* now and for some time to come. Features that mean value and versatility, like 26 ranges and *seven* functions, including conductance (which measures leakage to $10^{10}\Omega$). And three-way overload protection. Hi-lo power ohms. And more.

In fact, the 8020A is 13 ozs. of pocketable benchtop instrument performance, in the Fluke tradition. Performance you can count on for up to 200 hours of use with its inexpensive 9V battery, single custom CMOS LSI chip and low-power, razor-sharp 3½-digit LCD display.

Great performance, low cost: *That's* Fluke tradition. Where else can you get a field reliable tool built to precision lab standards? Or, factory calibration that's NBS traceable, with 0.25% dc accuracy? And, of course, the Fluke 8020A has a full year warranty including all specifications, with worldwide service backup.

The quickest way to get one is to call (800) 223-0474, toll free. Give us your chargecard number and we'll ship one immediately. Or come into our Midtown Manhattan showroom, 54 West 45th Street, New York, NY 10036.

TOLL FREE HOT LINE 800-223-0474

**ADVANCE
ELECTRONICS** 

A FLUKE AUTHORIZED DISTRIBUTOR

An 8080 Repeater Control System

— part I: an overview

This setup is the definition of "modern."

Robert Glaser N3IC
3922 Algiers Road
Randallstown MD 21133

When told I was going to install a microprocessor on our repeater as the controlling element, some felt, "A microprocessor on the repeater—what for?" After explaining that I would not add anything as complex as a microcomputer to the

repeater unless there was good reason to do so, there was no vocal opposition. I suspect that it was not until the control system was placed into operation that everyone became in favor of it. The reason I mention these facts immediately is that a quick first impres-

sion of the control system could very well be that the system is too complicated for the resultant benefits. In fact, the opposite is true. The system is indeed much more complicated than what is normally encountered in similar applications. However, the operations it can perform are much greater than would be found were the benefits only proportionate to the system complexity. With an intelligent controller, functions can be done which could not possibly be done otherwise with a reasonable amount of hardware.

Originally, the major function of the control system, and the reason for implementation with a microprocessor, was to provide many on/off output lines controllable through multiple digit decoding of touchtone™ signals. The existing system, consisting mostly of relays, was capable of at

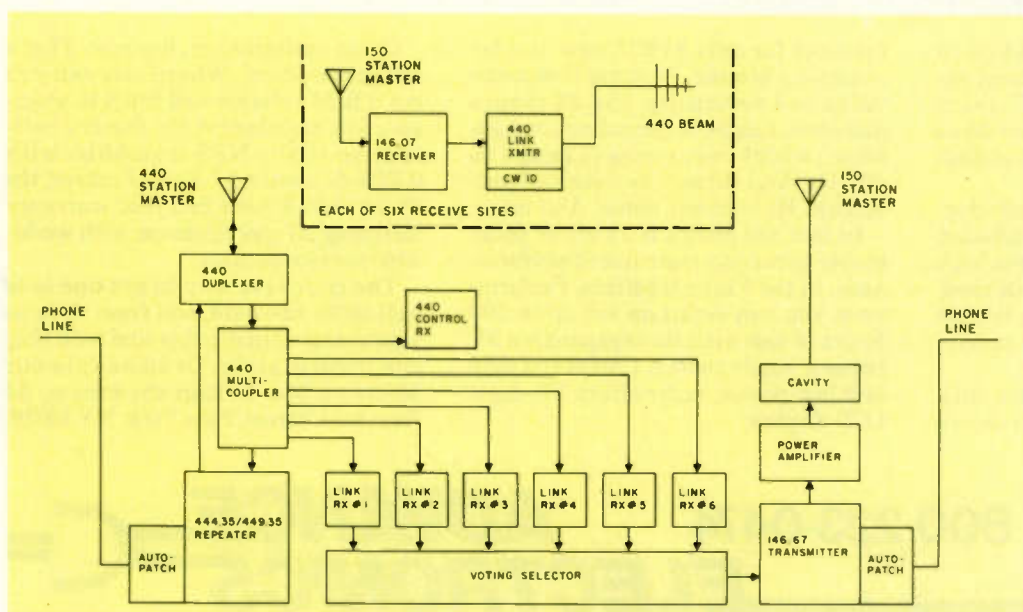

Fig. 1. WR3AFM equipment.

most six functions. We required several dozen functions, and simple expansion of the relay system would have made the repeater look and sound like a telephone company central office. After the new system was finished, the simple output functions took a back seat to the innovations which were not possible before.

In order to understand what the 8080 control system does, a brief description of the Baltimore Amateur Radio Club's repeater (WR3AFM) is necessary. Fig. 1 shows a block diagram of the repeater. There are actually two repeaters: a two meter repeater and a 440 MHz repeater. The 440 repeater is a simple duplexed one. It has an autopatch independent of the rest of the system. The two meter repeater is a multiple split site repeater. The two meter transmitter is located at the site of the 440 repeater. Spread around the city are up to six receive sites. Each receive site receives signals on the two meter input frequency and retransmits them on a 440 link frequency to the transmitter site. At the transmit site, signals are received from each of the links. Each link receiver feeds a voting selector, which continuously evaluates the signal-to-noise ratio of each signal and passes the best one on to the transmitter. The two meter repeater also has an autopatch. The repeaters can be controlled via the two meter repeater autopatch telephone line or a 440 receiver reserved for control. All told, there are eight 440 receivers; off the receive port of the 440 duplexer is a 440 multicoupler which splits and boosts the signals received from the 440 repeater antenna. As can be seen, we obtain maximum utilization (eight



Control system connected to repeater.

receivers and one transmitter) from the 440 antenna on the top of the tower (400 feet high)!

The voting selector can be directed to pass only one of its inputs to the transmitter, or to ignore some of its input receivers. This is a major function of the control system. As our repeater gradually expanded, it became more difficult to diagnose problems. A week would go by before we even realized that one of the receive sites was inoperative. With the new system, it is easy to check all sites by commanding the voter to pass each receiver one at a time. During the summer

months, we are plagued with skip signals from users of the two nearest repeaters on the same frequency: Hazelton PA and Trenton NJ. At times, our repeater is unusable due to constantly timing out from the extraneous signals. We can now command the voter to ignore our northeastern receiver, from which most of the interference arrives. These two basic functions provided the impetus for the construction of the 8080 system.

The system has other important functions. It allows the two meter and 440 repeaters to be linked when needed. A pre-

recorded tape loop can be activated on request, giving information about the repeater and the club. A feature is provided to test touchtone pads—the repeater tells the user in Morse code what it received. The processor controls the autopatch. Instead of the normal system, it gets the requested telephone number from the user and redials the number into the telephone system. If the proper number of digits is not received, it will not even access the telephone line. Single-digit codes permit dialing of emergency numbers. Non-collect toll calls are impossible. There

Using the System

The following text, after suitable modifications, is intended to be distributed to users of repeater systems using the 8080 control system. Use of the processor functions and the autopatch are described.

WR3AFM is now controlled by an 8080 microprocessor. The processor permits flexibility in the system as well as many functions which could not reasonably be implemented without a processor. There are five CW IDs; four are permanently stored, and one is remotely programmable via a touchtone pad. Any of the five IDs may be selected, or, as is often the case, the different IDs may be made to cycle. The programmable ID allows meeting announcements and anything else that could be useful to be placed on the repeater.

For testing and diagnosis, each of the individual receive sites on 07/67 may be either disabled or forced on through the voting selector. There are several modes of accessing the control system, so it is possible for control stations to work on the system without interfering with repeater users. For most functions, the 8080 responds to correct commands with an "R" in CW, so when "R"s are heard on 67 this means that someone is commanding it. Under such circumstances, be slow to pick up transmissions in case the control operator has any requests; if none are made, feel free to continue using the repeater and ignore the "R"s.

For those interested in the size of the 8080 system, it currently has about 2K of program in ROM, 256 bytes of RAM, seven eight-bit output ports, and three eight-bit input ports. The control program is about 1300 lines long, and the hardware consists of 57 integrated circuits.

The processor makes possible the redialing of telephone numbers, the virtual elimination of incorrect dialing for autopatches, and the prevention of toll-charge telephone calls. In addition to the control functions and the autopatch, the processor has five codes available for general use which are accessible via 146.07. Any ideas for additional functions will certainly be entertained. For each of the codes, it is necessary for the first digit to be held at least one full second. It doesn't hurt to hold any tone longer than required. With this in mind, here are the various codes:

1#1—Links the 146.07/146.67 repeater with the 444.35/449.35 repeater. The repeater answers with an "R" if the function is accepted. The linkup will remain up indefinitely until knocked down with a *. Signals on 146.07 will come out on both repeaters, and signals on 444.35 will come out on both repeaters. When disconnected, the repeater responds with an "R" as well. The intention of this function is for calling someone on the other repeater, not for extended rag chew-

ing on both repeaters simultaneously. When transmitting on 444.35, 1#1 will also link up the repeaters. This function on the 440 end is not controlled by the microprocessor, and it does not acknowledge with an "R". The * on 444.35 will kill the linkup if it was initiated on 444.35; alternatively, on the 440 end the linkup will time out after three minutes. This is only true for linkups made from the 440 repeater. The two linkups are separate; if linked on 146.07 they must be killed on that frequency, and if linked on 444.35 they must be killed on that frequency.

2#2—Initiates a prerecorded tape message giving information about the repeater. The tape will disable itself upon completion.

3#3—Disables the blocking of touchtones. Any tones sent after the 3#3 before the carrier is dropped will not be blocked. Normally, upon recognition of valid tones, the repeater mutes them. This is done to protect the ears of those of us who monitor often. It is done on a tone-by-tone basis to facilitate diagnosing problems, since you can hear a short blip for every digit and can tell how many tones were sent. For those hams with selective call decoders, it is necessary for the tones to pass unimpeded, which is the reason for this function. If only short tones are required, the selective call function need not be used, as the repeater does not initiate tone blocking until a valid tone of about one second is received. This is to prevent blocking of voices.

4#4—Touchtone test. Any digits sent after the 4#4 before the carrier is dropped will be sent in Morse to tell the user what the repeater decoded the digits as. Any sequence up to 24 digits can be accommodated.

5#5—If preceded by a 4#4 test, will repeat what the 4#4 sent. If preceded by an autopatch, the telephone number entered will be sent in Morse. If an autopatch attempt fails, 5#5 will show what the number requested was (if the autopatch code was accepted). If, after making an autopatch, you wish to clear your telephone number from the machine, simply do a 4#4.

NOTE: The functions 1#1 through 5#5 are intended for use by anyone, club member or not. The autopatch is restricted to club members and transients. When performing any of these commands, be certain to identify your station first. The functions are there to be used, but not abused. This is somewhat of an experiment in the hope that our repeater users will use these functions wisely. We hope to be able to continue this free access. Should it become necessary, any of the functions may be disabled by remote control. Please do not force us to deactivate them.

are several different CW identifications which may be selected, and special IDs can be loaded in minutes remotely. For a number of years, we have had a reprogrammable CW identifier (73 *Magazine*, April, 1976). It was a great success, and the ability to program an ID remotely makes it more useful. Any of the functions can be disabled, and, of course, the repeaters can be turned off if necessary. A complete explanation of the user codes appears elsewhere in this article. A sample of what can be placed on the tape message loop is given. A complete description of

the control functions, "Controlling the System," also appears elsewhere. It is more difficult to control the system than with a simple arrangement, but many times it is not even necessary to enter the control mode and forcefully disable functions. Merely by transmitting on the control frequency, everyone else loses access to the touchtone decoder. This is of great use when some user decides that he will execute some function without identifying himself, as required by FCC regulations. A simple transmission on the control frequency removes his access to the system, and it is not

even obvious to those listening. With any amount of luck, these individuals adjust their touchtone pads attempting to bring up a function and throw their pads away in disgust after being unsuccessful.

We have been quite pleased with the overall operation of the control system. The user codes have given the repeater users some involvement with the repeater, and, after the initial adaptation period, general user sentiment has been quite positive. Although the control system is fairly complex, the reliability so far has been good. In the first two months of operation,

the system crashed twice. In the software world, a computer "crash" refers to the occurrence of some error which causes a computer to ignore operator commands, necessitating a hardware restart. I added an error detection/recovery routine to the system, and there have been no crashes since. There have been no hardware failures.

In the following sections, I will show how you can duplicate the system, how the hardware and software functions are distributed, what the hardware components are, and provide explanations of how to use and control the

Autopatch Access Procedure

The following procedure is recommended for accessing the autopatch.

- 1) "N3ABC autopatch"
- 2) Send the autopatch code and the telephone number in one transmission. Remember to hold the first tone one second. It is imperative that the carrier continue throughout the entire operation of all ten digits. Upon the release of carrier, the repeater will determine if your number is valid. The number is valid if any one of the following conditions is met: exactly one digit which corresponds to a single digit emergency number; exactly seven digits, the first digit not a 1; exactly eight digits, the first number a 0; exactly eleven digits, the first number a 0. If the number is invalid, nothing will happen. It will act as though no autopatch code had been entered, and it is not necessary to send the knockdown digit. If the number is valid, the repeater will bring up the telephone line and redial your number.
- 3) After the number has been dialed, and the line has clicked over, "N3ABC".
- 4) Conversation
- 5) "N3ABC clear with John Doe at 12:37 PM on August 12."
- 6) Knockdown code. If the "beep" is heard, the patch has been killed.
- 7) "WR3AFM this is N3ABC clear."

If you have problems, remember the 5#5 code.

The repeater now has several single-digit special numbers. Make a note of these special codes:

- 2—Baltimore City Police
- 3—Baltimore City Transit and Traffic
- 4—Maryland State Police
- 5—Harbor Tunnel Information
- 6—Anne Arundel County Police
- 7—Coast Guard Search and Rescue
- 8—Baltimore County Police
- 9—Howard County Police

To use the single digit codes, send the autopatch code followed immediately by the single digit. The repeater will dial the proper number for you.

Half Duplex

The autopatch is half-duplex. This means that the audio from the telephone line is switched off when you push the PTT. This feature can be used to block obscene language, business communication, or whatever, if the called party gets carried away. However, "skip" or interfering signals also have the same effect. Therefore, it is not wise to initiate an autopatch under such conditions. If this problem occurs, remember that the party on the telephone can hear you perfectly—it is just that you cannot hear him whenever any signal is present on 146.07, be it yours or something else.

Autopatch Timer

The autopatch is to be used for short traffic only. A timer will automatically terminate the patch after three minutes. Once activated, the patch will stay up until terminated by the timer or the knockdown code. No kerchunking is needed to keep it up. Three minutes is more than adequate for most autopatches. However, sometimes when in communication with police regarding an emergency it is desirable to continue the autopatch past the three-minute limit. Because of this, the timer is automatically deactivated when a *single digit* emergency number is used. The patch will not time out for these calls. For normal calls, it is not possible to extend the three-minute limit. For all calls, think of what to say before calling.

system. The method of construction, a detailed circuit and program analysis, and some principles I learned in developing the project will be presented in subsequent parts.

Duplication

The 8080 control system can be duplicated for your repeater with few modifications. The control system supports some features of WR3AFM which may not be of use on

Tape Message Text (Time: 2 minutes, 50 seconds)

Welcome to the Baltimore Amateur Radio Club's 07/67 repeater, WR3AFM. The transmitter is located at the old WBAL tower on Park Heights Ave., and drives a 250-Watt amplifier, though only a portion of that power reaches the antenna through about 500 feet of feedline. The repeater has receivers north of the beltway on Old Harford Road, at the WRBS tower near I-95 south and the beltway, downtown at 4000 North Charles Street, and at the QTH of K3VC and N3JC at the top of the Jones Falls Expressway. Each of these receivers drives a 440-MHz link transmitter. At the transmit site, there is a link receiver for each receive site. Each signal is fed to a voting selector, which continuously evaluates the signal-to-noise ratio of each receiver, the best of which goes to the transmitter. All of the repeater equipment is of the General Electric MASTR make.

At the transmit site, there is also a duplexed 440-MHz repeater, 444.35 in and 449.35 out.

You will note that a short click is heard after releasing your carrier. This signifies that the repeater timer has been reset, and leaves time for breakers. It is not necessary to let the repeater carrier drop. 07/67 has an autopatch, limited to travelers and club members, but open to anyone for emergency traffic.

The repeater is set up to block touchtone signals. After a long first tone of about one second, any further tones will be blocked from repeating, and only a short blip will be heard. There are several codes that anyone is welcome to use. One pound one links the 67 machine with the 440 repeater. To acknowledge that function, the repeater sends an "R" in Morse. The repeaters remain linked until a star is sent, again acknowledged with an "R". We do not desire to use this function for more than a calling mode. Two pound two gives this recorded message. Three pound three will disable the repeater's blocking function until the carrier is dropped, permitting the tones to be repeated. Any touchtone digits sent after four pound four will be verified in Morse after the carrier drop. Five pound five will repeat what was sent during a four pound four operation or the telephone number dialed during an autopatch, whichever was last.

The control system for the repeaters is an 8080-based microprocessor, which performs the various functions including multiple identifications, as well as redials telephone numbers for the autopatch.

The Baltimore Amateur Radio Club has another two meter repeater, 34/94, which is a duplexed repeater in the Towson area. We hope you enjoy the use of our repeaters, and would like to see you at our meetings on the first and third Wednesdays of the month at the Ames Methodist Church in Pikesville at 8:00 pm. Listen for interesting bulletins weekdays on 67 at 7:30 am and rebroadcast on 94 at 6:00 pm. Code practice can be heard Mondays at 9:00 pm on 34/94. Should you desire to contact the club, write the Baltimore Amateur Radio Club, PO Box 5344, Baltimore MD 21209.

an average repeater. If nothing but the basic user codes, the multiple IDs, the autopatch functions, and on/off control for a simple repeater is needed, the 8080 control system would still be worthwhile to construct. If the system is totally duplicated, and portions are left unconnected (due to having no voter, 440 repeater, etc.), the system will operate and leave room for expansion. Alternatively, the appropriate pieces could be left out easily. In either case,

the program would remain the same. It may have codes which do nothing or do something different, but the program is the major work and is already done for you. If no changes are contemplated for the program, then it is not necessary to understand how it works. It is always informative to do so, but don't worry about it too much if you are not familiar with 8080 machine language. For those who wish to personalize the software, it can certainly

Controlling the System

The following text is intended for distribution to control operators of repeater systems utilizing the 8080 control system. The necessary codes will have to be changed.

The microprocessor control system is a complex but flexible and powerful system. It is of utmost importance to completely understand its operation before attempting to utilize it. Although at first the system may seem to be overly complicated, the structure of the control codes makes it easier to use than a first glance might show.

Basically, the system reads the output of the touchtone decoder to decipher the codes, and has 56 output lines which may be controlled by the proper input combinations. External to the processor itself is additional circuitry to perform the necessary functions, i.e., autopatch, remote base, control frequency repeat, and phone line control. User codes all operate on the outputs indirectly. The proper bits are set and reset to perform the desired function, but control codes are all direct changes of output lines which are assigned to control the various functions.

The basic decoding method used decodes three-digit codes. The first digit of the code must be held down for one second, or nothing will happen. After the release of the first digit, if three seconds elapse before another digit is received, the code will be canceled where it stands. After the release of the second tone, three seconds is likewise allowed to enter the third digit. During the time that the first tone exceeds the one second time period, and until the end of the digit sequence, the blocking relay will follow any valid touchtone signal. During an autopatch or remote base function, the blocking relay will follow the tones as well. At all other times the blocking relay is not activated. Due to this arrangement, in order to have voice signals blocked, the voice must be a valid touchtone signal for one second—certainly a rare if not impossible situation.

Telephone and Control Receiver Access

There are two modes for each of these devices: control and talk. The normal mode for both is control. For the control receiver, this means that the signal is not repeated on 67 but the control receiver grabs the touchtone decoder. The control receiver has highest priority, unless the control receiver touchtone bit is set, which effectively removes the control receiver from the system. If, while transmitting on the control frequency, a # is entered for five seconds, then the control receiver talk mode is entered. While in this mode, the control receiver is repeated on 67. The only way to exit this mode is to send a one-second * while on the control frequency. As long as the control receiver bit is not set, the control receiver always has the decoder. When in the non-talk mode, this allows control of repeater functions without bothering users of the repeater, except that they will not be able to access the touchtone decoder to make autopatches. For the telephone line, when a call-in is made, the mode is set to telephone control. You cannot hear anything. However, the touchtone decoder is listening only to the telephone line. In this manner, control can be exerted in the same way as with the control receiver. If you wish to hear the repeater on the phone line, a five-second # on the line will switch you out of the phone control mode, and the voter audio will be sent down the phone line when an incoming carrier is present. When a signal is present, it has the decoder, not the phone line. Otherwise, the phone line has the decoder. To return to the phone control mode, a * while on the telephone will do so, as will hanging up and redialing. If the telephone touchtone disable bit is set, it will be impossible to enter the phone control mode, and any touchtones received from the phone will be rejected.

Note that any of the three modes of control may be disabled: 150 input, control receiver, and telephone. Beware: If all bits are set, you go to the repeater and push the reset button (or wait for a power failure to reset it automatically). Naturally, it would be inconceivable to lock out all modes of control accidentally.

be done. If you do not have any support for the 8080, or for some other reason cannot program 2708 ROMs, I will provide the two ROMs for a cost of \$50. Specify your choice for the following codes: 67#, 2*2, 9#5, 6*#, #*6, #48. The knockdown digit will be * unless requested otherwise. Codes may not start

with whatever digit is chosen as the knockdown digit. Also specify the four IDs and the telephone numbers for the single-digit dialing. For obvious reasons, the above codes must be changed for each repeater.

This project is by no means a simple one, and it is not suitable for the

beginner. Construction experience with integrated circuits and a basic understanding of the system are required. It is not an extremely difficult project as long as care is taken during assembly. Probably the most difficult

part will be deciding how to interface a particular repeater to the system. The entire system can be constructed in one week (full-time) by a proficient builder. Do not shy away from the project if you have no prior experience with microprocessors. The "black box" approach is utilized, and detailed knowledge of the inner workings of microprocessors is not required. Total cost for the system is dependent upon how much peripheral equipment is available. The control system cost us about \$225, exclusive of the touchtone decoder and pad, amplifiers, and tape loop.

Hardware/Software Balance

Some of the control functions are implemented in software and some are implemented in special

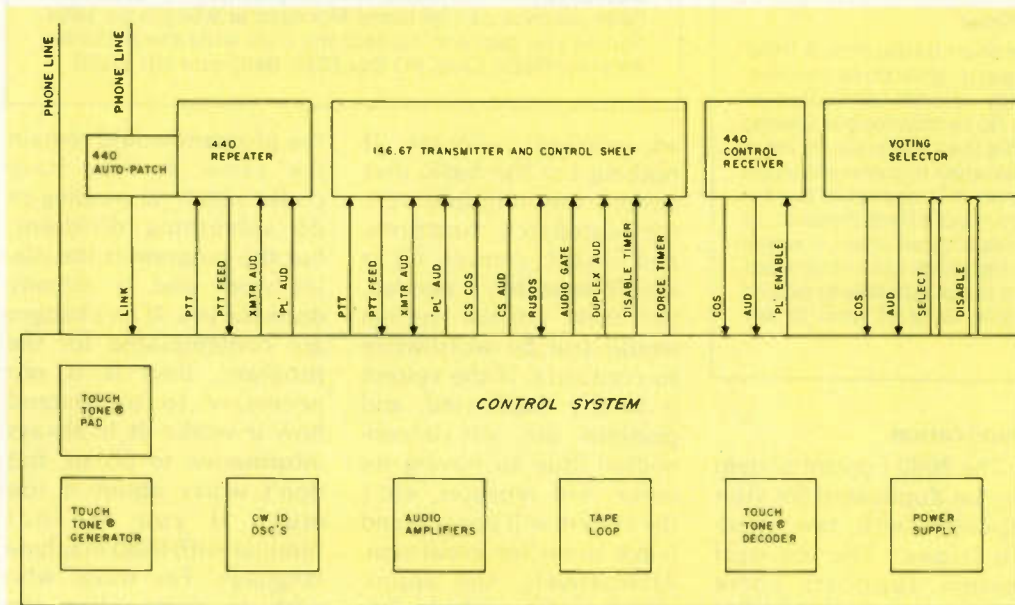

Fig. 2. Repeater/control system interface.

hardware. Deciding where to draw the line is an interesting problem. There are trade-offs which must be made. The major advantage of using a microprocessor is replacing hardware with software, so at first glance it may seem that everything that can be placed into software should be. However, I would rather add one flip-flop than add several hundred extra lines of program. Four years ago, I made the mistake of taking all possible hardware out of a system. My first attempt at computerizing WR3AFM started at that time when I constructed a system based on the 4004 CPU, a 4-bit machine. I designed the hardware, giving the software total control over the hardware. Everything was done with the software. At that time, being hardware oriented, I built the thing first and assumed that I would then write the program. The hardware functioned perfectly—unfortunately, I could not write the program. It could be done, but it was so complicated that it would have taken me several months of concentrated effort to accomplish the task. I effectively junked the project and am still trying to think up some possible use for the thing.

This time around I did not make the same mistake. There are four state flip-flops in the external hardware. These keep track of the autopatch, remote base, control receiver talk, and telephone control states. The processor does not know or need to execute its functions. It basically acts as a CW identifier and a multiple digit decoder. It does keep track of many internal states, but these states are not needed until a function is called which needs them. The extra dozen ICs greatly simplify the soft-

ware, and I believe that the hardware/software balance of this system is near optimal.

Hardware Description

The repeater block diagram shown in Fig. 1

was previously discussed. Fig. 2 shows how the control system interfaces with the repeater. Surely, each repeater will have to be reckoned with on an individual basis. Understanding how WR3AFM works

should demonstrate how to interface the control system with any repeater.

The 146.07/146.67 MHz repeater is referred to as 150 and the 444.35/449.35 MHz repeater is referred to as either 440 or 450. The

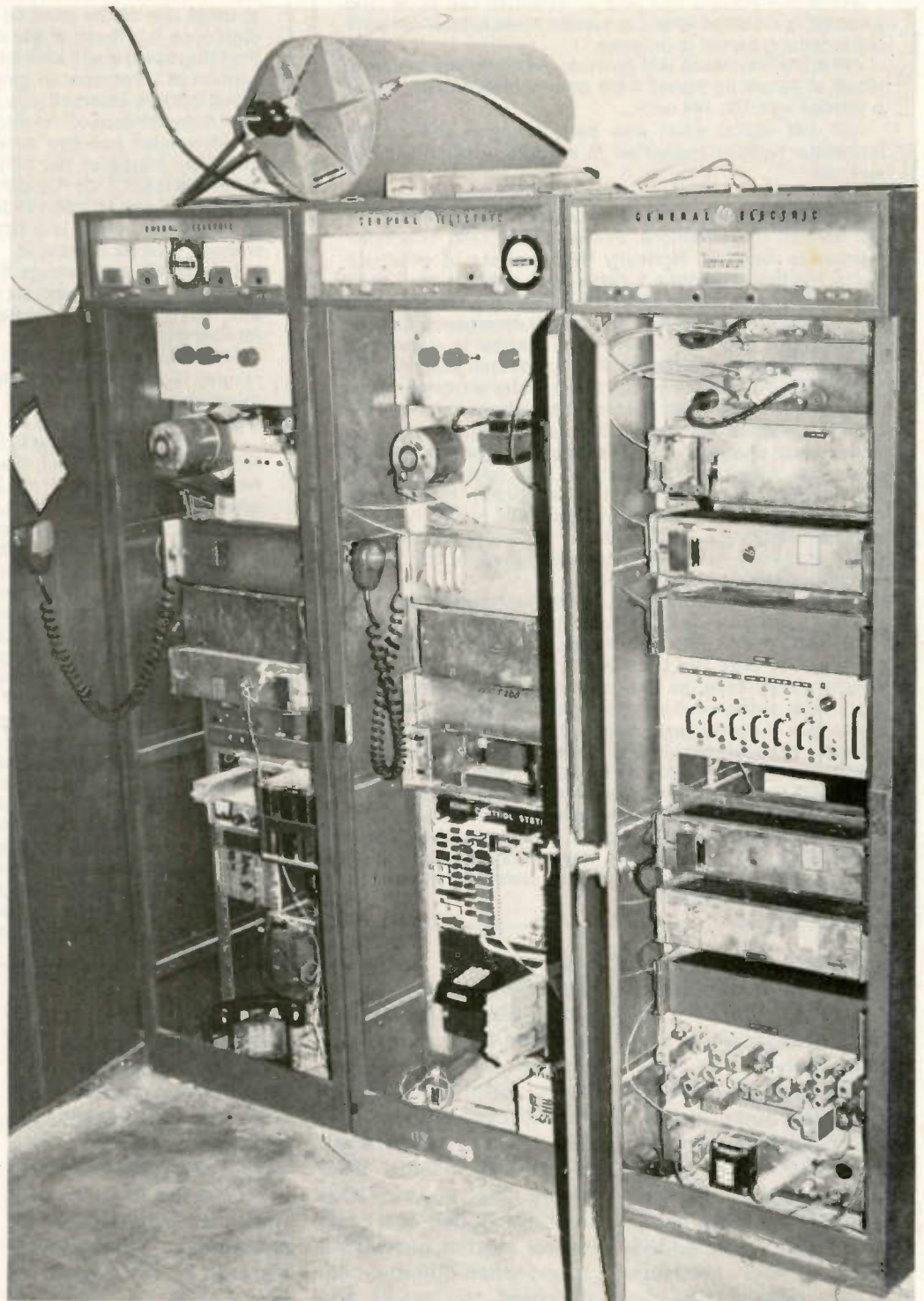

WR3AFM. Left cabinet—444.35/449.35 repeater. Top to bottom: power amplifier, transmitter, receiver, control panel, autopatch circuitry. Center cabinet—146.67. Top to bottom: power amplifier, transmitter, control receiver, control shelf, 8080 control system. Right cabinet—link cabinet. Top to bottom: 440 multicouplers, power supply for receiver #6, 5 link receivers, voting selector. Tube receiver on bottom no longer in use. 146.67 pass cavity on top. 440 duplexer out of view in left cabinet.

User Codes

There are eight user codes. 1#1 links 67 and 449.35. The two repeaters remain linked until they are unlinked by a single *. The proper output line is automatically set and reset for the link and unlink commands. To tell the user that the link or unlink has been established, the repeater acknowledges with an "R" in Morse.

2#2 plays the prerecorded tape loop. Once it is started, there is no way to stop it short of shutting down the repeater.

3#3 is the disable blocking or selective call code. The blocking is disabled after the second three is received until the incoming carrier is dropped.

4#4 is the touchtone test function. Any tones up to a maximum of 24 will be played back on CW after carrier drop if preceded with the 4#4 code.

5#5 will repeat what was sent during a 4#4, or the telephone number requested in an autopatch, whichever was last.

6#6 is the autopatch code. In one transmission, the code plus the telephone number must be sent. The processor will not access the telephone line unless a valid telephone number is received. Normally this consists of exactly 7 digits, the first digit not a 1. Other valid numbers are 8 or 11 digits, with the first digit a 0 and the single digit codes. If the single digit code is correct, the proper emergency number will be found and sent. If an invalid number is attempted, nothing happens, exactly as if no autopatch attempt had been made. For valid numbers, the repeater will bring up the telephone line and redial the stored telephone number. This system prevents incorrect calls due to signal chopping which cause shotgunning of the touchtones (which result in more than 7 digits). When a single digit code is used, the three-minute timer is defeated automatically. If the 6#6 is sent by itself and the direct autopatch bit is set, then the repeater will bring up the telephone line and permit the user direct access to the telephone dialing system. This is not normally done, as it is not needed.

9#9 is the remote base code. The normal method is to use this by calling in on the phone line. However, nothing prevents its use on the air. All it does is connect the repeater to the phone lines, but it will not initiate a call. This is not strictly a user code, as the users should not know it, but there is no technical distinction between it and the other user codes. If the repeater times out during an autopatch or a remote base function, those functions will be canceled.

2*2 also performs the tape function. There is no distinction between this and the 2#2 except that the 2*2 is for control stations only. The two codes may be disabled separately. By using the 2*2 function, if it becomes necessary to disable 2#2, control operators may activate the tape upon request without needing to get into command mode and enable the 2#2 function.

In order to exert command on the repeater, it is necessary to enter the command mode. 6*# initiates the request. After entering this code, the carrier must be dropped. If the command is from the telephone line, the procedure may continue immediately. A confirmation code must be entered next. The confirm code is #*6. *Important:* Once the command code is issued, the system will wait for the confirm code forever. If no tone is given, the system will not be reset until it receives another touchtone. After the confirm code is entered, the carrier must be dropped again. Next, a single digit code is entered. If the single digit is a valid command, then the repeater will acknowledge with an "R". With the exception of three special single digit commands, the command mode is automatically left, and operation is again normal. A description of the single digit codes follows.

The system has five different messages. Four are permanently stored in the ROM. They are presently (1) "DE WR3AFM BARC," (2) "DE WR3AFM BALTIMORE," (3) "73 DE WR3AFM," and (4) "DE WR3AFM BALTO ARC." In addition to these four, there is a fifth which may be programmed through another command.

Commands one through five select that number ID to be used always. Command six rotates through 1,2,3,4,1,2,3,4, etc., each time the repeater identifies. Command seven rotates through all five IDs.

Command nine resets all functions to the normal state. Normal is both repeaters enabled, ID #1 selected, and all other outputs ungrounded. This is the same thing as pushing the reset button on the control system.

Command * resets the ID timer. The next time one of the repeaters is kerchunked, that repeater will identify. A word here about the timing of IDs is in order. In the rest mode, as after the * command, the first repeater used identifies. If, in the subsequent three minutes, one or both of the repeaters is used, then one or both of the repeaters will identify three minutes later. In this manner, the repeater is a "tail-ender," and always gets in the last word (something that is very difficult for one of us mortals to do on the repeater).

Commands 8, 0, and # are the commands which do not exit the command mode immediately. Command eight is the ID load command. This loads ID #5 into memory. It does not change the specification of which ID is to be used. After entering the eight, and dropping carrier to hear the "R", the load program is waiting for further instructions. The ID is loaded in a character-by-character fashion. Dits are zero, dahs are one. The characters are loaded in the same as they are in Morse. For instance, take the letter "F". This is di-dah-dit, corresponding to 0,0,1,0. To enter "F", then the sequence should be 0,0,1,0. When the letter is entered, enter a 2 to signify that that letter is done. Continue loading characters in this manner. A 2 entered with no zeroes or ones will automatically be translated into a space. When the entire message has been entered, a 3 signifies that you are

equipment is General Electric MASTR. This includes the voting selector, receivers, transmitters, and control shelves. The voter has two outputs: the COS line and the audio output. The COS (carrier operated switch) is low when an incoming signal is present. This is at a transistor level, and, actually, we added single transistor inverters in several places throughout the system to interface the various components exclusive of the control system. All audio lines in the system are balanced. The control system is

designed for balanced lines; therefore, it will work with both balanced and unbalanced lines. If you use unbalanced lines, be certain to keep track of the hot and cold ends so that they match up. There are select and disable lines driving the voter. These lines are active low. The control system provides a ground when commanded; otherwise, the select and disable lines are open.

The 440 control receiver has the COS and audio lines the same as the voter. Additionally, Private Line™ or Channel Guard™ subau-

dible tones may be required to un-squelch it. This "PL" enable line requires a ground when it is desired to place the receiver into the PL mode.

The two meter repeater is connected to its control shelf (standard MASTR equipment) in the ordinary fashion. The PTT (push-to-talk) line is just that. The PTT interfaces with the rest of the system only through the control system. It is used for two purposes: to keep the transmitter on the air during IDs and to see if

the repeater has timed out. The control shelf provides the three-minute timer and drop delay timer. The PTT line is disconnected from its normal feed. During normal operation, the control system reconnects the PTT and feed. The transmitter audio pair is the audio input to the transmitter. This is shorted out to block repeating of touchtones and is shorted with the same lines from the 440 transmitter for linkups. The "PL" audio input is any audio input

Command Codes

done. The repeater acknowledges this with an "R", and the ID load and command commands are exited. Normally, place a space at the beginning and at the end to make the IDs uniform. Always be certain that the ID load mode is left, or the controller will be waiting to receive a "3" before it resumes its normal functions. After loading a message, you should select ID #5 and either wait to hear it or reset the ID timer to hear it to verify that it received what you think it did. After loading and verification, the desired ID mode can be set (either 5 or 7).

Command zero is the most powerful command, and it is through it that positive control is established. After releasing carrier and hearing the "R", the output mode is entered. In this mode, the repeater is waiting for three digit codes specifying which output bit to change. There are 64 bits arranged as eight eight-bit ports. Port 0 is a dummy port; it has no output lines and is used to disable the user functions. Port #1 is used by the indirect commands and is not normally used in the output mode. Ports #2 and #3 are enable functions. Port #4 is completely spare, port #5 is voter receiver disable, port #6 is voter receiver enable, and port #7 controls the touchtone generator. For ports #5 and #6, the bit number is the receiver number. This leaves room for eight receivers with no changes necessary. The normal configuration is all ports zero. This gives an ungrounded condition on the voter and spare ports. The three digit sequence for the output mode is XYZ, where X is the port number, Y is the bit number, and Z is either 0 (normal) or 1 (asserted). After each output sequence, the output routine acknowledges with an "R" if the command is valid. Invalid commands would be 831, 690, 300, 236, for obvious reasons. After each sequence, the output routine waits for further commands until a * is sent. The repeater sends an "R" to this and output and command modes are exited. For example, to turn off 67: enter command mode (6*#, #*6), 0, (output mode), 281 (turn it off), * (exit command).

Command # permits loading of the telephone number stored for the single digit #1. Simply send the telephone number followed by a *. An "R" acknowledges loading and exits command mode.

Always be sure that you have left the ID load, output, and load telephone number modes. If the repeater IDs, you have. This is true for all commands. A useful command to execute before ending a control session is the reset timer command, to hear the ID which guarantees that all is OK.

101 - 150/450 link
 202 - Tape loop
 303 - Disable blocking until carrier drop
 404 - Touch Tone (R) Test
 505 - Repeat 404 or autopatch number
 67# - Autopatch
 2*2 - Tape
 905 - Remote base

6*# - Command mode
 #*6 - Confirm command mode

After in command mode:

1 - Select ID #1: " DE WRJAFM BARC "
 2 - Select ID #2: " DE WRJAFM BALTIMORE "
 3 - Select ID #3: " 73 DE WRJAFM "
 4 - Select ID #4: " DE WRJAFM BALTO ARC "
 5 - Select ID #5: programmable through command 8
 6 - Rotate through IDs 1 through 4
 7 - Rotate through IDs 1 through 5
 8 - Load ID #5:

0 - Dit
 1 - Dah
 2 - End character
 3 - End load mode

9 - Reset all outputs and modes to normal operation

0 - Output mode:

XYZ - Port X, Bit Y, Output Z (exit output mode with *)

* - Reset ID timer (first repeater up IDs)

- Load single digit #1 telephone number (exit with a *)

Output Ports:

Port #0

1 - 101 disable
 2 - 202 disable
 3 - Direct autopatch enable
 4 - 404 disable
 5 - 505 disable
 6 -
 7 -
 8 - 2*2 disable

Port #1 - DO NOT USE

Port #2

1 - Beep disable
 2 - Control receiver PL enable
 3 - 150 Touch Tone (R) disable
 4 - Telephone Touch Tone (R) disable
 5 - Control Touch Tone (R) disable (when absolutely necessary)
 6 - Autopatch disable
 7 - 450 Repeater disable
 8 - 150 Repeater disable

Port #3

1 -
 2 -
 3 -
 4 -
 5 - DO NOT USE
 6 - Timer disable
 7 - DO NOT USE
 8 - DO NOT USE

Port #4

1 -
 2 -
 3 -
 4 -
 5 -
 6 -
 7 -
 8 -

Port #5 - Voter disable

1 - Receiver #1 (Charles Street)
 2 - Receiver #2 (Cub Hill)
 3 - Receiver #3 (K3VC)
 4 - Receiver #4 (WRNS)
 5 - Receiver #5
 6 - Receiver #6
 7 - Receiver #7
 8 - Receiver #8

Port #6 - Voter select, bits same as port #5

Port #7 - DO NOT USE

which is not affected by the normal talk audio. It is used for the CW ID tone. The CS COS (control shelf COS) will key the transmitter when grounded. This goes through the two timers in the control shelf and drives the PTT feed. The CS AUD (control shelf audio) pair goes through line amplifiers and compressors to drive the transmitter. This is normally connected to the voter audio output. The RUSOS lead is a lead which, when grounded, keeps the

transmitter on through the timers. A ground on the RUSOS lead will not feed back on the CS COS lead. The RUSOS lead is grounded for autopatches. The DUPLEX AUD is a bidirectional audio path. It is labeled "AUD" on the rear of the control shelf. When the CS COS is low, audio exits from the DUPLEX AUD lead. If +10 volts is placed on the AUDIO GATE line, audio placed on the DUPLEX AUD pair will be fed to the transmitter. This is used to place

telephone line audio on the air. When the DISABLE TIMER lead is grounded, the three-minute time-out timer is bypassed and the repeater will not time out. This is used during emergency telephone calls. The time-out timer is on the input, not the output of the repeater. Between each transmission, the timer resets. It is not necessary to let the repeater carrier drop. However, when the "beep" is active, a fraction of a second after the input signal disappears, the

repeater will beep. The FORCE TIMER line, when grounded, makes the control shelf believe that a signal is present even if it is not. This is used so that when the "beeper" is enabled, not waiting for the beep will not reset the time-out timer.

The connections for the 440 repeater use the same definitions as the 150 repeater. There is a separate interface for that repeater which provides an autopatch on a second telephone line. That is not

—Correction—

Yaesu FT-227RA

The product review of the Yaesu FT-227RA in the January issue of 73 incorrectly states that a conversion kit is available through Yaesu. There is no conversion kit available.

of importance when interfacing with the control system, except that the autopatch logic includes a #1 output function so that when that code is sent, the LINK line is grounded. This permits linking up the repeaters from the 440 end.

The telephone line interfaces with the control system and is switched properly by it. In this system, the telephone company interface device is at a member's house. There is a

dedicated line from his house to the repeater site. The audio and a reversing dc voltage are on the single pair, and its operation will be described later. If the telephone company interface device is to be located at the repeater, all of the necessary signals are present in the control system to handle it and it would be simpler than our arrangement. There is a tape recorder connected to the line during autopatches, and the recorder is located at the member's house rather than at the repeater. This allows changing tape easily.

There are various subassemblies in the control system. Rather than building everything from scratch, we used good quality commercial units where possible. There are three audio amplifiers. Two are used for the telephone line and one for

driving the touchtone decoder. The amplifiers are IT&T K227s. They are balanced input/output, 600 Ohm. The gain is variable from -5 to +36 dB, and they each draw 18 mA from a 16- to 24-volt supply. Similar amplifiers should not be too difficult to find, or a few op amps should do the trick nicely. The touchtone decoder is an IT&T K-247-B. It is normally 600 Ohms and is modified for 10k audio input impedance. The digit lockup is disabled. The decoder has 13 outputs: one for each of the 12 digits and one which detects any valid touchtone (VTT). Each of these lines is normally open and goes low when active. Any decoder may be used which follows these conventions, but beware of 567-type decoders which do not employ high/low audio group filtering. I en-

courage the use of commercial decoders. Lacking that, be sure to test homemade ones extensively. While the microprocessor is the brain of the system, the decoder is the heart of the system.

A standard touchtone pad is included to facilitate controlling the repeater when at the repeater site.

The tape loop is a Mohawk Message Repeater. This is an antique vacuum tube device which could certainly be replaced with a newer piece of equipment. When one pair of wires is shorted, it activates the tape. While the tape is running, an output pair is shorted. Any cartridge-type machine should be suitable, and a standard 8-track player could be modified for this use. The tape must turn itself off when completed. ■

DEALER DIRECTORY

Fontana CA

We carry the following: ICOM, Midland, Amcom, DenTron, KLM, Swan, Drake, Ten-Tec, Wilson, SST, MFJ, Hy-Gain, Lunar, Nye-Viking, B&W, Redi-kilowatt, Cush Craft, Mosley, Big Signal, Pipo, etc. Full Service Store **Fontana Electronics**, 8628 Sierra Ave., Fontana CA 92335, 822-7710.

Santa Clara CA

Bay area's newest Amateur Radio store. New & used Amateur Radio sales & service. We feature Kenwood, ICOM, Wilson, Yaesu, Atlas, Ten-Tec & many more. **Shaver Radio**, 3550 Lochinvar Avenue, Santa Clara CA 95051, 247-4220.

Denver CO

Experimenter's paradise! Electronic and mechanical components for computer people, audio people, hams, robot builders, experimenters. Open six days a week. **Gateway Electronics Corp.**, 2839 W. 44th Ave., Denver CO 80211, 458-5444.

New Castle DE

Paul WA3QPX, Rob WA3QLS—Serving amateurs in southern New Jersey, Delaware, and Maryland with the largest stock of amateur equipment and accessories in Delaware. **Delaware Amateur Supply**, 71 Meadow Road, New Castle DE 19720, 328-7728.

*Tell them you saw
their name in 73*

Boise ID

Alliance, Amcom, CIR, Cushcraft, Dentron, Edgcom, ICOM, Hustler, KDK, MFJ, NPC, NYE, SST, Ten-Tec, Wilson. **Custom Electronics**, 1209 Broadway, Boise ID 83706, Bob W7SC 344-5084.

Preston ID

Ross WB7BYZ, has the Largest Stock of Amateur Gear in the Intermountain West and the Best Prices. Call me for all your ham needs. **Ross Distributing**, 78 So. State, Preston ID 83263, 852-0830.

Bloomington IL

Retail—wholesale distributor for Rohn Towers—antennas by Cush Craft, Antenna Specialists, KLM, Wilson, Hy-Gain, Transceivers by Tempo, Regency, Wilson, Amcom. Also business and marine radios. **Hill Radio**, 2503 G.E. Rd., Bloomington IL 61701, 663-2141.

Terre Haute IN

Your ham headquarters located in the heart of the midwest. **Hoosier Electronics, Inc.**, 43B Meadows Shopping Center, P.O. Box 2001, Terre Haute IN 47802, 238-1456.

Littleton MA

The ham store of N.E. you can rely on. Kenwood, ICOM, Wilson, Yaesu, DenTron, KLM amps, B&W switches & wattmeters, Whistler radar detectors, Bearcat, Regency, antennas by Larsen, Wilson, Hustler, GAM. **TEI-COM**

Inc. Communications & Electronics, 675 Great Rd. Rt. 119, Littleton MA 01460, 486-3040.

Laurel MD

We stock Drake, Ten-Tec, Wilson, ICOM, DenTron, Tempo, Hy-Gain, Midland, Mosley, Hustler. 40-page ham catalog available for \$1.00 (refundable with 1st purchase)—write for cash quote! **The Comm Center, Inc.**, Laurel Plaza, Rte. 198, Laurel MD 20810, 792-0600.

St. Louis MO

Experimenter's paradise! Electronic and mechanical components for computer people, audio people, hams, robot builders, experimenters. Open six days a week. **Gateway Electronics Corp.**, 8123-25 Page Blvd., St. Louis MO 63130, 427-6116.

Camden NJ

X-Band (& other frequencies) Microwave Components & Equipment. Laboratory Grade Test Instruments, Power Supplies, 1000's in stock at all times. **BUY & SELL** all popular makes—HP, GR, FXR, ESI, Sorensen, Singer, etc. **Electronic Research Labs**, 1423 Ferry Ave., Camden NJ 08104, 541-4200.

Syracuse NY

We Deal, We Trade, We Discount, We Please! Yaesu, Kenwood, Drake, ICOM, Ten-Tec, Swan, DenTron, Midland, Cush Craft, KLM, Hy-Gain, etc. Complete 2-way service shop! **Ham-bone Radio (div. Stereo Repair Shop)**, 3206 Erie Blvd. East, Syracuse NY 13214, 446-2266.

Syracuse-Rome-Utica NY

Featuring: Yaesu, ICOM, Drake, Atlas, DenTron, Ten-Tec, Swan, Tempo, KLM, Hy-Gain, Mosley, Wilson, Larsen, Midland Southwest Technical Products. You won't be disappointed with equipment/service. **Radio World, Oneida County Airport-Terminal Building**, Oriskany NY 13424, 337-2622.

Cleveland OH

Need service on your late model or old time equipment? We service all makes and models. Rates \$19.96 hr. Call or write. **Communications World, Inc.**, 4788 State Rd., Cleveland OH 44109, 398-6363.

Souderton PA

Tired of looking at ads ??? Come and try our new and used equipment yourself—personal advice from our staff's 60 years combined ham experience. **Electronic Exchange**, 136 N. Main St., Souderton PA 18964, 723-1200.

Port Angeles WA

Mobile RFI shielding for elimination of ignition and alternator noises. Bonding straps. Components for "do-it-yourself" projects. Plenty of free advice. **Estes Engineering**, 930 Marine Drive, Port Angeles WA 98362, 457-0904.

DEALERS: Your company name & message can contain up to 25 words for as little as \$150 yearly or \$45 quarterly (prepaid). No mention of mail order business or area code permitted. Text & payment must reach us 45 days in advance. The deadline for the May issue is March 18th. Mail to 73 Magazine, Peterborough NH 03458. ATTN: Aline Coutu.

MFJ INTRODUCES

© MFJ ENTERPRISES, INC. 1979

NEW MFJ-940 VERSA TUNER II

For \$69.95 you can match any coax line or random wire from 1.8 to 30 MHz. Up to 300 watts RF OUTPUT. Built-in SWR, dual range watt-meter. Six position antenna switch. Efficient airwound inductor.



When you buy MFJ you buy proven MFJ quality . . . and a one year unconditional guarantee.

BRAND NEW

\$69⁹⁵

With the NEW MFJ-940 Versa Tuner II you can match your transmitter to any coax line or random wire continuously from 1.8 to 30 MHz.

Up to 300 watts RF power OUTPUT. Works with all solid state (like Atlas) and tube rigs.

Tune out SWR on your dipole, inverted vee, random wire, vertical, mobile whip, beam, quad, any coax fed or random wire antenna.

Operate all bands with just one antenna.

Increase bandwidth of your mobile whip by tuning out SWR from inside your car.

A SWR and dual range wattmeter (300 and 30 watts full scale) lets you measure RF power output for simplified tuning.

Six position antenna switch on rear lets you select 2 coax lines direct or thru tuner, random wire, and tuner bypass for dummy load.

A new efficient airwound inductor (12 positions) gives you less losses than a tapped toroid for more watts out.

Compact size 8x2x6 inches fits easily in small corner of suitcase for easy traveling.

S0-239 coax connectors for transmitter and coax fed antennas. Binding post for random wire, ground. 208 pf, 1000 volt capacitors.

Optional mobile mounting bracket, add \$3.00. Every single unit is tested for performance and inspected for quality. Solid American construction, quality components.

Beware of imitators. When you buy MFJ you buy proven MFJ quality . . . and a one year unconditional guarantee.

Order your MFJ-940 Versa Tuner II today.

MFJ-900 ECONO TUNER matches coax, random wires. Full band coverage 1.8 to 30 MHz. Up to 200 watts RF OUTPUT. Efficient airwound inductor.

Use any transceiver, solid state or tubes.

Increase antenna bandwidth. Operate all bands with a single antenna. Tune out SWR on your mobile whip from inside your car.

Efficient airwound inductor gives more watts out than tapped toroid. S0-239 coax connectors for transmitter and coax. Binding post for random wire, ground. Compact 5x2x6 inches.

MFJ-901 Versa Tuner available. Same as MFJ-900 but has 4:1 balun for balanced lines, \$49.95.

Beware of imitators. Some are still copying our

- Full band coverage 1.8-30 MHz.
- Efficient airwound inductor.

\$39⁹⁵

earlier models. MFJ has made major improvements.

For example, a new efficient airwound inductor gives you less losses than a tapped toroid for more watts out and plenty of inductance for full band coverage 1.8 to 30 MHz.



MFJ-900 has one year unconditional guarantee.

MFJ-16010 RANDOM WIRE TUNER lets you operate all bands — 1.8 to 30 MHz — with a simple random wire. Up to 200 watts RF OUTPUT.

Operate all bands — anywhere, with any transceiver — using a random wire and an antenna tuner small enough to carry in your hip pocket. Ultra compact 2x3x4 inches.

Operate from your apartment with a wall to wall antenna, or motel room with a wire dropped from a window. Enjoy ham radio on a camping or backpack trip with a wire thrown over a tree. Pre-

- Operate all bands with a simple random wire.

\$29⁹⁵

pare for an emergency. Take It on a DXpedition or Field Day. One year unconditional guarantee.

Match low and high impedances by Interchanging input and output. S0-239 coax connectors.



FOR YOUR NEAREST DEALER OR FOR ORDERS

CALL TOLL-FREE 800-647-1800

Order any product from MFJ and try it. If not delighted, return within 30 days for a prompt refund (less shipping).

Order today. Money back if not delighted. One year unconditional guarantee. Add \$2.00 shipping/handling.

For technical information, order/repair status, in Mississippi, outside continental USA, call 601-323-5869.

Order By Mail or Call TOLL FREE 800-647-1800 and Charge It On



MFJ ENTERPRISES, INC.

P. O. BOX 494

M52

MISSISSIPPI STATE, MISSISSIPPI 39762

INSTANT SOFTWARE™

Peterborough, New Hampshire 03458

NEW

MORE: Fun For Your Family and Friends



Command the Starship Enterprise and fight Klingon battle cruisers, Romulan warships, and Orion Destroyers. The Trek X Program has a full graphics display of enemy ships, moons, planets, suns, starbases, and has the added feature of allowing you to add sound to your Pet. \$7.95. Order No. 0032P.

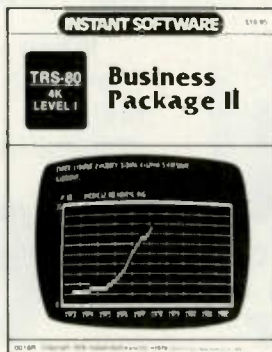

Would you like to be able to graph the sales of your firm... or a particular product? This program will do this automatically, and save the data for later use or modification. It will also calculate and graph the average sales for a year period, month by month... and calculate and graph the increase or decrease in sales. This program alone is worth the price of the entire package. \$19.95. Order No. 0016R.



In Car Race you and a friend can have fun racing your cars on a choice of two race tracks with your TRS-80. In Rat Trap you must trap the rat in the grid using your two cats. Aim your gun and shoot down the plane in the Antiaircraft game. \$7.95. Order No. 0011R.



You can bowl strikes and pick up spares with the Bowling Program on the TRS-80. Your computer will give you a visual display of the pins and keep score as well. \$7.95. Order No. 0033R.



In Tangle, you must maneuver your line across the screen and cause your opponent or the Pet to crash its line into an obstacle. Supertrap is an even more advanced version of Tangle, where you have the option of using changing backgrounds and obstacles to play the game. \$7.95. Order No. 0029P.

PLUS MANY MORE



Space Trek II

As commander of the Starship Enterprise, you must defend the galaxy against Klingon warships. Use your arsenal of phasers and photon torpedoes while moving in the quadrant under impulse power or jumping from quadrant to quadrant with your warp engines. \$7.95. Order No. 0002R.

Electronics I

With this group of five programs you can design coils for radio circuits, calculate the component values for tuned circuits, design preamplifiers using the LM-381 IC, and design timer circuits, either monostable or astable, using the 555 IC timer. \$7.95. Order No. 0008R.

Mortgage With Prepayment Option/Financier Two programs in one package of interest to people concerned about today's economy. Learn about interest, prepayments, profitable investments, depreciation schedules, salvage values, and more. Incredibly priced at \$7.95. Order No. 0006P.

Ham Package I

This group of eight programs will be of frequent help to any technician, experimenter, or ham operator. Included are programs for Ohm's Law calculations, frequency vs. reactance, series resistances, parallel resistances, series capacitances, parallel capacitances, dipole antenna design, and yagi antenna design. \$7.95. Order No. 0007R.

Oil Tycoon

Compete with a friend for the honor of being the wealthiest tycoon in the oil industry. You can explore and drill for oil, invest in research and development, and suffer from spills and well-head blowouts. \$7.95. Order No. 0023R.

Beginner's Backgammon/Keno

You'll never lack for a backgammon opponent again. This program is designed for the new player, but the computer's steady play will challenge an expert. Keno is a popular Las Vegas gambling game where you can win big. \$7.95. Order No. 0004R.

Golf

The Golf program and played of the Apple has some pretty tricky fairways lined with trees, sand traps, and water hazards. You have your choice of nine clubs to get your ball into the cup. But remember, the computer may give your ball an occasional slice. Just to keep things interesting. \$7.95. Order No. 0018A.

Dow Jones Find out first hand what the stock market is all about. Computer even offers broker's advice. High Influence option increases complexity of game. Entertain yourself and friends while learning at the same time. \$7.95. Order No. 0026P.

Personal Weight Control/Biorhythms Two contemporary concerns in one inexpensive package. Let your PET determine your ideal weight and then calculate the correct daily caloric intake to reach or maintain your weight goal. Chart your own biorhythms or anyone else's. \$7.95. Order No. 0005P.

Air Flight Simulation

Turn your TRS-80 into an airplane. Takeoff and land, do aerobatic maneuvers, and fly a course against any map you choose. The program includes full instruments and flight controls. \$7.95. Order No. 0017R.

Basic Lunar Lander/Intermediate Lunar Lander

Your automatic landing system has malfunctioned and you must make a manual landing. The retro rockets must be carefully controlled or they'll name the new crater after you. \$7.95. Order No. 0001R.

Business Package I

You can keep the books of a small business on your TRS-80. You'll be able to run off a list of your assets, run a trial balance and get a profit and loss statement when you want, with only a level I, 4K computer. \$29.95. Order No. 0013R.

Golf/Crossout

Play golf with your TRS-80. You have a choice of seven clubs to play the game on 18 different holes. Crossout is the peg puzzle game. Remove all the pegs but leave one in the center hole. \$7.95. Order No. 0009R.

Casino I

The Blackjack Program is not only fun to play but it will allow you to play every combination possible. It is so good that you can use it to practice before you go out to beat the house and get rich. \$7.95. Order No. 0014P.

Casino II

Casino II is not just a craps game, it's a tutorial program that will teach you the odds for every bet. You'll learn which bets give you the best odds. It's so realistic, it's like playing under actual house conditions. \$7.95. Order No. 0015P.

RELEASES

FOR 79

MORE: Efficiency in Your Business

INSTANT SOFTWARE \$7.95

TRS-80
4K LEVEL I
16K LEVEL II

Demo I
Computer Composer
Hi-Lo E.S.P. Horse Race
Petals Around The Rose
Baseball Slot Machine

Demo I is perfect for those times when you want a few short programs to show your friends what your TRS-80 can do. Programs included are Computer Composer, Baseball, Horse Race, ESP, Hi-Lo/Tic-Tac-Toe, Petals Around the Rose, and Slot Machine. \$7.95. Order No. 0020R.

INSTANT SOFTWARE \$7.95

PET
8K

Checkers
and
Baccarat

Sharpen your skill at checkers. The Pet will oppose you on the board, keep score, signal when you can jump, and time the moves with an on screen clock. The Baccarat Program gives you the choice of two styles of play. It will deal the cards and keep track of your bankroll. \$7.95. Order No. 0022P.

INSTANT SOFTWARE \$7.95

TRS-80
4K LEVEL I

Destroy All Subs
Bombers
Gunboats

In Destroy All Subs, you must track and hunt down three submarines. Evaluate sonar reports and fire your depth charges to get a kill. But watch out! Don't damage your ship by hitting a mine or being torpedoed, or you're sunk. Get all three subs and you can expect a hero's welcome. \$7.95 Order No. 0021R.

INSTANT SOFTWARE \$7.95

TRS-80
4K LEVEL I

Knight Quest
Robot Chase
Horse Race

Battle sea or mountain demons as you travel around the kingdom of Norsax, in your quest to gain the treasure and become a knight. You're surrounded by homicidal robots. In Robot Chase, while trapped in an electrified prison. To save yourself, you must lure the robots onto the walls of your prison. \$7.95. Order No. 0003R.

INSTANT SOFTWARE \$7.95

TRS-80
4K LEVEL I

Status of Homes
Auto Expenses

If you're a do-it-yourself builder with only one house or a contractor with an entire subdivision, you need the Status of Homes Program to help you keep track of all the expenses involved in the building of houses. The Automobile Expense Program will let you keep track of just how much it costs you to run your car or truck. \$7.95. Order No. 0021R.

MORE IN STOCK!

INSTANT SOFTWARE

TRS-80
4K LEVEL I
16K LEVEL II

Space Trek II

INSTANT SOFTWARE

TRS-80
4K LEVEL I
16K LEVEL II

Basic and Intermediate Lunar Lander

INSTANT SOFTWARE

TRS-80
4K LEVEL I
16K LEVEL II

Ham Package I

INSTANT SOFTWARE

TRS-80
4K LEVEL I
16K LEVEL II

Golf Cross-Out

INSTANT SOFTWARE

TRS-80
4K LEVEL I
16K LEVEL II

Air Flight Simulation

INSTANT SOFTWARE

PET
8K

Casino II
Crapé

INSTANT SOFTWARE

TRS-80
4K LEVEL I
16K LEVEL II

Electronics I

INSTANT SOFTWARE

PET
8K

Mortgage with Prepayment and Financier

Available at these Local Dealers*

CALIFORNIA

Amco Electronics Supply, Azusa
Byte Shop, Mountain View
Byte Shop, Citrus Heights
Byte Shop Computer Store, Walnut Creek
Computerland, Lawndale
Computerland of West LA, Inglewood
Hobby World Electronics, Northridge
Opamp Tech Books, Los Angeles

COLORADO

The Byte Shop, Colorado Springs

ENGLAND

L.D. Enterprises, Ilford, Essex

FLORIDA

AMF Electrical, Tampa
Computerland, Ft. Lauderdale
Dynamaton Enterprises, Ft. Lauderdale
Interstate Mktg. & Importing Co., Ft. Lauderdale

INDIANA

Home Computer Center (Digital Data Systems), Indianapolis

LOUISIANA

Computer Shoppe, Metairie

MARYLAND

Micro Center Inc., Annapolis

MICHIGAN

Computer Mart Inc., Royal Oak

MISSOURI

CDC Association, Florissant
Computer Country, Florissant

NEBRASKA

Omaha Computer, Omaha

NEW HAMPSHIRE

Computerland of Nashua, Nashua

NEW YORK

Computer Corner, White Plains
Computer Factory, New York

NORTH CAROLINA

Byte Shop of Raleigh, Raleigh
Dixie Computers, Inc., Chapel Hill

OHIO

Computer Stores of Toledo, Toledo
HeathKit Co., Columbus
Olson Electronics, Akron
21st Century Shop, Cincinnati

PENNSYLVANIA

Artco Electronics, Kingston
Artco Electronics, Shavertown
Personal Computer Corp., Frazer

TEXAS

Houston Microcomputer Tech., Bel Air
Interactive Computer, Houston
Learning Resources Center, San Marcos
Pan American Electrical Co., Mission

VIRGINIA

M. L. Gupta, Blacksburg

WASHINGTON

American Mercantile Co., Seattle
Personal Computer Inc., Spokane
Ye Old Computer Shop, Richland

WASHINGTON D.C.

Computer Cablevision

WEST VIRGINIA

The Computer Corner, Inc., Morgantown

WISCONSIN

Byte Shop of Milwaukee, Greenfield
Madison Computer Store, Madison

*To order direct call Toll Free 1-800-258-5473. Please have your credit card and mention Dept. 5-2

The Cosmac Connection: Part 2

— meeting Mr. Morse

Program your way to CW happiness.

Now you can reduce operator fatigue in that next CW contest by storing commonly used messages in your micro-computer, all ready to be sent automatically at the flick of a switch. Imagine relaxing in your arm-chair... you reach over to your computer, flick a switch, and out comes CQ FD CQ FD DE VE3CWY/3 K.

No answers? Flick the switch again for a repeat. You've got somebody. You casually call him with your hand key, W1XXX. Then push another button on the computer and presto! Out comes DE VE3CWY/3 QTH HR IS... You wait until it's finished. The code is the best you've ever heard. Now how much simpler could things get? Not

much, unless you also have an automatic Morse decoder, too! Of course, you don't have to be a contest operator to use this little gem. I use it now for many regular QSOS to put out the initial CQ and to send the first message, which, for most people, is simply a signal report, QTH, and operator's name.

Equipment Required

The Cosmac microcomputer constructed around the CDP1802CD CPU is used with 256 bytes of RAM of which 105 bytes are used for the main program, the rest being used for storage of the messages. Program timing assumes a clock frequency of 1 MHz, but it is easily adapted for other clock frequencies. Other hardware that you will need is shown in Fig. 1. This includes some ICs to interface the computer and hand key to the transmitter and a sidetone oscillator.

How the Program Works

The byte stored in M(0004) is selected initially by the operator from Table 1. This byte sets the length of a dot and hence sets the speed of the code. The program triples this to get a number that will represent the length of a dash; this is stored in R6.0. Four times the dot byte represents a word space, and this byte is

Speed (wpm)	5	7	10	13	16	20	25	30	35	40
Hex code	3F	2D	1F	17	13	0F	0C	0A	09	08

Table 1. Hex byte for code speed desired is entered in M(0004).

One-byte characters

A	22	N	21
B	41	O	37
B	41	O	37
C	45	P	46
D	31	Q	4B
E	10	R	32
F	44	S	30
G	33	T	11
H	40	U	34
I	20	V	48
J	4E	W	36
K	35	X	49
L	42	Y	4D
M	23	Z	43

Two-byte characters

1	50 1E	.	60 2A
2	50 1C	,	60 33
3	50 18	?	60 0C
4	50 10	/	50 09
5	50 00	double dash	50 11
6	50 01	end of message	50 0A
7	50 03	end of work	60 28
8	50 07	walt	50 02
9	50 0F		
0	50 1F		

word space	EE
stop	FF

Table 2. Hex codes for letters and punctuation.

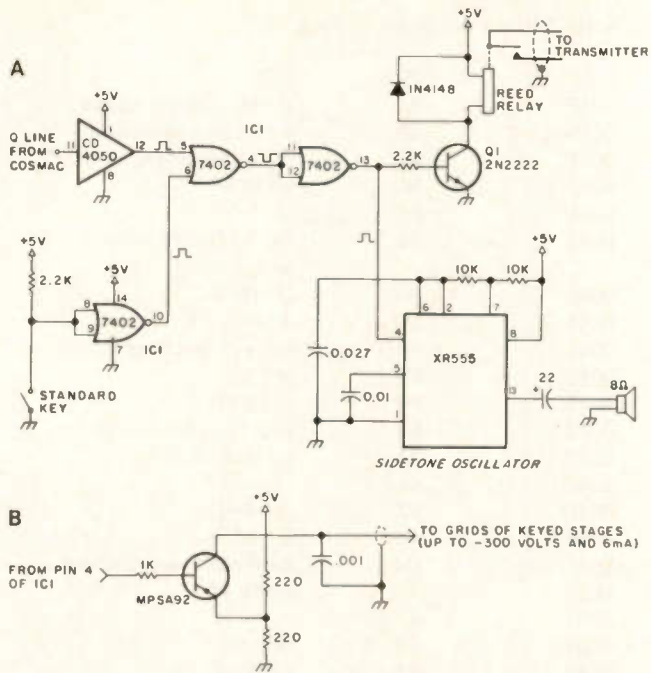

Fig. 1.(a) Interface between Cosmac and transmitter; (b) alternate circuit for rigs with grid-blocked keying eliminates relay and Q1.

stored in R7.0. Actually, this space gets added to the usual space of three dots that follows every letter so that the actual space between words is equal to seven dots. These bytes are later used to specify the length of a timed loop and thereby set the length of all the dots, dashes, and spaces.

The program fetches the first byte of the programmed message from M(0069). It is 45, which stands for the letter C, as you can see from Table 2. The first digit, 4, is the total number of dots and dashes in the letter. The second digit, 5, specifies the order in which the dots and dashes appear. Taking C as the example, — · — can be represented in binary form by 0101, where the 0 represents a dot and the 1 represents a dash. This is the binary code for the number 5. So byte 45 tells the computer the order of dots and dashes and the number of dots and dashes in the letter. To actually generate the code — · —, the number 0101 is stored in the D-register. D is shifted right giving 0010, and the 1 that

peels off the right end of the number tells the computer to send a dash first. D is shifted right again, giving 0001; this time, a 0 peels off the right end, producing a dot. A third shift gives 0000, pushing a 1 off the right end, thus making a dash. A fourth shift gives 0000, pushing a 0 off the right end; this makes the final dot. The computer stops shifting D now because the 4 in byte 45 tells it to make only 4 shifts. A letter space is then generated and the next byte is fetched from M(006A).

Since there are no letters that have more than 4 dots and dashes in total, the order of dots and dashes in any letter can be represented by four binary digits or one hex digit. The numbers, punctuation, and other special characters listed in Table 2 contain 5 or more dots and dashes. To handle each of these, two bytes are required; the first specifies the total number of dots and dashes, while the second specifies the order in which they occur.

The rest of the program is easy to follow from the

Fig. 2. Main program flowchart.

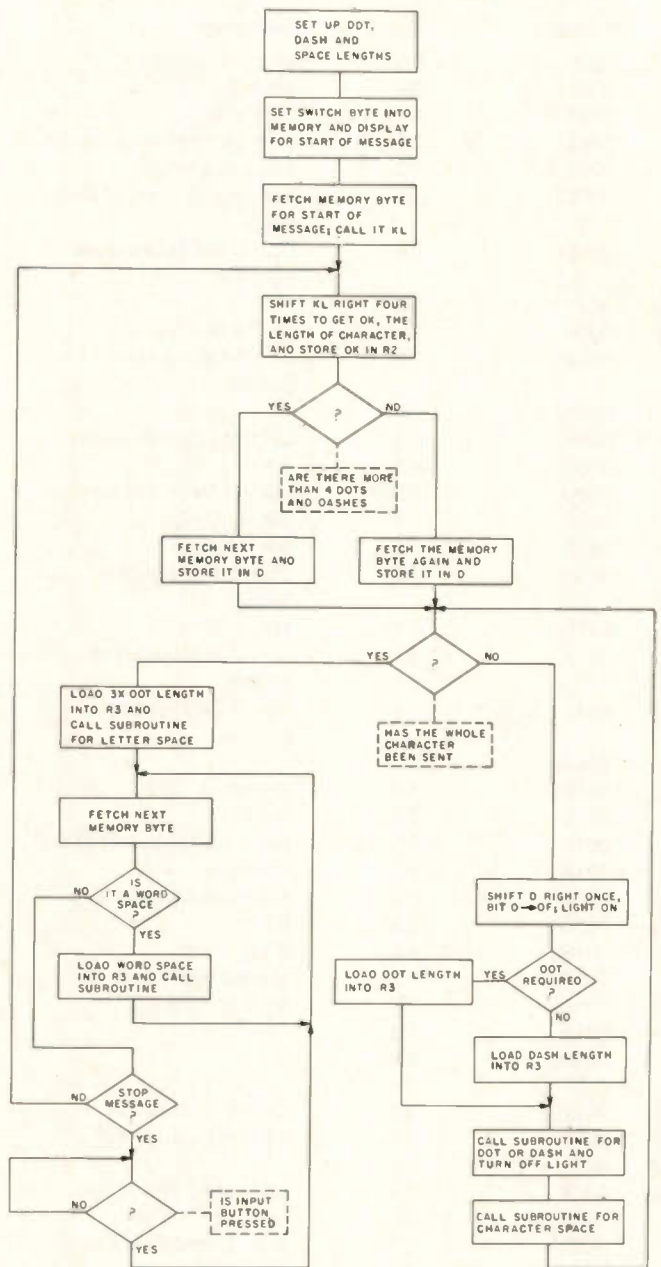

Subroutine flowchart

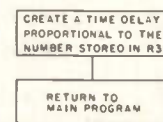

- R0—forms timed loop in subroutine, setting the speed of the code
- R1—main program counter
- R2—stores the total number of dots and dashes in the character being sent
- R3—stores length of dot, dash, or space for use in subroutine
- R4—subroutine counter
- R5—memory pointer for length of dot
- R6—stores dash length
- R7—stores word space length
- R8—stores address of the start of the recorded message
- R9—stores hex code for character being sent
- RA—memory pointer; points to M(0005)

Table 3. Register assignments.



Fig. 3. Program listing. Title: Programmable Morse code generator.

Address	Bytes	Comment	003E	25	R5-1
0000	F8	06→D set main	003F	A3	D→R3·0 make space
0001	06	program counter	0040	D4	4→P call subroutine
0002	A1	D→R1·0	0041	22	R2·1 decrement length
0003	D1	1→P go to main program	0042	30	go to 2B
0004	0D	store dot length	0043	2B	
0005		address of start of mes-	0044	86	R6·0→D load letter
		age			space
0006	F8	5C→D set subroutine	0045	A3	D→R3·0
		counter	0046	D4	4→P
0007	5C		0047	18	R8 + 1 fetch next byte
0008	A4	D→R4·0	0048	F0	MX→D
0009	F8	04→D set memory	0049	FF	D·EE→D
		pointer	004A	EE	test for word space
000A	04		004B	3A	go to 52 if D ≠ 00
000B	A5	D→R5·0 points to dot	004C	52	
000C	E5	5→X	004D	87	R7·0→D
000D	F0	MX→D fetch dot length	004E	A3	D→R3·0
000E	F4	MX + D→D	004F	D4	4→P make word space
000F	F4	MX + D→D	0050	30	go to 47
0010	A6	D→R6·0 store dash	0051	47	
		length	0052	F0	MX→D
0011	F4	MX + D→D	0053	FF	D·FF→D
0012	A7	D→R7·0 store word	0054	FF	test for end of message
		space	0055	3A	go to 1C if D ≠ 00
0013	F8	05→D set memory	0056	1C	
		pointer	0057	3F	go to 57 if EF4 = 0
0014	05		0058	57	wait
0015	AA	D→RA·0	0059	30	go to 47
0016	EA	A→X	005A	47	continue message
0017	6C	input switch byte→MX, D	005B	D1	1→P return to main
0018	A8	D→R8·0			program
0019	64	MX→display, RX + 1	005C	F8	4E→D start subroutine
001A	2A	RA-1	005D	4E	set speed
001B	E8	8→X	005E	A0	D→R0·0
001C	F0	MX→D fetch byte KL	005F	20	R0·1
001D	F6	shift D right			
001E	F6		0060	80	R0·0→D
001F	F6		0061	3A	go to 5F if D ≠ 00
0020	F6		0062	5F	
0021	A2	D→R2·0 store OK	0063	23	R3·1
0022	FD	04·D→D, carry→DF	0064	83	R3·0→D
0023	04		0065	3A	go to 5C if D ≠ 00
0024	3B	go to 28 if DF = 0	0066	5C	
0025	28		0067	30	go to 5B
0026	F0	MX→D fetch byte again	0068	5B	end of subroutine
0027	C8	long skip to 2A	0069	45	C recorded message
0028	18	R8 + 1	006A	4B	Q
0029	F0	MX→D fetch next byte	006B	EE	word space
002A	A9	D→R9·0 store character	006C	45	C
002B	82	R2·0→D OK→D	006D	4B	Q
002C	32	go to 44 if D = 00	006E	EE	word space
002D	44		006F	45	C
002E	89	R9·0→D	0070	4B	Q
002F	F6	shift D right, blt 0→DF	0071	EE	word space
0030	A9	D→R9·0	0072	31	D
0031	7B	1→Q start timed interval	0073	10	E
0032	3B	go to 38 if DF = 0	0074	EE	word space
0033	38		0075	48	V
0034	86	R6·0→D load dash	0076	10	E
0035	A3	D→R3·0	0077	50 }	3
0036	30	go to 3B	0078	18 }	
0037	3B		0079	45	C
0038	45	M5→D, R5 + 1 load dot	007A	36	W
0039	25	R5·1	007B	4D	Y
003A	A3	D→R3·0	007C	EE	word space
003B	D4	4→P call subroutine	007D	48	V
003C	7A	0→Q end of timed	007E	10	E
		interval	007F	50 }	3
003D	45	M5→D, R5 + 1	0080	18 }	

0081	45	C
0082	36	W
0083	4D	Y
0084	EE	word space
0085	35	K
0086	FF	stop
0087	33	G
0088	23	M
0089	EE	word space
008A	37	0
008B	23	M
008C	EE	word space
008D	50	} double dash
008E	11	
008F	EE	word space
0090	34	U
0091	32	R
0092	EE	word space
0093	32	R
0094	30	S
0095	11	T
0096	FF	stop
0097	40	H
0098	32	R
0099	EE	word space
009A	20	1
009B	21	N
009C		etc.

flowchart in Fig. 2. Two special bytes were set up. One is EE, which calls for a word space; the other is FF, which halts the program

until the input button connected to EF4 is depressed.

Using the Program

Select the code speed

desired from Table 1 and store this byte at M(0004). Table 1 was constructed assuming a clock frequency of 1 MHz. If your crystal is not 1 MHz, simply experiment a little with different hex bytes to get the different speeds. The code speed varies inversely with the size of byte.

After entering the main program, decide on the messages you want and select from Table 2 the bytes for each letter, number, or punctuation. Note that the numbers and punctuation require two bytes each. Terminate each message with FF so that the program will halt. To initiate one of the messages, enter the memory address of its first byte from the front panel of the computer using the toggle switches. Turn on the run switch. When the message terminates, you can make it carry on with the next

stored message by pressing the input button which is connected to EF4. This way, you can have pauses inserted in messages to allow you to enter a signal report or callsign manually.

Interface Circuitry

The circuits shown in Fig. 1 are just suggestive. They work for me, but you may have to adapt them to your own rig. One possible area of difficulty I have noticed is that of rf from the transmitter getting into the IC gates and playing havoc with them. The problem seems accentuated at 14 MHz and higher with my 180-Watt rig. Typically, after a few dots and dashes are sent, the transmitter comes on and stays on. The cure is to shield the IC circuits in a metal enclosure and bypass incoming and outgoing leads with 0.001 uF ceramic capacitors. ■

ANNOUNCING!

The 1979 Atlanta HamFestival and Georgia State ARRL Convention June 16-17, 1979

- GIANT covered Fleamarket/Swapshop!
- More than 50 Forums/Meetings!
- 15,000 sq. ft. Air Conditioned Exhibit Hall
- Parking for thousands of cars!
- 140 Major Exhibits!
- Special MICROPROCESSOR Section!
- Programs for Ladies & Children!
- Activities Galore!

The Best Hamfest in the World!

FOR EXHIBITOR INFORMATION WRITE: BOX 27553, ATLANTA, GA. 30327

Learning the Code

— a better way

Let your micro be your guide.

*George Waldie
26 1/2 S. Main St.
Mt Gilead OH 43338*

To get my ham license in 1949, I had to produce one minute of perfect copy at 13 wpm. A full year's striving to reach this goal resulted in a set of conditioned reflexes by which the code sounds entered my ears and came out my fingers as written text, after which the message was interpreted by my eyes. This roundabout process caused habits which have ever since inhibited both my skill and enjoyment where CW is concerned. The inclusion of my handwriting in the process was particularly unfortunate since, under pressure, my writing tends to become rather spastic. The process inhibits the ability to "copy behind" and to "copy in the head."

I needed a method of creating a new set of reactions which would generate mental images from the

code sounds. Many ideas came to mind, but none provided a simple method of coordinating audio and visual presentations of characters, together with flexibility, without complicated special-purpose equipment.

Then, a couple of months ago, we added an audio alarm to our office minicomputer. This alarm gives a single 960 Hz beep in response to PRINT HEX(07). It is used to signal the operator when the machine needs attention for any reason foreseen in the program. Once I found that the duration of the tone could be controlled by changing the number of iterations in a loop containing this statement, it was inevitable that I would program a code teaching machine.

I have written this article hoping that others with similar CW problems, or those conducting code classes, will find the system useful and will let me know how they fare.

The program contains a few wrinkles which may prove interesting to persons concerned primarily with programming methods.

Practice material can be stored in data statements in the program or, with simple changes, in external files. The program accommodates a full range of numerals, punctuation, and upper and lower case alphabetic character material. As the text is scanned, each character is converted into its audible CW equivalent and, an instant later, appears on the CRT as an addition to the string of previously sent characters.

The code element speed and the element and character spacings are adjustable, as well as the delay of the CRT display of the character. There are a number of apparent advantages to this system. A student working solo with this program need never try to memorize the code from any printed representation,

either in dots, dashes, or didahs. All that is stored in the program. The code sound is emitted, and then the letter appears on the screen to reinforce the character recognition. For code classes, practice material can be selected from any source and stored for later use. The instructor can input text to his machine and then recall it as CW at any speed appropriate to class needs. My equipment will store 80,000 characters on a cassette, some 16,000 words, or 64 typed pages of text. Such material can be used over and over at any desired speed.

Characters are handled in a computer as binary numbers which have decimal, octal, and hexadecimal equivalents. In developing this program, it was necessary only to consider the ASCII decimal equivalents of the various CW characters. Fortunately, and possibly not coincidentally, the characters used in CW transmissions

are represented by ASCII decimal numbers lying in the range 40 to 90. A table of these characters is shown in Fig. 1, together with the string symbols used to control the audio output. Lowercase letters are represented by ASCII decimals 97 to 122. A few characters — the star, semicolon, "less than" and "greater than" symbols, and the @ sign — have no international Morse symbols that I could find, so provision is made to skip these characters when encountered.

The equipment required to use this program is a small computer programmable in BASIC with STRING functions, a CRT display, and an audible tone alarm. The version of the program given here, which includes several lines of practice text, runs in about 2350 bytes.

My machine is a Wang WCS10T, which includes the CRT, cassette drive, and keyboard in a single console with an outboard CPU. The BASIC compiler is hard-wired, so I do not have access to the machine language. Wang BASIC is an augmented subset of general BASIC, and only those features special to STRING manipulation and character identification have been used. If your BASIC lacks any of these features, but you can write machine language functions, you should be able to run a version of this program. Notes relating to conversion of the program to other dialects are located at the end of the article.

The program can be followed readily from the listing of Fig. 2. A word is in order about this listing. The program was originally written and debugged using one statement per line. When operation was satisfactory, the program was "compressed" by removing REMs and combining as

ASCII No.	Character	Code Symbol	78	N	10
40	(101101	80	P	0110
41)	010010	81	Q	1101
42	.	2	82	R	010
43	+	01010	83	S	000
44	,	110011	84	T	1
45	-	100001	85	U	001
46	.	00200200	86	V	0001
47	/	10010	87	W	011
48	0	11111	88	X	1001
49	1	01111	89	Y	1011
50	2	00111	90	Z	1100
51	3	00011	97	a	01
52	4	00001	98	b	1000
53	5	00000	99	c	1010
54	6	10000	100	d	100
55	7	11000	101	e	0
56	8	11100	102	f	0010
57	9	11110	103	g	110
58	:	111000	104	h	0000
59	;	2	105	i	00
60	[2	106	j	0111
61	=	10001	107	k	101
62]	2	108	l	0100
63	?	001100	109	m	11
64	@	2	110	n	10
65	A	01	111	o	111
66	B	1000	112	p	0110
67	C	1010	113	q	1101
68	D	100	114	r	010
69	E	0	115	s	000
70	F	0010	116	t	1
71	G	110	117	u	001
72	H	0000	118	v	0001
73	I	00	119	w	011
74	J	0111	120	x	1001
75	K	101	121	y	1011
76	L	0100	122	z	1100
77	M	11			

Fig. 1. ASCII decimal codes, characters, and CW sound codes.

many statements as possible on each line. This saves a sensible amount of core and results in an almost unreadable LIST. To get the listing given here, the compressed program was processed by a utility which prints one statement per line and indents FOR/NEXT loops. The line numbers went unchanged throughout, except for deletions, accounting for the peculiar sequence shown here.

Now for program operation: At LN 30, the variables are dimensioned as necessary. C\$(52)8 provides for a list of 52 code symbols, each 8 characters or less.

M\$64 sets up a string variable containing up to 64 characters to receive text lines.

T(4) is a list of the speed control numbers.

T\$(4) is a string list to receive speed prompts. In this BASIC string, variables with no specified length take a default of 16 characters. So the prompts can be up to 16 characters in length.

A\$1 sets up a single character variable.

At LN 80, a loop READs the speed data prompts from DATA into list T\$(). Then another loop READs the code symbol strings into 52-element list C\$(). At LN 170, a third loop displays each of the prompts on the screen. An "edit" routine follows, providing for inputting the necessary control numbers. This method of data INPUT is one I use rather routinely,

but it is not essential to the program. The Wang INPUT statement allows the inclusion of the prompt message in the statement. If you lack this feature, you should use a PRINT statement "CHANGE ITEM #" preceding INPUT. Each INPUT of a value causes a loop back to LN 170 where PRINT HEX(03) blanks the screen and prints a new data display from the top. When the necessary controls have been entered, "0" used as an answer to "CHANGE ITEM?" will exit the edit routine.

The change of variables at LN320 may seem unnecessary. My computer has a HALT/STEP key which will interrupt program operation at any time and permit the program to

be restarted after changing the value of a variable. Use of the unsubscripted variables makes the value changing a mite simpler during an interrupted RUN.

The next statements blank the screen, set the DATA pointer to the beginning of the practice text, and move the cursor to the center of the screen, respectively. HEX(OA) is a line feed.

At LN 410, the next text line is READ and tested. If the DATA is not "*****", the program continues, otherwise the DATA system is reset and the program repeats from LN 410. If your BASIC does not have the ability to RESTORE to a particular DATA item, you

will have to program an alternative at this point. This version of the program assumes the practice text is stored in DATA statements. Changes at this READ routine will permit the text to be taken from some other storage medium.

LN 490 counts the characters in text line M\$, and the program enters a loop to process the line one character at a time. The next character is stored in A\$, and the ASCII decimal value of A\$ is put in A.

The following IF statements provide a means for accepting a variable only if it has a value between certain

limits. Letting U, L be the upper and lower limits, respectively, the comparison statement is set up as:

```
ABS(A - (U + L)/2).LE.(U - L)
and will reject any value outside the limits.
```

The first comparison rejects A unless it has a value between 40 and 90, which includes characters from "(" to "Z". Any value outside this range is tested again at LN 490. Values from 97 to 122 represent lowercase letters and are shifted to uppercase at LN 640. Any other value of A results in a blank being printed on the screen, and no code sound is gener-

ated. If your machine does not have lowercase, you can simplify the program by removing the second test of A.

A anomaly of the program as written is that a lowercase letter is interpreted so as to produce the same code sound as an uppercase, but the lowercase character is added to the screen. Of course, this presents no difficulty.

At LN 660, A is shifted in value to serve as the subscript for array C\$(), and the coding for the corresponding CW sounds is stored in C\$.

There follows the loop to process the code symbols. There are other ways of analyzing the symbol

Fig. 2. BASIC program listing.

10	REM DIDAH1.2 GW FEB 04, 1978	
20	REM GEORGE WALDIE 26½ S.MAIN, MT. GILEAD, OHIO 43338	
30	DIM C\$(52)8,M\$64,T(4),T\$(4),A\$1	
80	FOR J = 1 TO 4	
	READ T\$(J)	Read speed prompts
	NEXT J	
	FOR J = 1 TO 52	
	READ C\$(J)	Read code symbols
	NEXT J	
170	PRINT HEX(03)	
	FOR J = 1 TO 4	
	PRINT J;T\$(J);TAB(15);T(J)	Display control data
	NEXT J	
	PRINT	
	Q = 0	
	INPUT "CHANGE ITEM #",Q	Edit control data
	IF Q = 0 THEN 320	Exit edit routine
	INPUT "CHANGE TO",T(Q)	
	GOTO 170	
320	T1 = T(1)	
	T2 = T(2)	
	T3 = T(3)	
	T4 = T(4)	
	PRINT HEX(03)	Clear screen—home cursor
	RESTORE 57	Reset data
	PRINT HEX(030A0A0A0A0A0A0A)	Center display
410	READ M\$	Read data line
	IF STR(M\$, 1, 3) <> "*****" THEN 490	Test for end
	RESTORE 57	
	GOTO 410	Repeat
490	M = LEN(M\$)	Length of data string
	FOR J = 1 TO M	
	A\$ = STR(M\$, J, 1)	Next character
	A = VAL(A\$)	
	IF ABS(A - 65) < 25 THEN 660	Test for uppercase
	IF ABS(A - 109.5) <= 12.5 THEN 640	Test for lowercase
	A\$ = ""	
	GOTO 940	
640	A = A - 32	Shift from lowercase
660	C\$ = C\$(A - 38)	
	FOR I = 1 TO LEN(C\$)	
	CONVERT STR(C\$, I, 1) TO C	
	ON C + 1 GOTO 790, 840	

strings, but the method shown suits my equipment and is efficient. The next character in the symbol string is CONVERTed to a numeric which then controls the branching. Any value of C but 0 or 1 generates a blank.

In the DATA statements for the character codes, you will notice the appearance of "2"s in several places. In most cases, these mark characters for which no CW code combinations were found. However, the CW period does include internal spaces which require this "2".

The "normal" branches to LN 790 and 840 go, respectively, to generators for dits and dahs. These are identical loops, except that

the dah loop has twelve times as many iterations as the dit loop. If you are puzzled because you understand that a dah should be only three times as long as a dit, remember that the speed of the CPU enters here. In fact, you may have to adjust these loops to make the output sound right. The twelve multiplier was arrived at experimentally.

Both the dit and dah loops exit to 880, the intracharacter space loop. This is simply a "do nothing" loop to use up time. Again, you can change the multiplier to suit your taste (ear?). Notice that both dit and dah loops are controlled by T1, and the intracharacter loop by T2. At 940, B\$ is

a shift register to maintain, on the screen, the last 16 characters sent. In Wang BASIC, string variables are 16 characters long unless otherwise dimensioned. You must use whatever string length specification is required by your language. LN 940 moves the last 15 characters of B\$ to the first 15 positions, leaving a space at the tail of the string for the next character, which is added in the next statement.

Another loop delays the display of the shift register. In this case, a meaningless arithmetic operation is included to provide the delay with fewer loop iterations. In the initial learning stages, this delay can allow "capture" time for CW character recognition. The

delay can be reduced as the recognition time decreases.

Remember that, when a FOR/NEXT loop is encountered, it is exercised once even though zero iterations are called for. So, in this case, there will be a delay of the screen display equal to one iteration of the loop even if T4 is zero. This is the reason for the inclusion of the arithmetic operation within the loop. This seems to work well at CW speeds up to about 20 wpm, but this loop is a factor limiting maximum speed, since it does work once for every character. This is a point to look at when you try for maximum possible code speed.

After the shift register B\$ is printed, there is a space

```

      IF I<>1 THEN 880
      A$ = ""
      GOTO 880
790   FOR T = 1 TO T1
      PRINT HEX(07);
      NEXT T
      GOTO 880
840   FOR T = 1 TO 12*T1
      PRINT HEX(07);
      NEXT T
880   FOR T = 1 TO 9*T2
      T = T
      NEXT T
      NEXT I
940   STR(B$,1,15) = STR(B$,2,15)
      STR(B$,16,1) = A$
      FOR T = 1 TO 4
      T = SQR(T*T)
      NEXT T
      PRINT HEX(0C);TAB(20);STR(B$,1)
      FOR T = 1 TO 4*T3
      T = T
      NEXT T
      NEXT J
      GOTO 410
1120  DATA "CHAR. SPEED","LTR.SPACE","WORD SPACE","PRINT DELAY"
1180  DATA "011110","101101","010010","2","01010","110011"
1190  DATA "100001","00200200","10010","11111","01111","00111"
1200  DATA "00011","00001","00000","10000","11000","11100","11110"
1210  DATA "111000","2","2","10001","2","001100","2","01","1000"
1220  DATA "1010","100","0","0010","110","0000","00","0111","101"
1230  DATA "0100","11","10","111","0110","1101","010","000","1"
1240  DATA "001","0001","011","1001","1011","1100"
1290  DATA " THIS IS A PROGRAM TO TEACH THE INTERNATIONAL MORSE"
1300  DATA " CODE."
1302  DATA " A B C D E F G H I J K L M N O P Q R S T U V W X Y Z"
1304  DATA " 1 2 3 4 5 6 7 8 9 0"
1306  DATA " () * + - . / 0 1 2 3 4 5 6 7 8 9 ; : [ = ] ? @ a b c d e f g h i j k l m n o p q r s t u v w x y z"
1310  DATA " THE QUICK BROWN FOX JUMPED OVER THE LAZY DOG"
1350  DATA "*****"

1360  REM Compressed approx program length—1620 bytes
1370  END

```

Generate dit

Generate dah

Intraelement space

Register shift

Print delay

Print register

Space

Speed prompts

Code symbols

Practice text

between characters generated by the delay loop controlled by T3, after which the program goes back for the next text character and repeats the process just described until the entire text string has been used. It then proceeds to the next string of text data.

There is another possible anomaly you should be aware of. Some BASICs include trailing spaces in text strings; others do not. If your version of the language crops trailing spaces from the strings, as mine does, you will have to add a leading blank to each text line, or the last word of each string will run into the first word of the next string without a separating space. Notice the space I have included after the leading quote in each line of the DATA statements at LN 1290 to 1330.

This program illustrates very nicely how a general-purpose computer can

serve a very specialized purpose merely by software implementation.

Conversion Notes

The manual for Ohio Scientific, Inc., 6502 8K BASIC states that this dialect will run, without change, programs written for ALTAIR, IMSAI, and SWTP machines and, with slight changes, programs for PDP-8, PDP-11, and NOVA BASICs. The following notes have been prepared using this information. I regret that I have not been able to test the effects of these suggestions.

LN 30 — In Wang BASIC, the DIM statement is used to set the sizes of lists and arrays and also the number of bytes reserved for string variables. Thus C\$ is defined as a list of 52 elements of 8 or less characters. There is a default length of 16 characters. This specification appears to be unique

to the Wang system.

LN 170 — When the system is turned on, output is selected to the CRT. Alternate outputs can be selected, but are not pertinent to this program.

LN 170 and LN 320 — PRINT HEX(03) clears the screen and homes the cursor to the upper left corner of the screen — corresponds to TTY keyboard CTRL C.

LN 790 and LN 840 — PRINT HEX(07) keys the audio tone — corresponds to TTY keyboard CTRL G.

LN 940 — Each 0A in PRINT HEX(0A) issues a line feed — corresponds to TTY keyboard CTRL J. PRINT HEX(0C) moves the cursor up one line.

LN 320 and LN 410 — RESTORE 57 resets the DATA pointer to the 57th item of data, beginning of sample text. OSI BASIC does not offer this feature. Some other BASICs allow RESTORE to a particular DATA line number.

LN 410, LN 490, LN 660 and LN 940 — STR(M\$,1,3) refers to string M\$, starting with the 1st character, and including 3 characters, to create a substring of M\$. OSI uses MID\$(M\$,1,3) with same meaning.

LN 490 and LN 660 — LEN(M\$) returns the number of characters in M\$. OSI uses same function.

LN 490 — VAL(A\$) returns ASCII decimal value of 1st character of A\$. OSI uses ASC(A\$).

LN 660 — CONVERT STR(C\$,I1) to C sets to the numeric value of numeral(s) in string variable — corresponds to OSI CHR(MID(C\$,I,1)).

The relation operator .LE. is not accepted by my equipment, but is used here because my output writer does not have the usual left arrowhead on its type ball. The operator stands for "less than or equal to." ■

**There's only
one bad thing
about a
Kenwood
from G.I.S.M.O.
She'll hate it.**



Your poor wife. Now that G.I.S.M.O.'s handling Kenwood, it's only a matter of time until you own a TS-520S with DG-5 digital frequency readout, or one of Kenwood's other impeccable products. The TS-520S is the result of Kenwood expertise and your improvement suggestions. The DG-5 option gives you crystal clear, dead accurate readout while sending and receiving.

Only problem is your lady's going to see a lot less of you when you get hooked on Kenwood quality.

We've got the entire Kenwood line. For a free, instant quote (mail's too slow), call the toll free number below.

G.I.S.M.O. 1-800-845-6183

In S.C. call 1-366-7157
2305 Cherry Road, Rock Hill, S.C.
29730 (Exit 66-B off I-77)

YAESU ANNOUNCES THEIR SENSATIONAL COMPUTER AGE CPU-2500R/K 2-METER 25 WATT TRANSCEIVER

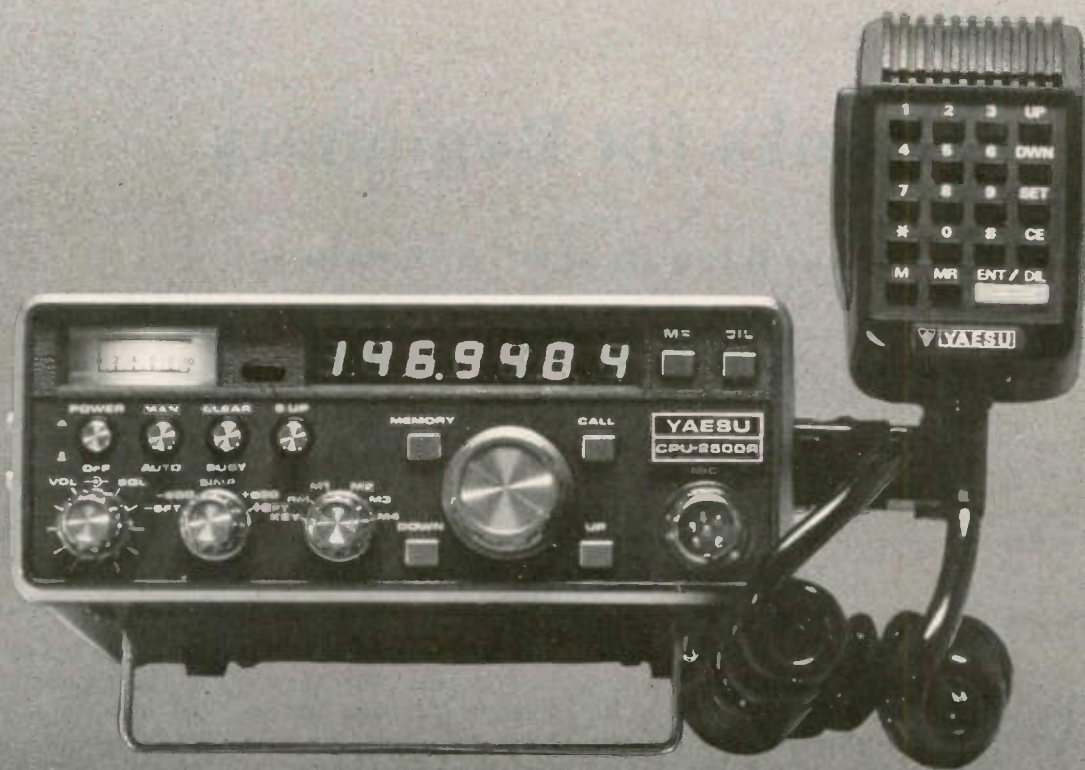

Again, Yaesu, THE RADIO, takes a giant step forward with their computer age 4-bit Central Processor Unit controlling the Phase Locked Loop. It allows selection of 800 PLL channels with touch button station selection built into the optional keyboard mike . . . **PLUS** automatic scan, up or down across the entire 2 meter band . . . **PLUS** four memory channels . . . **PLUS** optional tone squelch encoding . . . **PLUS** tone burst . . . **PLUS** high SWR and reverse voltage polarity protection . . . **PLUS** 3/25 watts of power . . . **PLUS** fixed ± 600 KHz offsets . . . **PLUS** programmable offsets . . . **PLUS** tone pad microphone option . . . **PLUS** bright 3/8" LED six digit frequency display and another LED for memory display . . . and much more.

The CPU-2500R/K is a space age radio for discriminating amateurs utilizing the latest solid state techniques and it's on your dealer's shelf today!

Price And Specifications Subject To
Change Without Notice or Obligation



YAESU *The radio.*

YAESU ELECTRONICS CORP., 15954 Downey Ave., Paramount, CA 90723 • (213) 633-4007
YAESU ELECTRONICS Eastern Service Ctr., 9812 Princeton-Glendale Rd., Cincinnati, OH 45246



Books for Beginners

— you have to start somewhere!

The Joy of Computing comes home.

Rod Hallen WA7NEV
Road Runner Ranch
PO Box 73
Tombstone AZ 85638

Programming a Microcomputer
—6502, Caxton C. Foster,
Addison-Wesley Publishing
Co., Reading MA 01867, 230
pages, 6" x 9" softcover, \$9.95.

The Little Book of BASIC Style,
John M. Nevison, Addison-
Wesley Publishing Co.,
Reading MA 01867, 150 pages,
6" x 9" softcover, \$5.95.

Although the instruction contained in *Programming a Microcomputer* —6502 pertains in a general way to any 6502 machine, it is based specifically on the KIM-1. In fact, for best utilization of this book, a KIM-1 should sit at the reader's fingertips. This would also make an excellent classroom text as long as one or more KIMs were available to the students.

An advertising flyer

states that this book is also usable with the PET, but since the PET is hard to program in assembly language as yet, this hinges on Commodore providing more information about how to operate the PET.

One unusual aspect of the book is a complete lack of mention of the 6502 except in the title and in the appendix, which lists op codes and addressing modes. All 6502 attributes are indicated as if they were KIM-1's exclusive features. To quote, "... the inventors of the KIM-1 provided a form of addressing that circumvents the problem. It is called 'immediate addressing.'" The inventors of the KIM-1 and the MCS6502 are indeed one and the same, but emphasis should be placed on the fact that we are really talking about the KIM-1.

As the result of a coincidence, I became the happy owner of a KIM two days before I received these books. I am an 8080-Z-80

programmer and the 6502 instruction set was a foreign language to me. From that point of view, I'm a beginner, I guess.

Chapter one is a discussion of how the instruction set is used and chapter two takes you step by step through the operation of the KIM-1. Both are well done, but the true neophyte would do well to go very slowly in chapter one. At one point in chapter two, the author failed to tell the student (me!) to restore the program counter after a STOP and before a GO, which means that the following steps didn't work.

Chapters three to thirteen comprise a group of experiments. A problem is presented and instruction on methods is given. The student then writes a program to gain the desired results and attempts to run it. The author's reasoning and solution to each problem are covered in an appendix. Extensive debug-

ging help is also given.

The experiments included involve a Morse-code oscillator, a piano keyboard, a combination lock, a tune player, a digital clock, and many more. In each case, whatever hardware is needed (very little) is fully explained. The chapters that I found most interesting concerned an interpreter and an assembler for a "Dream Machine." The "Dream Machine" is a pseudo-sixteen-bit processor whose instruction set is interpreted by a KIM program. While the instruction set is limited by the amount of KIM memory available, it is an informative and effective means of examining the operation of any instruction on any processor.

The appendices contain sections on binary math, KIM routines, 6502 op codes and addressing modes, and solutions to the programming problems contained in the text. These solutions are written

in assembly language and the student will have to reduce them to machine code in order to run them.

I would hesitate to recommend this book to the complete novice unless he has access to a KIM-1. However, by combining the information contained in the three manuals that come with the KIM-1 with *Programming a Microcomputer—6502*, I feel that I have become an effective 6502 programmer.

The Little Book of BASIC Style wasn't what I thought it would be. Rather than attempting to teach you how to program in BASIC, it is concerned with writing programs so that they can be more easily read by the user.

Nevison contends that programs that are readable are better programs and that they will run the first time with fewer problems. Twenty rules are presented and woven into a discus-

sion which advocates clear structured programs. Many of these rules make good sense, but some are difficult to put into practice.

Variable spacing within a line to make it easier to read won't work if your BASIC interpreter (like mine) eliminates all excess spaces. Using a blank line to separate blocks of code is also a good idea, but it is another no-no for my BASIC.

The author calls for more comments within the body of a program to make for better understanding. One of his programs contains more lines devoted to remarks than it does operational statements. If you are like most computer hobbyists, you don't have the excess memory that all of those remarks take. I like well-commented programs, but I usually strip off the remarks at entry time. But that doesn't mean that you

shouldn't use remarks while writing programs. They will clarify to you and anyone else who uses them what is intended.

Each of the rules is presented with one or more examples. Both good and bad methods are shown side by side so that it is easy to see the advantages of style. Many of the rules, such as matching the variable to its meaning—V = Value, I = interest, etc.—and labeling constants, make very good sense. Have you ever attempted to read a poorly-commented program and tried to figure out what purpose each variable and constant served?

After a discussion of the rules of style, some practical examples are given: sorting, craps, plotting, bar graphs, dealing a deck of cards, and more. And then comes the biggest program of all—STYLIST. STYLIST is designed to style your programs for you. While it

is a huge program meant to do a task that the programmer should be doing for himself, it does present itself as an example of how to structure a program correctly.

After studying *The Little Book of BASIC Style*, take one of the better programs that you have written and rewrite it according to Nevison's twenty rules. You'll be surprised at how much more readable it is, and six months from now, you'll still be able to figure out how it works without having to rewrite it again.

Addison-Wesley publishes many other computer titles and their 100-page *Business and Computer Science Catalog* should be in every computerist's library. I have just read an advance flyer on the third volume in *The Joy of Computing* series, *BASIC and the Personal Computer*, and I am looking forward to its publication. ■

NEW MFJ *DELUXE* Versa Tuner II

\$119.95 buys you one of the world's finest 300 watt antenna tuners with features that only MFJ offers, like . . . dummy load, SWR, forward, reflected power meter, antenna switch, balun. Matches everything from 1.8 thru 30 MHz: coax, random wires, balanced lines.



MFJ's Best Versa Tuner II . . .
Solid American Quality

\$119⁹⁵

BRAND
NEW

This is MFJ's best Versa Tuner II. And one of the world's finest 300 watt (RF output) tuners.

The MFJ-949 *Deluxe Versa Tuner II* gives you a combination of quality, performance, and features that others can't touch at this price . . . or any price.

PERFORMANCE: You can run your full transmitter power output — up to 300 watts RF output — and match your transmitter to any feedline from 1.8 thru 30 MHz whether you have coax, balanced line or random wire.

FEATURES: A 200 watt 50 ohm dummy load lets you tune up for maximum performance.

A sensitive meter lets you read SWR with only 5 watts and both forward and reflected power in two ranges (300 and 30 watts).

A flexible antenna switch lets you select 2 coax lines direct or thru tuner, random wire or balanced line and dummy load.

A large efficient airwound inductor 3 inches in diameter gives you plenty of matching range and less losses for more watts out.

1:4 balun. 1000 volt capacitors. SO-239 coax connectors. Binding post for balanced line, random wire, ground. 10x3x7 inches.

QUALITY: Every single unit is tested for performance and inspected for quality. Solid American construction, quality components.

The MFJ-949 carries a full one year unconditional guarantee.

Order from MFJ and try it — no obligation. If not delighted, return it within 30 days for a re-

fund (less shipping).

To order, simply call us toll free 800-647-1800 and charge it on your VISA or Master Charge or mail us a check or money order for \$119.95 plus \$3.00 for shipping/handling.

Don't wait any longer to tune out that SWR and enjoy solid QSO's. Order your *Deluxe Versa Tuner II* at no obligation, today. ✓ M52

MFJ ENTERPRISES, INC.

P. O. BOX 494

MISSISSIPPI STATE, MS 39762

CALL TOLL FREE . . . 800-647-1800

For technical information, order/repair status, in Miss., outside continental USA, call 601-323-5869.

The 2 Meter ECM Caper

—James Bond, move over!

Snake-Oil gets shut down.

*Byron H. Kretzman W2JTP
431 Woodbury Road
Huntington NY 11743*

The "Conditional," or Class C, license began many years ago when regular licenses were Class A and Class B. Honest in original intent, the Class C license was supposed to encourage ham radio for the handicapped and others who lived more than 75 miles from an examination point and couldn't make the expensive and time-consuming trip to an FCC office. Later, the distance limit became 175

miles. General Class privileges were available to the Conditional Class, which replaced the old Class C. All that was needed was for someone to swear that 13 wpm could be copied and, as for the Technician Class, to "supervise" the mail-order technical exam.

Because the change from 75 to 175 miles was made not too many years ago, a fair number of phony Conditionals exist, many of whom "bought" their licenses for cash or favors from some radio amateur without ethics. Phony Technicians exist, too, but we won't go into that since this is the story

of what happened to a certain phony Conditional. Two meter FM seems to attract these people, for some reason which escapes me.

The story is fascinating. I wouldn't believe it if it were told to me. I'll change a few names to protect the guilty. Even so, I'll bet a dime it reminds you of somebody on FM you know.

It all started when my old friend John came over one night to chew the rag about the DX he works and the DX I used to work. John is an electronics engineer at the local electronic countermeasures (ECM) factory, but he gets his

kicks out of working DX on CW. Like me, he uses 146.94 to keep in touch with his local ham friends. We were discussing VR6AY on Pitcairn Island when the .94 receiver opened up to interrupt us. There was Snake-Oil, sounding off like an expert to his phony Technician friends. John says, "Let's have some fun," taking my code practice oscillator off the shelf and standing it in front of the microphone. As soon as Snake-Oil stands by, John gives him a one-by-one call on the straight key at a brisk 10 wpm. Snake-Oil comes back, not to John, but to one of his friends, saying "Hey, the band is

really open tonight! Just heard the code ID of the repeater upstate!" John looked at me, reached for my *Callbook* and quickly thumbed through it. Finding Snake-Oil's call, he says, "Just as I thought!" and points to the "C". To prove the point, John broke in again with the CPO, sending only Snake-Oil's call, but three times, at about 5 wpm. No answer. Snake-Oil couldn't even recognize his own call!

As time went on, Snake-Oil more and more incurred the wrath of John and other old-timers by setting up a .34/.94 repeater, but his popularity as the local FM "expert" grew as the number of appliance operators grew. Within about six months, .94 became almost useless for a simplex channel. I told John it was impossible to fight this, but he answered, "Don't you ever watch 'Mission Impossible' on TV?" I thought he was kidding.

As I worked around the shack now, .94 never seemed to shut up. It was alive with talk about the coming Division convention. Snake-Oil was on the program and would demonstrate his FM repeater with its vast satellite receiver system which enabled anyone with a hand-held rice box to use the repeater from anywhere in the county. (Snake-Oil was a really busy fellow.) As I said, there wasn't much simplex activity on .94 anymore, and the old-timer didn't like standing in line to use the repeater while all those rice-box mobiles were telling each other what exit they just passed on the expressway. The local intercom feature of .94 seemed to be giving way to "progress."

One Sunday morning, while driving down a street near Snake-Oil's house, I

noticed a cable-TV truck parked by a telephone pole about a block away. I caught a quick glimpse of a guy in coveralls and a hard hat. There was something familiar about the guy, but I couldn't put my finger on it. On the way home that afternoon, I saw the cable-TV truck in another part of town. This time I took a real close look at the guy in coveralls. The bell rang—it was John, but with a mustache??? The next Sunday I saw him again in another part of town. What the hell was going on? John is a well-paid engineer. He wouldn't be moonlighting as a pole jockey for a cable-TV outfit, would he? And, how come on Sunday? Was this a gag?

The more I thought about it, the more curious I got. Finally, I couldn't stand it any longer. I called up John, who had been "too busy" lately to come over to chew the rag about DX, and insisted upon going over to see him that night. John was in his basement, at his workbench, apparently breadboarding a bunch of transistors and ICs. This struck me as strange, too. John wouldn't be doing any homework for his job, as his work was highly classified, and John's ham interest was operating—working DX.

I let him have it with both barrels. We were old enough friends, I told him. He could darn well let me know what was going on, as I had a strong feeling that it had something to do with ham radio.

John swore me to secrecy, and then proceeded to unfold the wildest, most complex scheme imaginable, a scheme designed to completely foul up Snake-Oil's coming Division convention demonstration of his repeater system. Pulling out a drawer of his workbench, John showed me a small collection of plastic pill bottles, each with a

very short, stiff wire coming out the top and a longer, flexible wire coming out the bottom. Then John took down from a shelf above his workbench a small black box, also with a short stiff wire on its top. The box had several push-button switches, one of which was labeled, "destruct." This switch had a safety cover which had to be flipped up and held up before the switch could be actuated.

As John explained it, each pillbox was a transponder which would generate white noise, upon command, across the entire 2 meter band. John demonstrated it on his .94 receiver. The noise compensated squelch of the FM receiver would simply cut off the audio in the presence of the white noise, which also covered any signal. Of course, the small size of the transponder made its range very short—hence John's crazy scheme of planting one on top of a convenient telephone pole (so it wouldn't be noticed from the ground) close to each one of Snake-Oil's satellite receivers. This he did by borrowing the cable-TV truck from another friend and using it on Sundays to climb the poles himself. The truck was as common a sight in this county as a telephone company truck.

"What's with the 'destruct' switch?" I asked John, having the distinct feeling that this was no gag either. Obviously, John was utilizing considerable know-how from his job at the ECM factory.

"Well," John replied, "with all these transponders out, sooner or later one would be discovered, and it wouldn't take the FBI long to trace it to me."

At this point, John took one of the miniature transponders and set it up on top of a stick stuck into the ground in the middle of his

backyard. "Watch!" John manipulated the buttons on his black box and the transponder went "pooff!" A bright flash, a small wisp of white smoke, and the transponder was gone! John said, "Don't worry, I've got plenty more of them!"

"What happened?" I asked.

"Thermite," John answered. "A small amount, in the bottom of each pill bottle."

I went home shaking my head. This whole crazy scheme (were all ECM engineers this crazy?) seemed to be an awful lot of trouble just to foul up Snake-Oil. I could think of lots of ways to foul him up, more simple ways, but they all involved long jail sentences for the violence required.

Two days before the convention, John called me up and told me that all was ready. All the transponders were planted, one near every one of Snake-Oil's satellite receivers, all over the county. The black box was mounted in John's car, ready for the operation and then the "destruct" trips around the county.

The night before the convention, John called me up excitedly. "Guess what?" he asked, immediately answering the question himself. "Snake-Oil got called in by the FCC for reexamination, and he flunked not only the 13 wpm test, but the 5 wpm test as well, so they lifted his license!"

What a let-down! All I could think of was the tremendous wasted effort John had put into this crazy jamming project. That night, on the ten o'clock news, it was reported that police switchboards all over the county had earlier lit up with a rash of phone calls, each reporting a mysterious flash of light in the sky. ■

"I Love My Ten-Tec!"

— a look at the 540/544

It's tough to argue with pulpit praise.

Rev. James R. Belt WA0JIH
1006 N. 76
Omaha NE 68114

For the past six and a half years, my hamming had become less and less enthusiastic. My reliable Swan 350 wasn't at fault. The level of activity on my favorite bands had increased, not diminished; that wasn't it either. There is just no way to know why our interests rise and fall. But then, something did happen. One morning, on one of my few remaining skeds, a good friend commented on the fact that tubes were becoming scarce. RCA had gone out of manufacturing tubes and others were soon to follow. What would replace them? Transistors, of course.

That did it. My mind went into a "red alert" condition, and I began reading and rereading all the ads

and specs of solid-state rigs. True enough, there were more and more solid-state transceivers for the HF bands. Heathkit's SB-104A and the Atlas 180 had given way to the 350XL, and the little 210X and 215X seven-pound delights were right there in the Atlas lineup. A strange new company had come out of nowhere, and they were producing something called a Triton IV (now termed the 540 or 544) which sounded good. Ten-Tec was its name. A quick overview of the situation reminded me of what I had forgotten. These were the people that came out with the little modules and finally the QRP rig, the Argonaut with 5 Watts input. That did it. Over to the local radio emporium I went. What a display. There they were—the Kenwood TS-520S and the TS-820S, the Yaesu models, the Atlas, the ever-changeless Drake line, and the Ten-Tec 540. One by one, I listened to them all,

but one was a standout: the Ten-Tec 540. Words fail me. It was like listening to pocket radios before walking into a high fidelity store for a demo. The receiver on the 540 was fantastic!

But, when I listened around the band, all I heard were TS-520s. What could I do? I took the plunge and bought a Ten-Tec 540, the CW filter, and the ac power supply. My ham life hasn't been the same since. My ham activity has skyrocketed.

It's been about 16 months since I first put the 540 on the air. The first thing I noticed was the absence of warm-up. Press the button and the machine speaks. The single-conversion receiver has a bandwidth of 2.7 kHz, which gives none of the squeezed audio that is often apparent with narrow designs. One overlooked factor comes in the audio distortion spec. Every receiver on the market has a 10% distortion allowance, but not the

540. It has 2%, or 1/5, the amount of unpleasant noise to listen to along with the signal. That makes a big difference when you are on the air for over an hour or so. The 540 has a little 2" speaker located in the center of the bottom of the unit that outperforms two separate outboard speakers that I've tried so far. The receiver and the transmitter are not tied together as they are in most of the transceivers on the market. Peaking up or detuning the receiver doesn't affect the transmitter at all. Using the remote vfo doesn't automatically mean that the further you go from the transmit frequency, the more your receiver is off resonance! That's quite a remarkable feature of broadband design, especially if you are a DXer. Stable? You bet. 10 Hz allowed by the specs per hour hardly makes it worth mentioning. The sensitivity is really closer to .2 μ V instead of the .3 that is advertised.

The standard for most units is .5 μ V. The receiver is quiet. The absence of the ac supply from the unit and the lack of tubes all make a contribution here.

The transmitter does as well as the Swan 350 with its 400 Watts input. The Ten-Tec 540/544 has 200 Watts input on all bands and all modes including CW and RTTY. Output is about 100 to 110 Watts. I have had many, many QSOs on crowded bands that have lasted 45 minutes to an hour with the Ten-Tec. The reports all indicate good audio and a lot of punch to the SSB signal.

It really does get out smoothly and superbly. I did buy a DenTron Super-Tuner to match the 540 to my old inverted-vee dipole. The swr bridge is built right into the 540/544 so that, in the transmit mode, you can monitor swr without an external meter. I just reach over and touch up the knobs on the tuner while I'm transmitting if I change frequency very much. This past year, I worked Sweepstakes for the first time. What fun! I'd just go from one end of 40 meters to the other, hitting all the strong signals instead of sitting in one place with a kilowatt. The sprightly rig and that broadbanded design made it work. Many folks don't like contests and don't move around the band that much, but I do and it's nice to have the capability.

The features of the Ten-Tec are well chosen, making it the most versatile rig I've ever come across. Take the 25-kHz calibrator. It's pulsed so you can distinguish it from a carrier. WWV is obtainable on both 10 and 15 MHz. It's the only rig I know of that has that capability on two frequencies. For the CW man, there is a \$25 filter for 150 Hz—that's right, a two-position filter. I tried another well-known out-board CW filter, and it

didn't surpass this little wonder. The full break-in keying for CW is like having your sinus cavities open... wide! One fellow 540 owner told me that he thought his transmitter wasn't working until the station came back to him. You can listen to the band in between the dits on the number 5. There's more for the CW addict. The sidetone not only has adjustable volume, but there is also an adjustment for the tone over a full octave to beat off the wearies of listening to the same tone. Both adjustments are made through a hole in the bottom of the unit that doesn't require moving the unit.

If you work round tables, you know how vexing it is to wander around from one station to another, so the Ten-Tec people have incorporated an offset tuning control on the front panel... with a little LED to let you know when it's working. It has an effective noise blanker for any kind of impulse noise for an additional \$29.

The back of the radio has all kinds of switches and plug-in possibilities. All of the plugs are available for phone patches, linear amplifiers, external receivers, external speakers, foot switches to activate the mike, and a plug to take the remote vfo or 160 meter converter.

The alc is adjustable on the front panel so you can reduce the power input to 75 Watts if you are on emergency power. The 540/544 is essentially a 12-pound dc-powered unit drawing 15 Amps on peaks, so it can function well on a 12-volt battery stuck in a corner of the shack for emergencies. Naturally, that 12 lbs. goes a long way toward making it an ideal mobile station. The dimensions are a bit larger than the Atlas 210X, but not nearly as great as many of

the hybrid (tube-transistor) rigs on the market.

What about protection? Well, the radio is designed to shut down if you forget to put the antenna on or if the swr is too high. It doesn't blow a fuse; it just quits playing. That has gone a long way toward keeping the transistors in the final from requiring replacement. The factory said that they have only replaced 6 transistors so far in the thousands of units on the air around the world.

The service of the Ten-Tec people is outstanding. I started off with a used Triton IV, and, soon after I purchased it, the antenna relay stuck and I had to key the mike to get it to go back into receive. It wasn't a big problem, but it was annoying. I called the factory, and they shipped me a little circuit board via UPS that took 3 days to arrive. I sent the old one

back. Even though the unit was way out of warranty, they made that swap at no expense to me. There are ten circuit boards in the unit that are all field replaceable. The rig is sure easy to service. There are no high voltages to induce a healthy fear in the amateur. The layout is clean, neat, and simple to get at. The manual is a joy to read. Every circuit board is clearly described and defined.

The Ten-Tec 540/544 is one of the finest, most versatile HF rigs I've ever seen and easily the best radio that has ever graced my ham shack. Over the months that I've been on the air with it, I've listened to many other amateurs operating this particular piece of equipment. They have experienced the same service that I've experienced from the factory, and they are uniformly delighted with their good fortune. ■

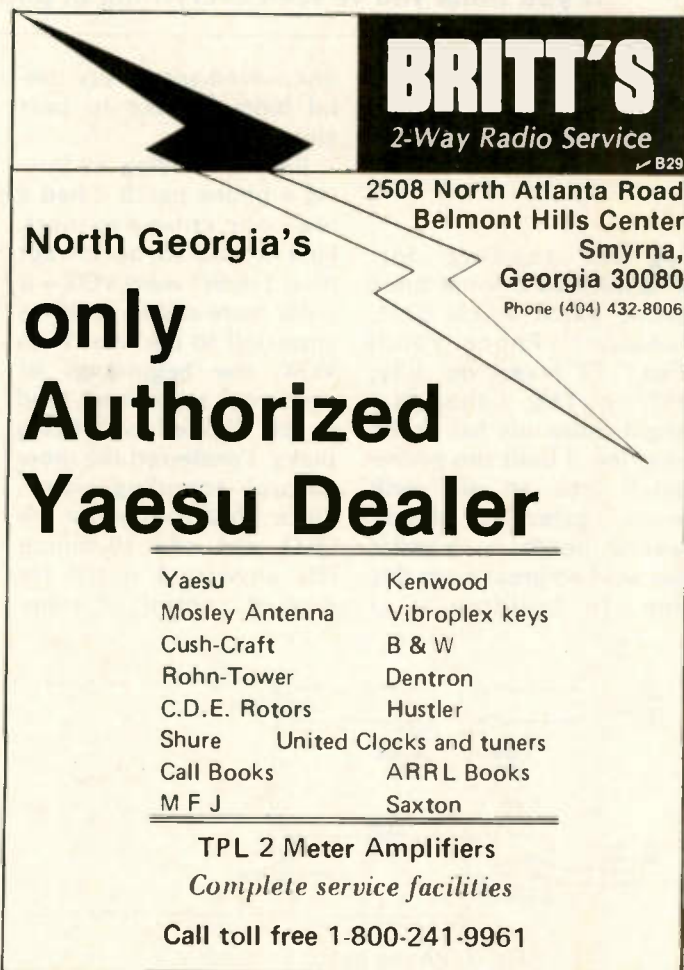

BRITT'S
2-Way Radio Service
B29

2508 North Atlanta Road
Belmont Hills Center
Smyrna,
Georgia 30080
Phone (404) 432-8006

North Georgia's
only
Authorized
Yaesu Dealer

Yaesu	Kenwood
Mosley Antenna	Vibroplex keys
Cush-Craft	B & W
Rohn-Tower	Dentron
C.D.E. Rotors	Hustler
Shure	United Clocks and tuners
Call Books	ARRL Books
M F J	Saxton

TPL 2 Meter Amplifiers
Complete service facilities
Call toll free 1-800-241-9961

A \$5 Phone Patch

— the darn thing really works

If you think you've seen everything in phone patches, check out this one's price tag.

Lewis Tarnopol WA6RJK
164 South Kingsley Drive
Los Angeles CA 90004

After reading Mr. Johnson's home brew phone patch article (D.H. Johnson, "Phone Patch Tips," 73 Magazine, July, 1977, p. 138), I thought I might throw my hat in the ring, too. I built this phone patch into an old desk model extension phone several months back and it has worked great from day one. In building it, I

discovered some very useful hints I'd like to pass along.

Before building or buying a phone patch, I had a few basic criteria to meet. First it had to be cheap! Also, I didn't want VOX—it costs more and its features appealed to me less. With VOX, the beginnings of sentences sometimes tend to be clipped off. Being picky, I preferred the more natural sounding voice. Since I had to monitor the QSO and add 10-minute IDs anyway, I opted for manual control of trans-

mission and receive. Installation of a small SPST switch to control my Drake T-4XC push-to-talk (transmit relay) circuit would allow the person on the phone to talk without receiver noise being present. Any transceiver or transmitter/receiver combo should be able to accept this simple switch, allowing hassle-free communication.

Once the decision had been made, I went to work drawing on paper what I needed and then scrounging in my junk box for the parts. Being a recording engineer, I found one small low-to-high impedance transformer, some audio cable, and all the plugs and jacks (audio-type) I needed. A quick trip to the neighborhood electronics shop took care of the rest.

matic is shown in Fig. 1. The phone line impedance is about 600 Ohms. It makes sense to match that impedance as closely as you can because doing so will yield excellent fidelity from the phone mouthpiece. Since I had one transformer with a low impedance side of 50 Ohms, I connected, in series with it, another transformer with a 500-Ohm side. Figuring 550 Ohms to be close enough, I let it go at that. Then I connected up one capacitor in series with each "hot leg" of the phone. This gave me isolation from any dc. I found that 3 uF was a good choice for fidelity reasons. This side of the circuit was then permanently connected to the phone inside the phone cover. I'd like to add that there have been no problems with this permanent arrangement and one could easily put in a switch to disconnect it if desired.

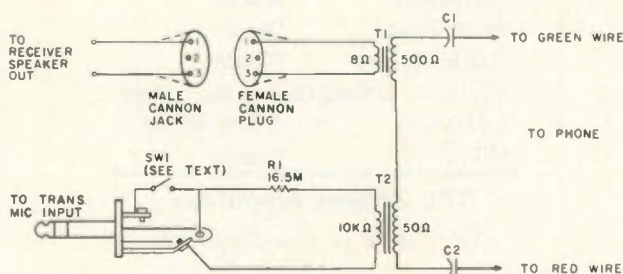

Fig. 1. Phone patch schematic.

Construction

The phone patch sche-

The other side of each transformer was hooked up to its respective device. The high-impedance (10k) leads went to the mic input of the transmitter and the low-impedance (8-Ohm) side went to the speaker output of the receiver. For the speaker, I ran speaker cable connected in parallel to the speaker output of the receiver, soldered on a male Cannon connector, mounted it in a small metal box I had handy, and attached it to the front of my ham desk. It's very accessible. I then soldered a female Cannon plug with about 3 feet of wire to the 8-Ohm side of the transformer. Thus, whenever I want the receiver audio in my phone, I simply plug the Cannons together. I made a plug which, when inserted in the mic jack of my Drake, connects together both the audio wires from the transformer and the two wires leading from my trans/receive (PTT) switch mounted in the phone cover. (For Drake, PTT amounts to shorting out ground and ring on the plug for transmit. I presume most ham PTT functions can be switched in and out similarly.) Cable for the mic section of the phone was good shielded cable. Its use prevented any possible hum from entering during transmission. I recommend always using shielded cable for high-impedance applications in audio.

Originally, the 16.5-megohm resistor (made from a 10-megohm and a 6.5-megohm in series) wasn't part of my plan. Without it, however, I cleverly discovered the phone mouthpiece would *clip* the input of the transmitter. Turning down the transmit gain didn't stop the distortion. Instead, I made the phone yield the same output voltage characteristics as my Shure 444. By inserting

the resistor, I had no distortion and excellent voice quality. Hooray for carbon mics!

Results

The very first day I assembled my phone patch I had the opportunity to use it. There was a ham in Iowa who wanted to patch into Glendale, California. I answered his CQ Glendale, and he explained he wanted to talk to a sick friend who had almost died from illness a week earlier. I made the patch without hesitation. When the call was done, I received many compliments from both sides, thanking me for helping out. I felt extremely good to have participated

in what was a very happy occasion for all.

I later made some on-the-air tests for voice quality. Nothing but compliments came from all those who heard me testing. Many times people couldn't tell the difference between my phone and my Shure! Having the ability to hook up my receiver to my phone (without the transmitter) is nice, too. When I hear something interesting, I call up a friend, plug my phone into my receiver, and we both listen. I might add that I find the transmit switch arrangement very convenient. All communications are done with the phone handset. Since my transmit

switch is mounted on the phone, my left hand holds the handset, and my right hand switches the trans/receive switch. Those of you inclined to mount the switch in the handset could pull off one-handed operation. Or, how about a footswitch?

The only change I've made was to add an on/off switch for my receiver. Now I can adjust the receiver gain in the phone to any level without the distraction of an outside speaker blaring away. Since then, I've been quite happy with my home brew phone patch. All in all, I spent less than five dollars. That's what I call cheap! ■

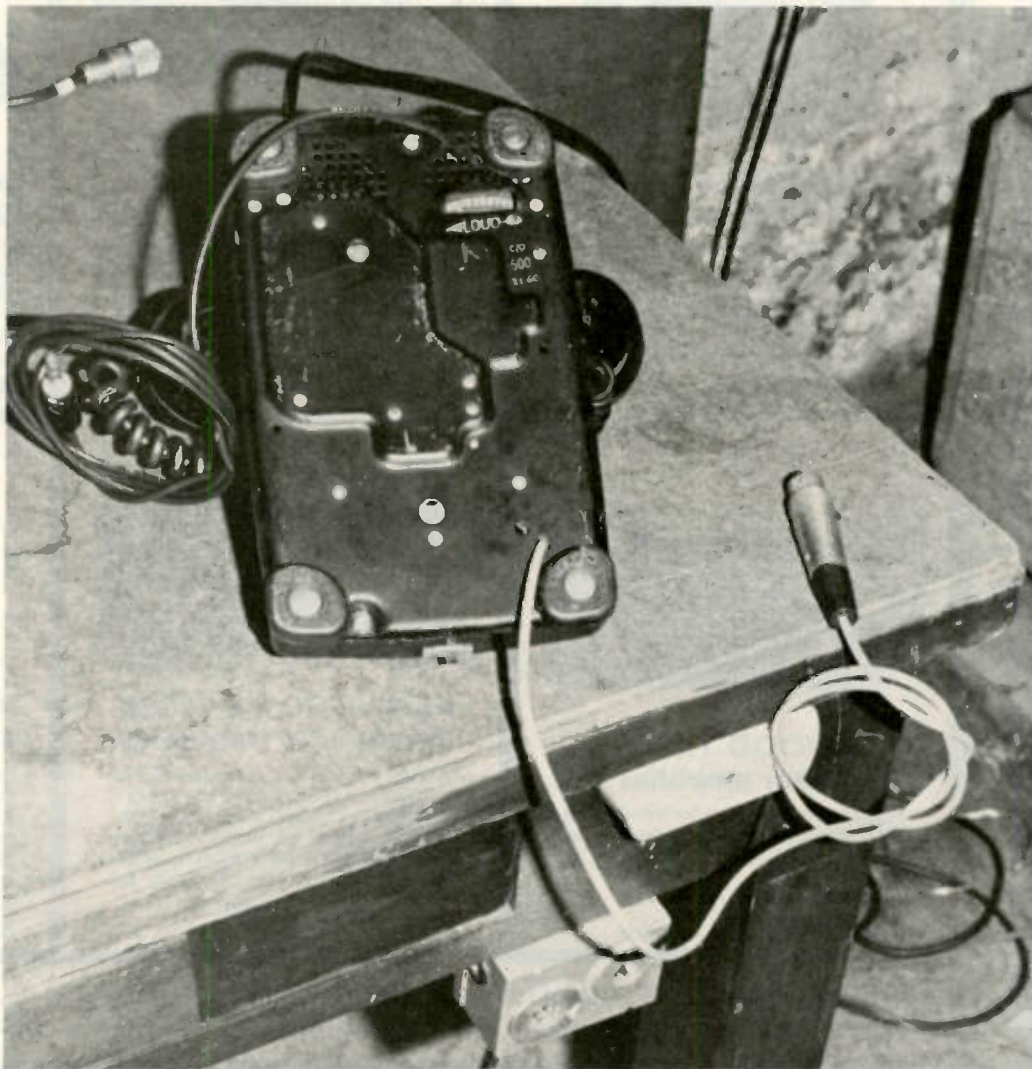

Underside view of phone with patch inside. The wire coming out of the uppermost part plugs into the Drake's mic input. The lower wire plugs into the Cannon box below the electrical outlet (bottom of picture). The PTT switch is centered in the bottom of the front of the phone.

CALL TOLL FREE 1-800-633-3410

Long's suggests KENWOOD

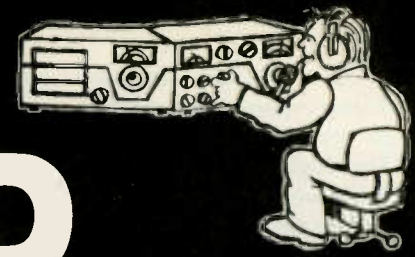

KENWOOD TS-820S transceiver

Features a factory installed digital freq. readout. • 160 thru 10 meter coverage • Integral IF shift • RF speech processor • VOX • Noise blanker • PLL • Built-in 25 KHz calibrator • CW side tone & semi-break-in • IF OUT, RTTY, & XVTR • Phone patch IN and OUT terminals.

1249.00 list. Call for quote.

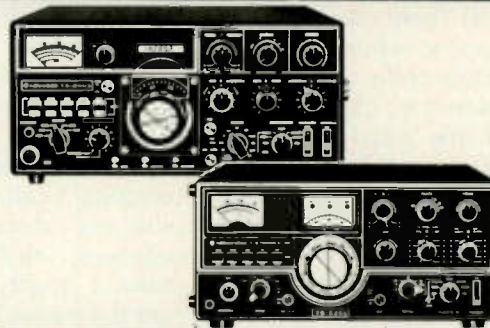

KENWOOD TS-520S SSB transceiver

160 thru 10 meter coverage • Optional DG-5 frequency display • New speech processor with audio compression amplifier • Built-in AC power supply (DC-DC converter, optional) • RF attenuator • Provision for separate receive antenna & phone-patch.

799.00 list. Call for quote.

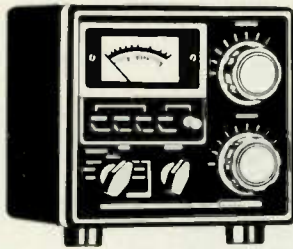

KENWOOD AT-200 6 band antenna tuner

Features a through line watt meter, SWR meter, antenna selector switch, & antenna coupler. Freq. range 1.8 to 29.7 MHz. Through power 200W at max. connectors for UHF, wire antenna, & a dummy load.

159.00 list. Call for quote.



KENWOOD TR-7600 The radio that remembers

Full 4-MHz coverage (144.00-147.995), 800 channels, 10 watts RF output/1 watt low, memory channel w/simplex or repeater offset, & LED. With the optional RM-76 select any 2m freq., store freq., auto stop on first busy or open channel, scan memories.

375.00 list. Call for quote.



KENWOOD TR-7400A 2m FM transceiver

Features: • CTCSS provisions, encode and decode • 25 watt output RF • Solid-state final stage • LED readout • PLL gives 800 discrete channels • Repeater offset circuit • PLL unlock protection circuit • MOS FET.

449.00 list. Call for quote.

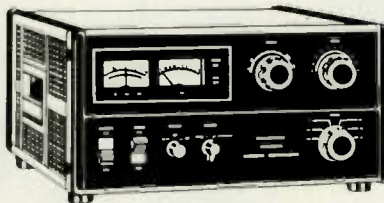

KENWOOD TL-922A HF linear amplifier

Featuring a time delay fan circuit, freq. 160 meters to 15 meters, drive power 80 watts, SSB; 2000W PEP CW, RTTY; 1000W DC. Power req. 120/220/240 VAC. 50/60 Hz.

1199.00 list. Call for quote.

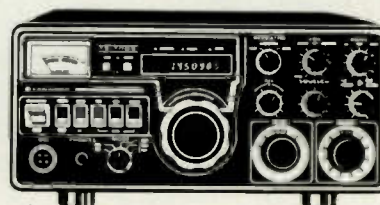

KENWOOD TS-700SP all mode 2m transceiver

Covers the entire 2 meter band. The features are SSB, CW, FM, AM and semi-break-in CW. Also side tone monitor, digital freq. readout, receiver preamp and 600 KHz repeater offset op (144.5-145.5 Hz) 10 watts RF output, AC/DC pow. supply.

759.00 list. Call for quote.

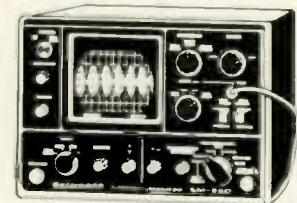

KENWOOD SM-220 station monitor scope

Features: built-in two tone generator, monitors SSB wave forms, helps adjust mic gain & speech-processor compression level & monitoring key clicks on CW, tests linear amps, observes signals transmitted from 1.8-30 MHz.

349.00 list. Call for quote.

Remember, you can Call Toll Free: 1-800-633-3410 in the U.S.A. or call 1-800-292-8668 in Alabama for our low price quote. Store hours: 9:00 AM til 5:30 PM, Monday thru Friday.



Long's Electronics



MAIL ORDERS: P.O. BOX 11347 BIRMINGHAM, AL 35202 • STREET ADDRESS: 2808 7TH AVENUE SOUTH BIRMINGHAM, ALABAMA 35233

Longs suggests YAESU

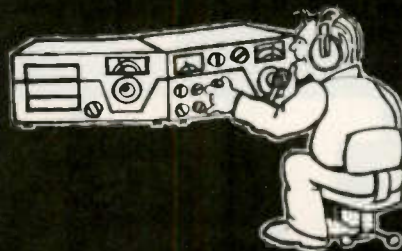

CALL TOLL FREE 1-800-633-3410

YAESU FT-901DM HF transceiver

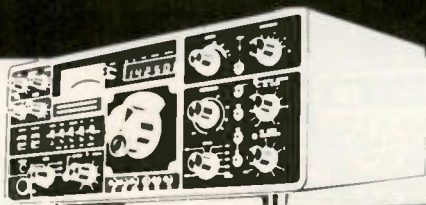

Reject tuning, variable IF band width tuning, audio peak frequency tuning, LED w/memory TX/RX, no external VFO required for split freq. operation, built-in Curtis keyer, 6146B final tubes, & 160 thru 10 meter coverage.

1459.00 Call for quote.



YAESU FT-101F transceiver

- Coverage: 160 thru 10 meters
- Built-in AC/DC power supplies
- Built-in RF speech processor
- 260 watts PEP on SSB, 180 watts on CW, 80 watts on AM
- Solid-state VFO
- VOX
- Auto break-in CW sidetone
- WWV/JJY reception
- Heater switch.

799.00 list. Call for quote.

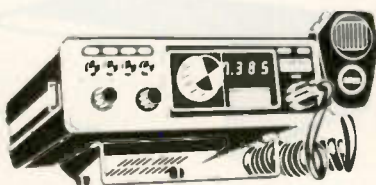

YAESU FT-227RA

One knob channel selection for 800 channels, frequency 144-148 MHz, 4-digit LED readout, fully synthesized frequency control, selectable 10 watt HI/1 watt Low output, 4 memories, touch control on mic for scanning, scan selectable for clear or busy channels.

399.00 Call for quote.



YAESU FT-227R "Memorizer"

- One knob channel selection using optical sensing to select 800 channels
- Memory circuit allows instant return to any frequency between 144-148 MHz
- 4-digit LED frequency readout
- Fully synthesized frequency control
- Selectable 10 watt HI/1 watt LOW output with one memory.

385.00 Call for quote.



YAESU CPU-2500RK 2m FM transceiver

Full 4 MHz coverage in 5 KHz steps 144-148 MHz • 4 memory channels may be programmed • Built-in scanner • keyboard mic allows for remote control of memories & dial frequencies • Also serves as an auto patch encoder • Power output 3 watts/25 watts.

585.00 list. Call for quote.



YAESU SP-101PB speaker/phone patch

The SP-101-PB features: • A shaped response speaker from 300 to 3000 Hz • Built-in hybrid phone patch with individual gain controls • VU meter. Full VOX operation • Receiver input impedance: 4 or 600 ohm • Output impedance: 600 ohm or high impedance.

67.00 Call for yours today.

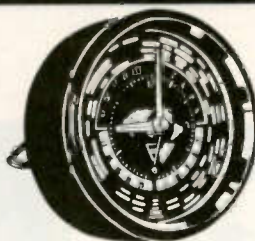

YAESU QTR-24 world clock

Features world time at a glance. Time in any principal city or time zone can be coordinated with local time on a 24-hour basis. The Time Zone Hour Disc automatically retains the correct time. Uses one "C" battery.

35.00 Call for yours today.

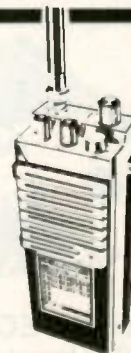

YAESU FT-202R 2m handheld FM transceiver

1 watt output min., 6 channel capability, flexible helical whip antenna, tone burst, compact size and light weight, S-meter and battery condition indicator, operates on NiCad or dry cell batteries, built-in speaker-mic.

199.95 Call for quote.

Remember, you can Call Toll Free: **1-800-633-3410** in the U.S.A. or call **1-800-292-8668** in Alabama for our low price quote. Store hours: 9:00 AM til 5:30 PM, Monday thru Friday.

VISA

Long's Electronics



CALL TOLL FREE 1-800-633-3410

Long's suggests

TEN-TEC

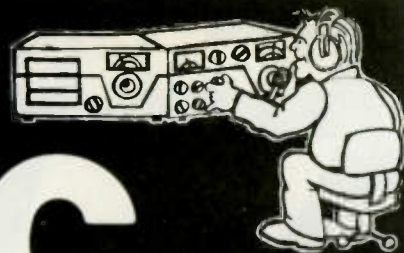

TEN-TEC Omni D transceiver

Totally solid state, 160 to 10 meters. LED readout, VOX and PTT, built-in squelch, built-in 4-pos. CW/SSB filter, 2 speed break-in, power input 200W, 100% duty cycle, basic 12 VDC operation, and more! Optional power supply 252M available.

1069.00 list. Call for quote.

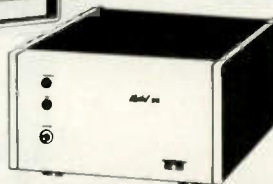
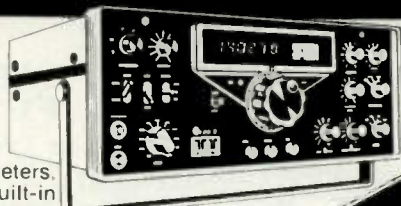

TEN-TEC 252M power supply

The 252M features: solid state circuitry with built-in metering, input 117 VAC, 50-60 Hz, output 13 VDC plus or minus 0.5V, regulation: better than 1% NL to FL at 117 VAC, current 0-18 amps.

119.00 list. Call for quote.



TEN-TEC Century 21 CW transceiver

Features: • Full break-in • 70 watts input • Solid-state • Built-in speaker • Receives CW or SSB • Instant band change • Offset receiver tuning • Overload protection • Sidetone with adjustable level • Regulated power supply • 80 thru 10 meters with crystals supplied.

299.00 list. Call for quote.

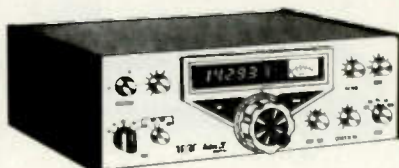

TEN-TEC 544 digital HF transceiver

The 544 features: • 3.5 to 30 MHz coverage • Solid-state • Instant band change • 8-pole crystal IF filter • LED digital readout • 200W input on all bands • WWV at 10 & 15 MHz • Full CW break-in • "S" meter and SWR bridge • 100% duty cycle, full power for RTTY & SSTV.

869.00 list. Call for quote.

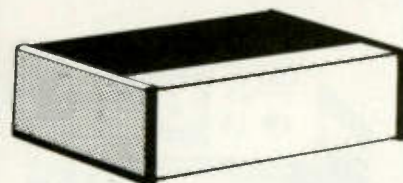

TEN-TEC project boxes

A complete line of modern enclosures to give your handcrafted gear professional appearance. They are high impact polystyrene with a brushed aluminum front.

ME-10 4 1/2" x 10-3/16" x 6-9/16"	14.00
DE-8 4 1/2" x 8 1/2" x 10-3/8"	18.50
DE-14 4 1/2" x 13 1/2" x 10 1/2"	25.00
JE-5 2-9/16" x 4-15/16" x 6"	7.00
JE-10 2-9/16" x 10-3/16" x 6-9/16"	14.00

Order yours today.

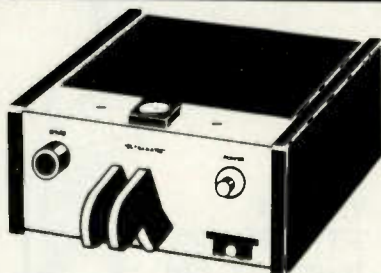

TEN-TEC KR-50 electronic keyer

• Speed range: 6-50 wpm • Weighting ratio range: 50-150% of classical dit length • Output: reed relay, contact rating 15 VA, 400 V max. • Sidetone: 500 Hz tone • Dit & dah memories with defeat switches.

110.00 list. Call for quote.

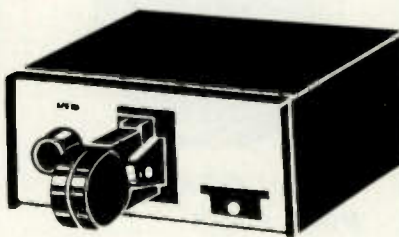

TEN-TEC 670 keyer

This is a solid state electronic keyer made especially for use with the Century 21 CW transceiver. It has adjustable speed.

29.00 Call for yours today.

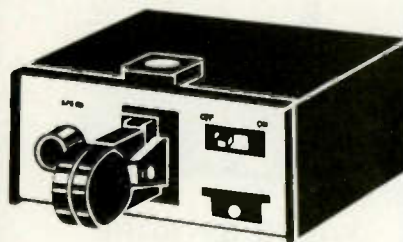

TEN-TEC KR-5A electric keyer

For portable, mobile or fixed stations • Reed relay 15V-amp contacts, 400 V max. • 6 to 50 WPM • Self-completing dits & dahs • Dit length increased approx. 10% @ 20 WPM.

39.50 Call for yours today.

Remember, you can Call Toll Free: 1-800-633-3410 in the U.S.A. or call 1-800-292-8668 in Alabama for our low price quote. Store hours: 9:00 AM til 5:30 PM, Monday thru Friday.

VISA

Long's Electronics



MAIL ORDERS: P.O. BOX 11347 BIRMINGHAM, AL 35202 • STREET ADDRESS: 2808 7TH AVENUE SOUTH BIRMINGHAM, ALABAMA 35233

Longs suggests ICOM

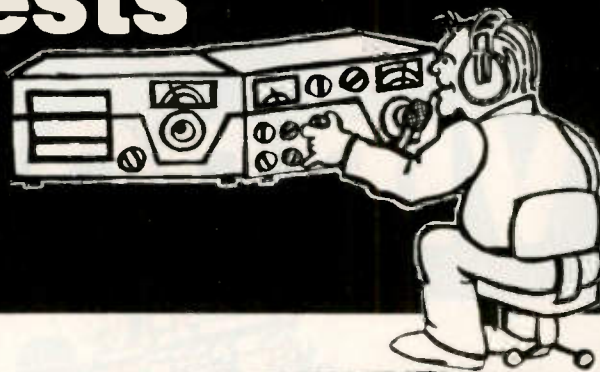

CALL TOLL FREE 1-800-633-3410

ICOM IC-701 HF transceiver and power supply

All solid state, even the finals, 100W continuous duty on all bands, all modes, 160 thru 10 meters, dual built-in individual digital VFO's for split freq. operation, VOX, semi-break-in CW, RIT, AGC, noise blanker, & built-in RF speech processor. Includes IC-701 PS (AC power supply).

1700.00 list. Call for quote.



ICOM IC-280 remobile 2m FM mobile

Frequency 143.90-148.11 MHz • Power: 10 watts Hi, 1 watt adj. Low • Power requirements: 13.8 VDC at 2.5 amps • Main PLL control head may be detached and remotely mounted • With microprocessor, stores 3 frequencies • Easy to read LED's.

480.00 list. Call for quote.

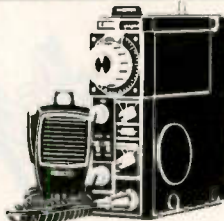

ICOM IC-402 432 MHz SSB & CW portable

Frequency range 430-435.2 MHz in any 200 KHz bands • Power output 3 watts PEP SSB • CW, USB, LSB • Receiver sensitivity 0.5 UV at 10 dB SINAD. Provisions for external antenna & power sources • BC-20 NiCad battery pack & charger optional 49.95.

499.00 list. Call for quote.



ICOM IC-215 2m FM transceiver

Features: • 15 channel capacity • MOS FET RF amplifier & 5 tuned circuits in the front end for optimum sensitivity and selectivity • S-meter on front panel • Dual power level, 3 watts HI for long distance, 0.5 watt LOW for local • Uses C batteries or rechargeable cel's.

239.00 list. Call for quote.



ICOM IC-202S 2m SSB portable

The IC-202 features: • Frequency coverage: 144-146 MHz • Modulation: A3J and A1 • RF output power: A3J 3 watts (PEP), A1 3 watts • Sensitivity: 0.5 microvolts at (S+N)/N 10 dB or better • Includes a true IF noise blanker • Requires "C" batteries or external 12 volt source.

379.00 list. Call for quote.



ICOM RM-2 microprocessor keyboard

This is a touch tone unit adaptable to the IC-701, IC-211, and the IC-245. It permits selectable scanning up or down, has four memories, a LED display, can program split freqs., and also serves as the touch tone pad for the IC-211 and the IC-245.

199.00 list. Call for quote.



ICOM IC-502 6m SSB, CW portable

The 502 is a 6 meter SSB and CW portable with telescoping antenna & hand mic. • Frequency coverage: 50 to 51 MHz • Modulation: A3J and A1 • RF output power: A3J, 3 watts PEP and A1, 3 watts • Sensitivity: 4 microvolts for 20 dB quieting • Virtually no intermod.

269.00 list. Call for quote.

Remember, you can Call Toll Free: 1-800-633-3410 in the U.S.A. or call 1-800-292-8668 in Alabama for our low price quote. Store hours: 9:00 AM til 5:30 PM, Monday thru Friday.

VISA

Long's Electronics



CALL TOLL FREE 1-800-633-3410

Long's suggests

VIBROPLEX

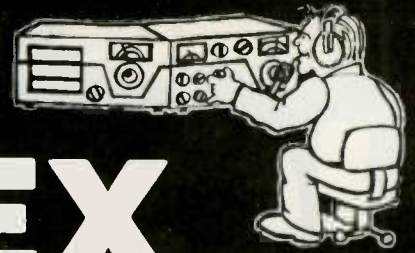

VIBROPLEX vibro-keyer standard

An electronic transmitting unit with large size contacts main frame, super finished parts, red finger and thumb pieces smooth trunion lever, adjustable standard finish.

46.50 Call for yours today.

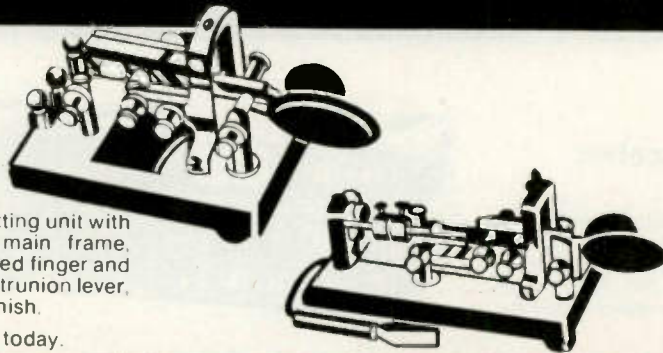

VIBROPLEX "The Original" deluxe

Can be sloed to 10 WPM or less or geared to a high rate of speed keeping high quality signal. Deluxe model-polished chrome w/jeweled movement & grey base.

59.95 Call for yours today.

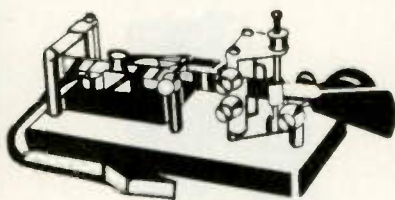

VIBROPLEX Lighting Bug Keyer deluxe

For high quality signals at all speeds use this flat pendulum model. The deluxe has a polished chromium base and top parts with a grey crystal base with a jeweled movement.

59.95 Call for yours today.

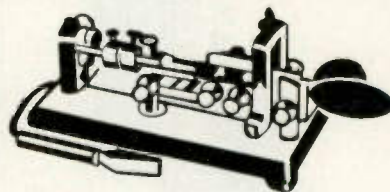

VIBROPLEX Presentation Super deluxe keyer

The finest bug ever built with 24 K gold-plated base top, patented jewel movement. It has a wider range of speed because the jewels in the movement reduce friction and maintain smoother operation.

72.50 Call for yours today.

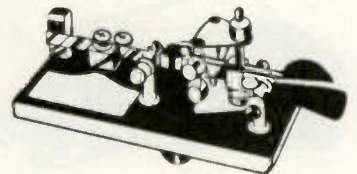

VIBROPLEX Champion standard keyer

Heavy base to prevent walking, grey crystal base with chromium finished top parts. Without circuit closer the keyer gives smoother even operation and a wide range of speeds.

46.50 Call for yours today.

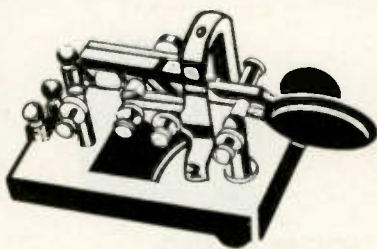

VIBROPLEX vibro-keyer deluxe

An electronic transmitting unit with large size contacts main frame, super finished parts, red finger and thumb pieces smooth trunion lever, adjustable. Deluxe finish.

58.50 Call for yours today.

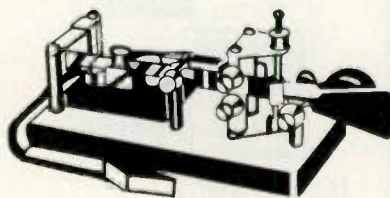

VIBROPLEX Lighting Bug standard keyer

The standard model gives you the same high quality signals at all speeds using the flat pendulum model. It has polished chromium top parts and a grey base.

49.95 Call for yours today.

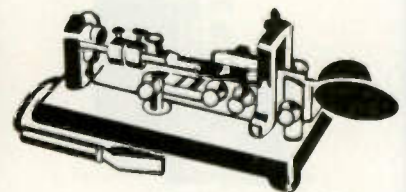

VIBROPLEX "the Original" standard

You can slow this down to ten WPM or gear it to a high rate of speed and always keep the signal quality very high. The standard has chromium top parts and a grey base.

49.95 Call for yours today.

Remember, you can Call Toll Free: 1-800-633-3410 in the U.S.A. or call 1-800-292-8668 in Alabama for our low price quote. Store hours: 9:00 AM til 5:30 PM, Monday thru Friday.

VISA

Long's Electronics



MAIL ORDERS: P.O. BOX 11347 BIRMINGHAM, AL 35202 • STREET ADDRESS: 2808 7TH AVENUE SOUTH BIRMINGHAM, ALABAMA 35233

Long's suggests MOBILE ANTENNAS

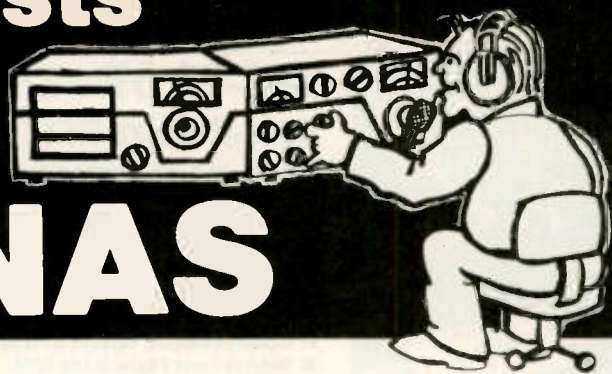

CALL TOLL FREE 1-800-633-3410

LARSEN LM-150 antenna

The famous 49" quadruple plated stainless steel rod with high efficiency, $\frac{3}{8}$ wave length, 3 dB gain, freq. range 144-174 MHz. Comes with Allen wrench and cutting chart. LM-Q $\frac{1}{4}$ wave antenna also available 2.65.

23.85 Call for yours today.

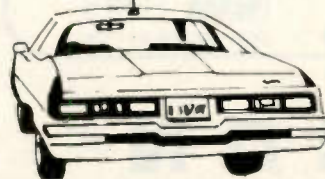

Mount your antenna one of 4 ways!

LM-TLM trunk lid mount	14.60
LM-MM magnetic mount	14.60
LM-GC gutter clamp	14.60
LM-K roof top mount	6.95

All units come with 17' RG A/U coax cable.

Call for yours today.

ANTLER A280 2m mobile antenna



Features a precision tuned coil, 47" tapered stainless steel whip, VSWR: less than 1.3, certified 3 dB gain, magnetic mount can withstand winds up to 100 MPH. A220 same as above except rooftop mount. 34.95

39.95 list. Call for quote.

SHAKESPEARE magnetic mount 2m mobile antenna

This high Q base loading coil is silver plated copper, the spring is stainless steel enclosed in fiberglass. $\frac{3}{8}$ wave design, 3 dB gain with a power rating in excess of 500W. Includes connector, 20' of coax cable, and base.

29.95 Order yours today.



HUSTLER

HUSTLER BBLT-144-A $\frac{5}{8}$ wave 2m antenna

Features: 3.4 dB gain over $\frac{1}{4}$ wave length antenna, 200W FM power rating, 52" high, trunk lip mount, 1.1:1 SWR at resonance, sturdy stainless steel impact spring.

34.95 Call for yours today.

HUSTLER

HUSTLER MO-2 HF mobile antenna

Fold over mast for quick and easy interchange of resonators or entering a garage. When operating the mast is held up right with a sleeve clutch. 54" mast serves as $\frac{1}{4}$ wave m antenna stainless base threaded to fit bumper mount. Also MO-1 for deck or fender mounting.

22.95 Call for yours today.

HUSTLER

Accessories include

RM 10 resonator 400 PEP	6.95
RM 15 resonator 400 PEP	7.95
RM 20 resonator 400 PEP	8.95
RM 40 resonator 400 PEP	14.95
RM 75 resonator 400 PEP	16.95
RM 80 resonator 400 PEP	17.95
BM-1 bumper mount	15.95
RSS-2 resonator spring	5.95
QD-1 quick disconnect	16.95
L-14-144 feedline 144"	4.95
L-14-240 feedline 240"	6.95
SSM-2 deck or fender mount	18.95

Call for yours today.

HUSTLER

HUSTLER SF-2

51" 2 meter, $\frac{3}{8}$ wavelength, 3.4 dB gain over $\frac{1}{4}$ wave mobile. Designed with $\frac{3}{8}$ " 24 base to fit your mount or a wide selection of Hustler mounts. (Mount or cable not included)

9.95 Call for yours today.

Remember, you can Call Toll Free: 1-800-633-3410 in the U.S.A. or call 1-800-292-8668 in Alabama for our low price quote. Store hours: 9:00 AM til 5:30 PM, Monday thru Friday.



Long's Electronics





TRS-80 OWNERS Send-Receive RTTY & CW

- Auto. send & receive: RTTY & CW.
- Complete hardware & software.
- Connects to TRS-80 User Port & key/headphone jacks.
- 10 message memories - 255 char. ea.
- Keyboard buffer-allows typing ahead.
- Uses built-in PLL or external TU.
- Morse trainer-random 5 letter words.
- Includes hardware, cassette & manual.
- Requires Level II Basic & 16K RAM.

\$99.
kit
\$129.
wired

- PET version available, 69.95 kit / 99.95 wired

Write or call for detailed brochure

MICROTRONICS

✓ M48



P.O. Box 747 (S) Keyes, CA 95328 (209) 634-8888 / 667-2888

California residents add 6% tax

DOVETRON

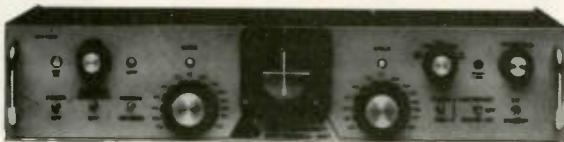

MPC-1000C

Multipath Correction
In-Band Diversity &
AFSK Tone Keyer

Amateur Net: \$545.00

Standard features include CONTINUOUSLY tuneable Mark and Space channels (1000 Hz to 3200 Hz), Dual Mode (MARK or FSK) Autostart and internal high level neutral loop keyer (20 to 60 ml). Both EIA and MIL FSK outputs are provided for direct interface to microprocessor and video terminal peripherals.



MPC-1000CR

Signal Regeneration &
Speed Conversion

Amateur Net: \$645.00

A front panel switch permits internal TSR-200 Signal Regenerator-Speed converter assembly to electronically "gear-shift" between 60, 67, 75 and 100 WPM. All incoming and outgoing signals are regenerated to less than 0.5% bias distortion. Also available with DIGITAL Autostart (TSR-200D): Amateur Net: \$695.00



MPC-1000R/- TSR-500

Dual UART Regeneration,
Speed Conversion, 200
Char. Memory, Word Cor-
rection & DIGITAL
Autostart

Amateur Net: \$895.00*

The MPC-1000R/TSR-500 provides Preloading and Recirculation of the 200 character FIFO Memory, a keyboard-controlled Word Correction circuit, Variable Character Rate, Tee Dee Inhibit, Blank/LTRS Diddle, a Triple Tone-Pair AFSK Tone Keyer and a Character Recognition/Speed Determination DIGITAL (DAS-100) Autostart mode.

*The MPC-1000R is also available without a TSR assembly and functions as a MPC-1000C with a Triple Tone-Pair AFSK Tone Keyer. This "Basic-R" permits future expansion with a TSR-100, TSR-200, TSR-200D or TSR-500 by simply lifting the lid and plugging in the appropriate TSR assembly: Amateur Net (Basic-R): \$595.00

Your QSL will bring complete specifications, or call: 213-682-3705.

✓ D23



627 FREMONT AVENUE
(P. O. BOX 267)
SOUTH PASADENA, CA. 91030

VHF
**Power
Duo!**

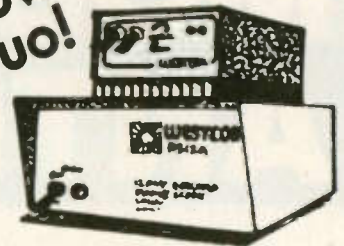

Max power for the \$
Extends weak signal range
Base or mobile use

What a combination! Westcom's new 2-meter, 90 watt linear amplifier, coupled with Westcom's ruggedized 12 amp. DC power supply. Now, base or mobile, you'll have power for that weak signal work. A natural for the OSCAR uplink. The amplifier, model number 2M 15X90L, is an add-on unit, no internal connections or adjustments required. Operates all modes: SSB; FM; AM; RTTY; and, CW. "microstrip" design provides high stability and optimum performance over wide bandwidth. The tough DC power supply, model number RS-12A, has computer grade components. Looks great with its matched linear amplifier! This "Power Duo" has been specially priced for a limited time, only. Order today, and get both units for **JUST \$219**

If not available from your local dealer contact: ✓ W17



**JAN CRYSTALS
KEEP YOU
ON THE AIR**



- CB
- CB standard
- 2 meter
- Scanners
- Amateur Bands
- General Communication
- Industry
- Marine VHF
- Micro processor crystals

easy
to
charge



Send 10¢ for our latest catalog
Write or phone for more details
2400 Crystal Drive
Ft. Myers, Florida 33901
all phones (813) 936-2397 ✓ J2

new COAX SWITCHES

from Barker & Williamson

Model 593

- **Single Pole 3** Position with grounding of all unused positions
- **Crosstalk** (measured at 30 MHz) is -45db between adjacent outlets and 60 db between alternate outlets



Model 594

- **2 Pole 2 Position**
- **Crosstalk** 45db (measured at 30 MHz)



Specifications for both switches

- **Power** 1 KW-2 KW PEP
- **Impedance** 50-75 ohms
- **VSWR** 1.2:1 up to 150 MHz
- **Dimensions** 1 1/4" high, 5" wide, 3" deep
- **Weight** 1 lb.
- **Mount** Wall or desk

✓ B23 Available at your B&W dealer



Barker & Williamson, Inc.
10 Canal St. Bristol, Pa. 19007
Telephone: (215) 788-5581



BOMAR
TWO METER
CRYSTALS

Standard / Icom / Heathkit / Ken / Clegg / Regency / Wilson / VHF Eng. / Drake / Motorola HT-220 and others!

LIFETIME GUARANTEE! NOW ONLY \$8.00 A PAIR!

Make/Model _____

Xmit. freq. _____

Rec. freq. _____

Name _____

Address _____

City _____ State _____ Zip _____

Bill: MC Visa Amex

Credit Card # _____

Exp. date _____

Signature _____

the indispensable
MINI 43



THRULINE
WATTMETER

Power Range	Frequency Bands (MHz)					
	30	25-60	50-125	100-250	200-500	400-1000
5 watts	—	5A	5B	5C	5D	5E
10 watts	—	10A	10B	10C	10D	10E
25 watts	—	25A	25B	25C	25D	25E
50 watts	50A	50A	50B	50C	50D	50E
100 watts	100A	100A	100B	100C	100D	100E
250 watts	250A	250A	250B	250C	250D	250E
500 watts	500A	500A	500B	500C	500D	500E
1000 watts	1000A	1000A	1000B	1000C	1000D	1000E
2500 watts	2500A	2500A	2500B	2500C	2500D	2500E
5000 watts	5000A	5000A	5000B	5000C	5000D	5000E

MODEL 43
Elements (Table 1) 2-30 MHz \$125.00
Elements (Table 1) 25-1000 MHz 45.00
Elements (Table 1) 25-1000 MHz 38.00
Carrying case for Model 43 & 6 elements 27.50

READ RF WATTS DIRECTLY! (Specify Type N or SO239 connectors)

T3

TUFTS
Radio Electronics

Send for our new catalog!
\$3.00 shipping charge
order • NO C.O.D.s!

209 B Mystic Ave
Medford MA 02155
1(800) 225-4428
(617) 395-8280

NOW AVAILABLE FROM M & M

The first West Coast dealership
for these unique antennae.



Array of 8 K2RIW 19s used by WB6NMT on 432 MHz EME. Louis QSOed W1JR 21 October 78 with this array to become the first amateur on FOUR BANDS EME (50, 144, 220 also), and all 4 bands were made only with home-to-home QSOs. "The 8 RIW array did the job in just under two months of work for the entire system. Much faster than had hoped for." (This configuration also included 8-1/2 element Yagis for 144 MHz EME.)

K2RIW 19 EL YAGI

With Tandem-reflector*

(pat. pend.)

HEY HFers!

How's your 10 meter receiver working? Signals a little weak? Having trouble pulling out those weak ones? Lunar has a new preamp just for you.

Their model PAI

28E-s is a mini-

inline 10 mtr.

preamp that will

perk up your

transceiver.



Small enough to fit inside most any HF rig, a flick of the switch bypasses the preamp, and the transceiver is back to normal operation for other bands. On 10 meter, another flick of the switch, and new life is added to that tired receiver. Stop missing those weak rare ones. Call for immediate delivery of this preamp, and all Lunar products, too.

- Outperforms all others
- 2° degree beamwidth
- Handles legal power
- Low VSWR, under 1.2:1 at 432 MHz
- Handles 434 MHz ATV also
- Complete with all hardware and balun
- Easily arrayed for increased gain
- Lightweight at 1.3 Kg

Call us for immediate delivery of these antennae. RIW Power Dividers, too.

M&M RF DISTRIBUTORS

P.O. BOX 82183 • SAN DIEGO, CA
92138 • (714) 299-9741.

SF

S-F Amateur Radio Services

(213) 837-4870

4384 KEYSTONE AVE., CULVER CITY, CA. 90230

the W6TOG* ✓ S33

RECEIVER MODIFICATION KITS

INCREASE SELECTIVITY • IMPROVE SENSITIVITY
LOWER INTERNAL NOISE

IMPROVE NOISE BLANKER OPERATION

COMBAT BLOCKING FROM LOCAL SIGNALS

TS-520 KIT	\$27.50	FT-101 SERIES KIT ...	\$32.50
TS-520S KIT	32.50	FR-101 SERIES KIT ...	34.50
TS-820 & 820S KIT ...	34.50	FT-301 SERIES KIT ...	34.50
R-599 A/D KIT	27.50	FT-901 SERIES KIT ...	34.50

EXPLICIT INSTRUCTIONS MAKE MODIFICATION A CINCH



IT'S MAGIC...

IT'S "MAGICOM"

PROCESSOR MODIFICATION KIT

IMPROVES AUDIO PUNCH

IMPROVES PROCESSED SPEECH QUALITY

Converts TS-820 / 820S speech processor from RF compressor to RF clipper \$27.50

RF speech processor for TS-520 / 520S \$42.50

The "MAGICOM" RF processor module provides up to 6dB increase in output with smooth, clean, non-distorted audio and more penetration for those pile-ups.

ENDORSED BY W6TOG AND BIG GUN DXers WORLD WIDE



the W6TOG*

INTERNAL ELECTRONIC KEYS

FOR ALL AMATEUR TRANSMITTERS OR
TRANSCIVERS USING GRID BLOCK KEYING

- No holes mounting with TS-820 Series
- Mounting options for TS-520, TS-520S, FT-101 Series, TR4 Series, T4X Series, T-599 Series and 32S Series.
- C-MOS DESIGN — Dot and dash memory — full iambic or manual operation.
- Simple installation \$49.50



THE S-F REJEKTOR FILTER

AN INTEGRATED CIRCUIT
ACTIVE BANDPASS FILTER
FOR PROCESSED RECEIVER AUDIO

- Separate active filter elements for CW and SSB audio output stage
- 8 ohm input and output impedance
- Headphone jack for convenience
- ON CW: from 500 hz to 100 hz, variable
- ON SSB: 2 KHz fixed bandwidth
- Rejects unwanted signal better than 60 dB
- Designed for today's transceivers or yesterday's older equipment \$49.50

*WELL KNOWN DXer WITH OVER 300 COUNTRIES CONFIRMED.

All prices postpaid - in Calif. add 6% sales tax - Mastercharge & Visa accepted
SATISFACTION GUARANTEED OR MONEY REFUNDED

QSO Tape™ and QXX Tape™ now with simulated exams!



only
\$4.95 ea.
\$20.95
with oscillator and key.

Kantronics Speed Building Kit

Get prepared!

To pass the new FCC code exams, you'll need to identify unusual names, places, antenna heights, rig types and a variety of other items garnered from **simulated QSOs**.

Now you can really study for the current exams with the Kantronics QSO Tape, (7½, 10, 13 and 15 WPM, or 13 WPM only) or the QXX Tape (20, 23 and 26 WPM). These C-60 cassettes generate computer-perfect "on-the-air" transmissions, and include a **text key and simulated exam for self-testing**.

If you've used these tapes before, you'll be glad to know we've introduced the QSO-2 Tape and QXX-2 Tape, in the same format! **There's no better way to study for the FCC exams!**

KANTRONICS
The Lightweight Champs.

1202 East 23rd Street
Lawrence, Kansas 66044

Phone: 913-842-7745

We accept Visa, Master Charge, check and money orders.

Special Purchase:

ITT NORTH ELECTRIC N13012A POWER SUPPLY

We have purchased a limited quantity of these power supplies through a Telephone company warehouse liquidation—so the prices are good only while they last. These supplies regularly sell for \$212.00.



SPECIFICATIONS:

Voltage Output:
Adjustable between 5.5 - 14.5V
Output Regulation:
10% off rated output voltage + 2 Dms. for any combination of the "input" and 0 to 100% load change
Inputs:
115V Plug, 500mA RMS with 45 - 85 Hz input
Current Output:
25°C: 1.0 amp At least 10 amp. intermittent duty
40°C: 0.8 amp
50°C: 0.5 amp
60°C: 0.3 amp
80°C: 0.1 amp
71°C: 0.1 amp

Overload Protection:
(1) Overtemperature—Thermal switch in series with AC input protects against overheating. Thermal switch resets after overtemperature condition is removed.
(2) Overcurrent—Fuses protect input and output from failure due to excess current.
(3) Electronic—Electronic overload circuit which will limit the output current to a safe level (130% of 40°C rated load with feedback)
Overheat:
No removal of rated output voltage under any power on full condition
Operating Temperature Range:
0 - 71°C

1 - 5 **\$94.00 ea.**
6 - 10 **\$89.00 ea.**
11 - up **\$84.00 ea.**

F.O.B. Hermosa Beach, Ca.
Shipped new in original cart-
on with complete manual.
Phone or mail orders ac-
cepted.

WEIGHT: NET 10 LBS, SHIP 16 LBS

SSS

ELECTRONICS
P.O. BOX 1 LAWDALE, CALIF.
90260 (213) 376-5887

✓ S10

AUXILIARY POWER
for Emergency or Portable Operation

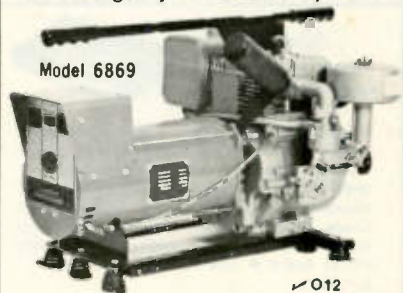

✓ O12

Light wt. Portable Alternator. Stand-by power for Ham Equipment, household needs during power outages or operation in remote areas. Operates lighting, refrigerators, heating systems or other appliances including freq. sensitive loads such as TV sets, induction motors and fluorescent lights. Solid-State voltage regulation. 3750W rating; 25% surge capacity. 120/240V at 31.3/15.6A. 8 HP/3600 RPM B&S engine. Alternator draws just enough engine output to meet load resulting in up to 25% fuel savings. Low interference. Advanced design. Drip-proof construction protects windings from rain and dirt assuring long life. One year warranty by manufacturer. 30"L x 18"W x 19"H. 128 lbs. Shipped via Truck PREPAID (No extra charges) \$659.95

- Electric Start \$110.00
- Battery Charging, 11.00
- Spark Arrest Muffler 21.00

Models available with 1350 to 7000 watt ratings. Write for our quote and additional information.

Mastercharge or VISA accepted

OUTDOOR OUTFITTERS

705 Elm Ct. Waukesha, WI 53186
Ph. 1-414-542-7772 • Ken, N9KS - Mgr.

The **ONLY** thing you need to know about

Quartz Crystals

is: **1-405-224-6780**

- Best delivery plus Emergency Service with Guaranteed Delivery
- Highest Quality with gold MIL-C-3098 Process
- Ask for Sentry Technology Manual

And, order Toll Free 1-800-654-8850

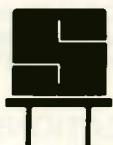

SENTRY

✓ S3 Crystal Park
Chickasha, Oklahoma
73018



THE FIRST CHOICE IN
REPEATER CONTROL

The Power and Flexibility of Microprocessor Technology

AUTOPATCH, REVERSE PATCH, SMART ID, ACCESS CODE MUTING, MORSE CODE ANNOUNCEMENTS, FLEXIBLE FUNCTION TIMEOUT, COURTESY TONE, LINKING, CONTROL OP. FUNCTIONS, TWELVE USER FUNCTIONS, ... AND MUCH MORE.

Call or write for specifications:

MICRO CONTROL SPECIALTIES (617) 372-3442



23 ELM PARK GROVELAND, MA. 01834

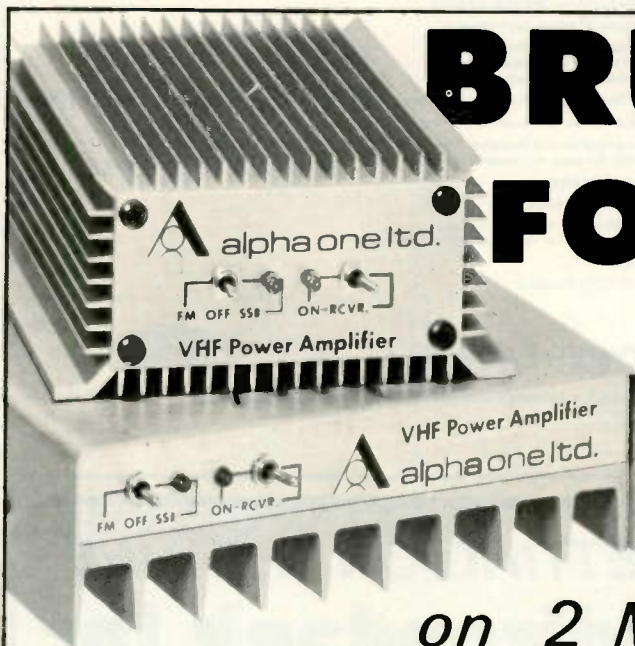

BRUTE FORCE

300 Plus Watts on 2 Meters!

- 2, 1 1/4 and 3/4 meter models
- Models from 25 to 300 plus watts out
- Models from 1 to 35 watt drive power
- Full band coverage — even 420-450 MHz!
- Bias switching for fully linear SSB operation (plug-in option)
- Harmonic-free stripline output filtering
- Low-noise receiver pre-amp (plug-in option)
- Local or remote control (plug-in option)

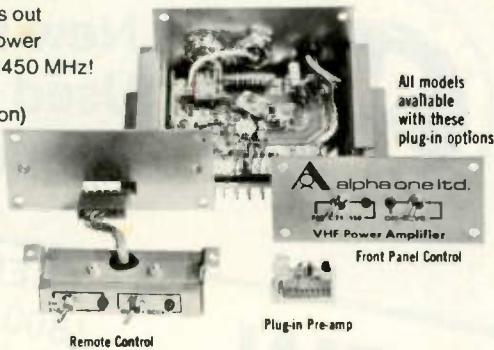

All models available with these plug-in options

Popular 2-Meter Models

Model Number	Drive Power	Nominal Output	Price
146C225	1.5 W	25 W	\$ 54.95
146C1070	5-14 W	70 W	139.95
146C10160	5-14 W	160 W	229.95
146C2300	1.5 W	300 W	379.95
146C25300	15-35 W	300 W	339.95

✓ A77

For boosting your hand-held's signal, or to deliver a pileup-crunching signal when the band's just opening, Alpha One has the amplifier you're looking for. More than 30 different models to match your precise need.



25 watt "mini"



alpha one ltd.

560 Iunt Avenue
Schaumburg, Illinois
60193

Write or call today for illustrated catalog.
(312) 893-5455

3/4 KILOWATT DC INPUT ALL MODE VHF AMPLIFIER

SPECIFICATIONS:

Frequency Range	: 144-148MHz; No Tuning
Power Output, Max.	: 350 to 400 Watts
Circuitry	: Fully Transistorized
Modes of Operation	: AM-FM-SSB-CW-RTTY
Duty Cycle	: Continuous Duty
Gain, Typical:	
8 Watts Input	: 300 Watts Output
12 Watts Input	: 350 Watts Output
15 Watts Input	: 400 Watts Output
Primary Wiring	: Built-in AC Power Supply, 115/230 VAC
T/R Switching	: Built-in 1KW Coaxial T/R Relay
Spurious	: 60dB down all Harmonics 60dB down all Spurious
Power Output Select	: 10 Watts (LOW) or 350 Watts (HIGH)
Metering, Lighted	: Front Panel All Mode Set Indicator
Cooling	: Convection SSB and CW Model F135 or F235 required for continuous FM operation
Temperature Control	: Built-in Thermo-Switch for Fan Control
Auxiliary Output	: + 13 Volt at 3 Amperes on Rear Panel
Design Layout	: Hinged Amplifier and Heatsink Top Assembly for easy Accessibility and Service
Weight	: 52 pounds; 24 kilograms
Size (W x H x D)	: 17 x 8 x 13"; 432 x 203 x 330 mm
Mounting	: Bench Mounting, Rubber Bumpers Rack Mounting, 19" Adaptor Kit (OPTIONAL)
Connectors	: SO-239 UHF
USA Price	: \$895.00 FOB Factory



MODEL: V350

FOR BASE STATION & REPEATER USE



RF POWER LABS, INC. ✓R27

11013-118th Place N.E. • Kirkland, Washington 98033 • Telephone: (206) 822-1251 • TELEX No. 32-1042



Key Electronics



Full ASCII Professional
Keyboard Kit, Model 756



• Full 128 Character ASCII • Tri-Mode MOS Encoding • MOS/DTL/TTL Compatible Output • Two-Key Rollover • Level and Pulse Strobe • Shift and Alpha Lock • Selectable Parity • Positive or Negative Logic • All New, OEM Grade Components • Gold Contact, Low Bounce Key Switches • Rugged G-10 Printed Circuit Board • Low Power Consumption ... and More

Model 756 Keyboard Kit \$64.95
Model 701 Plastic Enclosure \$14.95
Model 702 Steel Enclosure \$29.95

Send for catalogue of other NEW merchandise,
Semis, Sockets, ICs, Res., Caps, and MORE.

N.Y.S. Residents Add 4% Sales Tax

Send to: Key Electronics
P.O. Box 3506
Schenectady, NY 12303

✓K14

DISCOUNT SCANNERS

The Touch™



\$255.00

Prepaid
USA 

CHECK, M.O., MASTERCHARGE, VISA

BAY-COM ✓B32

196 FRONT STREET
SCITUATE MA 02066
617-545-9700

Other Regency models at
similar savings—send for list

...Mass. residents please add 5% tax...



Bearcat® 250

Only \$319.00 plus \$5.00 U.P.S. shipping.
Quantity discounts available!

Order toll free (800) 521-4414
or (313) 994-4444. Circle C5 on reader's
service card for a free catalog or write us
at Box 1002, Ann Arbor, Michigan 48106

 COMMUNICATIONS
ELECTRONICS™ ✓C5

JUST GETTING ON THE AIR?
See Adirondack for

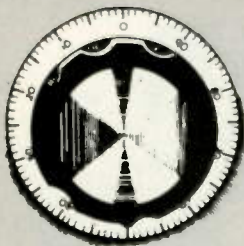

- New Equipment
- Used Gear
- Friendly Advice

NEW
✓A1

TOLL-FREE ORDER PHONE
(800) 833-8680
For technical information, order/repair
status or within New York State,
Call (518) 842-8350

ADIRONDACK Radio Supply

Amateur Headquarters for the Northeast

185-191 West Main Street • P.O. Box 88
Amsterdam, N.Y. 12010 Tel. (518) 842-8350
Just 5 minutes from N.Y. Thruway — Exit 27

The best buy on the market today!



PS 15C



PS 25M



PS 3012

Vhf engineering HIGH QUALITY POWER SUPPLIES

15, 25 and 30 amp regulated power supplies with fold back current limiting, over voltage and transient protection. Also, output voltage and current meters.

You might find a cheaper power supply, but you can't find one as well built with top quality components. Other power supplies with lighter weight transformers and components are no match for the VHF Engineering power supplies.

115/230 volt input – 50/60 cycle • Overvoltage protection • Fold back output limiter • Isolation from ground. The circuit is isolated from the case and ground. • Load regulation: 2% from no load to full load • Output voltage: adjustable 11 to 15 volts • Ripple: 50mV at rated current • Temperature range: operating 0 to +55 C • Black anodized aluminum heatsink.

PS 15C	10 Amps cont.	15 Amps Intermit. (50% duty cycle)	1 1/4 lbs.	\$134.95
PS 25C	20 Amps cont.	25 Amps Intermit. (50% duty cycle)	2 1/2 lbs.	\$169.95
PS 25M	Same as PS25C with meters			\$189.95
PS 3012	25 Amps cont.	30 Amps Intermit. (50% duty cycle)	25 lbs.	\$274.95

AVAILABLE ONLY AT THESE AUTHORIZED DEALERS

CALIFORNIA

C & A Electronic Enterprises, Carson, CA 90745, Ph. 213-834-5868
Tele-Com Electronics, San Jose, CA 95121, Ph. 408-274-4479
Zackit Corporation, Vallejo, CA 94590, 707-644-6676

COLORADO

A.E.S. Communications, Wes-Com, Colorado Springs, CO 80909,
Ph. 303-475-7050

FLORIDA

Amateur Electronic Supply, Orlando, FL 32803, Ph. 305-894-3238
N & G Distributing, Miami, FL 33126, Ph. 305-592-9685
VHF/JAX, Orange Park, FL 32073, Ph. 904-264-7176

GEORGIA

Creative Electronics, Marietta, GA 30065, Ph. 404-971-2122

ILLINOIS

Klaus Radio, Peoria, IL 61614, Ph. 309-691-4840
Spectronics, Oak Park, IL 60304, Ph. 312-848-6777

IOWA

Bob Smith Electronics, Fort Dodge, IA 50501, Ph. 515-576-3886

MASSACHUSETTS

Tufts Radio Electronics, Medford, MA 02155, Ph. 617-395-8280

MICHIGAN

Adams Distributing, Detroit, MI 48228, Ph. 313-584-4640
The Ham Shack, Kentwood, MI 49508, Ph. 616-531-1976

MINNESOTA

PAL Electronics, Minneapolis, MN 55412, Ph. 612-521-4662

MISSOURI

Alpha Electronic Labs, Columbia, MO 65201, Ph. 314-449-1362

NEBRASKA

Communications Center, Lincoln, NE 68504, Ph. 402-466-3733

NEVADA

Communications Center West, Las Vegas, NV 89106, Ph. 702-647-3114

NEW YORK

Barry Electronics, New York, NY 10012, Ph. 212-925-7000
Delmar Electronics, W. Babylon, LI, NY 11704, Ph. 516-420-1234
VHF Communications, Jamestown, NY 14701, Ph. 716-664-6345

OHIO

Universal Amateur Radio, Reynoldsburg, (Columbus) Ohio 43068
Ph. 614-866-4267

OKLAHOMA

Derrick Electronics, Broken Arrow, OK 74012, Ph. 918-251-9923

PENNSYLVANIA

LaRue Electronics, Scranton, PA 18509, Ph. 717-343-2124

SOUTH DAKOTA

Burghardt Amateur Center, Watertown, SD 57201, Ph. 605-886-7314

TEXAS

AGL Electronics, Dallas, TX 75234, Ph. 214-241-6414
Madison Electronics Supply, Houston, TX 77002, Ph. 713-658-0268

VIRGINIA

Radio Communications, Roanoke, VA 24016, Ph. 703-342-8513

WASHINGTON

A-B-C Communications, Seattle, WA 98155, Ph. 206-364-8300

WISCONSIN

Amateur Electronic Supply, Milwaukee, WI 53216, Ph. 414-442-4200

CANADA

Bytown Marine Ltd., Ottawa, Ontario, Can. K2H 7V1, Ph. 613-820-6910
Traeger Distributors, Richmond, BC, Can. V6X 2A7, Ph. 604-278-1541

Vhf engineering ✓ V5

DIVISION OF BROWNIAN ELECTRONICS CORP.

Prices and specifications subject to change without notice.

The Filcher Foiler Revisited

— vehicular protection

The best news for hot rods since the green light.

After reading Mr. Helvey's article ("Filcher Foiler Car Alarm," 73 Magazine, Dec., 1977), I decided that it was just what I needed to protect my old Ford hot rod with its chrome-plated engine, dual quads, custom gauges, etc. Being a middle-aged hot-rodder in a neighborhood full of fifteen-year-olds will almost always ensure a good-sized audience for my car projects. This day was no exception.

The first thing I did was purchase all the required parts, including the door switches. Upon completion of one door jamb, I overheard a supportive ten-year-old telling his older brother in no uncertain terms that, no, Mr.

Davis wasn't crazy, and, yes, it was undoubtedly going to be faster with dual light switches! After pretending (?) to go berserk and chasing all the youngsters away, I went inside to reread the article and see just why I was installing another set of door switches.

The very first thing I discovered, which was incidental to my quest, was that the relay as shown is not in a true latching-type configuration. The next thing I discovered is that most vans don't have door switches for the courtesy lights already installed. Hence Mr. Helvey's installation. Well, the Bondo job on the doorpost wasn't too difficult and neither is the new alarm system out-

lined here.

My hot rod and my Mustang were both wired the same, insofar as the courtesy lamps use switched 12 volts from the door switch while the other side of the lamp is grounded. Car manufacturers, however, being what they are, have probably made cars where the lamp is at 12 volts on one side and uses a switched ground on the other side. If your car falls in the latter category, simply reverse the grounds and 12-volt sources on the large schematic (not the two smaller alarm schematics), and reverse the polarity of diode D1. I have made provision in my system for hood and trunk switches; however, any number of extra switches may be used.

Isolation diode D1 has been included to prevent the courtesy lights from coming on when the trunk

or hood switch is closed. The size of this diode is not very critical, but it should be at least 25 V piv and have a current rating capable of handling the relay coil. Notice the configuration of the latching circuit for relay K1. This corrected design ensures that the relay will latch by positively holding the relay closed for as long as a switch is closed, which will be more than long enough for the armature to contact its latching contact. Mr. Helvey's problem with the relay buzzing rather than latching is not due to a defective relay, but rather to trying to have the relay do something it wasn't designed to do.

Two different methods of activating an alarm device are shown in my schematic: 1) using the existing car horns, where the

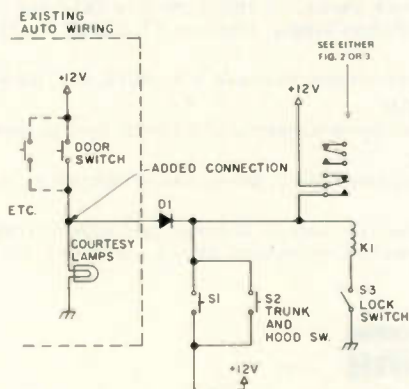

Fig. 1.

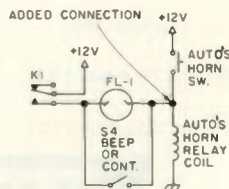

Fig. 2. For use with existing car horns with horn relay.

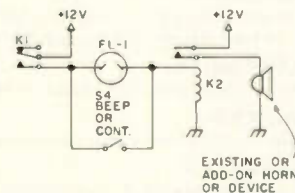

Fig. 3. For use with existing horns without horn relay or to use sirens, bells, or add-on horn.

horns are operated from a horn relay in the car, and 2) using the existing car horns where there is no horn relay (as in the case of most mid-60s Ford products) or for using a siren, bell, add-on horn, etc. Both above circuits are shown with a heavy-duty automotive flasher installed to provide a beeping alarm, rather than a continuous tone. A switch (S4) is included to change from beeping to

continuous tone. If not desired, this feature may of course be deleted entirely, thereby eliminating S4, the flasher, and relay K2 from the circuit. K2 is required only because the large current drain of the horns will not permit the flasher to operate properly and will burn out the flasher very quickly.

One last note: Use only a 12-volt source capable of supplying high current

(cigarette lighter, battery terminal, etc.), and use a heavy-gauge wire for all

wiring. This will prevent an electrical fire, which in a car is very dangerous ■

Parts List

D1	50 V 3 A silicon rectifier (Radio Shack 276-1141)	\$.69
FL1	Tung Sol 552 heavy-duty flasher (Auto Parts Store)	2.50
K1, K2	DPDT 12 V relay 10 A contacts minimum (275-208)	4.99; 9.98
S1, S2	Contact switch (for trunk and hood) (275-513)	1.49; 2.98
S3	SPST locking switch and key (275-511)	7.95
S4	SPST toggle switch (mode selection) (275-701)	.99

Lee Reed W4RBL
1406 Railton Street
Memphis TN 38111

Build An Economy Zener Checker

— versatile test rig

Why not do it right?

The device shown in Fig. 1 was developed to check zener diodes but it has also been found useful for other purposes.

With no load across the alligator clips, the panel meter will read about 50 volts. With a silicon rectifier across the clips, the

meter will still read 50 volts for one position of the switch but only .6 volt for the other position. Note that the switch is cross-connected to provide voltage reversal across the diode.

When the alligator clips are connected to a zener

diode, the meter will read .6 volt for one position of the switch, but for the other position it will read the rated zener voltage up to a maximum of 50 volts.

A third use is to check the total forward voltage across a string of series-connected rectifiers without applying power. This would be about .6 volt per rectifier. This check could not be made with most VOMs because their ohmmeter source voltage is not high enough.

This device *should not* be used to check germani-

um diodes unless the supply voltage is reduced. This can be done by forward biasing a silicon rectifier to obtain a .6-volt source. Then the germanium can be connected across the .6-volt source in both forward and reverse directions to see if the meter reading will drop to .2 volt in the conducting direction.

A 50-volt panel meter is probably optimum for this checker. However, other voltages could be used if the values of R1 and R2 are changed ■

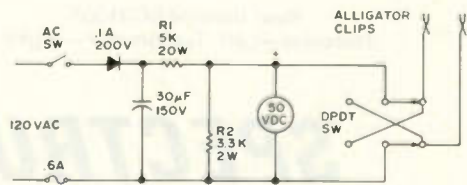

Fig. 1. Zener checker schematic diagram.

SCR 1000

The Repeater of Your Dreams!



*In Use
Around the
World!*

*Available With Optional
Features You've Only
Dreamed About!*

Like -

- Full Autopatch, with or without reverse patch, and "Landline" or Radio Remote Control of the Repeater.
- Radio and/or Landline TouchTone™ Remote Control of such repeater functions as HI/LO Power; Patch Inhibit/Reset; Switch ID Tracks; Repeater ON/OFF; PL ON/OFF, etc.
- 65 Wt. Transmitter!
- "PL"-CTCSS; HI/LO Pwr.; Multi-Freq.
- Up to 4 different IDs; Automatic switching to "Emergency Power ID" when on battery pwr.
- Ultra-sharp 10 Pole Xtal Filter; Xmtr. Xtal oven—for the "ultimate" in stability.
- Timeout—Timer Reset Tone Annunciator
- And many other "custom-designed" options per your request—such as auxiliary receivers, radio links, etc. Please Inquire.

Shown In Optional Cabinet

The SCR1000—*simply the finest repeater available on the market*—absolutely TOP QUALITY throughout... and often compared to (lesser featured) units selling for 2-3 times the price! This is a 30 Wt. unit, with a very sensitive & selective receiver. Included is a built-in AC Supply, NEW Expanded Memory CW IDer, full metering and lighted status indicators/control push-buttons, crystals, local mic, etc. Incidentally, we have designed every board and sub-assembly in the SCR1000 specifically for 100% continuous duty Repeater Service in extreme environments. (-30 to +60° C.) We use only professional quality boards—Not "transceiver", or cheap "kit type" boards!

Join the thousands of very pleased Spec Comm customers world-wide who are using our gear—knowledgeable Amateur Radio groups, Commercial 2X Radio users, Military & Government Agencies, Red Cross, Universities, etc.

So, make your dream a reality... Call or write Spec Comm today! Give us all of your repeater system requirements—whether modest... or "Super Deluxe," and let us give you a quote on the entire system!

The Spec Comm Repeater System... a sound, long-term investment—for those who demand the finest! Available only by direct factory order. Get your order in A.S.A.P!

Along with a complete line of Repeater System Accessories... such as: The Finest Duplexers, Cavities, Cabinets from 7" to 7', Antennas, "Hardline," Cables, etc.

2Mtr. & 220 MHz
(450 MHz Soon!)



Rear View of SCR1000
Receiver—Left. Transmitter—Right.

180 Day Warranty

TM—Registered Trademark of AT&T
Call or write today and get the details!



SPECTRUM

Export Orders — Contact our International Dept.

1055 W. Germantown Pk., Dept. S1

NOW Fully "Commercial"

We are proud to announce that the SCR1000 is now "FCC Type Accepted" for Commercial Service under Parts 21, 81, 89, 91, and 93!

SCR1000 Specifications

RF Output... 30 Watts typ.
Infinite VSWR proof
Sensitivity... 0.3uV/20dB Qt.
Selectivity: 6dB @ ± 6.5 kHz;
-75dB @ ± 15 kHz;
-100dB @ ± 30 kHz.
Includes 8 Pole Xtal Filt.
Sharper 10 Pole Filt.
(Available.)

FEATURES

- Full Metering of critical levels.
- Front Panel Controls for timers & AF levels.

- Lighted push-buttons for control/test functions & status indicators.
- State of the Art CMOS control logic & timers—No Relay problems!

Exclusive Spec Comm MOSFET/Hot Carrier Diode rcvr. front end—reduces 'dense' & IM problems!

- Built-in AC Supply w/instant btry. switchover for emergency pwr. (+Trickle Chgr.)

- Supplied with ± .0005% International precision Xtals, local mic., & FL-6 Pre-selector.
- Built-in CW IDer—Low current draw, 250 bit PROM Memory! Adjustable speed, pitch, time, etc.
- Jacks Provided for Remote Control, Auto-Patch, DC out, AF in/out, COR Switch, etc.
- True FM—For Rpt. Audio so good, "It sounds like direct!"

Mobile/Portable/Base Transceivers also available!

5-25 Wt.; 2, 6, & 12 Chan.; 2M & 220 MHz.



Write or call for further info.

SPEC COMM REPEATER BOARDS, SUB-ASSEMBLIES & ACCESSORIES

These are Professional "Commercial Grade" Units—Designed for Extreme Environments (−30 to +60° C).
All equipment assembled & tested. For 2M & 220 MHz.

SCR100 BOARD

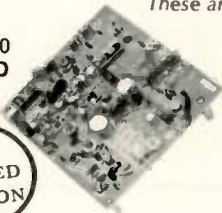

NEW REVISED VERSION

SCR100 Receiver Board

- Wide dynamic range! Reduces overload, 'desense', and IM.
- Sens. 0.3 uV/20 dB Qt. typ.
- Sel. -6dB @ ± 6.5 KHZ, -90dB @ ± 30KHZ, (-110dB w/opt. 8 Pole Filt.) 10 Pole Filt. Avail.
- 'S Meter' Output.
Exc. audio quality! Fast squelch! \$125.00 w/xtal. 8 Pole Filt. (Highly recommended.) \$15.00

SCR100 Receiver Assembly

- SCR100 mounted in shielded housing
- Same as used on SCR1000
- Completely asmbld. w/F.T. caps, S0239 conn., AF GAIN POT, etc. \$195.00



SCAP Autopatch Board

- Provides all basic autopatch functions
- See our Dec. 73 Ad for details. \$225.00

RPCM Board

- Used w/SCAP board to provide "Reverse Patch" and land-line control of rpt.
- Includes land line "answering" circuitry. \$79.95

WP641 Duplexer

- Superior Band Pass/Band Reject design
- Provides great rejection of "out-of-band" signals
- Extremely easy to adjust
- -93dB typ. isolation. \$495.00 (fully ckd. out w/SCR1000).

RX ASSY.



TX ASSY.



FL-6

FL-6 Rcvr. Front-End Preselector

- 6 HI Q Resonators with FET preamp.
- Provides tremendous rejection of "out-of-band" signals w/out the usual loss! Can often be used instead of large, expensive cavity filters.
- Extremely helpful at sites with many nearby VHF transmitters
- Gain: apx. 10 dB
- Selectivity: -20 dB @ ± 2.0 MHz; -60 dB @ ± 6 MHz (typ.). \$85.00

TRA-1 Timer Reset Annunciator Board

- Puts out a tone "beep" on rpt. xmtr. apx. 1 sec. after rcvd. signal drops — thus allowing time for breakers
- Resets rpt. time-out timer when tone is emitted
- Adjustable time delay and tone duration
- For use with CTC100 and ID100/250
- \$20.95 (Add \$18.00 for inst. & ck. out in SCR1000)

CTC100 COR/Timer/Control Board

- Complete COR circuitry
- Carrier 'Hang' & T.O. Timers
- Remote xmtr. Inhibit/Reset control
- Provision for panel control switches & lamps
- 100% Solid State CMOS logic
- Many other features \$35.00

ID250 CW ID & Audio Mixer Board

- Adjustable ID tone, speed, level, timing cycle
- 4 Input AF Mixer & Local Mic amp.
- COR Input & xmtr. hold circuits.
- CMOS logic; PROM memory—250 bits/chan.
- Up to 4 different ID channels!
- Many other features. Programmed \$65.00 (1 chan.) Add'l Chan. \$6.00 ea.
- Local MIC: \$18.95

SCT 110 BOARD

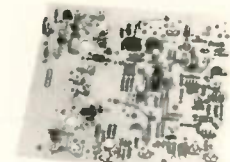

SCT110 Xmitter/Exciter Board

- 7 or 10 Wts. Output. 100% Duty Cycle!
- Infinite VSWR proof
- True FM for exc. audio quality
- New Design — specifically for continuous rpt. service
- Very low in "white noise"
- Spurious -70 dB
- With .0005% xtal. \$135.00
- BA-10 30 Wt. Amp board & Heat Sink, 3 sec. LPF & rel. pwr. sensor. \$51.95

SCT110 Transmitter Assembly

- SCT110 mounted in shielded housing
- Same as used on SCR1000
- Completely asmbld. w/F.T. caps, S0239 conn.
- 7 or 10 Wt. unit \$199.95. Add \$68.00 for 30 Wt. unit

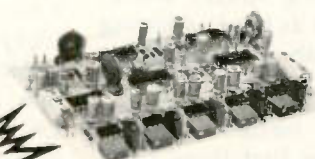

TTC100 TOUCHTONE™ CONTROL BOARD

TTC100 Touchtone™ Control Board

- 3 digit ON, 3 digit OFF control of a single repeater function. Or, 2 functions ON (2 digits each) with 1 digit (each) OFF.
- Can be used to pull in a relay, trigger logic, etc.
- Typically used for Rptr. ON/OFF, HI/LO Pwr., P.L. ON/OFF, Patch Inhibit/Reset, etc.
- Stable, anti-falsing design. 5s. Limit on access.
- \$85.00 (\$125.00 inst. & ckd. out in SCR1000.)



COMMUNICATIONS

MOBILE/PORTABLE TRANSCEIVERS ALSO AVAILABLE. 5-25 Wt., 2M & 220 MHz!

Send for Data Sheets!

(Ship./Handl.—\$3.75 PA residents add 6% tax)

Norristown, PA 19401 • (215) 631-1710

Alaskan Adventure

— stalking the elusive KL7

If you crank up your perseverance, you can WAS.

Yep, I got Alaska! After a solid year of frustration, anxiety, and keen disappointment, I finally corralled a KL7 station.

I believe *Reader's Digest* said that Alaska has something like thirty-seven million acres of land, and the *Callbook* shows something like fifteen hundred amateur radio stations having KL7 calls... so it looks like getting Alaska would be about as hard as hitting Texas with a seven and a half gallon hat.

Well, believe me, it ain't! The first thing I did was set up a sked with a station at the North Pole. I had already worked Hawaii and Australia, plus a few other DX points of interest, so, with a sked, things would be easy and I could spend more time on Delaware and the Dakotas. But the sked just didn't come off as expected... three times each week KL7IUM and I would toss

CQs back and forth at each other, but none of them made connections in a faithful six months of effort. One by one, the other states came dropping in until I was down to Delaware and Alaska... and try as I would, I just couldn't find the range.

A funny thing happened on the way to WAS, however... I was glued to the CW bands, and one day I heard a CQ that ended: "CQ, CQ, CQ de LA WARE!" I went back to him, not being sure where LA was, nor what country had calls without numbers. The *Callbook* said that LA was Norway, but they had a number after the "LA"... so I assumed I had read 3 into a W... missing a few dits in the translation. Could happen! So I called and called... no reply. Then I told my friend WB5WDD about it, and he said he had heard the same station but couldn't get it to come

back. We agreed it was Norway... and let it go at that. Finally I landed a Delaware station, and it was then and only then that I realized the CQ I heard was FOR Delaware and not FROM Norway. It could happen to anyone!

But, after concentration on Alaska, I began to hear a few KL7 stations... one of them coming in quite clearly on a Sunday afternoon. He called CQ South America, so I waited through several of his calls until finally I assumed he would not get his desired station. Then I called him and anxiously awaited his return call. It came like this: "Can't you hear? I am calling South America!" So there was lesson number XX on CQ courtesy... but I kept listening and dialing. One evening I heard a truck driver, mobile in California, rag chewing with a strong KL7 station... so I waited... and waited... and

waited... not daring to holler "break" after the previous experience. They gabbed a good half hour, and the truck driver, who evidently had not read the book on ham courtesy, either, closed by saying, "I have a buddy tuned in on us now that would like to have a word with you... so I'll be... etc., etc." And the buddy took over until the band closed! Well, it was important... the buddy was trying out a new rig, and he wanted the opinion of this stranger in Fairbanks on whether he should buy the rig or not!

Finally, in desperation, I decided that the next KL7 I heard would either pitch me out on my ear... or QSL! And then it came... again, a strong station in KL7-land hooked up with a California ham... and I sat through the usual routine of statistics before timidly shouting "break" plus other pertinent data that I thought would get

me through. There was a short silence and KL7 said, "I believe we had a breaker... come on in, breaker!"

Here was the chance I had been so long waiting for... and behold, my voice almost failed me! Finally I got it out: "KL7ABC, this is WB5WDG, Muskogee, Oklahoma. Do you copy?"

There was an exciting few seconds of dead silence, and then California said, "I believe he is calling you, KL7."

Then KL7 said, "No, I think he was calling you." and with that, they went back to their aforementioned QSO and never paid me another bit of attention. I snapped off the rig, snapped at my XYL, and told her where they could put Alaska if Russia ever wanted her back... and went to bed, only to roll and toss and count cari-

bou, grizzlies, fjords, and permafrost.

But the final blow came a couple weeks ago when KL7 came in quite clearly, slowly, and with a hesitating dahdididahdit followed by SA... so, naturally, I assumed that this was a Novice newly upgraded who was trying out his new wings. I went back to him in fear and trembling, hoping that this was it. And it was... he heard me and came back loud and clear. A real live KL7... and he was answering my call... at last, the big hunt was over. I was so excited that I almost missed his QTH when he gave it as Ft. Bragg, North Carolina. He had been transferred from a military base in Alaska and was still using his KL7 call... the SA I had heard after the dahdididahdit was not an SA at all, but a four. Your ears hear what you want them to hear.

But enough of that stuff... quitting never gets it... and I just didn't quit. Quite by accident, I heard a QSO that ended identifying itself as having a treasured Alaska station as one of the participants. Again I waited patiently until it ended, and I swung in behind the finale with my call. Believe it or not, the KL7 answered.

At last, my luck had changed and I was ready to apply for my WAS award. His signal was strong... his fist was great... and everything was deathly quiet. He acknowledged my call, gave me his name, and then started with his QTH—just as a 4-land station with a million-Watt linear started his big CQ, almost knocking my cans from my ears. I ditted a few thousand times and he stopped just as the lad in Anchorage was telling me that he had to get to work,

but would answer my QSL as soon as he got it. And that ended that... thanks to the million-Watter in orange country.

Only this time I was ready. This had happened to me before... many times... so I was prepared. While I was listening to the KL7 QSO, I was copying his data as he sent it to the former recipient... and even though Florida knocked the orange juice out of my coax, I was ready with the proper address and now have my QSL merrily on its way to Anchorage with an SASE enclosed!

Why didn't I refer to the *Callbook*? Well, this lad had already said that he was too new to be in the latest edition of the *Callbook* and he had to get his QSLs in care of his dad, who was in the book! Practice may not make perfect... but it helps. ■

NEW MFJ Dual Tunable SSB/CW filter lets you zero in SSB/CW signal and notch out interfering signal at the same time.



Ham Radio's Most Versatile Filter



\$79⁹⁵

The MFJ-752 Signal Enhancer is a dual tunable SSB/CW active filter system that gives you signal processing performance and flexibility that others can't match.

For example, you can select the optimum Primary Filter mode for an SSB signal, zero in with the frequency control and adjust the bandwidth for best response. Then with the Auxiliary Filter notch out an interfering heterodyne... or peak the desired signal.

For CW, peak both Primary and Auxiliary Filters for narrow bandwidth to give skirt selectivity that others can't touch. Or use Auxiliary Filter to notch out a nearby QSO.

The Primary Filter lets you peak, notch, low-pass, or highpass signals with double tuned filter for extra steep skirts. The Auxiliary Filter lets you notch a signal to 70 db. Or peak one with a bandwidth down to 40 Hz.

Tune both Primary and Auxiliary Filters from

300 to 3000 Hz. Vary the bandwidth from 40 Hz to almost flat. Notch depth to 70 db.

MFJ has solved problems that plague other tunable filters to give you a constant output as a bandwidth is varied. And a linear frequency control. And a notch filter that is tighter and smoother for a more effective notch.

Works with any rig. Plugs into phone jack. 2 watts for speaker. Inputs for 2 rigs.

Switchable noise limiter for impulse noise; trough clipper removes background noise.

Simulated stereo feature for CW lets ears and brain reject QRM. Yet off frequency calls can be heard.

Speaker and phone jacks. Speaker is disabled by phones. OFF bypasses filter. 110 VAC or 9 to 18 VDC, 300 ma. 10x2x6 inches.

Every single unit is tested for performance and inspected for quality. Solid American construction, quality components.

The MFJ-752 carries a full one year unconditional guarantee.

Order from MFJ and try it — no obligation. If not delighted, return it within 30 days for a refund (less shipping).

To order, simply call us toll free 800-647-1800 and charge it on your VISA or Master Charge or mail us a check or money order for \$79.95 plus \$3.00 for shipping/handling.

Don't wait any longer to use Ham Radio's most versatile filter. Order your MFJ Dual Tunable SSB/CW Filter at no obligation, today. ✓ M52

MFJ ENTERPRISES, INC.
P. O. BOX 494
MISSISSIPPI STATE, MS 39762
CALL TOLL FREE . . . 800-647-1800
For technical information, order/repair status, in Miss., outside continental USA, call 601-323-5869.

The Last DXpedition

— "QTH hr is Purgatory"

What the devil is going on here?

This old-timer was one-in-a-million, with a personal history dedicated to amateur radio. He was the envy of operators the world over. He held more certificates than the average ham ever knew existed, was winner of numerous contests and citations from all over the world for amateur radio services above and far beyond the call of duty, and was designer and builder of practically every type of radio equipment from the spark-gap days on up. This old-timer had just expressed his last "73" along with his final "dah-dit-dah." In simple words, he died.

He awakened, feeling no pain, and discovered he was lying on a very comfortable, elaborate bed, in a gorgeous room which was permeated by the faint odor of burning sulphur. "Oh, brother," sighed the old-timer, "I knew this would happen to me. I should have been more careful to always stay within the legal bands. I knew I was wrong in using that 'California Kilowatt' so often, and I should not have worked those guys with the HS, XU, XV, 3W8, and 8F calls. Yes,

I'm confined to eternal damnation!"

"Just a minute there, my friend. Don't be upset about what happened to you." Jumping from his bed, the old-timer found himself face-to-face with a man who was reddish of face and the epitome of sartorial splendor in his superbly tailored suit, bright red socks, and foot-long cigar. The old-timer could plainly see the horn-like protrusions, all polished and gleaming, near the top of the man's head, and even the shadow of a tail extended from his rear. "Allow me to introduce myself. I am lovingly called Satan by my many admirers and I welcome you to Purgatory. Now, don't get yourself all uptight about things you heard concerning me and my home from those narrow-minded people up there where you used to live. I've been given a bad press all my life, and I honestly don't feel I deserve such humiliating treatment. They don't like me up there for some reason, and they sure paint a black picture of Hell. Now, don't misunderstand me—it's Hell

down here alright, but we still have plenty going for us, as you'll soon discover. Here, have a glass of 20-year-old bourbon, a fine cigar, and pull up a chair. Tell me all about yourself, you lucky man!"

Before the old-timer had time to collect his thoughts, Satan started in again. "Look, pal, I'm going to try to make you like it down here. Sure it's Hell, but just for openers, tell me what you like the best. Do you want a dozen or so beautiful, sexy gals—or maybe you'd like to become a millionaire? Is it just hunting, fishing, and yachting you like? Tell me what 'turns you on' and it's yours, absolutely free of charge, with no strings attached."

"Well, Mr. Satan," replied the old-timer, "up there I was one hell, oh, pardon me, of a ham radio operator, and I thought just maybe you'd have..."

"A ham radio operator!" screamed Satan. "Why the hell didn't you say so in the first place! Quickly, come with me." Satan then rushed the old-timer outside to a warehouse, unlocked the door, and said, "We'll start with your

tower. Here's a nice medium height one of about 500 feet, OK?"

"Wow!" yelled the old-timer. "These are built better than the commercial towers up there. You sure there's no catch to this?"

"Aw, come on, pal," replied Satan. "Would I fool you when you're going to be my guest for quite some time? Why shouldn't I try to please you with the best of everything just to make you happy? Sure, it's Hell down here, as I said before, but we still have much more to offer a nice guy like you. Now, let's get some antennas up. How's this—a simple Christmas tree of rotary beams, simple 10-element beams for every band? I'll have them erected immediately."

"Yes, but what am I going to do for a transmitter and receiver?" queried the skeptical old-timer.

"Never fear, friend, Satan is here. Take a look and pick up any of these." Here was a room filled with every late model transmitter and receiver, all in sealed cartons. The old-timer was dumbfounded, as he had never owned any equipment that wasn't "home brewed."

"Wait a minute, friend," said Satan. "Pick up a good linear while you are at it. And by the way," he whispered, edging over to the old-timer, "how about one of my special 'Satanic Kilowatts' that makes those 'California Kilowatts' up there sound like peanut whistles? Here's a great new 10 kW job.

"Sure, this is Hell, but answer me truthfully, did anyone up there ever offer

a nice guy like you so much for free with absolutely no strings attached?"

The old-timer was absolutely at a loss for words. Having scrounged all his life for every dime to buy used parts to build anything he ever operated, he never dreamed he would be so fortunate as to have such magnificent appliances to operate for all eternity. "Let's get this set up!" yelled the old-timer.

"I just can't wait to get on the air!"

"Certainly," said Satan. With a wave of his smoking hand, there was a loud clap of thunder and a puff of sulphur-ridden smoke, and the old-timer found himself in a shack fit for a king, with everything properly set up.

"Great, great, absolutely beyond belief!" cried the old-timer. I just don't know how to thank you enough.

I'm going on the air to tell everybody up there the true story of you and your kindness, Mr. Satan. I'll tell them the absolute truth about the goodies you have to offer everyone. By the way, where do I plug in this magnificent equipment?"

"Well, my friend," replied Satan as he hastily headed for the door, "that's the hell of it—we have no electricity!" ■

Randy Hoffman WB6WQN
991 42nd Street
Sarasota FL 33580

An Audio Morse Memory

— got a tape recorder?

Listen to your own fist—and learn.

The tape recorder decoder (Fig. 1) can be very useful and is easy to duplicate. It converts an audio signal to dc to key a relay. Code can be recorded on a tape recorder, then played back through the decoder, thus keying a transmitter, monitor, or both. Works just dandy for a "CQ" tape or a "CQ field day" tape. CW can also be recorded from a receiver and then played back to key your transmitter, letting a fellow amateur hear

his own fist! A delayed test-transmission with a timer can also be arranged, allowing you to check signal quality from a friend's shack.

Parts List for Tape Recorder Decoder

Q1—For maximum sensitivity, a high-gain transistor such as a 2N447A (gain of 200) should be used. But any transistor of reasonable gain is OK (2N338, 2N3641, 2N3843, etc.). A PNP transistor can

be used as easily by reversing the polarity at the battery and C3 (2N1307, 2N404, 2N408, 2N1025 with a gain of 100).

C1—.001 to .005 μ F rf bypass.

C2—.1 to .25 μ F disc ceramic, mylar, or electrolytic (6 V).

L1—.5 H choke. A toroid is best because of its small size and low losses. The value is not critical and can be replaced with a 68- to 100-Ohm resistor, though performance is degraded slightly when demodulating low frequencies.

C3—1 μ F to 2 μ F, 3 V electrolytic.

T1—miniature transistor audio output transformer with primary of 8 Ohms (to match tape recorder output) and a secondary of 500

to 1000 Ohms.

D1-D4—1N34 or equivalent. Just about any small-signal, germanium diode will work.

K1—reed relay with 3- to 6-volt coil. A 10-Watt reed relay with coil can be bought at Lafayette Radio, or a range of relays, with and without coils, can be obtained at suppliers.

B—battery, 3 to 6 V.

None of the part values are critical. The volume control setting on playback and record will have to be adjusted to obtain the best results. Playback volume should be as low as possible to prevent background noise from causing odd clicks, or overloading from causing mushy characters. ■

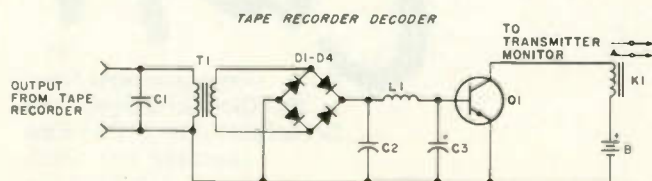

Fig. 1. Tape recorder decoder schematic diagram.

HAMTRONICS USED GEAR • TEST EQUIPMENT • SPECIALS

30-DAY GUARANTEE ■ 90-DAY FULL CREDIT TRADE-IN ■ FREE SHIPPING VIA UPS ONLY

Limited quantities. First come, first served. (if weight or size exceeds UPS max., we will ship freight collect)

Allied AX-190 Receiver \$159 Ameco PV-50 \$ 9 CN-50 29 CN-144 39 TX-62 79 621 VFO 45 B&W Waters Nuvertor 2+6 Conv. \$ 75 6100 SSB Xmitter 395 670 SSB Adaptor 39 Co-Dax Keyer 95 Central Electronics 100V Transmitter 325 MM-2 Scope 69 20-A SSB Adaptor 79 Clegg 22'er FM \$129 66'er 6M Xcvr 115 99'er 6M Xcvr 59 Interceptor BRCLR 275 Ant Pre Amp 22 All Bander 69 HT-146 125 2 Vess 259 FM-27-B Xcvr 325 Collins 75 A4 Receiver \$395 75S3B Receiver 695 75S1 Receiver 349 KWM-2 Xcvr 595 32S1 Xmitter 349 PM-2 AC Supply 95 516 F2 AC Supply 139 312B5 Console 425 361D2 Mount 29 Drake 2A Receiver \$149 2B Receiver 189 2AQ SPKR QMULT 29 R4 Receiver 289 R4-B Receiver 349 R4-C Receiver 399 MS-4 Speaker 19 2NT Transmitter 125 2NT Transmitter 99 TR-6 695	TR-22.2 Meter 140 T-4X Transmitter 339 TR-72.2 Meter FM 225 AC-4 AC Supply 95 TR-4 C Transceiver 449 CC-1 Console CPS-1 Supply SC-2 Conv SC-6 Conv SC-6 Conv The-1 Calibrator SC-10 all assembled complete pkg. Only \$200 Dycomm 10-0.2 M Ampl \$125 35-0 401N 110 Out 130 470-25 450 MC 120 P-1416 16 Amp Supply 95 Eico 720 Transmitter \$ 49 722 VFO 39 730 Modulator 39 Eimac AF-67 Transmitter \$ 45 PMR-8 Receiver 79 Genave GTX22M FM \$165 GTX-200 2M FM 149 Globe/Galaxy VHF 6+2 Transm \$ 39 Chief Transmitter 39 Galaxy III Xcvr 159 Galaxy V Xcvr 189 Galaxy V Mk II 239 GT-550 Xcvr 279 GT-500A Xcvr 329 AC 400 Supply 79 FM-210 2M FM 95 Gonset Com II 2M \$ 75 Com II 6M 69 Com IV 2M 129 GC-105 2M 115 G-28 Xcvr 149 G-50 Xcvr 149 Hallicrafters S-108 Receiver \$ 99 SX-101 Receiver 159 HT-32 Transmitter 179 HT-32B Transmitter 269 SX-99 Receiver 79 SX-115 Receiver 349	HT-37 Transmitter 159 HT-40 Transmitter 49 SX-99 Receiver 99 SX-117 Receiver 189 SR-150 Xcvr 259 SR-160 Xcvr 175 SX-146 Receiver 159 HT-44 Transmitter 159 SX-111 Receiver 149 SX-122 Receiver 249 S-36 UHF Receiver 125 Hammarlund HQ-110 A VHF Receiver \$189 HQ-110C Receiver 119 HQ-110AC Receiver 149 HQ-145X Receiver 169 HQ-170C Receiver 159 HQ-180 Receiver 379 HQ-215 Receiver 259 SP-600 Receiver 179 HX-50 Transmitter 169 Heathkit SB-300 Receiver \$199 SB-301 Receiver 229 HR-10-B Receiver 69 SB-303 Receiver 269 SB-320 Linear Amp 449 SB-102 Trivcwr 379 DX-60B Transmitter 69 HW-32 Transmitter 85 HW-100 Transceiver 249 SB-100 Transceiver 299 SB-401 Transmitter 249 SB-101 Transceiver 349 SB-650 Digital Freq. Display 149 HW-30 Twoer 29 Also Sixer 29 H-10 Monitor 69 VHF-1 Seneca 79 HW-12 Transmitter 75 HP-23 AC Supply 49 HP-23B AC Supply 59 HW-202 2M FM Xcvr 159 SB-620 Spectrum Analyz 120 SB-102 Xcvr 369 SB-610 Scope 95 HA-20 6m Linear 125 SB-634 Console 175 SB-604 Spkr 29.50 SB-644 VFO 129.50 SB-230 Linear 359 SB-104 Transceiver 625 ICOM IC-21 2M FM Xcvr \$299 IC-230 Demo 369 IC-22A 2M FM Xcvr 185 IC-30A 432 MCFM 269	Johnson 1-KW Matchbox/SWR \$195 Courier Linear 139 Ranger I Transmitter 85 Ranger II Transmitter 139 Vallant I Transmitter 129 Invader 2000 Xmitt 495 Kenwood T-599 Transmitter \$289 R-599 Receiver 289 TS-520 Tranc 429 QR-666 259 QR-666 Receiver 239 TV-502 Transverter 179 Knight T-60 Transmitter \$ 39 R-100 Receiver 59 TR-106 Trancur 2M 79 Lafayette HA-800 Receiver \$ 89 HP-350 Receiver 149 HE-45 Transceiver 49 Midland 509 H.T. \$149 Millen 92200 Transmatch \$149 90651-A Grid Dipper 95 National NC-270 Receiver \$119 NC-300 Receiver 129 NCX-5 Transceiver 279 NCX-SMK II Transcvr 299 NC-303 Receiver 199 AC-500 AC Supply 69 NCX-500 Transceiver 199 NCX-3 Transceiver 169 NC-190 Receiver 149 NC-105 Receiver 69 Regency HR-2B 2M FM \$169 HR-220 FM 220 MC 185 AR-2 2M Amplifier 85 HR-25 2M FM 225 HR-6 Meter FM 189 SBE SB-34 Transceiver \$249 SB-33 Transceiver 189 SB-144 2M FM 175 SBZ-LP Linear 179	Standard SRC-146 HT \$149 826 M Trnscvr 195 SRC-144 395 SRC-851T 250 Swan 700-CX Xcvr \$459 260 Cygnat 289 279 Cygnat 329 500 Xcvr 289 500 CX Xcvr 389 117-XC AC Supply 95 14X DC Module 39 MK II Linear 475 KK VI 6 Meter 550 250 C&M Xcvr 349 FM 2X2M Xcvr 169 FM-1210A 2M 249 350 Transceiver 269 350C Xcvr 299 600R Receiver 339 600T Transmitter 399 410 VFO 79	Tempo Tempo one Xcvr \$299 AC One Supply 79 FMH 2M H.T. 149 CL-220 Trncur 220 MC 179 FMH 2M w/Talkie 149 Ten Tec PM-3 Trnsur \$ 49 Argonaut Xcvr 199 KR-40 Keyer 79 RX-10 Receiver 49 S-30 Signalizer 29 Triton II 479 Yaesu FT-401 Xcvr \$499 FRDX 400SD Rec 325 FT-2 Auto 2M FM 249 FT-101B Xcvr 549 FL-2100B Linear 295 FV-101 VFO 79 101E Xcvr Demo 695
---	--	---	---	--	--

Test Equipment Bargains

Boonton "Q" Meter	\$295
Tektronix 5140	249
Tektronix 545A	950
5 3/54A Plug-in wide band preamp	75
Hickok 695 Generator	69
Bendix BC221 Freq Meter	39
Polarad Spectrum Analyzers A84T	1695
Hewlett Packard 400C	75
Precision E-400 Signal Generator	125
Electro Impulse Spectrum Analyzer	395
Dyna/Sciences Model 330 Digital Multimeter	195
Hewlett Packard 4905A Ultra Sonic Detector	550
Hewlett Packard 120A Scope	250
TS-323/UR Frequency Meter	175
Hewlett Packard 4910B Open Fault Locator	650
Bird Mod 43	80
General Radio 650A	150
Measurements Mod 80	195
Nems Clark 1400	495
Ballantine 300H	175
PACO Scope Mod-S-50	75
Singer FM-10C	349.5
Simpson 260 V.O.M.	49.50

The inventory quantities of the items shown in this list vary. There may be one or several of any item. Some items may be sold by the time you read this ad. It is also likely that we have items in stock that are not listed, as a result of the many trades we make each day. We reserve the right to sell accessories and power supplies with matching transceivers and transmitters. Please allow up to 10 working days to ship your order so that we may check and service the gear you purchase.



YAESU FT227RA
Regular \$399, save \$60. Your price \$339.
Cash—no trade.



MIDLAND 13-510
Regular \$399, save \$60. Your price \$339.
Cash—no trade.



KENWOOD Your price
TS820..... \$1055.00... \$896.75
TS80S..... \$1249.00... \$1061.65



Your price
FT101F..... \$799.00..... \$679.15
FT101EE... \$759.00..... \$645.90
FT101FX... \$699.00..... \$594.15
YAESU



YAESU CPU-2500RK
KEYBOARD MIKE
Regular \$585. Your price \$497.25.
Cash—no trade.

MAIL & PHONE ORDERS WELCOMED. BANK AMERICARD ACCEPTED. ALL UNITS GUARANTEED

HAMTRONICS

DIVISION OF

Trevoze Electronics

4033 BROWNSVILLE ROAD
TREVOSÉ, PA. 19047
Telephone: Toll Free:
(215) 357-1400 1 800-523-8998
(215) 757-5300

The Amazing Active Attenuator

— can you find a use for it?

The op amp is the answer.

I'm sure, by now, you have heard of many uses for op amps. But did you know that they can be used as attenuators? For some uses, they are better than attenuators consisting of only resistors. While the principle is very simple, I have not seen much mention of it in the various electronic magazines.

In an inverting op amp amplifier, as shown in Fig. 1, the gain can be varied from the open loop gain down to a gain of one. This gain is determined by the equation R_f/R_{in} , where R_f is the resistor from the output to the input and R_{in} is the resistor from the driving source to the input of the op amp (Fig. 1). Now, what happens if R_{in} becomes greater than R_f ? To save you the trouble of running this experiment, the answer is that there is a loss from input to output and the circuit becomes what I call an active attenuator.

There are, unfortunately, some disadvantages to this attenuator. The first problem is that an active

component, along with its associated power supply, is required. Also, frequency response is restricted to the bandwidth of this active component. Next, you must remember that this circuit inverts, so if you are using it for dc, you will get a negative voltage out if you feed in a positive voltage and vice versa.

Now, for the advantages. The output of this active attenuator, as in any op amp amplifier, is a low impedance (independent of resistor values). This means that any loading (within reason) of the output will not change the output voltage. Also, it is great for driving long, unshielded wires without the worry of hum. Also, although I am not yet sure what it is useful for, you can use this circuit as a summing attenuator. This is done by using different input resistors for each input desired. Fig. 2 gives the details.

Here are a few things to watch out for: First, the amplifier configuration must be inverting because

a non-inverting op amp amplifier has a minimum gain of one no matter what. Second, the input impedance is equal to R_{in} . So, when calculating the resistor values, choose R_{in} first, so that it is equal to the desired input impedance. Then choose R_f for the desired attenuation. Using this procedure, the resistor equation can be rearranged as $R_f = R_{in} \div$ desired attenuation. Also, make sure that the op amp is still useful at the desired frequency of operation. One thing that I am interested in knowing is what happens to the open-loop frequency response when the circuit is used as an attenuator. I know that as the gain of an op amp increases, the frequency

response drops, so with an active attenuator, does the frequency response increase?

Well, I hope that you can put this information to use. I have not given too many details because most of the information required can be found in many magazine articles and books dealing with using op amps. I have found the *IC Op-Amp Cookbook* by Walter G. Jung (Howard W. Sams & Co.) especially useful. If you come up with some new data or uses for the active attenuator, please let me know about it. If nothing else, you can use this circuit as an answer to those people who go around talking about "passive amplifiers and active attenuators." ■

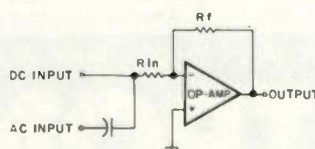

Fig. 1. Circuit for the active attenuator. $V_{out} = (R_f/R_{in})V_{in}$ and $R_{in} = R_f \times$ desired attenuation.

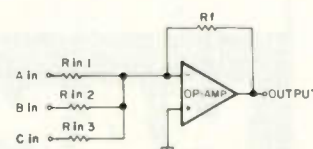

Fig. 2. Circuit for summing attenuator. Attenuation of $A_{in} = R_f/R_{in1}$, $B_{in} = R_f/R_{in2}$, and $C_{in} = R_f/R_{in3}$.

2 FOR 1!!



Subscribe to 73 Magazine this month and you will have the unprecedented opportunity to renew your subscription at half-price . . . for the rest of your life. Simply fill out the special subscription form attached, and you will begin receiving 73 Magazine each month at 2 issues for the price of 1. Your name will be placed with a select group of subscribers who will always be able to renew their subscriptions at half the newsstand price. This unbelievable offer expires on March 1, 1979, so act today. Return the postage-free card, and we'll bill you later.

YES! Enroll me as a "2 for 1" subscriber, which makes me eligible for half the newsstand price for life.

- New subscription Renewal
 1 year —\$15 (saves \$15 off current cover price)
 3 years—\$45 (saves \$45 off current cover price)
 Payment enclosed Bill me

Name _____

Address _____

City _____ State _____ Zip _____

Please allow 60 days for shipment of first copy.

01

73 Magazine • Peterborough NH 03458

S21

73
magazine
peterborough nh 03458

A Single IC Time Machine

— amazing clock

You name it— this does it.



Both clocks set up and operating. The small clock is on GMT, the other on local time. The radio is connected to the alarm output of the larger clock.

How would you like an electronic clock with options from the following assortment of features?

Single-chip operation	Am/pm and 1 Hz activity indicator
Fluorescent direct drive	50 or 60 Hz timebase operation
Simple forward or reverse time setting	Three-function wake select (radio tone, radio, followed by tone in 8 minutes)
4-digit nonmultiplexed display	Count inhibit

Power-up clear	volt battery backup
Leading zero suppression for tens of hours	Intensity control
Month-date or date-month format	Slow-up circuitry eliminates RFI
A second alarm time	12- or 24-hour display format
LED direct drive (10 mA/segment)	24-hour alarm
Low-voltage standby allows 9-	Variable sleep (1 to 59 minutes)
	Seconds display

INSTRUCTIONS

1. To adjust, remove a screw on each side and remove the cover. As viewed from the rear, left to right, there are 6 switches as follows:

#1 (Red toggle)	Set hours/month
#2 (Green toggle)	Set minutes/day
#3 Slide switch	Inhibit/run
#4 Slide switch	Spare
#5 Slide switch	Alarm select—UP alarm #2, DOWN alarm #1
#6 Slide switch	Display format—UP 24 hours, DOWN 12 hours

Note: In 12-hour mode, pm is indicated when 3 bars appear in the first digit position.

2. On initial light-off, all time functions will read 0:00, colon on or off, date will indicate 12 31, and seconds 00. To start the clock, momentarily place switch #2 (green toggle) in the advance position; seconds will start counting and the colon will flash. (Minutes may be set at this time if desired.)

3. To synchronize (to WWV or a time-tick), place switch #3 in its up position, stopping the clock as indicated by the absence of a colon and 00 seconds. At the instant of the "00 seconds" pulse from WWV or other time source, depress switch #3, restarting the clock.

Note: Step #2 must be performed first, after initial light-off.

4. Place function switch on LOCAL and set time:

(a) To set hours, use switch #1 (red toggle)—UP advances; DOWN decrements; and MID-POSITION is the normal run position.

(b) To set minutes, use switch #2 (green toggle) as in (a) above.

5. Place function switch on zone, alarm 1, or alarm 2, and set the desired time as in step 4(a) and (b). Repeat for each desired function.

6. Place function switch on DATE and set the desired date, using the #1 toggle for month and #2 toggle for the day.

Note: After the seconds have been initially synchronized, any and all times (and/or dates) may be changed at will. No further synchronization is required unless the timebase is gaining or losing time—or the clock is accidentally stopped when changing power sources.

7. To use the alarm(s), select the desired alarm with switch #5, and then place the front panel alarm switch to ON. When the alarm energizes, it may be stopped for 10 minutes by pressing SNOOZE, or by momentarily turning off the alarm switch. (A momentary turn-off rearms the alarm to energize at the designated time 24 hours later.)

Notes: SNOOZE inhibits the alarm for 10 minutes from the time it is pressed (not from the time entered), e.g., if the alarm is set for 06:00 and is "snoozed" at 06:03, it re-energizes at 06:13. This may be repeated indefinitely and makes the feature amenable for use as a 10-minute timer during long-winded QSOs. Also, if the display is blanked, the alarm feature will activate but will not sound off until the display is unblanked, if done within 1 hour of the time set. (Unless the snooze button is pressed, the alarm operates for an hour and then resets itself should the alarm circuit be on but the clock unattended.)

8. On the right side of the front panel are two slide switches which control the illumination level of the LEDs. The first blanks or unblanks the display; in the blank position, the alarm output is also made inoperative (see step 7, above). The second (outboard) switch controls the display illumination level: HI for daytime viewing and LO for nighttime viewing.

OPERATION

1. This clock is designed to operate from a number of power sources, 9 to 13 V dc or 6 to 9 V ac at the power input jack, without regard for polarity, or on a 9-volt transistor battery internally mounted. A small earphone-type jack is in parallel with the internal battery and may be used to (a) parallel the internal battery with an external battery while exchanging the internal battery, (b) provide a convenient test point for measuring the internal battery voltage condition, or (c) if necessary, be used as a recharge point for the internal battery.

2. The input to the power supply is a bridge rectifier which will accept ac or dc voltages of either polarity. A .5-volt regulator (7905) provides the LED voltage and a regulated 5-volt source for the internal crystal timebase. All circuits have been isolated from the case; therefore, it is safe to use this instrument in a car, using its battery connected to the power jack without regard to polarity. Caution: The shaft of the function switch is at circuit ground (+) and *must* have a plastic knob. Use of a metallic knob will invalidate the preceding statement.

3. The crystal timebase adjustment capacitor has been paralleled with a small piston-type capacitor to provide a "fine" adjustment, and is accessible via a small hole in the back skirt below the alarm speaker.

4. In operation, this unit draws current from the power source as follows:

7 mA	— Illumination blanked
26 mA	— Illumination LO
160 mA	— Illumination HI

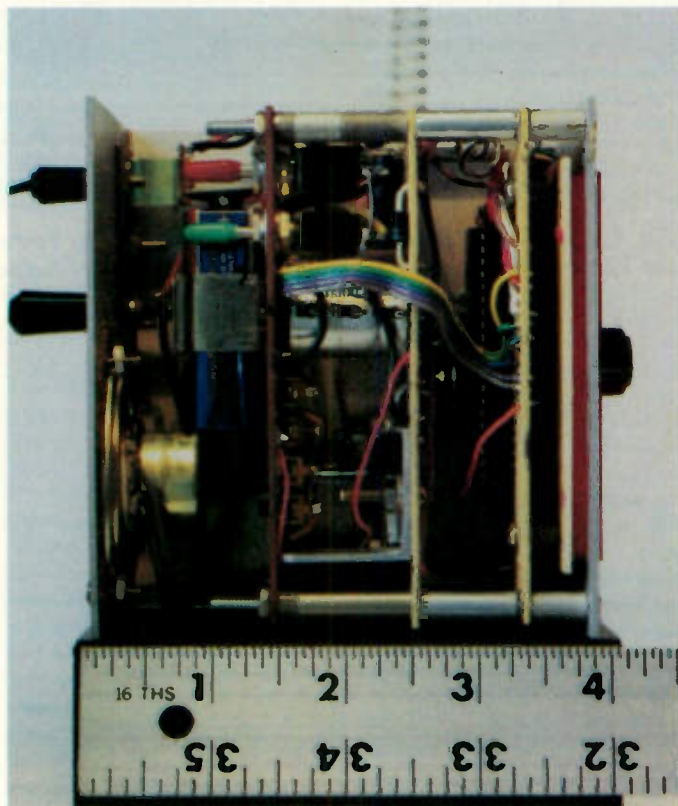

Battery version, top view.

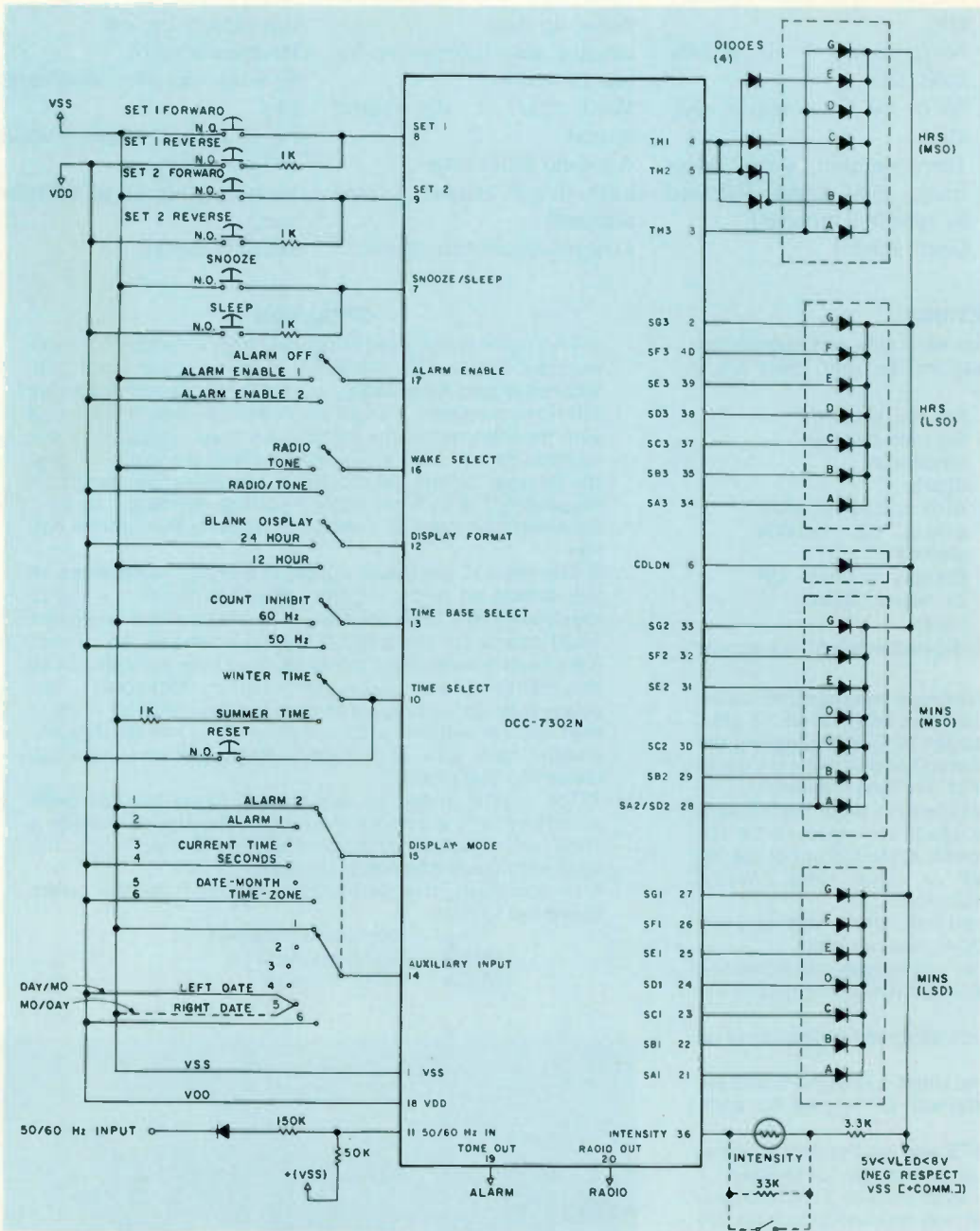

Fig. 1. Generalized circuit (24-hour or date left display format) — a modified drawing to show the 12- or 24-hour option, the 50/60 Hz option, and the manual intensity control option.

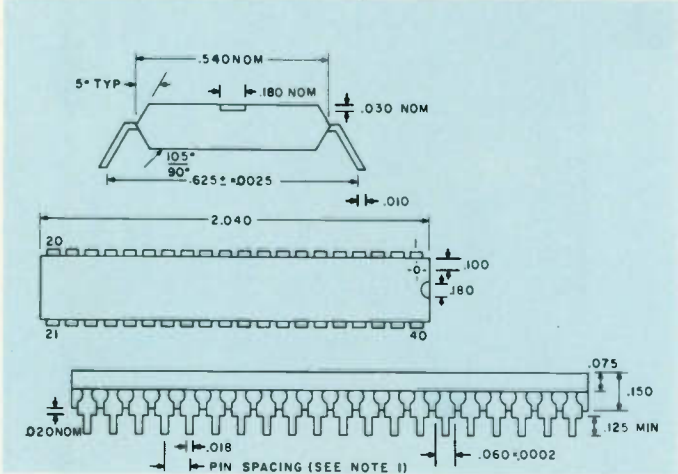

Fig. 2. The pin spacing is 0.100 between centerlines. Each pin centerline is located within $\pm .0010$ of its true longitudinal position relative to pins 1 and 40.

- Summer/winter time switch for Daylight Savings Time
- Brownout indication
- Four-year calendar
- One time zone register

Would you like to use it independently of power lines, as well — possibly in your car

or in foreign countries when you travel on 230/115 V, 50 or 60 Hz?

If you desire a clock with the above listed features, the DCC-7302N clock chip comes in a kit, available with fluorescent display, for about \$30. In order to add options, read on. The chips are available for about \$6.00 and an LED 4-digit display for about \$10, or you can fabricate your own display from individual LED readouts.

I have produced 2 clocks around the 7302N chip. One is designed to operate from 115/230 V, 50/60 Hz power lines and includes many of the published chip options. The second is designed to be operated from either a battery source or a filament transformer — in this, a bonus was obtained when it was discovered that the clock will function nicely on 9 V or less, and the battery drain may be minimized by using low illumination or a blanked display as much as possible. Blanked, the total current is 7 mA; at minimum illumination, it is 26 mA, and, at maximum illumination, 160 mA (using a 9 V source).

The 115/230-volt version uses the power lines as a timebase and has most of my desired options, as indicated in the drawings.

The battery-operated version uses a crystal timebase sold by S. D. Sales, and several options were deleted to conserve on space and the number of switches required. A 7905 negative regulator IC chip is used in this unit to provide 5 V regulated for the timebase and the supply voltage for the LEDs.

Caution: Although these chips use a positive ground

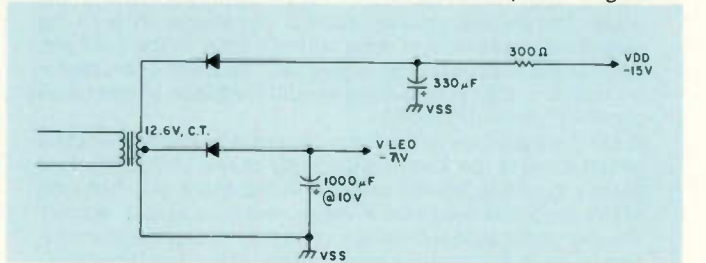

Fig. 3. Recommended power supply for LED operation.

(common), the LED display must be of the common cathode configuration.

PC Board Preparation

Lay out the circuits on graph paper, full scale, 10 lines to the inch, making a template. The template is then taped to the copper side of the PC board stock and each hole point lightly punched through the template. Remove the template and clean the copper with scouring powder and/or a steel wool soap pad, rinsing

Input function	VSS	Open	VDD	Aux input
Display mode	alarm 1	current time	seconds	open
Display mode	alarm 2	month-date		VSS
Display mode		date-month	time zone	VDD
Set 1	forward		reverse	N.A.
Set 2	forward		reverse	N.A.
Timebase select	60 Hz	count inhibit	50 Hz	N.A.
Display format	12 hour	blank	24 hour	N.A.
Wake select	tone	radio	Radio and tone	N.A.
Alarm enable	enable 1	off	enable 2	N.A.
Snooze/sleep	snooze	winter	sleep	N.A.
Time select	summer		reset	N.A.

Table 1. Input selection table.

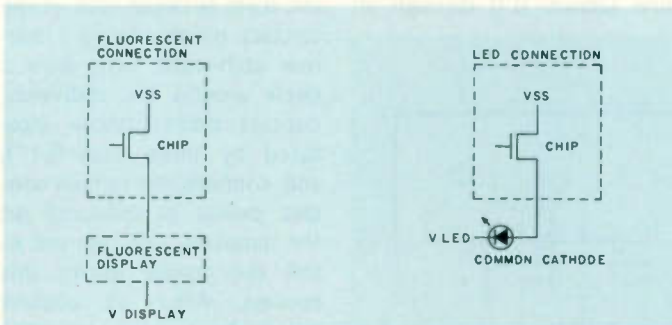

Fig. 4. Display connections.

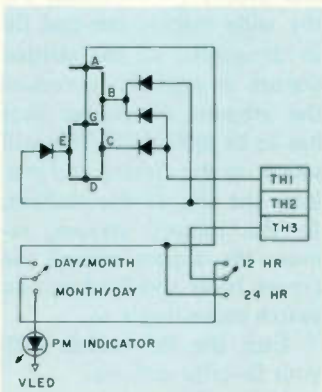

Fig. 5. Selectable 12-hour or 24-hour display.

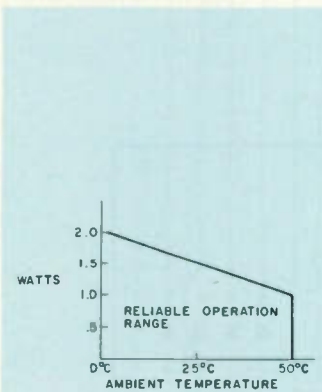
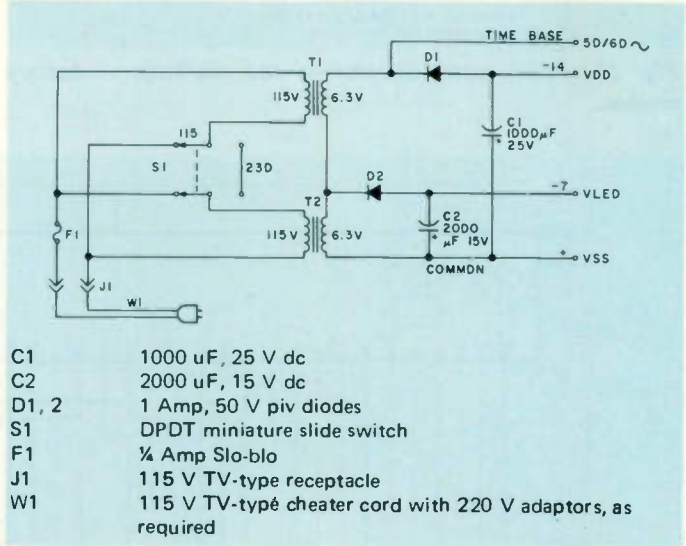
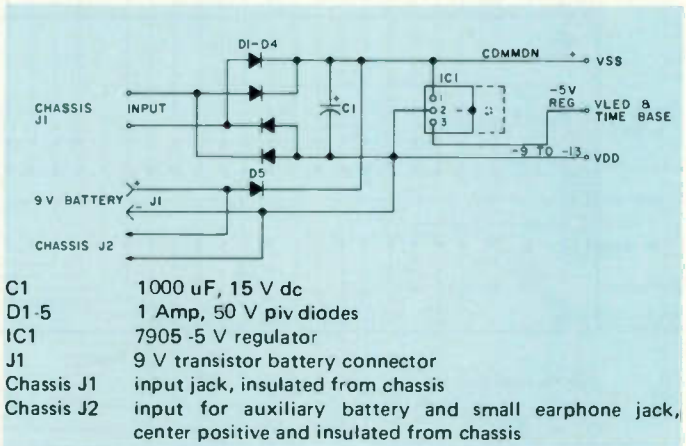

Fig. 6. Total chip power dissipation.



- C1 1000 uF, 25 V dc
- C2 2000 uF, 15 V dc
- D1, 2 1 Amp, 50 V piv diodes
- S1 DPDT miniature slide switch
- F1 1/4 Amp Slo-blo
- J1 115 V TV-type receptacle
- W1 115 V TV-type cheater cord with 220 V adaptors, as required

Fig. 8. 115/230-volt power supply. Note: there are at least 3 types of 230-volt receptacles in use in Europe.



- C1 1000 uF, 15 V dc
- D1-5 1 Amp, 50 V piv diodes
- IC1 7905 -5 V regulator
- J1 9 V transistor battery connector
- Chassis J1 input jack, insulated from chassis
- Chassis J2 input for auxiliary battery and small earphone jack, center positive and insulated from chassis

Fig. 9. Less than 2 inches must separate the capacitor and the chip, or a second capacitor will be required across the chip input.

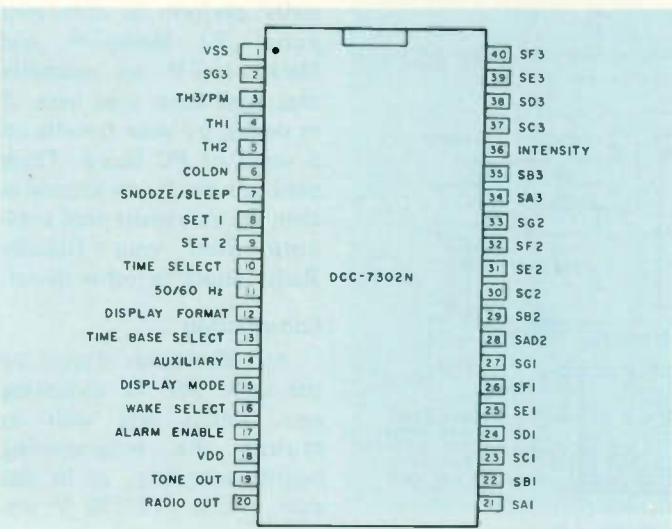

Fig. 7. Pin connections.

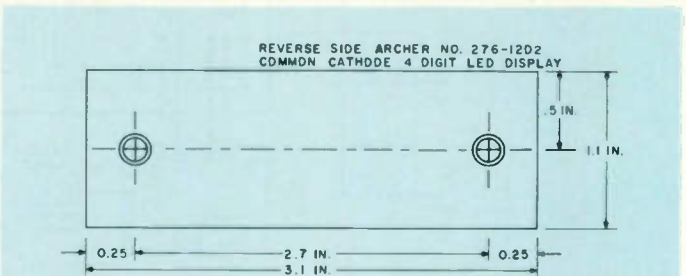

Fig. 10. Glue two spacers, 3/16" diameter x 1/4", i.d. tapped for #4-40 screws, to the two places shown. These spacers must align with the 2 holes in the main board.

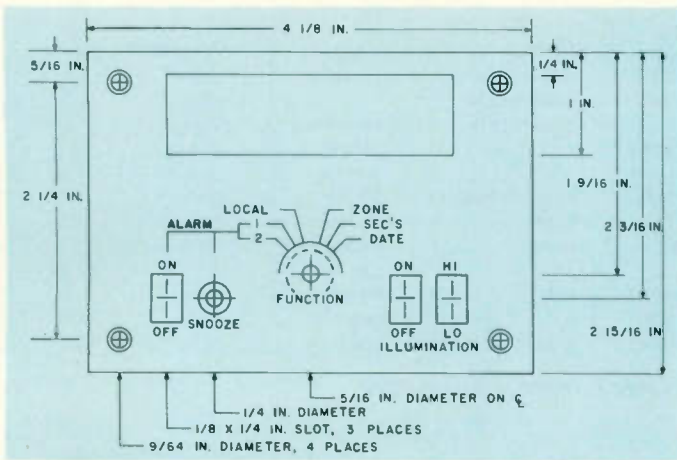

Fig. 11. Front panel dimensions and markings — battery version.

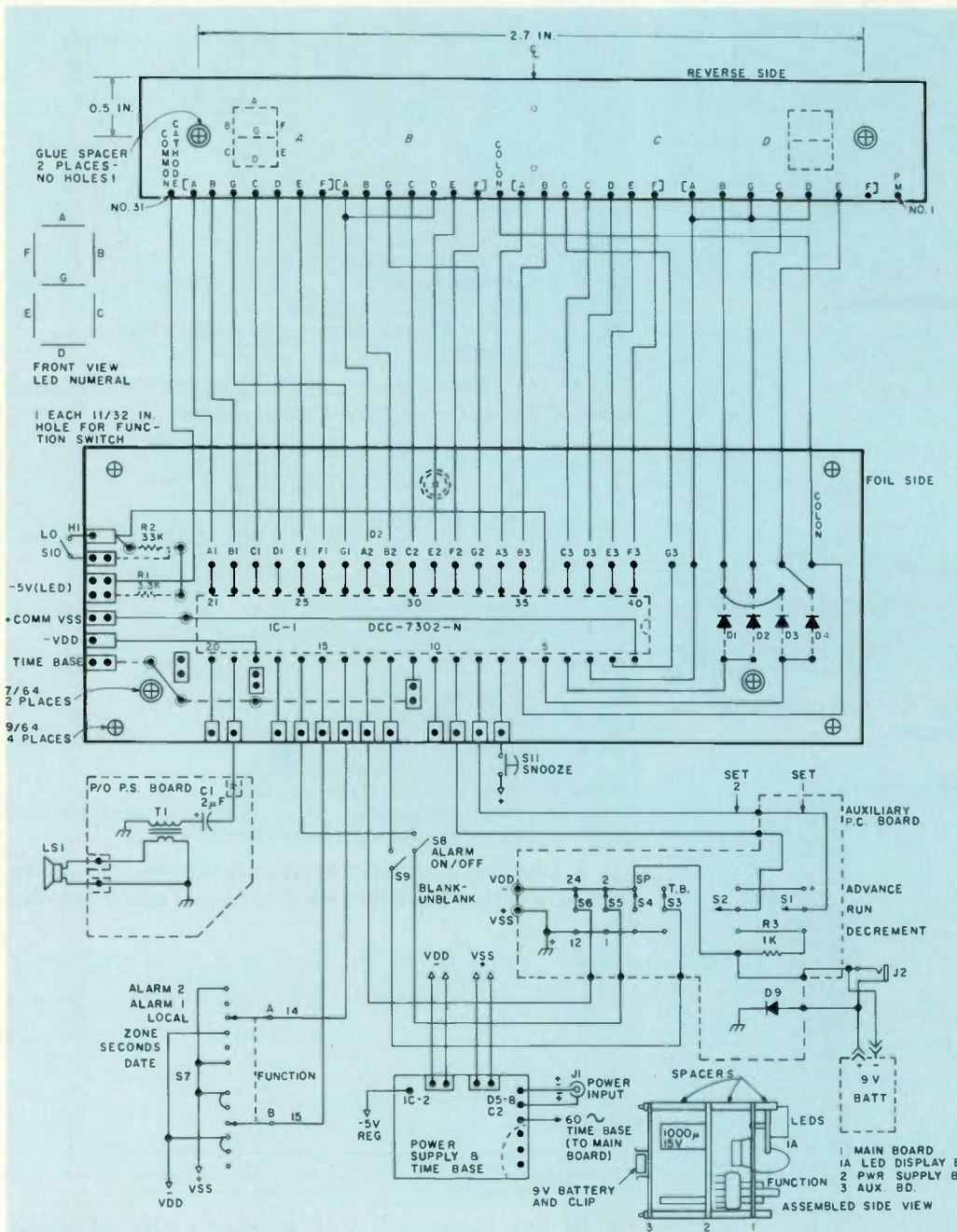

Fig. 13. Wiring arrangement used for the battery version. J1 and J2 must be isolated from the cabinet chassis.

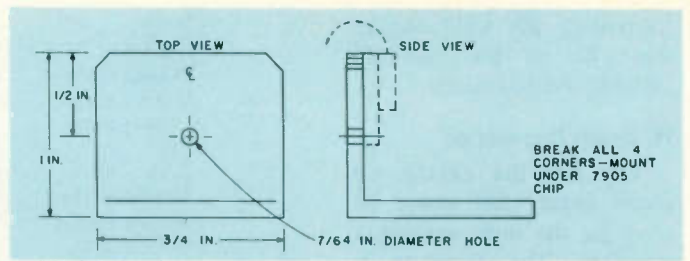

Fig. 12. Heat sink detail. Use 1" x 1" x 1/16" aluminum angle cut 3/4" wide or fabricate it from aluminum or copper stock.

and drying each PC board thoroughly.

After the PC board is dry, use a wide-tip permanent marking pen and draw a wide line (about 1/4") through all

close-spaced contact points (20 on each side of the chip and others). Then, using a straightedge and a scribe, remove about 1/64" of the ink from between each of the contact points. Using a narrow etch-resist pen, draw a circle around the individual contact points (those separated by more than 0.1"), and connect the various contact points as indicated on the template. Use care not to soil the copper during this process. After all contact points have been correctly and properly connected, use the wide marker pen and fill in as much of the unused copper as possible to reduce the amount of copper that has to be etched off. This will speed up the etching and prolong the life of the etchant. In the battery version, remove the copper around the corner holes and the function switch mounting hole.

Etch the PC boards with your favorite etchant.

Note: There are several permanent marking pens on the market that will satisfactorily perform as etch-resist pens: El Marko™ and Marks-a-lot™ are examples that have been used here. If in doubt, try your favorite on a scrap of PC board. These pens are much less expensive than the etch-resist pens available from your friendly Radio Shack or other dealer.

Construction

All PC boards should be the same size for mounting ease, unless you wish to mount the programming board separately, as in the case of the 115/230 V version.

Check over the features

and decide which ones you need and which ones you can live without. Then determine how many switches you need. Time can be set with push-buttons, but, to conserve space, use SPDT miniature toggle switches with center-off. For economy, use single-pole slide switches where possible. Minimize the number of front panel switches. In the 115/230 V version, I used 6 push-button switches, 5 SPDT center-off toggle switches, 2 SPST slide switches, and 1 DPDT slide switch. In the battery version, it came out 2 SPDT center-off toggles, 1 push-button, and 7 SPDT slide switches, of which one is a spare and 4 are used in SPST functions.

Two problems were encountered in the timebase inputs. In the 115/230 V

version, the chip would not initially clock. A copy of the kit schematic was obtained, and it indicated that pin 11 was biased back to common via a 150k Ohm resistor. This cured the clock problem but created another — the chip was clocking at 2 pulses per second rather than one pulse per second. A diode cured that. In the battery version, I found that pin 11 would drive directly off the output of the timebase without a diode, an isolation capacitor, or isolation resistor. However, I found that if the filter capacitor and the 7905 chip were not adjacent on the PC board, it would be necessary to place about 0.1 uF across the input to that chip to stabilize the output of the timebase.

A socket for the 7302N

chip is recommended but not necessary. When drilling the PC board, use care, and, if possible, use special drills* for glass epoxy boards. Use nothing larger than a #65 drill, except at the edge points where wire connections are made, where a #60 drill is more correct. Of course, the hardware holes must be of the correct sizes to accommodate the screw sizes used. If a drill press is not available, be very careful with a hand drill or it will drift or make slanted holes, and aligning 40 pins of a chip or socket is no fun under those conditions (experience speaketh).

*Special drills are available from: Ford Cutting Tools, M.A. Ford Mfg. Co., Inc., Davenport IA, or Tools & Metals, 301 N. Johnson, El Cajon CA 92020.

The 2-pole 6-position non-shorting function switch may be mounted on the same PC board as the chip. The LED display and the chip PC are mounted back to back with a 1/4" spacer between them (see drawings for details). Locate the positions on the back of the display that correspond to the positions on the template for the main board (with the chip). Thread the spacers for #4-40 screws, and use Super Glue™ (or its equivalent) to bond them in position.

I also used Super Glue to secure all slide switches in position, and, in the battery version, the battery clip was secured similarly. If done right, a good bonding is affected; if done wrong, try, try again (it took 3 passes for the battery clip to hang in there).

6-32 x 3" screws were used to mount the PC boards into the cabinets, using spacers and the front panel for support. If necessary, 1/4" Plexiglas™ tubing may be used to fabricate the desired spacers. The i.d. is slightly smaller than a 6-32 thread and can be either tapped or drilled out — for ease of assembly and disassembly, unthreaded spacers are recommended.

Use care in locating the 4 mounting holes for the 6-32 x 3" screws, the openings for the display, and the shaft of the function switch on the front panel. In the battery version, provide an insulated mounting for the switch or insulate the shaft with shrink tubing, and be sure there is no contact between the shaft and the case (this has been

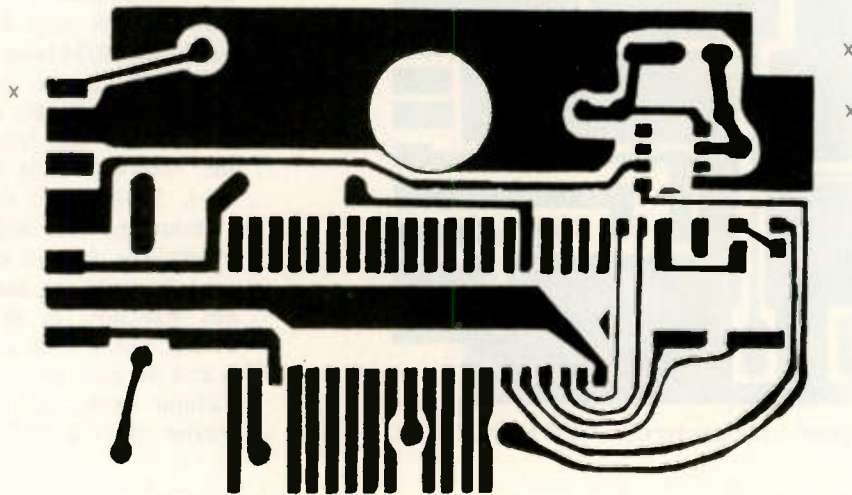

Fig 14(a). Main circuit board — PC board.

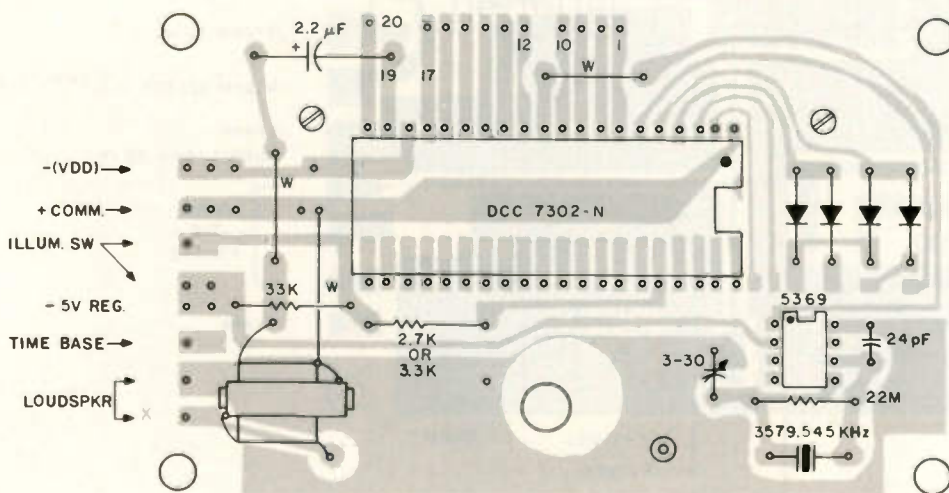

Fig 14(b). Main circuit board — component layout.

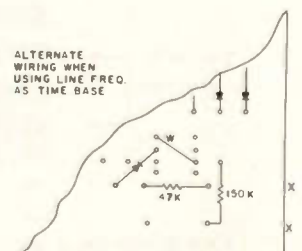
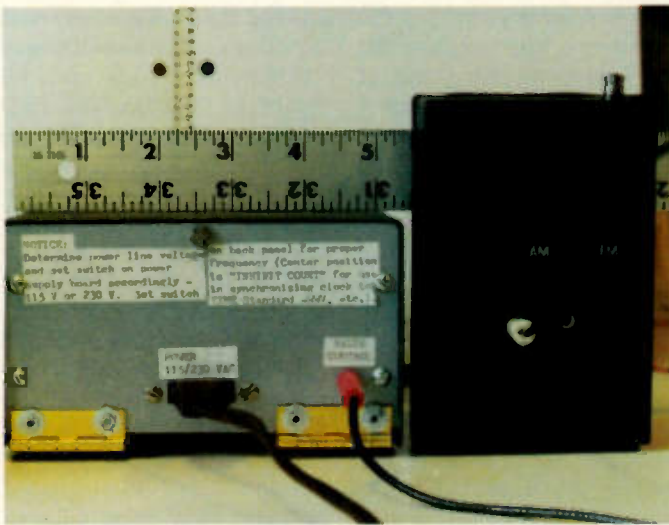

Fig 14(c). Alternate wiring when using line frequency as timebase.



Ac operated version, rear view.

corrected in the included template drawing).

The illumination control is a 33k Ohm resistor with an SPST switch in parallel to add or subtract the 33k to or

from the circuit. If desired, the switch and resistor may be replaced with either a 30k Ohm variable resistor or a photocell control of about 30k Ohms maximum resistance.

At this writing, it has been determined that the battery-operated unit is hard on 9 V transistor batteries, in spite of its low drain in the "low" or "blanked" conditions. A Duracell™ only lasted about 20 hours under a 26 mA load; a regular carbon-zinc battery lasted about 18 hours (both new batteries). Although the clock works satisfactorily on a 9 V battery charger, I learned that the circuit "loads" the charger to about 7.8 volts, and a new battery

inside the unit will supply power to the clock, in parallel, until it is at or below the input voltage from the charger.

When the clock is on the internal battery, it will continue to function (blanked or low) at terminal voltages below 7.0 volts, but disturbing the input power (paralleling the battery or applying an external supply) can and does cause glitches, if not done carefully. When glitches are introduced, the displays become random — like showing 65 seconds, or a 3 in the tens-of-hours column, or beeping the alarm tone when the alarm is turned off. Under these conditions, the best cure is to remove power completely and restore the correct voltage level; the clock needed resetting anyway.

If it is desired to use the pm indicator in the 12-hour mode (rather than display 3 bars), the 12/24-hour selector will have to be a DPDT (center-off) switch, and the date format will have to be the American style (month/day). Similarly, if only the 12-hour option is desired, the month/day format must be used in order to access the pm indicator, as the 3-bar output required for a 2 or a 3 is also the pm indicator in the 12-hour mode, and no digit greater than a "1" can be

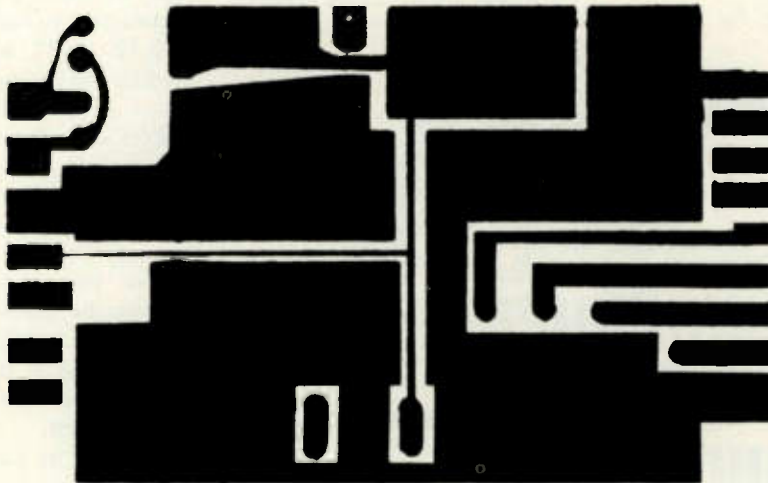

Fig. 15(a). Auxiliary board — battery version — PC board.

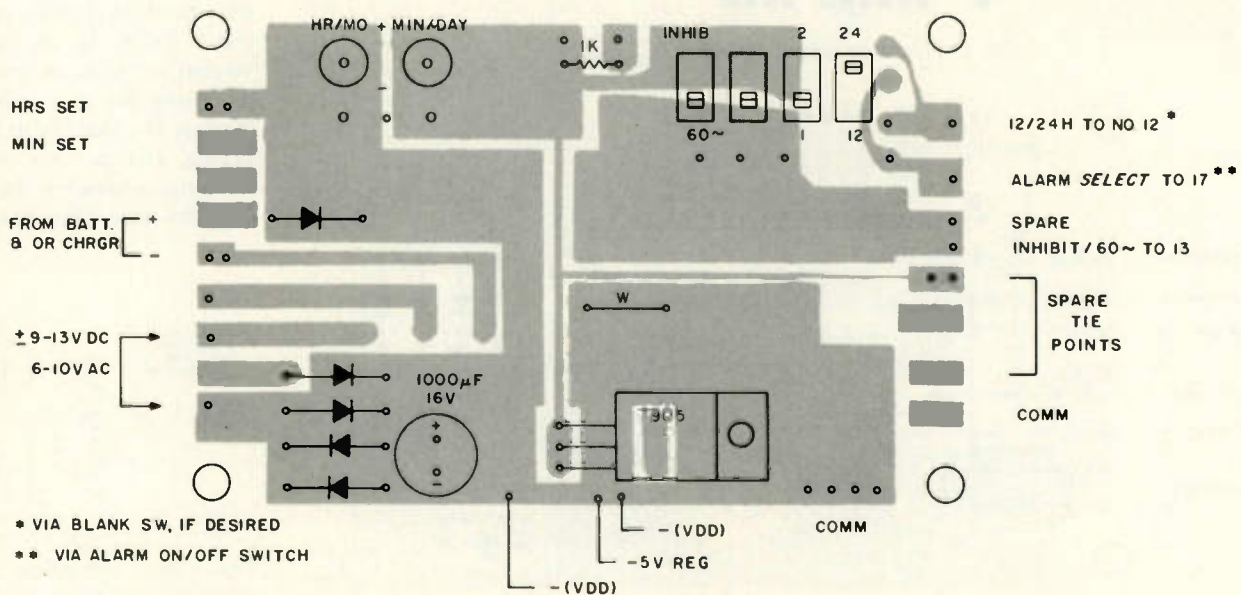

Fig. 15(b). Auxiliary board — battery version — component layout.

Parts List

Quantity	Description	115/220 V version	Battery version	Both	Price
1	7302N clock chip, Integrated Circuits Unlimited			x	6.00+
1	40-pin IC socket, ICU or IC Elex.			x	.50
1	LED display, four 1/2" digits + colon + pm indicator, Archer #276-1202			x	
5	Diodes, 1N277 or equivalent	x			
4	Diodes, 1N277 or equivalent		x		
2	Diodes, rectifier, 1N4001 or equivalent	x			
5	Diodes, rectifier, 1N4001 or equivalent		x		
1	7905 -5 V regulator chip, ICU or IC Elex.		x		
2	Transformer, 115 V pri., 6.3 V 300 mA sec., Radio Shack	x			1.69 ea.
1	Transformer, output, 1200Ω pri., 8Ω sec., Calectro D1-724			x	
1	Capacitor, 1000 uF, 15 V			x	
1	Capacitor, 2000 uF, 15 V	x			
1	Capacitor, 2.2 uF, 15 V			x	
1	Resistor, 33k, 1/4 W		x		
1	Resistor, 3.3k, 1/4 W		x		
1	Resistor, 1k, 1/4 W			x	
1	Resistor, 330Ω 1/4 W	x			
1	Resistor, 4.7k	x			
1	Resistor, 5.6k	x			
1	Resistor, 27k	x			
1	Resistor, 47k	x			
1	Resistor, 150k	x			
1	Speaker, 8Ω 0.12 W, 2", Calectro S2-202 or equivalent			x	
1	Relay, 6 V 5kΩ (SPST n.o. only used)	x			
2	Switch, SPDT center-off toggle MS167		x		
4	Switch, SPDT center-off toggle MS167	x			
1	Switch, push-button, n.o. Electrocraft 35.414		x		
6	Switch, push-button, n.o.	x			
1	Switch, slide, DPDT	x			
2	Switch, slide, SPST Electrocraft 35-202	x			
1	Switch, rotary, 2 pole 6 posit. miniature, Archer 275-1384 (nonshorting type)			x	1.70
2	Switch, slide, SPDT		x		
4	Switch, slide, SPST		x		
1	Timebase kit, S.D. Sales		x		5.95
3	PC board 4" x 2 1/2"		x		
2	PC board 5" x 2 1/2"	x			
1	PC board 5" x 1 1/2"	x			
1	Mini phone jack			x	
1	Jack, power input and matching plug set		x		
1	115 V power conn. TV type	x			
1	115 V TV cheater cord	x			
1	Cabinet 4 1/4" W x 3" H x 4-3/16" D, Ten-Tec TG 34		x		
1	Cabinet 5 1/4" W x 3" H x 5-7/8" D	x			
1	Transistor, 2N2219 or equivalent	x			
2	Hinge, brass 1 1/2" x 1/2"	x			
4	6-32 x 3" screws, cut to size as required			x	
1	Mounting clip for NEDA1604 transistor 9 V battery		x		
1	Battery connection for NEDA1604 transistor 9 V battery		x		
	Assorted hardware and spacers				

tolerated in the tens-of-hours digit when the pm indicator is desired.

The clocks were mounted in small utility boxes. The 115/230-volt version was installed in a box 3" H x 5 1/4" W x 6" D. The chassis was U-shaped, but the back panel (skirt) was sawed off at the bend, dressed up to allow for hinging, and hinges were installed. The programming board is mounted on this, and, when it is desired to set the clock or change the program, one thumb screw is removed and the back drops down, disclosing the programming switches. The

battery version is mounted in a Ten-Tec TG34 box which is 3" H x 4 1/4" W x 4 1/4" D. It is of a double "U" construction, and the top/sides piece is removed by removing one screw on each side, exposing the interior and making the set and program switches available.

An attempt to operate the battery clock off the cigar lighter outlet in the car met with failure, causing a glitch when the car was started. A filter is proposed, consisting of a small resistor and two 12 V zener diodes back to back to act as shorts for any transients. ■

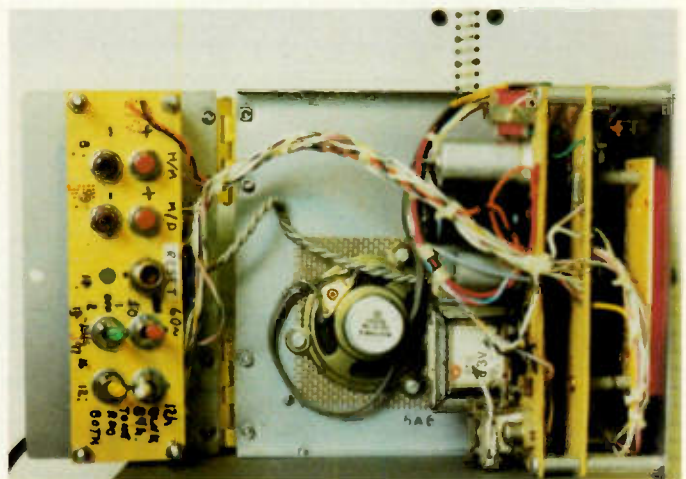

As operated version, top view with the rear skirt opened to disclose "program" switches.

Car Battery Charger

—junk-box special

This is the safe way.

David E. Roscoe W1DWZ
49 Cedar Street, RFD #2
East Bridgewater MA 02333

One of the most useful pieces of "junk" that can be found in any self-respecting ham's junk box is an old, but serviceable, 12-volt automotive battery. They can be very useful for bench testing, field day operation, running that mobile rig at the home QTH, jump-starting the wife's car, etc. To be maintained at the peak of their

usefulness, they do require occasional recharging. After getting along for a number of years with a haphazard (and dangerous) collection of hay wire and diodes, we decided to remedy the situation. Most of the commercially available chargers did not seem to meet the requirements we wanted, so we set out to fabricate our own. We wanted one that had the capacity to put out 15 Amperes or so if needed, yet have the capability of being adjustable to 1 or 2 Amperes for a trickle charge, or to some value in

between.

After experimenting briefly with series resistors and series-regulating pass transistors, these ideas were discarded as we found it difficult to dissipate such large quantities of power (and heat). While thumbing through some manufacturers' applications literature, we came upon one describing the triac and decided that this would be a really neat way to do it (Fig. 1).

A triac is basically two SCRs connected in parallel in opposite directions so that conduction is permit-

ted during both halves of the ac sine wave. By controlling the phase and amplitude of the signal to the gate, the firing point of the triac can be controlled and, thus, the conduction angle can be varied to regulate the input power to a transformer primary. A bilateral thyristor (D1, a diac) is used in the gate circuit to provide a threshold level for firing the triac. C3 and R4 provide a transient suppression network to protect the triac from damage when the power is switched off to the transformer primary.

R1, R2, R3, C1, and C2 provide a phase-shift network for the signal being applied to the gate. R1 is selected to limit the maximum charging current at full rotation of the control pot to stay within the ratings of the rectifiers, transformer, etc., of the specific components chosen by the builder. As is true of most ham projects, we tried to use what parts we had available. Readers wishing to build this unit could substitute whatever they might have in their junk boxes for the bridge and the transformer and their unit would only be limited by the voltage and current ratings of these components. ■

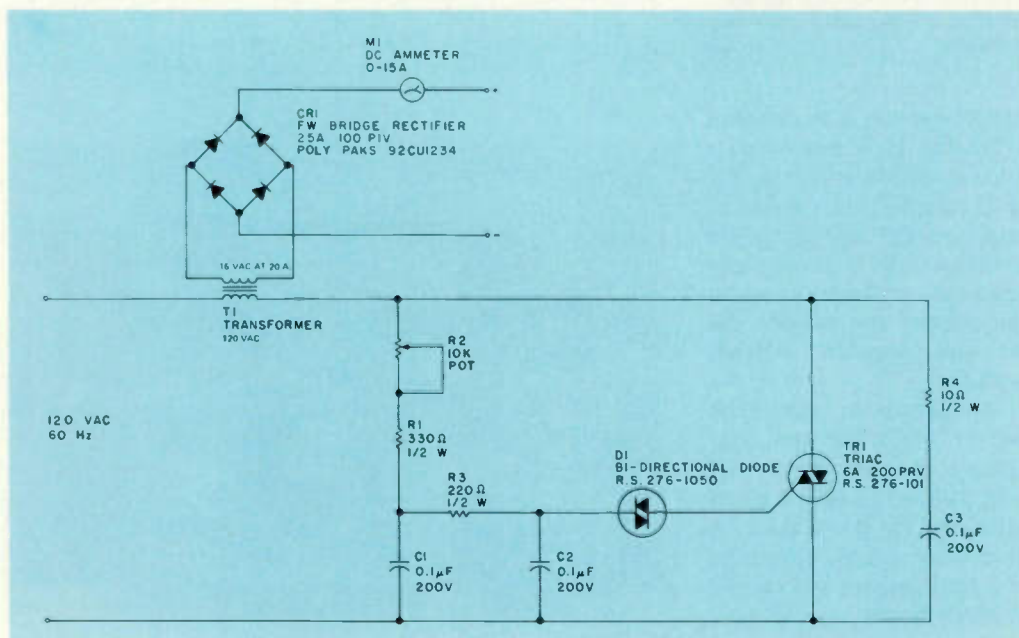

Fig. 1. Battery charger schematic diagram.

YOU ASKED FOR IT YOU GOT IT

DSI QUIK-KIT®

50 HZ TO 550 MHZ COUNTER KIT

95% ASSEMBLED 100% TESTED
Performance You Can Count On

FREQUENCY COUNTER APPLICATION:

- Ham Radio — Two Way Radio — CB
- Audio Amplifier & Receiver Repair
- Computer Maintenance & Construction
- A Must for TV & PLL Repair

\$99.95
MODEL 3550K

includes built-in
Pre-Amp & Prescaler



DSI OFFERS THE BEST OF TWO WORLDS . . .

An unprecedented DSI VALUE . . . in a high quality, LSI Design, 50 HZ to 550 MHZ frequency counter kit. And, because it's a DSI innovation, you know it obsoletes all competitive makes, both in price & performance.

With 95% of the assembly completed by DSI, you are only one hour away from solving all of those difficult bench problems, from adjusting 60 HZ clock-time bases to setting the frequency of a 468 MHZ Mobile Radio.

FACT: Every 3550 QUIK-KIT® PC board is factory assembled and tested before shipment. **FACT:** The problems of bad LED's, IC's, and Capacitors are a thing of the past. **FACT:** No manufacturer except DSI offers a 550MHZ frequency counter with . . . 8 digits, .5 in. LED's, TCXO, 1HZ resolution and a one year warranty on parts for under \$100.00. **FACT:** We do not know how long we can hold this low, low price. **GO WITH THE LEADER . . . BUY A DSI FREQUENCY COUNTER KIT TODAY. SAVE TIME & MONEY AND BE ASSURED IT WILL WORK THE FIRST TIME.**

DSI — GUARANTEED SPECIFICATIONS

Time Base TCXO 1PPM 65° to 85°F
Freq. Range 50HZ to 550MHZ incl. two SO239 inputs
Resolution 1HZ to 55MHZ, 10HZ to 550MHZ
Gate Time 1 sec & 1/10 sec with Auto Decimal Point
Display 8 digits, 1/2 inch LED with Leading Zero Blanking
Sensitivity 25MV @ 25MHZ, 150MHZ, 250MHZ;
75MV @ 450MHZ
Power Batt., 12VDC @ 300Ma, 110VAC (with AC-9)

3550K Kit \$99.95
T-101 Ant. 3.95
AC-9 AC Adp. 7.95
Shipping, Handling, Ins. . . . 10.00

3550W Wired 149.95
T-101 (incl.) NC
AC-9 (incl.) NC
Shipping (incl.) NC



CALL TODAY TOLL FREE: (800—854-2049) Cal. Res. CALL (800—542-6253) TO ORDER OR RECEIVE MORE INFORMATION ON DSI'S FULL PRODUCT LINE OF FREQUENCY COUNTERS RANGING FROM 10HZ TO 1.8GHZ

DSI INSTRUMENTS, INC.

7924 Ronson Road, Dept. G, San Diego, CA 92111

TERMS: MC - VISA - AE - Check - M.O - COD in U.S. Funds. Orders outside of USA & Canada, please add \$20.00 additional to cover air shipment. California residents add 6% Sales Tax.

CT-50 FREQUENCY COUNTER



**Outstanding
Performance
at an
Incredible
Price**

DESCRIPTION: The CT-50 is a versatile and precision frequency counter which will measure frequencies to 60 mHz and up to 600 mHz with the CT-600 option. Large Scale Integration, CMOS circuitry and solid state display technology have enabled this counter to match performance found in units selling for over three times as much. Low power consumption (typically 300-400 ma) makes the CT-50 ideal for portable battery operation. Features of the CT-50 include: large 8 digit LED display, RF shielded all metal case, easy pushbutton operation, automatic decimal point, fully socketed IC chips and input protection to 50 volts to insure against accidental burnout or overload. And, the best feature of all is the easy assembly. Clear, step by step instructions guide you to a finished unit you can rely on. Use the order blank below or call us direct and order yours today!

SPECIFICATIONS:

Frequency range: 5 Hz to 65 mHz, 600 mHz with CT-600
 Resolution: 10 Hz @ 0.1 sec gate, 1 Hz @ 1 sec gate
 Readout: 8 digit, 0.4" high LED, direct readout in mHz
 Accuracy: adjustable to 0.5 ppm
 Stability: 2.0 ppm over 10° to 40° C, temperature compensated
 Input: BNC, 1 megohm/20 pf direct, 50 ohm with CT-600
 Overload: 50VAC maximum, all modes
 Sensitivity: less than 25 mv to 65 mHz, 50-150 mv to 600 mHz
 Power: 110 VAC 5 Watts or 12 VDC @ 400 ma
 Size: 6" x 4" x 2", high quality aluminum case, 2 lbs
 ICS: 13 units, all socketed
 CT-600: 600 mHz prescaler option, fits inside CT-50
 CB-1: Color burst adapter, use with color TV for extreme accuracy and stability, typically 0.001 ppm

OPTIONS:

CB-1 option: The CT-50 time base may be locked to an external frequency standard. The television networks maintain extremely accurate atomic based frequency standards to maintain color tint on TV programs. These standards are typically accurate to one part in 10 to the 12. By locking the CT-50 to one of these network standards, we are able to get super accuracy. The CB-1 adapter interfaces a standard color TV receiver to the CT-50 so that one can take advantage of the TV network frequency standards. The CB-1 requires connection to a color television for operation.

CT-600 option: The CT-600 prescaler option enables the CT-50 counter to measure frequencies as high as 600 mHz with sensitivity in the 20 to 150 mv range, depending upon frequency. Typical sensitivity at 150 mHz is 25 mv. The CT-600 mounts on the same PC board as the CT-50, no extra boxes or PC boards are required. The scaler utilizes a state of the art ECL IC chip and two transistor pre-amplifier, thus eliminating the need for external pre-amp devices.



CT-50, 60 mHz Counter Kit \$89.95
CT-50 WT, 60 mHz counter, wired, tested 159.95
CT-600, 600 mHz prescaler option
for CT-50, add 29.95

ACCESSORIES

DC probe, direct input, general purpose type \$12.95
 High impedance probe, does not load circuit 15.95
 Low pass probe, used when measuring audio 15.95
 High pass probe, reduces low freq pickup 15.95
 VHF flexible rubber antenna, BNC connector 12.95
 Color burst adapter, for calibration, high accuracy 14.95
 typically 0,001 ppm accuracy, stability

Ramsey Electronics
 Box 4072 716-271-6487
 Rochester, NY 14610 ✓ R8



78

Quantity	Description	Price
	Shipping, handling, insurance	\$5.00
	N.Y. state residents, add tax	
	Total	
Name _____		
Address _____		
City _____ State _____ Zip _____		

ramsey electronics

Box 4072 Rochester NY 14610 (716) 271-6487

Come to Universal for all of your Amateur And Shortwave Radio needs.

We are now a "stocking distributor" for VHR Engineering Kits.

We are Drake TR7 Headquarters, too! Contact us for all of your Drake requirements. We have one of the largest showrooms in the nation. Come in and turn the knobs! See SSTV in action with the Robot Model 400 SSTV—Still only \$695.00!

See the new SWAN 100 MX transceiver. For your shortwave needs we have two great General Coverage receivers...the Yaesu FRG-7 and FRG-7000.

"Winter Specials"

as follows:

SAXON COAX RGPU Poly—22¢ per ft. in 100 ft. lengths, 20¢ per ft. in 500 ft. rolls. This is good coax, 95¢ braid coverage.

WILSON SYSTEM THREE—10-15-20m Beam \$139.95

Mosley TA 33—

10-15-20m Beam \$189.95

DSI Model—3600

A Frequency Counter \$189.95

Detron Big Dummy Loads ... \$ 26.95

All items, All prices plus shipping and handling.



✓ U6

**universal
amateur
radio inc**

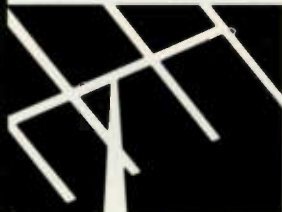

1280 AIDA DRIVE
COLUMBUS, OHIO
(Reynoldsburg) 43068

(614)-866-HAMS

All Bands Preamplifier



- Improved reception. For receivers and transceivers.
- Continuously tuneable 1.8 - 54 MHz. Covers all amateur bands 160 to 6 meters; all shortwave broadcast bands.
- Low noise figure. Up to 20 db gain. Reduces image and spurious response.

Here is an exciting new device to improve your reception on all bands 1.8 to 54 MHz. It gives up to 20 db extra gain and the low noise figure of a dual gate FET to pep up your noisy receiver or transceiver. And it adds a high Q tuned circuit to give improved overload capability and image reduction. Makes that tired old rig come to life again. Even helps new models dig into weak signal territory.

Works with all transceivers up to 350 watts input power. A unique and improved circuit automatically bypasses the preamplifier when the transceiver transmits. The bypass delay is continuously variable by front panel control.

The low profile cabinet takes minimum operating table space. A heavy die cast case gives better shielding and isolation. size: 6" x 7" x 2" high. A built-in 117 volt AC supply and a connecting coaxial cable for the transceiver are included.

Order yours now! Price \$89.50 plus \$2 shipping/handling U.S. & Canada. Calif. residents add sales tax.

Palomar Engineers

Box 455, Escondido, CA. 92025 • Phone: [714] 747-3343

Immortality for Vacuum Tubes?

— build a solid state tube saver

This circuit doesn't replace tubes — it prolongs their life!

Lewis J. Newmire K5KXM
217 South 103rd E. Ave.
Tulsa OK 74128

The deleterious effects of simultaneous application of heater and plate voltages to vacuum tubes are well known. High power transmitters have interlocks and time delays to prevent such occurrences. For reasons of economy, however, such interlocks or delays are seldom designed into consumer electronics.

The solid state circuit shown in Fig. 1 is a simple

but effective 60-second B+ delay. Q1 is any SCR able to block unloaded B+ voltage and pass the required load current. Using an RCA S-2061M, this circuit will perform in power supplies up to 600 volts and 4 Amperes.

This circuit is not a perfect switch. It has a voltage drop when on of about 1 volt and a "leakage" current when off equal to $(\text{Volts B unloaded} / 30)$ in mA. This "leakage" current of a few milliamperes limits plate voltages in most applications to only a few volts. The

10-Watt resistor is operated at full rating with a B+ of 600 volts, but only for 60 seconds at each turn-on.

Wire the B-delay into the power supply as shown in Fig. 2. The + end of the switch is connected to the input filter capacitor. All other wires except the one from the rectifier(s) must be removed from this capacitor and connected to the — end of the switch.

The B-delay may be in-

stalled in all types of vacuum tube equipment including receivers, transmitters, instruments, and TV receivers. Note: In a color TV receiver, the automatic degaussing may be visible on the screen for a few seconds after B+ is switched. The original B-delay used an RCA 40812 SCR. It has been operating in my black and white TV for 6 years, during which not a single tube has been replaced. ■

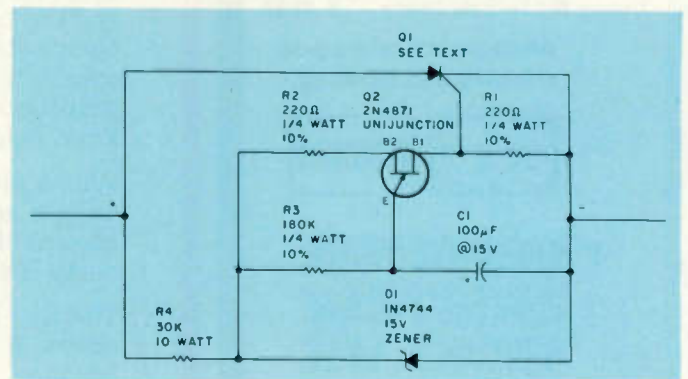
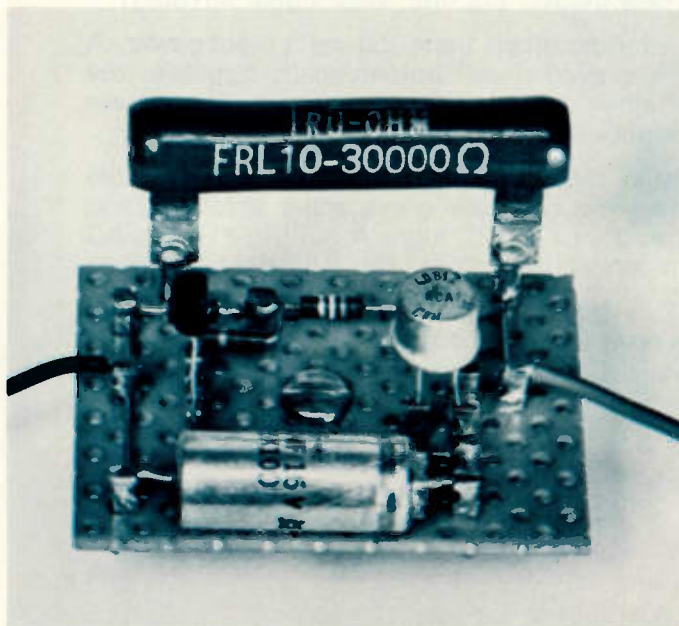

Fig. 1. Schematic.

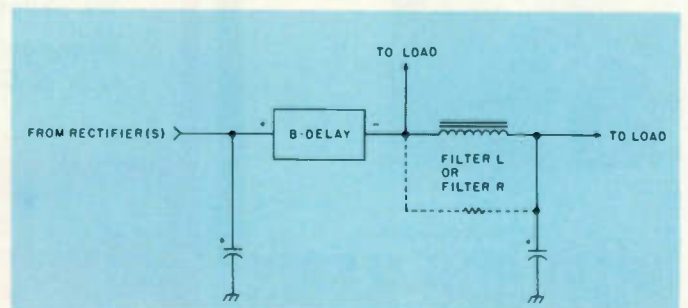

Fig. 2. Connection of B-delay in a power supply.

HEATHKIT[®] Amateur Radio Gear... with the quality that measures up!



VF-2031

Hand-Held 2-Meter Transceiver with a full 2 watts power

Shown with Optional Auto-Patch Encoder Installed



SB-104A Transceiver
Totally Broad-banded, All Solid-State CW/SSB

Heathkit Amateur Radio equipment has long been the favorite of Hams the world over because it provides the performance, specifications, dependability and long-term reliability that Hams are looking for. It should. It's designed by Hams, for Hams. For more than 25 years, Heath has been making fine Amateur Radio equipment. It's no surprise that Hams have come to expect Heath's experience and knowledge to translate into some of the finest equipment around.

For instance, our new VF-2031 2-meter Transceiver. It's portable, practical and it gets you on two with a clean, clear signal that really gets out! It has a minimum 2 watts out, separate speaker and microphone for outstanding audio quality, eight crystal-controlled channels and 600 kHz offset for a total of 8 receive and 24 transmit channels for real 2-meter versatility. A complete list of options includes auto-patch and tone

encoders, external mike and holster-style leather carrying case. And at just \$189.95* in kit form, we don't think you'll find a better all-around hand-held!

Then there's our world-famous SB-104A, a superior SSB/CW transceiver, the "heart" of any first-class station. Totally broadbanded, all solid-state, with TRUE digital readout - it's THE transceiver for the serious Amateur. And now, with its completely re-engineered front-end receiver board and transmitter IF, which are supplied factory assembled and tested, you can get on the air faster and better! For just \$699.95,* and a few evenings of kitbuilding, you'll have a rig that compares with equipment costing hundreds of dollars more! And, of course, there's a full line of accessories to add convenience and versatility to your SB-104A station.

There's more for the Ham at Heath.

FREE

HEATHKIT CATALOG
Send for yours today!

Read about our entire line of Amateur Radio Equipment including linears, 2-meter amps, antennas, mikes, wattmeters and more! If coupon is missing, write Heath Company, Dept. 011-500, Benton Harbor, MI 49022.

*Prices are mail order net F.O.B. Benton Harbor, Michigan. Prices and specifications are subject to change without notice.

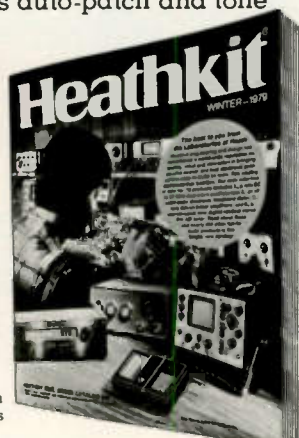

HEATH Schlumberger	Heath Company, Dept. 011-500 Benton Harbor, MI 49022	<input checked="" type="checkbox"/> H5
Please send me my FREE Heathkit Catalog. I am not currently receiving your catalogs.		
Name _____		
Address _____		
City _____		State _____
AM-384		Zip _____

LX303

ALL THE MOST WANTED FEATURES AT A MOST WANTED PRICE...

BIG 1/2" HIGH LCD DISPLAY
USE INDCORS OR OUT
200 HOUR 9V BATTERY LIFE
AUTO ZERO, POLARITY
OVERRANGE INDICATION
100 mV DC F.S. SENSITIVITY
19 RANGES AND FUNCTIONS



Removable cover stores test lead set furnished as part of the unit.



Available accessories include AC adapter, padded vinyl carrying case, 40KV DC probe, 1C A/D DC shunt.



X10 DCV probe adapter available for protecting input up to 10KV.



\$74.95

HICKOK

Here is the handfull of accuracy you've been waiting for. Hand-somely encased. Compact. Efficient. Only 8 ounces. Hickok's exciting, new LX 303, 3 1/2 digit Mini-Multimeter with high quality components, one year guarantee and rugged Cyclo-lac® case offers features previously found only in expensive units... at a price under \$75.00! So why wait any longer? The amazing LX 303 is here. NOW! Another American made test equipment breakthrough from Hickok, The Value Innovator. Order today!

See your local Hickok distributor or order below

SPECIFICATIONS:

DC VOLTS (5 RANGES): 0.1mV to 1000V; Accuracy: $\pm 0.5\%$ rdg $\pm 0.5\%$ f.s.; Input imped: 10M Ω ; Max. input 1kV except 500V on 200mV range
AC VOLTS (40Hz to 5kHz): 0.1V to 600V; Accuracy: $\pm 1.0\%$ rdg $\pm 0.5\%$ f.s. (-2dB max. at 5kHz); Max. input: 600V.
RESISTANCE (6 LOW POWER RANGES): 0.1 Ω to 20M Ω ; Accuracy: $\pm 0.5\%$ rdg $\pm 0.5\%$ f.s. $\pm 1.5\%$ rdg on 20M Ω range) input protected to 100VAC all ranges.
DC CURRENT (6 RANGES): 0.1mA to 100mA; Accuracy: $\pm 1.0\%$ rdg $\pm 0.5\%$ f.s.
DIMENSIONS AND WEIGHT: 5-7/8" x 3-3/8" x 1-3/4", 8 oz.; POWER: 9V battery (not included); Hickok AC adapter; READ RATE: 3/sec.

ADVANCE ELECTRONICS

TO ORDER CALL TOLL FREE
800-223-0474

54 West 45th Street, New York, NY 10036 212-687-2224



PLEASE SEND ME

_____ Hickok LX303 Digital Multimeters @ 74.95 ea.
 _____ RC-3 AC Adapter, 115VAC (220VAC avail.) @ 7.50 ea.
 _____ CG-3 Deluxe Carrying Case @ 7.50 ea.
 _____ VP-10 X10 DCV Probe Adapter @ 14.95 ea.
 _____ CS-1 1CA DC Current Shunt @ 14.95 ea.
 _____ VP-40 40 KV DC Probe @ 35.00 ea.

Payment encl. Bill my: Master Charge VISA

Account # _____ Exp. Date _____

Name _____

Address _____

City _____ State _____ Zip _____

Add \$3.00 Postage and Handling, N.Y. residents add sales tax.

The Hot Mugger X1

— coffee drinkers, rejoice!

There is no such thing as a cold drink.

Ever since Wayne Green's editorial in the July, 1977, issue of 73, I have been thinking about a coffee warmer. He gave some ideas on how to make one and also said that it should be a real money-maker. I, too, hate cold coffee with a passion and usually end up with such every time I bring a cup out to the shack. So, with his idea and my junk box of parts, I put together the Hot Mugger, destined to become the most popular piece of gear in the ham shack.

I have used the Hot Mugger for several months now, and it works very well. But I have left a lot of room for improvement and would be interested to see other ideas for a coffee warmer. I am surprised that no one has written one up yet, as it is a very practical item for the ham shack. I hope this will set the wheels in motion and we will see many improvements and innovations.

The Hot Mugger does not require much in the way of parts. My junk box yielded all that were needed. There are four 550-Ohm, 15-Watt power resistors in series parallel, which gives 26 Watts of power dissipation. The 26 Watts does a good job of keeping a cup of coffee warm. I don't know how much lower you can go in power dissipation and still

keep your cup warm, but you might try whatever you have on hand. I don't recommend exceeding 26 Watts, as this wattage will cause $\frac{1}{4}$ cup of coffee to become quite hot.

The cup should be a flat-bottomed one without any recess. I chose my cup before making the top for the coffee warmer so that I could cut the hole to the right size. The microswitch has a long actuator so that the cup will sit down on it and turn on the heating element (resistors). The base and housing were made out of printed circuit board, soldered and

screwed together with an opening cut out of the top for the cup.

That's just about it except for painting. I used Rust-oleum® primer, which I don't recommend because it gave off a fishy smell for a long time afterward. Probably a good auto engine paint would be a better choice. A nameplate could be added so that your friends will know what it is.

As I type this, the Hot Mugger X1 is on the job keeping my coffee warm to the last drop. What is there left to say except, "Try it; you will like it." ■

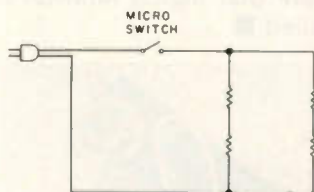

Fig. 1. Schematic.

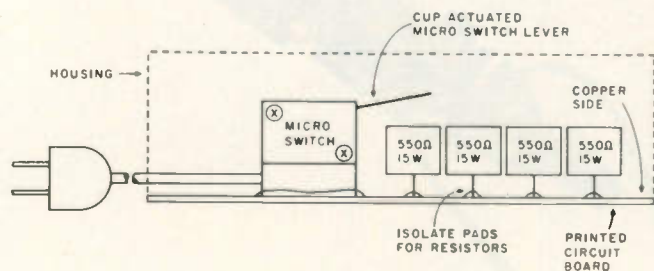

Fig. 2. Construction.



Side view of the finished Hot Mugger.

Build the Mini-Probe

— it's only logical

Decoding digital with a Polaroid™ pistol.

Here is an inexpensive logic probe that will determine all possible states of digital logic. It is built by point-to-point wiring on a piece of perforated board just wide enough to fit into a discard-

ed Polaroid™ film-coating container and about 2½ inches long.

The Circuit

Referring to Fig. 1, the plus 5 V and ground connections are made to the

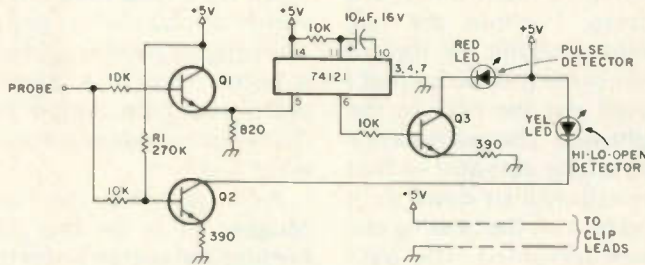

Fig. 1. Logic probe schematic diagram. Resistors ¼ Watt, 10%. Transistors ECG 123A or equivalent. LEDs as desired.

circuit under test, and the probe is touched to the pin under test. If the pin is open, Q2 will conduct slightly because of the bias introduced by R1. This will cause the yellow LED to light at about half brightness. If the pin under test is ground, both Q1 and Q2 are off so neither LED will light. If the pin is high, the red LED will blink once because Q1 puts a high signal into the one-shot, and the yellow LED will light at full brightness because Q2 is turned on. If only the yellow LED were used, it would be difficult to differentiate between an open and an oscillating

condition. This is where the one-shot goes to work. It gives a relatively long (.5 seconds or so) pulse anytime the probe goes high—even if for a very short duration. So if the probe contacts an oscillating pin, it will blink continuously.

Unless pulses of very high frequency are to be detected, there is nothing critical about the layout except for space economy so that the board can be slipped into the case.

So there, in a nutshell (plastic one), is a way to know what's happening inside that digital monster's mind. ■

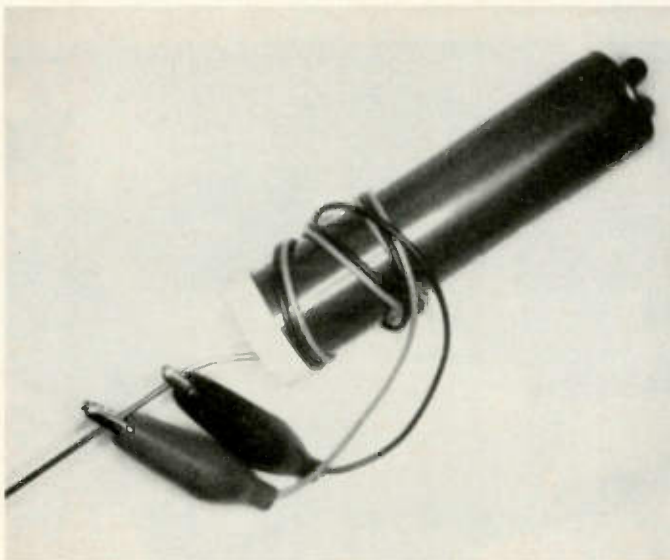

Completed probe.

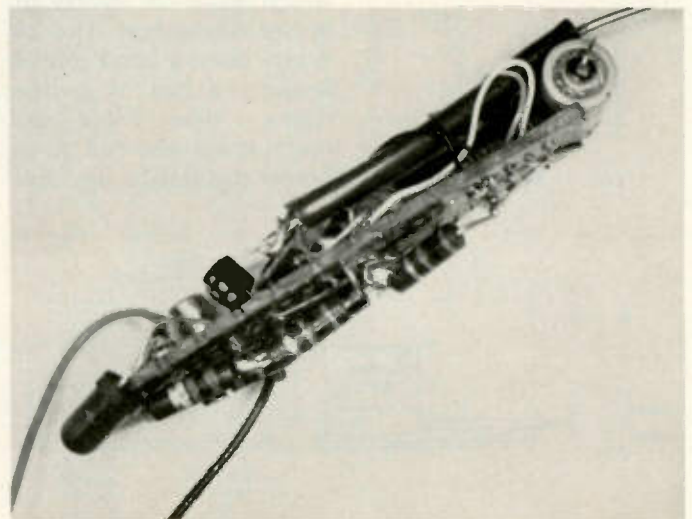

Circuit board assembly.

You're just a few digits away from name brand radio equipment - AT DISCOUNT PRICES!

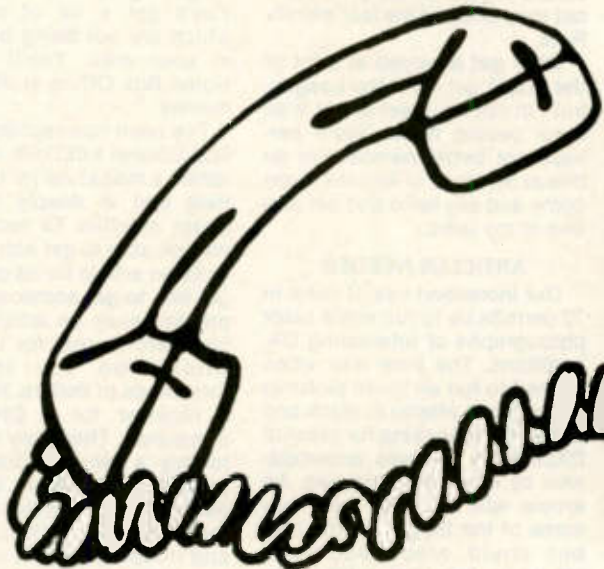

CALL TOLL FREE

1-800-228-4097
Communications Center

443 N 48th Street
Lincoln, Nebraska 68504
In Nebraska Call (402)466-8402

1-800-634-6227
**Communications Center
West**

1072 N. Rancho Drive
Las Vegas, Nevada 89106
In Nevada Call (702)647-3114

YAESU
KENWOOD
DRAKE
ICOM
STANDARD
EDGE COM
KDK
PANASONIC

DENTRON
HY-GAIN
MOSLEY
CUSHCRAFT
WILSON
HUSTLER
LARSEN
BENCHER

TAYLOR
SWAN
TEMPO
TEN-TEC
MIDLAND
CDE
AUTEK
MIRAGE

E.T.O. ALPHA
VHF ENGINEERING
BERK-TEK CABLE
CONSOLIDATED TOWER
SAY
SHURE
TELEX
ROBOT-SSTV

We carry all major lines of Antennas at Discount Prices

look

OUR NEW HOURS
at Lincoln store only

look

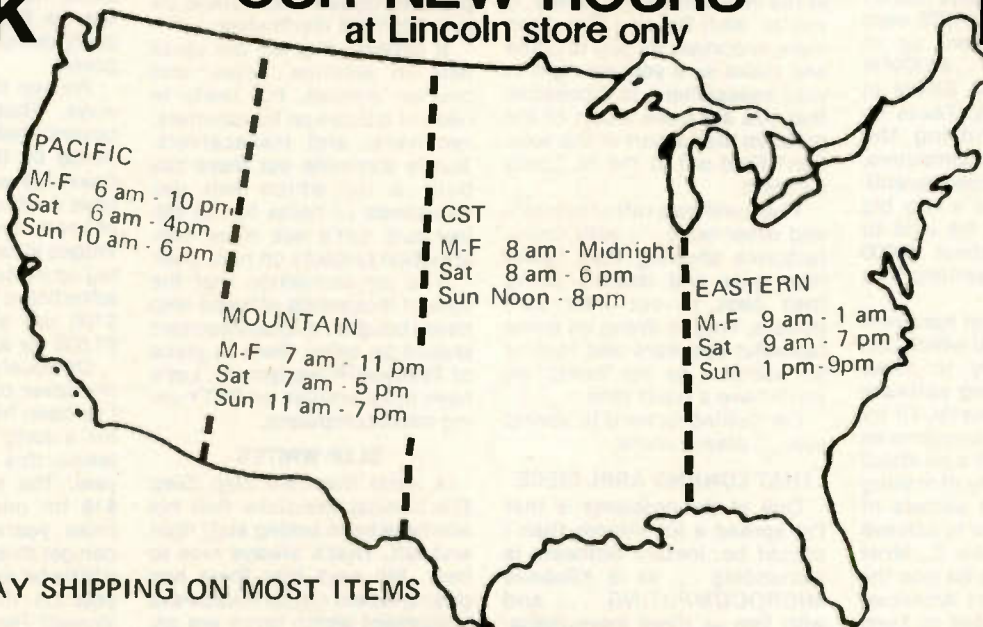

SAME DAY SHIPPING ON MOST ITEMS

1-800-228-4097

Communications Center

443 N. 48th, Lincoln, Nebraska 68504

In Nebraska Call (402)466-8402



✓ C58



W2NSD/1 NEVER SAY DIE

editorial by Wayne Green

from page 4

interested in the same end . . . a better world, helped along a whole lot by amateur radio. Hamming can only provide these benefits to the world if it is fun, so let's all try to do what we can to make amateur radio fun . . . for everyone. I don't ask you to speak out against those who are lousing things up, whether by intention or stupidity—I just ask that you look into these things with an open mind and vote with your conscience.

ALSO AT ATLANTA

In addition to laying it on the line about amateur radio . . . and I expect the usual goon squad . . . I'll be talking about microcomputers. I'll be talking about them primarily in terms which may be of particular interest to you . . . how to make money in microcomputing. I'd talk about how to make money in amateur radio, but I don't know anyone who has figured it out yet. Perhaps those who are pushing for the Communicator Class license on 220 have the answer.

The opportunities in microcomputing are still as good as ever for making a bundle. The industry has grown some since I got involved. Sales in 1975 were about \$5M. This went up to about \$25M in 1976 . . . \$100M in 1977 . . . and passed \$300M in 1978. With Atari and Texas Instruments now hitting the market with microcomputers, 1979 is still an unknown quantity. Radio Shack has a very big lead and may just be able to hold it, what with about 10,000 of their stores selling the TRS-80.

I'll be talking about hardware which is needed and which can be marketed easily to make money. I'll be putting software into perspective. Mostly, I'll try to answer as many questions as I can. I may even talk a bit about the whole philosophy of making money . . . what the secrets of success are and how to achieve success if you want it. Most people have blundered into the trap of the good old American system . . . guaranteed to keep you poor for life and with no real hope of spectacular success. Is there anything to do about this? I think so . . . and the first step is to become aware of the system and how it can be beaten.

Will I be seeing you at Atlanta

June 16-17th? I hope so. What about Dayton? I don't know . . . I skipped it last year, but haven't decided about this year yet. With two or three new magazines in various stages of getting started, Instant Software really getting going, and some other projects, I don't really have time to go most of the places where they want me, much less where they don't.

MEET ME IN ST. LOUIS

Yes, Wayne Green is coming to St. Louis . . . for the big hamfest on March 31st. I'll be talking about amateur radio . . . the good things and the bad. I'll be answering questions on just about anything. In addition to that, as at Atlanta, I'll be talking to microcomputer hobbyists about the many ways of making money in this new field. I'll try to give some perspective on what has happened and what I see as coming in both fields.

This will be my first trip to St. Louis, so I'm looking forward to it. I'll be getting in a day early, so I'll have a chance to get on the local radio and television stations and promote the hamfest.

If you're a Wayne Green fan, be sure to come to the show . . . at the new convention center. If you're anti-Green, it's even more important for you to come and make sure you are right in your assessment. Is it possible that you are more a part of the problem than a part of the solution? Find out at the St. Louis hamfest.

There will be a raft of exhibits and other talks . . . with manufacturers showing their latest ham gear and dealers doing their best to cut their own throats. They're lining up some fantastic speakers and forums (in addition to my talks), so you'll have a great time.

I'm looking forward to seeing you . . . please come.

THAT LONNNG ARRL PIECE

One of the problems is that I'm spread a lot thinner than I should be. Instant Software is demanding . . . as is *Kilobaud MICROCOMPUTING* . . . and with two or three more magazines in the planning stages, when do I sleep? This came to a head last month with my endless editorial about the League.

Normally, when I write an editorial, I sit down and write with smoke coming out of my

typewriter. Then I find the heat abated a bit and write a second draft which is a bit less fiery. If I don't like the first two drafts, I try a third time. In December, all of the drafts of my editorial managed to reach print, end to end. I'm supposed to get a chance to review my editorial before it goes to the printer . . . but they skipped me last month. Rats.

Oh, I get annoyed at a lot of the crap I get from the League, but I'm not as upset about it as most people think. You'll perhaps get better perspective on this at St. Louis or Atlanta if you come and say hello and get into one of my talks.

ARTICLES NEEDED

Our increased use of color in 73 permits us to run some color photographs of interesting DXpeditions. The time was when we had to run all those pictures of gorgeous places in black and white. We're looking for colorful DXpedition pictures accompanied by interesting articles. An article will not only help pay some of the freight for the trip, but could also encourage others to help out a bit when they send for your QSL card. DXing is one of the most exciting aspects of amateur radio, so let's see more of the DXing fun in articles for 73.

If I can get my new tower up, I'll be back in there scrapping with you for the rare ones. I'm a tough one to beat, so watch out! I racked up over 300 confirmed countries (all on 20m phone) in one year a while ago . . . and even managed 100 countries on 20m phone one weekend, just to prove to myself that I could do it. I didn't get much sleep.

It appears that we are up to here in antenna, keyer, and counter articles, but really in need of articles on transmitters, receivers, and transceivers. Surely someone out there has built a rig which will get thousands of hams hot to follow suit. Let's see more construction projects on ham gear.

It is my conviction that the tens of thousands of hams who have bought microcomputers should be using them in place of Teletype™ equipment. Let's have more articles on RTTY using microcomputers.

SLEP WRITES

A letter from Bill Slep (Slep Electronics) mentions that his ads have been selling stuff right and left. That's always nice to hear. Bill says that there has been a recent run on microwave equipment which hams are using to receive the TV satellites direct. I've been reading a lot about this recently and would like to encourage those who have been successful in getting something inexpensive together to do the job to write for us

about it.

Why bother to get TV direct from a satellite? Well, right off the top there is the challenge. It isn't easy. Once you get set up, you'll be getting network program feeds. This means that you'll be able to get, for example, Johnny Carson before the salty language is bleeped out. You'll get a lot of programs which are not being broadcast in your area. You'll get the Home Box Office stuff . . . late movies.

I've been corresponding with Bob Cooper K6EDX/5, who publishes a magazine for the CATV field and is deeply into this direct satellite TV reception. I may be able to get him to either write an article for us or at least get him to get someone else to prepare such an article. Using commercial gear for the effort would run you into the thousands of dollars. Heck, just a receiver for 4 GHz costs thousands. Then they want you to buy a ten-foot dish and a special preamplifier. Some experimenters have been getting the stuff with a lot less expense and trouble. If you're one, write to me about it.

NEW COVER PRICE

The new cover price shouldn't come as much of a surprise to anyone. A big part of it is inflation, which has been running about 10% of late. It's been two years since there has been an increase in cover price. If inflation keeps up like it has (if you continue to let your congressman spend money on more and more government), the price increases will have to come more often. How'd you like to find a different price every month? Keep it up, Congress!

We see the inflation in many ways. Postage has gone up beyond belief . . . made even worse by the great big, thick, heavy issues of 73. Paper costs have doubled in the last couple of years, and no end is in sight. Wages all around have been going up in step with inflation. Our advertising rates, once under \$100 per page, are now over \$1,500 for a page!

Obviously, the way to beat the cover price is to subscribe. I've been hinting gently at that for a long time. At \$2.50 per issue, this comes to \$30 per year. The subscription rate is \$18 for one year and \$36 for three years. That means you can get three years of 73 for just a little bit more than buying one year on the newsstand. Convinced? Remember when a life subscription was going for \$37?

Of course, those early issues of 73 were much smaller (about one half the size of this page) and thinner. You're getting eight times as much material for about six times the price . . .

so it is a good deal. Fifty-seven feature articles in the November issue! That's more than all the other magazines combined, isn't it?

THE 10 GHZ SAGA

Chuck Martin WA1KPS started off going great guns (Gunn's, that is) on 10 GHz with contacts with New Hampshire from Massachusetts, Vermont, Maine, and even the Granite State itself (106 miles between Pack Monadnock in southern New Hampshire and Mt. Washington, up north). From there on, the situation got more difficult.

A couple of tries from hills in Rhode Island didn't make it. The paths were even difficult on 220 MHz, so the failure on 10 GHz wasn't very surprising, even if it was disappointing.

Chuck got the two transceivers together and found little things to do which supposedly improved their action. He also

borrowed a two-foot dish to perk up his end of the signal, just in case this would help. It might push a signal through some trees, but it wouldn't boost it over any mountains.

On November 19th, I braved icy winds gusting to over 80 mph up in the superstructure of a tower on the Pack, while Chuck relaxed up in the branches of a tree on a hill in Rhode Island. Well, he was perhaps only partly relaxed, considering that he was trying to hold on to the tree while he aimed the dish and tuned the transceiver... and gradually froze.

Perhaps it was worth it all. We did manage some short contacts as the two transceivers drifted in frequency about 16 MHz as they cooled down to the subarctic temperatures. The AFC system is pretty good, but definitely not equipped to handle that kind of drift. And tuning the little bugger is about like trying to tie an

appendix with boxing gloves on. You have to turn the tuning knob about a thousandth of an inch to tune in a signal. This is interesting to do when you are being blown almost out of a tree or a tower by gusts of very cold wind... shivering... and your hands are turning blue as frostbite creeps up towards your armpits.

That makes five states on 10 GHz, with all contacts being over 50 miles. Anyone done better than that, or should we send it to the book of world records? Our laurels will not be crushed. Chuck has some ideas on pepping up the transceivers, and if we put the darned things outside so they can come to a steady temperature, we should avoid the drift miseries. The next stop obviously is Connecticut for state number six... if we can get organized before the snow hits.

Those little Microwave Associates Gunnplexers sure

are good fun. They put out enough of a signal so that you should not have to have any additional antenna for a contact over any line-of-sight path. Our contact of over a hundred miles was plenty strong.

Sherry has been itching to get a hot air balloon ever since we went down to Florida and made the balloon cover for 73 a couple of years ago. If we get one, I understand that contacts from the balloon count for New Hampshire as long as the balloon is tethered. I wonder if a 5,000-foot kite string counts as a tether?

OCTOBER WINNER

Our readers have selected "Antenna Design: Something New!" as the best article in our October issue, so Harry A. Mills W4FD and Gene Brizendine W4ATE will be sharing our \$100 Most Popular Article prize. Remember, your ballot is your Reader Service card.

DX

from page 14

from Greenland to South America out of our home base, Wright-Patterson AFB, on a two-week "worldwide" communications test of an experimental airborne satellite terminal. Among the crew of 25 men, we had four hams: Sandy Cole K1SC, Tom Waliiko K8NOQ, Bob Beach W8LCZ, and Wayne Beeson K8WB.

After landing (on Ascension Island) on Saturday night, we immediately searched for the acting base commander, Captain Lord, and finally found him in a barracks card game. Captain Lord informed us that the required forms and the British Islands Administrator's signature needed to obtain our own ZD8 calls would not be available until Monday morning. Meanwhile, he authorized the use of your call, ZD8KG, for us as guest operators. He presumed your kind permission since you were not then on the island.

The authorization seemed adequate, as we had the word of the Lord, so we rushed over to barracks 14 and set up our FT-101E and 18-foot vertical antenna. Our first QSO took place just after midnight on September 17th with W7PFZ on 20 meter SSB.

We then proceeded to have the time of our lives working our first pileup from the fun (rare) end of the QSO. An awesome and enjoyable experience almost every DXer has dreamed of was coming true.

All four of us took turns as noted in the enclosed log copy.

We worked 10, 15, and 20 meter CW and SSB. Conditions on 10 were great, so we used that band a lot in racking up 230 contacts from ZD8KG in about 36 hours.

On Monday, we filled out the required forms, got the necessary signatures, and finally received our own calls. Sandy got ZD8SC, Robert got ZD8RB, Wayne got ZD8WB, and I got ZD8TW. We still had some operating time left, so we returned to the rig and ran off 105 more contacts in the four hours before our plane took off for Brazil.

We totaled five continents, fifty countries, and 325 contacts, of which 101 were with stateside stations. We earned no awards but we had a terrific time.

During some hurried and confused packing, we yanked our antenna off the barracks roof in the middle of our last QSO with WB0TXV on ten meter SSB. A sudden end to our DXpedition. We all had a ball and can't wait to do it again. Our plane will return to Ascension Island in March, 1979, and again in the summer of 1980. We plan to bring multiple rigs next time and to use our new-found experience to cut through the pileups faster. Meanwhile, we left our aircraft number and 73 written with six-foot high rocks on the side of West Bay Hill near the barracks.

We requested everyone we

worked to QSL direct to our home calls, but if you or your QSL manager, K4KBL, receive any cards for contacts we made, you can forward them to me. Again, thanks for the use of your call and we hope to see you on a future trip to the island.

Tom Waliiko K8NOQ/ZD8TW
712 Sykes Circle
Wright-Patterson AFB OH 45433

BITS AND PIECES

As of this writing, no documentation has reached the ARRL for the HZ1BS/8Z4 neutral zone operation. No documentation, no recognition.

If you still haven't worked

KV4, there is really no excuse. KV4AA recently made his 38,000th QSO. Most are CW.

That W0DX who operated from Desecho recently is Bob Denniston, former president of the ARRL. He runs the Smuggler's Cove Hotel on the north side of the island group.

4U1ITU in Geneva reports that they are receiving QSL requests for 4U1UN in NYC. The correct QSL route for 4U1UN is UN Staff Radio Club, United Nations, Box 20, NYC NY 10017. SASE, of course.

For those who are still confused by the FCC call sign allocations in areas outside the continental U.S., the following should be of some help. The



George Lindley WA5HKW erecting his home-brew three-element beam. George built it from plans in Bill Orr's Beam Antenna Handbook for about one-third the cost of a commercial beam. He says it works great.

digit is the key. Alaska stations sign AL7, KL7, NL7, and WL7. The rest are as follows.

Atlantic: 1—Navassa Island; 2—Virgin Islands; 3—Serrana Bank; 4—Puerto Rico. Prefixes are KP, NP, and WP.

Pacific: 1—Baker, Canton, Howland Islands; 2—Guam; 3—Johnston Island; 4—Midway Island; 5—Kingman Reef (K suffix); 5—Palmyra, Jarvis; 6—Hawaii; 7—Kure Island; 8—American Samoa; 9—Wake Island; 0—Northern Mariana Islands. Prefixes are AH, KH, NH, and WH.

All the foreign nationals have been assigned YS9 prefixes in El Salvador. YS1WPE is now YS9YSS.

The operator at HF0POL, the Polish base in the South Shetlands, left and the new crew contains no amateurs. QSLs have been printed, but there is a holdup in getting them filled out and mailed.

The ARRL is planning to take the FCC ten meter linear ban to court. As noted before, the innocent hams were the only ones to suffer from this ban. The manufacturers of illegal CB linears either went underground or switched to manufacturing high-powered "amateur transmitters." CBers just plug in their transceiver as a vfo. Passing laws to make it illegal for lawbreakers to break the law has never made much sense to us.

Those working toward WAZ should bear in mind that UA0YAE, heard often on 15

meter CW, is located in Tana Tuva, which is in Zone 23. In fact, any UA0Y Is in Zone 23.

Gary Yarus WB0MSZ puts out a directory of stateside QSL managers that contains over 1300 managers. This is almost a necessity for the serious DXer and at only \$1.00, it's a great bargain. The address is: Gary Yarus, 921 N. Clay Avenue, St. Louis MO 63122, and the list is updated weekly.

UV0BB claims to be the first and only YL operator in Siberia.

SV1IT is considering a possible Mt. Athos effort this summer. Nothing definite as yet, but if you run across him, you might ask for the latest word.

Amateur radio continues to experience rapid growth. Amateur licenses in the U.S. are expected to top 366,000 by early this year. There were some 28,000 new licenses issued during 1978. The total number of licensed amateurs in the U.S. has increased better than 100,000 since 1975. CB licenses, on the other hand, dropped below 100,000 per month last summer for the first time in several years. Look for several of the larger CB equipment manufacturers to jump into the amateur market.

QSL manager ON5TO notes that the true-blue 9U5CA has not been active since 1971. The one showing in '76-'77 was a pirate. Only 9U5CB, 9U5DS, and 9U5CR are legit at present.

The U.S. and Surinam, PZ, completed a reciprocal operating agreement on October 12.

Amateurs of either country wishing to operate in the other country can do so upon application to the proper authorities. Information on this or any other reciprocal operating agreement can be obtained by sending an SASE to the ARRL. Reports indicate a reciprocal agreement with Spain is now in the works.

A note from K5OVC straightens out the Argentine-Antarctic callsign designations. LU-ZA, ZG, and ZM are South Orkneys. LU-ZY is South Sandwich. LU-ZC, ZI, ZO, SZ, and ZT are South Shetlands. Others are Antarctica.

Jim Henderson, who spent several months signing ZM7AH from the Tokelaus a few years back, wants to clean up any remaining need for ZM7AH cards and seal the logs permanently. Anyone still needing a card can reach Jim at 13490 Mt. Hood, Reno NV 89506.

The Mellish Reef operation, VK9ZR, managed some 16,000 contacts despite being plagued by generator problems that limited their output.

K4OD notes that he still has all logs from his previous overseas assignments and will be glad to confirm any contacts. Anyone needing a card from OA4DX ('68-'71), HP1XOD ('70-'71), PY1ZAL ('71-'73), EP2OD ('75-'77), or 9D5B ('76-'77) can reach Carl at PO Box 135, Front Royal VA 22630. SASE, of course.

E18H is a legitimate station, but any E18H/xx you hear is a definite phony. Pat has been getting loads of QSLs for these operations, but all are going into the trash and he requests that no more be sent.

ZD9GG can often be found on a list operation run by

WA7ZTL on 14245 kHz around 1445Z. An Asahi newspaper recently took some aerial photos of Okino Torishima. The outlines of the barrier reef are quite distinct and the foundation of the never-built weather station can be seen in the center. Only two rocks are visible at high tide. One is five feet tall. It is difficult to imagine another operation taking place from here for quite some time.

The DX gathering on 14225 kHz after 1500Z is a great hunting ground. Check it out.

The first DXCC for 160 meter operation was issued on November 15, 1976. Since that time, twelve have been issued. #1 went to W1BB, of course, #2 to W1HT, #3 to W8LRL and KV4FZ (two were issued), #5 to K1PBW, #6 to W4BRB, #7 to W2QD, #8 to W2DEO, #9 to W4QCW, #10 to W4YWX, #11 to K4CIA, and #12 to W9NFC. The east coast pretty well has a lock on this award.

8J1JCI was a special station on from the Japanese Chamber of Commerce and Industry Centennial Exhibition.

QSL INFORMATION

In the November column, a typo snuck in directing QSLs for GU5CIA, GU4EON, and GU3YIZ to K5YY. This was an error and San says no more, please. The correct route is to N6MA, whose address is listed below.

3D6BA to WA4HNL
3Y0BZ to VE7ZQ
3Y5DQ/3Y1VC to LA5NM
4079WARC to YU2DX
4N0D to YU2CQ
4N2EC to YU1JAS
7P8BH to WB9ZZK
8J3ITU to JH3DPB
9J2JN to WB2IZN
9K2FX to W4KA
GU5CIA to N6MA, 3800 J Street, Oxnard CA 93030
A7XAH to DJ9ZB
EX9A to Box 88, Moscow
H5RAC to WA4HNL
HH2DX to George Werner, 1045 Le Brun, Jacksonville FL 32205
HZ1AB to K8PYD
J28AZ to I8JN
JY3ZH to DJ9ZB
KA1MI to WB1GXU
KA1NC to K4JEX
KG4KG to YASME
LU3ZY to SARA, Malabia 3029, 1425 CF, Buenos Aires
N0TG/KP1 to Randy Rowe, 3237 Connecticut Drive, St. Charles MO 63301
S8GEH to WA4HNL
TF0DF to K4SAK
ZL3HI/C to N2CW, 207 West Fifth Street, Ship Bottom NJ 08008

Thanks to *The West Coast DX Bulletin*, the *Long Island DX Association Newsletter*, and *Worldradio Magazine* for much of the preceding information.

AMATEUR RADIO IN IRAQ

During a business trip to

Ever wonder what the shack of a rare DX station looks like? Here's the operating position of the much-sought-after Y11BGD, the only station currently active in Iraq. Pictured are ops Majid (seated) and Saad, along with their Atlas transceiver. Can you spot your QSL on the wall? Thanks to Jack Winterbourne VE3ITO and the CARF News Service for the photo.

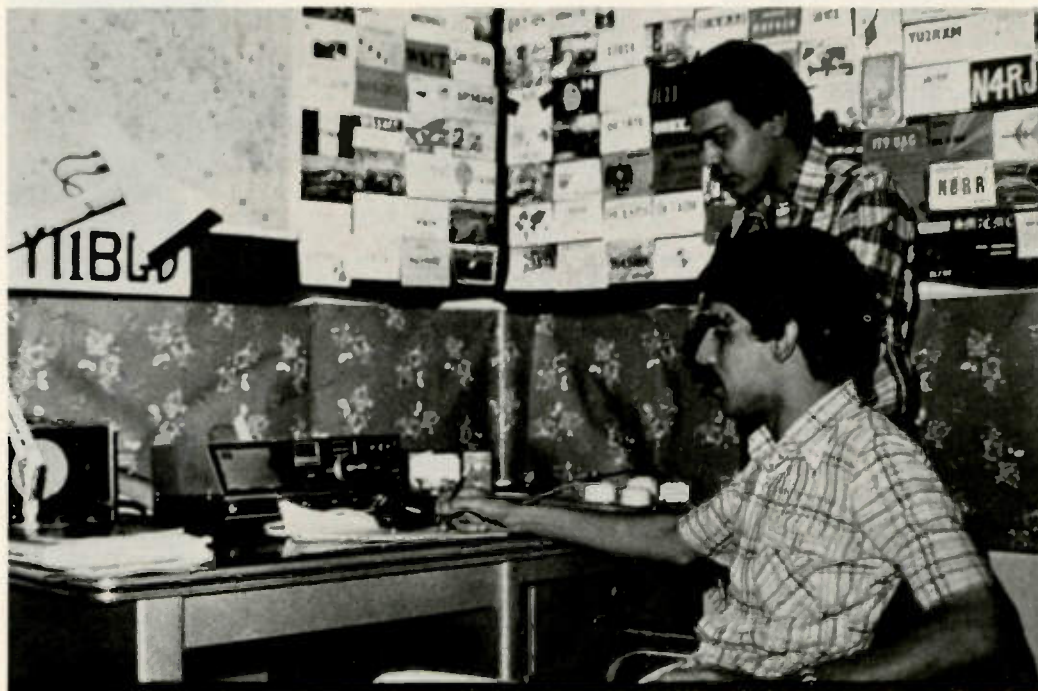

Baghdad in September, 1978, I contacted Majid Abdūlhamid, Chief Operator of the Radio Club of Baghdad, amateur radio station YI1BGD.

Majid gave me telephone directions to find the club premises, now located in the building of the General Directorate of Scientific Welfare in the Azamia district of Baghdad. This building also houses other scientific clubs.

I was met by Majid and another club operator, Saad Al Tai, both of whom accorded me a very courteous welcome.

On being informed of the general interest of North American amateurs in the situation of ham radio in Iraq, they explained their present status.

YI1BGD is the only legal ham station in Iraq at present. Majid is holder of the license, which is limited to the 20 meter band

and 100-Watt input.

The club hopes to be permitted soon to operate on other bands and with higher power.

The present membership, besides Majid, consists of seven operators, including two YLs. Majid expects the club to grow as their activities become more widely known.

The whole operation was made possible through a radio course given by YU1NFV, who has since left Iraq.

The club station commenced operation on April 14, 1978, and has logged a respectable number of countries and QSOs since that time.

The present station is equipped with an Atlas 210 and a two-element quad which is operated manually. Recently, they received a donation from Japan of a Yaesu FT-101, which is awaiting clearance at cus-

toms pending the revised station license.

YI1BGD's operating schedule is Monday and Wednesday on 14210 MHz, and on Friday from 2000 UTC until 0100 UTC, their beam is directed at North America. At that time they have regular skeds with VO1CU (Gordon) and 12CBM (Bert) who act as control stations on their behalf. The Friday frequency is 14310 MHz.

When I enquired if they had any QSLs for VE3-land which I could carry back, they showed me the station log which indicated almost 100 percent QSL response from them. Those hams who have sent QSLs are quite certain to receive confirmation, but it will take time. It does not appear that the club takes long to respond, but the distance and conditions really slow things down.

The club has received some publicity in the Long Island DX Association bulletin, one of the British magazines, and locally in an Arabic publication.

My friends were kind enough to let me take a few pictures of them and their station (I hope the film survives the security checks on the return trip), and also gave me a small black and white print of four of the operators in the shack—Kamal, Majid, Mohammed, and Dhia.

Judging by the enthusiasm of these two men, the DX hounds will continue making regular contact with YI1BGD, but it is doubtful that there will be any other YI stations for some time. This information came to us courtesy of Jack Winterbourne VE3ITO, and was first published in the Burlington, Ontario ARC bulletin.—Ed.

FCC

Reprinted from the Federal Register.

ADMINISTRATION OF TELEGRAPHY EXAMINATIONS TO HANDICAPPED APPLICANTS FOR OPERATOR LICENSES IN THE AMATEUR RADIO SERVICE

Order extending time for filing comments and reply comments

AGENCY: Federal Communications Commission.

ACTION: Order Extending Time to File Comments.

SUMMARY: The FCC is inquiring into the administration of its telegraphy examinations to handicapped persons who apply for amateur radio li-

censes. The comment period ends November 30, 1978. Mr. Norman Kaplan has petitioned to extend the comment period. The comment period is being extended to encourage as wide a participation in the proceeding as possible.

DATES: The comment period is extended to March 30, 1979. The reply comment period is extended to April 30, 1979.

ADDRESSES: Send comments to: The Secretary, FCC, 1919 "M" Street NW., Washington, D.C. 20554.

FOR FURTHER INFORMATION

CONTACT:

Mr. Robert Cassler, Personal Radio Division, Safety and Special Radio Services Bureau, 202-634-6620.

SUPPLEMENTARY INFORMATION: See attached document.

Adopted: November 21, 1978.

Released: November 24, 1978.

In the matter of the administration of telegraphy examinations to handicapped applicants for operator licenses in the Amateur Radio Service, Gen Docket No. 78-250.

1. On August 24, 1978, the Commission released a Notice of Inquiry into the administration of telegraphy examinations to handicapped applicants for operator licenses in the Amateur Radio Service. Comments were due no later than November 30, 1978. Reply comments were due no later than De-

ember 29, 1978.

2. A petition to extend the comment period to March 30, 1979 was submitted by Mr. Norman Kaplan of the Disabled American Veterans, North Miami Beach, Florida. Mr. Kaplan cites the need for as many handicapped persons to participate in the proceeding as possible. Because of the special nature of this proceeding, we agree with petitioner.

3. Accordingly, the Commission, by the Chief, Safety and Special Radio Services Bureau, pursuant to delegated authority granted to him by § 0.331 orders that the comment period and the reply comment period in General Docket No. 78-250 are extended to March 30, 1979, and April 30, 1979, respectively.

CARLOS V. ROBERTS,
Chief, Safety and Special
Radio Services Bureau.

OSCAR Orbits

Courtesy of AMSAT

FINDING OSCAR

The listed data tells you the time and place that OSCAR 7 and OSCAR 8 cross the equator in an ascending orbit for the first time each day. To calculate successive OSCAR 7 orbits, make a list of the first orbit number and the next twelve orbits for that day. List the time of the first orbit. Each successive orbit is 115 minutes later (two hours less five minutes). The chart gives the longitude of the day's first ascending (northbound) equatorial crossing. Add 29° for each succeeding orbit. When OSCAR is ascending on the other side of the world from you, it will descend over you. To find the equatorial descending longitude, subtract 166° from the ascending longitude. To find the time OSCAR 7 passes the North Pole, add 29 minutes to the time it passes the equator. You should be able to hear OSCAR 7 when it is within 45 degrees of you. The easiest way to determine if OSCAR is above the horizon (and thus within range) at your location is to take a globe and draw a circle with a radius of 2450 miles (4000 kilometers) from your QTH. If OSCAR passes above that circle, you should be able to hear it. If it passes right overhead, you should hear it for about 24 minutes total. OSCAR 7 will pass an imaginary line drawn from San Francisco to Norfolk about 12 minutes after passing the equator. Add about a minute for each 200 miles that you live north of this line. If OSCAR passes 15° east or west of you, add another minute; at 30°, three minutes; at 45°, ten minutes. Mode A: 145.85-.95 MHz uplink, 29.4-29.5 MHz downlink, beacon at 29.502 MHz. Mode B: 432.125-.175 MHz uplink, 145.975-.925 MHz downlink, beacon at 145.972 MHz.

OSCAR 8 calculations are similar to those for OSCAR 7, with some important exceptions. Instead of making 13 orbits each day, OSCAR 8 makes 14 orbits during each 24-hour period. The orbital

period of OSCAR 8 is therefore somewhat shorter: 103 minutes.

To calculate successive OSCAR 8 orbits, make a list of the first orbit number (from the OSCAR 8 chart) and the next thirteen orbits for that day. List the time of the first orbit. Each successive orbit is then 103 minutes later. The chart gives the longitude of the day's first ascending equatorial crossing. Add 26° for each succeeding orbit. To find the time OSCAR 8 passes the North Pole, add 26 minutes to the time it crosses the equator. OSCAR 8 will cross the Imaginary San Francisco-to-Norfolk line about 11 minutes after crossing the equator. Mode A: 145.85-.95 MHz uplink, 29.4-29.50 MHz downlink, beacon at 29.40 MHz. Mode J: 145.90-146.00 MHz uplink, 435.20-435.10 MHz downlink, beacon on 435.090 MHz.

Oscar 7 Orbital Information				Oscar 8 Orbital Information			
Orbit	Date (Feb)	Time (GMT)	Longitude of Eq. Crossing "W"	Orbit	Date (Feb)	Time (GMT)	Longitude of Eq. Crossing "W"
19272	1	0040:17	71.4	4636Abn	1	0133:06	65.9
19285	2	0134:34	85.0	4650Abn	2	0138:19	67.2
19297	3	0033:54	69.8	4663Jbn	3	0000:17	42.7
19310	4	0128:11	83.4	4677Abn	4	0005:29	44.0
19322qrp	5	0027:31	68.3	4691Abn	5	0010:42	45.4
19335	6	0121:48	81.8	4705Abn	6	0015:54	46.7
19347X	7	0021:09	66.7	4719X	7	0021:06	48.0
19360	8	0115:26	80.3	4733Abn	8	0026:18	49.3
19372	9	0014:46	65.1	4747Abn	9	0031:30	50.6
19385	10	0109:03	78.7	4761Jbn	10	0036:43	51.9
19397	11	0008:23	63.6	4775Jbn	11	0041:55	53.3
19410qrp	12	0102:40	77.2	4789Abn	12	0047:07	54.6
19422	13	0002:01	62.0	4803Abn	13	0052:19	55.9
19435X	14	0056:18	75.6	4817X	14	0057:31	57.2
19448	15	0150:35	89.2	4831Abn	15	0102:43	58.5
19460	16	0049:55	74.0	4845Abn	16	0107:55	59.8
19473	17	0144:12	87.6	4859Jbn	17	0113:07	61.1
19485	18	0043:32	72.5	4873Jbn	18	0118:20	62.5
19498qrp	19	0137:49	86.1	4887Abn	19	0123:32	63.8
19510	20	0137:10	70.9	4901Abn	20	0128:44	65.1
19523X	21	0131:27	84.5	4915X	21	0133:56	66.4
19535	22	0030:47	69.4	4929Abn	22	0139:08	67.7
19548	23	0125:04	82.9	4942Abn	23	0001:06	43.2
19560	24	0024:24	67.8	4956Jbn	24	0006:18	44.5
19573	25	0118:41	81.4	4970Jbn	25	0011:30	45.9
19585qrp	26	0018:01	66.2	4984Abn	26	0016:42	47.2
19598	27	0112:18	79.8	4998Abn	27	0021:54	48.5
19610X	28	0011:39	64.7	5012X	28	0027:06	49.8

New Products

from page 26

ing. The peak reading feature is a must for SSB transmitters. The MP1 also will display swr. Swr is measured directly, without having to use extra charts or graphs.

For ease of installation, the MP1 has a removable coupling unit which may be placed up to 4 feet from the meter.

The MP1 is portable. It contains the latest in low-power ICs and is powered by a 9-volt battery. For long-term non-portable operation, an optional ac adapter is available.

A low-battery-voltage indicator has been built into the wattmeter to indicate when the battery needs changing.

The MP1 will provide all the functions and features needed to maintain an efficient, well-operating HF amateur station.

For more information, please contact your local dealer or *Mirage Communication, PO Box 1393, Gilroy CA 95020; (408)-847-1857*. Reader Service number M75.

NEW MURA VOM MULTITESTER OFFERS DUAL-RANGE SENSITIVITY

Mura Corporation, manufacturer of home entertainment products, CB accessories, and

electronic parts and components, has introduced a new precision VOM multitester with extremely high dual-range sensitivity.

Designated Model 85-M, the new VOM multitester is ideal for use where measurements must not appreciably disturb a particular circuit being tested. It features high 50,000-Ohms/volt dc and 10,000-Ohms/volt ac sensitivities on one set of voltage ranges, and 25,000-Ohms/volt dc and 5,000-Ohms/volt ac on a second group of voltage ranges.

In conjunction with a power supply, the 85-M can be used to measure capacitance and inductance. Special circuitry has been included to protect the meter movement against accidental overload, and a mirror arc has been provided to help eliminate parallax error from readings. In addition, a convenient carrying handle, attached to the unit's high-impact casing, can be positioned for easy meter reading.

The new 85-M measures 6 3/4" x 5" x 2" and weighs 1 lb., 5 oz., with batteries. *Mura Corporation, 177 Cantlague Rock Road, Westbury NY 11590; (516)-935-3640*. Reader Service number M79.

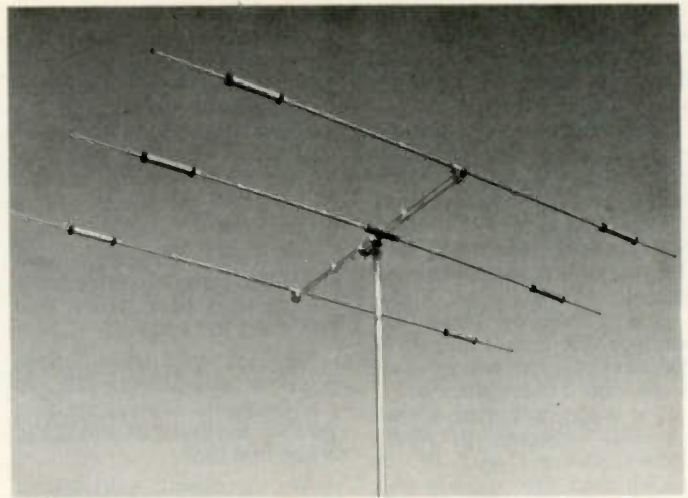

Wilson's "System Three."

"SYSTEM THREE" BY WILSON

Wilson Electronics is proud to announce the latest in tri-band antennas for 10-15-20 meters. The "System Three" features lightweight design, heavy-duty materials, low swr across all three bands, a boom length of 14' x 4", wind survival of 100 mph, direct feed with 52-Ohm coax or with a balun, and a capability of 2000 Watts.

For more information on the "System Three," see your favorite dealer or contact *Wilson Electronics, Consumer Products Division, PO Box 19000, Las Vegas NV 89119*. Reader Service number W2.

YAESU'S FT-202R

"The Handie," a new miniaturized two meter hand-held transceiver (Model FT-202R), has now been added to the Yaesu line of amateur radio equipment.

Measuring only 67 x 49 x 171 mm, the one-Watt-output, six-channel hand-held should please the most critical user with its excellent receiver performance and high-quality F3 transmitted signal.

The receiver is double-conversion, with a sensitivity measurement of 0.32 mV for 20-dB quieting. "The Handie" covers the entire two meter band and includes a flexible rubber ducky antenna and attractive carrying case. Crystals are supplied for three channels.

Other features include a combination "S"-meter and tuning meter, tone burst or subaudible squelch (optional), built-in speaker, and condenser microphone. Batteries required (not supplied) may be AA-size or nicads to provide 9.6 V dc (not to exceed 12 V dc).

For complete details on this new hand-held transceiver, see your Yaesu dealer or write to *Yaesu Electronics Corporation, PO Box 498, Paramount CA 90723*. Reader Service number Y1.

NEW CUSHCRAFT HF VERTICALS

Many hams are convinced that to work meaningful DX they need a couple of thousand Watts and a monster antenna array. While that undoubtedly helps, where is it written that the ham suffering a money or space cramp can't compete for his day in the DXCC sun?

Three new Cushcraft verticals, the ATV-3, ATV-4, and ATV-5, provide a commonsense solution to a commonplace problem. Specifically designed for the DXer, these antennas provide the low angle of radiation necessary for long-haul DX communication, along with the performance and quality long associated with the Cushcraft name. The ATV-3, ATV-4, and ATV-5 operate over the 10, 15, and 20 meter amateur bands, with the ATV-4 having built-in 40 meter coverage and the ATV-5 all set for complete 5-band operation.

All antennas feature a built-in PL-259 coax connector and stainless steel hardware for all electrical connections, and are matched to 50 Ohms and rated for a full 2000 Watts PEP. Factory-marked tubing and plain English instructions make assembly a snap.

Built to withstand the severest weather, the ATVs feature specially-designed high-Q traps employing large-diameter enameled copper wire and solid aluminum air-dielectric capacitors. The trap forms are manufactured from filament-wound fiberglass for minimum dielectric loss and high structure strength. Durable 6063-T832 aluminum tubing with 0.058" (1.5 mm) walls used for the vertical radiator and the heavy-duty phenolic base insulator ensure long life and durability. All this adds up to an antenna line that comes through winter after winter a winner!

For more information and a

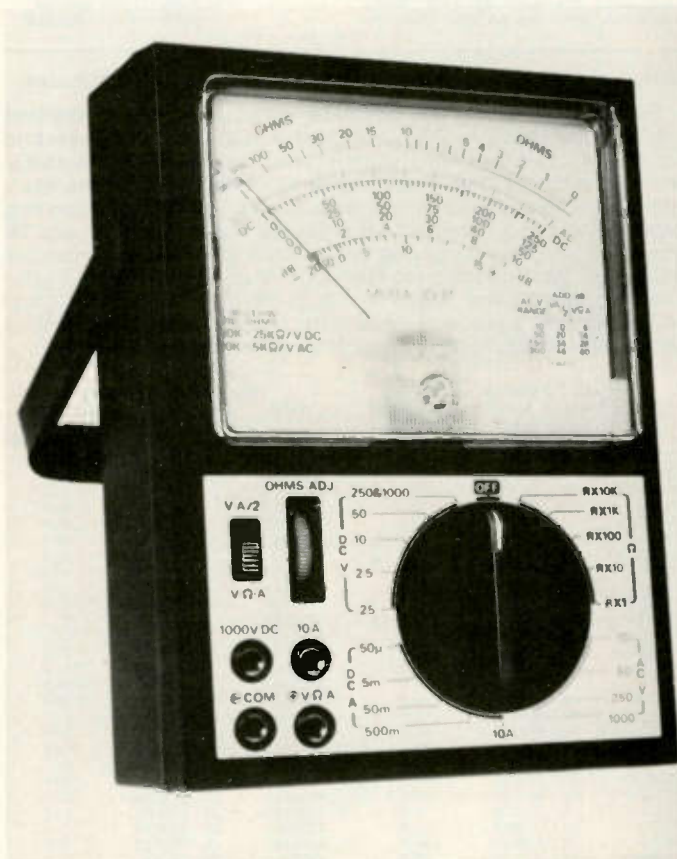

The Mura Model 85-M VOM multitester.



The new Mizuho SX-59 preselector from Gilfer.

full-color catalog highlighting the entire Cushcraft HF, VHF, and UHF antenna line, write to Cushcraft, PO Box 4680, Manchester NH 03108. Reader Service number C67.

GILFER INTRODUCES VERSATILE NEW RF PRESELECTOR/PREAMPLIFIER WITH AUTOMATIC ANTENNA SWITCHING

If you are missing out on those weak DX signals because your receiver needs more sensitivity, here's a low-cost way to hype it up: Add the new Mizuho SX-59 preselector/preamp from Gilfer.

The SX-59 adds 20 dB of gain (3 or 4 S-units) with low noise. Tunable in 3 switched bands from 3 to 30 MHz, the unit is completely automatic in antenna switching—turn it on and it

connects itself to the antenna, turn it off and the antenna is reconnected to the receiver. No manual bypass is needed.

Beautifully styled in a solidly-made beige-colored cabinet, the SX-59 has a built-in, switchable, 20-dB rf attenuator to cope with excessively strong signals, plus a range switch, rf gain control, tuning dial, LED "on" indicator, input and output coax (SO-239 and phono plug) antenna connectors, "remote" terminals, and a built-in power supply for 117 V ac.

It's easy to use. Just select the band and tweak the tuning dial for the maximum signal. You'll be surprised at what you're missing. And if you've an old single-conversion receiver, the SX-59 will also reduce those images by 4 or 5 S-units.



Staco's new RPS-8 power supply.

For complete information, write Gilfer, Box 239, Park Ridge NJ 07656. Reader Service number G6.

NEW STACO REGULATED 8-AMP POWER SUPPLY

A new regulated 8-Amp power supply from Staco, Incorporated, is built to operate amateur, commercial, and industrial transceivers, as well as other 12-volt dc equipment, from 120 volts ac.

The solid-state Staco RPS-8 is ideally suited for fixed output power. A unique current fold-back circuit and internal circuit breaker provide automatic dual overload and short-circuit protection. In the event of component failure, an automatic

crowbar circuit protects equipment from high voltage. The RPS-8 features a surge current of 8.0 Amps, a continuous current of 6.0 Amps, and a full 13.8-volt dc output. Ventilated steel housing is clad with black and white vinyl to prevent scratches or mars. Each unit is complete with input power cord, switch, pilot light, and operating instructions. Output connections are easily made to the terminal board on the rear of the unit. The RPS-8 measures 3-5/8 inches x 5 inches x 8 inches, and is backed by a 90-day limited warranty.

For more information, contact Staco, Incorporated, 301 Gaddis Boulevard, Dayton OH 45403. Reader Service number S78.

Corrections

I would like to offer a reed relay update to my October, 1978, article ("Happiness Is A Smart Scanner"). This information is from Allied's catalogue #790 (page 180). The following relays may be used: stock no. 929-377 (mfr. type MRR1ADS), stock no. 850-1552 (mfr. type W107DIP-3), or stock no. 703-2012 (mfr. type AMP2012). Also, please note my new address.

John P. Skubick K8JS
791 106th Ave. N.
Naples FL 33940

I just had a letter from Harold Drennon W0FSC who was nice enough to point out an error that he found in my OSCAR turnstile antenna article in the November, 1977, issue, page 63, Fig. 3. In the 2m driving harness, the wording below

coaxial line 2 read $\lambda/4$ RG-62A/U, but should be $\lambda/4$ RG-62A/U. This is the first notice of a problem I have had, and I am sorry it was not caught by me in the proofs. The original was okay, but the proofs are still my responsibility. I thoroughly checked the entire article again, while I was at it, and, sure enough, I found one of my own errors. Fig. 1 caption should be: "Vertical mast is $10' \pm 5'$..." Surely the builders caught that one or they got strange looks when they went shopping!

Dave Brown W9CGI
Noblesville IN

Eric Corbett WD8PYE and others have pointed out a few errors in the wiring diagram and description of the Novice keyer on page 44 of the March,

1978, 73 Magazine. The following should be noted:

Fig. 1: IC1 pin 7 should be pin 4. C2 should be reversed (negative side grounded).

Fig. 2: D2 should be connected to R6 at the crossover point.

Table 1: With power applied but key not contacting, IC2 pin 5 should be low (not high as indicated).

Several hams have written

with these difficulties, along with shorted diodes, etc. None of them has written to me a second time, so hopefully I have been able to explain enough to them to get their keyers working. If you are having any difficulties, and will describe any voltages differing from those in the article (with above corrections), I'll help you out.

Michael Windolph W0OGX
Chaska MN

Ham Help

I need information on how to update or increase the usability of a Hammarlund Super-Pro or BC-779 shortwave receiver. Any info would be appreciated.

Bill Koczon W2HWQ
85 Lakeland Dr.
Bricktown NJ 08723

I would like to convert a Johnson Canadian model

Messenger 352 mobile SSB/AM solid-state 23-channel CB transceiver into a 10 meter mobile transceiver. I would greatly appreciate receiving information regarding this conversion.

Raymond Boivin VE2BOL
282 Boul Monaco
Duberger, Quebec
Canada G1P 3H4

Contests

from page 24

other ZS1 stations. All modes or combination of modes permitted. All bands or combination of bands permitted. Closing date for the award is July, 1979. No QSL cards are required. Send a copy of your log verified by 2 local amateurs. Fee: US \$1 or 10 IRCs; ZS R1.00. Send applications to: The Award Manager, ZS1MO, PO Box 5100, Cape Town 8000, Republic of South Africa. A special indication is given for VHF contacts.

SECOND ANNUAL INTERNATIONAL SSTV CONTEST

The contest is sponsored by R. Brooks Kendall W1JKF and David Ingram K4TWJ.

CONTEST RULES:

Contest is held annually on the second full weekend of March from 1500 to 2200 GMT, Saturday and Sunday, 3/10/79 and 3/11/79. All amateur bands between 3.5 and 29.7 MHz may be used.

EXCHANGE:

Exchange of pictures should include call signs, RST report, and contest number. FCC rules require verbal exchange of call signs for U.S. stations. Do not include contact number.

CREDITS:

1 point for each station worked. A station may be worked once on each band for credit. 1 point for each state or province worked. 5 points for each country worked. 5 points for each continent worked.

Total score is the sum of all the credits. Excessive discrepancies in the contest entry may cause disqualification. Entries become the property of the contest committee. The decisions of the contest committee are final.

ENTRIES:

Activity sheets should show station worked, state or province, country, and band (80, 40, 20, 15, 10). Summary sheets should show number of stations worked, number of states or provinces worked, number of countries worked, number of continents worked, and total score. Contest entries should be postmarked no later than 4/10/79. Top scorer will be awarded a certificate and a year's subscription to the magazine of his or her choice. Certificates will also be awarded to the top scorer for the most countries and most continents worked.

Send entries to either: R. Brooks Kendall W1JKF, 10

Stocker Street, Saugus MA 01906, or David Ingram K4TWJ, Eastwood Village, No. 1201 South, Rt. 11, Box 499, Birmingham AL 35210.

THE WORKED ALL WEST AUSTRALIAN SHIRES AWARD AND THE WORKED ALL WEST AUSTRALIAN POST CODES AWARD

To become eligible for these awards, it is necessary for overseas amateurs to work 40 shires and 50 post codes, respectively, with proof of the QSOs to be forwarded to the Contest Committee, c/o PO Box 6250, Hay Street, Perth 6000, Western Australia, along with 10 IRCs or equivalent for the initial award. Subsequent stickers will be issued free, although return postage will be appreciated.

A map of West Australia showing all shires is available from the above address for \$2 Australian.

Ham Help

I am with the Canadians in Lahr, West Germany. My problem is this: The D.A.R.C. over here has a large number of QSL cards that belong to DA call holders. I am in the position of trying to locate amateurs and pass on the cards. I am not a QSL bureau, just a locating service.

At the time of writing, I find myself with over 5000 cards, DA1, DA2, DA4, and DJ (foreign civilians), all of which the D.A.R.C. is unable to locate. So, for some time now, I have been trying to locate same, with little or no luck. Most of the U.S. Army DA call holders are moving around all the time, including going back home, so a lot of amateurs are without their QSL cards. If you are missing some QSLs, let me know.

Michael R. Jackson
VE3KQI/DA1UO
Postfach 1771
7630 Lahr
West Germany

In the October, 1978, issue of *73 Magazine*, in Ham Help, I asked for a simple modification for the popular Kenwood TR-7400A. In order to receive the Civil Air Patrol frequency of 148.15 MHz. A reader (Gerald Gray WA0IKA of Topeka) came up with the mod, and I would like to pass it along for use by other 7400 owners. The only components needed are a small switch and a diode. Connect as follows: With the top cover of the radio removed, install an SPST switch with one

lug grounded to the cover. Locate the switch directly behind the CT1 terminal. Connect the cathode of a 1N914 diode to the other switch lug. Add a 2" piece of wire to the anode, and slip shrink tubing over switch lug, diode, and wire. Strip the other end of the wire approximately 1/2" and wrap it around terminal CT1 on PD board X50 1380 10 (refer to Kenwood manual); no solder is required. Install the cover. Label the switch "Receive, +600." With this switch in the closed position, I can receive the CAP frequency of 148.15 by setting the display dial of my transceiver on 147.550, and, with the TX offset of +600, I can simplex on the frequency. No change is required to transmit on this frequency, and just turn the switch off to receive the frequency displayed. My thanks to Gerald and *73 Magazine*.

George E. Taylor WA4GUW
Muscle Shoals AL

I need to get in touch with other amateurs, faculty members on the college or university level, who teach biomedical electronics and instrumentation. I'm on the faculty of the University of Texas School of Allied Health Science in Houston.

MDS interested in the subject are also very welcome. However, I am seeking resources on at least the post-graduate level in Health Related Science. In addition,

those interested should be "teaching oriented."

Jim McClure WB5MHA
801 S. Braeswood, Apt. 1313
Houston TX 77031

We recently obtained a multimeter, ME-26 D/U, serial no. 7747 (similar to HP-410B), manufactured by Sentinel Electronics, Inc. The company is not listed in the *Electronics Buyer's Guide*, and may be out of business. We need the operator's manual and schematic. Thanks for any assistance.

Heritage Christian School
Warren Pettit
Box 50002
6401 East 75th St.
Indianapolis IN 46250

I need the manual for a Heathkit Model V-6 vacuum tube voltmeter. I will gladly reimburse reasonable duplicating and mailing expenses, or I will duplicate on receipt and send back by return mail. Thanks.

V.F. Smith VE1BEA
46 Beaconsfield St.
Fredericton, New Brunswick
Canada E3B 5H2

I would like to hear from people who are using the FCC experimental band and learn where I can get plans for transceivers, transmitters, and receivers.

Rick Todd KA8AKL/N
14470 Basslake Road
Newbury OH 44065

I need a photocopy of *Surplus Schematic Handbook* (red and black, with white schematic on cover, part of CQ series, 8 1/2 x 11 inches). Also

need photocopy of Wolf's *Motorola Schematic Digest* and photocopy of manual or diagram for National NC-200 receiver.

Finally, I need Knight Signal Tracer and any data, and rigs for two meters in any condition.

John C. White WB6BLV
560 North Indiana
Porterville CA 93257

I would like to obtain a copy of the manual, or at least the schematic, for the Heathkit Model VF-1 vfo. I'll be happy to pay postage and copy costs. Thanks!

Mark F. Allen WD6GZJ
11401 Snowdrop Ave.
Fountain Valley CA 92708

I have an old Hallicrafters S-85 receiver and would like to modify and utilize it for DX work as the receiver is extremely sensitive. I am in need of a schematic and operator's manual. Thanks.

Charles Bott DL-579/WW
PSC Box 56
APO NY 09123

I am in need of an operations manual and schematic for a Dumont Labs type 350-R oscilloscope. I will pay for copies, or whatever arrangement we can come up with.

James G. Brown
15 New Ocean St.
Lynn MA 01902

I need a manual or complete schematic for a Motorola 41 V dispatcher (high band, 110/12 volts). It is needed for a club project.

Chuck Bennett WB8GQW
17060 Paver-Barnes Rd.
Marysville OH 43040

MESSAGE MEMORY KEYS

"BRAND NEW"



\$69.95

Features:

- Advanced CMOS message memory
- Two (50 char. each) message storage
- Repeat function
- Records at any speed—plays back at any speed
- Longer message capacity
- Example: send CD CD CD DX de WB2YJM WB2YJM K—then play second message on contact—de WB2YJM QSL NY NY 579 579 Paul Paul K
- Use for daily OSOs or contests

PLUS:

- State of the art CMOS keyer
- Self completing dots and dashes
- Both dot and dash memory
- Iambic keying with any squeeze paddle
- 3.50 rpm
- Speed, volume, tone, tune and weight controls
- Sidelane and speaker
- Low current drain CMOS battery operation—portable
- Deluxe quarter-inch jacks for keying and output
- Keys grid block and solid state rigs
- WIRED AND TESTED FULLY GUARANTEED—LESS BATTERY



\$36.50

CMDS Electronic Keyer

Features:

- State of the art CMOS circuitry
- Self completing dots and dashes
- Dot and dash memory
- Iambic keying with any squeeze paddle
- 3.50 RPM
- Speed, volume, tone controls, side tone and speaker

- Low current drain CMOS battery operation
- Deluxe quarter inch jacks for keying and output
- Handsome eggshell white base—woodgrain top
- Compact and portable 1-7/8 x 4-1/4 x 6-1/8
- Grid block keying
- Wired and tested—fully guaranteed—less battery

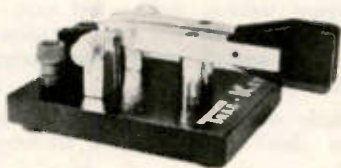

TRAC - KEY

FEATURES:

- Twin paddle squeeze key
- Extra heavy base—non skid feet
- Adjustable contact spacing
- Touch tension—capacitor keying
- Smooth friction free paddle movement
- Handsome crinkle finish base and rich red paddles
- Five way binding posts
- Use with Trac CMOS keyer or any keyer

\$25.95

plus \$2.00 ship
NY res. add tax

AT YOUR DEALER OR SEND CHECK OR MONEY ORDER.

TRAC ELECTRONICS, INC
1106 RAND BLDG. ✓ T18
BUFFALO NY 14203

THE BIG SIGNAL UNADILLA "W2AU" Baluns

DEMANDED BY PROFESSIONALS WORLD-WIDE OVER 12 YEARS

- The Original Lightning Arrest
- 650# Strength
- Stainless Hardware
- Sealed
- GUARANTEED



FULL-POWER, QUALITY HAM ANTENNA PARTS

AT YOUR DEALER

- BALUNS - TRAPS - INSULATORS
- QUAD PARTS - ANTENNA KITS
- BOOM / MAST MOUNTS - WIRE
- CABLE - CONNECTORS

WRITE FOR FULL CATALOG [Enclose 30c Stamps]

MICROWAVE UNADILLA/REYCO DIVISION (Dept. 73)
FILTER COMPANY INC
6743 KINNE STREET EAST SYRACUSE NEW YORK 13207 ✓ U9

DEALERS WANTED - OVER 300 WORLD-WIDE

SST HA-2 MOBILE ANTENNA

2 METER SSB

HORIZONTALLY POLARIZED ANTENNA

The SST HA-2 is a full half wave, horizontally polarized omnidirectional 2 meter antenna. With the horizontal polarization standard, the HA-2 is a must for 2 meter SSB mobile. With the vertical/horizontal adapter option, use it with your FM rig too!

Although the SST HA-2 was designed for mobile operation it will work well as a fixed or portable antenna—its small size provides the traveling ham with an antenna that can easily be packed in a briefcase.

Features:

- Mobile, portable, or fixed operation.
- Horizontal or vertical polarization with operational adapter.
- Greater than 3.5 MHz bandwidth.
- Less than 1.5:1 VSWR.
- High performance—additional data available on request.
- Solid construction—built to last.

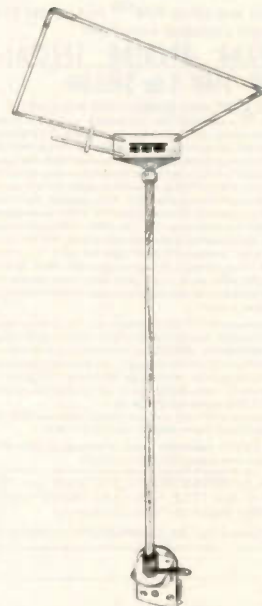

Pat. pending #88548

✓ S10

only \$39.95

GM-1 gutter mount \$5.95 VH-1 vertical/horizontal adapter \$5.95

Impedance matching is accomplished by means of a pre-adjusted gamma match and a variable capacitor. The HA-2 comes complete with RG-58, which is neatly fed through the center of the mast section, PL-259 coax connector, and 3/8 24 stud mount. The HA-2 fits standard mounts. Our recommended rain gutter mount is available as an option. Also optional is a vertical/horizontal adapter, which allows changeover to be made in minutes with a screw driver.

SST ELECTRONICS
P.O. BOX 1 LAWDALE, CALIF.
90260 (213) 376-5887

NOW! NOW! NOW! NOW! NOW!

The ultimate answer for eliminating the damaging effects of antenna weight on your rotor . . . it's the

"UDM THRUSTOR"



- Fits any taper tower or can be used with flat top.
- Accepts 1 1/2" mast pipe
- All steel construction.
- Utilizing precision ground & hardened ball-type thrust bearing.
- Comes ready to install.
- Eliminates the damaging effect on your rotor.
- Shipped prepaid UPS (U.S.A.)
- Check, cash, money order, Visa, MasterCard. \$49.95 complete.
- Also available for 2" mast pipe for \$59.95

UDM ENTERPRISES ✓ U10
P.O. Box 2037, Sandusky, Ohio 44870

KIM™ BUS IS A WINNER!

AIM™, VIM™, (SYM)™, KIM™ OWNERS
(and any other KIM™ bus users) buy the best 8K board available anywhere:
GRAND OPENING SPECIAL—HDE 8K RAM—\$169! 3 for \$465.00!

THE BEST HAM COMPUTERS AVAILABLE!
KIM™ is a complete 6502 CPU computer comes with 1K RAM, 2K ROM monitor, 23 key keypad, LED display, cassette interface, TTY interface, 2 programmable I/O ports and interval timer which are perfect for control applications (RTTY, etc.). The KIM comes with over 400 pages of documentation, and has been the subject of a multitude of articles and books. Expansion is easy via two 224 pin edge connectors. The KIM bus format is becoming another industry standard and is supported by Rockwell International, MTU, HDE, Synetab, the Computerist, and others. KIM-1 computer & documentation \$179; KIM-4 motherboard \$119; HDE 8K RAM for KIM bus computers \$189; 3 for \$465!; HDE prototyping board with reg. heat sink, switch address & decoding logic included \$49.50; reg power supply for KIM-1 alone \$45; enclosure for KIM-1 alone \$29; book "The First Book of KIM" \$9.95; book "Programming a Microcomputer—6502" \$4.95; **SPECIAL PACKAGE DEAL!** includes KIM-1, power supply. Both books listed above for only \$215! This is probably the best computer tutorial package available at any price! Over 30 application program listings!

Commodore PET™ 2001 computer with CRT display, digital cassette drive; 72 key keyboard; Memory expansion bus; fast time clock; programmable I/O port with handshake lines; IEEE-488 bus interfaces up to 15 devices; powerful and fast 9' digit MicroSoft BASIC language; prerecorded application programs available from many sources; now includes the manual, "PET Communication with the Outside World" which details how to use the IEEE bus, parallel port, BASIC PEERS and POKES to external devices, etc.

Commodore PET 2001 computer, complete (8K user RAM) \$795.00. BASIC BASIC programming course program, runs on PET \$9.95

All products assembled, tested, guaranteed at least 90 days. Shipping extra unless order prepaid with cashier's check.

PLAINSMAN MICRO SYSTEMS (div. 5C Corporation)
P.O. Box 1712, Auburn AL 36830: (205)745-7735
3803 Pepperell Parkway, Opelika ✓ P42

Dealers for OSI, COMMODORE, COMPUCOLOR, ALTOS



**RTTY
made
easy**

TU-170 kit...\$149.95
wired...\$219.95

State of the art design features make the TU-170 ideal for HF and VHF autostart operation at an unchallenged price.

- SIZE: 7 1/4" W x 3 1/4" H x 7 1/4" D
- Proved 170Hz shift 3 stage active filter demodulator
- Lighted tuning meter for easy tuning
- Current regulated loop keyer and power supply
- Autostart with threshold control and solid state relay
- Stable audio frequency shift oscillator, produces phase coherent sine wave tones
- TTL compatible inputs and outputs for auxiliary equipment
- High level output for scope tuning

FLESHER CORP.

P.O. Box 976

Topeka, Kansas 66601

(913) 234-0198 ✓ F5



Iron Powder and Ferrite
TOROIDAL CORES

Wide selection - Large stock
Fast, one-day service
Technical data with each order
Write for free Tech-Data-Flyer

AMIDON
✓ A26 Associates

12033 Otsego Street, North Hollywood, Calif. 91607
4930 Detmold 18, West Germany.



SST T-4 ULTRA TUNER



ULTRA TUNER DELUXE

The new SST T-4 Ultra Tuner Deluxe matches any antenna--coax fed or random wire on all bands (160-10 meters). Use it with your dipole, vertical, beam, etc. It works with any transceiver.

Tune out the SWR on your antenna for more efficient operation of your rig. One antenna can even be used for all bands. The SWR on mobile whips can be tuned out from inside your car.

An easy-to-read two color meter scale provides convenient indication of SWR for easy tuning. A back panel antenna switch allows you to select between two coax fed antennas, a random wire, or tuner bypass.

The SST T-4 Ultra Tuner Deluxe is compatible with any rig--solid state or tube. Its compact size (9" x 2-1/2" x 5") makes it ideal for mobile, portable, or home operation. Features an attractive bronze finished enclosure and exclusive SST styling. ✓ S10

Features:

- Matches any antenna - coax fed or random wire. 1.8-30 MHz.
- 300 watt output power capability.
- SWR meter.
- Antenna switch on back panel.
- Efficient tapped inductor.
- 208 pf. 1000v. capacitors for flexible, reliable operation.
- Johnson binding posts. Four SO-239 connectors.
- Made in USA.

Compare features, quality, and price--SST antenna tuners are your best value. This is our seventh year of manufacturing compact antenna tuners.

Available now at your SST dealer or order direct--information on following page.

only \$69.95



ELECTRONICS

P.O. BOX 1 LAWNOLE, CALIF.
90260 (213) 376-5887

Social Events

MADISON WI FEB 8-11

The 1979 Spirit of Ballooning Fiesta will be held on February 8-11, 1979, in Madison, Wisconsin. This is a national convention of hot-air balloonists. On the 8th and 9th, 10 balloons will take off each afternoon. On the 10th and 11th, eighty balloons are scheduled to lift off. Amateurs interested in providing communications should contact Clyde Downing W9HSY, PO Box 3403, Madison

WI 53704, (608)-244-4744, or contact him on the Madison 16176 two meter machine. Please provide days and type of equipment available (base, mobile, HT, etc.). K9BIL or K9VAL may also be contacted.

TRAVERSE CITY MI FEB 10

The Cherryland Amateur Radio Club will hold its annual Swap & Shop on February 10, 1979, from 9:00 am to 4:00 pm, at Northwestern Michigan Col-

lege Technical Center, Front St., Traverse City, Michigan. For information, please contact Greg North, Box 115, Lake Leelanau MI 49653.

MANCHESTER NH FEB 10

The Interstate Repeater Society will hold its 3rd annual auction and hamfest on February 10, 1979, beginning at 9:00 am, at the Manchester Armory, across the Amoskeag Bridge from I-93, in Manchester, New Hampshire. There will be commercial exhibits, and the auction will be held rain or shine. Admission and parking are free. Talk-in on 146.52,

146.25/.85, and 224.86/223.46. For information, contact Gary A. DeLong WB7NOH/KA1BCA, Interstate Repeater Society, PO Box 94, Nashua NH 03061.

MANSFIELD OH FEB 11

The Mansfield midwinter hamfest/auction will be held on February 11, 1979, in a heated building at the Richland County Fairgrounds in Mansfield, Ohio. There will be prizes and a flea market. Doors will open to the public at 8:00 am. Talk-in on 146.34/.94. Advance tickets are \$1.50; \$2.00 at the door. For information, contact Harry Fritchen K8HF, 120 Homewood,

ACCESSORIES

SST T-3

Mobile Impedance Transformer

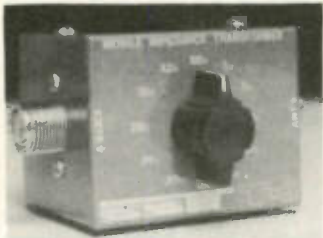

Matches 52 ohm coax to the lower impedance of a mobile whip or vertical. 12-position switch with taps spread between 3 and 52 ohms. Broadband from 1-30 Mhz. Will work with virtually any transceiver—300 watt output power capability. SO-239 connectors. Toroid inductor for small size: 2-3/4" x 2" x 2-1/4". Attractive bronze finish.

\$19.95

SST DL-1 K4RLJ DUMMY LOAD

The SST DL-1 is a unique non-corrosive chemical dummy load which has been developed and tested by K4RLJ for 12 years. There is no other dummy load like it. Unlike messy, oil-filled dummy loads, the DL-1 will not leak. It is sealed and ready to use.

A dummy load is a must for any ham station. High input to small size ratio makes the DL-1 ideal for portable, base station, and work bench operation for hams and commercial users. Accurate readings will result when used with SWR and power meters.

Specifications:
Max. power: 1000 watts PEP for 15 seconds.
SWR: less than 1.5:1 1 MHz - 225 MHz.
Size: 3-1/8" X 4-3/8"

\$17.95



SST AS-1 ANTENNA SWITCH



The SST AS-1 switches between up to three antennas without disconnecting coax connectors. Makes switching between antennas convenient and neat. Handles 300 watts output.

\$11.95

SST ELECTRONICS

T-1 RANDOM WIRE ANTENNA TUNER

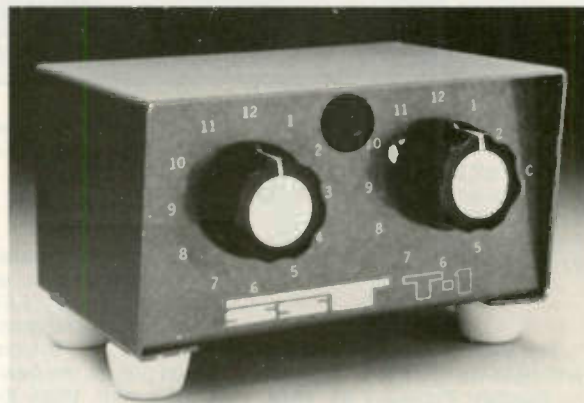

All band operation (160-10 meters) with any random length of wire. 200 watt output power capability - will work with virtually any transceiver. Ideal for portable or home operation. Great for apartments and hotel rooms—simply run a wire inside, out a window, or anyplace available. Efficient toroid inductor for small size: 4-1/4" x 2-3/8" x 3", and negligible loss. Built-in neon tune-up indicator. SO-239 connector. Attractive bronze finished enclosure.

only \$29.95

The Original Random Wire Antenna Tuner
... in use by amateurs for 7 years.

SST T-2 ULTRA TUNER

Tunes out SWR on any coax fed antenna as well as random wires. Works great on all bands (80-10 meters) with any transceiver running up to 200 watts power output.

Increases usable bandwidth of any antenna. Tunes out SWR on mobile whips from inside your car.

Uses efficient tapped inductor and specially made capacitors for small size: 5-1/4" x 2-1/4" x 2-1/2". Rugged, yet compact. Negligible line loss. Attractive bronze finished enclosure. SO-239 coax connectors are used for transmitter input and coax fed antennas. Convenient binding posts are provided for random wire and ground connections.



only \$39.95

TO ORDER:

Send a check or money order—or use your Master Charge or VISA card. COD and credit card orders are also accepted by phone. Simply give us your card number and expiration date. Our phone order desk is open at most hours for your convenience and so that you can take advantage of the very low before/after hour phone rates.

GUARANTEE:

All SST products are unconditionally guaranteed for 1 year. In addition, they may be returned within 10 days for a full refund (less shipping) if you are not satisfied for any reason.

Call (213) 376-5887 or 379-9572 to order
C.O.D., VISA or Master Charge

or send to: SST Electronics,
P.O. Box 1, Lawndale, Calif. 90260

Please add \$3 for shipping and handling (\$6 Air-mail Worldwide). California residents, please add sales tax. \$1 charge for COD.

Name _____
Street _____
City _____ State _____ Zip _____
Models Desired: Total Enclosed _____
\$ _____
or charge to: VISA M.C. C.O.D.
Card # _____ Exp. Date _____

SST ELECTRONICS
P.O. BOX 1 LAWNOALE, CALIF. 90260 (213) 376-5887

NEW
FROM XITEX

\$95 MORSE TRANSCIVER

SEND:

- 1 to 150 WPM (set from terminal)
- 32 character FIFO buffer with editing
- Auto Space on word boundaries
- Grid/Cathode key output
- LED Readout for WPM and Buffer space remaining

SERIAL INTERFACE:

- ASCII (110, 300, 600, 1200) or Baudot (45, 50, 57, 74) compatible
- Simplex Hi V Loop or T²L electrical interface
- Interfaces directly with the XITEX[®] SCT-100 Video Terminal Board; Teletypes[®] Models 15, 28, 33, etc.; or the equivalent



MRS-100 CONFIGURATIONS:

- \$95 Partial Kit (includes Microcomputer components and circuit boards; less box and analog components)
- \$225 Complete Kit (includes box, power supply, and all other components)
- \$295 Assembled and tested unit (as shown)

Overseas Orders and dealer inquiries welcome

COPY:

- 1 to 150 WPM with Auto-Sync.
- Continuously computes and displays Copy WPM
- 80 HZ Bandpass filter
- Re-keyed Sidetone Osc. with on-board speaker
- Fully compensating to copy any 'list style'

See your local dealer or contact XITEX[®] direct.

MC/Visa accepted

XITEX CORP.

13628 Neutron • P. O. Box 402110
Dallas, Texas 75240 • (214) 386-3859

Mansfield OH 44906, or phone (419)-529-2801 or (419)-524-1441.

LANCASTER PA FEB 18

The 7th annual Lancaster hamfest will be held on Sunday, February 18, 1979, at the Guernsey Sales Pavillion, US Rt. 30 & PA Rt. 896, Lancaster, Pennsylvania. Doors will open at 8:00 am and there will be a prize drawing at 2:00 pm. Admission is \$3.00, and table reservations are \$2.00 in advance. There is a new, larger indoor flea market area. Food and soft drinks will be available. Talk-in on 146.01/61. For further information, contact SERCOM, PO Box 6082, Rohrerstown PA 17603.

MARLBORO MA FEB 24

The Algonquin Amateur Radio Club will hold its annual electronic flea market on Saturday, February 24, 1979, from 10:00 am to 4:00 pm, at St. Mary's School Hall on Broad

Street in Marlboro, Massachusetts. There is easy access to the Hall from I-495 via Rt. 20 east. Seller setup is from 9:00 am to 10:00 am. Talk-in on .52. Sellers should contact Charlie W1BK at (617)-562-5622.

VIENNA VA FEB 25

The Vienna Wireless Society will hold its annual Winterfest on Sunday, February 25, 1979, at the Vienna Community Center, Vienna, Virginia. There will be tables, sales, prizes, food, and frostbite tailgating. Doors open at 6:30 am for vendors and 8:00 am for the general public. Admission is \$3.00, including one prize ticket; \$2.00 for an extra prize ticket, and \$1.00 for frostbite tailgating. Preteens with parents are free. Tables range from \$2.00 to \$5.00, depending on the quantity. Reservations close on February 15, 1979. For reservations, contact Carroll N. Guin, 7533 Oak Glen Court, Falls Church VA 22042. For in-

formation, contact the Vienna Wireless Society, PO Box 418, Vienna VA 22180.

LIVONIA MI FEB 25

The Livonia Amateur Radio Club would like to announce that the 9th annual LARC Swap 'n Shop will be held on Sunday, February 25, 1979, from 8:00 am to 4:00 pm, at the new location of Churchill High School in Livonia MI. Tables, door prizes, refreshments, and free parking will be available. Talk-in on 146.52 simplex. Reserved table space of 12-foot minimum is available. For further information, send an SASE to Neil Coffin WA8GWL, c/o Livonia Amateur Radio Club, PO Box 2111, Livonia MI 48151.

LAPORTE IN FEB 25

The LaPorte Amateur Radio Club will hold its winter hamfest on Sunday, February 25, 1979, at the LaPorte Civic Auditorium, LaPorte, Indiana.

There is a \$1.00 table charge. Donation is \$2.00 at the gate. Talk-in on .01/61 and .52. For more information, contact LARC, Box 30, LaPorte IN 46350.

AKRON OH FEB 25

The Cuyahoga Falls Amateur Radio Club will hold its annual electronic equipment auction and flea market on Sunday, February 25, 1979, at North High School, Akron, Ohio, from 9:00 am to 4:00 pm. Tickets are \$2.00. You may bring your own tables, and there will be some available for \$2.00 each. There will be refreshments, prizes, and a grand prize of a Triton IV. There is easy access to the high school on the Tallmadge Avenue off-ramp and the North Expressway (Rt. 8). Talk-in on 146.52 and 146.04/64. For details, write CFARC, PO Box 6, Cuyahoga Falls OH 44222, or phone Bill Sovinsky K8JSL at (216)-923-3830.

DAVENPORT IA FEB 25

The Davenport Radio Amateur Club will hold its hamfest on February 25, 1979, at the Masonic Temple in Davenport, Iowa. Admission is \$2.00 in advance, \$2.50 at the door. Refreshments and tables will be available. Talk-in on .28/88 and .52. For further information, send an SASE to John S. Birmingham WB0QCC, 2022 Brown St., Davenport IA 52804.

CIRCLEVILLE OH MAR 4

The King of the Pumpkin Ham Fiesta, sponsored by the Teays Amateur Radio Club, will be held from 9:00 am to 5:00 pm

... at last ...
your shack organized!

A beautiful piece of furniture — your XYL will love it!

\$149.95 S-F RADIO DESK

Deluxe - Ready to Assemble

Designed with angled rear shelf for your viewing comfort and ease of operation.

FINISHES: Walnut or Teak Stain.
Also available in Unfinished Birch, \$134.95

Additional Information on Request.
Checks, Money Orders, BankAmericard and Master Charge Accepted.

F.O.B. Culver City. (In Calif. Add 6% Sales Tax.)

S-F AMATEUR RADIO SERVICES ✓ S33

4384 KEYSTONE AVENUE • CULVER CITY, CALIF. 90230 — PHONE (213) 837-4870

\$95 Stand Alone Video Terminal

0123456789:;<=>?
!@#%&'()*+,-./0123456789:;<=>?
@ABCDEFGHIJKLMNPOQRSTUVWXYZ[\]^_`
abcdefghijklmnopqrstuvwxyz{|}~

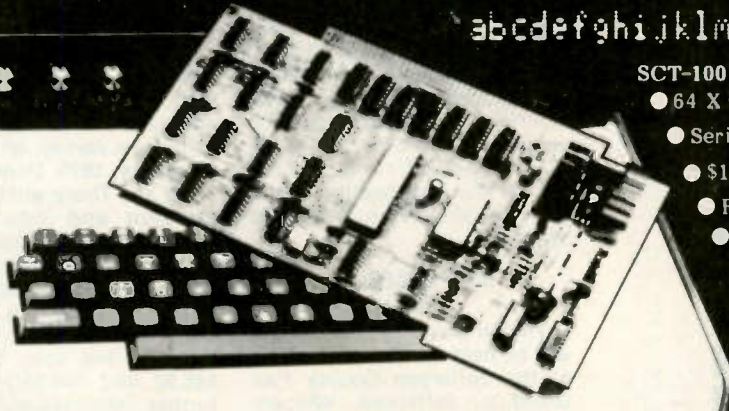

SCT-100 FEATURES:

- 64 X 16 line format with 128 displayable characters
- Serial ASCII or BAUDOT with multiple Baud rates
- \$187 Assembled or \$157 Kit (Partial Kit \$95)
- Full cursor control with scrolling and paging
- On board power supply

Call or write today. MC/VISA accepted

XITEX CORP 13628 Neutron P. O. Box 402110
Dallas, Texas 75240 (214) 386-3859
✓X1
Overseas orders and dealers inquiries welcome

on Sunday, March 4, 1979, at the fairgrounds coliseum, Circleville, Ohio. There will be an indoor flea market, new and used equipment, door prizes, refreshments, and free parking. Table spaces are available at \$3.00 each. Advance admission is \$1.00; \$2.00 at the door. For advanced reservations and information, contact Dan Grant W8UCF, 22150 Smith Hulse Road, Circleville OH 43113; (614)-474-6305.

STERLING IL MAR 4

Sterling Rock Falls Amateur Radio Society will hold its annual hamfest on March 4, 1979, at the Sterling High School Fieldhouse, 1608 4th Avenue, Sterling, Illinois. Tickets are \$1.50 in advance; \$2.00 at the door. A large indoor flea market is restricted to radio and electronic items only. There is plenty of free parking available, including an area to accommodate campers and mobile trailers. There will be no advance sale of tables. We will take reservations for commercial enterprises only. There will be bargains, miscellaneous prizes, and food. Talk-in on 146.94. For tickets, write Don VanSant WA9PBS, 1104 5th Avenue, Rock Falls IL 61071. Make checks payable to Sterling Rock Falls Amateur Radio Society. Please include an SASE.

FLEMINGTON NJ MAR 17

The Cherryville Repeater Association will hold its annual hamfest on March 17, 1979, from 10:00 am to 5:00 pm, at the Field House of Hunterdon Central High School, just north of Flemington, New Jersey, on

FAST SCAN ATV

ALL YOU NEED IN ONE BOX



Show the shack, home movies, computer games, etc. Connect to the ant. terminals of any TV set, add a good 450 antenna, a camera, and you are there...

- 10 Watts peak RF output. Specify 434.0 or 439.25 MHz
- Subcarrier sound with plenty of mic gain for distance pick-up.
- 8 MHz bandwidth, high resolution necessary for computer alphanumeric and color.
- Tuneable converter covers 420 to 450. (Covers CH 2, 3)
- Contains AC to 12VDC regulated 3 AMP power supply.
- Only \$399.00 direct mail. Check, Money Order, VISA. Send S.A.S.E. for catalog of ATV Modules and PC Boards.

P.C. ELECTRONICS

Maryann 2522 PAXSON Tom
WB6YSS ARCADIA, CA 91006 W6ORG

FLY YOUR RUBBER DUCKY !!

Get off the trunk lid and into the best location on the car... the center of the roof! Tests have proven that the low profile quarter-wave whip, or the rubber-ducky from a Handy-Talky, outperforms a 5/8 whip on the trunk. Take advantage of the super ground plane by converting to the FLYING-DUCKY magnetic mount. Although designed specifically for use with a H-T, it can be used with any mobile rig. Ten second installation.

FLYING-DUCKY magnetic mount consists of:

- Chrome-plated super magnet (holds 50 lbs.)
- Compatible coax plugs furnished to match rig requirements. Specify BNC, F type, PL259-SO239. For TNC Wison type add \$3.
- Coax cable 105 in. long.

FLYING DUCKY MOUNT AND CABLE... \$13.95
QUARTER WAVE WHIP
(specify connector) \$ 5.95
RUBBER DUCKY to match
(specify connector) \$ 7.95

Face-Traps Box 234
✓P15 Middlebury CT 06762
(203) 758-9228

50 144 REPEATERS - 220 450 Mhz

BASIC AUTO PATCH

*Access, #Disable and adjustable Timer.
COMPLETELY ASSEMBLED—\$75.00.

EXTENSION BOARD

Antifalsing, 3 digit sequential Touch Tone™ decoder with automatic reset, Antifalsing Ring detector, reverse auto patch capability for basic auto patch and two, half watt audio amplifiers.
COMPLETELY ASSEMBLED—\$100.00

Now with courtesy
beep and beacon
capability

Available Separately:

COR Identifier: All on one board, programmable, Fully adjustable, time out (.5-7 min.), hang time (0-1 min.), identifier (1-10 min.), tone, speed, volume, L.E.D. outputs, low current drain CMOS logic, plugs for easy installation and removal plus much more. \$79.95 COMPLETELY ASSEMBLED

Basic Repeater \$499.95 COMPLETELY ASSEMBLED
2M 130-175 MHz Basic Repeater for 2 meters with all the features of the Hi Pro Mk1 less the power supply and front panel controls and accessories.

Hi Pro Mk I
REPEATERS

50 MHz \$789.95 450 MHz 799.95
144 + 220 MHz \$699.95

PA Res. add 6% tax
PLUS SHIPPING

✓M36

Maggtore Electronic Laboratory

845 WESTTOWN RD.
WEST CHESTER, PA. 19380 PHONE 215 436-6051

DUPLEXERS

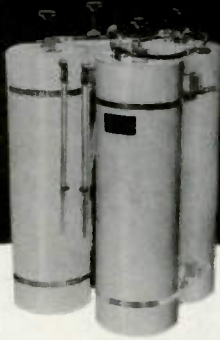

US PATENT
4080601

✓ W15

OUR NEW BANDPASS-
REJECT DUPLEXERS WITH
OUR EXCLUSIVE

BpBr CIRCUIT*

... provides superior perfor-
mance, especially at close
frequency spacing.

Models available for all Ham
bands. Special price for
Amateur Repeater Clubs

CALL OR WRITE FOR DETAILS:

WACOM PRODUCTS, INC.



Box 7307
Waco, Texas 76710
817/776-4444

Route 31. Admission is \$2.50 per person. There is plenty of space, with over 200 sellers' tables, and displays from major manufacturers. There will be seminars and door prizes.

VERO BEACH FL MAR 17-18

The Treasure Coast Hamfest will be held on March 17-18, 1979, at the Vero Beach Community Center, Vero Beach, Florida. Activities will include prizes, drawings, and a QCWA luncheon. Admission is \$3.00 per family. Talk-in on 146.13/.73, 146.52/.52, and 222.34/223.94. For information, write PO Box 3088, Vero Beach FL 32960.

JEFFERSON WI MAR 18

The Tri County ARC Hamfest will be held on March 18, 1979, at the Jefferson County Fair Grounds, Jefferson, Wisconsin. Advance tickets are \$1.50. Reserved 6-foot tables are \$2.00 in advance, while 6-foot space is \$1.00. For information, send an SASE to Glenn Elsenbrandt WA9VYL, 711 East Street, Fort Atkinson WI 53538.

LAWTON OK MAR 23-25

The Lawton Fort Sill Amateur Radio Club, Inc., will hold its

33rd annual hamfest at the Montego Bay Motel Complex at Lawton, Oklahoma, the weekend of March 23-25, 1979. There will be the usual large flea market, ARRL officials, technical programs, QCWA breakfast, and activities for the ladies.

EAST RUTHERFORD NJ MAR 24

The Knight Raiders VHF Club, Inc., will hold its world-famous flea market at St. Joseph's Church, East Rutherford, New Jersey, on Saturday, March 24, 1979. Doors open at 10:00 am. There will be free admission and free parking. Refreshments will be available. Flea market tables are available for: \$5.00/full table or \$3.00/half table, in advance; \$6.00/full table or \$3.50/half table, at the door. Talk-in on 146.52 and 144.65/145.25. For further information, call Bob Kovaleski at (201)-473-7113 or Jack Mandelberger at (201)-857-0016 (evenings only). Send reservations to: R. Wetzel, 419 Union Ave., Rutherford NJ 07070, and make checks payable to: Knight Raiders VHF Club, Inc.

WAUKEGAN IL MAR 25

The Libertyville and Munde-



The LEADER In the Northwest!

ATLAS • ICOM • KENWOOD • YAESU



KENWOOD Transceiver
TS-520S 160 thru 10M



KENWOOD Transceiver
TS-820S 160 thru 10M



YAESU HF SSB 160 thru 10M
FT 101F or FE

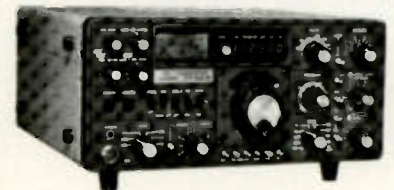

YAESU 901 DM



✓ A46



17550 15th Ave. N.E. • Seattle WA 98155 • (206) 364-8300

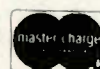

Other locations: (Walk-in customers only) • Bellevue—12001 N.E. 12th • Everett—4610 Evergreen Way • Open Mon. thru Sat.

lein Amateur Radio Society will hold its second annual Lamarsfest on Sunday, March 25, 1979, at the J. M. Club, 708 Greenwood Ave., Waukegan, Illinois. Doors will open at 7:00 am. There will be plenty of free parking, door prizes, and a large indoor flea market for radio and electronic items. Tables will be available at \$4.00 each. Advance tickets are \$1.50; \$2.00 at the gate, with children under 10 free. Hot lunch will be available and there will be plenty of commercial exhibits and demonstrations. Talk-in on 146.94. For further information, write LAMARS (include SASE, please) at 1226 Deer Trail Lane, Libertyville IL 60048, or call (312)-367-1599.

**MUSKEGON MI
MAR 30-31**

The Muskegon Area Amateur Radio Council is sponsoring the ARRL Great Lakes Division Convention and Hamfest at the Muskegon Community College in Muskegon, Michigan, on March 30-31, 1979. This event will feature manufacturers' exhibits, technical forums, and a large swap shop. Ample parking and dining facilities are available. Friday evening at the Muskegon Ramada Inn, there will be a "Ham Hospitality" with libation courtesy of the MAARC and a Wouf Hong initiation. For additional information, contact MAARC, PO Box 691, Muskegon MI 49443, or H. Riekels WA8GVK, (616)-722-1378/9.

**COLUMBUS GA
MAR 31-APR 1**

The Columbus Amateur Radio Club will hold first annual hamfest from March 31-April 1, 1979, at the Columbus Municipal Auditorium, US 27 & 280, Columbus, Georgia.

Donation is \$1.00 at the door. There will be plenty of free parking and overnight free RV space. Exhibitors and flea market will be inside, with a free flea market outside. Talk-in on 28/88. For advance registration and details, write Bob Glasgow N4BGN, 1503 Layard Drive, Columbus GA 31907; (404)-561-7746.

**WILLIAMSPORT PA
APR 29**

The West Branch Amateur Radio Association will hold its 15th annual Penn Central Hamfest on Sunday, April 29, 1979, from 11:00 am to 5:00 pm at the Woodward Township Fire Hall, Rt. 220 south from Williamsport. For more information, write Richard Sheasley K3QDA, RD 1, Box 454, Linden PA 17744, or call Tony at (717)-322-6017.

**NEENAH WI
MAY 5**

The 3-F Amateur Radio Club will hold its annual swapfest on Saturday, May 5, 1979, from 8:00 am to 3:00 pm, at the Neenah Labor Temple, 157 S. Green Bay Road, Neenah, Wisconsin, just off Highway 41 at the Highway 114 or 150 exit. Facilities include a large parking area and a large indoor swap area with a free auction at the end of the day. Food and beverage will be available. Advance admission for tickets and tables is \$1.50; \$2.00 at the door. Talk-in on 52/52. For reservations, write to Mark Michel W9OP, 339 Naymut Street, Menasha WI 54952.

**SALINE MI
MAY 13**

The ARROW Repeater Association will hold its annual Swap and Shop on Sunday, May 13, 1979, at the Saline, Michigan, fairgrounds. Admis-

**JUST GETTING ON THE AIR?
See Adirondack for**

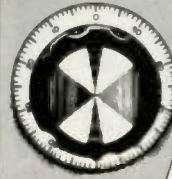

- New Equipment
- Used Gear
- Friendly Advice

ADIRONDACK Radio Supply

185-191 West Main Street • P.O. Box 88
Amsterdam, N.Y. 12010 Tel. (518) 842-8350
Just 5 minutes from N.Y. Thruway—Exit 27

sion, including parking on the fairgrounds, is \$1.50 in advance and \$2.00 at the door. There will be food, prizes, and a covered area for trunk sales, as well as indoor tables. Because of Mother's Day, wives will be

given free admission. Talk-in on 146.37/97, 223.18/224.78, and 448.5/443.5 MHz. For additional details, write ARROW, PO Box 1572, Ann Arbor MI 48106, or call George Raub AD8X at (313)-485-3562.

Ham Help

My divorce broke me. (Among other things, I lost my TR-4.) Does anyone have any ham gear to spare? A homebrew 40m CW transceiver would do. Thank you.

Lin Hamilton WB6PAV
14100 Chadron Avenue
#130
Hawthorne CA 90250

Hopefully, your Ham Help column can help me find the information I want. I would like to get in touch with anyone who is still using an old Galaxy V transceiver on the air today and find out what their opinions are of it.

Rick Todd K8AKL/N
14470 Basslake Road
Newbury OH 44065

I would very much appreciate help from anyone in finding a circuit diagram of the McMurdo Silver Masterpiece VI.

Reg Trickey G3DRB
31 Pensby Ave.
Chester, England

I would like to obtain a copy of the original owner's manual for a Viking "Courler" linear amplifier.

John I. Nelson AA7W
19025 73rd Avenue N.E.
Bothell WA 98011

I need a schematic for a Johnson Model 122 vfo. Any help in obtaining this will be greatly appreciated.

Bill Richmond WD4CPQ
122 E. Adair St.
Louisville KY 40214

IN STOCK!

THE REVOLUTIONARY NEW YAESU 2-METER FM LINE

CPU-2500RK



"The Ultimate Rig"
Microprocessor controlled, 25 watt, keyboard-entry transceiver.
Amateur net \$585.00

FT-202R



"Best Buy" 2-meter hand-held. Compact, lots of extras.
Amateur net \$199.00

FT-227RA



"Full-Featured Plus." Four memories, Autoscan remotely controlled from mike. Tone burst.
Amateur net \$399.00

For immediate delivery, best price . . .

TOWER ELECTRONICS

T44 24001 Alicia Parkway
Mission Viejo, CA 92675
Phone 714/768-8900



Hours:
Tues thru Fri: 10 am - 7 pm
Saturday: 9 am - 5 pm
Sunday: Noon - 4 pm

Yaesu service and repair specialists.

FREQUENCY COUNTERS



COMPLETE KITS: CONSISTING OF EVERY ESSENTIAL PART NEEDED TO MAKE YOUR COUNTER COMPLETE. HAL-600A 7-DIGIT COUNTER WITH FREQUENCY RANGE OF ZERO TO 600 MHz. FEATURES TWO INPUTS: ONE FOR LOW FREQUENCY AND ONE FOR HIGH FREQUENCY; AUTOMATIC ZERO SUPPRESSION. TIME BASE IS 1.0 SEC OR .1 SEC GATE WITH OPTIONAL 10 SEC GATE AVAILABLE. ACCURACY $\pm .001\%$, UTILIZES 10-MHz CRYSTAL 5 PPM.

COMPLETE KIT.....\$129

HAL-300A 7-DIGIT COUNTER WITH FREQUENCY RANGE OF ZERO TO 300 MHz. FEATURES TWO INPUTS: ONE FOR LOW FREQUENCY AND ONE FOR HIGH FREQUENCY; AUTOMATIC ZERO SUPPRESSION. TIME BASE IS 1.0 SEC OR .1 SEC GATE WITH OPTIONAL 10 SEC GATE AVAILABLE. ACCURACY $\pm .001\%$, UTILIZES 10-MHz CRYSTAL 5 PPM.

COMPLETE KIT.....\$109

HAL-50A 8-DIGIT COUNTER WITH FREQUENCY RANGE OF ZERO TO 50 MHz OR BETTER. AUTOMATIC DECIMAL POINT, ZERO SUPPRESSION UPON DEMAND. FEATURES TWO INPUTS: ONE FOR LOW FREQUENCY INPUT AND ONE ON PANEL FOR USE WITH AN INTERNALLY MOUNTED HALTRONIX PRE-SCALER FOR WHICH PROVISIONS HAVE ALREADY BEEN MADE. 1.0 SEC AND .1 SEC TIME GATES. ACCURACY $\pm .001\%$. UTILIZES 10-MHz CRYSTAL 5 PPM.

COMPLETE KIT.....\$109

PRE-SCALER KITS

HAL 300 PRE.....\$19.95
(Pre-drilled G10 board and all components)

HAL 300 A/PRE.....\$24.95
(Same as above with preamp)

HAL 600 PRE.....\$34.95
(Pre-drilled G10 board and all components)

HAL 600 A/PRE.....\$39.95
(Same as above but with preamp)

TOUCH TONE DECODER KIT

HIGHLY STABLE DECODER KIT. COMES WITH 2 SIDED, PLATED THRU AND SOLDER FLOWED G-10 PC BOARD, 7-567's, 2-7402, AND ALL ELECTRONIC COMPONENTS. BOARD MEASURES $3\frac{1}{2} \times 5\frac{1}{2}$ INCHES. HAS 12 LINES OUT. ONLY \$39.95

DELUXE 12-BUTTON TOUCHTONE ENCODER KIT utilizing the new ICM 7206 chip. Provides both VISUAL AND AUDIO indications! Comes with its own two-tone anodized aluminum cabinet. Measures only $2\frac{3}{4} \times 3\frac{3}{4}$ ". Complete with Touch-Tone pad, board, crystal, chip and all necessary components to finish the kit.

PRICED AT.....\$29.95

For those who wish to mount the encoder in a hand-held unit, the PC board measures only $9/16" \times 1\frac{3}{4}"$. This partial kit with PC board, crystal, chip and components.

PRICED AT.....\$14.95

ACCUKEYER (KIT) THIS ACCUKEYER IS A REVISED VERSION OF THE VERY POPULAR WB4VVF ACCUKEYER ORIGINALLY DESCRIBED BY JAMES GARRETT, IN QST MAGAZINE AND THE 1975 RADIO AMATEURS HANDBOOK. \$16.95

ACCUKEYER—MEMORY OPTION KIT THIS ACCUKEYER MEMORY KIT PROVIDES A SIMPLE, LOW COST METHOD OF ADDING MEMORY CAPABILITY TO THE WB4VVF ACCUKEYER. WHILE DESIGNED FOR DIRECT ATTACHMENT TO THE ABOVE ACCUKEYER, IT CAN ALSO BE ATTACHED TO ANY STANDARD ACCUKEYER BOARD WITH LITTLE DIFFICULTY. \$16.95

6-DIGIT CLOCK • 12/24 HOUR

COMPLETE KIT CONSISTING OF 2 PC G10 PRE-DRILLED PC BOARDS, 1 CLOCK CHIP, 6 FND 359 READOUTS, 13 TRANSISTORS, 3 CAPS, 9 RESISTORS, 5 DIODES, 3 PUSH-BUTTON SWITCHES, POWER TRANSFORMER AND INSTRUCTIONS. DON'T BE FOOLED BY PARTIAL KITS WHERE YOU HAVE TO BUY EVERYTHING EXTRA.

PRICED AT.....\$12.95

CLOCK CASE Available and will fit any one of the above clocks. Regular Price...\$6.50 But Only \$4.50 when bought with clock

SIX-DIGIT ALARM CLOCK KIT for home, camper, RV, or field-day use. Operates on 12-volt AC or DC, and has its own 60-Hz time base on the board. Complete with all electronic components and two-piece, pre-drilled PC boards. Board size $4" \times 3"$. Complete with speaker and switches. If operated on DC, there is nothing more to buy.

PRICED AT.....\$16.95
Twelve-volt AC line cord for those who wish to operate the clock from 110-volt AC. \$2.50

SHIPPING INFORMATION

ORDERS OVER \$15.00 WILL BE SHIPPED POSTPAID EXCEPT ON ITEMS WHERE ADDITIONAL CHARGES ARE REQUESTED. ON ORDERS LESS THAN \$15.00 PLEASE INCLUDE ADDITIONAL \$1.00 FOR HANDLING AND MAILING CHARGES. SEND SASE FOR FREE FLYER.



"HAL" HAROLD C. NOWLAND
WBZXH

HAL-TRONIX ✓H24

P. O. BOX 1101
SOUTHGATE, MICH. 48195
PHONE (313) 285-1782

SF

S-f Amateur Radio Services

(213) 837-4870

4384 KEYSTONE AVE., CULVER CITY, CA. 90230

the W6TOG*

✓S33

RECEIVER MODIFICATION KITS

INCREASE SELECTIVITY • IMPROVE SENSITIVITY
LOWER INTERNAL NOISE

IMPROVE NOISE BLANKER OPERATION

COMBAT BLOCKING FROM LOCAL SIGNALS

TS-520 KIT	\$27.50	FT-101 SERIES KIT ...	\$32.50
TS-520S KIT	32.50	FR-101 SERIES KIT ...	34.50
TS-820 & 820S KIT ...	34.50	FT-301 SERIES KIT ...	34.50
R-599 A/D KIT	27.50	FT-901 SERIES KIT ...	34.50

EXPLICIT INSTRUCTIONS MAKE MODIFICATION A CINCH

★
IT'S MAGIC...

IT'S "MAGICOM"

PROCESSOR MODIFICATION KIT

IMPROVES AUDIO PUNCH

IMPROVES PROCESSED SPEECH QUALITY

Converts TS-820 / 820S speech processor from RF compressor to RF clipper \$27.50

RF speech processor for TS-520 / 520S \$42.50

The "MAGICOM" RF processor module provides up to 6dB increase in output with smooth, clean, non-distorted audio and more penetration for those pile-ups.

ENDORSED BY W6TOG AND BIG GUN DXers WORLD WIDE

★
the W6TOG*

INTERNAL ELECTRONIC KEYS

FOR ALL AMATEUR TRANSMITTERS OR
TRANSCIVERS USING GRID BLOCK KEYING

- No holes mounting with TS-820 Series
- Mounting options for TS-520, TS-520S, FT-101 Series, TR4 Series, T4X Series, T-599 Series and 32S Series.
- C-MOS DESIGN — Dot and dash memory — full iambic or manual operation.
- Simple installation \$49.50

THE S-F REJEKTOR FILTER

AN INTEGRATED CIRCUIT
ACTIVE BANDPASS FILTER
FOR PROCESSED RECEIVER AUDIO

- Separate active filter elements for CW and SSB audio output stage
- 8 ohm input and output impedance
- Headphone jack for convenience
- ON CW: from 500 hz to 100 hz, variable
- ON SSB: 2 Khz fixed bandwidth
- Rejects unwanted signal better than 60 dB
- Designed for today's transceivers or yesterday's older equipment \$49.50

* WELL KNOWN DXer WITH OVER 300 COUNTRIES CONFIRMED

All prices postpaid - in Calif. add 6% sales tax - Mastercharge & Visa accepted
SATISFACTION GUARANTEED OR MONEY REFUNDED

3 YEARS WARRANTY!

EXACT Replacements for
SYLVANIA
ECG Transistor-Diodes-ICs

ECG#	ECG#	ECG#	ECG#
100	94	163	5.95
101	98	164	5.75
102	96	165	8.95
102A	98	171	1.37
103	1.05	172A	.72
103A	1.11	175	1.62
104	1.06	176	2.06
105	2.27	177	.49
106	80	179	5.69
107	79	180	5.88
108	89	181	4.85
121	2.15	182	3.35
123	69	183	3.63
123A	79	184	1.37
124	1.53	185	1.70
126	1.18	186A	1.46
127	4.80	187A	1.46
128	1.37	188	1.59
129	1.56	189	1.59
130	1.95	190	1.85
131	1.98	191	2.07
132	1.01	192	.98
133	1.14	193	1.04
152	1.43	194	.82
153	1.85	195A	2.67
154	1.85	196	1.98
155	2.02	197	1.89
157	1.43	198	1.89
158	1.08	199	.59
159	86	210	1.37
160	1.43	211	1.56
161	.98	218	3.08
162	5.75	219	4.36
		220	1.72
		221	1.90
		222	1.99
		223	2.79
		224	5.06
		225	4.34
		226	1.67
		228	1.38
		229	1.06
		230	3.60
		231	3.96
		232	.70
		233	.74
		234	.72
		235	2.45
		236	5.75
		237	5.07
		238	7.95
		239	3.02
		241	1.71
		242	1.90
		276	8.72
		278	2.38
		279	5.85
		280	5.06
		281	6.35
		282	4.24
		283	6.32
		284	7.35
		285	7.99
		286	5.75
		287	.69
		288	.74
		289	.88
		290	.98
		291	1.99
		292	2.26
		293	1.08
		294	1.14
		295	2.02
		297	1.13
		298	1.13
		299	2.02
		300	2.02
		302	2.80
		306	2.80
		307	2.57
		308	7.65
		309K	3.27
		310	7.65
		311	2.13
		312	1.13
		313	1.00
		314	7.85
		315	2.01
		316	2.74
		317	24.20
		318	20.60
		319	1.11
		320	26.00
		321	7.65
		322	1.80
		323	3.53
		324	3.53
		325	27.50
		326	.96

- R-U-S-H, All Orders Shipped Same Day Received
- FREE Freight on all prepaid orders
- EXCLUSIVE 3 YEAR CONDITIONAL WARRANTY!
- NO Min. Order-Quantity Discounts Available
- Exact ICs & Diodes In Stock
- Longer Hours Mon-Sat 9a-10p, Sun 1-7p
- Call or write today—to place your order (518)465-3367

Communications & T.V. Unlimited
Dept 73, 17 Washington St., Rensselaer, N.Y. 12144
DISTRIBUTOR INQUIRIES INVITED
T.V.-C.B.-AMATEUR RADIO-STEREO-MONITORS-
ELECTRONIC PARTS ✓ C105

2 METER CRYSTALS MANY IN STOCK

FOR THESE RADIOS ON
STANDARD ARRL REPEATER
FREQUENCIES

Clegg HT-146	Regency HR-212
Orake TR-22	Regency HR-2B
Orake TR-33 (rec only)	Regency HR-312
Orake TR-72	Regency HR-2MS
Genave	S.B.E.
Heathkit HW-2021 (rec only)	Sonar 1802-3-4, 3601
Heathkit HW-202	Standard 146/826
Icom/VHF Eng	Standard Horizon
Ken/Wilson	Swan FM 2X
Lafayette HA-146	Tempo FMH
Midland 13-505	Trio/Kenwood
Regency HR-2	Trio/Kenwood TR2200
	Trio/Kenwood TR7200

\$3.95 EACH — IN QUANTITIES
OF 10 OR MORE, \$3.50 EACH

Certified check or money order only —

ROLIN DISTRIBUTORS
P.O. Box 436 ✓ R15
Dunellen NJ 08812

OUR
CATALOGUE
WILL SAVE
YOU MONEY!

FREE
CATALOG

- RF CONNECTORS • ANTENNAS
- SWITCHES • TRANSFORMERS
- ETCHING KITS • RESISTORS
- HAM GEAR • CAPACITORS

P.O. BOX 2366 INDIANAPOLIS, IND. 46206

SAVE NOW!!

4-Digit 0.5" Liquid Crystal Display

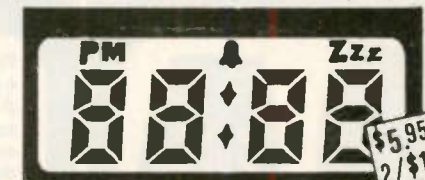

\$5.95 ea
2/\$11.00

Includes Socket
for Easy Mounting

Reflective type LCD display with snooze, alarm and PM indicators. Very low power requirements. Direct drive design needs only 4 to 10 VAC at 2 μA. Complete with socket and data sheet.

RAINBOW INDUSTRIES

ALL
NEW

Real-State-of-the-Art

TWO NEW AC•DC•BATTERY PORTABLE COUNTERS

OPTO-8000 .1A 10Hz to 600 MHz — FREQUENCY COUNTER

- Precision TCXO time base 0.1 PPM Stability 17-40°C
- Super Sensitivity with preamps in both HI-Z & 50 Ohm Inputs <10mV to 50MHz, 25 mV @ 150 MHz <50mV to 600MHz
- Auto Decimal Point • Aluminum Case • Socketed IC's
- Three position attenuator: X1, X10, X100 (avoids false counting)

#OPTO-8000.1A	Factory Assembled	\$329.95
#OPTO-8000.1AK	Kit Form	\$279.95
#NI-CAD-80	NI-CAD Battery Pack	\$ 19.95

OPTO-7000 10 Hz to 600 MHz MINIATURE COUNTER

- XTAL (TCXO) Time Base ±.08PPM/°C
 - Aluminum Case • HI-Z & 50 Ohm Inputs
 - 1 Sec. & 1/10 Sec. Gate times • Auto Dec. Pt.
 - Built-in Prescaler and Preamps Standard
- | | | |
|-------------|--|----------|
| #OPTO-7000 | Factory Assembled - 1 Year-Guar | \$139.95 |
| #OPTO-7000K | Kit Form | 99.95 |
| #AC-70 | AC Power Pack | 4.95 |
| #NI-CAD-70 | NI-CAD Battery Pack | 19.95 |
| #TCXO-70 | Precision TCXO Time Base
<0.1PPM, 17-40°C | 79.95 |

ACCESSORIES

PROBES:

#P-100	50 Ohm, 1X	\$13.95
#P-101	Lo-Pass	16.95
#P-102	H1-Z, 2X	16.95
#AP-8015	UHF Counter Preamp 20 MHz to 600 MHz 15-50 DB Gain (Not Shown)	\$49.95/Kit \$39.95

#D-450 Antenna

Rubber Duck RF Pick-up 450 MHz ... \$12.50

#D-146 Same as above

146.5MHz ... \$12.50

#RA-BNC Right-Angle BNC Adapter for
above Antenna ... 2.95

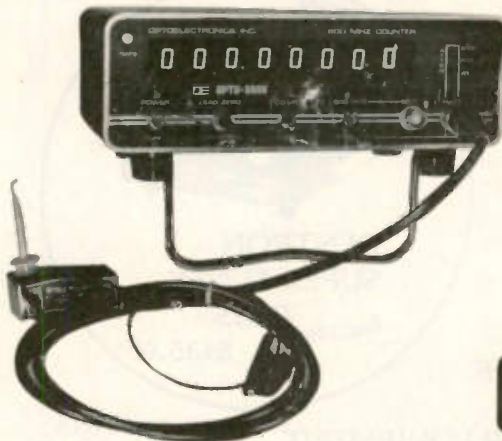

OPTOELECTRONICS, INC. ✓ O3

ORDER FACTORY DIRECT — PHONE OR MAIL

TERMS: Orders to U.S. and Canada, add 5% to maximum of \$10.00 per order for shipping, handling and insurance. To all other countries, add 10% of total order. Florida residents add 4% state tax. C.O.D. fee: \$1.00. Personal checks must clear before merchandise is shipped.

5821 NE 14 Avenue
Ft. Lauderdale, FL 33334
Phones: (305) 771-2050 771-2051
Phone orders accepted

**CES Model 230A
Micropad is the
Smallest Available**



39.95

This 3¼ by 2 inch micropad has auto PTT with tactile keys, adjustable level & tone balance and can be used with any transceiver using a 500 ohm mic. ✓ C115

A lot of Pad for only 39.95

At your Ham Radio Dealer
or Call or Write



399 W. Fairbanks Ave., Winter Park, Fla. 32789
305/645-0474

**The Only
Automatic Dialing
Touch Tone MIC**

The CES Model 235A Automatic Micro-dialer has a 10 number memory that can store even 11 digit numbers. Just dial * and one digit to bring up auto-patch, pause and dial phone number automatically. Program Dialing speed for virtually any repeater auto-patch, then dial number at fastest speed. Automatic PTT with manual or automatic dialing. All dialing and programming done from Keyboard. LED indicator for programming or PTT and ...



69.95



ALL CONTAINED IN A SMALL MIC.

At your Ham Radio Dealer
or Call or Write



399 W. Fairbanks Ave., Winter Park, Fla. 32789
305/645-0474

CIRCUIT BOARDS

- REPEATER CONTROL
- COMPUTER PROJECTS
- SENSITIZED BLANKS
- NEGATIVES/POSITIVES
- PROTO-TYPE BOARDS
- PARTS KIT
- CUSTOM ETCH/DRILL
- RCA 1802 MP BOARDS
- CIRCUIT BOARD DESIGN
- PROGRAMMING PADS
- ART MASTER PREPARATIONS

We can supply many of the items you need to make a p-c board. Send SASE + 25 cents for catalog.

O.C. Stafford ✓ S50

Electronic Service and Development
427 S. Benbow Rd.
Greensboro, NC 27401
919-274-9917 DAY/NITE
Serving Amateurs Around the World

—NOW!
DIGITAL READOUT FOR
YOUR YAESU FT-221/221R

YC-221 Digital Display. Only \$69.50 plus shipping. Kit for older FT-221s \$3.00 plus shipping. Built by Yaesu.

*California residents, add 6% sales tax to your order.

Send your check or
Money Order to:

**R. LEE TOWER
INTERNATIONAL**

13401 South Hoover Street
Gardena, CA 90247

CALL RUSH TOLL FREE
ELECTRONICS, INC.

1-800-251-0264

TENN. RESIDENTS 1-615-764-0831

AUTHORIZED DEALERS FOR

- | | |
|-----------|-------------|
| YAESU | ROHN TOWERS |
| DENTRON | LARSEN |
| CUSHCRAFT | TURNER |
| WILSON | CDE |
| HY-GAIN | HUSTLER |
| CES | KDK |
| BENCHER | VIBROPLEX |
| ATRONICS | ALLIANCE |
| | TEMPO |

AND MORE ...
ALSO: THE APPLE II PERSONAL
COMPUTER SYSTEM

CALL OR WRITE FOR THE
BEST PRICES
ON AMATEUR EQUIPMENT

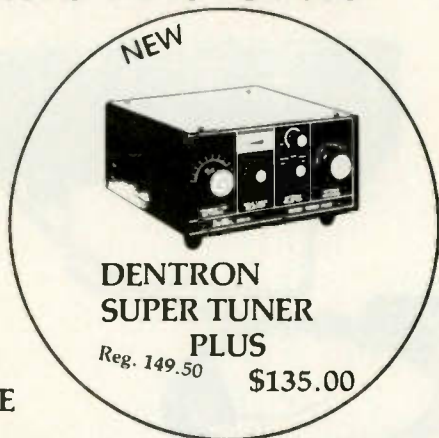

**DENTRON
SUPER TUNER
PLUS**
Reg. 149.50 \$135.00

SUPER TUNER PLUS
A full 1000 watts CW and
1200 watts 5SB power
handling capacity.



SOUTH'S FASTEST GROWING AMATEUR STORE

1315 BLUFF CITY HWY., BRISTOL, TN. 37620



**FT-227 "MEMORIZER"
OWNERS SCANNER KIT**

- Selectable sweep width (up to full band)
- Scans *only* the portion of band you select
- Scans at the rate of 200 kHz per second
- Switch modification on mike allows you to scan past, or lock on, any occupied frequency
- Complete kit with detailed instructions
- Installs *inside* rig; no obtrusive external connections
- Rig can easily be returned to original condition whenever desired
- Scans to preset limits and reverses
- Automatic bypass of locked frequency in 3½ seconds unless you press lock-on switch

Kit \$34.95

Pre-assembled and tested \$54

Add \$1.50 Postage & handling

DEALERS INQUIRIES INVITED



ELECTRONICS ✓ A60

750 LUCERNE RD
SUITE 120
TEL. 514-737-7293

MONTREAL, QUEBEC
CANADA H3R 2H6

NEW ELECTRONIC PARTS

Brand name, first line components. Stocked in depth. 24 hour delivery. Low prices and money back guarantee on all products we carry.

STAMP BRINGS CATALOG

SPECIALS KEYBOARD ENCLOSURES



SIX SIZES	W	D	H	PRICE
14" 8.3" 3"	14"	8.3"	3"	\$15.20
17" 8.3" 3"	17"	8.3"	3"	18.35
20" 8.3" 3"	20"	8.3"	3"	19.25
14" 11.3" 3"	14"	11.3"	3"	16.50
17" 11.3" 3"	17"	11.3"	3"	18.80
20" 11.3" 3"	20"	11.3"	3"	20.75

Blue base, specify white or black top.

MAGNA-LITE JR

ONLY
\$5.79



IDEAL FOR

- Private Microcircuit Reading
- Electronics — Debug, Production, Inspection
- Industrial — Empower, Technician, Draftsman
- Laboratory & Research

RTTY

UT4 SPEED CVTR BOARD
KIT \$109.95
BOARD ALONE \$18.95
AUTO CW ID KIT \$37.90



SHIPPING
INCLUDED
IN PRICE

Daypro Electronics, Inc.

Formerly NuData Electronics — D35

3079 N. WILSHIRE LN., ARLINGTON HTS. ILL. 60004
PHONE 312-870 0555

AMATEUR
TELEVISION
ON
439.25 MHz

INTERESTED? ACTIVITY IS
INCREASING EVERYWHERE
YOU CAN GET ACTIVE IN YOUR
AREA WITH OUR PRODUCTS —

AM1B FSTV CONVERTER
complete \$150.00
AX10B FSTV TRANSMITTER
complete \$385.00

CALL 812-336-4775, OR WRITE US,
FOR COMPLETE DETAILS

APTRON
LABORATORIES

PO BOX 323
BLOOMINGTON, INDIANA, 47401

COAKIT
RF ASSORTMENT
NUMBER ONE



CONNECTOR ASSORTMENT

\$25.00 \$23.50 each
Postpaid lots of three

Includes: 5 - PL259, 5 - SO239, 5 - UG175, 5 - UG176,
2 - PL258, 1 - DM, 1 - M358, 2 - M359, 1 - UG255,
1 - UG273, 2 - PL259PO, 1 - 1021-20, 1 - Lightning
Arrestor.

Master Charge & Visa accepted / Send for Free Catalog

COAKIT C21

P.O. Box 101-A Dumont, N. J. 07628
Circle C21 on Reader Service Card

electronic calculators

LIST	HAM NET
\$299.95	\$269.95
124.95	112.45
59.95	53.95
49.95	44.95
59.95	53.95
69.95	62.95

TEXAS INSTRUMENTS ELECTRONIC CALCULATORS

T.I.-59, 960 STEP PROGRAMMABLE SCIENTIFIC
T.I.-58, 480 STEP PROGRAMMABLE SCIENTIFIC
T.I.-57, 150 STEP PROGRAMMABLE SCIENTIFIC
T.I.-55, 32 STEP PROGRAMMABLE SCIENTIFIC
T.I. PROGRAMMER, CONVERTS DECIMAL/OCTAL/HEX
T.I. MBA, SUPER PROGRAMMED FINANCIAL

LIST	HAM NET
\$750.00	\$675.00
450.00	405.00
275.00	247.50
175.00	157.50
175.00	157.50
325.00	292.50
100.00	90.00
80.00	72.00
60.00	54.00
495.00	445.50
120.00	108.00
75.00	67.50

HEWLETT-PACKARD ELECTRONIC CALCULATORS

H.P.-97, 224 STEP PROG SCIENTIFIC PRINT/VISUAL
H.P.-87, 224 STEP PROG SCIENTIFIC
H.P.-19C, 98 STEP PROG SCIENTIFIC PRINT/VISUAL
H.P.-29C, 98 STEP PROG SCIENTIFIC
H.P.-10 BASIC HAND HELD PRINTER VISUAL
H.P.-91, PREPROGRAMMED SCIENTIFIC PRINT/VISUAL
H.P.-33E, 49 STEP PROG SCIENTIFIC
H.P.-32E, PREPROGRAMMED SCIENTIFIC WITH STAT
H.P.-31E, PREPROGRAMMED SCIENTIFIC
H.P.-92, PREPROGRAMMED FINANCIAL PRINT/VISUAL
H.P.-38E STEP PROGRAMMABLE SUPER FINANCIAL
H.P.-37E, PREPROGRAMMED FINANCIAL

WE STOCK ALL HEWLETT-PACKARD CALCULATOR SOFTWARE AND ACCESSORIES

SEND ME THE CALCULATOR(S) INDICATED BELOW. COMPLETE WITH INCLUDED ACCESSORIES, INSTRUCTIONS, AND MANUFACTURERS WARRANTY. I UNDERSTAND THAT IF I AM NOT COMPLETELY SATISFIED, I MAY RETURN IT WITHIN 10 DAYS FOR A COMPLETE REFUND (LESS SHIPPING)

MODEL(S) _____ QUANTITY _____ AMOUNT ENCLOSED \$ _____

WE HONOR _____ VISA _____ MASTERCHARGE _____ MONEY ORDERS _____ COD

ADD \$2.00 FOR POSTAGE AND HANDLING. PLEASE ALLOW 10 DAYS FROM DATE OF RECEIPT OF ORDER FOR DELIVERY. TEXAS RESIDENTS ADD 5% SALES TAX

CARD NUMBER _____ EXPIRATION DATE _____

FULL NAME _____ CALL _____

STREET _____ CITY _____ STATE _____ ZIP _____

MORE LITERATURE MODEL(S) _____

*****DEALER INQUIRIES INVITED*****

 **Hartwell's** ✓H26
Office World, Inc.

MAIL TO: 6810 LARKWOOD
HOUSTON, TEX 77074
ATTN: STEVE, WA50EN
PHONE: A.C. (713) 777-2673

NEW CoaxProbe* NEW

Coaxial RF Probe for Frequency Counters and Oscilloscopes That Lets You Monitor Your Transmitted Signal Directly From the Coax Line.

Only **\$12.95**
plus .50 postage

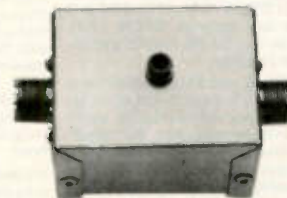

FINALLY! A RF PROBE that lets you connect into your coax cable for frequency measurements and modulation waveform checks directly from the transmitter.

JUST CONNECT THE CoaxProbe* into your transmission line and plug the output into the frequency counter or oscilloscope. Insertion loss is less than .2db so you can leave it in while you operate.

A NECESSITY IN ANY WELL-ORGANIZED HAM SHACK, the CoaxProbe* eliminates "jerry-rigging" and hassles when tapping into the coax line is desired.

A SPECIAL METHOD OF SAMPLING keeps output relatively constant with a wide variation of power. Power output of 8 watts gives .31v out, while 800 watts will give 1.8v out. (rms 3-30 mhz.) 2000 watts PEP rating too!

*Trademark of CoaxProbe Co. for rf sampling device.
© 1978 by CoaxProbe Co.

USE IT ON 2 METER RIGS TO ADJUST FREQUENCY. The CoaxProbe* has a range of 1.8 to 150 mhz.

MONITOR YOUR MODULATION WAVEFORM. With an oscilloscope of proper bandwidth, you can check your modulation for flat-topping, etc. Ideal for adjusting the speech processor.

NOW YOU CAN MONITOR SIGNALS when connected to the dummy load, eliminating unnecessary on-the-air radiation.

AVAILABLE FOR THE FIRST TIME TO AMATEURS. Try it for 10 days. If not satisfied, send it back for refund (minus shipping charges).

Order today from:

CoaxProbe Co. ✓C110
P.O. Box 426, Portage, MI 49081
Michigan Res. Add 4% Sales Tax

**SERVING
HAMS
BETTER!**

*North ... south ...
east ... west*



All leading brands ...
in-depth stocks ...
new/used gear.

Bob Ferrero, W6RJ/K6AHV, Jim Rafferty, N6RJ
other well known hams give you courteous,
personalized service.

NOW...FREE PHONE!

**800
854-6046**

CALIF. CUSTOMERS PLEASE CALL OR VISIT STORES LISTED BELOW

**PLUS FREE SHIPMENT
ALL ITEMS U.P.S. (Brown).**

CALL US FOR SPECIAL PRICES ON:

- ALDA • ALLIANCE • ALPHA • AMECO • ATLAS • BIRD •
- CDE • COLLINS • CUSHCRAFT • CURTIS • DENTRON •
- DRAKE • EIMAC • HUSTLER • HY-GAIN • ICOM •
- KENWOOD • KLM • MFJ • MOSLEY • PALOMAR • ROHN •
- ROBOT • SHURE • SWAN • TELEX • TEMPO • TEN-TEC •
- TRISTAO • TELREX • TRI-EX • WILSON • YAESU • more.

KENWOOD!



DRAKE!



ICOM!



YAESU!



ANAHEIM, CA. 92801

2620 W. La Palma
(714) 761-3033, (213) 860-2040
1 mile east Knotts Berry Farm

SAN DIEGO, CA. 92123

5375 Kearny Villa Road
(714) 560-4900
Highway 163 & Claremont Mesa Blvd.

BURLINGAME, CA. 94010

999 Howard Avenue
(415) 342-5757
5 miles south on 101 from S.F. Airport.

VAN NUYS, CA. 91401

6265 Sepulveda Blvd.
(213) 988-2212
San Diego Fwy. at Victory Blvd.



OVER THE COUNTER (Mon. thru Sat. 10 AM to 5:30 PM)

MAIL ORDER, Phone, Write.

SAVE \$25.00

Model 8100 Frequency Counter Kit

- Range: 20Hz to 100MHz
- High Sensitivity
- Resolution to 0.1Hz

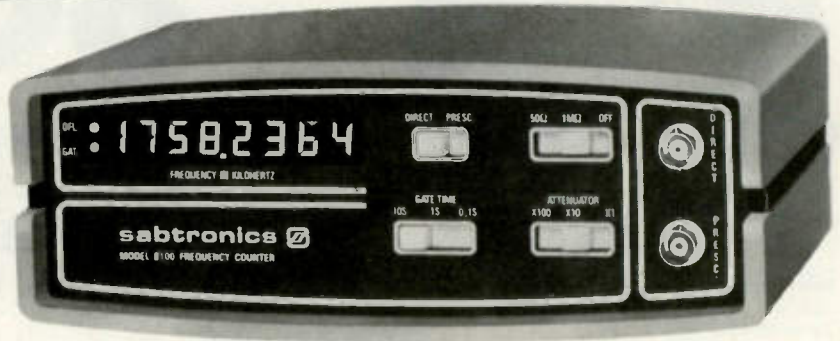

Now you can forget about price/performance trade-offs when you select a frequency counter. In Sabtronics' Model 8100 kit you get all the characteristics of superior performance at a low, affordable price.

This frequency counter, employing LSI technology, has the performance and input characteristics you demand: guaranteed frequency range of 20Hz to 100MHz (10 Hz to 120MHz typical); selectable hi/lo impedance; superior sensitivity; selectable resolution and selectable attenuation. Plus an accurate time base with excellent stability.

An 8-digit LED display features gate activity indicator, leading zero suppression and overflow indicator. You would expect to find all these features only on high-priced instruments — or from Sabtronics' advanced digital technology.

BRIEF SPECIFICATIONS:

- Frequency Range: 20Hz to 100MHz guaranteed. (10Hz to 120MHz typical)
- Sensitivity: 15mV RMS, 20Hz to 50MHz (10mV typical); 25mV RMS, 50MHz to 100MHz (20mV typical)
- Selectable Impedance: 1MΩ / 25pF or 50Ω
- Attenuation: X1, X10 or X100
- Accuracy: ± 1Hz plus time base accuracy
- Aging Rate: ± 5ppm/yr.
- Temperature Stability: ± 10ppm, 0°C to 40°C
- Resolution: 0.1Hz, 1Hz, 10Hz selectable
- Display: 8-digit LED, overflow indicator, gate activity indicator
- Overload Protection
- Power Requirement: 9-15 VDC @ 330mA

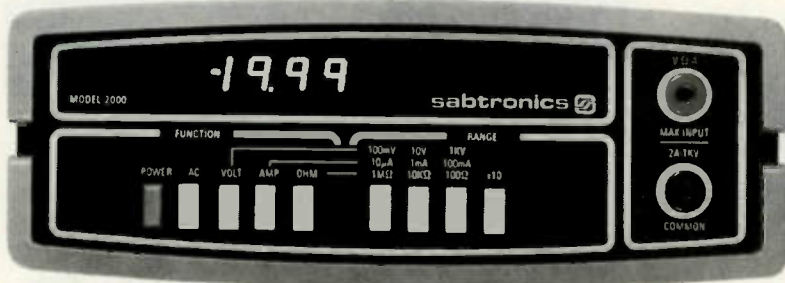

Model 2000, 3½ Digit DMM Kit

- 5 Functions, 28 Ranges
- Basic DCV Accuracy: 0.1% ± 1 Digit

The amazing Sabtronics 2000 is the choice of both professionals and hobbyists. It's the only portable/bench DMM that offers so much performance for such an astonishing low price.

You get basic DCV accuracy of 0.1% ± 1 digit; 5 functions giving 28 ranges; readings to ± 1999 with 100% overrange; overrange indication; input overload protection; automatic polarity; and automatic zeroing.

The all-solid-state Model 2000 incorporates a single LSI circuit and high-quality components. Our clear, step-by-step manual simplifies assembly. Complete kit includes a rugged high-impact case ideal for both test-bench and field use.

BRIEF SPECIFICATIONS:

- DC volts in 5 ranges: 100 μV to 1kV
- AC volts in 5 ranges: 100 μV to 1kV
- DC current in 6 ranges: 100 nA to 2A
- AC current in 6 ranges: 100 nA to 2A
- Resistance: 0.1Ω to 20MΩ in 6 ranges
- AC frequency response: 40 Hz to 50kHz
- Display: 0.36" (9.1mm) 7-segment LED
- Input Impedance: 10MΩ
- Size: 8"W x 6.5"D x 3"H (203 x 165 x 76 mm)
- Power requirement: 4.5-6.5 VDC-4 "C" cells (not included).

SPECIAL OFFER EXPIRES FEB. 15, 1979

Special Offer! Save \$25.00*

If you order both the frequency counter and DMM kits now, you pay only \$144.90 including shipping and handling. You save \$25.00 off the combined regular low price of \$169.90. Order both kits now. This special offer good for a limited time only.

*Special offer good in USA only.

Making performance affordable. ✓ S27

sabtronics

13426 Floyd Circle · Dallas, Texas 75243
Telephone 214/783-0994

Sabtronics International Inc. 13426 Floyd Circle Dallas Tx 75243		"73-2"
<input type="checkbox"/> Yes, I want to take advantage of your special \$25.00-off offer.*		
Please send _____ Model 8100 and Model 2000 kit(s) for only \$144.90 total including shipping and handling		
		\$ _____
Please send _____	Model 8100 Frequency Counter kit(s)	@ \$89.95 ea. \$ _____
	Shipping and handling	\$ 5.00/unit* \$ _____
Please send _____	Model 2000 DMM kit(s)	@ \$69.95 ea. \$ _____
	Shipping and handling	\$ 5.00/unit* \$ _____
	Texas residents add sales tax	\$ _____
	Total enclosed	\$ _____
<input type="checkbox"/> Check <input type="checkbox"/> Money Order <input type="checkbox"/> Charge my Master Charge <input type="checkbox"/> Visa		
	Acc. No. _____	Exp. Dt. _____
Name _____		
Address _____		
City _____ State _____ Zip _____		
*USA only. CANADA: \$6.50. FOREIGN: \$19.00 AIRMAIL.		

NEW!**NEW!****NEW!**

FM2016A

All Solid State-CMOS PL digital synthesized - No Crystals to Buy! 5KHz steps - 144-149 MHz-HUGE 3/8" LED digital readout PLUS MARS-CAP and MULTIPLE OFFSET BUILT IN.

- 5 MHz Band Coverage - 1000 Channels (instead of the usual 2 MHz to 4 MHz-400 to 800 Channels)
- 4 CHANNEL RAM IC MEMORY WITH SCANNING AND AUTO TRANSMIT
- MULTIPLE FREQUENCY OFFSETS
- ELECTRONIC AUTO TUNING - TRANSMIT AND RECEIVE
- INTERNAL MULTIPURPOSE TONE OSCILLATOR
- RIT
- RF ATT
- DISCRIMINATOR METER - 16 Watts Output-Unequaled Receiver Sensitivity and Selectivity - 15 POLE FILTER, MONOLITHIC CRYSTAL FILTER AND AUTOMATIC TUNED RECEIVER FRONT END, COMPARE!
- Superb Engineering and Superior Commercial Avionics Grade Quality and Construction Second to None at ANY PRICE.

**INTRODUCTORY
PRICE**
\$359⁰⁰

Regulated AC/PS
Model FMPS-4R . . . \$39.95



FMMC-1* Micro-
phone with Built-in
Touch Tone Pad.

**WHY BUY LESS?
THE FMMC-1
HAS IT ALL!**

- New! Auto key up
- Snap-Action Keyboard
- Adj. level and tone balance
- Use with any transceiver
- Only 3 3/4" x 2" \$39.95

SHOWN WITH OPTIONAL μ P-800 MICRO-PROGRAMMER*

- **FREQUENCY RANGE:** Receive and Transmit: 144.00 to 148.995 MHz, 5 KHz steps (1000 channels) + MARS-CAP and MULTIPLE OFFSET BUILT IN.
- **HUGE 3/8" LED DIGITAL READOUT.**
- **4 CHANNEL RAM SCANNER WITH IC MEMORY AND AUTO TRANSMIT:** Program any 4 frequencies and reprogram at any time using the front panel controls—search for occupied (closed) channel or vacant (open) channels. Internal Ni-Cad included to retain memory (no diode matrix to wire or change).
- **MULTIPLE FREQUENCY OFFSETS. NO CRYSTALS TO BUY - EVER -** Any offset any split! "Odd Ball" splits accomplished by digital programming. Never any need for crystals!
- **INTERNAL MULTIPURPOSE TONE OSCILLATOR BUILT IN:** Sine Wave 1750 Hz tone burst for "whistle on operation" and sub-audible tone operation. Internal 2 position switch for automatic and manual operation, tone burst or sub audible tone PL - adjustable 60-203 Hz (100 Hz Pre-Set).
- **AIRCRAFT TYPE FREQUENCY SELECTOR:** Large and small coaxially mounted knobs select 100KHz and 10KHz steps respectively. Switches click-stopped with a home position facilitate frequency changing without need to view LED's while driving and provides the slightest amateur with full Frequency Selection as standard equipment.
- **FULL AUTOMATIC TUNING OF RECEIVER FRONT END AND TRANSMITTER CIRCUITS:** DC output of PLL fed to varactor diodes in all front end RF tuned circuits provides full sensitivity and optimum intermodulation rejection over the entire band. APC (AUTO POWER CONTROL) - Keeps RF output constant from band edge to band edge. **NO OTHER AMATEUR UNIT AT ANY PRICE** has these features which are found in only the most sophisticated and expensive aircraft and commercial transceivers.
- **TRUE FM:** Not phase modulation - for superb emphasized hi-fi audio quality second to none.
- **RIT CONTROL:** Used to improve clarity when contacting stations with off frequency carrier.
- **MONITOR LAMPS:** 2 LED's on front panel indicate (1) incoming signal-channel busy, and (2) Transmit.
- **FULLY REGULATED INTEGRAL POWER SUPPLY:** Operating voltage for all 9v circuits independently regulated. Massive Commercial Hash Filter.
- **MODULAR COMMERCIAL GRADE CONSTRUCTION:** 3 Unitized modules eliminate stray coupling and facilitate ease of maintenance.
- **ACCESSORY SOCKET:** Fully wired for touch tone, phone patch, and other accessories. Internal switch connects receiver output to internal speaker when connector is not in use.
- **MULTI-PURPOSE METER:** Triple Function Meter Provides Discriminator Meter, "S" Reading on receive and Power Out on Transmit.
- **RECEIVE:** Better than .25uv sensitivity, 15 POLE FILTER as well as monolithic crystal filter and AUTOMATIC TUNED LC circuits provide superior skirt selectivity - COMPARE!
- **HIGH/LOW POWER OUTPUT:** 16 watts and 1 watt, switch selected. Low power may be adjusted anywhere between 1 and 16 watts. Fully protected - short or open SWR.
- **RF ATT:** Live right next to King Kong Repeater and can't operate? With the 2016A You Can - Just flick the RF ATT switch. Only the 2016A has this feature.
- **OTHER FEATURES:** Dynamic Microphone, built in speaker, mobile mounting bracket, external 5 pin accessory jack, speaker jack, and much, much more. Size 2 1/2 x 7 x 7 1/2". All cords, plugs, fuses, microphone hanger, etc. included. Weight 5 lbs.

Manufactured by one of the world's most distinguished Avionics manufacturers, *Kyokuto Denshi Kaisha, Ltd.*
First in the world with an all solid state 2 meter FM transceiver.

AMATEUR-WHOLESALE ELECTRONICS

8817 S.W. 129th Terrace, Miami, Florida 33176
Telephone (305) 233-3631 • Telex: 51-5628
U.S. DISTRIBUTOR

✓ A21

DEALER INQUIRIES INVITED

East: Sanford Communications, Inc.
Colonia, N.J.
(201) 574-3003
Northeast: Buzzards Bay Electronics
Buzzards Bay, Mass.
(617) 759-3376
West: The Radio Place
Sacramento, Cal.
(916) 441-7388
Northwest: Action Supply, Inc.
Boise, Idaho
(208) 344-5084
Midwest: Universal Service
Columbus, Ohio
(614) 221-2335
South: Electronic Communications
Highland Springs, Virginia
(804) 737-5100



GALLIUM PHOSPHIDE L.E.D.

Provides Higher Intensity Than Regular LED's; T1-3/4 Dome (Red Diffused) AND Part #114R 1.99... 22c 100+... 20c We stock the full line of AND L.E.D.'s

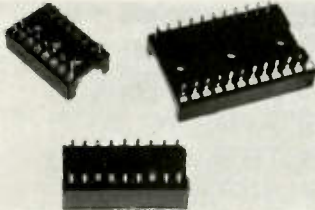

DIP SOCKET SPECIALS

16 Pin Low Profile Solder Tab	1.49	50+	20c	15c
18 Pin Standard Height Solder Tab	25c	20c	20c	15c
24 Pin Low Profile Solder Tab GOLD	60c	55c		

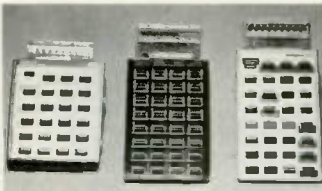

CALCULATOR GUTS Experimenter's delight. Each keyboard includes a monolithic calculator chip and a display. These are rejects. It might be something simple to repair or it could be very nasty. At this price, who cares! 9 volt. \$1.50 ea. 3/\$3.00.

HOBBY BAGS An assortment of misc. electronic parts. A genuine value and savings. Only \$2.99.

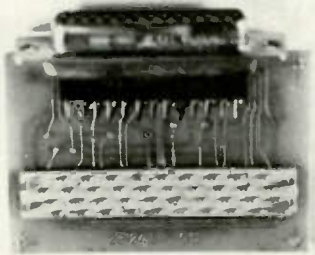

DB-25 FEMALE CONNECTOR

A unique assembly originally adapting the RS232 Type Connector to flat cable. \$1.50 each or 2/\$2.50.



INSTRUMENT/CLOCK CASE KIT Perfect for your opto projects. Solid aluminum construction with real walnut sides. O.D. 5-3/8" by 5-3/8" by 2". \$6.95 ea.

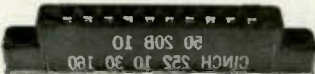

EDGE CARD CONNECTOR Cinch Jones 10/20 Pins .156 Spacing PC Mount 85c. Burndy 22/44 Pins, .156 spacing PC Mount, \$1.40 each.

M-M Electronic Sales

A division of **united products** Corporation

Corp. Hdqts., 2322 1st Ave., Seattle, Wash. 98121 • [206] 682-5025



LINE PRINTER HAMMER DRIVER BOARD

Each board contains approx. 130 each #MJE800 (Silicon Darlington NPN hfe 750, 1.5A). About \$130.00 worth, over 100 1N4001 diodes, plus support chips. The whole package is yours for only \$14.95. **HURRY, WE DON'T EXPECT THESE TO LAST VERY LONG!**

EUROPEAN 220V LINE CORD

Building something for export? Then you might need this. 40c ea. 10/\$3.00.

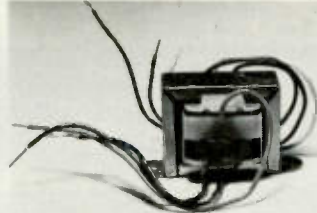

TRANSFORMER Pri. 110 VAC Sec. 11.2 and 5 VCT @ 1 amp. 95c ea.

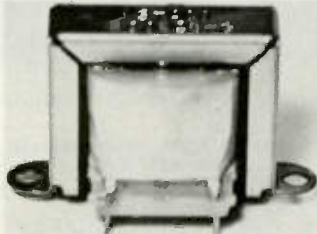

TRANSFORMER P-C mount. pri. 110 VAC Sec. 12:6 @ 1 amp. \$1.25 ea.



CLOCK DISPLAY National Sem. 6 Digit Multiplexed Display; .33" Characters (Common Cathode). A REAL BUY AT JUST \$1.00.



INSTRUMENT CLOCK CASE KIT A real jewel for those smaller projects. Hinged top door allows you to hide your control area. O.D. 4 1/2" x 4" x 1 3/4" \$1.99 each.

SMITH 5-WAY BINDING POSTS. 69c each

FAIRCHILD #78H05 Pcs. 5V 5 Amp Regulator (TO-3) NET \$11.00; Your Cost \$1.95 or 2/\$3.00

FLAT CABLE CONNECTOR Female 34 Pin Socket 50c each

PLASTIC PARTS BOX A nice little hinged-top box for storing all your small parts. O.d. 6 3/4" by 3 3/4" by 2". 75c ea. 10/\$5.00.

COMPUTER POWER SUPPLY TRANSFORMER PRI. 110/220 Vac; SEC. 12.1V @ 9A, 44.0V @ 2.5A, 12.9V @ 2.0A, 12.9V @ 3.2A. Only \$14.95 ea.

EDGE METER 100.0-100 ua 1/2" by 11/16". Compare with other meters costing \$6.00. ONLY \$2.00 ea. Why pay more?

CALCULATOR BUBBLE DISPLAY BRAND NEW pocket calculator displays. Ranging from 6-9 digit. Your luck \$1.25 ea. 3/\$3.00

KEYBOARD HOBBY BAG Compare, then really save with our calculator hobby bag assortment. Each one contains 3 calculator keyboards. All this for only \$1.75.

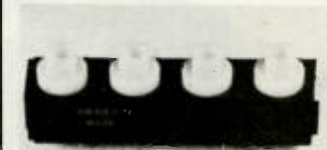

KEYBOARD SWITCH ASSEMBLIES Spring contact type 6/\$2.00 (Which enables you to re-assemble 3 complete groups of 4 switches.)



REPEAT OF A SELL-OUT A complete 12 hour digital clock. Some are manufacture line rejects, some are returns, and some are just scratched. Features: hours- minutes- alarm- snooze alarm. Parts value alone would equal \$20.00, you pay only \$6.00 ea.

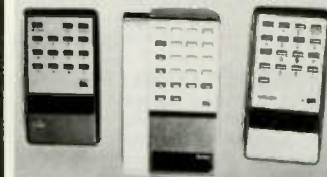

DEFECTIVE CALCULATORS Well, some are and some are not. We can't afford the time to test them. \$2.50 ea. Batteries not included. 2/\$4.00

#30 KYNAR Blk., Brn., Red., Or., Yel., Grn., Blu., Vio., Gry., Wh. We will do our best to ship the color you specify. To ensure prompt delivery of your order we will substitute colors should we be temp. out, unless you specify otherwise. \$2.36 per hundred foot spool; \$14.16 per thousand foot spool; Multiples of 100' only.

Call us for quotes on larger quantities.

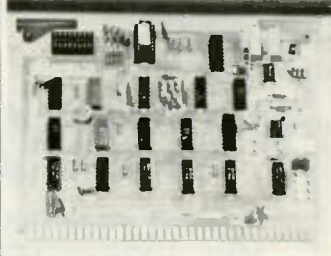

PARTS BOARDS A great way to buy parts on a budget. We guarantee your money's worth. ONLY \$1.00 ea.

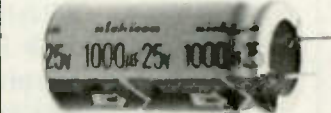

CAPACITORS

Capacitance	Voltage	Style	Price
1000uf	25 VDC	P-C	25c
220uf	25 VDC	P-C	25c
2000uf	25 VDC	AXIAL	50c
40/40	150 VDC	AXIAL	45c
1uf	15 VDC	AXIAL	19c
.018	100 V	MYLAR	25c
.001	100 V	MICA	11c
.01		DISC	7c
.02		DISC	6c
.1		DISC	9c

CLAIREX PHOTO CELLS These have a real USEFUL range to them. Any project involving control from ambient light levels will utilize this photo cell. Light resistance 1K. Fast response. .156 Diameter. 75c each or 2/\$1.00.

ROTRON WHISPER FAN #WR2H1 3 Blade 4" Diameter 75CFM 115VAC. NET \$17.00 YOUR PRICE \$9.95 Wait now, these are not pull-outs or something like that, these are new!



10 STATION PUSH BUTTON SWITCH ASSEMBLY 4 Push-On/Push-Off, 6 Ganged Push-On/Push-Off DPDT \$2.50 Each.

SELECTED VALUES

These items are chosen from our vast inventory of industrial quality components: Extruded heat sink 10 7/8" by 2 1/4" by 5/8" 20c
500 Ohm P-C mount trimmer 20c
Line cord #18 ga 6' 25c
74LS175 Quad D flip-flop 50c
S.P.D.T. sub-min slide switch 40c
S.P.S.T. P-C SWITCH 20c
ACID BRUSH 10c
SMITH #8523 SPACER .5 by #8 hole 5c
2 cond. #24 spiral wrap shld. cable 10c
14 PIN DIP HEADER 35c

For Master Charge/Visa Orders Use Our TOLL FREE HOT LINE: 1-800-426-0634 for areas outside Washington (incl. Alaska & Hawaii)

D.E.M.'s WELCOME



Terms: All orders shipped promptly. Minimum order \$5.00. Telephone orders accepted. All orders shipped UPS or PP. Add 5% extra for shipping & handling. Washington state residents add additional 5.4% sales tax. Master Charge & Visa cards accepted. Money orders & your personal or company check are welcome. Funds made payable in U.S. currency only. No C.O.D. orders. Your satisfaction is guaranteed on all merchandise purchased. All merchandise subject to prior sale. Open account to govt. agencies & publicly funded schools.

Store Hours M-F 9-6 • SAT 9-5

FREQUENCY COUNTER KIT

Outstanding Performance

Incredible Price **\$89.95**

CT-50



The CT-50 is a versatile and precision frequency counter which will measure frequencies to 60 mHz and up to 600 mHz with the CT-600 option. Large Scale Integration, CMOS circuitry and solid state display technology have enabled this counter to match performance found in units selling for over three times as much. Low power consumption (typically 300-400 ma) makes the CT-50 ideal for portable battery operation. Features of the CT-50 include: large 8 digit LED display, RF shielded all metal case, easy pushbutton operation, automatic decimal point, fully socketed IC chips and input protection to 50 volts to insure against accidental burnout or overload. And, the best feature of all is the easy assembly. Clear, step by step instructions guide you to a finished unit you can rely on. **Order your today!**

CT-50, 60 mHz counter kit

\$89.95

CT-50WT, 60 mHz counter, wired and tested

159.95

CT-600, 600 mHz scaler option, add

29.95

CB-1, Color TV calibrator-stabilizer

\$14.95

DP-1, DC probe, general purpose probe

12.95

HP-1, High impedance probe, non-load

15.95

SPECIFICATIONS:

Frequency range: 6 Hz to 65 mHz, 600 mHz with CT-600
Resolution: 10 Hz @ 0.1 sec gate, 1 Hz @ 1 sec gate
Readout: 8 digit, 0.4" high LED, direct readout in mHz
Accuracy: adjustable to 0.5 ppm
Stability: 2.0 ppm over 10° to 40° C, temperature compensated
Input: BNC, 1 megohm/20 pF direct, 50 ohm with CT-600
Overload: 50VAC maximum, all modes
Sensitivity: less than 25 mv to 65 mHz, 50-150 mv to 600 mHz
Power: 110 VAC 5 Watts or 12 VDC @ 400 ma
Size: 6" x 4" x 2", high quality aluminum case, 2 lbs
ICS: 13 units, all socketed

CAR CLOCK



The UN-KIT, only 5 solder connections

Here's a super looking, rugged and accurate auto clock, which is a snap to build and install. Clock movement is completely assembled—you only solder 3 wires and 2 switches, takes about 15 minutes! Display is bright green with automatic brightness control photocell—assures you of a highly readable display, day or night. Comes in a satin finish anodized aluminum case which can be attached 5 different ways using 2 sided tape. Choice of silver, black or gold case (specify).

DC-3 kit, 12 hour format

\$22.95

DC-3 wired and tested

\$29.95

110V AC adapter

\$5.95

Under dash car clock



12/24 hour clock in a beautiful plastic case features, 6 jumbo RED LEDs, high accuracy (1 min./mo.), easy 3 wire hookup, display blanks with ignition, and super instructions. Optional dimmer automatically adjusts display to ambient light level.

DC-11 clock with mtg bracket

\$27.95

DM-1 dimmer adapter

2.50

PRESCALER



Extend the range of your counter to 600 mHz. Works with any counter. Includes 2 transistor pre-amp to give super sens, typically 20 mv at 150 mHz. Specify +10 or +100 ratio.

PS-1B, 600 mHz prescaler

\$59.95

PS-1BK, 600 mHz orescaler kit

49.95

OP-AMP SPECIAL

741 mini dip

12/\$2.00

B1-FET mini dip, 741 type

10/\$2.00

VIDEO TERMINAL

A completely self-contained, stand alone video terminal card. Requires only an ASCII keyboard and TV set to become a complete terminal unit. Two units available, common features are: single 5V supply, XTAL controlled sync and baud rates (to 9600), complete computer and keyboard control of cursor, Parity error control and display. Accepts and generates serial ASCII plus parallel keyboard input. The 3216 is 32 char, by 16 lines, 2 pages with memory dump feature. The 6416 is 64 char, by 16 lines, with scrolling, upper and lower case (optional) and has RS-232 and 20ma loop interfaces on board. Kits include sockets and complete documentation.

RE 3216, terminal card

\$149.95

RE 6416, terminal card

189.95

Lower Case option, 6416 only

13.95

Power Supply Kit

14.95

Video/RF Modulator, VD-1

6.95

Assembled, tested units, add

60.00

CALENDAR ALARM CLOCK

The clock that's got it all: 6-5" LEDs, 12/24 hour, snooze, 24 hour alarm, 4 year calendar, battery backup, and lots more. The super 7001 chip is used. Size: 5x4x2 inches.

Complete kit, less case (not available)

\$34.95

DC-9

30 Watt 2 mtr PWR AMP

Simple Class C power amp features 8 times power gain. 1 W in for 8 out, 2 in for 15 out, 4 W in for 30 out. Max. output of 35 W. Incredible value, complete with all parts, less case and T-R relay.

PA-1, 30 W pwr amp kit

\$22.95

TR-1, RF sensed T-R relay kit

6.95

FM MINI MIKE KIT



A super high performance FM wireless mike kit! Transmits a stable signal up to 300 yards with exceptional audio quality by means of its built in electret mike. Kit includes case, mike, on-off switch, antenna, battery and super instructions. This is the finest unit available.

FM-3 kit

\$12.95

FM-3 wired and tested

16.95

CLOCK KITS



our Best Seller
your Best Deal

Try your hand at building the finest looking clock on the market. Its satin finish anodized aluminum case looks great anywhere, while six 4" LED digits provide a highly readable display. This is a complete kit, no extras needed, and it only takes 1-2 hours to assemble. Your choice of case colors: silver, gold, bronze, black, blue (specify).

Clock kit, 12/24 hour, DC-5

\$22.95

Clock with 10 min. ID timer, 12/24 hour, DC-10

27.95

Alarm clock, 12 hour only, DC-8

24.95

12V DC car clock, DC-7

27.95

For wired and tested clocks add \$10.00 to kit price.

Ramsey's famous MINI-KITS

FM WIRELESS MIKE KIT

Transmits up to 300' to any FM broadcast radio; uses any type of mike. Runs on 3 to 9V. Type FM-2 has added sensitive mike preamp stage.

FM-1 kit \$2.95

FM-2 kit \$4.95

VIDEO MODULATOR KIT

Converts any TV to video monitor. Super stable, tunable over ch. 4-6. Runs on 5-15V, accepts std. video signal. Best unit on the market!

Complete kit, VD-1

\$6.95

TONE DECODER

A complete tone decoder on a single PC board. Features: 400-5000 Hz adjustable range via 20 turn pot, voltage regulation, 567 IC. Useful for touch-tone decoding, tone burst detection FSK, etc. Can also be used as a stable tone encoder. Runs on 5 to 12 volts.

Complete kit, TD-1

\$5.95

COLOR ORGAN/MUSIC LIGHTS

See music come alive! 3 different lights flicker with music. One light for lows, one for the mid-range and one for the highs. Each channel individually adjustable, and drives up to 300W. Great for parties, band music, nite clubs and more.

Complete kit, ML-1

\$7.95

LED BLINKY KIT

A great attention getter which alternately flashes 2 jumbo LEDs. Use for name badges, buttons, warning panel lights, anything! Runs on 3 to 15 volts.

Complete kit, BL-1

\$2.95

WHISPER LIGHT KIT

An interesting kit, small mike picks up sounds and converts them to light. The louder the sound the brighter the light. Completely self-contained, includes mike, runs on 110VAC, controls up to 300 watts.

Complete kit, WL-1

\$6.95

SUPER SLEUTH

A super sensitive amplifier which will pick up a pin drop at 15 feet! Great for monitoring baby's room or as general purpose amplifier. Full 2 W rms output, runs on 6 to 15 volts, uses 8-45 ohm speaker.

Complete kit, BN-9

\$5.95

POWER SUPPLY KIT

Complete triple regulated power supply provides variable 6 to 18 volts at 200 ma and +5V at 1 Amp. Excellent load regulation, good filtering and small size. Less transformers, requires 6.3V @ 1 A and 24 VCT.

Complete kit, PS-3LT

\$6.95

SIREN KIT

Produces upward and downward wail characteristic of a police siren. 5W peak audio output, runs on 3-15 volts, uses 3-45 ohm speaker.

Complete kit, SM-3

\$2.95

ramsey electronics

BOX 4072, ROCHESTER, N.Y. 14610

PHONE ORDERS CALL

(716) 271-6487



TERMS: Satisfaction guaranteed or money refunded. COD, add \$1.50. Minimum order, \$6.00. Orders under \$10.00, add \$75. Add 5% for postage, insurance, handling. Overseas, add 15%. NY residents, add 7% tax.

SSB TRANSMITTING CONVERTERS



FEATURES:

- Linear Converter for SSB, CW, FM, etc.
- A fraction of the price of other units
- 2W p.e.p. output with 1 MW of drive
- Use low power tap on exciter or attenuator pad
- Easy to align with built-in test points

Frequency Schemes Available:

MODEL	INPUT (MHz)	OUTPUT (MHz)
XV2-1	28-30	50-52
XV2-2	28-30	220-222
XV2-3	28-30	222-224
XV2-4	28-30	144-146
XV2-5	28-29	145-146
XV2-6	26-28	144-146

ONLY \$59.95!

VHF Linear PA's

- Use as Linear or Class C PA's
- For XV-2 Xmtg Converters, T50 Exciters, or any 2W Exciter

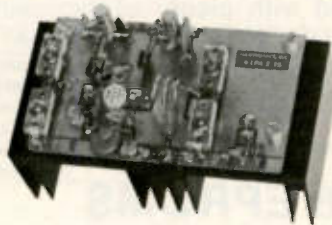

LPA 2-15 Kit \$59.95

- 15W out (linear) or 20W (class C)
- Solid State T/R Switching
- Models for 6M, 2M, or 220 MHz

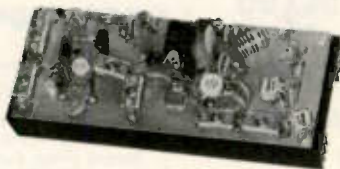

LPA 2-45 Kit \$109.95

- 45W out (linear) or 50W (class C)
- Models for 6M or 2M

LPA 8-45 Kit \$89.95
For 2M, 8-10W in, 45W out

T80 UHF POWER AMP

- Broadband PA
- No Tuning Required
- Class C PA
- 430-470 MHz
- 13-15W Out
- 200 mW Drive

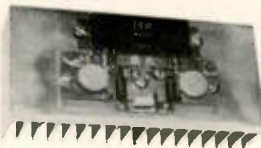

Model T80-450
\$79.95
Wired & Tested

VHF RECEIVING CONVERTERS

LET YOU RECEIVE OSCAR AND OTHER EXCITING SIGNALS ON YOUR PRESENT HF RECEIVER!



MODEL	RF RANGE	I-F RANGE
C28	28-32 MHz	144-148 MHz
C50	50-52	28-30
C144	144-146	28-30
C145	145-147	28-30
C146	146-148	28-30
C110	Aircraft	26-30
C220	220-222	28-30
C222	222-224	28-30
Special	Inquire About Other Ranges	

ONLY \$34.95

UHF RECEIVING CONVERTERS



MODEL	RF RANGE	I-F RANGE
C432-2	432-434	28-30 MHz
C432-4	432-436	144-146
C432-5	435-437	28-30
C432-7	427.25	61.25
C432-9	439.25	61.25
Special	Inquire About Other Ranges	

ONLY \$34.95

A9 Extruded Alum Case with BNC's for above Converters (Optional) ... \$12.95

VHF & UHF FM RECEIVERS

- ★ NEW GENERATION RECEIVERS
- ★ MORE SENSITIVE ★ MORE SELECTIVE (70 or 100 dB)
- ★ COMMERCIAL GRADE DESIGN
- ★ EASY TO ALIGN WITH BUILT-IN TEST CKTS
- ★ LOWER OVERALL COST THAN EVER BEFORE



R70 6-channel VHF Receiver Kit for 2M, 6M, 10M, 220 MHz, or com'l bands \$69.95
Optional xtal filter for 100 dB adj chan 10.00



R90 UHF Receiver Kit for any 2 MHz segment of 380-520 MHz band \$89.95

FAMOUS HAMTRONICS PREAMPS

let you hear the weak ones!

Great for OSCAR, SSB, FM, ATV. Over 10,000 in use throughout the world on all types of receivers.

P9 Kit \$12.95
P14 Wired \$24.95

Specify Band When Ordering



- Deluxe vhf model for applications where space permits
- 1-1/2 x 3"
- Models avail to cover any 4 MHz band in the 26-230 MHz range
- 12 Vdc
- 2 stages
- Ideal for OSCAR
- 20 db gain
- Diode transient protection
- Easily tunable

P8 Kit \$10.95
P16 Wired \$21.95

Specify Band

- Miniature vhf model for tight spaces - size only 1/2x2-3/8"
- Models avail to cover any 4 MHz band in the range 20-230 MHz
- 20 db gain
- 12V

P15 Kit \$18.95
P35 Wired \$34.95

- Covers any 6 MHz band in UHF range of 380-520 MHz
- 20 dB gain
- 2 stages
- Low noise



NEW FM/CW EXCITER KITS

BUILD UP YOUR OWN GEAR FOR MODULAR STATIONS, REPEATERS, & CONTROL LINKS

- Rated for Continuous Duty
- Professional Sounding Audio
- Built-in Testing Aids



T50 Six Channel, 2W Exciter for 2M, 6M, or 220 MHz (Specify band) \$49.95

T50U Six Channel, 1W Exciter for 430-450 MHz uhf operation \$49.95

► Ask For Free Catalog ◀

IT'S EASY TO ORDER!

CALL OR WRITE NOW FOR FREE CATALOG OR TO PLACE ORDER!

PHONE 716-392-9430. (Electronic answering service evens & weekends)

Use credit card, c.o.d., check, m.o.

Add \$2.00 shipping & handling.

IN CANADA, order from Communications Plus, 3680 Cote Vertu; St-Laurent, Quebec or phone 514-337-7255. Add 38% to cover duty, tax, and exchange.

Note New Address and Phone No.

hamtronics, inc.

65A MOUL RD · HILTON, NY 14468

--Dealer Inquiries Invited--

16K EPROM CARD-S 100 BUSS

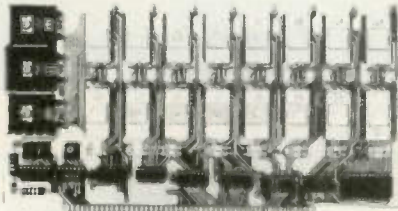

\$59.95
KIT

OUR
BEST
SELLING
KIT!

USES 2708's!

Thousands of personal and business systems around the world use this board with complete satisfaction. Puts 16K of software on line at **ALL TIMES!** Kit features a top quality soldermasked and silk-screened PC board and first run parts and sockets. All parts (except 2708's) are included. Any number of EPROM locations may be disabled to avoid any memory conflicts. Fully buffered and has WAIT STATE capabilities.

OUR 450NS 2708'S
ARE \$8.95 EA. WITH
PURCHASE OF KIT

ASSEMBLED
AND FULLY TESTED
ADD \$25

8K LOW POWER RAM KIT-S 100 BUSS

250 NS SALE!

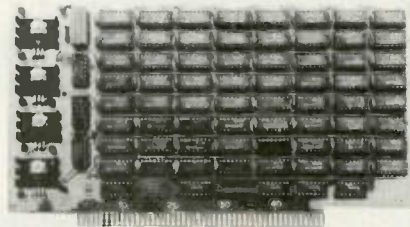

ADD \$5
FOR
250NS!

\$129 KIT

Use 21L02
450 NS RAMS!

Thousands of computer systems rely on this rugged, work horse, RAM board. Designed for error-free, NO HASSLE, systems use.

KIT FEATURES:

1. Doubled sided PC Board with solder mask and silk screen layout. Gold plated contact fingers.
2. All sockets included.
3. Fully buffered on all address and data lines.
4. Phantom is jumper selectable to pin 67.
5. FOUR 7805 regulators are provided on card.

Blank PC Board w/Documentation \$29.95
Low Profile Socket Set...13.50
Support IC's (TTL & Regulators) \$9.75
Bypass CAP's (Disc & Tantalums) \$4.50

ASSEMBLED AND FULLY
BURNED IN ADD \$30

16K STATIC RAM KIT-S 100 BUSS

\$295 KIT

FULLY
STATIC, AT
DYNAMIC PRICES

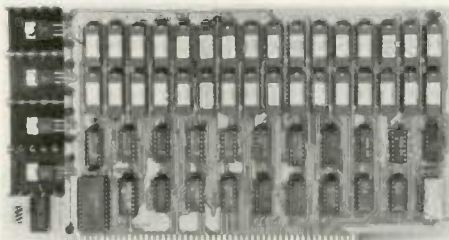

WHY THE 2114 RAM CHIP?

We feel the 2114 will be the next industry standard RAM chip (like the 2102 was). This means price, availability, and quality will all be good! Next, the 2114 is FULLY STATIC! We feel this is the ONLY way to go on the S-100 Bus! We've all heard the HORROR stories about some Dynamic RAM Boards having trouble with DMA and FLOPPY DISC DRIVES. Who needs these kinds of problems? And finally, even among other 4K Static RAM's the 2114 stands out! Not all 4K static RAMs are created equal! Some of the other 4K's have clocked chip enable lines and various timing windows just as critical as Dynamic RAM's. Some of our competitor's 16K boards use these "tricky" devices. But not us! The 2114 is the ONLY logical choice for a trouble-free, straightforward design.

KIT FEATURES:

1. Addressable as four separate 4K Blocks.
2. ON BOARD BANK SELECT CIRCUITRY (Cromemco Standard). Allows up to 512K on line!
3. Uses 2114 (450NS) 4K Static Rams.
4. ON BOARD SELECTABLE WAIT STATES.
5. Double sided PC Board, with solder mask and silk screened layout. Gold plated contact fingers.
6. All address and data lines fully buffered.
7. Kit Includes ALL parts and sockets.
8. PHANTOM is jumpered to PIN 67.
9. LOW POWER! under 2 amps TYPICAL from the +8 Volt Buss.
10. Blank PC Board can be populated as any multiple of 4K.

BLANK PC BOARD W/DATA—\$33

LOW PROFILE SOCKET SET—\$12
SUPPORT IC'S & CAPS—\$19.95

ASSEMBLED & TESTED—ADD \$30
2114 RAM'S—8 FOR \$69.95

16K STATIC RAM KIT SWTPC (SS-50) 6800 BUSS

USES 2114
4K RAMS!

\$295
COMPLETE KIT

WHY PAY MORE
FOR FINNICKY
DYNAMIC BOARDS?

At last an affordable static RAM board for this popular buss. Quality PC Board with solder mask and silk-screen. Fully buffered with plenty of bypassing for reliable operation. FOUR ON-BOARD REGULATORS.

16K DYNAMIC RAM CHIP

16K X 1 Bits. 16 Pin Package. Same as Mostek 4116-4. 250 NS access. 410 NS cycle time. Our best price yet for this state of the art RAM. 32K and 64K RAM boards using this chip are readily available. These are new, fully guaranteed devices by a major mfg. VERY LIMITED STOCK!

8 FOR \$89.95

NOT ASSOCIATED
WITH
DIGITAL RESEARCH
OF CALIFORNIA,
THE SUPPLIERS OF
CPM SOFTWARE.

450 NS! **2708 EPROMS**
Now full speed! Prime new units from a major U.S. Mfg. 450 N.S. Access time. 1K x 8. Equiv. to 4-1702 A's in one package.

~~\$15.75 ea.~~

\$9.95

4 FOR \$50.00

PRICE CUT

NATIONAL SEMICONDUCTOR JUMBO CLOCK MODULE

MA1008A
BRAND NEW!



\$6.95

3 FOR \$13

(IAC XFMR \$1.95)

ASSEMBLED! NOT A KIT!

ZULU VERSION!

We have a limited number of the 24 HR Real time version of this module in stock
#MA1008D — \$9.95

PERFECT FOR USE
WITH A TIMEBASE.

COMPARE AT UP TO TWICE
OUR PRICE!

MANUFACTURER'S CLOSEOUT!

WESTERN DIGITAL UART

TR1602A. PIN FOR PIN SUB FOR
AY5-1013 AND TMS6011.

FOR SERIAL I/O



\$2.99

EACH

SURPLUS SPECIAL

SALE!

1N4148 DIODES. SILICON.
Same as 1N914. New,
factory prime, Full Leads.
100 FOR \$2
1000 FOR \$17.50

New! REAL TIME
Computer Clock Chip

N.S. MM5313. Features
BOTH 7 segment and
BCD outputs. 28 Pin
DIP. \$4.95 with Data

Z-80 PROGRAMMING MANUAL

By MOSTEK, or ZILOG. The most detailed explanation ever on the working of the Z-80 CPU CHIPS. At least one full page on each of the 158 Z-80 Instructions. A MUST reference manual for any user of the Z-80. 300 pages. Just off the press.

\$12.95

COMPUTER PARTS

Z-80	- 19.95	8212	- 2.25
Z-80A	- 24.95	8255	- 6.95
8080A	- 6.95	2111AL-4	- 2.25
8080A-2	- 8.95	2708	- 9.95

MOTOROLA 7805R VOLTAGE
REGULATOR. Same as standard 7805
except 750 MA output. TO-220. 5VDC
output.

44¢ each

or

10 for \$3.95

Digital Research Corporation

(OF TEXAS)

P.O. BOX 401247 • GARLAND, TEXAS 75040 • (214) 271-2461

✓ D20

TERMS: Add 30¢ postage, we pay balance. Orders under \$15 add 75¢ handling. No C.O.D. We accept Visa, MasterCard and American Express cards. Tex. Res. add 5% Tax. Foreign orders (except Canada add 20% P & H. 90 Day Money Back Guarantee on all items.

60 Hz CRYSTAL TIME BASE

\$4⁹⁵ (Complete Kit)

Uses MM5369 CMOS divider IC with high accuracy 3.579545 MHZ Crystal. Use with all MOS Clock Chips or Modules. Draws only 1.5 MA. All parts, data, and PC Board included.

100 HZ CRYSTAL TIME BASE

\$5⁹⁵ (Complete Kit)

Same as above, except it uses a special MM5369. Perfect for frequency counter time bases, etc. Also use with MOSTEK MK50397 timer chip.



CINCH-JONES TERMINAL BLOCKS

5-140 5 Terminal — 3 FOR \$1
10-140 10 Terminal — 2 FOR \$1



NATIONAL SEMI MM5312

MOS CLOCK CHIP WITH
7 SEGMENT AND BCD
OUTPUTS

SURPLUS SPECIAL

\$1⁹⁹ WITH DATA

OUR CATALOG
is chocked full of rare
parts bargains, deals,
RAM or CPU kits, plus
much more. Yours
FREE! - CALL!

SUB-MINI INCANDESCENT LAMPS

Rated 8 Volts — 50 MA.
LONG LIFE — 6 FOR \$1

2N2904A Transistor

PNP Silicon. TO-5. House
no. VCEO-60V. 3 watts.
HFE is 40 to 120 at 150
MA. 100 MHZ.

GREAT BUY!

4/\$1.00

I.F. TRANSFORMERS — VARIABLE INDUCTORS

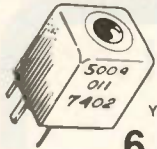

YOUR CHOICE

6 FOR \$1

We bought a load from a very large manufacturer of COM gear!
Please order by part #.

#5009-011: 7 TO 1.3 UH VARIABLE INDUCTOR (C.T.)
#5006-008: 455 KHZ IF TRANSFORMER
#5015-009: 27 MHZ RF TRANSFORMER (C.T. PRI.)
#5015-007: 4.3 MHZ IF TRANSFORMER

MICROMINI-SIZE

NOTE: The 5009-011 Variable Inductor can also be used as a 10.7 MHZ I.F. by using a 240 PF CAPACITOR

GENERAL INST. DUAL MOS-FET GATE



MPF-131. HIGH FREQUENCY.
DIODE PROTECTED GATES!
DEPLETION MODE. VDS-35V
N-CHANNEL. YFS-10,000
uMHOS LOW NOISE.

10 FOR \$3.95 **2 FOR \$1**

1N4148 DIODE SALE!

FULL LEADS! BRAND NEW!
COMPUTER MFG. SURPLUS

100 FOR \$2 1000 FOR \$17.50

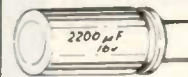

FILTER CAP

2200 MFD 16WVDC
BY PANASONIC. SMALL SIZE.

FRESH! **3 FOR \$1.25**

ZENER DIODES

3.6V. 400 MW (1N747A)	—	10/\$1
3.6V. 500 MW (1N5227B)	—	8/\$1
6.2V. 1 W. (1N3828A)	—	6/\$1
6.2V. 10 W. (1N3998A)	—	2/\$1
8.2V. 400 MW (1N756A)	—	8/\$1
8.2V. 1 W. (1N3018A)	—	6/\$1
9.1V. 400 MW (1N960B)	—	8/\$1
10V. 400 MW (1N758A)	—	8/\$1
15V. 1 W. (1N3024A)	—	5/\$1
27V. 400 MW (1N971B)	—	8/\$1
27V. 1W. (1N3030A)	—	5/\$1
33V. 400 MW (1N973B)	—	8/\$1

Please specify voltage and part number when ordering.

GE NICAD!

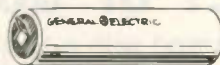

GE Ni-Cad Battery Pack
3 Cell pack. gives 4 volts
at 900MAH. Brand new,
factory fresh. Each cell is
2/3 "C" size. \$2.95.
**Buy 3 packs (12 volts)
for \$6.95. Limited stock!**

COMPLEMENTARY POWER TRANSISTORS

SILICON NPN AND PNP. TO-220 CASE.
VCEO - 40V PD - 30 WATTS

FOR AUDIO POWER AMPS, ETC.

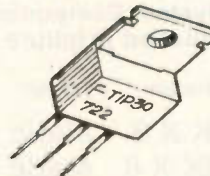

TIP29 - NPN
TIP30 - PNP

YOUR
CHOICE
3 FOR \$1

MOTOROLA POWER TRIAC TO-220 CASE

15 AMP 400 PRV
SPECIAL: **89¢** each
5 FOR \$3.95

"THE COLOSSUS"

FAIRCHILD SUPER JUMBO LED READOUT
A full .80 inch character. The biggest readout
we have ever sold! Super efficient. Compare at
up to \$2.95 each from others!
FND 847 Common Anode YOUR CHOICE
FND 850 Common Cathode **\$1⁴⁹** EA
(6 for \$6.95)

FAIRCHILD PNP "SUPER TRANSISTOR"

2N4402. TO-92 Plastic. Silicon PNP
Driver. High Current. VCEO-40 HFE-50
to 150 at 150 MA. FT-150 MHZ. A super
"BEEFED-UP" Version of the 2N3906.

8 FOR \$1

FAIRCHILD RED LED LAMPS

#FLV5057. Medium Size. Clear Case. RED EMITTING. These are not
retested off-spec units as sold by some of our competition. These are
factory prime, first quality, new units.

10 FOR \$1¹⁹
50 FOR \$4⁹⁵



"WE BOUGHT 250,000 PCS."

HY GAIN OP-AMP AND RELAY CONTROL BOARD

We do not know what these boards were used in, but they do contain
a wealth of quality components. Board has: 2-12VDC 200 OHM
SPDT Mini Relays, 1-CD4001 CMOS, 4-LM358 High Performance
OP AMPS (same as 1/2 LM324), 1-MOTOROLA MC3340 Mini Dip, 1-
Audio Output Transformer, 1-TIP30 30 WATT PNP Power
Transistor, plus 70 more assorted components. All parts easily
removed.

LIMITED STOCK: \$2.49 each

Digital Research Corporation

(OF TEXAS)

P.O. BOX 401247 GARLAND, TEXAS 75040 (214) 271-2461

TERMS: Add 30¢ postage. we pay balance Orders under \$15 add 75¢
handling. No C.O.D We accept Visa, MasterCard, and American Express
cards. Tex. Res. add 5% Tax. Foreign orders (except Canada) add 20% P & H.
90 Day Money Back Guarantee on all items.

QUESTION: WHAT'S BETTER THAN AN MA1003 CLOCK MODULE? ANSWER: AN MA1003 IN A BEAUTIFUL CASE . . . FOR ONLY \$19.95!

That's right, not just the module — but module and case — for \$19.95. The MA1003 has blue-green fluorescent readouts, a highly accurate built-in timebase (excellent for mobile applications and/or battery backup), and easy assembly: add 12 Volts DC with 3 time-setting switches and you're ready to go.

Our matching case has a woodgrain front, mounting bracket and hardware, and a blue filter that really brings out the best in the MA1003 readouts. And for those of you who already bought the clock module, don't worry; the case is available separately for \$5.95. The MA1003 is available separately for \$16.50 (3 modules/\$46).

Here's your chance to get a good-looking, easy to assemble clock . . . we've made it really simple for you.

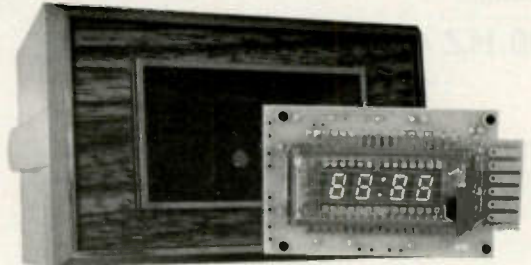

PARTS SPECIALS

2102L-1 (high speed/low power) 1K static RAMs are now only 99¢. Sorry, this price is only good on orders of 10 or more ICs.

1N571A zeners (5.1V) now available at 6/\$1. Stock up while the getting's good.

"BARE BOARD" HEATH MEMORY SPECIAL

Don't need the full 12K of our standard H8 compatible memory board? Then check this out: we'll sell you the bare board, mounting bracket, edge connector, and print for only \$35. Remember, this is a quality board — solder masked, legended, and double-sided. Populate it with readily available, low cost 2102s to build your memory up to full 12K whenever your budget permits full expansion.

MEET THE ECONORAM™ FAMILY OF QUALITY MEMORY

Cost-effective, low power, reliable memory . . . backed with a 1 year warranty. Available as unkits (sockets, bypass caps pre-soldered in place for easy assembly), assembled/tested, or qualified under the Certified System Component (CSC) program. CSC boards are burned-in for 200 hours and immediately replaced if failure occurs within 1 year of invoice date.

Name	Storage	Design	Buss	Guar. Speed	Unkit	Assm	CSC
ECONORAM II™	8K X 8	static	S-100	2 MHz	\$139	\$159	N/A
ECONORAM IV™	16K X 8	static	S-100	4 MHz	\$279	\$314	\$414
ECONORAM VI™	12K X 8	static	H8	2 MHz	\$200	N/A	N/A
ECONORAM VII™	24K X 8	static	S-100	4 MHz	\$445	\$485	\$605
ECONORAM X™	32K X 8	static	S-100	4 MHz	\$599	\$649	\$789
ECONORAM IX™	32K X 8	static	DigGrp	4 MHz	\$649	N/A	N/A
ECONORAM XI™	32K X 8	static	SBC	4 MHz	N/A	N/A	\$1050

TRS-80 CONVERSION KIT \$109 (3/\$320)

Our kit includes DIP shunts, 250 ns chips for 4 MHz operation, and 1 year guarantee. Upgrades 4K TRS-80 to 16K or populates Memory Expansion Module — our novice level instructions show you how. Also suitable for APPLE computers.

FREE CATALOGUE: No one ever said our flyer has a great plot, but what a cast of characters! Linears, CMOS, low power Schottky TTL, standard TTL, specials, music kits, power supplies, and much more cavort (in glorious black and white) on 40 pages of the cheapest paper we could find. If you're looking for bargains, this is the place. Send us your name and address, we'll take care of the rest. For 1st class delivery add 41¢ in stamps.

TERMS: Orders under \$15 add \$1 handling. Cal res add tax. VISA®/Master-charge® (\$15 min) call (415) 562-0636, 24 hrs. Allow 5% shipping, excess refunded. COD OK with street address for UPS.

GODBOUT

BILL GODBOUT ELECTRONICS
BOX 2355, OAKLAND AIRPORT, CA 94614

ASSOCIATED RADIO 913-381-5900

8012 CONSER BOX 4327
OVERLAND PARK, KANSAS 66204



CALL US WITH YOUR REQUIREMENTS
AMERICA'S NO. 1 Real Amateur Radio Store



**Associated Wants to Trade
Call US
913-381-5900**

TRADE BUY SELL

NEW AND RECONDITIONED EQUIPMENT.

**NOTE: SEND \$1.00 FOR OUR CURRENT CATALOG
OF NEW AND RECONDITIONED EQUIPMENT.**

***ALSO WE PERIODICALLY PUBLISH A LIST OF
UNSERVICED EQUIPMENT AT GREAT SAVINGS.
A BONANZA FOR THE EXPERIENCED OPERATOR.
TO OBTAIN THE NEXT UNSERVICED BARGAIN LIST,
SEND A SELF ADDRESSED STAMPED ENVELOPE.**



We're Expanding . . . We're Growing with our Biggest

"ONE PENNY GETS YOU TWO"

* Buy any \$1 item on this page and choose 2nd item for only one penny!

HOW TO ORDER

When ordering, always use catalog number, type no., the name of the magazine you are ordering from and the month

PLESSEY CAPS

10 for \$1 20 for \$1.01

Half and full postage stamp size, white ceramic. Vertical mtg. Units unmarked so please order only same values per item. All 100VDC. Cat. No. 5399A

Mfd	Mfd	Mfd
0015	068	11
01	11	27
015	12	1.00
047	22	

ONE DOLLAR PLUS A PENNY GETS YOU TWO

TWO DOLLARS PLUS A PENNY GETS YOU TWO

- 50 IF TRANSFORMERS, ass't sizes (#3594) 1.00
- 30 RADIO AND TV KNOBS, ass't styles, sizes (#212) 1.00
- 50 TUBULAR CAPACITORS, ass't volt and sizes (#219) 1.00
- 50 LOW NOISE RESISTORS 1/4, 1/2 W, MFL, etc (#220) 1.00
- 40 POWER RESISTORS, 3.5-7 W, axial, pop sizes (#228) 1.00
- 525 SURPRISE, 1/2 W, axial (#2363) 1.00
- 12 PANEL SWITCHES, rotary, slide, toggle, etc (#295) 1.00
- 50 COILS AND CHOKES, r1, parasitic, lf, etc (#297) 1.00
- 50 TERMINAL STRIPS, up to 4 solder lugs (#324) 1.00
- 50 PRECISION RESISTORS, 1/4 W, 1% axial (#333) 1.00
- 50 MICA CAPACITORS, ass't values (#337) 1.00
- 10 SETS RCA PLUGS AND JACKS, phono (#402) 1.00
- 50 DISC CAPACITORS, ass't values long leads (#437) 1.00
- 20 TRANSISTOR ELECTRO'S, ass't up and ass't (#445) 1.00
- 75 HALF WATTERS, resistors, color coded, ass't (#454) 1.00
- 35 SILVER MICAS, red backs, axial, ass't (#455) 1.00
- 5-50 AMP RECT, ass't volt up to 25, stud (#471) 1.00
- 100 GERMANIUM DIODES, ass't values, ass't (#482) 1.00
- 100 STABATORS, Regulator, sensing and computer, Axial, excellent yield (#1840) 1.00
- 100 PRINTED CIRCUIT 1/2 WATT RESISTORS, ass't (#1060) 1.00
- 12 TRANSISTOR SOCKETS, ass't npn and pnp types (#0851) 1.00
- 50 1 AMP SILICON RECTIFIERS, 5% axial, ass't V (#1853) 1.00
- 50 POLYSTYRENE CAPS, plastic coated, prec. (#10152) 1.00
- 10 NE-2 bulbs, for 110vac projects, hobby, etc (#1222) 1.00
- 10 PROXIMITY REED SWITCHES, ass't sizes (#1258) 1.00
- 8 2515 OUTLET JACKS, color coded (#1423) 1.00
- 30 MOLEX CONNECTORS, nylon, ass't sizes (#54) 1.00
- 50 MINI BLOCK CAPACITORS, Eria, red square disc, Ass't. values (#352) 1.00
- 4-CALCULATOR AC ADAPTOR JACK, standard threads 3 terminals (#2316) 1.00
- 50 ONE AMP IRED LED'S, 5mm pin tubes, ass't (#1385) 1.00
- 5-PA-263 THREE WATT PCB BOARDS, for amps (#2013) 1.00
- 5 MICRO MINI SLIDE SWITCHES, SPDT (#2254) 1.00
- 5 MINI MOTORS, 1/4 Vdc, for many hobby (#2251) 1.00
- 50 IN4000 RECTIFIERS, ass't to 800V, ass't (#1294) 1.00
- 15 PRINTED CIRCUIT BOARDS, ass't size, hobby (#2010) 1.00
- 2 MERCURY SWITCHES, silent touch, 5P5T (#2283) 1.00
- 6175 A SWAP, 9 VDC BATTERY, red in black lead (#2882) 1.00
- 8 1400 VOLT IRED LED'S, 1 AMP (#2290) 1.00
- 20 IN4148 SWITCHING DIODES, 4 nsec, axial (#3300) 1.00
- 6 10 AMP QUADRACS, w/trigger diode up 600V (#3620) 1.00
- 3 MICRO SWITCHES, push, ass't types (#3011) 1.00
- 40 SQUARE OISC SWITCHES, color coded (#3230) 1.00
- 30 TRANSISTORS TO 2824400 series, u test (#3291) 1.00
- 6 TRANSISTORS TRANSFORMERS, audio, inter, etc mini (#3295) 1.00
- 15 PRINTED CTR TRIMMER POTS, ass't values, etc (#3346) 1.00
- 6 UTILITY AC OUTLET JACKS, 1/2" min, w/clip, etc (#3352) 1.00
- 20 M CABLE, 1 cond shielded, 1/24, for phono (#3353) 1.00
- 7-2N3055 HOBBY NPN TRANSISTORS, TO-3 (#3371) 1.00
- 10-PHP 30 WATT TO-3 TRANSISTORS, hobby (#3372) 1.00
- 50 TUBE SOCKETS, 5-7 pin tubes, ass't (#3385) 1.00
- 1-10 AMP POWER LAB QUADRAC, 200 PIV, TO220, 2 trigger (#3390) 1.00
- 10 BULLET RECTIFIERS, 2 amp, 200V, axial (#84) 1.00
- 2-MA4000 READOUT, RED, com anode, size 19 (#1503) 1.00
- 10-REACTORS, MAN 3, common cath, LED, the claw, RED (#3338) 1.00
- 8-LED'S, 5mm, red, green, yellow, red, green, red (#3869) 1.00
- PHOTO FLASH ELECTRO. CAP, 600 MF @ 360 V (#3897) 1.00
- 2-CIRCUIT BREAKERS, glass coated, axial, rated @ 1 amp (#3905) 1.00
- MICRO MINI TOGGLE, SPST, 2 pos, on-off, 125V @ 3 amps (#3936) 1.00
- 5-CB CRYSTALS, 8MHz, 500 ohm, color coded (#4320) 1.00
- 4-PUSH BUTTON, SPST, PANEL, N.C. 125V, 1 A (#4289) 1.00
- 10-INSTRUMENT KNOBS, ass't. styles and colors, 1/2" diam (#5121) 1.00
- 4-TAPE HEADS, NII type (#5182) 1.00
- 8-TANTALUM ELECTROLYTIC CAPACITORS, 1000 uF (#5205) 1.00
- 2-INLINE FUSE HOLDERS, complete w/3 amp fuses (#5213) 1.00
- 30-4" CABLE TIES, non-slip white plastic (#5217) 1.00
- 30pc-HEAT SHRINK, ass't. sizes, 50% shrinkage (#5248) 1.00
- 20 TOROIDS, 1000 uF, 50V, axial (#5431) 1.00
- 18-15V ZENERS, 400mw, axial, glass case (#5404) 1.00
- 2-ALUMINUM HEAT SINKS, for TO-220 (#5338) 1.00
- 2-1V, 50, 10W, 10W ZENER, DO-4 case (#5287) 1.00
- 12-5MINI TRIMMERS, 100K, 100K, 100K, 100K (#3388) 1.00
- 60pc-PRECUT, PRETIMED WIRE, various lengths and colors (#1971) 1.00
- 60 MINI RESISTORS, for PC appl., vert. 1/8W, color coded (#2235) 1.00
- 8-TRANSISTOR RADIO EARPHONES, 8 ohms imp (#2948) 1.00
- 10-5R POTS, 50K, 100K, 200K, 500K, 1M (#5125) 1.00
- 10-182 MEG DUAL POTS, audio taper, "snap in" mtg (#5125) 1.00
- 50-1 AMP ZENERS, wide ass't. values, untested (#1964) 1.00
- 12-5C 5 S TRIACS, 10 AMP, ass't values, untested (#2087) 1.00
- 3-QUADRODS, 100V, 1000-2000 V, TO-220 (#3378) 1.00
- 20-MINI RECTIFIERS, 1/4 AMPS, 25V, epoxy, axial (#5374) 1.00
- 5-IN4007 1000V MINI RECTIFIER, epoxy case, axial leads (#2383) 1.00
- 60-MOLEX CONNECTOR Type M 1838-4, makes 14 to 40 pin sockets (#1609) 1.00
- 20-V. CHEATER CORDS, for AC power, 1/2" dia (#5552) 1.00
- 10-T.V. CHEATER CORD JACKS, for use with above (#5520) 1.00
- 10-1 AMP 200V MINI RECTIFIER, IN4003, epoxy, axial (#2379) 1.00
- 1-5V SILVER BRIDGE WATCH BATTERIES, specify dia (#5063) 1.00
- 3-LED WATCH READOUTS, 3/4" dia, 1/2" x 1/2" (#5119) 1.00
- 10-IC OICE CHIP, complete circuitry, ass't. sizes (#5065) 1.00
- 2-100MHz MARKER CRYSTALS, specify 104.067, 104.092, or 114.000 MHz (#3896) 1.00
- 12-1.5V LAMP AND SOCKET SET, 200ma, F2 style (#3958) 1.00
- 10-REA PHONO JACKING TRANSISTORS, TO18, 1/2" (#3374) 1.00
- 10-COAXIAL PIN HEAD LED'S, RED (#5617) 1.00
- 4-W" BLOCK TRIM POTS, 5K to 200K (#5618) 1.00
- 1 "FOTO-FEY" 1/2 CHANNEL, Crystalline, 1/2 Sealed Effect Transistor, (#1168) 1.00
- 1-VOLTAGE REGULATOR, TO202 case, 12V 600MA (#1900) 1.00
- 1-3 DIGITS ON A DIP, LED, red, DL-33 (#1887) 1.00
- 3-MM 5262 2K DYNAMIC RAM, ass't type (#3459) 1.00
- 10-2N711 HIGH CURRENT CALCULATING TRANSISTORS, TO18, 1/2" (#3374) 1.00
- 2-15W HI POWER TRANSISTORS, 220V, non, TO66 (#2787) 1.00
- 4-24 PIN IC SOCKETS (#2168) 1.00
- 1-MM5212 DIGITAL LOCK SHIP, 100% (#1523) 1.00
- 1-MM5214 FUNCTION GENERATOR, 100% (#1523) 1.00
- 1-MM5202 ERASABLE PROM, 100% (#1838) 1.00
- 3-10 AMP 25V BRIDGE RECT, comb style (#2447) 1.00
- 10-2N3565 RF TRANSISTORS, TO-18, 2N3531 (#3373) 1.00
- 10-LINEAR SWITCHING TRANSISTORS, 2N2908, pnp, TO18 (#3374) 1.00
- 50-2 AMP CYLINDRICAL RECT. up to 1K, u test (#4006) 1.00
- 5-OPEN FACE READOUTS, TO-18, red, some segs missing mostly duals (#3952) 1.00
- 10-2N2222 (for eqn.), LED, red, metal case (#1992) 1.00
- 40-TERMINAL IC SOCKETS, incl. long and wide type, for 12 to 20 pins (#3978) 1.00
- 10-DATA ENTRY SWITCHES, SPST, lamp, 125V norm open (#3961) 1.00
- 10-FLUORESCENT OVERFLOW READOUT TUBES, w/leads (#3288) 1.00
- 10-2N3104 TO 92 TRANSISTORS, 1.3505 1.00
- 1-2N3010 10V TRANSISTORS STUD (#2900) 1.00

- 100-CAPACITOR SPECIAL, discs, mylar, lytics, more (#2736) 2.00
- 10-VOLTAGE REGULATORS, hobby LM320, 340, TO-3 (#3300) 2.00
- 30-PANEL SWITCHES, slide, rotary, metal, etc (#3288) 2.00
- 200-RESISTOR SPECIAL, 1/2 to 1W, carbon, metal, 3054 2.00
- 200-HALF WATTERS, resistors, carbon, metal (#3044) 2.00
- 100-NATIONAL IC BOMAZZA, linear, 7400s ROM3 (#2800) 2.00
- 15-LM3847 VOLTAGE REGULATORS, 5 to 24V, TO-220 (#2835) 2.00
- 100-POLYSTYRENE CAPS, ass't'd values, voltage, 1/2 (#2729) 2.00
- 80-THERMISTORS, resistors that change with temp (#4088) 2.00
- 20-BRIDGES, untested, 2, 4, 8, amp, full wave (#4022) 2.00
- 15-MIXED READOUTS, hobby, untested, 127, 3, 5, etc (#3618) 2.00
- 150-DIPPED WATTERS, shiny finish, ass't'd values (#2878) 2.00
- 100-PLASTIC TRANSISTORS, untested, TO-92 (#2604) 2.00
- 200-PREFORMED RESISTORS, 1/4, 1/2, 1W, marked, ass't'd (#2608) 2.00
- 150-PRECISION RESISTORS, 1/4, 1/2, 1W, 1%, 2% marked (#2428) 2.00
- 40-DIPPED WATTERS, resistors, metal film, marked (#2413) 2.00
- 30-VOLUME CONTROLS, audio, linear, ass't'd values (#2421) 2.00
- 100-SILICON SIGNAL DIODES, micro, glass, zero test 50% yield (#2628) 2.00
- 15-CLOCK-CALCULATOR, may include MM5378, MM5375 (#5638) 2.00
- 10-PUSH SWITCHES, push-to-break, spot, alarm (#3288) 2.00
- 12-MICROPROCESSORS, and support IC's (#5639) 2.00
- 150-CLASS ZENERS, 400 MW, untested, better than 50% yield (#2740) 2.00
- 75-CARBON FILM RESISTORS, 1/4, 1/2 watt, 5% 10%, marked, ass't'd (#3834) 2.00
- 100-UMHIERIC CAPACITORS, polystyrene, molded, pop values (#3000) 2.00
- 100-IN4148/914 SWITCHING DIODES, 50% yield, untested (#1741) 2.00
- 30-PC TRIM POTENTIOMETERS, thumbwheel, screwdriver ass't'd (#3348) 2.00
- 18-LIBRE VOLUME CONTROLS, ass't'd values, audio, elings (#3037) 2.00
- 75-4" CABLE TIES, plastic, like "ty wrap" (#2118) 2.00
- 10-CRYSTALS, may include CB, Ham & other, untested (#2418) 2.00
- 100-TERMINAL STRIPS, from 2 lugs up (#3136) 2.00
- 30-ME-ZEON LAMPS, all 100% good (#2813) 2.00
- 40-M SHIELDED CABLE, 1 cond, milico, phono, (#3877) 2.00
- 3-SOUND TRIGGERS, sound trigger act w/amps (#3821) 2.00
- 10-CB CRYSTALS, for phase lock loop, NAM, KC/18 (#5050) 2.00
- 50-4 LAYER SHOCKLEY DIODES, Ass't. pop. values (#1072) 2.00
- 100-TTL & LINEAR MIXED, with 7400s, 50%+ yield (#2431) 2.00
- 100-MINI OIP IC's, linear, untested 50%+ yield, pop types (#2418) 2.00
- 30-LM380 AUDIO IC'S, 2 watts on a dip 50%+ yield (#3284) 2.00
- 75-LINEARS, OP AMPS, untested 50%+ yield, amp-dip-minidip (#2418) 2.00
- 100-TTL & LINEAR MIXED, with 7400s, 50%+ yield (#2431) 2.00
- 150-PREFORMED OISC CAPACITORS, mark-d values, ass't'd (#2608) 2.00
- 10-CALCULATOR KEYBOARDS, 20 keys and up (#3824) 2.00
- 2000-FACTORY REJECT DIODES, zener, rect, signal, untested (#5369) 2.00
- 40-AZIAL ELECTRO'S, ass't'd values & capacitance (#3227) 2.00
- 40-UPRIGHT ELECTRO'S, ass't'd values & capacitance (#3228) 2.00
- 150-RED DISC SPECIAL, Eria, mostly marked, pop values (#5341) 2.00
- "WATCH GUTS", LED, who knows how good (#5267) 2.00
- 10 100V 1 AMP RECTIFIERS, IN4007 (#2384) 2.00
- 10 2 AMP METAL CASE AL RECTS, up to 1KW (#4006) 2.00
- 25 POWER TAB TRANSISTORS, TO-202, 30 watts (#2425) 2.00
- 10 PUSHPM TOGGLE SWITCHES, ass't'd values (#5635) 2.00
- 10 MICRO TOGGLES, spst, dpdt, for panel, etc (#5636) 2.00
- 10 2 AMP METAL CASE AL RECTS, up to 1KW (#4006) 2.00
- 100-MINI BLOCK CAPACITORS, Eria, red sq disc style (#3528) 2.00
- 20 PLESSEY 1/2W @ 100VDC 1" SQUARE CAPS (#5581) 2.00
- 10 TV-FM 300 OHM TWIN LEAD SPLICERS (#5847) 2.00
- 10 25V BICOLOR BATTERY CHARGER, 110vac in, 110vac out (#5228) 2.00
- 4 MIKE HOLDERS, for CB's and other mobile rigs (#5834) 2.00
- 10 PLESSEY CAPS, 1M @ 100V 1" sq. CERAMICS (unmarked) (#5613) 2.00
- 100 PLESSEY CAPS, missed values marked and unmarked (#5613) 2.00

LINEAR AND SPECIAL IC SALE

Order by Type Number	1.50	1.81
TYPE PA-208	1.00	1.01
LM-268	1.50	1.51
LM-558	1.50	1.51
LM-703H	45	46
LM-709H	49	50
LM-709H	39	40
LM-710H	39	40
1500	39	40
1103	39	40
5262	89	90
75492	89	90

ZENERS! Order by Cat.

No.	5210A & Voltage & wattage	1 CA SALE
1	1 Watt	1.00
2	7.5V 3 for \$1.10 for \$1.01	1.01
3	8.2V 3 for 1.10 for 1.01	1.01
4	9.1V 3 for 1.10 for 1.01	1.01
5	10V 3 for 1.10 for 1.01	1.01
6	11V 3 for 1.10 for 1.01	1.01
7	12V 3 for 1.10 for 1.01	1.01

Order by Cat. No. 5210B

Watts	Sale	1 CA SALE
6 V	3 for 1.6 for 1.01	1.01
8.2V	3 for 1.6 for 1.01	1.01
15 V	3 for 1.6 for 1.01	1.01
24 V	3 for 1.6 for 1.01	1.01
30 V	3 for 1.6 for 1.01	1.01

WE'RE OVERLOADED WITH BRAND NEW IC'S

Sale	2 for	Order by type number	2 for
SN7401	\$1.18	SN7470	.29 .30
SN7402	.29	SN7472	.29 .30
SN7403	.18	SN7474	.35 .36
SN7420	.20	SN7480	.50 .51
SN7426	.29	SN7486	.65 .66
SN7437	.25	SN7416A	.80 .80
SN7440	.20	SN7416B	.80 .80
SN7450	.20	SN74182	.79 .80
SN7455	.20	SN74193	.79 .80
SN7464	.20	SN74195	.60 .70

RIBBON CABLE AT THIN PRICES

Cond	Sale	2 for	Ultra flat / 28 AWG
10	1.00	\$1.20	\$1.99
14	1.00	1.98	1.99
20	1.00	1.98	1.99
26	1.00	1.98	1.99
34	1.00	1.98	1.99
36	1.00	1.98	1.99
50	1.00	1.98	1.99
60	1.00	1.98	1.99

2 AMP METAL SILICON CYLINDER RECTIFIERS

50V	10 for \$3.50	20 for \$6.00
100V	10 for \$6.00	20 for \$7.00
200V	10 for \$7.00	20 for \$8.00
400V	10 for \$8.00	20 for \$9.00

LED'S: YOUR CHOICE \$ for \$1.00

Order by Cat. No.	17 TOPHAT RED	1795 JUMBO TAPER CLOUDY	1802 MICRO SINGLE PIN RED	1948 MICRO YELLOW	2135 JUMBO TAPER CLEAR	2136 JUMBO TAPER RED	2137 MICRO RED	2790 JUMBO RED CLEAR
10 for \$1.00	10 for \$1.00	10 for \$1.00	10 for \$1.00	10 for \$1.00	10 for \$1.00	10 for \$1.00	10 for \$1.00	10 for \$1.00

POLY PAKS®

GOD'S MAY BE PHONED!
P.O. BOX 942-A2
SO. LYNNFIELD, MA 01940
Terms: Add Postage Rated: Net 30
Phone: (617) 245-3828
Retail: 16-18 Del Carmine St.
MINIMUM ORDER: \$8 Wakefield, MA

"BEEM-O-LITE" LASER DIODES

2 for \$8.99 each

1N4000 Epoxy Rectifiers

Cat. No.	Type	Volta	Sale	1C SALE!
2377	1N4001	50	10 for \$7.20	20 for \$7.76
2378	1N4002	100	10 for \$8.20	20 for \$8.86
2379	1N4003	200	10 for \$9.20	20 for \$9.86
2380	1N4004	400	10 for \$1.20	20 for \$1.20
2381	1N4005	600	10 for \$1.20	20 for \$1.20
2382	1N4006	800	10 for \$1.20	20 for \$1.20
2383	1N4007	1000	10 for \$1.20	20 for \$1.20

7294 N.W. 54 STREET
MIAMI, FLORIDA 33166

SURPLUS ELECTRONICS CORP. ✓S43

PHONE: (305) 887-8228
TWX: 810-848-6085
WHOLESALE - RETAIL

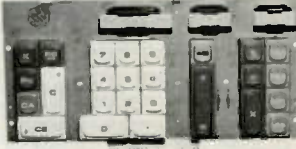
<p>PL 259's QUALITY AMERICAN MADE 10/\$5.00 100/\$35.00 50/\$20.00 1000/\$300.00</p>	<p>E. F. Johnson Desk Top Microphone Ceramic Element/High Imp \$20.00 ea While They Last</p>		<p>IC SOCKETS Cambion Gold Plated Wire Wrap 14 pin .35 ea 10/\$3.00 16 pin .38 ea 10/\$3.30</p>
<p>RCA POWER MODULE 450-470 MHz 10W UHF Hybrid \$20.00 ea.</p>	<p>TEXAS INSTRUMENT KEYBOARD</p>  <p>\$1.95 ea., 5 for \$8.00 10 for \$13.95</p> <p>Has 3 slide switches—28 different keys—keypads removable by removing 4 screws.</p>		<p>MODEM CABLE 50' cable contains 13 # 22 ga. wire DB-25p with DB-51226-1 cover on one end \$6.50 ea 10/\$50.00</p>
<p>EFJ Push-To-Talk Telephone Style Handset \$7.00 ea.</p>	<p>MINI TOGGLE SW C&H SPDT \$1.00 ea 6/\$5.00</p>	<p>12 Vdc RELAY SPST 35 Amp Contacts Open Frame Rugged, great for mobile use \$4.50 ea 5/\$20.00</p>	<p>EFJ CRYSTAL OVENS 6V/12V 75° \$5.00 ea.</p>
<p>White Porcelain Egg Insulator 1 1/2" x 1" 50c ea 3 for \$1.25</p>	<p>WIRE WOUND RESISTORS .1 Ohm—5 W .10 Ohm—10 W @ 15c each</p>	<p>RECEIVER FRONT ENDS Made by EFJ 132-174 MHz \$12.00 ea.</p>	<p>MOTOROLA SRF 574 house marked 9W 175 MHz Amp. \$5.00 ea.</p>
<p>PANEL METERS 2 1/4" x 2 1/4" also 2 1/4" x 3" 10-0-10 dc Amps } \$4.00 ea 0-20 dc Volts } 25-0-25 dc Volts } 2 for 0-25 dc Volts } \$7.00 0-50 ac Volts } -Shunt Required-</p>	<p>CB SPECIAL Brand new printed circuit board assembly. Used in all HyGain 40 channel CB transceivers. Fits many other manufacturers' units also. Squelch pot/volume control/channel selector switch not included. 1-9—7.50 ea. Board Dimensions 16" x 6 1/2" 10-49—6.50 ea. 50-99—6.00 ea. 100-up—5.50 ea.</p>		<p>MUFFIN FANS 3 Blades, 110 Vac, 4 3/4" sq. Removed from equipment—Excellent condition—\$4.95</p>
<p>CMOS RCA CD 4012 AE Dual 4 In Nand Gate 6/\$1.00 100/\$10.00 50/\$6.00 1000/\$80.00</p>	<p>12 Vdc RELAY SPST Open Frame 5 Amp Contacts Mfg-Magnecraft \$1.50 ea 4/\$5.00</p>	<p>POLYFOAM COAX—50 OHM Equal to RG174 \$4.95/100' Low Loss Polyfoam Coax Cable</p>	<p>"New" Muffin Fans 3 Blades-110 Vac, 4 3/4" sq. \$9.95</p> <p>TRIMMER CAPS Small enough to fit in your watch— 3.5 to 20 pF 5 to 30 pF \$.75 ea., 2 for \$1.25 5 for \$3.00</p>
<p>D Cell Nicad mfg. by G. E. 2.50 ea 1.2 volts 3.5 amp hrs. cat No. 41B004 AD08G5</p>	<p>Coax Connectors UG-273/U BNC-F/UHF-M 2.50 UG-255/U BNC-M/UHF-F 3.00 UG-146A/U N-M/UHF-F 4.50 UG-83B/U N-F/UHF-M 4.50 UG-175 RG-58 Adapt. .20 UG-176 RG-59 Adapt. .20</p>		<p>CRYSTAL FILTERS 10.7 3/Lead Can Type \$3.00 ea.</p>
<p>Computer Grades 23,200 uf @ 50 Vdc 3.00 ea 3" diam x 4 1/2" high G. E.</p>	<p>CERAMIC IF FILTERS EFC L455K \$3.50 ea.</p>	<p>CAPS 2200 UF @ 16V Radial Leads .25 ea. 10/\$2.00</p>	<p>NEW BOXER FANS 5 blades 110 VAC 4 3/4" sq.—\$11.95</p>
<p align="center">GOLD PLATED CARD EDGE CONNECTORS</p>			
<p>Double Row/Wire Wrap .100 25 pins \$3.49 ea 10/\$30.00 30 pins \$3.96 ea 10/\$32.00 50 pins \$5.43 ea 10/\$45.00</p>	<p>Double Row/Solder Eyelet .156 6 pins \$1.10 ea 10/\$9.00 15 pins \$1.55 ea 10/\$12.50 22 pins \$2.08 ea 10/\$17.00 43 pins \$3.66 ea 10/\$30.00</p>	<p>22 pins/Double Row/Dipped Solder .156 \$2.08 ea 10/\$17.00</p> <p>22 pins/Double Row/Wire Wrap .156 \$2.44 ea 10/\$19.00</p>	

TERMS: All material guaranteed • If for any reason you are not satisfied, our products may be returned within 10 days for a full refund (less shipping). Please add \$3 for shipping and handling on all orders. Additional 5% charge for shipping any item over 5 lbs. COD's accepted for orders totalling \$50.00 or more. All orders shipped UPS unless otherwise specified. Florida residents please add 4% sales tax. Minimum order \$15.00.

EQUIPMENT / COMPONENTS / WIRE & CABLE / ACCESSORIES

GET YOUR

NEW 1979

Published December 1st, 1978

RADIO AMATEUR CALLBOOKS

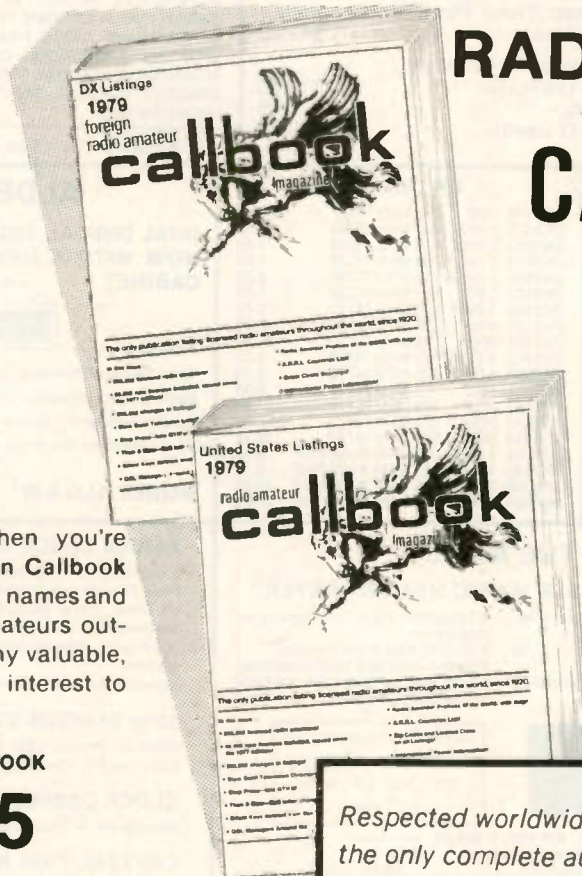

Specialize in DX? Then you're looking for the Foreign Callbook with over 280,000 calls, names and addresses of radio amateurs outside the USA plus many valuable, additional features of interest to the DX'r.

FOREIGN CALLBOOK
\$14.95
PLUS SHIPPING

The U.S. Callbook has over 350,000 W & K listings. It lists calls, license classes, names and addresses plus the many valuable back-up charts and references you come to expect from the Callbook.

UNITED STATES CALLBOOK

\$15.95
PLUS SHIPPING

*Respected worldwide as
the only complete authority
for radio amateur
QSL and QTH information.*

See your favorite electronics dealer for the latest issue or order direct from the publisher using handy order form.

Payment in U.S. funds must be sent directly to publisher not through a bank.

**Radio
Amateur** ✓ R1
callbook, INC.
925 SHERWOOD DRIVE
LAKE BLUFF, ILLINOIS 60044

ORDER FORM

Item	Price Each	Shipping	Total Price
<input type="checkbox"/> U. S. CALLBOOK	\$15.95	\$1.75	\$17.70
<input type="checkbox"/> FOREIGN CALLBOOK	\$14.95	\$1.75	\$16.70

Illinois residents only add 5% sales tax _____

Name _____

Address _____

TOTAL _____

City _____

State _____ Zip _____

Charge my: Visa Card Master Charge

Card No. _____ Expiration Date _____

Dept. B _____ Signature _____

ALDELCO ELECTRONIC CENTER

AT LAST!!! A PROFESSIONAL LOOKING
CAR CLOCK CABINET
FOR THE MA1003 CAR CLOCK MODULE

OVERVOLT 12

Crow Bar circuit protects Transceivers & Tape Decks from runaway power supply voltage that can zap expensive components. OV 12 causes fuse in Power Supply to blow if voltage exceeds preset level (approx. 16 to 18 volts). Rated at 25 Amperes. \$ 7.95
Model OV5. Protects 5 Volt circuits. Triggers at 7.5 Volts \$8.95
Other units available at 3.3 to 100 Trigger Voltages \$10.95 ea

THE LUNCH COUNTER



Build a 600 MHz 6 Digit Frequency Counter. We supply 3 PC Boards, Silk Screened Front Panel and complete Instructions Only \$12.50
Chips used in Counter
11C90 Prescaler \$14.50
74C925 9.95
F9368 (2 used) ea 3.95

Measures
3-5/8" Wide
2-1/8" High
1-15/16" Deep

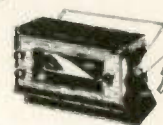

ONLY
\$5.95

PERFECT FOR VANS
AND RECREATIONAL
VEHICLES

ATTRACTIVE IMPACT RESISTANT ABS BLACK PLASTIC CABINET WITH CHROME TRIMMED FRONT. HAS REMOVABLE WOOD GRAIN INSERT THAT WILL MATCH OR COMPLIMENT MOST AUTO INTERIORS. CAN BE INSTALLED "IN DASH" OR MOUNTED ON DASHBOARD TOP OR BOTTOM WITH SUPPLIED BRACKET. CONTROL SWITCHES CAN BE MOUNTED REMOTE OR AS SHOWN.

MA1003 National Car Clock Module with 3 push switches \$17.95

AEC 1074 50Watt
@30 MHz \$21.15
AEC 1076 75Watt
@ 50 MHz \$24.00
both cases 500 4LFL

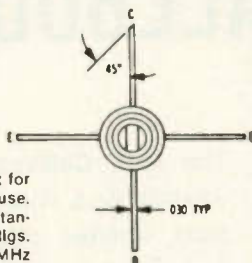

Hard to find replacement for VHF Mobile & Marine use. Successfully used in Standard and other VHF Rigs. Rated 12 Watts at 200 MHz 12.5 Volts with 5.3 DB Gain. Heat Sink stud (8/32) Isolated from leads. Only \$12.30

AEC 1158

RF DEVICES

2N2876 18W	200 MHz TO60	\$12.35
2N3375 3.0W	400 MHz TO60	5.60
2N3553 2.5W	175 MHz TO39	1.40
2N3866 1.0W	400 MHz TO39	1.25
2N3926 7.0W	175 MHz TO60	6.30
2N4427 1.0W	175 MHz TO39	1.35
2N5589 3.0W	175 MHz MT71	4.75
2N5590 10W	175 MHz MT72	7.80
2N5591 25W	175 MHz MT72	10.25
2N5913 1.75W	175 MHz TO39	1.70
2N6080 4.0W	175 MHz MT72	5.40
2N6081 15W	175 MHz MT72	8.45
2N6082 25W	175 MHz MT72	10.95
2N6083 30W	175 MHz MT72	12.30
2N6084 40W	175 MHz MT72	16.30
2N6094 4.0W	175 MHz X106 PNP	6.60
2N6095 15W	175 MHz X106 PNP	8.50
2N6096 30W	175 MHz X106 PNP	10.35
2N6097 40W	175 MHz X106 PNP	20.00

ALDELCO KITS

DUAL DIGITAL 12/24 HOUR CLOCK KIT
NOW WITH A NEW WALNUT GRAIN WOOD CABINET



Features:

- 12 or 24 Hour Operation on either clock
- Each Clock separately controlled
- Freeze feature for time set
- Easy assembly for clock and cabinet

BIG
0.5 LEDS

MODEL ALD 5-W ONLY \$49.95

LEDS

Monsanto MAN 72 Red LED Readout .300" High, Common Anode. ONLY \$.89

Monsanto MV5053 JUMBO LED and Holder only .25
LED Holders .10
Jumbo Red LEDES 8 for \$1.00
Jumbo Green, Orange or Yellow LEDES 5 for \$1.00

FETS

MFP102	.55
2N3819	.35
2N5457	.50
2N5458	.50
2N5459	.55
2N5485	.50
2N5486	.72

DARLINGTON

MPSA 13	.80
MPSA 14	.40
2N5306	.50
SCR	
C 106A	.55
C 106B	.65
C 122B	.85

— THE MIMIC —

PROGRAMMABLE IAMBIC MEMORY KEYS

- Four memory inputs, sixty letters each
- Five minutes of memory @ 10 wpm
- Operates on 110 V ac and 8-16 vdc
- Triggered clock for memory recording
- Built-in side tone monitor
- Speed control 5 to 40-plus wpm
- Two to three times the memory of nearest competitor



Comes in attractive light blue cabinet measuring 2 1/2" high x 4" wide x 5" deep.

KIT ONLY \$79.95
Kit with set of paddles \$104.95
Assembled unit \$99.95
Paddles only \$29.95

VOLTAGE REGULATORS

TO220 Package	
Positive \$1.00	Negative \$1.25
7805	7905
7806	7906
7808	7912
7812	7915
7815	

CLOCK CHIPS

5313	3.49
5314	3.49
5316	3.95
5375	3.95
CT7001	6.95

2200 MFD 16 volt
Radial Cap 3 for 89¢

ALARM CLOCK KIT

6 Big 0.5 LED Displays · On Board AC Transformer · 12 Hour Format with 24 Hour Alarm · Snooze Feature · Elapsed Timer. Timer feature makes this Popular in Broadcast Stations. It's a natural for cars, boats and campers when used with optional crystal time base. Fits our standard cabinet. \$19.95
Crystal time base when purchased with clock. \$2.95

12 or 24 HOUR DIGITAL CLOCK KIT

Uses 0.5 Display LED. 5314 Clock Chip. Freeze feature for accurate set, fits our standard cabinet. ONLY \$18.95

CLOCK CABINETS

Woodgrain or black leather ea. \$4.95

CRYSTAL TIME BASE KIT

Includes PC Board, Crystal, all parts and Instructions. \$4.95

CLOCK FILTERS

Blue, Red, Green, Amber or Smoke \$.60

Blinky Flasher Kit

PC board, 555 & all parts works on 9 volts. Mouse button—\$1.00

DIGITAL MULTIMETER & THERMOMETER

3 1/2 Digit—5 ranges on each function AC/DC 2 Volts to 2000 Volts Current 2 Microamps to 2 Amps Resistance 2000 Ohms to 2 Megohms. Includes PC Board, ICL7107 Chip and all parts. Only \$49.95

CRYSTAL SOCKETS

HOLDS 8 HC25U . . . \$.59
Single HC25U29

144 MHz 10 Watts
RF Transistor
2N5590 \$5.50 ea.



NEW!

Tunable 420 MHz
Fast Scan TV
Converter

Receive Fast Scan Amateur TV in the 420 to 450 MHz Band with any TV set. Low noise, high gain rf amp with Varactor tuned input and outputs. Built in AC supply. Comes in two tone walnut & beige cabinet measuring 1 7/8" x 4 1/4" x 4 1/8". Factory wired with 2 year guarantee. \$59.95

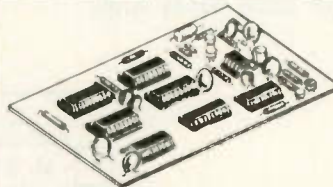

THE VERY POPULAR TOPE ACCUKEYER KIT

- Self Completing Dots & Dashes
- Iambic Operation
- Single Dot & Dash Memories
- Provision for attachment of 256 or 512 Bit Memory for DX or Contest work

Revised version of the Accukeyer featured in the ARRL Handbook. Has more logical IC Layout and ON Board sidetone Oscillator. Includes PC Board, TTL ICs, 555 Timer, IC Sockets, Switch, Speaker, Transistors, capacitors and resistors. Requires 5VDC. ONLY \$19.95

ACCUKEYER MEMORY KIT

Simple low cost Memory Kit. Uses 2 programmable 1101 Memory chips. Provides 2 canned messages of 30 Characters each. Adaptable to Handbook and other Accukeyers. Includes PC board (same size as accukeyer board) and all parts. Requires 5 VDC, 9 VDC. \$19.95

SPECIALS

MC1458P	.29
555 Timer	.3 for \$1.00
4011	.23

ADJUSTABLE POWER SUPPLY KITS

5-15 Volts 500 MA	\$6.95
12-28 Volts 500 MA	6.95

ALDELCO

2789A MILBURN AVE, BALDWIN, N.Y. 11510
516-378-4555

Add 6% shipping. Add \$1.00 for orders under \$10.00. Out of U.S.A. add 15% shipping and certified check or money order in U.S. funds.

DIODES/ZENERS			
QTY.			
1N914	100v	10mA	.05
1N4005	600v	1A	.08
1N4007	1000v	1A	.15
1N4148	75v	10mA	.05
1N4733	5.1v	1 W Zener	.25
1N753A	6.2v	500 mW Zener	.25
1N758A	10v	"	.25
1N759A	12v	"	.25
1N5243	13v	"	.25
1N5244B	14v	"	.25
1N5245B	15v	"	.25

SOCKETS/BRIDGES			
QTY.			
8-pin	pcb	.20 ww	.35
14-pin	pcb	.20 ww	.40
16-pin	pcb	.20 ww	.40
18-pin	pcb	.25 ww	.95
20-pin	pcb	.35 ww	.95
22-pin	pcb	.35 ww	.95
24-pin	pcb	.35 ww	.95
28-pin	pcb	.45 ww	1.25
40-pin	pcb	.50 ww	1.25
Molex pins	.01 To-3 Sockets		.25
2 Amp Bridge	100-prv		.95
25 Amp Bridge	200-prv		1.50

TRANSISTORS, LEDS, etc.			
QTY.			
2N2222	(2N2222 Plastic .10)		.15
2N2222A			.19
2N2907A	PNP		.19
2N3906	PNP (Plastic Unmarked)		.10
2N3904	NPN (Plastic Unmarked)		.10
2N3054	NPN		.45
2N3055	NPN 15A 60v		.60
T1P125	PNP Darlington		1.95
LED Green	Red, Clear, Yellow		.15
D.L.747	7 seg 5/8" High com-anode		1.95
MAN72	7 seg com-anode (Red)		1.25
MAN3610	7 seg com-anode (Orange)		1.25
MAN82A	7 seg com-anode (Yellow)		1.25
MAN74	7 seg com-cathode (Red)		1.50
FND359	7 seg com-cathode (Red)		1.25

9000 SERIES			
QTY.		QTY.	
9301	.85	9322	.65
9309	.35	9601	.20
9316	1.10	9602	.45

MICRO'S, RAMS, CPU'S, E-PROMS			
QTY.		QTY.	
8T13	1.50	2107B-4	4.95
8T23	1.50	2114	9.50
8T24	2.00	2513	6.25
8T97	1.00	2708	10.50
74S188	3.00	2716 D.S.	34.00
1488	1.25	2716 (5v)	59.00
1489	1.25	2758 (5v)	23.95
1702A	4.50	3242	10.50
AM 9050	4.00	4116	11.50
		6800	13.95
MM 5314	3.00	6850	7.95
MM 5316	3.50	8080	7.50
MM 5387	3.50	8212	2.75
MM 5369	2.95	8214	4.95
TR 1602B	3.95	8216	3.50
UPD 414	4.95	8224	3.25
Z 80 A	22.50	8228	6.00
Z 80	17.50	8251	7.50
Z 80 PIO	10.50	8253	18.50
2102	1.45	8255	8.50
2102L	1.75	TMS 4044	9.95

C MOS	
QTY.	
4000	.15
4001	.15
4002	.20
4004	3.95
4006	.95
4007	.20
4008	.75
4009	.35
4010	.35
4011	.20
4012	.20
4013	.40
4014	.75
4015	.75
4016	.35
4017	.75
4018	.75
4019	.35
4020	.85
4021	.75
4022	.75
4023	.20
4024	.75
4025	.20
4026	1.95
4027	.35
4028	.75
4029	1.15
4030	.30
4033	1.50
4034	2.45
4035	.75
4037	1.80
4040	.75
4041	.69
4042	.65
4043	.50
4044	.65
4046	1.25
4048	.95
4049	.45
4050	.45
4052	.75
4053	.75
4066	.55
4069/74C04	.35
4071	.25
4081	.30
4082	.30
4507	.95
4511	.95
4512	1.10
4515	2.95
4519	.85
4522	1.10
4526	.95
4528	1.10
4529	.95
MC 14409	14.50
MC 14419	4.85
74C151	1.50

LINEARS, REGULATORS, etc.			
QTY.		QTY.	
MCT2	.95	LM323K	5.95
8038	3.95	LM324	1.25
LM201	.75	LM339	.75
LM301	.45	7805 (340T5)	.95
LM308	.65	LM340T12	.95
LM309H	.65	LM340T15	.95
LM309K (340K-5)	1.50	LM340T18	.95
LM310	.85	LM340T24	.95
LM311D	.75	LM340K12	1.25
LM318	1.75	LM340K15	1.25
LM320H6	.79	LM340K18	1.25
LM320H15	.79	LM340K24	1.25
LM320H24	.79	LM373	2.95
7905 (LM320K5)	1.65	LM377	3.95
LM320K12	1.65	78L05	.75
LM320K24	1.65	78L12	.75
LM320T5	1.65	78L15	.75
LM320T12	1.65	78M05	.75
LM320T15	1.65		
		LM380 (8-14 Pin)	1.19
		LM709 (8-14 Pin)	.35
		LM711	.45
		LM723	.40
		LM725	2.50
		LM739	1.50
		LM741 (8-14)	.35
		LM747	1.10
		LM1307	1.25
		LM1458	.65
		LM3900	.50
		LM75451	.65
		NE555	.45
		NE556	.85
		NE565	.95
		NE566	1.25
		NE567	.95

- T T L -			
QTY.		QTY.	
7400	.10	7482	.75
7401	.15	7483	.75
7402	.15	7485	.55
7403	.15	7486	.25
7404	.10	7489	1.05
7405	.25	7490	.45
7406	.25	7491	.70
7407	.55	7492	.45
7408	.15	7493	.35
7409	.15	7494	.75
7410	.15	7495	.60
7411	.25	7496	.80
7412	.25	74100	1.15
7413	.25	74107	.25
7414	.75	74121	.35
7416	.25	74122	.55
7417	.40	74123	.35
7420	.15	74125	.45
7426	.25	74126	.35
7427	.25	74132	.75
7430	.15	74141	.90
7432	.20	74150	.85
7437	.20	74151	.65
7438	.20	74153	.75
7440	.20	74154	.95
7441	1.15	74156	.70
7442	.45	74157	.65
7443	.45	74161	.55
7444	.45	74163	.85
7445	.65	74164	.60
7446	.70	74165	1.10
7447	.70	74166	1.25
7448	.50	74175	.80
7450	.25	74176	.85
7451	.25	74180	.55
7453	.20	74181	2.25
7454	.25	74182	.75
7460	.40	74190	1.25
7470	.45	74191	1.25
7472	.40	74192	.75
7473	.25	74193	.85
7474	.30	74194	.95
7475	.35	74195	.95
7476	.40	74196	.95
7480	.55	74197	.95
7481	.75	74198	1.45
		74221	1.00
		74367	.95
		75108A	.35
		75491	.50
		75492	.50
		74H00	.15
		74H01	.20
		74H04	.20
		74H05	.20
		74H08	.35
		74H10	.35
		74H11	.25
		74H15	.45
		74H20	.25
		74H21	.25
		74H22	.40
		74H30	.20
		74H40	.25
		74H50	.25
		74H51	.25
		74H52	.15
		74H53	.25
		74H55	.20
		74H72	.35
		74H74	.35
		74H101	.75
		74H103	.55
		74H106	.95
		74L00	.25
		74L02	.20
		74L03	.25
		74L04	.30
		74L10	.20
		74L20	.35
		74L30	.45
		74L47	1.95
		74L51	.45
		74L55	.65
		74L72	.45
		74L73	.40
		74L74	.45
		74L75	.85
		74L93	.55
		74L123	.85
		74LS00	.30
		74LS01	.30
		74LS02	.30
		74LS04	.30
		74LS05	.35
		74LS08	.35
		74LS09	.35
		74LS10	.35
		74LS11	.35
		74LS12	.35
		74LS22	.35
		74LS32	.35
		74LS37	.35
		74LS38	.45
		74LS40	.40
		74LS42	.75
		74LS51	.45
		74LS74	.45
		74LS76	.50
		74LS86	.45
		74LS90	.65
		74LS93	.65
		74LS107	.50
		74LS123	1.20
		74LS151	.85
		74LS153	.85
		74LS157	.85
		74LS160	.95
		74LS164	1.20
		74LS193	1.05
		74LS195	.95
		74LS244	1.70
		74LS367	.95
		74LS368	.95
		74S00	.35
		74S02	.35
		74S03	.25
		74S04	.25
		74S05	.35
		74S08	.35
		74S10	.35
		74S11	.35
		74S20	.25
		74S40	.20
		74S50	.20
		74S51	.25
		74S64	.15
		74S74	.35
		74S112	.60
		74S114	.65
		74S133	.40
		74S140	.55
		74S151	.30
		74S153	.35
		74S157	.75
		74S158	.30
		74S194	1.05
		74S257 (8123)	1.05
		8131	2.75

INTEGRATED CIRCUITS UNLIMITED
 7889 Clairemont Mesa Blvd., San Diego, California 92111
 24 Hour Toll Free Phone 1-800-854-2211
 (714) 278-4394 California Residents 1-800-542-6239
 CABLE ADDRESS ICUSD

CUSTOMER NAME _____

STREET ADDRESS _____

CITY _____ STATE _____ ZIP _____

PHONE _____ CHARGE CARD # _____ AE Visa BA MC _____ EXP. DATE _____

C.O.D. _____ WILL CALL _____ UPS _____ POST _____ NET 10th OF THE MONTH _____ PO # _____

ALL ORDERS SHIPPED PREPAID - NO MINIMUM - COD ORDERS ACCEPTED - ALL ORDERS SHIPPED SAME DAY
 OPEN ACCOUNTS INVITED - California Residents add 6% Sales Tax. PRICES SUBJECT TO CHANGE WITHOUT NOTICE.
 We accept American Express / Visa / BankAmericard / Master Charge

SPECIAL DISCOUNTS

Total Order	Deduct
\$35-\$99	10%
\$100-\$300	15%
\$301-\$1000	20%

VARIABLE POWER SUPPLY KIT \$11⁹⁵

- Continuously Variable from 2V to over 15V
- Short-Circuit Proof
- Typical Regulation of 0.1%
- Electronic Current Limiting at 300mA
- Very Low Output Ripple
- Fiberglass PC Board Mounts All Components
- Assemble in about One Hour
- Makes a Great Bench or Lab Power Supply
- Includes All Components except Case and Meters

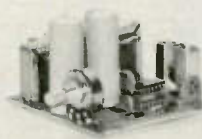

ADD \$1.25 FOR POSTAGE/HANDLING

SPECIALS—THIS MONTH ONLY

1N364	Germanium Diode 80V 10mA	10/51	LM308H	Low Bias Current Op Amp Super 709	\$0.84
1N210	Germanium Diode 80V 200mA	4/51	LM305K	5 Volt Regulator T-3	.14
1N914	Silicon Diode 100V 10mA	25/51	LM317K	Adjustable Voltage Regulator 2.37V	3.40
1N4223	Hot Carrier Diode (MP2800, etc.)	\$1.00	LM3800	2 Watt Audio Power Amplifier DIP	.94
F7	Power Varactor 1-2W Out @ 437MHz (Spec. & Circuits included with F7)	\$2.00	NE565A	Phase Locked Loop DIP	.94
DIODE GRAB BAG—Mixed zeners, rectifiers, etc.		50/51	LM723CN	Precision Voltage Regulator DIP	3/51
2N706	NPN High Speed Switch 75m	4/51	LM747	Dual 741 Compensated Op Amp DIP	2/51
2N918	UMT Transistor—Dca/Amp up to 1 GHz	4/51	2102	1024 Bit Static RAM (1024 x 1)	\$1.75
2N2609	P-Channel FET Amplifier 2500mhos	\$1.00	21450E	FET Input Op Amp like NE 536/μA740	1.95
2N2920	NPN Dual Transistor 3mV Match β225	2.85	CA3018A	4-Transistor Array/Darlington	1.45
2N3904	NPN Amp/Switch @100 40V 700mA	8/51	CA3028A	RF/IF Amplifier DC to 120MHz	1.45
2N4122	PNP RF Amplifier & Switch	3/51	CA3075E	FM IF Amp/Limiter/Detector DIP	1.45
2N4896E	N-Channel Audio FET Super Low Noise	2/51	RC4558	Dual High Gain Op Amp mDIP	3/51
2N4888	150 Volt PNP Transistor for Relay	2/51	MS565V	Precision Fast Op Amp mDIP	2/51
4112	N-Channel FET VHF RF Amp	3/51	MS568V	Dual Hi Gain Op Amp Comp. mDIP	3/51
TIS74	N-Channel FET High-Speed Switch 40V	3/51	8038	Function Generator/VCO with circuits	\$3.75
			LP-10	LOGIC PROBE kit—TTL, CMOS, etc. Mached case included—1/4 hr. assembly	\$7.85

SEND FOR ADVA'S NEW 1979 CATALOG
NEARLY 1000 SEMICONDUCTORS, KITS, CAPACITORS, ETC. SEND 25¢ STAMP.

OTHER ADVA KITS:

LOGIC PROBE KIT: Use with CMOS, TTL, TTL, RTL, HTL, HMITL and most MOS IC's. Built-in protection against polarity reversal and overvoltage. Draws only a few mA from circuit under test. Dual LED readout. Complete kit includes case and clip leads. **ONLY \$7.95**

FIXED REGULATED POWER SUPPLY KITS—Short-circuit proof with thermal current limiting. Compact size and typical regulation of 0.5% make these ideal for most electronic projects. Available for 5V @ 500mA, 8V @ 500mA, 9V @ 500mA, 12V @ 400mA, 15V @ 300mA. Specify voltage when ordering. \$8.95 ea.

These easy-to-assemble kits include all components, complete detailed instructions and plated fiberglass PC boards. Power supply kits do not include case and meters. Add \$1.25 per kit for postage and handling.

MAIL NOW! FREE DATA SHEETS supplied with many items from this ad. **FREE ON REQUEST—741 Op Amp** with every order of \$5 or more—749 Dual Op Amp or two E100 FET's with every order of \$10 or more, postmarked prior to 12/31/78. One free item per order. **ORDER TODAY—All items subject to prior sale and prices subject to change without notice.** All items are new surplus parts—100% functionally tested.

WRITE FOR FREE CATALOG #79 offering over 700 semiconductors carried in stock. Send 25¢ stamp. **TERMS:** Send check or money order (U.S. funds) with order. Add 5% postage for U.S. Canada and Mexico. \$1.00 handling charge on orders under \$10. Calif. residents add 6% sales tax. Foreign orders add 10% postage. COD orders—add \$1.00 service charge.

MORE SPECIALS:

RC41950N ±15V @ 50mA VOLTAGE REGULATOR IC. Very easy to use. Makes a neat Highly Regulated ±15V Supply for OP AMP's, etc. Requires only unregulated DC (18-30V) and 2 bypass capacitors. With Data Sheet and Schematics. 8-pin mDIP **\$1.25**

RC4136 Quad 741 Low Noise Op Amp mDIP **\$0.95**

LM1304 FM Multiplex Stereo Demodulator DIP **0.99**

LM2111 FM IF Subsystem (IF Amp, Det., Limiter) DIP **0.99**

1N6263 Hot Carrier Diode 0.4V @ 1mA @ 1.0m DD-35 **1.00**

ZENERS—Specify Voltage 3.3, 3.9, 4.3, 5.1, 6.8, 8.2 **400mW 4/51**
1 Watt 3/51

- MONEY-BACK GUARANTEE
- ALL TESTED AND GUARANTEED

ADVA ELECTRONICS
BOX 4181 GB, WOODSIDE, CA 94062
Tel. (415) 328-1500

FREE IC or FET's WITH \$5 & \$10 ORDERS.1 DATA SHEETS WITH MANY ITEMS.

DIODES	TRANSISTORS	TRANSISTORS	TRANSISTORS	LINEAR IC's
ZENERS & RECTIFIERS	2N706	2N4901	3N71	2N4136
1N456	2N718	2N4092	50.75	2N5640
1N458	2N720	2N4121	3/51	CP643
1N463	2N810	2N4122	3/51	CP650
1N485	2N1513	2N4124	5/51	CP661
1N486	2N1711	2N4248	5/51	E100
1N746	2N1890	2N4249	5/51	E101
1N758	2N1893	2N4250	4/51	F182
1N801*	1N2121	2N4259	5/51	E115
1N962	2N2222	2N4302	50.75	MPF102
1N974	2N2222A	2N4303	29	MPF1304
1N2064	2N2281	2N4308	5/51	MPF112
1N3600	2N2606	2N4360M	2/51	MPF501
1N4001*	12/51	2N2609	52	2N4398
1N4002	12/51	2N2905	50.24	2N4392
1N4004	12/51	2N2907*	5/51	2N4316A
1N4005	10/51	2N3553	51.50	2N4856
1N4006	10/51	2N3563	5/51	2N4861
1N4007	10/51	2N3564	4/51	2N4851E
1N4148	15/51	2N3545	6/51	2N4856E
1N4154*	25/51	2N3548	6/51	2N4881
1N4210	2/51	2N3638	6/51	2N4818
1N4372	2/51	2N3638A	5/51	2N4895
1N4454	15/51	2N3641	5/51	2N5007
1N4729	3/51	2N3642	5/51	2N5088
1N4753	4/51	2N3644	4/51	2N5075
1N5231	4/51	2N3647	4/51	2N5126
1N5238	4/51	2N3646	4/51	2N5138
		2N3688	3/51	2N5139
		2N3690	3/51	2N5153
		2N3691	5/51	2N5154
		2N3692	3/51	2N5155
		2N3693	3/51	2N5156
		2N3694	3/51	2N5157
		2N3695	3/51	2N5158
		2N3696	3/51	2N5159
		2N3697	3/51	2N5160
		2N3698	3/51	2N5161
		2N3699	3/51	2N5162
		2N3700	3/51	2N5163
		2N3701	3/51	2N5164
		2N3702	3/51	2N5165
		2N3703	3/51	2N5166
		2N3704	3/51	2N5167
		2N3705	3/51	2N5168
		2N3706	3/51	2N5169
		2N3707	3/51	2N5170
		2N3708	3/51	2N5171
		2N3709	3/51	2N5172
		2N3710	3/51	2N5173
		2N3711	3/51	2N5174
		2N3712	3/51	2N5175
		2N3713	3/51	2N5176
		2N3714	3/51	2N5177
		2N3715	3/51	2N5178
		2N3716	3/51	2N5179
		2N3717	3/51	2N5180
		2N3718	3/51	2N5181
		2N3719	3/51	2N5182
		2N3720	3/51	2N5183
		2N3721	3/51	2N5184
		2N3722	3/51	2N5185
		2N3723	3/51	2N5186
		2N3724	3/51	2N5187
		2N3725	3/51	2N5188
		2N3726	3/51	2N5189
		2N3727	3/51	2N5190
		2N3728	3/51	2N5191
		2N3729	3/51	2N5192
		2N3730	3/51	2N5193
		2N3731	3/51	2N5194
		2N3732	3/51	2N5195
		2N3733	3/51	2N5196
		2N3734	3/51	2N5197
		2N3735	3/51	2N5198
		2N3736	3/51	2N5199
		2N3737	3/51	2N5200
		2N3738	3/51	2N5201
		2N3739	3/51	2N5202
		2N3740	3/51	2N5203
		2N3741	3/51	2N5204
		2N3742	3/51	2N5205
		2N3743	3/51	2N5206
		2N3744	3/51	2N5207
		2N3745	3/51	2N5208
		2N3746	3/51	2N5209
		2N3747	3/51	2N5210
		2N3748	3/51	2N5211
		2N3749	3/51	2N5212
		2N3750	3/51	2N5213
		2N3751	3/51	2N5214
		2N3752	3/51	2N5215
		2N3753	3/51	2N5216
		2N3754	3/51	2N5217
		2N3755	3/51	2N5218
		2N3756	3/51	2N5219
		2N3757	3/51	2N5220
		2N3758	3/51	2N5221
		2N3759	3/51	2N5222
		2N3760	3/51	2N5223
		2N3761	3/51	2N5224
		2N3762	3/51	2N5225
		2N3763	3/51	2N5226
		2N3764	3/51	2N5227
		2N3765	3/51	2N5228
		2N3766	3/51	2N5229
		2N3767	3/51	2N5230
		2N3768	3/51	2N5231
		2N3769	3/51	2N5232
		2N3770	3/51	2N5233
		2N3771	3/51	2N5234
		2N3772	3/51	2N5235
		2N3773	3/51	2N5236
		2N3774	3/51	2N5237
		2N3775	3/51	2N5238
		2N3776	3/51	2N5239
		2N3777	3/51	2N5240
		2N3778	3/51	2N5241
		2N3779	3/51	2N5242
		2N3780	3/51	2N5243
		2N3781	3/51	2N5244
		2N3782	3/51	2N5245
		2N3783	3/51	2N5246
		2N3784	3/51	2N5247
		2N3785	3/51	2N5248
		2N3786	3/51	2N5249
		2N3787	3/51	2N5250
		2N3788	3/51	2N5251
		2N3789	3/51	2N5252
		2N3790	3/51	2N5253
		2N3791	3/51	2N5254
		2N3792	3/51	2N5255
		2N3793	3/51	2N5256
		2N3794	3/51	2N5257
		2N3795	3/51	2N5258
		2N3796	3/51	2N5259
		2N3797	3/51	2N5260
		2N3798	3/51	2N5261
		2N3799	3/51	2N5262
		2N3800	3/51	2N5263
		2N3801	3/51	2N5264
		2N3802	3/51	2N5265
		2N3803	3/51	2N5266
		2N3804	3/51	2N5267
		2N3805	3/51	2N5268
		2N3806	3/51	2N5269
		2N3807	3/51	2N5270
		2N3808	3/51	2N5271
		2N3809	3/51	2N5272
		2N3810	3/51	2N5273
		2N3811	3/51	2N5274
		2N3812	3/51	2N5275
		2N3813	3/51	2N5276
		2N3814	3/51	2N5277
		2N3815	3/51	2N5278
		2N3816	3/51	2N5279
		2N3817	3/51	2N5280
		2N3818	3/51	2N5281
		2N3819	3/51	2N5282
		2N3820	3/51	2N5283
		2N3821	3/51	2N5284
		2N3822	3/51	2N5285
		2N3823	3/51	2N5286
		2N3824	3/51	2N5287
		2N3825	3/51	2N5288
		2N3826	3/51	2N5289
		2N3827	3/51	2N5290
		2N3828	3/51	2N5291
		2N3829	3/51	2N5292
		2N3830	3/51	2N5293
		2N3831	3/51	2N5294
		2N3832	3/51	2N5295
		2N38		

CURTIS LSI's help you

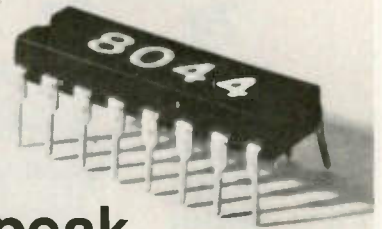

Speak MORSE

- ★ 8044; Keyer-On-A-Chip* (Replaces 8043). \$14.95
Apr '75 HR, Feb '76 OST, Radio Hdbk '75, Apr Hdbk '77-78
- ★ 8044-3; IC, PCB, Socket, Manual. 24.95
- ★ 8044-4; Semi-Kit 54.95
- ★ 8045; Morse Keyboard-On-A-Chip IC 59.95
- ★ 8045-1; IC, PCB, FIFO, Sockets, Manual 89.95
- ★ 8045-2; Semi-Kit 159.95
- ★ 8046; Instructokeyer-On-A-Chip IC 49.95
- ★ 8046-1; Semi-Kit 79.95
- ★ 8047; Message Memory-On-A-Chip IC 39.95
- ★ 8047-1; IC, PCB, RAM, Sockets, Manual 69.95
(add \$1.75 on above for postage and handling)
- EK-430; CMOS Keyer* (Feb '76 OST) 124.95
- IK-440A; Instructokeyer* (Mar '76 OST) 224.95

*now with dash memory as standard
System 4000 Ham Computer (see Jan '78 OST) (write)

Curtis Electro Devices, Inc.
Dept. 5 (415) 964-3136
Box 4090, Mountain View, CA 94040

ALL BAND TRAP ANTENNAS!

PRE-TUNED - COMPLETELY ASSEMBLED - ONLY ONE NEAT SMALL ANTENNA FOR UP TO 6 BANDS! EXCELLENT FOR CONGESTED HOUSING AREAS - APARTMENTS LIGHT - STRONG - ALMOST INVISIBLE!

COMPLETE AS SHOWN with 90 ft. RG58U-52 ohm feedline, and PL259 connector, insulators, 30 ft. 300 lb. test dacron end supports, center connector with built in lightning arrester and static discharge - molded, sealed, weatherproof, resonant traps 1"X8"-you just switch to band desired for excellent worldwide operation - transmitting and receiving! WT. LESS THAN 5 LBS.

160-80-40-20-15-10 bands 2 trap--149 ft. with 90 ft. RG58U - connector - Model 777BU . . . \$54.95
80-40-20-15-10 bands 2 trap -- 102 ft. with 90 ft. RG58U - connector - Model 998BU . . . \$49.95
40-20-15-10 bands 2 trap -- 54 ft. with 90 ft. RG58U coax - connector - Model 1001BU . . . \$48.95
20-15-10 bands 2 trap -- 26 ft. with 90 ft. RG58U coax - connector - Model 1007BU . . . \$47.95

SEND FULL PRICE FOR POST PAID INSURED DEL. IN USA. (Canada is \$5.00 extra for postage - clerical - customs - etc.) or order using VISA Bank Americard - MASTER CHARGE - AMER. EX. PRESS. Give number and ex. date. Ph 1-308-236-5333 9AM - 6PM week days. We ship in 2-3 days. PRICES MAY INCREASE SO - ORDER NOW AND SAVE! All antennas guaranteed for 1 year. Money back trial! Made in USA. FREE INFO. AVAILABLE ONLY FROM.

WESTERN ELECTRONICS ✓ W18 Dept. A7-2 Kearney, Nebraska. 68847

MFJ INTRODUCES A NEW 24 HOUR DIGITAL CLOCK

with HUGE 1-5/8 inch digits that you can keep set to GMT. Alarm and snooze functions let you use it as an ID Timer. Assembled, too!



\$29.95

BRAND NEW

MFJ Enterprises brings you a new 24 hour digital alarm clock with HUGE 1-5/8 inch orange 7 segment digits that you can see clear across the room.

This one is strictly for your ham shack, one that you can leave set to GMT. No more mental calculations to get GMT.

Use the alarm to remind you of a SKED or with the snooze function as an ID timer to buzz you in 8 minute intervals.

A constantly changing kaleidoscopic pattern indicates continuous operation.

Beige. 2-1/4 x 4-1/8 x 8-3/4 inches. UL listed. Requires 120VAC, 60Hz.

Order from MFJ and try it - no obligation. If not delighted, return it within 30 days for a re-

fund (less shipping). One year limited warranty by MFJ Enterprises.

To order, simply call us toll free 800-647-1800 and charge it on your VISA or Master Charge or mail us a check or money order for \$29.95 plus \$2.00 for shipping and handling.

Don't wait any longer to enjoy the convenience of a "Hams Only" clock. Order today.

MFJ ENTERPRISES, INC.

P. O. BOX 494 ✓ M52
MISSISSIPPI STATE, MS 39762
CALL TOLL FREE 800-647-1800

For technical information, order/repair status, in Miss., outside continental USA, call 601-323-5869.



You can build a better organ than you can buy!

A magnificent Schober Electronic Organ

What a marvelous way to put your special talents to work! With our Schober Electronic Organ Kits and your skill, you can build yourself some very special satisfaction, and a lifetime of great music!

Schober Organs are literally far superior to comparably-priced "ready-made" units. You could actually pay twice as much and get no better organ - and miss the fun of assembling it yourself. A PC board at a time, component by component, you'll assemble your own "king of instruments." And when you're done, you'll wish there was more to do. And there is! For then, Schober will help you learn to play, even if you've never played a note before!

Schober Organ Kits range from \$650 to \$2850, and you can purchase in sections to spread costs out... or have two-year time payments.

Just send the coupon for the fascinating Schober color catalog (or enclose \$1 for a record that lets you hear as well as see Schober quality.)

The Schober Organ Corp., Dept. D15
43 West 61st Street, New York, N.Y. 10023 ✓ S79

Please send me Schober Organ Catalog.
 Enclosed please find \$1.00 for 12-inch L.P. record of Schober Organ music

NAME _____
ADDRESS _____
CITY _____ STATE _____ ZIP _____

Radio Bookshop

license study guides & TAPES

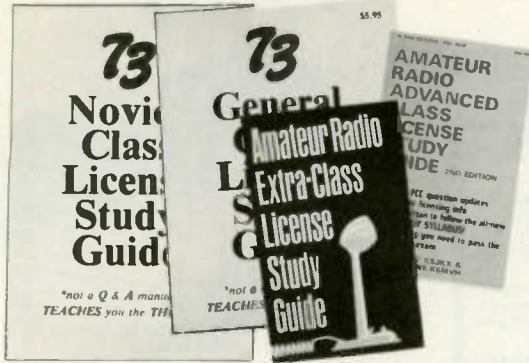

● **NOVICE STUDY GUIDE**—SG7357—Here is a completely new study guide and reference book for the potential ham. This is not a question/answer memorization course. Electronic and radio fundamentals are presented and explained in an easy-to-understand fashion, preparing the beginner for the Novice exam. Includes the latest FCC amateur regulations, as well as application forms. Easily the best path into the exciting world of ham radio! \$4.95.*

● **GENERAL CLASS STUDY GUIDE**—SG7358—A complete theory course for the prospective General or Technician. This reference explains transistor, amplifier, and general radio theory, while preparing the Novice for the "big" ticket. After getting your ticket, you'll use this guide again and again as an electronic reference source. Not a question/answer guide that becomes dated when the FCC updates the amateur exams. \$5.95.*

● **ADVANCED CLASS STUDY GUIDE**—SG1081—Ready to upgrade your license? To prevent retaking the FCC theory exam, you need the 73 Advanced theory guide. SSB, antenna theory, transmitters, and electronics measuring techniques are covered in detail in this easy-to-follow study guide. Special modes and techniques, such as RTTY, are also treated. An engineering degree is not necessary to master Advanced theory—try this book before visiting the examiner's office! \$5.95.*

● **EXTRA CLASS LICENSE STUDY GUIDE**—SG1080—Before going for your 1 x 2 call, it pays to be a master of the Extra class electronic theory. This study guide is the logical extension of the 73 theory course. All the theory necessary to pass the exam is presented. Antennas, transmission lines, SWR are discussed, as well as noise, propagation, and specialized communication techniques. This book is not a classroom lecture or memorization guide, but rather a logical presentation of the material that must be understood before attempting the Extra exam. Save yourself a return trip to the FCC and try the 73 method first! \$5.95.*



NOVICE THEORY TAPES

Startling Learning Breakthrough



● **NOVICE THEORY TAPES**—CT7300—Startling Learning Breakthrough. You'll be astounded at how really simple the theory is when you hear it explained on these tapes. Three tapes of theory and one of questions and answers from the latest Novice exams give you the edge you need to breeze through your exam. 73 is interested in helping get more amateurs, so we're giving you the complete set of our tapes for the incredibly low price of **ONLY \$15.95.***

Scientists have proven that you learn faster by listening than by reading because you can play a cassette tape over and over in your spare time—even while you're driving! You get more and more info each time you hear it.

You can't progress without solid fundamentals. These four hour-long tapes give you all the basics you'll need to pass the Novice exam easily. You'll have an understanding of the basics which will be invaluable to you for the rest of your life! Can you afford to take your Novice exam without first listening to these tapes? Set of 4—\$15.95.*

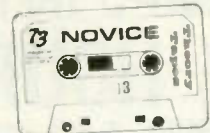

SSTV

● **SLOW SCAN TELEVISION TAPE**—CT7350—Prize-winning programs from the 73 SSTV contest. Excellent for Demo! \$5.95.*

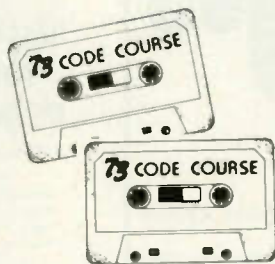

73 CODE SYSTEM TAPES

code, sent at the official FCC standard (no other tape we've heard uses these standards, so many people flunk the code when they are suddenly—under pressure—faced with characters sent at 13 wpm and spaced for 5 wpm). This tape is not memorizable, unlike the zany 5 wpm tape, since the code groups are entirely random characters sent in groups of five.

"COURAGEOUS"

20+ WPM—CT7320—Code is what gets you when you go for the Extra class license. It is so embarrassing to panic out just because you didn't prepare yourself with this tape. Though this is only one word faster, the code groups are so difficult that you'll almost fall asleep copying the FCC stuff by comparison. Users report that they can't believe how easy 20 per really is with this fantastic one hour tape.

Any Four Tapes For \$15.95! *
\$4.95 Each! *

"GENESIS"

5 WPM—CT7305—This is the beginning tape for people who do not know the code at all. It takes them through the 26 letters, 10 numbers and necessary punctuation, complete with practice every step of the way using the newest blitz teaching techniques. It is almost miraculous! In one hour many people—including kids of ten—are able to master the code. The ease of learning gives confidence to beginners who might otherwise drop out.

"THE STICKLER"

6+ WPM—CT7306—This is the practice tape for the Novice and Technician licenses. It is made up of one solid hour of

"THE CANADIAN"

10+ WPM—CT7310—73 hasn't forgotten the Canadian hams—our 10 WPM tape prepares you to breeze through your country's licensing exams. Like the other code groups, the tape is not memorizable and, once mastered, provides a margin of safety in the actual text situation.

"BACK BREAKER"

13+ WPM—CT7313—Code groups again, at a brisk 13 per so you will be at ease when you sit down in front of the steely-eyed government inspector and he starts sending you plain language at only 13 per. You need this extra margin to overcome the panic which is universal in the test situations. When you've spent your money and time to take the test, you'll thank heavens you had this back-breaking tape.

"OUTRAGEOUS"

25+ WPM—CT7325—This is the tape for that small group of overachieving hams who wouldn't be content to simply satisfy the code requirements of the Extra Class license. It's the toughest tape we've got and we keep a permanent file of hams who have mastered it. Let us know when you're up to speed and we'll inscribe your name in 73's CW "Hall of Fame."

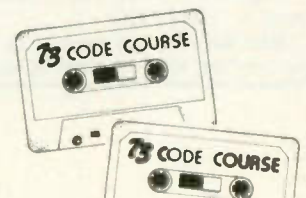

73 Radio Bookshop • Peterborough NH 03458. Be sure to include check or detailed credit card information.

Note: Prices subject to change on books not published by 73 Magazine.

FOR CUSTOMER SERVICE CALL 603-924-6132

RADIO BOOKSHOP

73 TECHNICAL LIBRARY

● **BEHIND THE DIAL**—BK7307—By Bob Grove. Get more fun out of shortwave listening with this interesting guide to receivers, antennas, frequencies and interference. \$4.95.*

● **THE CHALLENGE OF 160**—BK7309—is the newest book in the 73 technical library, dedicated to 160 meter operating. Si Dunn provides all necessary information to get started on this unique band. The all-important antenna and ground systems are described in detail. The introduction contains interesting photos of Stew Perry's (the King of 160) shack. This reference is a must for new and experienced "Top Band" operators. Price: \$4.95.*

● **IC OP-AMP COOKBOOK**—BK1028—by Walter G. Jung. Covers not only the basic theory of the IC op amp in great detail, but also includes over 250 practical circuit applications, liberally illustrated. 592 pages, 5½ x 8½, softbound. \$12.95.*

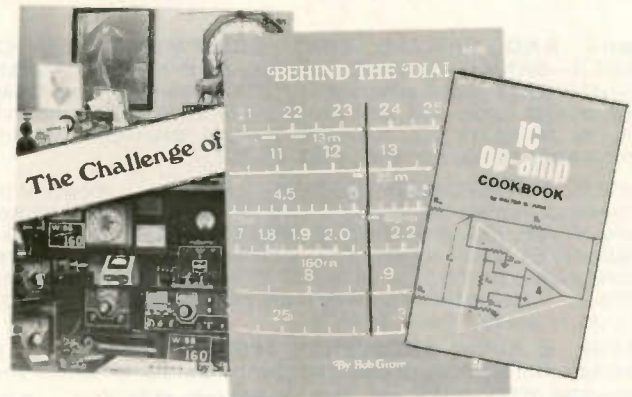

● **INTRODUCTION TO RTTY**—BK7380—A beginner's guide to radioteletype including teletypewriter fundamentals, signals, distortion and RTTY art. You can be a RTTY artist! A 73 publication. \$2.00.*

● **THE NEW RTTY HANDBOOK**—BK7347—Is a new edition and the only up-to-date RTTY book available. The state of the art has been changing radically and has made all previous RTTY books obsolete. It has the latest circuits, great for the newcomer and expert alike. \$5.95.*

● **PROPAGATION WIZARD'S HANDBOOK**—BK7302—by J. H. Nelson. When sunspots riddled the worldwide communications networks of the 1940's, John Henry Nelson looked to the planets for an answer. The result was a theory of propagation forecasting based upon interplanetary alignment that made the author the most reliable forecaster in America today. The book provides an enlightened look at communications past, present, and future, as well as teaching the art of propagation forecasting. \$6.95.*



● **SSB . . . THE MISUNDERSTOOD MODE**—BK7351—by James B. Wilson. Single Sideband Transmission . . . thousands of us use it every day, yet it remains one of the least understood facets of amateur radio. J. B. Wilson presents several methods of sideband generation, amply illustrated with charts and schematics, which will enable the ambitious reader to construct his own sideband generator. A must for the technically-serious ham. \$5.50.*

● **SSTV HANDBOOK**—BK7354(hardcover), BK7355(softcover)—This excellent book tells all about it, from its history and basics to the present state-of-the-art techniques. Contains chapters on circuits, monitors, cameras, color SSTV, test equipment and much more. Hardbound \$7.00, softbound \$5.00.*

● **WEATHER SATELLITE HANDBOOK**—BK7370—Simple equipment and methods for getting good pictures from the weather satellite. Antennas, receivers, monitors, facsimile you can build, tracking, automatic control (you don't even have to be home). Dr. Taggart WB8DQT. \$4.95.*



ANTENNAS



● **73 DIPOLE AND LONG-WIRE ANTENNAS**—BK1016—by Edward M. Noll W3FQJ. This is the first collection of virtually every type of wire antenna used by amateurs. Includes dimensions, configurations, and detailed construction data for 73 different antenna types. Appendices describe the construction of noise bridges, line tuners, and data on measuring resonant frequency, velocity factor, and swr. \$5.50.*

● **73 VERTICAL, BEAM AND TRIANGLE ANTENNAS**—BK1069—by Edward M. Noll W3FQJ. Describes 73 different antennas for amateurs. Each design is the result of the author's own experiments covering the construction of noise bridges and antenna line tuners, as well as methods for measuring resonant frequency, velocity factor, and standing-wave ratios. 160 pages. \$5.50.*

● **VHF ANTENNA HANDBOOK**—BK7368—The NEW VHF Antenna Handbook details the theory, design and construction of hundreds of different VHF and UHF antennas . . . A practical book written for the average amateur who takes joy in building, not full of complex formulas for the design engineer. Packed with fabulous antenna projects you can build. \$4.95.*

73 Radio Bookshop • Peterborough NH 03458. Be sure to include check or detailed credit card information.

Note: Prices subject to change on books not published by 73 Magazine.

FOR TOLL FREE ORDERING CALL 1-800-258-5473

Radio Bookshop

TEST EQUIPMENT

● **RF AND DIGITAL TEST EQUIPMENT YOU CAN BUILD**—BK1044—Rf burst, function, square wave generators, variable length pulse generators—100 kHz marker, i-f and rf sweep generators, audio osc, af/rf signal injector, 146 MHz synthesizer, digital readouts for counters, several counters, prescaler, microwave meter, etc. 252 pages. \$5.95.*

● **VOL. I COMPONENT TESTERS**—LB7359—... how to build transistor testers (8), diode testers (3), IC testers (3), voltmeters and VTVMs (9), ohmmeters (8 different kinds), inductance (3), capacity (9), Q measurement, crystal checking (6), temperature (2), aural meters for the blind (3) and all sorts of miscellaneous data on meters... using them, making them more versatile, making standards. Invaluable book. \$4.95.*

● **VOL. II AUDIO FREQUENCY TESTERS**—LB7360—... Jam packed with all kinds of audio frequency test equipment. If you're into SSB, RTTY, SSTV, etc., this book is a must for you... a good book for hi-fi addicts and experimenters, too! \$4.95.*

● **VOL. III RADIO FREQUENCY TESTERS**—LB7361—Radio frequency waves, the common denominator of Amateur Radio. Such items as SWR, antenna impedance, line impedance, rf output and field strength; detailed instructions on testing these items includes sections on signal generators, crystal calibrators, grid dip oscillators, noise generators, dummy loads and much more. \$4.95.*

● **VOL. IV IC TEST EQUIPMENT**—LB7362—Become a troubleshooting wizard. All you need to know about pulse, audio and sync generators, frequency counters, digital component testers, logic probes and more! Plus a cumulative index for all four volumes of the 73 Test Equipment Library. \$4.95.*



THE WELL-EQUIPPED HAM SHACK



Style X



Style W



Style Y

● **BACK ISSUES**—Complete your collection—many are prime collectibles now, classics in the field! A full collection is an invaluable compendium of radio and electronics knowledge! \$2.00 each*, or 5 for \$5.00.*

● **LIBRARY SHELF BOXES**—These sturdy white, corrugated, dirt-resistant boxes each hold a full year of 73 or *Kilobaud*. With your order, request self-sticking labels for any of the following: 73, *Kilobaud*, *CQ*, *QST*, *Ham Radio*, *Personal Computing*, *Radio Electronics*, *Interface Age*, and *Byte*. Order 1—BX1000—for \$2.00*; order 2-7—BX1001—for \$1.50 each*; order 8 or more—BX1002—for \$1.25 each*.



● **NEW REPEATER ATLAS OF THE ENTIRE WORLD**—BK7345—150% as big as any list ever available—nearly 900 more repeaters listed. New improved maps show the locations by frequency of every repeater in the States. Only \$1.95.*

● **QSL CARDS**—73 turns out a fantastic series of QSL cards at about half the cost of having them done elsewhere because they are run as a fill-in between printing books and other items in the 73 Print Shop. 250 Style W—QW0250—for \$8.95*; 500 Style W—QW0500—for \$13.95*; 250 Style X—QX0250—for \$8.95*; 500 Style X—QX0500—for \$13.95*; 250 Style Y—QY0250—for \$8.95*; 500 Style Y—QY0500—for \$13.95.*

● **73 MAGAZINE BINDERS**—Preserve and protect your collection for your lifetime! There's no excuse for lost issues when you have these handsome red binders with gold lettering. Order 1—BN1001—for \$6.50*; 2 or more—BN1002—for \$6.00 each.*



73 Radio Bookshop • Peterborough NH 03458. Be sure to include check or detailed credit card information.

Note: Prices subject to change on books not published by 73 Magazine.

FOR CUSTOMER SERVICE CALL 603-924-6132

Radio Bookshop

● **SSB... THE MISUNDERSTOOD MODE** —BK7351—by James B. Wilson. Single Sideband Transmission... thousands of us use it every day, yet, it remains one of the least understood facets of amateur radio. J. B. Wilson presents several methods of sideband generation, amply illustrated with charts and schematics, which will enable the ambitious reader to construct his own sideband generator. A must for the technically-serious ham. \$5.50.*

● **PROPAGATION WIZARD'S HANDBOOK** —BK7302—by J. H. Nelson. When sunspots riddled the worldwide communications networks of the 1940's, John Henry Nelson looked to the planets for an answer. The result was a theory of propagation forecasting based upon interplanetary alignment that made the author the most reliable forecaster in America today. The book provides an enlightened look at communications past, present, and future, as well as teaching the art of propagation forecasting. 6.95.*

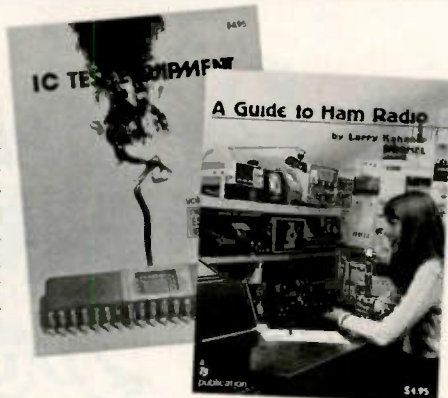

● **A GUIDE TO HAM RADIO**—BK7321—by Larry Kahner WB2NEL. What's Amateur Radio all about? You can learn the basics of this fascinating hobby with this excellent beginner's guide. It answers the most frequently asked questions in an easy-going manner, and it shows the best way to go about getting an FCC license. A Guide to Ham Radio is an ideal introduction to a hobby enjoyed by people around the world. \$4.95.*



● **VOLUME IV—IC TEST EQUIPMENT**—LB7362—it's easy and fun to build your own test equipment with ICs! Here in this fourth volume of the 73 TEST EQUIPMENT LIBRARY are 42 home construction projects for building test equipment to work with your ham station and in servicing digital equipment. Counters, scalars, frequency standards, synthesizers, logic probes... **JUST ABOUT EVERYTHING** you need and can build with ICs. \$4.95.*

73 Radio Bookshop • Peterborough NH 03458. Be sure to include check or detailed credit card information.
* Add \$1.00 handling charge for orders under \$10.00. Note: Prices subject to change on books not published by 73 Magazine.

THE 73 RADIO BOOKSHOP ORDER FORM

Qty.	Cat.#	Description	Unit Price	Total

Add \$1 shipping & handling:

Merchandise total:

Enclosed _____ Check Money order
 Bill my: Visa Master Charge American Express
 Credit card # _____ Expiration date _____
 Signature _____
 Name _____
 Address _____
 City _____ State _____ Zip _____

73
magazine
 peterborough nh 03458

For Toll Free Ordering: (800) 258-5473

(coupon expires in 60 days)

S2A

FOR TOLL FREE ORDERING CALL 1-800-258-5473

**21,560
pages.**



**That's the size of the world's
most comprehensive guide to
the subject of ham radio:
18 years of 73 Magazine.**

The back issues of 73 are a gold mine of interesting articles. Unlike the other magazines, which fill their pages with activity reports, there's little to go stale in 73. You'll find pioneering articles on SSTV, FM, repeaters, ICs, and computers. Even the editorials are fun as Wayne Green's dire predictions, like the debacle of incentive licensing, have come to pass.

Clip the coupon below and send for 73's new back issue catalogue. Treat yourself (or a friendly ham) to some fun, and a fantastic bargain to boot.

YES! Rush me 73's FREE Back Issue Catalogue!

Name _____

Address _____

City _____ State _____ Zip _____

S2

73 magazine
PETERBOROUGH NH 03458

IS HARD COPY STORAGE A PROBLEM?



73, as thick as it is, is more like a floppy when it comes to standing on the bookshelf. Try the 73 Library Shelf Boxes, . . . sturdy corrugated white dirt resistant cardboard boxes which will keep them from flopping around. We have self-sticking labels for the boxes, too, not only for 73, but also for *Kilobaud* . . . and for *CQ*, *QST*, *Ham Radio*, *Personal Computing*, *Radio Electronics*, *Interface Age*, and *Byte*. Ask for whatever stickers you want with your box order. They hold a full year of 73 . . . or *Kilobaud*. Your magazine library is your prime reference, keep it handy and keep it neat with these strong library shelf boxes . . . One box is \$2.00, 2 boxes are \$3.00 and eight boxes are \$10.00. Be sure to specify which labels we should send. Have your credit card handy and call our toll-free order number 800-258-5473, or use the order card in the back of the magazine and mail to:

73 magazine
PETERBOROUGH NH 03458

MOVING?

Let us know 8 weeks in advance so that you won't miss a single issue of 73 Magazine. Attach old label where indicated and print new address in space provided. Also include your mailing label whenever you write concerning your subscription. It helps us serve you promptly. Write to:

73 magazine
PETERBOROUGH NH 03458

- Address change only
- Extend subscription
- Enter new subscription
- 1 year \$18.00
- Payment enclosed (1 extra BONUS issue)
- Bill me later

If you have no label handy, print OLD address here.

AFFIX LABEL

Name _____ Call _____

Address _____

City _____ State _____ Zip _____

print NEW address here:

Name _____ Call _____

Address _____

City _____ State _____ Zip _____

PROPAGATION

by
J. H. Nelson

EASTERN UNITED STATES TO:

GMT:	00	02	04	06	08	10	12	14	16	18	20	22
ALASKA	21	14	7	7	7	7	7	14	14A	21	21A	
ARGENTINA	14A	14	14	7	7	7	14	21A	21A	21A	21A	21A
AUSTRALIA	21A	14	14	7B	7B	7B	7B	14	14	14	21	21A
CANAL ZONE	21	14	7A	7	7	7	14	21	21A	21A	21A	21
ENGLAND	7	7	7	7	7	7B	14	21A	21A	21	14	14B
HAWAII	21A	14	7	7	7	7	7	7B	14	21	21A	21A
INDIA	7	7	7B	7B	7B	7B	14	14A	14	7B	7B	7B
JAPAN	14A	14	7A	7B	7B	7	7	7	7B	7B	7B	14
MEXICO	21	14	14	7	7	7	7	14A	21	21A	21A	21A
PHILIPPINES	14A	14	7A	7B	7B	7B	7B	14	14	14B	14B	14
PUERTO RICO	14	7A	7	7	7	7	14	21A	21A	21	21	14
SOUTH AFRICA	14	7	7	7	7B	14	21	21A	21A	21A	21	21
U. S. S. R.	7	7	7	7	7	7B	14	21A	21A	14	14	7B
WEST COAST	21	14	7A	7	7	7	7	14	21	21A	21A	21A

CENTRAL UNITED STATES TO:

ALASKA	21	14	14	7	7	7	7	14	21	21	21A	
ARGENTINA	21	14	14	7	7	7	7A	21	21A	21A	21A	21A
AUSTRALIA	21A	21	14	7B	7B	7B	7B	7B	14	14	21	21A
CANAL ZONE	21	14	14	7	7	7	7	14A	21A	21A	21A	21
ENGLAND	7	7	7	7	7	7	7B	14	21A	21	14	14B
HAWAII	21A	21	14	7	7	7	7	7	14	21	21A	21A
INDIA	7	14	14	7B	7B	7B	7B	7	14	7B	7B	7B
JAPAN	21A	14	14	7B	7	7	7	7	7	7B	7B	14
MEXICO	21	14	7	7	7	7	7	14	21	21	21A	21
PHILIPPINES	21A	14	14	7B	7B	7B	7B	7	14	14B	14B	14
PUERTO RICO	14	14	7	7	7	7	14	21	21A	21A	21A	21
SOUTH AFRICA	14	14	7	7	7B	7B	14	21	21A	21A	21A	21
U. S. S. R.	7B	7	7	7	7	7B	7B	14	14A	14	7B	7B

WESTERN UNITED STATES TO:

ALASKA	21	14	14	7	3A	7	7	3A	7A	14	21	21A
ARGENTINA	21A	14A	14	7	7	7	7B	14	21	21A	21A	21A
AUSTRALIA	21A	21A	21	14	7B	7B	7B	7B	14	14	21	21A
CANAL ZONE	21A	14	14	7	7	7	7	14	21	21A	21A	21A
ENGLAND	7B	7	7	7	7	7	7B	14B	14	21A	14	14B
HAWAII	21A	21A	21	14	7	7	7	7	14	21	21A	21A
INDIA	7B	14A	14	7B	7B	7B	7B	7A	7A	7B	7B	
JAPAN	21A	21A	14	7B	7	7	7	7	7	7B	7B	14A
MEXICO	21A	14	7A	7	7	7	7	14	21	21A	21A	21A
PHILIPPINES	21A	21A	14	7B	7B	7B	7B	7	14	14	14B	14
PUERTO RICO	21	14	7A	7	7	7	7	14	21	21A	21A	21
SOUTH AFRICA	14	14B	7	7B	7B	7B	7B	14	21	21A	21A	21
U. S. S. R.	7B	7	7	7	7	7B	7B	14B	14	14B	7B	7B
EAST COAST	21	14	7A	7	7	7	7	14	21	21A	21A	21A

- A = Next higher frequency may also be useful
- B = Difficult circuit this period
- F = Fair
- G = Good
- P = Poor
- SF = Chance of solar flares

february

sun	mon	tue	wed	thu	fri	sat
				1	2	3
				G	G	G
4	5	6	7	8	9	10
G	G	G	F	F	P	F
11	12	13	14	15	16	17
G	G	G	G	G	P	G
18	19	20	21	22	23	24
G	F	F	F	P	G	G
25	26	27	28			
G/SF	F/SF	P/SF	P/SF			

READER SERVICE

A46 ABC Communications..... 178	G4 Godbout Electronics..... 194	R10 Rainbow Industries..... 181
A1 Adirondack Radio Sup. 134,179	* HAL Communications Corp. 9	R8 Ramsey Electronics..... 158, 190
A24 Adva Electronics..... 202	H24 Hal-Tronix..... 180	R27 RF Power Labs, Inc. 134
* Advance Electronics..... 93, 162	H2 Ham Radio Center..... 13, 19	* R. Lee Tower International..... 182
A60 AED Electronics..... 182	H31 Ham Radio Outlet..... 185	R15 Rolin Distributors..... 181
A2 Aidelco..... 200	H16 Hamtronics, NY..... 191	R21 Rush Electronics..... 182
A57 Alliance Manufacturing Co. 13	H8 Hamtronics, PA..... 145	S27 Sabtronics..... 186
A62 Antenna Specialists..... 18	H26 Hartwell's Office World..... 183	S79 The Schober Organ Corp. 203
A6 Apron Laboratories..... 183	H5 Heath Company..... 161	S3 Sentry..... 133
A77 Alpha I, Ltd. 133	H3 Henry Radio..... CII	S33 S-F Amateur Radio S. 132, 176, 180
A21 Amateur Wholesale..... 187	H4 Hy-Gain Electronics..... 27	S8 Spectrum Comm. 138, 139
A26 Amidon Associates..... 174	I1 ICOM..... 91	S10 SST Electronics. 132, 173, 174, 175
* Associated Radio..... 196	I32 Instant Software..... 104, 105	S78 Staco, Inc. 171
* Atlanta Hamfest..... 109	I9 Integrated Circuits, Unltd. 201	S50 O.C. Stafford Electronics..... 182
B1 Babylon Electronics..... 27	J1 Jameco Electronics..... 195	S43 Surplus Electronics..... 198
B23 Barker & Williamson..... 131	J2 Jan Crystals..... 130	* Ten-Tec..... 6, 7
B32 Bay-Com..... 134	K13 Kantronics..... 132	T55 TET U.S.A. 45
B29 Britt's 2-Way Radio..... 121	* Kilobaud..... 83	T34 Thomas Communications..... 59
B42 Brodie Electronics Company. 31	* Kenwood..... CIV, 5	T48 Tower Electronics Corp. 179
B8 Bullet Electronics..... 189	K14 Key Electronics..... 134	T18 Trac Electronics, Inc. 173
C88 C & A Electronic Enterprises. 77	L9 Long's Electronics..... 124-129	T3 Tufts Radio Electronics. 82, 131
C3 Clegg..... 51, 143	M35 Madison Electronics Supply. 15	U10 UDM Enterprises..... 174
C21 Cloakit..... 183	M36 Magglore Electronic Lab. 177	U9 Unadilla/Reyco Division..... 173
C110 Coax Probe Company..... 183	M52 MFJ Ent. 25, 103, 117, 141, 203	U8 Unltd Products..... 188
C105 Commun. & TV, Unltd. 181	M69 Micro Control Specialties..... 133	U6 Universal Amateur Radio Serv 159
C58 Communications Ctr, NE. 55, 165	M48 Microtronics..... 130	U21 Vega..... 26
C5 Commun. Electronics..... 134	M41 Midland International..... 65	V5 VHF Engineering..... 135
C115 Commun. Elec. Spec. 182	M75 Mirage Communications..... 26	W15 Wacom..... 178
C6 Communications Spec. 16, 17	M76 M & M RF Distributors..... 131	W17 Westcom Engineering..... 130
C9 Continental Specialties..... 26	M79 Mura Corporation..... 170	W18 Western Electronics..... 203
C90 Curtis Electro Devices..... 203	O3 Optoelectronics, Inc. 181	W2 Wilson Electronics..... 3, 170
C67 Cushcraft..... 170	O12 Outdoor Outfitters..... 133	Y1 Yaesu Electronics CIII, 41, 115, 170
D6 Peter W. Dahl Company..... 76	P15 Pace-Traps..... 177	X1 Xitex..... 176, 177
D35 Daytapro Electronics, Inc. 183	P30 Palomar Electronics..... 18	From 73..... 147, 204-210
D20 Digital Research Corp. 192, 193	* Paiomar Engineers..... 159	
D23 Dovetron..... 130	P41 P.C. Electronics..... 177	
D25 DSI Instruments..... 10, 11, 157	P44 Pickering Codemaster Co. 90	
F5 Flesher Corporation..... 18, 174	P42 Plainsman Micro Systems..... 174	
F12 Fujitsu Ten Corp of Amer. 23	P2 Poly Paks..... 197	
G12 Germantown Amateur Sup. 76	Q3 Quest Electronics..... 184	
G6 Glifer..... 171	R1 Radio Amateur Callbook, Inc. 199	
G22 G.I.S.M.O. 114	* Radio World..... 90	

*Reader Service inquiries not honored.
Please contact advertiser directly.

BOOKS, ETC.

BK1016 73 DIPOLE & LONG WIRE ANTENNAS..... \$ 5.50	QW0500 QSL CARDS—STYLE W—500..... \$13.95
ST0000 73 BACK ISSUE..... \$ 3.00	QX0250 QSL CARDS—STYLE X—250..... \$ 8.95
ST2500 73 BACK ISSUES—25 OUR CHOICE..... \$10.00	QX0500 QSL CARDS—STYLE X—500..... \$13.95
ST0500 73 BACK ISSUES—5 YOUR CHOICE..... \$ 7.00	QY0250 QSL CARDS—STYLE Y—250..... \$ 8.95
ST1000 73 BACK ISSUES—10 YOUR CHOICE..... \$12.00	QY0500 QSL CARDS—STYLE Y—500..... \$13.95
ST2501 73 BACK ISSUES—25 YOUR CHOICE..... \$20.00	BK7345 REPEATER ATLAS..... \$ 1.95
BK7307 BEHIND THE DIAL..... \$ 4.95	BK1044 RF DIGITAL TEST EQUIPMENT..... \$ 5.95
BN1001 BINDER—73—1..... \$ 6.50	BK7347 RTTY HANDBOOK..... \$ 5.95
BN1002 BINDER—73—2&UP..... \$ 6.00	BX1000 SHELF BOX—1..... \$ 2.00
BK7309 CHALLENGE OF 160..... \$ 4.95	BX1001 SHELF BOX—2..... \$ 1.50
CT7305 CODE TAPE—5 WPM..... \$ 4.95	BX1002 SHELF BOX—8 UP..... \$ 1.25
CT7306 CODE TAPE—6 WPM..... \$ 4.95	BK7351 SSB THE MISUNDERSTOOD MODE..... \$ 5.50
CT7310 CODE TAPE—10 WPM..... \$ 4.95	BK7354 SSTV HANDBOOK (HARDCOVER)..... \$ 7.00
CT7313 CODE TAPE—13 WPM..... \$ 4.95	BK7355 SSTV HANDBOOK (SOFTCOVER)..... \$ 5.00
CT7320 CODE TAPE—20 WPM..... \$ 4.95	CT7350 SSTV TAPE..... \$ 5.95
CT7325 CODE TAPE—25 WPM..... \$ 4.95	SG1081 STUDY GUIDE—ADVANCED CLASS..... \$ 5.95
CT7399 CODE TAPE—LEARN MORSE CODE..... \$ 4.95	SG1080 STUDY GUIDE—EXTRA CLASS..... \$ 5.95
CT7394 CODE TAPES (ANY FOUR ABOVE)..... \$15.95	SG7358 STUDY GUIDE—GENERAL CLASS..... \$ 5.95
BK7321 GUIDE TO HAM RADIO..... \$ 4.95	SG7357 STUDY GUIDE—NOVICE CLASS..... \$ 4.95
BK7325 HOW TO BUILD A MICROCOMPUTER..... \$ 9.95	LB7359 TEST EQUIP LIB V1—COMP TESTERS..... \$ 4.95
BK1028 IC OP AMP COOKBOOK..... \$12.95	LB7360 TEST EQUIP LIB V2—AUDIO TESTERS..... \$ 4.95
BK7380 INTRO TO RTTY..... \$ 2.00	LB7361 TEST EQUIP LIB V3—AUDIO EQUIP..... \$ 4.95
CT7300 NOVICE THEORY TAPES..... \$15.95	LB7362 TEST EQUIP LIB V4—IC TEST EQUIP..... \$ 4.95
BK1100 PRACTICAL TEST INSTRUMENTS..... \$ 4.95	BK1069 VERTICAL BEAM & TRIANGLE ANTNS..... \$ 5.50
BK7302 PROPAGATION WIZARD'S HANDBOOK..... \$ 6.95	BK7368 VHF ANTENNA HANDBOOK..... \$ 4.95
QW0250 QSL CARDS—STYLE W—250..... \$ 8.95	BK7370 WEATHER SATELLITE HANDBOOK..... \$ 4.95



SERVICESER
 READER R
 SERVICES
73 magazine
 ADER REA
 SERVICESER
 READER R
 SERVICES
 ER READE
 VICE SERVI

READER SERVICE To receive more information from any of the advertisers in this issue of **73**, postage-paid return cards are provided here for your convenience. If you wish to hear from one or several advertisers, refer to the ad itself. You will find numbers near the logo of each advertiser. Each represents the advertiser's individual Reader Service Number. Circle the corresponding numbers on one of the cards on this page, include your name, address & zip, and drop in a mailbox. In 4-6 weeks you'll hear from the advertiser directly.

ADER REA
 SERVICESER
 READER R
 SERVICES
 ER READE
 VICE SERVI
73 magazine
 READER R
 SERVICES
 ER READE

READER SERVICE REPLY CARD

Return this card to receive full information on the many products advertised in this issue. Limit: 25 requests. Subscriber Newsstand. This card is valid until April 30, 1979.

A1	A77	C9	D20	H2	I9	M48	P30	R27	T3	V21
A2	B1	C21	D23	H3	I32	M52	P41	S3	T18	W2
A6	B8	C58	D25	H4	J1	M69	P42	S8	T34	W15
A21	B23	C67	D35	H5	J2	M75	P44	S10	T48	W17
A24	B29	C88	F5	H8	K13	M76	Q3	S27	T55	W18
A26	B32	C90	F12	H16	K14	M79	R1	S33	U6	Y1
A46	B42	C105	G4	H24	L9	O3	R8	S43	U8	X1
A57	C3	C110	G6	H26	M35	O12	R10	S50	U9	
A60	C5	C115	G12	H31	M36	P2	R15	S78	U10	
A62	C6	D6	G22	I1	M41	P15	R21	S79	V5	

This month's **ARTICLE WINNER** (title page number): _____

Name _____

Address _____

City _____ State _____ Zip _____

S2



NO POSTAGE
NECESSARY
IF MAILED
IN THE
UNITED STATES

BUSINESS REPLY CARD

FIRST CLASS PERMIT NO. 17 PETERBOROUGH, NH 03458

POSTAGE WILL BE PAID BY ADDRESSEE

73 magazine



Peterborough NH 03458



Att: Mail Order

READER SERVICE REPLY CARD

Return this card to receive full information on the many products advertised in this issue. Limit: 25 requests. Subscriber Newsstand. This card is valid until April 30, 1979.

A1	A77	C9	D20	H2	I9	M48	P30	R27	T3	V21
A2	B1	C21	D23	H3	I32	M52	P41	S3	T18	W2
A6	B8	C58	D25	H4	J1	M69	P42	S8	T34	W15
A21	B23	C67	D35	H5	J2	M75	P44	S10	T48	W17
A24	B29	C88	F5	H8	K13	M76	Q3	S27	T55	W18
A26	B32	C90	F12	H16	K14	M79	R1	S33	U6	Y1
A46	B42	C105	G4	H24	L9	O3	R8	S43	U8	X1
A57	C3	C110	G6	H26	M35	O12	R10	S50	U9	
A60	C5	C115	G12	H31	M36	P2	R15	S78	U10	
A62	C6	D6	G22	I1	M41	P15	R21	S79	V5	

This month's **ARTICLE WINNER** (title page number): _____

Name _____

Address _____

City _____ State _____ Zip _____

S2

YAESU *The radio.*

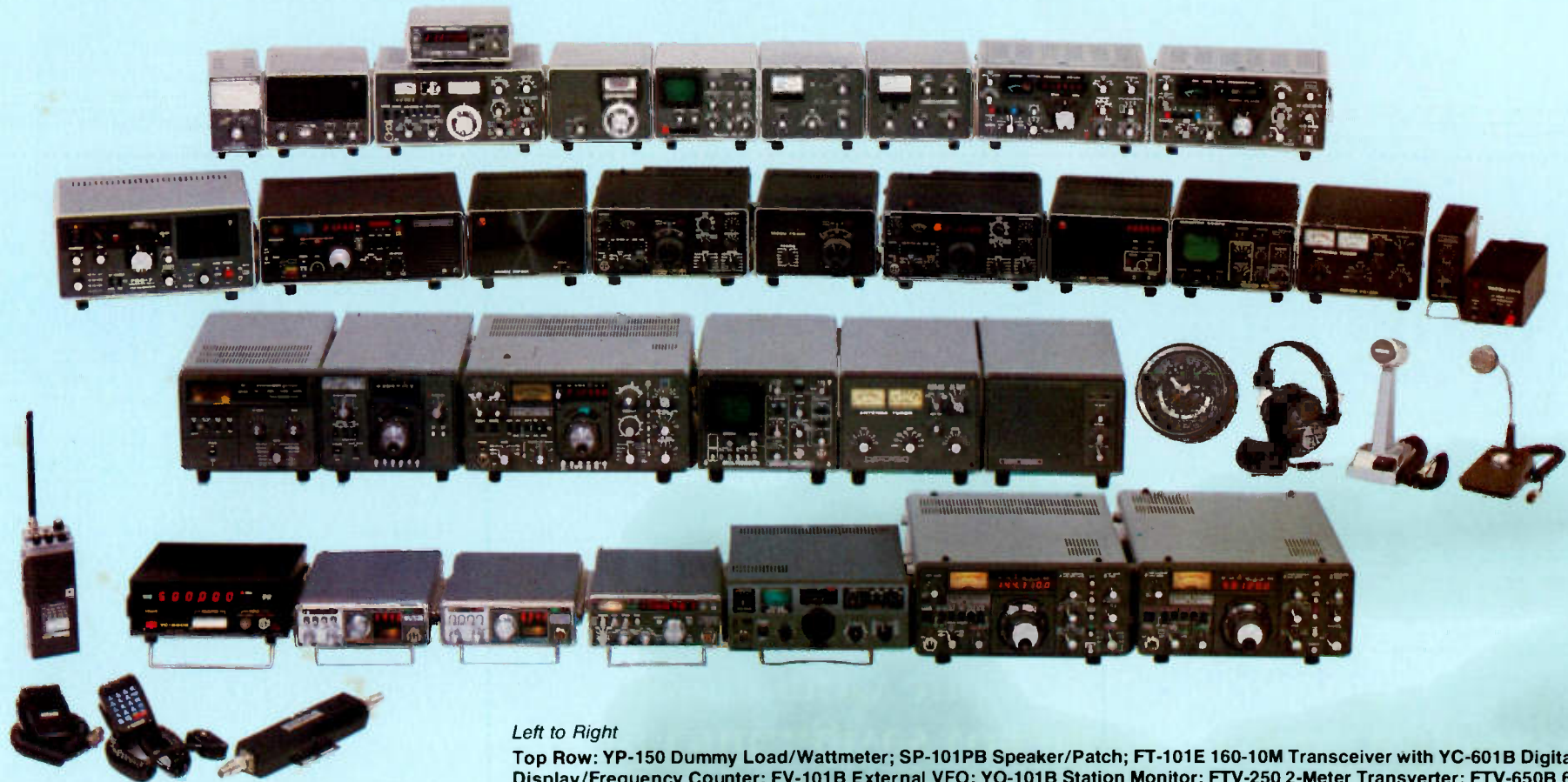

Left to Right

Top Row: YP-150 Dummy Load/Wattmeter; SP-101PB Speaker/Patch; FT-101E 160-10M Transceiver with YC-601B Digital Display/Frequency Counter; FV-101B External VFO; YO-101B Station Monitor; FTV-250 2-Meter Transverter; FTV-650B 6-Meter Transverter; FR-101 Digital 160M-10M Receiver; FL-101 All Band Transmitter.

Row 2: FRG-7 General Coverage Receiver; FRG-7000 General Coverage Digital Receiver; FP-301 13.8VDC Power Supply; FT-301 Solid State 160-10M Transceiver; FV-301 External VFO; FT-301D Solid State Digital 160-10M Transceiver; FP-301D 13.8VDC Power Supply with Clock & Identifier; YO-301 Station Monitor; FC-301 Antenna Coupler; LL-301 Landliner Phone Patch; FP-4 4A Power Supply.

Row 3: FTV-901 Three Band Transverter; FV-901DM Synthesized Scanning VFO; FT-901DM 160-10M "The Smart Radio" Transceiver; YO-901 Station Monitor/Analyzer; FC-901 Antenna Coupler; SP-901P Speaker/Patch; QTR-24 World Clock; YH-55 Super Soft Headset; YD-844A Hi/Lo Imp. Desk Microphone; YD-148 Hi/Lo Imp. Flexible Neck Desk Microphone.

Row 4: FT-202R Hand Held 2M Transceiver; YC-500E High Precision Frequency Counter; FT-227R 2M FM Mobile Transceiver "The Memorizer"; FT-227RA 2M FM Mobile Scanning Transceiver-4 Memory; CPU-2500R/K 2M FM Mobile Computerized Transceiver; FT-7 20W PEP Mobile Transceiver; FT-225RD 2M All-Mode Digital Transceiver; FT-625RD 6M All-mode Digital Transceiver.

Row 5: YM-24 Speaker/Microphone (FT-202 Accessory); YM-2500 Keyboard Microphone; FFDX-50 52 Ohm Low Pass Filter.



YAESU ELECTRONICS CORP.,

15954 Downey Ave., Paramount, CA 90723

EASTERN SERVICE CTR.,

9812 Princeton-Glendale, Cincinnati, OH 45246

Instant recall.

(And 25 watts of power)

Kenwood's exciting 25-watt TR-7625 and optional RM-76 Microprocessor Control Unit...gives you the power you want plus outstanding channel memory and scanning capability.

...there's more! The TR-7625 has a lot of versatility for a 2-meter FM transceiver and when teamed up with the RM-76 gives you a lot of rig. See the new TR-7625 and optional RM-76 now at any Authorized KENWOOD Dealer!

RM-76 MICROPROCESSOR CONTROL UNIT



 **KENWOOD**
...pacesetter in amateur radio

TRIO-KENWOOD COMMUNICATIONS INC.
1111 WEST WALNUT/COMPTON, CA 90220