

73 Magazine

for Radio Amateurs

- 26 **DXpeditioning**
—a "how to" guide WA2VMS
- 34 **VHF On Your Frequency Counter**
—an easy-to-build prescaler WB0CLH
- 38 **The KM1CC Story**
—hams celebrate Marconi's miracle WA1JWD
- 44 **Good News!**
—easy autoranging for your counter Lassagne
- 48 **Mighty Mods for the 820S**
—more power and convenience K4FK, WA4KIL
- 54 **Improving Heath's HT**
—a half-dozen swell mods WA6TLK
- 60 **Total Control**
—a versatile TT system WB2MPZ
- 64 **Oddball Splits and the IC-22S**
—work any repeater W6YUY
- 68 **The History of Ham Radio**
—part VI W9CI
- 72 **Reusing Coax Connectors**
—worthwhile salvage job W0FEV
- 74 **Building From Magazine Articles**
—the breadboard/wire-wrap way WA7NEV
- 78 **Super Simple TT Generator**
—uses almost no components WA6AFX
- 80 **Microstrip**
—magical PC technique explained N6TX
- 98 **Low-Pass Filter Primer**
—tells all K2OAW
- 102 **Hello Hamdom!**
—a CBer makes the switch WN3NNY
- 103 **More "Coming Of Age"** VE3FLE
- 104 **Rejuvenate A Pawnee!**
—put it on 2 K4GRT, W4IEV
- 112 **High Seas Adventure—Ham Style**
—part I WA6FEI
- 122 **Build A Better Beeper**
—variable time-interval generator W3QVZ
- 126 **DMM Buyer's Guide**
—expert tells all McClellan
- 130 **Triple Threat**
—Microlog's RTTY, Morse, and ASCII
system K3CMY
- 136 **The Ultimate T-Hunt**
—repeater jammer foiled again WB6JPI
- 142 **Two Meter HT Survey**
—data on 21 rigs K5XY
- 146 **Interrupts Made Easy**
—for 8080/S-100 users WB6LOA
- 154 **Use A Computer? Who, Me?**
—yes ... you! WB2HJD
- 156 **Bird Watching in BASIC Land**
—another use for your micro K6EW
- 161 **Computers and the Real World**
—practical D/A and A/D conver-
sion W1FZA
- 166 **World's Cheapest QSLs**
—BASIC program keeps your log,
too WA7VZR
- 182 **The Long-Term Effects of Working
with ICs**
—learn the five warning
signs WA2SUT/NNN0ZVB
- 184 **The Lady Saw Red**
—if the shoe fits WB4ZVZ
- 186 **The Frugal Alternative**
—home-brew an HT charger W8FX/4
- 188 **PLL Techniques**
—a practical guide Earnshaw
- 198 **Build A TTY Tester**
—works for TTL-compatible printers,
too K7YZZ
- 210 **It's A Ham's World**
—show this one to a non-amateur K2HTO
- 218 **Attention, Weather Watchers!**
—advanced circuitry for WEFAX
processing Cawthon
- 249 **Interchangeable Test Leads**
—individuality has limits K3MPJ
- 250 **Happiness Is A Smart Scanner**
—mods for the PBM/AWE FMSC-1 K8JS
- 252 **Tweaking Your Linear**
—the right way to tune it W5VSR
- 254 **CB to 10**
—part XII: convert a Kraco PLL rig W1PI
- 256 **Tuned Circuits In Your Junk Box**
—making do with what's on hand W3KBM
- 258 **Support Your Local Fire Chief**
—hams and the safety services W1FYR
- 262 **Improved Scanner for the VHF/One Plus**
—a \$4.00 mod does it W7AAY
- 268 **A Perfect Power Supply?**
—well ... almost WB3BUU/8/K8UR
- 270 **Mobile Security Blanket**
—remote control for older rigs WA1RTD
- 274 **Further Adventures of the IC-22S**
—our hero gets offset flexibility W6WUT
- 282 **Antenna Design: Something New!**
—controlled-current distribution ... W4FD, W4ATE
- 291 **Build An Audible Transistor Tester**
—it's a CPO, too WB7NZG/DA1DB



800

channels in the palm of your hand

Tempo presents the
S1 SYNCOM...the world's
first synthesized 800
channel hand held
transceiver

Shown with accessory touch tone pad

This amazing pocket sized radio represents the year's biggest breakthrough in 2-meter communications. Other units that are larger, heavier and are similarly priced can offer only 6 channels. The SYNCOM'S price includes the battery pack, charger, and a telescoping antenna. But, far more important is the 800 channels offered by the S1.

The optional touch tone pad shown in the illustration adds greatly to its convenience and we have available a 30 watt solid state power amplifier designed to give the SYNCOM S-1 the flexibility of operating as a mobile and base station as well.

SPECIFICATIONS

Frequency Coverage: 144 to 148 MHz
 Channel Spacing: Every 5 KHz
 Power Requirements: 9.6 VDC
 Current Drain: 17 ma -standby 400 ma -transmit
 Batteries: Ni-cad battery pack included
 Antenna Impedance: 50 ohms
 Dimensions: 40 mm x 62 mm x 165 mm (1.6" x 2.5" x 6.5")
 RF Output: Better than 1.5 watts
 Sensitivity: Better than .5 microvolts

SUPPLIED ACCESSORIES

Telescoping whip antenna, ni-cad battery pack, charger.

OPTIONAL ACCESSORIES

Touch tone pad, tone burst generator, CTCSS chips, Rubber flex antenna.

Price ... \$349.00 (or with touch tone pad... \$399.00)

Tempo also offers a complete line of solid state power amplifiers, pocket receivers, the FMH-2, 5 & 42 portables, the VHF/ONE PLUS mobile transceiver, and the FMT-2 & FMT-42 remote control mobile transceiver. All available from Tempo dealers throughout the U.S. Call or write for full information.

11240 W. Olympic Blvd., Los Angeles, Calif. 90064 213/477-6701
 931 N. Euclid, Anaheim, Calif. 92801 714/772-9200
 Butler, Missouri 64730 816/679-3127

Henry Radio

Prices subject to change without notice

The world's most popular 2 meter amateur hand-helds now are even better!!!

with the miniature-sized

Wilson

2.5 watt MARK II and 4.0 watt MARK IV amateur hand-helds

Wilson hand-helds have been known world-wide for exceptional quality and durable performance. That's why they have been the best selling units for years.

Now the American made Mark Series of miniature sized 2 meter hand-helds offers the same dependability and operation, but in an easier to use, more comfortable to carry size . . . fits conveniently in the palm of your hand. Like its size, the price is also the smallest on the market.

To obtain complete specifications on the Mark II and Mark IV, along with Wilson's other fine products, see your local dealer or write for our Free Amateur Buyer's Guide.

SPECIFICATIONS

- Range: 144-148 MHz
- 6 Channel Operation
- Individual Trimmers on TX and RX Xtals
- Rugged Lexan® outer case
- Current Drain: RX 15 mA
TX - Mark II: 500 mA
TX - Mark IV: 900 mA
- 12 KHz Ceramic Filter and 10.7 Monolithic Filter incl.
- 10.7 MHz and 455 KHz IF
- Spurious and Harmonics: more than 50 dB below carrier
- BNC Antenna Connector
- .3 Microvolt Sensitivity for 20 dB Quieting
- Uses special rechargeable Ni-Cad Battery Pack
- Rubber Duck and one pair Xtals 52/52 included
- Weight: 19 oz. including batteries
- Size: 6" x 1.770" x 2.440"
- Popular accessories available



Illustrated with optional Chomarics or Digitran Touch Pad.



Illustrated is Wilson's BC-2 Desk Top Battery Charger shown charging the Mark Series Unit or the BC-4 Battery Pack only.

Consumer Products Division



Wilson Electronics Corp.

W2

4288 South Polaris Avenue • P. O. Box 19000 • Las Vegas, Nevada 89119
Telephone (702) 739-1931 • TELEX 684-522

Prices and specifications subject to change without notice.

Staff

EDITOR/PUBLISHER
Wayne Green W2NSD/1

EXECUTIVE VICE PRESIDENT
Sherry Smythe

ASSISTANT PUBLISHER
Jeffrey D. DeTray WB8BTH/1

ADMINISTRATIVE ASSISTANT
Dotty Gibson

MANAGING EDITOR
John C. Burnett

ASSISTANT MANAGING EDITOR
Susan G. Philbrick

NEWS EDITOR
Gene Smarte WB6TOV/1

BOOK PUBLICATIONS
Christopher E. Smith

PRODUCTION MANAGER
Lynn Panciera-Fraser

ART DEPARTMENT
Craig Brown
Gayle Cabana
Bob Drew
Bruce Hedln
Carl Jackson
James Lamothe
Dion Owens
Noel R. Self WB1ARP
Robin M. Sloan

PRINTING
Gary Steinbach
Dan Morgan

PHOTOGRAPHY
Bill Heydolph
Tedd Cluff

TYPESETTING
Barbara J. Lattl
Mary Kinzel
Holly Walsh

BOOKKEEPER
Knud E. M. Keller KV4GG/1

CIRCULATION
Barbara Block
Laura Barnicle

DATA ENTRY
Mary Kinzel

DIRECTOR OF MARKETING
Robert R. LaPointe

BULK SALES MANAGER
Judy Waterman

SHIPPING
Ethan Perry
Bill Barry
Michelle Walsh

RECEPTIONIST
Donl Jarvis

ASSOCIATES
Robert Baker WB2GFE
E. H. Barnett WB0IX
Schley Cox WB9LHO
Tom DiBlase WB8KZD
Terry Fox WB4JF1
W. Sanger Green
Dave Ingram K4TJWJ
Larry Kahaner WB2NEL
Joe Kasser G3ZCZ
Bill Pasternak WA6ITF
John Schultz W4FA
Walter Scott K8DIZ
Peter Stark K2QAW
Bill Turner WA0ABI

COMPUTER PROGRAMMING
Richard J. Dykema
Ron Cooke WB9VHX
Steven B. Lionel

CUSTOMER SERVICE
Florence Goldman
Joyce Tarr

ADVERTISING
Aline Coutu
Marcia Stone
William G. York
Nancy Clampa

W2NSD/1 NEVER SAY DIE

editorial by Wayne Green



A WOMAN ARRL DIRECTOR?

Mary Lewis W7QGP is running against Robert Thurston W7PGY for the Northwest Division directorship of the League. Thurston is reported to have said that a woman can never be a director.

While I get along fine with some of the ARRL directors, I've found Thurston to be about as arrogant as they come... much taken with his own tremendous importance. His reaction when Mary Lewis ran for SCM against his personally handpicked candidate, and won, was one of outrage. Then Mary was instrumental in the QCWA annual convention being tied in with the ARRL national in Seattle last year and that tore it. Mary was fired as SCM on a trumped-up charge that she had not paid a \$25 bill for ARRL labels to send a mailing to the members in her area. I've looked into the growing file on this debacle, and I can find no sign whatever that the ARRL ever even billed Mary for the labels... which they should not have done anyway.

I've met and talked with Mary several times, and I've found her to be very well informed on both local and national matters. Even more important, I've found her interested in doing what she can for amateur radio rather than in ways to feed her ego. I have never met anyone who knows her who doesn't think she is top-notch.

The ARRL is desperately in need of cleaning out the old guard who come to Newington and rubber-stamp whatever headquarters wants. If Thurston is re-elected, I'll be ashamed of the Northwest.

REMOTE RECORDING

For several years I hauled around fairly good-sized tape recorders to keep a record of my talks, to tape other talks of interest, to tape interesting sounds, etc. I got started in this line of mischief way back when the Webcor wire recorders came on the market, a bit over 30 years ago.

As recorders have gotten smaller, I've kept up with them, and these days I carry around one of those very small cassette recorders, a Sony TC-55. This operates from 6 V dc with a couple of built-in nicads or an external 120 V ac operated power supply.

Eventually I got tired of lugging around 50 to 100 feet of line cord for this tiny recorder. Any less often made it impossible to reach a wall socket in larger auditoriums. The nicads lasted only a few minutes, impossibly undependable for any talk I really wanted to record... or music. I got the idea to buy a 6 V lantern battery and lug that instead of the line cord and power supply. I even have a place for the recorder and battery in my attache case.

With the lantern battery, I can record for days before exhausting it and there are no line cords to string or for people to trip over. Eventually even a lantern battery tires and a valuable recording can be lost. Two lantern batteries? One is heavy enough, thanks. Radio Shack came up with the ideal answer... a rechargeable lantern battery.

Now, when I get back from a trip, I put the battery on to charge for a day and then pack it back in the attache case. If it sits there for too long before my next trip to a hamfest or

computerfest, I give it an hour of juice before leaving. Since this system has been inaugurated, I've never had a failure.

The battery and 500 mA recharger are available from Radio Shack for about \$21.

Once you get used to having a cassette recorder with you, all sorts of uses turn up. I record magazine publishing workshops, bluegrass music in a Paris subway, ARRL officials talking, interviews with interesting businessmen, important agreements over the telephone, notes at exhibitions on new products, etc.

ASPEN HAM INDUSTRY CONFERENCE

The fourth annual Ham Industry Conference will be held (again) at Aspen, Colorado. This is a series of workshops for the examination of the ham market, how to sell, how to organize and finance a ham store, how to write advertising, etc. The conference is aimed at being of value to both manufacturers and dealers.

The conference will be held from January 6th (arrival that afternoon) until January 13th (leaving day). If you are interested in joining the group for some interesting workshops, some skiing, and some of the best food in the world, please drop a line to Aspen Workshop, *clo 73 Magazine*, Peterborough NH 03458. Please make your arrangements for accommodations and lift tickets, etc., with Joanie Eidsmo, Aspen Ski Tours, Box 320, Aspen CO 81611, (303)-925-9500. We will, as usual, be staying at the Continental Inn, about one block from beautiful downtown

Escape the rat race... try 440 MHz FM!



TR-8300

2 METERS IS GREAT! THAT'S WHY EVERYBODY IS ON THE BAND (SO IT SEEMS), AND YOU WILL HEAR THE POPULAR KENWOOD TR-7400A AND TS-700SP TRANSCEIVERS ON ALL THE REPEATERS AND SIMPLEX FREQUENCIES. BUT SOMETIMES YOU WISH THE BAND WERE NOT SO POPULATED... SO YOU COULD GET A WORD IN EDGEWISE... OR MONITOR A RELATIVELY QUIET CHANNEL FOR A FRIEND OR TWO... OR HEAR SIGNALS WITH LESS NOISE... OR USE A SOPHISTICATED REPEATER OR REMOTE BASE WITH BETTER COVERAGE. 440 MHz IS THE ANSWER. IT WILL SURPRISE YOU. IT WILL PENETRATE BUILDINGS WHERE 2 METERS WON'T, AND OFTEN YOU CAN EVEN WORK OUT FROM UNDERGROUND GARAGES... WHERE 2 METERS IS DEAD! BEST OF ALL, IT'S EASY TO GET ON 440 MHz (70 CM)... WITH A KENWOOD TR-8300 TRANSCEIVER. HIGH QUALITY IS CRITICALLY IMPORTANT ON UHF BANDS, AND THE TR-8300 IS JUST WHAT YOU NEED TO MEET ALL TECHNICAL REQUIREMENTS. IT FEATURES:

- 10 watts RF output (switchable to 1 watt)
- 23 crystal-controlled channels (3 supplied)
- 445 0-450.0 MHz transmit range
- 442 0-447.0 MHz receive range
- Transmitter and receiver adjustable over any 5-MHz segment from 440 to 450 MHz
- 5-section helical resonator and 2-pole crystal filter in IF to reject intermod
- SWR protection in final amplifier
- Excessive-voltage and reverse-polarity protection circuits
- 0.5 μ V for 20 dB quieting sensitivity
- Better than -60 dB spurious radiation
- 20 KHz (-6 dB), 40 KHz (-70 dB) selectivity
- Monitor switch that lets you check modulation and frequency "netting"
- Call CH switch that activates optional CTCSS (subaudible tone) function
- Large S meter

Move up to 440 MHz today... with a Kenwood TR-8300... for more reliable communications!

Aspen. Don't forget your HT, if you come ... with 146.52 set up.

UNSCREWING THE CONSUMER

A recent letter from Barry Goldwater suggested that we stop sitting around waiting for the government to adopt a law to force manufacturers of consumer electronic equipment to build in radio frequency filters which would permit them to work in the vicinity of radio transmitters. Since Barry has been trying to get this legislation through for quite a few years, perhaps he is on to something.

The logical extension of his idea is for radio amateurs to put enough pressure on Industry to force changes in designs. Since most ham clubs already have TVI committees to investigate interference from ham rigs, we have the nucleus to get something started.

Suppose TVI committees were to send in the name and model of any consumer electronic equipment which was inadequately designed and as a result was overly susceptible to interference from nearby transmitters. If this list was then published in *73* so all amateurs would have it at hand for helping advise neighbors,

friends, people at work, etc., as to which makes of equipment to avoid, the message might get through. With 300,000 hams putting out the word in every corner of the country, even the most recalcitrant of manufacturers might decide it was time to spend an extra fifty cents and include an input filter on their television set, hi-fi, etc.

If the idea is to be of any real value, it will take the cooperation of every ham and every club. I pledge the cooperation of *73 Magazine*. If your TVI committees will send in reports on consumer products, I'll contact the manufacturer. If I get no prompt assurance of change, they'll go on the list. I then want to know for sure that you will advise everyone you meet to hold up on buying this product until needed changes are made ... and that you'll also haunt any local dealers and drive them crazy. Letters to the newspapers, television consumer shows, news shows, won't hurt either. Yes, I think hams can do what the government was afraid to do. The EIA may have millions of dollars to stop such legislation going through, but they can't stop *73 Magazine* and the whole of amateur radio.

Are you game? Let's start getting some TVI committee

reports and see what we can do. Also, if you can get any of the other ham magazines to cooperate, all the better. This is no time for any one-man show.

QST MYSTERY COVER

One of the nicer *QST* covers in many months was the August cover promoting the San Diego ARRL Convention. Oddly, no credit was given for the cover drawing. Curious?

Below is the cover before *QST* blocked out the QCWA part of the drawing. The artist involved is Paul Hower WA6GDC, a 50-year ham, long-time member of QCWA, and International Vice Commander of the Happy Flyers, a club made up of ham-pilots.

The one major difference is the removal of the reference to the QCWA convention. Unhappily, it appears that as the Quarter Century Wireless Association has grown in members (and thus strength), the ARRL has taken a more and more belligerent attitude toward it. The ARRL has a long history of trying to destroy any organization in amateur radio which they don't control. I'm reminded of a talk I had with the sales manager of Data General, one of the larger minicomputer firms. I was interested in connecting a Teletype™ machine to their system, if I bought it. Anything I wanted to use with the Data General system which I didn't buy from them was termed "hostile" equipment.

How much have you seen in *QST* about the QCWA? This is

the second largest organization in amateur radio. It is made up of amateurs who have been licensed 25 years or more. One would expect the ARRL to be proud of the QCWA instead of trying to bury it.

In 1977, a big battle developed between the ARRL and their convention committee in Seattle because Seattle insisted on hosting the QCWA National Convention at the same time. Ask any ham in Seattle about the raw deal they gave the committee. I was there and saw it with my own eyes. The ARRL even forbid its HQ staff from attending the QCWA banquet! Surely I'm exaggerating. I wish I were.

Oddly enough, I've seen no resulting anti-ARRL reaction from the leaders of the QCWA ... and I have known them all for many years. Their patience with the Newington paranoia is heroic. Fortunately for the League, the QCWA has virtually no national organization, existing almost entirely through its many local chapters. If QCWA did have any significant national organization, we might find ourselves in the middle of a serious war between the bureaucrats in Newington and the old-timers who made this hobby what it is today. We don't need that.

There may be some ARRL supporters who wish to challenge what I've said. I'm not out to tear down the League, only to get it to work in the best in-

Continued on page 171

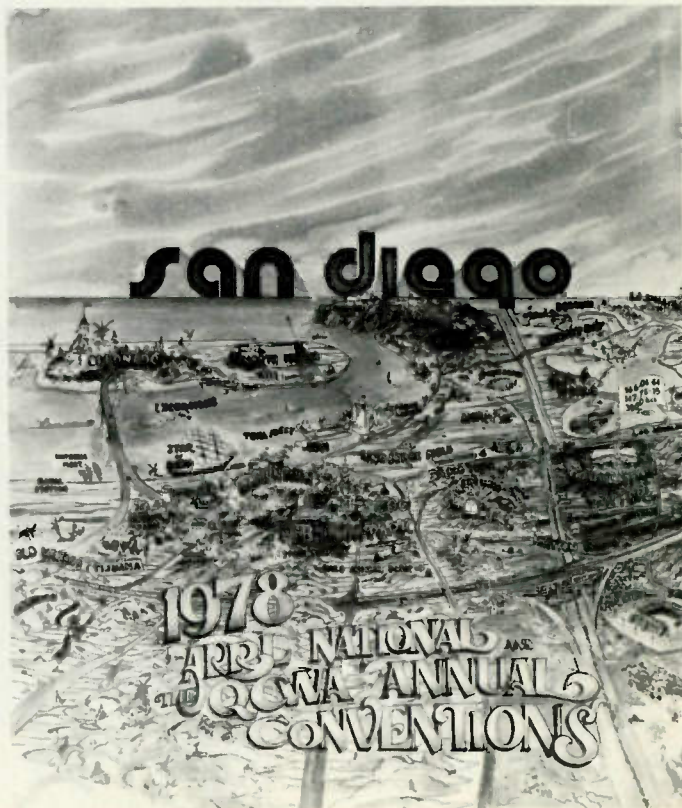
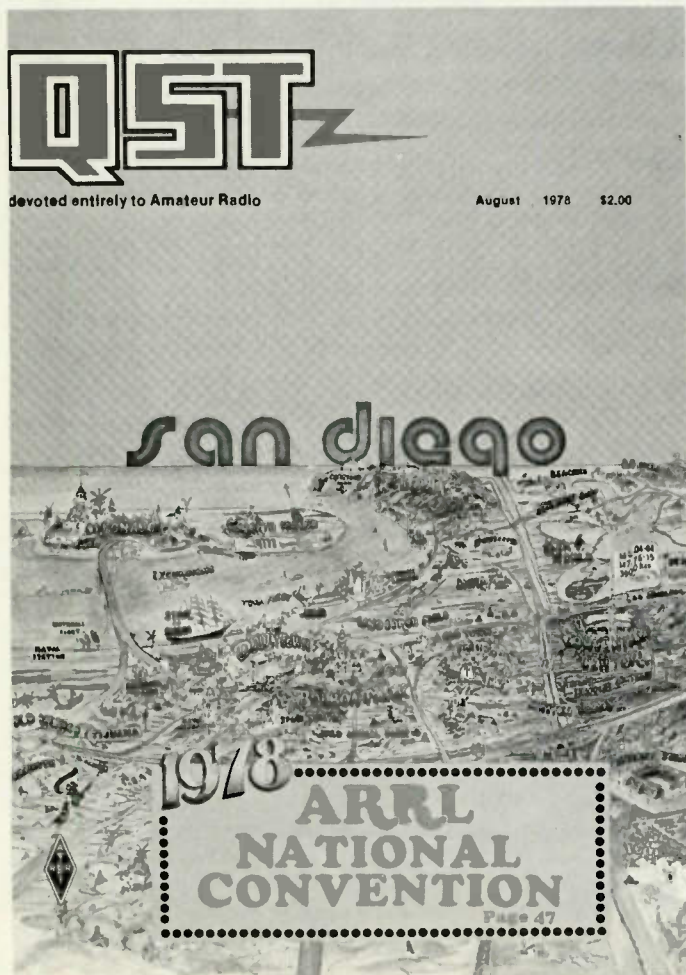

The ICOM LSI System



COMPATABILITY IS THE KEY TO SUCCESS

Owning an ICOM LSI radio is a true pleasure for anyone in Ham Radio. Putting two of them side by side in a matching station certainly more than doubles the pleasure and performance. The compatible styling of the **IC-211** and **IC-701** provides an operating station which is a beauty to look at as well as a joy to operate. The compactness of the units and the similarity of controls and switch layout help to take the confusion out of knowing which knob to turn. Microphones and other accessories are also compatible with both radios, such as the **RM-2** remote microprocessor frequency controller, shown above.

When used with the **IC-211** or **IC-701** (or **IC-245**, for that matter), the **RM-2** provides memory and frequency control, including automatic band change and memories for four different frequencies, plus auto-increment or single step tuning in 100 Hz, 1 KHz or 15 KHz steps. The **RM-2** also provides automatic offset for repeater operation when used with the **IC-211** or **IC-245**. The tone generator accommodates operation of telephone type devices or a two-tone signal for an external amp that needs to be tuned. (Naturally there is no tuning needed on an **IC-211** or **IC-701**.)

No one could ask for a better Oscar station than the **IC-211** and **IC-701** together for "mode A": and adding a transverter to the **IC-701** mode B or mode J opens newer, better satellite horizons. Within the ICOM LSI based radios there is the capacity for the technically minded Amateur to tune one radio of the pair with the VFO knob of the other. (Oscar transceive, anyone?) In addition, the LSI lends itself to being controlled by a parallel port on one of the increasing number of microprocessors now available for Amateur use.

The complexity of features built into these ICOM LSI twins will be used for a long time into the future. The possibilities are so numerous that even we have not thought of all of them yet.

All ICOM radios significantly exceed FCC specifications limiting spurious emissions.

Shown left to right: **IC-211**, multi-mode 4MHz trxvr; **RM-2**, remote microprocessor; **IC-701**, multi-mode HF trxvr; **IC-701PS**, power supply / speaker.

HF/VHF/UHF AMATEUR AND MARINE COMMUNICATION EQUIPMENT

DISTRIBUTED BY:



ICOM

¹¹ ICOM WEST, INC.
Suite 3
13256 Northrup Way
Bellevue, Wash. 98005
(206) 747-9020

ICOM EAST, INC.
Suite 307
3331 Towerwood Drive
Dallas, Texas 75234
(214) 620-2780

ICOM CANADA
7087 Victoria Drive
Vancouver B.C. V5P 3Y9
Canada
(604) 321-1833

Editor:
Robert Baker WB2GFE
15 Windsor Dr.
Atco NJ 08004

CONTESTS

VK/ZL OCEANIA CONTEST

Phone & RTTY
Starts: 1000 GMT
Saturday, October 7
Ends: 1000 GMT
Sunday, October 8
CW

Starts: 1000 GMT
Saturday, October 14
Ends: 1000 GMT
Sunday, October 15

Sponsored by the New Zealand Association of Radio Transmitters, the contest is open to all amateurs and SWLs.

EXCHANGE:

RS(T) plus serial number starting at 001.

SCORING:

Oceania stations score 2 points per QSO with VK/ZL, 1 point for QSO with Oceania other than VK/ZL. All other stations score 2 points per VK/ZL QSO, 1 point per Oceania (other than VK/ZL) QSO. Final score is derived by multiplying total QSO points by the sum of VK/ZL call areas worked on all bands. The same VK/ZL call area worked on different bands counts as a separate multiplier.

ENTRIES AND AWARDS:

Logs must show, in this

order: date/time in GMT, callsign of station contacted, band, serial number sent/received. Underline each new VK/ZL call area contacted and make separate logs for each band. Summary sheet must show callsign, name, address (please use block letters), details of equipment used, and for each band, QSO points for that band and total of VK/ZL call areas worked on that band. Allband score will be total QSO points multiplied by sum of VK/ZL call areas on all bands while single band scores will be that band's QSO points multiplied by VK/ZL call areas worked on that band only. Sign a declaration that all rules and regulations have been observed. Attractive colored certificates will be awarded top scorers. Send entries to: NZART Contest Manager, ZL2GX, 152 Lytton Road Gisborne, New Zealand, before Jan. 31.

SWL Section:

A VK or ZL station must be heard in a QSO and the following details noted in the log—date, time in GMT, call of

the VK or ZL station heard, callsign of the station he is working, RS(T) of the VK/ZL station heard, serial number sent by the VK/ZL station, band, and points. Scoring is on the same basis as for the transmitting section and the summary sheet should be similarly set out. Phone and CW are combined for SWLs.

Special Rules for RTTY:

Classes include single-operator, multi-operator, and SWL. Logs of multi-operator stations must be signed by all operators together with their callsigns. SWLs must show both number sent and the number received by the station logged. Incomplete entries are ineligible. Exchange consists of RST, zone number, and time in GMT. Scoring as per CARTG zone chart, multiplied by the number of countries worked, multiplied by the number of continents worked (6 max.). World stations add 100 points for each VK and ZL station worked after the above calculations. A station may be worked only once on each band, but may be worked on another band for further multipliers. Eligible country multipliers as per ARRL countries list plus each call district in VK/ZL, J, and W/K. Contact with one's own country does not count as a multiplier. Logs must show in this order: date and time in GMT, call of station worked, serial sent and received, points claimed. Use a separate log for each band. Summary sheet to show callsign, name and address in block letters, section in which competing, details of station, points claimed for each band, number of VK/ZL stations worked, total points, and declaration that relevant rules have been observed. Attractive colored certificates to be awarded to the first to third places on a world basis and for each country multiplier shown above. Logs must be received by the RTTY committee by January 1 at the following address: S.E. Molen VK2SG, 13 Pendle Way, Pendle Hill, Sydney, NSW Australia 2145.

CALIFORNIA QSO PARTY
Starts: 1800 GMT Saturday,
October 7
Ends: 2400 GMT Sunday,
October 8

This contest is sponsored by the Northern California Contest Club. Of the 30-hour period, the maximum operating time shall not exceed 24 hours.

Multi-operator stations may, however, operate the full 30-hour period. Times on and off must be clearly marked in a log. Each time off shall not be less than 15 minutes. All amateur bands may be used, and stations may be worked once on phone and once on CW on each band. VHF contacts are limited to simplex operation. A California station which changes counties (such as a mobile or portable) is considered to be a new station and may be contacted again on each band and mode. California stations may work each other. Also, DX stations may be worked by California stations for QSO points, but do not count as multipliers.

EXCHANGE:

CA stations send consecutive QSO numbers and county. Others send consecutive QSO number and state, province, or country.

SCORING:

Each completed QSO counts 2 points. CA stations multiply QSO points by the number of states plus Canadian districts (VE/VO 1-8)—58 maximum. Others multiply QSO points times number of California counties (58 max.).

FREQUENCIES:

CW—1805, 3560, 7060, 14060, 21060, 28060.
SSB—1815, 3895, 7230, 14280, 21355, 28560. Novice—3725, 7125, 21125, 28125. Try 10 meters on the hour and 15 on the half hour between 1800 and 2200 GMT.

ENTRIES & AWARDS:

Log information should include date, time, band, mode, callsigns, and exact exchanges sent/received. Please remember to number each new multiplier as worked. A summary sheet should be included showing your callsign, name, address, number of QSOs, total number of multiplier (58 max.), claimed score, and whether the entry is single- or multi-operator. Summary sheets are available from the NCCC. Certificates will be awarded to the highest-scoring station in each CA county, state, province, or country. A mobile station must make a minimum of 20 QSOs to be eligible for a county certificate. Second- and third-place awards will be made where justified. In addition, certificates will be awarded to the highest-scoring mobile, portable, and multi-operator station. A plaque will be awarded

CALENDAR

*Sept 30-Oct 1 Oct 7-8	Rocky Mountain Division QSO Party California QSO Party VK/ZL Oceania DX Contest— Phone & RTTY
Oct 14-15	VK/ZL Oceania DX Contest—CW Nine-Land QSO Party RSGB 21/28 MHz—Phone Manitoba QSO Party ARRL CD Party—CW
Oct 21-22	Jamboree-On-The-Air CARTG Worldwide RTTY DX "Dominion" Sweepstakes RSGB 7 MHz SSB ARRL CD Party—Phone
Oct 28-29	CQ Worldwide DX—Phone CQ-WE Contest
Nov 4-5	ARRL Sweepstakes—CW RSGB 7 MHz CW
Nov 11	OK DX Contest
Nov 11-12	IPA Contest Delaware QSO Party Missouri QSO Party
Nov 18-19	ARRL Sweepstakes—Phone All Austria Contest
Nov 25-26	CQ Worldwide DX—CW
Dec 2-3	ARRL 160 Meter Contest International Island DX Contest TOPS CW Contest
Dec 9-10	ARRL 10 Meter Contest
Dec 16-17	SOWP Christmas CW QSO Party

* = described in last issue

to the in-state and out-of-state clubs submitting the highest aggregate score.

All entries must be sent to: the NCCC, c/o George Varvitiotes WB6DSV, 801 Inverness Way, Sunnyvale CA 94087, and must be postmarked not later than October 31. A business-size SASE is requested with each entry.

OCTOBER QRP QSO PARTY

Starts: 2000 GMT

Saturday, October 7

Ends: 0200 GMT

Monday, October 9

Sponsored by the QRP Amateur Radio Club International, Inc., this contest is open to all amateurs and all are eligible for awards. Stations can be worked once per band; general call is CQ QRP DE.

FREQUENCIES:

CW—1810, 3560, 7060, 14060, 21060, 28060, 50360. SSB—1810, 3985, 7285, 14285, 21385, 28885, 50385. Novice—3710, 7110, 21110, 28110. All frequencies ± 5 kHz to avoid QRM, as license permits.

EXCHANGE:

Members send RS(T), state, province, or country, and QRP number. All others send RS(T), state, province, or country, and power input.

SCORING:

Each member QSO counts 3 points; non-members count 2 points per QSO; stations other than WVE count as 4 points. Multipliers based on input power of transmitter: greater than 100 Watts — x1; 25 to 100 Watts — x1.5; 5 to 25 Watts — x2; 1 to 5 Watts — x3; less than 1 Watt — x5. Total score is QSO points times total number of states or provinces or countries per band times power multiplier.

ENTRIES AND AWARDS:

Certificates to highest-scoring station in each state, province, or country and other places depending on activity. One certificate for the station showing three "skip" contacts using the lowest power. Send full log data, including full name, address, and bands used, plus equipment, antennas, and power used. Entrants desiring results please enclose a #10 SASE. Logs must be received by Oct. 31 to qualify. Send all entries to: QRP ARC Contest Chairman, E.V. Sandy Blaize N5BE, 417 Ridgewood Drive, Metairie LA 70001.

NINE-LAND QSO PARTY

Starts: 1800 GMT

Saturday, October 14

Ends: 2359 GMT

Sunday, October 15

A maximum of 24 hours of

the 30-hour period may be worked. The same station may be worked once per band and mode. If any station changes counties, it may be worked again.

EXCHANGE:

Nine-land stations send RST, county, and state. Others send RST, state, province, or ARRL country.

FREQUENCIES:

CW—1805, 3560, 7060, 14060, 21060, 28060, and VHF. SSB—1815, 3895, 7230, 14280, 21355, 28600, and VHF. Novice—3725, 7125, 21125, 28125.

SCORING:

Each QSO is worth 2 points. Scores shall be computed as follows: 9-land—number of QSOs times the sum of the number of states, provinces, ARRL countries, and 9-land counties times 2 points per QSO. All others—number of QSOs times number of 9-land counties times 2 points per QSO.

AWARDS:

Certificates to top score in each 9-land county, state, province, and ARRL country; 2nd and 3rd if justified. Also, top mobile, portable, multi-single, multi-multi, club, and Novice awards.

ENTRIES:

Submit summary sheet and log. Each new multiplier shall be clearly indicated. Send logs and a large SASE to: Ill Wind Contesters, c/o John Sikora WB9IWN, 8155 Woodlawn Street, Munster, Indiana 46321, for results.

JAMBOREE-ON-THE-AIR

The 21st Jamboree-On-The-Air will be held over the weekend of October 21 and 22. Suggested starting time is 0001 hours local time on Saturday, October 21, to terminate 48 hours later at 2359 hours local time, Sunday, October 22. These are suggested times only. Many stations find it more convenient to operate on the Friday evening and each station is completely free to select its own times and periods for operation. However, there is a better chance of finding overseas stations if the suggested times are followed.

Local regulations must be strictly adhered to. Look for stations around the official World Scout Frequencies, suggested by the World Bureau: Phone—3940, 7090, 14290, 21360, 28990, 53500. CW—3590, 7030, 14070, 21140, 28190.

This year's World Scout Bureau JOTA participation card uses a "key" symbol denoting JOTA's 21st birthday and copies will be sent to all participants, preferably to unit leaders for their units or to

hams for presentation to Scouts at unit meetings. They are available on request from Boy Scouts of America, Attention: W2GND, SUM-0101, North Brunswick NJ 08902.

Hams are requested to submit reports for consolidation and report to the World Bureau, with pictures if possible for publication.

K2BSA at the National Headquarters, Boy Scouts of America, will be operating on CW, SSB, and SSTV, and will QSL—same address as above.

The World Scout Bureau, in conjunction with Scouts from Switzerland, France, and from the Boy Scouts of America, Trans Atlantic Council, will operate from a special international camp established at the Centre Scout de Satigny, a small village some 15 km from Geneva. With the cooperation of operators from the CERN Amateur Radio Club, it is planned to operate several stations simultaneously on all bands, including SSTV, RTTY, and OSCAR.

More information is available from Harry A. Harchar W2GND/K2BSA, Boy Scouts of America, North Brunswick NJ 08902, (201)-249-6000.

CARTG WORLDWIDE RTTY DX "DOMINION" SWEEPSTAKES

Starts: 0200 GMT

Saturday, October 21

Ends: 0200 GMT

Monday, October 23

Sponsored by the Canadian Amateur Radio Teletype Group, VE3RTT. Not more than 30 hours of operation is permitted, with non-operating periods taken at any time during the contest. Summary of times on and off must be submitted with score. Use all amateur bands authorized for F1 emission (RTTY). Country status as per ARRL country list; KL7, KH6, W/K, VE/VO, and VK districts to be considered as separate countries.

EXCHANGE:

Messages will consist of RST, time in GMT, and zone.

SCORING:

All 2-way RTTY QSOs with own zone will earn 2 points; all others as per CARTG zone chart (send SASE if needed). Stations may not be contacted more than once on any one band. Multiplier is number of different countries contacted including one's own on each band. Total score is total number of exchange points times number of countries worked times number of continents (6 max.). Canadian bonus points to be added last —100 bonus points for each VE/VO contact on all bands.

ENTRIES AND AWARDS:

Use separate log sheet for

each band. Logs to contain band, date, time (GMT), RST, callsigns, and exchanges. Log sheets and zone charts available from CARTG for SASE or IRCs. Logs must be received before Jan. 1 to qualify. Engraved plaques to top 10 scorers plus other special categories. Certificates to top scorers in each US, VE/VO, and VK district and each country. Send logs, summary, and scores to: CARTG—VE3RTT, 85 Fifeshire Rd., Willowdale, Ontario, Canada M2L 2G9.

CQ WORLDWIDE DX CONTEST

Starts: 0000 GMT

Saturday, October 28

Ends: 2400 GMT

Sunday, October 29

Sponsored by CQ Magazine, the contest is open to all amateurs worldwide. Use all amateur bands, 160 through 10 meters. Entry classifications include: single-op, single and all band; multi-op (all band), single- or multi-transmitter.

EXCHANGE:

RS(T) and zone.

SCORING:

Contacts between stations on different continents count 3 points; stations on same continent but different countries 1 point, except for North American stations only!—contacts between stations within North American boundaries count 2 points. Contacts between stations in the same country are permitted for zone or country multiplier credit, but have zero point value. Multipliers are number of different countries on each band. Final score is result of total QSO points multiplied by sum of zone and country multiplier.

ENTRIES AND AWARDS:

Many various awards in different classes and categories. Plaque to highest club score. Logs should include all times in GMT; indicate zone and country multipliers only first time worked on each band. Logs must be checked for duplicate contacts; use separate sheets for each band. Each entry must be accompanied by a summary sheet showing all scoring information, category of competition, name and address in block letters, and a signed declaration that all contest rules and regulations have been observed. Official logs and summary sheets and zone maps are available from CQ; include a large SASE. All entries must be postmarked no later than Dec. 1 for phone and Jan. 15 for CW. Send logs to: CQ WW Contest Committee, 14 Vandeventer Avenue, Port Washington, LI, NY, USA 11050.

Check CQ Magazine for any last minute rule changes!

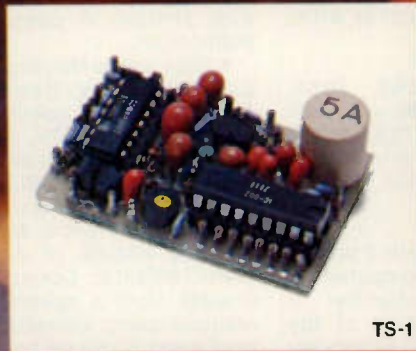

TS-1

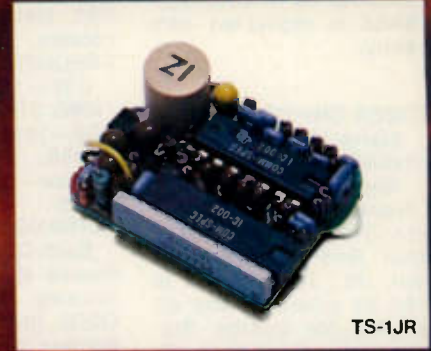

TS-1JR

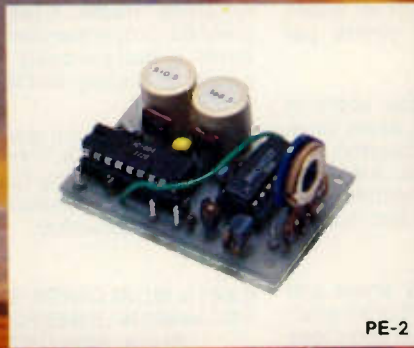

PE-2

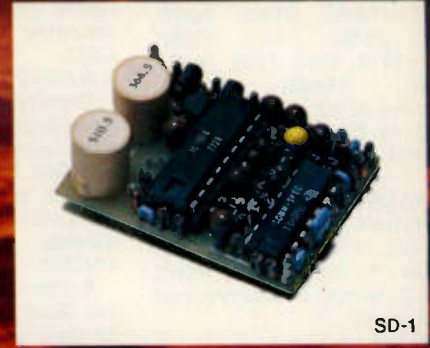

SD-1

THE DAWNING

The age of tone control has come to Amateur Radio. What better way to utilize our ever diminishing resource of frequency spectrum? Sub-audible tone control allows several repeaters to share the same channel with minimal geographic separation. It allows protection from intermod and interference for repeaters, remote base stations, and autopatches. It even allows silent monitoring of our crowded simplex channels.

We make the most reliable and complete line of tone products available. All are totally immune to RF, use plug-in, field replaceable, frequency determining elements for low cost and the most accurate and stable frequency control possible. Our impeccable 1 day delivery is unmatched in the industry and you are protected by a full 1 year warranty when our products are returned to the factory for repair. Isn't it time for you to get into the New Age of tone control?

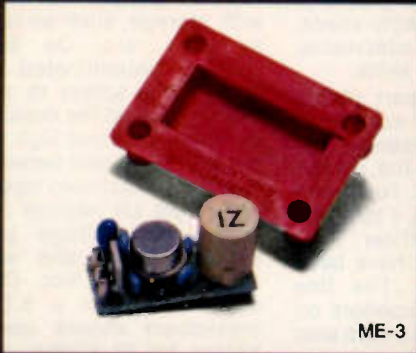

ME-3

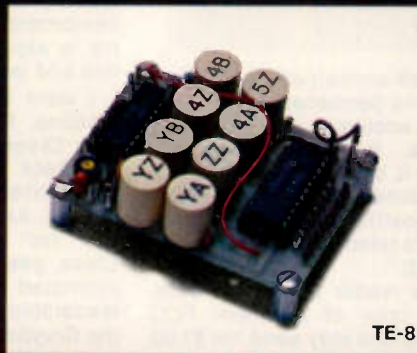

TE-8



TE-12

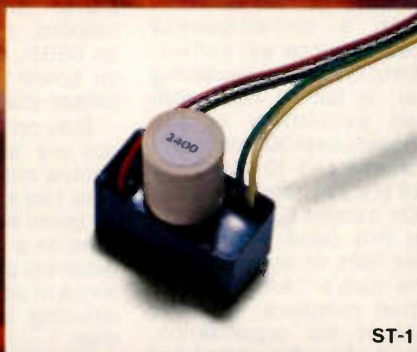

ST-1

OF A NEW AGE.

TS-1 Sub-Audible Encoder-Decoder • Microminiature in size, 1.25" x 2.0" x .65" • Encodes and decodes simultaneously • \$59.95 complete with K-1 element.

TS-1JR Sub-Audible Encoder-Decoder • Microminiature version of the TS-1 measuring just 1.0" x 1.25" x .65", for hand-held units • \$79.95 complete with K-1 element.

ME-3 Sub-Audible Encoder • Microminiature in size, measures .45" x 1.1" x .6" • Instant start-up • \$29.95 complete with K-1 element.

TE-8 Eight-Tone Sub-Audible Encoder • Measures 2.6" x 2.0" x .7" • Frequency selection made by either a pull to ground or to supply • \$69.95 with 8 K-1 elements.

PE-2 Two-Tone Sequential Encoder for paging • Two call unit • Measures 1.25" x 2.0" x .65" • \$49.95 with 2K-2 elements.

SD-1 Two-Tone Sequential Decoder • Frequency range is 268.5 - 2109.4 Hz • Measures 1.2" x 1.67" x .65" • Momentary output for horn relay, latched output for call light and receiver muting built-in • \$59.95 with 2 K-2 elements.

TE-12 Twelve-Tone Sub-Audible or Burst-Tone Encoder • Frequency range is 67.0 - 263.0 Hz sub-audible or 1650 - 4200 Hz burst-tone • Measures 4.25" x 2.5" x 1.5" • \$79.95 with 12 K-1 elements.

ST-1 Burst-Tone Encoder • Measures .95" x .5" x .5" plus K-1 measurements • Frequency range is 1650 - 4200 Hz • \$29.95 with K-1 element.



**COMMUNICATIONS
SPECIALISTS**

426 W. Taft Ave., Orange, CA 92667
(714) 998-3021

ou goons don't ever profic
lousy manuscripts from lat
burch "rock" ...
you liard ...
I insist that you print ev
tell Ma Bell that she 'shou

LETTERS

HAMS ON 49.9

Radio amateurs, caught up in the multitude of activities available on our bands, often fail to explore the possibilities in other regions of the radio spectrum. I believe 49 MHz is one such neglected area.

49 MHz (more specifically, 49.900 MHz) opened January 19, 1977, to non-licensed operators of any age. And, although the FCC's intention to provide a more viable alternative to 100 milliwatt walkie-talkies on CB channel 14 is an honorable one, the frequencies hold potential for the amateur.

Perhaps the most alluring aspect of 49 MHz is the allowance of any type of modulation. That's right: AM, FM, SSB, SSTV, RTTY, CW, radio control, telemetry, computer code, etc. You name it!

An important consideration, and one the XYL will appreciate, is the equipment. It's cheap. Name another type of transceiver that you can purchase a pair of for fifteen dollars. And most of these walkie-talkies function in two modes, AM and CW—AM by means of a push-to-talk bar on the radio side and code by a keying lever on the face.

Part 15, subpart D, low power communications devices of FCC regulations, differentiates, in terms of technical specifications, between marketed equipment (i.e., commercially available or home built in a quantity greater than five and not commercially available) and home-brew rigs. For example, commercial equipment may operate on 49.845, 49.875, or 49.890 MHz with a modulation bandwidth of 20 kHz maximum; rf power is less than 10,000 uV/m at 3 meters on the carrier frequency. Specs for home-built radios are not as "tight." Modulation and rf carrier products must remain in the 80 kHz bandwidth between 49.820 and 49.900 MHz and the rf power restriction is 100 mW under modulation.

Some specifications apply to both marketed and brewed transceivers; sections 15.118 (e) and 15.119 (d) are identical. They describe microphone and antenna parameters. I quote: "The device shall be complete-

ly self-contained with the antenna permanently attached to the enclosure containing the device. If a microphone is used, it shall be built into the enclosure. No remote operating position is permitted (only remote telemetry of data is permitted)."

Any reader desiring a complete copy of pertinent FCC regulations may send me \$1.00 (I'm not trying to make money, only cover expenses of duplicating, postage, etc.). If you simply have questions about 49 MHz, a self-addressed stamped envelope will suffice.

49 MHz is quickly becoming popular. In fact, a radio club devoted exclusively to the band boasts over 300 members in 30 states and 10 countries. The 49'ers sponsor contests, offer DX awards (25 km is rare DX on this band, folks), and compile lists of operators using the club's "AA 49" identification numbers. Information about the organization, founded by Dr. Michael Gauthier K6ICS, is available from: 49'ers Radio Club, P.O. Box 1400, Downey, California 90240.

While 49 MHz is not the future of ham radio, it offers the technician (type, not class, of amateur) a new frontier on which to experiment with flea power, the Novice a band for phone communications while studying to upgrade, and some members of W8UM (the University of Michigan Amateur Radio Club) an opportunity to build code speed. Certainly there are many more valuable uses for 49 MHz... but why stifle ham ingenuity with my suggestions?

F. J. Bartolomei WD8PCB
19442 Rockport Drive
Roseville MI 48066

J. B. FIELDS UPDATE

Several changes have come about in Navy training since I submitted my article last August (73, July, 1978). For one, code school does not graduate people at 22 wpm anymore unless that speed is stipulated in your orders.

One way to obtain the stipulation is to apply for the Submarine Radioman pipeline course in "A" school. If you are in the top ten percent of your

class and meet all requirements, this should be more than easy. Recruiters have the details.

The pipeline grooms the "A" school grad for leadership in the fleet. He is taught maintenance, troubleshooting, and repair of all the major pieces of equipment in the radio shack. He is also taught administrative and leadership skills.

I went through part of the pipeline, RM "C7" school, in San Diego after leaving the *Grayback*. I found the course very interesting, fun, and helpful. As a result, I took the test for Petty Officer First Class, passed, and have been promoted to PO1. The fine leadership of my superiors on the *Grayback* and the *Barb* also contributed to this success.

After "C" school I turned down orders to shore duty (never did care for landlubbers), requested orders to an SSBN, and am now serving on board the *USS Thomas A. Edison-Blue*.

Duty on *Edison* has rounded out my sub career. It is a Polaris missile submarine. We have two crews and take turns on board and in port. One crew goes on a three-month nuclear deterrent patrol while the other trains in port. So I'm once more enjoying the Hawaiian paradise.

The "New Navy" concept has brought some changes to the submarine service. Being a WWII sub vet, Wayne, you might be interested. We no longer take our paychecks to the bars on payday, though the legends remain. Today's sub jockey is better typified as a well-educated, happily-married professional. Church services underway are well attended and the bullying of subordinates is no longer permitted.

One final change. Though I spent two years on the *Barb*, I spent too much time in schools and in overhaul to complete quals. I finally completed submarine quals and received my Dolphins on board the *Grayback*. What stories I could tell about the *Grayback*!

J. Burford Fields III WB7SZC
FPO San Francisco

TERMINATIONS

In reference to Carl Wagar's article, "Sidetone Is A Must," in the August issue of 73, a basic TTL design rule was broken. Mr. Wagar states, "The peculiar thing about TTL is that when you leave an input unconnected, it treats it as though it were connected to a high (+5 V) voltage. So here we see that one input is connected to five

volts, and when the key is up, the other input acts as though it were connected to five volts."

An unused input to a TTL device *should not* be left floating, as it can act as an antenna for noise. This is even more important on devices with storage, such as latches, registers, etc. On storage devices, unterminated inputs allow noise spikes to change the contents of the memory. To terminate an input high, the input should be held between 2.4 V and the maximum input voltage. Most LS devices have a breakdown voltage greater than 7.0 volts and can be directly tied to Vcc. Devices specified with a 5.5 volt breakdown should use a 1 kilohm to 10 kilohm current limiting series resistor to protect against Vcc transients. Another method is to connect the unused input to the output of an unused gate that is forced high (output of an inverter whose input is tied to ground). To terminate at a low, the input may be tied to ground.

Although the practice of connecting the inputs together of the same NAND or AND function is recommended for standard TTL, it should not be used with LS. The unused input should be tied high or low, as two inputs tied together not only increase fan-in, but also increase input coupling capacitance and reduce noise immunity.

P. Keith Muller WB1EXN
Andover MA

PEOPLE REPEATERS

I am glad someone finally spilled the beans about the General Mobile Radio Service; thanks to WA4EOX for a fine article in the August issue.

The monopoly hams have held on repeaters, even autopatch repeaters, is now coming to an end. Now every citizen has a right to communications on 460 MHz. I carry a little grudge against my fellow hams and former friends on this issue.

I used to be very popular with the local group—I was a club officer, helped plan dinners, worked exhibits, etc. Then in January, a CB emergency group approached me about a Class "A" GMRS repeater. As I began work on their license, the local two meter hounds kept a watchful eye on my operations. Some discouraged the whole idea of people using repeaters without having a ham license. No one

Continued on page 58

TOWER//TUNER

RESONATES YOUR TOWER
ON 40, 80 AND 160 !

NOW
available for 160
meters

Now you can easily use your entire tower and present beam system as a complete low angle radiator on 40, 80 and 160 meters. It is common knowledge that a dipole or inverted-vee must be at least 1/2 wave length high (120 feet on 80 meters!) in order for it to be a low angle radiator. But your existing tower, if fed with the Stuart Electronics **TOWER TUNER**, can be made to be an optimum low angle radiator on 40, 80 and 160 meters. The **TOWER TUNER** can be installed and easily adjusted to a low swr on any tower no matter what the size or type. Tower can be grounded or not. Radials not necessary. No more haywire appearance of dipoles and I-V's. Even your wife will love it. The **TOWER TUNER** takes up virtually no extra space but greatly outperforms dipoles and I-V's at the same height plus it is easily adjustable from ground level. Start making better contacts on the 40, 80 and 160 meter bands with an antenna system that really gets out. The **TOWER TUNER** will handle 500 watts output.

PATENT
PENDING

We are so confident that you will like it that we offer a 30 day money back guarantee. If you are in any way dissatisfied. Priced from \$129.95 includes shipping in continental United States.

STUART ELECTRONICS

Dept. 9
578 KENNEDY RD.
AKRON, OHIO 44305
(216) 798-9431

S38

Loop Antenna



Here is an exciting new device to improve your reception on 160, 80, the broadcast band, and on VLF.

It is well known that loops pick up far less noise than most other antennas. And they can null out interference. Now Palomar Engineers brings you these features and more in a compact, carefully engineered, attractive desktop package.

Unlike ordinary direction-finder loops, it tilts to match the incoming wave front. The result: Deep nulls up to 70 db. You have to listen to believe it!

Does the Loran on 160 give you a headache? The loop practically eliminates it. Broadcast station 2nd harmonic ruining your DX? Turn and tilt the loop and it's gone. Does your friend in the next block with his kilowatt block those weak ones? Use the loop and hear him fade out.

Loop nulls are very sharp on local and ground wave signals but usually are broad or nonexistent on distant skywave signals. This allows local interference to be eliminated while DX stations can still be heard from all directions.

The loops are Litz-wire wound on RF ferrite rods. They plug into the Loop Amplifier which boosts the loop signal 20 db and isolates and preserves the high Q of the loop. The tuning control peaks the loop and gives extra preselection to your receiver.

Plug-in loops are available for these bands:

- 150-550 KHz (VLF)
- 540-1600 KHz (Broadcast)
- 1600-5000 KHz (160 & 80 meters)

Send for free descriptive brochure.

Loop Amplifier \$67.50; Plug-In Loop Antennas \$47.50 each [specify frequency band]. To order add \$2 packing/shipping. Calif. residents add sales tax.

Palomar Engineers

Box 455, Escondido, CA. 92025 • Phone: [714] 747-3343

New Products

PROFESSIONAL-GRADE MOISTURE REPELLENT FOR WATERLOGGED ELECTRONIC GEAR

A recent fire in the apartment adjoining mine resulted in considerable water and smoke damage to most of my possessions, particularly the equipment in the shack. At about the same time, a news release arrived describing a new product, Chemtronics' industrial-grade DPL® spray for displacing moisture in electrical and electronic equipment and said to be especially effective as a way to get water-damaged electronic gear back in action in a hurry.

DPL sounded like it was exactly what I needed to get my gear dried out and cleaned up, so a call was made to WB2GMK, a copywriter at Chemtronics' ad agency. A couple of days later, several samples of DPL arrived and I eagerly tried the product on the now rather sodden collection of equipment sitting on the operating desk.

Presto! It really worked... quickly and effectively. No doubt about it, the DPL certainly enabled me to get everything shipshape and back in operation with a minimum of time

and effort. And while most of my gear may no longer look truly mint, it is all working normally and without the need to replace any parts. There hasn't even been a blown fuse or tripped circuit breaker. With plenty of the DPL left, you can be sure that I'll routinely spray all of my equipment with it periodically in the future.

DPL is a newly-formulated industrial-grade spray that displaces moisture when applied to electrical and electronic circuitry, sockets, plugs, and other current-carrying areas of a device which has become wet, eliminating moisture-induced short circuits. As a bonus, the treated equipment retains a coating of DPL that protects against rust and corrosion outdoors for six months to a year and well over a year indoors. New equipment earmarked for use in wet areas can be given a light coat of DPL as a preventive measure. DPL has passed rigid lab and field tests for salt fog and humidity resistance, and is excellent for use on communications gear, radar, pump motors, engine ignition systems, and other electrical and electronic equipment aboard vessels of all types and

sizes operating in fresh or salt water.

Spraying damp wiring, spark plugs, coils, distributors, etc., will help get waterlogged engines going again. Virtually any outdoor equipment which has become wet due to rain, leaks, even complete immersion in flood waters, can be restored faster with DPL. This includes telephone equipment, vending machines, elevators, alarm hookups, antenna rotators, and a long list of other gear. In short, if it uses electricity, DPL can help.

DPL is available exclusively through Chemtronics distributors. Details may be obtained by writing *Chemtronics, Inc.*, 681 Old Willeys Path, Hauppauge NY 11787.

Morgan W. Godwin W4WFL
Peterborough NH

NEW MFJ SUPER FILTERS

For the past few years, I have used MFJ Enterprises' model CWF-2BX and SBF-2BX filters for CW and SSB with a variety of transceivers and receivers with results consistently superior to any other internal or external filters used. In one instance, after trying the MFJ CW filter with a \$6000 receiver with excellent mechanical filters, the performance with the outboard unit was so much more pleasing I never again used the built-in filters. The little filters have been used for home and portable operation both here and abroad and until a couple of weeks ago I would have said that nothing could cause me to cease using them. Then I tried MFJ's two new filters, the model 721 Super Selector CW/SSB Filter and the model 720 Deluxe Super CW Filter. Like their predecessors, both of the new filters offer outstanding selectivity with remarkable freedom from the ringing and attenuation so many other filters introduce, plus new features that make them even more effective.

The top-of-the-line model 721 Super Selector CW/SSB Filter features a 2-Watt audio amplifier, switchable noise limiting, and an input selector for two rigs. The CW filter is an eight-pole (four cascaded stages) active filter centered nominally at 750 Hz. It has four selectable bandwidths: 180, 150, 110, and 80 Hz. In the 80-Hz position, the response is at least 60 dB down one octave from the center frequency. The filter significantly reduces noise and provides a very useful improvement in signal-to-noise ratio.

By using a pair of stereo headphones, you can take advantage of the effect of simulated stereo reception which conveys the narrow

filtered signal to one ear and the unfiltered signal to the other. The ears and brain reject interference but allow off-frequency calls to be heard.

Among the performance-enhancing features of the model 721 is a self-adjusting automatic peak clipper for SSB. And for CW, there is a valley clipper which removes background noise smaller in amplitude than the received signal. Both do a very effective job.

The unit plugs into the transmitter's or receiver's phone jack and drives a speaker or earphones with 2 Watts of audio from an amplifier using an LM-380 audio power IC. It may also be used as an auxiliary audio amplifier. Power requirement is 9 to 18 V dc; an optional ac adapter is available (\$7.95). Size is a compact 5" x 2" x 6". The model 721 sells for \$59.95. Add \$2.00 for shipping and handling.

If you're a CW enthusiast, you're sure to be impressed with the new model 720 Deluxe Super CW Filter. It uses the same eight-pole active filter as the model 721. One reason for the filter's outstanding performance is that the frequency-determining components are hand-selected to within one Hz of the nominal 750 Hz center frequency, providing very steep skirts. Also contributing to the unit's performance is its low-Q cascaded design which minimizes ringing. There is also a built-in self-adjusting noise limiter.

Like the model 721, the Deluxe Super CW Filter plugs into your rig's phone jack and will drive a speaker or phones with its 2-Watt audio amplifier. A 9-volt transistor radio type battery or an external 9 to 18 V dc power source is required (an optional ac adapter is available for \$7.95). The unit measures 4" x 2" x 6". The model 720 is priced at \$44.95 (include \$2.00 for shipping and handling).

Both units are a delight to use. They provide several selectable degrees of selectivity to suit varying conditions on SSB and CW while also coping with noise and other problems that can make copying the desired signal difficult or even impossible at times.

The model 721 Super Selector CW/SSB Filter and model 720 Deluxe Super CW Filter are available directly from MFJ Enterprises. There is a 30-day money-back trial period. If you are not satisfied, you may return your purchase within 30 days for a full refund (less shipping). MFJ provides a one-year unconditional warranty on their products.



DPL from Chemtronics.

Continued on page 263

YOU ASKED FOR IT YOU GOT IT DSI QUIK-KIT®

550 MHZ COUNTER KIT Performance You Can Count On



OPERATES ON

- Batt 6-C Size
- DC 8.2 To 14.5 VDC
- AC Batt. Eliminator

\$99.95

MODEL 3550 KIT

DSI OFFERS THE BEST OF TWO WORLDS . . .

An unprecedented DSI VALUE . . . in a high quality, LSI Design, 550 MHZ frequency counter kit. And, because it's a DSI innovation, you know it obsoletes any competitive makes, both in price & performance. The basic 550 MHZ counter & time base are factory assembled, tested and burned-in. The problems of bad LEDS, IC's, capacitors, are a thing of the past with DSI QUIK-KIT®. But you can take pride in assembling the power supply, PC mounted selector switch, input connectors, and the final mechanical assembly of your 550 MHZ counter, into its' handsome cabinet. **GO WITH THE LEADER . . . BUY A DSI FREQUENCY COUNTER KIT. SAVE TIME & MONEY AND BE ASSURED IT WILL WORK THE FIRST TIME.**

SPECIFICATIONS

Time Base TCXO 1PPM 65° to 85°F
 Frequency Range 50HZ to 550MHZ
 Resolution 1HZ to 55MHZ, 10HZ to 550MHZ
 Gate Time 1 second - 1/10 second
 Sensitivity 25MV 150 & 250MHZ 75MV 550MHZ
 Display Eight 1/2-inch LEDS
 Input Two SO239 Connectors
 Power 6C-Size Batt., 15HR, or 8.2VDC to 14.5VDC
 Current 150 Ma standby 300 Ma operational

3550 KIT INCLUDES

- Pre-assembled, tested counter board
- Case, power supply, connectors, hardware
- Built-in prescaler & preamp
- Gate Light - Automatic Zero Blanking
- Automatic Decimal Point
- One to two hours assembly time
- One Year Warranty on all parts
- All new parts - not factory seconds or surplus

3550 Kit	\$99.95
T-101 Telescopic Antenna	3.95
AC-9 Battery Eliminator	7.95
Cigarette Lighter DC Adapter	2.95

TERMS: Orders to U.S. and Canada, add 5% to maximum of \$10.00 per order for shipping, handling and insurance. To all other countries, add 15% of total order. California Residents add 6% State Sales Tax.

SEE YOUR LOCAL DEALER
OR

CALL TOLL FREE (800) 854-2049
California Residents, Call Collect (714) 565-8402

DSI INSTRUMENTS, INC.

7914 Ronson Road No. G, San Diego, CA 92111

VISA • MC
AMERICAN EXPRESS
CK • MONEY ORDER
COD

Looking West

Bill Pasternak WA6ITF
24854-C Newhall Ave.
Newhall CA 91321

I would like to speak about a word I consider very indecent—the word is censorship. I find this word far more abhorrent than any of the seven words which the U.S. Supreme Court recently ruled were to be banned from the airwaves of America.

Now, don't get me wrong. I am in no way in favor of profanity. Far from it. However, I do feel that, like beauty, profanity lies in the eye or ear of the beholder. What concerns me at a real gut level is our government telling us what we may or may not be permitted to listen to via our radios—in other words, government-approved and -supported censorship.

This recent Supreme Court action is based upon appeals of lower court decisions in a case involving New York City radio station WBAI-FM and its airing of a portion of a George Carlin album. The particular piece under discussion is entitled "Seven Words You're Not Supposed To Say On Radio and TV." I have heard this cut, and for those of you not familiar with Mr. Carlin's work, he is one of the new generation of "avant-garde" comics. He is considered by many, myself included, to be one of today's comic geniuses. In this particular rendering, Mr. Carlin satirizes the reluctance of today's broadcast media to permit certain words to be used in their broadcasting. He further states that there are other words which he feels are far more indecent than those the broadcasters have unofficially banned. It is comic satire at its best, although there are people in our society or any society who might be offended by such material and who by personal decision should not listen to it. This I respect. However, when someone says that you or I may not listen to it because "they" adjudge it to be indecent by their own personal standards, I take exception. This is basically the crux of the WBAI situation and the final decision in this matter by the U.S. Supreme Court.

WBAI itself is rather unique in today's broadcasting world. It is a totally noncommercial station which obtains the monetary support it requires from those who listen to it. It, along with its sister stations in Washington, Los Angeles, San Francisco, and Houston, is

owned and operated by an organization known as the Pacifica Foundation. Both the Foundation and its media outlets believe in total freedom of expression as guaranteed by and under the Constitution of the United States, and the content of their programming reflects this dedication. I suspect that it was under this directive that the decision was made to air the Carlin album.

Now, as I understand the situation, and it is quite complex at best, a listener to WBAI found the particular material offensive and complained to the FCC about it. Eventually, this action took the entire matter into the courts and led to the Supreme Court decision. All well and good. However, one thing really bothers me. If a person finds such material offensive, then why does he continue to listen? If indeed he was so disturbed by it, why did he not exercise the best form of personal censorship available? Why not just turn it off or tune to a station whose program format was more in line with his personal tastes? I resent having your tax dollars and mine wasted on a matter such as this when all that one individual had to do was change the station. When you look at it in this context, the whole thing is pretty dumb.

What about WBAI? Were they right or wrong in airing this material? Frankly, I feel that they were legally right, even though they exhibited poor taste and bad judgment in doing so. I feel strongly that, as a broadcast outlet, WBAI had an obligation to at least be tasteful in what they offered their audience. They should have realized that somewhere a "Priscilla Goodbody," if I may borrow one of Johnny Carson's favorite expressions, was lurking in the woodwork, ready to pounce on them if given the opportunity.

Although WBAI should be admonished for poor judgment, I do not feel that one isolated case should be the foundation upon which government-approved censorship is erected. I would say that, in 99.9% of the cases, the broadcast industry's self-imposed guidelines have worked. What the broadcasters feel is offensive language has always been kept off the air. Therefore, if the Supreme Court felt that WBAI was wrong, it should have said so and gone no further. It should have looked at the overall record of the broadcast industry and then placed

the onus right where it belonged: on your shoulders and mine. It should have left it to us to decide what we did or did not want to hear.

220 AND THE ARRL DEPARTMENT

"220 CB IS DEAD AND THE ARRL SLEW IT" read a banner headline not long ago. So, if 220 CB is as dead as the ARRL said it was, why then the action at the recent Directors' meeting in Newington to investigate petitioning the FCC to give Novices phone privileges on that band? Could it be that Newington was a bit premature in its self-serving praise? I think so.

However, at least this once (and much to their credit) they have somewhat admitted the error of their ways and have taken what I consider justified action. I would like to see certain restraints placed on this proposal so as to minimize the overall environmental impact there would be if thousands or maybe millions of new licensees were to come to 220. Actually, although the restraints I would like to see imposed are few in number, they would serve to protect already existing activity and make for more orderly growth patterns. Here they are:

First, I would limit Novices to a maximum of 10 Watts rf output (20 Watts PEP SSB) on all modes. Second, rather than have the entire 220 MHz band open, I would limit Novice operation to 223.0-225.0, to ensure the sanctity of control and auxiliary link channels and thus keep repeaters in line with control requirements as outlined in Part 97 of the *Rules and Regulations*. In other words, we should limit the Novice operator who will obviously come to 220 with little or no prior amateur experience to a portion of the band where he can learn operation without harming an integral part of relay system operation.

Third and final, I do not feel that a Novice should be afforded the privilege of repeater and/or remote base ownership. Why not? Remember that today the size of one's bank account is the one and only determining factor in repeater establishment. Figuring the potential number of new spectrum users such a rules change would bring, I feel both that there should be some incentive for a Novice to upgrade, and at the same time that relay activity on a technical level should be left to those most technically competent. A newly licensed Novice, unless he happens to be a communications engineer or technician, will not possess

the competency level necessary to own and maintain a piece of mountaintop relay hardware. In essence, Novice phone privileges on 220 are a good idea—but for and on an operational level only. Realistically, this is what it will amount to anyway, with most Novices seeking out the best local repeater upon which to gab. Nothing wrong with that. I like to talk as much as the next ham, and it is only through talking with one another that we learn. The complexity of equipment required for 220 MHz operation does not lend the band to untrained and/or uneducated experimentation. Like 144 MHz and from 450 MHz up, 220 separates the neophyte from the educated professional. If I were going to create a new experimental operations subband for the Novice, the absolute maximum I would go would be 50 MHz.

This leads me to another point. True, repeater growth on 220 has slackened off with the opening of the new 144.5 to 145.5 subband, but the 50 to 54 MHz region is in even more dire straits. Unless six is open to some exotic DX, it becomes dead, wasted spectrum. Even in a city the size of L.A., hearing activity is far from a day-to-day occurrence. The fact is that the CBers could probably walk in and take over without much notice if they wanted to. If any band needs a shot of activity, it is six, and I would love to see the ARRL proposal for extended Novice privileges include this band, possibly with full privileges. That is the place to experiment—not on a developing band like 220. Used commercial AM equipment and older SSB equipment is cheap and plentiful, and there are many low-band FM boat anchors still available for a pittance. Six needs the activity far more than 220, and I cannot think of a better way to get it.

Now, I realize that this latter proposal will raise cries of indignation from the miniscule (by overall comparison) number of amateurs who reside on six, in the same way I expect the ARRL's 220 Novice proposal to meet with similar cries of distress from those amateurs already there. I have but one answer. If it were up to me, I would rather see licensed Novice amateurs, individuals who have shown some proof of their abilities, inhabiting both bands, than have a total of 9 MHz of "10-4, Good Buddy—Over To You." Sure, 220 is "full" in southern California and growing in other populous areas as well. But travel across the country and listen for yourself. Try to get a QSO on either band. You can call your

The parameters of the Palomar PTR-130k are the outer perimeters of logic technology.

Never before has any transceiver approached the capabilities of the Palomar PTR 130k!

It's the first completely multi-functional transceiver ever made available to the public!

The Palomar PTR 130k is a miniaturized mobile transceiver

capable of operating in 100 cycle resolution from 100 KHz to 30 MHz in all modes of transmission and reception.

Instant frequency selection is available with the touch of a finger.

The Palomar PTR-130k.

technology is pure space age... the price is strictly down-to-earth. Send for our full color brochure to:

Palomar Electronics Corporation
665 Opper Street
Escondido, CA 92025
Telephone: (714) 746-2666



TECHNOLOGY AT THE SPEED OF SOUND

lungs off all day and get nary a response. I may live in Los Angeles, but I do not judge overall 220 activity by what I hear here. Six? A few repeaters and a tad of SSB, and the only real activity comes with E or F2 skip. Even then, half of it is still AM. At least out here six won't be hurt one iota and 220 will get a lot more crowded. Elsewhere? Probably a lot more people will discover that there is a world above 148 MHz.

TWO METER EDUCATION DEPARTMENT

As you learned last month, the SCRA has changed its overall structure and split into two parallel organizations. With this column, I will put the SCRA name to rest; hereinafter, I will refer to the two organizations as SMA-144 and SMA-220.

SMA-144 has been quite active in a number of areas, although most of their major projects have been of an educational nature. They have entered into one joint project with the southern California chapter of Sidewinders on Two to produce a 10-minute educational "repeater QST," the purpose of which will be to acquaint area FMers with modes other than repeater and FM operation. It will include ex-

amples of such diverse operations as EME, weak signal SSB long-haul, and OSCAR work, to name but three. The tape, which will be produced through the facilities of the Westlink Radio Network, will also explain our two meter band plan covering all modes and why it is important that all amateurs respect this gentlemen's agreement. Copies will be sent free to all SMA-144 2 meter repeaters for dissemination to users as a QST. Also, copies of this area's band plan, along with an updated version of the "User Operations Guide and Repeater Listing," will be available. In the case of the area band plan, SMA-144 intends to distribute several thousand copies to all area equipment outlets and request that one be given free to each purchaser of any new or used two meter radio. The "User Operations Guide and Repeater Listing" will be updated to include the myriad of new recognized FM and SSB calling channels and established area two meter nets. This publication is available for 25¢ plus an 8½" x 11" SASE with 30¢ postage from SMA-144, PO Box 2606, Culver City CA 90230.

FLYING 220 DEPARTMENT
Dave Freedland WA6QXR is

an attorney, and his job constantly sees him traveling hither and yon. Recently, Dave took a Wilson 220 MHz hand-held along on a flight from Knoxville to Los Angeles via Chicago. His hand-held was equipped with the two most popular 220 repeater pairs: the high and low .34/.94s and 223.5 simplex. As they flew north toward the Chicago area, Dave reported a myriad of relay operations on both .34/.94 pairs, with call prefixes indicating the east coast. He found that the Chicago area had a rather high level of activity, with both repeater and simplex activity apparent. In fact, as his aircraft was making its descent into the Chicago area, he overheard a QSO on 223.5 simplex in which the participants were discussing 220 DXing. Although he was quite tempted to shake them up by breaking in with his "6" call, he decided to let discretion be the better part of valor in this case. After leaving the Chicago environs, Dave heard no other activity on his three select channels until he was around the Denver/Pueblo, Colorado, area, where he noted a rather whumping signal he assumed to be a 220 repeater in that area. Losing that as he winged westward toward L.A., the next signal he heard was the Mt.

Wilson "high" .34/.94 (WR6AJI) as he crossed Nevada. When he reached the Nevada/California border, his "home" machine, WR6AWQ on Loop Canyon above Sylmar, was audible. To Dave, hearing 'AWQ meant he was home.

Now, while this is by no means a conclusive survey of all 220 activity, it is a good indicator of what is where. I thought it might interest you. One thing. If you ever do your own survey, or just want to operate "air mobile" from a commercial airliner, remember that before you turn on that hand-held, you must obtain permission from the captain. He's the boss, and his word is the law on the matter.

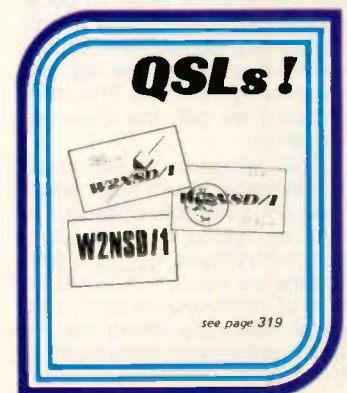

see page 319

Chuck Stuart N5KC
5115 Menefee Drive
Dallas TX 75227

In celebration of the beginning of a new sunspot cycle that promises to put all the deserving DXers on the "Honor Roll," and also because Wayne found an editor who would work cheap, *73 Magazine* is beginning a new monthly DX column with this issue.

This first column will serve mainly as an introduction to the new *73 Magazine* DX column and will give you a preview of some of the many features you can expect to find each month. Our aim is to keep you informed of what is happening on all fronts of the DX scene, including upcoming DX-peditions, new countries, new prefixes, QSL information, pictures and stories on interesting DXers, tips for the newcomers, and many more features. Let us know what interests you have concerning DX. If we are not covering your areas of interest, then let us hear from you.

We plan to cover most of the DX-peditions, not only in advance, but also later with in-depth articles, plenty of pictures, and even some of the behind-the-scenes goings-on.

Pictures! We plan to print pictures, lots and lots of pictures. Even some full-color shots of many of the major DX-peditions. We are also planning on a monthly "DX Photo Album" page containing ten or so pictures on each side of the same page that you can tear out and keep at the rig for handy reference. Just think, at last you'll know what that jerk who keeps covering you up in the pileups looks like, just in case you ever run into him in a dark alley some night. Also, it might keep the DX stations from "standing by for the YL" if they could see that the YL is really a 60-year-old OM with hairy legs and a beer belly faking the voice in order to get a contact. And don't think it isn't done every day. So send us pictures of yourself, the rig, the antenna system, etc. The more pictures we get, the more we can print.

That brings us to editorials. We probably won't have editorials per se in this column. I'm sure not going to try to compete with Wayne, but from time to time we would like to have a sort of point/counterpoint with guest editorials taking the pro and con sides of some topic of DX interest. Just send us about

500 words on any DX topic which you feel strongly about. Either for or against. When we receive both sides of the same issue, each presented in a fairly coherent and intelligent manner, we will print them side by side in the same column. This will allow a printed forum to air legitimate complaints, as well as give a chance to show both sides of issues that are important to DXers and hamdom in general. Feedback on these guest editorials will be printed in the regular letters to the editor section. We don't want to debate any issues in this column—just air both sides. All editorials will be identified with the author's name and call, so be sure to include that information.

Planned also is a "DXer of the month" profile on some active DXer each month. Not necessarily a "big gun" leading the honor roll or somebody just back from a DX-pedition to Clipperton, although we will have them also, but usually just a guy or gal who is an active DXer whom we feel you might like to know more about. Here again we will need some feedback from you letting us know who some of the DXers are that you would like to read about. We not only want to cover his DX life, but we also want to take you backstage as well and find out if he beats his wife and kicks his dog, or vice versa, and whether he drinks his Coors on tap or right out of the bottle. Nothing short of a QSL from Bouvet will keep us from telling all.

Now, if you can't appreciate the significance of a QSL from Bouvet, then you are obviously a newcomer to DXing. But hold on, because we plan to have a special section just for you each month. It has been said that there are only two kinds of hams, those who are DXers and those who wish they were. Believe it or not, the FCC issues an average of 17,000 amateur radio licenses each month. This figure may pale when compared to the 300,000 or so CB licenses which are issued each month, but it is a very healthy figure for ham radio.

Let's be generous and figure 20% of those newly issued ham licenses to be renewals or upgrades of existing licenses. That still leaves 13,400 new hams being licensed each and every month. Now if only 25% of those 13,400 new hams become DXers, and we all

know the figure is much higher than that (after all, what else is there?), that means that over 100 new DXers are coming on the HF bands every day. Now you know why the demand for even the most common DX can never be satisfied. It kind of makes you want to clean up our DX act when you realize how many newcomers every day are learning lifelong operating habits by listening to the way you operate.

In an attempt to help alleviate the mass confusion facing newcomers to DX, especially the ones not only new to DX, but new to ham radio as well, we will have a monthly "Novice Corner" explaining some of the terms and procedures particular to DXing. I'm sure we can all remember the first time we heard that the only way to get a QSL from a DX station that we had just contacted was to QSL via his manager with an SASE or with an SAE and IRCs, and thinking that that would be great but what is an SASE, an SAE, IRC, or QSL manager? Those are some of the terms, etc., that we will be explaining in detail each month.

Along with the new DX column, *73 Magazine* is also introducing a new DX Awards Program. Complete details on this new program can be found in next month's issue, so I will just hit the high spots here. The basic concept is a "Worked the World" series of awards consisting of a separate award for each of the six continents. Each award will be earned by contacting a certain percentage, approximately 80%, of the countries of that continent. There will be a "Worked Europe" award, a "Worked North America" award, etc. One interesting thing about the "Worked North America" award is the requirement of working most of the states as well as the other countries. Central America and the Caribbean will count towards the "Worked South America" award.

Elsewhere in this issue, you'll find information about contacts made on channelized ten meter AM. This is an effort to stir interest on this "use it or lose it" band. No contacts prior to the announcement date will count toward any of these awards. That way everyone will have the same chance for the special awards given for the first one awarded on each band/mode. The awards are very handsome and complement each other nicely.

As you can see, we have quite a few things coming up in the DX department here at *73*. I'm sure even more ideas will develop as we go along and as

we receive more input from you readers on which features you like and which features you dislike. So again, let us hear from you. Please direct all correspondence to me: Chuck Stuart N5KC, 5115 Menefee Drive, Dallas TX 75227, USA.

DX NOTEBOOK

Iraq YI1BDG

Government permission was received on May 1st to operate at any time on 10 through 80 meters using 100 Watts. Hopes are high that the contest group from YU1BCD will be allowed to operate the station during the CQWW DX contest this fall. This would be a high-power, multi-multi operation that should put a king-sized dent in the number needing Iraq. The Radio Club of Baghdad is steadily growing. Look for them from 1400Z to 1700Z most mornings around 14220. Sometimes when things get a bit crowded they will move to 14310. Just look for the pileups. You can also QSL directly to The Radio Club of Baghdad, PO Box 5864, Baghdad, Iraq.

St. Lucia VP2LBH

Bob Hardy K2IGW plans to operate the CQWW DX contest from St. Lucia. Look for him before and after the contest as well. QSL to 341 Tracey Lane, Grand Island NY 14072.

Midway Island KM6BI

QSLs for the period from January 1, 1973, to August 1, 1978, can be sent to John Daugherty, 1019 Larencord, Lancaster OH 43130.

Willis Island VK9ZM

Look for this one in the 15 meter Novice band just below 21200.

United Arab Emirates A6XP

Bob reports that, for now, all amateur operation in the UAE has been halted and no new licenses are being issued.

Amsterdam and St. Paul Islands FB8ZM

Look for Henry at 4040 from 1000Z to 1100Z. Then, at 14225, find W4LZZ as MC. Later, around 0400, Henry can usually be found on 14225 with W0AX and sometimes FH8CY. QSL to W4LZZ.

Solomon Islands

The Solomon Islands gained their independence on July 7, 1978. The new prefix is H44, replacing the old VR4. Suffixes remain the same.

Market Reef OJ0BW

This one was definitely a phoney. Save your postage and IRCs.

Continued on page 257

CURTIS 8043 retires with honors

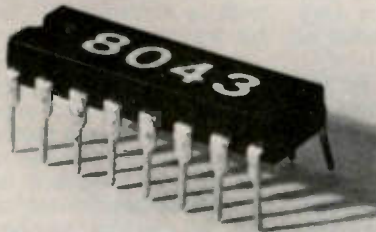

but look at our NEW STARS!

- ★ 8044; **Keyer-On-A-Chip*** (Replaces 8043) . . . \$14.95
Apr '75 HR, Feb '76 DST, Radio Hdbk '75, ARRL Hdbk '77-78
 - ★ 8044-3; IC, PCB, Socket, Manual. 24.95
 - ★ 8044-4; Semi-Kit 54.95
 - ★ 8045; Morse **Keyboard-On-A-Chip** IC. 59.95
 - ★ 8045-1; IC, PCB, FIFO, Sockets, Manual. 89.95
 - ★ 8047; Message **Memory-On-A-Chip** IC. 39.95
 - ★ 8047-1; IC, PCB, RAM, Sockets, Manual. 69.95
(add \$1.75 on above for postage and handling)
 - EK-430; CMOS **Keyer*** (Feb '76 DST) 124.95
 - IK-440A; **Instructokeyer*** (Mar '76 DST) 224.95
*now with dash memory as standard
 - System 4000 Ham Computer (see Jan '78 DST). (write)
- Curtis Electro Devices, Inc.
(415) 964-3136
Box 4090, Mountain View, CA 94040

INTER-OFFICE MEMO

TO: TOM BALL, Sales Manager
FROM: ROBERT BROWN, Chief Engineer

Here is the information on our "B" series of repeaters.
All features are standard on all units; kits as well as wired.
All checks indicate this is the hottest repeater on the market.

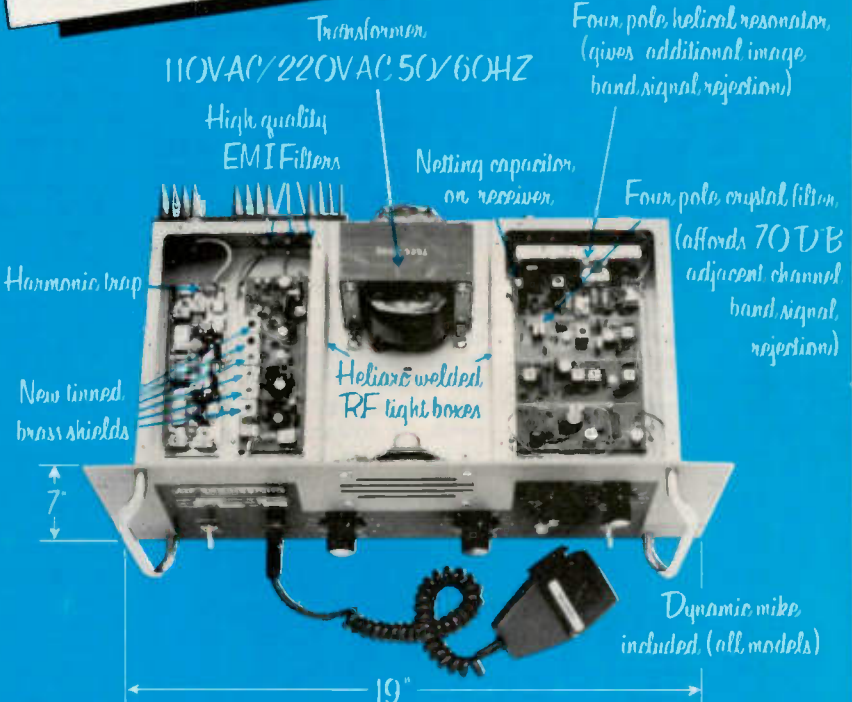

Tom - Not shown in photo is new power supply. Has fold back current limiting (you can short supply & will not damage it), also over voltage protection (a short in the supply will shut it down so repeater is not damaged.) Don't forget our CWID with its 159 bit field programable memory.

Bob

RPT 50B Kit	Repeater-6 meter-25w-complete (less crystals)	\$499.95
RPT 144B Kit	Repeater-2 meter-15w-complete (less crystals)	499.95
RPT 220B Kit	Repeater-220 MHz-15w-complete (less crystals)	499.95
RPT 432B Kit	Repeater-432 MHz-10w-complete (less crystals)	579.95
RPT 50B W/T	Repeater-6 meter-25w-factory wired & tested	799.95
RPT 144B W/T	Repeater-2 meter-15w-factory wired & tested	799.95
RPT 220B W/T	Repeater-220 MHz-15w-factory wired & tested	799.95
RPT 432B W/T	Repeater-432 MHz-10w-factory wired & tested	849.95

JAN CRYSTALS KEEP YOU ON THE AIR

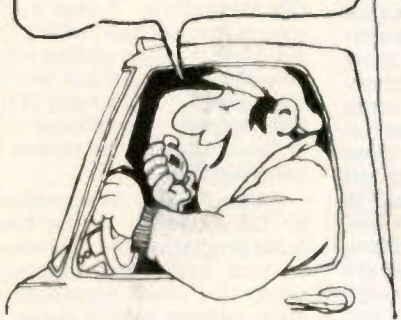

- CB
- CB standard
- 2 meter
- Scanners
- Amateur Bands
- General Communication
- Industry
- Marine VHF
- Micro processor crystals

easy to charge

Send 10¢ for our latest catalog
Write or phone for more details

2400 Crystal Drive
Ft. Myers, Florida 33901
all phones (813) 936-2397

JAN CRYSTALS

arma **Vhf engineering**

Division of Brownian Electronics Corp.

320 WATER STREET / BINGHAMTON, N.Y. 13901 / Phone 607-723-9574
Prices and specifications subject to change without notice. / Export prices slightly higher.

RTTY Loop

Marc I. Leavey, M.D. WA3AJR
4006 Winlee Road
Randallstown MD 21133

So far in this column, with few exceptions, references to Teletype™ machines have been to the Model 15 or Model 19. While I have felt justified in using these old workhorses as typical of the amateur station, many of you have taken me to task. Although a great many of you own Model 15s or Model 19s, many of you don't, and requests for information on other machines have arrived. I humbly comply.

Going way back, I doubt if there are still many Model 12s in service. This was the first Teletype machine generally available to amateurs. Most of them were manufactured in the mid-1940s, and they were built to last! These machines featured six individual selector magnets, a "latch" magnet, drew enough current to heat the shack, and produced enough RFI to jam the neighbor's radio. Still, it worked, and

got many a ham on RTTY. An interesting feature is that, unlike more modern machines, the Model 12's carriage moved back and forth with the paper roll, much as a standard typewriter does.

The Model 15 was the next version introduced by the Teletype people. We have discussed this machine rather extensively in the past, and will say very little now. Notable are the facts that in the Model 15, the carriage is stationary, while the type basket moves, and two selector magnets run on the "standard" 60 mA loop.

Progress being inevitable, the Model 26 was introduced as a successor to the Model 15. Intended as a replacement for that somewhat noisy machine, widely in use in wire services and pressrooms, it was smaller, lighter, and quieter. Interestingly, it featured a return to the moving carriage, as on the Model 12. Instead of type pallets, as previous machines used, it introduced a type wheel, which was rotated to

bring the correct character into position prior to striking it. You might visualize it as an early Selectric (IBM, forgive me!). Unfortunately, although the Model 26 was smaller, lighter, and quieter than the Model 15, it was much less durable. Under constant use they just didn't hold up, and many were sold to the amateur market in the late 1950s.

The next series to be introduced by Teletype, and for many years the sine qua non of RTTY, was the Model 28. Not just one machine, the Model 28 is a series which includes page printers, perforators, and transmitting-distributors. Since it comes in so many styles, let me take a moment to explain three commonly used designators:

RO—stands for "Receive Only." This is just a printer; no keyboard, no tape.

KSR—stands for "Keyboard Send Receive." This is the printer with keyboard; no tape.

ASR—stands for "Automatic Send Receive." Here is the printer, keyboard, reperforator and transmitting-distributor. A whole station!

In general, the Model 28 series of machines is a modern, quiet line that is easily interfaced for most amateur applications. With it, we return to the stationary carriage of the Model 15, but rather than individual lever-type pallets or a type wheel, there is a type box containing the individual type pallets, which are driven by a printing hammer. This makes for a quiet, efficient machine.

Unlike the Model 15, where the terminal strips used to connect the machine are located along the side of the teleprinter itself, the distribution for most 28-series machines is accomplished through three large strips mounted in the rear of the cabinet. There are three strips on the cabinet, from left to right, TB-751, TB-752, and TB-753. Each of these strips normally has ten terminals. Thus, terminals one through ten are on TB-751, eleven through twenty are on TB-752, and twenty-one through thirty are on TB-753. The ac power is brought in to terminals 29 and 30, usually through Z-751, an electrical noise suppressor mounted on the base. The incoming signal is filtered through Z-752, and then on to terminals 5 and 10. Terminal 10 is destined for the electrical motor control unit, deep in the bowels of the machine. The signal returns to terminal 9, where it surfaces, does a hair-pin turn through a jumper to terminal 8, and dives down again, bound for the keyboard contacts. After squeezing through

another noise suppressor, and clicking through the keyboard, the signal races upward and makes another pass through the terminal strip, coming out at terminal 7, goes around another jumper to terminal 6, and makes one more dive to the selector magnets. That trip ends up at terminal 5—remember that one?

To summarize, then, ac goes to 29 and 30; the keyboard is at 7 and 8; the selector magnets are at 5 and 6; and motor control (usually wired in series with the selector magnets) is at 9 and 10. By appropriate jumpering, the machine may be operated in full or half duplex. Fig. 1 is a schematic representation of the terminal strips with normal jumpering for single loop (half-duplex) operation.

Last month, we mentioned the compact, or rack-mounted, Model 28. On that style machine, rather than three large strips on the cabinet, one small strip is mounted directly on the machine. Owners of these machines are advised to study the manuals carefully before hooking them up.

A note from Reg Cherrill W3HQO/G3XNV touches on a common point of confusion. Reg writes, "... the FCC regulations ... seem rather lax in stating firmly that only FSK can be used on the HF bands, yet I printed a chap out west who stated he was running AFSK equipment." This seeming paradox is easy to explain. Recall that if a single tone is fed to the input of a single side-band transmitter, a single rf signal is put out, which is indistinguishable from one generated by a conventional CW transmitter. If that audio tone is then shifted (AFSK), the resultant rf will be shifted a like amount, and the result will be plain old FSK. With many of the SSB rigs being used today, this is the only practical means to generate FSK RTTY.

I was literally overwhelmed by the response to the computer program in the July issue. By your letters and telephone calls, you have expressed a huge interest in this mode of RTTY. Let me offer a few tips to anyone using that program. While written for the SWTPC 6800, it should run on any M-6800 computer if a few lines are changed. Calls to OUTE and PDATA, \$E1D1 and \$E07E, need to be changed to their respective routines in your monitor. OUTE puts the data in the A accumulator out to the terminal as an ASCII character, and PDATA repeatedly calls OUTE until a \$04 is encountered, which terminates the subroutine and executes a

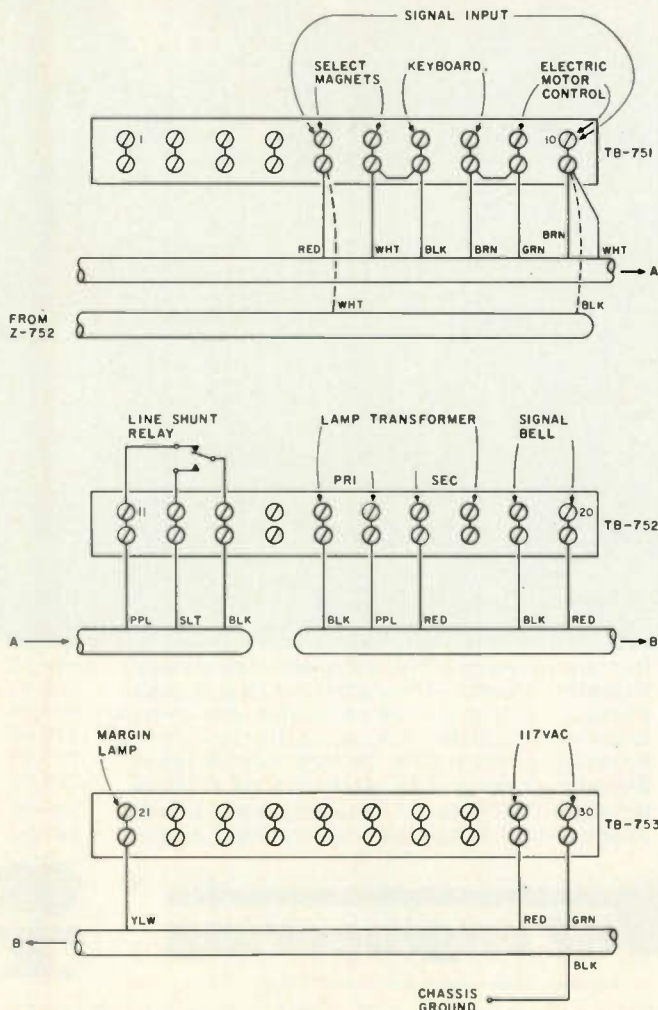

Fig. 1.

Continued on page 42

The evolution of the MLA

When the MLA-2500 was first introduced it was a new concept in high performance amplifiers. Low and sleek yet powerful enough for the military. Some wondered . . . needlessly.

A promise kept.

The MLA-2500 promised 2000 watts PEP input on SSB. A heavy duty power supply. Two Eimac 8875's. And as thousands of Amateurs across the world have proven, the MLA-2500 delivers!

Now DenTron is pleased to bring you **The new MLA-2500 B.** Inherently the same as the original MLA-2500, the B model includes all of the above specifications plus a few refinements. New high-low power switching for consistent efficiency at both the 1KW and 2KW power levels, and 160 - 15 meters.

Tested and proven.

What better test for an amplifier than the Clipperton DXpedition? Even after 32,000 QSO's, and an accidental dunk in the ocean, the same 3 MLA-2500's are still amplifying other rare DXpeditions around the world - listen for them.

Convinced? Isn't it time you owned the amplifier that powered Clipperton and thousands upon thousands of radio stations throughout the world?

MLA-2500 B \$899.50.



DenTron[®]
Radio Co., Inc.

2100 Enterprise Parkway
Twinsburg, Ohio 44087
(216)425-3173

the evolution of the MIA

Just Getting A

there's a world of difference
in TEN-TEC's *all-new*
hf transceiver—

 OMNI



OMNI—THE ALL-INCLUSIVE. Because OMNI has it all. Designed to give you every advantage, every capability, whatever your operating specialty. Designed to give you new conveniences and new levels of performance. Designed to give you the world of Amateur Radio with a world of difference—the OMNI world of unique features. An unusual combination not found in any other.

FUNCTIONAL STYLING. The “look” you requested. “Clamshell” aluminum case clad in textured black vinyl. Complementary nonreflective warm dark metal front panel. Extruded satin aluminum trim bezel and tilt bail. Convenient controls. Fully shielded. And everything in a larger, easier-to-use size: 5¾”h x 14¼”w x 14”d.

TOTALLY SOLID-STATE. Sharing the TEN-TEC heritage of solid-state design leadership with its companion transceivers, the highly successful 540/544, OMNI has all the advantages of proven solid-state technology—reliability, long life, cool performance, better stability.

8-BANDS. The world now and in the future. OMNI covers 160, 80, 40, 20, 15, and 10 meters now (crystals included for all present Amateur bands, 1.8-30 MHz). And it has convertible 10 MHz and “AUX” band positions for the future.

BROADBAND DESIGN. Permits changing bands without tune-up, without danger of out-of-resonance damage to the final stage.

ANALOG OR DIGITAL READOUTS. OMNI-A features an analog dial with 1 kHz dial markings. OMNI-D has 0.43” LED readouts with the 5 most significant in red and the 6th in green to show 100 Hz increments.

BUILT-IN VOX AND PTT. Smooth VOX action with 3 easy-to-adjust front panel controls. PTT control is available at both front and rear panel jacks; an external microphone switch may be used.

BUILT-IN SQUELCH. Unusual in an hf rig, but handy for tuning or monitoring for a net or sked.

BUILT-IN 4-POSITION CW/SSB FILTER. 150 Hz bandwidth with 3 selectable skirt contours for optimum CW reception.

8-POLE CRYSTAL FILTER. 2.4 kHz bandwidth, 1.8 shape factor.

SEPARATE MODE SWITCH. Permits using all filters in any mode.

2-SPEED BREAK-IN. Switch to “fast” or “slow” receiver muting to accommodate any band condition or mobile operating.

2-RANGE OFFSET TUNING. Switch-select the ±5 kHz range for off-frequency DX work or the ±0.5 kHz range for fine tuning.

OPTIMIZED RECEIVER SENSITIVITY. Ranges from 2 uV on 160 m to 0.3 uV on 10 m (10 dB S+N/N) to achieve ideal balance between dynamic range and sensitivity.

GREATER DYNAMIC RANGE. Typically exceeds 90 dB to reduce possible overload from nearby stations. Also includes switchable 18 dB PIN diode attenuator for additional overload prevention.

WWV RECEPTION. On the 10 MHz band switch position.

FRONT PANEL CONTROL OF LINEAR/ANTENNA BAND-SWITCHING. Auxiliary bandswitch terminals on back panel for simultaneous control of external relays or circuits with the OMNI bandswitch.

BUILT-IN PHONE PATCH JACKS. Provide interface to speaker and microphone audio signals for phone patch connection.

BUILT-IN “TIMED” CRYSTAL CALIBRATOR. In the OMNI-A a pulsed 25 kHz calibrator desensitizes the receiver and provides an automatic 5 to 10 second “on” time for easy two-hand dial skirt adjustment.

BUILT-IN ZERO BEAT SWITCH. Permits placing your transmitted signal exactly on the listening frequencies of CW stations.

BUILT-IN SWR BRIDGE. The “S” meter electronically switches to read SWR every time you transmit to provide a continuous antenna check.

FRONT PANEL MICROPHONE AND PHONE JACKS.

ADJUSTABLE AUTOMATIC LEVEL CONTROL. For setting output power level from low power to full output, for retaining low distortion at desired drive power to linear amplifier.

SEPARATE RECEIVING ANTENNA CAPABILITY. Rear panel switch and jack connect receiving section to common antenna or separate receiving antenna. Also acts as receiving antenna by-pass when used with instant break-in linear amplifiers.

BUILT-IN ADJUSTABLE SIDETONE. Variable pitch and volume.

DUAL COMPRESSION-LOADED SPEAKERS. Larger sound output, lower distortion, no external speaker needed.

POWER INPUT. 200 watts when used with 50 ohm load. Proven, conservatively-rated, solid-state final amplifier design with full warranty for first year and pro-rata warranty for 5 additional years.

100% DUTY CYCLE. Ideal for RTTY, SSTV, or sustained hard usage.

PLUG-IN CIRCUIT BOARDS. For fast, easy field service.

POWER. Basic 12 VDC operation for convenient mobile use; external supply required for 117 VAC operation.

OPTIONAL ACCESSORIES. As all-inclusive as OMNI is, there are a few options: Model 645 Keyer, 243 Remote VFO, 248 Noise Blanker, 252M Power Supply.

Model 545 OMNI-A \$899 Model 546 OMNI-D \$1069

Experience the world of difference of OMNI, see your TEN-TEC dealer or write for details.



TEN-TEC, INC.
SEVIERVILLE, TENNESSEE 37862
EXPORT: 5715 LINCOLN AVE., CHICAGO, ILL. 60646



- | | | |
|--|---|---|
| <p>1 Receiver RESONATE control for peak sensitivity.
2 Receiver Dual Range DIFFSET TUNING control for off-frequency work.
3 ZERO BEAT switch; spring-loaded, momentary contact.
4 6-Digit LED FREQUENCY READOUT for 100 Hz accuracy.
5 DIFFSET TUNING LED indicates DT switch is “on”.
6 MAIN TUNING KNOB; big, easy-to-grip with integral spinner.
7 AUTOMATIC LEVEL CONTROL LED indicates ALC-region operation.
8 Combination “S” and SWR METER; switches automatically.</p> | <p>9 Combination ALC control and NOISE BLANKER on/off switch.
10 DRIVE control for final stage.
11 SQUELCH combination on/off switch and control.
12 4-Position SELECTIVITY switch for SSB and CW.
13 4-Position MODE switch; automatic SSB Normal, Reverse, CW, and Lock (key down).
14 Combination push-pull POWER switch and AUDIO LEVEL control.
15 Combination RF ATTENUATOR on/off switch and control.
16 VDX GAIN control.</p> | <p>17 VOX DELAY control.
18 VOX ANTI-TRIP control.
19 11-Position BAND SWITCH.
20 MICROPHONE jack; hi-z input.
21 HEADPHONES jack.
22 RECEIVER OFF-SET TUNING SWITCH; 3-position: Max-Min-Off.
23 VOX-PTT SWITCH.
24 QSK (full break-in) SWITCH; 2-position: Fast-Slow.</p> |
|--|---|---|

if the **HUSTLER** 4-BTV weighs 39% more... what do others leave out?

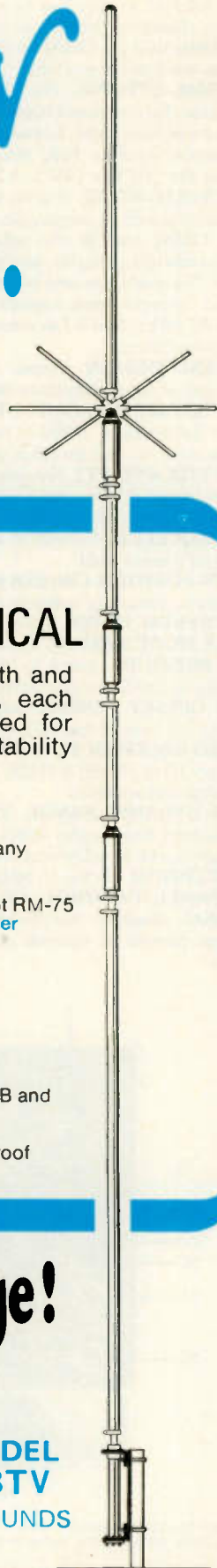

HUSTLER FIXED STATION FOUR BAND VERTICAL

The 4-BTV is longer for greater aperture, larger in diameter for strength and bandwidth, heavier traps for precision and safety factor. Individually, each subassembly weighs more to collectively give you an antenna designed for convenience of assembly and installation, a wide margin in mechanical stability and far superior electrical performance.

- **Lowest SWR**—PLUS!
- Bandwidth at its **broadest!** SWR 1.6 to 1 or better at band edges.
- Hustler exclusive trap covers "**Spritz**" extruded to otherwise unattainable close tolerances assuring accurate and permanent trap resonance.
- Solid one inch **fiberglass trap forms** for optimum electrical and mechanical stability.
- Extra heavy duty aluminum mounting bracket with **low loss—high strength** insulators.
- All sections **1 1/2" heavy wall**, high strength aluminum. Length 21'5".
- **Stainless steel clamps** permitting adjustment
- without damage to the aluminum tubing.
- Guaranteed to be **easiest assembly** of any multi-band vertical.
- Antenna has 3/8"-24 stud at top to accept RM-75 or RM-75-S Hustler resonator for **75 meter operation** when desired.
- Top loading on 75 meters for broader bandwidth and **higher radiation efficiency!**
- Feed with **any length** 50 ohm coax.
- Power capability—**full legal limit** on SSB and CW.
- Ground mount with or without radials; roof mount with radials.

one setting for total band coverage! 40 THROUGH 10 METERS



"the home of originals"

New Tronics patents: 3287732, 3513472, 3327311, 3419869, 3599214, 3873985, 3582951, 1017857 (Canada).

**MODEL
4-BTV
15 POUNDS**

**new
tronics
corporation** ANTENNA Engineers, Designers, Manufacturers
15800 commerce park drive
brookpark, ohio 44142
(216) 267-3150
N2

Available from all distributors
who recognize the best!



now 125!

the all new 2 meter VHF amplifier from Westcom.

- An add-on unit, no internal connections or adjustments required to associated equipment • Standard Amplifier Models operate FM. Linear Models operate all modes: SSB, FM, AM, RTTY, CW, etc.
- "Microstrip" design provides high stability and optimum performance over wide bandwidth • Factory adjusted, no tuning required.
- Mobile mounting bracket included • RF sensing T/R switching, adjustable dropout delay • Remote keying capability • Thermally coupled biasing • Reverse Voltage protected and fused • Conservatively rated with oversized heat sink • Red LED indicators for monitoring DC and RF • Ninety day material and workmanship warranty

MODEL NO.	INPUT POWER (watts)	MINIMUM OUTPUT W. (at max input)	MAXIMUM CURRENT 13.8 VDC	PRICE
<i>FM Mode: 144-149 MHz</i>				
2M 15x90	5-15	90	11	139.95
2M 25x125	10-25	125	18	169.95
<i>All Mode - Linearized:</i>				
<i>144-149 MHz</i>				
2M 15x90L	2-15	90	11	149.95
2M 25x125L	5-25	125	18	179.95
<i>FM Mode: 220-225 MHz</i>				
1.3M 15x70	5-15	70	10	available soon

*Linear; AM, CW, FM, SSB, RTTY. Linear models work well with low power transmitters of 2-3 watts to yield 30-40 w output. size: 4 1/8 x 5 1/2 x 2 5/8
technical specifications and data subject to change without notice

IF NOT AVAILABLE FROM YOUR LOCAL DEALER, CONTACT:

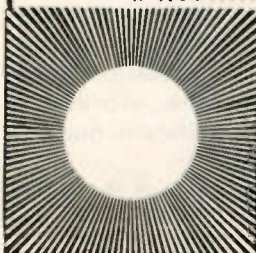

WESTCOM

ENGINEERING W17

1320 Grand Avenue San Marcos
California 92069 (714) 744-0728



If you can't hear them...



Dx'ing Contesting • Ragchewing Traffic Handling

There's a Telex Headphone that will let you do it better. Sure, sometimes you just can't hear them. But if there's a chance, it's easier with a Telex headphone. There's one for every discriminating choice. At better ham outlets everywhere, or write ...

PRODUCTS OF SOUND RESEARCH

TELEX

COMMUNICATIONS, INC. T33

9600 ALDRICH AVE. SO., MINNEAPOLIS, MN 55420 U.S.A.
telephone: 612-884-4051, telex: 29-7053

Europe: 22, rue de la Legion-d'Honneur, 93200 St. Denis, France.
telephone: 820-98-46, telex: 63-0013

DXpeditioning

— a "how to" guide

Paul S. Goble WA2VMS
40 Boxwood Circle
Bryans Road MD 20616

The Wiesbaden Amateur Radio Club has embarked upon three DXpeditions in as many years.

The first, to Luxembourg, was a learning experience. The second, in May, 1976, to Liechtenstein (see *73 Magazine*, October, 1976), was a qualified success, and the third, also to Liechtenstein, in May, 1977, was an unqualified

roaring success! This article is an attempt to share the DXpeditioning experience of the Wiesbaden club with as many hams as possible. It is hoped that by doing so more groups not presently so inclined due to lack of appropriate in-

formation will feel encouraged to undertake DXpedition activities.

The Basis

First of all, what is a DXpedition? There are probably as many definitions for the term as there are radio amateurs, but for the purposes of this article, a DXpedition is considered to be any trip to an area of low amateur radio activity in order to provide a desired increase in said activity. Note that there are three elements to this definition:

1. The aspect of travel and accompanying requirements for the necessities of life, i.e., food, shelter, sanitary considerations, etc.

2. An area (country, county, province, state, mountaintop, or whatever) with which a significant number of amateurs highly desire a contact.

3. The aspect of activity, which includes consideration of the frequencies and modes of operation desirable to the aforementioned significant number of amateurs.

In the case of the Wiesbaden club, the choice of location for a DXpedition



The Wiesbaden DXpeditioners (from left to right): Chuck DA1BZ, Hugo DJ0LC, Paul DA2PG, Gerry DA2BA, Jean DC0HO, Terry DA1TH, Enge DA4BR, Carl DA1TT, and Mike DA1BM. Missing are Doug DA2AJ, John DA1NO, and John DA1HL. Lurking behind DJ0LC with the HB0XAA sign is Jeanette, XYL of DA1BZ and fanatic club supporter. DA1TT and DA4BR are husband and wife.

was made fairly easy by virtue of club location. The principality of Liechtenstein, on the border between Austria and Switzerland, is approximately six hours travel from Wiesbaden, Germany, by auto via the fantastic German and Swiss high-speed freeway system. There are only three active amateurs with HBØ callsigns, and a contact with the principality would be highly desirable to a significant number of amateurs on almost any frequency and in almost any mode of operation. As we say in Germany, "Prime" (pronounced "premah" and meaning "prime" or "number one" or "right on" or almost anything along those lines). Having been stationed in Wiesbaden for some time, I have lost track, but there was a time when the same criteria could be satisfied with a trip up a tall New Hampshire mountain with a six meter transceiver, battery, and hilltopper beam.

The Organization

Picking a location for a DXpedition is a group effort based primarily on economics and time constraints. The Wiesbaden club brainstormed for a couple of monthly meetings and then wrapped up most of the details on two meter FM, thereby generating increased interest and whetting appetites of those club members not already involved. The process can be generalized as follows:

1. Make a list of all possible (practically speaking) locations which fit the definition of "rare" or "desirable." Using the Wiesbaden club to illustrate: Andorra, Liechtenstein, Luxembourg, San Marino, Spitzbergen, miscellaneous islands throughout the European area, etc.

2. Determine which loca-

tion(s) would not be economically prohibitive to reach and where licensing is not impossible. Again using the Wiesbaden club example:

Liechtenstein—six hours by auto, therefore no special conveyances required. Everything else significantly further away. The only expense would be fuel, lubricants, and possible on-the-road repairs. Licensing is merely a matter of writing to the proper office of the Swiss government for application forms and sending the completed forms with a suitable sum in Swiss francs and a copy of one's home license back to them. Our club vice president, DCØHO, took care of this for the whole club. The result is a three-month temporary HBØ operating authorization which makes it all legal. Prime!

3. Determine the time-frame during which the greatest number of interested club members can make the trip.

Our planners came up with the last half of May, the same as the previous year. This time, however, based on increasing interest and the number of people who missed out last year due to limited DXpedition duration, it was decided to go for a total of about two weeks rather than only one. The easy access to the location picked was conducive to such a decision since people could come and go as their schedules permitted. At least one club member should be on location for the entire duration in order to provide continuity to the effort and establish relations with hosts and neighbors. DA1BZ and his XYL were able to fulfill this requirement in our case.

4. Determine the most desirable living method.

Several of the prospective DXpeditioners owned tents. A location on the



Hugo DJØLC taking lunch break by his auto-turned-HF station from which, using CW and dipole antennas almost exclusively, he worked 1015 contacts in 7 leisurely days of operation.

outskirts of the little town of Planken was arranged through an HBØ amateur (again by our very own DCØHO) to include a water supply, toilet facilities, electricity, and an area in which to erect our tents. Planken lies on the western slope of a mountain ridge which forms the east side of the Rhine valley at that point on the river. The border of Austria and the principality is marked by the ridge line.

5. Determine what equipment would be desirable, what equipment is

available, and get commitments from people to supply same. In the Wiesbaden case, we derived the following list: DA1AY—Swan 350; DA2AJ—Atlas 210X, SB-200, transmatch, headphones, tent; DA2BA—matchbox, HW-202, The Quad! A Truck! 2m yagi; DA1BM—antenna wire, 2m yagi, 70 cm yagi; DA1BZ—SB-401, SB-303, SB-200, tent, large spool of wire; DCØHO—IC-202, 25 W 2m linear, tent; DA1HL—A Truck!; DJØLC—HW-101, SB-200, antenna tuner,



Chuck DA1BZ—#1 operating tent. #2 operating tent is in the background. The 2m SSB station is in #1 op tent behind Chuck, and the 70 cm FM station is in the back of the truck shown at top left of photo.



View of the DXpedition site from the quad installed just above the site. View is roughly WNW.

dipole antennas; DA1NO—HW-101, vertical antenna; DA2PG—QF-1, VOMAX, SB-614, IC-30A + GLB 450, headphones.

Miscellaneous items for which members "signed up" are listed below:

Grounding:

- Ground rods (6 ft. minimum desirable)
- Grounding strap or cable
- Grounding connectors (clamps, "bug nuts," and the like)

Power Considerations:

- Transformers (European ac power is 220 V, 50 Hz)
- Extension cords (of sufficient current rating)
- Multiple outlet adapters (both outdoor and indoor)

Rf Considerations:

- Coax cable (short interconnecting pieces and long runs)
- Coax connectors and adapters
- Dipole center insulators
- Antenna masts
- Low-pass filters for

the transmitters as appropriate
A large roll of insulated wire (we used #12 solid copper)

Common User Items:

- Tables
- Chairs
- Tents (if applicable)
- Coffee pot with supplies
- Miscellaneous

Be sure that you do not skimp on tables and chairs. Each station requires a table and at least one chair (unless installed in a car). If the logging function is to be accomplished by someone other than the operator, two chairs are required for each station. Those people on site not actually at an operating position will need a place to sit as well, making the requirement for tables and chairs perhaps larger than might at first be apparent.

6. Personal equipment and sundries should be the responsibility of each participating individual.

If you're camping, like the Wiesbaden club, an individual's kit might include

the following: sleeping bag, air mattress, two blankets, toiletries, towels, changes of clothing (be sure the clothes fit the climate!), a dirty clothes bag, etc.

7. Plan who will be on site, when, for how long, with what equipment, and who will be the last to leave (the clean-up crew).

This part can get pretty complicated with a large multi-station effort. Brace yourself: In our case, DA2BA and his son, DA1BZ and his XYL, DCØHO, and DJØLC all went to the site on 16 May with the preliminary truck and carloads of tents, equipment, and antennas. DA2AJ and DA2PG arrived the next day with another tent and more equipment. DA2AJ had to leave on the 20th, but DA1BM, DA4BR, DA1NO, DA1TH, and DA1TT all arrived on the 21st. On 23 May, DA2BA and son, DCØHO, DJØLC, DA2PG, and DA1TH left with a truck and carload of tents, equipment, and miscellaneous excess

paraphernalia. All that was left was carefully coordinated with those club members staying on site to ensure that enough tent space, equipment, and antennas were left to keep everyone happy. DA1BM returned on the 26th, DA1HL arrived on site on the 28th with his camper, and then, on the 30th, the clean-up crew of DA1BZ and XYL, DA4BR, DA1HL, and DA1TT formed the rear guard and returned to Wiesbaden. Whew! All this would have been a whole lot simpler with only one or two stations and three or four people involved, but we found that it was pretty much a case of "the more, the merrier!"

The Rewards

The results of planning along the lines delineated thus far can be illustrated by synopsisizing the operations of the Wiesbaden Amateur Radio Club DXpedition of 1977. The effort went from 16 May 1977 to 30 May 1977 under the callsign of HBØXAA. Between the 16th and 23rd, we had some 3000+ contacts, operating 80m through 70 cm. Modes of operation were SSB and CW on 80m through 10m, SSB, CW, and FM on 2m, and FM only on 70 cm. At one point during the weekend of May 21-22, we were operating simultaneously on 40m through 70 cm with the 40m station switching to 80m and back periodically. Needless to say, conditions were excellent that weekend! During this especially hectic time, one of the die-hard club members burst from an operating tent screaming "QRZed Pileup! QRZed Pileup!" as he bolted up the hill to the little house with the outside plumbing. Note the capital "P" on "Pileup!" That indicates a type of reverence reserved for those who have never been the cause

of a pileup, since it is a truly unique experience and is appreciated most fully by those who never caused one before. Remember your very first QSO? Very similar feelings!

At the height of the operation, there were two living tents, two operations tents (each of which housed an HF station and one of which also housed the 2m SSB/CW station), two HF stations installed in the back seats of autos, two 2m FM mobile stations, and a 70 cm FM station in the back of DA2BA's covered truck. Antennas consisted of a tri-band quad for 10m, 15m, and 20m, an 800' longwire with transmatch, a 350' sloping wire with matchbox, various dipoles, a base-loaded vertical, three 2m yagis of 4, 11, and 32 elements, and an 8-element yagi for 70 cm.

Overall for the entire period, there were approximately 3800 contacts. More than 1400 of them were with stateside stations including Alaska, Hawaii, the Canal Zone, Guantanamo Bay, and Puerto Rico. Another 700 or so were Gs and Es. We could have increased the overall number significantly if more operators had desired to stay up all night. With 20m open into the states from 8:00 pm to 7:00 am local Liechtenstein time and with 80m open simultaneously, one band went wanting for an operator on all but two nights when there happened to be two nightowls on site at the same time. Those two nights were really productive! This is not to say that more people should have felt obligated to stay up all night; DXpeditions should not only provide contacts to people needing a given area, but should be enjoyable to all involved in the effort as well. So it was for the Wiesbaden club!



A look at a portion of the outskirts of Planken, Liechtenstein. View is roughly southerly from quad site.

Any club effort of any type has its memorable moments and this DXpedition was no exception. We noted that, since as band conditions changed we operated 80m through 10m, theoretically HBØXAA could have supplied a full 1% of a quest for the 5-band DXCC award. Since the only chance many of us had to be part of a station with which many amateurs desired a contact was this DXpedition, and since the only time we had been on the receiving end of a pileup was again on DXpeditions, this fact gave us a nice warm feeling. DA2BA got an individual charge when an amateur in Andorra called and asked for a QSL card. How often have you been called by Andorra for a QSL? DJØLC made 1015 contacts from the back seat of his cart-turned-HF station, primarily using CW and dipole antennas, in less than a week and never going without a meal nor without a good six to eight hours of sleep per night. He showed

handily that he is worthy of the Master Operator title which he holds! DA1BM answered a stateside "QRZed" with "This is HBØXAA, do you copy?" and the stateside station operator nearly fell off his chair, coming back with "You have GOT to be kidding!" After all, a new country (number 202 for him, if we recall his comments correctly) without having to fight QRM, rude operators (are there any of them?), and pileups in general only happens to the other guy! DA2PG was discovered asleep at the mic, having gone down with the 20m band sometime between 6:45 and 7:30 am local time with the last log entry lacking a closeout time. We wonder what the W6 on the other end of that QSO must have thought at the time! There was also an informal contest for the best DX contact. The candidates include Hawaii, Easter Island, New Zealand, and maybe something we have yet to find in the logs or in-

coming QSLs. We are hoping that almost everyone sends a QSL because we made WAC, we think we made WAS (Thanks for the contact, Gary! We hope that other guy's address is wrong in the callbook or we may not have North Dakota!), we are checking to see if we even came close to DXCC, we worked all provinces and territories in Canada (too early for their new award—phooey!), and we absolutely and thoroughly enjoyed every minute of the whole thing. What more could one ask?

The Lessons

There are several things which experience taught the Wiesbaden Amateur Radio Club DXpeditioners. The first and main thing is that old Murphy isn't nearly so tough if you plan and organize thoroughly enough. Aside from a bit of trouble from wet equipment due to condensation and a few rf shocks from grounding problems, the 1977 effort was remarkably

free from the usual incapacitating Murphy-like problems which one might expect in such an under-

taking.

We also showed that if you are going to a non-English-speaking country,

have someone along who speaks the language if it is at all humanly possible. The simplest of arrangements or transactions can become a tremendous burden if you cannot communicate with your hosts. As an example, we experienced a TVI problem which could have turned ugly and ruined the trip; only our fluency in German and French prevented a small problem from becoming a large one.

Take along a large amount of insulated wire. We used #12 solid copper, but it could just as easily have been #18 and either solid or stranded. It was cut to quarter wavelengths for all HF bands used by a given station and connected to the back of the station transmitter. The result was a substantial reduction in rf shocks from the equipment. This measure was taken in addition to and as a complement to the normal electrical grounding systems already on site. Our hats off to Bill Orr for this one! Some of our wire and transmatch systems left quite a bit of rf floating around each station until we accomplished the above.

HF energy got into our ac power cords and made it impossible at times to operate 2m and 70 cm stations from the commercial ac power. This was not surprising since we were fairly space-limited to an area less than 60 feet on a side for all tents, operating and living alike, and we had three to four stations operating at any given time, up to three of which had 1000 Watts PEP output capability. The extension cords strung from end to end and side to side made great antennas. We had to run the 2m and 70 cm stations from automotive 12 V dc systems which, while no technical problem, was an inconvenience, especially when we ran one car bat-

tery down to the point that jumper cables had to be employed to start the car.

We found that in a multi-station, multi-operator situation it is desirable to have at least two tri-band antennas for 10m, 15m, and 20m, or a good beam for each band individually. We had only the quad and found ourselves limited several times. The wire antennas and dipoles just did not perform in the marginal situations!

Be sure to have a method of QSLing worked out in advance. In 1976, we had each operator QSL his own contacts, giving his DAXXX call as the source of an HBØXAA QSL card for that contact. This caused quite some confusion and led to long delays in QSLing. For 1977, we tried a better approximation of the proven QSL manager approach, with DCØHO the QSL manager for all phone contacts and DJØLC as manager for CW contacts. We still have yet to iron out the problem of having to wait until after the trip is over and the number of contacts is tallied before knowing how many QSL cards to order. This year the order totaled over \$100 and the delays incurred during tallying, ordering, and waiting to receive the cards from the printer are, of course, delaying our efforts to reply to all the cards we started receiving even before we returned from the trip. Also, be prepared to hold a few extra club meetings to fill out QSL cards and don't forget cards for SWLs!

Headphones are invaluable for helping to keep the noise level on site down. We had our stations fairly well separated acoustically and still needed them. This was especially true during nighttime operations since tents do not keep sound in or out very effectively.



HBØXAA sign with #1 operations tent in background. Many visitors came to the site during the 2 weeks of operations.



The quad—view from behind the antenna looking west over the Rhine Valley to the Swiss mountaintops.

A tool kit with soldering implements and supplies is also a must, along with a selection of common capacitors and resistors. While proper planning can keep Murphy pretty well at bay, he is still going to sneak a couple of things by you, so be prepared for some minor repairs.

A Suggestion

We devised a method for raising the high end of a sloping or longwire antenna to be used in those situations when climbing is impossible. It may not be new, but it may be of value to some amateurs and is included here as a matter of interest. Attach a pulley assembly, complete with halyard, to the top section of a sufficiently long pole. Just below the top, perhaps 8 to 12 inches down the pole, attach a long rope. Select a tall tree, tower, or other slim structure which cannot be climbed, stand the pole up against it, and, while someone holds the halyard clear, wrap the rope around the combination pole-tree or pole-tower in Maypole fashion until the newly-installed pole is fastened securely to its support. We used this method to raise one end of a 500+ foot sloping wire, securing it to a smooth 4-inch diameter metal light pole, and for an 800+ foot wire which was secured to a tree located up the side of the mountain above the operating site. The tree, of course, was devoid of branches to well above the height of our halyard pole. In our case, the halyard pole was in sections with swaged ends which, as the top section with pulley and securing rope attached was raised vertically alongside the tree, were added at the bottom until the desired height was achieved. See the accompanying drawing for a depiction of our installation. Note that the halyard itself was a con-

tinuous loop to prevent such things as one end of the line ending up at the top of the pole stuck in the pulley, necessitating lowering the pole to get that end of the halyard. A synopsis of the installation procedure follows:

1. Raise and secure the halyard pole as described above.

2. Secure insulators to the appropriate lines at both ends of the proposed installation. In our case, one end was fixed to a utility pole and the other insulator was fastened to the halyard.

3. Lay out the antenna wire and secure at the end opposite the halyard.

4. Temporarily fasten the remaining end of the wire to the halyard insulator.

5. Raise the halyard insulator and antenna wire to the top of the halyard pole.

6. Check the antenna wire for sag.

7. Lower the antenna and remove wire as necessary to make the antenna tight when it is subsequently raised.

8. Secure the antenna wire to the halyard insulator again and raise it once more to the top of the pole.

9. Repeat steps 6, 7, and 8 until you decide that it is not practical to try to get more sag out of the antenna. Remember that for the longer antennas, the strength of the wire becomes important since the wire might break before the antenna is tight enough to achieve minimum sag, so be careful to select a wire having sufficient tensile ratings.

Final Comments

Note that there is quite a bit of similarity between the Wiesbaden club concept of DXpeditioning and Field Day operations. With the exception of the use of commercial power, this is the case. The only big dif-



Doug DA2AJ in #2 operations tent. Audio processing gear, both TX and RX (VOMAX, AUTEC QF-1, respectively) proved to be quite effective during noisy and/or pileup conditions.

ference is the aspect of travel, which is in itself merely an expansion/extension of the transportation which is also required for Field Day. More care is required in packing and transporting the equipment, but how much trouble is that?

"That's all well and good," you say to yourself. "These Wiesbaden clowns live right in the middle of some of the greatest DX in the world. It's easy for them to talk about DXpeditions!" Well, you are absolutely right, but so what? Don't let that stop you. So you might not be able to go to an exotic location every

year. Do you have to go every year? What about that six meter station to New Hampshire—is that still a valid DXpedition? If not, is some other state rare on 6m, 2m, 1 1/4 m, or 70 cm? How about a site on the North/South Dakota state line, with one operating station in one state and another just across the state line in the other state, if not on VHF, then HF. The trick is to look back to the definition of DXpedition. Where can you go and what mode should you operate on what bands in order to cause a pileup? The definition of pileup varies, too.



Gerry DA2BA at the helm in #1 operations tent.

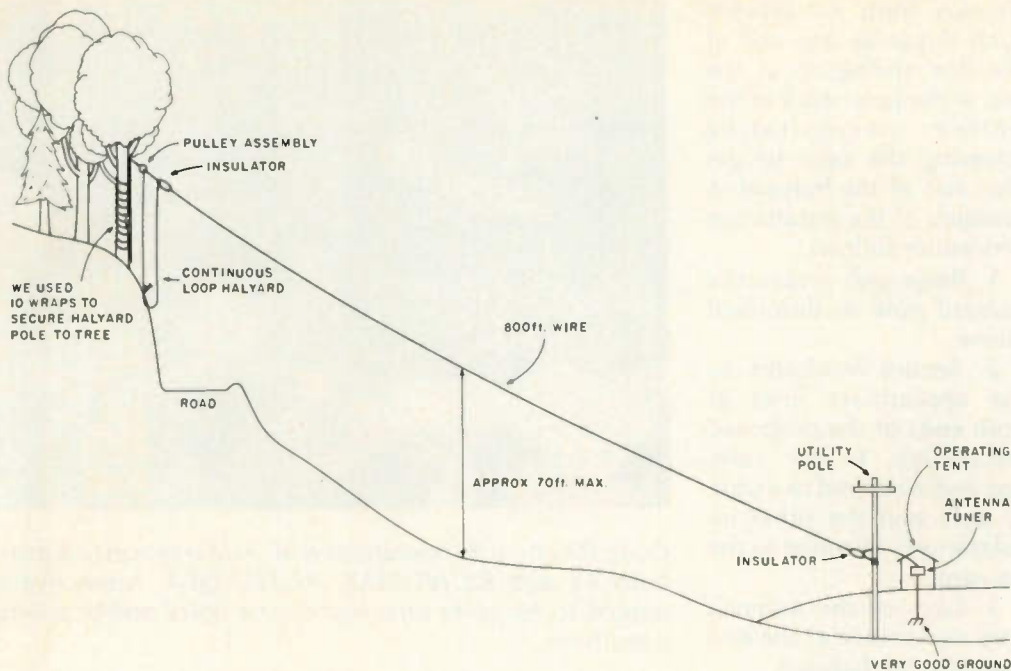

What kind of pileup did the Pack Rats get in the EME mode from South America? Compare that to one which might be generated on 20m. It's all relative.

If, after all is said and done, an exotic location is

a must for you, then the planning stage can be extended somewhat to include a fund-raising function if necessary. It is amazing how much money a refreshment/hamburger stand can net at a hamfest.

It is equally amazing how easily a modest income may be realized by sponsoring a hamfest. There are also any number of excuses to have a bake sale at your local shopping mall. The possibilities are

endless. Merely set guidelines beforehand as to what each member of the proposed DXpedition is going to supply in terms of fund-raising, time, and/or equipment or whatever. Once the guides are set, anyone not meeting his end of the bargain stays home. On the other hand, all who do their part stand to go on a paid vacation (well, almost paid... subsidized?) to Ham Heaven for a while! It has been shown that any club can do anything to which it sets its collective mind. Clubs are demonstrating this daily throughout the world. It is sufficient to say that, with proper planning and effort coupled with great attention to detail, you, too, can experience the excitement and delight of putting a rare location on the air.

Of course, there is always the alternative of sitting there and eating your heart out! ■

If you expect to invest in a new ham antenna in the next 90 days, invest 15¢ postage to get Antenna Specialists' brand new, complete ham catalog today.



Amateur Radio spoken here!

FREE decal just for fun!

Name _____

Address _____

City _____ State _____ Zip _____



the antenna specialists co.

A62

© Shows of Quality
a member of The Allen Group Inc.
12435 Euclid Ave. Cleveland, Ohio 44108
Export, 2200 Shames Drive, Westbury, L.I., New York 11590
Canada: A. C. Simmonds & Sons, Ltd.

Toss 80 and 40 meters in your briefcase.



only \$79.95

Kantronics 8040-B Receiver

It weighs about as much as a loaf of bread!

The **Kantronics 8040-B CW receiver** measures 3"x5"x7" (HWD) and runs on two 9 volt transistor batteries. **It's small enough to fit in your briefcase**, light enough to take on a hiking trip and sensitive enough to pick up signals at a microvolt.

Now you can copy code from 3.650 to 3.750 MHz on 80 meters and 7.050 to 7.150 MHz on 40 meters **almost anywhere you have room for a pad and pencil!** A simple dipole brings in armchair copy on both bands.

Check with your dealer about the **8040-B**, or order direct from our address below.

K13 KANTRONICS
The Lightweight Champs.

1202 East 23rd Street
Lawrence, Kansas 66044
We accept Visa, Master Charge, check and money orders.

Phone: 913 842 7745

MADISON ELECTRONICS SUPPLY, INC.

1508 MCKINNEY
713/658-0268

HOUSTON, TEXAS 77002
Nites 713/497-5683

NEW! EXCITING! BREAKTHROUGH!

YAESU FT 901 DM
Transceiver & Accessories



FT 9010M	\$1,459.00
Speaker/Patch	74.00
CW Filter	45.00
FV-901 VFO	415.00

CALL FOR QUOTES ON:

YAESU	KENWOOD
FT901 DM	TS820S
FT625	TS520S
FT225	TR7400A
ALDA, AMCOMM, ETO ALPHA	
TEMPO VHF ONE PLUS	



ETO — ALPHA

Buy The Best First!
Full Power + C.C.S. Ratings.

76A	\$1,395.00
76PA	1,695.00
374A	1,795.00
78	2,395.00

**CALL FOR FAST QUOTES
SPECIAL ORDERS WELCOME**

TERMS: All prices FOB Houston. Prices subject to change without notice. All Items Guaranteed. Some Items subject to prior sale. Send letterhead for Amateur dealers price list. Texas residents add 5% tax. Please add postage estimate.

MADISON FABULOUS FALL BUYS

KLM: Antennas, Linears, Accessories All in Stock. Free balun w/2 meter base antenna.
FINCO AMATEUR BEAMS in Stock — Call! 6N2 and 2 Meter\$61.00
 2 + 2 Horiz/vertical\$37.50
BIRD 43 Wattmeter plus slugs, In stock, prepaid freight.
BENCHER keyer paddles in stock \$39.95; chrome \$49.95
YAESU
 FT-301D + Free FP301\$935
 FT-301 + Free FP301\$769
YAESU FT-901D series Call for Quote
MICROWAVE MODULES MMT 432-28S\$259
 UPS Paid.
F9FT TONNA antennas: 144/16 el\$65.95
 9/19 OSCAR\$63.95
JANEL Preamps QSA-5\$41.95
TECHNICAL BOOKS: AMECO, ARRL, Sams, TAB, TI, Rider, Radio Pub., Callbook, Cowan, TEPABCO, many others call
HAM X ROTOR (New Model) Turns 28 sq. ft. of antenna. List \$325. In stock Your Price \$249
CDE HAM-III\$129.00
SWAN METERS: WM 6200 VHF Wattmeter\$49.95
 SWR 3 Mobile\$9.95
TELEX HEADSETS: In stock
CETRON 572B\$27.95 ea.
RAYTHEON 572B\$24.95
ADEL nibbling tool, \$6.45; punch \$3.50
CABLE 5/32", 6-strand, soft-drawn guy cable. For mast or light tower, 3¢ foot.
BELDEN COAX CABLE: 9888 double shield RG8 foam coax, 100% braid, suitable for direct bury 39¢ ft., 8237 RG8 21¢ ft., 8214 RG8 foam 25¢/ft., 8448 8-wire rotor cable 16¢ ft., 8210 72 ohm kw twinhead \$19/100 ft., 8235 300 ohm kw twinlead \$12/100 ft., Amphenol PL-259, silverplated 59¢, UG175 adapter 19¢, PL-258 dbl female \$1.00. BNC female chassis mount 59¢ ea.;
BELDEN 14 gauge cop. stranded antenna wire \$5/100 ft.
TIMES 1/2" foam hardline 60¢/ft. connectors \$15 ea.
 7/8" Foam Hardline 1.50 ft. Connectors \$25.00 ea.
KESTER SOLDER 1 lb. 60/40 .062 \$6.50
LEADER — GDM LDM815 \$89.95
MALLORY 2.5A/1000 PIV epoxy diode 19¢ ea.
.001 MFD 20 KV CAP \$1.95
GE receiving tubes 50% off list
GE6146B,8950 \$7.95 ea.
SWAN 750CW + Free PSU-3 \$675

THIS MONTH'S SPECIAL

KENWOOD TR7500A \$249

16 ELEMENTS — F9FT — 144 MHz



The 'Tonna' You've been hearing about

17.8 dBi	SWR 1.2:1
144/146 MHz	Wt. 4.4 kg.
50 ohms	Horiz./Vert.
length 6.4 m.	F/B ratio 22 dB
Horizontal aperture	2 x 16° (-3 dB)
Vertical aperture	2 x 17° (-3 dB)
Side lobe attenuation	60 dB

\$65.95

MADISON M35 ELECTRONICS SUPPLY, INC.

1508 MCKINNEY
713/658-0268

HOUSTON, TEXAS 77002
Nites 713/497-5683

VHF On Your Frequency Counter

—an easy-to-build prescaler

Any ham with a few sets of crystals in his two meter rig can tell you why the frequency counter is becoming a popular piece of test equipment. With this upsurge in interest, it is a welcome coincidence that counter prices have decreased significantly. Fortunately, there have been accompanying reductions in size. Buying a counter, however, can be a difficult process because of the many options. These options include kits, home-brew equipment, and many fully-assembled units.

I chose the Heath IM4100 because of its low price and high function. Combining this counter with an easy-to-build prescaler for VHF work proved to be a winning combination.

The Basic Counter

The Heath counter contains some excellent features

not normally found in a unit of this price range. It provides for interval measurement as well as counting up to 99,999 events. An input attenuator allows a wide range of input voltage levels. Also, provision is made for power to be supplied from a 12-volt source. It would be nice to have some additional display positions, but the selectable timebase allows reading non-prescaled frequencies to the nearest cycle. The timebase is not temperature-compensated. Consequently, a WWV source is useful for periodic calibration. Heath specifies the frequency range of the IM4100 as 30 MHz. In practice, however, the counter appears to work well into the 40 MHz range (mine went to 45 MHz).

The Prescaler

Although several assembled prescalers are available, building your own is a

good choice. They are simple to build and the savings can be significant. I chose the 11C90DC because it is readily available and requires few external components. Also, it should run cooler than its predecessor, the 95H90. The 11C90 divides the measured frequency by ten. This multiplies the effective range of your counter by ten. This should extend the capability of the IM4100 through the VHF range and possibly into the UHF band.

The prescaler circuit provides a second input to the counter for higher frequencies and a switch for input selection. In the schematic, J1 is the existing front panel BNC jack. In nonprescaled operation, the signal merely passes through SW1A and back to the existing input circuitry of the counter. At this time, the prescaler is isolated from the circuit with power removed. This reduces heating and current consumption. When the prescaler switch is turned on, voltage is applied to the 11C90 through SW1B. A BNC jack on the rear panel (J2) provides signal input to the prescaler. Prescaler output is routed to the normal counter input through SW1A.

Supply voltage for the 11C90 is provided by the counter. The Heath circuitry

draws approximately 1.1 Amps from the five-volt regulator. The prescaler adds less than 100 mA to that load. I noticed no loss of regulation or regulator heating with power applied to the prescaler. The 7805 regulator used in the counter has an output current rating which varies by manufacturer. It is normally rated in excess of one Amp.

Construction

PC board mounting is recommended for best performance of the 11C90. The PC board is mounted in a location where there are few components on the main board. It may be necessary to bend over C14 on the counter to give sufficient clearance for your PC board. The prescaler is mounted by removing an existing PC mounting screw. This is replaced with a hollow spacer and a screw of suitable length.

When I began the project, it was my intent to preserve the value of the counter by avoiding significant modifications to the chassis or wiring. With this in mind, I mounted the rear panel jack and switch in two existing holes. This required sacrificing the external oscillator input. Wires connected to these jacks are taped back. If you want to retain the oscillator jacks, there is ample room to drill the required holes. Be sure to include a solder lug when mounting the new jack.

On the front panel, the red wire is removed from the existing signal jack. This wire should be connected to the center conductor of RG-174 coaxial cable leading to SW1A-1. The front jack is then connected to another cable leading to SW1A-3. All shields should be grounded. Install cable to connect the prescaler with J2 and SW1A-2 according to the schematic.

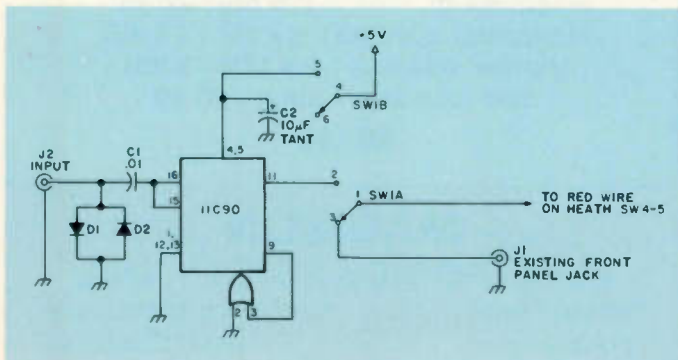

Fig. 1.

jumpers near D3 on the counter.

Testing

When wiring is complete, power up the counter without the 11C90 in its socket. Turn on the prescaler switch and ensure that voltage is present at pins 4 and 5 only. Having checked this, power down and insert the 11C90. Be sure it is not installed backwards. Power up and check the 11C90 for moderate warmth (beware of ac voltage). If the chip becomes extremely hot, power down quickly and double check your wiring. If everything looks fine, check the counter five-volt supply to be sure that it does not drop with the prescaler turned on.

An initial check of the prescaler can be made using the counter's internal clock. It is available at the rear panel. If you borrowed the oscillator jack, it is the orange wire that you removed. Connecting this signal to the front panel jack will yield a reading of 1.0 MHz. Routing this signal through the prescaler should produce a reading of .1 MHz. The prescaled input seems to produce the best results with the attenuator in the X1 position.

I fashioned an antenna from a BNC connector, an old CB whip, and some RG-8 insulation for a grommet. Using this antenna, a one-Watt handie-talkie produced a stable reading. Since the counter is unaware that the input has been divided by ten, the decimal point will be incorrect when prescaling. To correct for this, just multiply readings by ten.

Parts

All parts, except the BNC connector, may be obtained from Jameco Electronics, 1021 Howard Ave., San Carlos CA 94070. A PC board for the prescaler is available for \$3 from RTC Electronics, PO Box 2514, Lincoln NE 68502. Diodes D1 and D2 are 1N914 or 1N4148. C2 is a 10

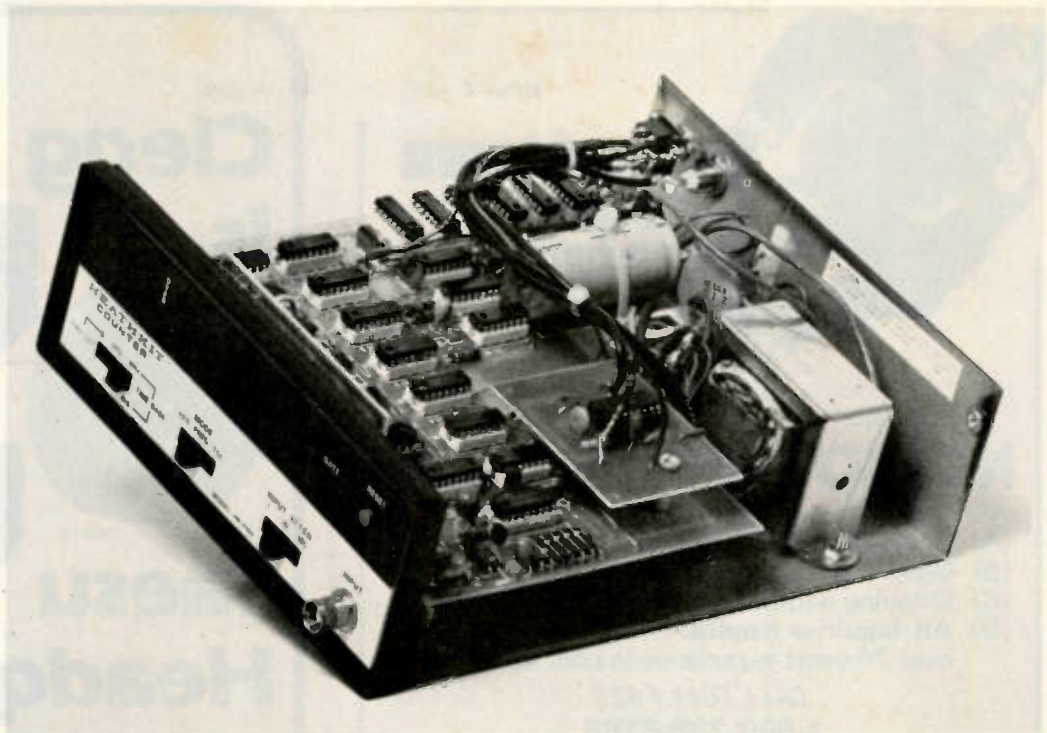

The prescaler board is mounted above the main counter board. Coaxial cable connects the prescaler with the front and rear panels.

uF tantalum capacitor. A 16-pin socket is also convenient for the 11C90.

I am very pleased with the

performance of the counter after modification. The result is a versatile and extremely useful piece of test equip-

ment. If you are one of the hams who still likes to do a little home brewing, I know you will enjoy this project. ■

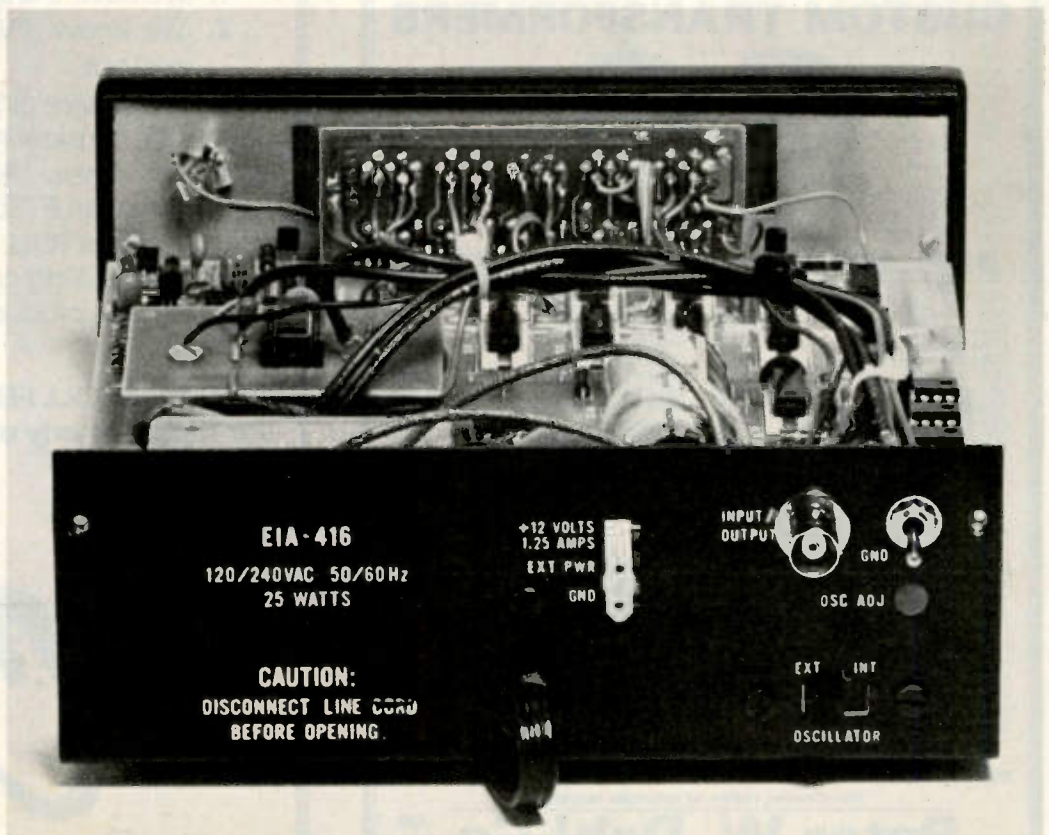

Existing chassis holes were used for the prescaler input and on-off switch. These components are shown mounted in the upper right-hand corner of the rear panel.



**Germanatown
Amateur
Supply,
Inc.**

MEMPHIS, TENNESSEE

G-12

NO MONKEY BUSINESS!

- (A) Complete Service Facilities
- (B) Good Deals on most Brands
- (C) Shipping within 24 Hours
- (D) All inquiries handled by Active Hams with over 20 years experience in ham radio

CALL TOLL FREE
1-800-238-6168

IN TENNESSEE, CALL 901-452-4276
MONDAY - SATURDAY 8:30-5:30
FOR YOUR SPECIAL.

Write: 3202 Summer Ave., Memphis, Tennessee 38112

CUSTOM TRANSFORMERS

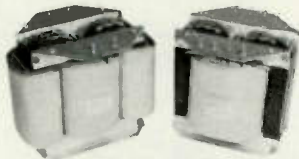

HEAVY DUTY REPLACEMENT TRANSFORMERS

ALPHA A77D Power	\$135	HEATH DX-100 Modl	\$ 95
BTI LK-2000 Plate	\$135	HEATH HX-10 Power	\$ 95
COLLINS 30S-1 Power	\$215	HEATH SB-220 Plate	\$125
COLLINS KWS-1 Plate	\$135	HENRY 2K Plate	\$150
COLLINS 516F-2 Power	\$ 95	HENRY 2K-2 Power	\$155
DENTRON 160-10L Power	\$125	HENRY 2K-4 Power	\$165
DRAKE L4B Plate	\$165	HENRY 3K-A Plate	\$165
GONSET GSB-100 Power	\$ 95	HENRY 3K-A DC Choke	\$ 85
GONSET GSB-201 Power	\$135	EFJ T-BOLT Plate	\$125
H-CRAFTER5 HT-32 Power	\$ 95	EFJ 500 Modulation	\$ 95
H-CRAFTER5 HT-37 Power	\$ 95	EFJ 500 DC Choke	\$ 75
HEATH DX-100 LV Power	\$ 95	NATL NCL-2000 Plate	\$125

OFF-THE-SHELF SPECIALS

PLATE XFMR:	2400 VAC @ 1.5A ICAS 220/240 PRI-4 1LB	\$150
PLATE XFMR:	3000 VAC @ 1.5A CCS 230 PRI-60LB	\$195
PLATE XFMR:	3000 VAC @ 0.7A ICAS 115/230 PRI-27LB	\$115
PLATE XFMR:	3500 VAC @ 1.0A ICAS 115/230 PRI-4 1LB	\$150
PLATE XFMR:	4000/4600 VAC @ 1.5A ICAS 230 PRI-60LB	\$195
PLATE XFMR:	6000 VCT @ 0.8A CC5 115/230 PRI-4 1LB	\$150
FILMT XFMR:	5.0 VCT @ 30A 117 PRI-9 5LB	\$ 30
FILMT XFMR:	7.5 VCT @ 21A 117 PRI-9 5LB	\$ 30
FILMT XFMR:	7.5 VCT @ 55A 115/230 PRI-14 6LB	\$ 65
FILMT XFMR:	7.5 VCT @ 75A 115/230 PRI-20 2LB	\$ 95
FIL CHOKE:	30 AMP Bifilar Wound on 1/2" x7" rod	\$ 9
DC CHOKE:	8.0 Henries @ 1.5 AMP DC 4 1LB	\$150
SWG CHOKE:	5-30 Henries @ 1.0 AMP DC 23LB	\$100

ALL TRANSFORMERS & CHOKES GUARANTEED FOR 24 MONTHS

Many others also available. Write for free list or quote on any custom transformer, choke, or saturable reactor.

Peter W. Dahl Co. D6

4007 Fort Blvd. • El Paso, Texas 79930

Telephone (915) 566-5365 or (915) 751-4856

Clegg is

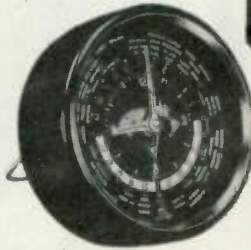

QTR-24



FT-901



FT-301

Yaesu Headquarters

Dozens of Distributors offer you a selection of YAESU products. Some might even quote you a slightly lower price. But—no one can serve you better than Clegg when you choose any item from YAESU's extensive product line. Because:

1. We have YAESU products in stock.
2. We know YAESU products inside and out.
3. We service all YAESU products.

If you are considering upgrading your station with a new YAESU FT901—or an FT-225RD—or an FT301—or merely a YAESU clock—call us TOLL FREE today.

YAESU and Clegg guarantee your satisfaction with the product and with the service.

Call Clegg TOLL FREE 1-(800)-233-0250, for YAESU or any other requirement for your station.

Clegg

Communications Corp.
1911 Old Homestead Lane
Lancaster, PA 17601

C3

WITH COMPETITIVE PRICES GOING SKY-HIGH THE YAESU FT-101 SERIES IS STILL YOUR BEST BUY!



FT-101E

Top of the series, the FT-101E has everything—RF speech processor, AC and DC operation, plug-in PC boards for easy servicing—nothing has been omitted for excellent 160-10 meter performance.



FT-101EE

Just one step down is the FT-101EE identical in every respect—but less the RF speech processor—an item many hams can live without, thus saving a few dollars.



FT-101EX

The FT-101EX is the same basic unit, less DC/DC converter, 160M, WWV, and three of four 10 meter crystals and the RF speech processor. Many hams do not need these features and would just as soon save the money. All accessories may be added later and the "EX" can then become an "E".



Amateur radio's first all plug-in PC board transceiver, the FT-101 series has a long pedigree of success dating back to the FT-101 and FT-101B. More than a quarter million are in use all over the world! Refinements have been added over the years to update the equipment and we believe it is the most thoroughly satisfactory and trouble-free transceiver money can buy. Compare price and features with any "Brand X" and you'll choose Yaesu!



YAESU
The radio.



The KM1CC Story

—hams celebrate Marconi's miracle

The raucous simulated rotary spark-gap transmitter inside the surplus army barracks over the dunes from the Atlantic surf in South Wellfleet sent President Carter's words

honoring Guglielmo Marconi out from Cape Cod to the Cornish Radio Club at Poldhu, England, and to the world in general. It was an old sound searching the air waves for new ears 75

years after Marconi's first wireless message traveled the same ocean.

Marconi's message to King Edward VII from President Theodore Roosevelt in 1903 was the first of

its kind, paving the way for amateur and commercial radio as it's known today. The Town of Barnstable Radio Club Special Event Station, KM1CC, was on the air nine full days, January 14 to 22, 1978, on all bands, in all modes, even during a major snow storm, commemorating this great feat of 75 years ago. It talked with amateurs around the world from near the original Marconi station site.

Some 60 operators manning eight transmitter/receivers made 7,740 contacts during Marconi Week. About 40 percent were with stations outside the United States, including an SSTV contact with Ascension Island. But that was not the high point.

That came promptly at eight pm on the 18th when head man and control operator Robert Doherty K1VV opened an Angelo's paper bag and carefully fed the prepunched paper tape, containing three notable messages, into the keying head. Three-quarters of a century to the minute after Marconi sent the first wireless message from the United States to



Young Marconi, about 25, in England, several years before he came to the United States.

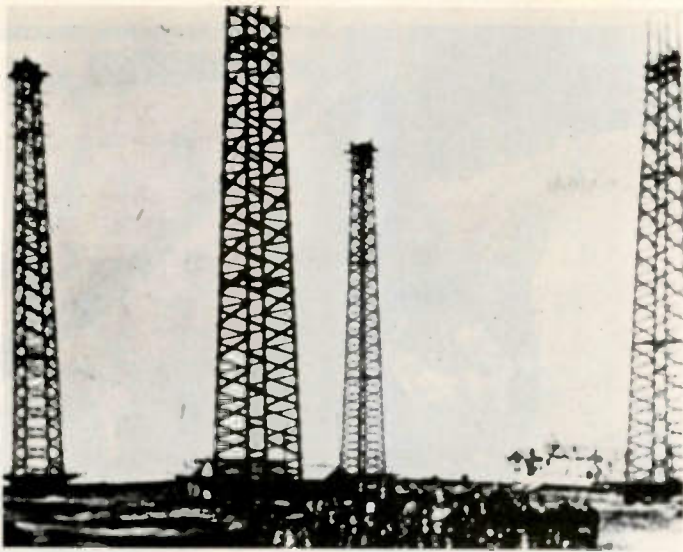

Reinforced wooden towers surround station CC buildings from which the famous message was sent January 18, 1903.

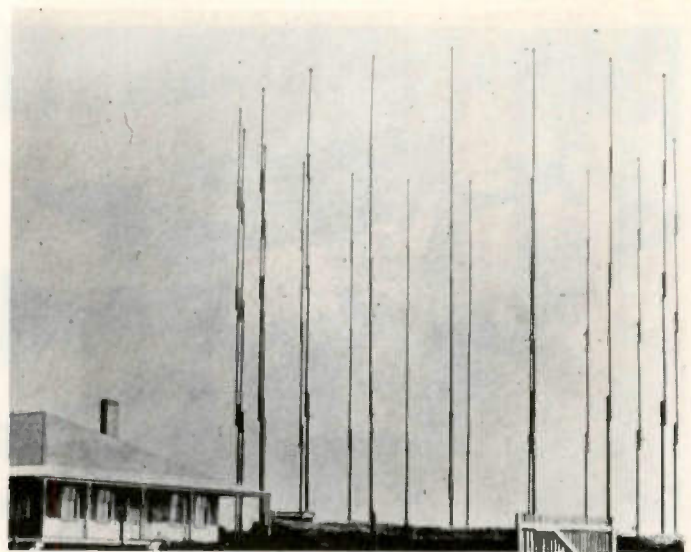

A September gale in 1901 took these 20 towers, 200 feet tall, down before they could be put to use. Four reinforced wooden towers were quickly put up.

England and got one back, another message was on its way. In Poldhu, it was one in the morning the next day. A great man was being honored.

News reporters crowded the room, and radio station WQRC broadcast live a description of the tape, simultaneously keying the 80, 40, 20, and two meter transmitters. Benjamin Tillson W1HWO read the messages on 40 meter SSB, also.

The President's message was followed by another

from President Giovanni Leone of Italy and one from Marconi's daughter, Gioia Marconi Braga. It took nearly an hour, and smart hams had their tape recorders running, striking in rock the 240 Hz tone.

President Carter said in his message to the world:

"Seventy-five years ago, a new era of international communications was heralded in by an historic exchange of messages across the Atlantic...

"That exchange marked a milestone in the history of communications. Since then, we have built on the invention of the distinguished Italian physicist and others a global communications system that allows instant contact...

"It is fitting that we commemorate the event both with gratitude for the ways in which science and engineering have

helped to unite us and with fervent hopes that such communications will serve the future course of peace and human progress everywhere."

President Leone of the Republic of Italy said:

"...I recall with admiration this great Italian's inventive capabilities and enthusiasm which have given new dimension to the contacts be-



Retired Army barracks housed KM1CC during Marconi Week, January 14 to 22, not far from the original transmitter site.



Frank Caswell W1ALT mans the "ole pump handle" of this working model of the rotary spark-gap transmitter which Marconi used. Caswell built it in his spare time, and it is housed in the National Seashore Visitor's Center.

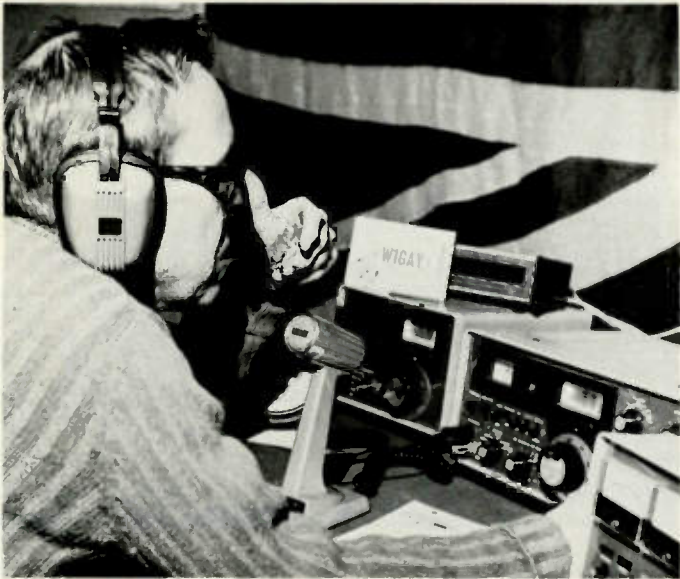

Duncan Kreamer W1GAY, QSL manager, worked 80, 40, and 20 meters SSB.

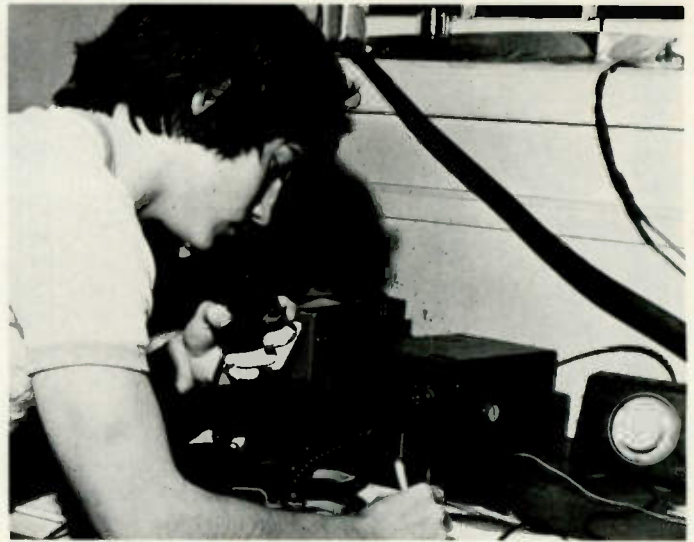

Douglas Carey WA1UMC, KM1CC's youngest operator (17 years old), takes a turn here on two meters. Doug worked mostly 40 meter CW.

tween men of every continent by achieving a decisive step forward for science.

"All over the world, radio amateurs participate in this new dimension and, with the same

enthusiasm, have created among themselves a close network of contacts. To this network is owed daily the savings of human lives, both on land and on the sea, as well as the pro-

gressive deepening of a sense of solidarity which overcomes all boundaries and which strengthens the hope for a better future."

In her tribute to her father, Ms. Braga said:

"... He considered amateurs part of his spiritual family. To a young man who downgraded himself because he was only an amateur, my father replied, 'Don't forget, young man, that I, too, am only an amateur.'

"I think we all owe a debt of gratitude for the services amateurs have rendered unselfishly to mankind on so many occasions... more dramatically in times of emergency, but more consistently from day to day in just keeping watch over the waves of the air...

"The magic of radio endures in their hearts..."

The messages ended and Doherty began work on the 80-meter transmitter. It had quit in midmessage,

and two more transmissions were scheduled...one at ten o'clock and the last at midnight. Besides, there were lots of stations out there clamoring for a contact and a QSL card with Marconi's picture.

The activities that night, though fast in passing, took a long time to get ready for. The messages were the bottom line for Doherty and The Barnstable Radio Club on over two years of work. From the 18th to Sunday was pure pleasure (with the exception of a snow storm), but, before that, it had been sweat. However, Doherty believes, Marconi's amazing gift to civilization of instant worldwide communications deserved all the labor.

Doherty contacted businesses, institutions, and people in communications for funds and equipment. Club members and non-members alike loaned and donated gear. CW, RTTY, SSTV, SSB, and OSCAR activities were planned. Massachusetts Governor Michael Dukakis proclaimed January 12 to 22 Marconi Week, and the FCC issued a Special Event Station KM1CC license for the same time.



President Carter's message goes out on 40 meter SSB with Ben Tillson W1HWO doing the reading. Commercial station WQRC announcer monitors in background.



Robert Doherty K1VV, in charge of the The Barnstable Radio Club's Marconi Anniversary event, keys the fuzzer (240 Hz tone) while working MCW on 3555 kHz.

Services of the National Seashore were invaluable, Doherty said, as was the Nauset Regional School District, which provided the building, a signal flag's distance from the original site.

The National Seashore Visitor's Center near the operating site had on exhibit a working model of Marconi's rotary spark-gap transmitter constructed by Marconi historian Frank Caswell W1ALT. On view also, a decade-by-decade showing of radio equipment, from an early coil coupler to a modern WCC inked paper readout receiver, loaned by RCA Globcom, Inc., in Chatham, rolled back the years for the hundreds that visited daily. Alan Curran WA1WIE had the job of putting it all together.

Caswell and members of the Club explained other exhibits, including pictures and memorabilia from the old site, and offered a slide show about the Marconi station. And there was outdoor work, also.

To prevent the white-finger syndrome so common to radio hobbyists during the winter, halyards, pullies, and poles had been put in place during the

warm months of the summer and field-day tested. Reworking and adjustments continued up to the last minute with a crew directed by W1HWO. Amateurs way out there weren't overlooked either.

Worldwide announcements went out on amateur radio networks in all modes, and the historian put the bits and pieces together for those who didn't know.

Caswell observed that Marconi's old station had, at different times, calls of CC and MCC. In commemoration, the FCC licensed the station KM1CC. A commercial offshoot of Marconi's station, WCC in Chatham, handles world messages to ships at sea today. But what about the old station?

Marconi's 30,000-Watt transmitter rammed electric sparks similar to lightning across an air gap. Each time a spark jumped, an electromagnetic wave radiated away at 186,000 miles per second and, at about 200 kHz, hugged the Earth pretty well. This latter point astounded physicists and engineers of that time. Short-interval sparks meant a dot, longer intervals a dash — very nearly a continuous wave.



On RTTY, around 3610 kHz, was Lewis Masson K1LJS of Chatham.

KM1CC, isolated as it was among the dunes, experienced no difficulty with TVI. It would be easy to conjecture that Marconi, too, had little difficulty in that sense, since there weren't any TV sets then. Not so, according to former Park Historian

Edison P. Lohr. It seems the station cook was afraid to hang out the wash because the damp clotheslines, loaded with rf, delivered nasty bites.

There also were complaints at the time about telephone interference, but nothing materialized,



Six meters attracted quite a few off-Cape stations, shown here being worked from KM1CC by Ben Richardson WB1CUA.

Lohr said.

Lohr also reports the antenna of the first station caused mutterings in the local Cape community. Twenty 200-foot masts had been planted in a circle in the sand near the sea cliff in South Wellfleet. Marconi wanted nothing but sea water between his high wire and Poldhu.

But the Cape Codders knew, and true to their predictions, a soon-a-

comin' nor'easter, similar to the storm that whacked KM1CC January 19 and 20, took the poles down. Marconi put up four reinforced wooden towers, a complex of wire radiators, and transmitted the first wireless messages across the Atlantic.

Launched by Marconi on its historic mission in 1903, the station lasted until 1917, when it had to be abandoned because of the

crumbling cliff and the sea's steady inland march.

Today, a visit to Marconi Beach shows only half the land of the original site remaining. A few timbers, cement anchors, and iron hardware poke from the sand in silent reminder of pioneer radio's giant step.

The Barnstable Radio Club operators and guests were on the air at the site often 24 hours a day during Marconi Week, promising

Duncan Kreamer W1GAY, the QSL manager, a busy time. Caswell was KM1CC's first radio contact on the 14th and its last on Sunday the 22nd.

Marconi's early pioneering made instant communications to the world's farthest corner not only possible, but practical. The Barnstable Radio Club operated 'CC once again as their way of saying thanks 75 years later. ■

RTTY Loop

from page 20

return from subroutine (RTS [\$39]). The PIA is on SWTPC port #7, which is \$801C. The registers are thus at: \$801C—data direction register A; \$801D—control register A; \$801E—data direction register B; \$801F—control register B.

This program uses the B side of the PIA. Other possibilities

can be worked out as long as the hardware is properly configured and initialization routines are modified appropriately.

Be bold in adjusting the value of the delay constant if you have a different clock frequency. Don't start by 480, 481, 482, etc., but by 480, 490, 4A0, etc., or more. When you get it within \$10 or \$20, then start fine tuning. Owners of the "fast" MP-A2 CPU boards can expect

a number around \$600, depending on their individual clock. Since the MITS 680 has a slower 500-kHz clock, I would expect the value to be reduced. I have not heard from anyone using such a machine, however.

Finally, we have found that some fast terminals appear to generate errors, as they put the data out and return, still during the last half of the fifth data pulse. It has become advisable to ensure that we are in the STOP pulse before starting to send anything to the terminal. Addition of a line, "00725 BSR MSEC10", will accomplish that

delay. Of course, the program needs to be reassembled following that insertion.

An updated source listing, including the line added above, is available for the cost of copying. Please send one dollar and a business-sized SASE to me at the above address. Be sure to enclose a note to tell me what you want. You have no idea how frustrating it is to get money and an envelope with no explanations.

More excitement next month and yes to the many questions—additional programs are in the works.

Ham Help

I purchased a Robyn International Model TRS-100 23-channel CB (AM-SSB) for conversion to 10 SSB. I have not seen any articles on converting the TRS-100 to 10 SSB. Has this been done? We have the receiver working with a single crystal from International which puts us on ten, but the transmitter output is way down—less than 1/10 of a Watt. We tried writing to Robyn International, Box 478, Rockford MI 49341, for an alignment instruction book, but had no luck. Also, there are no "Sams" books for this transceiver. Does anyone have any suggestions?

R.J. Doherty K1VV
RFD #1, 14 Pine St.
Sandwich MA 02563

I've been a subscriber to 73 since its inception and have been sitting back enjoying years of reading enjoyment. I was disappointed when the magazine and the hobby turned so drastically towards computers, microprocessors, etc. I guess I yearn for the old days

of home brewing. Frankly, I have gotten bitten, but only slightly—and there lies the problem. I have acquired a Viatron 21 data terminal. They were sold locally by Meshna in Lynn, Mass.; you had the ad in 73 a few years back.

I can get the thing to light up and print, but that's about as far as I can reason it out. I can't find anyone who has a manual or any information on the unit. I understand Ma Bell used them here in the MA area. Can anyone give me some help on this unit?

Lou Venturelli WA1NIX
64 Cross St.
Quincy MA 02169

We are in the process of reestablishing the Auburn University Amateur Radio Club after a four year period of inactivity. There is no equipment left over from the previous clubs here, and we will be starting from scratch in rebuilding.

We would like to know if anyone who attended Auburn and has knowledge of the club's activities in past years

could contact us.

Robert A. Alexander WA4RRN
President, AUARC
James E. Foy Union
Auburn University
Auburn AL 36830

I need a simple modification for the Kenwood TR-7400A 2 meter rig in order to receive the national Civil Air Patrol repeater frequency of 148.15 MHz. (I can transmit by setting the dial at 144.500 and using a -600 offset to give an output frequency of 143.90, which is the repeater input frequency.) I have contacted Kenwood and they cannot help me.

George E. Taylor WA4GUW
209 Lakeshore Drive
Muscle Shoals AL 35660

Anyone who has converted an Alaron 1025-B AM CB is requested to contact me. Specifics, directions, and schematics would be appreciated.

Frederick Bartolomei WD8PCB
19442 Rockport Drive
Roseville MI 48066

I would like to contact any amateur who is using a computer for Morse or RTTY, to exchange ideas and information.

Also, I'd like to contact anyone interested in computer-to-computer communications on the HF bands (such as program exchanges or 24-hour traffic nets on RTTY).

Barry W. Polley
6619 Southpoint
Dallas TX 75248

I need an instruction manual with schematic for the Tektronix 535A oscilloscope.

If anyone has a manual which is not for sale, I will pay for copying the manual and all postage. Any help along this line will be greatly appreciated.

Henry R. Leggette WB4MNV
1555 Galveston ST.
Memphis TN 38114

I need a schematic for the surplus BC-348R model military receiver. I also need advice regarding the installation of a product detector in the same radio.

Paul J. Uhlig, M.D. K0MD
1342 Estate Ct.
Wichita KS 67208

I am interested in contacting a ham in this area.

Albin J. Gietzen K3TUC
606 N. Ohio Ave.
Gaylord MI 49735

TWO OF THE THREE BEST THINGS IN LIFE COME FROM EDGECOM . . .



SYSTEM 3000A

Featuring: Twenty front-panel-programmable memory channels . . . Memory channel scanner . . . Band scanner . . . Two priority channels . . . Any transmitter offset . . . Full coverage (144-147.995 MHz) in 5 kHz steps . . . Memory channel monitor . . . Advanced microcomputer-controlled PLL synthesizer with electronic push-button tuning . . . Extraordinary receiver with five-pole front-end and ten-pole IF . . . 25 Watts output (adjustable) . . . MARS/CAP coverage optional (142-150.99 MHz) . . . Small, light weight . . . Full TWO-YEAR WARRANTY . . . An incredible bargain at \$549.

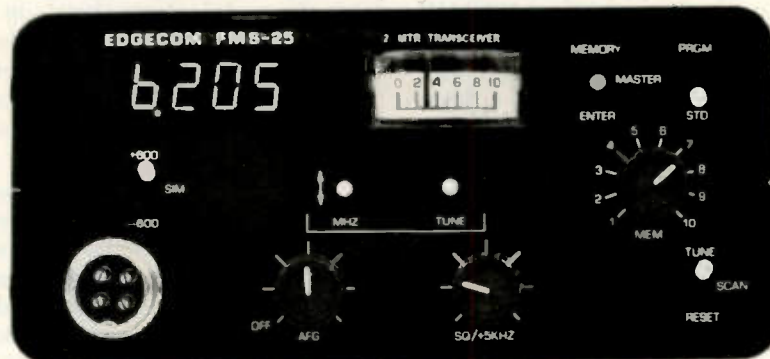

FMS-25

Features: Ten front-panel-programmable memory channels . . . Built-in band scanner . . . Any transmitter offset . . . Full 144-147.995 MHz in 5 kHz steps . . . Advanced microcomputer-controlled PLL frequency synthesizer . . . Electronic push-button tuning . . . The same fantastic receiver and transmitter as System 3000A . . . Full TWO-YEAR WARRANTY . . . Low price: \$439.

SYSTEM 3000A/FMS-25 . . . PERFORMANCE TO CHALLENGE YOUR IMAGINATION

See them at selected dealers or write for more information.

Edgecom Inc. E19

2909 Oregon Ct—A3, Torrance CA 90503 (213) 533-0433

Good News!

—easy autoranging for your counter

Ted Lassagne
21853 Monte Ct.
Cupertino CA 95014

The frequency counter on your bench is a handy and useful instrument. But unless it's a high-priced one, you most likely have to operate the range switch by hand. Adding automatic range switching, or "autoranging," can make that counter much more convenient to use. The good news is that it can be done with just a handful of parts.

I originally started out to improve the range switch in my home-brew version of the popular K2OAW counter. The idea was to replace the two-position range switch with a four-position switch and eliminate the switch flipping necessary to get five-digit readings in the range between 100 kHz and 10 MHz.

The K2OAW counter range switch uses a scheme called dc switching. That is, the switch on the panel controls only dc voltages to gates which actually

select the timebase frequencies. The high frequencies are kept away from the panel where they might cause a "noisy" situation.

Keeping the dc switching seemed like a good idea, so I put together the circuit shown in Fig. 1. The circuit uses a 74153 data selector/multiplexer (U1) to select the timebase frequency and a 74145 (U2) to indicate the range by positioning the decimal point on the display. Because the 74153 has two sections, it can be used as a two-pole "switch." The K2OAW counter control circuits use two timebase inputs, so both sections of the 74153 are used here. Only one of the sections would be necessary in most other types of timebase circuits. The timebase inputs to U1 (pins 3-6 and 10-13) come from the counter's timebase divider, which is usually a string of 7490s. The control lines labeled RS0 and RS1 were connected to a two-pole, four-position rotary switch wired to supply the proper

dc voltages. The gate duration and the decimal point for each setting are shown in Fig. 1. The display always reads in kHz, so no range indicator lights other than the decimal point are necessary.

After wiring up this circuit and getting it working, the next logical step was to try to make the switch operate itself—that is, to add "autoranging"—provided that not too many ICs were required.

Now, the logic that you use to operate a range switch manually on a counter is not too complicated. When the overflow light goes on, you switch to a shorter gate period. When the left-hand digit (as you face the display) is zero, you use a longer gate period, unless it is already set for the maximum length. To put this logic into circuit form, we need a two-bit counter to control U1 and U2, and signals to let us know (1) when the overflow light goes on, and (2) when there is a zero in the left-hand digit.

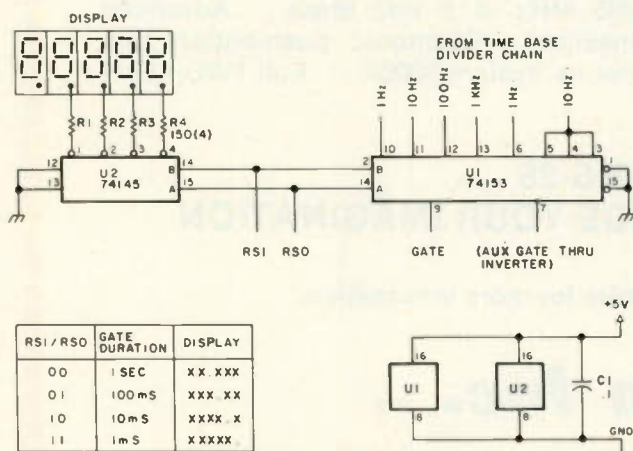

Fig. 1. Range-switching circuit.

The overflow is the easy one—there is an overflow latch already in practically all counter circuits. Detecting a zero in the left-hand digit is a little more of a problem. The cheapest way seemed to be an R-S flip-flop (made from two gates of a 7402) connected to the "A" output of the 7490 counter for that digit. The R-S flip-flop will latch high if the "A" output ever goes high in a count period, which means that there is not a zero in that digit. After every count period, we reset the R-S flip-flop using the counter reset pulse.

For the two-bit counter, we use a 7473 wired to stop on the count which represents the longest timebase interval (one second). It looks like we would need an up/down counter here, but we can avoid this kind of complication by being a bit devious on the logic. Instead of counting down one count when the gate period needs to be shortened, we merely reset to the shortest gate period and let it count up two counts. On the three shortest gate periods, the range switching is done every tenth of a second, so this simplified logic takes only two tenths of a second longer, and keeps the number of ICs down.

The autoranging control circuits are shown in Fig. 2. U3a and U3b are the R-S flip-flop which detects the zero/non-zero condition in the left-hand digit. At the start of each count period, the positive reset pulse sets the output of U3b low. During the count period, any positive input to U3a sets its output low and the output of U3b high. If the left-hand digit is zero, the output of U3b will stay low, and when the counter strobe pulse arrives at U4a, a positive pulse will cause the count on U5 to advance, resulting in a longer gate period. If both Q out-

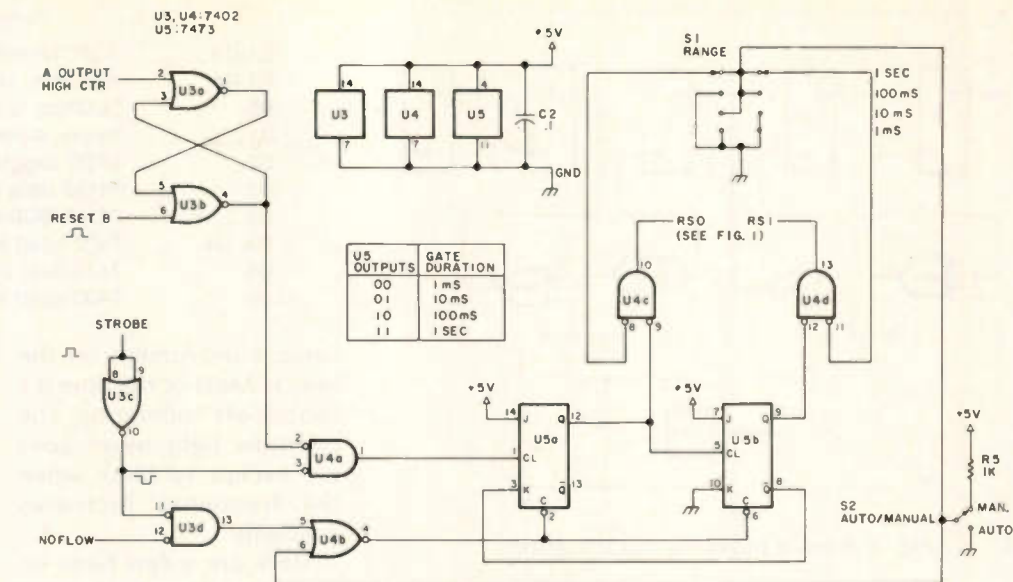

Fig. 2. Autoranging control circuits.

puts of U5 are high (i.e., the gate period is 1 second), the pulse has no effect.

The overflow detection circuit uses U3d and U4b. The NOFLOW (high if no overflow) signal is from the \bar{Q} output of the overflow latch (pin 8 of IC21A in the K2OAW counter), and is low when overflow has occurred. The strobe pulse gates a negative pulse to the C (clear) inputs of U5, causing the shortest gate period (1 ms) to be selected.

Selection of either the manual or autoranging mode is done with an SPDT switch. In the "manual" position, the output of U4b is held low, keeping the clear inputs of U5 low, causing both Q outputs to remain low. The panel switch voltages are gated through U4c and U4d (inverted) and control the range selection circuitry of Fig. 1. In the "autoranging" position, all the panel switch outputs are held at zero volts, which causes U4c and U4d to gate U5's Q outputs (inverted), which then control the range selection circuits. In addition, U4b acts as an inverting gate for the strobed overflow signal. If you are tempted to combine the autorange/manual switch with the range switch,

don't. It's more useful to have them as separate controls.

One other change was made to the counter to add a "touch of class" and make the display more readable. The 7447 seven-segment decoder has a built-in feature to blank leading zeroes. There are two pins, called RBI (for Ripple Blanking Input) and RBO (for Ripple Blanking Output). If RBI is held low, a zero digit will be blanked out. If RBI is open or high, a zero digit will not be blanked. When a zero gets blanked, RBO for that digit is low; otherwise it is high. So, by holding RBI of the

left-hand digit low and tying RBI of each of the other digits to RBO of the digit to its left, all leading zeroes can be blanked.

This poses one problem for a display with a moving decimal point. We don't want any blanks after the decimal point. The circuit of Fig. 3 provides the kind of display we want. The second and third digits from the right are "unblanked" if the decimal point is to their left or if any digits to their left are on. U6 handles the logic for this. The left-hand digit (RBI4) is tied to the overflow flip-flop to eliminate blanking when

Fig. 1	Connection	Pin	Of
	1 kHz	11	IC26
	100 Hz	11	IC27
	10 Hz	11	IC28
	1 Hz	11	IC29
	Gate	1	IC33a
	Aux Gate	4-5	IC32b
Fig. 2	A output high ctr	12	IC18
	Reset B	Coll.	Q5
	Strobe	Coll.	Q4
	Noflow	8	IC21
Fig. 3	RBI4	5	IC20
	RB04	4	IC20
	RBI3	5	IC17
	RB03	4	IC17
	RB12	5	IC14
	RB02	4	IC14
	RBI1	5	IC11
	RB10	5	IC8

Table 1. Connections to K2OAW counter (73, July, 1972).

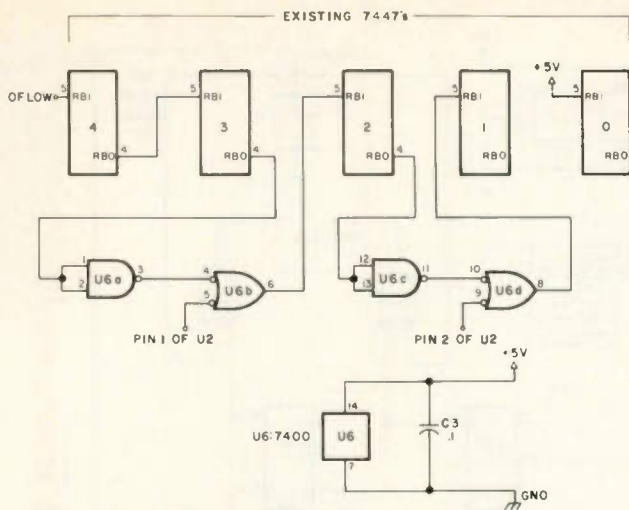

Fig. 3. Ripple blanking modifications.

overflow occurs; we don't want to blank anything in the lower half of a number. The right-hand digit's RBI (RBI0) is tied high so that the digit will always be displayed. That lets you know the counter is turned on and the display is working.

This whole project involved only the addition of

six ICs, a few resistors and capacitors, and a rotary switch to the existing counter. The old range switch was used as the autorange/manual switch. The circuitry is not critical and a wire-wrapped version (interfaced with the K20AW control circuit) works just fine. The new result is a much more con-

venient instrument on the bench. Most of the time it's "hands-off" operation. The overflow light never goes on, except to blink when the frequency increases suddenly.

Here are a few hints on operation: Most of the time you will want to use the autoranging mode. If you want to get more than five-digits resolution, set the range switch to the one-second gate and flip the autorange/manual switch back and forth to read the additional digits. If the frequency is varying around the upper end of a range—between 99 and

101 kHz, let's say—you probably will want to switch to manual temporarily. If a frequency less than 100 kHz is varying fairly rapidly and you want to track it, switch to manual and set the range switch to the 0.1-second gate position. The display will be updated 10 times a second instead of just once.

My experience with this improved counter has convinced me that it was well worth the small investment in time and parts to build in autoranging. Why not build it into your counter? ■

Parts List

C1-C3	.1 µF, 10-volt bypass
R1-R4	150 Ohm, ¼ Watt
R5	1k Ohm, ¼ Watt
S1	2-pole, 4-position rotary switch
S2	SPDT toggle switch
U1	74153 data selector/multiplexer
U2	74145 BCD-to-decimal decoder/driver
U3, U4	7402 quad NOR gate
U5	7473 dual J-K flip-flop
U6	7400 quad NAND gate

New!

Throw rocks on 40 meters for \$19.95*.



only \$19.95

Kantronics Rockhound transmitter

Jump into QRP.

The **Kantronics Rockhound QRP transmitter** generates a one watt CW signal anywhere on 40 meters. With the right crystal, and a little luck, Granite Falls, MI is just a stone's throw from Boulder, CO.

Slip the Rockhound in your pocket for mountain hikes or camping trips. Our **8040-B** receiver makes a lightweight companion. For power, just hook 12-15 VDC in-line with your key.

Start throwing today, our address is below.

*22.95 with 7.125 MHz crystal.

K13 **KANTRONICS**
The Lightweight Champs.

1202 East 23rd Street
Lawrence, Kansas 66044 Phone: 913-842-7745
We accept Visa, Master Charge, check and money orders.

Test with the professionals.

Our Directional RF Wattmeters are the choice of professional RF engineers everywhere. Can discriminate between forward and reflected power in all types of 50 ohm coaxial transmission line. Use plug-in elements for power measurements from 100 milliwatts to 50k watts at frequencies from 2 to 1000 MHz with ± 5% accuracy.

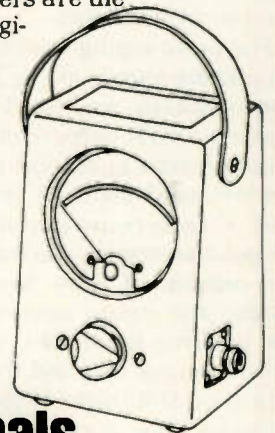

Wattmeters for professionals.

For the name of your local distributor call toll free 800-341-9678

GS DIELECTRIC COMMUNICATIONS
A UNIT OF GENERAL SIGNAL
RAYMOND, MAINE 04071 • TEL 207-655-4555 • 800-341-9678 D29

Cohoon Amateur Supply

NOW STOCKING THE INCREDIBLES



- Twenty Memory Channels
- Memory Scanner
- Band Scanner
- Two Priority Channels
- Memory Channel Monitor
- Bargain Price: \$549

EDGECOM SYSTEM 3000A

- Ten Memory Channels
- Band Scanner
- Any Transmitter Offset
- Full Coverage
- Small/Light Weight
- Only \$439



EDGECOM FMS-25

Both of these outstanding 2m FM transceivers offer you an unbelievable receiver, 25 Watts of power (adjustable), and advanced microcomputer-controlled frequency synthesizer, electronic push-button tuning, any transmitter offset and a FULL TWO-YEAR WARRANTY. Call, write or come in and compare for yourself. Find out why the Edgecom SYSTEM 3000A and FMS-25 are called the incredibles.

**Cohoon
Amateur
Supply** C95

Hwy. 475 Trenton, Kentucky 42286

502-886-4534

Mighty Mods for the 820S

— more power and convenience

Photos by James R. Allison WA4KIL

Robert H. Walker K4FK
400 Tivoli Ave.
Coral Gables FL 33143

James R. Allison WA4KIL
14 Veragua Ave.
Coral Gables FL 33134

What! Buy a transceiver? No way! My reaction was short and definitive-sounding when one of the locals suggested that a new solid-state transceiver might be a logical replacement for my aging Collins S/Line. True, the S/Line had caused me a great deal of trouble over the past several years and I had been considering a replacement, but a transceiver? While it's intuitively clear that a transceiver is perfectly adequate, perhaps even desirable, for routine SSB operation, I use SSB about six times a year. I greatly prefer CW and RTTY, and we all know

that a transceiver lacks the flexibility required by the serious user of those modes.

Nevertheless, within two weeks of first using the Kenwood TS-820S, I had purchased one, along with the companion VFO-820 and the YG-88C 500-Hz crystal filter. Obviously, the rig had impressed me!

Many operating hours and several modifications later, I am extremely pleased with the rig. But our initial encounter was rather tempestuous. When I first fired it up, the TS-820S receiver section was intermittent and the transmitter section was inoperative. Several of the internal connectors had vibrated loose from the circuit boards during shipping. Reconnecting them and then seating all of the remaining connectors with a small-bladed screwdriver effected the needed repair.

After several weeks of

use, I had a pretty clear impression of the TS-820S. It proved to be an excellent SSB rig. I could think of no necessary improvements for that mode. It put out excellent CW and RTTY signals as well. But even with the outboard VFO-820 and digital readout, it lacked an easy method of zero beating a given frequency. It can be done, often very accurately, using the digital readout, but I found this to be both slow and psychologically unsettling. I like to hear the actual note rather than see the displayed difference between transmitter and receiver frequency, even though the latter is potentially more accurate.

Having become accustomed to the 250-Hz crystal filter in the Collins 75S-3, the 500-Hz filter in the TS-820S seemed wider than the proverbial barn door. Additionally, the Collins tunable bfo allowed centering a signal in the filter passband. On the TS-820S, the signal is off on the skirt of the filter, making the exact point of zero beat difficult to find.

I preferred the transmitter section of the TS-820S to my 32S-1. I wanted to keep my 75S-3,

however, and modify the TS-820S for its role of main transmitter and auxiliary receiver.

The following modifications have proven reliable, easy to install, and, for me, they greatly heighten the pleasure of using the rig. While most operators probably won't want, or need, to install them all, there is something here for every taste:

- Increased power output
- Switch-selected band-pass in both the CW and FSK modes without resetting the mode switch
- Complete control of an outboard receiver
- Low-level spot signal for use with an outboard receiver
- Switch-selected FSK shift for RTTY
- "Key-lock" switch to eliminate the need for shorting the CW key during tune-up

Each modification can be installed independently with the exception of the control of an outboard receiver and the low-level spotting signal. These two use a common single relay.

Before tearing into your new TS-820S, you need to give some thought as to where you want to place some extra switches. Each

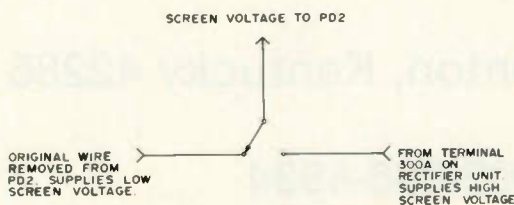

Fig. 1. Two levels of screen voltage—switch selected.

modification will require a miniature toggle switch to operate it. There are already twenty-nine front panel controls, so even if you are willing, the front panel is definitely not the spot!

WA4KIL uses his 820 as a portable and carries it back and forth to his weekend home in the Florida Keys. He didn't need all the modifications, just the selectable filters and FSK shift, so he found the rear panel to be a convenient location for his two switches.

At K4FK, no portable or mobile operation was contemplated, so I mounted four switches on an aluminum bracket that is suspended under the front panel. I used the front screws which fasten the bottom half of the case to hold the bracket in position. All leads going to the switches exit from the transceiver through the existing round hole in the bottom half of the case.

Other possibilities would be to mount the switches in a completely separate panel or to mount them toward the front of the upper half of the case. I would avoid the latter possibility because, aside from the necessity of drilling holes in the case, this arrangement places the switches in a rather inconvenient location for use.

Increased Power Output

Who couldn't use just a few more Watts output? I have experimented with three approaches to this. The easiest place to start is with your ac line voltage. The TS-820S power output is directly related to the "stiffness" of the ac source. One test transceiver put out 85 Watts at 14 MHz with 114 V ac and 100 Watts when the line voltage was raised to 120. If your line voltage is low, you might consider run-

ning your transceiver from a variac or autotransformer to keep the ac line voltage up around 120.

The second method of raising the power output was accidentally discovered. Being rather conservative, this is the method I have opted to retain in my 820. Late one evening, R6 on the rectifier unit opened completely. The schematic shows this to be a 470-Ohm resistor, while the one in my unit was marked 4700 Ohms. I lacked a replacement and installed a jumper across the open resistor to get the rig back in operation. This raised the screen voltage to around 230 volts, allowing me to load the final to between 230 and 250 mA. The power output runs from 100 to 115 Watts at 14 MHz.

While this modification raises the screen voltage on the 12BY7A driver tube as well, I have encountered no problems with overheating, instability, or premature component failure in either the driver or the final stages.

How about a few more Watts? The screens of the finals are fed from the internal 210-volt supply. By providing a toggle switch to connect them to the 300-volt supply instead, you can raise your power output to between 120 and 140 Watts at 14 MHz, depending on the ac line voltage.

Fig. 1 depicts this modification. You will need to disconnect the screen voltage source at PD2 on the final unit and run this lead to one side of an SPDT switch. The switch will allow you to select either 210 or 300 volts for the screens. Connect the switch's common to PD2. The other side of the switch will go to the 300-volt supply. Terminal 300A on the rectifier unit is a good source.

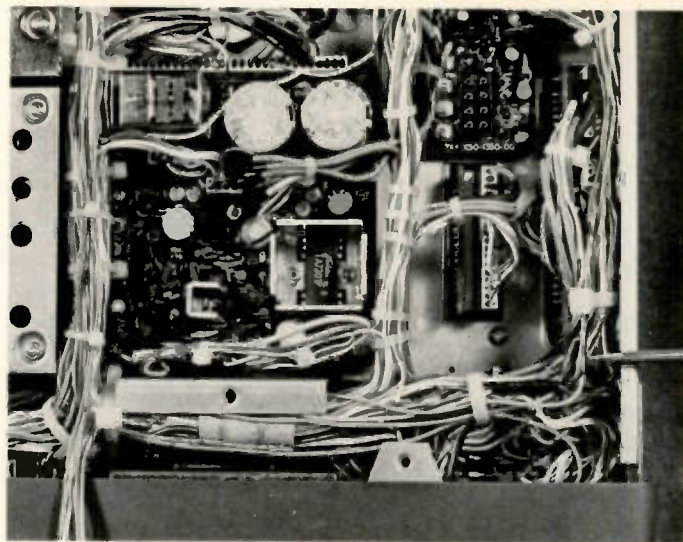

Fig. 2. The TS-820S viewed upside down with the front panel toward the bottom of the photograph. The screwdriver blade points out a convenient spot to break into the wiring harness for the selectable bandpass modification. The bundle of wires toward the lower left will eventually connect to the control panel.

The idling current on the final tubes will run considerably higher with the increased screen voltage, so it will be necessary to make one other change to allow the idling current to be set at its normal level. Short out resistor R25 on the rf unit. It is the 12k resistor located at the top of the board near the second connector. A solder bridge across the back of the board does the job nicely and can be easily removed if desired.

Readjust your idling current for 50 to 60 mA and you're ready to go. You can now load your TS-820S to between 275 and 300 mA of plate current, realizing greatly increased output power. The drive may have to be run a little higher as will both the mike gain and the compression. The rig has plenty of reserve to handle this, however.

You will notice that when you operate using the normal 210-volt screen supply, the increased bias will drop your idling current to approximately 20 mA. Experimentation has indicated that this produces no noticeable distortion or other operating

difficulties despite moving the finals into a region somewhere in between Class AB₂ and Class B.

I discontinued using this approach because of the noticeable increase in operating temperature. No difficulties were experienced, but then I only ran the rig for a few days in this configuration.

With either of these approaches to raising the screen voltage, placing the mode switch in the FSK or tune position will continue to drop the screen voltage to normal levels for that mode. Thus, you will probably want to leave your screen switch in the 300-volt position most of the time.

Switch-Selected Bandpass on Receive for Both CW and RTTY

Without the optional YG-88C 500-Hz crystal filter, the TS-820S provides a bandwidth of 2400 Hz for SSB and FSK and an 1800-Hz bandpass for CW. These are automatically selected by the mode switch. With the optional filter installed, the mode switch automatically selects bandwidths of 2400

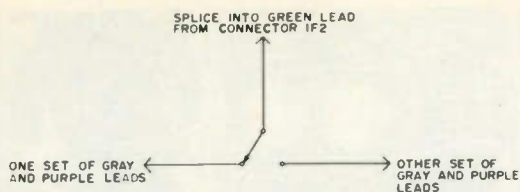

Fig. 3. Switch-selected bandpass in the CW and FSK modes.

Hz for SSB, 500 Hz for CW, and either 2400 or 500 Hz for RTTY. The latter is determined by the placement of an internal connector at the time the filter is installed. This modification will allow you much greater flexibility in selecting your bandpass when the mode switch is in either the CW or the FSK position.

To begin, locate connector IF2 on the lower section of the i-f unit. Three color-coded leads attach to this connector: one green, one purple, and one gray. Depending on where you plan to bring out your three leads for this modification, you may need to remove some of the tie-wraps on the wiring harness which runs alongside the i-f unit.

The screwdriver blade in Fig. 2 shows one convenient spot to break into the harness.

Sever the gray and the purple leads. Solder each gray to the matching purple as indicated in Fig. 3. Each pair of gray and purple leads will attach to opposite poles of an SPDT switch. Splice the switch's common into the green lead.

Reinstall connector IF2 in position "B" (closest to the long connector). The mode switch will now continue to select 2400-Hz bandpass in either of the SSB positions. In the CW position, the added SPDT switch will select either 1800- or 500-Hz bandpass. And, in the FSK position,

the switch will select either 2400- or 500-Hz bandpass.

Switch-Selected Shifts for RTTY

The TS-820S has proven to be an excellent RTTY rig. It has the limitation, however, of only being able to transmit one shift unless an internal connector is physically moved. Another SPDT switch can easily be used to give you the option of transmitting either of two shifts at will. From the factory, the 820 is set to give either a 170- or 850-Hz shift, but this is easily readjusted, should the need arise.

Locate the FSK connector on the back of the carrier unit. Remove the con-

ductor and retain it in case you ever want to return the rig to stock condition. Solder three leads to the circuit board pads associated with the connector. You can now select either shift by using your switch to short either of the outer pads to the inner pad. Fig. 4 depicts this modification.

Key-Lock Switch

When a key is plugged into the TS-820S for CW operation, you cannot tune up the final amplifier stage without closing the key. If your bug or keyer lacks some method of being shorted, tune-ups can be rather irritating, as only one hand is free to adjust the final controls unless you remove the CW key plug from the transceiver. Fig. 5 shows the addition of a key-lock switch which will allow you to lock your transceiver in the transmit mode.

Simply ground the hot side of your key jack through an SPST switch. The hot side of the key jack is the side which is farthest above ground. This modification will have no effect whatsoever when there is no plug in the key jack, nor will it operate unless the VOX is turned on or the send/rec switch is in the send position. This way, even when the switch is brought out to the front of the rig, there is little danger of inadvertently keying up the finals.

Low-Level Spotting Signal and Control of an Outboard Receiver

I have always marveled that while some transceiv-

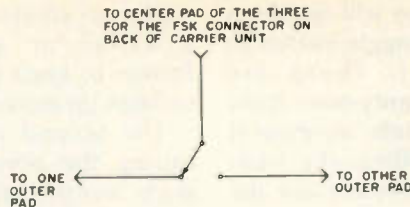

Fig. 4. This switching arrangement allows transmission of either 170- or 850-Hz shift for RTTY use.



This prototype control panel was silver with black lettering. Future versions will be black-anodized, with white photoengraved lettering.

ers make provision for the control of outboard receivers, few are equipped to generate a low-level spotting signal for use with such a receiver. The addition of this feature is the most extensive modification I have made to the TS-820S. For me, it has been one of the most useful and important.

I made the assumption that an operator who wanted to use an outboard HF receiver for added flexibility probably wouldn't be using one of the Kenwood VHF transverters. Accordingly, I used the transverter connector and one of the transverter phono jacks in this modification. The transverter-in jack remains unchanged, so this modification in no way affects your ability to calibrate the counter.

To accomplish both outboard receiver control and low-level spotting, four things must be done:

1. The outboard receiver must be muted while transmitting, but unmuted during receive and spot.
2. The TS-820S transmitter section must be brought up with the finals inoperative during spot.
3. The outboard receiver must be connected to the antenna in such a manner that it can never be connected to the transmitter section's rf output.
4. Both the CW key jack and the push-to-talk line must be grounded during spot.

All of these were accomplished through the use of a Potter and Brumfield R10-E1-X4-V185 relay. This is a 4PDT relay with a 12-volt dc coil. The last photo shows it nestled in the underside of the

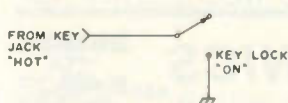
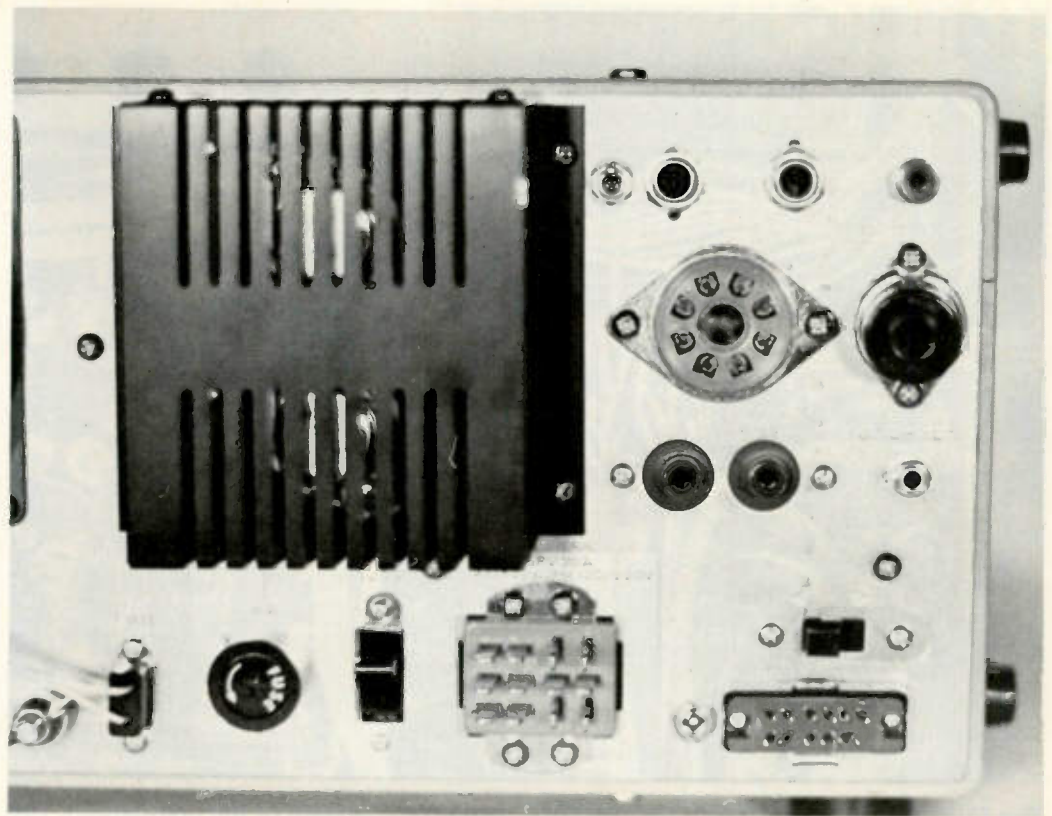

Fig. 5. Key-lock switch allows tuning the final amplifier without shorting the CW key.



If your 820 gets carried around much, the rear panel may be a good place to add your switches. The upper toggle switch next to the RTTY key jack selects the CW and FSK bandpass. The lower one, next to the transverter connector, selects 170- or 850-Hz FSK shift.

TS-820S chassis. It is sandwiched in between the marker unit, two wiring harnesses, and the metal shielding which surrounds the rectifier unit. If mobile operation is anticipated, a drop of epoxy cement will hold the relay firmly in place. At K4FK, the relay is seated tightly enough when sandwiched into position that no additional mounting is necessary. Fig. 6 shows the complete schematic for this modification.

The outboard receiver's antenna connection goes directly to the TS-820S transverter-in jack. Its muting connection goes to the TS-820S transverter-out jack. I disconnected the gray lead at pin 8 of the transverter connector and ran it to the added relay for use as the muting control for the Collins 75S-3. The S/Line receivers require

their muting contacts to be grounded for operation and ungrounded for mute, but many receivers mute in exactly the opposite fashion from the S/Line. This type of receiver could probably be handled by adding your own lead to the normally open contacts of RL-2 rather than using the gray

lead from the transverter connector. Additionally, pin 10 of your added 4PDT relay would have to remain ungrounded.

I retained a rather clever idea which Kenwood incorporates into the TS-820S. When the screen grid switch is in the off position, not only is the screen voltage disconnected from the final tubes, but negative bias is applied to the

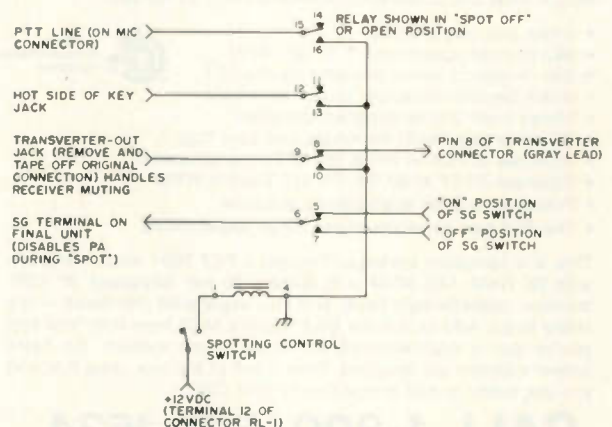
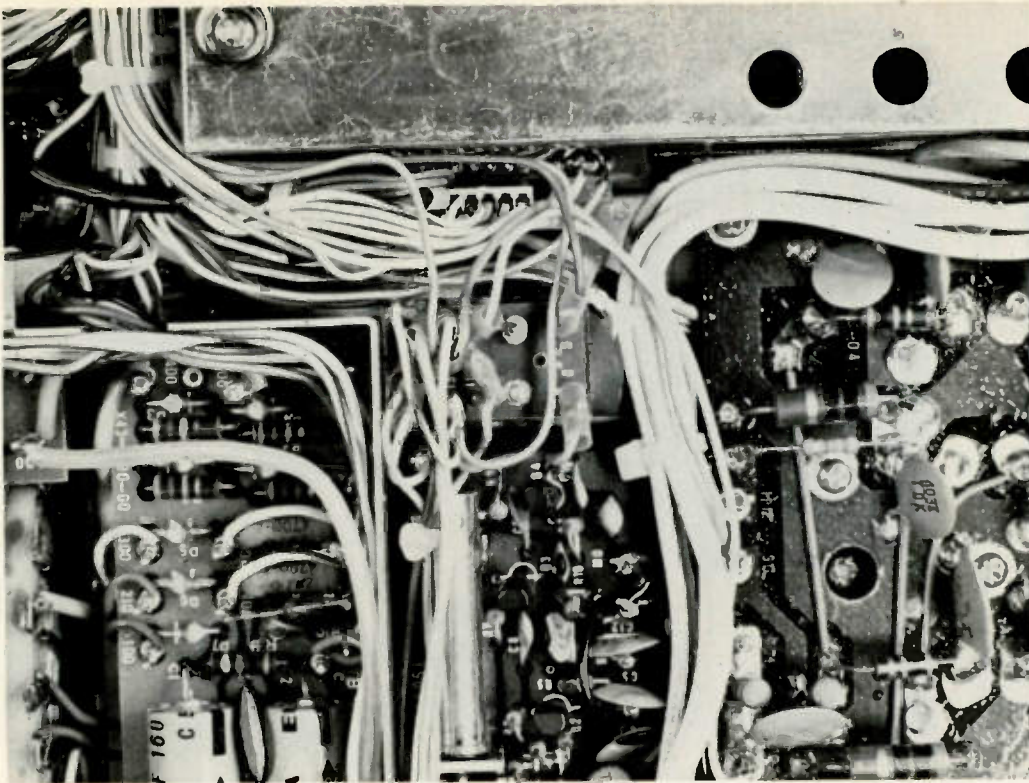

Fig. 6. Complete schematic for the control of an outboard receiver. Low-level spotting is included. The relay is a Potter and Brumfield R10-E1-X4-V185 4PDT with 12 V dc coil.



The TS-820S upside down with the rear panel toward the bottom of the photograph. The 4PDT Potter and Brumfield R10-E1-X4-V185 relay (center) fits as though Kenwood intended it to go there. The soldered connections on the circuit board next to the counter (upper center) are for the FSK shift modification. Also shown is the jumper across the open 4700-Ohm resistor on the rectifier unit (lower left).

screens. By retaining this feature, the spot signal will be more than strong enough for use with a local outboard receiver, but attenuated enough that others won't hear you zero-beat.

The Kenwood TS-820S is a generally satisfying rig to own and operate. It seems well constructed and has proved to be reliable. With the addition of these few simple modifications, it has become a truly versatile companion which should provide many hours of pleasure.

I have not attempted the modification of any other Kenwood gear, but according to the TS-820S Operation Manual, the factory-installed digital readout is the only difference between the TS-820 and the TS-820S. It seems likely, therefore, that these modifications should apply directly to both versions. ■



PET/MICROTRONICS

GENERAL PURPOSE
COMPUTER FOR HAMS

LOWEST PRICE EVER FOR A UNIT OF THIS TYPE

Now get general purpose computer flexibility for less than the cost of dedicated gear serving the same function. The versatile PET 2001 computer together with the Microtronics M-65 Ham Interface and Included programs can automate your station. Whether you run CW or RTTY, you can use the PET CRT and keyboard to receive, display and transmit text using your existing equipment.

We're so sure you'll find this combination indispensable that we offer a 10-day money back guarantee. If you don't like it, send it back for a full refund.

Here's what this powerful combination can do for you:

- Costs you only \$899.00
- Morse code speed from 1 to 100 WPM
- CW reception speed adjusted by the PET
- Store canned messages (e.g., call letters)
- Morse code trainer program included
- Attaches to speaker terminals and your bug
- Attaches to FSK or AFSK for RTTY transmission
- Receives RTTY at 60, 66, 75, 100 Baudot WPM
- Future slow-scan applications possible
- The PET can serve countless other applications



This is a complete package. You get a PET 2001 microcomputer with 8K RAM, 14K ROM with BASIC, 73 key keyboard, 9" CRT monitor, cassette tape deck, and four expansion interfaces — it's ready to go. Add to this the Microtronics M-65 Ham Interface and you've got a sophisticated communications system. No extra power supplies are required. Take it out of the box, plug it in and you are ready to add a new line to your QSO.

CALL 1-800-521-1534

NCE/Compumart 1250 N. Main St., Dept. 7398
N9 P.O. Box 8610 Ann Arbor, Mi. 48107 (313) 994-4445

FT-227 "MEMORIZER" OWNERS SCANNER KIT

- Selectable sweep width (up to full band)
- Scans only the portion of band you select
- Scans at the rate of 200 kHz per second
- Switch modification on mike allows you to scan past, or lock on, any occupied frequency
- Complete kit with detailed instructions
- Installs inside rig; no obtrusive external connections
- Rig can easily be returned to original condition whenever desired
- Scans to preset limits and reverses
- Automatic bypass of locked frequency in 3½ seconds unless you press lock-on switch

Kit \$34.95

Pre-assembled and tested \$54

Add \$1.50 Postage & handling

DEALERS INQUIRIES INVITED



ELECTRONICS

750 LUCERNE RD. SUITE 120 A60
MONTREAL, QUEBEC CANADA
TEL. 514-737-7293 H3R 2H6



IF YOU HAVEN'T USED EDGECOM EQUIPMENT, YOU JUST HAVEN'T LIVED

SYSTEM 3000A

- 20 Memory Channels
- Any Transmitter Offset
- Memory Scanner
- Band Scanner
- Two Priority Channels
- Memory Channel Monitoring
- Only \$549



FMS-25

- Ten Memory Channels
- Band Scanner
- Any Transmitter Offset
- Full Coverage
- Low Price: \$439

Both the System 3000A and FMS-25 provide you with an extraordinary receiver (five-pole front-end, ten-pole IF), 25 Watts of output power, advanced PLL synthesizer with electronic push-button tuning, small size, light weight and a full TWO-YEAR WARRANTY. Call, write or visit us for more information on these incredible 2m transceivers from Edgcom. It's time you really started to live.

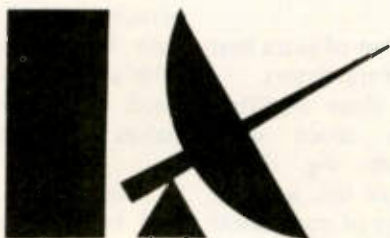

**VHF
COMMUNICATIONS** v18

915 N. MAIN ST. JAMESTOWN NEW YORK 14701
[716] 664-6345

Improving Heath's HT

— a half-dozen swell mods

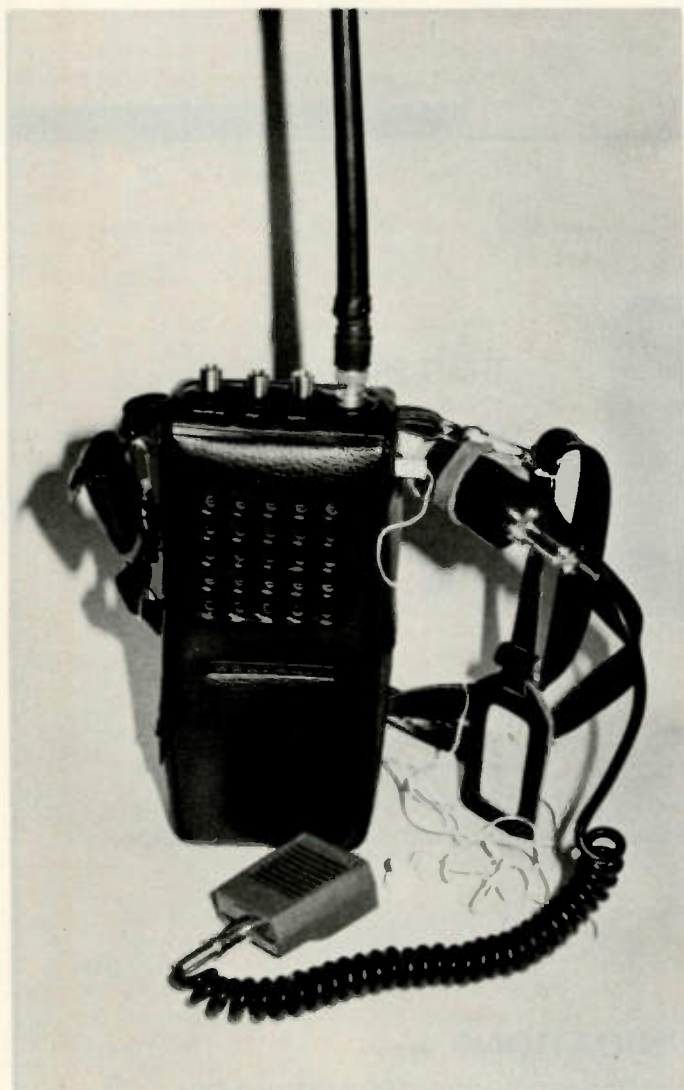

Unit ready for external PTT and private listening. Heath microphone element had been installed in the Motorola housing to keep the system matched.

carried out while the kit was under construction.

The first change consisted of installing a BNC-type antenna connector in place of the 5/16" threaded bushing supplied. I used the Amphenol K-79-106 connector for this mod. I chose this particular connector because it has a slightly longer threaded shank which allowed the soldering eyelet to extend into the case for easy soldering. Some care must be exercised with this simple but useful modification.

A problem arose, for me at least, in that there is only half of a hole in which to install the connector. This, of course, is due to the fact that the connector and all of the operating controls — channel switch, squelch, and on/off/volume — are mounted on the centerline along the top of the unit where the case separates into two halves. The solution I found was actually a compromise. In place of the lock washer supplied with the connector, I installed the largest flat washer I had in my hardware stock that would fit the threaded portion of the connector snugly. This allowed me to tighten down the nut and squeeze the edge of the hole between the washer and the flange on the connector. However, upon bearing down on the nut to get a secure installation, the washer cocked slightly toward the top of the unit. This then prevented the case front from being installed properly. To get around this, I used a fairly sharp pocket knife to shave away a small amount of the plastic case along the inside edge of the connector hole in the speaker/mike half of the case. The case is thermoplastic, and, with a little trial and error, a good fit of the two case halves was possible.

Although it's an excellent two meter receiver/transmitter, the Heathkit HW-201 HT, I felt, could be made far more versatile through the employment of a few minor modifications. This article will describe some of the many modifications possible with this unit. Listed are those which I have performed on my HT:

1. The installation of a BNC-type antenna connector in place of the 5/16" threaded bushing.
2. The use of the external antenna connector for an external earphone/speaker jack.
3. The use of RG-174 coaxial cable for the rf lead and the rerouting of the wiring to get rid of the rat's nest of interconnecting wires between case halves.
4. The installation of a push-to-talk (PTT) relay.
5. The addition of a ± 600 kHz crystal and crystal switch.
6. The addition of extra heat sinks to the rf transistors.

Some of these modifications came about while assembling the rig, others from on-the-air use, and still others because of component failures. I'll start with the first group — those changes

Once this modification had been accomplished, the next one was logical — the use of the external antenna

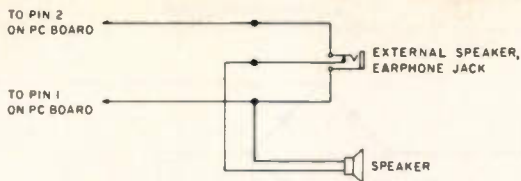

Fig. 1. External speaker/earphone hookup using the external antenna jack.

jack as an external speaker/earphone jack. (See Fig. 1.) This comes in handy when I am using the unit, in conjunction with a trunk-mounted 5/8 whip, as my mobile rig. I can carry on a QSO or monitor the local repeaters without bothering the spouse with the constant chitchat and squelch tails that fill the Toyota. Of course, when alone, I use the speaker attached to the broadcast receiver installed in the car. Here I simply added two wires directly across the vehicle's speaker, brought them out to the appropriate length, and added a miniature phone plug. No switching between the broadcast receiver and HT is employed, and no adverse results have been noted.

Not using this jack for its intended purpose added greatly to the next change I felt was in line. This was the reduction of the rat's nest of wire that resulted when it came time to mate the two case halves. Originally, to close the unit, a total of ten separate connections had to be made. By eliminating the external antenna jack function from the front side of the case, four of these connections were removed. Also, if you use miniature shielded cable for the microphone connections, no coax will be connected to the front side of the case. This results in a small bundle of wires connecting the case halves. This bundle, when laced together, gives better access to the internal workings of the unit and makes it far easier to separate and mate the two case halves. I, however, used RG-174 coaxial cable for my mike connections, not having any small shielded audio

cable at the time of assembly. This type of coax was also used to connect the BNC connector to the circuit board. I found it far easier to work with than that supplied by Heath with no adverse results.

This brings me to the next group of modifications, those which resulted from actual use of the unit. The first was the addition of a plus or minus 600 kHz function to the HT. The crystal supplied with the unit allows for only a minus 600 kHz offset of the transmit frequency. This is accomplished by pushing down the offset switch on the left side of the unit. By doing this, you are selecting a 10.1 MHz crystal and disconnecting the 10.7 MHz crystal used for direct or simplex operation. By selecting this 10.1 MHz crystal, you are lowering the offset oscillator frequency by 600 kHz. This oscillator, in turn, supplies one of the two signals that go to the transmitter mixer, Q21. If this frequency is raised or lowered, the transmitter frequency is raised or lowered a like amount. Thus, to gain a plus 600 kHz offset, an 11.3 MHz crystal is required. These can be acquired from any crystal manufacturer for around \$10. But how do you select one of three crystals using a switch having only two positions?

I did this by getting rid of the switch. In place of the offset switch provided with the unit, I installed two SPDT subminiature switches, Electrocraft 35-202. These switches fit nicely into the retaining slots provided for the original switch, but, as usual, all was not well. I found the slot for the original switch to be too long to hold

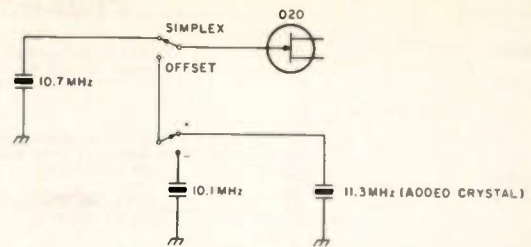

Fig. 2. Schematic of the offset oscillator with the addition of an 11.3 MHz crystal, giving a ± 600 kHz offset option.

the smaller replacements firmly and too shallow to allow the case halves to be mated with the switches in place. The first problem was solved by sliding into the spaces at each end of the switches small pieces of metal cut from the shanks of two small ground lugs. The second problem was solved by filing the hole larger. Being soft thermoplastic, this took a small amount of effort, and the bottom of the hole was soon even with the PC board. The tab on the front half of the case also had to be filed down even with the case edge. This took care of the switch mounting problems.

Mounting the crystal came next. This was no real problem at all, for, with the larger original offset switch removed, adequate room was gained to allow the crystal to be mounted next to the new switches. First, two small holes were drilled through the PC board for the crystal pins.

Since one side of the crystal went to ground, one hole was drilled just large enough for the pin to fit and the pin was then soldered to the PC board. I was able to do this because the area in which the crystal is installed is a fairly large ground pad and no extra wiring was needed. The hole for the other crystal pin was enlarged to ensure the pin did not come into contact with the foil on either side of the board. To this pin was soldered a short piece of small-gauge wire which in turn was routed up to the component side of the board through a small hole drilled for that purpose. This wire was then connected to the new ± 600 kHz switch.

After these changes were made, I had two small switches on the left side of the HT in place of the one larger switch — one to select simplex or offset and the other for either +600 kHz or -600 kHz. I chose to have the

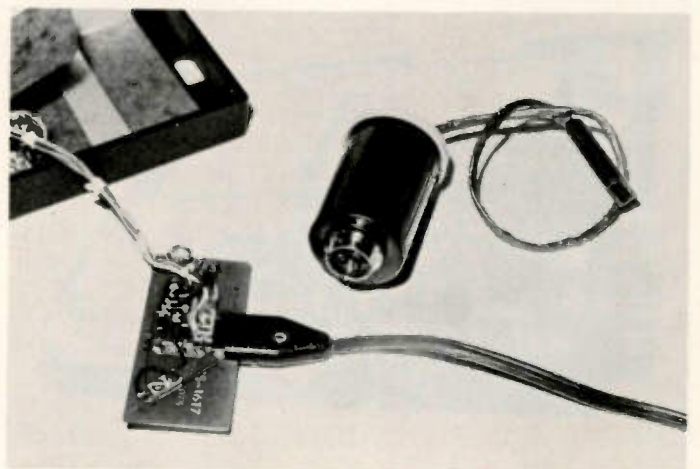

The external microphone adapter mentioned in the text and the SPST switch added to the battery charger board. The notched battery charger connector is plugged in, showing how the notch keeps the switch from functioning during battery charging.

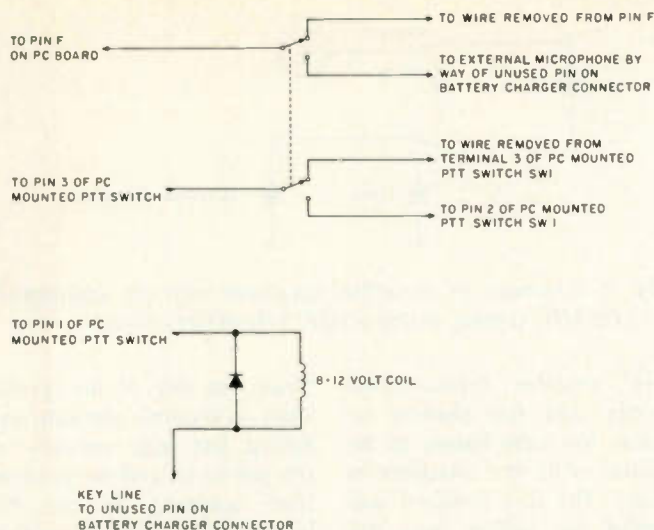

Fig. 3. The PTT schematic. The diode across the relay coil can be any silicon diode, such as a 1N457.

switch toward the back of the unit the simplex/offset switch with the down position being the offset position and up being for simplex. The front switch then became the ± 600 kHz switch, with the +600 kHz being the up position and the -600 kHz being the down position. The hookup for the switches is shown in Fig. 2.

The next modification (PTT) came about for two reasons. One was that I use this unit as an HT, home QTH rig, and for my mobile rig. In other words, it is my one and only two meter rig and I got tired of having to

pick up the entire radio each time I wanted to say something. This was awkward due to the size of the thing (it gets heavy after a few exchanges) and the trailing external antenna and speaker cables. The other reason was that I wanted to see if it could be done with no major rewiring of the rig.

The first problem was how to connect a microphone with a PTT switch to the internal workings of the rig. This was done by using the two extra pins on the battery charger connector on the rear of the set. One became audio in, one the PTT key line, and

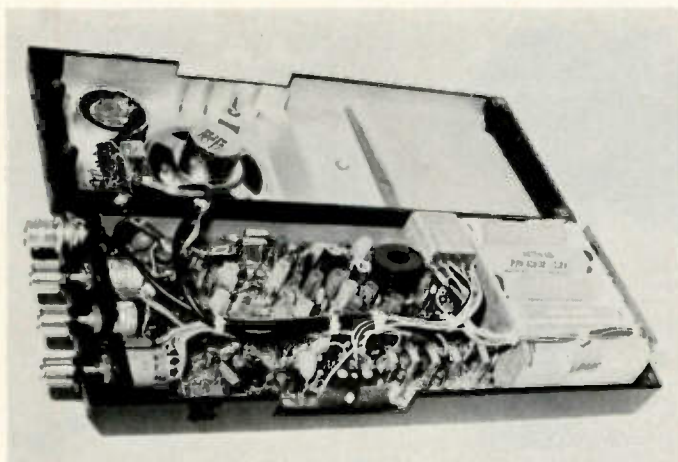

Overall view of most of the changes. The BNC antenna connector, two new offset oscillator switches and crystal, reduced tangle of interconnecting wires, the double heat sink on Q26 (round black object in center) with the two aluminum tubing heat sinks on Q24 and 25 to the left of Q26, and the PTT relay to the right of Q26.

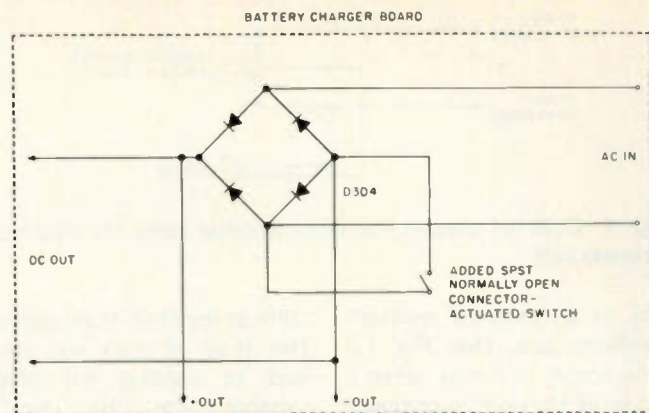

Fig. 4. Schematic of battery charger with the adapter actuated SPST normally-open switch connected across D304.

then I ran out of pins. To get around this and still not have to add another connector to the rig, which was one of my aims, I borrowed one of the battery charging pins open when the unit is being used with the external microphone. To do this required the addition of a simple SPST normally-open switch to the battery charger board in the bottom of the HT. This switch, when actuated by plugging in the microphone adapter, shorts out D304 in the battery charging circuit, thus giving me a third wire for the ground return needed for the PTT relay and the shield of the mike cable. This is shown in Fig. 4. To prevent this switch from being actuated when the batteries are being charged, a notch was cut in the corner of the battery charger connector to keep it from coming into contact with the switch mechanism. The switch itself came from a relay in the junk box. A microswitch would do, as well as any number of other switches.

Once these mechanical problems were overcome, the modification to the electronic portion of the unit was no major undertaking. First a small DPDT 12-volt dc relay was selected to do the switching. The relay shown was used because I could not find a subminiature relay that I could mount directly on the PC board and because I had a dozen of them in the junk box. This relay drew about

35 mA at 12 volts, so I felt it would not greatly add to the battery drain. The next step was to find a place and means to mount the relay. I chose not to mount the relay at all. Instead, the relay is held in place by the seven wires soldered to its terminals and by the pressure of a piece of foam rubber I added to the front of the unit. This foam keeps the relay in place and also keeps the battery pack from rattling. The location of the relay was chosen, as shown, so that it would be close to the audio input terminals on the PC board and because it sat nicely on top of coils L1 and L22.

Now, to switch this rig from receive to transmit using an external PTT switch, two requirements have to be met: Twelve volts must be switched from the receiver to the transmitter, and the microphone input pin F on the PC board has to be switched from the internal mike to the external mike. The internal microphone must be disconnected to prevent it from picking up extemporaneous audio and to prevent the input impedance of the audio amplifier from being upset by having two microphones connected to it in parallel.

As I said, this rewiring was not a major undertaking. I started with the +12 volts switching. First I removed the lead connecting the PC board to terminal 3 of the PC board-mounted PTT switch,

SW1. To this lead, I connected a wire leading to one of the normally-closed contacts of the new PTT relay. From terminal 3 of the PTT switch, I ran a wire to the arm of the same relay half. This left the normally-open pin of the relay, which was then connected to terminal 2 of the board-mounted PTT switch. That completed the dc switching change. Now when the relay is energized, the dc to the receiver is interrupted and switched to the transmitter. When not in use, the relay just sits there and the board-mounted PTT switch does the work.

The audio wiring changes were equally as simple. First I disconnected the audio cable going to pin F on the PC board. A short piece of wire was then used to connect pin F to the unused relay wiper arm. To the normally-closed contact of this half of the relay, I connected the internal microphone cable. These two connections were made using the extra wire connector pins and sockets supplied with the kit. Finally, a small shielded cable was connected to the last unused normally-open contact of the PTT relay. This is the side that goes to one of the unused pins on the battery charger connector and carries the external microphone audio into the unit. One end of the shield on this cable was connected to pin Y (ground) on the PC board, and the other end was connected to the negative (-) battery terminal on the battery charger PC board.

I would like to mention that just about any microphone will work as an external microphone, but, to keep everything matched as Heath did, I ordered a replacement element and installed it in my microphone housing. Before doing this, I would get reports of being too tinny or too bassy from the local group. But now there is no difference between the internal and external audio quality using

the Heath element.

As for wiring, all that was left then was to hook up the supply voltage and control line for the PTT relay. The +12 volts for the relay coil was obtained by running a wire from pin 1 of the PC board PTT switch to one side of the relay coil. The key line from the other side of the relay coil was then routed, along with the existing battery wires and the new microphone input cable, to the battery charger connector where it was connected to the last unused pin. To provide clearance for these new wires, which must run over the battery charger holder, a small notch was cut in the top of each end of the holder. Also, a kickback diode should be connected across the relay coil. I placed mine physically on the battery charger board, connecting it from the PTT key line to the + terminal on the board. This had the same effect as putting the diode directly on the relay but saved me the hassle of soldering in a crowded area. Be sure to watch the polarity with the cathode going to the + terminal. The relay hookup is shown in Fig. 3. This PTT scheme has now been used for over eight months with no problems encountered. However, other problems have developed, and this brings me to the last modification, which actually is an addition.

From the time I first got the rig on the air, it seemed to me that transistors Q24, 25, and 26 ran unreasonably hot. However, a check of another 2021 showed the same conditions, so it was considered normal. Right after this check, however, the HT used for comparison failed and Heath resolved the problem by replacing Q24 and 25. This made me wonder if indeed this was a normal condition. My suspicions were further aroused when Q25 in my rig failed due to a collector-to-base short. To me, this meant something was not right. After replacing Q25 and

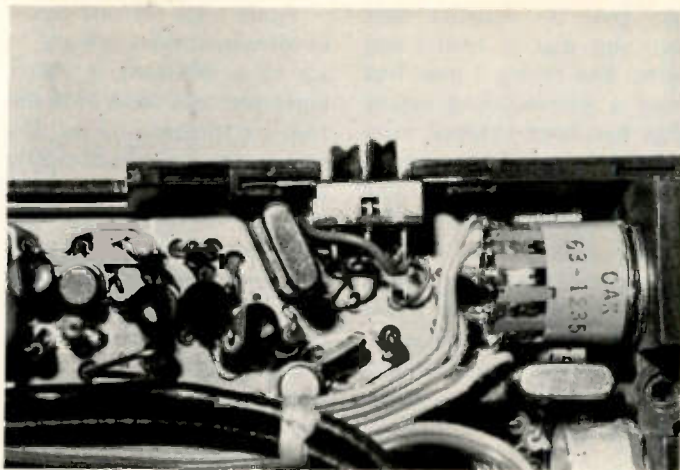

Close-up of the added 11.3 MHz crystal and two new slide switches. Only one piece of wire was added; all other leads are those disconnected from the original offset switch.

checking all voltages and currents, I decided that heat was my villain.

Q26 is provided with a slip-on round heat sink, while Q24 and 25 are on their own as far as heat dissipation is concerned. To try to cool down Q26, the power amplifier transistor, I first obtained from Heath another heat sink like the one supplied with the kit, part number 215-45, at a cost of 55¢. I then bent inward the portion of the heat sink that normally fits onto the transistor body until it was small enough to fit inside of the top of the installed heat sink. Then a liberal amount of silicone transistor grease was used to fill any gaps, and the two heat sinks were pressed to-

gether. This addition effectively doubled the cooling capacity available. That took care of Q26.

Q24 and 25 were a little more difficult, and, again, a compromise had to be accepted. First, I tried some store-bought TO-18 slip-on finned heat sinks, but these two transistors are surrounded by coils and resistors and the fins were always hitting something. I then tried some home-brew finned heat sinks, but they wouldn't stay in place and again were too close to the other components for comfort.

I then hit on the idea of using some thick-walled aluminum tubing as a simple slip-on heat sink. They aren't finned or in any fancy shape,

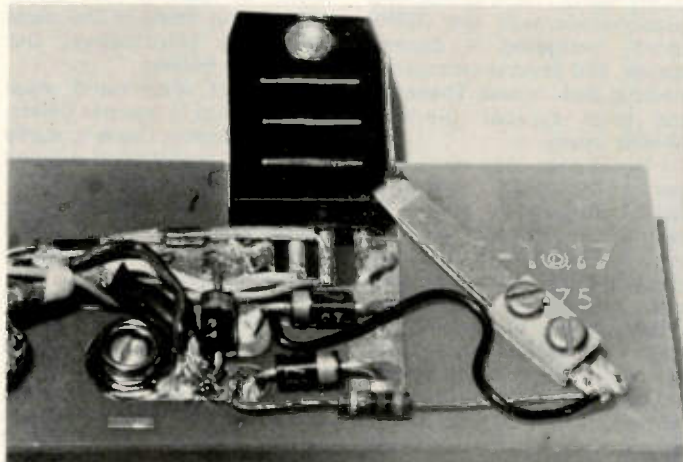

Close-up of SPST switch added to charger board with external microphone adapter plugged in actuating the switch, shorting out D304. Resistor shown was for test purposes only.

but they do conduct heat well and that is what I was after. The tubing I used had been a one-inch-long spacer that had been stripped from some piece of equipment some time ago. First, using the appropriate size drill bit, I slowly enlarged the hole in each end of the spacer until it would fit about 9/10 of the way over the transistors. I then cut the spacer in half and painted the two pieces flat black.

Again using silicone grease to increase conduction and to act as a lubricant, I lightly taped the heat sinks onto the two transistors. For the purists, these pieces of tubing will change the tuning of the collector circuits since the collectors of these transistors are connected to the metal cases of the transistors. But I found it to be such a small change that it wasn't worth bothering with. Possibly if the lengths of tubing were

made longer, problems could develop, but these half-inch sections don't seem to create any electrical degradation and do carry away some of the heat. I don't know what their thermal resistance is or their dissipation capacity, but I haven't had a transistor failure since I installed them, so I feel they have solved the problem.

That sums up the changes I have made to my HT. I have several others in the long-

range planning stage, such as a synthesizer and channel scanner, but these are going to take time to complete. With this rig, any number of additions can be made easily. The circuitry is not complex and plenty of room is available for several additions to fit into the case. So, if you have an HW-2021 and think it could be a bit more versatile, make a few changes and enjoy your rig that much more. ■

LETTERS

from page 12

was happy about my attempts to help a bona fide emergency group.

Hams should wake up. People are entitled to good communications, better than CB. If amateurs want to flight movements in the GMRS area, they can kiss public support of our hobby good-bye. Radio amateurs should understand we are very lucky to have our frequencies and our hobby. Our knowledge should be shared with the community, not locked away in the ham shack.

Since January, the license was granted and the repeater was put on the air. But I lost many friends and associates who thought I had "sold out" ham radio. To replace those crusty hams, I have gained new relationships with the GMRS users, including a doctor, lawyer, and several emergency medical technicians. These are not your typical die-hard 27-MHz users.

I could care less what happens at the WARC, as long as GMRS frequencies remain intact. Radio amateurs are turning a hobby into a professional lifestyle, with expensive equipment, 11nears, and towers. Let's remember the fun and excitement of a breadboard and inverted vee on the Novice band.

Many hams should consider whether or not to help groups trying to start a GMRS repeater. Like WA4EOX points out, if a two meter club operates a Class A repeater, non-hams can join in the fun without worrying about a

license. Superior public service can be provided on these currently semiprivate frequencies.

Only thing that is needed now is a national coordination of these frequencies on the GMRS band, so citizens can use repeaters in other communities. I hope people don't think I'm down on ham radio. I enjoy DXing and "radio scouting," but I don't enjoy defensive VHFers worried about someone else using a repeater 300 MHz away.

Dave Swelgert WB9VKO
Fort Wayne IN

THE CHOSEN FEW

I am one of your avid readers and enjoy *73 Magazine* very much. In reading your editorials, I find them in the most part very informative, but somewhat biased.

I cannot understand what your hangup is against CBers, but it is chronic. I have to agree that the 10 meter band is being unduly penalized by the FCC. I feel they are going about it the wrong way; it seems it's like cutting off the child's thumb because he sucks it.

Now, back to the problem of CB versus amateur radio, unless things have changed since I have written you this letter. There are bad manners and ratchet jaws like you wouldn't believe—try any city 2 meter band. As for insolence and bad manners, just try a net check-in. I am ashamed to say it, but some of those so-called chosen ones think they are

Moses leading us all to greener pastures. I realize that the CB is the stepchild. The reason for this is the FCC failure in general and the hams' stuffiness, let's face it! When CB becomes full-grown and has been around as long as amateur radio, there is no telling what may happen.

They are both needed in this day and age; we should all work together for a more solid understanding—help one another, not sit back and look down our noses and back-stab each other. Amateur radio has its place for the long calls, hobby activities, and help in emergencies, but so does the CB on the local scene—high-way information, help for a stranded lady with a flat tire, and the good work of the REACT group. The Highway Patrol has had more help from the CBers than the hams, and we all know it.

The radio is a part of life that is here to stay, so let us all use it and its aspects to form a common bond to help all mankind, not have a private hassle on who should and who should not.

I will now get off the soap-box and let you have it back. I hope you will use your influence to help both phases of our freedom of speech, and channel it to the benefit of all.

I do hope you will print this, as it is about time we took a long look at ourselves.

I am in the process of getting my ham ticket so I may enjoy the best of both modes.

Jim Foust
Liberty MO

CONGRATULATIONS

In regard to the recent string of letters you've published taking you to task for your magazine's contents, "Let me say this about that": I know the substance of a radio magazine

should be radio and not flying or computers or butterfly collecting. But I always enjoyed your dad's column on "ancient" aviating, and I think it's more than coincidence. It seems to me that flying and amateur radio are related in that they both have to do with a highly technical area of proficiency—it should be no accident that a pilot/ham is likely to be one and the same person. In spite of what you think of the FCC, it has always seemed to me that the FAA and the FCC are a large cut above the usual bureaucracy, and it is for the same reason in each case: They deal in an area of technical expertise, not merely in the administration of pork-barrel projects. I think it's not merely coincidence that *World Radio News* carries a regular feature about flying and amateur radio, while not bothering to focus on amateur radio in butterfly collecting.

For myself, I haven't any use for the myriad of computer articles I see in your book, but with more than 200 pages to the issue, I can skip over 90 percent of the contents and still get my money's worth.

As for the materials on beating the cops, etc., let me commend you on a public service of true professional journalism. Lesser publishers would just be interested in keeping their subscribers happy. Your approach to exposing the wrongs in government and government-sponsored private monopolies like the telephone system represents the highest calling of constitutionally-protected free speech. The alternative to publishing is to let things smolder until they really get so bad as to erupt into open revolution. That's the theory of a free press—that we may constantly keep our eye on things and hopefully there-by keep the society on an even

Continued on page 118

EDGECOM SYSTEM 3000A AND FMS-25 ... PERFORMANCE THAT CHALLENGES YOUR IMAGINATION.



SYSTEM 3000A: 144-147.995 MHz FM transceiver that features: • Twenty front-panel-programmable memory channels • Memory scanner • Band scanner • Any transmitter offset • Memory channel monitoring • Two priority channels • Extraordinary receiver • 25 Watts output • American made • Full two-year warranty • \$549.



FMS-25: Uses the same fantastic receiver and transmitter as System 3000A. Features: • Ten front-panel-programmable memory channels • Built-in band scanner • Full coverage in 5 kHz steps • Electronic push-button tuning • Any transmitter offset • Wired for commercially available Touchtone microphones • American made • Full two-year warranty • Only \$439.

Minimum \$3.00 for
shipping & handling
on ALL ORDERS.

Prices FOB Medford MA.
MA residents add 5% sales
tax.



T45

Radio Electronics
209 Mystic Avenue
Medford MA 02155
(617) 395-8280

Total Control

— a versatile TT system

Fig. 1. 1 + 3 digit controller.

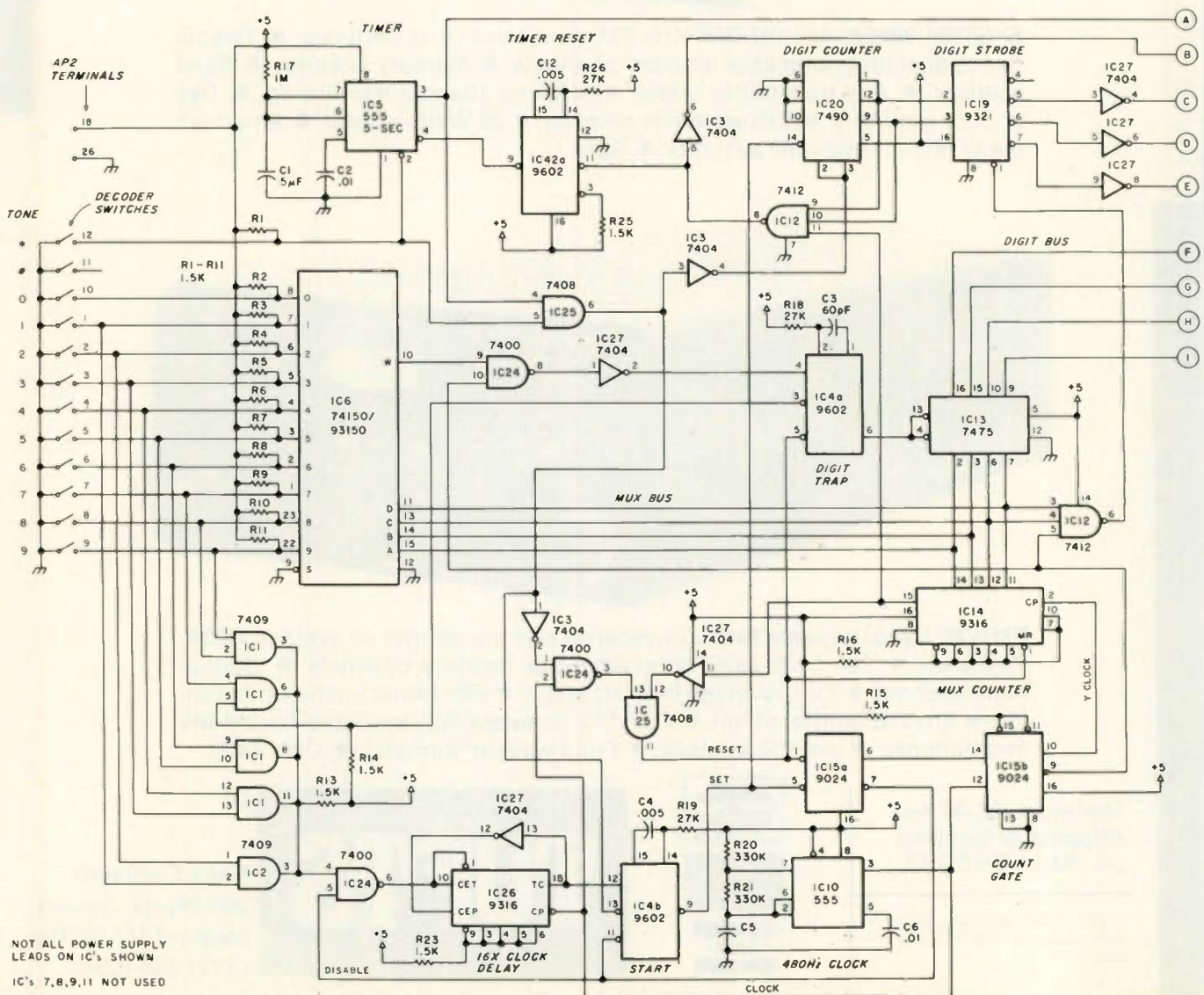

Anthony Sperduti WB2MPZ
4740 Newton Rd.
Hamburg NY 14075

This system was designed to control the Buffalo (Orchard Park) 2 meter Navmarcormars repeater. It can really be used for the control of just about anything you want. All that is needed is the input switching, which could also be push-buttons for local control. What it is on our system is relays from a touchtone™ decoder.

To operate, you must

first close the * switch; you then have 5 seconds to complete 3 more contact closures. Each digit has a set time of 100 ms to register. It is necessary to hold each switch closed for at least 75 ms to insure that the scanner sees the contact closed. After the third digit has been scanned, you will get a pulse out of the controller. This time can be adjusted to your

liking by changing the clock frequency. All timing in the controller is controlled by this clock. To speed it up, just speed up the clock; to slow it down, slow the clock. The input switch must be active for 16 clock pulses before it is acknowledged. The pulse out of the controller can be used to set or reset a flip-flop that can turn on or off a driver that can be used to pick up a low-voltage relay or operate any device you want to interface it to. The 0-switch is not used, as this is a so-called fail-safe feature. If the scan is started and you let go of the button too soon, a 0 is sent to the 7442 of that digit. Now, via a three-input NAND gate, you will inhibit IC25, which passes the control pulse. This en-

sures that you always get 3 valid digits before an operation can occur.

The 555 timer, IC10, is the main clock of the controller. It just runs at 480 Hz as long as the power supply is turned on. The 480 Hz pulses cannot get through the 9024 IC15B gate, so the 9316 IC14 BCD counter is not counting. Also note that the 555 five-second timer, IC5, is holding the 7490 digit counter at zero via IC25 and IC3, pin 4. It also inhibits the 9602 IC4B one-shot from passing any false start pulses and holds the 9316 IC14 mux bus driver to zero via IC3, 24 and 24, pin 11. When the * switch is closed, the output #3 of timer #1 goes high for five seconds or as long as the *

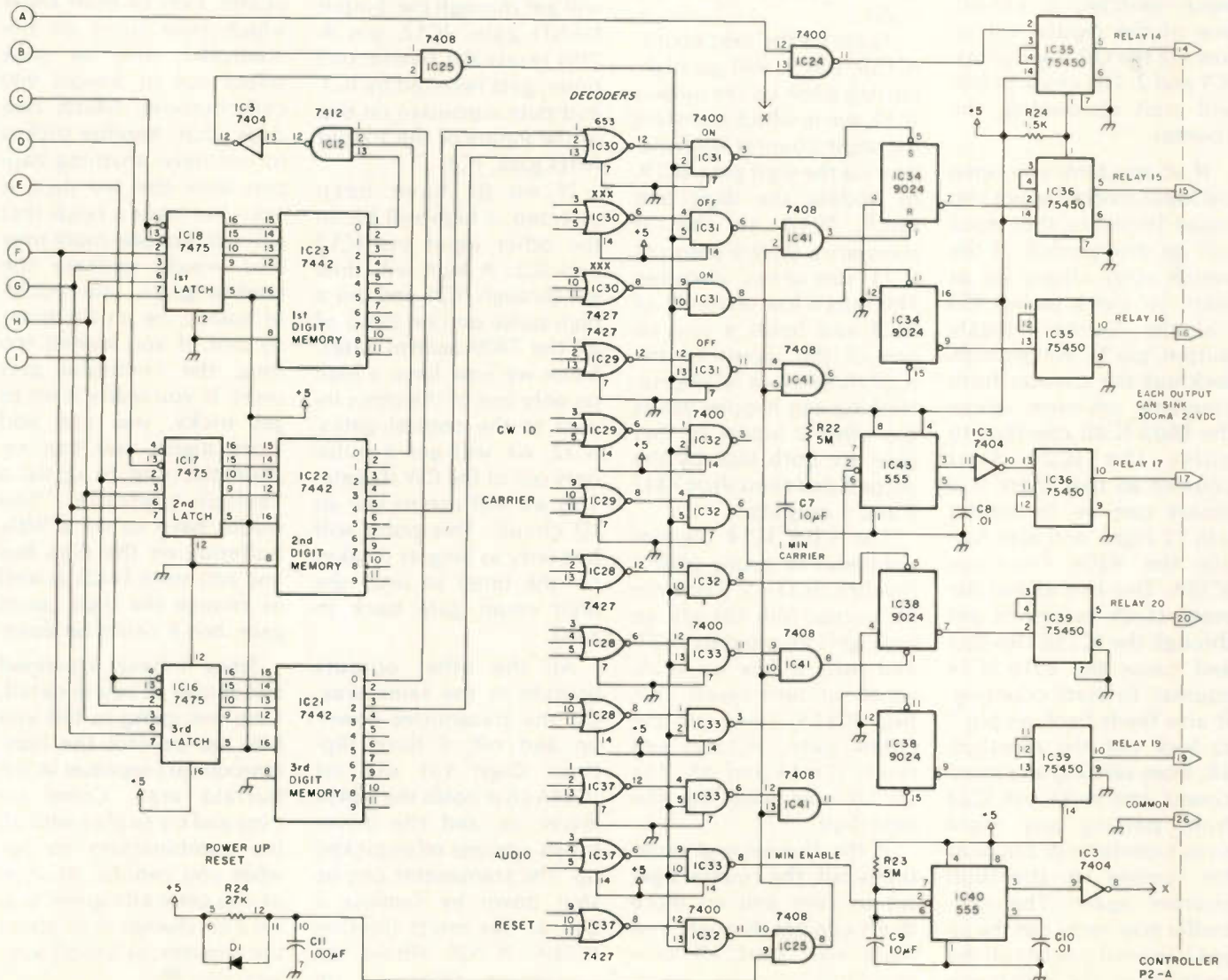

switch is closed. The audio-off relay is picked up via pins 9 and 8 of IC3 and shorts out the receiver audio line so that the tones will not be transmitted. As soon as the * switch is released, the resets are lifted on the digit counter, IC20, and the mux bus driver, IC14. The 4B one-shot is also enabled. Note that the 9316 IC26 counter is used for a delay circuit.

On my first attempt to build the controller, I did not filter the input lines. I was going to put a filter on all the lines, but this turned out to be much better. Now the clock pulses, 480 Hz from pin 3 of IC10, cannot upcount the 9316, as IC24 is holding the rest line, pin 1, low via IC24. Both inputs to this gate are high. Now, when one of the input switches is closed, one of the inputs will go low via the OR logic gates, IC1 and 2. The clock pulses will start upcounting the counter.

If at any time you open the input switch before you count 16 pulses, that input will be disregarded. If the switch stays closed for at least 16 clock pulses (33 ms), the counter's toggle output, pin 15, will go high, lock out the counter from counting anymore, allow the 9602 IC4B one-shot to pulse the IC20 digit counter so that there is a binary one on its output (pin 12 high), and also toggle the 9204 flip-flop, IC15A. This first allows the main clock pulses to get through the IC15B flip-flop and cause the 9316 IC14 counter to start counting. It also feeds back on pin 7 to lock out the one-shot, 4B, from sending any more counts and locks out IC24 from passing any more switch contacts or bounces for starting up the filter counter again. The controller now locks out the input line until it scans all the switches to see which one

was closed.

Let's say the first digit you selected was a 9. The clock, through the count gate, will pulse the 9316 IC14 and keep changing the BCD address of the 74150 multiplexer bus until the bus has the address 9 on it. The output, pin 10 of the 74150, will go high, as it will invert the input number 9 which we have now held low via the switch. On the next count into the count gate, 15B, the not-Q output, pin 9, will go high and put a low on the output of IC24. This gets inverted by IC27 and causes the IC4A one-shot to update the 4-bit latch, IC13, so that it transfers a BCD 9 from the multiplexer's address bus to the digit bus. Now the 9316 counter continues to count until it reaches 12 (c and d high).

Again on the next count, IC15B, pin 9, will go high, putting a low on the output IC12, pin 6, which transfers the digit counter information via the digit gate, IC19, to update the digit one latch, IC18, so that it transfers a BCD 9 onto the IC23 one-of-ten decoder. This puts a low on pin 11 of IC23 and holds a low on one of the inputs of the IC29 three-input NOR gate. Nothing can happen yet as the other 2 inputs of that gate are both high by the second and third digit 7442 2 and 3 outputs.

The 9316 IC14 counter continues to count until it reaches BCD 15. Then the TC output (pin 15) will go high, gets inverted by IC27, and puts a low on IC25, which in turn resets flip-flop IC15A, turns off the count gate, IC15B, and resets ICs 14 and 4A. The circuit now waits for the next digit.

If the five-second timer times out, the counters get set to zero and no more digits can get through. You must now start all over again by hitting the * input.

If the timer has not timed out and you press another digit 9, the whole process is done over again, except the digit counter is set to 2 (pin 9 high and 12 low). Now the second nine will be transferred to IC22 and a low output on pin 11 will put a low on the second input of IC29.

On the third digit, if the timer has not timed out, we again select, say, a nine. This will be transferred to the third 7442, and the third input of IC29 is low. The output of this gate will go high, putting a high on one of the inputs of the 2-input NAND gate, CW ID IC32. On the third digit, the 2 outputs of the digit counter, pins 9 and 12 of the 7490, are high. On the fifteenth count of IC14 on the third digit only, a pulse will get through the 3-input NAND gate, IC12, pin 8. This resets the five-second timer, gets inverted by IC3, and puts a positive on one of the inputs of the 2-input AND gate, IC3.

If no 0s have been selected, a high will be on the other input via IC12 and IC3. A high will then get through IC25 and put a high pulse on one input of all the 7400 control gates. Since we now have a high on only one of the other inputs to the control gates, IC32, we will get a pulse only out of the CW ID gate. This we will use to key an ID circuit. This pulse will last only as long as it takes for the timer to reset the digit count gate back to zero.

All the other outputs operate in the same way. On the transmitter power on and off, I have flip-flops. Digit 131 will set IC34A so it holds the 75450 driver on and the driver keeps a power relay picked up. The transmitter can be shut down by sending a 246, as this resets flip-flop IC34A. A 321 allows the carrier-on relay to be

picked up so the transmitter will repeat the receiver. An 888 will turn on the transmitter for 1 minute and is used to either check the output of the repeater or to tune up the receiver to the repeater. Gone are the days when you have to call up another station to key the repeater so you can check your receiver frequency.

The three-digit controller I have shown here can be started and stopped by using any of the input signals as the activate key. You do not have to use the *; you could use, say, the 5 digit as the turn-on and then use the * in place of the 5.

You can see that it would be difficult for someone to tell just how you are controlling your repeater. First he must know which tone turns on the controller; then he must select out of almost 900 combinations which one does what. Another trick is to not have anything happen after the 3rd digit is sent, but have a latch that will wait for one more tone that would operate the control gates. This would, of course, be on the timer so that, if you waited too long, the controller gets reset. If you really want to get tricky, you can add more digits; you can expand this unit to up to a 15-digit controller. You would have to do a little buffering on the digit bus and add more 7442s as well as change the digit count gate, but it could be done.

Since I have explained this circuit to you in detail, I am not going to tell you how we control the Navmarcormars repeater in the Buffalo area. Come on over and try to play with all the combinations to see what you can do. As soon as you get it all figured out, we can change it in about ten minutes, as it is all wire-wrapped. ■

EDGECOM'S FMS-25 . . . THE FANTASTIC 2M FM MOBILE RIG

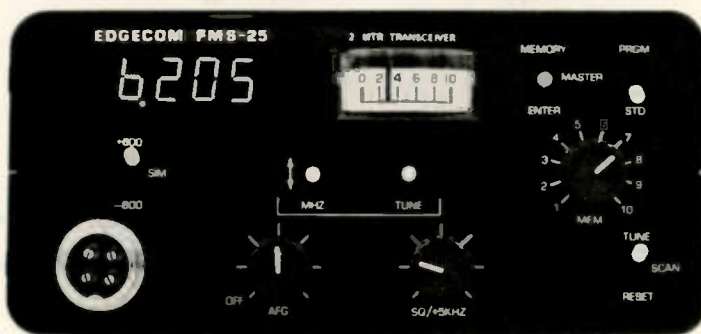

Edgcom's FMS-25 2m FM transceiver is nothing short of ideal for 2m mobile operation. Ten front-panel-programmable memory channels provide you with fingertip convenience for recalling your favorite frequencies, the microcomputer-controlled PLL frequency synthesizer gives you full coverage with any transmitter offset using push-button tuning, and the built-in band scanner lets you automatically tune the band. Add to these features an absolutely superior receiver, 25 Watts of output power and you have a combination that provides unexcelled performance at the low price of \$439.

FOR THE ULTIMATE IN FLEXIBILITY, THE INCOMPARABLE SYSTEM 3000A



The Edgcom SYSTEM 3000A 2m FM transceiver provides unequalled performance, incredible flexibility and several features that go beyond the imagination. Twenty front-panel-programmable memory channels, a memory scanner, a band scanner, two priority channels, any transmit offset, electronic tuning, 25 Watts of output power and the superior Edgcom receiver are a few of the several outstanding features that make the System 3000A the forerunner in the state-of-the-art in amateur communications.

MIDCOM

We'll Make You Glad You're A Ham
ELECTRONICS, INC. M62

Call Collect Now to Order (314) 961-9990

2506 S. BRENTWOOD BOULEVARD
ST. LOUIS, MISSOURI 63144

Oddball Splits and the IC-22S

—work any repeater

Robert E. Bloom W6YUY
8622 Rubio Ave.
Sepulveda CA 91343

Do you have a favorite repeater with frequencies so nonstandard that your Icom 22S cannot be programmed to it? Fear not—the 22S can be made to operate on any odd split and will operate in the reverse mode, to boot.

The intent of this article is threefold: first, to provide information that is difficult to extract from the instruction manual furnished; second, to provide basic technical information to help you solve your particular problem; and, finally, to show one of the several methods used to

get into one of the country's oldest, most modern, and most populated repeaters—WR6AMD (previously WR6ABE).

If you read 73's "Looking West" column by Bill Pasternak WA6ITF, you may be somewhat acquainted with this famous repeater. If you plan to visit within 300 or so miles of Los Angeles, you most likely would like to access it from your transceiver.

First, here are a few points of interest about WR6AMD and its environment. WR6AMD is located more than a mile high in the mountain section known as Mount Wilson. There are also about 300 commercial stations in the area. The environment is so

hostile that no vacuum tube voltmeter is usable, as the meter always reads full scale. In addition, WR6AMD occupies one of the highest points on the mountain. Its antenna is mounted 180 feet above the ground at the top of an FM station's antenna tower. WR6AMD operates on the odd split frequencies of 146.40 out and 147.435 in.

How do you program such a rare split? The following should make this clear.

Some important statistics about the way the IC-22S operates should come in handy at this point. If you look at the coding charts in the rear section of the instruction manual, the left half of the

page provides information relating to the basic frequency that is to be programmed. This is the received frequency. For duplex transmissions, the output frequency will be 600 MHz higher. Programming is accomplished by stuffing diodes into a diode matrix board inside the set. The information on the right-hand side of the coding chart page relates to the digital code and diode placement. Note that the left side of the page has a column entitled "Total N," and, for the lowest frequency listed, 146.010, there are 108 total "N". This "N" is the decimal addition of the total number of bits in the binary coding.

Table 1 is a replica of

Simplex	Set freq. (MHz)	Duplex	PLL out freq. (MHz)	1/M Total freq. N (MHz)	Diode Insert Positions								
					128 D7	64 D6	32 D5	16 D4	8 D3	4 D2	2 D1	1 D0	
1	146.010		135.310	1.620 108				
2	146.025		135.325	1.635 109	
27	146.40			2.010 134	.					.	.		
56	146.835			2.445 163	
60	146.895			2.505 169

Table 1.

portions of the binary coding taken from that section of the instruction manual. Adding together the decimal total for the binary values for just those columns containing an asterisk, you will verify that the frequency 146.010 has an "N" of 108. Each succeeding "Set freq." listed increases the frequency by 15 kHz, while the "N" total count increases by one binary bit. The conclusion to be derived here is simply that, for each additional binary bit programmed, the frequency will increase by 15 kHz. The column "1/M freq. (MHz)" indicates the frequency 1.620 MHz. Multiplying an "N" of 108 x 15 kHz = 1.620 MHz. Now we know how this column is derived. Subtracting 1.620 MHz from 146.010 produces a frequency of 144.390, which we can conclude would be the reference frequency upon which all the other frequencies are based. In addition, it is the equivalent of a frequency that could be generated if no diodes at all are placed in the matrix.

With this basic information, let's see what would be necessary to generate the frequencies for the questioned repeater with a receiving frequency of 146.40 and a transmitting frequency of 147.435. Refer to Table 1 where some additional matrixing frequencies have been inserted. Simplex channel no. 27 indicates this frequency, and it takes diodes in D7, D2, and D1, producing a total "N" of $128 + 4 + 2 = 134$. If we duplex this by adding the 600 kHz, the output frequency would be $146.40 + .600 = 147.00$. But we need 147.435. 147.435 would like to see a receive frequency of 147.435 minus 600 kHz, or 146.835. So we have shown in Table 1 what coding 146.835 would re-

quire as a receive frequency. Simplex no. 56 relates this. From information previously furnished, it can be verified that a total "N" of 163 is required. 163 is made up from diodes placed in D7, D5, D1, and D0. Now we have reached the full impact of the situation on hand, and we must evaluate what we have.

Since 146.40 produces a transmit frequency of 147.00, and we need 147.435, which takes a receive frequency of 146.835, what is necessary to deceive the 22S into thinking that, at the moment the mike switch was activated, the receive frequency was not 146.40 but 146.835? We have to have an electronic switch to switch in the required additional diodes to make the receive frequency appear as 146.835 at the instant the mike button is depressed.

This can be done with gates. We will have gates activated into the circuit and plug in the additional diodes, D5 and D1. Let's add the "N" count and verify that this will actually happen. When the mike button is pressed, the diode matrix sees diodes in D7, D5, D2, D1, and D0, or $128 + 32 + 4 + 2 + 1$ for an "N" of 167. Something's wrong! Referring to the chart, 167 is a frequency of 148.895. We have 4 bits more than we require. Looking at Table 1 again, we see that we have a (4 bit) diode in the D2 position for 146.40, and there is no programming of a diode in this position for 146.835. Surely if we can switch in diodes, why can't they be switched out the same way?

Results of the evaluation show that we must switch two diodes into positions D5 and D0 while switching out diode D2. This can be done by using a single chip with multiple NAND gates. Use CMOS for low current

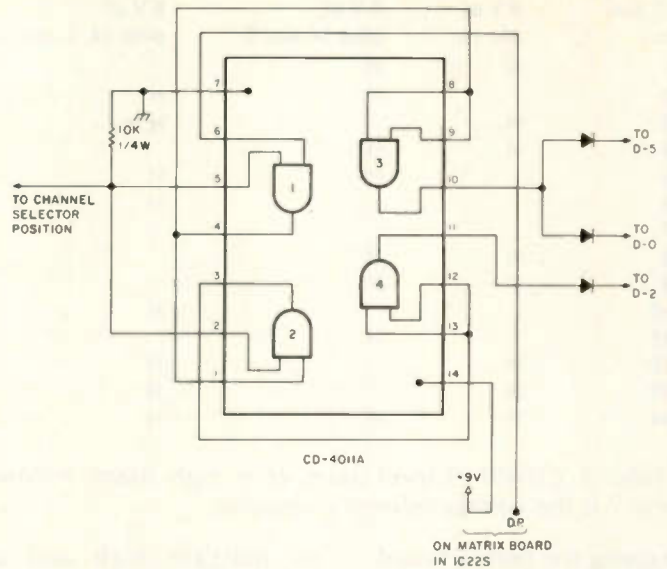

Fig. 1. Diodes are 1N914 or other silicon computer diodes.

drain. Looking through vendors' catalogues, the RCA CD-4011A looks like a good choice.

Now we must look at the voltage changes that take place during transmit switching. Refer to the IC-22S diode matrix unit schematic which is on the backside of the large schematic furnished with the manual. Note that, on the corner of the matrix board in the receiver, there is a solder tab labeled 9 V, which is a regulated voltage. Right next to it there is a solder tab labeled DP. The 9 volts is ever present at the 9 V tab, but it is only on DP when in the transmit position. It will be necessary to solder a wire to each of these points. When a channel is selected by the channel selector switch, it places 9 volts to the diodes in the matrix for that channel, thus acti-

vating the receiver mode of operation.

The small module to be described is placed on a canned PC board about 1" square. The only thing on this board is the IC type CD-4011A, three silicon diodes, and one 10k Ohm resistor. The piece of PC board, which I snipped off a larger board, had a conductor strip along one edge. This made it possible to mount it to one of the shield partitions. A spot of solder to the board and partition in two places or seamed along the edge will contain the module. Thin teflon-covered stranded wire is run from the module in 2" to 4" total lengths. Select an unused channel or channel 23, as I did. Channel 23 has no wire running to the switch, but there is an unused position visible by turning the set to the side opposite that con-

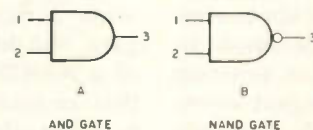

AND gate			NAND gate		
Inputs		Output	Inputs		Output
1	2	3	1	2	3
L	L	L	L	L	H
H	L	L	H	L	H
H	H	H	H	H	L

Fig. 2.

IC pin no.	9 V at pin 14	9 V at pins 14 and 5	9 V at pins 14, 5, and 6
1	H	H	
2		H	H
3	H		H
4	H	H	
5		H	H
6			H
7			
8	H	H	
9	H	H	
10			H
11		H	
12	H		H
13	H		H
14	H	H	H

Table 2. CD-4011A level states. H = high. Blank = low. Pin 7 is the voltage reference negative.

taining the matrix board.

To satisfy yourself that this unused tab is indeed channel 23, check continuity by placing the ohmmeter leads from the 9 V point and the vacant switch tab. Set the switch to the channel next to 22, which shows a dot when in position. There are two dot positions on the dial. The dot adjacent to channel one is not the one you want. (Nō, I don't know what that is for.)

We are now ready to examine the CD-4011A circuitry required and how it works. A nice thing about this circuit is that you can test it before attempting to place it into your IC-22S. All that is required is a 9 V supply or transistor radio battery and a voltmeter.

Refer to the IC, a quad NAND gate, in Fig. 1. Its function on receive is to put one diode in the D2 position on the matrix board. On transmit, remove the D2 diode and put two others in D5 and D0. Let's say we decide to wire this in for operation in channel 23. This position requires the longest wires, but lead length does not appear to introduce any problems. When switching to channel 23, a plus 9 volts is placed on pin 5 (the input of one of the gates). Table 2 indicates the voltage levels on the IC in three different states. An H is used

to indicate high and a blank for low.

The first column indicates the pin voltages with voltage applied to the minus and plus terminals only, pins 7 and 14. This entire test can be made on the bench prior to installation in the set. The second column shows conditions when adding a 9 V connection to the signal input point, pin 5. And the third column shows the voltage state when 9 volts is added to pin 6. This is the transmit state. In the receive state, we are looking for a plus (or H) level at the anode of D2 and a low on D5 and D0; in the transmit state, the opposite. For those who need information on the operation of an AND or a NAND gate, Fig. 2(a) and Fig. 2(b) provide a brief explanation of how they function. Also provided is a truth table. This shows the various voltage level states under any condition.

Fig. 2(a) is a dual-input AND gate; Fig. 2(b) represents a dual-input NAND gate. The dot on the output of a NAND gate indicates that an inversion of polarity takes place. Gates can have one or more inputs, depending on the complexity of the circuit requirements. When many inputs are required, referencing a truth table is the easiest way to follow all functions.

In an AND gate when all inputs are of the same level, the output level will be the same as the input. In a NAND gate when, and only when, all inputs have the same level, the output will have the opposite level. Refer to Table 2. Now that we understand how gates work, let's see what happens in Fig. 1 and follow through in Table 2. Place 9 volts on pin 14, negative on pin 7. This biases the chip for operation. Add a 9 V + level to the signal input, pin 5, and follow through with the logic levels. The individual gates have been assigned arbitrary identification numbers. The first gate shows input 5 high and 6 low for an output at 4 that is high. #2 then has pins 1 and 2 high for a low on pin 3. #3 has pins 1 and 2 high for a low on pin 10. Diodes D5 and D0 are off (like out of circuit). #4 has pins 12 and 13 low for the output pin 11 to be high. D2 is high, as are the diodes in D7 and D1 on the matrix board. This places the transceiver in the mode for receiving 146.40.

Now let's put +9 V on pin 6, which depicts the transmit mode. Following through once again, #1 gate has pins 5 and 6 high, output pin 4 low. #2 has pin 1 low and 2 high, while the output is high. #4 has 12 and 13 high and 11 low, taking D2 out of the circuit as required. #3 has pins 8 and 9 low for a high output which turns on diodes D5 and D0 as required. We have shown how and why it works. This same logic can be applied to repeaters you may like to have but thought you would have to do without.

Wiring It In

The small circuit board you have just finished will need a total of 7 short wire leads, 6 if you have a piece of foil on the board that can be soldered to a case

shield. Pin 7 from the IC is ground and goes to this point. The unit can be mounted between the panel and the outside of the partitioned module containing the 43.9 MHz and 10.24 MHz oscillators. See page 15 in the manual.

The other 6 leads all go to the matrix board selector position on the matrix. Pin 14 goes to the tab marked 9 V, pin 6 to the DP tab on the board. Pins 1, 4, and 5 of the IC go to the input selector position of your choice. The diode cathodes of D5, D0, and D2 go to the cathode input point of the selected channel on the matrix.

For normal operation, the duplex switch will be in the B position. Placing the switch in the A position reverses the operation, and 147.435 now becomes the receive frequency.

Still, some may have the question, "That's fine for a WR6AMD modification, but how do I handle a problem that requires two diodes to be switched out of the receive position when I go into transmit? In addition, I also need one more diode for transmit than you show coming out of the CD-4011A." Looking at Fig. 1, two diodes are fanned out from the gate feeding pin 10 (D5 and D0), so you can fan out an additional diode. Likewise for the diodes you wish to switch out. You can do that from pin 11.

It is always necessary to program the lowest of the frequencies for receive. Looking over the program chart, you see that you will always need either D7 or D6; when you do not need D7, you almost always need D6 and D5. That only leaves 5 more positions maximum that can possibly require additions or subtractions, and the information in these pages should lead you to a solution to your personal problem. ■

THE INCREDIBLES FROM EDGECOM ... NOW AT TOWER ELECTRONICS

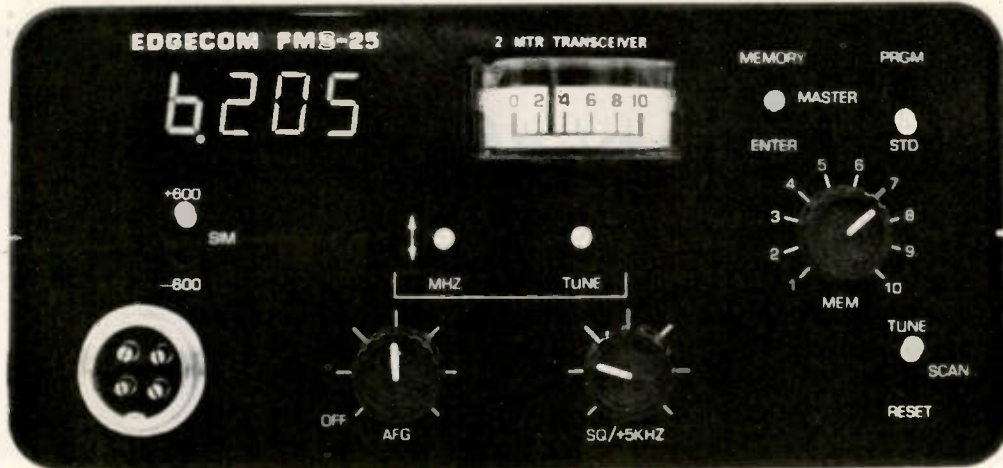

FMS-25

Designed to be the perfect mobile rig, the FMS-25 provides you with the same outstanding receiver and transmitter as the System 3000A plus several operating features that provide the utmost in mobile operating convenience. Ten front-panel-programmable memory channels, a built-in band scanner, any transmitter offset, full coverage (144-147.995 MHz), electronic push-button tuning and an advanced PLL synthesizer are just a few of the operating features that make the FMS-25 a fantastic rig. At the low price of \$439 it leaves all the others behind.

TOWER ELECTRONICS CORP.

T44

24001 ALICIA PARKWAY
MISSION VIEJO, CALIFORNIA 92675

(714) 768-8900



SYSTEM 3000A

The incomparable System 3000A starts by giving you a receiver with absolutely unequalled performance. The five-pole front-end provides virtually intermod-free reception, even in the most populated areas. Images are at least -60 dB and desensing a minimum of -100 dB. The ten-pole IF filters make adjacent-channel interference a thing of the past (-80 dB at 15 kHz). Add a transmitter that gives you 25 Watts of power, fully adjustable, and advanced PLL synthesizer and you have a pretty good rig. But Edgecom didn't settle for "pretty good." System 3000A also features: Twenty memory channels, a memory channel scanner, a band scanner, any transmitter offset, two priority channels, memory channel monitor, electronic push-button tuning and a full TWO-YEAR WARRANTY. These, and all of the other fine features of System 3000A make it a pretty incredible rig. And at the bargain price of \$549, you're getting much more than your money's worth.



The History of Ham Radio

—part VI

Reprinted from QCC News, a publication of the Chicago Area Chapter of the QCWA.

In the winter of 1920-1921, radio amateurs were openly dreaming about beaming radio signals across the Atlantic Ocean. However, their

plans were not very well organized, and attempts during February, 1921, resulted in failure. No signals were heard, although many British stations were listening intently.

The effort prompted the operating department of the American Radio Relay League to make a renewed

attempt. This time, to eliminate confusion and unnecessary QRM, a contest was planned and executed to select the stations within the American continent whose signals had the capability to cover the long distance. Applicants were required to first fill out a prescribed form. (The wording on this form was reproduced in the last chapter of "The History of Ham Radio," 73, December, 1977.)

The renewed attempt was planned for the period of December 7-16, 1921. Test transmissions were to start at 7 pm and continue uninterrupted until 1 am EST. Each amateur radio district was to alternate, using a 15-minute time period, in making transmissions.

Phillip R. Coursey of London, editor of *Wireless World*, who was also instrumental in arranging the prior effort during the

previous February, was in complete charge of all receiving stations in England and the other countries in Europe. All correspondence was routed through him. To assist and supplement the efforts of the British amateurs in coping with the problems (and there were many) of reception of American signals, the ARRL traffic department decided to have an American amateur sent to England to make sure that the most desirable and effective means were employed to insure success of the venture. Paul F. Godley, a native of Montclair NJ, who was a seasoned amateur radio operator and well versed in the use of shortwave equipment, agreed to undertake the assignment. Mr. Godley had adapted the Armstrong regenerative circuit to shortwave work.

Photos were taken from the 1BCG Commemorative Issue of the Proceedings of the Radio Club of America, Inc., *The Story of the First Trans-Atlantic Short Wave Message*, October, 1950.

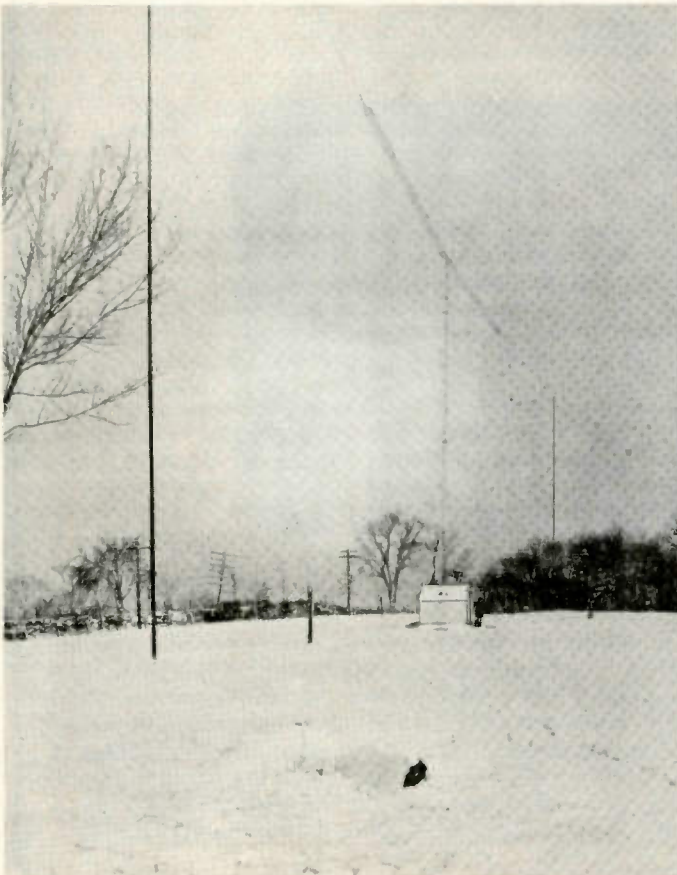

General view of 1BCG showing the station building, the masts, and the antenna system. The mast to the right is 100 feet high, the one at the left is 80 feet. The antenna is of the so-called cage type, T-shape, a new form of aerial construction, at the time, which was especially effective in continuous wave transmission because of its uniformity. The flattop section of this antenna is 100 feet long, and its down lead is placed in the exact center and is about 80 feet long. Instead of a ground connection, a counterpoise forms the other part of the radiating system. The counterpoise is simply a secondary antenna system located a certain distance below the actual antenna and a certain distance above the ground.

So Godley and the equipment which he selected to take with him, along with the British and their receivers, made the undertaking an all-amateur project with everybody participating. With this in mind, the ARRL traffic department set up the following overall schedule: Six hours each night, for ten successive nights, signals were to be beamed in the direction of England and Europe. The French and the Dutch, as well as all other amateurs, were intensely interested in what was being attempted. From 7 to 9:30 pm, a free-for-all schedule was to be followed. This two and one-half hour period was divided into ten sections of fifteen minutes each. During each section, all amateurs in a given amateur radio district would transmit. This would enable all amateur stations to take part. This part of the program was designed to open up the ether routes, one way or another, hoping that someone would get through.

The second and major period of each of the ten nights, from 9:30 pm to 1 am, was arranged exclusively for those qualifying amateur stations with the long-distance records. They were asked to beam their signals according to a prescribed selective schedule which was given to them by the operating department and kept secret until the day of transmission. Each station in the contest, free-for-all and selective, would initiate a call addressed to TEST, calling three times and signing three times, repeating this as often as desired during the periods assigned to the district. For example: TEST TEST TEST de 1BGD 1BGD 1BGD (repeated).

Godley would keep an accurate log of all signals

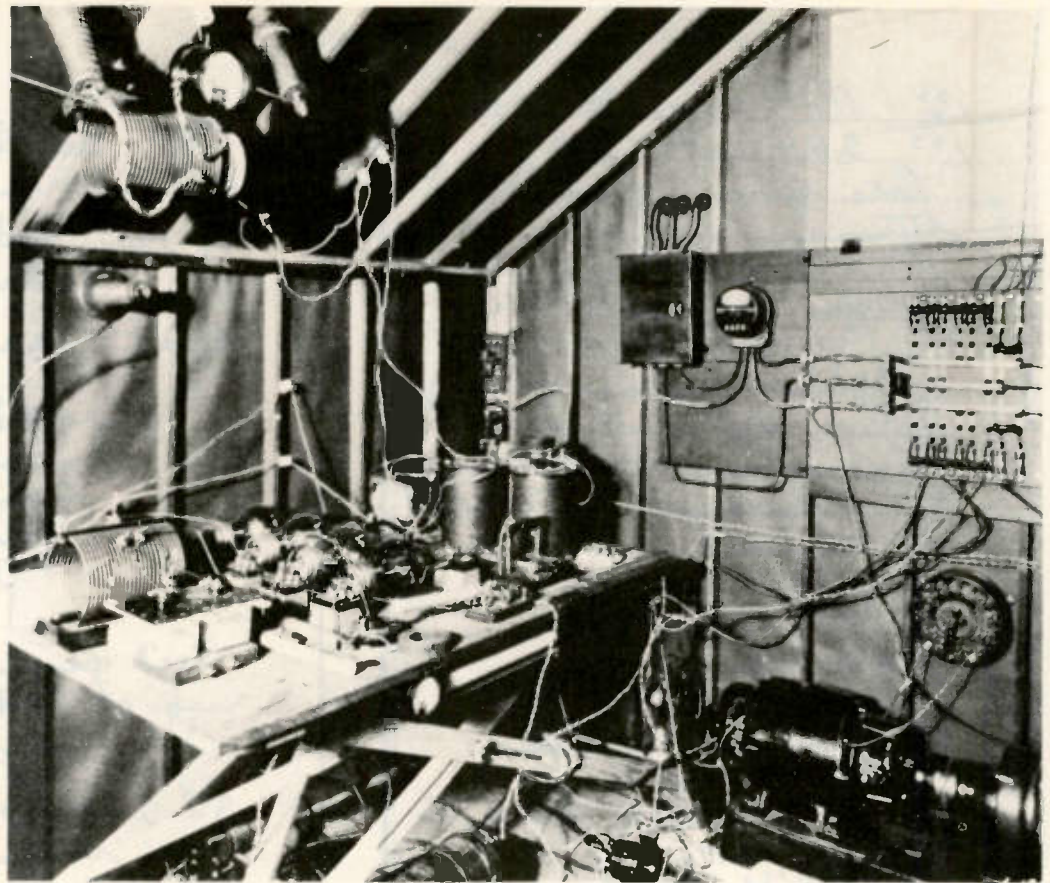

Interior view of the station.

heard and have witnesses to monitor all records kept. After each night of the tests, the results would be given to one of the British longwave stations and the results of the previous amateur transmissions relayed to the listeners in America. In this way, every amateur in the United States and Canada would immediately be informed of the outcome of their endeavors. Commercial station MUU at Carnarvon, on a wavelength of 14,000 meters with plenty of power, could be copied anywhere on the American side. As a special concession and because of the great interest that commercial companies took in these tests, the daily messages given by Godley to MUU were repeated by WII, the RCA station in New Brunswick, by slow Morse code, in order to let amateurs everywhere copy direct. This was done at 7 am GMT, and everybody

knew within hours how well many were doing. A summation of the entire undertaking is to be found

narrated in the January and February, 1922, issues of QST, with both Godley and Coursey reporting in detail.

Call	Location	Type	Wave	Cypher
1AFV	Salem MA	CW	200	YLPMV
1TS	Bristol CT	CW	200	AOTRB
1RU	W. Hartford CT	CW	200	BPUSC
1DA	Manchester MA	CW	200	CQVTD
1AW	Hartford CT	Spk.	210	DRWUF
1BCG	Greenwich CT	CW	230	GODLY
2BML	Riverhead NY	CW	200	FSXVG
2FD	New York NY	CW	200	GTYWH
2FP	Brooklyn NY	CW	200	HUZXJ
2OM	Ridgewood NJ	Spk.	200	JVAYK
2EL	Freeport NY	CW	200	KWBZL
3DH	Princeton NJ	CW	210	LXCAM
4GL	Savannah GA	CW	200	MYDBN
3BP	Newmarket Ont.	Spk.	200	NZFCO
8DR	Pittsburgh PA	CW	200	OAGDP
9KO	St. Louis MO	Spk.	200	PBHFQ
9AW	Toronto Ont.	CW	200	QCJGR
1ZE	Marion MA	CW	375	RDKHS
2ZL	Valley Stream NY	CW	325	TGMKU
3ZO	Parkeburg PA	CW	360	UHNLV
5ZZ	Blackwell OK	Spk.	375	VJOMW
6XH	Stanford University CA	CW	375	WKPNX
7ZG	Bear Creek MT	Spk.	375	XLQOY
8XK	Pittsburgh PA	CW	375	YMRPZ
9ZY	Lacrosse WI	CW	260	RZQMY
9ZN	Chicago IL	Spk.	375	ZNSQA
9XI	Minneapolis MN	CW	300	SFLJT

Table 1.

1⁵⁰ - 1BCG says "B1 hour"
 1⁵⁵ 2EH cut "Test"
 Lots jamming from Holland
 stations
 1⁵³ 2FP in strong ICW
 2⁰⁵ Am 2ARY ICW "Test"
 Lots of QRM from
 Poldhu's press on Harmonics
 Other press schedules
 also going & all seem
 to have harmonics makes
 it difficult
 2¹¹ 3FB spk "Test"
 QRM FFU
 2¹⁴ 2AGW cly 2OE cut
 2²⁴ 2EH cut cly 2AXV.
 VRT are jamming
 2³⁵ 2EL calling Weak ✓
 2³⁹ 1ARY cut surge
 2⁴⁰ 2EH cly 2AFP very steady
 2⁵⁰ 1BCG in with surge

2⁵² Am
 "Nr 1 de 1BCG W-12
 Newyork Date 1/12-21
 To Paul Godley
 Ardrossan Scotland
 Hearty congratulations
 Burghard
 Inman
 Ginn
 Armstrong
 Amy
 Cronkhite."
 Rec'd from 1BCG finish-
 ing at 3 Am.
 He says "bi two hour"
 3⁰³ 2EH working 2XQ
 very steady x
 3¹¹ 1RZ in CW. Resolves
 Also many weather over
 jammed by HP str.

The first message. This is a facsimile of pages 44 and 45 from the original log kept by Paul Godley in Ardrossan, Scotland, showing the now famous "Nr. 1" as he copied it from station 1BCG at 2:52 am GMT on December 12, 1921. This 12-word message was the first ever to be sent across the Atlantic on shortwaves.

Many of the English amateurs, as well as some French and other stations, reported copying American signals. According to Godley, 22 CW and 6 spark stations were heard. The stations who made the grade are listed in Table 1.

Godley had set up his receiving station in Ardrossan, a small fishing village twenty miles to the west of Glasgow, Scotland. He chose this location in northern England rather than a location near London knowing that the previous effort had gone astray primarily because of regenerative receivers used in early 1921 causing a great deal of heterodyne interference.

To the credit of a group of American amateurs determined to make a success of the opportunity offered, a station was built from the ground up, starting on November 19, 1921. Shortly after, Godley departed for England on December 15 on the *Aquitania*, with the parting words to his well-wishers, "Please build a station that will get over there."

Six amateurs pooled their enthusiasm and assembled a station using the latest techniques known with the most advanced pieces of equipment available. They constructed an aerial system considered to be the best layout in theory and design

for 200 meter radiation. The station was located in Greenwich CT, licensed 1BCG, the call of Mr. Cronkhite, who was one of the six.

The transmitter was initially put in operation on December 6, 1921. To inspect its performance, an agreed-upon long CQ was started on December 7th at 3:30 am that lasted until 4:30 am. This was the first day of the transatlantic tests. From the records of the log kept by Godley, these first signals were not heard. The log kept by Godley between the 8th and the 16th, monitored and checked by a Mr. Pearson, an observer, had the following statements re-

peated very often:

"Weather wet and boisterous, find atmospheric very heavy—harmonics jamming reception—reception conditions very sporadic—having to fight heavy static continuously—the interference from many stations is almost constant . . ."

It is interesting to read about these adverse conditions under which Godley and his observer had to operate. Their receiving equipment was located in a large tent out in an open field near the seashore. The wind, rain, mist, and chilling breezes made the situation very unpleasant. Since it was December, the temperature was usually in

the 30s, and they had no heat except a small oil stove. Keeping constant vigil was a trial, a severe test of endurance.

The receiving antenna was a 1300-foot longwire Beverage. It was strung up on ten twelve-foot-long wooden poles, not too firmly set into soft soil (which was covered with seaweed and very slippery to walk on). The cold rain and heavy squalls gave the men what came naturally under such conditions—a heavy cold and near pneumonia. As Godley aptly logged the situation, "A continuous fight against static and harmonic and cold and wet that drove one almost crazy."

The receiving equipment consisted of a Paragon regenerative receiver, together with a type DA-2 detector amplifier and a super-heterodyne receiver using ten tubes, a resistance-coupled amplifier, and an external beat oscillator. This equipment was chosen as being the best possible for both sensitivity and selectivity. Godley's aim in his receiver selection was to find an answer to the secrets of the Armstrong regenerative circuit, especially when reception of CW versus damped waves was concerned. This was a problem, one of the major ones, in the early 1920s.

Then, on the night of December 11, the signals from 1BCG came booming through with clarity and volume over much QRN and other interference. The message was logged by Paul Godley:

"Nr. 1 de 1BCG words 12, New York, December 11, 1921: To Paul Godley, Ardrossan, Scotland. Hearty congratulations. Burghard, Inman, Grinan, Armstrong, Amy, Cronk-hite."

The story on the success

RADIO NEWS

REG. U.S. PAT. OFF.

20 Cents
February
1922

Over 125 Illustrations
Edited by H. GERNSBACK

"THE 100% WIRELESS MAGAZINE"

Radio News for February, 1922

697

Amateurs Span the Atlantic

As reported by PIERRE BOUCHERON

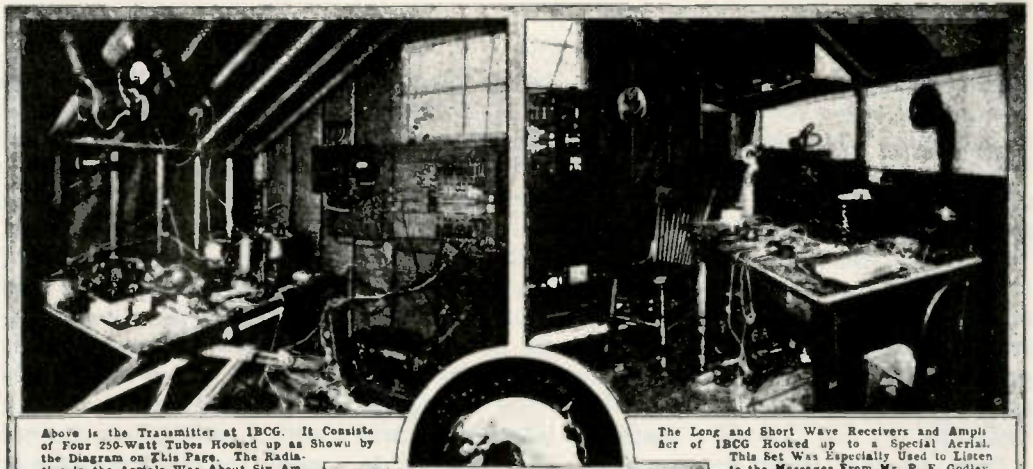

Above is the Transmitter at 1BCG. It consists of Four 250-Watt Tubes Hooked up as Shown by the Diagram on This Page. The Radiation in the Aerials Was About Six Amperes.

The Long and Short Wave Receivers and Amplifier of 1BCG Hooked up to a Special Aerial. This Set Was Especially Used to Listen to the Messages From Mr. P. F. Godley. Sent by MUU Everyday.

THE Continuous Wave method of transmission has conclusively won its laurels for twenty (20) of the twenty-five (25) identified

The first amateur radiogram to be sent from the United States and to be received in Scotland during the great test is as follows:

2EH—C.W.—Radio Engineers' Club, Riverhead, L. I.
2FD—C.W.—J. DiBlasi, New York, N. Y.

of 1BCG in all of its details may be found in a booklet entitled *The Story of the First Trans-Atlantic Short Wave Message*, published by the Radio Club of America, Inc. The message transmitted on the night of December 11, 1921, and acknowledged by cable to the ARRL headquarters by Godley was the first message to cross the Atlantic by shortwave amateur radio.

Now that this endeavor was successfully accomplished, an amateur fraternity grew in spite of amateurs being relegated to the short wavelengths of 200 meters, where it was considered impossible to

carry messages to any great distances with a power input not to exceed 1000 Watts. The event opened the door to bigger doings. The part played by amateurs, and exclusively by amateurs, in sending a message across the Atlantic with their simple homemade equipment was now recorded history. The distance covered was several thousand miles. Not until about 1926 were commercial circuits of a practical nature inaugurated on shortwaves, several years after amateurs had explored and demonstrated that the higher frequencies below 200 meters were feasible

and practical and of real value in long-distance communication.

What happened in December, 1921, marked a turning point in radio history. What had appeared in books and been propounded in theory up to now, this "knowledge of the art," was now disproved. A new field of investigation was opened up for exploration. Through experiments, amateurs tackled the unknown ether bands and came up with answers.

In the next chapter, I will explore the part amateurs contributed to the early days of radio broadcasting. ■

Reusing Coax Connectors

—worthwhile salvage job

Recently, the price of coaxial cable connectors has risen dramatically. The most commonly used coax connector by amateurs is the familiar PL-259. This plug is useful for the RG-8/U size cables (.450-inch diameter) as well as smaller sizes with an appropriate adapter, reducers such as RG-58/U, RG-59/U, etc.

Prior to this price increase, most users simply discarded "used" plugs and bought new ones for each new cable assembly being made. Now, however, it becomes almost an economic necessity to use these same plugs over again for each new assembly.

The reason they were usually discarded was that it was more trouble than they were worth to attempt to recover them for reuse. Often the salvaging process damaged them to the point they were practically worthless, both from an appearance and a functional standpoint.

The most damage results from the unsoldering operation. Due to the "heat sink" properties of the connector body, considerable heat is needed to unsolder the shield braid, especially

with the larger diameter cables and if it was a "good" solder job to begin with. In an attempt to get enough heat, you may be tempted to use your propane torch. Don't. True—you can easily unsolder the cable and pull it out in a few seconds, but you will no doubt carbonize some or all of the insulation material, usually Micarta or other filled plastic. In many cases, it may crack. Heat is not the answer. These plugs can easily be removed by a mechanical process, after only unsoldering the center conductor.

First cut the connector free from the cable; leave about 1 to 2 inches of cable on the connector. Remove the shell. Next strip back the jacket and slide the braid up toward the connector body. Use a sharp knife or razor blade and cut through the cable insulation all the way around and slip it off to expose the center conductor. When this step is complete, you can heat the connector tip with your soldering gun and with a small pair of pliers pull the center conductor free. Using the pliers again, try to pull or "tease" the remaining

center piece of insulation material out. Don't worry if you can't. It may have melted into the braid during the original soldering job when first assembled. By now you are no doubt thoroughly frustrated and thinking of reaching for the "torch." Instead, lightly clamp the connector body in a small vise, or hold it with a small pliers. Do not apply too much pressure or you may deform the body. Use your electric or hand drill with a 1/8-inch diameter drill and drill through the solder ports of the connector. These can be easily located as they may show some braid through or be filled with solder. Drill straight through so the drill will come out the opposite hole (solder port). Be careful; you don't need any more holes here.

Do this for both sets of holes, even if they are not soldered. I usually only solder two opposite holes when assembling. Try again to pull the stub, braid and all, out. It will most likely come out easily, but if it still won't, go to the next step. Pull or otherwise dig out enough of the original cable insulation to get near the solder ports, or at

least flush with the end of the body. Select a 1/4-inch diameter drill and, using a low or variable speed drill, drill down axially toward the tip end through the insulation. Do not drill too deep. Now try to "pick" between the braid and the connector body with a small screwdriver or other similar tool. This should do the trick. As a final step, use a 11/32-inch diameter drill in a hand-held holder such as a pair of vise grips or pliers and sort of "ream" out any solder, solder flux, and other debris. Run this drill all the way into the connector insulation and lightly scrape it clean.

This will give you a connector body "clean as a whistle" and ready to use again. It will not be discolored, but better still, the insulation will have retained its original properties.

This same procedure can be used to remove the smaller diameter cables after being sure to remove the adapter. If it somehow got soldered in, drilling through the solder ports should free it. This, of course, will ruin the adapter, but they are cheaper than a whole new plug. Good luck. ■

Building From Magazine Articles

— the breadboard/wire-wrap way

In a previous article, I described a system for breadboarding IC circuits.¹ Carrying on from there, I would like to show how easy it is to pick projects out of magazines, build them up on the breadboard, and then transfer the whole thing to a more permanent arrangement.

The Design Console

For those of you who missed my first article, a brief description of the breadboard design console is in order. Four CSC² Experimenter Breadboard Sockets were mounted on a Bell & Howell Design Console that came with one of their corre-

spondence courses (Photo A). The console contained a variable 0-to-30-volt dc power supply and I added a +5-volt dc regulated supply. In the article, I also gave schematics and other details for building your own design console from scratch.

Using the breadboard as an intermediate step between a magazine circuit or original design and the finished product has some very real advantages. It allows you to try the design first. This is especially important if you find it necessary to use components other than those specified by the author. Since changes are so easily

made, this is the stage where you can try out any modifications that occur to you.

While it is true that many components are getting hard to get, such is not the case where integrated circuits are concerned. They are readily available and prices are rock bottom as will be apparent by checking the ads in this issue of 73. After you read the ads, flip through the pages from cover to cover and see how many articles you can find that contain circuits which could be built up on the design console in a half hour or less. In the December, 1977, issue, I found seven, and other issues have that many or more.

Pick a circuit, put it on the breadboard, and see what makes it tick. This is an educational process as well as a productive one.

I always mount my ICs so that they all face the same direction. That way I'm always counting pins from the same starting point. Following the schematic, wire the ICs together. I cut lots of one-

two-, three-, and four-inch pieces of insulated twenty-four gauge wire and then strip ¼ inch off each end. I keep the different lengths in half-pound margarine cups and they are always handy. This is much easier than cutting wire as you go along. Do not use wire larger than twenty-two gauge. This includes the leads on half-Watt resistors and larger capacitors. Wire larger than twenty-two gauge will damage the connectors inside the breadboard socket.

Most schematics flow from left to right, so I build that way, testing as I go. Many circuits contain transistors, resistors, and capacitors which are easily incorporated into the layout on the console.

Troubleshooting

Whether you test as you go along, as I do, or wait until the whole project is laid out, some method of debugging is needed. Because of defective components, miswiring, or incorrect design, your circuit may not work properly at first. That is when I put my

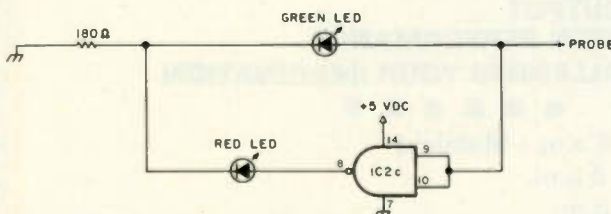

Fig. 1. A simple logic probe. Using two different colored LEDs makes for a more distinctive display but they can both be the same color. Vary the value of the resistor for best brightness. Remember that LEDs are light-emitting diodes and must be forward biased in order to light.

logic probe to work.

In the breadboarding article previously mentioned, I described a quick and easy logic probe that you can build (see Fig. 1). Construct this probe on your breadboard and then try touching the probe to the plus and minus power supply terminals. Either one LED or the other should light, depending on the polarity probed. If you touch the probe to a point in a circuit that is pulsing (alternating between positive and negative), the LEDs will follow this alternation if the frequency is low enough.

This probe is satisfactory for static testing, but for dynamic testing (when things are happening rapidly), it has two drawbacks. Pulses that occur more than a few times per second will light either one or

the other or both LEDs continuously, depending on the polarity. This is confus-

ing since you can't tell whether you are looking at a steady signal or a rapidly

changing one. Also, a very rapid single pulse will be gone too fast for the LEDs

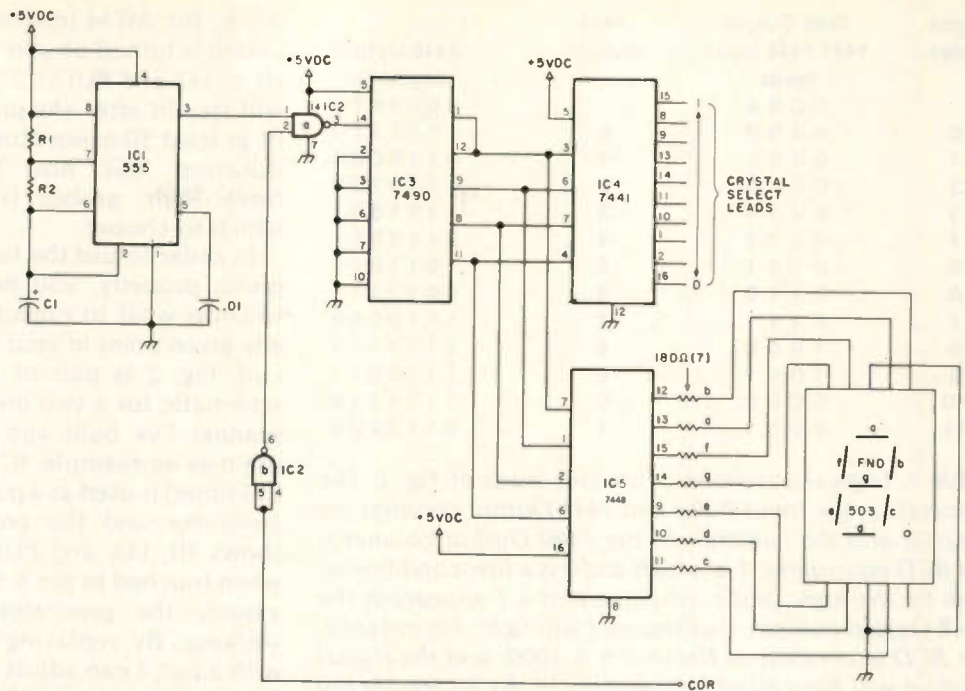

Fig. 2. Schematic of the two meter scanner. $R1 = 1$ megohm, $R2 = 1.5$ to 4.7 megohm, and $C1 = .1 \mu F$. The scanner is disabled by removing the +5 V dc from the ICs.

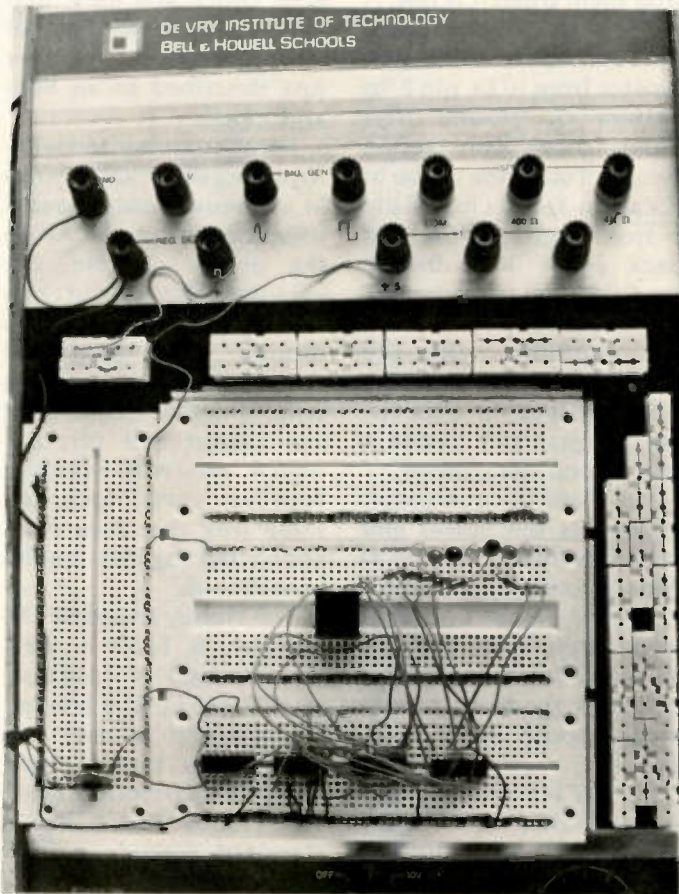

Photo A. Bell & Howell Design Console modified for IC breadboarding. This is nice to work with but all that is really needed are some breadboards and a +5-volt dc regulated power supply (Fig. 3).

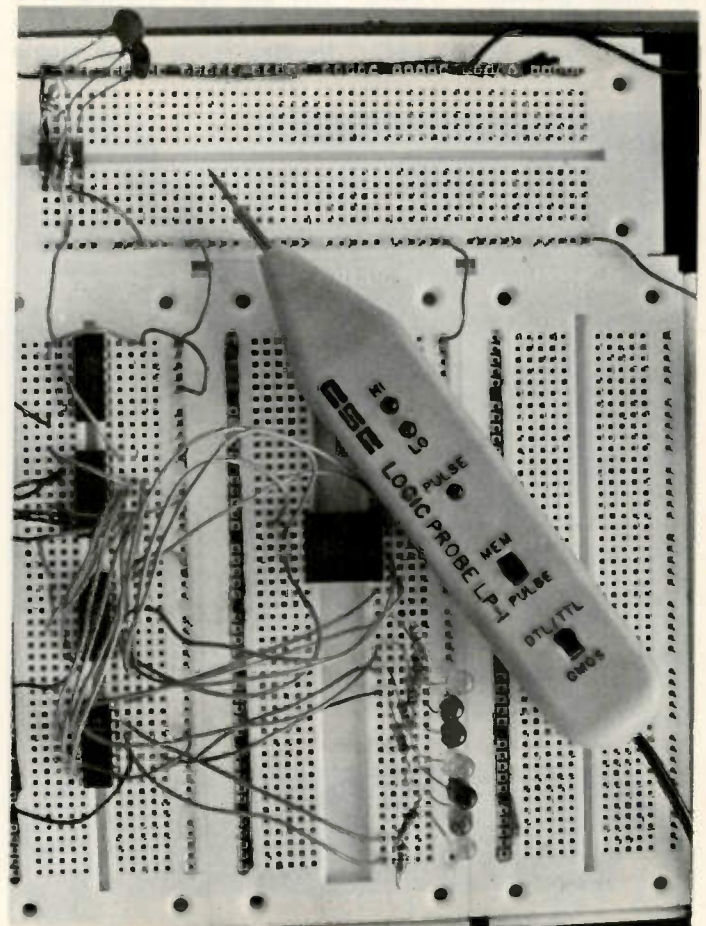

Photo B. The scanner as it looks on the design console. Also shown is the CSC LP-1 Logic Probe used to check out circuit operation.

Input Pulse	7490 Output 7441-7448 Input leads	7441 Output	7448 Output segments
	DCBA		abcdefg
0	0000	0	1111110
1	0001	1	0110000
2	0010	2	1110101
3	0011	3	1111001
4	0100	4	0110011
5	0101	5	1011011
6	0110	6	0011111
7	0111	7	1110000
8	1000	8	1111111
9	1001	9	1110011
10	0000	0	1111110
11	0001	1	0110000

Table 1. Logical condition of various leads of Fig. 2. The numerals in the Input Pulse and 7441 Output columns are decimal and the numerals in the 7490 Output column is the BCD equivalent. 1 is a high and 0 is a low condition as seen by the logic probe. Anytime that a 1 appears in the 7448 Output column, that segment will light. For instance, the BCD equivalent of decimal 8 is 1000, and the digital readout will have all of its segments lit. By increasing the value of C1 in Fig. 2, the pulses can be made to occur so slowly that you can follow this action.

to react.

The LP-1 logic probe by CSC² is the solution to both of these problems (Photo B). In addition to HI and LO LEDs, it has a PULSE LED.

Anytime that pulses are detected, the PULSE LED will light, indicating that you are not looking at a steady signal level. When looking for a quick single

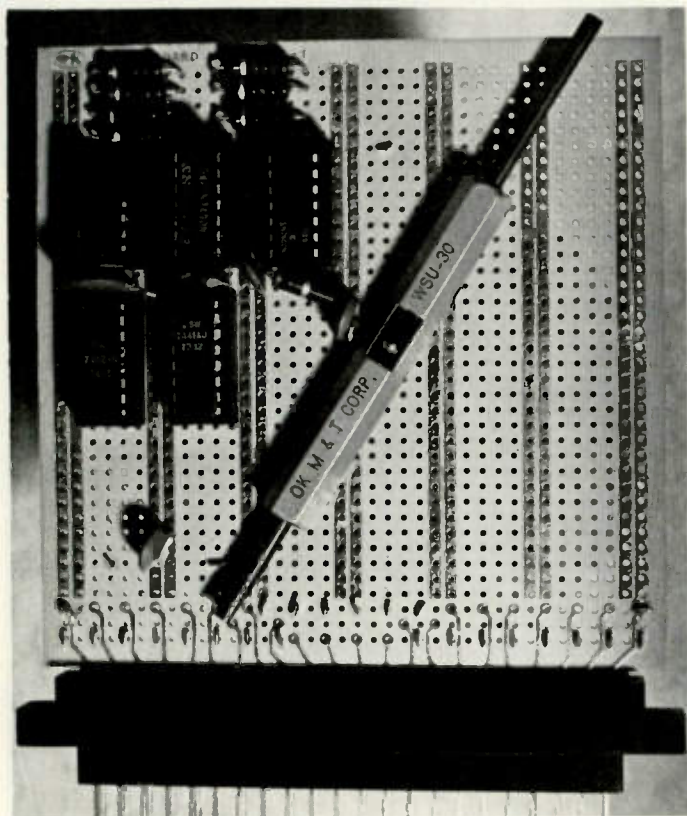

Photo C. The scanner only takes up a small area on the Hobby Board. The wrapper, also by OK Machine & Tool, tied it all together.

pulse, the MEM (memory) switch is turned on and the HI or LO and PULSE LEDs will stay lit after any pulse of at least 50-nanoseconds duration. CSC now has three logic probes from which to choose.

In order to use the logic probe properly, you have to know what to expect at any given point in your circuit. Fig. 2 is part of the schematic for a two meter scanner I've built and I'll use it as an example. IC1 (a 555 timer) is used as a pulse generator and the probe shows HI, LO, and PULSE when touched to pin 3. Obviously the generator is working. By replating R1 with a pot, I can adjust the output frequency of IC1 to any value I desire. To really slow it down, increase the size of C1.

IC2a (7400 NAND gate) will pass the pulses from IC1 when pin 2 is high and stop them when it is low. A high or low can be created by running a 1000-Ohm resistor from IC2a, pin 2, to battery or ground. The probe shows this action clearly. Touch the probe to IC2a, pin 3, and change pin 2 from high to low and back again. IC2b inverts the COR lead from my two meter transceiver to make it compatible with the scanner. The COR is high when the receiver is receiving a signal and I need a low to stop the scanner.

IC3 (7490 decade counter) counts the pulses and indicates this count in BCD (binary-coded decimal) format on its A, B, C, and D leads (pins 8, 9, 11, 12). With pulses entering IC3 on pin 14, the A, B, C, and D leads should react as in Table 1.

IC4 (7441 decade decoder) takes this binary count and converts it to a one-out-of-ten format. These ten output leads actually do the channel scanning by sequentially grounding the crystal select leads in the receiver.

IC5 (7448 seven-segment decoder/driver) also takes this BCD format from IC3 and drives a seven-segment digital readout that tells us which channel we've stopped on.

The logic probe makes finding malfunctions in a circuit like this very simple if you know what to look for. More complex circuits are harder to debug, but the principle is the same. The important point to remember is that you have to figure out what you should find at a given location before you can determine whether you have a problem there or not.

Now that everything is working properly, you'll want to transfer all of this to a more permanent arrangement. After trying many different methods of construction, I have found that wire-wrapping is quick and easy for one-shot projects. Quick and easy, that is, once you get the hang of it. I finished the scanner just described in an hour and a half.

Breadboarding and wire-wrapping have many things in common—both advantages and methods. As on the design console, the wire-wrapped layout can be easily changed as desired. The majority of the solid-state components used in this type of project are integrated circuits which are wire-wrapped together very much the same way that they were connected together on the breadboard.

The Hobby Board by OK Machine & Tool³ is ideal for this kind of construction (Photo C). The scanner leaves plenty of room for other ideas that I might want to incorporate later. The Hobby Board has a standard forty-four contact edge connector and sockets are readily available. This project could also be wire-wrapped on a piece of perf-board and permanently

mounted. The feature that I like about the Hobby Board/socket combination is the ease of making changes. The board is unplugged, changes or additions made, and the board is plugged back in.

Now, something other than a pair of longnose pliers is needed to do the actual wire-wrapping. OK Machine & Tool also makes a wire-wrap kit called the WK-2 which contains a wrapper/unwrapper/stripper, a fifty-foot spool of wire, and a batch of pre-cut and stripped wire. The wrapper/unwrapper/stripper (WSU-30) and the spools of wire can be purchased separately. I haven't tried it, but OK also has a wire dispenser that cuts and strips wire to any length.

ICs are installed in sockets made for wire wrapping. Resistors, capacitors, and transistors with their leads clipped short can be inserted into IC sockets, or special component sockets can be obtained. As an alternative, the leads can be inserted through the board, wire-wrapped, and soldered. The soldering is necessary because the connecting wire does not wrap as tightly on round leads as it does on the square wire-wrap posts.

Battery, ground, input, output, and control lines are brought onto the board via the edge connector. A +5-volt dc regulator could have been mounted on the board, but it is a better idea to put the regulator on a good heat sink on the chassis.

To get from the edge connector to different points on the board, I solder to the edge-connector contact and then wire-wrap the other end of the wire where it is needed (Photo D). Buses on the board are used to distribute battery and ground. I place .01 uF disc

ceramic capacitors between the battery and ground buses at various points to help filter the spikes that are generated by the rapid switching action taking place within the ICs.

The first step is to mount the IC sockets. I orient them so that the IC pins all count the same way. As a further aid, I draw a view of the bottom with all pin numbers shown. I also glue the sockets in place with rubber cement. It holds them fast but they can still be removed at a later date if need be.

Install the wires one at a time, following the schematic, just as you did when building your projects on the breadboard. Cut the wires long enough to allow some slack. Here also, I cut and strip a lot of wire to different lengths and store the pieces in plastic margarine cups.

Do not draw the wire bowstring-tight between posts, and be very sure that all of the wire stripped bare is actually wrapped on the post or it could short to adjacent posts. When it is necessary to put more than one wire on a post, the second wrap goes above the first. Some wrap posts are called three-level posts because there is room for three wrapped wires.

When the wrapping is finished, temporarily connect battery and ground and check things out as you did on the design console. Use your logic probe, and, if everything is right, you're ready to mount the perfboard or Hobby Board in its final location. I'll leave that part up to your ingenuity and circumstances.

Using the same wire-wrapping techniques, you could move from schematic to finished product without going through the breadboard stage, but I think that breadboarding makes the whole process

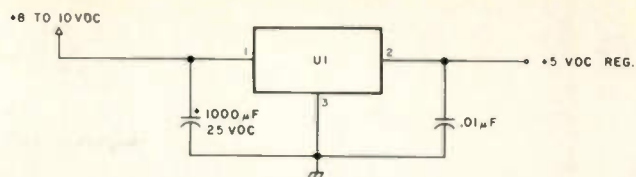

Fig. 3(a). +5-volt dc regulated power supply. The input voltage can be higher than that shown, but as the input voltage rises, U1 is required to dissipate more heat. U1 can be any of the following: LM309K, 7805, LM340K-5, or LM340T-5. Be sure to mount on a metal chassis with a good heat sink.

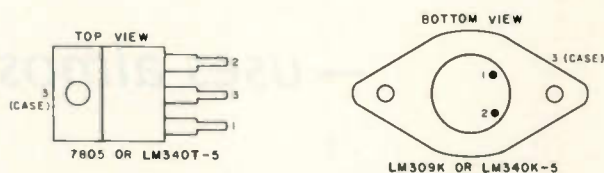

Fig. 3(b). Connections for various +5-volt dc regulators.

easier. If you are doing your own designing or extensive modifications, then the breadboarding is invaluable.

Either way, the monthly magazines are full of ideas, circuits, and finished projects. Pick one out and try it for yourself. I think that you will be surprised and

happy with the result. ■

References

1. "Hey, Old-Timers! The Breadboard Is Back!", *73 Magazine*, May, 1978, pp. 46-51.
2. Continental Specialties Corporation, 70 Fulton Terrace, New Haven CT 06509.
3. OK Machine & Tool Corporation, 3455 Conner St., Bronx NY 10475.

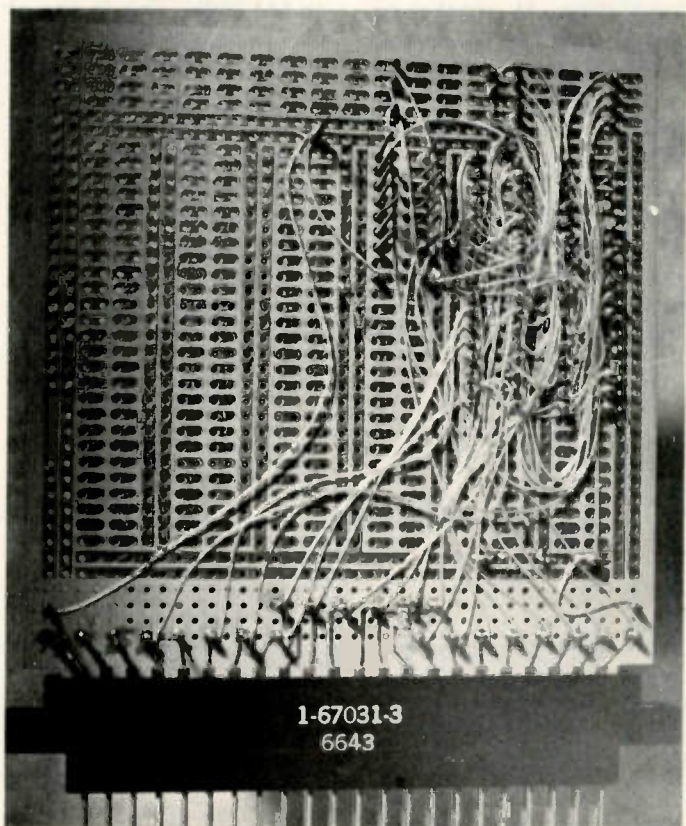

Photo D. While the wiring looks quite complex, wires are placed one at a time and it is really not difficult.

Super Simple TT Generator

— uses almost no components

Mark M. Minot WA6AFX
16763 Bollinger Dr.
Pacific Palisades CA 90272

Fig. 1 shows a schematic detailing my circuit for the generation of touch-tone™ frequencies. The circuit, to my knowledge, is the first to use an IC amplifier. It works extremely well, is quite easy to construct, and is inexpensive. Total cost for the project was under nineteen dollars.

The oscillator is a Motorola MC14410CP chip using a 1 MHz crystal. The chip generates both the high and low tones, feeding the energy to the amplifier

through the 1k resistors and the 1-microfarad capacitor. Values for the output resistors can vary from a few hundred Ohms to about 60 kilohms. The value of the resistor shunting the crystal can vary from about three to fifteen megohms.

The amplifier consists of an LM-380N. This is one of the handiest linear chips around. It can output as much as two Watts of audio with a minimum of components. In the configuration shown (this configuration may be used for just about any audio amp application, as a look around my shack will evidence), input from the

oscillator is fed to the inverting input. The value of this component may vary from about 470 pF to about .003 microfarads. The 4.7k resistor controls the tone of the outputted signal. If desired, a pot may be substituted for the fixed resistor, and any tone which will both work and please the operator's ears may be selected. Output is taken through a 25-microfarad capacitor and an 8-Ohm speaker. The 380 is designed to operate into 8-Ohm loads. The value of the capacitor may range from about 18 microfarads to well over 100. For 12-volt operation, change the 4.7k resistor between

pins 2 and 6 of the LM380 to a 1k and add a .01 uF capacitor between pin 6 and ground.

Construction is easy. I built mine on a small piece of vectorboard using telephone wire to make connections. A later model was built using a PC board. It is highly recommended that an IC socket be used for the MC14410CP. I used sockets on both chips. They are inexpensive and can save a lot of grief! An old transistor radio box was used to house the unit and keyboard. I used the Chomerics EF-21360 keyboard. The terminals will only stand very brief periods of heat, as evidenced by the fact that I ruined one while overzealously trying to attain a good connection. On the second one, I held the wire against the keyboard terminal with pieces of spaghetti. Heat-shrinkable tubing may also be used. I put a pot into the output line between the speaker and capacitor to reduce the volume, as the 380 can put out quite a lot of audio! I also installed an external jack, as shown in the schematic, to permit direct connection to my rig. ■

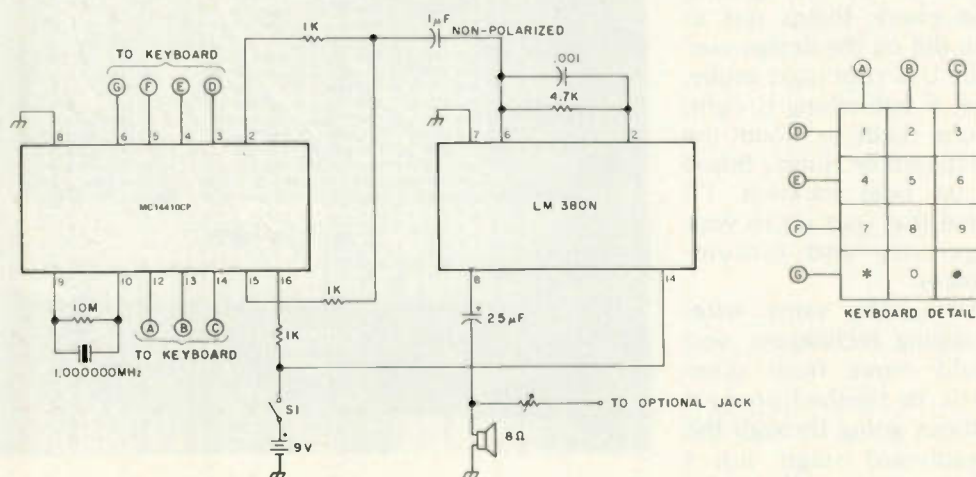

Fig. 1.

EDGECOM SYSTEM 3000A

AND FMS-25. . .



INCOMPARABLE PERFORMANCE

AND FLEXIBILITY

SYSTEM 3000A



INCREDIBLY PRICED AT \$549

- Twenty Front-Panel-Programmable Memory Channels
- Any Transmitter Offset
- Built-In Memory Scanner
- Built-In Band Scanner
- Memory Channel Monitor
- Superior Receiver
- 25 Watts Output (adjustable)
- American Made/FULL 2-YEAR WARRANTY

FMS-25

- Ten Front-Panel-Programmable Memory Channels
- Built-In Band Scanner
- Same Fantastic Receiver/Transmitter as System 3000A
- Any Transmitter Offset
- Push-Button Tuning
- American Made/Full 2-Year Warranty



BARGAIN PRICED AT \$439



Aureus Electronics Inc.
1415 North Eagle
Naperville IL 60540
(312) 420-8629



A64

Microstrip

—magical PC technique explained

H. Paul Shuch N6TX
Microcomm
14908 Sandy Lane
San Jose CA 95124

Microstrip is a transmission line, much like coax or twinlead, except that it is fabricated not from wire or tubing, but generally by etching traces on a printed circuit board. Now, it's a cinch the

average radio amateur isn't about to run a long, thin strip of printed circuit board up his tower, so the actual application of microstrip transmission lines is likely to be something other than feeding antennas. In fact, microstriplines are especially useful in developing couplers, baluns, power dividers and combiners, matching transformers, capacitive and inductive reactances, and a whole host of structures which utilize the distributed properties of transmission lines in lieu of "lumped" components.

The recent acceptance of microstrip techniques by radio amateurs has allowed PC layouts to be developed such that the traces used to interconnect components will themselves be used as circuit components. I have recently presented microstripline circuits for amplifiers,^{1,2} mixers,^{3,4,5} filters,⁶ and complete converters.⁷ In each case, successful duplication of the designs re-

quired only selecting the proper printed circuit material and adhering closely to the published layout and dimensions. This article is in response to numerous inquiries from radio amateurs who had successfully duplicated some of my designs, but wanted to know how the magical PC trace dimensions were determined.

Transmission Line Parameters

Any transmission line, be it coax, twinlead, microstrip, or what-have-you, can be described in terms of its characteristic impedance (Z_0) and length. Characteristic impedance is the terminating impedance seen looking into an infinitely-long section of the transmission line and is a function of the dimensions of the conductors, their orientation with respect to one another, and the dielectric constant of any material separating them. Transmission line length may refer to a physical di-

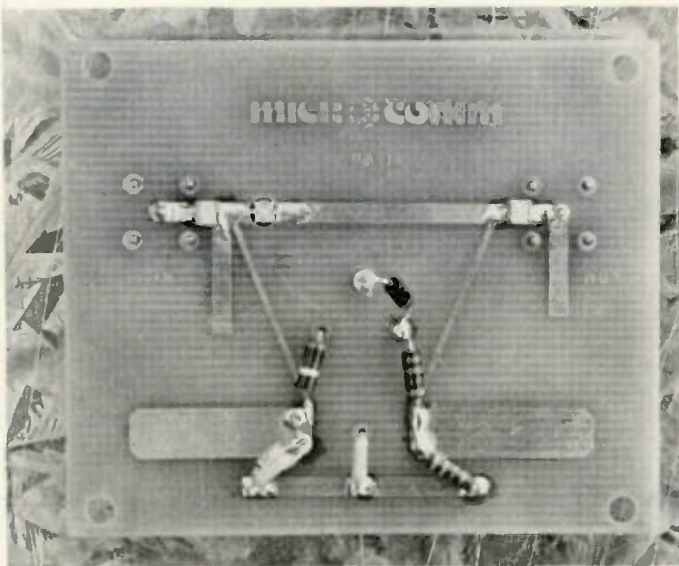

Typical microstripline preamplifier. In this circuit, the PC traces perform as matching transformers, inductors, rf chokes, and bypass capacitors. This particular preamplifier was designed for use in receiving weather satellites at 1.7 GHz, although the author has built similar units to cover the 420 MHz, 1215 MHz, and 2300 MHz ham bands.

mension, but more often denotes the phase delay (measured in electrical degrees) of a signal being propagated down the line at a particular operating frequency. Such an electrical length is, of course, a function of the velocity at which the signal is propagating down the line; hence, if we specify a transmission line's velocity of propagation, we can generally calculate the electrical length of any physical line at any desired frequency. Since the velocity of propagation of electromagnetic radiation in free space equals the speed of light (a universal constant), and since this velocity cannot be exceeded by a signal propagated down an actual transmission line, it is common practice to specify for any transmission line its relative velocity of propagation (with respect to the speed of light), or *propagation constant*. From this decimal number, the electrical length at a given frequency is easily found for any physical length of transmission line.

I have recently published design techniques⁸ which determine the characteristic impedance and electrical length required of transmission lines to be inserted at specified locations within amplifier circuits. Similar techniques exist for other types of circuit designs. What remains is to determine the required dimensions and layout for achieving the desired transmission lines. Since microstriplines can be fabricated over a wide range of characteristic impedances and at practically any length (limited only by circuit board size restrictions), microstrip transmission lines would seem an ideal medium for most circuit design, from frequencies of a few hundred MHz up through

several tens of GHz.

Microstripline Variables

Any transmission line may be considered as a combination of series inductive and shunt capacitive elements, or sections, acting together as a delay line. The characteristic impedance of the resulting line can be shown to be proportional to the ratio of inductance to capacitance for a unit length.⁹ Algebraically,*

$$Z_0 = \sqrt{L/C}$$

Consider Fig. 1, which is a representation of a typical microstrip transmission line etched from double-clad printed circuit stock. The thin strip atop the board, with respect to the unetched ground plane, comprises the transmission line. A signal injected (or "launched") into the strip at one end will emerge, after a given propagation delay, from the other end. Since the above equation holds for at least a first-order approximation, determining the characteristic impedance of the microstrip transmission line in Fig. 1 involves merely quantifying the inductance and capacitance per unit length.

Like any conductor, the etched trace in Fig. 1 exhibits an inductance per unit length which is inversely proportional to its width, W , and thickness, t . The capacitance between the strip and the ground plane varies directly with the line width, W , varies directly with the dielectric

*Strictly speaking, this relationship only holds for transmission lines propagating signals in the transverse electromagnetic (TEM) mode—that is, with electric and magnetic lines of force both at right angles to each other and at right angles to the direction of propagation. Fortunately, microstriplines closely approximate TEM propagation in most applications.

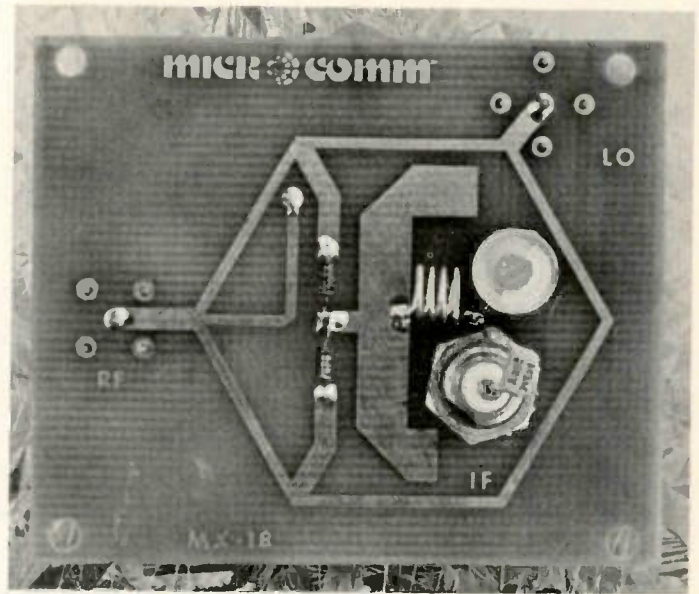

Balanced mixer. Here microstriplines are used to introduce rf and LO signals to a pair of mixer diodes (center of board) in the proper phase relationship for linear heterodyne conversion to take place. The PC traces also furnish impedance matching i-f filtering and dc return for the mixer diodes. Again, this particular mixer is optimized for weather satellite reception at 1.7 GHz, but similar designs have been used for transmit or receive conversion in any of the amateur microwave bands.

constant, ϵ_r , of the material separating the plates of the capacitor, and varies inversely with the spacing, h , between the plates.

Thus a series of proportionalities can be developed:

$$\begin{aligned} Z_0 &\propto \sqrt{L/C} \\ L &\propto \frac{1}{Wt} \\ C &\propto \frac{W\epsilon_r}{h} \end{aligned}$$

Therefore,

$$Z_0 \propto \sqrt{\frac{1/Wt}{W\epsilon_r/h}}$$

where α (the Greek lowercase alpha) indicates that the quantities are proportional rather than equal.

Inverting the denominator within the radical sign and multiplying it by the numerator, we get:

$$Z_0 \propto \sqrt{\frac{h}{W^2\epsilon_r t}}$$

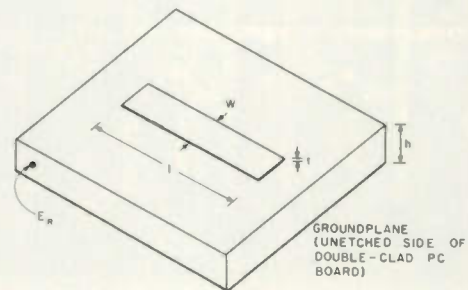

Fig. 1. Representation of a typical microstrip transmission line etched from double-sided printed circuit board. Variables affecting the line's electrical performance include the width, W , of the microstripline, the height, h , of the strip above the ground plane (this being related to board thickness), the thickness, t , of the strip metallization, the length, l , of the strip, and the relative dielectric constant, ϵ_r , of the substrate.

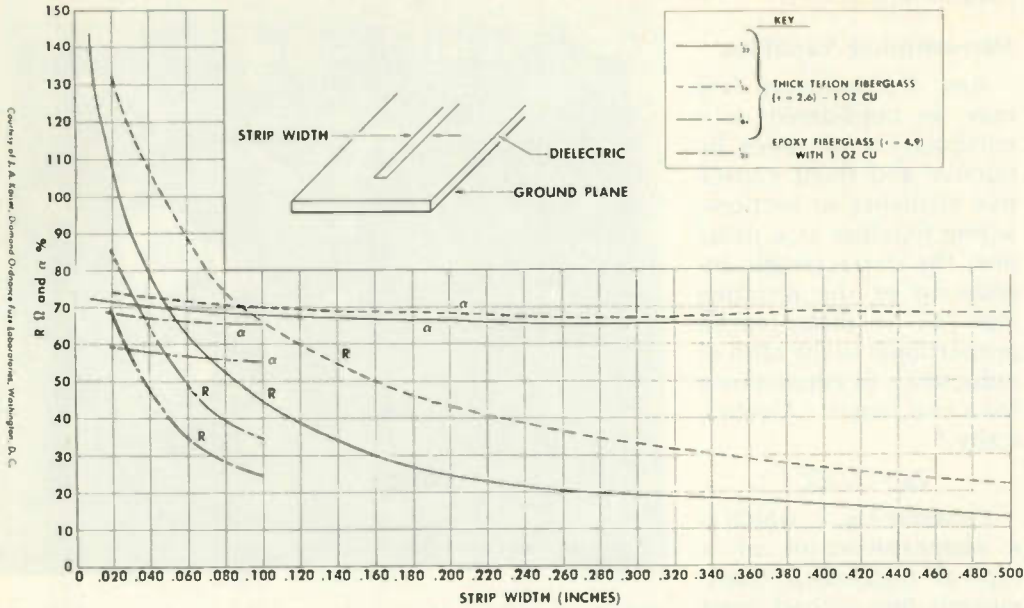

Fig. 2. Measured microstripline impedance and propagation constant versus strip width.

which at least allows us to draw some general conclusions about microstripline dimensions, if not determine them directly.

Generalization #1:

Wide lines have low characteristic impedance, while narrow lines exhibit high characteristic impedance.

Generalization #2:

For a given characteristic impedance, the required line width is narrower for thin substrates

than it is for thick substrates.

Generalization #3:

For a given characteristic impedance, line width will be greater on low dielectric-constant materials than it will with higher dielectric constants.

Generalization #4:

Increasing the thickness of the metallization tends to decrease the characteristic impedance of the line (this will be discussed in greater detail in a later section of this article).

A similar series of proportionalities can be developed for describing the velocity of propagation along a microstrip transmission line, starting from the relationship:⁹

$$v = \frac{1}{\sqrt{LC}}$$

Without belaboring the calculations, let us generalize:

Generalization #5:

Velocity of propagation decreases with increasing dielectric constant.

Generalization #6:

Velocity of propagation increases slightly as microstriplines become more narrow (that is, for higher characteristic impedances).

Generalization #7:

For a given dielectric constant, as long as strip width is adjusted to hold characteristic impedance constant, propagation velocity is independent of substrate thickness.

Since the computations involved in actually determining dimensions for a particular microstripline are quite involved and often fraught with error, the above approximations not only lend themselves to a better understanding of the mechanism of microstrip, but they also provide a "test of reasonableness" for evaluating the results of a more rigorous computational analysis.

Quantifying Microstripline Behavior

A set of equations frequently encountered in the engineering literature¹⁰ which provides a good first-order approximation of the characteristic impedance and propagation velocity of microstriplines is as follows:

$$Z_0 = \frac{377(h/W)}{\sqrt{\epsilon_r}}$$

and

$$v = \frac{c}{\sqrt{\epsilon_r}}$$

where W, h, and ϵ_r are as defined in Fig. 1, c represents the velocity of propagation of radiant energy in free space, and the number 377 is an expression for the characteristic impedance of free space in Ohms.*

Although the above for-

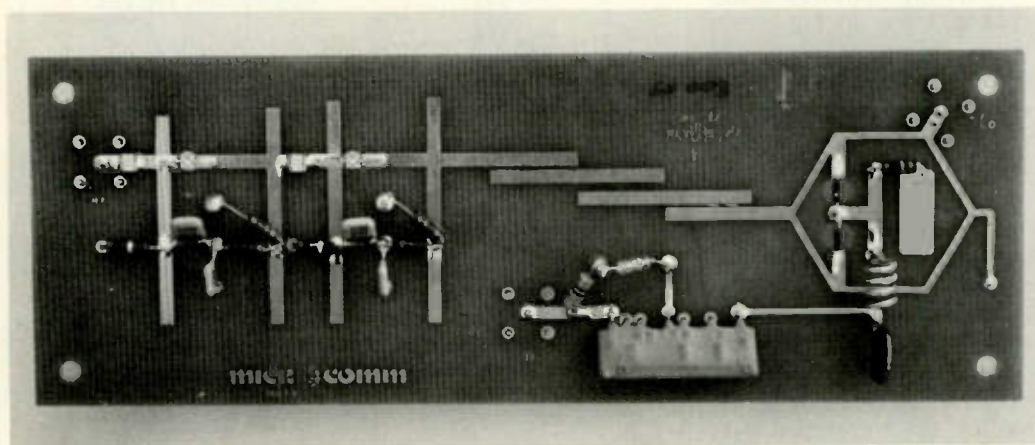

Integrated microstrip assembly. This board is a complete front end for the reception of TV signals from satellites at 2.6 GHz. Microstriplines provide matching and bias feeds for the two preamplifiers (left) and i-f amplifier (bottom right), furnish ample bandpass filtering for spurious-free reception (center), and phase rf and LO signals in a balanced mixer (far right). This particular board provides 30 dB of conversion gain, a 3 dB noise figure, and better than 20 dB of image frequency rejection. A similar unit has been used for successful ATV reception in the 2.4 GHz band.

* $Z_0 = \sqrt{\mu_0/\epsilon_0}$, from reference 9. Since μ_0 , the permeability of free space, is approximately $4\pi \times 10^{-7}$ Henrys per meter, and ϵ_0 , the permittivity of free space, is approximately $1/36\pi \times 10^9$ Farads per meter, it can be shown that $Z_0 \approx 377\Omega$.

mulas yield results which conform to the generalizations introduced previously, they are at variance with measured data on actual microstriplines. This is because the ideal formulas assume true TEM propagation, with the conductors completely immersed in the dielectric medium, and ignore such ever-present anomalies as fringing capacitance (capacitive coupling between the microstrip and the outside world) and flux leakage (mutual inductive coupling between the strip and its surroundings). Throughout the 1950s and '60s, numerous studies were performed by Cohn, Wheeler, Sobol, Schneider, and others to more completely characterize the behavior of microstriplines under "real-world" conditions. Documentation of these investigations may be found in references 11 through 22. The calculations are involved but have enabled a number of graphical aids for the dimensioning of microstriplines to be developed.

Graphical Analysis—Wheeler's Charts

The technique most commonly used by microwave engineers to dimension microstriplines involves a set of graphs known as "Wheeler's Charts," after Harold A. Wheeler, the author of references 15 and 16. The charts, published in numerous technical journals, were not actually developed by Wheeler, but are generally based upon a set of equations derived by him. Wheeler's Charts take several forms, and may be used for determining the proper width for a microstripline of a desired characteristic impedance, for determining the resulting velocity of propagation, or both. Like any graphical design tool,

Wheeler's Charts are only approximate, being limited in resolution by their finite size. Nonetheless, data derived from these charts has provided a good starting point for literally thousands of successful microwave designs.

Fig. 2 is one form of Wheeler's Chart, published for several years in the *Microwave Engineer's Handbook*.²³ From it, one can determine to a high degree of accuracy the required strip width for a desired characteristic impedance and the resulting propagation velocity (as a percentage of the speed of light) for two particular types of substrate material in three popular thicknesses. No information as to effects of trace thickness is given in this chart, but it seems to hold for 1 oz. (0.0014" thick) and 2 oz. (0.0028" thick) copperclad PC laminate.

The Wheeler's Charts in Figs. 3, 4, and 5 are more general in that they allow microstriplines to be dimensioned independently of substrate thickness or dielectric material. These charts were published a couple of years ago by Communications Transistor Corporation²⁴ and formed the basis of most of the microstrip dimensions presented in my various construction articles. To use Fig. 3, it is necessary to know the relative dielectric constant (ϵ_r) of the substrate material (its permittivity relative to that of free space). For a given characteristic impedance, the chart gives the ratio of required microstripline width to height (the dielectric thickness). Thus the required strip width is found merely by multiplying this ratio by the actual substrate thickness used, making this chart applicable to any desired substrate thickness.

Figs. 4 and 5 similarly

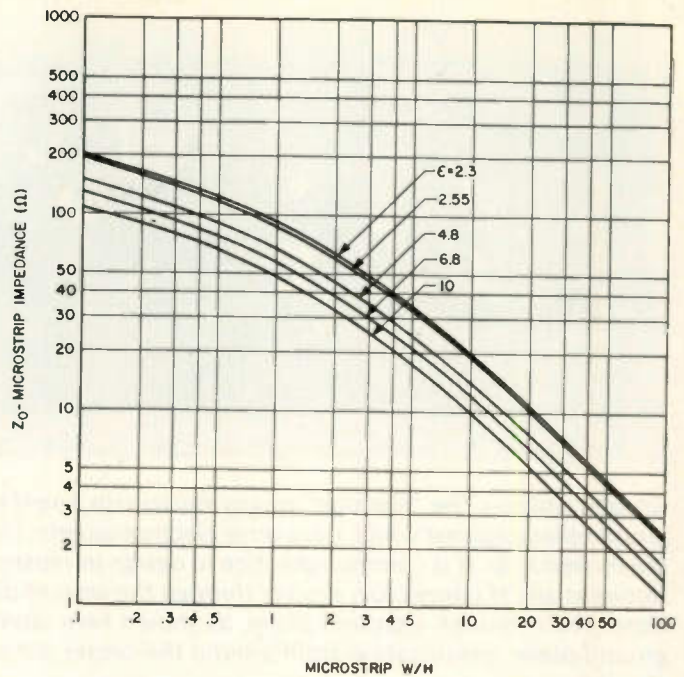

Fig. 3. Microstrip impedance versus width/height.

employ the width-to-height ratio of a microstrip and are used indirectly to determine propagation velocity. To understand their use, it is necessary to first introduce the parameter which the charts erroneously call relative dielectric constant, but which more properly should be referred to as effective dielectric constant, ϵ_{eff} .

Effective Dielectric Constant

The first-order approximations given earlier for microstripline characteristic impedance and propagation velocity would hold if the dielectric material completely surrounded the strip conductor and completely contained all magnetic and electrical lines of force. In fact, the dielectric constant of the substrate (between the strip and the ground plane) and that of the material above the strip (typically air) are sufficiently different that a sizable dielectric discontinuity exists. This is further aggravated by the fringing capacitance and magnetic flux leakage problems mentioned earlier. Now, if

all these discontinuities were taken into account, a correction factor could be developed, tacked onto the textbook formulas for Z_0 and v_{rel} , and all would be well. Unfortunately, this correction factor to Z_0 is actually a function of Z_0 , which is why the formulas developed by Wheeler, Sobol, Schneider, and others are so complex. But assuming the actual Z_0 of a stripline were found, and, if it were compared to the assumed Z_0 from the textbook equation, a correction factor could be derived for each particular microstripline measured. That correction factor could then be multiplied by ϵ_r , the permittivity of the dielectric relative to that of free space, resulting in the parameter which I call ϵ_{eff} , effective dielectric constant.

Since, for a given microstripline dimension, ϵ_{eff} encompasses all the corrections necessary for fringing capacitance, flux leakage, and dielectric discontinuity, the first-order formulas could be used if ϵ_{eff} were substituted for ϵ_r throughout. The only problem remaining is to deter-

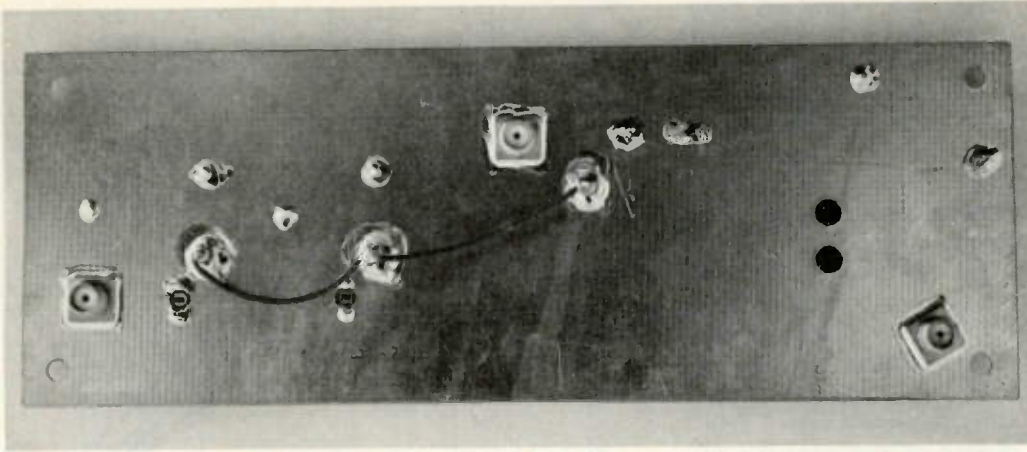

Ground plane—The “flip side” of any microstrip board remains unetched, to serve as a ground plane against which transverse electromagnetic (TEM) waves can propagate down the etched strip. It is common practice to design microstrip boards so that dc power feed-throughs and rf connectors project through the ground-plane side. When mounting coax connectors through a ground plane, as shown here, don’t forget to remove a bit of the ground-plane metallization from around the center pin or you’ll end up shorting out all signals!

mine the value of ϵ_{eff} , which leads us to another generalization.

Generalization #8:

Since all flux lines surrounding the stripline pass both through the substrate (of dielectric constant ϵ_r) and also through air (dielectric constant $<\epsilon_r$), the effective dielectric constant, ϵ_{eff} , will always be less than ϵ_r .

ferent relative dielectric constant, ϵ_r , the effective dielectric constant, ϵ_{eff} , as a function of width-to-height ratio (which was itself a function of characteristic impedance). From ϵ_{eff} , it is relatively easy to determine v_r , relative propagation velocity as compared to the speed of light, from the formula:

$$v_r = \frac{1}{\sqrt{\epsilon_{eff}}}$$

Effects of Metallization Thickness

Nowhere in Wheeler’s Charts is there any correction for t , the thickness of the strip conductor and ground-plane metallization. Actually, generalization #4 notwithstanding, varying the metallization thickness over a fairly wide range has virtually no effect upon the properties of the microstrip. This is because skin effect forces

most of the current to flow at or near the surface of a conductor, and this effect is amplified as frequency increases. As long as the metallization thickness is sufficient to support the required current flow (and, at microwave frequencies, a few microns will suffice), circuit operation is relatively independent of trace thickness.

Yet it is important to know the metallization thickness when dimensioning microstriplines. This is so because the specified thickness of copperclad printed circuit laminates is generally inclusive of metallization thickness, but the microstripline formulas or charts require a knowledge of the substrate thickness alone.

Consider a printed circuit board 1/32” (0.79 mm) thick, double-clad with 2-ounce copper. The copper thickness will be 0.0028” (0.071 mm) on each side, leaving only 0.65 mm of dielectric thickness. Obviously, any microstripline calculation which ignores metallization thickness, and assumes a 0.79 mm dielectric, will be in error.

As mentioned previously, Fig. 2 seems to provide adequate results with either 1- or 2-ounce copper thickness. Nonetheless, when utilizing the width-to-height ratios of Figs. 3, 4, or 5, or any time high precision is required, the actual metallization thickness should be taken into account when determining the height, h , of a microstrip above the ground plane.

Characteristic Impedance Limitations

There is a finite range of widths (hence characteristic impedances) over which an etched microstrip will perform as a TEM transmission line. As a line becomes very wide, its capacitance per unit

Figs. 4 and 5 list, for various substrates of dif-

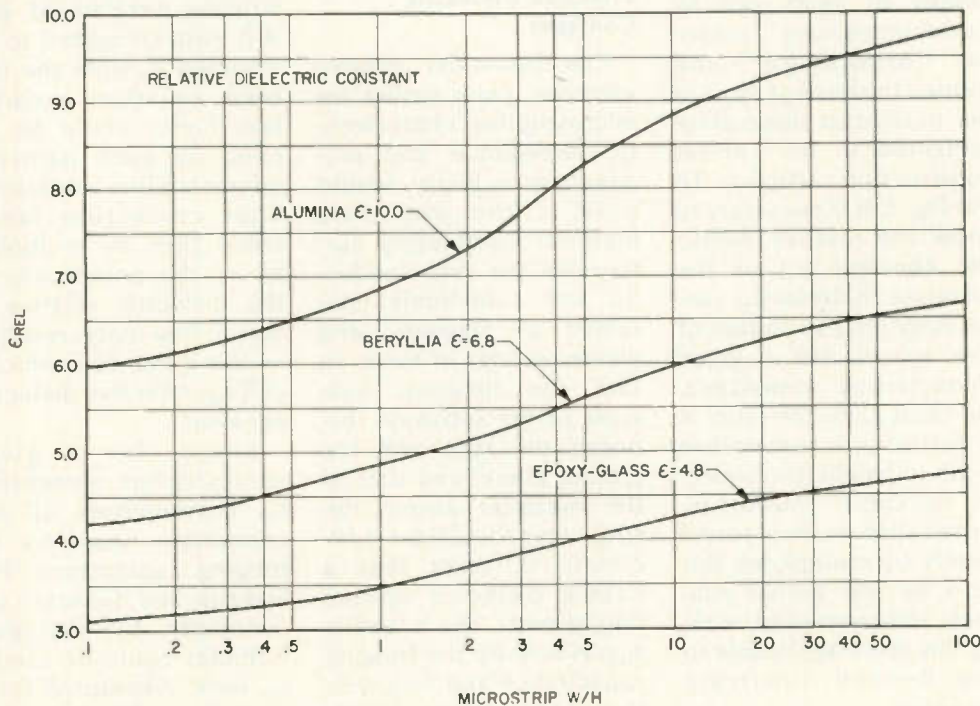

Fig. 4.

length becomes so great as to completely dominate its behavior. The inductance per unit length becoming insignificant, the line can no longer behave as a transmission line, but rather forms a lumped shunting capacitance to ground. This transition begins to occur when the width of the strip exceeds about 10 times its height above the ground plane. Similarly, for very narrow lines, the capacitance per unit length becomes insignificant, the inductance per unit length predominates, and the line no longer supports TEM propagation but instead degenerates to a series inductor. This transition seems to occur when the height of the strip above ground exceeds the strip's width by about a factor of ten.

From Fig. 3, it can be seen that the above limitations tend to restrict the useful range of microstrip-line characteristic impedances to about 15 to 150 Ohms. Needless to say, the ability to construct TEM transmission lines of any desired characteristic impedance between these two extremes is hardly a severe limitation and will likely accommodate just about any design requirement.

Length Limitations

Microstriplines which are very short relative to their width similarly tend to act as shunt capacitances rather than transmission lines. This occurs because the signal, rather than propagating along the length of the line, actually propagates from the center of the line out toward the edges. It is apparent that with signals traveling in this direction, they are no longer perpendicular to the magnetic and electric fields, so the strip no longer acts as a TEM transmission line.

As a rule, no microstrip-line should be designed into a circuit such that its width exceeds its length. In circuits requiring a short electrical length of transmission line, a certain amount of ingenuity is required. In many applications, it is possible to take advantage of the property of repeating impedances at half-wave intervals. For example, if a circuit should require a shunt 0.1-wavelength transmission line, but if the frequency were sufficiently high to make the microstripline short relative to its width, a 0.6-wavelength transmission line may well suffice.

In applications where it is not practical to add an integral half wavelength to the transmission line, it may be possible to design with a longer transmission line of some other impedance or perhaps a short length of transmission line with a higher characteristic impedance (hence narrower strip width). Where such circuit modifications are not possible, it may be necessary to redesign the circuit onto a thinner substrate. This has the effect of reducing the width of all microstriplines in the circuit.

Since attenuation in a microstripline, as in any transmission medium, is a direct function of transmission line length, it should be obvious in designing circuits that no line should be made longer than absolutely necessary. An exception is the use of long, lossy sections of transmission line as attenuators in a circuit.

Selecting Stripline Laminates

Throughout the microwave industry, the use of such prosaic materials as fiberglass-epoxy printed circuit board as microstrip-line laminates is met with scorn. Nonetheless, I have

Z ₀	1/32" TFE, 1 oz Cu			1/16" TFE, 1 oz Cu		
	W	ε _{eff}	v/v ₀	W	ε _{eff}	v/v ₀
15	.377	2.35	.65	.791	2.34	.65
20	.268	2.29	.66	.564	2.29	.66
25	.204	2.25	.67	.429	2.25	.67
30	.162	2.21	.67	.340	2.21	.67
35	.132	2.18	.68	.277	2.18	.68
40	.109	2.16	.68	.231	2.15	.68
45	.092	2.13	.68	.195	2.13	.68
50	.079	2.11	.69	.166	2.11	.69
60	.059	2.07	.70	.124	2.07	.70
70	.045	2.03	.70	.095	2.03	.70
80	.035	2.00	.71	.074	2.00	.71
90	.028	1.97	.71	.059	1.98	.71
100	.022	1.95	.72	.047	1.95	.72
110	.018	1.92	.72	.038	1.92	.72
120	.014	1.91	.72	.030	1.91	.72
130	.011	1.90	.72	.024	1.91	.72
140	.009	1.90	.73	.019	1.90	.73
150	.007	1.89	.73	.015	1.89	.73

Table 1: Width (in decimal inches), effective dielectric constant, and velocity factor for various characteristic impedance microstriplines etched on two different thicknesses of fluorocarbon-dielectric (ε_r = 2.55) printed circuit stock, double-clad with 1 oz. copper. This table is also applicable to various low-dielectric-constant polyolefin and glass-derived printed circuit materials, as discussed in the text.

achieved a reasonable degree of success with microstriplines on such inexpensive circuit stock, as reported in my previous articles.

The attitude of the industry is not without some basis, as process controls in the manufacture of garden-variety glass-epoxy PC board are somewhat lacking. The laminate thickness and dielectric constant will vary widely between vendors and for different production runs of board from the same manufacturer, as reported by Motorola.²⁵ Nonetheless, it is possible to design the circuit to be forgiving of such anomalies, especially if variable tuning elements are incorporated in the circuit for impedance matching. Further, Sobol's microstrip equations (reference 18) permit strips to be dimensioned for any board thickness and dielectric constant encountered, as long as the material to be used is measured.

Whenever I purchase a quantity of glass-epoxy circuit board, I make it a

point to strip back the metallization on both sides of a sample and measure the actual dielectric thickness. I have never observed deviations from optimum of more than a few percent, so the manufacturer's published thickness is probably close enough for dimensioning striplines. As for relative dielectric constant, ε_r, I measure it by determining the capacitance of a scrap of double-sided laminate whose dimensions are precisely known. This is most easily done on an automatic RCL bridge, but any available capacitance-checker should suffice. Dielectric constant is then found from the formula:

$$\epsilon_r = \frac{hC}{8.85A}$$

where C is capacitance in pF, h is dielectric thickness in meters, and A is the area of either plate in square meters.

If the resulting dielectric constant is reasonably close to the theoretical 4.8 for fiberglass-epoxy PC board, go ahead and design

Z_0	1/32" glass-epoxy 1 oz. Cu			1/16" glass-epoxy 1 oz. Cu		
	W	ϵ_{eff}	v/v_0	W	ϵ_{eff}	v/v_0
15	.262	4.15	.49	.551	4.15	.49
20	.184	4.01	.50	.387	4.01	.50
25	.138	3.91	.51	.290	3.91	.51
30	.107	3.82	.51	.226	3.82	.51
35	.086	3.74	.52	.181	3.74	.52
40	.070	3.68	.52	.148	3.68	.52
45	.058	3.61	.53	.123	3.62	.53
50	.048	3.55	.53	.103	3.56	.53
60	.034	3.45	.54	.074	3.46	.54
70	.026	3.37	.54	.055	3.37	.54
80	.019	3.28	.55	.041	3.29	.55
90	.014	3.23	.56	.031	3.24	.56
100	.011	3.22	.56	.023	3.22	.56
110	.008	3.20	.56	.017	3.20	.56
120	.006	3.18	.56	.013	3.18	.56
130	.004	3.15	.56	.010	3.16	.56
140	.003	3.13	.56	.007	3.14	.56
150	.002	3.11	.57	.005	3.12	.57

Table 2. Width (in decimal inches), effective dielectric constant, and velocity factor for various characteristic impedance microstriplines, etched on two different thicknesses of fiberglass-epoxy dielectric ($\epsilon_r = 4.8$) printed circuit stock, double-clad with 1 oz. copper.

microstriplines from Wheeler's Charts or from the tables included in this article. If not, you have the option of selecting another batch of PC stock and trying again or designing your strip dimensions around the actual ϵ_r of the material on hand.

The majority of commercial microstripline users employ a type of circuit

board exhibiting tightly controlled dielectric properties. Traditional materials include fluorocarbon laminates (such as Teflon, a DuPont trade name for tetra-fluoro-ethylene), polyolefins (such as polyethylene), or glass derivatives such as "duroid" or "rexolite." All of these materials exhibit a much lower dielectric constant

than fiberglass-epoxy (on the order of 2.5, as opposed to 4.8), which results in wider, longer striplines—a decided advantage at higher frequencies where strips might otherwise become so short as to be unmanageable. Although these stripline laminates are quite a bit more costly than glass-epoxy, they offer exceptionally consistent properties and excellent performance well beyond ten GHz. Glass-epoxy, on the other hand, is only marginally useful at 2300 MHz and becomes extremely lossy beyond 3 GHz.

Military and aerospace microwave circuitry is frequently fabricated by depositing gold traces on a ceramic substrate of highly controlled dimensions and dielectric properties. The most popular of these substrates is alumina, which has an extremely high dielectric constant (around 10). The very high ϵ_r , considerably reduces microstripline dimensions, which is a definite asset in high-density applications such as microwave integrated circuits, although it greatly increases the dimensional precision required both in design and fabrication. Until recently, such high- ϵ_r materials were completely beyond the reach of the average experimenter. A new microstripline laminate from 3M Company, called epsilon 10, promises to change that. This board has a ceramic-impregnated dielectric material whose dielectric properties match those of alumina, but which can be machined like conventional printed circuit material. The board is supplied double-clad with 1-ounce copper and can be etched with either ferric chloride or chromic-sulphuric acid. Although the cost is quite high (on the order of \$1 per square inch), epsilon 10 promises

to make high-density techniques available to the interested microwave amateur without requiring investment in exotic processing equipment.

Introducing Sobol's Tables

Wheeler's Charts, as seen in Figs. 2 through 5, provide a convenient technique for determining microstripline dimensions for a desired characteristic impedance and electrical length. However, it is frequently more convenient to have this information available in tabular form, especially when a limited number of standard dielectric types and thicknesses are used. I recently developed a set of such tables for finding width, effective dielectric constant, and velocity factor of microstriplines over a wide range of characteristic impedances for six different frequently-encountered laminates.

Since the calculations are quite involved, require multiple iterations and conditional branching, and include parameters which are interactive, it was decided to employ a programmable pocket calculator (in this case, the Hewlett-Packard Model 25). From a wide field of available equation sets, I selected Sobol's equations from reference 18, primarily because they lent themselves to entry within the limitations of my calculator's 49-step program capacity.* The calculator programs are available to anyone interested in such

Z_0	.025" alumina deposited gold traces			.050" alumina deposited gold traces		
	W	ϵ_{eff}	v/v_0	W	ϵ_{eff}	v/v_0
15	.146	8.28	.35	.293	8.29	.35
20	.100	7.95	.35	.201	7.96	.35
25	.073	7.69	.36	.146	7.69	.36
30	.055	7.46	.37	.111	7.46	.37
35	.043	7.26	.37	.086	7.26	.37
40	.033	7.06	.38	.068	7.09	.38
45	.026	6.89	.38	.054	6.91	.38
50	.022	6.77	.38	.045	6.78	.38
60	.015	6.50	.39	.030	6.50	.39
70	.010	6.43	.39	.020	6.43	.39
80	.006	6.35	.40	.013	6.36	.40
90	.004	6.28	.40	.009	6.30	.40
100	.003	6.24	.40	.006	6.24	.40
110	.002	6.18	.40	.004	6.18	.40
120	.001	6.07	.41	.002	6.07	.41
130				.001	5.97	.41

Table 3. Width (in decimal inches), effective dielectric constant, and velocity factor for various characteristic impedance microstriplines of gold traces deposited on two different thicknesses of alumina ($\epsilon_r = 10.3$) substrate. This table is also applicable to the new 3M brand "epsilon 10" high-dielectric-constant printed circuit stock, as discussed in the text.

*It is recognized that Sobol's equations, having been derived more than a decade ago, are less precise than others published more recently. However, since the errors in microstripline dimensions utilizing Sobol's equations seldom exceed a few percent, they are considered entirely satisfactory for amateur (if not government) work.

calculations,* but the results are presented in Tables 1, 2, and 3.

I had actually intended to name these tables after myself. After all, a great deal of time and effort went into writing the programs and computing the data. Then I had the unexpected pleasure of meeting Dr. Harold Sobol for the first time, at a recent International Microwave Symposium. I found Hal to be stimulating, personable, enjoyable—a "gentleman and a scholar" in the true sense of the expression. Thus I decided that the tables which I am presenting here, like Wheeler's Charts, should be named after the person who derived the formulas, rather than the person who applied them in a convenient form.

Conclusion

Microstrip transmission lines lend themselves to the design of impedance matching networks, coupling structures, and reactive circuit elements. Their usefulness extends from the VHF region far into the microwave spectrum. This article has presented several generalizations about the dimensioning of microstriplines, which may be verified by examining Sobol's Tables (Tables 1 through 3).

Actual dimensions for microstrip transmission lines of a desired characteristic impedance and electrical length can be determined graphically, from tables, or with the aid of a programmable calculator. Try microstripline for

*The HP-25 programs used to develop Tables 1 through 3 form a part of a microwave design program library developed by the author and are available for a nominal charge. For details, send a stamped self-addressed envelope to Microcomm, 14908 Sandy Lane, San Jose CA 95124.

your next microwave design or construction project. It's simpler than you realized and more rewarding than you can imagine! ■

References

1. H. Paul Shuch WA6UAM, "Microstripline Preamplifiers for 1296 MHz," *Ham Radio*, April, 1975, p. 12.
2. H. Paul Shuch WA6UAM, "Low Cost 1296 MHz Preamplifier," *Ham Radio*, October, 1975, p. 42.
3. H. Paul Shuch WA6UAM, "How to Use Double Balanced Mixers on 1296 MHz," *Ham Radio*, July, 1975, p. 8.
4. H. Paul Shuch WA6UAM, "Rat-Race Balanced Mixer for 1296 MHz," *Ham Radio*, July, 1977, p. 33.
5. H. Paul Shuch WA6UAM, "Packaging for UHF DIP Double-Balanced Mixers," *Ham Radio*, October, 1977, p. 41.
6. H. Paul Shuch WA6UAM, "Microstripline Bandpass Filters for 1296 MHz," *Ham Radio*, December, 1975, p. 46.
7. H. Paul Shuch WA6UAM, "High Performance Conversion Module for the 23 cm Band," *Radio Handbook*, 20th edition, Howard W. Sams, Indianapolis IN, 1975, p. 20-66.
8. H. Paul Shuch WA6UAM, "Solid-State Microwave Amplifier Design," *Ham Radio*, October, 1976, p. 40.
9. A. L. Lance, *Introduction to Microwave Theory and Measurements*, McGraw-Hill, Inc., 1964, ch. 1.
10. *Reference Data for Radio Engineers*, Fifth Edition, Howard W. Sams, Indianapolis IN, 1972, p. 22-25.
11. D. D. Grieg and F. H. Englemann, "Microstrip—A New Transmission Technique for the Kilomegacycle Range," *Proceedings of the IRE*, December, 1952, p. 1644.
12. S. B. Cohn, "Characteristic Impedance of the Shielded-Strip Transmission Line," *IRE Transactions on Microwave Theory and Techniques*, July, 1954, p. 52.
13. S. B. Cohn, "Shielded Coupled-Strip Transmission Line," *IRE Transactions on Microwave Theory and Techniques*, October, 1955, p. 29.
14. Tai Tsun Wu, "Theory of the Microstrip," *Journal of Applied Physics*, March, 1957, p. 299.
15. H. A. Wheeler, "Transmission-Line Properties of Parallel Wide Strips by a Conformal-Mapping Approximation," *IEEE Transactions on Microwave Theory and Techniques*, May, 1964, p. 280.
16. H. A. Wheeler, "Transmission-Line Properties of Parallel Strips Separated by a Dielectric Sheet," *IEEE Transactions on Microwave Theory and Techniques*, March, 1965, p. 172.
17. H. Caulton, J. J. Hughes, and H. Sobol, "Measurements on the Properties of Microstrip Transmission Lines for Microwave Integrated Circuits," *ACA Review*, September, 1966, p. 377.
18. H. Sobol, "Extending IC Technology to Microwave Equipment," *Electronics*, March 20, 1967, p. 112.
19. P. Silvester, "TEM Wave Properties of Microstrip Transmission Lines," *Proc. IEE (London)*, January, 1968, p. 43.
20. E. Yamashita and R. Mittra, "Variational Method for the Analysis of Microstrip Lines," *IEEE Transactions on Microwave Theory and Techniques*, April, 1968, p. 251.
21. T. G. Bryant and J. A. Weiss, "Parameters of Microstrip Lines and of Coupled Pairs of Microstrip Lines," *IEEE Transactions on Microwave Theory and Techniques*, December, 1968, p. 1021.
22. M. V. Schneider, "Microstrip Lines for Microwave Integrated Circuits," *Bell System Technical Journal*, June, 1969, p. 1421.
23. *Microwave Engineer's Handbook and Buyer's Guide*, Horizon House, Inc., 1964, p. 90.
24. "Design Charts to Aid in RF Power Amplifier Design," *Communications Transistor Corp.*, San Carlos CA, pp. 6-8.
25. Glenn Young, *Application Note AN-578*, Motorola Semiconductor Products, Phoenix AZ, 1973.

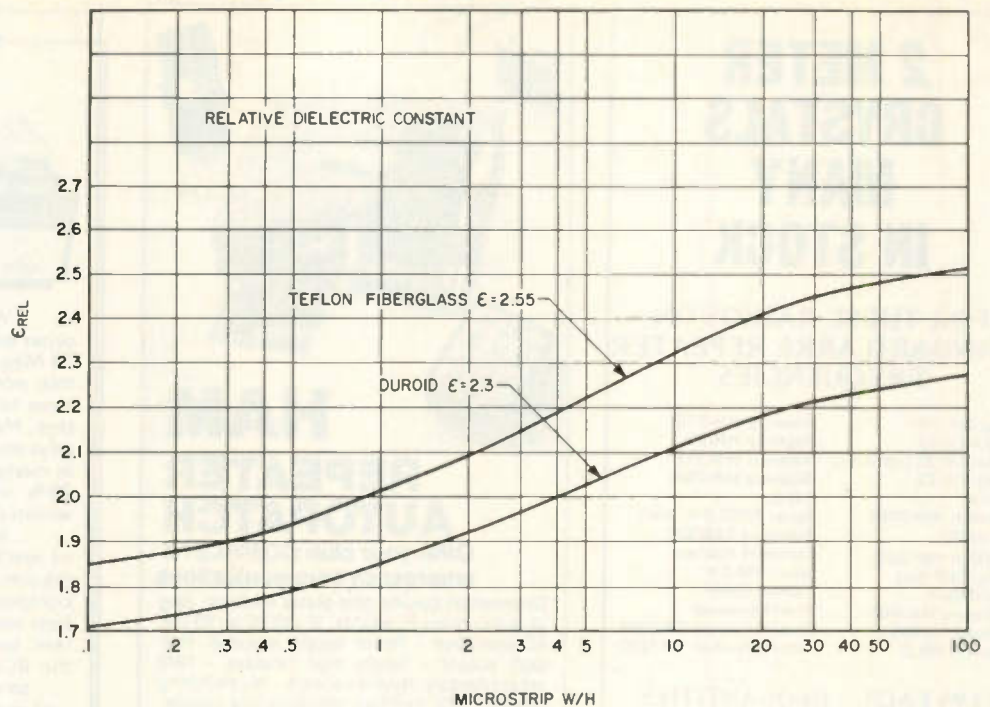

Fig. 5.

2 METER CRYSTALS MANY IN STOCK

FOR THESE RADIOS ON
STANDARD ARRL REPEATER
FREQUENCIES

Clegg HT-146	Regency HR-212
Drake TR-22	Regency HR-2B
Drake TR-33 (rec only)	Regency HR-312
Drake TR-72	Regency HR-2MS
Genave	S.B.E.
Heathkit HW-2021	Sonar 1802-3-4, 3601
(rec only)	Standard 146/826
Heathkit HW-202	Standard Horizon
Icom/VHF Eng	Swan FM 2X
Ken/Wilson	Tempo FMH
Lafayette HA-146	Trio/Kenwood
Midland 13-505	Trio/Kenwood TR2200
Regency HR-2	Trio/Kenwood TR7200

\$3.95 EACH - IN QUANTITIES
OF 10 OR MORE, \$3.50 EACH

Certified check or money order only -
NO CODs

ROLIN DISTRIBUTORS
P.O. Box 436 R15
Dunellen NJ 08812
(201)469-1219



HAM REPEATER AUTOPATCH

Offer your club **COMPLETE**
emergency communications

Commercial quality, gold plated contacts, plug in, epoxy glass PC boards. 12 volt DC or 115 volt AC operation - Power supply included. Four digit access - Single digit releases - field programmable. Hybrid network - No switching required. FCC certified telephone line coupler. Auxiliary "In Use" contacts supplied. Land line "call-in" signalling control contacts provided. Price complete \$498 + \$3 shipping & handling. Master Charge, Bank money order, or certified check acceptable.

Accessories: CES-300 powered tone pad - \$59 BUS-COM Soft-touch® telephone powered mike/pad element - \$34.95. M76

MONROE ELECTRONICS, INC.
412 Housel Ave., Lyndonville, N.Y. 14098

QUASAR VIDEO TAPE RECORDER SALE!

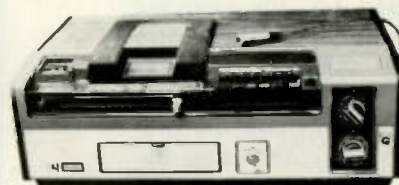

We are constantly testing ham and other electronic equipment for review in 73 Magazine. In order to be able to keep this not inexpensive project going we have to sell off the equipment used for test. Most of it has been used for a few days and is in every way as good as new. In many cases it is better than new since 95% of the equipment failures come within the first few hours of operation.

In this case we are running a series of tests of VTR systems, using them for regular, ham TV, SSTV, and even micro-computer programming tests. One of the best we've found so far is the Quasar system, but we still have to go on and test the RCA, JVC, and many other systems . . . so our Quasar is up for sale. We paid well over \$1,000 for the Quasar . . . used it for a few days and have gone on to test more systems.

Quasar VTR
System special like new \$675.
Quasar two hour cassettes,
each (new \$25) special like new \$12.50

Major Credit Cards Accepted.
73 Magazine • Peterborough NH 03458

Hey!
Something New

ARSON AUCTION

Bid by mail on the following new and used gear.

AUCTION ITEMS

1. Yaesu FT 301 S - new demo List \$559.⁰⁰
2. ICOM IC 245 - new demo List \$499.⁰⁰
3. Tempo FMH-2 Handi Talkie 4 sets xtals - new List \$249.⁰⁰
4. Collins Station - Excellent cond. used KWM-2 "wing" s/n 10410 with Waters & DX Eng. Proc. 516F-2 PM-2, 312 B-5, Spectronics DD-IC Dig. display bid on complete station only - subject to prior sale at asking price \$1295.⁰⁰
5. Heath Station - SB-102, SB-650 dig. display, SB-600 speaker, HP-23B P.S. Mint Condition Subject to prior sale at asking price of \$650.⁰⁰
6. Heath Station Accessories - SB-620 spec analyzer, SB-610 Scope, SB-630 Stat. Console HM-102 SWR Meter HM-2102 SWR Meter. Mint cond. Subject to prior sale at asking price of \$450.⁰⁰
7. Midland 13-510 with "PL" - Mint used. List \$430.⁰⁰

HOW TO BID

1. Enclose personal check in the amount of your bid and indicate which item bid is for.
2. Enclose complete shipping address (not P.O. Box) and mailing address.
3. Enclose phone number.
4. Enclose self-addressed stamped envelope.
5. Send to Arson Auction, Arson, Inc., 615 So. Gallatin Rd., Madison, Tennessee 37115.

TERMS OF AUCTION

1. Absolute Auction - sale to highest bidder.
2. Bids opened Oct. 23
3. Highest bid will be notified by phone that item is being shipped.
4. All checks for losing bids will be returned if you include S.A.S.E. - otherwise destroyed.
5. All sales final.
6. New items have 90 days manufacturer guarantee.
7. Used items 30 days guarantee.
8. Shipping will be collect.

Amateur Radio Supply of Nashville, Inc. A40

615 So. Gallatin Road, Madison, Tennessee 37115 Phone (615) 868-4956

NEW! MFJ INTRODUCES THE GRANDMASTER MEMORY KEYERS

At \$139.95 this MFJ-484 GRANDMASTER memory keyer gives you more features per dollar than any other memory keyer available — and Here's Why . . .

WEIGHT CONTROL TO PENETRATE ORM. PULL TO COMBINE MEMORIES A AND B FOR 1, 2, OR 3 FIFTY CHARACTER MESSAGES.

MESSAGE BUTTONS SELECT DESIRED 25 CHARACTER MESSAGES.

RESETS MEMORY IN USE TO BEGINNING.

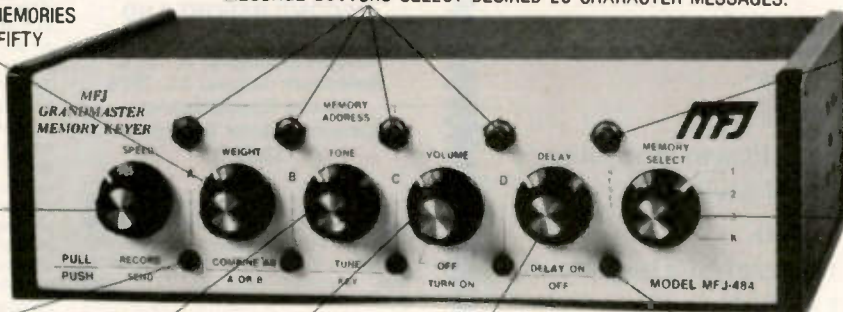

SPEED CONTROL, 8 TO 50 WPM. PULL TO RECORD.

MEMORY SELECT: POSITIONS 1, 2, 3 ARE EACH SPLIT INTO MEMORY SECTIONS A, B, C, D (UP TO TWELVE 25 CHARACTER MESSAGES). SWITCH COMBINES A AND B. POSITION K GIVES YOU 100, 75, 50, OR 25 CHARACTERS BY PRESSING BUTTONS A, B, C, OR D.

LEDs (4) SHOW WHICH MEMORY IS IN USE AND WHEN IT ENDS.

TONE CONTROL. PULL TO TUNE.

VOLUME CONTROL. POWER ON-OFF.

DELAY REPEAT CONTROL (0 TO 2 MINUTES). PULL FOR AUTO REPEAT.

LED INDICATES DELAY REPEAT MODE.

NOW YOU CAN CALL CQ, SEND YOUR QTH, NAME, ETC., ALL AUTOMATICALLY.

And only MFJ offers you the MFJ-484 Grandmaster memory keyer with this much flexibility at this price.

Up to twelve 25 character messages plus a 100, 75, 50, or 25 character message (4096 bits total).

A switch combines 25 character messages for up to three 50 character messages.

To record, pull out the speed control, touch a message button and send. To playback, push in the speed control, select your message and touch the button. That's all there is to it!

You can repeat any message continuously and even leave a pause between repeats (up to 2 minutes). Example: Call CQ. Pause. Listen. If no answer, it repeats CQ again. To answer simply start sending. LED indicates Delay Repeat Mode.

Instantly insert or make changes in any playing message by simply sending. Continue by touching another button.

Memory resets to beginning with button, or by tapping paddle when playing. Touching message button restarts message.

LEDs show which 25 character memory is in use and when it ends.

Built-in memory saver. Uses 9 volt battery, no drain when power is on. Saves messages in memory when power loss occurs or when transporting keyer. Ultra compact, 8x2x6 inches.

PLUS A MFJ DELUXE FULL FEATURE KEYER. Iambic operation with squeeze key. Dot-dash insertion.

Dot-dash memories, self-completing dots and dashes, jamproof spacing, instant start (except when recording).

All controls are on front panel: speed, weight, tone, volume. Smooth linear speed

control. 8 to 50 WPM.

Weight control lets you adjust dot-dash-space ratio; makes your signal distinctive to penetrate ORM.

Tone control. Room filling volume. Built-in speaker.

Tune function keys transmitter for tuning.

Ultra reliable solid state keying: grid block, cathode, solid state transmitters (-300 V, 10 ma. max., +300 V, 100 ma. max.). CMOS ICs, MOS memories. Use 110 VAC or 12 to 15 VDC. Automatically switches to external batteries when AC power is lost.

OPTIONAL SQUEEZE KEY for all memory keyers. Dot and dash paddles have fully adjustable tension and spacing for the exact "feel" you like. Heavy base with non-slip rubber feet eliminates "walking". \$29.95 plus \$2.00 for shipping and handling.



THIS MFJ-482 FEATURES FOUR 25 OR A 50 AND TWO 25 CHARACTER MESSAGES.

- Speed, volume, weight, tone controls
- Combine memory switch
- Repeat, tune functions
- Built-in memory saver

\$99⁹⁵



Similar to MFJ-484 but with 1024 bits of memory, less delay repeat, single memory operating LED. Weight and tone controls adjustable from rear panel. 6x2x6 inches. 110 VAC or 12 to 15 VDC.

THIS MFJ-481 GIVES YOU TWO 50 CHARACTER MESSAGES.

- Repeat function
- Tune function
- Built-in memory saver

\$79⁹⁵



Similar to MFJ-482 but with two 50 character messages, less weight controls. Internal tone control. Volume control is adjustable from rear panel. 5x2x6 inches. 110 VAC or 12 to 15 VDC.

For Orders Call toll-free **800-647-1800**

Order any product from MFJ and try it. If not delighted, return within 30 days for a prompt refund (less shipping).

Order today. Money back if not delighted. One year unconditional guarantee. Add \$2.00 shipping/handling. For technical information, order/repair status, in Mississippi, outside continental USA, call 601-323-5869.

Order By Mail or Call TOLL FREE 800-647-1800 and Charge It On



MFJ ENTERPRISES, INC.

P. O. BOX 494

M52

MISSISSIPPI STATE, MISSISSIPPI 39762

ZZZ ELECTRONICS, INC.



**Call Now For HAM
Prices**

**We Sell & Service
These Lines:**

ICOM	Ameco
KLM	SAY Power Supplies
Dentron	B&W Switches
SWAN	Shore
KDK2015R	Integrated Electronics
TenTec	LARSEN
Wilson	ADI Auto Dialers
Telex	PanaVise
Hustler	Amphenol
Mosley	Aluma Towers
Cushcraft	And Many More

**Special Prices On
These Items Now:**

ICOM 211	KLM 144-148-14
KDK 2015R	KLM 144-148-50
Ten Tec 570	RG8X COAX
Ten Tec 574	Dentron Big Dummy
Dentrol All Band	Dentron Jr. Monitor
Doublett	YAESU 7T101EE
SWAN TB4HA	ICOM 245SSB
SWAN TB3HA	SAY Elect. Power Supplies
Dentron MT2000A	KLM 2-25B
Dentron MT3000A	10' & 15' Roof Top TriPods
ICOM 1C215	
KLM 144-148-16	

We accept
MC & Visa & Interbank Cards
— will ship UPS C.O.D.
422 ARMOUR CIRCLE N E
ATLANTA GA 30324
(404) 876-0631
Come by or call
William/WA4SVY

FCC

Before the
Federal Communications
Commission
Washington DC 20554
In the Matter of
Deregulation of Part 97 of the
Commission's Rules regarding
emissions authorized in the
Amateur Radio Service
Docket 20777
RM-1429 RM-2163
RM-2170 RM-2330
RM-2429 RM-2507
RM-2545 RM-2550

**SECOND REPORT AND
ORDER**

Adopted: August 8, 1978;
Released: August 18, 1978
By the Commission:
Commissioner Washburn
absent.

1. A Notice of Proposed Rulemaking in Docket 20777, concerning the types of radio emissions that are permitted in the Amateur Radio Service, was released April 22, 1976, and published in the *Federal Register* on April 28, 1976 (41 FR 17789). A First Report and Order was released on March 10, 1977, and published in the *Federal Register* on March 15, 1977 (42 FR 14111). In the First Report and Order, the Commission adopted regulations regarding the purity of emissions in the Amateur Radio Service. The regulations adopted conformed to the international standards of emission purity. This Second Report and Order will deal with the major issue of Docket 20777, authorized bandwidth.

**WHAT DID THE COMMISSION
PROPOSE?**

2. The Notice of Proposed Rulemaking in Docket 20777 was concerned with the types of radio emissions that are permitted in the Amateur Radio Service. At present, when an amateur wishes to use a certain type of emission (such as telephony, telegraphy, or television) he must refer to the emissions table and see that he may use telephony in the 14.20 to 14.35 MHz range, but not in the 14.00 to 14.20 MHz range.

3. The Commission has received from the amateur community in the last few years a number of petitions which propose to enlarge the frequency ranges which are available for various types of emissions, or allow various kinds of emissions which are not specifically provided for in the amateur emissions table. Rather than deal with each suggested emission change individually, the Commission, in its Notice of Proposed Rulemaking in Docket 20777, proposed to delete the emissions table entirely, and substitute a table of maximum authorized bandwidths. A table of maximum authorized bandwidths would permit any type or mode of emission to be used by an amateur, so long as the occupied bandwidth of that emission did not exceed the limits on the bandwidth established for that frequency. For example, it was proposed that when using the frequency segment 28.50 to 29.70 MHz, the maximum authorized bandwidth would be 35 kHz. That means that any emission whatsoever would be permitted in that frequency range so long as the emission did not

occupy more than 35 kHz of the spectrum. It was felt that such a deregulation would provide the freedom for amateurs to experiment with many new and unusual emission types, or use well-known emission types in new areas of the spectrum.

WHAT DID THE COMMENTS SAY?

4. A total of 333 persons and 8 clubs filed comments. In addition, 23 petitions were filed as comments. Numerous commenters raised objections to our proposals. For example, the maximum bandwidth table, as proposed, would not permit any emission type whose bandwidth was greater than 3.5 kHz to be used below 28.5 MHz. This would have the effect of banning in the lower amateur bands the use of double sideband (AM) telephony, which requires 6 kHz. Although efficient use of the spectrum would be encouraged, the comments indicated that this rule change would force many amateurs to convert to new equipment at a very considerable expense. Additionally, the privilege to utilize any type or mode of emission carries with it the responsibility of accurately measuring the bandwidth of these. Many commenters argued that they would have to either build, or buy, the equipment necessary to measure their signal's bandwidth.

**WHAT ACTION IS THE
COMMISSION TAKING?**

5. The comments indicated that for the sizable portion of the amateur community who do not experiment, the present emissions table is preferable. Accordingly, the Commission will not adopt the proposed maximum bandwidth table. We are disappointed that the comments on our proposal were unfavorable, because we continue to believe deregulation is a sound idea. This proposed new bandwidth table would have given the Amateur Radio Service a new opportunity to fulfill one of its bases and purposes, "advancement of the radio art," by allowing the amateur the freedom to experiment with new emissions. However, many commenters disagreed with the bandwidth concept because of the added cost and responsibility they said it would place on amateurs. This loses sight of the concept that amateurs should be in the forefront of technical advancement, and that any attempt by the Commission to spur amateur experimentation will necessarily increase amateur responsibility. The Commission will continue to consider ways of introducing further deregulation and simplification in the Amateur Radio Service.

6. One major issue on which there was general agreement in the comments was the need for the Amateur Rules to be amended to permit the use of ASCII—the American National Standard Code for Information Interchange. At present, the use of ASCII is prohibited. Section 97.69 of the Amateur Rules, the Section governing radio teleprinter signals, permits the use of the Baudot code only. In the Notice of Proposed Rulemaking in this proceeding, the Commission proposed to delete Section 97.69, thereby giving amateurs the freedom to choose any type of radio teleprinter code so long as the signal used was kept within the proposed maximum bandwidths. This proposal brought many favorable comments



because such action would make the use of ASCII permissible for amateurs. We agree that ASCII should be an authorized emission for amateur radio stations. However, because we are not adopting the proposed maximum authorized bandwidth table, it may be necessary to introduce certain technical standards concerning the use of ASCII. Since technical standards have never been the subject of public commenting, we feel it would be inappropriate to adopt ASCII standards without further public input. Therefore, the Commission today is adopting a Further Notice of Proposed Rulemaking in Docket 20777 to consider the appropriate standards for the use of ASCII in the Amateur Radio Service.

7. Finally, we are dismissing with this Report and Order those rulemaking petitions associated with this docket which deal with the authorized emissions portion of this pro-

ceeding. In addition, two rulemaking petitions not originally associated with this docket are being dismissed because the issues they raise are addressed by this docket. RM-2076, submitted by George Bonadio, would authorize simultaneous voice and facsimile transmissions in all amateur subbands in which A3 and F3 emissions are permissible. RM-2770, submitted by Mr. Robert J. Roehrig of Batavia, Illinois, petitions for free experimentation with all emissions in amateur radio within properly set bandwidth limitations.

8. Accordingly, in view of the foregoing, IT IS ORDERED that RM-1429, RM-2163, RM-2076, RM-2170, RM-2330, RM-2507, and RM-2770, RM-2545 to the extent that these petitions have not been granted, ARE DISMISSED. IT IS FURTHER

ORDERED that this proceeding IS CONTINUED.

FEDERAL COMMUNICATIONS COMMISSION
William J. Tricarico
Secretary

Before the
Federal Communications
Commission
Washington DC 20554
In the Matter of
Deregulation of Part 97 of the
Commission's Rules regarding
emissions authorized in the
Amateur Radio Service

Docket 20777
RM-2429
RM-2550
RM-2771

NOTICE OF INQUIRY AND
FURTHER NOTICE OF
PROPOSED
RULEMAKING
Adopted: August 8, 1978;
Released: August 18, 1978
By the Commission:
Commissioner
Washburn absent.

1. The Commission gives notice that it proposes to authorize the use of the American National Standard Code for Information Interchange

CHICAGOLAND

See us for Integrated Circuits,
Transistors, Resistors, Capacitors,
Heat Sinks, Edge Connectors, Leds,
etc., etc.

Authorized Distributors For:
Continental Spec. (Breadboarding
Devices)

Datak Corp. (Photo Etch Supplies)
Vector Electronics (Perf Board)
OK Machine (Wire Wrap Supplies)
E-Z Hook (Test Clips and Jumpers)

Visit our Retail Store, Open Daily at 10:A.M.

MINI DIP SLIDE SWITCH

7 Switches — \$1.50
5/\$7.00

This offer good thru
12/31/78.

Reg. price—\$1.65 ea.



47.6 MFD-4500VDC CAPACITOR

Ideal for linear power
supplies. De rate to approx.
2750VDC for continuous duty.

Mfd: Cornell-Dubilier

Ship: Wt. 28 lbs.

Dim: 12½"H x 8"W x 4"D

\$30.00 ea. 2/\$55.00



HEAT SINKS

6030 B—Vertical Board
Mount For TO-220
Devices.

6/\$1.00



6010 B—For 14 &
16 Pin DIP IC's

10/\$1.00

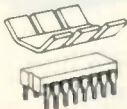

All Merchandise New and 100% Guaranteed.
Please include shipping charges with your order.

R. W. ELECTRONICS, INC.

3203 North Western Avenue

Chicago, Illinois 60618

312-248-2480

R18

BEWARE!!

Aluminum towers are not usually as strong as steel towers — ask for engineering facts before purchasing any tower. Aluminum towers, in most cases, are one-half as strong as steel towers within the same price range.

Notice Paid For By Unarco-Rohn U2

(Advertisement)

(ASCII) in the Amateur Radio Service.

WHAT IS THE BACKGROUND OF THIS PROCEEDING?

2. In the Notice of Proposed Rulemaking in this proceeding, released April 22, 1976, and published in the *Federal Register* on April 28, 1976 (41 FR 17789), the Commission proposed to substitute a maximum authorized bandwidth table for the

present emission table in the amateur rules. This would mean that instead of limiting the types of emissions an amateur could use to the types listed in the emissions table, an amateur might use any type of emission so long as the occupied bandwidth of the emission was within the maximum bandwidth proposed for the particular frequency being used. As part of that original proposal, the

Commission also proposed to remove all rules concerning radio teleprinter signals, proposing to give amateurs the freedom to choose any type of radio teleprinter code so long as the signal was kept within the proposed maximum bandwidth.

3. In the Second Report and Order in this proceeding adopted today, the Commission decided not to adopt the proposed maximum authorized band-

width table, but noted that the proposal to remove the rules concerning radio teleprinter signals had met with a very favorable response mainly because that action would make it possible for amateurs to use a code of information interchange known as ASCII. The Commission felt that ASCII should be authorized for amateur radio operators, but that to adopt a rule with specific ASCII standards would be inappropriate because no standards for ASCII were proposed in the original docket (the proposal, as stated above, was simply to delete the rule section on radio teleprinter signals), and no opportunity for commenting on specific ASCII standards was given the public. We are, therefore, in this combined Notice, addressing this topic of ASCII standards for Rule Part 97.

WHAT IS ASCII?

4. ASCII is a code for the exchange of information. It stands for the American National Standard Code for Information Interchange. Each character in the code is comprised of seven binary data bits, each bit being either "0" or "1". For example, 0100101 represents the character "R" in ASCII.

5. At present, the use of ASCII is not permissible in the Amateur Radio Service. Section 97.69(a) of the Amateur Rules requires that the transmission of radio teleprinter signals must be done by means of "a single channel five-unit (start-stop) teleprinter code." This is the Baudot code, which is the only code recognized by the Commission for amateur transmissions. In recent years, however, ASCII has replaced the Baudot code as the most popular code for information exchange in use today. Its popularity is due in part to the fact that a seven-unit code has a capacity for 128 different characters ($2^7 = 128$), whereas Baudot, a five-unit code, is limited to 32 characters ($2^5 = 32$), or 64 characters when upper and lower case characters are used. ASCII has been officially adopted by the National Bureau of Standards as the standard code for information interchange in the United States. The comments we received in response to our proposal to deregulate the amateur rules on radio teleprinter signals centered almost exclusively on the practical effect that this would make ASCII available for use by amateurs.

10 thru 80 the easy way !!!

"BIG SIGNAL" W2AU BALUN * "OLD RELIABLE" W2VS ANTENNA COILS * ANTENNA KIT

These two old friends* get together with 120 feet of high quality #14-7 strand copper antenna wire and a pair of "END-SULATORS" end insulators to create a superior 80 through 10 meter. 108 foot long, full power (1,000 watts/2,000 watts P.E.P.) antenna. Instructions included. Price \$48.25 plus \$1.00 handling charge. In Calif. add 6% sales tax. Mastercharge & Visa accepted.



Order from: S-F AMATEUR RADIO SERVICES

4384 KEYSTONE AVE., CULVER CITY CALIFORNIA 90230 Ph. (213) 837-4870

ALL BAND TRAP ANTENNAS!



PRETUNED - COMPLETELY ASSEMBLED - ONLY ONE NEAT SMALL ANTENNA FOR UP TO 6 BANDS! EXCELLENT FOR CONGESTED HOUSING AREAS - APARTMENTS LIGHT - STRONG - ALMOST INVISIBLE!

FOR ALL MAKES & MODELS OF AMATEUR TRANSCEIVERS - TRANSMITTERS - GUARANTEED FOR 2000 WATTS SSB 1000 WATTS CW. FOR NOVICE AND ALL CLASS AMATEURS!

COMPLETE AS SHOWN with 90 ft. RG58U-52 ohm feedline, and PL259 connector, insulators, 30 ft. 300 lb. test dacron end supports, center connector with built in lightning arrester and static discharge - molded, sealed, weatherproof, resonant traps 1" X 6" - you just switch to band desired for excellent worldwide operation - transmitting and receiving! WT. LESS THAN 5 LBS.

80-40-20-15-10 bands 2 trap --- 102 ft. with 90 ft. RG58U - connector - Model 998BU .. \$49.95
40-20-15-10 bands 4 trap --- 54 ft. with 90 ft. RG58U coax - connector - Model 1001BU .. \$48.95
20-15-10 bands 2 trap --- 26 ft. with 90 ft. RG58U coax - connector - Model 1007BU \$47.95

SEND FULL PRICE FOR POST PAID INSURED DEL. IN USA. (Canada is \$5.00 extra for postage - clerical - customs - etc.) or order using VISA Bank Americard - MASTER CHARGE - AMER. EXPRESS. Give number and ex. date. Ph 1-308-236-5333 9AM - 6PM week days. We ship in 2-3 days. PRICES MAY INCREASE SO - ORDER NOW AND SAVE! All antennas guaranteed for 1 year. Money back trial! Made in USA. FREE INFO. AVAILABIE ONLY FROM.

WESTERN ELECTRONICS

Dept. A7-10

Kearney, Nebraska, 68847

NEW!

\$36.50

plus \$1.50 s/h
NY res. add tax



FEATURES: CMOS ELECTRONIC KEYS

- State-of-the-art CMOS circuitry
- Self completing dots and dashes
- Dot and dash memory
- Iambic keying with any squeeze paddle
- 5-50 WPM
- Speed, volume, tone controls, side tone and speaker
- Low current drain CMOS-battery operation
- Deluxe quarter-inch jacks for keying and output
- Handsome eggshell white base—woodgrain top
- Compact and portable—1-7/8 x 4-1/4 x 6-1/4
- Grid block keying
- Wired and tested—fully guaranteed—less battery

BRAND NEW!

\$25.95

plus \$2.00 s/h
NY res. add tax



FEATURES:

- Twin paddle squeeze key
- Extra heavy base—non skid feet
- Adjustable contact spacing
- Touch tension—comfort keying
- Smooth friction free paddle movement
- Handsome crinkle finish base and rich red paddles
- Five way binding posts
- Use with TRAC CMOS keyer or any keyer

TRAC - KEY

T18 TRAC

ELECTRONICS, INC
1106 RAND BLDG.
BUFFALO NY 14203

BOARDS INSIDE CABINET

- 1 CARR OSC unit
- 2 VOX unit
- 3 AF unit
- 4 IF unit
- 5 Filter unit
- 6 Noise Blanker/RF Processor
- 7 Rectifier unit
- 8 Rectifier unit
- 9 Power XFMR
- 10 Final Amplifier unit
- 1 VCO unit
- 2 TUNE control
- 3 PLL unit
- 4 RF unit
- 5 Counter Display unit
- 6 FM unit

FT-901DM

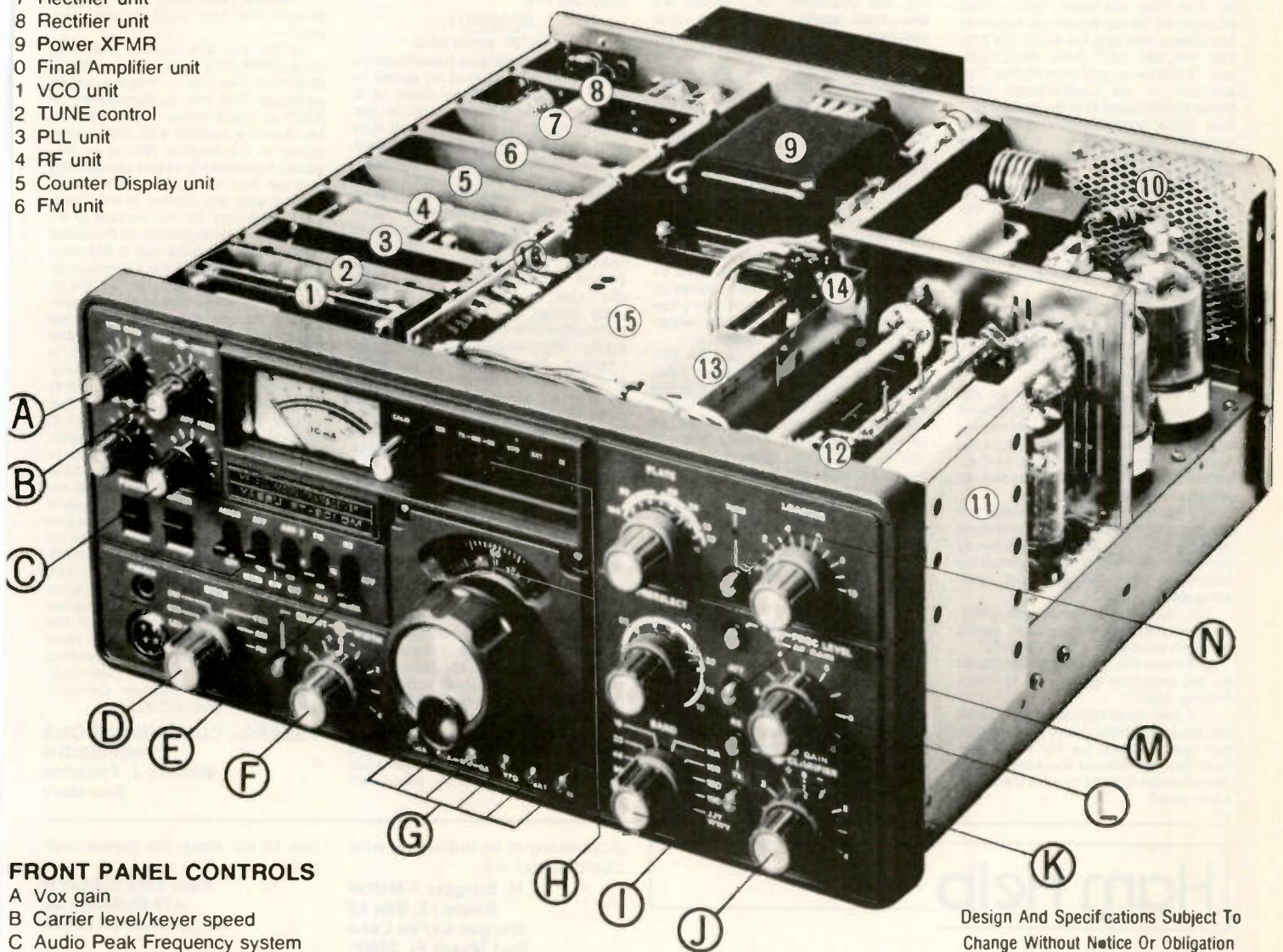

FRONT PANEL CONTROLS

- A Vox gain
- B Carrier level/keyer speed
- C Audio Peak Frequency system
- D MODE switch (SSB, CW, FSK, AM, FM)
- E Crystal calibrator/Noise blanker
- F Rejection tuning/variable IF passband tuning
- G Frequency memory system
- H Digital plus analog frequency readout
- I Band switch (160-10 meters + WWV/JJY receive)
- J Clarifier control
- K RX/TX Clarifier selector
- L RF Processor level
- M RF attenuator
- N TUNE control (Places transmitter in "TUNE" condition for ten seconds, then returns to "receive" condition to protect final tubes from excessive key-down time)

Design And Specifications Subject To Change Without Notice Or Obligation



THE SYMBOL OF TECHNICAL EXCELLENCE

YAESU The smart radio

1C78



YAESU ELECTRONICS CORP., 15954 Downey Ave., Paramount, CA 90723 (213) 633-4007
YAESU ELECTRONICS CORP., Eastern Service Ctr., 613 Redna Ter., Cincinnati, OH 45215

WHAT STANDARDS ARE WE CONSIDERING?

6. *Data Transmission Rate.* One of the main differences between ASCII and Baudot is that ASCII is commonly sent at speeds far greater than Baudot. In ASCII and in Baudot, the baud is the rate of data transmission, and represents the number of data bits sent in one second. The four standard baud rates recognized by the Commission for amateur Baudot are 45, 50, 56.25, and 75 baud. In contrast to this, the standard baud rates recognized by the American National Standards Institute for ASCII are 110, 150, 300, 600, 1200, 2400, 4800, 9600, and 19,200 baud, and even higher. The concern of the Commission with these higher speeds is the bandwidth that these transmissions would occupy. The questions which the Commission would like the comments to address are:

a. Should technical limitations be placed on the use of ASCII in the Amateur Radio Service?

b. If yes, should limitations be placed by reference to occupied bandwidth? data transmission rate? emission type?

c. If limitations are placed on the bandwidth that a transmission using ASCII occupies, what should the maximum bandwidth be for each amateur frequency band?

d. If limitations are placed on the data transmission rates, should there be standard operating speeds similar to those established by the American National Standards Institute, or maximum speeds (such as "a speed no greater than 3000 baud")?

e. If standard operating speeds are required, what should be the standard speeds for each amateur frequency band? What should the permissible tolerance from the standard operating speeds be?

f. If maximum speeds are used, what should be the maximum speed for each amateur frequency band?

g. Should any limitations be placed on the emission types used in transmitting ASCII?

h. If yes, what should the permissible deviation from the mark signal to the space signal be for frequency-shift keying? Should the permissible deviation be related to data transmission rates?

i. What should the highest permissible fundamental modulating audio frequency be for A2 or F2 emissions? Should this standard be related to data transmission rate?

7. *Use of Parity Bit.* ASCII itself is merely a seven-unit code, but the method of sending that code can vary in a number of ways. The first way it can vary is in the use of a parity bit. A parity bit is sometimes employed to assure that each character sent is received correctly. For example, taking the character "R", which we described above as 0100101, and assuming the two parties to the communication have agreed that the parity bit shall be "even," the person sending the character "R" will also send an eighth bit, a parity bit, and the transmission will look like this: 01001011. Because the two parties agreed that parity would in this case be "even," the receiver of the communication would see that the number of data bits represented by the number "1" was even, and that the character was received correctly. If, for some reason, the parity bit made the number of data bits represented by the number "1" odd, the receiver of the communication would recognize that there was a mistake in the reception of that particular character.

8. In using the parity bit, the two parties to the communication have the option of determining whether the parity bit shall be "even" or "odd." The two parties could also agree not to send a parity bit. Finally, the two parties could agree to send an eighth signal bit, most commonly "0", which would not be used as a parity bit. This would not aid accuracy, but would be necessary if the receiver of the message is expecting an eight-unit code. The questions which the Commission would like the comments to address is:

j. What standards, if any, on the use of parity should be adopted for amateur use of ASCII?

9. *Synchronous-asynchronous.* ASCII may be sent either in a synchronous mode or an asynchronous mode. Either mode is designed to tell the receiving station when information is about to be sent. In an asynchronous transmission, there is a bit added to the beginning and end of each character. The bit added to the

beginning of the character, most commonly "0", is the start bit, and tells the receiving station that a character code will follow. The bit added to the end of the character, most commonly "1", is the stop bit, and tells the receiving station to end operation until it gets another start bit. Each character therefore, in an asynchronous transmission, is sent in a 10 bit code.¹ For example, the character "R", using even parity and an asynchronous transmission, now looks like this:

0010010111
start "R" parity stop

10. In a synchronous transmission, there is no start or stop bit added to each character. Rather, there is a start character which is sent at the beginning of the message, and it is followed by a steady stream of data bits until a stop character is transmitted telling the receiving station the message is ended until another start character is sent. Because the receiving station was synchronized with the sending station by the start character, it can break down the data stream which followed the start character into segments of eight units (seven units plus parity) for translation into characters and, eventually, the information being exchanged. The successful transmission of the data, therefore, depends on the two stations being synchronized by the start character. The question which the Commission would like the comments to address is:

k. Should both asynchronous and synchronous transmission be authorized for amateur use of ASCII?

11. *Least Significant Bit-Most Significant Bit.* Within any one character the bits are identified by b7, b6 . . . b1, where b7 is the highest order, or most significant bit, and b1 is the lowest order, or least significant bit. The most common method of sending data bits is in the order of least significant bit to most significant bit. It is conceivable, however, that two stations might make a different arrangement and send the

¹Sometimes 11 bits are used, where, to ensure accuracy in an asynchronous transmission, two stop bits are sent at the end of each character.

data bits in a different order. For example, the character "R" which we have been following is 0100101 in the order of least significant bit to most significant bit, but becomes 1010010 in the order of most significant bit to least significant bit. A station not expecting a deviation from the commonly used order of transmitting data bits would not be able to translate the message. The question which the Commission would like the comments to address is:

l. Should standards be adopted determining the order of the data bits?

12. We are associating with this docket RM-2771, submitted by Bruce Brown of Alexandria, Virginia, which petitions for the authorization of ASCII in the Amateur Radio Service. Mr. Brown's petition was filed subsequent to the original Notice of Proposed Rulemaking in this proceeding and we find it appropriate to associate it with this docket at this time.

13. Authority for our Notice of Inquiry and Further Notice of Proposed Rulemaking is contained in Sections 4(i), 303, and 403 of the Communications Act of 1934, as amended. We invite interested parties to submit comments concerning the proposal and/or inquiry on or before November 15, 1978, and reply comments on or before December 15, 1978. An original and five copies of all comments and reply comments shall be furnished the Commission, pursuant to Section 1.419 of the Rules. Respondents wishing each Commissioner to have a personal copy of the comments may submit an additional six copies. Members of the public wishing to express interest in our proposals but unable to provide the required copies may participate informally by submitting one copy of their comments, without regard to form, provided the correct docket number is specified in the heading of the comments. All comments and reply comments filed in this proceeding should be sent to the Secretary, Federal Communications Commission, Washington DC 20554.

FEDERAL COMMUNICATIONS COMMISSION
William J. Tricarico
Secretary

Ham Help

Is there a company or a known individual who can or will custom-design a solid state circuit for a person such as myself for either their own use or for a possible future patentable idea/design? I am one of the "tube-type" school

who quit design and application when s/s was beginning, and, try as I will, I just cannot use it. The devices or circuits are not complicated or unusual, but they are beyond my knowledge.

I would appreciate it greatly if anyone could advise me as to

a company or an individual who could assist me.

J. H. Burgess K4HNW
Route 13, Box 42
Morgan LaFee Lane
Fort Myers FL 33901

like to increase the power output.

Paul Ellis WA6JVH
419 Bellevue St.
Santa Cruz CA 95060

I am trying to obtain the schematic and service manual for an HW-7/HW-8.

Wieslaw Dyduch SP1EYG
PL-70 965 Szczecin-5
Box 91
Poland

Social Events

EBENSBURG PA OCT 1

The Conemaugh Valley Amateur Radio Club and the Laurel Mountain VHF Society will hold its annual hamfest on Sunday, October 1, 1978, at the Ebensburg Fairgrounds in Ebensburg, Pennsylvania.

Food and refreshments will be available as well as large outdoor and indoor flea markets and displays with ample parking. There will be terrific prizes and a nominal admission charge. For information, contact David Knepper W3BJZ, Box 43, Sidman PA 15955.

WARRINGTON PA OCT 1

The Mt. Airy VHF Radio Club (the Packrats) will hold Hamarama 78 on Sunday, October 1, 1978, 8:00 am to 4:00 pm, rain or shine; registration \$2.00, tailgating \$2.00/space (bring your own table). Talk-in on 146.52 MHz. Advance registration to the Mid-Atlantic States VHF Conference includes admission to Hamarama 78. For information, contact Ron

Whitset WA3AXV, Chairman, PO Box 353, Southampton PA 18966; (215)-355-5730.

BERRIEN SPRINGS MI OCT 1

The Blossomland annual fall Swap-Shop will be held Sunday, October 1, 1978, at the Berrien County Youth Fair Grounds, Berrien Springs, Michigan. There will be large and convenient facilities, prizes, refreshments, and fun.

Announcing



HENRY RADIO'S 1KD-5

A BRAND NEW MEMBER OF THE FAMOUS HENRY RADIO FAMILY OF FINE AMPLIFIERS

The 2KD-5 and 2K-4 linear amplifiers completely fulfill the needs of discriminating amateurs who want the very best and are willing to pay the price. But we have long felt that many amateurs would be satisfied with less power if they could still have the same high quality and dependability.

The 1KD-5 fulfills that need beautifully.

- Quality that is unmatched in any other linear in its class. The same high standards of engineering and construction as the 2KD-5 and 2K-4. Heavy duty components guarantee years of trouble free, dependable performance.
- Smaller and lighter. Weighs about 27 pounds less... easier to take along on vacation trips and DXpeditions.
- Less expensive. If your budget is limited, but you still want a GOOD quality linear to kick your signal way up, with sharp, clear signals, the 1KD-5 will give you just about everything you want... and without sacrificing quality.

GENERAL INFORMATION

The 1KD-5 is a 1200 watt PEP input (700 watt PEP nominal output) RF linear amplifier, covering the 80, 40, 20 and 15 meter amateur bands. (10 meters on units shipped outside the U.S.)

Tube Complement: Eimac 3-5000Z glass envelope triode operating in a grounded grid circuit.

ALC Circuit: ALC Circuit to prevent overdrive from high power exciter, also boosts average talk power.

Type of Emission: SSB, CW, RTTY or AM

Antenna Relay: DC relay system for hum-free operation, requires shunting contact to ground during transmit to key amplifier into transmit.

Power Output Indicator: Self-contained relative RF power meter.

Tank Circuit: Pi-L place circuit with a rotary silver plated tank coil for greatest efficiency and maximum attenuation of unwanted harmonics.

Input Circuits: Cathode Pi input matching circuits for maximum drive and linearity.
Power Supply: Conservative power supply with solid state rectifiers for reliable, long term operation.

Dimensions: 8.75" high x 14" wide x 15" deep.

Weight: 48 pounds.

Price \$695.00

2K-4 floor console linear amplifier... still the "workhorse" of Amateur Radio. Engineering, construction and features second to none. Provides a long life of reliable service while its heavy duty components allow it to loaf along at full legal power. \$1095.00

2KD-5 desk model linear amplifier... lighter, more compact and less expensive, but still a heavy duty, high quality linear that will operate at full legal power month after month for years to come. \$895.00

Tempo 2002 amplifier for 2-meter operation. 2000 watts PEP input on SSB or 1000 watts input on FM or CW. \$745.00

Tempo VHF/UHF solid state power amplifiers for use in most land mobile applications. Call or write for list of models available.

Tempo 100AL10 VHF linear amplifier. Power output of 100 watts (nom.) with only 10 watts (nom.) in. \$209.00

3K-A linear amplifier (for export and military use only) Superior quality, extremely reliable. At least three kilowatt PEP input on SSB... 2000 watt PEP output. \$1495.00

4K-ULTRA linear amplifier (for export and military use only) For the most demanding operation... SSB, CW, FSK or AM. For general coverage operation from 3.0 to 30 MHz, but can be modified for operation on frequencies up to 100 MHz. 100 watts drive delivers 4000 watts PEP input. \$3250.00

All of the above except the 2002, 3K-A & 4K-ULTRA are available at Tempo dealers throughout the U.S.

11240 W. Olympic Blvd., Los Angeles, Calif. 90064 213/477-6701
931 N. Euclid, Anaheim, Calif. 92801 714/772-9200
Butler, Missouri 64730 816/679-3127

Henry Radio

H3

Prices subject to change without notice.

Open all night for set up. Table space restricted to radio and electronic items. Advance ticket donation is \$1.50; tables \$2.00. Talk-in on .22/.82 and .94. For further info, write John Sullivan, PO Box 345, St. Joseph MI 49085. Make checks payable to Blossomland Hamfest.

LANSING MI OCT 1

The Central Michigan Amateur Radio Club and the Lansing Repeater Association will hold a Swap and Shop on Sunday, October 1, 1978 at the Grand Ledge High School, 950 Jenne Street, Lansing, Michigan. The school is located 6 blocks north of M-43, 7 miles west of Lansing. There will be prizes and also food and tables available. Talk-In on .34/.94 and .22/.82. For additional information, contact the Lansing Repeater Association, PO Box 10073, Lansing MI 48901, or phone (517)-321-2765.

BLUEFIELD WV OCT 5

On Thursday, October 5, 1978, the Office of Continuing Education and Department of Computer Science at Bluefield State College will sponsor southern West Virginia's first seminar and exhibition of the business and engineering application of mini/microcomputers. The seminar will be conducted by Mr. William Parks, of Walters State Community College, and members of our own computer science staff. Plans are being made to host approximately 20 exhibitors, although more will be welcomed. The seminar will be conducted in the morning and afternoon, while the exhibit will be open in the afternoon and evening. There is a \$15.00 fee for both seminar participants and exhibitors. For further information, contact Dr. Alvin Hall, Director of Continuing Education, Bluefield State College, Bluefield WV 24701, or phone (304)-325-7102.

SYRACUSE NY OCT 7

The Radio Amateurs of Greater Syracuse (New York) will host their 14th annual hamfest at the New York State Fair Grounds, Arts and Home Center, Syracuse NY, on Saturday, October 7, from 9 am to 6 pm. There will be exhibitor booths, indoor and outdoor flea markets, awards, films, an organ concert, and ladies' programs. Refreshments available on the grounds. Tickets before October 1st are \$1.50, or \$2.00 at the gate. Children under age 12 are free. Overnight and trailer parking is available. Talk-in on 90/30-31/91. For

tickets or information write R.A.G.S., PO Box 88, Liverpool NY 13088.

ASHEVILLE NC OCT 7

The Western Carolina Amateur Radio Society, Inc., is pleased to announce the all new Asheville Autumnfest, which takes on an entirely new look this year. It will be held on Saturday, October 7, 1978, at the Asheville Civic Center, with all activities, dealers, displays, and flea market areas, indoors. There will be some form of social activity in the Civic Center Saturday evening, after the normal hamfest activities. For further information, contact Carl E. Smith N4AA, PO Box 1488, Asheville NC 28802.

GAITHERSBURG MD OCT 8

The Foundation For Amateur Radio will hold its annual hamfest at the Gaithersburg Fairgrounds, Gaithersburg, Maryland, on Sunday, October 8, 1978. Featured are a large flea market, food service, exhibits, ladies' events, supervised children's program, and many prizes. Main events are all indoors and will be held rain or shine. Picnic grounds and free parking available. Participation fee is \$2.00. Sales space for flea market is \$5.00 per space on a first-come basis; commercial exhibitors \$15.00 each space with pre-registration required prior to October 4th. Talk-in will be provided, and nearby motel rooms available. For information, write or call Ron Levin W3GBU, 802 Greenview Court, Reisterstown MD 21136; (301)-833-1816.

CEDAR RAPIDS IA OCT 8

The Cedar Valley Amateur Radio Club annual hamfest will be held on Sunday, October 8, 1978. Top prize is a new Drake TR-7/DR-7 transceiver and power supply. Other prizes include a Heathkit HW-8, a Clegg FM-76, and much more. There will be technical talks and movies all day. Manufacturers and dealers are welcome, with Saturday afternoon setup available. Talk-in on 146.16/76, 146.52, 223.5, and 3.970 MHz. Advance tickets are \$1.50; \$2.00 at the door. For complete information, write CVARC Hamfest, Box 994, Cedar Rapids IA 52406.

LEAGUE CITY TX OCT 8

The Tidelands Amateur Radio Society will hold its Hamfest '78 on Sunday, October 8, 1978, at Galveston County Park in League City,

Texas (approximately 25 miles south of downtown Houston) from 9:00 am to 4:00 pm. Those individuals who are participating with exhibits, booths, etc., may construct them on Saturday, October 7, from noon until the following day. Individuals will be present overnight to protect equipment and exhibits. Drawings will be held for various prizes throughout the day of the hamfest. For more information, contact Michael Sandberg WD5CHJ, 2317 Pecan, Dickinson TX 77539 or phone (713)-534-6656.

YONKERS NY OCT 8

The Yonkers Amateur Radio Club will hold its second annual hamfest on Sunday, October 8, 1978, 9:00 am to 6:00 pm, at Cook Field in Yonkers, New York. Admission is \$3.00 for sellers and \$1.00 for buyers. There will be picnic and sanitary facilities available as well as recreation for the kids. Bring your own table. There will be an extensive menu. There will be a general auction at 2:00 pm and many dealer displays and planned events. Talk-In on 146.265/.865 and .52. For advanced registration or further information, contact Otto Supliski WB2SLQ, 53 Hayward St., Yonkers NY 10701; (914)-969-1053.

DALLAS TX OCT 12-14

The Medical Amateur Radio Council (MARCO) will hold its 12th International Meeting on October 12-14, 1978, at the Fairmont Hotel, in Dallas, Texas. MARCO is a worldwide organization of medical and other interested people with a common interest in communications and electronics, namely, amateur radio. The purposes of MARCO include the exchange of scientific and technical information among its members and providing communications to remote areas in times of natural disaster or other emergency situations where medical consultation is needed. The meeting in Dallas will focus on the practical role computers can play in day-to-day medical practice and post-graduate education. Also, the use of space satellites in the exchange of biomedical information will be introduced. Practical live demonstrations will be given using OSCAR and the Communications Technology satellite. The meeting will be held in conjunction with the University of Texas Health Science Center, the A. Webb Roberts Center for Continuing Medical Education, and Baylor Medical Center. Continuing medical education credits will

be available to doctors needing them. MARCO membership is not required for attendance at the meeting. Registration information may be obtained from Mervin Grossman, M.D., PO Box 18114, Dallas TX 75218.

LONDON ONT OCT 13-15

The London Amateur Radio Club will hold the most exciting R.S.O. convention ever on October 13, 14, 15. Every aspect of amateur radio activities will be represented, from antique radio displays right through to moon shots and TV. But, best of all, just wait until we can let you in on the lineup of prizes for attending! Drawings will be frequent and worthwhile. The R.S.O. convention will be held at the Holiday Inn (downtown) in London on October 13, 14, and 15, 1978.

KANSAS CITY MO OCT 13-15

The MO-KAN Council of Amateur Radio Clubs is pleased to present the ARRL Midwest Division Convention to be held Friday through Sunday, October 13-15, 1978, at the Kansas City Hilton Airport Plaza Inn, 8801 N.W. 112. Happenings include ham sessions, dignitaries, exhibits, a ladies' program, dinner theater, and a fashion show. There will be a Saturday night banquet (\$12.00/person). Make reservations directly with the hotel. Mention ARRL discounted rates. Lend your support with a \$3.00 pre-registration. Mail checks to the MO-KAN Council of Amateur Radio Clubs, PO Box 704, Kansas City MO 64141.

WASECA MN OCT 14

The Viking Amateur Radio Society will hold its 8th annual swapfest on Saturday, October 14, 1978, at Waseca High School, from 9:00 am to 4:00 pm. For further information, contact VARS, Box 3, Waseca MN 56093.

EAST RUTHERFORD NJ OCT 14

The Knight Raiders VHF Club will hold its auction and flea market on Saturday, October 14, 1978, beginning at 10:00 am, at St. Joseph's Church, East Rutherford, New Jersey. Free parking and admission. Refreshments will be available. Tables are \$5.00/full table and \$3.00/half table in advance; \$6.00/full table and \$3.50/half table at the door. Talk-in on 144.65/145.25 and 146.52. For further information, contact Bob Kovaleski (201)-473-7113 or Bob Czyzewski (201)-791-5651. For reservations, make checks payable to Knight Raiders VHF

Club, Inc., PO Box 1054, Passaic NJ 07055.

MEMPHIS TN OCT 14-15

The annual Memphis Hamfest will be held on October 14-15, 1978, at the Mid-South Fairgrounds, in the Youth Center Building, in Memphis, Tennessee. Activities include a flea market and exhibition area (both inside and air-conditioned), the traditional hospitality party, and a tour of Elvis's Graceland Mansion for the ladies. There will be many prizes, including a Drake TR-7. There is plenty of free parking and trailer hookups are also available. Registration is \$3.00 per person over 14. Tables are \$3.00 per day. Talk-in on .34/.94 and .04/.64. For tickets and flea market reservations, write Greater Memphis Hamfest, PO Box 3845, Memphis TN 38103.

FAIRFIELD NJ OCT 14

The Livingston Amateur Radio Club will hold its annual flea market on Saturday, October 14, 1978, 10:00 am to 4:00 pm, at the Fairfield United Methodist Church, Fairfield, New Jersey. The church is located at the corner of Plymouth and Horseneck Rd., close to Route 80 and one long block in from Route 46. Admission is free. Sellers' fee is \$4.00 per car space. Refreshments will be available. For information, contact LARC, 116 Orton Rd., W. Caldwell NJ 07006; (201)-226-7943.

BOXBOROUGH MA OCT 14-15

The New England ARRL Convention has moved from Boston to Boxborough, Massachusetts, on Route 495, Exit 28. There will be a large flea market inside and outside, free parking, 50 booths by the leading exhibitors of amateur gear and accessories, and seminars on both days. Special YL programs include a fashion show, brunch, and a bus tour of Lexington and Concord. Saturday night there will be a prime-rib banquet, nightclub show, and dancing. The prize program has been altered so that awards will be made both days. FCC exams will be given Saturday only and only by appointments, with correctly filled out 610 forms received by September 20 by the exam chairman: K1LJN, 40 Isabella St., Stoneham MA 02180. No exceptions—FCC rules. There will be a bus tour to the ARRL headquarters in Newington Saturday morning leaving the convention at 10:00 am (price to be announced). Early-bird registration \$4.00; \$5.00 at the door. Kids under 16 are free. Banquet/show/dance tickets

for Saturday night are \$16.00 per person. Tickets available from W1ZQQ, 17 Barnes Avenue, East Boston MA 02128. The show's sponsor is the Federation of Eastern Massachusetts Amateur Radio Associations. Hotel Reservations should be made directly with the Sheraton Boxborough Hotel: \$34 single; \$40 double; kids under 18 free with parents. Campers permitted only at the Minuteman KOA Campgrounds approximately 3 miles away in Littleton MA. Hook-ups available. Write Box 122, Littleton MA 01460.

ISLIP NY OCT 15

The Long Island Mobile Amateur Radio Club, Inc., will hold its annual hamfest on the hardtop area of the Islip Speedway, one block south of Exit 43 of the Southern State Parkway, Islip, New York, beginning at 9:30 am. Main door prize is a frequency counter. Bring your two-meter gear for frequency, audio, and deviation checks. Sellers' and exhibitors' spaces are \$3.00 per space. General admission is \$1.50. Ladies and children under 12 admitted free. Food and refreshments will be available. For complete information, write Hank Wener WB2ALW, 53 Sherrard St., East Hills NY 11577 or phone (516)-484-4322 or (516)-379-6463 at night.

WAKEFIELD MA OCT 21

The annual auction of the Quannapowitt Radio Association will be held on Saturday, October 21, 1978, at St. Joseph's Parish Hall, near the railroad station in Wakefield, Massachusetts. The doors open at 10:00 am and the auction starts at 10:30. Admission is free.

WESTBORO MA OCT 22

The Massachusetts 2-Way Radio Association is pleased to announce the "Challenger Road Rally," to begin October 22nd at 11:01 am, from the Westmeadow Plaza in Westboro, Massachusetts. After approximately two hours of routing through area towns, the rally will end at the Northboro Fish & Game Club in Northboro MA. The cost will be \$2.00 per person (children under 12 free) with a maximum of \$5 per car. At least two persons must be in each car, and all drivers must have a valid driver's license. This is a car rally—no big trucks, motorcycles, or racers. If you wish to participate in something other than a car, you should call and make sure it is acceptable. Trophies will be awarded for

first place team and first place individual; also for "Last, but not finished" Individual. All pre-registered teams will receive a participation award. No dealers. Refreshments will be available. Trophies are to be awarded at approximately 3:00 pm. For information, contact Mass 2-Way Radio Association, Challenger Road Rally, Box 203, Northboro MA 01532, or call (617)-845-2079.

TAYLOR MI OCT 22

The Repeater Association of Downriver Amateur Radio (RADAR) is holding its second annual Swap & Shop on Sunday, October 22, 1978, 9:00 am to 3:00 pm, at Kennedy High School, Taylor, Michigan. The school is located on Northline Rd., east of Telegraph Rd. (U.S. 24). There will be door prizes, plenty of parking, and food available. Admission is \$2.00. Talk-in on 147.93/.33, .52, and .94. For information, contact RADAR, Inc., PO Box 1023, Southgate MI 48195.

BILOXI MS OCT 22

The Gulf Coast Ham/Swap Fest will be held on Sunday, October 22, 1978, at the International Plaza, which is located at the west end of the Biloxi/Ocean Springs bridge on Highway 90 in Biloxi, Mississippi. Tickets are \$1.00. Tables are \$2.00. Talk-in on 146.13/.73 and 146.52. Free parking, including RV's, from 9:00 am on Saturday, October 21. For information, advance tickets, and table reservations, contact Irvin L. Kelly K5YIN, 116 Wiltshire Blvd., Biloxi MS 29531.

FORT LAUDERDALE FL OCT 28-29

The Broward Amateur Radio Club will hold their Pan-American Ham Exposition Jamboree on Saturday and Sunday, October 28 and 29, 1978, at the National Guard Armory on State Road 84, two blocks west of Andrews Ave., Fort Lauderdale, Florida. Activities include awards, prizes, and manufacturers' displays. Admission is \$2.50 advance; \$3.00 at the door. For complete information and a floor plan, contact Ian Seidler W4MRR, 10221 N.W. 36th St., Coral Springs FL 33065.

PLYMOUTH IN OCT 29

The Marshall County Amateur Radio Club will conduct its 3rd annual Swap and Shop Hamfest on Sunday, October 29, 1978, at the Armory at 11th and West Madison Street, in Plymouth, Indiana. Food services will be available and there will be many door prizes. No

charge for tables and they can be reserved. Tickets are \$2.00. Doors open to public from 7:00 am to 4:00 pm. For further information, contact Melvin Mahler, PO Box 151, Plymouth IN 46563.

SOUTH GREENSBURG PA NOV 4

The Foothills Radio Club of Greensburg will hold its annual swap-n-shop on Saturday, November 4, 1978, from noon to 5:00 pm, at St. Bruno's Church at the junction of U.S. Rte. 119 and Rte. 819 in South Greensburg, Pennsylvania, just off turnpike exit 8. There will be an indoor flea market. Talk-in on .07/.67 and .52. For further information, contact Melvin Ruble WA3RVD, Mark Drive, Delmont PA 15626.

HOUSTON TX NOV 4-5

The Houston chapter of Ten-X, S.H.O.T., will hold its second annual Houston Hambash on Saturday and Sunday, November 4 and 5, 1978, at Spring Creek Park. There will be a barbecue, soft drinks, beer, prize drawings, and planned activities for all, including the kids. Full camping facilities, including hookups, are available. All amateurs are invited. For more information, contact Bob Libbers WB5FII, 4034 Jackwood, Houston TX 77096.

SAND KEY FL NOV 25-26

The Florida Gulf Coast Amateur Radio Council's second annual convention will be held on November 25 and 26, 1978, at the Sheraton Sand Key Hotel.

LAUREL MD NOV 26

The Columbia Amateur Radio Association will hold its 2nd annual hamfest on Sunday, November 26, 1978, beginning at 8:00 am, at the Laurel Race Way, three miles north of Laurel on Route 1. Admission is \$2.00 and tables are \$5.00. There will be food services, prizes, and a giant flea market. Everything is indoors. Talk-in on 147.735/.135, 146.16/.76, 146.52/.52, and CB channel 1. For information and reservations, contact Sue Crawford N3SC, 6880 Mink Hollow Road, Highland MD 20777.

OAK PARK MI NOV 26

The Oak Park High School Electronics Club presents the ninth annual Swap 'N Shop on Sunday, November 26, 1978, at Oak Park High School, 13701 Oak Park Blvd., Oak Park, Michigan 48237. There will be refreshments and door prizes. Donation is \$1.50. Tables are \$1.00 and \$2.00.

Low-Pass Filter Primer

—tells all

Although my interest in active low-pass filters is due mainly to my interest in RTTY, they can be found in other places as well—transmitters, speech amplifiers, synthesizers, etc. (If you are interested in active bandpass filters, see my article in the September, 1977, issue of *73 Magazine*. That article also provides some background information that is of use in connection with low-pass filters.)

An active filter is a filter which uses an amplifier, usually an operational amplifier integrated circuit such as a 741, in an RC circuit which achieves the same performance as would otherwise require an LC circuit. As opposed to the LC filter, an active filter is usually cheaper to build since it does not require expensive and bulky inductors, and is often easier to design and trim as well. In

case your knowledge of filters needs a little brushing up, the following discussion will bring you up to date and introduce some of the basic concepts of filters.

Single-Stage Filters

A passive low-pass filter—that is, one not using an amplifier—can be built with either just RC components or with an LC circuit. Fig. 1 shows the diagrams of several such simple low-pass filters, while Fig. 2 shows their frequency response. The simplest is the single-stage RC filter, Fig. 1(a). Because it has just one reactive component, a capacitor, it is called a one-pole filter. Its frequency response curve is the top curve in Fig. 2.

Looking at the top curve in Fig. 2, we see that the far left of it approximates a straight line, and the far right of it also is like a straight line. If we take a ruler and draw two dashed lines as shown, continuing the straight portions of the curve toward the middle, they meet at what is called the *cutoff frequency* or *corner frequency*—this is the frequency where the two straight lines meet at a corner. To keep things simple, this frequency response drawing assumes a corner frequency of 1 Hz, but the

curve would have the same shape regardless of what the frequency is. For instance, a 50 Hz filter would look the same, but all frequency readings shown along the bottom would be multiplied by 50.

The plain RC filter's response is down 3 dB at the corner frequency; at half this frequency it is down 1 dB, while at twice that it is down 7 dB. Once it becomes straight, beyond 4 Hz or so, it continues to drop 6 dB for every doubling of frequency (this is called *6 dB per octave*), which is the same as 20 dB for every *decade* (a decade is a 10 to 1 ratio of frequency).

When two stages of RC filtering are put together, as in Fig. 1(b), they interact to some extent and produce strange results. But if it is done right, or if the two stages are separated by an amplifier so the second does not load down the

output of the first, then the result is the bottom curve of Fig. 2. Here the corner frequency is the same, but the response at this frequency is down 6 dB, 3 dB for each stage. It is down 2 dB at half the frequency, 14 dB at twice the frequency, and it drops at the rate of 12 dB per octave or 40 dB per decade, exactly twice the rate for the single-filter stage. This filter has two reactive components, both capacitors, and so it is called a two-pole filter.

Another two-pole filter is the LC filter of Fig. 1(c) which has two reactances, one inductor and one capacitor. If designed just right, it, too, has a response curve like the bottom one in Fig. 2. But depending on the Q of the filter—the amount of resistance in the circuit introduced by the LC components—the LC filter can have other response curves as well, as shown in Fig. 3. A lossy cir-

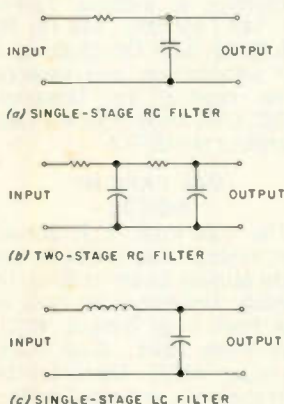

Fig. 1. Some simple passive filters.

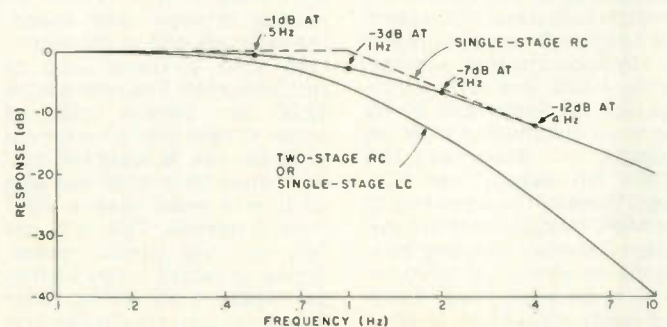

Fig. 2. Passive filter frequency response.

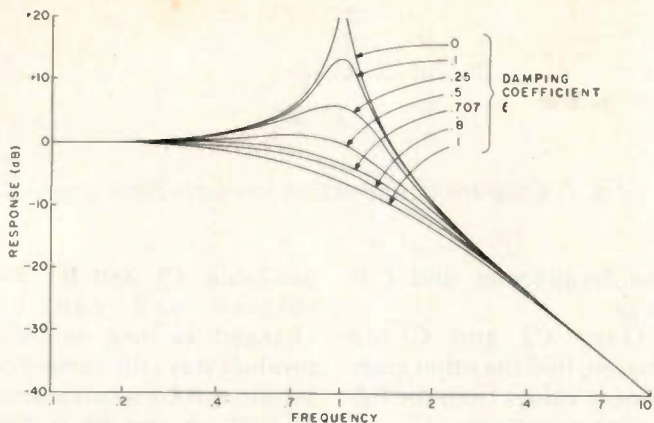

Fig. 3. Possible two-pole low-pass filter responses.

circuit with high resistance in it will have the lowest curve shown, the same as that for the two-stage RC filter. On the other hand, if the resistance in the circuit is small, then the low-pass filter will actually act like a series resonant circuit which will peak at the corner frequency to give a large peak, as shown by the top curve. Any of the curves shown could be achieved.

To describe the precise shape of the filter curve, engineers define something called the *damping coefficient*, signified by the Greek letter zeta (ζ). The top curve, which is completely undamped and has a large peak, has $\zeta = 0$. The bottom curve, which is completely damped so that it resembles the curve for RC stages, has $\zeta = 1$. (Although Q is not always used with low-pass filters, if you know the coil Q at the corner frequency, then $\zeta = 1/2Q$ gives the damping coefficient.)

Although the bottom curve is a typical two-stage RC filter, you can see that LC filtering can give a better response. The curve for $\zeta = .707$, for example, is flatter across the top, below the cutoff frequency, and drops off faster above it. If a slight rise in the response is allowed, then $\zeta = .5$ may be even better. Ultimately, though, each of the filters, regardless of its ζ , drops down to

the same -40 dB at 10 Hz, and then continues dropping at the same 12 dB per octave. The difference between all of them occurs only near the corner frequency. The filter whose top is the straightest without having an overshoot is called the *Butterworth*; another name for it is *maximally flat*. It is the flattest without going above 0 dB. Its $\zeta = 0.707$.

Butterworth filters are nice because, in addition to their even frequency response, they are easy to design and also have a fairly smooth effect on the phase of signals passing through them. It is also possible to design Butterworth high-pass and band-pass filters; see the article in the September, 1977, issue of *73 Magazine* for instructions on how to design bandpass Butterworth filters.

Though the two-pole Butterworth filter response of Fig. 3 (for $\zeta = .707$) has a smooth frequency response, it still has a fairly gradual cutoff near the cutoff frequency, and it still drops only at the rate of 12 dB per octave. But it is possible to build better Butterworth filters by combining two or more LC stages.

Fig. 4 shows how this is done. If we take one stage which is fairly highly damped with $\zeta = 0.924$ and combine it with a second stage which has a peak

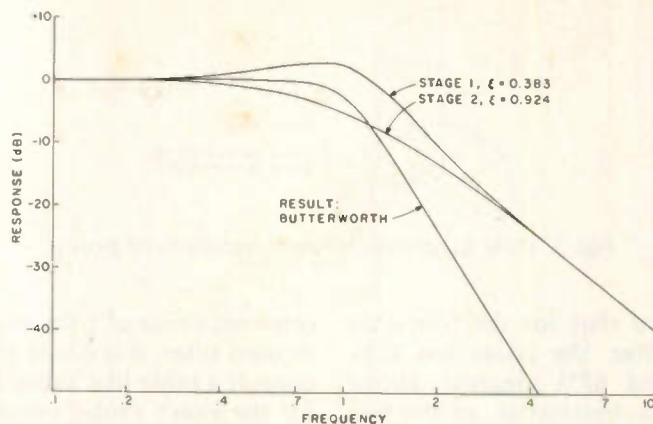

Fig. 4. Making a four-pole Butterworth filter.

($\zeta = 0.383$), then we get a result which is very flat across the top, drops by 3 dB at the corner frequency, and continues to drop at the rate of 24 dB per octave at high frequencies. This is the Butterworth filter shown in Fig. 4. By combining more stages, we can get Butterworth filters having more poles: two stages give four poles, three stages give six poles, and so on. The trick comes in knowing just what ζ to use for each stage. This can be done graphically or by using a table. The term *pole* is an engineering term having to do with complex numbers and values of a certain term which causes a circuit equation to "blow up," that is, become in-

finite. The precise meaning is unimportant, though, because these poles can be graphed as in Fig. 5. For a two-pole filter, for instance, there are two poles, shown as Xs graphed on a semicircle. Whatever the number of poles, they have to be evenly spaced around the semicircle, and the angle between poles has to be equal to 180° divided by the number of poles. In the case of two poles, this makes them 90° apart, so that the angle of the pole on the right-hand side is 45° above the bottom line. The ζ is simply the sine of this angle, and can be found with any calculator which has a sine key.

Going down in Fig. 5, we

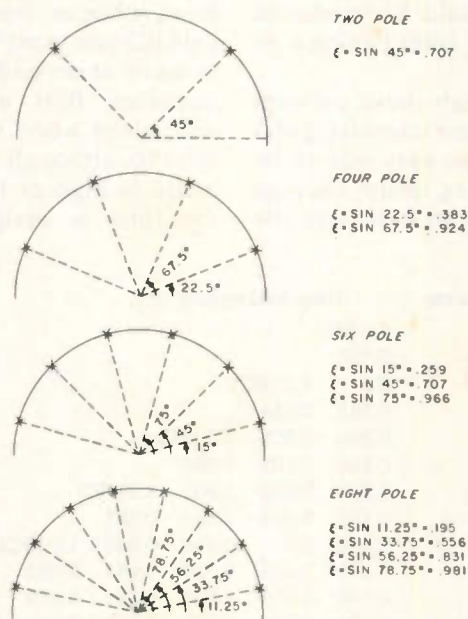

Fig. 5. Pole locations for even numbers of poles.

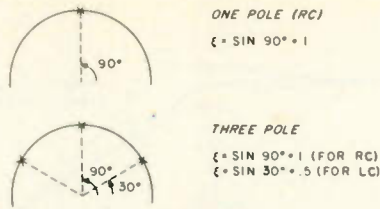

Fig. 6. Pole locations for odd numbers of poles.

see that for the four-pole filter, the poles are $22\frac{1}{2}$ and $67\frac{1}{2}$ degrees above the horizontal, so the two values of ζ needed are $\sin 22\frac{1}{2}^\circ = 0.383$, and $\sin 67\frac{1}{2}^\circ = 0.924$. Keeping in mind how the poles have to be located on the circle, you could draw your own pole locations for as many poles as you want. For every two poles you would then need one LC circuit.

Although Fig. 5 shows only even numbers of poles, it is possible to build Butterworth filters having odd numbers of poles. For instance, a single RC stage has a single pole, at the very top of the semicircle as shown in Fig. 6, at the top. In this case, the angle above the horizontal is 90° . A three-pole filter, shown at the bottom of Fig. 6, would have three poles still evenly spaced, 60° apart. The top pole would be produced by an RC filter stage, while the other two poles would be produced by an LC filter having $\zeta = 0.5$.

Although these pictures of poles are interesting and provide an easy way of remembering where they go and how to calculate the

required value of ζ for any desired filter, it is easier to consult a table like Table 1 for the exact values needed.

So far we have been discussing only RC and LC filters. But, as mentioned before, LC filters are hard to adjust, expensive, and often large. Fortunately, an active filter, using just RC components plus an operational amplifier integrated circuit, can produce the same response as an LC filter.

Active Filters

Though there are several filter circuits which can be used, that of Fig. 7 is probably the simplest, using just one operational amplifier IC, three resistors, and two capacitors.

The design procedure is to start off by picking a convenient value for capacitor C2; most audio designs use values of perhaps 0.01 or 0.1 μF . Next, choose how much gain (G) you want the filter to have at dc and low frequencies. Best operation will occur when G is less than 10, although it can be made as high as 100 when the filter is designed for

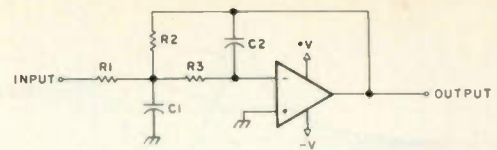

Fig. 7. Diagram of one active low-pass filter stage.

low frequencies and ζ is large.

Once C2 and G are chosen, find the other component values from the following equations:

$$C1 = \frac{C2(1+G)}{\zeta^2}$$

$$R2 = \frac{\zeta}{2\pi f C2}$$

$$R1 = \frac{R2}{G}$$

$$R3 = \frac{R2}{1+G}$$

Although it would certainly be nice to use the exact calculated values in building your circuit, such accuracy is not usually needed; commercial values are usually good enough since the exact operating frequency or damping of low-pass filters is not usually critical.

Nevertheless, if you find you want to play with the circuit values a bit after they are calculated, here are some hints. Changing R1, within a fairly large amount, affects only the gain, since $G = R2/R1$. So making R1 smaller will increase the gain, while making it larger will decrease the gain. But keep the gain below 10 if ζ is small.

Sometimes, it may be handy to change the value of C1 if it comes out to be different from what is

available. C1 and R3 are related and can be changed as long as their product stays the same. For instance, if C1 is calculated at 0.02 μF and R3 is 590 Ohms, you could cut C1 by two to 0.01 μF and double R3 to 1180 or 1200 Ohms; the circuit performance would stay the same, since dividing one by 2 and multiplying the other by 2 keeps their product the same.

When building active filters, you must use good components. Do not use disk capacitors, even for testing; polystyrene or polycarbonate capacitors are best, though plain tubulars or mylar capacitors will work well, too. Also use good op amps, such as the 741, 1458, 5558, or 747; I have had bad luck with the LM3900 in some filters. If you need two or more op amps for the same filter, use separate ICs; I have found some undesirable interactions between two amplifiers in the same IC when used in high-gain filters.

A Practical Example

For use as a low-pass filter for RTTY, I needed a low-pass filter with a cutoff frequency of 50 Hz. I decided I wanted a four-pole filter which would cut off rather quickly, so I went for two active filter stages, as follows:

No. of poles	Required values of ζ					
1	1.0 (RC)					
2	0.707					
3	0.5	1.0 (RC)				
4	0.383	0.924				
5	0.309	0.809	1.0 (RC)			
6	0.259	0.707	0.966			
7	0.223	0.623	0.901	1.0 (RC)		
8	0.195	0.556	0.831	0.981		
9	0.174	0.5	0.766	0.940	1.0 (RC)	
10	0.156	0.454	0.707	0.891	0.988	
11	0.142	0.415	0.655	0.841	0.959	1.0 (RC)
12	0.131	0.383	0.609	0.793	0.924	0.991

Table 1. Values of ζ for Butterworth low-pass filters.

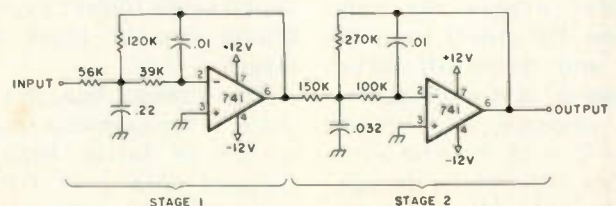

Fig. 8. Complete four-pole low-pass filter.

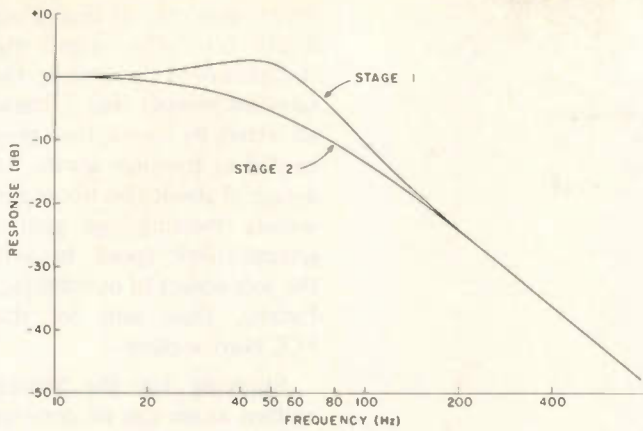

Fig. 9. Response of two filter stages.

Stage 1: $f = 50$ Hz; desired gain $G = 2$; from Table 1 we need $\zeta = .383$; I chose $C2 = 0.01$ μ F. From the equations, I got the following:
 $R1 = 60,956$ Ohms
 $R2 = 121,912$ Ohms
 $R3 = 40,637$ Ohms
 $C1 = 0.2045$ μ F

Since I did not have exactly these values, I let $R1 = 56k$, $R2 = 120k$, $R3 = 39k$, and $C1 = 0.22$ μ F.

Stage 2: $f = 50$ Hz;

desired gain $G = 2$; from Table 1 we need $\zeta = 0.924$; I chose $C2$ again at 0.01 μ F. From the equations, I got the following:
 $R1 = 147,059$ Ohms
 $R2 = 294,118$ Ohms
 $R3 = 98,039$ Ohms
 $C1 = 0.0351$ μ F

The values actually used were $150k$ for $R1$, $270k$ for $R2$, $100k$ for $R3$, and 0.032 μ F for $C1$ (0.022 in parallel with 0.01). The complete circuit is shown in Fig. 8.

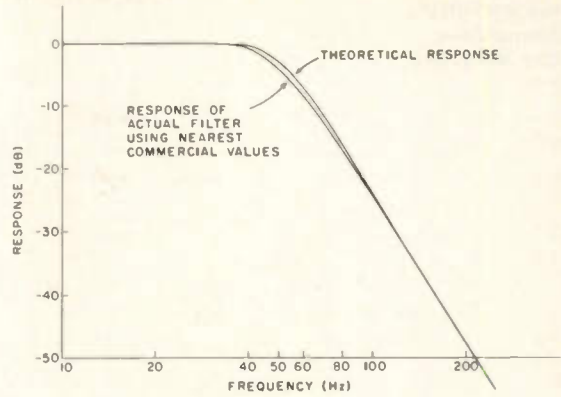

Fig. 10. Actual low-pass filter response.

The frequency response calculated for each of the two stages is shown in Fig. 9. Fig. 10 gives the theoretical response for the four-pole Butterworth filter, along with the frequency response actually measured on the circuit using the commercial equivalent values given in Fig. 8. Although the test equipment was not particularly fancy—the output above about 150 Hz was too low to be measured by my

meter—this shows that the equations seem to work. Only the gain was slightly off; theoretical gain should have been 4 (2 in each stage), while the total gain measured only a bit more than 3 . Nevertheless, the total gain could have been easily adjusted by changing the value of $R1$ in either stage. In general, the performance of these low-pass filters is close to what you would expect from the equations. ■

30 YEARS...

of experience in supplying top quality antennas to Ham Radio operators at rock bottom prices guarantees high quality and low prices to novice and experienced operator alike.

TWO ELEMENT QUAD with full wavelength driven element and reflector. All metal construction. Gain is equal to that of a three element beam and directivity is exceptional. Assembled weight 25lbs. 10/15/20 quad, totally complete and ready for simple assembly . . . **JUST \$59.95.**

FULL SIZE BEAMS for full size performance. Includes boom, all hardware and gamma match.

- | | | |
|-----------------------|-----------------------|-----------------------|
| 12 EL 2M Beam \$56.95 | 6 EL 6M Beam \$54.95 | 5 EL 10M Beam \$59.95 |
| 4 EL 6M Beam \$45.95 | 3 EL 10M Beam \$45.95 | 3 EL 15M Beam \$54.95 |
| 5 EL 6M Beam \$49.95 | 4 EL 10M Beam \$49.95 | 4 EL 15M Beam \$59.95 |

FREIGHT PREPAID on 2, 6, and 10M beams shipped to the 48.

ALL BAND VERTICAL ANTENNAS absolutely complete including loading coil.

V40 vertical antenna for 40, 20, 15, 10 and 6 meter bands. Especially suitable for the novice who operates 40 and 15. **JUST \$25.95**

V80 vertical antenna for 80, 40, 20, 15, 10 and 6 meter bands. Used by thousands of novices, technicians and general license hams. **JUST \$27.95**

V160 vertical antenna for 160, 80, 40, 20, 15, 10 and 6 meter bands. Same as other vertical antennas, but with larger loading coil. **JUST \$29.95**

How to order: Remit total amount with order. We ship verticals, 2, 6, and 10M beams (except 5 EL 10M Beam) prepaid to the 48. Other beams and all quads sent freight collect cheapest way, due to size of package. Check your local truck lines for estimated freight rates. For fast COD service on all prepaid antennas, call (305) 573-2080. For literature, send self-addressed stamped envelope.

Florida residents add 4% sales tax.

GOTHAM, INC.

2051 N.W. 2nd Avenue Dept. 73
Miami, Florida 33127

**VERTICALS SHIPPED
FREIGHT PREPAID
ANYWHERE IN
THE WORLD!**

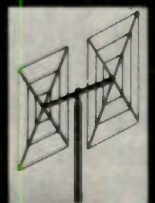
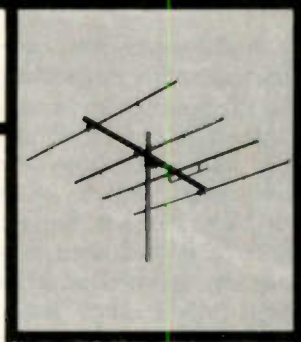

Hello Hamdom!

— a CBer makes the switch

At the county fair, amateur radio occupied the esteemed position to the left of the wheel of fortune and across the path from the 4-Hers' prize pigs. I would never have found it had my little brother not been possessed by an unappeasable longing to feel animal hides. Having left him in the fresh air of the swine exhibit, I was standing outside an antenna-topped trailer when a gray-haired man waved to me, indicating I should come closer. My interest in electronics had already sprouted (manifesting itself in CB and a room full of construction projects in constant peril from my mother's roving wastebasket), so I needed little urging to investigate a trailer with an antenna. The gray-haired man ushered me in. Tables lined the whole trailer length, supporting a dozen radios of unfamiliar origin — certainly not Johnson or Lafayette CB trans-

ceivers. My host introduced himself as "Bill" and introduced the trailer as the local ham radio club's mobile exhibit.

Ham radio had seemed as unapproachable to me as communicating with the Apollo mission from Houston Space Center until that night at the fair. Here sat six men tuning receivers and transmitting to Arizona, Germany, Texas, and Hawaii. Since this was my first exposure to amateur radio, the dramatic demonstration left me in complete awe and quite dissatisfied with the limited range of CB.

I asked Bill what I must do for a ham radio license.

"Dave," he yelled, "can you come here a minute?" Dave, a short, plump gentleman of about fifty years, strolled over. "This young man wants to get his ticket. Are you still giving code lessons?"

"Indeed I am. You want to learn the code?"

My mind answered "yes" eight times before I got one into the air.

"Good. Here's my phone number. Give me a call when you're ready to start."

Saying "thanks," I hurried out of the trailer inebriated with dreams of becoming a ham and armed with enough vitality to survive the home-canned vegetable contest.

Right after the fair, our family departed for a vacation in Ocean City MD, so it wasn't until two weeks later that I called Dave. As friendly as ever, he invited me over the next night. Code practice began immediately.

Dave provided me with no short-cut methods for learning Morse code — no verbal quizzes, no flash cards, no sound associations. He wrote the alphabet with the dits and dahs to the right, and I memorized them for my session the next Tuesday.

From then on, all practicing dealt strictly with the straight-keyed oscillator. He satisfied himself that I knew all letters by sound, then proceeded to transmit words. At a pace of about two hours per weekly meeting, we gained ground until speed became the sole object of our drilling. Finally, Dave sent for the FCC Novice exam.

Studying for the Novice written exam can be done in two ways: the fundamental understanding method or the "get me past the written test" method. I started with lofty ideals — several books on electronic theory and a pamphlet of radio regulations rested in a convenient spot on the desk. However, a week of subjects no less fascinating than front end image response, coupled tuned rf circuits, and screen modulation sent me searching for a better attack. Bring on the *ARRL License Manual*, faithful advisor and dog-eared servant. Memorizing questions and answers representative of those on the exam proved to be a very efficient way of preparing for the ordeal.

Dave's basement shack seemed ominous on test day. First, Dave instructed me to send words from his master list at approximately five words per minute to loosen up. I was particularly careful with the letter spacing, since my mentor always stressed its importance. Next, Dave warned me to "get used to his keying" in order to be well prepared for the listening test. After twenty-five five-letter words worth of "getting used to his keying," wily Dave announced that I had passed the code.

The FCC, in addition to regulating communications, stretches the patience of anxious, license-awaiting citizens to unbearable limits. I spent my fall looking over (and over . . .) a copy of *CQ* I happened to find in a magazine rack. I hunted ceaselessly for beams atop houses for the

satisfaction of knowing that that person belonged to the select group I might shortly join. I daydreamed to excess in school, preferring visions of how my station would be arranged to endless analyses of *The Red Badge of Courage*.

A few days before my October birthday the license arrived — my own call sign, WN3NNY. Leave it to Dad to put things in a different perspective.

"Well, NINNY," he ob-

served.

The next day, Dad and I drove to the local amateur supply shop where I bought my equipment, an Eico 720 transmitter and Hallicrafters SX-110 receiver. Stringing the antenna remained as the last necessity.

"Bob, the Hayek boy's in the backyard throwing a hammer at the tree."

"Trying to get rid of the squirrels that ate their peaches this summer?"

"No, it's the oak tree —

the one he lost the wrench in yesterday. I think he's trying to hang something."

"He loses any more tools in the tree and his parents are going to hang something."

With my dipole finally hung high in the backyard and my radio station assembled on my desk, I attended to the last-minute equipment connections — power plugs in, receive antenna (a long wire) attached, dipole attached to the transmitter, speaker plugged into

the receiver, and key plugged into the transmitter. Unfortunately, the key wandered unrestrained on my desktop, but I was too anxious to wait to build a heavy base. The station lit up. The receiver was receiving! The transmitter was loading! Hundreds of signals squawked at me. I answered my first CQ with a shaky call (my fist was steady; it was that damned loose key) and anticipation as great as if I were about to talk to Apollo. ■

L. Foord VE3FLE
763 Gladstone Dr.
Woodstock, Ontario
Canada N4S 5T1

The rig was lying on its side, obstinately refusing to reveal the cause of my intermittent audio, when Teresa came into the room. "Hi, Daddy," she said cheerfully. "What are you doing?"

The XYL had warned me she was at the inquisitive age, that fathers should avail themselves with infinite patience and understanding. "They're in their formative years," were her words. But patience was a melting virtue; I'd just spent three hours searching for some erratic component or elusive cold solder joint. "Trying to get the radio to work," I replied, as cheerfully as I could under the circumstances.

"Boy, there sure are a lot of wires and things in there! Is that bionic?"

I had to smile. "No. I think maybe you're watching too much television."

"No, I don't think so," was her very serious reply. "What's that?" she asked, pointing to the key.

"That's Daddy's key."

"Sure is a funny looking key. What does it unlock?"

"It's not that kind of key. I use it to send Morse code. You know, dots and dashes. That's called CW. When I get tired of talking, I use CW instead of phone."

"You should tell Mommy to do that."

"Why?"

"Well, you always say she uses the phone too much. Maybe she could use your key."

"Good idea," I conceded.

"Want me to tell her?"

"No, it's O.K. I'll tell her later."

There were a few moments of thoughtful silence as I probed and prodded in vain. "Daddy," she went on. "I don't want to move. We haven't lived here very long and I like it here."

"We're not moving," I protested. "What made you think something like that?"

"I heard you call your room a shack, and I thought since you didn't like it, you might want to move again."

I laughed. "That's just an expression. All radio operators call their rooms 'shacks.' It doesn't mean they aren't nice rooms."

"Oh," she replied. "And I

heard you tell someone on the radio that since we moved here you were disappointed because there wasn't much traffic. I thought you would like it because it's so easy for me to cross the street by myself."

"Honey, that's a different kind of traffic. It means messages on the radio."

She gave me a quizzical glance. "Then we're not moving?"

"Not a chance."

"Good. If we're not moving, when are we going to get the fireplace?"

"Where did you get that idea?"

"I heard you say you had so many logs you should burn some of them. So I figured we're getting a fireplace."

"They're a different kind of log," I said, feeling desperation creeping into my voice.

"Another . . . expression?"

"Yes, I'm afraid so."

"Is that like a riddle?"

"Sort of."

"Guess I'll go play," she announced.

"Have fun."

She paused at the doorway. "Want to hear a riddle?"

"Sure."

"What kind of radio would you eat for dinner?"

"I give up."

"Ham radio," she said, and burst into laughter.

I laughed politely and went back to the rig. That was when I discovered the loose microphone cord. ■

More "Coming Of Age"

Rejuvenate A Pawnee!

—put it on 2

Sherman P. Wantz K4GRT
424 NW Lakeview Drive
Sebring FL 33870

Garold F. Shepherd W4IEV
1803 Prospect Street
Sebring FL 33870

There must be thousands of HW-20 "Pawnee" two meter AM transceivers gathering dust in active ham shacks throughout the country. I can't conceive of a ham so

affluent—or so unappreciative of mechanical beauty—that he could discard his Pawnee irrespective of his need for more space. The Pawnee's cool green cover adorned

by dual tuning dials and eight chrome-plated (chrome!) knobs continues to cry out for recognition, even after twenty years of retirement.

It's little wonder that my Pawnee caught the eye of "Shep" Shepherd W4IEV when he visited my shack to discuss an equipment trade. He owned a twenty meter beam that I needed desperately. I offered my Pawnee in exchange when Shep said he'd like to put it to use on the two meter FM band.

The look in Shep's eyes reassured me that my Pawnee would be gaining an appreciative owner. So I parted with it.

I'm glad I did. Shep resurrected the old warrior, gave it a discriminator and a phase modulator, and is now using it quite successfully to hunt repeater stations throughout central Florida.

This article describes Shep's modification. Those of you who were fortunate enough to have held on to your HW-20s can make the simple changes Shep recommends and experience the pleasure that comes with operating a continuously tunable receiver and a ten-Watt "rock-stable" vfo-con-

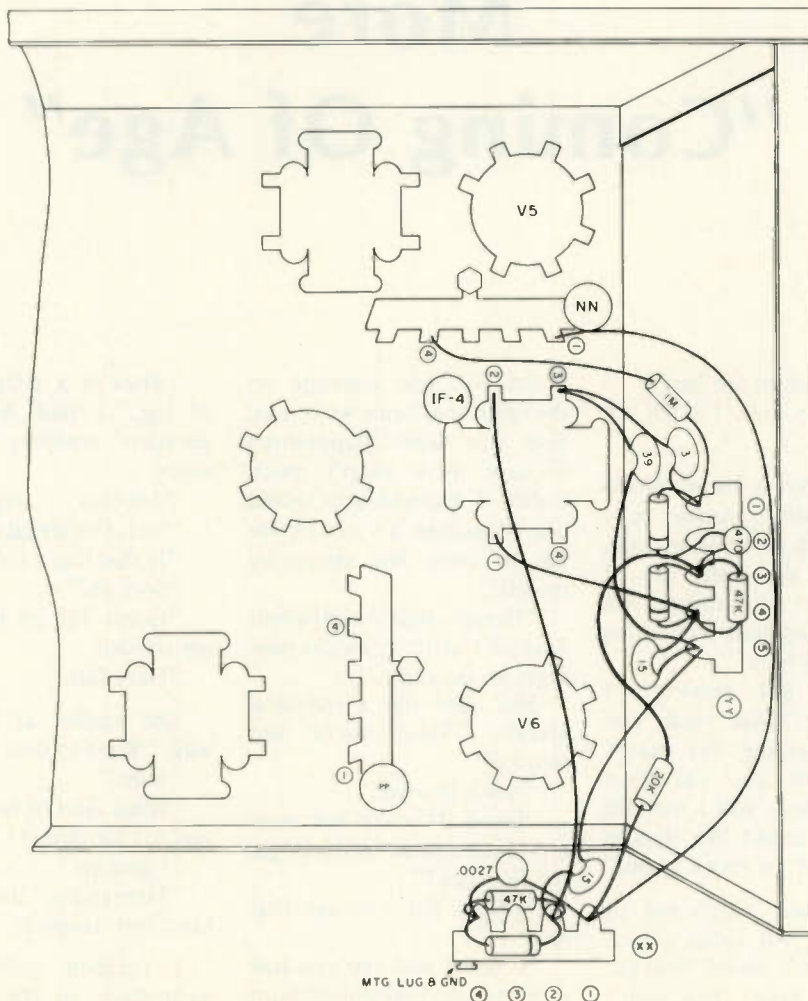

Fig. 1.

trolled transmitter to sample the interesting QSOs that are taking place daily on numerous repeater stations in your area.

Modifying the Receiver

Test the receiver to be certain that it is still operating properly. Tune it to a station on the air or tune it to a signal produced by a signal generator. If necessary, troubleshoot and repair the receiver before you attempt to modify it and save yourself at least one headache.

In order to make space for the two new terminal strips required in the receiver section, remove the external speaker phono jack on the rear apron adjacent to tube V6. The wire leading to this jack may be clipped near the cable breakout point or be taped and tucked out of the way.

Remove the modulation monitor slide switch and solder the black wire leading to pin #1 of the switch to the headphone jack pin #3. Remove the spaghetti-covered lead that connects pin #2 of the switch to headphone jack pin #3. The gray lead that used to connect to switch terminal #3 may be either



Heath's twenty-year-old two meter AM Pawnee transceiver is just too beautiful to become a museum piece. It's easy to recycle it for operation in the two meter FM band.

clipped or tucked out of the way.

Remove the 0.56 pF capacitor connected between pin #1 of IF-4 transformer and pin #7 of V8. Discard this capacitor.

Refer to Fig. 1 for a review of component symbols used by Heath Company and repeated here to

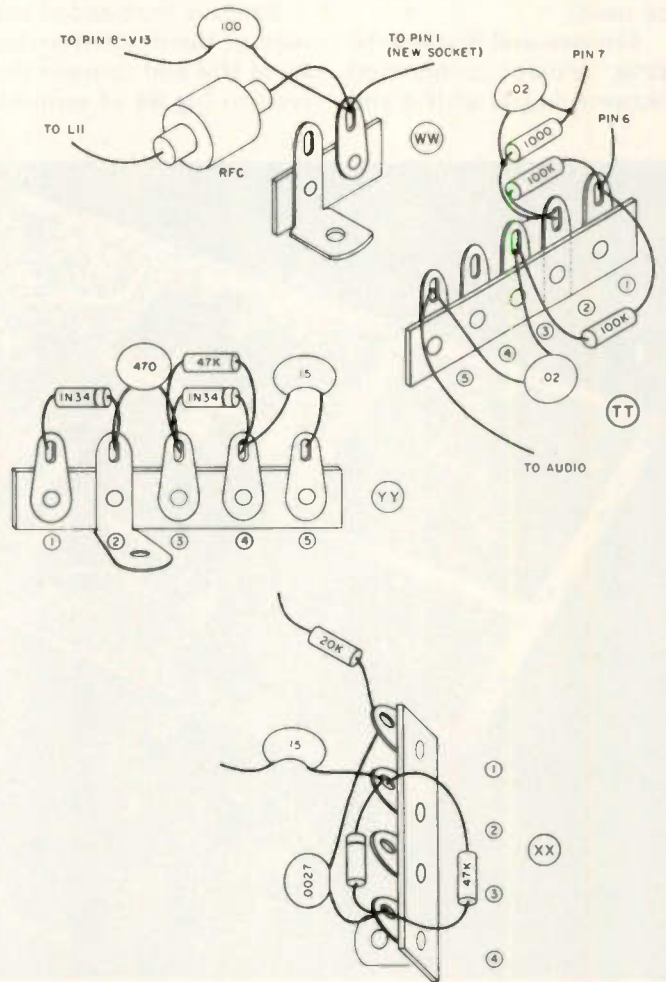

Parts List

Receiver

- 1 capacitor, 3 pF, 600 V dc, silver mica
- 1 capacitor, 39 pF, 600 V dc, silver mica
- 2 capacitors, 15 pF, 600 V dc, silver mica
- 1 capacitor, 470 pF, disc, 50 V dc
- 1 capacitor, .0027 uF, disc, 50 V dc
- 3 diodes, 1N34 or equivalent
- 2 resistors, 47k, 1/4 W
- 1 resistor, 20k, 1/4 W
- 2 terminal strips (see note below)

Transmitter

- 1 tube, 6J6 or 6C4
- 1 tube socket, 7-pin miniature, and shield
- 2 capacitors, 100 pF, 600 V dc, silver mica
- 2 capacitors, .02 uF, 500 V dc, disc
- 2 resistors, 100k, 1/4 W
- 1 resistor, 10k, 1/4 W
- 1 resistor, 1k, 1/4 W
- 1 resistor, 4.7k, 1 W
- 1 choke, rf, 2.5 mH
- 2 terminal strips (see note below)

Note: Terminal strips may be customized from a package of four (eight-lug each) strips purchased from Radio Shack (#274-692) and clipped as in Fig. 2.

Fig. 2. A package of four terminal strips may be purchased from Radio Shack (#274-692) and cut with diagonals to give the above configurations.

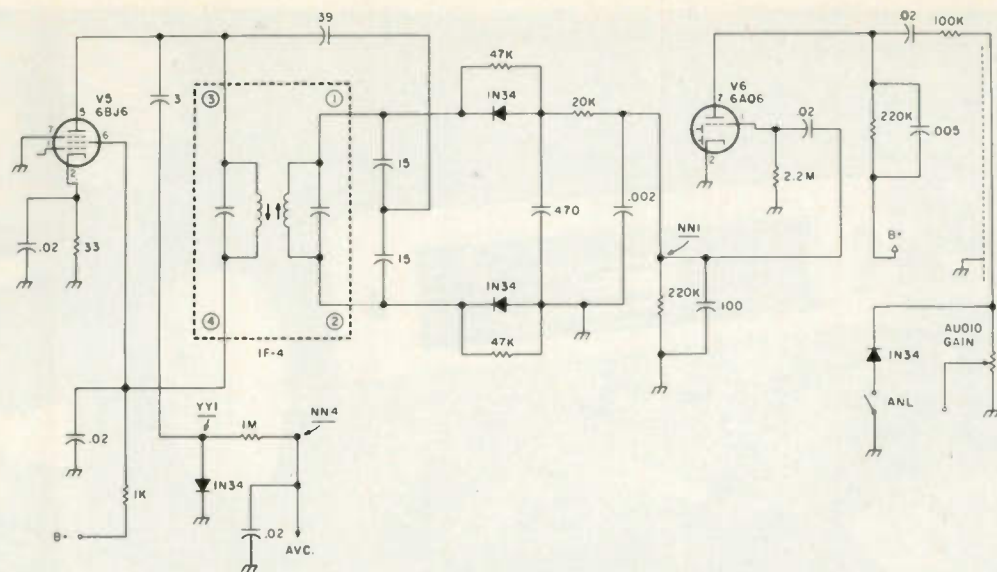

Fig. 3. I-f discriminator and first audio circuitry after modification.

make the modification instructions easier to follow.

Remove the lead between pin #1 of IF-4 and pin #6 of V6 (note: the diode section of V6 will no longer be used).

Remove and discard the 220k resistor connected between lug #2 of IF-4 and

pin #1 of terminal strip NN. Remove and discard the 100 pF capacitor connected between lug #2 of IF-4 and terminal #3 of strip NN (ground).

Remove the banded end lead of the diode from lug #2 of IF-4 and connect this lead to lug #4 of terminal

strip PP so that it connects to one end of a 100k resistor.

Remove the lead end of the 1 meg resistor connected to lug #2 of IF-4 and bend the resistor back out of the way. It will be connected later to a pin on a

new terminal strip.

Drill 6/32 screw holes in the chassis for mounting terminal strips XX and YY on the left side and rear chassis skirts. See Fig. 1 for locations.

Make the following connections inside the receiver section of the chassis:

Solder one end of a 39 pF capacitor to terminal #3 of IF-4.

Solder one end of a 3 pF capacitor to the same (#3) terminal of IF-4.

Solder one end of a wire about four inches long to terminal #2 of IF-4.

Solder one end of a wire about four inches long to terminal #1 of IF-4.

Solder one end of a wire about five inches long to terminal #1 of strip NN.

Mount components on the new terminal strips XX and YY as shown in Fig. 2. Mount strips XX and YY as shown in Fig. 1.

Solder the free end of the 39 pF capacitor to terminal #5 of strip YY.

Solder the free end of the 15 pF capacitor connected to terminal #2 of strip XX to terminal #5 of strip YY.

Solder the free end of the 20k resistor from terminal #1 of strip XX to terminal #3 of strip YY.

Solder the free end of the 3 pF capacitor from pin #3 of IF-4 to terminal #1 of strip YY.

Solder the free end of the 1 meg resistor (which was earlier disconnected from lug 2 of IF-4) to terminal #1 of strip YY.

Solder the free end of the wire coming from terminal #1 of strip NN to terminal #1 of strip XX.

Solder the free end of the wire from pin #2 of IF-4 to terminal #2 of strip XX.

Check to be sure that all connections to strips XX

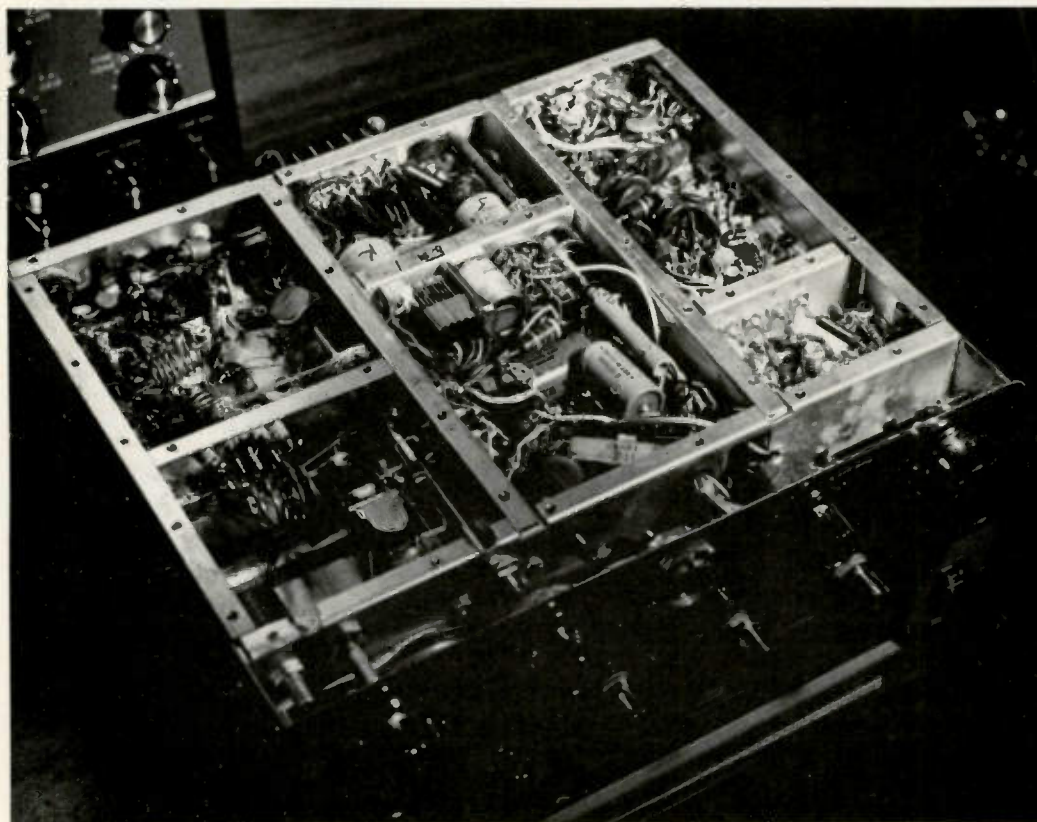

The phase modulator is installed in the transmitter section shown in the upper left corner. Components needed to convert the AM detector to a discriminator are installed in the upper right compartment.

Sunspot Cycle Madness

WE'RE CELEBRATING - WITH SUPER DEALS FOR YOU!

THOMAS COMMUNICATIONS



YAESU
FT-7



YAESU
FT-901



ICOM
IC-701



DRAKE
TR-7



KENWOOD
TS-820S



YAESU
FT-227R



TEN TEC
544



PANASONIC RECEIVER
RF 4800



KENWOOD
TS-700SP



KDK
2015R



DENTRON
MLA-2500B



WILSON
MARK IV

"OVER 50 BRANDS IN STOCK"

- KENWOOD • YAESU • KDK • DENTRON • WILSON • MFJ • SWAN • DRAKE • LARSEN •
- TEMPO • KLM • BEARCAT • B & W • ARRL PUBLICATIONS • MOSLEY • REGENCY • ASTATIC •
- CUSHCRAFT • MICROLOG • HAM KEY • CDE • PIPO • ICOM • TEN TEC • PANASONIC •
- DAYBURN INSULATORS • BIRD • AMECO • HUSTLER • CALL BOOK • SAXTON • ALLIANCE •

★ COMPLETE RADIO SERVICE SHOP ★

- FAST EFFICIENT SERVICE — WE REPAIR ALL BRANDS —
- ALL WORK GUARANTEED — AMATEUR EXTRA / FIRST CLASS LICENSES —
- SEND US YOUR DEFECTIVE EQUIPMENT U.P.S. COLLECT —
- FREE SHIPPING BOTH WAYS IF WORK IS DONE —
- MOST REPAIRS DONE AND SHIPPED WITHIN 7 DAYS —
- ★ OUR FINE REPUTATION SPEAKS FOR ITSELF ★

"YOU SHIP IT — WE FIX IT"

- ★ NEW AND USED EQUIPMENT — "Get on our used equipment mailing list" —
- ★ TRADES WELCOME — "The best allowances anywhere" — "We buy good used SSB gear" —
- ★ FREE CATALOG — "Prices of all major manufacturers" —
- ★ SAME DAY U.P.S. SHIPPING — "Just a phone call away" —



Telephone Orders
203-667-0811
Call Today!

Call or write for
your super quote today!



T34 **THOMAS COMMUNICATIONS** - "Near ARRL Headquarters"

95 KITTS LANE, NEWINGTON, CONNECTICUT 06111

OPEN MON.-FRI. 10-6 • THURS. 10-8 P.M. • SAT. 10-4

EASY DIRECTIONS: Rt. 15 South — 2 blocks past McDonald's (Berlin Turnpike)

and YY have been soldered.

Caution: Be careful not to substitute capacitors larger than 15 pF across the secondary (pins 1 and 2) of transformer IF-4, or it will be impossible to tune the transformer during alignment of the discriminator.

Aligning the Discriminator

To perform the alignment, you may use either the receiver's S-meter or you may use a dc vacuum tube voltmeter (VTVM). Use of the VTVM is preferred since small increments of change may be more readily seen during alignment.

If you are using a VTVM, connect its negative lead (connect the positive lead to the chassis) through a 100k resistor to the junction of three components—the diode, the 1 meg resistor, and the 3 pF capacitor—at terminal #1 of strip YY. This is the avc voltage which will be of negative polarity and about one to two volts magnitude. Noise should cause the VTVM to peak at about 0.2 volts.

If the transceiver were properly aligned before the modification project was begun, you should not have to adjust any intermediate frequency transformers except IF-4, which is now the discriminator transformer. Refer to Fig. 3.

Allow about 15 minutes for warm-up of the HW-20. Tune the transmitter dial to approximately 147 MHz and set the "spot" switch to its "on" position. With the avc switch on and the "squench" control set fully counterclockwise, tune the receiver to the transmitter's frequency. Adjust the receiver's main tuning control for either maximum VTVM reading or maximum S-meter reading. (Note: The rf gain control should be set to its maximum clockwise position.)

Using a slug tuning tool, adjust the slug nearest the top of the IF-4 transformer, tuning it for maximum VTVM or S-meter reading.

Push the tuning tool carefully through the top slug of IF-4. Slowly turn this slug in the direction that gives an increase in noise output from the transceiver's speaker. There should be a buildup of noise until, suddenly, the receiver quiets. This null is very sharp. Adjust the bottom slug on both sides of this null until maximum quieting is achieved, then carefully withdraw the tuning tool from the transformer.

Turn the "spot" switch off and the noise should reappear. Turning the "spot" switch on and off should alternately quiet the receiver and bring up the noise.

If you can find a strong two meter FM signal on the air, it may be advantageous to use it for alignment instead of using the "spot" signal. Be sure to tune the receiver for maximum S-meter reading or maximum VTVM reading before you adjust the IF-4 slug for a null (full quieting). If you fail to do this, maximum S-meter reading and maximum undistorted audio output will not occur at the same spot.

If the receiver dial needs calibration or further i-f alignment, follow instructions contained in the Heath manual.

Modifying the Transmitter

As you did with the receiver, check to be sure that the transmitter portion of your HW-20 is operating properly before you begin this modification procedure.

Remove crystal sockets X1 through X4 from the rear portion of the chassis.

Remove the wire from the 100 pF capacitor at the

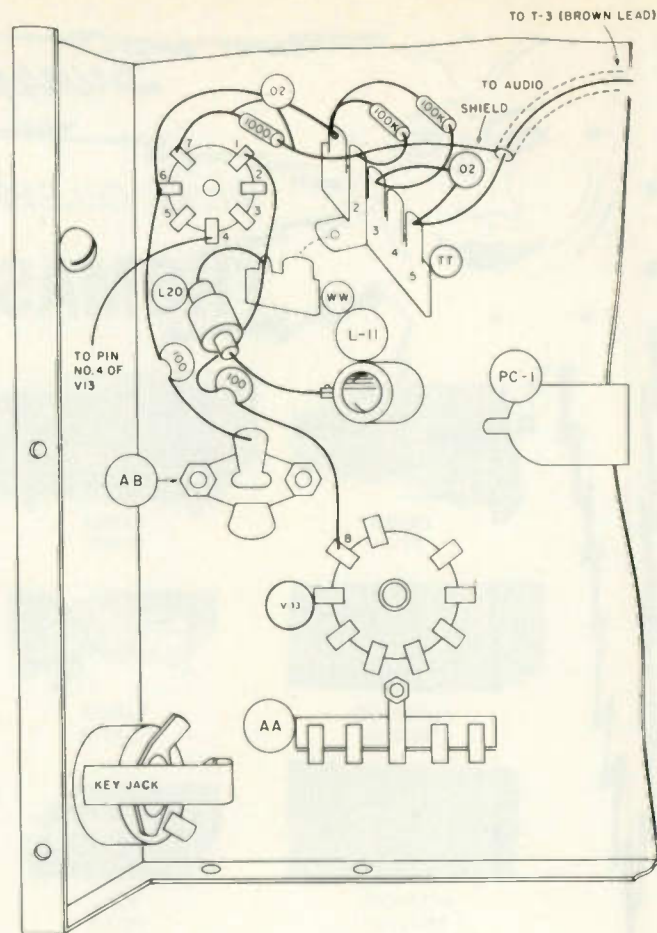

Fig. 4.

crystal selector switch and bend it back out of the way. It will be connected again later.

Remove the crystal selector switch and its mounting bracket. Neither will be used in this modification.

Using a 5/8" socket punch, cut a hole in the chassis in the space that was formerly occupied by crystal socket X1. Insert the tube socket punch draw-down bolt through the crystal socket X1 hole that is located nearest the selector switch you just removed.

Mount a seven-pin miniature tube socket and shield base in the 5/8" hole next to the filter condenser can. Position the socket so that pins 5, 6, and 7 face the rear apron of the chassis (see Fig. 4).

Solder the 100 pF capacitor lead (formerly attached to the crystal

selector switch) and a four-inch length of wire to pin #6 of the new tube socket.

Solder a 1k resistor and a .02 uF disc capacitor combination to pin #7 of the tube socket.

Solder a 12-inch length of wire to pin #4 of the tube socket. The free end of this wire will be connected later to pin #4 of V13.

Place a ground lug under the tube socket mounting screw and solder it to pin #3 of the socket.

Solder a four-inch length of wire to pin #1 of the socket.

Assemble components on terminal strip TT as shown in Fig. 2 and mount the strip adjacent to the new tube socket (per Fig. 4). Mount terminal strip WW under the same mounting screw used to secure TT and position it as shown in Fig. 4.

Solder the wire from tube socket pin #1 to the

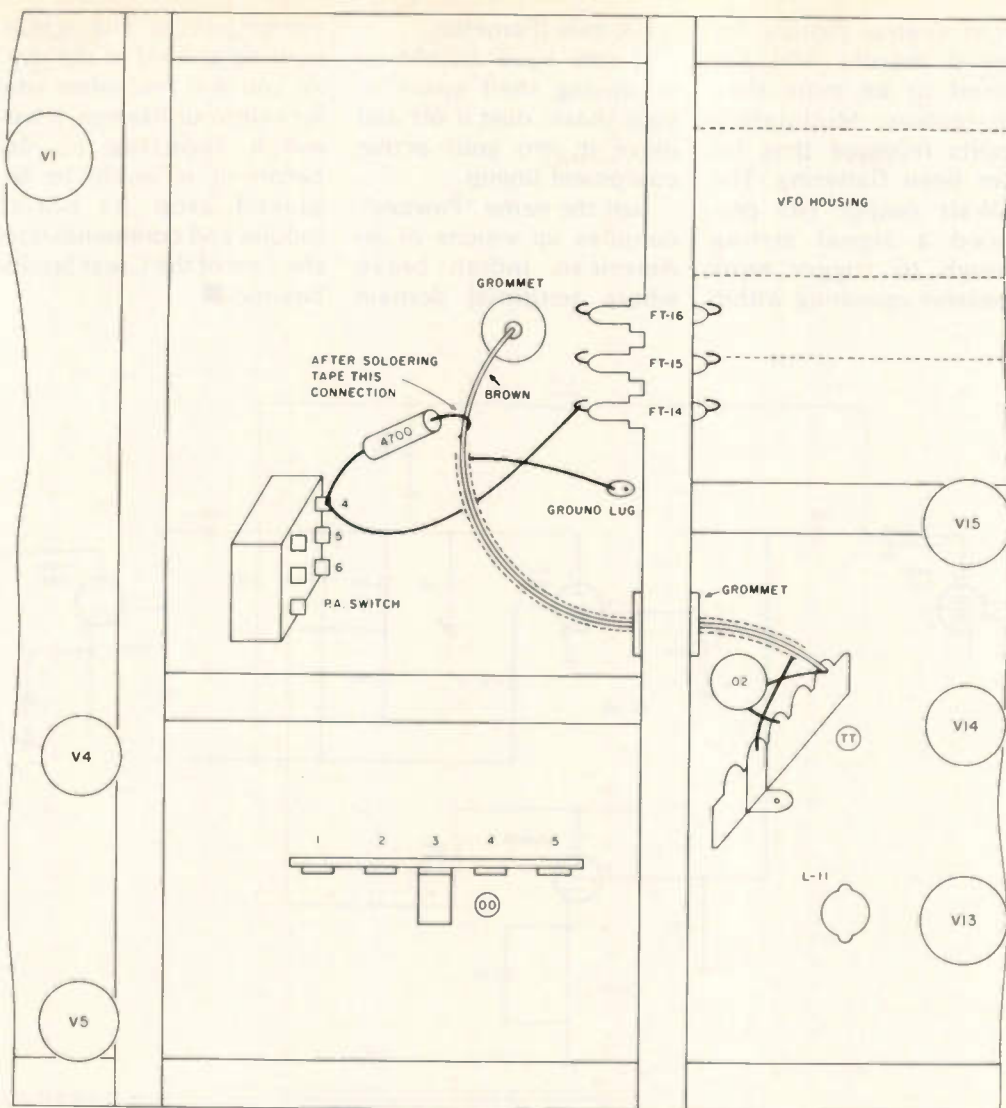

Fig. 5.

ungrounded terminal of strip WW. Also solder a 100 pF capacitor from this ungrounded terminal to pin #8 of V13.

Mount rf choke L20 between the ungrounded lug of strip WW and the top terminal of coil L11.

Route the 12-inch long wire from pin #4 of the new tube socket along the chassis apron and solder its end to pin #4 of V13.

Solder the lead from pin #6 of the tube socket to terminal #1 of strip TT.

Solder the free end of the 1k resistor/.02 uF capacitor combination connected to pin #7 of the tube socket to terminal #2 (ground) of strip TT.

Solder the inner conductor of a small shielded cable or coax cable to ter-

terminal #5 of strip TT and solder the braided shield to terminal #2 of TT. Route this cable through the grommet used to bring the main harness wiring into the rf section of the transmitter. It will be a close fit so use an awl (carefully) to aid your pushing the shielded cable through the grommet.

Remove the brown lead from feedthrough FT-14 on the audio section side (not the vfo side) of the feedthrough. This brown lead comes through grommet B (which is located in the audio section) from the modulation transformer.

Solder one end of a 4.7k, 1 W resistor to terminal #4 of the push-pull "PA" switch (see Fig. 5). Solder a wire to this same switch

terminal #4 and connect it to feedthrough FT-14 from which the brown lead was removed.

Solder the brown wire from the modulation transformer to the free end of the 4.7k resistor. Also solder the center wire of the shielded lead coming from the rf section to this 4.7k resistor lead. Solder the cable's shield to the nearest available ground lug.

Insert a 6J6 tube in the new miniature tube socket and slide a tube shield over the tube.

Transmitter Alignment and Audio Adjustment

Turn the transceiver on and allow it to warm up for several minutes. Tune the transmitter dial to 147

MHz. Set the VTVM to read a negative dc voltage on its 15-volt range. Connect the negative probe in series with a 100k resistor to pin #8 of V13. The positive probe should be connected to the chassis.

To better understand this procedure, refer to Fig. 6 for the following operations.

Connect the microphone to the transceiver and press its push-to-talk switch. (An alternative to this step is to slide the "AM-CW" switch to its "CW" position.)

Adjust the slug in coil L10 for maximum indication on the VTVM.

Release the push-to-talk switch (or slide the "AM-CW" switch to its "AM" position).

Remove the resistor and negative probe from pin #8 of V13 and attach them to pin #2 of the same tube (V13).

Activate the microphone switch (or "AM-CW" switch) and tune coil L11 for maximum indication on the VTVM. Release the mike switch (or "AM-CW" switch).

Switch the VTVM to its 15-volt ac range and attach the VTVM resistor/probe combination to terminal #5 of strip TT (audio line coming from the modulation transformer). Rotate the modulation level control located on the rear skirt of the chassis to its fully counterclockwise position.

Press the microphone switch, and, as you talk in a normal voice into the mike, advance the modulation level control clockwise until you get an eight- to ten-volt indication on the VTVM. Unless the transceiver was in need of alignment prior to the modification, no further adjustment should now be necessary. If, however, transmitter alignment is required, refer to the HW-20 manual and proceed as directed.

If another two meter FM

receiver is available, listen to your HW-20 as you touch up the modulation control to be sure that overdeviation and distortion do not occur.

Final adjustment of the modulation level control can be made on the air as you are checking the transceiver's operation while talking to another station.

On-the-Air Operation

It's a simple matter to set the transmitter's frequency for simplex operation. You merely beat the transmitter signal against the incoming signal by using the "spot" switch and adjust the transmitter dial to obtain a zero beat.

If you own a frequency counter, use it to tune the transmitter frequency to "bring up" a nearby repeater. If you don't have a counter, you can get by very well without it. It's possible to activate most repeaters merely by tuning the Pawnee transmitter to their receive frequencies, relying solely on the dial calibration for hitting the repeater.

If, after you "trip" the repeater, you receive a report that you are slightly off frequency, adjust the main transmitter knob to slide up or down the band to hit the repeater receive frequency exactly.

A Footnote

With the modification described above, you can have a hot transceiver that is capable of working any of the thousands of two meter FM repeaters that are now operating throughout the country.

The modified HW-20 is primarily a rig to be used in the shack. But, if you prefer to operate mobile, the Pawnee's receiver and vfo are certainly stable enough to serve you well in that capacity.

Shep's modified Pawnee has been operated on the

air in central Florida for several months and has proved to be more than satisfactory. Modulation reports received thus far have been flattering. The 10-Watt output has produced a signal strong enough to trigger most repeaters operating within

a 100-mile diameter.

If you have an HW-20 occupying shelf space in your shack, dust it off and move it into your active equipment lineup.

Just the name "Pawnee" conjures up visions of an American Indian brave whose territorial domain

encompasses the great hunting ground in the sky. As you will find when you recycle your Pawnee, it has much scouting to do before it is ready to be placed atop its burial mound and commended to the care of the Great Spirits beyond. ■

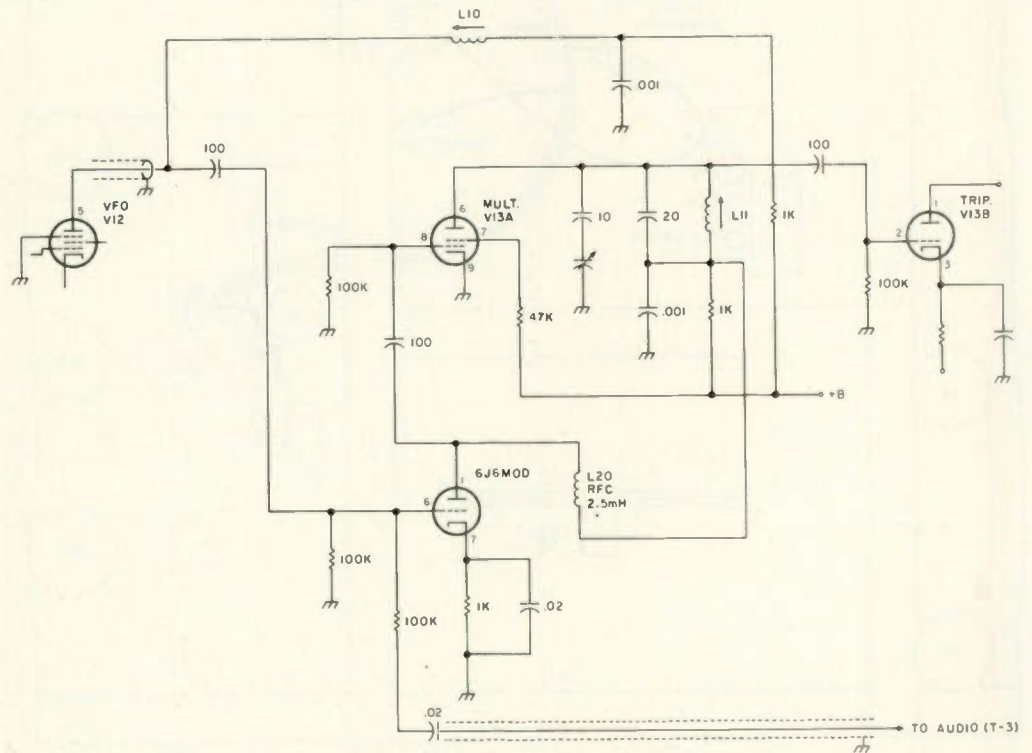
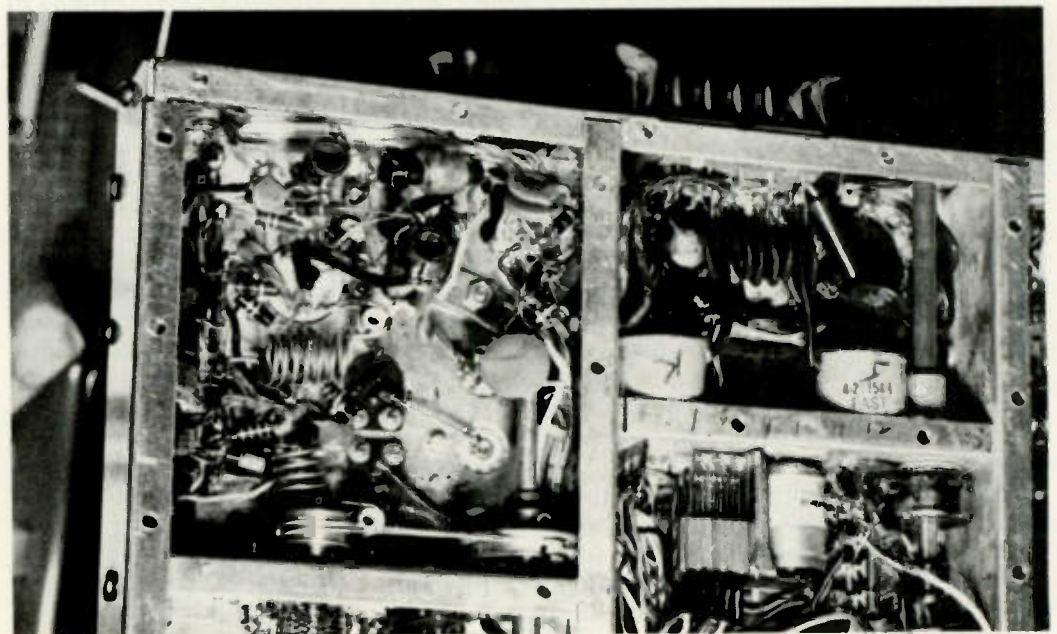

Fig. 6. Vfo, modulator, and multiplier circuitry after modification.



A close inspection of the compartment in the upper-left quadrant shows the phase modulator tube socket and two terminal strips that were added to modify the Pawnee transmitter.

UNFORTUNATELY...



**Radio
equip-
ment
doesn't
grow
on
trees!**

You have worked hard for your money—don't gamble when you buy that next rig, antenna or even accessories. Contact C&A where they have been serving the amateur and commercial market for almost two decades. C&A can offer you the best prices plus the assurance that they will be there to back up your purchase with their staff of experienced LICENSED technicians and a genuine desire to add your name to their long list of satisfied customers.

CALL OR WRITE for all your needs to:



C&A Electronic Enterprises

Distributors of Commercial and Amateur Radio Equipment C88

Two locations to serve you better:

22010 S. Wilmington Ave., Suite 105
Carson, CA 90745
(213) 834-5868

5773 Overland
Boise, Idaho 83705
(208) 377-5274

High Seas Adventure — Ham Style

— part I

Photos by Jules Wenglare W6YO

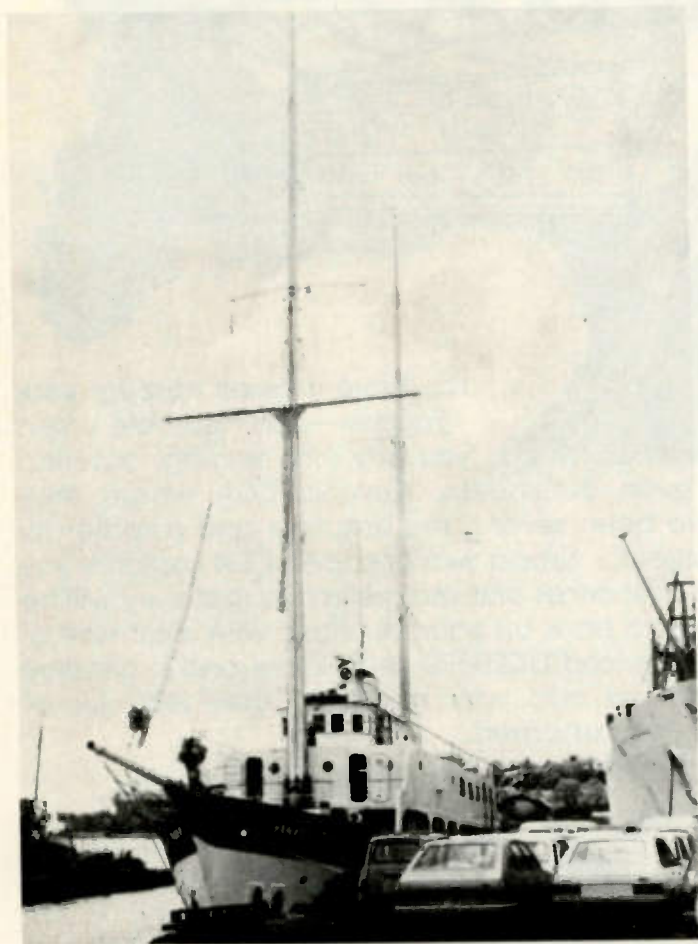

For Jules Wenglare W6YO, the *Yankee Trader*, of the *Windjammer Cruises*, Miami Beach, Florida, was home for his 10-month around-the-world cruise. The *Trader*, pictured here somewhere in the West Indies, stopped at some 53 ports around the globe on her 30,000-mile search for adventure to strange and exotic ports of call. For Jules, it could be called a worldwide DXpedition.

To embark on a 10-month around-the-world cruise to strange and exotic ports of call is true adventure in itself. But if you take amateur radio and put the two together, you have the greatest sea experience and personal search for adventure ever possible. For one ham, this rare opportunity is no longer a dream.

Jules Wenglare W6YO set sail on February 15, 1977, from Freeport in the Bahamas aboard the *Yankee Trader* to chase adventure, explore the wonders of the world, and operate amateur radio from the four corners of the globe. This voyage visited the ports and countries of Haiti, Balboa, C.Z., Ecuador, Galapagos, Tahiti, Fiji, and American Samoa, with several stops in between. The *Trader* also docked at Singapore, Madagascar, and South Africa, some fifty-three ports in all, before the cruise headed back to the Bahamas and Jules took a flight home to California.

Jules met many an amateur radio operator on a face-to-face basis during this trip. One of those was Father Dave Reddy CEØAE on Easter Island. If you have read "Pitcairn Island — an inside

look at VR6TC," which I wrote for the March, 1977, issue of 73, you'll know all about Tom Christian, a direct descendant of Fletcher Christian of *HMS Bounty* fame. Jules spent almost two days on Pitcairn with Tom and his family.

I may be a ham and I may be a writer, but I'm not a magician. So, before I go any further and you begin to wonder how I have come up with so much detail about this trip, I'll let the cat out of the bag — right here.

Jules and I know each other, personally, and we made prior arrangements for the writing of this article. I made several contacts with him as W6YO/MM and received several of his letters from different ports, but the main system for information has been through cassette tapes he made of the trip at intervals along the way. These have given me more interesting material than I can possibly use here. It took over eighty hours to transcribe twenty-five 90-minute tapes and eight hours to view and edit photos from thirty boxes of color slides. The results are what you will read here. I only wish that everyone could have had the chance to hear the trip as I

have. It was most enjoyable.

With a 15 and 20-meter dipole antenna at about 100 feet, a heavy-duty battery and charger for emergency power, his Swan 350, an Atlas 210X — on loan courtesy of the Atlas people in Oceanside CA — and everything set up in cabin 25, stern, portside, Jules and the *Yankee Trader* were sailing en route to their first port of call — Cape Haitien, Haiti, West Indies.

Jules's first contact at sea as W6YO/MM was with a French station. He said he worked both Australia and New Zealand on long path; he also worked South Africa. He said he made contact with an operator aboard a cruise ship from England that had just left New Caledonia on her way to Fiji with 1300 passengers and a crew of 800. That's a lot more than the 50 passengers aboard the *Trader*.

When the ship arrived at the rugged north-central coast of Haiti, it was in a drizzling rain, and Jules didn't get to take the sight-seeing tours he had planned. However, he did get to go to an American religious broadcast station, 4VEH. The transmitters there were the old vintage type and air cooled. The station has a combined power output of 27,000 Watts. One of the antennas was a two-element tri-band quad up about seventy-five feet, fed directly with large coax.

"Cape Haitien," Jules wrote, "is where Christopher Columbus, in the year 1492, made a landing and lost his flagship, *Santa Maria*. The crew remained ashore, and, when Columbus came back the following year to pick them up, there was no sign of their existence. This was when the Indians were cannibalistic."

Jules did get to see some of the city, and on the last evening in port he took in a voodoo dance. "The performer danced around on broken glass bottles, fire ashes, and set torches of flame against his head and

body. Of course," Jules mentioned, "he had drunk some potent alcohol before performing. From our inside-the-ring view, we could really smell it."

The ship sailed on Monday, the 21st, to Port-au-Prince, the capital of Haiti. Upon arrival, Jules mentioned seeing two 400-foot towers which he believes were part of the U.S. Marine station of long ago. The antenna was of the cage type and the end insulator near the ground was about seven or eight feet long with corona rings eighteen inches in diameter. Jules said he used to work HH7C of the Marines here in the 30s and relayed messages to his home in Pennsylvania.

Jules viewed the President's Palace, downtown, where there bristled the latest looking towers and antennas of an elaborate communications system. The government buildings were very impressive — all white with gold domes.

Since U.S. hams can't operate amateur radio in most foreign ports, Jules always welcomed getting back to sea. While en route to Martinique Island, it was radio time, again. He worked Archie K4IBO in Miami, where he had stayed a couple of weeks before this trip began. He also worked VK land and two Israeli stations along with some stateside contacts. It's amazing what a simple dipole can really do.

Jules made contact with Austin VP2DAJ. "He spoke perfect English," Jules stated. "There were five visitors in the cabin and Austin really did an excellent job of describing the island of Dominica. The QSO lasted over an hour."

The *Trader* sailed "about twelve to fifteen miles north of Aves Island, a tiny island about 300 by 50 yards and eight feet high, where, in August of 1958, I, along with Danny Weil of the famous Yasme DXpedition and two YV hams stayed one week to



This is Trans World Radio, a religious shortwave broadcast station on Bonaire Island. Jules's interest in broadcasting is due to his association with the Voice of America in Delano, California. He was employed at the VOA prior to his retirement. Jules spent many hours at TWR viewing the transmitter setup.

activate YVØAB. It was some experience for me," Jules wrote, "sailing there and back for one week from St. Thomas in the Virgin Islands where Dick KV4AA was directing the Yasme original operations."

After almost a thousand miles of sailing across the Caribbean Sea, the *Trader* dropped anchor at Fort-de-France, Martinique, next to the *Yankee Clipper*, another Windjammer cruise ship. Within a short time, the *Trader* was placed in drydock for standard procedure certi-

fication and repairs. They had planned on doing this later in Singapore but decided to stop here instead. The workers here arc welded dozens of zinc plates to the ship's hull to prevent electrolysis from eating holes in her.

When the ship arrived here, Jules had made 140 contacts with all continents, eight long-path contacts into VK and ZL land, and some thirty phone patches for passengers aboard ship. Since he couldn't operate in port, he spent a lot of time working on the antenna system.



The Trader as she journeys through one of the many locks in the Panama Canal. There are six locks that either raise or lower a ship as it travels nearly 50 miles in 10 hours from the Atlantic Ocean to the Pacific. Jules stated, "It was an interesting and scenic trip."



Father Dave Reddy CEØAE on Easter Island. Father Dave (as he prefers to be called) is a member of the A1 Operator's Club and the holder of the Eagle Scout Award. He is world renowned and sought after as a ham operator. Father Dave is the pastor of Santa Cruz Church on Easter Island.

Jules had previously made up everything for a rotatable two-element quad, but it didn't get installed. It rained too much and he didn't like the idea of hanging from a bosun's chair for such a difficult installation. He did, however, put up an antenna on top of the 135-foot foremast — a touchy situation at that height swinging from that bosun's chair. He said there were two confident people handling the control ropes from the bottom. Jules said, "It was an exhausting job to install the antenna, connections, and coax."

After a week in port, the ship set sail for Bequia, a small British island. He reported seeing several beautiful sailing yachts here in the harbor from all over the world. And, for the first time in ten years, he went snorkeling. "The visibility wasn't too good," Jules said. "The view under water was a little disappointing."

It rained the following day, and he didn't go anywhere. He did report meeting a retired California school teacher who was on a scholarship tour. She was a ham but didn't mention the call. The rig she had with her had gone out, so Jules took some messages and later relayed

them back to relatives in the States advising them that everything was alright and she was trying to get the equipment repaired.

The stops at some of the ports visited were of short duration and very little occurred in Jules's reporting. After leaving Bequia, he handled some phone patches and did some remodeling of the equipment shelves.

There are double bunks in cabin 25. Jules slept on the bottom and used the upper as a storage area for some extra gear and baggage. He bought a small folding chair in Florida to use at his operating table. He said the small trickle battery charger wasn't keeping the battery up enough. To make matters worse, the alarm clock he bought for the trip lasted two days.

Bonaire is about 150 miles off the coast of Venezuela, slightly northwest of Caracas. This was the last stop for the *Trader* before heading for the Canal Zone. While eating lunch here aboard ship, Jules had a visit from an engineer and his two sons from Trans World Radio, a religious shortwave station on the island. The engineer was Chuck PJ4CR. They were given a tour of the ship and

the radio shack. A little later, two more hams and their families came aboard and received the guided tour.

Jules took a tour, also. His went to Trans World Radio. He said it was quite impressive with its 550-foot towers with changeable direction capability. The full power capacity of the station is 3 megawatts. They rewind their own transformers here, as it's cheaper than buying new ones. They also have their own riggers who climb these huge towers every week, apparently for inspection. Jules said he spent a great deal of time at the station.

Jules's fascination with broadcast stations is attributed to his association with the Voice of America in Delano, California. He was employed there for about nine years before retiring in December of 1976. I took a tour of that station and can say that it was fascinating to see the setup for each individual transmitter and the antenna systems used. Modulation transformers that stood six feet tall, tubes that were rated at 100,000 Watts, and miles of copper tubing for the antenna transmission lines. It is also of interest that about half the employees at the VOA are hams.

After leaving Bonaire, Jules handled several phone patches for some of the passengers. "For one person, I made six different efforts at six different locations without any answer by phone. It was disappointing that he couldn't find anyone at home for those numbers."

Jules had been at sea for one month now as they headed for Cristobal, Canal Zone. He worked Hal KZ5HP and told him that the *Trader* would be arriving in several hours. When it did arrive, he met Hal and his XYL, Norma.

Jules went to the U.S. post office and made arrangements to pick up mail for Pitcairn Island. A month before, another ship had picked up over two dozen bags for the island. This time there were

only two — about fifty pounds. In addition to this mail, the *Trader* had some freight aboard for Pitcairn.

Before the *Trader* sailed through the Canal itself, Jules took a train ride along the Panama Canal and through the jungle. He stopped at Fort Clayton for a visit but gave no details.

While going through the Panama Canal, the passengers, and any person within several miles, received quite an entertaining surprise. Jules mentioned that four or five C-130 planes dropped hundreds of paratroopers from their bellies. The sky was filled with descending white parachutes. It was a very unusual treat.

After going through the three stages of Gatun Locks, the ship had been elevated to Gatun Lake, 85 feet above sea level. About thirty miles across the lake, Pedro Miguel and two Miraflores Locks lowered the *Trader* back down to sea level. The trip from the Atlantic to the Pacific Ocean took about 10 hours. Jules stated, "It was an interesting and scenic trip."

When the *Trader* docked at Balboa, C.Z., some of the passengers had a desire for — ice cream? Yes, homemade ice cream. They pooled some money and — you guessed it — Jules was elected to go after the ingredients.

He said he couldn't locate case lots of powdered milk so he bought six large boxes of KLIM (KLIM is milk spelled backwards). He said he remembers buying KLIM in Turkey back in the 1940s. He also bought some pure Hershey chocolate for the topping along with the remaining ingredients and two ice cream mixers. It took a couple of hours to locate all the items needed, and the taxi bill alone came to \$12. About 10 pm that night, aboard the *Trader*, the passengers ate homemade ice cream. "It was a little bit soft," Jules commented, "but good."

While in port, Jules did



Get into "220" Mobile the Easy Way with Midland

Midland has a pair of proven performers, crystal controlled or P.L.L. synthesized . . . both designed to be easy on the pocketbook

To start with, here's Midland's Model 13-509. It's a compact, rugged mobile with capacity for 12 crystal-controlled channels. The "509" transmits with 10-watt or 1-watt output. Its receiver has a dual gate MOS FET front end with hi-Q resonator and ceramic filters. There are SWR and polarity protection circuits, internal DC filtering and electronic switching. With its jack for optional tone burst and discriminator meter, the "509" has even been the basis for many repeaters.

Midland's choice alternative in "220" is P.L.L. synthesized Model 13-513. Here's advanced design with modular construction and digital frequency readout. It's programmed for 500

frequencies between 220 and 225 MHz, with a 5 KHz shift up giving 500 more . . . and 4 offsets are available for repeater use. The receiver has a multiple FET front end with monolithic crystal and ceramic filters. The transmitter switches for 20-watt, 10-watt or 2-watt output. With automatic SWR and polarity protection, internal DC filtering, electronic switching and a jack for tone burst and discriminator meter, the "513" is a very desirable "220" mobile . . . or base.

Pair either of Midland's "220" mobiles with Midland's trunk/roof mount or magnet mount antennas (Models 18-950 and 18-951) for top-notch performance on the band.

 **MIDLAND**
INTERNATIONAL

For more about Midland "220" Mobile, write: Midland Amateur,
P.O. Box 1903, Kansas City, Missouri 64141

some more antenna work. He cut down one antenna and put up another one for 15 meters at the 135-foot height. He was up there for almost three hours. The next day, he went up for another three hours to complete the installation. The first 15 meter antenna didn't want to cooperate on the swr. No matter what he did to it, the swr wouldn't come down below a 5 to 1 reading. He said the steel ship must have something to do with the problem. On 20, the swr is 1 to 1.2 and real hot.

Before the ship left, he met Ernst KZ5EK, a doctor who works for the U.S. Public Health Service. Jules went to his home, met his XYL, and saw the ham room.

After leaving Balboa, Jules made his first 15 meter contact of the trip. He was tuning up the rig when John W6UZ broke in and said, "Is that you, Jules?" John and Jules are very good friends and have been meeting on 20 almost every day. John is with the VOA in Delano.

Later that evening, contact was made with Bud HC8GI on Galapagos Island. Jules told him that some of the passengers, including himself, were going to make a special trip there by charter plane from Ecuador since the *Trader* wasn't scheduled to stop at the island. Jules made several other contacts, then ran a few more phone patches.

Apparently it is a custom to celebrate or have a party when a ship crosses the equator. The *Trader* was no exception, and it must have been one of the most exciting times Jules had. He was laughing so hard when he recorded the details that I couldn't get enough information to put down. I do know that everyone was dressed up in an unusual fashion and a couple of the passengers had mop heads for wigs. Jules acted as a surgeon and, from what I understand, was the life of the whole thing.

Guayaquil (pronounced Y-Keil), Ecuador, is just

below the equator and inland about forty miles. When the ship arrived, Jules learned that someone was looking for him on the pier. It was Ray HC2JX and his XYL, Helen HC2HV. After a very nice conversation, the hospitality of these two amateur radio operators was graciously extended to Jules and seven other passengers. They all — how, I don't know — piled into Ray's car and for the next two hours were given the grand tour of the city of Guayaquil. They went everywhere, with a few stops to get out and stretch their legs. With four people in the front and six in the back, I think some laps must have been a little tired.

That evening, after the excursion around town, Ray and Helen further demonstrated the hospitality so often found in the ham fraternity with an invitation to dinner. Jules went to their beautiful penthouse-type apartment. "It was absolutely elaborate," Jules said, "and the dinner was exquisite." He said it was one of the best-served and most enjoyable dinners he had ever eaten.

The Galapagos island group is 650 miles west of Ecuador and was once known as the "Enchanted Isles." Galapago is, of course, Spanish for tortoise. The Galapagos turtles on the island grow as large as five hundred pounds. The iguana, a lizard, sometimes up to four feet long, is the most fantastic of all the animals on this 15 island group. On Tuesday, March 29, Jules and several other people left by plane from Ecuador and, within two and one half hours, landed on Santa Cruz in the Galapagos Islands.

Aboard a 45-foot ketch called the *Suliday*, they took a tour of several of the islands over the next few days. On one, Jules said, "Some of the seals wouldn't let the people pass on the path, so everyone had to go around them. There were at least 100 seals and numerous iguanas. A bull seal

held everyone at bay and even chased some of the party." Jules mentioned that he was one of the first to get by the big bull seal and one of the men that followed came very close to getting caught by a pair of unwelcoming jaws.

Jules described one of the islands as having pink sand. He said it was almost as fine as talcum powder. If you got it in your hair while swimming, it was very hard to get out. On yet another island, he went snorkeling again. It must have been the fact that one could see up to 150 feet deep that persuaded him to go. He said everyone else refused — there were sharks in the area. After seeing the movie *Jaws*, I wouldn't have even stuck my big toe in that water.

Jules met Rolf HC8WW on Floreana. Rolf was born there in the Galapagos Islands. "A real nice fellow," Jules said, "who could really talk radio."

When they arrived at Santa Cruz, Jules went to the Darwin Research Station. He visited the pens where some of the large turtles are kept. These turtles are so big that a child can sit on one of their backs and take a nice ride.

He met and went to the

home of Forrest HC8FN and spent a lot of time with him. Jules mentioned that he had a very unusual antenna. It was a three-element beam, but the center element was used for 40 meters. Jules also met Bud HC8GI and his XYL, Doris. He gave Bud 200 feet of coax that Hal KZ5HP had given him to deliver.

There was a lot more activity enjoyed on Galapagos than what Jules mentioned. He tried to cover the highlights of interest without going into a lot of detail about everything he did. This was also true in recording information at other *Trader* ports of call.

When Jules returned to Ecuador, Ray and Helen were there to meet him. They spent several hours aboard the *Trader* to see the ship and visit with him.

During this tape, Jules said that it's nice that, when you meet hams in person, they turn out like they have been on the air. On the air, it's easy to make friends, but, in person, it's sometimes a different thing. So far, everyone has proven that hams can be wonderful people in person, also.

The *Trader* set sail from Ecuador for a 10-day voyage to Easter Island. Jules made



Jules Wenglar W6YO and Father Dave Reddy CEØAE standing beside one of nearly a thousand solid rock carvings on Easter Island. Although some of these stone head carvings are nearly 50 feet high, the average is about like this one — 20 feet tall.



Easter Island, a 64-square-mile dot of land where mysterious goliath monuments stand as silent survivors of a lost culture. Their distant past has puzzled scientists for generations. The solid volcanic rock used was provided from the volcano Raraku. Monuments weighing up to 90 tons were chipped from soft stone and carried up to 10 miles away where they were placed in various locations.

contact with Tom Christian VR6TC on Pitcairn, and they talked about his forthcoming visit there. While Jules was recording this, he stated: "Yesterday I made contact with Father Dave CEØAE. Oh, I should be looking for him now, it's schedule time." (Click) Five seconds later, Jules said he made contact and they talked for quite some time. (The actual time lapse from his schedule with CEØAE and his return to the recorder was two days.)

Jules said that he really had a chance to work a lot of stations during this long trip. The band openings were tremendous with contacts into Iran, India, and the Philippines, to mention a few. Each day, he would check into the South Pacific MM Net and report the ship's position. He also ran a lot of phone patches.

If you work a rig long enough, something is bound to happen. It did. The power supply went out. Jules said that the problem was in the bridge rectifier circuit and was quickly repaired.

Jules was going to do some more antenna work at sea while the ship had good smooth sailing weather. He

got up to the 50-foot height and learned that it was too rough up there to work. He was being tossed around too much and had to come down and wait until the ship was in port. I guess the mast acted like a bullwhip even though the ship itself was seemingly smooth.

The food aboard the *Trader*, Jules says, was very good. But, with a million square miles of ocean to fish in, why not use it? One of the passengers caught a 10-pound tuna that took more than a half hour to land. The ship was sailing at about 11 knots and the pull was very heavy. It's a miracle he got it aboard. "He really worked up a sweat catching that one," Jules said.

Jules also mentioned that some of the passengers saw dolphins chasing a school of flying fish. I would have enjoyed seeing that myself.

Some 6,175 miles into this around-the-world cruise, the *Trader* dropped anchor in Hanga Roa (Cook Bay), Easter Island. One of the first persons Jules met after going ashore was Father Dave Reddy CEØAE.

Jules visited the church and then went to Father Dave's home. That evening,

they went on the air but made only a few contacts. The rig had developed a few problems: no drive, no output.

The following day, Jules toured the island and saw many of the huge stone head carvings which ancient Polynesian artisans carved from volcanic rock. These purse-lipped statues, numbering close to a thousand, are scattered around the perimeter of the island in shrines. The tallest figure is somewhere around 50 feet tall; the average height is about 20 feet. Jules said it was "very impressive seeing these statues scattered about the fields for miles. It was a sight to see."

Jules went right up on top of the rim of one of the extinct volcanos with Father Dave. They also took a dip in the ocean during the tour. Jules mentioned that, while they were swimming, sand blew all over his camera on the beach. He later cleaned it out but said the shutter would stick sometimes. (Unfortunately some of his pictures taken from this island stop to other locations were blank. The shutter still sticks about every third photo.)

Jules tried to locate the problem in Father Dave's rig but had no success. They went aboard the *Trader* and listened for a W6 but had no success on 20 meters. On 15, at least a dozen calls were made for southern California. Finally, contact was made. A message was given to the other operator and a phone call was made. Shortly, word came back: The Atlas Company hereby grants permission to leave the Atlas 210X on loan to Jules with Father Dave.

When Jules and Father Dave got back on shore, the first thing they did was get that rig hooked up. It was hamming time. They made many contacts that afternoon, thanks to Atlas and to Jules for his consideration and thoughtfulness.

The departure time on Easter Island had arrived, and the ship was barely under way when Jules got on the air. Most of the contacts were stateside. He worked some foreign countries and that evening worked Father Dave, only a few hours after leaving his home.

Aboard the *Trader*, there is a small newsletter printed about the various stops the ship makes called the *Trader Tales*. Copies are sent out by some of the passengers like letters. In the one detailing the Easter Island visit, Jules wrote the following, with the heading "He Who Stands Tall On Easter Island": "The mysterious race which carved the hundreds of twenty-foot statues on Easter Island looked up to their statues. Today's population of 2000 looks up to and depends on Father Dave Reddy, not only in religion, but because of his ham radio station CEØAE, which is world renowned and sought after.

"Father Dave himself is a tall, impressive, jovial person and devoted to his church work and his hobby, which helps keep people on the island and amateur radio operators around the world happy."

Not too long after the *Trader* left Easter Island, I made contact not only with W6YO/MM3, but also with Father Dave CEØAE, both at the same time. It was one of those things we would like to have happen, but it usually doesn't. This time it did. We had a very enjoyable three-way QSO.

Jules made contact with Tom Christian VR6TC on Pitcairn, the island the ship was now heading for. They discussed the weather and the possibility of not being able to stop there. If the small storm raging at Pitcairn didn't subside soon, the *Trader* might not be able to stop.

In the March article about Pitcairn Island and VR6TC, I noted that Bounty Bay was the only entrance and exit from the island. It is, by

world standards, not big enough to even be called a bay. A small indentation in the sheer cliffs has enabled these people to launch their longboats and go out to waiting ships. A ship cannot go in. If the weather is too severe, the longboats do not go out. The Pitcairners and the passengers aboard the *Trader* were hoping the weather would change from bad to favorable. The *Trader* was due to arrive in less than two

days. The weather did change. This, to Jules, would be one of the most memorable experiences in his life: a face-to-face QSO with one of the most sought-after contacts in amateur radio — Tom Christian VR6TC, great-great-grandson of Fletcher Christian of *HMS Bounty* fame.

Jules not only met Tom, his wife Betty, and their family, but also the OM of

Pitcairn himself, Andrew Young VR6AY. He also operated there as W6YO/VR6. Two days after leaving the island, the ship ran into a severe storm and several hams combined forces to provide weather data in order to aid a change in course.

Later in Tahiti, Cook, American Samoa, Fiji, and even Australia, Jules met some more fabulous people in amateur radio. He even saw what is possibly the world's

largest great circle map. He also had something unusual happen to him in the jungle on Bora Bora.

Due to the type of trip Jules was taking, the number of stops made, and the adventures which unfolded as each day passed, you will have to wait to see and read about these in the next article in this series. It will be as interesting as what you have already read, perhaps even more so. ■

LETTERS

from page 58

keel. The lineup of letters lambasting you for publishing materials related to fighting fire with fire is a display of distorted self-righteous indignation, and your very willingness to publish these letters shows your liberality even better than it exposes the dangerous mentalities of the writers.

Let me close by congratulating you not only on the fine publication you issue, but also on your exercise of the finest principles of journalism in a free society. Many times the best journalism is that which most people would turn their eyes from, but we've got to keep at it if we're to have hope for our society.

Harry Church W0KXP
Dickinson ND

LAW CHANGING

Man, it finally came! I received the July issue of 73 and was intrigued by all those letters against WA4WDL's article in regard to hamming on the police radar frequencies. I was not upset by any of them.

When the 55 mph speed limit went into effect, no one asked the public—it was just done. When those who knew sent our young to die in places they couldn't pronounce, it was just done! And so now we get radar. Under the guise of protecting us from ourselves, we get irradiated from those who protect.

How naive most of those letters sound when reread with an open mind. If we were to suggest righting a (by vote) wrong, then it could be done. Remember we tried that during Vietnam. We elected our hero, and more died. Now he is taking credit. We did that twice!

Corporations use the law to break the law; the FCC changed CB rules because the law was broken so frequently. Changing the law sometimes requires breaking the law, but rights of property and person prevail. We should all be a bit perturbed at our status as sheep off to slaughter.

Independent thinking is dangerous. It makes those who can't think that way nervous. It becomes a threat. Thanks, Wayne. At times I get disappointed in 73, but then again we all have our ups and downs. Encouraging it is to see more than just the shirt and tie philosophy, for the world ain't just so, and baby, neither is ham radio.

Jozef Boniakowski WB2MIC
Neptune NJ

MICROWAVE LIBRARY

With the increase in interest in microwave communications (MWC), I suggest that a microwave communications information exchange should be started to collect and distribute MWC information.

For those persons who are interested in the exchange, I will send a list of available articles and the names and ad-

dresses of the persons who have written articles and are interested in MWC. This list can be had for an SASE and will be updated every two months. If you wish to have the list sent to you for, say, the next 10 months, just send along 5 SASEs. Then I will notify you when your SASEs are about to run out.

I will also compile a library of MWC data that you, the users of this service, will help compile. You can find the information in books, magazines, and newspapers. If you wish to send in information that you find, send a good photocopy that can be photocopied at a later time for others.

The price of photocopying will be 15¢ for one page or two for a quarter. The price of the articles will be included in the update list which will be sent every two months.

Be sure to include an SASE if you want a reply and if you want to get further updated lists. Don't forget to include as many SASEs as you want. Do not forget to send any MWC data that you may have.

Garold C. Casler
RR #1
Chatfield MN 55923

THE AWAKENING

I read with great interest the letter from WD4BFD in the June issue of 73, and it brought back more memories about my early days as a ham than I care to remember. I got my Novice license about 12 years ago as a young teenager, back when it was fashionable to be loyal to the ARRL. I cursed you like the Red Baron and branded you a "radical," Wayne, because of your constant criticism of the beloved ARRL. At the time, I wouldn't even buy *73 Magazine* because of your attitude towards the ARRL. As the years passed on, though, I

began to notice that when the hams had a problem, almost without fail the League would turn its back on the ham (i.e., a ham involved with the FCC and one of his neighbors in a TVI battle). After awhile, it became evident that the League was glad to take our money and forget us. Unfortunately, I guess this is a lesson in life that most new hams must learn for themselves.

The fact that they sold us out at the 1971 ITU, as they probably will next year, and now the "blackmail" or whatever, should be enough to wake up even the staunchest supporter of the ARRL. It is perfectly OK for the ARRL to spend hundreds of thousands of dollars for that pretty new Headquarters Building so that the honchos can be comfy, but then the League cries that it is too poor to support some of our more prominent hams for trips abroad to try and save us at the 1979 ITU. Newcomers should search the record books and find the last time that the ARRL did something really substantial for the ham community.

Wayne, I apologize for the years that I branded you a radical, and now I want to thank you for being honest enough to tell us what the League does when they get behind closed doors. I hope that in time WD4BFD and others like him will realize that all we get from the ARRL is a con job, and a tighter fitting noose with each passing ITU. Personally, I think the noose they have us wearing now is exactly 237,247.27 MHz too tight.

Dave Allen WB4IAG
APO New York

SKIN DISEASE

I am writing this letter to pro-

Continued on page 160

Clegg is Transceiver Headquarters!

Who was it that said "There's nothing new under the sun?" He was wrong! There now is a generation of truly new concepts in Ham Transceivers. Any one of the rigs shown here has features and performance that never before were available. Regardless of what transceiver you currently own, we contend that replacement with any one of these three will increase your station performance. Each of the three has unique features. The only question is "which best suits your personal operating requirements?" Let us help you decide!



DRAKE TR-7

Drake's "7 SYSTEM" incorporates more innovative technical advances than any product we have seen in many years. Receiver dynamic range exceeds that of all others. If your QTH is in KW alley you'll experience a substantial relief from overload. If you've worried about changes in our bands after the WARC assemblage—the TR-7 can dispell your fears because it accommodates any future possible band relocations and new allocations. The frequency stability of Drake's "full-synthesis" and the large brilliant digital display add to the delight of any TR-7 owner. Space here is inadequate to define the numerous design and operational features of this superb transceiver. Call us for descriptive literature; better yet, drop by and try one in our demonstration room.

You'll discover—as we have—that Drake has created a real winner. One that the others will be hard pressed to equal for years to come. And if you prefer to operate with "separates" the forthcoming R7 Receiver gives you the performance of "twins" plus the convenience of a full performance transceiver for traveling or in the mobile.



YAESU FT-901

YAESU's FT901 system. If you're looking for a transceiver that not only outperforms others on any band from 160 through 10 meters but also has a single matching accessory to conveniently and efficiently cover 6, 2 and 3/4 meter bands, the 901 is it! Even if the VHF and UHF transverter doesn't interest you now, it surely will as OSCAR satellites become the way of life in the next few years. Of all the transceivers we've tested (both on the air and in the lab) none offers the superb control of receiver selectivity offered by YAESU's Variable Selectivity and Notch Filter. And if you work CW, the Tuneable Audio filter will delight you. Nor have we found another Speech Processor system that sounds as good while doing so much for signal punch as that on the 901. Add to this such features as a built in keyer plus both FM and AM detectors. Watch for a gigantic increase in membership in the Fox Tango Club when the gang discovers this great new transceiver.

Watch for YAESU's new matching SCOPE with "panoramic" display and the new synthesized external VFO accessories.



ICOM IC-701

ICOM's IC-701 has to rank very high on our list of best available transceivers. Most of its great features aren't immediately apparent when you first take it out of the box. In fact, after you operate it for a week you'll still be finding new things to like about this all solid state, sophisticated unit. The operating flexibility provided by the dual VFO feature appeals to everyone here at Clegg. It's the first unit that makes no compromise as a fixed station and yet so conveniently mounts in virtually any compact mobile. If you hop from band to band—or chase DX around any single band you'll love its frequency agility and large bright frequency display.

Also available is the matching IC-211 with all mode coverage of 2 meters.

Whatever your needs in Transceivers, Amplifiers, Antennas, Keyers, Station Accessories, etc., call Clegg Toll Free 1-(800)-233-0250; in Pennsylvania call collect—717-299-7221 or write today for our latest catalog!

Clegg

Communications Corp. c3
1911 Old Homestead Lane
Greenfield Industrial Park East
Lancaster, PA 17601

INSTANT SOFTWARE™

*IMP™ for **TRS-80** ONLY \$7.95 ea.

Level I on one side, Level II on the other



● **SPACE TREK II**—by KB1 (for the TRS-80™) This Space Trek game will challenge the most skillful and careful player. As commander of the Enterprise, you must defend the galaxy against enemy Klingon warships using your arsenal of phasers and photon torpedoes to best advantage. The Enterprise is also equipped with impulse power for moving within the quadrant, and warp power for jumping from quadrant to quadrant. \$7.95. Order no. 0002R.

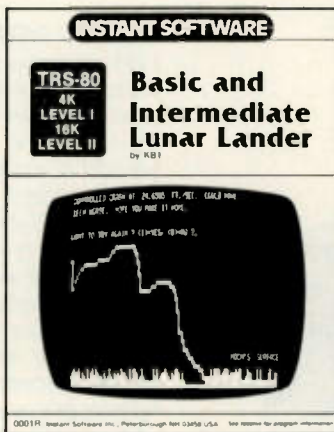

● **BASIC LUNAR LANDER/INTERMEDIATE LUNAR LANDER**—by KB1 (for TRS-80™) Your automatic landing system has malfunctioned and you are forced to make a manual landing. Taking control at 15,000 feet, the pilot's success requires precise manipulation of the lunar lander's retro-rockets. After mastering the basic game, the able commander will be taxed by the difficult intermediate program. \$7.95. Order no. 0001R.



● **BEGINNER'S BACKGAMMON/KENO**—by Fred Schild and KB1 (for the TRS-80™) You will never be in need of a backgammon companion again! Schild's program is designed for the newcomer to the game, but the computer's steady play will challenge the careless expert. **KENO** is a popular Las Vegas gambling game. As in many games of chance, the odds are against you, but when you win you can win big. \$7.95. Order no. 0004R.

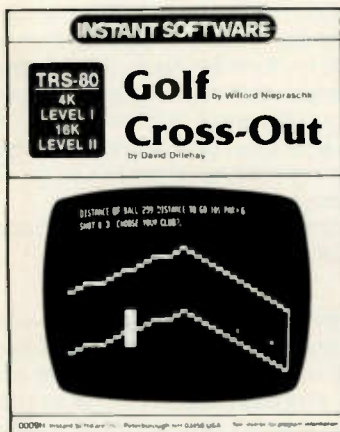

● **GOLF/CROSS-OUT**—by Wilford Niepraschk and David Dillehay. Playing golf on a computer? You bet and frustrating, too. You have your choice of seven clubs—three irons, three woods, a chip and a putter. The program has 18 different fairways, each diabolically designed. You have to pick the right club and angle for hitting the ball or else you end up in the woods or a trap. The green calls for putting skills. The program has excellent graphics and you'll have a ball... golf ball. **CROSS-OUT** is the old peg puzzle, but in computer form. You have to jump pegs, removing each one jumped. The idea is to end up with but one peg, and that one in the middle hole. The program will rate your skill at the end of each try. \$7.95. Order no. 0009R.

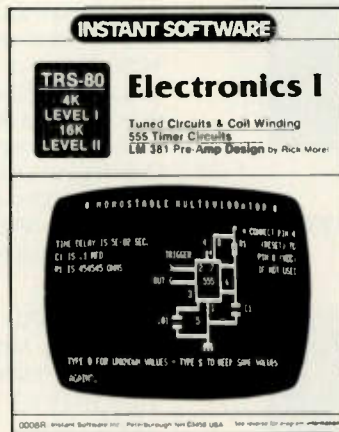

● **ELECTRONICS I** by Rick Morel. With this group of five programs you will be able to design coils for radio circuits, calculate the component values for tuned circuits, design preamplifiers using the LM-381 IC and timer circuits, either monostable or astable using the 555 timer IC. Coils can be designed with the use of tables or special calculators, but they are difficult to use. This package has a coil designing program which is simple to use and the computer does all the work. There is also a program for designing tuned circuits, audio or radio frequency—fixed or variable frequency. The LM-381 program draws the circuit diagram and gives you the component values for your needs. It will calculate any unknown values for you. The two 555 programs do the same, giving you the diagrams for either one-shot timers or astable timing systems (clocks). It will do all the calculations for you, providing times or component values. These programs are not only helpful around any workshop or lab, they also are wonderful for teaching the fundamentals of electronics to newcomers. \$7.95. Order no. 0006R.

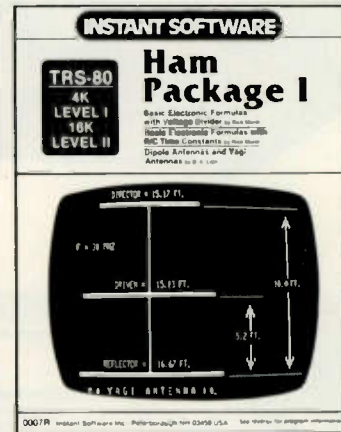

● **HAM PACKAGE I** by Rick Morel and D. A. Lien. This group of eight programs (we like to give you plenty) will be of frequent help to any experimenter or ham operator. **OHM'S LAW CALCULATIONS** SERIES CAPACITANCES **FREQUENCY VS REACTANCE** PARALLEL CAPACITANCES **SERIES RESISTANCES** DIPOLE DESIGN **PARALLEL RESISTANCES** YAGI DESIGN. These programs draw the circuits or antennas involved and let you fill in the pertinent data, giving you the dimensions, etc. This series of programs is not only an excellent way to learn the fundamentals of electronics and the handling of simple formulas, they will also be of constant use in any workshop or hamshack. \$7.95. Order no. 0007R.

INSTANT SOFTWARE™

*IMP™ for **PET**

INSTANT SOFTWARE™
for your **PET**

INSTANT SOFTWARE™
for your **PET**

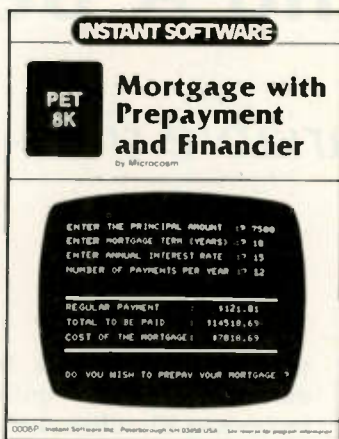
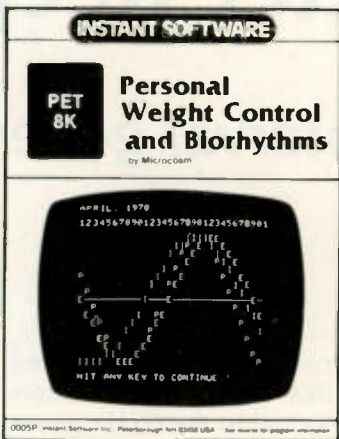

● **PERSONAL WEIGHT CONTROL/BIORHYTHMS**—by Microcosm (for the PET™) Here's a program that will let you chart any individual's biorhythm cycle, showing physical, emotional, and intellectual highs and lows. If your neighbors find out you've got it, they will never leave you in peace. **PERSONAL WEIGHT CONTROL** is a must for the diet-conscious. Once your ideal weight has been determined, the program will calculate the correct daily caloric intake necessary to reach your goal over a certain time period. \$7.95. Order no. 0005P.

● **MORTGAGE WITH PREPAYMENT OPTION/FINANCIER**—by Microcosm (for the PET™) Before you go to the bank, calculate your mortgage payment schedule and find out what you can afford. You will learn how much prepayments save, and can easily compare the true costs of variations in interest. **FINANCIER** is actually three programs in one and is guaranteed to make you a financial wizard. In part I you'll learn to tell which investments will pay off. Part II calculates annual depreciation schedules, providing rates, amounts, and salvage values, which is great when tax time rolls around. The final section figures costs of borrowing, payment terms, and remaining balances on loans of all sizes. \$7.95. Order no. 0006P.

\$7.95 ea.

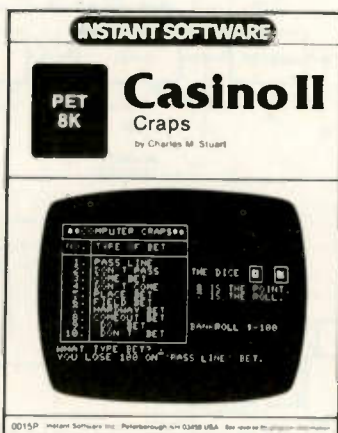
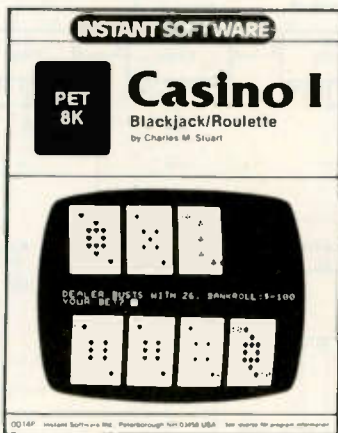

● **CASINO I** by Charles M. Stuart. There are blackjack games galore, but not many of them are so dependable that you can use them to prepare to make your fortune at Vegas. This blackjack program is not only fun to play, it is also tutorial and allows you to play every combination which you could play at the MGM Grand Hotel in Las Vegas.

There are several systems which will beat the house at blackjack, but before you go investing your cash in a get rich quick attempt, try out your system on this program and see how it does in actual practice.

Roulette programs are more difficult to find, yet this is another very popular casino game—and one you'll want to get some experience with before you venture to go up against the professionals at Vegas. Remember that there are a lot of people who have worked out systems to beat the house at these games and they make a comfortable living going to Vegas every now and then to rebuild their fortunes.

This roulette program is tutorial and gives you the odds on each type of bet.
All you need is the expertise and a little luck to go along with it and you'll pay for your computer in no time. \$7.95. Order no. 0014P.

● **CASINO II** by Charles M. Stuart—Yes, there are a lot of craps programs around—so why should you buy this one? The big difference is that this one is not just a crap game. It is also a tutorial program which will give you the odds on every type of bet so you can steer clear of the idiot bets that impoverish the unwary. Did you know that there are bets which give the house as little as 0.8% advantage? It takes precious little luck to overcome such a slight edge—but you have to know where to find these bets before you can use them.

If you use this program to get experienced with craps you should be able to walk away from any craps table a winner. Once you know what bets to make and are able thereby to take the best advantage of lucky streaks, betting lightly to wait through the lean times, you'll have quite an edge.

This program uses the exact rules used at the MGM Grand Hotel in Las Vegas, so you'll be playing under actual gambling house conditions. You should be able not only to pay for the program, but also for your computer system the next time you go to Vegas or Atlantic City. \$7.95. Order no. 0015P.

Send me the following Instant Software:

Quantity	Catalog	Program name	Unit Cost	Total cost
			\$7.95	
			7.95	
			7.95	
			7.95	
Shipping				\$1.00
Total order				

Check Money Order
 VISA AMEX
 Card # _____ Expir. date _____
 Name _____
 Address _____
 City _____ State _____ Zip _____

Instant Software Inc.
Dept. S10
Peterborough NH 03458

Build A Better Beeper

— variable time-interval generator

A while back, a friend of mine requested a scheme for putting beeps (time marks) on magnetic tape. He wanted beeps of 1 second, 5 seconds, and 10

seconds, adjustable in duration from 25 milliseconds to 50 milliseconds. He also wished to have control of the beep pitch. He wanted a timing ac-

curacy of .05%. It looked like some TTL counters locked to the 60 Hz power line and a few 555 timer ICs would do the trick.

To reduce the complexi-

ty of the scheme somewhat, we settled on a variable beep-pitch scheme common to all three beeps, but with independent control of each

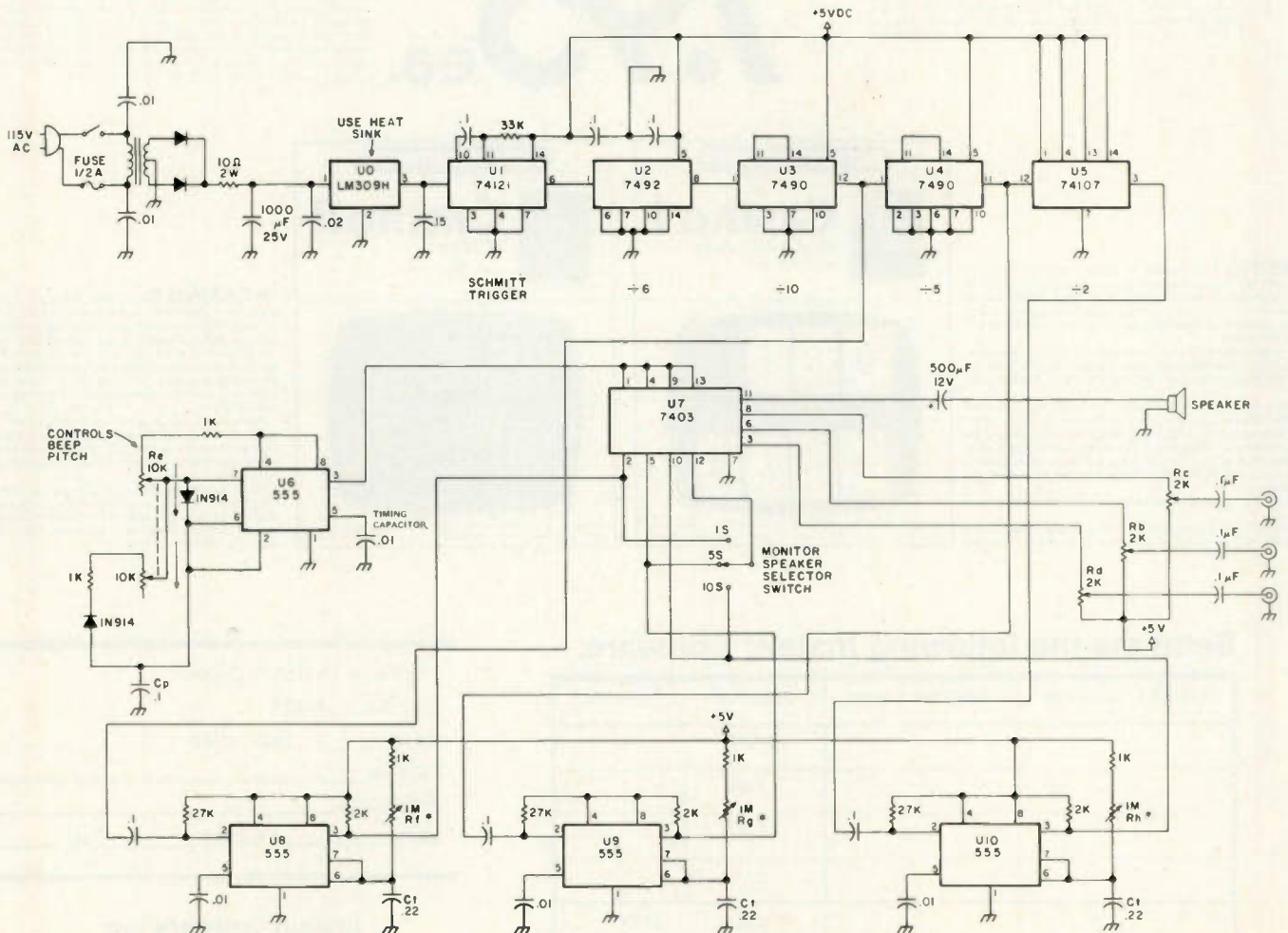

Fig. 1. *Rf, Rg, and Rh control beep duration.

Choosy People LOVE Standard! ♥



Standard Communications offers you a choice of 2 meter handheld radios in either the pocket sized C-118 or the professional sized 146A.

Why Buy The C-118?

- Compact — can be slipped in pocket or purse
- 6 channels but affords 18 channels transmit with unique offset switch which produces transmit offset of ± 600 kHz
- Requires only one crystal for each channel
- BNC antenna connector
- Rubber flex antenna at no additional charge
- LED status lights indicate channel busy and RF output
- 1+ Watts output

Why Buy The 146A?

- More room means larger battery capacity
- Larger case affords greater audio fidelity
- Room for tone options
- Provisions for remote speaker mic
- Full size telescoping antenna is standard feature
- 5 channels
- Meter for RF and signal strength
- 2+ Watts output

Both the C-118 and 146A...

- ... Are ready to operate on 146.94 simplex and 34/94 repeat
- ... Have excellent sensitivity and selectivity characteristics

 **Standard
Communications**

member:



Attn: Advertising Manager
Standard Communications Corp.
P.O. Box 92151
Los Angeles, CA 90009

Gentlemen:

Please send me additional information on

- C-118 2 meter 1 Watt FM Handheld Radio
- 146-A 2 Watt VHF Handheld Radio

Name _____

Address _____

City _____ State _____ Zip _____

S18

C

of the three beep pulse widths. Fig. 1 depicts the overall schematic diagram. A 12.6-volt ac secondary winding on T1 supplies about 8 volts dc into the LM309H regulator. All other circuitry is 5 V TTL components.

The 74121 Schmitt trigger is driven by the partially-squared input via zener D3. The 74121 output triggers the succeeding counters to yield divisions of 6, 10, 5, and 2. The negative-going edges out of the counters at A, B, and C, respectively, trigger three 555s connected as variable on-time monostable multivibrators. These adjustable on-time gates are fed to 3 sections of a

7403 NAND gate. The other inputs of each NAND gate section are fed from a free-running 555 connected as an astable multivibrator. Consequently, whenever a gate pulse appears at the output of U8, 9, or 10, a train of pulses supplied by U6 will appear at the appropriate 7403 outputs.

The fourth section of the 7403 is used to drive a small 3" speaker to aurally monitor the desired beeping channel via S1. The desired level for driving a tape recorder input, monitor amplifier, etc., can be adjusted for all three channels via Ra, Rb, and Rc. Perfboard construction was used, as can be seen in the accompany-

ing photos.

I experienced no critical layout problems. With the values for the beep duration shown for U8, 9, and 10, the beep duration could be varied from a click to about 1/2-second duration. Longer duration times for the 5- and 10-second beep spacings could be readily achieved by increasing Ct on U8, U9, and U10. If independent pitch control is desired on each of the 3 timed outputs, two additional free-running astables could be employed and their outputs fed to the 7403 NAND gate terminals 4 and 9 separately. With the timing capacitor shown for U1, the frequency was ad-

justable from approximately 200 to 800 Hz. No buffer was used to isolate the speaker monitor selector switch. Therefore, a glitch (switching) transient will generate an extra pulse when switching. A buffer could be added to preclude this if it is necessary to switch the monitor speaker while recording the timing beeps onto tape and not generate glitches. The gates from ICs U8, 9, and 10 could also be used to drive relays via suitable current amplifiers, etc., to provide timed sequences. If a divider chain using programmable dividers were employed, any desired sequence could be obtained. ■

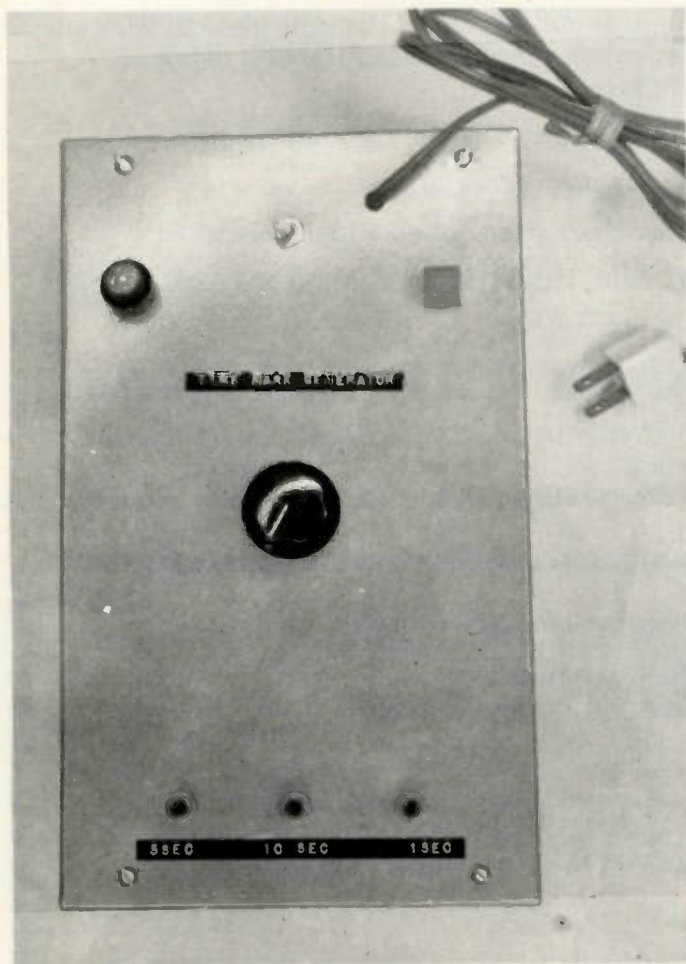

The unit is housed in a 10 x 6 x 3 1/2-inch Bud minibox, CU3010A. The center knob determines which sequence, i.e., 1, 5, or 10 seconds, is heard on the monitor speaker. Outputs on the bottom jacks are simultaneously available. The line fuse, off-on switch, and pilot light can be seen across the top portion of the minibox.

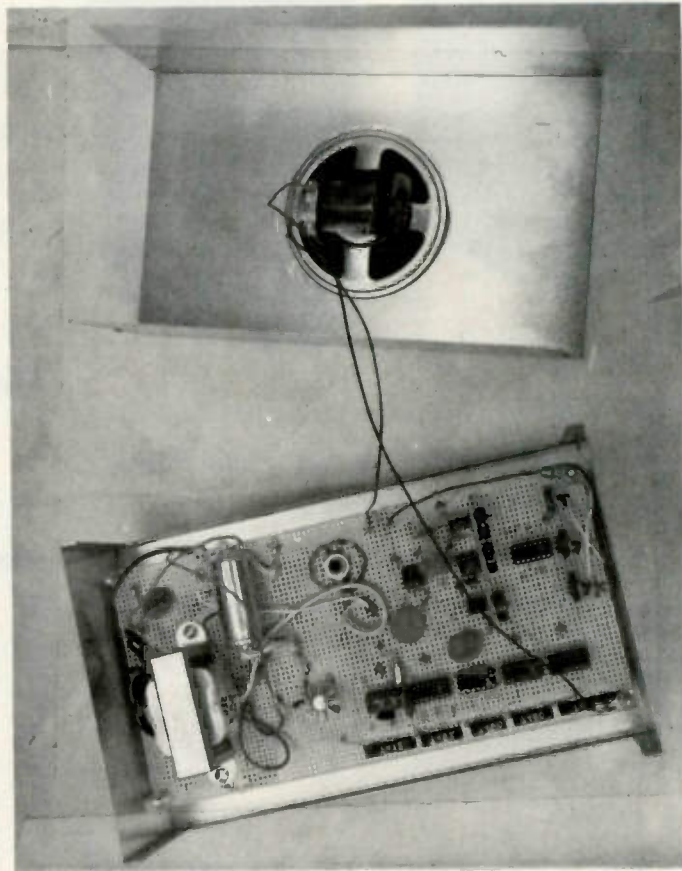

Interior view of the unit, showing the perfboard (.1-inch hole spacing) construction. Sockets were employed for all ICs except the LM309H regulator. The three vertically-mounted (PC board-type) pots on the extreme left end of the perfboard are the output level controls, which can be set to accommodate any high-level audio input, i.e., 100 mV and up. The next three pots to the right are the beep-duration controls. The beep-pitch control is a standard pot, seen near the top center of the perfboard.

Pick a card...any card

CALL TOLL FREE

1-800-228-4097
Communications Center

443 N 48th Street
 Lincoln, Nebraska 68504
 In Nebraska Call (402)466-8402

1-800-634-6227
Communications Center
West

1072 N. Rancho Drive
 Las Vegas, Nevada 89106
 In Nevada Call (702)647-3114

C58

Sale subject to limited supply

K
♥



YAESU
FT-901 DM
 List \$1459
 Price too low
 to print, call
 for quote.

♠ **K**

9
♣



Buy a FT-301
 digital for
\$935 and get a
 power supply &
 CW filter free!

♣ **6**

J
♦



YAESU
FT-101E
 List \$799
 Price too low
 to print, call
 for quote.

♦ **J**

J
♣



YAESU
FT-7 Mobile
 List \$549
 Call for discount
 price

♣ **J**

Q
♠



KENWOOD
TS-820S
 List \$1099
 Call for low
 price

♥ **Q**

K
♠



KENWOOD
TS-520s
 List \$739
 Our price too
 low to print,
 call for it!

♥ **K**

2
♣



KENWOOD
TR 7400
 List \$399
 Call for discount
 price

♣ **2**

K
♦



R4C List \$699
 Your price \$599
T4XC List \$699
 Your price \$599

♦ **K**

10
♦



YAESU
FT-227R
 List \$349
 Call for discount
 price

♦ **10**

DMM Buyer's Guide

—expert tells all

Digital multimeters are rapidly increasing in popularity; it seems like everyone wants one. And it's for a good reason. Digital multimeters offer a lot of advantages. They are easy to read, with all data displayed in large and easy-to-read numbers. There's no squinting at a dial, no interpreting scales, and, in short, no guessing at a reading. Digital multimeters offer easier operation, and, in most cases, setting the knobs is easier than with a VOM or VTVM. If you look at quality units, you'll see no zero or Ohms adjust to tweak. Best of all, prices are dropping, and, if you are considering replacing that sick VOM or VTVM, now is the time.

In this article, I am going to show you some of the things to look for in a digital multimeter and, to be perfectly honest, to avoid. I will also define some of the terms you see in ads all of the time. By the end of this article, you should be a lot better prepared to choose a digital multimeter to suit your personal needs.

I am a test equipment designer/head of a growing test equipment company. I work with test equipment every day, and I am fully aware of the features of digital multimeters. So, if my comments help you to make a good digital multimeter choice, so much the better! A wise buy may easily be worth the price of that magazine

subscription!

Do I Really Need a Digital Multimeter?

Surprisingly, you may not want or be able to use a digital multimeter (herein referred to as "DMM"). For example, you may be on a limited budget and can only dream of owning a DMM. I would guess that there are more than a few people who fit into that category. I will caution you that DMMs won't drop in price like calculators will, so don't wait for a \$9.95 DMM blister packed on your favorite radio store's wall. Digital multimeters contain precision parts, such as resistors and a precision voltage source. DMMs are also complex and that spells cost. So a \$9.95 DMM is a very long way off! I will hazard a guess that DMMs will be selling for about \$50 or less within the next 10 years, and I think that's realistic. How would you like to sit around all day and make 0.1% resistors and ICs for literally pennies? Of course you wouldn't.

Another problem is that you could be blind, and it would be tough to read a DMM under these circumstances. But I am sure that there are enterprising radio amateurs who have

gotten around this problem. If so, my hat is off to you!

You might stay with a VOM or VTVM if you do little servicing. There's no need to spend \$50 and up for a DMM to check your car battery and then work on the transceiver once a year. But many readers have proven to me many times that they really do build things regularly, and that means a DMM will be a powerful asset on the bench or in the shack.

Check Your Requirements

The first thing to do before checking out DMMs is to take a look at your requirements. By that I mean you try to determine what tasks you normally do with a DMM and then ultimately select a unit that does the job at least cost. Only you can do this because your jobs may be different than the next person's. Relax; this should be easy!

Ask yourself, "What do I do with my meters right now?" Say you work on solid state devices. Since you are dealing with low voltage, low-to-moderate impedance circuits, you would want a voltage range to at least 20 volts dc and ac. You would also want resistance ranges of at least 1k to 2k minimum and a maximum range of at least 2 megohms. Most DMMs fulfill these requirements easily, but it pays to check. Optionally, a 0 to 100 mV or 0 to 200 mV full scale dc or ac volts scale would be desirable. Also, dc/ac current of up to several Amps would be nice, but not absolutely necessary. These are the minimum requirements for any DMM you would want to use. You can do without the 100-200 mV scale and current ranges, but get the rest.

But suppose you are working with tubes. The re-



What would an article by Gary McClellan be without a Gary meter? This is the model 101 and it reads ac volts, dc volts, and Ohms.

quirements above apply, plus a few new ones. You should get a meter with at least a 0 to 1200 volt dc (and usually 0 to 750 volts rms ac) scale to handle any of the higher voltages you will inevitably encounter. Surprisingly, there are more meters around that have such high scales. I know of several that stop at 200 volts full scale. Avoid these. You will also want a top resistance scale of 20 megohms. This is for measuring those grid leak resistors and for checking leakage in paper capacitors. The vast majority of DMMs on the market have been set up with these extra ranges, so you will have no problems getting a meter.

Now that you have a general idea of what voltage, resistance, and, if desired, current ranges you want, you should take a look at how you are going to use the DMM. Ask yourself, "Where am I going to use my DMM?" Are you going to use it in the shack or on the bench? Then get an ac-powered bench model. The result will be a more accurate instrument with no batteries to worry about. In battery-operated DMMs, the accuracy may vary with battery voltage. Also, you may have no way of knowing if the batteries are weak and the readings you get are wrong. Play it safe and get an ac-powered model for around the house. The slight extra cost is usually offset by better accuracy. Are you going to be working away from ac power, or do you need a more compact DMM? The battery unit has to be your choice. Note that some models are ac/battery and offer the best of both worlds: battery portability and ac accuracy. This is a fairly popular configuration and you might want to go this routine. But, if you choose battery-only opera-

tion, try to get a unit with a low battery indicator to save you the grief of bad readings caused by weak batteries. And always carry a set of spare batteries. By the way, the \$169 Fluke model 8020 DMM has a low battery indicator and is one of the few that do.

Now let's look at some of the other features a DMM can have that can be useful. The number of digits is important. Today, you will see 3-digit displays, which are called 1000 count units, 3½-digit displays or 2000 count units, and 4½-digit displays or 20,000 count units. And there are 3¾-digit display meters which may be out by the time you read this, to complicate matters. You can get up to 6 digits if you are willing to pay the price (about \$8000!). So which one do you buy? Get the 3½-digit unit if possible. The 3½-digit unit is a very good compromise between cost and performance. I strongly urge you to avoid the 3-digit "toys" on the market. You get more out of the popular 3½-digit unit. Suppose you are reading a 15-volt power supply. The toy will read "15.0" and the 3½-digit unit will read "15.00." Inside the case, the electronics cost about the same, so the 3½-digit display wins hands down. The larger display units are for more accurate measurements, and, unless you are working in a laboratory, you won't need the extra accuracy or want to pay the higher costs. The Data Precision DMM shown is a 4½-digit unit, and sells for around \$350.00. So now you know what size display to get.

As for the type of display, you should look for easy reading ½" LEDs, like on the Gary McClellan and Co. model 101 DMM kit, or a liquid crystal display. Avoid gas dis-

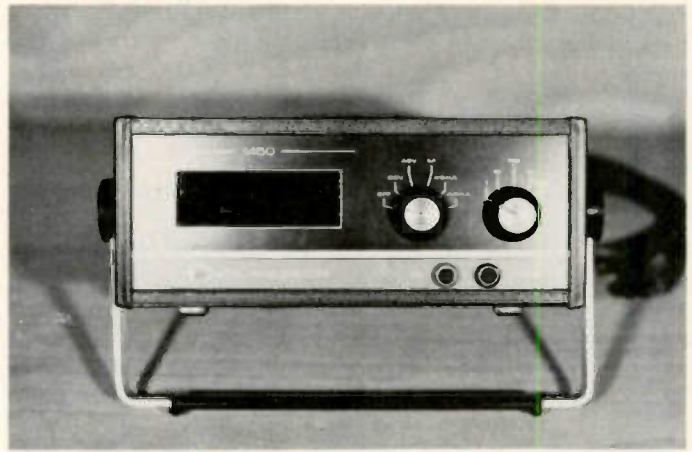

A low-cost 4½-digit lab multimeter. This is a Data Precision model and it offers high accuracy for around \$350.00. That's a bargain in 4½-digit meters!

charge displays (bright orange) because they are obsolescent and some have problems. My Data Precision is on its third set of gas displays already. A word to the wise: If you are getting a battery DMM, go for a liquid crystal display. The battery life will astound you, as a liquid crystal display draws under several microamps of power. The drawback of liquid crystals is that they don't produce light and they must be illuminated to be read in dimly lit places.

Another area to look over is electrical specifications. But before I get down to specifics, there is one thing you should look for in a DMM and that is overload protection. I can't stress this too highly. This is particularly important if you work with high voltages. A lot of manufacturers of otherwise fine meters hide the fact that their meters aren't overload protected very well. You want a meter that is protected on all scales and functions; if it isn't, you run the risk of damaging your meter every time you measure a voltage higher than the meter is set to or applying a voltage to it while the meter is on a resistance range. Look for overload protection, and, if it isn't mentioned, ask

about it. Don't forget about the resistance ranges. They are very hard to protect, and you will pay heavily for a well protected unit. But the cost may be worth it. The model 101 will take up to 1 kV overload on ac/dc volts for very short periods and up to 30 volts on the bottom resistance range for a short period (higher on other ranges). And it is designed so that relatively inexpensive parts fail (5¢ resistors) and can be replaced and put into service without calibration. Overload characteristics are typical for low-cost meters. The cost of better protection is expensive; the cost to protect Ohms better is more than the entire Ohms circuitry cost! So there you are. TV repairmen take note because of the high pulse voltages found in TV sets. One TV test equipment company had to redo its products because they were failing in TV repair applications.

Let's Look At Specifications

If you have done much reading of ads for digital multimeters, you have noticed specifications and terms that are particular to digital multimeters. Let's look at some of these things in order of importance and define them. The

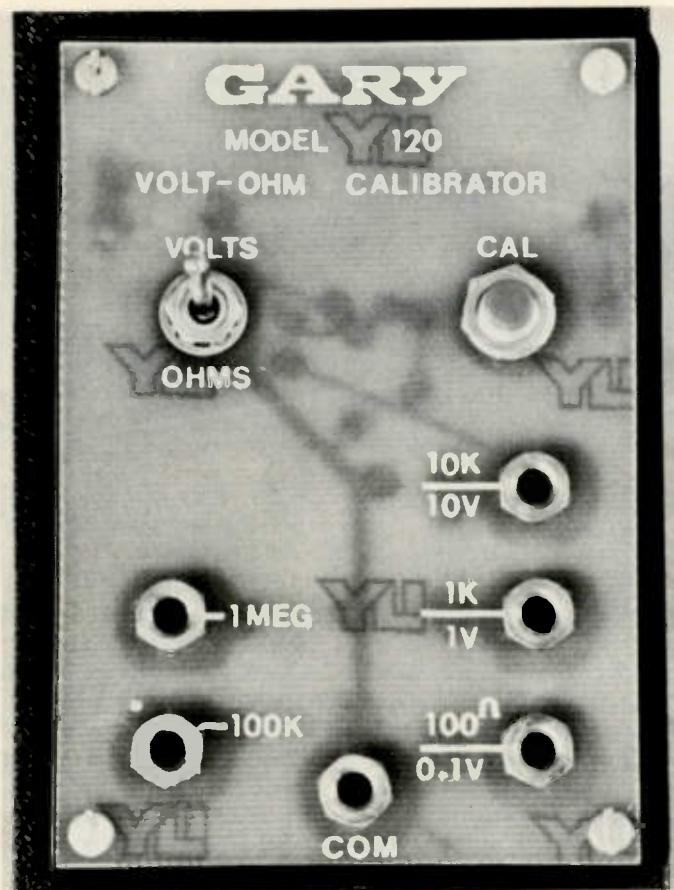

Most kit DMMs have no way of calibration, and the factory may not do calibration. This \$34.95 box will calibrate the ranges of most multimeters with little fuss.

first term you will see is something called "basic accuracy." This is the best accuracy spec of the unit and it refers to the dc volts function. Usually, the range switch is set to the lowest range of voltage, so that the meter's voltage attenuator is switched out of circuit. It is important to remember that basic accuracy is the best spec the meter has. Other functions use this dc voltmeter, and their errors add to the basic accuracy. The result is that all other accuracy specs are worse than the basic accuracy. So you want to get a DMM with the best basic accuracy you can. Good ones run about 0.05% to 0.5% and you must avoid units above 0.5%.

Say you are reading 15.00 volts on a 3½-digit meter. The reading can vary from 14.92 to 15.08 volts and be on the edge of

the specs. As a result, the farthest digit doesn't mean a great deal—the total change is 0.16 volts. You might as well cover up that last digit with a piece of tape. Don't buy anything above 0.5% basic accuracy; you're wasting money. Besides, the technology for about 0.05% to 0.3% basic accuracy is cheap and readily available; you don't have to put up with less.

Another specification that you should be interested in is the ac accuracy. This spec will always be much greater than the basic accuracy, and a good DMM will have an ac accuracy of 0.3% to 1%. The reason there is more error here is that converting the ac input signal to be measured to dc and then reading out on a dc voltmeter (basic accuracy applies here!) introduces a lot of inaccuracy. If you

want very high accuracy, you will pay a bundle for it; good ac accuracy doesn't come easy. Did you know that some 5½-digit DMMs (about \$6k to \$8k each) have an accuracy of only 0.07% to 0.1%? It's tough for the big guys, too.

As far as you're concerned, 0.5% ac accuracy will be more than sufficient; this level offers a good compromise between price and performance. The problem is that, when you read the ads or data sheet for DMMs, the ac accuracy is nowhere to be found. If that's the case, ask! This spec is important, but, unfortunately, a lot of low-cost DMM manufacturers "hide" their data because they think it will scare off customers. They could be right. I built a DMM kit several years ago that seemed to have terrific accuracy on dc volts and Ohms. But, in the fine print, the ac accuracy was 2%.

You should be concerned about frequency response; specifications for most DMMs are derived using a 60 Hz input. Other frequencies can cause trouble. You should know that virtually all low cost DMMs are low fidelity in their response characteristics. Some are only good to about 1 kHz. Check with the manufacturer if you want more data on frequency response. For the most part, if you do wide-range testing, you'll want to stick with the analog voltmeter. DMMs just don't have wide frequency responses yet, and that includes some very expensive units. Personally, I use our model 101 DMM to measure signals in the 30 Hz to 5 kHz range and then switch to a Hewlett-Packard 400H analog voltmeter to read out to 4 MHz.

The Ohms specification should be of interest to you. Good ohmmeter sec-

tions run from 0.05% to about 0.5%, and anything above this is so bad that comment is unnecessary. The high spots of Ohms specifications are the accuracy (easy to get in properly designed units), overload protection, and the number of ranges. As for overload protection, try to get it. One old dodge is to put a separate jack on the meter for Ohms. It works, but a lot of lead switching is necessary. That is the simplest. Instead, get an ohmmeter with at least protection to 12 volts and higher. This isn't great, but it is better than nothing; remember that I said how difficult Ohms are to protect. Better protection is coming someday. As for scales, you want to read down to at least one Ohm accurately, so the lowest scale you get should be R x 2k or so. For the top scale, you want at least R x 2 megs, with R x 20 megs being preferable. This means 5 scales or so of resistance, and you will be able to measure from 1 Ohm to 20 megohms with ease.

The final specifications you should be concerned about are for any current ranges you wish. Most meters offer ac current and dc current, and the accuracies you get are determined by the ac accuracy plus the current shunt resistor tolerance (ac current) or basic accuracy plus current shunt tolerance (dc current). Accuracies of 1% to 2% are typical here, and you can go up to 5% or 10%. The reason accuracy is so terrible is the shunt resistors. To keep costs down, non-precision resistors are often used here. Specifications in this area are usually a disaster, and, in fact, we left out the current functions on the model 101 DMM because of this. Also, the cost of precision resistors is high, a decided

drawback to accurate current measurement at this time. If you really want current ranges on your meter, you'll find them, but beware of any accuracy claims. It's better to save money by using your own external shunts for current measurements.

One more thing while I am on current measurements: Some meters have a two-volt drop to read full scale current (e.g., 200 mA, 2 Amps). This is called insertion loss, and meters with this much drop should be avoided. Here's a true case history. I was checking a TV game which draws 2 Amps at 5 volts. Hooking a commercial 2-volt drop meter in series with the power supply killed everything! There was only about 4 volts on all ICs. If you are ever in this situation, use a higher current range for less voltage drop (I tied a 10-Amp shunt across the meter), or, better

yet, get a meter with only a 200 mV drop on the current ranges. Ask the manufacturer if he doesn't quote insertion loss on his data sheet.

Odds and Ends

By now you should have a good idea of what you want in a DMM and at least be aware of the strengths and weaknesses of most digital multimeters. There are a few other features in digital multimeters that may interest you. The first is autoranging. This feature allows you to read many different voltages/resistances/currents without changing the range switch. This is a real boon if you are working in a tight area and hate to be turning a range switch all the time. Just select the function you want (ac volts, dc volts, Ohms, etc.) and the meter does the rest. You will pay for this feature, but it is often worth the ex-

tra cost. Gary McClellan and Co. plans to offer a \$100 autoranging DMM, the model 102, and it should be out by the time you read this. However, if you have a certain amount to spend, always spend it on accuracy and not on special features if you can.

There are a lot of op-

tional accessories out for digital multimeters, such as HV probes, rf probes, and thermometers. Check out the Heath catalog or the Fluke catalog for more data.

For a summary of this article, take a look at Table 1, which shows the specs and their limits. ■

1. Basic accuracy	$\pm 0.05\%$ to $\pm 0.5\%$ (Less is better.)
2. Ac accuracy	0.3% to 1% (Less is better.)
3. Ohms accuracy	0.1% to 0.5% (Less is better.) See text for overload protection.
4. Dc current	$\pm 1\%$ to $\pm 5\%$ (Less is better.) Watch insertion loss (see text).
5. Ac current	1% to 5% (Less is better.) Watch insertion loss (see text).
6. Other features	Must have overload protection; $\frac{1}{2}$ " LED or LCD displays recommended; Ac operation recommended (see text); $\frac{3}{4}$ -digit display recommended.

Table 1. DMM specifications summary.

N888 HAND-HELD HF/SSB

- 10 Watts PEP
- 2-9 MHz
- USB/LSB
- Rechargeable batteries
- Accessories

The N888 permits long range communications in difficult and adverse locations, thereby offering important communication advantages over AM and FM.

The smallest complete personal H.F. SSB communication system available.

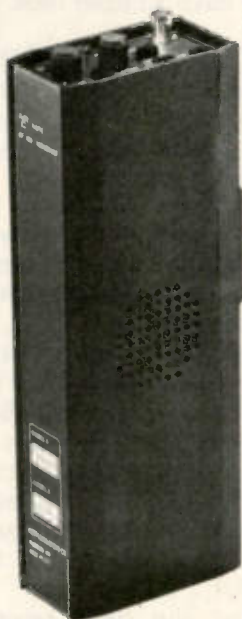

NORTHERN RADIO COMPANY
COMMUNICATION PRODUCTS
14975 NORTHEAST 40TH, REDMOND, WASHINGTON 98052, USA
(206) 883-7700 TELEX. 32-1160. CABLE ADDRESS: NORLECTRAD

N14

THE NEWEST KEY IN THE WORLD...TRY QUIK-KEY!

1. Downward Pressure Assures, Key Will Not Walk or Slide
2. Adjustable Tension & Finger Spacing
3. Works With Any Keyer, Iambic Too!
4. Small & Compact Size. $2\frac{1}{8} \times 5 \times 1\frac{1}{8}$ "



5. Precision Machined Highest Quality
6. Black Plastic Top Satin Chrome Base
7. Personalized, With Your Call (Specify)
8. It's Engineered, Try It.... You'll Like It

PAT. PEND.

SEE YOUR DISTRIBUTOR
OR ORDER DIRECT

ONLY \$39.⁹⁵ PLUS \$2.⁰⁰ POSTAGE

QUIK-KEY P.O. BOX 73
KATONAH, N.Y. 10536

Q6

FOREIGN ORDERS: U.S. FUNDS / N.Y. STATE RESIDENTS
PLUS POSTAGE & INSURANCE / ADD 5% SALES TAX

Immediate Delivery-Order Now

Dealer Inquiries Invited

Triple Threat

—Microlog's RTTY, Morse, and ASCII system

Ralph E. Delligatti K3CMY
17651 Amity Drive
Gaithersburg MD 20760

After nearly a quarter century of designing, building, using, and troubleshooting communications equipment, it is rare when something new comes along that is exciting. The Morse, RTTY, ASCII keyboard, decoder, and video monitor manufactured by the Microlog Corporation certainly qualify as one of these rare joys!

The Microlog system is composed of three separate and distinct units: the AKB-1 keyboard, the AVR-1 decoder, and the video monitor (VM). These units may be purchased separately or together to form the complete "system," which can be expanded later with options which may be installed either at the factory or by the user/owner.

Living in an apartment or in a town house (as do I) has certain advantages, to be sure, but there are also some distinct disadvantages—such as RTTY operation. The neighbors do not appreciate the clatter—especially in early-morning hours.

Not wanting to give up RTTY, nor to be hanged, not even in effigy, by irate neighbors, I started combing the ad pages of my favorite ham magazines looking for a solid-state replacement for the venerable old "15." Everything to be found, and there isn't what you would call an overwhelming selection, was either too expensive or appeared to be lacking in some refinements. Then it happened! A friend called and asked if I had heard of a company which was new to amateur radio: the Microlog Corporation.

A call to Microlog put me in touch with Bob

WA3VPE and Joe N3JL, who, it turned out, are the co-developers of the Microlog units. Immediately arrangements were made to visit their offices and have a closer look.

The Most Enjoyable Test

Several days after the initial telephone call, I was in the engineering offices of Microlog. After a brief introduction to some of the other hams working with the company, I was offered unlimited use of their ham station facilities (N3JL), including a complete Microlog system with most of the options installed. Bob showed me the basics of the rig they use and left me with the equipment and a pair of instruction manuals for the AKB-1 and the AVR-1.

For the next several hours, I was to experience one of the most enjoyable tests I have ever participated in. The first hour or so was spent in both

amazement and disbelief as I put the AVR (decoder) through its paces: a five-station pileup on the lower end of twenty CW, numerous RTTY signals on forty and eighty (some so poor to the ear that at times I wasn't even sure that they were RTTY until I switched in the AVR), and still more CW, some of which reminded me of a "left-footed" kid somewhere deep in my past!

I found that the AVR would easily handle just about everything. It gave near perfect copy on a couple of CW and RTTY signals that were barely discernible by ear. Once the AVR locks onto a signal, the speed can increase or decrease by as much as 2:1, and it will follow right along. If the speed slowly increases (or decreases) steadily in one direction only, the AVR will also track right along. Even character spacing can vary, within reasonable

limits, and copy will be solid. Of course, if a lid is sending CQ with his left foot and chooses to send NN MA as CQ, the AVR will copy *exactly* what is being sent: NN MA!

Cleanliness Is Easy Listening

Those of you who have come away from the rig after a few hours of CW and have felt wiped out could literally see why if you were to look at some of those CW stations you worked on the screen of the Microlog. The AVR displays what it hears. If it hears good clean CW (3:1 dash/dot ratio) with good letter and word spacing, copy is perfect. On the other hand, if it hears junk, it will display junk. Although the AVR is by no means a substitute for a good operator and sound (no pun intended) knowledge of CW, it is certainly a boon to modernizing the amateur station. With its auxiliary TTL terminal on the rear, it is also an excellent training aid for a new operator to use in learning to send good CW with any kind of key. It is an invaluable aid in assisting a "bug" operator with proper setup for a good dot/dash ratio.

Forget The Home Brew

Those of you who follow the many fine articles in 73 and have dabbled in home computers have no doubt seen character generation on a modified production-type television receiver. If you have continued to be captured by that fascinating hobby, you have probably also seen character generation displayed on a commercial-quality video monitor. If you have, you will be able to understand my comparing the converted television's video quality with the quality of a picture produced by a pinhole camera when compared to commercial pro-



Microlog AKB-1 keyboard. Although there are many options available for the keyboard, only one is visible from the exterior. In the upper row, third key from the right, a special key-cap is installed with the owner's call when the ID option is ordered. All other options are internal.

ducts. Both are readable, but in terms of extended viewing time, the commercial monitor is by far the better choice and wiser investment.

This companion, which I consider both necessary and a perfect match to the AVR, is the VM video monitor. It is a quality product, produced by a major manufacturer of video devices and, most importantly, it is designed with the requirements of a video character display in mind.

Perfect CW

All of us who have labored through numerous FCC exams, have, at one time or another, been treated to a session of copying "perfect" CW. The CW commonly heard at FCC Field Offices, W1AW, and other locations is often referred to as "machine sent" which is indicative of its precise nature.

The AKB could give any FCC CW machine a run for

its money, and keep you on the air without the risk of broken tapes, as W1AW has experienced on occasion. Not only is it capable of perfect CW (weight, ratio, speed, etc.), but it also is just as capable of handling RTTY or ASCII with the same precision.

Although there is not much apparent difference from one keyboard to the next, those of you who have already tried more than one may well know the frustrations of "bouncing" key contacts sending more than the desired number of characters. Some keyboards are too sensitive and it's easy to trigger a string of gibberish just by grazing a key with a finger. The performance of the AKB should set aside these fears forever! Some of the other very desirable features included in or available as options on the AKB are: automatic CW identification from the keyboard when in the RTTY mode (operating the

control ID command transmits your call in Morse and then resets the AKB automatically for continued RTTY operation); selectable CW speed from the keyboard in one word-per-minute increments from three to ninety-nine words-per-minute; completely keyboard-controlled buffer entry/exit; ID and name/QTH keys, to save repeating these often-used groups; keyboard-controlled character spacing.

No Fun For Knob Twisters

Operationally, this system is no fun for knob twisters! The AVR has only two basic controls, and the function of one of the controls is directly related to the options chosen or added later. The on/off switch is incorporated into the function switch, which, depending on the options chosen, allows you to select CW, RTTY (at all common speeds), or ASCII. The other control is a sim-

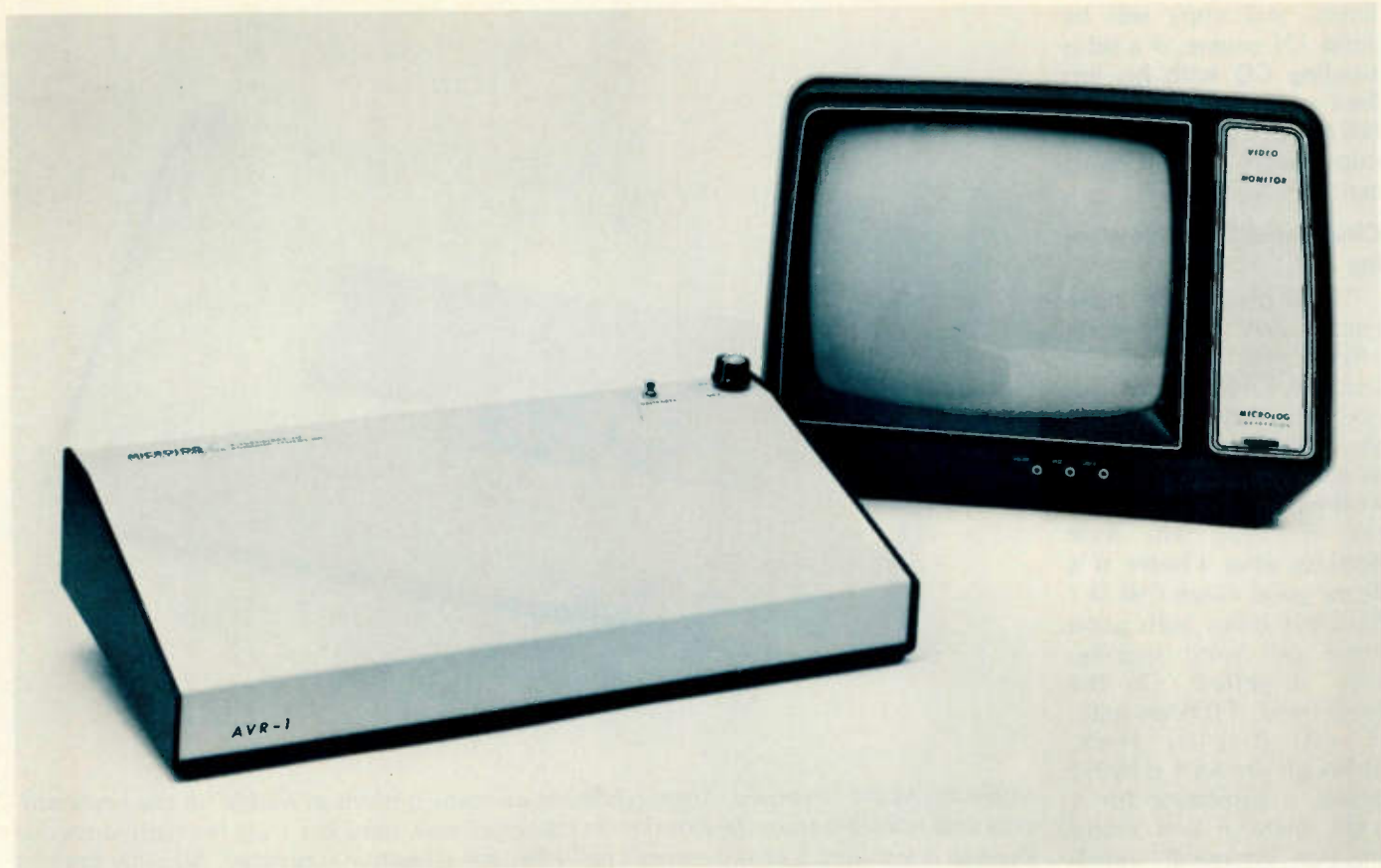

Microlog AVR-1 decoder and VM video monitor. As you can see, the AVR-1 is not much to look at—virtually a box with a knob! However, the size relationship between the AVR-1 and the video monitor provides some visual comparison of the two. The video monitor shown is the 12-inch (diagonal) version.

ple push-button switch which is used to initialize the automatic speed tracking part of the Motorola 6800 microprocessor program which is the heart of the AVR. Initialization merely consists of depressing the button long enough for the AVR to "hear" one CW character composed of at least one dot and one dash. That's all! For RTTY, the calibrate button functions to change speeds. The function switch places the unit in RTTY operation at sixty words per minute, and then each press of the calibrate button steps up the speed (60, 66, 75, and 100 wpm), with automatic rollover from 100 back to sixty. ASCII is selected by the function switch and is fixed at a standard baud rate of 110. When operating HF RTTY, no terminal unit (TU) is necessary as long as the rig you are using has either separate vfos

or an RIT control. In fact, the use of a terminal unit will provide a minimal improvement in signal handling of only about 3 dB. Although all standard RTTY functions are present on the keyboard, the AVR has been selectively programmed to ignore certain ones, such as the line feed (LF) function. This conserves space on the video display and makes comprehension of the transmitted copy easier.

What CW Filter?

With the AVR, there is no serious need for any special extra cost filters for your rig. In fact, it doesn't even matter if you have a standard (in most rigs) SSB filter. Some minor improvement may be noticed in performance with the use of a 400- to 500-Hz CW filter. The AVR incorporates its own four-pole filter within its input cir-

cuitry. This filter has an effective bandwidth of approximately 100 Hz and is centered at about 750 Hz. The audio input is also protected against accidental overload, with a combination of diode clipping and its own agc circuitry. Additionally, this marvelous little input system utilizes signal regeneration for virtually clean audio at its output, regardless of the crud which may have been riding on the signal coming out of the receiver and into the AVR. For the benefit of those wishing to hear as well as see the incoming signal, the regenerated audio of the AVR is accessible on a rear terminal strip.

Don't Argue With Success

The AKB (keyboard) also utilizes the same "brain" as its companion AVR—the Motorola 6800 microprocessor. Complete con-

trol of the operation of the AKB is accomplished via the 6800, which does everything from debouncing the keyboard to providing random code generation for code practice use. It seems that the N3JL/WA3VPE team knew better than to argue with the success of the 6800 in the AVR and wisely incorporated it in the keyboard design as well. A 124-character buffer in the AKB allows full editing capability by means of a back-space command, as well as repeat functions, from one character to a complete sentence of up to 124 characters. In order not to keep anyone dependent on the monitor for following the CW, a sidetone monitor is also built into the keyboard. The keying circuit will handle TTL, cathode (up to 40 V dc at 300 mA), and grid-block (up to -150 V dc at 100 mA)

keying. A mercury keying relay is also available as an option. In the RTTY and ASCII modes, an outboard loop may be keyed.

Beyond the Instruction Manual

Needless to say, that first visit to the Microlog office and manufacturing facility "hooked" me but good—I soon thereafter became a "system" owner. As most hams who have been kicking around the bands for a few years do, I have accumulated my share of equipment, which, for the purposes of this article, proved to be very beneficial. I have operated the AKB-1 and AVR-1 (along with the VM) both separately and together, as appropriate, on the following equipment: an Atlas 210-X/NB; the Drake twins (T-4XB/R-4B); an ancient Hallicrafters S-38C; and a Ten-Tec Argonaut 509. Results with all of this equipment were excellent, even, to my amazement, with the S-38C! On VHF RTTY, a terminal unit is a necessity, and with one of the basic units described in *The New RTTY Handbook*, 73, Inc., 1977, excellent results can be expected. Microlog offers an AFSK modulator which fits nicely into the AKB-1 and is fully compatible with HF or VHF RTTY operation.

During the initial testing at my home QTH, I experienced a fair amount of video "suck-out" on the monitor. After carefully checking all connections and finding the problem still present, I replaced all of the interconnecting wiring with shielded audio cable and found the problem virtually nonexistent. I mention this because the manual does not indicate any specific cabling requirements. Also, with the conversion to shielded cable, I found the terminal strips (standard screw-type) less than ideal for intercon-

nects, and added paralleled phone or phone jacks, as appropriate, to the rear panel of both the AKB and the AVR. Modifications of this type, or any others which do not destroy or cause destruction to the basic circuitry, do not void the warranty(ies). This is something which I was very careful to verify with the folks at Microlog before I began. While making these modifications, I noticed the chassis and cabinet of both units are of the heaviest type that I have seen used on amateur equipment in many years.

According to the folks at Microlog, little items which are nice, but which would run up the cost of these units, such as ac power-on indicators, a disable switch for the sidetone oscillator, a remote "calibrate" switch for the AVR, and a remote on-off/function switch, were intentionally left out. They may be added, as well as any other user-desired modification, at no risk to the warranty. Those who have no need for these extras are not burdened by a higher price tag... a nice touch, to say the least. But, remember, the designers are hams, too!

What's That Again?

For the benefit of the technically inclined, or those who are just fascinated by specifications, here's a more matter-of-fact review of the Microlog products (* = optional feature; ** = part of keyboard speed control option; *** = part of RTTY option):

AKB-1 Keyboard

- Motorola 6800 microprocessor controlled;
- Four-contact-per-key, gold-plated contact keyboard;
- Keyboard debounced by the 6800;

- 124-character running buffer with LED status indicator;
- 64-character message memory with up to four addressable sections;
- Keyboard Morse speed control;*
- Variable character spacing;**
- Morse speed range = 3 to 99 words-per-minute;
- Baudot speeds of 60, 66, 75, and 100 words per minute;*
- ASCII operation at 110 baud;*
- RY test generator;***
- Random code generator;*
- ID and name/QTH keys;*
- AFSK modulator;*
- Standard alphanumerics and punctuation in all modes;
- Special function keys for LTRS, FIGS, CR/LF, and LF;***
- Special Morse signal keys standard: \overline{AR} , \overline{AS} , \overline{BK} , \overline{BT} , \overline{KN} , and \overline{SK} ;
- Sidetone oscillator;
- Solid-state keying;
- Mercury relay keying.*

AVR-1 Decoder

- Motorola 6800 microprocessor controlled;
- 100-Hz four-pole filter with 750 Hz center frequency;
- Regenerated audio with internal agc and input clipping;
- 12-dB dynamic range with minimum input of .1 V rms;
- RTTY decoded via mark pulse only;*
- ASCII operation at 110 baud;*
- RTTY speed ranges of 60, 66, 75, and 100 words per minute;***
- Video output provides approximately 1,000 characters/full screen;
- CW speed range = approximately 3 to 99 words per minute;
- US standard compatible video output;
- Printer driver output port;*

- Local loop keying output;***
- 1k audio input impedance—will not load speaker line;
- Auxiliary keying input for code practice, etc.

Both units measure 3.7" H x 17.8" W x 9.5" D, and power requirements are 117 V ac at 60 Hz each. The AKB-1 consumes twenty Watts of power while the AVR-1 requires thirty-five Watts.

All three units are shipped well-packed, and, unless otherwise specified, are shipped via United Parcel Service (UPS) throughout the US. In addition, all three units carry a one-year warranty which is not voided by user-installed modifications which do not interfere with or damage the basic circuitry.

In checking with the folks at Microlog, I have been informed that the complete system will be on display, for all to see and use, at the Foundation for Amateur Radio Hamfest to be held at Gaithersburg, Maryland, in October. For those who don't want to wait till then, write Charlie Talbot K3ICH, at Microlog Corporation, 4 Professional Drive, Gaithersburg MD 20760, or phone (301)-948-5307. Charlie is in charge of Amateur Sales and Customer Service.

With base prices of \$299.00 for the AKB-1 keyboard, \$349.00 for the AVR-1 decoder, and \$159.00 for the video monitor (VM), you are purchasing a product which is competitive in price and more than competitive in performance with anything currently on the market which has been made available to me for testing. And perhaps the nicest feature is that you can add to your system as you desire, and modify it, without risk, at your convenience. ■

Join the Silent Revolution...



A Digital Receiving System for MORSE and RTTY (BAUDOT & ASCII)

Microprocessor controlled system automatically interprets and displays MORSE/RTTY Codes at various speeds. A unique signal analysis permits copy of MORSE Code with large variations in speed and weight. Receives standard RTTY speeds (60, 66, 75 and 100 WPM) plus ASCII. Direct hook-up to your receiver eliminates the need for any additional equipment. Attractive heavy duty aluminum enclosure (13 3/4 x 13 x 3 in. high).

Newly incorporated standard features:

- 24 hour 6 digit clock on screen
- Video display of operating mode & RTTY speed
- Normal and inverted video (black or white)
- Easier to read text format
- Improved narrow band active audio filter
- Audio/visual tuning indicators built-in

Use the feature packed AKB-1 programmable memory keyboard to send perfect MORSE and RTTY.

AVR-2	\$369.00 (RTTY add \$50.00)
AKB-1	299.00 (RTTY add \$50.00)
VM-4209 9 in. Sanyo Monitor	169.00
VM-4215 15 in. Sanyo Monitor	259.00

*Prices subject to change.

CUSTOMS OPTIONS AND PACKAGE PRICING AVAILABLE. Write for additional information. One year warranty on all products. Add \$4.00 shipping per item. MD residents add 5% sales tax. SEND YOUR ORDER NOW TO:



M55

MICROLOG
CORPORATION

4 Professional Drive - Suite 119
Gaithersburg, Maryland 20760
Telephone (301) 948-5307

Happy Days ARE HERE Again!

When it comes to . . .
**FAST DELIVERY,
 HONEST DEALING &
 PROMPT DEPENDABLE**
"S-E-R-V-I-C-E"
 We don't just advertise it —
WE GIVE IT!

DENTRON MLA-2500

160 thru 10 Meter Amplifier



REG. \$899⁵⁰

While they last . . . Only \$799⁵⁰*

CDE HAM-III

New/Improved
 Heavy Duty

ROTORS

NOW

ONLY

\$129.95

with Control
 (LESS CABLE)

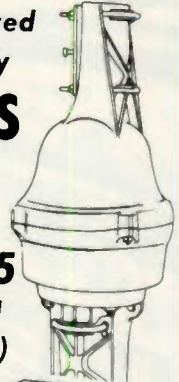

SPECIAL TRI-BAND BEAM OFFER

MAIL AND TELEPHONE ORDERS "WELCOMED" . . . They're our business!!



SAVE 10% PLUS

10% "CASH" SAVINGS NOW IN EFFECT on these popular TRI-BAND BEAMS! AND . . . with "PACKAGE" PURCHASE of selected TRI-BANDERS . . . you can BUY A NEW CDE

HAM-III ROTOR for LESS THAN ONE HUNDRED DOLLARS! LIMITED — ORDER NOW & SAVE! CALL or WRITE TODAY . . .

*TERMS: "CASH" means CHECK, MONEY ORDER or C.O.D.

MAKE/MODEL		REGULAR PRICE	SPECIAL "CASH" PRICES*	
			BEAM ONLY	BEAM & ROTOR
CUSHCRAFT ATB-34	4-Element 2-KW	\$259.95	\$209.95	\$319.95
HY-GAIN TH3-JR.	3-Element/300W	\$144.50	\$129.95	\$242.50
HY-GAIN TH3-MK3	3-Element/1KW	\$219.95	\$179.95	\$289.95
HY-GAIN TH6-DXX	6-Element/2KW	\$296.95	\$246.95	\$349.95
MOSLEY TA-33-JR	3-Element/1KW	\$151.85	\$136.50	\$247.50
MOSLEY TA-33	3-Element/2KW	\$206.50	\$185.00	\$294.50
MOSLEY TA-36	6-Element/2KW	\$335.25	\$299.95	\$399.95
MOSLEY CL-33	3-Element/2KW	\$232.50	\$209.00	\$317.25
MOSLEY CL-36	6-Element/2KW	\$310.65	\$279.50	\$384.50
WILSON SYSTEM I	4-Element/2KW	\$274.95	\$224.95	\$329.95
WILSON SYSTEM II	3-Element/2KW	\$219.95	\$179.95	\$289.95

FREIGHT: ALL SHIPPING CHARGES "COLLECT" — F.O.B. WATERTOWN!



Write today for our latest Bulletin/Used Equipment list.

Burghardt INC. AMATEUR CENTER

"America's Most Reliable Amateur Radio Dealer"

PHONE NO. (605)-886-7314 P.O. BOX 73 WATERTOWN, SOUTH DAKOTA 57201



The Ultimate T-Hunt

— repeater jammer foiled again

*Bob Thornburg WB6JPI
13135 Ventura Blvd.
Studio City CA 91604*

In the midst of getting WR6AMD/WR6ABE back on the air (it was turned off for 60 days to realign the control procedures), a new MCW ID appeared. At over 20 wpm, it sent "JPI SUCKS" through the repeater on a random basis. The signal was strong enough to capture most all users. Since WB6JPI is the licensee of the repeater (WR6AMD), this MCW signal was of primary concern (at least to me).

An initial analysis of the signal showed that it lasted for about 4 seconds on what appeared to be a random basis on the average of 7 times per hour and ran more or less 24 hours per day. The signal first occurred about January 22, 1977.

The jammer committee was involved with a num-

Ground-plane antenna made of coat-hanger wire, pipe clamps, and a broom stick. It is located inside a vicious agave bush.

ber of mobile jammers considerably more destructive to the repeater operation than the new MCW signal. But it was of concern. In their spare time, some measurements were attempted, but it could not be heard on the input from the usual base stations. This fact, coupled with the random nature of the signal's occurrence, began to stimulate a challenge. It was not going to be easy.

A concentrated effort by WB6WDV, WA6QZK, WB6JPI, and WA6VSK, with coordination by Paul W6AOP, began to yield some results. It could be heard in parts of Glendale, Pasadena, and Sierra Madre, but very weakly. Bearings seemed to point north from the 210 freeway toward the Angeles National Forest (which Mt. Wilson is in), but it could not be heard elsewhere in the L.A. basin. The Ventura/210/10 freeways had been checked from Ventura to San Bernardino during the course of January 24 through February 2, as well as most of L.A. and Orange counties.

It was Gary WB6WDV who was first to be convinced it was in the mountains. The signal strength was not super strong; some base stations and 3-400 Watt erp mobiles could overcome it. Since even 1/2 Watt on Mt. Wilson was stronger than that, the mountain had been largely discredited as being the host. But Gary was convinced and on February 4 he went up the hill. He obtained strong bearings from near the repeater site pointing ENE and an even stronger signal from Mt. Wilson Road where it overlooked the canyon in back (north) of Mt. Wilson. The MCW transmitter was definitely up there somewhere.

A brief description of this area is that it is rugged.

Mt. Wilson is 5,700 feet high and forms the south edge of a large canyon about 20 miles long and some 6-8 miles across. The west fork of the San Gabriel River is created in this canyon. Red Box (4,900 feet) is at the west end and the Angeles Crest Highway

runs along the north side at about 5,000 feet. The bottom of the canyon is about 2,700 feet. A dirt road runs down into the canyon from Red Box (Rincon Road) as far as West Fork, then it goes up the south rim of the canyon east of Mt. Wilson.

The terrain is rugged, not only mountainous but full of overgrowth — mostly manzanita, yuccas, and such bushes. It also had up to 2 feet of snow on the north and east slopes.

On Saturday, February 5, Rich WA6VSK, Paul W6AOP, and Bob WB6JPI



Rick Penunuri WA6VSK and Gary Jaegers WB6WDV holding the antenna.



Transmitter and batteries coming out of their burial place.



Rick Penunuri WA6VSK and Gary Jaegers WB6WDV loaded up to pack the box out still operating.

met Gary and his wife Mearl WA6WXI at Mt. Wilson and indeed confirmed the bearings from Mt. Wilson Road. Bearings from the north rim (Angeles Crest Highway) pointed at Mt. Wilson across the canyon. The intersection of the bearings from Mt. Wilson Road and Angeles Crest Highway crossed at about West Fork. Another reading further up Angeles Crest Highway pointed at the observatory on Mt. Wilson and did not correlate at all with the previous reading.

Meanwhile, Leonard WB6QZK drove up Highway 39 to Crystal Lake and reported no signal. Gary took his antique Monza down the Rincon to West Fork (or what he thought was West Fork) but could hear it only at high spots with no consistent bearings. Rich and Jippy (short for JPI) went along various points from Red Box to Barley Flats on Angeles Crest Highway, always get-

ting bearings pointing at the observatory. The area in Mt. Wilson Park also showed very weak signals.

On Sunday, February 6, it was arranged to gain access to the observatory area. A strong bearing from the cliff was obtained to the NE across the canyon, indicating that the bearings from Angeles Crest pointing toward Mt. Wilson must be reflections.

Rick and Jippy drove around to Shortcut Road and hiked down into the canyon (about 8 miles), while Gary once again drove the Rincon, this time getting to West Fork and up the south side to where Shortcut Road met Rincon (at 4,400 feet—Shortcut Road started at 4,900, dropped to 2,700, and went back up). Much pooped and it being almost dark, Rick and Jippy arrived at the river after obtaining almost no bearings except NE. Rather than climb up to either end, they left the

road and headed cross country, following the river to West Fork. Gary met them there and reported that he had no new bearings other than northeast. We concluded it was not on Mt. Wilson nor on the bottom of the canyon.

During the following week, Gary made several trips into the mountains with the first new data coming from Windy Gap on Angeles Crest Highway. This bearing pointed south, which crossed the Wilson Road bearings just north of Cogswell Reservoir. He also drove the Rincon-Red Box road again, this time getting as far as Monrovia Peak before ice on the road halted the progress of his antique Monza. The bearing from this point was a little west of north. Gary and Leonard then approached the road from the east end, climbing to the top of Pine Mountain in Leonard's 4-wheel-drive Blazer. Gary relaxed and enjoyed the view into the canyons below, knowing that this time he was traveling the steep, narrow dirt roads in an appropriate vehicle in expert hands. Then Leonard remarked that this was the first time he had driven his Blazer on anything but flat ground. Gary closed his eyes and hid under the dashboard.

The bearings from Pine Mountain were WNW, crossing the other bearings in the area between Windy Gap and Cogswell Reservoir. A weak WSW reading from Twin Peaks Point on Highway 39 was obtained as a final check. Good bearings from all directions indicated that the transmitter was in the area of Bobcat, Lobo, or perhaps Devil's Canyon.

On Friday, February 11, Gary hiked along the ridge on the east side of Bobcat Canyon (runs southwest from Windy Gap) and obtained very strong bearings

that indicated that the transmitter was in Bobcat Canyon.

Saturday, February 12, Rick, Jippy, Gary, and Mearl went along the ridge once again confirming Gary's readings. A cross was indicated just below a 200-foot hill and on down into Bobcat Canyon. Although the team had originally decided to just confirm the bearings from the ridges on Saturday and go in on Sunday, it looked so good that it was decided to venture forth.

There is no trail or road or anything along the ridge. At the point of leaving the ridge, the team had traversed about 2 miles, dodging bushes and the deadly agave (yucca). Rick had a bloody ankle from one of these vicious killers. The ridge had dropped about 800 feet from the road. Leaving the ridge was no mean feat, as the undergrowth now became dense and was coupled with a steep slope. You could stand still on this slope, but only after coming to a stop against something (hopefully, not one of those deadly yuccas).

This area is lovingly known as the San Gabriel Wilderness Area. It is protected and controlled by the National Forest Service. We had obtained special permits to allow us to enter the area. The interest shown by the Forest Service and the California Highway Patrol with our problem (we were stopped several times with our weird DF equipment and strange behavior) is to be commended, although we are sure they think we're nuts. Back to Bobcat Canyon.

We knew we were very close to the transmitter as we progressed (slid) down from the ridge. The signal was extremely strong on our DF equipment. In fact, it was so strong that the

modulation was apparently coming from a different direction (2-3°) from the carrier. This is a quirk of the L-PER receiver for very strong signals. (Remember, it is an AM receiver and has no limiting.) After about 300 yards of downsliding, we stopped (with some difficulty) with Jippy about 20 feet uphill from Rick and waited for it to come on again.

For those who have been on T-hunts, the convenience of a continuous transmitter must be appreciated. You can take bearings whenever it is convenient. This transmitter was not so obliging. Being random, it only came on when it felt like it. We waited. Since it was only on for a few seconds when it did come on, we waited with DF equipment on and ready. We waited. Often the wait was 10 or more minutes, with the record being 35 minutes.

Balanced on the slope of the canyon wall, we waited for about 5 minutes. It came on, finally. Jippy pointed with his finger outstretched to Rick to look about 10 feet to his right. We all scrambled around looking in bushes without much success, missing the next transmission due to keeping balance, etc. Finally, in an attempt to become organized, Rick climbed back up to Jippy's level and we waited. While waiting, Rick found it. "I found it!" rang out for all in Bobcat Caynon to hear. A coyote ran out of the bushes, scared by the noise.

With much yelling and a little help from .52, Gary and Mearl, who were 100 yards up the hill, slid down and we all stared at Rick's discovery. It was a ground-plane antenna, handmade from coat-hanger wire and a PL-259 connector, located well inside a

menacing yucca bush. It was well enough hidden that Jippy's outstretched finger 1/2 hour before was about one foot away and pointing right at it. Poor blind Jippy.

But no transmitter. We old experienced T-hunters have a saying: "Where there is a radiating antenna, there must be a transmitter." Following the RG-58 coax from the antenna (it was buried in the ground), we found the transmitter about 3 feet away, also buried in the ground. In fact, it was buried directly under where poor blind Jippy was standing for the now famous finger-stretching exercise.

The transmitter was carefully dug out, using gloves to ensure that all fingerprints were not ours. The transmitter was contained in a parts bin, about 15" x 8" x 6", sealed up with a fiberglass cover and RTV. Alongside were found two batteries of the type used in lanterns or electric fences.

Now, someone went to a lot of trouble to put this thing here. It was Saturday afternoon (2 pm), and if it went off the air now, it would be apparent to the installer that it had been found. But, if it went off at midnight on Monday, it would be apparent that it died on its own, since no one would be wandering around in this desolate area at midnight on Monday. So, rather than give the originator the satisfaction of knowing why it went off, it was decided to pack the unit out, still operating, and keep it running until Monday midnight. We also considered disabling the transmitter and leaving it there to see if anyone came to fix it, but decided that we didn't want to stake it out. Besides, the originator must have "written it off" when it was planted and

probably wouldn't come back anyway.

So the unit was loaded into Gary's pack, fully operational with the antenna sticking out the top, and up the hill we went. It was loaded (still running) into Rick's car and driven out of the mountains and carefully installed in Rick's bedroom in Burbank. During all this moving around, the signal strength into the repeater varied, but from Burbank it was only a little weaker than in the canyon. No one seemed to notice. At midnight Monday, Rick cut the battery wires and it was forever silent.

Later in the week, the transmitter box and batteries were run through a local police department SID for fingerprints and other identifying characteristics. This was the first time we saw the inside of the box. The digital portion was assembled on a perfboard using wire-wrap and IC sockets for the 17 CMOS ICs and 7 transistors. The transmitter was an exciter board from a Heathkit HW-101 with an output of about a Watt.

What kind of person would go to the trouble of building such a complex device and truck it into the boonies just to tantalize the repeater? Note that although the jammer was annoying (especially to JPI), it really didn't interfere significantly with

the repeater operations. It was illegal in being unlicensed, not identifying itself, being located in Forestry land without a Forestry permit, and the installer entered the Wilderness Area without a permit (we checked). It could not be considered malicious in the FCC sense. The conclusion one comes to is that it was a game—a challenge to those who find jammers, a protest against repeaters, a gauntlet thrown in JPI's face. From the jammer's point of view, winning would be to cause the most disturbance (as is usually the case for any jammer). The users of WR6AMD were very good about not discussing the jamming on the air (although off the air, JPI sure heard about it), so no satisfaction was awarded by the users.

The T-hunt activities described above were not made public until several weeks after the transmitter was disabled, so the jammer did not gain satisfaction from witnessing that activity. So, other than this article, what did he gain? Nothing. If one were to score the game, it might go as shown in Table 1.

Even deducting 50% of the hunters' labor for the obvious benefits of camaraderie, fresh air, and exercise, the jammer has won, except for one thing—we know the identity of the jammer. ■

Jammer:

Material			\$	85
Gas				5
Design/Assemble/Test Logic	75 hrs			
Assemble Transmitter	4			
Package & Test	12			
Install	6			
Total Hours	97 hrs.	@	\$5/hr	485
Jammer Total:				\$ 575

Hunters:

Gas			\$	85
Labor	275 hrs.	@	\$5/hr	1,375
Hunter Total:				\$1,460

Table 1.

The Full Spectrum of VHF

SCR 1000 - Standard of Comparison In Repeaters - Now Available with Autopatch - and Many Other Options!



Optional Cabinet \$130.00

*Now in Use
Around the
World!*

FCC TYPE ACCEPTANCE
For Commercial Services
NOW PENDING!

The SCR1000/SCAP Combination — A New Dimension in Autopatch Repeater Performance

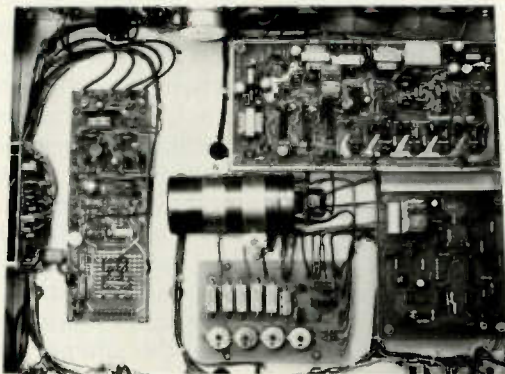

Under chassis view of SCR1000 with Autopatch Installed.

2M & 220 MHz

Now Spec Comm has taken the hassle out of putting an autopatch repeater on the air! The SCR1000/SCAP is a fully self-contained 30 watt repeater with built-in autopatch and land line control. You simply plug in the phone line, hook up the duplexer, and you're on the air! The usual months of problems are eliminated! The SCR1000/SCAP has been meticulously engineered to provide the smoothest performing patch together with a positive land line control of the repeater. Just look at all these features:

Features:

- Normal patch, or secure "reverse" patch
- 3 digit anti-falsing access — single digit disconnect
- 3 digit on-off control of repeater transmitter
- 4 sec. time limit on access
- Built-in adjustable time-out function — patch shuts down in 30-90 sec. if no carrier is received
- Wide range AGC on audio input and output
- User can mute phone line audio simply by keying his mic button — prevents embarrassing language from being repeated
- Patch access and repeater control — either over the air or over the land line

The SCR 1000/SCAP is a complete Autopatch Repeater — fully assembled, set-up and checked-out in our lab. As with all Spec Comm products, all workmanship and components are of the very highest quality. The price? A very reasonable \$1700.00 complete. (\$2195 w/WP641 Duplexer). Get your order in A.S.A.P.!

180 Day Warranty

Call or write today and get the details!



SPECTRUM

Export Orders — Contact Shere in our Int'l. Dept.

1055 W. Germantown Pk.,

/FM Repeater Equipment

The SCR 1000 "Dream Machine" System is Continually Being Improved -and Expanded!

Recent Improvements

- New, More stable, 'low-noise' transmitter exciter
- Improved Rcvr. Front-End & I.F. Selectivity. (FL-6 Preselector & 8 Pole Crystal Fitr. now Standard!)
- New, greatly expanded memory CW IDer. (Up to 4 different IDs as an option!)
- Improved Power Supply long-term reliability.

SCR1000 System Options

- Full Autopatch, 'Reverse-Patch'/Rptr. landline control.
- Touchtone™ Control of various rptr. functions. (e.g. Rptr. or "PL" ON/OFF, HI/LO Pwr., etc.)
- "PL"; Multi-Freq.; HI/LO Pwr.; 10 Pole Xtal Fitr.; Up to 4 IDs; Timer Reset Tone; TX Xtal Oven.
- 60-70 Wt. Transmitter
- Duplexers, Cable, Antennas, Cabinets, etc. Please Inquire.

We feel the SCR1000 is simply the finest repeater available. It is often compared to other (lesser featured) units selling for 3X the price! This 30 Wt. unit has a very sensitive & selective receiver, and its superb repeat audio quality is famous for "sounding like direct"! Included is a built-in AC Supply, CW IDer, full metering & lighted status indicator/control push-buttons, crystals, local mic, etc. Also provided are jacks for Emergency Power, Remote Control, Autopatch, Aux AF In, etc.

The Spec Comm Repeater System . . . a sound long-term investment—for those who demand the finest! An excellent value at \$1150.00. (\$1065.00 w/o Preselector.) Available only by direct factory order.

SPEC COMM REPEATER BOARDS, SUB-ASSEMBLIES & ACCESSORIES

SCR100 BOARD

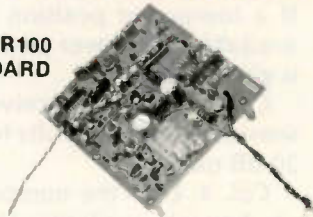

SCR100 Receiver Board

- Wide dynamic range! Reduces overload, 'desense', and IM.
 - Sens. 0.3uV/20dB Qt.
 - Sel. -6dB @ ± 6.5 KHz, -90dB @ ± 30KHz, (-110dB w/opt. 8 Pole Fitr.)
 - 'S Meter' Output.
- Exc. audio quality! Fast squelch! \$125.00 w/xtal. 8 Pole Fitr. (Highly recommended.) \$15.00

SCR100 Receiver Assembly

- SCR100 mounted in shielded housing
- Same as used on SCR1000
- Completely asmbld. w/F.T. caps, S0239 conn., AF GAIN POT, etc. \$195.00

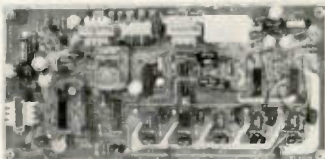

SCAP Autopatch Board

- Provides all basic autopatch functions
- See features on opposite page. \$225.00

RPCM Board

- Used w/SCAP board to provide "Reverse Patch" and land-line control of rptr.
- Includes land line "answering" circuitry. \$79.95

WP641 Duplexer

- Superior Band Pass/Band Reject design
- Provides great rejection of "out-of-band" signals
- Extremely easy to adjust
- -93dB typ. Isolation. \$495.00 (fully ckd. out w/SCR1000).

All equipment assembled & tested. For 2M & 220 MHz.

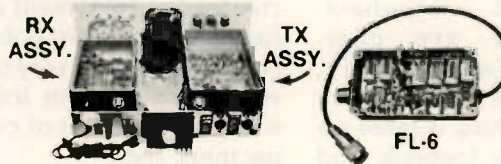

FL-6 Rcvr. Front-End Preselector

- 6 section filter with preamp.
- Provides tremendous rejection of "out-of-band" signals w/out the usual loss!
- Extremely helpful at sites with many nearby transmitters
- Gain: apx. 12dB
- Selectivity: -20 dB @ ± 2.0 MHz; -60 dB @ ± 6 MHz (typ.)
- \$85.00

TRA-1 Timer Reset Annunciator Board

- Puts out a tone "beep" on rptr. xmtr. apx. 1 sec. after rcvd. signal drops — thus allowing time for breakers
- Resets rptr. time-out timer when tone is emitted
- Adjustable time delay and tone duration
- Used with CTC100 and ID100/250
- \$20.95 (Add \$18.00 for inst. & ck. out in SCR1000)

CTC100 COR/Timer/Control Board

- Complete COR circuitry
- Carrier 'Hang' & T.O. Timers
- Remote xmtr. control
- 100% Solid State CMOS logic
- Many other features \$35.00

ID250 CW ID & Audio Mixer Board

- Adjustable ID tone, speed, level, timing cycle
- 4 Input AF Mixer & Local Mic amp.
- COR Input & xmtr. hold circuits.
- CMOS logic; PROM memory—250 bits/chan.
- Up to 4 different ID channels!
- Many other features. Programmed \$65.00 (1 chan.)
- Local MIC: \$18.95

SCT 110 BOARD

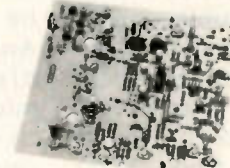

SCT 110 Xmtlr/Exciter Board

- 7 or 10 Wts. Output
- Infinite VSWR proof
- True FM for exc. audio quality
- New Design — specifically for continuous rptr. service
- Very low in "white noise"
- Spurious -70 dB
- With .0005% xtal. \$135.00
- BA-10 30 Wt. Amp board & Heat Sink. 3 sec. LPF & rel. pwr. sensor. \$51.95

SCT110 Transmitter Assembly

- SCT110 mounted in shielded housing
- Same as used on SCR1000
- Completely asmbld. w/F.T. caps, S0239 conn.
- 7 or 10 Wt. unit \$199.95. Add \$62.00 for 30 Wt. unit.

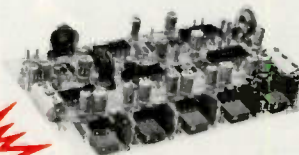

TTC100 TOUCHTONE™ CONTROL BOARD

TTC100 Touchtone™ Control Board

- 3 digit ON, 3 digit OFF control of a single repeater function. Or, 2 functions ON (3 digits each) with 1 digit which turns both OFF.
- Can be used to pull in a relay, trigger logic, etc.
- Typically used for Rptr. ON/OFF, HI/LO Pwr., P.L. ON/OFF, etc.
- Stable, anti-falsing design.
- \$85.00 (\$110.00 Inst. & ckd. out in SCR10000.)



COMMUNICATIONS

(Ship./Handl. — \$3.50. PA residents add 6% tax)

Norristown, PA 19401 • (215) 631-1710

Send for Data Sheets!



S8

Two Meter HT Survey

— data on 21 rigs

One of the most exciting things about the proliferation of two meter repeaters is the resulting wide-area coverage possible with exceedingly compact transceivers. Without repeaters, two meter hand-held transceivers, or HTs, would be mostly toys. With repeaters, they are the

traveling ham's pride and joy. Usually less than two pounds in weight and compact enough to put into a briefcase, they can easily be carried everywhere. And they are complete — power supply, microphone, and antenna — everything is there except for the logbook, and the FCC has simplified log-

ging, too. To be able to travel the countryside with a complete ham station and comfortably talk to the local hams greatly increases the enjoyment one can get from this hobby. Local hams find it very convenient to keep in touch with these marvels of compactness, too.

This article is designed to summarize some of the more important characteristics of most of the hand-held two meter units that are commonly available. These characteristics are collected in Table 1. The information has been collected from advertisements, contacts with the manufacturers, and from the units, but one must remember that specifications change and that definitions often differ from manufacturer to manufacturer, so this table should be used to familiarize yourself with the range of possibilities available and to select those products which you would like to investigate further for your particular use.

Here is a detailed explanation of what each column in Table 1 represents.

Col. 1: Lists a number which refers to the name and address of the manufacturer (see Table 2) and gives the model number of

the HT.

Col. 2: Lists the power output of the unit in Watts. If a low-power position is available, the lower power is given after the /.

Col. 3: Lists the receiver sensitivity in microvolts for 20 dB quieting.

Col. 4: Lists the number of channels available. The number of channels supplied with the basic unit is given in parentheses.

Col. 5: Tells whether or not the unit comes with a meter and, if so, what the meter measures. S means received signal strength, B means battery voltage, and O means relative power output.

Col. 6: Lists the current drain with the receiver squelched.

Col. 7: Lists the current drain when transmitting in the high-power position.

Col. 8: Tells whether (Y) or not (N) the unit contains a microphone separate from the speaker.

Col. 9: Tells what kind of external antenna connector is in the unit. PP means phone plug socket.

Col. 10: Gives the number and type of batteries used. Most use the AA size. The number 8/10 means that the manufacturer recommends that 8 zinc-carbon cells or 10 nicad cells be used. Sp means that a special nicad



The IC-215 by Icom.

	Equipment	Power	Microvolts	Channels	Meter	Sq. Drain mA	Xmit Drain mA	Sep. Mike	Ant. Conn.	Battery	Weight (oz)	Volume (in. ³)	Price
1	CR-V026	3	0.45	6	no				BNC	8AA	36	27	w ⁵
2	TR-33C	1.5	0.5	12(2) ^{1, 2}	S-B-O	30	400	Y	UHF	10AA	70	131	230w
3	HW-2021	1	0.75	5 ^{1, 3} (1)	no	35	>500	Y	PP	10AA	32	56	170w K
4	3806	1	0.5	6(1)	S-B	20	380	Y	BNC	8AA(Sp)	35	54	190
5	GTX-1	3.5/1	0.35	6	no	35	650	N	BNC	8AA	36	27	250
6	GTX-4	1.5		4(1)	no			Y			30	28	200w
6	IC-215	3/0.4		15	S	40	750	Y	UHF	9c	67	110	230
7	TR-2200A	2/0.4	0.4	12(6)	S-B	45	700	Y	No	10AA	56	91	250w
8	HRT-2	2/1	0.7	5(1)	no	30	600	Y	PP	Sp		63	180
9	SRC-146A	2	0.4	5(2)	S-B	15	620	Y	PP	8/10AA	32	44	300
9	C-118	1	0.4	6(1) ^{1, 2}	no	25	300	Y	BNC	Sp	21	27	240w
10	FMH-2	2/1	0.5	6(1)	S-B	20	500	Y	BNC	8/10AA	28	57	220
10	FMH-5	5/1	0.5	6(1)	S-B	20	1000	Y	BNC	8/10AA	28	57	280
11	HT1448	2	0.35	4(1)	no	10	500	N	None	10AA(Sp)	22	35	130K
12	1402SM	2.5	0.3	6(1)	S-B	25	500	Y	TNC	10AA	27	48	255
12	1405SM	5/1	0.3	6(1)	B	25	900	Y	TNC	10AA	28	45	330
12	WE-800	1/12 ⁶	0.3	all ⁴	S-O	45	290	N	BNC, UHF	10AA	59	104	500
12	Mark II	2.5	0.3	6(1)	no	15	500	N	BNC	nicad(Sp)	19	26	230
12	Mark IV	4	0.3	6(1)	no	15	900	N	BNC	nicad(Sp)	19	26	260
12	1407SM	7/1	0.3	6(1)	B	15	1200	N	TNC	nicad(Sp)	28	45	385
13	Mini-1	1.8	0.3	6(2) ^{1, 2}	no	20	330	Y	BNC	10N	18	23	240w

Table 1. Two meter HT survey. ¹Only one crystal per channel needed; ²three offsets supplied; ³two offsets supplied; ⁴synthesized four offsets available; ⁵not sold in U.S.A.; ⁶external power needed for high power out.

battery pack is required or is available.

Col. 11: Gives the weight in ounces of the unit with batteries.

Col. 12: Gives the volume occupied by the unit in cubic inches.

Col. 13: Lists a usual price. A w means that the

price includes nicad batteries. K means that the unit is a kit.

If no entry appears in any column, it means that

the manufacturer does not establish a value for that quantity or that information was not available when the table was

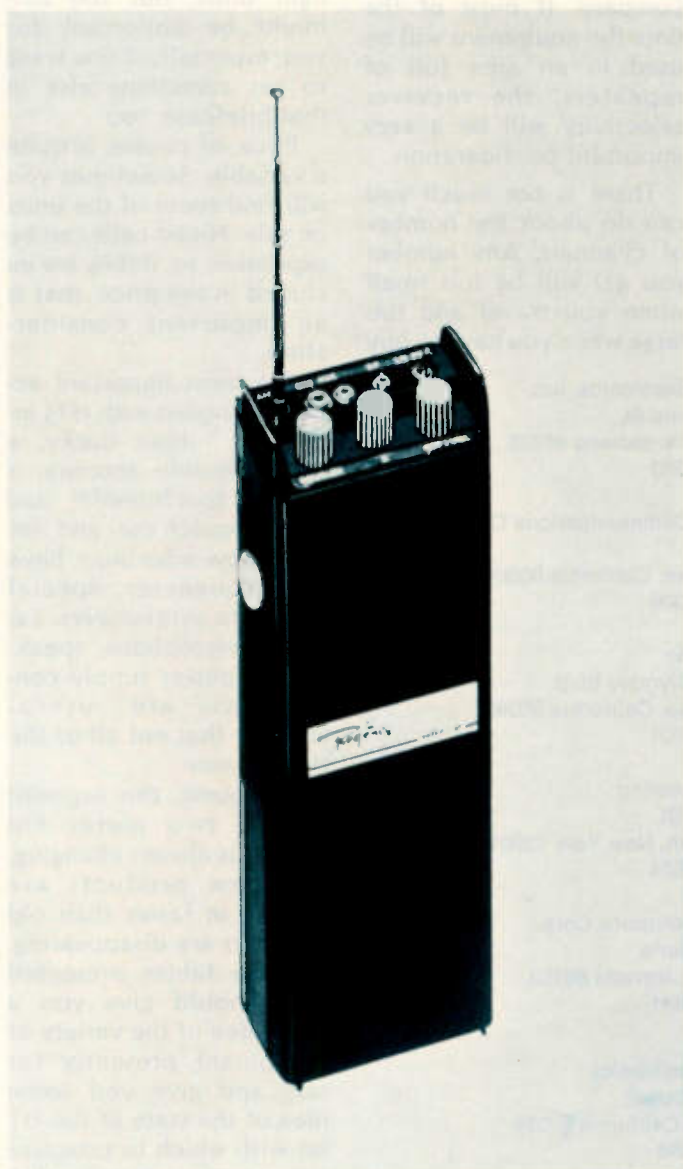

The HRT-2 by Regency.



The HW-2021 by Heathkit.



The GTX-1 by Genave.

1. CR Electronics
1155 Triton Dr., Suite D
Foster City, California 94404
(415)-574-3571
2. R.L. Drake Co.
540 Richard St.
Miamisburg, Ohio 45342
(513)-866-2421
3. Heath Company
Benton Harbor, Michigan 49022
(616)-982-3411
4. Hy-Gain Electronics Corp.
8601 Northeast Highway 51x
Lincoln, Nebraska 68505
(402)-464-9151
5. Genave
4141 Kingman Drive
Indianapolis, Indiana 46226
(317)-546-1111
6. ICOM West, Inc.
13256 Northrup Way
Bellevue, Washington 98005
(206)-747-9029
7. Trio-Kenwood Communications, Inc.
116 East Alondra
Gardena, California 90248
(213)-770-4350
8. Regency Electronics, Inc.
7707 Records St.
Indianapolis, Indiana 46226
(317)-545-4281
9. Standard Communications Corp.
Box 92151
Los Angeles, California 90009
(213)-532-5300
10. Henry Radio
11240 W. Olympic Blvd.
Los Angeles, California 90064
(213)-477-6701
11. VHF Engineering
320 Water St.
Binghamton, New York 13901
(607)-723-9574
12. Wilson Electronics Corp.
4285 S. Polaris
Las Vegas, Nevada 89103
(702)-739-1931
13. Palomar Electronics
665 Opper Street
Escondido, California 92025
(714)-746-2666

Table 2. Addresses of manufacturers.

prepared.

There is a lot of information in the main table; however, there is also a lot of important information which cannot be given in any table. Quality of construction is one type of information which is impossible to objectively present. The completeness of instruction manuals and the availability of service have not been considered. Neither have the terms of any warranty or the reputation of the maker.

The most important feature which is not included here is receiver selectivity. There are many different ways to report receiver selectivity, most of which are difficult to compare. If most of the time the equipment will be used in an area full of repeaters, the receiver selectivity will be a very important consideration.

There is not much you can do about the number of channels. Any number you get will be too small when you travel and too large when you have to buy

crystals (except for the WE-800).

A meter is not essential, but it is very useful, especially when you are on the fringe of a repeater and are walking around your room looking for a hot spot.

The importance of current drain is quite dependent on your operating habits and the distance to recharging facilities. Most batteries used in these units will supply about 500 milliamp-hours of energy. If you intend to use the unit away from the power line for long periods of time, current drain will be particularly important.

Not many people worry about the weight of these light units, but the size might be important for you, especially if you want to get something else in that briefcase, too.

Price, of course, is quite a variable. Sometimes you will find some of the units on sale. Nicad cells can be expensive, so, if they are included in the price, that is an important consideration.

The most important accessories used with HTs include a rubber ducky, a short, flexible antenna; a built-in touchtone™ pad for autopatch use; and, for the fellow who must have all frequencies, special miniature synthesizers. External microphone, speaker, and power supply connections are useful features that not all of the HTs possess.

Of course, this segment of the two meter FM market is always changing, and new products are coming in faster than old products are disappearing. But the tables presented here should give you a good idea of the variety of equipment presently for sale and give you some idea of the state of the HT art with which to compare any new equipment that you run across. ■

DSI Instruments Inc.

Performance You Can Count On



MODEL 3550W
\$149.95
INCLUDES TCXO ± 1 PPM



MODEL 3600A
\$199.95
INCLUDES OVEN TIMEBASE $\pm .5$ PPM



MODEL 3240HH
\$119.95
BATT. OPERATED

The 3600A, 3550W and 3240HH Frequency Counters represent a significant new advancement, utilizing the latest LSI Design... which reflects DSI's ongoing dedication to excellence in instrumentation, for the professional service technician and amateur radio operator. Before you buy a DSI instrument you know that the specification is. We publish complete and meaningful specifications which state accuracy over temperature and sensitivity at frequencies you need. And we guarantee those specifications in writing. **JOIN THE RANKS OF THOUSANDS OF SATISFIED CUSTOMERS. PLACE YOUR ORDER TODAY AND BE THE ONE ON FREQUENCY.**

DSI — GUARANTEED SPECIFICATIONS — MADE IN U.S.A.

Model	Frequency Range	Accuracy Over Temperature	@150MHZ	@250MHZ	@500MHZ	Number Of Readouts	Size Of Readouts	Power Requirements	Size
3600A	50HZ-600MHZ	OVEN .5PPM 50° to 100°F	10MV	10MV	50MV	8	.5 inch	115VAC or 8.2-14.5VDC	2 7/8" H x 8" W x 5" D
3550W	50HZ-550MHZ	TCXO 1PPM 65° to 85°F	25MV	25MV	75MV	8	.5 inch	115VAC or 8.2-14.5VDC	2 7/8" H x 8" W x 5" D
3240HH	2MHZ-250MHZ	3PPM 65° to 85°F	100MV	100MV	NA	7	.4 inch	4AA Batt.	5" H x 3" W x 2" D

**ALL UNITS ARE FACTORY ASSEMBLED,
TESTED AND CARRY A FULL 1 YEAR WARRANTY.**

See Your Dealer
OR

Call Toll Free (800) 854-2049 **DSI Instruments, Inc.**
California Residents, Call Collect (714) 565-8402

VISA • MC • AMERICAN EXPRESS • CHECK • MONEY ORDER • COD
7914 Ronson Road, No. G, San Diego, CA 92111

• NO EXTRA COSTS •

FREE Shipping anywhere in U.S.A.
& Canada. All other countries Add \$10.00.
Strongest warranty in the counter field,
ONE YEAR Parts and Labor
Satisfaction Guaranteed.

Interrupts Made Easy

— for 8080/S-100 users

Jim Marr WB6LOA
1837 Midwick Dr.
Altadena CA 91001

When my Intel 8080-based S-100 bus system was finally up and running, I began looking around for ways to increase its flexibility. The first thing I

needed was a means of getting out of a program that was running and back into the monitor without using front panel switches. Interrupt capability was clearly needed. Unfortunately, parts of my software resided in the section of memory that the 8080 uses for its restart instructions, so I couldn't use an interrupt controller such as Intel's 8214.

After a few minutes of thumbing through data sheet catalogs, I discovered the solution to my problem — Intel's 8259 programmable interrupt controller. The 8259 uses a call instruction instead of a restart instruction, which allows the interrupt-handling routines to be located anywhere in memory. As an extra bonus, the 8259 also allows interrupt priorities to be changed or individual interrupt lines to be disabled at any time during processor operation.

In this article, I will describe how interrupts work in an 8080-based system, the 8259 chip, how to interconnect the 8259 to the S-100 bus, and a simple software routine to get the 8259 working.

Interrupts and the 8080

Basically, an interrupt is a request by a peripheral device for immediate service by the central processor. In an 8080-based system, the sequence of events following an interrupt is as shown in Fig. 1. You must first assume that the processor is busy executing some program, which I have called "Main," for lack of a better name. When our external device decides that it needs to be serviced, it pulls the INT (interrupt) line (pin 14) on the 8080 chip high, providing an interrupt request to the 8080. The 8080 ignores this line until it has completed the current instruction cycle.

For those unfamiliar with the 8080, an instruction cycle consists of everything the 8080 must do to get and to

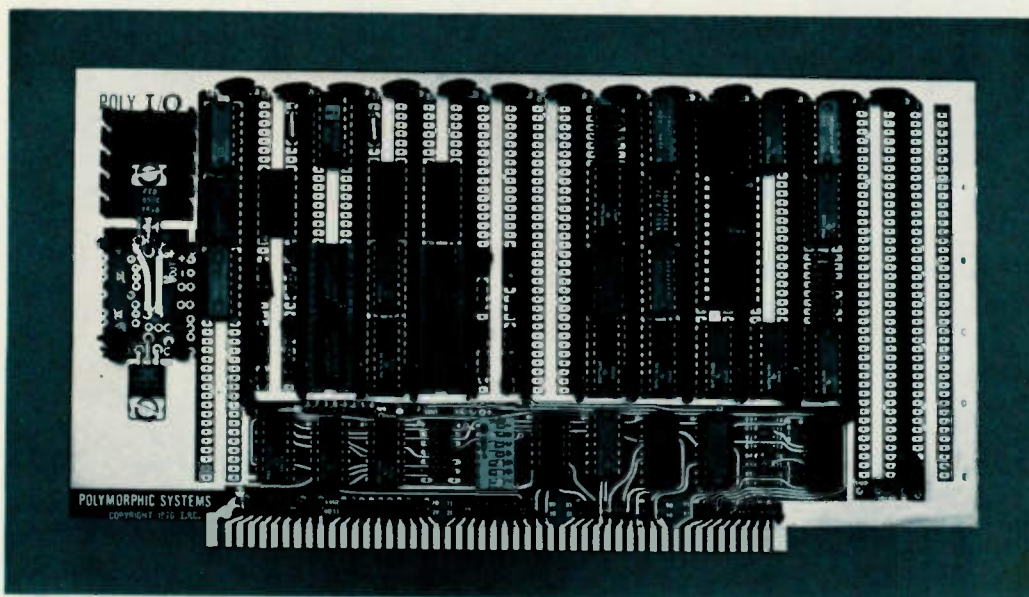

My 8259 interrupt controller is assembled on a PolyMorphic I/O board; however, none of the address decoding circuitry provided on that board was utilized. The interrupt controller is the large block of chips on the right side of the board. The 8259 is the large chip in the center of the block. (Photo by Mark Friedman.)

process a single instruction. Each instruction cycle is subdivided into smaller parts called machine cycles. The first machine cycle in any instruction cycle is the instruction fetch, or M1, cycle. Whether or not any more machine cycles are required depends on the type of instruction the 8080 obtained while in the M1 machine cycle. Many 8080 instructions do not require more than one machine cycle, while some require up to five.

After the current instruction cycle is completed, the INT line is examined. If it is high, the 8080 also looks at its internal interrupts enabled (EI) flip-flop. This flip-flop is software controllable, using the EI (enable interrupts) and DI (disable interrupts) instructions, and must be set before interrupts will be accepted by the 8080. If the EI flip-flop is not set, the 8080 ignores the interrupt request on its INT line and continues running the program Main. If the EI flip-flop is set, the 8080 sets its internal interrupt flip-flop, resets the EI flip-flop (disabling any further interrupts), and begins an interrupt-instruction cycle.

The 8080 tells the outside world what type of machine cycle it is entering by placing eight status bits onto the data bus at the beginning of each machine cycle. The first machine cycle in the interrupt-instruction cycle is indicated by having status bits M1 (instruction fetch), W0 (processor write, active low), and INTA (interrupt acknowledge) high and all others low. These bits are latched into an eight-bit register by the SYNC pulse sent out by the 8080 on pin 19 when the status bits are stable on the 8080 data bus. The status bits can then be used to control circuitry external to the 8080 (as I will do later).

During a normal instruction fetch, the 8080 would increment its program

counter register at this time. Following the interrupt, however, the program counter register is not incremented. This allows you to keep track of the address of the next instruction to be executed in program Main so that you can continue execution after the interrupt is processed.

Next, the 8080 resets its internal interrupt flip-flop and inputs an instruction from the data bus. It is assumed that the interrupting device has placed an instruction on the data bus for the 8080 to get. The external circuitry associated with the device-requesting service has the responsibility to see that the right instruction is placed on the data bus at the right time.

The type of instruction that the 8080 receives from the data bus determines what happens next. If the instruction is not one of the 8080's restart instructions or a call instruction, it is simply executed, and the program Main then continues where it left off. This feature is useful if it is desired to increment or decrement one of the 8080's internal registers in response to some outside trigger while a program is running (for example, a counter). There are probably lots of clever ways to use this feature of the 8080 that have not yet been tried.

If the 8080 gets a call instruction, then it fetches two more bytes which are the address of the routine being called. This is normally the address of the service routine for the interrupt. It may not be immediately apparent, but a lot has to take place in the circuitry external to the 8080 for this to occur. That's what the 8259 is for.

If, instead, the 8080 gets a restart instruction, the address of the service routine is automatically set by a three-bit pattern imbedded in the single-byte restart instruction itself. Obviously, only eight such three-bit patterns exist, so you only have eight places in memory to locate your

service routines. These start at address 0000 hex and are spaced every eight bytes in memory. These addresses correspond, in order, to the restart instructions RST0 through RST7.

Regardless of whether the instruction was a call or a restart, the 8080 now pushes (stores) the current program counter register contents

onto its stack (the area of memory devoted to keeping addresses for future use) so that it will be available after completion of the interrupt service routine. This is necessary because the program counter register contains the address of the next instruction to be executed in program Main. The appropriate address from the call instruc-

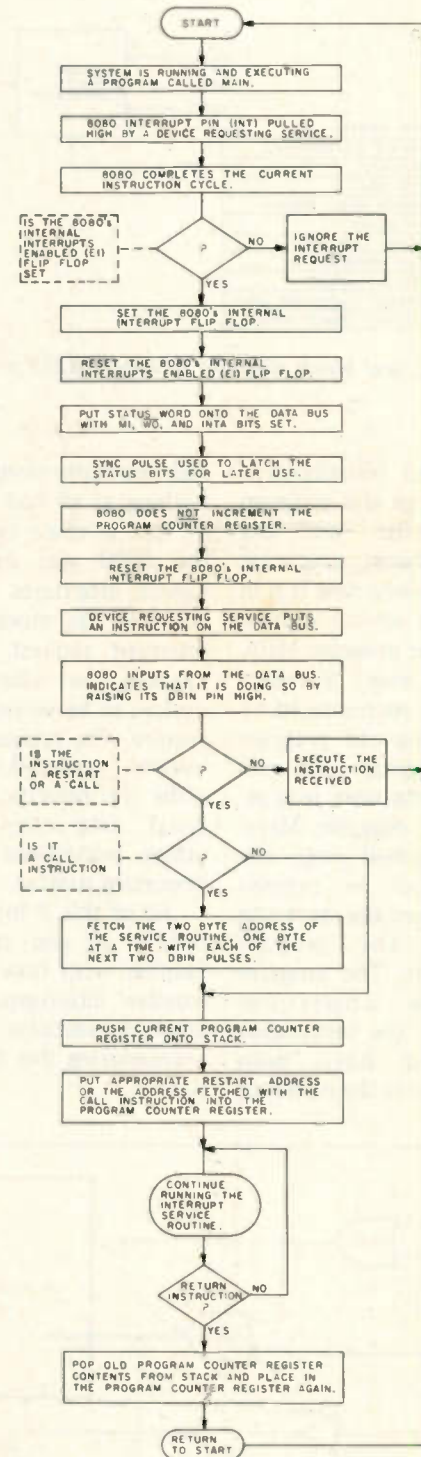

Fig. 1. Flowchart of the event sequence for interrupts in an 8080-based system.

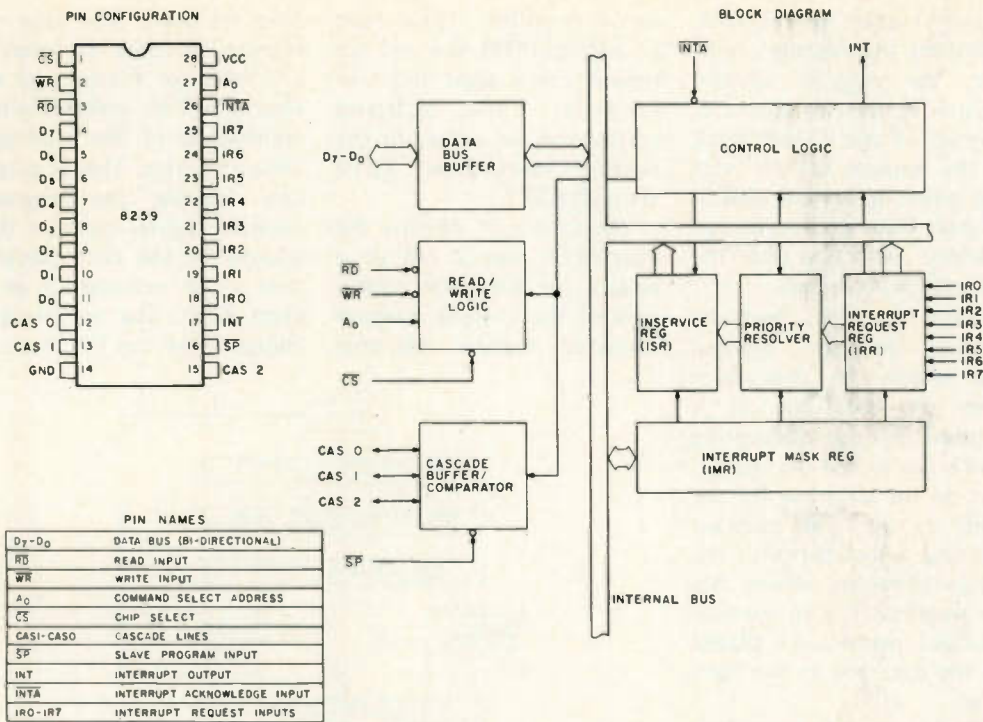

Fig. 2. Pinout and block diagram of Intel's 8259 programmable interrupt controller. (Courtesy of Intel.)

tion or restart instruction is then placed in the program counter register, and the 8080 continues executing instructions, only now it is in the interrupt service routine instead of the program Main.

When (if ever) a return instruction is encountered by the 8080, the old program counter register contents (address of the next instruction in the program Main) that was pushed onto the stack earlier is popped (removed) from the stack and placed in the program counter again. The program Main now continues executing at the instruction that would have been executed next if the interrupt

had not come along, just as if nothing at all had happened.

This is more or less how the 8080 was designed to handle interrupts. Normally, you will use more than one interrupt request line in a system to allow several devices to be serviced as they require. The request lines are usually arranged in some order of priority, with the most important devices taking precedence over less important devices.

All of this is intended as a review if you are already familiar with how the 8080 handles interrupts, or as a brief introduction if you are encountering this for the first time.

The 8259

The 8259 gets around most of the limitations that the 8080 has in handling interrupts. Fig. 2 is a block diagram of the 8259. The chip has its own internal bidirectional data bus and is interfaced to the 8080 data bus through the eight-bit bidirectional data-bus buffer.

The interrupt-request register (IRR) is basically an 8-bit positive edge-triggered latch that holds a record of those devices that have requested service. The "positive edge-triggered" business means that, when the interrupt-request (IR) pulse is making the transition from low to high, the flip-flop is set.

The priority resolver determines which (if any) of the interrupts will be serviced next and then sets the appropriate bit in the in-service register (ISR). The in-service register then determines which address is to be placed on the data bus in response to the INTA pulses from the 8080.

Individual interrupt-request lines may be masked off, which simply means that

they can be inactivated, by setting the appropriate bit in the interrupt-mask register (IMR).

The control logic block takes care of synchronizing the various internal parts of the chip. Its primary duty is to issue an interrupt to the 8080 in response to a valid interrupt request at one of the 8259's eight interrupt-request lines and then gate the three bytes of the call instruction onto the 8080's data bus in response to the three INTA pulses from the 8080 support circuitry.

Programming and reading the status of various registers in the chip are handled by the 8080's I/O (input/output) instructions and the read/write logic block of the 8259. The chip requires two I/O port addresses for proper operation.

More than one 8259 can be tied together through the use of the cascade buffer/comparator. One 8259 is designated as the master, and all other 8259s in the system are designated as slaves to the master. The slave's INT line is connected to one of the master's interrupt-request lines so that, when the slave chip gets an interrupt request on one of its interrupt-request lines, it sets the master 8259's interrupt-request register flip-flop. The master 8259 then issues an interrupt request to the 8080 on its INT line. An 8259 chip is designated as a master by tying its slave program (SP) pin high or as a slave by tying the SP pin to ground. Up to eight slave 8259s may be used with a single master.

When a slave 8259 receives an interrupt request, the slave outputs a high on its INT pin which is connected to one of the master 8259's interrupt-request (IR) pins. If that IR pin is not masked off by the master 8259's interrupt-mask register (explained later), the master 8259 issues an INT to the 8080. When the 8080 acknowledges with the first of the three required INTAs, the master 8259 puts the call

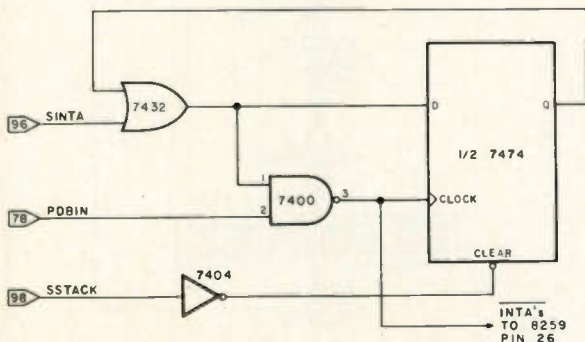

Fig. 3. INTA pulse generator circuit. (Bus pin numbers are those of the S-100 bus.)

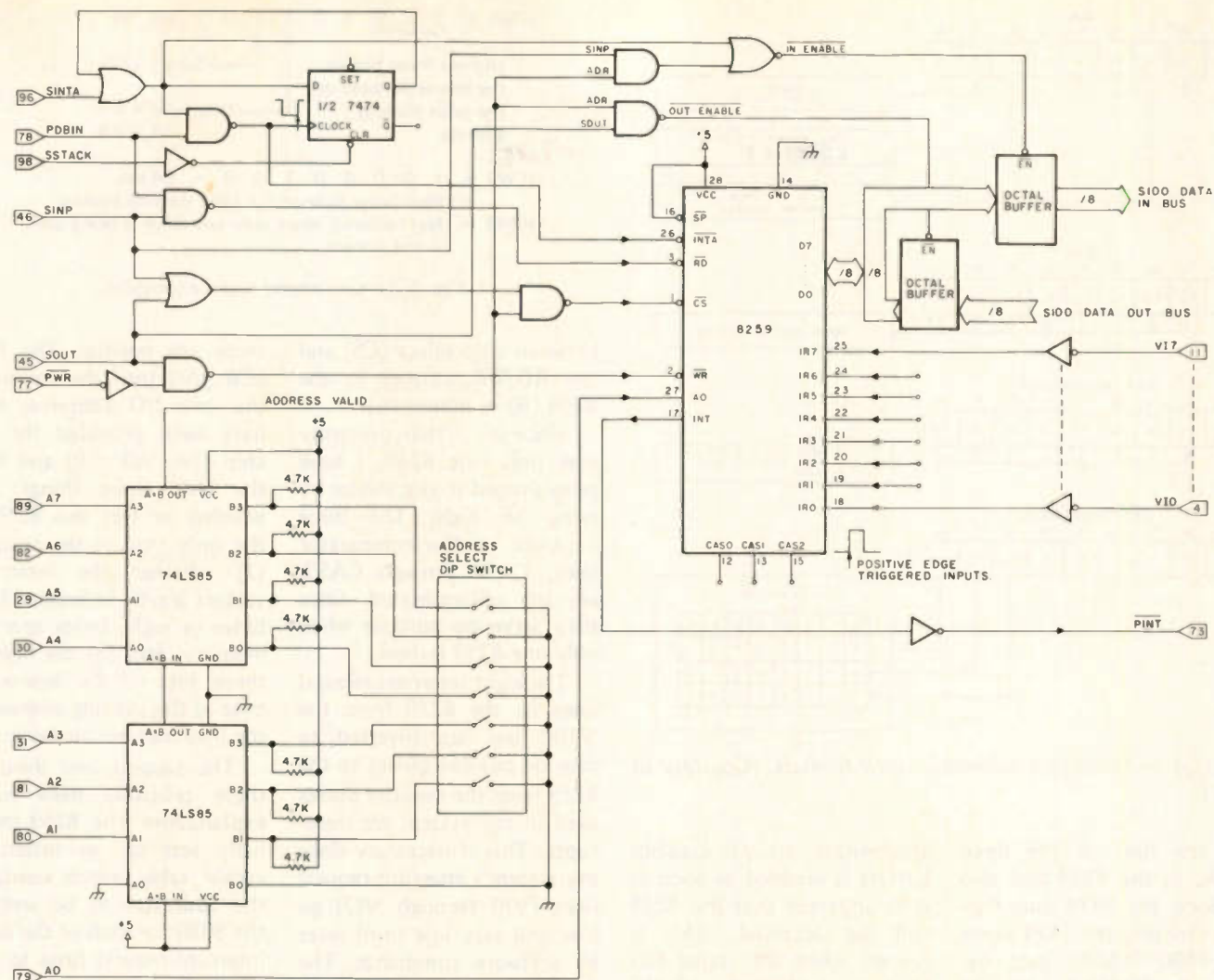

Fig. 4. Logic diagram of the 8259 implementation in S-100 bus systems.

instruction onto the data bus. The master also puts the address (one of eight) of the slave 8259, the one which received the interrupt request from the device needing service, onto the cascade buffer/comparator output lines, CAS0 through CAS2. This address (connected to the slave's cascade buffer/comparator lines) enables the slave 8259 to put the required service routine address onto the 8080 data bus with the next two INTAs from the 8080.

Clearly, since a call instruction is used instead of a restart instruction, the service routine may be located nearly anywhere in the 64K of memory available to the processor. The master/slave feature allows as many as 64 interrupt-request lines to be serviced by 64 different rou-

tines, if desired.

The interrupt-mask register (IMR) allows for maskable interrupts. Again, this means that the user can disable any or all of the interrupt-request lines to any 8259 chip. To accomplish this, you set the desired bit(s) in the interrupt-mask register. You thus have the option of turning off any particular interrupt(s) without turning them all off.

The priority resolver allows the user to change the priority of any interrupt-request line at any time during system operation. Suppose, for instance, that, after servicing a particular device, you wish to assign it to the lowest priority, giving the remaining devices in the system a higher priority. This is easily accomplished with a single command to the 8259,

which reprograms the priority resolver to do what you want.

By this time, you must already realize just how versatile the 8259 is. The chip has exactly the kind of flexibility that I needed to solve my interrupt problems. The next step was to get the chip operating in the S-100 bus environment.

Interfacing to the S-100 Bus

This section deals specifically with the S-100 bus standardized by the Altair 8800. If you are not familiar with this bus structure and wish to know more about it, you might refer to the article, "Introducing the S-100: Standard Small Computer Bus Structure," by W. M. Goble, which appeared in the June, 1977, issue of *Interface Age* magazine.

All of the interfacing is

fairly straightforward, except for one small part.

Intel designed the 8259 to work in a system that employs the 8228 system controller and bus driver chip. For those not familiar with this chip, it is basically a status bit latch and bidirectional data-bus driver all in one chip. It also has another unique function. When a call instruction is issued in response to an INTA status bit, the 8228 issues three INTA pulses, one during each of the next three machine cycles, so that the 8080 will get all three bytes of the call instruction. Since S-100-based systems do not use the 8228, I needed another method of producing these three pulses.

A very simple solution to this problem is shown in Fig. 3. When the INTA status bit is valid, PDBIN is allowed to



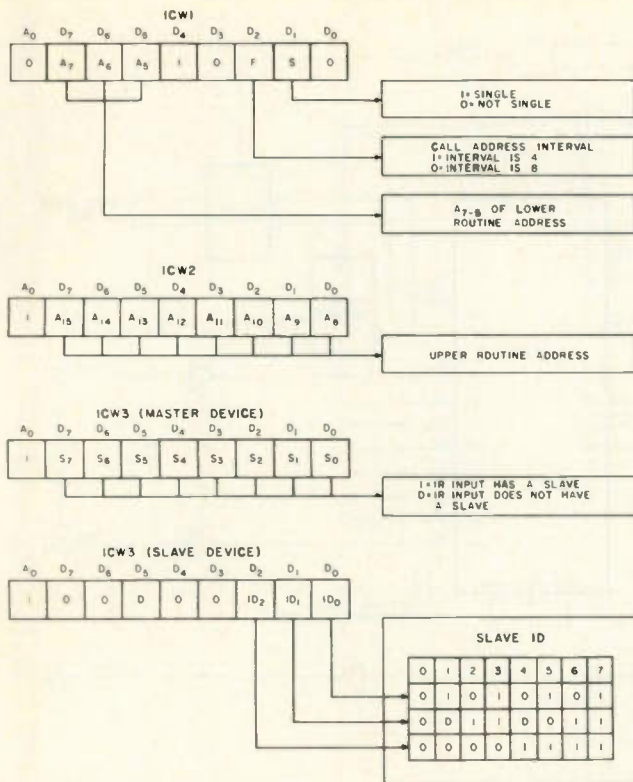

Fig. 5(a). Initialization command word formats. (Courtesy of Intel.)

give the first of the three \overline{INTA} s to the 8259 and also to clock the 7474 dual flip-flop. Clocking the 7474 keeps the 7400 NAND gate between the PDBIN bus pin and the 7474 enabled (i.e., pin 1 of the 7400 is high) so that the next two PDBINs can give the 8259 the next two \overline{INTA} s that it requires to gate the address onto the data bus.

After getting all three bytes of the call instruction, the very next thing that the 8080 will do is push the contents of the program counter register onto stack. Since the \overline{INTA} s must be stopped after the 8259 has received three of them, the stack-status bit (SStack) is used to reset the 7474 flip-flop, turning off the 7400 NAND gate between PDBIN and the 7474 (i.e., making pin 1 of the 7400 low), stopping the \overline{INTA} pulses to the 8259.

The entire logic diagram is shown in Fig. 4. The \overline{INTA} pulse generator of Fig. 3 is shown in the upper left-hand corner of Fig. 4. As shown in the diagram, the 8259 is selected (\overline{CS} low), and the

appropriate set of data-bus buffers is enabled as soon as it is apparent that the 8259 will be accessed. This is known when the status bits have been latched and the address has been decoded. The bus drivers to the S-100 data IN bus are also enabled when a status \overline{INTA} bit is received in response to an interrupt request, allowing the 8259 to give the three-byte call instruction to the 8080.

Address decoding is done using two 7485 four-bit magnitude comparators and an 8-bit DIP switch, which allows the interrupt controller to be addressed at any pair of the 8080's 256 input/output ports. Notice that, since two I/O ports are required for operation of the 8259, address bit A₀ has been connected directly to the A₀ pin of the 8259.

Read (\overline{RD}) or write (\overline{WR}) strobes (active low) are obtained by NANDing PDBIN with \overline{SINP} (the status input bit) or \overline{PWR} (processor write signal) with \overline{SOUT} (the status output bit), respectively. This gives the necessary delay time

$$ICW1 = \underline{1101}0110 = D6 \text{ hex}$$

Highest three bits of the low-order byte of the table starting address.
 Single 8259 if = 1.
 Interval = 4 if 1.
 = 8 if 0.

$$ICW2 = 10000100 = 84 \text{ hex}$$

= High-order byte of the table starting address.

ICW3 = Not required, since only one 8259 is being used in the system.

Fig. 5(b). Command word examples.

between chip select (\overline{CS}) and the $\overline{RD}/\overline{WR}$ strobes to the 8259 (50 ns minimum).

Since my system presently uses only one 8259, I have programmed it as a master by tying \overline{SP} high. The three cascade buffer/comparator lines, CAS₀ through CAS₂, are left unterminated, since they serve no purpose when only one 8259 is used.

The eight interrupt-request lines to the 8259 from the S-100 bus are inverted to provide positive pulses to the 8259 from the negative pulses used in my system for interrupts. This is necessary since my system's interrupt-request lines (VI₀ through VI₇) go low and stay low until reset by software commands. The 8259, on the other hand, only acknowledges an interrupt if the interrupt-request register flip-flop is set by the rising edge of a pulse. Clearly, if I did not invert the interrupt-request lines before applying them to the 8259, the 8259 would never acknowledge an interrupt.

That completes the interfacing of the 8259 to the S-100 bus. The next problem is to program the 8259 to get it to do some of the fantastic things that it is supposed to be able to do.

Programming the 8259

The 8259 requires two types of commands to set it up for operation: (1) initialization command words (ICWs) and (2) operation command words (OCWs).

Initialization command words must be given to the 8259 before it is capable of doing anything. At least two are required, but, if the system is using any slave 8259s,

three are needed. The first ICW goes into the lower of the two I/O addresses that have been provided for the chip (i.e., A₀ = 0) and tells the chip three things: (1) whether or not this 8259 is the only one in the system, (2) whether the interrupt vectors are to be located four bytes or eight bytes apart in memory, and (3) the highest three bits of the low-order byte of the starting address of the interrupt-vector table.

The second and third of these probably need some explanation. The 8259 internally sets up an interrupt-vector table which contains the addresses to be sent to the 8080 for each of the eight interrupt-request lines to the 8259. Rather than have the user input the address of the service routine for each separate interrupt-request line, Intel decided to have the user input only the address of the first one (i.e., that corresponding to the IRO line), and all of the rest of the addresses (i.e., those corresponding to the remaining seven IR lines) are spaced equally (either four or eight bytes) above the first one. So, you have to tell the chip, using the ICWs, where to start the table (i.e., the first address) and how far apart to space the addresses in the table. Table 1 shows how the low-order address bytes are set up in the 8259's internal interrupt-vector table for both the four- and eight-byte spacings.

You have probably already guessed that the second ICW is the high-order byte of the table starting address. This word must immediately follow ICW1 and must be sent

	Interval = 4								Interval = 8							
	D7	D6	D5	D4	D3	D2	D1	D0	D7	D6	D5	D4	D3	D2	D1	D0
IR 7	A7	A6	A5	1	1	1	0	0	A7	A6	1	1	1	0	0	0
IR 6	A7	A6	A5	1	1	0	0	0	A7	A6	1	1	0	0	0	0
IR 5	A7	A6	A5	1	0	1	0	0	A7	A6	1	0	1	0	0	0
IR 4	A7	A6	A5	1	0	0	0	0	A7	A6	1	0	0	0	0	0
IR 3	A7	A6	A5	0	1	1	0	0	A7	A6	0	1	1	0	0	0
IR 2	A7	A6	A5	0	1	0	0	0	A7	A6	0	1	0	0	0	0
IR 1	A7	A6	A5	0	0	1	0	0	A7	A6	0	0	1	0	0	0
IR 0	A7	A6	A5	0	0	0	0	0	A7	A6	0	0	0	0	0	0

Table 1. Low-order interrupt vector byte constructed by the 8259. Refer to text for explanation. (Courtesy of Intel.)

to the higher of the two I/O ports assigned to the 8259 (i.e., A0 = 1).

The third ICW is only required by the 8259 if you are using some slave 8259s in your system. This word tells the master 8259 which of its interrupt-request lines will be coming from a slave 8259. The slave 8259(s) also needs ICW3 to tell it (them) which address on the cascade buffer/comparator lines it is to respond to. Most systems will be using only a single 8259 and will not require this word at all. You should note that bit 1 of ICW1 tells the 8259 whether or not to expect ICW3. If needed, ICW3 is sent to the higher of the two I/O ports assigned to the 8259.

Fig. 5(a) shows the format for each of the three ICWs required by the 8259. You should study this figure carefully before attempting to program your 8259.

An example might help you understand what's going on here. Suppose that you want to set up a jump table that is to start at 84C0 hex and is to have its addresses spaced four bytes apart in memory. (A jump table is just a table of jump instructions to other places in memory so that, when the interrupt vector brings you to one of these jump instructions, you immediately jump to the appropriate service routine located elsewhere in memory. This technique is used because most interrupt service routines are longer than four or eight bytes.) Assume also that you are using only one 8259. The two required ICWs are shown in Fig. 5(b).

Immediately after re-

ceiving the two (or three) ICWs, the 8259 is completely operational in the fully-nested mode. This means that the eight interrupt-request lines have a fixed priority structure, with IRO having the highest priority and IR7 having the lowest priority. It

should be clear that, if you start your interrupt-vector table at address 0000 hex and have an address spacing of eight bytes between interrupt vectors, the 8259's operation will be indistinguishable from other interrupt controllers, such as the 8214. Specifi-

cally, each interrupt request will cause the program to get to one of the eight addresses spaced eight bytes apart, starting at address 0000 hex, just as if the interrupt controller had used a restart instruction instead of the call instruction.

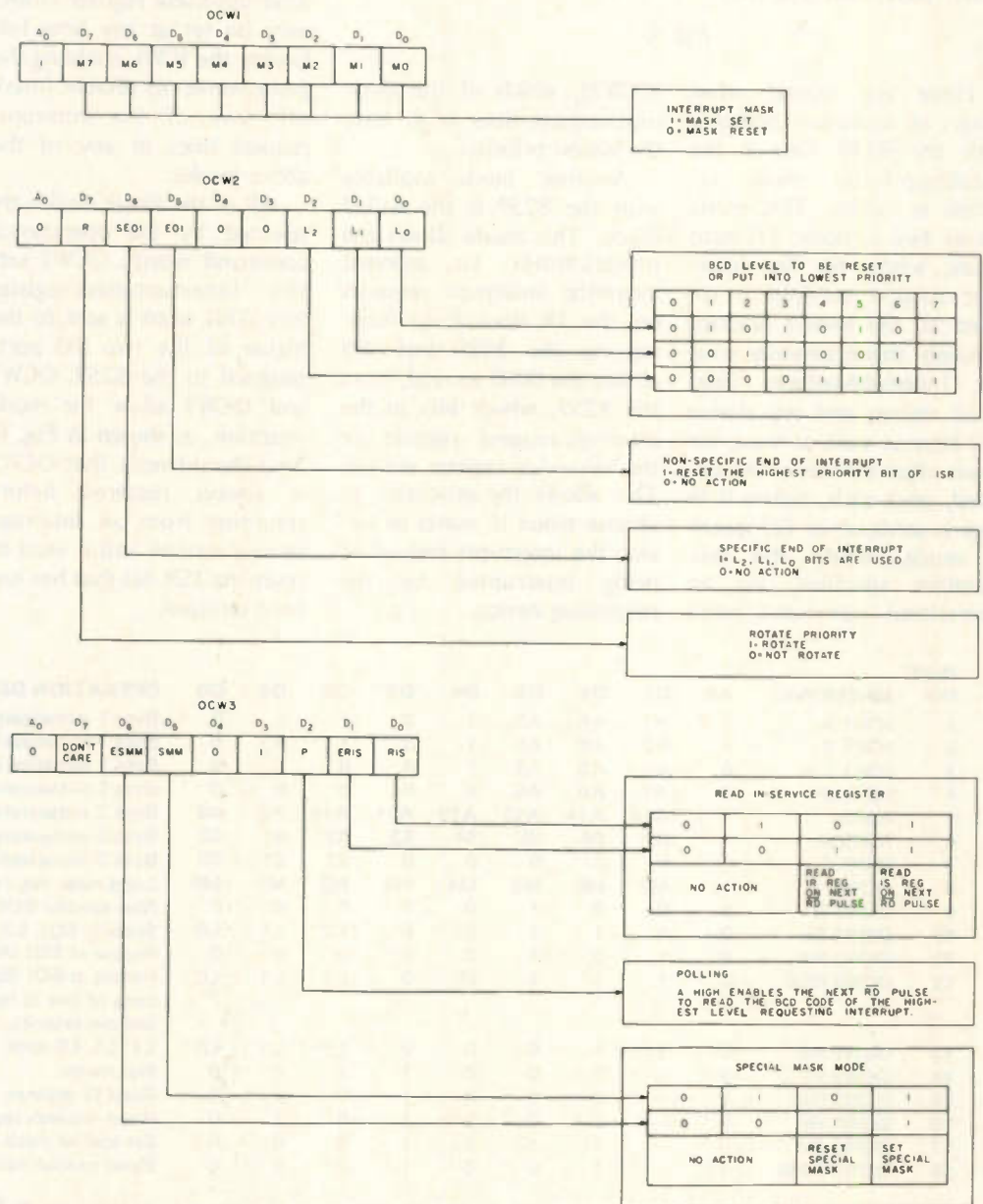

Fig. 6. Operational command word formats. (Courtesy of Intel.)

ICW1 = 0 0 0 1 0 1 1 0 = 16H
 Upper 3 bits of the lower byte of the jump table starting address.
 Single 8259.
 Interval = 4 bytes.

ICW2 = 1 0 0 0 0 1 0 0 = 84H
 ICW3 = Not needed, since only one 8259 is in the system.

Fig. 7. Initialization command word example.

```
MVI A, 16H      ;Put ICW1 into the accumulator register.
OUT FCH        ;Output it to the lower 8259 I/O port.
MVI A, 84H     ;Put ICW2 into the accumulator register.
OUT FDH        ;Output it to the upper 8259 I/O port.
```

Fig. 8.

```
8400 JMP (Address for IR0) ;The addresses here are those
8404 JMP (Address for IR1) ;of the service routines for
8408 JMP (Address for IR2) ;the interrupt-request lines
840C JMP (Address for IR3) ;indicated.
.
.
.
841C JMP (Address for IR7)
```

Fig. 9.

There are several other modes of operation available with the 8259. One is the rotating-priority mode referred to earlier. This mode allows two options: (1) auto mode, where the last interrupt request serviced is rotated to the lowest priority position; this essentially gives all interrupt-request lines equal status, and any device will have to wait, at most, for seven other devices to be serviced, once each, before it in turn is serviced; or (2) specific mode, where the programmer specifies, via an operational command word (OCW2), which of the interrupt-request lines is to have the lowest priority. Another mode available with the 8259 is the polled mode. This mode allows the programmer to prevent incoming interrupt requests on the IR lines from interrupting the 8080 but still allows the 8080 to read, from the 8259, which bits in the interrupt-request register or the in-service register are set. This allows the processor to choose when it wants to service the interrupts instead of being interrupted by the requesting device.

```
(Address for IR2) Push B      ;Push contents of 8080's internal
                  Push D      ;registers onto stack for safe
                  Push H      ;keeping.
                  Push PSW
                  EI           ;Enable interrupts.
                  Interrupt service routine
                  DI           ;Disable interrupts.
                  MVI A, 20H  ;End of interrupt command (OCW2).
                  OUT FCH    ;Send it to the 8259.
                  POP PSW    ;Restore 8080's internal registers
                  POP H      ;to preinterrupt status.
                  POP D
                  POP B
                  EI           ;Enable interrupts again.
                  RET        ;Return to interrupted program.
```

Fig. 10.

OCW2 = 0 0 1 0 0 X X X = 20H
 No rotate. No specific EOI. EOI = 1 to reset highest priority bit of the ISR. Don't care.

Fig. 11.

It should be noted that the interrupt-mask register (IMR) may be set at any time following the ICWs, enabling the programmer to disable (mask off) any of the interrupt-request lines in any of the above modes.

All of the above modes are selected by the operational command words. OCW1 sets the interrupt-mask-register bits. This word is sent to the higher of the two I/O ports assigned to the 8259. OCW2 and OCW3 allow for mode selection, as shown in Fig. 6. You should note that OCW2 is always required before returning from an interrupt service routine and is used to reset the ISR bit that has just been serviced.

Some practice is needed to get used to using the ICWs and OCWs, but it is really not as formidable as it seems at first. I recommend that you study Figs. 5 and 6, along with Intel's data sheet on the 8259, prior to doing any fancy programming involving the chip. Intel's 1977 *Data Catalog* is available for \$2.50 from: Intel Corporation, Literature Department, 3065 Bowers Avenue, Santa Clara CA 95051.

Programming Example

This example will be somewhat simple and will show only the basics in using the 8259 as a more-or-less conventional interrupt controller. An "H" following any num-

INST. NO.	MNEMONIC	A0	D7	D6	D5	D4	D3	D2	D1	D0	OPERATION DESCRIPTION
1	ICW1 A	0	A7	A6	A5	1	0	1	1	0	Byte 1 initialization, format = 4, single.
2	ICW1 B	0	A7	A6	A5	1	0	1	0	0	Byte 1 initialization, format = 4, not single.
3	ICW1 C	0	A7	A6	A5	1	0	0	1	0	Byte 1 initialization, format = B, single.
4	ICW1 D	0	A7	A6	A5	1	0	0	0	0	Byte 1 initialization, format = B, not single.
5	ICW2	1	A15	A14	A13	A12	A11	A10	A9	A8	Byte 2 initialization (Address No. 2).
6	ICW3 M	1	S7	S6	S5	S4	S3	S2	S1	S0	Byte 3 initialization — master.
7	ICW3 S	1	0	0	0	0	0	S2	S1	S0	Byte 3 initialization — slave.
8	OCW1	1	M7	M6	M5	M4	M3	M2	M1	M0	Load mask reg, read mask reg.
9	OCW2 E	0	0	0	1	0	0	0	0	0	Non-specific EOI.
10	OCW2 SE	0	0	1	1	0	0	L2	L1	L0	Specific EOI. L2, L1, L0 code of ISFF to be reset.
11	OCW2 RE	0	1	0	1	0	0	0	0	0	Rotate at EOI (Auto Mode).
12	OCW2 RSE	0	1	1	1	0	0	L2	L1	L0	Rotate at EOI (Specific Mode). L2, L1, L0 code of line to be reset and selected as bottom priority.
13	OCW2 RS	0	1	1	0	0	0	L2	L1	L0	L2, L1, L0 code of bottom priority line.
14	OCW3 P	0	—	0	0	0	1	1	0	0	Poll mode.
15	OCW3 RIS	0	—	0	0	0	1	0	1	1	Read IS register.
16	OCW3 RR	0	—	0	0	0	1	0	1	0	Read requests register.
17	OCW3 SM	0	—	1	1	0	1	0	0	0	Set special mask mode.
18	OCW3 RSM	0	—	1	0	0	1	0	0	0	Reset special mask mode.

Table 2. Summary of the 8259 instruction set. In the master mode, \overline{SP} pin = 1, in slave mode \overline{SP} = 0. (—) = do not care. (Courtesy of Intel.)

ber indicates that the number is in hexadecimal.

Assume that the system is to be set up as follows: (1) You want to operate in the fully-nested mode, no bits masked off, and interrupt-request zero (IRO) is to have the highest priority. (2) You will have a jump table starting at 8400H, and the jump instructions will be spaced every four bytes in memory. (3) The 8259 I/O ports will be located at FCH and FDH. The initialization com-

mand words (ICWs) for this configuration are shown in Fig. 7.

The program necessary to put the sample ICWs into the 8259 is shown in Fig. 8. The 8259 is set up to operate in the fully-nested mode as desired.

You must still set up a jump table, starting at 8400H in memory. It might look something like Fig. 9.

A typical interrupt service routine might look something like Fig. 10 for, say, IR2.

The OCW2 used in this routine is obtained as shown in Fig. 11. Again, you should remember that OCW2 must appear in every service routine before returning to the interrupted program. This is necessary to set up the 8259 for handling the next interrupt.

Conclusion

In this article, I have attempted to describe how to implement Intel's 8259 programmable interrupt con-

troller into an 8080-based system utilizing the S-100 bus structure. The controller as shown will, of course, work in any S-100 system whose processor emulates the 8080. The circuitry required is fairly simple and works quite well, as shown in Fig. 4. This interrupt controller provides far more flexibility than any other interrupt controller that I have seen and yet is simple enough so that anyone can use it. Try it; you'll like it. ■

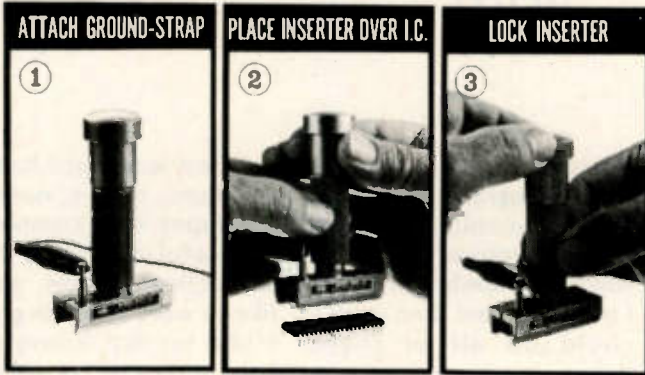

IC INSERTION TOOL 36-40 PIN CMOS-SAFE

Unique new insertion tool. Also aligns bent-out pins. A twist of the handle compresses the pins to proper .600 inch spacing and locks the IC into the tool. Then simply place the tool on the socket and depress the plunger for instant and accurate insertion. Features heavy chrome plating throughout for reliable static dissipation. Includes terminal lug for attachment of ground strap.

\$795
EACH

MINIMUM BILLING \$25.00 ADD SHIPPING CHARGE \$1.00
NEW YORK STATE RESIDENTS ADD APPLICABLE TAX



05

OK MACHINE & TOOL CORPORATION
3455 CONNER ST., BRONX, N.Y. 10475 U.S.A.
TELEX 125091

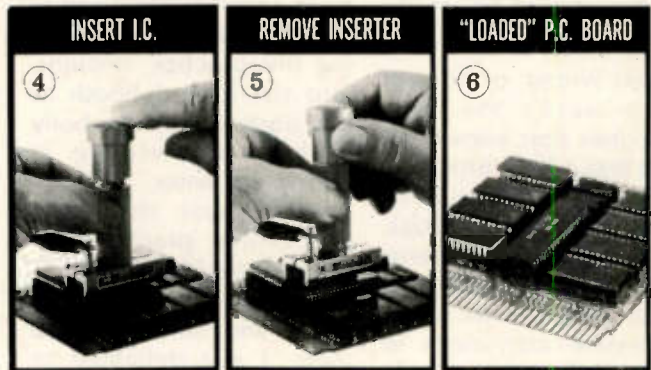

There's a new, eighth OSCAR satellite in orbit, and the AMSAT team helped put it there!

Your help is needed for future satellites. Join AMSAT and support the new, advanced Phase III series of OSCARs, engineered to provide communications over transcontinental distances for hours at a time.

Send \$10 membership dues to AMSAT, P.O. Box 27, Washington, D.C. 20044. Life membership is available for a tax-deductible donation of \$100 or more, payable in quarterly installments if you wish.

Phase III satellite solar cells may be sponsored for \$10 each, and we'll send you a certificate specifying the cells you are sponsoring.

For a tax-deductible contribution of \$1,000 or more, we'll even inscribe your name on a plaque to be placed in orbit aboard the Phase III spacecraft for posterity, and we'll send you a replica honoring your contribution.

Dues and contributions may be charged to VISA or Master Charge. Phone us at (202) 488-8649.

Radio Amateur Satellite Corporation
P.O. Box 27, WASHINGTON, D.C. 20044



Use A Computer? Who, Me?

— yes . . . you!

I've been seeing those computer-related articles in amateur radio magazines for some time now, and flipping right past them without even giving myself a chance to see what aspect of computer knowledge they dealt with. I assumed not that they wouldn't interest me, but that they would be totally incomprehensible.

I was wrong, of course, but it wasn't the ham magazines that convinced me. It was a little brochure from my community library. I am lucky enough to live in a progressive neighborhood—well, a neighborhood with some progressive *individuals* in it. One of these individuals managed to procure a primary-source computer and several terminals for the school district, and he negotiated to have one terminal placed in the library. This necessitated offering the public an opportunity to learn to use it, and an announcement of the resulting course was what I read in the library brochure.

I'm not sure even now what motivated me to sign up for the course (maybe all those articles I'd seen?). But by the end of the first session, when we were

given an opportunity to actually sit at the machines and punch the keys, I knew I was hooked. Computers are permeating our society, and we may as well learn to use them, I told myself. My children will use them later, I'm convinced, so they may as well become comfortable with them now, I rationalized as I took them with me, during my practice sessions, into the locked booth at the library which nobody without *knowledge* is allowed to enter.

Once past the early glitch-filled practice sessions where I learned what mistakes I was prone to make and how to avoid them, I was delighted to see what I could do. I could play games that had previously been programmed into the computer memory for our entertainment and learning. These included "Stock Market," "Pollution," and the inevitable tic-tac-toe. Better, I could produce my own programs. I could write into the machine my own series of messages and have the computer type out one, several, or all of them as I chose. I could have it write vertical or horizontal columns of numbers. I could correct a

single line or wipe out my whole program and begin again. I could have the machine repeat a process whatever number of times I told it to, and then stop. I could do all of these things, combined into one short program. It was a powerful feeling. But it was temporary.

When I had totally mastered the material we had been given and the five-session course came to an end, I was ready for more. Would a more advanced course begin? No. There was too much demand to repeat the introductory one. By the time the "advanced" course could be offered, the summer would be over and I would be involved in teaching adult education courses two nights a week.

So instead, I bought a copy of *Basic BASIC* (James S. Coan, Hayden Book Co.) and *Discovering BASIC* (Robert E. Smith, also Hayden), which I like even better (I've been told that *BASIC* by Albrecht is even better, and I've obtained Bob Albrecht's *My Computer Likes Me When I Speak In BASIC*), and I determined to use them to teach myself during the day.

But I had a problem. My

problem was that I had no *problems*, that is, none of the types that computers are useful in handling. I am a practical person, and I like to work towards goals. I like for my interests to have potential for growth. I'm not willing to use the computer merely as an elaborate toy. (I am willing for *other* people to do that—I recognize the element of serendipity that can result in the discovery of something terribly important, whether doing pure research or just "fooling around.")

I thought of a way the computer could be useful to me. Why couldn't our library terminal be used to tap into computers that store library references—the type you don't usually find in *Reader's Guide*? I recently ran all over the place scouting out medical libraries to find articles I needed to help me do a medical research article. I'd hate to go through that again in some other area of interest. No doubt the librarian would have to call this service up, and it might cost, but I, for one, would be willing to pay.

I mentioned my idea to the reference librarian. "Oh," she said, "we have

that already. We just don't mention it unless someone comes in with a problem that in our judgment could be best solved that way." She showed me booklets and brochures. Sure enough, there it was. The service had been there all along, even before the Teletype™ had been put into the library. Half a dozen memory banks across the country were accessible.

"How much does this usually cost?" I asked.

"It can run from ten to about fifty dollars, but the average is about twenty-five dollars."

That was too much for me. I had envisioned about two dollars—maybe five. (Isn't everything at libraries supposed to be cheap?) And you had to pay for the search even if the computer came up with nothing. (Later, to my delight, I discovered a local medical library that

provides a medical-articles search at a fee of only \$3 for the public—more for doctors.)

But I couldn't tap into these services myself, just because I had access to an ASR-33. What use did I have for a computer? None at all, I concluded.

But that was before I talked to Hans Napfel WB2ZZB, who knows how to let a computer make life easier in the ham shack and in the rest of the house as well. And that was before Paul Wade WA2ZZF introduced me to the beauty of computer-generated art. It was also before the "Personal Computing '77 Trade Fair" in Atlanta drew 5,000 people and 140 exhibitors.

When the Wright brothers managed to keep their plane aloft, when Alexander Graham Bell managed to transmit a message intelligibly, and when Edison invented the

phonograph, people asked, "But what do we do with it?"

Maybe I don't have much need for computers—now. But I've discovered how much fun they can be. And my

children have been introduced to them, will be re-introduced periodically, and are not afraid to use them. When—not if—they become a necessary part of all our lives, I'll be ready. ■



Christopher and Juliane watch as I enter the program. This isn't at all like a typewriter, they're thinking.

ok® wire wrapping center ok®

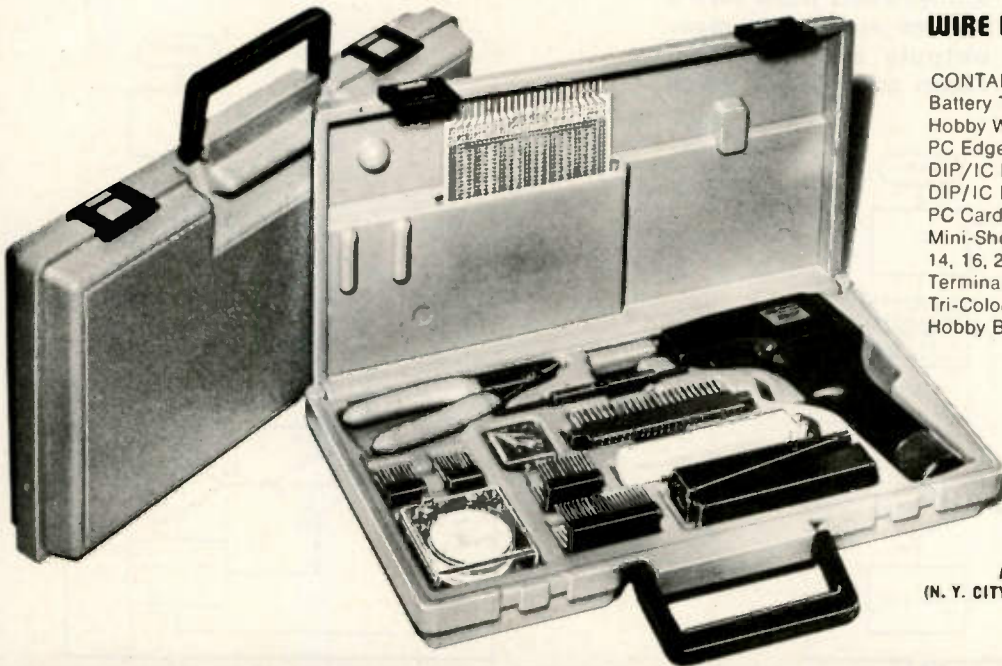

WIRE WRAPPING KIT WK-5

CONTAINS:
 Battery Tool BW-630
 Hobby Wrap Tool WSU-30 M
 PC Edge Connector CON-1
 DIP/IC Extractor Tool EX-1
 DIP/IC Insertion Tool INS-1416
 PC Card Guides & Brackets TRS-2
 Mini-Shear with Safety Clip SP-152
 14, 16, 24 and 40 DIP Sockets
 Terminals WWT-1
 Tri-Color Wire Dispenser WD-30-TRI
 Hobby Board H-PCB-1

\$74.95

ADD \$1.00 FOR SHIPPING
 (N. Y. CITY AND STATE RESIDENTS ADD TAX)

OK MACHINE & TOOL CORPORATION

05

3455 Conner St., Bronx, N.Y. 10475 (212) 994-6600 / Telex 125091

Bird Watching in BASIC Land

— another use for your micro

In the past two years or so, the microprocessor (uP) has had a substantial effect on amateur radio. Many articles on repeater controllers, CW machines, beam rotators, and the like attest to this. Nearly all these articles describe applications in which the uP exercises some sort of control function. However, as uP-based home computers become more powerful, and capable of "number-crunching," they will become more useful in the design of amateur radio equipment, as well. This

article describes such a design application.

Several months ago, I set out to build a QRP CW transmitter which would cover the first 100 kHz of 40, 20, 15, and 10 meters. Rather than use a 40 meter vfo and a series of multipliers, I was inclined to try some sort of heterodyning scheme for frequency generation. Of course, the risk of generating objectionable outputs (birdies) always exists when such a scheme is used, since many outputs are produced. Charts are available which

are useful in determining the frequencies at which these objectionable outputs will be produced.* However, using the charts soon becomes a tedious process, to say the least. To avoid the tedium, I wrote a program (in BASIC) which searches out and identifies the birdies.

The Problem

Applying signals at two different frequencies to a mixer produces a large number of outputs. Some of these outputs are harmonics (including the fundamental) of each of the applied signals. The remaining outputs are "beat products"—the so-called sum products and difference products. These are outputs at frequencies corresponding to $IF_1 \pm$

*Markel, J. D., "Shrinking Intermodulation," *EDN*, August, 1967, pp. 56-65.

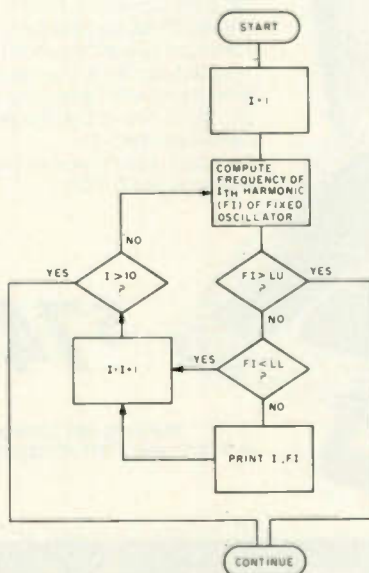

Fig. 1. Flowchart of the routine which searches for harmonics of the fixed oscillator.

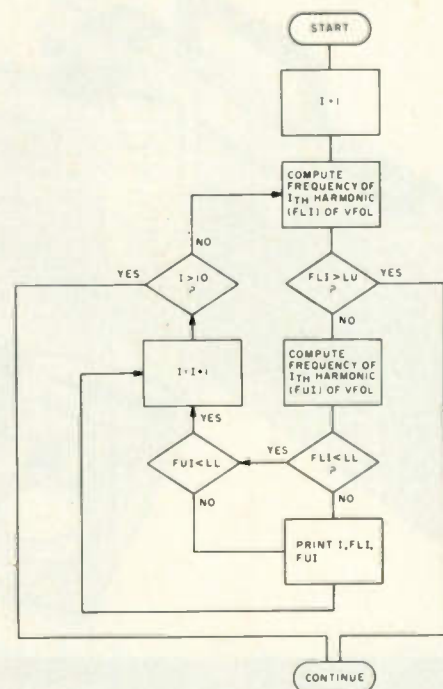

Fig. 2. Flowchart of the routine which searches for harmonics of the vfo.

JF_2 , where I and J are integers and F_1 and F_2 are the frequencies of the applied signals. The sum, $I + J$, is called the order of the signal. For example, the difference product which is composed of the third harmonic of F_1 and the fourth harmonic of F_2 is a seventh-order product. Similarly, the sixth harmonic of F_1 is a sixth-order product, since $I = 6$.

Generally, the second-order sum or difference product is the signal of interest in a heterodyne frequency-generating process. For example, a very common way to implement an 80/20 meter rig is to mix the output of a 9 MHz crystal oscillator with the output of a 5.0-5.5 MHz

vfo. As the vfo is tuned from 5.0 to 5.5 MHz, second-order outputs will be produced at 14.0-14.5 and 4.0-3.5 MHz. One or the other is selected by appropriately tuning the output of the mixer. The frequency of the other second-order beat product is sufficiently far away to be of little concern. Whether any of the remaining beat products or any harmonic is troublesome depends on the order of the product or harmonic, the type of mixer which is used, and the frequency of the product. Generally, the higher the order, the lower the amplitude. If a double-balanced diode mixer is used, it will suppress to a degree both fundamental

frequencies, their even-order harmonics, and all beat products involving even-order harmonics of either frequency. Of course, if the frequencies of the vfo and fixed oscillator are chosen so that no undesirable outputs fall within or near the desired range, the design and implementation of the circuit is simpler. That's the purpose of the program.

The Program

The program consists of five sections. The first allows the operator to specify values for the lower and upper limits of the frequency of the vfo (VFOL and VFOU, respectively), the frequency of the fixed oscillator (FXD), and the lower and upper limits of the range of interest (LL and LU, respectively). If any birdie falls within these limits, its characteristics

will be listed.

The remaining four sections of the program search for various types of birdies. The first section determines if any harmonics of the fixed oscillator fall within the range of interest. The second performs a similar search for harmonics of the vfo. The third searches for sum products while the fourth searches for difference products. Harmonics and beat products through the tenth order are examined.

Flowcharts of each of the latter four sections are shown in Figs. 1, 2, 3, and 4. Most of the terms which are used in the flowcharts differ from the corresponding terms in the listing of the program, Fig. 5. The terms in the flowcharts were chosen to help make the logic clear. They can't be used in the program because of the restriction in BASIC concerning the number of characters in

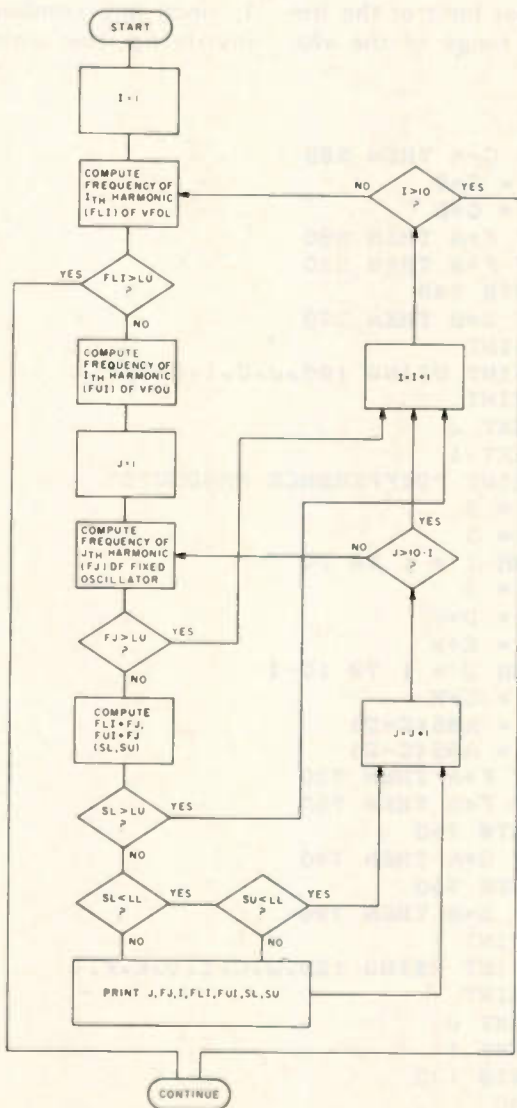

Fig. 3. Flowchart of the sum products search.

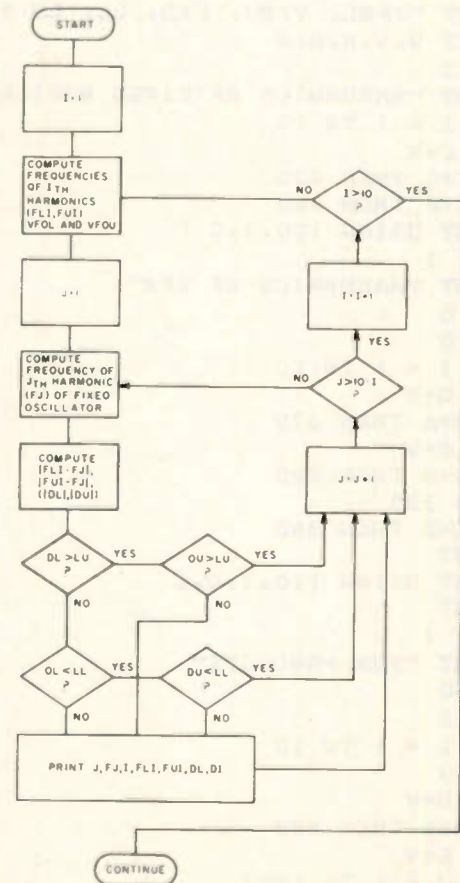

Fig. 4. Flowchart of the routine which searches for difference products.

the name of a variable.

Fig. 1 is a flowchart of that part of the program which searches for harmonics of the fixed oscillator that fall within the range of interest. Starting with $I = 1$, the program computes the I th harmonic of the frequency of the fixed oscillator (FI) and compares it with the limits of the range of interest (LL and LU). If FI lies above the range, the program immediately branches to the next section, since all higher harmonics must also lie above the range. If FI falls within the range of interest, the order (I) and the frequency (FI) of the harmonic are listed. If FI lies below the range, the frequency of the next higher harmonic is screened.

Fig. 2 is a flowchart of

that part of the program which searches for harmonics of the vfo that fall within the range of interest. Starting with $I = 1$, the program computes the frequency of the I th harmonic of the lower limit of the frequency range of the vfo (FLI) and compares it with the upper limit of the range of interest (LU). If FLI lies above the range, the program immediately branches to the next section, since all higher harmonics must also fall above the range. If FLI does not lie above LU, the program computes FUI, the I th harmonic of the upper limit of the frequency range of the vfo. If either FLI or FUI fall within the range of interest or if they lie on opposite sides, the order (I) and the limits of the frequency of the har-

monic (FLI and FUI) are listed. If both FLI and FUI lie below the range, the next higher pair of harmonics is screened.

Fig. 3 is a flowchart of that part of the program which searches for sum products that fall within the range of interest. Starting with $I = 1$, the program computes the frequency of the I th harmonic of the lower limit of the frequency range of the vfo (FLI). If FLI lies above the range of interest, the program immediately branches to the next section, since sum products which are produced by all higher harmonics of the vfo must lie above the range of interest. If FLI does not lie above LU, the program computes FUI, the I th harmonic of the upper limit of the frequency range of the vfo.

The program then computes the frequency of the J th harmonic of the fixed oscillator. For any given value of I , J runs from 1 to $10-I$ or to a value such that IJ lies above the range of interest. In the latter case, I is incremented and J is reset to 1 even though it did not reach the value of $10-I$. For each pair of I and J which is not excluded by these tests, the program computes the frequencies of the sum products which are produced by the lower and upper limits of the frequency range of the vfo and the fixed oscillator (SL and SU, respectively). It then compares these with the limits of the range of interest (LL and LU). If SL lies above the range, I is incremented and J is reset to 1, since any combination involving the unincree-

```

100 :### #####.###
110 :### #####.### #####.###
120 :### #####.### ### #####.### #####.###
130 PRINT "VF0L, VF0U, FXD, LL, LU ?"
140 INPUT V,W,X,B,A
150 C = 0
160 PRINT "HARMONICS OF FIXED OSCILLATOR"
170 FOR I = 1 TO 10
180 C = C+X
190 IF C>A THEN 230
200 IF C<B THEN 220
210 PRINT USING 100,I,C
220 NEXT I
230 PRINT "HARMONICS OF VF0"
240 D = 0
250 E = 0
260 FOR I = 1 TO 10
270 D = D+V
280 IF D>A THEN 370
290 E = E+W
300 IF D<B THEN 320
310 GOTO 330
320 IF E<B THEN 360
330 PRINT
340 PRINT USING 110,I,D,E
350 PRINT
360 NEXT I
370 PRINT "SUM PRODUCTS"
380 D = 0
390 E = 0
400 FOR I = 1 TO 10
410 C = 0
420 D = D+V
430 IF D>A THEN 590
440 E = E+W
450 FOR J = 1 TO 10-I
460 C = C+X
470 IF C>A THEN 580
480 F = C+D
490 G = C+E
500 IF F>A THEN 580
510 IF F<B THEN 530
520 GOTO 540
530 IF G<B THEN 570
540 PRINT
550 PRINT USING 120,J,C,I,D,E,F,G
560 PRINT
570 NEXT J
580 NEXT I
590 PRINT "DIFFERENCE PRODUCTS"
600 D = 0
610 E = 0
620 FOR I = 1 TO 10
630 C = 0
640 D = D+V
650 E = E+W
660 FOR J = 1 TO 10-I
670 C = C+X
680 F = ABS(C-D)
690 G = ABS(C-E)
700 IF F>A THEN 730
710 IF F<B THEN 750
720 GOTO 760
730 IF G>A THEN 790
740 GOTO 760
750 IF G<B THEN 790
760 PRINT
770 PRINT USING 120,J,C,I,D,E,F,G
780 PRINT
790 NEXT J
800 NEXT I
810 GOTO 130
820 END

```

Fig. 5. Listing of a program which searches for undesired outputs.

mented value of I and a higher value of J will produce an SL (and SU) which lie above the range. If either SL or SU falls within the range of interest, or if they lie on opposite sides of the range, the order (J) and frequency (FJ) of the harmonic of the fixed oscillator, the order (I) and the frequencies of the harmonics of the vfo range (FLI and FUI), and the limits of the frequency range of the sum product (DL and DU) are listed.

```
VF0L, VF0U, FXD, LL, LU ?
75.4,5.5,12.5,6.5,7.6
HARMONICS OF FIXED OSCILLATOR
HARMONICS OF VF0
SUM PRODUCTS
DIFFERENCE PRODUCTS
```

1	12.500	1	5.400	5.500	7.100	7.000
2	25.000	6	32.400	33.000	7.400	8.000

Fig. 6. Output from the program, showing products which result when the outputs from a fixed oscillator at 12.5 MHz and vfo at 5.4-5.5 MHz are mixed to produce a signal at 7.1-7.0 MHz. The signal at 7.4-8.0 MHz is a birdie. The range of interest is 6.5-7.6 MHz.

```
VF0L, VF0U, FXD, LL, LU ?
75.4,5.5,19.5,13,15.1
HARMONICS OF FIXED OSCILLATOR
HARMONICS OF VF0
SUM PRODUCTS
DIFFERENCE PRODUCTS
```

1	19.500	1	5.400	5.500	14.100	14.000
1	19.500	6	32.400	33.000	12.900	13.500

```
VF0L, VF0U, FXD, LL, LU ?
75.4,5.5,26.5,20.,22.1
HARMONICS OF FIXED OSCILLATOR
HARMONICS OF VF0
```

4 21.600 22.000

```
SUM PRODUCTS
DIFFERENCE PRODUCTS
```

1	26.500	1	5.400	5.500	21.100	21.000
2	53.000	6	32.400	33.000	20.600	20.000
1	26.500	9	48.600	49.500	22.100	23.000

```
VF0L, VF0U, FXD, LL, LU ?
75.4,5.5,33.5,26.5,29.6
HARMONICS OF FIXED OSCILLATOR
HARMONICS OF VF0
```

5 27.000 27.500

```
SUM PRODUCTS
DIFFERENCE PRODUCTS
```

1	33.500	1	5.400	5.500	28.100	28.000
2	67.000	7	37.800	38.500	29.200	28.500

Fig. 7. Output from the program showing some products which result when a 5.4-5.5 MHz vfo is heterodyned to 20, 15, and 10 meters.

Fig. 4 is a flowchart of that part of the program which searches for difference products. Frequencies of the difference products (DL and DU) are computed in about the same way as are frequencies of the sum products. However, absolute values are used in order to avoid the need to deal with negative numbers. For example, if the quantity $5F_1 - 6F_2$ is negative, there will be a beat product with a frequency of $6F_2 - 5F_1$. Computing the absolute value of $5F_1 - 6F_2$ produces the same result.

All possible difference products must be screened. Unlike the previous cases, even if a given combination of I and J produces a birdie which lies above the range of interest, the combination of, say, I+1 and J+1 may not.

The difference products are screened in much the same way as the other types of birdies. Each pair of DL and DU is tested to see if both members lie outside the range of interest and on the same side. If they do not, the characteristics of the birdie are listed.

Output

Output from the program is as shown in Fig. 6. This particular case involves a vfo which tunes between 5.4 and 5.5 MHz and a fixed oscillator at 12.5 MHz. The objective is

to produce a signal in the lower 100 kHz of the 40 meter band. The range of interest lies between 6.5 and 7.6 MHz (500 kHz either side of the desired operating range). Neither the fixed oscillator nor the vfo produces harmonics which fall within the range of interest, nor are there any sum products within the range of interest. The latter is usually true whenever a difference

product is the desired signal. In such a case, the frequency of either the vfo or the fixed oscillator must lie above the desired operating range and generally lies above the range of interest. The desired signal is the second-order difference product. One other difference product lies within the range of interest. It's an eighth-order product which is composed of the second harmonic of the

fixed oscillator and the sixth harmonic of the vfo. As the vfo is tuned from 5.4 to 5.5 MHz, the birdie moves from 7.4 to 8.0 MHz. Since it's of relatively high order, its amplitude is fairly low. Further, since it's composed of even-order harmonics, a double-balanced diode mixer likely can deal effectively with it.

For those who are interested, an analysis of the

scheme which I settled on for a transmitter is shown in Fig. 7 without comment.

Finally, there is a useful extension to the program which is worth consideration by the person who has access to a CRT display. A multiband version could be written which would display the results in graphical form. In this way, the effects of the various parameters could quickly be evaluated. ■

ou rooms don't ever proof
lousy manuscripts from bat
burch
you
I insist that you print ev
tell Ma Bell that she shou

LETTERS

from page 118

tect readers of 73 who may also get QST. Twenty-five months ago I sent to Kencso Communications of Quincy, Mass., for crystals for my two meter transceiver. Six weeks went by, so I wrote a letter of inquiry. No response. So I sent to the Federal Trade Commission Register to get my money refunded. Hundreds of others have been skinned by the Kencso name; now it is changed to Southeastern Communications, 2729 Independence Ave., Quincy MA 02169.

Wayne, I guess the boys at Newington are having a long nap when they will place an ad

in QST for a corrupt company such as Southeastern Communications, formerly Kencso. Things got too hot so they changed their name, phone, and box number

**Emil Carver K3MZO
Plymouth PA**

Sorry to hear you got stung by a QST advertiser. When we drop an advertiser from 73, we watch with interest when the ads appear in QST... particularly in view of the rectitude of their recent editorial on protecting the members. Several advertisers in QST are not acceptable in 73. Re Kencso: They went bankrupt and Southeastern bought out their stock of crystals at a

bankruptcy sale, so there is no real connection between the two. We are not accepting ads from Southeastern, by the way.—Wayne.

RAVING AT 13 WPM

After many years of hard work and struggling to get my code speed up with different code tapes (all of which had coded text on them) and copying W1AW, I decided to try the 13+ tape that you raved so much about.

Well, after using it, I have to say it's great. I went down with between 80% to 90% solid copy and passed my general exam with a score of 100%. And you were right when you said that you could fall asleep taking the code exam. I might have if I hadn't had the normal case of the jitters and shakes.

So, in closing, I say thanks for the proper study material needed for my exam. Oh, yes, some of the others that took their exams with me had used

W1AW's 15 and 18 wpm text, but they had very long faces when they came out with their new blank 610 forms to resubmit for another try. That's all the proof I need to get the 20+ tape for my Extra exam.

**David L. Kessler WB2JUJ
Hoosick Falls NY**

CAUTION

The article, "The Heavyweight," by David Boyd in the August, 1978, issue mentions a technique that is dangerous. If you pour molten lead on top of water (in this case, mud), you may vaporize the water. The steam pressure can be quite high and could "blow" molten lead out of the mold and into the face of the pourer.

A safer procedure would be to make the mold out of plaster of Paris and bake it in the oven to completely dry it. You could then pour lead into it without risk.

**Edward W. Menke N2AAJ
Schenectady NY**

Ham Help

I wonder if your readers can perhaps supply me with information on the Ollvetti TE300 terminal. While any information is welcome, I am specifically interested in a service manual for the keyboard/printer unit, ideally with electrical information. A wiring diagram for the power supply unit would also be helpful.

**Charles Boelens
7311 Coronado Dr.
Burnaby BC
Canada V5A 1P9**

Last January, I purchased while living in Baltimore a twelve-volt power supply, model POS-12202. This, as you

may know, is a twenty-Amp power supply. I am aware now that this company went bankrupt. When I opened the power supply and was ready to put it in service after moving to Atlanta, Georgia (I purchased this the day we were moving out of town), I found that two of the capacitors had exploded. I immediately began searching to replace those, which I have done (with a higher grade computer capacitor).

However, now I find that the three power transistors mounted on the rear of the cabinet seem not to be functioning. I can trace power to these transistors but nothing beyond them. My problem is

that I have had difficulty locating these transistors and am told that this is not a normal number. Could anyone help? The number shown on the transistor is 915-DNA-2-7721. I would appreciate any assistance anyone can give me

concerning this matter.

**Fred Musgrave, Captain
Project Director
Southern Territorial
Headquarters
The Salvation Army
675 Seminole Ave., NE
Atlanta GA 30307**

Corrections

Tom W7DND (see page 170, June, 1978, 73) has written me that if you have trouble getting low SWR on the current feed, he trimmed his coax for a match. It is now 1:1.3.

**Jerrold Swank W8HXR
Washington Courthouse OH**

Somebody should have noticed by this time discrepan-

cies between the schematic and the PC board artwork on page 129 of the May, 1978, issue: for example, the B-E short on Q2; and the preferred connection for the speaker on the artwork as compared to the schematic (although I suppose you'll find audio almost anywhere on this circuit).

**H.E. Eddy W2BU
Oneonta NY**

Computers and the Real World

—practical D/A and A/D conversion

Kenneth D. Tentarelli W1FZA
Woodside Drive
Atkinson NH 03811

Aside from computers and their peripherals, much of the rest of the world is analog. Computers can perform many valuable tasks in isolation, but application possibilities are far greater when a computer can communicate directly with the analog world. Communication from a computer to the analog world is normally done using a digital-to-analog, or D/A, converter

to change the digital output of the computer to an analog voltage. Similarly, an analog-to-digital, or A/D, converter can be used to convert analog voltages to digital words which can be sensed and measured by a computer.

Integrated circuits designed to be the heart of D/A converters are now becoming available from several mail-order parts suppliers. Although these devices were originally developed for use with additional custom control circuits, they can be used in conjunction with a microcomputer to do D/A

and A/D conversion. In fact, one of the circuits described below can be set by a switch to do either D/A or A/D conversion. Thus, it enables communications to and from the analog world, depending upon application, with a minimum of components.

D/A Conversion

The most basic form of D/A converter is shown in Fig. 1. It consists of switches which are used to represent a binary word and binary weighted resistors which contribute current to the output in proportion to the bit positions of the switches. This particular converter has eight switches, so it can convert an eight-bit digital word into an output current having $2^8 = 256$ step values. The output current for this type of converter is equal to the voltage source value divided by the largest weighting resistor value (here 128Ω) and multiplied by the decimal

equivalent of the digital word. The digital word represented in the figure is 10011000, so the output current would be $152\text{ V}/128\Omega$ Amperes. The output current could be set to values from 0 Amperes, for a digital word of 00000000, to $255\text{ V}/128\Omega$ Amperes, for a digital word of 11111111, in steps of $\text{V}/128\Omega$ Amperes. Notice that we call the output of a D/A converter an analog signal but that it actually varies in discrete steps and only approaches an analog signal when the step sizes are small. Usually, it is more useful to have the output be in the form of a voltage rather than a current, and an operational amplifier is included to do the current-to-voltage translation.

A Practical D/A Converter

One disadvantage of using binary weighted resistors to make a D/A converter is that the resistors span a wide range of values. It is difficult to make accurate integrated

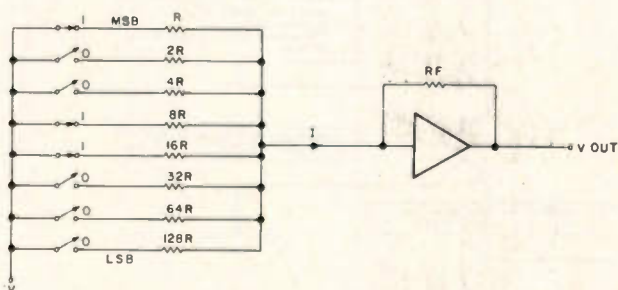

Fig. 1. Prototype D/A converter using binary weighted resistors.

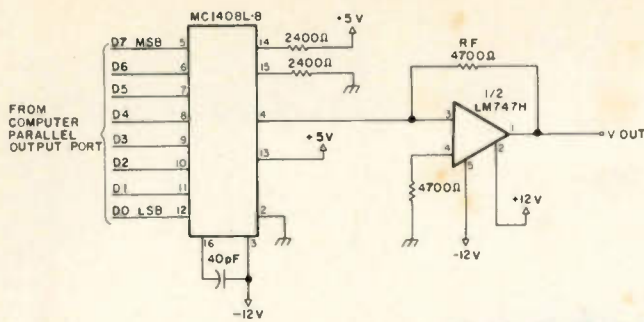

Fig. 2. A practical D/A converter having an output range of 0 to 10 volts in 0.039-volt steps.

circuit resistors over a 128-to-1 resistance range, so most integrated circuit D/A converters use a different type of resistor network, known as an R-2R ladder, which can give very high resolution with only two moderately sized resistor values. Fig. 2 shows an 8-bit D/A converter built around a Motorola MC1408L-8. Internally, this device uses an R-2R ladder, but, externally, it behaves the same as the binary weighted resistor prototype converter.

The MC1408 has eight input leads (D7-D0) which control the settings of internal current switches. The inputs are TTL compatible, so they may be driven directly by a microcomputer parallel output port, such as an 8212 or MC6820. As with the prototype converter, an amplifier is included to change the MC1408 output current to a voltage. The amplifier output voltage is given by:

$$V_{out} = 0.0021R_f \left[\frac{D7}{2} + \frac{D6}{4} + \frac{D5}{8} + \frac{D4}{16} + \frac{D3}{32} + \frac{D2}{64} + \frac{D1}{128} + \frac{D0}{256} \right]$$

where D0 through D7 are binary values, either zero or one. Resistor R_f determines the amplifier gain and, therefore, its output voltage range. With R_f equal to 4.7kΩ, as shown in Fig. 2, the maximum amplifier output voltage is approximately 10 volts,

and the step size is 0.039 volts. R_f may be decreased if a smaller output range is desired. For example, the maximum output voltage will be 5 volts, and the step size will be 0.0195 volts, if R_f is 2.4kΩ.

Using the D/A converter is straightforward, since it needs essentially no software driver program. All you need to do is output a digital word to the microcomputer parallel output port, and the converter will produce the corresponding analog voltage level at its output.

In many applications, a D/A converter is used to generate a time varying signal, such as a sine wave, by having the computer output a series of digital words. In these cases, it may be important to know how fast the D/A converter can react. The converter shown in Fig. 2 can convert a digital word to an analog output voltage in about 2 microseconds, which is faster than the instruction cycle time of all but bipolar microprocessors. In general then, the microcomputer rather than the D/A converter will limit the maximum frequency which the D/A converter produces.

Now Add A/D Conversion Capability

One of the most popular means of performing analog-to-digital conversion is known as the successive-approximation technique, and the heart of

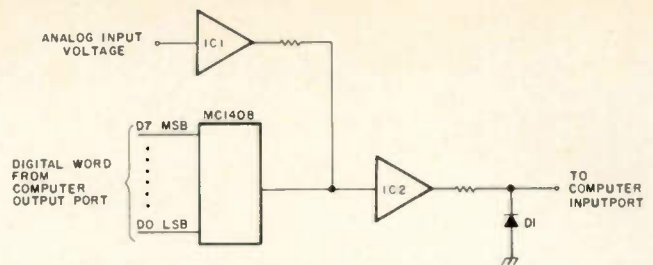

Fig. 3. A basic analog-to-digital converter.

a successive-approximation A/D converter is a D/A converter such as the one described above. An A/D converter has an analog input signal, usually a voltage, as its input, and the circuit tries to find a digital representation for the signal. The successive-approximation converter does this by using a D/A converter to generate an analog voltage which can be compared to the input signal. When the two analog signals are equal, the digital word applied to the D/A converter is also a valid representation for the analog input signal.

A basic block diagram of a successive-approximation A/D converter using an MC1408 is shown in Fig. 3. The analog input signal is applied to IC1, which is a high input impedance amplifier that keeps the converter from loading down the analog source. Output currents from IC1 and the MC1408 are compared by high-gain amplifier IC2. Whenever the output current of the MC1408 is greater than that of IC1, the output of IC2 will appear as logic 1 to the computer input port. Conversely, when the output current of the MC1408

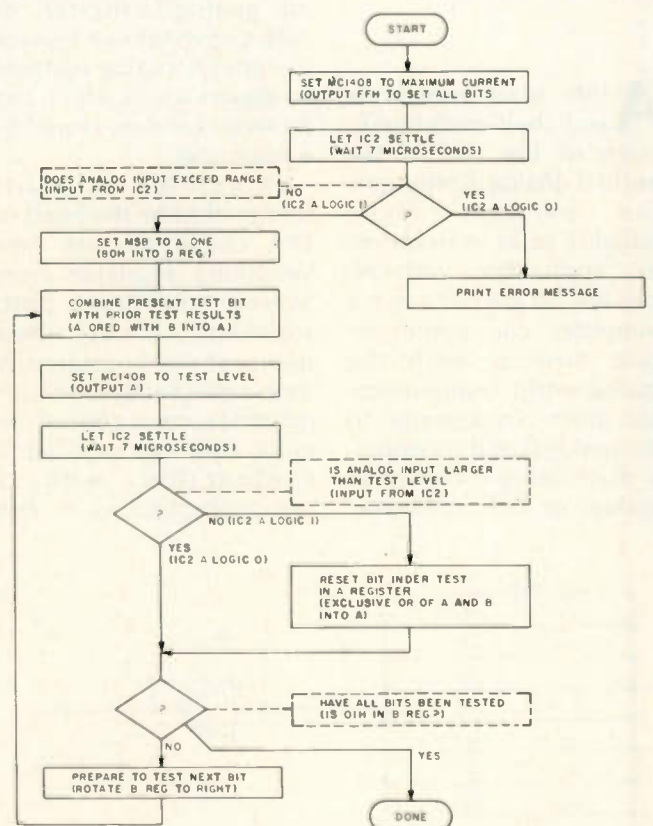

Table 1. A/D conversion routine. Register A contains results of all prior bit tests. Register B contains a logic one in the bit position under test.

TRY kilobaud... ON US!

Return the attached postage-free card, and we'll have your trial copy of Kilobaud on the way to you within a few days. Wayne is willing to go to this expense because he feels that all hams can profit (and he means \$\$\$) from an understanding of the basics of microcomputing. The fact is, there's a revolution going on, even more important than the one that replaced vacuum tubes with solid state, and you'll want to be a part of it and join the fun. **Over 20,000 hams already have their own computers up and running and are having a ball.**

Kilobaud is the only magazine in the field written specifically for newcomers to computers, and many of the articles are ham-oriented . . . after all, many of the pioneers of microcomputers are hams. Don't let this revolution pass you by. Return the subscription card and your trial issue will be on the way, along with a bill for a year's subscription at a special introductory rate of \$12. If you're not completely satisfied, just write "cancel" on the bill and return it to us within 30 days . . . and keep the trial copy.

Rush me my trial copy of Kilobaud and enter my subscription at half the newsstand price (\$12). If I'm not completely satisfied, I'll return the bill marked "cancel" within 30 days and keep the trial copy.

Name _____

Address _____

City _____ State _____ Zip _____

Please allow 30 days for shipment of first copy.

50

S101

kilobaud

peterborough nh 03458

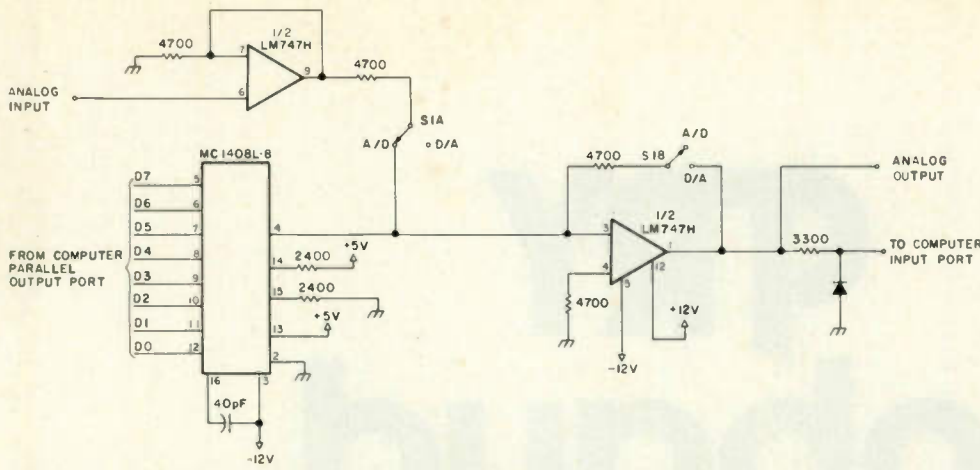

Fig. 4. A converter which can perform either D/A or A/D conversion, depending upon the setting of switch S1.

is less than that of IC1, the computer input port will see a logic zero (the output of IC2 will be a large negative voltage, but diode D1 will prevent the negative voltage from reaching the computer input).

By comparing Figs. 2 and 3, you can see that the differences between A/D and D/A converters are small. The circuit of Fig. 4 takes advantage of their similarity because it can be used as an A/D converter when desired, and, at the flip of a switch, it can be changed into a D/A converter for use in other applications. In the D/A conversion mode, IC1 is disconnected, and R_f is connected to establish the proper gain for IC2. In the A/D mode, IC1 is connected, and the gain of IC2 is made very high by disconnecting R_f .

Thus far, in discussing the A/D converter, I have

ignored the problem of determining the exact digital word which should be presented to the MC1408 input so that its output is identical to the analog signal being applied to the D/A converter. The only way to determine the correct digital word is to sequentially generate digital words in a judicious manner so that each successive word corresponds more closely to the analog voltage. It is this sequential process which gives the successive-approximation converter its name. An algorithm which converges rapidly on the correct digital word is one which individually tests bits, beginning with the most significant bit, to determine whether that bit should be set to a one or zero. Each bit is tested by outputting a word with that bit set to a one. If the output of the MC1408 pro-

duced by the test word is less than the analog input signal (IC2 outputs a logic zero), then that bit should remain a one. If the MC1408 output is greater than the analog input (IC2 outputs a logic one), then that bit should be set to a zero. After a bit is tested and its value is known, the next most significant bit is tested in a similar fashion until all bit values are known.

A flowchart listing of the successive-approximation algorithm is given in Table 1. First, the analog voltage is checked to see if it exceeds the range of the converter. This is done by outputting word FFH (all bits set to one), which corresponds to an analog voltage of 10 volts. If the output of IC2 is a logic zero, then the input voltage must be greater than 10 volts, and an error message is printed. If the output of

IC2 is a logic one, you can begin the testing of individual bits. Register B always contains a single one in the bit position being tested. After the bit test is completed, register B is rotated right to move the one into position for the next test. Results of all previous bit tests are combined in register A. An example of how the algorithm proceeds is given in Table 2.

A/D conversion is a slower process than D/A conversion because 8 digital words must be generated sequentially (one for each bit test) to complete the conversion of one analog value. After each word is output, a delay of at least 7 microseconds should be allowed for IC2 to settle, so the hardware limits the maximum conversion speed to 56 microseconds. To this, you must add the time needed for the microprocessor to cycle through the conversion algorithm instructions. Generally, this will extend the conversion time to several hundred microseconds. Fortunately, changes in the analog world tend to take place comparatively slowly.

Possible Applications

D/A converters synthesize sounds. With them, you can have a function generator of almost unlimited flexibility for amplifier testing, music creation, and perhaps even synthetic speech generation. A/D converters have possibilities which may be even more exciting, for they can tell a computer what is going on around it. They can tell it the temperature, how much power the house is consuming, how much sunlight is falling on a solar collector, and even whether it should be in pain because a brownout is occurring. ■

	A-register contents	B-register contents
First test (to see if input is greater than 5 volts)	80H (10000000)	80H (10000000)
Test passes (IC2 a logic 0)		
Next test (to see if input is greater than 7.5 volts)	C0H (11000000)	40H (01000000)
Test fails (IC2 a logic 1)		
Next test (to see if input is greater than 6.25 volts)	A0H (10100000)	20H (00100000)
Test fails (IC2 a logic 1)		
Tests continue until all bit positions are tested		

Table 2. This example shows how the conversion algorithm proceeds. Results of the first three bit tests are given for an analog input voltage assumed to be 6.0 volts.

For free catalog including parts lists and schematics, send a self-addressed stamped envelope.

APPLE II SERIAL I/O INTERFACE *

Part no. 2
Baud rate is continuously adjustable from 0 to 30,000 • Plugs into any peripheral connector • Low current drain. RS-232 input and output • On board switch selectable 5 to 8 data bits, 1 or 2 stop bits, and parity or no parity either odd or even • Jumper selectable address • SOFTWARE • Input and Output routine from monitor or BASIC to teletype or other serial printer. • Program for using an Apple II for a video or an intelligent terminal. Also can output in correspondence code to interface with some selectrics. Board only — \$15.00; with parts — \$42.00; assembled and tested — \$62.00.



T.V. TYPEWRITER

Part no. 106
• Stand alone TVT • 32 char/line, 16 lines, modifications for 64 char/line included • Parallel ASCII (TTL) input • Video output • 1K on board memory • Output for computer controlled cursor • Auto scroll • Non-destructive cursor • Cursor inputs: up, down, left, right, home, EOL, EOS • Scroll up, down • Requires +5 volts at 1.5 amps, and -12 volts at 30 mA • All 7400, TTL chips • Char. gen. 2513 • Upper case only • Board only \$39.00; with parts \$145.00



8K STATIC RAM

Part no. 300
• 8K Altair bus memory • Uses 2102 Static memory chips • Memory protect • Gold contacts • Wait states • On board regulator • S-100 bus compatible • Vector input option • TRI state buffered • Board only \$22.50; with parts \$160.00

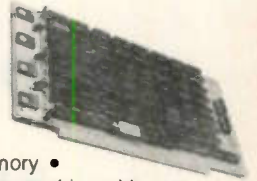

MODEM *

Part no. 109
• Type 103 • Full or half duplex • Works up to 300 baud • Originate or Answer • No coils, only low cost components • TTL input and output-serial • Connect 8 ohm speaker and crystal mic. directly to board • Uses XR FSK demodulator • Requires +5 volts • Board \$7.60; with parts \$27.50

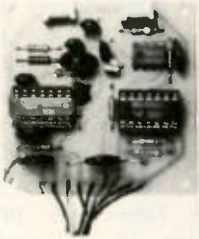

TIDMA *

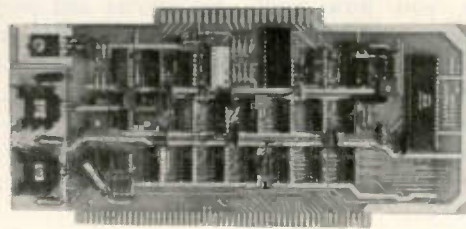

Part no. 112
• Tape Interface Direct Memory Access • Record and play programs without bootstrap loader (no prom) has FSK encoder/decoder for direct connections to low cost recorder at 1200 baud rate, and direct connections for inputs and outputs to a digital recorder at any baud rate. • S-100 bus compatible • Board only \$35.00; with parts \$110.00

DC POWER SUPPLY *

Part no. 6085
• Board supplies a regulated +5 volts at 3 amps., +12, -12, and -5 volts at 1 amp. • Power required is 8 volts AC at 3 amps., and 24 volts AC C.T. at 1.5 amps. • Board only \$12.50; with parts excluding transformers \$42.50



TAPE INTERFACE *

Part no. 111
• Play and record Kansas City Standard tapes • Converts a low cost tape recorder to a digital recorder • Works up to 1200 baud • Digital in and out are TTL-serial • Output of board connects to mic. in of recorder • Earphone of recorder connects to input on board • No coils • Requires +5 volts, low power drain • Board \$7.60; with parts \$27.50

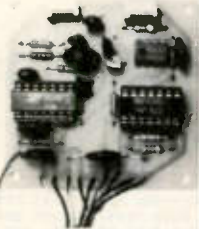

UART & BAUD RATE GENERATOR *

Part no. 101
• Converts serial to parallel and parallel to serial • Low cost on board baud rate generator • Baud rates: 110, 150, 300, 600, 1200, and 2400 • Low power drain +5 volts and -12 volts required • TTL compatible • All characters contain a start bit. 5 to 8 data bits, 1 or 2 stop bits, and either odd or even parity. • All connections go to a 44 pin gold plated edge connector • Board only \$12.00; with parts \$35.00 with connector add \$3.00



RS 232/TTY * INTERFACE

Part no. 600
• Converts RS-232 to 20mA current loop, and 20mA current loop to RS-232 • Two separate circuits • Requires +12 and -12 volts • Board only \$4.50, with parts \$7.00



RS 232/TTL * INTERFACE

Part no. 232
• Converts TTL to RS-232, and converts RS-232 to TTL • Two separate circuits • Requires -12 and +12 volts • All connections go to a 10 pin gold plated edge connector • Board only \$4.50; with parts \$7.00 with connector add \$2.00

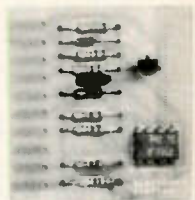

ELECTRONIC SYSTEMS Dept. 73, P.O. Box 21638, San Jose, CA. USA 95151

To Order:

Mention part number and description. For parts kits add "A" to part number. In USA, shipping paid for orders accompanied by check, money order, or Master Charge, BankAmericard, or VISA number, expiration date and signature. Shipping charges added to C.O.D. orders. California residents add 6.5% for tax. Outside USA add 10% for air mail postage, no C.O.D.'s. Checks and money orders must be payable in US dollars. Parts kits include sockets for all ICs, components, and circuit board. Documentation is included with all products. All items are in stock, and will be shipped the day order is received via first class mail. Prices are in US dollars. No open accounts. To eliminate tariff in Canada boxes are marked "Computer Parts." Dealer inquiries invited. 24 Hour Order Line: (408) 226-4064



* Circuits designed by John Bell

World's Cheapest QSLs

—BASIC program keeps your log, too

Charles Zappala WA7VZR
8051 N.E. 143rd Street
Bothell WA 98011

This article describes an expansion of a BASIC program I wrote to manage log entries and provide an inquiry feature for the radio amateur. When I first wrote

the program, I thought about perhaps modifying it to include printing QSL cards. This final program (Fig. 1) will show you how your microcomputer will not only print the QSL cards, but will also fill them out for you.

Imagine the work that is involved in filling out QSL cards after a contest weekend

or field day! This system will log in the contacts, and then an additional function (PRINT QSLs) will read the log entries and print a QSL for each contact requiring a card! My IMSAI computer with 12K of RAM, 8K BASIC, and ASR-33 Teletype™ printer can print and fill out a QSL in about 30

seconds. The cards may not be very pretty, but they sure are fast and cheap. Anyway, who said that a QSL card has to be professionally printed to confirm a contact? I've sent a number of them out, and many hams consider them a novelty in QSL cards. And they are accepted.

The QSL itself is located between lines 910 and 945, thus allowing you to customize your own QSL. By using direct PRINT statements, you can easily substitute your own call and personal station information. Lines 936 and 937 read the R\$ variable to insert the appropriate text for acknowledging receipt of a card or to please send a card. Line 938 leaves room for the operator to sign his name, thus making the card official.

Lines 918 to 926 are used to print the station call sign on the left side and a message to the effect that the QSL was printed by a microcomputer system on the right side. With some imagination

Fig. 1. Program listing.

```

10 REM ***** AMATEUR RADIO LOG, QSL AND INQUIRY SYSTEM *****
11 REM                                     BY COMPUTER
12 REM WRITTEN BY CHUCK ZAPPALA WA7VZR 8051 NE 143RD BOTHELL WA 98011
13 REM
14 REM THIS PROGRAM IS RELEASED TO PUBLIC DOMAIN          AUG 1977
15 REM
16 REM VERSION 1.1    WRITTEN IN ALTAIR 8K BASIC VERSION 3.1
17 REM
18 REM *****
100 PRINT:PRINT"AMATEUR RADIO LOG AND INQUIRY SYSTEM":PRINT
102 PRINT:INPUT"ENTER TODAY'S DATE (YYMMDD)":D:PRINT
105 PRINT:PRINT"SELECT ONE OF THE FOLLOWING FUNCTIONS":PRINT:PRINT
110 PRINT"  1. ADD LOG ENTRIES"
115 PRINT"  2. PRINT LOG ENTRIES BY DATE"
120 PRINT"  3. PRINT LOG ENTRIES BY CALL SIGN"
125 PRINT"  4. PRINT ALL LOG ENTRIES"
130 PRINT"  5. PRINT QSL CARDS"
145 PRINT:INPUT"ENTER FUNCTION NUMBER":F
160 IF F=1 THEN GOTO 300
165 IF F=2 THEN GOTO 400
170 IF F=3 THEN GOTO 500
175 IF F=4 THEN GOTO 600
180 IF F=5 THEN GOTO 900
200 PRINT"INVALID, TRY AGAIN":GOTO 145
300 REM ADD LOG ENTRIES
302 PRINT:PRINT
304 PRINT"ADDING LOG ENTRIES BY DATA STATEMENTS":LIST 1000
400 REM PRINT LOG ENTRIES BY DATE
402 PRINT:PRINT
404 INPUT"ENTER FIRST DATE (YYMMDD)":N1:PRINT
406 INPUT"ENTER NEXT DATE (YYMMDD)":N2:PRINT
408 PRINT"LOG ENTRIES BETWEEN 'N1;' AND 'N2:PRINT:GOSUB 800
412 GOSUB 700
414 IF Z=999999 THEN 950
416 IF Z=>N1 AND Z<=N2 THEN 420
418 GOTO 412
420 GOSUB 720
422 GOTO 412
500 REM PRINT LOG ENTRIES BY CALL SIGN
502 PRINT:PRINT
504 INPUT"ENTER CALL SIGN":M1:GOSUB 800
506 GOSUB 700
508 IF A=999999 THEN 950
510 IF M1=X1 THEN 514
512 GOTO 506
514 GOSUB 720
516 GOTO 506
600 REM PRINT ALL LOG ENTRIES
602 PRINT:PRINT
604 GOSUB 800
606 GOSUB 700
610 GOSUB 720
612 GOTO 606
700 REM READ DATA FILE
702 READ A:Z=A:IF Z=999999 THEN GOTO 950

```

```

704 READ A$:Y1=A$
706 READ B$:Y2=B$
708 READ C$:Y3=C$
710 READ D$:Y4=D$
712 READ E$:Y5=E$
714 READ F$:Y6=F$
716 READ G$:Y7=G$
718 READ H$:Y8=H$
720 READ J$:Y9=J$
722 RETURN
724 REM PRINT DATA RECORD
726 PRINT Z:" "Y1:" "Y2:" "Y3:" "Y4:" "Y5:" "Y6:" "Y7:" "Y8:" "Y9:"
728 PRINT TAB(22) Y9:" "Y5:" "Y6:" "Y7:" "Y8:" "Y9:" "Y1:" "Y2:"
730 RETURN
800 REM REPORT HEADER
802 PRINT"REPORT DATE ":D:PRINT
804 PRINT" DATE      GHT CALL FREQ  MODE  RST  QSL NAME  DTH  "
806 PRINT"          TIME                H-M  S-R      "
808 FOR N=1 TO 51:PRINT":::NEXT N:PRINT":::"
810 RETURN
900 REM PRINT QSL CARDS
902 PRINT:PRINT:PRINT" QSL CARDS DATE ":D:PRINT
904 GOSUB 700
906 IF A=999999 THEN 950
908 IF S1="N" THEN 910
910 IF S1="Y" THEN PRINT X$:" HAS BEEN QSL'D. ": GOTO 904
912 PRINT
914 PRINT"*****"
916 PRINT"CHUCK ZAPPALA, 8051 N.E. 143RD STREET, BOTHELL, WA. 98011"
918 PRINT:PRINT
920 PRINT" W  W  A  77777  V  V  ZZZZ  RRRR  : THIS QSL WAS PRINTED "
922 PRINT" W  W  A  A  7  V  V  Z  R  R  : BY A MICROCOMPUTER. "
924 PRINT" W  W  A  A  A  7  V  V  Z  R  R  : THE DATA IS PRINTED "
926 PRINT" W  W  A  A  7  V  V  ZZZZ  R  R  : DIRECTLY FROM THE LOG "
928 PRINT:PRINT:PRINT
930 PRINT" TO: "X$: " CONFIRMING OUR QSO AT "Y1:" GHT "Z:" DATE "
932 PRINT" ON "Y5:" MHZ. MODE "Y6:" USING 260 WATTS "
934 PRINT" YOUR RST "Y7:" RIG IS FT101EE, ANT IS TH3JR AT 37 FT. "
936 IF R3="N" THEN PRINT " PLEASE QSL "
938 IF R3="Y" THEN PRINT " TXN FER UR QSL 0X1!!"
940 PRINT" 73'S TNX FER QSO. SIGNED:                OP "
942 PRINT"*****"
944 GOTO 904
950 REM END OF REPORT
952 PRINT"END OF REPORT":RESTORE:GOTO 105
954 END
1000 DATA 770532,1885,K9OAG,14.2,55B,57.58,N,N,MEPNIE IL
1001 DATA 770501,1889,WB6RPF,14.2,55B,56.57,N,N,GLEN CA
1002 DATA 770725,2129,023YL,14.2,55B,56.56,Y,Y,EPIC DENMARK
1003 DATA 770738,8885,V7PCK,14.2,55B,59.59,N,N,JOHN WASH
1004 DATA 770801,1245,W5VCG,14.2,55B,57.56,Y,N,DAVE NEV MEX
1005 DATA 999999

```

DUAL TRACE 15 MEGAHERTZ

PORTABLE MINISCOPE

\$435.00



**MADE
IN THE
U.S.A.!**

**BATTERY
OPERATED!**

FEATURES

- Dual Trace - 2 channel; separate, chopped or alternate modes.
- 15 megahertz bandwidth.
- External and internal trigger.
- Time Base - 0.1 microseconds to 0.5 Sec/div - 21 settings.
- Battery or line operation.
- Automatic and line sync modes.
- Power consumption less than 15W.
- Vertical Gain - 0.01 to 50 volts/div - 12 settings.
- Weight is only 3 pounds.

From the originator of the Digital Voltmeter, Non-Linear Systems comes the MS-215 Miniscope. It is a fine electronic instrument with a great deal of measuring capability and excellent accuracy. Its design is modern, utilizing the latest in low-powered integrated circuits, and it is packaged into the smallest practical size. The instrument fits into many briefcases and tool boxes with room to spare.

Operating characteristics have been chosen so that the MS-215 will make all of the measurements needed in servicing most electronic equipment. It is field-portable so its use is not restricted to the bench.

SPECIFICATIONS:

Vertical Mode: CH1, CH2, CH1 & CH2 (Chopped) & CH1 & CH2 (Alt.)
The Following Specifications apply to each channel

Y Axis Vertical Input: 10mV/div to 50V in 12 Calibrated ranges, as follows:
x1-10mV/div to 10V/div in four ranges, each continuously variable
x2-20mV/div to 20mV/div in four ranges, each continuously variable
x5-50mV/div to 50mV/div in four ranges, each continuously variable.
Accuracy is 3%.

Input Impedance: 1M ohm shunted by 50 pF

Bandwidth: DC/DC to 15 Mhz 16 db (DC to 8 Mhz 13 db). AC, same as DC down to 3Hz

Rise Time: Approximately 23 nS @ 1 division deflection.

Input Voltage: 250 maximum (DC and Peak AC).

Horizontal Mode: Internal Time Base or External Horizontal, switch selectable. In the XY mode, vertical input is through CH1 and horizontal input is through CH2

Bandwidth: DC to 200 KHz (13 db).

Coupling: AC, DC or ground, switch selectable. Low frequency point on AC is 3 Hz.

Input Impedance: 1Meg ohm shunted by 50 pF

Deflection Factor: 10mV/div to 50V/div in 12 calibrated ranges. The ranges can be calibrated with the CH2 gain control 250V maximum (DC and Peak AC).

Input Voltage: 0.1uS/div to 0.5 Sec/div in 21 calibrated ranges, as follows:
x1, uS-0.1uS/div to 100 uS/div. x2, uS-0.2uS/div to 200 uS/div.
x5, uS-0.5uS/div to 500 uS/div. x1, mS-0.1mS/div to 100 mS/div
x2, mS-0.2mS/div to 200 mS/div. x5, mS-0.5mS/div to 500 mS/div
all in four ranges, each continuously variable. (Range increments are 1, 1, 10, 100) With vernier in full clockwise position, calibrated time measurements are possible. Accuracy is 3%.

Triggering Internal: Sweep triggered from internal trigger source (In the dual trace modes, the internal trigger source is CH1).
Automatic: Trigger source is internal calibrator frequency. To be used if there is no other trigger source available to synchronize the sweep

Line: Trigger is derived from line frequency when using the battery charger
External: Controls function as for internal triggering (1 Megohm input impedance).
Slope: Selects sync to positive- or negative-going waveform.
Coupling: AC
Sensitivity: Less than 1 div for internal trigger and less than 1 volt for external trigger.

Level: Trigger Level control permits continuous adjustment of trigger point in all modes except Auto.

Internal Calibrator: A square-wave signal of 1 volt p-p 15% is provided. Frequency is approximately 1KHz.

Display Graticule: 4x5 div, each division is 0.25 inch. Viewing area 1.1" Hx 1.35" W
CRT: Bluish-white phosphor, medium persistence. CRT uses low power filament for low battery drain. Instant on!

Power On-Board Batteries: Three sealed, rechargeable lead acid "D" Cells
Operating Time: Typically 4 hours.
Charging Time Scope Operating: Will run indefinitely but not reach full charge
Sixteen hours
Non-operating: Battery charger 115 vac (220 vac on request). 50-400Hz, less than 15 watts.
External Power: 3.1" Hx 6.4" Wx 8.0" D.
Dimensions: Three pounds.
Weight: Three pounds.
Environment Operating Temperature: 0° to 40°C
Shock and Vibration: Designed to withstand normal shock and vibration encountered in commercial shipping and handling.

Accessories Furnished: Tilt stand, battery charger, 2 input cables, and 3 miniature banana plugs.
Optional: Leather carrying case and probes
Warranty: One year parts and labor. Made in the U.S.A.

MS-215 with Rechargeable Batteries and Charger \$435.00

Leather Carrying Case

The leather case has 2 separate compartments. One to hold the scope, the other to hold the charger, probe, shoulder strap, etc. The case can be worn on the belt, or over the neck.

The snaps used on the case are "one way", thus accidental striking of the case against an object will not undo the snaps or let it be pulled off your belt.

41-140 \$45.00

Probes

10 to 1 probe with 10 megohm input.

Probe uses spring hook tip for sure connection. Compensation network is located at the connector rather than at the probe, so as to keep size and weight to a minimum.

41-141 \$27.00

Deluxe Combination Probe

Switchable 10to1/1to1 probe with an assortment of probe tips to suit any situation.

41-3495 \$36.00

\$50.00 OFF

On Any Accessories Purchased with MS-215 MINISCOPE, Just Send or Mention the COUPON and 73 Magazine

MS-15 Single Trace version of MS-215

\$318.00



PRIORITY ONE ELECTRONICS

49115 West Rosecrans, Hawthorne, CA 90250

Terms VISA, MC, BAC, check, Money Order, C.O.D. U.S. Funds Only. CA residents add 6% sales tax. Minimum order \$10.00. Orders less than \$75.00 include 10% shipping and handling, excess refunded. Just in case please include your phone no. "Sorry, no over the counter sales." Good thru NOV 1978

Send for our latest brochure.

phone orders welcome (213) 973-4876

OEM and institutional inquiries invited.

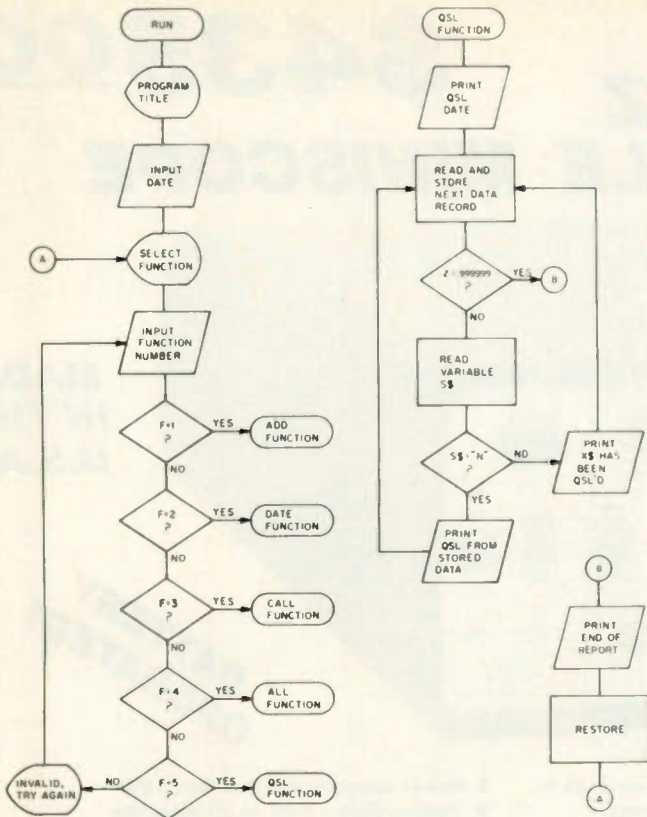

Fig. 3. System flowchart (partial) showing QSL function flow only.

and endurance, you could get carried away here and design a really elaborate QSL card suitable for framing like those fancy RTTY pictures and have the computer insert the QSL data on the picture.

Fig. 2 shows a sample of how the program looks. Functions 3 and 4 have been selected first. Notice that the data log entries are lined up evenly and that a log header is used.

Function 5 is then selected and the computer starts printing QSL cards. Notice that, after the second card, the printout shows that station OZ3YI has been QSLed, so no card is needed,

and it begins printing the next QSL.

As QSL cards are received and sent, the operator should use the computer's BASIC text editor routines to modify the R\$ and S\$ ("Ys" and "Ns") for telling the computer the status of the QSL data. The first Y/N refers to QSLs sent, so don't mix them up. If you forget, refer to the printed header as shown in Fig. 2. If you don't have a good BASIC text editor, this program won't be very much fun to use — at least, the QSL feature won't be. However, it won't make any difference in contest operating, so there go all the QSL pencil cramps forever! ■

Fig. 2. Sample run.

```

RUN
AMATEUR RADIO LOG AND INQUIRY SYSTEM

ENTER TODAY'S DATE (YYMMDD)? 770804

SELECT ONE OF THE FOLLOWING FUNCTIONS:

1. ADD LOG ENTRIES
2. PRINT LOG ENTRIES BY DATE
3. PRINT LOG ENTRIES BY CALL SIGN
4. PRINT ALL LOG ENTRIES
5. PRINT QSL CARDS

```

ENTER FUNCTION NUMBER? 3

ENTER CALL SIGN? VB5VCG
REPORT DATE 770804

```

DATE GMT CALL FREQ MODE RST QSL NAME QTH
TIME H-M S-R
-----
770801 1245 VB5VCG 14.2 55B 57 56 Y N DAVE NEW MEX
END OF REPORT

```

SELECT ONE OF THE FOLLOWING FUNCTIONS

1. ADD LOG ENTRIES
2. PRINT LOG ENTRIES BY DATE
3. PRINT LOG ENTRIES BY CALL SIGN
4. PRINT ALL LOG ENTRIES
5. PRINT QSL CARDS

ENTER FUNCTION NUMBER? 4

REPORT DATE 770804

```

DATE GMT CALL FREQ MODE RST QSL NAME QTH
TIME H-M S-R
-----
770502 1805 K9QAG 14.2 55B 57 58 N N HERNIE IL
770501 1809 W6RRF 14.2 55B 56 57 N N GLEN CA
770725 2129 OZ3YI 14.2 55B 56 56 Y Y ERIC DENMARK
770730 0805 W7PCK 14.2 55B 59 59 N Y JOHN WASH
770801 1245 VB5VCG 14.2 55B 57 56 Y N DAVE NEW MEX
END OF REPORT

```

SELECT ONE OF THE FOLLOWING FUNCTIONS

1. ADD LOG ENTRIES
2. PRINT LOG ENTRIES BY DATE
3. PRINT LOG ENTRIES BY CALL SIGN
4. PRINT ALL LOG ENTRIES
5. PRINT QSL CARDS

ENTER FUNCTION NUMBER? 5

QSL CARDS DATE 770804

CHUCK ZAPPALA, 8051 N.E. 143RD STREET, BOTHELL, WA. 98011

```

W V A 7777 V V ZZZZ RRRR : THIS QSL WAS PRINTED
W V A A 7 V V Z R R R : BY A MICROCOMPUTER.
W V W A A 7 V V Z RRRR : THE DATA IS PRINTED
W V W A A A A A 7 V V Z R R R : DIRECTLY FROM THE LOG
W V A A 7 V ZZZZ R P P : ENTRIES IN MEMORY

```

```

TO: K9QAG CONFIRMING OUR QSO AT 1805 GMT 770502 DATE
ON 14.2 MHZ. MODE 55B USING 260 WATTS
YOUR RST 57 RIG IS FT101EE, ANT IS TH3JR AT 37 FT.
PLEASE QSL
73'S TNX FER QSO. SIGNED:

```

CHUCK ZAPPALA, 8051 N.E. 143RD STREET, BOTHELL, WA. 98011

```

W V A 7777 V V ZZZZ RRRR : THIS QSL WAS PRINTED
W V A A 7 V V Z R R R : BY A MICROCOMPUTER.
W V W A A 7 V V Z RRRR : THE DATA IS PRINTED
W V W A A A A A 7 V V Z R R R : DIRECTLY FROM THE LOG
W V A A 7 V ZZZZ R R R : ENTRIES IN MEMORY

```

```

TO: W6RRF CONFIRMING OUR QSO AT 1809 GMT 770501 DATE
ON 14.2 MHZ. MODE 55B USING 260 WATTS
YOUR RST 56 RIG IS FT101EE, ANT IS TH3JR AT 37 FT.
PLEASE QSL
73'S TNX FER QSO. SIGNED:
OZ3YI HAS BEEN QSL'D.

```

CHUCK ZAPPALA, 8051 N.E. 143RD STREET, BOTHELL, WA. 98011

```

W V A 7777 V V ZZZZ RRRR : THIS QSL WAS PRINTED
W V A A 7 V V Z R R R : BY A MICROCOMPUTER.
W V W A A 7 V V Z RRRR : THE DATA IS PRINTED
W V W A A A A A 7 V V Z R R R : DIRECTLY FROM THE LOG
W V A A 7 V ZZZZ R R R : ENTRIES IN MEMORY

```

```

TO: W7PCK CONFIRMING OUR QSO AT 0805 GMT 770730 DATE
ON 14.2 MHZ. MODE 55B USING 260 WATTS
YOUR RST 59 RIG IS FT101EE, ANT IS TH3JR AT 37 FT.
TNX FER UR QSL QM!!!
73'S TNX FER QSO. SIGNED:

```

VB5VCG HAS BEEN QSL'D.
END OF REPORT

SELECT ONE OF THE FOLLOWING FUNCTIONS

1. ADD LOG ENTRIES
2. PRINT LOG ENTRIES BY DATE
3. PRINT LOG ENTRIES BY CALL SIGN
4. PRINT ALL LOG ENTRIES
5. PRINT QSL CARDS

ENTER FUNCTION NUMBER?

SALE S-100 BUS EDGE CONNECTORS SALE

+9704 **NLS**
1c SALE

LM3A 3 dig 1% DC \$134.00
LM3.5A 3 1/2 dig .5% DC \$158.50
LM40A 4 dig .1% DC \$209.00
LM4A 4 dig .03% DC \$250.00

- Rechargeable batteries and charger included
- Measures DC Volts, AC Volts, Ohms and Current
- Automatic polarity, decimal and overload indication
- Rechargeable batteries and charger
- Measures DC Volts, AC Volts, Ohms and Current
- Automatic polarity, decimal and overload indication
- No zero adjustment and no full-scale ohms adjust
- Battery-operated — NiCad batteries; also AC line operation.
- Large LED display for easy reading without interpolation
- Size: 1 9/16" H x 2 7/8" W x 4" D
- Parts & Labor guaranteed 1 year
- Tin stand option \$ 3.50
- Leather case \$20.00

Purchase any of the LM series Meters and buy the LEATHER CASE for 1c

NLS
\$318.

MS-15 MINISCOPE With Rechargeable Batteries & Charger Unit

- 15 megahertz bandwidth.
- External and internal trigger.
- Time base — .1 microsec. to 0.5 Sec/div - 21 settings, .33%.
- Battery or line operation.
- Automatic & line sync modes.
- Power consumption < 15 watts.
- Vortical Gain — 30 to 50 v/div - 12 settings ± 3%.
- Viewing area 1 1/2" x 3 3/8"
- Case size 2 7/8" H x 4 1/8" W x 7 7/8" D, 3 pounds.
- Parts & Labor guaranteed 1 year
- 10 to 1, 10 meg probe
- Leather carrying case

PROBE 1c
PROBE IC with the purchase of SCOPE and the MENTION of this MAGAZINE

NLS
\$27.
\$45.

MS-215 Dual Trace Version of MS-15 \$435.

3 LEVEL GOLD WIRE WRAP SOCKETS

	1-24	25-49	50-99	100-249	250-999	1K-5K
8 pin*	.41	.38	.35	.31	.27	.23
14 pin*	.39	.38	.36	.32	.29	.27
16 pin*	.43	.42	.39	.35	.32	.30
18 pin	.63	.58	.54	.47	.42	.36
20 pin	.80	.75	.70	.63	.58	.53
22 pin*	.90	.85	.80	.70	.61	.57
24 pin	.90	.84	.78	.68	.63	.58
28 pin	1.10	1.00	.90	.84	.76	.71
40 pin	1.50	1.40	1.30	1.20	1.04	.89

Sockets purchased in multiples of 50 per type may be combined for best price.

All sockets are GOLD 3 level closed entry * End and side stackable. 2 level, Solder Tail, Low Profile, Tin Sockets and Dip Plugs available. CALL FOR QUOTATION

SALE S-100 BUS EDGE CONNECTORS SALE

\$100-WMG 50/100 Cont. 125 cts 3 LEVEL WIRE WRAP .025" pitch on 250 spaced rows GOLD plated 1.4 5-9 10-24 \$4.00 \$3.76 \$3.90	\$100-STG 50/100 Cont. 125 cts DIP SOLDER TAIL on 250 spaced rows for VECTOR and MASI motherboards GOLD plated 1.4 5-9 10-24 \$4.00 \$3.75 \$3.50	R681G 50/100 Cont. 125 cts DIP SOLDER TAIL on 140 spaced rows for ALLTAIR motherboards GOLD plated \$5.00	R681-3 50/100 Cont. 125 cts PIERCED SOLDER EYELET tails GOLD \$2.38
--	---	--	--

Other Popular Edge Connectors

R644-G 22/44 Cont. 156 cts PIERCED SOLDER EYELET tails GOLD plated 1.4 5-9 10-24 \$3.00 \$2.75 \$2.90	R644-3 22/44 Cont. 156 cts WIRE WRAP tails GOLD \$4.71
---	---

ATTN: OEM'S and Dealers, many other connectors available call or quotation

8803 **Vector**
MOTHER BOARD FOR \$100 BUS MICRO-COMPUTERS

- Kit includes 12 tantalum capacitors for +5, +12, -12 volts and 100 uho timing capacitors
- Wiring side silicon. Cam potentiometer bare epoxy glass with white markings to component locations.
- 010 epoxy glass base with 2 ounce copper solder coated and .038 ounce holes for leads.
- Solder mask with solder windows at etched critical to avoid electrical short circuits
- Mounts 18 sockets with 100 contacts (12 rows) on .525 centers with 250 row spacing. Vector part number 8801-2; or mounts 10 receptacle plug interconnects to smaller mother board for expansion.
- Includes etched traces and instructions for option of active, pull-up, or floating terminations.
- Large sockets — 5V and 0V (10 AMP), 8, 12V or 16V (17 AMP). Current ratings as per IEC 150-275 with 10PC test.
- Fits in Vector gas enclosure.
- Fits in BMSA 8000 microcomputer as expansion board.

Price: \$29.50

Vector **Plugboards**

8800V Universal Microcomputer/processor plugboard, use with S-100 Bus. Complete with heat sink & hardware. 5.3" x 10" x 1/16"

1-4	5-9	10-24
\$19.95	\$17.95	\$15.95

8801-1 Same as 8800V except plain; less power buses & heat sink.

1-4	5-9	10-24
\$14.95	\$13.45	\$11.95

3682 9.6" x 4.5" \$10.97
3682-2 6.5" x 4.5" \$9.81

Hi-Density Dual-In-Line Plugboard for Wire Wrap with Power & Grd. Bus Epoxy Glass 1/16" 44 pin con. spaced 156

3677 9.6" x 4.5" \$10.90
3677-2 6.5" x 4.5" \$9.74

Gen Purpose D.I.P. Boards with Bus Pattern for Solder or Wire Wrap. Epoxy Glass 1/16" 44 pin con. spaced 156

3662 6.5" x 4.5" \$7.65
3662-2 9.6" x 4.5" \$11.45

P pattern plugboards for IC's Epoxy Glass 1/16" 44 pin con. spaced 156

3690-12 CARD EXTENDER Card Extender has 100 contacts-50 per side on .125 centers-Attached connector-is compatible with S-100 Bus Systems \$25.00
3690 6.5" 22/44 pin .158 ctrs. Extenders \$12.00

2708 **8K 450 ns**

EPROM FACTORY PRIME \$ 9.00 EA. 25 + Call For Price

14 & 16 PIN GOLD 3 LEVEL WIRE WRAP SOCKETS

14 - G3 100 for \$30.00
16-G3 100 for \$30.00
50 of each for \$32.00

Sockets are End & Side stackable, closed entry

1/16" Vector BOARD
.042 dia holes on .01 spacing for IC's

Phenolic

PART NO.	SIZE	1-9	10-19
64P44XXXP	4.5x6.5"	\$1.49	1.34
169P44XXXP	4.5x17"	\$3.51	3.16

Epoxy Glass

64P44	4.5x6.5"	\$1.70	1.53
84P44	4.5x8.5"	\$2.10	1.89
169P44	4.5x17"	\$4.30	3.87
169P84	8.5x17"	\$7.65	6.89

ELLY-WRAP

Wires insulated wire on .025" square posts
FOUR TIMES FASTER

P180 with two 100' spools of 28 ga wire \$24.50

P180-4T includes charger, wire \$75.00

SLIT-N-WRAP WIRE 12" package
NO 28 GAUGE INSULATED WIRE, 100' SPOOLS
W78-2-Pkg 3, Green W78-2-Pkg 3, Clear W78-2-Pkg 3, Red W78-2-Pkg 3, Blue

14 & 16 PIN GOLD 3 LEVEL WIRE WRAP SOCKETS

14 - G3 100 for \$30.00
16-G3 100 for \$30.00
50 of each for \$32.00

Sockets are End & Side stackable, closed entry

LIQUID CRYSTAL DIGITAL CLOCK-CALENDAR

- For Auto, Home, Office
- Small in size (2 1/2 x 1 1/2)
- Push button for seconds resetting with AM/PM indicators and colors. Direct drive. PIN to PIN interface with **8799A** I.C. Just add switches, AC Supply, Alarm, Display and I.C. only
- 2 MODELS AVAILABLE
- LCD-101, portable model runs on self-contained batteries for better than a year
- LCD-102, runs on 12 volt system and is back lighted
- LCD-101 or LCD-102 your choice

\$34.95.. \$2.00

LEDU MG 10A List \$72. **\$44.95**

Perfectly balanced, fluorescent lighting with precision magnifier lens. For prof'l, techni & hobbyist. Has die cast protective snout. Inst. start 3 dropper lens, 42" reach

SPECIAL

SC-5 With Rechargeable Batteries & Charger Unit \$98

FM-7 With Rechargeable Batteries & Charger Unit \$215

Features include: * By using the new NLS SC-5 Prescaler, the range of the FM-7 frequency Meter, which is 10 KHz to 60 MHz, may be extended to 512 MHz (the upper VHF & UHF frequency bands). * The FM-7 utilizes an LED readout, providing 7 digit resolution. * The FM-7 can be calibrated to an accuracy of 0.00001%. * The SC-5 is accurate to one part per million. * Each unit has 30 microvolts sensitivity, is battery powered and has a charger unit included. * Dimensions of each are 1.9" H x 2.7" W x 3.9" D. * The units may be obtained separately or as a "frequency duo." * Parts & Labor guaranteed 1 year.
Tin stand option \$ 3.50
Leather case \$20.00

MICRO-KLIP for .042 dia. holes (all boards on this page)
T-42-1 pkg. 100 \$ 1.50
T-44-1 pkg. 1000 \$11.00
P-149 hand installing tool \$ 2.03

.8" LED ALARM CLOCK
12 hr. LED Alarm Clock uses 3 1/2 digit .8" LED Display with AM/PM indicators and colors. Direct drive. PIN to PIN interface with **8799A** I.C. Just add switches, AC Supply, Alarm, Display and I.C. only

\$7.95 or 2/\$15.00

Price Breakthrough! \$17.50

MA1003 CAR CLOCK

Bright Green Fluorescent Display Crystal Time Base Assembled, just add switches and 12 VDC.

SPECIAL
14CS2 100 for \$14.00
16CS2 100 for \$16.00
14 pin CS2 10 for \$2.00
16 pin CS2 8 for \$2.00

These low cost DIP sockets will accept both standard width plugs and chips. For use with chips, the sockets offer a low profile height of only .125" above the board. These sockets are end stackable.

Vector **WRAP POST** for .042 dia. holes (all boards on this page)
T-44 pkg. 100 \$ 2.28
T-44 pkg. 1000 \$14.00
A-13 hand installing tool \$ 2.80

24 PIN DIP PLUGS WITH COVERS
3 / \$1.00
40 / \$10.00

PRIORITY ONE ELECTRONICS
49115 West Rosecrans, Hawthorne, CA 90250

Terms: VISA, MC, BAC, check, Money Order, C.O.D., U.S. Funds Only. CA residents add 6% sales tax. Minimum order \$10.00. Orders less than \$75.00 include 10% shipping and handling; excess refunded. Just in case please include your phone no. "Sorry, no over the counter sales" Good thru October, 1978

Send for our latest brochure. phone orders welcome (213) 973-4876 OEM and Institutional inquiries invited.

SALE S-100 BUS EDGE CONNECTORS SALE

NLS MS-215 DUAL TRACE MINISCOPE \$435.00

NLS MS-215 DUAL TRACE MINISCOPE \$435.00

TELETYPE[®] MODEL 33 ASR

COMPUTER I/O COMPLETE WITH:

- Tape Punch
- Ready to Go
- Tape Reader
- Line/Local Wired
- Guaranteed 30 Days

\$840⁰⁰

INCLUDING PACKING
F.O.B. - N.E. FACTORY

COMPLETE COVER READY TO INSTALL	\$ 15.00
COPY HOLDER (H2020)	\$ 14.00
TAPE UNWINDER (12" NEW)	\$ 40.00
QUICK-UP PAPER TAPE REWINDER (17")	\$ 15.00
ELECTRIC PAPER REWINDER (LPM 300 NEW)	\$ 50.00
DISC TYPING READER RUNCARD	\$ 45.00
AUDIO-TO-COMPLER	
QUINTEK 501 (NEW)	\$180.00
READER POWER PACK (182134)	\$ 35.00
EAR 95232 INTERFACE	\$ 35.00
AUDIO-TO-COMPLER with FAX (NEW)	\$294.00

If its for TELETYPE[®] We Have It.
If you don't see what you need
CALL or WRITE!



TELETYPEWRITER COMMUNICATIONS SPECIALISTS
550 Springfield Avenue Berkeley Heights, N.J. 07922
12011 464-5310 • TWX: 710-945-3016 • TELE: 13-6439

T13 SUBSIDIARY OF VAN'S W2DLT ELECTRONICS.

RADIO WORLD

CENTRAL NEW YORK'S FASTEST
GROWING HAM DEALER



Featuring Yaesu, Icom, Drake, Atlas, Dentron, Ten-Tec, Swan, Regency, Standard, Tempo, KLM, Hy-Gain, Mosley, Larsen, Midland, Wilson, Southwest Technical Products. We service everything we sell! Write or call for quote. YOU WON'T BE DISAPPOINTED.

We are just a few minutes off the
NYS Thruway (I-90) Exit 32

RADIO WORLD

ONEIDA COUNTY AIRPORT
TERMINAL BUILDING
ORISKANY, NY 13424
315-337-2622

Warren
K2IXN

Bob
WA2MSH

THE CRITIC'S CHOICE



DM-170

Active Filter
Demodulator

Critical buyers are choosing the DM-170 RTTY demodulator to give them more features at lower cost. Write for information and compare.

Discover what the critics have: \$39.95 Kit \$59.95 Wired

FLESHER CORP.

P.O. Box 976 F5

Topeka, Kansas 66601

(913) 234-0198



New from Island Antennas . . .

A 20 M BEAM FOR MARITIME MOBILES

Extremely rugged and lightweight, this is the first beam specifically engineered for the demands of service at sea. Using helically wound fiberglass mobile whips as elements, it can withstand 130 mph winds, yet weighs only 4 lbs. and has 1/2 sq. ft. area, so it can be relied on under storm conditions. Electrically, the whips provide two 12' elements, large enough for 10-15 db attenuation off the back and sides. Cuts QRM, lets you work signals you never knew existed. Broadband helical windings let you cover the band without a tuner. While helical beams usually are expensive, the "Mickey Mouse" is only \$75, with a two week money back guarantee. Owners manual, charts, gain, f/b, SWR vs frequency, one dollar. SASE for info.

gain 3dbi boom 6'
power 500w VSWR 1.5 200 kHz
feed 50Ω direct

Island Antennas
Block Island, RI 02807
Custom antennas our specialty.

119

Trans Com T35 Tone Signaling Equipment

Featuring the TC-1B Sub-Audible Tone Encoder
Compatible with P.L., CG and other systems

Features:

- Low sine wave distortion of less than 1.5% THD
- Plug in tone element
- Excellent Temperature & frequency stability
- Low current draw using CMOS IC's
- Immunity to RF

Two year warranty



Also Available



Touch tone encoders from \$29.95, touch tone decoders and two tone sequential tone encoders and decoders.

Order from or for further information contact

Trans Com

P.O. Box 120, Addison, Illinois 60101 312-653-6724

DISCOUNT SCANNERS

The Touch.[™]



\$255.00

Prepaid
USA

Regency

CHECK, M.O., MASTERCARD, VISA

BAY-COM 832

196 FRONT STREET
SCITUATE MA 02066
617-545-9700

Other Regency models at
similar savings—send for list

...Mass. residents please add 5% tax...

FLY YOUR RUBBER DUCKY !!

Get off the trunk lid and into the best location on the car . . . the center of the roof! Tests have proven that the low profile quarter-wave whip, or the rubber-ducky from a Handy-Talky, outperforms a 5/8 whip on the trunk. Take advantage of the super ground plane by converting to the FLYING-DUCKY magnetic mount. Although designed specifically for use with a H-T, it can be used with any mobile rig. Ten second installation.

FLYING-DUCKY magnetic mount consists of:

- Chrome-plated super magnet (holds 50 lbs.)
- Compatible coax plugs furnished to match rig requirements. Specify BNC, F type, PL259-SO239. For TNC Wilson type add \$3.
- Coax cable 105 in. long.

FLYING DUCKY MOUNT AND CABLE . . . \$13.95
QUARTER WAVE WHIP
(specify connector) . . . \$ 5.95
RUBBER DUCKY to match
(specify connector) . . . \$ 7.95

Pace-Traps
P15

Box 234
Middlebury CT 06762
(203) 758-9228

NEW for '78

The FM Deviation Meter Anyone
Can Afford

\$189

less batteries
and crystals

ECM-5B MK-II fm modulation meter

- Now used by the U.S. Government in over 50 locations
- All new unbreakable A.B.S. cabinet
- 0-6 kHz peak reading linear scale
- Operates 25 MHz to 500 MHz
- Crystal controlled for easy operation
- Audio/Scope output with earphone
- Options: NICAD power PAK \$34.95
Charger \$39.95

Write or call for complete information. Send check or money order for \$189. Shipping prepaid in U.S. Indiana residents add 4% sales tax. Crystals \$7.95 each.

ECM Corporation
412 N. WeInbach Ave.
Evansville IN 47711
812-476-2121 E1



W2NSD/1 NEVER SAY DIE

editorial by Wayne Green

from page 6

interests of all of us instead of just what HQ perceives as its best interests. One of my long-term wishes is that the League could be gotten to work as the democratic organization it pretends to be.

This magazine is an open forum on any ham matters, so use it.

COMMENTS ON DOCKET 20777

1. In the original proposed rule making Docket 20777, the Commission proposed a set of bandwidth restrictions be placed on amateur operations. For various reasons amateurs objected to the limitations placed on them by these restrictions.

2. The stated purpose of Docket 20777 was to pursue the concept of deregulating amateur radio. While the proposed changes would to some degree have simplified the amateur regulations, they would have also placed a whole new set of restrictions upon experimenting amateurs. Thus, while many amateurs commented negatively on the proposal for reasons which would affect them personally, my objections were of a philosophical nature.

3. The Commission should take particular note of its own regulations when promulgating new rules for amateurs. There is one rule, and one rule only, in Part 97 which can only be interpreted as laying out the ground rules for the Commission and having no relevance whatever to individual amateurs. I refer to 97.1c of the amateur regulations, which bids the Commission to provide rules which will encourage experimenting and pioneering by amateurs. The Commission has been particularly blind to this regulation during the last twenty years, with virtually every proposal put forth being directly in conflict with it.

4. Now, in the matter of Docket 20777 and the request for amateur opinions on what should be permitted in the way of ASCII emissions, if the Commission is not to be in contempt of its own regulations, it should seriously consider unfettering amateurs from ar-

tificial and unneeded restraints. Amateurs should not have to beg and plead for permission to experiment with ASCII. They should, as a matter of course, be permitted to use any and every type of emission or transmission format. Unfortunately, the fact is that not only have amateurs been prohibited from experimenting by the formal rules, but they have also not even been able to get exceptions to these rules in the form of Special Temporary Authority (STA) to conduct these experiments. This is not just shameful—it invites legal action by amateurs. If amateurs had any real guiding body, they would have long ago taken the FCC to court for dereliction of its duty to amateurs and to the country, as well as for violation of its own regulations.

5. In Docket 20777, the Commission asks for comments on allowable bandwidth for the various amateur bands, on data transmission rates, on standards for baud rates, emission types, deviation, parity bits, and so on. The Commission managed to prevent radio amateurs from making any serious contributions to radio Teletype™ designs and concepts by establishing severe restrictions on techniques, allowing amateurs virtually no latitude to use their imaginations and experiment with new ideas. In fact, the Commission prohibited radio amateurs from using FSK techniques on the major amateur bands for a period of many years. I was one of those who fought the Commission to get FSK permitted on the amateur bands, and the fight went on over a period of many years.

6. It appears that the Commission is full of talk and promises for deregulation, but at every step of the way is afraid to let loose the apron strings and permit amateurs to have the latitude they need to experiment and pioneer some truly new communications techniques. The halting and restrictive approach in this docket is a perfect example of this reluctance.

7. The Commission is not unaware that radio amateurs, despite the virtually criminal restrictions put on them by the Commission, have still come

up with many of the communications techniques which are in use today. Most shortwave telephone transmissions are today using single sideband, a technique made possible by a radio amateur and developed on the amateur bands. Most VHF voice communications are today using narrowband frequency modulation (NBFM), a technique pioneered by an amateur (W2GDG) on an amateur band (20m). I happen to be one of the original experimenters with this technique, some 30 years ago. I also was one of the early users of SSB some 20 years ago. Since then, we have had amateurs pioneering slow scan television (SSTV), inventing the parametric amplifier (W1FZJ), etc. That these inventions and pioneering efforts were carried out despite the severe restrictions by the Commission is a further testament to the amateur spirit. Imagine what might have come from this group of pioneers if they had not been restricted and discouraged by the Commission at every turn!

8. Has the overzealousness of the Commission been necessary? I think not. In case after case, amateurs, when permitted to govern themselves, have done it far better than the Commission has been able to. Rule changes via the Commission take years to be made, moving through the corridors with glacial speed. By the time most of them eventually emerge, so changed in concept as to be an embarrassment to the sincere amateurs who promulgated them, they have been unneeded and a blight. If amateurs are going to be regulated, they need a fast service, one which can keep up with the rapidly changing technology. The FCC has proven itself unable to provide such a service and should stop trying. This was the concept of deregulation.

9. May I remind the Commission that the concept of deregulation of the amateur rules came about as a result of a hearing held before the full Commission in January, 1974. I organized and led the discussion of this hearing, at which evidence was put forth which showed that amateurs, when left alone, are well able to establish their own rules and abide by them. We do not in any way need the Commission or any of the "services" it is furnishing. In fact, amateurs

would do far better if permitted to be wholly self-sustaining.

10. Amateur radio has long been recognized by the Commission as being the best self-policed service under the FCC's jurisdiction. In today's climate of hooliganism and increasing crime, amid a growing disrespect of government and authority, amateur radio has held up very well. Sure, there have been isolated cases of bad amateurs, but these have been relatively few and far between. Only the belief of many amateurs that the FCC will take care of these problems for them has held them back from tackling these isolated cases and trying to deal with them without government help.

11. As a case in point, when amateur repeaters first started spreading over the country, the frequencies used were without plan. This led to so-called "repeater wars" where one group would try to force another off a disputed frequency. These lasted only a short time, and eventually the groups got together and formed repeater councils. These councils established frequency allocations for the repeaters and a national standard emerged to which about 98% of the repeaters today adhere. It was just at this time in history that the FCC's foolish repeater regulations were finally put into effect. These rules screwed things up for a couple of years, benefitting no one and causing a lot of wasted time and money for amateurs and for the Commission. The Commission suffered an unforgettable black eye over these rules and their dictatorial application by Prose Walker.

12. Going back in history a bit further, we have another similar example of amateurs self-governing their growth. When SSB was first being pioneered, there were reactions from the AM users. SSB stations set up a workable agreement whereby they would use the relatively unused high end of 20m for their experimental work and thus cause AM stations a minimum of interference. Eventually SSB grew until it worked its way down to the low end of the phone band. There were skirmishes, but the overall effect was a relatively peaceful transition from AM to SSB.

13. Now, to get back to a brief discussion of band-

HAM OF THE YEAR AWARD

Nominations for the award are due in to *73 Magazine* by November 15, 1978, and are to be 500 words or less, giving the details of the reason for the nomination. See editorial in the September 73 for details.

widths. Who is the FCC to say that bandwidth is everything? If amateurs wish to experiment on a ham band with wideband transmissions, why should they not? Bandwidth is a matter of sending a certain amount of intelligence per unit time. If amateurs want to try sending messages in a few microseconds instead of minutes and this requires a wide bandwidth, what is wrong with that? This type of experimentation could lead to time-sharing of bands instead of frequency sharing. The end result could be the same.

14. As a case in point, the Commission should be familiar with double sideband suppressed carrier (DSSB) emissions. With these the bandwidth is the same as an AM transmission, yet when it comes to frequency conservation, it is far more conservative than SSB, even though SSB requires only half of the bandwidth. The reason for this is in the detection system. SSB requires relatively little interference within the band of frequencies being used for good reception. With DSSB and a synchronous receiving detector, it is possible to have many stations using very slightly different frequencies and still have a minimum of interference between the stations. DSSB has the possibility of having perhaps ten times as many stations sharing the same band as there would be with SSB. With synchronous detection, only signals appearing on both sidebands simultaneously pass through the detector. At the time of the discovery of this system (by an amateur), it was not very practical due to the complexity of the detector. Today, with integrated circuits, such a system would be simple and inexpensive. Without amateurs to develop it and pioneer it, there is some question as to whether it will ever be popular.

15. As more and more microcomputers and microprocessors are brought into use for communications, we will see the need for higher and higher data transmission rates. Amateurs should be permitted to experiment with short-burst wideband systems. Any of these systems will be self-regulating. If amateurs cause too much difficulty to other amateurs, and the reasons for the trouble do not seem reasonable, amateurs use peer pressure to curtail offending transmissions.

16. In my position as the editor and publisher of an amateur magazine, I have gotten to know most of the pioneers and experimenters personally. I have found them

almost without exception to be sincerely interested in providing something of value to amateur radio and our country. I have not found them to be arrogant about it or overbearing. In general, they go out of their way not to cause trouble. When frequencies were selected for radio Teletype transmissions, they were chosen to be of the least interference to any other services. Repeater groups have historically gone out of their way to protect small groups of experimenters using their bands. In amateur radio it is not the majority which carries the day, it is generally the minority which is zealously protected . . . and with the support of the majority.

17. It is a fact that only a small percentage of the radio amateurs can be considered to be experimenters and pioneers. This is no reason to put the others down. We all can't be pioneers. We have to have followers to use the systems which have been invented and pioneered by others. A few dozen pioneers got amateur repeaters started. Now we have approximately 75,000 amateurs using these systems. This has resulted in a pressure for further experimenting and inventing. Some of the repeaters today are almost incredible in their sophistication. This has only been made possible by the large number of users and the financing and interest they provided.

18. It is time for the Commission to stop putting down amateur radio and to truly start serious deregulation. I believe that the history of radio amateurs shows that they are capable of acting intelligently and in the best interests of everyone, particularly including the minority interests which include experimenting and the pioneering of new techniques.

19. The Commission could turn over the bulk of the license examinations to amateur radio clubs, thereby saving the Commission a great deal of time and expense. The Commission could encourage amateur groups to step up their self-polishing efforts, thereby saving the Commission much expense in monitoring.

20. True deregulation of the amateur bands would allow amateurs to set up their own subbands and modes of emission. I believe the amateurs are capable of coping with the responsibilities involved. This was certainly demonstrated by the evolution of repeater groups, councils, and regional council meetings.

21. If freedom ever actually comes to amateur radio, I

believe we will see an interest in experimenting and pioneering that is far beyond anything we've ever seen before and that the results will be beneficial to our country and the world. I believe that we might see some systems of communications which are far beyond anything even envisioned today. Such developments can *only* come from amateurs.

22. Commercial equipment manufacturers and government laboratories are unable to come up with truly creative improvements in communications because they are governed by practical monetary restraints. It is an unfortunate fact of scientific life that it is virtually impossible to get funds for the development of an idea that might not work. It has to be a proven idea before funding is possible. Amateurs work under no such constraint, which is why virtually every major breakthrough in history has been made by an amateur. This holds for all fields of science. Only an amateur can afford to spend years trying to get some fool idea to work . . . and have it fail. We need amateurs, but we need to have them able to work and try out ideas without it taking the FCC ten years to come up with permission for even the first experimenting.

23. Should the Commission again decide to limit amateur experimentation, it is entirely possible that the invention of a way for hundreds of stations to exchange computerized information (data) within a relatively small bandwidth could be prevented. Let's suppose that amateurs developed time-sharing double sideband techniques which permitted stations to operate within a few cycles of each other, even though each was very wide. The net result would be the ability of commercial and military stations to greatly increase their effective rate of information exchange.

24. Amateurs, by virtue of their numbers, also have an edge on government and commercial laboratories. Thousands of amateurs can work on problems which could only be funded for a handful of paid researchers. And, through this self-interest, thousands of amateurs would be developing knowledge and skills which would accrue to the benefit of our country. Would we have anywhere near the scientific population we have at present if it were not for amateur radio and the ability of this "hobby" to interest people in learning and developing skills?

25. The nearly 400,000 licensed radio amateurs in this country have an impact all out

of proportion to their numbers. You will find amateurs in many of the top spots in the electronics and communications industry. They are there by virtue of their intense personal interest in electronics and communications. By unfettering amateurs from useless and archaic rules, we will encourage more amateurs to become interested in experimenting—and this will reflect itself in an even more valuable industry.

26. The Commission must be aware of the serious threat posed by the intensive construction of civil defense installations within the Soviet Union. They are also aware of the almost total lack of any similar preparation by the United States for nuclear war. Should such an event occur, it is very likely that much of the communications responsibility for this country would fall upon radio amateurs. In this case, the more sophisticated our systems, the better we will be able to meet the emergency. If we have to depend upon CW rigs and a few mobile transceivers, we will not be able to help very much. If we have high capacity data channels we can set up and run on a moment's notice, we will possibly be able to help hold things together. A decision by the Commission at this time to continue the present and past restrictions on amateur development could in this case be catastrophic for the country.

27. While it appears much too late to do anything constructive toward gaining the confidence of the African nations which have been devastating the ITU during the last few years, despite the fact that amateur radio could be of enormous benefit to these countries if they only knew about it, the possibility that our amateur bands may be severely restricted at the WARC conference next year further puts pressures on the Commission to allow amateurs to quickly develop systems which will permit communications even with a small fraction of our present bands. If the ham bands are cut to 50 kHz width or even to 20 kHz width next year, it will be too late by then for amateurs to start doing the experimenting they should be doing right now. This is assuming that the amateur bands are not deleted entirely, which seems quite possible, unfortunately.

28. Should amateurs lose their shortwave bands at the ITU next year, the need for advanced repeater and satellite communications will increase considerably. This will bring about the need for intensive development of better com-

munications systems for longer ranges than are usual on the VHF bands. This could intensify the need for high speed data channels, which could be developed by amateurs if they were not prohibited by the FCC.

29. Should amateurs lose their VHF bands at the ITU meeting next year, they would then need ways to accommodate perhaps 75,000 more amateurs on the already crowded shortwave amateur bands. Will we have to wait until then to even start trying to develop the communications systems we might be needing? Will amateurs again have to wait for years for the Commission to relax its prohibitions on experimenting before systems can be developed to cope with the changes?

30. The FCC should immediately start a serious program of actual deregulation of amateur radio. This could be done by dropping all emission restrictions within the amateur bands. While I don't doubt that the result would be chaotic for a short while, the need for a set of self-imposed rules would quickly bring things back into order. Time may be running out for this long-needed change.

31. The development of the microprocessor has made inevitable the continued development of electronics and its use in ever more areas of our lives. We are now seeing the beginnings of electronic transfer of funds (ETF), electronic mail systems (EMS), computer-to-computer exchange of data, computerized education (CAI), home computers, computerized designing of machinery and systems, etc. This means that our country (and the world) will be depending even more on a continued supply of people with an interest in electronics. Amateur radio has been the major supplier of this type of person—indeed, no other source of personally interested and dedicated people has been discovered—so without an increasing number of personally involved people we could lack the talent needed to develop and run the systems which seem inevitable. This is a further reason for the Commission to make every effort to unfetter amateur radio from restrictive and paralyzing rules, rules which are in direct opposition to the mandate provided by rule 97.1c.

32. One can only surmise how much the progress of electronics has already been stifled by the past repression of amateur radio. In the period from the end of World War II (1946) until 1963, when the FCC, under heavy pressure from the ARRL, proposed what

was amusingly called "Incentive Licensing" (which proved to be exactly the opposite), the growth of amateur radio was a yearly 11%. For a period of 11 years after Incentive Licensing was proposed, amateur growth stopped dramatically. Had that growth not been stopped, we would today have well over one million radio amateurs, roughly three times as many as we have at present. How much has our country lost in new developments which these people would have brought us? How far behind is our industry today as a result of this setback in the supply of top talent for our electronics and communications industries?

33. One of the lessons of World War II which seems to be in danger of being forgotten was the enormous value of the body of radio amateurs. That war was the first of the electronic wars, with heavy dependence upon radar, data computers, sonar, electronics countermeasures, and instant communications. Having served aboard one of our submarines during that war, I am personally familiar with the role of electronics and communications and its effect upon the enemy. When I went to electronics school in the Navy, I found that virtually every instructor was a radio amateur. I found, also, that of 50,000 licensed amateurs, 80% (40,000) joined the armed services. Had I not been a radio amateur, I would not have had the interest to volunteer for service and thus operate and service all of the electronic equipment on a submarine. While we all hope that such an event will never come again, history tells us rather clearly that we must be prepared. This means we must have a strong body of radio amateurs. This means, in turn, a responsibility on the part of the Commission to do all in its power to assure the strength and potency of this body of individuals. The more amateurs are encouraged to experiment and pioneer in electronics and communications, the more value amateurs will have as a body. You cannot turn off the power to invent through restrictive rules and a refusal to grant special temporary authority for experimenting and then expect a quick recovery from these repressive measures.

34. Even though every lesson of psychology and animal training teaches us that both animals and humans respond better to encouragement and rewards, there is a strong tendency to approach every problem caused by people with a punishment reflex. The Commission, goaded on by the

THE 73 MAGAZINE 10 METER AWARDS

The return of vigorous solar activity means that 10 meters is once again a band to be reckoned with. Ol' Sol's 11-year cycle of sunspot production is about to hit a peak, with the result that QRP 10 meter DX is possible.

Now's the perfect time to convert that old CB rig to 10 (or buy a brand new one from Bristol or Standard) and join the fun. We've had many articles showing you just how easy a CB-to-10 conversion really is. To give you an added incentive, 73 is offering two nifty Certificates of Achievement for 10 meter channelized communications.

For domestic types, there is the 10-40 Award. This one should be pretty easy—just work 40 of the 50 states. The DX Decade Award goes to DXers who work 10 or more foreign countries with a channelized 10 meter rig. We have endorsement stickers, too—the whole bit.

To give everyone an equal shot at award #1, only contacts made October 1, 1978, or after will be valid.

Well, don't just sit there. Get out your soldering iron, order some crystals, and put that CB rig on 10. This is going to be fun, so don't miss out!

RULES

1) All contacts must be made in the 10 meter amateur band using channelized AM equipment. Both converted Citizens Band equipment and commercially-produced units (such as those available from Bristol Electronics and Standard Communications) may be used.

2) To be eligible for award credit, all contacts must be made October 1, 1978, or after.

3) The 10-40 Award is available to applicants showing proof of contact with stations in at least 40 of the 50 United States. A special endorsement sticker will be available to those working all 50 states.

4) The DX Decade Award is available to applicants showing proof of contact with at least 10 foreign countries. Endorsement stickers will be awarded for 25, 50, 75, and 100 countries.

5) A log of stations worked, with the date, time, and type of equipment used for each contact, must be submitted when applying for each award or endorsement.

6) Each application for an award or endorsement must be accompanied by a signed statement that all claimed contacts are valid. No QSL cards need be sent, but they must be in the possession of the applicant.

7) To cover costs, a fee of \$5.00 must accompany each application for the 10-40 or DX Decade Award. The fee for endorsement stickers will be \$2.00 each.

8) All award applications should be mailed to: Chuck Stuart N5KC, 5115 Menefee Drive, Dallas TX 75227.

ARRL, has been responding to growth problems of amateur radio in this way and it has not worked. No amount of punishment was able to force amateurs to take the Extra Class license exam, as witness the utter failure of Incentive Licensing. But as soon as the Commission provided rewards, there was an immediate change. In my response to the Incentive Licensing docket, I proposed the institution of special call signs as a reward for achieving the Extra Class license. The Commission chose instead to follow the ARRL path of taking frequencies away from General Class licensees in order to force them to get a higher class license. They did not do this. When the special calls were finally authorized, years later, amateurs responded to this reward. Although it may go against the bureaucratic grain to even consider the solution to amateur problems in terms

of providing rewards instead of punishments, the Commission will get far faster and better results in solving problems by this type of reasoning.

35. Much of the hesitancy of the Commission to authorize unusual communications techniques for amateur use was tied to a firm belief that FCC field monitoring stations should be able to spy on every amateur transmission. This meant that amateurs could not use any equipment or techniques not already in common use by the FCC. This, obviously, meant that amateurs were prohibited from experimenting with novel communications techniques. Should any remnants of this type of bureaucratic thinking still be in effect within the Commission, I put forth the same argument I did when I challenged the need for severe log keeping by amateurs: Has there been any serious historic need for this type of total monitoring of

amateur transmissions? I think not. The fact is that no matter what type of emission amateurs try out, there will be other amateurs able to monitor them—and the self-policing nature of amateur radio will prevail. In the early days of slow scan television, we had a few amateurs (not in the U.S.) who took advantage and transmitted pictures of an objectionable nature. It took very little time before this was squelched.

36. Since most of us pride ourselves on the freedoms we have in the United States, I feel it is important for every citizen to rise up in anger at restrictions and at repression. I feel that bad laws should be fought with every means at our disposal. The constitution of the State of New Hampshire reinforces this concept, blinding its citizens to take up arms against any laws deemed unreasonable. The FCC regulations hamstringing (pardon) amateur radio are certainly repressive and restrictive. They should be quickly abolished. If the Commission is afraid to trust amateurs with the amateur bands, then at least let us try a test of freedom within one of our bands and see if it is not possible for amateurs to determine their own agreements. Perhaps we could, as a test, remove all emission restraints on one ham band... perhaps 15m. I believe that the responsibility for the orderly use of our bands will bring amateurs together as they never have been before, and bring about a much more fraternal bond. I can see the developing, should our frequency bands survive WARC, of national conventions or conferences where new emissions and uses for our bands are discussed and evaluated. This would not be on the glacial scale of FCC rules, but an immediate and direct response to changing technologies.

DETROIT BOMBS AGAIN

It's been over 20 years since I've been really involved with an American car. In 1957, I bought my first Porsche and that car stayed with me for over 200,000 miles and 15 years. I doubt if I'll ever find a car as remarkable as that one.

Since sports cars can't be used for everything, I've used many other cars down through the years—a couple VW vans, a couple VW bugs, a couple VW hatchbacks, a Volvo station wagon, a Mercedes 300 sedan, a Rover 2000TC sedan, etc. The Mercedes was by far the most luxurious of the cars, but the Rover was the best driving by a wide margin. I once made the 250-mile trip from New York City to Peterborough in 2½

hours in the Rover... and that includes a gas stop. Fantastic car and incredibly safe to drive.

In the sports car division, when I finally sold my Porsche Speedster in 1972, I found that Porsches had priced themselves out of my market. Then I saw the Datsun 240Z. On first look I knew I had to have one of those. It was not a Porsche in handling by any means, but it was fun, and, with proper radar detection and CB alerting, it could get me to appointments even when I started late. This was updated with the 280Z 2+2, which handled a lot better than the 240. Datsun had learned something.

The recent flood of advertising and enthusiastic reviews for the Mazda RX7 caught me up. We've been using a Mazda truck which has defied even the most determined efforts by employees to destroy it, so I knew Mazda was something more than a G.E. lamp... if your memory goes back that far. The RX7, I'm delighted to report, is fantastic. You really need a radar detector with it because when you think you are driving 40 mph, you look at the speedometer and find it around 80. The car is comfortable and quiet at 100 mph and is so steady you can take your hands off the wheel until the passenger is chewing the upholstery.

All this brings me to the 73 traveling office, a Dodge van we bought last year to make it possible for me to keep on working while being driven to give talks to clubs, to go to hamfests, to see advertisers, etc. Peterborough may be a wonderful place to live and work, but it is an hour and a half away from Boston and two hours or more from everything else. This means that a trip wastes three to five hours of my time, time needed to answer mail, write newsletters, edit articles, etc.

Since there isn't enough room in a car to do much work, the obvious answer was a van. We shopped around and finally decided on a Dodge. This turned out to be one of my more glaring errors of judgment. We put \$200 down at a nearby Dodge dealer and awaited the promised delivery. When the dealer had exhausted all sources east of the Mississippi, we came across exactly what we had been looking for about two miles further down the road... with the only exception being that this van had already been converted into just what we needed.

The Dodge dealer admitted that he had known about the Dodge down the road, but that guy wasn't an authorized Dodge dealer. We bought the

converted van and asked for our \$200 back. It's now over a year later and we still haven't gotten back the \$200 deposit. The dealer, if anyone is interested, is Hackler Motors in Milford, N.H.

A few days after getting the van, I popped into it and drove to downtown Peterborough... and it stopped dead in the middle of town. It wouldn't start. It turned out to be a choke problem which required the removal of the engine cover inside the van and the manual manipulation of the carburetor. Three visits to the local Dodge garage and dozens of stalls with removals of the engine cover and much hassle brought no relief.

In desperation, we had a manual choke installed. This works, but it takes a trained expert to keep the damned engine going. It dies constantly and Dodge is unable to do anything about it. No wonder Chrysler is in deep trouble. How dare they put out a car with an engine which is so poorly designed that even their own garages can't get it to work?

Unfortunately, that wasn't the only problem with the van. We mounted an IBM typewriter on the table and I tried for several months to work while we drove. The idea was good, but the bucking and swaying of the van made it almost impossible to hit the right typewriter key or to read while in motion. I don't get upset from reading while my letters are bouncing up and down, but I sure get tired and it is difficult to keep my mind on what I am reading. Oh, we tried special shocks, anti-sway bars, and everything else we could find. The hulk still bounced high with every slight wave of the pavement. Even the seemingly smooth interstate highways are like roller coaster rides in the van.

Driving the van is much like maneuvering an ocean liner. It sways and lumbers around, with virtually no visibility aft. Few car drivers appreciate how little a van driver can see. It is foolhardy to come up on a van on its right or to follow very close... the driver just won't know you are there. You want some real fun... park a van... particularly one of the extended Dodge models. You don't get good at this without a lot of practice. It is an art form. Perhaps this explains the wrinkled look on the back end of many vans.

Vans have a lot of good uses, undoubtedly, but I really can't enthusiastically recommend them for mobile offices. At least, I sure can't recommend a Dodge... for anything.

HOME SECURITY OPPORTUNITY

A recent announcement that Tandy (Radio Shack) will be opening a pilot store in Ft. Worth selling security equipment brought to mind the several editorials I have run down through the years urging radio amateurs interested in starting their own businesses to give this line some serious consideration.

The security business is a natural for the ham, since it requires a knowledge of electronics and some experience in putting things together and getting them to work. It is a business which can be started very small and with very little initial investment. It's a business where every home, every car, and every business in your neighborhood or town is a prime prospect for a sale.

Security can cover the whole gamut from a simple door alarm on a house to a sophisticated system which will detect heat, smoke, dampness, intruders, etc. It can tie in with microcomputers, slow scan television, and all those nice toys hams have been playing with for the last couple of years. What store owner wouldn't like to have a system whereby he could see what is going on in his store right from his home living room? With slow scan television and a dedicated phone line, the cost is remarkably low, even after your generous commission. You can even add a motion detector to call him to the monitor, should he get wrapped up in a ball game.

While I'd rather see the security business bring in money to thousands of entrepreneurs with their own shops, the Tandy pilot store, should it work out the way they hope, will bring home security stores into every locality in the country... and the end result will be a plus for everyone but the crooks.

THE ENTREPRENEUR PHILOSOPHY

There are three basic ways to go in our country... working for yourself, working for someone else, or working for the government. Two of those virtually preclude making any substantial money... the third at least has possibilities, if no assurances.

Working in any government position is a sure loser for life, even at the few top jobs. Even if you do figure out how to get the gravy you can be found out, as a recent vice president discovered. It would require a fairly large book to evaluate the various opportunities and roads to success, but a reasonable blanket statement

can be made that few people make very much working for others.

I can't give you a six-week course in how to achieve success within the confines of an editorial in 73, but even a casual consideration of the matter should make it clear that the best chances for personal success lie in the entrepreneurial direction. I can't

help thinking of the two 19-year-old kids out in California who went into business instead of going to college and are today worth about \$10 million. They've been in business now for over two years, so perhaps you might not consider their growth meteoric.

Of course I'm talking about Steves Wozniak and Jobs, who,

because they didn't have enough money to buy a computer kit two years ago, designed their own. Today the firm is known as Apple Computers.

Both computers and security are guaranteed growth industries, so the chances of losing with either of these is a lot lower than it is with other pursuits. Both are still in their in-

fancy and have incredible possibilities.

JUNE WINNER

Our readers have voted "The S-Meter Bender" as the most popular article in our June issue, so author Jerrold Swank W8HXR will be receiving a bonus \$100 check from us at his Washington Court House OH QTH.

Ham Help

I need help with the alignment instructions for a Hallicrafters S-22R. If anyone has a service manual, I would appreciate the use of it just long enough to make a copy. I will gladly pay postage for certified mail, both ways, plus any reasonable fee. This was my late brother's first receiver, and I would like to use it for QSOs once again.

Neil D. Reznik WB3KIL
532 Portland Drive
Broomall PA 19008

I'm looking for the maintenance manuals and

schematics for the National HRO-500 receiver. These receivers have been used in MARS programs over the years. I am willing to pay for duplication costs, if not too exorbitant.

Anton M. Giroux
DA1NF/WD6AXL
HHT, 2d ACR, SigO
APO NY 09093

I have a National SW-3 regenerative receiver and would greatly appreciate it if anyone could send me coil data on this set or would sell me the coils or coil forms. I also could use a bottom panel,

if anyone has one wasting away in the junk box.

Kurt Denke WB7WRR
3253 20th Avenue West
Seattle WA 98199

Help! Does anyone have experience in eliminating noise from VW Rabbits or Sciroccos? The voltage regulator is built into the alternator in these cars, and I still have excessive noise on my 15 and 10 meter rigs.

Kenneth M. Price XE1TIS
PO Box 337
Irapuato
Mexico

The International Association of Airline Hams is attempting to locate hams working for all the world's airlines so that

they may be given the opportunity to join our club. They should contact me for more information.

Carl H. Crumley N4VD
Secretary, IAAH
512 N. Harrison Ave.
Cary NC 27511

I would like someone to design and possibly build an autopatch-like telephone interconnection device. I would pay a fair fee. Write for specifics.

Gabe Gargiulo WA1GFI
160 Elm St.
North Haven CT 06473

I need the schematic for a Hallicrafters S-129.

Felix Mullings W5BVF
021-16th St.
Galveston TX 77550

OSCAR Orbits

FINDING OSCAR

The listed data tells you the time and place that OSCAR 7 and OSCAR 8 cross the equator in an ascending orbit for the first time each day. To calculate successive OSCAR 7 orbits, make a list of the first orbit number and the next twelve orbits for that day. List the time of the first orbit. Each successive orbit is 115 minutes later (two hours less five minutes). The chart gives the longitude of the day's first ascending (northbound) equatorial crossing. Add 29° for each succeeding orbit. When OSCAR is ascending on the other side of the world from you, it will descend over you. To find the equatorial descending longitude, subtract 166° from the ascending longitude. To find the time OSCAR 7 passes the North Pole, add 29 minutes to the time it passes the equator. You should be able to hear OSCAR 7 when it is within 45 degrees of you. The easiest way to determine if OSCAR is above the horizon (and thus within range) at your location is to take a globe and draw a circle with a radius of 2450 miles (4000 kilometers) from your QTH. If OSCAR passes above that circle, you should be able to hear it. If it passes right overhead, you should hear it for about 24 minutes total. OSCAR 7 will pass an imaginary line drawn from San Francisco to Norfolk about 12 minutes after passing the equator. Add about a minute for each 200 miles that you live north of this line. If OSCAR passes 15° east or west of you, add another minute; at 30°, three minutes; at 45°, ten minutes. Mode A: 145.85-.95 MHz uplink, 29.4-29.5 MHz downlink, beacon at 29.502 MHz. Mode B: 432.125-.175 MHz uplink, 145.975-.925 MHz downlink, beacon at 145.972 MHz.

OSCAR 8 calculations are similar to those for OSCAR 7, with some important exceptions. Instead of making 13 orbits each day, OSCAR 8 makes 14 orbits during each 24-hour period. The orbital period of OSCAR 8 is therefore somewhat shorter: 103 minutes.

To calculate successive OSCAR 8 orbits, make a list of the first orbit number (from the OSCAR 8 chart) and the next thirteen orbits for that day. List the time of the first orbit. Each successive orbit is then 103 minutes later. Due to incorrect tracking information obtained during the early days of OSCAR 8, the equator crossing times given in most published charts are in error. To correct this error, multiply the orbit number by 0.00205 minutes and add the result to the equator crossing time as printed in the chart. For

example, the published time for orbit number 3352, the first equatorial crossing on November 1, 1978, is 0018:50 UTC. Thus, for orbit number 3352, the corrected equatorial crossing time would be:

$$\begin{aligned} \text{Corrected time} &= 0018:50 + (3352 \times 0.00205 \text{ minutes}) \\ &= 0018:50 + (6.8716 \text{ minutes}) \\ &= 0025:42.3 \end{aligned}$$

The longitude figures contained in the OSCAR 8 chart are virtually unaffected by this tracking error. The chart gives the longitude of the day's first ascending equatorial crossing. Add 26° for each succeeding orbit. To find the time OSCAR 8 passes the North Pole, add 26 minutes to the time it crosses the equator. OSCAR 8 will cross the imaginary San Francisco-to-Norfolk line about 11 minutes after crossing the equator. Mode A: 145.85-.95 MHz uplink, 29.4-29.5 MHz downlink, beacon at 29.40 MHz. Mode J: 145.90-146.00 MHz uplink, 435.20-435.10 MHz downlink, beacon at 435.090 MHz.

Oscar 7 Orbital Information				Oscar 8 Orbital Information			
Orbit	Date (Oct)	Time (GMT)	Longitude of Eq. Crossing °W	Orbit	Date (Oct)	Time (GMT)	Longitude of Eq. Crossing °W
17731	8bn	1 0031:05	67.2	2920	Jbn	1 0104:13	57.0
17744	8bn	2 0125:22	80.8	2934	Abn	2 0109:25	58.3
17756	Abn	3 0024:43	65.6	2948	Abn	3 0114:37	59.6
17769	8bn	4 0119:00	79.2	2962	X	4 0119:49	60.9
17781	8bn	5 0018:21	64.1	2976	Abn	5 0125:01	62.2
17794	Abn	6 0112:38	77.7	2990	Abn	6 0130:13	63.6
17806	8bn	7 0011:59	62.5	3004	Jbn	7 0135:24	64.9
17819	8bn	8 0106:16	76.1	3018	Jbn	8 0140:36	66.2
17831	Abn	9 0005:37	61.0	3031	Abn	9 0002:35	41.7
17844	8bn	10 0059:54	74.5	3045	Abn	10 0007:46	43.0
17857	8bn	11 0154:11	88.1	3059	X	11 0012:58	44.3
17869	Abn	12 0053:32	73.0	3073	Abn	12 0018:10	45.6
17882	8bn	13 0147:49	86.6	3087	Abn	13 0023:22	46.9
17894	8bn	14 0047:10	71.4	3101	Jbn	14 0028:34	48.2
17907	Abn	15 0141:27	85.0	3115	Jbn	15 0033:45	49.6
17919	8bn	16 0040:47	69.9	3129	Abn	16 0038:57	50.9
17932	8bn	17 0135:05	83.5	3143	Abn	17 0044:09	52.2
17944	Abn	18 0034:25	68.3	3157	X	18 0049:21	53.5
17957	8bn	19 0128:43	81.9	3171	Abn	19 0054:32	54.8
17969	8bn	20 0028:03	66.7	3185	Abn	20 0059:44	56.1
17982	Abn	21 0122:20	80.3	3199	Jbn	21 0104:56	57.4
17994	8bn	22 0021:41	65.2	3213	Jbn	22 0110:08	58.7
18007	8bn	23 0115:58	78.8	3227	Abn	23 0115:19	60.1
18019	Abn	24 0015:19	63.6	3241	Abn	24 0120:31	61.4
18032	8bn	25 0109:36	77.2	3255	X	25 0125:43	62.7
18044	8bn	26 0008:57	62.1	3269	Abn	26 0130:54	64.0
18057	Abn	27 0103:14	75.7	3283	Abn	27 0136:06	65.3
18069	8bn	28 0002:35	60.5	3297	Jbn	28 0141:17	66.6
18082	8bn	29 0056:52	74.1	3310	Jbn	29 0003:15	42.1
18095	Abn	30 0151:09	87.7	3324	Abn	30 0008:27	43.4
18107	8bn	31 0050:30	72.5	3338	Abn	31 0013:38	44.7

Fall means . . . last minute antenna work

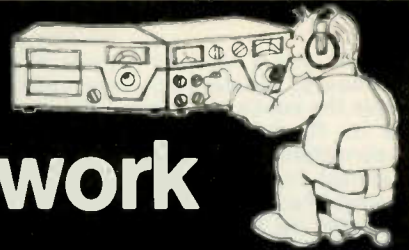

1-800-633-3410

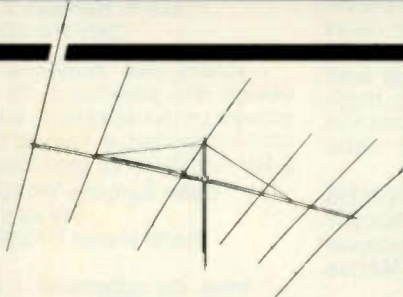

HY-GAIN TH6DXX The Ultimate tribander

Gain 8.7 dB • Front-to-back ratio 25 dB • SWR (at resonance) less than 1.5:1 • Number of elements 6 • Frequency 10, 15, and 20 meters • Longest element 31.1' • Boom length 24' • Wind load at 80 m.p.h., 207 lbs. • Surface area 8.09 sq. ft. Balun BN-86 recommended 15.95.

296.95 list. Call for quote.

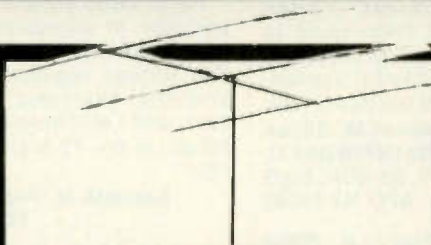

HY-GAIN TH3MK3 Super 3-element tribander

Gain 8dB • Front-to-back ratio 25 dB • SWR (at resonance) less than 1.5:1 • Frequency 10, 15, and 20 meters • Power rating: maximum legal limit • Longest element 27' • Boom length 14' • Wind load at 80 m.p.h., 131 lbs. • Surface area 5.10 sq. ft. Balun BN-86 recommended 15.95.

219.95 list. Call for quote.

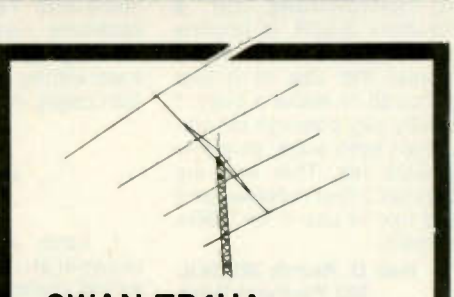

SWAN TB4HA 4 element tri-band beam

All four elements active on all three bands. The heavy duty TB4HA features: • Gain 9dB • Front-to-back 24-26 dB • Boom length 24' • Longest element 28 ft. 10 in. • Wind surface area 6 sq. ft. • 10-15-20 meters.

259.95 list. Call for quote.



HY-GAIN 18AVT/WB 80-10M vertical

Self-supporting 25 ft. omnidirectional antenna. Low angle radiation, automatic band switching. SWR 2:1 or less. Impedance 50 ohms. Max. legal power 10-40 meters. SO-239 connector.

97.00 Call for yours today.

MOSLEY RV-4C vertical antenna

The RV-4C self-supporting vertical features: • Power rating 2000 watts PEP SSB input • Feet Point Impedance: 52 ohms • VSWR at resonance 1.5/1 or better • Height 22' • Max. radial length 34.7" • Wind surface area 2.049 sq. ft. • Covers 10, 15, 20 & 40 meters.

63.35 Call for yours today.

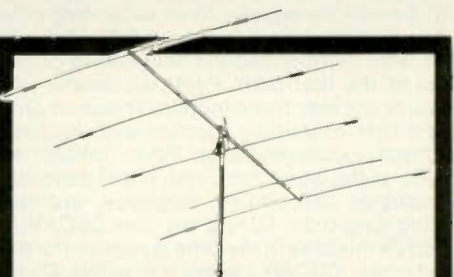

WILSON SYSTEM I 10, 15, 20 meter tribander

A DX'ers delight! A full 26' boom with 4 active elements on 20 meters. 4 operational elements on all 3 bands. Gain: 10 dB, F/B ratio: 20-25 dB. Surface area 8.6 sq. ft. Longest element 26.7". Balun BN50A optional 16.95.

274.95 list price. Call for quote.

Remember, you can Call Toll Free: **1-800-633-3410** in the U.S.A. or call **1-800-292-8668** in Alabama for our low price quote. Store hours: 9:00 AM til 5:30 PM, Monday thru Friday.



Long's Electronics



MAIL ORDERS: P.O. BOX 11347 BIRMINGHAM, AL 35202 • STREET ADDRESS: 2808 7TH AVENUE SOUTH BIRMINGHAM, ALABAMA 35233

Fall means . . . last minute tower work

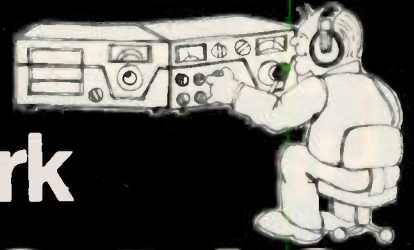

1-800-633-3410

ROHN 25G 50 foot tower

Comes complete with four 10 ft. sections, plus an 8 ft. 25AG-3 3 in. OD top section. All Rohn towers are "Hot Dip" galvanized to resist corrosion. Two oz. of molten zinc per sq. ft. of surface is fused to the steel, inside and out.

378.55 list. Call for quote.



ROHN tower accessories

SB25G 3 ft. 4 in. short base for concrete List 24.30
BPC25G concrete base plate List 40.55
SBH25G 3 ft. 4 in. hinged short base for concrete List 40.00
BPH25G hinged base plate for concrete List 59.50
HB25AG 0 to 15 in. house bracket List 19.05
HB25BG 15 to 24 in. house bracket List 23.80
HB25CG 24 to 36 in. house bracket List 28.55
AS25G accessory shelf. Will fit CDE-44, Ham II, Ham III & Tail Twister rotors List 11.90
25G 10 ft. tower section List 73.80



CDE Ham III antenna rotor

Snap action switched wedge brake & rotational controls brings accuracy to any directional beam. Features pre-brake and lock-in place action. Ideal for in-tower mounting.

159.95 list. Call for quote.

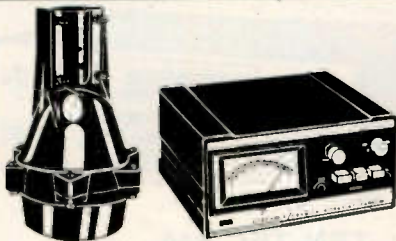

CDE tail twister T²X antenna rotor

Designed to handle antennas up to 28 sq. ft. Inside tower installation. The rotator features 138 ball bearings (3 races). Control box features: 110-120 VAC input. Line cord: 3 wire grounded. Control cable requires Belden 8448 up to 120 ft.

325.00 list. Call for quote.

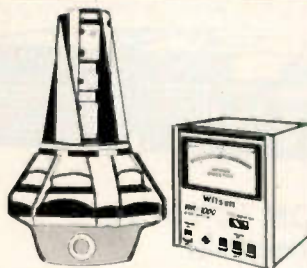

WILSON WR-1000 antenna rotor

Features: Antenna loads 40 sq. ft., controlled wedge brake, 116 Ball bearings will support 1 ton of balanced weight. Plate mounting only — 8 bolts.

514.95 list price. Call for quote.

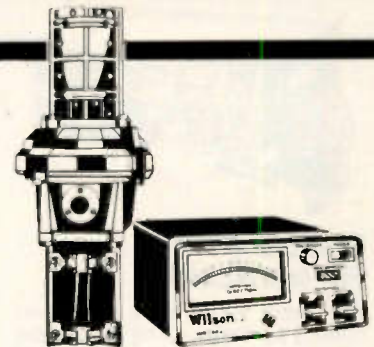

WILSON WR-5000 antenna rotor

Features: Antenna loads: 6 sq. ft., 10 sq. ft. with STB-50 Thrust bearing (optional), Disc Brake 98 Ball bearings will support 750 lbs. In line or tower mounting.

164.95 list price. Call for quote.

Remember, you can Call Toll Free: **1-800-633-3410** in the U.S.A. or call **1-800-292-8668** in Alabama for our low price quote. Store hours: 9:00 AM til 5:30 PM, Monday thru Friday.



Long's Electronics

L9



MAIL ORDERS: P.O. BOX 11347 BIRMINGHAM, AL 35202 • STREET ADDRESS: 2808 7TH AVENUE SOUTH BIRMINGHAM, ALABAMA 35233

Fall means . . . HF values from Longs

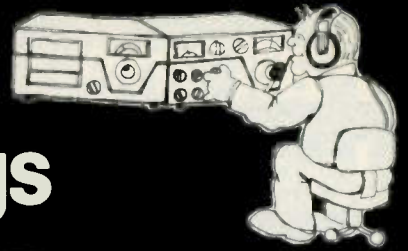

1-800-633-3410

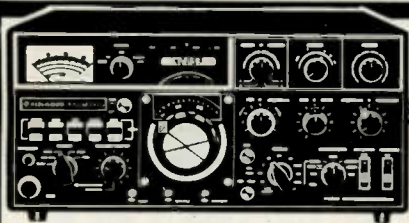

KENWOOD TS-820S transceiver

The TS-820S features a factory installed digital frequency readout.

- 160 thru 10 meter coverage
- Integral IF shift
- RF speech processor
- VOX
- Noise blanker
- PLL
- Built-in 25 KHz calibrator
- CW side tone & semi-break-in
- IF OUT, RTTY, & XVTR
- Phone patch IN and OUT terminals.

1098 list price. Call for quote.



KENWOOD TS-520S SSB transceiver

TS-520S features:

- 160 thru 10 meter coverage
- Optional DG-5 frequency display (on top of unit)
- New speech processor with audio compression amplifier
- Built-in AC power supply (DC-DC converter, optional)
- RF attenuator
- Provision for separate receive antenna & phone-patch.

739.00 list price. Call for quote.

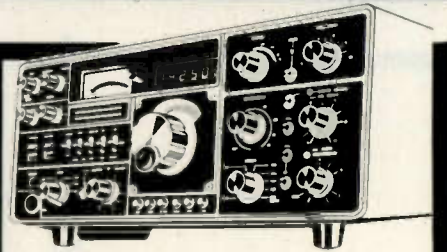

YAESU FT-901DM HF transceiver

Check these:

- Reject tuning
- Variable IF band width tuning
- Audio peak frequency tuning
- Digital LED frequency display w/memory for TX & RX, no external VFO required for split frequency operation
- Built-in Curtis keyer
- Rugged GE 6146B final tubes
- 160 thru 10 meter coverage & much more!

1459.00 list price. Call for quote.

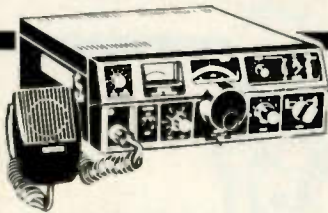

YAESU FT-7 HF transceiver

The NEW FT-7 features:

- Frequency coverage: 10 thru 80 meters
- Sensitivity: 0.5 micro volts for S/N 20 dB
- Emissions: LSB, USB, CW
- Input power: 20 watts DC
- Completely solid-state, single knob tune-up
- 100 KHz calibrator built-in
- Semi-break-in with sidetone
- Receiver offset tuning
- Extremely compact for installation under dashboard.

549.00 list price. Call for quote.

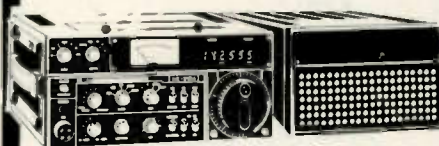

ICOM IC-701 HF transceiver

The NEW IC-701 features:

- Solid-state
- RF speech processor
- 100 W continuous on all bands, all modes
- USB, LSB, CW, CW-N, RTTY operation
- Double balanced Schottky Diode Mixer used in both RX/TX
- Dual built-in digital VFO
- Price includes mic & power supply.

1495.00 list price. Call for quote.

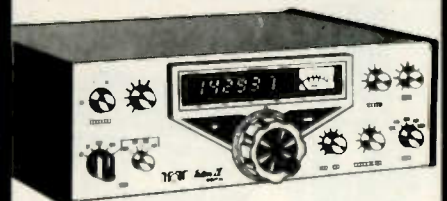

TEN-TEC 544 digital transceiver

- Solid-state
- Instant band change
- Covers 3.5 to 30 MHz
- 200W input on all bands
- RX sensitivity: p.3mV
- 8-pole crystal IF filter
- LED readout
- WWV at 20 & 15 MHz
- Separate receiving capability
- S-meter and SWR bridge. Offset receiver tuning.

869.00 list price. Call for quote.

Remember, you can Call Toll Free: **1-800-633-3410** in the U.S.A. or call **1-800-292-8668** in Alabama for our low price quote. Store hours: 9:00 AM til 5:30 PM, Monday thru Friday.



Long's Electronics



MAIL ORDERS: P.O. BOX 11347 BIRMINGHAM, AL 35202 • STREET ADDRESS: 2808 7TH AVENUE SOUTH BIRMINGHAM, ALABAMA 35233

Fall means . . .

Dentron values from Longs

1-800-633-3410



DENTRON MT-3000A antenna tuner

- 160 thru 10 meter coverage • Handles a full 3KW PEP • Continuous tuning 1.8-30 mc • Built-in dual watt meters • Built-in 50 ohm dummy load for proper exciter adjustment • Antenna selector switch enables you to by-pass the tuner direct or select the dummy load or 5 other antenna systems.

349.50 list price. Call for quote.



DENTRON MT-2000A antenna tuner

An economical, full power tuner, designed to handle virtually any type of antenna. Features: • Continuous tuning 1.8 to 30 MHz • Handles a full 3 KW PEP • Front panel coax bypass switching • Built-in 3-core balun • Front panel grounding switch • Sleek styling to match other Dentron units.

199.50 list price. Call for



DENTRON 160-10AT super tuner

Balanced line, coax cable, random, or long wire antennas, the 160-10AT will match it — 160 thru 10 meters • Continuous tuning, 1.8-30 mc • 3 inputs • Handles 500 watts DC, 1000 watts PEP • Heavy duty, 2-core Balun (3½" dia. x 3" H) • Tapped inductor #12 ga. wire.

129.50 list. Call for quote.

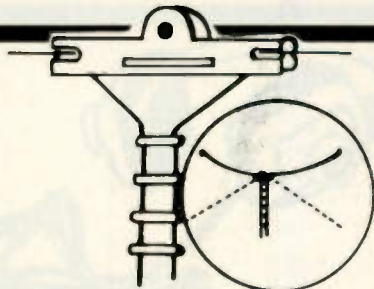

DENTRON All Band Doublet antenna

- Has a total length of 130 feet (14 ga. stranded copper) • Center fed through 100 ft. of 470 ohm PVC covered balanced transmission line • Assembly complete • Tune 10 thru 160 with one antenna • Requires antenna tuner).

24.50 Call for yours today.



DENTRON Big Dummy Load

Tune-up off the air with Dentron's Big Dummy Load. All full power dummy load, it has a flat SWR, full frequency coverage from 1.8 to 300 MHz. A high grade industrial cooling oil is furnished with the unit. Fully assembled and warranted. Help cut out the QRM factor NOW!

29.50 Call for yours today.



DENTRON MLA-2500B

The MLA-2500B has 2000 watts PEP input on SSB. Uses two Eimac 8875s. New high-low power switching for both 1KW & 2KW power levels, and 160-15 meters.

899.50 list price. Call for quote.

Remember, you can Call Toll Free: 1-800-633-3410 in the U.S.A. or call 1-800-292-8668 in Alabama for our low price quote. Store hours: 9:00 AM til 5:30 PM, Monday thru Friday.



Long's Electronics

L9



MAIL ORDERS: P.O. BOX 11347 BIRMINGHAM, AL 35202 • STREET ADDRESS: 2808 7TH AVENUE SOUTH BIRMINGHAM, ALABAMA 35233

Fall means . . . Good values in accessories

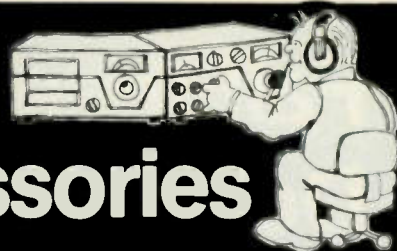

1-800-633-3410



SHURE 444 desk microphone

Economical station mic. Has PTT switch, adjustable head height, solid, high impact plastic construction. Frequency response: 300 to 3000 Hz. Omnidirectional polar pattern. Controlled magnetic mic element designed for SSB. High impedance: 50K ohms.

35.00 Call for yours today.



LUMITIME CC-24 24 hr. digital clock

The CC-24 is the perfect addition to any ham shack. Large 2 in. digital display makes telling time easy at a glance. The 24 hr. alarm with 8-10 min. snooze button can also be used as a station ID buzzer. 110 volts A/C operation.

29.95 Call for yours today.

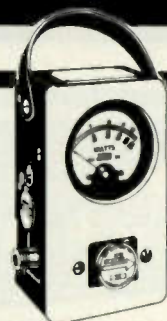

BIRD Model 43 Thruline wattmeter

50 ohms nominal impedance. VSWR insertion with UHF connectors: 1.05 max. • Accuracy: plus or minus 5% full scale. Shock mounted 30 microamp meter has scales of 25, 50 & 100 to permit to permit direct reading from 100 Mw to 10,000 watts.

125.00 Call for yours today.



TELEX CM-1320 headset

"Top of the line" with a boom microphone — ceramic, high impedance. The choice of DX-peditions. Model CM-1320S same as above but with single ear piece 57.25.

71.70 Call for yours today.



YAESU YH-55 headphone set

Comes equipped with a soft pad for long hours of listening with maximum comfort. Compatible with all Yaesu equipment. 8 ohms impedance.

15.00 Call for yours today.



KENWOOD HS-4 headphones

For extended periods of wear, the HS-4 is comfortably padded and completely adjustable. Frequency response is 300 to 3000 Hz, 8 ohms, just right for amateur radio use.

19.50 Call for yours today.

Remember, you can Call Toll Free: 1-800-633-3410 in the U.S.A. or call 1-800-292-8668 in Alabama for our low price quote. Store hours: 9:00 AM til 5:30 PM, Monday thru Friday.



Long's Electronics



MAIL ORDERS: P.O. BOX 11347 BIRMINGHAM, AL 35202 • STREET ADDRESS: 2808 7TH AVENUE SOUTH BIRMINGHAM, ALABAMA 35233

Fall means . . . Good values in accessories

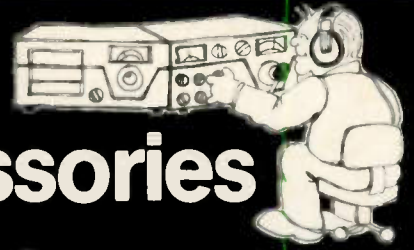

1-800-633-3410



NPC 104R regulated power supply

Converts 115 VAC to 13.6 VDC, 200 millivolts. Handles 4 amps continuous and 6 amps max. Solid-state. Excellent where DC stability is important such as small Ham or CB rigs, or 8 track car stereos. Use to trickle-charge 12V car batteries.

49.95 Call for yours today.

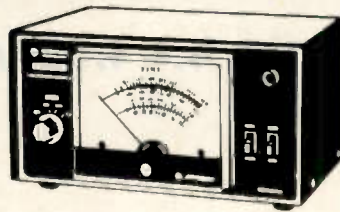

SWAN WM-3000 precision PEAK/RMS wattmeter

Read forward or reflected power with maximum accuracy from 3.5 to 30 MHz. RMS readings available with the flick of a switch. Four scales from 0 to 2000 watts. Requires 117 VAC power source.

87.95 Call for yours today.



MFJ 400 econo keyer

Speed 8 to 50 wpm pull-to-tune, adjustable sidetone and volume. Internal weight control lets you adjust dot-dash space ratio. Dot memory. May be used with squeeze key for iambic operation.

39.95 Call for yours today.

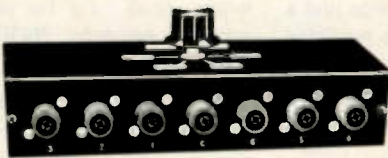

B & W 595 coax switch

The B & W 6-position coax switch features: Outputs 6, power rating: 2 KW PEP, VSWR less than 1.2:1 up to 150 MHz. Grounds all unused antennas. Perfect addition to any ham shack.

18.50 Call for yours today.

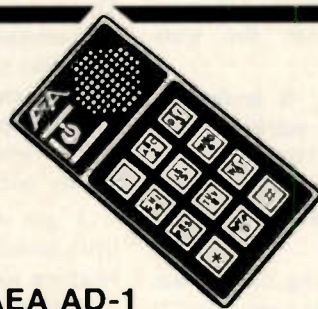

AEA AD-1 automatic dialer

You get 18 numbers from a 1-2 punch. Make quick and safe auto-patch calls. The AD-1 features: Key-Pad programmable memory, built-in speaker, MOS microprocessor. Crystal controlled & mates with virtually all FM transceivers.

129.95 Call for quote.

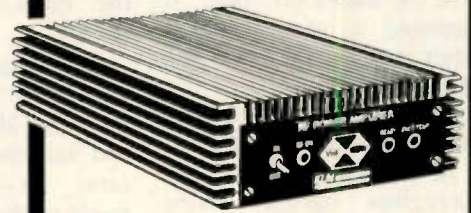

KLM PA15-160BL 2m mobile amplifier

- Frequency 144-148 MHz • Modes: FM & SSB selectable • Power output: Typical • 15 watts input = 160 watts output • Power requirements: 13.5 volts at 22 amps • VSWR protected • New heat sink design, full-length radiating fins on top and sides • Thermal protected.

289.95 Call for quote.

Remember, you can Call Toll Free: **1-800-633-3410** in the U.S.A. or call **1-800-292-8668** in Alabama for our low price quote. Store hours: 9:00 AM til 5:30 PM, Monday thru Friday.



Long's Electronics

L9



MAIL ORDERS: P.O. BOX 11347 BIRMINGHAM, AL 35202 • STREET ADDRESS: 2808 7TH AVENUE SOUTH BIRMINGHAM, ALABAMA 35233

The Long-Term Effects of Working with ICs

—learn the five warning signs

I am writing about a little known and understood illness that could affect almost any ham. The profile is drawn from the experiences of many amateurs.

The conversations were taped over a period of time and wherever possible their own words will be used.

Q. How did you get started with ICs?

A. I didn't at first. It happened so slowly that I didn't notice until it was too late.

Q. Can you tell me in your own words how it happened?

A. It began years ago. The magazines started talking about something called state of the art which had something to do with solid state.

There weren't any more articles about using the type 30 tube. There hadn't been in years. I was getting to feel more and more alienated.

It wasn't so bad when they just added a few more elements to the tubes. I could understand that. Even tried a few, but I don't like them as well as the 30. No class.

All of a sudden I found that I was far behind the field. Even the schematics were funny looking. Then, in the early sixties, it happened.

Q. What happened?

A. The nuvistor tube came out. It was a dinky little thing, only a thumbnail big, but it was a triode. I could dig it. After all that transistor stuff, I could work with something they said was state of the art.

First thing, of course, I hooked it up to a decent circuit, a regenerative receiver. That really separates the tubes from the transistors.

It worked. It broke my heart, but it worked better than the 30. Had more gain and sensitivity. They finally came up with a decent modern tube.

I guess losing the 30 was what really broke me loose. It shook the foundation of my electron theory. But at least I was riding the crest. I was state of the art.

Just as I was getting the hang of working with them and getting to understand the funny new symbols and the articles about them (it was less than a year), the field-effect transistor hit.

Man, what a wallop! The nuvistor went down like it had been shot. There were no more articles about them or projects using them. It had become an un-tube.

Now everything was FETs. This was a new kind of transistor. "The transistor that thinks it's a tube," it was called.

All transistors had delusions of grandeur then. You have to understand the time. Then, it was said that transistors never went bad. They either worked or they didn't. There was no talk then of base-emitter leakage or anything like that.

Well, anyway, it was just a slight jump from the nuvistor to the field-effect transistor. I hardly noticed it at the time.

I got to work building little circuits with the FETs. Nothing too fancy, just some oscillators and a few little amplifiers.

I hardly got my feet on the ground when the first of the ICs hit. I just wasn't expecting that. I wasn't prepared. All of a sudden everything was back to transistors and ICs.

There was no in between. No more nuvistors and only a few FETs. Even they were becoming an endangered species. I guess that's when it all began to come apart.

Q. What happened then?

A. Nothing right at first. I just hung in there and waited

for it to go away. Only it didn't go away. It got worse. Much worse. Whole projects were coming out with nothing but ICs in them.

That's when I started popping bipolars. Nothing fancy, just some of the old stuff. A few 2N404s once in a while. I'd throw a few on the bench and whip up some little audio circuit or other.

Well, it didn't take long. Pretty soon I was into the heavy stuff. I'd be popping some power jobs, 2N3055s or something like that.

I'd be hanging bipolars together until I had the whole circuit strung out. I'd really hit the electronic pits.

Q. What happened then?

A. Then someone I knew got me turned on to digital. He told me that they were really easy to work with. Just string them together. It's so easy.

I started out with the 7400s. A few little circuits and then I learned about some of the higher 7400s, the counters and decoders.

Once I got switched onto digital, I had to keep looking for bigger kicks. That's when I hit onto linear.

It was the regulators that made it sound so innocent.

Just one IC and a few caps and you got regulated output. Do you know what easy regulated voltage does to an old-time tube man?

Then that insidious name. Linear. I had to find out why it was called linear. I found out; there was lots of stuff that wasn't digital.

All those seductive amplifiers. Whole audio sections that would just plug in with a few extra parts. It was so easy to fall into the trap.

I can still remember the thrill, but it seems so long in the past now, when an evening could be happily spent in building and debugging an audio section.

It called for experience and craftsmanship. You could see the filaments light up and almost feel the signal flowing through the circuit.

Now you just plug in a little plastic thing and it's done. There's no room left for skill . . . or pride. You get lazy and take any cheap plastic electronic pill.

Now you have to keep looking for more to do with them. Something to give you back a feeling of electronic self. You buy more and more of them. You get bigger and more complex ICs, looking for the ultimate IC high.

I'm an addict. I know that now. I didn't know what those first few transistors would do to me. I thought I could just take a few now and then.

I thought I would still be in control and I could stop any time I wanted. It's too late for me now. I just hope I can keep the kids from becoming hooked.

Q. Do you think that is going to be much of a problem?

A. Oh, yes. The stuff is all around them. The magazines are full of articles describing the joys of this new electronic kick.

The ads are full of the paraphernalia. Power supplies, miniature components, IC boards, and test gear. The

ICs are shown at prices that are almost a giveaway.

Any kid on the street knows the local pushers who have this material available just by walking right in off the street.

It's legal. They can sell this stuff to the unsuspecting kids and the law can't touch them. The only way to fight it is with public awareness of the problem . . .

This story is not unique. Many amateurs have become IC addicts. But there are signs that can be recognized by the families or friends of any ham.

1. One early sign is that the victim starts popping ICs. This is easy to spot. They make a distinctive sound when they crunch. Often the victim will sprinkle ICs on top of his favorite breakfast cereal.

2. Another sign is Widget Fidgets. This is an electronic form of delirium tremens caused by trying to work with components far too

small for human beings.

3. Every now and then you may find the victim reading a copy of *73* hidden behind another magazine such as *Playboy* or *Field and Stream*.

4. Certain words may creep into his vocabulary, words like mini-DIP, fanout, and nanosecond.

5. Another sure tip-off is that the victim can often be found sitting alone in a darkened room, chanting Ohm's Law over and over.

By the time it has progressed this far, the victim may even be a pusher, writing articles for the magazines and getting others hooked, to pay for his habit.

There is no known cure for IC addiction and treatment is not generally available. If the disease has progressed far, there is little hope.

All you can do is keep the victim comfortable and hope that he never discovers micro-processors. ■

Hey!
Something New

ARSON AUCTION

Bid by mail on the following new and used gear.

AUCTION ITEMS

1. Yaesu FT 301 B - new demo List \$559.⁰⁰
2. ICOM IC 245 - new demo List \$499.⁰⁰
3. Tempo FMH-2 Handi Talkie 4 sets xtals - new List \$249.⁰⁰
4. Collins Station - Excellent cond. used KWM-2 "wing" s/n 10410 with Waters & DX Eng. Proc. 516F-2 PM-2, 312B-5, Spectronics DD-IC Dig. display bid on complete station only - subject to prior sale at asking price \$1295.⁰⁰
5. Heath Station - SB-102, SB-650 dig. display, SB-600 speaker, HP-23B P.S. Mint Condition. Subject to prior sale at asking price of \$650.⁰⁰
6. Heath Station Accessories - SB-620 spec analyzer, SB-610 Scope, SB-630 Stat. Console HM-102 SWR Meter HM-2102 SWR Meter. Mint cond. Subject to prior sale at asking price of \$450.⁰⁰
7. Midland 13-510 with "PL" - Mint used. List \$430.⁰⁰

HOW TO BID

1. Enclose personal check in the amount of your bid and indicate which item bid is for.
2. Enclose complete shipping address (not P.O. Box) and mailing address.
3. Enclose phone number.
4. Enclose self-addressed stamped envelope.
5. Send to Arson Auction: Arson, Inc., 615 So. Gallatin Rd., Madison, Tennessee 37115.

TERMS OF AUCTION

1. Absolute Auction - sale to highest bidder.
2. Bids opened Oct. 23
3. Highest bid will be notified by phone that item is being shipped.
4. All checks for losing bids will be returned if you include S.A.S.E. - otherwise destroyed.
5. All sales final.
6. New items have 90 days manufacturer guarantee.
7. Used items 30 days guarantee.
8. Shipping will be collect.

Amateur Radio Supply of Nashville, Inc. A40

615 So. Gallatin Road, Madison, Tennessee 37115 Phone (615) 868-4956

The Lady Saw Red

— *if the shoe fits . . .*

James C. Grady WB4ZVZ
PO Box 158
Kenly NC 27542

I guess the antenna on my chimney attracted him. At any rate, he telephoned saying he wanted to come look in my shack as he was getting interested in amateur radio. I urged him to come and bring his XYL. Perhaps he and I could sell her on it, too. That would be better than having her hostile while he tried to get going.

They came on the double. I barely had time to make the shack semi-presentable before they walked in. She gave the cold-fish eye to the disorder almost before she got inside. We sat down, talked for a few minutes, and I learned that it was my four-element, two meter beam that had caught their attention. It was so much less obtrusive than their neighbor's moonraker. The lady was obviously attuned to the exterior appearance of her home. It was then that I

made the fatal mistake. I switched on my rig to give them a demonstration of the fun benefits of two meters without first laying the groundwork.

A voice erupted from my little three-inch speaker: "Break, break." I saw the lady wince and realized immediately that she had heard that kind of squawk from her neighbor's chicken rig. Then came a garbled slur of letters and numbers. The identification process was wasted on us. Nobody could have copied it, even with long experience.

Then another station in the group answered promptly, adding, "Got no time fer yew, Mac. XYL sez I gotta clean up this QTH pronto!"

"What's XYL?" the lady asked. "And what's QTH? Why do they speak in riddles? I don't understand. It's jargon."

I explained that XYL meant wife.

"Then why didn't he say wife instead of XYL?" she asked. "Wife is easier to say

and easier to understand, too."

I told her that symbols were devised for telegraphy to make transmission faster and easier and that this bird's use of XYL on the phone was simply a carryover from brass pounder's language.

"But he's not using Morse code," she retorted hotly. "XYL is more difficult to pronounce and has no meaning except to you amateurs. Was he trying to prevent uninitiated listeners from knowing what he was talking about?"

I continued the soothing effort although I could plainly see I was making no headway whatever.

"And why did he use QTH? What in heaven's name does that mean?" she demanded. At that same instant the almost unintelligible voice slurred out, "Home QTH." The lady almost vaulted from her chair.

I explained that QTH meant home, but the lady was more agitated and distraught than ever.

"Then why did he use QTH when he had already said 'home'? That's the same as saying 'home home' and that's even worse than a double negative. Do all of you amateurs talk that way? Aren't you capable of understanding and speaking the English language?"

I was getting nowhere in a hurry. The lady's faint-hearted husband squirmed in his chair but did not muster the courage to say anything. There was no way for me to help him unless I came up with something and fast. And it was easy to see why they were considering amateur radio. It is a hobby that a man can enjoy without being let out of the house. Just then a voice on the radio answered the garbled one. "Roger Dodger, old man. We're about to destinate."

That did it. The lady exploded belligerently. "What is that moron about to design?"

I sat there with a dumb, blank expression, not because I adopted it, but because I couldn't help it. I just plain

didn't know what she was talking about.

Then she let me know. "Webster defines destinate as to design or appoint. At best, it is an extremely ill-chosen word. It does not mean 'to arrive.' I can see that all of you amateurs desperately need language training. What a pity you don't spend some of your study time learning to communicate with proper English rather than simply learning to use pig grunts and squeals. Your mastery of technology is of little use if you cannot transfer intelligence. It's no wonder that others are after the frequencies you enjoy. They might well make better use of them."

That last sentence really hurt. It cast a new dimension on her diatribe, but she did have a point. I explained that the language we use is the same used by amateurs all over the world, that all of us understand it, that we can't all talk like Harvard PHDs. I

was pouring on the logic and the humility and thought I was finally making some headway when the term "QS'ing to five-two" broke into the shack. The lady boiled over again.

"What does that nonsense mean?" she demanded. "Couldn't it be expressed so everyone can understand or has it some meaning that is subversive or maybe vulgar?"

This was her most vicious parry yet, so I explained that it meant only a frequency change. She seemed to accept this, but I could see that she was not impressed. Then there was a distorted slurring noise by the drooling ham and more pointless driveling ending with a shouted "73."

Her dander rose again. "What does 73 mean?" she almost shouted. "He has again obviated sensible communication. Couldn't he say whatever he means and quit this insane code practice?"

I could see that the meek one's chance of ever passing

Uncle Charlie's exam or owning a rig were running down the drainpipe. No doubt about who was head of their household. Oh well, there is always stamp collecting for his type. Then I explained that 73 means "best regards," but by this time I was unable to convince even myself that hams are either articulate or wise.

"73 has four syllables," she shot back. "Best regards has three syllables. Where is the saving? Your system substitutes mumbo-jumbo for simple words. It adds time and complication. It defies understanding. It makes your messages almost totally senseless for non-hams and convinces everyone that you already have more frequencies at your disposal than you deserve. You're no better than chicken banders and we have far too many of them already. Horace will be better off to forget this silly diversion. You can bet I'll see to that."

"Yes ma'am," I answered passively, "I'm sure you will." The lady led her silent husband out of my shack.

After they had gone, I sat down to think seriously about the route that we are traveling and came to the conclusion that the lady did have some logic on her side. And this winter I'm going to enroll in a college course in English instead of the club's upgrading course. So, in the future, if you hear me on two meters, or 10, or 15, or wherever, utter any of these things I've told you about, or use shout for call, or we for I, or affirmative for yes, or negatory for no, or I know wotcha mean, or real fine, please call my attention to my oversight. I'm trying to do a public relations job for amateur radio by upgrading my conversation. I hope I won't be entirely alone.

And I count myself lucky with the lady. She never even mentioned "Roger Dodger." ■



MAKE PROFESSIONAL LOOKING P.C. BOARDS FAST AND EASY

• SENSATIONAL • REVOLUTIONARY • FANTASTIC

STAMP-IT ETCH-IT

See June 77 73 page 178 for more info.

Reduces Printed Circuit Board Art Work From 2 Hours to 10 Min. . . .

Simple as A.B.C.

A. Stamp Components on P.C. Board B. Use Pen to Interconnect Lines. C. Etch Board

Are you tired of the hours of small, detailed, eye-straining art work that goes into making printed circuit boards? "STAMP IT, ETCH IT" is introducing a NEW product called "STAMP IT, ETCH IT" Kit. This Kit will take the tedious art work and many tiresome hours out of printed circuit board preparation. In just a few short minutes you have a professional looking etched printed circuit board ready for drilling!

The "STAMP IT, ETCH IT" Kit is exactly as the name implies. Following the step by step simple instructions, you can have a printed circuit board and have saved hours of frustration. As easy as you use a rubber stamp to stamp messages on paper, you stamp your component connections on copper clad printed circuit boards.

In your "STAMP IT, ETCH IT" kit we supply all component stamps shown in SE-2 Kit. In the SE-2 kit we also have resist ink enough for months and months of experimenting, ink stamp pad, resist pen, and etching containers. The most revolutionary item in your "STAMP IT, ETCH IT" Kit is . . . The Fool Proof System of etching your printed circuit boards.

With our kits and our etching containers, you are able to etch a printed circuit board as fast as bubble etching machinery and the results are as good or better.

AT LAST . . . COMPLETE LINE OF STAMP-IT ETCH-IT DIP IC SOCKETS

A DREAM COME TRUE
No Previous PCB Experience Necessary

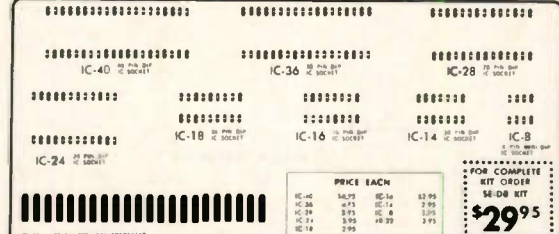

IC-40	IC-36	IC-28	IC-20
IC-18	IC-16	IC-14	IC-8
IC-24			

IC-40	\$4.95	IC-14	\$2.95
IC-36	\$3.95	IC-12	\$2.95
IC-28	\$2.95	IC-10	\$2.95
IC-24	\$3.95	IC-8	\$2.95
IC-18	\$2.95		

\$29.95

FOR COMPLETE KIT ORDER SEE OUR LIST

RAINBOW INDUSTRIES MADE UP A SE-D KIT FOR THE PRINTED CIRCUIT BOARD MAKER WHO WANTS EVERYTHING . . . And Just For You

One Complete Package Pictured Below

SE-2 KIT

CONNECTOR FINGERS

- 18 PIN DUAL IN LINE IC SOCKET
- 10 PIN ROUND IC SOCKET
- 8 PIN ROUND IC SOCKET
- TO-5 TRANSISTOR SOCKET
- TO-18 TRANSISTOR SOCKET
- LARGE & SMALL DONUT PAD

RESIST INK
INK PAD
RESIST PEN

\$9.95

PLUS 1 LB. POSTAGE

ADDITIONAL STAMPS

Bread board stamps for all integrated circuits "Great for experimenters"

Only \$2.95 each or all four \$9.95

#1 DUAL IN LINE

#2 FLAT PACK

#3 8-PIN ROUND

#4 10-PIN ROUND

- RESIST INK . . . 95c per bottle
- RESIST PEN ea. 95c
- INK PAD ea. \$1.15
- Etching Containers . . . 10 for 95c

SE-08 KIT

ONE COMPLETE SE-D8 KIT

\$54.95

ASK FOR SE-D8000 KIT

<p>PRINTED CIRCUIT BOARDS</p> <p>G-10 FIBERGLASS</p> <table border="1" style="width: 100%; text-align: center;"> <tr> <th>Size</th> <th>1 Side</th> <th>2 Sided</th> </tr> <tr> <td>2" x 4"</td> <td>.25</td> <td>.35</td> </tr> <tr> <td>3" x 6"</td> <td>.50</td> <td>.65</td> </tr> <tr> <td>4" x 6"</td> <td>.65</td> <td>.90</td> </tr> <tr> <td>6" x 6"</td> <td>.90</td> <td>1.35</td> </tr> <tr> <td>6" x 12"</td> <td>1.50</td> <td>2.50</td> </tr> <tr> <td>12" x 12"</td> <td>2.95</td> <td>3.95</td> </tr> </table>	Size	1 Side	2 Sided	2" x 4"	.25	.35	3" x 6"	.50	.65	4" x 6"	.65	.90	6" x 6"	.90	1.35	6" x 12"	1.50	2.50	12" x 12"	2.95	3.95	<p>AMPHENOL PL259's</p> <p>10 / \$4.50 100 / \$39.95</p> <p>OTHER R.F. CONNECTORS AVAILABLE. SEND FOR CATALOG</p>	<p>MUFFIN FANS PULL OUTS</p> <p>4 3/4" Sq.</p> <p>GUARANTEED LIKE NEW \$8.95 each</p>
Size	1 Side	2 Sided																					
2" x 4"	.25	.35																					
3" x 6"	.50	.65																					
4" x 6"	.65	.90																					
6" x 6"	.90	1.35																					
6" x 12"	1.50	2.50																					
12" x 12"	2.95	3.95																					

RAINBOW INDUSTRIES

P.O. BOX 2366 R10

Indianapolis, Indiana 46206

\$5.00 Minimum Order PLEASE ADD POSTAGE

MASTER CHARGE PHONE ORDERS WELCOME 317-297-2717

The Frugal Alternative

—home-brew an HT charger

Having a set of dead nicads in your HT is no fun—especially when you really need them! If you find yourself in this situation and haven't bought your handie-talkie complete with charging base at the outset, chances are good that you will want to purchase one in the very near future. The Wilson HT's charging posts, which are recessed into the battery slide tray on the underside of the unit, make it very difficult to charge the unit without one.

Custom charger bases, accessories designed to service a specific manufacturer's HT, are expensive. There are ways to charge the Wilson 1402SM and other similar units having tray-mounted charging terminals, though doing so takes a bit of ingenuity.

I've experimented with a number of alternatives to charging my unit, including removing the battery tray from the case and charging it separately. Most of the approaches I tried were rather

cumbersome. I've found the simplest approach to recharging the 12-volt pack to involve no more than an inexpensive CB-type hand-held recharger and a junked commercial charging base. Here's how it's done:

Purchase a Radio Shack #21-516, or similar nicad charger, of the type used to charge their line of 12-volt CB hand-helds. The battery packs of these units are electrically similar to the Wilson's, though they are mechanically very different. Both use 10 series-connected AA-size nicads, each having an open-circuit voltage of 1.2 to 1.25 volts, to produce a supply voltage of 12 to 12.5 volts. This charger, which resembles an ordinary transistor radio ac adapter or battery eliminator, has a stated output voltage of 17.4 V dc as indicated on its case. Don't worry about this. It won't harm the nicads, as the voltage tapers off as the cells charge, and the charging rate is limited to 40 or 50 mA.

As supplied, the charger comes with a cord which is terminated in a standard "inverted" dc power plug. This is a standard charging and power plug, and it is intended to plug directly into any of the Radio Shack CB hand-helds' charging jacks. To use the charger with the Wilson or similar HT is more of a mechanical problem than

an electrical one. You need to scout out a junked commercial charging base for any kind of radio pager, monitor, pocket scanner, or small HT. We're not looking for a good *charger*, just the *base* that can be modified to physically support the Wilson and provide a means of feeding it the charger's output. I located a defunct "Page-ette" base (used to recharge a small pocket-radio pager) at a local hamfest for all of \$2.50, purchased on an as-is basis. Other possible sources for these units, other than the flea-market circuit, are local fire and police departments, two-way radio repair shops, and other commercial users. They may have unrepairable or obsolete bases lying around either free for the asking or which can be obtained for a very small sum. Use your scrounging skills here! One word of caution, however: If you should find a charger base that appears to be intact electrically and you want to use it *directly* to charge your unit, be *sure* to check out the charging voltage and current. Many of these units are low-voltage, high-current types, which would not be suitable for charging the Wilson, even if it might fit snugly. Using such a base might even damage your HT or battery pack, as well.

In any case, the charger base you locate will almost

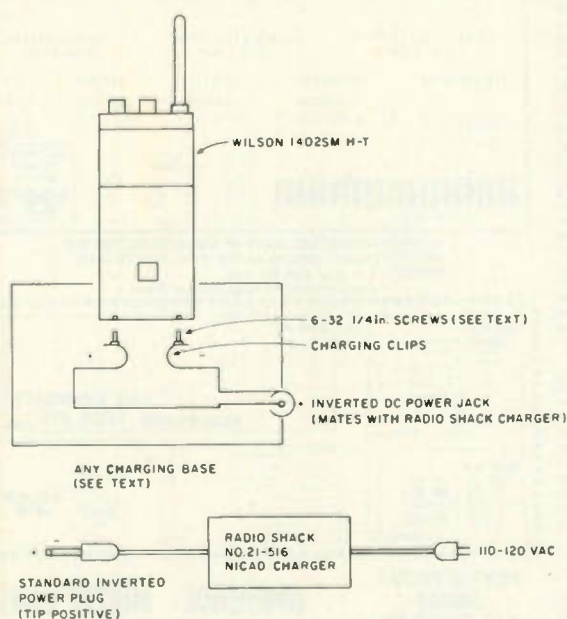

Fig. 1. Charging system shown above provides an inexpensive means of charging the Wilson 1402SM and similar handie-talkies that are charged by means of terminals recessed in the battery pack. An old, defunct charger base is modified to accept the Wilson and provides mechanical support while charging.

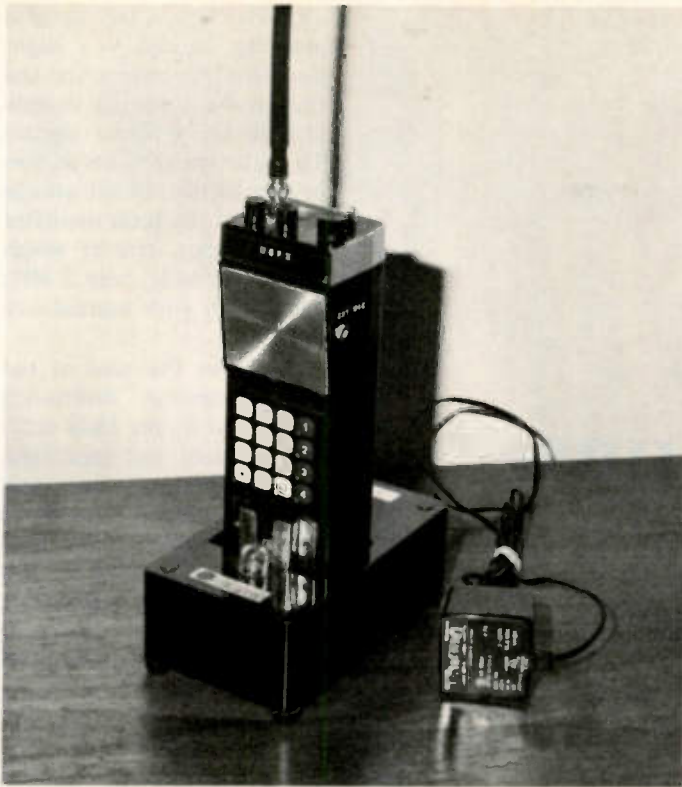

Photo A. Wilson 1402SM HT is shown in the charge position, ready to be charged up from the small CB-type battery charger.



Photo B. HT is shown in the non-charging reclining position. Once charging is complete, the unit can be disconnected from the charger and is ready to operate portable or fixed-base as shown in the photo.

certainly not accommodate the Wilson without modification to the base. You will find that the Wilson is a physically large HT (at least the 1402SM is), and is much larger than most pagers and commercial units. So, the base must be modified to accept it. To do this, first remove the plastic sleeve generally used to hold the pager or HT securely in place atop the charger base. It can be discarded, as it won't fit the Wilson. Next, carefully file the rectangular opening in the base until the Wilson can be freely inserted without undue binding. Be sure, however, not to make the hole too large, which would allow excessive slippage when the unit is inserted (it won't have the support of the sleeve, which has been discarded).

Next, install a chassis-mount "inverted" dc power jack on the rear of the base to accept the plug on the Radio Shack charger. These jacks, despite their strange name, are standard items and can be obtained from Radio Shack, Olson Electronics, Burstein-

Applebee, and most other mail-order stores. Remove or disconnect the existing charger wiring — you won't be needing it. Route the leads from the jack to the base's charging clips, being especially careful to observe correct polarity. The tip on the charging plug is positive and the shell is negative. Wiring is shown in Fig. 1. Note that on the Wilson 1402SM HT, when looking at the unit from the *front*, the *positive* terminal is on the *left*, while the *negative* terminal is on the *right*. Failure to observe correct polarity is guaranteed to be an expensive mistake!

You're almost finished, but getting a good, solid connection to the recessed charging terminals on the Wilson can be a bit tricky. Usually, a very short (1/4" or less) 6-32 screw, soldered upside down to the top of the base's charger clip, will do the trick and make good contact with the Wilson's terminals. In some cases, a "pointed" solder blob on each clip will be what is needed to make

good continuous contact when the HT is inserted and standing vertically in the charger (Photo A). You will, of course, have to inspect your charger base to determine what kind of clips it uses and what must be done to accept the Wilson or whatever HT you want to use with it. Usually, modifying and adjusting the clips is no problem, but it takes a little patience to get the HT to seat just right.

The Radio Shack charger I used will fully charge the nicad pack in about 12 to 14 hours. Although it can be left connected to the HT's terminals, it's best to disconnect it to prevent any possibility of overcharging the cells and to eliminate any possibility of fire from overheating or failure of the charger unit. This can be done very simply by unplugging the charger from the ac outlet, removing the Wilson, and reinserting it so that it's no longer resting directly on the charger clips, but, rather, is reclining on the charger base at a 45-degree

angle so that charging current cannot flow to the terminals. This position also makes for a dandy fixed-base operating position for the HT (Photo B).

While the best charging philosophy to follow is a highly-charged subject (pun intended), I believe that you can help ensure maximum battery life by recycling the nicads three or four times a year. This means letting the batteries discharge completely before recharging them. Doing this tends to inhibit "plating" which reduces the batteries' efficiency. By exercising a little care in charging (not overcharging and not charging in too many short spurts), you should get well over a thousand charge cycles from a set. Be sure, when charging, that *each* of the ten nicads in your battery tray is a good one, and that each is seated properly so that the charging current flows through it in the right direction.

Who says you can't charge up a Wilson on a budget? ■

PLL Techniques

— a practical guide

Lester A. Earnshaw
PO Box 1584
Sedona AZ 86336

Recently, I had occasion to work on several different phase locked loop systems. One system was relatively straightforward, but two of the systems had to utilize a heterodyning process, and these proved to be anything but straightforward. More recently, I came across a statement made by a Mr. R. E. Funk of RCA (*COS/MOS Digital Integrated Circuits, Solid State Handbook SSD-203B, page 460*). Mr. Funk says: "The disadvantage of the heterodyne technique is that, because a second reference crystal and a mixer are needed, the designer may be afforded an unsought opportunity to demonstrate his process in eliminating spurious beat and sum frequencies." This is the understatement of the year! But Mr. Funk certainly knew what he was talking about.

The purpose of this article is to share some of my experiences. There is a definite shortage of practical phase

locked loop material. The publication just mentioned and the *Phase Locked Loop Systems Data Book* put out by Motorola contain practically all the useful data I could find. I recommend that the serious experimenter obtain these publications.

There have been various ham articles on phase locked loop systems, but these have been somewhat limited in content and spread over a number of publications. I propose, therefore, for the purpose of completeness, to begin at the beginning and build up to a practical system. Hopefully, this discussion on the various pitfalls will save you a few headaches and frustrations!

First of all, you may ask, "Why do I want a phase locked loop system at all? What is the advantage of it?" To answer this, it is necessary to discuss the shortcomings of some other systems. For example, an FM transmitter may generate the FM at a low frequency, 3 MHz being typical, and double and triple many times until the desired output frequency is obtained. This is fine, except for one

thing — the output of the transmitter may contain many spurious signals such as 6 MHz, 9 MHz, 12 MHz, and so on. This is the reason the 2 meter transmitter contains so many tuned circuits — regulations and good practice say that these products must be kept at home.

In many cases, it is necessary to obtain a local oscillator injection voltage that is too high in frequency for a stable vfo. The usual method is that a low-frequency vfo is mixed with a higher-frequency crystal oscillator output, and the sum or the difference product is utilized. But this method also provides a lot of spurious outputs, and, unless the mixer output is adequately filtered, it will result in the reception of all sorts of unwanted signals. As an example, a 5 MHz vfo may be mixed with a 33 MHz crystal in order to obtain a 38 MHz local oscillator signal which, when used with a 12 MHz i-f, will allow 50 MHz operation. In this instance, the sum product has been used, but there is also a difference product. 33 MHz less the vfo frequency of 5 MHz equals

28 MHz. Unless this signal is properly filtered, you might find 40 MHz commercial stations coming through in addition to the 6 meter signals. To make matters worse, harmonics of the vfo will also be present in the local oscillator chain output, one of which will be 40 MHz, only 2 MHz away from your wanted output.

Now, in the case of the FM transmitter mentioned earlier and in the local oscillator system just described, an oscillator operating right at the output frequency would eliminate the need for multiple tuned circuits and elaborate filters, because a properly designed oscillator will be free of all spurious signals except harmonics, and, usually, these are sufficiently removed in frequency not to be troublesome. Unfortunately, unless it is possible to lock the high-frequency oscillator to a stable source, you will have traded a spurious signal problem for a frequency stability problem. This is where the phase locked loop enters the picture. The system allows the high-frequency oscillator to be locked to a stable source. If crystal control is required, a 154 MHz oscillator, for example, may be locked to a 1 MHz or a 10 MHz crystal oscillator. However, to supply many different local oscillator frequencies, many crystals must be used or, alternatively, a synthesizer inserted into the circuit (more on this later).

The local oscillator or the FM transmitter may also be locked to a lower frequency vfo. But, before I discuss this, refer to Fig. 1, and see how a vfo may be locked to a crystal. Incidentally, when a vfo is locked in this manner, it is called a vco — voltage controlled oscillator. Referring to Fig. 1, the vco feeds output into a kind of mixer which is usually termed a phase detector (0 detector). Actually, many phase detectors are simple mixers. At the same time, the crystal oscil-

lator, which is now called the reference oscillator or sometimes the clock, also feeds output to the mixer or phase detector. When there is a difference in frequency between the two input signals, certain mixers will deliver a dc output which is either negative or positive in polarity, but will have no output if the two input frequencies (and phase) are the same. It is this + or - output voltage which distinguishes a phase detector from a simple mixer. The dc output from the phase detector may now be used to change the capacitance of a variable-capacitance diode which is part of the vco tuned circuit and thus vary the vco output frequency. If the circuit is properly designed, the dc voltage (usually known as the control or error voltage) will move the vco frequency toward the reference frequency. When the two frequencies are the same, there will be no error voltage, and the vco frequency will stabilize. If the vco moves higher in frequency, the phase detector will deliver a + error voltage, which will increase the diode capacitance and lower the frequency. Conversely, if the vco drifts lower in frequency, a negative error voltage will move the vco higher. Thus the vco is locked to the crystal.

Of course, there is little advantage in using the simple circuit just described. It would be simpler to use the crystal oscillator directly. However, the circuit does illustrate the principle. What if the reference oscillator was "dirty," that is, it contained a number of unwanted spurious products? Well, just what we would like to happen would: The vco would clean up the signal. Because the vco is in itself a sine wave oscillator, kept on frequency only by occasional squirts of dc, it should have pure output. In practice, this is not always the case, but a properly designed system will certainly reduce spurious signals, usually to an acceptable level.

Incidentally, the vco may also be a multivibrator type, delivering square wave output. The type I propose to discuss, because it may be used with SSB receiving and transmitting equipment and thus must contain little phase jitter, will be the sine wave generator.

The block diagram shown in Fig. 2 illustrates a scheme utilized in many modern CB sets where, because of the large number of crystals required to give complete channel coverage, a system that mixes a smaller number of crystals is preferred. The outputs of oscillators #1 and #2 are fed into a conventional mixer. Either the sum or the difference product is selected, whichever is convenient, and the resultant product is fed to the phase detector. Of course, a double-balanced-type mixer has to be used here to suppress the two original frequencies, otherwise the vco will not know which signal to lock to. However, a "dirty" signal has now been made clean.

Although Fig. 2 is a practical system used by many manufacturers, it still requires something like 11 crystals in the case of a 23-channel CB set. Generally speaking, crystals are a nightmare of supply problems to most manufacturers of original equipment. Fortunately, there is another way. Referring again to Fig. 1, let's say that in some mysterious manner we are able to "rubber" the crystal 1 MHz higher in frequency. What will happen to the vco? It will follow right along and stay locked to the reference. So the problem really is how to "rubber" the crystal to where we would like it.

Referring now to Fig. 3, it will be seen that a new building block has been added between the vco and the phase detector which is labeled divide-by-N. For the moment, let's have $N = 2$. A simple flip-flop, costing less than 50 cents, will fill this

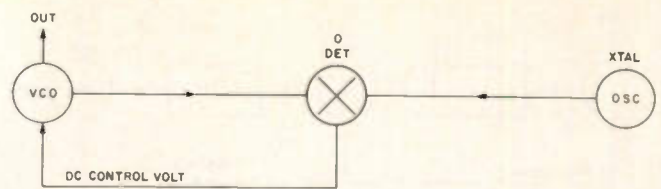

Fig. 1. This block diagram shows how a vco may be locked to a crystal oscillator. Both the vco (herein called a vco) and the crystal oscillator feed signal to the phase detector. The phase detector generates a dc voltage which "steers" the vco on to frequency whenever there is a difference in frequency between the two oscillators.

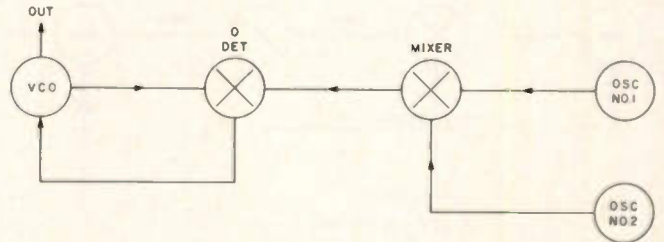

Fig. 2. When a high-frequency local oscillator is required, a vco (osc. 1) may be mixed with a crystal oscillator (osc. 2) to obtain the necessary high-frequency output. This signal will contain many unwanted spurious outputs. However, if the "dirty" signal is only used to lock the vco, the unwanted products will be filtered out.

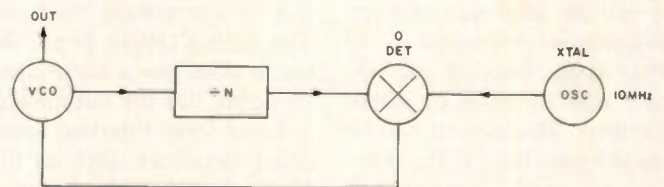

Fig. 3. In this system, unlike that shown in Fig. 1, the vco may operate on a different frequency from the crystal. For example, if the $\div N = 2$, the vco may operate at 20 MHz. See the text for more on this.

block. Because the output of the vco is connected to the flip-flop input, the vco output is divided by two, and the result is given to the phase detector. The block diagram shows that in this instance the reference frequency is 10 MHz. Had the vco been generating a signal around 10 MHz, the vco would divide this by two and feed a 5 MHz signal to the phase detector. Because the 10 MHz reference signal is considerably different in frequency from the 5 MHz received at the input port, a large error voltage will be produced, and the vco will be retuned until both ports receive 10 MHz signals. This means that the vco will now be delivering output at 20 MHz. If we add

a second flip-flop in tandem with the first so that $N = 4$, the vco will move to 40 MHz in order to reach lock. Thus, merely by changing the value of N , a number of vco frequencies may be obtained which are all locked to the reference frequency. The manufacturers of integrated circuits have come to our aid with a number of inexpensive flip-flops in one package. The package may readily be programmed to give a number of division ratios. For example, the RCA CD4018 will divide by any number between 2 and 10. When a number of counters are combined in this manner, the simple flip-flop counter becomes a synthesizer.

Referring again to Fig. 3,

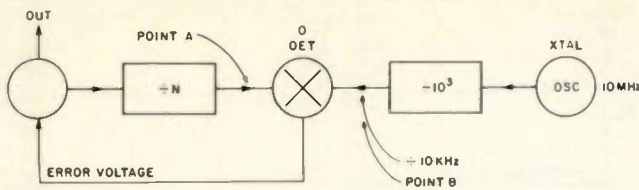

Fig. 4. The system shown in Fig. 3 allowed the vco to move only in 10 MHz steps. By dividing the reference oscillator down to a lower figure (for example, 10 kHz, point B), then the vco may supply outputs only 10 kHz apart.

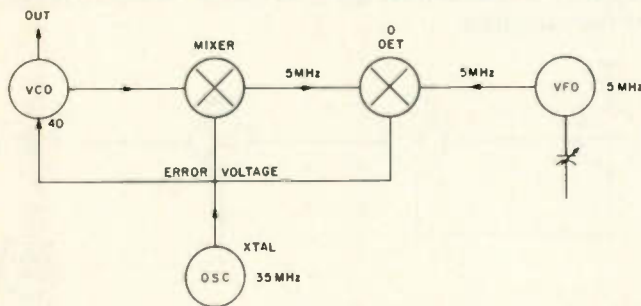

Fig. 5. In this scheme, the vco is heterodyned against a crystal oscillator to produce a difference signal in the same frequency range as the vfo. When both the heterodyned output and the vfo output are fed to the phase detector, the vco will lock to the vfo and have the same stability.

it will be seen that the vco output can only move in 10 MHz steps, because you are only able to divide by whole numbers. However, it will be readily seen that, if the reference frequency is lowered to 1 MHz, the vco will move in 1 MHz steps. Thus, if a 10 kHz channel spacing is required, the reference frequency must be 10 kHz. A 10 kHz crystal is kind of expensive, but, fortunately, you can retain your 10 MHz or 1 MHz crystal and simply divide it down by using a number of inexpensive flip-flops. A few type-7490 ICs will do this job for less than a dollar. This scheme is shown in Fig. 4. Input to the phase detector at point A in Fig. 4 will not always be 10 kHz, but it will always be 10 kHz when the system is in lock. When there is an 11 MHz signal at point A, an error voltage will immediately develop and, regardless of the value of N, will move the vco frequency until 10 kHz appears at point A.

In the above explanations, it was said that only a dc error voltage was obtained from the phase detector, but

this is not always the case. The RCA CD4046 phase detector does give a fairly clean dc signal, but the output still requires some filtering. Some phase detectors, such as the Motorola MC4044, deliver a series of pulses at the output terminal, and the output may require considerable filtering. Each type of phase detector has its particular usages. Currently, I am using both types in newly-designed equipment. The divide-by-N part of the circuit is beyond the scope of this article.

The systems outlined above have one serious disadvantage. While they operate well if fixed-channel operation is required, such as is used in the 2 meter band, they do not lend themselves to the sweeping or the searching across the spectrum. To properly tune SSB, one must be able to tune to within 10 Hz, not 10 kHz. To find a buddy due to come up somewhere between 14230 and 14250 requires a vfo knob, not a number of synthesizer knobs. At first thought, it would seem that the simple answer is to replace the reference oscillator with a vfo. I

wish it was that easy. Unfortunately, this scheme suffers from the same disadvantage you have when a vco is multiplied to obtain a higher local oscillator frequency; the frequency instability is multiplied by the same factor.

In our case, if the divide-by-N = 8, the frequency instability of the vfo will also be multiplied by eight. What was a 100 Hz drift per hour now becomes an 800 Hz drift per hour! Additionally, each time the divide rate is altered, not only does the frequency drift rate change accordingly, so does the amount of frequency covered by the dial. This makes for difficult dial calibration unless a digital readout is used.

The Heterodyning Method

Just as you can heterodyne a vfo to a new frequency by beating it against a crystal oscillator, so you use this technique in the phase locked loop system. The basic scheme is shown in Fig. 5. In this example, a 40 MHz local oscillator is required for a 6 meter receiver. Output from the 40 MHz vco is fed into an ordinary mixer together with signal from a 35 MHz crystal oscillator. The 5 MHz difference output from the mixer is then fed to one input port of the phase detector. Output from a 5 MHz vfo is simultaneously fed into the other input port of the phase detector. If a difference between the two input signals exists, an error voltage is dispatched to the vco and its frequency moved until lock is obtained. When the vfo is moved, this, too, generates an error voltage, and the vco is forced to follow. If the vfo is moved 10 kHz, the vco will move 10 kHz. If the system is properly designed, the vco output will be clean and contain none of the 35 MHz component, vfo harmonics, or the like. And so it appears that the heterodyning system is the panacea to our problems, and, in some cases, this is so. However, in many other instances, the problems are

just beginning.

In the example shown in Fig. 5, when it's first turned on, before lock is obtained, the vfo output frequency may be anything within the range of the system. If the phase detector output is able to vary from 0.5 volts to 4.5 volts, which is typical (with 2 volts being the nominal center frequency), the variable capacitance diode may have its capacitance changed by as much as 100 pF. This change may readily sweep the vco as much as 20 MHz before lock is obtained. If, referring to Fig. 5, perchance the vco is moved down to 30 MHz, this frequency when mixed with the 35 MHz oscillator will also produce a 5 MHz difference signal at the mixer output. Naturally, the loop will try to lock to this signal. However, as the error voltage will now be of the wrong polarity, lock will not be obtained, the phase detector will be thoroughly confused, and the vco will settle at some highly unstable frequency below 35 MHz. Fortunately, in the example given, the image is sufficiently removed in frequency from the wanted signal. The vco swing may be sufficiently restricted so that it is not capable of running into this highly dangerous area. But, in instances where the difference frequency is small, this phenomenon becomes a real and serious problem. There are various ways one may overcome this problem. One method makes use of the fact that, when the vco is tuned to the image frequency, the error voltage will become highly negative with respect to the nominal frequency (in this instance only; it may become positive in other instances). When the high negative voltage is produced, it may be caused to trigger a ramp generator which, in turn, forces the lock line in the other direction. Such circuits, in my experience, also contain numerous gremlins and tricky elves.

Another method may

make use of a tuned circuit lightly coupled to the vco tuned circuit. If the accessory tuned circuit is tuned to the dangerous frequency area, it will receive a signal when the vco is in that general area. The signal may be rectified and used to ramp the lock line.

Some phase detectors will lock to a harmonic of the wanted signal voltage. One of the phase detectors in the RCA CD4046 package (there are two) displays this annoying characteristic. It's quite disconcerting to obtain good lock, but on the wrong frequency.

Whatever the system employed, the heterodyne method almost always requires that the mixer output be filtered to eliminate the vco and crystal oscillator outputs and also the unwanted image frequency. If the difference frequency is used, a simple low-pass filter may be sufficient, but, often as not, a quite elaborate filter must be installed between the mixer and the phase detector.

And this brings us to a new problem, also quite common and often serious. If the vco is able to swing sufficiently far in one direction so that the mixer output frequency is greater than the low-pass filter cut-off frequency, the filter will prevent the signal from reaching the phase detector. The phase detector, in alarm, will send a panic voltage to the variable-capacitance diode, which, in turn, is sent even further away in frequency. The system has latched up and will stay latched until a ramp is activated or the supply voltage is removed and replaced.

From all of the above, it would seem that the easiest thing to do is to limit the vco swing so that the dangerous latch-up area cannot be entered. Indeed, this is mandatory in most cases. The vco is often preset. That is, each time the MHz bandswitch on a receiver is moved, for example, an additional diode across the vco tuned circuit

has the voltage across it altered so that the vco is "steered" near the wanted frequency.

If the vco swing is too restricted, it will be found that this lock will not be fully obtained near the band edges. Instead, the vco will "skip" cycles and never quite make it.

Other problems, not only peculiar to the heterodyning method, but also to the other methods outlined at the beginning of this article, are caused when the vco is allowed to swing beyond the "capture range" of the system. With each phase detector and PLL system there are extremes beyond which lock cannot be obtained; however, if they are forced into lock, lock will be maintained.

The capture range, to a major extent, is also dependent upon the loop bandwidth, which is tied up with the capture time. This is highly dependent upon the type of filtering required in the lock line. Because the error voltage to the variable-capacitance diode may contain spurious voltages, especially the reference voltage, it must be filtered. If the reference frequency is in the audio range, for example, filtering may become quite troublesome. If the filtering is inadequate, the vco signal may be modulated by the spurious components. Often, if the filtering is good, the lock-up time and thus the capture range may suffer. Filters must often be skillfully designed, and this design may well be one of the more difficult parts of the system. Capture range is exactly what it says — the frequency range over which an out-of-lock system will lock. It will be apparent that, once lock is obtained, moving the frequency of either of the oscillators at a rate slower than the time required to obtain lock will cause only a small error voltage, and correction and lock will be easily maintained. If, however, lock-up time is very slow, the error voltage change may arrive too

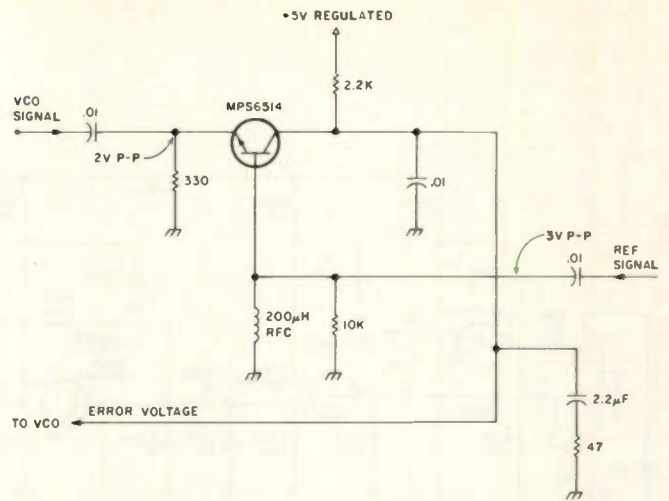

Fig. 6. A simple phase detector. This detector has poor lock capture ability. Various other phase detectors are described in the article.

late, and the system may drop out of lock. This is particularly true when a different crystal is switched into circuit, resulting in a large frequency shift and possibly a temporary loss of signal at the input to the phase detector. Before the error voltage can arrive, the system may have dropped out of lock and even latched up.

Contrary to general belief, the signal to the phase detector must be fairly "clean." Some phase detectors do practically ignore spurious signals mixed with the wanted signal, but others are driven to a cantankerous behavior. The previously-mentioned CD4046 phase detector contains two different types of detectors in the one package, only one of which is affected by "dirty" signal frequencies (phase detector #2). On the other hand, phase detector #1 readily accepts signals amid static, shot noise, and other garbage, but it readily responds to harmonics. In instances where the signal is "dirty" and the system could lock to harmonics, the MC4044 has proven an excellent choice.

The #2 detector in the CD4046 package, because its output is not a series of pulses, is very readily filtered, usually only requiring a resistor and a capacitor unless the reference frequency is low. Even then, the filter network

will be simple and inexpensive. Phase detector #1 and the MC4044, because they deliver a series of positive- or negative-going pulses, require much more elaborate filtering and may even require active two-step filter systems.

From reading this, it may seem that only two phase detectors are available on the market, but this is far from the case. Fig. 6 shows a simple phase detector. This type of detector is suitable for many applications, but it has a very small capture range unless ramped. The sample-and-hold-type detector has very clean output, usually utilizing two or more field effect transistors. The diode-type double-balanced mixer or modulator makes an excellent phase detector, but it has very limited capture range. The digital types, such as those mentioned earlier, because they have been especially designed for phase detector application, do make for simple detection. Unfortunately, these devices have a limited frequency of operation, especially the CD4046, which is quoted at 1.2 MHz upper frequency. The MC4404 is quoted at 8 MHz. This means that, in many circuits, both the signal and the reference frequencies must be divided lower in frequency merely to get within the operating range of the device, an unfortunate com-

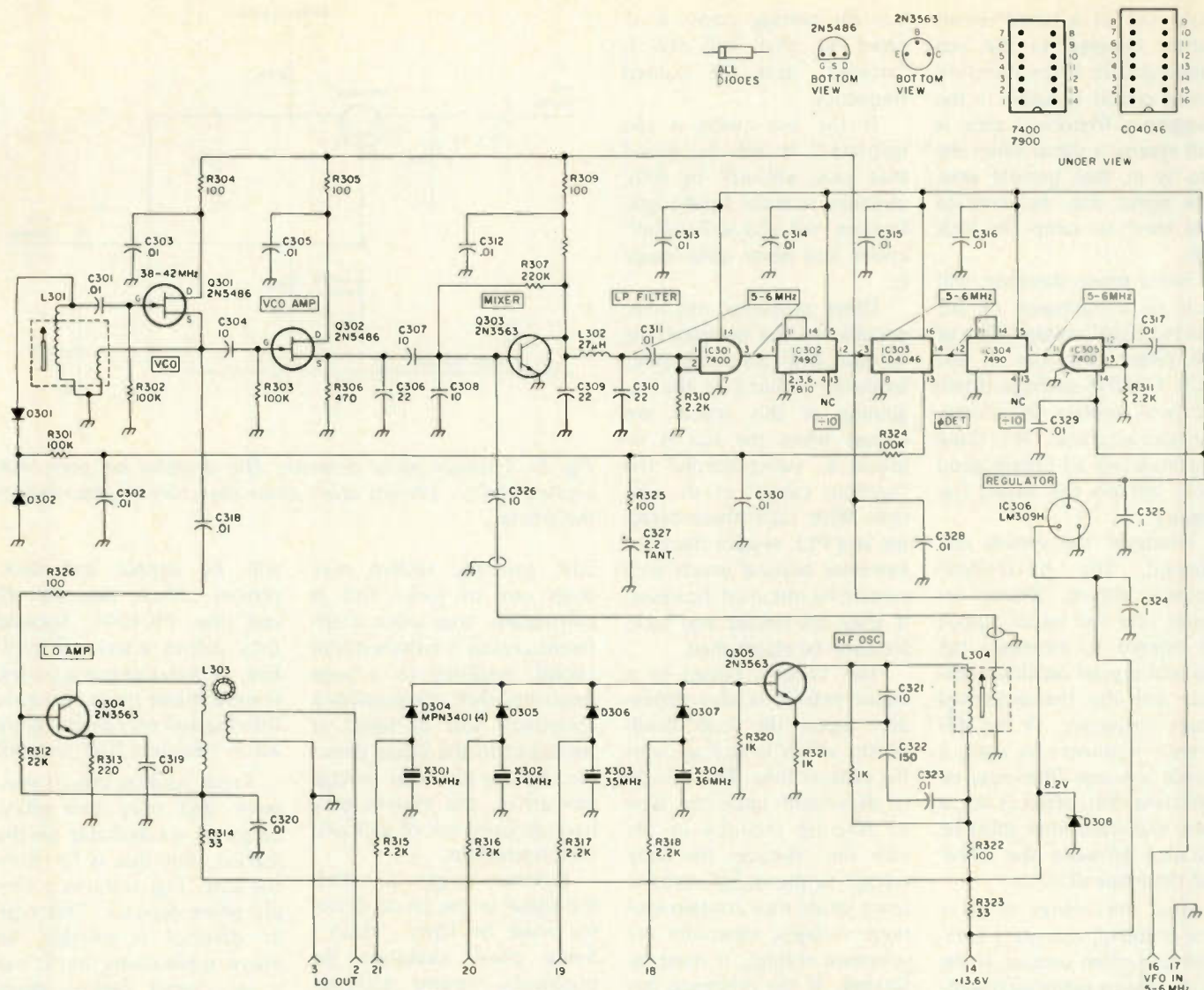

Fig. 7. The schematic diagram allows a vco covering the frequency range of 38 MHz to 42 MHz to be locked to a vfo covering the frequency range 5 MHz to 6 MHz.

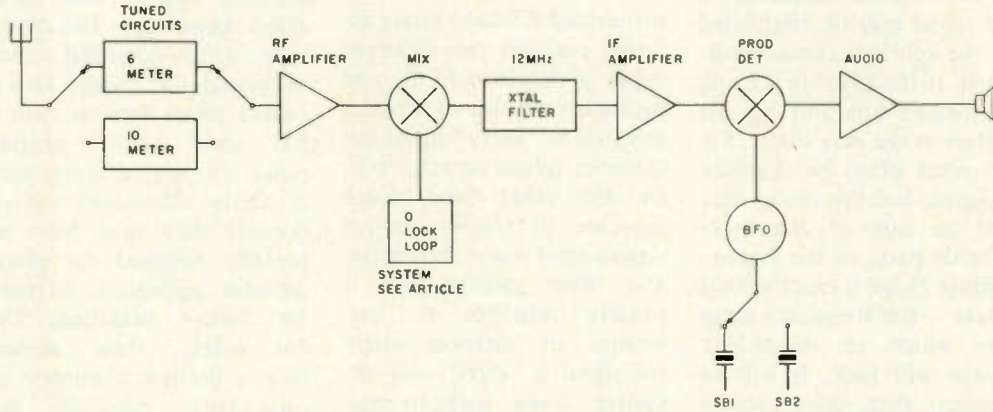

Fig. 8. The phase locked loop system shown in Fig. 7 and covered in the article may be used with a receiver which will allow operation on both the 10 and the 6 meter bands. Although the system uses a high-frequency local oscillator, the stability is equal to and determined by the vfo which operates over the frequency range 5 MHz to 6 MHz. The block diagram shows that it is only necessary to change the front-end tuned circuits to change bands.

fronted with a host of others. This is especially true if he possesses a spectrum analyzer and can more readily see what is happening. In many ways, life before the invention of the spectrum analyzer was less hectic!

A Practical Phase Locked Loop System

The PLL system shown in schematic form (Fig. 7) is derived from the block diagram of Fig. 5. In this particular system, a vco operates over the 38 MHz to 42 MHz frequency range, allowing either 10 meter or 6 meter operation with an i-f frequency of 12 MHz. The vco, Q301, is an FET Hartley-type oscillator, the output of which is fed to an amplifier

plication. Please note that only some of the more serious problems have been touched upon in this article. There are other problems, such as phase jitter,

that space will not allow to be discussed. The more serious designer will be con-

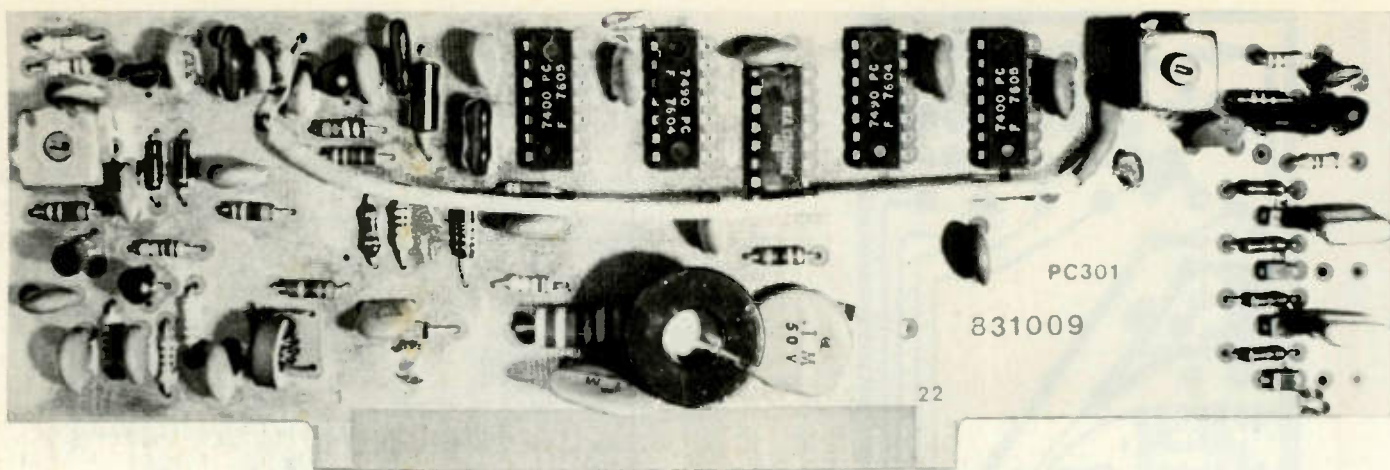

Photo A.

sine or square wave with an amplitude of at least 0.3 volts rms, is also shaped and amplified by a section of a 7400 quad gate, IC305. The output from this device is also divided by 10, and the resultant 0.5 MHz to 0.6 MHz signal is applied as the reference to the phase detector. The error voltage output from the phase detector, pin 13, is filtered by components R324, C330, R325, C327, and C302 before being applied to the variable capacitance diodes, D301 and D302. The diodes shown are somewhat expensive KV1501s, but it has been found that rectifier diodes (1N4001s) functioned quite well in this circuit. It may be necessary to select diodes, and they may be somewhat noisier (a white noise effect).

The vco coil was wound on a Micrometals form #L43-6-CT-F-5. The primary consists of 6 turns of #30

enameled wire spaced the diameter of the wire. The secondary consists of two turns wound between the turns at the bottom of the primary. It is necessary to observe the correct polarity of the windings if oscillation is to be obtained. If the Micrometals form is not available, other forms may be used. Temporarily disconnect the lock line from R301, feed 2 volts into the resistor, and adjust the coil slug until oscillation is obtained at about 40 MHz. This will get the coil into the correct range. IC306 is a three-terminal regulator which drops the supply voltage to 5 volts required by the ICs.

Transformer L304 is wound on the same form as L301. The primary consists of 12 turns of #30 closewound and the secondary of 4 turns closewound over the bottom of the primary.

To adjust the loop, first

adjust L304 until reliable oscillation is obtained on all four crystals. (Note that, since Photo A was taken, the position of the crystals and diodes was reversed to obtain better operation. The schematic is correct.) While observing the output of L303 on a high-frequency oscilloscope and while measuring the frequency, adjust the slug in L301 until the voltage on the lock line is about 2 volts when the vfo is set at 5.5 MHz.

The frequency should remain stable and not move unless the vfo is moved. To check for proper operation, short the lock line to ground for a moment. The vco should immediately return to frequency.

The wideband transformer L303 is wound on an Indiana General Q1-type core and consists of 4 turns trifilar wound using #26 enameled wire. Almost any core suit-

able for wideband work may be used here.

The oscillator and PLL system, if used with a 12 MHz i-f, will have a 'birdie' in the receiver when the vfo is at the 6 MHz part of the range. This is due to the second harmonic of the vfo falling in the i-f range. This is readily removed if the crystal and vfo are moved a few kHz to get the harmonic out of the passband.

The practical PLL system described, while not of use to everyone, has been constructed and operated in a receiver covering 6 and 10 meters. It may serve to assist others building similar equipment. Other similar systems have been designed covering a wider frequency range. In these systems, the mixer was replaced with a double-balanced type to remove the two oscillator signals. Other designers will have their own ideas on this. ■

50 144 REPEATERS 220 450 Mhz

Available Separately:



COR Identifier: All on one board, programmable, Fully adjustable, time out (5-7 min.), hang time (0-1 min.), Identifier (1-10 min.), tone, speed, volume, L.E.D. outputs, low current drain CMOS logic, plugs for easy installation and removal plus much more. \$79.95

Basic Repeater \$499.95

2M 130-175 MHz Basic Repeater for 2 meters with all the features of the Hi Pro Mk I less the power supply and front panel controls and accessories.

OPTIONS

- Duplexers
- Basic auto patch
- Matching cabinet
- .0005% High stability crystals



Hi Pro Mk I

50 MHz \$789.95 450 MHz 799.95

144 + 220 MHz \$699.95 PLUS SHIPPING PA Res. add 6% tax

Maggiore Electronic Laboratory

845 WESTTOWN RD. M36
WEST CHESTER, PA. 19380 PHONE 215 436-6051



The HEATHKIT SB-104A

good enough to measure up...to you!

In choosing the SB-104A you join a pretty select fraternity of fellow Amateurs. They're individuals whose imaginations were fired by the looks, feel, and reputation for outstanding performance that, since its inception, has become the trademark of Heath's entire line of famous SB series Amateur equipment.

You've joined a group of people who want state-of-the-art perfection, still insist on building their own to insure handcrafted quality, prefer to do their own maintenance and service, and above all want a rig that's good enough to measure up to their abilities, standards, and the reputations they've built for themselves.

Heath's SB-104A, it's the only choice when you're ready for a transceiver that's good enough to measure up....to you!

**Heath Amateur Radio Gear....
....the quality that measures up!**

FREE Heathkit Catalog

Catalogs also available at the 50 Heathkit Electronic Centers coast-to-coast (units of Schlumberger Products Corp.) where Heathkit products are displayed, sold, and serviced. Retail prices on some products may be slightly higher. See your white pages.



HEATH
Schlumberger

Heath Company, H5
Dept. 011-460
Benton Harbor,
MI 49022

Gentlemen, please send me my free Heathkit Catalog
I am not on your mailing list.

AM-372A

Name _____

Address _____

City _____ State _____

Price is mail order, F.O.B. Benton Harbor, Mi.
Prices and specifications subject to change without notice. Zip _____

The LEADER In the Northwest!



ATLAS • ICOM • KENWOOD • YAESU

Come to ABC Communications today for the best solution to your particular communication requirements, whether they be Amateur, Two-way Business Band, VHF Marine or Police Scanner.



ATLAS Transceiver 210X
80 thru 10M



DENTRON MT-3000A
Deluxe Tuner

ATLAS Transceiver 215X (not shown)
160 thru 15M

DENTRON 160-10 AT (not shown)
Super Tuner



KENWOOD Transceiver
TS-820S 160 thru 10M



KENWOOD Transceiver
TS-520S 160 thru 10M



KENWOOD 2M FM
TR-7400A



NATIONWIDE TOLL FREE NUMBER

1-800-426-6937

washington state: 1-800-562-7625



ICOM Transceiver 2M FM
SSB IC 211



ICOM Transceiver 2M FM IC 245



YAESU 901 DM



YAESU HF SSB 160 thru 10M
FT 101F or FE



We also handle Wilson, Cushcraft, Hy-Gain, Antenna Specialists, KLM, etc.
Attention Washington residents: Come on in for excellent service in our complete Communications Repair Shop.

Write or call for SPECIAL tower, rotor, antenna package! Tri-Ex, Rohn, Wilson Towers. Shipping info: F.O.B. Seattle via UPS, truck, or parcel post.

Washington residents add sales tax.

A46

17550 15TH AVE. N.E. • SEATTLE, WASH. 98155 • (206) 364-8300



Other locations: (Walk-in customers only) • Bellevue — 12001 N. E. 12th • Everett — 6920 Evergreen Way • Open Mon. thru Sat.

NEW

Top-of-the-line performance for today's crowded HF bands



RTTY

FSK-1000 Demodulator

In the past, the serious hf dx-er had to spend over 500 dollars to attain this level of performance.

- State-of-the-art computer-aided design
- Unparalleled selectivity from selectable-bandwidth filters
- True limiterless operation over wide dynamic range
- Independent active detection for diversity operation
- Sophisticated decision level correction circuitry automatically maintains copy during selective fading
- FSK or mark-only autostart with selectable attack and threshold adjust
- ΔF precision shift tuning
- Quality components in rugged extruded aluminum enclosure

Now, the FSK-1000 demodulator will offer these features and more.

Introductory Price
Write for complete specifications.



127

\$397 FOB

2686 SOUTHRIDGE DR.
COLUMBUS, OH 43224

The RUGGED



CC-51
Wing-nut External Connections

Dipole Antenna Connectors



CC-50
Soldered External Connections

Stand Up to Winter's Worst

- Black die-cast aluminum body
- Steatite insulators with welded eyebolts
- Flat-top or Inverted-V
- Handle full amateur power

Commercial quality / Amateur price



At your B&W dealer.

Barker & Williamson, Inc. B23
10 Canal St. • Bristol, PA 19007
Telephone: (215) 788-5581

CALL RUSH TOLL FREE



1-800-251-0264

TENN. RESIDENTS 1-615-764-0831

FOR BEST QUOTE ON

FAST SERVICE
FULL REPAIR
FACILITY

Authorized Dealers for:

- Dentron**
- TEMPO**
- HUSTLER**
- CDE ROTORS**
- Wilson**
- CUSHCRAFT**
- YAESU**
- HY-GAIN**
- MANY OTHERS**

OUR FALL SPECIAL WITH PURCHASE OF

FREE
CES
Touch-Tone
Pad
Value \$49.95

The Memorizer



only 349.95

Yaesu FT 227R
Fully Syn 2M FM



SOUTH'S FASTEST GROWING AMATEUR STORE
R21
1315 BLUFF CITY HWY., BRISTOL, TN. 37620



TOWERS

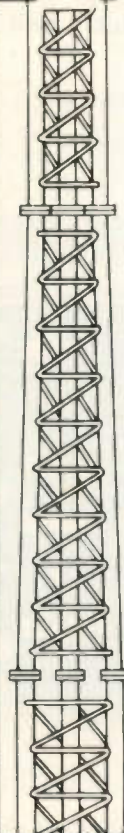

- FREE STANDING
- DESIGNED TO UNIFORM BUILDING CODE REQUIREMENTS
- HIGH TENSILE ALUMINIUM ALLOY
- SIZES TO SUPPORT ANTENNAS FROM 5-15 SQ. FT. OF AREA
- WRITE FOR FREE BROCHURE (QSL CARD IS FINE)

MARKO MFG. INC.

P.O. BOX L M56
SO. WINDSOR, CT 06074

Build A TTY Tester

— works for TTL-compatible printers, too

Louis I. Hutton K7YZZ
12235 SE 62nd Street
Bellevue WA 98006

During the construction of various interface units for my microcomputer, I found I needed some sort of self-contained device that would provide a source of Baudot TTY test signals. The unit should

generate selectable characters at either a 60 or 100 wpm data rate with outputs suitable for driving a TTL or TTY loop circuit.

A search of literature on TTY test equipment turned up a unit published in *The RTTY Journal* that I decided to use as a basis for the TTY test signal generator described in this article. My unit is battery operated

and provides a two-character output, switch-selected, in Baudot format (Fig. 1). The TTL output is negative going and is UART signal compatible. It is also of the same format as the Baudot TTL output signal that appears at port 2, least significant bit, of The Digital Group microcomputer when using Maxi-BASIC in the TTY hard-copy output

mode.

Circuit Description

The circuit consists of three integrated circuit chips and two transistors. IC1 (74122) is a clock oscillator with the timing set by the TTY output speed switch to either 60 or 100 wpm. The output of the clock oscillator is connected to the input of IC2 (7493), a binary counter. The counter provides a binary-coded sequence that is outputted to pins 8, 9, 11, and 12. This sequence is fed to the input of the multiplex switcher, IC3 (74150).

The two data-selector inputs of the 74150 are coded in Baudot format by the 10 front-panel-mounted SPDT slide switches. The multiplex switcher scans the two Baudot-coded inputs and converts the parallel inputs into a serial bit stream appearing on pin 10. This data rate is either 60 or 100 wpm depending on the setting of the output speed switch. When the mode select switch is in the mark hold (MH) position, the output of the 74150 is switched to a steady low state.

The two-character TTY serial bit stream is fed to a

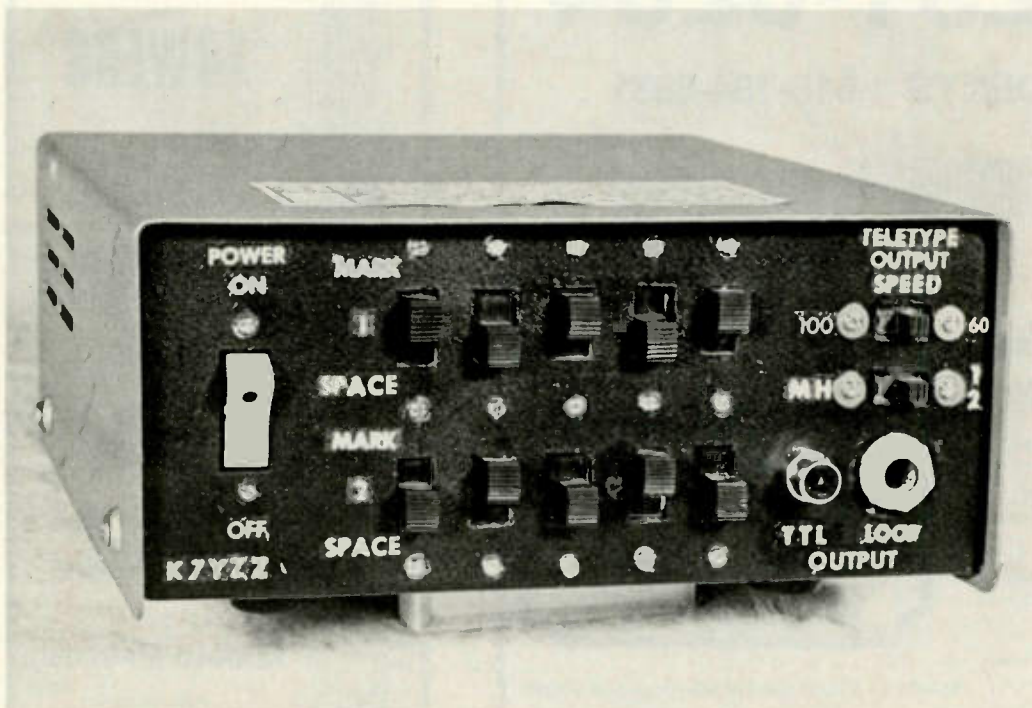

Front-panel view showing switch arrangement.

buffer transistor and on to the loop driver transistor (MJE 340). A diode bridge (1N4004s) is employed for loop polarity isolation. The TTL output is taken at the output of the driver transistor. This signal is normally high, with negative-going pulses.

Construction

The ICs, transistors, diodes, capacitors, and resistors were mounted on perf-board. The leads were poked through the holes in the board and wired on the back side. Three battery holders, each holding two size AA cells, were mounted on the rear of the perfboard. The total current drain is about 70 milliamperes at 4.5 volts. No sockets were originally used with the ICs, but during testing I found my surplus 74122 was bad, and once I removed it, I installed a socket. It is strongly suggested that sockets be used on all ICs and transistors, as it will make troubleshooting much easier.

The cabinet is a Radio Shack model number 270-254, and is 6-1/4" by 2-3/4" by 7-1/4". The front panel was repainted a dull black after all the component mounting holes were drilled. The decals were then applied and the front panel was covered with two coats of clear Krylon™ spray.

A chart was prepared which identifies the Baudot code for each character to aid in setting up the 10 switches. This chart was cemented to the top of the cabinet with model airplane cement. Baudot code format may be found in the 73 *RTTY Handbook*.

Testing

After all the components are mounted on the perf-board and wired, a complete point-to-point wire check should be made before the batteries are installed. The battery output

should be checked to be sure it is 4.5 volts. The power can then be turned on and pin 14 of IC1, 5 of IC2, 24 of IC3, and the collector of the 2N2222 are checked for B-plus before the ICs are installed.

If the wiring and voltage checks are OK, then the ICs and transistors are installed and power is again applied. The mark space switches, rows 1 and 2, are set to the TTY R-Y code. The mode select switch is set to the 1-2 position, and the TTY output speed switch is set to 60 wpm.

Using an oscilloscope with a calibrated timebase, measure the width of a pulse in the pulse chain appearing on pin 10 of IC3. It should be 22 ms wide for the 60 wpm speed and 13.4 ms wide for 100 wpm speed. If the pulse widths are not as specified, then substitute a potentiometer (25k) for the 18k or 15k resistor in the oscillator circuit and adjust it until the specified pulse width is obtained. Then measure the resistance of the potentiometer and replace it with a fixed resistor as close to the measured value as possible. With the mode select switch in MH (mark hold),

the output on pin 10 of IC3 should go to a steady low.

The unit is now ready for use in tests via a TTY dc loop or computer TTL interface. ■

References

1. "An Intelligent RTTY Station," *73 Magazine*, April, 1977.
2. "Computerized RTTY Take-over," *73 Magazine*, May, 1977.
3. "A TTL R-Y Generator," *The RTTY Journal*, January, 1974.

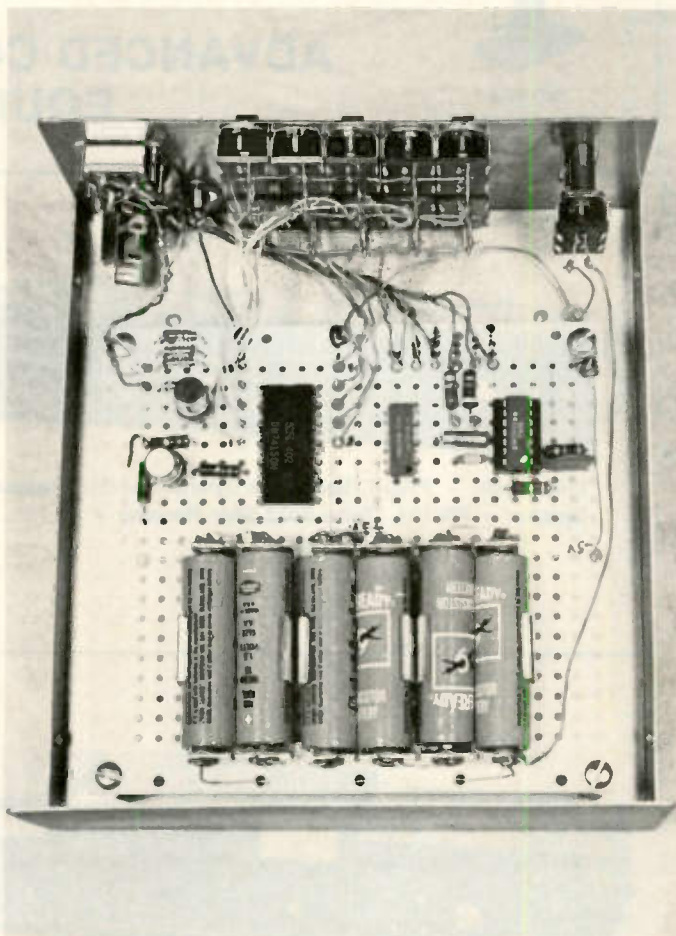

Inside view of the TTY test set.

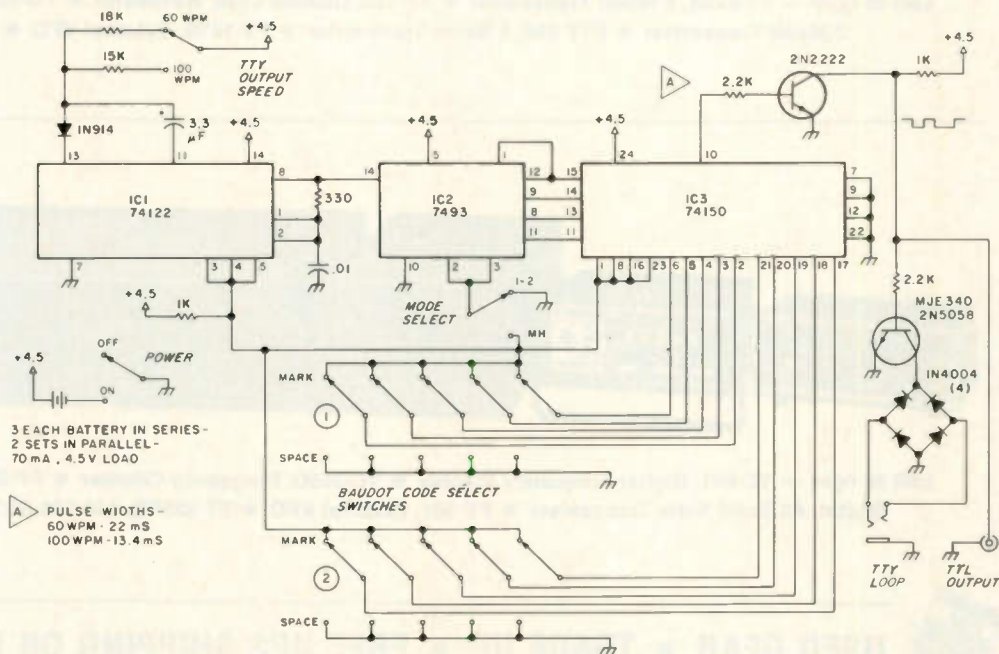

Fig. 1. TTY test set schematic diagram.

WE HAVE WHAT YOU NEED AT...



YD-844
Dynamic Mike

YAESU

ADVANCED COMMUNICATION EQUIPMENT



QTR-24
World Clock

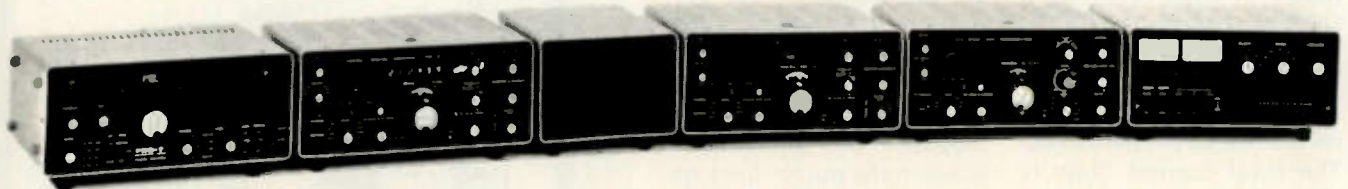

Left to right - FRG-7, Solid State Synthesized Communications Receiver • FR-101 Digital, Solid State Receiver • SP-101B, Speaker • FR-101, Digital Solid State Receiver • FL-101, 100 W Transmitter • FL-2100B, 1200 W PEP Input Linear Amplifier



Left to right - FT-620B, 6 Meter Transceiver • YP-150, Dummy Load Wattmeter • YO-101, Monitor Scope • FTV-250, 2 Meter Transverter • FTV-650, 6 Meter Transverter • FV-101B, External VFO • FT-101F 160-10M Transceiver



Left to right - YC-601, Digital Frequency Display • YC-355D, Frequency Counter • FP-301, AC Power Supply • FT-301S Digital, All Solid State Transceiver • FV-301, External VFO • FT-225RD, 144-148 All Solid State All Mode Transceiver



USED GEAR • TRADE UP • FREE UPS SHIPPING ON PREPAID ORDERS

\$2,000,000 HAM INVENTORY

HAMTRONICS-WHERE THE HAM IS KING

THE LOWEST POSSIBLE PRICES



THE PACESETTER IN AMATEUR RADIO



7005T \$729.00

2M ALL MODE BASE/MOBILE TRANSCEIVER. SSB (upper and lower), FM, AM and CW. AC and OC. 4 MHz band coverage (144 to 148 MHz). Dial in receiver frequency and TS-700A automatically switches xmitter freq. 600 KHz for repeater operation. Xmit, Rcv capability on 44 Ch. with 11 xtals.



TR-7400A \$399.00

2M MOBILE TRANSCEIVER. Synthesized PLL. Selectable output, 25 watts or 10 watts. 6 Digit LEO freq. display. 144-148 MHz, 800 CH. in 5 KHz steps. 600 KHz repeater offset. Continuous tone-coded squelch (CTSC). Tone Burst.



TS-820S \$1098.00

SSB TRANSCEIVER. PLL RF Monitor Noise Blanker. Digital hold locks counter & display at any frequency, but allows VFO to tune normally. True RF compressor adjustable speech processor. IF shift control. RF attenuator. VOX, GAIN, ANTIVOX and VOX delay controls. RF negative feedback. Optional digital readout. ORS Dial. High stability FET VFO.



TS-520S \$739.00

SSB TRANSCEIVER. Proven in the shacks of thousands of discriminating hams, field day sites, OX and contest stations and mobile installations. Superb engineering and styling.

SP-520 \$33.00
Optional external speaker for better readability.

TV-502S \$279.00
TRANSVERTER. Puts you on 2M the easy way. 144-145.7 MHz or optional 145-146 MHz.



R-820 — INTRODUCING — \$1049.00

THE ULTIMATE IN RECEIVER DESIGN... THE KENWOOD R-820 With more features than ever before available in a ham band receiver. This triple-conversion (8.33 MHz, 455 kHz, and 50 kHz IFs) receiver, covering all Amateur bands from 160 through 10 meters, as well as several shortwave broadcast bands, features digital as well as analog frequency readouts, notch filter, IF shift, variable bandwidth tuning, sharp IF filters, noise blanker, stepped RF attenuator, 25 kHz calibrator, and many other features, providing more operating conveniences than any other ham-band receiver. The R-820 may be used in conjunction with the Kenwood TS-820 series transceiver, providing full transceive frequency control.



MC-50 \$39.50

Dynamic microphone designed expressly for amateur radio operation. Complete with PTT and LOCK switches, and a microphone plug. (600 or 50k ohm)



S-599D-\$25.00 R-599D-\$499.00 T-599D-\$499.00

SSB TRANSMITTER. 3.5 to 29.7 MHz. Stable VFO. 1 KHz dial readout. 8 pole Xtal filter. AM Xmission available. Built-in AC pwr supply. Split frequency control available.



VFO-820 \$155.00

Designed exclusively for use with TS-820. RIT circuit and control switch. Fully compatible with optional digital display.

VFO-520 (Not Shown) \$139.00

Solid State Remote VFO. RIT circuit with LED indicator.



SM-220 \$329.00

KENWOOD'S SM-220 STATION MONITOR. The SM-220's unexcelled versatility allows you to monitor your transmissions, monitor incoming signals, and monitor the amount and strength of band activity* and performs as a general-purpose 10 MHz oscilloscope, as well.



R-300 \$249.00

ALL BAND COMMUNICATIONS RECEIVER. AC, batteries or external DC. 170 KHz to 30 MHz in 6 bands. Foreign broadcasts or ham radio in AM, SSB and CW. Dual gate MOS/FET transistors & double conversion. Band spread dial. 500 KHz marker.

CALL JIM TITUS FOR FREE QUOTES ON TOLL FREE NO. 800-523-8998

HAMTRONICS

DIVISION OF TREVOSE ELECTRONICS
4033 Brownsville Rd • Trevose, Pa. 19047
(215) 357-1400/(215) 757-5300

THE BIG 'H' FOR ALL YOUR HAM NEEDS!

WE HAVE WHAT YOU NEED AT...



KNOWN FOR QUALITY THROUGHOUT THE WORLD

HAMTRONICS-WHERE THE HAM IS KING

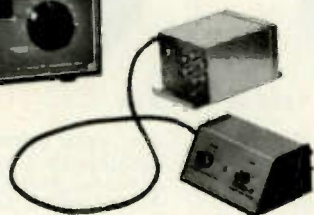

RECEIVERS

DSR-2	VLF-HF Digital Synthesized SSB, AM, CW, ISB, RTTY	\$3200.00
R-4C	C-Line, HF, 160-10M	\$699.00
4NB	Noise Blanker for R-4C	\$74.00

TRANSMITTER

T-4XC	C-Line, HF, 160-10M	\$699.00
-------	---------------------	----------

TRANSCEIVERS

TR-7	Transceiver	\$1100.00
DR-7	Digital Readout	\$195.00
RV-7	Remote VFO for TR7	\$195.00
FA-7	Fan for TR-7	\$25.00
MS-7	Speaker for TR-7	\$33.00
7077	Dynamic Desk Mike for TR7	\$45.00
34PNB	Plug-in Noise Blanker for TR-4 Series	\$100.00

SYNTHESIZER

FS-4	General Coverage for 4-Line and SPR-4	\$300.00
------	--	----------

LINEAR AMPLIFIER

L-4B	Linear and w/power supply & tubes	\$995.00
------	-----------------------------------	----------

MATCHING NETWORKS

MN-4C	Antenna Matching Network. 200W	\$165.00
MN-2000	Antenna Matching Network. 1000W	\$250.00
RCS-4	Remote Control Antenna Switch	\$120.00

W-4	RF Wattmeter, 1.8 to 54 MHz	\$79.00
WV-4	RF Wattmeter, 20 to 200 MHz	\$89.00
7073	Hand-Held Microphone	\$19.00
1525EM	Push-button Encoding Microphone	\$49.95
HS-1	Head Phones	\$10.00
AA-10	10W, 2M Amplifier	\$49.95
TV-300-HP	300 ohm High Pass TV Set Filter	\$10.60
TV-75-HP	75 ohm High Pass TV Set Filter	\$13.25
TV-42-LP	Transmitter Low Pass Filter. 100W	\$14.60
TV-3300-LP	Transmitter Low Pass Filter. 1000W	\$26.60
TV-5200-LP	Transmitter Low Pass Filter. 1000W. 100W, 6M	\$26.60



USED GEAR • TRADE UP • FREE UPS SHIPPING ON PREPAID ORDERS

\$2,000,000 HAM INVENTORY

THE LOWEST POSSIBLE PRICES

COLLINS AMATEUR EQUIPMENT



KWM-2A TRANSCEIVER \$3533.00
 Unmatched for mobile and fixed station applications. 175W on SSB, 160W on CW. Switch select up to 14 optional Xtals. Can be used for RTTY. Filter type SSB generation. Automatic load control. Inverse RF feedback. Reimbursement-tuned variable oscillator.



75S-3C RECEIVER \$3000.00
 Sharp selectivity. SSB, CW and RTTY. Single control rejection tuning. Variable BFO. Optional mechanical filters for CW, RTTY and AM. 2.1 KHz mechanical filter. Zener regulated oscillators. 3-position AGC.

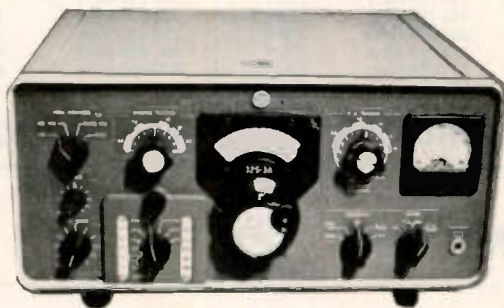

32S-3A TRANSMITTER \$3250.00
 Covers all ham bands between 3.4 MHz and 30 MHz. Nominal output of 100W. 175W, SSB and 160W CW. Dual conversion. Automatic load control. RF inverse feedback. CW spotting control. Collins mechanical filter.

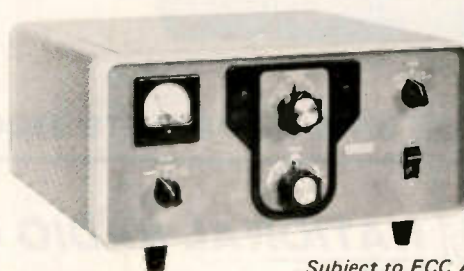

30L-1 LINEAR AMPLIFIER \$1689.00
 1000 Watts PEP on SSB and 1000 Watts average on CW. SSB and CW, covers the 80, 40, 20, 15, and 10m bands — general coverage use, too. Automatic load control provides maximum talking power without over-driving and distortion. Grounded grid linear amplifier using four 811A triodes, instantly heated, no warm-up delay. Uses an exclusive comparator circuit operated by adjusting tuning and loading controls.

Subject to FCC Approval



312B-3 SPEAKER
 \$95.00



312B-4 SPEAKER CONSOLE
 \$648.00



312B-5 VFO CONSOLE
 \$1616.00



516F-2 AC POWER SUPPLY
 \$440.00



302C-3 DIRECTIONAL WATT METER
 \$493.00



DL-1 DUMMY LOAD
 \$270.00

CALL JIM TITUS FOR FREE QUOTES ON TOLL FREE NO. 800-523-8998

HAMTRONICS

DIVISION OF TREVOSSE ELECTRONICS
 4033 Brownsville Rd • Trevose, Pa. 19047
 (215) 357-1400 / (215) 757-5300

THE BIG 'H' FOR ALL YOUR HAM NEEDS!

WE HAVE WHAT YOU NEED AT...

BIRD THRULINE® WATTMETER

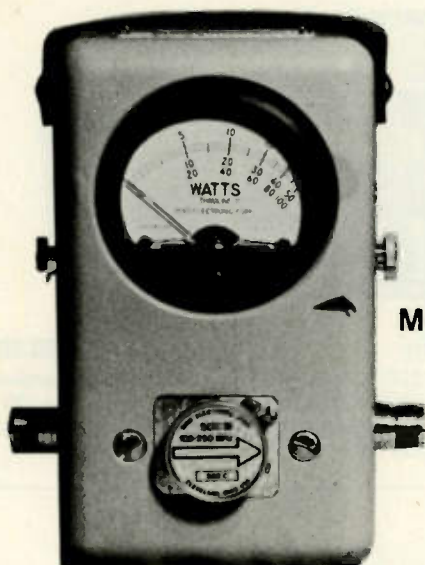

MODEL 43

- BUY ONLY THE ELEMENTS YOU NEED AND ADD EXTRA RANGES AT ANY TIME
- READ RF WATTS DIRECTLY

Table 1
STANDARD
ELEMENTS

Power Range	Frequency Bands (MHz)					
	2-30	25-60	50-125	100-250	200-500	400-1000
5 watts	—	5A	5B	5C	5D	5E
10 watts	—	10A	10B	10C	10D	10E
25 watts	—	25A	25B	25C	25D	25E
50 watts	50H	50A	50B	50C	50D	50E
100 watts	100H	100A	100B	100C	100D	100E
250 watts	250H	250A	250B	250C	250D	250E
500 watts	500H	500A	500B	500C	500D	500E
1000 watts	1000H	1000A	1000B	1000C	1000D	1000E
2500 watts	2500H					
5000 watts	5000H					

Table 2
LOW-
POWER
ELEMENTS

1 watt	Cat. No.	2.5 watts	Cat. No.
60-80 MHz	060-1	60-80 MHz	060-2
80-95 MHz	080-1	80-95 MHz	080-2
95-125 MHz	095-1	95-150 MHz	095-2
110-160 MHz	110-1	150-250 MHz	150-2
150-250 MHz	150-1	200-300 MHz	200-2
200-300 MHz	200-1	250-450 MHz	250-2
275-450 MHz	275-1	400-850 MHz	400-2
425-850 MHz	425-1	800-950 MHz	800-2
800-950 MHz	800-1		

WE HAVE A COMPLETE STOCK OF ALL BIRD WATTMETERS AND SLUGS



NATIONAL RADIO COMPANY, INC.

NRCI

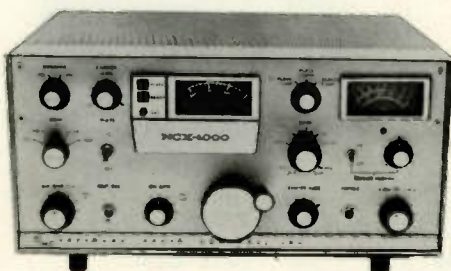

NCX-1000

The only 1000 watt, "single package" transceiver. Heavy duty design... results of 50 years of design leadership in amateur equipment. State of the art speech processing, linear amplifier, power supply, all in one package. Nothing extra to buy. Covers all amateur bands in the HF spectrum... AM, SS' CW' **\$1,600**

NCL-2000

Linear Amplifier. A full 10 dB gain. 20 watts in 2000 watts out. Can be driven with one watt. Continuous duty design utilizes two 8122 ceramic tetrode output tubes, designed for both AM and SSB operation. The industry standard for 12 years. Thousands in use all over the world.

\$1,200



HRO-500

The ultimate short wave receiver. This synthesized (phase lock loop) receiver incorporates all facilities for AM, Single Side Band (SSB), and CW reception in all frequencies from the bottom of the very low frequency band (VLF) to the top of the high frequency band (HF). National's "dead accurate" dial means no searching for transmissions. Dial up the frequency and it's there: aeronautical, marine, CB, amateur, military, etc. Continuous coverage. **\$3,000**



USED GEAR • TRADE UP • FREE UPS SHIPPING ON PREPAID ORDERS

\$2,000,000 HAM INVENTORY

HAMTRONICS-WHERE THE HAM IS KING

THE LOWEST POSSIBLE PRICES

NYE VIKING



No. 114-310-003 \$9.65



No. 114-310-004GP \$50.00



No. 114-404-002 \$20.75

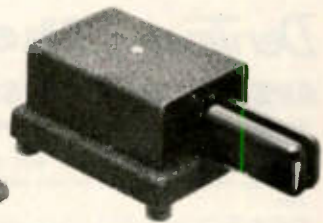

No. SSK-1 \$23.95



No. 250-46-1 \$36.50



No. 250-46-3 \$46.50



No. 250-20-1 \$19.95



No. MB2-1 \$315

NPC

2.5 AMP



12CB4 29.95

4 AMP



103R 39.95

6 AMP



104R 49.95

12 AMP

108 RM
99.95

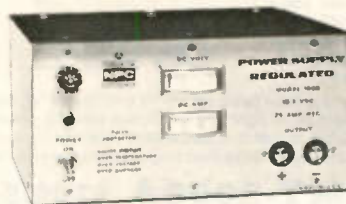

25 AMP

109R 149.95

VIBROPLEX



"PRESENTATION"
72.50



"ORIGINAL"
49.95



"LIGHTNING BUG"
49.95



"CHAMPION"
46.50

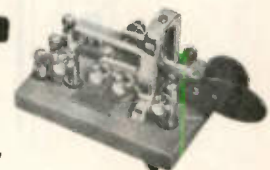

VIBRO-KEYER
46.50

CALL JIM TITUS FOR FREE QUOTES ON TOLL FREE NO. 800-523-8998

HAMTRONICS

DIVISION OF TREVISE ELECTRONICS
4033 Brownsville Rd • Trevose, Pa. 19047
(215) 357-1400 / (215) 757-5300

THE BIG 'H' FOR ALL YOUR HAM NEEDS!

WE HAVE WHAT YOU NEED AT...

DenTron The MT-3000A

SPECIFICATIONS:

- Power handling capability in excess of 3 KW PEP
- Front Panel Antenna Switch with 5 Antenna Inputs plus Tuner bypass position
- Built-In 50 Ohm—250 Watt dummy load
- Dual Wattmeters
- Compact: 5 1/4" x 14" x 14", 18 pounds
- Continuous Tuning 160-10 meters
- 3 Core Heavy-Duty Balun



349.50

DenTron Super Tuner



160-10 Meters
Balanced Line,
Coax, Random
or Long Wire

Maximum Power Transfer, Xmitter to Antenna.

1 KW Model \$129.50

3 KW Model \$229.50

The evolution of the MLA



When the MLA-2500 was first introduced it was a new concept in high performance amplifiers. Low and sleek yet powerful enough for the military. Some wondered... needlessly.

A promise kept.

The MLA-2500 promised 2000 watts PEP input on SSB. A heavy duty power supply. Two Elmac 8875's. And as thousands of Amateurs across the world have proven, the MLA-2500 delivers!

Now DenTron is pleased to bring you The new MLA-2500B. Inherently the same as the original MLA-2500, the B model includes all of the above specifications plus a few refinements. New high-low power switching for consistent efficiency at both the 1KW and 2KW power levels, and 160-15 meters.

Tested and proven.

What better test for an amplifier than the Clipperton DXpedition? Even after 32,000 QSO's, and an accidental dunk in the ocean, the same 3 MLA-2500's are still amplifying other rare DXpeditions around the world—listen for them.

Convinced? Isn't it time you owned the amplifier that powered Clipperton and thousands upon thousands of radio stations throughout the world?

MLA-2500B \$899.50

If they copy the quality, they can't meet the price.

The original DenTron Super Tuner. The original Super Tuner. The original MT-3000A. And now DenTron brings you the original MT-2000A, an economical, full-power tuner designed to handle virtually any type of antenna.

The sleek styling and low profile of the MT-2000A is beautiful, but be assured that is only a part of the excitement you'll derive from the MT-2000A. The MT-2000A is designed and engineered using heavy-duty all-metal cabinetry, and high quality American components throughout.

When you consider the MT-2000A's unique features: 5 1/4" H x 14" D x 14" W, front panel coax bypass switching, front panel lightning protection antenna grounding switch, 3KW PEP, and the ability to match coax, random wire and balanced feedline, we're sure you'll decide to buy an American original and stay with DenTron.



DenTron

MT-2000A \$199.50

DenTron JR. MONITOR™ Antenna Tuner



Continuous tuning from 1.8-30 MHz. 300 watt power capability. Forward reading relative output power meter—simply tune JR. MONITOR™ controls for maximum RF output on the meter. Built-in balun. Mobile mounting bracket. Ceramic rotary 12-position switch. Capacitor spacing 1000 volts. Tapped toroid inductor. Antenna inputs: coax unbalanced SO 239, random wire, balanced feed line 75-660 ohm. Weight: 2 1/2 pounds.

\$79.50

Big Dummy w/coolant



\$29.50

All Band Doublet



This All Band Doublet or inverted Type Antenna covers 160 thru 10 meters. Has total length of 130 feet (14 ga. stranded copper) although it may be made shorter if necessary. This tuned Doublet is center fed through 100 feet of 450 ohm PVC covered balanced transmission line. The assembly is complete. Add rope to the ends and pull up into position. Tune with the DenTron Super Tuner and you're on 10 through 160 meters with one antenna! Now just for the DenTron All Band Doublet.

\$24.50

DenTron W-2 PAD INLINE WATTMASTER

Read forward and reflected watts at the same time



Tired of constant switching and guesswork?

Every serious ham knows he must read both forward and reverse wattage simultaneously for that perfect match. So upgrade with the DenTron W-2 Dual In Line Wattmeter.

\$99.50

USED GEAR • TRADE UP • FREE UPS SHIPPING ON PREPAID ORDERS

\$2,000,000 HAM INVENTORY

HAMTRONICS—WHERE THE HAM IS KING

THE LOWEST POSSIBLE PRICES

TEN-TEC INC.

TRITON IV EQUIPMENT



TRANSCEIVERS

MODEL 540-200W, SSB/CW
3.5 - 30 MHz \$699.00

MODEL 544- DIGITAL, 200W
SSB/CW, 3.5 - 30 MHz \$869.00



MODEL 240 \$110.00
ONE - SIXTY CONVERTER



MODEL 242 \$179.00
REMOTE VFO



MODEL 244 \$197.00
DIGITAL READ OUT/COUNTER



MODEL 262-M \$145.00
DELUXE POWER SUPPLY



ARGONAUT

MODEL 509 \$369.00
SW, SSB/CW, 3.5-30 MHz

LINEAR AMPLIFIER

MODEL 405 \$159.00
100W, 3.5 - 30 MHz

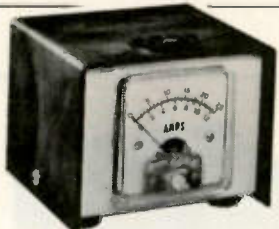
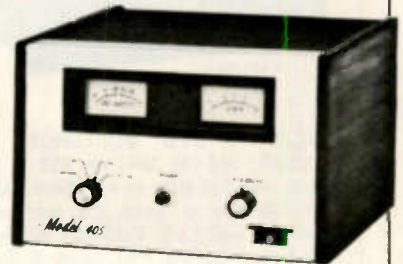

AMMETER
207 \$14.00



XTAL CALIBRATOR
206-A \$29.00

KEYERS



ELECTRONIC KR-50
\$110.00

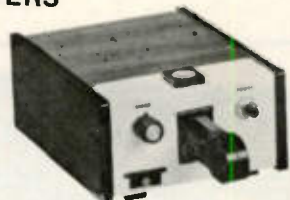

ELECTRONIC KR20-A \$69.50



ELECTRONIC KR-5A
\$39.50



KR-2A \$17.00

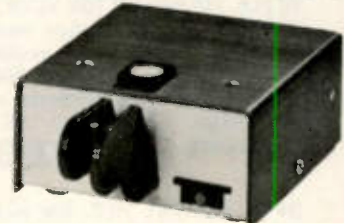

KR1-A \$35.00

CALL JIM TITUS FOR FREE QUOTES ON TOLL FREE NO. 800-523-8998

HAMTRONICS

DIVISION OF TREVOSE ELECTRONICS
4033 Brownsville Rd • Trevose, Pa. 19047
(215) 357-1400 / (215) 757-5300

THE BIG 'H' FOR ALL YOUR HAM NEEDS!

WE HAVE WHAT YOU NEED AT...



ICOM

VHF/UHF AMATEUR & MARINE EQUIPMENT



VHF/UHF AMATEUR & MARINE EQUIPMENT

IC-245. 146 MHz FM 10W XCVR. LSI synthesizer with 4 digit LED readout. Xmit & Rcv frequencies independently programmable. 60 dB spurious attenuation.

\$545.00

IC245SSB.....**\$689.95**

IC-215. 2 METER FM PORTABLE. Three narrow filters for superb performance. 3W or 400 mW. 15 CH. capacity. MOS FET RF Amp & 5 tuned ckts. S-meter front panel.

\$229.00



\$249.00

IC-502. 6 METER SSB & CW PORTABLE XCVR. Includes antenna & battery pack. 3W PEP & stable VFO for fun & FB QSO's. Covers first 800 KHz of 6M band, where most activity is.



IC-211

IC-211. 4 MEG, MULTI-MODE 2M XCVR. 144-145 MHz on SSB & CW, plus 146-147 MHz on FM. Work AMAT OSCAR six or seven. LSI synthesizer with 7 digit LED. MDS FET RF Amp, 5 helical cavities, FET mixer & 3 I.F. filters.

\$850.00

\$1650.00

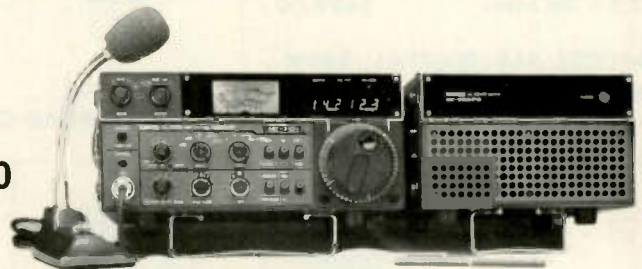

IC701 W/POWER SUPPLY & MIKE • Dual Independent UFO's Built-in • 100 Watts Output • All HF Bands, 160-10M • Fully Synthesized Tuning • Continuously Variable Bandwidth • Double Balanced Schottky Diode 1st Mixer • RF Speech Processor • VOX; Fastbreak in CW; RIT; AGC; Noise Blanker; Full Metering •

IC280.....**\$480.00**



IC-21A. 146 MHz FM 10W XCVR. MOS FET RF Amp & 5 helical resonator filter, plus 3 I.F. filters. IDC modulation control. Variable output pwr: 500 MW to 10W Front panel discriminator meter. SWR bridge. 117 VAC and 13.6 VDC pwr supplies.

\$399.00

DV-21. DIGITAL VFO. Use with IC-21A to complete 2M band.

\$299.00

IC-202. 2 METER SSB PORTABLE XCVR. Puts sideband in your hand! Internal C batteries or external 12 VDC. 3W PEP. True I.F. noise blanker. 144.0, 144.2 on two other 200 KHz bands, selectable. Hamtronics stocks 145.2 and 145.8 - 146.0 MHz for calling frequency & satellite band.

\$275.00



IC-30A. 450 MHz FM LOW XCVR. 1W or 10W. Low noise MOS-FET RF Amp & 5 section helical filter. 22 CH. capacity. S-meter & relative power output meter. IDC modulation control.

\$440.00

CALL JIM TITUS FOR FREE QUOTES ON TOLL FREE NO. 800-523-8998

\$2,000,000 HAM INVENTORY

HAMTRONICS-WHERE THE HAM IS KING

Fall Clearance Specials

All Items subject to Prior Sale

- Kantronics 8040 B 80 and 40 meter battery operated receiver, great for code practice \$ 77.95
- C.W. Filter for the 8040 B 33.95
- Newtronics 4BTV Antenna—40 thru 10 meters 85.95
- Wilson 5 element 20 meter beam M520 239.95
- Wilson 40-10M vertical antenna 61.95
- Kirk Quad Antenna—the best Quad going
1322 2 element
10-15-20 meters 202.95
- 1323 3 element
10-15-20 meters 291.95
- Heights aluminum towers in stock to put these Quads on.
- We are an authorized dealer for Robot SSTV and Info-Tech C.W. and RTTY converters.
- DSI frequency counter—pick up by radiation .5 ppm accuracy 174.95

Call for prices on all major equipment needs.
All prices F.O.B. Reynoldsburg, Ohio
Master Charge and VISA accepted



universal amateur radio inc



U6

1280 AIDA DRIVE
COLUMBUS OHIO
(Reynoldsburg) 43068

(614)-866-HAMS

Iron Powder and Ferrite TOROIDAL CORES

Wide selection - Large stock
Fast, one-day service
Technical data with each order
Write for free Tech-Data-Flyer

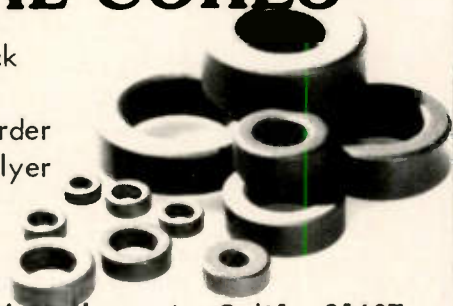

AMIDON
Associates

12033 Otsego Street, North Hollywood, Calif. 91607

In Germany: Elektronikladen, Wilhelm - Mellies Str. 88
4930 Detmold 18, West Germany. A26

Special Purchase:

ITT NORTH ELECTRIC N13012A POWER SUPPLY

We have purchased a limited quantity of these power supplies through a Telephone company warehouse liquidation—so the prices are good only while they last. These supplies regularly sell for \$212.00.



SPECIFICATIONS:

Voltage Output:
Adjustable between 9.5 - 14.5V.
Output Regulation:
0.2% (of rated output voltage) + 2.0mv. for any combination of the "input" and 0 to 100% static load change.
Ripple:
Less than .5mv RMS with 45 - 65 Hz input.
Current Output:
25°C 10.0 amps. At least 15 amps intermittent duty.
40°C 8.0 amps
50°C 7.3 amps
60°C 7.3 amps
60°C 6.5 amps
71°C 4.8 amps

Overload Protection:
a) Overtemperature—thermal switch in series with AC input protects against overheating. Thermal switch resets after overtemperature condition is eliminated.
b) Overcurrent fuses protect input and output from failure due to excess current.
c) Electrical—Electronic overload circuit which will limit the output current to a safe level (130% of 40°C rated load with foldback).
Overshoot:
No overshoot of rated output voltage under any power on/off condition.
Operating Temperature Range:
0 - 71°C.

1 - 5 \$94.00 ea.
6 - 10 \$89.00 ea.
11 - up \$84.00 ea.

F.O.B. Hermosa Beach, Ca.
Shipped new in original carton with complete manual.
Phone or mail orders accepted.



WEIGHT: NET 15 LBS, SHIP 18 LBS.

Visit our Warehouse Outlet at: 1215 Manhattan Ave., Hermosa Beach, Calif. 90254 (213) 376-5887

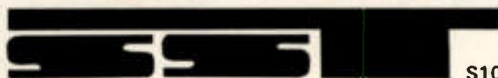

S10

ELECTRONICS
P.O. BOX 1 LAWNOALE, CALIF.
90260 (213) 376-5887

It's A Ham's World

— show this one to a non-amateur

This is the fantastic world of amateur radio. More than a hobby, amateur radio is a service recognized and encouraged by the governments of most nations. It has possibilities that are as unlimited as the universe itself.

Amateur radio operators (hams) come from all walks of life. There are no boundaries of race, color, or creed. Common goals and interests unite hams spreading international goodwill via the airwaves.

You can have the world at your fingertips in two-way communication, from an

expedition through the deepest jungles of the Amazon to one on a desolate Antarctic outpost. Orbiting satellites can carry your signals over vast areas never before dreamed possible. Television transmitters span the oceans, allowing you to see your contacts. Signals amplified by repeaters increase your coverage tenfold. You can bounce signals off the moon to distant stations, witness the marvels of radio-teletype (RTTY), or be astounded by automation via microcomputers. Whether your interests will center on

contests, foreign stations (DX), public service, building and experimentation, satellite communication, certificate hunting, rag chewing, or any one of the many other facets, these realities can be yours.

True, most hams would need more than one lifetime to cover every aspect of amateur radio. It has also been said that they would need a bank account to match. Amateur radio is an investment — an investment in the education of the young for a lifetime career in electronics, for lifesaving communication when all other means may fail, and for your own enjoyment — an investment that is considerably less, dollarwise, than almost all the other pastimes imaginable and one that is much more rewarding. Once that initial investment is made, it may cost you only as much as the cost of the extra electricity you consume. On the other hand, it can also cost you the price of that new equipment you must have to keep up with the Joneses. But, by starting out with a modest station, new or used, many of the aforementioned activities can be realized.

Your License

Every 10 or 20 years, a World Administrative Radio Conference (WARC) is held. Preparations are now being made for the next one, which will take place in Geneva in 1979. This conference (WARC-79) will decide the frequency allocations for all radio services for the remainder of this century. Regardless of size, each country has one vote.

Amateur radio, which is included, must abide by the rules, regulations, and frequency allocations as set forth by the Federal Communications Commission (FCC) as a result of the conferences.

Because of its scope, certain requirements have been made regarding the amateur radio service. You must pass tests in international Morse code and electronic theory. Questions on rules and regulations are also included. The tests are of a multiple-choice nature.

There are 5 license classes: Novice (beginners), Technician, General, Advanced, and Amateur Extra. You start out as a Novice and work up the ladder to Amateur Extra, in each case taking the extra

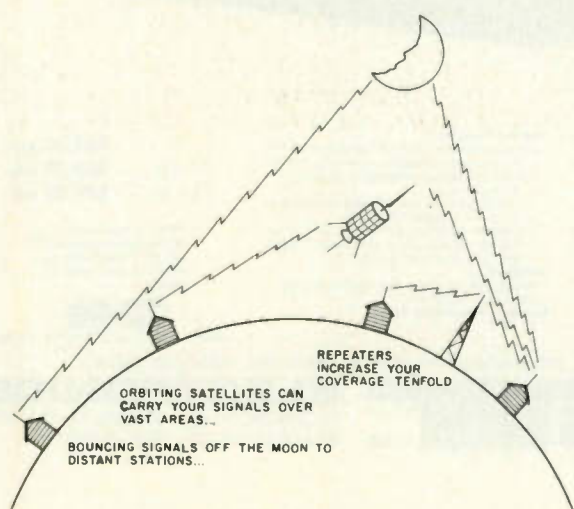

Fig. 1. The world at your fingertips through the airwaves.

test elements needed for advancement. All tests, except the Novice class, are given by FCC examiners at your closest FCC exam point. The Novice test may be taken in your own home, supervised by an amateur volunteer with a General class license or better.

Courses are held by many radio clubs. You can check to see if one is available in your area by getting in touch with a local amateur. If not, you may request help through some of the monthly amateur radio magazines. License manuals, code tapes, records, and practice materials are available from many sources.

There are no age limits in the United States. Armed with your determination, the passing of the FCC exam can be only weeks away. If you fail? So what! Take it over again at a later date. How many of us fail our first driver's test and pass the second one with flying colors? Sooner than you realize, that ticket will be in the mail with your own distinctive call sign.

1976, a year of surprises, saw the passing of a Novice exam by a 5-year-old boy from Vincennes, Indiana. Little Neil "Rusty" Rapp WN9VPG, not quite in the first grade, mastered the code and gained sufficient knowledge to earn a Novice license. The test was administered by a radio club and signed by the entire radio class as witnesses. The spark responsible for igniting his interest was the use of the Citizens Band (CB), on which he used the handle "Little Shadow." He is truly an inspiration for anyone contemplating upgrading, whether it be within the amateur ranks or converting from CB to ham radio.

Confirmation (QSL) Cards

When you receive your license, you will most likely set an initial goal. Whatever that may be, over-the-air contacts will be made. Communication is the name



Certificates recognize your abilities and achievements as a ham.

of the game. No doubt you will want confirmation, in the form of QSL cards, as proof of some of your prized contacts.

Some QSL cards are very colorful and interesting. Others may be very simple black and white hand-designed forms of standard postcard size. Either type will contain the necessary data needed for verification that the stated contact did take

place. The cards are used as proof of contact for many of the certificate and award programs that are available.

In the past, an exchange of QSL cards with each station you worked was considered a final act of courtesy. With today's ever-increasing postal rates, however, the exchange of cards (QSLing) is kept to a minimum. Many amateurs will not return a card to you unless you enclose a self-

addressed stamped envelope (SASE). In some of the rarer states, rare in terms of amateur population — such as Alaska, it is not uncommon for active hams to receive thousands of cards each year. That's quite a financial burden if they have to supply return postage also. A New York ham may receive none unless his requests contain an SASE.

Foreign (DX) amateurs

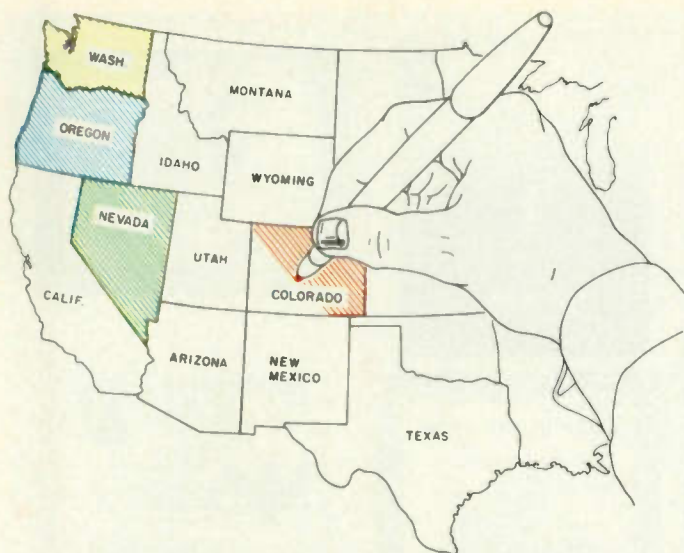

Fig. 2. With one appealing form of recordkeeping, hams enjoy coloring in maps as new areas are worked.

may request international reply coupons (IRCs), which are obtainable at your local post office. This coupon is exchanged by the foreign amateur for stamps of the corresponding denomination at his local post office.

To offset the high cost of QSLing, QSL bureaus are used in most countries having a considerable amount of ham activity. They are incoming and outgoing clearinghouses that permit you to accumulate cards and mail them at bulk rates to a central point for redistribution.

QSL cards are available from many printers as advertised in many of the amateur radio magazines. You can make your own personalized cards, if you so desire.

Your Logbook

Although present FCC rules require a minimum of recordkeeping, an accurate logbook is still a necessity for the active ham. The log is a written record of your contacts and achievements toward your goal. It contains all the necessary data for QSLing. It is a list of all the stations you worked, how, when, and where. You can buy logbooks or make them if you prefer.

Certificates and Awards

One particular pursuit in

the world of amateur radio is certificate hunting. It is considered a hobby within a hobby. Certificates are awards for your achievements. They can be the final step of one goal or the start of another.

Thousands of certificates are available, more than you may ever come close to earning. Most are of the paper or parchment variety. Some of the super awards are wall plaques. Many are in full color; others are black and white. Professionally printed or hand drawn, all are suitable for framing. They are your rewards for working the required amount of counties, states, countries, continents, zones, or whatever your goal was to achieve the award. It can show your Morse code proficiency or your moonbounce efficiency.

Novelty certificates are also available. There are certificates for having certificates and ones for almost having certificates, certificate-haters' certificates, and rag-chewers' certificates. Some are easy to earn; others can take a lifetime plus some. A nominal fee to help cover printing costs and postage is required for most certificates, although some may be free of charge. That is the exception rather than the rule.

Many of the popular awards started years ago. Some are very recent. Special event awards are also very popular, as hams witnessed during the United States Bicentennial of 1976, perhaps never to be matched until the Tricentennial of 2076. Hams all over the world were trying to contact and confirm as many U.S. stations as possible in all 50 states for the special bicentennial awards that were available.

Commemorative QSL cards and certificates are issued for historical events, also. These special cards can be considered miniature certificates. One such event was the landing of the Viking spacecraft on the planet Mars during the U.S. Bicentennial of 1976. Special event station N6V was put on the air by the Jet Propulsion Laboratory Amateur Radio Club from Pasadena, California. The lucky thousands who contacted this station now possess a historical document in the form of a commemorative QSL card.

Certificate Hunting

Several popular award programs will issue a certificate when you reach a minimum plateau. Endorsement stickers will be issued to be attached to the certificate as you pass each predetermined stage toward the certificate goal. This method is very popular in the United States County Hunters Award, among others.

1. County Hunting (USA-CA)

The award program for trying to contact all U.S. counties can also be considered a hobby within the certificate-hunting hobby because of its scope. It involves contacts with 3076 counties to complete the award. There are two different versions. One calls for the initial certificate to be awarded upon QSL proof of any 500 counties. The other requires a minimum level of 300 counties, as long as all 50

states are included. QSLs are not needed for this one, but an approved list is.

County hunting can be the source for obtaining many certificates. County and certificate hunters have formed chapter clubs throughout the U.S. Many issue certificates when you complete working all counties of that particular state, which also serves as a morale booster in your quest for all 3076 counties. It's not an easy feat, but is quite enjoyable as far as you can go.

The Certificate Hunters Club (CHC) is an aid for county hunters as well as other groups. Regular over-the-air schedules are held where members may get together. This get-together is called a network (net). One person usually keeps things in order. This task is undertaken by the net control station (NCS). Nets are quite common for many special-interest groups. They allow an up-to-date transfer of information and permit those who sign into a net to work other stations that may be needed for their certificate goals. New stations are welcome to call in. Special QSL bureaus are available for county hunters.

2. Ten-Ten (10-X) International Net

Amateur operating frequencies are found throughout the radio spectrum. Each group of frequencies is referred to as an amateur band. The frequency privileges hams enjoy are directly related to the license class they hold.

The Ten-Ten Net operates on the 10 meter amateur band. It is a very popular and novel source for obtaining a variety of fascinating awards. Unlike the county hunters who operate more than one amateur band to gain credit toward their goal, the Ten-Ten Net utilizes only the 10 meter band.

Each member has an assigned number called a ten-ten number. U.S. stations

may become members by collecting 10 ten-ten numbers. You are issued a certificate, along with your own ten-ten number, making you a member of the Ten-Ten Net. It is an international club. Foreign stations need 5 ten-ten numbers for membership.

Chapter clubs issue awards that are termed self-propagating or nonpropagating. Self-propagating awards are generated by a chain reaction. The award holder can pass the certificate number over to you for credit, regardless of his (her) geographical location. For a nonpropagating one, you must work the local chapter members directly. Once you receive a non-propagating certificate, you are unable to pass that certificate number on to the next station, unless you yourself also reside in the geographical area and are a member of that chapter. An average of 5 members must be worked for the majority of the ten-ten chapter awards. A few require a contact with at least 1 local member and any other 4. Some use a point system.

Super category awards are also issued. There are senior, super, and VIP programs available. Some hams may favor collecting ten-ten numbers only. Large collections of the numbers qualify you for various awards. Collecting 500 different numbers makes you a VIP in the Ten-Ten Net; 1000 merits you a plaque. Log information only is needed for 99% of the award programs; very few will require QSL cards. Many nets are active throughout the country, and you are invited to sign into one.

3. Worked All States (WAS)

This award is considered to be one of the most sought-after awards. It is as standard to amateur radio as bait is to fishermen. Rules are quite simple. Contact and confirm all 50 of the United States. Contacts may take place on

any band. The super version of this award is a lot tougher. Rules, again, are simple. Contact and confirm all 50 states on each of 5 different amateur bands (250 contacts in all). Accomplish this and you have earned the 5-Band Worked All States Award (SBWAS).

The plaque available for the SBWAS is charged for. It is higher than the nominal fees required for most certificates, but I don't think anyone has ever passed this one up because of the higher fee.

Some states are easy to catch; others are difficult. What holds true on one band may be reversed on another. Transmission conditions on the same frequency tend to vary with the year, season, and with the time of day, so results are not always predictable.

There are many nets to which stations from all over the United States call in. If permissible, sign into one of these nets and request permission to call the stations in those states you are lacking. Do not overdo this, as many other stations will be waiting for you to finish your contacts so they can finish whatever business they have with the net. During 1976, the special Bicentennial Net had check-ins from all 50 states, and that was all in one evening. You may have to work a state more than once if the first contact did not produce a QSL card. Making contact will not guarantee you a confirmation card, even if you have enclosed an SASE with your request.

The three previous award programs summarized can be enjoyed by concentrating your operations on United States stations. Let's go international and review some of the other programs available.

4. DX Century Club (DXCC)

Perhaps faraway places and exotic lands excite you? If so, the DXCC award program will be your taste of

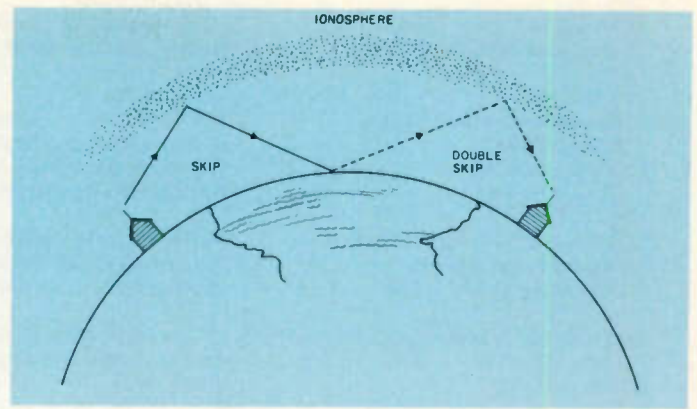

Fig. 3. Hams talk to the world by means of "skip" signals, which are signals reflected off the ionosphere to distant areas.

honey. In popularity, it shares the limelight with the WAS award. Rules are simple. Contact and confirm 100 different countries. Endorsement stickers are issued afterwards for each group of new ones you confirm. At first, this may appear a little more difficult than it actually is.

Countries are added and deleted from a master list. As history changes, so may the geographical status of what we define as a country change. The term "country" is an arbitrary one and does not necessarily agree with the dictionary definition. One criteria in determining a country is its distance from the mainland. There are, at present, more than 300 countries by the standards used to maintain an official amateur radio country listing. Uninhabited islands and some reefs are included in the listings.

In the WAS program, you have no choice but to confirm all 50 states. The DXCC program gives you the choice of 100 out of more than 300 countries. This tends to lessen the difficulty of achieving the established goal.

Because no amateurs live in certain areas of the world, expeditions are undertaken by various amateur groups and organizations to put them on the map, as we say. Permission to do so must be granted by the governments of the countries involved. Operations in this manner are referred to as DXpeditions. Radio gear is set up, and

thousands of contacts may be made.

This situation may create what we call a pileup. It occurs when untold numbers of stations all pile up on or near the same frequency to call the rare DX station. Competition from your peers is directly related to the rarity of the station. Your contact exchange information will be kept to an absolute minimum under these circumstances, though this does not mean that you will be always unable to have lengthy conversations with hams in foreign and exotic lands.

The thrill of confirming the rare countries far exceeds any problems encountered in doing so. Reaching the goal of DXCC is not difficult. It rests solely on the capabilities of the operator and his station.

The program also maintains an honor roll that many an avid DXer would like to reach. The excitement of working a new country can be likened to the saying: "When asked of the mountain climber, why did he scale Mount Everest, he replied, 'Because it's there!'"

The super version of DXCC is similar to SBWAS. Contact and confirm 100 countries on 5 different amateur bands. For this achievement, a plaque is available subject to the higher fee. You can send QSLs direct or via DX QSL bureaus.

5. Worked All Continents (WAC)

73 Magazine
Peterborough NH 03458

American Radio Relay League
225 Main Street
Newington CT 06111

CQ, The Radio Amateur's Journal
14 Vanderventer Avenue
Port Washington NY 11050

International Amateur Radio Society
PO Box 385
Bonita CA 92002

Ten-Ten (10-X) International Net
Richard Levy WB2MAN
30A Arleigh Road
Great Neck NY 11021

10-40 Award and 10m DX Decade Award,
novelty and other certificates
available from time to time

Worked All States (WAS) and 5BWAS,
DX Century Club (DXCC) and 5BDXCC,
Worked All Continents (WAC),
Rag Chewers Certificate, and others.

United States of America Counties Award (USA-CA),
Worked All Zones (WAZ),
Worked All Prefixes (WPX).

United States County Hunters Award (USA-CA),
Certificate Hunter's Club (CHC) Directory of Certificates
and Awards.

Table 1. For further details and complete rules towards the certificate programs listed, direct your inquiries (with a self-addressed stamped envelope) to the sponsors listed here.

The WAC award program rules require one confirmation in each of the six continents of the world. Confirm Africa, Asia, Europe, North America, Oceania, and South America and the certificate is yours. Problems in reaching this goal are negligible. U.S. stations on the east coast may encounter some difficulties in working Asia. West coast stations will find Europe more difficult. Many hams have accomplished this feat in one day using low-power transmitters and simple antennas. Verified reports show the accomplishment reached in less than an hour. Nets are active that have stations signing in from all continents. This is just one more award you will be proud to have.

6. Worked All Prefixes (WPX)

Many years ago, amateur radio operators were responsible for pioneering the airwaves. They communicated over paths not thought possible at that time. Radio was in its infancy and government control was yet to come. It was unclear where stations were originating from, and it became apparent that some form of call letters had to be used to designate a station's point of origin. The wireless pioneers decided to use a letter to designate their country, followed by a num-

ber, in some cases, to show the geographical area of that country. The prefix, in many cases, was followed by the operator's initials. Thus, a station in Japan may have used the callsign J3TL.

Some years later, government controls became operational. Rules, regulations, and frequency allocations were imposed through international radio conferences. Blocks of prefixes for use as radio call letters were assigned to all countries. Amateurs worldwide were licensed and reassigned distinctive callsigns by their respective governments. The WPX program makes use of that fact.

Confirmation of 300 different radio prefixes will qualify you for the initial WPX certificate. Endorsement stickers are issued afterwards. If you consider the fact that there are more than 300 countries on the official amateur radio country listing and multiply that by the combination of prefix arrangements for each country, the results will be in the thousands. The U.S. alone has over 50 possibilities. Actually, there is no count of the total number of prefixes possible. Special event stations may also use special calls. There is no ending to the WPX program. Your challenge will be to remain on top.

7. Worked All Zones (WAZ)

The world is broken up into 40 radio zones. Each zone consists of 1 or more countries. You must confirm at least 1 country in each of the 40 zones. Some of the zones are quite easy to work and confirm. Zone 23 (Tibet, the People's Republic of China, and Mongolia) may test your patience. You may have to wait for a DXpedition to the rarer zones before attempting a contact.

In the DXCC program, you can achieve the initial certificate without ever working a rare country. The choice you have in the WAZ program is that only 1 country is required in each zone. In a rare zone, you may have a choice of more than 1 country. This, like any other award program, will be a challenge. If the challenge were not there, the certificates would have no merit.

There is an adage used in amateur radio: "You can't work them if you don't hear them." This is also true in reverse. The station you call may not be able to hear you. You must also remember that a contact will remain unconfirmed until you receive that QSL card. Until that confirmation is received, you will be unable to use that contact towards most of the award programs. Once the challenge

is met, the confirmation also becomes more meaningful.

Other Award Programs

There is something for everyone in the world of amateur radio. This also holds true in certificate hunting. The award programs listed are by no means a complete listing. This list does not even cover a fraction of those available. They are mentioned solely for the purpose of giving you an idea of the fun involved, the skill required, and the challenges to be met in reaching the goals for the various certificate programs. Other award programs may appeal to you more than those summarized.

The United States is not alone in certificate programs. Many other countries offer their versions. Canada offers an award for working provinces, just as we offer one for working states. New programs are constantly being introduced. The certificate hunter can keep abreast of them. Certificate directories are available. The Certificate Hunters Club is another source of up-to-date information.

Getting Started

Once licensed, you should try to amass as many QSL cards as possible in as many geographic areas as possible. This gives you a head start when you are ready to pursue a certificate goal.

QSL cards are very versatile. They may be used as confirmation for more than one award program. A QSL from one United States contact may be used towards a county (USA-CA), a state (WAS), a country (DXCC), a zone (WAZ), or even a prefix (WPX), among others. When pursuing one goal, you will be accomplishing more than you realize towards another goal, perhaps killing five birds with one stone.

As a beginner, it will be wiser to concentrate on the easier award programs. When you have upgraded your skills, you may want to

specialize in one of the tougher ones. Amateurs with less competitive equipment find it easier to use Morse code instead of voice to work the DX stations. Some with the best of stations may also prefer Morse code. During adverse conditions, dots and dashes come through more clearly than other modes of communications.

Recordkeeping

Keeping track of your progress can be a tedious chore if you are unorganized. Special record books and formats are available for you to track your progress towards an individual award. They are an aid in keeping your record chores simple. Duplications are avoided. It can be frustrating trying to work some hard-to-get stations, only to find out later that you already had confirmed that area.

Many enjoy coloring in maps as new areas are worked and confirmed. Record books and forms are available from the sponsors of the larger award programs. Some are available from commercial sources. You may also design your own.

Contests

Many contests are held each year, and most are annual events. They are an aid in allowing many quick contacts. Each contest can be an asset to you in your hunt for certificates. If you are skilled and lucky enough, you may work all 50 states, 100 or more countries, hundreds of counties, or whatever you need to get a big jump on that desired certificate.

The majority of contests are held on weekends when most amateurs can find some time to participate. It is not necessary to go all out and try to win a contest. Those who do may go without sleep for the entire contest period. You may operate as little as you want or as much as you are allowed to by the contest rules. It can possibly take you



This display of QSL cards shows the variety possible in design and the printed message they convey.

a year or more to make as many contacts as can take place on one contest weekend. Contests keep you alert, help to develop your skills, and make you a better operator.

Amateur Radio Versus Citizens Band

There is no denying the benefits of CB, but amateur radio is the answer to those

desiring something more advanced. The original CB concept was to provide reliable short-range communications, not to exceed 150 miles. Communications over this range are covered by radio signals that tend to hug the surface of the Earth — "ground-wave" signals.

Signals reflected off the ionosphere to distant areas are called "skip" signals.

Whereas CB users rely on ground-wave signals, hams take advantage of skip conditions to talk to the world, and it is very much legal. Most of the shortwave amateur frequencies are allocated on a worldwide basis to the amateur radio service.

Skip conditions increase on the higher shortwave bands during sunspot cycle peaks. Intense layers of

ionization in the atmosphere cause this phenomenon. The sunspot cycle runs its course every 11 years. Educated predictions place the next peak around 1982 for cycle #21. During these peaks, the ionosphere tends to play tricks with radio and TV signals, as many have witnessed in the past with reception of distant TV stations. There is also a likelihood that, at times, the CB band will be useless for short-range communications with skip stations overriding all but the strongest local stations.

Don't miss out on the benefits of operating as an amateur during the current upswing of cycle #21. Now is the time to enter the world of amateur radio.

Hams are not limited to channelized operations as found in the CB service. They may move anywhere in the frequencies assigned by the use of variable frequency oscillators (VFOs), commonly called sliders in CB

lingo. VFOs provide greater flexibility and help to minimize interference.

You may use power levels up to 200 times as much as afforded the CB service.

Wide choices of communication modes are available. You have an excellent chance to share in experimentation of new modes that may develop in the future.

You will literally make worldwide acquaintances, some leading to lifelong friendships. Chances of meeting your DX friends are enhanced through international ham-hop clubs. It's "the greatest hobby in the world," say kings, princes, governors, senators, astronauts, and other celebrities who are licensed hams.

The sportsmen, actors, and actresses have their trophies and awards for their achievements. The amateur radio operator is rewarded with certificates and the knowledge that his achievements are made possible by a

radio privilege that he has earned by proving his qualifications.

Your Benefits from A to Z

Amateurs talk to the world.

Bands of frequencies are allocated to amateurs on a worldwide basis.

Contests are aids in your quest for certificates.

DXCC is an award for your achievements.

Educational values enhance lifelong careers.

Friendships are made throughout the world.

Governments worldwide recognize and encourage amateur radio.

Ham-hop clubs enable person-to-person visits with DX friends.

International goodwill is spread via the airwaves.

Justification of the amateur radio service is an international fact.

Knowledge of foreign cultures is enhanced.

Licensed amateurs have

proven their qualifications.

Marvel to the wonders of radioteletype.

Nets are held by many special-interest groups.

Orbiting satellites can carry your signals over vast areas.

Power levels up to 200 times as much as those afforded the CB service may be used.

QSL cards are confirmations of your contacts.

Repeaters amplify your signals and increase your coverage.

Skip signals help amateurs to work long distances.

Television is a mode of amateur communication.

Unlimited possibilities await you.

VFOs are used for greater flexibility.

Worked All States is enjoyed by many.

Xcitement galore.

You have the world at your fingertips.

Zones are an asset towards certificate programs. ■

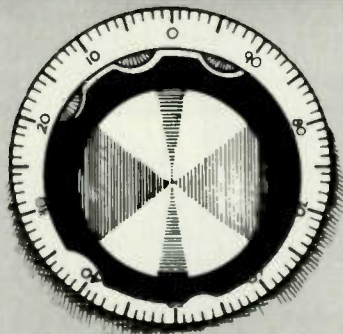

Adirondack has it!

Kenwood

Larsen

Icom

Dentron

Nye Viking

Drake

Mosley

Ten-Tec

Atlas

Hustler

Cushcraft

Yaesu

ADIRONDACK Radio
Supply

Amateur Headquarters for the Northeast

185-191 West Main Street • P.O. Box 88
Amsterdam, N.Y. 12010 Tel. (518) 842-8350
Just 5 minutes from N.Y. Thruway - Exit 27

PEOPLE BUY BIRD FROM US



Model 43: \$120
CC-1 Leather Case: \$25
Elements: \$36 to \$42

who live in Florida, Georgia and Louisiana.

We have regular Bird customers in Texas, Alaska, Minnesota and dozens of other states as well as Washington. They come to us because they know we have a gigantic stock of Bird and that we ship the same day and that we prepay Bird orders over \$145. Add to this the fact that we are the oldest and largest Amateur store in the Pacific Northwest and you get a glimpse of why we're so popular —

AMATEUR RADIO SUPPLY SEATTLE

A55

6213 13th Ave. So., 98108 (206) 767-3222

Washington Residents: To order, CALL TOLL-FREE 1-800-562-8326.

CT-50 FREQUENCY COUNTER



**Outstanding
Performance
at an
Incredible
Price**

DESCRIPTION: The CT-50 is a versatile and precision frequency counter which will measure frequencies to 60 mHz and up to 600 mHz with the CT-600 option. Large Scale Integration, CMOS circuitry and solid state display technology have enabled this counter to match performance found in units selling for over three times as much. Low power consumption (typically 300-400 ma) makes the CT-50 ideal for portable battery operation. Features of the CT-50 include: large 8 digit LED display, RF shielded all metal case, easy pushbutton operation, automatic decimal point, fully socketed IC chips and input protection to 50 volts to insure against accidental burnout or overload. And, the best feature of all is the easy assembly. Clear, step by step instructions guide you to a finished unit you can rely on. Use the order blank below or call us direct and order yours today!

SPECIFICATIONS:

Frequency range: 5 Hz to 65 mHz, 600 mHz with CT-600
 Resolution: 10 Hz @ 0.1 sec gate, 1 Hz @ 1 sec gate
 Readout: 8 digit, 0.4" high LED, direct readout in mHz
 Accuracy: adjustable to 0.5 ppm
 Stability: 2.0 ppm over 10° to 40° C, temperature compensated
 Input: BNC, 1 megohm/20 pf direct, 50 ohm with CT-600
 Overload: 50VAC maximum, all modes
 Sensitivity: less than 25 mv to 65 mHz, 50-150 mv to 600 mHz
 Power: 110 VAC 5 Watts or 12 VDC @ 400 ma
 Size: 6" x 4" x 2", high quality aluminum case, 2 lbs
 ICS: 13 units, all socketed
 CT-600: 600 mHz prescaler option, fits inside CT-50
 CB-1: Color burst adapter, use with color TV for extreme accuracy and stability, typically 0.001 ppm

OPTIONS:

CB-1 option: The CT-50 time base may be locked to an external frequency standard. The television networks maintain extremely accurate atomic based frequency standards to maintain color tint on TV programs. These standards are typically accurate to one part in 10 to the 12. By locking the CT-50 to one of these network standards, we are able to get super accuracy. The CB-1 adapter interfaces a standard color TV receiver to the CT-50 so that one can take advantage of the TV network frequency standards. The CB-1 requires connection to a color television for operation.

CT-600 option: The CT-600 prescaler option enables the CT-50 counter to measure frequencies as high as 600 mHz with sensitivity in the 20 to 150 mv range, depending upon frequency. Typical sensitivity at 150 mHz is 25 mv. The CT-600 mounts on the same PC board as the CT-50, no extra boxes or PC boards are required. The scaler utilizes a state of the art ECL IC chip and two transistor pre-amplifier, thus eliminating the need for external pre-amp devices.



CT-50, 60 mHz Counter Kit	\$89.95
CT-50 WT, 60 mHz counter, wired, tested	159.95
CT-600, 600 mHz prescaler option for CT-50, add	29.95

ACCESSORIES

DC probe, direct input, general purpose type	\$12.95
High Impedance probe, does not load circuit	15.95
Low pass probe, used when measuring audio	15.95
High pass probe, reduces low freq pickup	15.95
VHF flexible rubber antenna, BNC connector	12.95
Color burst adapter, for calibration, high accuracy typically 0,001 ppm accuracy, stability	14.95

Ramsey Electronics
 Box 4072 716-271-6487
 Rochester, NY 14610 R8



78

Quantity	Description	Price
	Shipping, handling, insurance	\$5.00
	N. Y. state residents, add tax	
	Total	
Name _____		
Address _____		
City _____ State _____ Zip _____		

ramsey electronics

Box 4072 Rochester NY 14610 (716) 271-6487

Attention, Weather Watchers!

— *advanced circuitry
for WEFAX processing*

The purpose of this article is to present some solid state circuitry ideas on reproducing satellite APT/WEFAX pictures. I have felt for some time

now that there has been room for improvement in equipment currently in use. Most people have been resorting to a small army of vacuum tubes to

do the work in facsimile machines. Almost everyone is using a sensitive solid state receiver, so now it's time to improve the video processing. The

schematics on the following pages are currently being used here to process GOES WEFAX. They have been doing so since GOES WEFAX was initiated in the

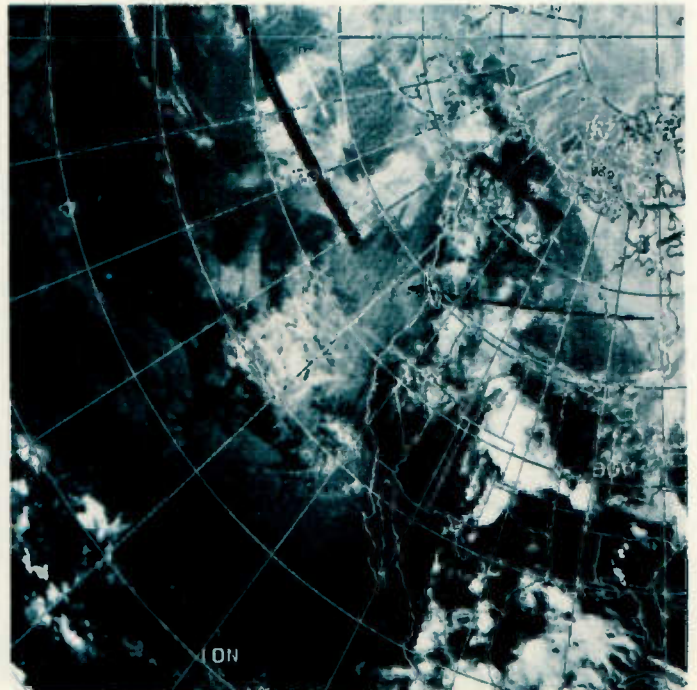

summer of 1975 through SMS-1 on a regular schedule. Some of the features these circuits offer are:

1. Solid state design.
2. Closed-loop automatic gain control (agc).
3. Selectable agc time constants.
4. Precision video demodulator.
5. Low-ripple video filter with high out-of-passband attenuation.
6. High reliability.

These circuits by no means approach the state of the art; however, they can make a vast improvement in your satellite photos. The satellite photos displayed in this article were transmitted over the GOES WEFAX data link and were processed by my homemade facsimile machine. I feel that, with careful construction and planning, most homemade

facsimile machines can equal or surpass many commercial APT displays. The following discussion on video processing and the schematics should throw some light on what I am currently doing with GOES WEFAX.

Theory of Operation

In Fig. 1, you see the input video amplifier. The receiver input, tape-recorder input, and test-pattern generator switching relays are also shown.

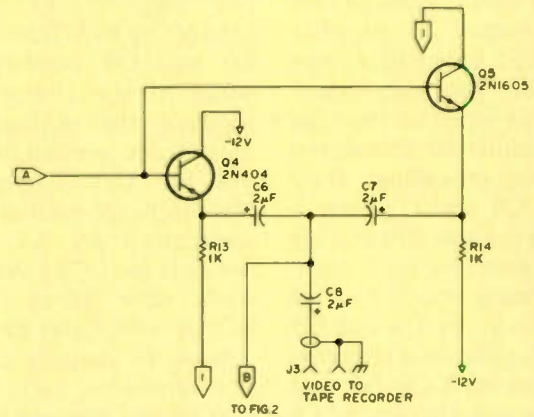
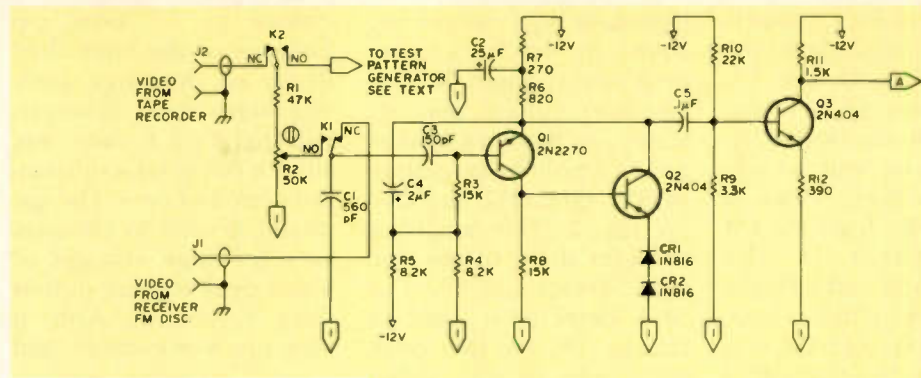

Fig. 1. Input amplifier and relay switching.

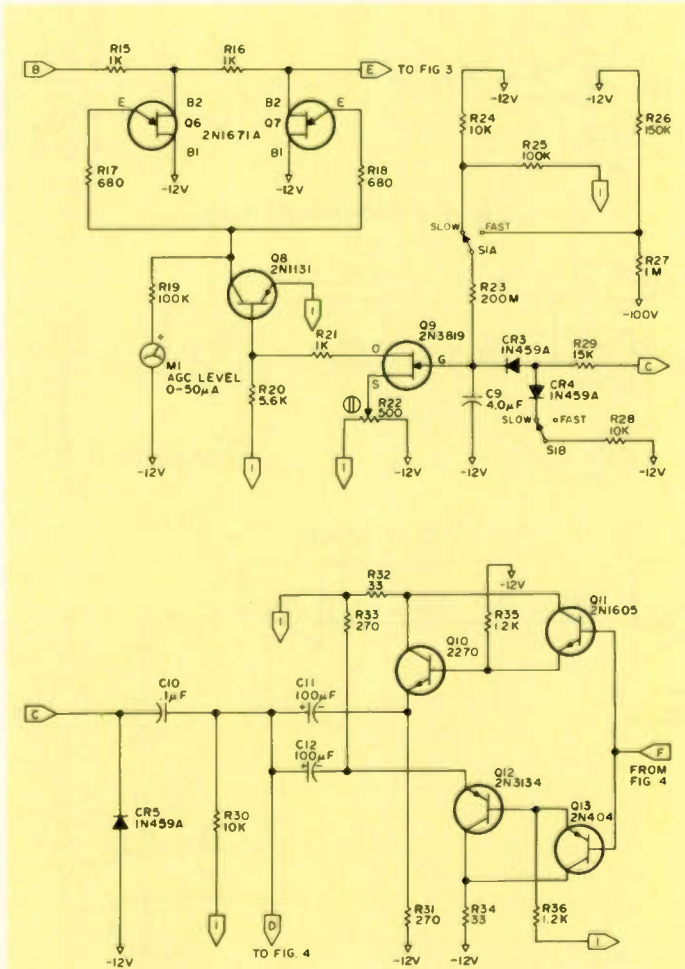

Fig. 2. Electronic attenuator and agc detector.

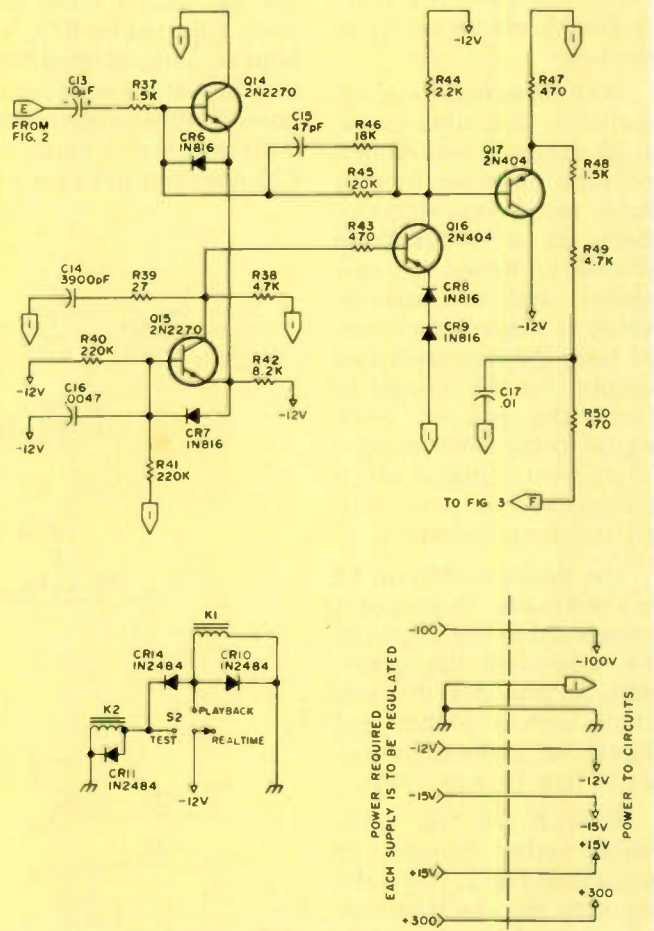
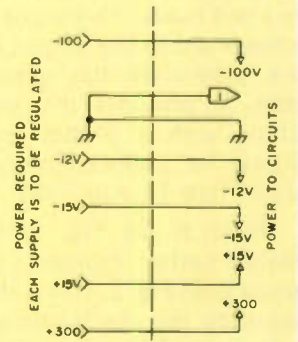

Fig. 3. Agc amplifier and mode selector.



Switch S2, in Fig. 3, selects the operating mode, or the position K1 or K2 is in. For now, assume S2 is in the real-time mode. With S2 in real time, K1 and K2 are normally closed. Video is now supplied from the FM discriminator in the receiver to J1 and into the video preamplifier. Transistors Q1, Q2, Q3, Q4, and Q5 amplify the input signal from the receiver sufficiently to drive the J3 output. Output J3 supplies amplified video to a tape recorder. The high-impedance line input on the tape deck should be connected here for recording. Transistors Q1 and Q2 form a Darlington pair; Q4 and Q5 are connected in a complementing circuit. Output J3 is driven by Q4 and Q5 and coupled to the signal via capacitors C6, C7, and C8. The negative end of C8 is supplied to Fig. 2, point B. I will pick up here in a moment with Fig. 2, but, first, I still have two more operating modes on S2 to discuss.

With S2 in real time, my station is acquiring spacecraft data and recording it on tape. In order to play back previously recorded data, S2 is switched to playback. Relay K1 now closes, and the satellite video is played back into J2 from the tape-deck line output. Pot R2 is used to limit the played back signal to the same approximate level as that at which the receiver output is during real-time operation.

The final position on S2 is a test mode. This input is connected to the output of my grey-scale bar generator. It provides the machine with a proper test signal for calibration purposes (see 73, Apr., '78).

Point B on Fig. 1, as stated earlier, connects to point B on Fig. 2. This is the input to the electronic attenuator. The attenuator output, point E, drives a

high-gain agc amplifier, shown in Fig. 3. Its open-loop gain is about 80. The amplifier output, point F, feeds a four-transistor power amplifier consisting of Q10, Q11, Q12, and Q13 on Fig. 2. This amplifier provides drive to the agc peak detector, CR3. The peak detector is used to charge C9 to the peak amplitude of the video signal at point D in Fig. 2. The charge on C9 is slowly bled off by R23. Transistors Q9 and Q8 amplify the value of the charge and produce the voltage/current source needed to control the UJT attenuator. The discharge path of C9 is controlled by S1. Fast decay is for GOES WEFAX, while slow decay is for NOAA radiometer data.

Now, to simplify confusion somewhat, I will try to sum up the purpose of the agc circuit. The main idea here is to control the peak-to-peak level at point D. The agc circuit, when properly adjusted by R22, will hold an unmodulated 2400 Hz input at 3.3 volts p-p on point D. When video variations are present, capacitor C23 does not have time to

charge to 3.3 volts p-p because of the controlled decay or discharge path. The video sync, however, will be at 3.3 volts p-p, since it occupies a substantial period of time. The agc circuit is used to compensate for large changes of video peak-to-peak output from a receiver. Also, it sets up a maximum and

minimum signal level with which to work. In this case, signals fall between 3.3 volts p-p and the system noise floor.

Knowing these levels, the video detector, filter, and lamp driver were designed. The agc output at point D drives the precision video demodulator on Fig. 4. The incoming

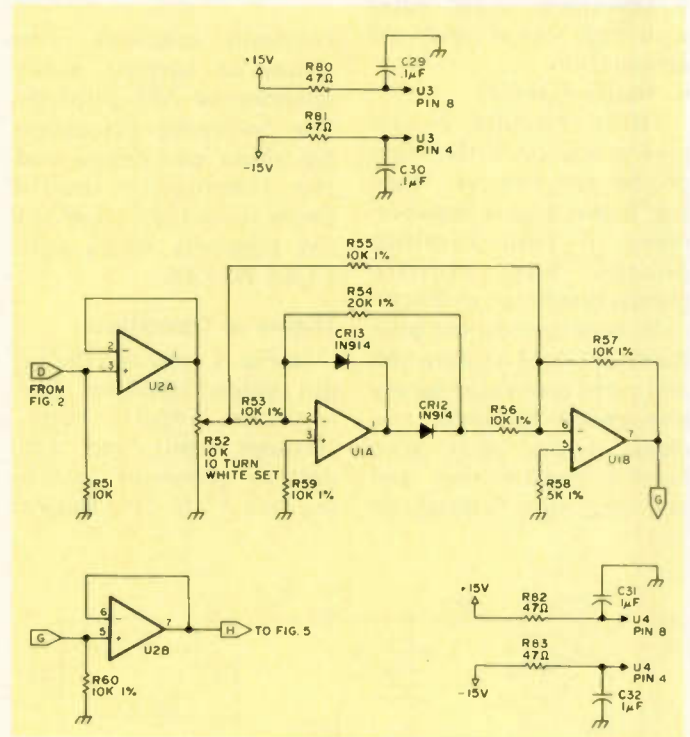

Fig. 4. Video demodulator.

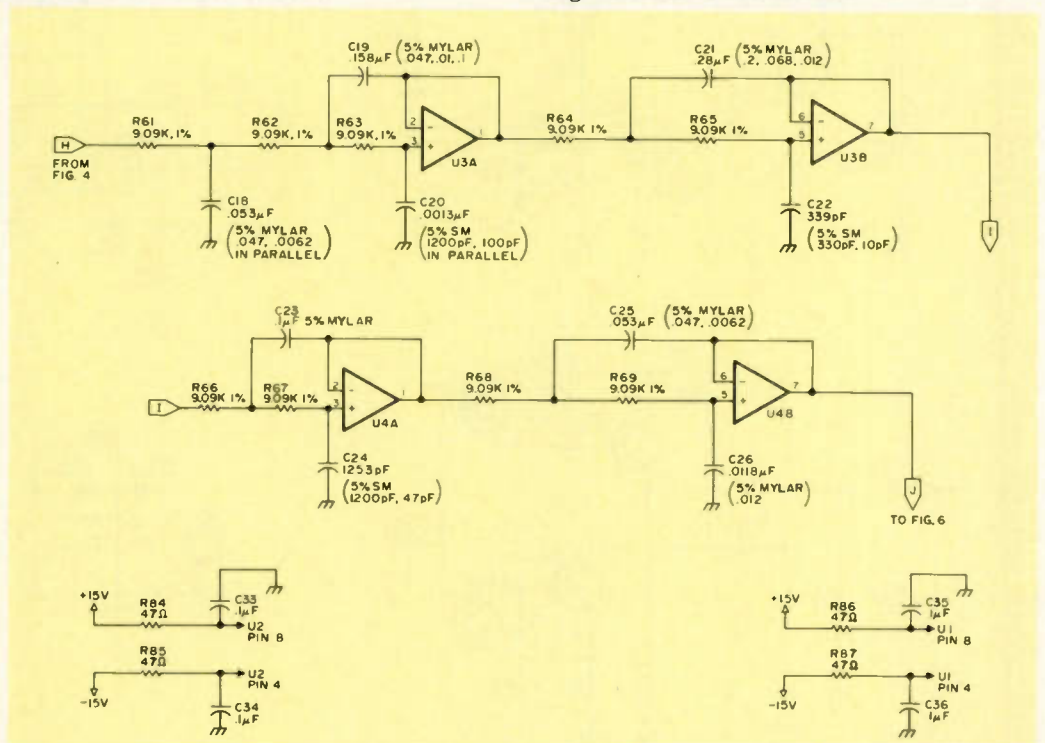

Fig. 5. Video filter. C18-26 are made up from capacitors in parallel.

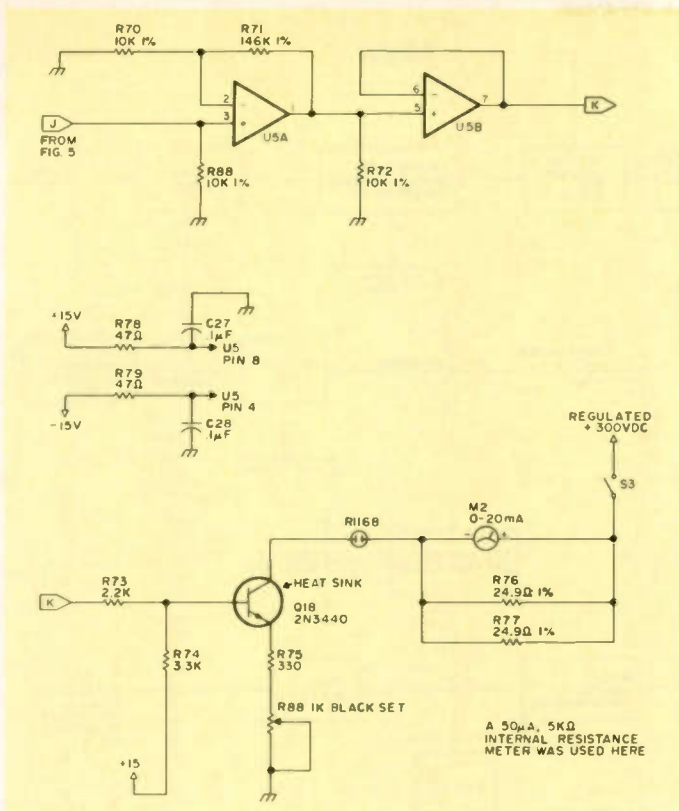
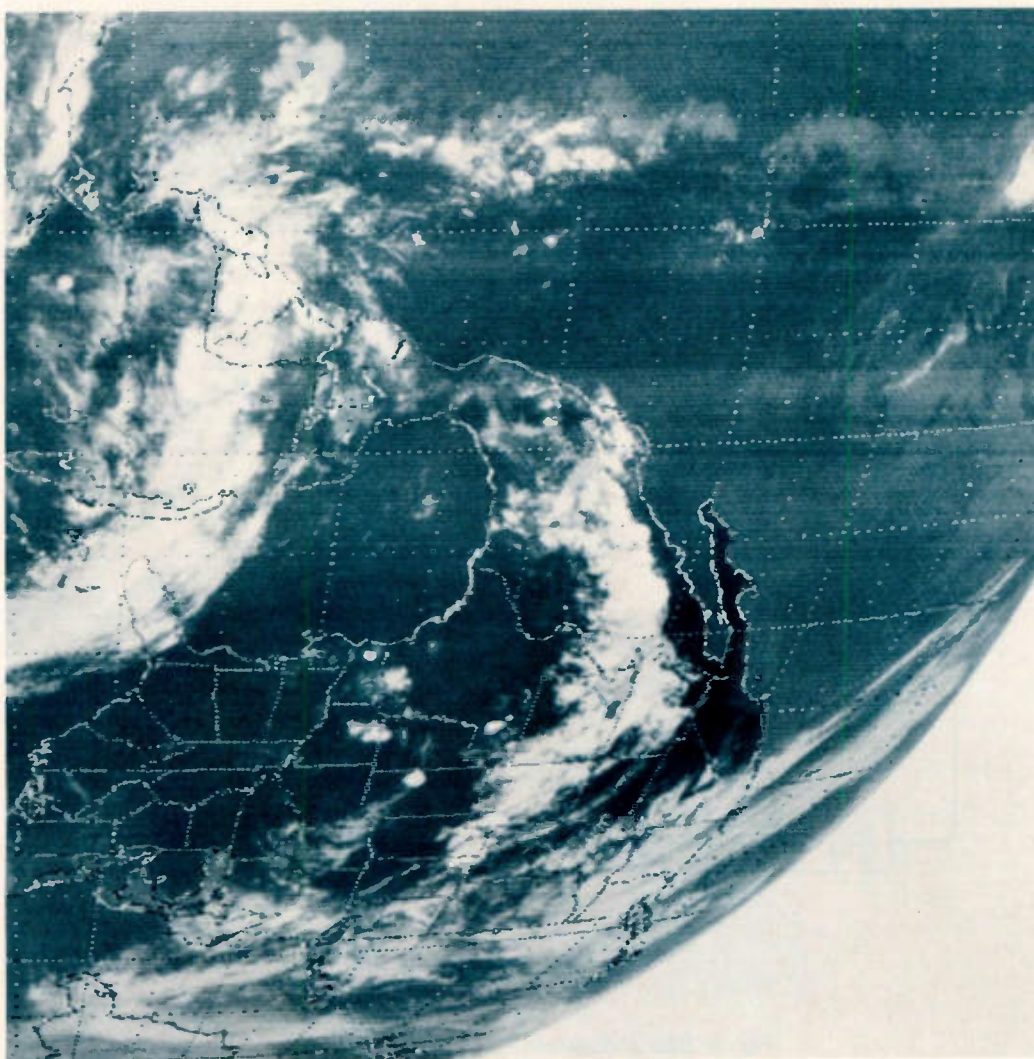

Fig. 6. Lamp driver.



video, point D, is the composite double-sideband AM signal on a 2400 Hz subcarrier. This signal is buffered by U2A and is coupled to the video detector by pot R52. Pot R52 sets the video drive level and is labeled white set. This adjustment controls the white density of the satellite picture.

ICs U1A and U1B comprise the full-wave video demodulator. The demodulated, or rectified, signal at U2, pin 7, contains the subcarrier along with the 0-1600 Hz video information. This rectified video signal is routed to Fig. 5, point H, and becomes the input to the video filter. The video filter is a low-pass, 9th order, .5 dB ripple Chebyshev. It is very flat from 0 to about 1700 Hz and then drops off rapidly

to the noise floor. The 0-to-1700 Hz passband allows the desired video information to pass while presenting a high attenuation to the 2400 Hz subcarrier. Once the subcarrier is removed, you are left only with dc variations corresponding to shades of grey in the satellite picture.

The filter output, point J, finds its way to the lamp driver circuit in Fig. 6. ICs U5A and B accept and amplify the filter output to a level sufficient to drive the 2N3440 lamp driver transistor. The video information is used to control the current through Q18 and, in turn, modulate a suitable light source. In this case, an R1168 glow-tube modulator is used. The polarity of the signal on Q18 is such that black, minimum signal, produces the most lamp current, while a white level decreases lamp current. Pot R88 in the emitter circuit of Q18 is used to set the desired black current.

It should be apparent that, with the polarities given, the circuit is set up for positive printing on photographic enlarging paper. I get best results on Kodabrome RC-FH paper. The milliammeter in the collector circuit of Q18 measures lamp current. It is used for calibration of R52 and R88. Finally, a calibration procedure is needed for the video processor. The few simple adjustments are given next.

Calibration

First of all, check the wiring! If you have come this far, you have probably already vowed never again to build another satellite project and are certainly in no mood for an explosion. After all, this thing takes some time to wire. A good point to start calibration is by measuring the p-p output level of your receiver discriminator. You should have at least 250-500

millivolts p-p of video output for this circuit. I am getting by with 150 mV, but a bit more drive should be used.

Once you have established the level from your receiver, find a 2400 Hz sine wave signal source and set its output to the same level. Switch S2 to real time, and put the test signal into J1. Set your agc recovery switch to fast. With a scope connected to point D in Fig. 2, adjust R22 slightly and wait. The wait period is to give the agc circuit time to recover. Note the meter reading on M1 as you adjust R22. The meter should not be pegged, but should be somewhere between 10 to 30 μ A. Finally, after a few patient minutes, you should have a 3.3 V p-p signal at point D.

Now disconnect the 2400 Hz test signal, and observe the agc level shown on M1 slowly go to zero. Next, reconnect the test signal while watching M1. The current should climb very fast and settle on a steady value. You must have this quick-attack, slow-decay characteristic. When R22 is properly set, the agc circuit will perform in this manner while holding the test signal to 3.3 V p-p.

Next, the white and black set pots are adjusted. First, set S2 to real time and disconnect anything attached to J1. Set R52 and R88 fully counterclockwise. Keep your agc recovery switch in the fast mode. Turn on the lamp with S3. Advance pot R88 clockwise until 9.5 mA is reached on M2. This is the black current set. Reconnect the test signal and turn R52 clockwise until M2 falls within 1.5 and 2.0 mA. This is the white current set. During live reception, the lamp current will average out at 3-5 mA or so. With these current settings and about a 40-second development

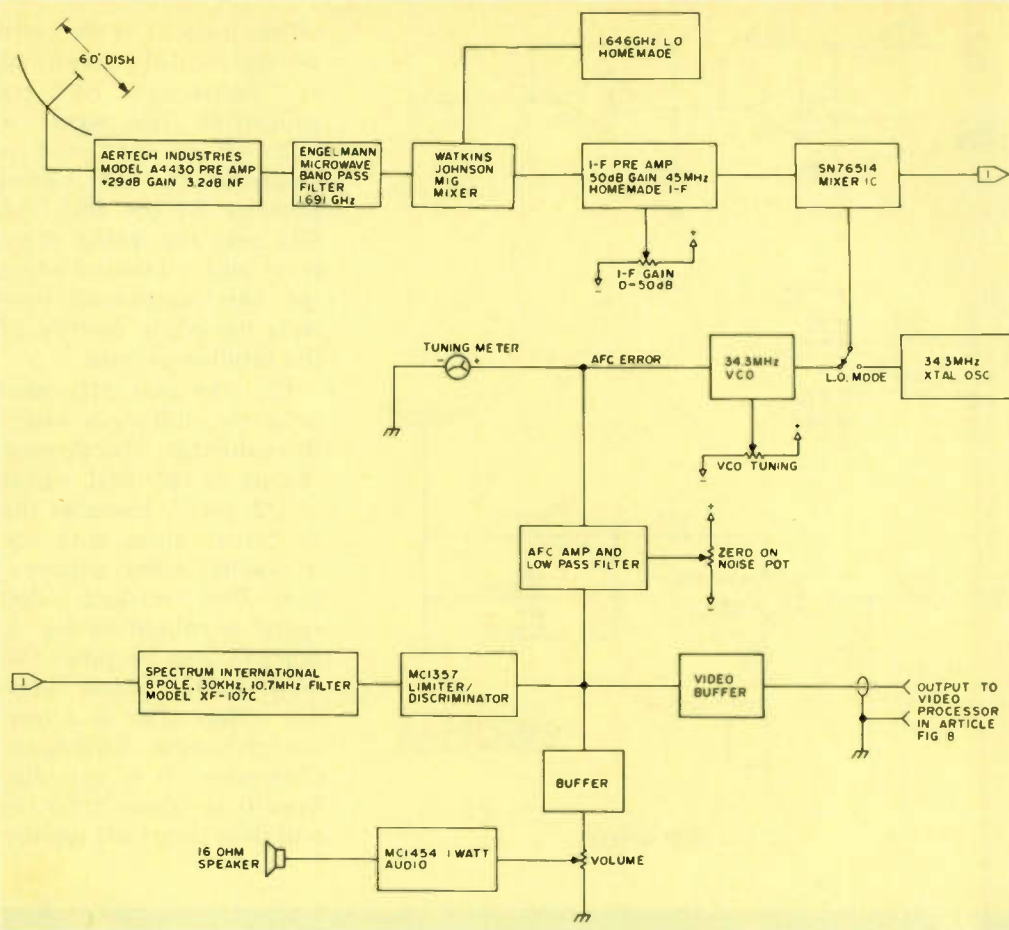

Fig. 7. Receiver at author's station — block diagram.

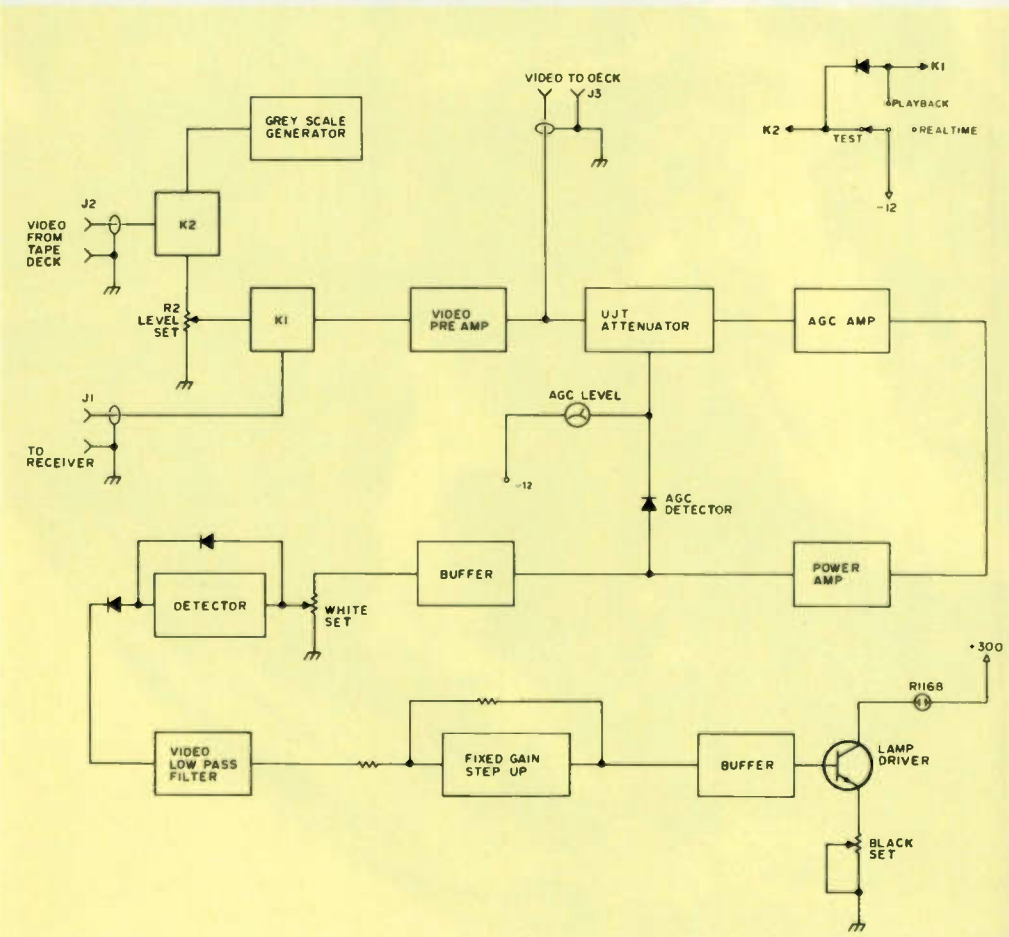

Fig. 8. Block diagram of video processor.

Parts List

C1	560 pF, 5%, silver mica	R7	270, .25 W, 10%	R62	9.09k, 1%, .25 W
C2	25 uF, 25 V	R8	15k, .25 W, 10%	R63	9.09k, 1%, .25 W
C3	150 pF, 5%, silver mica	R9	3.3k, .25 W, 10%	R64	9.09k, 1%, .25 W
C4	2 uF, 25 V	R10	22k, .25 W, 10%	R65	9.09k, 1%, .25 W
C5	.1 uF, 50 V, monolithic	R11	1.5k, .25 W, 10%	R66	9.09k, 1%, .25 W
C6	2 uF, 25 V	R12	390, .25 W, 10%	R67	9.09k, 1%, .25 W
C7	2 uF, 25 V	R13	1k, .25 W, 10%	R68	9.09k, 1%, .25 W
C8	2 uF, 25 V	R14	1k, .25 W, 10%	R69	9.09k, 1%, .25 W
C9	4.0 uF, 200 V, mylar	R15	1k, .25 W, 10%	R70	10k, 1%, .25 W
C10	.1 uF, 50 V, monolithic	R16	1k, .25 W, 10%	R71	146k, 1%, .25 W
C11	100 uF, 50 V	R17	680, .25 W, 10%	R72	10k, 1%, .25 W
C12	100 uF, 50 V	R18	680, .25 W, 10%	R73	2.2k, .25 W, 10%
C13	10 uF, 50 V	R19	100k, .25 W, 10%	R74	3.3k, .25 W, 10%
C14	3900 pF, 5%, silver mica	R20	5.6k, .25 W, 10%	R75	330, .5 W, 10%
C15	47 pF, 5%, silver mica	R21	1k, .25 W, 10%	R76	24.9, .5 W, 1%
C16	.0047, 100 V, mylar	R22	500 pot	R77	24.9, .5 W, 1%
C17	.01 uF, 50 V, monolithic	R23	200 meg, 5%	R78	47, .25 W, 10%
C18	.053 uF	R24	10k, .25 W, 10%	R79	47, .25 W, 10%
C19	.158 uF	R25	100k, .25 W, 10%	R80	47, .25 W, 10%
C20	.0013 uF	R26	150k, .25 W, 10%	R81	47, .25 W, 10%
C21	.28 uF	R27	1 meg, .25 W, 10%	R82	47, .25 W, 10%
C22	339 pF	R28	10k, .25 W, 10%	R83	47, .25 W, 10%
C23	.1 uF	R29	15k, .25 W, 10%	R84	47, .25 W, 10%
C24	1253 pF	R30	10k, .25 W, 10%	R85	47, .25 W, 10%
C25	.053 uF	R31	270, .25 W, 10%	R86	47, .25 W, 10%
C26	.0118 uF	R32	33, .25 W, 10%	R87	47, .25 W, 10%
C27	.1 uF, 50 V, monolithic	R33	270, .25 W, 10%	R88	1k pot, 2 W
C28	.1 uF, 50 V, monolithic	R34	33, .25 W, 10%	Q1	2N2270
C29	.1 uF, 50 V, monolithic	R35	1.2k, .25 W, 10%	Q2	2N404
C30	.1 uF, 50 V, monolithic	R36	1.2k, .25 W, 10%	Q3	2N404
C31	.1 uF, 50 V, monolithic	R37	1.5k, .25 W, 10%	Q4	2N404
C32	.1 uF, 50 V, monolithic	R38	4.7k, .25 W, 10%	Q5	2N1605
C33	.1 uF, 50 V, monolithic	R39	27, .25 W, 10%	Q6	2N1671A
C34	.1 uF, 50 V, monolithic	R40	220k, .25 W, 10%	Q7	2N1671A
C35	.1 uF, 50 V, monolithic	R41	220k, .25 W, 10%	Q8	2N1131
C36	.1 uF, 50 V, monolithic	R42	8.2k, .25 W, 10%	Q9	2N3819
CR1	1N816	R43	470, .25 W, 10%	Q10	2N2270
CR2	1N816	R44	2.2k, .25 W, 10%	Q11	2N1605
CR3	1N459A	R45	120k, .25 W, 10%	Q12	2N3134
CR4	1N459A	R46	18k, .25 W, 10%	Q13	2N404
CR5	1N459A	R47	470, .25 W, 10%	Q14	2N2270
CR6	1N816	R48	1.5k, .25 W, 10%	Q15	2N2270
CR7	1N816	R49	4.7k, .25 W, 10%	Q16	2N404
CR8	1N816	R50	470, .25 W, 10%	Q17	2N404
CR9	1N816	R51	10k, .25 W, 10%	Q18	2N3440
CR10	1N2484	R52	10k, 10-turn precision pot	U1-5	MC1458 op amp
CR11	1N2484		panel mount	K1-2	12 V dc reed relays
CR12	1N914	R53	10k, 1%, .25 W	S1	DPDT toggle
CR13	1N914	R54	20k, 1%, .25 W	S2	1-pole, 3-position rotary
CR14	1N2484	R55	10k, 1%, .25 W	S3	1-pole, 1-position ceramic rotary
R1	47k, .25 W, 10%	R56	10k, 1%, .25 W	M1	0-50 uA Simpson meter model 1212
R2	50k pot	R57	10k, 1%, .25 W	M2	0-20 mA or 50 uA w/ shunt, 5k int. resistance
R3	15k, .25 W, 10%	R58	5k, 1%, .25 W		
R4	8.2k, .25 W, 10%	R59	10k, 1%, .25 W		
R5	8.2k, .25 W, 10%	R60	10k, 1%, .25 W		
R6	820, .25 W, 10%	R61	9.09k, 1%, .25 W		

time on the picture, I get excellent results.

Now for the moment you have been waiting for: Switch S2 to the test mode. If you have the test-pattern generator working properly, set its output level pot to give the same agc level on M1 you normally see in real time. This will

protect the agc circuit from accidental saturation. Now, switch on the lamp, start your drum recorder, and make a test photo. If everything is fine, you should see 12 very nice steps from black to white.

A final note here: Since this article has only dealt with the electronics in the

video processing, it is assumed that you already have a facsimile machine. I feel that the *Weather Satellite Handbook* and articles appearing in *73 Magazine* should be explored before attempting construction of a satellite facsimile recorder. I will be more than happy to share

some of my automatic picture phasing circuits and phased locked horizontal sync circuits with anyone interested in automating their drum-type facsimile machine. For any help or requests for additional information, please enclose an SASE to speed the return. ■



YAESU
The radio.



Is Our Number 1 Line At

Cohoon Amateur Supply

C83

TO SERVE YOU BETTER

3 LOCATIONS



Cohoon Amateur Supply

SOUTH

Hwy. 475 Trenton, Kentucky 42286

502-886-4534



Cohoon Amateur Supply

NORTH

Box 4073 Austintown, Ohio 44515

216-538-3424



Cohoon Amateur Supply

WEST COAST OUTLET

728 Juniper Lompoc VAFB, CA. 93437

805-734-4693



1. Full Repair Service
 2. Sub-Dealers Welcome
 3. Good Prices
 4. Ship UPS The Same Day
 5. All Used Gear
- Has A 90 Day Warranty.

Also Stocking:

KENWOOD	KANTRONICS
TEN-TEC	ATLAS
TEMPOC	DENTRON
WILSON	CUSHCRAFT
INFO-TECH	

Write for used equipment sheets and dealer inquiries.

slinky

LINKY! \$43.95 Kit A LOT of antenna in a LITTLE space New Slinky® dipole with helical loading radiates a good signal at 1/10 wavelength long!

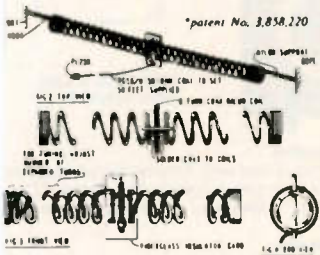

This electrically small 80/75, 40 & 20 meter antenna operates at any length from 24 to 70 ft. • no extra balun or transmatch needed • portable — erects & stores in minutes • small enough to fit in attic or apt. • full legal power • low SWR over complete 80/75, 40 & 20 meter bands • much lower atmospheric noise pickup than a vertical & needs no radials • kit incl. a pr. of specially-made 4" dia. by 4" long coils, containing 335 ft. of radiating conductor, balun, 50 ft. RG58/U coax, PL259 connector, nylon rope & manual.

ASTATIC MICROPHONES

T-UP9-D104 transistORIZED w/push bar base \$64.20
 T-UG-D104 transistORIZED \$52.80
 T-UG-D104 "Silver Eagle" transistORIZED \$71.60
 UC-D134 ceramic or crystal \$46.80

HY-GAIN'S MODEL 269

Continuously loaded VHF antenna designed for portable and walkie-talkie applications. Constructed to withstand rough handling, completely insulated with special vinyl coating. It can be bent at all angles without destroying or cracking protective finish. Cannot be accidentally shorted out.

RUBBER DUCKIES

No. 269 — Fits Standard, Motorola, Hy Gain \$8.00
 No. 274 — BNE Base \$9.00
 No. 226 — TNC Base w/ Wilson 5 Watts \$10.00
 No. 228 — "F" Base w/ Wilson 2 Watt & Tempo \$10.00
 No. 273 — SO 239 Near, Kenwood, Drake \$9.00

YAESU



COMPETITION GRADE HF XCVR

FT-801DM	180-10M XCVR	\$1459
FT-801D	180-10M XCVR	1259
FT-901DE	180-10M XCVR	1259

INTERNATIONAL GRADE HF XCVR

FT-101F	180-10M XCVR	799
FT-101FE	180-10M XCVR	759
FT-101FX	180-10M (40 Only)	699

SOLID STATE HF XCVR

FT-301D	180-10M 240W Digital	935
FT-301	180-10M 240W Analog	799
FT-7	80-10M 20W XCVR	549

VHF TRANSCEIVERS

CPU-2500	FM Mobile	840
FT-225R	2M XCVR	895
FT-225RD	2M XCVR w/Digital	895
FT-227R	FM Mobile 2M	349
FT-227RA	AutoScan 4 Mem. 2M	TBA
FT-825RD	All Mode 6M	895
FT-825R	All Mode 6M	840

SOLID STATE RECEIVERS

FRG-7	Communications RCVR	315
FRG-7000	All Band HF RCVR	629
FR-101S	180-2M RCVR	599
FR-101SD	180-10M/SW Digital	749

INTERNATIONAL GRADE TRANSMITTER

FL-101	180-10M XMTTR	649
--------	---------------	-----

LINEAR AMPLIFIER

FL-2100B	80-10M Linear	529
----------	---------------	-----

TEST EQUIPMENT

YC-500J	500 mHz 10 PPM	239
YC-500S	500 mHz 1 PPM	399
YC-500C	500 mHz 0.02 PPM	537
YP-150	Dummy Load	86

ACCESSORIES FOR ALL MODELS

YM-35	Headset	18
YD-148	Hi-LOZ Desk Mike	30
YD-844A	Hi-LOZ Desk Mike	30
YD-646	Hi-Z Hand Mike	30

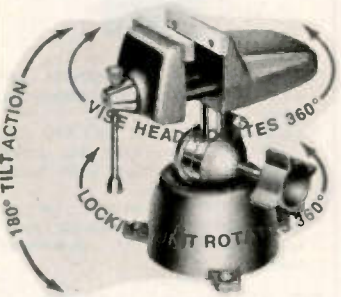

PANAVISE
 It's like no other tool you've ever used. Its head rotates a full 360 degrees — and tilts 180 degrees from vertical to horizontal. Imagine how that kind of versatility simplifies work procedures, just one convenient knob locks work in any desired position.

PANAVISE offers a variety of interchangeable work holding heads, bases and accessories for every imaginable function. But, just because it's small, doesn't mean you can't use PANAVISE for some pretty rugged work. It's a vise every craftsman deserves.

MODEL 300 Original Base
 Designed for all normal permanent installations. Three lugs spaced 120 degrees apart provide maximum mounting stability. Overall height: 3-13/16" (97 mm). Base diameter: 5" (127 mm).

MODEL 303 Original Vise Head
 Wide 2 1/2" (63 mm) jaws open to 2 1/4" (57 mm). Head is pressure diecast aluminum alloy, with steel and brass inserts. Hammertone gray/green finish. Replaceable nylon jaws. Package includes both Models 300 & 303 for \$21.95.

TUFTS CATALOG INDEX

Advanced Electronics—2	16
AMECO—7	34
Amphenol—17	TBA
Antenna Specialists—20	35
Astatic—1	
Atlas—8, 12	
Autek Research—2, 5	
Benchcraft—17	
Bird—7	
Bomar—4	
B & W—16, 24	
CDE—5	
CES—9	
CIR—18	
Covercraft—9	
Cushcraft—10, 11	
Data Signal—2, 8	
Dentron—4, 16	
Drake—3	
ETO—18	
F9FT—21	
Finco—6	
Ham Key—13	
Hustler—12	
HyGain—1, 22, 23	
ICOM—15	
JMR—17	
KLM—8	
Kenwood—7	
Larsen—15	
MFJ—13	
Microwave Filter—8	
Microwave Modules—17	
Morgain—15	
Mosley—19	
Nemarc—17	
NP—2	
Nye Viking—2, 19	
OK Tools—9	
Pana Vise—1	
Pipo Communications—17	
Radio Amateur Callbook—19	
Regency—2	
Rohn—6	
Sams—20	
Save Your Radio—19	
Sharp Calculators—24	
Slinky—1	
SST—10	
Stinger—6	
Swan—4	
Ree/Ax—17	
Teletower—5	
Telex—7, 23	
Tempo—8	
Ten Tec—18	
Texas RF—17	
Tonna—21	
Triplet—2	
Tri Ex—10	
Van Gorden—9	
Vibroplex—19	
Vista—5	
VHF Eng—14	
Wilson Electronics Corp.—19	
World Radio TV Handbook—10	
W2AU—8	
W2VS—8	
Yaesu—1	

TUFTS RADIO CATALOG TUFTS RADIO

GIANT FLEA MARKET! THOUSANDS OF \$\$\$\$ IN PRIZES!

Don't Miss The N.E. ARRL Convention
 Oct. 14th-15th
 At The Beautiful Sheraton Boxborough
 Boxborough, Mass.



Name _____ Call _____
 Address _____
 City _____ State _____ Zip _____
 Order: _____

 Check enclosed Visa Master Charge American Express _____
PRICES SUBJECT TO CHANGE WITHOUT NOTICE
 Credit card # _____
 Signature _____ Card expiration date _____

TUFTS

Radio Electronics
 209 Mystic Avenue
 Medford MA 02155
 (617) 395-8280

Prices FOB Medford MA.
 MA residents add 5% sales tax.
 Minimum \$3.00 for shipping & handling on ALL ORDERS.



MODEL	NET PRICE		
12V4	\$19.95	104R	\$49.95
102	\$24.95	108RA	\$79.95
107	\$28.95	108RM	\$99.95
103R	\$39.95	109R	\$149.95



MODEL 109R

NPC 25 Amp Regulated Power Supply. 4-Way Protected, Output Voltage and Current Meters.

Extra heavy-duty unit quietly converts 115 volts AC to 13.6 volts DC ± 200 millivolts. 10 amps continuous, 25 amps max. All solid state. Features dual current overload, overvoltage and thermal protection. Ideally suited for operating mobile Ham radio and linear amplifier in your home or office. Excellent bench power supply for testing and servicing of mobile communications equipment.

	TYPICAL	MAXIMUM
Output Voltage	13.6 ± 2VDC	13.6 ± 3VDC
Line/Load Regulation	30 mV	100 mV
Ripple/Noise	5 mV RMS	10 mV RMS
Transient Response	20 µSec	
Current Continuous	10 Amp	
Current Limit	25 Amp	
Overvoltage Protection	14.5 V	15 V
Thermal Protection	180°	

Case 4" (H) × 8" (W) × 8" (D). Shipping Weight: 15 lbs.

MODEL 108RM

NPC 12 Amp Regulated Power Supply. Solid State. 3-Way Protected. Current Meter.

This heavy-duty unit quietly converts 115 volts AC to 13.6 volts DC ± 200 millivolts. 8 amps continuous, 12 amps max. All solid state. Features dual current overload and overvoltage protection. Ideally suited for operating mobile Ham radio 2 meter AM-FM-SSB transceivers in your home or office. Can also be used to trickle-charge 12 volt car batteries.

	TYPICAL	MAXIMUM
Output Voltage	13.6 ± 2VDC	13.6 ± 3VDC
Line/Load Regulation	20 mV	50 mV
Ripple/Noise	2 mV RMS	5 mV RMS
Transient Response	20 µSec	
Current Continuous	8 Amp	
Current Limit	12 Amp	
Current Feedback	2.5 Amp	
Overvoltage Protection	14.5 V	15 V

Case 4 1/2" (H) × 7" (W) × 5" (D). Shipping Weight: 9.5 lbs.

ALSO AVAILABLE AS MODEL 108RA WITHOUT METER AND OVERVOLTAGE PROTECTION.

MODEL 107

NPC 4 Amp Power Supply. 6 Amp Max. Solid State. Overload Protected.

Functions silently in converting 115 volts AC to 12 volts DC. 4 amps continuous, 6 amps max. Enables anyone to enjoy CB radio, car 8-track cartridge, cassette player or car radio in a home or office.

	TYPICAL	MAXIMUM
Continuous Current (Full Load)	4 Amp	16 V max
Output Voltage (No Load)	12 V min	12 V min
Output Voltage (Full Load)	10.000 V	10.000 V
Filtering Capacitor	5 v RMS	5 v RMS
Ripple (Full Load)	Thermal Breaker	Thermal Breaker
Short Circuit Protection		

Case 8" (H) × 4" (W) × 5" (D). Shipping Weight: 5 lbs.



MODEL 104R

NPC 6 Amp Power Supply. Solid State. Dual Overload Protection.

Converts 115 volts AC to 13.6 volts DC ± 200 millivolts. Handles 4 amps continuous and 6 amps max. Ideally suited for applications where excellent DC stability is important, such as CB transmission, small Ham radio transmitter, and high quality eight-track car stereos. Can be used to trickle-charge 12 volt car batteries.

	TYPICAL	MAXIMUM
Output Voltage	13.6 ± 2VDC	13.6 ± 3VDC
Line/Load Regulation	20 mV	50 mV
Ripple/Noise	2 mV RMS	5 mV RMS
Transient Response	20 µSec	
Current Continuous	4 Amp	
Current Limit	6 Amp	
Current Feedback	2 Amp	
Short Circuit Protection		

Case 3" (H) × 5" (W) × 6" (D). Shipping Weight: 8 lbs.

MODEL 12V4

NPC 1.75 Amp Power Supply. 3 Amp Max.

Functions silently in converting 115 volts AC to 12 volts DC. Ideally suited for most applications including 8-track stereo, burglar alarm, car radio and cassette tape player within power rating.

	TYPICAL	MAXIMUM
Continuous Current (Full Load)	1.75 Amp	16 V max
Output Voltage (No Load)	12 V min	12 V min
Output Voltage (Full Load)	10.000 V	10.000 V
Filtering Capacitor	5 v RMS	5 v RMS
Ripple (Full Load)	Thermal Breaker	Thermal Breaker
Short Circuit Protection		

Case 3" (H) × 4" (W) × 5" (D). Shipping Weight: 3 lbs.



MODEL 103R

NPC 4 Amp Regulated Power Supply. Solid State. Dual Overload Protection.

Converts 115 volts AC to 13.6 volts DC ± 200 millivolts. Handles 2.5 amps continuous and 4 amps max. Ideally suited for applications where no hum and DC stability are important such as CB transmission, small Ham radio transmitter, and high quality eight-track car stereos. Can also be used to trickle-charge 12 volt car batteries.

	TYPICAL	MAXIMUM
Output Voltage	13.6 ± 2VDC	13.6 ± 3VDC
Line/Load Regulation	20 mV	50 mV
Ripple/Noise	2 mV RMS	5 mV RMS
Transient Response	20 µSec	
Current Continuous	2.5 Amp	
Current Limit	4 Amp	
Current Feedback	1 Amp	
Short Circuit Protection		

Case 3" (H) × 4" (W) × 5" (D). Shipping Weight: 4 lbs.

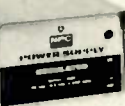

MODEL 102

NPC 2.5 Amp Power Supply. 4 Amp Max. Solid State. Overload Protected.

Functions silently in converting 115 volts AC to 12 volts DC. Ideally suited for most applications including 8-track stereo, burglar alarm, car radio in a home or office.

	TYPICAL	MAXIMUM
Continuous Current (Full Load)	2.5 Amp	16 V max
Output Voltage (No Load)	12 V min	12 V min
Output Voltage (Full Load)	10.000 V	10.000 V
Filtering Capacitor	5 v RMS	5 v RMS
Ripple (Full Load)	Thermal Breaker	Thermal Breaker
Short Circuit Protection		

Case 3" (H) × 4" (W) × 5" (D). Shipping Weight: 4 lbs.



Model MB II \$285 (with Balun) \$315

MB II provides:
 * Constant SWR monitoring * Precision tuning of final amp * Harmonic suppression
 * Receiver input impedance-matching * Maximum power transfer to antenna * Continuous frequency coverage 1.6 to 30 MHz * Precision tuning of any wire 1/2 wavelength or longer, with SWR of 1:1
 MB II features:
 * Finest quality, made-in-USA components * Large, precision, easy-to-read dials with 360° readout * Optional 3000 watt Balun for twin lead antennas.

TRIPLETT



200 (20,000 Ohms per Volt).
 AC VOLTS: 0-3-12-60-300-1, 20 (5,000 Ohms per Volt).
 OHMS: 0-20k-200k-2m Ω -20M Ω (200 Ohm center scale on low range).
 DC MICROAMPERES: 0-600 a 250 mV.
 DC MILLIAMPERES: 0-6-60-600 at 250 mV.
 ACCURACY: ±3% DC; ±4% AC (full scale).
 SCALE LENGTH: 2-1/8".
 METER: Self-shielded; diode overload protected; spring backed jewels.
 CASE: Molded, black, high impact thermoplastic with slide latch cover for access to batteries and fuse, 2-3/4" w x 1-5/16" d x 4-1/4" h.
 BATTERIES: NEDA 15V 220 (1), 1 1/2V 910F (1): Complete with 42" leads, alligator clips, batteries and instruction manual. Shpg. Wt. 2 lbs.
 MODEL 310 Cat. No. 3018\$53.00

RANGES
 DC VOLTS: 0-3-12-60-300, 1, 20

- Drop-resistant, hand-size V-O-M with high-impact thermoplastic case.
- 20,000 Ohms per volt DC and 5,000 Ohms per volt AC; diode overload protection with fused Rx1 Ohms range.
- Single range switch; direct reading AC Amp range to facilitate clamp-on AC Ammeter usage.

AUTOPATCH — Ready to go!



A Complete Autopatch facility that requires only a repeater and a telephone line. Features include single-dial access/disconnect, direct dialing from mobile or hand-held radios, adjustable amplifiers for transmitter and telephone audio, and tone-burst transponder for acknowledgement of patch disconnect.
 RAP-200 P. C. Card \$199.50
 RAP-200R Rack Mount \$249.50



ADVANCED ELECTRONIC APPLICATIONS, INC.

The AUTO DIALER that really works!

- you get 18 numbers from a 1-2 punch
- for making Quick and Safe Auto-Patch Calls
- with Key-Pad Programmable Memory



Model AD-1 \$129.95

- Check These Features:
- Automatically dials with 1 or 2 buttons
 - Exclusive MOS Microprocessor
 - Automatic Push-to-talk
 - Programmable tone duration
 - Programmable time between tones
 - High quality tactile Key-Pad
 - Built in speaker
 - Program RAM memory with Key-Pad (10 numbers in less than a minute)
 - Optional ROM adds 8 permanent numbers
 - Crystal controlled
 - Mates with virtually all amateur FM transceivers

Autek Research QF-1 Active Filter

For CW & SSB \$59.00



AUTEK pioneered the ACTIVE AUDIO FILTER way back in 1972. Today, their

fantastic performance is widely acclaimed. But, today, we're still way ahead with the most advanced — our QF-1. Thousands are already in use improving Yaesu, Kenwood, Drake, Swan, Atlas, Tempo, Collins, etc. Hooks up in minutes to ANY rig. Plugs into phone jack. Drives a speaker with 1 watt, or phones. Its secret is an exclusive "infinitely-variable" cascaded design. You can vary frequency over the ENTIRE audio range — 250 to 2500 Hz — in all positions. Vary selectivity 40:1 or more. Instantly zero-in on signals or optimize response! PEAK CW or voice with 50 Hz bandwidth, variable to 2000 Hz. Imagine what the NARROWEST CW FILTER MADE will do to QRM! Reject whistles, carriers, etc. with the most flexible NOTCH you've heard. Wide or narrow. Depth to 70 dB. Cope with SSB hiss and splatter in LOW-PASS. Steep skirts in all positions add to your rigs skirts.

EXPERIENCE the Ultimate in Scanners



The Touch.™

by Regency

- Over 15,000 frequencies at your fingertips
 - Scans the Channels in 1.3 Seconds
 - Special Weather Alert® and Priority Scan features
- \$249.95

Most Orders
shipped the
same
day

Most Orders
shipped the
same
day

Touch-n-go with
DRAKE 1525EM



Push-Button Encoding Mike
Drake 1525EM, microphone with
tone encoder and connector for
TR-33C, TR-22, TR-22C, ML-2 —
● Microphone and auto-patch en-
coder in single convenient pack-

LINEAR AMPLIFIER
Model L-4B

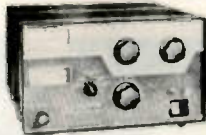

L-4B Linear Amplifier . . \$995.00
● 2000 Watts PEP-SSB ● Class B
Grounded-Grid — two 3-500Z
Tubes ● Broad Band Tuned-Input
● RF Negative Feedback ● Trans-
mitting AGC ● Directional Watt-
meter ● Two Tautband Suspension
Meters ● L-4B 13-15/16" W,
7-7/8" H, 14-5/16" D. Wt.: 32
lbs. ● Power Supply 6-3/4" W,
7-7/8" H, 11" D, Wt.: 43 lbs.

age with coil cord and connec-
tor. Fully wired and ready for
use.

- High accuracy IC tone gener-
ator, no frequency adjustments.
- High reliability Digitran® key-
board.
- Power for tone encoder ob-
tained from transceiver through
microphone cable. No battery
required. Low current drain.
- Low output impedance allows
use with almost all transceivers.
- Four pin microphone plug: di-
rectly connects to Drake
TR-33C without any modifica-
tion in transceiver. Compatible
with all previous Drake and
other 2 meter units with minor
modifications.
- Tone level adjustable.
- Hang-up hook supplied.



Drake T-4XC

Solid State Linear permeability-
tuned VFO with 1 kHz dial
divisions. Gear driven dual cir-
cular dials. High mechanical,
electrical and temperature sta-
bility. Covers ham bands with
crystals furnished. Covers all of
80, 40, 20 and 15 meters, and
28.5-29.0 MHz of 10 meters.

Covers 160 meters with acces-
sory crystal. Four 500 kHz ranges
in addition to the ham bands plus
one fixed-frequency range can be
switch-selected from the front
panel.



Drake R-4C

Solid State Linear permeability-
tuned VFO with 1 kHz dial di-
visions. Gear driven dual circular
dials. High mechanical, electrical
and temperature stability. Covers
ham bands with crystals furn-
ished. Covers all of 80, 40, 20
and 15 meters, and 28.5-29.0
MHz of 10 meters.

Covers 160 meters with acces-
sory crystal. In addition to the
ham bands, tunes any fifteen 500
kHz ranges between 1.5 and 30
MHz, 5.0 to 6.0 MHz not recom-
mended. Can be used for MARS,
WWV, CB, Marine and Shortwave
broadcasts.



DRAKE
TR-7 TRANSCEIVER

sections for sharp cut off below
channel 2, and to attenuate trans-
mitter harmonics falling in any
TV channel and fm band. 52
ohm, SO-239 connectors built in.

Drake TV-3300-LP Model 1608
1000 watts max. below 30 MHz.
Attenuation better than 80 dB
above 41 MHz. Helps TV i-f inter-
ference, as well as TV front-end
problems.

DRAKE TV-5200-LP Model No.
1609. 200 watts to 52 MHz. Ideal
for six meters. For operation
below six meters, use TV-3300-LP
or TV-42-LP.



DRAKE TV-42-LP Model No.
1605 is a four section filter de-
signed with 43.2 MHz cut-off and
extremely high attenuation in all
TV channels for transmitters
operating at 30 MHz and lower.
Rated 100 watts input.

DRAKE TVI FILTERS
High Pass Filters for TV sets
provide more than 40 dB atten-
uation at 52 MHz and lower. Protect
the TV set from amateur trans-
mitters 6-160 meters.



Drake TV-75-HP
Model No. 1610. For 75 ohm TV
coaxial cable; TV type connectors
installed

LOW PASS FILTERS FOR
TRANSMITTERS have four pi



Drake TV-300-HP
Model No. 1603. For 300 ohm
twin lead



DRAKE

COMMUNICATIONS RECEIVERS AND ACCESSORIES

DSR-2	VLF-HF Digital Synthesized Communications Laboratory Receiver SSB, AM, CW, RTTY, ISB	\$ 3200.00
R4C	Amateur HF Receiver, 160-10 meters	699.00
4-NB	Noise Blanker for R4C	74.00
FL-250	Accessory I.F. Filter	52.00
FL-500	Accessory I.F. Filter	52.00
FL-1500	Accessory I.F. Filter	52.00
FL-4000	Accessory I.F. Filter	52.00
FL-6000	Accessory I.F. Filter	52.00
TRANSCEIVERS AND ACCESSORIES		
TR-7	HF Transceiver 160-10 meters	886.00
	Analog Dial Readout	
DR-7	Digital Readout/Gen. Cov. Board	186.00
TR-7/DR-7	Allows continuous receive from 1.5-30 MHz	
Aux-7	Above units, factory installed DR-7	1072.00
	Range Program Board for TR-7 and TR-7/DR-7	38.00
	Allows receive 0-1.5 MHz and transceive or receive 1.5-30 MHz. Accommodates any 8 500 kHz ranges. Must be used with either RRM-7 range receive module or RTM-7 range transceive module. Use one mode per 500 kHz range. Modules are customer programmable, instructions provided. Proof of license necessary for RTM-7, contact sales dept.	
RRM-7	Range Receive Module — plugs in to Aux-7. Customer Programmable in any 500 kHz range 0-30 MHz.	5.00
RTM-7	Range transceive module — plugs in to Aux-7. Customer Programmable in any 500 kHz range from 1.5-30 MHz except 26-28 MHz. Send proof of license.	5.00
RV-7	Remote VFO for TR-7	156.00
FA-7	Fan for TR-7 or PS7	24.00
NB-7	Noise Blanker for TR-7	74.00
SL-300	Crystal filter, 300 Hz	49.00
SL-500	Crystal filter, 500 Hz	49.00
SL-1800	Crystal filter, 1800 Hz	49.00
SL-6000	Crystal filter, 6000 Hz	49.00
TRANSMITTERS		
T4XC	Amateur HF Transmitter 160-10 meters	699.00

TRANSCEIVERS AND ACCESSORIES

TR33C	2-meter FM transceiver, 12 channel portable	229.95
MMK-33	Mobile/Dash/Desk Mount for TR33C	12.95
UMK-3	Remote trunk kit for UV-3 system	69.95
UV-3	144	595.00
UV-3	144-220	695.00
UV-3	144-440	695.00
UV-3	144-220-440	795.00
UV-3E	144-430, European model	695.00
*Prices above include factory installed modules for bands as listed. Factory installed "add-on" 220 or 440 modules. (Modules not sent to field).		
POWER SUPPLIES		
AC-4	110/220V power supply for 4 line transmitters and transceivers	150.00
PS-3	AC Supply [120/240 V.A.C.] for any UV-3 Model	89.95
DC-4	12 VDC power supply for 4 line transmitters, transceivers, & receivers	160.00
PS-7	120/240V A.C. supply for TR-7	166.00
MAJOR ACCESSORIES & MISCELLANEOUS		
L4B	Linear Amplifier with Power Supply & Tubes	995.00
MN4C	Antenna Matching Network, 160-10 meters, 250 watts	165.00
MN-7	Antenna Matching Network, 160-10 meters, 250 watts.	165.00
MN2000	Antenna Matching Network, 2000 watts.	250.00
B-1000	4:1 Balun Designed for use with MN4C/MN-7	24.95
MS-4	Matching Speaker for 4 line	33.00
MS-7	Matching Speaker for 7 line	33.00
W-4	HF RF Wattmeter 1.8 to 54 MHz 200/2000 watts	79.00
WH-7	HF RF Wattmeter 1.8 to 54 MHz 20/200/2000 watts	89.00
1525EM	Encoder Microphone w/plug for TR33C/UV-3	49.95
7079	Vinyl Case for TR33C	9.95
HIGH PASS FILTERS		
TV-300HP	High Pass Filter for 300 ohm twin lead	10.60
TV-75HP	High Pass Filter for 75 ohm TV coax, type F	13.25
LOW PASS FILTERS FOR TRANSMITTERS		
TV42LP	For transmitting below 30 MHz, 100 watt continuous/50 ohms/SO-239 connectors	14.60
TV3300LP	1000 watts continuous to 30 MHz with sharp cutoff above 41 MHz/50 ohms/SO-239 connectors	26.60
TV5200LP	100 watts continuous on 6 meter amateur band	26.60

TUFTS RADIO CATALOG TUFTS RADIO



MODEL	DESCRIPTION	BEAMS	AMATEUR PRICE
TB4HA	4 Element 20/15/10. All four elements function all bands and are full sized		\$279.95
TB3HA	3 Element 20/15/10		\$219.95
TB2A	2 Element 20/15/10		\$149.95
MB40H	2 Element 40 meter		\$219.95
VERTICALS			
1040V	10-40 Golden Swan Trap		\$122.95
75-MK	75 meter add-on kit for 1040V		\$ 39.95
4010V	10-40 Slim-line trap		\$ 79.95
75-AK	75 meter add-on kit for 4010V		\$ 39.95
MOBILE			
45	75/40/20/15/10, 1000W PEP Gold Plated contacts. Manual band switching		\$119.95
742	75/40/20, 500W PEP, no manual switching required. Fully automatic after initial tune up to desired frequency.		\$109.95
M34	20/15/10 slim line tri-bander 500W PEP. Coil for 40 or 80 or 160 with top section may be added to make unit four bander.		\$ 69.95
M34T	Top section used with 40/80 or 160 coils. Not required for basic M34.		\$ 6.95
M34E	Base extender rod for use when mounting M34 on bumper.		\$ 13.95
M34/160	160 meter coil (M34T required)		\$ 21.95
M34/80	80 meter coil (M34T required)		\$ 19.95
M34/40	40 meter coil (M34T required)		\$ 19.95

*M34/11 27 MHz coil available only upon special request. Delivery six weeks \$16.95. May be utilized in lieu of 10 meter coil on basic M34.

NEW TRANSCEIVERS



750 CW—\$679.95

If you're ready for 700 loud talking watts, you're ready for the new 750CW. 700 watts P.E.P. input on SSB. 400 watts DC input on CW. CW audio filter selectable 80 or 100 Hz. CW sidetone monitor with adjustable pitch and volume control. 80 through 10 meters, USB, LSB, CW. Selectable 25 or 100 kHz crystal calibrator. Standard 5.5 MHz, 2.7 Hz bandwidth crystal filter or optional accessory 16 pole filter available with 140 Db ultimate rejection. Accessories: Vx-2 Vox. Mk-II linear amplifier. DD-75 Digital Dial. The 750CW is a CW man's dream come true. What's more there's a long list of accessories you can add later for increased performance.



350B—\$649.95

300 watts P.E.P. input SSB. 200 watts DC input on CW. 80 through 10 meters, USB, LSB, CW. 5.5 MHz, 2.7 kHz bandwidth crystal filter. Oscillators are solid state and IC regulated for stability. CW sidetone monitor with adjustable pitch and volume. CW audio filter 80 and 100 Hz selectable. Built in 117 VAC power supply and speaker. 120V VAC power supply available on special request. Accessories: Vx-2 Vox. 14A DC Converter. 1200X linear amplifier. Crystal Calibrator (150A only).



350D—\$749.95

Same basic features as 350A except added feature of 5 Digit LED frequency display with readout to 100 Hz. Both the 350A and the 350D are compatible with the same line of Swan accessories that has built a reputation for reliability and performance that's second to none, including linear amplifiers to boost your power to the legal limit. So they're perfect for novices or anyone else because you can build capability as you need it.

OUR NEW M-34 EXPANDABLE MOBILE ANTENNAS

The M-34 mobile antenna gives you 10, 15, and 20 meters and great performance in a tough, rugged design for only \$52.75. Then whenever you want it you can buy the optional 160, 80 or 40 meter coil and top section for \$20.00 to \$25.00 depending on the band and make a full capability four bander out of it. One that never needs coil changes or adjustments after initial tuning. What's more, at no extra cost you get features like 500 watts PEP, low standing wave ratio at resonance, independent resonance adjustments on each of the four bands, exceptional bandwidth and a neat, clean, low wind resistance profile that also goes great with mobile homes, motor homes and apartments. That's the kind of innovative, problem-solving thinking that goes into Swan mobile antennas. Not just the M-34 but these, too:

742 Automatic. Swan automates mobile antennas with the 742 tri-band antenna. Work 20, 40 or 75 meters with your 742 without need for coil change or other adjustments after initial tuning. A high Q mobile antenna designed for maximum efficiency capable of 500 watts PEP. \$109.95

Mobile 45. This switch-adjustable 5-band antenna features a Swan Hi-Q coil and positive-stop, 9-position switch with GOLD-PLATED contacts. Select 10, 15, 20, 40 plus five positions for 75 meters and go to work knowing this rugged antenna's doing its job. \$119.95

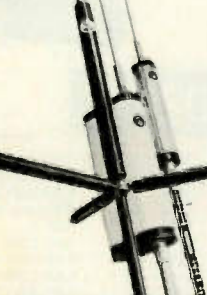

SWAN METERS



THESE WATTMETERS TELL YOU WHAT'S GOING ON. With one of these in-line wattmeters you'll know if you're getting it all together all the time. Need high accuracy? High power handling? Peak power readings? For whatever purpose we've got the wattmeter for you.

WM2000 IN-LINE WATT-METER WITH MUSCLE. Scales to 2000 watts. New flat-response directional coupler for maximum accuracy. \$69.95.



WM3000 PEAK-READING WATTMETER. Reads RMS power, then with the flick of a switch, true peak power of your single-sideband signal. That's what counts on SSB. \$87.95

WM1500 HIGH-ACCURACY IN-LINE WATTMETER. 10% full scale accuracy on 5, 50, 500 and 1500 watt scales, 2 to 30 MHz, Forward and reflected power. Use it for troubleshooting, too. \$74.95



THE SWAN METER SHOWCASE.



Shifts out radiated power wherever it is. This little unit is so compact it could measure relative radiated power in your pocket. Telescoping range of 15 MHz all the way to 200 MHz. FS-1 Field Strength Meter. \$13.95



Easy-on-the-pocket pocket SWR. Mighty mate SWR meter with high accuracy. SWR-3 gives you 1:1 to 3:1 SWR at 50 ohms on frequencies from 1.7 to 55 MHz. Precision PC board directional coupler makes it a solid value at a rock-bottom price. SWR-3 Pocket SWR Meter. \$14.95



SWR bridge bridges the price barrier. This little jewel gives you relative forward power and SWR on two 100 microampere meters at a remarkably low price. Indicates 1:1 to infinity. VSWR of up to 1000-watt signals on frequencies from 3.5 to 150 MHz. With low insertion loss. It's great for mobile operators, too. SWR-1A Power Meter and SWR Bridge. \$29.95



At last. A precision wattmeter for the 6 and 2-meter man. We design the WM-6200 for the upper-band man who needs to know with $\pm 7\%$ accuracy. Reads power of 50 to 150 MHz signals on two scales to 200 watts plus SWR on expanded range scale from 1:1 to 3:1 with \pm accuracy. WM-6200 In-Line Wattmeter. \$87.95



Put your power up in lights. The new WMD-6200 does everything our WM-6200 does and ends guesswork, interpolation errors and eyestrain besides with a 4-digit readout. 50 to 150 MHz, power to 200 watts with an accuracy of $\pm 10\%$. SWR from 1:1 to 19.99:1 with $\pm 3\%$ accuracy. WMD-6200 Digital SWR Power Meter. \$269.95 (requires AC source)

The new WM-200A does it all. As an in-line wattmeter it gives you power to 200 watts on two scales plus SWR from 1:1 to 3:1 for signals from 50 to 150 MHz. And as a peak reader it reads true peak envelope power of your voice modulated signal. Fast response forward or reflected power on scales to 200 watts in switch-selected RMS or peak. WM-200A Peak Reading Wattmeter. \$89.95



Nifty little meter just for VHF mobile. This brand new, easy-to-install swivel-mount unit is the perfect illuminated wattmeter for 2-meter mobile. Compact and capable, it gives you two scales, 0-200 watts and 0-200 watts at 10% accuracy. SWR from 1:1 to 3:1. Frequencies from 50 to 150 MHz. WMM-200 SWR Power Meter. \$49.95



Dentron MLA-2500 \$899.50

Dentron Radio has packed all the features a linear amplifier should have into their new MLA-2500. Any Ham who works it can tell you the MLA-2500 really was built to make amateur radio more fun.

- ALC circuit to prevent overloading
- 160 thru 15 meters
- 1000 watts DC input on CW, RTTY or SSTV Continuous Duty
- Variable forced air cooling system
- Self-contained continuous duty power supply
- Two EIMAC 8875 external anode ceramic/metal triodes operating in grounded grid
- Covers MARS frequencies without modifications
- 50 ohm input and output impedance
- Built-in RF wattmeter
- 117V or 234V AC 50-60 hz

- Third order distortion down at least 30 db
- Frequency range: 1.8MHz (1.8-2.5) 3.5MHz (3.4-4.6) 7MHz (6.0-9.0) 14MHz (11.0-16.0) 21MHz (16.0-22.0)
- 40 watts drive for 1 KW DC input
- Rack mounting kit available (19" rack)
- Size: 5 1/2" H x 14" W x 14" D w/ 47 lbs.



BOMAR Crystal Company

Novice Crystals (Specify Band Only) **TWO METERS** Motorola HT 220 Crystals In Stock!

Standard • Icom • Heathkit • Ken • Clegg • Regency • Wilson • VHF Eng • Drake • And Others!

LIFETIME GUARANTEE! NOW ONLY \$7.00 A PAIR!

Make/Model	Xmit Freq.	Rec. Freq.

PROGRAMMABLE CMOS KEYS

AUTEK RESEARCH

CALLS CQ WHILE YOU RELAX!

Also remembers name, QTH, contest exchanges, etc

MODEL MK-1

ONLY \$99.50

- 4 Messages
- Instant record or reprogram
- Designed for Novice, as well as CW "Pro" and Contest OP



An Advanced Programmable Keyer - Yet Priced Lower Than Many Ordinary Keyers

Programmable memory keyers are the biggest advance to come along in 15 years for CW. When you use one, CW truly becomes FUN again! Until the MK-1, quality memory keyers cost \$150 to \$400. But now, anyone can afford a "miniature computer," instead of an ordinary keyer. It's an investment in enjoyable operation for years to come. And an incredible bargain at our breakthrough low price!

ADVANCED "MOS" MEMORY

- Just tap button to start any of four messages
- You record CQ, contest exchanges, name, QTH, or anything you want in the four messages
- Record instantly by simply sending the message
- Play out recording as often as desired
- Change by simply recording over the old message. No factory programmed extra cost IC's to buy
- Large 1024 bit total memory stores about 100 characters. Each message holds about 25 characters, depending on character length and pauses, e.g., "CQ CQ DE WEDYD WEDYD CQ TEST W"
- "Combine C/D" switch combines 2 of the 4 messages for extra length of about 50 characters, e.g., "QTH IS LA LA NAME IS BILL BILL RIG HR IS KW ES BEAM ES NEW MEMORY KEYS"
- REPEAT SWITCH repeats message forever until reset. Very useful for longer CQ's, or leave a moderate pause at end of CQ. If no answer, the keyer automatically repeats the CQ until answered, YOU SIT BACK AND WAIT FOR A CALL!
- ADDED CONTEST FEATURES: Instant memory reset with button, or by tapping paddle when playing. Tapping message button restarts message.

PLUS A GREAT AUTOMATIC KEYS

- Dot AND dash memories "forgive" your minor timing mistakes. Most keyers have just a dot memory or none at all. The MK-1 makes sending easier.
- IAMBIC OPERATION. Squeezing dot and dash paddles produces alternate dots and dashes, making it easier to send letters such as C, F, K, O, R, etc. Most keyers put out only dots, or only dashes when paddles are squeezed, making you work harder.
- FULL CMOS construction. No TTL logic to heat up or draw heavy current. Battery operation if desired (50 ma @ 9V, 60 ma @ 12 V, typical)
- SELF-COMPLETING characters Jamproof.
- Extensive RFI protection. 8-50+ WPM
- Silent transmitter output. No clicking relays to fail. (Max. 300 V, .15 ma. grid blocked rig #200 ma. cathode keyed rigs at key)
- TRIGGERED CLOCK (except when recording) starts instantly at key closure. No confusing wail, or need for you to "keep time," as with many keyers.
- Built-in monitor/speaker. Volume control (panel). Widely adjustable tone (internal trimpot).

To prevent loss of recorded messages when AC power is lost, a 9 V battery may be connected to the rear battery input. No power is drawn from a battery if AC power is on. This makes the MK-1 ideal for field use or excursions. The MK-1 may be left on continuously in fixed stations. If desired. (Draws less than 1.5 watts AC). The MK-1 may be used with any paddle. A dual-line (square) paddle is recommended to take advantage of iambic operation, but a single-line paddle will also work.

185 VAC or 9-14 VDC. 6-2 1/2 x 5 1/2. 2.5 lbs. Handmade light gray panel with silver lettering. Black steel case. Comes assembled and tested with full instructions.

VISTA power supplies

quality power conversion products for car, boat, home, trailer, truck or recreation vehicle



deluxe regulated R series convert 120 vac, 60 Hz to 13.8 vdc ± 0.5 vdc

The VISTA series of regulated models is of the highest quality, utilizing the latest in integrated circuit (IC) technology, designed for long life and superior performance with hum-free, highly regulated stabilized output voltage... the standard of the industry.

models

- VISTA IIR... 2 amps continuous, 4 amps surge auto-reset breaker. UL listed, case size 3 1/2x5 1/2x5 1/2 inches **\$29.95**
- VISTA IIR... 3 amps continuous, 5 amps surge auto-reset breaker. UL listed, case size 3 1/2x5 1/2x5 1/2 inches **\$33.95**
- VISTA IIR... 4 amps continuous, 6 amps surge current limiting, crowbar over-voltage protected. fuses. UL listed features, case size 3 1/2x5 1/2x7 1/2 inches **\$43.95**
- VISTA IIR... 5 amps continuous, 8 amps surge current limiting, crowbar over-voltage protected. fuses. UL listed features, case size 3 1/2x5 1/2x7 1/2 inches **\$51.95**
- VISTA IIR... 8 amps continuous, 11 amps surge current limiting, crowbar over-voltage protected. fuses. UL listed features, case size 4 1/2x6 1/2x8 1/2 inches **\$79.95**
- VISTA IIR... 10 amps continuous, 13 amps surge current limiting, crowbar over-voltage protected. fuses. UL listed features, case size 4 1/2x6 1/2x8 1/2 inches **\$94.95**
- VISTA IIR... 16 amps continuous, 20 amps surge current limiting, crowbar over-voltage protected. fuses. UL listed features, case size 4 1/2x6 1/2x8 1/2 inches **\$103.95**
- VISTA IIR... 20 amps continuous, 26 amps surge current limiting, crowbar over-voltage protected. fuses. UL listed features, case size 4 1/2x6 1/2x8 1/2 inches **\$139.95**
- VISTA IIR... 30 amps continuous, 40 amps surge current limiting, crowbar over-voltage protected. fuses. UL listed features, case size 4 1/2x6 1/2x8 1/2 inches **\$164.95**

applications

- Home use of low power mobile AM-CB radios, quality car tape players, truck battery charging
- Home use of high power mobile AM-CB radios, quality car tape players, truck battery charging
- Home use of mobile single side band CB, high power AM-CB and small ham radios, quality car tape players, tape recorders
- Home use of single side band CB radios, high power car stereo, for the HiFi perfectionist, low power 2 meter ham radios
- 10 watts, 2 meter ham, FM-CB, marine and business band radios, low power linear amplifiers
- 25 watts, 2 meter ham, FM-CB, marine and business band radios, low power linear amplifiers
- 50 watts, 2 meter ham and FM-CB band radios, linear amplifiers
- 50 and 75 watts, 2 meter ham band linear amplifiers test bench power supply
- 100 and 160 watts, 2 meter ham band linear amplifiers, test bench power supply

*Output 12.5 VDC ± 0.5 VDC

GIANT SALE NOW IN PROGRESS!

GIANT SALE NOW IN PROGRESS!

GIANT SALE NOW IN PROGRESS!

GIANT SALE NOW IN PROGRESS!

GIANT SALE NOW IN PROGRESS!

GIANT SALE NOW IN PROGRESS!

GIANT SALE NOW IN PROGRESS!

GIANT SALE NOW IN PROGRESS!

The only completely free-standing, telescoping, breakover tower you can buy.



The only completely free-standing, telescoping, breakover tower you can buy.

They telescope. Crank up or down easily to pinpoint best reception. They breakover. Your feet never have to leave the ground when you pull maintenance - even on your tallest breakover tower.

One-piece price. You get the whole tower, ready to install. No extra charges for base plates, guy wire, etc. Old-fashioned craftsmanship. Every Tele-Tow'r is cut, assembled, and welded by hand.

Old-fashioned value. Orville Bond found a way to make better towers for less money. Our model 40, which we believe is the most durable, convenient non-breakover 40-footer you can buy, is \$224.21. Our Breakover Model 55, the only tower you can buy that is totally free-standing, telescoping, and a breakover, is just under \$500. Completely free-standing. No guy wires, no brackets. Yet, by stretching the windload over the entire tower, we've made them stronger than wired or bracketed towers.

- 55 Concrete Sleeve \$32.00
- 40 Concrete Sleeve \$32.50
- Model 40 (extends from 23'-40') \$224.21
- Model 55 (extends from 23'-55') \$410.16
- Breakover Model 40 (extends from 23'-40', with breakover at ground level) \$381.30
- Breakover Model 55 (extends from 23'-55', with breakover at ground level) \$572.65

TELE TOWER



Two NEW Rotors from Cornell-Dubilier

TAIL TWISTER™



HAM III



- For the New Super Communications Antennas
- New Thickwall Casting
- New Steel Ring Gear
- New Metal Pinion Gear
- New Motor Prebrake
- New Super Wedge Brake
- New L.E.D. Control Box
- Safe 26 Volt Operation

Designed for the newest of the king-size communications antennas, the TAIL TWISTER™ is the ultimate in antenna rotational devices. The TAIL TWISTER™ starts with a deluxe control box featuring snap action controls for brake and directional controls; L.E.D. indicators signal rotation and brake operation, while the illuminated meter provides direction readout. This new control box couples to the newest bell rotor. Using the time tested bell rotor principle, the TAIL TWISTER™ is a brand new design with thickwall castings and six bolt assembly. A brand new motor with prebrake action brings the antenna system to an easy stop, while the massive square front brake wedge locks the assembly in place. A new stainless steel spur gear system provides final drive

into a new steel ring gear for total reliability. Triple race, 138 ball bearing assembly carries dead weight and maintains horizontal stability. An optional heavy duty lower mast adaptor is available for lighter loads with mast mounting. Price: \$259.00

The HAM III sets new levels of performance. Snap action switched wedge brake and rotational controls brings pinpoint accuracy to large directional arrays popular in communications. A new motor provides pre-brake action to assist in slowing down rotational mass, and the new thicker wedge brake offers far stronger lock-in phase action. To take full advantage of this new design, the HAM III is designed for in-tower mounting. A new optional heavy duty lower mast adaptor is available when the HAM III is to be mast mounted with smaller arrays. A stainless steel spur gear system multiplies the torque into the dual race 98 ball bearing support assembly assuring years of trouble free performance. Price: \$139.00.

TUFTS RADIO CATALOG TUFTS RADIO

FINCO STINGER VHF/UHF Antennas

2 meter Stinger A 2-10—\$41.15

The model Stinger A 2-10 is a high performance wide spaced ten-element 2-meter yagi designed for the serious VHF operator. Utilizing the Stinger construction features, the A 2-10 is almost indestructible to matter what weather conditions are encountered. Complete coverage of the 2-meter band and low V.S.W.R. is assured through the use of non-linear spaced elements thus also achieving maximum forward gain. Power rating—2,000 watts P.E.P.

SPECIFICATIONS — A 2-10	
ELECTRICAL—	MECHANICAL—
Forward Gain 13.8dB	Boom Length 10 ft.
Front-to-Back Ratio 25dB	Longest Element 42 in.
V.S.W.R. (at resonance) 1.1:1	Turning Radius 71 in.
Half Power Beam Width 40°	Maximum Surface Area 2.36 sq. ft.
Bandwidth 144 to 148 MHz	Wind Load at 80 MPH 26.2 lbs.
Impedance 50 Ohms	Weight 9.8 lbs.
Matching System Adjustable Gamma	

Stinger A 2-5—\$25.60

The model Stinger A 2-5 is a five-element high gain antenna similar to the A 2-10 but having physically less of a profile. The A 2-5 finds excellent application as a portable antenna as it disassembles into a very compact package. Like the A 2-10, the antenna can be mounted for vertical or horizontal polarization for repeater or general coverage work. Constructed of the Stinger heavy duty materials, the A 2-5 is ideal for locations encountering adverse weather conditions. Power rating 2,000 watts P.E.P.

SPECIFICATIONS — A 2-5	
ELECTRICAL—	MECHANICAL—
Forward Gain 9.5dB	Boom Length 5.5 ft.
Front-to-Back Ratio 22dB	Longest Element 41 in.
V.S.W.R. (at resonance) 1.1:1	Turning Radius 42 in.
Half Power Beam Width 51°	Maximum Surface Area 1.23 sq. ft.
Bandwidth 144 to 148 MHz	Wind Load at 80 MPH 13.3 lbs.
Impedance 50 Ohms	Weight 6.5 lbs.
Matching System Adjustable Gamma	

Stinger A 2+2—\$41.75

The model Stinger A 2+2 is a ten-element, dual polarization 2 meter antenna designed for OSCAR communications or where switching from horizontal to vertical polarization is required. The A 2+2 can even be phased to operate on both horizontal and vertical polarization at the same time. This is not only ideal for OSCAR work but gives your station versatility for ground communications.

Wide, non-linear element spacing gives the A 2+2 superior gain, however, since it is a five element beam in one gain plane, the half power beam width does not make satellite tracking difficult because of sharp directivity. The dual gamma match assemblies provide for a very low V.S.W.R. and will withstand 2,000 watts P.E.P.

SPECIFICATIONS — A 2+2	
ELECTRICAL—	MECHANICAL—
Forward Gain 9.5dB	Boom Length 6 ft.
Circular Gain 10.5dB	Longest Element 41 in.
Front-to-Back Ratio 22dB	Turning Radius 42 in.
Half Power Beam Width 51°	End Mount 5.5 ft.
Horizontal Polarization 50°	Center Mount 3.4 ft.
E Plane 50 Ohms	Maximum Surface Area 1.51 sq. ft.
Vertical Polarization 50°	Wind Load at 80 MPH 13.4 lbs.
E Plane 52°	Weight 11 lbs.
Circular Polarization 52°	
Bandwidth 144 to 148 MHz	
Impedance 50 Ohms	
Matching System Adjustable Gamma	

1 1/4 meter Stinger A 1 1/4—\$29.65

The model Stinger A 1 1/4 is a ten element 1 1/4-meter (220 MHz) high performance yagi designed for all 220 MHz communication needs. Designed to be mounted in either the vertical or horizontal plane, the A 1 1/4 is adaptable for OSCAR, repeater, or general communication work. Incorporating the Stinger heavy duty materials, boom and bracket assemblies, the antenna easily withstands 120 mph wind loads under 1/4" ice conditions. A low loss gamma matching system assures a low V.S.W.R. and is power rated at 1,000 watts.

SPECIFICATIONS — A 1 1/4	
ELECTRICAL—	MECHANICAL—
Forward Gain 13.8dB	Boom Length 8 ft.
Front-to-Back Ratio 25dB	Longest Element 28 in.
V.S.W.R. (at resonance) 1.2:1	Turning Radius 4.3 ft.
Half Power Beam Width 40°	Maximum Surface Area 1.32 sq. ft.
Bandwidth 220 to 226 MHz	Wind Load at 80 MPH 17.9 lbs.
Impedance 50 Ohms	Weight 8 lbs.
Matching System Adjustable Gamma	

10 meter Stinger A 10-4—\$57.15

The model Stinger A 10-4 is a wide spaced, full size, high gain four element 10-meter monobander designed for optimum DX performance. Utilizing the exclusive Stinger Series square boom construction, the A 10-4 is light enough to be easily stacked for an additional 3 dB gain yet strong enough to withstand the most adverse weather conditions. The highly efficient gamma match system easily withstands 2,000 watts P.E.P. of power and maintains a relatively low V.S.W.R. across the entire 10-meter amateur band.

SPECIFICATIONS — A 10-4	
ELECTRICAL—	MECHANICAL—
Forward Gain 10dB	Boom Length 16 ft.
Front-to-Back Ratio 25dB	Longest Element 18.2 ft.
V.S.W.R. (at resonance) 1.1:1	Turning Radius 7.4 ft.
Half Power Beam Width 55°	Maximum Surface Area 4.4 sq. ft.
Bandwidth 28 to 30 MHz	Wind Load at 80 MPH 118 lbs.
Impedance 50 Ohms	Weight 12.5 lbs.
Matching System Adjustable Gamma	

6 meter Stinger A 6-5—\$41.95

The model Stinger A 6-5 is a highly directional 6 meter five element beam specifically designed for maximum forward gain with a "no compromise" front to back ratio. The elements are constructed of high tensile strength seamless aluminum tubing plus the exclusive Stinger square boom and bracket assemblies. For maximum power transfer and low V.S.W.R., a carefully designed gamma matching assembly capable of withstanding 2,000 watts P.E.P. is incorporated. Wide element spacing assures optimum DX performance and good operating efficiency across the entire 50 to 54 MHz 6-meter band. The square boom allows optional vertical mounting for accessing 6 meter repeaters.

SPECIFICATIONS — A 6-5	
ELECTRICAL—	MECHANICAL—
Forward Gain 11dB	Boom Length 13 ft.
Front-to-Back Ratio 25dB	Longest Element 10 ft.
V.S.W.R. (at resonance) 1.1:1	Turning Radius 8.3 ft.
Half Power Beam Width 52°	Maximum Surface Area 3.23 sq. ft.
Bandwidth 50 to 54 MHz	Wind Load at 80 MPH 40.2 lbs.
Impedance 50 Ohms	Weight 11.5 lbs.
Matching System Adjustable Gamma	

Stinger A 6-3—\$27.30

The model Stinger A 6-3 is a 3-element high gain 6-meter beam similar to the A 6-5 but expressly designed for the casual 6-meter enthusiast. The A 6-3 also finds excellent application for portable use as it disassembles into a compact package. Due to the units light weight and minimal wind load, the antenna is ideal for double stacked and quad stacked arrays for the real 6 meter DXer. The A 6-3 is rated at 2,000 watts P.E.P. and incorporates a square boom and high tensile strength aluminum elements.

SPECIFICATIONS — A 6-3	
ELECTRICAL—	MECHANICAL—
Forward Gain 7.0dB	Boom Length 6.0 ft.
Front-to-Back Ratio 21.0dB	Longest Element 10 ft.
V.S.W.R. (at resonance) 1.1:1	Turning Radius 5.4 ft.
Half Power Beam Width 60°	Maximum Surface Area 1.75 sq. ft.
Bandwidth 50 to 54 MHz	Wind Load at 80 MPH 17.6 lbs.
Impedance 50 Ohms	Weight 7 lbs.
Matching System Adjustable Gamma	

6 and 2 meter Stinger A 62—\$68.60

The model Stinger A 62 is a truly remarkable combination 6 and 2 meter beam designed for optimum performance on both bands yet only requiring ONE transmission line. This is accomplished through the use of exclusive phasing elements to accomplish dual band operation with no sacrifice to either band—NO SWITCHING REQUIRED!

On 2-meters, the A 62 has 6 collinear elements—equivalent to three 1/2 λ 6-element yagis stacked side by side—thus giving outstanding performance. Maximum forward gain is assured on 6-meters through the use of four wide spaced elements. The heavy duty Stinger construction is used throughout so that the antenna will withstand 100 mph plus wind loads.

The A 62 is ideal for mounting on the same mast as your 6-meter or other antenna thus easily opening up the world of 6 and 2-meter VHF communication.

SPECIFICATIONS — A 62	
ELECTRICAL—	MECHANICAL—
Forward Gain 6 meters 9.5dB	Boom Length 10.1 ft.
2 meters 12.0dB	Longest Element 10 ft.
Front-to-Back Ratio 6 meters 19dB	Turning Radius 6.7 ft.
2 meters 22dB	Maximum Surface Area 4.43 sq. ft.
V.S.W.R. (6 & 2 meters) 1.1:1	Wind Load at 80 MPH 43 lbs.
Half Power Beam Width 40° to 55°	Weight 13.8 lbs.
Bandwidth 6 meters 50 to 54 MHz	
2 meters 144 to 148 MHz	
Impedance 50 Ohms	
Matching System Adjustable Gamma	

ENGINEERING FEATURES

□ Antenna design engineering is a specialty at FINCO. Top quality lab standard test equipment is used throughout the development and design of all antennas. The FINCO antenna test range has been carefully checked for erroneous reflection characteristics that could cause errors in antenna designs. Shown is the sophisticated stub and matching system that has been developed for the Stinger A 62, 6 and 2 meter dual band beam. No traps or coils to burn out or detune, thus assuring you of the highest possible performance on both 6 and 2-meters.

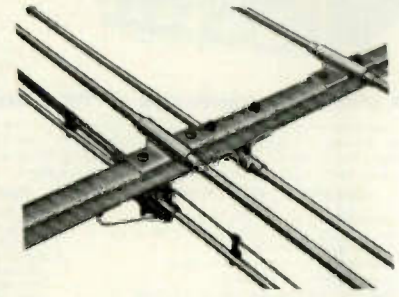

□ Exclusive Stinger square boom construction is used on all amateur antennas. The 1 1/2" square booms are of .064 wall high tensile strength aluminum which is many times stronger than its round counter part. Also, special bracket assemblies have been developed to allow instant element to boom alignment—plus they stay aligned in the highest wind and ice loads. All elements are of thick wall high tensile strength aircraft quality aluminum.

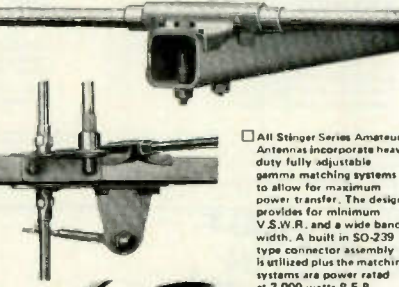

□ All Stinger Series Amateur Antennas incorporate heavy duty fully adjustable gamma matching systems to allow for maximum power transfer. The design provides for minimum V.S.W.R. and a wide bandwidth. A built in SO-239 type connector assembly is utilized plus the matching systems are power rated at 2,000 watts P.E.P.

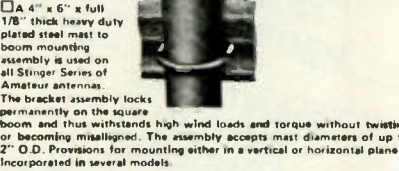

□ A 4" x 6" x full 1/8" thick heavy duty plated steel mast to boom mounting is used on all Stinger Series of Amateur antennas. The bracket assembly locks permanently on the square boom and thus withstands high wind loads and torque without twisting or becoming misaligned. The assembly accepts mast diameters of up to 2" O.D. Provisions for mounting either in a vertical or horizontal plane is incorporated in several models.

ROHN NO. 25G TOWER & ACCESSORIES

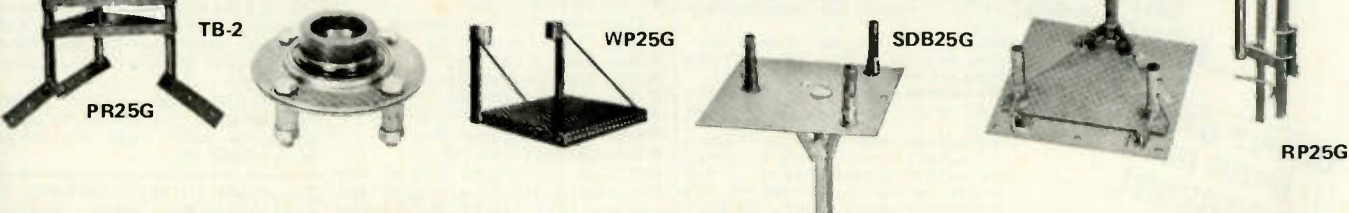

- SB25G 3/4" SHORT BASE section for concrete — \$17.90
- SBh25G* 3/4" HINGED SHORT BASE section for concrete — \$29.15
- HGB25G* 3' HINGED GROUND BASE (use without concrete) — \$58.35
- SDB25G* SINGLE DRIVE-IN BASE — \$25.00
- BPH25G* HINGED BASE PLATE for concrete — \$50.00
- FR25G* FLAT ROOF MOUNT — \$34.10
- PR25G* PEAK ROOF MOUNT — \$26.25
- *Note: Towers mounted on these bases must be bracketed or guyed.
- RP25G ROTOR POST — \$4.40
- AS25G ACCESSORY SHELF (for mounting Ham-M rotor) — \$8.35
- GA25G GUY ASSEMBLY with torque bars — \$15.85
- GB25G GUY BRACKET ONLY without torque bars — \$10.00
- Adjustable House Brackets
- HB25AG 0-15" — \$14.15
- HB25BG 0-24" — \$17.50
- HB25CG 0-36" — \$20.85
- Eave Brackets
- EB2515G 15" — \$8.35
- EB2524G 24" — \$9.15
- EB2525G UNIVERSAL EAVE BRACKET — \$10.00
- TB-2 THRUST BEARING \$41.65
- TB-3 HEAVY DUTY THRUST
- BEARING — \$58.35
- WP25G WORK PLATFORM — \$24.60
- Side Arm
- SA25G-224 — \$45.70
- SA25G-524 — \$45.70
- 24" SIDE ARM
- SAB25G-2 — \$28.90
- SIDE ARM BRACKET — \$28.90
- SA25G-67 67" SIDE ARM — \$45.70
- UHF25G SIDE ARM MOUNT (for UHF & FM antenna) — \$6.65
- BPC25G* CONCRETE BASE PLATE — \$29.60
- 25G — (10' straight section of tower) — \$49.50
- 25AG-3 — (top section 2 1/2" tube type; 2" most fits snugly inside) — \$55.00
- 25AG-4 — (top section, upper end terminates in 11" flat plate for mounting TB-2 or TB-3 thrust bearing) — \$55.00
- 3/8" TBE&J — (turnbuckles 3/8" x 6" 6,000 lbs ultimate strength) — \$8.45 each.
- 3/16" CCM — cable clamps — 45¢ ea.
- 1/4" TH — thimbles — 30¢ ea.
- 1/2" TBE&J — (1/2" x 12" turnbuckles; 11,000 lbs. ultimate strength) — \$14.35 each.
- 3/16" EHS — Guy wire: 250' — \$27.50 500' — \$55.00 1000' — \$110.00
- GAC-25-3 — concrete guy anchor — \$16.65 each

(NOT UPS SHIPPABLE)

TELEX PROFESSIONAL HEADPHONES & HEADSETS

BOOM MIC HEADSETS

For the ultimate in communications convenience and efficiency, select a boom mic headset. Long-time favorites of professional communicators, boom mic headsets allow more personal mobility while always keeping the mic properly positioned for fast, precise voice transmission. Boom microphones are completely adjustable to allow perfect positioning. And, boom mic headsets leave both hands free to perform other tasks.

All models are supplied with "close talking" microphones to limit ambient noise pickup and provide superior intelligibility. Each model has a convenient, spring push-to-talk switch, which can be used for either push-to-talk relay control or mic circuit interrupt for voice operator operation. The switch may be used as a momentary push-button or it can be locked in the down position. All models have tough, flexible, 8-foot cords which are stripped and tinned, un terminated. Communication gray with black trim.

MODEL	C 610	SWL 610	C 1210	C 1320	CM 610	CM 1210	CM 1320	CM 1320S
Headphone Sensitivity Ref. 0002 Dynes/cm ² @ 1mW input, 1kHz	103dB SPL ±5dB	103dB SPL ±5dB	103dB SPL ±3dB	105dB SPL ±5dB	103dB SPL ±5dB	103dB SPL ±3dB	105dB SPL ±5dB	105dB SPL ±5dB
Headphone Impedance	32 20 ohms	2000 ohms	32 20 ohms	20 ohms	32 20 ohms	32 20 ohms	32 20 ohms	32 20 ohms
Microphone Frequency Response				50 8000 Hz	50 8000 Hz	50 8000 Hz	50 8000 Hz	50 8000 Hz
Microphone Impedance				High	High	High	High	High
Microphone Sensitivity Below 1 volt/microbar at 1kHz				-51dB ±5dB	-51dB ±5dB	-51dB ±5dB	-51dB ±5dB	-51dB ±5dB
Price:	\$10.45	\$12.25	\$29.70	\$41.80	\$47.20	\$62.75	\$75.25	\$59.95



Model C610 (SWL 610) Model C 1320 Model CM 610 Model C 1210



Model CM 1210 Model CM 1320 Model CM 1320S



The NEW KENWOOD TS-820S transceiver

TS-820S now has factory installed digital readout • 160 thru 10 meter coverage • 200 watts PEP • Integral IF shift • Noise blanker • VOX & PLL circuitry • DRS dial • IF out, RTTY, XVTR capabilities • Phone patch IN and OUT terminals • RF speech processor. \$1098.00.

KENWOOD PRICE LIST

Model	Description	Price
HF EQUIPMENT 820 PACESETTER SERIES		
TS-820S	TS-820 Deluxe Transceiver with Digital Display (DG-1) installed. 160-10 meters, IF shift	1,098.00
TS-820	Deluxe HF Transceiver 160-10 meters, RF speech processor, IF shift, RF negative feedback	919.00
DG-1	Digital Frequency Display for TS-820	179.00
VFO-820	Deluxe Remote VFO for 820 Series. Includes its own RIT circuit; frequency reads out on transceiver's digital display	149.00
SP-820	Deluxe External Speaker. Includes audio filters for added versatility on receive; 2 audio inputs	49.00
CW-820	500 Hz CW Filter for TS-820	49.00
520 SERIES		
TS-520S	160-10 HF Transceiver. Digital Display (option) speech processor, RF attenuator, super noise blanker	739.00
DG-5	Digital Display for TS-520S. Doubles as a frequency counter, tool Adaptable to TS-520 and 599 series	189.00
VFO-520S	Remote VFO for TS-520S. Built in RIT circuit provides super operating flexibility	135.00
SP-520	Matching External Speaker for TS-520S. 8 Ohms. Frequency response 100-5000 Hz	30.00
CW-520	500 Hz CW Filter for TS-520	49.00
599D Series		
R-599D	160-10 Solid State Amateur Receiver. 2 and 6 meters (optional). SSB, CW, AM, FM Transceivers/splits with T-599D	549.00
T-599D	80-10 Meter Amateur Transmitter. Solid State (except driver and finals). Semi break-in, sidetone, built in power supply	549.00
S-599	External Speaker for 599 Series. 8 Ohms. Frequency response: 100-5000 Hz	25.00
CC-29A	2 Meter Converter for R-599D	35.00
CC-69A	6 Meter Converter for R-599D	35.00
FM-599A	FM Filter for R-599D	45.00
HF MISCELLANEOUS		
R-300	All Band Communications Receiver. 170 kHz to 30 MHz - 6 bands, AC/DC/Batteries; built in speaker	249.00

the indispensable BIRD 43



THRULINE WATTMETER

Power Range	Frequency Bands (MHz)				
	2-30	25-60	100-250	200-500	600-1000
5 watts	—	5A	4C	5D	5E
10 watts	—	10A	10C	10D	10E
25 watts	—	25A	25C	25D	25E
50 watts	50H	50A	50C	50D	50E
100 watts	100H	100A	100C	100D	100E
250 watts	250H	250A	250C	250D	250E
500 watts	500H	500A	500C	500D	500E
1000 watts	1000H	1000A	1000C	1000D	1000E
2500 watts	2500H	2500A	2500C	2500D	2500E
5000 watts	5000H	5000A	5000C	5000D	5000E

MODEL 43

- Elements (Table 1) 2-30 MHz \$125.00
- Elements (Table 1) 25-1000 MHz 45.00
- Carrying case for Model 43 & 6 elements 38.00
- Carrying case for 12 elements 27.50
- Carrying case for 12 elements 17.00

READ RF WATTS DIRECTLY! (Specify Type N or SO239 connectors) 0.45 - 2300 MHz, 1-10,000 Watts ±5%, low insertion VSWR - 1.05. Unequaled economy and flexibility. Buy only the element(s) covering your present frequency and power needs, add extra ranges later if your requirements expand.

Now you can receive the weak signals with the Ameco PT-2 pre-amplifier!

Model PT-2 is a continuous tuning 6-160 meter Pre-Amp specifically designed for use with a transceiver. The PT-2 combines the features of the well-known PT with new sophisticated control circuitry that permits it to be added to virtually any transceiver with No modification. No serious ham can be without one. Price: \$69.95.



- Improves sensitivity and signal-to-noise ratio.
- Boosts signals up to 26 db.
- For AM or SSB.
- Bypasses itself automatically when the transceiver is transmitting.
- FET amplifier gives superior cross modulation protection.
- Simple to install. • Advanced solid-state circuitry.
- Improves immunity to transceiver front-end overload by use of its built-in attenuator.
- Provides master power control for station equipment.

ALL BAND PREAMPLIFIERS



- 6 THRU 160 METERS
- TWO MODELS AVAILABLE
- RECOMMENDED FOR RECEIVER USE ONLY
- INCLUDES POWER SUPPLY

MODEL PLF employs a dual gate FET providing noise figures of 1.5 to 3.4 db., depending upon the band. The weak signal performance of most receivers as well as image and spurious rejection are greatly improved. Overall gain is in excess of 20 db. Panel contains switching that transfers the antenna directly to the receiver or to the Preamp. Model PLF 117V AC, 60 Hz. Wired & Tested \$44.00

AT-200	Antenna Tuner. Includes an antenna coupler, SWR meter, power meter, antenna switch, 200W	149.00
TL-922	Deluxe 160-10 Linear Amplifier. 2 KW PEP	TBA
DK-520	2 x 3-500Z tubes, rugged built in power supply	
DS-1A	Digital Adaptor Kit (TS-520)	
VHF/UHF EQUIPMENT		
TS-600	DC-DC Converter for TS-820/TS-520S Series	65.00
TS-700S	6 Meter All Mode Transceiver. SSB, CW, F.M., AM, 10 watts. Built in AC/DC power supplies	699.00
VFO-700S	2 Meter All Mode Transceiver. SSB, CW, F.M., AM, semi break-in, CW sidetone. Digital readout, receiver pre-amp	729.00
SP-700S	External VFO for TS-700S. Frequency displays on TS-700S. Special "frequency check" feature	129.00
SP-70	8 Ohms External Speaker Matches TS-600 and TS-700S. Excellent frequency response	30.00
TR-2200A	2 Meter Portable Transceiver. FM, 12 channels (6 supplied); NI-CAD batteries, charger are included	229.00
TR-7400A	2 Meter Synthesized Transceiver. 25 Watts, 800 channels, 4 MHz, continuous tone-coded squelch (option)	399.00
TR-7500	2 Meter FM Transceiver; digital readout, one knob channel selector system, 10 watts output	299.00
TR-8300	70 CM FM Transceiver. 23 channels (3 supplied). 10 watts, broadband design	299.00
TV-502S	2 Meter Transceiver, 8 watts; SSB and CW easily hooks up to 520/820 Series	TBA
TV-506	6 Meter Transceiver, 10 watts; SSB and CW, easily hooks up to 520/820 Series	249.00
OTHER ACCESSORIES		
HS-4	KENWOOD Headphone set (8 Ohms)	16.00
MB-1A	Mobile bracket for TR-2200 A	13.00
MC-50	Dynamic Microphone for all KENWOOD stations (HI/Lo Z)	39.50
PS-5	AC Power Supply; 12 VDC @ 3.5 Amps, matches TR-8300; built-in digital clock with timer	79.00
PS-6	AC Power Supply; 12 VDC @ 3.5 Amps; matches TR-7500; 8 Ohm speaker included	79.00
PS-8	AC Power Supply; 12 VDC @ 8 Amps; matches TR-7400A; well regulated; current limiting	129.00
VOX-3	VOX Unit for TS-700A and TS-600	25.00

TUFTS RADIO CATALOG TUFTS RADIO

GIANT FLEA MARKET!
THOUSANDS OF \$\$\$\$ IN PRIZES!
 Don't Miss The N.E. ARRL Convention
 Oct. 14th-15th
 At The Beautiful Sheraton Boxborough
 Boxborough, Mass.

GIANT FLEA MARKET!
THOUSANDS OF \$\$\$\$ IN PRIZES!
 Don't Miss The N.E. ARRL Convention
 Oct. 14th-15th
 At The Beautiful Sheraton Boxborough
 Boxborough, Mass.

ATLAS 350-XL

- ALL SOLID STATE
- 350 WATTS P.E.P. DR CW INPUT
- SSB TRANSCEIVER
- 10 THROUGH 160 METER COVERAGE



Illustrated with optional AC supply, Auxiliary VFO, and Digital Dial.

The all new Atlas 350-XL has all the exciting new features you want, plus superior performance and selectivity control never before possible. Price: \$1195.00

- 10-160 Meters
- Full coverage of all six amateur bands in 500 kHz segments. Primary frequency control provides highly stable operation. Also included is provision for adding up to 10 additional 500 kHz segments between 2 to 22 MHz by plugging in auxiliary crystals.
- 350 WATTS P.E.P. and CW input.
- Model 350 XL - \$1195.00

IDEAL FOR DESKTOP OR MOBILE OPERATION
 Measuring just 5 in. high x 12 in. wide x 12 1/2 in. deep, and weighing only 13 pounds, the Atlas 350-XL offers more features, performance and value than any other transceiver, regardless of size, on the market today!

- 350-PS matching AC supply - \$225.00
- DD-6XL plug-in digital dial readout - \$229.00
- 305 plug-in auxiliary VFO - \$155.00
- 311 plug-in crystal oscillator - \$135.00
- DMK-XL plug-in mobile mounting kit - \$65.00

DELUXE RECEIVER PREAMPLIFIERS

Ideal for Receivers - Converters
 High Gain - Low Noise

- FEATURES:**
- Small size
 - Increases sensitivity of most receivers
 - Gold-plated copper shielding
 - Single or double stage models
 - Diode protected, dual-gated FETs

SPECIFICATIONS:
 Power: 6 VDC to 18 VDC (12 VDC recommended)
 Size: a. Single stage: 1" x 1 1/4" x 1 1/2"
 b. Double stage: 2" x 1 1/4" x 1 1/2"
 MOSFET: FT 0601, 500 MHz, dual-gate diode protected MOSFET

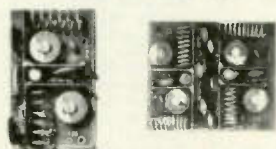

When ordering be sure to specify:
 1. frequency of operation
 2. single or double band stage
 3. kit or assembled version

FREQ. (MHz)	USE	STAGES	DELUXE PREAMPLIFIER GAIN dB	NF dB	WIRED
50 to 54	6 METER	SINGLE	25	2	\$15.50
		DOUBLE	48	2	\$28.50
108 to 144	VHF AIRCRAFT	SINGLE	20	2.5	\$14.50
		DOUBLE	40	2.5	\$26.50
135 to 139	SATELLITE	SINGLE	20	2.5	\$14.50
		DOUBLE	40	2.5	\$26.50
144 to 148	2 METER	SINGLE	20	2.5	\$14.50
		DOUBLE	40	2.5	\$26.50
146 to 174	HIGH BAND	SINGLE	20	2.5	\$14.50
		DOUBLE	40	2.5	\$26.50
220 to 225	1 1/4 METER	SINGLE	18	2.5	\$14.50
		DOUBLE	35	2.5	\$26.50
225 to 300	UHF AIRCRAFT	SINGLE	15	2.5	\$14.50
		DOUBLE	30	2.5	\$26.50

DATA SIGNAL, INC.



Highest quality, American-made "brand" transistors are fully protected for VSWR, short and overload, reverse polarity. Highly effective heat sinking assures long life, reliable performance. Black anodized containers...exclusive KLM extrusions, have seven, full length fins on both sides!

KLM RF Power Amplifiers

- A simple, add-on-immediately RF amplifier.
- Merely coax-connect amplifier between antenna and transceiver.
- No tuning! Efficient strip-line broad band design.
- Automatic! Internal RF-sensor-controlled relay connects amplifier whenever transmitter is switched on.
- Manual, remote-position switching is optional.
- Models for 6.2, 1 1/4 meters, 70CM amateur bands plus MARS coverage.
- Two types: Class C for FM/CW, Linear for SSB/AM/FM/CW.
- Negligible insertion loss on receive.
- American made by KLM.

New Model	List Price		
PA 2-25B	\$ 69.95	PA 4-70BC	189.95
PA 4-70BL	189.95	PA 15-60BC	164.95
PA 15-40BL	109.95	PA 45-120BC	209.95
PA 15-80BL	179.95	PA 4-40C	169.95
PA 15-160BL	259.95	PA 15-35CL	154.95
PA 45-140BL	219.95	PA 15-110CL	279.95

TEMPO VHF/ONE PLUS

The Tempo/ONE PLUS offers full 25 watt output or a selectable 3 to 15 watt low power output, remote tuning on the microphone, sideband operation with the SSB/ONE adapter, MARS operation capability, 5 kHz numerical LED, and all at a lower price than its time tested predecessor... the Tempo VHF ONE.



The Tempo VHF/One Plus is a VHF/FM transceiver for dependable communication on the 2 meter amateur band. Full 2 meter coverage, 144 to 148 MHz for both transmit and receive.

Full phase lock synthesized (PLL)

- Automatic repeater split - selectable up or down
- Two built-in programmable channels
- All solid state
- 800 selectable receive frequencies with simplex and +600 kHz transmit frequencies for each receive channel.
- Price: \$399.00

THE BIG SIGNAL



UNADILLA "W2AU" BALUN
 \$14.95

THE OLD RELIABLE



REYCO "W2VS" ANTENNA COILS
 \$21.95

World Famous Amongst Armored Forces, Communications Industry, Why?

- Each BALUN W2AU PEP tested
- Lightning Arrester
- 800V Pull-In Insulator Needed
- Only 7/8" and 8" x 1 1/2" diameter
- Reduces TVI
- Improves F/B ratios
- Weatherproof
- Complete Instructions
- Antenna Length Table

Turns Your Antenna Into A Multi-Band Professional Demand Repeal Why?

- Precision Matched
- Frequency Matched Pairs
- Only 8" and 5 1/2" x 1 1/2" diameter
- Rugged - Over 300+ Pull
- Weatherproof
- Models for 10, 15, 20, 40 meters
- Complete Instructions
- Multi-Band Length Tuning Data

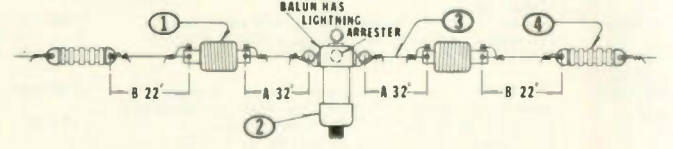

W2AU/W2VS • 5 BAND 10/80 METER ANTENNA KIT by UNADILLA/REYCO

GIVES YOU OPERATION ON 10 • 15 • 20 • 40 • 80 METERS
 (DESIGNED CLOSELY TO 5 BAND TRAP DIPOLE PARAMETERS PER A.R.R.L. HANDBOOK, HF ANTENNA CHAPTER 21 'A MULTIBAND TRAP ANTENNA')

& ARMED FORCES FACILITIES - AROUND THE WORLD - FOR OVER 10 YEARS! COMPLETE KIT (Nothing else needed)

- 2 ea. W2VS REYCO KW-40 TRAPS
- 1 ea. W2AU 'BIG SIGNAL' BALUN 1:1
- 120 Ft RUGGED #14-7 Strand Copper Wire
- 2 ea. W2AU SHATTERPROOF END-SULATORS
- INSTRUCTIONS
- \$48.25

Every Component of This Kit is a Highly Crafted, old Line UNADILLA/REYCO Product Time Tested by HAMS, COMMERCIAL





DIP/IC INSERTION TOOL with PIN STRAIGHTENER

The board contains a matrix of 240 circular holes on 100 inch centers. The component side contains 76 two-hole pins that can accommodate any DIP size from 8-40 pins, as well as discrete components. Typical density is 18 of 16-pin or 18-pin DIP's. Components may be soldered directly to the board or intermediate sockets may be used for soldering of wire-wrapping.

Two independent bus systems are provided for voltage and ground on both sides of the board. In addition, the component side contains 14 individual buses running the full length of the board for complete wiring flexibility. These buses enable access from edge contacts to discrete components. These buses can also serve to augment the voltage or ground busses, and may be cut to length for particular applications.

14-16 Pin Dip IC Insertion	INS-1416	\$3.49
----------------------------	----------	--------

DIP/IC EXTRACTOR TOOL

The EX-1 Extractor is ideally suited for hobbyist or lab engineer. Featuring one piece spring steel construction. It will extract all LSI, MSI and SSI devices from 8 to 24 pins.

Extractor Tool	EX-1	\$1.49
----------------	------	--------

P.C. BOARD

The 4 x 8.5 x 1.16 inch board is made of glass coated EPOXY Laminate and features solder coated 1 oz. copper pads. The board has provision for a 2214 four sided edge connector, with contacts on standard .35 spacing. Edge contacts are non dedicated for maximum flexibility.

Hobby Board	H-PCB-1	\$4.99
-------------	---------	--------

PC CARD GUIDES

TR-1 consists of 2 guides precision molded with unique spring finger action that dampens shock and vibration yet permits smooth insertion or extraction. Guides accommodate any card thickness from .040 to 100 inches.

Card Guides	TR-1	\$1.89
-------------	------	--------

PC CARD GUIDES & BRACKETS

TRS-2 kit includes 2 TR-1 guides plus 2 mounting brackets. Support brackets feature unique stabilizing post that permits secure mounting with only 1 screw.

Guides & Brackets	TRS-2	\$3.79
-------------------	-------	--------

PC EDGE CONNECTOR

44 Pin, dual read out. .156" (3.96 mm) Contact Spacing, .025" (0.63 mm) square wire-wrapping pins.

P.C. Edge Connector	CON-1	\$3.49
---------------------	-------	--------

P.C.B. TERMINAL STRIPS

The TS strips provide positive secure activated stamping action, accommodate wire sizes 14-30 AWG (1.0-5.0mm). Pins are solder plated to copper, .047 inch (1.2mm) diameter, and .270 inch (6.9mm) centers.

4-Pole	TS-4	\$1.39
8-Pole	TS-8	\$1.89
12-Pole	TS-12	\$2.99

WIRE-WRAPPING KIT

Contains: Hobby Wrap Tool WSU-30 M, Wire Dispenser WD-30-B, (2) 14 DIP's, (2) 16 DIP's, Hobby Board H-PCB-1, DIP/IC Insertion Tool INS-1416 and DIP/IC Extractor Tool EX-1

Wire-Wrapping Kit	WK-4B (Blue)	\$25.99
-------------------	--------------	---------

HOBBY WRAP TOOL

Wire-wrapping, stripping, unwrapping tool for AWG 30 on .025 (0.63mm) Square Post.

Regular Wrap	WSU-30	\$6.95
Modified Wrap	WSU-30M	\$7.95

WIRE-WRAPPING TOOL

For .025" (0.63mm) sq. post "MODIFIED" wrap, positive indexing, anti-overwrapping device.

For AWG 30	BW-630	\$34.95*
For AWG 26-28	BW-2628	\$39.95*

Bit for AWG 30	BT-30	\$3.95
Bit for AWG 26-28	BT-2628	\$7.95

*USE "D" SIZE Ni-CAD BATTERIES (NOT INCLUDED)

ROLLS OF WIRE

Wire for wire-wrapping AWG-30 (0.25mm) KYNAR® wire, 50 ft. roll, silver plated, solid conductor, easy stripping.

10 AWG Blue Wire 50ft. Roll	R-30B-0050	\$1.99
10 AWG Yellow Wire 50ft. Roll	R-30Y-0050	\$1.99
10 AWG White Wire 50ft. Roll	R-30W-0050	\$1.99
10 AWG Red Wire 50ft. Roll	R-30R-0050	\$1.99

WIRE DISPENSER

With 50 ft. Roll of AWG 30 KYNAR® wire-wrapping wire.

- Cuts the wire to length.
- Strips 1" of insulation.
- Refillable (For refills, see above)

Blue Wire	WD-30-B	\$3.95
Yellow Wire	WD-30-Y	\$3.95
White Wire	WD-30-W	\$3.95
Red Wire	WD-30-R	\$3.95

PRE CUT STRIPPED WIRE

Wire for wire wrapping AWG-30 (0.25mm) KYNAR® wire, 50 wires per package, stripped 1" both ends.

10 AWG Blue Wire 1' Long	10-B-50-010	\$1.99
10 AWG Yellow Wire 1' Long	10-Y-50-010	\$1.99
10 AWG White Wire 1' Long	10-W-50-010	\$1.99
10 AWG Red Wire 1' Long	10-R-50-010	\$1.99
10 AWG Yellow Wire 2' Long	10-Y-50-020	\$1.99
10 AWG White Wire 2' Long	10-W-50-020	\$1.99
10 AWG Red Wire 2' Long	10-R-50-020	\$1.99
10 AWG Blue Wire 3' Long	10-B-50-030	\$1.99
10 AWG Yellow Wire 3' Long	10-Y-50-030	\$1.99
10 AWG White Wire 3' Long	10-W-50-030	\$1.99
10 AWG Red Wire 3' Long	10-R-50-030	\$1.99
10 AWG Yellow Wire 4' Long	10-Y-50-040	\$1.99
10 AWG White Wire 4' Long	10-W-50-040	\$1.99
10 AWG Red Wire 4' Long	10-R-50-040	\$1.99
10 AWG Blue Wire 5' Long	10-B-50-050	\$1.99
10 AWG Yellow Wire 5' Long	10-Y-50-050	\$1.99
10 AWG White Wire 5' Long	10-W-50-050	\$1.99
10 AWG Red Wire 5' Long	10-R-50-050	\$1.99
10 AWG Yellow Wire 6' Long	10-Y-50-060	\$1.99
10 AWG White Wire 6' Long	10-W-50-060	\$1.99
10 AWG Red Wire 6' Long	10-R-50-060	\$1.99
10 AWG Blue Wire 6' Long	10-B-50-060	\$1.99

WIRE-WRAPPING KIT

Contains: Hobby Wrap Tool WSU-30, Roll of wire R-30B-0050, (2) 14 DIP's, (2) 16 DIP's and Hobby Board H-PCB-1.

Wire-Wrapping Kit	WK-3B (Blue)	\$16.95
-------------------	--------------	---------

DIP SOCKET

Dual-in-line package, 3 level wire-wrapping, phosphor bronze contact, gold plated pins .025 (0.63mm) sq., .100 (2.54mm) center spacing.

14 Pin Dip Socket	14-DIP	\$0.79
16 Pin Dip Socket	16-DIP	\$0.89

RIBBON CABLE ASSEMBLY SINGLE ENDED

With 14 Pin Dip Plug 24" Long (609mm)	SE14-24	\$3.55
With 16 Pin Dip Plug 24" Long (609mm)	SE16-24	\$3.75

DIP PLUG WITH COVER FOR USE WITH RIBBON CABLE

14 Pin Plug & Cover	14-PLG	\$1.45
16 Pin Plug & Cover	16-PLG	\$1.59

QUANTITY: 2 PLUGS, 2 COVERS

RIBBON CABLE ASSEMBLY DOUBLE ENDED

With 14 Pin Dip Plug 2' Long	DE-14-2	\$3.75
With 14 Pin Dip Plug 4' Long	DE-14-4	\$3.85
With 14 Pin Dip Plug 8' Long	DE-14-8	\$3.95
With 16 Pin Dip Plug 2' Long	DE-16-2	\$4.15
With 16 Pin Dip Plug 4' Long	DE-16-4	\$4.25
With 16 Pin Dip Plug 8' Long	DE-16-8	\$4.35

TERMINALS

- .025 (0.63mm) Square Post
- 3 Level Wire Wrapping
- Gold Plated

Slotted Terminal	WWT-1	\$2.98
Single Sided Terminal	WWT-2	\$2.98
IC Socket Terminal	WWT-3	\$3.98
Double Sided Terminal	WWT-4	\$1.98

75 PER PACKAGE

TERMINAL INSERTING TOOL

For inserting WWT-1, WWT-2, WWT-3, and WWT-4 Terminals into .040" (1.01mm) Dia. Holes.

INS-1	\$2.49
-------	--------

WIRE CUT AND STRIP TOOL

Easy to operate... blade moves back to 4" in stripping cut with wire extending beyond cutter blades... press tool and pull wire is cut and stripped to proper wire-wrapping length. The rounded steel cutting blades and sturdy construction of the tool insure long life.

Strip length easily adjustable for your applications.

DESCRIPTION	MODEL NUMBER	ADJUSTABLE STRIP LENGTH OF STRIPPER (INCHES)	Price
24 ga. Wire Cut and Strip Tool	ST-180-24	1 1/2" - 1 3/4"	\$ 8.75
26 ga. Wire Cut and Strip Tool	ST-180-26	1 1/2" - 1 3/4"	\$ 8.75
28 ga. Wire Cut and Strip Tool	ST-180-28-278	1 1/2" - 1 3/4"	\$ 8.75
30 ga. Wire Cut and Strip Tool	ST-180-30	1 1/2" - 1 3/4"	\$11.50
32 ga. Wire Cut and Strip Tool	ST-180-32	1 1/2" - 1 3/4"	\$11.50

THE ABOVE LIST OF CUT AND STRIP TOOLS ARE NOT AVAILABLE FOR DELIVERY IN 11-000 RESIDUAL.

WIRE-WRAPPING KITS

Contains: Hobby Wrap Tool WSU-30, (50 ft.) Roll of wire R-30B-0050, (2) 14 DIP's, (2) 16 DIP's and Hobby Board H-PCB-1.

Wire-Wrapping Kit (Blue)	WK-2 B	\$12.95
Wire-Wrapping Kit (Yellow)	WK-2 Y	\$12.95
Wire-Wrapping Kit (White)	WK-2 W	\$12.95
Wire-Wrapping Kit (Red)	WK-2 R	\$12.95

HI-Q BALUN

- For dipoles, yagis, inverted vees, doublets & quads
- For full legal power & more
- Puts power in antenna
- Broadbanded 3-40Mhz.
- Small, light, weather-proof
- 1:1 Impedance ratio
- Replaces center insulator
- Helps eliminate TVI
- Fully Guaranteed

\$9.95

Van Gorden Engineering U.S.A.

DUST COVERS

Our covers are custom designed to protect all popular equipment models. They are made of rugged high quality vinyl and are machine stitched for extra strength. They add that professional look to your station. \$3.95.

COVER CRAFT

Model 210

CES Touch Tone Pads

- Model 300 - acoustic coupling, \$49.95
- Model 210 - for mounting on walkies or hand-helds, \$39.95
- Model 220 - CES can now offer you a TOUCH TONE back for Standard Communications hand-held radios. This is the complete back assembly with the TOUCH TONE encoder mounted and ready to plug into the private channel connector. Also included is a LED tone generator indicator and an external tone deviation adjustment. \$59.95.
- Model 215 (miniature version of 210) - \$39.95
- Model 221 long - \$59.95
- Model 221 short - \$59.95

Model 300 Model 221 Model 220

Motorola HT220 Back with Pad Mounted

ATB-34



4 ELEMENT BEAM

10-15-20 METERS

Cushcraft engineers have incorporated more than 30 years of design experience into the best 3 band HF beam available today. ATB-34 has superb performance with three active elements on each band, the convenience of easy assembly and modest dimensions. Value through heavy duty all aluminum construction and a price complete with 1-1 balun.

SPECIFICATIONS	
FORWARD GAIN - EXCELLENT	LONGEST ELEMENT - 32 ft
F/B RATIO - 30 db	TURNING RADIUS - 18' 9"
VSWR - 1.5:1	WIND SFC - 5.4 Sq Ft
POWER - 2000 WATTS PEP	WEIGHT - 42 Lbs.
HANDLING - 2000 WATTS PEP	WIND SURVIVAL - 90 MPH
BOOM LENGTH/DIA. - 18 x 2 1/8"	

UPS SHIPPABLE complete

\$259.59

ENJOY A NEW WORLD OF DX COMMUNICATIONS WITH ATB-34

VHF - UHF DX-ARRAYS 144, 220, 430 mhz

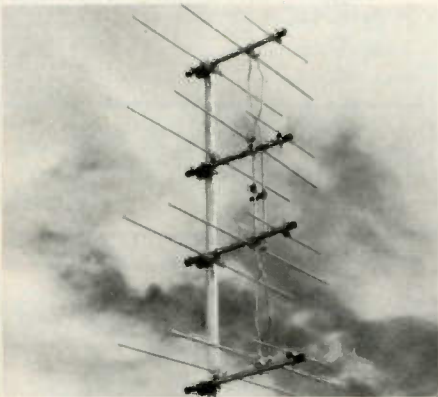

20 ELEMENT DX - ARRAYS

20 ELEMENT SPECIFICATIONS	
Forward Gain ----- 14.2 db	Impedance ----- 52 ohms
F/B Ratio ----- 20 db	VSWR at Frequency ----- 1 - 1
Fwd. Lobe at 1/2 Pwr. Point	Bandwidth W/VSWR
horizontal ----- 48°	Less than 2 - 1 ----- 4 mhz
vertical ----- 26°	Power Handling -- 2 KW PEP
Height	144 Mhz 220 Mhz 432 Mhz
Width x Depth	118" 78" 42"
Turning Radius	75" x 30" 53" x 20" 29" x 11"
Maximum Mast Dia.	48" 32" 18"
Net Weight Lbs.	1 1/2" 1 1/2" 1 1/2"
	8 7 6

40 ELEMENT DX - ARRAYS

40 ELEMENT SPECIFICATIONS	
Forward Gain ----- 17 db	Impedance ----- 52 ohms
F/B Ratio ----- 20 db	VSWR at Frequency ----- 1 - 1
Fwd. Lobe at 1/2 Pwr. Point	Bandwidth W/VSWR
horizontal ----- 32°	Less than 2 - 1 ----- 4 mhz
vertical ----- 26°	Power Handling -- 2 KW PEP
Height	144 Mhz 220 Mhz 432 Mhz
Width x Depth	118" 78" 42"
Turning Radius	192" x 30" 132" x 20" 72" x 11"
Maximum Mast Dia.	101" 65" 38"
Net Weight Lbs.	2 1/2" 2 1/2" 2 1/2"
	32 22 12
Wind Rating	90 mph 90 mph 90 mph
Stack Kit No.	DXK-140 DXK-240 DXK-440
Amateur Net	\$ 65.95 \$59.95 \$45.95

80 ELEMENT DX - ARRAYS

80 ELEMENT SPECIFICATIONS	
Forward Gain ----- 20 db	Impedance ----- 52 ohms
F/B Ratio ----- 29 db	VSWR at Frequency ----- 1 - 1
Fwd. Lobe at 1/2 Pwr. Point	Bandwidth W/VSWR
horizontal ----- 32°	Less than 2 - 1 ----- 4 mhz
vertical ----- 12°	Power Handling -- 2 KW PEP
Height	144 Mhz 220 Mhz 432 Mhz
Width x Depth	275" 182" 97"
Turning Radius	192" x 30" 132" x 20" 72" x 11"
Maximum Mast Dia.	101" 65" 38"
Net Weight Lbs.	2 1/2" 2 1/2" 2 1/2"
	64 43 24
Wind Rating	90 mph 90 mph 90 mph
Stack Kit No.	DXK-180 DXK-280 DXK-480
Amateur Net	\$119.95 \$99.95 \$89.95

HF MONOBEAMS 10 15 20 METERS

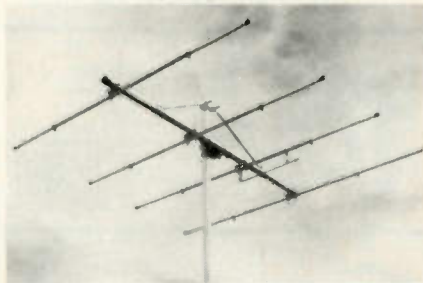

10 METERS

3 ELEMENT BEAM: You can have an outstanding signal using this compact three element beam. It is easily mounted on a lightweight rotator and takes only a limited amount of space. Model No. A28-3—\$79.95
4 ELEMENT BEAM: A real DX'er's beam for the active ham who wants a top signal on 10 meters. Mount on a good ham rotator. Model No. A28-4—\$89.95

SPECIFICATIONS	A28-3	A28-4
BOOM	1 1/2" x 10'	1 5/8" x 18'
LONGEST ELEMENT	17' 6"	18'
ELEMENT DIAMETER	7/8" - 1/2"	7/8" - 3/4"
TURNING RADIUS	10'	14' 3"
FORWARD GAIN	8 db	10 db
FRONT TO BACK	22 db	25 db
SWR @ FREQUENCY	1 to 1	1 to 1
WEIGHT	11 lbs.	21 lbs.

15 METERS

3 ELEMENT BEAM: A high quality beam which can be mounted on a mast with other antennas. A heavy duty TV rotator will handle it. Model No. A21-3—\$99.95
4 ELEMENT BEAM: For the 15 meter enthusiast this beam will give real DX performance. When mounted on a good ham rotator it will withstand the most adverse weather conditions. Model No. A21-4—\$129.95

SPECIFICATIONS	A21-3	A21-4
BOOM	1 5/8" x 12'	1 3/4" x 21' 6"
LONGEST ELEMENT	22' 10"	22' 10"
ELEMENT DIAMETER	7/8" - 3/4"	7/8" - 3/4"
TURNING RADIUS	13' - 3"	15' - 8"
FORWARD GAIN	8 db	10 db
FRONT TO BACK	22 db	25 db
SWR @ FREQUENCY	1 to 1	1 to 1
WEIGHT	16 lbs.	32 lbs.

20 METERS

2 ELEMENT BEAM: Full size beam performance for the active 20 meter ham with limited space and budget. Model No. A14-2—\$119.95
3 ELEMENT BEAM: A real DX'er's beam with full .15 wave-length element spacing. The heavy duty construction gives years of trouble-free service. Model No. A14-3 \$159.95

SPECIFICATIONS	A14-2	A14-3
BOOM	1 5/8" x 10'	1 5/8" x 20' 6"
LONGEST ELEMENT	35' 10"	35' 10"
ELEMENT DIAMETER	1 1/8" - 3/4"	1 1/8" - 3/4"
TURNING RADIUS	18"	21"
FORWARD GAIN	5 db	8 db
F/B RATIO	13 db	22 db
SWR @ FREQUENCY	1 to 1	1 to 1
WEIGHT	20 lbs.	35 lbs.

World Radio TV Handbook 1978

A Complete Directory of International Radio and Television

The most extensive and authoritative guide to broadcasting and television stations around the world today. **WORLD RADIO TV HANDBOOK 1978** is an indispensable manual for anyone with a working interest in radio and television. Features:

- Names and addresses of broadcast companies and stations by country
- Names and titles of leading officials and personnel
- Listing by frequency of shortwave stations around the world
- Program data including frequencies, wave lengths, transmitter power, call signs, times announcements (in each language)

Plus a special in-depth critical section with professional critiques, suggestions and tips—and much, much more! **WORLD RADIO TV HANDBOOK 1978** is available now for only \$11.95.

HF Verticals 10-80 Meters

- efficient top ring
- fiberglass trap forms
- enameled wire coils
- solid aluminum capacitors
- no tuning required
- full compression clamps
- omnidirectional coverage
- reinforced base
- mast or ground mounting
- pre-marked sections
- easy assembly
- superior quality

3 BAND 20-15 meters/Model ATV-3 \$49.95
4 BAND 4'20"15'10 meters/Model ATV-4 \$89.95
5 BAND 80'40'20'15'10 meters/Model ATV-5 \$109.95

Speak up.

We know all about up. In fact, we're number one from the ground up...when it comes to amateur communications towers. We've been building them for HAMS for more than two decades.

Whether you're thinking crank-up, guyed or free-standing, check with us first. We're Tri-Ex. Reliable, dependable.

When we say number one from the ground up, we're talking about towers like Tri-Ex's new "Big W" shown here. It's a free-standing crank-up with a height of 80-ft, providing good DX capability at low cost. Ideal for serious HAMS.

Model W51
(51' Self-supporting)
\$850.00

SST T-1 RANDOM WIRE ANTENNA TUNER

All band operation (160-10 meters) with any random length of wire. 200 watt output power capability — will work with virtually any transceiver. Ideal for portable or home operation. Great for apartments and hotel rooms — simply run a wire inside, out, a window, or anyplace available. Toroid inductor for small size: 4-1/4" x 2-3/8" x 2-3/8". Built-in neon tune-up indicator. SO-239 connector. Attractive bronze finished enclosure. Only \$29.95

SST T-2 ULTRA TUNER

Tunes out SWR on any coax fed antenna as well as random wires. Works great on all bands (160-10 meters) with any transceiver running up to 200 watts power output. Increases usable bandwidth of any antenna. Tunes out SWR on mobile whips from inside your car.

Uses toroid inductor and specially made capacitors for small size: 5/4" x 2/4" x 2/4". Rugged, yet compact. Attractive bronze finished enclosure. SO-239 coax connectors are used for transmitter input and coax fed antennas. Convenient binding posts are provided for random wire and ground connections. Only \$49.95

SST T-3 IMPEDANCE TRANSFORMER

Matches 52 ohm coax to the lower impedance of a mobile whip or vertical. 12 position switch with taps spread between 3 and 52 ohms. Broadband from 1-30 MHz. Will work with virtually any transceiver — 300 watt output power capability. SO-239 connectors. Toroid inductor for small size: 2-3/4" x 2" x 2-1/4". Attractive bronze finish. Only \$19.95

6 METER BEAMS

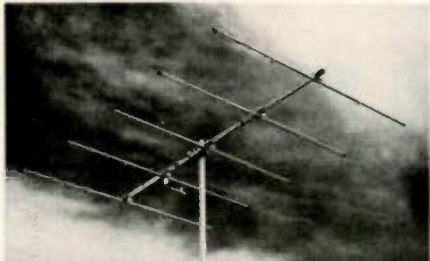

3-5-6-10 ELEMENTS

Proven performance from rugged, full size, 6 meter beams. Element spacings and lengths have been carefully engineered to give best pattern, high forward gain, good front to back ratio and broad frequency response.

Booms are .058 wall and elements are 3/4" - 5/8" - .049 wall seamless chrome finish aluminum tubing. The 3 and 5 element beams have 1 3/8" - 1 1/4" booms. The 6 and 10 element beams have 1 5/8" - 1 1/2" booms. All brackets are heavy gauge formed aluminum. Bright finish cad plated bolts are adjustable for up to 1 5/8" mast on 3 and 5 element and 2" on 6 and 10 element beams. All models may be mounted for horizontal or vertical polarization.

New features include adjustable length elements, kilowatt Reddi Match and built-in coax fitting for direct 52 ohm feed. These beams are factory marked and supplied with instructions for quick assembly.

Description	3 element	5 element	6 element	10 element
Model No.	A50.3	A50.5	A50.6	A50.10
Boom Length	6"	12"	20"	24"
Longest El.	117"	76"	117"	117"
Turn Radius	6"	11"	11"	13"
Fwd. Gain	7.5 dB	9.5 dB	11.5 dB	13 dB
F/B Ratio	20 dB	24 dB	26 dB	28 dB
Weight	7 lbs	11 lbs	18 lbs	25 lbs.

COAXIAL DUAL STACKING KITS

Double your effective radiated power by stacking 6 meter beams. Cush Craft coaxial stacking kits provide a simple and efficient method for realizing 3 db additional gain while maintaining the superior characteristics of our angle beams. The stacking kits are complete with RG-59/U cable and preassembled fittings for direct 52 ohm feed.

Model No.	For stacking:	Amateur Net
A535-SK	A50.3 or A50.5	\$17.95
A561-SK	A50.6 or A50.10	\$19.95

new RINGO RANGER for FM

4.5 dB* - 6 dB**
Omnidirectional
GAIN
BASE STATION
ANTENNAS
FOR
MAXIMUM
PERFORMANCE
AND
VALUE

Cush Craft has created another first by making the world's most popular 2 meter antenna twice as good. The new Ringo Ranger is developed from the basic AR-2 with three half waves in phase and a one eighth wave matching stub. Ringo Ranger gives an extremely low angle of radiation for better signal coverage. It is tunable over a broad frequency range and perfectly matched to 52 ohm coax.

- ARX-2, 137-160 MHz, 4 lbs., 112"
- ARX-220, 220-225 MHz, 3 lbs., 75"
- ARX-450, 435-450 MHz, 3 lbs., 39"

* Reference 1/2 wave dipole.
** Reference 1/2 wave whip used as gain standard by many manufacturers.

Work full quieting into more repeaters and extend the radius of your direct contacts with the new Ringo Ranger.

You can up date your present AR-2 Ringo with the simple addition of this extended kit. The kit includes the phasing network and necessary element extensions. The only modifications required are easy to make saw slits in the top section of your antenna.

ARX-2K CONVERSION KIT

2 METER ANTENNAS FM

A.FM RINGO 3.75 dB Gain (reference 1/2 wave whip). Half wave length antennas with direct dc ground. 52 ohm feed takes PL-259, low angle of radiation with 1-1 SWR. Factory preassembled and ready to install. 6 meter partly preassembled, all but 450 MHz take 1 1/2" mast. There are more Ringos in use than all other FM antennas combined.

Model Number	AR-2	AR-25	AR-6	AR-220	AR-450
Frequency MHz	135-175	135-175	50-54	220-225	440-460
Power-Hdg. Watt	100	500	100	100	250
Wind area sq. ft.	.21'	.21'	.37'	.20'	.10'

B-4 POLE Up to 9 dB Gain over a 1/2 wave dipole. Overall antenna length 147 MHz - 23' 220 MHz - 15', 435 MHz - 8', pattern 360° - 4 dB gain, 180° - 9 dB gain. 52 ohm feed takes PL 259 connector. Package includes 4 complete dipole assemblies on mounting booms, harness and all hardware. Vertical support mast not supplied.

AFM-4D	144-150 MHz, 1000 watts, wind area 2.58 sq. ft.
AFM-24D	220-225 MHz, 1000 watts, wind area 1.85 sq. ft.
AFM-44D	435-450 MHz, 1000 watts, wind area 1.13 sq. ft.

D-POWER PACK The big signal (22 element array) for 2 meter FM, uses two A147-11 yagis with a horizontal mounting boom, coaxial harness and all hardware. Forward gain 16 dB, F/B ratio 21 dB, 1/2 power beamwidth 42°, dimensions 144" x 80" x 40", turn radius 60", weight 15 lbs. 52 ohm feed takes PL-259 fitting.

A147-22 146 - 148 MHz, 1000 Watts, wind area 2.42 sq. ft.

D-YAGI STACKING KITS VPK includes horizontal mounting boom, harness, hardware and instructions for two vertically polarized yagis gives 3 dB gain over the single antenna.

A14-VPK	complete 4 element stacking kit
A14-SK	4 element coax harness only
A147-VPK	complete 11 element stacking kit
A147-SK	11 element coax harness only
A449-SK	6 + 11 element coax harness only

E-4-6-11 ELEMENT YAGIS The standard of comparison in VHF-UHF communications, now cut for FM and vertical polarization. The four and six element models can be tower side mounted. All are rated at 1000 watts with direct 52 ohm feed and PL-259 connectors.

Model Number	A147-11	A-147-4	A449-11	A449-6	A290-11
Boom/Longest ele.	144"/40"	44"/40"	60"/33"	33"/26"	102"/26"
Wght./Turn radius	8 lbs. 72"	3 lbs. 44"	4 lbs. 60"	3 lbs. 18"	5 lbs. 51"
Gain/F/B ratio dB	13.2/28	9/20	13.2/28	11/25	13.2/28
1/2 Power beam	48°	66°	48°	60°	48°
Wind area sq. ft.	1.21	.43	.39	.30	.50
Frequency MHz	146-148	146-148	440-450	440-450	220-225

F-FM TWIST 12.4 dB Gain. Ten elements horizontal polarization for low end coverage and ten elements vertical polarization for FM coverage. Forward gain 12.4 dB, F/B ratio 22 dB, boom length 130", weight 10 lbs. longest element 40", 52 ohm Reddi Match driven elements take PL-259 connectors, uses two separate Feed lines.

A147-20T 145 - 147 MHz, 1000 watts, wind area 1.42 sq. ft.

HIGH PERFORMANCE VHF YAGIS

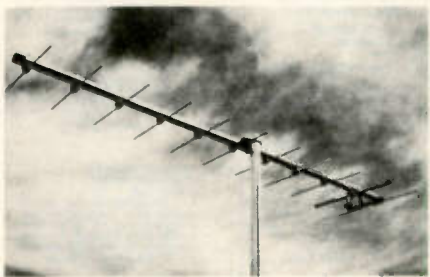

3/4, 1-1/4, 2 METER BEAMS

The standard of comparison in amateur VHF/UHF communications Cush Craft yagis combine all out performance and reliability with optimum size for ease of assembly and mounting at your site.

Lightweight yet rugged, the antennas have 3/16" O. D. solid aluminum elements with 5/16" center sections mounted on heavy duty formed brackets. Booms are 1" and 7/8" O. D. aluminum tubing. Mast mounts of 1/8" formed aluminum have adjustable u-bolts for up to 1-1/2" O. D. masts. They can be mounted for horizontal or vertical polarization. Complete instructions include data on 2 meter FM repeater operation.

New features include a kilowatt Reddi Match for direct 52 ohm coaxial feed with a standard PL-259 fitting. All elements are spaced at .2 wavelength and tapered for improved bandwidth.

Model No.	A144.7	A144.11	A220.11	A430.11
Description	2m	2m	1 1/2m	1 1/2m
Elements	7	11	11	11
Boom Length	98"	144"	102"	57"
Weight	4	6	4	3
Fwd. Gain	11 dB	13 dB	13 dB	13 dB
F/B Ratio	26 dB	28 dB	28 dB	28 dB
Fwd. Lobe @ 1/2 pow. pt.	46°	42°	42°	42°
SWR @ Freq	1 to 1	1 to 1	1 to 1	1 to 1



AMATEUR FM ANTENNAS

A147-4	\$ 22.95
A147-11	34.95
A147-20T	59.95
A147-22	99.95
A220-7	23.95
A220-11	32.95
A220-22	82.95
A449-6	23.95
A449-11	32.95
AFM-4D	64.95
AFM-24D	62.95
AFM-44D	81.95
AR-2	24.95
AR-6	36.95
AR-25	32.95
AR-220	23.95
AR-450	23.95
ARX-2	36.95
ARX-2K	14.95
ARX-220	36.95
ARX-450	36.95

AMATEUR FM STACKING KITS

A14-SK	\$ 17.95
A14-VPK	26.95
A147-SK	17.95
A147-VPK	32.95
A449-SK	17.95
A449-VPK	26.95

BIG WHEEL ANTENNAS

ABW-125	\$ 17.95
ABW-145	27.95
ABW-144	36.95
BLITZ BUG	
LAC-1	\$ 4.95
LAC-2	4.95

DX-ARRAYS-20 ELEMENT

DX-120	\$ 47.95
DX-220	42.95
DX-420	36.95

DX-ARRAY BALUNS

DX-15M	\$ 14.95
DX-25M	14.95
DX-45M	14.95
DX-VFB	10.95

SQUALO ANTENNAS

ASQ-2	\$ 19.95
ASQ-6	29.95
ASQ-22	42.95
ASQ 65K	17.95
ASQ-M	17.95

DX-ARRAY-40 ELEMENT

DXK-140	\$ 65.95
DXK-240	59.95
DXK-440	45.95

DX-ARRAY-80 ELEMENT

DXK-180	\$119.95
SXK-280	99.95
DXK-480	89.95

HF MONOBEAMS

A14-2	\$119.95
A14-3	159.95
A21-3	99.95
A21-4	129.95
A28-3	79.95
A28-4	89.95

MULTI BAND HF ANTENNAS

NAS	
AFB-1	\$ 15.95
ATB-34	259.95
ATV-3	49.95
ATV-4	89.95
ATV-5	109.95

PROLINE VHF BEAMS

APL-25K	\$ 24.95
APL-65K	29.95
APL-85	159.95
APL-210	119.95

TWIST ANTENNAS

A147-MB	\$ 17.95
A144-10T	39.95
A144-20T	59.95
A144-30T	36.95
A432-20T	54.95

VHF/UHF BEAMS

ASO-3	\$ 36.95
ASO-5	54.95
ASO-6	79.95
ASO-10	109.95
A144-7	23.95
A430-11	24.95
A430-11	27.95

VHF/UHF STACKING KITS

A11-SK	\$ 17.95
A17-SK	17.95
A41-SK	17.95
A535-SK	17.95
A561-SK	18.95
AKK-144	79.95
AKK-444	79.95

MOBILE ANTENNAS

AMS-147	\$ 34.95
ATS-147	32.95

TUFTS RADIO CATALOG TUFTS RADIO



For all you hams with little cars ...
We've got the perfect mobile rig for you.



The Atlas 210x or 215x measures only 9 1/4" wide x 9 1/4" deep x only 3 1/4" high, yet the above photograph shows how easily the Atlas transceiver fits into a compact car. And there's plenty of room to spare for VHF gear and other accessory equipment. With the exclusive Atlas plug-in design, you can slip your Atlas in and out of your car in a matter of seconds. All connections are made automatically.

BUT DON'T LET THE SMALL SIZE FOOL YOU!
 Even though the Atlas 210x and 215x transceivers are less than half the size and weight of other HF transceivers, the Atlas is truly a giant in performance.

200 WATTS POWER RATING!
 This power level in a seven pound transceiver is incredible but true. Atlas transceivers give you all the talk power you need to work the world barefoot. Signal reports

constantly reflect great surprise at the signal strength in relation to the power rating.

FULL 5 BAND COVERAGE
 The 210x covers 10-80 meters, while the 215x covers 15-160 meters. Adding the Atlas Model 10x Crystal Oscillator provides greatly increased frequency coverage for MARS and network operation.

NO TRANSMITTER TUNING OR LOADING CONTROLS
 With Atlas' total broadbanding. With your Atlas you get instant QSY and band change.

MOST ADVANCED STATE OF THE ART SOLID STATE DESIGN
 Not only accounts for its light weight, but assures you years of top performance and trouble free operating pleasure.

PLUG-IN CIRCUIT BOARDS
 and modular design provides for ease of servicing.

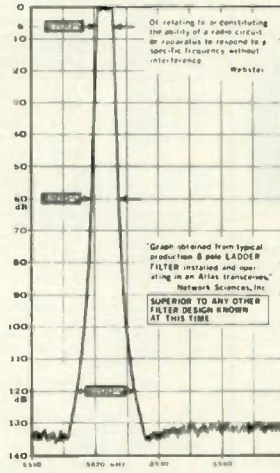

PHENOMENAL SELECTIVITY
 The exclusive 8 pole crystal ladder filter used in Atlas transceivers represents a major breakthrough in filter design, with unprecedented skirt selectivity and ultimate rejection. As the above graph shows, this filter provides a 6 db bandwidth of 2700 Hertz, 50 db down of only 4300 Hertz, and a bandwidth of only 9200 Hertz at 120 db down! Ultimate rejection is in excess of 130 db; greater than the measuring limits of most test equipment.

EXCEPTIONAL IMMUNITY TO STRONG SIGNAL OVERLOAD AND CROSS MODULATION. The exclusive front end design in the receiver allows you to operate closer in frequency to strong neighboring signals than you have ever experienced before. If you have not yet operated an Atlas transceiver in a crowded band and compared it with any other receiver or transceiver, you have a real thrill coming.



A WORLD WIDE DEALER NETWORK TO SERVE YOU.
 Whether you're driving a Honda in Kansas City or a Mercedes Benz in West Germany, there's an Atlas dealer near you.

Atlas 210X or 215X w/noise blanker	\$765.00
Accessories:	
AC Console 110/220 V	\$155.00
Portable AC supply 110/220 V	\$105.00
Plug-in mobile kit	\$55.00
10X Osc, less crystals	\$65.00
Digital Dial DD-6B	\$235.00

For complete details see your Atlas dealer, or drop us a card and we'll mail you a brochure with dealer list.



HUSTLER

"the home of originals"

AMATEUR ANTENNAS

STANDARD GAIN MOBILES

- Two Meters
- 5/8 wavelength — 3.4 db gain over 1/4 wave mobile
- Frequency coverage—143 to 149 MHz
- Power rating—200 watts FM

MODEL BBL-144
 47" antenna complete with easy to install, no holes to drill, trunk lip mount, impact spring and 17 MIL SPEC RG-58-U and PL-259 Antenna removable from mount.
 Price: \$33.75

MODEL BBL-144
 47" antenna mounts on any flat surface, roof, deck or fender in 3/8" hole. Includes impact spring, 17 MIL SPEC RG-58-U and PL-259 Antenna removable from mount.
 Price: \$31.65

HUSTLER "BUCK-BUSTER"

MODEL SF-2
 51" two meter, 5/8 wavelength, 3.4 db gain over 1/4 wave mobile. Designed with 3/4" base to fit your mount or a wide selection of Hustler mobile mounts. (Mount or cable not included).
 Price: \$9.00

DELUXE MOBILE MOUNTS

For medium length, light weight antennas with 3/4" — 24 base



MODEL TLM
 Trunk lip mount for no holes installation on side or edge of trunk lid. Includes 17 RG-58-U connectors attached.
 Price: \$14.85

MODEL MLM
 Deluxe trunk lip mount with 180 degree swivel ball for positioning antenna to vertical. Easy — no holes — installation. Includes 17 RG-58-U cable and connectors attached. Price: \$17.20

MODEL MM-1
 Covert mount installs in 1" hole. Includes 180° swivel ball and SO-239 connectors.
 Price: \$7.50

MODEL MM-1
 Covert mount installs in 1" hole. Includes 180° swivel ball and SO-239 connectors.
 Price: \$7.50

MODEL GCM-1
 Rain gutter mount fits all shapes angles even latest trim line gutters. Includes 180° swivel ball. Price: \$9.00

MODEL TGM-1
 Trunk groove mount installs in hidden area of groove under trunk lid. Mounting hardware included. Price: \$8.00

MODEL C-32
 Ball mount complete with mounting hardware.
 Price: \$8.20

MODEL C-32
 Ball mount complete with mounting hardware.
 Price: \$8.20

SUPER GAIN MOBILES

- Two Meters
- 5.2 db gain over 1/4 wave mobile antenna
- Frequency coverage—143-149 MHz
- SWR at resonance—1:1.1 typical
- Power rating—200 watts FM

TWO AND SIX METERS—TRUNK LIP MOUNT
MODEL HFT
 Four section telescopic antenna permits separate adjustment for simultaneous resonance on two and six meters. Operational height: 48". Complete with trunk lip mount, 17 MIL SPEC RG-58-U and factory attached PL-259.
 Price: \$22.55

VHF/UHF ANTENNA—TRUNK LIP MOUNT
MODEL UMT-1
 Field trimmable radiator for 1/4 wave operation on any frequency from 140 to 500 MHz. Cutting chart included. Mounts on any flat surface, roof, deck, fender in 3/8" hole. Includes 15 RG-58-U.
 Price: \$9.95

RESONATOR SPRING—STAINLESS STEEL
MODEL RSS-2
 Installs between Hustler mount and resonator. Absorbs shock when antenna strikes overhanging obstructions. Supplied ready for easy installation.
 Price: \$4.50

QUICK DISCONNECT—100% STAINLESS STEEL
MODEL QD-1
 Remove antenna from mount with easy press and twist release. Comports any amateur mobile antenna. Includes cycloic base, steel backstop plate and mounting hardware.
 Price: \$16.95

FEED LINE **MODEL L14240**
 Get known performance, maximum strength for minimum price. Pick up in 17 MIL SPEC 20' length of RG-58-U cable, supplied with connectors attached for use with ball or bumper mount and brackets.
 Price: \$6.55

MODEL G6-144A — Deluxe, Two-Meter Colinear for Repeater or any fixed station operation. 6 db gain over a 1/2 wave dipole. Maximum radiation at the horizon. Shunt with D.C. grounding. Radiator: 1/2 wave lower section, 1/2 wave phasing, 1/2 wave upper section. Height: 117". SWR at resonance: 1.2:1 or better. Power rating: 1,000 Watts FM. Wind survival: 100 MPH. Installs on vertical pipe up to 1 1/2" O.D. SO-239 coax connector.
 Price: \$67.55

MODEL CGT-144
 Get big signal performance, superior receiving capability with this 25' colinear antenna. Easy installation on side or edge of trunk lip without drilling — complete with 17 MIL SPEC RG-58-U and PL-259.
 Price: \$41.30

MODEL CG-144
 Same characteristics as CGT-144 supplied with 3/4" — 24 base to fit all mobile ball mounts — Length is 17 MIL SPEC RG-58-U and PL-259 included. Price: \$25.50

VHF/UHF ANTENNA—TRUNK LIP MOUNT
MODEL TWF
 Field trimmable radiator permits quarter wave operation on any frequency from 140 to 500 MHz. Cutting chart included. Complete with trunk lip mount, 17 RG-58-U and PL-259. Price: \$16.55

SSM-2
QO-1

STAINLESS STEEL BALL MOUNT FOR DECK, FENDER OR ANY FLAT SURFACE
MODEL SSM-2
 Heavy 2" reinforced stainless steel 180° adjustable ball mount easily supports any amateur mobile antenna. Includes cycloic base, steel backstop plate and mounting hardware.
 Price: \$19.20

QUICK DISCONNECT—100% STAINLESS STEEL
MODEL QD-1
 Remove antenna from mount with easy press and twist release. Comports any amateur mobile antenna. Includes cycloic base, steel backstop plate and mounting hardware.
 Price: \$16.95

MODEL G6-144A — Deluxe, Two-Meter Colinear for Repeater or any fixed station operation. 6 db gain over a 1/2 wave dipole. Maximum radiation at the horizon. Shunt with D.C. grounding. Radiator: 1/2 wave lower section, 1/2 wave phasing, 1/2 wave upper section. Height: 117". SWR at resonance: 1.2:1 or better. Power rating: 1,000 Watts FM. Wind survival: 100 MPH. Installs on vertical pipe up to 1 1/2" O.D. SO-239 coax connector.
 Price: \$67.55

All resonators are precision wound with optimized design for each band. Assembly includes 17-7 PH stainless steel adjustable tip rod for lowest SWR and band edge marker. Choose for medium or high power operation.

STANDARD HUSTLER RESONATORS

Power Rating: 400 Watts SSB

Model	Band	Price
RM-10	10 meters	\$ 6.50
RM-15	15 meters	6.95
RM-20	20 meters	7.30
RM-40	40 meters	13.20
RM-75	75 meters	15.50
RM-80	80 meters	15.95

SUPER HUSTLER RESONATORS

Power Rating: Legal Limit SSB
 Supers have widest bandwidth

Model	Band	Price
RM-10S	10 meters	\$11.30
RM-15S	15 meters	12.65
RM-20S	20 meters	13.00
RM-40S	40 meters	15.50
RM-75S	75 meters	30.00
RM-80S	80 meters	30.40

For 6-10-15-20-40-75-80 Meters

Fold over mast for quick and easy interchange of resonators or entering a garage. When operating, mast is held vertical with shakeproof sleeve clutch. S4 mast also serves as 1 1/4 wavelength 6 meter antenna. Stainless steel base has 3/4" — 24 threads to fit mobile ball mount or bumper mount.

MODEL MD-1
 For bumper mounting—Fold in at roof line 27" above base. Price: \$22.00

MODEL MD-1
 For deck or fender mounting—Fold in at roof line 15" above base. Price: \$22.00

Covers 10 - 15 - 20 - 40 Meters
 Only Hustler Gives One Setting for Whole Band Coverage

MODEL 4-BTV

- Lowest SWR—PLUS
- Bandwidth at its broadest! SWR 1.6 to 1 or better at band edges
- Hustler exclusive trap covers "Spritz" extruded to otherwise unattainable close tolerances assuring accurate and permanent trap resonance
- Solid one inch fiberglass trap forms for optimum electrical and mechanical stability
- Extra heavy duty aluminum mounting bracket with low loss, high strength insulators. Mounting hardware included
- All sections 1 1/4" heavy wall, high strength aluminum
- Stainless steel clamps permitting adjustment without damage to the aluminum tubing
- Guaranteed to be easiest assembly of any multi-band vertical
- Antenna has 3/4" — 24 stud at top to accept RM-75 or RM-75-S Hustler resonator for 75 meter operation when desired.
- Top loading on 75 meters for broader bandwidth and higher radiation efficiency!
- Feed with any length 50 ohm coax.
- Power capability—full legal limit on SSB or CW
- Mounting Ground mount with or without radials, or roof mount with radials.

Weight: 15 lbs
 Length: 21' 5"
MODEL 4-BTV
 Price: \$99.95

This NEW MFJ Versa Tuner II . . .

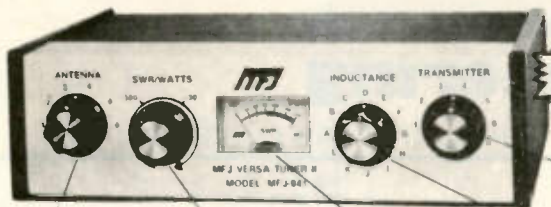

BRAND NEW

has SWR and dual range wattmeter, antenna switch, efficient airwound inductor, built-in balun. Up to 300 watts RF output. Matches everything from 160 thru 10 meters: dipoles, inverted vees, random wires, verticals, mobile whips, beams, balance lines, coax lines. \$79.95.

Antenna matching capacitor. 208 pf. 1000 volt spacing.

Sets power range, 300 and 30 watts. Pull for SWR.

Meter reads SWR and RF watts in 2 ranges.

Efficient airwound inductor gives more watts out and less losses.

Transmitter matching capacitor. 208 pf. 1000 volt spacing.

Only MFJ gives you this MFJ-941 Versa Tuner II with all these features at this price:

A SWR and dual range wattmeter (300 and 30 watts full scale) lets you measure RF power output for simplified tuning.

An antenna switch lets you select 2 coax fed antennas, random wire or balance line, and tuner bypass.

A new efficient airwound inductor (12 positions) gives you less losses than a tapped toroid for more watts out.

A 1:4 balun for balance lines. 1000 volt capacitor spacing. Mounting brackets for mobile installations (not shown).

With the NEW MFJ Versa Tuner II you can run your full transceiver power output — up to 300 watts RF power output — and match your

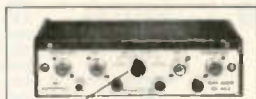

ANTENNA SWITCH lets you select 2 coax fed antennas, random wire or balance line, and tuner bypass.

transmitter to any feedline from 160 thru 10 Meters whether you have coax cable, balance line, or random wire.

You can tune out the SWR on your dipole, inverted vee, random wire, vertical, mobile whip, beam, quad, or whatever you have.

You can even operate all bands with just

one existing antenna. No need to put up separate antennas for each band.

Increase the usable bandwidth of your mobile whip by tuning out the SWR from inside your car. Works great with all solid state rigs (like the Atlas) and with all tube type rigs.

It travels well, too. Its ultra compact size 5x2x6 inches fits easily in a small corner of your suitcase.

This beautiful little tuner is housed in a deluxe eggshell white Ten-Tec enclosure with walnut grain sides.

50-239 coax connectors are provided for transmitter input and coax fed antennas. Quality five way binding posts are used for the balance line inputs (2), random wire input (1), and ground (1).



\$59.95

BRAND NEW

MFJ-901 VERSA TUNER

New efficient air wound coil for more watts out! Only MFJ uses an efficient air wound inductor (12 positions) in this class of tuners to give you more watts out and less losses than a tapped toroid. Matches everything from 160 thru 10 Meters: dipoles, inverted vees, random wires, verticals, mobile whips, beams, balance lines, coax lines. Up to 200 watts RF output. 1:4 balun for balance lines. Tune out the SWR of your mobile whip from inside your car. Works with all rigs. Ultra compact 5x2x6 inches. 50-239 connectors. 5 way binding posts. Ten-Tec enclosure.

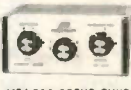

\$49.95

BRAND NEW

MFJ-900 ECONO TUNER

Same as MFJ-901 Versa Tuner, but does not have built-in balun for balance lines. Tunes coax lines and random wire.



\$39.95

MFJ-16010 RANDOM WIRE TUNER

Operate 160 thru 90 Meters. Up to 200 watts RF output. Matches high and low impedances. 12 position inductor. 50-239 connectors. 2x3x4 inches. Matches 25 to 700 ohms at 9.8 MHz.



\$49.95

BRAND NEW

MFJ-202 RF NOISE BRIDGE

This MFJ RF Noise Bridge lets you adjust your antenna quickly for maximum performance. Measures resistance, frequency, radiation resistance and reactance. Exclusive range extender and expanded capacitance range (2-180 pF) gives you much extended measuring range.

Tune resonant frequency and switch to shorten or lengthen your antenna for maximum SWR. Adjust your single or multi band dipole, inverted vee, beam, vertical, mobile whip or random system for maximum performance. 1 to 100 MHz. 50-239 connectors. 2x3x4 inches. 9 volt battery.

400% MORE RF POWER PLUGS BETWEEN YOUR MICROPHONE AND TRANSMITTER



\$49.95

LSP-520BX. 30 db dynamic range IC log amp and 3 active filters give clean audio. RF protected 9 V battery. 3 conductor, 1/4" phone jacks for input and output. 2-3/16 x 3-1/4 x 4 inches.



\$59.95

LSP-520BX II. Same as LSP-520BX but in a beautiful 2-1/8 x 3-5/8 x 5-9/16 inch Ten-Tec enclosure with uncommitted 4 pin Mic jack, output cable, rotary function switch.



\$29.95

CWF-2BX Super CW Filter

By far the leader. Over 5000 in use. Razor sharp selectivity. 80 Hz bandwidth, extremely steep skirts. No ringing. Plugs between receiver and phones or connect between audio stage for speaker operation.

• Selectable BW: 80, 110, 180 Hz • 60 db down one octave from center freq. of 750 Hz for 80 Hz BW • Reduces noise 15 dB • 9 V battery • 2-3/16 x 3-1/4 x 4 in.



\$54.95

CMOS-8043 Electronic Keyer

State of the art design uses CURTIS-8043 Keyer-on-a-chip.

• Built-in Key • Dot memory • Iambic operation with external squeeze key • 8 to 50 WPM • Sidetone and speaker • Speed, volume, tone, weight controls • Ultra reliable solid state keying • 300 volts max • 4 position switch for TUNE OFF ON SIDETONE OFF • Uses 4 penlight cells • 2-3/16 x 3-1/4 x 4 inches



\$29.95

SBF-2BX SSB Filter

Dramatically improves readability.

• Optimizes your audio to reduce sideband splatter, remove low and high pitched QRM, hiss, static crashes, background noise, 60 and 120 Hz hum • Reduces fatigue during contest, DX, and ragchewing • Plugs between phones and receiver or connect between audio stage for speaker operation • Selectable bandwidth IC active audio filter • Uses 9 volt battery • 2-3/16 x 3-1/4 x 4 inches



\$27.95

MFJ-200BX Frequency Standard

Provides strong, precise markers every 100, 50, or 25 KHz well into VHF region.

• Exclusive circuitry suppresses all unwanted markers • Markers are gated for positive identification CMOS IC's with transistor output. • No direct connection necessary • Uses 9 volt battery • Adjustable trimmer for zero beating to WWV • Switch selects 100, 50, 25 KHz or OFF • 2-3/16 x 3-1/4 x 4 inches



\$17.95

NEW

CPO-555 Code Oscillator

For the Newcomer to learn the Morse code. For the Old Timer to polish his fist. For the Code Instructor to teach his classes.

• Send crisp clear code with plenty of volume for classroom use • Self contained speaker, volume, tone controls, aluminum cabinet • 9 V battery • Top quality U.S. construction • Uses 555 IC timer • 2-3/16 x 3-1/4 x 4 inches



\$29.95

MFJ-40T QRP Transmitter

Work the world with 5 watts on 40 Meter CW.

• No tuning • Matches 50 ohm load • Clean output with low harmonic content • Power amplifier transistor protected against burnout • Switch selects 3 crystals or VFO input • 12 VDC • 2-3/16 x 3-1/4 x 4 inches

MFJ-40V, Companion VFO \$27.95

MFJ-120C, IC Regulated Power Supply, 1 amp, 12 VDC \$27.95



\$49.95

MFJ-1030BX Receiver Preselector

Clearly copy weak unreadable signals (increases signal 3 to 5 "S" units).

• More than 20 db low noise gain • Separate input and output tuning controls give maximum gain and RF selectivity to significantly reject out-of-band signals and reduce image responses • Dual gate MOS FET for low noise, strong signal handling abilities • Completely stable • Optimized for 10 thru 30 MHz • 9 V battery • 2-1/8 x 3-5/8 x 5-9/16 inches

THE HAM-KEY NOW 5 MODELS

NEW MODEL HK-5 ELECTRONIC KEYS \$69.95



- Iambic circuit for squeeze keying.
- Self completing dots & dashes.
- Dot memory.
- Battery operated with provisions for external power
- Built-in side-tone monitor.
- Speed, Volume, tone & weight controls.
- Grid-block or direct keying.
- Use with external paddle such as HK-1.



Model HK-1 \$29.95

- Dual lever squeeze paddle.
- Use with HK-5 or any electronic keyer.
- Heavy base with non-slip rubber feet.
- Paddles reversible for wide or close finger spacing.



Model HK-2 \$19.95

- Same as HK-1, less base for those who wish to incorporate in their own Keyer.



Model HK-3 \$16.95

- Deluxe straight key.
- Heavy base, no need to attach to desk.
- Velvet smooth action.



Model HK-4 \$44.95

- Combination of HK-1 & HK-3 on same base.

TUFTS RADIO CATALOG TUFTS RADIO

Vhf engineering

THE WORLD'S MOST COMPLETE LINE OF VHF-FM KITS AND EQUIPMENT

RX28C	28-35 MHz FM receiver with 2 pole 10.7 MHz crystal filter	\$ 64.95
RX28C W/T	same as above—wired & tested	117.95
RX50C Kit	30-60 MHz rcvr w/2 pole 10.7 MHz crystal filter	64.95
RX50C W/T	same as above—wired & tested	117.95
RX144C Kit	140-170 MHz rcvr w/2 pole 10.7 MHz crystal filter	74.95
RX114C W/T	same as above—wired & tested	119.95
RX220C Kit	210-240 MHz rcvr w/2 pole 10.7 MHz crystal filter	74.95
RX220C W/T	same as above—wired & tested	117.95
RX432C Kit	432 MHz rcvr w/2 pole 10.7 MHz crystal filter	84.95
RX432C W/T	same as above—wired & tested	129.95

RECEIVERS



RXCF	accessory filter for above receiver kits gives 70 dB adjacent channel rejection	8.95
RF28 Kit	10 mtr RF front end 10.7 MHz out	13.50
RF50 Kit	6 mtr RF front end 10.7 MHz out	13.50
RF144D Kit	2 mtr RF front end 10.7 MHz out	18.50
RF220D Kit	220 MHz RF front end 10.7 MHz out	18.50
RF432 Kit	432 MHz RF front end 10.7 MHz out	29.50
IF 10.7F Kit	10.7 MHz IF module includes 2 pole crystal filter	29.50
FM455 Kit	455 KHz IF stage plus FM detector	18.50
AS2 Kit	audio and squelch board	16.00

TX50	transmitter exciter, 1 watt, 6 mtr.	44.95
TX50 W/T	same as above—wired & tested	64.95
TX144B Kit	transmitter exciter—1 watt—2 mtrs	34.95
TX144B W/T	same as above—wired & tested	59.95
TX220B Kit	transmitter exciter—1watt—220 MHz	34.95

TRANSMITTERS



TX220B W/T	same as above—wired & tested	59.95
TX432B Kit	transmitter exciter 432 MHz	49.95
TX432B W/T	same as above—wired & tested	79.95
TX150 Kit	300 milliwatt, 2 mtr transmitter	24.95
TX150 W/T	same as above—wired & tested	39.95

PA2501H Kit	2 mtr power amp—kit 1w in—25w out with solid state switching, case, connectors	64.95
PA4010H Kit	2 mtr power amp—10w in—40w out—relay switching	64.95
PA50/25 Kit	6 mtr power amp, 1w in, 25w out, less case, connectors & switching	54.95
PA144/15 Kit	2 mtr power amp—1w in—15w out—less case, connectors and switching	44.95
PA144/25 Kit	same as PA144/15 kit but 25w	54.95
PA220/15 Kit	similar to PA144/15 for 220 MHz	44.95
PA432/10 Kit	power amp—similar to PA144/15 except 10w and 432 MHz	54.95
PA140/10 W/T	10w in—140w out—2 mtr amp	219.95
PA140/30 W/T	30w in—140w out—2 mtr amp	189.95

POWER AMPLIFIERS

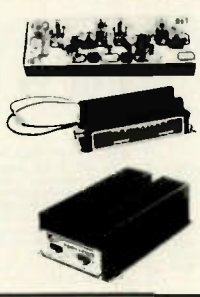

Blue Line	RF power amp, wired & tested, emission—CW-FM-SSB/AM			
	Model	BAND	Power Input	Power Output
	BLC 10/70	144 MHz	10W	70W
	BLC 2/70	144 MHz	2W	70W
	BLC 10/150	144 MHz	10W	150W
	BLC 30/150	144 MHz	30W	150W
	BLD 2/60	220 MHz	2W	60W
	BLD 10/60	220 MHz	10W	60W
	BLD 10/120	220 MHz	10W	120W
	BLE 10/40	420 MHz	10W	40W
	BLE 2/40	420 MHz	2W	40W
	BLE 30/80	420 MHz	30W	80W
	BLE 10/80	420 MHz	10W	80W

PS15C Kit	15 amp—12 volt regulated power supply w/case, w/fold-back current limiting and overvoltage protection	94.95
PS15C W/T	same as above—wired & tested	124.95
PS25M Kit	25 amp—12 volt regulated power supply w/case, w/fold-back current limiting and ovp, with meter	154.95
PS 25M W/T	same as above—wired & tested	179.95

POWER SUPPLIES

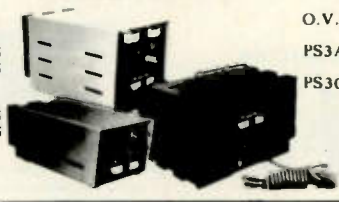

O.V.P.	adds over voltage protection to your power supplies, 15 VDC max.	12.95
PS3A Kit	12 volt—power supply regulator card with fold-back current limiting	10.95
PS3012 W/T	new commercial duty 30 amp 12 VDC regulated power supply w/case, w/fold-back current limiting and overvoltage protection	249.95

RPT50 Kit	repeater—6 meter	499.95
RPT50	repeater—6 meter, wired & tested	799.95
RPT144 Kit	repeater—2 mtr—15w—complete (less crystals)	499.95
RPT220 Kit	repeater—220 MHz—15w—complete (less crystals)	499.95
RPT432 Kit	repeater—10 watt—432 MHz (less crystals)	579.95
RPT144 W/T	repeater—15 watt—2 mtr	799.95
RPT220 W/T	repeater—15 watt—220 MHz	799.95
RPT432 W/T	repeater—10 watt—432 MHz	849.95

REPEATERS



DPLA50	6 mtr close spaced duplexer	575.95
DPLA144	2 mtr, 600 KHz spaced duplexer, wired and tuned to frequency	379.95
DPLA220	220 MHz duplexer, wired and tuned to frequency	379.95
DPLA432	rack mount duplexer	319.95
DSC-U	double shielded duplexer cables with PL259 connectors (pr.)	25.00
DSC-N	same as above with type N connectors (pr.)	25.00

TRX50 Kit	Complete 6 mtr FM transceiver kit, 20w out, 10 channel scan with case (less mike and crystals)	244.95
TRX144 Kit	same as above, but 2 mtr & 15w out	234.95
TRX220 Kit	same as above except for 220 MHz	234.95
TRX432 Kit	same as above except 10 watt and 432MHz	254.95
TRC-1	transceiver case only	29.95
TRC-2	transceiver case and accessories	49.95

TRANSCEIVERS



OTHER PRODUCTS BY VHF ENGINEERING

CD1 Kit	10 channel receive xtal deck w/diode switching	\$ 7.95
CD2 Kit	10 channel xmit deck w/switch and trimmers	15.50
CD3 Kit	UHF version of CD1 deck, needed for 432 multi-channel operation	13.50
COR2 Kit	carrier operated relay	22.75
SC3 Kit	10 channel auto-scan adapter for RX with priority	19.95
Crystals	we stock most repeater and simplex pairs from 146.0-147.0 (each)	5.00
CWID Kit	159 bit, field programmable, code identifier with built-in squelch tail and ID timers	39.95
CWID	wired and tested, not programmed	54.95
CWID	wired and tested, programmed	59.95
MIC 1	2,000 ohm dynamic mike with P.T.T. and coil cord	12.95
TS1 W/T	tone squelch decoder	59.95
TS1 W/T	installed in repeater, including interface accessories	89.95
TD3 Kit	2 tone decoder	35.95
TD3 W/T	same as above—wired & tested	59.95
HL144 W/T	4 pole helical resonator, wired & tested, swept tuned to 144 MHz ban	29.95
HL220 W/T	same as above tuned to 220 MHz ban	29.95
HL432 W/T	same as above tuned to 432 MHz ban	29.95

SYNTHESIZERS



SYN II Kit	2 mtr synthesizer, transmit offsets programmable from 100 KHz—10MHz. (Mars offsets with optional adapters)	169.95
SYN II W/T	same as above—wired & tested	239.95
SYN 220 Kit	same as SYN II Kit except 220-225 MHz	169.95
SYN 220 W/T	same as above—wired & tested	239.95



IC-211
4 MEG, Multi-mode
2 Meter Transceiver
ALL MODE

• 144-145 MHz operation on SSB and CW as well as 146-147 MHz operation on FM is possible with the IC-211. Try 144 MHz DX or just local rag chew with friends. Work the Amsat Oscar six or seven using the IC-211 for either the receiver or transmitter.

TUNING SYSTEM

• A large weighted flywheel knob mounted with low friction ball bearings is used to drive an optical chopper to provide pulses to the ICOM LSI synthesizer. A breaking mechanism, which operates inertially, changes to provide a smooth feel at slow speeds similar to the old PTO type units.

FULL FUNCTIONS BUILT IN

pulse type noise blanker
VOX with adjusting VOX gain, antivox semi-break-in C. W. Operation
Built in SWR bridge
CW monitor
automatic power control
AC or DC operation
• The synthesizer designed by ICOM and implemented in the proprietary LSI chip operates in 100 Hz steps from 144 to 146 MHz and in 5 KHz steps from 146 to 148 MHz for FM operation.
• The IC-211 contains both the 117VAC and the 13.6VDC power supplies.



IC-502
6 Meter SSB & CW Portable

• Get In on the fun of working 6 meters with this great portable radio. Operate QRP on 6 SSB or CW with this self contained transceiver, including antenna and battery pack. (Nicads and charger are now available.) Grab it and take it with you wherever you go... hill top, lakeside or car. The aluminum diecast frame provides a rugged radio for travel. Three watts PEP and the stable VFO make for fun and FB QSO's. There is even an RIT for the receiver, as well as a true I.F. noise blanker that really works on six meters!

• The VFO used in the IC-502 covers the first 800 KHz of the 6 meter band where most of the activity is. The excellent stability of the VFO and the smooth tuning dial make operating the IC-502 even in cold mountain top climates a pleasure worth the effort of getting there. The three watt PEP signal really gets through when the band is open and provides sufficient drive for an AB1 type linear amplifier.



IC-245
146 MHz FM 10 W Transceiver

• The ICOM developed LSI synthesizer with 4 digit LED readout in the IC-245 offers the most for mobile. In FM, the synthesizer command frequency is displayed in 5 KHz steps from 146 to 148 MHz, and with the sideband adapter the step rate drops to 100 Hz, from 144 to 146 MHz. For maximum repeater flexibility, the transmit and receive frequencies are independently programmable on any separation. The IC-245 even comes equipped with a multiple pin Molex connector for remote control.

• Optional equipment for the IC-245 includes a single sideband adapter which attaches as an integral part of the transceiver. With this easy to make conversion, your IC-245 operates in both FM and SSB/CW modes.



IC-215
2 Meter FM portable

• An extremely rugged, high quality, radio with 15 channel capacity.
• The 'C' size cells may be replaced with rechargeable cells of the same size and very simple modification made to provide FULL CHARGE from either the auto electrical system or the IC-3PS power supply while the IC-215 is in operation. This feature is possible due to the BC-20 battery pack and charger.



IC-202
2 Meter SSB Portable

• A full 3 watts PEP from this compact transceiver is plenty of punch when the band is open. Three watts PEP will also dim most home-brew amps to full output or our optional amplifier to 10 watts.

• This unit also includes a true I.F. noise blanker that really gets the job done on reducing pulse type interference.
• The band switch selects 144.0, 144.2 or two other 200 KHz bands as selected by the user. Your ICOM distributor stocks 145.0-145.2 MHz and 145.8-146.0 MHz for the technician calling frequency and the satellite band.



MODEL		RM-2	175.00
IC-30A	399.00	IC245/SSB	444.00
IC-202	259.00	IC-502	249.00
IC-20L	98.00	IC-50L	98.00
IC211	799.00	IC-701 AC	1,499.00
IC215	229.00	IC-701 DC	PRICE
IC215/BC-20	249.00	IC-3PS	99.00
IC202S	335.00	IC-3PE	99.00

MIC-500M	Mobile Mic (specify model)	\$18.00
SM-2	Electret Base Mic (for 4 pin mic conn)	34.50
IC-MM	Mobile Mount (specify model)	13.95
IC-DCC (22S)	DC Power cord (245,22S,211) w/fuse	3.00
IC-DCC (std)	Power cord (specify model AC or DC)	2.00
IC-PC	Power connector (specify model)	.50
RRD	Reverse dial (22A, 30A, 22S)	2.00
9PP	9 Pin Plug	2.00
BC-20	900 mAh Batteries & Charger for 202, 215, 502	49.95
24PP	24 Pin Plug	3.00
24PP set	24 Pin Set w/Bracket (22S)	6.00

DON'T FORGET \$3.00 MINIMUM SHIPPING CHARGE!

DON'T FORGET \$3.00 MINIMUM SHIPPING CHARGE!

DON'T FORGET \$3.00 MINIMUM SHIPPING CHARGE!

Larsen Kūlrod® Antennas

- Handle full 200 watts • low-low V.S.W.R.
- Deliver 3 dB gain and more!
- Pick the one that best fits your needs:

MAGNETIC MOUNT
stays put even at 100 mph!

MM-JM-150 for 144 MHz use } Only \$38.50
MM-JM-220 for 220 MHz use } complete
MM-JM-440 for 440 MHz use }

TRUNK LID MOUNT
No holes and low silhouette tool!

TLM-JM-150 for 144 MHz use } Only \$38.50
TLM-JM-220 for 220 MHz use } complete
TLM-JM-440 for 440 MHz use }

And 1/4 wave antenna for trunk and magnetic mount — \$18.50

ROOF or FENDER MOUNT
Goes on quick and easy in 3/8" or 3/4" with fewest parts.

JM-150-K for 144 MHz use } Only \$31.50
JM-220-K for 220 MHz use } complete
JM-440-K for 440 MHz use }

And 1/4 wave antenna for roof and fender mounts \$11.50

Above antennas all complete with mounting hardware, coax, connector plug, allen wrench and complete instructions.

FULLY AIR TESTED — THOUSANDS ALREADY IN USE

#16 40% Copper Weld wire annealed to it handles like soft Copper wire — Rated for better than full legal power AM/CW or SSB-Coaxial or Balanced 50 to 75 ohm feedline — VSWR under 1.5 to 1 at most heights — Stainless Steel hardware — Drop Proof Insulators — Terrific Performance — No coils or traps to break down or change under weather conditions — Completely Assembled ready to put up — Guaranteed 1 year — ONE DESIGN DOES IT ALL.

MOR-GAIN

MODEL	BANDS (Meters)	PRICE	WEIGHT (Oz./Kg)	LENGTH (Ft./Mtrs)
40-20 HO	40/20	\$49.50	26/73	36/10.9
40-10 HO	40/20/15/10	59.50	36/101	36/10.9
80-40 HO	80/40 • 15	57.50	41/115	69/21.0
75-40 HO	75/40	55.00	40/112	66/20.1
75-40 HO (SP)	75/40	57.50	40/112	66/20.1
75-20 HO	75/40/20	66.50	44/123	66/20.1
75-20 HO (SP)	75/40/20	66.50	44/123	66/20.1
75-10 HO	75/40/20/15/10	74.50	48/134	66/20.1
75-10 HO (SP)	75/40/20/15/10	74.50	48/134	66/20.1
80-10 HO	80/40/20/15/10	76.50	50/140	69/21.0

NO TRAPS — NO COILS — NO STUBS — NO CAPACITORS

MOR-GAIN HD DIPOLES . . . • One half the length of conventional half-wave dipoles. • Multi-band, Multi-frequency. • Maximum efficiency — no traps, loading coils, or stubs. • Fully assembled and pre-tuned — no measuring, no cutting. • All weather rated — 1 KW AM, 2.5 KW CW or PEP SSB. • Proven performance — more than 15,000 have been delivered. • Permit use of the full capabilities of today's 5-band xcvrs. • One feedline for operation on all bands. • Lowest cost/benefit antenna on the market today. • Fast QSY — no feedline switching. • Highest performance for the Novice as well as the Extra-Class Op.

EXCLUSIVE 66 FOOT, 75 THRU 10 METER DIPOLES

- All models above are furnished with crimp/solder lugs.
- All models can be furnished with a SO-239 female coaxial connector at additional cost. The SO-239 mates with the standard PL-259 male coaxial cable connector. To order this factory installed option, add the letter 'A' after the model number. Example: 40-20 HD/A.
- 75 meter models are factory tuned to resonate at 3950 kHz. (SP) models are factory tuned to resonate at 3800 kHz. 80 meter models are factory tuned to resonate at 3650 kHz. See VSWR curves for other resonance data.

Master Charge and VISA accepted!

Master Charge and VISA accepted!

TUFTS RADIO CATALOG TUFTS RADIO



NEW
Jr. Monitor Antenna Tuner

- Continuous tuning 1.8-30 MHz
- Forward reading relative output power meter
- 300 watt power capability
- Built-in encapsulated balun
- Mobile mounting bracket
- Ceramic Rotary Switch 12-position
- Capacitor spacing 1000 volts
- Tapped toroid inductor
- Antenna inputs:
 - a. Coax unbalanced SO239
 - b. Random wire
 - c. Balanced feedline 75-660 Ohm
- 5 1/4" w. x 2 3/4" h. x 6" d.
- All metal black wrinkle finish cabinet
- Weight: 2 1/2 pounds



AMPLIFIERS

- MLA-2500 Amplifier (with Built-in Power Supply) \$899.50
- MLA-1200 Amplifier 399.50
- AC-1200 / AC Power Supply for MLA-1200 159.50
- DC-1200 / DC Power Supply for MLA-1200 199.50

TUNERS

- MT-3000A Tuner 349.50
- MT-2000A Tuner 199.50
- 160-10AT Super Tuner 129.50
- Jr. Monitor Tuner 79.50

ANTENNAS

- 160M Mobile Antenna "Mobile Top Bander" (160 meters) 59.50
- Center Feed All Band Doublet Antenna 24.50

ACCESSORIES

- Bfg Dummy with coolant 29.50
- W-2 Wattmeter 99.50
- 160 XV Transverter "Top Bander" 249.50

Read forward and reflected watts at the same time



READ FORWARD AND REFLECTED WATTS AT THE SAME TIME. Tired of constant switching and guesswork? Every serious ham knows he must read both forward and reverse wattage simultaneously for that perfect match. So upgrade with the DenTron W-2 Dual in line Wattmeter. \$99.50.

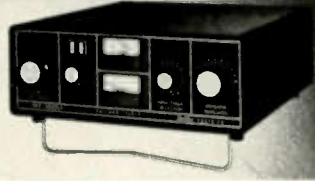

The MT-3000A

- SPECIFICATIONS:**
- Power handling capability in excess of 3 KW PEP
 - Front Panel Antenna Switch with 5 Antenna Inputs plus Tuner bypass position
 - Built-In 50 Ohm - 250 Watt dummy load
 - Dual Wattmeters
 - Compact: 5 1/4" x 14" x 14", 18 pounds
 - Continuous Tuning 160-10 meters
 - 3 Core Heavy-Duty Balun

- 160 XV MARS Dual Band 279.50
- 100 ft. 2kw 300 Transmission Line 19.50
- 100 ft. 470 Ohm Ladder Line 12.00
- 1 Kilowatt Balun 4:1 Chassis Mt. 27.50
- 3 Kilowatt Balun 4:1 Chassis Mt. 29.50



THE MLA-2500 SPECIFICATIONS

- 160 thru 10 meters
- 2000+ watts PEP input on SSB
- 1000 watts DC Input on CW, RTTY, or SSTV Continuous Duty
- Variable forced air cooling system
- Self-contained continuous duty power supply
- Two EIMAC 8875 external-anode ceramic/metal triodes operating in grounded grid.
- Covers MARS frequencies without modifications
- Harmonic Suppression better than 50 dB
- Built-in ALC
- Built in RF Wattmeter
- 117V or 234 V AC 50-60 Hz
- Third order distortion down at least 30 dB
- Frequency Range: 1.8 MHz (1.8-2.5) 3.5 MHz (3.4-4.6) 7 MHz (6.0-9.0) 14 MHz (11.0-16.0) 21 MHz (16.0-22.0) 28 MHz (28.0-30.0)
- 40 watts drive for 1 KW DC input
- Rack mounting kit available (standard 19" rack)
- Size: 5 1/4" H x 14" W x 14" D
- Weight: 47 lbs.

Match everything from 160 to 10 with the new 160-10 MAT



NEW: The Monitor Tuner was designed because of overwhelming demand. Hams told us they wanted a 3 kilowatt tuner with a built-in wattmeter, a front panel antenna selector for coax, balanced line and random wire. So we engineered the 160-10m Monitor Tuner. It's a lifetime investment at \$299.50.



Meet the Super Tuner

MEET THE SUPER TUNER 160-10 AT. The DenTron Super Tuner tunes everything from 160-10 meters. Whether you have balanced line, coax cable, random or long wire, the Super Tuner will match the antenna impedance to your transmitter. All DenTron tuners give you maximum power transfer from your transmitter to your antenna, and isn't that where it really counts? 1 KW MODEL \$129.50.



Model 333 dummy load wattmeter - Favorite Lightweight Portable-250 WATT RATING - Air Cooled. Ideal field service unit for mobile 2-way radio - CB, marine, business band. Best for QRP amateur use, CB, with zero to 5 watts full scale low power range.

- Frequency Range: DC to 300 MHz
- VSWR: Less than 1.3:1 to 230 MHz
- Power Range: 250 watts intermittent
- Wattmeter Ranges: 0.5, 0.50, 0.125, 0.250
- SO-239
- Connector: 4" x 7" x 8"
- Size: 2 lbs.
- Shipping Weight: 2 lbs.
- Price: \$98.50



High Power - 1000 WATT RATING - Oil Cooled - model 334A dummy load wattmeter. Our most popular combination unit. Handles full amateur power. Meter ranges individually calibrated. Can be panel mounted.

- Frequency Range: DC to 300 MHz
- VSWR: Less than 1.3:1 to 230 MHz
- Power Range: 1000 watts CW intermittent, Warning light signals maximum heat limit.
- Wattmeter Ranges: 0.10, 0.100, 0.300, 0.1000
- SO-239 (thermally sealed)
- Input Connector: 4" x 9" x 10 1/2"
- Size: 12 lbs.
- Shipping Weight: 12 lbs.
- Price: \$174.00



Model 374 dummy load wattmeter - Top of the Line - 1500 WATT RATING - Oil Cooled. Our highest power combination unit. Rated to 1500 watts input (intermittent). Meter ranges are individually calibrated for highest accuracy.

- Frequency Range: DC to 300 MHz
- VSWR: Less than 1.3:1 to 230 MHz
- Power Range: 1500 watts DC intermittent, Warning light signals maximum heat limit.
- Wattmeter Ranges: 0.15, 0.50, 0.300, 0.1500
- Input Connector: SO-239 (thermally sealed)
- Size: 4 1/2" x 9" x 10 1/2"
- Shipping Weight: 12 lbs.
- Price: \$215.00



Wide range attenuator - Model 371-1. Seven rocker switches provide attenuation from 1 dB to 61 dB in 1-dB steps. Switches are marked in dB, 1-2-3-5-10-20-20. Sum of actuated switches (IN position) gives attenuation. With all switches in OUT position, there is NO insertion loss. Attenuator installs in coaxial line using UHF connectors.

- Power Capacity: 1 watt
- VSWR: 1.3:1 maximum, DC to 225 MHz
- Impedance: 50 ohms
- Accuracy: 1 dB/dB, DC to 60 MHz
- 0.1 dB/dB 20.5 dB, DC to 160 MHz
- 0.1 dB/dB 21.0 dB, DC to 225 MHz
- Size: 8 1/2" x 2 1/2" x 2 1/2"
- Shipping Weight: 1 1/2 lbs.
- Price: \$49.50



Model 331A transistor dip meter - Portable RF single generator, signal monitor, or absorption wavemeter. Lightweight (1 pound, 6 ounces with all coils), battery-powered unit is ideal for field use in testing transceivers, tuning antennas, etc. Can also be used to measure capacity, inductance, circuit Q, and other factors. Indispensable for experimenters, it is easily the most versatile instrument in the shop. Continuous coverage from 2 MHz to 230 MHz in seven ranges.

- Frequency Coverage: 2 MHz to 230 MHz in 7 overlapping ranges by plug in coil assemblies:
 - 2 MHz-4 MHz, 4 MHz-8 MHz, 8 MHz-16 MHz, 16 MHz-32 MHz, 32 MHz-64 MHz, 50 MHz-110 MHz, 110 MHz-230 MHz
- Accuracy: 2%
- Modulation: 1000 Hz, 25% to 40%
- Power: 9-volt transistor battery, Burgess 2U6 or equivalent
- Size: 7" x 2 1/2" x 2 1/2"
- Shipping Weight: 1 lb., 6 oz.
- Price: \$120.00



Coaxial antenna changeover relay. Model 377.

- Power Rating: 1000 watts CW (2000 watts SSB)
- VSWR: Less than 1.15:1, DC to 150 MHz
- Power Requirements: 0.015 Amperes, 45 to 130 volts AC
- Connectors: UHF Type SO-239
- Dimensions: 3 1/2" x 1 1/2"
- Shipping Weight: 1 lb.
- Price: \$17.95



Model 359. Increase your transmitter's effective speech power up to four times. This two stage, transistorized Audio Preamp/Limiter can be used with all types of transmitters.

- Input Impedance: 100,000 ohms
- Input Level: 5 millivolts to 20 millivolts
- Voltage Gain: 10 dB
- Receiver Level: 60 millivolts
- Output Impedance: 50,000 ohms
- Power: 9-volt transistor battery, Burgess 2U6 or equivalent
- Size: 2 1/2" x 3" x 4 1/2"
- Shipping Weight: 6 1/2 oz.
- Connectors: Terminal strip
- Price: \$37.50



Model 372 CLIPREAMP. Get maximum legal modulation without danger of splatter.

- Input Impedance: 100,000 ohms
- Input Levels: 5 millivolts to 20 millivolts
- Voltage Gain: 10 dB
- Output Level: 60 millivolts
- Output Impedance: 50,000 ohms
- Power: 9-volt transistor battery, Burgess 2U6 or equivalent
- Size: 2 1/2" x 3" x 4 1/2"
- Shipping Weight: 7 oz.
- Connectors: Terminal strip
- Price: \$27.50



PHONE PATCH

Universal hybrid coupler II phone patch. Model 3002W and model 3001W. The hybrid circuit provides for effortless VOX operation of the phone patch. A built-in Compreamp speech preamplifier/limiter (in Model 3002W) increases the level of weak phone signals and also prevents overmodulation when the local telephone is used as the station microphone. (The Compreamp also functions as a preamplifier/limiter with the station microphone, if desired.)

- Model 300 2W with Compreamp \$125.00
- Model 300 1W without Compreamp \$85.00

- Inputs from:
 - Line: 600 ohms
 - Receiver: 4 ohms
 - Microphone: High Impedance (50,000 ohms) crystal or dynamic 4 ohms
- Tape Recorder: 4 ohms
- Outputs to:
 - Transmitter: 50,000 ohms
 - Receiver/Speaker: 4 ohms
 - Tape Recorder: 0.5 megohm
- Size: 8 1/2" x 7 1/2" x 3"
- Shipping Weight: 3 1/2 lbs.
- Power: 9-volt battery, Burgess 2U6 or equivalent
- Connectors: Phone



2-meter mobile AT-200 Antenna Matcher. Use your cars AM/FM antenna for your 2-meter mobile rig. Tunes from the front panel for max. output, min. VSWR (1.2:1 or less for most car antennas). \$24.95



Two-way-radio headset with superior fidelity
Electret-Capacitor boom microphone and
palm-held talk switch.

\$69.95

FOR BROADCAST-QUALITY TRANSMISSION AND RECEPTION FOR BOTH MOBILE UNITS AND BASE STATIONS.

- Boom-mounted electret-capacitor microphone delivers studio-quality, undistorted voice reproduction. Variable gain control lets you adjust for optimum modulation.
- Cushioned earcup lets you monitor in privacy — no speaker blare to disturb others. Blocks out environmental noises, too. Made of unbreakable ABS plastic.
- Headband self-adjusts for comfortable wear over long hours. Spring-flex hinge lets you slip headset on and off with just one hand. Reversible for right or left ear.
- Headset can be hung on standard microphone clip.
- Compact palm-held talk switch lets you keep both hands on the wheel for safer driving. Made of unbreakable ABS plastic.
- Built-in FET transistor amplifier adapts microphone output to any transceiver impedance.
- Compatible with most two-way radios including 40-channel CB units.
- Built-in Velcro pad for easy mounting of the talk switch.
- Made in U.S.A.

SPECIFICATIONS

Earphone impedance and type: 8 ohms, dynamic
Microphone type: Electret capacitor
Microphone frequency response: 200-6000 Hz
Amplifier type: FET transistor, variable gain
Amplifier battery: 7-volt Mallory power: TR-175
Switching: Relay or electronic

IDEAL FOR EVERY TWO-WAY RADIO COMMUNICATIONS NEED...

- CB operators • Amateur radio operators • Police and fire vehicles • Ambulances and emergency vehicles • Taxis and trucks • Marine pleasure and work boats • Construction and demolition crews • Industrial communications • Security patrols • Airport tower and ground crews • Remote broadcast and TV-camera crews • Foresters and fire-watch units •

GIANT SALE NOW IN PROGRESS!

GIANT SALE NOW IN PROGRESS!

GIANT SALE NOW IN PROGRESS!



The Bencher Ultimate Paddle... a dual lever, iambic keyer paddle that will increase your speed, accuracy & operating comfort.

- **ADJUSTABLE CONTACT POINT SPACING** — Precision screw adjustments on each set of contacts make exact settings easy. Contact posts are split and locked by set screws, eliminating the need for locknuts.
- **WIDE RANGE OF TENSION ADJUSTMENT** — Tension on finger knobs is maintained by a long expansion spring. Dual screw adjustments adjust spring tension to match your "fist."
- **SELF ADJUSTING NEEDLE BEARINGS** — Keying shafts pivot in nylon bearings that "float" on machined brass fittings. Spring tension prevents free play and slop; eliminates contact bounce and backlash.
- **SOLID SILVER CONTACT POINTS** — The contact points are solid silver for a lifetime of flawless keying.
- **PRECISION-MACHINED COMPONENTS** — Main frame, contact posts, spring post and bearing ring are all machined from solid brass... polished and chrome plated for durability and rich appearance. The Bencher Paddle looks as good as it works!
- **HEAVY STEEL BASE; NON-SKID FEET** — Finished in an attractive black wrinkle finish (chrome plating optional), the base measures 9.5cm x 10.2cm x 1.3cm thick. It weighs 1 kilogram, and with its non-skid rubber feet is as solid as a rock.

Model BY-1 Standard Black Base... \$39.95. Model BY-2 Polished Chrome Base... \$49.95.

Bencher, Inc.

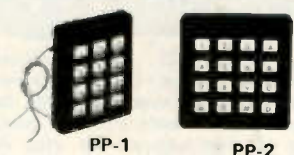

M series is for mounting to surfaces inaccessible from the rear (walls, mobiles, systems interface, panels, test equipment). K series is self-contained with a relay inside the encoder. When keys are pressed contact closer occurs with a 2 sec. delay (adjustable). Contacts are rated at 110 mA @ 28 volts switched, 500 mA carry. PP-2K contains delay exclusion for the fourth column. However, by jumping D-5, 4th column is restored. Unit is operable from 4.5-60 volts at temperatures from 0°-140° F. Output level will drive any transmitter or system. Adjustable output level is controlled with an extremely stable multi-turn trimpot, w/access from the front of the encoder (not behind), saving time for level setting, which amounts to hours when involved w/a system.

PP-1 \$55 (12 keys); PP-1m \$55 (lettering optional add \$1); PP-1K \$66; PP-2 \$58; PP-2m \$58 (lettering optional add \$1); PP-2K \$69; PP-1A \$68 (for standard comm hand-held).

Pipo Communications

MICROWAVE MODULES TEXAS RF

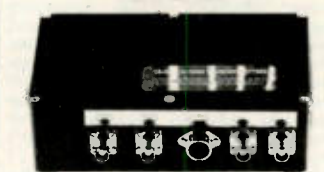

MICROWAVE MODULES HIGH PERFORMANCE UNITS FOR 144, 432 and 1296 MHz

144 MHz MOSFET CONVERTER - MMC144/28 With dual grounded gate Mosfet RF Amplifier and Mixer stages. Input frequency: 144-146 MHz I.F. output frequency: 28-30 MHz Typical gain: 30 dB Guaranteed maximum noise figure: 2.5 dB Typical image rejection: 65 dB Crystal oscillator frequency: 116 MHz (zero controlled) Maximum frequency error at 144 MHz: 3 KHz Power requirements: 12 volts DC 325% at 50 mA Other I.F. output frequencies available: 12-14, 14-16, 18-20, 24-26 MHz

144 MHz MOSFET CONVERTER - MMC144/28 LC Similar to the MMC144/28, this unit features an additional 116 MHz buffer amplifier to provide a local oscillator signal suitable for transmitter use.

144 MHz DOUBLE CONVERSION MOSFET CONVERTER - MMC144/28 This unit has been developed to meet the requirement for a converter suitable for use with receivers having better performance at lower frequencies. Input frequency: 144-146 MHz I.F. output frequencies available: 2.4, 4.6 MHz Oscillator frequency: 71 MHz (2.4 MHz IF), 70 MHz (4.6 MHz IF) Maximum frequency error at 144 MHz: 3 KHz Typical gain: 30 dB Guaranteed maximum noise figure: 2.5 dB Power requirements: 12 volts DC 325% at 30 mA

144 MHz DUAL OUTPUT MOSFET PREAMPLIFIER - MMA144 This two-stage matched preamplifier has two separate isolated outputs, for leading two receivers, for example. Input frequency: 144-146 MHz Typical gain: 18 dB Guaranteed maximum noise figure: 2.5 dB Bandwidth: 5 MHz at 3 dB, 8 MHz at -10 dB Power requirements: 12 volts DC 325% at 25 mA

432 MHz MOSFET CONVERTER - MMC432/144 Two RF Amplifiers and a Mosfet Mixer combine for high sensitivity and low cross-modulation characteristics. Input frequency: 432-434 MHz I.F. output frequencies available: 14-16, 18-20, 28-30, 144-146 MHz Typical gain: 30 dB Guaranteed maximum noise figure: 3.8 dB Crystal oscillator frequency: 116 MHz (28-30 MHz IF) (zero controlled): 96 MHz (144-146 MHz IF) Maximum frequency error at 432 MHz: 20 KHz Power requirements: 12 volts DC 325% at 45 mA

1296 MHz CONVERTER - MMC1296/28 - MMC1296/144 A hybrid ring mixer with a matched pair of hot-carrier diodes, driving a dual-gate mosfet I.F. amplifier. Input frequency: 1296-1298 MHz I.F. output frequencies available: 28-30, 144-146 MHz Typical gain: 25 dB Guaranteed maximum noise figure: 8.5 dB Crystal oscillator frequency: 105.866 MHz (28-30 MHz IF) (zero controlled): 96 MHz (144-146 MHz IF) Maximum frequency error at 1296 MHz: 20 KHz Power requirements: 12 volts DC 325% at 50 mA Connectors: 50 ohm BNC

TRANSVERTERS:
MMT 144/28 198.95
MMT 144/50 198.95
MMT 432/28S 259.95
MMT 432/50S 259.95
MMT 432/144S 298.95

RECEIVING CONVERTERS:
MMC 144/28 55.95
MMC 144/28LO 60.95
MMC 432/28S 65.00
MMC 432/144 65.00
MMC 1296/28 71.95
MMC 1296/144 71.95

VARACTOR TIPLER:
MMV 1296 81.50
ATTENUATORS:
MAA 15 16.00

TEE/AX



Patent Pending Model SW-5000
TEE/AX Coax Toggle Switch - \$39.95

- All brass construction • Teflon insulated • Captivated internal contacts • available in UHF, BNC, N, E, all series. • 52 Ohms • SPDT, DPDT • Power 1 KW

TEE/AX, INC.

AMPHENOL

BUNKER RAMO

SERIES 31 - BNC CONNECTORS
Amphenol's BNC connectors are small, lightweight, weatherproof connectors with bayonet action for quick disconnect applications.

Shells, coupling rings and male contacts are accurately machined from brass. Springs are made of beryllium copper. All parts in turn are ASTRO-plated® to give you connectors that can take constant handling, high temperatures and resist abrasion.

- BNC BULKHEAD RECEPTACLE 31-221-385 UG-1094 Mates with any BNC plug. Receptacle can be mounted into panels up to 104" thick. \$1.25
- BNC (M) TO UHF (F) ADAPTER 309-2900-385 UG-255 Adapts any BNC jack to any UHF plug. \$3.63
- DOUBLE MATE ADAPTER 83-877-385 Both coupling rings are free turning. Connects 2 female components. \$2.72
- JACK ADAPTER 31-95 5 T 5-1 0 2-3 8 5 Adapts 83-15P-385 to Motorola type auto antenna jack or pin jack. PANEL RECEPTACLE 83-1R-385 SO239 Mounts with 4 fasteners in 11/32" diameter hole. \$1.17
- PANEL RECEPTACLE



BNC(F) TO UHF (M) ADAPTER 31-028-385 UG-273 Adapts any BNC plug to any UHF jack. \$2.39
PUSH-ON 83-55P-385 Features an unthreaded, springy shell to push fit on female connectors. \$2.27

LIGHTNING ARRESTOR 575-105-385 Eliminates static build-up from antennas. Protects your valuable equipment against lightning damage. \$4.80

BNC PLUG 31-002-385 UG-88 Commonly used for communications antenna lead cables. For RG 55/U & RG 58/U cables. \$2.12
BNC STRAIGHT ADAPTER 31-219-385 UG-914 1 9/32" long, allows length of cables to be joined. Mates with BNC plugs \$2.12
BNC PANEL RECEPTACLE 31-003-385 UG-290 Mounts with 4 fasteners in 29/64" diameter hole. \$1.74

83-878-385 SO239SH Mounts in single 21/32" diameter hole. Knurled lock nuts prevent turning. \$1.59
BNC ANGLE ADAPTER 31-009-385 UG-306 Adapts any BNC plug for right angle use. \$4.23
BNC TEE ADAPTER 31-008-385 UG-274 Adapts 2 BNC plugs to 31-003-385 or other female BNC type receptacle. \$4.56

PL-259 ... 90d UG-175 (Adapter for RG 58U) ... 25d



Model M-1S

- Nemarc Auto Console Model M-1
- Universal mount for CB and amateur radios, tape players, AM & FM tuners, & scanners.
- Sculptured design for "original equipment" look.
- Low profile for non-slip mounting: 13-1/2" x 10-1/2" x 5-8/8" high.
- Easy-to-install & remove for theft protection.
- Tough unbreakable copolymer with rich brown textured finish.
- Integral cup holder and coin tray.
- \$14.95
- Auto Console Model M-1S: Same features as above model PLUS:
- Specially designed 3" x 5" oval speaker for voice communication. Frequency response: 150 Hz-7 KHz, voice coil: 9/16" diameter.
- \$19.95

Nemarc

TUFTS RADIO

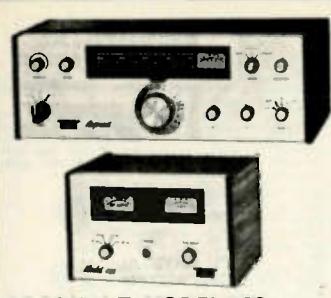

ARGONAUT, MODEL 509
 Covers all Amateur bands 10-80 meters. 9 MHz crystal filter. 2.5 kHz bandwidth. 1.7 shape factor @ 6/50 dB points. Power required 12-15 VDC @ 150 mA receive, 800 mA transmit at rated output. Construction aluminum chassis, top and front panel, molded plastic end panels. Cream front panel, walnut vinyl top and end trim. Size HWD 4 1/2" x 13" x 7". Weight 6 lbs.

LINEAR AMPLIFIER, MODEL 405
 Covers all Amateur bands 10-80 meters. 50 W output power, continuous wave. RF wattmeter SWR. Power required 12-15 VDC @ 8 A, max. Construction aluminum chassis, top and front panel, molded plastic end panels. Cream front panel, walnut vinyl top and end trim. Size HWD 4 1/2" x 7" x 8". Weight 2 1/2 lbs.

TRITON IV Digital Model 544
 The new ultra-modern fully solid-state TRITON makes operating easier and a lot more fun, without the limitations of vacuum tubes. For one thing, you can change bands with the flick of a switch and no danger of off-resonance damage. And no deterioration of performance with age. But that's not all. A superlative 8-pole i-f filter and less than 2% audio distortion, transmitting and receiving, makes it the smoothest and cleanest signal on the air. The TRITON IV specifications are impeccable. For selectivity, stability and receiver sensitivity. And it has features such as full CW break-in, preselectable ALC, off-set tuning, separate AC power supply, 12 VDC operation, perfectly shaped CW waveform, built-in SWR bridge and on and on.



DISCONTINUED

KR20-A ELECTRONIC KEYS
 A fine instrument for all-around high performance electronic keying. Paddle actuation force is factory adjusted for rhythmic smooth keying. Contact adjustments on front. Weighting factor factory set for optimum smoothness and articulation. Over-ride "straight key" conveniently located for emphasis, QRS sending or tune-up. Reed relay output. Side-tone generator with adjustable level. Self-completing characters. Plug-in circuit board. For 117 VAC, 50-60 Hz or 6-14 VDC. Finished in cream and walnut vinyl. Price \$69.80

KR5-A ELECTRONIC KEYS
 Similar to KR20-A but without side-tone oscillator or AC power supply. Ideal for portable, mobile or fixed station. A great value that will give years of troublefree service. Housed in an attractive case with cream front, walnut vinyl top. For 6-14 VDC operation. Price \$39.80

KR1-A DELUXE DUAL PADDLE
 Paddle assembly is that used in the KR50, housed in an attractive formed aluminum case. Price \$35.00

KR2-A SINGLE LEVER PADDLE
 For keying conventional "TO" or discrete character keys, as used in the KR20-A. Price \$17.00

KR50 ELECTRONIC KEYS
 A completely automatic electronic key fully adjustable to your operating style and preference, speed, touch and weighting, the ratio of the length of dits and dahs to the space between them. Self-controlled keyer to transmit your thoughts clearly, articulately and almost effortlessly. The jamble

(squeeze) feature allows the insertion of dits and dahs with perfect timing. Memories provided for both dits and dahs but either may be defeated by switches on the rear panel. Thus, the KR50 may be operated as a full jamble (squeeze) keyer, with a single memory or as a conventional type keyer. All characters are self-completing. Price \$110.00

SPECIFICATIONS
 Speed Range: 6-50 w.p.m.
 Weighting Ratio Range: 50% to 150% of classical dit length.

Memories: Dit and dah. Individual defeat switches.
 Paddle Actuation Force: 5-50 gms.
 Power Source: 117VAC, 50-60 Hz, 6-14 VDC
 Finish: Cream front, walnut vinyl top and side panel trim.
 Output: Reed relay. Contact rating 15 VA, 400 V. max.
 Paddles: Torque drive with ball bearing pivot.
 Side-tone: 500 Hz tone.
 Adjustable output to 1 volt.
 Size HWD: 2 1/4" x 5 1/4" x 8 1/4"
 Weight: 1 1/4 lbs.



tuning, crystal frequency stability at each frequency of operation, and over 40,000 HF channels displayed in 100 Hz increments ... 150 Hz fine tuning for continuous ham band coverage.

Each circuit board is "baked-in" for over 100 hours prior to installation in the transceiver assembly.

Discover the ease and accuracy of electronic tuning. Calibrate all bands with WWV at the turn of a switch. Lowest frequency drift, with no VFO to calibrate. Only 2.8" high x 9.5" wide x 12.3" deep. Ideal for mobile use or with accessories, provides complete fixed station operation. Price \$995.00.

Accessories AC Power supply \$135.00. Speaker in cabinet \$29.95. Station operating console with phone patch, 24 hr. digital clock, speaker, 10 min. timer \$295.00. Desk microphone \$38.00. Mobile mount \$12.00. Mobile mic \$15.00. 400 Hz narrow band CW filter \$50.00.



FIRST WITH SSB HF DIGITAL TUNING, IS ONLY THE BEGINNING OF WHAT THE AMATEUR GETS FROM THE CIR ASTRO 200A.

Standard Features:
 Electronic Tuning / All Solid State / Digitally Synthesized / 200 Watts PEP Input / Full RF Filtering / Digital Readout / Noise Blanker / Squelch / Variable Speech Processing / Full Metering / WWV Receiver / VOX / LSB-USB-CW

The heart of the ASTRO-200A is the frequency synthesizer. The latest in phase-lock-loop technology is incorporated to provide the built-in versatility of all electronic

ACCESSORIES

- 206 Crystal Calibrator \$29.00
- 207 Ammeter for Models 251, 252G, 262G 14.00
- 208 CW Filter, for Model 509 29.00
- 212 Crystal, for Models 540, 544, 29.0-29.5 MHz 5.00
- 213 Crystal, for Models 540, 544, 29.5-30.0 MHz 5.00
- 215P Microphone, Ceramic with plug 29.50
- 240 One-Sixty Converter, for Models 540, 544 97.00
- 241 Crystal Oscillator, for Models 540, 544 29.00
- 242 Remote VFO, for Models 540, 544 169.00
- 244 Digital Readout/Counter, for Model 540 197.00
- 245 CW Filter, for Models 540, 544 25.00
- 249 Noise Blanker, for Models 540, 544 29.00
- 271 Crystal, for Model 570, 21.0-21.5 MHz 5.00
- 272 Crystal, for Model 570, 28.0-28.5 MHz 5.00
- 273 Crystal, for Model 570, 28.5-29.0 MHz 5.00
- 276 Crystal Calibrator, for Model 570 29.00
- 1102 Snap-Up Legs, per pair 1.00

POWER SUPPLIES

- 210 117 VAC, 13 VDC, 1 A 30.00
- 210/E Same as Model 210, but 115/230 VAC 35.00
- 251 117 VAC, 13 VDC, 9 A 85.00
- 251/E Same as Model 251, but 115/230 VAC 92.00
- 252G 117 VAC, 13 VDC, 18 A 109.00
- 252G/E Same as Model 252G, but 115/230 VAC 116.00
- 262G Same as Model 252G, with VDX & speakers 139.00
- 262G/E Same as Model 262G, but 115/230 VAC 146.00

LINEARS AND TRANSCIVERS

- 509 Argonaut Transceiver, SSB/CW, 5 W. 3.5-30 MHz 359.00
- 540 Triton IV, SSB/CW, 200 W. 3.5-30 MHz 699.00
- 544 Triton IV, Digital, SSB/CW, 200 W. 3.5-30 MHz 869.00
- 570 Century/21, CW, 70 W. 3.5-30 MHz 299.00
- 574 Century 21, Digital 399.00

KEYERS

- 670 Single Paddle, for Model 570 only 29.00
- KR-1A Paddle Assembly, Dual 35.00
- KR-2A Paddle Assembly, Single 17.00
- KR-5A Single Paddle Keyer, 6-14 VDC 39.50
- KR-20A Single Paddle Keyer, 117 VAC/6-14 VDC 69.50
- KR-50 Ultramatic, Dual Paddle, 117 VAC/6-15 VDC 110.00

THE SURPRISE OF THE CENTURY

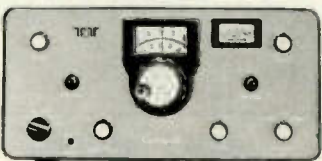

0.3" high, accurate to nearest 1 kHz. Model 570: marked in 5 kHz increments from 0-500 kHz, MHz markings for each band displayed, tuning rate typically 17 kHz per tuning knob turn.

Century 21, the exciting 70-watt, 5-band CW transceiver that surprised everyone with its super performance and low cost, has another surprise for you. A second model with digital readout (and a mod kit for those who would like to convert their dial model). Both Models 570 and 574 have the same unique circuitry that has won raves from everyone - both have the same fine features:
 ● Direct Frequency Readout (Model 574:5 red LED digits,

- Full Break-In
- Full Band Coverage on 3, 5, 7, 14, 21 MHz Bands, 1 MHz on 28 MHz Band
- 70 Watts Input
- Total Solid-State
- Receives SSB and CW
- Receiver Sensitivity 1 μV
- Instant Band Change, No Tune-up
- Offset Receiver Tuning
- 3-Position Selectivity
- Adjustable Sidetone Level
- Linear Crystal-Mixed VFO
- Overload Protection
- Built-In AC Power Supply
- Black & Gray Styling
- HWD: 6-1/8" x 12-1/2" x 12", 15-1/2 lbs.
- Matching Accessories

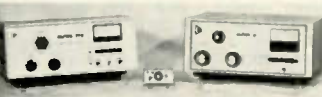

10 dB extra to 'punch through', with the ALPHA/VOMAX split band speech processor?

- ALL THE ROCK-CRUSHING POWER YOUR LICENSE ALLOWS - on all modes -
- INSTANT BANDCHANGE "NO-TUNE-UP" all the way from 10 through 80 meters, with the ALPHA 374A?
- COVERAGE ALL THE WAY DOWN TO 160 METERS with the smooth-tuning, extra-rugged ALPHA 76A powerhouse?
- CRISP, PENETRATING "TALK POWER" - as much as

THE PROTECTION OF A FACTORY WARRANTY THAT RUNS A FULL 18 MONTHS - six times as long as competitive units? [ETO tries to build every ALPHA to last forever... and we're making progress: not one single case of ALPHA 76A, 77DX, or 374A power transformer failure has ever been reported!]
 ● ALPHA 76A - \$1195.00,
 ALPHA 77DX - \$3295.00,
 ALPHA 374A - \$1595.00.





THE IMPROVED "ORIGINAL" VIBROPLEX. Suitable for All Classes of Transmitting Work Where Speed and Perfect Morse Are Prime Essentials. This great new Vibroplex is a smooth and easy working BUG. It has won fame on land and sea for its clarity, precision and ease of manipulation. Can be slowed down to 10 words per minute or less or geared to as high rate of speed as desired. Maintains the same high quality signal at whatever speed, insuring easy reception under all conditions. Weight 3 lbs. 8 oz. DeLuxe - Chromium base and top parts, with jeweled movement. \$59.95



THE "LIGHTNING BUG" VIBROPLEX High Quality Signals at All Speeds. Flat pendulum model. Weight 3 lbs. 8 oz. Standard - Polished Chromium top parts, grey base. \$49.95



THE "CHAMPION" VIBROPLEX Weight 3 lbs. 8 oz. Without circuit closer. Standard finish only. Chromium finished top parts, with grey crystal base. \$46.50



VIBRO-KEYER Over the years, we have had many requests for Vibroplex parts to be used for construction of a keying mechanism for an electronic transmitting unit. This beautiful and most efficient "Vibro Keyer" is ideal for this job.

FEATURES OF THE "VIBRO-KEYER"

- Beautiful beige colored base, size 3 1/2" x 4 1/2", weight 2 1/2 pounds
- Same large size contacts as furnished on Deluxe Vibroplex.
- Same main frame and super finished parts as Deluxe Vibroplex
- Colorful red finger and thumb pieces.
- Has the same smooth and easy operating Vibroplex trunion level
- A real "Gem" adjustable to suit your own "taste"

Standard - \$46.50; Deluxe Finish \$58.50

There's nothing like it!



RADIO AMATEUR CALLBOOK - There's nothing like it! Foreign Radio Amateur Callbook DX Listings - \$13.95; United States Callbook - All K&W Listings - \$14.95.



No. SSK-1 \$23.95
No. SSK-1CP Chrome - \$29.95

NYE VIKING SQUEEZE KEY
Extra-long, finger-fitting molded paddles with adjustable spring tension, adjustable contact spacing. Knife-edge bearings and extra large, gold plated silver contacts! Nickel plated brass hardware and heavy, die cast base with non-skid feet. Base and dust cover black crackle finished. SSK-1 - \$23.45. SSK-1CP has heavily chrome-plated base and dust cover. Price - \$29.45

CODE PRACTICE SET

You get a sure, smooth, Speed-X model 310-001 transmitting key, linear circuit oscillator and amplifier, with a built-in 2" speaker, all mounted on a heavy duty aluminum base with non-skid feet. Operates on standard 9V transistor type battery (not included). Price - \$18.50

PHONE PATCH Model No. 250-46-1 measures 6-1/2" wide, 2-1/4" high and 2-7/8" deep. List price, \$36.50. Model 250-46-3, designed for use with transceivers having a built-in speaker, has its own built-in 2" x 6" 2 watt speaker. Measures 6-1/2" wide, 2-1/4" high and 2-7/8" deep. Price - \$44.50



No. 114-320-003 - \$9.90
No. 114-322-003 - Brass - \$10.30
No. 114-320-001 - \$8.30
No. 114-322-001 - Brass - \$8.65
No. 114-310-003 - \$8.25
No. 114-312-003 - Brass - \$8.65

NYE VIKING SPEED-X KEYS
NYE VIKING Standard Speed-X keys feature smooth, adjustable bearings, heavy-duty silver contacts, and are mounted on a heavy oval die cast base with black wrinkle finish. Available with standard, or Navy knob, with, or without switch, and with nickel or brass plated key arm and hardware.

Pamper yourself with a Gold-Plated NYE VIKING KEY! Model No. 114-31C-004GP has all the smooth action features of NYE Speed-X keys in a special "presentation" model. All hardware is heavily gold plated and it is mounted on onyx-like jet black plastic sub-base. Price \$50.00

Wilson Electronics Corp.



- COMMON FEATURES**
- 5 Channel Operation
 - Individual Trimmers on all TX/RX Keys
 - All Axial plug in
 - Microwatch control of TX/RX
 - Rubber Flex Antenna furnished
 - Convenient Size - Fits in hip pocket
 - 90 Day Warranty
 - Can be modified for MARS or CAP
 - Built for rugged use
 - Inexpensive power source with rechargeable Ni-Cad
 - Easily accessible circuitry
 - One year Xcels furnished with each radio (limited)
- 1402SM 146.52/52 4502SM 446.00/00
1405SM 146.52/52 2202SM 223.50/50

NEW 2 METER MARK II AND MARK IV
As the smallest size hand-held ever marketed, the radios feature excellent adjacent channel selectivity, and Innermod/image rejection. The attractive blue-gray Lexan® outer case is rugged and durable. Mark II (2.5 watt) \$229.98. Mark IV (4 watt) \$259.98

Riding the crest of the new wave of multi-channel two-meter rigs is the Wilson WE-800. Designed as an all-purpose mobile or portable unit, the WE-800 is loaded with enough features to satisfy even the most discriminating amateur. The "800" is for channels, from 144 to 148 MHz in 5 KHz steps, up or down 500 KHz for your local repeater. There are even provisions for pre-programming five of your favorite frequencies or changing to two optional off-sets, in case your area repeater is nonstandard. Add to these features; internal rechargeable power pack optional (uses 10 AA NiCad cells, not included), detachable rubber flex antenna, built-in S-meter/output indicator, built-in

high-low power option switch (1 or 12 watts, when used mobile or base), built-in connectors for external antenna, speaker and power. Whether you're just getting your feet wet on two-meters, or a seasoned amateur, you'll find the WE-800 to be the most lightweight, versatile base/mobile/portable rig on the market today. The WE-800 comes complete with plug-in speaker-microphone, mobile mounting bracket/handle, rubber flex antenna, 12V DC Charger Cord, instruction booklet and 90 day limited warranty. Rechargeable internal battery pack optional.



- GENERAL SPECIFICATIONS**
- Frequency range: 144.050 - 147.999 MHz, 799 @ 5 kHz, or 799 @ 10 kHz
 - Operating mode: Direct frequency modulation or simplex on transmitter (other 1600 kHz, 15.8 VDC requires ground)
 - Type of communication: 10 to 15 VDC range
 - Operating range: 10 to 15 VDC range
 - Current drain: 200 mA at full 40 watt output
 - Antenna impedance: 50 ohm nominal
 - Size: 8 1/4" x 6 3/4" x 1 7/8" inches (208 mm x 171.5 mm x 47.6 mm)
 - Weight: 1 lb 13 oz - 14 1/2 lbs. (3 lb 11 oz (16.16 kg) with batteries)
 - Frequency determining method: Frequency determining method
 - Other Option: E-Match phase locked loop
- Two optional offset frequencies also available

LEATHER CARRYING CASE

- LC-1 for 1402 SM - \$18.95
- LC-3 for Mark II, IV - \$16.95
- LC-2 - all others - \$18.95

110V-AC DESK BATTERY CHARGER
For new units Mark II, IV - use the Model BC-2; for Models 1402, 1405, 1407, 2202 and 4502, use Model BC-1. \$40.95

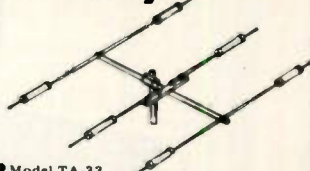

- Model TA-33
- Model TA-33, 3 elements, 10.1 dB forward gain (over isotropic source) - \$206.50
- Model TA-33 Jr., 3 elements, 10.1 dB forward gain (over isotropic source) - \$151.85
- Model MPK-3, 7500 Watts AM/CW and 2000 Watts P.E.P. SSB - \$52.25
- Model TA-36, 6 elements - \$335.25
- AK-60 mast plate adapter - \$11.15
- Model CL-33, 3 elements - \$232.50
- Model CL-36, 6 elements - \$310.65
- Model CL-203, 3 elements - \$227.65
- Model TA-40 KR - 40 meter conversion kit - \$92.25
- Signal-master antenna - \$267.50

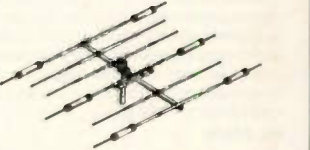

WATT BATTERY CHARGER
110 V-AC Charger... use WC-12 (\$19.95) for 1402, 1405, 1407, 2202, 4502; use WC-14 (\$15.95) for Mark II, IV.

ACCESSORIES
BC-12 - \$14.95
CIGARETTE LIGHTER MOBILE POWER PLUG
SPEAKER MIC
SM1 - for Models 1402, 1405, 1407, 2202, 4502.
SM3 - (Mark II, Mark IV)
SM2 for Models 1402, 1405, 1407, 2202, 4502. (\$30.95).

RECHARGEABLE BATTERY PACKS

Use the following Ni-Cad Packs for the unit you select:

- BP-1 - 10 loose cells - 500 mA (1402, 1405) - \$18.95
- BP-2 - strapped cells - 600 mA (1405, 2202, 4502) - \$24.95
- BP-4 - Mark II, Mark IV pack - \$20.95
- BP-7 - 1407 SM high power pack - \$24.95

Other options include: Touch Tone® Pad (installed only), TE-1 Tone Encoder, TE-2 Encoder/Decoder, BNC Rubber Duck Antenna, TNC Rubber Duck Antenna.



SAVE YOUR RADIO!



DESIGNED FOR COMMERCIAL USE UP TO 1000 MHZ.

The TUFTS SAVE-YOUR-RADIO bracket can save you a bundle... and a lot of hassle. Why worry about rig snuff? The TUFTS SVR bracket mounts quickly and easily in your car and makes it possible to snap your rig out of its bracket when you park and put it out of sight.

The connector system has a special coaxial cable connector which will provide you with a lossless connection right up to 1000 MHz! In addition to the quick cable connector there are also four power and accessory connectors which are made automatically when the rig is slid into its bracket... just what you need for feeding power and four-speaker connections to the rig.

This is a rugged bracket and connector system... it'll take a beating. There is a hole on each side of the 16 gauge steel plate for a padlock in case you want to leave the rig for short periods in its bracket. They'll have to rip out the drill to get in... and it won't be the first time for that.

With two of these brackets you can bring the mobile rig into the house and use it in seconds. On trips you can take an AC supply for the rig and use it in your hotel room. Price: \$29.95

TUFTS RADIO CATALOG

TUFTS SELECTED TITLES OF POPULAR SAMS PUBLICATIONS



RADIO HANDBOOK (20th Edition)

by William I. Orr, W6SAI. A completely updated 20th edition of the famous communications handbook that is the electronics industry standard for engineers, technicians, and advanced amateurs. Explains in authoritative detail how to design and build all types of radiocommunications equipment. Contains greatly enlarged section on semiconductor and IC circuit design. Includes ssb design and equipment; rty circuits; linear amplifiers, both solid-state and tube types; vhf and uhf transmitters and converters; as well as special-purpose and logic circuitry, plus completely revised chapter on electronics mathematics. 1080 pages; 6 1/2 x 9 3/4; hardbound.

No. 24032 \$19.50

HAM AND CB ANTENNA DIMENSION CHARTS

by Edward M. Noll, W3FQJ. Tabulates dimension information in feet and inches for all the popular antenna configurations. Gives data for dipole antennas, quarter-wave verticals, two-element beams, quads, triangles, inverted dipoles, and inverted vees. Includes information for cutting transmission lines to a preferred wavelength, dimensioning phasing lines, cutting a matching stub, and spacing antenna elements. 64 pages; 6 x 9; softbound.

No. 24023 \$2.75

COMMERCIAL RADIOTELEPHONE LICENSE QUESTION & ANSWER STUDY GUIDE (3rd Edition)

by Edward M. Noll. Prepares the reader to take the examinations for the various grades of radiotelephone licenses. Emphasizes those subjects that are most important or most likely to be misunderstood. The questions are representative of those used in the FCC examinations. 304 pages; 6 x 9; softbound.

No. 24033 \$8.50

RADIO TRANSMITTER PRINCIPLES AND PROJECTS

by Edward M. Noll, W3FQJ. Devoted entirely to the subject of radio transmitters, this book is a helpful gathering of modern transmitter principles, ideas, circuits, techniques, and learn-by-doing projects. Covers Bipolar CW and A-M Transmitter Circuits, Transistor/Tube Circuits, Basic Principles of SSB-DSB Generation, Integrated Circuit Fundamentals, VHF/VHF Circuits and Principles, Frequency Modulation, and more. 320 pages; 5 1/2 x 8 1/2; softbound.

No. 24031 \$6.95

73 DIPOLE AND LONG-WIRE ANTENNAS

by Edward M. Noll, W3FQJ. Covers practically every type of wire antenna used by amateurs. Gives dimensions, configurations, and construction data for 73 different antennas, plus appendices covering construction of noise bridges, line tuners, and data on measuring resonant frequency, velocity factor, and swr. 160 pages; 5 1/2 x 8 1/2; softbound.

No. 24006 \$5.50

73 VERTICAL, BEAM, AND TRIANGLE ANTENNAS

by Edward M. Noll, W3FQJ. The second book in a series of practical antenna construction and design methods. Contains data on practically all types used by amateurs. Not a rehash of previously published data, but a compilation of the author's own experiments with various antenna configurations. The 73 different antennas have all been built and air-tested by the author. 160 pages; 5 1/2 x 8 1/2; softbound.

No. 24021 \$5.50

FIRST-CLASS RADIOTELEPHONE LICENSE HANDBOOK (4th Edition)

by Edward M. Noll. An excellent study guide for the first-class radiotelephone license examination. Contains all the material needed to pass Element IV of the FCC examination. Including all the questions and answers found in the latest FCC Study Guide. Has three simulated examinations, presented in the multiple-choice form of the FCC tests, as well as answers and evaluations to help the reader find his weak areas. 416 pages; 5 1/2 x 8 1/2; softbound.

No. 21144 \$7.95

SECOND-CLASS RADIOTELEPHONE LICENSE HANDBOOK (5th Edition)

by Edward M. Noll. Provides all the study material needed to pass the FCC second-class radiotelephone license examination (Elements I, II, and III). All material is based on the FCC Study Guide and Reference Material for Commercial Operator Examination. Two tests are included to simulate the actual examination. 448 pages; 5 1/2 x 8 1/2; softbound.

No. 21111 \$7.95

THIRD-CLASS RADIOTELEPHONE LICENSE HANDBOOK (4th Edition)

by Edward M. Noll. Serves as a practical study guide for the aspiring radio operator as well as a ready reference for those working in the field. Designed as a study aid for obtaining licenses up to and including the Radiotelephone Third-Class Operator Permit with Broadcast Endorsement, this newest edition contains questions and answers similar to those given on the actual examination. 208 pages; 5 1/2 x 8 1/2; softbound.

No. 21353 \$5.95

CMOS COOKBOOK

by Don Lancaster. Tells all you need to know to understand and profitably use this inexpensive and genuinely fun to work with digital logic family. First an explanation of what CMOS is, how it works, and how to power it, plus usage rules, state testing, breadboarding, interface, and other basics is given. Then a minicatalog of over 100 devices, including pinouts and use descriptions is given. Subjects covered include gate fundamentals, tri-state logic, redundant logic design techniques, multivibrators, non-volatile memory techniques, clocked JK and D flip-flops, counter and register techniques, op amps, analog switches, phase-locked loops and much more. A must for the student, hobbyist, teachers, technician, or engineer who wants to learn about CMOS. Filled with practical applications. 416 pages; 5 1/2 x 8 1/2; softbound.

No. 21398 \$9.95

IC OP-AMP COOKBOOK

by Walter G. Jung. The first book of its kind to be published. Covers not only the basic theory of the IC op amp in great detail, but also includes over 250 practical circuit applications, liberally illustrated. Organized into three basic parts: introduction to the IC op amp and general considerations, practical circuit applications, and appendixes of manufacturers' reference material. 592 pages; 5 1/2 x 8 1/2; softbound.

No. 20969 \$12.95

IC TIMER COOKBOOK

by Walter Jung. Provides an excellent introduction to the field of IC timers by presenting a collection of various circuit "recipes" useful in applying the devices. Arranged in three parts, the first part gives basic and generalized information. Part II, the applications section, is the "meat" of the book and includes over 100 different circuits for a wide range of uses. Part III contains reproductions of manufacturers data sheets, second-source manufacturers, and more. This book is a valuable reference for the hobbyist, the technical or engineering student, or professional. 288 pages; 5 1/2 x 8 1/2; softbound.

No. 21416 \$9.95

TTL COOKBOOK

by Donald Lancaster. A complete and detailed guide to transistor-transistor logic (TTL). Explains what TTL is, how it works, and how to use it. Discusses practical applications, such as a digital counter and display system, events counter, electronic stopwatch, digital voltmeter, and a digital tachometer. 336 pages; 5 1/2 x 8 1/2; softbound.

No. 21035 \$8.95

HOW TO BUY & USE MINICOMPUTERS & MICROCOMPUTERS

by William Barden, Jr. Discusses these smaller computers and shows how they can be used in a variety of practical and recreational tasks in the home or business. Explains the basics of minicomputers and microcomputers, their hardware and software, peripheral devices available, and the various programming languages and techniques. Includes selection, buying, and programming your own system and gives detailed descriptions of currently available systems. 240 pages; 8 1/2 x 11; softbound.

No. 21351 \$9.95

MICROCOMPUTER PRIMER

by Mitchell Waite and Michael Pardee. Introduces the beginner to the basic principles of the microcomputers. Discusses the five main parts of a Computer—Central processing unit, memory, input/output interfaces, and programs. The important characteristics of several well-known microprocessors are given and a chapter is included on programming your own microcomputer. 224 pages; 5 1/2 x 8 1/2; softbound.

No. 21404 \$7.95

THE 8080A BUGBOOK: MICROCOMPUTER INTERFACING AND PROGRAMMING

by Peter H. Rony, David G. Larsen, and Jonathan A. Titus. The principles, concepts, and applications of an 8-bit microcomputer based on the 8080 microprocessor IC chip. The emphasis is on the computer as a controller. Covers the four fundamental tasks of computer interfacing: (1) generation of strobe and device select pulses; (2) latching of accumulator output; (3) acquisition of input data by the accumulator; (4) generation of interrupt signals to the computer. Intended to help develop the skills needed to use an 8080-based breadboard microcomputer system. 5 1/2 x 8 1/2; softbound.

No. 21447 \$9.95

F9FT TONNA ANTENNAS

9 Elements—144 MHz —\$27.95

TECHNICAL DATA

Frequency range MHz	144/146
Gain ISO	14 dB
Horizontal aperture angle*	2 x 19°
Vertical aperture angle*	2 x 23°
Front-to-back ratio	15 dB
Side lobe attenuation	>50 dB
SWR	≤ 1,3
Impedance	50
Weight	1,9 kg
Physical length	3,3 m
Windload*	6,4 kgp

*The indicated value is given at -3 dB

16 Elements—144 MHz —\$55.95

TECHNICAL DATA

Frequency range MHz	144/146
Gain ISO	17,8 dB
Horizontal aperture angle*	2 x 16°
Vertical aperture angle*	2 x 17°
Front-to-back ratio	22 dB
Side lobe attenuation	>60 dB
SWR	≤ 1,2
Impedance	50
Weight	4,4 kg
Physical length	6,4 m
Windload*	16 kgp

*The indicated value is given at -3 dB

21 Elements—432 MHz —\$45.95

TECHNICAL DATA

Frequency range MHz	432/435
Gain ISO	19 dB
Horizontal aperture angle*	2 x 12°
Vertical aperture angle*	2 x 13°
Front-to-back ratio	23 dB
Side lobe attenuation	> 40 dB
SWR	≤ 1,1
Impedance	50
Weight	2,6 kg
Physical length	4,6 m
Windload*	6,4 kgp

*The indicated value is given at -3 dB

21 Elements — 432 MHz

9 & 19 Elements
— 144/435

9 Elements — 144 MHz

16 Elements — 144MHz

Special OSCAR—9 & 19 Elements— 144/435—\$53.00

TECHNICAL DATA

Frequency range MHz	144/146	430/440
Gain ISO	14 dB	17 dB
Horizontal aperture angle*	2 x 19°	2 x 14°
Vertical aperture angle*	2 x 23°	2 x 16°
Front-to-back ratio	15 dB	23 dB
Side lobe attenuation	>50 dB	> 38 dB
SWR	≤ 1,3	≤ 1,2
Impedance	50	50
Weight	1,9 kg	1,1 kg
Physical length	3,3 m	3,2 m
Windload*	6,4 kgp	5,4 kgp

*The indicated value is given at -3 dB



HM-180



HM-187

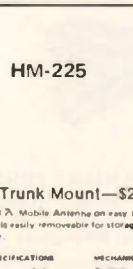

HM-225

3 dB Gain High Performance Vehicular Antenna Series

- HM-179 Low Profile Mount—\$29.00
- HM-180 Trunk Mount—\$33.50
- HM-187 Magnet Mount—\$36.50

All new, low profile antennas feature a 5/8" wavelength high conductive whip. Spring and whip may be removed leaving only 1 3/16" high base for minimal car wash clearance.

Coils are low loss, shock-resistant, directly fed ungrounded configuration and encased in plastic base. New high conductive whips are made of 13.2 PH stainless steel, coated with copper and nickel for high conductivity and greater heat dissipation. Mounts are Teflon-insulated, aluminum and plated steel.

ELECTRICAL SPECIFICATIONS

Antenna power rating	100 watts
Frequency range	144-148 MHz
SWR	1.5:1 or less
Nominal input impedance	50 ohms
Transformer	16 AWG copper wire, low loss coil, waterproof cover
Gain	3 dB over 1/4 λ whip

HM-223 Trunk Mount—\$29.00 (220 MHz)

3 dB Gain 5/8 λ Mobile Antenna on easy to install "Quick-Grip" trunk mount. Whip is easily removable for storage or car washes. 17' RG 58/U and connector.

Gain	3 dB
Bandwidth	5 MHz
Power rating	100 watts
Impedance	50 ohms

Mechanical Specifications	Radius	175 dia. 13 1/2 PH stainless steel coated with copper and nickel
Length	20"	9 1/2"

HM-224 Trunk Mount—\$33.50 (220 MHz)

The most powerful mobile antenna available for 1.166 meter mobile activity. 4 dB gain is achieved by stacking a 5/8 λ and 1/4 λ radiator. "Quick-Grip" trunk mount means easy no hole mounting. Whip is quickly removed for car washes or storage. 17' RG 58/U and connector.

Gain	4 dB
Bandwidth	5 MHz
Power rating	100 watts
Impedance	50 ohms

Mechanical Specifications	Radius	11 1/2 PH stainless steel coated with copper and nickel
Length	20"	9 1/2"

HM-225 Unity Gain (marine mobile service) —\$45.00 (220 MHz)

UNITY Gain 3' fiberglass antenna for marine use. No ground plane required. Can be mounted at masthead on sailboats or on any vertical surface on power boats. Comes with 2' RG 58/U cable.

Gain	Unity 1 λ, 0 dB gain reference
Bandwidth	20 MHz
Frequency range	220-224 MHz
Impedance	50 ohms

Mechanical Specifications	Length	3'
Radius	3"	3"
Material	Copper encapsulated in fiberglass	Anodized aluminum bracket



HMR 172 5 Element Yagi—\$30.00

Whether you use a low-powered ORP "lunch-box" rig or the full legal limit, the HMR172 offers 10 dB gain and 4 MHz bandwidth for superior performance under any band conditions. Can be mounted either vertical or horizontal. Adjustable gamma match for best possible VSWR.

ELECTRICAL SPECIFICATIONS

Forward gain	10 dB
Front-to-back ratio	15 dB
Bandwidth	4 MHz
Nominal input impedance	50 ohms
VSWR	1.5:1
3 dB beamwidth	58°
Power capability	500 watts

MECHANICAL SPECIFICATIONS

Element configuration	5 element yagi
Length	6'
Turning radius	3 5/8" (horizontal)
Weight	3 lbs.
Rated wind velocity	100 mph
Windload area	53 sq. ft.

HMR 173 11 Element Yagi—\$52.00

Whether your interest lies in Moon Bounce, Tropo, or meteor scatter, the HMR173 is the solution to longhaul communications. The unsurpassed gain (13 dB) and 36° (3 dB) beamwidth makes the HMR173 the best antenna for the VHF world. Covers the entire 2 meter band. Can be mounted either vertical or horizontal. Adjustable gamma match. For minimum VSWR. — Information available on "high-gain" systems requiring 2A, or 8 HMR173 yagi antennas.

ELECTRICAL SPECIFICATIONS

Forward gain	13 dB
Front-to-back ratio	16 dB
Bandwidth	4 MHz
Nominal input impedance	50 ohms
VSWR	1.5:1
3 dB beamwidth	36°
Power capability	800 watts

MECHANICAL SPECIFICATIONS

Element configuration	11 element yagi
Length	17'
Turning radius	9 3/8" (horizontal)
Weight	6.5 lbs.
Rated wind velocity	100 mph
Windload area	1.25 sq. ft.

HM 20 Marine Mobile Service—\$39.00

Unity gain 3' fiberglass antenna for marine use. No ground plane required. Can be mounted at masthead on sailboats or on any vertical surface on power boats. Comes with 2' of RG 58/U cable.

ELECTRICAL SPECIFICATIONS

Gain	Unity reference 1 λ dipole
Power	25 watts
Frequency range	146-148 MHz
Nominal impedance	50 ohms

MECHANICAL SPECIFICATIONS

Length	Approximately 5'
Radiator material	Copper encapsulated in fiberglass
Mount	Anodized aluminum bracket

ASPR 619 Coupler—\$17.00

Coupler for simultaneous 2 meter and AM/FM broadcast radio usage.

TUFTS RADIO CATALOG TUFTS RADIO

There is no substitute for quality, performance, or the satisfaction of owning the very best.

Hence, the incomparable Hy-Gain 3750 Amateur transceiver. The 3750 covers all amateur bands 1.8-30 MHz (160-10 meters). It utilizes advanced Phase-Lock-Loop circuitry with dual gate MOS FET's at all critical RF amplifier and mixer stages. There's a rotating dial for easy band-scanning and an electronic frequency counter with digital readout and a memory display that remembers frequencies at the flip of a switch. And that's just the beginning.

Matching speaker unit (3854) and complete external VFO (3855) also available.

See the incomparable Hy-Gain 3750 at your radio dealer or write Department MM. There is no substitute.



3854

3750

3855

There is no substitute.

hy-gain
Amateur Radio Systems.

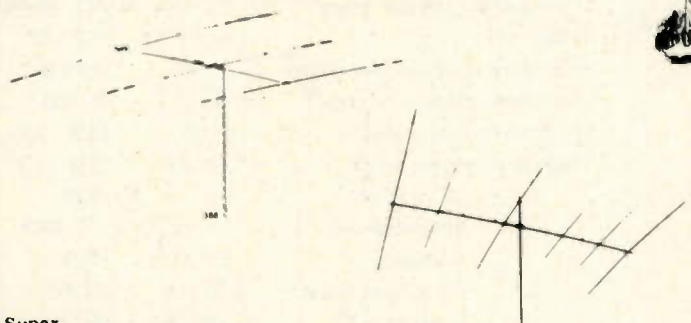

Super 3-Element Thunderbird for 10, 15 and 20 Meters Model TH3Mk3 — \$199.95

Hy-Gain's Super 3-element Thunderbird delivers outstanding performance on 10, 15 and 20 meters. The TH3Mk3 features separate and matched Hy-Q traps for each band, and feeds with 52 ohm coax. Hy-Gain Beta Match presents tapered impedance for most efficient 3 band matching, and provides DC ground to eliminate precipitation static. The TH3Mk3 delivers maximum F/B ratio, and SWR less than 1.5:1 at resonance on all bands. Its mechanically superior construction features taper swaged slotted tubing for easy adjustment and larger diameter. Comes equipped with heavy tiltable boom-to-mast clamp. Hy-Gain ferrite balun BN-86 is recommended for use with the TH3Mk3.

Electrical	TH6DXX	TH3Mk3
Gain—average	8.7dB	8dB
Front-to-back ratio	25dB	25dB
SWR (at resonance)	Less than 1.5:1	Less than 1.5:1
Impedance	50 ohms	50 ohms
Power rating	Max legal	Max legal

Mechanical	TH6DXX	TH3Mk3
Longest element	31.1'	27'
Boom length	24'	14'
Turning radius	20'	15.7'
Wind load at 80 MPH	156 lbs.	103.2 lbs.
Maximum wind survival	100 MPH	100 MPH
Net weight	57 lbs.	36 lbs.
Mast diameter accepted	1 1/4" to 2 1/2"	1 1/4" to 2 1/2"
Surface area	6.1 sq. ft.	4.03 sq. ft.

6-Element Super Thunderbird DX for 10, 15 and 20 Meters Model TH6 DXX \$249.95 Separate HY-Q traps, featuring large diameter coils that develop an exceptionally favorable L/C ratio and very high Q, provide peak performance on each band whether working phone or CW. Exclusive Hy-Gain beta match, factory pretuned, insures maximum gain and F/B ratio without compromise. The TH6DXX feeds with 52 ohm coaxial cable and delivers less than 1.5:1 SWR on all bands. Mechanically superior construction features taper swaged, slotted tubing for easy adjustment and readjustment, and for larger diameter and less wind loading. Full circumference compression clamps replace self-tapping sheet metal screws. Includes large diameter, heavy gauge aluminum boom, heavy cast aluminum boom-to-mast clamp, and heavy gauge machine formed element-to-boom brackets. Hy-Gain's ferrite balun BN-86 is recommended for use with the TH6DXX.

HY-GAIN'S INCOMPARABLE HY-TOWER FOR 80 THRU 10 METERS

- Model 18HT**
- Outstanding Omni-Directional Performance
 - Automatic Band Switching
 - Installs on 4 sq. ft. of real estate
 - Completely Self-Supporting

By any standard of measurement, the Hy-Tower is unquestionably the finest multi-band vertical antenna system on the market today. Virtually indestructible, the Model 18HT features automatic band selection on 80 thru 10 meters through the use of a unique stub decoupling system which effectively isolates various sections of the antenna so that an electrical 1/4 wavelength (or odd multiple of a 1/4 wavelength) exists on all bands. Fed with 52 ohm coax, it takes maximum legal power... delivers outstanding performance on all bands. With the addition of a base loading coil, it also delivers outstanding performance on 160 meters. Structurally, the Model 18HT is built to last a lifetime. Rugged hot-dipped galvanized 24 ft. tower requires no guyed supports. Top mast, which extends to a height of 50 Ft., is 6061ST6 tapered aluminum. All hardware is iridite treated to MIL specs. If you're looking for the epitome in vertical antenna systems, you'll want Hy-Tower, Shpg. Wt., 96.7 lbs. Order No. 182, Price: \$279.95. NEW Special hinged base assembly on Model 18HT allows complete assembly of antenna at ground level... permits easy raising and lowering of the antenna.



BROAD BAND DOUBLET BALUN for 10 thru 80 meters Model BN-86 \$15.95

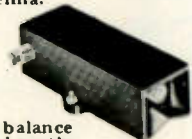

The model BN-86 balun provides optimum balance of power to both sides of any doublet and vastly improves the transfer of energy from feedline to antenna. Power capacity is 1 KW DC. Features weatherproof construction and built-in mounting brackets. \$15.95 Shpg. Wt. 1 lb. Order No. 242



MULTI-BAND HY-Q TRAP DOUBLET'S Hy-Q Traps

- Install Horizontally or as Inverted V
- Super-Strength Aluminum Clad Wire
- Weatherproof Center and End Insulators

Installed horizontally or as an inverted V, Hy-Gain doublets with Hy-Q traps deliver true half wavelength performance on every design frequency. Matched traps, individually pretuned for each band feature large diameter coils that develop an exceptionally favorable L/C ratio and very high Q performance. Mechanically superior solid aluminum trap housings provide maximum protection and support to the loading coil. Fed with 52 ohm coax, Hy-Gain doublets employ super-strength aluminum clad single strand steel wire elements that defy deterioration from salt water and smoke... will not stretch... withstand hurricane-like winds. SWR less than 1.5:1 on all bands. Strong, lightweight, weatherproof center insulators are molded from high impact cycolac. Hardware is iridite treated to MIL specs. Heavily serrated 7-inch end insulators molded from high impact cycolac increase leakage path to approximately 12 inches.

- MODEL 2BDQ for 40 and 80 meters. 100' 10 1/2" overall. Takes maximum legal power. Shpg. Wt., 7.5 lbs \$49.95 Order No. 380**
- MODEL 5BDQ for 10, 15, 20, 40 and 80 meters. 94' overall. Takes maximum power. Shpg. Wt., 12.2 lbs. \$79.95 Order No. 383**

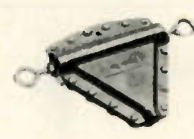

CENTER INSULATOR for Multi-Band Doublets Model CI

Strong lightweight, weatherproof Model CI is molded from high impact cycolac. Hardware is iridite treated to MIL specs. Accepts 1/4" or 3/4" coaxial. Shpg. Wt., 0.6 lbs. \$5.95 Order No. 155

MULTI-BAND ANTENNA Dipole Antenna — Model DIV-80 \$13.95

For 10 thru 80 meters — choice of one band

A dipole antenna for the individuals who prefer the "do-it-yourself" flexibility of custom-designing an antenna for your specific needs. (Work the frequencies you wish in the 10 through 80 meters bands).

The DIV-80 features: Durable Copperweld wire for greater strength, Mosley Dipole Connector (DPC-1) for RG-8/U or RG-58/U coax and all the technical information you will need to construct your custom-designed antenna.



END INSULATORS for Doublets Model EI

Rugged 7-inch end insulators are molded from high impact cycolac that is heavily serrated to increase leakage path to approximately 12 inches. Available in pairs only. Shpg. Wt., 0.4 lbs. \$3.95 Order No. 156

WIDE BAND VERTICAL for 80-10 Meters Hy-Gain's 18 AVT/WB

Take the wide band, omni-directional performance of Hy-Gain's famous 14AVQ/WB, add 80 meter capability plus extra-heavy duty construction—and you have the unrivalled new 18AVT/WB. In other words, you have quite an antenna.

- Automatic switching, five band capability is accomplished through the use of three beefed-up Hy-Q traps (featuring large diameter coils that develop an exceptionally favorable L/C ratio).
- Top loading coil.
- Across-the-band performance with just one furnished setting for each band (10 through 40).
- True 1/4 wave resonance on all bands.
- SWR of 2:1 or less at band edges.
- Radiation pattern has an outstandingly low angle whether roof top or ground mounted.



CONSTRUCTION ... of extra-heavy duty tapered swaged seamless aluminum tubing with full circumference, corrosion resistant compression clamps at slotted tubing joints... is so rugged and rigid that, although the antenna is 25' in height, it can be mounted without guy wires, using a 12" double grip mast bracket, with recessed coax connector.

Order No. 386 Price: \$97.00

The Versatile Model 18V for 80 thru 10 Meters

The Model 18V is a low-cost, highly efficient vertical antenna that can be tuned to any band, 80 thru 10 meters, by a simple adjustment of the feed point on the matching base inductor. Fed with 52 ohm coax, this 18 ft. radiator is amazingly efficient for DX or local contact. Constructed of heavy gauge aluminum tubing, the Model 18V may be installed on a short 1 1/2 inch mast driven into the ground. It is also adaptable to roof or tower mounting. Highly portable, the Model 18V can be quickly knocked down to an overall length of 5 ft. and easily re-assembled for field days and camping trips. Ship. Wt., 5 lbs.

Order No. 193 Price: \$33.00

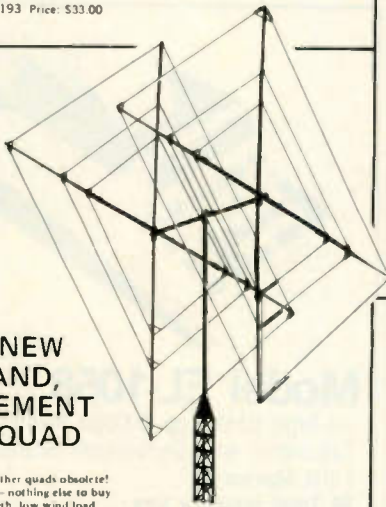

ALL NEW 3-BAND, 2 ELEMENT HY-QUAD

- Makes all other quads obsolete!
- Complete—nothing else to buy
- High strength, low wind load

The Hy-Quad from Hy-Gain makes all other quads obsolete! Here's why: First, it's the only quad that is complete. There is nothing more to shop for or buy.

Secondly, it is uniquely designed so that it overcomes all of the previously undrable features inherent in quads.

The all aluminum structure stays up! The single feed line and diamond shape simplifies lead line routing.

Hy-Gain's all new Hy-Quad will outdo all other quads because it's engineered to do just that. The Hy-Quad is new, it's superior, it's complete, it's the first quad to have everything: spreaders are broken up at strategic electrical points with Cycloc Insulators / tri-band 2 element construction with individually resonated elements with no interaction / Hy-Quad requires only one feed line for all three bands / individually tuned gamma matches on each band with Hy-Gain exclusive vertex feed / full wave element loops require no tuning stubs, traps, loading coils or baluns / heavy duty mechanical construction of strong swaged aluminum tubing and die formed spreader-to-boom clamps / extra heavy duty universal boom-to-mast clamp that fits and mounts on any mast 1 1/4" to 2 1/2" in diameter / aluminum stranded wire. You can open and close the bands with this antenna. You'll experience the thrill of real DX.

Order No. 244 Price: \$219.95

SPECIFICATIONS

Overall length of spreaders	25'5"	Forward gain	8.5 db
Turning radius	13'6"	Input impedance	52 ohms
Weight	42 lbs.	VSWR	1.2:1 or better at resonance on all bands
Boom diameter	2"	Power	Maximum
Boom length	8'	Front-to-back ratio	25-35 db
Mast diameter	1 1/4" to 2 1/2"	Surface area	6.4 sq. ft.
Wind survival	100 mph	Wind load at 100 mph	256.0 lbs.
Surface area	6.4 sq. ft.	Polarization	Horizontal



For 10, 15, and 20 Meters
New Hy-Gain Model 12 AVQ

Completely self-supporting, the Model 12AVQ features Hy-Q traps...12" double-grip mast bracket...taper swaged seamless aluminum construction with full circumference compression clamps at tubing joints. It delivers outstanding low angle radiation. SWR is 2:1 or less on all bands. Overall height is 13'6". Shipping weight 7.2 lbs. Price: \$47.00

Order No. 384

New, improved successor to the world's most popular vertical!

Hy-Gain Model 14 AVQ/WB for 40-10 Meters.

- Wide band performance with one setting (optimum settings for top performance furnished)
- New Hy-Q Traps • New 12" Double-Grip Mast Bracket • Taper Swaged Seamless Aluminum Construction

The Model 14AVQ/WB, new improved successor to the world famous Model 14AVQ, is a self-supporting, automatic band switching vertical that delivers omni-directional performance on 40 through 10 meters. Three separate Hy-Q traps featuring large diameter coils that develop an exceptionally favorable L/C ratio and a very high Q, provide peak performance by effectively isolating sections of the antenna so that a true 1/4 wave resonance exists on all bands. Outstandingly low angle radiation pattern makes DX and other long haul contacts easy. Superior mechanical features include solid aluminum housing for traps using air dielectric capacitor...heavy gauge taper swaged seamless aluminum radiator...full circumference compression clamps at tubing joints that are resistant to corrosion and wear...and a 12" double-grip mast bracket that insures maximum rigidity whether roof-top or ground mounted. The Model 14AVQ/WB also delivers excellent performance on 80 meters using Hy-Gain Model LC-80Q Loading Coil. Overall height is 18 feet. Shipping weight 9.2 lbs. Unsurpassed portability...outstanding for permanent installations. Price: \$67.00

Order No. 385

TYPICAL 14AVQ/WB VSWR CURVES

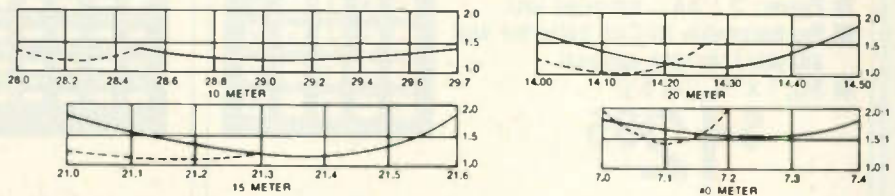

ROOF MOUNTING KIT—Model 14RMQ provides rugged support for Model 14AVQ/WB.

Order No. 184. Price: \$28.95

Hy-Gain REEL TAPE PORTABLE DIPOLE for 10 thru 80 Meters Model 18TD

The most portable high performance dipole ever...

The Model 18TD is unquestionably the most foolproof high performance portable doublet antenna system ever developed. It has proven invaluable in providing reliable communications in vital military and commercial-applications throughout the world. Two stainless steel tapes, calibrated in meters, extend from either side of the main housing up to a total distance of 132 feet for 3.5 mc operation. 25 ft. lengths of polypropylene rope attached to each tape permits installation to poles, trees, buildings...whatever is available for forming a doublet antenna system. Integrated in the high impact housing is a frequency to length conversion chart calibrated to meter measurements on the tapes...makes installation foolproof. Feeds with 52 ohm coax. Delivers outstanding performance as a portable or permanent installation. Measures 10x5 1/2x2 inches retracted. Wt., 4.1 lbs.

Order No. 228 Price: \$94.95



PRODUCTS OF SOUND RESEARCH TELEX COMMUNICATIONS, INC.

Lightweight Headphones



HFC-91

Ultra-light underchin. Acoustic delay of 1 millisecond enhances intelligibility on CW or SSB. Low impedance 8-20 ohms. Shaped response—100 - 3,000 Hz. 15 ounces

Order by Catalog No. 18135-013 \$9.90

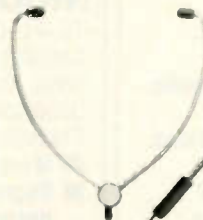

HMC-2

Featherweight—Underchin, rugged aluminum tone arms direct signals into the ear—great for contests. 1.2 ounces, 100 - 3,000 Hz. Low impedance: 8-20 ohms

Order by Catalog No. 18183-002 \$15.50



HTC-2

Lightest! Dual driver headset. Choice of the pros who must wear them for hours. 1.6 ounces, 100 - 3,000 Hz. Low impedance: 8-20 ohms

Order by Catalog No. 3775-002 \$24.50



PC-100 Headphone

Full cushion comfort—performance and long life make these dynamic phones ideal for novice or extra 50 - 12,000 Hz. Low impedance: 8 - 200 ohms, weight 12 ounces

Order by Catalog No. 63510-010

\$16.95



Headphone Jack Box

Ham Clubs, field day, contest operation. No more jury rigs for multiple headphones. six 1/4" phone jacks with individual volume controls. 4 foot cord with 1/4" phone plug

Order by Catalog No. 62753-000

\$14.30

TUFTS RADIO CATALOG TUFTS RADIO

SHARP

CALCULATORS

Model EL-8131

8-Digit Calculator with Memory,
Square Root and Percent

- 5-key direct access memory.
- Large, bright 8-digit display.
- Square root key.
- %-key.
- Clear and clear entry keys.
- Overflow error check device.
- Power: 2 "AA" batteries incl.
- Rechargeable Ni-Cad batteries and adapter/charger optional.
- $3\frac{5}{32}$ " x $2\frac{25}{32}$ " x $5\frac{1}{8}$ "

\$12⁹⁵

Model EL-500

6 + 2 Digit Scientific Calculator
 ■ Scientific notation up to ± 99
 dynamic range.

- Direct access memory.
- Degree, minutes, seconds to decimal degree conversion.
- Trigonometric, inverse trigonometric & logarithmic calc.
- Square root, root and pi keys.
- Power: 2 penlight batteries incl.
- AC adapter optional.
- $1\frac{3}{16}$ " x $3\frac{5}{32}$ " x $5\frac{1}{16}$ "

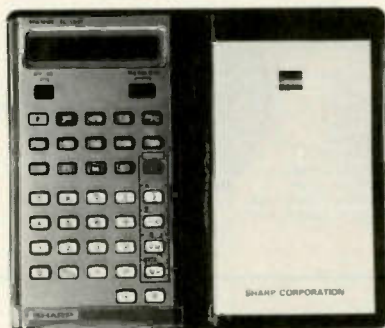
\$16⁹⁵

Model EL-5806

Billfold Type Advanced Scientific
calculator only 7.6mm Thin

- 8-digit mantissa/2-digit scientific notation.
- Pre-programmed for 24 functions.
- Statistical calculations.
- Easy to read Hi-Contrast LCD.
- Indicators for minus, memory, battery and statistical mode.
- Constant, chain, power, scientific and statistical calculations.
- 1,000 hours on 2 watch batteries.
- Soft vinyl carrying case included.
- $1\frac{9}{16}$ " x $2\frac{23}{32}$ " x $4\frac{31}{32}$ "

\$29⁹⁵

Model EL-5001

10 + 2 Digit Sophisticated Scientific
Calculator Featuring Linear Equations,
Complex Number, Integration,
Quadratic Equations, Vector and
Statistical Calculations

- More than 25 basic functions.
- Degree/Minute/Second \leftrightarrow decimal notation degree.
- Polar coordinates \leftrightarrow rectangular coordinates.
- Degree - Radian - Gradian mode.
- Power: Ni-Cad batteries and AC adapter/charger included.
- 6 " x 1 " x $3\frac{1}{2}$ "

\$49⁹⁵

Model EL-1058

10-Digit Desk Top 2-Color Printing
Calculator with Convenient Grand
Total Memory

- Total memory key.
- 2-color printer (red & black).
- Easy to operate "Human Engineered" keyboard layout.
- Handy non-add/sub-total key.
- Add mode, decimal (0,2,3) and constant/floating decimal selector.
- Power: 120V.
- 6 " x 9 " x $3\frac{1}{2}$ "

\$74⁹⁵

Interchangeable Test Leads

— individuality has limits

How many pieces of test equipment do you have? If the answer is greater than one, then it's very likely that they employ different types of connectors for their test leads. This condition has led to a lot of frustration for me over the years because of the need for several sets of incompatible test leads. But I finally

thought of a solution to allow the use of my scope probes with my VOM, VTVM, counter, etc.

The idea was to fabricate a custom connector to fit each individual piece of equipment, so that all my test leads would have a common termination. I selected the bayonet-style connector (BNC) because of the following reasons: 1.

the quick disconnect feature; 2. the ability to maintain the impedance of coaxial test leads that are a must when working with rf; and, above all, 3. their cheap availability on the surplus market.

As shown in Photo A, I fabricated the custom BNC adapter from the heaviest gauge solid wire that I could fit into the connec-

tors, even though it took a little filing, to obtain the maximum mechanical stability. For this same reason, I chose to use every mechanical advantage available to me while creating other adapters. In addition to the holding power of solder, I used washers and lock nuts, crimped where I could, used setscrews, etc. If you reuse the original connectors from existing test leads, you won't have to buy new ones to use on the male side of these adapters.

When you're done, you will have an easily removable adapter that in no way defaces or modifies the original equipment, as illustrated in Photo B. But, best of all, every set of test leads will be interchangeable. What more could you ask? ■



Photo A.



Photo B.

Happiness Is A Smart Scanner

— mods for the PBM/AWE FMSC-1

In my travels, many have asked me about the automatic repeater offset and LED scanner-on modifications for this very popular scanner, the PBM/AWE FMSC-1. For the unfamiliar, this search-type scanner is a plug-in option for the KDK FM transceiver and the Kenwood 7400A. It searches

2 MHz in 4 seconds!

Automatic ± 600 kHz Offset

This mod only uses a few parts and takes about one hour to install. The SPDT center-off toggle switch labeled "UP, OFF, DOWN" is replaced with a DPDT center-off switch. Mount the rest of

the parts on a $2\frac{1}{2} \times 1\frac{1}{4}$ -inch piece of .100" x .100" perf-board. Wrap the board and mounted components with one loose layer of electrical tape, and then contact cement it within that big empty space inside the scanner.

The schematics in Figs. 1, 2, and 3 show the details. Be sure to ground the unused gates of the TTL by connecting them to the minus side of the power supply. TTLs are rather current hungry when the inputs are left floating.

After this simple mod is done, the former "UP, OFF (simplex), DOWN" switch now becomes "NORMAL, SIMPLEX, REVERSE." This switch can be left in the NORMAL, SIMPLEX, or REVERSE position when the scanner is off (DELAY control pot rotated counterclockwise to "OFF").

How the Mod Works

BCD logic from the MHz readout drives the appropriate section of AND gate which in turn drives a transistor relay driver. The reed relays, K1 and K2, control the offset information routing through the NORMAL, SIMPLEX, REVERSE

switch. As the rig's readout changes between (14)6.XXX and (14)7.XXX, the offset information routing is being switched when the scanner is ON.

No doubt you hawk-eyed logic lovers will have spotted the way I "cheated" in Fig. 2 to get the easily obtained dual-input AND gates to function in this circuit! The perfectionists among us may prefer Fig. 3, which uses a triple-input AND gate. Either way works well. Fig. 3 might be preferred if someday repeaters are allowed "all over" the two meter band. I used a socket for the IC. My mental logic goes like this: "If the IC is made plug-in, it won't burn out!"

All of the parts are readily available from Allied Radio through Radio Shack. Allied's catalog can be obtained from practically any Radio Shack store. Many of 73's parts advertisers should not be overlooked, either. Don't forget, though, that the reed relays specified must be the type that are very small in physical size. They are almost the size of ICs. Other "regular" reed relay configurations may be too large physically to fit on the added circuit board.

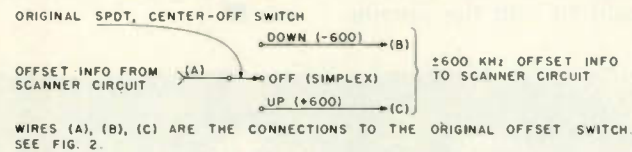

Fig. 1. Scanner's original (manual) repeater offset wiring.

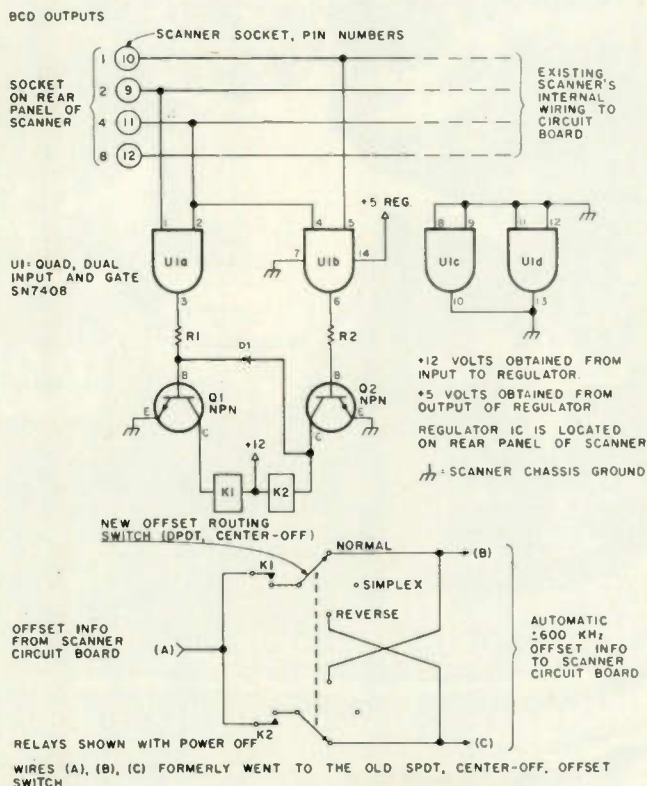

Fig. 2. New automatic-offset circuit added to scanner socket and offset wiring.

Parts List

- U1 AND gates, TTL, 7408 or 7411
- Q1, Q2 Any NPN silicon transistor such as 2N2222
- K1, K2 Reed relays, SPST, 12-volt coil, tiny size such as Allied Radio AMP 2007 (stock #7003-2007, \$1.91 each plus shipping)
- 14-pin DIP IC socket
- R1, R2 500 to 1000 Ohms, 1/4-Watt resistors
- DPDT center-off miniature toggle switch
- Perfboard, $2\frac{1}{2} \times 1\frac{1}{4}$ inches, with .100" hole centers
- D1 1N34 or any germanium diode

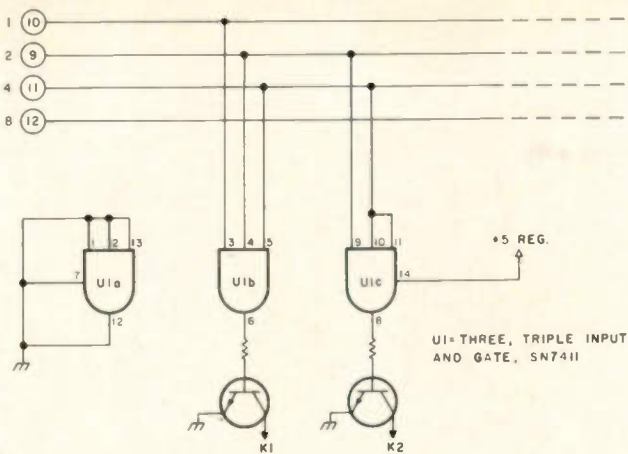

Fig. 3. Alternate logic circuit for perfectionists.

For what it's worth, I might add that the scanner's BCD outputs are TTL compatible only. CMOS gates would not trigger in this circuit. Otherwise, the parts are not critical at all.

It is uncanny to see the scanner doing the offset switching chores automatically every time the rig's MHz readout changes back and forth between 146 and 147.

This mod also works when the scanner is switched from PROGRAM to 1 MHz. Now the rig is controlling the auto-offset switching when the scanner is on.

First, the scanner searches and finds, and you latch it to a desired repeater. All you have to do now is squeeze the PTT and fire away. Your eyes stay on the road, without further wear and tear on your

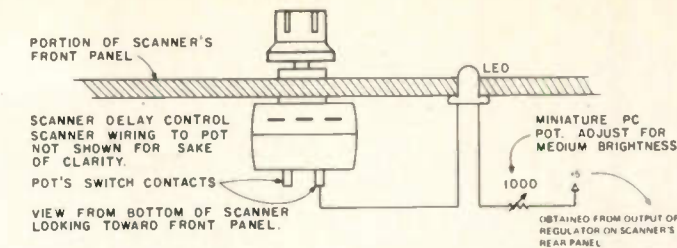

Fig. 4. Scanner OFF-ON indicator. Recommended LED: Radio Shack subminiature LED (276-042). Its ratings are 1.6 V at 20 mA. Actual size and ratings aren't important; what is necessary is that the LED you choose must have an opaque lens so that it can be viewed from any angle and also illuminate the SCAN-HOLD switch.

fingertips and repeater offset switch.

Another Modification

Quite a few delighted owners of this scanner have expressed the desirability of seeing, at a glance, whether or not the scanner is controlling the rig's frequency. Here it is in Fig. 4, with all the electrical details.

I drilled a 1/8-inch hole in the front panel about 3/8 of an inch to the left of the

SCAN-HOLD switch and inserted the tiny LED from behind. A micro-drop of Super Glue™ holds it in place. Contact cement also works well. Now, day or night, I can easily see when the scanner is ON. The tiny LED also illuminates the SCAN-HOLD switch in the dark. Handy, eh?

All inquiries sent with a self-addressed stamped envelope will be gladly answered. ■

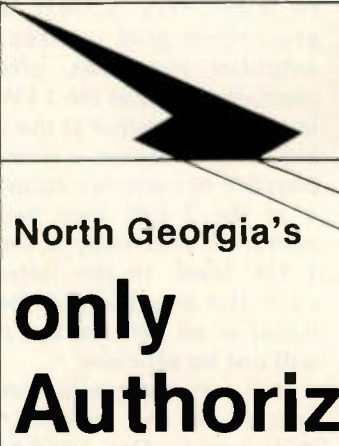

BRITT'S

2-Way Radio Service B29

2508 North Atlanta Road
Belmont Hills Center
Smyrna,
Georgia 30080
Phone (404) 432-8006

North Georgia's

only Authorized Yaesu Dealer

Yaesu	Kenwood
Mosley Antenna	Vibroplex keys
Cush-Craft	B & W
Rohn-Tower	Swan meters
C.D.E. Rotors	Hustler
Shure	United Clocks and tuners
Call Books	ARRL Books
M F J	Saxton

TPL 2 Meter Amplifiers
Complete service facilities

Call toll free 1-800-241-9961

Stop overfeeding your antennas.



only
\$29.95

Kantronics Sky Switch antenna isolator

RG-58/U costs too much to use more than you need!

Kantronics Sky Switch antenna Isolator can save you enough in RG-58/U alone to pay for itself*. With a **Sky Switch** mounted on your antenna tower, **you can bring your HF and 2 meter antennas in on the same feedline!** No special relays or control wires are needed, the **Sky Switch** chooses the proper antenna for you.

This means less coax, less wire hanging around, less cash outlay and less headaches for you! **Put your antennas on a diet, order a Sky Switch today.**

*Assuming you use a 40 foot tower, 20 feet from your station, and coax at \$.50 a foot.

K13 **KANTRONICS**
The Lightweight Champs.

1202 East 23rd Street
Lawrence, Kansas 66044
We accept Visa, MasterCard, check and money orders. Phone: 913-842-7785

Tweaking Your Linear

— the right way to tune it

A. J. Massa W5VSR
Box 6075
New Orleans LA 70114

Did you know that many manufacturers' recommended tune-up procedures for grounded-grid linear amplifiers are misleading and, if followed to the letter, may cause your potentially "linear" amplifier to be not linear at all? The types of grounded-grid linear amplifiers which I refer to are the Heath SB-200 and SB-220, Dentron 160-10L, Yaesu FL-2100B, Drake L-4B, Collins 30L-1, Henry, Swan, etc., as well as some of the older Hunter Bandits, Tempos, and Hammarlunds. I have either owned or had experience with all of these, plus a few home-brew amplifiers.

To illustrate my point, I will use the Heath SB-220 as an example of a typical modern Class B grounded-grid amplifier. It is probably the best value in amplifiers on the market

today, and it is capable of all the power the law will allow (and then some). It is efficient and relatively "clean" when tuned and operated correctly.

The important specifications of the SB-220 are as follows:

- Driving power required—100 Watts

- Maximum power input—SSB: 2000 Watts PEP; CW: 1000 Watts; RTTY: 1000 Watts

- Duty cycle—SSB: continuous voice modulation; CW: continuous (maximum key-down 10 minutes); RTTY: 50% (maximum transmit time 10 minutes)

Although output power is not specified by Heath, it can be expected to approximate 1200 Watts PEP SSB and 600 Watts CW-RTTY when correctly adjusted for maximum legal power input for those respective modes. These are reasonable expectations for commercially-built grounded-grid linear amplifiers, as well as many described in the *Radio*

Handbook (Editors and Engineers) and *The Radio Amateur's Handbook* (ARRL).

Caution! Heath's specifications look innocent enough, but they may be misleading already. "Driving power required— 100 Watts." Add "maximum." "Maximum power input—SSB: 2000 Watts PEP; CW: 1000 Watts; RTTY: 1000 Watts." Add "PEP" after "CW: 1000 Watts" and after "RTTY: 1000 Watts." You see, PEP and key-down CW or RTTY are the very same. That is, the peak envelope power of a kilowatt CW signal is 1000 Watts. Isn't it logical then that 2 kW PEP SSB should be the same as 2 kW key-down CW? It is logical, and it is correct.

A very useful feature of the SB-220 is a front panel switch marked "CW-Tune/SSB." It permits the selection of either 3000 V dc (for high power SSB) or 2000 V dc (for CW, RTTY, lower-than-maximum power SSB and initial tune-up), ensuring optimum plate load im-

pedance and efficiency for the two power levels, 2 kW and 1 kW. It is impossible to correctly adjust a grounded-grid linear amplifier for clean, efficient operation at the 1 kW level and operate it at the 2 kW level. Likewise, it is impossible to correctly adjust it at the 2 kW level and operate it efficiently at the 1 kW level. In the latter case, the amplifier will be linear as all get out, but it will not be efficient.

In a very comprehensive article on this subject,* William I. Orr W6SAI (Manager, Amateur Service Division of EIMAC) said, "To achieve 2000 Watts PEP input (usually assumed to equal 1000 Watts under voice conditions), the amplifier *must be tuned* and loaded at the 2000 Watt level, unless some rather sophisticated test equipment is at hand." I really don't know what

*Orr, William I. W6SAI, "A Grounded-Grid Two-Kilowatt PEP Amplifier," *Ham Radio*, February, 1969.

sophisticated test equipment Bill referred to, but I can think of one manufacturer's amplifiers which can be properly tuned and loaded at an input level lower than maximum rated power. Those are the Collins 30L-1 and 30S-1. They incorporate a simple, inexpensive, and effective comparator circuit which allows proper adjustment of the amplifiers at about one-fifth maximum power level. I don't understand why other manufacturers don't put this same feature in their amplifiers. If you want to add it to yours, it is described in *Amateur Single Sideband* (originally published by Collins Radio Company, now available from the Ham Radio Publishing Group, Greenville, NH 03048).

Look now at Heath's specification, "Driving power required—100 Watts." There it is, plain as day, 100 Watts. If only Heath had added "maximum," some of us wouldn't find ourselves driving a nail with a sledgehammer—trying to jam 200 Watts, 335 Watts, or (ugh!) 470 Watts into an amplifier which requires only one hundred Watts of rf to drive it actually past the legal limit. The 200, 335, and 470 Watts figures are what you can expect to come out of exciters like the Drake TR-4, Swan 500, and Swan 700, respectively.

If the amplifier requires only 100 Watts of drive, what do you suppose happens to the extra hundred to four hundred Watts? I've heard that it's passed through to the antenna. I really don't think so. What I think happens is that it simply overdrives the amplifier, beyond its legal limits, and quite likely causes an excessively broad, distorted signal—"flattopping," if you will.

"But you can always turn down the microphone

gain on these super-power exciters and keep from overdriving them," you say. "Nay, Nay!" say I, especially if you want to maintain an optimum peak/average power ratio and take advantage of the benefits of your exciter's ALC feature. By turning down the microphone gain to the point where you will not exceed 100 Watts PEP output, you will never reach the power level in your exciter where ALC begins to control peaks. You might as well turn off the amplifier and talk the exciter up to its rated limit. Your signal will be louder.

Another disadvantage of the turn-the-mike-gain-down technique is that the carrier suppression and noise figures of the exciter will deteriorate.

Heath's instructions say, "Tune your exciter for full CW output at the desired frequency," nothing more. If full CW output is between 90 and 120 Watts, more or less, you're in good shape. You're in good shape, too, if full output as indicated on an output meter coincides with the dip in plate current. If it doesn't, tune the exciter for maximum output instead of plate current dip (really, you should neutralize those final tubes). What Heath doesn't say is that if full output from your exciter is much in excess of about 120 Watts—200 Watts or more, for example—you run a good chance of overdriving the amplifier, running illegal power, flattopping, distorting, having an unnecessarily broad signal, shortening the life of those expensive power triodes, splattering, generating excessive harmonics, and maybe even being cited by the FCC for at least one of the above violations. Horrors! The least the manual could have said is that if your exciter puts out much more than the required 100

Watts, you should swamp down the output with a suitable attenuator network.

Don't get the idea that I'm picking on Heath and the SB-220 exclusively. I like the SB-220. I have one and therefore am most familiar with it. I realize that Heath expects us hams to have enough good sense and expertise to use their instructions as a general guide, and not as the "final" word. But a lot of us do sometimes follow instructions to the letter. And I realize that Heath used to produce an excellent station accessory, the SB-610 monitor scope (with two-tone generator). I know that every ham who uses a kW or multi-kW amplifier should have and use a monitor scope, but Heath's has gotten so expensive, and they left out the two-tone generator. By the way, don't be surprised if, within the next year, another relatively inexpensive scope/2-tone generator hits the market at less than \$100.

I have operated, or at least read the manuals for, the following manufacturers' linear amplifiers—Collins, DenTron, Drake, Heath, Henry, Hunter, Swan, and Tempo—and all are capable of being improperly adjusted if the manuals are followed to the letter. This is understandable, as it would be practically impossible for each manufacturer to give exact instructions for proper operation of its amplifier with every possible exciter/amplifier combination. Also, some exciters are simply incompatible with most commercial amplifiers; they are just too powerful to drive amplifiers which require only 100 Watts drive or less.

So, what is there to do? Read the manual for your amplifier thoroughly and follow these tips. I'm sure

that your amplifier, operators on adjacent frequencies, and those on your frequency who are trying to understand what you are saying will appreciate it.

1. Use an exciter that is power-compatible with your amplifier. If you already have a super-power exciter, ask the amplifier manufacturer to provide you with the circuit for a suitable swamp-ing network.

2. Tune up your amplifier to the power level at which you will operate it. If you have a 1 kW PEP amplifier, tune it for 1 kW key-down. If you have a 2 kW PEP amplifier, tune it for 2 kW key-down.

3. Don't try to see how high you can make the meters fly on voice peaks. The right plate current meter peak is usually about one-half of maximum current with key-down. Higher peaks don't mean stronger signals, just more distortion and splatter.

4. Get, and use, a scope to monitor your transmitted signal, preferably one which will display a trapezoidal pattern. Even an ordinary bench scope will do, but "Christmas Trees" are harder to interpret for linearity than are trapezoids.

5. Practice tuning your exciter and amplifier using a dummy load, so that the final finishing touches on the air will take but a few seconds. And remember that unless your antenna shows vswr of 1:1 and the input to your amplifier shows vswr of 1:1, finishing touches of amplifier and exciter adjustments (key-down) should be made.

6. Limit key-down time to 10 seconds or less. If you don't think that 10 seconds is a long time, hold your breath for 10 seconds.

May your expensive PA tubes and plate transformers last forever! ■

CB to 10

—part XII: convert a Kraco PLL rig

When a CB transceiver gets down to \$20 or \$30, it's time to consider buying one for use on 10 meters. Like many others, I did just that. After looking over the many rigs available in the \$30 class, I decided to tackle the Kraco Model KCB-2310B. The main reason for selecting this rig was its phase locked loop synthesizer, especially since most of the conversion articles I had been reading usually advised the reader to stay away from rigs with PLL because of the complexity of the conversion. To a certain extent, those articles are correct.

In any event, once I had purchased the rig, I set out to learn as much about phase locked loop circuitry as possible. Not having had much need for this information before, I was extremely ignorant in this area. I am most grateful to George R. Allen W1HCI for his excellent article, "Synthesize Yourself," in the October, 1977, issue of *73 Magazine*. This allowed me to familiarize myself with the basic operation of the PLL circuit and understand its operation.

When I began looking at the schematic diagram of the unit, one thing became immediately apparent. I wasn't going to learn much by looking at it, and, besides that, it was too small. So I trotted down to my neighborhood electronics parts distributor

and purchased *SAMS Photo-fact CB-153*, November, 1977. Although this does not have the Kraco Model KCB-2310B, it does have the 2320B, which is identical except for a Delta-Tune selector.

After many days of examining the new schematic and block diagram of the circuit, I began wondering if I had bitten off more than I could chew in attempting this conversion. I just couldn't make heads or tails of what was happening inside the PLL chip, an NPC 7624 (ECG 1167 is listed as a substitute). Endless on-the-air conversations failed to enlighten me very much more. I am, however, grateful to WB5HVV and many others for their many suggestions and comments.

Finally, when things began to look their blackest as far as the conversion was concerned, I saw a little light on the horizon. While browsing in a local Radio Shack, I came across the National Semiconductor *CMOS Databook*, and in it was a circuit for a CB transceiver PLL. After examining the application data for their MM55114 chip, I concluded that this chip and circuit description looked very similar in appearance to the one in my Kraco.

The Kraco, like the circuit in the *Databook*, uses a 3-crystal setup. It uses a 10.240-MHz crystal for the reference oscillator, a

10.695-MHz transmit mixer, and a 11.8066-MHz offset generator. For our purposes, we can forget the first two crystals and concentrate on the third. This 11.8066-MHz oscillator is the key to the circuit's conversion.

The frequency range for the conversion I selected was that recommended by the 10-10 International, Inc., in its *Fall Bulletin*. The frequency to be covered by AM rigs is from 28.760 through 29.050 MHz. Simply put, replacement of the 11.8066-MHz crystal with a 12.4047-MHz crystal and realignment of the transmitter and receiver, plus the synthesizer's vco (voltage-controlled oscillator) output circuit, will be all that is necessary to put your Kraco 2310B or 20B on ten meters.

For those of you who are interested in the "how it works" aspect of the PLL, I will cover that in greater detail at the end of the conversion.

The frequency-determining factor for the circuit is the 37-MHz output from the unit's vco. In normal 11 meter operation, this output is heterodyned against a 10.695-MHz transmit crystal for output on 27 MHz. The vco output is from 37.6592 MHz for channel 1 through 37.9492 MHz for channel 23. It is our intent to raise the output of the vco by 1.795 MHz. This will raise the vco to 39.4542 through 39.7442 MHz. This, in turn,

gives us coverage from 28.760 to 29.050 MHz.

Although a frequency counter would be a definite plus, the station receiver, transmitter, dummy load, VTVM, and rf probe were all that was really required in the way of test equipment. My Drake TR-3, keyed into a dummy load, was used for realignment of the Kraco receiver. The Drake's receiver section was used to align the synthesizer upon completion of the conversion.

The first step in the conversion is to apply power to the CB transceiver, turn to channel one, and check test point #8 (one side of R-113) for 1.5 volts dc. A switch of the channel selector to channel 23 should change the voltage to about 2.7 volts. Switching to the blank position on the channel selector will cause the voltage to change to approximately 5 volts. It is important to observe that these voltages vary as you change from channel 1 to channel 23 and that this voltage is the controlling voltage for the vco. We will come back to this test point in a moment.

The next step is to replace crystal X101 (the 11.8066-MHz crystal) with a 12.4047-MHz crystal. This is an HC-18/U crystal holder and the tolerance is ± 0.01 percent. Once the crystal has been installed, you will observe that the dc voltage at TP #8 jumps to 5 volts, regardless of the position of

the channel selector. Turn the rig again to channel 1 and adjust vco-output transformer T-101 until the voltage begins to drop. Generally, this requires turning the slug in a clockwise direction. Continue adjusting this slug until you read 1.5 volts at TP #8. This indicates the vco is functioning correctly, and rotation of the channel selector will again indicate a gradual increase. This nearly completes the vco alignment. Attach an rf probe to TP #3 and adjust T-111 for maximum. If the output is too low to measure here, attach the probe to the collector of Q-108 and again adjust T-111 for maximum. This completes the vco alignment.

Having completed the synthesizer adjustments, we now turn to the receiver. With a signal generator (or in my case, my Drake transceiver), provide a receive signal at approximately 28.9 MHz. I loaded my Drake into a dummy load (lightly) and

adjusted T-104 and T-105 for maximum S-meter reading on the Kraco. This required a couple of turns and completes the receiver alignment.

With a dummy load connected to the Kraco, attach the rf probe to the collector of Q-110 (xmit mixer) and adjust L-103 and L-104 for maximum rf out. Move the probe to the base of Q-111 (xmit buffer) and adjust T-102 for maximum. Again check and adjust L-103 and L-104 with the probe still connected to the base of Q-111. Next, attach the probe to the collector of Q-111 and adjust T-103 for maximum. By this time, you should have enough rf to see output on your power or wattmeter. With the probe at the antenna connector, adjust L-106, L-109, and L-110 for maximum output. On my rig, it was about 4½ Watts.

Turn the channel selector to channel 4. With the station receiver tuned and calibrated to 28.8 MHz, key the Kraco

into a dummy load and adjust CT-101 until the output of the rig is exactly 28.8 MHz. I found the rig to be within 2 kHz prior to this adjustment. This completes the conversion.

For those of you who are wondering how the Kraco's synthesizer works, let me say this. First of all, I am not an electronics engineer and I may not be totally accurate in my description of what is going on internally within the PLL chip, but I feature it to be happening like this: The 10.240-MHz output from the reference oscillator is internally divided by a 1024 oscillator/divider which outputs a 10 kHz signal to the frequency detector. This, by the way, establishes the 10-kHz spacing for the vco. The vco is being controlled by the frequency detector. Its output is approximately 39.455 MHz. This signal is mixed with the output of our 12.4047-MHz oscillator's third harmonic of 37.215

MHz (rounded off for convenience). The resultant 2.240-MHz signal is fed to the PLL's programmable divider (divide by 224 through 250), where in this case it is divided by 224. This 10-kHz output is also fed to the frequency detector causing the vco to lock on 39.455 MHz. The channel selector changes the programmable divider, and changing it to a new channel will cause the signal fed to the frequency detector to be more or less than 10 kHz. This will vary the vco output until the input signals again match, and a new locked condition is met. For more information, I refer you to page 4-25 of the *CMOS Databook* by National Semiconductor.

I hope this information is of some use to anyone considering converting their Kraco to ten meters. I know I had a lot of difficulty finding information about such conversions. The majority of information was garnered from *73 Magazine*. ■

DEALER DIRECTORY

Fontana CA

We carry the following: ICOM, Midland, Amcom, DenTron, KLM, Swan, Drake, Ten-Tec, Wilson, SST, MFJ, Hy-Gain, Lunar, Nye-Viking, B&W, Redi-kilowatt, Cush Craft, Mosley, Big Signal, Pipo, etc. Full Service Store **Fontana Electronics, 8628 Sierra Ave., Fontana CA 92335, 822-7710.**

Sacramento CA

Largest amateur radio selection in the Sacramento Valley. To serve you, Gary W6NJU, Dennis WB6ISO, Dan WB6RVU and Mike WA6DPN. Mon-Fri 10-6, Sat 10-5. **The Radio Place, 2964 Freepoint Blvd., Sacramento CA 95818, 441-7388.**

Santa Clara CA

Bay area's newest Amateur Radio store. New & used Amateur Radio sales & service. We feature Kenwood, ICOM, Wilson, Yaesu, Atlas, Ten-Tec & many more. **Shaver Radio, 3550 Lochinvar Avenue, Santa Clara CA 95051, 247-4220.**

Colorado Springs CO

Finest selection of amateur equipment, antennas, & accessories in southern Colorado, including Tempo, Wilson, Cush Craft, Newtronics, KDK, Amphenol, Astatic, Alliance, Ham Key, & Nye. **A.E.S. Communications, 404 Arrawanna St., Colorado Springs CO 80909, 475-7050.**

Tell them you saw
their name in 73

New Castle DE

Paul WA3QPX, Rob WA3QLS—Serving amateurs in southern New Jersey, Delaware, and Maryland with the largest stock of amateur equipment and accessories in Delaware. **Delaware Amateur Supply, 71 Meadow Road, New Castle DE 19720, 328-7728.**

Bloomington IL

Retail—wholesale distributor for Rohm Towers—antennas by Cush Craft, Antenna Specialists, KLM, Wilson, Hy-Gain. Transceivers by Tempo, Regency, Wilson, Amcom. Also business and marine radios. **Hill Radio, 2503 G.E. Rd., Bloomington IL 61701, 663-2141.**

Terre Haute IN

Your ham headquarters located in the heart of the midwest. **Hoosier Electronics, Inc., 43B Meadows Shopping Center, P.O. Box 2001, Terre Haute IN 47802, 238-1456.**

Wichita KS

Microwave Modules—KLM—KDK—ICOM—Kenwood—Wilson—Standard—ICIR—SWAN—Lunar. We STOCK The Best Communications. **Revcom Electronics, 6247 N. Hydraulic, Wichita KS 67219, 744-1083.**

Dalton MA

Western Massachusetts. Complete 2 meter FM headquarters. Yaesu, KDK, Regency, Larsen, Cush Craft. All kinds of ham gear. **Blue Max Inc., Box 97, Dalton MA 01226, 684-0039.**

Littleton MA

The ham store of N.E. you can rely on. Kenwood, ICOM, Wilson, Yaesu, DenTron, KLM amps, B&W switches & wattmeters, Whistler radar detectors, Bearcat, Regency, antennas by Larsen, Wilson, Hustler, GAM. **TEL-COM Inc. Communications & Electronics, 675 Great Rd. Rt. 119, Littleton MA 01460, 486-3040.**

Laurel MD

We stock Drake, Ten-Tec, Wilson, ICOM, DenTron, Tempo, Hy-Gain, Midland, Mosley, Hustler. 40-page ham catalog available for \$1.00 (refundable with 1st purchase)—write for cash quote! **The Comm Center, Inc., Laurel Plaza, Rte. 198, Laurel MD 20810, 792-0600.**

Camden NJ

X-Band (& other frequencies) Microwave Components & Equipment. Laboratory Grade Test Instruments, Power Supplies, 1000's in stock at all times, BUY & SELL all popular makes—HP, GR, FXR, ESI, Sorensen, Singer, etc. **Electronic Research Labs, 1423 Ferry Ave., Camden NJ 08104, 541-4200.**

Syracuse NY

We Deal, We Trade, We Discount, We Please! Yaesu, Kenwood, Drake, ICOM, Ten-Tec, Swan, DenTron, Midland, Cush Craft, KLM, Hy-Gain, etc. Complete 2-way service shop! **Ham-bone Radio (div. Stereo Repair Shop) 3206 Erie Blvd. East, Syracuse NY 13214, 446-2266.**

Syracuse-Rome-Utica NY

Featuring: Yaesu, ICOM, Drake, Atlas, DenTron, Ten-Tec, Swan, Tempo, KLM, Hy-Gain, Mosley, Wilson, Larsen, Midland Southwest Technical Products. You won't be disappointed with equipment/service. **Radio World, Oneida County Airport-Terminal Building, Oriskany NY 13424, 337-2622.**

Souderton PA

Tired of looking at ads ??? Come and try our new and used equipment yourself—personal advice from our staff's 60 years combined ham experience. **Electronic Exchange, 136 N. Main St., Souderton PA 18964, 723-1200.**

Port Angeles WA

Mobile RFI shielding for elimination of ignition and alternator noises. Bonding straps. Components for "do-it-yourself" projects. Plenty of free advice. **Estes Engineering, 930 Marine Drive, Port Angeles WA 98362, 457-0904.**

DEALERS

Your company name and message can contain as many as 25 words for as little as \$150 yearly (prepaid), or \$15 per month (prepaid quarterly). No mention of mail order business or area code permitted. Directory text and payment must reach us 45 days in advance of publication. For example, advertising for the November issue must be in our hands by September 18th. Mail to 73 Magazine, Peterborough NH 03458, ATTN: Aline Coutu.

Tuned Circuits In Your Junk Box

—making do with what's on hand

Reading the mail can be fun, bring back memories, and also provide the impetus to put some thoughts down on paper. This is the result of a conversation overheard recently on two meters. The point in discussion was what to do if you want to duplicate a piece of gear that requires tuned circuits and your available parts do not match up with the parts list.

The two groups of values in Table 1 will provide a kickoff point.

What is shown by the two groups of values points to the ease of scaling LC values so that you can produce a tank that will tune to the frequency of your choosing. The fundamental rule if you want to keep the same frequency of a given tank but change the relative LC values to fit what is on hand is shown by

the middle line of each example. That is, if you multiply one value of the tank by a given factor and divide the other tank value by the *same* factor, then the resultant tank will tune to the same frequency as that of the original tank circuit.

Another thing that becomes painfully obvious from the above example is just how powerful an animal the picofarad can be if unrealistic values are chosen.

It is obvious, if you wanted to design a six meter LC circuit, that the figures in example B would be much easier to handle in terms of tuning rates, not to say ideally, but much closer to the ball park than the values in A (even though the median values in both groups tune to the same frequency).

A further use for the concept of scaling would be

handy if we had used the median values in example B for six meter work and wanted to scale these values upward to provide a starting point for a two meter tank circuit. Since we realize that values at 144 MHz are going to be substantially smaller than at 50 MHz, let us start with the median values in example A (1 uH and 10 pF).

All we have to do is take a ratio of the new frequency to the old frequency. We divide 144 by 50.329, which gives us approximately 2.861. We then divide the LC values of the six meter tank by this ratio and our tank now tunes to 144 MHz. The resultant values are 0.350 uH and 3.5 pF.

Here again a correction is called for in order to get the C value up to a readily obtainable component. Once again we can scale our components in the direction desired. Let us arbitrarily pick a scaling factor of four and multiply the C value by this factor. Then, in order to keep the frequency of the tank where we want it, we must divide the L value by the same factor.

The new values are

approximately 14 pF and 0.88 uH, which are values that we can find in the average junk box or flea market sale.

While we are still up on two meters, it is once more interesting to note the power of the picofarad. If you put this tank into a home brew super-regen, you would hit the band all right, but a change of *one* picofarad would swing the tank frequency from 144 MHz all the way up to 149.35 MHz. This makes a very convincing case for the good vernier dial and the bandset/bandspread method of tuning any piece of VHF gear.

If we drop down into the low frequency bands, life becomes a bit simpler. Perhaps the commonest scaling question here is what tuning range can be expected from a 100 pF tuning condenser when it is hooked up with an inductance of about 20 uH. A bit of calculation will show the above tank to hit in the area of 3500 kHz. The answer here is found in the fact that the tuning range varies as the square root of the tuning capacity. Thus, if your capacitor is 10 pF

A	uH	pF	Frequency MHz
	1	9	53.052
	1	10	50.329
	1	11	47.987
B	uH	pF	Frequency MHz
	0.1	99	50.583
	0.1	100	50.329
	0.1	101	50.079

Table 1.

minimum and 100 pF maximum and you neglect stray circuit capacities, your ratio of maximum to minimum capacity is 10 and the square root of 10 is 3.16. This means that your tuning range would be 3500 kHz times this factor, 3.16, or 11.06 MHz. Thus, your tank would tune from about 3500 kHz to about 11,000 kHz (11 MHz).

The 20 uH inductance value can be calculated according to the usual formula or, once again, we can

illustrate another use of scaling from known data.

Notice in the median values in example B that a value of tuning capacity of 100 pF is specified, which is the same value we had on hand to construct our low frequency tank. We can scale the inductance information needed as follows.

First we make a ratio of the frequency of the known tank divided by the frequency of the desired tank. This would appear as 50.329

over 3.5. Always make sure in setting up your ratios that you do not mix MHz with kHz or the results will be less than desired due to decimalitis. The ratio in this case is approximately 14.38. This ratio factor is then squared and multiplied by the original inductance values. 14.38 squared is about 206, which, when multiplied by the original L value of 0.1 uH, gives you your new value of about 20 uH.

These little scaling kinks

can make life a lot easier if your data on hand does not fit the frequency of immediate interest. You can manipulate known good LC data all over the lot very easily. The two words "about" and "approximately" are used to denote that calculator answers with eight places to the right of the decimal point were rounded off as they serve no real purpose in our little corner of the world. That's what trimmers are for! ■

DX

from page 18

Walvis Bay

The United Nations Security Council has recommended that Walvis Bay be made part of independent Namibia, formerly Southwest Africa (ZS3), but left the final decision to be worked out between Namibia and South Africa. South Africa refuses to give up control of Walvis Bay and compares the situation to asking the U.S. to give up Alaska because it is closer to Canada than to the U.S. Work them when you hear them, but don't expect any decision on the DXCC status of Walvis Bay un-

til after WARC 79. The same goes for S8 and H5.

QSL INFORMATION

C31MJ to EA3MS
C31MK to EA3WZ
C31MS to EA3MS
D68AF to K5YY
DA1GR/OH0 to Box 395, APO New York 09611
F0CH/FC to HB9TL
F0ALZ/FH0 to K5YY
FB8ZM (see text)
FH8CY to Box 50, Island of Mayotte, Comoro Islands
ID9ON to I3ON
JD1YAK to JA1KSO
KM6BI (see text)
OH6DX to OH8RC
PY0RO to George Hintz, 37

Easy Street, Sudbury MA 01776

SL1FRO to SM5AHK
TF6M to Box 1058, Reykjavik, Iceland
TZ6ET to DL7SS
VE3FXT/S8/H5/etc., to George Colins, PO Box 431, Cambridge, Ontario, Canada
VK9YS to F6CYL
VP2EEK to KP4KK
VP2LBH (see text)
VP2LFL to WB8ZRV
VP2VEN to K5GOE
Y11BDG (see text)
ZE8JJ to K9UIY
ZK2AP to W0JRN
ZK2TT to Box 22572, Tel Aviv, Israel
3B6DA to 3B8DA
3B8YY to K5YY
5W1BN to KH6JEB
6O1FG to I2MPQ, Pietro Ambrosia, Via Stradella 13, 20129 Milano, Italy

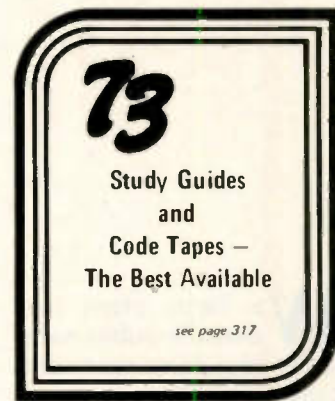

4X30CJ to 4X4CJ
9V1TE to W0TKJ

Thanks to the *West Coast DX Bulletin* for much of the above information.

Ham Help

My hearing loss is in the 1500 to 2000 cycle range (near my XYL's voice box). Sometimes it's a comedy routine watching me purchase an item, if the clerk asks a question or makes a recommendation. You can imagine my concern about getting on the airwaves with people who have a little different accent than ones I'm accustomed to. I've read in 73 and QST about a number of people with handicaps much, much more severe than mine. Although they are inspirational, these articles do not solve my particular problem.

How can you help? Well, let me give you an example. I bought an MFJ CWF2BX filter for my Kenwood 820S. It worked fine (cut out a lot of side noise), but I was forced to wear earphones all the time. This isn't good if it can be avoided by most people with some

hearing loss. MFJ accepted the CWF2BX (because it was new) on a trade, and I upgraded for a 721 which drives a speaker. Now I'm wondering what speaker will be right for my ears. As I progress in hamdom, I'm sure this will be a minor problem because I will understand more about reading the specifications of equipment and relating them to my particular problem. Not so, today—I'm green as Wayne is Green and need all the help I can get. The manufacturers and distributors know their products and, as widespread as the hearing problem is, must have many hard-of-hearing working for them. They could save themselves a lot of problems (returns and complaints) by offering a "blip" of some kind to the hard-of-hearing in their advertisements.

I've taken lip reading courses and seminars of all

kinds to stay up with the "norms." It ain't easy! The most pathetic part is to see some folks become recluses or shun unknown areas because of this minor defect. Does anyone have any suggestions to help me out?

Charlie Kline WD0DJP
1307 S. Lincoln
Longmont CO 80501

Our repeater group is interested in purchasing a G.R. Stephen Company Model 1A-220 linear amplifier.

Allen Communications, N.E., from Chester, Conn., used to handle this amp about 2 years ago, but now we can't seem to get ahold of anyone at Allen.

We also tried to get a phone number and/or address of the G.R. Stephen Company, but so far we haven't had any luck.

We would appreciate any info on either company so that we might be able to purchase this amplifier.

Dave Strickler WA3THB
323 S. 3rd Ave.
Lebanon PA 17042

Has anyone had experience in converting a Bendix Model 1V14CA or similar 2-way radio to amateur service? Any information would be appreciated.

Paul Combs AA4NL
PO Box 176
Langley KY 41645

I need the following back issues of 73 Magazine to complete my collection: January, March, April, August, 1976. I will pay the newsstand price plus postage, if they are in good condition. 73 is out of stock of these.

Thomas Cooper
PO Box 386
Temperance MI 48182

I just bought a used Heathkit SB-303 receiver and an SB-401 transmitter, and I would like to know if anyone knows about any articles published about this gear in the past seven years.

Tony Castaner KZ5TC
PO Box 834
Albrook AFS
Panama Canal Zone

Support Your Local Fire Chief

—hams and the safety services

We hams often feel that the public safety services don't ever need communications assistance from the ham fraternity because of the very sophisticated radio systems now in use by the fire and police departments. Not so, friends! For example, on September 17-18,

1977, the Meadowood County Area Fire Department in Fitzwilliam, N.H., hosted a fire training school for all of New England. Over 1400 fire fighters attended the two-day school, which was sponsored by the New Hampshire Association of Fire Chiefs. A number of

different locations were used, including the Meadowood Drill Yard and Fire Stations in Fitzwilliam, several buildings at Keene State College, and two other locations in Keene for pump courses. In all, 27 pieces of fire apparatus were deployed in the area.

As can be well imagined,

communications could be a real problem with such an elaborate program, in view of the fact that the fire frequencies had to be kept free for emergency traffic. To add to the problem, several pieces of fire apparatus were on frequencies not used in the local area, and were therefore unable to communicate with the local dispatch center or with other equipment.

WR1AHO, "The Keene Machine" (147.975-375), was used to coordinate the entire affair and to handle the non-emergency traffic, thereby freeing the fire frequencies for emergency traffic. K1XR, WA1UNN, and W1FYR were deployed in the area with base stations and portables. The repeater coverage was excellent, with all course sites easily covered with handie-talkies, even though the locations were some 15 miles apart.

The Keene Machine is located on Hyland Hill on the border of Keene and Westmoreland, at approximately a 1500' elevation. The machine runs about 65 Watts to a 5.2 dB gain



Alan W1FYR on an HT with an oil pit fire burning in the background.

YOUR BEST BUYS IN KITS & FREQUENCY COUNTERS

6 GOOD REASONS FOR BUYING A HAL-TRONIX FREQUENCY COUNTER

(1) 100% COMPLETE KIT. (2) EASY ASSEMBLY. (3) COMPLETELY ENCLOSED IN METAL CABINET. (4) IC SOCKETS USED THROUGHOUT FOR EASY TTL REPLACEMENT. (5) EASY ON YOUR POCKET BOOK, AND (6) NO EXPENSIVE CHIPS TO REPLACE (EXAMPLE—IF YOU LOSE A DECODER, LATCH OR DRIVE IN A HAL-TRONIX COUNTER, THE AVERAGE COST OF REPLACEMENT OF THE LOW-COST TTLS IS LESS THAN \$1.00 EXCLUDING THE PRE-SCALE CHIP. IN SOME OF THE NEWER COUNTERS NOW BEING MARKETED BY MY COMPETITION, THEY ARE USING THE EXOTIC SINGLE CHIP AND WOULD COST YOU CLOSE TO \$30.00 TO REPLACE). THIS IS SOMETHING YOU SHOULD CONSIDER.

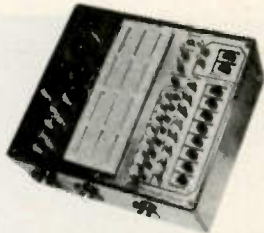

ANALOG-DIGILAB KIT \$139.50

DESIGNED BY HAL-TRONIX AND MIKE GOLDEN OF R.E.T.S. ELECTRONICS SCHOOL OF DETROIT. FOR SUGGESTED CLASSROOM USE.

FOR THE RADIO AMATEUR, STUDENT, EXPERIMENTER OR DESIGNER SPECIFICATIONS: OUTPUT VOLTAGES: +5V, +12V, -12V; USABLE CURRENT: 750mA; % Regulation at 500mA: 0.2%; Short-circuit limited at 1.0 amp; Thermal overload protected. Power requirements: 117VAC, 60HZ, 40 Watts. Function Generator: Frequency range: 1HZ to 100HZ in 5 bands. Amplitude adjustable from 0 to 10 VPP. DC offset adjustable from 0 to ± 10V. Waveforms: Sine, square, triangular and TTL Clock. TTL Clock 0 to +5V level, 200 ns rise and fall time. Frequency determined by Function Generator. Output Impedance 1.2K ohm.

Most of all, it's easy to construct and service. PC boards are predrilled, plated thru and solder flowed. Over 1000 units sold to schools.



FROM HAL-TRONIX FIRST TIME OFFER

SIX-DIGIT ALARM CLOCK KIT for home, camper, RV, or field-day use. Operates on 12-volt AC or DC, and has its own 60-Hz time base on the board. Complete with all electronic components and two-piece, pre-drilled PC boards. Board size 4" x 3". Complete with speaker and switches. If operated on DC, there is nothing more to buy.

PRICED AT \$16.95
Twelve-volt AC line cord for those who wish to operate the clock from 110-volt AC. \$2.50

*Fits clock case advertised below.

TOUCH TONE DECODER KIT

HIGHLY STABLE DECODER KIT. COMES WITH 2 SIDED, PLATED THRU AND SOLDER FLOWED G-10 PC BOARD, 7-567's, 2-7402, AND ALL ELECTRONIC COMPONENTS. BOARD MEASURES 3 1/2" x 5 1/2" INCHES. HAS 12 LINES OUT. ONLY \$39.95

6-DIGIT CLOCK • 12/24 HOUR

COMPLETE KIT CONSISTING OF 2 PC G10 PRE-DRILLED PC BOARDS, 1 CLOCK CHIP, 6 FND 359 READOUTS, 13 TRANSISTORS, 3 CAPS, 9 RESISTORS, 5 DIODES, 3 PUSH-BUTTON SWITCHES, POWER TRANSFORMER AND INSTRUCTIONS. DON'T BE FOOLED BY PARTIAL KITS WHERE YOU HAVE TO BUY EVERYTHING EXTRA.

PRICED AT \$12.95

CLOCK CASE Available and will fit any one of the above clocks. Regular Price ... \$6.50 But Only \$4.50 when bought with clock

60-HZ TIME BASE CRYSTAL TIME BASE KIT. WILL ENABLE MOST ALL DIGITAL CLOCKS TO OPERATE FROM 12 VDC. LOW PROFILE UNIT, EASY 3-WIRE HOOKUP. ACC 2PPM, ADJUSTABLE. COST ONLY \$5.95 EACH OR 2 FOR \$10.00—OR ONLY \$4.50 WITH CLOCK PURCHASE.

10-MHZ CRYSTALS HI-QUALITY CRYSTALS, DESIGNED FOR FREQUENCY CONTROL AND ELECTRONIC TIME PIECES. AGING FACTOR 5PPM. MEETS OR EXCEEDS MIL-C-3098 SPECS. MADE ESPECIALLY FOR HAL-TRONIX BY SENTRY. PRICE \$4.95 OR 2 FOR \$9.00

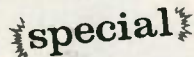

INTERSIL EVALUATION KIT

BUILD YOUR OWN D.V.M. or D.M.M. LOW COST DIGITAL PANEL METER DESIGN—KIT INCLUDES COMPLETE ASSEMBLY INSTRUCTIONS ALONG WITH A PREDRILLED P.C. BOARD, 4 LED READOUTS AND THE INTERSIL 7107 CHIP. ALONG WITH ALL REQUIRED ELECTRONIC PARTS TO COMPLETE KIT. ALL YOU NEED IS THE SUPPLY VOLTAGE. FEATURES FULL SCALE READING OF 200 MV OR 2.00V. HAS A CLOCK ON BOARD, WITH AUTO ZERO AND OVER RANGE FEATURES. \$19.95

ACCUKEYER (KIT) THIS ACCUKEYER IS A REVISED VERSION OF THE VERY POPULAR WB4VVF ACCUKEYER ORIGINALLY DESCRIBED BY JAMES GARRETT. IN QST MAGAZINE AND THE 1975 RADIO AMATEURS HANDBOOK. \$16.95

ACCUKEYER—MEMORY OPTION KIT THIS ACCUKEYER MEMORY KIT PROVIDES A SIMPLE, LOW COST METHOD OF ADDING MEMORY CAPABILITY TO THE WB4VVF ACCUKEYER. WHILE DESIGNED FOR DIRECT ATTACHMENT TO THE ABOVE ACCUKEYER, IT CAN ALSO BE ATTACHED TO ANY STANDARD ACCUKEYER BOARD WITH LITTLE DIFFICULTY. \$16.95

SHIPPING INFORMATION

ORDERS OVER \$15.00 WILL BE SHIPPED POSTPAID EXCEPT ON ITEMS WHERE ADDITIONAL CHARGES ARE REQUESTED. ON ORDERS LESS THAN \$15.00 PLEASE INCLUDE ADDITIONAL \$1.00 FOR HANDLING AND MAILING CHARGES. SEND SASE FOR FREE FLYER.

BY POPULAR DEMAND



— we are continuing to offer with any purchase of \$99 or more from ad or flyer, a Fairchild Clock Module FCS-8100A (suggested retail price of \$20).



look at these Summer Specials

COMPLETE KITS: CONSISTING OF EVERY ESSENTIAL PART NEEDED TO MAKE YOUR COUNTER COMPLETE. HAL-600A 7-DIGIT COUNTER WITH FREQUENCY RANGE OF ZERO TO 600 MHZ. FEATURES TWO INPUTS: ONE FOR LOW FREQUENCY AND ONE FOR HIGH FREQUENCY; AUTOMATIC ZERO SUPPRESSION. TIME BASE IS 1.0 SEC OR .1 SEC GATE WITH OPTIONAL 10 SEC GATE AVAILABLE. ACCURACY ± .001%, UTILIZES 10-MHZ CRYSTAL 5 PPM.

COMPLETE KIT ~~\$149~~ \$129

HAL-300A 7-DIGIT COUNTER WITH FREQUENCY RANGE OF ZERO TO 300 MHZ. FEATURES TWO INPUTS: ONE FOR LOW FREQUENCY AND ONE FOR HIGH FREQUENCY; AUTOMATIC ZERO SUPPRESSION. TIME BASE IS 1.0 SEC OR .1 SEC GATE WITH OPTIONAL 10 SEC GATE AVAILABLE. ACCURACY ± .001%, UTILIZES 10-MHZ CRYSTAL 5 PPM.

COMPLETE KIT ~~\$124~~ \$109

HAL-50A 8-DIGIT COUNTER WITH FREQUENCY RANGE OF ZERO TO 50 MHZ OR BETTER. AUTOMATIC DECIMAL POINT, ZERO SUPPRESSION UPON DEMAND. FEATURES TWO INPUTS: ONE FOR LOW FREQUENCY INPUT, AND ONE ON PANEL FOR USE WITH AN INTERNALLY MOUNTED HAL-TRONIX PRE-SCALER FOR WHICH PROVISIONS HAVE ALREADY BEEN MADE. 1.0 SEC AND .1 SEC TIME GATES. ACCURACY ± .001%. UTILIZES 10-MHZ CRYSTAL 5 PPM.

COMPLETE KIT ~~\$124~~ \$109

ATTENTION RADIO CLUBS For club or group projects, request FREE information about our DISCOUNTS on any of the HAL-TRONIX kits. Discounts range from 10-25%, depending upon the quantity needed. We are experienced in supplying kits in volume quantities to schools, laboratories, clubs, and common-interest groups. Nobody beats HAL-TRONIX quality and price. Just try us and see for yourself.



FROM HAL-TRONIX

DELUXE 12-BUTTON TOUCHTONE ENCODER KIT utilizing the new ICM 7206 chip. Provides both VISUAL AND AUDIO indications! Comes with its own two-tone anodized aluminum cabinet. Measures only 2 3/4" x 3 3/4". Complete with Touch-Tone pad, board, crystal, chip and all necessary components to finish the kit.

PRICED AT \$29.95

For those who wish to mount the encoder in a hand-held unit, the PC board measures only 9/16" x 1 3/4". This partial kit with PC board, crystal, chip and components.

PRE-SCALER KITS \$14.95

HAL 300 PRE \$19.95

(Pre-drilled G10 board and all components)

HAL 300 A/PRE \$24.95

(Same as above with preamp)

HAL 600 PRE \$34.95

(Pre-drilled G10 board and all components)

HAL 600 A/PRE \$39.95

(Same as above but with preamp)

SPECIAL OFFER—While they last

FND-70 Common cathode readouts direct replacement for the FND-359 same pin-out.

10 units (.40c) — 10/ 4.00

100 units (.35c) — 100/ 35.00

500 units (.30c) — 500/150.00

1000 units (.25c) — 1000/250.00



"HAL" HAROLD C. NOWLAND
WB8XH

HAL-TRONIX H24

P. O. BOX 1101
SOUTHGATE, MICH. 48195
PHONE (313) 285-1782

antenna on a 125' tower. The machine has emergency standby power and a commercial autopatch, which has been modified by WA1UNN to its present excellent condition. The autopatch allowed us to keep in touch with the local dispatch center, and with monitors on the local frequencies, the crew was able to coordinate all activities with almost no confusion or errors. The members of the New Hampshire Association of Fire Chiefs were unanimous in their praise for the excellent and very professional job done by the repeater and its crew.

Amateur repeater groups should explore this area of public service further if they have not already done so. There are many areas in public safety where a 2 meter repeater and a well-organized crew with handie-talkies can be of real and significant assistance to fire and police departments. CB has sometimes left a bad taste in the mouths of many public officials, so the amateurs may have to do a selling job to get a foot in the door. (Once in, though, let's not flub it!) Two meter repeaters are a natural for this type of public service, particularly if the machine has an autopatch and auxiliary power. In a disaster situation, this is obvious. Hopefully, the repeater group will set up some type of plan to first offer its services, and then to fill the need. It might also pay the group to explore the areas of need from a communications point of view. Not only can repeaters be used in a disaster, but also, as the Meadowood Fire School so aptly illustrated, they can be used on a fairly regular basis for other major "non-disaster" situations.

One area that should be explored in certain parts of

the county is "overload" on the fire (and perhaps police) frequencies. Chief Clayton Higgins of the Concord, New Hampshire, Fire Department related an instance where, because of a particular set of circumstances, 37 calls came into their central dispatch center within a 20-minute period, with, among other things, two 2-alarm brush fires. Not necessarily a disaster situation, but a real problem! Because of the tremendous overload, the fire frequencies were useless except for local truck-to-truck communications. What a natural for two meter repeaters! A few HTs at the right places (with a chief or other officer at some of the larger fire scenes) and an avenue of communication would be established between the central dispatch and the field.

Our own fire and police central dispatch covers all of Cheshire County, N.H., and parts of Vermont and Massachusetts. There are over 30 fire departments in this excellent system. The frequencies available to them are adequate for "normal" loads, but should there be a disaster or just a set of circumstances such as Concord experienced, it would severely overload the existing frequencies so that communications would be virtually impossible. We feel that the Keene Machine could be used as an alternate link for high priority "White Hat" (chiefs') traffic. It might just "save the day" some day!

Many groups of communities have a central dispatch system with a limited number of frequencies. Repeater groups should certainly explore the possibility of assisting when the existing frequencies are overloaded, and the same groups should make some plans to enable them to get into action

with the least amount of hassle.

We are needed, folks! We can be of real value if we sell ourselves and then are willing to follow through and do a professional job. The impact on the community from the

point of view of public relations is tremendous! Let's not miss the boat—we need all the goodwill we can get. Furthermore, it can be a lot of fun for the participants, as we all found out at Meadowood. ■



Pumpers at Meadowood (Bowker Pond) supplying water for the practical sessions.



Oil pit fire for extinguisher practice.

Because K6SSS loves DX, his neighbors sent him on a little expedition.



One neighbor sued him for interfering with Lawrence Welk. Another filed a complaint about that "monstrosity" in his backyard—a tribander at 40 feet.

7,781 tangled with the law

The K6SSS case is an example of what can happen to you these days. No matter where you live. It is hypothetical. But real lawsuits are being fought right now by people like K50VC, W2LTP, WB7NOM, W8NRM and W6UFJ/N6QQ to name a few. Last year nearly 8,000 unsuspecting hams and CB'ers ran afoul of the law. Sure, they're taking their fight to court—but they're losing! Never mind that they've got building permits for their towers. Or that the FCC says their rigs are "clean." Judges are ruling against them. The alarming part is that every suit lost makes it that much easier to nail the next guy. Prosecuting attorneys love to cite recent adverse decisions during a trial.

Legal ammunition available

The tragedy is that suits are being lost that could have been won. But TVI/RFI and tower cases fall into a little-known area of the law. Unless your lawyer is a specialist, he could spend hundreds of hours researching court decisions. And still not be sure he's put together the strongest defense possible. It's expensive (expect to spend an average \$4,000 to \$8,000 if you're sued). And risky. Which is why we formed the non-profit Personal Communications Foundation* To provide your lawyer with legal ammunition.

Who we are

We're a handful of ham lawyers, professors and judges (all volunteers) who wanted to help before it's too late. We're putting together the first research library of personal communications and zoning law. And having briefs written by the best legal brains. It's all available to your lawyer. For 10¢ a page. We can't guarantee you'll win. We can't try the case for you. But if you or your lawyer contacts us, we'll sure make sure you get a fighting chance.

(space donated by the publisher)

Give us a fighting chance

To be even more successful in future battles, we're building an arsenal of weapons to use in court. For example, we're commissioning a study by real estate experts on the effect of a backyard tower on neighborhood property values. The pricetag is a stiff \$11,000. But without the study, more cases will be lost. And more dangerous precedents will be set.

We are winning. But it takes money to keep fighting. You can help us fight by sending a check. The ARRL did. Think of us as your insurance policy against a lawsuit. All checks are 100% tax-deductible.

Please act today. We've already got a late start.

*Non-profit Cal. membership corp. #788-085

Kenneth S. Widelitz, WA6PPZ, President
Personal Communications Foundation*
Suite 1504
10960 Wilshire Blvd.
Los Angeles, CA 90024 (213) 478-1749

I want to give you a fighting chance. Enclosed is my 100% tax-deductible membership application.

- Life member \$250 Contributing member \$100
 Full member \$25 Associate member \$10

All members receive our free legal kit and newsletter.

name call

address

city state zip

PCF  Personal Communications Foundation
Defending the rights of hams

Improved Scanner for the VHF/One Plus

— a \$4.00 mod does it

The Tempo VHF/One Plus is a fine two meter FM rig. Synthesized from 144 to 148 MHz with 25 Watts power, it can be used on SSB with the SSB/One adapter. The one feature that decided it for me, though, was the built-in 1 MHz scanning feature. The One Plus has two buttons on the microphone that can single step the digitally displayed frequency 10 kHz per step, up or down. If the buttons are held down, the frequency changes at a rate of approximately 200 kHz per

second.

Since my One Plus scanned a little fast for me, I adjusted the 50k pot, R2, on the scan board to slow it down. I slowed it down even further by replacing C1 on the scan board with a 2 uF capacitor in place of the original 1 uF.

I still wasn't completely happy with the scan system, however. The scan unit must be turned off to use the two programmed or MARS channels. Also, when the scan function is turned off, it does not retain the

selected frequency when turned back on. I wanted to be able to use the local/remote switch to select between two channels, one selected by the front panel switches and the other selected by the scan circuitry.

The modification described below provides this feature. The programmed channels can also be used with either setting of the local/remote switch. Parts required are three 1N914 type diodes, a 2.2k ¼-Watt resistor, and a single SN74LS244 integrated circuit. The 244 contains eight non-inverting buffers with tristate outputs which are put into the third or open state to disable the scan function. Originally, the One Plus removed power from the scan circuits to disable them, thus also losing the selected channel.

Build the 74LS244 circuit per the schematic, Fig. 1(a). I built it on a small piece of .100 inch perfboard which fits in the area of CR1-8 on the scan board. Two-inch

jumper wires were connected to the buffer inputs and outputs, 5-inch jumpers to GND and Vcc, and 10-inch ones to the 1N914s.

Remove the four bolts that hold the scan board to the plate on which the speaker is mounted.

Remove diodes CR1 through CR8 on the scan board.

Connect the eight buffers of the 74LS244 in place of the diodes with the buffer inputs wired to the original diode anode connection points and the corresponding outputs wired to the original diode cathode points.

Connect Vcc and GND of the IC to the scan board +5 V and GND terminals.

Route the three wires connected to the 1N914 diodes up to the front panel area.

Connect one of these wires to the M1 bus on the main board and another to the M2 bus. These are the buses to which the anodes of the programming diodes are soldered.

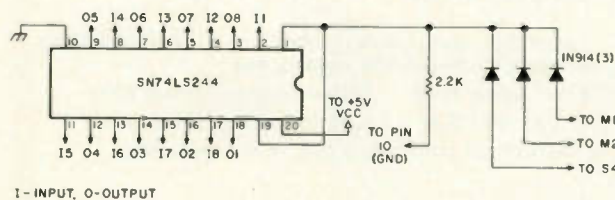

Fig. 1(a). SN74LS244 wiring. Connect all SN74LS244 inputs (I1 through I8) to the original anode connection points of CR1 through CR8 on the scan board. Connect the corresponding outputs (O1 through O8) to the original diode cathode connection points (closest to edge of scan board). Build on 0.6 x 1.4 inch .100 inch perfboard. The SN74LS244 is available from Tri-Tek, Inc., 7808 N. 27th Ave., Phoenix AZ 85021, for under \$3.00.

Remove the local/remote switch, S4. Remove the green and the white/green wires attached to the switch section located toward the center of the One Plus. Connect them together and solder both to the originally unused terminal on the same switch section.

Connect the third 1N914 wire to the now vacant center terminal of the switch. Connect the third

terminal to ground (I soldered it to the switch body).

Reinstall S4 and the scan board, making sure that the 74LS244 board and wiring are in such a position that you don't have to worry about shorting.

Believe me, it's not much harder to do than it is to describe. I'm really pleased with the operation of this modification in my VHF/One Plus. I can now

go off a fixed frequency, scan for a clear channel, return to the original frequency, and QSY to the selected channel very easily. Also, I can switch back and forth between repeater

inputs and outputs (or any other two frequencies) by just using the local/remote switch. If you have a VHF/One Plus, I'm sure you'll also find this modification worthwhile. ■

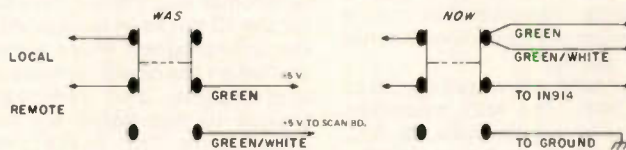

Fig. 1(b). Local/remote switch wiring changes.

New Products

from page 14

Order by mail, or call toll-free (800)-647-8660. *MFJ Enterprises, PO Box 494, Mississippi State MS 39762.*

Morgan W. Godwin W4WFL
Peterborough NH

ICOM IC-502 6 METER SSB PORTABLE TRANSCEIVER

To get reacquainted with 6 meters after being off the band for the past few years, I have recently gotten into the habit of keeping an Icom IC-502 portable SSB transceiver on the living room coffee table occasionally checking the band for activity during TV commercials, and, now and then, for longer periods when there have been interesting skip conditions. Over the past three weeks or so, I have heard several dozen stations in ten states ranging from Florida in the south to Missouri to the west, as well as three Canadian provinces and the Caribbean. All reception has been with the built-in telescoping whip antenna and while the rig has been sitting on the coffee table.

On transmit, the IC-502's three Watts PEP has produced excellent signal reports from several stations within a range of thirty to forty miles. Connected to a beam or even an outdoor dipole, the rig should be capable of producing plenty of DX contacts when the skip is in. CW operation is possible by simply plugging a key into the front panel jack and placing the mode switch in the CW-T position.

While designed as a portable rig, the IC-502's i-f noise blanker, RIT, S/Rf meter, VFO, CW capability, and other features make it an excellent choice for fixed-station opera-

tion as well. The unit is powered by nine C-cell batteries or an external 13.8 V dc source. For fixed-station operation, Icom's IC-3PS not only supplies power for the IC-502, but also doubles as a stand and holder for the IC-50L ten-Watt linear amplifier.

Frequency coverage of the IC-502 is 50 to 51 MHz and rf power output is 3 Watts PEP on USB and 3 Watts on CW. Controls and connections are tuning knob, RIT, mode switch, noise blanker switch, volume, function (power on/off, dial light), external speaker jack, key jack, mike connector, S/Rf meter, external antenna receptacle, external power supply jack, and mike hanger. There is an LED power indicator that shows when power is on and serves to indicate battery condition.

With its solid construction, compact size, and quasi-military appearance, the IC-502 makes an attractive, rugged, and handy unit for portable and mobile operation that also lends itself to fixed operation, particularly when used with the IC-3PS power supply and IC-50L linear amplifier.

The Icom IC-502 is priced at \$249.95. Distributed by *Icom West, Inc., Suite 3, 13256 Northrup Way, Bellevue WA 98005* and *Icom East, Inc., Suite 307, 3331 Towerwood Drive, Dallas TX 75234.*

Morgan W. Godwin W4WFL
Peterborough NH

HEATH ANNOUNCES NEW LOGIC PROBE FOR TTL AND CMOS TESTING

Heath Company, world's largest manufacturer of electronic kits, has released the IT-7410/ST-7410 logic probes which are designed for in-

circuit testing of TTL and CMOS integrated circuits. Features include switch selection of threshold levels for either TTL or CMOS circuitry and lamps that turn on when the input voltage crosses the appropriate level. A memory circuit is incorporated in the design of the unit to turn on an LED when either threshold level is crossed.

The manufacturer points out that the new probes provide true logic level detection at high frequencies (not ac coupled) and that it will detect pulses as short as 10 ns. Upper

frequency limits are 100 MHz (TTL or CMOS @ 5 V dc square wave) and 80 MHz (CMOS @ 15 V dc square wave). Power for the logic probe is drawn from the circuit under test via two spring-loaded insulated clips. A ground lead is provided for high frequency operation. Probe overload protection is 50 V dc continuous and 175 V dc for 5 seconds. The IT-7410 is the kit version while the ST-7410 is the assembled version. The two are otherwise identical.

For more information about the new logic probes, send for your free copy of the latest



Heath's new logic probe for TTL and CMOS testing.

Heathkit catalog. Write *Heath Company, Dept. 350-690, Benton Harbor MI 49022.*

MP2 VHF WATTMETER

Mirage Communications has entered the amateur radio market with the introduction of the MP2 VHF wattmeter.

The MP2 is designed to provide the VHF amateur with a versatile instrument to insure optimum performance from his VHF station.

The MP2 will work from 50 to 200 MHz. The MP2 measures power in three ranges, 50, 500, and 1500 Watts full scale. The MP2 displays power, either as average, for FM or CW, or peak reading, for SSB.

SWR may also be measured with as little as 2 Watts of power and is displayed directly, without having to use charts or graphs. The SWR and peak reading features have not been available on a single instrument before.

The coupler unit may be remotely mounted for added installation convenience.

For further information, contact your local dealer or *Mirage Communications, PO Box 1393, Gilroy CA 95020, (408) 847-1857.*

HI PRO COR-IDENTIFIER

This complete all-on-one board fully adjustable COR and identifier is designed to mate

easily with any repeater system. The board consists of high quality components familiar to the industrial and medical industry.

Some of the features are the normal high and low inputs to the COR, another input which can be connected directly to the squelch noise amplifier, and LED outputs to monitor the COR timer and the ID. The LED for the ID blinks in unison with the code program. Plugs are installed on the board for ease of installation and removal. Unique to this board are the provisions for installing anywhere a switch which controls the resetting of the COR timer on either the input or the output, or disabling the timer to allow the repeater to operate without timing out, avoiding cutting short a message during an emergency. This is accomplished with one single-pole, double-throw center-off switch. Another feature provides for a switch that will allow either all or partial scanning of the diode matrix. CMOS logic is used, and can be operated from 8 to 16 volts with very low current drain—a thing to think about when on emergency power. Potentiometers are used liberally on the board for ease of adjustment—no need to juggle components to get the right setting. Wide spacing of diodes on the matrix

makes it very easy to program and reprogram in the field with less chance of solder bridges and shorting. All this plus the normal control functions associated with a COR and identifier comes completely assembled. *Maggiore Electronic Laboratory, 845 Westtown Rd., West Chester PA 19380.*

DIELECTRIC INTRODUCES THE SNIFFER®

Dielectric Communications announces the introduction of the model 7004 Sniffer®, a non-directional, adjustable-amplitude, rf signal-sampling element designed to permit convenient sampling of a high-power rf signal at a level more convenient for spectrum analysis, frequency counting, or oscilloscope display. The unit is inserted into the Dielectric model 1000 rf wattmeter or into an auxiliary line section designed for use with the 7004. It may also be used with many other popular rf wattmeters and line sections.

The Sniffer exhibits extremely low VSWR and insertion loss, and can be used over the 2-1000 MHz range at power levels up to 1000 Watts. Rf output sample is adjustable ± 8 dB around a nominal -43 dB. The standard range of field-interchangeable Dielectric quick-match connectors may be used on the aux-

iliary line section for quick and easy installation with any connector system already in use.

The Sniffer is available alone or together with a line section. Delivery time is 2 weeks after order. *Dielectric Communications, Raymond ME 04071.*

60-CHANNEL ICOM-22S SWITCH

Valley Instrument Products offers the IC-22S60, a 60-channel switch for the Icom IC-22S 2 meter transceiver. The IC-22S60 gives your IC-22S full channel capabilities with 56 channels from 146.01-146.43, 146.61-147.39, and 147.60-147.99 MHz programmed into the switch plus 4 user-programmable channels. No need for all those diodes!

Installation is easy. The IC-22S60 replaces the IC-22S switch exactly. All you do is remove the 22-channel switch and install the IC-22S60, supplied with the new dial, and wire into your diode matrix board.

The IC-22S60 gives you full channel capabilities with your IC-22S for just \$25.00. Why pay more for bulky, complicated encoders? *Valley Instrument Products, Division of Nevins Communications, PO Box 339, Bartlett IL 60103.*

**Morgan W. Godwin W4WFL
Peterborough NH**



The MP2 VHF wattmeter from Mirage.

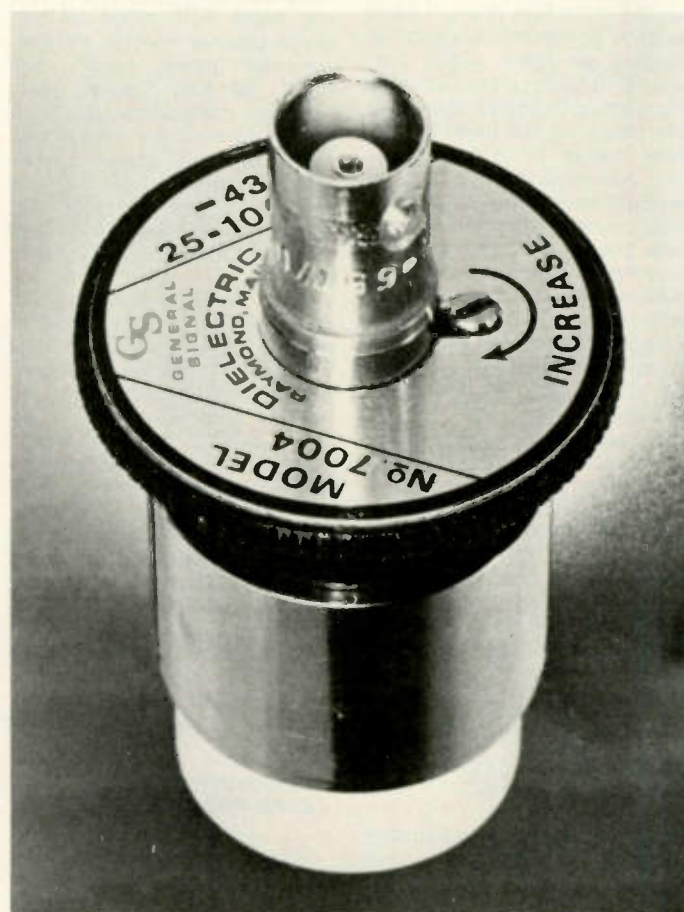

The Sniffer from Dielectric.

MFJ INTRODUCES NEW SUPER CW/SSB FILTERS

This new MFJ-721 Super Selector CW/SSB Filter gives you 80 Hz BW, steep SSB skirts, noise limiting, 2 watts for speaker plus more.



BRAND NEW \$59⁹⁵

This New MFJ-721 Super Selector CW/SSB Filter gives you a combination of performance and features available only from MFJ: • Razor sharp 80 Hz non-ringing CW filter • Steep skirt SSB filter • Selectable peak and trough noise limiting • Plugs in phone jack • Two watts for speaker • Simulated stereo reception • Inputs for 2 rigs • Speaker and phone jacks • Auxiliary 2 watt amplifier, 20 dB gain.

The CW filter gives you 80 Hz bandwidth and extremely steep skirts with no ringing for razor sharp selectivity. Lets you hear just one CW signal on the crowded Novice bands.

Bandwidth is selectable: bypass, 80, 110, 150, 180 Hz. Response is 60 dB down one octave from center freq. for 80 Hz BW. Center freq. is 750 Hz. Up to 15 dB noise reduction.

8 pole active IC filter. Low Q cascaded stages eliminates ringing. Hand matched components.

The SSB filter dramatically improves readability by optimizing audio bandwidth to reduce

sideband splatter, remove low and high pitched QRM, hiss, static crashes, background noise, and hum.

Makes listening for long periods pleasurable and less fatiguing. Ideal for contest and OX.

IC active filter includes 375 Hz highpass cut-off plus selectable lowpass cutoffs at 2.5, 2.0, 1.5 KHz (36 dB per octave rolloff).

Switchable automatic noise limiter for impulse noise; trough clipper removes background noise.

For Simulated Stereo, the raw signal goes to one ear and the filtered signal to the other. The signal appears in both ears and the QRM in only one. The ears and brain reject QRM yet off-frequency calls can be heard. Requires stereo phones.

Switch selects one of two rigs. OFF position connects speaker to rig. Speaker disables when phones are used. Requires 9 to 18 VDC, 300 ma. max. 5x2x6 inches. Optional AC adapter is \$7.95. Order yours now.

This New MFJ-720 Deluxe Super CW Filter gives you 80 Hz BW, no ringing, 2 watts out.

Same 8 pole Super CW Filter as in MFJ-721. 80 Hz BW, extremely steep skirts with no ringing for razor sharp selectivity. Selectable BW: 80, 110, 180 Hz. Center freq. 750 Hz. Automatic noise limiter. Plugs in phone jack to drive speaker to 2 watts. 2x4x6 in. Requires 9-18 VDC, 300 ma. max. Optional AC adapter, \$7.95.

BRAND NEW

\$44⁹⁵



These MFJ active filters are the most copied in Industry.

CWF-2BX MFJ SUPER CW FILTER

SBF-2BX MFJ SSB FILTER

\$29⁹⁵ each



But performance is not copied. Only MFJ hand selects components so the center frequency of each CW stage is within one Hz of each other.



CWF-2BX and the SBF-2BX are the same CW and SSB filter as in the MFJ-721 but less speaker amplifier and noise

limiter. Plugs in rig to drive phones or connect between audio stage for full speaker operation. Uses 9 V battery. 2x3x4 inches.

For Orders, Call Toll Free

800-647-1800

ORDER TODAY BY MAIL OR CALL TOLL FREE 800-647-1800 AND CHARGE IT ON VISA OR MASTER CHARGE. Order any product from MFJ and try it. If not delighted, return it within 30 days for a prompt refund (less shipping). One year unconditional guarantee. Add \$2.00 shipping/handling. For order/repair status, in Mississippi and outside continental USA, call 601-323-5869.



MFJ ENTERPRISES, INC.

P. O. BOX 494 MISSISSIPPI STATE, MISSISSIPPI 39762 M52

SWR Power Meters



COMBINATION SWR/FIELD STRENGTH METER
Measures SWR up to 3:1, or higher. Meter has sensitive movement and easy-reading two-color scale. 5% accuracy. 52 ohms impedance. SO-239 female coaxial connectors. 6" high x 2" wide x 2 3/4" deep. Model SWR-A \$14.95

MINI SWR METER

Small size makes this the perfect mobile or portable meter. Sensitive meter with easy-to-read two-color scale. Metal case 1-5/8" x 2-1/8" x 2-1/8". Model SWR-B

\$12.95



POWER/SWR/F.S. METER

Measures SWR and power on 0-10 and 0-100 watt ranges. Good up to 225 MHz for SWR function, up to 148 MHz for power functions. Accuracy: 5% on SWR, 10% on power functions. 2" x 4 3/4" x 2 1/4" Model SWR-C

\$26.95



DUAL METER SWR BRIDGE

Shows output power and reflected power simultaneously. Can be used as reference power meter, too. Wide scale, easy-to-read meter faces. Dual meters make antenna tuner adjustments a snap. Good through 175 MHz. May be left in-line up to 2,000 watts. Model SWR-D

\$29.95

Call (213) 376-5887 to order COD or with VISA or M.C.

Card # _____

Exp. date _____

Name _____

Street _____

City _____

State _____ Zip _____

Models desired: _____

\$2 shipping per order. Calif. res. add tax
Check or M.O. enclosed \$

S10

SSS ELECTRONICS

SST T-1 RANDOM WIRE ANTENNA TUNER

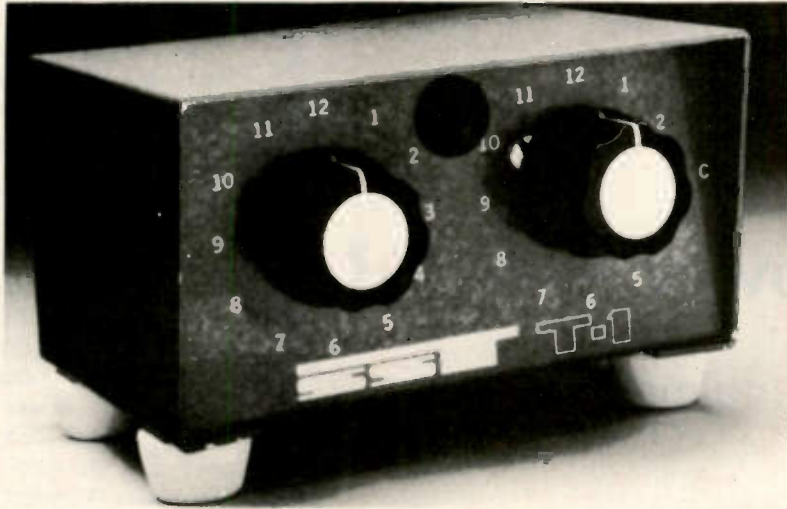

All band operation (160-10 meters) with any random length of wire. 200 watt output power capability—will work with virtually any transceiver. Ideal for portable or home operation. Great for apartments and hotel rooms—simply run a wire inside, out a window, or anyplace available. Efficient toroid inductor for small size: 4-1/4" x 2-3/8" x 3", and negligible loss. Built-in neon tune-up indicator. SO-239 connector. Attractive bronze finished enclosure.

only **\$29.95**

THE ORIGINAL Random Wire Antenna Tuner... in use by amateurs for 6 years.

SST T-2 ULTRA TUNER

Tunes out SWR on any coax fed antenna as well as random wires. Works great on all bands (80-10 meters) with any transceiver running up to 200 watts power output.

Increases usable bandwidth of any antenna. Tunes out SWR on mobile whips from inside your car.

Uses efficient toroid inductor and specially made capacitors for small size: 5-1/4" x 2-1/4" x 2-1/2". Rugged, yet compact. Negligible line loss. Attractive bronze finished enclosure. SO-239 coax connectors are used for transmitter input and coax fed antennas. Convenient binding posts are provided for random wire and ground connections.



only **\$39.95**

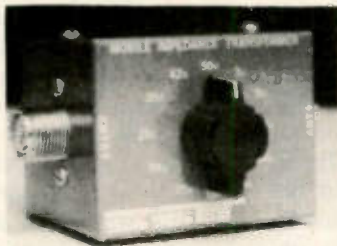

only **\$19.95**

SST T-3 Mobile Impedance Transformer

Matches 52 ohm coax to the lower impedance of a mobile whip or vertical. 12-position switch with taps spread between 3 and 52 ohms. Broadband from 1-30 Mhz. Will work with virtually any transceiver—300 watt output power capability. SO-239 connectors. Toroid inductor for small size: 2-3/4" x 2" x 2-1/4". Attractive bronze finish.



GUARANTEE



All SST products are guaranteed for 1 year. In addition, they may be returned within 10 days for a full refund (less shipping) if you are not satisfied for any reason. Please add \$2 for shipping and handling. Calif. residents, please add sales tax. COD orders OK by phone.

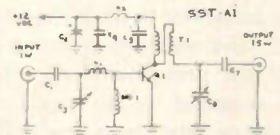

only **\$29.95**

\$49.95 wire and tested

SST A-1 VHF Amplifier Kit

1 watt input gives you 15 watts output across the entire 2 meter band without re-tuning. This easy-to-build kit (approx. 1/2 hr. assembly) includes everything you need for a complete amplifier. All top quality components. Compatible with all 1-3 watt 2-meter transceivers. Short and open protected—not damaged by high SWR.

Kit includes:

- Etched and drilled G-10 epoxy solder plated board.
- Heat sink and mounting hardware. All components—including pre-wound coils.
- Top quality TRW RF power transistor.
- Complete assembly instruction with details on a carrier operated T/R switch.



S10

ELECTRONICS

P.O. BOX 1 LAWNSDALE, CALIF.
90260 (213) 376-5887

A Perfect Power Supply?

— well . . . almost

Here is a cheap but very adequate way to obtain 5 to 15 regulated volts without zapping your wallet.

Output regulation is typically on the order of .1 volts for loads from a few milliamps to 4 Amps or so, depending on the components used. This circuit is very noncritical and easy to get going. With it, just about any reference voltage may be had. The only requirement is that the unregulated dc voltage supplied to the regulator circuitry must be a few volts greater than the reference voltage of the zener. That only makes sense, doesn't it?

The transformers I used were two 6.3-volt filament junk box specials with the primaries connected in parallel for 110-volt primary voltage. 220-volt primary may be used for wiring primaries in series. Caution must be used to keep the phasing

correct. If you get no output, change the pairing of wires in the primary.

With the full-wave circuit described in Fig. 1, the unregulated output should be about 17 volts or so. This should be adequate for the regulation of 12 volts.

If you want 14 or 15 volts regulated, you may need to increase the unregulated voltage to the regulator circuit. A full-wave bridge should do this.

However, the pass transistor (or Darlington, whichever you decide to use) will run cooler with the lowest possible unregulated voltage on it to maintain good regulation. To determine what is adequate, try the full wave first and measure the regulated voltage output. If it varies more than a volt on full load from the supply, an increase in the unregulated voltage is needed

and a full-wave bridge should be used.

U1, the op amp, can be any type of 709, 741, etc. It is operating with essentially an open-loop gain, and its job is to bias the Darlington or pass transistor. When the unregulated voltage wants to drop, the noninverting input referenced by the zener diode and the inverting input of the op amp "see" a difference voltage and amplify it, supplying the base additional bias which enables Q1 to amplify more and hold the regulated output constant by pulling the voltage back up.

The reference voltage in the noninverting input of the op amp is determined by the zener reference. I use a 12-volt zener and a regular silicon diode, connected as illustrated in the schematic (Fig. 2).

The pair gives about 12.6 volts as a reference — 12 volts for the zener and about a .6 drop across the silicon diode.

The zener alone could be used for just 12 volts, or more diodes could be used for .6-volt increases for each additional diode used with the zener.

C1 is any old filter capacitor — the more capacity, the better. And, of course, it is rated for at least the unregulated voltage.

Q1 is the main factor in determining the current that can be taken from the supply. The larger the maximum collector current of Q1 is, the more the current that can be taken from your machine. A Radio Shack power Darlington (TO-3 case) for \$1.98 was used, and the supply is good for about 4 Amps. With a high-gain power Darlington, the output of a 741 is all that is needed to drive it. If more current demand is required, a larger Darlington or regular power transistor can be used. However, if the beta of the transistor is fairly low, a driver is needed between the 741 and the pass transistor. Just about any PNP transistor will do. It should be connected as shown in Fig. 3.

If lots of current is wanted, say 10 Amps, a large pass transistor is needed. Pass transistors this large typically have betas of 60 or less, which will require a driving current of about 1/6 Amp, which is far too much for the 741 and most other op amps. Therefore, a driver transistor with a high gain (beta) should be used to allow the small output of a 741 or similar op amp to drive anything.

If the op amp heats up to the touch, a drive transistor should be used. Q1 should be well heat sunk, and, of course, the transformer used should be capable of handling whatever current you want at the load.

C2 is a .001 to help keep any rf out of the regulator if the supply is to be used for your 2m radio or the like. If used with digital projects, a 10 uF filter capacitor can be placed across Z1, if noise is a problem, and/or a slightly smaller R1 used to move Z1

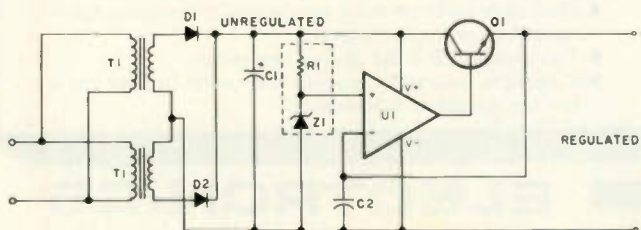

Fig. 1.

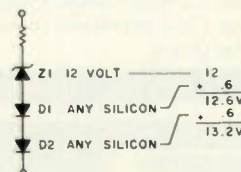

Fig. 2.

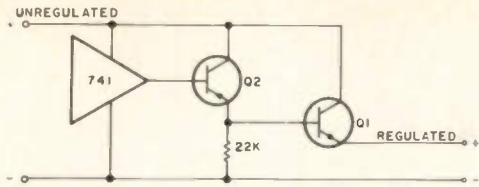

Fig. 3.

from the knee region where noise occurs.

This circuit was built because I had problems with the straight pass transistor concept. The bias on the transistor must be changed to

maintain good regulation for various load currents. The circuit described in this article is the first that I have seen that does not regulate in only a segment of the pass transistor's operating curve,

Parts List	
T1	6.3 V filament transformer or equivalent
D1, 2	about 50 piv at desired current, plus 50%
C1	20 to 20,000 uF, 25 volts
R1	470 to 820 Ohm, 1/4 Watt
Z1	12 V zener, or desired value from 2.4 to 33 volts
U1	741, 709, etc., op amp
Q1	power Darlington or 100-Watt or more pass transistor, NPN
Q2	any PNP: 2sc710, etc.
C2	.001 uF, 50 V

but regulates well everywhere — from no current to maximum smoke from the pass transistor.

described in the *ARRL Handbook*, using the pass transistor idea cover 6 to 10 Amps, for example, but suffer from poor regulation. ■

Typical circuits, as

DELAWARE AMATEUR SUPPLY D31

Serving amateurs in Southern New Jersey, Delaware, and Maryland

WITH the largest stock of amateur equipment and accessories in Delaware

Paul WA3QPX
Rob WA3QLS

71 MEADOW ROAD
NEW CASTLE, DELAWARE 19720
(302) 328-7728

Build Your Own CW Keyboard Keyer

Save Over \$175

QSL for full details

ECM ECM Corporation
412 N. Weinbach Ave.
Evansville, IN 47711
812-476-2121 E1

CIRCUIT BOARDS

- REPEATER CONTROL
- COMPUTER PROJECTS
- SENSITIZED BLANKS
- NEGATIVES/POSITIVES
- PROTO-TYPE BOARDS
- PARTS KIT
- CUSTOM ETCH/DRILL
- RCA 1802 MP BOARDS
- CIRCUIT BOARD DESIGN
- PROGRAMMING PADS
- ART MASTER PREPARATIONS

We can supply many of the items you need to make a p-c board. Send SASE + 25 cents for catalog.

O.C. Stafford S50

Electronic Service and Development
427 S. Benbow Rd.
Greensboro, NC 27401
919-274-9917 DAY/NITE
Serving Amateurs Around the World

RTTY made easy

TU-170 kit...\$149.95
wired...\$219.95

State of the art design features make the TU-170 ideal for HF and VHF autostart operation at an unchallenged price.

- SIZE: 7 1/2" W x 3 1/4" H x 7 1/2" D
- Proved 170Hz shift 3 stage active filter demodulator
- Lighted tuning meter for easy tuning
- Current regulated loop keyer and power supply
- Autostart with threshold control and solid state relay
- Stable audio frequency shift oscillator, produces phase coherent sine wave tones
- TTL compatible inputs and outputs for auxiliary equipment
- High level output for scope tuning

FLESHER CORP. VISA

P.O. Box 976
Topeka, Kansas 66601
(913) 234-0198 F5

Sere-Rose & Spencer Electronics S39

1465 WELLS STATION ROAD
MEMPHIS, TENN. 38108
PH (901) 683-9125—685-8461

Authorized Dealer

DRAKE—ICOM—KENWOOD
REGENCY—TEMPO—DENTRON

CALL OR WRITE FOR BEST DEAL

MILITARY SURPLUS WANTED

WE NEED:

ARC-34, ARC-51BX, ARC-92, ARC-94, ARC-102, ARC-109, ARC-115, ARC-116, ARC-131, ARC-134, ARC-164, ARN-82, ARN-83, ARN-84, ARA-48, ARA-50, APN-81, APN-133, APN-147, APX-64, APX-72, 618T, 490T-1, CU-1658A, CU-1669A, 807A, GRC-106, URC-9.

Top dollar paid or trade for new amateur gear. Write or phone Bill Slep, (704)524-7519. Slep Electronics Company, Highway 441, Otto, North Carolina 28763. S4

Mobile Security Blanket

—remote control
for older rigs

Tom Yocom WA1RTD
21 Bayberry Rd.
Acton MA 01720

One way to solve the problem of mobile radio theft is to mount the radio in the trunk. This idea isn't new. Remember that many of the old commercial radios of 20 years or more ago were designed for trunk installation—probably due to their size more than to avoid theft. A Motorola T43GGV is certainly a lot larger than the new solid-state dash-mount rigs of today!

If you have a favorite repeater or simplex frequency that you enjoy being confined to, you can

take an older radio such as a Regency HR2 and rather easily remote-control the basic transmit/receive functions. Frequency changes and squelch adjustments will require a trip to the trunk.

I mounted an HR2 in the trunk and then used a standard 500-series touch-tone™ desk-style telephone set (equipped with a new handset which included a push-to-talk button) as the control head. This approach provided more than just a long extension of the microphone and speaker. The telephone included the pad required for autopatch operation, and the whole phone could be unplugged and stored in the glove

compartment when not needed.

A surplus Motorola speaker enclosure is installed under the dash and equipped with a pilot light, switch, and volume control. The switch is used to control power to the remote transceiver. The telephone provides keying, a microphone, a touchtone pad, private listening (if desired), and speaker muting (removing the handset mutes the speaker). This feature can be suppressed via the exclusion switch. You might want to reverse the logic so that the exclusion switch turns the speaker off for those few times when you want to be semiprivate.

Fig. 1 is a general block diagram and shows the approach that was used. The interface circuit changes the telephone two-wire circuitry into a four-wire circuit (one pair of wires for transmit and another pair for receive) and mutes the telephone handset when the speaker is picked up. The speaker box houses the local speaker and also provides a convenient place for mounting a local

volume control, power on/off switch, and fuse.

Fig. 2 shows the speaker box schematic. There are no critical components. Use a good communications speaker that will accept the full audio power from the receiver without distorting. The size of the pilot light depends upon where you plan to mount the speaker box. If the lamp is too bright, it can be very annoying at night.

Fig. 3 shows the interface unit and the important parts of the telephone. The transformer is a 120H telephone repeat coil. The small power supply (a battery could be used) provides a source of direct current for the telephone (about 50 mA). The .33 μ F capacitor allows the audio signal to bypass the power supply. The two primary wires from the telephone (red and green) are attached to two of the windings, the audio for the transmitter is derived from the third winding, and receiver audio is applied to the fourth winding. If the transceiver has a high input impedance, use the 50k resistor and shielded

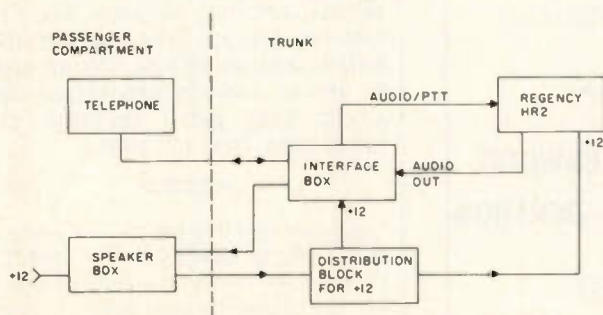

Fig. 1. Block diagram of system.

cable—otherwise omit the 50k resistor and use any convenient cable.

Audio is applied to the speaker when the relay is turned off. The relay is operated (thus interrupting the audio to the speaker) when the handset is lifted. This action can be inhibited by operating the exclusion switch, which has a normally-closed pair of contacts connected in series with a pair of extra contacts of the hook switch. You can use any 12-volt relay in the circuit.

Fig. 4 details the small regulated power supply. If you have to purchase the parts new, you might elect to use a couple of D cells in series. If you have a well endowed junk box, you can build the power supply, and it will occupy less room, enabling a smaller box to be used for the interface unit.

The output of the pad will generally be much

higher than the level of your voice. One solution to this problem is to swamp the pad when any button is depressed. The desired effect can be accomplished by connecting a resistance across the R and C terminals on the telephone's network. If you use a 100-Ohm fixed resistor in series with a 1k trimpot, the desired level for the pad can be set by adjusting the pot.

I have experienced good results with this trunk-mounted arrangement. Just set the transceiver volume control to near maximum and adjust the

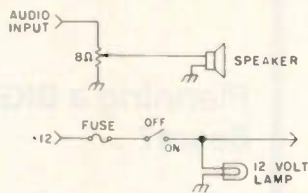

Fig. 2. Speaker/power control box mounted in passenger compartment.

squelch control for normal operation. There has been no theft problem—and, if you're content to monitor one frequency, it works just fine. If you're deter-

mined to remotely control the frequency, you might consider an Icom IC-225 equipped with a set of remote frequency-programming switches. ■

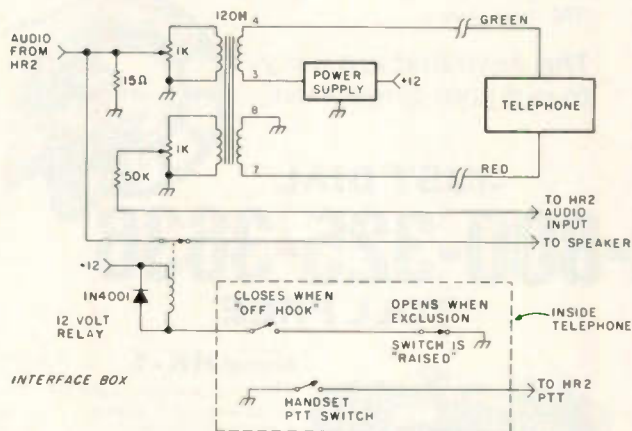

Fig. 3. Interface unit and associated circuits.

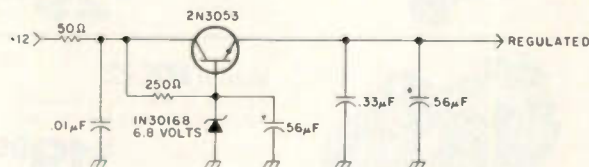

Fig. 4. Power supply schematic diagram.

LINEARIZED AMPS by LUNAR



INTRODUCING OUR NEW AMP MODEL 2M25-150P

- 10 watts in, 100 watts output.
- 25 watts in, 150 watts output.
- Very linear operating amplifier compatible with all SSB rigs up to 25 watts.

LUNAR'S RECEIVING PRE-AMPS

These ultra performance receiving preamplifiers are suitable to the most demanding needs where low noise figure is important! Construction is of the highest quality with PC boards double solid plated holes to ensure maximum performance.

BI-LINEAR VHF MODELS

- Covers entire Amateur Band w/o Tuning
- Built-in Receive Preamplifier
- Automatic T-R Switching
- Exceeds FCC R&D 20777 Requirements of -60 dB
- Variable T-R Delay for SSB/CW use
- Preamp & Power Amp Independently Controllable
- Preamp nom 10 dB gain, 2 dB Overall NF
- Functionally Designed Package

MODEL	FREQUENCY (MHz)	POWER IN	POWER OUT	CURRENT	H	X	W	X	L	WT	PRICE
2M10-80P	144-148	10W	80W	12A	7.0	14.9	20.3	cm	1.0kg	\$189.95	
VHF 10-80P	148-174 (5 MHz)	10W	80W	12A	7.0	14.9	20.3	cm	1.0kg	\$229.95	
1.3M10-70P	220-225	10W	70W	11A	7.0	14.9	20.3	cm	1.0kg	\$199.95	
2M30-160P	144-148	25W	160W	25A	7.0	14.9	32.5	cm	1.6kg	\$249.95	
VHF30-160P	128-174 (5 MHz)	30W	160W	25A	7.0	14.9	32.5	cm	1.6kg	\$289.95	
1.3M30-140P	220-225	25W	140W	23A	7.0	14.9	32.5	cm	1.6kg	\$269.95	
2M25-150P	144-178	25W	150W	25A	7.0	14.9	32.5	cm	1.6kg	\$299.95	

Models available for the 148-174 MHz bands, 5 MHz segments. Other models 50 thru 432 MHz bands plus higher power units out in near future.

Louis Anciaux
WB 6NMT



PRICES ON ALL LUNAR AMPS AND PRE-AMPS WILL BE INCREASED NOV. 15TH. ORDER NOW!

the famous
HAM·KEY™

TM Trade-Mark

The keys that are easy
to put your fingers on!



JUST DIAL
1-800-325-3636
TOLL FREE



Model HK-1

- Dual-lever squeeze paddle
- Use with HK-5 or any electronic keyer
- Heavy base with non-slip rubber feet
- Paddles reversible for wide- or close-finger spacing

\$29⁹⁵

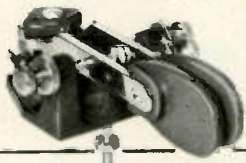

Model HK-2

- Same as HK-1, less base for incorporation in own keyer

\$19⁹⁵



Model HK-3

- Deluxe straight key
- Heavy base - no need to attach to desk
- Velvet smooth action

\$16⁹⁵

Model HK-3A

- Same as above less base **\$9.95**

Navy type knob, only **\$2.75**

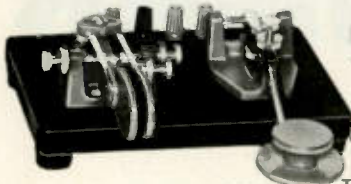

Model HK-4

- Combination of HK-1 and HK-3 on same base

\$44⁹⁵

- Base only with rubber feet **\$12.00**

Terminals, red or black, \$.75 each



NEW AND IMPROVED

**Model HK-5A
Electronic Keyer**

- New Cabinet Colored-Keyed to Match most modern radio equipment
- Iambic Circuit for squeeze keying
- Self-completing dots and dashes
- Dot memory
- Battery operated with provision for external power
- Built-in side-tone monitor
- Grid block or direct keying
- Speed, volume, tone and weight controls all mounted on front panel
- For use with external paddle, such as HK-1 or HK-4
- Can be used as Code practice oscillator with straight-key, such as HK-3

\$69⁹⁵

Same day shipment . . . **PREPAID**



We welcome the use of your



HAM RADIO CENTER

H2

8340-42 Olive Blvd. • P.O. Box 28271 • St. Louis, MO 63132

**Clegg
is...**

**... Antenna
Headquarters**

Planning a **BIG
Beam?**

Planning
Moonbounce?

Looking for a
Tri-Bander?

Going **Mobile?**

We stock a complete line of antennas, antenna hardware, rotators, cable etc. Whatever you're planning—we have what you need!

Call TOLL FREE 1-(800)-233-0250, for fast delivery of products by:

MOSLEY, WILSON, HUSTLER, CDE, ASP, DENTRON, W2AU, W2VS, KLM, F9FT and others.

Clegg
Communications Corp.
911 Old Homestead Lane
Lancaster, PA 17601

C3

Full Features and Superior Performance

ST-6000 RTTY DEMODULATOR

Select Rx & Tx Shifts
 Accurately Tuned Rx Filters
 Crystal Controlled Tx Tones
 True Transceive Operation

Invert Both Rx Demod,
 and Tx Tones

Data Status Indicators
 Loop 1 Post-Autostart Pre-Autostart

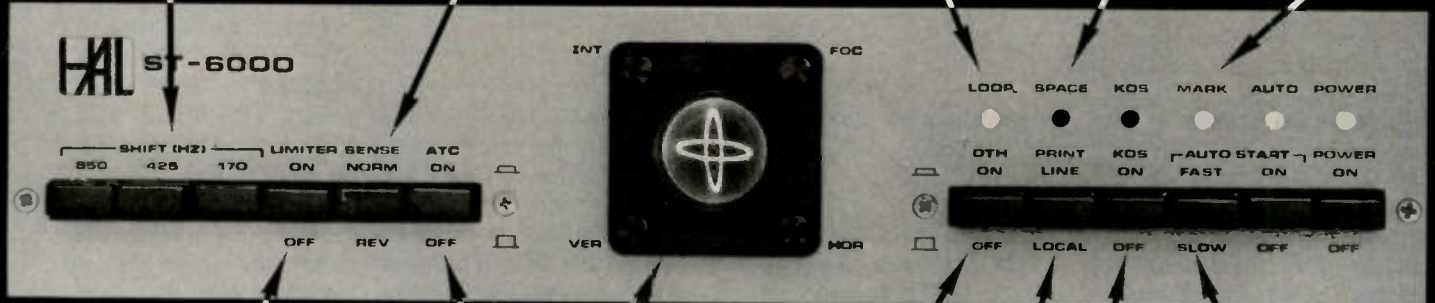

Hard-Limiting [FM]
 or
 Non-Limiting [AM]
 Reception

Correct for
 Bias Distortion

Correct For
 Multi-Path Distortion

Local Loop Operation

Autostart with:
 ○ Motor Control
 ○ Mark Hold
 ○ Antispace

Tuning Oscilloscope
 [Front Panel Controls]
 Meter Indicator Option
 Also Available

Automatic Tx/Rx Station
 Control with Keyboard
 Operated Switch [KOS]



Why not have the best?

The HAL ST-6000 Demodulator offers outstanding performance, versatility, and ease of operation. The Receive Demodulator features multiple-pole active filters available for "high" or "low" tones. These filters are frequency-matched to the transmit tone crystals for true transceive operation. Input bandpass filters, discriminator filters, and post-detection filters are carefully designed and tested for optimum weak-signal recovery. The ST-6000 has an internal loop power supply, 2 loop keyers, RS-232, MIL-188C, and CMOS data I/O, and rear panel connections to data and control circuits for connection to UART and computer devices. Use it with the HAL DS-3000 KSR for the best in RTTY performance.

\$595.00

Write today for HAL's latest RTTY catalog.



HAL COMMUNICATIONS CORP.
 Box 365
 Urbana, Illinois 61801
 217-367-7373

For our Overseas customers:
 see HAL equipment at:
 Richter & Co.; Hannover
 I.E.C. Interrelco; Bissone
 Vicom Imports; Auburn, Vic., Australia

Further Adventures of the IC-22S

— our hero gets offset flexibility

Here is a way to add offsets to the Icom IC-22S 2m transceiver beyond the standard 600 kHz offset. This can even be accomplished without defacing the transceiver in any way.

Some repeaters on 2 meters have input-to-output frequency differences that are not 600 kHz. If you want to use one of these repeaters and own an IC-22S, a modification must be made. The solution is found in the way that Icom controls the programmable divider and the receive-to-transmit change-

over. I was motivated to find this solution by the existence in my area of repeater WR6AMD (formerly WR6ABE). This repeater has a 147.435 MHz input frequency and a 146.400 MHz output frequency, or an offset of 1.035 MHz.

The concept outlined here is applicable to any offset within the limits of the IC-22S programmable phase locked loop (PLL). The limits are any two frequencies from 146.010 MHz to 147.990 MHz in 15 kHz increments. Unlike the regular IC-22S operation, you do not have to

worry about being out of the band using this circuit when it's programmed at 147.405 MHz and above, with the duplex/simplex (DUP/SPX) switch in the DUP B position (which adds 600 kHz more to the programmed frequency). The only operating restriction with this modification is that you won't be able to conveniently work simplex (direct). I do not mind this restriction. I have found limited use for the simplex frequencies that I do have programmed, and I have no

need to operate on a repeater frequency direct.

How It Is Done

In the IC-22S, there are some positive voltages available for the solution proposed. These are the 9 volts that is present when the transceiver is on and is available through the channel switch to the diode matrix (+9 V and SW 9 V), the positive voltage present only during receive (RX 9 V) which drops to nearly zero volts during transmit, and the positive voltage (TX 9 V) available during transmit which drops to nearly zero during receive. These last two voltages are at the DUP/SPX switch with RX 9 V at the DUP A position and TX 9 V at the DUP B position. The channel switch has no wire at position 23 (more about this later), and detent 24 is an off position with the wiper arm of the switch on itself. Therefore, the +9 V goes nowhere.

For the sake of demonstration only, add a single-pole, double-throw or double-pole, double-throw (DPDT) switch and wire it, as in Fig. 1, between two rows of diodes and the two positive voltages at the DUP/SPX

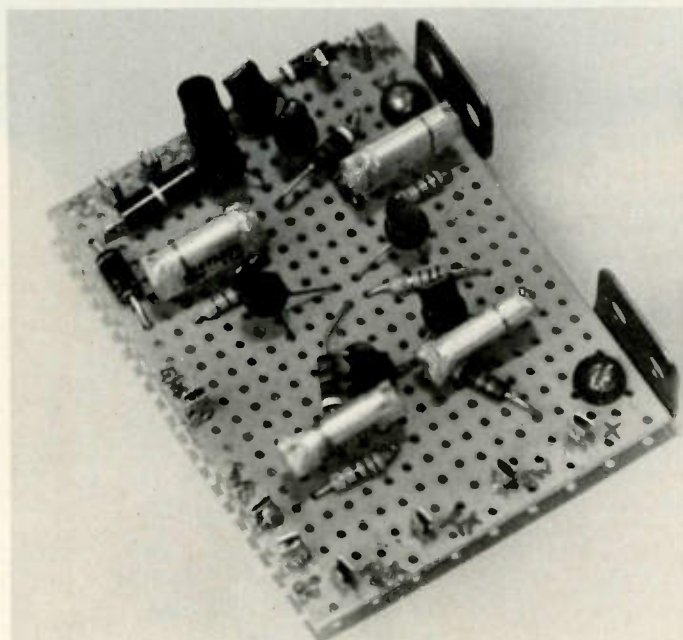

Circuit assembly using 0.1-inch perforated board.

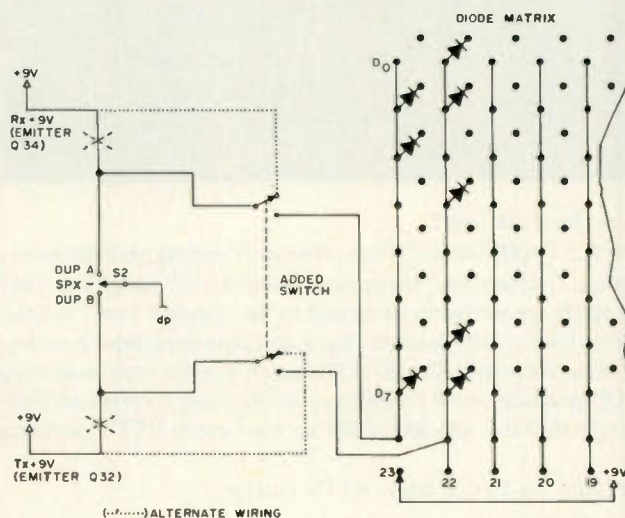

Fig. 1. Basic concept. Not a practical circuit, since the duplex/simplex switch must be in the SPX position, the channel switch must be in detent 23 or 24 (off), and the added switch must be off for all other channel positions to operate properly. A DPDT switch would allow disconnecting the duplex/simplex switch function but would leave all other possible errors.

FIRST QUALITY CARBON RESISTOR KITS

Each kit contains all the EIA designated 10% values from 2.2 ohms to 8.2 megohms. Your cost: Only \$.02 per resistor.



KIT A
1,000 Pcs. 19⁹⁵
 Includes FREE ppd.
 9-drawer box
 (\$5.00 value)



KIT B
500 Pcs. 9⁹⁵
 Includes FREE ppd.
 compartmentalized
 box (\$2.00 value)



KIT C
250 Pcs. 4⁹⁵
 in Poly Bag ppd.

MANY OTHER KITS

Aluminum Electrolytic,
 Tantalum and Ceramic
 Capacitor Kits. Semicon-
 ductor Kits, too. Lamps also.

We have **over 2,000**
 quality Receiving Tubes.
 Many hard-to-get types.
All at 75% off list.

ORIGINAL JAPANESE SEMICONDUCTORS

Full range available to
 fill just about any
 requirement.

Send for
 complete
 catalog



TO ORDER:
 Send check or Money Order—
 N.Y. residents add appropriate tax.

STEVEN PRODUCTS

P.O. BOX 698, MELVILLE, N.Y. 11746

DUPLEXERS

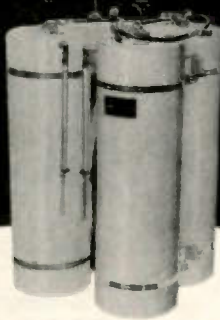

US PATENT
 4080601

OUR NEW BANDPASS-
 REJECT DUPLEXERS WITH
 OUR EXCLUSIVE

BpBr CIRCUIT*

... provides superior perfor-
 mance, especially at close
 frequency spacing.

Models available for all Ham
 bands. Special price for
 Amateur Repeater Clubs

CALL OR WRITE FOR DETAILS:
WACOM PRODUCTS, INC.



Box 7307
 Waco, Texas 76710
 817/776-4444 W15

JAN CRYSTALS KEEP YOU ON THE AIR



- CB
- CB standard
- 2 meter
- Scanners
- Amateur Bands
- General
- Communication
- Industry
- Marine VHF
- Micro processor crystals

easy
 to
 charge



Send 10¢ for our latest catalog
 Write or phone for more details
 2400 Crystal Drive
 Ft. Myers, Florida 33901
 all phones (813) 936-2397

J2

electronic calculators

LIST	HAM NET	TEXAS INSTRUMENTS ELECTRONIC CALCULATORS
\$299.95	\$269.95	T.I.-59, 960 STEP PROGRAMMABLE SCIENTIFIC
124.95	112.45	T.I.-58, 480 STEP PROGRAMMABLE SCIENTIFIC
59.95	53.95	T.I.-57, 150 STEP PROGRAMMABLE SCIENTIFIC
49.95	44.95	T.I.-55, 32 STEP PROGRAMMABLE SCIENTIFIC
59.95	53.95	T.I. PROGRAMMER, CONVERTS DECIMAL/OCTAL/HEX
69.95	62.95	T.I. MBA, SUPER PROGRAMMED FINANCIAL
LIST	HEWLETT-PACKARD ELECTRONIC CALCULATORS	
\$750.00	\$675.00	H.P.-97, 224 STEP PROG SCIENTIFIC PRINT/VISUAL
450.00	405.00	H.P.-87, 224 STEP PROG SCIENTIFIC
275.00	247.50	H.P.-19C, 98 STEP PROG SCIENTIFIC PRINT/VISUAL
175.00	157.50	H.P.-29C, 98 STEP PROG SCIENTIFIC
175.00	157.50	H.P.-10 BASIC HAND HELD PRINTER VISUAL
325.00	292.50	H.P.-91, PREPROGRAMMED SCIENTIFIC PRINT/VISUAL
100.00	90.00	H.P.-33E, 49 STEP PROG SCIENTIFIC
80.00	72.00	H.P.-32E, PREPROGRAMMED SCIENTIFIC WITH STAT
60.00	54.00	H.P.-31E, PREPROGRAMMED SCIENTIFIC
495.00	445.50	H.P.-92, PREPROGRAMMED FINANCIAL PRINT/VISUAL
120.00	108.00	H.P.-38E STEP PROGRAMMABLE SUPER FINANCIAL
75.00	67.50	H.P.-37E, PREPROGRAMMED FINANCIAL

WE STOCK ALL HEWLETT-PACKARD CALCULATOR SOFTWARE AND ACCESSORIES

SEND ME THE CALCULATOR(S) INDICATED BELOW. COMPLETE WITH INCLUDED ACCESSORIES INSTRUCTIONS, AND MANUFACTURERS WARRANTY. I UNDERSTAND THAT IF I AM NOT COMPLETELY SATISFIED, I MAY RETURN IT WITHIN 10 DAYS FOR A COMPLETE REFUND (LESS SHIPPING)

MODEL(S) _____ QUANTITY _____ AMOUNT ENCLOSED \$ _____

WE HONOR _____ VISA _____ MASTERCHARGE _____ MONEY ORDERS _____ COD _____

ADD \$2.00 FOR POSTAGE AND HANDLING PLEASE ALLOW 10 DAYS FROM DATE OF RECEIPT OF ORDER FOR DELIVERY TEXAS RESIDENTS ADD 5% SALES TAX

CARD NUMBER _____ EXPIRATION DATE _____

FULL NAME _____ CALL _____

STREET _____ CITY _____ STATE _____ ZIP _____

MORE LITERATURE MODEL(S) _____

*****DEALER INQUIRIES INVITED*****

 **Hartwells** H26
Office World, Inc.

MAIL TO: 6810 LARKWOOD
 HOUSTON, TEX 77074
 ATTN: STEVE, WA5OEN
 PHONE: A.C. (713) 777-2673

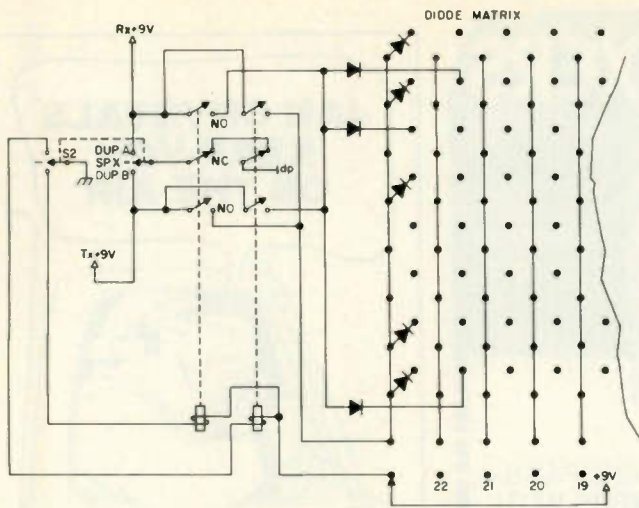

Fig. 2. A relay solution with frequency pair reversing and 600 kHz offset function disconnect. Without the reverse pair feature, a single DPDT relay would be enough.

switch (RX 9 V and TX 9 V). You would then have any receive and separate transmit frequencies the diodes could program, as long as the channel switch was in position 23 or 24. However, this is too simple to be practical. There would be too many cockpit errors possible, such as the channel switch being in a wrong position, the DUP/SPX not being in the SPX position, and, of course, the added switch not being off when using the regularly programmed channels. The concept of Fig. 1, however, does demonstrate the basic approach based on RX 9 V causing a receive set of diodes to control the transceiver frequency and TX 9 V causing a separate set of diodes to take over when the push-to-talk switch is closed. This is instead of the normal operation of routing these voltages to pin "dp" of the duplex control circuit through the DUP/SPX switch, causing the logic to add exactly 600 kHz to the programmed frequency in either the DUP A or DUP B positions (receive +600 kHz or transmit +600 kHz, respectively).

Icom's Generosity — No Need to Add Switches

You can take advantage of the unwired position 23 on the channel switch and of the fact that half of the

DUP/SPX switch is not used. Position 23 can be wired, for example, as in Fig. 2 to activate relays. To avoid some cockpit error, a set of the relay contacts can be wired to disconnect the +600 kHz offset function of the DUP/SPX switch. Also, wiring the SW 9 V from position 23 of the channel switch through the unused half of the now disabled DUP/SPX switch to a second

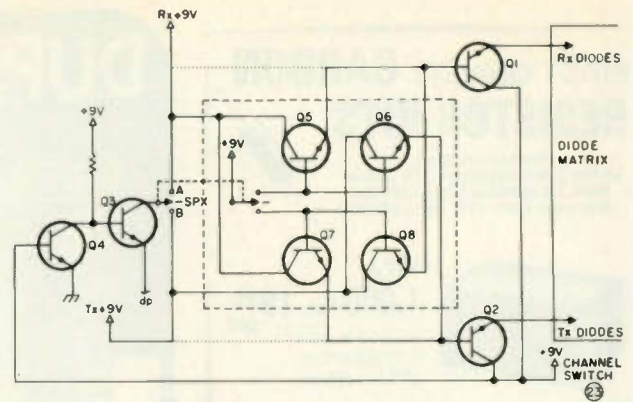

Fig. 3. Simplified diagram of the solid state version. The dashed lines enclose the optional frequency pair reversing circuitry. Q1 — receive frequency diodes activation; Q2 — transmit frequency diodes activation; Q3 — regular +600 kHz offset activation; Q4 — regular +600 kHz offset disconnect; Q5 — receive voltage to Q1 in the DUP A position; Q6 — transmit voltage to Q2 in DUP A position; Q7 — receive voltage to Q2 in DUP B (reverse) position; Q8 — transmit voltage to Q1 in DUP B (reverse) position.

relay will allow reversed frequency pair operation. A single DPDT relay is enough if reverse pair capability is not desired. This solves most operating concerns but leaves the problems of relays. Relays have problems of physical dimensions, mounting arrangements, power drain, and mechanical

have miniature relays; miniature relays cost a lot. I used semiconductors to eliminate the relay problems.

A Better Solution

Positive voltages forward bias NPN Darlington transistors. Darlington transistors in saturation act like closed switches and, with the base grounded or the collector voltage removed, act

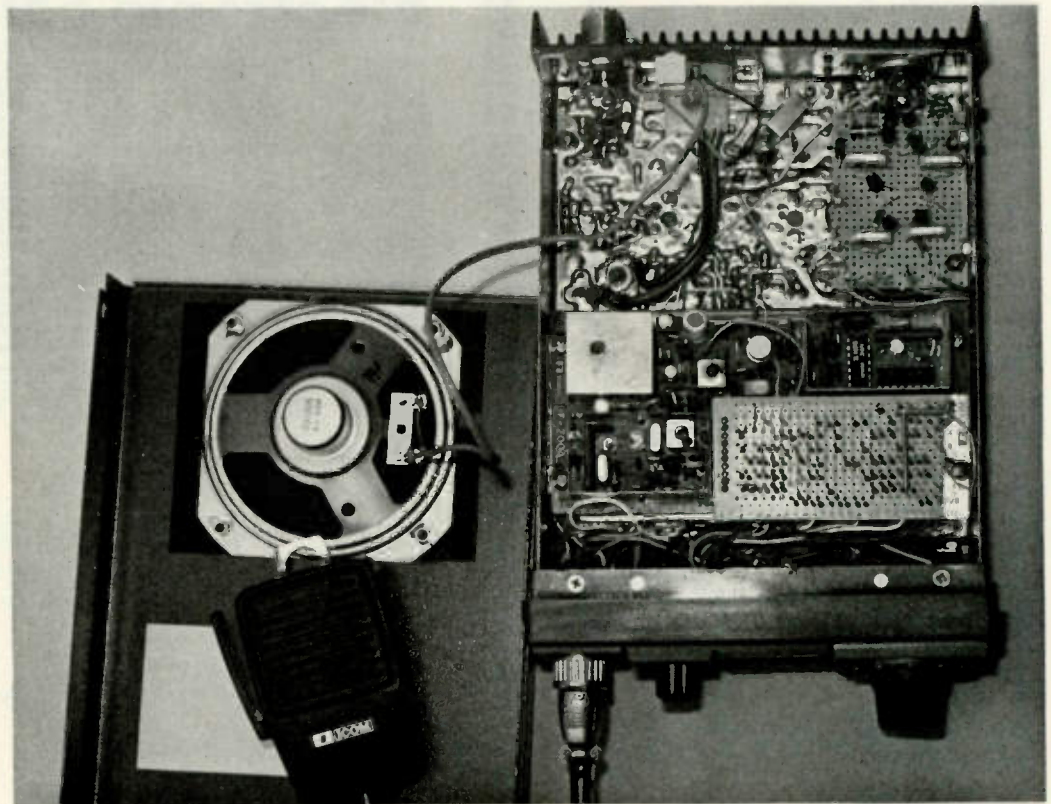

Assembly installed in Icom IC-22S.

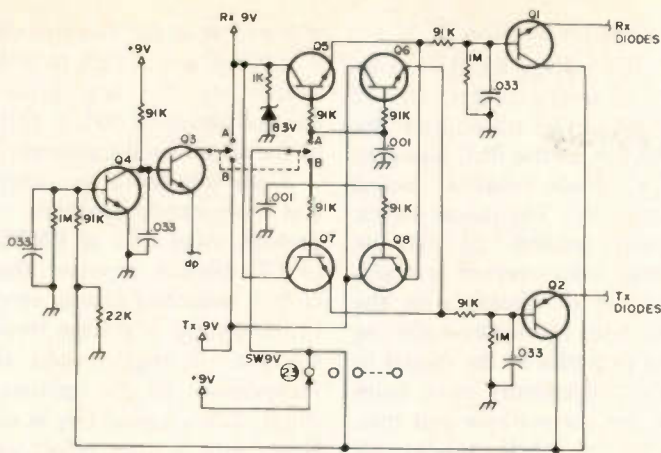

Fig. 4. Complete circuit as installed at W6WUT. Q1 through Q8 are 2N5306s.

like open circuits. Putting these characteristics together with the positive voltages of the Icom IC-22S leads to the diagram of Fig. 3. In this figure, Q1 supplies the voltage to the receive frequency determining diodes and Q2 the voltage to the transmit frequency determining diodes. Q5, 6, 7, and 8 are boxed in to show that they are optional. They are the DPDT function for reversing the frequency pair. I operated

for several months without them and only occasionally missed the ability to listen on the input of WR6AMD to find out if I could copy someone direct. Q3 and Q4 are the regular +600 kHz offset disconnect feature that is necessary in order to avoid operator error. If wired without the reversing capability (which uses the other half of the DUP/SPX switch), the DUP/SPX switch is completely out of the circuit. It



IC-22S installed in center console of Subaru.

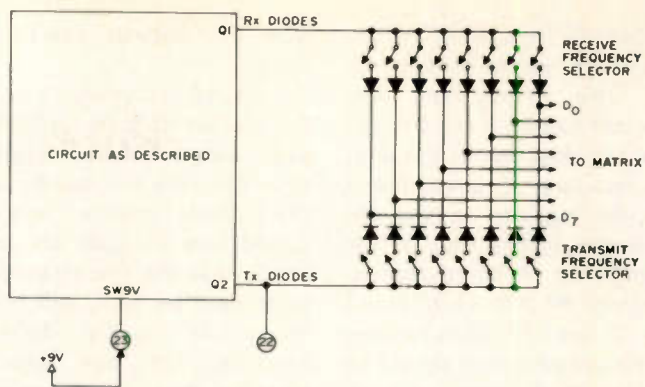

Fig. 5. External frequency programming embellishment.

won't matter what position you leave it in while operating in the nonstandard off-set channel.

Actual Circuit

Fig. 4 is my complete circuit with nominal values shown. None of the values is particularly critical. The 2.2k resistor on the switched 9 V line to Q4 was found necessary because of a small positive voltage present even with the channel switch in other positions. This voltage was enough to forward bias Q4 all the time, causing the DUP/SPX switch to be disabled at all times. The zener diode and 1k resistor may not be strictly necessary, but, since the RX voltage tended to rise to as much as 13.6 V when not loaded by the duplex control circuit (dp), I felt more comfortable with it pegged at approximately 9 volts. The base bypass capacitors are there to prevent the rf environment of the transceiver from biasing the Darlington transistors and can be almost any convenient size. The range of .005 to .05 uF should be all right. As for the transistors, any NPN Darlington around should work for Q1 through Q8. Mine are all 2N5306s.

Embellishment

For those who insist on the ultimate and don't mind adding outboard devices, only one more wire than the nine already required will allow switching any pair of frequencies in at any time. This selection of separate receive

and transmit frequencies can be combined with the diode switching method proposed by others, as shown in Fig. 5. Eight additional diodes and another switch or set of switches for selecting the added frequency are necessary at the outboard device. One channel switch position (such as 22) can be used for transmit frequency selection with regular +600 kHz offset operation, with a second channel position (such as 23) for the independent receive and transmit frequency selection feature.

Could you want more? You have all 21 predetermined frequencies, a fully programmable channel with standard offset, and an independently programmable receive and transmit frequencies channel. That's quite a bit for just one more wire brought out of the transceiver than what many IC-22S owners are bringing out now. As for me, I am satisfied not to have holes, added-on switches, or other visible signs of modification. Besides, my transceiver slides neatly into my '73 Subaru wagon center console as if it were made for it. Switches or cables or connectors sticking out of the top, sides, or bottom would interfere with this delightful coincidence of dimensions.

Construction

If care is taken, there is enough space under and to the side of the speaker. I mounted my circuit assembly on the side of the case be-

tween the PLL board and the accessory socket at the rear of the transceiver. The speaker can be rotated to get the lead lugs out of the way, if necessary. I remounted it so the lugs are toward the opposite (coax) side of the transceiver. A board approximately 40 mm (1-9/16 in.) by 65 mm (2-9/16 in.) will be a bit crowded but should be sufficient. A couple of small angles can mount the board with 4-40 screws, so the screw heads will not show

with the bottom cover in place.

I strongly recommend that the speaker leads be replaced with longer, more rugged wire. Also, the wire bundle to the diode matrix board should have the spot ties cut off so that the fine stranded wires used by Icom will not break as readily during handling. The new added wires for the circuit assembly can go under the PLL circuit board. The only empty lug on the channel selector switch is

the one for position 23.

The voltage for Q3 can be found several places, one of which can be traced from the end pin of the PLL board to the diode matrix board connector. The diode matrix board column 23 can be either your receive or transmit set of diodes, with the other set formed by soldering the cathodes of the diodes in any conveniently open holes of the correct row and then tying all their anodes together. This common anodes

connection is then treated as a column and wired to the emitter of the appropriate control transistor (Q1 or Q2) of the added circuit assembly.

I am sure there are other and more exotic solutions — perhaps using FET or CMOS or TTL devices. However, the circuit described draws very little current, is voltage level tolerant, is rugged, and is inexpensive. In my opinion, the IC-22S is a good buy as is. Now, with a little effort, it can be even more flexible. ■

DOVETRON



MPC-1000C

Multipath Correction
In-Band Diversity &
AFSK Tone Keyer

Amateur Net: \$545.00

Standard features include CONTINUOUSLY tuneable Mark and Space channels (1000 Hz to 3200 Hz), Dual Mode (MARK or FSK) Autostart and internal high level neutral loop keyer (20 to 60 ml). Both EIA and MIL FSK outputs are provided for direct interface to microprocessor and video terminal peripherals.



MPC-1000CR

Signal Regeneration &
Speed Conversion

Amateur Net: \$645.00

A front panel switch permits internal TSR-200 Signal Regenerator-Speed converter assembly to electronically "gear-shift" between 60, 67, 75 and 100 WPM. All incoming and outgoing signals are regenerated to less than 0.5% bias distortion. Also available with DIGITAL Autostart (TSR-200D): Amateur Net: \$695.00



MPC-1000R/ TSR-500

Dual UART Regeneration,
Speed Conversion, 200
Char. Memory, Word Cor-
rection & DIGITAL
Autostart

Amateur Net: \$895.00*

The MPC-1000R/TSR-500 provides Preloading and Recirculation of the 200 character FIFO Memory, a keyboard-controlled Word Correction circuit, Variable Character Rate, Tee Dee Inhibit, Blank/LTRS Diddle, a Triple Tone-Pair AFSK Tone Keyer and a Character Recognition/Speed Determination DIGITAL (DAS-100) Autostart mode.

*The MPC-1000R is also available without a TSR assembly and functions as a MPC-1000C with a Triple Tone-Pair AFSK Tone Keyer. This "Basic-R" permits future expansion with a TSR-100, TSR-200, TSR-200D or TSR-500 by simply lifting the lid and plugging in the appropriate TSR assembly: Amateur Net (Basic-R): \$595.00

Your QSL will bring complete specifications, or call: 213-682-3705.

D23



627 FREMONT AVENUE
(P. O. BOX 267)
SOUTH PASADENA, CA. 91030

TRS-80 OWNERS NOW SEND MORSE CODE!

- Level I & II cassettes included
- 4 or 16K
- Assembled & tested PC board
- All hardware • complete instructions
- 4 separate recallable messages
- Keyboard buffer • you type ahead
- Keyboard one-key speed change
- Plugs on the TRS-80 port
- No modifications to TRS-80 required
- Keys solid state & grid block rigs
- Sidetone included
- Machine language program • not basic

SEND PERFECT CW



\$39.95



MICRO-KEYER
BOX K
KINGSPORT, TN 37662

M58

NEW ELECTRONIC PARTS

Brand name, first line components. Stocked in depth. 24 hour delivery. Low prices and money back guarantee on all products we carry.

STAMP BRINGS CATALOG

SPECIALS

KEYBOARD ENCLOSURES

SIX SIZES	W	D	H	PRICE
14"	8.3"	3"		\$15.20
17"	8.3"	3"		18.35
20"	8.3"	3"		19.25
14"	11.3"	3"		16.50
17"	11.3"	3"		18.80
20"	11.3"	3"		20.75

Blue base, specify white or black top.

MAGNA-LITE JR
ONLY
\$5.79



- Printed Microcircuit Reading
- Electronics — Design, Production & Inspection
- Industrial — Engineers, Technicians, Draftsmen
- Laboratory & Research

RTTY

UT4 SPEED CVTR BOARD
KIT \$109.95
BOARD ALONE \$18.95
AUTO CW ID KIT \$37.90



SHIPPING
INCLUDED
IN PRICE

Daytapro Electronics, Inc.

Formerly NuData Electronics — D35

3029 N. WILSHIRE LN., ARLINGTON HTS. ILL. 60004
PHONE 312-870 0555

New Products

from page 265

combination of these. Conductive coupling frequently manifests itself as common-mode interference through a ground return used in common by two circuits.

EMI is radiated through openings of any kind in equipment enclosures (hatches, drawers, and panels), and through imperfect joints in the enclosures. It may also be radiated from leads and cables leaving a source, or picked up by leads and cables entering a susceptible device.

EMI sources may be natural or man-made, and the man-made sources may be intentional (e.g., radar transmitters) or unintentional (e.g., ignition systems). Natural sources of EMI include terrestrial and extraterrestrial sources. Since natural sources cannot be controlled, EMI from such sources can be reduced only at the susceptible equipment. Terrestrial sources include the ionosphere, or charged layers of atmosphere, lightning discharges, precipitation, and sand and dust storms. All of these produce atmospheric noise, the intensity of which varies with locations, season, and time of day. Extraterrestrial sources include the sun, which produces solar noise, the galaxy, which produces galactic noise, and extragalactic space, which produces cosmic noise. Solar noise comprises a low background level of thermal noise from the "quiet" sun, and sporadically higher levels of non-thermal noise from sunspots when the sun is "disturbed."

Galactic noise comprises a general background level from the galactic sources, which varies with the location and intensity of those sources. Cosmic noise comes mainly from the direction of certain stars that emit radio frequencies. Man-made sources of EMI, as noted above, include intentional sources, designed to generate electromagnetic energy, and unintentional sources, which generate EMI only incidentally to their intended function.

Man-made EMI sources and nearby EMI-susceptible equipment may be made electromagnetically compatible by reducing the EMI from sources, by reducing the susceptibility of equipment, and by introducing attenuation in all EMI paths between sources and susceptible equipment. Ideally, reduction of EMI should begin by

designing the source so that it generates less EMI. The remaining EMI may then be contained within the enclosure by filtering and shielding.

EMI susceptibility of equipment may be reduced by designing the components and circuits so that the device is inherently less sensitive to interference. Conductive susceptibility may then be reduced by inserting filters in each line at the point where it enters or leaves the enclosure. Radiative susceptibility may then be reduced by shielding. All shielding problems may be divided logically into four major categories, by the nature of the result required: 1) containment shielding; 2) exclusion shielding; 3) exclusion/containment shielding plus pressure shielding; and 4) grounding and contacting.

To eliminate or reduce EMI, Anemco, Inc., of Anaheim, California, offers a selection of EMI shielded enclosures:

The double-shielded Lindsay Structure, considered the epitome, offers the greatest shielding effectiveness over the widest range of frequencies. Of all metal construction (zinc-coated steel), the Lindsay Structure provides the greatest strength-to-weight ratio with single or double wall panels of 24 gauge steel. The panels are stressed and held together by "U" and "M" channel and tensioner framing members. This construction affords excellent electrical and mechanical joints and seams to assure the highest level of shielding effectiveness. Doors are easy opening, with three-point latch.

Solid laminated sheets are most widely accepted for general shielding needs, providing good strength and attenuation. Panels are constructed of solid core sandwiched between steel sheets. Core and steel finishes are designed to match customers' needs and uses. Panels are joined with 1/8-inch steel hat and flat "U" and "W" channels. The rooms are easily installed, modified, and moved.

Screen rooms offer a medium amount of shielding effectiveness. The screen is secured to a wood frame for easy installation. Each panel is interlocked with the next. Wainscoting is attached to protect the lower portion of the room. The screen enclosure was developed to offer a lightweight and an inexpensive portable means of interference suppression. The enclosures can be as small as a desk-top

model (one cubic foot) or as large as a research laboratory. The frequency range of attenuation is dc to greater than 400 MHz to E fields, covering approximately 95 percent of normal applications.

All rooms are constructed of quality material using proven joining techniques to offer maximum shielding. Standard enclosures, based on nominal two- and four-foot increments, are readily available. Special sizes and accessories take a little longer. All are easily installed with simple tools. Cost could be directly related to the amount of suppression or attenuation requested. Anemco, Inc., can also update, move, modify, certify, and maintain existing enclosures.

Anemco, Inc., has a staff of experienced personnel to assist you with your questions. They will help you to incorporate your requirements into an effective structure. Turn-key requirements are welcome. The Anemco, Inc., staff has modified, assisted, designed, and installed rooms at many sites including Vandenberg AFB, Goldstone, TRW, Hughes Aircraft, U.S. Navy, and aerospace, radio, and TV sites, and also in the commercial CB, communications, hospital, computer, and classified areas.

For full information on how Anemco, Inc., can help solve your EMI attenuation/suppression problems, write *Anemco, Inc., 157 Freedom Avenue, Anaheim CA 92801, or call (714)-879-6092.*

Morgan W. Godwin W4WFL
Peterborough NH

HAMTRONICS 2 METER TRANSMITTING CONVERTER

Whether you're interested in local rag chews, terrestrial DX, moonbounce, or OSCAR operation, Hamtronics' new 2 meter transmitting converter is a quick and easy way to produce a useful signal at low cost. The XV2 transmitting converter is designed to convert 1 milliwatt of 10 meter energy to provide 2 Watts PEP output on 2 meters. A modified CB SSB transceiver can also be used as an exciter. And, since it is a linear converter, the XV2 may be used on any mode: SSB, CW, AM, FM, etc.

The transmitting converter kit comes in three versions for 2 meters, XV2-4 (28-30 MHz = 144-146 MHz), XV2-5 (28-30 MHz = 145-147 MHz), XV2-6 (26-28 MHz = 144-146 MHz), as well as models for 6 meters and 220 MHz (other special frequency combinations are possible). Rf input requirement is less than 1 mW PEP (100 mV into 50 Ohms or -7 dBm typical). Rf output is 2 Watts PEP continuous on SSB or keyed CW and 2 Watts

at 50 percent duty cycle on FM or carrier.

Frequency conversion is accomplished by two n-channel J-FETs operating in a balanced mixer configuration. Injection is generated by a 39-MHz crystal oscillator operated from a regulated power source. The oscillator frequency is tripled and spurious multiplier products are filtered in two stages following the oscillator. The 2 meter mixer output is amplified in two class A amplifiers and a class AB output stage to provide an rf output of 2 Watts PEP. This rf output may be used to drive a linear amplifier or it may be fed directly to an antenna. A low-pass filter in the output minimizes harmonics so that direct operation may be safely undertaken.

While the instructions that accompany the XV2 kit are not of the precise, step-by-step nature of those provided by some kit manufacturers, they are certainly detailed enough to provide all the guidance needed to easily and successfully assemble and align the unit in trouble-free fashion. The instructions are, in fact, pretty much like those to be found in a well-written magazine construction article. Read over the explanatory material two or three times, particularly the page headed "General Construction Notes," and you'll be prepared to start putting the unit together.

I tend to be a rather slow worker, but even with several interruptions the assembly and tune-up proceeded smoothly and without incident to make an interesting and enjoyable day's project. Even the winding of the coils—something I ordinarily hate like blazes to do—went without a hitch on the first try.

All that's needed to align the XV2 transmitting converter is a VTVM, 2-Watt dummy load, a 10 meter signal generator capable of supplying 300 mV of rf, and a 13.6 V dc regulated power supply with an internal or external milliammeter (up to 500 mA). If a signal generator is not available, the 10 meter exciter may be used; however, caution must be used to ensure that the transmitting converter is not overdriven, and some means of varying the carrier level must be provided.

Alignment instructions are quite detailed and, if properly followed, you should have no difficulty in putting the converter on the air quickly and easily. Should you run into a problem, the section on troubleshooting will enable you to pinpoint and correct it.

Since it seems probable that most exciters used to drive the XV2 transmitting converter will

You're just a few digits away from name brand radio equipment - AT DISCOUNT PRICES!

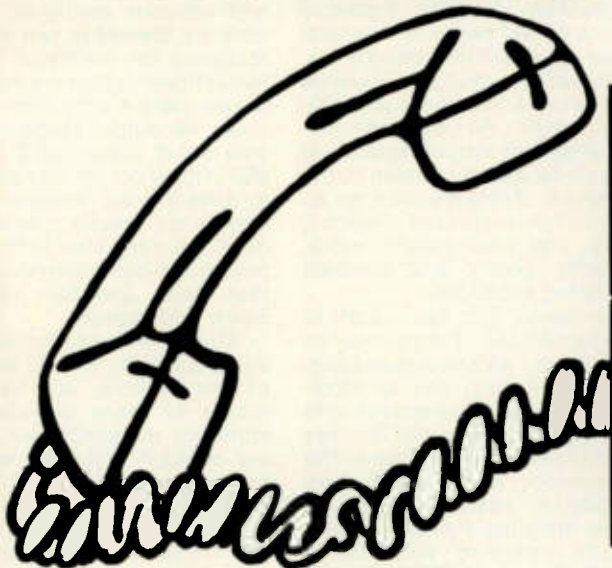

CALL TOLL FREE

1-800-228-4097
Communications Center

443 N 48th Street C58
Lincoln, Nebraska 68504
In Nebraska Call (402) 466-8402

1-800-634-6227
**Communications Center
West**

1072 N. Rancho Drive
Las Vegas, Nevada 89106
In Nevada Call (702) 647-3114

YAESU
KENWOOD
DRAKE
ICOM
STANDARD
EDGECOM
KDK

DENTRON
HY-GAIN
MOSLEY
CUSHCRAFT
WILSON
HUSTLER
LARSEN

TAYLOR
SWAN
TEMPO
TEN-TEC
MIDLAND
CDE
AUTEK

E.T.O. ALPHA
VHF ENGINEERING
BERK-TEK CABLE
CONSOLIDATED TOWER
SAY
SHURE
TELEX

plus many more

1-800-228-4097

CALL TOLL FREE FOR

1-800-634-6227

ANTENNAS

HY-GAIN
TH6 DXX
TH3MK III
18 AVT/WB

MOSLEY
CLASSIC 33
CLASSIC 36
TA-33

CUSHCRAFT
ATB-34
ARX-2
A-147-20T

HUSTLER
4BTV
66-144A
RM-75s

WILSON
SYSTEM 1
SYSTEM 2

Specials on CDE Rotors

Ham III - \$125.00
Taitwister - \$225.00

■■■■■ LOOK! ■■■■■

HOURS: Monday - Friday 8 a.m. - Midnight
Saturday 8 a.m. - 8 p.m.
Sunday Noon - 8 p.m.

SAME DAY SHIPPING ON MOST ITEMS

**We carry all major lines of antennas
at DISCOUNT PRICES
call for quotes: 1-800-228-4097**



produce considerably more output than is required, the information included on attenuators is particularly helpful. In addition to explaining the construction and use of attenuators as well as typical component values to drop the output of your exciter to the required 1 milliwatt level, there are instructions for modifying the exciter to provide a low power tap and for using a Cantenna or similar dummy load to reduce the output to the appropriate value.

If you need more than the 2 Watts PEP provided by the converter, you can use it to drive one of the several linear amplifiers Hamtronics offers, such as the LPA 2-15 or LPA 2-45.

The XV2 is designed to be mounted in Hamtronics' companion A25 cabinet or, by utilizing the six mounting holes provided in the corners and center of the circuit board in conjunction with suitable screws and spacers, it can be installed in any cabinet or panel arrangement to suit your individual requirements.

If you're looking for a way to get on 2 meters quickly and easily without breaking the family budget, the XV2 can't be beat if you've got an exciter with output in the 26-30-MHz range and are willing and able to put in a few hours to build and tune up the little converter.

The model XV2 series transmitting converter kits are priced at \$59.95. A new free catalog describing the complete Hamtronics product line is available upon request. *Hamtronics, Inc., 182 Belmont Road, Rochester NY 14612, (716)-663-9254.*

Morgan W. Godwin W4WFL
Peterborough NH

TEN-TEC ANTENNA TUNERS

I enjoy operating all of the HF amateur bands with my FT-101B, using a variety of antennas fed with coax and open wire feeders as well as an end-fed random wire. As a result, I need a good wide-range antenna tuner and Ten-Tec's model 247 and 277 tuners have been doing a beautiful job for me on 160 through 10 meters. Both models use inductive/capacitive networks for matching unbalanced 50-75 Ohm output impedances of transmitters and transceivers to a variety of balanced and unbalanced loads over the 1.8 to 30 MHz frequency range (maximum balanced load 1.8 to 4.0 MHz is 600 Ohms). Rf power rating for both units is 200 Watts (continuous). Model 277 has a built-in swr bridge and meter.

The tuner circuit is the same in both models, a parallel circuit consisting of an inductor and two variable capacitors

connected in series. The input is applied to the center of the series capacitors and ground. Another variable capacitor is connected in series with the output lead to the coax and single-wire terminals. For balanced outputs, a balun is connected so that the basic tuner output is applied to one half of the winding, and transformer action produces the opposite half with reference to chassis ground. Thus the balanced output will provide twice the rf voltage, symmetrical to ground. The arrangement produces an impedance transformation step-up of four times on the antenna side, enabling you to match just about any antenna system impedance to 50 Ohms.

When the tuner circuit is adjusted to a match, the parallel-tuned circuit will be approximately in resonance at the frequency involved. The load's reactive components will be compensated for by the series output capacitor and a slight off-resonance setting of the parallel circuit. Since both the inductor and shunt capacitor are variable, there are, of course, many possible settings of these components that will resonate at a given frequency. As pointed out in the instructions that accompany the tuners, a high inductance with small capacitance will resonate just as well as a small inductance with large capacitance. This raises the obvious question as to whether one way is better than the other. The answer is yes.

When matching your rig's output to high impedances, there must be a certain amount of inductance present to effect a proper match. The step-up transformation of resistance is dependent upon the "Q" of the circuit, which is a function of the inductance. Further, the L-to-C ratio of the circuit determines the frequency range over which operation with an acceptable swr is possible without retuning. The smaller the L/C ratio, the greater the bandwidth. The following results from Ten-Tec lab tests illustrate how effective this becomes at low frequencies: At 3.75 MHz and with a 50-Ohm load, setting the tuner for maximum L/C ratio produced a frequency range of 50 kHz (± 25 kHz of center frequency) before an swr of 2:1 was encountered. However, adjusting the tuner circuit for lowest L/C ratio increased the frequency range to 400 kHz before the swr exceeded 2:1. Also, with the broader-band L/C ratio, tuner adjustments are much less critical and the dip to 1:1 on the swr meter is broad. With high L/C ratios, the dip is very narrow

and sharp, making it easy to miss.

Ten-Tec has thoughtfully included a 7-page pamphlet packed with instructions and information to enable users to get the most out of their tuners. The concise explanations of antenna systems matching theory, transmission lines, antennas, swr, and more is a fine touch and one that will certainly result in improved performance for those who follow the sound advice provided within those few pages.

The model 247 (tuner only) measures a compact 2-15/16" x 7-3/4" x 6-11/16" while the model 277 (with swr meter) is 3 1/2" x 10-1/4" x 6-1/2". Both units weigh approximately 3 lbs. Model 247 is housed in a case with etched aluminum chassis and front panel and model 277 has a grey chassis and front panel and black textured sides and top. Both will make an attractive and most useful addition to your shack. Model 247 sells for \$69.00 and model 277 for \$85.00. *Ten-Tec, Inc., Sevierville TN 37862.*

Morgan W. Godwin W4WFL
Peterborough NH

NEW COMPACT AMATEUR HAND-HELD RADIO NOW AVAILABLE FROM STANDARD COMMUNICATIONS

A new very compact 1+ Watt 2 meter amateur hand-held FM transceiver is now available from Standard Communica-

tions Corp. of Carson, California.

This radio, designated C-118, measures 2-43/64" wide x 6-1/16" high x 1-41/64" deep (or approximately the size of a dollar bill) and permits the user to transmit +600 kHz, -600 kHz, or receive and transmit on the simplex frequency with just one crystal. This provides a total of 18 transmit channel capabilities with only six crystals.

The C-118 also incorporates a built-in condenser microphone and LED status lights for "channel busy" and transmit. Also included at no additional charge is a BNC connector with rubber flex antenna, provisions for external dc power supply, and earphone. It has a frequency range of 144-148 MHz and is equipped with one crystal for operation on 146.94 simplex and .34/94 MHz.

To obtain a free copy of the C-118 data sheet, write *Standard Communications Corp., PO Box 92151, Los Angeles CA 90009.*

YAESU APOLOGIZES

Early Yaesu advertisements for the new FT-225RD transceiver were incorrect in that they tended to indicate that the memory unit is included in the price, whereas in fact it is an option. Yaesu apologizes for this error and hopes that it has caused their valued customers no inconvenience.



Standard's C-118 hand-held transceiver.

Harry A. Mills W4FD
Box 280
Bullard Route
Dry Branch GA 31020

Gene Brizendine W4ATE
600 Hummingbird Drive SE
Huntsville AL 35803

Antenna Design: Something New!

—controlled-current distribution

Antenna elements to date, whether grounded or ungrounded, are by and large composed of electrically continuous conductors whose dimensions are based on formulas related to the free-space dimensions of radio waves. The presence of standing waves and losses due to end effects have heretofore been accepted as more or less necessary in the transfer of radio frequency energy into space.

Our thinking in this regard has changed very little since the medium of radio was discovered more than a hundred years ago.

The greatest impediment to progress in antenna development over such a long time has been the belief that an "antenna" is merely a length of wire in space, whose dimensions are locked to the operating frequency. The second problem, also linked with the first, is the notion that the antenna should sustain a standing wave. Thirdly are the problems associated with lossy end effects. There is also the excessive copper heat loss that must occur at the center of the conventional dipole. The losses due to high current (and rf field) density multiply when the usual antenna is erected as a quarter-wave vertical radiator.

directly from a capacitor is so minor does not justify its virtual elimination from use in antenna systems. As a device for the control of phasing, it looms as the most important consideration of all, both for pushing that antenna current to all parts of the radiator and, importantly, to distribute it in phase, so the resulting field is efficiently directed. Interestingly enough, superior results occur when the current distribution becomes more equal in the system. Lo and behold, best results are obtained upon elimination of the standing wave.

The insertion of capacitors in series with an antenna was briefly described by Terman.¹ Some ideas were added by Charman, with the advice that the technique "well deserves further investigation."

But all of this was BC (before capacitors). The fact that the radiation

¹Terman, *Radio Engineering Handbook*, McGraw-Hill, New York, 1943, page 773.

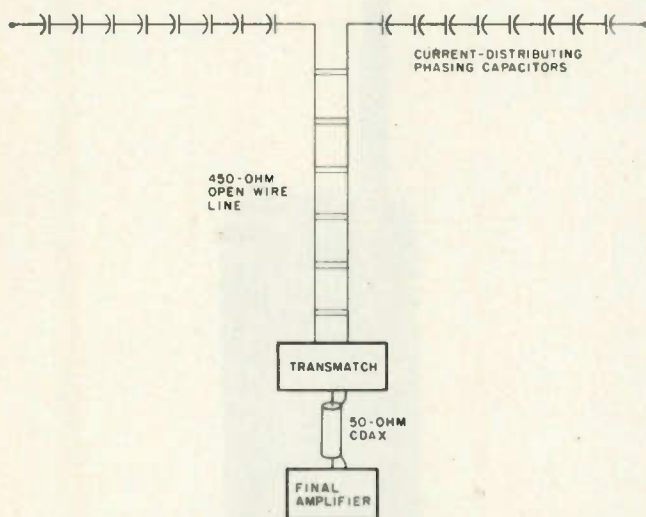

Fig. 1. Controlled-current distribution antenna general arrangement. Details of construction and adjustment are included in the text. A feedline length which is a multiple of $\frac{1}{2}$ wavelength at the lowest (design) frequency is desirable.

tion."² How long it has taken us to grasp the handle on this rocket, on which we may escape the prison of conventional thinking! Let us take that flight, without further delay.

It is difficult to face the fact that, for all these years, we failed to take advantage in antenna design of that most important characteristic of a capacitor, its inherent low loss. The lowly capacitor is well established as man's best friend in the design of power and audio filters over these many years. Somehow, a blind spot has prevented us from seeing it in the vital role of filtering out antenna current into a most efficient distribution pattern.

Additionally, by equalizing current throughout the radiator by use of capacitors, we realize another very important improvement. Over the years, we have tolerated that wasteful spray of high-angle radiation which occurs from the high-impedance, high-voltage portions of our antenna as though it were an unavoidable evil. In reality, a standing-wave-type radiator thrusts out energy at widely varying angles, becoming worse toward the ends. When we approach equal current along the antenna, radiation begins to focalize at a low angle. Lo and behold again, our antenna begins to perform amazingly well on DX, even when close to or near the ground. In brief, the equalized current element becomes an improved performer when substituted for the conventional dipole form in all kinds of configurations.

The present paper was written to encourage a breakthrough and breakthrough from conventional

impeding practices. Some simple theory and practical construction details are included to introduce the improved system.

Developmental Background

The controlled-current distribution (CCD) principle was recognized more than ten years ago, during the development of a compact 3-element rotary beam. Ferrites were used, not only to dramatically shorten the antenna elements, but also to provide a means whereby a special type of cored ferrite material could be used to electrically tune each element individually over a wide range of operating frequencies. Controls for tuning are conveniently located at the operating position.

The CCD principle is implicit in the basic United States patent 3,564,551, granted to W4FD on February 16, 1971, which covers the scheme whereby a dipole antenna element employing ferrite is tunable over a wide range of frequencies, in either transmitting or receiving modes, by varying the permeability of the sleeved cores. Permeability variation is accomplished by magnetically biasing the cores with controlling field current windings.

It is well known that ferrite material must be employed in rf circuits under conditions of high current and low voltage because of its inherently high dielectric properties. Previous use of this material had been limited to the middle one-third to one-half of the dipole.

Fig. 2. (a) Conventional half-wave radiator showing the concentration of current at the middle half of the antenna. (b) Small section of a vertical CCD antenna showing current loops at each capacitor-wire section. Loop amplitudes decrease as the radiator end is approached. However, very significant improvements in gain and other features now result from expanding current distribution outward from the antenna center to better utilize the entire radiator.

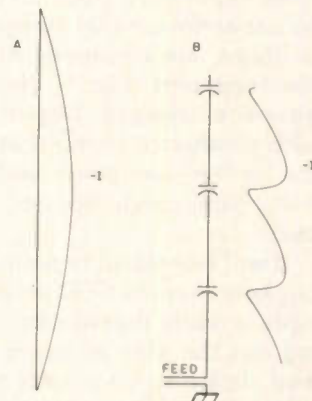

To offset this limitation, a means to obtain a near-constant rf current along the conductor was conceived. This CCD scheme made it practical to utilize cored sleeves over the entire radiator and to greatly extend the frequency tuning range.

In brief, the system made possible the operation of elements as short as hundredths of a wavelength, with spacing of beam elements likewise reduced. Upward of 300 foreign countries were contacted by W4FD, under the previous call W3UZ, using the shortened ferrite antennas between the years 1959 and 1973. Moreover, many of these contacts were made while radiating from ferrite elements in a basement in Washington, DC, 5 or 6 feet below outside ground level.

Continued experimentation with the CCD scheme, following its initial use in ferrite antennas, revealed that the gain realized from conventional wire, beam, mast, or tower antennas of all types could be markedly improved by employment of the controlled-current distribution principle. In short, it improves the operation of antennas at both dimensional extremes.

The Controlled-Current Distribution Theory

It is well established that a maximum field is produced around conductors at points of maximum current. Points of high voltage and low current, conversely, produce small fields. It follows that, should some means be provided to maintain the antenna current at a constant or near-constant value along a conductor, the resulting field should translate into improved gain from the radiator. This condition of tracking the antenna current in phase would not only redistribute the excessive I^2R conductor heating loss present at the center point of peak current, but would also reduce or eliminate the dielectric end effect losses. Such a current distribution would not only make it possible to efficiently employ constant cross-section area sleeves in a ferrite radiator, but also to improve other antenna systems.

Band meters	Length feet	Section inches	Sections number	Capacitor pF	Capacitors number	"K"
160	560	140	48	1560	46	33.92
80	280	70	48	780	46	16.96
40	140	35	48	390	46	8.48
20	70	17.5	48	195	46	4.24

Table 1. Construction guidelines for CCD antennas one space wavelength long.

²Charman, RSGB Bulletin, London, July, 1961.

The problem of current distribution was resolved by cutting the antenna conductor into twenty-two or more even-numbered sections of equal length, to which were interconnected in alternate series twenty or more equally-valued fixed capacitors. Note that no capacitors, either series or shunt, are employed at the feedpoint, Fig. 1. The antenna always begins with conductor sections at the center feedpoint and ends with conductor sections.

It will be helpful to point out here that the CCD principle is really that of carrying out the idea of top or end loading, so often utilized in the conventional shortened antenna. The ultimate result is that of improving the current distribution throughout any length radiator. Control of current distribution by means of interconnected series conductor-capacitor sections with fanned end radials or large discs (but without lumped inductance in the circuit) begins at one-half wavelength for the dipole or a quarter of a wavelength for the grounded vertical. Thus, by using the horizontal dipole as a guide, it can be seen that the addition of aluminum screen discs at the ends, plus the cutting of a half-wavelength

radiator into a series of alternate wire and capacitor sections, could improve both the current distribution and gain of the resultant radiator. However, this is only the beginning of the possibilities.

The Antenna Aperture Concept

One aperture can be conveniently defined, for the purposes of this article, as the in-space dimension of a half wavelength at a particular frequency. By this definition, the conventional thin-wire dipole, because of its end-effect characteristic, may be said to have an aperture of about 0.95. Antennas constructed of tubing or cylindrical elements have an even smaller aperture.

Aperture as a concept involves the idea of exposure to a wavefront. The idea may be referred to a slot antenna, cavities, or even to the raster of a television picture scan. In a sense, all radiating systems which present an exposure which is less than a wavefront in free space distance may be said to suffer from a degree of "wavefront distortion." In other words, the full potential of the wave-sweep or scan is not present in a transmitting or receiving antenna of contracted dimensions.

Real exposure effi-

ciency, or maximum aperture usage, begins at the point where an in-phase equal-current coverage fills the conductor or slot medium.

Exposure efficiency begins in a smaller way with the CCD scheme, plus element end or top capacitance loading, and emerges more or less full-blown with antenna lengths of two apertures or more.

The improvement in gain that can be effected through the use of a constant-current distribution arrangement can be illustrated with the 5/8-wavelength horizontal antenna. This radiator produces its peak gain at this length partly because of the trade-off between an increasing out-of-phase component and its expanded aperture. Gain begins to decrease at antenna lengths above and below the 5/8-wavelength figure.

It is customary to provide the 1/8 wavelength (extending the 1/2-wave dipole) by loading the antenna with a non-radiating series inductor. However, inductors introduce substantial losses. Therefore, any trade-off scheme to increase gain through the use of either inductor or capacitors should favor the inherently

lower-loss capacitor. Moreover, the CCD principle can be employed not only to eliminate the loading inductor losses, but also to effectively distribute the current so that resonance is restored to the 1/2-wavelength value. Not only is the out-of-phase component effect greatly reduced, but the resultant current distribution can be made phase-aiding also. Furthermore, the trade-off limitation at the 5/8-wavelength dimension disappears, and the way is opened for continued increase of aperture, in phase, with increasing antenna length.

Controlled-Current Distribution Principles

The CCD process can be more easily visualized by comparing it to full-wave rectification of a multi-phased alternating current to iron out the ac ripple component. No rectification of the rf in the antenna element is, of course, taking place in the CCD system. However, in the alternate conductor-capacitor arrangement, as values of capacitors are progressively increased and wire length in each section is decreased, within reason, the rf standing-wave "ripple" along the antenna will tend to smooth out. The better the distribution of the current, approaching a true in-phase condition, the more effective the antenna. The capacitance loading discs employed serve the purpose of carrying uniform distribution of current nearer to the radiator's very end.

An illustration of current patterns through the X_C and X_1 components is shown in Fig. 2(b). A vertical radiator is depicted, so that positive X_1 and negative X_C values may be shown right and left respectively. The wire sec-

Date	Time DST	Antenna	Height in feet	Ferris 32-B level, dB	Relative
7-2-77	1:45P	#4 CCD	60	20	Relative
		REF	60	15	
	2:10P	#7 CCD	60	20	
		REF	60	15	
7-4-77	7:20P	#4 CCD	60	20	
		REF	60	15.5	
7-5-77	10:56A	#4 CCD	60	20	
		REF	60	15	
7-14-77	10:40A	#4 CCD	60	20	
		REF	60	15	

Test antenna specifications:

#4 CCD—150 feet overall, 36-inch sections, 390 pF caps.

#7 CCD—136 feet overall, 38-inch sections, 390 pF caps.

Reference model 67 feet overall. A conventional dipole.

All three antennas normal to a bearing of 45 degrees true, and the standard Ferris model 32-B antenna.

All inactive antennas were floated during each reading.

Table 2. CCD comparative field intensity measurements.

tion is distributed X_1 , comprising most of the radiator, and the X_C contributes only minor power in the radiation process.

Contrasting the CCD features to another type of long antenna, the collinear array, its performance superiority is readily apparent. When several one-wavelength CCD radiators are configured as a collinear array, no longer are the usual 180-degree phase-shifting stubs required at one-half wavelength intervals along the radiator. Stubs are only needed to separate each one full electrical wavelength, thereby reducing the number of stubs by one-half in a given array.

The simplified and improved antenna will prove to be outstanding in gain for 2 meter and higher frequency applications and particularly in color television, where a broadband response is mandatory.

The user of the CCD will be especially pleased with its performance as a vertical radiator. The longer his CCD with respect to the electrical half wave, the less will be the need for the labor-consuming radials which are so important to the conventional standing-wave system. Since current is nicely distributed throughout the radiator, no longer are we troubled by the heavily-concentrated field and resulting lossy ground-return currents directly at the vertical antenna base. The heavy field around the base becomes less and less as the antenna is lengthened to one-half wavelength and performs quite well with shorter radials. At one wavelength, we realize a low-angle radiator par excellence and may dispense with the radial plow.

The user will be most agreeably surprised when he learns that the almost uniform distribution of cur-

rent throughout the CCD not only provides a more favorable antenna resistance at the fundamental frequency (usually double), as compared to the conventional dipole, but also the current distribution at the second harmonic will be only a few hundred Ohms (usually less than 450), provided he utilizes 50 or more distribution capacitors. Moreover, most of the radiation will occur broadside to the antenna, as has been found during operation at the fundamental frequency.

Elaborate measurements and adjustments could be performed, measuring antenna resistance and resonant frequency with rf bridge and detector, while adjusting end-loading capacitor screen discs to the exact diameter. However, in practical application, such elaborate tailoring is not justified, because the antenna will generally be used over a wide range of frequencies.

How the CCD Antenna Differs

It has long been assumed that, because radio frequency energy becomes an accurately measurable standing wave in free space, the radiating element itself should be dimensionally designed to also contain a standing voltage wave. This locked-in concept, far from having basis in fact, is one of the bottlenecks to the realization of greater efficiency and versatility in antenna design and construction.

Here are features wherein the improved CCD antenna departs radically from the usual dipole. First, we select the wire section length desired and then determine what capacity in picofarads is necessary to partially cancel the inductive reactance of the wire sections.

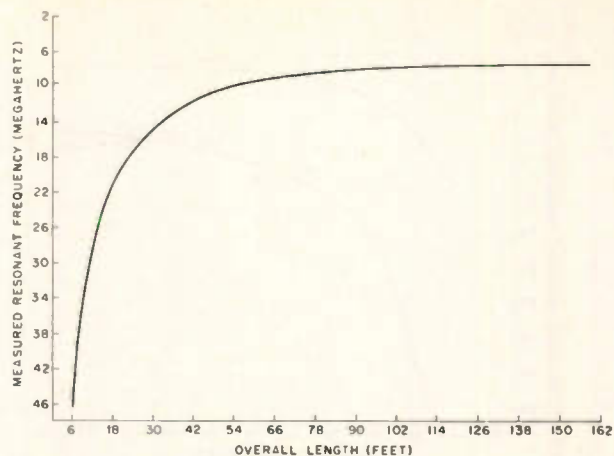

Fig. 3. The Mills controlled-current distribution antenna. Measurements were taken during assembly on March 24, 1977. Sections—3 feet; capacitors—silver mica 390 pF (50 each); dip meter—Millen Solid; coupling turns—8. For exact measurement data, see Table 3.

Too low a capacity will create too high a capacitive reactance in Ohms and thereby over-cancel the inductive reactance of the wire section. Conversely, incorporating capacitors of too small a value will prevent ever achieving resonance, regardless of how many sections are added. The X_1 to X_C ratio is the key to proper CCD antenna performance. If the difference is too small, we will require an impracticable number of wire sections and series capacitors to obtain resonance at the desired frequency, and the magic of controlled-current distribution disappears.

The superior characteristics of the controlled-current distribution system become apparent when the radiator overall length is extended to one electrical wavelength and beyond. The end-loading discs may then be eliminated, except in instances where it is desired to feed the antenna at some point considerably off center. In such cases, the use of a disc is recommended only at the shorter end. When off-center feed is employed, a balun should be inserted between antenna and feedline to isolate the

feedline circulating currents and to maintain balance. Since the antenna impedance along its length is practically constant, no feed problems should be experienced at any point, provided that balancing techniques are employed.

The broadbanding characteristics of the CCD radiator are remarkable, increasing in proportion to antenna length. Since standing waves are now conspicuous by their absence in the conventional sense, the need for a phase-inverting stub (which limits bandwidth in the collinear array) no longer exists. In one fell swoop, controlled-current distribution removes both a long-standing obstacle to broadbanding and also the wire loss introduced by the stub.

Heretofore, the capacitor has not been employed to any great extent directly in antenna elements. It is passive insofar as its contribution to the radiation process. However, its low losses and its ability to control current distribution, and hence phasing, give it a unique place in antenna design. Importantly, it provides the antenna designer with flexibility in tailoring his radiating system for the

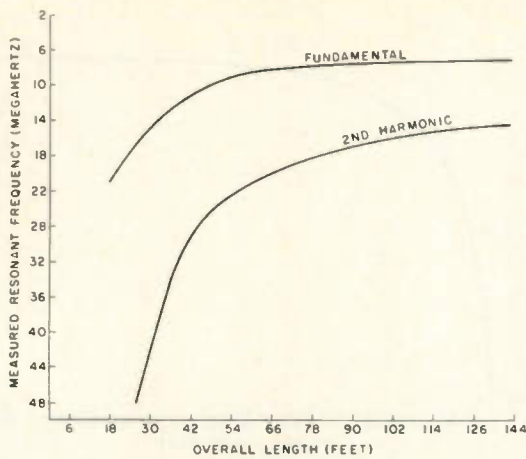

Fig. 4. The Mills controlled-current distribution antenna. Graph made from data taken during assembly on July 20, 1977. Section length—11 inches; capacitors—1500 pF; number of capacitors—160; dip meter—Millen Solid. For exact measurement data, see Table 4.

most efficient use of the available ground space.

One startling characteristic of the CCD antenna is its almost complete immunity to the effects of close-by nonresonant conductors or semiconductors. In one test, consistent S-9 reports on 7 MHz were received by W4FD from stations in Miami, Cincinnati, New Orleans, and Louisville with the CCD antenna lying flat on the ground during a soak-

ing rain. With the CCD arranged in a square, again flat on the ground and under several inches of snow, I2CUV reported a signal of 549 on January 28, 1977. A two-wire non-radiating feeder 9 feet long was used, and no arcing was found along the radiator with an input of 500 Watts.

Advantages of the CCD Antenna

1. Greater gain.

2. Great reduction or elimination of end effects.
3. Higher antenna resistance.
4. Full use of antenna element—no nodes.
5. Lower radiation angle—good DX radiator.
6. No high voltage points—can be laid on tree limbs.
7. Good field day antenna—works well at only 8 feet up.
8. No phase-inverting stub required.
9. Can be made any convenient length for available space.
10. Improved broadband characteristics.
11. Improved broadside radiation at early harmonics—good harmonic antenna.
12. Current distribution effects lower losses in both antenna and ground.
13. Very effective for quads, deltas, etc.
14. Changes in height produce progressively less relative changes in antenna resistance as the number of capacitors and overall length are increased.

15. Harmonic operation becomes more and more effective as the number of capacitor units is increased and the conductor sections are proportionately shortened. Rule of thumb shows that, for a given overall antenna length, shortening the wire sections by one half doubles both the number and the capacitance values of the fixed capacitors required. Broadside pattern characteristics are proportionately improved at both the fundamental and harmonic frequencies with an increasing number of sections.

CCD Disadvantages

1. Increased cost because of the added wire, capacitors, and insulators.
2. Greater care in construction and testing.
3. Requires more erection space than is available to some amateurs.
4. In CCD antennas for 3.5 MHz and lower, the capacitors should be protected from static charge by shunting resistors. If a cluster of CCDs is used, only the longest one needs this protection.

These are really minor inconveniences in contrast to the fifteen overwhelming benefits listed above. The old adage, "Every nickel spent on the antenna is worth more than a dollar spent on the station gear," was never truer. Give that good rig a chance with an equally good antenna!

Comparative Field Intensity Measurements of the CCD Antenna

At the W4FD antenna range, carefully controlled gain measurements are made using a laboratory standard Ferris model 32-B field intensity meter, fitted with its standard 41-inch antenna. Power to both the plates and filaments is regulated to 1 percent. The laboratory equipment is

Length overall (feet)	Fundamental (MHz)	2nd harmonic (MHz)	3rd harmonic (MHz)	4th harmonic (MHz)
6	46	125		
12	30.1	86	140	
18	22	63.5	104	
24	17.8	57	83.5	
30	14.4	42.5	71	
36	13	36.6	59.5	
42	11.5	31.7	52.6	
48	10.5	28.4	48	
54	9.9	25.5	40.8	
60	9.3	23.5	38	
66	8.9	21.6	35	
72	8.65	19.8	32.5	
78	8.3	18.5	30	
84	8.1	17.3	28.3	
90	7.9	16.15	26.35	
96	7.8	15.5	25	34
102	7.7	14.6	23.6	32.5
108	7.6	14.1	22.4	30.4
114	7.5	13.4	21.3	29
120	7.35	12.9	20.3	27.9
126	7.25	12.4	19.2	26.4
132	7.15	12.0	18.3	25.4
138	7.1	11.7	17.8	24.5
144	7.05	11.4	17.15	23.1
*150	7.0	11.3	16.0	21.8

Table 3. Measured CCD antenna fundamental and harmonic resonances versus overall length, as measured during construction. The graph in Fig. 3. was plotted using these values. *With 2-foot square aluminum screens attached to each end during last measurement.

housed in a permanent isolated building located normal to the test antennas and 56 wavelengths distant (at 7 MHz). A 67-foot-long dipole, for comparison, is mounted parallel with the CCD antennas and is elevated 60 feet.

Two identical separate drivers and finals are carefully matched for equal outputs and feed identical impedance-matching networks and transmission lines to the antennas being compared. To minimize the effects of fading, provision is made for rapid alternate switching between the two antennas being compared, both while transmitting and receiving. See Table 2.

Overseas Signal Reports

The results of DX tests and transmission and reception have favored the CCD by between 5 and 7 dB over the reference dipole. On good DX nights, reports on 7 MHz CW have been 10 to 20 dB over S9 from Europe and Asia to W4FD using 500 Watts.

CCD Construction Guidelines

Several methods of assembling the capacitor/wire sections have been employed successfully. These have included: (1) bridging the components across small strain insulators; (2) utilizing spacing insulators salvaged from large coaxial transmission lines; (3) encapsulating the components inside a light plastic tube (Figs. 5 and 6); and (4) spiraling dual wires about a nylon rope and taping each capacitor for waterproofing (Fig. 7).

The construction method selected depends upon individual siting problems. The major requirements are: (1) mechanical strength sufficient to support the antenna during wind and icing conditions,

Length overall (feet and inches)	Fundamental (MHz)	2nd harmonic (MHz)	Number of capacitors
20' 8"	19.1	57	24
25' 7"	16.6	48	30
32' 7"	13.2	36.4	42
38' 9"	11.5	30.9	50
47' 5"	10.25	26.5	60
58' 2"	9.45	22.2	70
74' 2"	8.85	19.2	80
82' 5"	8.5	18	90
90' 7"	8.2	17.2	100
98' 9"	8.0	16.4	110
106' 11"	7.85	15.8	120
115' 1"	7.6	15.4	130
123' 3"	7.4	15.0	140
131' 0"	7.2	14.6	150
139' 0"	7.05	14.15	160

Table 4. Fundamental and harmonic resonances versus overall length for a CCD antenna containing 160 capacitors, as measured during the assembly phase. The graph in Fig. 4 was plotted from these values. Note: Frequency measurements for the 131- and 139-foot lengths are extrapolated, due to unavoidable circumstances during construction.

and (2) protection of components from moisture, salt water, etc. Obviously, a CCD mounted within an attic would have less stringent requirements.

Method (4) above was developed by W4FD and has proven very effective in situations where the assembled radiator must be dragged through tree branches or over rugged terrain during erection. This method of assembly will be described later in detail because the CCD, for the first time, opens the door for successful antenna operation in treetops and in many other sites which have been found unfavorable for other antenna systems.

The types of capacitors preferred are polystyrene, silver mica, or mica, in that order. Capacity tolerance should be 5%, and the dc working voltage may be 200 volts, due to the relatively small rf voltage imposed across each unit in the CCD application, even at the legal power limit. Polystyrene capacitors provide the advantages of stability, excellent sealing, small size, and lightest weight. Capacitors of wider tolerance are equally satisfactory, provided they are selected for the recommended tolerance by

means of an rf Q-meter or bridge.

Lightning and static charge protective chokes were originally used across each capacitor. These may produce random resonance indications which are misleading during dipmeter measurements which are necessary to adjust the CCD antenna to resonance. For that reason, the substitution of 1-Watt, 20 to 50k Ohm resistors is recommended.

Proper capacitor values lie between the two extremes which were mentioned above, the key to efficient CCD performance being the condition of partial cancellation of wire section positive X_1 by the negative reactance X_C . A range of useful values and wire section dimensions is included in Table 1. A simple mathematical equation can now be established in which the CCD series capacitors can be equated to a certain K value for each band. For example, if you have 26 five-foot sections (with 24 capacitors) in the antenna

series string and find that 270 pF per capacitor is proper for resonance at 7.0 MHz, then:

$$K = 270/24 = 11.25$$

This is, of course, the effective series capacity of the string. But, more importantly, we can use this K figure for determining fairly closely what capacitor value to use within other bands and with different wire section lengths and capacitor values. As indicated above, both the capacitance and wire section lengths are indirectly proportional to the operating frequency (i.e., K for 3.5 MHz would be around 22).

CCD antennas for higher frequencies may be designed by ratioing capacitors and wire section length from the data in Table 1. Similarly, the builder may completely fill his available land space by scaling the wire and capacitor sizes.

If capacitor values not shown in Table 1 are available, they may also be used to construct an efficient CCD antenna. It is only necessary to adjust

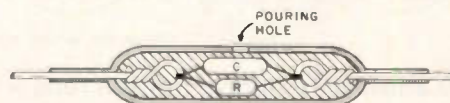

Fig. 5. CCD capacitor/resistor assembly encapsulated inside plastic hot and cold water pipe. See text for construction details.

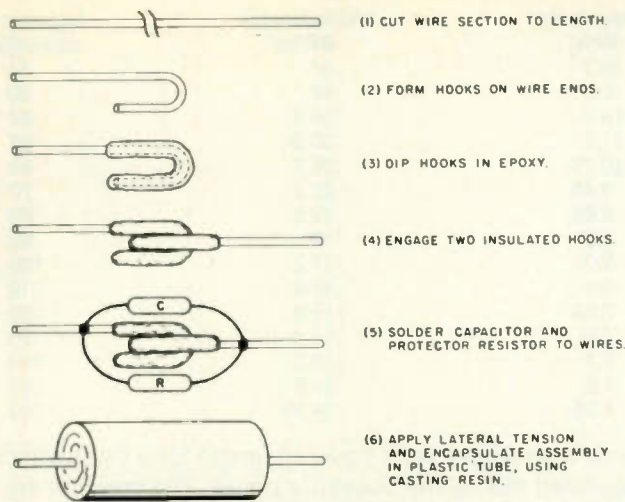

Fig. 6. Steps for constructing one type of rugged weather-proof capacitor/resistor assembly.

section wire lengths and numbers proportionately. For example, suppose that 470 pF capacitors are on hand, and a 7 MHz CCD is desired.

First, find the even number of wire sections required: $470 \text{ pF} / 8.48 \text{ ("K" for 7 MHz)} = 56$ wire sections. The overall antenna length is 140 feet (from Table 1) or 1680 inches. Then, find the section wire lengths: $1680 / 56 = 30$ inches. The number of capacitors is always 2 less than the number of wire sections, or 54 in this example.

Harry's Magic Rope Trick

At his 40-acre antenna range on a 400-acre plot, Harry W4FD solved the special problem of raising controlled-current distribution antennas to the tops of the living 100-foot-plus Georgia pine trees which God so helpfully provided.

First, a 20-pound weight monofilament fishing line is shot from a spinning reel,

over the trees, using a 45-pound pull bow. The arrow is weighted at the front by taping on a 14-inch length of $\frac{1}{4}$ -inch-diameter steel rod. This added weight pulls the arrow and line to the ground after clearing the trees.

A 250-foot length of 40-pound-weight nylon cord is employed as an intermediary step. This cord, wound on a spool, is placed in a topless cardboard box. The cord end is then secured to the end of the monofilament line, following its removal from the arrow. The monofilament line is then pulled back through the tree by means of the reel (attached to the bow), until the forward end of the unwinding nylon cord is retrieved. The heavier nylon cord is then used to pull the antenna through the tree branches. The last step is simply a matter of rewinding the nylon cord on its spool un-

til the forward end of the antenna is retrieved. (Note: It will usually be found best to lay the antenna out at the site in the form of two arm-wound coils, assuming you are using a center feedline. The pulling operation of antenna ends through the trees will then involve releasing one antenna coil at a time, working out from the center.)

To withstand the stress of dragging the capacitor/line sections through the tree branches, W4FD designed a special type of CCD antenna. A single continuous nylon rope of $\frac{1}{4}$ -to $\frac{3}{8}$ -inch diameter provides all insulation and serves as a messenger to protect the antenna components during erection and also to provide a rugged support after the antenna is pulled into its operating position. In this form, the CCD becomes a versatile antenna which may be quickly unreel for rigorous use in military, amateur field day, or emergency services.

General Construction

Two wires are paralleled in each section, spiralled in opposite directions about a continuous nylon rope. The use of two wires provides symmetry and improved performance. Electrically, the wire ends of each section are joined together and attached to the adjacent capacitor/wire section assembly, as in Fig. 7.

Construction Details

1. Test every capacitor for value, within 5%. The CCD will fail to operate properly with even a single defective capacitor. Form the capacitor leads in a straight line, pointing away from the capacitor body.

2. Cut sections of soft-drawn #17 or #18 enameled copper wire into lengths appropriate for the desired frequency of operation (see Table 1 for dimen-

sions). Add one inch more to each wire section end for connections. Scrape clean the one-inch portions for soldering.

3. Arrange a comfortable work position for anchoring, stretching, and assembling one antenna section at a time. (W4FD uses two vises spaced on a workbench.)

4. Allow sufficient rope at each end for tying the finished CCD to its supports, and stretch the first rope section preparatory to applying the two wires. Anchor a single end of the wire to the rope using vinyl tape.

5. Simultaneously twist-wind the two wires about the rope in a crisscross (spiralling turns in opposite directions) manner, making 12 or 14 turns for the typical 5-foot section. The number of crossover turns is not critical. The purpose is to provide snug adherence of the wire to the rope. Experiment with the first section until you are satisfied with your technique.

6. Wrap two turns of both cleaned ends of the antenna section wires around a capacitor lead and one protector resistor lead close to the unit bodies.

7. Solder the two wrapped wires, ensuring that solder flows onto all wires and penetrates the joint. Well-soldered connections are essential to proper CCD performance; therefore, do not solder until all joints are clean.

8. Hold the capacitor and attached #17 wire sections snugly against the rope and apply one layer of vinyl plastic tape, starting on the rope about 2 inches from the capacitor/resistor ends. Lap the tape one half of its width for each wrap. Continue taping over the capacitor and resistor until the remaining capacitor/resistor leads are just exposed.

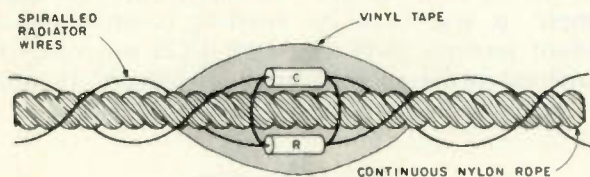

Fig. 7. CCD antenna assembly on nylon rope which provides insulation, support, and protection. Two wires are spiralled in opposite directions around the rope. The capacitor, resistor, and connections are protected against weather and rough usage with vinyl electrical tape.

9. Wrap two other previously cleaned #17 (next section) wires around the exposed capacitor/resistor leads, and solder well, ensuring that the solder flows onto all joining surfaces. (Note: All soldered connections must have smooth surfaces to eliminate any sharp projections of wire or solder which could puncture the waterproofing tape during erection.)

10. Apply a final wrapping on the entire capacitor/resistor assembly, starting on the rope about one-half inch beyond the end of the first taping. Continue taping until the leads are covered at both ends. (Note: An alternate method to taping may utilize heat-shrinkable tubing of a suitable diameter.)

This method of assembling the CCD on a taut rope, plus the crisscross winding of the #17 wire sections, will ensure, if carefully done, that no strain will be placed on the component pigtail leads during normal service.

Encapsulated Assembly Construction

The second Mills CCD antenna was built by W4ATE, as shown in Fig. 5. Thin-wall hot/cold plastic water pipe and the liquid casting material were purchased at Sears. The #18 copperweld wire and polystyrene capacitors are stocked by Burstein-Applebee, 3199 Mercier St., Kansas City MO 64111.

Construction Steps

1. Cut wires to the length selected from Table 1, allowing sufficient material to form anchoring loops at each end.

2. Form simple loops at each end and solder the wrapped turns (to prevent any movement after final assembly).

3. Solder a protector resistor across each capacitor, without heat

damage to either. Do not trim the capacitor leads. (Note: Care must be observed during the following steps to avoid breakage of small component leads.)

4. Wrap one capacitor and one resistor lead around the antenna wire loop, and solder well. Repeat, until capacitors and resistors are soldered to one end of each antenna wire section to be used in the entire CCD antenna.

5. Saw the hot/cold pipe into 2-inch lengths. Drill a 3/8-inch hole near the center of each (encapsulating liquid is poured into the hole later). (Note: Patience and coordination are required in the next step. A few practice runs are suggested using scrap pipe and wire.)

6. Soften one end of the pipe for 1/2 inch by inserting a small soldering iron. Caution: This operation must be performed outdoors, or in a well-ventilated room to avoid breathing the fumes.

After the pipe end becomes completely soft, the pipe is centered over the capacitor/resistor assembly. The softened pipe end is clamped flat in a vise so that the loop wrap portion is embedded in the softened pipe.

Again, this step requires patience, but careful execution will result in a strong and permanent antenna with no exposed connections. Repeat until a capacitor/resistor and pipe section is installed on one end of each wire section.

7. Assemble the antenna sections, using the same techniques as in step 6, to close the remaining pipe ends.

8. Seal all pipe ends temporarily with masking tape, to prevent any leakage of the encapsulating liquid.

9. Mix clear plastic casting liquid and catalyst

in a small paper cup. (A convenient pouring spout is formed by creasing the cup edge.) Fill the pipe cavity completely, tilting it to free any trapped air bubbles. This will flow the liquid around the wire anchor loops to provide a solid, one-piece assembly. The filled pipe may be handled freely, after temporarily sealing the pouring hole with masking tape. Repeat until all assemblies have been poured.

10. After completely hardening, the masking tape may be removed. Any obvious voids or openings noted should be filled with the potting liquid.

Adjustments

Every CCD antenna constructed must be resonated by adding or subtracting complete sections while the frequency is being monitored with an accurate dip meter. The overall CCD lengths shown in Table 1 are intended as guidelines, which may be modified to achieve resonance at the frequency desired. An equal number of sections must be added or removed at each end of the radiator in order to maintain system balance. It is desirable that resonance occurs at the low-frequency end of the operating (design) band. This condition will also improve performance of higher-frequency harmonic operation.

During adjustment, the CCD may be suspended at a convenient 5 or 6 feet above ground. Due to its minimal end-effect characteristics, much less change in resonant frequency will occur upon being raised to its final operating height. A temporary coil is installed at the antenna feedpoint for coupling to the dip meter. Eight turns are suggested as a starting value, which should be reduced wherever possible for best

measurement accuracy.

Inspection of the graphs in Figs. 3 and 4 reveals a very slow lowering of the fundamental frequency as the design goal is approached during assembly. This could prove to be frustrating to the builder who is assembling his first CCD. To enable the builder to better anticipate reaching the desired frequency and antenna length, frequent measurement of higher harmonic resonances will prove helpful. Optimum performance occurs at the length where the addition of more sections produces little or no change in the resonant frequency. Operation at lengths which fall along the knee of the graph is to be avoided. Final adjustment to resonance must be made while observing dip-meter indications at the fundamental frequency.

The Future

Future work will expand into the use of ferrite elements and CCD principles in minibeam, the improved performance found to result from the application of controlled-current distribution in loop-element beams, and the superiority of driven-element CCD arrays over parasitic configurations.

Preliminary tests with CCDs using very short sections (10 inches at W4FD and 5.73 inches at W4ATE) promise an improved antenna for underwater submarine communications.

Laboratory-type field intensity studies, as stated above, plotting at a microwave range, mathematical modeling, and computer analysis can unlock further secrets of the CCD principles. Meantime, we radio amateurs are in as unique a position as always, with 300,000 testing sites in this country alone, to again improve man's profoundly important instrument, communications. ■

FAST SCAN ATV

ALL YOU NEED IN ONE BOX



Show the shack, home movies, computer games, etc. Connect to the ant. terminals of any TV set, add a good 450 antenna, a camera, and you are there ...

- 10 Watts peak RF output. Specify 434.0 or 439.25 MHz
- Subcarrier sound with plenty of mic gain for distance pick-up.
- 8 MHz bandwidth, high resolution necessary for computer alphanumeric and color.
- Tuneable converter covers 420 to 450. (Covers CH 2, 3)
- Contains AC to 12VDC regulated 3 AMP power supply.
- Only \$399.00 direct mail. Check, Money Order, VISA. Send S.A.S.E. for catalog of ATV Modules and PC Boards.

P.C. ELECTRONICS

Maryann WB6YSS 2522 PAXSON Tom W6ORG
ARCADIA, CA 91006

REGULATED POWER SUPPLY

- Fully regulated, dual protected, 13.8 volts
- Illuminated on/off switch
- Hammertone metal case

33 Amp (30 Amp continuous)... \$119.95
20 Amp (16 amp. cont.) \$74.95
8 Amp (6 amp. cont.) \$39.95

TIMES CABLE

RG-8U - 100' multiples 18¢/ft.
RG-213U - (Non-contaminating jacket)
- 100' multiples 22¢/ft.
½" Aluminum Jacketed hardline - 75 ohm.
1000' rolls only 29¢/ft.
PL259 connectors 25/50¢ ea.
or 100/45¢ ea. POSTPAID

UNIVERSAL TOWERS

SUPER DISCOUNTS —
S.A.S.E. for brochure and prices!

Send S.A.S.E. for additional information. Include shipping charges with check or money order. (Ohio residents add 4½% sales tax).

JRS ELECTRONICS JB
P.O. Box 1893—Cincinnati, Ohio 45201



CONNECTOR ASSORTMENT

\$25.00 Postpaid
\$23.50 each lots of three
Includes: 5 - PL259, 5 - SO239, 5 - UG175, 5 - UG176, 2 - PL258, 1 - DM, 1 - M358, 2 - M359, 1 - UG255, 1 - UG273, 2 - PL259PO, 1 - 1021-20, 1 - Lightning Arrester.

Master Charge & Visa accepted / Send for Free Catalog
COAKIT
P.O. Box 101-A Dumont, N. J. 07628
Circle C21 on Reader Service Card

solid state continuous coverage

THE COMM CENTER



The Drake TR-7

AREA CODE (301) WASHINGTON 953-9535 - BALTIMORE 792-0600
9624 FT. MEADE RD. LAUREL, MD. 20810

INC.

HIGH PERFORMANCE CONVERTER AND PRE-AMP FOR OSCAR

UHF Converter



Model C-432A (408)

\$5995

- Converts 432 or 435 MHz to 29 MHz. (Be sure to specify the input frequency you want)
- 2 tuned RF stages using low noise J-FETS eliminates the need for a separate UHF pre-amp
- Special RCA dual-gate MOSFET mixer gives good conversion gain and minimum cross modulation
- High frequency quartz crystal oscillator and multiplier stages use 1.2 GHz transistors for maximum efficiency
- Conversion gain is more than 20 dB (typically 25 dB) therefore assuring you .1 microvolt sensitivity when used with an average communications receiver
- Just connect a simple turnstile antenna (see Nov. '77 of 73 Magazine) and a 12 volts DC power source (only 30 mA required) and you're ready to receive.

SEE OUR OTHER PRODUCTS IN THE FULL PAGE AD OF THE DECEMBER 1977 ISSUE OR WRITE FOR CATALOG SHEET.

Low Noise • High Gain Pre-Amp For 29 MHz.



Model 201-29

\$2995

- 35 to 40 dB power gain at 29 MHz with a noise figure of only 2.0 dB and a bandwidth of 1 MHz.
- Makes reception of OSCAR possible even with low cost receivers or old receivers with poor sensitivity at 29 MHz.
- Two RF stages using dual-gate MOSFETS
- Manual gain control and provision for AGC
- Requires 12 volts DC at 10 mA.

For immediate shipment of either item call (212) 468-2720 or mail your order with payment plus \$1.00 for air mail to:

VANGUARD LABS
196-23 Jamaica Ave.
Hollics, NY 11423

V1

Build An Audible Transistor Tester

— it's a CPO, too

Richard J. Molby WB7NZG/DA1DB
 HHB 3rd BN 84th Arty
 APO New York 09176

If this sad experience has happened to you, it may be because you are like many experimenters who routinely use an ohmmeter to test transistors and diodes. Though this method is effective, it can also cause the instant death of low-current semiconductor devices. The typical ohmmeter can, on some scales, apply a rather high voltage and current across the test leads, which may cause the destruction of some semiconductor devices. Another fault of the ohmmeter method is that the instrument must be checked visually; this can lead to erroneous results or damage to equipment if a test lead slips while making continuity checks. What is needed is a low current (under 1 mA) device which gives an audible indication

of continuity. Such a device should also be low in cost (for those of us who are cheapskates or poor) and simple to assemble. Fig. 1 shows such a device using a single 555 IC timer as a square wave oscillator and an NPN general purpose transistor for switching. Any method of construction can be used, as there is nothing critical about the circuit, but the most convenient method is perfboard and a socket for the IC. The checker can be assembled as shown in Fig. 1 for use as a continuity tester or, if desired, the device can also be used as a code practice oscillator. If it is desired to use the device as a CPO, it would be advantageous to be able to vary both the tone and volume, although this will run the cost up a

couple of dollars unless the builder has the required parts in the junk box. The two potentiom-

eters can be added to the circuit as indicated in Fig. 2. Safe testing, and build, build, build! ■

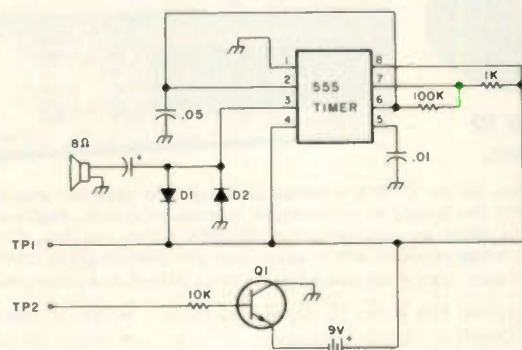

Fig. 1. Test oscillator (low current).

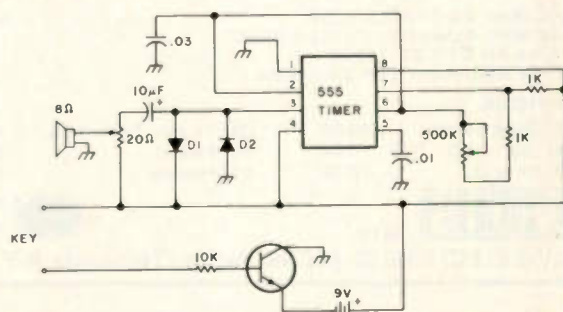

Fig. 2. Code practice oscillator.

\$95 Stand Alone Video Terminal

```

@BTG eBUXpvmΣφψωR0123 92±+*[]|←→+
!"#$%&'()* ++, -./012456789:;<=>?
@ABCDEFGHIJKLMNPOQRSTUVWXYZ[\]^_
`abcdefghijklmnopqrstuvwxyz{|}~*
    
```



SCT-100 FEATURES:

- 64 X 16 line format with 128 displayable characters
 - Serial ASCII or BAUDOT with multiple Baud rates
 - \$187 Assembled or \$157 Kit (Partial Kit \$95)
 - Full cursor control with scrolling and paging
 - On board power supply
 - Many additional features
- Call or write today. MC/VISA accepted

XITEX CORP. P.O. Box #20887

Dallas, Texas, 75220 ● Phone (214) 386-3859
Overseas orders and dealer inquiries welcome

"THE PROFESSIONALS"

NEW

MODEL CTR-2A • 500 MHz & 1 GHz

COUNTERS

NEW
Period
Measurement

1 us to
1 sec.



NEW
Built-in
Pre-Amp

10 mv @
150 MHz

The New Model CTR-2A Series Counters are designed and built to the highest standards to fulfill the needs of commercial communications, engineering labs and serious experimentors. With an accuracy of +.00005% (oven option) the CTR-2A can handle the most critical measurements and is about half the cost of other commercial counters.

If you need a reliable counter at an affordable price, the CTR-2A is the answer.

- Built-in Pre-Amp 10 mv @ 150 MHz
- 8 Digit .3" LED Display
- High Stability TCXO Time Base
- Built-in VHF-UHF Prescaler
- Automatic Dp Placement
- TCXO Std. ± 2 ppm
- Period Measurement (Optional)
- Input Diode Protected
- 12V-DC Operation (Optional)
- Oven Controlled Crystal (Optional) ± .5 ppm
- Selectable Gate Times - .1 & 1 sec.

500 MHz Kit CTR-2A-500K	\$249.95
500 MHz Assembled CTR-2A-500A	349.95
1GHz Kit CTR-2A-1000K	399.95
1GHz Assembled CTR-2A-1000A	549.95

OPTIONS

02) Oven Crystal	\$49.95	05) 10 sec. Time Base	\$ 5.00
03) .43" LED	10.00	06) Period	15.00
04) 12 V-DC	10.00	07) Handle	10.00



D10

DAVIS ELECTRONICS 636 Sheridan Dr., Tonawanda, N.Y. 14150 716/874-5848



PROBES
Hi-Z
\$15.00
●
Low Pass
\$15.00

October specials

HY-GAIN	
TH6DXK 6 Element Tribander	\$189.95
TH3MK3 3 Element Tribander	\$150.00
TH3JR Low Power Beam	\$104.00
1BAVT/WB 10-80 Meter Vertical	\$ 70.00
MOSLEY	
TA33 3 Element Tribander	\$159.95
CL33 3 Element Tribander	\$175.00
CL36 6 Element Tribander	\$235.00
TA33JR Low Power Beam	\$125.00
MPK3 Power Conversion Kit for TA33JR	\$ 45.00
RV-4C 10-40 Meter Vertical	\$ 49.00
RV-8C 80 Meter Kit for RV-4C	\$ 31.00
RKV-345 Roof Mount Kit	\$ 10.00
WILSON	
System One 5 Element Tribander	\$209.00
System Two 4 Element Tribander	\$167.00
WV-1 10-40 Meter Vertical	\$ 50.00
CUSHCRAFT	
ARX-2 Bingo Ranger	\$ 25.75
A147-11 Z Meter Beam	\$ 25.75
A147-22 Z Meter Beams	\$ 73.95
ROTORS	
Cornell Dubilier Ham III	\$117.00
Cornell Dubilier Ham T2X	\$217.00
Alliance HD-73	\$ 99.00
HUSTLER	
4-BTV 10-40 Meter Vertical	\$ 65.00
BM-1 Bumper Mount	\$ 9.75
MO-2 Mast	\$ 14.50
RM-10 Standard Hustler Resonator for 10M	\$ 4.25
RM-10S Super Hustler Resonator for 10M	\$ 7.50
RM-15 Standard Hustler Resonator for 15M	\$ 4.50
RM-15S Super Hustler Resonator for 15M	\$ 8.25
RM-20 Standard Hustler Resonator for 20M	\$ 4.75
RM-20S Super Hustler Resonator for 20M	\$ 8.50
RM-40 Standard Hustler Resonator for 40M	\$ 8.75
RM-40S Super Hustler Resonator for 40M	\$ 10.00
RM-75 Standard Hustler Resonator for 75M	\$ 10.00
RM-75S Super Hustler Resonator for 75M	\$ 19.50
WIRE	
Sawtron Products—see ad in September issue of this magazine.	

COMMUNICATIONS SERVICES

C89

326A WEST MAIN STREET
PHILADELPHIA, MS 39350
PHONE: 601-456-5341
HOURS: 8-5 Mon-Fri.



Send stamp for price sheet or \$1 check for full line catalog. \$1 refundable on first order. We do not export. All shipping is collect.

NEW
FROM XITEX

\$95 MORSE TRANSCIVER

SEND:

- 1 to 150 WPM (set from terminal)
- 32 character FIFO buffer with editing
- Auto Space on word boundaries
- Grid/Cathode key output
- LED Readout for WPM and Buffer space remaining

SERIAL INTERFACE:

- ASCII (110, 300, 600, 1200) or Baudot (45, 50, 57, 74) compatible
- Simplex Hi V Loop or T²L electrical interface
- Interfaces directly with the XITEX[®] SCT-100 Video Terminal Board; Teletypes[®] Models 15, 28, 33, etc.; or the equivalent



COPY:

- 1 to 150 WPM with Auto-Sync.
- Continuously computes and displays Copy WPM
- 80 HZ Bandpass filter
- Re-keyed Sidetone Osc. with on-board speaker
- Fully compensating to copy any 'fist style'

MRS-100 CONFIGURATIONS:

- \$95 Partial Kit (includes Microcomputer components and circuit boards; less box and analog components)
- \$225 Complete Kit (includes box, power supply, and all other components)
- \$295 Assembled and tested unit (as shown)

Overseas Orders and dealer inquiries welcome

See your local dealer or contact XITEX[®] direct.

MC/Visa accepted

XITEX CORP.
P.O. Box 20887
Dallas, Texas 75220
(214) 386-3859

ALUMA TOWERS

A47

VERO BEACH, FLORIDA 32960

MFG'S OF
ALUMINUM TOWERS

- ★ TELESCOPING
(Crank Up)
- ★ WALL MOUNTED
- ★ TILT-OVER
- ★ GUYED MODELS
(to 100 Ft.)

Excellent for
Ham Communications.

HIGH QUALITY — LOW PRICES

MADE IN LONG-
LASTING
NO-RUST
ALUMINUM!

McCLARAN SALES TAKES IN
ANYTHING ON TRADE FOR NEW
ALUMA TOWERS.

NEED: Scanners, CB, 2 Meter, Marine,

Antiques, Coins,
Ham Gear.

We accept Master Charge & Visa Cards

FOR SALES & TRADES CONTACT
R.D. McCLARAN SALES

430 Franklin at Beach
Indianapolis, Florida 32903
(305) 723-4793



MFJ INTRODUCES A NEW 24 HOUR DIGITAL CLOCK

with HUGE 1-5/8 inch digits that you can keep set to GMT.
Alarm and snooze functions let you use it as an ID Timer.
Assembled, too!



\$29⁹⁵

BRAND
NEW

MFJ Enterprises brings you a new 24 hour digital alarm clock with HUGE 1-5/8 Inch orange 7 segment digits that you can see clear across the room.

This one is strictly for your ham shack, one that you can leave set to GMT. No more mental calculations to get GMT.

Use the alarm to remind you of a SKED or with the snooze function as an ID timer to buzz you in 8 minute intervals.

A constantly changing kaleidoscopic pattern indicates continuous operation.

Beige. 2-1/4 x 4-1/8 x 8-3/4 inches. UL listed. Requires 120VAC, 60Hz.

Order from MFJ and try it — no obligation. If not delighted, return it within 30 days for a re-

fund (less shipping). One year limited warranty by MFJ Enterprises.

To order, simply call us toll free 800-647-1800 and charge it on your VISA or Master Charge or mail us a check or money order for \$29.95 plus \$2.00 for shipping and handling.

Don't wait any longer to enjoy the convenience of a "Hams Only" clock. Order today. M52

MFJ ENTERPRISES, INC.

P. O. BOX 494

MISSISSIPPI STATE, MS 39762

CALL TOLL FREE 800-647-1800

For technical information, order/repair status, in Miss., outside continental USA, call 601-323-5869.

JUST GETTING ON THE AIR? See Adirondack for



- New Equipment
- Used Gear
- Friendly Advice

Adirondack Radio Supply

185-191 West Main Street • P.O. Box 88
Amsterdam, N.Y. 12010 Tel. (518) 842-8350
Just 5 minutes from N.Y. Thruway - Exit 27

P.O. Box 4430M Santa Clara, CA 95054

For will call only: (408) 988-1640

2322 Walsh Ave.



Same day shipment. First line parts only. Factory tested. Guaranteed money back. Quality IC's and other components at factory prices.

INTEGRATED CIRCUITS

74007L	74LS28n	41	LM340T-15	1.10	7114	8.50
7400N	74LS33N	25	LM340T-18	1.10	7120	8.30
7402N	74LS33N	39	LM340T-24	1.10	7121	1.49
7404N	74LS33N	35	CMOS		7122	4.00
7405N	74LS37n	25	CD3000	50	7123	3.00
7410N	74LS37n	47	CD4001	25	7124	3.00
7411N	74LS37n	51	CD4002	25	7125	3.00
7420N	74LS37n	51	CD4003	25	7126	3.00
7421N	74LS37n	51	CD4004	25	7127	3.00
7422N	74LS37n	51	CD4005	25	7128	3.00
7430N	74LS107n	35	CD4006	25	7129	3.00
7432N	74LS107n	35	CD4007	25	7130	3.00
7445N	74LS113N	35	CD4008	25	7131	3.00
7447N	74LS113N	35	CD4009	25	7132	3.00
7448N	74LS113N	35	CD4010	25	7133	3.00
7449N	74LS113N	35	CD4011	25	7134	3.00
7450N	74LS113N	35	CD4012	25	7135	3.00
7474N	74LS157n	67	CD4013	25	7136	3.00
7475N	74LS157n	67	CD4014	25	7137	3.00
7485N	74LS157n	67	CD4015	25	7138	3.00
7486N	74LS157n	67	CD4016	25	7139	3.00
7487N	74LS157n	67	CD4017	25	7140	3.00
7488N	74LS157n	67	CD4018	25	7141	3.00
7489N	74LS157n	67	CD4019	25	7142	3.00
7490N	74LS157n	67	CD4020	25	7143	3.00
7491N	74LS157n	67	CD4021	25	7144	3.00
7492N	74LS157n	67	CD4022	25	7145	3.00
7493N	74LS157n	67	CD4023	25	7146	3.00
7494N	74LS157n	67	CD4024	25	7147	3.00
7495N	74LS157n	67	CD4025	25	7148	3.00
7496N	74LS157n	67	CD4026	25	7149	3.00
7497N	74LS157n	67	CD4027	25	7150	3.00
7498N	74LS157n	67	CD4028	25	7151	3.00
7499N	74LS157n	67	CD4029	25	7152	3.00
7500N	74LS157n	67	CD4030	25	7153	3.00
7501N	74LS157n	67	CD4031	25	7154	3.00
7502N	74LS157n	67	CD4032	25	7155	3.00
7503N	74LS157n	67	CD4033	25	7156	3.00
7504N	74LS157n	67	CD4034	25	7157	3.00
7505N	74LS157n	67	CD4035	25	7158	3.00
7506N	74LS157n	67	CD4036	25	7159	3.00
7507N	74LS157n	67	CD4037	25	7160	3.00
7508N	74LS157n	67	CD4038	25	7161	3.00
7509N	74LS157n	67	CD4039	25	7162	3.00
7510N	74LS157n	67	CD4040	25	7163	3.00
7511N	74LS157n	67	CD4041	25	7164	3.00
7512N	74LS157n	67	CD4042	25	7165	3.00
7513N	74LS157n	67	CD4043	25	7166	3.00
7514N	74LS157n	67	CD4044	25	7167	3.00
7515N	74LS157n	67	CD4045	25	7168	3.00
7516N	74LS157n	67	CD4046	25	7169	3.00
7517N	74LS157n	67	CD4047	25	7170	3.00
7518N	74LS157n	67	CD4048	25	7171	3.00
7519N	74LS157n	67	CD4049	25	7172	3.00
7520N	74LS157n	67	CD4050	25	7173	3.00
7521N	74LS157n	67	CD4051	25	7174	3.00
7522N	74LS157n	67	CD4052	25	7175	3.00
7523N	74LS157n	67	CD4053	25	7176	3.00
7524N	74LS157n	67	CD4054	25	7177	3.00
7525N	74LS157n	67	CD4055	25	7178	3.00
7526N	74LS157n	67	CD4056	25	7179	3.00
7527N	74LS157n	67	CD4057	25	7180	3.00
7528N	74LS157n	67	CD4058	25	7181	3.00
7529N	74LS157n	67	CD4059	25	7182	3.00
7530N	74LS157n	67	CD4060	25	7183	3.00
7531N	74LS157n	67	CD4061	25	7184	3.00
7532N	74LS157n	67	CD4062	25	7185	3.00
7533N	74LS157n	67	CD4063	25	7186	3.00
7534N	74LS157n	67	CD4064	25	7187	3.00
7535N	74LS157n	67	CD4065	25	7188	3.00
7536N	74LS157n	67	CD4066	25	7189	3.00
7537N	74LS157n	67	CD4067	25	7190	3.00
7538N	74LS157n	67	CD4068	25	7191	3.00
7539N	74LS157n	67	CD4069	25	7192	3.00
7540N	74LS157n	67	CD4070	25	7193	3.00
7541N	74LS157n	67	CD4071	25	7194	3.00
7542N	74LS157n	67	CD4072	25	7195	3.00
7543N	74LS157n	67	CD4073	25	7196	3.00
7544N	74LS157n	67	CD4074	25	7197	3.00
7545N	74LS157n	67	CD4075	25	7198	3.00
7546N	74LS157n	67	CD4076	25	7199	3.00
7547N	74LS157n	67	CD4077	25	7200	3.00
7548N	74LS157n	67	CD4078	25	7201	3.00
7549N	74LS157n	67	CD4079	25	7202	3.00
7550N	74LS157n	67	CD4080	25	7203	3.00
7551N	74LS157n	67	CD4081	25	7204	3.00
7552N	74LS157n	67	CD4082	25	7205	3.00
7553N	74LS157n	67	CD4083	25	7206	3.00
7554N	74LS157n	67	CD4084	25	7207	3.00
7555N	74LS157n	67	CD4085	25	7208	3.00
7556N	74LS157n	67	CD4086	25	7209	3.00
7557N	74LS157n	67	CD4087	25	7210	3.00
7558N	74LS157n	67	CD4088	25	7211	3.00
7559N	74LS157n	67	CD4089	25	7212	3.00
7560N	74LS157n	67	CD4090	25	7213	3.00
7561N	74LS157n	67	CD4091	25	7214	3.00
7562N	74LS157n	67	CD4092	25	7215	3.00
7563N	74LS157n	67	CD4093	25	7216	3.00
7564N	74LS157n	67	CD4094	25	7217	3.00
7565N	74LS157n	67	CD4095	25	7218	3.00
7566N	74LS157n	67	CD4096	25	7219	3.00
7567N	74LS157n	67	CD4097	25	7220	3.00
7568N	74LS157n	67	CD4098	25	7221	3.00
7569N	74LS157n	67	CD4099	25	7222	3.00
7570N	74LS157n	67	CD4100	25	7223	3.00
7571N	74LS157n	67	CD4101	25	7224	3.00
7572N	74LS157n	67	CD4102	25	7225	3.00
7573N	74LS157n	67	CD4103	25	7226	3.00
7574N	74LS157n	67	CD4104	25	7227	3.00
7575N	74LS157n	67	CD4105	25	7228	3.00
7576N	74LS157n	67	CD4106	25	7229	3.00
7577N	74LS157n	67	CD4107	25	7230	3.00
7578N	74LS157n	67	CD4108	25	7231	3.00
7579N	74LS157n	67	CD4109	25	7232	3.00
7580N	74LS157n	67	CD4110	25	7233	3.00
7581N	74LS157n	67	CD4111	25	7234	3.00
7582N	74LS157n	67	CD4112	25	7235	3.00
7583N	74LS157n	67	CD4113	25	7236	3.00
7584N	74LS157n	67	CD4114	25	7237	3.00
7585N	74LS157n	67	CD4115	25	7238	3.00
7586N	74LS157n	67	CD4116	25	7239	3.00
7587N	74LS157n	67	CD4117	25	7240	3.00
7588N	74LS157n	67	CD4118	25	7241	3.00
7589N	74LS157n	67	CD4119	25	7242	3.00
7590N	74LS157n	67	CD4120	25	7243	3.00
7591N	74LS157n	67	CD4121	25	7244	3.00
7592N	74LS157n	67	CD4122	25	7245	3.00
7593N	74LS157n	67	CD4123	25	7246	3.00
7594N	74LS157n	67	CD4124	25	7247	3.00
7595N	74LS157n	67	CD4125	25	7248	3.00
7596N	74LS157n	67	CD4126	25	7249	3.00
7597N	74LS157n	67	CD4127	25	7250	3.00
7598N	74LS157n	67	CD4128	25	7251	3.00
7599N	74LS157n	67	CD4129	25	7252	3.00
7600N	74LS157n	67	CD4130	25	7253	3.00

74007L	74LS28n	41	LM340T-15	1.10	7114	8.50
7400N	74LS33N	25	LM340T-18	1.10	7120	8.30
7402N	74LS33N	39	LM340T-24	1.10	7121	1.49
7404N	74LS33N	35	CMOS		7122	4.00
7405N	74LS37n	25	CD3000	50	7123	3.00
7410N	74LS37n	47	CD4001	25	7124	3.00
7411N	74LS37n	51	CD4002	25	7125	3.00
7420N	74LS37n	51	CD4003	25	7126	3.00
7421N	74LS37n	51	CD4004	25	7127	3.00
7422N	74LS37n	51	CD4005	25	7128	3.00
7430N	74LS107n	35	CD4006	25	7129	3.00
7432N	74LS107n	35	CD4007	25	7130	3.00
7445N	74LS113N	35	CD4008	25	7131	3.00
7447N	74LS113N	35	CD4009	25	7132	3.00
7448N	74LS113N					



INSTRUMENT/CLOCK CASE KIT

Perfect for your opto projects. Solid aluminum construction with real walnut sides. O.D. 5-3/8" by 5-3/8" by 2". \$6.95 ea.

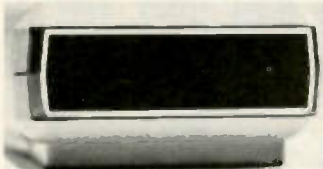

INSTRUMENT/CLOCK CASE KIT

A real jewel for those smaller projects. Hinged top door allows you to hide your control area. O.D. 4 1/2" by 4" by 1 1/4". \$1.50 ea.



MULTIPLEXED CALCULATOR KEYBOARD Ideal for the experimenter. Easy-mounting with all terminations accessible. \$1.10.



CLOCK DISPLAY NATIONAL SEMICONDUCTOR 6 digit multiplexed display. 1/8" characters. (Common anode) A real buy at just \$1.00 ea.

SPECTRA-STRIP Multi-color ribbon cable #22 stranded. 20 cond. 75¢ a foot ... 1-99; 50¢ ... 100+



SUPER SENSITIVE ELECTRET MIC. Smaller than a dime and yet responds to over 35 kHz. Output level -55 dB. Output Imp. 5K Ohm nominal. Built in F.E.T. preamp. \$6.95 ea. LIMITED QUANTITY!

M-M Electronic Sales U8

A division of **united products Corporation**

Corp. Hdqts., 2322 1st Ave., Seattle, Wash. 98121 • (206) 682-5025

1/4 WATT SANYO-OHM 5% RESISTORS CARBON FILM All standard EIA values. Multiples of 200 per value only. All non-standard values will be substituted by closest value. \$3.00 per pk. of 200; \$4.00 per pk. of 200 for values 1 Meg. and above.



36 PIN GOLD-PLATED HEADER Break off to desired length. Has dip spacing. List price \$1.36. Your price 65¢.

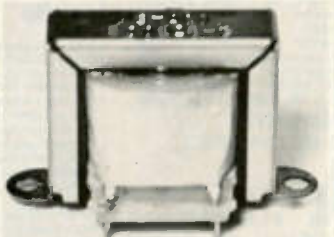

TRANSFORMER P-C mount. pri. 110 VAC Sec. 12:6 @ 1 amp. \$1.25 ea.

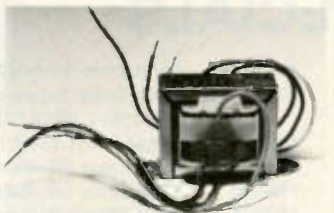

TRANSFORMER Pri. 110 VAC Sec. 11:2 and 5 VCT @ 1 amp. 95¢ ea.

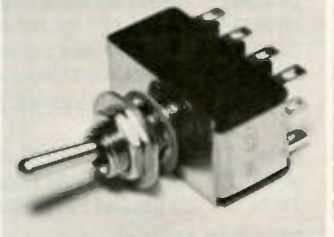

TOGGLE SWITCH J.B.T. #JMT 423, Subminiature 4 P.D.T. 5 amp. @ 125 VAC. LIST PRICE \$5.95. YOUR PRICE \$1.11 ea.

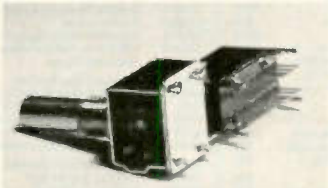

ROTARY SLIDE SWITCH 4P.3T. P-C mount, 1/4" round shaft. Ideal for that special application. 75¢ ea.

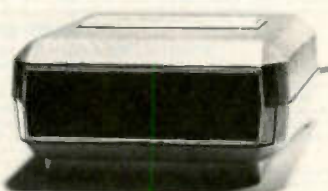

COMPLETE DIGITAL CLOCK

*Line rejects
*Returns
*They don't work right
*They don't do anything
We guarantee them to be defective. (A parts bonanza.) Our retail store has yet to have a dis-satisfied customer. \$6.00 ea.

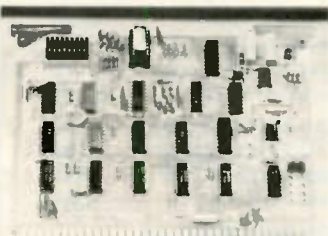

PARTS BOARDS A great way to buy parts on a budget. We guarantee your money's worth. Only \$1.00 ea.

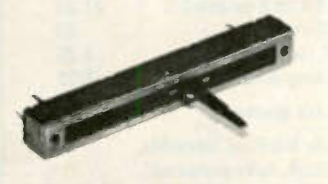

NOBLE SLIDE POT 500 OHM. LINEAR TAPER. CENTER DETENT. 3-1/8" Mtg. Ctrs. A nice little balance control! \$1.99 ea.



D-C ADAPTER 22 volt @ 140 ma. Makes an excellent power supply! 95¢ ea.



CAPACITORS

Capacitance	Voltage	Style	Price
1000uf	25 VDC	P-C	25¢
220uf	25 VDC	P-C	25¢
2000uf	25 VDC	AXIAL	50¢
40/40	150 VDC	AXIAL	45¢
1uf	15 VDC	AXIAL	19¢

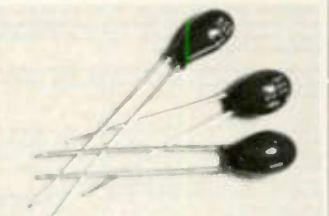

DIPPED TANTALUMS

Capacitance	Voltage	Tol.%	Price
1uf	50 V	20	28¢
2.2uf	50 V	20	42¢
4.7uf	50 V	20	62¢
22uf	20 V	20	51¢

We stock the full line of MICONICS dipped tantalums.

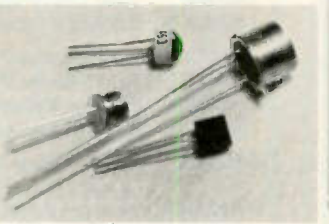

DISCRETÉS

1N4005	600V @ 1A	20¢
1N4148		13¢
1N3754		20¢
2N3054		95¢
CR13(TO-5)	SCR25V @ 1.6A	30¢

SELECTED VALUES

Line cord #18ga 6'	25¢
F.I.F.O. (AMD2841)64/4bit 16 pin Dip	\$2.00
10 Turn Trimpot (CTS308) P-C 100K	75¢
Coil Cord 2 Cond. 3' ext.	95¢
L.E.D. Fairchild FLV-118 (clr. red)	20¢
Acid Brush	10¢
Telescoping Antenna 3'	\$1.00
Edge Meter 100-0-100 ua. 1/2" x 11/16"	\$2.00

#30 KYNAR Blk., Brn., Red., Or., Yel., Grn., Blu., Vio., Gry., Wh. We will do our best to ship the color you specify. To ensure prompt delivery of your order we will substitute colors should we be temp. out, unless you specify otherwise. \$2.36 per hundred foot spool; \$14.16 per thousand foot spool; Multiples of 100' only. Call us for quotes on larger quantities.

TERMS
All orders shipped within 24 hours. Minimum order \$5.00. Telephone orders accepted. All orders shipped U.P.S. Add 5% extra for shipping and handling. Washington State residents add additional 5.4% sales tax.

ATTN: PURCHASING AGENTS
Our surplus division is always looking for new sources of inventory. For a prompt reply, send samples, a list or call us at (206) 682-5025.
Store Hours M-F 9-6 • SAT 9-5

TOLL FREE HOT LINE 1-800-426-0634

for areas outside Wash. State incl. Alaska and Hawaii
MasterCharge and Visa cards accepted. Money orders and your personal or company check are welcome. Funds made payable in U.S. currency only. No C.O.D. orders. Your satisfaction is guaranteed on all merchandise purchased. All merchandise subject to prior sale. Open account to govt. agencies and publicly funded schools.
FREE GIFT TO FIRST 2000 MAIL ORDER CUSTOMERS THIS MONTH.

O.E.M.'s WELCOME

VARIABLE POWER SUPPLY KIT \$11⁹⁵

- Continuously Variable from 2V to over 15V
- Short-Circuit Proof
- Typical Regulation of 0.1%
- Electronic Current Limiting at 300mA
- Very Low Output Ripple
- Fiberglass PC Board Mounts All Components
- Assemble in about One Hour
- Makes a Great Bench or Lab Power Supply
- Includes All Components except Case and Meters



ADD \$1.25 FOR POSTAGE/HANDLING

SPECIALS—THIS MONTH ONLY

1N34A	Germanium Diode 60V 10mA	10/S1	LM308H	Low Bias Current Op Amp Super 709	\$0.84
1N270	Germanium Diode 80V 200mA	4/S1	LM309K	8 Volt Regulator	TO-3 .84
1N914	Silicon Diode 100V 10mA	25/S1	LM317K	Adjustable Voltage Regulator	2-37V 3.50
1N6763	Hot Carrier Diode (HP780, etc.)	\$1.00	LM380N	2 Watt Audio Power Amplifier	DIP .94
F7	Power Varactor 1-2W Out @ 432MHz (Specs & Circuits included with F7)	\$2.00	NE565A	Phase Locked Loop	DIP .94
DIODE GRAB BAG—Mixed zeners, rectifiers, etc.		50/S1	LM723CN	Precision Voltage Regulator	DIP 3/51
2N706	NPN High Speed Switch 75ns	4/S1	LM747	Dual 741 Compensated Op Amp	DIP 2/51
2N918	UHF Transistor—Osc/Amp up to 1 GHz	4/S1	2740DE	FET Input Op Amp like NE 536/A740	1.99
2N2609	P Channel FET Amplifier 2500, mhas	\$1.00	CA3018A	4 Transistor Array/Darlington	.95
2N2920	NPN Dual Transistor 3mV Match .225	2.95	CA3028A	RF/IF Amplifier DC to 120MHz	1.45
2N3044	NPN Amp/Switch 100 40V 200mA	8/S1	CA3075E	FM IF Amp/Limiter/Detector	DIP 1.45
2N5122	PNP RF Amplifier & Switch	3/S1	RC4556	Dual High Gain Op Amp	mDIP 3/51
2N4656E	8-Channel Audio FET Super Low Noise	2/S1	NE555V	Precision Fast Op Amp	mDIP 2/51
2N4888	150 Volt PNP Transistor for Keyer	2/S1	NE555V	Dual HI Gain Op Amp Comp.	mDIP 3/51
E112	N Channel FET VHF RF Amp	3/S1	8038	Function Generator/VCO with circuits	\$3.75
T1574	H Channel FET High Speed Switch 400	3/S1			

SEND FOR ADVA'S NEW 1979 CATALOG
NEARLY 1000 SEMICONDUCTORS, KITS, CAPACITORS, ETC. SEND 25¢ STAMP.

OTHER ADVA KITS:

LOGIC PROBE KIT—Use with CMOS, TTL, DTL, RTL, HTL, HNIL and most MOS IC's. Built-in protection against polarity reversal and overvoltage. Draws only a few mA from circuit under test. Dual LED readout. Complete kit includes case and dip leads. ONLY \$7.85

FIXED REGULATED POWER SUPPLY KITS—Short-circuit proof with thermal current limiting. Compact size and typical regulation of 0.5% make these ideal for most electronic projects. Available for 5V @ 500mA, 8V @ 500mA, 9V @ 500mA, 12V @ 400mA, 15V @ 300mA. Specify voltage when ordering. \$8.95 ea.

These easy-to-assemble kits include all components, complete detailed instructions and plated fiberglass PC boards. Power supply kits do not include case or meters. Add \$1.25 per kit for postage and handling.

MAIL NOW! FREE DATA SHEETS supplied with many items from this ad. FREE ON REQUEST—741 Op Amp with every order of 85 or more—749 Dual Op Amp or two E100 FETs with every order of \$10 or more, postmarked prior to 12/31/78. One free item per order.

ORDER TODAY!—All items subject to prior sale and prices subject to change without notice. All items are new surplus parts—100% functionality tested.

WRITE FOR FREE CATALOG #79 offering over 700 semiconductors carried in stock. Send 25¢ stamp.

TERMS: Send check or money order (U.S. funds) with order. Add 5% postage for U.S., Canada and Mexico. \$1.00 handling charge on orders under \$10. Calif. residents add 6% sales tax. Foreign orders add 10% postage. COD orders—add \$1.00 +/cc charge.

MORE SPECIALS:

RC4195DN ±15V @ 50mA VOLTAGE REGULATOR IC. Very easy to use. Makes a neat Highly Regulated ±15V Supply for OP Amp's, etc. Requires only unregulated DC (18-30V) and 2 bypass capacitors. With Data Sheet and Schematics. 8-pin mDIP \$1.25

RC4136 Quad 741 Low Noise Op Amp mDIP \$0.95

LM1304 FM Multiplex Stereo Demodulator DIP 0.99

LM2111 FM IF Subsystem (IF Amp, Det., Limiter) DIP 0.99

1N6263 Hot Carrier Diode 0.4V @ 1mA 0.1ns DO-35 1.00

ZENERS—Specify Voltage 3.3, 3.9, 4.3, 5.1, 6.8, 8.2 400mW 4/S1.00
9.1, 10, 12, 15, 16, 18, 20, 22, 24, 27, or 33V (±10%) 1 Watt 3/S1.00

- MONEY-BACK GUARANTEE
- ALL TESTED AND GUARANTEED

ADVA ELECTRONICS
BOX 4181 GB, WOODSIDE, CA 94062
Tel. (415) 328-1500

FREE IC or FET'S WITH \$5 & \$10 ORDERS.† DATA SHEETS WITH MANY ITEMS.

DIODES	TRANSISTORS	TRANSISTORS	TRANSISTORS	LINEAR IC'S
ZENERS & RECTIFIERS	2N706 \$0.74	2N4091 3/S1	2N5638 2/S1	LM1340K \$1.20
1N4656 to 1N4835	2N720 .48	2N4092 3/S1	2N5640 2/S1	LM1340T 1.20
1N4835 to 1N4845	2N751 3/S1	2N4122 3/S1	CP650 50.00	LM1340T-1 1.20
1N4845 to 1N4855	2N1813 50.75	2N4124 5/31	CP651 50.00	LM1340T-15 1.20
1N4855 to 1N4865	2N1711 29	2N4248 5/31	E100 4/51	LM1340T-24 1.20
1N4865 to 1N4875	2N1850 38	2N4250 4/51	E101 3/51	LM1375H 1.55
1N4875 to 1N4885	2N1853 38	2N4250 4/51	E102 3/51	LM1377N 2.50
1N4885 to 1N4895	2N1219 24	2N4274 5/31	E175 3/51	LM1380A 1.29
1N4895 to 1N4905	2N2222 6/51	2N4302 50.78	MPF102 3/51	NE555V 2.75
1N4905 to 1N4915	2N2222 6/51	2N4302 50.78	MPF102 3/51	NE565A 50.90
1N4915 to 1N4925	2N2222 6/51	2N4302 50.78	MPF102 3/51	LM1092CN .28
1N4925 to 1N4935	2N2222 6/51	2N4302 50.78	MPF102 3/51	LM1092CN .28
1N4935 to 1N4945	2N2222 6/51	2N4302 50.78	MPF102 3/51	LM1092CN .28
1N4945 to 1N4955	2N2222 6/51	2N4302 50.78	MPF102 3/51	LM1092CN .28
1N4955 to 1N4965	2N2222 6/51	2N4302 50.78	MPF102 3/51	LM1092CN .28
1N4965 to 1N4975	2N2222 6/51	2N4302 50.78	MPF102 3/51	LM1092CN .28
1N4975 to 1N4985	2N2222 6/51	2N4302 50.78	MPF102 3/51	LM1092CN .28
1N4985 to 1N4995	2N2222 6/51	2N4302 50.78	MPF102 3/51	LM1092CN .28
1N4995 to 1N5005	2N2222 6/51	2N4302 50.78	MPF102 3/51	LM1092CN .28
1N5005 to 1N5015	2N2222 6/51	2N4302 50.78	MPF102 3/51	LM1092CN .28
1N5015 to 1N5025	2N2222 6/51	2N4302 50.78	MPF102 3/51	LM1092CN .28
1N5025 to 1N5035	2N2222 6/51	2N4302 50.78	MPF102 3/51	LM1092CN .28
1N5035 to 1N5045	2N2222 6/51	2N4302 50.78	MPF102 3/51	LM1092CN .28
1N5045 to 1N5055	2N2222 6/51	2N4302 50.78	MPF102 3/51	LM1092CN .28
1N5055 to 1N5065	2N2222 6/51	2N4302 50.78	MPF102 3/51	LM1092CN .28
1N5065 to 1N5075	2N2222 6/51	2N4302 50.78	MPF102 3/51	LM1092CN .28
1N5075 to 1N5085	2N2222 6/51	2N4302 50.78	MPF102 3/51	LM1092CN .28
1N5085 to 1N5095	2N2222 6/51	2N4302 50.78	MPF102 3/51	LM1092CN .28
1N5095 to 1N5105	2N2222 6/51	2N4302 50.78	MPF102 3/51	LM1092CN .28
1N5105 to 1N5115	2N2222 6/51	2N4302 50.78	MPF102 3/51	LM1092CN .28
1N5115 to 1N5125	2N2222 6/51	2N4302 50.78	MPF102 3/51	LM1092CN .28
1N5125 to 1N5135	2N2222 6/51	2N4302 50.78	MPF102 3/51	LM1092CN .28
1N5135 to 1N5145	2N2222 6/51	2N4302 50.78	MPF102 3/51	LM1092CN .28
1N5145 to 1N5155	2N2222 6/51	2N4302 50.78	MPF102 3/51	LM1092CN .28
1N5155 to 1N5165	2N2222 6/51	2N4302 50.78	MPF102 3/51	LM1092CN .28
1N5165 to 1N5175	2N2222 6/51	2N4302 50.78	MPF102 3/51	LM1092CN .28
1N5175 to 1N5185	2N2222 6/51	2N4302 50.78	MPF102 3/51	LM1092CN .28
1N5185 to 1N5195	2N2222 6/51	2N4302 50.78	MPF102 3/51	LM1092CN .28
1N5195 to 1N5205	2N2222 6/51	2N4302 50.78	MPF102 3/51	LM1092CN .28
1N5205 to 1N5215	2N2222 6/51	2N4302 50.78	MPF102 3/51	LM1092CN .28
1N5215 to 1N5225	2N2222 6/51	2N4302 50.78	MPF102 3/51	LM1092CN .28
1N5225 to 1N5235	2N2222 6/51	2N4302 50.78	MPF102 3/51	LM1092CN .28
1N5235 to 1N5245	2N2222 6/51	2N4302 50.78	MPF102 3/51	LM1092CN .28
1N5245 to 1N5255	2N2222 6/51	2N4302 50.78	MPF102 3/51	LM1092CN .28
1N5255 to 1N5265	2N2222 6/51	2N4302 50.78	MPF102 3/51	LM1092CN .28
1N5265 to 1N5275	2N2222 6/51	2N4302 50.78	MPF102 3/51	LM1092CN .28
1N5275 to 1N5285	2N2222 6/51	2N4302 50.78	MPF102 3/51	LM1092CN .28
1N5285 to 1N5295	2N2222 6/51	2N4302 50.78	MPF102 3/51	LM1092CN .28
1N5295 to 1N5305	2N2222 6/51	2N4302 50.78	MPF102 3/51	LM1092CN .28
1N5305 to 1N5315	2N2222 6/51	2N4302 50.78	MPF102 3/51	LM1092CN .28
1N5315 to 1N5325	2N2222 6/51	2N4302 50.78	MPF102 3/51	LM1092CN .28
1N5325 to 1N5335	2N2222 6/51	2N4302 50.78	MPF102 3/51	LM1092CN .28
1N5335 to 1N5345	2N2222 6/51	2N4302 50.78	MPF102 3/51	LM1092CN .28
1N5345 to 1N5355	2N2222 6/51	2N4302 50.78	MPF102 3/51	LM1092CN .28
1N5355 to 1N5365	2N2222 6/51	2N4302 50.78	MPF102 3/51	LM1092CN .28
1N5365 to 1N5375	2N2222 6/51	2N4302 50.78	MPF102 3/51	LM1092CN .28
1N5375 to 1N5385	2N2222 6/51	2N4302 50.78	MPF102 3/51	LM1092CN .28
1N5385 to 1N5395	2N2222 6/51	2N4302 50.78	MPF102 3/51	LM1092CN .28
1N5395 to 1N5405	2N2222 6/51	2N4302 50.78	MPF102 3/51	LM1092CN .28
1N5405 to 1N5415	2N2222 6/51	2N4302 50.78	MPF102 3/51	LM1092CN .28
1N5415 to 1N5425	2N2222 6/51	2N4302 50.78	MPF102 3/51	LM1092CN .28
1N5425 to 1N5435	2N2222 6/51	2N4302 50.78	MPF102 3/51	LM1092CN .28
1N5435 to 1N5445	2N2222 6/51	2N4302 50.78	MPF102 3/51	LM1092CN .28
1N5445 to 1N5455	2N2222 6/51	2N4302 50.78	MPF102 3/51	LM1092CN .28
1N5455 to 1N5465	2N2222 6/51	2N4302 50.78	MPF102 3/51	LM1092CN .28
1N5465 to 1N5475	2N2222 6/51	2N4302 50.78	MPF102 3/51	LM1092CN .28
1N5475 to 1N5485	2N2222 6/51	2N4302 50.78	MPF102 3/51	LM1092CN .28
1N5485 to 1N5495	2N2222 6/51	2N4302 50.78	MPF102 3/51	LM1092CN .28
1N5495 to 1N5505	2N2222 6/51	2N4302 50.78	MPF102 3/51	LM1092CN .28
1N5505 to 1N5515	2N2222 6/51	2N4302 50.78	MPF102 3/51	LM1092CN .28
1N5515 to 1N5525	2N2222 6/51	2N4302 50.78	MPF102 3/51	LM1092CN .28
1N5525 to 1N5535	2N2222 6/51	2N4302 50.78	MPF102 3/51	LM1092CN .28
1N5535 to 1N5545	2N2222 6/51	2N4302 50.78	MPF102 3/51	LM1092CN .28
1N5545 to 1N5555	2N2222 6/51	2N4302 50.78	MPF102 3/51	LM1092CN .28
1N5555 to 1N5565	2N2222 6/51	2N4302 50.78	MPF102 3/51	LM1092CN .28
1N5565 to 1N5575	2N2222 6/51	2N4302 50.78	MPF102 3/51	LM1092CN .28
1N5575 to 1N5585	2N2222 6/51	2N4302 50.78	MPF102 3/51	LM1092CN .28
1N5585 to 1N5595	2N2222 6/51	2N4302 50.78	MPF102 3/51	LM1092CN .28
1N5595 to 1N5605	2N2222 6/51	2N4302 50.78	MPF102 3/51	LM1092CN .28
1N5605 to 1N5615	2N2222 6/51	2N4302 50.78	MPF102 3/51	LM1092CN .28
1N5615 to 1N5625	2N2222 6/51	2N4302 50.78	MPF102 3/51	LM1092CN .28
1N5625 to 1N5635	2N2222 6/51	2N4302 50.78	MPF102 3/51	LM1092CN .28
1N5635 to 1N5645	2N2222 6/51	2N4302 50.78	MPF102 3/51	LM1092CN .28
1N5645 to 1N5655	2N2222 6/51	2N4302 50.78	MPF102 3/51	LM1092CN .28
1N5655 to 1N5665	2N2222 6/51	2N4302 50.78	MPF102 3/51	LM1092CN .28
1N5665 to 1N5675	2N2222 6/51	2N4302 50.78	MPF102 3/51	LM1092CN .28
1N5675 to 1N5685	2N2222 6/51	2N4302 50.78	MPF102 3/51	LM1092CN .28
1N5685 to 1N5695	2N2222 6/51	2N4302 50.78	MPF102 3/51	LM1092CN .28
1N5695 to 1N5705	2N2222 6/51	2N4302 50.78	MPF102 3/51	LM1092CN .28
1N5705 to 1N5715	2N2222 6/51	2N4302 50.78	MPF102 3/51	LM1092CN .28
1N5715 to 1N5725	2N2222 6/51	2N4302 50.78	MPF102 3/51	LM1092CN .28
1N5725 to 1N5735	2N2222 6/51	2N4302 50.78	MPF102 3/51	LM1092CN .28
1N5735 to 1N5745	2N2222 6/51	2N4302 50.78	MPF102 3/51	LM1092CN .28
1N5745 to 1N5755	2N2222 6/51	2N4302 50.78	MPF102 3/51	LM1092CN .28
1N5755 to 1N5765	2N2222 6/51	2N4302 50.78	MPF102 3/51	LM1092CN .28
1N5765 to 1N5775	2N2222 6/51	2N4302 50.78	MPF102 3/51	LM1092CN .28
1N5775 to 1N5785	2N2222 6/51	2N4302 50.78	MPF102 3/51	LM1092CN .28
1N5785 to 1N5795	2N2222 6/51	2N4302 50.78	MPF102 3/51	LM1092CN .28
1N5795 to 1N5805	2N2222 6/51	2N4302 50.78	MPF102 3/51	LM1092CN .28
1N5805 to 1N5815	2N			

REAL, STOP-THE-PRESS ETCO BARGAINS!

FREE 20 BALL POINT "STICK" PENS WITH EACH ORDER OF \$10.00 OR MORE!



Request 20 No. 033MS037 (20 oz.) One Gift per order, Please!

GREAT POWER SUPPLY BUYS

- 033HP325 (10 oz.) 6 VDC @ 65 ma. \$2.49, 10/\$19.95
- 033HP288 (10 oz.) 7 1/2 VDC @ 100 ma. \$2.49, 10/\$19.95
- 033HP079 (5 oz.) 6 VDC @ 30 ma. 99c ea., 10/\$8.95, 50/\$39.95
- 033HP233 (2 lb.) 12 VDC @ 2 1/2 A. \$9.95 ea., 10/\$89.95
- 033HP156 (10 oz.) 7 1/2 VDC @ 150 ma. \$2.95 ea., 10/\$24.95

SPECIAL VALUES

NOT PREVIOUSLY ADVERTISED!

- 033TR499 (3 lb.) - Synchronous Movie Camera (record only) Cassette Recorders - \$9.95
- 033AL058 (3 lb.) - Ultrasonic 12 vdc motion detector intrusion alarm. \$39.95
- 033TR233 (2 lb.) - 2500 ft. BASF recording tape, 10 1/2" reel, NAB hub. \$12.88
- 033TR574 (1 lb.) - 10 1/2" Metal tape reel, NAB (reconditioned). \$2.95, 10/\$24.95
- 033TE050 (8 oz.) 2 1/2" Square (200 ua) "S" meter. \$3.95
- 033SU321 (8 oz.) - Curtis Mathes Ultra sonic hand transmitter. \$4.95
- 033DR446 (2 lb.) Unusual Motorola No. 96S-226A01 Cathode ray tube. \$4.95
- 955 Government Surplus acorn tube (2 oz.). \$1.95
- 033SU305 (1 lb.) - Unusual electromechanical 1-3/8" digital clock mechanism. \$4.95
- 033PH008 (3 lb.) 3-line (1704-3AT) touch tone telephones. \$49.95
- 033SU324 (1 lb.) As is - "you fix 'em SWR meters for CB. \$7.95
- 033SU323 (3 lb.) Ultrasonic remote control transmitter and receiver. \$29.95
- 033SP012 (15 lb.) Leslie rotating tremolo organ speakers. \$49.95
- 033SP004 4" 3.2 ohm replacement spkrs (8 oz.). 59c ea., 10/\$4.95, 100/\$42.88
- 033SP410 5" x 7" B ohm replacement spkrs. (1 lb.). \$2.99 ea., \$2.49 ea./24 lot

Sansui

QC-04 CD-4 FOUR CHANNEL QUAD RECORD DEMODULATOR!

12.95 EACH

\$9.95 ea., lots of 3
\$8.95 ea., lots of 1001

SENSATIONAL VALUE! Brand new Factory Surplus, with minor parts missing. A goldmine of parts! & semiconductors! 1000 purchased. Schematic included. (5 lb.) 033HP099

3-TRANSISTOR AUDIO AMPLIFIER!

99¢

WE BOUGHT 'EM ALL!

FACTORY SURPLUS!

10/\$7.95
100/\$59.95

BRAND NEW FACTORY SURPLUS - 12,000 IN STOCK! With schematic. Crystal cartridge Input, 8 ohm output, 10,000 ohm volume control. Operates on 6 vdc. (3 oz.) 033PK032

Your own electronic percussion orchestra—

PANASONIC "MINI SIDEMAN"

39.95

Amazing electronic synthesizer produces realistic cymbal, snare and bass drum sounds. Creates 2-beat, 4-beat, jazz, waltz and rock tempos manually or automatically. Plugs in to any stereo, recorder, P.A. or music amp. Operates on 9 volt battery (not included). Limited quantity - order early! (2 lb.) 033HP028

REDUCED!

Worth it for the Speakers Alone!

HOME CONVERTER FOR CAR STEREO!

12.95

Reg. \$19.95

FALL SPECIAL!

A Sensational ETCO purchase! Designed to accept and power AR car stereo models SPC-5002 and SPE-5004, but can be adapted to just about any car stereo or radio. (could power CB sets and scanners, too!) 2 speakers included. Exactly as pictured, less car stereo unit. AR No. HCS-5103. Walnut woodgrain finish. Built in 110 vac power supply, Pilot light, on-off switch, Stereo headphone jack. Original factory sealed cartons. An excellent dealer item! (9 lb.) 033HP725. Speakers: 12"H x 8"W x 7 1/2"D.

EVEREADY FALL SPECIAL!

MALLORY ALKALINE PENCELL (SIZE "AA") BUYOUT!

39¢

Reg. 59c

37c ea./10 lots
33c ea./100 lots

SPECIAL PURCHASE

Sensational ETCO Purchase - 14,000 In Stock! Mallory Duracells and Eveready Alkalines! Every cell fully guaranteed. Selling below nationally advertised prices! (2 oz.) 033BA220

12 VOLT 2 AMP **POWER SUPPLY**

7.89

Reg. \$9.95

FALL SPECIAL!

Sensational Purchase of European inventory! Easily capable of 3-4 amp. surges! Excellent for CB, car stereo, and general hobby applications. Make an excellent battery charger! Incredible value! Dealers: Stock up NOW! (2 lb.) 033HP233

NEW!

TELEPHONE PULSE-OUT DIALER WITH LAST-NUMBER MEMORY!

49.95

\$44.95 ea., 3 lots.
\$39.95 ea., 10 lots.

Allows "touch-button" operation on dial exchanges! Convert dial phones or build "touch" phones with this state of the art module. Touch single button for last number recall. FREE data sheet (request 032B.043). Complete with installation instructions. (12 oz.) 033HP006

TOUCH KEYBOARD PADS - exactly as used in above (less electronics). (3 oz.) 033SW263 **\$6.95 ea.**, 3/\$18.95

CLOSE-OUT!

General Motors Surplus CADILLAC HEADLIGHT TURNOFF TIMERS!

2.95

\$2.49 ea./10 lots
\$1.95 ea./100 lots

FALL SPECIAL!

GM No. 4L2-0015-01-UCC2181. Original Cadillac solid state headlight turnoff timers. Brand new, with schematic and sheet showing timer, burglar alarm and automotive applications. Times from 1 second to 3 minutes. (1 lb.) 033HM162

POPULAR SINGLE-HOLE MOUNT SO-239 SOCKET

89¢

SPECIAL PURCHASE! (2 oz.) 033MS027

79c ea., 10 lot.
69c ea., 50 lot.

SAVE!

MOTOROLA

FALL SPECIAL!

FINE QUALITY - 100% SHIELDED!

7¢/FT. \$5.49/100 ft.
Reg. 9c/ft. \$49.95/1000 ft.

RG58/U COAXIAL CABLE!

033WR002 (3 lb./100')

24 HOUR - 7 DAY A WEEK TELEPHONE ORDER SERVICE!
Call in your CHARGE CARD Orders at Low Weekend and Evening Rates! Dial: 1-518-561-8700.

E31

FREE

No. AA CATALOG packed with bargains and unusual items. Write or circle No. E31 on the information service card at the back of this issue.

NOTE: If you have ordered from ETCO previously and your address remains unchanged, you will automatically receive all new catalogs.

ETCO T.M.

ELECTRONICS LIQUIDATORS OF EXCESS ELECTRONIC INVENTORIES

Rush Your Order Today

ETCO ELECTRONICS North Country Shopping Center, Route No. 9, Plattsburgh, N.Y. 12901.

MERCHANDISE SUBJECT TO PRIOR SALE. Full remittance with each order, please. Money order, Certified check, BANKAMERICARD, VISA, MASTERCHARGE, or CHARGE. Add 15% for UPS (or postage) and handling (we refund excess). Please try to bring your order total to \$10 or more. Worldwide export orders solicited. Open account to Government agencies, schools, institutions and triple "A" rated industrial & commercial accounts. Special quotes for quantities. Dealer inquiries invited. N.Y. state residents: Add 7% Sales tax.

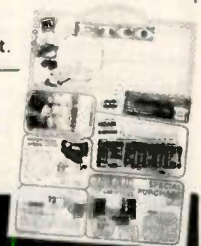

NEW

Frequency Counter

\$89.95 kit



UTILIZES NEW MOS-LSI CIRCUITRY

You've requested it, and now it's here! The CT-50 frequency counter kit has more features than counters selling for twice the price. Measuring frequency is now as easy as pushing a button, the CT-50 will automatically place the decimal point in all modes, giving you quick, reliable readings. Want to use the CT-50 mobile? No problem, it runs equally as well on 12 V dc as it does on 110 V ac. Want super accuracy? The CT-50 uses the popular TV color burst freq. of 3.579545 MHz for time base. Tap off a color TV with our adapter and get ultra accuracy — .001 ppm! The CT-50 offers professional quality at the unheard of price of \$89.95. Order yours today!

- CT-50, 60 MHz counter kit \$ 89.95
- CT-50 WT, 60 MHz counter, wired and tested 159.95
- CT-600, 600 MHz prescaler option for CT-50, add 29.95

SPECIFICATIONS

- Sensitivity: less than 25 mv.
- Frequency range: 5 Hz to 60 MHz, typically 65 MHz
- Gate time: 1 second, 1/10 second, with automatic decimal point positioning on both direct and prescale
- Display: 8 digit red LED .4" height
- Accuracy: 2.0 ppm, .001 ppm with TV time base!
- Input: BNC, 1 megohm direct, 50 Ohm with prescale option
- Power: 110 V ac 5 Watts or 12 V dc @ 1 Amp
- Size: Approx. 6" x 4" x 2", high quality aluminum case

Color burst adapter for .001 ppm accuracy

CB-1, kit \$14.95

MINI-KITS



CLOCK KIT 6 digit 12/24 hour

Want a clock that looks good enough for your living room? Forget the competitor's kludges and try one of our! Features: jumbo .4" digits, Polaroid lens filter, extruded aluminum case available in 5 colors, quality PC boards and super instructions. All parts are included, no extras to buy. Fully guaranteed. One to two hour assembly time. Colors: silver, gold, black, bronze, blue (specify).

- Clock kit, DC-5 \$22.95
- Alarm clock, DC-8, 12 hr only 24.95
- Mobile clock, DC-7 25.95
- Clock kit with 10 min ID timer, DC-10 25.95

Assembled and tested clocks available, add \$10.00

VIDEO TERMINAL KIT \$149.95

A compact 5 1/2 inch PC card that requires only an ASCII keyboard and a TV set to become a complete interactive terminal for connection to your microprocessor synchronous interface. Its many features are: single 8-volt supply, crystal controlled sync and baud rates (up to 9600 baud), 2 pages of 32 characters by 16 lines, read to and from memory, computer and keyboard operated cursor and page control, parity error display and control, power on initialization, full 64 character ASCII display, block-type search cursor, Keyboard/computer control backspaces, forward spaces, line feeds, rev. line feeds, home, returns cursor. Also clears page, clears to end of line, sets to page 1 or 2, reads from or to memory. The card requires 5 volts at approx. 900 ma and outputs standard 75 ohm composite video.

- TH3216 Kit \$149.95
- TH3216, Assembled and Tested 239.95
- VD 1, Video to RF Modulator Kit 6.95

CAR CLOCK KIT \$27.95



- 12/24 Hour 12 Volt AC or DC
- High Accuracy (1 minute/month)
- 8 jumbo .4" LED readouts
- Easy, no polarity hookup
- Display blanks with ignition
- Case mounting bracket included
- Super instructions
- Complete Kit, DC 11 \$27.95

AUTO-DIMMER
\$2.50
Automatically adjusts display brightness according to ambient light level. For DC 11 Car Clock.

STONE DECODER KIT

A complete tone decoder on a single PC Board. Features: 400-5000 Hz adjustable frequency range, voltage regulation, 567 IC. Useful for touch-tone decoding, tone burst detection, FSK demod, signaling, and many other uses. Use 7 for 12 button touchtone decoding. Runs on 5 to 12 volts.

Complete Kit, TD-1 \$4.95



SUPER SLEUTH AMPLIFIER

A super-sensitive amplifier which will pick up a pin drop at 15 feet! Great for monitoring baby's room or as a general purpose test amplifier. Full 2 watts of output, runs on 6 to 12 volts, uses any type of mike. Requires 8-45 ohm speaker.

Complete Kit, BN-9 \$4.95

FM WIRELESS MIKE KIT

Transmit up to 300' to any FM broadcast radio, uses any type of mike. Runs on 3 to 9 V. Type FM-2 has added super sensitive mike preamp.

FM-1 \$2.95 FM-2 \$4.95

COLOR ORGAN/MUSIC LIGHTS

See music come alive! 3 different lights flicker with music or voice. One light for lows, one for the mid-range and one for the highs. Each channel individually adjustable, and drives up to 300 watts. Great for parties, band music, nite clubs and more.

Complete Kit, ML-1 \$7.95

LED BLINKY KIT

A great attention getter which alternately flashes 2 Jumbo LEDs. Use for name badges, buttons, or warning type panel lights. Runs on 3 to 9 volts.

Complete Kit \$2.95

POWER SUPPLY KIT

Complete triple regulated power supply provides variable ±15 volts at 200 mA and +5 volts at 1 Amp. 50 mV load regulation good filtering and small size. Kit less transformers. Requires 6-9 V at 1 Amp and 18 to 30 VCT.

Complete Kit, PS-3LT \$6.95



SIREN KIT

Produces upward and downward wail characteristic of police siren. 5 watts audio output, runs on 3-9 volts, uses 8-45 ohm speaker.

Complete Kit, SM-3 \$2.95

DECADE COUNTER PARTS

Includes: 7490A, 7475, 7447, LED readout, current limit resistors, and instructions on an easy to build low cost frequency counter.

Kit of parts, DCU-1 \$3.50

CHEAP CLOCK KIT \$8.95

- DC-4 Features:
 - 6 digit .4" LED
 - 12 or 24 format
- Does not include board or transformer
- PC Board \$2.95
- Transformer \$1.49

600 MHz PRESCALER



Extend the range of your counter to 600 MHz. Works with all counters. Less than 150 mv sensitivity. Specify +10 or -100. Wired, tested, PS-1B \$59.95

Kit, PS-1B \$44.95

30 watt 2 meter Power Amp

The famous RE class C power amp now available mail order! Four Watts in for 30 Watts out, 2 in for 15 out, 1 in for 8 out, incredible value, complete with all parts, instructions and details on T-R relay. Case not included.

Complete Kit, PA-1 \$22.95

CALENDAR ALARM CLOCK

Has every feature one could ever ask for. Kit includes everything except case, build it into wall, station or even car! FEATURES:

- 6 Digits, .5" High LED
- 12/24 Hour Format
- Calendar shows mo./day
- Snooze button
- True 24 Hour Alarm
- 1001 chips does all!
- Battery back up with built in on chip time base
- Complete Kit, less case, DC-9 \$34.95

LINEAR		REGULATOR		TRANSISTORS	
5314 Clock	\$2.95	555	\$.50	78MG	\$1.49
74S00	.35	556	.75	309K	.89
74S112	.75	566	1.49	309H	.99
7447	.79	567	1.49	340K-12	.99
7473	.35	1458	.50	7805	.89
7475	.50	LED DRIVER		7812	.89
7490A	.55	75491	.50	7815	.89
74143	3.50	75492	.50	7818	.89

DIODES: 1KV, 2.5A \$/1.00 100V, 1A 10/\$1.00 1N914A type 50/\$2.00

LED DISPLAYS

- FND 35975
 - FND 510 1.25
 - DL 707 1.25
 - HP 7730 1.25
- Red Polaroid Filter 4.25" X 1.125"59

741 DP-AMP SPECIAL

Factory prime mini dip with both Xerox and 741 part numbers

10 for \$2.00

SOCKETS

- 14 PIN 5/\$1.00
- 16 PIN 5/\$1.00
- 24 PIN 2/\$1.00
- 24 PIN 3/\$2.00

FERRITE BEADS

- with info and specs
- 15/\$1.00
- 6 hole Balun Beads 5/\$1.00

ramsey electronics

P.O. Box 4072 Rochester NY 14610
(716) 271-6487

TELEPHONE ORDERS
WELCOME



Satisfaction guaranteed or money refunded. COO, add \$1.00. Orders under \$10 add \$75. NY residents add 7% tax. Add \$5 for postage, insurance, and handling. Minimum order \$6.00.

NEW FM/CW EXCITER KITS

BUILD UP YOUR OWN GEAR FOR MODULAR STATIONS, REPEATERS, & CONTROL LINKS

- Rated for Continuous Duty
- Professional Sounding Audio
- Built-in Testing Aids



T50 Six Channel, 2W Exciter Kit for 2M, 6M, or 220 MHz \$49.95

FAMOUS HAMTRONICS PREAMPS

let you hear the weak ones!

Great for OSCAR, SSB, FM, ATV. Over 10,000 in use throughout the world on all types of receivers.

P9 Kit \$12.95

P14 Wired \$24.95

Deluxe vhf model for applications where space permits.



- 1-1/2 x 3"
- Covers any 4 MHz band
- 12 Vdc
- Ideal for OSCAR
- Diode protection
- 20dB gain

MODEL	RANGE
P9-LO	26-88 MHz
P9-HI	88-172 MHz
P9-220	172-230 MHz
P14 Wired	Give exact band



P8 Kit \$10.95

P16 Wired \$21.95

- Covers any 4 MHz band
- 20 dB gain
- 12 Vdc

Miniature VHF model for tight spaces - size only 1/2 x 2-3/8 inches.

MODEL	RANGE
P8-LO	20-83 MHz
P8-HI	83-190 MHz
P8-220	220-230 MHz
P16 Wired	Give exact band

P15 Kit \$18.95

P35 Wired \$34.95

- Covers any 6 MHz band in UHF range of 380-520 MHz
- 20 dB gain
- Low noise



YOU ASKED - HERE THEY ARE!

VHF Linear PA's

- Use as Linear or Class C PA's
- For XV-2 Xmtg Converters, T50 Exciters, or any 2W Exciter

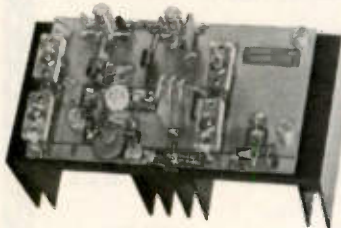

LPA 2-15 Kit \$59.95

- 15W out (linear) or 20W (class C)
- Solid State T/R Switching
- Models for 6M, 2M, or 220 MHz

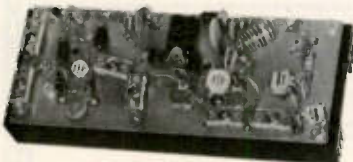

LPA 2-45 Kit. \$109.95

- 45W out (linear) or 50W (class C)
- Models for 6M or 2M
- LPA 8-45 Kit \$89.95
- For 2M, 8-10W in, 45W out

AT LAST! 6M, 2M, & 1 1/4 M SSB TRANSMITTING CONVERTERS

At a price you can afford

Use inexpensive recycled 10 or 11 meter ssb exciter on VHF bands!

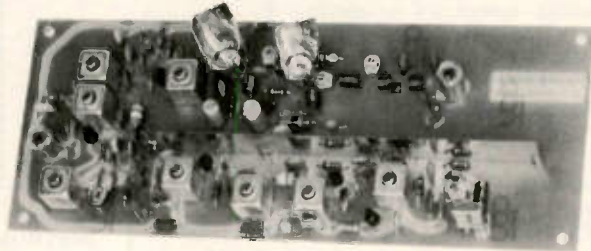

FEATURES:

- Linear Converter for SSB, CW, FM, etc.
- A fraction of the price of other units
- 2W p.e.p. output with 1 MW of drive
- Use low power tap on exciter or attenuator pad
- Easy to align with built-in test points

Frequency Schemes Available:

XV2-1	28-30 MHz =	50 - 52 MHz
XV2-2	28-30 MHz =	220-222 MHz
XV2-4	28-30 MHz =	144-146 MHz
XV2-5	28-29 MHz =	145-146 MHz
XV2-6	26-28 MHz =	144-146 MHz

XV2-() TRANSVERTER KIT \$59.95

A25 Optional Cabinet for Xverter & PA \$20

New VHF&UHF Converter Kits

let you receive OSCAR signals and other exciting SSB, CW, & FM activity on your present HF receiver.



either one
- ONLY \$34.95
including crystal

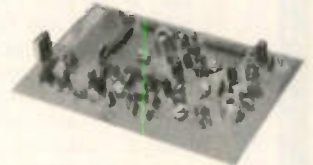

MODEL	RF RANGE (MHZ)	I-F RANGE
C50	50-52	28-30
C144	144-146	28-30
C145	145-147 (OSCAR)	28-30
C146	146-148	28-30
C110	Aircraft	28-30
C220	220 band	28-30
Special	Other i-f & rf ranges available	

MODEL	RF RANGE (MHZ)	I-F RANGE
C432-2	432-434	28-30
C432-5	435-437 (OSCAR)	28-30
C432-7	427.25	61.25
C432-9	439.25	61.25
Special	Other i-f & rf ranges available	

A9 Extruded Alum Case/Connectors \$12.95

VHF/UHF FM RCVR KITS

- ★ NEW GENERATION RECEIVERS
- ★ MORE SENSITIVE ★ MORE SELECTIVE (70 or 100 dB)
- ★ COMMERCIAL GRADE DESIGN
- ★ EASY TO ALIGN WITH BUILT-IN TEST CKTS
- ★ LOWER OVERALL COST THAN EVER BEFORE



R70 6-channel VHF Receiver Kit for 2M, 6M, 10M, 220 MHz, or com'l bands..... \$69.95
Optional xtal filter for 100 dB adj chan 10.00



R90 UHF Receiver Kit for any 2 MHz segment of 380-520 MHz band..... \$89.95

* FREE 1978 CATALOG *

NEW JUNE 1978 CAT. IS YOURS FOR THE ASKING!

IT'S EASY TO ORDER!

- ☎ CALL OR WRITE NOW FOR FREE CATALOG OR TO PLACE ORDER!
- ☎ PHONE 716-663-9254. (Answering service evenings and weekends for your convenience. Personal service 9-5 eastern time.)
- ☎ Use credit card, c.o.d., check, m.o.
- ☎ Add \$2.00 shipping & handling.

IN CANADA, send to Comtec; 5605 Westluxe Ave; Montreal, Que H4W 2N3 or phone 514-482-2640. Add 38% to cover duty, tax, and exchange rate.

hamtronics, inc.

182-J Belmont Rd; Rochester, NY 14612 H16

BULLET ELECTRONICS

B8

P.O. Box 19442E Dallas, TX. 75219 (214)823-3240



MC3301P HOUSE #
4 OP AMPS IN ONE PACKAGE. USES SINGLE SUPPLY. (4 to 28VDC). INTERNALLY COMPENSATED. SIMILAR TO MC3401, BUT HIGHER GAIN. **49¢**

MC1437P DUAL 709 OP AMP
HIGH OPEN LOOP GAIN, LOW NOISE. 14 PIN DIP **3/1.00**

MC1351P FM-IF AMP AND DISCRIMINATOR

USED IN FM & TV SOUND CIRCUITS. REQUIRES MINIMUM EXTERNAL COMPONENTS. 14 PIN DIP DIRECT REPLACEMENT FOR HEPC 6060, ECG 748 and MANY OTHERS. HOUSE # **50¢**

HOUSE #

LM3900 QUAD NORTON AMP

WE BOUGHT A LARGE QUANTITY OF THESE HOUSE NUMBERED PARTS AT A BARGAIN PRICE THAT ALLOWS US TO SELL THEM AT A LOW, LOW **39¢**

TIL312 COMMON ANODE READOUT



3" CHARACTER SIZE WITH PINOUT .65 **6/3.00**

MPF131 N-CHANNEL DUAL GATE MOSFET



50¢

DESIGNED FOR AMPLIFIER AND MIXER APPLICATIONS TO 200 MHZ. PLASTIC CASE. UNITS ARE HOUSE NUMBERED WITH SPECS.

IL-1 OPTO ISOLATORS

BY LITRONIX 6 PIN DIP STANDARD PINOUT LED-TRANSISTOR COMBINATION. **50¢** WHILE THEY LAST!



SMALL SKIRTED BLACK INSTRUMENT KNOB.

FITS 1/8" SHAFT WITH SET SCREW.



5/1.00

MJ900 - MJ1000

COMPLIMENTARY PNP, NPN DARLINGTON POWER TRANSISTORS. 8 AMPS. WE SUPPLY A SCHEMATIC TO BUILD A HIGH POWER (35W) LOW DISTORTION AUDIO AMP WITH ONLY ONE ADDITIONAL TRANSISTOR AND A DOZEN INEXPENSIVE COMPONENTS! TO-3 CASE STYLE. BUY A PAIR FOR **\$3.00!**

1N4148 DIODES

LEADS ARE TARNISHED BUT CLEAN UP EASILY. THE BOSS SAYS "DUMP 'EM"...SO CHECK THIS PRICE! **50/1.00**



HOUSE # PNP POWER TO-3

150 WATTS
80 VCEO
10 AMPS



IDENTICAL TO 2N3790 **1.00**

MC1469R POSITIVE VOLTAGE REGULATOR

1/2 AMP COMPLETE SPECS AND APPLICATIONS SHOW HOW TO BUILD FIXED OR VARIABLE POWER SUPPLIES FROM 3 TO 30VDC. DRIVE EXTERNAL SERIES PASS FOR CURRENT TO 20 AMPS!



1.25 EA.
10/10.00

HOUSE #

FANTASTIC SOUND EFFECTS CHIP

AVAILABLE ONLY FROM BULLET!
THIS 28 PIN MARVEL CONTAINS A LOW FREQUENCY OSCILLATOR, VCO, NOISE OSCILLATOR, ONE SHOT, MIXER AND ENVELOPE CONTROL. WITH 8 PAGE MANUAL. 5 to 9VDC **3.95**

ALL COMPONENTS 100% GUARANTEED



- CA3011 WIDEBAND IF AMP w/specs **50¢**
- 2N3569 NPN EPOXY 1W **6/1.00**
- 741 OP AMP 8 PIN DIP **5/1.00**
- 723 VOLTAGE REG. 14 PIN DIP **50¢**
- MPS6530 NPN HOUSE # **8/1.00**
- 725 OP AMP LOW NOISE HOUSE # **99¢**
- 7815 15V 1A REGULATOR HOUSE # **69¢**
- LM340T-12 12V 1A VOLT. REG. w/specs **75¢**
- TCA430 QUAD OSCILLATOR 1/specs **69¢**
- 2N4343 P CHANNEL J FET **4/1.00**
- 2N6111 PNP MED PWR 40W TO-220 **3/1.00**
- 2N6028 PROGRAMMABLE UNIJUNCTION w/specs **50¢**
- TRIAC 200V 8A UNMARKED **3/1.00**



INCANDESCENT PANEL LAMP

WITH TINNEMAN NUT YOUR CHOICE OF RED, GREEN, YELLOW, WHITE 12-24VDC **15¢**



POWER SUPPLY METERS

Quality 3 1/2" meters for the PS-14, 0-15VDC & 0-25A. Matched set, individually packaged, NOT SURPLUS! **12.95/set**

CAPACITORS

SMALL SIZE!

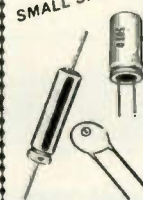

- 2200 MFD @ 16 VDC RADIAL **3/1.00**
- 500 MFD @ 35VDC **5/1.00 AXIAL**
- 220 MFD @ 25VDC **7/1.00 AXIAL**
- 1 MFD @ 20VDC DISC CERAMIC **15/1.00**

FND510 69¢

COMMON ANODE READOUT 1/2" CHARACTER **LIMIT 24 PER CUSTOMER!**



Miniature 7K Pot w/switch PC Mount or panel mount 1/8" shaft **49¢**
Black plastic knob for above **FREE**

LIMITED QTY Computer Grade FILTER CAP Screw Terminals 2" x 5/8" **9500 mfg#75V 2.95 or 4.95**

New!

ULTRASONIC SENDER RECEIVER KIT US-02

TOTAL SECURITY! Completely invisible ultrasonic (23KHZ) sound beam works like a photoelectric beam but is unaffected by light, heat or noise. Separate Transmitter and Receiver can be used from 8 inches to 25 feet! A solid object breaking the beam causes an output to go low that will sink up to 150 MA to Drive a Relay, TRIAC, etc. Complete electronics are provided. Works on 12VDC (unregulated) and draws less than 100 MA. Use it for burglar alarms, object counters, automatic door openers, automatic door bells, electronic rat trap(?) and more.

COMPLETE KIT LESS CASES **21.50**

Optional entry delay and Alarm Timeout Circuit will source or sink up to 200 MA DC. **3.95**

LED'S JUMBO: RED 5/.89 GREEN 4/.89

- MEDIUM: RED .15 MINI: GREEN .16 RED .10 YELLOW .16

1.5V 10-30 ma

POWER SUPPLY KIT PS-14

- * Better than 200mV load and line regulation
- * Foldback Current Limiting
- * Short Circuit Protected
- * Thermal Shutdown
- * Adjustable Current Limiting
- * Less than 1% ripple.
- * 15 amps 11.5 to 14.5V
- * All parts supplied including heavy duty transformer.
- * Quality plated fiberglass PC board.

Less Case, meters & jacks

42.95 UPS SHIPPING PAID!

OVERVOLTAGE PROTECTION KIT 6.95

Provides cheap insurance for your expensive equipment. Trip voltage is adjustable from 3 to 30 volts. Overvoltage instantly fires a 25A SCR and shorts the output to protect equipment. Should be used on units that are fused. Directly compatible with the PS-12 and PS-14. All electronics supplied. Drilled and plated PC board. (Order OVP-1)

Public Notice!

WE WOULD LIKE TO GIVE OUR CUSTOMERS A CHANCE TO PURCHASE THE KIT AT THIS PRICE BEFORE A SCHEDULED INCREASE TO 43.00 IN SEPTEMBER.

MINI GRANDFATHER CLOCK KIT

- * Chimes the hour (ie: 3 times for 3 O'clock)
 - * Unique "swinging" LED pendulum
 - * Tick tock sound matches pendulum swing.
 - * Large 4 digit .5" LED readout
 - * All CMOS construction
 - * Complete electronics including transformer & speaker; drilled and plated PC boards measure 4.5" x 6.5"
- 39.95**
- BEAUTIFUL SOLID WALNUT**
Custom case for above kit. Over 9 1/2" tall. **19.95**

MK-03A CLOCK/TIMER KIT

Features 24 hour Zulu time and up to 24 hours of elapsed time on the same set of six digit LED readouts. Totally independent operation of both functions. Clock has pre-settable alarm with 10 minute snooze. Timer has reset, hold, and count functions. Full noise and overvoltage protection. 24 hour only. Readouts has dimmer feature or they can be turned off without disturbing the clock or timer. Timebase included (.01% accuracy). Because of the many options and mounting considerations the case and switches are not included. Switches are standard types. Will fit inside standard aircraft instrument case. **9-14VDC 28.95**

WARBLE ALARM Kit

A fun EASY kit to assemble that emits an ear piercing 10 watt dual tone scream. Resembles European siren sound. Great for alarms or toys. Operates from 5-12VDC at up to 1 amp (using 12VDC 8 ohm speaker). Over five thousand have been sold. All parts including PC board, less speaker. **ORDER WB-02**

2.50



- * NO C.O.D.'S
- * SEND CHECK M.O. OR CHARGE CARD NO.
- * PHONE ORDERS ACCEPTED ON VISA AND MASTERCARD ONLY.

- * ADD 5% FOR SHIPPING
- * TX. RES. ADD 5% STATE SALES TAX
- * ORDERS OF \$50. & OVER TAKE 10% DISCOUNT
- * FOREIGN ORDERS ADD 10% (20% AIRMAIL) U.S. FUNDS ONLY.

600 MHZ. FREQUENCY COUNTER ±0.1 PPM TCXO

OPTO-8000.1

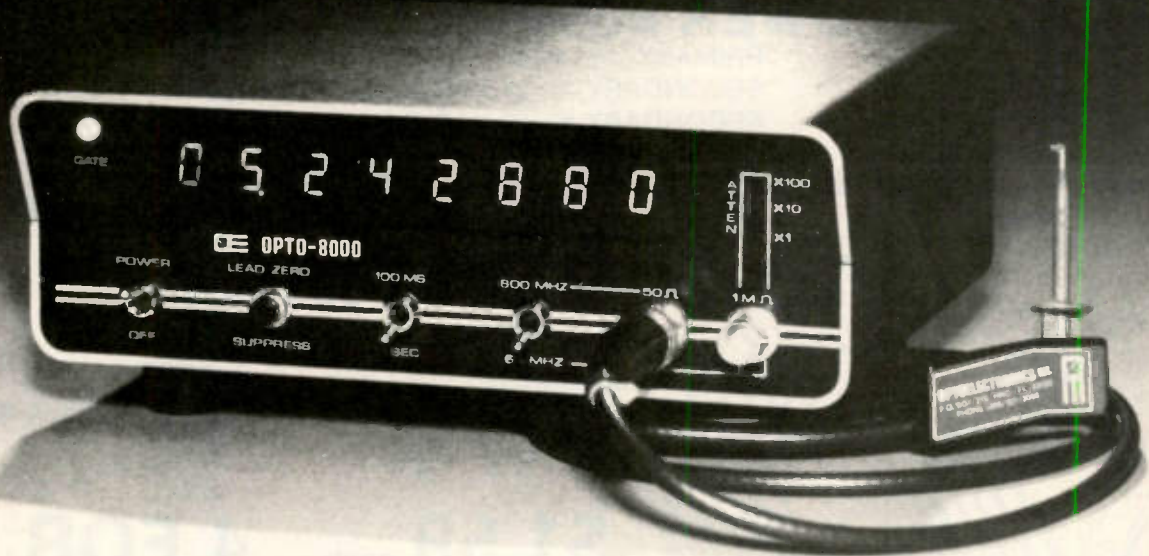

This new instrument has taken a giant step in front of the multitude of counters now available. The Opto-8000.1 boasts a combination of features and specifications not found in units costing several times its price. Accuracy of ± 0.1 PPM or better — *Guaranteed* — with a factory-adjusted, sealed TCXO (Temperature Compensated Xtal Oscillator). **Even kits require no adjustment for guaranteed accuracy!** Built-in, selectable-step attenuator, rugged and attractive, black anodized aluminum case (.090" thick aluminum) with tilt bail. 50 Ohm and 1 Megohm inputs, both with amplifier circuits for super sensitivity and both diode/overload protected. Front panel includes "Lead Zero Blanking Control" and a gate period indicator LED. AC and DC power cords with plugs included.



SPECIFICATIONS:

Time Base—TCXO ± 0.1 PPM GUARANTEED!
 Frequency Range—10 Hz to 600 MHz
 Resolution—1 Hz to 60 MHz; 10 Hz to 600 MHz
 Decimal Point—Automatic
 All IC's socketed (kits and factory-wired)
 Display—8 digit LED
 Gate Times—1 second and 1/10 second
 Selectable Input Attenuation—X1, X10, X100
 Input Connectors Type —BNC
 Approximate Size—3" h x 7 1/2" w x 6 1/2" d
 Approximate Weight—2 1/2 pounds
 Cabinet—black anodized aluminum (.090" thickness)
 Input Power—9-15 VDC, 115 VAC 50/60 Hz
 or internal batteries
 OPTO-8000.1 Factory Wired \$299.95
 OPTO-8000.1K Kit \$249.95

ACCESSORIES:

Battery-Pack Option—Internal Ni-Cad Batteries and charging unit \$19.95
 Probes: P-100—DC Probe, may also be used with scope \$13.95
 P-101—LO-Pass Probe, very useful at audio frequencies \$16.95
 P-102—High Impedance Probe, ideal general purpose usage \$16.95
 VHF RF Pick-Up Antenna-Rubber Duck w/BNC #Duck-4H \$12.50
 Right Angle BNC adapter #RA-BNC \$ 2.95

FC-50 — Opto-8000 Conversion Kits:

Owners of FC-50 counters with #PSL-650 Prescaler can use this kit to convert their units to the Opto-8000 style case, including most of the features.

FC-50 — Opto-8000	Kit \$59.95
*FC-50 — Opto-8000F	Factory Update \$99.95
FC-50 — Opto-8000.1 (w/TCXO)	Kit \$109.95
*FC-50 — Opto-8000.1F	Factory Update \$149.95

*Units returned for factory update must be completely assembled and operational



OPTOELECTRONICS, INC.

5821 NE 14 Avenue
 Ft. Lauderdale, FL 33334
 Phones: (305) 771-2050 771-2051
 Phone orders accepted 6 days, until 7 p.m.

03



TERMS: Orders to U.S. and Canada, add 5% to maximum of \$10.00 per order for shipping, handling and insurance. To all other countries, add 10% of total order. Florida residents add 4% state tax. C.O.D. fee: \$1.00. Personal checks must clear before merchandise is shipped.

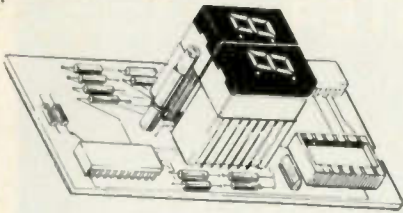

LED READOUT BOARD

Mfg. by Xerox. Has two OPCOA SLA-1 common anode, .33 Inch Readouts. Also has 2 - 7447 drivers and 2-14 pin W.W. sockets plus 2 small lamps. Used in word processors.

\$159 EACH



MYLAR CAPS

DIPPED, RADIAL LEADS
.1MFD 250 WVDC
10% TOLERANCE
NEW! 10 FOR \$1

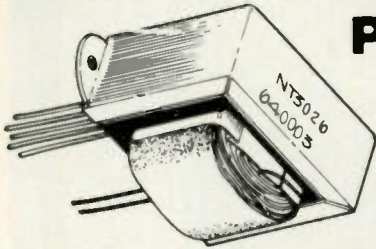

POWER SUPPLY TRANSFORMER #2

PRIMARY: 115 VAC 60HZ
SECONDARY #1: 24 VAC AT 1.5 AMPS
SECONDARY #2: 20 VAC C.T. AT 1.5 AMPS

BRAND NEW!!! \$395 EACH

PART # 640003

TO-3 HEATSINK

BLACK ANODIZED ALUMINUM.
DRILLED FOR ONE TO-3 CASE.
HEAVY DUTY. PERFECT FOR LM309K OR POWER TRANSISTORS.

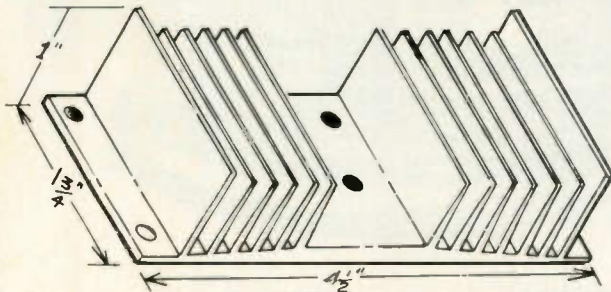

\$1.59 each **4 FOR \$5**

VECO PRECISION THERMISTORS

GLASS BULB TYPE. SUPER SMALL. VECO #41A72. 8.2K OHMS AT ROOM TEMP. VERY SENSITIVE.

\$3 VALUE!

75¢ EACH 3 FOR \$2



INDIVIDUALLY PACKED IN PLASTIC VIALS.

PRECISION OPTICS

31.5 POWER f:2.8
THREADED MOUNT

\$195 each

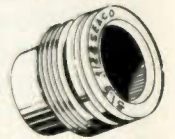

ORIG. COST \$16
These were used in MICRO-FILM equipment. Perfect for experiments.

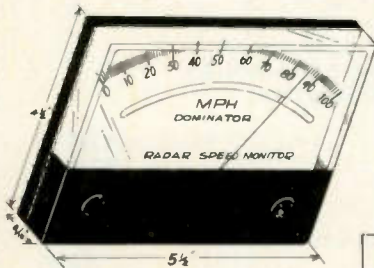

MIRRORED SCALE!

BRAND NEW!

WESTON BIG—SCALE PANEL METER

Super precision, originally used in Police Radar. 0 - 1 MA Movement. Scale Reads 0 To 100. Originally cost \$46.71 each. Very Limited Stock.

\$8.95 ea.

PLASTIC LENS

High Power. 3/4" Sq.
Perfect for experiments.



8 FOR \$1

BRAND NEW!

I.F. TRANSFORMERS — VARIABLE INDUCTORS

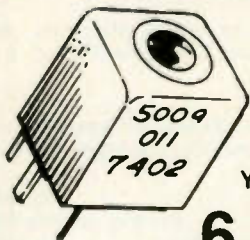

YOUR CHOICE

6 FOR \$1

We bought a load from a very large manufacturer of COM. gear!
Please order by part #.

- #5009-011: .7 TO 1.3 UH VARIABLE INDUCTOR (C.T.)
- #5006-008: 455 KHZ IF TRANSFORMER
- #5015-009: 27 MHZ RF TRANSFORMER (C.T. PRI.)
- #5015-007: 4.3 MHZ IF TRANSFORMER

MICROMINI-SIZE

NOTE: The 5009-011 Variable Inductor can also be used as a 10.7 MHZ I.F. by using a 240 PF CAPACITOR

Digital Research Corporation

(OF TEXAS)
P. O. BOX 401247 • GARLAND, TEXAS 75040 • (214) 271-2461

SEE OPPOSITE PAGE FOR TERMS

New!

16K E-PROM CARD

IMAGINE HAVING 16K OF SOFTWARE ON LINE AT ALL TIME!

KIT FEATURES:

1. Double sided PC board with solder mask and silk screen and gold plated contact fingers.
2. Selectable wait states.
3. All address lines & data lines buffered!
4. All sockets included.
5. On card regulators.

KIT INCLUDES ALL PARTS AND SOCKETS (except 2708's). Add \$25. for assembled and tested.

S-100 (Imsai/Altair) Buss Compatible!

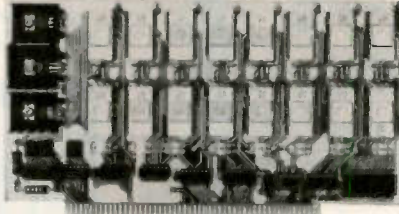

PRICE CUT!

\$57.50 kit

WAS \$69.95

SPECIAL OFFER:

Our 2708's (450NS) are \$8.95 when purchased with above kit.

Fully Static!

ADD \$20 FOR 250NS

KIT FEATURES:

1. Doubled sided PC Board with solder mask and silk screen layout. Gold plated contact fingers.
2. All sockets included.
3. Fully buffered on all address and data lines.
4. Phantom is jumper selectable to pin 67.
5. FOUR 7805 regulators are provided on card.

(450NS)

8K LOW POWER RAM KIT - \$149.00

S-100 (Imsai/Altair) Buss Compatible!

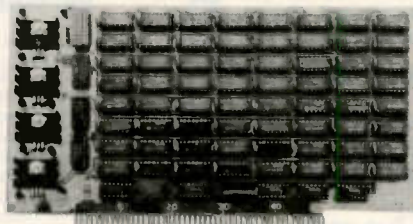

USES 21L02 RAM'S!

2 KITS FOR \$279

- Fully Assembled & Burned In \$179.00
- Blank PC Board w/ Documentation \$29.95
- Low Profile Socket Set 13.50
- Support IC's (TTL & Regulators) \$9.75
- Bypass CAP's (Disc & Tantalums) \$4.50

MOTOROLA QUAD OP - AMP MC 3401. PIN FOR PIN SUB. FOR POPULAR LM 3900.

3 FOR \$1

ALARM CLOCK CHIP N.S. MM5375AA. Six Digits. With full Data. New!

\$2.49 each

FULL WAVE BRIDGE 4 AMP. 200 PIV. 69¢ 10 FOR \$5.75

NOT ASSOCIATED WITH DIGITAL RESEARCH OF CALIFORNIA, THE SUPPLIERS OF CPM SOFTWARE.

MOTOROLA 7805R VOLTAGE REGULATOR Same as standard 7805 except 750 MA output. TO-220. 5VDC output.

44c each or 10 for \$3.95

450 NS! 2708 EPROMS Now full speed! Prime new units from a major U.S. Mfg. 450 N.S. Access time. 1K x 8. Equiv. to 4-1702 A's in one package.

~~\$15.75 ea.~~ **\$9.95** ~~4 FOR \$50.00~~ PRICE CUT

SALE! 16K DYNAMIC RAM CHIP

16K X 1 Bits. 16 Pin Package. Same as MOSTEK 4116-4. 250 NS access. 410 NS cycle time. Our best price yet for this state of the art RAM. 32K and 64K RAM boards using this chip are readily available. These are new, fully guaranteed devices by a major mfg.

VERY LIMITED STOCK! **\$17.95 EACH 8 FOR \$129**

4K STATIC RAM'S 2114. The new industry standard. Arranged as 1K x4. Equivalent to 4-21 L02's in 1 package! 18 pin DIP. 2 chips give 1Kx8.

2/\$19 8 FOR 69.95

OPCOA LED READOUT SLA-1. Common Anode. .33 inch character size. The original high efficiency LED display. 75c ea.

4 FOR \$2.50

Z-80 PROGRAMMING MANUAL By MOSTEK, or ZILOG. The most detailed explanation ever on the working of the Z-80 CPU CHIPS. At least one full page on each of the 158 Z-80 instructions. A MUST reference manual for any user of the Z-80. 300 pages. Just off the press. **\$12.95**

NATIONAL SEMICONDUCTOR JUMBO CLOCK MODULE



ASSEMBLED! NOT A KIT!

ZULU VERSION We have a limited number of the 24 HR Real time version of this module in stock. #MA1008D - \$9.95

\$6.95

2 FOR \$13

(AC XFMR \$1.95)

PERFECT FOR USE WITH A TIMEBASE.

COMPARE AT UP TO TWICE OUR PRICE!

MANUFACTURER'S CLOSEOUT!

MA1008A BRAND NEW!

- FEATURES
- FOUR JUMBO 1/2 INCH LED DISPLAYS
- 12 HR REAL TIME FORMAT
- 24 HR ALARM SIGNAL OUTPUT
- 50 OR 60 Hz OPERATION
- LED BRIGHTNESS CONTROL
- POWER FAILURE INDICATOR
- SLEEP & SNOOZE TIMERS
- DIRECT LED DRIVE (LOW RFI)
- COMES WITH FULL DATA

SALE! 1N4148 DIODES. SILICON.

Same as 1N914. New, factory prime, Full Leads. 1000 FOR \$2 1000 FOR \$17.50

New! REAL TIME Computer Clock Chip

N.S. MM5313. Features BOTH 7 segment and BCO outputs. 28 Pin DIP. \$4.95 with Data

MICRO-MINI TOGGLE SWITCH



99¢

EACH

SPDT. By RAYTHEON. MADE IN USA! WITH HDWR.

6 FOR \$5

Digital Research Corporation

(OF TEXAS)

P. O. BOX 401247 • GARLAND, TEXAS 75040 • (214) 271-2461

TERMS: Add 30¢ postage, we pay balance. Orders under \$15 add 75¢ handling. No C.O.D. We accept Visa, MasterCard, and American Express cards. Tex. Res. add 5% Tax. Foreign orders (except Canada) add 20% P & H. 90 Day Money Back Guarantee on all items.

AT YOUR SERVICE

IF YOU SPEAK TRS-80 THEN READ THIS...

We introduced our TRS-80 Conversion Kit so that anybody could upgrade their 4K machine to a 16K machine. But apparently, that's not all our kit can do (which might explain why it's selling so well). One user wrote to say that our conversion chip set not only works in the mainframe, but also works with the memory expansion module offered by Radio Shack... and that he is currently running 32K of memory in his TRS-80. Some dealers have also mentioned using these chips to expand APPLES.

No matter what you use it for, our conversion kit comes with eight uPD416 16K RAMs, DIP shunts, and full instructions. We back up our parts with a 1 year warranty.

Single kit price is \$190, or take advantage of our "Memory Expansion Special": 3 kits for \$540.

IF YOU'RE INTO COMPUTERS, THIS IS THE BEST PART OF THE AD...

Econoram™ memories are known throughout the industry for reliability and the ability to mate with all S-100 buss mainframes... and they're the boards to use in your computer. We offer fully static design, full buffering, high speed/low power parts, intelligent mechanical design, and an enviable reputation for quality.

Following are our two latest boards. These are available in 3 forms: unkit (with sockets and bypass caps pre-soldered in place), assembled and tested, and qualified under the Certified Systems Components program. CSC boards are assembled, tested, guaranteed to run at 4 MHz, burned in for 200 hours, and serial numbered. We exchange (not repair) the board if failure occurs within one year of invoice date.

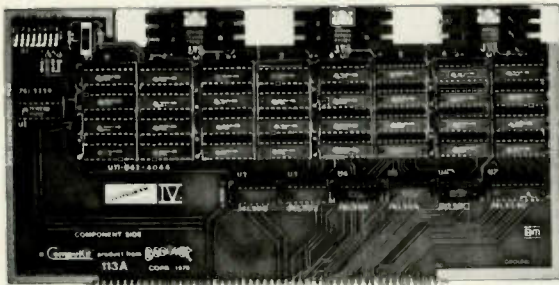

16K ECONORAM IV™ \$279 unkit

(Assm \$314, CSC \$414) Current under 2000 mA; manual write protect for 4K blocks; use with or without phantom line. Excellent where you need a big chunk of cost-effective memory.

24K ECONORAM VII™ \$445 unkit

(Assm \$485, CSC \$605) Our top of the line, full feature memory draws under 2000 mA current. Configured as two 4K and two 8K blocks, with independent write protect for each block; use with or without phantom lines; and has provisions for two unused qualifiers.

MA1003 CLOCK MODULE—\$16.50!

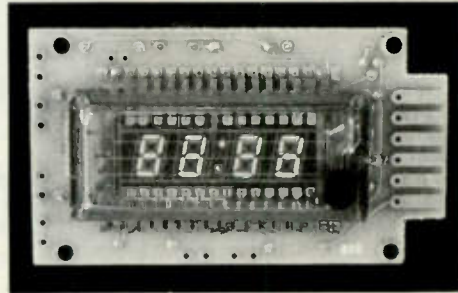

Finally... here is a clock that is simple to build, good looking, and at our price, inexpensive. Needs only 12V DC and 3 time-setting switches for operation in boat, truck, van, car, or home. Excellent as a gift item for non-electronically oriented friends who'd like a digital timepiece in their vehicle.

Features 4 digit, 0.3" green fluorescent display with blinking colon. When wired in car, display turns off when ignition is off. Accurate to ± 1/2 second per day thanks to built-in crystal timebase.

If you've been looking for a beautiful clock that won't set you back a lot of money, here you go.

Want to save more? Order 3 kits for \$46.

12V 8A SUPPLY KIT

\$44.50 plus shipping

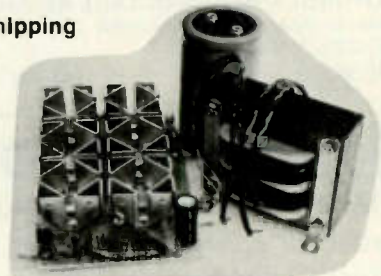

Handles 12A peaks with 50% duty cycle. Ideal for powering automotive tape players, 12V televisions, car CB rigs, and similar devices in the home. Features 0.05V regulation, adjustable output 11-14V, crowbar overvoltage protection, short protection, current limiting, custom wound transformer, and easy assembly. Less case and hardware.

RF TRANSISTORS

- #2NRF1 2 GHz power transistor. Pd max 3.5W, Pout minimum 1.0W, Pin 310 mW, efficiency 30%. Similar to RCA 2N5470. \$4.95
- #2NRF2 2 GHz power transistor. Pd max 8.7W, Pout min 2.5W, Pin 300 mW, efficiency 33%. Similar to RCA TA8407. \$5.95
- #2NRF3 2 GHz power transistor. Pd max 21W, Pout min 5.5W, Pin 1.25W, efficiency 33%. Similar to RCA 2N6269. \$6.95
- #2NRF4 2GHz power transistor. Pd max 29W, Pout min 7.5W, Pin 1.5W, efficiency 33%. Factory selected prime 2N6269. \$7.95

GODBOUT

BILL GODBOUT ELECTRONICS
BOX 2355, OAKLAND AIRPORT, CA 94614 G4

TERMS: Add \$1 to orders under \$15; Cal res add tax. Please allow up to 5% for shipping; excess refunded. COD orders accepted with street address for UPS. For VISA®/Mastercharge® orders (\$15 min) call our 24 hour order desk at (415) 562-0636.

7400 TTL

SN7400N	15	SN7401N	18	SN7402N	18	SN7403N	18	SN7404N	18	SN7405N	20	SN7406N	20	SN7407N	20	SN7408N	20	SN7409N	20	SN7410N	18	SN7411N	25	SN7412N	25	SN7413N	40	SN7414N	40	SN7415N	40	SN7416N	40	SN7417N	25	SN7420N	20	SN7421N	29	SN7422N	29	SN7423N	25	SN7425N	29	SN7426N	29	SN7427N	25	SN7428N	29	SN7429N	29	SN7430N	25	SN7431N	25	SN7432N	25	SN7433N	25	SN7434N	25	SN7435N	20	SN7436N	20	SN7437N	20	SN7438N	20	SN7439N	20	SN7440N	20	SN7441N	49	SN7442N	49	SN7443N	75	SN7444N	75	SN7445N	75	SN7446N	75	SN7447N	75	SN7448N	75	SN7449N	75	SN7450N	20	SN7451N	20	SN7452N	20	SN7453N	20	SN7454N	20	SN7455N	20	SN7456N	20	SN7457N	20
---------	----	---------	----	---------	----	---------	----	---------	----	---------	----	---------	----	---------	----	---------	----	---------	----	---------	----	---------	----	---------	----	---------	----	---------	----	---------	----	---------	----	---------	----	---------	----	---------	----	---------	----	---------	----	---------	----	---------	----	---------	----	---------	----	---------	----	---------	----	---------	----	---------	----	---------	----	---------	----	---------	----	---------	----	---------	----	---------	----	---------	----	---------	----	---------	----	---------	----	---------	----	---------	----	---------	----	---------	----	---------	----	---------	----	---------	----	---------	----	---------	----	---------	----	---------	----	---------	----	---------	----	---------	----	---------	----

BUGBOOK®

Continuing Education Series

BUGBOOK I
\$17.00 per set
By Peter B. Neary, David G. Larson, WSHYJ

BUGBOOK II
\$5.00
By Peter B. Neary, David G. Larson, WSHYJ

BUGBOOK III
\$16.00
By Peter B. Neary, David G. Larson, WSHYJ, Jonathan A. Tines

BUGBOOK IV
\$19.00 per set
By Peter B. Neary, David G. Larson, WSHYJ, Jonathan A. Tines

BUGBOOK V
\$19.00 per set
By Peter B. Neary, David G. Larson, WSHYJ, Jonathan A. Tines

THE 555 TIMER APPLICATIONS \$6.95
SOURCEBOOK WITH EXPERIMENTS
By Howard M. Berlin WSHB

OP AMP MANUAL \$9.00
By Howard M. Berlin WSHB

DRUG \$5.00
By Howard M. Berlin WSHB

INSTRUCTOR'S MANUAL \$3.00
By Howard M. Berlin WSHB

COMPLETE MANUAL FOR DIGITAL CLOCKS \$9.95
By John Wales and John Roberts

WIRE-WRAP KIT — WK-2-W
WRAP • STRIP • UNWRAP

- Tool for 30 AWG Wire
- Roll of 50 Ft. White or Blue 30 AWG Wire
- 50 pcs. each 1", 2", 3" & 4" lengths — pre-stripped wire

\$12.95

WIRE WRAP TOOL WSU-30
WRAP • STRIP • UNWRAP \$6.95

25 ft. min. \$1.25 50 ft. \$1.95 100 ft. \$2.95 1000 ft. \$15.00
SPECIFY COLOR — White - Yellow - Red - Green - Blue - Black

WIRE DISPENSER — WD-30

- 50 ft. roll 30 AWG KYNAR wire wrap wire \$3.95 ea.
- Cuts wire to desired length
- Strips 1" of insulation Specify — Blue-Yellow-White-Red

REPLACEMENT DISPENSER SPOOLS FOR WD 30
Specify blue, yellow, white or red \$1.98/spool

EXAR

Function Generator Kit (includes all components, P.C. Board and instructions)

XR-1555 \$1.50
Micro-Power version of the popular 555 Timer and directly interchangeable. Dissipates 1/15th the power and operates down to 2.7 volts. Perfect for battery operation and CMOS circuits.

XR2242CP \$1.50
Precision timing circuit for generating timing pulses in milliseconds, hours and days or up to 1 year by using 2 Reducible cost of time delay circuits. Basic 555 Timer with built-in 8-bit Counter.

20% Discount 100 pcs combined order 25% - 1000 pcs combined order

CMDS

CD4000	23	CD4001	23	CD4002	23	CD4006	119	CD4007	25	CD4009	49	CD4010	49	CD4011	23	CD4012	25	CD4013	39	CD4014	139	CD4015	139	CD4016	49	CD4017	119	CD4018	119	CD4019	49	CD4020	119	CD4021	39	CD4022	119	CD4023	23	CD4024	79	CD4025	23	CD4026	23	CD4027	69	74C00	39	74C01	55	74C02	75	74C03	75	74C04	75	74C05	75	74C06	75	74C07	75	74C08	75	74C09	75	74C10	75	74C11	75	74C12	75	74C13	75	74C14	75	74C15	75	74C16	75	74C17	75	74C18	75	74C19	75	74C20	75	74C21	75	74C22	75	74C23	75	74C24	75	74C25	75	74C26	75	74C27	75	74C28	75	74C29	75	74C30	75	74C31	75	74C32	75	74C33	75	74C34	75	74C35	75	74C36	75	74C37	75	74C38	75	74C39	75	74C40	75	74C41	75	74C42	75	74C43	75	74C44	75	74C45	75	74C46	75	74C47	75	74C48	75	74C49	75	74C50	75	74C51	75	74C52	75	74C53	75	74C54	75	74C55	75	74C56	75	74C57	75	74C58	75	74C59	75	74C60	75	74C61	75	74C62	75	74C63	75	74C64	75	74C65	75	74C66	75	74C67	75	74C68	75	74C69	75	74C70	75	74C71	75	74C72	75	74C73	75	74C74	75	74C75	75	74C76	75	74C77	75	74C78	75	74C79	75	74C80	75	74C81	75	74C82	75	74C83	75	74C84	75	74C85	75	74C86	75	74C87	75	74C88	75	74C89	75	74C90	75	74C91	75	74C92	75	74C93	75	74C94	75	74C95	75	74C96	75	74C97	75	74C98	75	74C99	75	74C100	75
--------	----	--------	----	--------	----	--------	-----	--------	----	--------	----	--------	----	--------	----	--------	----	--------	----	--------	-----	--------	-----	--------	----	--------	-----	--------	-----	--------	----	--------	-----	--------	----	--------	-----	--------	----	--------	----	--------	----	--------	----	--------	----	-------	----	-------	----	-------	----	-------	----	-------	----	-------	----	-------	----	-------	----	-------	----	-------	----	-------	----	-------	----	-------	----	-------	----	-------	----	-------	----	-------	----	-------	----	-------	----	-------	----	-------	----	-------	----	-------	----	-------	----	-------	----	-------	----	-------	----	-------	----	-------	----	-------	----	-------	----	-------	----	-------	----	-------	----	-------	----	-------	----	-------	----	-------	----	-------	----	-------	----	-------	----	-------	----	-------	----	-------	----	-------	----	-------	----	-------	----	-------	----	-------	----	-------	----	-------	----	-------	----	-------	----	-------	----	-------	----	-------	----	-------	----	-------	----	-------	----	-------	----	-------	----	-------	----	-------	----	-------	----	-------	----	-------	----	-------	----	-------	----	-------	----	-------	----	-------	----	-------	----	-------	----	-------	----	-------	----	-------	----	-------	----	-------	----	-------	----	-------	----	-------	----	-------	----	-------	----	-------	----	-------	----	-------	----	-------	----	-------	----	-------	----	-------	----	-------	----	-------	----	-------	----	-------	----	-------	----	-------	----	-------	----	-------	----	-------	----	-------	----	--------	----

DISCRETE LEADS

TYPE	POLARITY	HT PRICE	TYPE	POLARITY	HT PRICE
MAN 1	Common Anode-red	270 2 95	MAN 5680	Common Cathode-orange	560 99
MAN 2	5 x 7 Dot Matrix-red	300 4 95	MAN 6710	Common Anode-red D	560 99
MAN 3	Common Cathode-red	125 25	MAN 6730	Common Anode-red	560 99
MAN 4	Common Cathode-red	167 1 95	MAN 6740	Common Cathode-red D	560 99
MAN 5	Common Cathode-green	300 1 25	MAN 6750	Common Cathode-red	560 99
MAN 6	Common Cathode-red	300 1 25	MAN 6760	Common Anode-red	560 99
MAN 7	Common Anode-red	300 99	MAN 6780	Common Anode-red	560 99
MAN 7A	Common Cathode-red	300 1 25	DL701	Common Anode-red	300 99
MAN 81	Common Anode-yellow	300 99	DL702	Common Cathode-red	300 125
MAN 82	Common Cathode-red	300 99	DL704	Common Cathode-red	300 99
MAN 84	Common Cathode-yellow	300 99	DL707	Common Anode-red	300 99
MAN 3620	Common Anode-orange	300 99	DL741	Common Anode-red	600 1 25
MAN 3630	Common Anode-orange	300 99	DL746	Common Anode-red	630 1 49
MAN 3640	Common Cathode-orange	300 99	DL747	Common Cathode-red	600 1 25
MAN 4610	Common Anode-orange	400 99	DL789	Common Cathode-red	1 330 1 49
MAN 4640	Common Cathode-orange	400 99	DL750	Common Cathode-red	600 1 25
MAN 4710	Common Anode-red	400 99	DL738	Common Cathode-red	610 35
MAN 4730	Common Anode-red	400 99	FD700	Common Cathode	250 69
MAN 4740	Common Cathode-red	400 99	FD717	Common Anode	560 1 95
MAN 4810	Common Anode-yellow	400 99	FND503	Common Cathode (FND500)	500 99
MAN 5610	Common Anode-orange D	560 99	FND507	Common Cathode (FND510)	500 99
MAN 5630	Common Anode-orange	560 99	5082-7300	4 x 7.5g Digit-LED	600 19 95
MAN 5650	Common Cathode-orange D	560 99	5082-7302	4 x 7.5g Digit-LED	600 19 95
MAN 5660	Common Anode-orange	560 99	5082-7340	4 x 7.5g Digit-LED	600 22 50

DISCRETE LEADS

TYPE	POLARITY	HT PRICE	TYPE	POLARITY	HT PRICE
XC209 Red	5/81	XC526 Red	5/81	XC556 Red	100/58
XC209 Green	4/81	XC526 Green	4/81	XC556 Green	4/81
XC209 Yellow	4/81	XC526 Yellow	4/81	XC556 Yellow	4/81
XC222 Red	5/81	XC526 Red	5/81	XC556 Red	100/58
XC222 Green	4/81	XC526 Green	4/81	XC556 Green	4/81
XC222 Yellow	4/81	XC526 Yellow	4/81	XC556 Yellow	4/81
SS-22 RT	4/81	XC526 Clear	4/81	XC556 Orange	7/81

RCA LINEAR

CA3013	2.15	CA3082	2.00	CA3013	2.15	CA3082	2.00
CA2023	2.56	CA3083	1.60	CA2023	2.56	CA3083	1.60
CA3035	2.48	CA3086	8.75	CA3035	2.48	CA3086	8.75
CA3039	1.35	CA3089	3.75	CA3039	1.35	CA3089	3.75
CA3046	1.30	CA3130	1.39	CA3046	1.30	CA3130	1.39
CA3059	3.25	CA3140	1.25	CA3059	3.25	CA3140	1.25
CA3060	3.25	CA3160	1.25	CA3060	3.25	CA3160	1.25
CA3080	85	CA3401	49	CA3080	85	CA3401	49
CA3081	2.00	CA3600	3.50	CA3081	2.00	CA3600	3.50

CLOCK CHIPS

MM5309	5.99	MM5311	4.95
MM5325	2.95	MM5334	4.95
MM5336	1.95	MM5338	4.95
MM5339	2.95	MM5341	4.95
MM5342	1.95	MM5343	4.95
MM5344	2.95	MM5345	4.95
MM5346	1.95	MM5347	4.95
MM5348	2.95	MM5349	4.95
MM5350	1.95	MM5351	4.95
MM5352	2.95	MM5353	4.95
MM5354	1.95	MM5355	4.95
MM5356	2.95	MM5357	4.95
MM5358	1.95	MM5359	4.95
MM5360	2.95	MM5361	4.95
MM5362	1.95	MM5363	4.95
MM5364	2.95	MM5365	4.95
MM5366	1.95	MM5367	4.95
MM5368	2.95	MM5369	4.95
MM5370	1.95	MM5371	4.95
MM5372	2.95	MM5373	4.95
MM5374	1.95	MM5375	4.95
MM5376	2.95	MM5377	4.95
MM5378	1.95	MM5379	4.95
MM5380	2.95	MM5381	4.95
MM5382	1.95	MM5383	4.95
MM5384	2.95	MM5385	4.95
MM5386	1.95	MM5387	4.95
MM5388	2.95	MM5389	4.95
MM5390	1.95	MM5391	4.95
MM5392	2.95	MM5393	4.95
MM5394	1.95	MM5395	4.95
MM5396	2.95	MM5397	4.95
MM5398	1.95	MM5399	4.95
MM5400	2.95	MM5401	4.95
MM5402	1.95	MM5403	4.95
MM5404	2.95	MM5405	4.95
MM5406	1.95	MM5407	4.95
MM5408	2.95	MM5409	4.95
MM5410	1.95	MM5411	4.95
MM5412	2.95	MM5413	4.95
MM5414	1.95	MM5415	4.95
MM5416	2.95	MM5417	4.95
MM5418	1.95	MM5419	4.95
MM5420	2.95	MM5421	4.95
MM5422	1.95	MM5423	4.95
MM5424	2.95	MM5425	4.95
MM5426	1.95	MM5427	4.95
MM5428	2.95	MM5429	4.95
MM5430	1.95	MM5431	4.95
MM5432	2.95	MM5433	4.95
MM5434	1.95	MM5435	4.95
MM5436	2.95	MM5437	4.95
MM5438	1.95	MM5439	4.95
MM5440	2.95	MM5441	4.95
MM5442	1.95	MM5443	4.95
MM5444	2.95	MM5445	4.95
MM5446	1.95	MM5447	4.95
MM5448	2.95	MM5449	4.95
MM5450	1.95	MM5451	4.95
MM5452	2.95	MM5453	4.95
MM5454	1.95	MM5455	4.95
MM5456	2.95	MM5457	4.95
MM5458	1.95	MM5459	4.95
MM5460	2.95	MM5461	4.95
MM5462	1.95	MM5463	4.95
MM5464	2.95	MM5465	4.95
MM5466	1.95	MM5467	4.95
MM5468	2.95	MM5469	4.95
MM5470	1.95	MM5471	4.95
MM5472	2.95	MM5473	4.95
MM5474	1.95	MM5475	4.95
MM5476	2.95	MM5477	4.95
MM5478	1.95	MM5479	4.95
MM5480	2.95	MM5481	4.95
MM5482	1.95	MM5483	4.95
MM5484	2.95	MM5485	4.95
MM5486	1.95	MM5487	4.95
MM5488	2.95	MM5489	4.95
MM5490	1.95	MM5491	4.95
MM5492	2.95	MM5493	4.95
MM5494	1.95	MM5495	4.95
MM5496	2.95	MM5497	4.95
MM5498	1.95	MM5499	4.95
MM5500	2.95	MM5501	4.95
MM5502	1.95	MM5503	4.95
MM5504	2.95	MM5505	4.95
MM5506	1.95	MM5507	4.95
MM5508	2.95	MM5509	4.95
MM5510	1.95	MM5511	4.95
MM5512	2.95	MM5513	4.95
MM5514	1.95	MM5515	4.95
MM5516	2.95	MM5517	4.95
MM5518	1.95	MM5519	4.95
MM5520	2.95	MM5521	4.95
MM5522	1.95	MM5523	4.95
MM5524	2.95	MM5525	4.95
MM5526	1.95	MM5527	4.95
MM5528	2.95	MM5529	4.95
MM5530	1.95	MM5531	4.95
MM5532	2.95	MM5533	4.95
MM5534	1.95	MM5535	4.95
MM5536	2.95	MM5537	4.95
MM5538	1.95	MM5539	4.95
MM5540	2.95	MM5541	4.95
MM5542	1.95	MM5543	4.95
MM5544	2.95	MM5545	4.95
MM5546	1.95	MM5547	4.95
MM5548	2.95	MM5549	4.95
MM5550	1.95	MM5551	4.95
MM5552	2.95	MM5553	4.95
MM5554	1.95	MM5555	4.95
MM5556	2.95	MM5557	4.95
MM5558	1.95	MM5559	4.95
MM5560	2.95	MM5561	4.95
MM5562	1.95	MM5563	4.95
MM5564			

DIODES/ZENERS

1N914	100v	10mA	.05
1N4005	600v	1A	.08
1N4007	1000v	1A	.15
1N4148	75v	10mA	.05
1N4733	5.1v	1 W Zener	.25
1N753A	6.2v	500 mW Zener	.25
1N758A	10v	"	.25
1N759A	12v	"	.25
1N5243	13v	"	.25
1N5244B	14v	"	.25
1N5245B	15v	"	.25

SOCKETS/BRIDGES

8-pin pcb	.20	ww	.35
14-pin pcb	.20	ww	.40
16-pin pcb	.20	ww	.40
18-pin pcb	.25	ww	.75
22-pin pcb	.35	ww	.95
24-pin pcb	.35	ww	.95
28-pin pcb	.45	ww	1.25
40-pin pcb	.50	ww	1.25
Molex pins	.01	To-3 Sockets	.25
2 Amp Bridge		100-prv	.95
25 Amp Bridge		200-prv	1.95

TRANSISTORS, LEDS, etc.

2N2222	NPN (2N2222 Plastic .10)	.15
2N2907	PNP	.15
2N3906	PNP (Plastic - Unmarked)	.10
2N3904	NPN (Plastic - Unmarked)	.10
2N3054	NPN	.35
2N3055	NPN 15A 60v	.50
T1P125	PNP Darlington	.35
LED Green, Red, Clear, Yellow		.15
D.L.747	7 seg 5/8" High com-anode	1.95
MAN72	7 seg com-anode (Red)	1.25
MAN3610	7 seg com-anode (Orange)	1.25
MAN82A	7 seg com-anode (Yellow)	1.25
MAN74A	7 seg com-cathode (Red)	1.50
FND359	7 seg com-cathode (Red)	1.25

C MOS

4000	.15	7400	.10
4001	.15	7401	.15
4002	.20	7402	.15
4004	3.95	7403	.15
4006	.95	7404	.10
4007	.20	7405	.25
4008	.75	7406	.25
4009	.35	7407	.55
4010	.35	7408	.15
4011	.20	7409	.15
4012	.20	7410	.15
4013	.40	7411	.25
4014	.75	7412	.25
4015	.75	7413	.25
4016	.35	7414	.75
4017	.75	7416	.25
4018	.75	7417	.40
4019	.35	7420	.15
4020	.85	7426	.25
4021	.75	7427	.25
4022	.75	7430	.15
4023	.20	7432	.20
4024	.75	7437	.20
4025	.20	7438	.20
4026	1.95	7440	.20
4027	.35	7441	1.15
4028	.75	7442	.45
4030	.35	7443	.45
4033	1.50	7444	.45
4034	2.45	7445	.65
4035	.75	7446	.70
4040	.75	7447	.70
4041	.69	7448	.50
4042	.65	7450	.25
4043	.50	7451	.25
4044	.65	7453	.20
4046	1.25	7454	.25
4049	.45	7460	.40
4050	.45	7470	.45
4066	.55	7472	.40
4069/74C04	.25		
4071	.25		
4081	.30		
4082	.30		
MC 14409	14.50		
MC 14419	4.85		
4511	.95		
74C151	1.90		

7473	.25	74176	.85
7474	.30	74180	.55
7475	.35	74181	2.25
7476	.40	74182	.75
7480	.55	74190	1.25
7481	.75	74191	.95
7483	.75	74192	.75
7485	.55	74193	.85
7486	.25	74194	.95
7489	1.05	74195	.95
7490	.45	74196	.95
7491	.70	74197	.95
7492	.45	74198	1.45
7493	.35	74221	1.00
7494	.75	74367	.75
7495	.60		
7496	.80	75108A	.35
74100	1.15	75491	.50
74107	.25	75492	.50
74121	.35		
74122	.55		
74123	.35	74H00	.15
74125	.45	74H01	.20
74126	.35	74H04	.20
74132	.75	74H05	.20
74141	.90	74H08	.35
74150	.85	74H10	.35
74151	.65	74H11	.25
74153	.75	74H15	.45
74154	.95	74H20	.25
74156	.70	74H21	.25
74157	.65	74H22	.40
74161	.55	74H30	.20
74163	.85	74H40	.25
74164	.60	74H50	.25
74165	1.10	74H51	.25
74166	1.25	74H52	.15
74175	.80	74H53J	.25
		74H55	.20

74H72	.35	74S133	.40
74H101	.75	74S140	.55
74H103	.55	74S151	.30
74H106	.95	74S153	.35
		74S157	.75
74L00	.25	74S158	.30
74L02	.20	74S194	1.05
74L03	.25	74S257 (8123)	1.05
74L04	.30		
74L10	.20	74LS00	.20
74L20	.35	74LS01	.20
74L30	.45	74LS02	.20
74L47	1.95	74LS04	.20
74L51	.45	74LS05	.25
74L55	.65	74LS08	.25
74L72	.45	74LS09	.25
74L73	.40	74LS10	.25
74L74	.45	74LS11	.25
74L75	.55	74LS20	.20
74L93	.55	74LS21	.25
74L123	.85	74LS22	.25
		74LS32	.25
		74LS37	.25
		74LS38	.35
		74LS40	.30
		74LS42	.65
		74LS51	.35
		74LS74	.35
		74LS86	.35
		74LS90	.55
		74LS93	.55
		74LS107	.40
		74LS123	1.00
		74LS151	.75
		74LS153	.75
		74LS157	.75
		74LS164	1.00
		74LS193	.95
		74LS367	.75
		74LS368	.65

9000 SERIES

9301	.85	95H03	1.10
9309	.35	9601	.20
9322	.65	9602	.45

74S188	3.00	8214	8.95
1702A	4.50	8224	3.25
MM5314	3.00	8228	6.00
MM5316	3.50	8251	8.50
2102-1	1.45	8255	8.50
2102L-1	1.75	8T13	1.50
2114	9.50	8T23	1.50
TR1602B	3.95	8T24	2.00
TMS 4044	9.95	8T97	1.00
		2107B-4	4.95
8080	8.95	2708	9.50
8212	2.95	280 PIO	8.50

MCT2

MCT2	.95
8038	3.95
LM201	.75
LM301	.45
LM308 (Mini)	.95
LM309H	.65
LM309K (340K-5)	.85
LM310	.85
LM311D (Mini)	.75
LM318 (Mini)	1.75
LM320K5(7905)	1.65
LM320K12	1.65

LINEARS, REGULATORS, etc.

LM320T5	1.65
LM320T12	1.65
LM320T15	1.65
LM324N	1.25
LM339	.75
7805 (340T5)	.95
LM340T12	.95
LM340T15	.95
LM340T18	.95
LM340T24	.95
LM340K12	1.25

LM340K15	1.25
LM340K18	1.25
LM340K24	1.25
78L05	.75
78L12	.75
78L15	.75
78M05	.75
LM373	2.95
LM380 (8-14 PIN)	.95
LM709 (8,14 PIN)	.25
LM711	.45

LM723	.40
LM725N	2.50
LM739	1.50
LM741 (8-14)	.25
LM747	1.10
LM1307	1.25
LM1458	.65
LM3900	.50
LM75451	.65
NE555	.35
NE556	.85
NE565	.95
NE566	1.25
NE567	.95

INTEGRATED CIRCUITS UNLIMITED 19

7889 Clairemont Mesa Boulevard, San Diego, California 92111
(714) 278-4394 (Calif. Res.)

All orders shipped prepaid No minimum
Open accounts invited COD orders accepted

Discounts available at OEM Quantities California Residents add 6% Sales Tax
All IC's Prime/Guaranteed. All orders shipped same day received.

24 Hour Toll Free Phone 1-800-854-2211

American Express / BankAmericard / Visa / MasterCard

SPECIAL DISCOUNTS

Total Order	Deduct
\$35 - \$99	10%
\$100 - \$300	15%
\$301 - \$1000	20%

POLY PAKS' REBELLION

WE'RE FIGHTING BACK INFLATION WITH THIS EXCLUSIVE 1¢ SALE
BUY 1 AT SALE PRICE, GET 2ND FOR 1¢ MORE!!!

THIS SPECIAL ONE CENT SALE IS FOR MAGAZINE ADS ONLY

LED WATCH GUTS

\$1.95 2 for **\$1.96**

Factory "play-around's." Do they work? Who knows! A micro digital technician's bonanza. The complete guts are there. With black case and leatherette band. Functions: HOURS, MINUTES, SECONDS, MONTH, & DATE. Sorry, no space. Cat. No. 9A5267 Wt 4 oz.

LED OR FLUORESCENT CALCULATOR GAMBLE!

IMAGINE GETTING A CALCULATOR REJECT FOR ONLY A PENNY!!!!

Your Choice **\$5.95** 2 for **\$5.96**

PARTS ALONE ARE WORTH MORE THAN PRICE!

The gamble of a lifetime. YOU CAN'T LOSE! Factory dumps his production-line rejects and customer returns. Why are these rejects? Mostly keyboard problems, we are told. But at these prices, who cares! Fun at pocket size only 3 1/2 x 1 1/2 deep.

Choose from 2 styles: GREEN Fluorescent or RED all-FED 125' digit. Both styles feature 8 digits, 22 keys, 4 arithmetic functions, 4 memory functions, percent, equals, clear. All units complete, include operation manual. (Batteries not included). Wt. 6 oz.

9A5292 Fluorescent
 9A5291 LED

PARTS & SEMI "ONE CENTERS"

Quan.	Description (Order by Cat. No. in parenthesis)	1CSALE	2 for
1	1-40 CHANNEL CB SELECTOR, w/hnob, for PLL circuits (#9A5045)	1.00	2 for 1.01
1	1-23 CHANNEL CB SELECTOR, w/hnob, for PLL & 2nd (#9A5046)	1.00	2 for 1.01
1	15-"POP" OPTICAL LENSES, plano-convex, 1" dia, plastic (#9A5042)	1.19	2 for 1.20
1	10-IC "DICE", microcircuit circuits, teaches theory (#9A5065)	1.19	2 for 1.20
1	1-8" MF-I SPIDER, full range, for car-home (#9A5294)	4.95	2 for 4.96
1	1-LED WATCH GUTS, men's, how good? We put 28 IC's (#9A5267)	1.95	2 for 1.96
1	1-UMF TUNER, solid state, standard type (#9A2927)	1.00	2 for 1.01
1	10-SLIDE SWITCHES, assist pop styles (#9A1495)	1.00	2 for 1.01
1	4-TANTALUM CAPACITORS, 6.8 uF 35V, dipped (#9A2821)	1.00	8 for 1.01
1	5-PANCAKE PHOTOCELLS, 800 to 1500 nm (#9A2916)	1.00	2 for 1.01
1	1-100KHZ MARKER CRYSTALS, approx for marker gen (#9A3896)	1.50	2 for 1.51
1	1-MOTHERBOARD EDGE CONNECTOR, 106 pins, 125' (#9A3897)	1.50	2 for 1.51
1	1-40-PIN EDGE CONNECTOR, 156' spacing (#9A3963)	1.95	2 for 1.96
1	1-METER, 50uA, 1W, square, 0-200 (#9A2915)	1.19	2 for 1.20
1	1-5PST RELAY, norm, open 12-24 VDC, 1250 ohms, dip style (#9A5175)	1.49	2 for 1.50
1	1-VEEDER ROD COUNTER, 000-999, resettable, panel mt, (#9A5081)	1.49	2 for 1.50
1	2-DUAL GATE MOSFET, sim, to 3M200, 3M187, for RF & Mixer (#9A5101)	1.00	4 for 1.01
1	2-400 THERMAL INDICATORS, 800 to 1500 nm, 7x1/8, flat base (#9A5195)	1.00	4 for 1.01
1	1-10YJSTICK, four 100K pots, with knob (#9A3208A)	4.95	2 for 4.96
1	1-ECCO THUMBWHEEL SWITCH, BCD, 0-7 (#9A270A)	1.49	2 for 1.50
1	1-FLISSEY TV SIDEBAND FILTER, for chan. 3 or 4 (#9A3978)	1.95	2 for 1.96
2	2-MI CABLE HEADS, with plug, 125' 118' CAC (#9A4008)	1.49	2 for 1.50
20	20-DATA ENTRY PUMP SWITCHES, spat, norm open, for keyboards (#9A2878)	4.00	2 for 4.01
78	78-SM7400 TTL ICs, untested 50%+ yield, pop types (#9A2415)	2.00	150 for 2.01
100	100-MINI DIP ICs, linear, untested 50%+ yield, pop types (#9A3248)	2.00	150 for 2.01
30	30-L380 AUDIO ICs, linear, untested 50%+ yield, pop types (#9A3248)	2.00	60 for 2.01
78	78-LINEARS, OP AMPS, untested 50%+ yield, amp, dip, minidip (#9A2418)	2.00	150 for 2.01
100	100-TTL & LINEAR MIXED, with 7400s, 50%+ yield (#9A2413)	2.00	200 for 2.01
1	1-10YJSTICK, two 10K pots, for computers, TV games (#9A5037)	2.95	2 for 2.96
1	1-B TRACH TAPE HEADS, with plug, 125' 118' CAC (#9A4008)	2.50	2 for 2.51
150	150-PREFORMED DISC CAPACITORS, math & value (#9A2608)	2.00	300 for 2.01
150	150-TRIMMER CAPACITORS, mica compression, piston, ass'd. (#9A3714)	2.00	120 for 2.01
60	60-YELLOW JACKET MYLAR CAPACITORS, marked, pop values (#9A3478)	2.00	150 for 2.01
150	150-GLASS ZENERS, 400 MW, untested, better than 50% yield (#9A2740)	2.00	300 for 2.01
78	78-CARBON FILM RESISTORS, 1/4, 1/2 watt, 5% & 10%, mat'd, ass'd (#9A3558)	2.00	300 for 2.01
250	250-UNMARKED CAPACITORS, polystyrene, molded, pop values (#9A3805)	2.00	500 for 2.01
300	300-SILICON SIGNAL DIODES, micro, glass, zener, total 50% yield (#9A2628)	2.00	600 for 2.01
8-IC	8-IC SOCKETS, 14, 18 pin, solder tab, (#9A3621)	2.00	16 for 2.01
100	100-1N4148/514 SWITCHING DIODES, 50%+ yield, mat'd, ass'd (#9A3558)	2.00	200 for 2.01
30	30-PC TRIM POTENTIOMETERS, thumbwheel, dualdriver ass't. (#9A3344)	2.00	60 for 2.01
15	15-SLIDE VOLUME CONTROLS, ass't'd values, dual, singles (#9A5057)	2.00	30 for 2.01
78	78-4" CABLE TIES, plastic, like "Tie-wrap" (#9A5218)	2.00	150 for 2.01
10	10-CRYSTALS, may include CB, MCM & more (#9A3218)	2.00	20 for 2.01
100	100-TERMINAL STRIPS, from 2 lugs up to (#9A3136)	2.00	150 for 2.01
30	30-NE-2NEON LAMPS, all 100% good (#9A2613)	2.00	60 for 2.01
40	40-M SHIELDED CABLE, 1 cond, miles, phone, (#9A3577)	2.00	80 for 2.01
5	5-SOUND TRIGGERS, sound trigger w/amp (#9A3266)	2.00	10 for 2.01
10	10-CB CRYSTALS, for phase lock loop, HAM, HC/10 (#9A5050)	2.00	20 for 2.01
100	100-DISC CAPACITORS, long leads, marked, ass'd. (#9A2988)	2.00	200 for 2.01
100	100-CAPACITOR SPECIAL, discs, mylar, lycra, more (#9A2738)	2.00	200 for 2.01
10	10-VOLTAGE REGULATORS, 5, 10, 15, 20, 30, 35, 50, 75, 100 (#9A2930)	2.00	60 for 2.01
30	30-PANEL SWITCHES, slide, rocker, mod, etc (#9A3266)	2.00	400 for 2.01
200	200-RESISTOR SPECIAL, 1/4 to 1W, carbon, metal (#9A3054)	2.00	400 for 2.01
200	200-HALF WATTERS, resistors, carbon, metal, (#9A3044)	2.00	400 for 2.01
100	100-NATIONAL IC BONDERS, linear, 7400s, 50%+ yield (#9A2628)	2.00	200 for 2.01
15	15-1M340V VOLTAGE REGULATORS, 5 to 24V, TO-220 (#9A2635)	2.00	200 for 2.01
100	100-POLYSTYRENE CAPS, ass't'd values, voltage, M-C (#9A2729)	2.00	100 for 2.01
50	50-THERMISTORS, resistors that change with temp (#9A6089)	2.00	40 for 2.01
20	20 BRIDGES, with 4 cond, 100K, 10K, 1K, 100 (#9A2608)	2.00	40 for 2.01
25	25-LAMP SOCKET SETS, micro, L5V, T2 (#9A3957)	2.00	30 for 2.01
18	18-MIXED READOUTS, hobby, untested, 127, 3, 5, etc (#9A3619)	2.00	30 for 2.01
150	150-QUARTER WATTERS, resistors, metal film, marked (#9A3413)	2.00	200 for 2.01
100	100-PLASTIC TRIMMERS, untested, 7400s, 50%+ yield (#9A2628)	2.00	200 for 2.01
200	200-PREFORMED RESISTORS, 1/4, 1/2, 1W, 1%, 2%, marked, ass'd (#9A2608)	2.00	400 for 2.01
60	60-DIPED RELAYS, shiny finish, ass't'd values (#9A2977)	2.00	120 for 2.01
30	30-VOLUME CONTROLS, linear, ass't'd values (#9A2977)	2.00	60 for 2.01
30	30-CLOCK CHIPS, national, hobby & untested, alarm (#9A5089)	2.00	60 for 2.01
30	30-MMS262 2K RAMS, hobby, untested (#9A3940)	2.00	60 for 2.01
10	10-PUSH SWITCHES, push-to-break, spst, alarm, (#9A5289)	2.00	20 for 2.01
25	25-CD-4000 TRIMMERS, push-to-break, spst, alarm, (#9A5289)	2.00	50 for 2.01
1	1-CHARACTER GENERATOR, 5 x 7 Motech MK 202P (#9A3198)	4.95	2 for 4.96
1	1-CONDENSER MIXES, sensitive, 500 ohm 1.8V volts (#9A3178)	4.95	2 for 4.96

TTL'S AT "CENT-CIBLE" PRICES

Order by Cat. No. 9A1981	& Type No.	Each	2 For	Type No.	Each	2 for	Type No.	Each	2 for
9A1981	9A1981	1.00	2.00	9A1981	1.00	2.00	9A1981	1.00	2.00
9A1982	9A1982	1.00	2.00	9A1982	1.00	2.00	9A1982	1.00	2.00
9A1983	9A1983	1.00	2.00	9A1983	1.00	2.00	9A1983	1.00	2.00
9A1984	9A1984	1.00	2.00	9A1984	1.00	2.00	9A1984	1.00	2.00
9A1985	9A1985	1.00	2.00	9A1985	1.00	2.00	9A1985	1.00	2.00
9A1986	9A1986	1.00	2.00	9A1986	1.00	2.00	9A1986	1.00	2.00
9A1987	9A1987	1.00	2.00	9A1987	1.00	2.00	9A1987	1.00	2.00
9A1988	9A1988	1.00	2.00	9A1988	1.00	2.00	9A1988	1.00	2.00
9A1989	9A1989	1.00	2.00	9A1989	1.00	2.00	9A1989	1.00	2.00
9A1990	9A1990	1.00	2.00	9A1990	1.00	2.00	9A1990	1.00	2.00
9A1991	9A1991	1.00	2.00	9A1991	1.00	2.00	9A1991	1.00	2.00
9A1992	9A1992	1.00	2.00	9A1992	1.00	2.00	9A1992	1.00	2.00
9A1993	9A1993	1.00	2.00	9A1993	1.00	2.00	9A1993	1.00	2.00
9A1994	9A1994	1.00	2.00	9A1994	1.00	2.00	9A1994	1.00	2.00
9A1995	9A1995	1.00	2.00	9A1995	1.00	2.00	9A1995	1.00	2.00
9A1996	9A1996	1.00	2.00	9A1996	1.00	2.00	9A1996	1.00	2.00
9A1997	9A1997	1.00	2.00	9A1997	1.00	2.00	9A1997	1.00	2.00
9A1998	9A1998	1.00	2.00	9A1998	1.00	2.00	9A1998	1.00	2.00
9A1999	9A1999	1.00	2.00	9A1999	1.00	2.00	9A1999	1.00	2.00
9A2000	9A2000	1.00	2.00	9A2000	1.00	2.00	9A2000	1.00	2.00

POP-AMPS AT "CENT-CIBLE" PRICES

Case code: T=TO-220 Power Tab; V=Mini dip; K=TO-3; H=TO-5; N=DIP

Type No.	Each	2 for	Type No.	Each	2 for	Type No.	Each	2 for
LM300N	\$.79	\$.80	LM340T-5	1.49	1.50	LM703M	.59	.60
LM300M	.49	.50	LM340T-6	1.49	1.50	LM704M	.19	.20
LM301V	.45	.46	LM340T-8	1.49	1.50	LM709M	.19	.20
LM301H	.45	.46	LM340T-12	1.49	1.50	LM709N	.49	.50
LM301B	.45	.46	LM340T-18	1.49	1.50	LM733M	.79	.80
LM308V	.29	.30	LM340T-18	1.49	1.50	LM733N	.25	.26
LM308M	.69	.70	LM340T-24	1.49	1.50	LM741H	.30	.31
LM308H	.29	.30	LM350N	.49	.50	LM741M	.59	.60
LM309K	1.49	1.50	LM350M	.49	.50	LM743M	1.49	1.50
LM311V	.29	.30	LM377M	2.25	2.26	LM747M	1.49	1.50
LM311H	1.49	1.50	LM380M	1.39	1.40	LM747N	1.79	1.80
LM318V	.99	1.00	LM381M	1.99	2.00	LM747N	1.79	1.80
LM320M-5	.99	1.00	LM386M	1.49	1.50	LM749M	.80	.81
LM320M-12	.99	1.00	LM386N	1.49	1.50	LM749N	.80	.81
LM320M-18	.99	1.00	LM386P	1.49	1.50	LM754M	.25	.26
LM320M-24	.99	1.00	LM532M	.25	.26	LM3028T	.65	.66
LM322M	1.19	1.20	LM532N	.25	.26	LM3900N	.49	.50
LM324N	1.79	1.80	NE540M	5.95	5.96	LM3909V	1.25	1.26
LM324V	1.79	1.80	NE540N	5.95	5.96	LM4250	1.20	1.21
LM340K-5	1.49	1.50	LM555M	1.79	1.80	LM7451	.69	.70
LM340K-6	1.49	1.50	LM558V	.39	.40	LM75453	.69	.70
LM340K-8	1.49	1.50	LM558N	.39	.40	LM75491	.80	.81
LM340K-12	1.49	1.50	LM561M	1.00	1.01	LM75492	.80	.81
LM340K-15	1.49	1.50	LM565N	1.00	1.01	LM75494	.60	.61
LM340M-18	1.49	1.50	LM565H	1.00	1.01	PA263	1.50	1.51
LM340M-24	1.49	1.50	LM566	2.49	2.50	DM8864N	1.29	1.30
LM567	2.39	2.40	LM567	2.39	2.40			

PENNIES FOR YOUR MEMORIES!

Type	Description	1CSALE	1.30	Order by
1103	1K Dynamic RAM	1.29	1.30	9A3459 &
5202	2K Prom	2.95	2.96	9A3459 &
5262	2K x 1 Dynamic RAM	.99	1.00	Type No.
1702A	256 x 8 PROM	4.95	4.96	
MMS280*	4K x 1 Dynamic RAM	3.95	3.96	

*Removed from new tested equipment

1N4000 Epoxy Rectifiers

Cat. No.	Type	Volts	1CSALE	1.50	Order by
9A2377	1N4001	100	10 for \$.75	20 for \$.76	Type No.
9A2378	1N4002	100	10 for .95	20 for .96	
9A2379	1N4003	200	10 for .95	20 for .96	
9A2380	1N4004	400	10 for 1.19	20 for 1.20	Ampl
9A2381	1N4005	600	10 for 1.39	20 for 1.40	Mini
9A2382	1N4006	800	10 for 1.39	20 for 1.40	Mini
9A2383	1N4007	1000	10 for 1.59	20 for 1.50	aturl

BULLET RECTIFIERS!

Order by Cat. No. 9A6084 and voltage

1.5 AMP	2 AMP	3 AMP	4 AMP	5 AMP
50V	10 for \$.59	20 for \$.60	10[m]	10[m]
100V	10 for .69	20 for .70	10[m]	10[m]
200V	10 for .79	20 for .80	10[m]	10[m]
400V	10 for .89	20 for .90	10[m]	10[m]

LYTIC KLINIC

Order by Cat. No. 9A3228 and value

Electrolytic Capacitors	1CSALE
100	\$1.95 2 for \$1.96
200	1.49 2 for 1.50
400	1.99 2 for 2.00
800	2.25 2 for 2.26
1600	2.50 2 for 2.51

CONDENSER MIKE ZENERS!

Order by Cat. No. 9A5210A voltage & wattage

1 Watt	1CSALE	1.50
7.5V	5 for \$1.10	10 for 1.01
8.2V	5 for 1.10	10 for 1.01
9.1V	5 for 1.10	10 for 1.01
10.0V	5 for 1.10	10 for 1.01
11.0V	5 for 1.10	10 for 1.01
12.0V	5 for 1.10	10 for 1.01
15.0V	5 for 1.10	10 for 1.01

7-SEGMENT READOUTS

ONE CENT SALE	2 for
---------------	-------

ASSOCIATED RADIO

8012 CONSER BOX 4327
OVERLAND PARK, KANSAS 66204

A50

913-381-5900



CALL US WITH YOUR REQUIREMENTS



OUR
32ND
YEAR

AMERICA'S #1 Real Amateur Radio Store

TRADE SELL BUY

NOTE

**SEND \$1.00 FOR OUR CURRENT CATALOG OF
NEW AND RECONDITIONED EQUIPMENT.**

*** ALSO WE PERIODICALLY PUBLISH A LIST OF
UNSERVICED EQUIPMENT AT GREAT SAVINGS.
A BONANZA FOR THE EXPERIENCED OPERATOR.
TO OBTAIN THE NEXT UNSERVICED BARGAIN LIST,
SEND A SELF ADDRESSED STAMPED ENVELOPE.**

(Cut on dotted line and keep next to your radio equipment)

(Cut on dotted line and keep next to your radio equipment)

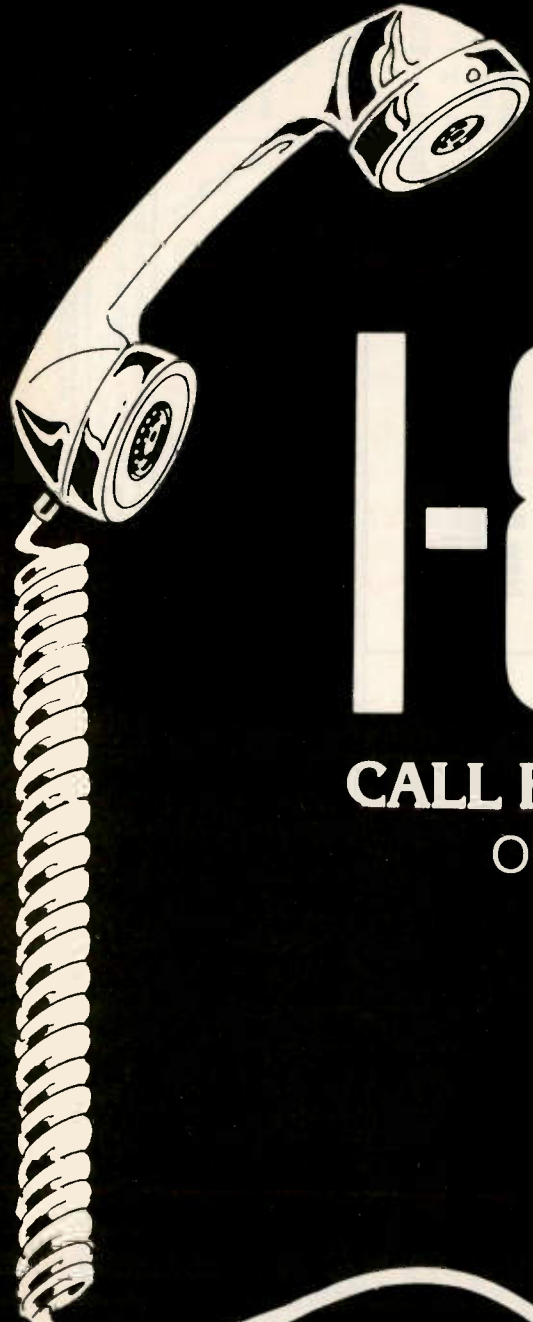

Call our toll-free number first

... and it's the last call you'll have to make!

(NO CHARGE TO CALLING PARTY)

1-800-325-3636

CALL FOR THE BEST PRICE AND FAST DELIVERY

ON THE FOLLOWING LINES:

ATLAS
COLLINS
DENTRON
DRAKE
HY GAIN

ICOM
INFO-TECH
KENWOOD
MOSLEY
STANDARD

SWAN
TEMPO
TEN-TEC
WILSON
YAESU

... AND MANY OTHERS.

HAM RADIO CENTER

8340-42 Olive Blvd. P.O. Box 28271 St. Louis, MO 63132



7294 N.W. 54 STREET
MIAMI, FLORIDA 33166

SURPLUS ELECTRONICS CORP. S43

PHONE: (305) 887-8228

TWX: 810-848-6085

WHOLESALE - RETAIL

<p>RADIO TRANSMITTER Type T-20/ARC-5 5.3 to 7 MC or 4-5.3 MC Brand new—Never used— Tubes alone are worth the price \$24.95 only 30 left less cover</p>	<p>— NORTH ELECTRIC TRANSFORMER — 2470—9024 117 V 50/60 Hz—Multiple windings will produce: + 24 V dc—50 Amp + 12 V dc—100 Amp - 12 V dc—50 Amp Other voltages can be obtained, complete with specification sheets—Limited Qty. \$49.95 \$49.95</p>		<p>KESTER #44—SOLDER 63/37 Alloy .032 diameter. —5lb. Spools Only— \$6.00 per lb.</p> <hr/> <p>12 Vdc SIRENS Very Loud \$8.95</p>
<p>SURPRISE PACKAGE Resistors, Caps, Semis, Pots, Relays, etc. We guarantee it to be \$25.00 worth of material. Every package is different. \$5.00</p>	<p>TEXAS INSTRUMENT KEYBOARD Has 3 slide switches—28 different keys— keypads re- movable by removing 4 screws.  \$1.95 ea., 5 for \$8.00 10 for \$13.95</p>		<p>CERAMIC PRECISION CAPS-ERIE 47 pF—100 V 220 pF—100 V \$.10 ea. 470 pF—100 V 500 pF—100 V 15 for \$1.00 560 pF—100 V 1000 pF—100 V 50 for \$3.25 2000 pF—100 V</p>
<p>White Porcelain Egg Insulator 1 1/2" x 1" 50¢ ea 3 for \$1.25</p>	<p>SIGNAL DIODE 1N4148 \$ 5.00 per hundred \$25.00 per thousand or, 15 for \$1.00</p>	<p>POWER MATCH CONVERTER Pearce-Simpson —Max Loads 30 Watts converts: for positive 6 to 12 Vdc or negative 6 to 18 Vdc ground systems 12 to 24 Vdc } 3 1/2" x 3 1/2" x 2" \$7.95</p>	<p>STANCOR TRANSFORMER #P-8180B—117 V in— 25.2 V ct at 1 Amp \$3.00 ea., 2 for \$5.00 3 for \$6.50</p>
<p>Neon Panel Light 110 Vac Amber, w/ built in resistor & wire leads—3 for \$1.50</p>	<p>WIRE WOUND RESISTORS .1 Ohm—5 W .10 Ohm—10 W @ 15¢ each</p>		<p>MUFFIN FANS 3 Blades, 110 Vac, 4 1/4" sq. Removed from equipment— Excellent condition—\$4.95</p> <hr/> <p>"New" Muffin Fans 3 Blades-110 Vac, 4 1/4" sq. \$9.95</p>
<p>PANEL METERS 2 1/4" x 2 1/4" also 2 1/4" x 3" 10-0-10 dc Amps } \$4.00 ea 0-20 dc Volts } 25-0-25 dc Volts } 2 for 0-25 dc Volts } \$7.00 0-50 ac Volts } -Shunt Required-</p>	<p>New Dry Nickel-Cadmium Battery 2 1/4" x 2 3/4" x 8 3/4" General Electric 12.0 Volts dc @ 4.0 Amp hrs. \$19.95 while they last.</p>		<p>TRIMMER CAPS Small enough to fit in your watch— 3.5 to 20 pF 5 to 30 pF 7 to 40 pF \$.75 ea., 2 for \$1.25 5 for \$3.00</p>
<p>POWER SUPPLY 110 AC to 12 VDC 550 mA 23 Watts 3 1/2" w x 4" h x 6 1/2" d \$9.95</p>	<p>HOOK-UP WIRE Size 20 or 22— various colors— no color selection solid \$6.00/1000' \$10.00/2000'</p>	<p>POLYFOAM COAX—50R Equal to RG174 \$4.95/100' Low Loss Polyfoam Coax Cable</p>	<p>JOY STICK For TV games and hi fi with four, 100K pots 2 3/4" X 2 3/4" X 1" with 1" handle—\$3.95</p>
<p>Heavy Duty Instrument Case Grey vinyl over wood—inside also lined w/ vinyl & foam padding. Flip- top w/ handle and keylock w/ key. inside dem. 4 1/2"D x 8 1/4"W x 10"H \$25.00 value—\$9.95</p>	<p>E2000 Memory 52 x 52 200 WD 12 DG \$4.95</p>	<p>New Boxer Fans 5 Blades 110V ac 4 3/4"—\$11.95</p>	<p>Varo Bridge Rectifier 10 amps. 220 Vdc—\$1.50</p>

SPECIALS—SPECIALS—SPECIALS—SPECIALS—SPECIALS—SPECIALS—SPECIALS—SPECIALS—SPECIALS

<p>Computer Grade Caps 1000 mf—50 V 10,000 mf—20 V 8200 mf—25 V 30,000 mf—15 V 21,000 mf—25 V \$2.50 ea.</p>	<p>CTS DIP Switches 8 position \$1.25 ea., 2 for \$2.00</p>	<p>Trimmer Cap Arco/Elmenco PC-402 2 to 20 pF \$.60 ea. 5 for \$2.50, 15 for \$5.00</p>	<p>MASSA Ultrasonic Transducer 37 or 40 kHz \$1.50 ea. 2 for \$2.50, 5 for \$5.00</p>	<p>Relay—P & B 4 PDT—110 Vdc 6050 Ohm coil 10 Amp contacts \$1.50 ea., 2 for \$2.75, 3 for \$3.25</p>	<p>Bourns Trimpot #200L—1—201M 200 Ohm \$1.50 ea., 2 for \$2.50, 5 for \$6.75</p> 	<p>Stancor Transformer #P-8650 Step down/Isolation 117Vpal-12V6.5Amp. w/cord & receptacle \$5.95</p>
--	---	---	---	---	---	--

TERMS: All material guaranteed • If for any reason you are not satisfied, our products may be returned within 10 days for a full refund (less shipping). Please add \$3 for shipping and handling on all orders. Additional 5% charge for shipping any item over 5 lbs. COD's accepted for orders totaling \$50.00 or more. All orders shipped UPS unless otherwise specified. Florida residents please add 4% sales tax. Minimum order \$15.00.

EQUIPMENT / COMPONENTS / WIRE & CABLE / ACCESSORIES

GET YOUR

1978

RADIO AMATEUR

CALLBOOKS

The **U.S. Callbook** has over 350,000 W & K listings. It lists calls, license classes, names and addresses plus the many valuable back-up charts and references you come to expect from the **Callbook**.

\$14.95
PLUS SHIPPING

Specialize in DX? Then you're looking for the **Foreign Callbook** with over 280,000 calls, names and addresses of radio amateurs outside the USA plus many valuable, additional features of interest to the DX'r.

\$13.95
PLUS SHIPPING

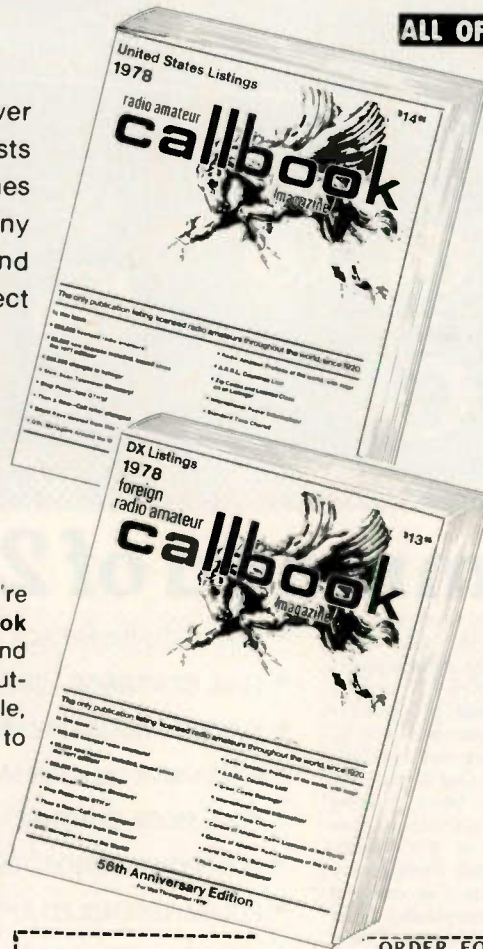

ALL OF THESE EXTRA FEATURES INCLUDED

- International Radio Amateur Prefixes!
- Radio Amateur Prefixes by Countries!
- A.R.R.L. Phonetic Alphabet!
- Great Circle Bearings and Charts!
- International "Q" and "Z" Signals!
- World Standard Time Charts!
- International Postal Information!
- World Prefix Map!
- F.C.C. Examination Points!
- Where to Buy!
- Telegraphers' Abbreviations!
- DX Operating Code!
- A.R.R.L. Countries List!
- At Your Service — Amateur Radio Dealers!
- QSL Managers Around the World!
- World Wide QSL Bureaus!
- Census of Radio Amateurs of the World!
- Telegraph Codes!
- AMSAT — Oscar Users Directory!
- Slow Scan Television Directory!
- Reciprocal Licenses!
- Hawaii Included!
- Many Other Features!

Respected worldwide as the only complete authority for radio amateur QSL and QTH information.

Save \$1.50 order both send \$30.40

See your favorite electronics dealer or write direct for free catalog to the publisher.

RADIO AMATEUR callbook INC
Dept. B 925 Sherwood Drive
Lake Bluff, Ill. 60044

R1

ORDER FORM			
Item	Price Each	Shipping	Total Price
<input type="checkbox"/> U. S. CALLBOOK	\$14.95	\$1.50	\$16.45
<input type="checkbox"/> FOREIGN CALLBOOK	\$13.95	\$1.50	\$15.45

Illinois residents only add 5% sales tax _____

Name _____ Total _____

Address _____

City _____

State _____ Zip _____ Total Enclosed _____

Charge: BankAmericard Master Charge Interbank # _____

Credit card # _____ Expiration date _____

Signature _____

NEW!

Synthacoder 509



Ask about
Group Purchases

ONLY
\$129⁹⁵
postpaid

Take Command of 220 MHz!

The Synthacoder 509 represents the first of a totally new generation of frequency synthesizers based on the latest advances in CMOS-LSI techniques. "Matrix Modules", which contain programming diodes, make adding new channels a cinch. Simply snip the leads on the diodes not needed, plug it in, and you are **On The Air!** Our unique interface design allows you to use your existing crystal positions even though the synthesizer has been installed. The Synthacoder is also easily adapted for **Scanning** and **External Frequency Control**. To sum it up—We are sure that you will find the new Synthacoder 509 **Everything You Want** in a 220 MHz synthesizer—And at a **Price Comparable to Crystals!**

- * SIMPLE TO INTERFACE - Three wires and no holes!
- * FULL COVERAGE - 220-225 MHz in 20 KHz steps
- * MATRIX PROGRAMMABLE - No more crystals
- * EXCLUSIVE "MATRIX MODULES" - Program in seconds
- * FULL MODE CONTROL - Simplex, Repeater, Reverse
- * LOW POWER CMOS - Draws only 60 ma
- * FULLY ASSEMBLED AND CALIBRATED - Not a kit
- * FITS MIDLAND, COBRA, and CLEGG 220 MHz transceivers

Engineering Specialties

P. O. BOX 2233
1247 COMMERCIAL AVENUE
OXNARD, CA 93030
(805) 486-0817

7310

- 'I'LL BITE! Please send more info.
 'I'M HOOKED!' Please RUSH my Synthacoder.

YES, I would like to purchase a Synthacoder for my 220 radio. Enclosed please find my \$129.95 (Price includes postage and handling). California residents add 6% sales tax.

\$ _____ enclosed Check Money Order
Please charge my Master Charge BankAmericard
Credit card # _____
Interbank # _____
Expiration date _____
Signature _____

Name _____ Call _____
Address _____
City _____ State _____ Zip _____



ALDELCO ELECTRONIC CENTER

NEW!
THE FUTURE NOW!
FM2015R



Does Your Unit Cover The Item?
Sub-band 144.5 - 145.3 MHz?
The FM2015R Does. PLUS MARS-CAP.

OVERVOLT 12

Crow Bar circuit protects Transceivers & Tape Decks from runaway power supply voltage that can zap expensive components. OV 12 causes fuse in Power Supply to blow if voltage exceeds preset level (16 Volts). Rated at 25 Amperes. \$ 7.95
Model OV5. Protects 5 Volt circuits. Triggers at 7.5 Volts \$ 7.95
Other units available at 3.3 to 100 Trigger Voltages \$10.95 ea

THE LUNCH COUNTER

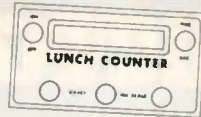

Build a 600 MHz 6 Digit Frequency Counter. We supply 3 PC Boards, Silk Screened Front Panel and complete Instructions Only \$14.95

Chips used in Counter
11C90 Prescaler \$14.50
74C925 9.95
F9368 (2 used) ea 3.95

All Solid State CMOS PLL digital synthesized. No Crystals to Buy! 5KHz steps - 144 - 149 MHz LED digital readout PLUS MARS-CAP.

• 5 MHz Band Coverage - 1000 Channels (instead of the usual 2MHz to 4MHz - 400 to 800 Channels) • 4 CHANNEL RAM IC MEMORY WITH SCANNING • MULTIPLE FREQUENCY OFFSETS • ELECTRONIC AUTO TUNING - TRANSMIT AND RECEIVE • INTERNAL MULTIPURPOSE TONE OSCILLATOR • RIT • DISCRIMINATOR METER - 15 Watts Output - Unequaled Receiver Sensitivity and Selectivity - 15 POLE FILTER, MONOLITHIC CRYSTAL FILTER AND AUTOMATIC TUNED RECEIVER FRONTEND. COMPARE! • Superb Engineering and Superior Commercial Avionics Grade Quality and Construction Second to None at ANY PRICE.

INTRODUCTORY PRICE
\$449.95



ALD1158

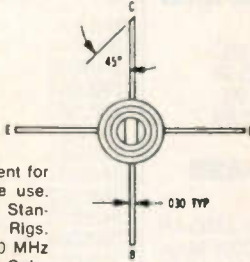

Hard to find replacement for VHF Mobile & Marine use. Successfully used in Standard and other VHF Rigs. Rated 12 Watts at 200 MHz 12.5 Volts with 5.3 DB Gain. Heat Sink stud (8/32) isolated from leads. Only \$12.30

RF DEVICES

2N2876 18W	200 MHz TO60	\$12.35
2N3375 3.0W	400 MHz TO60	5.60
2N3553 2.5W	175 MHz TO39	1.40
2N3866 1.0W	400 MHz TO39	1.25
2N3926 7.0W	175 MHz TO60	6.30
2N4427 1.0W	175 MHz TO39	1.35
2N5589 3.0W	175 MHz MT71	4.75
2N5590 10W	175 MHz MT72	7.80
2N5591 25W	175 MHz MT72	10.25
2N5913 1.75W	175 MHz TO39	1.70
2N6080 4.0W	175 MHz MT72	5.40
2N6081 15W	175 MHz MT72	8.45
2N6082 25W	175 MHz MT72	10.95
2N6083 30W	175 MHz MT72	12.30
2N6084 40W	175 MHz MT72	16.30
2N6094 4.0W	175 MHz X106 PNP	6.60
2N6095 15W	175 MHz X106 PNP	8.50
2N6096 30W	175 MHz X106 PNP	10.35
2N6097 40W	175 MHz X106 PNP	20.00

ALDELCO KITS

DUAL DIGITAL 12/24 HOUR CLOCK KIT
NOW WITH A NEW WALNUT GRAIN WOOD CABINET



Features:
12 or 24 Hour Operation on either clock
Each Clock separately controlled
Freeze feature for time set
Easy assembly for clock and cabinet

MODEL ALD 5-W ONLY \$49.95

LEDS

Monsanto MAN 72 Red LED Readout .300" High, Common Anode. ONLY \$.89
Monsanto MV5053 JUMBO LED and Holder only .25
LED Holders .10
Jumbo Red LED 8 for \$1.00
Jumbo Green, Orange or Yellow LED 5 for \$1.00

FETS

40673 1.55
MPF102 .55
2N3819 .35
2N5457 .50
2N5458 .50
2N5459 .55
2N5485 .50

DARLINGTON

MPSA 13 .80
MPSA 14 .40
2N5306 .50
SCR
C 106A .55
C 106B .65
C 122B .85

VOLTAGE REGULATORS

TO220 Package
Positive \$1.00 Negative \$1.25
7805 7905
7806 7906
7808 7912
7812 7915
7815 7918
LM309H TO5 \$1.10
LM309K TO3 .10
LM723 14 pin ORTO5 .55

TTL SPECIALS

7403 .17
7404 .17
7405 .17
7473 .32
7474 .32
7490 .49
74116 2.60
74193 .98
74283 1.65
74S00 .25
74H10 .25
74H40 .22
74S74 .45
74175 1.25
We have more items listed. Send stamp for our catalog.

RECTIFIERS

2 amp 50 volt 20 for \$1.00
2 amp 1000 volt 10 for 1.00
2 amp 1500 volt 5 for 1.00
10 amp stud 50 volt .150
10 amp stud 600 volt .450
40 amp stud 50 volt .120
40 amp stud 750 volt .205
100 amp stud 200 v .850

BRIDGES

2 amp T05 50 volt .35
2 amp T05 200 volt .50
2 amp T05 600 volt 1.25
3 amp 50 volt .50
3 amp 400 volt 1.10
25 amp 200 volt 1.50
25 amp 600 volt 5.50
25 amp 1000 volt 8.50

CLOCK CHIPS

5313 3.49
5314 3.49
5316 3.95
5375 3.95
CT7001 6.95

ALARM CLOCK KIT

6 Big 0.5 LED Displays * On Board AC Transformer * 12 Hour Format with 24 Hour Alarm * Snooze Feature * Elapsed Timer. Timer feature makes this Popular in Broadcast Stations. It's a natural for cars, boats and campers when used with optional crystal time base. Fits our standard cabinet. \$19.95
Crystal time base when purchased with clock. \$2.95

12 or 24 HOUR DIGITAL CLOCK KIT

Uses 0.5 Display LED. 5314 Clock Chip. Freeze feature for accurate set, fits our standard cabinet. ONLY \$18.95

CLOCK CABINETS

Woodgrain or black leather ea. \$4.95

CRYSTAL TIME BASE KIT

Includes PC Board, Crystal, all parts and instructions. \$4.95

CLOCK FILTERS

Blue, Red, Green, Amber or Smoke \$.60

Blinky Flasher Kit

PC board, 555 & all parts works on 9 volts. Mouse button—\$1.00

DIGITAL MULTIMETER & THERMOMETER

3 1/2 Digit—5 ranges on each function AC/DC .2 Volts to 2000 Volts Current 2 Microamps to 2 Amps Resistance 2000 Ohms to 2 Megohms. Includes PC Board, ICL7107 Chip and all parts. Only \$49.95

CRYSTAL SOCKETS

HOLDS 8 HC25U . . . \$.59
Single HC25U29

Amphenol

8 Pin Round IC Socket44



NEW!

Tunable 420 MHz Fast Scan TV Converter

Receive Fast Scan Amateur TV in the 420 to 450 MHz Band with any TV set. Low noise, high gain rf Amp with Varactor tuned input and outputs. Built in AC supply. Comes in two tone walnut & beige cabinet measuring 1 7/8" x 4 1/4" x 4 1/8". Factory wired with 2 year guarantee. \$49.95
Kit (critical circuits prewired) \$39.99

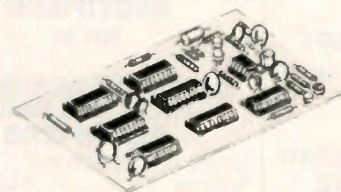

ACCUKEYER KIT

- Self Completing Dots & Dashes • Provision for attachment of 256 or 512
- Iambic Operation Bit Memory for DX or Contest work
- Single Dot & Dash Memories

Revised version of the Accukeyer featured in the ARRL Handbook. Has more logical IC Layout and ON Board sidetone Oscillator. Includes PC Board, TTL ICs, 555 Timer, IC Sockets, Switch, Speaker, Transistors, capacitors and resistors. Requires 5 VDC. ONLY \$19.95

ACCUKEYER MEMORY KIT

Simple low cost Memory Kit. Uses 2 programmable 1101 Memory chips. Provides 2 canned messages of 30 Characters each. Adaptable to Handbook and other Accukeyers. Includes PC board (same size as accukeyer board) and all parts. Requires 5 VDC, 9 VDC. \$19.95

ADJUSTABLE POWER SUPPLY KITS

5-15 Volts 500 MA \$6.95
12-28 Volts 500 MA 6.95

ALDELCO

A2

2281A BABYLON TURNPIKE, MERRICK NY 11566
516-378-4555

Add 6% shipping. Add \$1.00 for orders under \$10.00. Out of U.S.A. add 15% shipping and certified check or money order in U.S. funds.

SEMICONDUCTORS SURPLUS

S63

2822 North 32nd Street/Unit -1 Phoenix, Arizona 85008 (602) 956-9423

We accept checks, MasterCard, and Visa

R.F. CONNECTORS

SO-239	49
PL-259	59
UG-175	39
M-358	1.95
M-359	2.00
PL-258	2.00
UG-88E/U	89
UG-492A/U	2.00
UG-306B/U	2.00
UG-290A/U	99
UG-274/U	2.00
UG-260B/U	1.10
UG-273/U	2.50
UG-201A/U	2.50
UG-58/U	1.99
UG-491A/U	2.25
UG-260/U	99
UG-1094/U	89

FERRITE BEADS

12/.89 or 100/4.00

TOROIDAL CORES

T-37-6 6/1.00 25/4.00 50/6.00
100/10.00

TOROIDAL CORES

T-30-2 & T-30-12 5/1.00

1N914/1N4148

30/1.00 or 120/3.00

2C39/7289 TUBES

\$4.00 each or 10/\$35.00

TRIMMERS 5-80PF

45¢ each or 10/ 3.50 or
100/25.00

CHOKE (U252) 2.5MH 150 MA 30 MHZ

2/\$1.00

TRIMMER CAPS

Small enough to fit in your
watch 3.5-11 pf 75¢ each or
10/\$6.00

RG-174 52 OHM COAX MADE BY H.P.

\$5.00/100 ft.

MINIATURE SWITCHES

SPST ON-ON 3/1.00 Used

F.E.T.S

MPF4391	75 or 10/6.50
MPF112	.69 or 10/5.50
MPF102	.43 or 10/3.50
40673	1.39 or 10/10.00
3N128	1.35 or 10/10.00
2N5248	.60 or 10/4.50
MPF131	.60 or 10/5.00
2N4303	.45 or 10/3.50
2N3958	2.95 each
MFE2000	.90 or 10/8.00
MFE2001	.99 or 10/8.00
MFE2008	4.20 or 10/36.00
MFE2009	4.80 or 10/39.00
MFE3002	3.35 each
MMF-5	5.00 each
MFE120	1.00 or 10/8.50
2N3436	2.25 each
2N4416	1.00 each
MFE131	1.05 each

PISTON CAPS 1.2-10 PF

75¢ each or 10/5.50

LM566V VCO Function Generator

99¢ each

LM340T-5 & LM340T-12

75¢ each

1500PIV 1.5 AMPS RECTIFIERS

10/1.50

SEMTECH MINISTIC, HIGH VOLTAGE RECTIFIERS

SFMS 20K 20,000 PIV
500ma \$1.99 each

MOTOROLA I.C.s

MC4024P & MC4044P \$3.27 ea.

HEP 170 2.5 AMPS

1000PIV 10/2.00 or
100/14.50

MOTOROLA R.F. AMPS

MC1550G 1.50 each
MC1590G 6.90 each

POTTER & BRUMFIELD RELAYS

12VDC 4PDT 3Amps 2.95
12VDC SPDT 25Amps 5.95
12VDC 2PDT 3Amps 1.99
12VDC 4PDT 25Amps 6.99

DRAKE LOW PASS FILTERS

TV-42-LP TV-3300-LP
100W Max. 1000W Max.
30 MHz \$9.95. 30 MHz \$19.95

TUBES

2E26	5.00
3B28	5.00
4X150A	15.00
4CX250B	24.95
4CX250R	29.95
4CX250F	26.00
6146	3.99
6146A	5.25
6146B	6.25
6146W	6.95
6360/A	7.95
6907	35.00
6939	5.96
7289	9.95
7984	6.95
8072	45.00
8106	1.75
8560A/AS	30.00
8950	5.95
6KD6	4.65
6LQ6/6JE6	6.20
811	6.00
811A	10.95
717A	8.00
572B/T160L	29.00
4-400AX	39.95
4-125A	20.00
4CX15000A	150.00
8437	250.00
7007/6166A	600.00
3-500Z	69.00

R.F. TRANSISTORS

2N2857	1.80
2N2857JAN	2.35
2N2947	16.00
2N3375	6.00
2N3553	1.80
2N3818	5.50
2N3866	1.05
2N3866JAN	3.14
2N3866JANTX	4.25
2N3925	6.00
2N3948	2.00
2N3950	26.00
2N3960	4.70
2N4072	1.70
2N4427	1.24
2N4877	2.57
2N4957	2.50
2N5108	3.90

R.F. Transistors, con't.

2N5109	1.55
2N5179	59
2N5589	4.00
2N5583	5.00
2N5590	6.00
2N5591	10.00
2N6080	5.00
2N6081	6.00
2N6082	10.75
2N6083	12.00
2N6084	13.00
2N6095	10.00
2N6097	27.00
MRF502	99
MRF8004	69
SS2548	75
40281	10.90
40282	11.90

BRIDGES 25 AMPS 500PIV

\$2.99 each

ROTRON FEATHER FANS

Factory Fresh Type 213
230VAC 20W Max. \$12.95

MUFFIN FANS, REMOVED

from new equipment \$6.95

TEKTRONIX SCOPES

545/CA Plug-in \$499.95
585/82 PPlug-in 599.95

ELECTRO/DATA PANORAMIC RECEIVER PLUG-IN UNIT

Model PN1011, will work in
Tektronix Scopes and will make
into Spectrum Analyzers. 1000
to 12,000 MHz \$299.95

LINEAR I.C.s

LM308H	1.00
LM309K	1.00
LM380N-14	.60
LM301V	.30
LM301H	.30
LM1458V	.50
LM304H	.79
LM307V	.35
LM310H	2.00
LM312	1.75
LM555V	.49
LM555H	5.00
LM318H	1.00
LM324N	1.00

ASTRAL ELECTRONICS CORP.
 321 PENN. AVE. P.O. BOX 707
 LINDEN, NEW JERSEY 07036
 201 - 486-3365 A63

PRIME QUALITY
TUBES • SEMICONDUCTORS • IC'S • LED'S
 IF YOU DON'T SEE IT, SEND A SASE
 AND WE WILL QUOTE.

FAMCHILD	SCW4	4.75	10AMP900V	3.65
VHF Preselector	777	18.50	25AMP 50V	1.95
Onky	7N7	18.50	25AMP100V	2.25
95W900C	8C172A	329.00	25AMP200V	2.55
95W910C	572B	27.50	25AMP400V	2.95
11C011FC	807	4.50	25AMP900V	4.25
11C020C	811A	10.75	SOLID STATE PLUG IN	
11C060C	813	17.90	REPLACEMENTS FOR ELEC.	
11C240C	866A	3.90	FROM TUBES DESIGNED TO	
11C241C	1625	8.90	MEET OR EXCEED ORIGINAL	
11C300C	689A	3.50	SPECIFICATIONS NO WARR.	
11C700C	6146B	6.10	UP TIME LONG LIFE HIGH	
11C830C	6360	4.70	TEMPERATURE OPERATION	
11C900C	6883B	5.20	TYPE TO BE	
11C910C	7094	64.90	Replaced	Price
RF	7586	7.50	3R7	8.20
Transistors	7587	9.50	5R4	6.10
2N2787	7788	13.95	5Y5A	39.50
2N3375	798A	8.95	6R6A	8.20
2N3553	8072	42.00	6Y2A	27.40
2N3886	8122	54.90	6X8	27.40
2N4427	8236	21.50	6X8	27.40
2N5589	8283	299.00	6X8	27.40
2N5590	8295	325.00	6X8	27.40
2N5591	8404AS	52.00	6X8	27.40
2N5913	8643	87.50	6X8	27.40
7N6020	8908	5.20	6X8	27.40
7N6081	8950	4.75	6X8	27.40
7N6082	10.90	8.00	6X8	27.40
7N6083	10.90	24.95	6X8	27.40
7N6084	12.25	26.00	6X8	27.40
7N6094	5.70	5.00	6X8	27.40
7N6095	8.50	105.00	6X8	27.40
7N6096	10.35	108.00	6X8	27.40
7N6097	19.85		6X8	27.40
Tubes	HEAT	Price	6X8	27.40
3 400Z	SH-4	4.70	6X8	27.40
3 500Z	HR 7	4.70	6X8	27.40
3 1000Z	HR 8	4.70	6X8	27.40
3CX1000A7	HR 10	4.70	6X8	27.40
4 125A	41.50		6X8	27.40
4 250A	57.00		6X8	27.40
4 400A	54.90		6X8	27.40
4 400C	65.95		6X8	27.40
4 1000A	189.75		6X8	27.40
4CX250B	27.50		6X8	27.40
	10AMP400V	2.05	6X8	27.40

Free Metric Converter With Each Order

FREE CATALOG WITH ORDER
WE PAY POSTAGE
 N. J. RES. ADD 5% SALES TAX MINIMUM \$10.00
SEND STAMP FOR FREE CATALOG

ATTENTION KENWOOD & YAESU OWNERS!!!

the W6TOG*
RECEIVER MODIFICATION KIT

- INCREASES SELECTIVITY
 - IMPROVES SENSITIVITY
 - LOWERS INTERNAL NOISE
 - COMBATS BLOCKING FROM LOCAL SIGNAL
 - IMPROVES NOISE BLANKER OPERATION
- | | | |
|-------------------|-------|---------|
| TS-520 KIT | | \$27.50 |
| TS-520S KIT | | 32.50 |
| TS-820 & 820S KIT | | 34.50 |
| FT-101 SERIES KIT | | 32.50 |
| FR-101 SERIES KIT | | 34.50 |

EXPLICIT INSTRUCTIONS MAKE MODIFICATION A CINCH
 *WELL KNOWN DXer WITH OVER 300 COUNTRIES CONFIRMED.

Order from
S-F AMATEUR RADIO SERVICES
 4384 KEYSTONE AVE., CULVER CITY, CA. 90230 S33
 (213) 837-4870

IT'S MAGIC—IT'S "MAGICOM"
PROCESSOR MODIFICATION KIT

IMPROVES AUDIO PUNCH • IMPROVES PROCESSED SPEECH QUALITY

Converts TS-820 speech processor from RF compressor to RF clipper

The "MAGICOM" RF processor module provides up to 6db increase in output with smooth, clean, non-distorted audio and more penetration for those pile-ups. Price \$27.50

ENDORSED BY W6TOG AND BIG GUN DXers WORLD WIDE

SATISFACTION GUARANTEED OR MONEY REFUNDED
 All prices postpaid - in Calif. add 6% sales tax - Mastercard & Visa accepted

MOVING?

Let us know 8 weeks in advance so that you won't miss a single issue of 73 Magazine. Attach old label where indicated and print new address in space provided. Also include your mailing label whenever you write concerning your subscription. It helps us serve you promptly. Write to:

73 magazine
 PETERBOROUGH NH 03458

- | | |
|---|--|
| <input type="checkbox"/> Address change only | <input type="checkbox"/> Payment enclosed |
| <input type="checkbox"/> Extend subscription | <input type="checkbox"/> (1 extra BONUS issue) |
| <input type="checkbox"/> Enter new subscription | <input type="checkbox"/> Bill me later |
| <input type="checkbox"/> 1 year \$15.00 | |

If you have no label handy, print OLD address here.

Name _____ Call _____

Address _____

City _____ State _____ Zip _____

print NEW address here:

Name _____ Call _____

Address _____

City _____ State _____ Zip _____

TICKETS TO COMPETENCE!

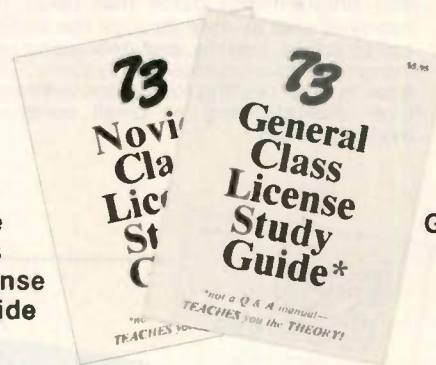

Novice Class License Guide

General Class License Guide

Novice Guide — This excellent reference will launch you into the exciting world of ham radio! Covers radio and electronic fundamentals, preparing you to pass the Novice exam; also includes the latest FCC amateur regulations and application forms. \$4.95

General Guide — If you're looking ahead to your General or Technician exam, or are already licensed, this excellent reference work is a must for you! Covers completely transistor, amplifier, and general radio theory; you'll use it again and again! \$5.95.

73 Magazine • Peterborough NH 03458

NEW ADDITIONS



● **A GUIDE TO HAM RADIO—BK7321**—by Larry Kahaner WB2NEL. What's Amateur Radio all about? You can learn the basics of this fascinating hobby with this excellent beginner's guide. It answers the most frequently asked questions in an easy-going manner, and it shows the best way to go about getting an FCC license. A Guide to Ham Radio is an ideal introduction to a hobby enjoyed by people around the world. \$4.95.*

● **VOLUME IV—IC TEST EQUIPMENT—LB7362**—it's easy and fun to build your own test equipment with ICs! Here in this fourth volume of the 73 TEST EQUIPMENT LIBRARY are 42 home construction projects for building test equipment to work with your ham station and in servicing digital equipment. Counters, scalars, frequency standards, synthesizers, logic probes... **JUST ABOUT EVERYTHING** you need and can build with ICs. \$4.95.*

**SPECIAL:
PRE-PUBLICATION OFFER**
(orders will be filled on
a first-in, first-out basis)

● **HOW TO BUILD A MICROCOMPUTER—AND REALLY UNDERSTAND IT—BK7325**—by Sam Creason. The electronics hobbyist who wants to build his own microcomputer system now has a practical "How-To" guidebook. Sam Creason's book is a combination technical manual and programming guide that takes the hobbyist step by step through the design, construction, testing, and debugging of a complete microcomputer system. This book is must reading for anyone desiring a true understanding of small computer systems. \$9.95.*

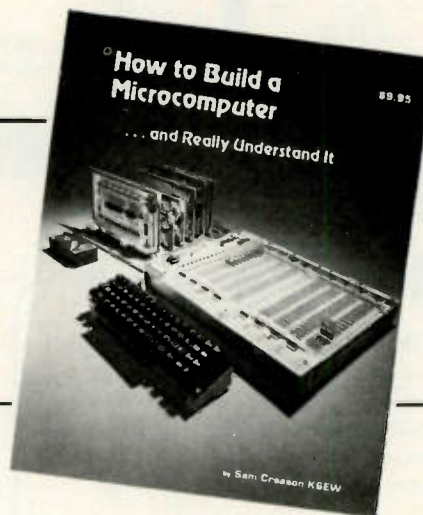

● **SSB... THE MISUNDERSTOOD MODE—BK7351**—by James B. Wilson. Single Sideband Transmission... thousands of us use it every day, yet, it remains one of the least understood facets of amateur radio. J. B. Wilson presents several methods of sideband generation, amply illustrated with charts and schematics, which will enable the ambitious reader to construct his own sideband generator. A must for the technically-serious ham. \$5.50.*

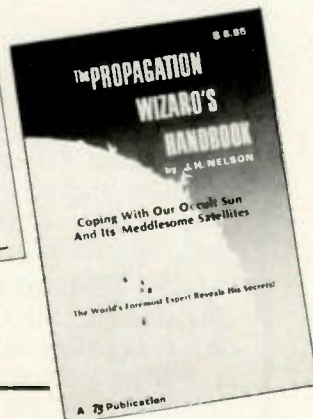

● **PROPAGATION WIZARD'S HANDBOOK—BK7302**—by J. H. Nelson. When sunspots riddled the worldwide communications networks of the 1940's, John Henry Nelson looked to the planets for an answer. The result was a theory of propagation forecasting based upon interplanetary alignment that made the author the most reliable forecaster in America today. The book provides an enlightened look at communications past, present, and future, as well as teaching the art of propagation forecasting. 6.95.*

Use the order card in the back of this magazine or itemize your order on a separate piece of paper and mail to:
73 Radio Bookshop • Peterborough NH 03458. Be sure to include check or detailed credit card information.

* Add \$1.00 handling charge for orders under \$10.00. Note: Prices subject to change on books not published by 73 Magazine.

FOR TOLL FREE ORDERING CALL 1-800-258-5473

Radio Bookshop

license study guides & tapes



● **NOVICE STUDY GUIDE**—SG7357—Here is a completely new study guide and reference book for the potential ham. This is not a question/answer memorization course. Electronic and radio fundamentals are presented and explained in an easy-to-understand fashion, preparing the beginner for the Novice exam. Includes the latest FCC amateur regulations, as well as application forms. Easily the best path into the exciting world of ham radio! \$4.95.*

● **GENERAL CLASS STUDY GUIDE**—SG7358—A complete theory course for the prospective General or Technician. This reference explains transistor, amplifier, and general radio theory, while preparing the Novice for the "big" ticket. After getting your ticket, you'll use this guide again and again as an electronic reference source. Not a question/answer guide that becomes dated when the FCC updates the amateur exams. \$5.95.*

● **ADVANCED CLASS STUDY GUIDE**—SG1081—Ready to upgrade your license? To prevent retaking the FCC theory exam, you need the 73 Advanced theory guide. SSB, antenna theory, transmitters, and electronics measuring techniques are covered in detail in this easy-to-follow study guide. Special modes and techniques, such as RTTY, are also treated. An engineering degree is not necessary to master Advanced theory—try this book before visiting the examiner's office! \$5.95.*

● **EXTRA CLASS LICENSE STUDY GUIDE**—SG1080—Before going for your 1 x 2 call, it pays to be a master of the Extra class electronic theory. This study guide is the logical extension of the 73 theory course. All the theory necessary to pass the exam is presented. Antennas, transmission lines, SWR are discussed, as well as noise, propagation, and specialized communication techniques. This book is not a classroom lecture or memorization guide, but rather a logical presentation of the material that must be understood before attempting the Extra exam. Save yourself a return trip to the FCC and try the 73 method first! \$5.95.*



NOVICE THEORY TAPES Startling Learning Breakthrough



● **NOVICE THEORY TAPES**—CT7300—Startling Learning Breakthrough. You'll be astounded at how really simple the theory is when you hear it explained on these tapes. Three tapes of theory and one of questions and answers from the latest Novice exams give you the edge you need to breeze through your exam. 73 is interested in helping get more amateurs, so we're giving you the complete set of our tapes for the incredibly low price of **ONLY \$15.95.***

Scientists have proven that you learn faster by listening than by reading because you can play a cassette tape over and over in your spare time—even while you're driving! You get more and more info each time you hear it.

You can't progress without solid fundamentals. These four hour-long tapes give you all the basics you'll need to pass the Novice exam easily. You'll have an understanding of the basics which will be invaluable to you for the rest of your life! Can you afford to take your Novice exam without first listening to these tapes? Set of 4—\$15.95.*



SSTV

● **SLOW SCAN TELEVISION TAPE**—CT7350—Prize-winning programs from the 73 SSTV contest. Excellent for Demo! \$5.95.*

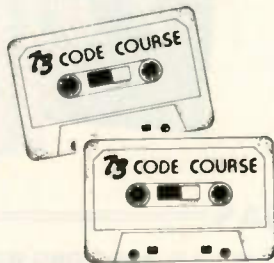

73 CODE SYSTEM TAPES

Any Four Tapes For \$15.95! *
\$4.95 Each! *

"GENESIS"

5 WPM—CT7305—This is the beginning tape for people who do not know the code at all. It takes them through the 26 letters, 10 numbers and necessary punctuation, complete with practice every step of the way using the newest blitz teaching techniques. It is almost miraculous! In one hour many people—including kids of ten—are able to master the code. The ease of learning gives confidence to beginners who might otherwise drop out.

"THE STICKLER"

6+ WPM—CT7306—This is the practice tape for the Novice and Technician licenses. It is made up of one solid hour of

code, sent at the official FCC standard (no other tape we've heard uses these standards, so many people flunk the code when they are suddenly—under pressure—faced with characters sent at 13 wpm and spaced for 5 wpm). This tape is not memorizable, unlike the zany 5 wpm tape, since the code groups are entirely random characters sent in groups of five.

"THE CANADIAN"

10+ WPM—CT7310—73 hasn't forgotten the Canadian hams—our 10 WPM tape prepares you to breeze through your country's licensing exams. Like the other code groups, the tape is not memorizable and, once mastered, provides a margin of safety in the actual text situation.

"BACK BREAKER"

13+ WPM—CT7313—Code groups again, at a brisk 13 per so you will be at ease when you sit down in front of the steely-eyed government inspector and he starts sending you plain language at only 13 per. You need this extra margin to overcome the panic which is universal in the test situations. When you've spent your money and time to take the test, you'll thank heavens you had this back-breaking tape.

"COURAGEOUS"

20+ WPM—CT7320—Code is what gets you when you go for the Extra class license. It is so embarrassing to panic out just because you didn't prepare yourself with this tape. Though this is only one word faster, the code groups are so difficult that you'll almost fall asleep copying the FCC stuff by comparison. Users report that they can't believe how easy 20 per really is with this fantastic one hour tape.

"OUTRAGEOUS"

25+ WPM—CT7325—This is the tape for that small group of overachieving hams who wouldn't be content to simply satisfy the code requirements of the Extra Class license. It's the toughest tape we've got and we keep a permanent file of hams who have mastered it. Let us know when you're up to speed and we'll inscribe your name in 73's CW "Hall of Fame."



Use the order card in the back of this magazine or itemize your order on a separate piece of paper and mail to: 73 Radio Bookshop • Peterborough NH 03458. Be sure to include check or detailed credit card information.

* Add \$1.00 handling charge for orders under \$10.00. Note: Prices subject to change on books not published by 73 Magazine.

FOR CUSTOMER SERVICE CALL 603-924-6132

Radio Bookshop

73 TECHNICAL LIBRARY

● **BEHIND THE DIAL**—BK7307—By Bob Grove. Get more fun out of shortwave listening with this interesting guide to receivers, antennas, frequencies and interference. \$4.95.*

● **THE CHALLENGE OF 160**—BK7309—is the newest book in the 73 technical library, dedicated to 160 meter operating. Si Dunn provides all necessary information to get started on this unique band. The all-important antenna and ground systems are described in detail. The introduction contains interesting photos of Stew Perry's (the King of 160) shack. This reference is a must for new and experienced "Top Band" operators. Price: \$1.95.*

● **IC OP-AMP COOKBOOK**—BK1028—by Walter G. Jung. Covers not only the basic theory of the IC op amp in great detail, but also includes over 250 practical circuit applications, liberally illustrated. 592 pages, 5½ x 8½, softbound. \$12.95.*

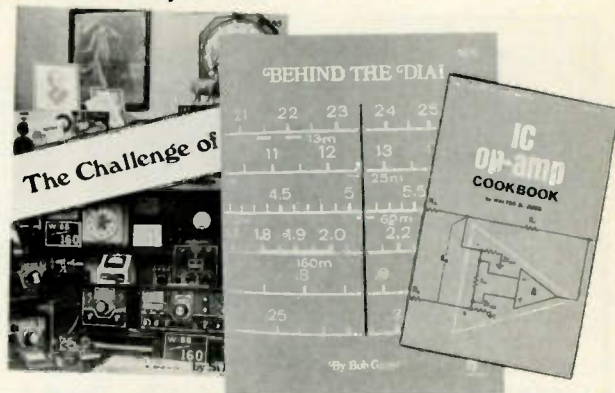

● **INTRODUCTION TO RTTY**—BK7380—A beginner's guide to radioteletype including teletypewriter fundamentals, signals, distortion and RTTY art. You can be a RTTY artist! A 73 publication. \$2.00.*

● **THE NEW RTTY HANDBOOK**—BK7347—is a new edition and the only up-to-date RTTY book available. The state of the art has been changing radically and has made all previous RTTY books obsolete. It has the latest circuits, great for the newcomer and expert alike. \$5.95.*

● **PROPAGATION WIZARD'S HANDBOOK**—BK7302—by J. H. Nelson. When sunspots riddled the worldwide communications networks of the 1940's, John Henry Nelson looked to the planets for an answer. The result was a theory of propagation forecasting based upon interplanetary alignment that made the author the most reliable forecaster in America today. The book provides an enlightened look at communications past, present, and future, as well as teaching the art of propagation forecasting. \$6.95.*



● **SSB . . . THE MISUNDERSTOOD MODE**—BK7351—by James B. Wilson. Single Sideband Transmission . . . thousands of us use it every day, yet it remains one of the least understood facets of amateur radio. J. B. Wilson presents several methods of sideband generation, amply illustrated with charts and schematics, which will enable the ambitious reader to construct his own sideband generator. A must for the technically-serious ham. \$5.50.*

● **SSTV HANDBOOK**—BK7354(hardcover), BK7355(softcover)—This excellent book tells all about it, from its history and basics to the present state-of-the-art techniques. Contains chapters on circuits, monitors, cameras, color SSTV, test equipment and much more. Hardbound \$7.00, softbound \$5.00.*

● **WEATHER SATELLITE HANDBOOK**—BK7370—Simple equipment and methods for getting good pictures from the weather satellite. Antennas, receivers, monitors, facsimile you can build, tracking, automatic control (you don't even have to be home). Dr. Taggart WB8DQT. \$4.95.*



ANTENNAS



● **73 DIPOLE AND LONG-WIRE ANTENNAS**—BK1016—by Edward M. Noll W3FQJ. This is the first collection of virtually every type of wire antenna used by amateurs. Includes dimensions, configurations, and detailed construction data for 73 different antenna types. Appendices describe the construction of noise bridges, line tuners, and data on measuring resonant frequency, velocity factor, and swr. \$5.50.*

● **73 VERTICAL, BEAM AND TRIANGLE ANTENNAS**—BK1069—by Edward M. Noll W3FQJ. Describes 73 different antennas for amateurs. Each design is the result of the author's own experiments covering the construction of noise bridges and antenna line tuners, as well as methods for measuring resonant frequency, velocity factor, and standing-wave ratios. 160 pages. \$5.50.*

● **VHF ANTENNA HANDBOOK**—BK7368—The NEW VHF Antenna Handbook details the theory, design and construction of hundreds of different VHF and UHF antennas . . . A practical book written for the average amateur who takes joy in building, not full of complex formulas for the design engineer. Packed with fabulous antenna projects you can build. \$4.95.*

Use the order card in the back of this magazine or itemize your order on a separate piece of paper and mail to:

73 Radio Bookshop • Peterborough NH 03458. Be sure to include check or detailed credit card information.

* Add \$1.00 handling charge for orders under \$10.00. Note: Prices subject to change on books not published by 73 Magazine.

FOR TOLL FREE ORDERING CALL 1-800-258-5473

RADIO BOOKSHOP

TEST EQUIPMENT

● **RF AND DIGITAL TEST EQUIPMENT YOU CAN BUILD**—BK1044—Rf burst, function, square wave generators, variable length pulse generators—100 kHz marker, i-f and rf sweep generators, audio osc, affrf signal injector, 146 MHz synthesizer, digital readouts for counters, several counters, prescaler, microwave meter, etc. 252 pages. \$5.95.*

● **VOL. I COMPONENT TESTERS**—LB7359—... how to build transistor testers (8), diode testers (3), IC testers (3), voltmeters and VTVMs (9), ohmmeters (8 different kinds), inductance (3), capacity (9), Q measurement, crystal checking (6), temperature (2), aural meters for the blind (3) and all sorts of miscellaneous data on meters... using them, making them more versatile, making standards. Invaluable book. \$4.95.*

● **VOL. II AUDIO FREQUENCY TESTERS**—LB7360—... jam packed with all kinds of audio frequency test equipment. If you're into SSB, RTTY, SSTV, etc., this book is a must for you... a good book for hi-fi addicts and experimenters, too! \$4.95.*

● **VOL. III RADIO FREQUENCY TESTERS**—LB7361—Radio frequency waves, the common denominator of Amateur Radio. Such items as SWR, antenna impedance, line impedance, rf output and field strength; detailed instructions on testing these items includes sections on signal generators, crystal calibrators, grid dip oscillators, noise generators, dummy loads and much more. \$4.95.*

● **VOL. IV IC TEST EQUIPMENT**—LB7362—Become a troubleshooting wizard. All you need to know about pulse, audio and sync generators, frequency counters, digital component testers, logic probes and more! Plus a cumulative index for all four volumes of the 73 Test Equipment Library. \$4.95.*



THE WELL-EQUIPPED HAM SHACK



● **NEW REPEATER ATLAS OF THE ENTIRE WORLD**—BK7345—150% as big as any list ever available—nearly 900 more repeaters listed. New improved maps show the locations by frequency of every repeater in the States. Only \$1.95.*

● **QSL CARDS**—73 turns out a fantastic series of QSL cards at about half the cost of having them done elsewhere because they are run as a fill-in between printing books and other items in the 73 Print Shop. 250 Style W—QW0250—for \$8.95*; 500 Style W—QW0500—for \$13.95*; 250 Style X—QX0250—for \$8.95*; 500 Style X—QX0500—for \$13.95*; 250 Style Y—QY0250—for \$8.95*; 500 Style Y—QY0500—for \$13.95.*

● **73 MAGAZINE BINDERS**—Preserve and protect your collection for your lifetime! There's no excuse for lost issues when you have these handsome red binders with gold lettering. Order 1—BN1001—for \$6.50*; 2 or more—BN1002—for \$6.00 each.*



Style X



Style W

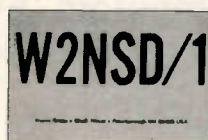

Style Y

● **BACK ISSUES**—Complete your collection—many are prime collectibles now, classics in the field! A full collection is an invaluable compendium of radio and electronics knowledge! \$2.00 each*, or 5 for \$5.00.*

● **LIBRARY SHELF BOXES**—These sturdy white, corrugated, dirt-resistant boxes each hold a full year of 73 or *Kilobaud*. With your order, request self-sticking labels for any of the following: 73, *Kilobaud*, *CQ*, *QST*, *Ham Radio*, *Personal Computing*, *Radio Electronics*, *Interface Age*, and *Byte*. Order 1—BX1000—for \$2.00*; order 2-7—BX1001—for \$1.50 each*; order 8 or more—BX1002—for \$1.25 each*.



Use the order card in the back of this magazine or itemize your order on a separate piece of paper and mail to: 73 Radio Bookshop • Peterborough NH 03458. Be sure to include check or detailed credit card information.

* Add \$1.00 handling charge for orders under \$10.00. Note: Prices subject to change on books not published by 73 Magazine.

FOR CUSTOMER SERVICE CALL 603-924-6132

**21,560
pages.**



**That's the size of the world's
most comprehensive guide to
the subject of ham radio:
18 years of 73 Magazine.**

The back issues of 73 are a gold mine of interesting articles. Unlike the other magazines, which fill their pages with activity reports, there's little to go stale in 73. You'll find pioneering articles on SSTV, FM, repeaters, ICs, and computers. Even the editorials are fun as Wayne Green's dire predictions, like the debacle of incentive licensing, have come to pass.

Clip the coupon below and send for 73's new back issue catalogue. Treat yourself (or a friendly ham) to some fun, and a fantastic bargain to boot.

YES! Rush me 73's FREE Back Issue Catalogue!

Name _____

Address _____

City _____ State _____ Zip _____ S10

73 magazine
PETERBOROUGH NH 0345B

IS HARD COPY STORAGE A PROBLEM?



73, as thick as it is, is more like a floppy when it comes to standing on the bookshelf. Try the 73 Library Shelf Boxes . . . sturdy corrugated white dirt resistant cardboard boxes which will keep them from flopping around. We have self-sticking labels for the boxes, too, not only for 73, but also for *Kilobaud* . . . and for *CQ*, *QST*, *Ham Radio*, *Personal Computing*, *Radio Electronics*, *Interface Age*, and *Byte*. Ask for whatever stickers you want with your box order. They hold a full year of 73 . . . or *Kilobaud*. Your magazine library is your prime reference, keep it handy and keep it neat with these strong library shelf boxes . . . One box is \$2.00, 2 boxes are \$3.00 and eight boxes are \$10.00. Be sure to specify which labels we should send. Have your credit card handy and call our toll-free order number 800-258-5473, or use the order card in the back of the magazine and mail to:

73 magazine
PETERBOROUGH NH 03458

PROPAGATION

by
J. H. Nelson

EASTERN UNITED STATES TO:

	GMT: 00	02	04	06	08	10	12	14	16	18	20	22
ALASKA	14	14	7	7	7	7	7	14	14	14A	21	
ARGENTINA	14A	14	14	7A	7	7	14	21	21A	21A	21A	21
AUSTRALIA	21	14	7B	7B	7B	7B	14	14	14	21	21A	
CANAL ZONE	14	7A	7	7	7	7	14	21	21	21A	21A	21
ENGLAND	7	7	7	3A	7	7B	14	21A	21A	21	14	7B
HAWAII	21	14	7B	7	7	7	7	7B	14	21	21A	21A
INDIA	7	7B	7B	7B	7B	7B	14	21	14	14	14B	7B
JAPAN	14	7A	7B	7B	7B	7	7	7	7B	14	14A	
MEXICO	14	14	7	7	7	7	7A	14	21	21	21	21
PHILIPPINES	14	14B	7B	7B	7B	7B	7	7	7A	14	14B	14
PUERTO RICO	7A	7	7	7	7	7	7A	14	14A	21	21	21
SOUTH AFRICA	7A	7	7	7B	7B	14	21	21A	21A	21A	21	14
U. S. S. R.	7	7	7	7	7	7B	14	21A	14	14	14B	7B
WEST COAST	14A	7A	7	7	7	7	7	14	21	21	21A	21A

CENTRAL UNITED STATES TO:

	GMT: 00	02	04	06	08	10	12	14	16	18	20	22
ALASKA	14A	14	7	7	7	7	7	14	14	21	21	
ARGENTINA	21	14	14	7	7	7	7A	21	21A	21A	21A	21
AUSTRALIA	21A	14	7B	7B	7B	7B	7A	14	14	21	21A	
CANAL ZONE	21	14	7	7	7	7	7A	21	21	21A	21A	21
ENGLAND	7	7	7	3A	7	7B	14	14	21	14	7B	
HAWAII	21A	14	14	7	7	7	7	7	14	21	21A	21A
INDIA	7B	7B	7B	7B	7B	7B	7B	14	14	14	14B	7B
JAPAN	14A	14	7B	7B	7B	7	7	7	7B	14	21	
MEXICO	14	7A	7	7	7	7	7	14	14A	21	21	21
PHILIPPINES	14A	14	7B	7B	7B	7B	7B	7	7	14	14B	14A
PUERTO RICO	14	7	7	7	7	7	7A	14	21	21A	21A	21
SOUTH AFRICA	14	7	7	7B	7B	7B	14	21	21	21A	21A	14
U. S. S. R.	7	7	7	7	7	7B	7B	14	14A	14	14B	7B

WESTERN UNITED STATES TO:

	GMT: 00	02	04	06	08	10	12	14	16	18	20	22
ALASKA	14A	14	7A	7	7	3A	7	7	14	14	14	14A
ARGENTINA	21	14	14	7B	7	7	7B	14	21	21A	21A	21A
AUSTRALIA	21A	21A	14	14	7B	7B	7B	7	7A	14	21	21A
CANAL ZONE	21	14	7	7	7	7	7	14	21	21	21A	21A
ENGLAND	7B	7	7	3A	7	7	7B	14	21	14	7B	
HAWAII	21A	21	14	7	7	7	7	7	14	21	21A	21A
INDIA	14	14A	14	7B	7B	7B	7B	7B	14	14	14	14B
JAPAN	21A	21	14	7B	7B	7	7	7	7	7B	14	21
MEXICO	21	14	7	7	7	7	7	14	21	21	21	21
PHILIPPINES	21	21	14	7B	7B	7B	7	7	7	14	14B	21
PUERTO RICO	21	14	7	7	7	7	7	14	14A	21	21	21
SOUTH AFRICA	14	14B	7	7B	7B	7B	7B	14	14A	21A	21A	21
U. S. S. R.	7B	7	7	7	7	7B	7B	7A	14	14	14B	7B
EAST COAST	14A	7A	7	7	7	7	7	14	21	21	21A	21A

- A = Next higher frequency may also be useful
- B = Difficult circuit this period
- F = Fair
- G = Good
- P = Poor
- SF = Chance of solar flares

october

sun	mon	tue	wed	thu	fri	sat
1 F	2 P	3 P	4 F	5 G	6 G	7 G
8 G	9 G	10 F/SF	11 F/SF	12 F	13 F	14 G
15 G	16 G	17 G	18 F	19 P/SF	20 P/SF	21 P/SF
22 F	23 G	24 G	25 G	26 F	27 F	28 G
29 G	30 P	31 F			☉ ☽ ☿ ♀	

Hot Item!!

WEATHER SATELLITE HANDBOOK \$4.95

Weather Satellite Antenna Systems, Receivers, How To Find & Track Satellites . . .



A complete satellite ground station can be built for less than the cost of a good television set! And you don't have to be a mechanical or electrical genius, either. This text is fully illustrated and you will find information on simple equipment, methods for producing good pictures from the weather satellite, antennas, receivers, monitors, tracking & automatic control.

73 magazine
PETERBOROUGH NH 03458

READER SERVICE

A46	ABC Communications	196	D15	DenTron	21	M55	Microlog Corporation	134	S43	Surplus Electronics	310
A1	Adirondack Radio Supply	216, 294	D29	Dielectric	46	M48	Microtronics	294	T13	Teletypewriter Communications Specialists	170
A24	Adva Electronics	296	D20	Digital Research Corporation	302, 303	M62	Mid Com Electronics, Inc./Edgecom	63	T33	Telex Communications, Inc.	25
A60	AED Electronics	52	D23	Dovetron	278	M41	Midland International	115	*	Ten-Tec	22, 23
A2	Aidelco	313	D25	DSI Instruments	15, 145	M57	Monroe Electronics	88	T34	Thomas Communications	107
A47	Aluma Tower Company	293	E1	ECM Corporation	170, 269	N7	Newman Computer Exchange	52	T44	Tower Electronics, Corp./Edgecom	67
A34	Amsat	153	E19	Edgecom	43	N2	New-Tronics	24		Trac Electronics, Inc.	92
A55	Amateur Radio Supply	216	*	Electronic Systems	165	N14	Northern Radio	129	T18	Trans Com	170
A40	Amateur Radio Supply of Nashville, Inc.	88, 183	E12	Engineering Specialties	312	O5	OK Machine & Tool	153, 155	T35	Tufts Radio Electronics	225-248
A26	Amidon Associates	209	E31	ETCO Electronics	297	O3	Optoelectronics, Inc.	301	T3	Tufts Radio Electronics/Edgecom	59
A62	Antenna Specialists	32	F5	Flesher Corporation	170, 269	P15	Pace-Traps	170	T45	Unarco-Rohn	91
A6	Apron Laboratories	294	G12	Germentown Amateur Supply	36	P30	Palomar Electronics	17	U2	United Products	295
A50	Associated Radio	308	G4	Godbout Electronics	304	P1	Palomar Engineers	13	U8	Universal Amateur Radio Service, Inc.	209
A63	Astral Electronics Corporation	315	G19	Gotham, Inc.	101	P41	P.C. Electronics	290	U6	Vanguard Labs	290
A64	Aureus Electronics, Inc./Edgecom	79	*	HAL Communications Corp.	273	*	PCF	261		VHF Engineering	19
B23	Barker-Williamson	197	H24	Hal-Tronix	259	P2	Poly Paks	307	V1	VHF Engineering/Edgecom	53
B32	Bay-Com	170	H2	Ham Radio Center	272, 309	P26	Printed Circuit Products	294	V18	Wacom	275
B29	Britt's 2-Way Radio	251	H16	Hamtronic, NY	299	P21	Priorly One	167, 169	W15	Westcom Engineering	25
B8	Bullet Electronics	300	H8	Hamtronic, PA	200-208	Q3	Quest Electronics	294	W17	Western Electronics	92
B30	Burghardt Amateur Center	135	H26	Hartwell's Office World	275	O6	Quik-Key	129	W18	Willson Electronics	3
C88	C & A Electronic Enterprises	111	H5	Heath Company	195	R1	Radio Amateur Callbook, Inc.	311	W2	Xitex	292, 293
C3	Clegg	36, 119, 272	H3	Henry Radio	C11, 95	*	Radio World	170	X1	Yaesu Electronics Corp. CIII, 37, 93	
C21	Coakit	290	I1	ICOM	7	R10	Rainbow Industries	185	Y1	ZZZ Electronics, Inc.	90
C83	Cohoon Amateur Supply	224	I27	Instant Software	120, 121	R8	Ramsey Electronics	217, 298	Z1		
C95	Cohoon Amateur Supply/Edgecom	47	J1	Integrated Circuits	306	R15	Rolln Distributors	88			
C75	Comm Center, Laurel	290	J2	IRL	197	R21	Rush Electronics	197			
C58	Communications Center, NE	125, 280	K13	Island Antennas	170	R18	R. W. Electronics, Inc.	91			
C96	Communications Center, NE/Edgecom	73	K14	Jameco Electronics	305	S63	Semiconductors Surplus	314			
C89	Communications Services	292	L9	Jan Crystals	19, 275	S39	Sere-Rose & Spencer Electronics	269			
C6	Communications Specialists	10, 11	L17	JRS Electronics	290	S33	S-F Amateur Radio Services	92, 315			
C90	Curtis Electro Devices, Inc.	19	M35	Kantronics	32, 46, 251	S33	Slep Electronics Company	269			
D6	Peter W. Dahl Company	36	M36	Kenwood	CIV, 5	S4	Spectrum Communications	140, 141			
D35	Daytapro Electronics, Inc.	278	M56	Key Electronics	170	S4	SST Electronics	209, 266, 267			
D10	Davis Electronics	292	M52	Long's Electronics	176-181	S8	O. C. Stafford Electronics	269			
D31	Delaware Amateur Supply	269	M58	Lunar Electronics	271	S10	Standard Communications	123			
				Madison Electronics Supply	33	S10	Steven Products	275			
				Maggiore Electronic Labs	194	S50	Stuart Electronics	13			
				Marko Manufacturing, Inc.	197	S18					
				MFJ Enterprises	89, 266, 293	S64					
				Micro-Keyer	278	S38					

*Reader Service inquiries not honored.

From 73. Pages 315-322

BOOKS, ETC.

BK1016	73 DIPOLE & LONG WIRE ANTENNAS	\$ 5.50	QW0500	QSL CARDS—STYLE W—500	\$13.95
ST0000	73 BACK ISSUE	\$ 3.00	QX0250	QSL CARDS—STYLE X—250	\$ 8.95
ST2500	73 BACK ISSUES—25 OUR CHOICE	\$10.00	QX0500	QSL CARDS—STYLE X—500	\$13.95
ST0500	73 BACK ISSUES—5 YOUR CHOICE	\$ 5.00	QY0250	QSL CARDS—STYLE Y—250	\$ 8.95
ST1000	73 BACK ISSUES—10 YOUR CHOICE	\$12.00	QY0500	QSL CARDS—STYLE Y—500	\$13.95
ST2501	73 BACK ISSUES—25 YOUR CHOICE	\$20.00	BK7345	REPEATER ATLAS	\$ 1.95
BK7307	BEHIND THE DIAL	\$ 4.95	BK1044	RF DIGITAL TEST EQUIPMENT	\$ 5.95
BN1001	BINDER—73—1	\$ 6.50	BK7347	RTTY HANDBOOK	\$ 5.95
BN1002	BINDER—73—2&UP	\$ 6.00	BX1000	SHELF BOX—1	\$ 2.00
BK7309	CHALLENGE OF 160	\$ 4.95	BX1001	SHELF BOX—2	\$ 1.50
CT7305	CODE TAPE—5 WPM	\$ 4.95	BX1002	SHELF BOX—8 UP	\$ 1.25
CT7306	CODE TAPE—6 WPM	\$ 4.95	BK7351	SSB THE MISUNDERSTOOD MODE	\$ 5.50
CT7310	CODE TAPE—10 WPM	\$ 4.95	BK7354	SSTV HANDBOOK (HARDCOVER)	\$ 7.00
CT7313	CODE TAPE—13 WPM	\$ 4.95	BK7355	SSTV HANDBOOK (SOFTCOVER)	\$ 5.00
CT7320	CODE TAPE—20 WPM	\$ 4.95	CT7350	SSTV TAPE	\$ 5.95
CT7325	CODE TAPE—25 WPM	\$ 4.95	SG1081	STUDY GUIDE—ADVANCED CLASS	\$ 5.95
CT7399	CODE TAPE—LEARN MORSE CODE	\$ 4.95	SG1080	STUDY GUIDE—EXTRA CLASS	\$ 5.95
CT7394	CODE TAPES (ANY FOUR ABOVE)	\$15.95	SG7358	STUDY GUIDE—GENERAL CLASS	\$ 5.95
BK7321	GUIDE TO HAM RADIO	\$ 4.95	SG7357	STUDY GUIDE—NOVICE CLASS	\$ 4.95
BK7325	HOW TO BUILD A MICROCOMPUTER	\$ 9.95	LB7359	TEST EQUIP LIB V1—COMP TESTERS	\$ 4.95
BK1028	IC OP AMP COOKBOOK	\$12.95	LB7360	TEST EQUIP LIB V2—AUDIO TESTERS	\$ 4.95
BK7380	INTRO TO RTTY	\$ 2.00	LB7361	TEST EQUIP LIB V3—RADIO EQUIP.	\$ 4.95
CT7300	NOVICE THEORY TAPES	\$15.95	LB7362	TEST EQUIP LIB V4—IC TEST EQUIP.	\$ 4.95
BK1100	PRACTICAL TEST INSTRUMENTS	\$ 4.95	BK1069	VERTICAL BEAM & TRIANGLE ANTNS.	\$ 5.50
BK7302	PROPAGATIONS WIZARD'S HANDBOOK	\$ 6.95	BK7368	VHF ANTENNA HANDBOOK	\$ 4.95
QW0250	QSL CARDS—STYLE W—250	\$ 8.95	BK7370	WEATHER SATELLITE HANDBOOK	\$ 4.95

SEND FOR YOUR FREE PRODUCT CATALOGS

Return this card to receive full information on the many products advertised in this issue. Simply circle the Reader Service # below for each advertised product. The codes appear in the index of advertisers on the facing page, and near the company's logo on the ad pages. Please provide full address and zip. (Limit: 25 requests) Subscriber Newsstand

A1	A55	C3	D6	E12	H8	K13	M56	P2	R10	S39	T35	W15
A2	A60	C6	D10	E19	H16	K14	M57	P15	R15	S43	T44	W17
A6	A62	C21	D15	E31	H24	L9	M58	P21	R18	S50	T45	W18
A24	A63	C58	D20	F5	H26	L17	M62	P26	R21	S63	U2	X1
A26	A64	C75	D23	G4	I1	M35	N2	P30	S4	S64	U6	Y1
A34	B8	C83	D25	G12	I9	M36	N7	P41	S8	T3	U8	Z1
A40	B23	C89	D29	G19	I27	M41	N14	Q3	S10	T13	V1	
A46	B29	C90	D31	H2	J1	M48	O3	Q6	S18	T18	V5	
A47	B30	C95	D35	H3	J2	M52	O5	R1	S33	T33	V18	
A50	B32	C96	E1	H5	J8	M55	P1	R8	S38	T34	W2	



This month's ARTICLE WINNER (title page number): _____

Name _____

Address _____

City _____ State _____ Zip _____

S10



FIRST CLASS
Permit No. 17
Peterborough NH 0345B

BUSINESS REPLY MAIL

No postage stamp necessary if mailed in the United States

Postage will be paid by

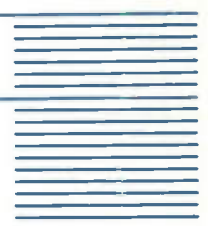

**44 Main Street
Peterborough NH 03458**

Attn: Mail Order

SEND FOR YOUR FREE PRODUCT CATALOGS

Return this card to receive full information on the many products advertised in this issue. Simply circle the Reader Service # below for each advertised product. The codes appear in the index of advertisers on the facing page, and near the company's logo on the ad pages. Please provide full address and zip. (Limit: 25 requests) Subscriber Newsstand

A1	A55	C3	D6	E12	H8	K13	M56	P2	R10	S39	T35	W15
A2	A60	C6	D10	E19	H16	K14	M57	P15	R15	S43	T44	W17
A6	A62	C21	D15	E31	H24	L9	M58	P21	R18	S50	T45	W18
A24	A63	C58	D20	F5	H26	L17	M62	P26	R21	S63	U2	X1
A26	A64	C75	D23	G4	I1	M35	N2	P30	S4	S64	U6	Y1
A34	B8	C83	D25	G12	I9	M36	N7	P41	S8	T3	U8	Z1
A40	B23	C89	D29	G19	I27	M41	N14	Q3	S10	T13	V1	
A46	B29	C90	D31	H2	J1	M48	O3	Q6	S18	T18	V5	
A47	B30	C95	D35	H3	J2	M52	O5	R1	S33	T33	V18	
A50	B32	C96	E1	H5	J8	M55	P1	R8	S38	T34	W2	



This month's ARTICLE WINNER (title page number): _____

Name _____

Address _____

City _____ State _____ Zip _____

S10

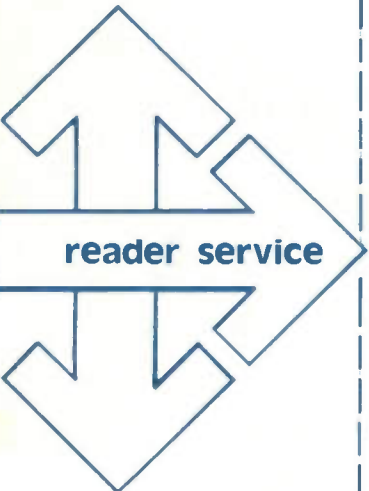

FRG-7

COMMUNICATIONS RECEIVER



SYNTHESIZED ALL SOLID STATE HI-PERFORMANCE GENERAL COVERAGE RECEIVER AND QTR-24 WORLD CLOCK

The Model FRG-7 is a precision-built communications receiver with continuous coverage (500 kHz to 29.99 MHz) featuring:

- Drift Canceling Circuit
- RF Attenuator
- Noise Suppression Circuit
- 5 kHz Direct Dial Readout
- Ceramic IF Filters
- AC-DC or Internal Battery
- Hi Sensitivity
- Excellent Stability
- USB/LSB/AM/CW
- Triple Conversion

Completely Solid State Circuitry for Stable Trouble-Free Operation ■ Built-in Front Mounted Speaker ■ RF Attenuator for Reception of Local or High Powered Stations ■ Outstanding Frequency Stability through the use of Drift Cancellation Circuit (Wadley Loop) ■ Recording Output Jack provides Constant Output Level Regardless of Audio Volume Control Settings ■ 3-Position Audio Range Selector 1. Normal (Broad) 2. Narrow (Hi & Low Cut Off) 3. Low (Hi Cut Off) ■ Excellent IF Receiver for VHF/UHF Converters.



YAESU *The radio.*

YAESU ELECTRONICS CORP., 15954 Downey Ave., Paramount, CA 90723 • (213) 633-4007
YAESU ELECTRONICS Eastern Service Ctr., 9812 Princeton-Glendale Rd., Cincinnati, OH 45246

TS-700SP



STILL THE SAME FINE, TIME PROVEN RIG. BUT NOW WITH THE SIMPLE ADDITION OF A PLUG-IN CRYSTAL, THE TS-700SP WILL BE ABLE TO UTILIZE THE NEW REPEATER SUBBAND (144.5 TO 145.5 MHz). STILL FEATURES ALL OF THE FINE ATTRIBUTES OF THE TS-700S: A DIGITAL FREQUENCY DISPLAY, RECEIVER PRE-AMP, VOX, SEMI-BREAK IN, AND CW SIDETONE. OF COURSE, IT'S ALL MODE, 144-148 MHz, VFO CONTROLLED... AND KENWOOD QUALITY THROUGHOUT.

TS-520S

AND DG-5 DIGITAL FREQUENCY DISPLAY

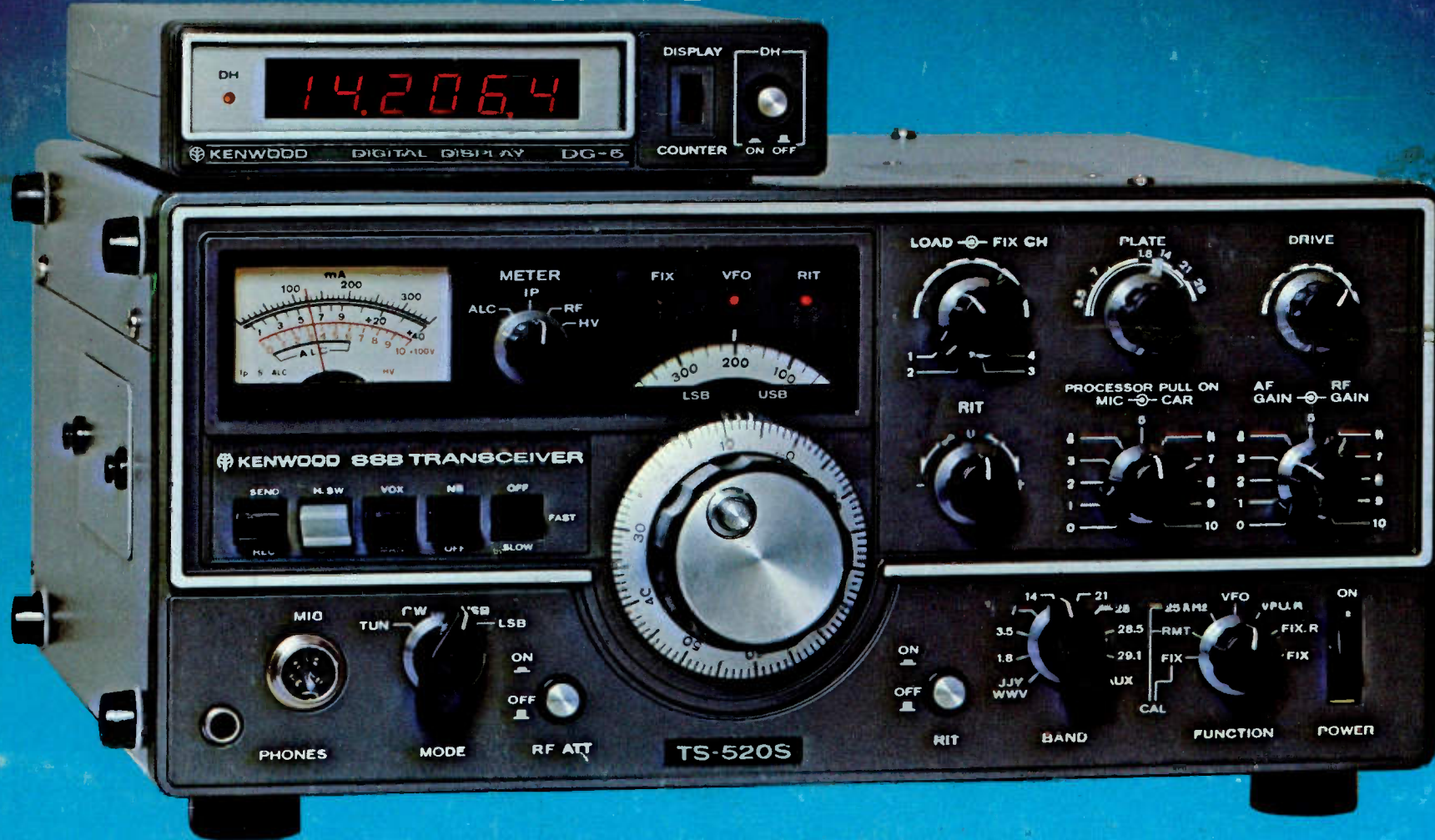

BASED ON THE CONCEPT OF THE WORLD FAMOUS TS-520 ECONOMY TRANSCEIVER. THE SAME SUPERB PERFORMANCE AND RELIABILITY... EVEN GREATER VERSATILITY... PLUS NEW FEATURES INCLUDING THE OPTIONAL DIGITAL FREQUENCY DISPLAY... UNMATCHED COST PERFORMANCE. AN UNSURPASSED VALUE.

TRIO-KENWOOD COMMUNICATIONS INC. 1111 WEST WALNUT/COMPTON, CA 90220

 **KENWOOD**
...pacesetter in amateur radio