

# 73

## magazine for radio amateurs

\$1.00  
May 1973

26009



VHF REPEATER  
SC-A RPT-1

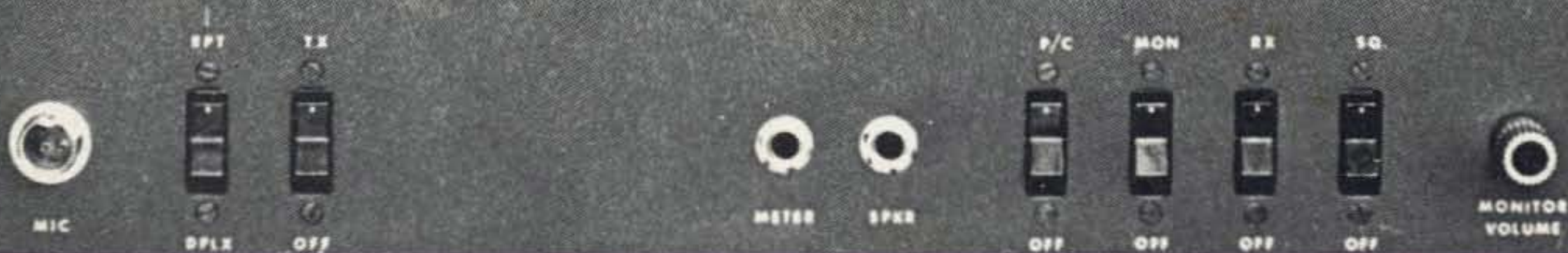

**for over 20 years we've  
been designing VHF-FM  
antennas for some  
pretty tough customers.**

**we know  
you're just as tough.**

A product in the amateur market gets a reputation very quickly. It measures up to what you expect in engineering, performance and quality — or else. That's why A/S amateur antennas are built to the identical design and construction standards as their commercial counterparts. Standards that have made them specified for more police and public safety vehicle installations than all other brands combined.

**HM-177  
2 Meters**

Features new high conductivity copper and nickel coated 17-7 PH stainless steel whip. Shunt fed coil encased in waterproof PVC jacket. All fittings chrome plated brass. Easy snap-in mounting. 3 dB gain.\*



**NEW! HM-223  
1 1/4 Meters  
(220 MHz)**

High performance 5/8 wavelength design for the new 220 MHz activity! Directly fed with low loss coil in new low-profile design. Spring and whip easily removable leaving only 1 3/16" high base for car wash clearance. 3 dB gain.\*



**HM-175  
3/4 Meters**

Collinear design with truly hot performance! Base fittings have silver plated contacts. Can handle 100 watts. Whip and phasing coil assembly is a one piece molded design to resist vibration and moisture. 5 dB gain.\*



**HM-4  
2 Meters**

Tough, virtually indestructible antenna for hand-helds. Completely insulated. Base fitting matches Motorola HT, E. F. Johnson, and Standard portables.



**HM-5**

Same as above but for Drake and other packset portables with SO-239 fittings.

**NEW ASCOM® TOWERS**

High strength, low maintenance aluminum towers for HF and VHF antenna installations. There is a complete line of ASCOM self-supporting towers — in heights from 30 to 90 feet — at attractive prices!

\*Measured over a 1/4 wavelength whip

WRITE FOR FREE AMATEUR ANTENNA  
and/or TOWER CATALOGS



**the antenna  
specialists co.**

© "Stripes of Quality"

Division of ORION INDUSTRIES, INC., 12435 Euclid Ave., Cleveland, Ohio 44106

Export: 2200 Shames Dr., Westbury, L.I., New York 11590 Canada: A. C. Simmonds & Sons, Ltd.

### EDITORIAL STAFF

Wayne Green W2NSD/1  
Keith Lamonica W7DXX/1  
Ron Subka WA9FPP/1  
Yvette Grimes WA8ULU/1

### ASSOCIATES

Gus Browning W4BPD  
Mike Frye WB8LBP  
Bill Hoisington K1CLL  
Dave Ingram K4TWJ  
Jim Kyle K5JKX  
Harry Simpson A4SCF  
Bill Turner WA0ABI  
Jim Weir WB6BHI

### PRODUCTION

Ruthmary Davis  
Karen Hebert  
Biff Mahoney  
Janet Oxley  
Lynn Panciera-Fraser  
Philip Price  
Cynthia Schlosser  
Alexandra Schmidt  
Bill Suderman  
Bill Sundberg

### BUSINESS

Gigi Sage

### CIRCULATION

"Ace" Goodwin W1GRO  
Barbara Block  
Dorothy Gibson

### TRANSPORTATION

Kurt Schmidt

### PROPAGATION

John Nelson

### DRAFTING

T.M. Graham W8FKW  
Bill Morello  
Wayne Peeler K4MWW

### Cover:

The new 220 rigs pictured on this month's cover are, from left to right, the Tempo CL220, Clegg FM-21, Gladding 220 and the Drake ML-220. Below is the first 220 repeater, manufactured by Standard Communications.

## FEATURES

- |                         |                             |
|-------------------------|-----------------------------|
| 2 Amateur Radio News    | 12 Hamburglar               |
| 5 Never Say Die W2NSD/1 | 12 Traveling Ham            |
| 5 SSTV Scene            | 12 Ham Help                 |
| 6 50 MHz Band           | 13 Looking West             |
| 7 DX Footnotes          | 14 Social Events & Contests |
| 8 AMSAT News            | 15 New Products             |
| 8 Novice                | 107 Caveat Emptor           |
| 10 Repeater Update      | 109 Letters                 |
|                         | 144 Propagation             |
- 
- |                                                                     |         |
|---------------------------------------------------------------------|---------|
| 19 Mobile Burglar Alarm System . . . . .                            | WA4SAM  |
| Belt beeping burglar baffler.                                       |         |
| 25 The Burst Box . . . . .                                          | WA7NMO  |
| A real tone-ic for the FMer.                                        |         |
| 29 Power Inverter w/Sine Wave Output . . . . .                      | W70XD   |
| For people with short extension cords.                              |         |
| 33 450 MHz Preamp . . . . .                                         | WB6BIH  |
| 10 dB gain on the receiver is a lot easier than on the transmitter. |         |
| 39 Roof Mounted VHF Whips . . . . .                                 | WB6HYD  |
| Phacts and phallacies.                                              |         |
| 47 LED Readout Crystal Switch . . . . .                             | WA3AJR  |
| Make everyone green with envy.                                      |         |
| 53 Voltage Limit Sensor . . . . .                                   | W4UXJ   |
| Car battery warning light.                                          |         |
| 55 Build a Digital Clock with 19 inexpensive ICs . . . . .          | WA6QVQ  |
| Is the round clock doomed?                                          |         |
| 61 Portable Use for the HR-2A . . . . .                             | W2KPE   |
| Judi Repeater approves of this.                                     |         |
| 63 Fixed and Mobile 2m Antennas . . . . .                           | WB8HEE  |
| How to make your car look ridiculous.                               |         |
| 65 Two Meter FM Transmitter . . . . .                               | WB6BIH  |
| Roll your own.                                                      |         |
| 71 Mini-Repeater Control System, Part II . . . . .                  | WA0ZHT  |
| Have you read the book yet?                                         |         |
| 81 Audio Boost for Mobile Transceivers . . . . .                    | W2EEY   |
| Mobile audio booster IC.                                            |         |
| 83 6m 5W Amplifier . . . . .                                        | K1CLL   |
| For the kitchen table builder.                                      |         |
| 89 Hand Transceiver Madness . . . . .                               | W2NSD/1 |
| Got yours yet?                                                      |         |
| 93 QRP on 180 kHz . . . . .                                         | W5SOT   |
| Tried 1700m yet?                                                    |         |
| 97 Solid State Automobile Burglar Alarm . . . . .                   | WA1KON  |
| Blows horn or siren.                                                |         |
| 105 Circuits, Circuits, Circuits . . . . .                          | WR1AAB  |
| Keep 'em coming.                                                    |         |

73 Magazine is published monthly by 73, Inc., Peterborough, New Hampshire 03458. Subscription rates are \$7 for one year in North America and U.S. Zip Code areas overseas, \$8 per year elsewhere. Three years, \$14, and \$16 overseas. Second class postage paid at Peterborough NH 03458 and at additional mailing offices. Printed at Menasha, Wisconsin 54952 U.S.A. Entire contents copyright 1973 by 73 Inc., Peterborough NH 03458. Phone: 603-924-3873. Microfilm edition of 73 available from University Microfilms, Ann Arbor, MI 48106. Magnetic tapes available from Science for the Blind, 221 Rock Hill Rd., Bala Cynwyd PA 19004. The nude cover is still in the works — so eat your heart out, if you are that kind of a debased person — or live one more month in fear if you are a gay libber or the mere sight of a girl is disgusting to you, as some readers have admitted. This month's cover emphasizes the progress that is being made in 220 gear — with four of the 220 rigs and the first 220 repeater. More, much more, is coming — so think 220. FCC action on the possible CB occupancy of the low end of our 220 band is imminent — will it be delaying tactics or will it be the dreaded docket?

# Amateur Radio

MAY MCMLXXIII

Monthly Ham

## TVI BILL

We've got a TVI Bill in the 93rd Congress, reintroduced by Congressman Teague of California. Its number in the current session is HR 3516. Except for the number, it is identical to HR 16916 (92nd Congress). As was the case last year, the Bill was referred to the House Interstate and Foreign Commerce Committee.

Now we have to go to work. We have to convince the Chairman of this committee to hold a hearing. But this will take letters . . . and lots of them. Letters from clubs, individuals, amateurs and non-amateurs alike; we have to flood the Chairman's desk with letters of support. Send your letters and petitions to your Congressman as well as to: The Honorable Harley O. Staggers, Chairman, House Interstate and Foreign Commerce Committee, 2366 Rayburn Building, Washington, D.C. 10515 and to The Honorable Torbert H. MacDonald, Communications and Power Sub-Committee, Room 215, Rayburn Building, Washington, D.C. 20515.

## TWO METER TUNE-UP CLINIC

The Naval Research Laboratory Amateur Radio Club, W3NKF, will sponsor a 2 meter tune-up clinic on Saturday morning, May 19, 1973 from 9:00 a.m. to 12:00 noon. All amateur radio operators are cordially invited to bring in their rigs for calibration using the latest available test equipment. Club personnel will provide assistance with transmitter checks and adjustments for frequency, deviation and power output. Auto-patch frequencies will also be checked. Facilities will be available for testing either indoors or directly from the mobile so that removal of semi-permanently mounted installations will not be necessary. There will be no charge for this service.

Also, many NRL scientific displays of general interest to amateurs will be on exhibit including displays such as SSTV, color television, moonbounce and automatic Morse conversion.

### H.R. 3516 A BILL

To amend the Communications Act of 1934 to require that radio and television receivers meet certain technical standards for filtering out interference.

*Be it enacted by the Senate and House of Representatives of the United States of America in Congress assembled,* That section 303(s) of the Communications Act of 1934 is amended by inserting "(1)" after "(s)" and by adding at the end thereof the following:

"(2) Have authority to require that apparatus designed to receive broadcasts comply with standards of the Commission under this paragraph (2), when such apparatus is shipped in interstate commerce, or is imported from any foreign country into the United States, for sale or resale to the public. Standards under this paragraph shall be prescribed by rule for the purpose of requiring the filtering out of interference. Such standards shall include a requirement that all interference from any amateur station, and any citizens radio service station, operating on its assigned frequency, be filtered out."

## HAM

## SCHOLARSHIPS

The Foundation for Amateur Radio, Inc., a non-profit organization with its headquarters in Washington, D.C., announces its intent to award three scholarships for the academic year 1973-74. All amateurs, wherever resident in the U.S. and holding an FCC license of at least General class, can compete for one or more of the awards.

The John W. Gore Scholarship pays \$500. Applicants must intend to pursue a career in electronics or a related science and have completed at least one year in an accredited college or university.

The Richard G. Chichester Scholarship pays \$250. Applicants must be a member of the ARRL and be sponsored by an ARRL-affiliated club. There is no restriction on the course of study, but applicants must be enrolled in or have been accepted by an accredited university, college or technical school.

The FAR Technical Scholarship pays \$200. Applicants must have been accepted or enrolled in an accredited technical school.

Application forms can be requested from the Chairman, Scholarship Committee, 8101 Hampden Lane, Bethesda, Maryland 20014. Requests must be postmarked prior to June 1, 1973.



The largest amateur radio club in the east with over 400 members is the Northern Virginia FM Association, Inc. (NVFMA). The repeater is located near Washington, D.C. in Tysons Corners, VA on 146.31-91. From left to right in the first photograph are the officers: Bud K4ASU, treasurer; Don WB4QAX, president emeritus; Charlie W4YEB, director; John K4GGY, president; Bob W4GPD, director; Thom K4LHB, vice president. At the right is newly elected director Walt W3PWB.

# News Pages

News of the World

73 MAGAZINE

## LANCASTER HAMFEST

Hundreds attended the first winter hamfest in Lancaster County PA on Feb. 11th. It was sponsored by SERCOM of Lancaster County who operates the 01-61 repeater for the community and the local CD RACES unit. Highlights were an amateur TV demonstration and a two meter FM information session also attracted interest. Amateurs from as far away as New York State and Washington, D.C. made their way to the Naval Reserve Center in Lancaster.



Amateur TV demonstration by Ron Cohen K3ZKO of Philadelphia PA and George Gadbois W3FEY and Allen McQuate K3HOC, both of Lancaster, and employed at RCA. They supplied one of RCA's newest TV camera systems for the demonstration.

## HAM OPERATOR SETS WHEELS IN MOTION TO AID HEMOPHILIAC

From the L.A. Times, 3/5/73

A young man was bleeding to death on a hospital bed in Guatemala, and doctors were unable to staunch the flow completely.

German Daniel Corso, 20, a hemophiliac, suffered an injured leg in a traffic accident in Guatemala City. Doctors were forced to amputate the leg. They gave him plasma, and hoped, but Corso continued to lose blood steadily.

As the young man lay dying on March 3rd, ham operator Harold Walker of Canoga Park was tuning around on his radio. He was hoping to make contact with Australia, when he stopped to listen to the excited voice of a woman with a Spanish accent.

The woman, Anna Maldonado, of Guatemala City, was telling an Arcadia ham, Peter Grillo, how a hemophiliac was dying and no medicine was available to stop the bleeding.

Grillo and another local ham, John Alexander of Palos Verdes Estates, were wondering how to find a doctor who knew where the medicine was available. Walker broke into the transmissions.

"I know a doctor," Walker told them. "I'll try to get him."

It was just after midnight Sunday morning when Dr. Don Michaelson got to Walker's home and on the radio. After talking with Mrs. Maldonado, he knew young Corso needed a medicine called Proplex, which came from a Los Angeles laboratory.

A plane was ordered from Travis AFB and much red tape was encountered, and cut, that involved getting the C-130 across Mexico into Guatemala on such short notice.

The next evening they got the word: The C-130 had delivered the Proplex to Guatemala City and the medicine was being given to young Corso. Doctors said he would recover.

## NORTHERN CANADA TO ADD TWENTY AMATEUR STATIONS

(CARF News Service)

Government employees being posted to isolated stations will soon be able to keep in touch with things "back home" via amateur radio stations now being supplied at some twenty locations in various provinces and the Territories.

DOC will issue amateur calls, with an official of the Ministry of Transport in Ottawa, Frank Lay, VE3ZN, as licensee. A series of 3-letter suffixes will be available in order to readily identify these stations to other amateurs. The suffix block "MTA" to "MTL" will be assigned, with the usual prefix "VE," plus the district digit. The stations will be operated only by holders of amateur tickets.

There are already a number of isolated post amateur stations in the Northwest Territories; VE8ML at Alert; VE8MB, Resolute; VE8MD at Isaachsen, VE8MC at Mould Bay and VE8MA at Eureka are at far north weather stations under the Department of the Environment. There are two Canadian Coast Guard vessels, VE0MC and VE0MZ. These will be joined by the twenty additional stations for the following posts: Battle Harbour and Sable Island in the MOT Atlantic Region; Inoucdjouac, Lake Eon, Nitchequon, Resolution Island and Poste-de-la-Baleine in the Quebec

Region; Baker Lake, Chesterfield Inlet, Coral Harbour, Ennadai Lake in the Central Region; Sachs Harbour, Fort Good Hope, Tuktoyaktuk, Wrigley, Coppermine and Cambridge Bay in the Western Region; Bull Harbour, Ethelda Bay and Spring Island in the Pacific Region.

## LEAD POISONING AVERTED

From the Knoxville News-Sentinel

A Knoxville ham radio operator recently accidentally heard an emergency call for help from an Argentine hospital — triggering a series of events resulting in a 6-year-old girl's life being saved through international Good Samaritanism.

Harry Kroll was trying to contact a Venezuelan missionary when he heard an Argentine official pleading for help from anyone who could provide an antidote for lead poisoning.

Mr. Kroll took notes about the emergency plea and called University Hospital's emergency department here. The hospital, in turn, contacted Mt. Sinai Hospital in Miami and the hospital there managed to get the antidote on a plane to Argentina.

# COMPANIONS FOR CLEGG'S FM 27B TRANSCEIVER AND ALL 2 METER RIGS

## POWER SUPPLY

Clegg's Model 011 Power Supply delivers a highly filtered, regulated source of 13.5 volts for base station mobile radio sets handling up to 6.5 Amperes current. Model 011 offers reliable service with any of the popular 5 to 25 watt transceivers and many other devices which operate within the 011's voltage and current levels.

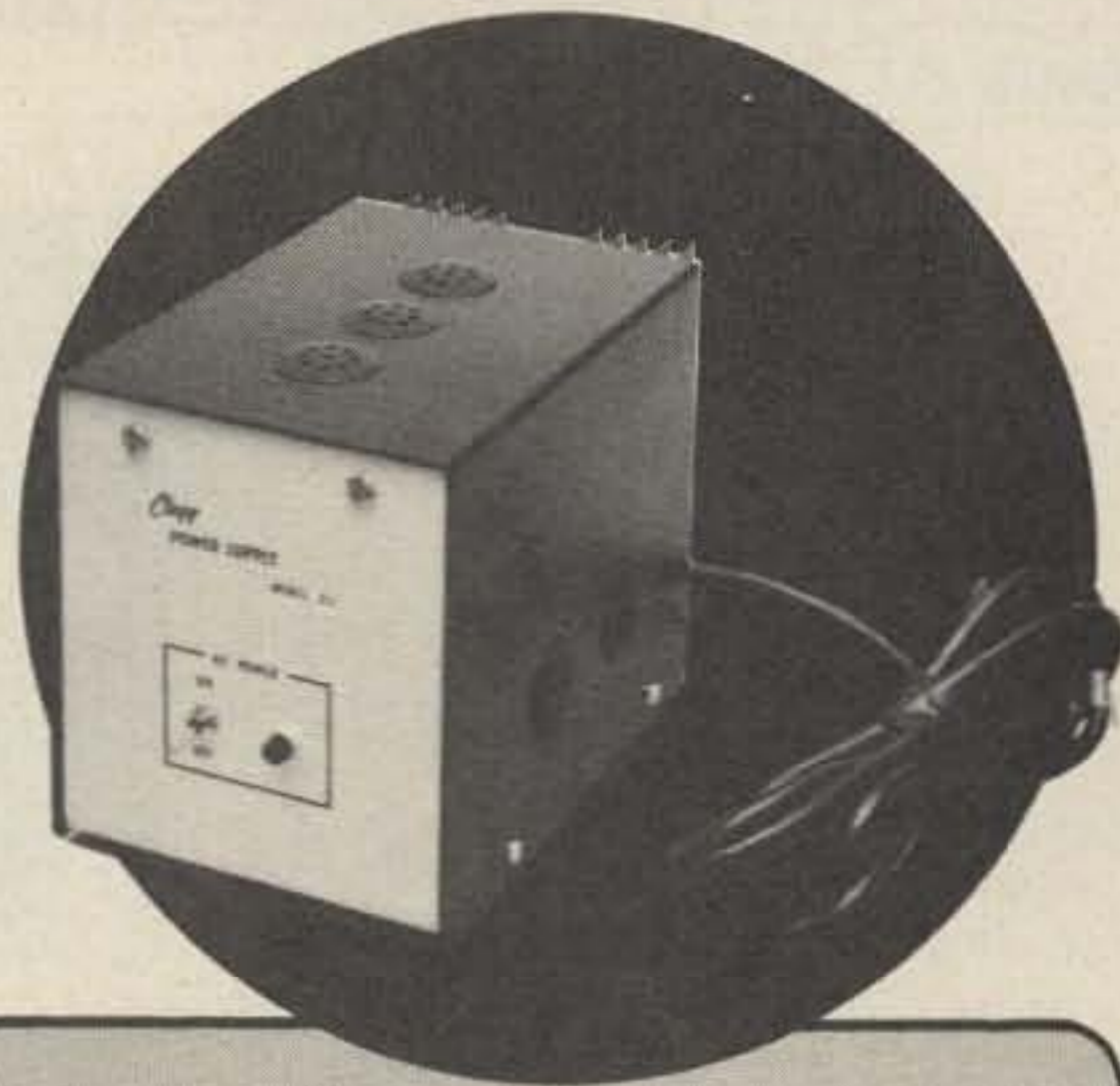

### SPECIFICATIONS:

**Output Voltage:** 13.5,  $\pm$  0.5 VDC / **Input Voltage:** 105-125 VAC, 60 Hz / **Maximum Current:** 6.5 Amps, DC  
**Regulation:** Less than 0.2 volt change: a. for load current from 100 Ma to 6.0 Amperes b. for line voltage from 105 to 125 volts with load current at 6.0 Amperes.  
**Output Ripple:** Less than 50 MV RMS at full load with 110 VAC supply  
**Amateur Net:** 79.95



### SPECIFICATIONS:

**Gain in Receive:** 14-18 dB  
**Pass Band:**  $\pm$ 3 dB, 143.5-148.5 MHz  
 —30 dB at 130 and 160 MHz  
**Noise Figure:** Less than 2.5 dB (typical)  
**Input/Output Impedance:** 50 ohms  
**V S W R on Xmit:** Less than 1.1  
**Insertion loss on Xmit:** Less than 0.1 dB  
**Power Required:** 10-15 VDC, 100 Ma  
**Connectors:** UHF Females SO-239  
**Amateur Net:** 47.50

## T/R BOOSTER ANTENNA PREAMPLIFIER

### *A Point About Receiving Sensitivity:*

The usable sensitivity of any receiving system is determined by the system's first stage Noise Figure. Typically, a 3 to 10 dB feed line loss exists between the antenna and receiver input. This must be added numerically to the receiver unit's attenuation to derive a realistic System Noise Figure. Many good 2 meter receivers have Noise Figures as low as 2 dB. Adding the attenuation of usual antenna/receiver interconnecting cable can result in as much as a 6 dB Noise Figure. Adding a preamplifier at the receiver barely improves the condition.

The Clegg T/R Booster Antenna Preamplifier is designed to establish a receiving Noise Figure where it counts—at the antenna, thereby avoiding feed-line loss. Relay actuated (in receive mode), 14 to 18 dB gain is provided with a 2-3 dB noise figure.



**Clegg** DIVISION

3050 Hempland Road  
 Lancaster, Pennsylvania 17601  
 (717) 299-3671 Telex: 84-8438

CLEGG—the PROFESSIONAL amateur line!



NEVER SAY DIE

...de W2NSD/I

EDITORIAL BY WAYNE GREEN

### ARRL IN BATTLE

While every effort is being made to keep the fight as secret as possible from the U.S. amateurs, the fact is that there is a power battle going on in Canada between the ARRL and the Canadian Amateur Radio Federation (CARF).

The League has successfully managed to sidetrack all past efforts to organize the amateurs of Canada — and they may be able to do it again. It all depends on how well the CARF is supported by the Canadians.

The issue at stake is the expansion of the Canadian phone bands in retaliation to the recent expansion of the U.S. phone bands. The ARRL is against it — and CARF is furious. They are angry enough to have sparked the Canadian Department of Communications into agreeing to poll all Canadian amateurs to find out whether the DOC should listen to the ARRL or CARF.

It may be a bit premature for CARF to bring on a showdown. They have just now started a monthly publication, *The Canadian Amateur*, and they might have done better to wait a year or so until they had built up a larger following. Amateurs interested in subscribing to TCA can do so for \$4 per year. The address is Box 356, Kingston, Ontario.

Since the need for separate Canadian phone bands has dwindled with the shift to sideband, the CARF may have seized upon a weak issue for the test of strength. Until the day comes when there are a significant number of Extra Class U.S. amateurs — a day that is not yet even within estimation — the U.S. Extra bands are empty enough to provide all of the isolation that Canadian amateurs might want. The concept of there being a U.S. phone band and a DX phone band began to fade away with the shift to sideband. In the old AM days, the U.S. phone band was a mess and foreign amateurs stayed out of it most of the time. Today the U.S. phone band is used world wide and little other than Spanish contacts seeping up from South America is heard in the DX phone band. And other than an occasional DXpedition,

you hardly ever hear a contact being made between the U.S. phone band and the DX band.

When there were large numbers of low powered VE ops using AM, there was a definite advantage to having a small separate preserve. Today, when sideband has wiped out that type of operation almost completely, there is little need for such exclusiveness.

Any DXpedition operator will tell you that it is exceedingly difficult to make contacts outside of the U.S. phone bands, even with DX stations. Moving below 14,200 brings a halt to the rush of contacts.

Well, it certainly is time for the VE amateurs to start deciding their own destiny and to get the ARRL out of their hair. It should be a matter of national pride, if nothing else. That should be of more importance than any possible interference from the mere handful of Extra Class licensees who are sharing the Canadian phone bands — only about 4% of the U.S. amateurs have the Extra.

### WR1AAB ISSUED!

The first repeater license issued went to WR9AAA in Joliet, who submitted an exhaustively thorough 75-page application. Lest amateurs think this was to be the best way to get a license, the second application accepted was for the old WA2SUR repeater in Manhattan. George and I made a trip to Washington in early December to find out the best way to submit an application and get it accepted. On the basis of this we held a symposium in New York on December 7th and spilled the beans for any repeater groups interested.

For some reason most repeater clubs seemed more interested in doggedly pursuing their ideas on filling out applications rather than trying to profit from our Washington visit. George did pay attention though, and in a few days he was ready with a very simple application. Not wanting to leave anything to chance he personally took it to the FCC in Washington and got them to check it out on the spot.

Continued on page 110.....

## U.S. AMATEUR FREQUENCY ALLOCATIONS

	CW Only	Phone & CW
Extra Class	3.500— 3.775	3.775— 4.000
	7.000— 7.150	7.150— 7.300
	14.000—14.200	14.200—14.350
	21.000—21.250	21.250—21.450
	28.000—28.500	38.500—29.700
	50.000—50.100	50.100—54.000
Advanced Class	3.525— 3.775	3.800— 4.000
	7.025— 7.150	7.150— 7.300
	14.025—14.200	14.200—14.350
	21.025—21.250	21.270—21.450
	28.000—28.500	28.500—29.700
	50.000—50.100	50.100—54.000
General Class	3.525— 3.775	3.890— 4.000
	7.025— 7.150	7.225— 7.300
	14.025—14.200	14.275—14.350
	21.025—21.250	21.350—21.450
	28.000—28.500	28.500—29.700
		50.100—54.000
Novice Class	3.700— 3.750	
	7.100— 7.150	
	21.100—21.200	
	28.100—28.200	

### SSTV Frequencies

	Suggested
3.775— 3.890	3.845
7.150— 7.225	7.220
14.200—14.275	14.230
21.250—21.350	21.340
28.500—29.700	28.680
50.100—54.000	

### LICENSE FEES

Initial License .....	\$ 9
Renewal .....	\$ 9
New Class .....	\$ 9
Modification .....	\$ 4
Special Call Sign .....	\$25

Use FCC Form 610 and mail with appropriate fee to:

Federal Communications Commission  
Gettysburg PA 17325

## SSTV SCENE

Dave Ingram K4TWJ  
Rte. 11, Box 499, Eastwood Vil. 50N  
Birmingham AL 35210

This month I would like to begin with a review of some "Getting Started in Slow Scan" information for our many newcomers. You can get started with only a monitor and tape recorder. (And some tapes with your call, picture, etc., possibly recorded by the same "source" as your monitor.) Later a camera or Flying Spot Scanner may be added so you can "go live" and make up new programs for changing pace. Cassette recorders (the

better quality ones) are handy, since separate "carts" for each program can be made up, end labeled and wall racked for instant use. If this same program is recorded on each side (direction) the cart will be rewinding while playing. Cassette speed (1 7/8 i p s) is slightly slow for absolute perfect sync stability, so a small amount of "jiggle" on vertical lines may be apparent on reproduced pictures. This can be reduced somewhat by using only top quality cartridges. Should you personally find this minute "jiggle" objectionable, a reel to reel recorder (preferably running at 7 1/2 or 15 i p s) might be the better choice for perfectly reproduced pictures. I would suggest separate reels for each "program," marked at their exact beginning and with leader tape. (You can write on paper leader with a ball-point pen.) A small label on the reel could show content. It would also be advisable to record (and play back) with the same size reels on each side, (feed and take-up) and only in the tape's middle portion for perfect reproductions.

Produced tape programs might include pictures of yourself, XYL, rig, city, and plenty of ID's. Some ID's could be catchy and snazzy; others (maybe for DX) would be better with white letters on a black background. Your call 3 or 4 times horizontally per frame would be quite effective also. When operating with these newly acquired tapes, try to describe them briefly before transmitting, so the other fellows will have some idea of what you are sending. Then usually 3 or 4 frames are sufficient for good copy without getting dull.

Although Slow Scan is one of the most fascinating modes of communication today, often we find ourselves falling into a "rut" as to program content. (Are we spending more time developing it than enjoying it?) Actually, there's no limit to the possibilities obtainable with just a camera and some time. A pet hamster would be good for some shots with the close-up lens (imagine *that* face filling your screen!) and what better way is there to pass along schematics on your pet projects. Understood, larger diagrams might require multiple frames, but these can be redrawn off the monitor screen after reception to "re-assemble" the full circuit. (What... you've never built something from a schematic received over the air?) That homebrew monitor you recently finished would be a natural for an SSTV program. Why not make up a tape on it, with different angular views, close-up details, and under chassis shots. In fact, practically everything of interest to visitors in

your shack would be a prime SSTV "subject."

Commercial Fast Scan TV stations have recently begun to use Digital Character Generators interfaced with teletypewriters for information print out on TV screens. Possibly you have seen this during newscasts or sports events, where weather conditions appear across the screen either mixed with the "weather girl" or on a black background. Naturally, items like this are applicable to Slow Scan, and experimentation is presently being conducted on interfacing teletypewriters to Slow Scan generators. Then you can just type out those ID's, QSLs, etc. from the old "mill." Watch for more info on this to appear by late '73 (and in 73!).

I'm sure most of you are familiar with Professor Fanti I1LCF, who writes the SSTV column for *CQ Elettronica* of Italy, the sponsor of the World Wide SSTV contest. Although he is still active in SSTV, he is also developing facsimile, plus writing a book on FAX. Franco would like to exchange ideas with those of you also working in FAX. Here's your chance to get in on weather satellite copy or develop FAX/SSTV converters. You might drop him a letter if you miss him on 21.300 kHz Thursdays at 1300 GMT, when he meets stateside schedules.

And, finally, a recently heard comment on 20 meters after an "operator mugshot" transmission on Slow Scan: "Mommy... buy me a face like that for Halloween!" Gad!

73, Dave, K4TWJ

---



---

## 50 MHz BAND

Bill Turner WA0ABI  
Five Chestnut Court  
St. Peters MO 63376

K0TVD comments on mild Aurora worked February 22nd and 23rd. Chuck managed to work Ron K0ALL of Fargo ND on CW and SSB on the 22nd and heard him again the following evening. Chuck says he is about half finished with a pair of 4-400A's and hopes to have them on the air in time for the June contest.

WA1EXN says Maine had an excellent Aurora on February 21st; he traded 20/9 reports with WB4YAB in Kentucky. The 22nd brought a weak repeat, CW quality only, with only 1's and 2's being heard. The 23rd the Aurora was again excellent but there was little activity. Art also mentions a marathon one-minute meteor burst at 1518Z on the 19th of February dur-

ing which he exchanged S9 plus reports with W8YUS and W3BWU. A total of 75 DX contacts were made during the first 60 days of the year.

Late word has been received to the effect that the 1973 West Coast VHF/UHF Conference will be held May 5th at the Pen and Quill Hotel, 3501 North Sepulveda Blvd, Manhattan Beach CA. Anyone wishing information should contact the conference chairman, WA6HXM, Box 2473, Palo Verdes Peninsula CA 90274.

The Central States VHF Society conference will be held August 17, 18 and 19 at the Mariott Inn, Bloomington MN. Further information is available from John C. Fox, W0LER, 321 109th Lane NW, Minneapolis 55433. The program this year includes talks on Es by W2BOC and WA5HMK, VHF-UHF solid state amplifiers by Roy Hejhall of Motorola and meteor scatter by W4LTU.

During the past month I have had some very interesting correspondence from ZL1Q1. Paul says he is one of about 12 ZL's active on 6 meters. He runs a homebrew transverter with 40 watts out from a single 6146. The receiving converter is solid state (FET's). The antenna is a four element Yagi at 40', the basic rig is a Yaesu FT-200. The New Zealand 6 meter band is 51-53 MHz, while in VK land it is 52-54 MHz. Paul's best DX to date is a VK5 at 2300 miles. As in many countries, the TV channels usurp portions of the 6 meter band (as we know it). This is not all bad, as Paul points out. New Zealand channel 1 sound is on 50.75 and has been heard in the KH6 and KL7 areas. This transmitter runs 100 KW ERP and makes an excellent beacon. Paul mentions too the jamming of New Zealand (40 MHz) police radio by the Chicago's Finest radio system. Paul normally listens at 52 MHz but does tune the entire ZL portion of the band. Normal operating times are 2100Z Sundays and about 1200Z several days during the week.

One can't help but wonder if the forming of Collins Radio Co. of Japan Ltd. in conjunction with Kyokuto Boeki Kaisha Ltd. for the purpose of producing maritime and amateur gear will produce any equipment for 6 meters. Collins has been out of the VHF field since the 62S1 was dropped several years back.

WA0ABI

---



---

DRBRMYU YJTRR HOGY  
DINDVTOQYOPMD EOAA NR  
TRZRZNRTRF SAA URST APMH.  
FPY HONDPM





Those of you who have worked your 73 countries in the first 73 days of 1973 should send in your list of the 73 countries so I can issue you the 73-73-73 award (remember the year 1973 is 73 magazine year). Maybe we should try to get President Nixon to make some sort of a "declaration" ! I bet if Goldwater was in this would "maybe" be done, because he understands such things.

The WTW is coming right along again and the applications are coming in very good. I still think this is the best DX award there is, because it can keep you busy on the various bands and modes. The big trouble with the ARRL 5BDXCC is when you make the 5BDXCC you have worked yourself out of a job ! With our WTW, you can keep on going. You will always have something to do.

We are still looking for DX Clubs to have as verification points in our WTW. We would like to have one in each USA call district, one for Canada and one in each of the foreign countries. A good way for these clubs to get a little publicity because we will list the various confirmation clubs in this magazine. I would not think the work load would ever become heavy with each call area having its own check-point. How about it, some of you "wide awake" DX Clubs ?

You fellows who operate on the low bands, fighting all the summertime QRN should keep in mind that the fellows in the southern hemisphere are not having any summertime QRN, they are in their wintertime, so you might have some good contacts with them if your ears and nerves can stand the strain. Watch out for them and give them a chance to work you without a lot of QRN.

If any of you know of any upcoming DXpeditions or other events that someone has planned for about 3 months in advance I sure would appreciate you letting me know because I would like to let the DXers know what's in store for them so that they can arrange to be at home when the "event" takes place. You would be very much surprised to know how many DX'ers seem to "get sick" when they know of a new country that's about to come on or is already on the air. Bill Orr at Eimac once told me that I almost shut down the whole Eimac plant when I showed up at a "rare" or new country. (They must have a lot of DX'ers working out there at Eimac.)

The Old Sun Spot cycle is showing its stuff, and is on its way downhill. Sure hope most of you have worked the 10 meter band dry and are doing the same right now on 15 because, "it wont be long" before the DX will just be non-existent on these bands. In fact it looks like the 10 meter band has already "had it" as far as the real good DX coming thru is concerned and I would guess that 15 meters will be in the same shape in a few more years from now. Even the good old 20 meter band will be a little "shaky" at times. If ALL the those sun spots would disappear we DX'ers would be in real trouble as far as working DX the usual way is concerned wouldn't we ? Let's all of us hope the sun never loses all of its spots. They are what gives us all that dx and it seems as if there is no way to fight it. I guess we all would have to go to Moon-bounce or satellite stuff when and if this ever happens. I guess this would be a real deal if there were enough DX countries operating by these modes.

Shortly now we will have our WTW country list printed up, and it will be designed in such a way that it can be used for your application for any of the WTW plateaus (WTW-100, WTW-200, WTW-300, phone or CW etc.) When they are done I will be glad to send you a few of them if you send me about 6 cents in stamps for EACH set of forms you request. You will observe that the WTW list of countries have a few that's not on the ARRL DXCC country list. Without going into a lot of details as to why, let's just say this is the WTW list of countries - OUR LIST, AMEN !

For those of you who are serious DX'ers there are a number of weekly, and semi-monthly publications, most of them are single or two page items they are known as "bulletins" and one of them is a weekly magazine. That last one is published, printed and edited by me - W4BPD, it has from 16 to 24 pages each week and since the lead date for news in this magazine is only a few days, it is natural that the DX news is the news of events that are taking place at the time you are reading it. Some of the other bulletins are the Long Island DX Club bulletin, the West Coast DX bulletin, Geoff Watts' news sheet, and there are a number of DX Clubs that at times print (usually mimeograph) bulletins about various DX events that should interest the serious DX'er. In the "gud ole days", the only way you could find about DX was for you to be on the air when it "popped" or else you just put on your headphones, opened up your RF gain, put your head down on the operating

table and very carefully scanned the band from one end to the other, and you kept on doing this hour after hour, listening for that very, very weak T3 signal, mixed up in QRM/N, hoping it would, maybe be AC4YN, FN8D, CR10 AA, C8YR, J8CA, PK6XX, VQ3PBD, FB8XX ( I got all these JUST LIKE THAT ! ) because there was no such a thing as any DX magazine or DX bulletins to let you know what good DX was coming up. Hunting DX these days is about like hunting doves in a "baited field" ! It is impossible for a monthly magazine to dish out DX info of some DX event that will take place in a few days or a week or so in the future. We would like to receive any announcements of up-coming DXpeditions that are some months in the future so that we can give out the good news to the DX gangs across the country. Please remember us and it will speed things up considerably if you shoot the news directly here to me (drawer DX, Cordova, S.C. 29039).

I hope all of you got SY1MA who operated at Mount Athos, it's a new one and is now considered as a country by ARRL towards their DXCC (and also a new country for our WTW, too.) I would think others will be going there now since the ice has been broken. Maybe now someone can get the doors opened to The Royal Order of The Knights of Malta who has a small (one city block) enclave right smack in the city of Rome, Italy. There are a number of similiar set-ups in the world, and it would be a fine idea as far as I, myself, am concerned to count 'em all as new countries, the more the better ! There is an Italian province (?), actually inside Switzerland, it's called Compion d'Italia and it's located on Lake Lugano. I was there under the call of IC1IN and after all the trouble getting the necessary license etc. ARRL said it was not a new country and my Italian friend who was along with me had to have a Passport to get there ! I think we will put it in our WTW list of countries. Around the world you will find many "Neutral Zones" - the Kyber Pass is one I have in mind, I was there and would have put it on the air if ARRL could have said it would count for a new country. Quite a few will be found around some of the Arab countries where they allow herds to graze when the grass happens to sprout up. Either country will allow their natives to go there whenever they want to without any passport, custom inspections etc. I would think since they are true "neutral zones" they should be called new countries.

C U ON THE LOW END  
de, *W4BPD*

# AMSAT NEWS

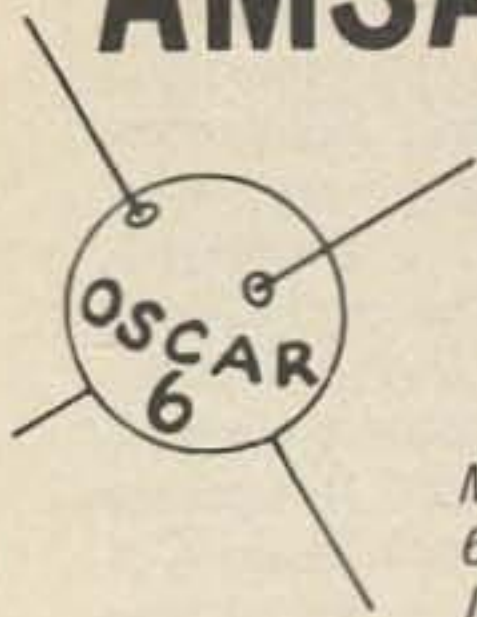

Michael Frye WB8LBP  
640 Deauville Dr.  
Dayton OH 45429

Something that must be remembered by those who read this column is that there is a two month delay between me writing it and your reading it. In a field as quickly changing as OSCAR 6 it is nearly impossible to have last minute news. However, since this can be obtained from the nets, the purpose of this column is to advise and attempt to interest more amateurs in participating actively in OSCAR 6. Since some amateurs are still just beginning, it provides a backlog of useful information.

Many amateurs are running some fine scores in the various contests through OSCAR 6. A full list will appear next issue with a rundown of hams who have won the ARRL OSCAR 6 "1000" award, plus hams who have records in counties contacted, etc.

## OSCAR 6 EQUATOR CROSSINGS

Period = 114.9946 minutes per orbit. Longitude increment = 28.7484 degrees per orbit.

Orbit	Date	Time (GMT)	Longitude of Equator Crossing °W
2396	Apr 25	0036	56.2
2409	Apr 26	0131	70.0
2421	Apr 27	0031	55.0
2434	Apr 28	0125	68.7
2446	Apr 29	0025	53.7
2459	Apr 30	0120	67.4
2471	May 1	0020	52.4
2484	May 2	0115	66.1
2496	May 3	0015	51.1
2509	May 4	0110	64.8
2521	May 5	0010	49.8
2534	May 6	0105	63.5
2546	May 7	0005	48.5
2559	May 8	0100	62.2
2572	May 9	0155	75.9
2584	May 10	0055	60.9
2597	May 11	0160	74.7
2609	May 12	0049	59.6
2622	May 13	0144	73.4
2634	May 14	0044	58.3
2647	May 15	0139	72.1
2659	May 16	0039	57.0
2672	May 17	0134	70.8
2684	May 18	0034	55.8
2697	May 19	0129	69.5
2709	May 20	0029	54.5
2722	May 21	0124	68.2
2734	May 22	0024	53.2
2747	May 23	0119	66.9
2759	May 24	0019	51.9
2772	May 25	0113	65.6
2784	May 26	0013	50.6
2797	May 27	0108	64.3
2809	May 28	0008	49.3
2822	May 29	0103	63.0
2834	May 30	0003	48.0
2847	May 31	0058	61.7

Once you have at least one solid contact through OSCAR 6 you are qualified to become a member of the Satellite Communications Club. Just send SASE along with date and time of contact and call sign of the station you worked to AMSAT, P.O. 27, Washington DC 20044. You will receive a nice certificate to hang on the wall of your shack.

Have you heard of, seen, or done anything notable or unusual with OSCAR 6, such as making contacts — using only a whip antenna or working through the satellite while riding on a bike? If so, please send the details to me. Also, if you have taken a lot of time and effort in setting up a nice station, send me a photo with you at the controls.

At this writing, the 435.1 MHz beacon is definitely out. There have been a lot of opinions as to the cause, but as of now nothing definite.

Has anyone observed any odd propagations connected with OSCAR 6? A few amateurs — unfortunately I don't have their calls — have observed what is possibly skip in various contacts. Anyone experiencing this or any other odd propagation please send date, time and call to me.

The Dayton Hamvention is promising to be one of the biggest and best this year. A whole list of programs is in the making. AMSAT will conduct a number of seminars that will prove to be interesting. A station is being set up at the Hamvention for working through the satellite, and a number of people will be there to help with any problems or compare notes. Take a day off and visit the Dayton Hamvention. See you there.

WB8LBP

## TOUCHTONE FOLLIES

Can man ever take an invention seriously? To quell the insatiable desire to (subvert?) — find new uses for old things, someone started tapping out tunes on their Touchtone telephone. The practice has apparently turned into a rage and commonly heard tunes are being uncommonly heard everywhere.

While it is obvious that the FCC would frown on an amateur serenading his girl over the local repeater because of the regulations restricting the transmission of music, what's to stop a group from setting up the access code for their machine to sound like "Mary Had a Little Lamb" . . . or for the larger repeaters, "Strangers in the Night"?

Either way, we'll be printing a few of the more popular songs in these pages strictly for your own amusement.

### MARY HAD A LITTLE LAMB

6 0 4 0 6 6 6  
Mar-y had a lit-tle lamb  
2 2 2 6 6 6  
Lit-tle lamb, lit-tle lamb  
6 0 4 0 6 6 6  
Mar-y had a lit-tle lamb  
6 8 8 6 8 4  
Its fleece was white as snow

### STRANGERS IN THE NIGHT

4 8 8 4 8  
Stran-gers in the night  
4 8 6 8 4  
Ex-chang-ing glan-ces

### AMERICA

5 5 6 1 5 9  
My coun-try, 'tis of thee  
0 0 8 0 8 4  
Sweet land of lib-er-ty  
8 4 2 4  
Of thee I sing



## novice

Schley Cox WN9LHO  
219 Kilgore Avenue  
Muncie IN 47305

At 0011 GMT the other night I called a WN8 in answer to his CQ. I didn't get a chance to give him his 479C signal report because he answered my call with a too-lengthy preamble and then sent "QRM 73 CUL" and then signed off the air. At 0015 I logged an end to my shortest contact on record outside the Novice Round-up.

I know that sometimes we get on the air and the dinner call suddenly comes 30 minutes early or the envelope starts to melt on the final amplifier tube, but I have a suspicion that sometimes the super-short contact is due to one or both operators having nothing to say.

Tradition has saved some new ops from mike fright by dictating that the RST, QTH and name be sent on the first transmission; the rig and antenna on the second; and finally heart-warming 73's and fervent CUL's on the third and last.

This is unfortunate unless there is a distinct need for brevity — e.g., contests, traffic or emergencies. There is a

# 2 Meter FM THE BIG THREE FOR '73!

## GTX-10

10 watts output power nom.; accommodates 10 channels; rotatable frequency selector; adaptable for portable operation (with HamPak, below).

**\$199.95**

(Includes 146.94 MHz)



## GTX-2

30 watts output power nom.; accommodates 10 channels; push-button frequency selection; back-lighted for night operation.

**\$249.95**

(Includes 146.94 MHz)



## GTX-200

30 watts output power nom.; accommodates 100 channel combinations; features independent selection of transmit and receive frequencies, and switch for pre-selected pairing.

**\$259.95**

(Includes 146.94 MHz)



## HamPak

Battery pack for GTX-10 portable operation. Uses 10 D cells (not included).

**\$39.95**

(Includes portable antenna, carrying handle & mike clip)



**\$6.50**

Additional Crystals per crystal for Xmit or receive

Made in U.S.A.  
In Facilities Inspected by U. S. Gov't.



**VISIT YOUR LOCAL AMATEUR DEALER  
AND MEET THE "BIG THREE" IN PERSON!**

General Aviation Electronics, Inc., 4141 Kingman Drive, Indianapolis, Indiana 46226 — Area 317 - 546-1111

# 73 REPEATER ATLAS REGISTRATION

REPEATER CALL (WR only)		FORMER CALL		LOCATION (City)		STATE
INPUTS	OUTPUTS	TT Wh TB PL	FM AM RTTY	AUTO PATCH	ERP	USEFUL RANGE (RADIUS)
		Hz				
		Hz				
		Hz				
		Hz				
EQUIPMENT						ANTENNAS & HEIGHT <input type="checkbox"/> SPLIT SITE <input type="checkbox"/> DIPLEXER
REPEATER GROUP/SPONSOR						
TRUSTEE			ID-TYPE OR MFR.			
<input type="checkbox"/> I certify that I have received no outside assistance while completing this form.						
DATE	SOURCE (NAME/CALL)	SPECIAL OR EMERGENCY FUNCTIONS				

lot to talk about even at 5 wpm. I like to learn something about the person I am talking with on the air — what he or she does for a living, how old he is, how many states he has worked, is he a buyer or builder, has he ever visited Indiana (or wherever I might be).

One of the important things I like to hear from other ops is how my signal sounds. I have heard a few Novices get into lengthy discussions about signal reports, and maybe how one person's signals are not quite chirpy but that there is a definite frequency change during key down.

Some amateurs seem to be afraid to tell the other operator if they have a little chirp or click. There are some people on the air who either never work weak stations or they just can't bring themselves to give an honest 249 signal report.

Most Novice ops have to depend on signal reports from other hams for any idea how their transmitter or antenna is performing. Sending an inflated signal report in hopes of avoiding embarrassment or insuring receipt of a much-needed QSL card is a disservice to any operator.

If you feel like talking awhile, you may have to ask some questions of the other guy before you get the conversation going. But if you do get a rag chew going, remember to keep the

transmission short to make sure you are being copied.

There is very little reason for hit and run contacts on the Novice bands. The ARRL suggests we refrain from talking about religion, politics or sex on the air. That leaves a pretty good selection of things we can and should be discussing.

WN9LHO



## NEW LICENSE ARRIVED?

When your repeater receives its new WR call, the second thing that you should do (after changing the identifier) is fill out the above form and mail it to 73. This will enable us to keep our repeater listing current and accurate. It will also make sure that the FM world doesn't forget you... for the 73 Atlas is recognized as the one complete listing of repeaters for the entire world.

## UPDATES NEEDED

If you know of a new repeater or of an established machine that has received its WR call, mail in the above form completed with as much information possible. We would prefer having duplicate — triplicate — even megaplicate information rather than none at all.

CA	WB6ZRR	Novato	Closed	146.40-147.51
GA	K4GCR	Albany		34-94
ID	W7CTX	Boise		28-88
MA	WR1AAA	Malden		31-91
	ex-W1BHD			
NH	WR1AAB	Peterborough		19-79
	ex-WA1KGO			
NY	WR2AAA	Manhattan		147.73-146.73
NY	WA2VNV	Stonybrook L.I.		16-76
NY		Flushing L.I.		147.09-146.69
PA	WA3KXE	Harrisburg		446.00-440.00
SC		Caesar's Head		04-64
TN	WB4KLO	Chattanooga		19-79
WI	WA9AOL	Milwaukee		146.25-146.85
WI	WA9AOL	Milwaukee		449.50-444.50
WI	WA9AOL	Milwaukee		1250.0-1220.0
WI	K9YFF	Racine		52.600-52.525
WI	WB9AES	Maukesha	PL	146.22-146.82
WI	W9WK	Milwaukee		146.07-146.67
		Milwaukee		448.75-443.75

### CANADA

ALBERTA	VE6CAM	Lethbridge		28-88
PRINCE EDWARD ISLAND	VE1ATN	Charlottetown		146.10-52.525
				52.525-147.00
			T	146.10-147.00

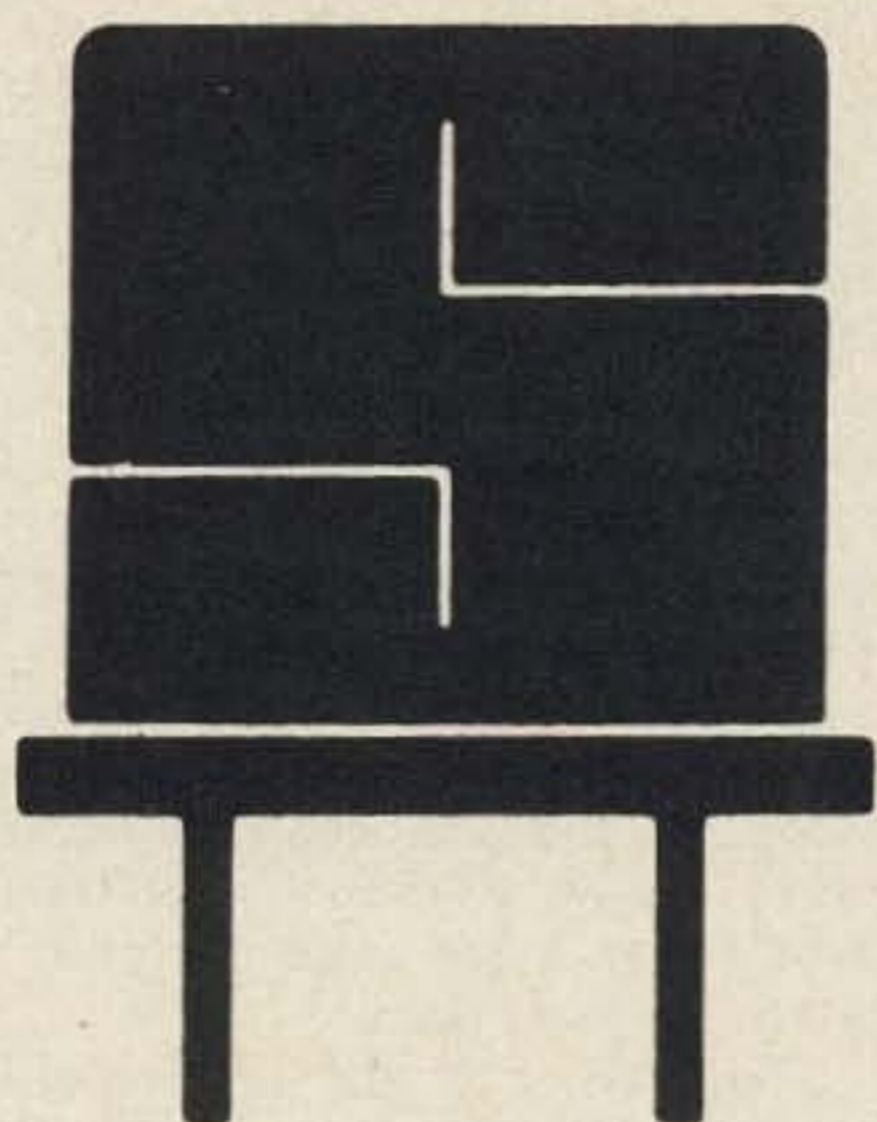

## REPEATER OWNERS

Don't Take Chances. SENTRY offers custom made crystals made exactly to your specifications. When it comes to crystals for your repeater, BUY THE BEST - SENTRY.

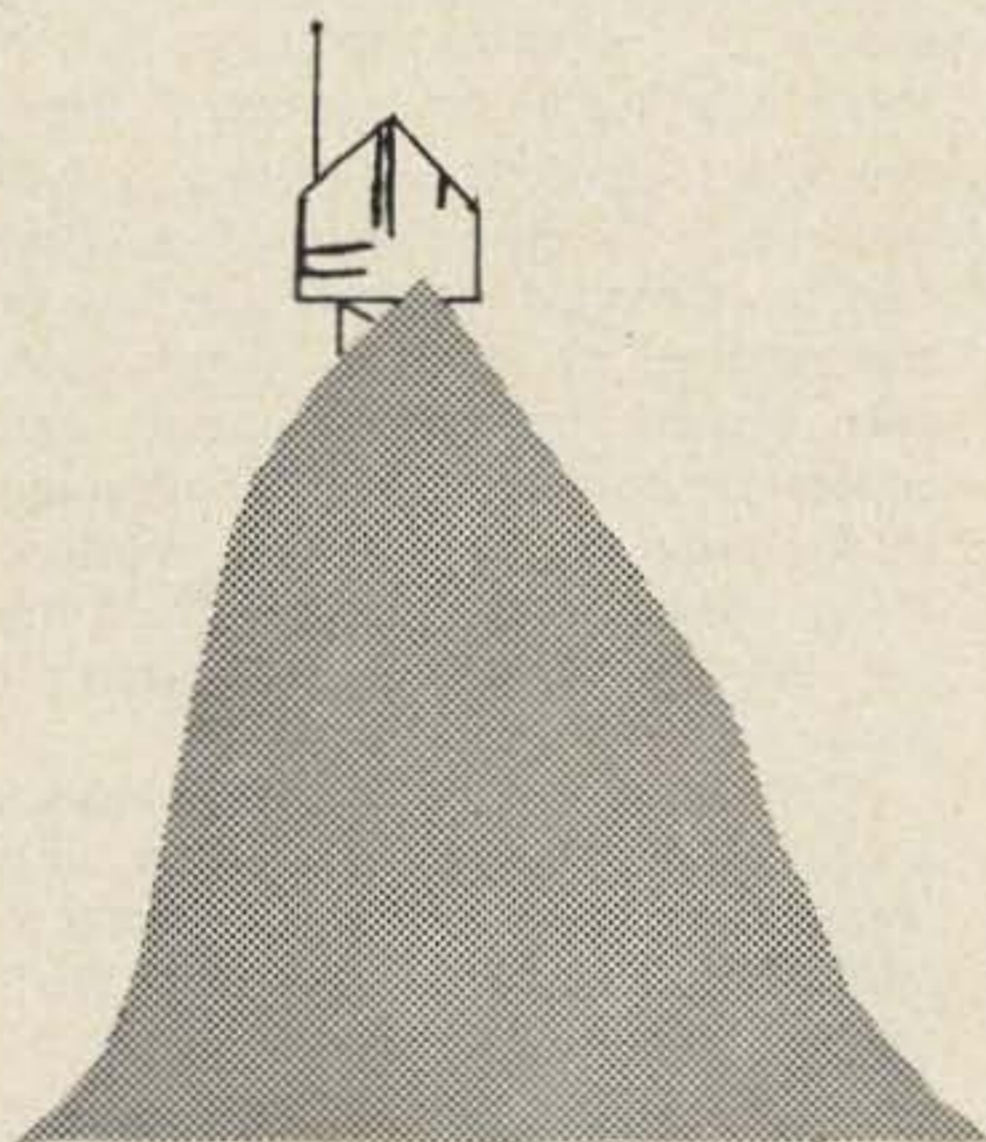

## REPEATER USERS

If you want reliable access to the repeaters in your area, you want and need SENTRY CRYSTALS. SENTRY CRYSTALS are custom made for your rig. We don't stock a large quantity of crystals for a certain frequency and hope you can tweak them to frequency in your rig. We do offer FAST service on crystals made especially for you and your rig. If you want reliable, on-frequency operation, INSIST ON SENTRY.

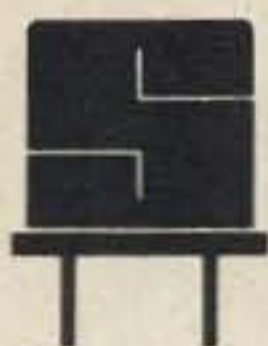

**SENTRY MANUFACTURING COMPANY**  
Crystal Park, Chickasha, Oklahoma 73018

PHONE: (405) 224-6780

TWX-910-830-6425



## The Hamburglar STRIKES AGAIN!

SAUL A. COHEN  
HAM RADIO EQUIPMENT STORE  
1000 W. 10TH AVENUE  
DENVER, CO 80202

73 Magazine  
Dear OM:

I am pleased to advise that my Swan Cygnat 270 # 313022 stolen 9/72 has been recovered and can be removed from your list, "Hamburglar Strikes Again".

Thanks very much.

73  
Saul A. Cohen  
K4ACT

List from Past Issues: Mfr., Model, Ser. No. Coll. 62S1 No. 10728	Owner	Issue
WRL Duo-Bndr 6010AT302	WA6FCY	6/72
HR-2A, 11 chan., 04-07152	WA1NVC	9/72
Swan Cygnat 270, No. 313022	K4ACT	9/72
Collins Mic, Mod.MMs, No. 4294	K4ACJ	9/72
Heath HW-100 & AC PS	WA2JGP	10/72
Swan 270B, No. M-395430	W8HST	11/72
AF68 No. 10888	K5LKL	1/73
PMR8 No. 10918		
M1070 pwr supply		
Trio TR2200 No. 241969	WA2ZBV	1/73
Clegg 22er No. 1900-578	WIDHP	2/73
Standard 826M, No. 112007	WA8PCG	3/73
FM27B No. 27013-1141	W2LNI	4/73
FM-144-10L No. F459	WA6WOA	4/73
NPC 107m pwr supply 2, 5AJ-IPL Onan Gen., No. 327885		



Joe Kasser  
1701 East-West Highway, Apt. 205  
Silver Spring MD 20910

The travelling ham usually carries a lot of valuable stuff in the car. How does he protect it? Car alarms are quite readily available and usually work by frightening off any would-be thief by the use of the car horn. For example, either the door or the rig is

fixed with a microswitch that sounds the horn if anyone tries to tamper with the equipment. There are many such units available, but since any thief who knows his stuff is aware of the plentiful supply of such devices, some counter moves must have been developed (I do not have any first hand knowledge of any myself, since as far as I know none of my friends are in the car thievery business). One simple method that comes to mind is to open the hood and disconnect the wires to the horn. Very quick, simple and effective.

Now the travelling ham has a car full of electronic equipment. A VHF-FM unit for local communications, and an HF-SSB rig for talking back home. Why can't this stuff be put to use in an alarm?

The early FM gear was modified commercial equipment, usually trunk-mounted with a control head under the dash. Why can't a tape cassette player be connected to the FM rig such that if the car is stolen (driven off by someone other than the owner) the rig will transmit a recorded message repetitively. The rig could be put on 52, 94 or the local repeater channel and broadcast, "I am a blue Dodge demon, I am being stolen, my license plates are GJP 887 Michigan." The rig should of course be set up so that if there is a signal on frequency when the theft alarm is activated, it will wait until the frequency clears. That can be arranged by judicious use of the receiver squelch line. The broadcast should not be continuous but should be repeated at regular intervals in the order of two to three minutes. If no indicator light comes on in the car, the thief will never know what hit him!

That takes care of the bloke who is going to try to steal your car, but what about the one who just wants to help himself to your belongings? Well, any body getting into your car could cause the transmitter to start sending tone bleeps on an unused channel (by everyone else that is), you would hear them on the handytalky attached to your belt and come running, or talk back to the car by means of the same handytalky and scare off the intruder. You could even arrange for any sounds in the car to be transmitted to you so that you can monitor the progress of the intruder while you race back to the car.

Small low power modules to build such alarms are advertised regularly in 73 as transmitters and receivers but may easily be incorporated into active theft alarms.

Such devices could be incorporated into private repeaters located within the trunk of one's car. It is thus possible to have the high power rig in

the car and talk through a low power hand-held unit to the car, out to a distant repeater or on a simplex channel. This can all be made quite legal in spite of the recent FCC repeater docket if use is made of model control techniques and frequencies and citizen band equipment and frequencies. There are a large number of frequencies available in the USA where any transmitter with an input power of less than 100 mW does not require any license whatsoever. Think about it. The serious ham engineer should be able to work something out.

...G3ZCZ/W3

Editor's Note: And it has been worked out... see p. 19!

## HAM HELP

This column is for those needing help in obtaining their amateur radio license.

If you are interested, send 73 your name, address and phone number. Don't be bashful - remember, it's always easier when you have someone to give you that added bit of confidence.

73 would appreciate amateurs and clubs looking this list over and helping whoever they can. Do you remember when you needed help?

Earl L. Grove  
891 Commonwealth Ave  
Venice CA 90291  
213-396-7315

Kenneth Hand  
Montauk Highway  
Bridgehampton, L.I., NY 11932  
537-3862

David Sundin  
PO Box 225  
Camden AR 71701

William Grandin  
Box 127  
Roulette PA 16746

David Ellithorpe  
194 Forbes St. Ext.  
Amsterdam NY 12010

Tom Mohr  
1513 Traeger  
Green Bay WI 54304  
414-494-4434

Donald E. Morris  
7022 Old Trail Rd.  
Fort Wayne IN 46809  
219-747-4607



Bill Pasternak WA2HVK/6  
14732 Blythe Street #17  
Panorama City CA

Well, as you all know by now, the earthquake Wayne prophesied at the end of my March column came to pass, but I am happy to report that Los Angeles is still where it is supposed to be. After going to the trouble of filing for a 6 land call, having to re-file for a KL7, somewhat boggles my mind! The only damage at this QTH was a box of open carpet tacks that fell off my desk and scattered all over the shag carpet in the shack. Ever try to recover a hundred or so of these tacks from that type of carpet? I still get one in the foot now and then. Aside from that, the quake itself felt like a train passing through my back yard. At my old home in Brooklyn we had the Sea Beach subway running open pit about 20 feet from our rear window, so I know that feeling quite well.

Now, back to amateur radio and what this column is all about. No new news out of Phoenix on the situation there.

Turning to the local happenings in and around Los Angeles, the big news is in the form of a brief report on the second meeting of the Southern California Repeater Association. In fact I should subtitle the following, "How to Report on a Meeting Without Being There." The secret lies in owning a good cassette tape recorder and having friends like Tony WB6MIE, Dave WA6CGR, Bob WA6JGW and Chris WB6HGW. They have become the official LW recording staff and did a job that would make pros in the business take note. After spending a good part of Sunday listening to the meeting in the comfort of my own shack, I can pretty well state that this is one of the best run amateur organizations anywhere. I have rarely heard or participated in a meeting that gives those in attendance as much a chance to actively participate, yet accomplished with complete order and decorum. No, S.C.R.A. has not yet solved all the problems we face here in Southern California, but it is my belief they have the ability to do so.

The meeting, held March 3 in Culver City, was hosted by the Pallisades Amateur Radio Club and emceed by Fred Deeg K6AEH. Though this was the second meeting of this organization, it was the first planned official meeting and was held to really get the group going. It should be noted that at their first meeting last September they made amateur history by coming up with and agreeing on a band plan for two meters in a matter of hours. This plan, now in use here, has not only proved itself quite workable with slight exception, but has shown that we as amateurs can work together for the common good of all involved. If you keep in mind that Southern California was for many years the nation's sore spot when it came to channel standardization, getting a viable system going in as short a time as they did is a real feather in their collective cap.

There was a discussion of a band plan for 220, and it was decided that no action would be taken at this time. Rather, the Technical Committee was instructed to come up with one that would suit the needs of the area before July 1st. Though I had hoped to hear something definite come out of the meeting concerning 220, after considering what was accomplished in such a short time on two meters, I have a feeling that when S.C.R.A. announces their 220 plan it's going to be something that may well help set a national standard for that band. Call it a premonition or what, I think this organization is going to make it. It is one of the few regional repeater organizations that is both owner and user oriented, and makes membership open to all. They believe in action rather than talk, and the results are evident.

**A 34-94 Repeater in L.A.?** There may be a bit of a storm brewing out here. For many years 146.94 has been the area simplex frequency. Unlike many other places where 94 is designated for simplex but not used, in L.A. there are several hundred FMers who use that channel daily.

There have been, I've been told, attempts made in the past to put a 34-94 repeater on the air in this area. All have met with failure. To the traveler, a repeater on that channel would be welcome, but is it a definite necessity? The tradition here is strong; 94 is simplex. However, I ask all parties to use proper judgment in resolving the matter. No repeater can hope to function if the majority is against it. I as a reporter stand neutral on the matter. I cannot print long letters due to space limitations, but if you want, I will try to present both sides of the question.

**Transcontinental Repeater Link.** In a short time I hope to be able to report the first linkup of a repeater here in L.A. with one on the East Coast. This has been your reporter's pet project and plans for it are under way. We hope to legally link (via telephone) for a few hours and give amateurs on both coasts a chance to meet and exchange ideas.

...WA2HVK/6



#### FFVHF CONTEST

The Five Flags ARC VHF contest will take place on 0001 GMT 19 May '73 to 2400 GMT 20 May '73; operate any or all of the 48 hours authorized. Exchange RST, QSO number and section. Repeater contacts will count only once. Each contact will have the following - Points per band per QSO; 50 MHz = 1, 144 MHz = 2, 220 MHz = 3, 420 MHz = 4, all other bands above 420 MHz = 5, crossband operation not permitted. Power Mult. 5W or less X 4, 30W or less X3, 320W or less X2 and 1000W or less X 1. Mode Mult. CW and SSB X 1, all others X 2. ARRL sections and new countries count 1 per band for mult. Total sections times total points for final score. Send log and summary sheets to WA3ODA/4, 1801 Border St., Lot 37, Pensacola FL 32505, postmarked NLT 1 June '73. Send SASE for contest results and/or award.

#### GEORGIA QSO PARTY

Starts 2000 GMT, Sat., May 5, 1973. Ends 0200 GMT, Monday, May 7, 1973. The twelfth annual Georgia QSO Party is sponsored by the Columbus Amateur Radio Club, Inc. There are no time nor power restrictions and contacts may be made once on phone and once on CW on each band with the same station. Each complete contact counts 2 points. Georgia stations multiply their total QSO points by number of different states and Canadian provinces worked. DX stations may be worked for QSO points but do not count as multipliers. Out-of-state stations will use the number of Georgia counties worked for their multiplier (a possible total of 159). Write to CARC, Inc., Attention: John T. Laney K4BA1, P.O. Box 421, Columbus GA 31902 for full information on the contest.

### RCMP CENTENNIAL

The Royal Canadian Mounted Police will be operating an Amateur Radio Station at Ottawa, Ontario, to commemorate their 100th anniversary. This station will operate during the period commencing 23 May 1973 to 30 August 1973 from 1200 hours GMT to 0400 hours GMT daily. Operation will be on 80 through 2 meters, using CW, SSB and FM. A special call sign, VE3RCMP, has been approved by the Department of Communications for this purpose. A commemorative QSL card will be sent to all stations worked. No IRC or funds for cards will be required. Amateur radio operators visiting Ottawa during this period are invited to visit this station which will be located within a large centennial exhibit in the R.C.M.P. Training Center, on St. Laurent Blvd., Ottawa, Ontario. For further information, please write to the Commissioner, R.C.M.P. Police, 1200 Alta Vista Drive, Ottawa, Canada K1A or OR2. Attention: Telecommunications Branch.

### TENNESSEE QSO PARTY

Contacts must take place between 2200 GMT May 19 and 2200 GMT May 20. No time or power restrictions. All licensed amateur bands may be used, but operation is restricted to the General class segments.

The exchange will consist of a signal report and QTH (Non-Tennessee participants will give their State or Country. Tennessee participants will give their County only). Logs must include date, time in GMT, station worked, exchange, band, mode and county multiplier. Stations may be worked on each band/mode. Portables and mobiles may be reworked if they change counties. Logs must be post-marked no later than June 22, 1973 in order to be eligible for award consideration. Send logs to: Mel Wardell K4PJ, Box 489, Oak Ridge TN 37830.

### GAITHERSBURG SWAPFEST

The Gaithersburg MD Swapfest will be held Sunday, May 20, at the Gaithersburg Civic Center, located on South Summerset Ave., next to the U.S. Post Office. Talk-in is on 52, 94 and 04/64. For information call Larry W3ZPO at 948-9029, or write to MARC, P.O. Box 611, Gaithersburg MD 20760.

### VHF/UHF CONFERENCE

The 1973 West Coast VHF/UHF Conference will be held May 5th and 6th at Pen and Quill Hotel, 3501 N. Sepulveda Blvd, Manhattan Beach CA. The registration fee is \$3.00. Those wishing information should contact WA6HXM, Box 2473, Palos Verdes Peninsula CA 90274.

### HURON VALLEY SWAP

The Huron Valley Amateur Radio Association will hold its 7th annual Swap and Shop, Sunday, May 27, 1973, at the Saline Country Fairgrounds, Saline, Michigan. Sales will be outdoors from your car, or in case of inclement weather, a large building is available. Plenty of prizes and no parking problems. Donation \$1.25, or \$1.00 in advance. Contact Terry Marsh, 702 Stanley, Ypsilanti, Michigan 48197. Telephone 313-482-9577.

### I AM CURIOUS . . .

The third annual Yellow Thunder Hamfest will be held at the Dellview Hotel in Lake Delton, Wisconsin on May 19, 1973. Afternoon programs will include NAVY MARS, ARPSC and VHF repeaters, with a cocktail hour and banquet in the evening. For further information contact Kenneth A. Ebnetter, K9GSC, 822 Wauona Trail, Portage, Wisconsin 53901.

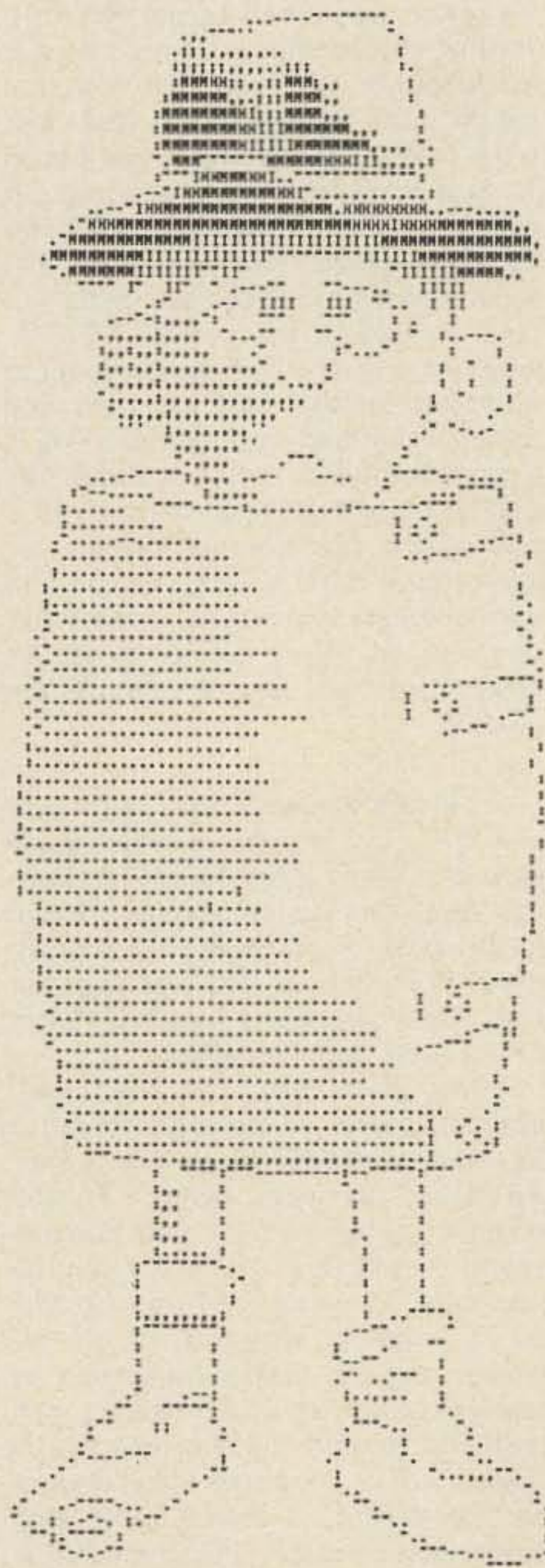

RTTY PICTURE — Courtesy K2AGI

### WOODEN QSL?

The Indiana County (PA) Amateur Radio Club, Inc., has just received authorization to operate a special events amateur radio station with the special call sign of WT3REE. Indiana County, Pennsylvania, is known as "The Christmas Tree Capital of the World." Last year over 700 contacts were made and more are expected this year. The station will be in operation from May 17 through May 20 especially on 80 & 40 meters (others if possible). A colorful QSL is available. For further information contact Sheldon K. Davis W3FVU, Indiana County Amateur Radio Club, 98 Rex Ave., Indiana PA 15701.

### NY FM HAMFEST

The FM Division of CVT, Inc. (Poughkeepsie Amateur Radio Club) will hold its 1st annual hamfest and auction on Saturday, May 5, 1973, between 11:00 A.M. and 7:00 P.M. at Gerring Park, Fishkill, N.Y. — near routes 52 and 84 intersection. There will be talk-in on W3CVT 37-97 as well as 94 and 52. Refreshments and door prizes — rain date is May 12, 1973. Donations per person are \$1.00 admittance, \$3.00 for tables. Children under 12 and XYL's admitted free. CVT, Inc., c/o R. W. Perry, RD 1, Glen Ave., Fishkill NY 12524.

### NW MISSOURI HAMFEST

The P.H.D. Amateur Radio Association will hold their fourth annual Northwest Missouri Hamfest at Kansas City MO on Sunday, May 6th, in the Kansas City North Community Center, one mile south of Antioch Road-Highway I and 135 interchange at 3930 North Antioch Road. For further information write to them at P.O. Box 11, Liberty MO 64068.

### FRESNO HAMFEST

Included in the program for the thirty-first annual Fresno Hamfest will be a Home-Brew contest and a segment of particular interest to the FM crowd. The Hamfest will be held May 4, 5 & 6, 1973 at The Sheraton Inn, Highway 99 & Clinton Ave., Fresno CA. Pre-registration at \$10.50 prior to April 27th, and queries may be sent to F.A.R.C., P.O. Box 783, Fresno CA 93712.

### HUMBOLDT HAMFEST

The Humboldt (Tennessee) annual hamfest will be held on Sunday, May 20, at Shady Acres City Park, Trenton TN. Prizes, flea market, ladies' activities, and a playground for the children. For more information contact W4IGW, Ed Holmes, 501 N. 18th Ave., Humboldt TN 38343.



### SPARC HAMFEST

The St. Petersburg Amateur Radio Club will hold its annual hamfest on Sunday, May 6, 1973, from 9:00 A.M. to 3:00 P.M. at Lake Maggiore, 9th Street So. at 38th Ave., St. Petersburg FL. Registration is \$1.00 per family, and extra tickets for prizes will be 50¢ each. Contact Lee L. Kanarian K4WXS, 461 Pinellas Way, So., St. Petersburg FL 33707.

### BREEZE SHOOTERS

The 19th annual Breeze Shooters Hamfest will be held Sunday, May 20th, at White Swan Park (Parkway West, 4 miles east of the Greater Pittsburgh Airport). There are no fees and parking is free. Tables and swap-and-shop are available plus the amusement park for your family's enjoyment. Check in on 29.0 MHz and 146.96 MHz. For complete information contact Herb Heller W3OF1, 2873 Beechwood Blvd., Pittsburgh PA 15217.

### BURBANK HAMFEST

The Hamfest will be held on Saturday, May 19, 1973, from 10 AM - 8 PM, at the Lockheed facility, which is located just seven blocks east of the Hollywood-Burbank Airport. There is ample parking in paved and patrolled areas with uniformed guard protection. Tickets are good for prize drawings. Hot coffee and cold coke will be served. Attendance runs near 1500. For further information contact William G. Welsh W6DDB, Hamfest Publicity Coordinator, Amateur Radio Club W6LS, Lockheed Employees Recreation Club, 2814 Empire Ave., Burbank CA 91504. Home telephone: 213-848-9340.

### WEXAUKEE MI SWAP

The Wexaukee Radio Club is holding their 13th annual Swap & Shop & Eyeball at the National Guard Armory in Cadillac MI on May 5th. Doors open at 9 A.M. Your junk may be gold to someone else. More info from P.O.Box 386, Cadillac MI 49601.

### MADISON HAMFEST

The Madison County Amateur Radio Club presents their annual spring Hamfest Sunday, May 6, 1973 from 10 A.M. till 5 P.M. The location is 4 miles north of Anderson, Indiana (west of state road 9) at the Madison County Civil Defense building (old Linwood school). The Talk-In frequencies to be monitored are 146.94 and 146.22/146.82 MHz FM and 3.92 MHz SSB. All buyers, sellers, and visitors are welcome. Plenty of refreshments and prizes.

### ROCHESTER HAMFEST

Preparations are under way for our fortieth annual Hamfest to be held at the Monroe County Fair Grounds, Rochester, New York, May 11 and 12. We expect to greet over 4000 of the ham fraternity from Eastern U.S. and Canada. For information contact Lawrence E. Brassie WA2GHQ, 524 Parish Road, Honeoye Falls NY 14472.



### MIDLAND 220 TRANSCEIVER



One of the benefits of the proposed CB band on the low end of our 220-225 MHz ham band is that it has provided that extra inducement to get some of the manufacturers into production with 220 rigs for us. The fact is that they can't lose - if we hold the 220 band it will probably be because we occupy it - this means sales - if we don't hold on to it, the CB influx will make for monumental sales.

The newest of the 220 transceivers is this one by Midland. It has twelve channels - and that ought to be plenty for some time to come, even in the bigger urban areas. There are several interesting features to this unit, such as crystal warping capacitors on both transmit and receive crystals, illuminated S-meter and r-f monitor, on-off switch separate from the squelch or volume controls so you don't louse up your setting every time you turn the rig off, remote speaker jack on the back panel so you can use the regular car speaker, a low power position for use with batteries or for very local communications - this cuts the output down to one watt instead of the normal ten watts - and, best of all, a jack on the back of the unit for plugging in tone burst, continuous tone, touch-tone, and things like that - plus a discriminator meter output and transmitter keyed output for switching an antenna relay or an amplifier. Midland has thought of almost everything!

Another plus is the better than average instruction booklet - all in English.

The final is protected from mishap - like a shorted antenna - or *no* antenna. This is worth its weight the first time you happen to short out the antenna or disconnect it and turn on the transmitter. Without the protective circuit - blip!

If *Midland Electronics*, 1909 Vernon Street, North Kansas City MO 64116 does not jump at the chance to send you more details on this beauty, you write to old Uncle Wayne and you let him know... y'hear?

### 100 WATT OP AMP

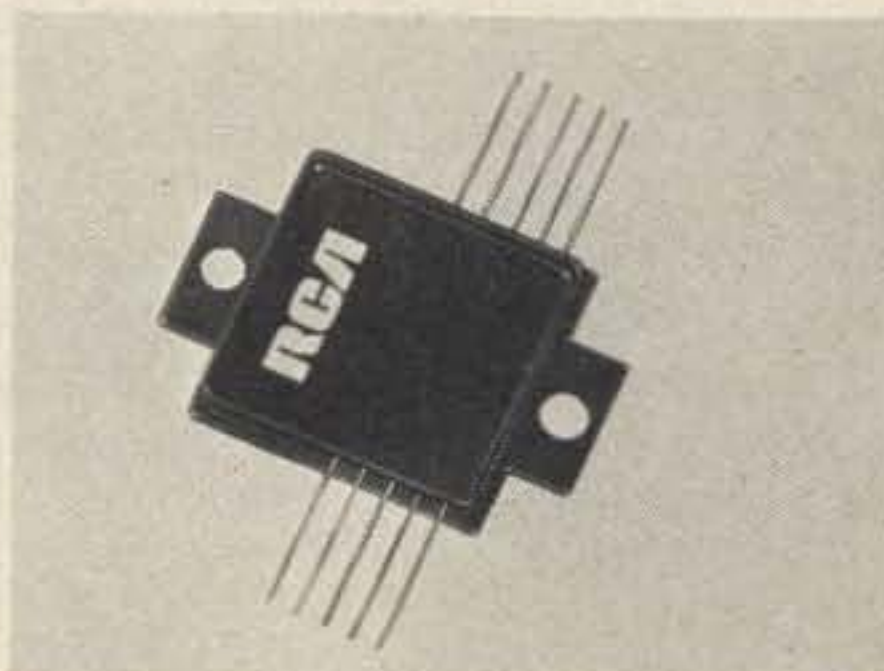

A new multi-purpose 7-ampere, low-distortion, operational amplifier has been announced by the RCA Solid State Division.

Designated RCA TA8651A, this developmental power hybrid circuit is a low-distortion, 100-watt linear amplifier. The output section can be externally biased class AB for low intermodulation (0.05% at 50 mW) and low total harmonic distortion. Terminals are available for external frequency compensation, external short-circuit protection, and inverting and non-inverting inputs. The TA8651A is supplied in a compact hermetic package, for which a socket is available for ease in mounting and connecting. Further information may be obtained from RCA Solid State Division, Box 3200, Somerville NJ 08876.

### NEW SEMICONDUCTOR REPLACEMENT MANUAL

A comprehensive 52-page Semiconductor Replacement Manual has just been released by Sprague. Containing over 30,000 OEM part numbers listed alpha-numerically which are cross referenced with Sprague's new line of 82 popular semiconductor devices, the manual also includes performance characteristics, outline drawings and pertinent parameters for the entire Sprague line.

Copies of Semiconductor Replacement Manual K-500 may be obtained

without charge from Sprague distributors or by writing to *Sprague Products Company, 517 Marshall St., North Adams MA 01247.*

### TRW RF POWER TRANSISTOR



The PT5757 is the first of a series of reasonably priced NPN power transistors by TRW that are designed specifically for amateur radio. It is capable of amplifying a 1 watt two meter FM signal to 10 watts and costs only 10 dollars in single lot quantities. The collector efficiency is 70% and the transistor is designed for a handy operating voltage of 12.5V dc.

A small 10W amplifier can be assembled in a couple of hours using this transistor. After etching out the pads as shown in the circuit board layout, carefully solder the components onto the copper side of the board according to the placement noted on the board and in the photograph. (If you've never worked with rf power transistors before, construction hints can be had in the two articles on 2m amplifiers by WB4DBB in the Dec. 72 and Apr. 73 issues of 73.) Be sure to heatsink the transistor with a good sized piece of thick aluminum before testing. The heatsink need not be insulated from ground. Tune-up consists of adjusting C1 and C4.

The unit assembled here at 73 works great. Driving it with a TR22 increases the transceiver's range considerably! Since the amp is uncomplicated and requires no special parts other than the transistor, it would seem to make a good project for clubs or beginning FM'ers.

The PT5757 is available from any TRW distributor or from *Ham Radio Center, 8342 Olive Blvd., St. Louis MO 63132, (324) 993-6060.*

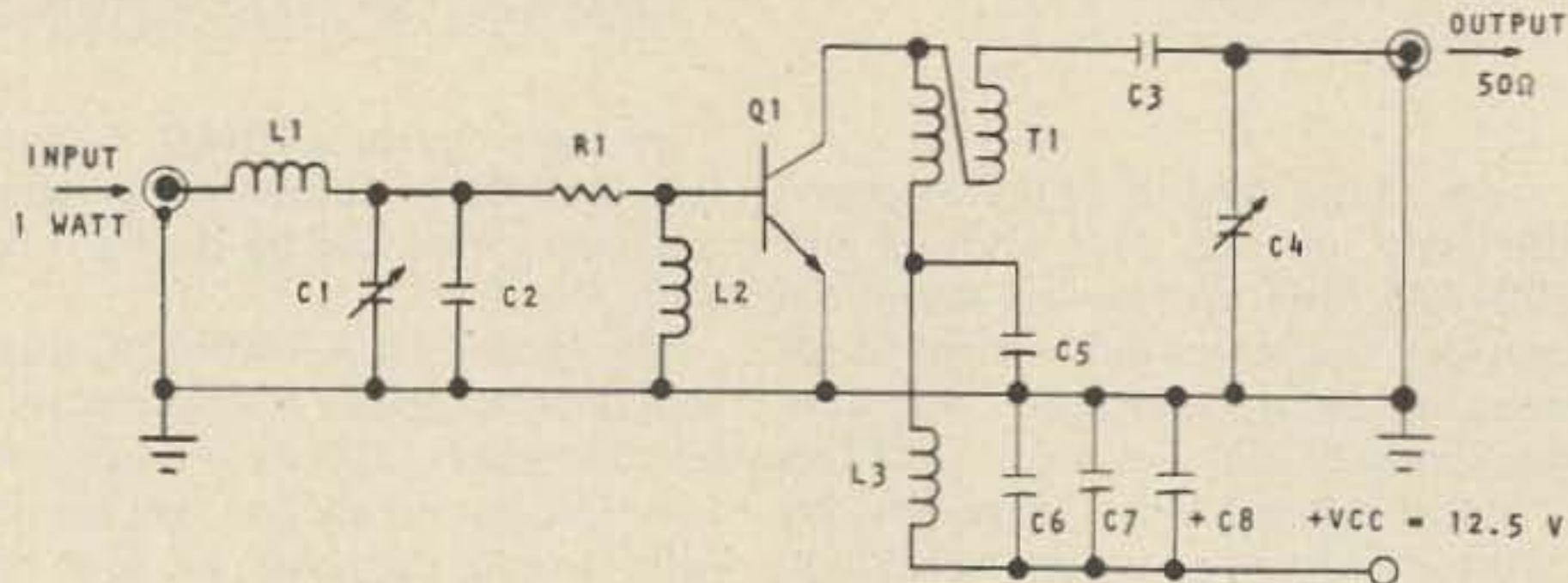

#### PARTS LIST

- Q1 - TRW PT5757
- C1 - 51 pF 5%, DIPMICA
- C2, C4 - 8-60 pF
- C3 - 100 pF DISC
- C5 - .001  $\mu$ F DISC
- C6 - .01  $\mu$ F DISC
- C7 - .1  $\mu$ F DISC

- C8 - 10  $\mu$ F 20V dc
- L1 - 4 No. 20 0.3 cm I.D.
- L2 - 12T no. 28 0.3 cm I.D.
- L3 - 10 no. 20 0.3 cm I.D.
- T1 - 4:1 transmission line transformer, made up of a 3" length of twisted pair, no. 20 enameled wire.
- R1 - 1.0 $\Omega$  5% 1/2W

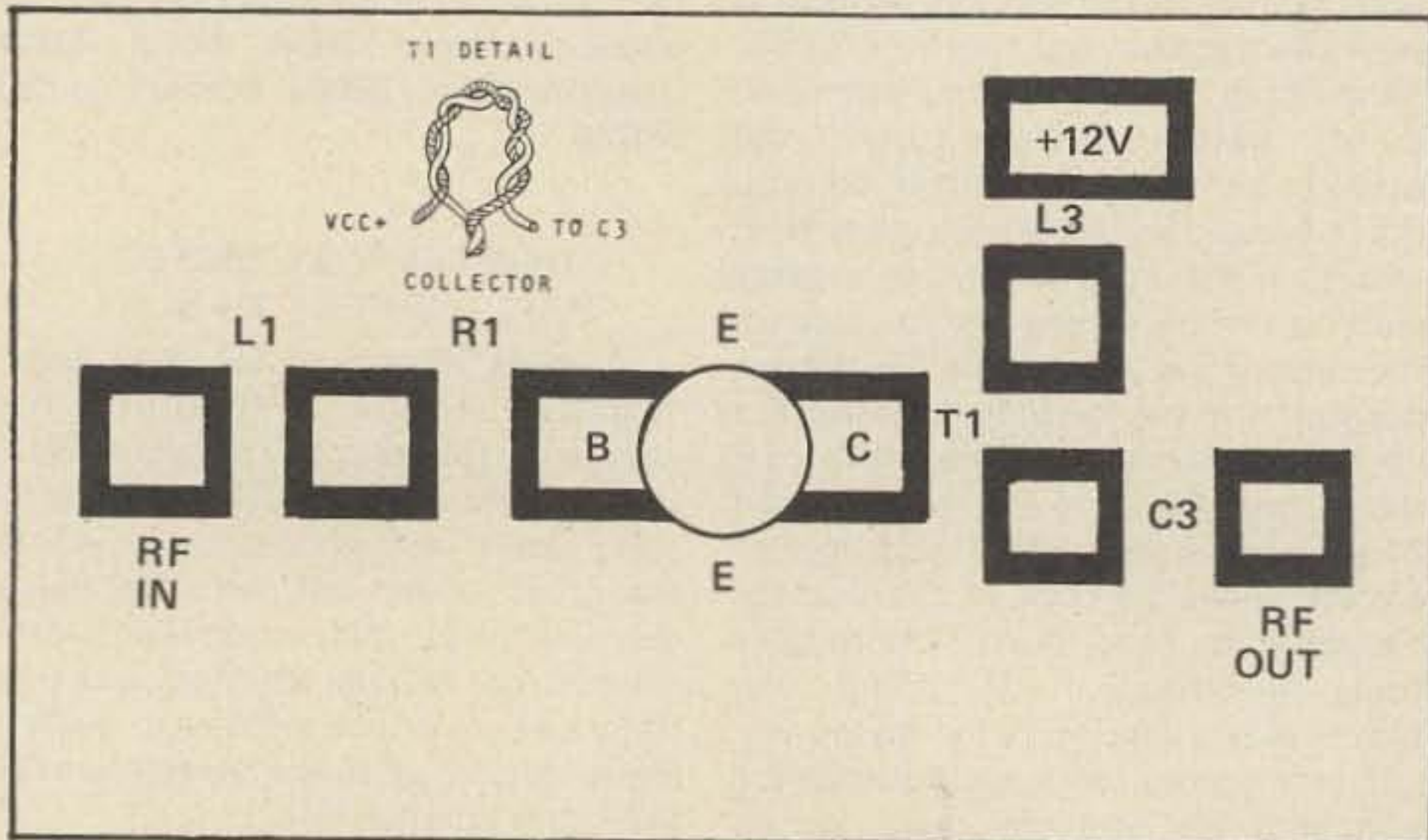

Full size layout of the circuit board used for a 10 watt 2m amplifier using the PT5757.

### TWO METER CONVERTER



Janel Labs has announced a new crystal-controlled two meter converter that combines performance with low price. This new converter, the 144CC, rounds out the Janel line that already includes the deluxe 144CA high performance two meter converter. Other products include converters for 50, 220 and 432 MHz.

The 144CC uses gate-protected dual gate MOSFETs to provide high sensitivity while avoiding overload effects. One rf stage is used to prevent cross-modulation overload by keeping the signal level low at the mixer. The converter is claimed to be free from birdies, due to the use of a seventh overtone crystal oscillator. This eliminates the need for multipliers and has been found to be very effective in reducing spurious responses. Typical specifications are: Gain - 20 dB, Noise Figure - 3-5 dB, Power - 12V dc with i-f outputs available on 26-30 MHz or 28-32 MHz. The price is \$49.95 from *Janel Laboratories, P.O. Box 112, Succasunna NJ 07876.*

### 432 MHz LOW NOISE PREAMPS



As part of their line of VHF/UHF products, Janel Labs has announced a series of 432 MHz preamps. Four models are available offering low noise figures in a choice of two price ranges, each having the option of an ac power supply. Models without power supply have a compact sheet aluminum enclosure while those with power supply feature a rugged cast aluminum case.

The gain of all models is an ample 20 dB. Bandwidth (3 dB) is about 20 MHz. Stock units can be supplied for any center frequency between 420 and 470 MHz and other frequencies are available on special order.

The basic circuit is a two stage amplifier. It uses a KMC bipolar tran-

# 73's WORLDWIDE SALES REPRESENTATIVES



sistor first stage and a 3N159 dual gate MOSFET second stage. The 432PA uses a K2073 first stage to produce a 3.5 dB noise figure and the 432PC uses the new K6007 to achieve an extremely low 1.5 to 2.0 dB noise figure.

The 432PA models are priced from \$29.95 to \$54.95 and the 432PC models cost from \$69.95 to \$94.95. They are available from *Janel Labs*.

## IS YOUR RIG INSURED?

One of the members of the Electchester N.Y. ARC recently experienced the theft of his car with a trunk full of ham gear. Some of the gear was installed in the car (bolted and wired in place) but most of it was loose and merely being transported, as the owner was leaving on a vacation and intended to operate portable in Pennsylvania.

The car was insured and covered for "comprehensive." Do you think that covers radios? Unless you have a special policy, you are probably not covered. The usual coverage extends to what is required to make the car operative plus luggage and clothing up to a limit. Cameras, sporting goods, tape decks, recorders, stereos and radios are not covered unless you have a special policy giving such items specific coverage. Better read your car policy carefully if you think it covers you — it's just about a lead pipe cinch it does not.

The New Yorker also had a Homeowners policy with off-premises coverage for personal property which he was sure gave him coverage. Wrong again. In 1971 most insurance companies doing business in New York State changed their policies due to the tremendous increase in thefts from cars.

Check your policy! Radios, stereos, tape decks, cameras, etc., are covered only if specifically stated in the policy when they are lost off the premises. Unless your agent has changed your policy to cover your radio gear, the chances are you are not covered. Better get it out, give it a good look, and then check with your agent to make sure.

### U.S. AREA REPRESENTATIVES

New Mexico/West Texas  
Ambrose G. Barry, W4GHV/5  
1010 Juniper Avenue  
Alamogordo, New Mexico 88310

State of Michigan  
Gloria M. Ligon, K8WKE  
47160 Condor Street  
Utica, Michigan 48087

### DX REPRESENTATIVES

BCN Agencies Pty. Ltd.  
178 Collins Street  
Melbourne 3000, Victoria  
Australia

The Wireless Institute of Australia  
478 Victoria Parade  
P.O. Box 36  
East Melbourne, Victoria  
Australia

Carlos Rohden  
Caixa Postal 5004  
Sao Paulo, S.P.  
Brasil

Jim Coote  
56, Dinsdale Avenue  
Kings Estate  
Wallsend  
Northumberland, England

Radio Society of Great Britain  
35 Doughty Street  
London WC1N 2AE, England

Short Wave Magazine  
55 Victoria Street  
London, SW1, England

Bryan Fogerty  
Irish Radio Transmitters Society  
9 Wellington Street,  
Dun Laoghaire, Eire

Orion Books  
13-19 Akasaka 2-chome  
Minato-ku  
Tokyo 107, Japan

Tama Electronics Co., Ltd.  
Towa Building 502  
515 Higashi Oizumi, Nerima-Ku,  
Tokyo 177, Japan

Sun Electron Corporation  
15-20 Takaban-1-chome  
Meguro-ku, Tokyo 152, Japan

Kushal Harvant Singh  
83, Aulong Road off Stephens Road  
Kampong Boyan  
Taiping, Perak, Malaysia

Gordon and Gotch Ltd.  
P.O. Box 584  
Auckland, New Zealand

G. H. Gillman  
Smarts Road  
Waikuku RMD  
Rangiora, North Canterbury  
New Zealand

New Zealand Assn. of Radio  
Transmitters  
P.O. Box 1459  
104 Hereford Street  
Christchurch, New Zealand

Harold C. Leon  
P.O. Box 61141  
Marshalltown, Transvaal  
South Africa

South African Radio Publications  
P.O. Box 2232  
Johannesburg, South Africa  
South African Radio Relay League  
P.O. Box 3911  
Cape Town, South Africa

Julio Antonio Prieto Alonso, EA4CJ  
Donoso Cortes No. 58  
Piso 50, Letra B  
Madrid 15, Espana (Spain)

Eskil Persson, SM5CJP  
Frotunagrand 1  
194 00 Upplands Vasby  
Sweden



"Quiet, those CB'ers are working DX again."

# CONSIDERABLY SPECIAL CONSIDERING THE SPECS

## 2 METER FM TRANSCEIVER

Model SRC-146A



Frequency . . . . . 143-149 MHz  
(2MHz spread)  
Number of channels . . . . . 5  
Supplied with 146.94 simplex,  
146.34 / .94 (same plug in  
crystals as SR-C826M)  
R.F. output . . . . . 2 watt minimum  
Sensitivity . . . . . better than 0.4  
uv / 20 DB Q.S.  
Audio output . . . . . 500 mw  
Meter . . . . . monitors battery voltage on  
Tx, S Meter on Rx  
Current drain . . . . . 620 ma Tx,  
15 ma Rx standby  
Size . . . . . 8<sup>3</sup>/<sub>8</sub>" high x 3" wide x 1<sup>5</sup>/<sub>8</sub>" deep  
Weight . . . . . 24 oz., less batteries

Options: *Private channel (CTCSS), external mic, or mic-speaker, stubby flexible antenna, desk top charger, leather case.*

**\$289 00**  
Suggested  
Amateur  
Net Price

## NEW 2 METER REPEATER

SCA-RPT-1

All solid state, 2M, 10W, FM  
REPEATER. Built-in C.O.R., adjustable  
carrier delay and time out timer.



*Write for complete specifications and cost.*



**Standard**  
COMMUNICATIONS CORP.

213 / 775-6284 • 639 North Marine Avenue, Wilmington, California 90744

# MOBILE BURGLAR ALARM SYSTEM

**A**t 9:20 p.m. on a Friday evening last year, my wife and I were enjoying a play at a theater in Norfolk, Virginia. She, as usual, complained bitterly about the HT-220 I had on my belt that made me look like a detective. (Why couldn't I use a "thing" like doctors have — i.e., a pager.) It was the quietest part of the performance. Suspense hung in the air like a cloak, the stage was hushed and there was not a sound from the audience. Suddenly, BANG! There was a loud, shrill noise — a 1 kHz tone — that seemed to burst from the audience like a child demanding attention. I jumped out of my shoes; then realized it was my HT-220 sounding off.

Having cleverly gotten seats in the center of the theater, I ran to the aisle, ruining twelve pair of shoes doing so. There was an exit door straight ahead which seemed to lead to the side of the building. I ran to it like a fool, with the "thing" still beeping — I couldn't find the volume control in my excitement. The door was heavy metal, designed to lock when shut but allowing for easy egress. I passed through it. When it shut, it insured that any hope of going into *that* theater in the future may as well be forgotten. My wife said later that the audience thought there was an explosion. Standing on the steps, I looked for my car. The intermittent beeping could be only one thing — the tamper alarm on my car was being triggered.

Myopically squinting in the dark, I could see there was a man (larger than I) sitting in the front seat of my car. I ran over to him and, because of the difference in size between us, politely asked the gentleman why he was there. He had been happily unscrewing my tape deck, but he paused, surprised, as I did so. At the same time, he shifted in the seat. Realizing I was outnumbered both in size and weight, I opened the door and grabbed my hidden .32 pacifier.

The alarm had been set and went off — loudly. Clearly, the man did not know what to do. Neither did I, for I had not drawn a gun on anyone in my life. I decided to seek sanctuary in the theater, and I directed him to walk to the main entrance. It was interesting to note the look on the ushers' faces as I escorted the man at gun point into the posh theater with 1,100 people watching the play.

Later, in the police station, the surprised thief learned how he was caught. The secret is a small 1W General Electric Voice Commander II transistorized transmitter to which a tone generator is attached. This is triggered by an assembly, fastened to the car, which consists of a piece of spring steel with a lead weight on the end. As the car is moved, the weight causes the spring steel to ground against an adjusting screw. The adjustment can be set so that driving down the street will barely close the contact or so that blowing on the car will trigger the alarm. This device has been marketed under the name "Devil Dog" by Northwest Electrical Company, Mitchell, South Dakota.

The alarm system itself consists of several relays and parts arranged in such a fashion as to set off a mechanical siren, a Federal electronic siren (in the "yelp" mode) and intermittently the horn and high beam headlights. Additionally, separate contacts close for the transmitter. Thus, if the car is tampered with or bumped by one of those lazy drivers who get out of a parallel parking space by backing until they hit something (my car), a pulsing beep is heard in my receiver. If they open something (the rear lift gate, doors or hood), the alarm goes off and a steady tone is heard.

It is worthy to note that the system really works on a dependable basis. My car was broken into nineteen times while I was in Norfolk, Virginia. Eighteen times the alarm sounded and scared the intruder off. The

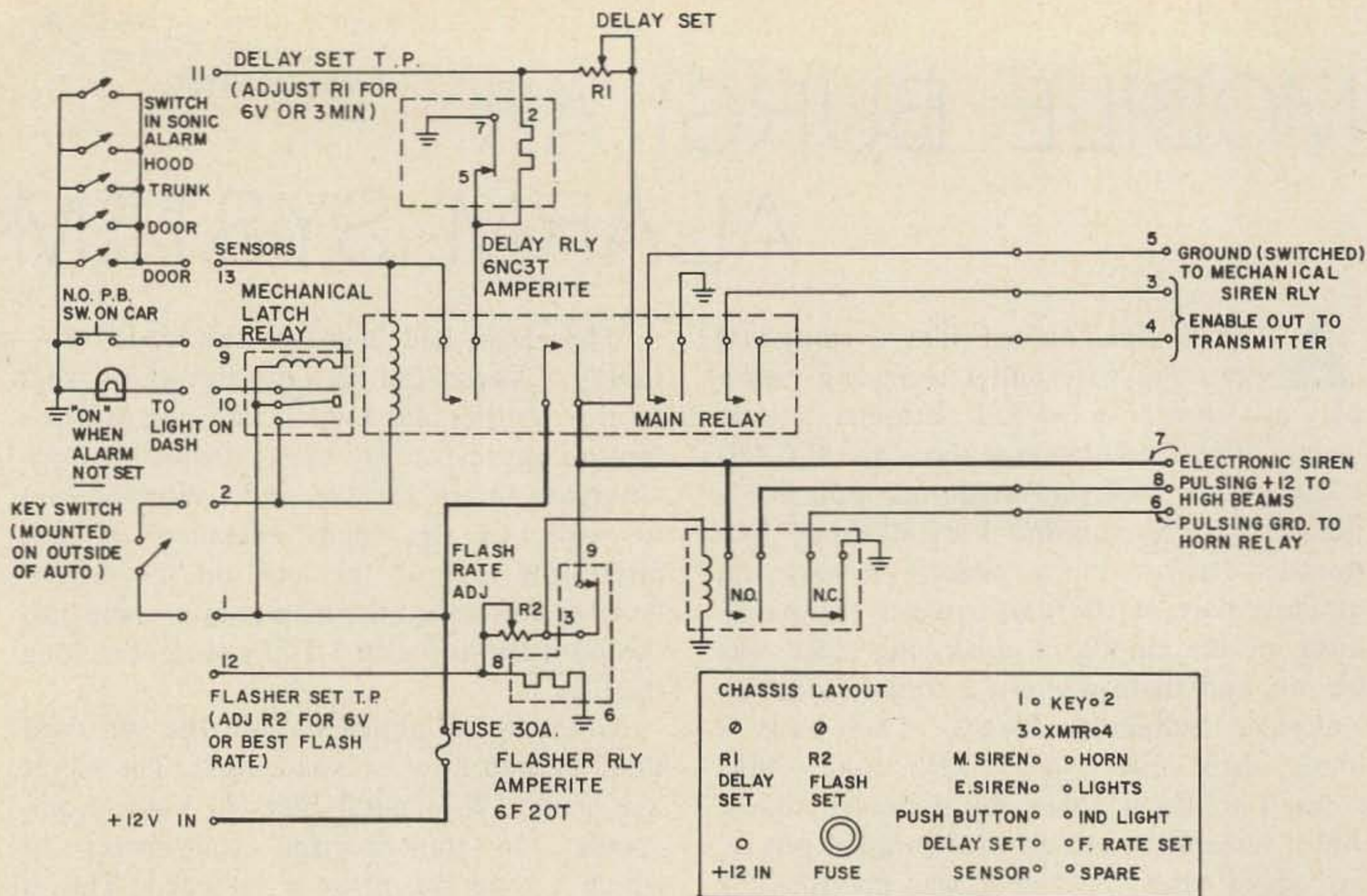

Fig. 1. Main switching system — master alarm. 1. Heavy lines indicate #16 (or heavier) wire. 2. All parts mounted in 6x3x4 minibox mounted on firewall. 3.  $R1 = 40\Omega$ ;  $R6 = 40\Omega$  4. Mechanical latch relay surplus. A Volkswagen headlight dimmer relay may be used here.

nineteenth time, as described above, a window was broken and, due to a broken wire, the seat switches did not work. If it were not for the transmitter, everything would have been lost. Still, I was not happy about depending on the transmitter only, so I installed one more fail-safe device — a sonic alarm.

The basic alarm system has been described in another article (*C.Q. Magazine*, August 1971, p. 54, "The Ultimate in Automobile Alarms, Part II") and is presented in Fig. 1. Basically, I used electro-mechanical devices to keep this as simple as possible and not have to worry about temperature extremes affecting critical semi-conductors. Sensors are the door interior light switches and an extra switch has been added to each door to insure reliability.

The transmitter keying circuit is shown in Fig. 2. Any transmitter can be used, either positive or negative ground. Various brands are out on the market and advertised in the ham magazines. I am using a G.E. Voice

Commander II board, which is positive ground. Two Burgess 4F5H 7.5V batteries are used in series since this is not easily compatible with the negative ground system in the car. These batteries are about \$6 each but have been in operation for over a year with full voltage still showing under load. The transmitter board was housed in a mini-box and holes were drilled over the adjustments to facilitate tuning. Also in the mini-box is a tone oscillator wired into the microphone circuit through a coupling capacitor, and a tone encoder board which will be discussed later in this article.

The antenna deserves special mention. I have had some ripped off (literally) in the past and needed some unlikely way to effectively radiate a signal the length of a massive parking lot, into a building and downstairs into a theater through steel beams and cement, etc. At the same time, I did not want it to show. After investigating the possibilities in my 1972 Hornet, I decided to mount it inside the rear window.

The feed line from the transmitter follows the various channels through the car into the molding between the roof and rear window. A hole drilled into the side of the molding allows the coax to protrude about three inches. The shield is stripped back one inch and clamped to the metal directly above the window glass. The inner conductor was soldered to a piece of #22 bare wire. The other end of this wire has a loop formed in it and is soldered to prevent deformation or slippage of the anchor string. A piece of nylon fish line is passed through the loop, tied securely and the end heated to prevent it from slipping free. This anchor line is run the remaining depth of the window to a spring which holds the antenna taut.

There are various other ways to mount the antenna, depending on the model of the car and your ingenuity. I own a station wagon with a lift gate and had to enter from the top of the window with enough slack in the coax to prevent the line from bending back and forth and finally breaking as the rear was opened and closed. Regular sedans can be attacked from underneath the rear ledge just inside the rear window, running the antenna up to the inside window molding at the top of the glass. It is anchored as described above.

To tune the antenna I used a through line wattmeter and an SWR bridge. Keying the transmitter, the wire was cut and pruned from a length of 30 cm in half cm increments until the SWR went as low as possible. The actual length turned out to be 27 cm but this will vary from car to car due to the adjacent metal (or lack of metal).

The receiver used for a long time was an HT-220. This was great until one night at a movie, with the volume turned up, W4... announced that he was QRZ on the frequency, to the embarrassment of my wife, and stares from fellow movie-goers. This happened many times on subsequent occasions. There was no one frequency clear all the time. Also, there were some frequencies on which I could not go because they happened to be local repeater input frequencies. Finally, after some searching around, I came up with a used tone access Page Boy receiver. I modified it to the 2 meter FM band and removed the reeds. In their place I

installed an HT-220 P.L. board. A reed relay was installed in this P.L. board and an encoder to generate a tone corresponding to that reed decoder was installed in the transmitter mini-box. This was much better. The receiver will not sound unless my own particular transmitter is activated. Then it beeps or sounds a steady tone, depending on what is going on in the car. The encoder was built from an article in *73 Magazine*, but a better circuit appeared in the February '73 issue (p. 37). The actual encoder used is unimportant, but the frequency should be the same as the P.L. reed relay used.

Choosing the transmitter output should be done judiciously. It is not nice to trigger the local repeater with your alarm. A busy channel will not be suitable if you do not have P.L. If you do, your car may interfere with other QSO's. In my area, 94 is relatively quiet with respect to the places I frequent. My coverage is about three miles. 97 and 91 are local repeater output channels with others spaced in every possible frequency spread. I finally put the transmitter output on 146.94 after considering possibilities outside the normally used ham

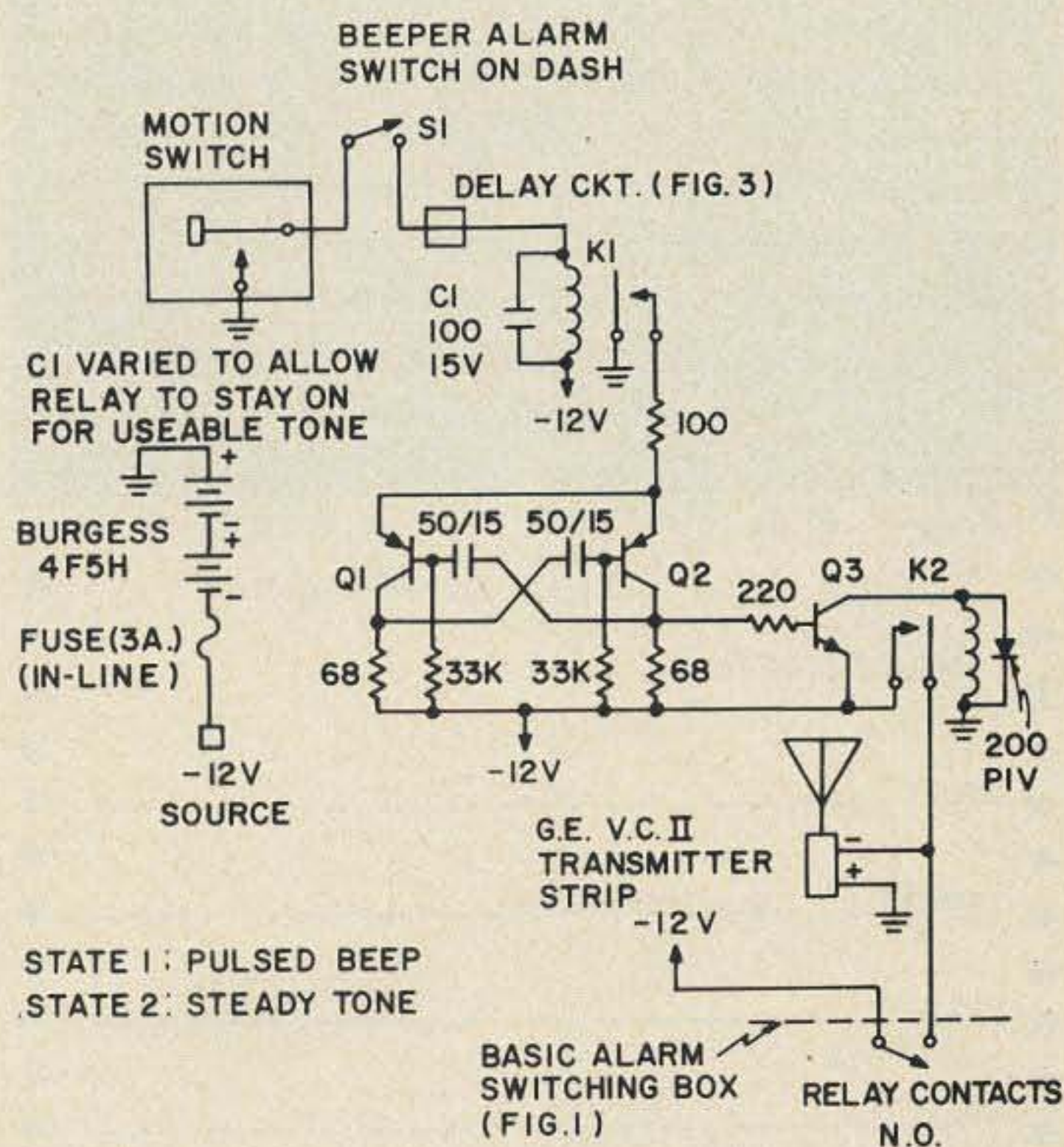

Fig. 2. Transmitter keying circuit used in a 1972 Hornet. The transistors are any audio or small signal type; Q1,2—PNP; Q3—NPN. Adjust the 50 $\mu$ F capacitors and the 33K resistors at the bases of Q1,2 for best pulse rate.





keep them around. Also, since my system runs off the aforementioned batteries, I wanted as little current drawn as possible (i.e., none). To bias a transistor off requires only a few microamperes, but several in a system can shorten the life of those expensive batteries by one half. Batteries were considered very necessary not only because of the positive ground requirements of the transmitter, but also because an enterprising thief has only to cut your car battery lead from underneath if he suspects you have an alarm. The one I caught in Norfolk had enough brains to realize I might have had an alarm, which is why he broke a window for entry. If the alarm does not go off, at least this will be a fail-safe device.

Sensors may be the above Devil Dogs or mercury switches suspended in such a manner as to close when the car is moved. The Devil Dogs are probably the best idea and several may be scattered around the car in strategic places and angles. If more than one is used, it is preferable to place them at 90° to each other to compensate for any motion — lateral, up-down or angular.

The only other part of the system is a must for a station wagon. An ultrasonic alarm is available for about \$40 from Radio Shack. Mine is a Mallory CA1 dc Crime Alert which was already on hand. If a window is broken or a hand is stuck in through an open window, the car alarm is set off. It is mounted in a corner in the rear of the car facing toward the front. There is an inherent 20-second delay before it arms. A switch in the front of the car (next to the tamper-set switches) sets this alarm. Any movement inside the car changes the received 40 kHz frequency and triggers a relay in the unit, which grounds the interior light system. This in turn sounds the main alarm if the key or pushbutton switches have been set. To get into the car, the main alarm is disarmed and the door opened. As this closes, the sonic alarm will sound until you turn the control switch off. This is effective in checking its operation. I have it hooked to the 15V batteries because the greater voltage provides a stronger field. With all the carpeting and foam rubber in the seats, the field is reduced significantly. One useful addition would be to trigger the alarm transmitter inde-

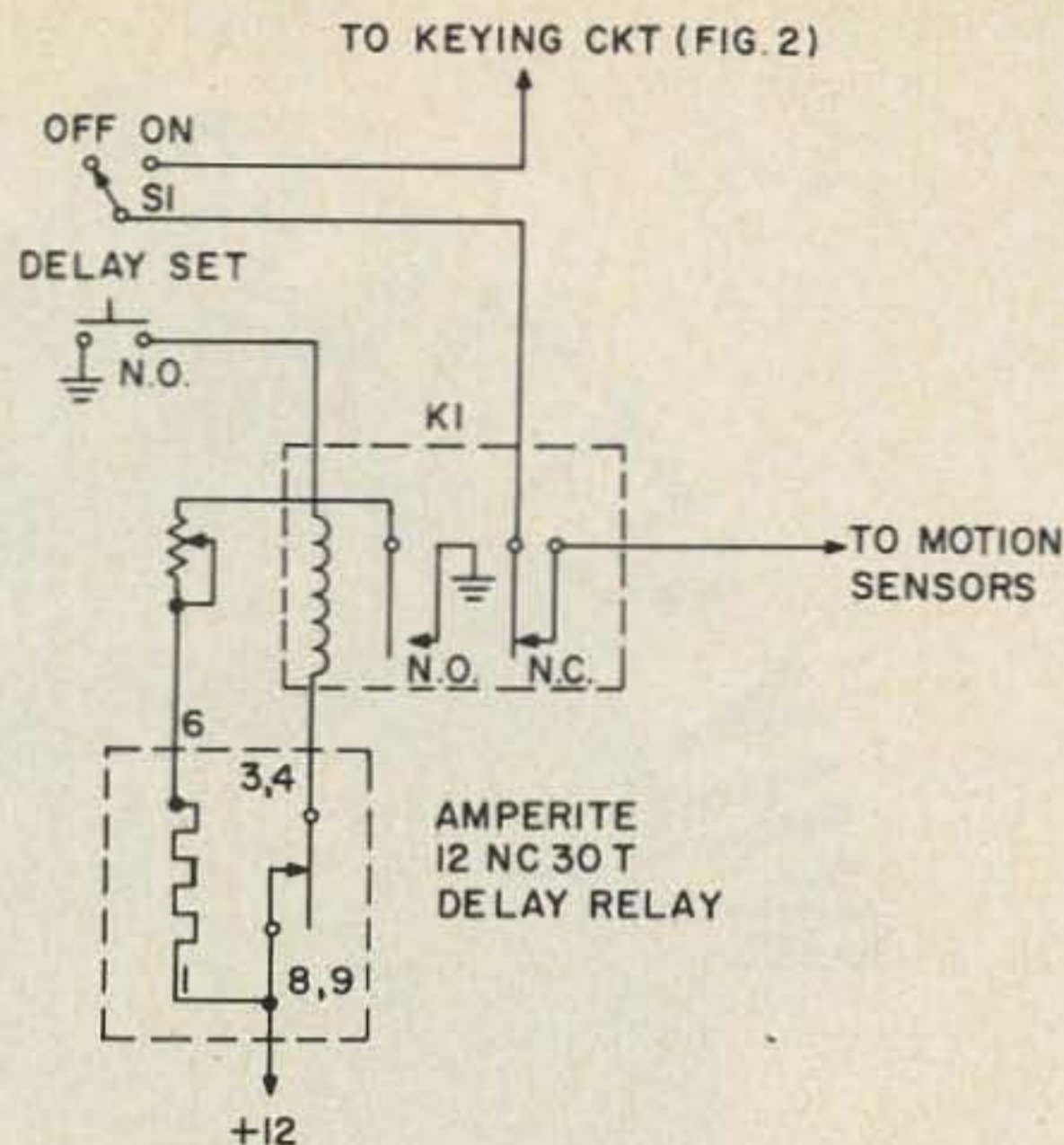

Fig. 3. Delay circuit for transmitter. S1 from Fig. 2 is incorporated into this diagram.

pendently of the main alarm with this unit, in case of failure of the tamper sensors.

Some sort of delay circuit is needed to give the sensors time to settle down so the car will not beep after you get out of it. The circuit of Fig. 3 shows how this was accomplished. A delay relay and relay K1 are energized by means of a front panel switch S1. When the delay relay resets, relay K1 de-energizes to its normally closed state, thereby connecting the sensors to the unit.

The alarm has been quite dependable and only a few modifications have been made to improve it. One of these was the set-release pushbutton switch mounted behind the driver's door handle. The A.M.C. cars have the flush door handles that you grasp from within a well in the door and pull out. The miniature pushbutton switch hidden behind this latch is invisible and invaluable for quick stops. It triggers a mechanical latching relay which shorts the key switch contacts when pulsed. In the unset position, another set of contacts turns a light on the dashboard on. Thus, when the light is out, the alarm is set.

For those of you in high risk areas, this should be the answer to your problems. I would like to hear from anyone who tries it and has the method work, and whether an arrest was made or not. If enough people install this, maybe we can all lobby for cheaper theft insurance rates, or even be able to get coverage for uninsurables like tape decks, etc.

...WA4SAM

**WHY SETTLE FOR HALF A RIG?**  
 Get ALL the  
 versatility, capability  
 and quality you REALLY want...  
 at a surprisingly low price!



**Clegg**  
**FM 27B**

The only 2-meter rig  
 with any combination of  
 Transmit or Receive Frequency  
 from 146 to 148 MHz.

After buying any other transceiver, plus an amplifier with 25 watts or more and a handful of crystals, you've spent more than the cost of the Clegg FM 27B. And you still don't have the **only** rig that's totally integrated with all the coverage built-in. Why settle for half a rig? Get it all—get a Clegg FM 27B!

Amateur Net \$479.95



**Clegg** DIVISION  
 3050 Hempland Road  
 Lancaster, Pennsylvania 17601  
 (717) 299-3671 Telex: 84-8438

CLEGG—the PROFESSIONAL amateur line!

The Clegg FM 27B ACTUALLY COSTS YOU  
 LESS in the long run!

Check these specifications:

**GENERAL**

**POWER REQUIREMENTS:** 12 to 14 VDC

Current Consumption at 13.5 VDC:

Receive: 400 Ma squelched,  
 1.2 amps unsquelched.

Transmit: 6 amps max.

**DIMENSIONS:** 7<sup>3</sup>/<sub>8</sub>" x 3<sup>1</sup>/<sub>2</sub>" x 9<sup>1</sup>/<sub>4</sub>"  
 deep; 4 lbs. net weight.

**RECEIVER**

**TUNING RANGE:** 146.00 to 148.00 MHz,  
 continuously tuneable with reset  
 capability of approx. 1 KHz to any  
 frequency in range.

**SENSITIVITY:** .35  $\mu$ v max. for 20 db  
 quieting; .1  $\mu$ v for reliable squelch action.

**SELECTIVITY:** 11 KHz at 3 db; Less than  
 30 KHz at 70 db. Adjacent (30 KHz  
 spaced) channel rejection more than 70 db.

**AUDIO OUTPUT:** 2.0 watts (min.) at less  
 than 10% THD into internal or external  
 ohm speaker.

**TRANSMITTER**

**TUNING RANGE:** Same as RECEIVER.

**POWER OUTPUT:** 25 watts Min. into 50  
 ohm load. P/A transistor protected  
 for infinite VSWR.

**MODULATION:** Internally adjustable up to  
 10 KHz deviation and up to 12 bd  
 peak clipping.

Bruce Fette WA7NMO  
 Staff Engineer, Motorola Inc.  
 1206 E. Lemon, #22  
 Tempe AZ 85281



The burst circuitry can be mounted in a box with a touchtone pad for total operating convenience.

# THE BURST BOX

Incorporated in "The Burst Box" is a versatile tone generator that features two output ranges. Continuous sub-audible or high frequency bursts may be switch selected for use with various repeaters.

The Tone Burst Box is more often becoming a requirement to key up desired FM repeaters. Generally speaking, the new solid state transceivers don't have room for the additional circuitry required to generate a tone burst. This article describes an outboard box requiring no batteries, deriving power from the transceiver, but using only a two wire connection so that miniature earphone jacks are sufficient. A touchtone pad may also be included in the box for mobile telephone operation.

The circuit works as follows: switched power is derived from the transceiver at a terminal which goes positive during transmit. This will be the collector supply for the multiplier and buffer amplifier stages. This power is fed through a 330Ω resistor down to a convenient earphone jack and down the cord to the burst box. It then goes through a 200Ω resistor and charges a 100 μF capacitor. The capacitor provides B+ to a CMOS square wave oscillator whose frequency is adjusted by the 1 meg potentiometer and the selected .001 or .01 capacitor giving a

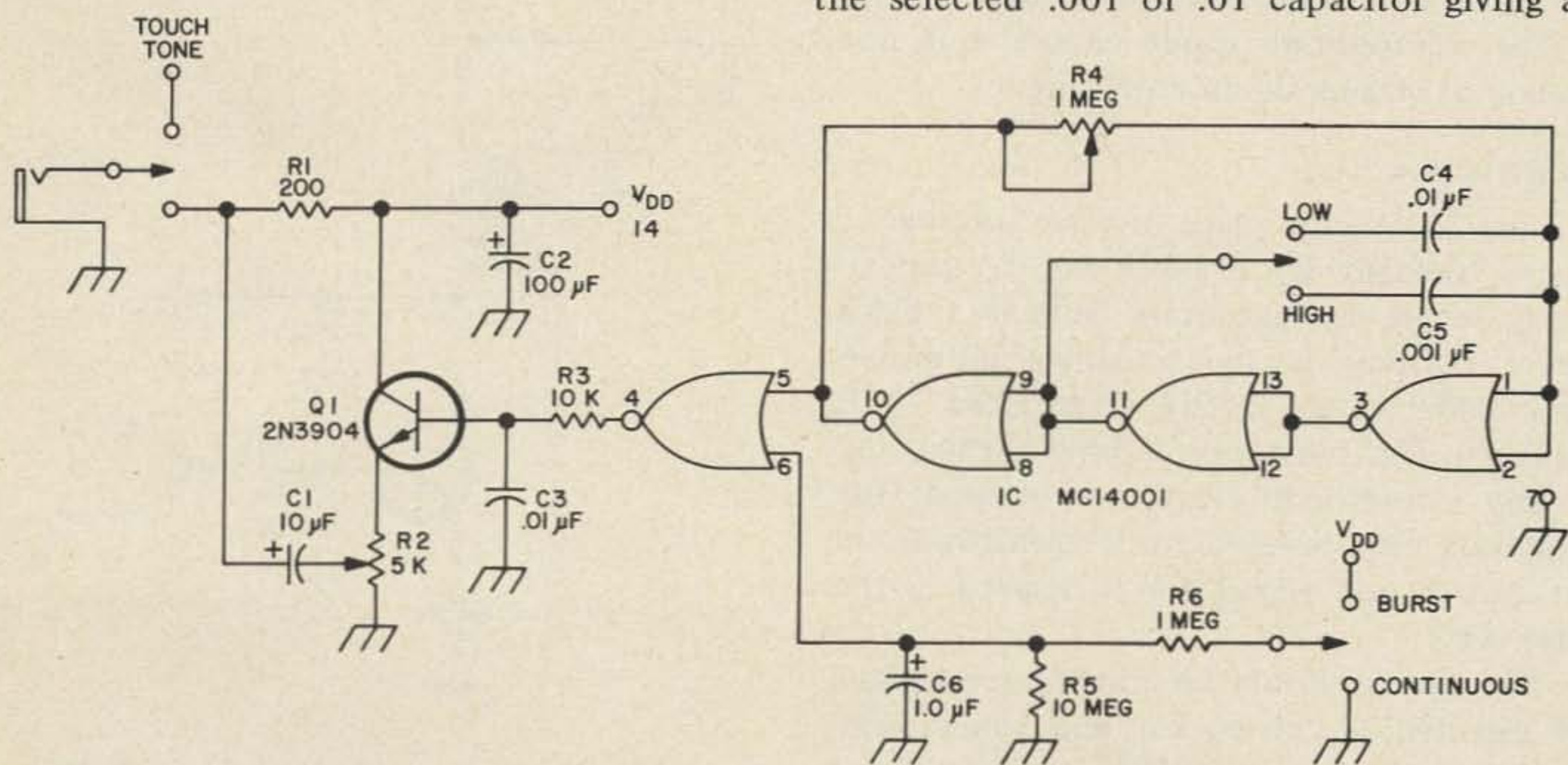

Fig. 1. Schematic diagram of the tone generator used in the Burst Box.

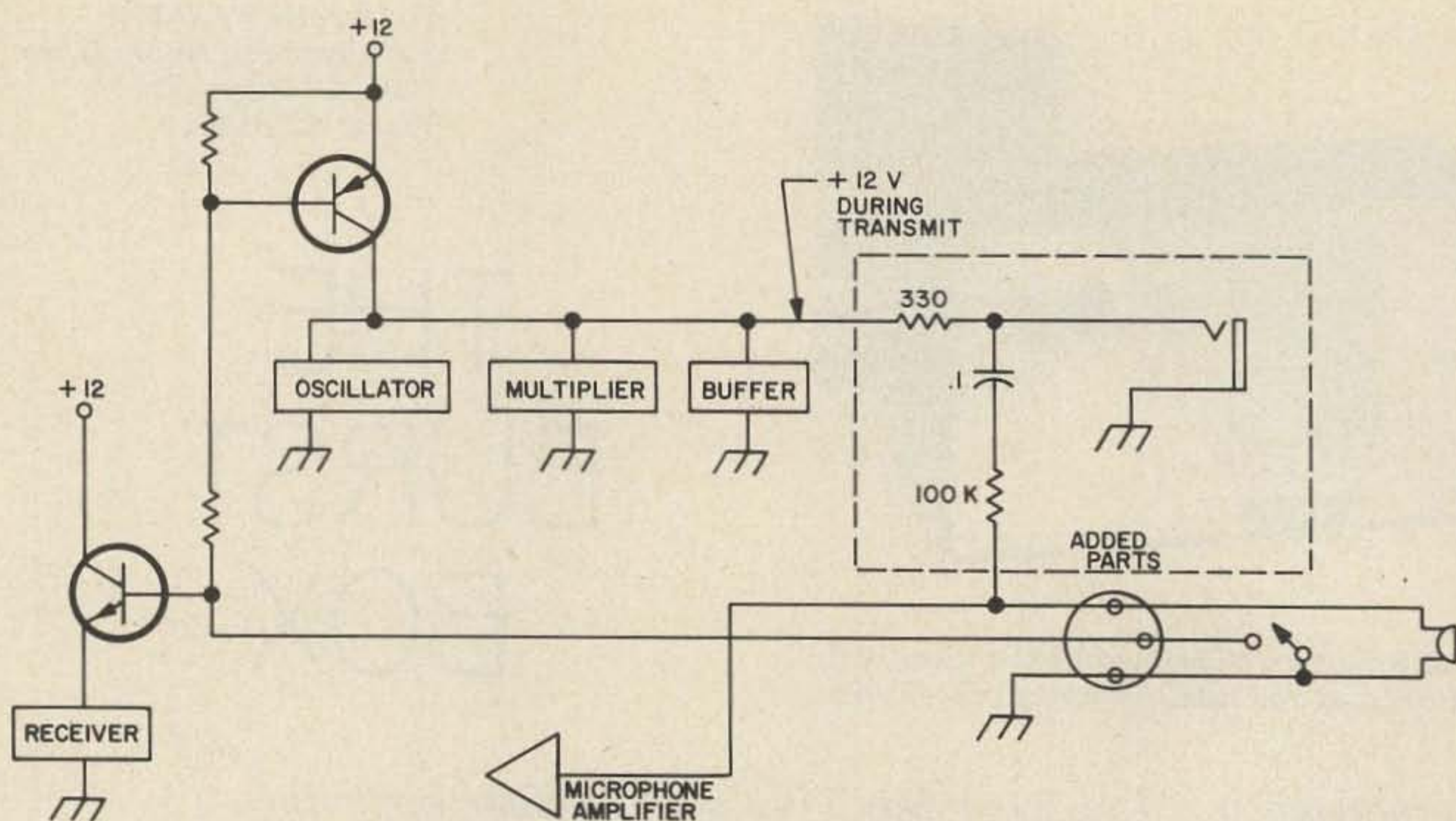

Fig. 2. The area inside the dotted lines show the extra components needed for connecting the Burst Box to a transceiver. Power is drawn through the  $330\Omega$  resistor.

frequency range of 100 Hz to 1 kHz or 1 kHz to 10 kHz ( $f \approx 1/RC$ ). In the burst mode, a  $1\text{ M}\Omega$  resistor charges up a  $1.0\ \mu\text{F}$  capacitor in roughly .6 second which gates off the square wave. High frequency components of the square wave are filtered by the  $10\text{ K}\Omega$  and a  $.01\ \mu\text{F}$  capacitor. The emitter follower drives the volume control, which couples signal as an ac component superimposed onto the dc coming from the transceiver. This ac component is coupled off inside the transceiver by a  $.1\ \mu\text{F}$  capacitor and a  $100\text{ K}\Omega$  resistor, feeding the audio to the microphone input circuit, but not loading or biasing the microphone.

### Construction

First locate the place in your transceiver where transmit B+ (+12V) can be tapped. Next, locate an earphone jack at a place where it may be conveniently mounted. Now solder in the  $330\Omega$ ,  $.1\ \mu\text{F}$ , and  $100\text{ K}\Omega$  resistors. The burst box is now constructed in any convenient chassis. If desired, the same box may be used for a touchtone, and the power and signal for it derived in the same way.

The circuit should be constructed using a 14 pin dual inline socket and some small scrap P/C board. The CMOS quad two input NOR MC14001 should be handled with

some caution. It is shipped with its leads in a black conductive foam. When the box construction is complete, remove it from the foam and plug it in.

Be sure to check that pin 1 of the package is in pin 1 of the socket and connects to the frequency potentiometer. Do not put the MOS device in styrofoam, or put it in a plastic tray, since static electricity may destroy its high impedance gates. I have found these devices to be rugged and have

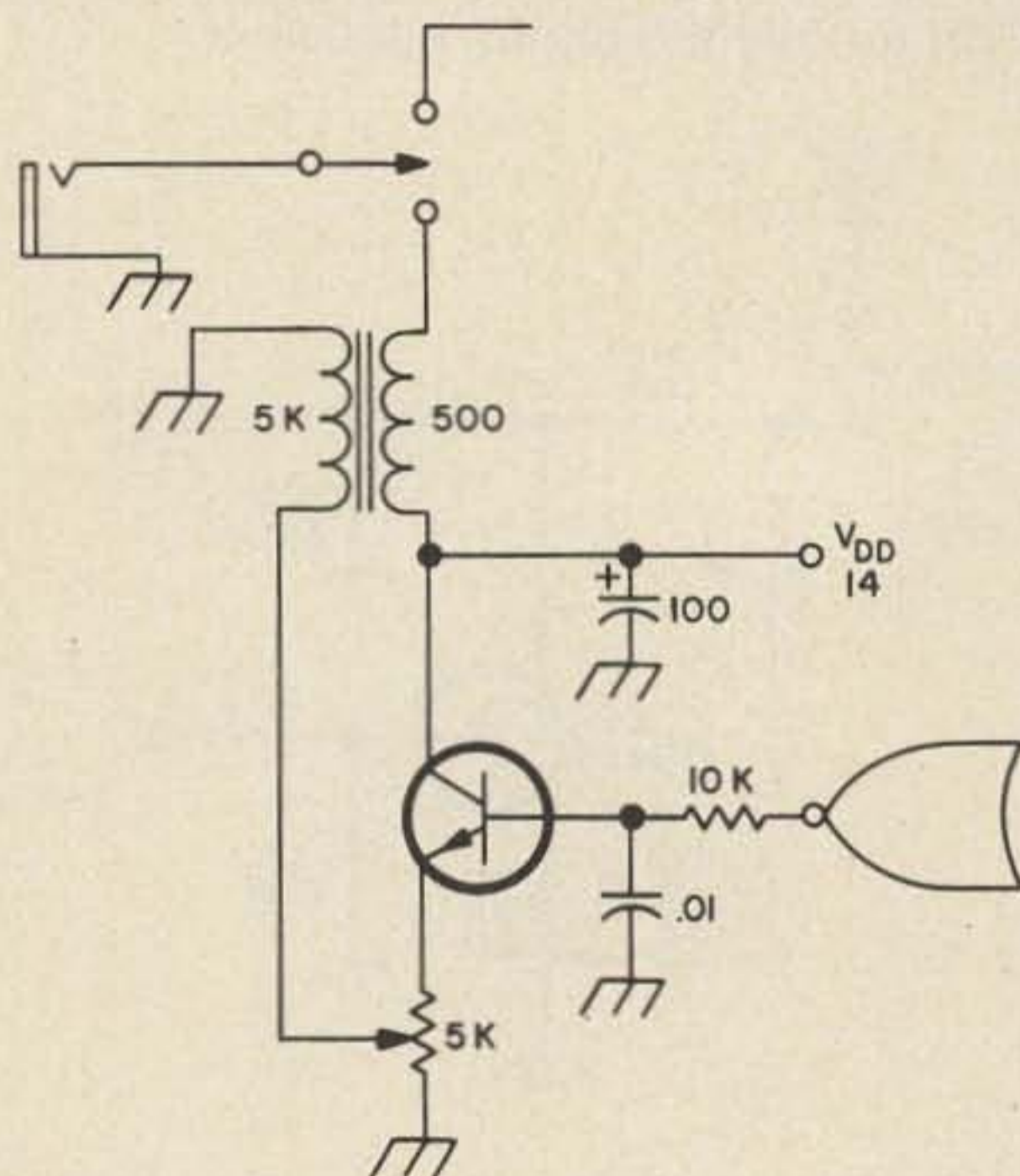
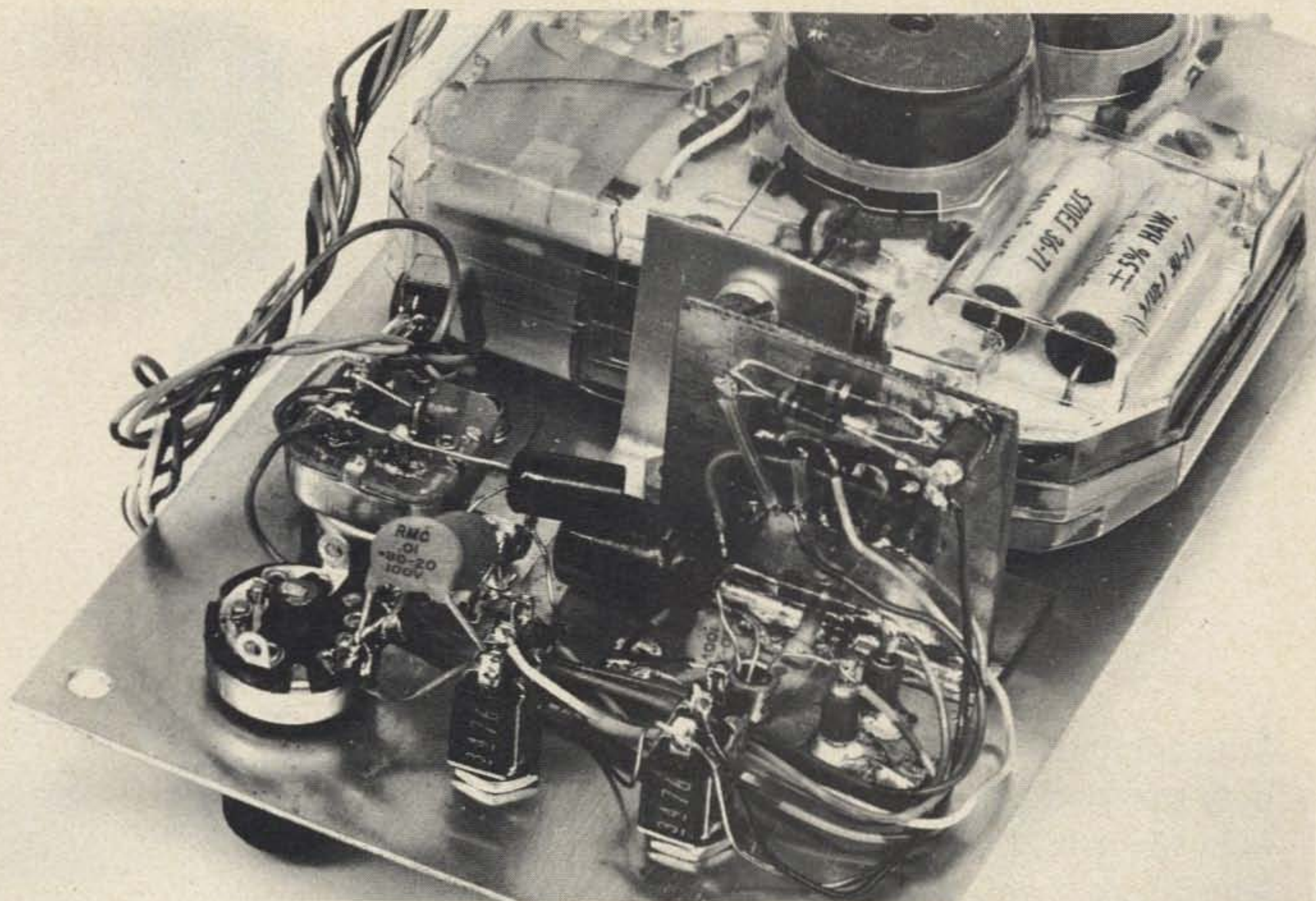

Fig. 3. The output from this alternate circuit looks more like sine waves than that from Fig. 1.



Inside of burst box. The IC is mounted on the upright PC board near the center of the panel. R4 and R2 are at the left.

never burned one out, but the manufacturer suggests caution.

After checking the wiring, try it.

### Operation

The face to the box should be frequency calibrated, either in kHz steps or by marking

locally used frequencies. This can be done with a scope and calibrated audio generator. Set the frequency range switch to whatever range is necessary in your area; set the burst-continuous switch to continuous. Couple +9V through a 330Ω resistor, making sure the positive side connects to the 200Ω resistor inside the box. Pick audio off the 330Ω resistor into the oscilloscope vertical input, and the audio generator into the horizontal, and adjust for a Lissajous pattern. Note that the burst box does not generate sine waves. (The waveforms generated will more closely resemble sine waves if transformer coupling instead of capacitive coupling from emitter follower to transmitter is used.) Calibrate the frequencies on the face plate. If your repeater uses continuous sub-audible tones, use the low frequency and continuous-mode. If your repeater uses tone burst, use the high frequency and burst mode. On direct (simplex) turn the volume all the way down or switch off the burst box.

Thanks to Jim Jeager WA8KDR, for his assistance in this project. . . .WA7NMO

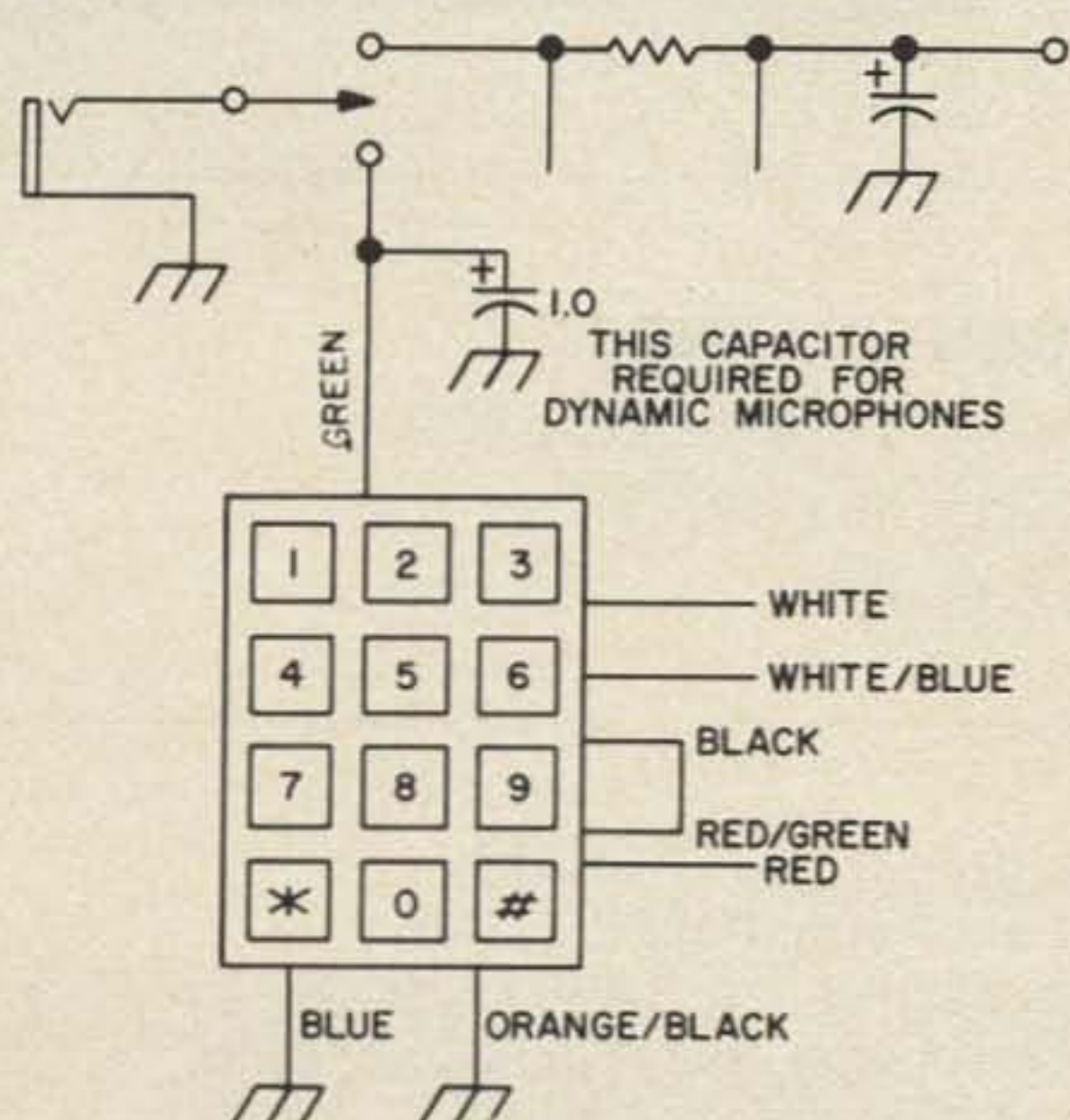

Fig. 4. Diagram showing touchtone connections to the Burst Box.

# HAM & YAESU

## Another American Favorite!

A discriminating ham and Yaesu products go together like that old American favorite, ham and eggs. That's why there's an ever-increasing demand for the complete line of amateur radio products now available from Yaesu Musen USA Inc.

Yaesu products are a natural for American hams because of their strict standard of high quality. And because Yaesu now has its own factory in the U.S. to provide direct service and to back up its dealers throughout the country.

Another American favorite. Ham and Yaesu.

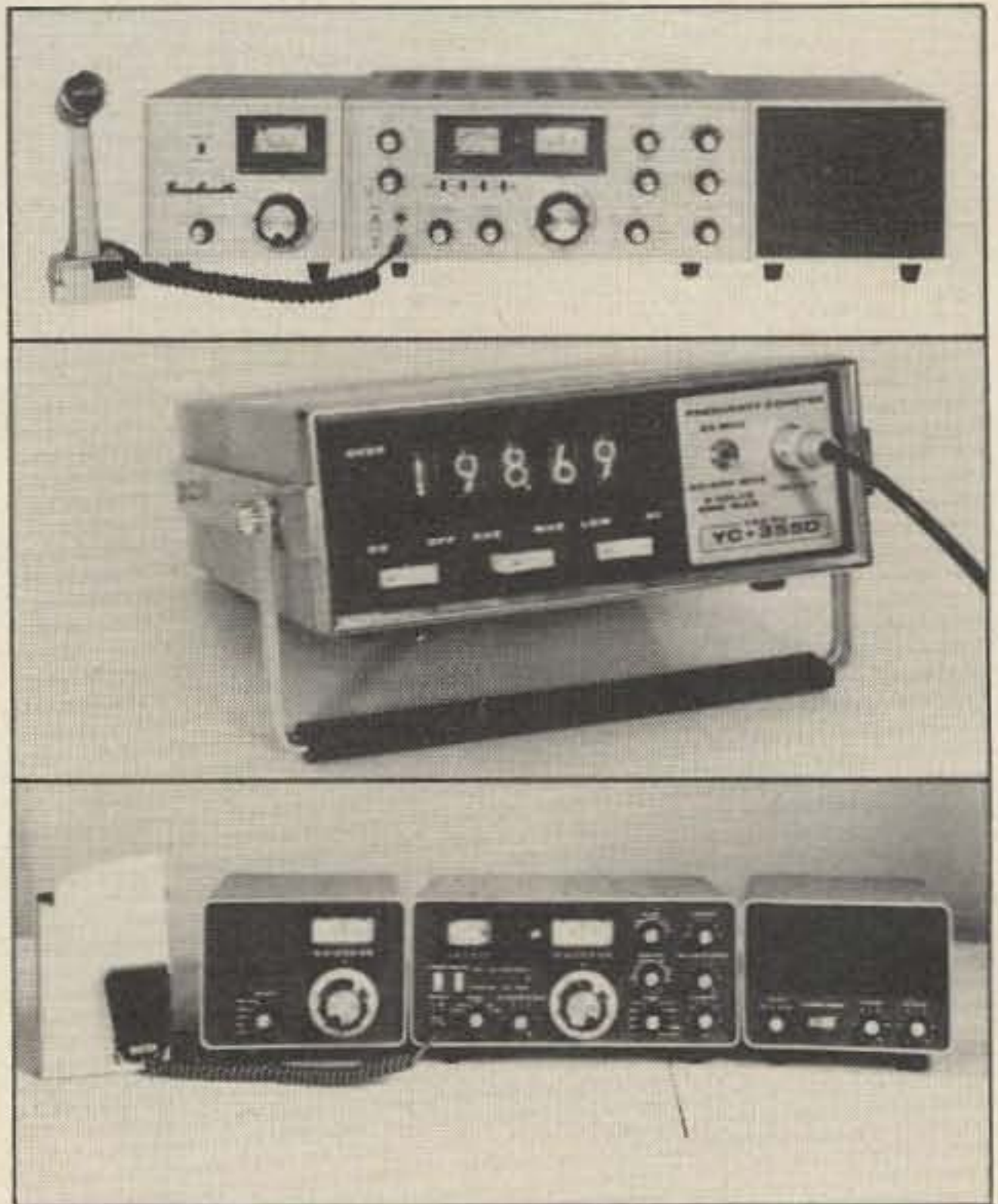

### YAESU MUSEN USA INC.

7625 East Rosecrans Ave., Unit #29,  
Paramount, California 90723  
Phone: (213) 633-4007

#### YAESU DEALERS:

##### HENRY RADIO STORES

Los Angeles, Anaheim, Calif.; Butler, Mo.

##### HAM RADIO OUTLET

Burlingame, Calif.

##### RACOM ELECTRONICS

Renton, Wash.

##### WILSON ELECTRONICS

Pittman, Nev.

##### ED JUGE ELECTRONICS

Fort Worth, Dallas, Texas.

##### AMATEUR ELECTRONICS SUPPLY

Milwaukee, Wis.; Cleveland, Ohio.

##### FRECK RADIO & SUPPLY

Asheville, No. Carolina.

##### HARRISON RADIO

Farmingdale, New York, Valley Stream, N.Y.

# POWER INVERTER WITH SINE WAVE OUTPUT

*Why put up with noise generated by square wave inverters when you can get 60 Hz sine wave output at little extra expense?*

**H**ow would you like to have a 115 volt 60 cycle outlet in your car? It would be extremely convenient for use with that receiver, transmitter, or tape recorder having only a built-in ac power supply. For around \$30 you can buy a little 100 watt solid state inverter using power switching transistors; but wait til you connect your nice store-bought power inverter to a device having a high gain audio amplifier in it. I'm afraid you will be in for quite a shock. The sharp-cornered square wave output often with accompanying sharp little spikes all too frequently seeps through to your low level, high gain audio stages producing the most annoying cacophony of sounds you have heard in a long time. The simple square wave output power inverters are great for razors, electric drills, soldering irons, and even some electronic gear, but for more demanding requirements you need an inverter with a good old sine wave output.

The expense and number of parts required to build a sine wave power inverter are not much greater than for a noisy square wave switching-type supply. Just an additional three or four small transistors, a dozen or so resistors and capacitors, two or three pots and a small driver transformer are all

the extra parts that are needed. A glance at Fig. 1 will suffice to show that the basic idea of a sine wave power inverter is exceedingly simple. The block diagram reminds one of a simple 80 meter CW transmitter, and this comparison is quite valid. Basically only the frequency is different; 60 Hz instead of 3.5 MHz. And generating 100 watts of sine wave ac is considerably simpler at 500,000 meters (60 Hz) than at 80 meters (3.5 MHz). A typical circuit is shown in Fig. 2. I do not particularly recommend this circuit over other similar circuits which you can easily devise. The essentials are a sine wave oscillator, a buffer amplifier, and a power amplifier. Let me make a few comments about the requirements on each.

## The Oscillator

The oscillator can be any type, but a good choice for practical reasons is one using

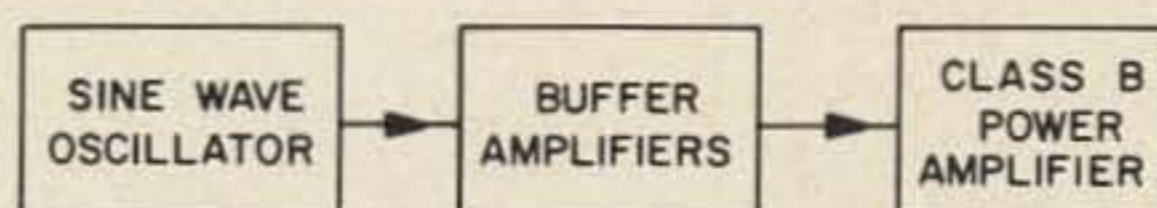

Fig. 1. Block diagram of a power inverter with sine wave output.

RC combinations. Even an oscillator using an inductor-capacitor combination such as the Hartley or Colpitts can be used at 60 Hz, but the problem of varying the frequency in order to adjust it to 60 Hz is made much, much easier by using an oscillator whose frequency is determined by an RC network, since the frequency can then be adjusted by merely setting a potentiometer. In Fig. 2 the 10K potentiometer in the oscillator section enables one to adjust the frequency. Make sure your oscillator does produce a sine wave. Some RC oscillator circuits are designed to produce square waves and others a sawtooth output. Don't use these, or you will end up with an inverter that is as good a hash producer as the simple power-switching type. The 3.9K potentiometer in the oscillator section of the circuit shown in Fig. 2 controls the amount of gain in the feedback loop. Too much gain will result in severe distortion of the sine wave.

### The Oscillator Frequency

Incidentally, there may be times when you will want to run your inverter at other than 60 Hz. I at one time used my inverter to power a reel-type tape deck operating in my car. In order to run through a 60 minute

reel containing voice material during a drive which normally required 50 minutes, I ran the frequency at about 70 Hz, thus speeding up the tape deck motor. This procedure would certainly not be acceptable with music, but you soon adapt to the slightly higher pitch of voices. This approach would be a natural for varying the speed of a code practice tape. You should, however, carefully check that your equipment, and in particular its motors and transformers, can be operated without overheating before subjecting it to use for extended periods of time at frequencies other than 60 Hz.

How can you set your oscillator to 60 Hz? Any of the standard ways of measuring an audio frequency can be used. You might compare your oscillator's frequency with the commercial line voltage frequency either by observing Lissajous figures on an oscilloscope or by listening to and setting the beat frequency to zero. Or if you have access to a digital frequency counter, go first class and use it to measure and set the frequency to 60 Hz.

### Output Voltage

In addition to having the frequency right, you will want to have the output voltage

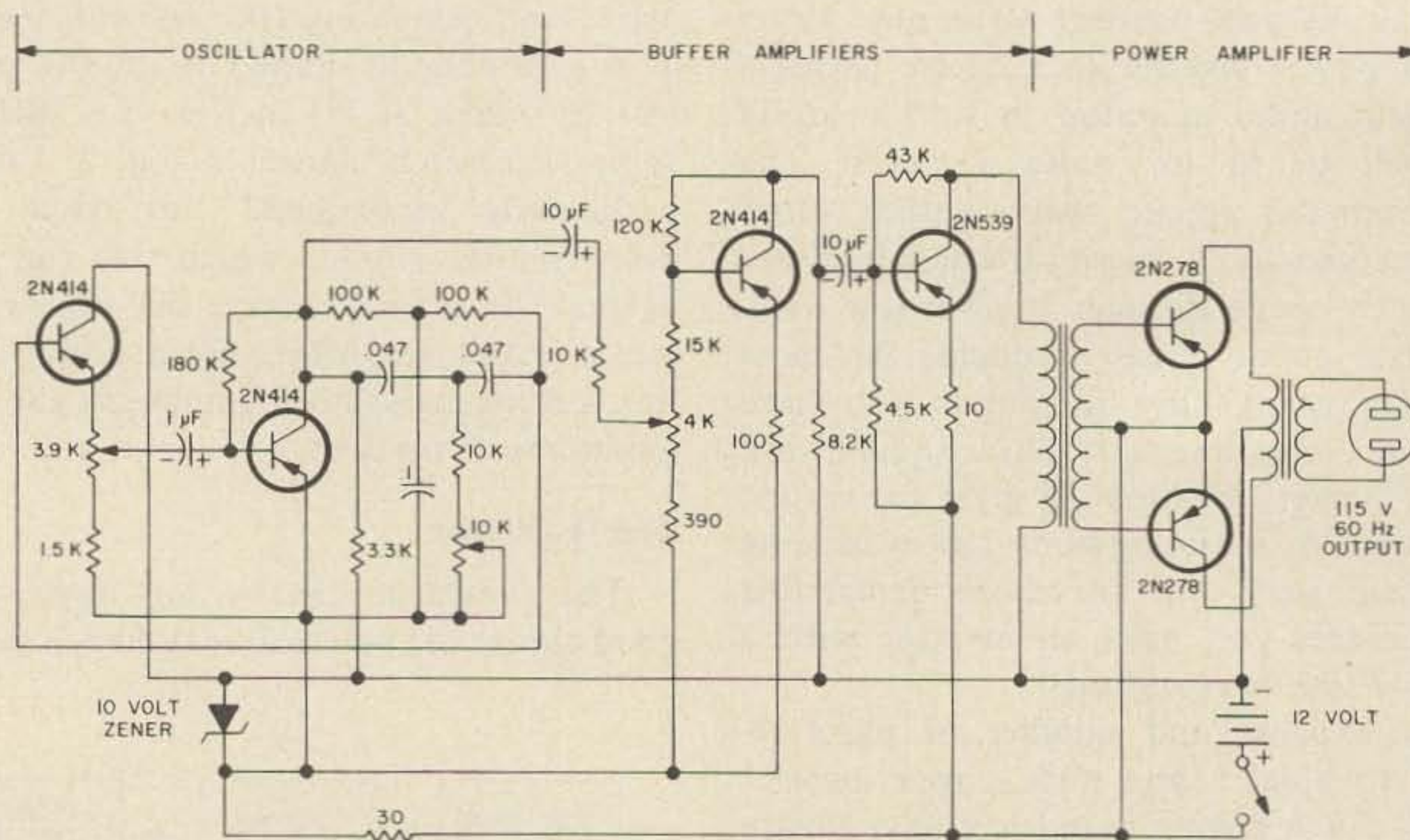

Fig. 2. Schematic of the sine wave output power inverter. The inverter is nothing more than a vfo controlled, push-pull output transmitter operating at 60 Hz. Frequency can be varied by the 10K potentiometer in the oscillator section. The transformers in the output stage can be any filament transformers with adequate power ratings.



reasonably near the desired range of 115–120 volts. In the circuit of Fig. 2, the output voltage is determined by the setting of the 4K potentiometer between the oscillator and the buffer amplifier stages. Of course this pot is nothing more than what we would normally call a volume control, and the following amplifier stages are merely conventional audio amplifiers, operating in our case at 60 Hz. If you want a deluxe setup for continuously monitoring the voltage output of your inverter, you can build in a standard ac voltmeter. A simpler and less expensive approach which will enable you to monitor the output voltage quite adequately is illustrated in Fig. 5. A simple voltage-divider resistor network is used in connection with a small neon lamp to indicate the output voltage. The neon lamps indicated are the type requiring an external resistor for operating on 115 volts. R1 and R2 are selected by trial and error so that the first neon lamp ignites at 110 volts, and R3 and R4 are chosen so that the second neon starts at 120 volts. Then by setting the potentiometer controlling the voltage output so that the first neon lamp is on and the second is off, you are assured that the voltage output is in the range 110–120 volts. Depending on the type of neon lamp used, suitable values for R1, R2, R3 and R4 will lie in the range 30 K to 150K.

### The Buffer and Power Amplifier

The particular circuit and transistors chosen for the buffer amplifiers is completely non-critical. Any sort of audio amplifier with sufficient oomph to drive the power amplifier will be quite satisfactory. Just remember that you will need good bass response since the operating frequency is 60 Hz. In other words, don't scrimp on the size

of the coupling capacitors. The same general remarks apply to the power amplifier. The input and output transformers need not be regular audio transformers. In fact, you will be better off using ordinary 60 Hz power transformers. The driver transformer, for example, could be a small power transformer having three filament windings. One winding could be used for the primary, and the other two in series could make up the center-tapped secondary. A center-tapped filament transformer would be quite suitable for the output transformer. With a 12 volt dc supply, one would expect the power amplifier transistors to produce an ac voltage in the range of 7–9 volts peak value or 5–6.5 volts rms. Thus a 12 volt center-tapped filament transformer with its 115 volt winding used as the secondary or output should be quite satisfactory. The size or current rating of the filament transformer is determined by the amount of power you will want to handle. A 5 ampere, 12V transformer will be quite adequate for powers up to 50 or 60 watts. The possibility of paralleling transformers in order to take care of higher powers should not be overlooked.

The choice of transistor type to be used in the power amplifier is determined largely by how much power you need to develop, and by what transistors you may have available. I insured adequate cooling of the 2N178's used by immersing them and their heat sinks in a large volume of antifreeze. The five leads were brought out through insulated feedthroughs soldered into the wall of the antifreeze container, making a splash and spill proof assembly.

### Efficiency

The power amplifier stage operates Class B, or nearly so. The theoretical efficiency

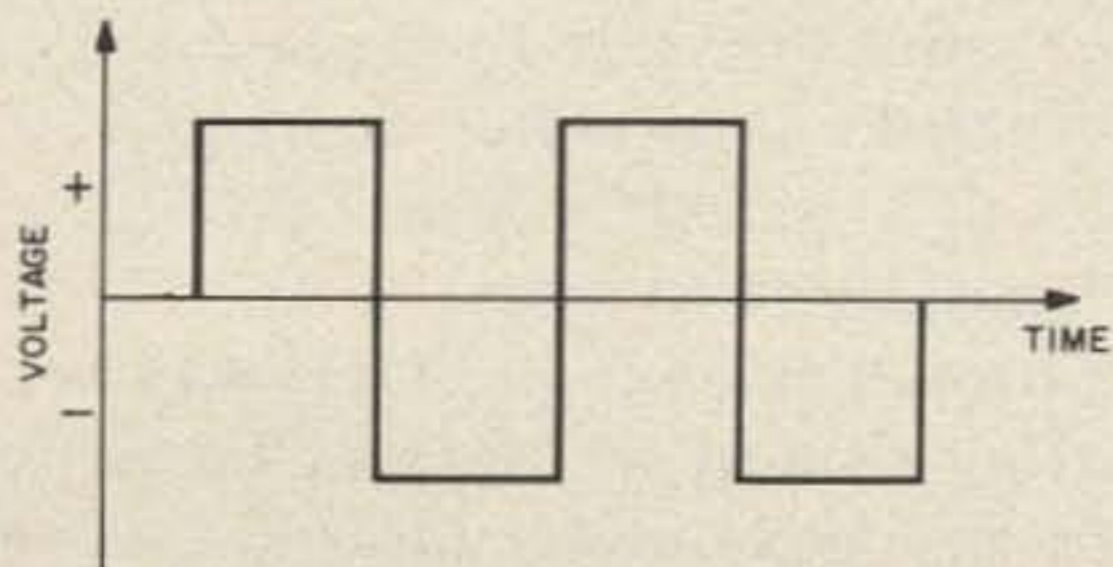

Fig. 3. Idealized output wave of a power inverter using power switching transistors.

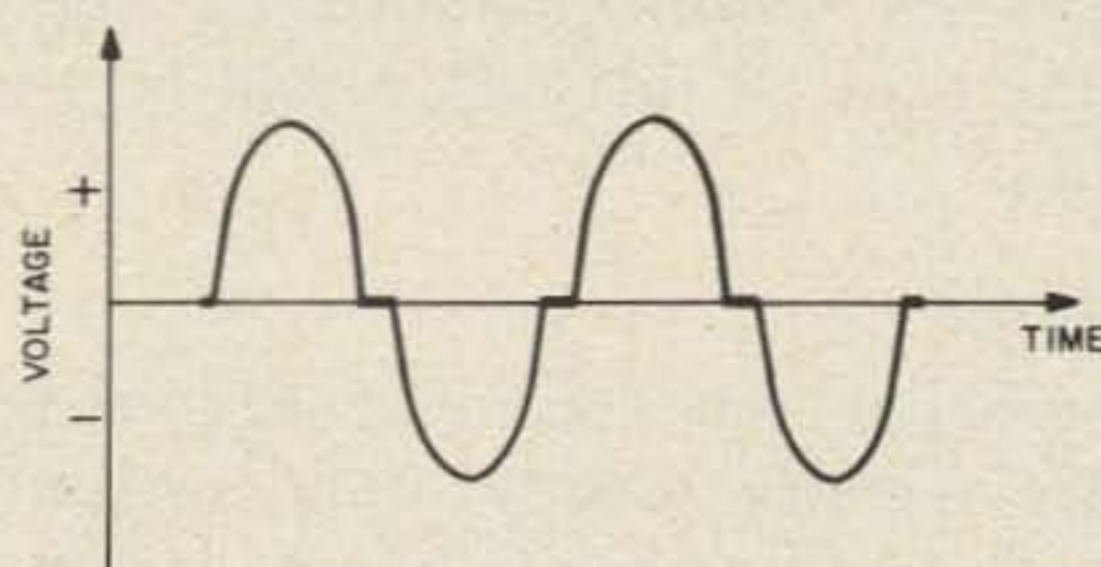

Fig. 4. Output waveform of power inverter shown in Fig. 2.

# NEW Instant access to 144 frequency pairings with 20 watts out on the new HR-212 twelve channel 2 Meter FM Transceiver by Regency

## Specifications

Power Output: 20 watts (nom.) at 13.8 V DC

Frequency Range: 144-148 MHz

Channels: 12; crystal controlled

Sensitivity: 0.4 uv, 20 DB quieting

Spurious Rejection: 60 DB



**Model HR-212** \$259 Amateur Net  
Includes microphone, mounting bracket and factory installed transmit and receive crystals for 146.94 MHz.

## for all your 2 Meter FM needs

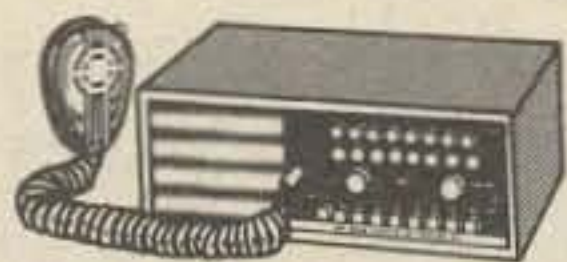

**Model HR-2MS** 8 channel Transcan™ with signal search reception and 15 watts minimum output. \$319.00 Amateur Net



**Model HR-2A** 6 channel transmit, 12 receive 2 Meter FM Transceiver with 15 watts minimum output. \$229.00 Amateur Net



**Model AR-2** Amplifier boosts 2 Meter FM output power 300%. \$119.00 Amateur Net

**Regency** Electronics, Inc.

7900 Pendleton Pike • Indianapolis, Indiana 46226

Regency 2 Meter FM—American made at import prices

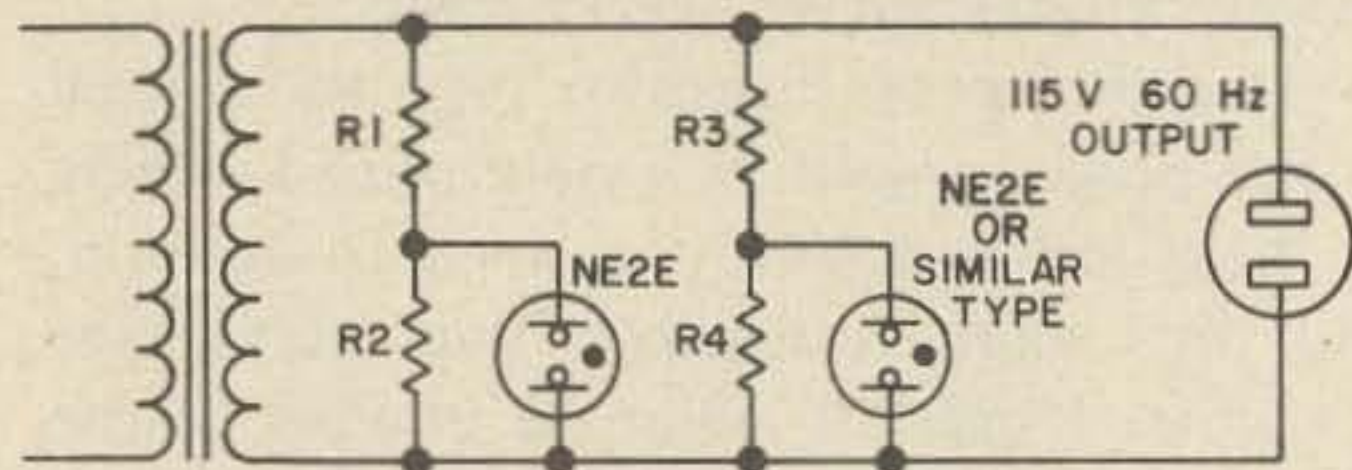

Fig. 5. A simple scheme for monitoring the output voltage.

for Class B amplifiers is 78.5% with practical amplifiers achieving 60–70% efficiency. Assuming that your power amplifier turns out to be 65% efficient and that you are delivering 100 watts to a 115V 60 Hz load, how many amps will your 12V battery have to deliver to the power inverter? Working through the arithmetic involved indicates that the load on the battery will be 14–15 amperes.

### Waveforms

The actual waveform obtained from my inverter departs slightly from a true sine wave. As can be seen in Fig. 4, each power transistor of my power amplifier has an operating angle slightly less than  $180^\circ$ , that

is, Class C type operation is being approached. A small shift in bias would bring the amplifier back to true Class B, but since no noise pickup is observed, the additional effort to change the bias did not seem worthwhile.

### A Caution

Transistors are quite sensitive to temperature. This fact was brought vividly to my attention when I discovered that my power inverter in its original form would not function on cold winter days until the interior of my car warmed up. The oscillator would simply fail to take off because the gain in the feedback loop was too low. This sad situation was corrected by making the 3.9K potentiometer accessible so that it could be manually reset to increase the gain in the feedback loop. After the temperature rose, the gain was then lowered to prevent distortion of the waveform.

If you are looking for a simple way to run gear having built-in 60 Hz supplies in your car, this sine wave power inverter may well be your answer.

...W7OXD

# EASY PREAMP FOR 450 MHz

**W**ith the wide availability and low cost of used 450 MHz commercial transceivers and also with the new FM transceivers on the market, the 450 band is really enjoying popularity. Many 450 repeaters are also being combined with VHF repeaters. Good 450 coverage is essential to a remote base system if it is to be used from a mobile control point. The mobile receiver is often the weakest link since it is affected by local noise that does not bother the mobile transmitter or remote receiver. Since most 450 tube radios have trouble hearing signals weaker than  $.8 \mu\text{V}$  or so, addition of an rf preamplifier will make a significant improvement in receiver sensitivity and quieting.

Here is a simple 450 preamplifier that can be built easily, using a minimum of parts. It

will provide up to 10 dB of gain with a noise figure low enough to provide a major improvement when used with older tube type receivers. Detailed construction description is included to assist the inexperienced builder.

## Circuit

Figure 1 shows a single stage common base amplifier. The simplicity of this single stage amplifier allows for the use of a minimum number of parts. Addition of a second stage would not be justified unless the receiver to be used were really poor. The 800 pF dc blocking capacitors allow the use of trough-line inductors to simplify construction. 1N914 diodes may be added in parallel at the input jack to protect the transistor from burn-out by a nearby trans-

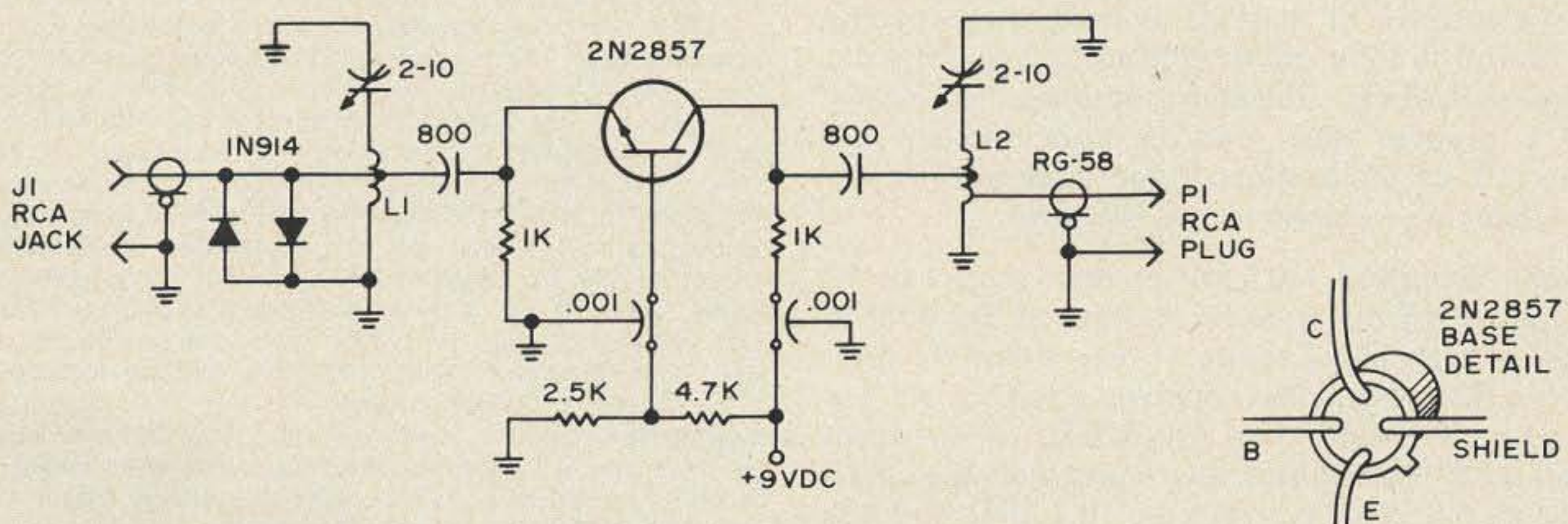

Fig. 1. Schematic of the 450 MHz preamplifier.

# Heathkit® 2-Meter FM gear is here!



NEW Heathkit  
2-Meter  
FM Transceiver

**179<sup>95</sup>\***

HW-202 shown above  
with Tone Burst  
Encoder installed.

• **All solid-state design** • **Can be completely aligned without instruments** • **36-channel capability** — independent push-button selection of 6 transmit and 6 receive crystals • **10-Watts Minimum Output** — designed to operate into even an infinite VSWR without failure • **Optional Tone Burst Encoder** — mounts inside, gives front-panel selection of four pre-settable tones

The Heathkit HW-202 compares with the best wired amateur 2M/FM rigs. Plus it has: 36-channel capability via independent selection of 6 transmit and 6 receive crystals. Solid-state circuitry with complete built-in alignment procedures using only the manual and the front-panel meter allow operation over a 1 MHz segment from 143.9 to 148.3 MHz. Removable front-panel bezel permits installation of the new Heathkit HWA-202-2 Tone Burst Encoder.

**10-15 watts transmission into an infinite VSWR** — indefinitely, with no failure! The HW-202 needs no automatic shut-down — it continues to generate a signal regardless of antenna condition. Transmitter deviation is fully adjustable from 0 to 7.5 kHz, with instantaneous deviation limiting. Harmonic output is greater than -45 dB from carrier. The push-to-talk ceramic microphone supplied has an audio response tailored to the HW-202.

**Excellent reception** — 0.5 uV or less produces 12 dB Sinad, or 15 dB quieting. Output at the built-in speaker is typically 2 watts at less than 3% total harmonic distortion. The receiver circuitry utilizes diode-protected dual-gate MOSFETS in the front end; an IC IF that completely limits with less than a 10 uV signal; dual conversion, 10.7 MHz and 455 kHz via a 4-pole monolithic 10.7 MHz crystal filter. Image response is -55 dB or better. Spurious response is -75 dB or better.

The Heathkit HW-202 comes with two crystals used in initial set-up and alignment, give you simplex operation on 146.94. Kit includes microphone, quick-connecting cable for 12-volt hook-up, heavy duty alligator clips for use with a temporary battery, antenna coax jack, gimbal bracket, and mobile mount that lets you remove the radio from the car by unscrewing two thumbscrews. The HWA-202-2 Tone Burst Encoder provides four presettable pushbuttons for instant repeater access. Fixed station operation is as easy as adding the HWA-202-1 AC Power Supply. The HA-202 2-Meter Amplifier puts out 40 watts for 10 watts in, and externally it's a perfect mate for your HW-202.

Kit HW-202, 11 lbs., mailable ..... **179.95\***

Kit HWA-202-2, Tone Burst Encoder, 1 lb. . . **24.95\***

Kit HWA-202-1, AC Power Supply, 7 lbs. . . **29.95\***

Kit HWA-202-3, Mobile 2-Meter  
Antenna, 2 lbs. .... **17.95\***

Kit HWA-202-4, Fixed Station 2-Meter  
Antenna, 4 lbs. .... **15.95\***

**HW-202 SPECIFICATIONS — RECEIVER** — Sensitivity: 12 dB SINAD\* (or 15 dB of quieting) at .5µv or less. Squelch threshold: 3 µv or less. Audio output: 2 W at less than 10% total harmonic distortion (THD). Operating frequency stability: Better than ±.0015%. Image rejection: Greater than 55 dB. Spurious rejection: Greater than 60 dB. IF rejection: Greater than 75 dB. First IF frequency: 10.7 MHz ±2 kHz. Second IF frequency: 455 kHz (adjustable). Receiver bandwidth: 22 kHz nominal. De-emphasis: -6 dB per octave from 300 to 3000 Hz nominal. Modulation acceptance: 7.5 kHz minimum. **TRANSMITTER** — Power output: 10 watts minimum. Spurious output: Below -45 dB from carrier. Stability: Better than ±.0015%. Oscillator frequency: 6 MHz, approximately. Multiplier factor: X 24. Modulation: Phase, adjustable 0-7.5 kHz, with instantaneous limiting. Duty cycle: 100% with ∞ VSWR. High VSWR shutdown: None. **GENERAL** — Speaker impedance: 4 ohms. Operating frequency range: 143.9 to 148.3 MHz. Current consumption: Receiver (squelched): Less than 200 mA. Transmitter: Less than 2.2 amperes. Operating temperature range: -10° to 122° F (-30° to + 50° C). Operating voltage range: 12.6 to 16.0 VDC (13.8 VDC nominal). Dimensions: 2¾" H x 8¼" W x 9⅞" D.

\*SINAD =  $\frac{\text{Signal} + \text{noise} + \text{distortion}}{\text{Noise} + \text{distortion}}$

# ...and here!

## NEW Heathkit 2-Meter Amplifier for cleaner FM copy on the fringe... **69<sup>95</sup>\***

40 watts nominal out for 10 watts in —  
requires only 12 VDC supply.

Fully automatic operation — with any  
2-meter exciter delivering 5-15 watts drive.

Solid-state design — all components  
mount on single board for fast,  
easy assembly.

If you're regularly working from a fringe area, the new Heathkit HA-202 can boost your mobile output to 40 watts (nominal), while pulling a meager 7 amps from your car's 12-volt battery.

Install it anywhere...in the trunk, under the hood or dashboard. Use it with any 2-meter exciter delivering 5-15 watts drive. Features fully automatic operation. An internal relay automatically switches the antenna from transmit to receiver mode when you release the mike button.

All solid-state design features rugged, emitter-ballasted transistors, combined with a highly efficient heat sink, permitting high VSWR loads. Tuned input-output circuits offer low spurious output to cover the 1.5 MHz segment of the 2-meter band without periodic readjustment. All components mount on a single printed circuit board for easy,



4-hour assembly. Manual shows exact alignment procedures using either a VOM or VTVM. And installation is just as simple.

Kit includes transceiver connecting cable, antenna connector. Operates from any 12 VDC system — additional power supplies are not required. Add HA-202 power to your mobile 2-meter rig, and boom out of the fringe. **Kit HA-202**, 4 lbs.

**HA-202 SPECIFICATIONS** — Frequency range: 143-149 MHz. Power output: 20W @ 5 W in, 30W @ 7.5W in, 40W @ 10 W in, 50W @ 15 W in. Power input (rf drive): 5 to 15W. Input/output impedance: 50 ohms, nominal. Input VSWR: 1.5:1 max. Load VSWR: 3:1 max. Power supply requirements: 12 to 16 VDC, 7 amps max. Operating temperature range: -30° F. to +140° F. Dimensions: 3" H x 4 1/4" W x 5 1/2" D.

# ...and here!

## New Heathkit VHF Wattmeter/SWR Bridge ... **29.95\***



Perfect tune-up tool for your 2-meter gear. Tests transmitter output in power ranges of 1 to 25 watts and 10 to 250 watts  $\pm 10\%$  of full scale. 50 ohm nominal impedance permits placement in transmission line permanently with little or no loss. Built-in SWR bridge for tuning 2-meter antenna for proper match, has less than 10-watt sensitivity. **Kit HM-2102**, 4 lbs.

**HM-2102 SPECIFICATIONS** — Frequency range: 50 MHz to 160 MHz. Wattmeter accuracy:  $\pm 10\%$  of full-scale reading.\* Power capability: To 250 W. SWR sensitivity: less than 10 W. Impedance: 50 ohms nominal. SWR bridge: Continuous to 250 W. Connectors: UHF type SO-239. Dimensions: 5 1/4" W, 5 1/8" H and 6 1/2" D, assembled as one unit.

\*Using a 50  $\Omega$  noninductive load.

See them at your Heathkit Electronic Center —  
or fill out coupon for FREE Heathkit catalog

### HEATHKIT ELECTRONIC CENTERS

ARIZ.: Phoenix, 2727 W. Indian School Rd.; CALIF.: Anaheim, 330 E. Ball Rd.; El Cerrito, 6000 Potrero Ave.; Los Angeles, 2309 S. Flower St.; Pomona, 1555 Orange Grove Ave. N.; Redwood City, 2001 Middlefield Rd.; San Diego (La Mesa), 8363 Center Dr.; Woodland Hills, 22504 Ventura Blvd.; COLO.: Denver, 5940 W. 38th Ave.; CONN.: Hartford (Avon), 395 W. Main St. (Rte. 44); FLA.: Miami (Hialeah), 4705 W. 16th Ave.; GA.: Atlanta, 5285 Roswell Rd.; ILL.: Chicago, 3462-66 W. Devon Ave.; Downers Grove, 224 Ogden Ave.; IND.: Indianapolis, 2112 E. 62nd Ave.; KANSAS: Kansas City (Mission), 5960 Lamar Ave.; MD.: Baltimore, 1713 E. Joppa Rd.; Rockville, 5542 Nicholson Lane; MASS.: Boston (Wellesley), 165 Worcester St.; MICH.: Detroit, 18645 W. Eight Mile Rd. & 18149 E. Eight Mile Rd.; MINN.: Minneapolis (Hopkins), 101 Shady Oak Rd.; MO.: St. Louis, 9296 Gravois Ave.; N.J.: Fair Lawn, 35-07 Broadway (Rte. 4); N.Y.: Buffalo (Amherst), 3476 Sheridan Dr.; New York City, 35 W. 45th St.; Jericho, L.I., 15 Jericho Turnpike; Rochester, Long Ridge Plaza; OHIO: Cincinnati (Woodlawn), 10133 Springfield Pike; Cleveland, 5444 Pearl Rd.; PA.: Philadelphia, 6318 Roosevelt Blvd.; Pittsburgh, 3482 Wm. Penn Hwy.; TEXAS: Dallas, 2715 Ross Ave.; Houston, 3705 Westheimer; WASH.: Seattle, 221 Third Ave.; WIS.: Milwaukee, 5215 Fond du Lac.

HEATH Schlumberger	
HEATH COMPANY, Dept. 11-5 Benton Harbor, Michigan 49022	
<input type="checkbox"/> Please send FREE Heathkit Catalog.	
Enclosed is \$ _____, plus shipping.	
<input type="checkbox"/> Please send model(s) _____	
Name _____	
Address _____	
City _____ State _____ Zip _____	
*Mail order prices; F.O.B. factory AM-282	

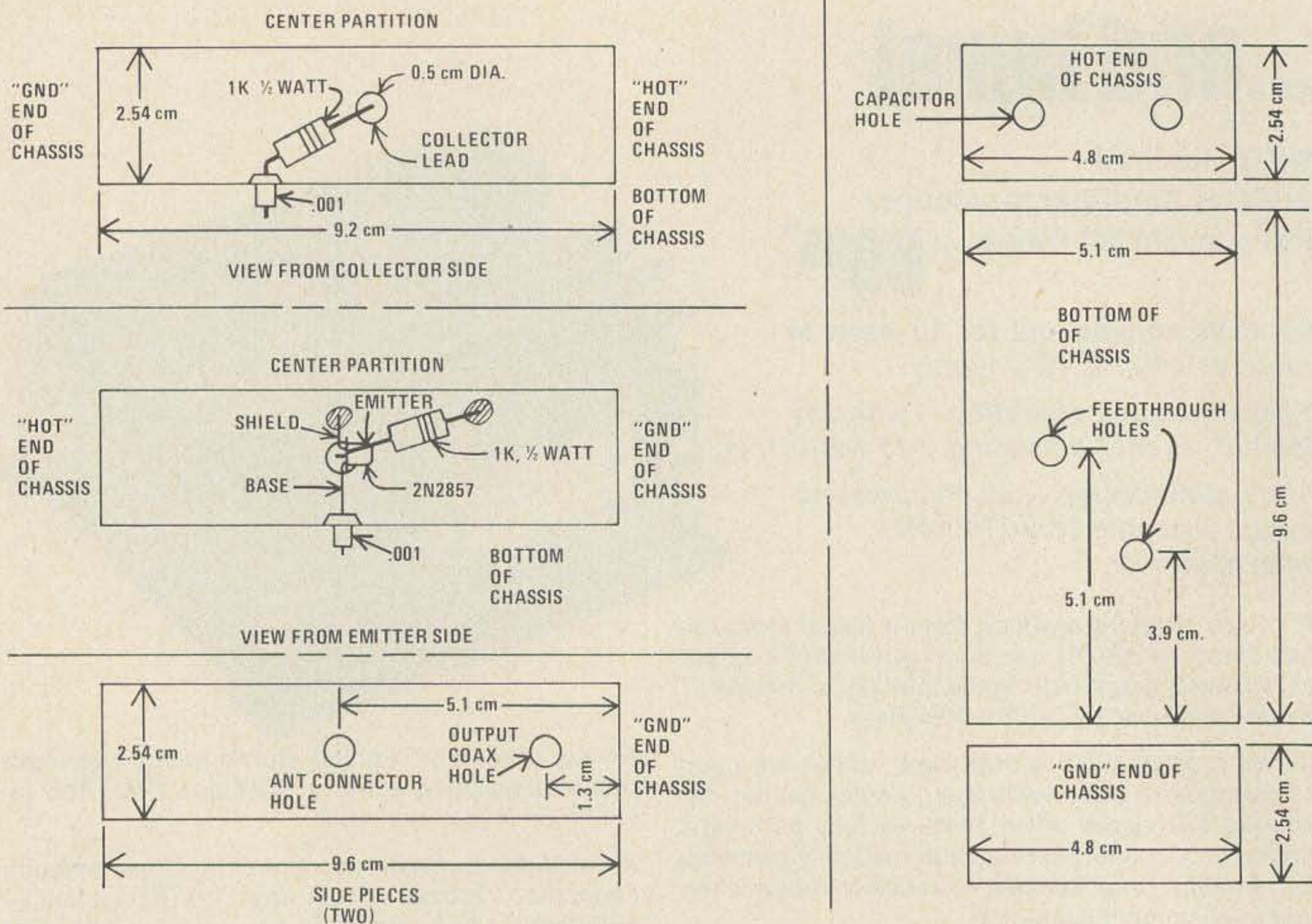

Fig. 2. Construction details and dimensions.

mitter. Other types of silicon NPN UHF transistors such as the 2N3839 may be used in place of the 2N2857.

### Construction

The first step in construction is to cut out the six parts of the chassis as indicated in Fig. 2. The use of epoxy PC board results in construction that is much stronger or lighter, and is easier to work with, than in the case where copper or brass sheet is used. The PC board may be either single or double clad. It should be good quality material such as epoxy to prevent peeling when heated.

Figure 2 shows two views of the center partition, one from each side to show circuit construction details. One view is shown of both the side pieces, which are different. One hole only is drilled in each piece. The size of the hole for the antenna jack will depend on the type of connector used. RCA jacks are used almost universally in all receiver strips. The output connection from the preamplifier is a short length of RG 58 with an RCA plug on the end.

The pieces of board should be cleaned to facilitate soldering after they are cut out. Steel wool will do a good job here.

The center partition should be soldered to the bottom board first. Spot solder it together with two small blobs of solder so that its position may be adjusted if it is placed incorrectly the first time. Using a large soldering iron or gun, run a smooth bead of solder along the joint. The joint will be permanent after the entire length is soldered, and will be very difficult to remove. The hot and gnd ends of the chassis are added next in the same manner. The structure now should be quite sturdy, and at this point the internal circuitry may be added.

Mount feedthrough bypass capacitors in the holes in the bottom plate. Bend the leads of the transistor out axially from the bottom of the case, and solder the shield lead to the center partition so that the collector lead extends through the hole in the partition. The base lead will connect to the feedthrough capacitor on the bottom plate. Next

add the 1K resistors on opposite sides of the partition to the two free transistor leads as shown in Fig. 2. Keep the leads as short as possible.

The tuned circuits are added next. L1 and L2 are made from 1/4 in. diameter copper tubing and should be 8.6 cm long, including the length of the capacitor. Many types of capacitors may be used in this circuit, but they should have a maximum of about two picofarads when at minimum capacitance. Ten picofarad capacitors peak near the minimum capacitance end of their range. If a piston type capacitor is used, the capacitor is mounted first and the tubing is cut to fit from the capacitor to the end of the chassis. The length of the coil is not extremely important since the capacitance may be varied. If another type capacitor is used, the coil tubing is soldered to the end of the chassis first. This is strong enough to support the capacitor while it is soldered from the end of the coil to ground by its leads. The hole in the end of the chassis is now used for access to the capacitor for tuning. Be sure to put the rotor lead of the capacitor to ground so that the tuning tool will not detune the circuit when it is touched. L1 is tapped at 5 cm from the ground end, and L2 is tapped at 5 cm for the collector, and one half inch for the output coax lead.

With the coils in place the 800 pF capacitors can be added. These were small disc ceramics stripped from an old TV receiver chassis. The critical point with these capacitors is size – the smaller the better.

The two sides can be added now that the center circuitry is completed. It is easier to mount the input jack after the side panel is mounted to make soldering the long joint easier. On the output side it may be easier to solder the coax braid on first, since this may be difficult. The coax is passed through the hole with about 0.6 cm of braid exposed. The braid is spread out axially and soldered to the chassis. The insulation is stripped before mounting the panel and soldered after the side panel is secured. Be sure to run a smooth bead of solder around all corner joints. The internal wiring is now completed.

The 2.5K and 4.7K resistors are mounted externally under the bottom plate. It is necessary to drill a hole through the bottom

## TONE BURST ENCODER



- New! Eleven tones in one encoder.
- LC oscillator. Stable; no RC circuits to drift.
- No batteries needed.
- Full one year warranty.

- Now, all the popular tone frequencies in one encoder. Panel switch selects 1650, 1800, 1950, 2000, 2100, 2250, 2400, 2550, 2700, 2850, 3000 Hz.
- High and low impedance outputs - works with all transmitters. Level adjustment provided.
- 1/2-second tone burst time also adjustable. Continuous tone if needed.
- Free descriptive brochure on request.
- Order direct. Price \$37.50 PPD USA (5% tax Calif.)

## PALOMAR ENGINEERS

BOX 455, ESCONDIDO, CA 92025

### HAM RADIO CENTER Announces!



**NOW:** Call your order in, and we'll pick up the tab for the phone call. (Minimum order \$25.00)  
**HOW:** Place station to station call. When phone bill is received, forward copy along with our invoice covering order phoned in, we'll send refund check. DO NOT CALL COLLECT.

**COMPLETE STOCKS ALL NATIONAL BRANDS  
WE BUY-SELL-TRADE USED EQUIPMENT**

Write for List  
**HAM RADIO CENTER, INC.**  
8342 Olive Bl., St. Louis, Mo. 63132  
Phone (314) 993-6060

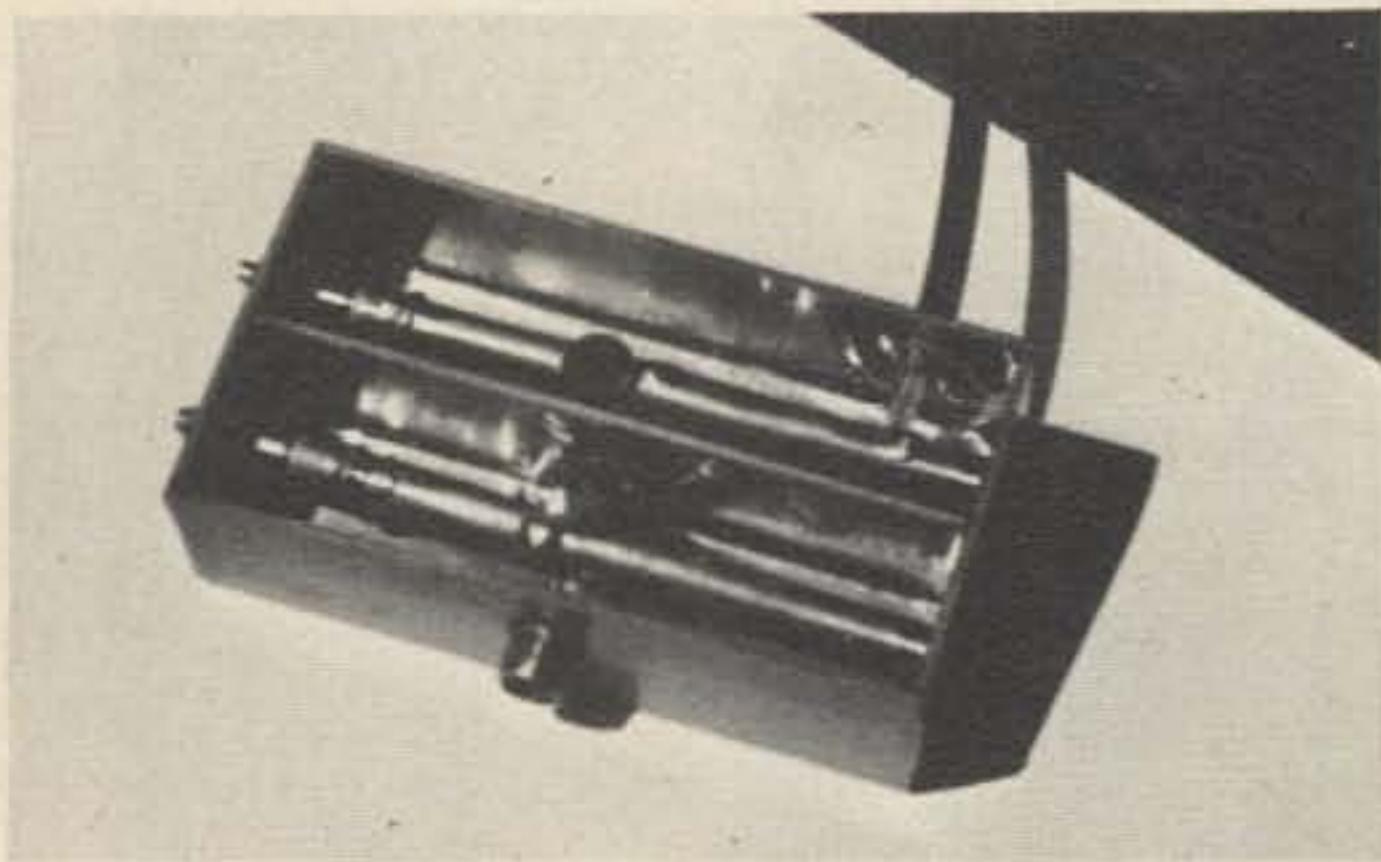

Top view of the 450MHz preamp. The chassis is made of epoxy PC board for ease in construction.

to ground the 2.5K resistor. A top cover can be made by soldering bolts (with the heads cut off) around the edges and center of the top of the chassis. Poke the extended bolts through a piece of paper to make a template for drilling holes in the cover. As a final step the inside of the chassis can be cleaned with a solvent such as toluene, acetone, or lacquer thinner, and a stiff acid brush. Do not use ordinary rubbing alcohol; it will leave a residue. The cleaning will remove the rosin and any solder balls or metal filings that may be sticking to the rosin.

### Operation

Just plug it in and tune it up. The amplifier should pull about 1.5 mA at 9V. The voltage may be obtained from a dropping resistor and a 9V zener diode, or 6V could be obtained from a 6V tube filament in a series connected 12V filament receiver

## B & J Bargain Buys

1000V - 2.0 amp diodes RCA 28¢ ea. 1000  $\mu$ F - 450V dc electrolytic \$1.66 ea. Quam 6" X 9" air suspension w/10 oz magnet dual cone spkrs \$4.99. .01, .001, .02, .002, .05, .005, @ 1000V dc 16¢ each. Dealers for SBE, Turner, ARCO CAPS, NTT Connectors, Quam Spkrs, ARRL books, Mosley, CushCraft, Surplus, write for needs.

Prices F.O.B. Liberty, Texas

B & J Electronics 314 Main

Liberty, Texas 77575 713-336-7751

system. If the preamplifier is mounted externally to the receiver it may be powered by a 6V lantern battery left permanently connected.

It may be necessary to reduce the value of the 2.5K resistor if the amplifier pulls more than about 1.5 mA. As the bias is increased, the current is increased; this will increase gain, but will also increase noise generated by the transistor. As bias is increased, instability may result and bias will have to be reduced by making the 2.5K resistor smaller. Instability is discovered by the appearance of spurious signals, or the capacitors may tune for a peak at more than one point.

The diodes may now be added and the preamplifier rechecked to determine whether performance has been affected. The entire front end of the receiver should now be retuned. The input circuit of the preamplifier should tune broadly and the collector circuit should tune rather sharply. The tuning should be smooth and within the range of the capacitors.

The preamplifier may not work well in duplex operation since it is susceptible to cross modulation problems typical to bipolar transistors, and the single input tuned circuit does not provide much selectivity.

### Results

The amount of receiver performance was indicated in a weak signal area where the remote transmitter signal was chopping in and out of the mobile receiver in a moving vehicle. Addition of the preamplifier under the same conditions reduced the deep chop to popping, eliminating the dead spots. Even with severe popping an FM signal is still intelligible, but if it chops out completely part of the signal is lost.

This simple preamplifier turned out to be very easy to construct and represented so great an improvement in system performance it was hard to understand why it was not built sooner. Everybody should have one!

...WB6BIH



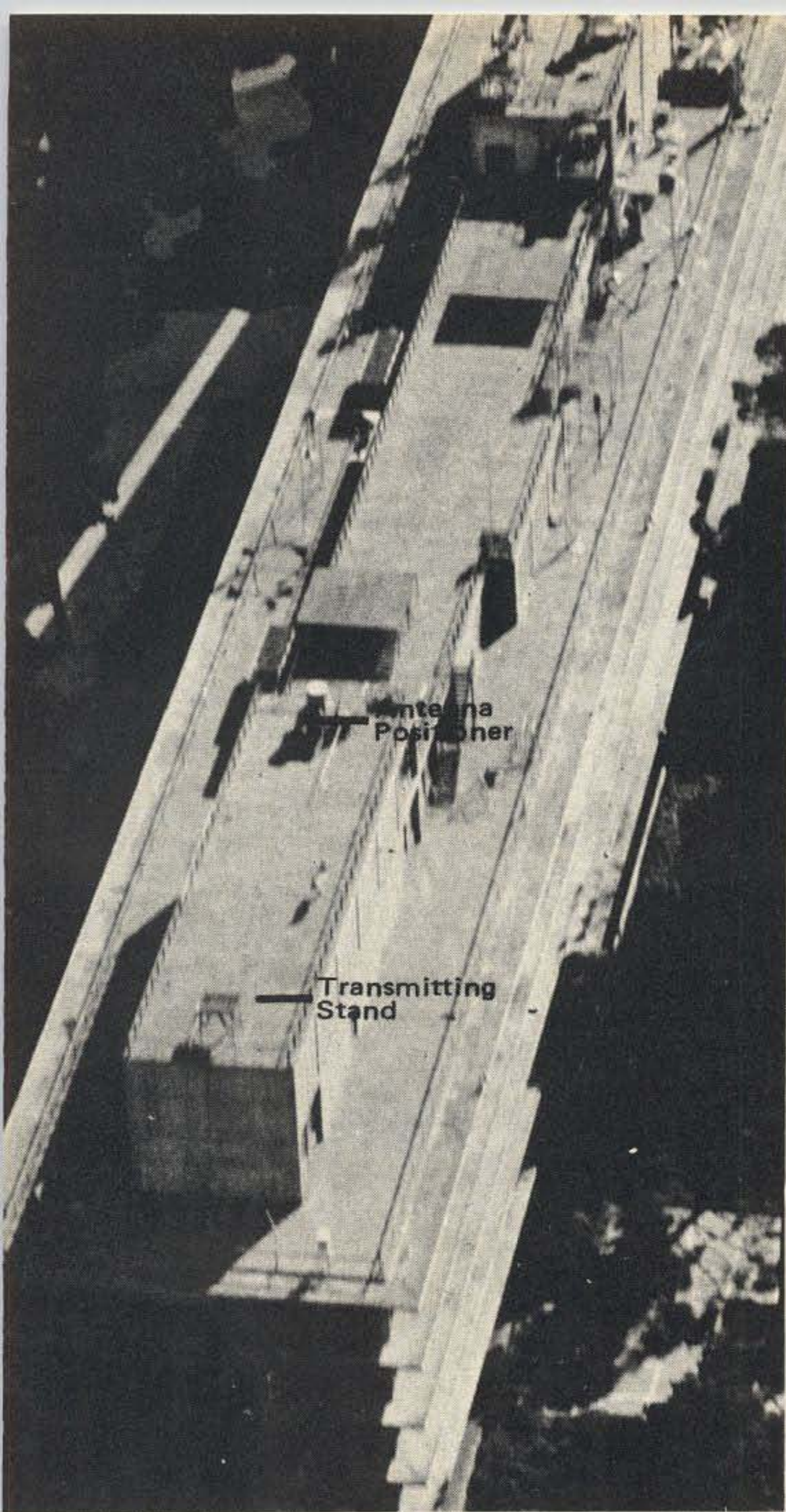

Antenna test range at the U.S. Naval Postgraduate School in Monterey, California.

# WHIP ANTENNAS TESTING ROOF MOUNTED

Tom R. Minnis WB6HYD  
VICOM  
77 Ortega Avenue  
Mountain View CA 94040

The stimulus for this article has come from the lack of actual test results and the compounding of misinformation regarding mobile VHF whip antennas. There are many books and papers published that go into the theory of antenna performance, but none have been found that show the actual pattern and gain in addition to valid comparisons between the different types.

This article presents actual test results of three basic mobile VHF whip antennas. The three antennas are the one-quarter wave whip, a base loaded one-half wave "gain" antenna that most two meter FM'ers gradu-

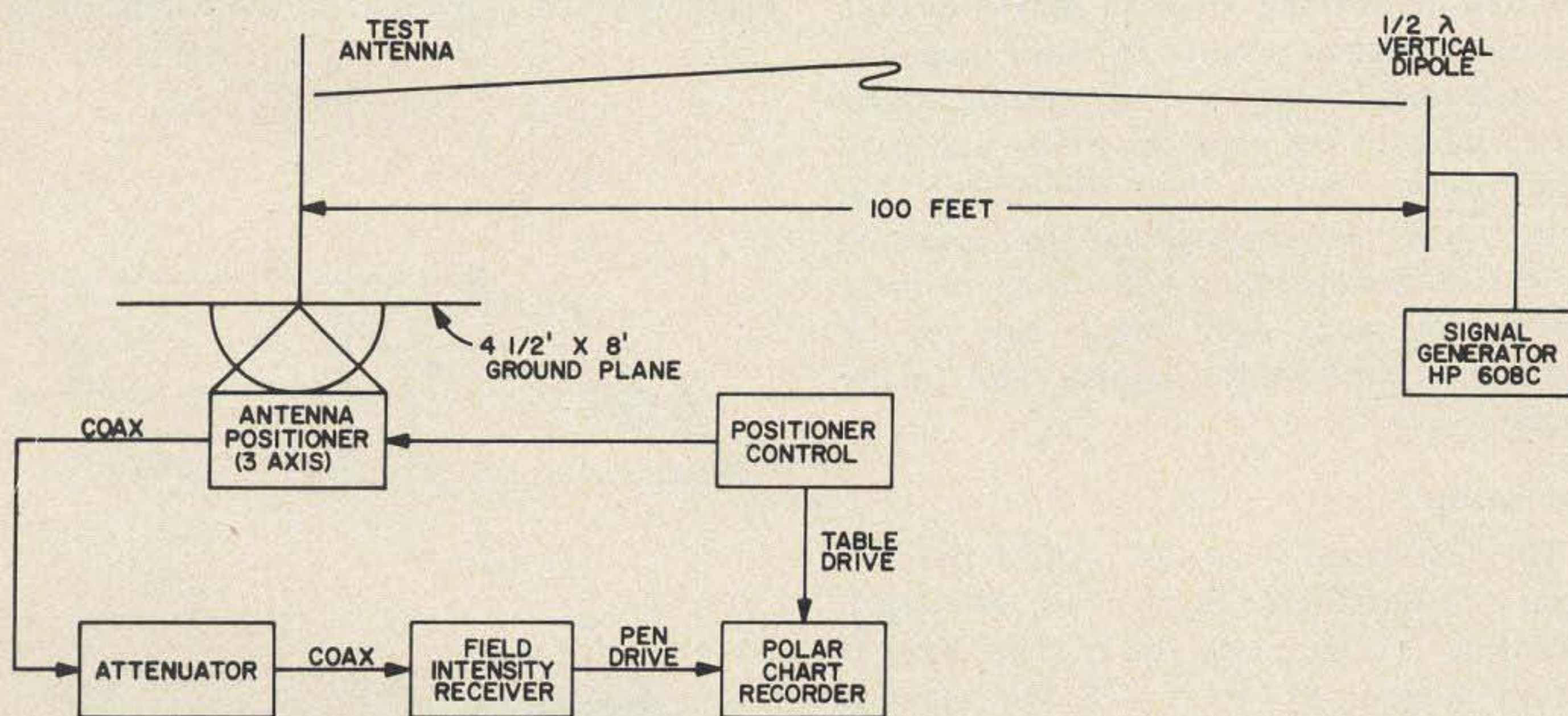
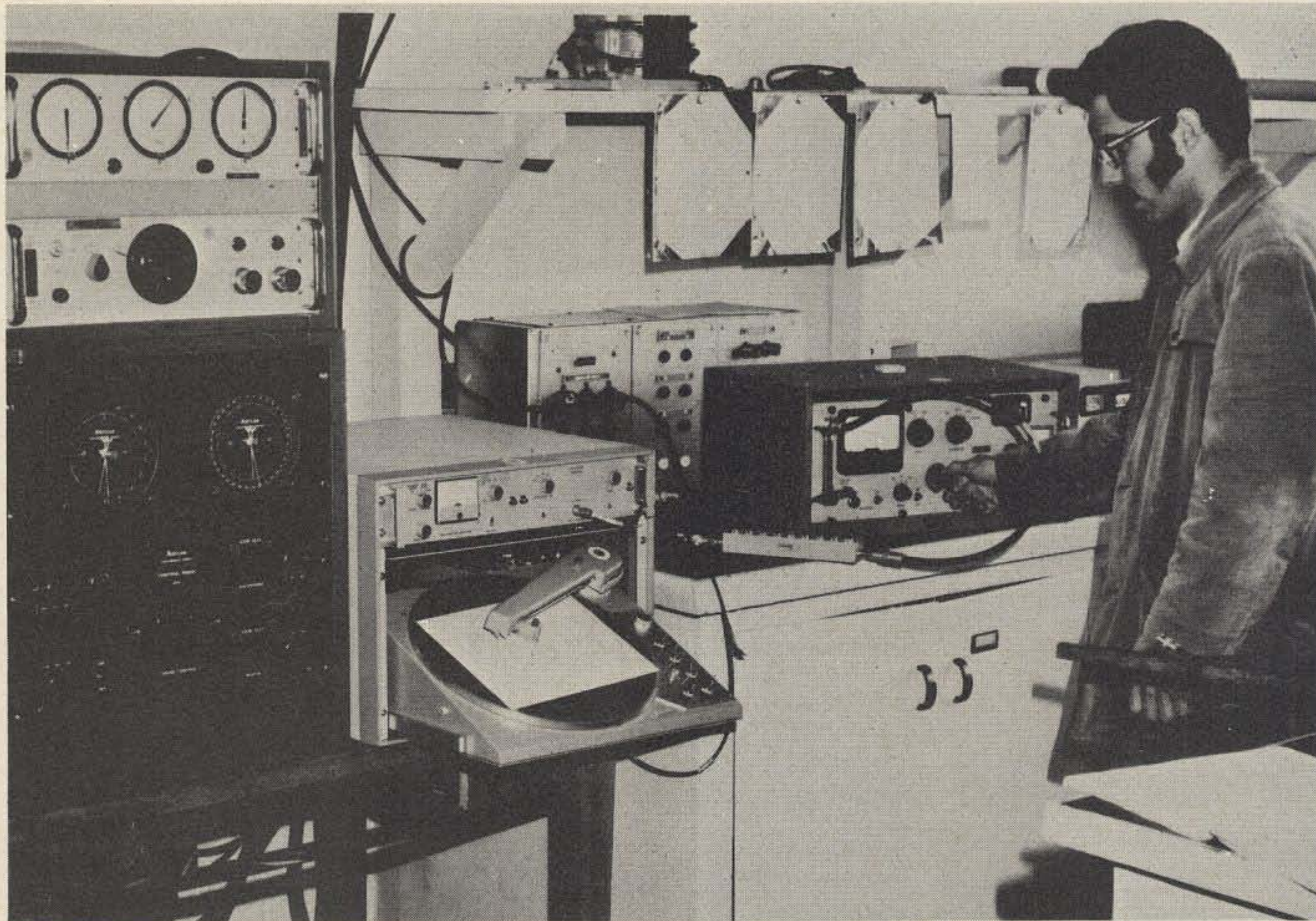

Fig. 1. Functional block diagram of test range.



*Positioner controller, polar chart receiver, attenuator, field strength receiver.*

ate to, and a balanced end-fed one-half wave "J" antenna. Antenna talk among professionals as well as amateurs is a highly emotional topic, due to all the different misconceptions that have been proliferated.

By measuring an antenna pattern in a realistic situation, one gets a realistic pattern and not an ideal pattern. Great care must be exercised in making antenna measurements to avoid mistaken results. To make meaningful antenna measurements, certain parameters have to be kept constant, like path distance, the receiver and transmitter frequency and gain settings and the losses in the test antenna feedline system. All of these details and more were taken care of by months of hard work, anguish, and finally success.

### Test Setup

The test range is on the roof of the U.S. Naval Postgraduate School in Monterey, California. To simulate the roof of a car or station wagon, a 140 x 250 cm sheet of sixteen gauge brass was attached to the three-axis antenna positioner. The equip-

ment hook-up is shown in the block diagram and the photos.

### The Coordinate System

The coordinate system is shown in Fig. 2. The antennas under test are oriented along the Z axis when the ground plane is parallel to the earth. The X Y plane is in the ground plane when it is parallel to the earth, the X

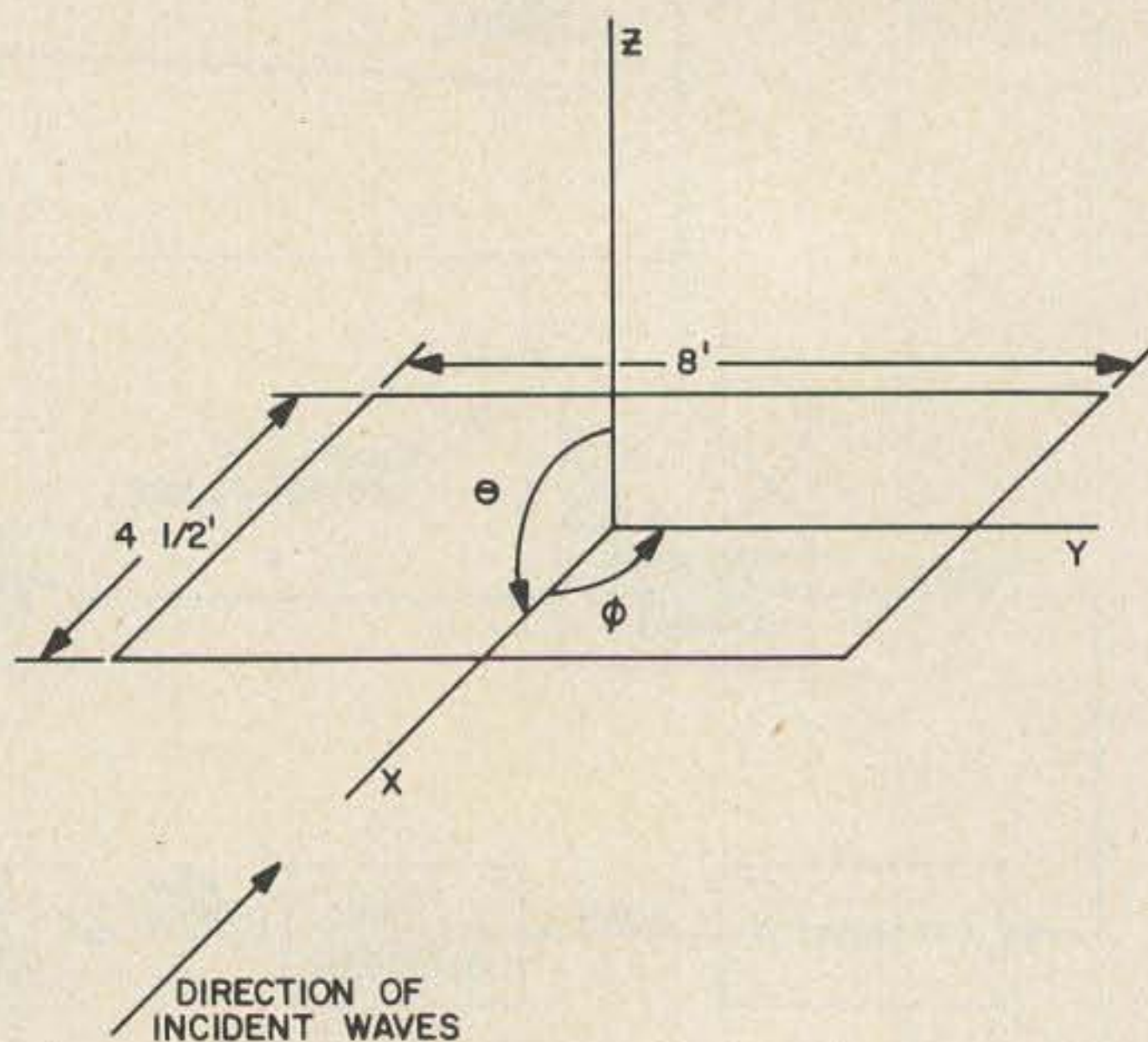

*Fig. 2. Coordinate system.*

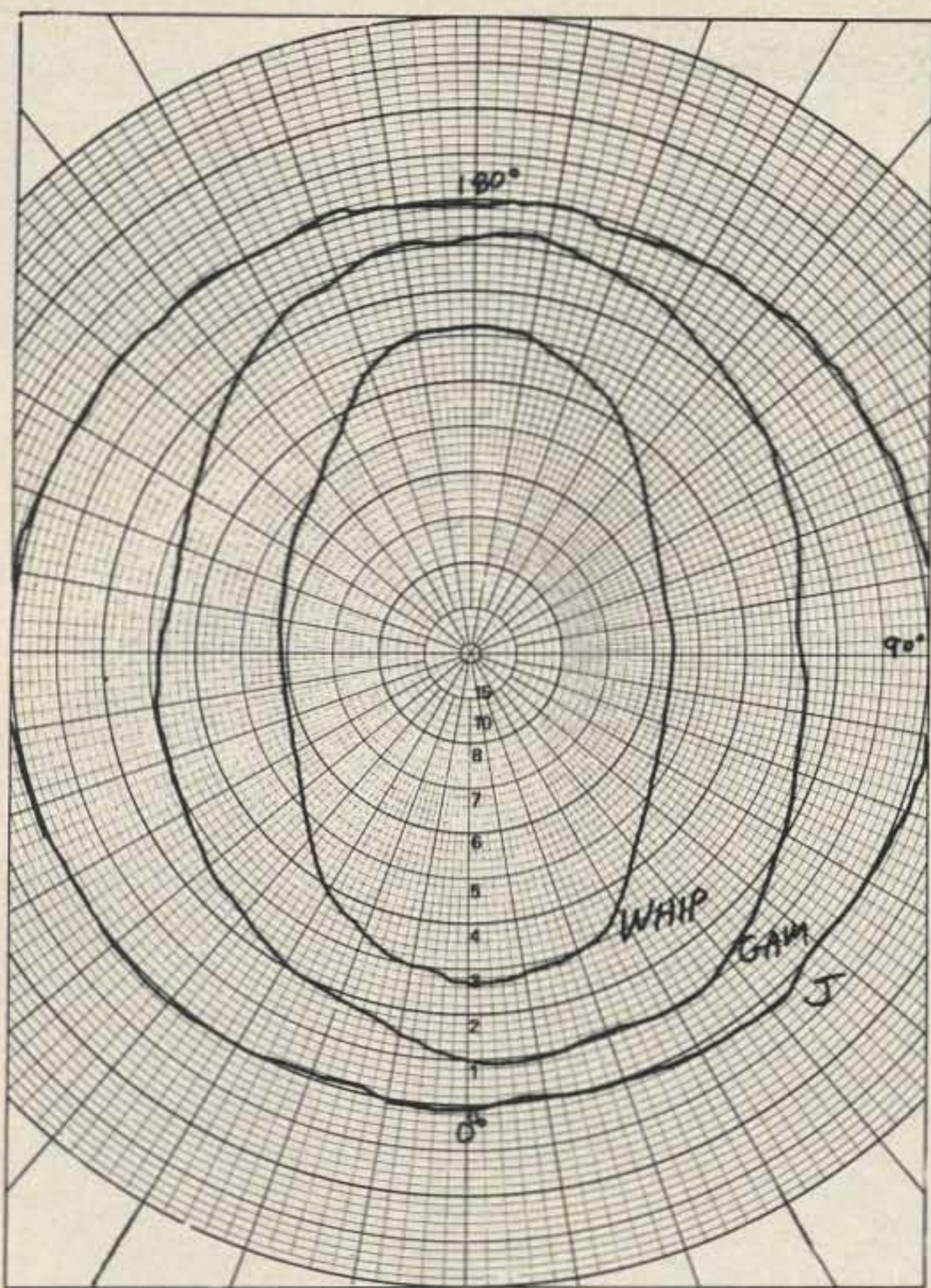

Fig. 3. Horizontal patterns.  $\theta$  is held constant at  $90^\circ$ , while  $\phi$  varies from  $0^\circ$  to  $360^\circ$ .

axis is in the direction of the transmitting antenna.

The azimuth or horizontal angles of rotation,  $\phi$ , is measured from the X axis in degrees. The elevation on vertical angles,  $\theta$  is measured from the Z axis downward toward the X Y plane. An example of the coordinate system:  $\theta = 90^\circ$  and  $\phi = 0^\circ$  references the ground plane parallel to the earth with the received signal arriving along the X axis or perpendicular to the long side of the ground plane.

#### Antenna Adjustment

The "J" antenna is basically an end fed one-half wave radiator. Only the upper one-half wave length of the antenna radiates, since the one-quarter wave matching section has balanced transmission line currents on it. A 4:1 one-half wave balun made from  $50\Omega$  coax is used to feed the  $200\Omega$  feed point impedance. The one-quarter wave whip was cut to resonance and connected directly into a bulkhead coax fitting on the ground plane. The one-half wave base tuned antenna (a Gam model TU-2) was also trimmed for minimum swr. The swr of all three whips

was checked over a 2 MHz band centered on 146 MHz and found to be less than 1.5:1. The reference dipole used was a commercially made, tunable, standard antenna used for field strength measurements. Preliminary measurements indicated that the "J" antenna was the most sensitive of the three, therefore it was used as the zero dB reference in the pattern measurements. The receiver and the polar chart recorder were checked using a calibrated attenuator to ascertain their ability to accurately track the signal strength.

#### Test Results

First, all the antennas were rotated about the Z axis giving an azimuth on horizontal plane pattern. Referring to Fig. 3, it can be seen that the horizontal pattern for the "J" is within a  $\frac{1}{2}$  dB of being circular. The one-half wave vertical had an elliptical pattern. At  $\phi = 0^\circ$  and  $180^\circ$ , (along the short dimension of the ground plane) the one-half wave vertical was 1 dB down, but at  $90^\circ$  and  $270^\circ$ , (the long dimension) it was almost 3 dB down! For the quarter-wave whip, the elliptical pattern starts to approach a rec-



Reference dipole on transmitting platform.

# "HAMTRONICS" IS

A DIVISION OF TREVOSE ELECTRONICS

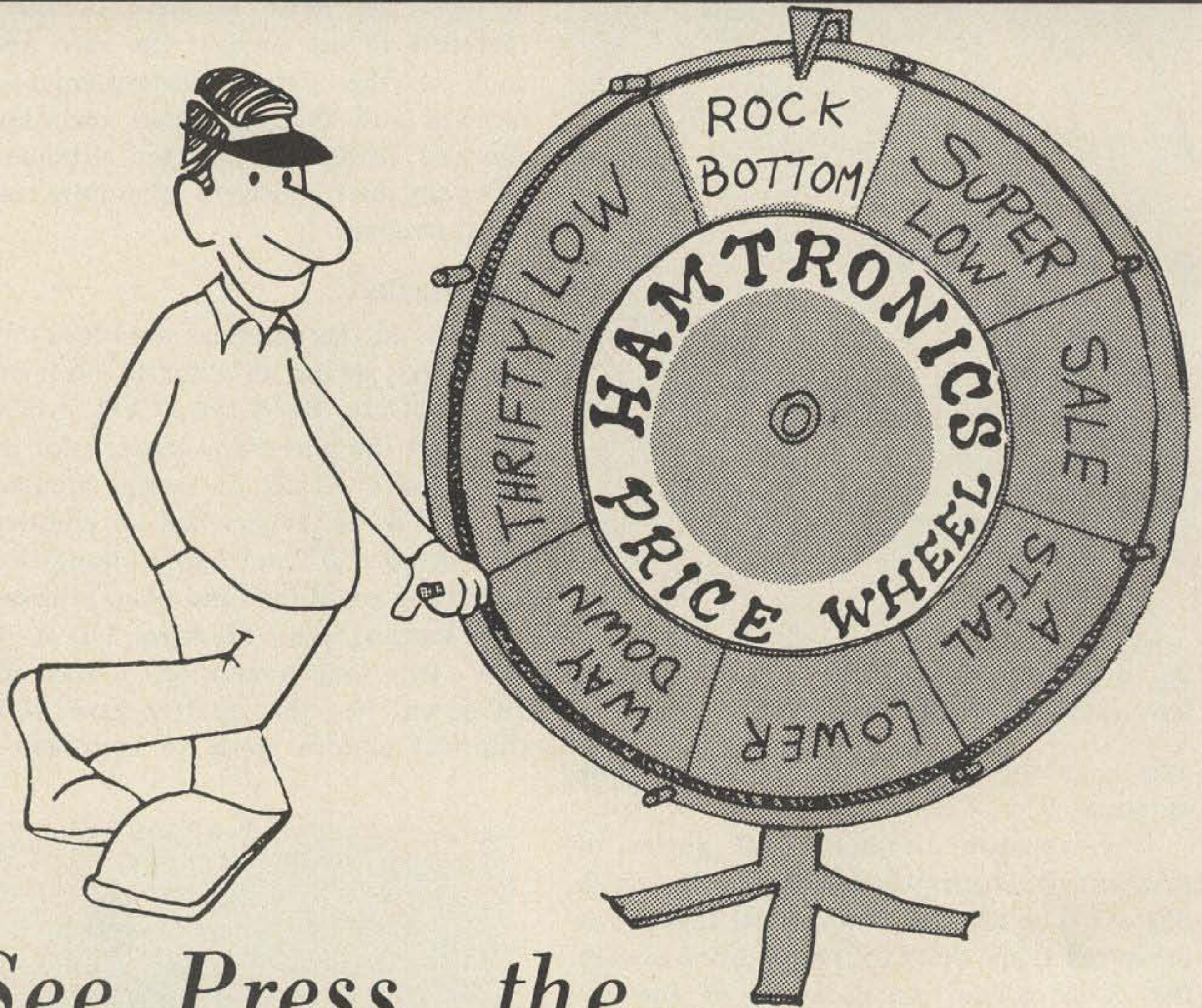

*See Press, the...*

## **WHEELER DEALER**

*He'll beat any deal anywhere!*

Telephone us at NO CHARGE anywhere in the U.S.A.

Send us a copy of your telephone bill and we'll send you a check.

**PLUS**, we ship **FREE** anywhere by U.P.S.

4033 BROWNSVILLE RD., TREVOSE, PA. 19047

# FM HEADQUARTERS!

IT'S **HAMTRONICS**  
FOR THE FANTASTIC NEW  
**MIDLAND** LINE.

## 2 METER 13520

Order now and receive FREE  
2 extra pairs of crystals!

**\$229<sup>95</sup>**

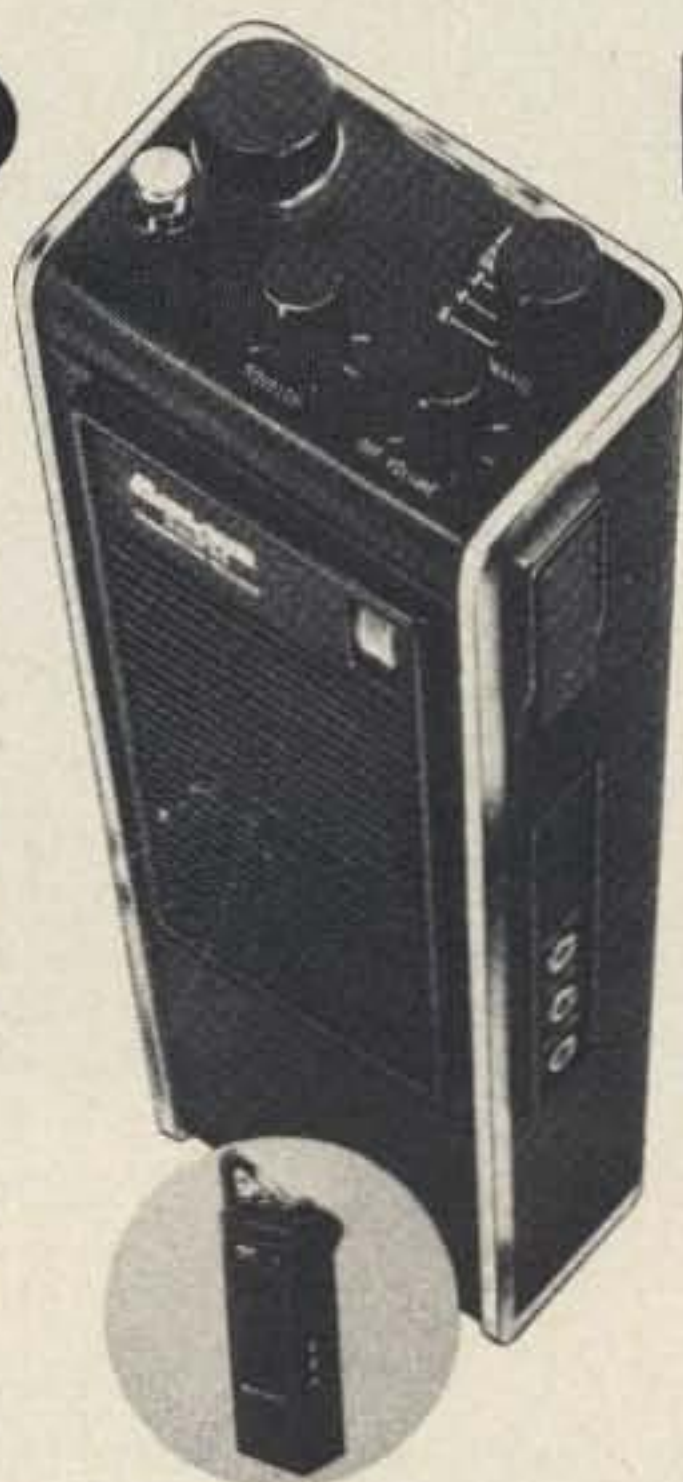

## 220 / 13509

**\$219<sup>95</sup>**

Buy now and get a  
Huster BBL-220 antenna  
at NO EXTRA COST!

## 2 METER 13500

If you send your order  
in now you'll receive  
FREE the Hustler  
BBL-144 antenna!

**\$249<sup>95</sup>**



Remember we deliver FREE anywhere in the U.S.A. via U.P.S.

(215) 357-1400

PHONES

(215) 757-5300



$\frac{1}{2}\lambda$  Gam mounted-on ground plane.

tangle. At  $\phi = 0^\circ$  and  $180^\circ$ , the pattern of the whip was down 3 dB from the "J" and at  $90^\circ$  and  $270^\circ$  it was down about 7 dB. Notice how each succeeding antenna becomes more and more dependant on the ground plane!

Next  $\phi$  was kept constant at  $0^\circ$ ,  $45^\circ$ , and  $90^\circ$  and a portion of an elevation plane pattern was obtained by tilting the ground plane from horizontal. The antennas and the ground plane were rotated from  $0^\circ$  to  $90^\circ$  in the  $\theta$  direction with  $\phi$  held at  $0^\circ$ . Looking at Fig. 4, the "J" has its maximum lobe directly on the horizon in this direction. The half-wave vertical has a maximum lobe which is  $13^\circ$  up from the horizon in this direction. The quarter-wave whip has an almost circular pattern from  $\theta = 90^\circ$  to  $65^\circ$ . The response of the quarter-wave whip varies about 3 dB from maximum to minimum in the  $\theta$  direction, whereas the response of the "J" varies about 15 dB from maximum to minimum in the  $\phi = 0$  direction.

As would be expected by this time, elevation cuts in the  $\phi = 90^\circ$  direction show an even more pronounced difference. Look-

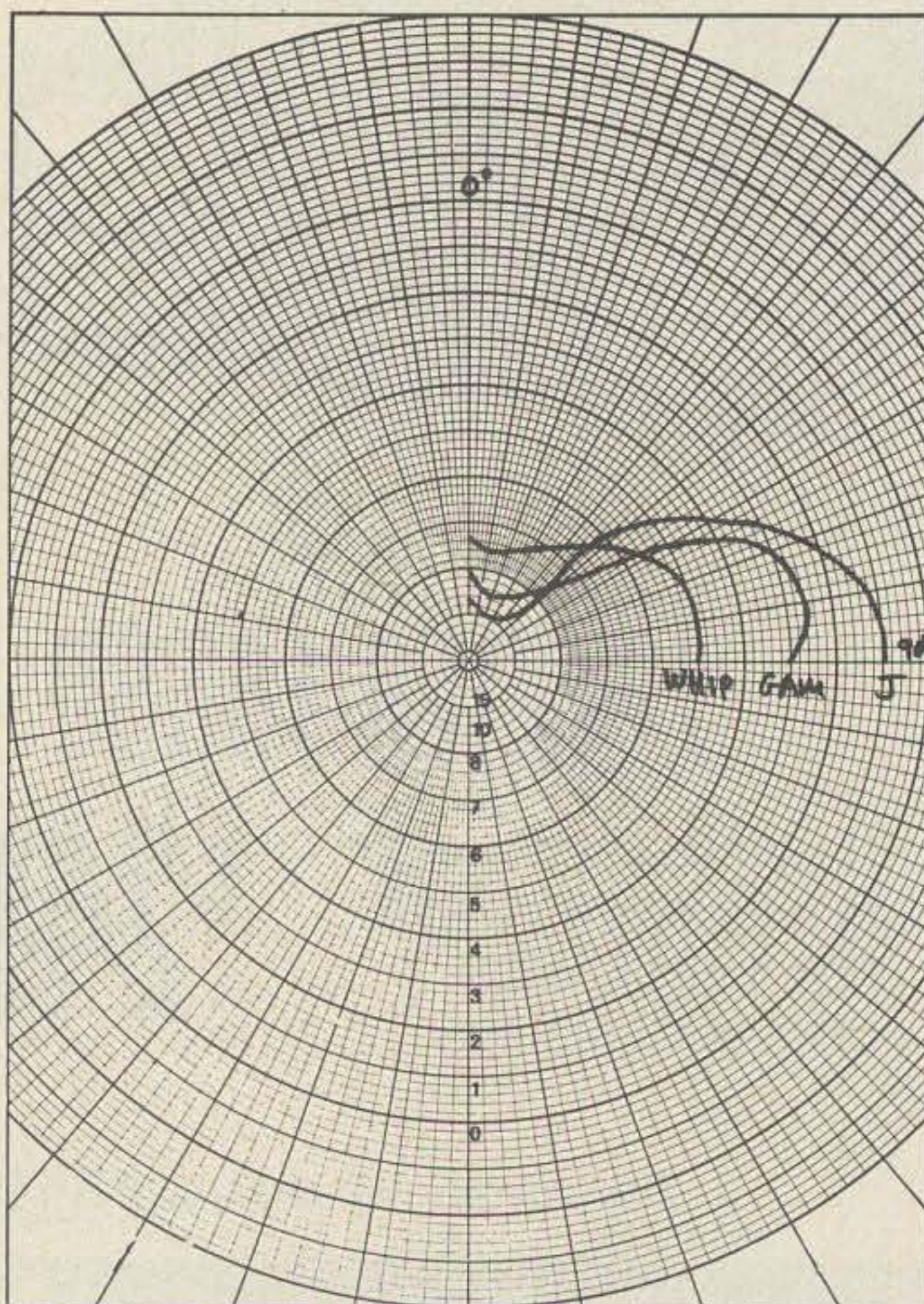

Fig. 4. Vertical cuts. Here  $\phi$  is constant at  $0^\circ$  while  $\theta$  is changed from  $0^\circ$  to  $90^\circ$ .

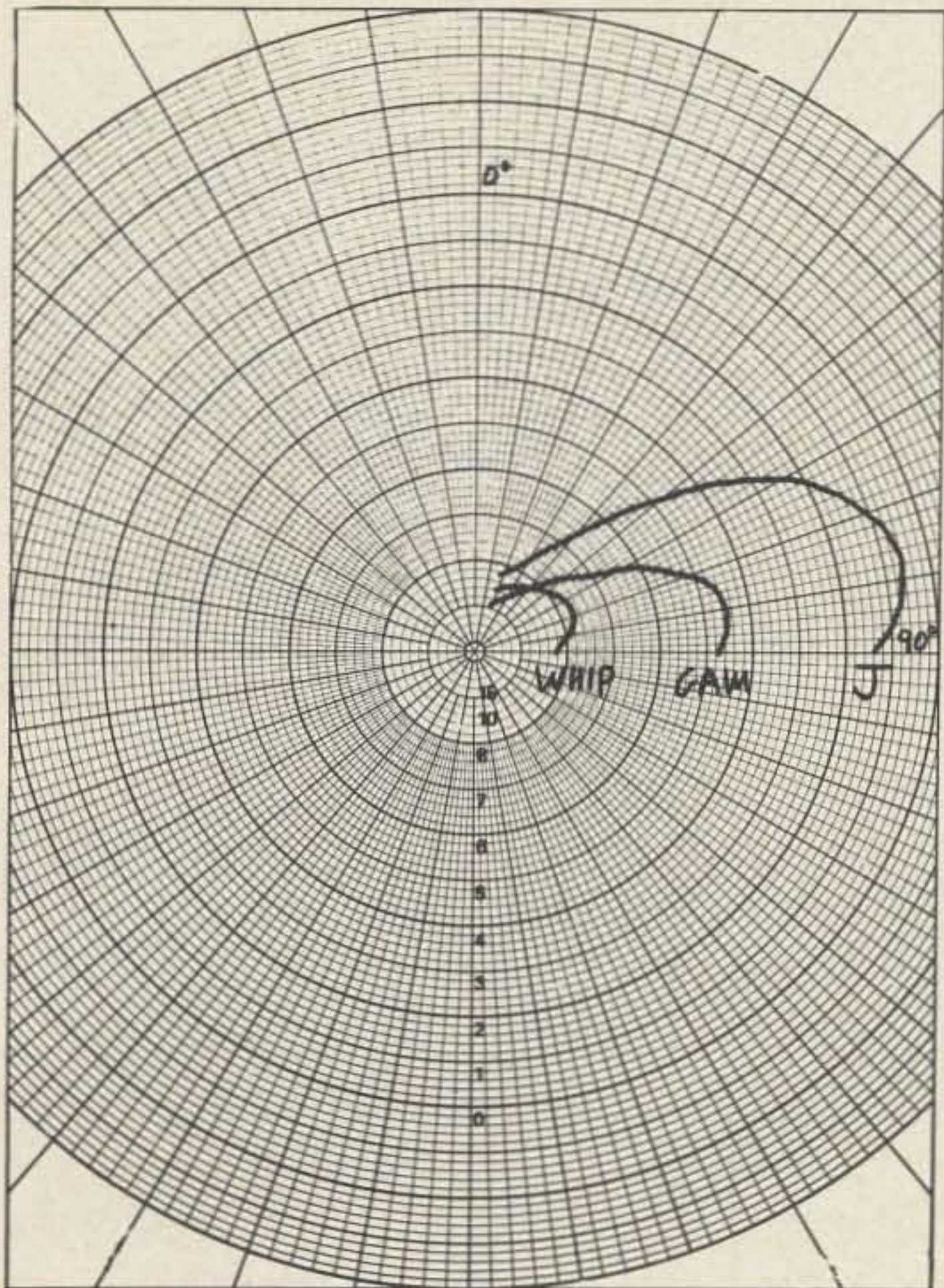

Fig. 5. Vertical cuts.  $\phi$  is constant at  $90^\circ$ ,  $\theta$  varies from  $0^\circ$  to  $90^\circ$ .

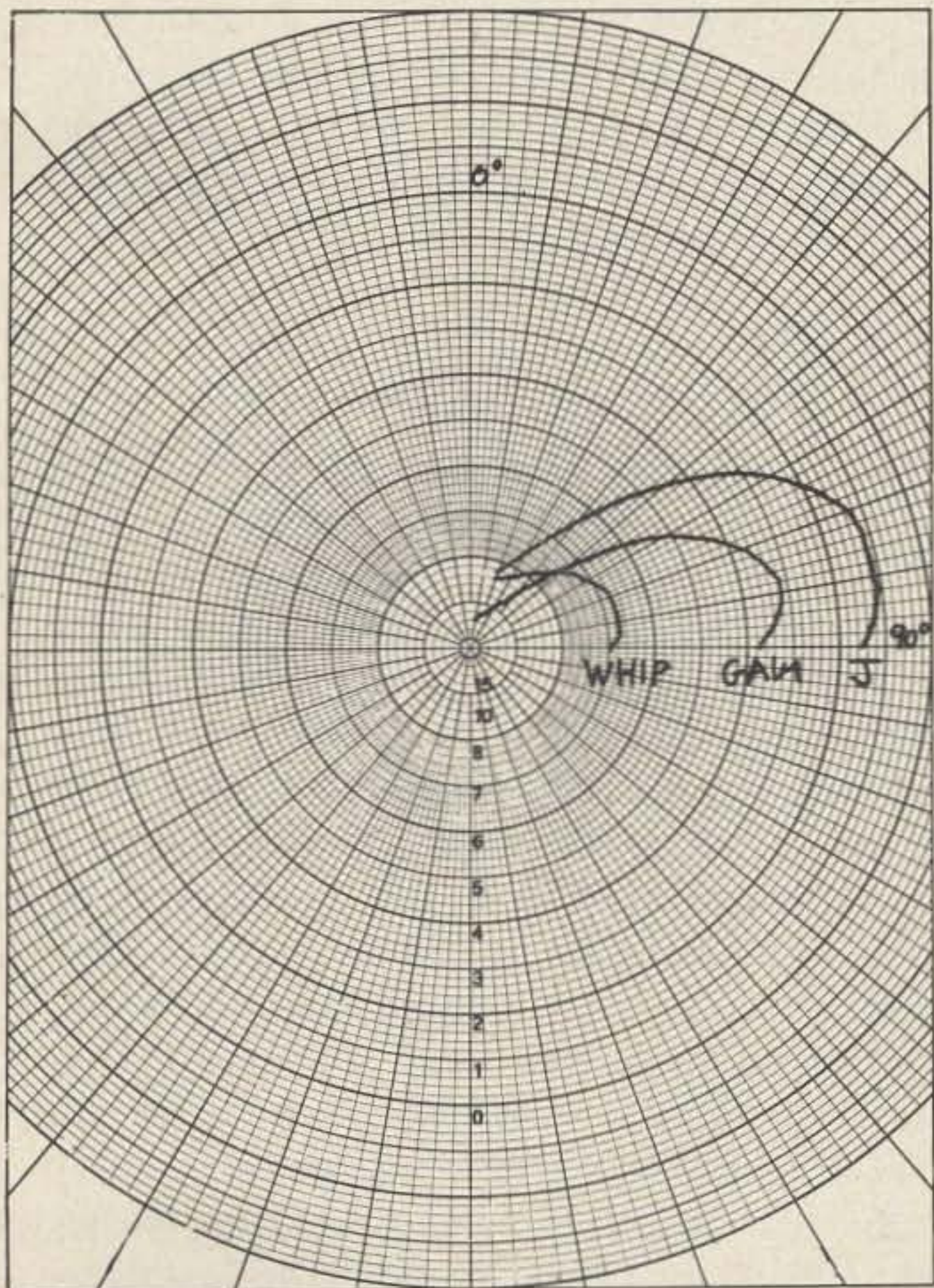
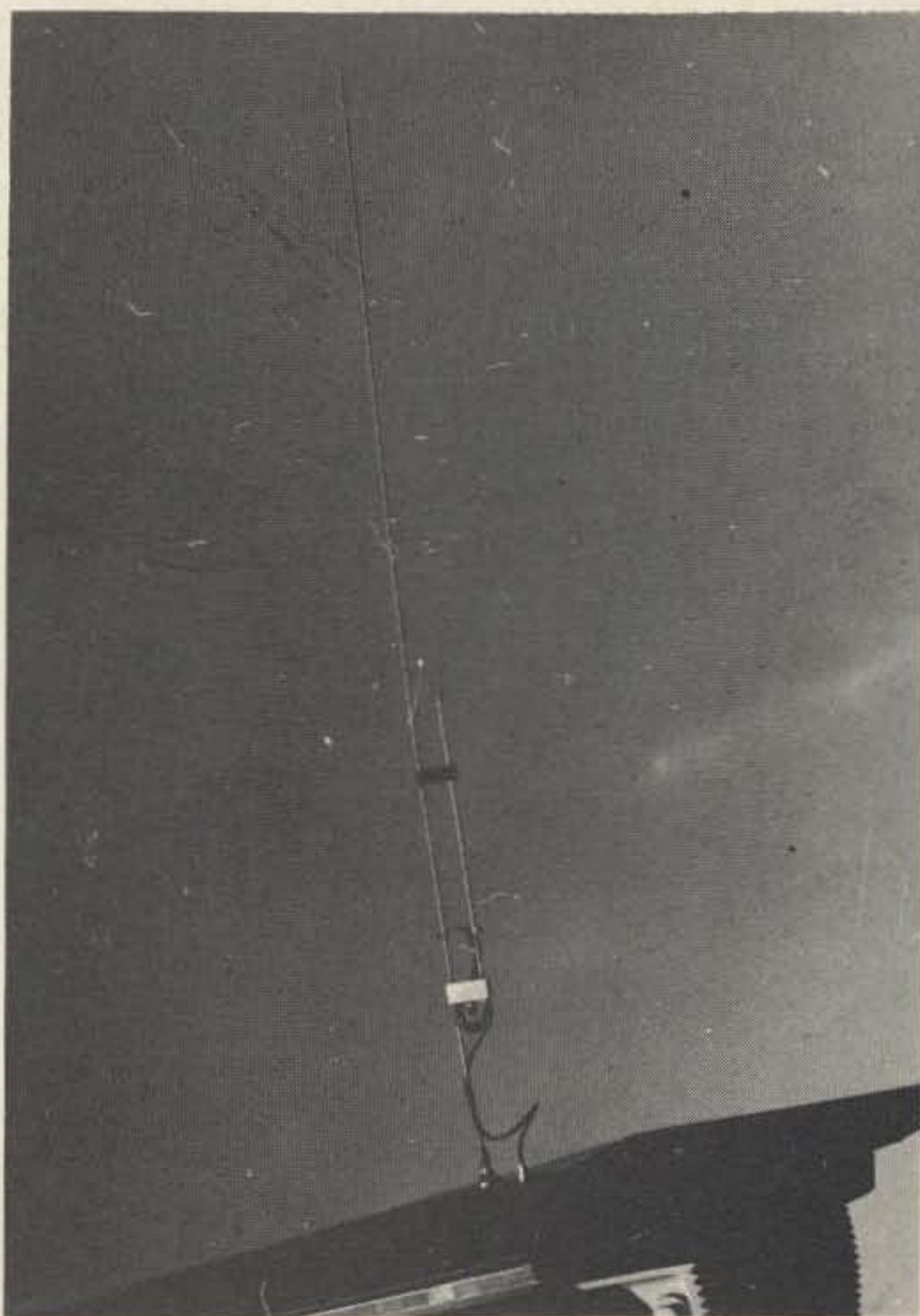

Fig. 6. Vertical cuts. Here  $\phi = 45^\circ$ , while  $\theta$  varies from  $0^\circ$  to  $90^\circ$ .

ing at Fig. 5, where  $\phi = 90^\circ$ , it can be seen that the presence of the ground plane actually degrades the "J" performance by lifting the major lobe about  $17^\circ$  above the horizon! The direction of the major lobe of the half-wave vertical remains the same (about  $10^\circ - 15^\circ$ ), but the overall response in that direction is down 2 dB from the maximum. The quarter-wave whip begins to show a bit more directivity with a lobe up about  $25^\circ$  from the horizontal.

The  $\theta$  or vertical patterns in the  $\phi = 45^\circ$  plane (Fig. 6) appear half-way between the extremes found in Figs. 4 and 5, and by symmetry can be reasonably reflected through the Z axis to give an accurate three-dimensional field strength pattern of these roof mounted antennas.

Since the "J" had the most symmetrical pattern and had the least dependency on the ground plane, it was compared with the reference dipole to arrive at a gain figure. The reference dipole major lobe field strength was compared to the "J's," using the same cable and connectors. This orientation is with  $\theta = 90^\circ$  and  $\phi = 0^\circ$ . Negligible differences were found between the "J" and



"J" mounted to the ground plane.

the dipole. By probing the incident fields over the area in front of the ground plane with the dipole and the "J," we found less than a ½ dB fluctuation in signal strength, indicating that reflections from surrounding objects were not sufficient to cause differences in the patterns from one antenna to the next. This means that the "J" can be considered to be a reference vertical dipole.

These results aroused a considerable amount of discussion in our local repeater group! In an attempt to keep from losing friends who owned half-wave Gams and quarter-wave Ground Planes, an attempt was made to find a set of conditions where the Gam and quarter-wave Ground Plane approached "specs." A classic quarter-wave ground plane was constructed using four drooping wires for the ground plane and the quarter-wave vertical radiator. This new ground plane antenna was mounted on a wooden pole well away from other metal objects (about 10 ft above the antenna positioner). Curiosity over the effect of radials on the horizontal pattern prompted a quick test. Figure 7 shows the results of the horizontal pattern for the ground plane.

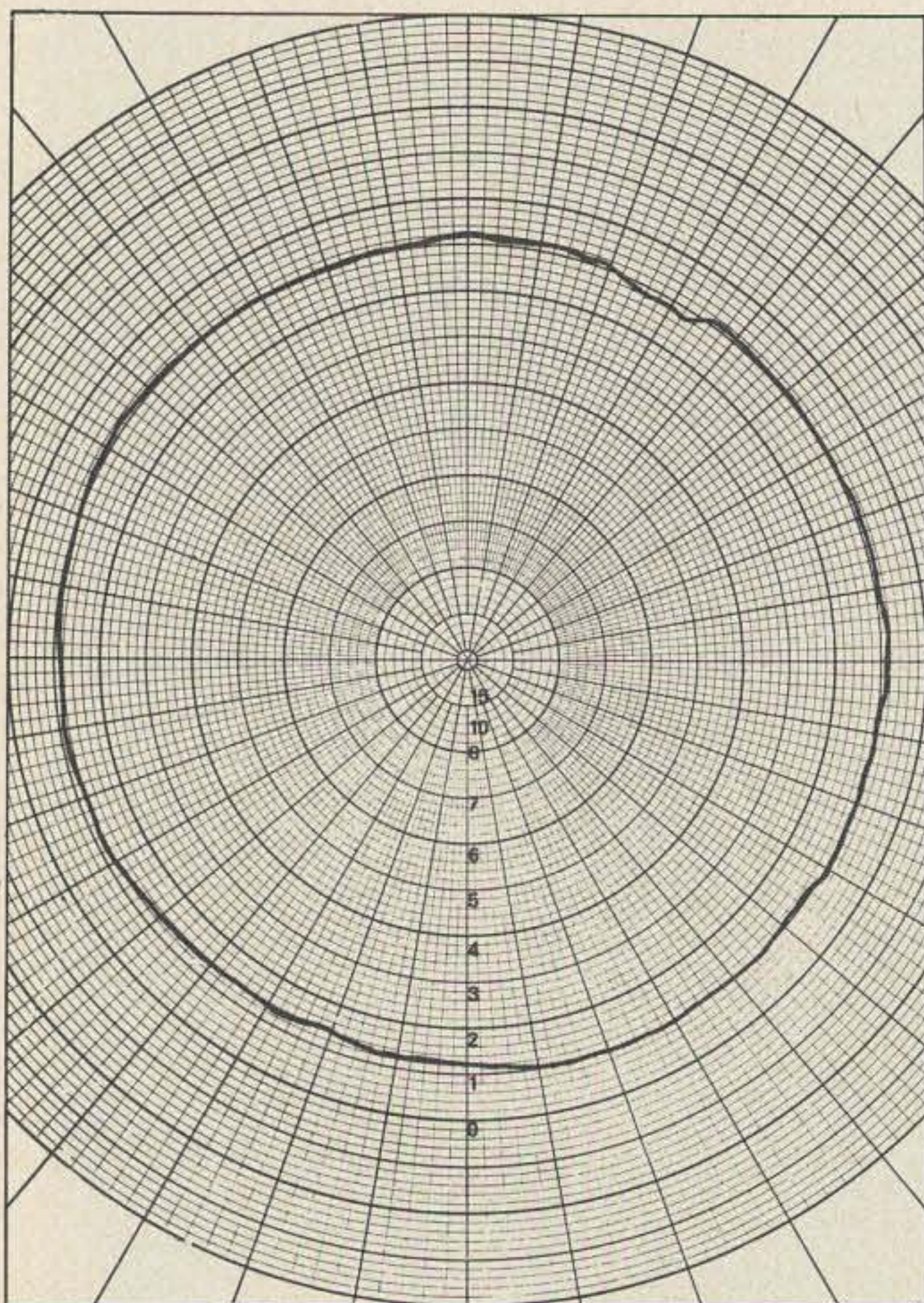

Fig. 7. Horizontal pattern for  $\frac{1}{4}\lambda$  whip on a stick whip with radials.

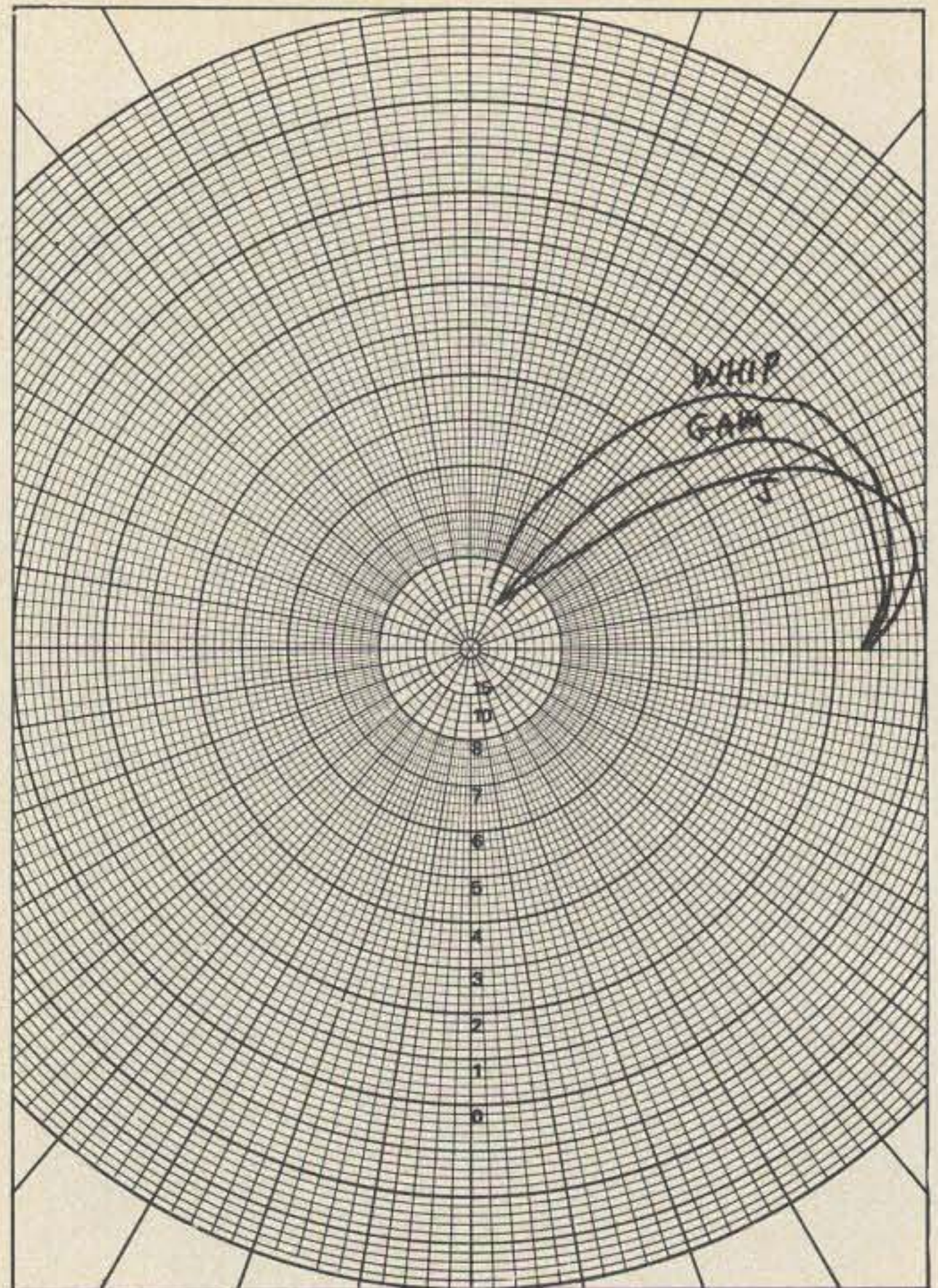

Fig. 8. Free space vertical patterns.

Delight followed the completion of such a smooth pattern! Next, the vertical patterns were compared in Fig. 8. The gain on the horizon for all three was essentially the same when they were in a "free space" condition. At best, all three antennas show the same gain as a vertical dipole.

### Conclusion

We have shown that the effects of a nonresonant ground plane, such as a car roof, can be disastrous for antennas that "need" a ground plane to operate and can spoil the patterns of antennas that don't need ground planes for impedance matching. Further speculation is left to the reader as to just exactly how high above the nonresonant ground plane one would need to place a quarter-wave whip and the half-wave vertical, but I'm sure someone will become curious enough to try it. Until then, it would be unwise to believe what someone speculates, or we will be in the same fix we all were in before this article was written!

Special thanks are due to Dick Adler WA6KPF, who helped with the measurements and the writeup.

...WB6HYD



# LED READOUT CRYSTAL SWITCH

*This modification enables the transmit and receive pair you are using to be directly read via diode matrices and LED readouts.*

**T**he search for something distinctive is nowhere more apparent than among ham builders. The latest state-of-the-art circuitry is constantly employed to produce electronics far surpassing the commercial variety. An even larger group of hams is perennially modifying their commercial equipment to improve its performance or convenience. I have written this to cater to those who desire more than is available commercially.

A dial readout is described here that was designed for displaying FM crystal channels, but which can be made applicable to many detented switch schemes. It uses diode matrixing and Light Emitting Diode (LED) readout, for a minimum of current draw and a maximum of flexibility and reliability.

The readout unit itself (Fig. 1) is constructed on a one-sided glass epoxy printed circuit board. The copper is etched into the seven segment pattern using standard printed circuit techniques. Either thin tape or liquid resist may be used for the pattern. Size is dependent on the space availability in the individual rig. Compartments are then constructed using flashing copper or metal claimed (recycled!) from a "tin" can. The can must be tin plated steel and not aluminum, as it is too difficult to solder to

aluminum. A child's magnet will easily separate the steel from the non-ferrous metal if you are not sure. An LED is placed in each compartment and secured with a glob of silicon rubber sealant, such as Silastic or RTV. The chambers are then sealed by soldering on a metal top. This shields the LED from the effects of rf, and due to the long life of an LED there should be no need to open the compartment, once sealed. The use of the glass epoxy board is recommended due to the translucency and stability of the material.

Alternatively, slots could be cut in the panel of the rig with a saw or nibbling tool, and thin plastic frosted with steel wool placed behind the panel (Fig. 2). Such plastic may be a piece of acetate used for wallet photo compartments or notebook picture protectors. To frost, rub a fine grade of steel wool over the plastic until it becomes uniformly etched with fine scratches. Mount the plastic (with the frosted side in) on the outside of the unit. The slots will then be visible only when illuminated, as is the case with the printed circuit board, and a more distinctive, less homebrew look will result. Compartments here can be made with either metal or plastic, glued to the rear of the panel. If

# 73 is growinG

*We need several people in different departments.  
Male or female, hams preferred.*

Call  
**Keith Lamonica W7DXX/1**  
**73 Magazine**  
**1-603-924-3873**

available, of course, a standard seven segment commercial LED readout could be used.

The matrix is a seven diode maximum per character circuit that uses from two to seven diodes to form each digit. The matrix desired is selected by an additional wafer on the transmit and receive crystal switch. A single-pole switch is used, with as many

positions as needed for the number of channels to be covered. Each switch position is connected to two matrix busses in order to provide two digits. Figure 3 is a sample two digit readout set up for 76 and 94. Diodes are placed in the matrix in accordance with the scheme shown in Fig. 4 to provide any of the desired digits. If a decimal point is needed, another LED with

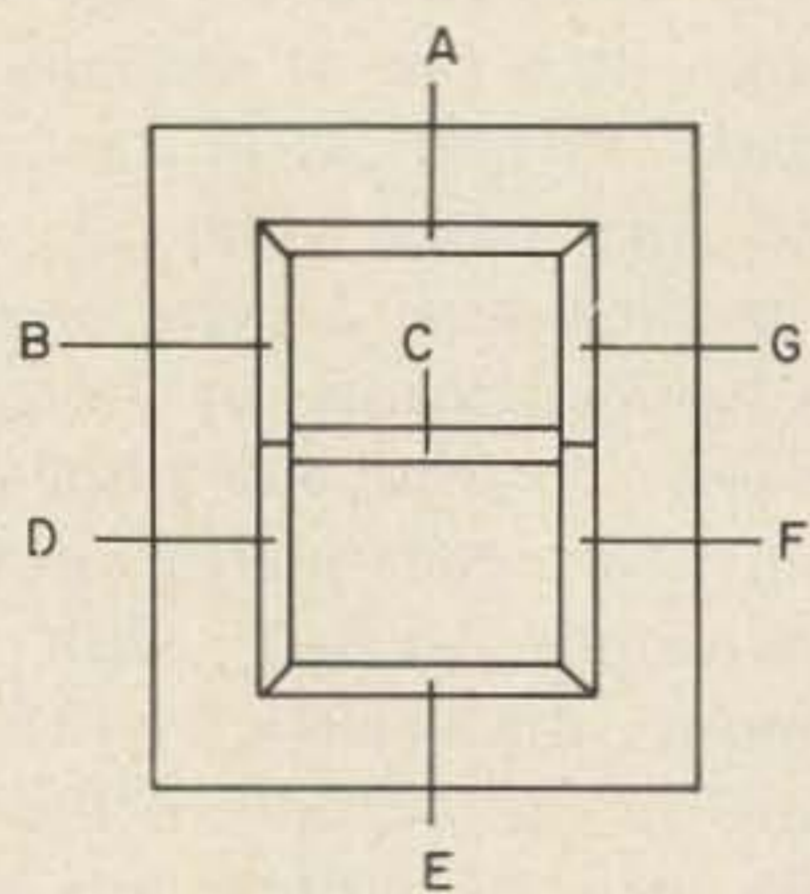

FRONT VIEW SHOWING SEGMENT DESIGNATIONS. LETTER MAY BE TILTED IF DESIRED.

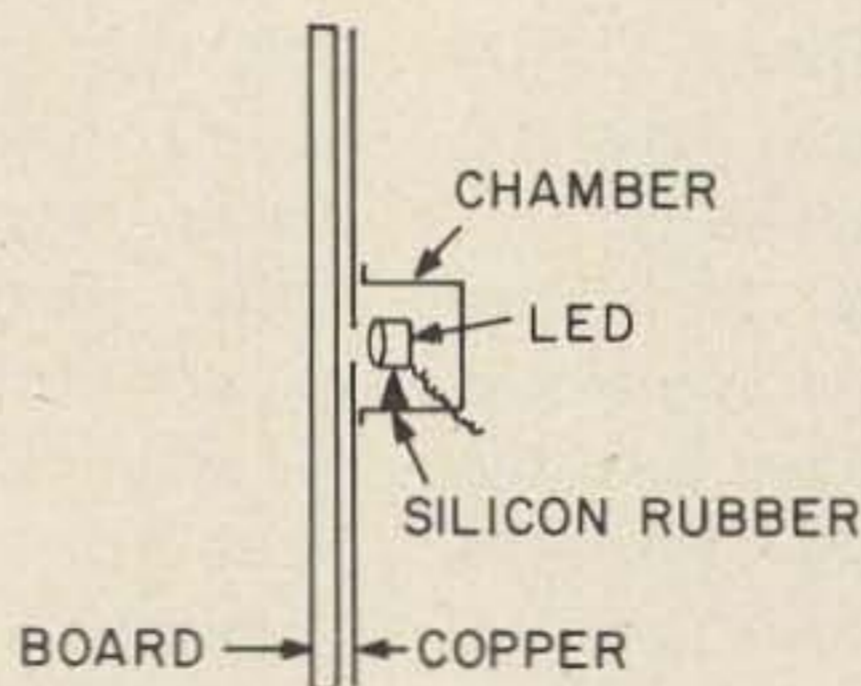

EXAGGERATED SIDE VIEW

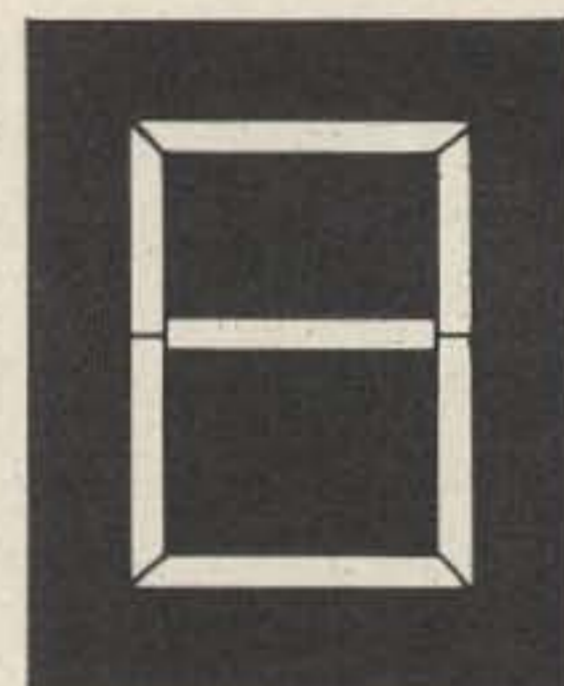

REAR VIEW SHOWING COPPER ETCH PATTERN. BLACK AREAS ARE COPPER REMAINING

Fig. 1. Construction details of the readout from single sided glass epoxy board.

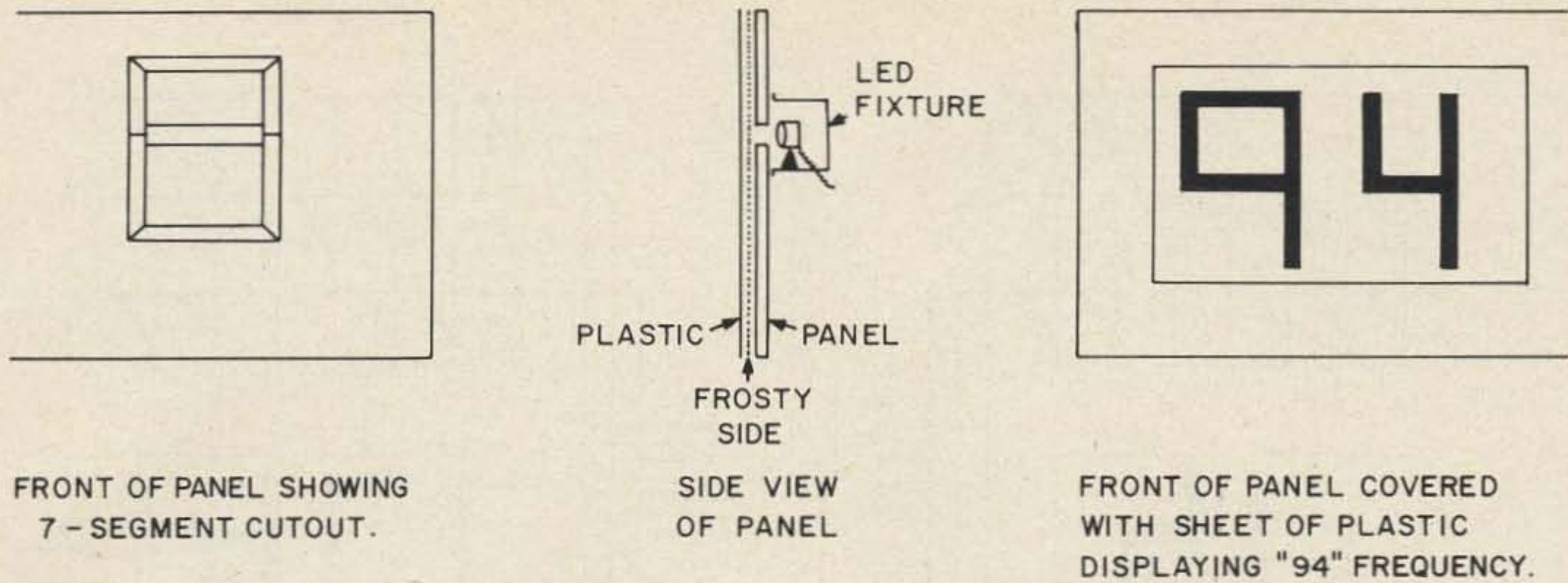

Fig. 2. Alternate construction technique using panel cutouts and frosted plastic.

its resistor could be connected directly to the supply to provide that function.

A sample schematic is shown in Fig. 5. Here three transmit and receive frequencies are provided for: transmit frequencies are 16, 28 and 94; receive frequencies are 76, 88 and 94. Double ended boards are used for each pair of readouts. A large board with four matrices could easily be used.

While printed circuit technique with double sided boards is undoubtedly the most convenient way to make the matrix, per-

forated board can be used with flea clips and bus wires. A hybrid board, using one set of etched conductors and one set of bus wires may be the most satisfactory solution to many builders. Figure 6 illustrates the various types of construction.

The entire unit is powered from a 12 volt supply and is directly applicable to mobile rigs. For base station use, a simple voltage

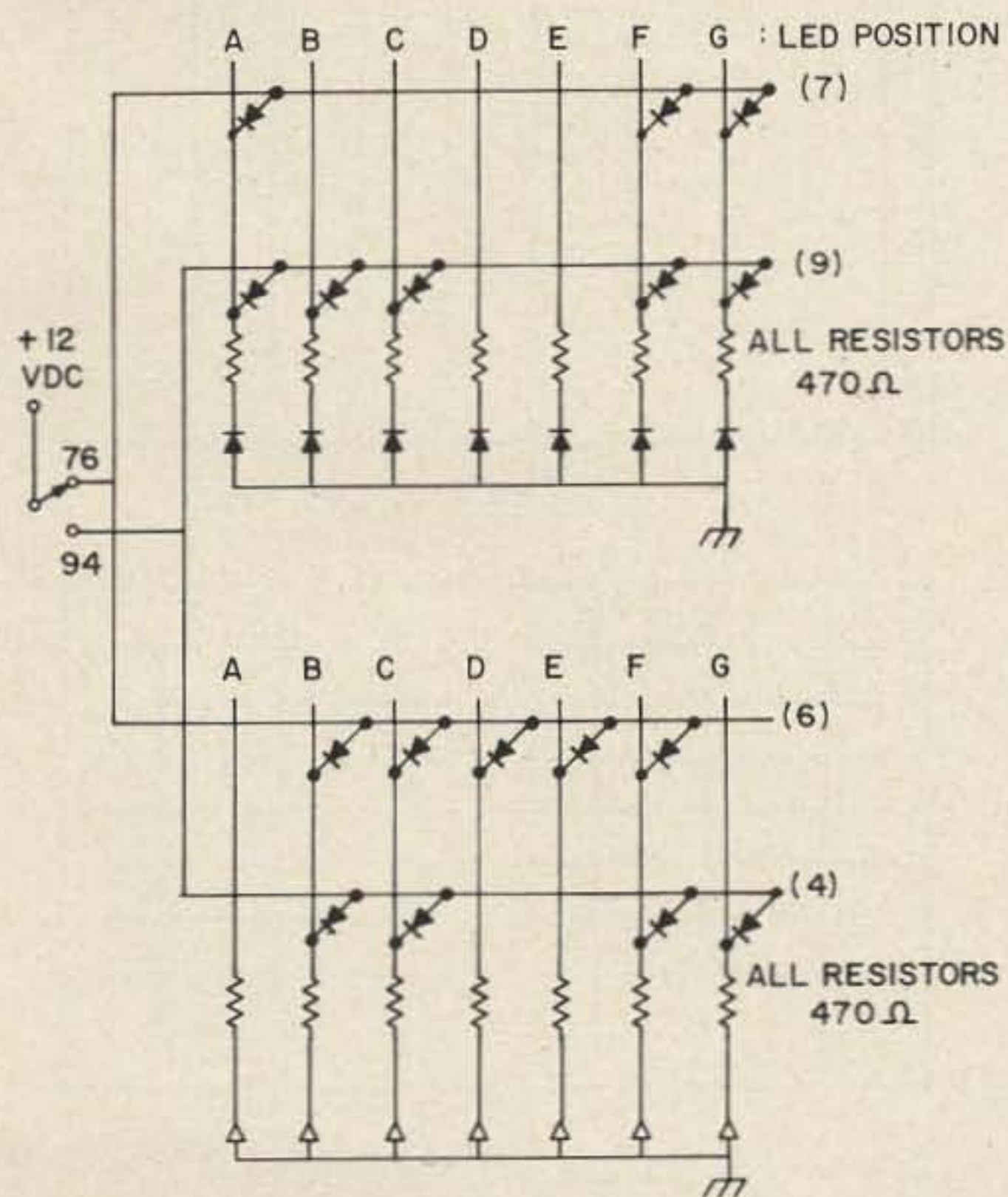

Fig. 3. Schematic of a simple 76-94 switch.

		SEGMENT						
		A	B	C	D	E	F	G
D I G I T	1						X	X
	2	X		X	X	X		X
	3	X		X		X	X	X
	4		X	X			X	X
	5	X	X	X		X	X	
	6		X	X	X	X	X	
	7	X						X
	8	X	X	X	X	X	X	X
	9	X	X	X				X
	0	X	X		X	X	X	X

X = DIODE NEEDED

Fig. 4. Encoding scheme for the matrix. Referring back to Fig. 3: To display 76, diodes are connected from the 76 position on the switch to the A, F, and G busses for the number 7, and the B, C, D, E and F busses for the number 6.

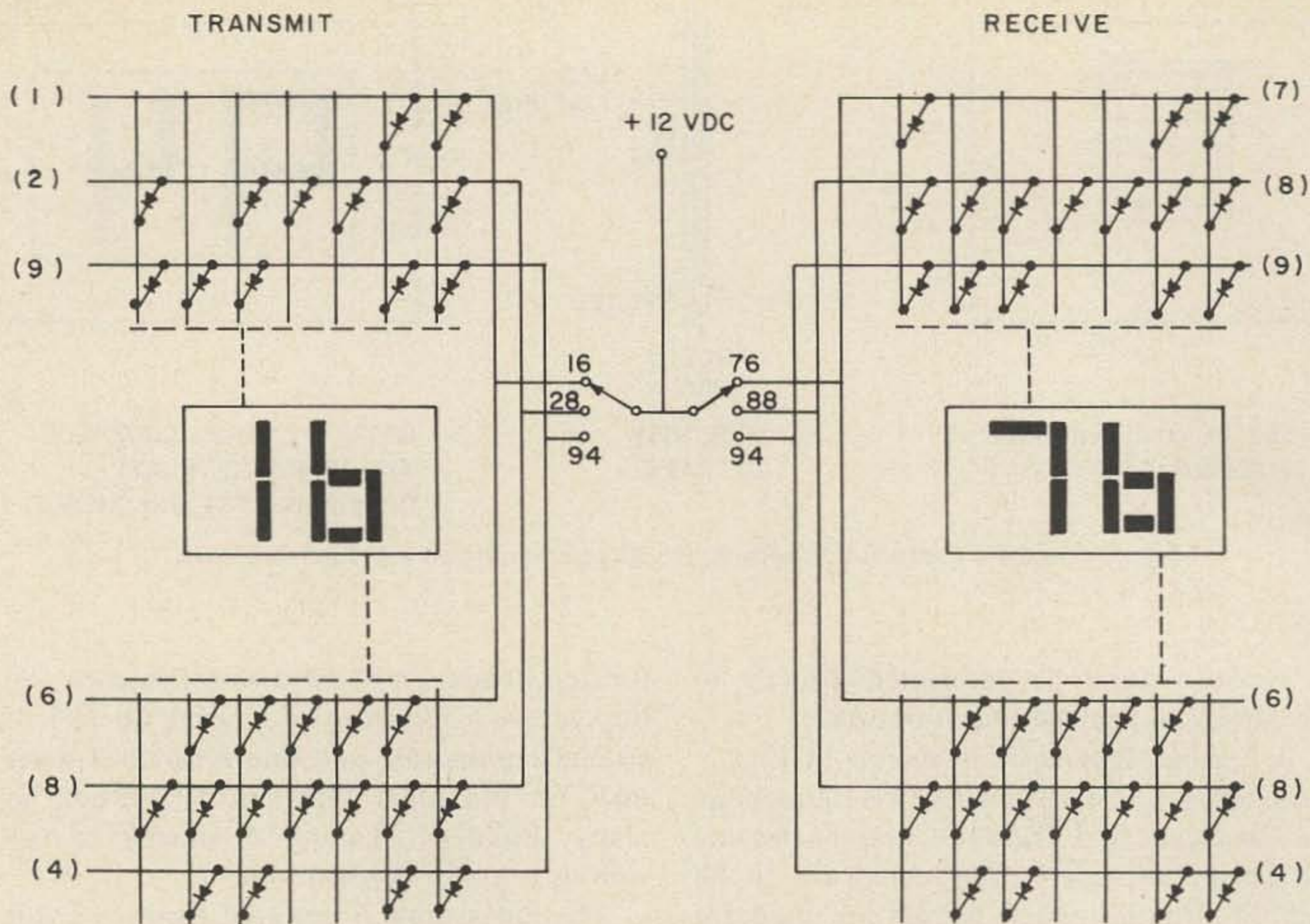

Fig. 5. Typical circuit that will display 16-76, 28-88, and 94-94.

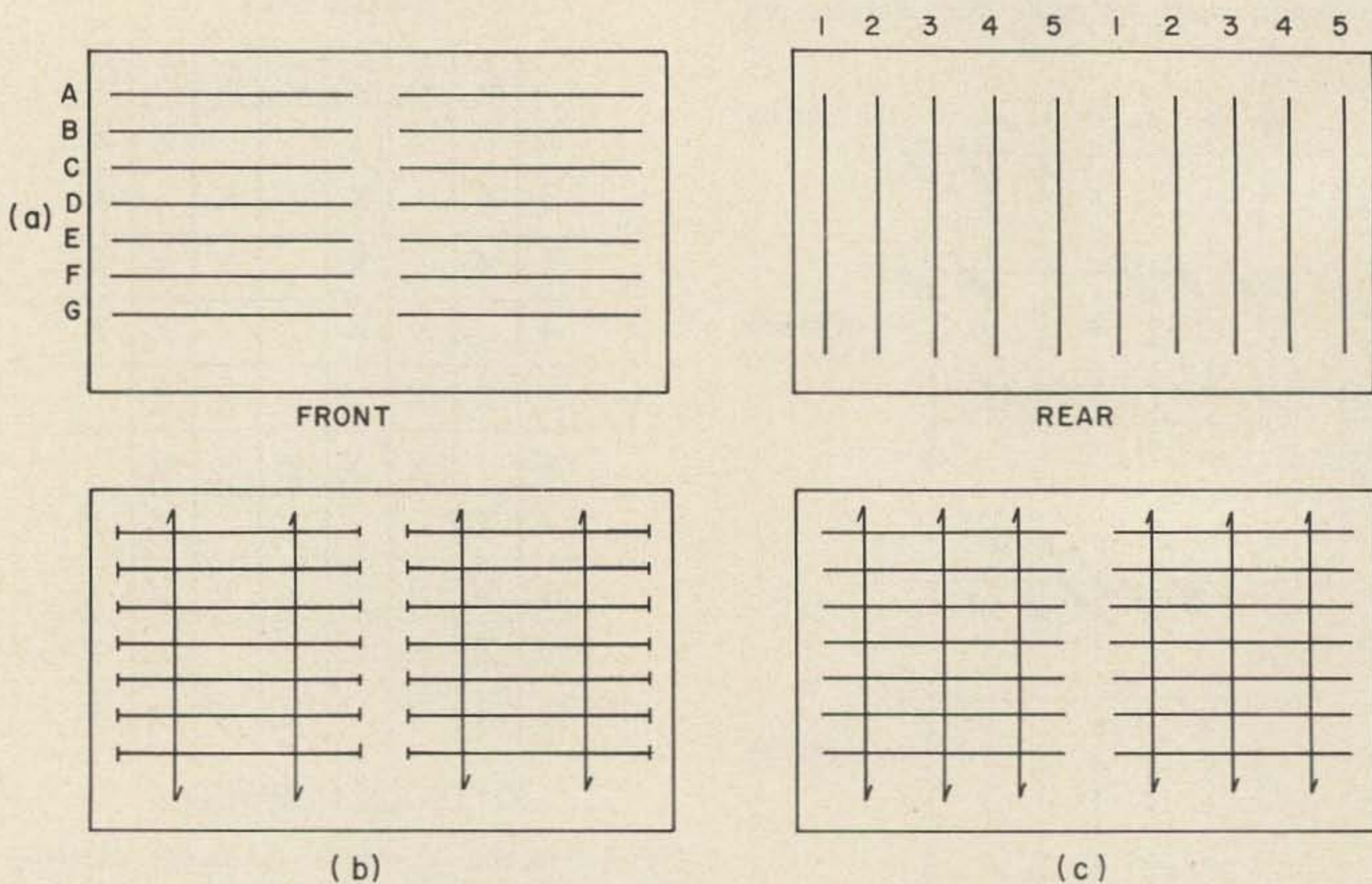

Fig. 6. Types of matrix construction. (a) PC double sided board etched for 5 frequencies, 2 digit readout. (b) Perf board with flea clips for 2 frequencies. (c) Perforated PC board with etched segment busses and wire individual digit busses.

divider from B+, or a tap onto a 12 volt supply can be used. Voltage is not critical, and anything from 10-15V dc will work.

Parts for this setup are not the most critical in the world. The LED's can be bought from several companies, among them Poly-Paks, for around one dollar each. The diodes are the common type that can be had from many sources for around ten for a dollar. Boards, resistors, etc., are stock items.

Although this is a simple scheme, it works as well as much more complicated ones. Seven segment decoder/drivers are available as integrated circuits that will take the place of the matrix used here, but their cost is prohibitive. It is felt that the techniques used here allow a distinctive look to be imparted to many projects at a level most builders are able to afford. The seven segment readout and matrix can be applied to items besides FM gear: receiver band-switches, clocks, and anywhere else a highly legible data display is needed at a minimum of cost.

...WA3AJR/3



**GLADDING 25 \$249.95\***  
 \* 6 separately switchable transmit & receive channels \* 2 meter transceiver \*Suggested list price

**PEARCE-SIMPSON**  
 DIVISION OF GLADDING CORPORATION  
 P.O. Box 800 Biscayne Annex Miami, Florida 33152

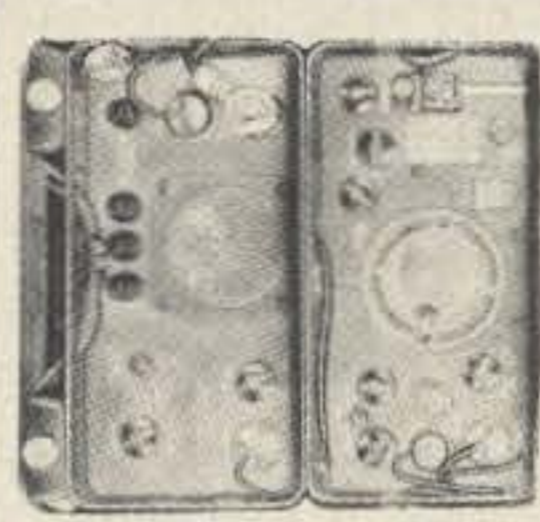

**AN/GRR-5 RECEIVER**  
 1.5 to 18 MHz in 4 Bands, AM, CW and MCW, continuous tuning & 10 pre-set frequencies, 200 kHz crystal calibrator, 4" P.M. speaker, 12 tubes, with power supply for 115 V. 50/60 cyc., 6, 12 or 24 V. DC - Also dry cells 90 & 1.5 V. DC. Size 13 1/2" x 8 1/2" x 12 1/2" Shpg. Wt.: 75 lbs. USED, repairable... \$49.50  
 CHECKED...\$59.50 Power Plug: \$2.00  
 Manual...\$7.50

**R-392 RECEIVER** - 500 kHz to 32 MHz, 32 Bands, 25 Tubes, 24/28 V. DC. Size: 11 1/2" x 14" x 11"; 70 lbs. USED, repairable: \$295. CHECKED: \$350. Manual: \$8.50

All Prices F.O.B., Lima, Ohio - Dept. 73

**SEND FOR OUR BIG NEW CATALOG!**  
**FAIR RADIO SALES**  
 1016 E. EUREKA · Box 1105 · LIMA, OHIO · 45802

Announcing a new dealer for YAESU FT 101 and other models...

**RACOM Electronics Inc.**  
 15051 Southeast 128 Street  
 Renton, Washington 98055  
 Tel. 206-255-6656

**FM POWER PACK**  
 16 db GAIN      24 db f/b RATIO

- WORK DISTANT REPEATERS
- NULL OUT LOCAL INTERFERENCE

A quality Cush Craft array, complete with two 11 element antennas, harness, support boom and all hardware. Features direct 52 ohm feed, dimensions 144" x 80" x 40", turn radius 60", weight 15 lbs.

A147-22	146-148 MHz	\$49.50
---------	-------------	---------

---

**NEW** 450 MHz 6 ELEMENT REAR MOUNT  
 11db GAIN      A449-6      \$10.95

IN STOCK WITH YOUR LOCAL DEALER

**Cush Craft CORPORATION**      621 HAYWARD STREET  
 MANCHESTER, N.H. 03103

**ACTIVE AUDIO FILTERS**

IC'S FOR SUPER HIGH PERFORMANCE

**CW FILTER:**  
 Get razor sharp selectivity. No impedance matching! BW (selectable) 180 Hz, 110 Hz and 80 Hz; Center frequency  $f_c = 750$  Hz. Skirts 60 db down at  $\frac{1}{2}f_c$  and  $2f_c$ . 4 op amps, 2"X3" PC board. \$12.95 wired, tested, guaranteed.

**LOW PASS FILTER:**  
 Resistors set cutoff 500 Hz to 20. kHz. Factory set to 2.5 KHz. Rolloff max 48 db/pct. min 40. Input imp 1M; Load > 2K. Gain = 1.5 op amps, 2"X3" PC board \$15.95 wired, tested, guaranteed.

\*\*Write for free spec sheets\*\*  
 \*Dealer inquiries invited\*

**MFJ ENTERPRISES**  
 P.O. Box 494, State College MS 39762

**CW FILTER**      9<sup>95</sup> KIT

**LOW PASS FILTER**      13<sup>95</sup> KIT

**NEW COAXIAL ANTENNA CHANGEOVER RELAY**

Barker & Williamson Model 377 Coaxial Antenna Changeover Relay is a compact unit providing an efficient and economical method for switching antenna to receive. Receiver connector automatically grounded when in the transmit position.

VSWR ..... 1.15:1  
 Frequency Range ..... D.C. to 150 MHz  
 Power Rating ..... 1 KW-2 KW PEP

**PRICE.....\$11.95**

See your dealer or write:  
**Barker & Williamson, Inc.** **BW**  
 Canal Street, Bristol, Pa. 19007

# STEP UP TO TELREX

## Professionally Engineered Antenna Systems

### Single transmission line "TRI-BAND® ARRAY"

By the only test that means anything . . . on the air comparison . . . this array continues to outperform all competition . . . and has for two decades. Here's why . . . Telrex uses a unique trap design employing 20 HiQ 7500V ceramic condensers per antenna. Telrex uses 3 optimum-spaced, optimum-tuned reflectors to provide maximum gain and true F/B Tri-band performance.

#### ONLY TELREX GIVES YOU ALL THESE FEATURES . . .

- Power rating 4 KW PEP . . . rain or shine
- Wind rating survival 110 MPH
- Patented broad-band coaxial Balun
- Heavy-duty steel gusset mounting plate
- Aluminum boom 2 in., 2½ in. O.D. x 18 ft.
- Large diameter, .058 wall taper-swaged dural elements for minimum

weight and exceptional strength to weight ratio

- Stainless steel electrical hardware

With a Telrex Tri-band Array you get 49 lbs. of educated aluminum engineered and built to provide many, many years of performance unmatched around the world by any other make. Longest element 36 ft. Turning radius 20 ft. Shipping weight 65 lbs. Shipping container 13 in. x 5 in. x 13 ft.

Note: If not available from your dealer, order direct. You'll get fast, personal service.

Telrex Labs are design engineers, innovators and manufacturers of the world's finest ¾ to 160 meter communication systems and accessories priced from \$25 to \$25,000.

For technical data and prices on complete Telrex line, write for Catalog PL 71.

TB5EM **\$395**

Other  
Multi-Band  
Arrays Available

Elements shortened  
to show details.

BALUN



TRAP



#### TYPICAL TELREX "MONO-BAND" ANTENNAS

15M317	- "Monarch", 10 DBD, 3 El., 4 KWP, 2-1/2" O.D., 17' boom	\$175.00
20M326	- "Monarch", 10 DBD, 3 El., 8 KWP, 3-1/2" O.D., 26' boom	\$355.00
2M609	- "Monarch", 14 DBD, 6 El., 6 KWP, 1" O.D., 9' boom	\$ 39.95
2M814	- "Monarch", 16 DBD, 8 El., .8 KWP, 1.375" O.D., 14' boom	\$ 59.00
6M516	- "Monarch", 13 DBD, 5 El., .8 KWP, 1.5" O.D., 16' boom	\$ 63.95

and ----- many, many more! send for PL-71 Dept. C

**telrex** LABORATORIES

TV And Communications Antennas Since 1921  
Asbury Park, New Jersey 07712 201-775-7252

# VOLTAGE LIMIT SENSOR

*A sensor that continuously monitors your mobile's electrical system and indicates voltage variance outside a prescribed range.*

The voltage limit sensor (VLS) is a compact, self-contained go, no-go indicator which tells at a glance if the voltage in an automobile or boat electrical system is satisfactory. Many of the latest state-of-the-art electronics equipment have incorporated into them various sensors which continuously monitor test points. Whenever one of these test points deviates outside prescribed limits, a warning light or indicator of some type alerts the operator. In the go, no-go variety of indicators, similar to the oil pressure, generator and temperature lights on automobiles, only a critical condition will necessitate some action on the part of the human operator. The low cost sensor described in this article provides an alerting indicator if the voltage in the electrical system falls outside safe limits.

## Theory of Operation

Operation of the sensor is very straightforward. Referring to the schematic diagram, Fig. 1., the voltage input provides both the sense voltage and the supply voltage needed to operate the VLS.

The undervoltage part of the VLS consists of Q1, Q2, DS1, and D1 along with three resistors R1, R2, and R3. When the

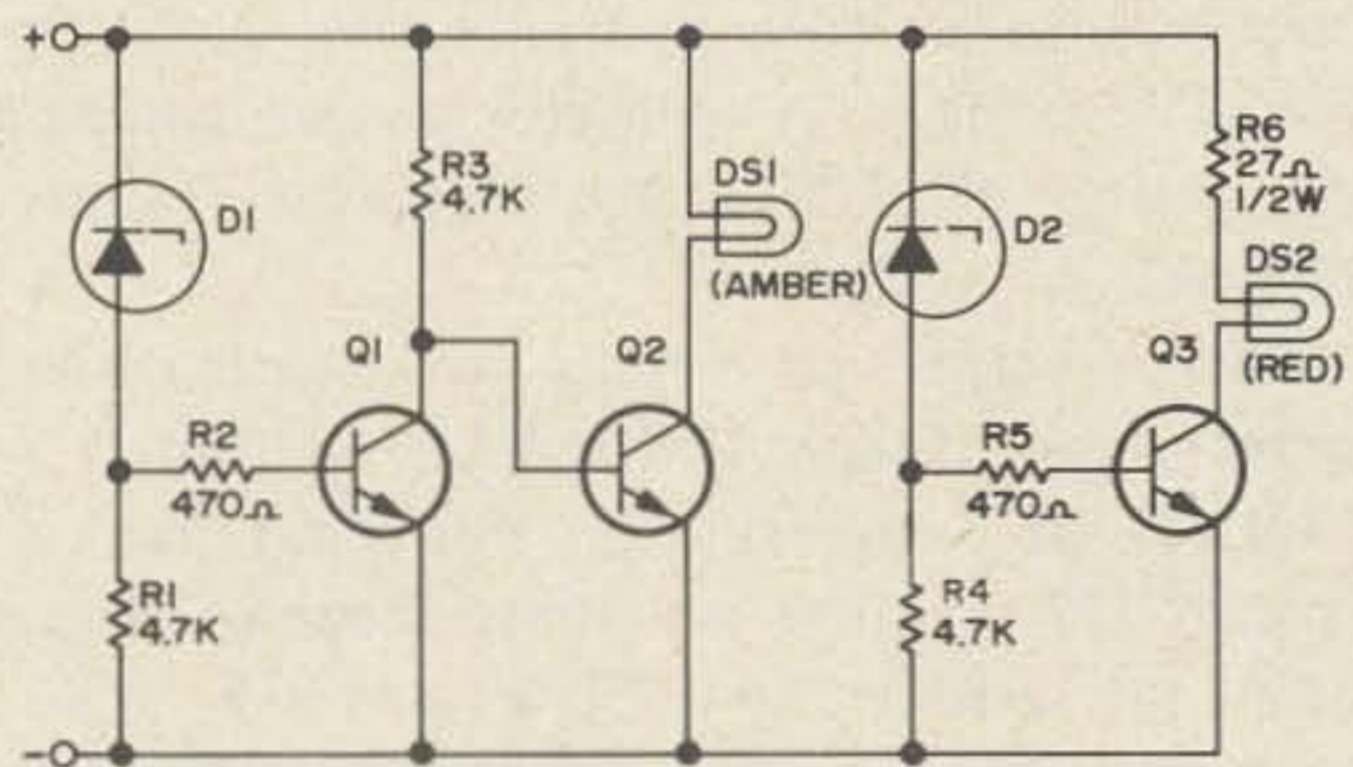

Fig. 1. Parts List: Q1, Q2, Q3 — Motorola MPS 3704; D1 — Motorola IN 5243B, 13V  $\pm$  5% zener diode; D2 — Motorola IN 5245B, 15V  $\pm$  5% zener diode; PL1 — Dialco MS 25256 Pilot Lamp Assembly (Amber Lens) with #330 Bulb (T-1  $\frac{3}{4}$ , 14V at 80 mA); PL2 — Dialco MS 25256 Pilot Lamp Assembly (Red Lens) with #330 Bulb (T-1  $\frac{3}{4}$ , 14V at 80 mA); R1, R3, R4 — 4.7 K $\Omega$ ,  $\frac{1}{4}$ W; R2, R5 — 470 $\Omega$ ,  $\frac{1}{4}$ W; R6 — 27 $\Omega$ ,  $\frac{1}{2}$ W; misc. hardware — CU 2101A minibox, terminal strips, rubber grommet, etc.

input voltage is less than the breakdown voltage of D1, transistor Q1 is turned off. This in turn allows the current flowing through Q1's collector load resistor, R3, to flow into the base of Q2. This causes Q2 to go into saturation acting like a switch to light the amber indicator, DS1. As the input voltage goes through the zener breakdown point, current begins flowing into the base of Q1. When Q1 has gone into saturation, no base current is available for Q2 which turns off. Indicator, DS1, also goes out since Q2 is cut off. Resistor R1 assures a sharp turn on of Q1 and also provides a path for collector leakage of Q1. R2 limits the base current into Q1 after D1 is conducting.

The overvoltage part of the VLS consists of Q3, DS2, D2 and resistors R4, R5, and R6. Q3 is cut off until the input voltage exceeds the zener breakdown of D2. At this point, base current flows into Q3 turning on the indicator, DS2. R4 and R5 serve similar functions as R1 and R2 described above. R6 is a current limiting resistor so DS2 does not burn out for the higher input voltages.

#### Design Criteria and Construction

Silicon transistors are used to assure stable operation over a wide range of temperatures. The transistors, Q1, Q2 and Q3 were chosen to have high beta of 100 to 300, and a high collector current rating of at least 100 mA. Voltage breakdown can be 20–25V or more. A collector power dissipation rating of 300 mW or greater is also desirable.

The voltage at which an automobile operates its primary low voltage system is a function of temperature. For example, a typical GM product will have a range from 13.5V at 150°F to 15.2V at 0°F. The combination of zener diodes, D1 and D2, plus the small base to emitter voltage drops of Q1 and Q3 were chosen such that any voltage less than 13.5V would light the amber indicator and any voltage more than 15.2V would light the red indicator. The 5% zener diodes assure an accurate turn on and turn off without any adjustments.

Since the VLS detects a voltage falling outside these defined limits, it was felt that tracking as a function of battery temperature was not justified. An elaborate tempera-

ture sensing circuit was deemed unnecessary and beyond the basic requirements of the VLS.

The circuit was constructed in a small Bud Minibox without crowding. The two pilot lamp indicators are mounted in one end and a rubber grommet in the other end for the two wires. If the VLS is to be used on a negative ground system and the unit is to be securely fastened to the metal ground of the automobile or boat, then the negative lead can be grounded to the case internally and only one wire, the positive lead, brought out of the unit. No special wiring precautions are necessary; however, if sockets are not used for the transistor it is recommended that a heatsink be used on the leads during the soldering operation. This will prevent the possibility of damage to the transistors from excessive heat.

#### Checkout and Installation

Since the VLS draws a negligible amount of current during normal operation and only 80 mA during the time an indicator is on, power can be obtained from almost any point in the low voltage electrical system. However, it should be switched on and off with normal ignition and accessories since with just 12V input, the amber indicator will be on drawing continuous current.

During operation at an ambient temperature of about 75°F where the voltage input will be about 14.2V or so, it is possible to use a 1.5V dry cell battery placed in series with the positive lead to check the VLS. With the 1.5V battery positive terminal connected to the VLS (battery voltage adding), the red indicator should light. With the 1.5V battery negative terminal connected to the VLS (battery voltage subtracting), the amber indicator should light. This test will generally work unless the automobile low voltage is not adjusted properly or the ambient temperature is very high or very low. In these cases, a bench-type variable-voltage power supply could be used for final checkout.

The voltage limit sensor will monitor your 12V battery and charging system alerting you only to potential unsafe conditions not indicated on the usual idiot light.

...W4UXJ



William F. Splichal, Jr. WA6QVQ  
1160 Brace Ave., Apt. 8  
San Jose CA 95125

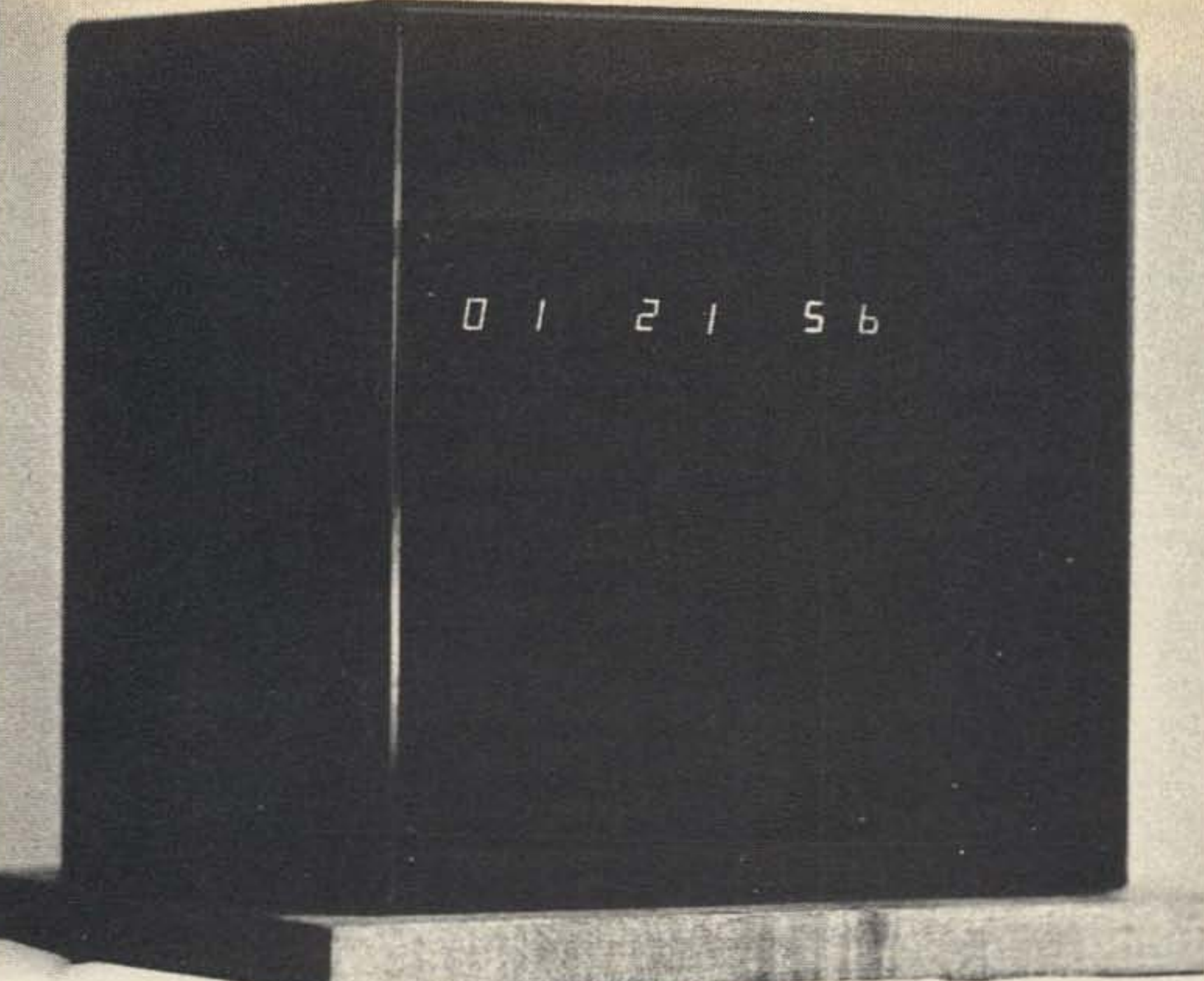

0 1 2 1 5 6

*Smoky plastic case gives a neat finished appearance to the clock and hides its innards.*

## BUILD A DIGITAL CLOCK WITH 19 INEXPENSIVE ICS

**T**he normal 60 Hz line current can be tricked into counting time with this simple and easy to build digital clock. The clock requires only 19 standard, inexpensive TTL integrated circuits and six light emitting diode (LED) displays which are housed in a plastic box. The clock design is unique in that up-down counters are used to count hours in order to minimize the number of components that would otherwise be required in other complex counter and decoder arrangements.

Referencing timing pulses for the clock are obtained by counting each cycle on the 60 Hz line and dividing by 60. The rise and fall of the raw 60 Hz sine wave is too slow and therefore must be reshaped before applying to the TTL integrated circuits which are designed to operate at high frequencies (typically 20 MHz). Positive 60 Hz pulses are obtained from the secondary of the power transformer with a half wave rectifying diode. The pulses are clamped to approximately 2.5V by the forward voltage drop

across four series diodes placed across the input of one of the Schmitt triggers in the dual NAND Schmitt trigger, Q1. The SN7413 dual NAND Schmitt trigger has the capability of producing jitter-free square wave output when triggered by slow rise time pulses as in the case of the 60 Hz line frequency. False signals due to transients on the 60 Hz line are minimized by the 1.7V minimum signal level required by the Schmitt trigger for cycling. 60 Hz square waves from the Schmitt trigger are applied to the input of the divide-by-twelve counter, Q2, which produces ten counts per second. Output from Q2 is connected to the input of the decade counter, Q3, which provides an output of one count per second. The 1 Hz timing pulses from Q3 are applied through switches SW1 and SW2 for either counting or setting the time.

When switch SW1 is in the "ON" position, the 1 Hz pulses are applied to the input of the decade counter, Q4 (seconds coun-

ter). Output pulses from Q4 are applied to the BCD-to-seven-segment decoder/driver, Q5, which drives the seven segment LED display, D1. The 0.1 Hz output signal from pin 11 of Q4 is coupled via a 2N4148 diode and a .01  $\mu$ F capacitor to the input of the divide-by-six counter, Q6 (tens of second counter). Use of the series connected diode and capacitor allows the output of the seconds counter, Q4, to be isolated from the output of the decade counter, Q3, when the tens of seconds counter, Q6, is being advanced.

The tens of seconds counter, Q6, although actually connected to divide by twelve divides the output from Q4 by six twice before resetting. Only the A, B, and C outputs are used from the tens of second counter Q6 which yield a normal BCD code for counts 0 to 5 and repeats the same BCD

code for counts 6 through 11 before resetting at the count of 12. If the tens of seconds counter, Q6, was connected for a true divide by six operation, the output would be in a binary code in lieu of a BCD code which is required by decoder/driver Q7. Output from Q6 is applied to the BCD-to-seven-segment decoder/driver and, also, to the inputs of three of the inverters in the Hex Inverter, Q8. Outputs from the three inverters of Q8 are applied to the triple input NAND gate Q9 which provides the  $f/60$  signal for the minutes decade counter, Q10. The  $f/60$  signal is thus provided from the output of Q9 when the A, B, and C outputs of Q6 simultaneously reach a logic state of one (count of 6 and 12).

Output from Q9 is coupled with a diode and capacitor as in the case of the output from the previous seconds counter, Q4, to

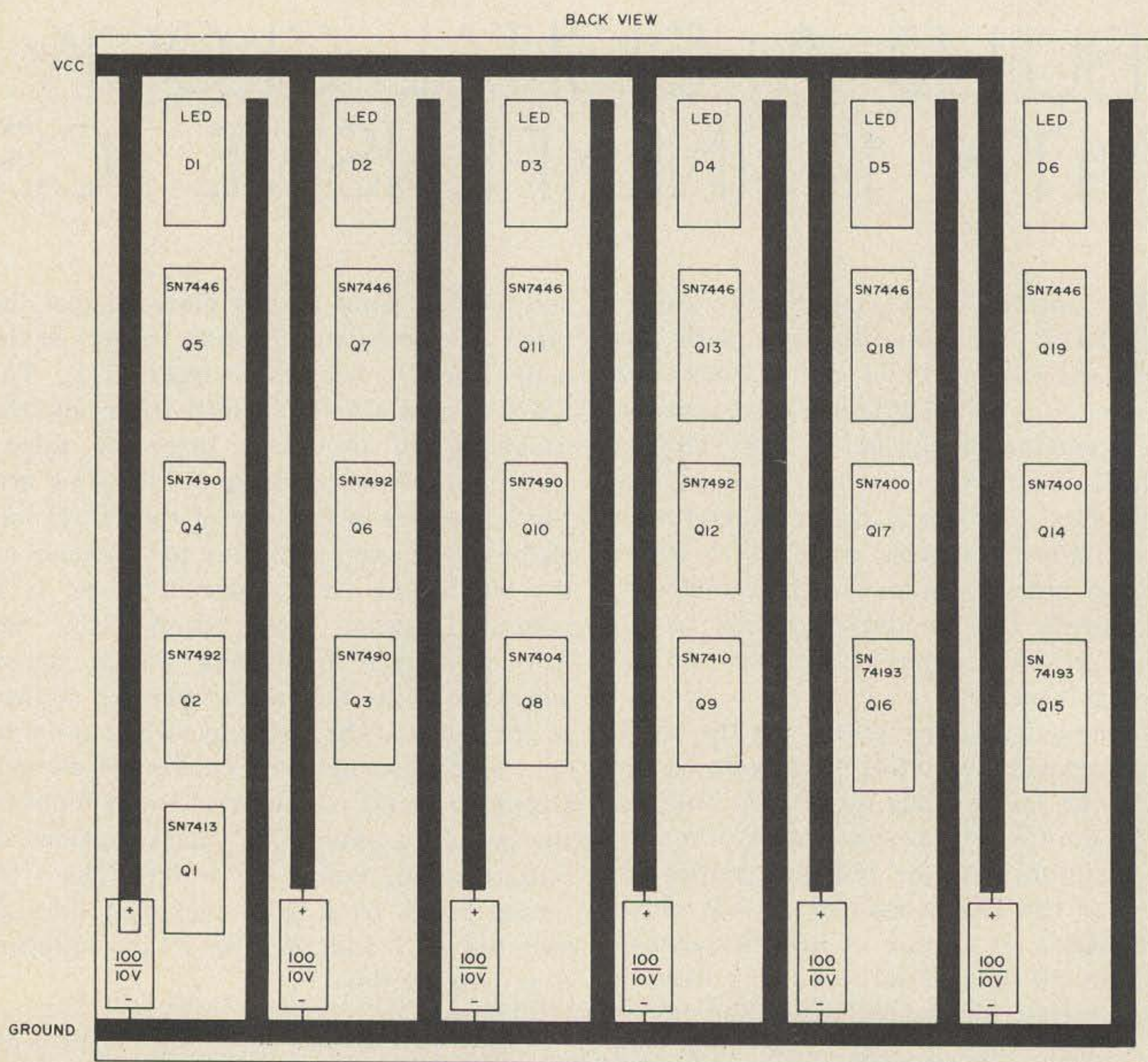

Fig. 1. Circuit board, showing the positive and ground busses running between the ICs.

provide isolation of the triple NAND gate output when the minutes counter, Q10, is advanced. A 220 pF capacitor is placed across the output of Q9 to prevent false output conditions during the time required for the four internal JK flip-flops of counter Q6 to change logic states which do not all occur simultaneously. These false output signals are suppressed by the 220 pF capacitor during the counting interval 1 to 5 and 7 to 11 and therefore are not counted by Q10 as real  $f/60$  signals.

The  $f/60$  output from Q9 is applied to the minutes counter, Q10, and tens of minutes counter, Q12, which function identically to the seconds and tens of seconds sections of the clock.

Counting of the hours and tens of hours is accomplished with the use of up-down counters Q15 and Q16. Using another de-

cade counter would divide the  $f/3,600$  output of the tens of minutes counter to a  $f/36,000$  output, but could not directly drive a BCD-to-seven-segment decoder/driver because the tens of hours display, D5, must show 0 for nine hours and a 1 for three hours. The up-down counters Q15 and Q16 have presettable inputs which enables the output to be preset to any desired state for programmed cycling and provides a BCD output for the decoder/drivers. Counter Q15 is connected to count from 1 to 13 and then reset to 1 by the triple input NAND gate Q9 when the A, C, and D outputs of counter Q15 simultaneously reach a logic ONE state at the count of 13. The Q16 counter is connected to count from 1 to 9 and 0 to 3 alternately, resetting and loading in a 0 or 1 respectively, with the flip-flop comprised of two dual input NAND gates in Q14. Thus,

*With the case removed, the digital clock still looks neat and clean. Base is stained hardwood.*

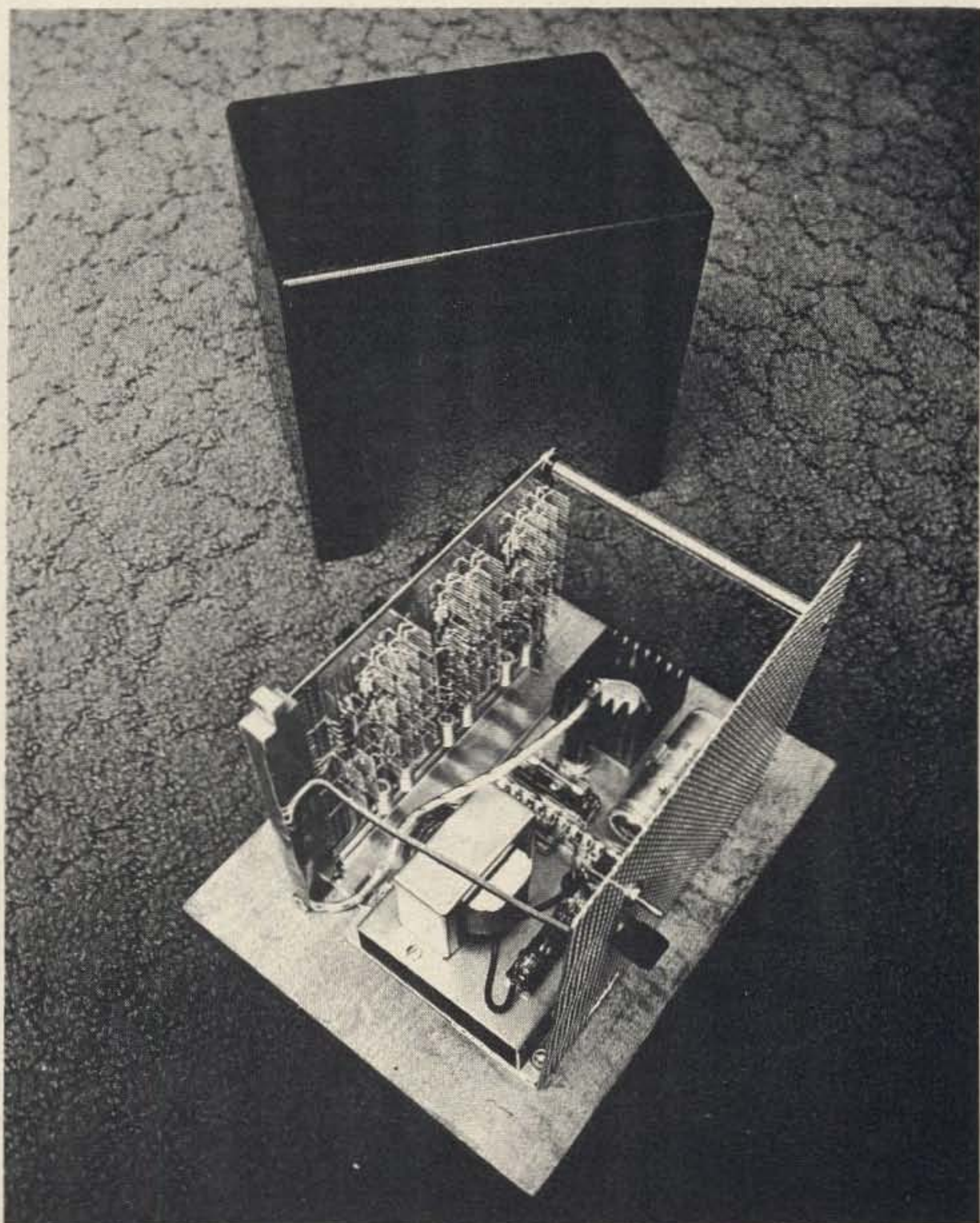



### PARTS LIST

Q1	Dual NAND Schmitt Trigger SN7413
Q2, 6, 12	Divide-By-Twelve Counter SN7492
Q3, 4, 10	Decade Counter SN7490
Q5, 7, 11, 13, 18, 19	BCD-To-Seven Segment Decoder/ Driver SN7446
Q8	Hex Inverter SN7404
Q9	Triple 3-Input Positive NAND Gate SN7410
Q14, 17	Quadruple 2-Input Positive NAND Gate SN7400
Q15, 16	Up-Down Counters SN74193
D1, 2, 3, 4, 5, 6	Seven-Segment LIGHT Emitting Diode Displays; Litronix Data-Lit 10 or Monsanto MAN 1.

1	5000 $\mu$ F 10V electrolytic
3	.01 $\mu$ F 50V ceramic
2	220 pF @ 300V, silver mica
1	.001 $\mu$ F @ 500V ceramic
6	100 $\mu$ F @ 10V electrolytic
1	3 amp fuse
1	1 amp fuse
1	68 $\Omega$ , 1/4W
2	470 $\Omega$ , 1/4W
12	2.2K, 1/4W
1	1K, 1/4W
42	82 $\Omega$ , 1/4W
7	1N4004
3	1N4148
1	2N3715
1	Stancore P8130 xfmr
1	5.6V 1N4734A zener
1	Thermalloy type 6003B-2 Heat Sink
1	Phono Plug and Jack
2	Fuseholders
8	14 pin IC Sockets
17	16 pin IC Sockets
1	Alcoswitch MST-105E (SW1)
1	Centralab PA2001 (SW2)
15.2 x 15.2 cm "P" pattern, Micro-Vectorbord	
17.8 x 8.9 x 2.54 cm. aluminum chassis	

the hours counter Q16 is reset by either the two input NAND gate Q17 connected to the B and D outputs of Q16 when both reach a logic ONE state at the count of 10 to load in a zero, or when the Q15 counter resets at the count of 13, at which time the Q15 counter loads in a count of one. This allows the clock to count to a logic state of 13:00:00 which remains for only a few nanoseconds before the counters reset and the displays change to 01:00:00. The BCD output from the hours counter Q16 is connected to the decoder/driver Q18 which drives the hours LED display, D5. During the 10 to 13 hours segments of time, the flip-flop Q14 also gates the A input of the

### SPACE-AGE TV CAMERA KITS & PLANS



BE A PIONEER IN HOME TELECASTING! Build your own TV CAMERA. Model XT-1A, Series D, \$116.95 pp. Solid-State. Step-by-step construction manual. High quality. Connects to any TV without modification. Ideal for hams, experimenters, education, industry, etc.

PHONE or WRITE for CATALOG.  
DIAL 402-987-3771

Many other kits, parts and plans available including starter kits, focus/defl. coils, vidicon tubes, const. plans, etc.

1301 N. BROADWAY **ATV Research** DAKOTA CITY, NEBR. 68731

## VIBROPLEX

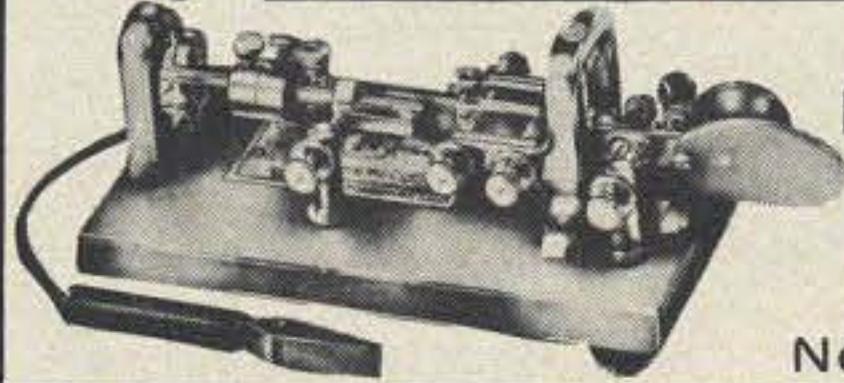

ENJOY EASY,  
RESTFUL KEYING  
\$21.95 to \$43.95  
THE VIBROPLEX  
CO., INC.  
833 Broadway,  
New York, NY 10003

**HELP!** Send for **FREE** list of  
over 200 pieces good used  
equipment. Priced to  
sell.

**FRECK RADIO & SUPPLY CO.**  
40 Biltmore Avenue  
P.O. Box 7287  
Asheville, North Carolina, 28807

## This will turn your repeater on.



### Automatic Station Identifier \$65

The CWID-50 provides precisely timed automatic CW ID. The heart of the unit is a factory programmed IC; no more cumbersome diode matrices. The CWID-50 comes ready to install with preset parameters (user may adjust): code speed — 20 wpm, ID interval — 3 min, audio frequency — 1020 Hz, initial delay — 750 msec. The CWID-50 will bring up the repeater for final ID after last use. This is the smallest, most versatile, lowest price CW identifier on the market! To order yours, give call sign and whether you desire 'de'. Enclose \$65 and we pay postage, or remit \$10 and pay balance COD. Fully guaranteed for one year. We also have CWID's for other applications. Write us for more information. Or call us: (303)-794-7234.

**GSC**

**CONTROL SIGNAL COMPANY**  
5964 W. Columbia Pl., Denver, Colorado 80227

# MORE RANGE . . . with NO NOISE

FOR ALL  
MOBILE UNITS

ENGINEERING  
ESTES  
COMPANY

CUSTOM SYSTEMS  
KITS • ACCESSORIES

ELECTRO-  
SHIELD

ELIMINATE IGNITION NOISE  
**ELECTRO-SHIELD®**  
YOUR ENGINE

FROM \$44.95

**ESTES ENGINEERING CO.**

543 W. 184th St., Gardena, Calif. 90247



**NEW**

## 2 Meter Converter

144CC

\$49.95

postpaid



High sensitivity • Very resistant to overload • Free from birdies • 12 VDC Power • Deluxe die cast cabinet

*This new addition to our VHF/UHF Converter Line is well suited to DX, FM and general purpose applications.*

## And a Proven Favorite . . .

144CA

\$74.95

postpaid



2.5 DB Noise figure • Exclusive gain control circuit • Crystal switch • 117 VAC or 12 VDC Power • Deluxe die cast cabinet

*This proven performer is now being used by many leading VHF'ers. Sensitivity to pull out the really weak ones. Write for details on these and other fine converters and preamps.*



**JANEL  
LABORATORIES**

BOX 112, SUCCASUNNA, NJ 07876  
Telephone: 201-584-6521

tens of hours decoder/driver, Q19, to change from 0 to a 1 on the tens of hours display, D6.

The digital clock is synchronized with WWV by advancing the counters with the 1 Hz signal from the output of Q3. Switch SW1 is switched from the "OFF" to the "SET" position to advance the counter selected by the time advance switch SW2. After all of the counters have been preset to the next upcoming WWV timing tone, the clock is left in a stand-by state by leaving switch SW1 in the "OFF" position. The clock is then restarted and synchronized with WWV by placing switch SW1 in the "ON" position when the timing tone is transmitted by WWV.

The IC circuitry and power supply were built separately and mounted on a stained hardwood base plate (20.3 x 25.4 cm). The clock is covered by a smoked plastic box (20.3 x 20.3 x 15.2 cm). A 15.2 x 17.8 cm ventilation hole was cut out in the back of the box, then covered by a metal screen. All of the 19 integrated circuits and six LED displays can be laid out and wired with No. 28 insulated wire on a 15.2 x 15.2 cm "P" pattern, Micro-Vectorbord (see Fig. 1). The "P" pattern Micro-Vectorbord has pre-punched holes spaced on .254 cm centers which is identical to that of dual-in-line circuits and LED displays. The use of IC sockets to hold the integrated circuits and LED displays, although not required, greatly facilitates the pin-to-pin wiring. Strips of .32 cm wide uninsulated braid should be used for the VCC and ground lines which run parallel to each row of IC's as shown in Fig. 1. Each of the six VCC lines should be decoupled with a 100  $\mu$ F capacitor to insure low impedance signal return paths. Number 28 insulated wire should be used from the circuit board to switches SW1 and SW2, and should be kept as short as possible to minimize wire to wire capacitance.

The power supply was constructed on a 17.8 x 8.9 x 2.54 cm aluminum chassis. A heat sink must be used with the series regulator transistor in the power supply. Connection between the power supply and the IC circuitry was made with a standard three conductor phone plug and jack.

. . .WA6QVQ

Mitchel Katz W2KPE  
147-11 76th Avenue  
Flushing NY 11367



## THE REGENCY HR-2A WALKIE-TALKIE

**L**istening in on the local 2 meter repeaters, it becomes obvious that one or two watts output from a transmitter can do a fine job in walkie-talkie type operation. This is what prompted the work to reduce the power output of the Regency HR-2A transceiver. At the rated 15 watts output, the battery drain on transmit is 3 amperes. An early attempt at using this rig on D-cells was most disappointing. The battery drain was excessive and they ran down in no time at all.

In analyzing the circuit of the transmitter, the method by which to reduce power soon became obvious. The vswr protection circuit can be used to reduce the drive to the power amplifier stage and so the output. In normal operation, if the swr is high enough, it can actually cut off the output completely. This is to prevent damage to the expensive power output transistor.

As the vswr increases, a positive voltage from diode CR 301 is applied to the base of transistor Q304, causing the transistor to conduct. This reduces the bias on Q305 which has the effect of adding resistance into the emitter circuit of the tripler stage Q306. Varying the emitter resistance is the method used to control the output of the tripler and also the drive to the following stages.

The power output of the HR-2A transmitter can be reduced for portable operation by adding a small positive voltage to the base of transistor Q304. This was accomplished experimentally by using a battery pack delivering 13.5 volts. A 15000 ohm resistor

in series with the positive lead and connected to the base of transistor Q304 reduced the power output to three watts as measured on a Bird Termaline dummy load-wattmeter. At this output the battery drain during transmit was 1 ampere. Using an antenna having a finite swr, the protection circuit comes into play and adds an additional positive voltage to Q304. This has the effect of further reducing the power output as well as the battery drain. Another interesting point to note is that as the batteries start to run down the voltage on the base of the control transistor is reduced. This results in an increase of the transmitter output to compensate for the failing batteries.

### Installation

The actual installation of the power reduction circuitry can be completed in less than a half hour and is extremely simple. On the printed circuit side of the transmitter board Regency has added a 1000 ohm  $\frac{1}{4}$  watt resistor to permit the HR-2A to operate at full output with a slightly elevated swr. One end of this resistor goes to the base of transistor Q304 while the other end goes to ground. At the base end, solder a length of wire. Attach another lead to the transmitter side of the on-off switch. The proper terminal of the switch can be determined with an ohmmeter. With the switch in the off position you should get a reading of about 40 ohms to ground. The other terminal should show an open if no power supply is connected. Toward the rear-center of the transceiver there are a number of

# 2 METER F M

## TALK POWER!

TEMPO POWER AMPS up to 135 W output with 1 to 25 W drive from mobile, base or HT...



Solid State  
Micro-Strip Circuit.  
Ready-to-go,  
cables supplied.

7 Models

All U.S. Made.  
In stock. Shipped  
the same day U.P.S.  
prepaid, Cashier's  
Check or M.O.

MODEL	POWER (in/out)	PRICE
252	1W/25W	\$ 85.00
502	10W/50W	105.00
502B	1W/50W	130.00
802	10W/85+W	180.00
802B	1W/85+W	195.00
1002-3	10W/120+W	220.00
1002-3B	1W/120+W	235.00

## ERICKSON COMMUNICATIONS

4657 North Ravenswood Avenue  
Chicago, Ill. 60640 (312) 334-3200

# Outperforms ALL OTHERS!

The finest crystals you can put to work for you come from Bomar! Precision ground, highly active quartz . . . each crystal exceeds FCC regulations for frequency tolerance by 40%. With a Bomar crystal you're right in the middle of the channel with clearer signals and no drift! Long life is assured by hermetic sealing with ingredient Double-N.

AVAILABLE FOR ALL POPULAR 2-METER TRANSCEIVERS

WRITE FOR NAME OF NEAREST DEALER



# BOMAR CRYSTALS

the "long playing" crystals

BOMAR CRYSTAL COMPANY  
201 Blackford Ave., Middlesex, N. J. 08846  
Phone (201) 356-7787

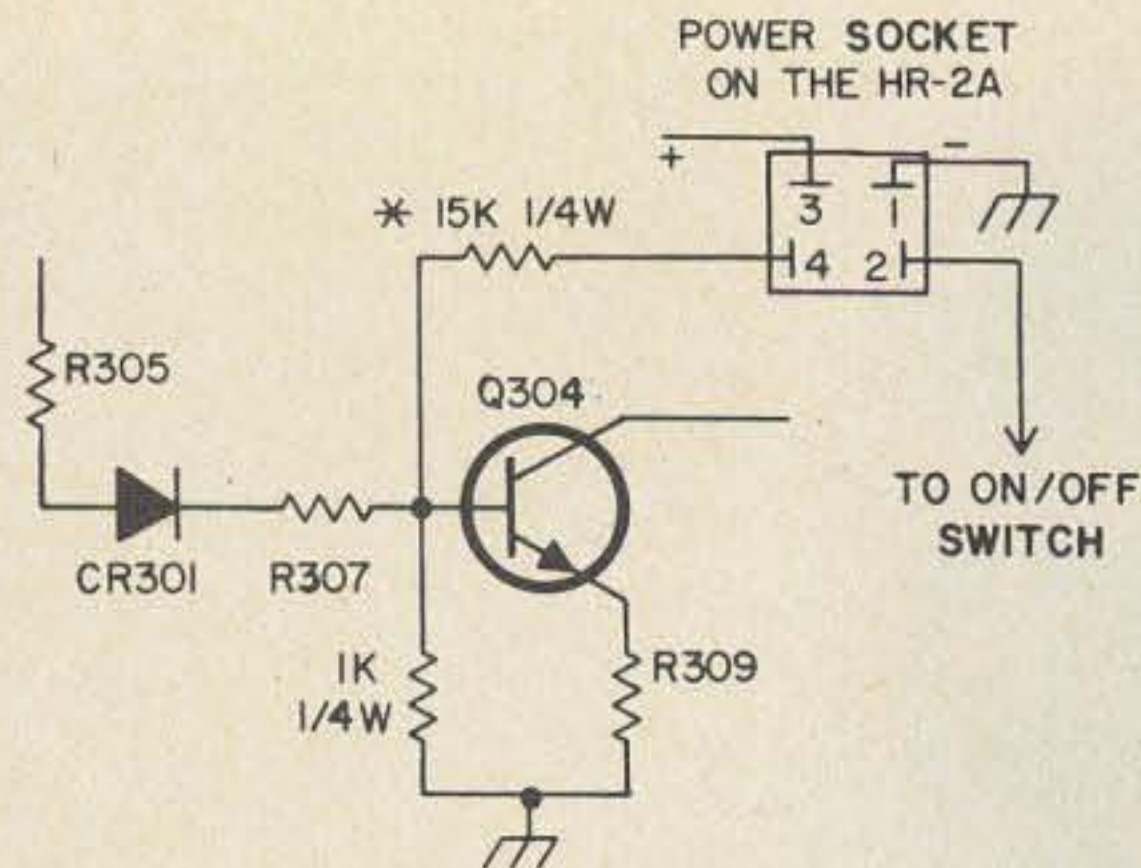

Fig. 1. \*Added resistor.

small holes that are not being used. The 15000 ohm ¼ watt resistor can be inserted into two of these holes and soldered to the foil. The lead from the 1000 ohm resistor should be run along the edge of the transceiver and connected to one end of the 15K resistor. The other end of this resistor should be connected to the power socket on the terminal beneath the positive supply lead. The wire from the switch goes to the other terminal of the power socket. This completed the wiring.

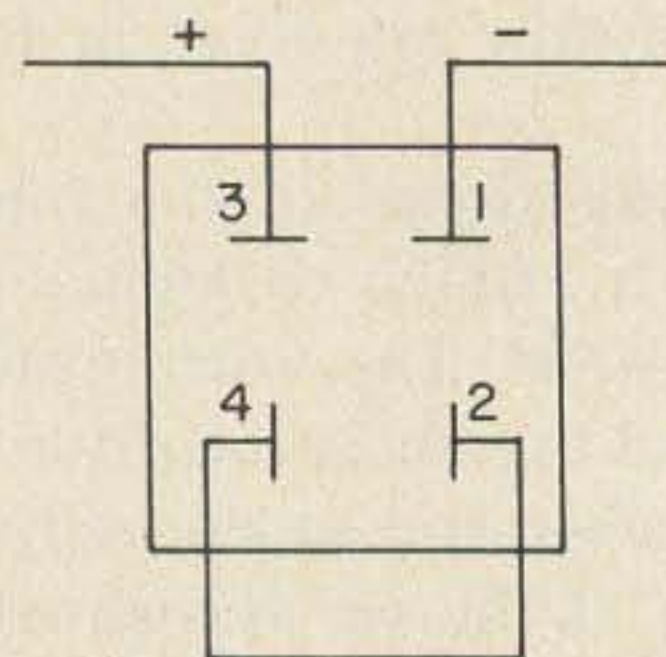

Fig. 2. Power plug for walkie-talkie battery plug only.

A battery pack was built up using 9 D-cell size Alkaline cells in series to supply the necessary 13.5 volts. In addition to the positive and negative leads to the plug a jumper is added across the other two terminals. This automatically cuts in the power reduction circuit when using the battery pack. The jumper is not used on the plugs for the ac and mobile cords permitting the full 15 watts output.

Operation of the Regency HR-2A has been most reliable at the reduced output. A partial circuit, showing the modification, is shown in Fig. 1, while Fig. 2 shows the power plug on the transceiver.

...W2KPE



# DIFFERENT MOBILE AND FIXED ANTENNAS

*designed to improve 2m FM*

**T**ired of spotty, picket fence mobile operation on 2m FM into your favorite repeater? Read on your XYL will hate you, but you'll love the new range and Q5 reports.

Whitmore Lake is about 65 road miles from the Detroit River, and about 40 miles from the Detroit repeaters. The nearest repeater is ARROW on 37-97 in Ann Arbor, about 10 miles away. To work into the DART or Great Lakes repeaters took a high hill, power, or a lot of luck, with a multitude of dead spots throughout the area. The problem was how to work into Detroit with a Rising Sun Special 15W Super Sniffer? An amplifier would certainly do the job, but the cost was too much for the household budget, without giving up Saturday night popcorn. So the idea changed from increasing power to increasing effective radiated power (antennas to you appliance ops). To increase antenna gain from a  $\frac{1}{4}$  wave to a  $\frac{5}{8}$  wave antenna (about  $3\frac{1}{2}$  dB) is easy. Go down and buy a new antenna for about \$30, a mount, and drill a new hole, or go a different way, save the car, and get more gain. A  $\frac{1}{2}$  wave antenna seemed the answer, as it is about as long as the average  $\frac{5}{8}$  whip and offers a smidgeon more gain. To eliminate flutter, a solid or very stiff radiator was needed. Not wanting to be outdone, by mounting the half wave above a  $\frac{1}{2}$  wave

mirror image would give 3-4 dB more gain.

My XYL notwithstanding, it was decided to spend \$12.50 on a CushCraft Ringo, a fixed station antenna, and mount it on the car - no mean task indeed. Since the antenna is 38 in. from top insulator to top of radiator, and a  $\frac{1}{2}$  wave mount would also be 38 in. and all solid as a rock, it looked like a good tree trimmer project like the old 160 meter mobile monsters. But a little ham ingenuity proved to be the fitting touch. Mount a standard roof rack luggage carrier (single bar) near the front of the old VW square back. Mount two plumbing floor flanges, one on top and one on the bottom

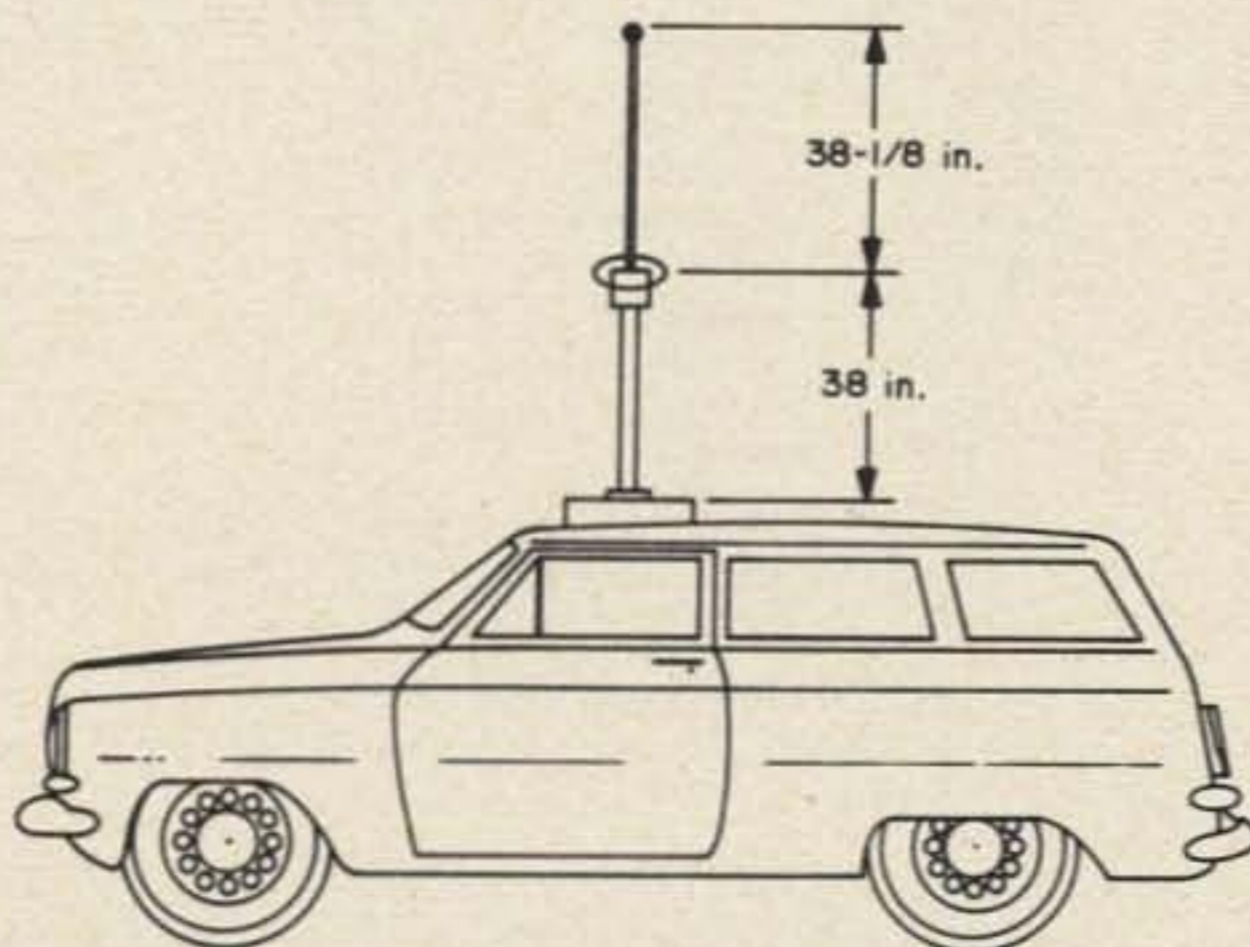

Fig. 1. Mounting the Ringo antenna  $\frac{1}{2}$  wavelength above the automobile's roof does wonders for your radiation pattern.

with 3/16 in. bolts, two of which run through the carrier holes. Screw a 31 in. long 1 in. OD water pipe in the top flange, weld a 6 in. stainless steel spring on top of the pipe and a 4 in. piece on top of the spring and mount the Ringo on top of the 4 in. piece. *Shazam*, a new super mobile antenna which doesn't get permanent wave treatment on bridges or trees. Leaving the spring out can cause a lot of trouble, as the first model proved.

RG-8 was used for feed line, dressing it down the support pipe and in through a side window in the VW. The rig used for all tests was a Drake ML-2.

Now, what about results? Fantastic! While the useful limit of range into Detroit was west to a few miles past Ann Arbor, range was now extended to Jackson, Michigan, with spotty results from Parma. An increase of 30-40 miles. Nothing short of spectacular.

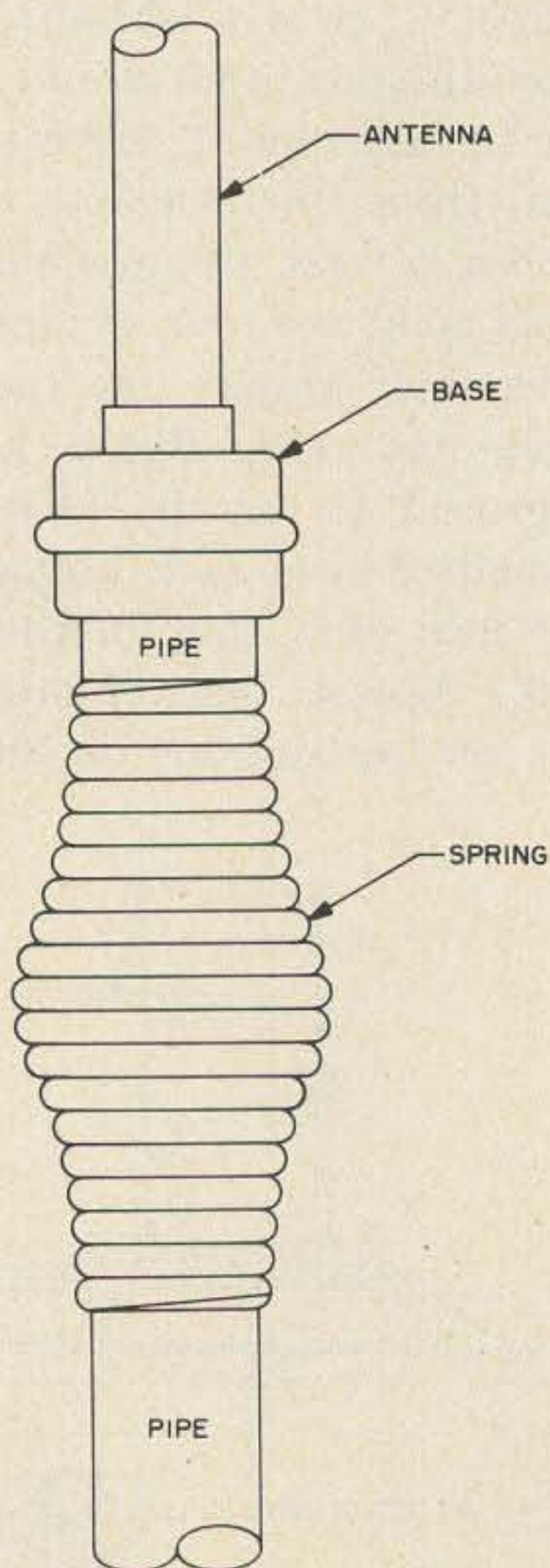

Fig. 2. A spring is used as the Ringo/pipe junction . . . this makes it easy on those low hanging branches.

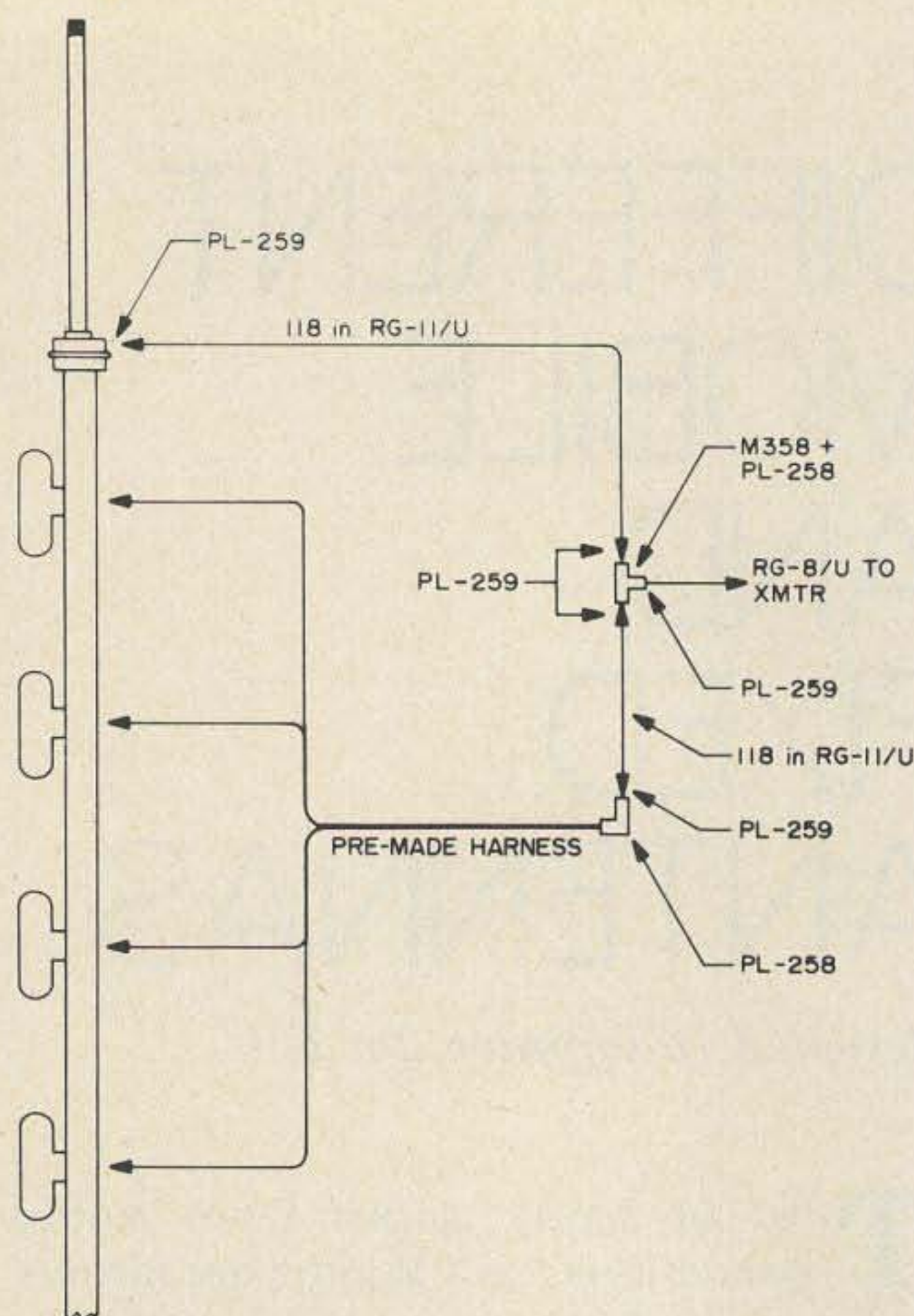

Fig. 3. The Ringo can be added to a dipole array to improve the radiation pattern.

Now what do you do if you bought the Ringo and won't break down and put it on your car (or the XYL said nothing doing to the family chariot). Stack it on top of a 4 dipole array for additional gain and range. If the dipole is set up for unidirectional coverage, the CushCraft Ringo, when mounted 38 in. above the topmost element of the other antenna will fill in the back and side areas to round out the pattern with some additional forward gain. If the vertical dipoles are arranged for omnidirectional gain, the figure and range are increased in all directions. Again, the bottom insulator of the Ringo should be 38 in. above the top of the uppermost dipole element. To match into a 50Ω coax, make a harness of two lengths, each 118 in. long of RG11 solid coax. Connect one end to the Ringo, the other to the end of the harness supplies by the dipole manufacturer (i.e., FM4D) and connect the other ends to a T connector, to which you connect the coax from your transceiver. If this still doesn't give you enough range, buy an amplifier.

...WB8HEE

# TWO METER FM TRANSMITTER

*An inexpensive rig offering compact construction without sacrificing circuit quality.*

**T**his article describes a simple narrow band two meter FM transmitter that uses inexpensive transistors and provides a little more than one watt output. It features double-tuned circuits for selectivity, a mosfet buffer for frequency stability, and voice-shaped audio frequency response.

For the amateur who has had some experience in solid state VHF circuitry, this transmitter can provide a convenient and inexpensive way to join the activity on the local repeater. Although this article describes a base station unit, this circuit could also be used as part of a handy-talkie or mobile installation.

## The Circuit

The transmitter is built in three semi-modules; the voltage controlled crystal oscillator (VCXO), the amplifier-doubler (Amp-Doubler), and the power supply. Figure 1 shows the VCXO. Two 40398's amplify a ceramic or crystal microphone input to drive a pair of MV-835 varicap diodes. Bypass and coupling capacitors were selected to give a one dB 300 to 3000 Hz bandpass. A small amount of negative feedback was used on the second 40398 (100 K resistor) to reduce excessive gain, while slightly reducing distortion in that stage. It may also help to improve bias stability, thus improving the frequency stability of the oscillator since the



varicaps are biased directly by the collector of the 40398. Using this direct coupling eliminates the need for a coupling capacitor and separate bias for the varicap. The varicap would be biased at the same voltage as the collector quiescent voltage anyway. The only drawback is the fact that the frequency stability is dependent on the bias stability of the 40398. Using two varicaps in parallel provides more dynamic capacitance change, even though it doubles the total capacitance. Direct FM is used on the 18 MHz fundamental cut crystal. The crystal was cut for a 20 pF load capacitance. The 2N918 oscillator uses an old and familiar circuit to drive a 3N128 mosfet buffer. The common source buffer provides about 1.3V rms at the input of the Amp-Doubler. The use of a mosfet buffer reduces the problem of frequency "pulling" caused by tuning or load changes in the Amp-Doubler.

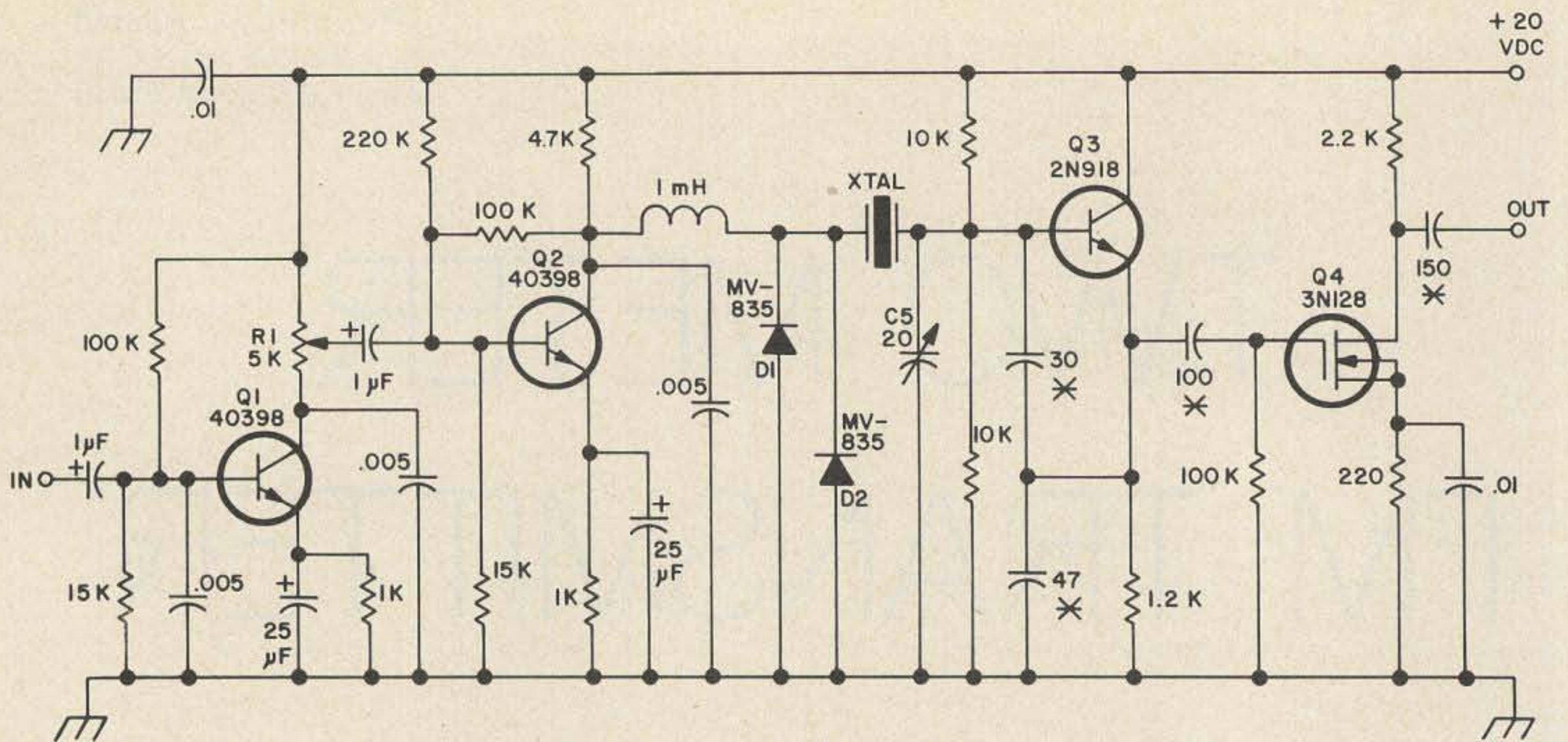

Fig 1. VCXO Board. Capacitors marked with + are electrolytic. Capacitors marked with \* are mica. Other capacitors are disc ceramic. C5 is a small ceramic trimmer.

A 24V rms 20 volt-amp power transformer, a bridge rectifier, and a large filter capacitor provide 28 volts to drive the last three stages of the Amp-Doubler. A dropping resistor and zener diode with another large capacitor give clean regulated voltage for the VCXO and first doubler.

The Amp-Doubler is the most interesting and most difficult part of the transmitter. Many basic considerations go into VHF transmitter circuitry. As frequency decreases there is a six dB per octave increase in transistor gain. This can give a stage much higher gain at lower frequencies, and cause low frequency oscillation. This type of oscillation can usually be traced to poor power supply bypassing, component self-resonances, or rf choke resonances with other circuit capacitances. Each stage must be bypassed so as to be effective at lower frequencies as well as at VHF. This is the reason for dual bypass capacitors. Any rf chokes should be low Q. Wirewound resistors and ferrite beads have good success, but ordinary carbon resistors can be used with a Q of almost zero. Collector rf chokes can be eliminated by using a coil that is part of the tuned circuit to supply B+ current. Inter-stage coupling was accomplished by experimentally tapping coils to obtain an approximate match. Efficiency could probably be much better, but each stage could be easily

driven to meet or exceed its power rating. Resistors are used across tuned circuits where necessary to reduce any tendency toward parasitic oscillation. Since the first two stages use double tuned circuits, the problem of unwanted harmonics from the oscillator getting through are greatly reduced. This makes two tuned circuits at each multiplied frequency.

### Construction

A popular small size LMB cabinet (LMB No. CO-3) was used for this project. The first step was to secure parts for the power supply and assemble it on the chassis provided with the cabinet. The VCXO was assembled quite easily with the pc board layout provided for it. All parts on the VCXO were mounted by soldering directly to the board, including the HC 18/U crystal. The board was a double clad epoxy type with enough of the foil on top of the board etched away for the components to pass through. The top foil is then grounded to the outer bottom foil. Since it was difficult to find a small 5K audio taper potentiometer in a small size at low cost, a standard transistor radio control was used. The lugs for the switch on the pot were simply cut off and not used. The frequency trimmer capacitor with about 20 pF could have been used. Tubular components such as resistors

# DuPage FM

**WILL NOT BE UNDERSOLD!**

## USED FM GEAR

*Compare our prices on these fine pieces of FM gear...*

### General Electric Transistor Progress Line TPL.

These units have all solid state receiver, exciter and power supply. Standby drain is under 50 mils which is ideal if you are in the habit of leaving the rig turned on when you leave the car, or if you have battery problems.

All are narrow band and can be used for commercial service if desired.

Model FE73JA6	80 watts output	.....	\$195.00
Model TE63JA6	50 watts output	.....	\$165.00
Model TE53JA6	35 watts output	.....	\$155.00

These units are complete with mike, power speaker and cables when needed.

### For motorcycle fans we offer a real deal!

Motorola T33BAT 10 watts out on two meters, solid state receiver and power supply. Easy conversion to 12 volts if needed, (see article on page 26 of Ham Radio for July 1972 for details). Most are complete with mounting brackets and accessories. These are a real steal at only ..... \$65.00

DuPage FM, Inc.

Send your check or money order today to:

P.O. Box 1

Lombard, Ill. 60148

Terms: All equipment sold as is. If not satisfied return for exchange or refund within five days of receipt, shipping charges prepaid. Illinois residents add 5% for sales tax.

Phone: 312-627-3540

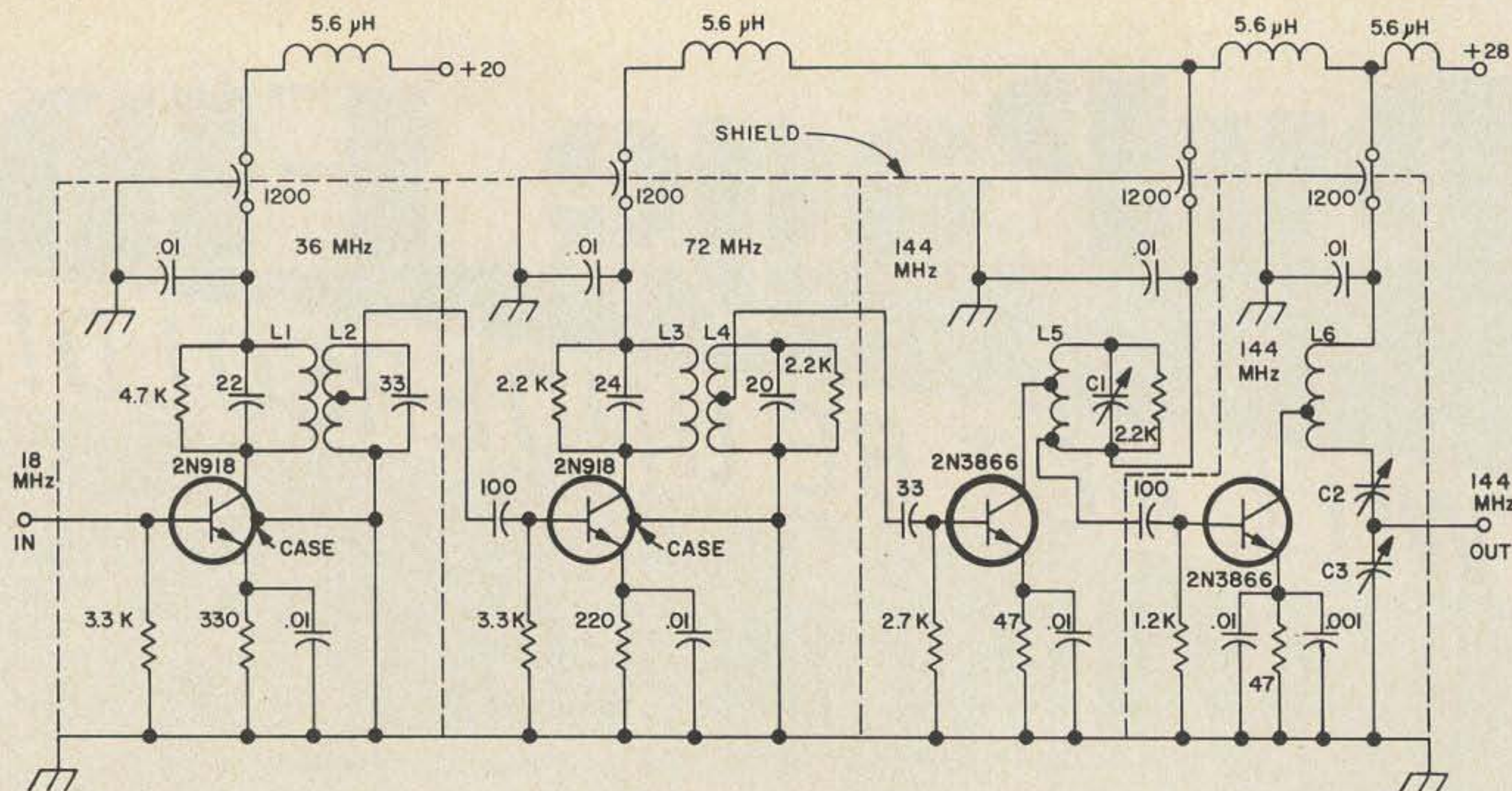

Fig. 2. Amplifier-Doubler strip. Unmarked parts: L1 - 10 turns #26; L2 - 10 turns #26 center tapped; L3 - 8 turns #24; L4 - 8 turns #24 center tapped; L5 - 5 turns #24, 3/8" long, tapped at 1.5 turns and 3 1/4 turns from the "cold end"; C1 - 2.5 to 11 pF; C2 - 5.5 to 18 pF; C3 - 3 to 15 pF. (L1 through L5 wound on 10/32 Glastork forms. L1, L2 - iron slug, L3, L4 - brass slug.)

and electrolytic capacitors were mounted perpendicular to the board to conserve board space. After completing the assembly, the shorting wire was removed from the leads of the 3N128. The leads were shorted together to prevent damage to the insulated gate junction. No trouble was encountered with the VCXO, and both units that were built worked the first time. It was possible to hear the output of the VXCO in a nearby FM receiver on the two meter frequency. As a matter of fact, with about a foot of wire on the VXCO, it could be used as a transmitter with a range of about fifty feet.

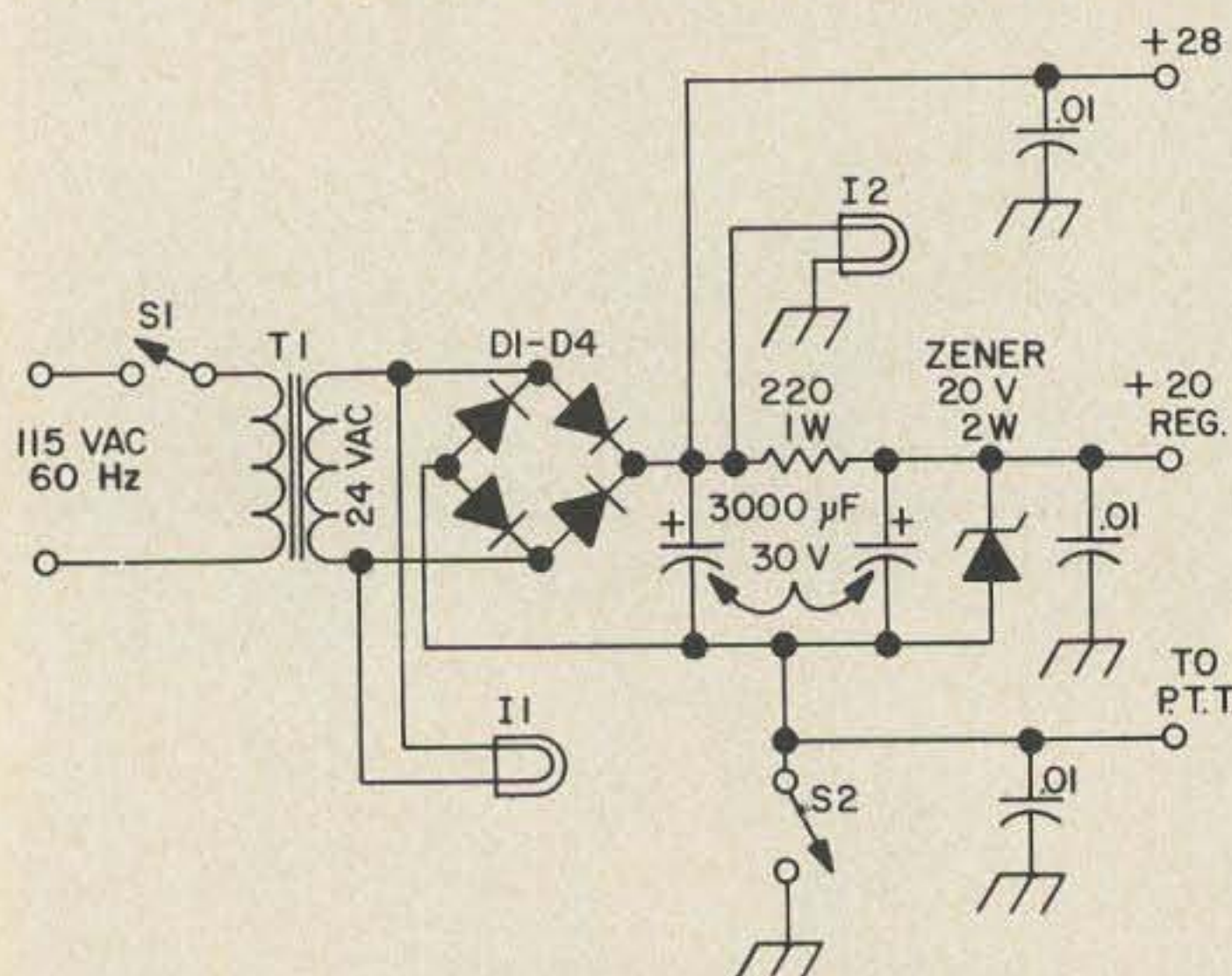

Fig. 3. Power supply. T1 has a 24V, 20 volt-amp secondary. D1-D4 are 400 PIV one amp. S1 and S2 are SPST toggle switches and the two pilot lamps I1 and I2 are 28V surplus.

As previously mentioned, the Amp-Doubler is the most important part of the transmitter. Generally, circuit layout and construction are most important in VHF transistor amplifier design. The chassis should be highly conductive and copper is generally used because of its availability in pc board stock. Since the copper foil is thin, it is light and easy to heat for soldering, and the epoxy board provides excellent strength. Epoxy board provides excellent strength under soldering and unsoldering of experimentation. Short and direct wiring is standard procedure for rf circuitry since any conductor has a resistive and inductive component that may be significant compared to other circuit impedances. All grounds in a stage should be as close together as possible because the chassis may have significant inductance between ground points. Good emitter bypassing is important for good gain in common emitter stages. Unwanted inter-stage coupling causing instability can be noticed by strange tuning characteristics as well as outright oscillation. Care should be taken to see that each tuned circuit tunes smoothly to a relatively broad peak, and drops off symmetrically on both sides of the peak. Of course, the circuit should be checked to see that it tunes both above and below the desired frequency so that the peak

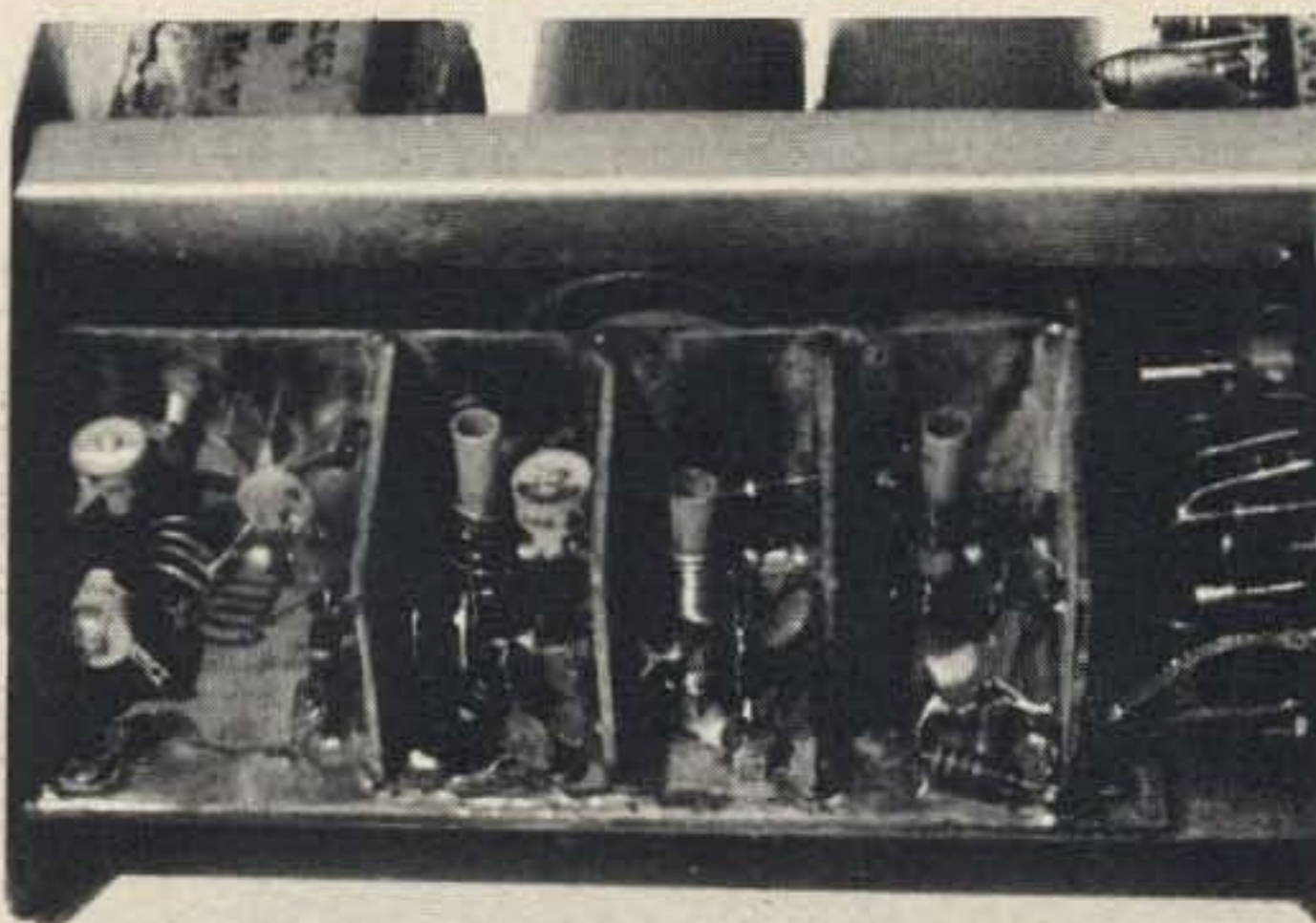

Fig. 4. Full size printed circuit VCXO board layout.

is at actual resonance. Sharp peaks indicate instability caused by regeneration. This is similar to the effect of a Q multiplier, set just before actual oscillation. If sharp peaks or strange tuning characteristics appear, they can usually be eliminated by putting resistors across tuned circuits. Resistors between 470 and 4700 ohms usually will give desired results. Using resistors in this way can be thought of as a cheap and dirty cure for poor components and layout, but it works. In any case, complete stability should be attained before putting the transmitter on the air, and efficiency is a secondary consideration. The common practice of tuning and experimenting with a minimum of shielding, and closing the shielding after the circuit is stable provides a safety factor on stability. Heat dissipation is a major limiting factor in solid state circuitry. Care must be taken to assure that transistors are not destroyed during prolonged periods of tuning since mismatch conditions produce highest heat dissipation. In normal operating, transistors in the Amp-Doubler strip are running near or exceeding their continuous duty dissipation. The transistors will become quite hot if the transmitter is keyed continuously, but normal FM transmissions are seldom more than a few seconds long on a busy repeater. If adequate heat sinks were provided, the transistors would be within their ratings, however.

Specifically, the Amp-Doubler housing was built of double clad printed circuit board. Partitions between stages stiffen the structure, provide shielding, and holes in the shields allow coupling. Components were assembled by soldering their leads together as closely as possible. The coils were wound

on Glastork 10/32 coil forms. These forms were obtained from Coilform Co., Kaneville Rd. at Randall Rd., Geneva, Ill. 60134. L1 and L2 were wound on the same form in the first section of the Amp-Doubler. After final tweaking, the windings were about 1/4" apart on the form. The cores (slugs) in the first two coils were obtained from Micrometals, 228 No. Sunset, City of Industry, CA 91747, part number 36-1185. When the first doubler is completed, it can be checked. Drive and power was measured by measuring the voltage drop across the emitter resistor. 1.5V was obtained across the 330Ω resistor, giving 45 mA. This makes about 80 mW, but transistor and other component characteristics will vary, making different transmitter versions different. After it was established that the first stage was being driven, the output was tuned with the aid of a grid dip meter used as a wavemeter. No instability was encountered until the following stage was assembled. At this time, resistors were added to stop the instability. Drive to the following stage was measured by measuring its emitter voltage and tuning the previous



Doubler and amplifier section of transmitter. Note the heat sinks and shielding.

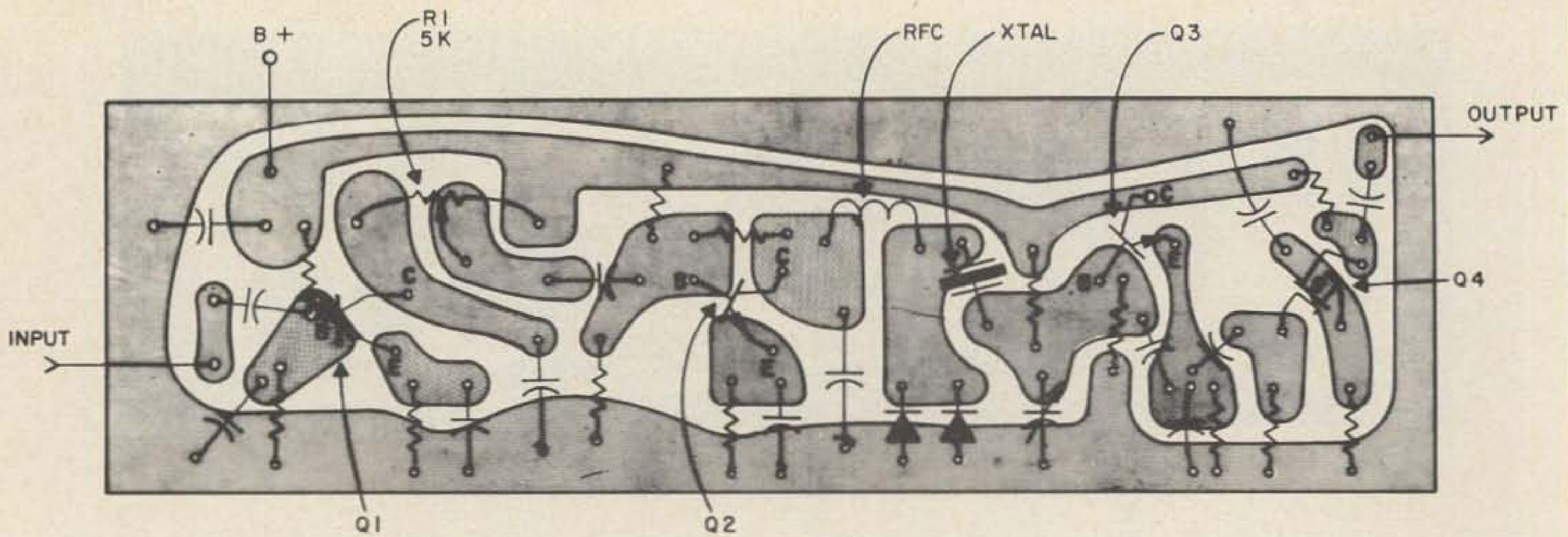

Fig. 5. Approximate locations of parts on VCXO board.

stage for a maximum. The slugs in L3 and L4 were made by cutting off brass bolts and sawing a notch in them to allow tuning. The other stages are capacitor tuned. The capacitors were the JFD DV11 type, as listed in the schematic. Coil forms are mounted vertically in the housing through holes in the chassis, and secured with epoxy. L5 and L6 were mounted perpendicularly to each other to reduce spurious coupling. After drive and output was obtained in all stages, final adjustments were made to obtain desired power levels. Coupling taps on coils, and coupling capacitors were adjusted for drive. Emitter resistors were adjusted, making them smaller to increase transistor voltage and power, or larger to provide greater safety. This final tweaking is mostly a matter of personal feel, looking for smooth tuning, good efficiency, and good power. After everything was set, the coils were doped, cold solder joints cleaned up, and components epoxied down securely. A hair dryer was found to be very helpful to make the epoxy flow smoothly and cure fast. Some

care was taken to prevent epoxy from connecting rf points to ground because it does have some conductance. Finally, the last portions of the shield were soldered in place as well as possible, considering the lack of space while reaching down inside the shields. A last clean-up can be made with a solvent such as toluene or lacquer thinner to remove solder resin and other small foreign particles.

#### Conclusion

The results of this project were completely successful as they were planned. The one watt power is completely adequate for use in a repeater system, and increasing power would be very expensive compared to the cost of a one watt stage. To get a good ten dB power gain would cost about another ten dollars in transistors alone. A big mistake on this project was making the transmitter a single channel device. This depends on local activity, of course, but three channels should be about right. With a tripler and amplifier it should be possible to get a watt on 450 MHz, but test equipment (and experience) are lacking. This would make an excellent base station, and tripling would give wideband deviation which is still used on 450. The audio on this transmitter was left linear, but all sorts of audio clipping and compression can be used to increase intelligibility.

Circuit boards will be available from MFJ Enterprises, P.O. Box 494, State College MS 29762.



Top view of VCXO board.

...WB6BIH



# "MINI" REPEATER CONTROL SYSTEM PART II

**P**art 1 described a "Mini" Repeater Control system composed of approximately 30 integrated circuits. (This count includes basic system logic, identifier, identifier decoding, and lamp drivers for the diagnostic test set.) The control system included timers, an identifier, and the related logic to fully implement a repeater equipped with an autopatch. The system used a method of construction designed to allow the system components to be easily accessed for servicing. A modular approach was employed and featured a Diagnostic Test Set to facilitate stand-alone testing as well as system performance monitoring.

## Diagnostic Test Set

Photo 2 shows how the diagnostic test set (DTS) is interconnected with the system logic unit (SLU) for bench testing. The DTS consists of a series of switches and lamps and an integral audio oscillator. The switches are used to simulate inputs to the control logic comparable to those normally generated by the "support" circuits, i.e., carrier detector, tone detector, ring signal detector, etc. The lamps are used to display the formal outputs as well as intermediate test points. The oscillator is provided to facilitate evaluation of the identifier and pseudo ring signal indicator.

When the test set is used to monitor the "live" system, the simulation switches are all

placed in the OFF position (except for the RING signal switch). The switches should be operated only when a bench diagnostic is being performed. In the case of a few switches such as RPTR ENABLE, PATCH ENABLE, and BURST, the switches can be operated to control the mode of the system's operation. More typically, though, external contacts, controlled via a landline or radio link, are used to provide the contact closures analogous to the simulation switches.

Photo 3 shows the front panel of the diagnostic test set. Notice the pushbutton switch provided for simultaneous lamp and oscillator test. The TEST switch was included so that the unit's basic test aids could

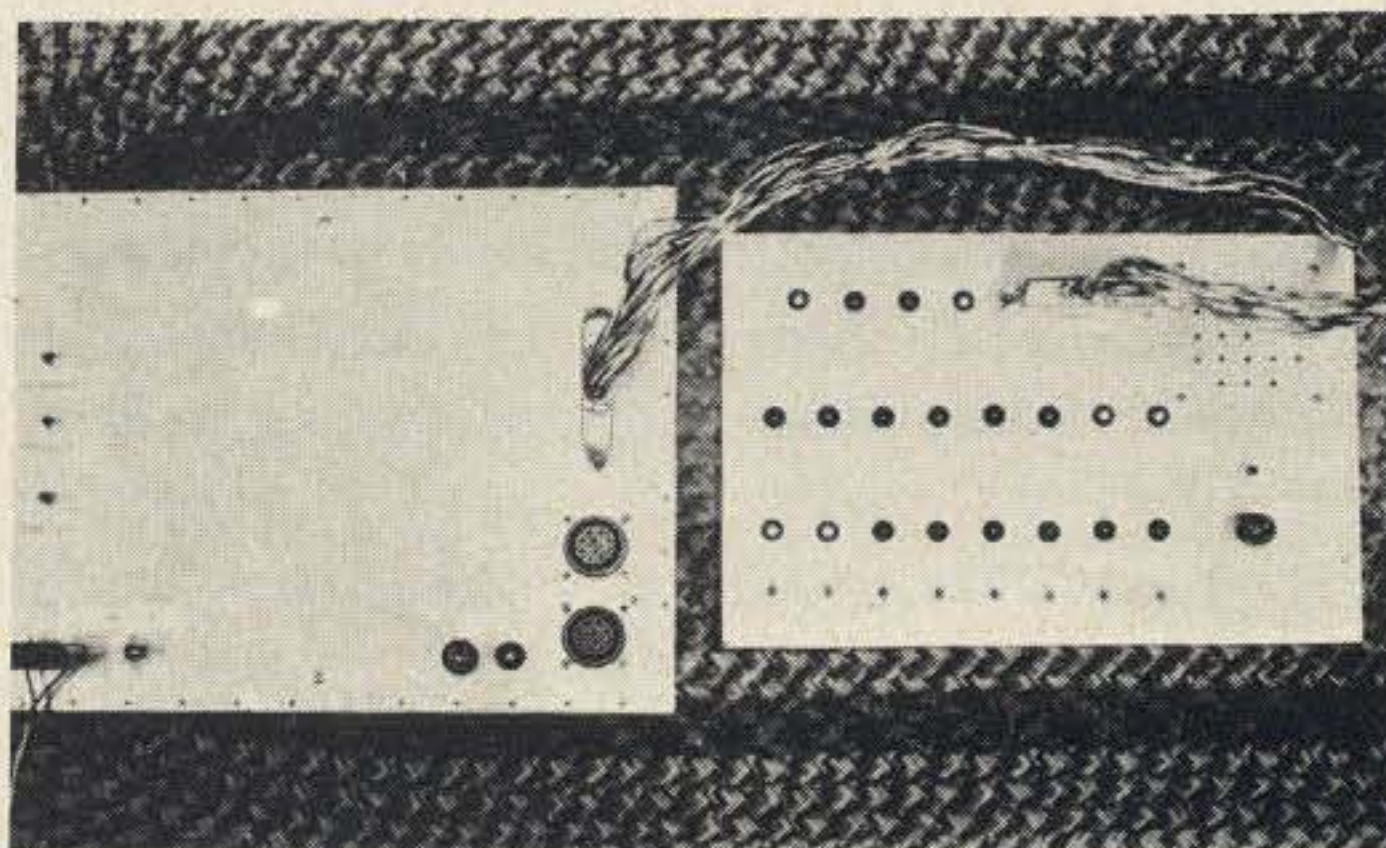

Photo 2. DTS interconnected to the system logic unit for bench testing.

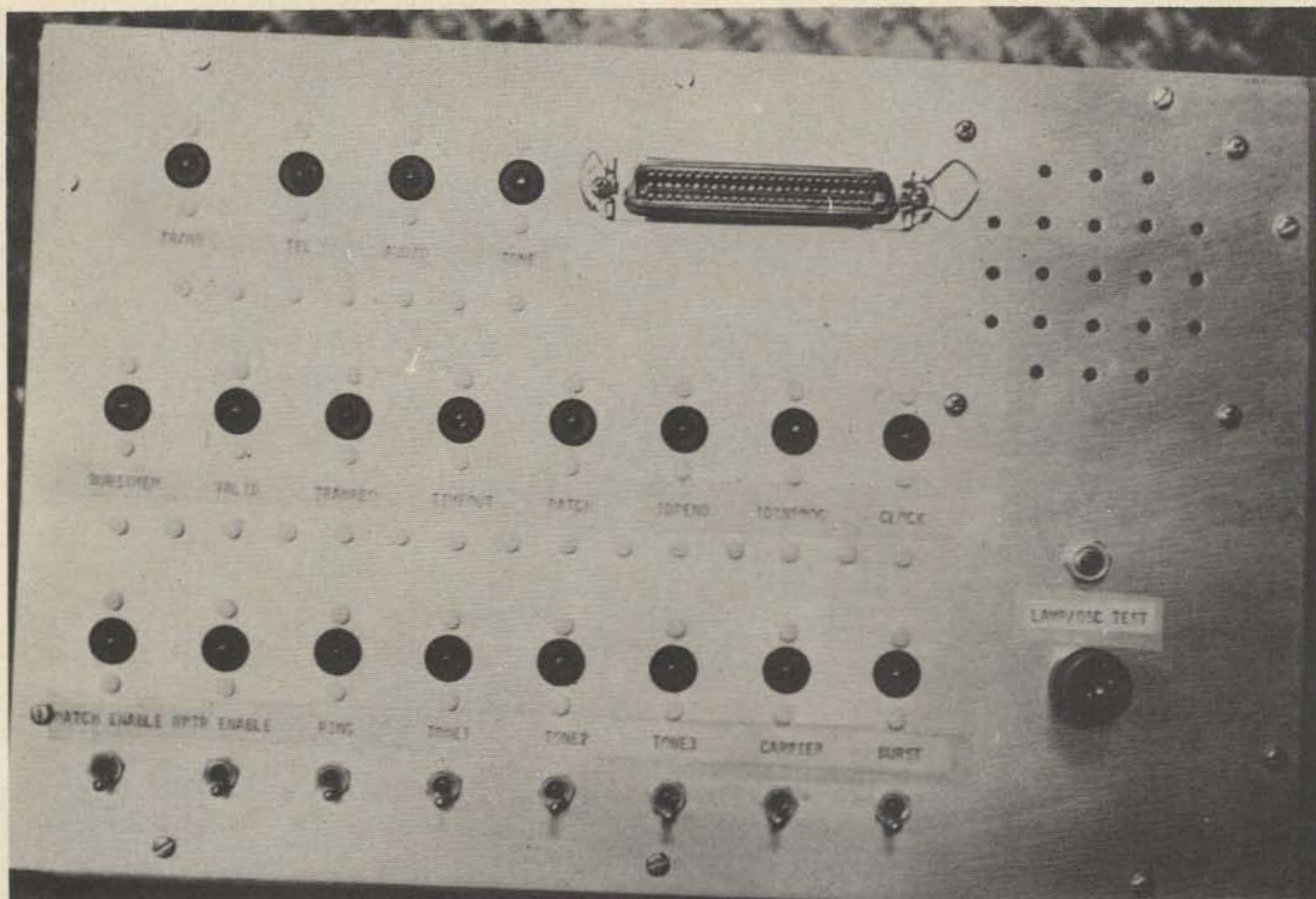

Photo 3. Front panel of diagnostic test set.

be verified prior to beginning a diagnostic sequence; pushing the TEST switch should cause all of the lamps to light and should simultaneously cause the oscillator to be heard in the monitor speaker. The lamp display consists of 20 individual lamps arranged (top-to-bottom) as formal outputs, informal outputs (test points from within the control logic), and inputs. There are 8 switches for simulating various input combinations.

#### Test Procedure

With 8 different input switches, each capable of being turned either ON or OFF, it is possible to configure 256 different switch settings! Fortunately, we are not interested in all of the combinations. In addition, since the logic being tested incorporates memory elements and timers, the proper output is not predictable in terms of the inputs alone; we need to establish an orderly sequence of instructions — a program — which can be followed to systematically evaluate the system control logic. It is necessary to establish a known starting point and then perform the step-by-step analytic procedure. A known starting point is established by the

logic initialization switch (INIT) included as an integral part of the System Logic Unit.

The following paragraphs present the individual “programs” required to evaluate the system control logic. In all of the programs, “VERIFY” steps indicate the *expected* response; failure to observe this response indicates an abnormality. In many cases there will be responses that need not be verified and should therefore be ignored, e.g., an I.D. may be produced as a natural part of the normal operation and yet may not be of interest to the particular test in progress.

#### Initialization Program

The initialization program verifies that the basic test circuits are functioning properly before they are used to evaluate the system logic. The program verifies proper operation of the following:

- a. lamp display
- b. audio oscillator
- c. identifier
- d. transmitter keying

1. Interconnect the Diagnostic Test Set (DTS) and System Logic Unit (DTU) as shown in Photo 2.

2. Attach power leads to the banana plugs on the SLU. A 12V, 2A, source is required; a battery or regulated supply may be used.
3. Place all simulation switches in the OFF position. This assures a known set of initial inputs to the logic.
4. Turn POWER switch ON (located on SLU). This switch controls the distribution of 12V to the SLU and DTS.
5. Verify pilot light on SLU. The pilot light is connected to the output of the SLU's 5V regulator. When the light is on, it indicates that 12V is available to both units and that 5V is available to the SLU.
6. Perform Lamp/Oscillator test. Press the lamp/oscillator TEST switch on the DTS; all lamps should turn on. Careful examination of the lamps in the off state should reveal that the lamps are slightly on all of the time.
7. Momentarily press the Logic Initialization (INIT) switch; wait for BURST-MEM to extinguish. The initialization switch (INIT) forces the logic into the repeater mode, clears any pending identification, and terminates an ID-in-progress.
8. Press KEY switch on SLU; verify TRANS light ON on DTS. The KEY switch causes the transmitter to be keyed; the TRANS light is turned ON whenever the transmitter is keyed.
9. Momentarily press I.D. button on LSU; verify I.D. sequence in DTS speaker. This checks out the identifier.

#### Input Signal Program

For each of the 8 simulation switches, perform the following steps:

1. Place switch in ON position.
2. Verify that the associated lamp is ON.
3. Place switch in the OFF position.

NOTE: At the completion of this test, all switches should be in the OFF position. Because the RING switch was operated, an I.D. will be generated. Because the BURST switch was operated, the BURSTMEM lamp will be on for 5 seconds.

#### Ring Signal Program

1. Set RING switch ON. This simulates the

presence of a ring signal on the telephone line.

2. Verify tone in speaker. This is indicative of the audio that would be directed to the transmitter.
3. Verify TRANS light ON. The transmitter is keyed to broadcast the ring signal.
4. Set RING switch OFF. Remove the simulated ring signal.
5. Verify I.D. 8 seconds after performing step 4. Use of the transmitter requires an eventual identification; the anticipator causes the I.D. to be generated.
6. Set RING switch ON. Simulate telephone ring signal.
7. Press ID button on SLU. Initiate an I.D.
8. Verify blockage of pseudo ring signal during I.D. The ring signal should be present before and after the I.D.
9. Set RING switch OFF. I.D. will follow.

#### Repeater Program

1. Set RPTR ENABLE switch ON. Allow use of the transmitter for repeater or autopatch operation.
2. Set CARRIER switch ON. Simulate the presence of a signal on the input frequency.
3. Set Burst switch ON. Simulate receipt of a burst tone.
4. Verify TRANS light ON. The TRANS light should come on only if a signal is accompanied by a burst tone.
5. Set BURST switch OFF. A burst tone is only required at the beginning of a transmission.
6. Verify TRANS light ON. Although the burst tone is removed, the transmitter should remain keyed; this is the basic logic of burst access.
7. Set CARRIER switch OFF. Remove the simulated input signal.
8. Verify BURSTMEM light OFF 5 seconds after performing step 7. The BURSTMEM light represents the amount of time during which a new carrier will be accepted without a burst tone.
9. Verify I.D. 8 seconds after performing step 7. Because the transmitter was used, an I.D. is pending and will be initiated by the anticipator.
10. Set RPTR ENABLE switch off.

when you think CW...



**MEMORY-MATIC 8000 DELUXE**  
Capacity for 8000 bits in 8 Read/Write Pluggable Memories. Each memory can store either a single message or a number of sequential messages. Near-full and Overload alarms. "Message Stop" for char. insertion. "Full Control" weight ratio, message interrupt switch, var. trans. delay, 115/220V ac, 50/60 Hz, incl. SM-21B and MST-60 features. Sh. wt. 8 lbs. (Incl. 3-500 and 1-1000 bit memories.) ..... \$398.50  
Additional Memories, 500 bit for ..... \$21.50  
..... 1000 bit \$37.50



**MEMORY-MATIC 500-B**  
500 or 800 bit R/W memory. Stores either a single message or a number of sequential messages. "Message Stop" for char. insertion. Near-full and Overload alarms, remote control for Stop/Start of message. Incl. SM-21B features. Sh. wt. 4 lbs. (500 bit memory) ..... \$198.50  
(800-bit memory) ..... \$219.50



**HF FREQUENCY STANDARD - FMS-3**  
Markers at 5, 10, 25, 50, 100, 200 and 400 kHz. 400 kHz crystal. No unwanted markers. Latest low-power ICs. Osc. and output buffered. Sh. wt. 2 lbs (Less Batteries) ..... \$32.95



**SPACE-MATIC 21-B**  
This SWITCHABLE keyer gives you "eight-keyers-in-one." Rear switches can delete dot or dash memories or char./word spacing. Instant start, self-completing dots, dashes and char./word spacing. Adj. weighting, sidetone/speaker, dot-dash memories, Iambic, 115V ac or 12V dc (SM-21B only.) Sh. wt. 4 lbs ..... \$89.50

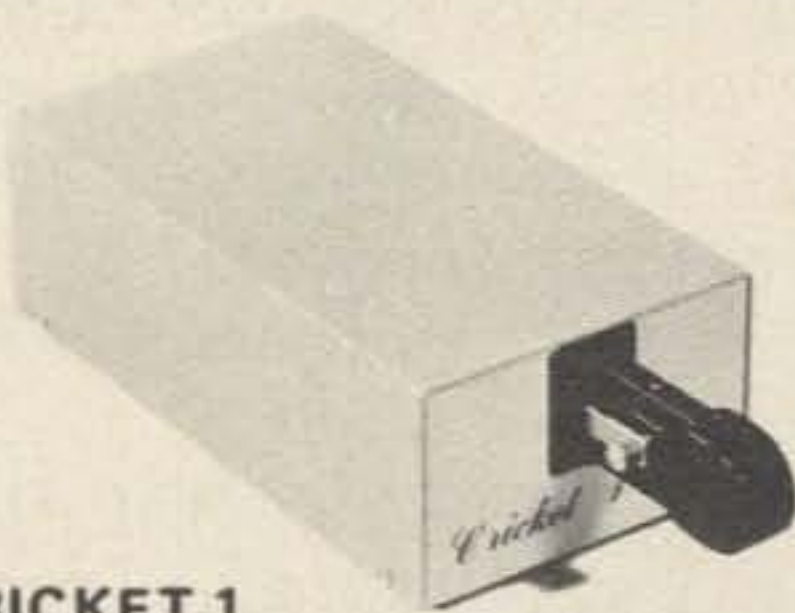

**CRICKET 1**  
The "feature-packed" moderately-priced keyer! Keyed time base, jam-proof spacing, sidetone/speaker. Rear controls for weight, speed, volume, tone, auto-semi-auto., tune. 115V ac or 12V dc. Sh. wt. 3 lbs. .... \$49.95

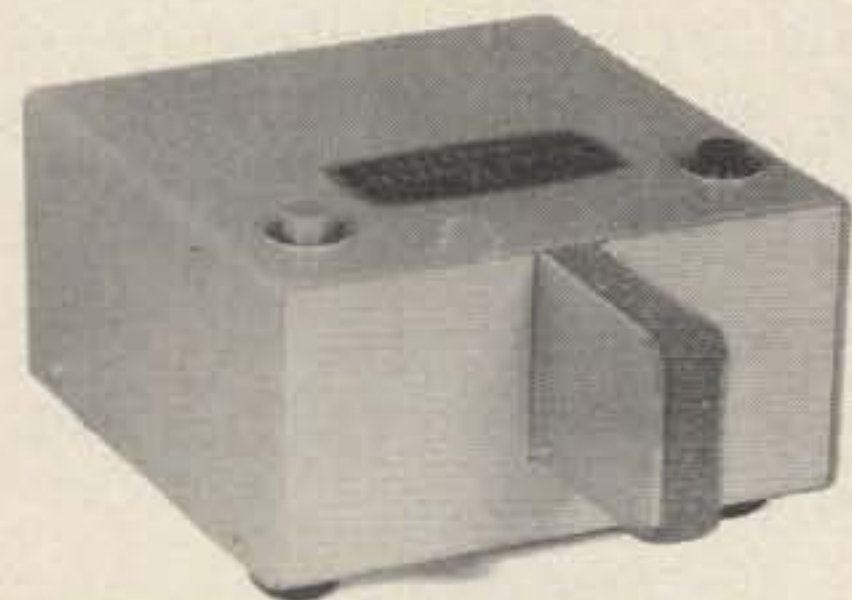

**ELECTRONIC FEATHER TOUCH KEY**  
A completely solid-state key. Detects mere touch of finger. Use as single or twin lever key. Operates with all positive or negative ground digital keyers. Sh. wt. 2 lbs. .... \$22.95  
(Remote S/S Swts. for MM-500B and MM-8000) ..... \$27.95

think Data Engineering

# EXCITING NEW FM PRODUCTS

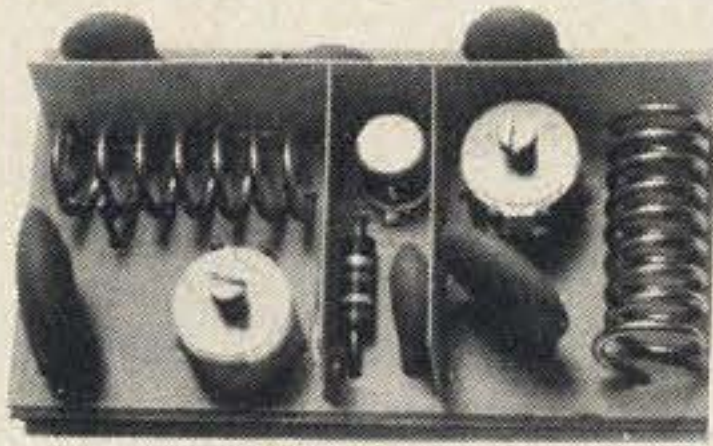

## 2-METER PREAMP

..... \$9.50 Kit  
 ..... \$12.50 Wired  
 20 dB Gain, 2.5 N.F. 12V dc, Size 1" x 1 3/4" x 1/2". Diode protected MOSFET. 90-day guarantee. Sh. wt. 4 oz. Major Components Separately Shielded.

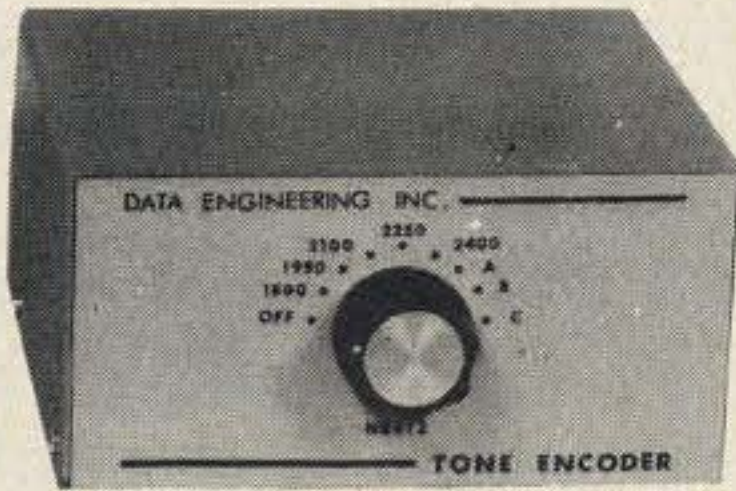

## TONE ENCODER

Eight pre-adjusted tones. Duration and Output adjustable, PLL circuitry for extreme stability. Choice of continuous or tone burst operation. Tone burst operation requires no batteries. Easy to install. Includes three special single or dual tones.

TE-8-K Complete Kit  
 ..... \$31.95  
 TE-8 Tone Burst Encoder (1800, 1950, 2100, 2250, 2400, plus any 3 single or dual tones above 1200 Hz.)  
 ..... \$39.95



## TOUCH-TONE DIALER

The electronic touch-tone dialer for home and car. It's safer and more accurate to use than a pad. Memory includes Access Code plus five phone numbers. Numbers easily updated. Built-in monitor. Complete PPT operation with transmitter hold.

TTD-4K (Complete Kit)  
 ..... \$49.00  
 TTD-4 (Assembled) \$59.00

## AUTO-PATCH CONSOLE

This mobile or home console includes all the features you need for complete auto-patch operation. A Touch-Tone Pad; an automatic dialer for sending one access code plus five Touch-Tone phone numbers; a single/dual tone burst encoder adjusted to your choice of frequency above 1200 Hz, and a built-in motor. Complete PTT operation with one second transmitter hold.

APC-4K Complete Kit  
 ..... \$84.50  
 APC-4 Assembled . \$98.50

## PAD-PULSER

Now you can also obtain pulsed operation from your Touch Tone Pad. Convert Touch-Tone frequencies to decimal pulses at 2805 Hertz with just a flip of the switch. Option can be added to TTP-2/K, TTD-4/K and APC-4/K.

PP-12K P.C. Board Kit  
 ..... \$22.95  
 PP-12 Assembled . \$29.95

## TOUCH-TONE PAD

In less than 15 minutes you can convert your portable transceiver to Touch-Tone operation.

TTP-1K Complete Kit  
 ..... \$34.50  
 TTP-1 Touch-Tone Pad  
 ..... \$44.50

Assembled in attractive case for home or mobile use. Complete PTT operation with one second transmitter hold. Built-in monitor.

TTP-2K Complete Kit  
 ..... \$34.50  
 TTP-2 (Assembled) \$44.50

## TOUCH-TONE DECODER

A highly reliable twelve digit decoder with input protection, and PLL circuitry for extremely stable operation. Heavy duty output relays, small size, plug-in circuit board. All these major features at an UNBEATABLE price.

TTD-12K P.C. Board Kit  
 ..... \$89.50  
 TTD-12 Touch-Tone Decoder ..... \$129.50



## VHF FREQUENCY STANDARD - FMS-5

Cal. receive and transmit crystals in 10, 6, 2 and 1/4 meter FM bands. Markers for all FM channels. Check deviation. Precision 12 MHz crystal. No unwanted markers. Osc. and output buffered. Sh. wt. 2 lbs. (Less Batteries) .. \$44.50

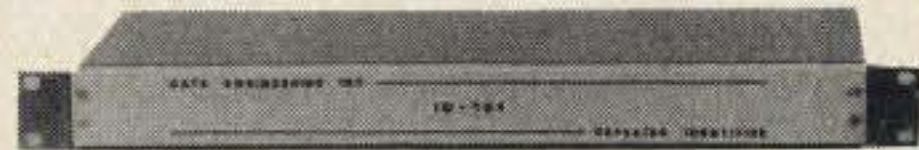

## REPEATER ID

Highly stable oscillator for automatic timing. AC or DC operation. ROM provides for more than 25 characters, more than necessary for DC "any call" RPT. AUX is automatically added to ID if desired when main power is lost. Toneburst operation available.

ID-101K P.C. Board Kit  
 ..... \$49.95  
 ID-101 P.C. Board, wired and tested ..... \$69.95  
 ID-101R Assembled in 1 1/2" rack cabinet \$109.00



## TONE DECODER

Versatile single/dual tone decoder. PLL circuitry for extreme stability. 1 amp output relay can be reset automatically or manually. Monitor position. Adjustable sensitivity. Internal strap selects single or dual tone operation.

TD-2K Complete Kit  
 ..... \$31.95  
 TD-2 Single/Dual Tone Decoder ..... \$39.95  
 (Specify any freq. above 1200 Hz)

5-year guarantees. Send for Catalog



**Data Engineering, Inc.** 5554 Port Royal Road

Ravenworth Industrial Park, Springfield VA 22151

### Autopatch Program

1. Set RPTR ENABLE switch. *All on repeater operation.*
2. Set CARRIER switch ON. *Simulate a signal on the input.*
3. Set BURST switch ON. *Allow signal to be acknowledged.*
4. Verify TRANS light ON. *Transmitter is granted.*
5. Set BURST switch OFF. *Burst tone is required only for initial access.*
6. Set PATCH ENABLE switch ON. *Allow the "\*" to configure the system as an autopatch when it is received.*
7. Set TONE1 switch ON. *First tone for "\*" character.*
8. Set TONE2 switch ON. *Second tone for "\*" character.*
9. Set TONE1 and TONE2 switches OFF. *Remove the "\*" character.*
10. Verify PATCH light ON. *The patch mode is entered when the "\*" is received.*
11. Verify TRANS light ON. *The transmitter should be enabled for the patch (providing ENABLE RPTR is ON).*
12. Verify AUDIO light ON. *The audio input to the transmitter is switched when a carrier is present and the system is in the patch mode (see step 1).*
13. Verify TEL light ON. *The telephone line should be connected when the "\*" character terminates.*
14. Set CARRIER switch OFF. *Remove the signal from the input.*
15. Verify AUDIO light OFF. *The input to the transmitter is not switched when a carrier is not present.*
16. Set CARRIER switch ON. *Simulate a signal on input.*
17. Set TONE1 and TONE3 switches ON. *Simulate the "#" character.*
18. Verify PATCH light OFF. *The system should revert to the repeater mode when the "#" character is received.*
19. Set CARRIER switch OFF. *Remove the input signal.*
20. Verify I.D. 8 seconds after performing step 18. *An I.D. will be pending due to the transmitter usage; the anticipator will generate the I.D.*
21. Set PATCH ENABLE; RPTR ENABLE, TONE1, and TONE3 Switches OFF.

### 2-Minute Timer Program

1. Set RPTR ENABLE switch ON. *Allow repeater operation.*
2. Set CARRIER switch ON. *Simulate a signal on the input frequency.*
3. Set BURST switch ON. *Simulate signal accompanied by burst tone.*
4. Set BURST switch OFF. *Burst tone is only required at the beginning of a transmission.*
5. Verify TRANS light ON. *Input signal is being repeated.*
6. Verify TRANS light OFF two minutes after performing step 2. *The transmitter should be disabled when a carrier persists on the input frequency.*
7. Verify TIMEOUT light ON. *The timeout flip-flop is set when a two minute timeout has occurred.*
8. Verify I.D. 8 seconds after the TRANS light is turned OFF by shutdown (step 4). *Timeout removes the transmitter request and the anticipator produces an I.D.*
9. Set CARRIER switch OFF. *Remove simulated input signal*
10. Verify TIMEOUT light OFF. *Timeout flip-flop is reset when the carrier is removed from the input frequency.*
11. Set RPTR ENABLE switch OFF.

NOTE: A seemingly inappropriate I.D. may follow Step 9 due to contact bounce in the simulation switch.

### 1-Minute Timer Program

1. Set RPTR ENABLE and PATCH ENABLE switches ON. *Allow repeater and autopatch operation.*
2. Set CARRIER switch ON. *Simulate a signal on the input.*
3. Set BURST switch ON. *Accompany signal with burst tone.*
4. Set BURST switch OFF. *Burst signal is momentary.*
5. Set TONE1 and TONE2 switches ON. *Simulate "\*" character.*
6. Set TONE1 and TONE2 switches OFF. *Simulate removal of "\*" character.*
7. Set CARRIER switch OFF. *Remove the input signal; this implies that the telephone party is talking.*

8. Verify TRANS light OFF, TELLIGHT OFF and PATCH light OFF one minute after performing step 7. *User must transmit once each minute or system reverts to the repeater mode.*
9. Verify I.D. 8 seconds after TRANS light is turned OFF. *Pending I.D. is generated by the anticipator.*
10. Set PATCH ENABLE and RPTR ENABLE switches OFF.

### 3-Minute Timer Program

1. Set RPTR ENABLE switch ON. *Allow repeater operation.*
2. Set BURST switch ON. *Simulate open access.*
3. Set CARRIER switch ON for one minute. *Simulate signal in input frequency.*
4. Momentarily reset CARRIER. *Turn CARRIER switch OFF and then back ON.*
5. Set CARRIER switch ON for one minute. *Simulate signal in input frequency.*
6. Momentarily reset CARRIER. *Turn CARRIER switch OFF and then back ON.*
7. Set CARRIER switch ON. *Simulate signal on input frequency.*
8. Verify I.D. three minutes from start of second step. *The system has been in use for three minutes without the anticipator producing an I.D. and so an I.D. is required and generated by the 3-minute timer.*
9. Verify two minute shutdown; timeout light ON. *Step 6 generates a continuous carrier on the input frequency.*
10. Verify I.D. 8 seconds after the shutdown. *The shutdown occurs 1 minute after the 3-minute I.D.; since the transmitter has been in use after the I.D. and additional I.D. is pending and will be produced by the anticipator.*
11. Set BURST, RPTR ENABLE and CARRIER switch OFF. *Expect I.D. from contact bounce.*

### 2-Minute Timer Program (Autopatch Mode)

This program evaluates the 2-minute timer when the system is in the autopatch mode.

1. Set RPTR ENABLE and PATCH ENABLE switches ON. *Allow repeater and patch operation.*
2. Set CARRIER switch ON. *Simulate an input signal.*
3. Set BURST switch ON. *Accompanied with burst signal.*
4. Set BURST switch OFF. *Burst tone is momentary.*
5. Set TONE1 and TONE2 switches ON. *Simulate "\*" character.*
6. Set TONE1 and TONE2 switches OFF. *Simulate removal of "\*" character.*
7. Momentarily reset carrier. *Turn CARRIER switch OFF and then back ON.*
8. Verify TRANS light OFF and PATCH light OFF two minutes after step 7. *A continuous carrier on the input frequency during the patch mode causes the system to shut down the transmitter and revert to the repeater mode.*
9. Verify I.D. 8 seconds after the system reverts to the repeater mode. *The pending I.D. is generated by the anticipator.*
10. Set CARRIER, PATCH ENABLE, and RPTR ENABLE switches OFF. *Expect I.D. due to contact bounce.*

### I.D. Clock Signal Program

1. Momentarily depress I.D. pushbutton on SLU. *Initiate an I.D.*
2. Verify consistent flash rate of CLOCK lamp. *The clock generator output is not directly sampled since the clock pulse is of such duration that a lamp would not respond. The clock is indirectly examined by looking at the output of gate I3 which reflects clock and flip-flop integrity.*

### Tone Generator Program

1. Depress I.D. button on SLU. *Initiate an I.D.*
2. Verify TONE light ON in synchronism with audio heard in monitor speaker. *The TONE light simulates the system's tone oscillator used to generate the pseudo ring signal and I.D.*

### Validated Carrier Program

1. Set CARRIER switch ON. *Simulate a signal*

2. Set BURST switch ON. *Accompanied by burst tone.*
3. Verify VALID light ON. *Carrier was accompanied by burst tone.*
4. Set BURST switch OFF. *Remove burst tone stimulation.*
5. Verify VALID light ON. *A valid carrier is a carrier that is initially accompanied by a burst tone.*
6. Set CARRIER switch OFF. *Remove the input signal.*
7. Verify VALID light OFF. *A carrier is not present.*

#### Transmitter Requests Program

1. Set RING switch ON. *Simulate a telephone ring signal.*
2. Verify TRANREQ light ON. *The transmitter is requested when the telephone rings.*
3. Set RING switch OFF. *Remove pseudo ring signal.*
4. Set CARRIER switch ON. *Simulate signal on input frequency.*
5. Set BURST switch ON. *Simulate burst tone.*
6. Set ENABLE RPTR switch ON. *Allow repeater operation.*
7. Verify TRANSREQ light ON. *Transmitter requested by repeater.*
8. Set PATCH ENABLE switch ON. *Allow autopatch operation.*
9. Set TONE1 and TONE2 switches ON. *Simulate the "\*" character.*
10. Set TONE1 and TONE2 switches OFF. *Remove the "\*" character.*
11. Verify PATCH light ON. *System is in the autopatch mode.*
12. Verify TRANSREQ. *Transmitter is requested in patch mode.*
13. Set CARRIER switch OFF. *Simulate called party being broadcast.*
14. Verify TRANSREQ light ON. *Transmitter is keyed when in patch mode and carrier is not present.*
15. Set RPTR ENABLE, PATCH ENABLE and BURST switches OFF.
16. Momentarily depress INIT switch.

#### I.D. Pending Program

1. Set RPTR ENABLE switch ON. *Allow repeater operation.*

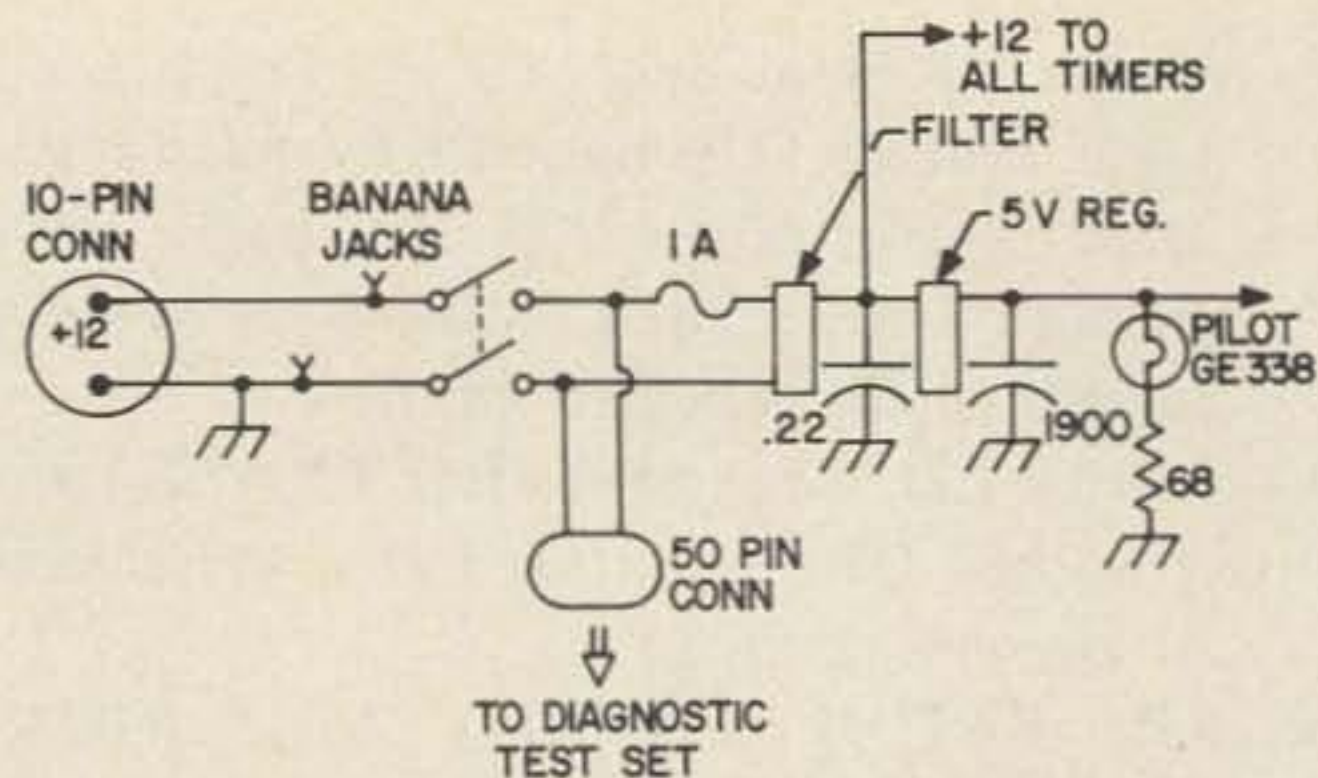

Fig. 12. Overall power distribution.

2. Set CARRIER and BURST switches ON. *Simulate use of the system as a repeater.*
3. Verify IDPEND light ON. *Because the transmitter has been used, and I.D. is pending.*
4. Set CARRIER and BURST switches OFF. *Remove the input signal.*
5. Verify I.D. 8 seconds after performing step 4. *The pending I.D. is generated by the anticipator.*

#### I.D. In Progress Program

1. Momentarily depress I.D. button on SLU. *Initiated an I.D.*
2. Verify IDINPROG light ON. *The light is ON while the I.D. is being generated.*

#### Power Distribution

The power for the system logic unit and the diagnostic test set enters via a 10-pin connector on the SLU. The voltage supplied via the connector is internally connected to a pair of banana jacks. This is to provide a parallel input path that is utilized when power is applied from a battery or bench supply during off-line testing. Figure 12 shows a general drawing of the power distribution technique.

The raw 12 volts is cleaned up to remove spikes by a filter network such as the one shown in Fig. 13. The 12 volts is then directly applied to the UJT timers discussed

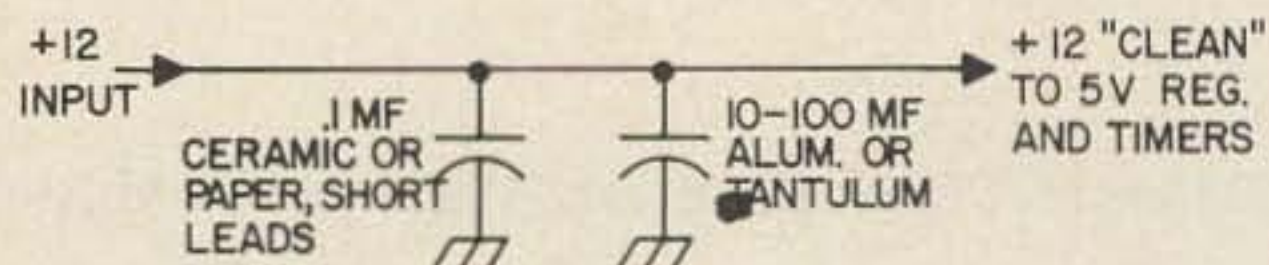

Fig. 13. 12V filter.



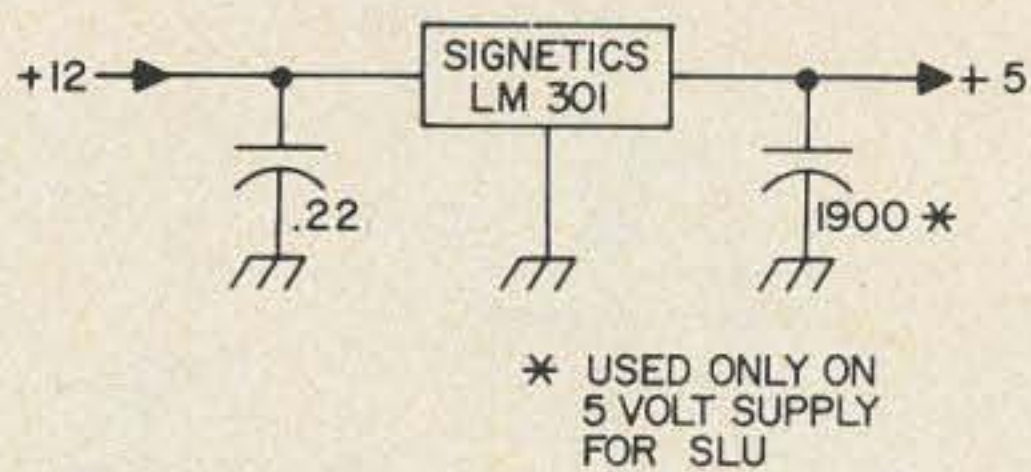

Fig. 14. Regulator circuit. Separate regulators are used for the logic unit and the test set.

in Part 1. A 5 volt regular is used to reduce the input voltage to the 5.0 volts required for the TTL logic circuits. A separate Signetics LM301 regulator is installed in the SLU and DTS; this approach minimizes the current requirements that would be required if a single regulator were used and does not provide an additional noise path into the SLU from the DTS (see Fig. 14).

The pilot light is attached to the output of the regulator in the SLU. The lamp is a GE 338 and is operated at reduced ratings to prolong the lamp life and minimize the current requirements (approximately one half the current required at 5 volts). When the light is ON it indicates that the regulator is producing output which in turn implies that the 12 volt input is present.

The power supply is fused in the 12 volt portion of the circuit for a current of 1 ampere; the 5 volt regulator incorporates current limiting and overvoltage protection as an integral part of the design.

The raw 12 volt input is controlled by a DPDT switch. When the switch is in the ON position, power is applied to the SLU and to the DTS (if the interconnecting cable is plugged into the 50-pin connector).

Figure 15 shows the power distribution scheme for the DTS. A fuse is again provided in the 12 volt line (1 ampere rating). There is no ON/OFF switch in the DTS since all 12

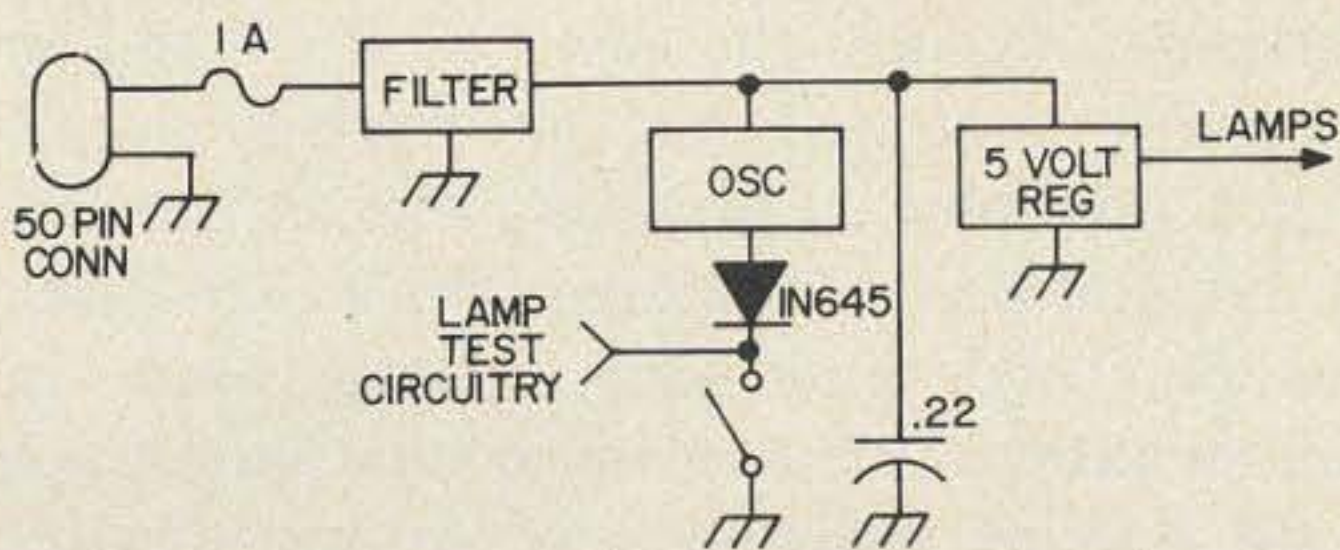

Fig. 15. Power distribution for the DTS.

volt power is controlled by the switch in the SLU enclosure.

The average power consumption of the SLU is 275 milliamperes at 12 volts; the quiescent power consumption for the DTS is 280 milliamperes at 12 volts (during lamp/oscillator test, the consumption increases to 630 milliamperes). When the DTS is connected to the SLU for monitoring the system's operation, the total power consumption is thus approximately 600 milliamperes at 12 volts. Variations on the order of 300 milliamperes occur as the various status lamps are lighted. Maximum power consumption is approximately 1 amp (12 watts).

### Display Circuitry

Figure 16 shows a partial diagram of the lamp display circuitry. The 270 ohm resistors are used to bias the lamps so that they are normally dimly lighted. This is done so that the lamp driver integrated circuits will not have to endure the high current associated with a cold lamp when the lamp is initially turned on. The lamp drivers are essentially transistor switches that ground the appropriate display lamp.

The diodes are used to tie all of the lamps together for lamp test purposes. The diodes isolate the lamps during normal usage while permitting them to operate concurrently for test purposes. The tone oscillator, like the lamps, is enabled by supplying a ground signal. The detailed oscillator circuit is

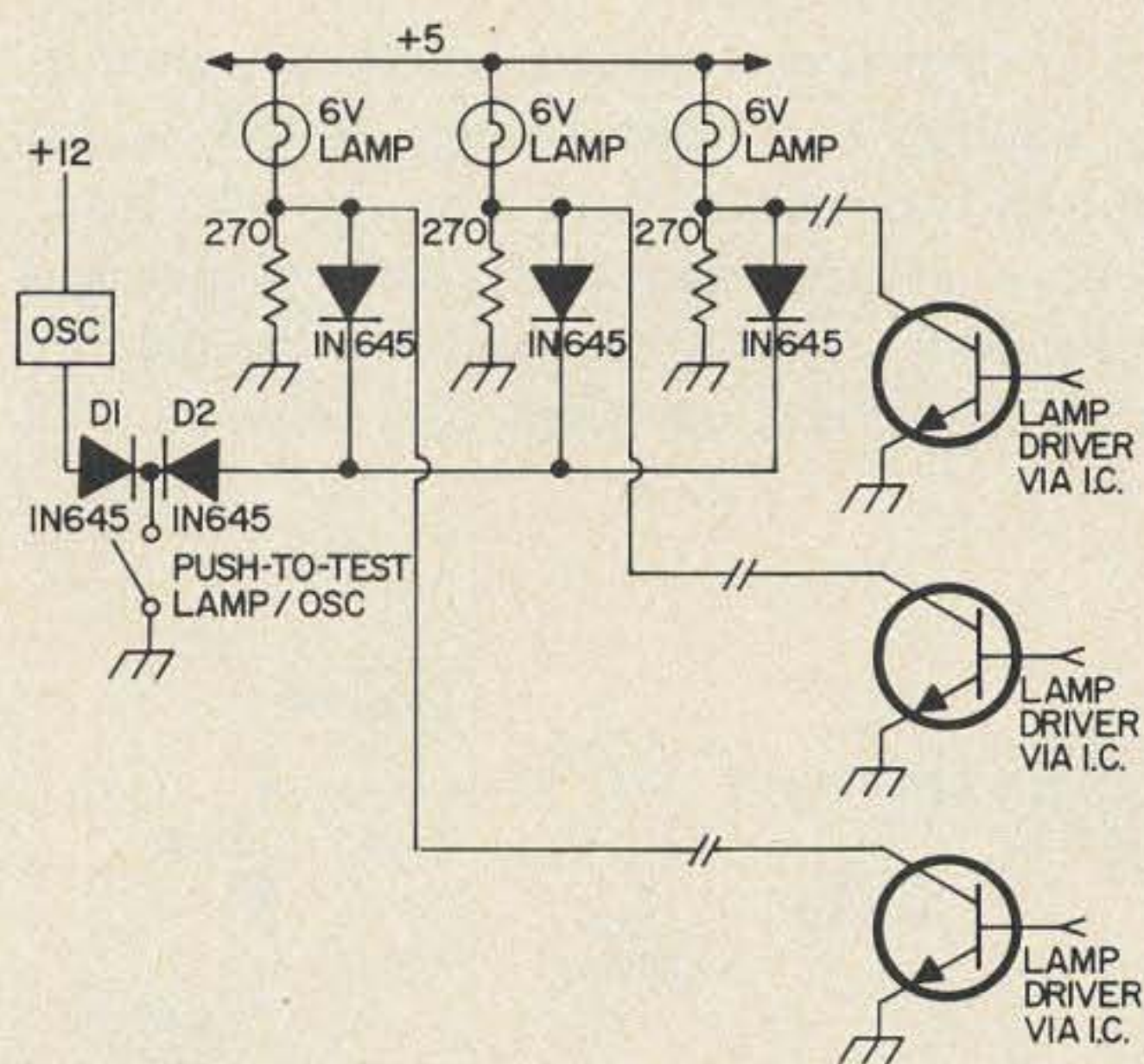

Fig. 16. Partial diagram of the lamp display circuitry.

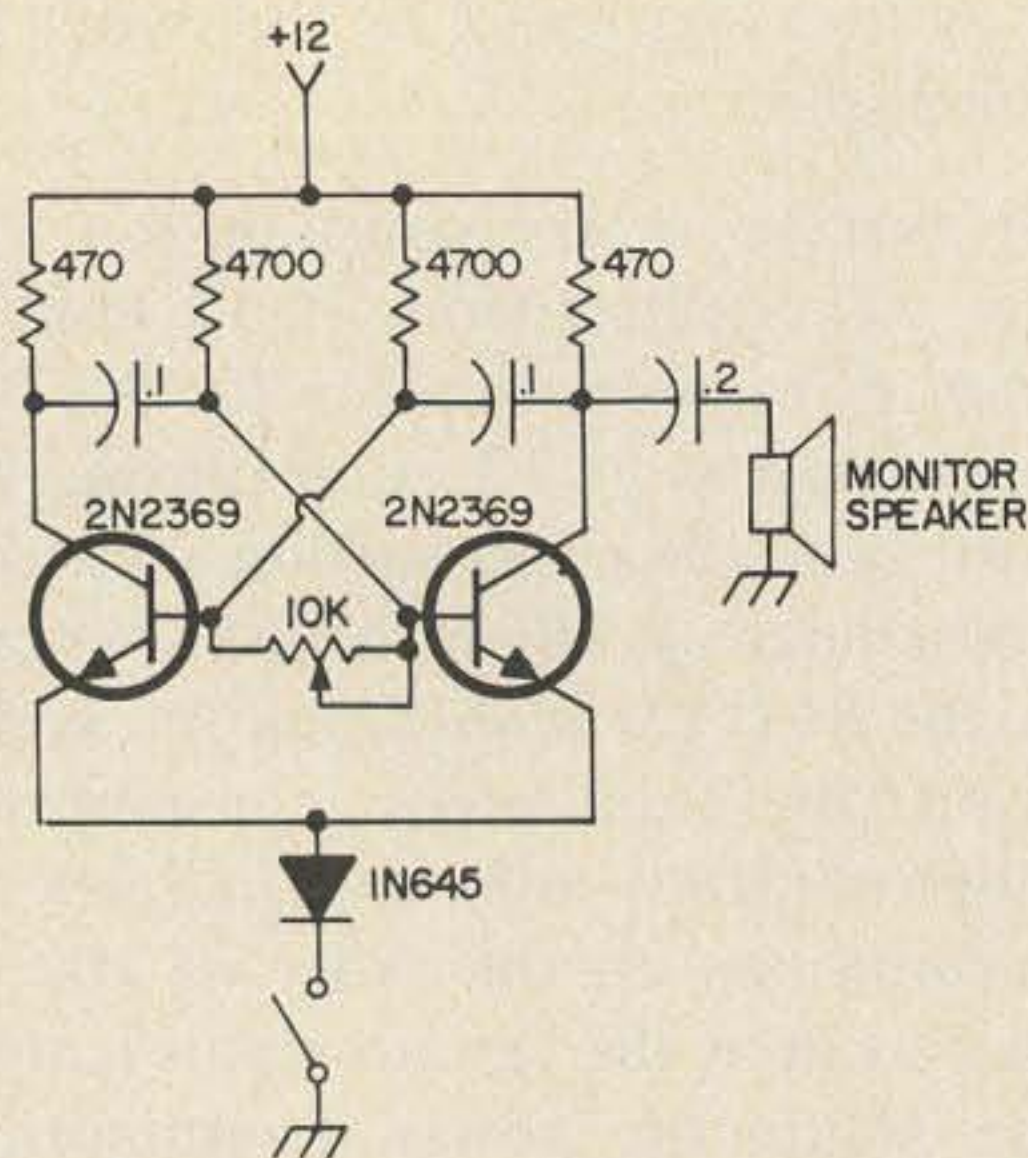

Fig. 17. Tone oscillator circuit.

shown in Fig. 17. Diodes D1 and D2 allow a single switch to be used for test purposes with the 12 volt supply and 5 volt supply sharing a common ground return.

### Lamp Drivers

The lamp drivers are essentially 2-input NAND gates with open collector outputs which function like conventional transistor switches (see Fig. 16). For each point in the logic to be sampled and displayed, a configuration such as is shown in Fig. 18 is employed. The transistor switch in the lamp driver is in parallel with the lamp test circuitry (diode and switch).

### Formal Outputs

The formal system outputs (key transmitter, enable tone generator, switch audio input to transmitter, and connect telephone line) are already open collector switches and can be used directly for enabling the display lamps. However, so that the DTS can be

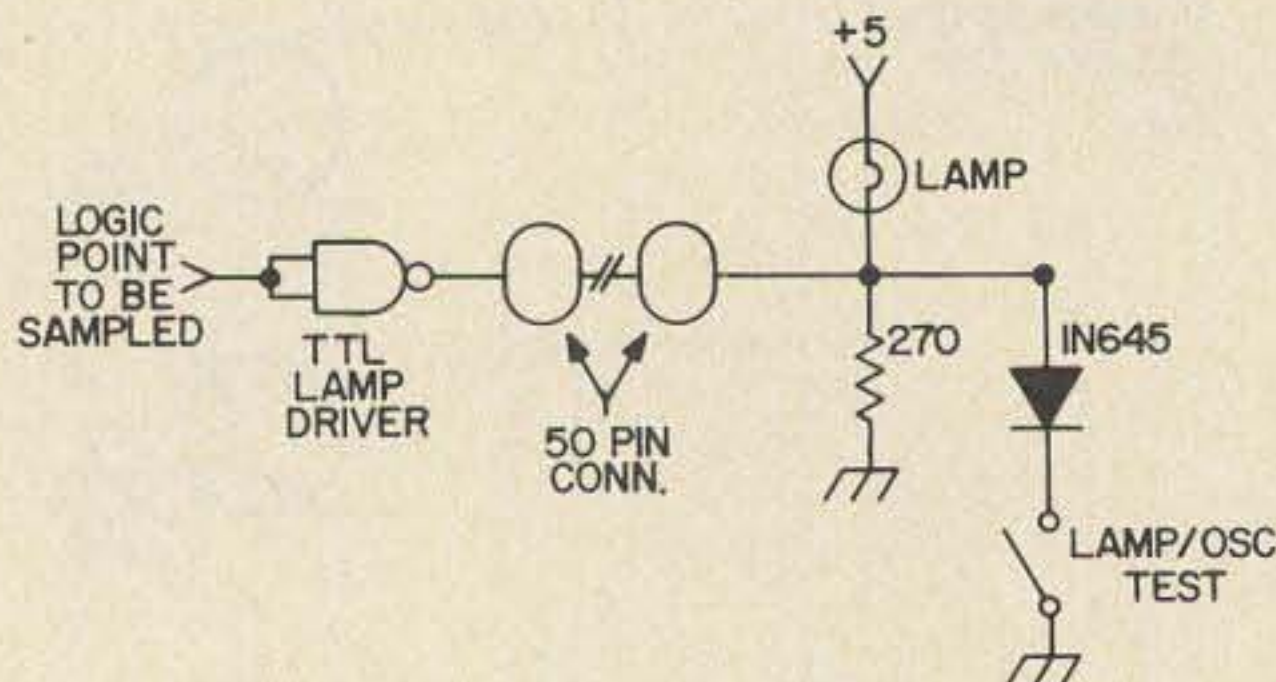

Fig. 18. Lamp driver circuit.

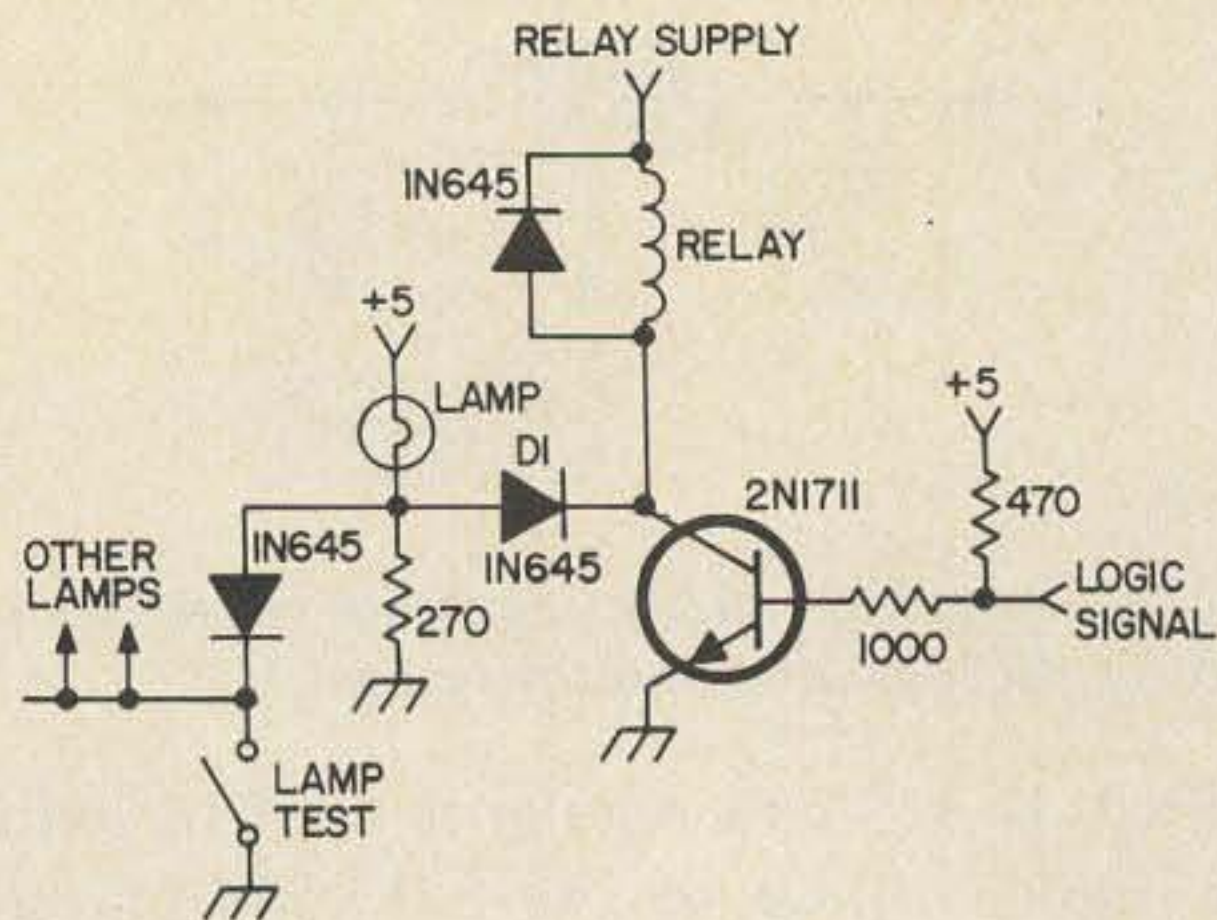

Fig. 19. The diode D1 permits system monitoring.

used to monitor the system's normal operation, an extra diode is used to block the external relay supply voltage from entering the display circuitry. Figure 19 shows diode D1 connected to block the unwanted supply voltage. Failure to include the diode would allow the external supply to flow through the relay and into the display circuitry and associated power supply.

### Conclusion

The foregoing two-part presentation introduces a repeater control system that offers many of the features frequently asked for by repeater users. The initial design goal was to create a small, reliable package that would provide a good repeater without an excessive number of components. Since this control logic was designed and built, the state-of-the-art has again progressed significantly; the diminishing cost of ROM memories, coupled with the announcement by Signetics of an I.C. timer, now makes still another "generation" immediately feasible.

I am currently pursuing a revised version of the system employing these newer devices. While the system described here was built using flatpacks mounted on "any board" and unijunction timers constructed on Teflon standoffs, the new system will be designed around the use of dual in-line packages mounted on a printed circuit board. The new system may also include, as an integral part of the logic, the Touch-Tone decoders and burst tone detector units. In the meantime, the existing system serves as a good starting point for any serious repeater group.

...WAØZHT/1

# AUDIO BOOST FOR MOBILE TRANSCEIVERS

Small portable VHF transceivers as well as some mobile units suffer from a lack of sufficient audio power output. This is particularly true of portable equipment when it is used in a mobile installation. The simple audio amplifier/loudspeaker unit described in this article was specifically developed to boost the audio output level of a portable transceiver. However, the circuit used has far wider application in solid-state receiver and accessory units. The circuit can be used as the complete audio section (preamplifier and power output stages) in a receiver and is also ideal for use as the audio section in a multitude of receiver accessory units such as outboard product detector adapters, audio selectivity units, etc.

## Basic Amplifier Unit

The heart of the accessory unit, and indeed almost the entire unit, is a new microcircuit unit (hybrid integrated circuit unit, depending upon how you define such units) developed by Bendix Semiconductor, Holmdel, N.J. Designated the BHA-0004 and

available for about \$6, it is a complete audio preamplifier/power amplifier unit in a plastic case measuring about 1 x 2 x 1/3 in. thick. Certainly other integrated circuit amplifiers are available, but what makes this unit unique is that it will deliver 5W continuous (not peak) power output using 12–14V dc, requires no heat sink of any sort and requires only a few external components. The high impedance input (20 K $\Omega$ ) and low impedance output (3–8 $\Omega$ ) make for easy interface with a detector stage output and a loudspeaker.

Figure 1A shows the internal circuitry of the BHA-0004. Basically it consists of a preamplifier stage and a class B complementary audio power stage. The idle current and center voltage are preset for correct operation over a wide range of load conditions. A 20 mV maximum input will produce 5W output into 3 $\Omega$  with a supply voltage of 12–14V dc. The distortion over the 300–3,000 cycle range is less than 1%.

Figure 1B shows the BHA-0004 connected up with its external components for use as an audio boost accessory. A very simple noise limiter circuit is shown being used ahead of the amplifier. It may, of

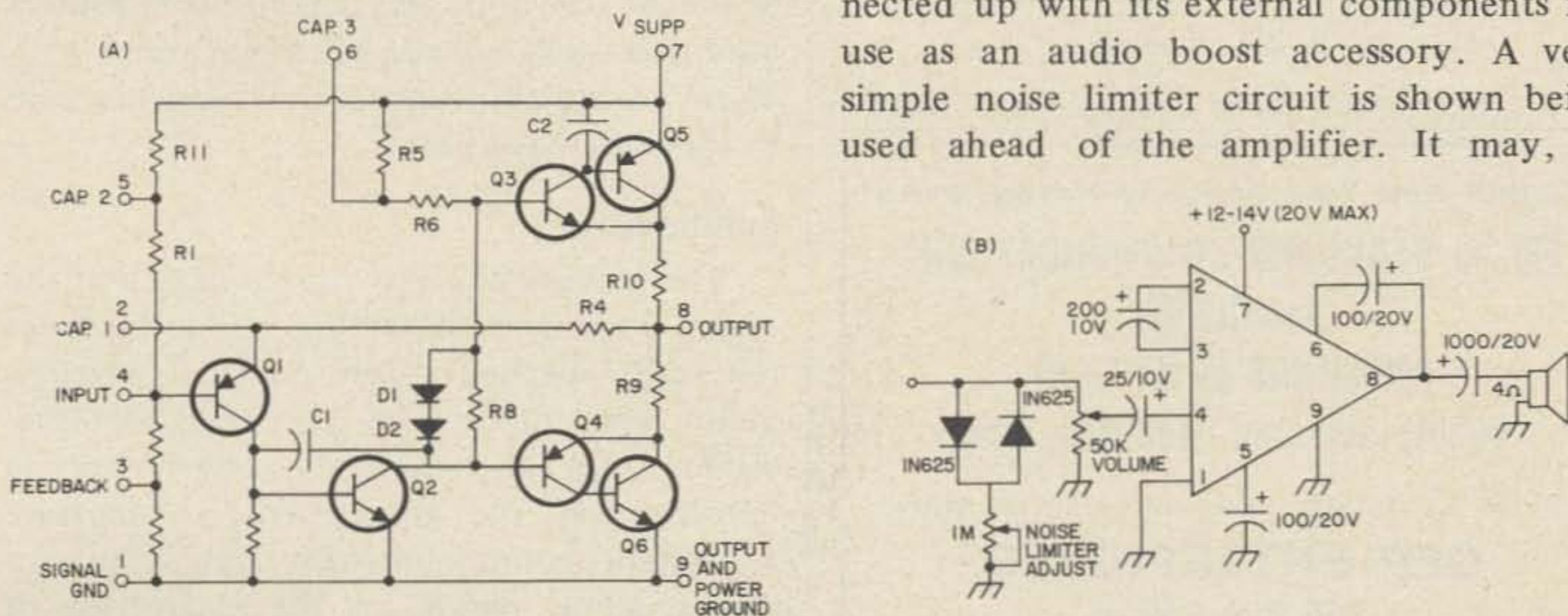

Fig. 1. Internal schematic of the BHA-0004 amplifier unit (A) and schematic of the amplifier as used for an audio boost accessory unit (B).

## B & W MODEL 331A LITTLE DIPPER

A solid state R. F. Dip Oscillator. Battery operated. Ideal for lab, bench or field use when measurements of tuned circuits, antenna and the many other needs of a grid dip oscillator are required.

### Specifications:

Continuous 2-230 MHz with 7 plug-in coils (all coils included)  
Frequency accuracy  $\pm 3\%$   
One type 9 Volt battery to operate

PRICE..... ONLY \$94.50



See your dealer or write:

Barker & Williamson, Inc.



Canal Street, Bristol, Pa. 19007

## WORLD QSL BUREAU

5200 Panama Ave., Richmond CA USA 94804

THE ONLY QSL BUREAU to handle all of your QSLs to anywhere; next door, the next state, the next county, the whole world. Just bundle them up (please arrange alphabetically) and send them to us with payment of 5¢ each.

## PARTS! CORNELL TUBES!

FREE Send For FREE

CORNELL'S  
New Color  
Catalog

48 Pgs. New Items

33¢ per tube

IN LOTS OF 100

36¢ per tube

ORDER FREE  
IF NOT SHIPPED  
IN 24 HOURS!

4215 S University Ave. San Diego, Calif. 92105

## \$ale \$ale \$ale

### Solid State Tube Replacements

5U4/\$2.50, 5R4/\$3.25, 866A/\$7.50

Voltage Doubler-10KV Input/\$6.95

Send for FREE CATALOG

Contains Over 300 Popular Devices

Add 25¢ Postage

G. F. ELECTRONICS Box 14 Greenwood, Mass. 01880

Central New York Specialty Headquarters

FM by STANDARD COMMUNICATIONS

and CLEGG

ANTENNAS by HY-GAIN

Quality-Selected Used Ham Gear

Write for listing, updated twice monthly

**CFP ENTERPRISES**

866 Ridge Road

Ludlowville, N. Y. 14862

607-533-4297

course, be eliminated for use of the unit as a straight audio amplifier. It was added because of the specific use for which the accessory unit was intended — operation of a portable transceiver in a mobile situation — since most portable transceivers do not contain noise limiter circuits. The capacitor values shown are not critical in an application where speech response only is required and similar units of perhaps as little as half the capacitance values shown may be used.

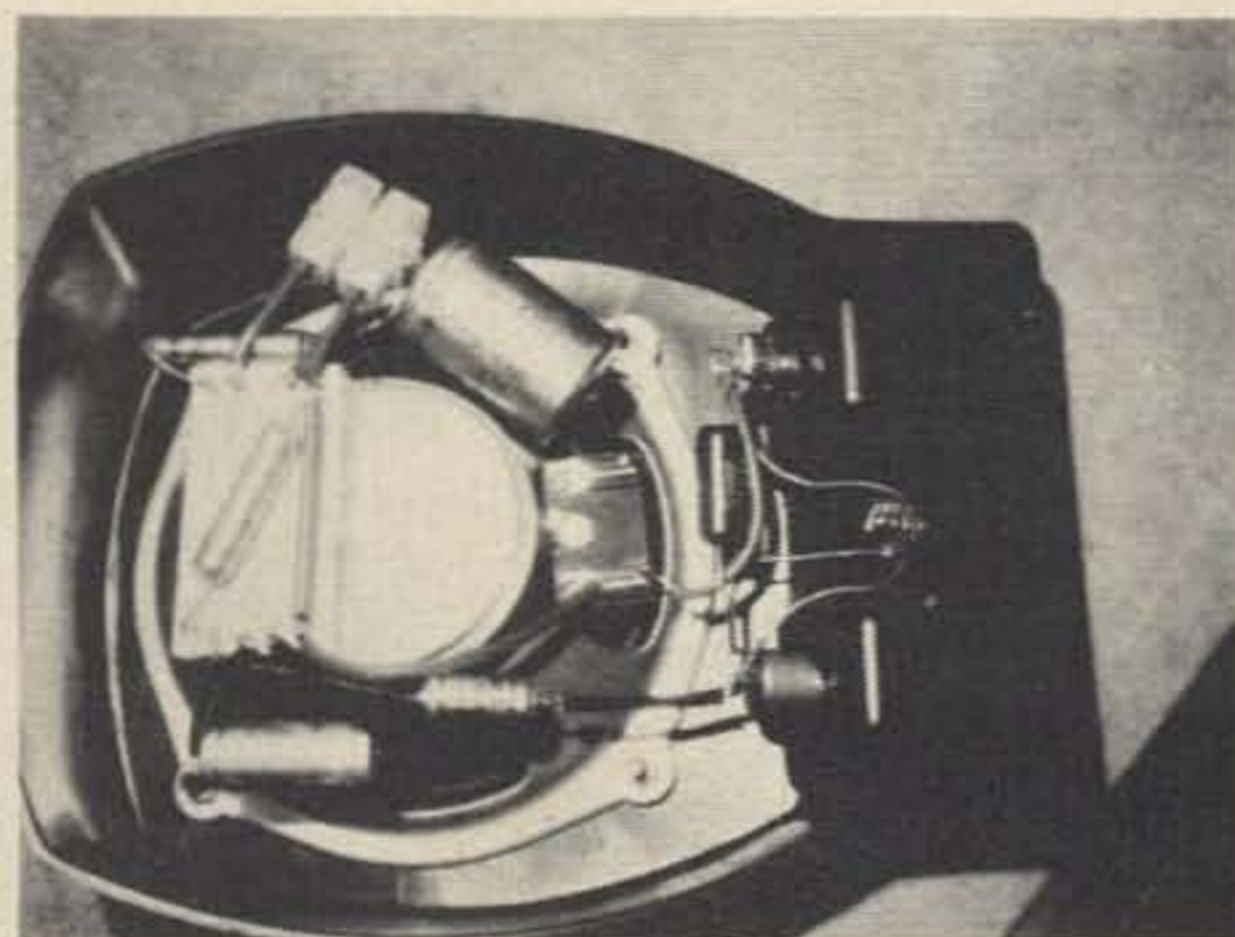

### Construction

The photograph shows how the amplifier unit is mounted inside a simple loudspeaker enclosure. The BHA-0004 is simply fastened to the back of the loudspeaker face by epoxy cement. This method of mounting appears simple but is actually extremely secure. In fact, it may be undesirable in some cases since the unit cannot be removed without breaking it, other than by the use of special epoxy cement solvent. The capacitors are wired directly to the amplifier unit and between the unit and the potentiometers mounted on the loudspeaker enclosure wall. There are no adjustments that need be made to the completed unit.

### Summary

The compacting and simplification of the audio portion of communications receivers has really reached a new point of development with units such as the BHA-0004. Aside from the extreme convenience in construction, the greater cost of separate solid-state components for similar performance alone augurs for the greater use of such amplifier units in amateur designs.

...W2EEY/1

# LOW-COST POWER ON SIX METERS

*For battery portable, mobile and emergency rigs, FM and AM.*

**T**his is a description of design methods, circuits, and components for homebrew generation of up to 5W (input) on 6 meters, for use with FM or AM, using reasonable cost transistors. A  $\frac{1}{2}$  to  $\frac{3}{4}$ W output is obtained from a crystal oscillator, followed by a parallel connected pair of Motorola HEP 75 transistors. These list for \$2.95 amateur net, so you can see the truth of the low-cost mention.

The output can be pushed to equal that of the famous Gonset Communicator series, and nothing stops you from adding a couple more 75's, using the described methods, for a 10W rig.

The actual specs furnished say "total dissipation, 3 watts". That's for *each* transistor! You're out of the dry cell class then, but the Globe Co. has remarkable non-spillable lead oxide storage batteries that will surprise you, for portable and emergency work. So here are the details.

## The Motorola HEP 75

In a box of goodies recently received from Motorola were some HEP 75 transistors which are the HEP low cost version of the famous 2N3866, the solid state "Little

Five Watter" for VHF and up into UHF. The real test was soon applied by soldering one in on 432-450 MHz in the place of a 2N3866, and sure enough it showed up equally well. Since that day I have used them for added power in a variety of places from 50 to 450 and they have all worked like the 2N3866, so here we go with details of how to add a 5W amplifier to your present 6 meter FM or AM solid state portable rig.

## The One Watt Crystal Oscillator

Time was, in the good old tube days, you could run a lot of power out of a crystal controlled oscillator. The Taylor Tube Co. once advertised a crystal circuit, using exactly two tubes (Taylor, of course) that ran one KW (one kilowatt) dc input to the final. CW that was. These days control crystal manufacturers seem very reluctant to say just how much milliwattage you *can* run through their thin little pieces of quartz. So, unless or until they come up with a definite figure beyond "two or three milliwatts," we're on our own for awhile.

It's all very well for them to say "a couple of milliwatts" but if you pursue this policy down the line, and up in frequency,

you can end up with a lot more transistors, amplifier stages, coils, and other components, than you originally planned on, as well as having spent more time, dollars, and cerebration than absolutely needed. Let's see what can be done to push the power per stage a little with these \$2.95 devices with their 3W dissipation figure.

The schematic (Fig. 1) shows my favorite crystal oscillator starting out in the 1970 decade which runs one of these — the lively, always ready to go — HEP 75-2N3866. There is a slight difference in the specs on the HEP 75 and the RCA 2N3866, this latter rated at 55V and the former 20V. So for an AM rig watch out for that collector rating under modulation which can double the battery dc voltages.

Recently, needing maximum power in a minimum package (always an interesting idea!) I kept pushing the 50 MHz oscillator power up and up until there was over a watt going into it and over ½W coming out, which was driving the final in great style. Remembering the old trick of putting a pilot light bulb in series with the crystal, I soldered in a No. 48 bulb, as can be seen in Fig. 1, and sure enough, it lit up. Just a dull red glow, but checking with the "Amateur's milliwattmeter" I found between 10 and 25 mW, depending on the tuning and output loading, as well as the battery voltage. This can also tell you interesting things about the oscillator such as how much of the generated power is being devoted to feedback and how much to the next stage.

Just how much power can you run through these VHF crystals? Recalling those not-so-long-ago (the late 1950's) tube days when over 100V and 20 mils to the plate of the oscillator brought on crystal instability, I pushed the oscillator under test still further, first making sure I was not using one of my favorite crystals. The oscillator output came up to ¾W at 50.2 MHz, and the rf showing in the bulb in series with the crystal indicated about 20 mW. So far, no frequency shifts, noise, power jumps, or other noxious conditions have shown up. You can leave the crystal current indicator in or not, as you please. I checked the output with the bulb in and out and you can just see the difference, of some 15 mW out of perhaps 500 or so.

I just checked once again on the stability by listening to the carrier on my lab receiver which has a reasonably narrow bandwidth, and everything sounds fine. A good, solid "plunk" is heard when the oscillator is tuned in from one side, using L1 and C1 of Fig. 1, and an even, gradual climb on the other.

Incidentally, the coil being used just now is one of those tiny Piconic Co. jobs, the BK121K713Y1, less than 1.8th in. thick, so it's evident that you can pack the whole oscillator down to a real small size.

The emitter circuit as shown allows you to choose the power and current you want, and then put in a single resistor of the value found. The power control with R1 is very smooth as it should be. Check the output coupling very carefully when the oscillator is running and loaded with the amplifier input, because it is easily possible to overload it and keep it from starting up, even though it is a very good oscillator.

That about winds up the oscillator details. It is quite easy to assemble, and is not critical or touchy at any point.

### The RF Power Amplifier

With the crystal oscillator bowling along nicely at ½ to ¾W output what will the amplifier do? The schematic, Fig. 2, shows the circuit, which runs smooth as silk and started off with a watt and a half output right away. The layout is shown in Fig. 3. After a number of tries in paralleling the

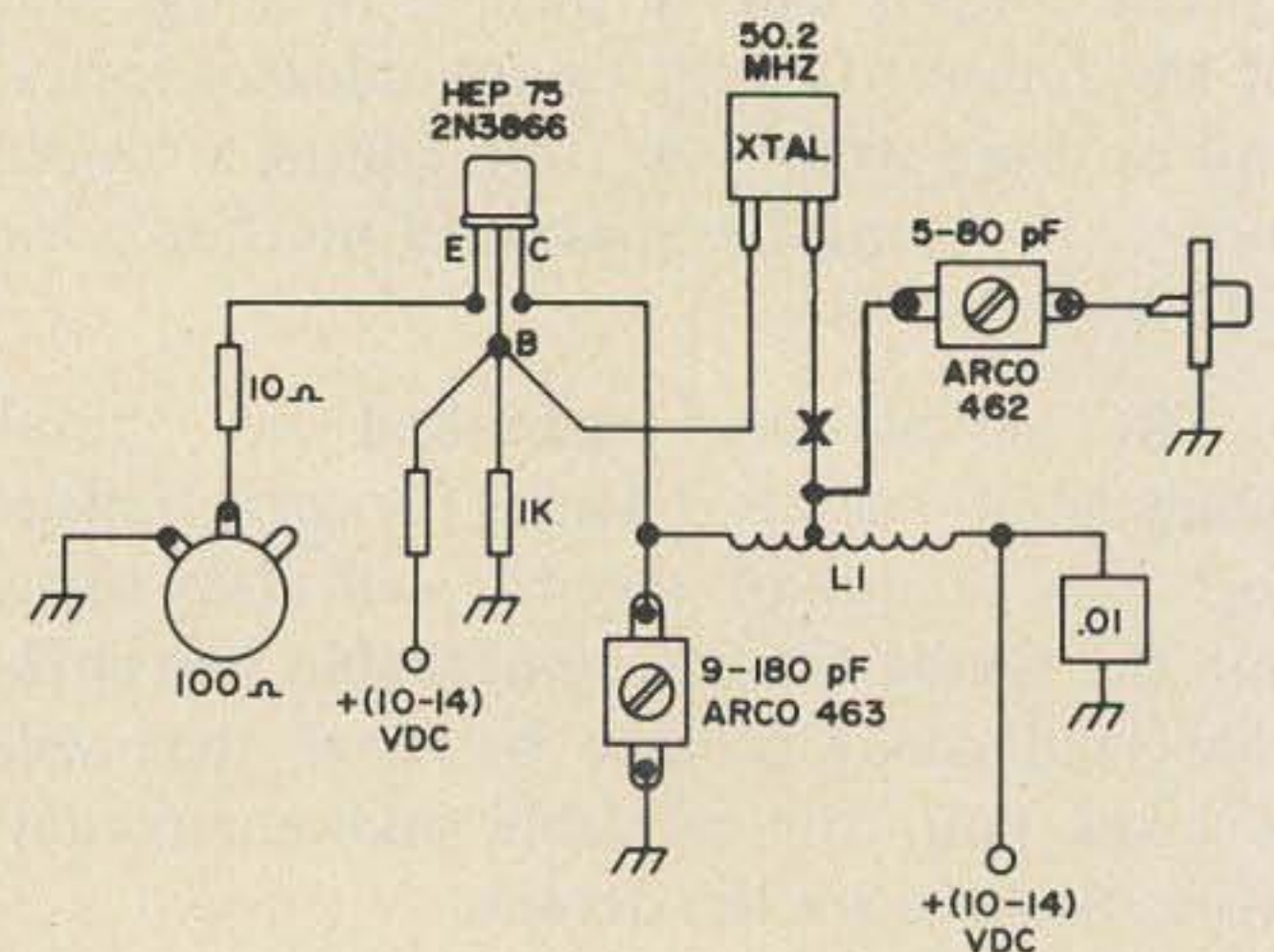

Fig. 1. Pictorial view of the oscillator schematic. For tuneup purposes, insert a No. 48 bulb at point "X" in the crystal lead. The resistor connected from the base to + (10-14V) should be 4.7K. L1 is 10 T No. 22 ¼" diameter with the tap at 4T from the collector end.

HEP 75 transistors, with wires, soldering to the cans, etc., — not all successful I must admit, with some trouble from overheating when soldering the cans onto the relatively heavy copper strap of L1 — I took a little time to work up a mechanical paralleling holder which did an excellent job immediately and can be modified to hold not only two transistors but three or even four. This simple little plank is shown in Fig. 4 and is made of copper clad stock. If you want to be real fancy and obtain better heatsinking at the same time, use a piece of copper of some thickness, such as 1/8 in. Heat is a *bulk* effect and is conducted away faster by a *thicker* piece of metal. Notice the machine screws tapped into the copper clad, which allows insertion of the transistors *after* soldering to the copper strap of L1. This avoids excessive heat on these devices which, even though made of silicon and able to stand a certain amount of soldering, I'm beginning to think do not really appreciate such treatment. In fact, I'm going to keep my iron away from them in the future. After all, that little plank shown in Fig. 4 can easily be skinned down to very small size if needed for higher frequency. As mentioned, you could easily put three, or even four in the circuit. I started out with a pot in each emitter circuit but found nothing critical there either, so I don't think it is necessary to have adjustments for each emitter, although it is always interesting during tuneup to have a few more knobs to twirl.

The collector circuit is well tapped down on L1, as you can see, and has always behaved perfectly, tuning at very close to the same place on the 100 pF variable capacitor C5, of Fig. 2. The combination of a copper strap inductance, the groundplane, the shield wall, and the low-impedance collector tap all make for a good Q, which shows up in the good handling of the resonance curve of L1.

The output circuit is the usual series capacitor, also tapped down on the inductance L1, and is well able to variably load both test bulbs and 50Ω cables.

After you get the breadboard amplifier running properly in the size shown, you could think about installing it in a minibox. For instance, substitute a much smaller coil

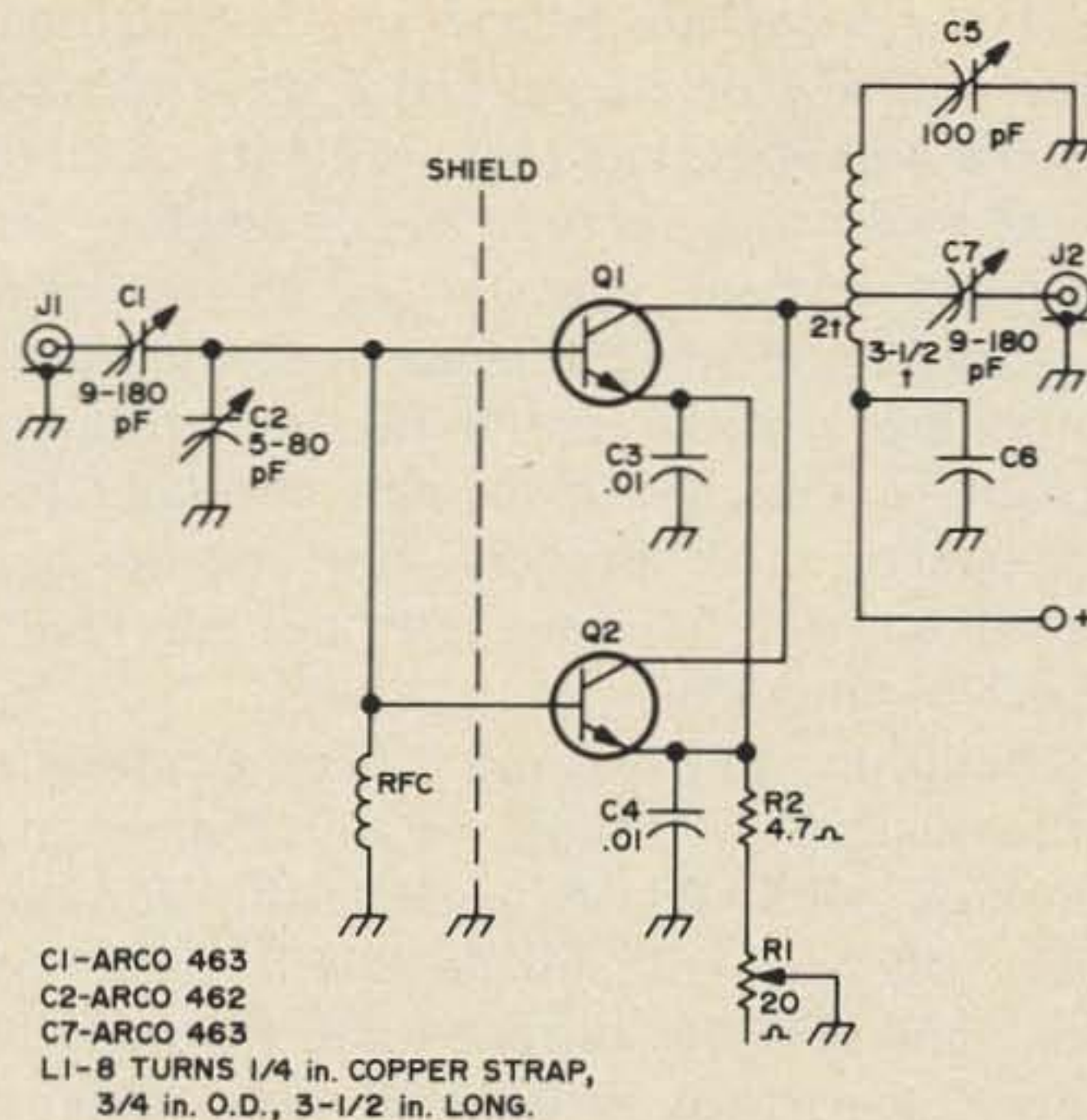

Fig. 2. Schematic of the 5W amplifier. The rfc should be approximately 7–10 μH. C6 is 1000 pF disc ceramic. Q1 and Q2 are HEP 75's.

for L1, which is the largest component, being sure to check it for output power when you do, and you could put in a Johnson type M variable which is only 5/8ths by 3/4 in. in size, plus a fixed capacitor as needed. And test them *first* on the breadboard as shown!

### Tuning Up

This should include voltage tests, current, frequency checks, and output. Hour after hour get used up on the bench with this sort of work, but it's fun and if it also saves *you* time, well, that's fine with me.

I often think — having been in "radio" for over half a century now, that if I have trouble tuning up these little beasties, what will the beginner do? Well, if he reads this he can at least overcome the troubles I found.

The first thing in tuning up is to get some drive into the amplifier base and start building up current from that. Actually, there are two coupling capacitors shown, and you really only need one. These are C2 of Fig. 1, and C1 of Fig. 3, which are seen to be in series when you connect the oscillator to the amplifier. If you leave them on two separate planks this is handy sometimes for cable matching, but if you mount these units on one baseboard you only need one coupling capacitor.

There being no dc bias on the amplifier base you rely on the oscillator drive to turn on the amplifier, and there is plenty of drive there to do this. As soon as you begin to get collector current you start in on the main tuneup job, most of it being concerned with obtaining a good match for the collector circuit, a matched load, and checking for resonance in L1. Be very sure you are not tuned up on a harmonic. It's not too likely but it can happen.

Build up the drive and collector current a little cautiously, using C1 of Fig. 2 and working with R1 to adjust the current. Generally you will not be able to push (via drive and R1) the current up to the full 350 mils, or perhaps 400, until everything is matched and tuned. You may notice a buildup and then a drop in rf output as you push the current up, before you reach the happy condition of having everything going right. This is why you generally see a variable resistor in most of my emitter circuits, at least for breadboards.

The oscillator drive you need should also be adjusted with R1 of Fig. 1, along with the

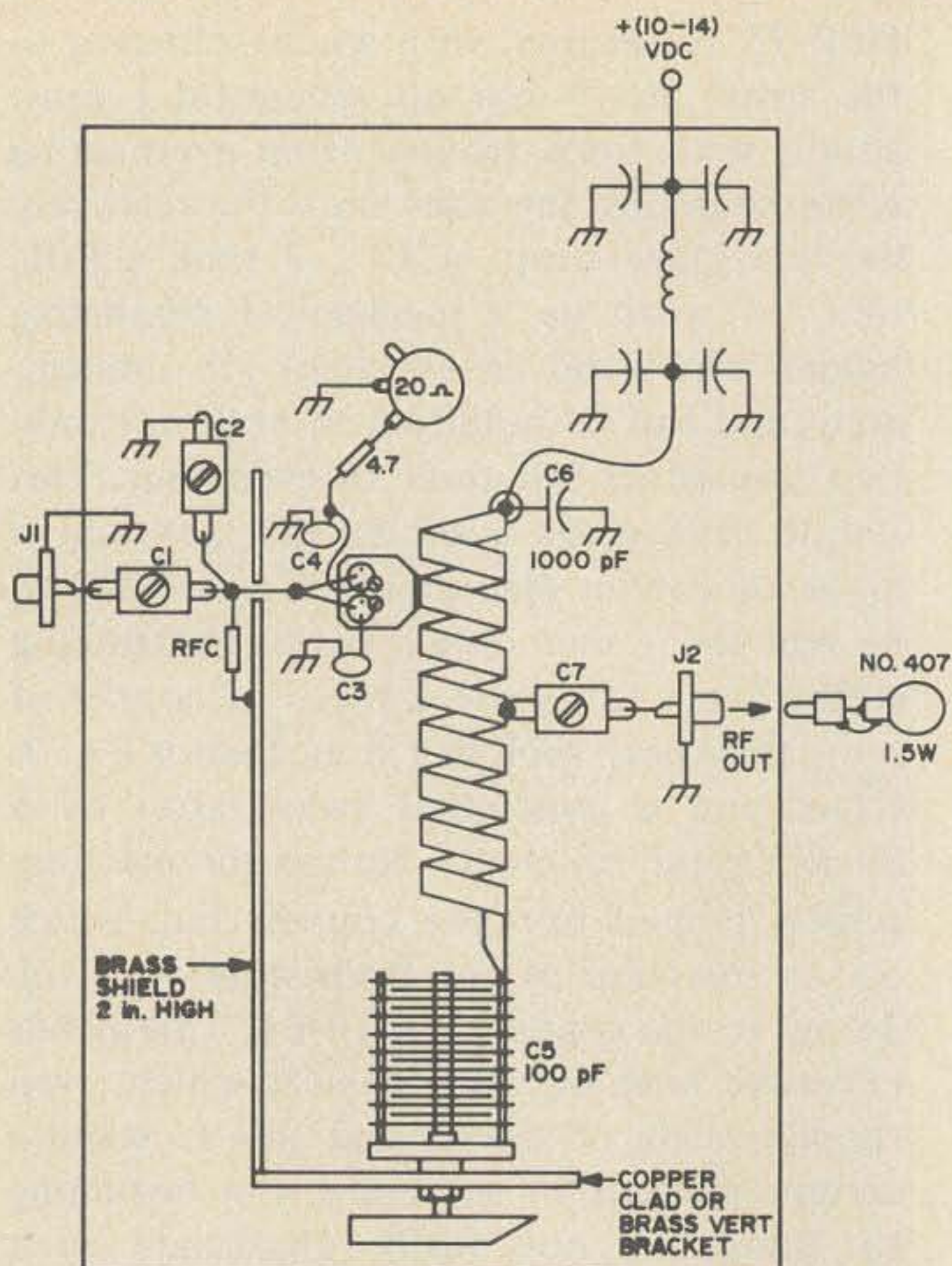



Fig. 3. Layout of the 5W solid state 6 meter amplifier. The rf decoupling network between the amp and +12 can consist of 4 .001 disc ceramics and 50T No. 28 on a 1/2W resistor.

## Model 372 Clipreamp



Increase your talk power without exceeding legal limits. The Model 372 Clipreamp will keep your audio levels uniform for maximum efficiency of your transmitter. Compression level variable to meet your requirements.

PRICE ..... ONLY \$19.95

See your dealer or write:  
Barker & Williamson, Inc.   
Canal Street, Bristol, Pa. 19007

## KITS

Sub-Audible tone

Decoder \$9.95

Encoder \$8.95

- Compatible with all sub-audible tone systems such as Private Line, Channel Guard, Quiet Channel, etc.
- Glass epoxy PCB's & silicon xstrs throughout.
- Any reeds, except special dual coil types may be used: Motorola, G.E., RCA, S.D.L., Bramco, etc.
- All are powered by 12 vdc.
- Use on any tone frequency 67 Hz to 250 Hz
- Small size 1.5 x 4 x .75"
- All parts included except reed and reed socket
- Postpaid - Calif. residents add 5% sales tax

**COMMUNICATIONS SPECIALISTS**  
P.O. Box 153 Brea CA 92621

**NOW**

EXCLUSIVE 66 FOOT

**MDR GAIN**

75 THRU 10 METER DIPOLE

NO TRAPS — NO COILS — NO STUBS — NO CAPACITORS

Fully Air Tested — Thousands Already in Use



**IS  
BACK**

#16 40% Copper Weld wire annealed so it handles like soft Copper wire—Rated for better than full legal power AM/CW or SSB-Coaxial or Balanced 50 to 75 ohm feed line—VSWR under 1.5 to 1 at most heights—Stainless Steel hardware—Drop Proof Insulators—Terrific Performance—No coils or traps to break down or change under weather conditions—Completely Assembled ready to put up—Guaranteed 1 year—ONE DESIGN DOES IT ALL; 75-10HD—ONLY \$12.00 A PAND!

Model 75-10HD	\$60.00	66 Ft	75 Thru 10 Meters	Model 75-40HD	\$40.00	66 Ft	75 Thru 40 Meters
Model 75-20HD	\$50.00	66 Ft	75 Thru 20 Meters	Model 40-20HD	\$33.00	35 Ft	40 Thru 20 Meters
			Model 80-40HD	\$42.00			69 Ft 80-40-15 Meter (CW)

ORDER DIRECT OR WRITE FOR  
FULL INFORMATION

**MDR GAIN**

300 S. Shawnee  
Leavenworth, Kansas 66048

OR THRU YOUR FAVORITE  
DISTRIBUTOR



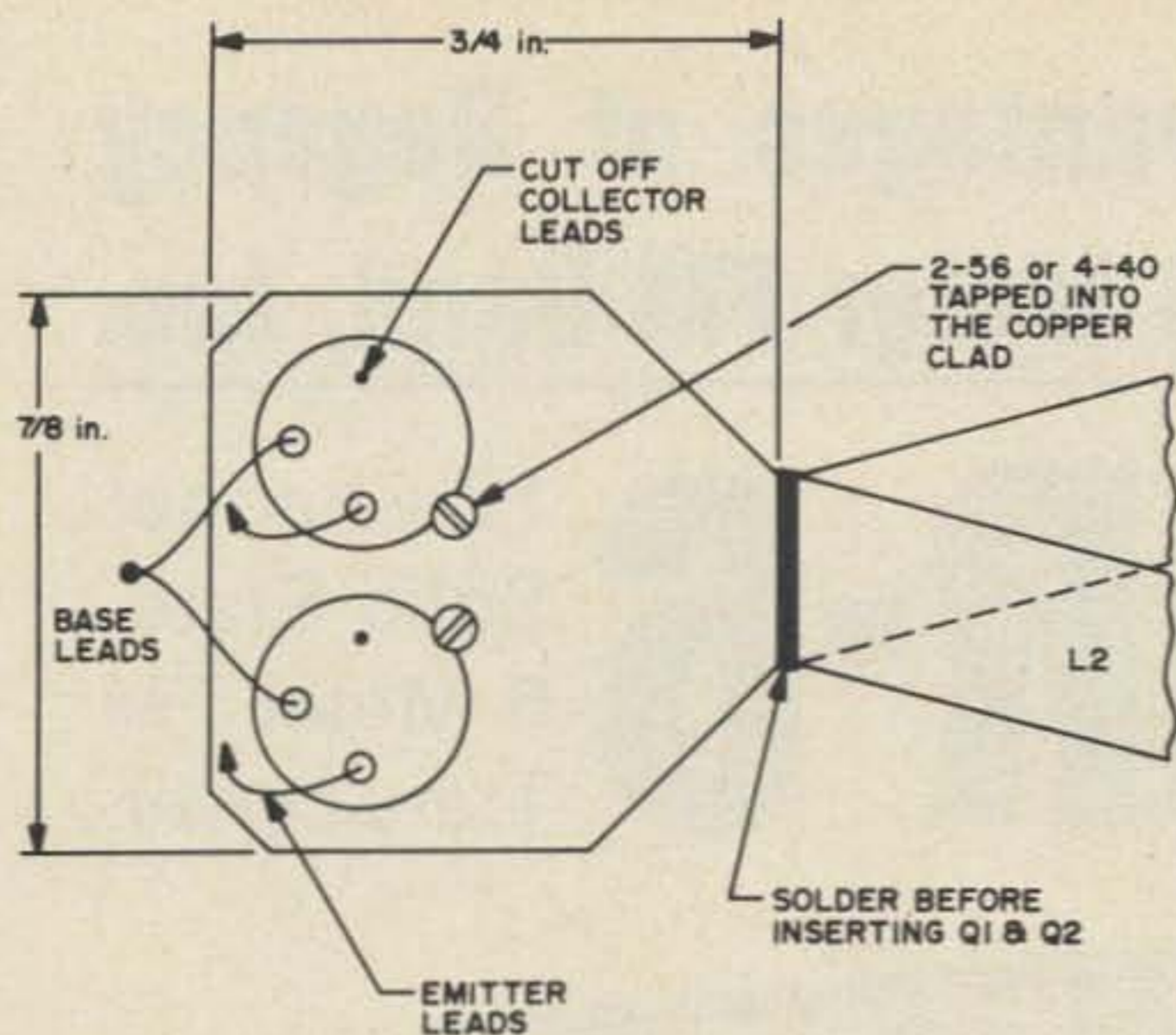

Fig. 4. Parallel adaptor for HEP 75 transistors. The material can be copper clad; or for better heat-sinking, solid copper. Drill the holes for the transistors for a tight fit and lock them into place with the machine screws.

oscillator output coupling capacitor C2. After a little playing around with these controls, and the others on the amplifier, you will get the hang of it (with luck) and find your output climbing toward 2W or even a little more. You can add another 407 bulb to check the output power. Use a separate series matching capacitor for *each* bulb, and check loading, possibly using the output tap at three turns, or even two turns, instead of at four as shown, because the impedance of two loading bulbs in parallel is naturally lower than one only. About this time also, keep checking the temperature of Q1 and Q2. Putting your finger on them after running a few minutes will do for a start. If you can keep your finger there, you're all right. If you wet your finger and it sizzles, that's not so good! Several small drops of wax in a line running from the transistor case over the paralleling plank and onto L1 can tell you quite a story about your heatsinking! Of course you don't *have* to run 5W to them, and you can also parallel four instead of two, as mentioned. Rated dissipation is 3W each, and with an efficiency of around 50% you should do all right at 5W total for the two.

For output indication I have been using the 1½W No. 407 bulbs lately, which show up well as an easy-to-match rf load, and work even up to 450 MHz, except for the fact that they are the flashing type with a

bimetal contactor *inside* the bulb where you can't get at the darn thing to choke it off! As soon as this pesky little strip in the bulb warms up it begins to turn your load on and off at about one second per click. The story is that not all bulbs load up well with rf, but this one does. Hope to find time soon to test a bunch of them for you. On 450 MHz by the way, use as little as less than 1 pF for the series matching capacitor to ground. That is for the pilot light bulb No. 407 used as a test load and rf indicator for output.

Once again, when everything is tuned up and matched, the oscillator inductance with the crystal, the proper amount of oscillator drive into the amplifier base, L1 tuning correct, amplifier collectors fastened properly and matched, the whole assembly is so stable you can put your finger on the hot end of L1 and the bulb will still light, although it will be less brilliant of course. I use a switch to throw in two lantern batteries for about 10V (after a few days) and three of them for 14.5V. This simple battery-saver scheme is quite useful for local contacts.

Hope you have as good luck with your tuneup.

#### Power Considerations

We're now getting up into the battery drain which is near the practical and economic limit for dry cell batteries. The usual "lantern" batteries are rated at 500 mils (½ an ampere) by Union Carbide, with some of the heavier ones going up to 1A, so with 14½V on the final, and the class B modulator still to be reckoned with, if you're on AM, the next step for portable power looms. As far as I'm concerned this is the lead oxide battery of the Globe Co. It is non-spillable and maintenance-free, and you can draw 40A from one of them without damage (to the battery, that is!). This kind of power from a portable battery begins to make our dream of a 25W jacket-pocket rig realizable.

Well, if two transistors in parallel are better, how about three or maybe even four? (I'm reserving the push-pull parallel job for my 25W dream rig.) Also, high powered transistors can be brought into play if they're not too high also in dollars.

...K1CLL

**Now! Get all the advantages of Regency  
2 Meter FM...on the 6 Meter FM Band, too.**

# NEW HR-6

12 Channel  
Solid State  
6 Meter FM  
Transceiver



Model HR 6  
\$239.00  
Amateur Net

Designed and use tested to perform against TVI. Designed to utilize the most modern components of the solid state art—integrated circuits, dual gate MOSFET transistor, silicon BET power transistor, etc. Designed with the power in the frequency range to work FM Skip. And, designed and built in America in a compact package that will appeal to your taste and pride of ownership.

**Complete dash mount  
operation . . . does not  
require black box power  
hog in your trunk**

**25 Watts Out  
Long Range Signal Capability  
12 T and R Channels  
Independently Switched  
144 Frequency Combinations  
5 Watts Audio output  
Compact for Dash Mount.**

## SPECIFICATIONS

Power Output:	25 watts Min. @ 13V DC
Frequency Range:	52-54 MHz
Channels:	12 with independent switching
Sensitivity:	.35 $\mu$ V (nom) 20db quieting
Selectivity:	6db $\pm$ 16KHz
Audio Output:	5 watts max.
Size:	2 5/8" x 6 1/2" x 9 1/2"

State of the art receiver utilizes MOSFET mixer for superior front end overload and intermodulation performance.

**Regency**

**ELECTRONICS, INC.**

7707 Records Street • Indianapolis, Indiana 46226

American Made



## HAND TRANSCEIVER MADNESS

**D**id you know that Motorola has the name Handy Talky all sewed up – and that includes Handie-Talkie or any similar deviations? Bless Motorola and their lawyers who are trying to preserve this most descriptive term from public use.

Most of the early ham band transceivers were Motorolas, whether they were rebuilt seconds from the production line which had fallen into amateur hands or merely stolen units which mysteriously surfaced at hamfests and conventions. Some of them worked pretty well – others remained the seconds they started out.

The main source of these HT boards and parts has been Art Housholder, the chap who runs Spectronics (Illinois) – and who has a multi-million dollar inventory of stuff from nearby Motorola. Art seems to always have a few HT's in his pockets ready for sale.

The result for the amateur has been that he could get together with Art at a hamfest or convention and buy a complete HT-220 transceiver for about \$275 that would cost perhaps double that or more if bought from Motorola directly. This is why there have been so many HT's at hamfests and conventions – hams know a good deal when they see one. This is good for Motorola, too, for it provides a way of getting something for HT's that otherwise might not be satisfactory – there is no evidence to indicate positively that fresh new HT's are being sold through this system, though it would seem that they could be moved along at that price and still make a profit, since the high cost of commercial selling and commissions would be eliminated. This might run Motorola into trouble with commercial customers and maybe even the government – isn't there some rule against selling the exact thing for two different prices?

Hams have benefited greatly from the flood of HT's. Thousands upon thousands of them are now everywhere wherever hams get together. Channel 94 sounds like a CB channel at bigger conventions.

The more serious FMers latched onto HT's early in the game and they keep them at hand day and night. There are more repeater owners than you might think who sleep with their HT's more than they do their wives.

Picture yourself as the proud owner of a new repeater – walking along in the local shopping mall with one HT on each hip – volume turned up high and squelch on. You leave your ham buddies for a minute to go through a crowded restaurant to the rest room in the back. Just as you are in the middle of the place one of your friends breaks through the repeater with, "Which way is the toilet?" About one hundred

people suddenly are completely silent as your face turns bright red and you spin around and head out as fast as you can.

Varitronics came out with an HT-2 shortly before disappearing into the woodwork, leaving a lot of customers and others screwed. The rig was nice, but the shock to the Japanese manufacturer was so severe that he has only just recently been trying to sell to the U.S. again. Pity, for the gear is great.

The next hand transceiver to come out was the Standard 146. This five channel job with one watt out was priced competitively with the HT-220 at \$279. It was about the same size as the HT-220 with the Omni case – the one used for the five watt model or the six channel two watt model, but was a little longer to allow room for the nicad penlite cells instead of the special (and extremely expensive) nicads required by the HT. The 146 also used the regular HC-25/U crystals instead of specially made crystals which have to be soldered into place. Changing crystals in the HT's is so difficult and so expensive that it is normally avoided in every way possible. The 146's can be changed to new channels in a minute or so – and they use the regular Standard 826 crystals which are in stock at most dealers.

The provision for an external mike on the 146 made it very nice for hamfests where it can be worn on a belt and the mike hung on the case when not in use.

The introduction of the 146A resulted in dealers selling off their stocks of 146's for around \$220, certainly one of the best bargains seen in amateur radio in recent years.

Standard Communications got into a bind for a while when the deliveries of automatic battery chargers got way behind the 146 deliveries. Fortunately it turned out to be very simple to charge up the transceivers and the chargers were not badly needed. The nicad cells plug into a battery holder, which in turn snaps into the transceiver with ordinary battery connector such as is used on 9 volt transistor radio batteries. Any twelve volt power supply can thus be used to charge the nicads. The battery pack comes out of the 146 in two shakes and snaps onto the twelve volt supply.

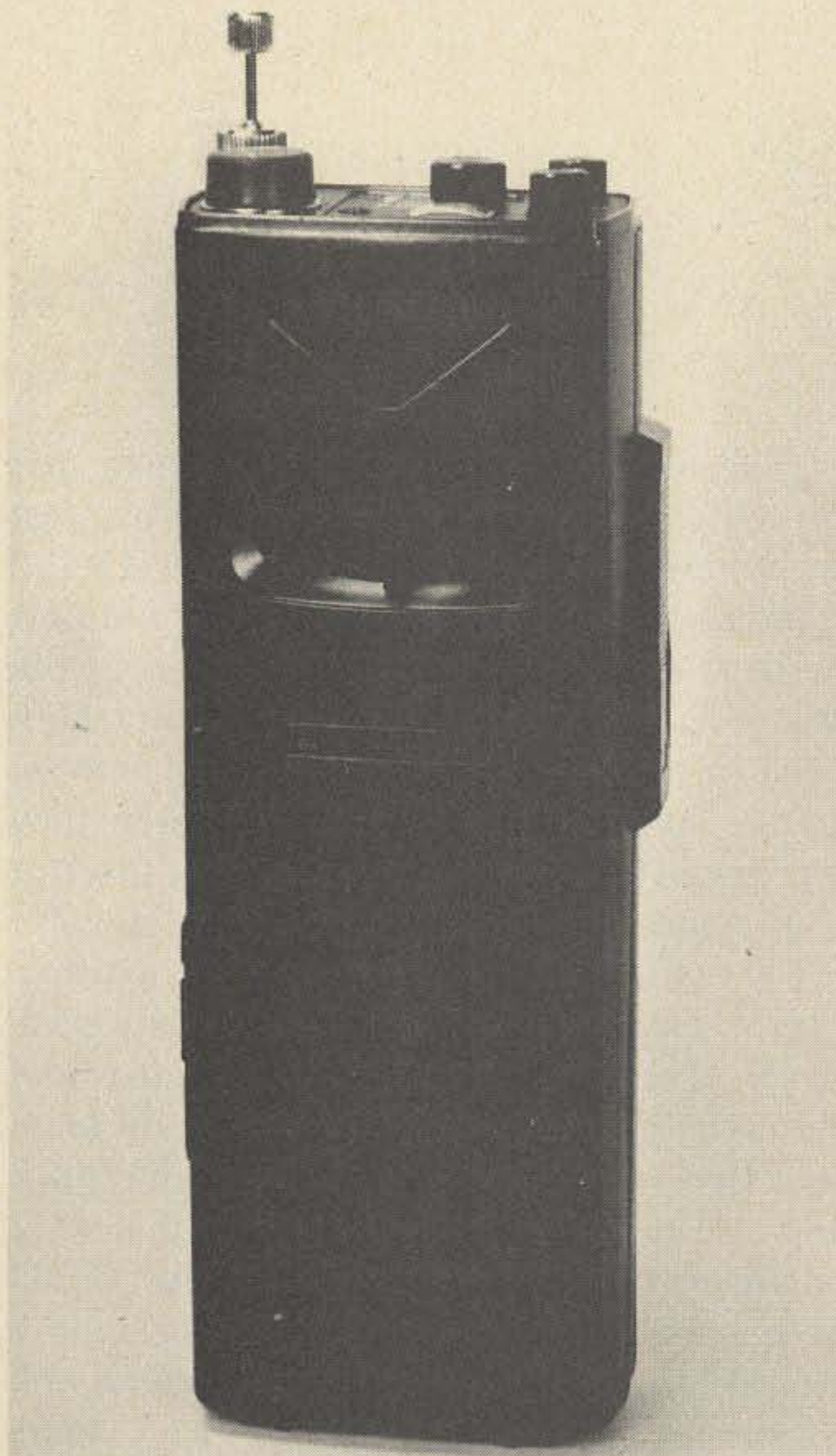

*The Standard 146A is a 5 channel unit that runs 2 Watts output.*

Now that Standard chargers are available in quantity it is a bit easier — you just set the transceiver into it and snap the switch to normal charge or trickle charge.

The newest hand unit has just been announced by Henry Radio — with the first ad being in the December issue of 73. This one has six channels — plug in crystals — uses regular nicad cells — is made of very light weight (but strong) material — runs two watts out (three watts when fully charged) — and is almost exactly the same size as the Standard 146A. Henry is selling the Tempo/fmh for \$189.

One other company is also importing the KP-202 hand units — the same rig Henry is selling — and this is Grove Electronics. They are small and were advertising for a while only in the Repeater Bulletin. Recently they have joined the ranks in 73. They have the advantage of having a full set of accessories available for the unit — short rubber whip with the special antenna connector on it — a set of ten AA nicads — a leather case — and, best of all, a \$25 charger unit with a timer built in for fast or slow charging. The Grove nicads can be fully charged in three hours with this system. Grove is selling the whole bundle — transceiver — nicads — rubber and regular telescoping antenna — case and charger for \$270.

Some of the other manufacturers of commercial hand transceivers might do well to take a closer look at the Motorola system for moving seconds. The GE, Bell & Howell, Sonar, Hallicrafters, Johnson, etc., are all good units, but out of reach of the amateur. The amateur market for hand units has just been scratched.

Those amateurs using hand transceivers have been having a fabulous time. Some have been using them for such esoteric achievements as making horseback mobile contacts — skiing mobile — kiddy car mobile — skateboard mobile — ice skate mobile — swivel chair mobile — etc. The latest FCC regulations dictate that a hand unit be called mobile, wherever it is used, even in bed.

One and two watt hand units will usually get into a repeater just fine if it is line of sight. Repeaters such as WIKOO on Mt. Mansfield pull in hand units from 50 or more miles out with ease, enabling contacts

over 150 to 200 mile paths to higher powered mobiles in Ontario from the northern parts of New Hampshire.

The term "Walkie-Talkie" is not registered and this is safe to use with any hand transceiver, being beyond the grasp of Motorola and its horde of lawyers. Generally the larger transceivers are thought of in this context — units such as the Drake TR-22 which is more of a shoulder strap rig than a hand-held.

The TR-22 is a very good deal, really, selling at under \$200 and having its own self-contained batteries (nicads, usually), with built in charger, six channels, etc. This one watt rig has astounded thousands of delighted users with its coverage.

Another very similar unit is the Tempo/fmp, with eight channels, plug in whip antenna, battery pack that unsnaps, hi-low power switch (3 watts max), and other features. This sells around \$225 with battery pack.

Amateur ingenuity can be used to convert some of the smaller transceivers into walkie-talkies. The Ross and White is ideal for this, with its power saving 10-1-0.1 watt switch. In the car you switch to 10 watts — on the shoulder to 1/10th watt, with 1 watt available in times of need — or even 10 watts, if your battery will take it. This has twelve channels too.

The application for hand units is unlimited. Once you have one you find that you are using it a lot of the time. If you have much in the way of ham friends you will find yourself using rigs for talking between cars on trips — for keeping in touch when you are walking around a town separately — for checking out other gear — club meetings — in restaurants to show off to non-ham friends — on hunting trips (this can be bad if you are using a repeater channel as your rig will suddenly start making a big noise just as a deer is in sight and that will blow the whole thing). If your wife is licensed you can use your rigs in place of CB gear so she can remind you of things she needs when you are at the store — or she can tell you about non-business calls — there are just too many applications to cover.

...W2NSD/1

# GET TO THE FAST TOP!

NOW YOU CAN CHANGE, ADJUST OR JUST PLAIN WORK  
ON YOUR ANTENNA AND NEVER LEAVE THE GROUND!

ROHN manufactures towers that are designed and engineered to do specific jobs and that is why we have the FOLD-OVER TOWER . . . designed for the amateur. When you need to "get at" your antenna just turn the handle and there it is. Like other ROHN big communication towers, they're hot dip galvanized **after** fabrication to provide a maintenance free, long lived and attractive installation. ROHN towers are known and used throughout the world . . . for almost a quarter century . . . in most every type of operation. You'll be in good company. Why not check with your distributor today?

**ROHN** MANUFACTURING

®

DIVISION OF



P.O. Box 2000 / Peoria, Ill. 61601



# QRP ON 180 kHz

*An old amateur band revisited.*

**W**hile browsing through FCC Rules and Regulations governing low-power communication devices, Part 15.203 caught my attention. The FCC radiation limit placed on a low-power device operating between 10 and 490 kHz is determined by dividing a constant (2400) by the frequency in kilohertz. This

yields field strength in microvolts per meter at 1000 ft from the device. For 240 kHz the computed value would be  $10 \mu\text{V}$ . Part 15.203 allows the use of 1W maximum plate input power to a communication device operating between 160 and 190 kHz. Although plate power is increased, a limit is placed on the length of antenna. The antenna cannot exceed 50 ft total length as measured from the plate coupler. The lead-in or transmission line must be counted as part of the antenna.

QRP rigs have always interested me, and this challenge in the low frequency bands could not go unaccepted. I built the rig shown in Fig. 1 and tested it for distance with the friendly assistance of Bill Hansen (WA5JVY) and Bill Baird (W5GXU). With short antennas, such as 5–10 ft connected to the pi network, the local coverage is good even though my QRP rig is working at about 500 mW instead of the allowable 1W. Three distances were tried: 10 miles, 2 miles, and 1 mile. The only distance from which I could receive a signal was 1 mile and under.

Many factors enter into the distance at which reception is possible, and a full discussion is beyond the intent here. Factors pertinent to a distance test are contained in many textbooks and in other excellent sources from which notes have been compiled over a number of years. In those years no thought was given to publication. It is regrettably impossible therefore to list sources or give deserved credit inasmuch as my notes are incomplete. However, these examples from my notes

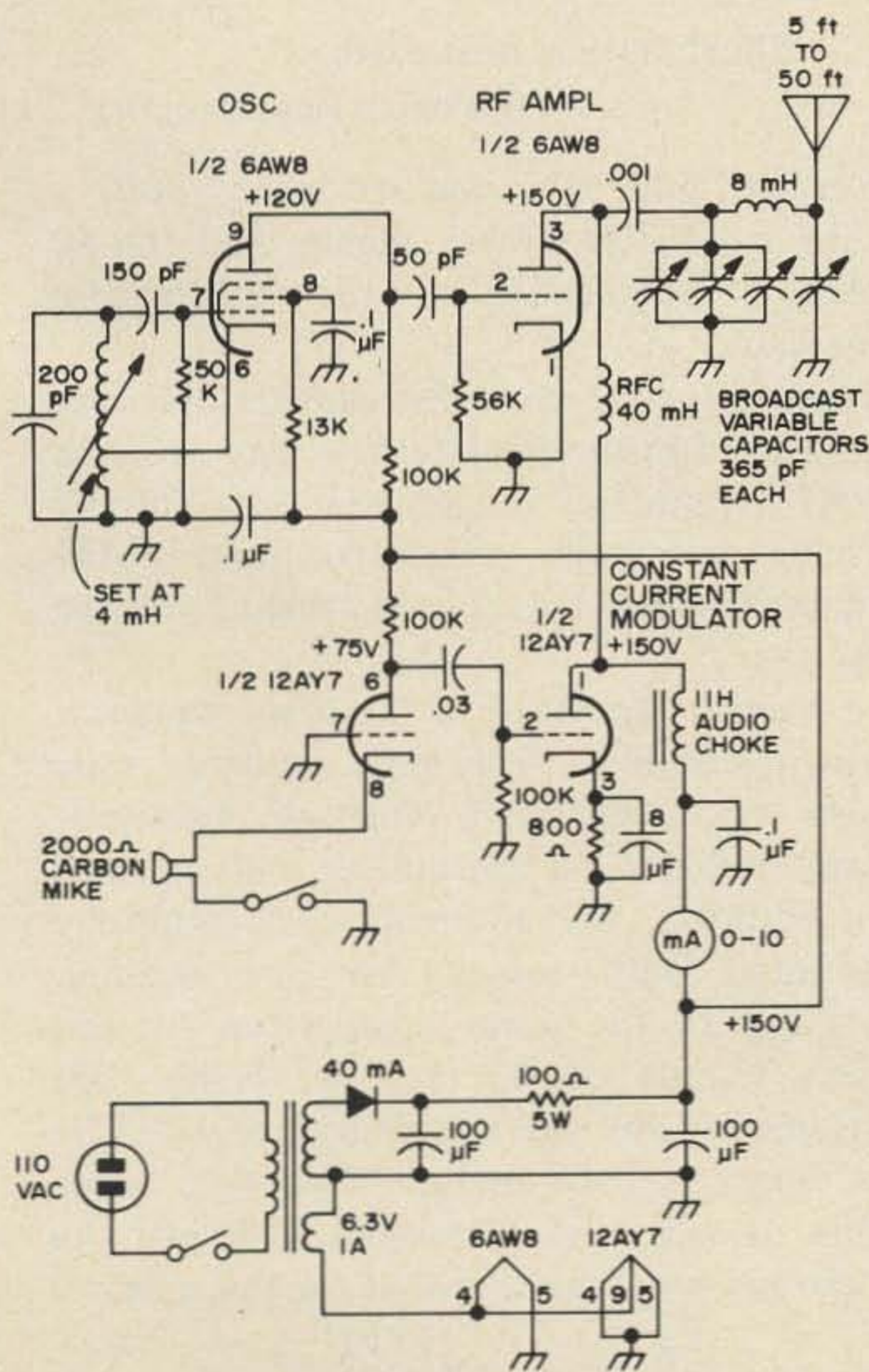

Fig. 1. Experimental rig for tests on 180 kHz.

will help to illustrate some of the principles which govern transmitting and receiving rf energy.

The free-space transfer of power between two antennas depends upon the number of wavelengths between antennas rather than the numerical distance. The energy available at a common receiving location for 500 kHz and 50 MHz can be compared when the effective radiated power at the transmitter is 1 kW and the distance, in this example, is about 18.6 miles (30 kilometers).

$$\text{Wavelength} = \frac{3 \times 10^5}{\text{freq in kHz}} = \text{meters}$$

Therefore, 500 kHz = 600 meters

50 MHz = 6 meters

(one wavelength for each frequency)

$$\text{Separation is: } \frac{30,000}{600} = 50 \text{ wavelengths}$$

$$\frac{30,000}{6} = 5000 \text{ wavelengths}$$

$$\text{Then, } \frac{\text{Power Received}}{\text{Power Transmitted}} = \frac{P_R}{P_T} = \left(\frac{.119}{n}\right)^2 = \text{watts}$$

where  $n$  is number of wavelengths between transmitter and receiver.

By substitution,

$$\frac{P_R}{1000} = \left(\frac{.119}{50}\right)^2 = 5.6 \text{ mW for 500 kHz}$$

$$\frac{P_R}{1000} = \left(\frac{.119}{5000}\right)^2 = 0.56 \mu\text{W for 50 MHz}$$

Remember, these are examples for the same physical distance and serve to demonstrate why receivers for high frequency and VHF generally have high-gain front ends and why broadcast band receivers can get by with a mixer stage coupled to a self-contained loop antenna. Bringing the 6-meter signal up to the 5.6 mW level would require about 40 dB of amplification. Furthermore, to build each of these signals to about 600 mW at a detector would require about 20 dB amplification for the low-frequency signal and 40 + 20 dB for the high-frequency signal. That is a respectable amount of amplification and becomes

a reason why several i-f stages are to be found in HF and VHF gear.

Rf power passing through a free-space area does not depend on frequency. The amount available can be stated in watts per square meter by using this formula:

$$\frac{3 P_T}{8 \pi d^2} \quad \frac{P_T}{d^2} = \text{watts transmitted}$$

$$= \text{meters from transmitter}$$

But, the power available to the receiver is dependent on frequency because the effective area for capture of rf energy by the receiving antenna is dependent on wavelength. The power available to a receiver is:

$P_R = \text{watts/square meter} \times \text{the area (effective)}$

Without going through the calculations, let me jot down from my notes several approximate values for *effective areas*:

Half-wave antenna

$$0.130 \times (\text{wavelength})^2$$

Short Dipole  $0.119 \times (\text{wavelength})^2$

Short vertical near earth

$$0.059 \times (\text{wavelength})^2$$

For the 500 kHz case we have:  $(600)^2 \times .119 = 43,200$  square meters and for 50 MHz it becomes  $(6)^2 \times .119 = 4.32$  square meters.

These effective areas for capture illustrate another fundamental reason why HF and VHF enthusiasts put up beams or literally "hang out more wire" to improve the signal strength before it is passed on to the receiver.

Now to get back to the low-frequency, low-power tests. The tests we made were over poor, dry soil, with at least one canyon between transmitter and receiver. In addition, the antennas were randomly oriented with respect to one another. Making all the same calculations for our test, 1 mile comes close to being 1.61 kilometers and the wavelength of 180 kHz is close to 1667 meters. Therefore, since this discourse is illustrative, I'll beg the rigorous issues and say that for this case:

$$\frac{P_R}{0.45 \text{ watts}} = \left(\frac{.119}{1}\right)^2 =$$

$$0.45 \times .014 = 6.3 \text{ mW}$$



Which would be a respectable signal if our transmitting antenna were efficient and all of the power was radiated. The hooker is the 50 ft limit on the antenna. It is extremely short compared to a half-wave and the efficiency of radiation is decidedly low. The poor soil and randomly oriented antennas didn't help matters. I felt we were fortunate to hear anything from the QRP rig at 1 mile. An old surplus Navy RAK-7 receiver which has two stages of rf amplification ahead of an oscillating detector apparently made the difference. No effort was made to match my 160m inverted-L station antenna to the RAK-7.

There isn't much need to elaborate on the QRP rig. It was built from junkbox parts. A 6U8 tube would have been preferable over the 6AW8. The former has a rapid heat-up filament. The oscillator is an electron-coupled type which affords a measure of isolation and minimizes frequency shift due to modulation. The rf amplifier is self-biased in order to make the most of the available drive. The 40 mH choke in the amplifier plate circuit is nearly self-resonant to 180 kHz. The pi network was selected to load a 50 ft piece of wire reasonably well in the face of a 50 k $\Omega$  plate impedance. The modulator is a constant-current type and matches the impedance of the rf amplifier fairly well.

Any other microphone preamplifier will work in place of the one shown. I happened to have a surplus carbon microphone which has 2 k $\Omega$  resistance. The power supply is of the small preamp type and happens to be the limiting factor for the power input to the final amplifier. Modulation was less than 100%; however, we had to resort to CW for the 1 mile test so that didn't matter.

This experiment made it obvious why CB equipment is designed for use in the 11m and higher frequency bands. A small transistorized 1W 180 kHz transmitter and receiver would not be hard to build, but, that 50 ft collapsible antenna would be something of a problem!

... W5SOT

# NEW!

*how to use*

# FM

*by wayne green*

\*Editor and Publisher of 73 Magazine

**\$1.50**  
postpaid

This new 73 book, by W2NSD/1, gives you the basics of 2m FM operation...and gets you on FM quickly and easily. A fast reading of "How To Use FM" can help you avoid beginners' pitfalls...opens the door to a world of fun and friendly people. Order your copy today with the coupon below!

73 Magazine, Peterborough NH 03458

Enclosed is \$\_\_\_\_\_. Please rush \_\_\_\_\_ copies (@ \$1.50) of "How To Use FM" to:

Name \_\_\_\_\_

Address \_\_\_\_\_

City \_\_\_\_\_ State \_\_\_\_\_ Zip \_\_\_\_\_

# NEW!

# 1973

# REPEATER

# ATLAS

**\$150**  
postpaid

Complete up-to-date list of repeaters for the entire world! Maps pinpoint U.S. and Canadian repeaters and all listings contain call, location, frequency and access requirements. The Atlas features a concise history of 2m FM repeaters and a section on How To Use Repeaters by W2NSD/1. If you're using repeaters now... if you're planning to join the fun on FM... you need this book *now*! Send the coupon in today.

73 Magazine, Peterborough NH 03458

Enclosed is \$\_\_\_\_. Please rush \_\_\_\_ copies (@ \$1.50) of the 1973 FM Repeater Atlas to:

Name \_\_\_\_\_

Address \_\_\_\_\_

City \_\_\_\_\_ State \_\_\_\_\_ Zip \_\_\_\_\_

# SOLID STATE AUTOMOBILE BURGLAR ALARM

*A unit that triggers a state of alarm when approached by a burglar! The alarm automatically resets itself after 1½ minutes and is ready for the next thief.*

Looking at the prices for car burglar alarms these days, one wonders if it's really worth the \$30 or so they cost. Recently a friend of mine asked me if I could build an alarm for his car, as he was worried about his new tape deck. As a result, I built this alarm in a few evenings. It's solid state, except for one relay.

The alarm is actuated by the standard door switches used to turn on the dome light. It uses the horn in your car as the alarm, thus saving the expense of purchasing an auxiliary horn or siren. If you are worried about the alarm discharging your battery too much, forget it: a built-in timer shuts it off after about a minute and a half, and resets it. It's simple enough to build in a couple of evenings, and most of the parts are inexpensive and non-critical.

A look at the block diagram will clarify the basic operation of the device. When the triggering terminal is brought to ground potential, or near it, the gate latches and supplies power to the alarm circuit. The triggering terminal is connected to the door

switch. Once the gate is turned on it becomes independent of the triggering circuit. Thus, if the door is closed a few milliseconds after it is opened, the alarm will still sound off. The timer then starts, and the unijunction pulse generator starts producing dc pulses at the base of the relay driver stage. The relay will then open and close with approximately a one second cycle. The relay can be connected in parallel with the horn button, or wired directly in series with the battery and horn. After about one and a

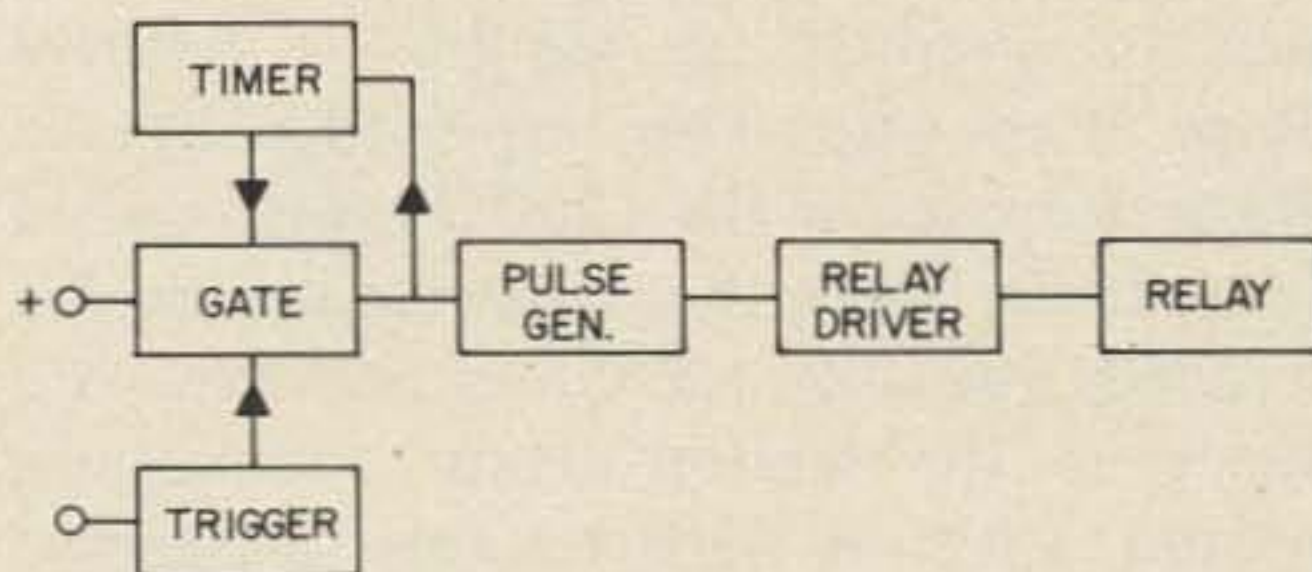

Fig. 1. Block diagram

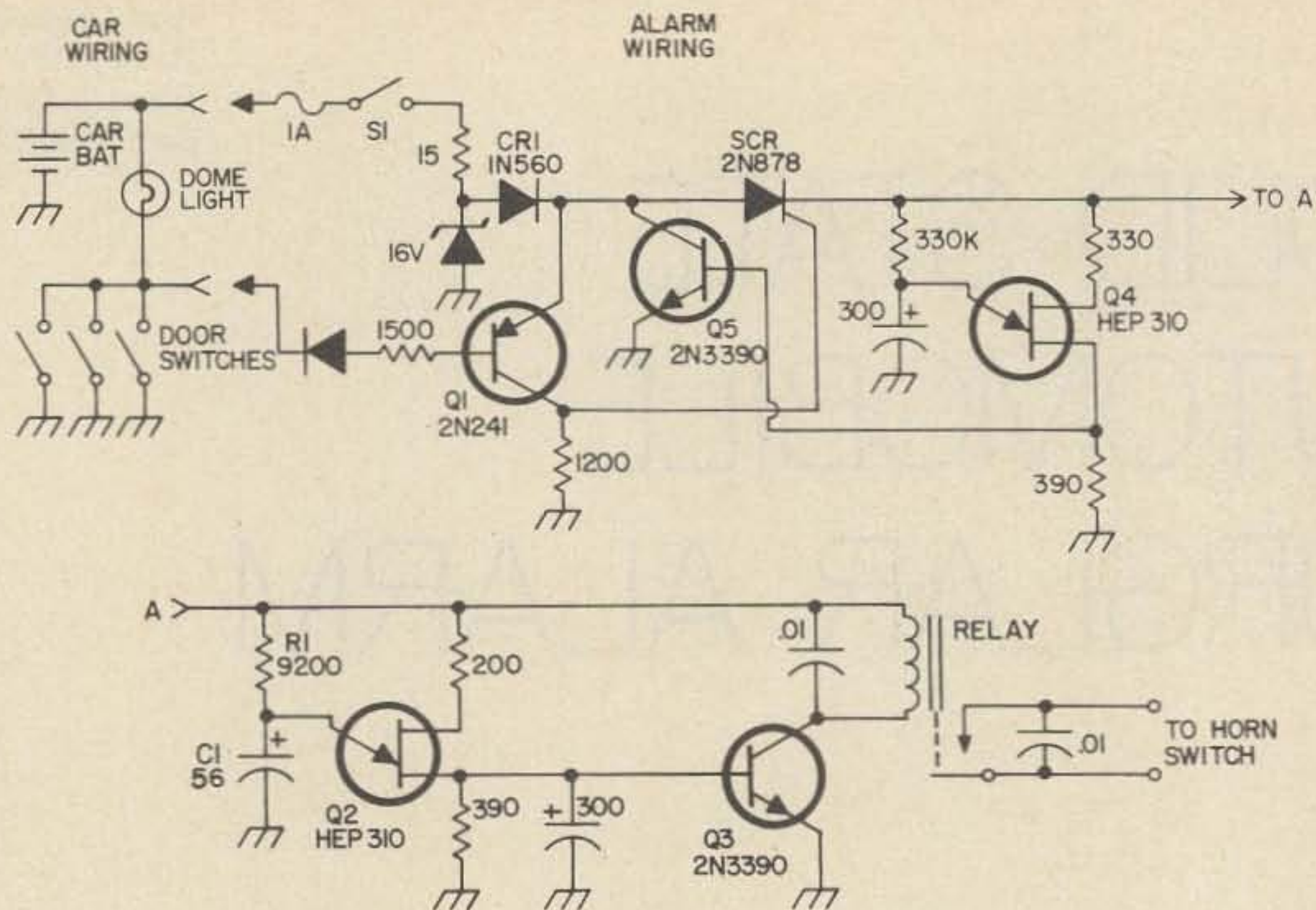

Fig. 2. Schematic diagram of the alarm.

half minutes, the timer will turn off the gate, thus turning off the alarm. A relay was chosen for the horn control rather than a transistor because in some cars it must switch over ten amperes, and a relay is cheaper.

The schematic shows in detail how the thing works. Starting at the battery terminal, the 15Ω resistor is just used to limit the overall current through the alarm, in case of a short circuit. The zener diode is used to clip off any transients that might be present in car wiring, such as those caused by turning on the lights or the horn, and which could damage the transistors. The operating voltage rating is not too critical, and can be anywhere from 16–30 volts. The rectifier, CR-1, is just to protect against damage resulting in improper battery polarity when wiring it in the car.

The silicon controlled rectifier is the latching device used to turn the alarm on. In order to conduct, it requires a positive voltage at its gate. This is provided by the voltage drop across the 1200Ω resistor when Q1 conducts. When the triggering terminal is grounded, the base of Q1 is negative with respect to the emitter, thus it conducts. Rectifier CR-2 is used to keep a positive voltage off the base, as its cathode is normally at +12 volts. The 1500Ω resistor limits the base current.

When the SCR conducts, a voltage will build up on C1. When it reaches about 8 volts, Q2 will conduct, producing a voltage drop across the 390Ω resistor. The voltage across C1 will then drop to about 5 volts, and it will start charging again through R1. A positive voltage at the base of Q3 will allow it to conduct, closing the relay contacts. The .01 capacitor across the relay coil helps to reduce voltage transients that could destroy Q3. The timing circuit is basically the same as the pulse generator, but with a much greater RC time constant. The 300 μF capacitor must be of high quality, with high leakage resistance, or the circuit will not operate properly. When Q4 conducts, it produces a voltage drop across the 390Ω resistor, thus allowing Q5 to conduct. Q5 effectively bypasses the SCR, making it stop conducting, and turning off the alarm. It's a quick and dirty way to shut it off, but works well.

The components used are strictly junk box parts. The relay should be able to switch ten amperes and should pull in reliably at ten volts dc. The unijunction transistors are Motorola HEP 310's, commonly available at electronic parts stores. The transistors can be almost any small signal types, observing of course the difference between NPN and PNP types. I used one ampere rectifiers for CR1 and CR2. The SCR is a 2N878. It can be

# SBE

# SB-50

50.050-50.280 MHz

## six shooter

SBE scores again, encourages occupancy of the higher frequency amateur bands with moderately priced, full-feature equipment.

Now—hit those challenging 6 meter targets—be there—be ready instantly for those thrilling DX breakthroughs and skip happenings. In the interim, join a select group who have discovered that mobile SSB on the low end of 6 approaches the ideal for solid, uncluttered local contacts. Here now—from SBE, SB-50, a very tidy package that provides all the ammo you need for 6 meter bullseyes! **Synthesized frequency selection** is an example in point: No crystals to buy, no concern about VFO stability. The band between 50.050 and 50.280 MHz is divided into 23 channels, spaced at 10kHz intervals. A clarifier control allows the master crystal frequency to be moved anywhere between two 10kHz points. SBE, SB-50, is a transceiver but switching to RIT enables a drifting signal to be zeroed without affecting transmitter frequency. A fine receiver with high sensitivity insures that the weak ones will be heard during band openings. Exclusive SBE "Super Shape" BP filters provide excellent SSB/AM response, both transmit and receive. A lighted panel meter monitors what's coming in—and going out. Squelch, noise limiter contribute to performance. Power input is 20 watts p.e.p. on SSB, 8 watts on AM. Equipment is all solid state, easy on car battery. Dynamic microphone is provided.

SEE IT AT YOUR SBE DEALER



SSB and AM... push button selection.

SYNTHESIZED!  
No crystals to buy.

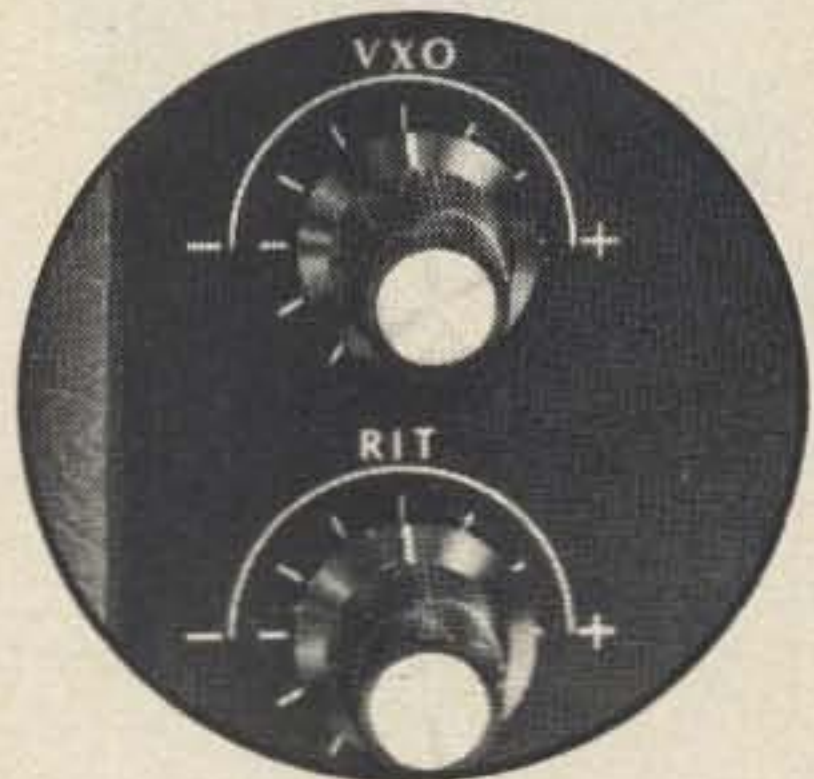

Tunable  $\pm 6$ kHz, any 10kHz point.

Receiver frequency separately adjustable with RIT

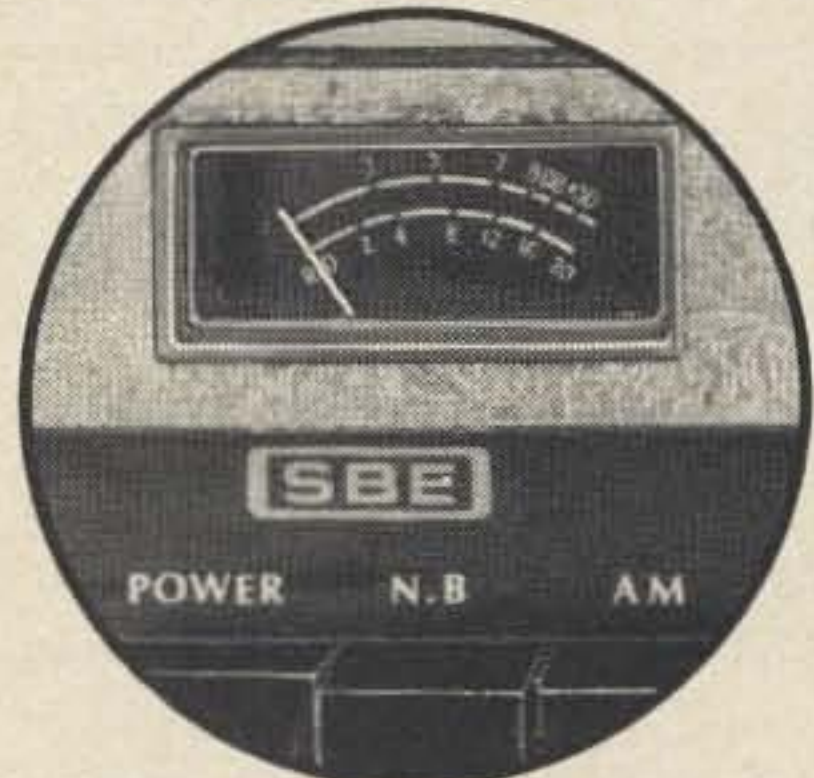

Lighted meter shows "S" units receive—power output SSB/AM



SBE exclusive "Super Shape" Bandpass SSB filter

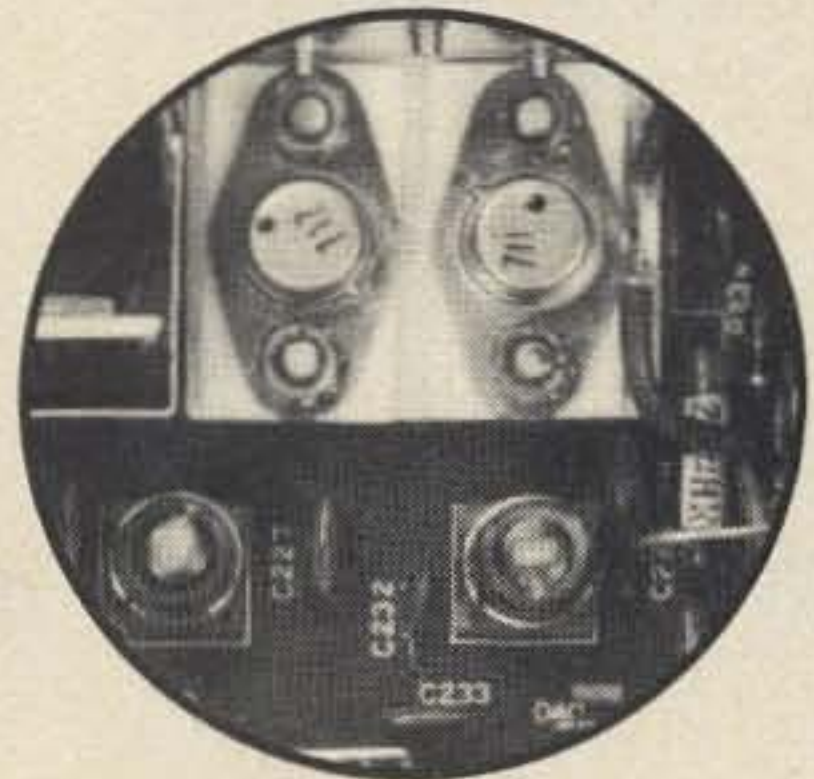

All solid state. Low drain on 12V car battery.

**SBE**

LINEAR SYSTEMS, INC.  
220 Airport Blvd.  
Watsonville, CA 95076.

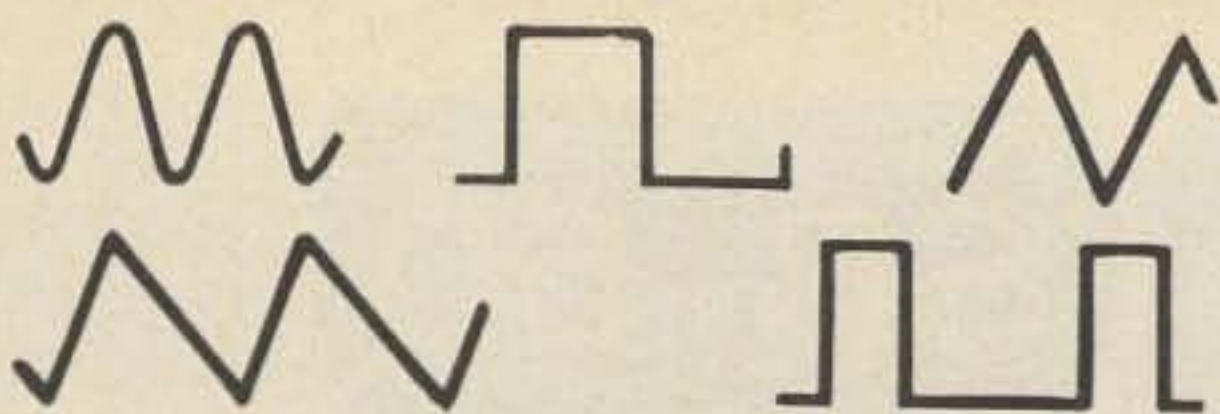

**0.1 Hz. to 100 KHz.**



**For only \$39.95**

Our new FG-2 Function Generator Kit gives you all five of the most useful waveforms for design and testing at one fourth the cost of previous similar instruments. Thanks to improved IC's the FG-2 now features amplitude stability of  $\pm 1$  dp over any range, Sine wave distortion of less than 1% from 20 Hz. to 20,000 Hz, and an output of 4.0 Volts peak-to-peak with adjustable offset. The offset selector lets you put the positive peak, negative peak, or the center of the waveform on DC ground. The DC coupled circuit keeps the waveforms in exactly the same position no matter what the level control setting.

Gray impact plastic case  $5\frac{1}{4} \times 6\frac{3}{4} \times 2\frac{1}{2}$ . 115 Volts 60 cycle power supply included.

FG-2 Function Generator Kit  
shipping weight 3.0 lbs. \$39.95 + postage

*BankAmericard and Master Charge  
Welcome*

Get our

## **NEW 1973 CATALOG**

listing this and other unique kits

**“ F R E E ”**

by simply checking our box  
on the reader service card

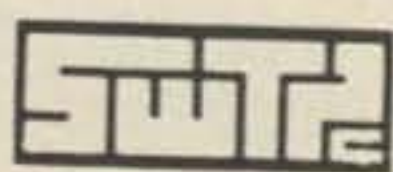

**SOUTHWEST TECHNICAL  
PRODUCTS CORPORATION**

Dept. 73

219 W. Rhapsody, San Antonio, Texas 78216

purchased from a local Allied-Radio Shack store in one of their plastic blister packs.

Installation of the device is not very difficult. Switch S1 should be a key operated type, easily obtained from most electronics mail order houses. The relay is best connected in parallel with the horn button of the car. The alarm unit itself should not be mounted in the engine compartment, as there is arcing across the relay contacts. Any gas fumes present when this happens, and it's all over. Besides, a box would have to be weather proofed in order to protect the relay contacts and other components.

Power for the device can be obtained from an unswitched accessory fuse terminal. The main power cable from the battery should be run through some BX cable, as well as the wire going to the horn, in order to discourage a thief from cutting the wires. By obtaining a couple door switches from a junk yard, one can make a bracket and mount them in the hood and trunk. They should be connected in parallel with the other door switches.

I found that one of the most useful aspects of this project was that it was a painless way to learn about the various operations of a unijunction transistor. It certainly is a good "first project" for someone who doesn't have much experience with solid state construction.

Various additions could be made to the basic unit. A time delay unit could be built that would allow the ignition switch of the car to be used for the alarm actuating switch. When the ignition is turned off, one would have fifteen seconds or so to leave the vehicle before the alarm would arm itself. Upon entering the car, the alarm wouldn't sound for another fifteen seconds, allowing ample time to put the key in the ignition. On the newer cars, some type of circuit could be designed that utilizes the 'key-still-in-ignition' idiot buzzer switch.

I will be happy to answer any questions, as long as a SASE is enclosed. Remember, one of the best ways to insure the safety of that mobile rig is to not tempt the potential thief. Keep your doors locked, and if possible, remove the rig from the car when not in use.

...WAIKON



## UNDERCOVER AGENT 00...



### MAKE YOUR QSLs PAY OFF!

*As Undercover Agent 0073 you can get up to \$100 for a \$1 investment.*

How would you like to make your QSLs start paying you? You can do this by signing up as an undercover agent for 73 Magazine — this is the key to being able to make a substantial side income. That's right, you can let your hobby help to pay for itself!

When you send out your QSL cards, all you have to do is include a special 73 subscription application with your card for the other operator to send direct to us. Your name as Undercover Agent 0073 will be on that card and you will receive one dollar for each one year subscription sent in.

You can sign up as an Undercover Agent 0073 and get 100 of these subscription applications — for only \$1 (to cover the cost of handling).

Most of the operators you contact would enjoy reading 73, if they knew about it. Your QSLs will help spread the word — and bring you a commission to boot.

### Bonus \$100

As a further bonus — the first 73 undercover agent who gets \$100 in commissions will receive an extra \$100.

***SIGN UP RIGHT NOW AND START THE MONEY ROLLING IN!***

MAY 1973

### UNDERCOVER AGENT 0073 APPLICATION

*Ok — Send my cards and sign me up for this good deal.  
My \$1 is enclosed to cover the cost of handling.*

Name \_\_\_\_\_ Call \_\_\_\_\_

Address \_\_\_\_\_ City \_\_\_\_\_ State \_\_\_\_\_ Zip \_\_\_\_\_

73 MAGAZINE PETERBOROUGH NH 03458 USA

# 73 BOOKS

**Slow Scan Television Handbook**, by Don C. Miller, W9NTP and Ralph Taggart WB8DQT.

This excellent book tells all about it, from its history and basics to the present state-of-the-art techniques. Contains chapters on circuits, monitors, cameras, color SSTV, test equipment, and much more. 272 pages, softbound \$5, hardbound \$7.



**Digital Control of Repeaters**, by Tom Yocom, WA0ZHT.

Here's a book for the FM'er who wants to design and build a digital repeater control system. Contains sections on repeaters, basic logic functions, logic circuit design, control systems, support circuits, mobile installations, touch-tone, plus special section on a "mini" repeater control system. 224 pages, softbound \$5; hardbound \$7.

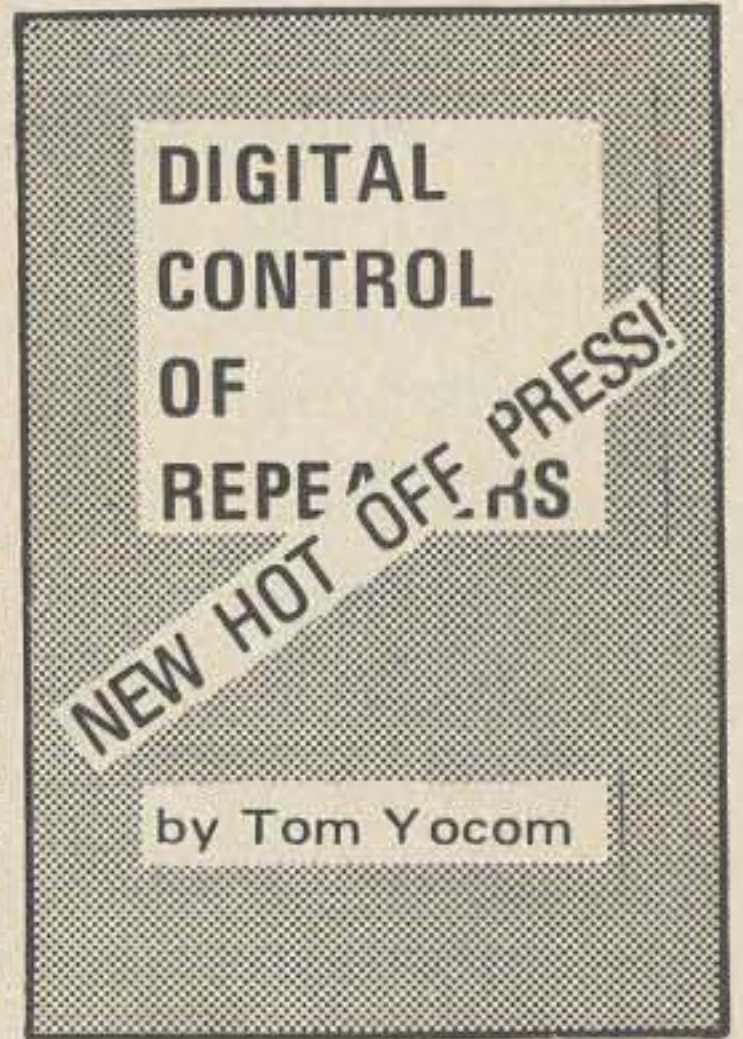

**FM Repeater Circuits Manual**, by Ken Sessions

Contains almost every conceivable circuit that might be needed for use with a repeater. All circuits explained in detail and easily understood. All aspects covered, from the operator to the antenna. Also contains chapters on setting up a mobile station and many other articles for the use of the VHF and UHF enthusiasts. 305 pages, softbound, \$5. Hardbound, \$7.

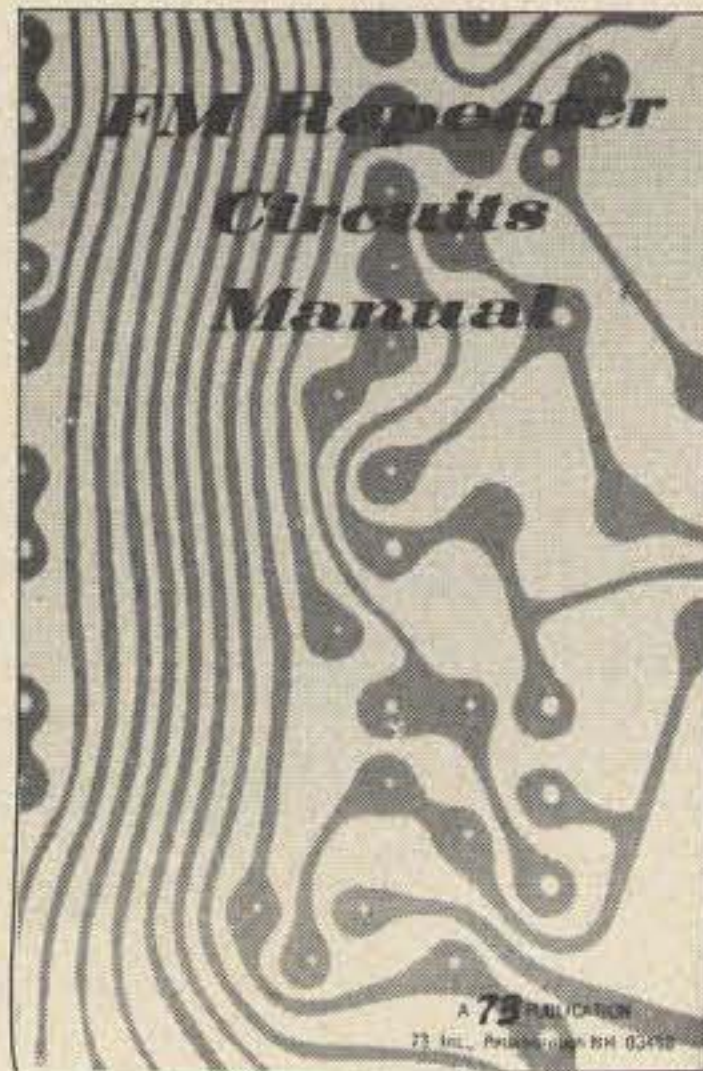

**RTTY Handbook**, Wayne Green, Editor.

A comprehensive book covering all areas of radio teletype, from getting started with the basic principles, what equipment to procure and how to make it work. The only up-to-date book available on the subject. Well written, easy to read and understand. 320 pages, softbound. \$6.

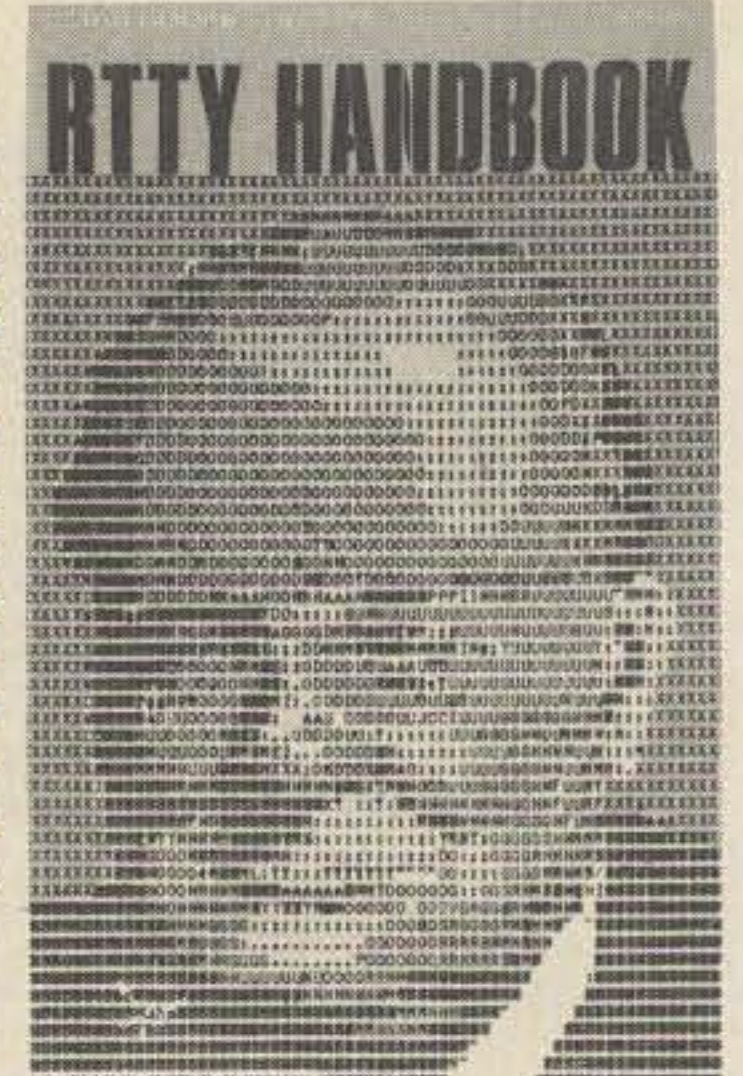

**Solid State Projects** Wayne Green, Editor.

Here are more than 60 projects of interest to anyone in electronics. The devices range from a simple transistor tester to an electronic counter — and from a capacity meter to a ham TV receiver. The idea of this collection is not only to provide you with interesting and practical projects to build, but also to help you become more intimately acquainted with such modern components as ICs, varactors and zeners. 224 pages, softbound. \$4.

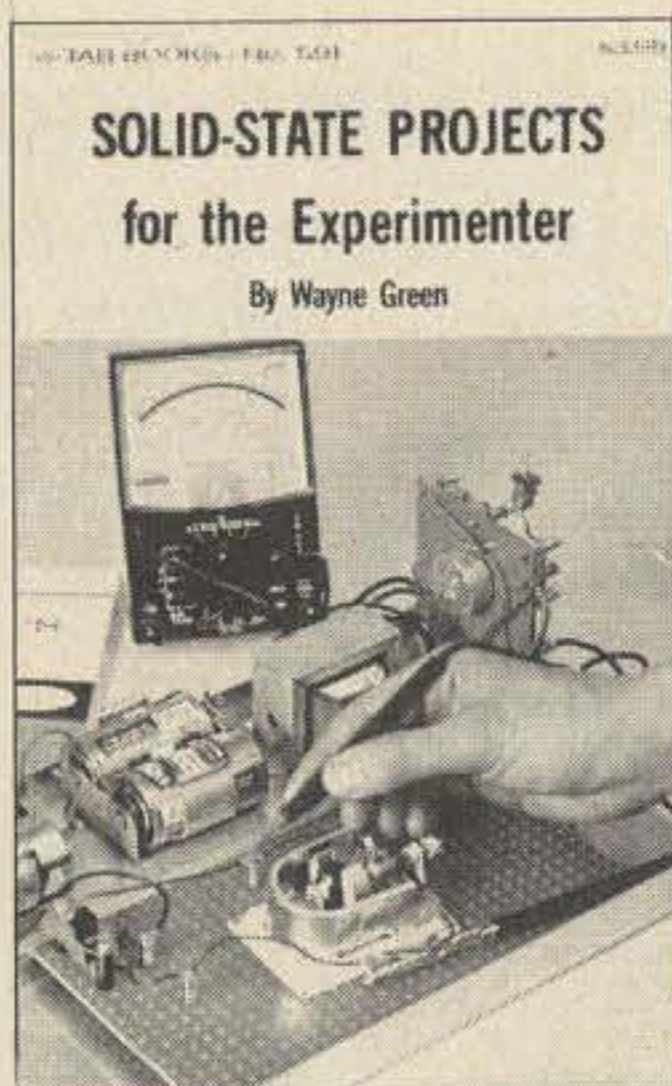

**IC Projects**, Wayne Green, Editor.

The transistor replaced the tubes in the 1960's, and soldering guns replaced the 100 watt soldering irons — but today in the 1970's, integrated circuits and soldering pencils are replacing transistors. This book tells how to understand and use ICs, with numerous construction projects. For the ultra-modern home brewer. 189 pages, softbound. \$4.

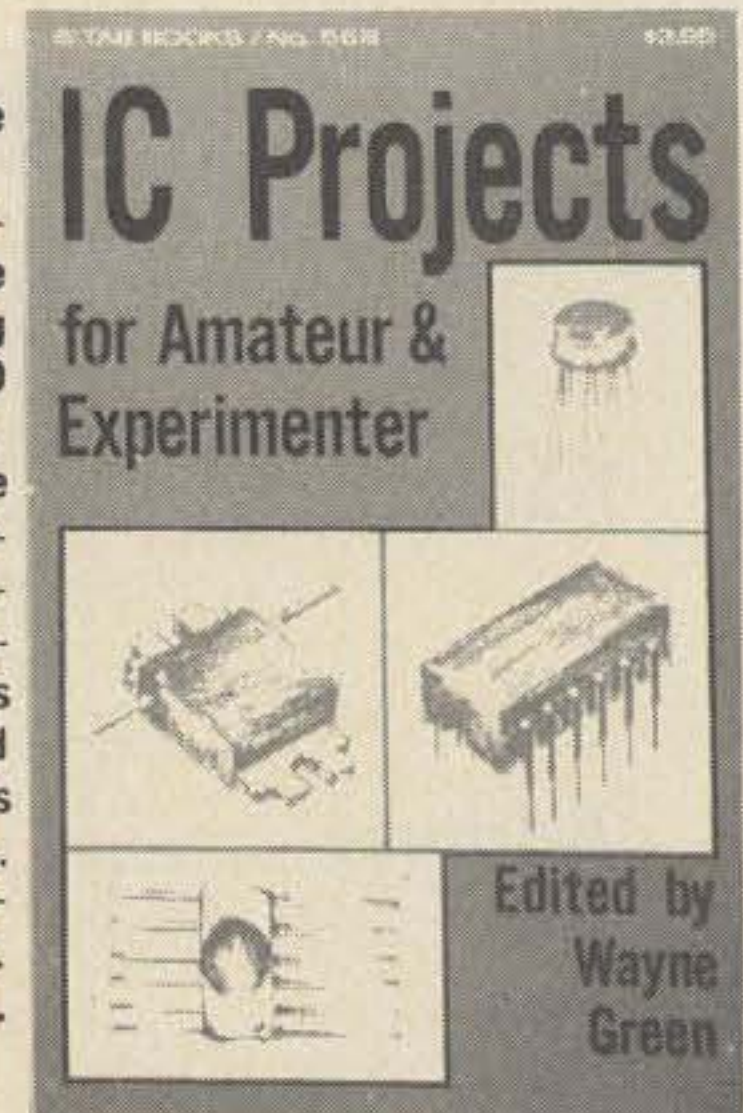



# Extra Class



# Study Guide Special

As you probably know, it is virtually impossible to do well in any contest unless you have an Extra Class license. Also with the DX stations mostly in the Extra Class bands, you don't have much chance of working the hard ones unless you have your Extra.

Before the 73 Extra Class Study Guide this was a problem. There just wasn't any book that adequately prepared you for this difficult exam. Since studying the 73 book makes passing the technical part a snap, there is absolutely no reason whatsoever for you to be a second class citizen on the ham bands. Why not go **FIRST CLASS** and enjoy all the privileges?

In addition to your regular license and upon application to the FCC (with no charge), all Extra Class ops are entitled to a large Extra Class certificate, suitable for framing. Why not display one of these in your shack?

We have sold all our softbound (\$5) copies of this excellent book and have a limited number of hardbound copies left. The hardbound regularly sells for \$7, but for a limited time we are reducing this book to \$5. Why not order today and start enjoying more of amateur radio?

*de* W1GRO

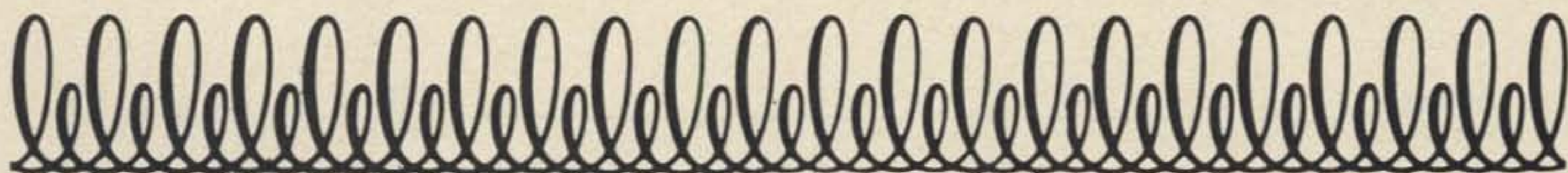

---

## BOOKS ORDER FORM

May 73

Name \_\_\_\_\_

\$ \_\_\_\_\_ enclosed

Call \_\_\_\_\_

Books wanted:

Address \_\_\_\_\_

City \_\_\_\_\_

State \_\_\_\_\_ Zip \_\_\_\_\_

*73 Magazine, Peterborough NH 03458 USA*

**73**

**LOWERS**

**37¢**

**SUBSCRIPTION**



Would you believe that there are some of us who remember when 73 Magazine was only 37¢ a copy? (How time does fly!)

At the present time our subscriptions are increasing over 1,000 per month and we're beginning to realize that 1973 is our year (obviously).

In order to further accelerate this trend, we're rolling back the calendar... yes, back to 1960... and 37¢ a copy. We realize that we cannot get rich this way, but who cares when you can make so many subscribers happy!

Now... for a limited time only... (until we regain our senses)... you can subscribe to 73 for only 37¢ a copy on a 3-year subscription. That's only \$13.32 for 3 years.

Subscribe NOW and have it end in '76. That's the spirit!

Subscription Order Form  
73 Magazine  
Peterborough NH 03458 USA

MAY 1973

3 yrs, \$13.32

1 yr, \$7

Name \_\_\_\_\_ Call \_\_\_\_\_

Address \_\_\_\_\_

City \_\_\_\_\_ State \_\_\_\_\_ Zip \_\_\_\_\_

**AMATEUR RADIO**  
is more fun with  
**73 — SUBSCRIBE NOW**

# CIRCUITS, CIRCUITS, CIRCUITS...

The following circuits have appeared in the referenced books, magazines, application notes, etc. While we try to reproduce all of the information that should be needed by an experienced constructor, readers may want to avail themselves of the original sources for peace of mind.

Readers are requested to pass along any interesting circuits that they discover in sources other than U.S. ham magazines. Circuits should be oriented toward amateur radio and experimentation rather than industrial or computer technology. Submit circuit with all parts values on it, a very brief explanation of the circuit and any additional parts information required, give the source and a note of permission to reprint from the copyright holder, if any, and the reward for a published circuit will be a choice of a 73 book. Send your circuits to 73 Circuits Page, 73 Magazine, Peterborough NH 03458.

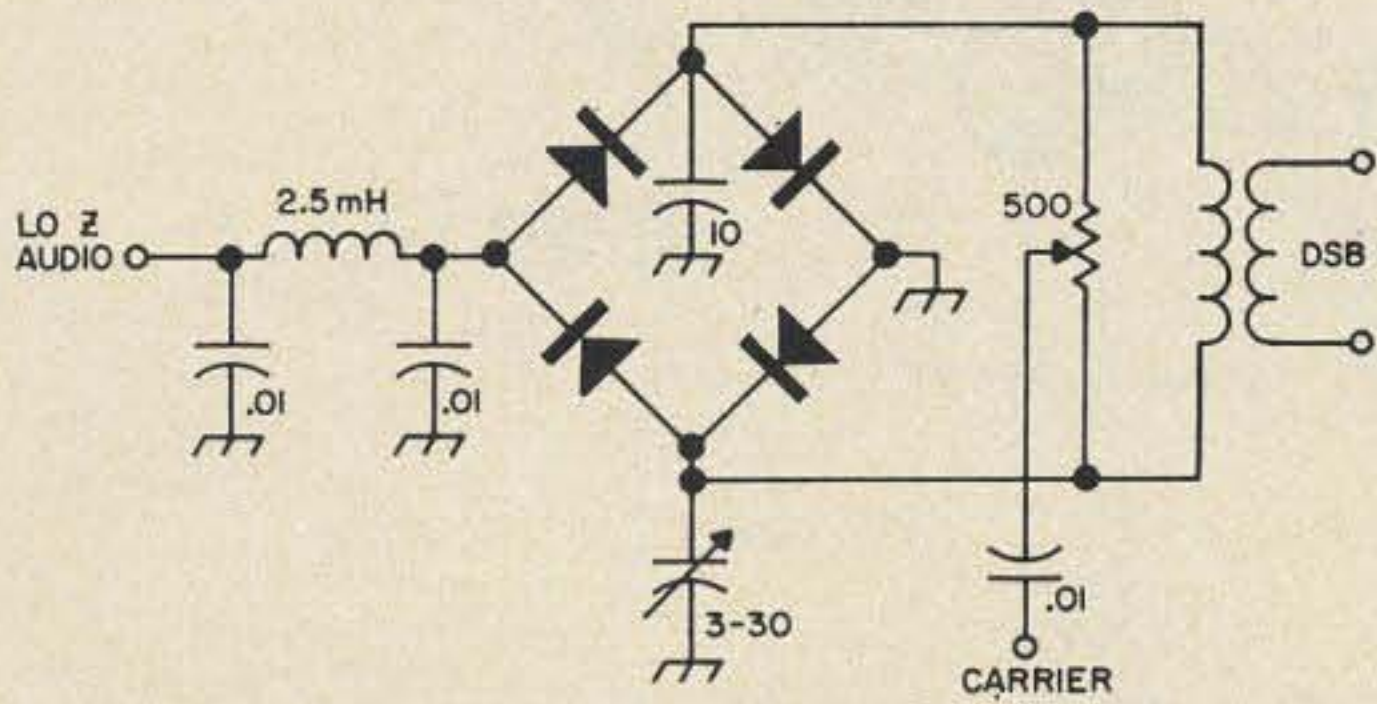

A bridge balanced modulator for generating a double sideband-suppressed carrier signal. Match the diodes as carefully as possible — any surplus diodes will work — and use symmetrical layout when assembling. The primary of the coil should be a few turns around the secondary, which is resonant at the carrier frequency.

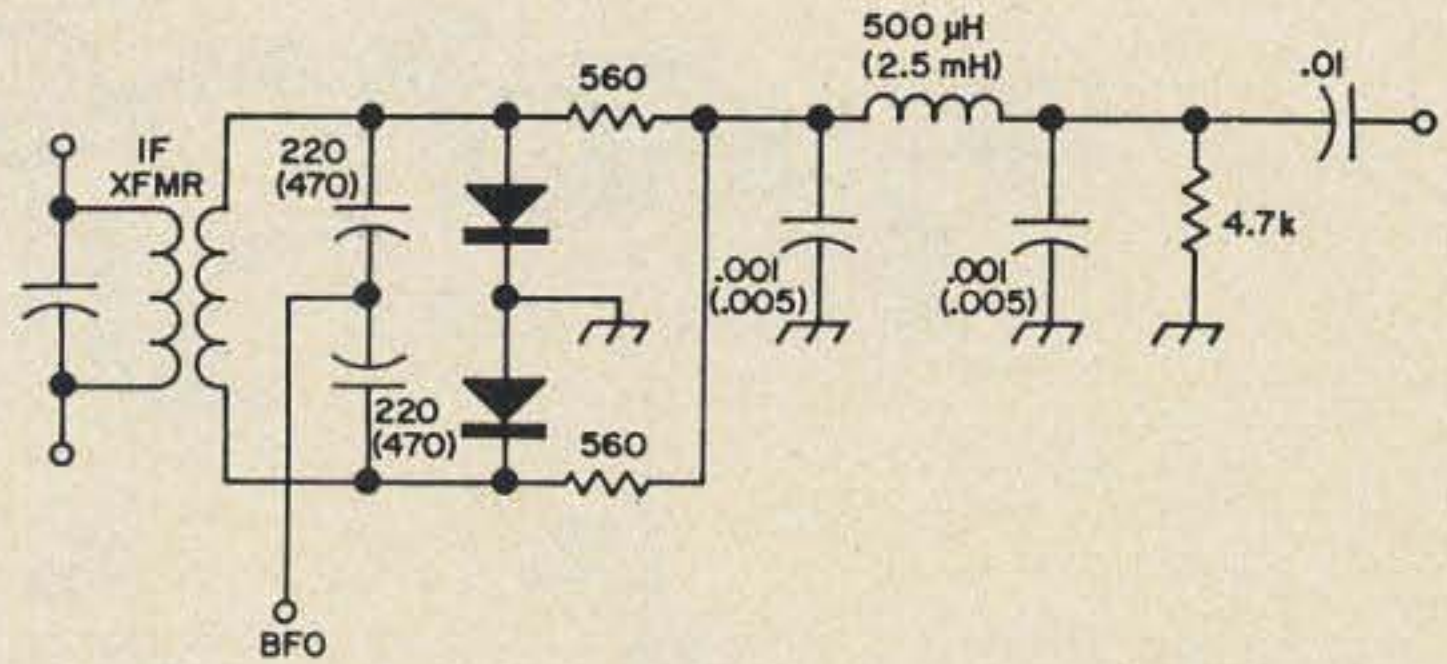

A product detector for 9 MHz SSB. The values in parentheses are for 455 kHz.

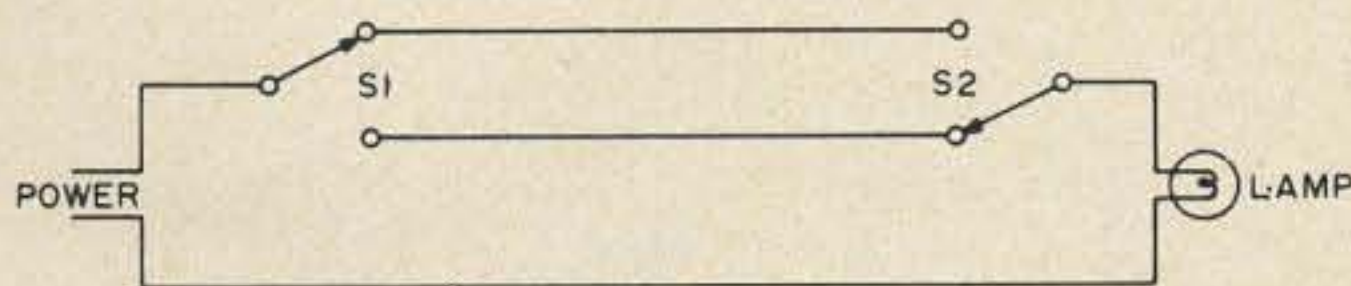

This simple circuit, known to electricians as a three-way switch, for controlling a light from two separate locations, is also a rather exotic digital logic circuit. No gate used in digital logic is any more complex than this circuit, though it may have more control points.

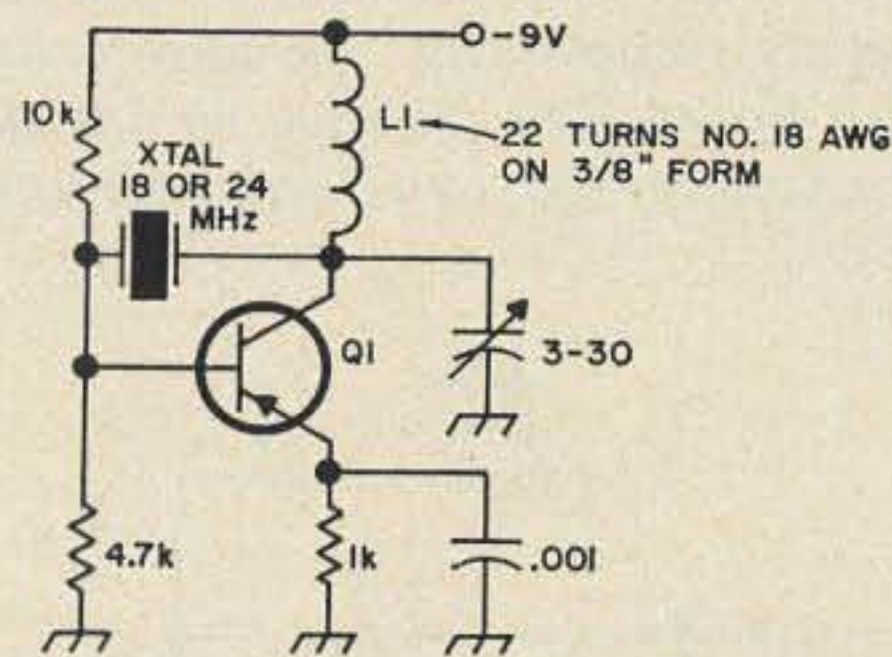

This two meter band edge marker provides useful harmonics up to several hundred MHz with 18 or 24 MHz crystals. Though originally designed for a PNP transistor, a NPN type such as the 2N706 or HEP55 may be substituted if you reverse the supply voltage connections.

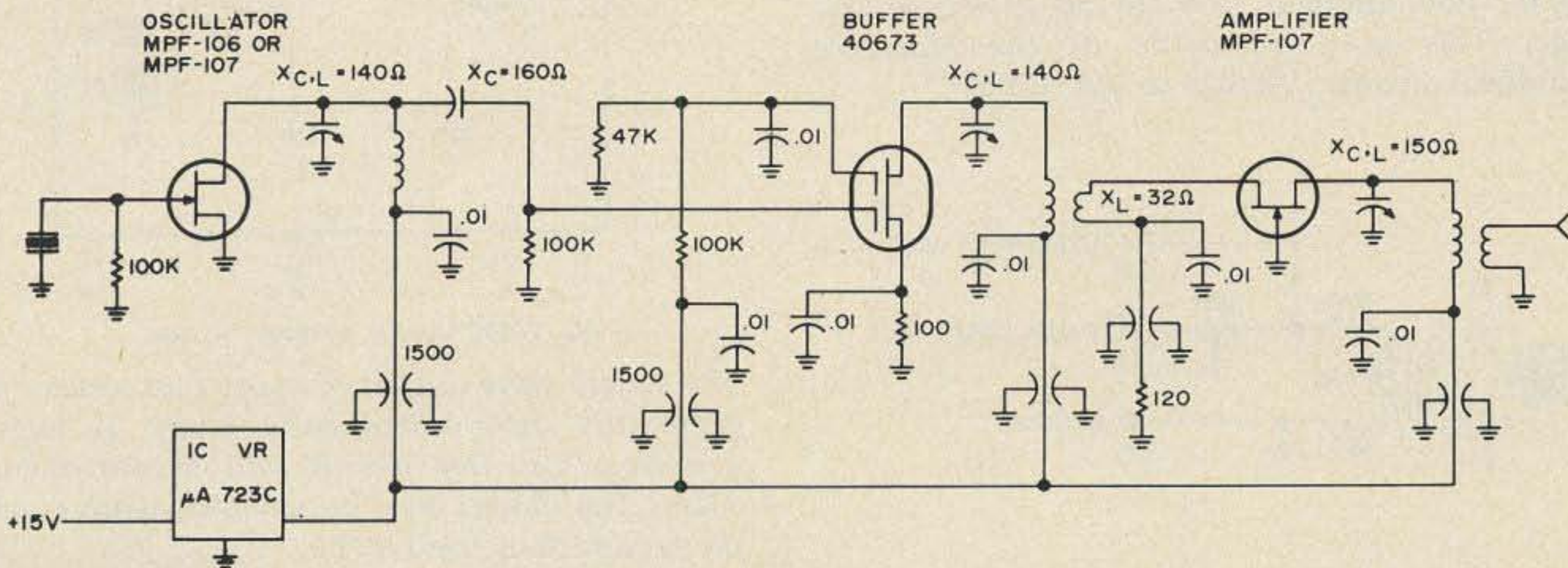

Ultra high stability crystal oscillator circuit that is useful for microwave transmitter frequency control. Use crystals from 1.6 to 160 MHz, fundamental or overtone. For best results get the values of the coils and capacitors for any specific frequency from your friendly neighborhood reactance chart. Thanks to WA2NKL.

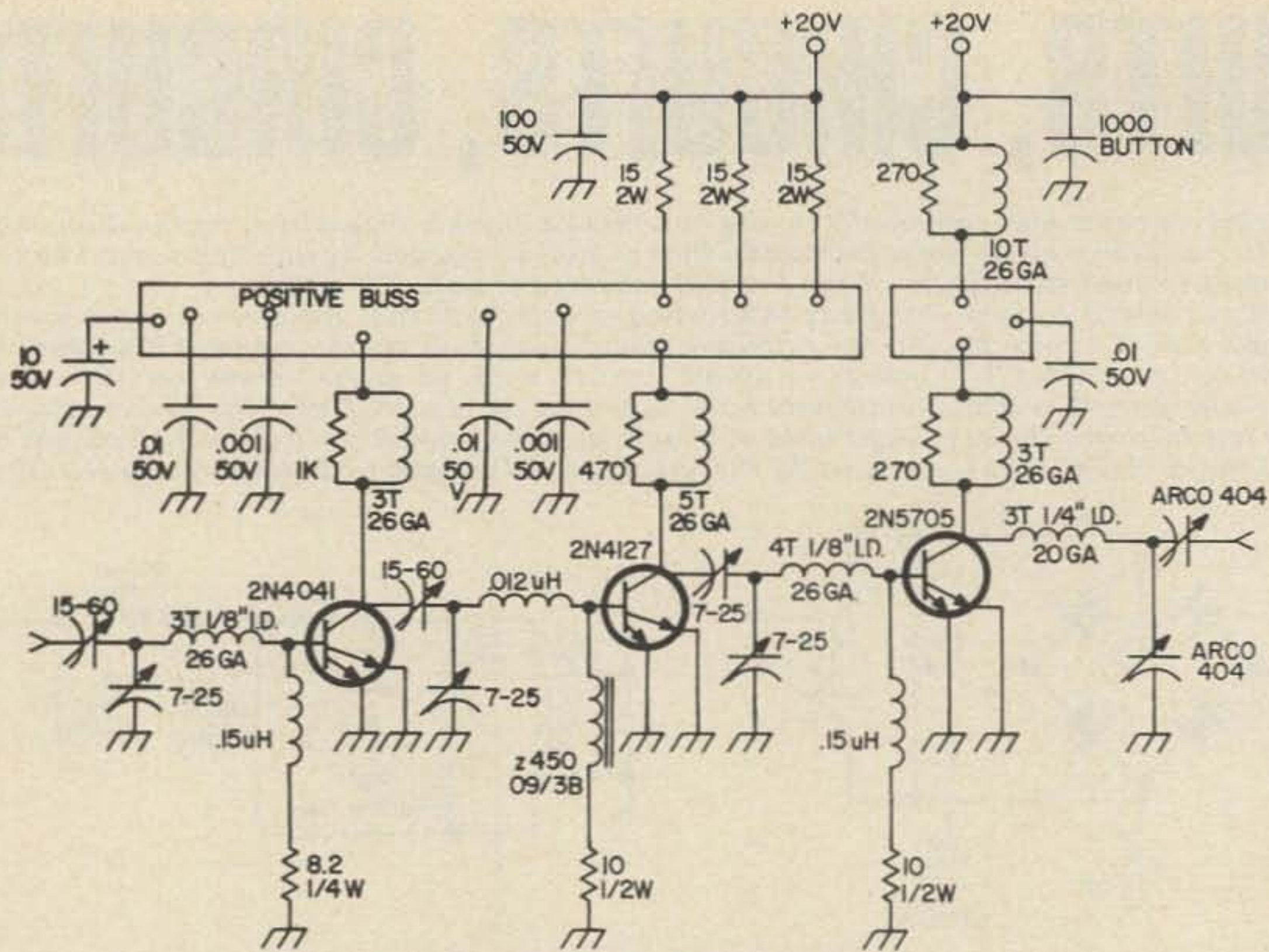

ALL CAPS IN MFD UNLESS OTHERWISE NOTED

2 meter amplifier that has 20 dB gain. 100 or 200 mW input will be amplified to 10 and 20 watts respectively. Be sure to keep leads short and make all grounds directly to the circuit board. The positive buss is separated so the final can be AM modulated. For FM, just connect the two terminals together. Don't forget to use heat sinks! Thanks to K6TOV.

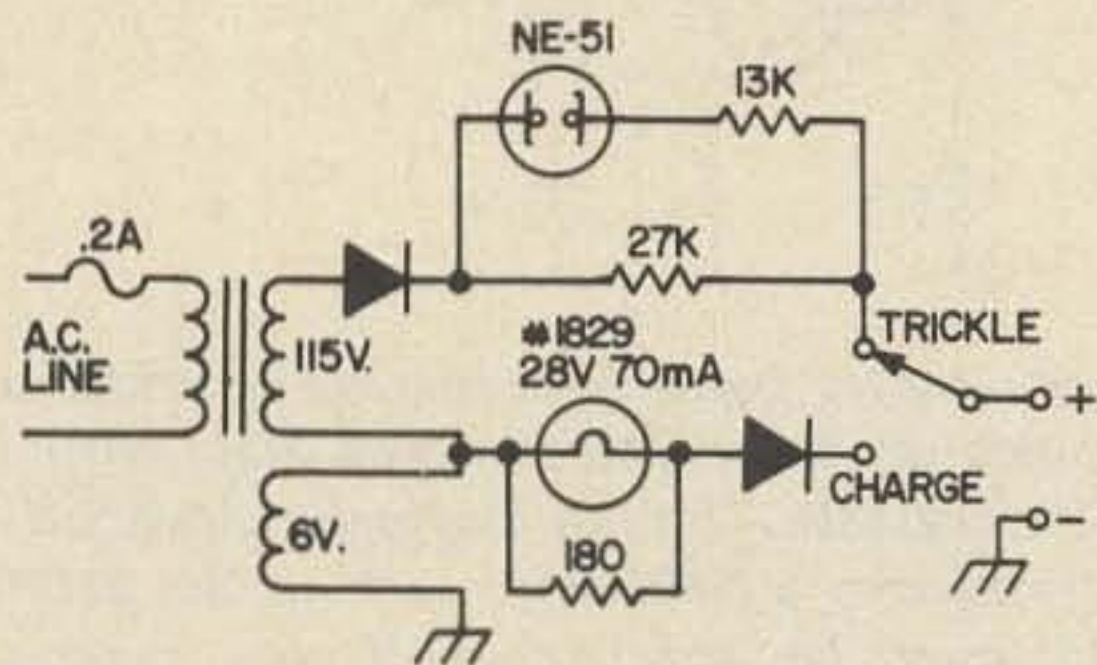

Nicad charger suitable for the HT220 or other hand held rigs. The dual indicator lights automatically let you know if you are on trickle or full charge. This is a schematic of the Motorola NLN6804A charger. Thanks to WA7CYY.

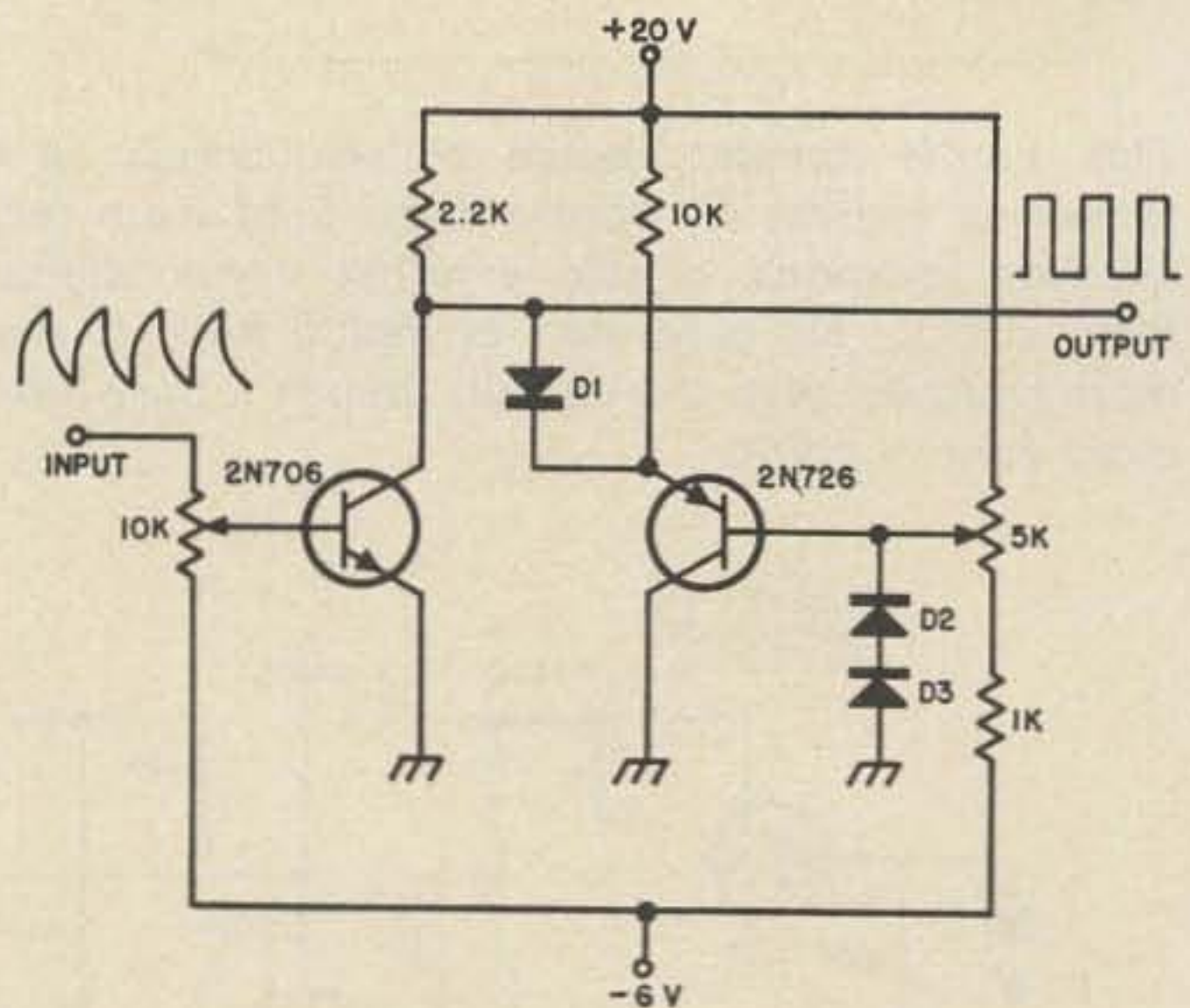

ALL DIODES GENERAL PURPOSE SILICON

The square wave output of many inexpensive signal generators deteriorates quite badly at high frequencies, but this circuit will square them off again. The diodes may be any inexpensive computer type such as the 1N914.

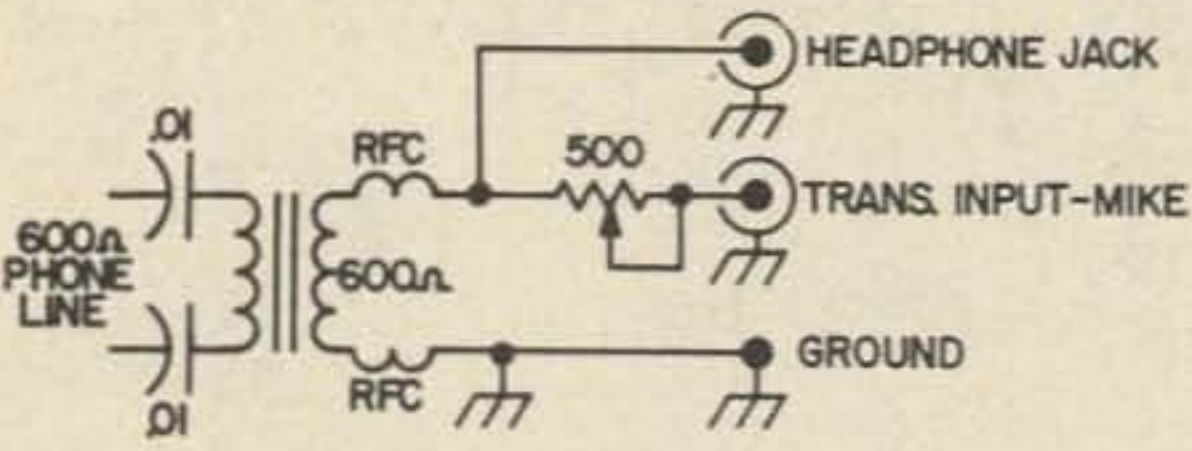

Simple phone patch for experimentation purposes. Adjust the mike gain on the transmitter as you would normally and set the 500Ω potentiometer for proper modulation by the telephone audio. Thanks to WA7CYY.

(Continued on page 143)

# Caveat Emptor?

Price — \$2 per 25 words for non-commercial ads; \$10 per 25 words for business ventures. No display ads or agency discount. Include your check with order.

Deadline for ads is the 1st of the month two months prior to publication. For example: January 1st is the deadline for the March issue which will be mailed on the 10th of February.

Type copy. Phrase and punctuate exactly as you wish it to appear. No all-capital ads.

We will be the judge of suitability of ads. Our responsibility for errors extends only to printing a correct ad in a later issue.

For \$1 extra we can maintain a reply box for you.

We cannot check into each advertiser, so Caveat Emptor . . .

**HELP WANTED** — Assistant Circulation Manager for 73 Magazine, male or female. Must be fluent in English, have proficiency in reading/writing Spanish, and have typing ability. Prefer ham or previous ham, domestic or foreign. Send resume c/o Circulation Manager, 73 Magazine, Peterborough NH 03458.

**COMPLETE** 36 page QSL catalog, 3rd edition. New "SPARKLING" QSLs. Hundreds of cuts, ten report forms, thirteen colored stocks, 25¢. Ten sample QSL cards. Corneilson's Quality QSLs, 321 Warren St., N. Babylon, N.Y. 11704.

**STANDARD 826M** 8 channels with battery pack & antenna, excellent condition. \$250. Gary Goldberg WA2FAS, 24 Gardenia Drive, Maple Shade NJ 08052.

**WARREN HAMFEST**, Largest family style Hamfest in East. Sunday, August 19th, @ Famous Yankee Lake Park. Giant Fleamarket, Swimming, Picnicking — All Free. Details QSL W8VTD.

**VOICE MULTIPLEX** 50 Channels Solid State SSB RFL2710R, 2710WRR 5 years old mint, 50% off new price. 610 South Arroyo Parkway, Pasadena, California 91105. 213-648-2000.

**YOUR CALL LETTERS**. Two sets, for windshield and rear glass. Smart white letters with red outline. Easily installed pressure sensitive decals. \$1.00, postage paid, anywhere. Satisfaction guaranteed. Lake Jordan Artists, Slapout AL 36092.

**SELL:** E.E. and other technical books. SASE for list. Roger A. Baim, WB9BDP, 2753 W. Coyle, Chicago, Ill. 60645.

## EQUIPMENT FROM 73

The following list of gear, unless otherwise noted, consists of brand new equipment purchased for testing purposes only. Some have been tested, some remain unopened in original cartons. We are offering this gear at a considerable discount on a first-come-first-served basis.

Hallicrafters FPM 300	
SSB xcvr	\$480
Heath IB 101 and Vanguard Scaler	\$250
Miida Digipet 60 counter with Digipet 160 converter	\$400
Tempo CL 220 220 xcvr	\$265
HR2MS 8 ch scanning 2m xcvr 15W	\$255
TME-H-LMU 16 ch scanning rcvr 6/2 <sup>3</sup> / <sub>4</sub> m	\$255
Digital Logiclocks	\$80

**FOR SALE TO THE HIGHEST BIDDER** — Collins KWM2-A, AC power supply, station control, 30-L1 Linear Amplifier, mobile mike — offered as one unit... Complete Collins S Line: 31S3, 75S3, AC power supply, station control, recently calibrated by Collins. Excellent condition. Send offers to: WA2KNC Jack Aviv, 106 Glenn Avenue, Lakewood, NJ 08701.

**SSTV FOCUS/DEFLECTION COIL KIT** for K7YZZ 1<sup>1</sup>/<sub>4</sub>" Plumbicon type camera circuit (re., 73 Magazine, Sept. 72) complete with reprint article, \$19.95 postpaid in U.S. and Canada. Also fast scan 1<sup>1</sup>/<sub>4</sub>" coil kits as well as many other SSTV kits, parts and plans. See regular ad elsewhere in magazine. Write or phone for free catalog. ATV RESEARCH, 1301 N. Broadway, Dept. 73C, Dakota City, Nebr. 68731.

**"Don and Bob" guaranteed buys.** Triex W-51 386.00; MW50 250.75; MW65 331.50; Ham-M 99.00; TR44 59.95; AR22R 31.95; Belden 8214 RG8 foam coax 17¢/ft; 8448 rotor cable 10¢/ft; HyGain TH6DXX 139.00; 204BA 129.00; TH3MK3 114.00; 400 rotor 179.95; Mosley CL36 149.00; CL33 124.00; TA33 114.00; MCQ3B 91.00; S402 143.00; 3/16" cable clamp 18¢; Mallory 2.5A/1000PIV epoxy diode 29¢; Polygon fiberglass spreader 7.50; KY65 code ID 5.95; write quote Midland, Regency; Clegg FM27B; Hallicrafters FPM300A; Drake, SBE, Standard, Eimac, Collins, CDE Replacement parts. Shipping charges collect; warranty guaranteed. Mastercharge, BAC. Madison Electronics, 1508 McKinney, Houston, Texas 77002. (713) 224-2668.

**TECH MANUALS** for Govt surplus gear only \$6.50 each: R-389/URR, R-390/URR, TS-497B/URR, CV-591A/URR, URM-25D, TT-63A/FGC, TS-382D/U, URM-32, W3IHD, 7218 Roanne Drive, Washington, DC 20021.

**FREE KIT CATALOG:** Tone encoders, Decoders, Scramblers, Alarms, Sounders, Automatic Telephone Recorder Phone Patch, IC Kits and more. KRYSTAL KITS, 2202 S.E. 14th, Bentonville, Arkansas 72712.

**HR-2**, twelve channels, fully crystallized, pre-amp, A/C supply, nicad field pack, charger, antenna, \$280. 10w/50w Dycomm, \$70. Bruce Berg, 13 Lisa La., Cherry Hill, N.J. 08003.

**SALE** Drake TR-4, RV-4, AC-4 mint condition \$500. WA3QNS J. Reed, 1031 W. Lafayette St., Norristown, Pa. 19401, 215-279-1517.

**GREAT CIRCLE BEARING CHARTS.** Computer generated for your exact QTH. Each chart gives bearings, distances, and return bearings for 660 locations throughout the world, and consists of six handy-sized 8<sup>1</sup>/<sub>2</sub> x 11 inch pages. Price \$1.00 postpaid worldwide. This non-profit project described in detail in Ham Radio Magazine (New Products) March 1973, and Radio Communication (article) November 1972. Send name and address; name of town for which you want the chart (if rural area, or under 10,000 population, include latitude and longitude or carefully describe location); \$1.00. To: Great Circle, 1808 Pomona Drive, Las Cruces, New Mexico 88001.

**CANADIANS** — FREE 120 page Electronics Catalog. ETCO-B, 474 McGill, Montreal.

**DELMARVA HAMFEST** — August 19, 1973. Harrington Fairgrounds. Registration fee \$2 advance, \$3 at the gate. For information, write Delmarva Hamfest, Inc., Route 2, Box 90, Laurel, Del. 19956.

**HOOSIER ELECTRONICS** — Your ham headquarters in the heart of the Midwest where only the finest amateur equipment is sold. Individual, personal service by experienced and active hams. Factory-authorized dealers for Drake, Regency, Standard, Ten-Tec, Galaxy, Hy-Gain, CushCraft, Mosley, Ham-M, Hustler, electronic pocket calculators, plus many more. Orders for in-stock merchandise shipped the same day. Write or call today for our quote and try our personal, friendly Hoosier service. Hoosier Electronics, R.R. 25, Box 403, Terre Haute, Indiana 47802. (812)-894-2397.

**WANTED:** Touch-tone receiver SD94148. Sell: Gonset Aircraft Tuner (108-128 M.C.) w/squelch; Topaz 250 watt mobile power supply. #2E; 1301 W. Estes; Chicago, Ill. 60626.

**HT-220** two watt two channel with case — best offer over \$75. Box 12, 73 Magazine, Peterborough NH 03458.

Continued on page 122 . . . . .

**MIDLAND**  
ELECTRONICS COMPANY

**COMING  
ON  
STRONG!**



**15 WATTS**  
RF OUTPUT POWER

***New 2-Meter,  
12-Channel VHF/FM Mobile Transceiver***

Midland, for years one of the top names in communications equipment, proudly introduces this sensational new 15-watt Amateur mobile. More power than most sets, it drives linear amplifiers to full output. And there's a low-power position switch for short-range 1-watt output. Instantaneous final protection circuit prevents damage from excessive VSWR. Receiver has multiple F.E.T. front end with high "Q" resonator filter, ceramic filters in I.F. — superb selectivity, sensitivity, and bandpass characteristics. King-size illuminated S/RF meter, channel selector. Variable squelch, volume controls. ADL circuit maintains deviation level without distortion. Crystals supplied for .16-.76, .34-.94, and .94 simplex. Each receive-and-transmit crystal has individual frequency trimmers. Equipped with connector for attaching tone burst and discriminator meter accessories. Includes dynamic mike and mounting hardware. Suggested price for Model 13-500 is only \$249.95.

For information on Midland Amateur radio, write for our full-line brochure: P.O. Box 19032, Kansas City, Missouri 64141

**MIDLAND**  
ELECTRONICS COMPANY®  
"Coming on Strong in Amateur Radio"

ou goons don't ever proofr  
 leasy men...  
 bunch of rocks...  
 you ignored my comments in  
 I inslist that you print ev

UFO's

Wayne, are you still interested in UFO's? I've come across a strange reference in a 17th century book. Robert Burton's, *The Anatomy of Melancholy*, 6th edition, 1651, in a discussion of Kepler's theory of the Solar System (Part. 2, Sect. 2, Memb. 3), asks "... and it may be those two green children which Nubrigensis speaks of in his time that fell from Heaven, came from thence;..." Egad!

Dell and Jordan-Smith in their edition of Burton's "Anatomy," Tudor Pub. Co., N.Y., 1927, identify Guillelmus Nubrigensis as William of Newbury (or Newberry), 12th century English ecclesiastic and chronicler.

Perhaps one of your more scholarly readers could examine Newbury's works to find further information on a possible 12th century visitation.

Edward Knobloch WB2BDF  
 Jamaica NY

### FAST SCANNING

I got the Slow Scan Television Handbook yesterday and started work on a monitor last night. It makes SSTV so interesting, might even work for my amateur license (after 34 years!) to be able to use it.

Dirck Spicer  
 Wallingford CT

### 1 MHz

Many thanks to authors K4GGI et al, for their letter regarding 990 kHz spacing for repeaters on two meters. The calculated improvement of 8.7 dB in going from 600 kHz to 990 kHz is much more than I would have expected. After calculating their result, I'm afraid the authors missed the full significance of their findings.

Not all repeater operators can afford duplexers. A fact which was apparently overlooked by the authors. Further I must point out that the decibel scale is logarithmic. An 8.7 dB change, no matter where you started, is a 7.4 times change in power level, not 10% as cited. For example, it could be the difference between 10 watts output and 74 watts output, or the difference between an unreadable signal and a signal with considerable quieting. In actual practice, the repeater operator would trade off between receiver sensitivity and transmitter power to achieve best overall system balance.

The FCC regulations setting aside 146 to 148 MHz for a repeater sub-band create a powerful incentive to go to 1 MHz spacing. If we project the growth of repeaters a few years into the future, we must realize the need for more channels. Presumably there will be a saturation point but it does not appear to be close at hand. Considering both the technical advantages and the need for maximum spectrum utilization, 1 MHz spacing should be based on a projection of the ultimate limit on minimum adjacent channel separation and then start out at some multiple of that number. For example if we project 12.5 kHz as the minimum acceptable with foreseeable technical improvements, we should start with 50 kHz spacing, then split to 25 kHz, etc. (I have deliberately avoided the use of currently popular spacings in the preceding example.) Compatibility with RACES is a necessity.

How to get to 1 MHz spacing after just setting up on 600 kHz is a tougher question to answer because it

brings us out of the theoretical realm into the real world. As an immediate step I suggest all new repeaters go in 1 MHz spacing using the midband channels, i.e., 146.40 in, 147.40 out; 146.43 in, 147.43 out, etc. A gradual reshuffling of existing repeater frequencies could then follow. Granted, this is much easier to say than to do.

The problem of allocating channels for simplex operation is also involved. It seems clear as we project repeater growth into the future that the 146-147 MHz spectrum will eventually be saturated with repeaters. The frequencies below 146 MHz have been set aside exclusively (except for RACES) for simplex operation in Docket 18803. AMSAT is now using frequencies up to 146.07 MHz for satellites. Again this is an area where users other than repeaters must be considered when deciding on standards.

I suggest that the repeater associations, ARRL, AMSAT, and Civil Defense (RACES) all get together and create a compatible spectrum utilization plan for the foreseeable future. Too often in the past individual groups have gone in their own direction with resulting chaos and poor spectrum utilization.

George S. Gadbois W3FEY  
 Lancaster PA 17601

### ONE MORE TWO METER ...

In reference to my article, "Two More Two Meter Amplifiers," in the April issue, a slight change can be made to the input of the 6W amp that will improve the impedance match and make it a bit easier to drive. The following circuit uses only 3 additional parts and will fit easily onto the circuit board.

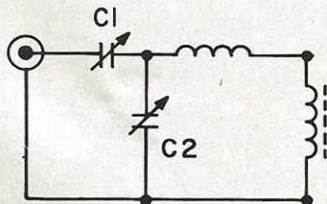

C1 is an ARCO 403 (4-40 pF), C2 is an ARCO 423 (7-100 pF) and the coil is similar to the output coil L1. I hope this will cure any problems that have arisen with the amplifier.

Herman Cone III WB4DBB  
 Chapel Hill NC

WAØYQO

FOR WHAT IT'S WORTH?

73 MAGAZINE: A TRULY DEMOCRATIC PUBLICATION, BY AMATEURS FOR AMATEURS.

KEITH STOWELL  
 OM. 2715 N. 44TH ST.  
 KANSAS CITY, KS  
 66104

Can you dig my QSL?  
 Keith WAØYQO

### MODIFIER

73 is a fine magazine. I enjoy every article. The TR-22 mod in K4EOE's article, Feb. 73, worked very nicely in my rig. I had one experience with it which could have been easily avoided with more care on my part. After peaking TC-27, be sure to check the output of the transmitter to insure that you've peaked TC-27 to the proper frequency. It is possible to peak on the wrong signal from Q27 and end up with birdies all over the upper 2 meter band and outside it! I did and discovered the problem when my rig wiped out the AFC's Command FM Net at a distance of half a block! I returned while simultaneously listening with a Clegg 22 MK II - a tweak of TC-27 cleaned up this goof! Good luck!

Paul Hoover WØNMF/W5UIE  
 Lee's Summit MO

### LICENSE REVIEW

W1AW's license comes up for renewal every 5 years. If a group of individuals were to file petitions to deny that license renewal, then the FCC would have to hold hearings on the subject. The issue would be, is the ARRL in fact doing a public service, is acting in the behalf of all amateurs, is

Continued on page 122. . . .

## CRYSTAL BARGAINS

Depend on . . .

We supply crystals from 16KHz to 100MHz. Over 6 million crystals in stock.



DIVISION OF BOB WHAN & SON ELECTRONICS, INC.

2400 Crystal Dr.  
Fort Myers  
Florida 33901  
(813) 936-2397

**SPECIAL**  
Crystals for most amateur 2-Meter F.M. Transceivers:

**\$3.75 Each**

Inquire about quantity prices. Order direct. Send check or money order.

For first class mail add 15¢ per crystal...for airmail add 20¢ ea.

Send 10¢ for new catalog with oscillator circuits and lists of thousands of frequencies in stock.

### SPECIALS! CRYSTALS FOR:

Frequency Standards	
100 KHz (HC13/U)	\$4.50
1000 KHz (HC6/U)	4.50
Almost All CB Sets, Trans. or Rec. (CB Synthesizer Crystal on request)	2.50
Any Amateur Band in FT-243 (Except 80 meters)	1.50
80 Meter Range in FT-243	4 for 5.00
Color TV 3579.545 KHz (wire leads)	2.50
	1.60
	4 for 5.00

..... W2NSD/1 continued from page 5.

Result: WR2AAA — a dream fulfilled for George.

I, too, made out as simple a filing as possible and submitted it. I didn't have circular graph paper on hand at the time, so I printed some up later and filed the antenna pattern on that — and this was accepted. In view of George getting WR2AAA it was unlikely that the Commission would issue him WR1AAA too (for his WA1KKG repeater) — and since I had been pushing Prose very hard on getting the repeater rules changed, it seemed extremely unlikely that I would get WR1AAA. I figured they would give this prize to some third party

When Mel W1BHD, who runs a very small 31-91 machine down in Skunk Hollow (Malden) called to tell me that he had just had a call from the Commission asking him to send along a paper he had forgotten on his application, I assumed they were grooming him for AAA. Ideal. Mel is a real old-timer — he has done everything there is to do in amateur radio — a real old-time experimenter and builder. And you couldn't ask for a nicer chap. What a difference from some of the arrogant overbearing egos that have risen to the top of a couple

of groups.

Sure enough — a few days later Mel called — he'd just gotten WR1AAA. I think Prose couldn't have done better. If I'd gotten it, there would have been lots of grumbles (from aforementioned big egos) — now there could be no gripes. The next day my WR1AAB arrived — and I was most pleased. Better, really. Keith, who takes the incessant crap spewing up from Connecticut on 79 more to heart than I, drove immediately up to our mountain and, with some restraint, tested WA1KGO from his mobile rig — knowing that he was also going through WA1KGO — "testing through WR1AAB," he said. There was a short pause, then — Ohhhhhh #\*\$@!" came a voice that sounded amazingly like Dana. Keith was chuckling for days.

### ANY QSL'S TO SHOW?

If you have any particularly unusual DX cards around that you think the readers might enjoy seeing — and perhaps you might like to brag about — please send them in and we'll try to work them into the newspapers so the DXers can eat their hearts out.

More years ago than I like to think I ran a monthly QSL contest — with the winner each month receiving a free one year subscription. The win-

ning card was picked by me on the basis of its being unusual, inventive or in some way outstanding. This contest is open again, so if you've got a particularly interesting QSL card, why not send it in to the QSL Contest, 73 Magazine, Peterborough NH 03458? You might be a winner — and you might get your card out there in front of most of hamdom. You can bet that the fellows will be after you for a card when they hear you on the air once they've seen it in 73.

### MAKING DXPEDITIONS PAY

While a DXpedition is largely an exercise done for the fun of the trip — there are few DXpeditioners who don't give a lot of thought to ways to help recover some of the money spent.

The dollar per QSL device, pioneered by Danny Weil back in the 50's, left a lot of irritated DXers with their backs up. That's just too much like making a business out of ham radio — pecuniary interest. It also put the burden on the DXer who "needed" the cards for an operating award such as DXCC. Either he spent the buck per card or he didn't make the award.

Then came the era of the DXpedition financed by "donations." With

TAPE RECORDING HEADS, Cassette style dual half track, by NORTRONICS. Track width .056", spacing .088" c-c. Record head type W2R8N, or record-playback head W2R6F. Only . . . . . \$1.50 each, 12 for \$15.00 NEW.

FILAMENT TRANSFORMER. 6.3 volts ct. @25 amps., 115/230 v. 60 Hz. primary. 3/4" x 4/4" x 5/2" h. Hermetically sealed. 14 lbs. . . . . \$4.00 each

LEKTRA TM-8 PHOTO TIMER, Range .1 to 111 seconds. With 2 foot switches Exc. cond. . . . . \$50.00

OMEGA D-3 ENLARGER, Autofocus, 4 x 5, with Aristo Cold Light Source. Less lens. Exc. cond. . . . . \$150.00

TEKTRONIX Input Normalizer, #067-0533-00. 2:1 attenuation. UHF connectors. New. . . . . \$2.50

Type D Plug-in for TEKTRONIX. High-gain DC Differential, sensitivity 1 mv./cm. Made by Hickok. Exc. cond. . . \$40.00

ELECTRO INSTRUMENTS 4000 Digital Voltmeter, 4 digits, range 1 mv.—1 Kv. Rack mount. Exc. cond. . . . . \$100.00

BRUSH RD-5616 Servo Analyzer. Drives Brush oscillograph. Brand new. Only . . . . . \$37.50

BC-221 Frequency Meter with cal. book & xtal. Exc. cond. \$50.00

TS-118A Dummy Load with 5 thermocouples & carrying case. Exc. . . . . \$135.00

H-P 500-B Audio Freq. Meter with 506-A Tachometer Head. Like new. . . . . \$100.00

TX-35 X-band Test Set. 8.5-9.6 GHz. 115sv. 60 Hz. power. Measures power, freq, rcvr. sensitivity. Exc. cond. . . \$35.00

Send for our new catalog —

25¢ for handling.



We use Master Charge.

All orders must include shipping charges.

# JEFF-TRONICS

4252 Pearl Rd., Cleveland, OH 44109





## CAMP ALBERT BUTLER RADIO SESSION

14th year — July 28—Aug. 10th

Courses Taught: General Theory and Code  
Advanced Theory and Code  
Amateur Extra Theory and Code

Golf privileges at New River Country Club; also fishing

**TRULY A VACATION WITH A PURPOSE!!!**

People attended from the following states and areas:

North Carolina, South Carolina, Missouri, Tennessee, Utah, Florida, Oklahoma, West Virginia, Alabama, New Hampshire, Iowa, District of Columbia, Vermont, Arizona, Indiana, Ohio, New Jersey, New York, Massachusetts, Maryland, Virginia, Illinois, Michigan, Georgia, Kansas, Mississippi, Nebraska, Maine, Kentucky, California, New Mexico, Arkansas, Texas, Wisconsin, Louisiana, Oregon, Connecticut, Minnesota, Pennsylvania.

**OUT OF STATE:** Puerto Rico; Saskatchewan, Canada; Ontario, Canada; Quebec, Canada; Granada, Spain; London, England; Geneva, Switzerland; Netherland, Antilles; St. Croix, Virgin Islands; Holland; Columbia; Thailand.

C.L. Peters, K4DNJ, *Executive Director*  
Gilvin Roth Y.M.C.A., Elkin, North Carolina

Please send me the Booklet and Application Blank for the Camp Albert Butler Radio Session.

Name \_\_\_\_\_ Call \_\_\_\_\_

Address \_\_\_\_\_

City/State/Zip \_\_\_\_\_

some DXpeditioners the donations seemed to be voluntary — with others they seemed obligatory. One chap bragged he was able to rake in tens of thousands of dollars per year in "donations." This system got many of the old-time DXers so uptight that they quit the race.

When a group of us went to Navassa last year we had such an investment in the trip that we wanted to try and get some donations from interested DXers to help lighten the burden. There was some pressure to go the dollar per card route, but I suggested that we send everyone who worked us a QSL and with it an announcement of the availability of a special Worked Navassa Certificate — for one dollar. This, I am happy to say, has been most successful.

A special certificate dresses up the ham shack infinitely more than a mere QSL card and, in reality, provides far more of a bargain for the dollar than the little pasteboard, which gets lost among all the others of much less significance.

Certificates can be designed for each DXpedition and can include a short summary of the trip — a map — a few pictures — thus making it well worth while to the DXer to have it on his wall for visitors to see.

Let's encourage this type of "donation" for DXpeditions rather than buck a card ripoffs — okay?

### STARLING TROUBLES?

Are starlings using your rotary beam for a perch? Unless you've experienced these pests you can't appreciate what a nuisance they can be. Many attempts have been made to get these birds to move on, once they settle in — and most are ineffective. The problem is that they move in by the hundreds or thousands and make a terrible racket, day and night!

K5IKE has forwarded a newspaper clipping with a solution to the problem. Ma Bell had a problem in Lawton (Okla) and a chap there came up with the idea of using some toy rubber snakes tied to the microwave towers. The snakes cost about 73¢ each (how about that!) and three of them cured the starling problem.

### 220 CB POSSIBILITIES

One two way dealer I've talked with is waiting with baited breath for the FCC to open the new 220 CB band. He figures he's worked out a way to make a mint from it once it is there.

One of the major uses for the band, he figures, will be for short range crime communications. Why do a

bank job without a couple of helpers outside with radios? They can't do much now with that on 11 meters because the high power and skip stations ruin the dependability of the communications. Crooks don't want to get caught because Big Mutha in Georgia is working someone and bombing them out in New York.

For a couple of hundred dollars he can rent them a no-questions-asked set of hand units — mobiles — and even a repeater, if it will help them. All to be returned a few days later. It could, for a few months — possibly a year or two — revolutionize crime. Eventually the police will work out a way to monitor all of the CB channels in all parts of the country — but this has to take a while — a long while.

The criminals would stand out if they were to use empty channels — but the background of other CBers will provide a wonderful anonymity to mask their capers.

The dealer figures this to be a big market, not just a small one. He estimates that he can have up to hundreds of communications systems rented out. When you multiply this out it comes to several million dollars a year for him. Any wonder he's been to Japan, sizing up the equipment market?

Wayne

# GATEWAY ELECTRONICS

8123-25 PAGE BOULEVARD  
ST. LOUIS, MISSOURI 63130  
(314) 427-6116

L.E.D. 7 SEGMENT READOUT - MAN 1  
TYPE - NEW ..... \$2.75

10 MHZ CRYSTAL - Standard HC-6/U  
style in 24 volt oven, 1 lb. .... \$2.50

12 BUTTON TOUCH TONE PAD - new -  
manf. by W.E. - w/diagram, 1 lb. \$19.50

12/24 VOLT TRANSFORMER - 5 amp -  
4x3 1/2x3, 7 lb. .... \$5.00

T HUMBWHEEL SWITCHES -  
0.5x2.125x1.78 - 10 position decimal  
..... \$3.00

10 position BCD & Compliment \$4.00  
End Plates (per pair) ..... \$1.45

MINIATURE SIZE - 0.312x1.3x1.3 -  
10 position decimal ..... \$2.50

10 position BCD & Compliment \$2.75  
End Plates (per pair) ..... \$1.00

\$5 Minimum Order

Please include sufficient postage

*Visit us when in St. Louis*

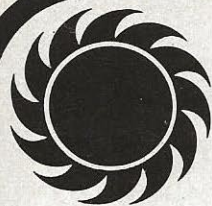

## Go all the way into the **REPEATER**

There's nothing half-way about the new Hy-Gain *REPEATER LINE*. Designed for the man who demands professional standards in 2 meter mobile equipment, the *REPEATER LINE* is the 2 meter HAM's dream come true. It's got everything you need for top performance... toughness, efficiency and the muscle to gain access to distant repeaters with ease. Reaches more stations, fixed or mobile, direct, without a repeater.

The right antennas for the new FM transceivers...or any 2 meter mobile rig.

Rugged, high riding mobiles. Ready to go where you go, take what you dish out...and deliver every bit of performance your rig is capable of.

- 261 Commercial duty 1/4 wave, claw mounted roof top whip. Precision tunable to any discrete frequency 108 thru 470 MHz. Complete with 18' of coax and connector. 17-7 ph stainless steel whip.
- 260 Same as above. Furnished without coax.
- 262 Rugged, magnetic mount whip. 108 thru 470 MHz. Great for temporary or semi-permanent no-hole installation. Holds secure to 100 mph. Complete with coax and connector. Base matching coil for 52 ohm match. 17-7 ph stainless steel whip.
- 263 Special no-hole trunk lip mount. 3 db gain. 130 thru 174 MHz. 5/8 wave. Complete with 16' coax. Operates at DC ground. Base matching coil for 52 ohm match. 17-7 ph stainless steel whip.
- 264 High efficiency, vertically polarized omnidirectional roof top whip. 3 db gain. Perfect 52 ohm match provided by base matching coil with DC ground. Coax and connector furnished.
- 265 Special magnetic mount. 3 db gain. Performance equal to permanent mounts. Holds at 90 mph plus. 12' of coax and connector. Base matching coil for 52 ohm match. 17-7 ph stainless steel whip. DC ground.
- 269 Rugged, durable, continuously loaded flexible VHF antenna for portables and walkie talkies. Completely insulated with special vinyl coating. Bends at all angles without breaking or cracking finish. Cannot be accidentally shorted out. Furnished with 5/16-32 base. Fits Motorola HT; Johnson; RCA Personalphone; Federal Sign & Signal; and certain KAAR, Aerotron, Comco and Repco units.

2 meter mobile! with

**LINE** from **Hy-gain**

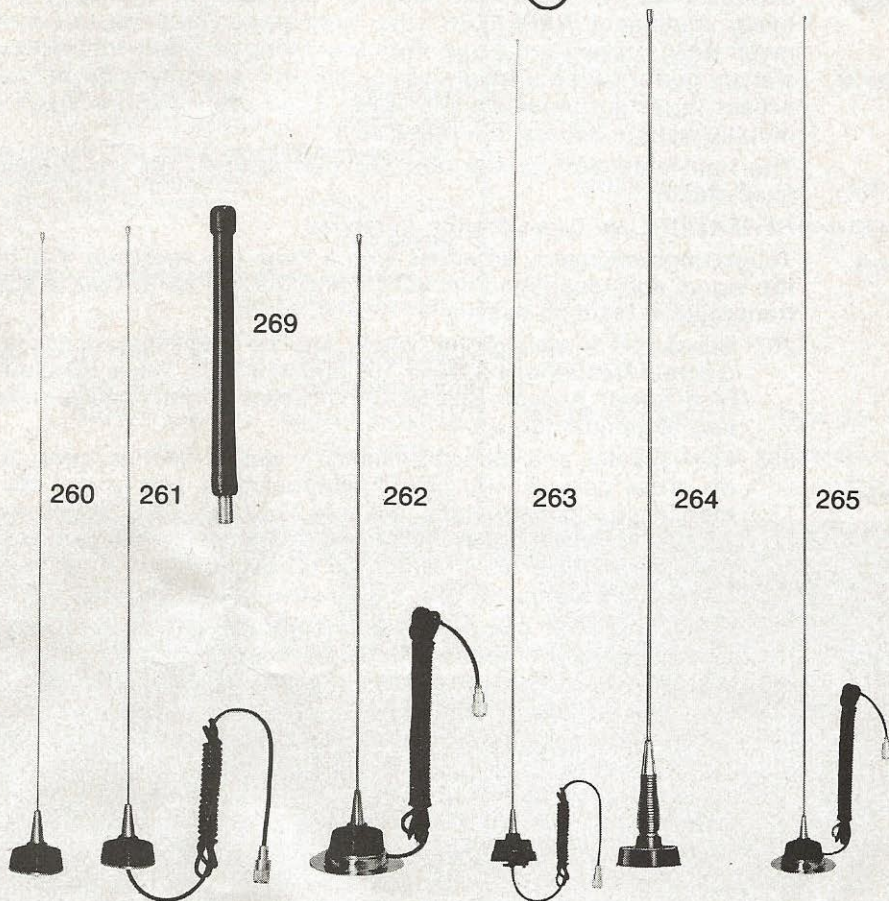

Top performance for 2 meter mobiles  
**THE REPEATER LINE**

from

**HY-GAIN ELECTRONICS CORPORATION**

BOX 5407-WH / LINCOLN, NEBRASKA 68505

**WRITE FOR DETAILS**



# NEW REPEATER

## 2 Meter Fixed Station

Designed for the man who demands professional standards in 2 meter equipment. *REPEATER LINE* fixed station antennas are the 2 meter HAM's dream come true. With everything you need for top fixed station performance...toughness, efficiency and the gain to gain access to distant repeaters with ease. Work many stations, fixed or mobile, without access to a repeater.

The right antennas for the new FM transceivers...or any 2 meter fixed station.

### *REPEATER LINE* Fixed Station Antennas

Tough, high efficiency antennas with a long, low radiation. For the top signal and reception you want...and the top performance your transceiver's ready to deliver.

- 267 Standard 1/4 wave ground plane. May be precision tuned to any discrete frequency between 108 and 450 MHz. Takes maximum legal power. Accepts PL-259. Constructed of heavy gauge seamless aluminum tubing.
- 268 For repeater use. Special stacked 4 dipole configuration. 9.5 db offset gain. 6.1 db omnidirectional gain. Heavy wall commercial type construction. 144 thru 174 MHz. 1.5:1 VSWR over 15 MHz bandwidth eliminates field tuning. Extreme bandwidth great for repeater use. Center fed for best low angle radiation. DC ground. Complete with plated steel mounting clamps.
- 338 Colinear ground plane. 3.4 db gain omnidirectionally. Vertically polarized. 52 ohm match. Radiator of seamless aluminum tubing; radials of solid aluminum rod. VSWR less than 1.5:1. All steel parts iridite treated. Accepts PL-259.
- 362 SJ2S4 high performance all-driven stacked array. 4 vertically polarized dipoles. 6.2 omnidirectional gain. 52 ohm. May be mounted on mast or roof saddle. Unique phasing and matching harness for perfect parallel phase relationship. Center fed. Broad band response. DC ground.
- 340 3 element high performance beam. 9 db gain. Coaxial balun. Special VHF Beta Match configuration. Unidirectional pattern. VSWR 1.5:1. 52 ohm impedance. Heavy gauge aluminum tubing and tough aluminum rod construction.
- 341 8 element high performance beam. 14.5 db gain. Coaxial balun. VHF Beta Match. Unidirectional. Boom length 14'. VSWR 1.5:1. 52 ohm feedpoint. Heavy gauge commercial type aluminum construction.
- 231 15 element high performance beam. 17.8 db gain. Coaxial balun. Beta Match. Unidirectional. Boom length 28'. VSWR 1.5:1. 52 ohm feedpoint. Extra-strength heavy wall commercial aluminum tubing.

# LINE from **Hy-gain** Antennas with real PUNCH!

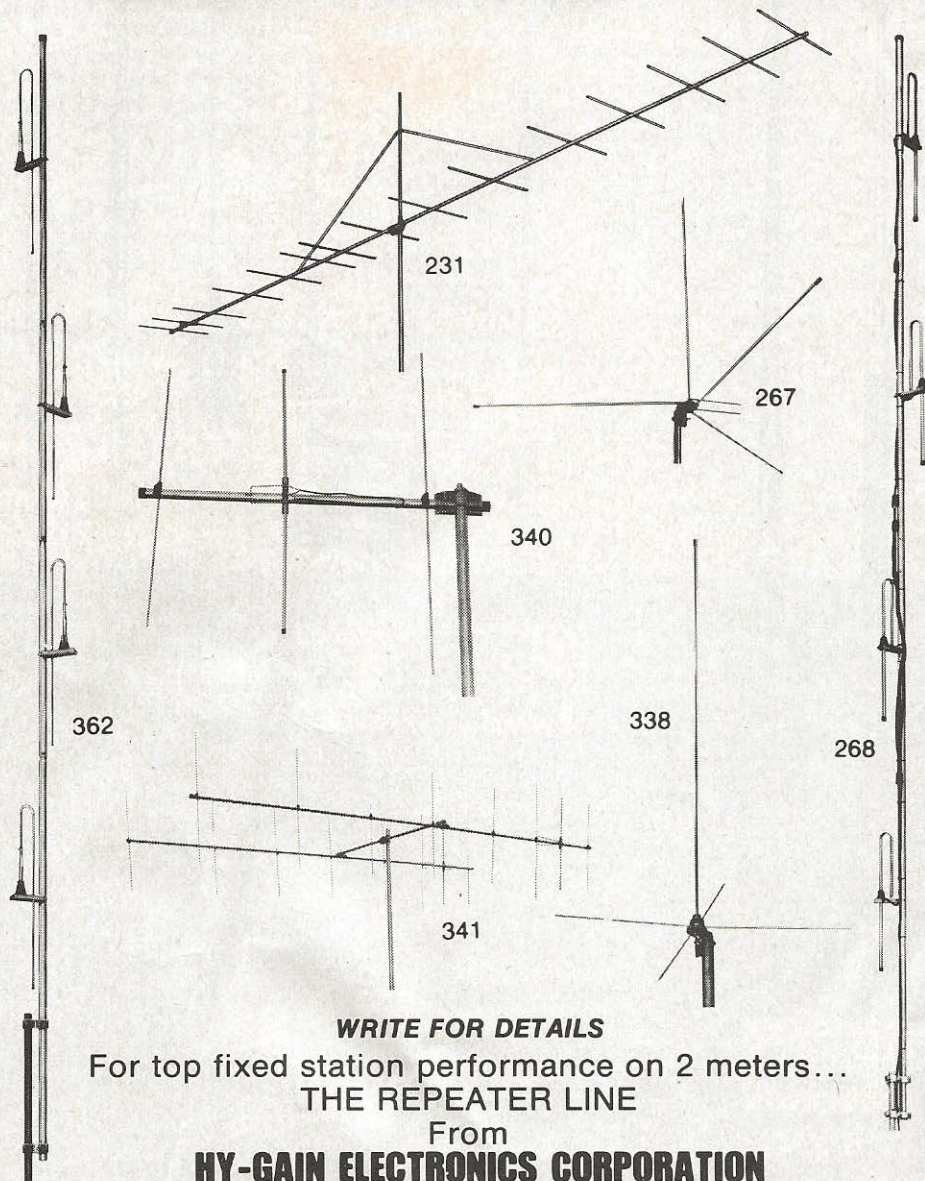

**WRITE FOR DETAILS**

For top fixed station performance on 2 meters...

**THE REPEATER LINE**

From

**HY-GAIN ELECTRONICS CORPORATION**

P. O. Box 5407-WH Lincoln, Nebraska 68505

# The GAM Line

Famous for POWER . . . powerful performance,  
VHF/Antennas ● BASE/MOBILE  
144 to 160 MHz

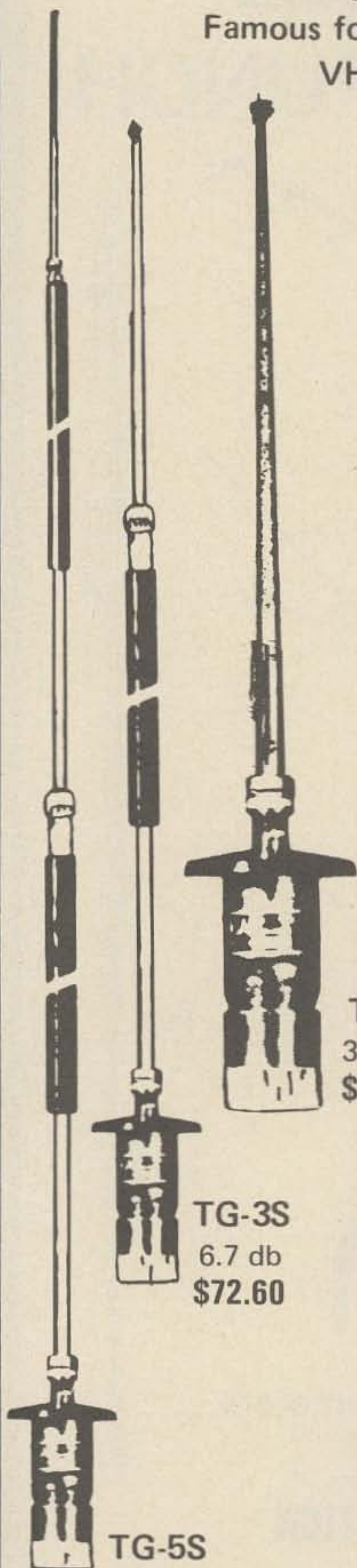

TG-3  
3.7 db  
\$38.75

TG-3S  
6.7 db  
\$72.60

TG-5S  
8.2 db  
\$104.50

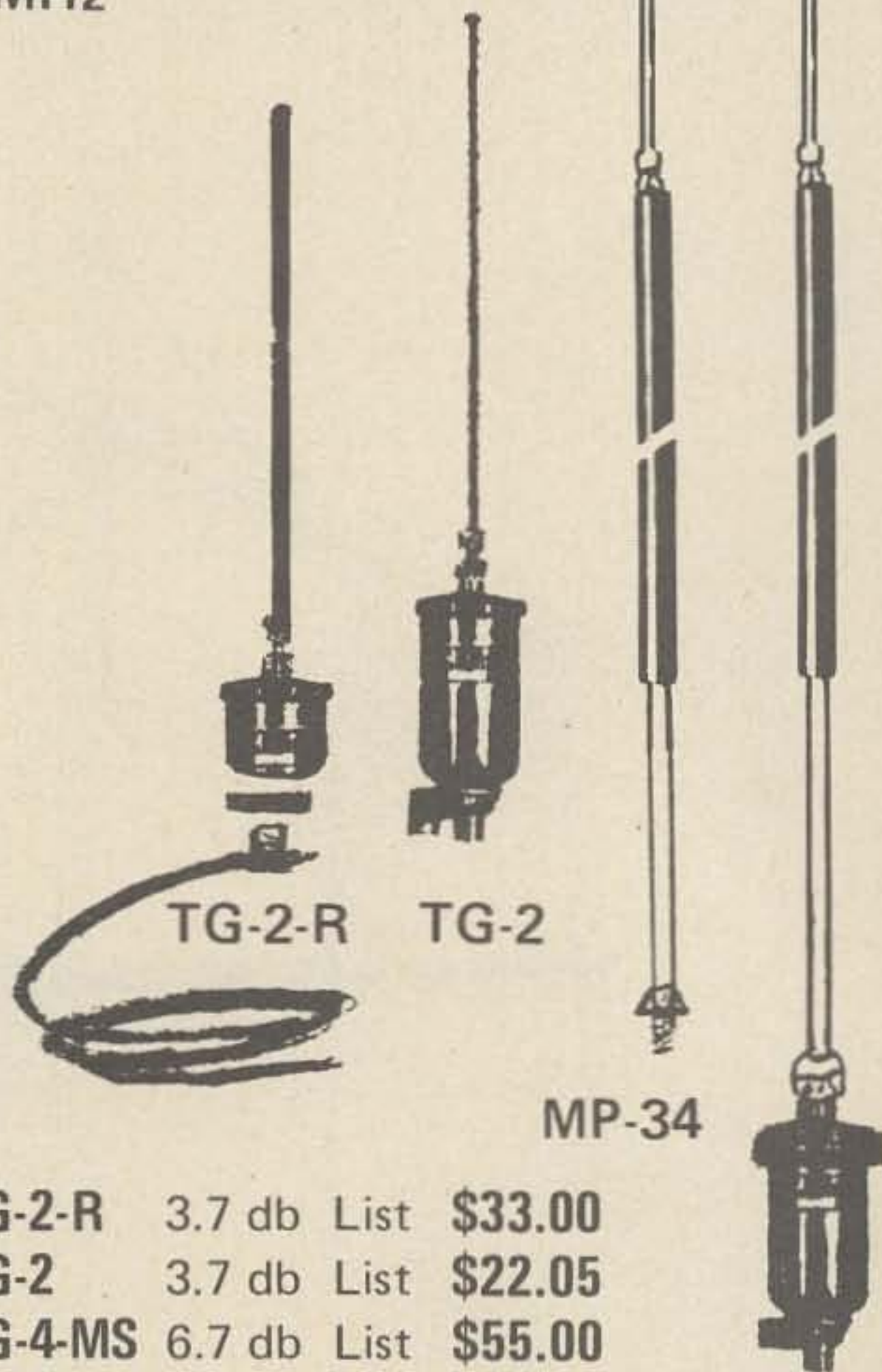

TG-2-R

TG-2

MP-34

TG-4-MS

TG-2-R	3.7 db	List	\$33.00
TG-2	3.7 db	List	\$22.05
TG-4-MS	6.7 db	List	\$55.00
MP-34	6.7 db	List	\$34.65

**14.9 db Omni-Directional Gain**

*In System Performance*

(Using the TG-5S and the TG-4-MS)

**GAIN OVER ISOTROPIC RADIATOR**

**GAM**  
**Electronics**

191 VARNEY STREET  
MANCHESTER NH 03102  
TEL. (603) 627-1010

ALPHA 77 by ETD



Featuring the new Giant from Eimac, the 8877 air-cooled grounded-grid triode, with a conservative 1500 watts of plate dissipation.

Extremely reliable, trouble-free operation is the basis of our new Alpha Warranty: 12 months on all parts & labor, tube warranty by Eimac. 24 months on the 1500 watt power transformer and oil-filled filter capacitor.

YOU CAN BUY WITH CONFIDENCE WITH THE LONGEST, STRONGEST WARRANTY IN THE INDUSTRY.

Volume Production Allows a NEW LOW PRICE:

**\$1495**

Phone/write DON PAYNE, K4ID, for a brochure, personalized service, and a KING-SIZE trade-in on any gear you have - one piece - or the whole Station.

Phone  
six days  
(615) 384-5573

**PAYNE RADIO**

Box 525  
Springfield, Tenn. 37172

Phone  
Nites - Sundays  
(615) 384-5643



**CX7A**

**SPECIAL PURCHASE SALE**

Last chance to purchase a CX7A @\$1895\*. An integrated station that should sell for \$4000.00.

Full 90 day warranty at (5) different locations - with a complete inventory of parts.

Phone/write DON PAYNE, K4ID, for a brochure, personalized service, and a KING-SIZE trade-in on any gear you have - one piece - or the whole Station.

Phone  
six days  
(615) 384-5573

**PAYNE RADIO**

Box 525  
Springfield, Tenn. 37172

Phone  
Nites - Sundays  
(615) 384-5643

# THE SATISFIERS

INOUE'S 2-METER FM GEAR



**IC-22**    **IC-21**  
**22 Ch.**    **24 Ch.**  
**1/10 W.**    **1/10 W.**



**IMAGINE:**

**On the NEW IC-22 . . . you'll get . . .  
 22 Channel Unit for just \$289.00!**

- . . . 5 channels supplied
- . . . large built-in speaker
- . . . separate light indicators on squelch break & Xmitt
- . . . quick release mobile mount included
- . . . green back lighting on front panel
- . . . super compact . . . 23/32"X6"X8 1/2" 4.5 lbs.
- . . . matching regulated, filtered ac supply available.

**With the IC-21 you'll enjoy . . .**

**24 Channel Base-Mobile Unit for \$389.**

- . . . 7 channels supplied
- . . . dual voltage power supplies — 110/220vac power supply and a regulated dc supply.
- . . . p.a. tuning control — allows the power output to be optimized over a wide frequency separation.
- . . . r.i.t. control — offsets the receiver frequency to bring in signals which are not properly calibrated.
- . . . s.w.r. bridge — built right into the front panel is an accurate s.w.r. bridge for 2-meter work. An invaluable aid for vhf antenna experiments.
- . . . discriminator meter — front panel meter allows you to accurately tell if you or other stations in the QSO are on frequency.
- . . . netting switch — this feature allows the IC-21 to listen to itself for calibration purposes.
- . . . modular construction — quicker servicing if needed.
- . . . optional rev. vfo, plug it in and find out what's going on over the rest of the band.

*On both the 21 and 22 . . .*

Cross channel interference is virtually eliminated with 5 helical resonators in the RF amplifier coupled with 2 i.f. filters to virtually eliminate intermod.

The difference of a truly hot RCVR with INOUE'S MOS FET front end providing better than .4µV/20db sensitivity.

**WARRANTY & SERVICING:** When you buy from the **AUTHORIZED INOUE** team listed below, you will get the kind of warranty and servicing you can count on, that's backed up by the factory.

*See the complete INOUE line at the authorized ICOM dealers listed below.*

**ARIZONA**

Ell Dee Enterprises  
 1342-A E. Indian School Rd.  
 Phoenix, Arizona 85014  
 602-942-9715

Sequoia Stereo  
 773 8th St.  
 Arcata, California 95521  
 707-822-0318

Devlin Electronics  
 4817 E. 35th Ct.  
 Tulsa, Oklahoma  
 918-742-7246

Trimble Electronics  
 2810 Alexandria  
 Tyler, Texas 75701  
 214-593-1123

**CALIFORNIA**

ICOM FM Sales  
 6234A Fountain Avenue  
 Hollywood, California 90028  
 213-225-6620

Robert Foster Sales  
 Box 198 Escevosia Star Route  
 Tieheras, New Mexico 87059  
 505-281-3975

**TEXAS**

Bellaire Electronics Supply  
 5204 Bellaire Blvd.  
 Bellaire, Texas 77401  
 713-667-4294

**WASHINGTON**

NHE Communications  
 15112 S.E. 44th  
 Bellevue, Washington 98006  
 206-747-8421

Henry Radio  
 11240 W. Olympic Blvd.  
 Los Angeles, California 90064

Blacks Radio Company  
 413 N.E. 38th Terrace  
 Oklahoma City, Oklahoma 73105  
 405-528-0193

Electronics Center Inc.  
 3939 N. Haskell  
 Dallas, Texas  
 214-526-2023

**DISTRIBUTED BY:**



**ICOM-EAST**

Box 331, Richardson, Texas 75080  
 A Division of A.C.S.

**ICOM-WEST**

15112 S.E.44th, Bellevue, WA 98006  
 Dealer Inquiries Invited



## BE GOOD TO YOURSELF! . . .

Before you buy or trade anywhere get our deal! All the hams at THE HAM SHACK pledge prompt, personal service. We'll plan a package deal on a whole station from Mike or Key to Antenna. Our trading shoes are always on - try us. You'll be glad you did.

Bill - WB4JFK

### hi-gain Power-Full GALAXY transceiver



Galaxy GT-550A transceiver. Full 550 watts, SSB, 360 watts, CW. Compact, beautiful! Really hot receiver; on-frequency selectable sideband, superb AGC. 17 pounds weight! **\$595.00**

RF-550A WATTMETER  
AND ANTENNA SWITCH  
**\$75.00**

SC 550A/AC400 SPEAK-  
ER/SOLID STATE AC  
SUPPLY **\$129.90**

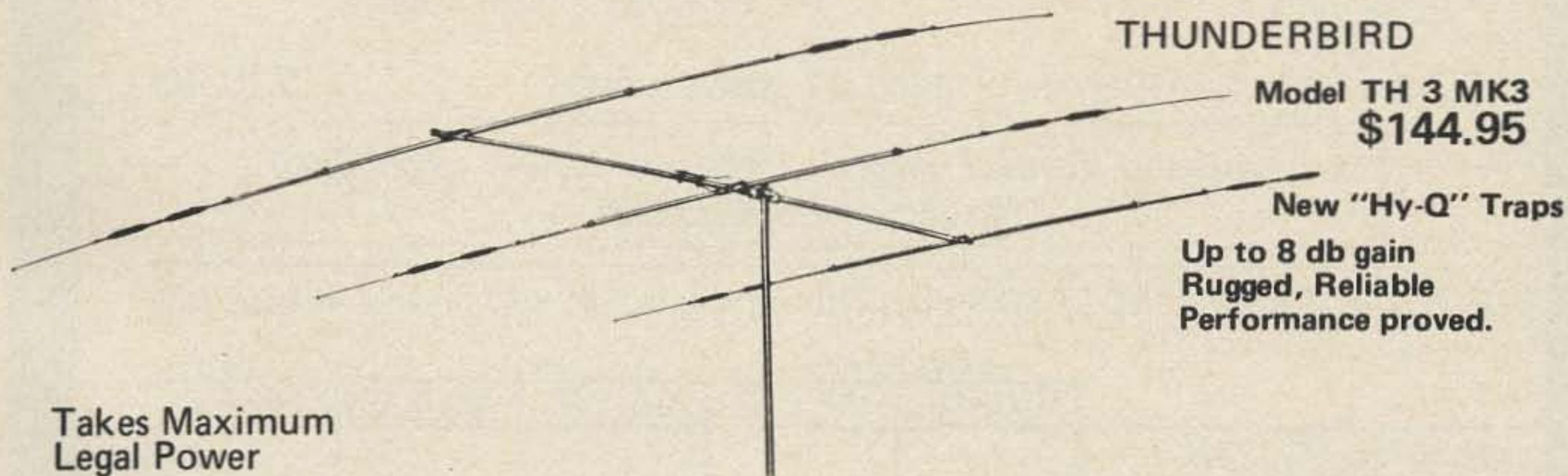

### THUNDERBIRD

Model TH 3 MK3  
**\$144.95**

New "Hy-Q" Traps  
Up to 8 db gain  
Rugged, Reliable  
Performance proved.

Takes Maximum  
Legal Power

STOCKING ALL MAJOR  
HAM LINES'

MASTER CHARGE CREDIT

# THE HAM SHACK

AMATEUR RADIO SALES AND SERVICE

2116 BEE RIDGE RD. SARASOTA, FLA. 33579  
TEL. (813) 921-4602

# FM 2 Meter UHF 6 Meter USED

GENERAL ELECTRIC ... RCA ... MOTOROLA

## General Electric Progress Line 2 Meter Mobile Units

14" case (less accessories & ovens)



**MA/E33** **\$58**  
6/12 volts, 30 watts,  
vibrator power supply



**MT/33** **\$128**  
12 volts, 30 watts,  
transistor power supply

Accessories available for each of above units . . . . . \$30.00

*Just Arrived! General Electric "Message Mates" High Band Receivers with SEL-Call.*

G.E. PROGRESS LINE STRIPS physically complete, but sold on an as-is basis only.

	LOW BAND		VHF		UHF
	MA/E13	MA/E16	MA/E33	MA/E36	MA/E42
Power supply, 30W, less vibrator	\$20	—	\$20	—	\$20
Power supply, 60W, less vibrator	—	\$25	—	\$25	—
TX narrow band, less final tubes Note: MA/E42 wide band	\$18	\$25	\$25	\$30	\$12
RX wide band, less ovens	\$18	\$18	\$18	\$18	\$12

- 14" Progress Line Case, consisting of front basket and front plate with lock . . . . . \$10.
  - Low band dual front end, 2 freq. strip . . . . . \$20.
  - Hi-Band TPL RX with TX exciter strips less speaker, as is, missing parts . . . . . \$25.
- 15,000 2-way FM mobile units in stock! Send for new '73½ catalog.



**GREGORY ELECTRONICS CORP.**

*The FM Used Equipment People*

243 Route 46, Saddle Brook, N. J. 07662

Phone (201) 489-9000

Dept. 73

Hugain

Clegg

BOMAR

Regency

SBE

Cushcraft CORPORATION

Standard Communications

# A & W has the "BIG NAMES"

## in HAM Equipment

*Many pieces of equipment are in working displays. You can try it right in the store. ★★★★★★★★★★ Dealer inquiries are invited. No better dealer prices anywhere. ★★★★★★★★★★*

**WE LOVE "trade-ins".** Whatever you've got, bring it in and we'll dicker with you.

WRITE FOR OUR LATEST CATALOG



# A & W ELECTRONICS

500,000 ELECTRONIC PARTS ALWAYS IN STOCK

491 RIVERSIDE AVENUE, MEDFORD, MASS.  
at Fellsway Shopping Plaza, Medford  
Junction of Route 16 and 28, right near Interstate 93

it — as a corporate entity — giving its members a fair shake... are they polled about thoughts, or is it in fact a self-sustaining outfit run for the financial benefit of a few?

A full and open hearing on this subject would be most interesting and could force the League into some thoughtful changes needed.

Nick Johnson tells you how in his stuff directed to TV listeners protesting license renewals of broadcast stations. The same thing would work for the League, you know.

If anybody sees this, or knows what the expiration date of W1AW's license is, let me know and send me copies.

Art Brothers W7NVY  
Grouse Creek, Utah 84313

*While some major reforms are about 30 years overdue in ARRL management, should these be forced at the risk of losing the W1AW license? The bulletin announcements, self-serving as many of them are, are certainly worth some effort to keep the facility going — and the code practice is invaluable, though it is always possible that if W1AW were not there with it that others would provide the service, as has happened in many other countries.*

### CB SOLUTION

I have changed my mind about CBers. Why doesn't the FCC just legalize the use of 11 meters, completely? Then all they have to do is arrest *all* of the band users. The legitimate ones won't operate when this law takes effect, just as they didn't break previous laws. Thus, the big guys who have sunk thousands into their pseudo-ham setups will just be left. Although this may be impractical from some standpoints, I am indicating to you my recent realization of the seriousness of some of these fellows. The guy down the street just isn't going to stop killing my 10 meter rig. I think we are soon going to change our local transmitter hunts to CB hunts.

Thomas A. Behrens WB6MDP  
Sacramento CA

*Good idea.*

### A BAD LETTER

I thoroughly enjoy your magazine and look forward to its arrival. My only regret or complaint is that I did not start my subscription sooner. While you are like all the other magazines in that you print all the good letters about 73, you differ in that you also print the bad letters about it. I always read your "Letters to the Editor" column and I believe it takes some backbone to print some of the derogatory letters. Keep it up. My only other comment is that it a very fine magazine.

Ron Hughes KL7HJE  
Alaska

### HAPPY ENDING

Last February I wrote to you asking that the theft of my YAESU FT101 be listed in your magazine. In December the equipment was returned to me via the police and my insurance company. To make a long story short, the recovery was attributable directly to the notice in 73 Magazine, 73's policy of continuing the listing indefinitely in subsequent issues of the publication rather than just once, and the alertness of Gary WB2PSS and Bill of the Pennsauken (NJ) Electronic Service Co., and George WA2VKV.

Many thanks for your help.  
Frank W. Widmann WA2YSW  
Haddonfield NJ

### ECONOMICS PAYS

Congratulations on the really superb article "Repeater Economics" on page 105 of the April issue. Mr. Cohn's story is almost precisely what we have done here in the Mid-Oklahoma Repeater, Inc. for the past nine months. The results have been outstanding. The "MORI" membership has increased from 60 members on 1 July 72 to 131 members on 21 March 73.

The few differences between MORI and NVFMA procedures are minimal. We call the freeloaders "prospective members." We also use my own and

the Trustee's address for club correspondence.

About the one real difference is that we use a computer for the membership list. The computer is located at a small junior college. The key-punching and machine runs take only a few moments of time. The benefit is that the MORI officers can ask for a current membership list at any time. It's a matter of dropping in the cards and making the list. We also use the card deck to print the mailing list and it certainly simplifies mailing to 160 or so members and prospective members. We also have a card deck of all other active amateurs in about a 50-mile radius which we have made a mailing to once in the past 9 months.

Newcomers to VHF-FM get into the MORI card deck by just signing their call on the repeater. (Their expiration date is that date until they pay the dues.) From then on, they get everything we send such as bulletins, meeting notices, and the like.

For the various VHF-FM clubs, I suggest that the officers contact the local junior college or the computer company and get the mechanized list thing working for them. Saves a lot of wear and tear when making a mailing and the instant membership list allows the club officers to be active recruiters.

Again, congrats for the fine article.  
Frank Jerome W5OJZ  
Midwest City OK

... Caveat Emptor continued from p. 107.

**DES MOINES HAWKEYE HAMFEST** will be held on Sunday, June 17, 1973 at the Iowa State Fairgrounds. Plenty of free parking. Flea Market, covered display booths available, small charge; open arena — no extra charge. Dealer displays, valuable prizes, and XYL activities. Saturday night auto races and camping — extra. Registration \$1.50 advance / \$3.00 at gate. Write Des Moines Radio Amateur Association, Box 88, Des Moines, Ia. 50301.

**CURTISS ELAPSED TIME METER** \$1.00 each. Famous G.E. P A 222 1 watt audio amplifier \$1.95 each. 100K ½ watt ½% RN70C resistors 4 for \$1.00, 1,000 lot price upon request. Walter Jurek, 1615 S. 59 Ct., Cicero, Ill. 60650.

**WANTED, OLD RADIO TRANSCRIPTION DISCS.** Any size or speed. Send list and details to Larry Kiner, W7FIZ, 7554 132nd Ave. N.E., Kirkland, Wash. 98033.

**MOTOROLA: P33DEN-1100A** PT-300's with nicad low split \$165. U43HHT-3100A MOTRAC with acc. \$175. Robert Anderson, WA3PVD, 10314 Pierce Drive, Silver Spring, Md. 20901. 301-593-6993.

**SALE: HW12A \$90. TWO'er, 6 mtr FM REPEATER, HA750, more. SASE for details and list. WA3HRB/3, 3110 Knights Road, B18, Cornwell Heights, Pa 19020.**

### ILLINOIS REPEATER COUNCIL

Regular meeting will be held on Sunday, May 20, at 1 p.m. at the Lee County Law Enforcement Bldg., Dixon IL. Talk-in on 146.94.

**MODERNIZE FOR PEANUTS!** Frame & display QSL's with 20 pocket plastic holders. Two for \$1.00, seven for \$3.00. Prepaid, guaranteed. Universally used and approved. Order now. TEPABCO, Box 198S, Gallatin, Tennessee 37066.

**GIANT N.E. CONVENTION** sponsored by FEMARA Sept. 29 & 30 at Dunfey's Hyannis Resort on Cape Cod. Huge flea market, seminars, FM, SSTV, NEDXCC, AMSAT, YL trips, 2 pools, golf, beaches, sailing. Early bird registration still only \$3 from W1KCO, 572 Berkley Street, Taunton, MA. 02780. Special early bird hotel discount available.

**PRINTED CIRCUIT NEGATIVES MADE. SASE AND QUARTER FOR INFORMATION/PRICES. P-C NEGA SYSTEMS, 186 - 80th STREET, NIAGARA FALLS, NEW YORK 14304.**

**\* FLASH \* FLASH \* FLASH \***  
 Look at what you get for NO REPEAT NO EXTRA CHARGE. The GTX-200 has a supersensitive Dual Gate Mos Fet pre-amplifier BUILT IN the receiver front end for superb, less than .25 microvolt sensitivity. THE BEST receiver now even better!



100% AMERICAN MADE

**Marine/Master-25w**  
 2-Way VHF-FM Marine Radio Telephone

**GTX-200**

2 meter



**FM transceiver**

- (1) GTX-200 (with built-in DC PS) . . . . . \$259.95
  - (2) AC POWER SUPPLY . . . . . \$49.95
  - (3) 2 Extra xtals (stock list) . . . . . \$12.00
- REGULAR \$321.90

**OUR SPECIAL PACKAGE PRICE! \$249.95**

30 WATTS OUTPUT, ALL SOLID STATE (no tubes). TRUE FM (not Phase modulation) for superb audio quality. 100 channels with 146.94/146.94 included. Three pole low pass filter on both transmit and receive. 1 watt low power position. Provision for tone encoder. Multi-channel use of any crystal. Microphone and mobile mounting bracket supplied. G-10 glass board. Professional level construction by distinguished Avionics Mfg. — General Aviation Electronics, Inc. The finest amateur FM transceiver available at any price. Size: 9 x 6 1/2 x 2 1/2. Weight 5 lbs. Current Drain: Receive: .09 amps. Transmit: High: 5.0 amps, Low: 1.7 amps.



- (1) MARINE MASTER — 25W
- (2) 6 1/2 Channels, WX, 6, 16, 68, 28, 12.
- (3) 54" 3 db Gain lay down white fiberglass antenna

REGULAR \$329.95  
**OUR SPECIAL PACKAGE PRICE! \$259.00**

Please add \$35 for 8 ft. 6 db gain antenna.

Full 25 watts power. ALL SOLID STATE (no tubes) reliability. 10 channels with 6 1/2 pairs of crystals installed for calling and distress, weather, ship-to-ship, ship to coast and public and port operations. Complete with gleaming white fiberglass 3 db gain laydown deck mount antenna. Self contained, compact. Pre-tuned, Vinyl covered unit is splash proof — impact, humidity and fungus resistant. Can be mounted in panel, on bulkhead, on or below table top with universal mounting bracket included.

**JUST CONNECT TWO WIRES and YOU'RE ready to OPERATE!**

REGENCY, CLEGG, MIDLAND, SBE, INOUE, GLADDING, MIIDA, CUSH CRAFT, DATA ENG., BIRD, OLIVER SWAN (KLM), TEEC SSTV, HY-GAIN, SAVOY, SIGNAL/ONE, B&K, LEADER, MITS KENWOOD, TEMPO, TEN TEC, DX ENG., MINI-PRODUCTS, SWAN, ETC., IN STOCK — PLEASE WRITE FOR QUOTE.

RECONDITIONED EQUIPMENT — 30 days parts and labor guarantee.  
**COMPARE OUR PRICES!**  
**WE TRADE ON BOTH NEW AND USED EQUIPMENT.**

**Service Manual**  
**CX7-CX7A**  
**\$29.95 ppd.**

	Reg.	Our Price		Reg.	Our Price		Reg.	Our Price
<b>ALPHA</b> ALPHA-70 PA-70V vapor cooled linear, brand new cond.	1,275	975.00	<b>GALAXY</b> FM-210 FM w/AC-210 amp.	189.00	129.00	<b>MOTOROLA</b> Motrac 100W with 94/94 & 34/76, spk., mic, control head, cables, etc., complete, like new	295.00	225.00
<b>AMECO</b> CN-144 2 m conv. (7-11 + 14-18 I.F.) w/ PS-1 AC, new cond.	39.00	24.00	<b>GLADDING</b> Gladding 25 w/AC and 4 xtals, latest, new cond.	229.00	199.00	<b>NATIONAL</b> NCX-5 conv. to MK-2 w/NCX-A AC/spk, 100 kc, cal.,	429.00	325.00
<b>BIRD</b> 43 wattmeters (new) limited quantity		95.00	<b>GONSET</b> 6m Comm IV	149.00	89.00	NCX-3 w/NCX-A AC/spk, new cond.	249.00	189.00
<b>COLLINS</b> KWM-1 xcvr w/516F-1 AC and 3129-3 (same as 312B-4, patch, SWR, etc.) latest, new cond.		425.00	<b>HALLICRAFTERS</b> SX-111 rcvr., latest w/prod. dect.	129.00	99.00	<b>SWAN</b> SW-240 w/117B AC ps	229.00	179.00
62S-1 VHF conv., Like new		595.00	SR-150 scvr w AC/spk	350.00	249.00	250C 6m xcvr w/117XC AC/spk, VOX, NS-1 noise silencer, new cond.	430.00	389.00
30L-1 linear, new cond.	425.00	375.00	HT-46 SSB-CW xmitter w/HA-16 Vox acc. (receives w/SX-146)	249.00	199.00	117X basic AC supply	65.00	59.00
<b>CLEGG</b> 99er 6 m. xcvr, working, as is	59.00	39.00	SR-42A xcvr. 2m, new cond., w 2 stals	149.00	119.00	350C, 117XC AC/spk, DC mod, VOX, mic	419.00	389.00
Thor 6 xcvr w/AC-mod.	169.00	129.00	SR-46A 6m xcvr., new cond., w/4 xtals	109.00	89.00	<b>SIGNAL/ONE</b> CX7-A 3 mos. new in carton, brand new cond.	1,795.00	1,495.00
<b>COMDEL</b> CSP-11 RF processor, new cond.	79.00	55.00	HA-26 VFO, 6 + 2 VFO	39.00	29.00	<b>TEST EQUIPMENT</b> Eico 435 DC to 4.5 Mc 3" scope w/3 probes, like new	179.00	99.00
<b>DRAKE</b> T4XB w/custom AC/spk by Drake, new cond., in carton	439.00	389.00	<b>HAMMARLUND</b> HQ-150 gen. cov. rcvr., w/cal., excellent	129.00	89.00	Eico 1020 PWR supply, like new	35.00	15.00
DC-3, DC PS	89.00	69.00	<b>HEATH</b> HD-1 "Q" mult. w/built in AC PS		10.00	Eico 324 RF sig. gen., like new	35.00	19.00
TR-22 w/5 chanls., new Ni-Cads, checked by Drake, New cond.	175.00	149.00	S8A-300-3 6m conv.		10.00	Eico 378 Lab. audio gen., like new	89.00	39.00
R4A w/7 extra xtals includ. 160 maters, new cond.	279.00	249.00	<b>JOHNSON</b> Ranger II xmitter	139.00	109.00	Clemmons SG-83B sig. gen.	295.00	225.00
T4X xmitter, like new	295.00	269.00	<b>KNIGHT</b> TR-108 15 watt, 2m xcvr. w/AC, DC, mic., like new	99.00	79.00	RCA WV-98C senior VTVM, new	99.00	59.00
SW4A gen. cov. rcvr, new cond.	229.00	199.00	<b>LAFAYETTE</b> HA-460 20 watt 6m xcvr /built in VFO, AC, DC, Mic., etc., new	129.95	89.00	Heath 10W-102 solid state scope, new	189.00	129.00
<b>EICO</b> DX-718 gen. cov. rcvr.	49.00	29.00	Starflit KT-390 90 Watt CW-AM xmitter	59.00	39.00	Knight KG-625 6" VTVM, like new with probe	59.00	39.00
			<b>MAGNUM</b> Magnum 6 RF speech processor for Kenwood T-599, brand new, warranty	139.95	99.00	WINSLOW megohm meter (megger)	150.00	69.00
						<b>LEADER</b> — write for prices		
						<b>B &amp; K</b> — write for prices		
						<b>MIIDA</b> — freq. counters, digital voltmeters, etc.		

**AMATEUR-WHOLESALE ELECTRONICS**

8817 S.W. 129 Terrace—Miami, FL 33156

Telephone — days (305) 233-3631 — nights and weekends — (305) 666-1347

**NO ONE ANYWHERE BEATS OUR DEAL!**





**GENERAL ELECTRIC  
RADIOTELEPHONES**

**DT03 150MHz 5 Channel less  
accessories..... \$195.00**

**ST05 450MHz 2 Channel less  
accessories.....\$139.00**



**KELVIN HUGHES MODEL 822**

**10 Watt 10 Channel 150 MHz  
Complete with all Accessories,  
less Crystals and Antenna. All  
solid state. 12 VDC. New, as-is**

**..... \$149.00**



**CANADIAN MARCONI  
100 WATT AMPLIFIER**

**138-174 MHz. All solid state  
12 Volt DC. Three to ten  
watts input. New, as-is .....**

**\$119.00**



**NINIC NFM 22**

**150 MHz 609 V solid state**

**Rcvr with Case..... \$ 39.00**



**FLEX ANTENNA**

**For HT 200, HT 220..... \$ 3.95**

**PAGING BATTERIES (not shown) NICKEL CADMIUM**

**for Motorola Tone and Voice, tone only Page Boy 1**

**Pagers and Cook Pagers. New, Full One Year Warranty. 170 MAH \$ 6.00**

**235 MAH \$ 7.00**

**Write or call for quantity discounts on all Batteries.**

**MANN**

**COMMUNICATIONS &  
ELECTRONICS, INC.**

**P.O. DRAWER M, 28710 CANWOOD, AGOURA, CALIF. 91301**

**213/889-6666**

*also located at* **2837 North 24th Street, Phoenix, Ariz. 85008 (602) 955-4570**



All distributors offer basically identical equipment for sale. Some advertise package deals, big trade-ins, financing with easy terms . . . each asking for your business in his own way. How do we at Juge Electronics entice you to deal with us?

First, being Amateurs, we realize that when the decision is made to purchase a major item or a new accessory, you wish you had it "yesterday." We always try to ship your order the day it reaches us. Whoever takes the order follows it through packing, addressing, billing and shipping so that it doesn't get delayed by paperwork. In the event we're out of stock, we have telex links with all but two or three suppliers, and will have them drop-ship to you the same day.

Second, if you tell us it's OK, we prefer to open and thoroughly check your gear before shipping. Nothing is more frustrating than getting a new rig which doesn't work! When that happens, it's a real headache for us, and we don't like headaches, so we much prefer to take this little added precaution . . . and it is that much more assurance to you of receiving a rig in really tip-top shape.

Third, if you should have a problem, we handle it just as fast as humanly possible, and to your complete satisfaction. We try to answer all letters the day they arrive, whether orders, questions, or problems. We'll also give you honest answers to questions about gear you're considering . . . we don't want you to buy something you won't be happy with, as that is just going to be another headache for us.

Of course we offer financing through General Electric Credit Corp., with 10% down and up to three years to pay the balance. We accept your BankAmericard and Mastercharge. Our phone is answered automatically during the time we're closed so you can phone in your order at night when rates are low. We stock equipment by Drake, DyComm, Galaxy, Hallicrafters, Kenwood, SBE, Standard, Swan, Regency, Ten-Tec, Tempo and Yaesu, along with a full line of accessories, parts, and used equipment. In short, we offer almost everything our competitors do, plus the service described above. Our goal is quality, not quantity. We don't operate on a 10% markup, but we are competitive . . . we can't provide the service we want associated with the Juge name, on 10% markup. We're finding that more and more Amateurs are becoming more interested in really good service than they are in an extra ten dollar saving on a trade. We hope you'll write us, and try our service on your next purchase. We think you'll be pleasantly surprised!

## **ED JUGE ELECTRONICS, INC.**

3850 SOUTH FREEWAY  
PHONE (817) 926-5221

FT WORTH, TX 76110  
TELEX 75-8329

Hours: 9:00-5:30 Tues. thru Sat.

# FM TRANSCEIVER under \$100.00

YOU SUPPLY CASE – MIKE – SPEAKER – CONTROLS.

## 144–220 TRANSMITTER KIT

**ANNOUNCING! A Breakthrough for the Homebrewer**

COMPLETE WITH DRILLED BOARD

**\$29.95**

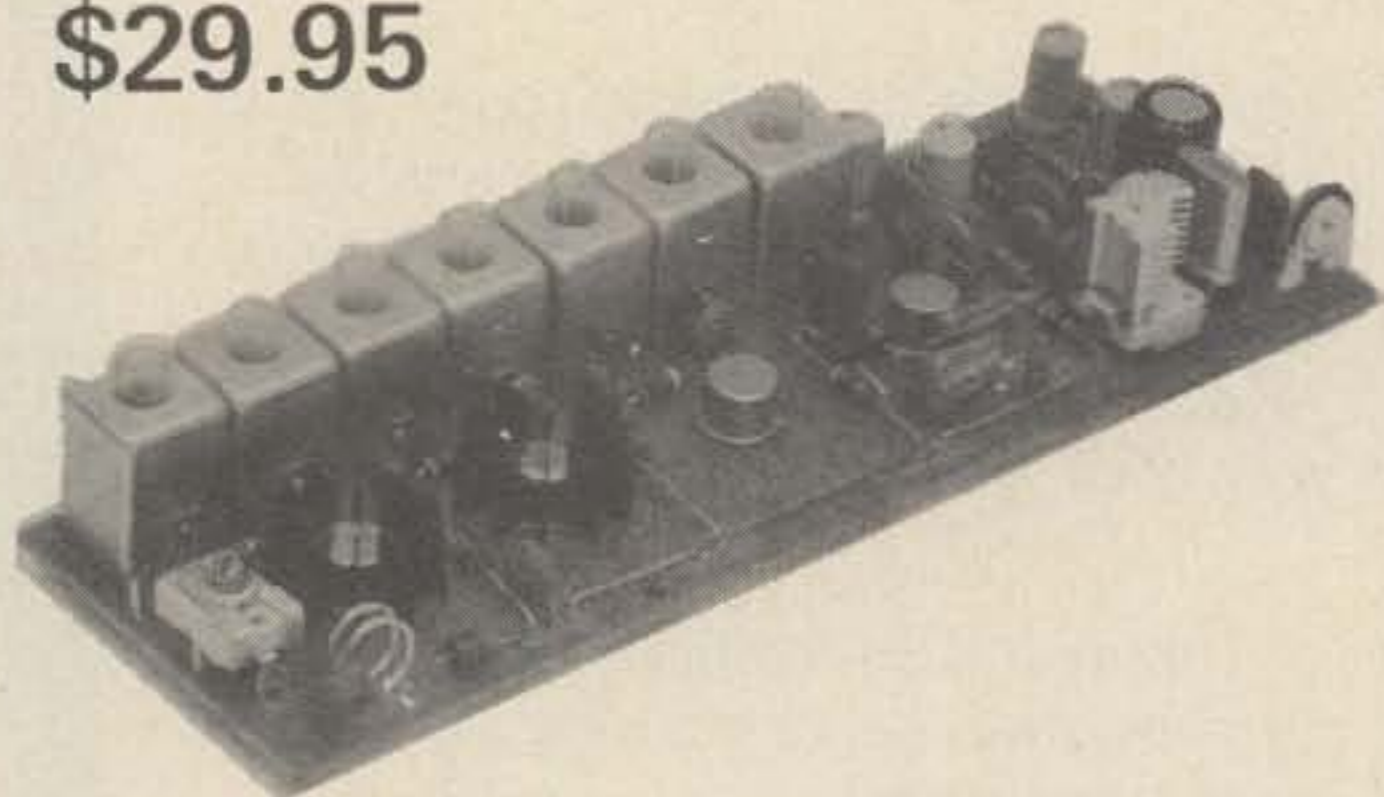

- TYPICALLY 1 1/2 WATTS OUTPUT AT 12.6 VOLTS (1 WATT ON 220)
- ADJUSTABLE DEVIATIONS TO 10 kHz
- AUDIO CLIPPING AND ACTIVE FILTER
- CRYSTAL NETTING TRIMMER
- DOUBLE TUNED RF STAGES FOR A CLEAN SIGNAL
- STANDARD 12 MHz CRYSTALS (14 MHz FOR 220)
- ZENER REGULATED OSCILLATOR
- PROVISIONS FOR METERING EACH RF STAGE
- PREDRILLED AND TINNED GLASS CIRCUIT BOARDS
- MEASURES ONLY 2" x 6"

A one watt exciter using four RF transistors, two diodes, and one integrated circuit. The RF transistors are operating well below their ratings allowing long keying periods without damage. The exciter may be used alone as a transmitter or with our PA-144 or 220 amplifier for a 15 watt station.

## 144–220 MODULAR RECEIVER KIT

COMPLETE WITH DRILLED BOARD

**\$59.95**

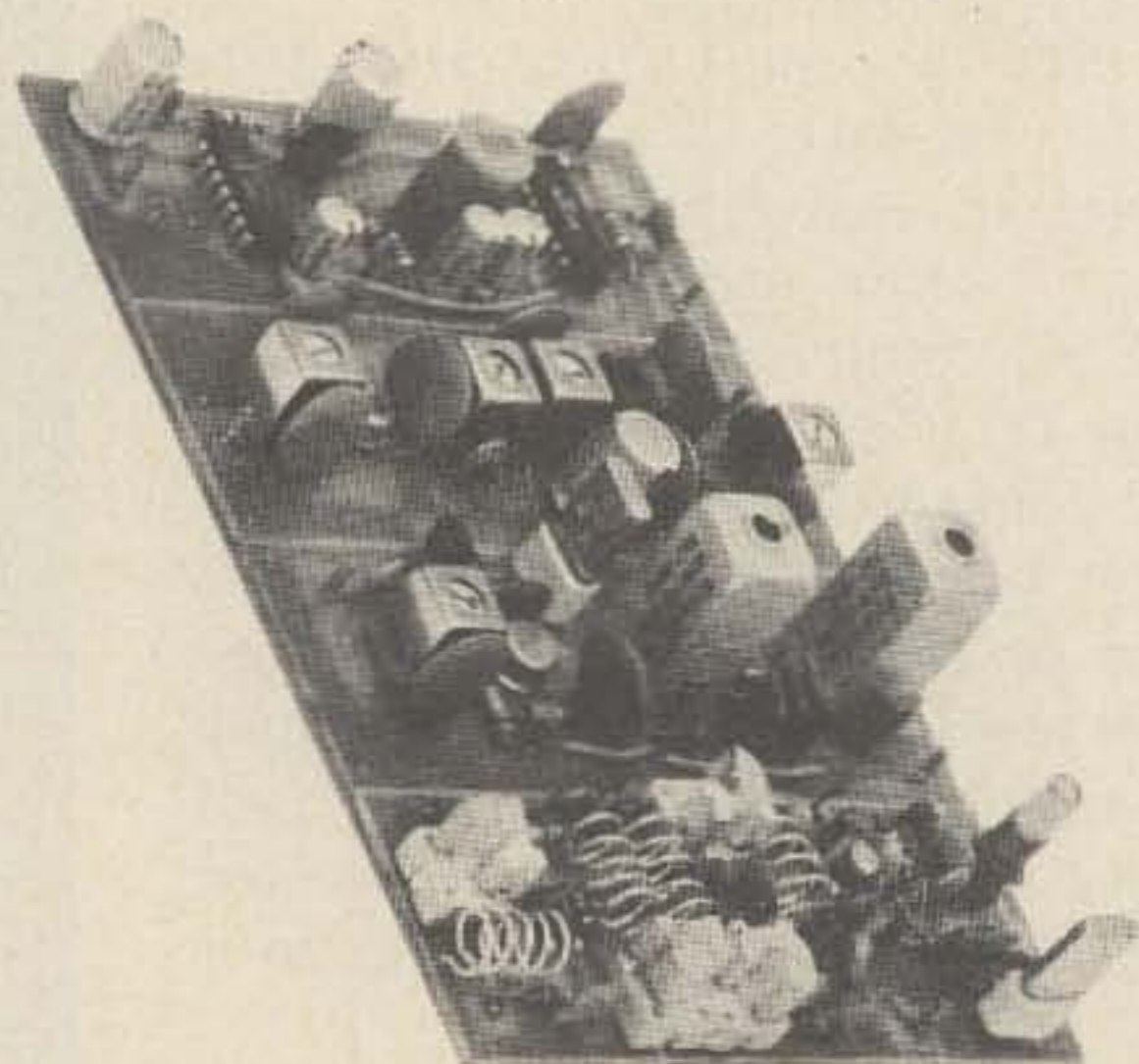

- SENSITIVE NOISE OPERATIVE SQUELCH
- BETTER THAN .3  $\mu$ V SENSITIVITY
- 15 KHz BAND WIDTH
- ONE WATT AUDIO OUTPUT
- DUAL CONVERSION 10.7 Mhz AND 455 KHz IFs
- ALL IC EXCEPT FOR FRONT END
- STANDARD 45 Mhz CRYSTALS
- OPTIONAL CERAMIC FILTER
- OPERATES FROM 12 VOLTS NEGATIVE GROUND

Measures only 4" x 6"

Order TX-144 or 220—\$29.95; PA-144 or 220—\$29.95; RX-144 or 220—\$59.95.

Receiver with 7 KHz ceramic filter — \$65.95. Include \$1.00 postage and handling for each kit ordered. New York state residents add 6% sales tax.



# VHF ENGINEERING

320 Water Street POB 1921  
BINGHAMTON, NEW YORK 13902



# NEW POWER-BOOSTER

Measures  
7 x 9 x 3½

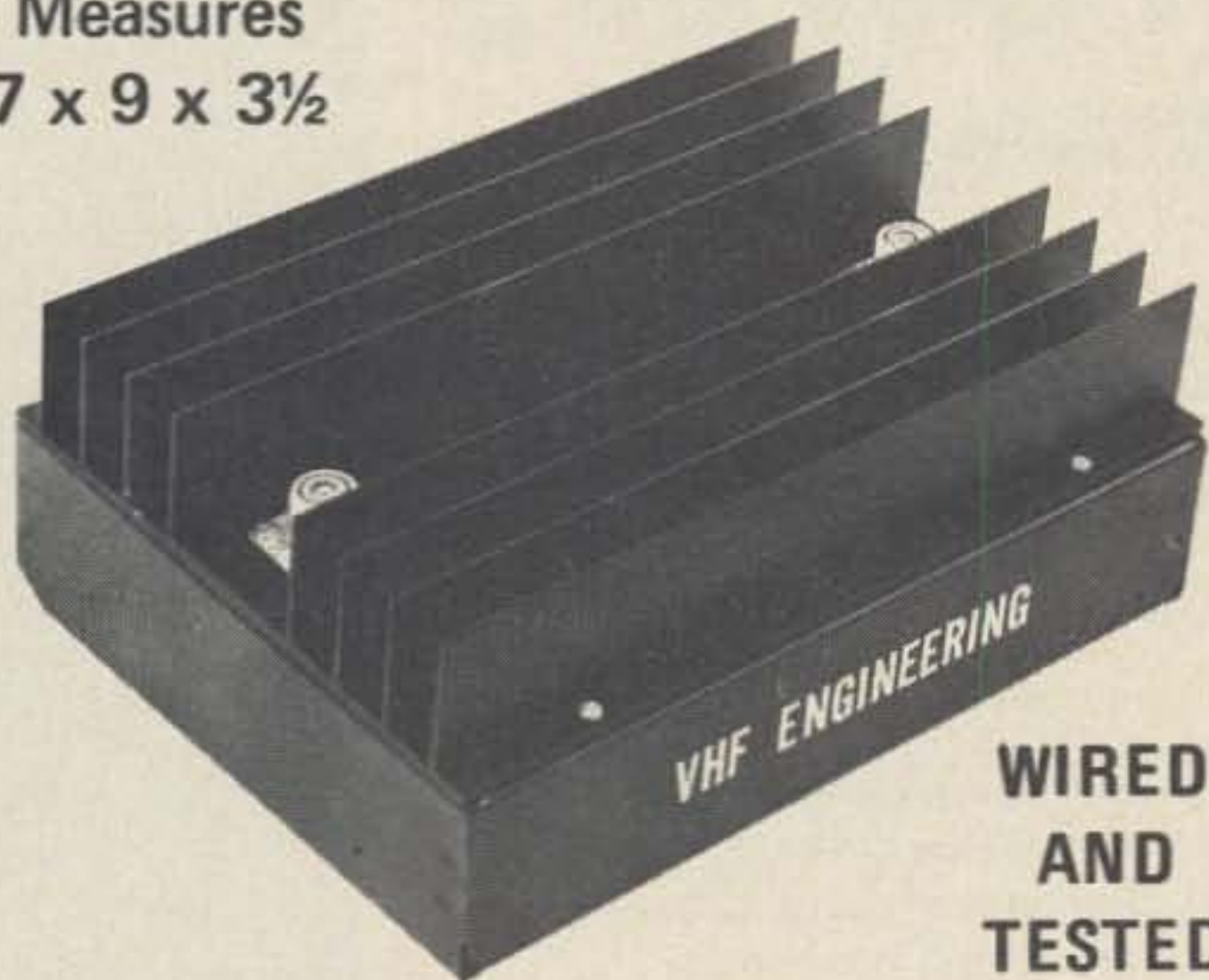

WIRED  
AND  
TESTED

## 60-90 Watts

### TWO MODELS

8005H 2-6 watts in 60-90 watts out  
(60 watts from your standard)

8020H 10-25 watts in 60-90 watts out  
(Increase the power of your  
REGENCY by over 400%)

8005H      \$159.95

8020H      \$129.95

Not a kit, but a completely wired and tested power amplifier with automatic antenna switching. Uses NEW not surplus, balance emitter power transistors for missload protection. Large heat sink for cool operation. Less than 1 dB loss on receive. SO 239 connectors, nominal 50 ohm impedance.

## NEW RX-144C KIT

### \$69.95

*For Repeaters or Those  
Who Need The Best*

### With 10.7 Crystal Filter

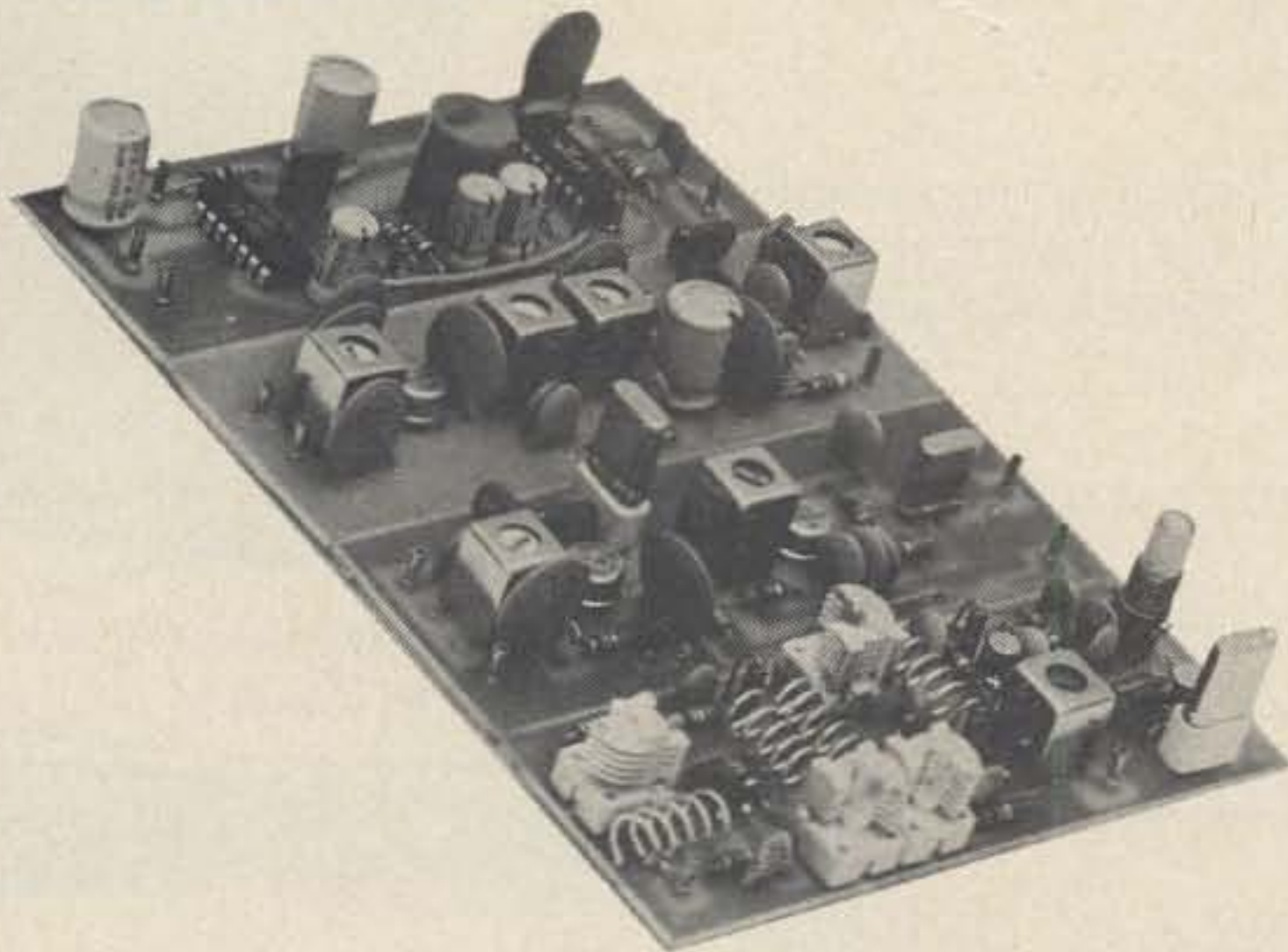

- LOW CROSS MODULATION FRONT END
- 10.7 Mhz CRYSTAL FILTER
- COR OUTPUT FOR CONTROL
- 2 WATTS AUDIO OUTPUT
- LESS THAN .2µV SENSITIVITY
- MEASURES 4 x 6 x 1 inches

*We are now in our new location . . . please note new address . . .*



# VHF ENGINEERING

320 Water Street POB 1921  
BINGHAMTON, NEW YORK 13902

WORLD ACCLAIMED

# UNIVERSAL TOWERS

## FREE STANDING ALUMINUM TOWER

**LIGHTWEIGHT - RUST FREE - EASY TO ASSEMBLE - RUGGED STRENGTH  
FOR TV - FM - HAM RADIO - INDUSTRIAL INSTALLATIONS - FIRE - POLICE - MARINE - CB**

Anyone interested in a tower should consider the tremendous advantages of aluminum over steel towers.

### WHEN IT COMES TO ANTENNA SYSTEMS

ELECTRONIC DISTRIBUTORS, INC., originated Antenna System "packages" over 23 years ago. These are RECOMMENDED matched systems designed to work together - yet with flexibility to meet YOUR needs. Many other combinations available, of course.

### THE BEST ANTENNA PACKAGES YET!

#### EDI "STANDARD" PACKAGE U1140

- Universal 11-40 Tower - \*\*
- Universal B-18 Hinge-Up Base
- Universal R-11 Rotor Mount
- CDR AR22R Rotator \*
- 100 ft. Rotor Cable
- 100 ft. RG8/U Foam Coax

Complete with one of the following antennas:

- Hy-Gain TH2-MK3 . . . Reg. \$446. EDI \$325.
- Hy-Gain TH3JR . . . . . Reg. \$446. EDI \$325.
- Hy-Gain Hy-Quad . . . . . Reg. \$476. EDI \$351.
- Hy-Gain 203BA . . . . . Reg. \$486. EDI \$359.
- Hy-Gain TH3-MK3 . . . . . Reg. \$491. EDI \$364.

\*TR44 Rotator & Cable - Add . . . . . \$ 29.

\*Ham-M Rotator & Cable - Add . . . . . \$ 65.

\*\*11-50 (50') Tower w/B22 Base - Add \$ 84.

Light Weight - In addition to its weight advantages aluminum offers maintenance free life time beauty. Eliminates painting and ugly rust inherent in steel towers.

Strength - Important to your choice of a tower. Universal towers are tested for 80 m.p.h. winds and are designed to exceed that wind velocity.

Easy Assembly - Child's play to assemble. You can easily assemble a tower on the ground and walk it up, or assemble it erect section by section.

In addition to all of these advantages total cost of a Universal Aluminum Tower is less than similar steel towers extended over the life of the tower.

LET US RECOMMEND THE PROPER TOWER FOR YOU. Request WHOLESAL catalog.

### ALSO COMPLETE LINES ANTENNA SYSTEMS AND HAM GEAR

Hy-Gain, Mosley, Telrex, Cushcraft, Wilson, A/S, Newtronics, Collins, Drake, Galaxy, Hallicrafters, Ten-Tec, Tempo, Regency, Clegg, Tri-Ex, Rohn, etc., etc.

(GECC revolving credit available)

LET US QUOTE AND SUPPLY your EVERY need. ONE-STOP service.

Available ANYWHERE IN THE WORLD directly from

# ELECTRONIC DISTRIBUTORS, INC.

-Communication Specialists for over 34 years -  
1960 Peck Street, Muskegon, Michigan 49441 Tel. (616) 726-3196

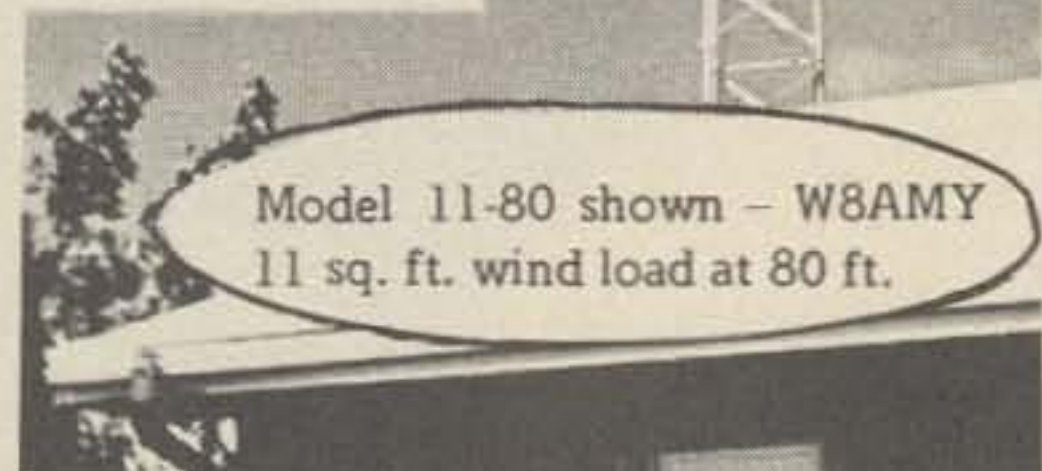
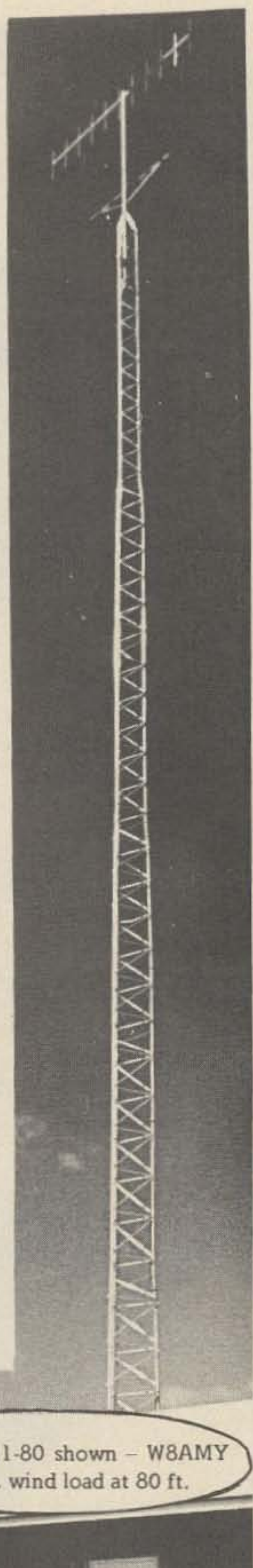

Model 11-80 shown - W8AMY  
11 sq. ft. wind load at 80 ft.

# WALLER ELECTRONICS TEST EQUIPMENT SALES

P.O. Box 9913, Chevy Chase, Md. 20015  
Telephone 301-652-0996

The "TESCO-PAD" has no tuned coils to go off frequency, no tuning necessary or even there! It's all in one "Black Box I.C." ready to go. The "TESCO-PAD" has a 1 second hold-up for your transmitter, complete P.T.T. operation, available with dual audio output levels, 12 or 16 tone combinations.

**KIT \$34.95      \$39.95 Wired**  
(Add \$1.00 for 16 tone version)  
(\$2.00 for dual output version)

(Add \$1.00 for postage and handling.)

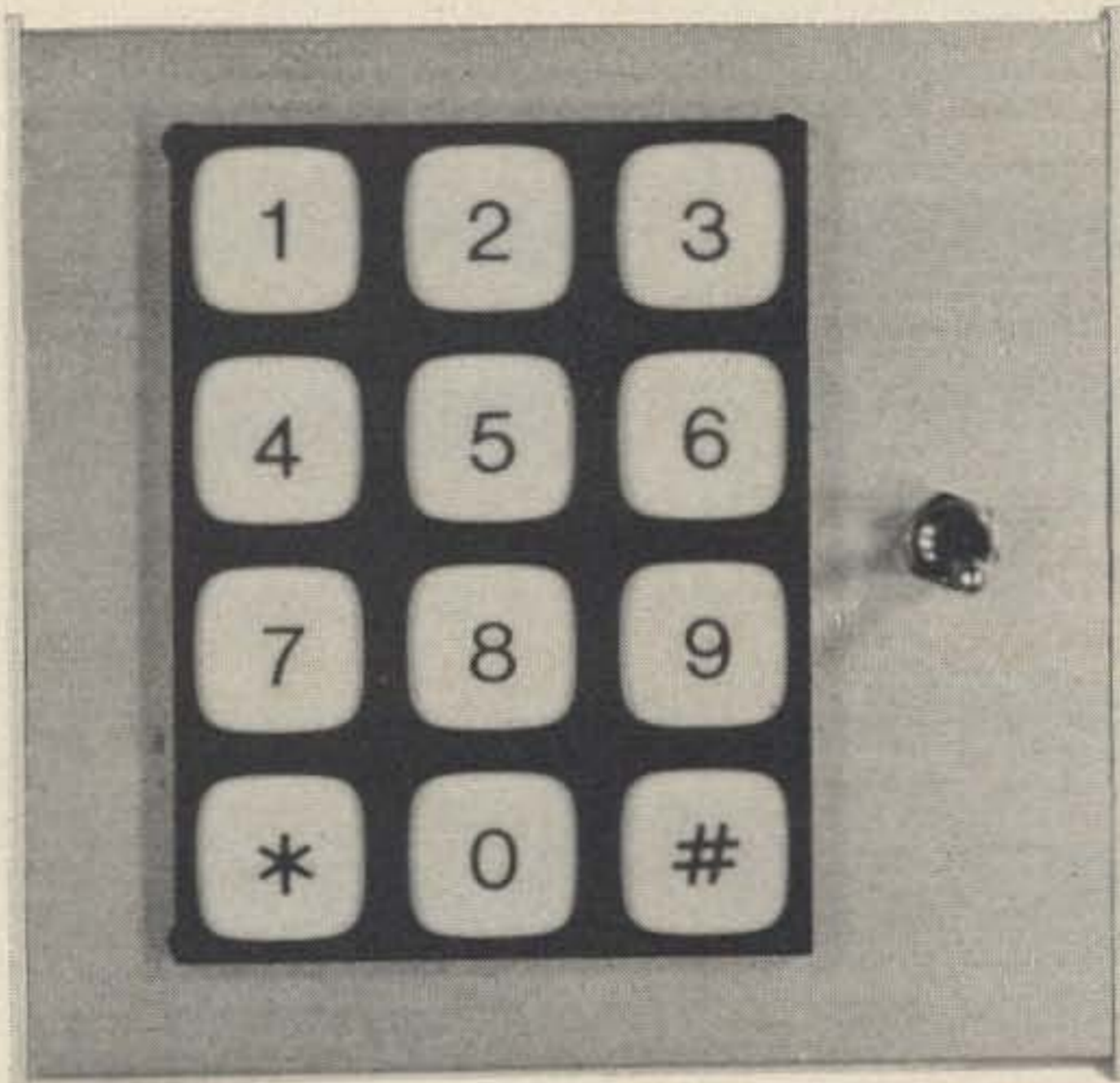

## NOW BRUTE FORCE IN A 12V BENCH SUPPLY – THE WALLER 60 AMP 12 VOLT SUPPLY!

A bench power supply for mobile equipment. This brute of a supply will run a mobile rig and even an amplifier from 110V ac. The output is a nominal 12V dc at 50 amps and is usable to a full 60 with a slightly lower output voltage. The heart of this supply is a constant voltage transformer rated at a constant output of 60 amps. The supply features built in voltage and current metering. The Waller 12 volt 60 amp supply is only . . . . . **\$100 in kit form or \$125 wired.**

*This unit shipped freight collect.*

Portable Tune Up Meter with cables to plug into Motorola, Link, GE, Standard, etc. This unit gives you the meter functions of the radio being tested. It also operates as a portable dc voltmeter with the following full scale ranges: 1.5, 5, 15, 50, 150, 500, 1 KV with a special 3 volt range for GE Progress Line equipment. The UT-1 can be set zero center for discriminator readings. Also featured in the UT-1 is a field strength meter. Place your order now. Kit form **\$42.50**. Wired **\$49.95**. Extra cables of your choice (specify rig) . . . . . **\$5.00 ea.**

*(\$2.00 for postage and handling.)*

## CALL OR WRITE WALLER NOW

# DRAKE

*is Great!*

*and*











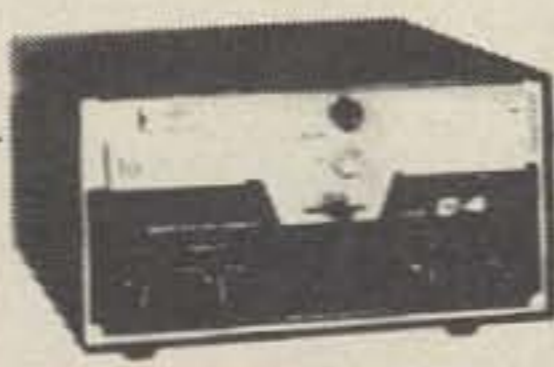

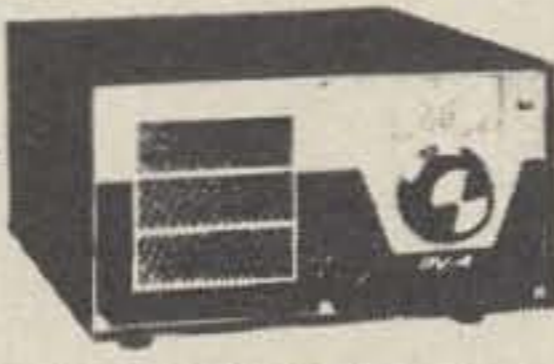
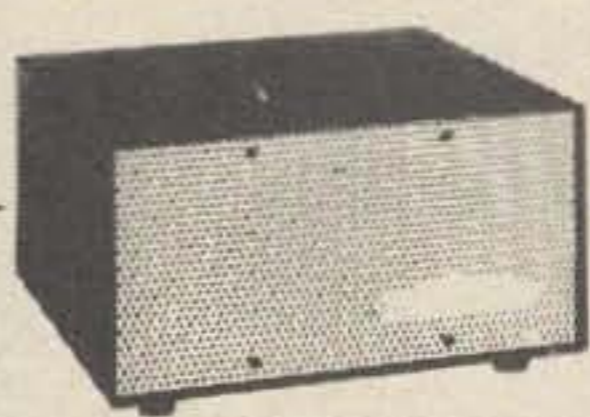

# Harrison

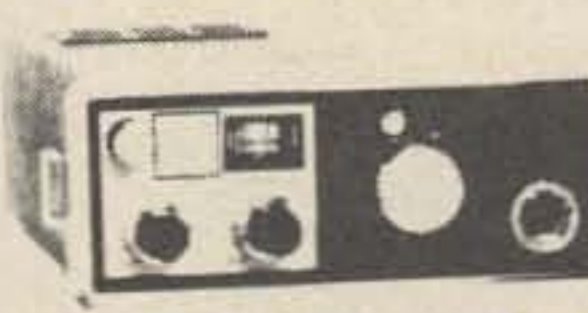
*is where it's at!*

For well-engineered, solidly constructed, high QSO scoring equipment, Drake is your most logical greater-value-per-dollar choice.

Worth more at trade-in time than any kits or import orphans—so, it really costs you less per year to enjoy Drake dependability and superior performance.

For competent assistance by knowledgeable hams,—for quickest delivery of factory-fresh, latest production equipment—for top trade-in deals—for greatest satisfaction and pleasure—your most logical more-for-your-money choice is HARRISON!

			
R-4B RECEIVER	C-4 STATION CONSOLE	T-4XB TRANSMITTER	L-4B 2KW LINEAR
			
TR-4 TRANSCEIVER	RV-4 REMOTE VFO	MS-4 SPEAKER	MN-2000 ANTENNA MATCHER
			
TR-22 2 METER FM TRANSCEIVER	ML-2 2 METER FM TRANSCEIVER	TC-2 2 METER XMTR CONVERTER	TR-6 6 METER TRANSCEIVER
			
SPR-4 SOLID STATE RECEIVER	SW-4A SWL RECEIVER	2-C RECEIVER	2NT CW AND NOVICE TRANSMITTER

**CHARGE IT!** On your Master Charge, Bank Americard or Uni-Card. Spread payments up to two years.

**ORDER NOW!** Or, ask for literature.

**PROMPT ORDER DEPT.**

We carefully pack and ship ham gear, accessories and parts to most any part of the world. Address your orders to:  
**18 SMITH STREET**  
Farmingdale, N.Y. 11735  
Or — Phone your orders to  
**(516) 293-7990**

# Harrison

"Ham Headquarters, U.S.A."®

- FARMINGDALE, L.I. 2265 ROUTE 110 2 miles South of LIE exit 49S (516) 293-7990
- NEW YORK CITY 8 BARCLAY STREET Near City Hall BARclay 7-7922
- VALLEY STREAM 10 SUNRISE HWY. (At Rockaway Ave.) (516) 872-9565

# INTRODUCING: SUPER CRYSTAL —

## The New DELUXE DIGITAL SYNTHESIZER from **RP**



**MFA-22 Dual Version: \$275.00\***

- SUPER ★ TRANSMIT and RECEIVE OPERATION — SIMPLEX and REPEATER MODES in both versions.
- SUPER ★ READOUT — DIRECT DIGITAL READOUT — fast acting lever switches.
- SUPER ★ LOW SPURIOUS OUTPUT LEVEL — low spurious output is similar to a crystal output, not spurious laden as with some other units.
- SUPER ★ FAST ACTING CIRCUITS — 0.15 second typical settling time.



**MFA-2 Single Version: \$210.00\***

- SUPER ★ ACCURATE FREQUENCY CONTROL — .0005% accuracy, both transmit and receive, on all channels.
- SUPER ★ STABLE LOW DRIFT OUTPUT — 20 Hz per degree C typical drift rate.
- SUPER ★ COVERAGE — FULL 2 METER BAND COVERAGE: 144.00 to 147.99 MHz in 10 KHz steps.
- SUPER ★ LOW IMPEDANCE OUTPUTS — 50 ohm output impedance allows long cable runs, both transmit and receive, for trunk or remote units.

SEND FOR FREE DETAILS TODAY      ORDER DIRECT or THROUGH YOUR DEALER  
 (\* Add \$3.00 per unit shipping charge. UPS areas. \$5.00 otherwise. ILLINOIS RESIDENTS add 5% Illinois sales tax.)

### TONE BURST ENCODERS AND DECODERS

- UP to 5 fixed tones (factory set)
- ADJUSTABLE — Duration — Output
- NO BATTERIES needed.
- FULLY ADAPTABLE
- EASY INSTALLATION
- CONTINUOUS TONE POSSIBLE
- FULL 1 YEAR RP Warranty

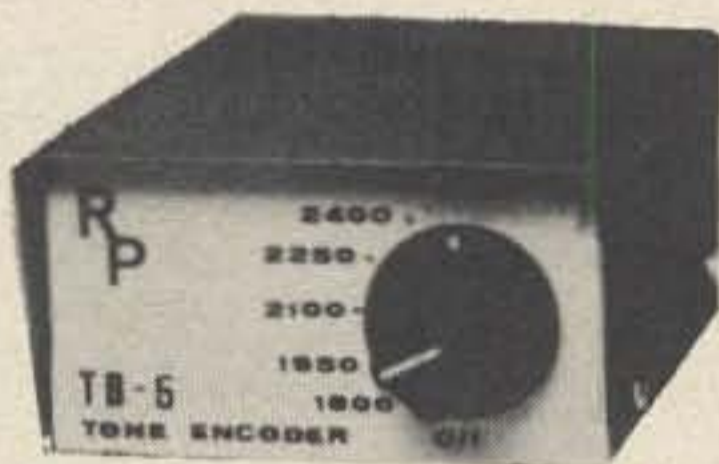

**PRICES:**

- TB-5 5 tone std. encoder ..... \$37.50  
(1800, 1950, 2100, 2250, 2400 Hz.)
- ST-2 Single tone decoder ..... \$37.50  
(Specify 1800, 1950, 2100, 2250, or 2400 Hz.)

Special tones — Inquire  
 Add \$1.80/unit for shipping  
 (Ill. residents add 5% tax)

### A SPEECH COMPRESSOR THAT REALLY WORKS



RPC-3,3U Internal Unit (\$24.95)



RPC-3C Cabinet Model (\$34.95)

- Low distortion circuit.
- Fully wired & tested. NOT A KIT
- Works with phone patch.
- Internal units & modules work mobile.
- FULL WARRANTY — ONE YEAR
- INTRODUCTORY LOW PRICES

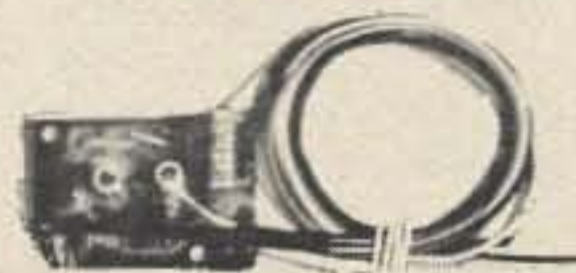

RPC-3M Module (ONLY \$22.50)

- (Illinois residents add 5% Sales Tax)
- Add \$1.00/unit shipping (RPC-3, 3U, 3M)
- Add \$2.00/unit shipping (RPC-3C)

**RP ELECTRONICS**

BOX 1201B  
 CHAMPAIGN, ILL. 61820

**R.F. AMPLIFIERS**

TUNES 50 to 100 mhz - COMPACT ALL ALUM. CASE 12" x 15" x 6 1/4" WITH SK 600 EIMAC SOCKET. 1 LARGE AIR VARIABLE CAP. - 2 SMALL AIR VARIABLE TRIMMERS - TEFLON MOUNTED ROTARY INDUCTOR - GOOD FOR LINEAR AMPLIFIER - CAN USE EITHER 4 CX150A or 4 CX250 - LESS TUBE, PRICE: ..... \$14.95 WITH 4 CX150A, PRICE: ..... \$19.95

**WINTRONIX MODEL 850 INDUCED WAVE FORM ANALYZER.** This unit in conjunction with your present oscilloscope, permits you to view wave forms in the range from audio thru MHz without any direct connection. The probe is simply placed over the tube in question and the wave form is displayed on the oscilloscope. It may also be used as a high gain amplifier to increase scope sensitivity. Excellent for T.V., radio, amplifier, and transmitter repair and maintenance. Brand new, with probe. SHIP. WT. 13# PRICE: \$19.95 ea.

**B-7971 LARGE ALPHA NUMERIC READOUT**

With sockets & driver board. Can be hardwired to form unusual house address numbers. 2 tubes, 2 sockets, mounted on one driver board. Save \$3.00

PRICE: 2/\$5.00

**ROTRON FANS SAUCER FANS**

280 CFM 7" DIA. x 2 1/2" DEEP 115V-50-60 cy. PRICE: \$4.95 EA.

**METERS PANEL TYPE WESTON MODEL 1238**

0-500 microamps full scale calibrated .005 to 500 roentgens/hours. 270 degree scale, approx. 3" dia. excellent for wavemeter etc. New and in original boxes. PRICE: \$1.95 ea. or 3/\$5.00

**TEKTRONIX MODEL 360**

WAVE FORM INDICATOR - BANDWIDTH DC - 500 kHz PRICE: \$24.95

**MODERN ALUMINUM BENCH RACK CABINET**

11 1/2" H x 18" D x 19" W. 8" panel openings w/rubber feet and disappearing handle. Lt Blue PRICE \$7.95

**VARIACS PANEL MOUNT**

2 AMP \$3.95  
4 AMP \$5.95  
6 AMP \$7.95  
240V - 60 cy or use on 120V with slightly lower amp ratings

**TRANSISTOR REGULATED POWER SUPPLY**

115V - 60 cycle in +12 - 12 - 6V @ 2 amp output. Front Panel adj + or -10%. On-off switch. Fuses. Barrier strip output. 6" x 5" x 7". Excellent Cond. Ship. Wt. 10# PRICE \$14.95

**50 AMP VARIAC**

230 V. input 60 Hz. Unused Price \$99.50

**WE APOLOGIZE**

SORRY WE RECENTLY SOLD OUT DUE TO HEAVY DEMANDS ON OUR INVENTORY. GOOD NEWS - HOWEVER, MORE IS ON THE WAY. WE BEG YOUR INDULGENCE IN THE MEANTIME AND THANK YOU FOR YOUR PAST PATRONAGE, IN OUR ENDEAVORS TO SELL THE MOSTUST - FOR THE LEASTEST".

THANK YOU!!!!!!!!!!!!

**TOROID TRANSFORMERS**

MOST VERSATILE WE EVER HAD  
3 1/2" RD 3" H  
WT 3#  
4-14 V INPUT WINDINGS  
4-5V FEED BACK WINDINGS  
2-333V - 1/2 amp. WINDINGS  
2-167V - 1/2 amp. WINDINGS  
WILL SUPPLY 1000V @ 1/2 amp.  
CAN USE ANY COMBINATIONS OF ABOVE.  
SHIP. WT. 5# PRICE: \$5.95 or 2/10.00

**MINOR REPAIRS NEEDED**

T.S. 323/UR  
ALL HAVE CAL. BOOKS BARGAIN NOT JUNK  
PRICE: \$24.95

**ADJUSTABLE PRINTED CARD BOX**

For Rack Mount  
5" to 7 1/4" - 16 slides and sockets - includes 30 double contact position edge connector type  
PRICE \$9.95

**COMPUTER TYPE CAPACITORS**

40,000 @ 20V  
32,500 @ 25V  
55,000 @ 15V  
100,000 @ 8V  
50¢ each or 5 for \$2.00  
40,000 @ 10V  
30,000 @ 10V  
PRICE: 3 for \$1.00

**TRANSFORMER**

12.6 VCT @ 10 amps. or  
6.3 VCT @ 20 amps.  
WT. 10 lbs. PRICE: \$4.95

**METERS**

0-150 VAC 3 1/2" PRICE \$3.00  
0-300 MA. DC 3 1/2" NEW PRICE: \$2.50  
FREQ. METER 60 cy. REED TYPE 3 1/2" PRICE:  
PRICE: ..... \$4.95

ALL PRICES ARE F.O.B. OUR WAREHOUSE, PHILADELPHIA, PA. ALL MERCHANDISE DESCRIBED ACCURATELY TO THE BEST OF OUR KNOWLEDGE. YOUR PURCHASE MONEY REFUNDED IF NOT SATISFIED. TERMS ARE CASH. MIN. ORDER \$5.00. ALL MERCHANDISE SUBJECT TO PRIOR SALE. RFE - REMOVED FROM EQUIPMENT.

1206 South Napa Street **SELECTRONICS** Philadelphia, PA 19146  
215-468-7891 215-468-4645

# WORLD'S LARGEST SELECTION OF

NEW & USED TV CAMERAS & ASSOC. EQUIPMENT

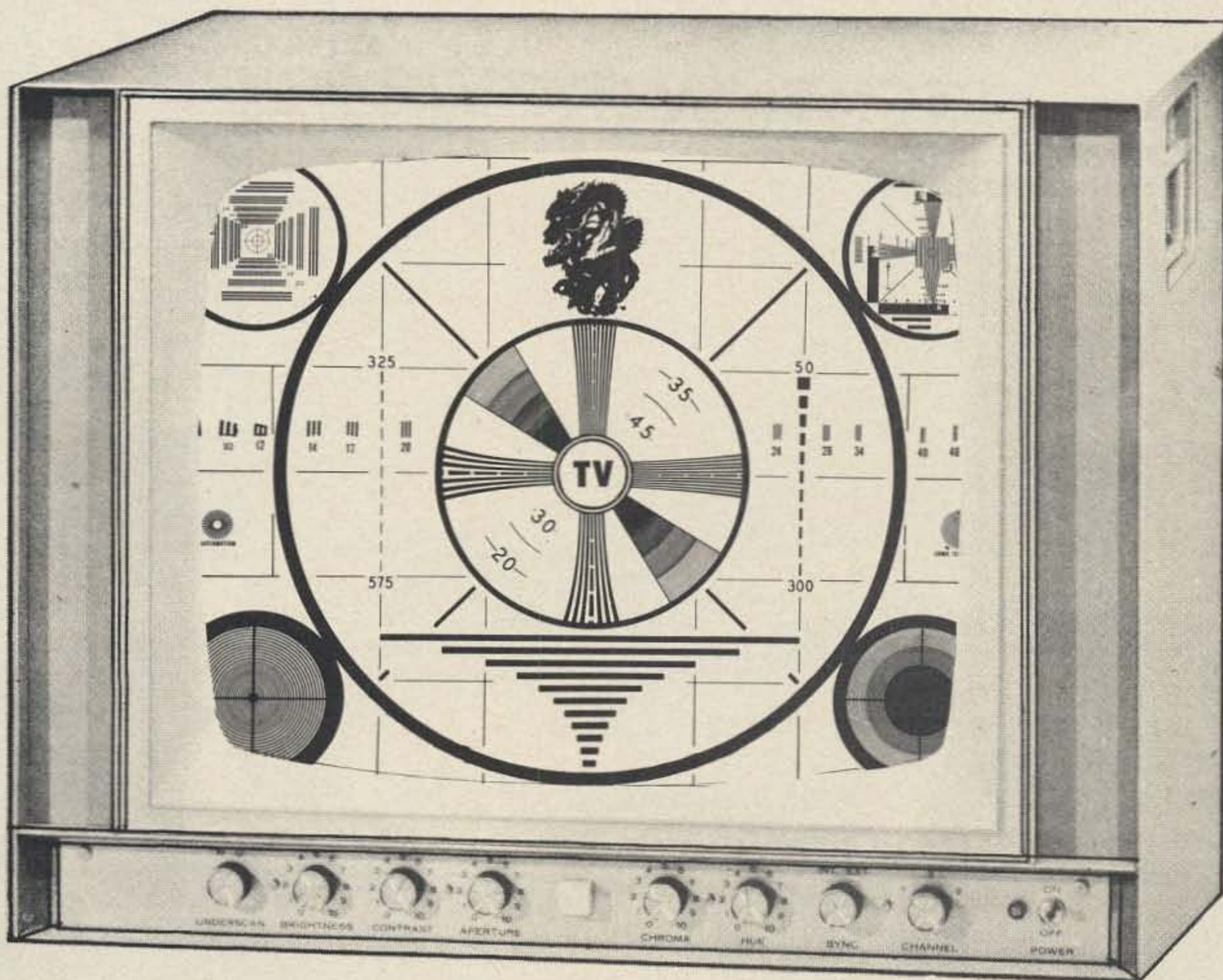

**1973**

INDEX PAGE 142

Broadcast & Closed Circuit TV  
Audio and Video Systems

PRICE  
\$1.00

CATALOG #  
**973A1**

\$1.00 ppd USA—\$2.00 Foreign.  
Free to requests on Company  
Letterhead.

**THE DENSON ELECTRONICS CORP.**

*9AM - 4PM Monday thru Friday; otherwise by appointment.*

OFFICE: Longview St. Tel. Area Code 203/875-5198

MAIL: Post Office Box 85

ROCKVILLE, CONN. 06066 USA

Come on. If your feet itch for a bit of adventure, take off your shoes and hop aboard. We're doin' our thing loafing through the little West Indie Isles. Fun your way through tropic islands with those funny little names... Saba, Nevis, St. Marteen, Antigua, Mustique, Montserrat, Guadalupe. Great grub and a daily ration o' greg for all shipmates. Your share from \$245. No stuffed shirts... just a great bunch of adventuresome guys and gals. Groove aboard for 10 days of white sail, sunshine and Caribbean moon. Come on!



Name

Address

City

State - Zip

Phone

Windjammer  
Cruises.

# Take off your shoes.

Write Cap'n Mike for adventure brochure, P.O. Box 120, Dept. 934E, Miami Beach, Florida 33139



# your REPEATER PROBLEMS are solved!

## the SUPER BLACK BOX\*

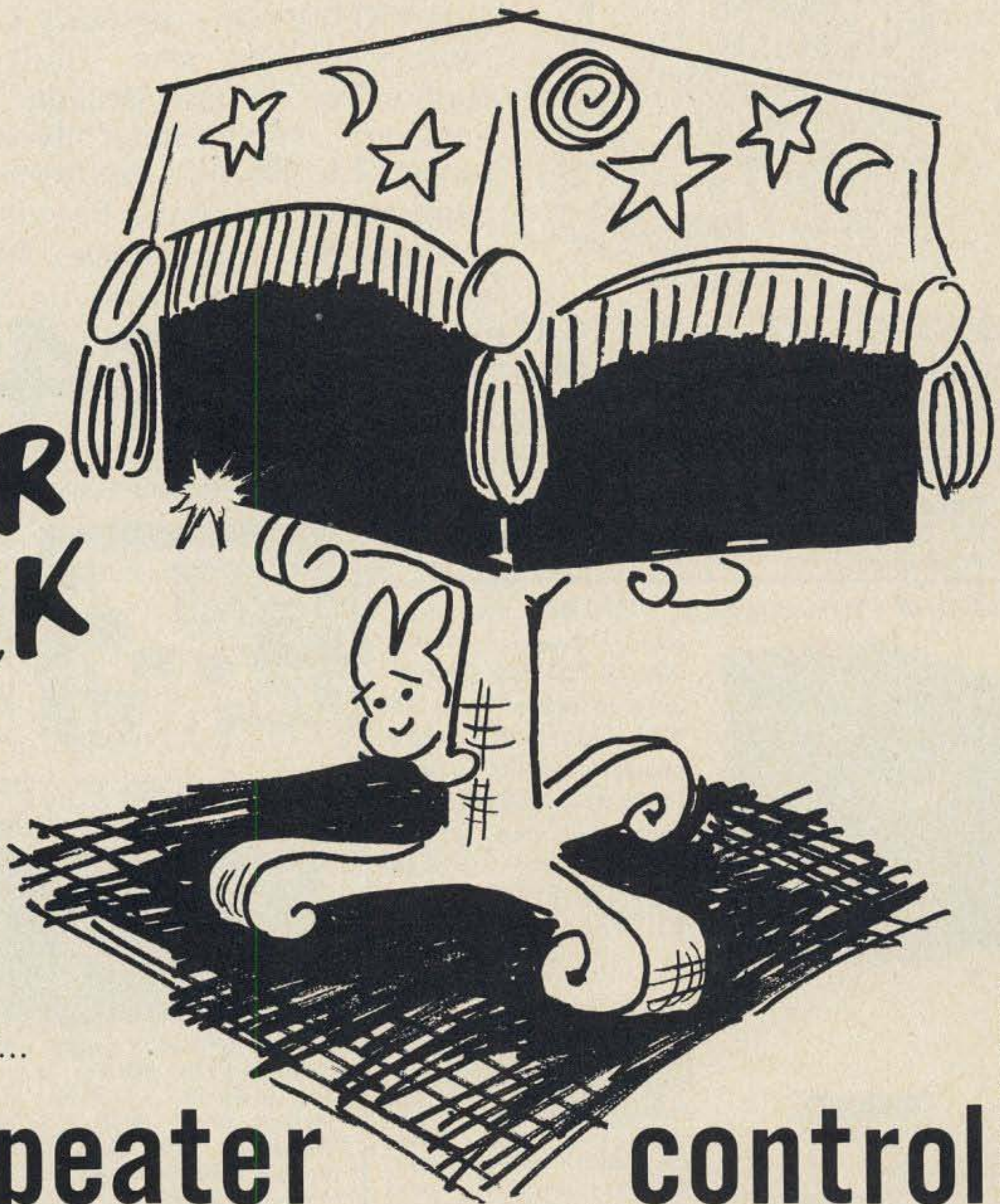

*\*Works like magic...*

## for repeater control

CONFORMS TO LATEST FCC RULES • SOLID STATE REPEATER CONTROL SYSTEMS • ANY RECEIVER TRANSMITTER POWER FREQUENCY AND ID SYSTEM • 3 MINUTE TIME OUT • 5 SECOND DELAY DROP OUT • CARRIER OPERATED SENSOR • ID CONTROL • AUDIO INTEGRATOR • OPTIONAL TONE BURST DECODER WITH AUDIO NOTCH FILTER, TELEPHONE REMOTE CONTROL, TONE DECODER VHF LINK REMOTE CONTROL, LOGGING CONTROL • 120 VOLT AC OPERATION WITH AUTOMATIC 12 VOLT DC SWITCHOVER • CYCLING TRICKLE CHARGER • FUNCTION STATUS DISPLAY LIGHT AND CONTROLS • 10 CALL MONITOR SPEAKER AND MIKE • REMOTE RECEIVER SQUELCH • ALL FUNCTIONS ON PRINTED CIRCUIT CARD • ADD NEW FUNCTIONS AT ANY TIME WITH BUILDING BLOCK CONCEPT • FLEXIBLE SYSTEMS FOR HIGHLY VERSATILE REPEATER STATION •

— Look for complete details in June issue of 73 —

# UNIDYNE, INC.

3224 Peachtree Road N.E.  
Atlanta, Georgia 30305

Phone: 404-458-0700

# Save over \$9,000.00 on this AN/WRR-2 SSB Receiver!

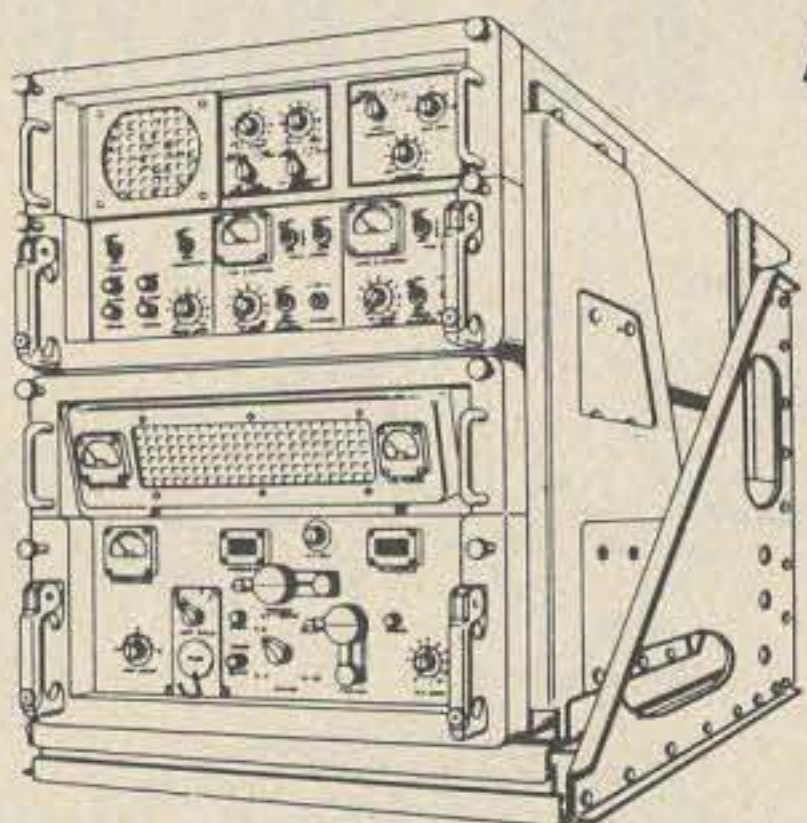

Original government cost: over \$10,000.00! One of Navy's most modern radio receiving sets. Built by National Radio Co. in last decade. A triple conversion super-heterodyne. Frequency range: 2 to 32 MC. continuously, or in 1 kc increments. 4 bands. Featuring full carrier suppression, unit receives AM, CW, MCW, voice, facsimile, Teletype and ISB. RE-

QUIRES NO MODIFICATION! Greatly superior to earlier R390A/URR model. Good cond. Complete, operational. Spec sheet available. Spare parts as needed

## \$495.

Overhauled and certified . . . \$595.00

Xerox copy of Operation Repair Manual: \$35.00. Add \$100.00 for 1/2 kc in lieu of 1 kc increments.

### RADIO RECEIVER R-108/GRC Late model



Army Comm. Recvr! 20-28 MC FM. Continuous or preset freq. OK for AM with simple modification. With schematic and hookup info. Like new. Smashing low price! \$19.95  
24 VDC POWER SUPPLY for above \$4.95

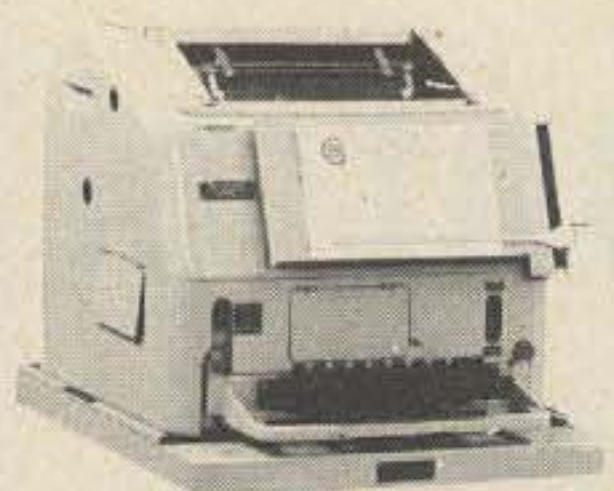

### MODEL 15 TELETYPE PAGE PRINTER

Rebuilt like new by US Navy. In orig. govt. packing! With table, power supply and manual. BARGAIN! 15 KSR WITH KEYBOARD . . . \$200.00  
15 RO. NO KEYBOARD . . . \$175.00

### IP-69/ALA-2 PANADAPTER

This compact unit can be used with most Ham Receivers after conversion. Complete with conversion info and schematic. Good condition . . . \$19.95

### HEWLETT-PACKARD SPECTRUM ANALYZER

The famous Model 8551B with Display H.P. 851B. Excel. cond. CERTIFIED with new TWT. Now reduced to less than half of original price! Special. Only \$5500.00

### NAVY TCS TRANSMITTER



Just arrived! This collector's item is now available in new condition! 1.5 to 23 Mc. CW and AM. 50 watt CW. Ideal for a raft of multipurpose uses. Designed by Collins Radio. Brand new! A Columbia special . . . \$75.00

### 2 METER AIRCRAFT MONITOR RECEIVER 130-150 MC

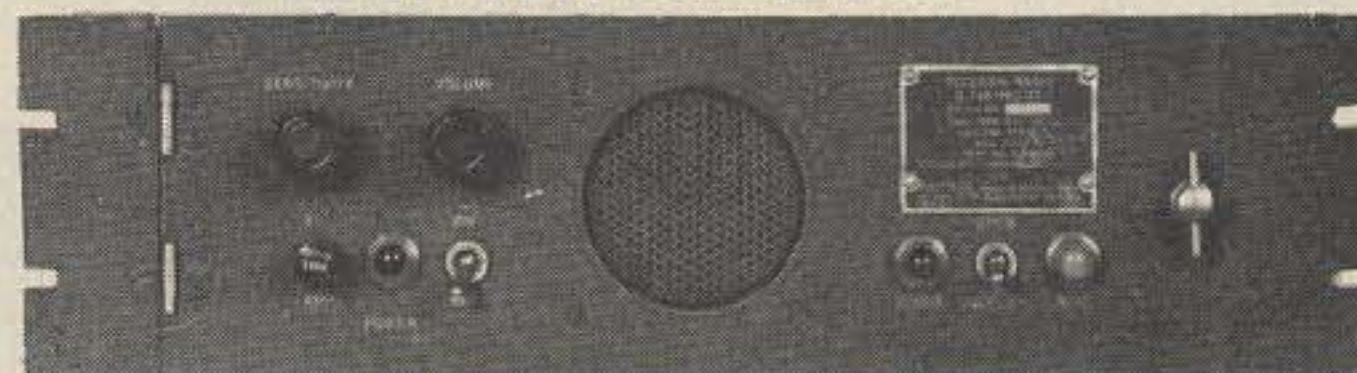

R-748/TRC-47 single channel AM crystal controlled 110V 60CPS, pwr supply & speaker built in, squelch, r-f gain, dual conversion modern design. Size 19"W x 5"H x 14"D for rack mtg. Supplied with schematic & hookup info. No conversion required. Exl condition . . . \$29.95

### FM TRANSMITTERS & RECEIVERS

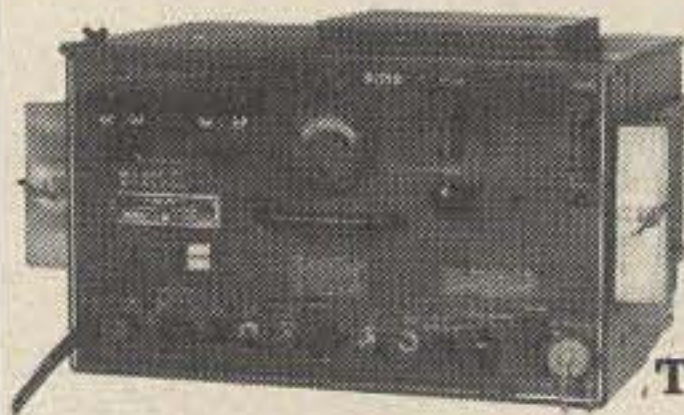

T-14/TRC-1 R-19/TRC-1

70-100 Mc. Single channel. 50 W. output. 110 V, 60 cycle. New and like new.

R-19/TRC-1 Receiver . . . \$49.50  
T-14/TRC-1 Transmitter . . . \$49.50

FREE schematics. Convertible to 6 or 2 meters.

190-550KC Q-5er Good Condition Recvr \$14.95  
or like New Receiver . . . \$19.95  
6-9MC 40 Meters Good Condition Recvr . . \$9.95  
2.13MC T 18/ARC-5 New Xmtr . . . \$4.95  
4-5.3MC T-20/ARC-5 Excl. Condition Xmtr \$3.95  
4-5.3MC BC-475 New Xmtr . . . \$5.95  
MD-7/ARC-5 Plate Modulator for Above Xmtrs  
Exl. Condition . . . \$4.95

## Columbia Electronic Sales, Inc.

P.O. Box 9266, 7360 Atoll Ave., North Hollywood CA 91609 Tel (213) 875-2970 & 764-9030

# PRICES GOING UP!

INCREASED DEMAND FOR IC'S IN GENERAL AND TTL'S IN PARTICULAR HAS CAUSED SEVERE SHORTAGES AND SHARP INCREASES IN OUR COST. REGRETFULLY, WE ARE FORCED TO INCREASE OUR PRICES IN ORDER TO BE ABLE TO OBTAIN THESE PARTS FOR YOU. WE WILL, HOWEVER, ACCEPT ORDERS AT OUR PREVIOUSLY ADVERTISED PRICES IF POST-MARKED OR CALLED IN BY APRIL 20TH, 1973.

Catalog Number	Any Quantity Per Item (Mix)		Multiples of 10 Per Item (Mix)		Catalog Number	Any Quantity Per Item (Mix)		Multiples of 10 Per Item (Mix)	
	1-99	100-999	1000 up	100-990		1-99	100-999	1000 up	100-990
7400	.34	.32	.30	.28	74175	2.00	1.90	1.80	1.70
7401	.34	.32	.30	.28	74180	1.30	1.23	1.16	1.09
7402	.34	.32	.30	.28	74181	5.20	4.90	4.60	4.30
7403	.34	.32	.30	.28	74182	1.26	1.19	1.12	1.05
7404	.36	.34	.32	.30	74192	2.10	2.00	1.90	1.80
7405	.36	.34	.32	.30	74193	2.10	2.00	1.90	1.80
7406	.56	.53	.50	.47	74198	3.10	2.95	2.80	2.65
7407	.56	.53	.50	.47	74199	3.10	2.95	2.80	2.65
7408	.38	.36	.34	.32	SCHOTTKY TTL				
7409	.38	.36	.34	.32	74800	.88	.84	.79	.75
7410	.34	.32	.30	.28	74801	.88	.84	.79	.75
7411	.34	.32	.30	.28	74803	.88	.84	.79	.75
7413	.60	.57	.54	.51	74804	1.00	.95	.90	.85
7416	.54	.51	.48	.45	74805	1.00	.95	.90	.85
7417	.54	.51	.48	.45	74808	.88	.84	.79	.75
7418	.38	.36	.34	.32	74809	.88	.84	.79	.75
7420	.34	.32	.30	.28	74810	.88	.84	.79	.75
7421	.34	.32	.30	.28	74815	.88	.84	.79	.75
7423	.84	.80	.76	.72	74820	.88	.84	.79	.75
7425	.54	.51	.48	.45	74821	.88	.84	.79	.75
7426	.40	.37	.34	.31	74822	.88	.84	.79	.75
7430	.34	.32	.30	.28	74840	1.00	.95	.90	.85
7437	.56	.53	.50	.47	74850	.88	.84	.79	.75
7438	.56	.53	.50	.47	74851	.88	.84	.79	.75
7440	.34	.32	.30	.28	74860	.88	.84	.79	.75
7441	1.73	1.64	1.55	1.46	74864	.88	.84	.79	.75
7442	1.34	1.27	1.20	1.13	74865	.88	.84	.79	.75
7443	1.34	1.27	1.20	1.13	74873	1.82	1.73	1.63	1.54
7444	1.34	1.27	1.20	1.13	74874	1.82	1.73	1.63	1.54
7445	1.71	1.62	1.53	1.44	748107	1.82	1.73	1.63	1.54
7446	1.34	1.27	1.20	1.13	748112	1.82	1.73	1.63	1.54
7447	1.30	1.23	1.16	1.09	748114	1.82	1.73	1.63	1.54
7448	1.44	1.37	1.29	1.22	748140	1.00	.95	.90	.85
7450	.34	.32	.30	.28	LINEAR IC'S				
7451	.34	.32	.30	.28	NE501A	2.99	2.82	2.66	2.49
7453	.34	.32	.30	.28	NE526A	3.59	3.38	3.17	2.95
7454	.34	.32	.30	.28	NE531V	3.81	3.58	3.36	3.14
7459	.34	.32	.30	.28	NE536T	7.31	6.88	6.45	6.02
7460	.34	.32	.30	.28	NE540T	2.40	2.25	2.10	1.95
7470	.46	.43	.40	.37	SE540T	4.48	4.20	3.92	3.64
7472	.40	.38	.36	.34	NE550A	1.30	1.23	1.16	1.09
7473	.52	.49	.46	.43	NE555V	1.10	1.05	1.00	.95
7474	.52	.49	.46	.43	N5556V	2.10	1.95	1.80	1.65
7475	.80	.76	.72	.68	N5558V	1.00	.95	.90	.85
7476	.58	.55	.52	.49	NE560B	3.57	3.36	3.15	2.94
7480	.80	.76	.72	.68	NE561B	3.57	3.36	3.15	2.94
7482	1.10	1.05	1.00	.95	NE562B	3.57	3.36	3.15	2.94
7483	1.72	1.64	1.56	1.48	NE565A	3.57	3.36	3.15	2.94
7485	1.58	1.51	1.44	1.37	NE566V	3.57	3.36	3.15	2.94
7486	.60	.57	.54	.51	NE567V	3.57	3.36	3.15	2.94
7490	.85	.80	.75	.70	N5111A	.90	.86	.82	.78
7491	1.48	1.41	1.34	1.27	N5595A	3.40	3.20	3.00	2.80
7492	.85	.80	.75	.70	N5596A	1.87	1.77	1.66	1.56
7493	.85	.80	.75	.70	709V	.50	.47	.44	.41
7494	1.32	1.26	1.20	1.14	710A	.50	.47	.44	.41
7495	1.32	1.26	1.20	1.14	711A	.55	.52	.49	.46
7496	1.32	1.26	1.20	1.14	723A	1.00	.95	.90	.85
74100	1.80	1.70	1.60	1.50	733A	1.90	1.80	1.70	1.60
74104	.70	.67	.64	.61	741V	.55	.52	.49	.46
74105	.70	.67	.64	.61	747A	1.10	1.04	.98	.92
74107	.54	.51	.48	.45	748V	.60	.57	.54	.51
74121	.60	.57	.54	.51	LM335	2.85	2.72	2.64	2.55
74122	.74	.71	.68	.65	LM336	3.85	3.66	3.46	3.27
74123	1.30	1.20	1.10	1.00	LM337	4.05	3.70	3.51	3.31
74141	1.75	1.66	1.57	1.48	TRANSISTORS AND DIODES				
74145	1.50	1.43	1.36	1.29	1N270	.15	.14	.13	.12
74150	2.00	1.85	1.70	1.55	1N914	.10	.09	.08	.07
74151	1.30	1.24	1.18	1.12	1N4001	.10	.09	.08	.07
74153	1.70	1.60	1.50	1.40	1N4002	.11	.10	.09	.08
74154	2.75	2.55	2.35	2.05	1N4003	.13	.12	.11	.10
74155	1.56	1.49	1.42	1.35	1N4006	.15	.14	.13	.12
74156	1.46	1.39	1.31	1.23	1N747A - thru				
74157	1.56	1.48	1.39	1.31	1N758A	.25	.22	.19	.16
74158	1.56	1.48	1.39	1.31	2N3860	.25	.23	.21	.19
74160	2.20	2.10	2.00	1.90					
74161	2.20	2.10	2.00	1.90					
74162	2.20	2.10	2.00	1.90					
74163	2.20	2.10	2.00	1.90					
74164	2.20	2.10	2.00	1.90					
74166	2.30	2.20	2.10	2.00					

All IC's are supplied in 8-, 14-, or 24-pin DIP (Dual-in-line) plastic or ceramic package except for NE536, NE540, and SE540 which come in TO-5 package. Voltage Regulators LM335, LM336 and LM337 are supplied in TO-3 (Diamond) package.

We give FREE data sheets upon request, so ask for those data sheets that you NEED, even for those listed IC's that you are not buying.

## LED 7-SEGMENT DISPLAY:

Solid State Systems has now expanded its line of LED Displays and also reduced their cost. The following are now available from us at these prices.

	1-49	50-99	100-499	500-999	1,000 up
SSS-1	4.50	4.25	3.75	3.40	3.00
SSS-1C	4.75	4.50	4.00	3.65	3.25
SSS-2	4.50	4.25	3.75	3.40	3.00
SSS-3	7.75	7.50	7.00	6.75	6.50
SSS-4	7.75	7.50	7.00	6.75	6.50
SSS-7	3.50	3.25	3.00	2.75	2.50
SSS-9	3.50	3.25	3.00	2.75	2.50
Minitrons*	3.00	2.75	2.50	2.25	1.90

The SSS-7 and SSS-9 are the common .33 in character height 7-Segment and overflow display respectively, with decimal point on the left and wide angle viewing. The SSS-1 and SSS-2 have the same physical dimensions as the SSS-7 and SSS-9 with increased life and slightly lower current requirement. The SSS-1C is the same as the SSS-1 except it has a colon instead of a decimal point, making it ideal for use in a digital clock. The SSS-3 and SSS-4 are the new giant .77 in character height 7-Segment and overflow display respectively, with decimal point on the right and readability up to 40 feet. \*Also included above is a new reduced price on our Incandescent 7-Segment Display.

Package of 8, 1/4 watt current limiting resistors ..... \$0.30.

MOLEX IC SOCKET PINS: Use these economical pins instead of soldering your IC's to PC boards. Sold in continuous strips in multiples of 100 pins only.

100 for \$1.00	200 for \$1.80	300 for \$2.60	400 for \$3.40
500 for \$4.20	600 for \$5.00	700 for \$5.80	800 for \$6.60
900 for \$7.40	1000 for \$8.20	each additional 1,000 \$7.50	

Dual-in-line SOCKETS. Brand new with gold plated pins.

	1-49	50-99	100-499	500-999	1,000 up
14 Pin } Solder	.50	.45	.40	.35	.25
16 Pin } Solder	.55	.50	.45	.40	.30
14 Pin } Wire Wrap	.55	.50	.45	.40	.30
16 Pin } Wire Wrap	.60	.55	.50	.45	.35
14 Pin } Closed-Entry	.05	.05	.04	.04	.03
16 Pin } Cap	.05	.05	.04	.04	.03

STANCOR TRANSFORMERS: Ideal for use with LM series.

P-8180, 25.2VCT, 1 amp	\$3.00
P-6134, 6.3VCT, 1.2 amp	\$2.75

HEAT SINKS: Wakefield series 680 circuit board coolers. 1/4" high with a dissipation up to 20 watts. Designed for use with TO-3 package.

	1-49	50-99	100-499	500-999	1000 up
Type 680-1.25A	1.20	1.10	1.00	.90	.80

ALLEN-BRADLEY MIL-GRADE (5-band) RESISTORS. Any of the 84 STANDARD 10% values from 2.7Ω to 22MΩ 1/4 or 1/2 WATT. EACH ..... \$0.05.

CERAMIC DISC CAPACITORS. Type 5GA-1000WVDC:

5, 7.5, 10, 12, 15, 20, 22, 25, 27, 30, 33, 39, 50, 56, 68, 75, 82, 100, 120, 150, 180, 200, 220, 250, 270, 300, 330, 360, 390, 470, 500, 560, 680, 750, 820, 1000, 1200, 1500, 1800, 2000, 2200, 2500, 2700, 3000, 3300, 3900, 4700, 5000μF.	EACH	\$1.10	
0.01μF. EACH	\$1.11	0.02μF. EACH	\$1.12

LOW VOLTAGE DISCS. Type UK.

1.0μF, 3V	\$0.25	0.47μF, 3V	\$0.25	0.2μF, 10V	\$0.20
.1μF, 10V	\$0.12	2.2μF, 3V	\$0.30	0.01μF, 16V	\$0.10

ELECTROLYTIC CAPACITORS: All values are available in both, axial or upright (PC Board) mount. Please indicate your choice.

10μF, 15V	\$0.10	30μF, 35V	\$0.20	5μF, 50V	\$0.10
30μF, 15V	\$0.10	50μF, 35V	\$0.20	10μF, 50V	\$0.15
50μF, 15V	\$0.10	100μF, 35V	\$0.20	20μF, 50V	\$0.20
100μF, 15V	\$0.10	500μF, 35V	\$0.40	50μF, 50V	\$0.20
220μF, 15V	\$0.15	1000μF, 35V	\$0.50	100μF, 50V	\$0.20
500μF, 15V	\$0.20	1μF, 50V	\$0.10	200μF, 50V	\$0.40
1000μF, 15V	\$0.30	2μF, 50V	\$0.10	500μF, 50V	\$0.55
20μF, 25V	\$0.15	3μF, 50V	\$0.10		

TERMS: Rated firms NET 30 days. Otherwise check or money order with order. BankAmericard and Mastercharge are welcome. All invoicing is now done by computer therefore, the following standard charges will automatically be added to your order.

If your merchandise total is between:

			SPECIAL CHARGES	
\$ 0.00 - \$ 4.99	add	\$1.00	COD	\$1.00 additional
\$ 5.00 - \$24.99	add	\$0.75	Air Mail	\$0.50 additional
\$ 25.00 - \$49.99	add	\$0.50	Postal Insurance	\$0.25 additional
\$ 50.00 - \$99.99	add	\$0.25	Special Delivery	\$0.75 additional
\$100.00 and up	add	\$0.00		

With this new system all shipments will be F.O.B. destination, via First Class or UPS (your choice). These charges include shipping, handling and insurance.

MISSOURI RESIDENTS: Please add 4% sales tax.

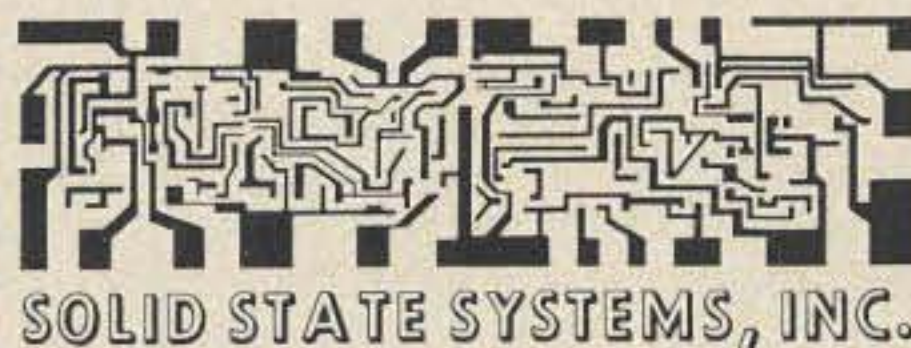

P. O. BOX 773 • COLUMBIA, MISSOURI 65201

TWX 910-760-1453 • PHONE 314-443-3673

Your  
**BANKAMERICARD**  
welcome here

ORDER DESK  
(TOLL FREE)  
1-800-325-2595

**master charge**  
THE INTERBANK CARD

# MAN 1 LED

- high brightness--350ft-L @20ma
- single plane, wide angle-viewing---150°
- standard 14 DIP
- long life---solid state
- operates with IC voltage requirements
- displays all digits and 9 distinct letters

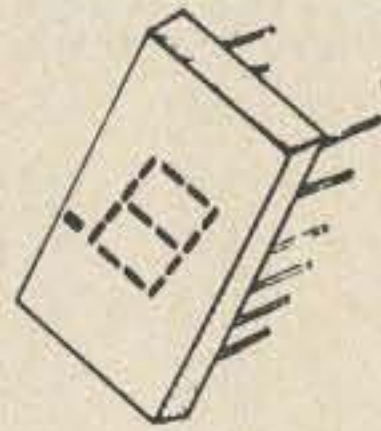

\$4.25 EACH

## Schottky TTL \$3.00 EACH

- 82S30 8 input multiplexer
- 82S33 2 input 4 bit multiplexer
- 82S41 quad EX/OR element
- 82S42 4 bit comparator
- 82S62 9 bit parity gen./checker
- 82S67 2 input 4 bit multiplexer

## 7400 series DIP

7400 .25	74H11 .50	7451 .25	74H74 .85
74L00 .35	7413 1.75	74L51 .35	7475 1.15
74H00 .35	7420 .25	74H51 .35	7476 .55
7401 .25	74L20 .35	74H52 .40	74L78 1.00
74H01 .35	74H20 .35	7453 .25	7480 .50
7402 .25	74H22 .50	74H53 .40	7483 1.15
7403 .25	7430 .25	7454 .30	7486 .65
7404 .25	74L30 .35	74L54 .35	7489 3.00
74L04 .35	7440 .25	74L55 .35	7490 1.00
74H04 .35	74H40 .40	7460 .25	7491 1.15
7405 .25	7441 1.30	74L71 .50	7492 .90
74H05 .35	7442 1.00	7472 .40	7493 .90
7406 1.00	7446 1.50	74L72 .50	7495 1.15
7408 .40	7447 1.50	7473 .55	74L95 2.00
74H08 .50	7448 1.25	74L73 .80	74107 .55
7410 .25	7450 .25	7474 .40	74153 1.75
74L10 .35	74H50 .40	74L74 .80	74192 2.25
			74193 2.00
			74195 1.00

all IC's shipped within 24hrs.

## CD-3 universal counter

Can be programmed to count to any modulus 2-9 for one kit, 2-99 for two kits, etc. Includes board, 7490, 7447, RCA DR2010 Numitron display tube and five programming components. Full instructions included - perfect for displaying second, minutes and hours, etc. **KIT \$8.95**

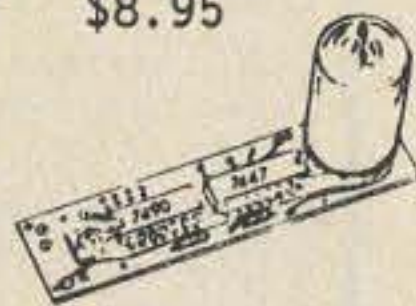

## CD-2 digital counter

Unit includes board, 7490, 7475 quad latch, 7447 seven segment driver, and RCA DR2010 **KIT \$9.95**  
**ASSEMBLED 12.00**



## 8000 series TTL DIP

8200	4 bit comparator	1.60
8210	8 line to 1 line selector	1.40
8220	parity gen/checker	1.00
8223	256 bit programmable ROM	7.50
8230	8 input multiplexer	2.00
8233	2 input 4 bit multiplexer	1.75
8242	4 bit comparator	1.00
8251	BCD to decimal decoder	1.00
8261	fast carry extender	2.00
8266	2 input 4 bit multiplexer	1.50
8270	4 bit PI, SI, PO, SO	2.00
8271	4 bit shift register	2.00
8273	10 bit SI, PO register	3.00
8274	10 bit PI, SO register	3.00
8280	45MC presetable decade counter	1.15
8281	45MC presetable binary counter	1.15
8290	presetable dec. counter 75MC	3.50
8292	presetable dec. counter 10MC	.90
8520	25MC divide by "N" 2 to 15	2.00
8551	tri state quad latch	2.00
8570	8 bit SI, PO	2.50
8590	8 bit PI, SO	1.50
8275	quad bistable latch	.90

748	op amp T05	1.50		
NE555	prec. timer MINI	1.25	CA3065	TV/FM sound system DIP .75

All IC's are new and fully tested - leads are plated with gold or solder. Orders for \$5 or more will be shipped prepaid. Add 35¢ handling and postage for smaller orders. California residents add sales tax. IC orders are shipped within two workdays of receipt of order - kits are shipped within ten days of receipt of order. **MONEY BACK GUARANTEE ON ALL GOODS SOLD.....**  
.....COD's may be phoned in.....

# BABYLON ELECTRONICS

P.O. BOX J CARMICHAEL, CALIF.  
95608 (961) 966-2111

## linears

LM100	positive DC regulator T0-5	.80
NE526	high speed comparator DIP	1.00
NE560	phase lock loop DIP	3.25
NE561	phase lock loop DIP	3.25
NE565	phase lock loop T0-5 or MINI	3.25
NE566	function generator T0-5 or MINI	3.50
NE567	tone decoder T0-5 or MINI	3.50
709	popular op amp DIP	.35
710	voltage comparator DIP	.50
711	dual comparator DIP	.75
723	precision voltage reg. DIP	1.00
5558	dual 741 op amp MINI	1.00
810	dual op amp DIP	.80
747	dual 741 op amp DIP	1.00
LM302	op amp voltage follower T0-5	1.25
LM308	op amp T0-5	2.00
LM311	comparator T0-5	1.50
LM380	2W audio amp DIP	1.50
LM703	RF-IF amp epoxy T0-5	.80
LM309K	5V-1A power supply module T0-3	2.50
LM309H	5V-200ma power supply T0-5	1.00

## calculator on a chip 40 pin DIP

- Add, subtract, multiply, and divide
- 12 digit display and calculate
- Chain calculations
- True credit balance sign output
- Automatic overflow indication
- Fixed decimal point at 0, 2, 3, or 4
- Leading zero suppression
- Complete data supplied with chip



SILICON  
signal diodes  
100 PIV - 80 ma  
60 for \$2.50

## RCA 2010 NUMITRON

- digital display tube
- incandescent 5V
- 7 segment
- .6" high numeral
- visible at 30 feet
- left hand decimal
- 9 pin base (solderable)



EACH \$ 5.00  
5 FOR 20.00

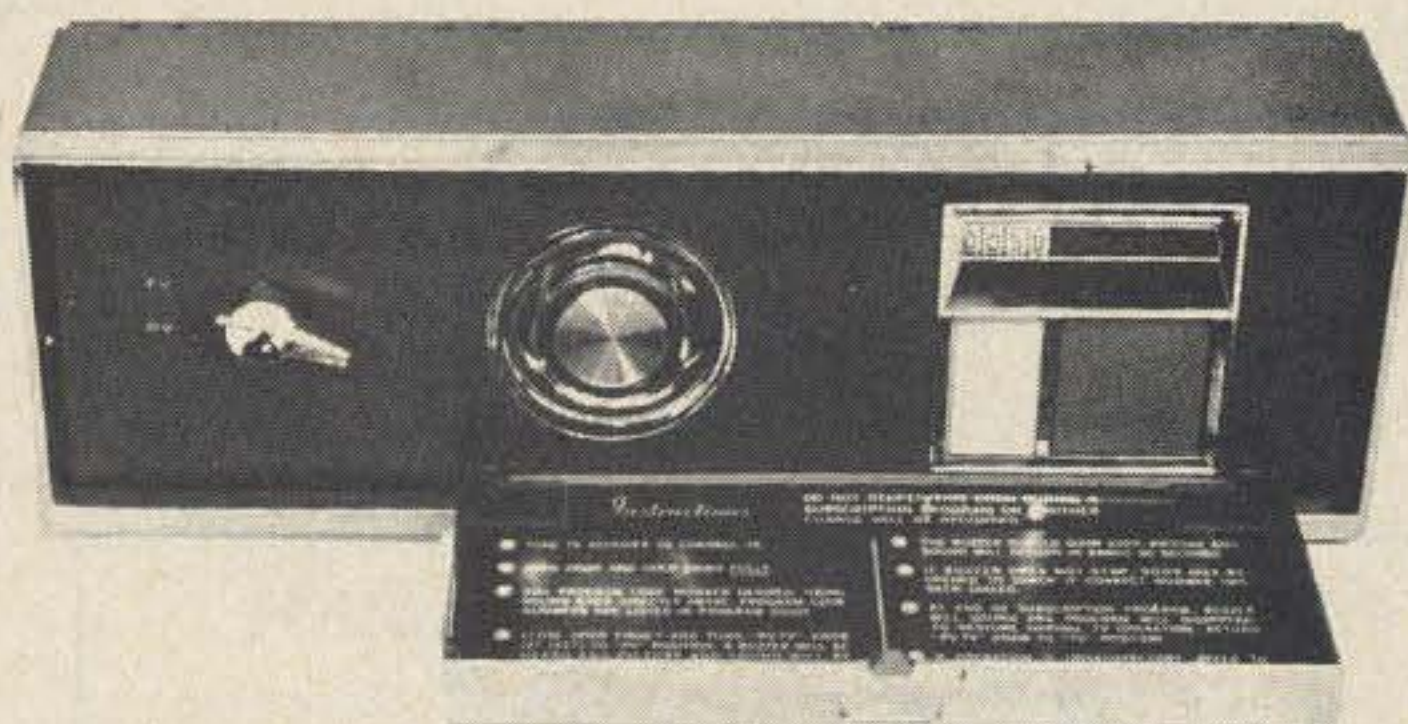
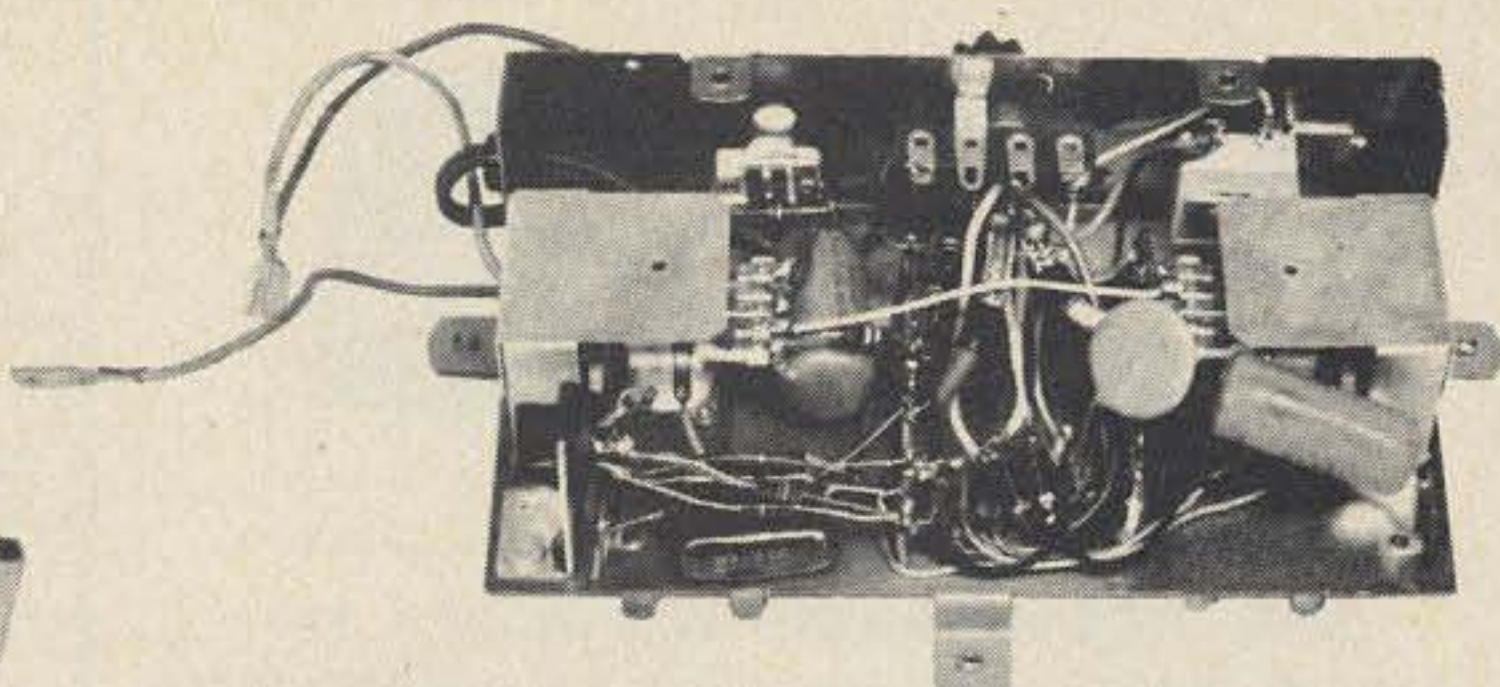
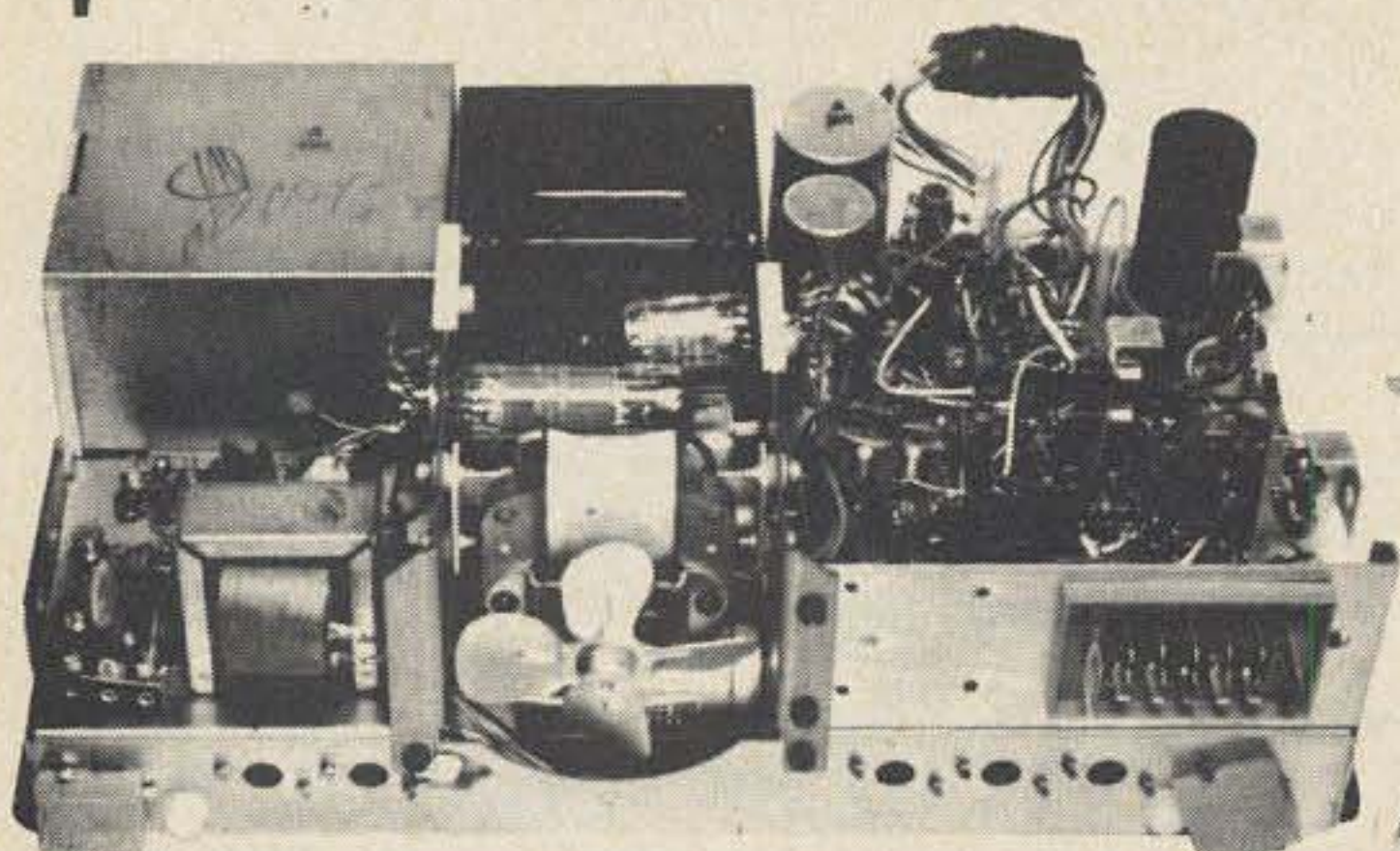

## PAY TV ASSEMBLY \$15.00

A "Super Value" for the gadgeteer. A complete Pay TV installation made for ZENITH and all in original packing (3 cartons — wgt 36 lbs) and all unused. Operates on regular 115 volt 60 cycle power. A wealth of parts, easily removed due to long leads on components, most over one inch long. The 3 units consist of Translator, Adapter, Decoder. Transistors, tubes, solid state bridge power supply, geared clock motor, 35mm geared transport, time recorder, solenoid, relays, hundreds of small parts such as resistors, caps, etc. Our estimate as to cost to Zenith, approx \$1,000 per set. Schematics with each purchase. One set of 3 units \$15.00 wgt of 36 lbs. Special . . . 3 sets \$35 wgt of 106 lbs. All unused, original boxed.

## COOLING FAN BARRAGE \$12.00

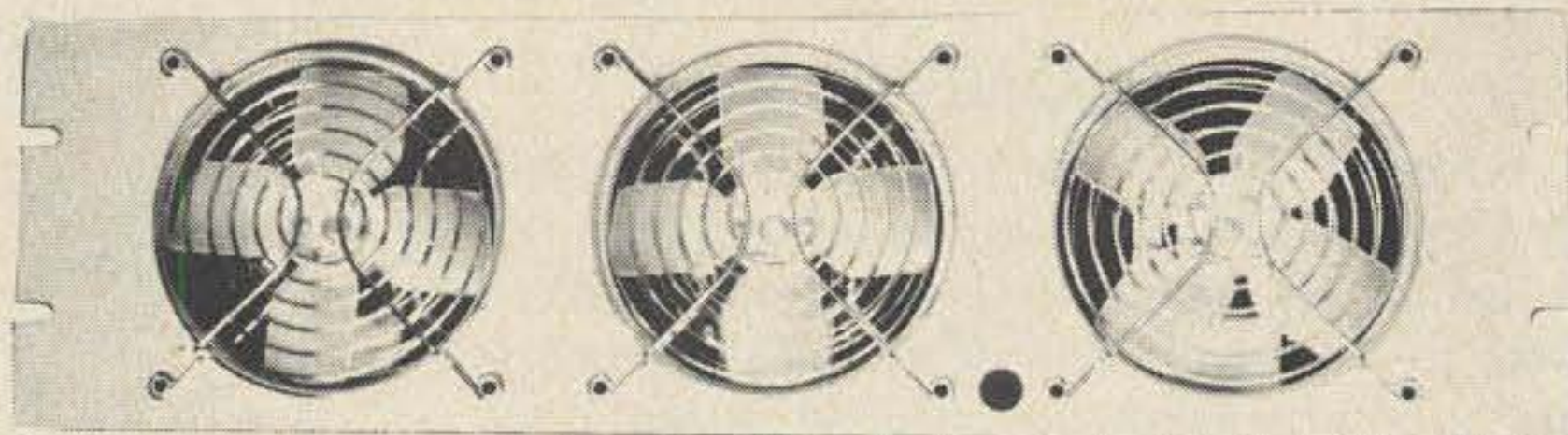

For the photo enthusiast, electronic industry, people cooler, etc. Brand new assembly made by HOWARD Industries, 3 fans per panel, 115 volt 60 cycle. Each fan good for 100 cfm and have blade guards both sides of each fan. To reverse flow of air, mount panel backwards. All brand new, ready to use. Silver gray panel finish. Standard 19 inch panel, 5 1/4 inches high. \$12 per panel of 3 fans or 2 panels of 6 fans for only \$20. Ship wgt 7 lbs per panel.

### 12VDC 3 AMP POWER KIT \$5.00

Just right for powering car tape deck, CB sets, car radio, etc. from regular house current. We furnish parts — transformer, silicon bridge, filtering caps, directions. All new parts, order #KT-3 at \$5.00 ea or 6 for \$25.00

### AM-FM RADIO \$20.00

Fully built chassis by Delmonico with front panel, solid state. Also has stereo tape and stereo turntable inputs, 115 VAC power. Brand new with schematics. \$20.00. Made for console installation. Cost over \$100.00.

Postage extra on above. MESHNA PO Bx 62 E. Lynn Mass. 01904

*Meshna*

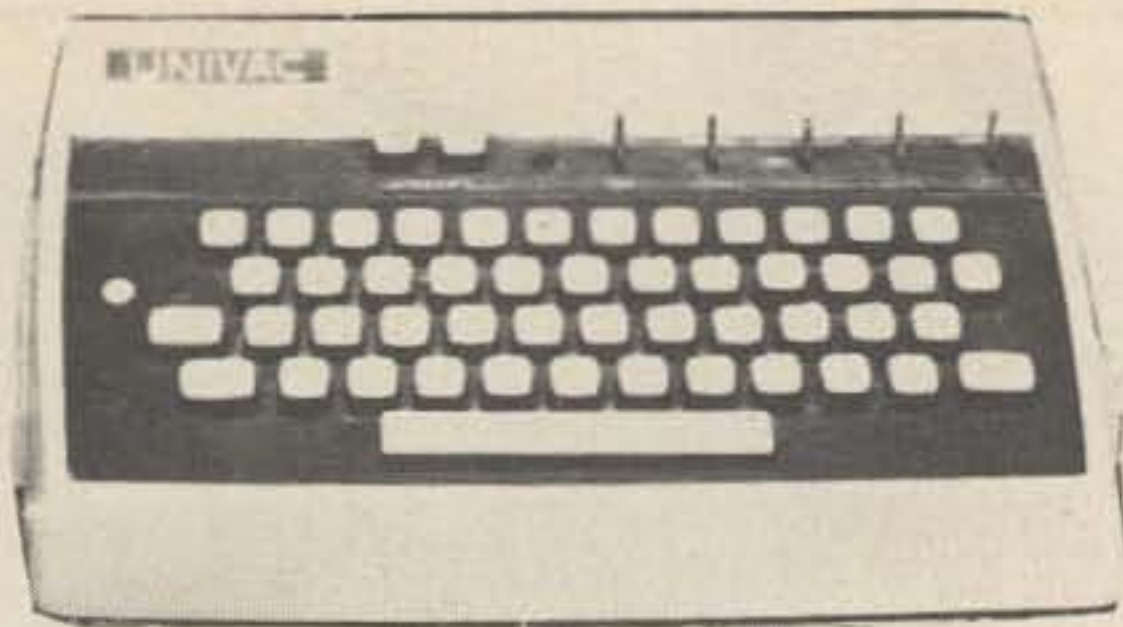

**COMPUTER KEYBOARD W/ENCODER \$35**

Another shipment just received. Alpha-numeric keyboard excellent condition. Once again we expect an early sellout. Price of \$35 includes prepaid shipment in the US and shipment made within 24 hours of receipt of order.

**POWER TRANSFORMER**

115ac/12V@3 amps . . . \$2.50

**POWER AMP TRANSFORMER**

Brand new compact, regular 115 V 60 cycle input. Output of 40 VCT at 4 amps plus another winding 6V at 2.5 amps. Fine business for Power Amps, Logic or Op Amp supply.

\$5.50 each or 5 for \$25.00

**12VCT 2A XFMR \$1.50**

Regular 115 volt 60 cycle input. 12 volt transformers are always in demand, these are brand new.

\$1.50 each or 10 for \$12.00

**60-SECOND TIMER**

A bonanza for the photo lab or any requirement for a precision spring-wound timer. May be set at any interval 0-60 seconds. Contacts rated at 15 amps. Contacts close while running and open at end of time interval. Brand new.

\$1.50 each, 10 for \$12

**455 KC IF ASSEMBLY**

Complete miniature 455kc IF. amp assembly. 1.5 inches long, little over 1/2 inch square. Ready to use w/schem. Sim to Miller 8902 . . . . . 2.50

**RF VACUUM SWITCH**

Made for the ART-13 good for 100 watts RF, no doubt handles much more due to being underrated for the military . . . #71-17 3/2.00

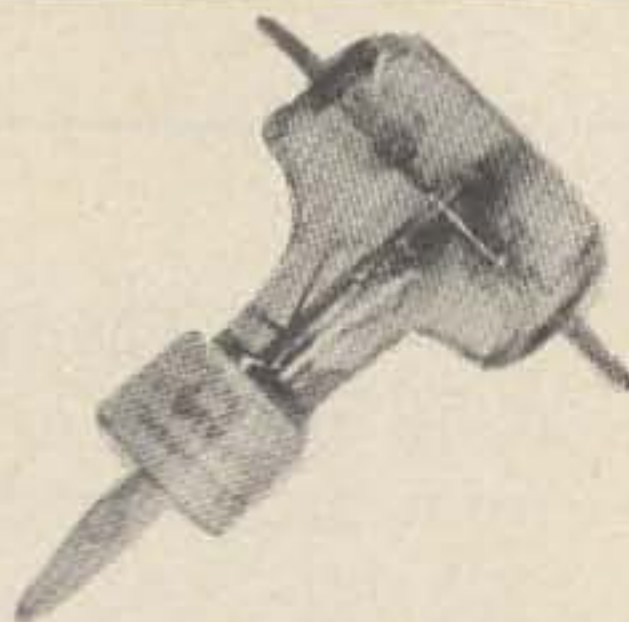

**7400 SERIES IC GRAB BAG**

Mix of 7400 series DIP, unmarked untested. Some schematics provided . . . . . 10 for 1.00

100 for 8.00

1000 for 60.00

**IC SPECIAL - ONE MONTH ONLY**

Our regular \$15 IC board with approx. 140 DIP ICs on them, with ident sheet. For one month only we are pricing them at \$6.50 per board to reduce our inventory. #IC-S \$6.50 Or 5 for \$25

**COPPER CIRCUIT BOARD**

Brand new GE 2-sided glass epoxy G-10, the standard of the industry, bright and shiny new. 6 x 12, \$1.00. 12 x 12, \$1.50.

**AM-FM RADIO \$5.50**

Due to the West Coast ship strike they came in too late for the customer. Now it's your bargain. Use it as is or build it into your own cabinet, desk, wall, etc. All built, ready to use, with AC supply. To make it portable all you do is power it with a couple of "D" cells. Fully assembled solid state chassis with AC power supply, less speakers. Covers full AM as well as FM broadcast. The price. . . an astounding meager \$5.50

**PISTON CAPS 1-8 μF  
3 for \$1.00**



Unused Military surplus. For hi freq. work. List price over \$3.00 each. We have 1 size only, 1-8 μF. No hardware.

#73-18

3 for \$1.00

**BATTERY ELIMINATOR-CHARGER**

Plugs into 115 volt 60 cycle and puts out approx. 12 volts DC 100 mls. Sufficient to power most any small transistor radio and also useful for charging small dry cells and small ni-cad cells. Fully built, ready to use.

\$1.00 each, 6 for \$5.00

**RF FERRITE CORE CHOKE**

Hi-permeability, ultra midget style, coated for moisture resistance, color coded. Used in xmtrs, receivers, converters, TV-peaking. Brand new, worth 40¢ each. Assortment of 1.8, 27.0, 330 μH. Pack of 30, \$12.00 value.

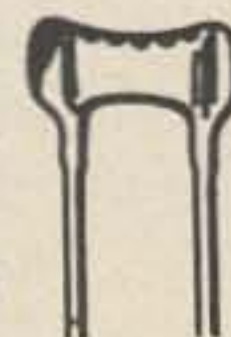

#A-71 30/\$1.00 180/\$5.00

**UHF TRANSMITTER**

One of the later designs being released. Superb workmanship by HUGHES. Utilizes 3 pencil triodes worth over \$46.00. Looks like a "natural" for 220 mc transmitter as it's on .264mc now. Simple to lower freq. W/tubes & schematic. Built-in power supply 400 cycle would have to be changed. Measures only 3x4x8 inches. Nice piece of scarce gear, easy to work on & first class condition.

4 lbs. . . . . #TA-40IC 15.00

*Meshna*

Postage extra on above. MESHNA PO Bx 62 E. Lynn Mass. 01904



Numitron 5V 7-Segment  
Slimline or Regular \$2.50 ea.

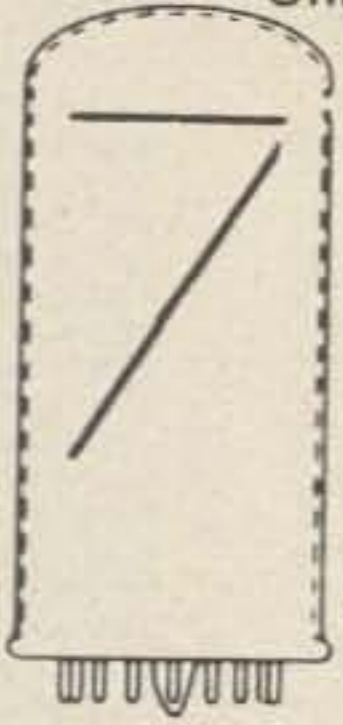

- ZM 1000 Neon \$1.75
- GE Y 4075 25V Miniature \$1.75
- GE Y 1938 24V Standard \$1.75
- RAY CK 1905 Standard \$1.75

MAN-3 1.7V Miniature  
\$3.50 ea. 10/\$30

**GIANT ALPHA NUMERIC**

B7971 \$1.00

**OIL CAPS 16 MFD 5000 VOLT**  
Rare find. \$9.00 each 3/\$25.00

**NOISE ACTUATED SWITCH \$1.35**  
Solid state noise actuated switch fully wired, includes mike pick-up, amplifier, SCR switch. Actuates by noise or whistle. Useful for burglar alarms, lamp lighter, etc. 15 ft range.

**LIGHT EMITTING DIODES 3/\$1.00**  
Ruby red, gold plated leads. With mercury cell for instant testing.

Alpha-numeric keyboards. Excellent to new in condition. Styles may vary slightly from picture. Two models available, one with ASCII encoder in base \$55.00 postpaid in the U.S. Keyboard with no encoder in base \$35.00 postpaid in U.S.

**KEY BOARDS**  
\$35.00 & \$55.00



**RCA MEMORY STACK 32x32x9**

3rd generation, ultra compact. Measures 1x4 1/4x7. Brand new. \$50.00 3 for \$125.00

**H.H. SCOTT MULTIPLEX**

Solid state brand new multiplex module w/ schematic. Possibility of conversion of various mono sets to stereo. \$3.00 each 10 for \$25.00

**URC-11 WALKY TALKY**

243 MC 2 way radio, hand held, measures only 3x4 inches. Used for survival in downed aircraft. Can be converted for other freqs. URC-11 \$15 each 3 for \$40.00

**CHARACTER GENERATOR SETS \$50**

64 bit ASC II Character Generator IC sets. Vertical scan set includes SK0002 kit, two MM502 and one NH0013C. Horizontal scan sets includes SK0001 kit, two MM502, and one NH0013C. Make your own CRT readout or use it for hard copy. Either set only \$50 and includes 10 pages of info on character generators.

**15¢**

**IC BONANZA**

Brand new DTL dual inline (DIP) package, factory marked ceramic type. The price is too good to be true. Fully guaranteed and with specs.

- 930 Dual 4 input NAND gate similar to 7420
- 931 Clocked flip flop " 74110
- 932 Dual 4 input Expand Buff " 7440
- 933 Dual 4 input expander " 7460
- 936 Hex Inverter " 7405
- 945 JK Flip Flop " 74110
- 946 Quad 2 input gate " 7400
- 962 Triple 3 input gate " 7410

15¢ each. Buy \$100 worth and deduct 10%.

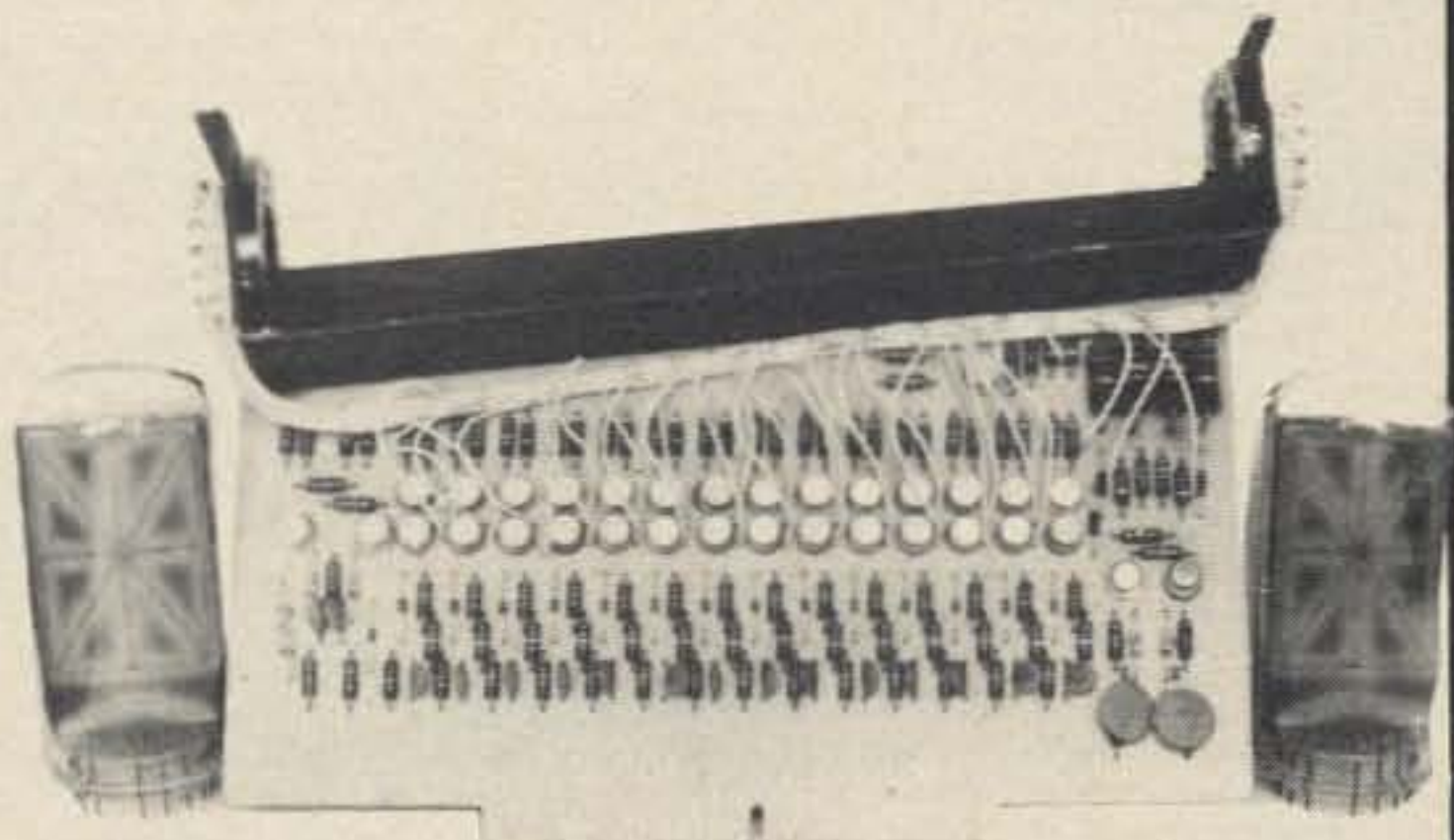

**GIANT B-7971 NIXIES (2)** with 2 sockets and driver board containing hi voltage transistors. Complete plug-in board as removed from operational equipment. Schematics included. Unbelievable but true... just \$2.50 for the complete package. . . #72S-10 \$2.50  
B-7971 Nixie Only ..... \$1.00

Postage extra on above. MESHNA PO Bx 62 E. Lynn Mass. 01904 MASS. 01904

*Meshna*

## EPOXY FULL WAVE SILICON BRIDGE RECTIFIERS

PIV 2 Amp	6 Amp
50 <input type="checkbox"/> \$3.69	<input type="checkbox"/> \$3.88
100 <input type="checkbox"/> .79	<input type="checkbox"/> .99
200 <input type="checkbox"/> .95	<input type="checkbox"/> 1.25
400 <input type="checkbox"/> 1.19	<input type="checkbox"/> 1.50
600 <input type="checkbox"/> 1.35	<input type="checkbox"/> 1.75
800 <input type="checkbox"/> 1.59	<input type="checkbox"/> 1.95
1000 <input type="checkbox"/> 1.79	<input type="checkbox"/> 2.25

Code: 2 amp TO-5 case  
6 Amp 1/2 x 1/2 x 3/16 sq



3 for \$10.  
 Only **\$3.95**

## MAN-4 EQUAL LED 7-SEGMENT READOUTS

0-9 plus letters, Snaps in 14-pin DIP socket. 3/4" x 1/4" x 3/8". 5V 10ma, with decimal point. Like MAN-1  
 Socket for above, 50c

## NIXIE



Only **\$5.95**

## COUNTING SYSTEM

Includes SN7490, decade counter, SN7475 latch, SN7441 BCD decoder driver. 0-to-9 Nixie tube, instructions.

## SILICON TUBES

<input type="checkbox"/> 5U4	\$1.49
<input type="checkbox"/> 5R4	3.95
<input type="checkbox"/> 866	7.95



## 3PDT \$2.98 Potter & Brumfield KAP RELAYS

Excellent for "HAM" use as antenna switching, latching, transmit, receive, etc., and 100's of commercial or industrial uses. Includes plastic dust-cover with diagram and hookup info, 11-pin plug-in base. Contacts movable gold flashed silver, stationary overlay, with silver cadmium oxide movables. All contacts 10 amp 3PDT. Coil data, 115VAC 2250 ohms, 17.5 ma, 12 VDC 21 mils 168 ohms. Size: 2 1/4" x 1 5/16". Wt. 4 ozs. Center pin missing. Comar Mfg. type equal too.

## LED READOUTS 4.50

0-9 plus letters, for SN7446 or SN7447. Snaps in 14-pin DIP socket. 3/4 x 3/8 x 3/8", characters: 1/4 x 3/16". 5V, 20-mils per seg. characters: 1/4 x 3/16". Famous MAN-1 type.  
 Sockets .50 ea.

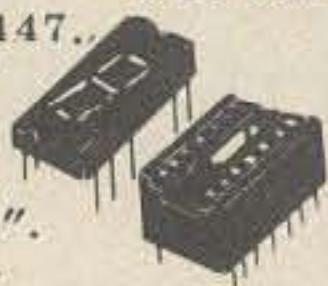

\$2.95  
Buy 3 — Take 10%

This display is excellent for small portable electronics, such as DVM's, calculators, etc. Equivalent to Monsanto MAN 3A. Operates from 5V, 20 milliamperes, with 47 ohm dropping resistor.



## "DIGITAL CLOCK ON A CHIP" Only \$14.95

SD-5314 direct substitute to famous U.S. maker. 24-Pin DIP — IMAGINE! ONE CHIP ELIMINATING 15 IC & other parts. Space Saver! Money saver! Latest in clock design. Features 12 or 24-hr. operation. 4 or 6 digits. 40 or 60 Hz operation. Internal digit multiplex oscillator, leading zero blanking, high output current for simple readout interface. Single power supply operation. Digit blanking for reduced current drain. 11 thru 19 volt range. Full MOS LSI. Spec sheets included.

**NEW**  
Buy 3 Take 10%

Lowest Prices

# Largest Selection TTL IC's

Buy 3 or more. 10% discount

Brand New \* "DIP" Packages Order by type number! Spec sheets on request "ONLY"

<input type="checkbox"/> SN7400 .25	<input type="checkbox"/> SN7437 .50	<input type="checkbox"/> SN7476 .44	<input type="checkbox"/> SN74151 1.13
<input type="checkbox"/> SN7401 .25	<input type="checkbox"/> SN7438 .51	<input type="checkbox"/> SN7480 .65	<input type="checkbox"/> SN74153 1.49
<input type="checkbox"/> SN7402 .25	<input type="checkbox"/> SN7440 .25	<input type="checkbox"/> SN7481 1.10	<input type="checkbox"/> SN74154 2.10
<input type="checkbox"/> SN7403 .25	<input type="checkbox"/> SN7441 1.30	<input type="checkbox"/> SN7482 .88	<input type="checkbox"/> SN74155 1.39
<input type="checkbox"/> SN7404 .28	<input type="checkbox"/> SN7442 1.12	<input type="checkbox"/> SN7483 1.25	<input type="checkbox"/> SN74156 1.39
<input type="checkbox"/> SN7405 .27	<input type="checkbox"/> SN7443 1.21	<input type="checkbox"/> SN7486 .49	<input type="checkbox"/> SN74157 1.25
<input type="checkbox"/> SN7406 .45	<input type="checkbox"/> SN7444 1.21	<input type="checkbox"/> SN7489 3.50	<input type="checkbox"/> SN74158 1.48
<input type="checkbox"/> SN7407 .45	<input type="checkbox"/> SN7445 1.50	<input type="checkbox"/> SN7490 1.00	<input type="checkbox"/> SN74160 1.79
<input type="checkbox"/> SN7408 .29	<input type="checkbox"/> SN7446 1.50	<input type="checkbox"/> SN7491 1.25	<input type="checkbox"/> SN74161 1.79
<input type="checkbox"/> SN7409 .29	<input type="checkbox"/> SN7447 1.50	<input type="checkbox"/> SN7492 .75	<input type="checkbox"/> SN74162 1.79
<input type="checkbox"/> SN7410 .25	<input type="checkbox"/> SN7448 1.25	<input type="checkbox"/> SN7493 .75	<input type="checkbox"/> SN74163 1.79
<input type="checkbox"/> SN7411 .25	<input type="checkbox"/> SN7450 .25	<input type="checkbox"/> SN7494 1.10	<input type="checkbox"/> SN74165 3.50
<input type="checkbox"/> SN7413 .95	<input type="checkbox"/> SN7451 .25	<input type="checkbox"/> SN7495 .95	<input type="checkbox"/> SN74180 1.10
<input type="checkbox"/> SN7416 .48	<input type="checkbox"/> SN7453 .25	<input type="checkbox"/> SN7496 1.10	<input type="checkbox"/> SN74181 4.50
<input type="checkbox"/> SN7417 .48	<input type="checkbox"/> SN7454 .25	<input type="checkbox"/> SN74100 1.41	<input type="checkbox"/> SN74182 1.10
<input type="checkbox"/> SN7420 .25	<input type="checkbox"/> SN7455 .25	<input type="checkbox"/> SN74107 .49	<input type="checkbox"/> SN74184 2.50
<input type="checkbox"/> SN7421 .25	<input type="checkbox"/> SN7460 .21	<input type="checkbox"/> SN74121 .49	<input type="checkbox"/> SN74185 2.50
<input type="checkbox"/> SN7426 .32	<input type="checkbox"/> SN7470 .39	<input type="checkbox"/> SN74122 .65	<input type="checkbox"/> SN74192 1.75
<input type="checkbox"/> SN7430 .25	<input type="checkbox"/> SN7472 .36	<input type="checkbox"/> SN74123 .99	<input type="checkbox"/> SN74193 1.75
<input type="checkbox"/> SN7432 .25	<input type="checkbox"/> SN7473 .44	<input type="checkbox"/> SN74141 1.45	<input type="checkbox"/> SN74195 1.19
	<input type="checkbox"/> SN7474 .39	<input type="checkbox"/> SN74145 1.25	<input type="checkbox"/> SN74198 2.65
	<input type="checkbox"/> SN7475 1.00	<input type="checkbox"/> SN74150 1.25	<input type="checkbox"/> SN74199 2.65

## INTEGRATED CIRCUIT SOCKETS

Buy Any 3 - Take 10% Discount!

<input type="checkbox"/> 14-Pin, dual in line	\$.45
<input type="checkbox"/> 16-Pin, dual in line	.50
<input type="checkbox"/> TO-5, 8 or 10 pins	.29

WIRE-WRAP  79c each  
INTEGRATED CIRCUIT SOCKETS 3 for \$2.00

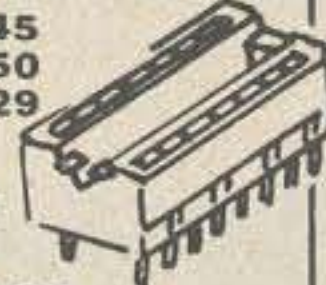

## NATIONAL "OP" AMPS

Type	Description	Buy any 3 Take 10%
<input type="checkbox"/> LM-300	Super 723 V. regulator	T05 \$1.00
<input type="checkbox"/> LM-301	Hi-performance amp	.49
<input type="checkbox"/> LM-302	Voltage follower T05	1.19
<input type="checkbox"/> LM-304	Neg. voltage regulator T05	1.49
<input type="checkbox"/> LM-305	Pos. voltage regulator T05	1.49
<input type="checkbox"/> LM-307	Super 741	.59
<input type="checkbox"/> LM-308	Super gain op amp T05	1.98
<input type="checkbox"/> LM-309H	5V 200ma V. regulator T05	1.50
<input type="checkbox"/> LM-309K	5V 1 amp V. regulator T03	2.25
<input type="checkbox"/> LM-350	Dual peripheral driver T05	.88
<input type="checkbox"/> LM-370	AGC squelch aop amp T05	1.49
<input type="checkbox"/> LM-373	AM-FM SSB if strip T05	3.75
<input type="checkbox"/> LM-380	2 Watt amplifier	1.25

## 'HAM' UHF 400 MC HIGH POWER TRANSISTORS

3 for \$10.



By RCA or equal 2N3632. Only **\$3.95**  
NPN, 23 watts, 3 amps, TO-60 case, with stud mtg. VCEV max 65.

## LINEAR Op Amps

FACTORY MARKED Buy Any 3 PAKS — Take 10% Discount

<input type="checkbox"/> 531 Hi slew rate op-amp (TO-5)	\$2.50
<input type="checkbox"/> 532 Micro power 741 (TO-5)	2.50
<input type="checkbox"/> 533 Micro power 709 (TO-5)	2.50
<input type="checkbox"/> 536 FET input op amp (TO-5)	3.95
<input type="checkbox"/> 537 Precision 741 (TO-5)	2.50
<input type="checkbox"/> 540 70W pwr driver amp (TO-5)	2.04
<input type="checkbox"/> 550 Precision 723 voltage reg. (DIP)	1.17
<input type="checkbox"/> 555 Timer 2 uSeconds to 1-hr (A)	1.00
<input type="checkbox"/> 556 5 Times faster than 741C	2.50
<input type="checkbox"/> 558 Dual 741 (mini DIP)	.88
<input type="checkbox"/> 560 Phase lock loops (DIP)	3.25
<input type="checkbox"/> 561 Phase lock loops (DIP)	3.25
<input type="checkbox"/> 562 Phase lock loops (DIP)	3.25
<input type="checkbox"/> 565 Phase lock loops (A)	3.25
<input type="checkbox"/> 566 Function generator (A)	3.25
<input type="checkbox"/> 567 Tone generator (A)	3.25
<input type="checkbox"/> 595 Four quadrant multiplier	3.10
<input type="checkbox"/> 702C Hi-grain, DC amp (TO-5)	.44
<input type="checkbox"/> 703C RF-IF, amp, 14 ckts (TO-5)	.69
<input type="checkbox"/> 709C Operational amp (A)	.39
<input type="checkbox"/> 709CV Op amp (mini DIP)	.49
<input type="checkbox"/> 710C Differential amp (A)	.39
<input type="checkbox"/> 711C Dual diff. comp (A)	.39
<input type="checkbox"/> 723C Voltage regulator (A)	.95
<input type="checkbox"/> 741C Frequency compensator 709 (A)	.41
<input type="checkbox"/> 741CV Freq. comp 709 (Mini DIP)	.49
<input type="checkbox"/> 747C Dual 741C (A)	1.25
<input type="checkbox"/> 748C Freq. adj. 741C (A)	.44
<input type="checkbox"/> 748CV Freq. adj. 741C (mini DIP)	.49
<input type="checkbox"/> 709-709 Dual 709C (DIP)	1.00
<input type="checkbox"/> 739-739 Dual stereo preamp	1.98
<input type="checkbox"/> 741-741 Dual 741C (A)	1.00
<input type="checkbox"/> 75450 Dual peripheral driver (DIP)	.69

(A) TO-5 or DIP dual in line pak

## 12-DIGIT "CALCULATOR ON A CHIP"

Similar to Mostek 5001. Outperforms Texas 8-digit TMS1802. A 40-pin DIP. Adds, multiplies, subtracts, and divides. Use with 7-segment readouts, Nixies, and LED's. We include schematics, instructions to build calculator.

Only **\$12.95**  
3 for \$35



## HOT MOS FETS

- 2-MOS FETS, N channel 10k umos 3N128, TO-18, RCA \$1
- 2-MOS FETS, DUAL GATE, N chan., 3N187-1, TO-18, \$1
- 2-MOS FETS, DUAL GATE, N chan., 3N140-1, TO-18, \$1

## LED—PHOTO—SOLAR 'DOLLAR STRETCHERS'

- 3 — "LEDS", visible, micro-miniature, axial leads \$1
- 2 — "LEDS", infrared, jumbo, TO-18 \$1
- 2 — "LEDS", visible, jumbo, red, TO-18 \$1
- 1 — "LED", invisible, parabolic reflector, RCA \$1
- 1 — PHOTO TRANSISTOR, with darlington amp filter, lens \$1
- 2 — PHOTO TRANSISTORS, with darlington amp, 2N5777 \$1
- 4 — PHOTO CELLS, Clairex, pancake, 30K-70 ohms \$1
- 2 — SILICON SENSORS, TEXAS, H-38 Matchstix, visible \$1

## LED MITY DIGIT 'DCM'S'

Will outperform any other DCM on the market today, not gaseous, not incandescent, but a device that will READ almost for life. MAN-4, Monsanto equal.

Kit includes: 3 x 2" printed ckt board, with fingers too! Side-mounting MAN-4 socket, resistors, 7448, 7475, 7490, booklet.

**9.99**

Terms: add postage, cod's 25%. Rated: net 30  
Phone Orders: Wakefield, Mass. (617) 245-3829  
Retail: 16-18 Del Carmine St., Wakefield, Mass. (off Water Street) C.O.D.'S MAY BE PHONED



15c CATALOG on Fiber Optics, 'IC's', Semi's, Parts

## POLY PAKS

P.O. BOX 942A, LYNNFIELD, MASS. 01940



# MORE CIRCUITS...

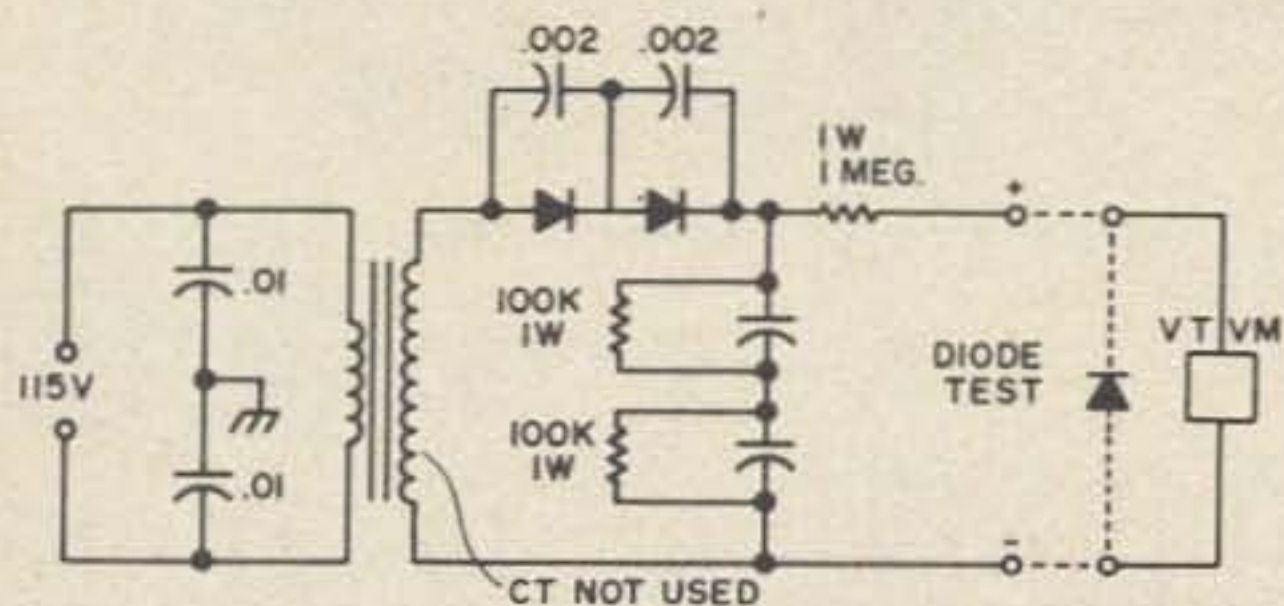

A circuit for testing characteristics of "bargain pack" diodes. The transformer is 600-1000V CT and the two diodes in the half wave circuit are 1000 PIV. The filter capacitor should be approximately 40  $\mu$ F apiece with suitable voltage rating. To test an unknown diode, connect as shown and read the voltage on the VTVM. Two thirds of this reading can be interpreted as a safe PIV rating. Reversing the diode reads forward characteristics - a reading of less than 3V indicates a good diode. No voltage indicates a shorted diode.

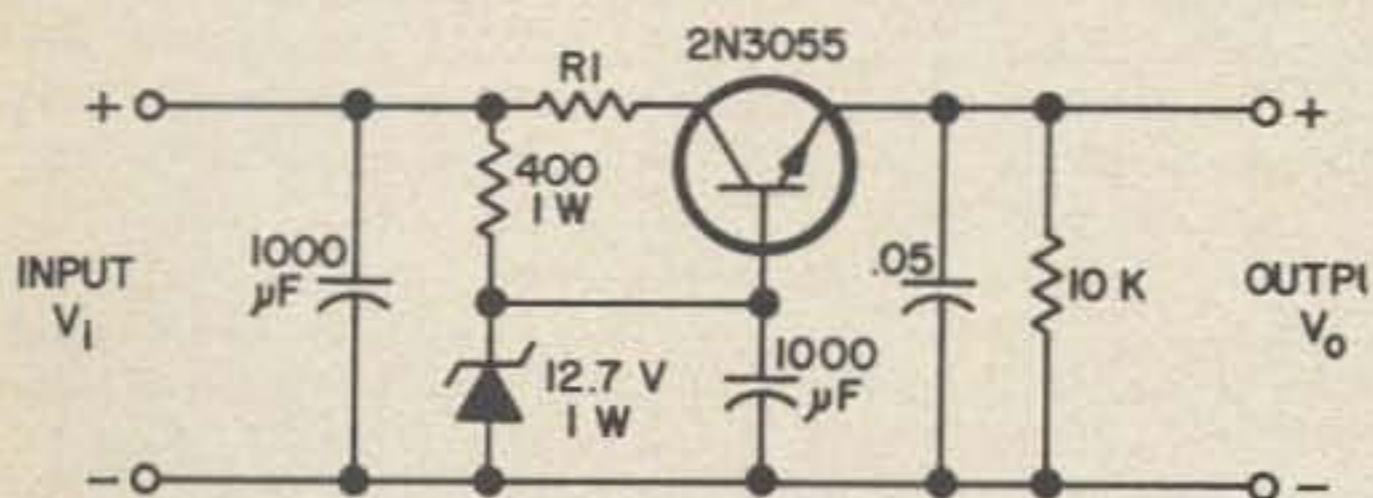

A power supply for a transistorized transceiver. Since rigs tend to draw much more current when transmitting, the transistor in the power supply must dissipate more current. The use of R1 lowers the amount of power dissipated and enables a smaller inexpensive transistor to be used. Choose R1 so the total voltage drop is about 2 volts.  $R1 = (V_i - V_o - 2V/xmit \text{ current})$ . Thanks to WA3EEC/1.

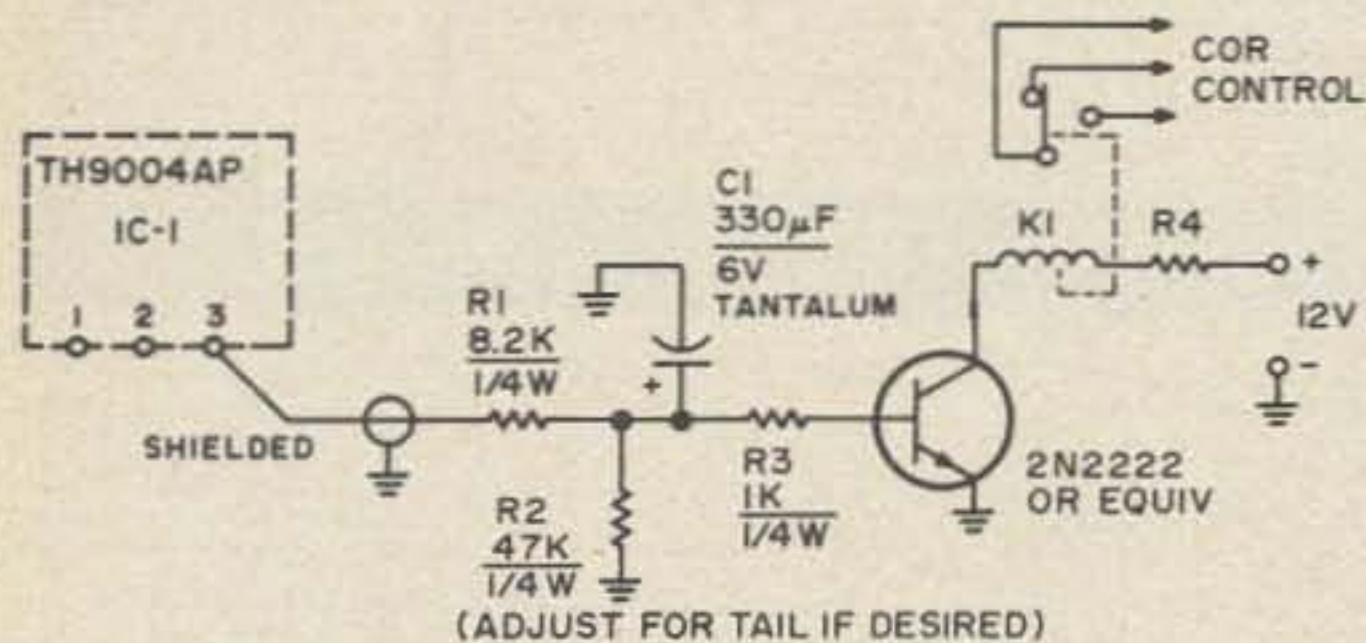

Schematic of a COR circuit for the IC20/21. R4 must be adjusted to keep the collector current of the transistor less than 750 mA. The value is dependent on the relay resistance. The R2/C1 combination controls tail time. The values shown will not respond to quick button pushers also. Thanks to W1WJR.

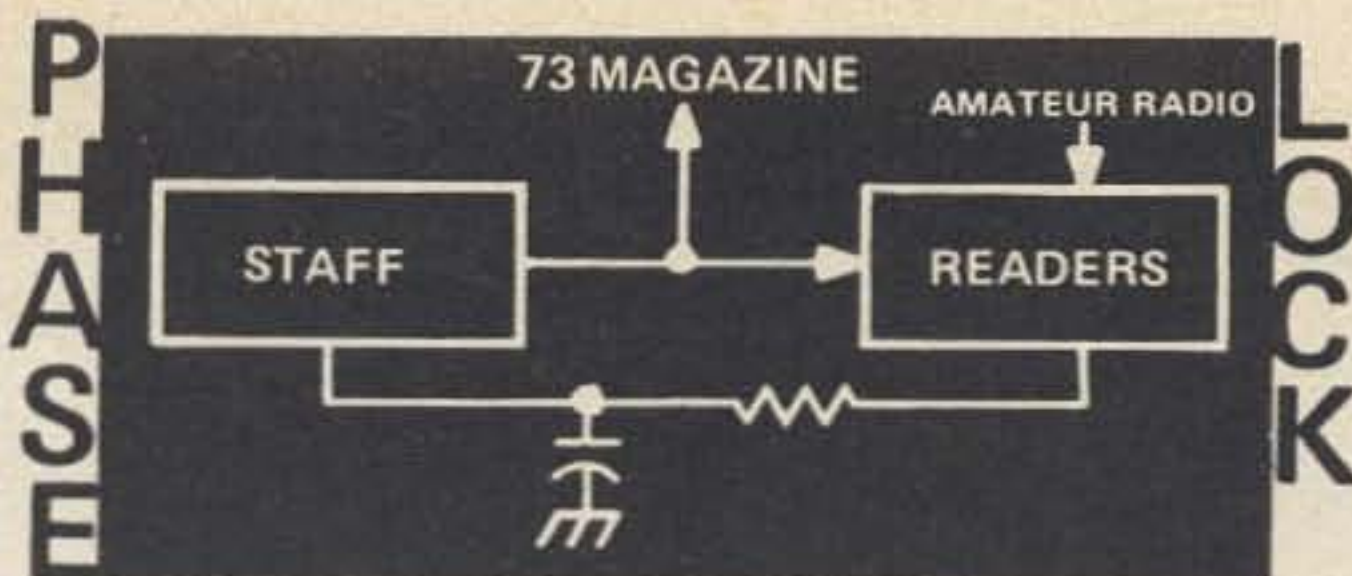

In this issue, do you think there is a need for more

	Yes	No
Simple construction projects	<input type="checkbox"/>	<input type="checkbox"/>
Complex construction projects	<input type="checkbox"/>	<input type="checkbox"/>
General interest articles	<input type="checkbox"/>	<input type="checkbox"/>
Humor articles	<input type="checkbox"/>	<input type="checkbox"/>
Specialized columns	<input type="checkbox"/>	<input type="checkbox"/>
Operating news	<input type="checkbox"/>	<input type="checkbox"/>

Please use the following space for comments on the articles and newspapers in this issue. If you have a specific idea of what you feel would improve 73, please send it to us. If you have two ideas, the space below will probably not be sufficient. Instead of attaching a separate sheet (which would be bulky and awkward), you can vastly simplify the process by buying another copy. This second copy should be kept in a safety deposit box as insurance against fires, floods and thefts by nonsubscribers.

Do you receive 73 from subscription   
newsstand

Fill out this form immediately and mail it with the Reader Service coupon on the reverse side (or vice versa).

# Savoy

HIGH ACCURACY CRYSTALS  
FOR OVER 30 YEARS



TYPE 900 A

**\$3.75**

Postpaid in U.S.A.

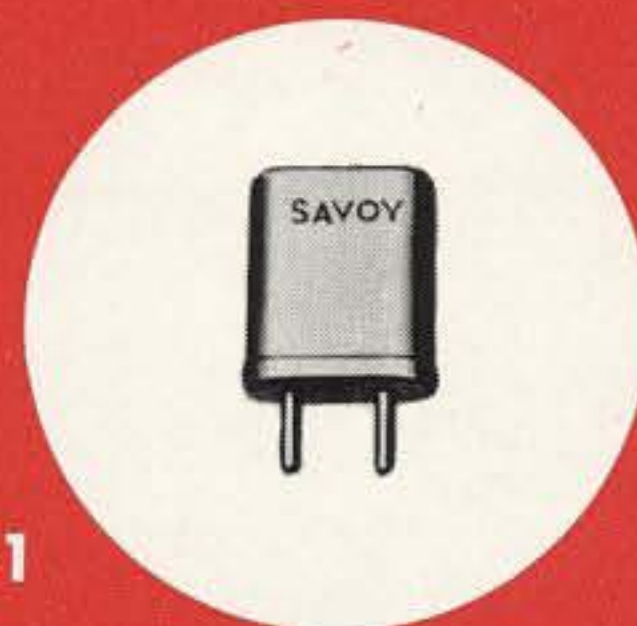

TYPE 901

Either type for amateur VHF in Regency, Swan, Standard, Drake, Varitronics, Tempo, Yaesu, Galaxy, Trio, Sonar, Clegg, SBE, transmitter or receiver. GE, Motorola, RCA or Oven use \$4.95. Quotes on others.

Specify crystal type, frequency, make of equipment and whether transmit or receive when ordering.



## BASSETT VACUUM TRAP ANTENNA SYSTEM

Complete packaged multi-band antenna systems employing the famous Bassett Sealed Resonators and Balun from which air has been removed and replaced with pure helium at one atmosphere. Operating bands are indicated by model designation.

MODEL DGA-4075	...	\$59.50
MODEL DGA-204075	..	\$79.50
MODEL DGA-2040	...	\$59.50
MODEL DGA-152040	..	\$79.50

## BASSETT VACUUM BALUN



The famous sealed helium filled Balun . . . employed with the DGA Series Antenna Systems. Solderless center insulator and easily handles more than full legal power while reducing unwanted coax radiation. Equipped with a special SO-239 type coax connector and available either 1:1 or 4:1.

MODEL DGA-2000-B . . . \$12.95  
Postpaid in U.S.A.

CONTACT YOUR DISTRIBUTOR OR WRITE FOR DATA

# Savoy Electronics, Inc.

P.O. Box 7127 - Fort Lauderdale, Florida - 33304

Tel: 305-566-8416 or 305-947-1191



# the tempo line

## ...a reputation built on quality and value

IN LESS THAN THREE YEARS THE TEMPO LINE HAS ESTABLISHED A SOLID REPUTATION FOR FIRST RATE PERFORMANCE AT A REASONABLE PRICE. WHETHER YOUR INTERESTS LIE IN HIGH FREQUENCY SSB OR VHF/UHF FM, TEMPO DESERVES YOUR SERIOUS CONSIDERATION. YOU WILL NEVER BE SORRY.



### THE TEMPO ONE SSB TRANSCEIVER

Look at the specifications . . . look at the price tag . . . ask any of the thousands of Tempo ONE owners about its reliability . . . and the reason for its unparalleled popularity will be obvious. The Tempo ONE is now the proven ONE.

**FREQUENCY RANGE:** All amateur bands 80 through 10 meters, in five 500 khz. ranges: 3.5-4 mhz., 7-7.5 mhz., 14-14.5 mhz., 21-21.5 mhz., 28.5-29 mhz. (Crystals optionally available for ranges 28-28.5, 29-29.5, 29.5-30 mhz.)

**SOLID STATE VFO:** Very stable Colpitts circuit with transistor buffer provides linear tuning over the range 5-5.5 mhz. A passband filter at output is tuned to pass the 5-5.5 mhz. range.

**RECEIVER OFFSET TUNING (CLARIFIER):** Provides  $\pm 5$  khz. variation of receiver tuning when switched ON.

**DIAL CALIBRATION:** Vernier scale marked with one kilohertz divisions. Main tuning dial calibrated 0-500 with 50 khz. points.

**FREQUENCY STABILITY:** Less than 100 cycles after warm-up, and less than 100 cycles for plus or minus 10% line voltage change.

**MODES OF OPERATION:** SSB upper and lower sideband, CW and AM.

**INPUT POWER:** 300 watts PEP, 240 watts CW

**ANTENNA IMPEDANCE:** 50-75 ohms

**CARRIER SUPPRESSION:** -40 dB or better

**SIDEBAND SUPPRESSION:** -50 dB at 1000 CPS

**THIRD ORDER INTERMODULATION PRODUCTS:** -30 dB (PEP)

**AF BANDWIDTH:** 300-2700 cps

**RECEIVER SENSITIVITY:**  $\frac{1}{2}$   $\mu$ v input S/N 10 dB

**AGC:** Fast attack slow decay for SSB and CW.

**SELECTIVITY:** 2.3 khz. (-6 dB), 4 khz. (-60 dB)

**IMAGE REJECTION:** More than 50 dB.

**AUDIO OUTPUT:** 1 watt at 10% distortion.

**AUDIO OUTPUT IMPEDANCE:** 8 ohms and 600 ohms

**POWER SUPPLY:** Separate AC or DC required. See AC "ONE" and DC1-A.

**TUBES AND SEMICONDUCTORS:** 16 tubes, 15 diodes, 7 transistors

TEMPO "ONE" TRANSCEIVER \$349.00

AC/ONE POWER SUPPLY 117/230 volt 50/60 cycle \$ 99.00

DC/1-A POWER SUPPLY 12 volts DC \$110.00

VF-ONE EXTERNAL VFO \$ 99.00



### THE TEMPO 2001 LINEAR AMPLIFIER

Small but powerful, reliable but inexpensive, this amplifier is another top value from Henry Radio. Using two 8874 grounded grid triodes from Eimac, the Tempo 2001 offers a full 2 KW PEP input for SSB operation in an unbelievably compact package (total volume is .8 cu. ft.). The 2001 has a built-in solid state power supply, a built-in antenna relay, and built-in quality to match much more expensive amplifiers. This equipment is totally compatible with the Tempo One as well as most other amateur transceivers. Completely wired and ready for operation, the 2001 includes an internal blower, a relative RF power indicator, and full amateur band coverage from 80-10 meters. PRICE: \$545.00

### THE TEMPO 6N2

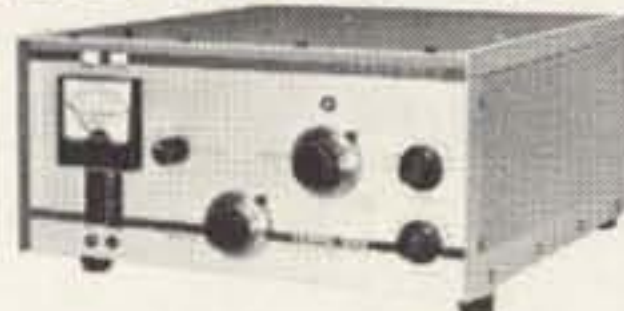

For 6 and 2 meter amateur operation. 2000 watts PEP input on SSB or 1000 watts input on FM or CW. Completely wired in one small package with an internal solid-state power supply, built-in blower, and RF relative power indicator. \$595.00

Prices subject to change without notice.

### THE TEMPO RBF-1

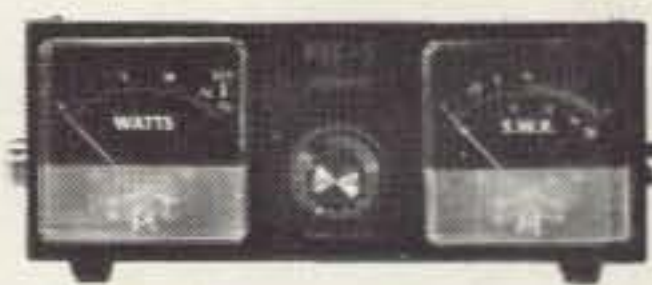

Dual meters continuously monitor output power and SWR during transmission. Offers two power scales of 0-200 and 0-2000 watts plus operation from 1.9 to 150 MHz. Tempo offers this combination in-line SWR bridge and wattmeter at a surprisingly low \$29.95.

The Tempo line is available at select dealers throughout the U.S.

Henry Radio stores can now supply the complete line of Yaesu equipment.

# Henry Radio

11240 W. Olympic Blvd., Los Angeles, Calif. 90064 213/477-6701  
931 N. Euclid, Anaheim, Calif. 92801 714/772-9200  
Butler, Missouri 64730 816/679-3127

"World's Largest Distributor of Amateur Radio Equipment"