

# AMATEUR RADIO

# 73

October 1960

37¢







# WHERE TIME AND DEPENDABILITY COUNT IN COMMUNICATIONS . . .

INTERNATIONAL'S \*ONE DAY CRYSTAL PROCESSING  
SERVICE AVAILABLE WORLD WIDE

**AMATEURS • EXPERIMENTERS • COMMERCIAL**

**AMATEUR CRYSTALS** (FA-5, FA-9 spot frequencies 1000 KC to 137 MC .01% Tolerance.

Wire mounted, plated crystals for use by amateurs and experimenters, where tolerances of .01% are permissible and wide-range temperatures are not encountered.

Designed to operate into a load capacitance of 32 mmf on the fundamental between 1000 KC and 15 MC. Designed to operate anti-resonance on 3rd overtone modes into grid circuit without additional capacitance load. Fifth overtone crystals and seventh overtone crystals are designed to operate at series resonance. (Write for recommended circuits.)

**Custom made COMMERCIAL CRYSTALS 70 KC to 100 MC**

Wire mounted, plated crystals, for use in commercial equipment (Type F-6) where close tolerances must be observed. All units are calibrated for the specific load presented by equipment.

Circuit: As specified by customer. Crystals are available for all major two-way equipment and in most cases the necessary correlation data is on file.

Prices on request.

How To Order: For fastest service, our crystals are sold direct. Terms F.O.B. Oklahoma City.

*\*One Day Processing . . . Orders for less than five crystals will be processed and shipped in one day. Orders received on Monday through Thursday will be shipped the day following. Orders received on Friday will be shipped the following Monday.*



*Now* IN ONLY MINUTES **CONVERT YOUR CAR RADIO**  
FOR SHORT WAVE RECEPTION WITH A **MOBILETTE**



**International's NEW all transistor, Crystal Controlled Converter.**

- Easy to Install.
- Works on 6 or 12 volts without change.
- Power connector plugs into cigarette lighter socket. (No external power supply needed.)

Designed by International for Amateurs, Citizens Licensees, Short Wave Listeners, Hobbyist.

Available in Seven frequency ranges covering the Amateur bands, 75 through 10 meters, the Citizens band, and WWV National Bureau of Standards Time Broadcasts.

Three simple steps to install (1) Remove antenna lead from car radio and plug into input of Mobilette. (2) Plug jumper wire from Mobilette into antenna connection of car radio. (3) Plug power connector into cigarette lighter socket. Mobilette normally wired for negative ground battery system. When ordering positive ground, add Suffix "P" to catalog number.

**International Mobilettes cover these short wave bands.**

Catalog No.	Frequency	Catalog No.	Frequency
630 - 105	75 meters (Amateur)	630 - 102	15 meters (Amateur)
630 - 104	40 meters (Amateur)	630 - 101	11 meters (Citizens)
630 - 106	10 MC (WWV Time)	630 - 100	10 meters (Amateur)
630 - 103	20 meters (Amateur)		28.5 - 29.5 MC

Available soon for 6 and 2 meters at slightly higher price.

**INTERNATIONAL  
CRYSTAL MANUFACTURING CO., INC.**

18 NORTH LEE • OKLAHOMA CITY, OKLA.



Complete, ready to  
plug in and operate  
... only \$19.95

Order direct from International. Terms F. O. B. Okla. City. Include postage. Shipping weight 2 lbs.

Send for FREE Catalog covering International's complete line of Crystals and Equipment.



# STABILITY



1 PART  
IN  $10^8$   
PER DAY

DIRECT  
READING  
320,000  
FREQUENCIES

COLOR  
CODED  
CONTROLS

BOTH METER  
AND NEON  
SYNC INDICATOR

SPECIAL  
CRYSTAL  
FILTERS

15 KC  
BAND WIDTH  
(7.5 PER  
SIDE BAND)

PULL-OUT  
FLIP-OVER  
DRAWER  
CONSTRUCTION

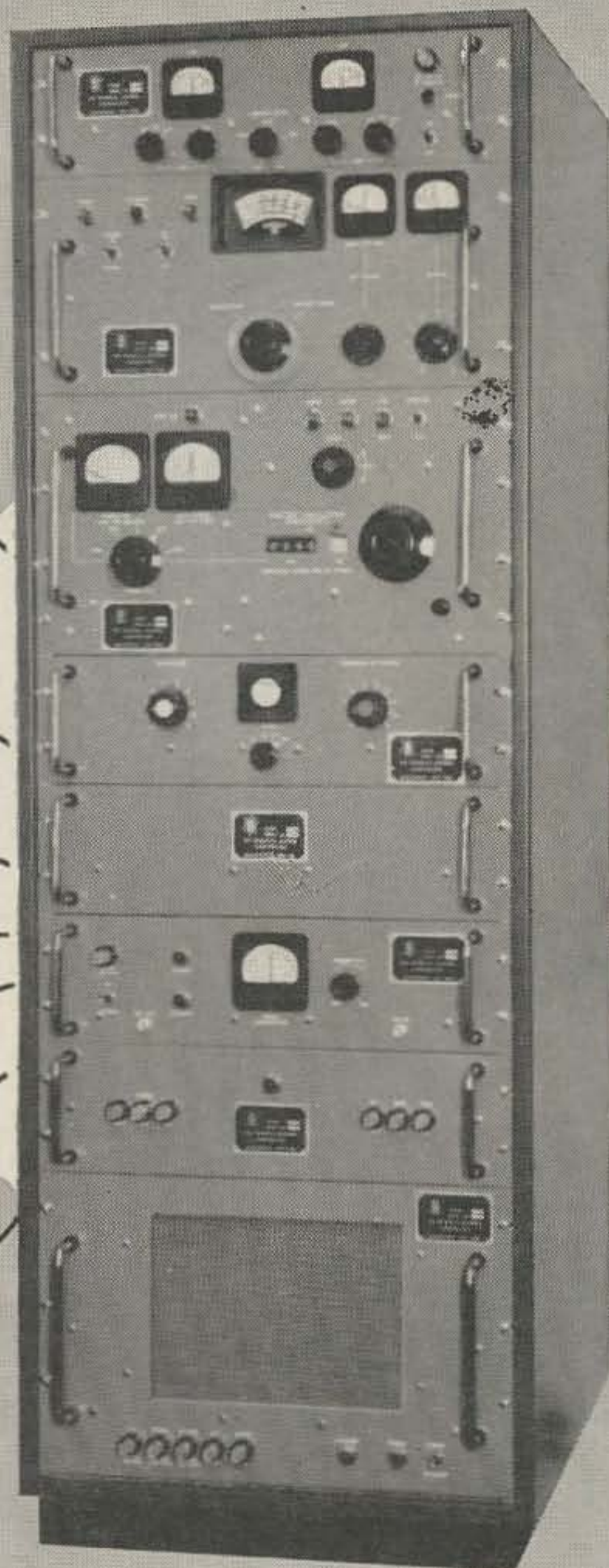

**AN/URA-30**

## SBG-1 SINGLE SIDEBAND GENERATOR

For full detailed  
information write for  
**BULLETIN 228**

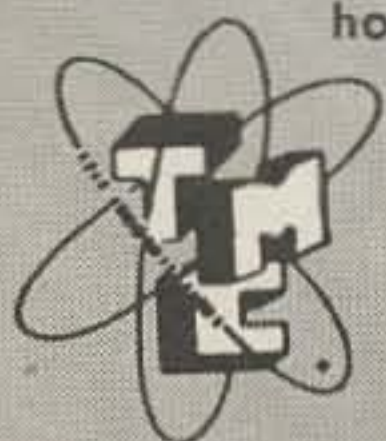

The Model SBG-1, Single Sideband Generator, is a stabilized direct reading exciter system adjustable to 320,000 frequencies over the range of 1.75 to 33.75 megacycles in 100 cycle steps with a basic stability of 1 part in  $10^8$  per day. The generator is an all purpose device providing SSB, DSB, ISB, and AM.

All frequency determining elements in the SBG-1 are derived from a 1 mc source which has a phasing control for correction to an external standard. Also, the unit may be connected to an external standard of greater stability without degeneration to the standard. When the sideband exciter unit is bypassed, the Model SBG-1 may be used as an ultra stable R.F. frequency source.

Housed in a standard relay rack with 60 inches of panel space, the control portion requires only 29½ inches of rack space. The other components may be housed separately in the event this makes for a more convenient installation.

**The TECHNICAL MATERIEL CORPORATION**

IN CANADA

TMC Canada Ltd., Ottawa, Ontario

Main Office: MAMARONECK

NEW YORK

Write directly to TMC, Mamaroneck, N.Y. for literature and name of distributor covering your area.  
Cable: TEPEI, Mamaroneck, N.Y.



1379 East 15th Street  
Brooklyn 30, N. Y.

## Table of Contents

<b>Audio Booster</b> .....	Jim Kyle K5JKX/6 .....	8
A three transistor amplifier that hooks across the mike to give you more talk power for SSB or AM without distortion.		
<b>Something New in FM</b> .....	R. E. Baird W7CSD .....	10
Using the new Varicap as an FM modulator.		
<b>Bantam Converters</b> .....	John Wonsowicz W9DUT .....	12
Two tube VHF converters for 50-108-144-152-220 mc bands.		
<b>Risky Hobby</b> .....	Carole Hoover K9AMD .....	16
How to fall off your tower for fun and profit.		
<b>Tubeless Electronic Key</b> .....	D. L. Cabaniss WITUW .....	18
Just uses some relays. Also tells how to convert your bug.		
<b>Digest of Surplus</b> .....	Gordon E. Hopper WIMEG .....	20
Short lecture tour through your local surplus emporium.		
<b>Direct Reading Capacity Meter</b> .....	Roy A. McCarthy W6EAW .....	22
Two transistors. You've got a lot of resistance if you can keep from building this gadget.		
<b>Gotta Patch?</b> .....	K. A. Johnson W6NKE .....	24
Instructions for phone patching and avoiding trouble.		
<b>Three-Way Power Supply</b> .....	Don Smith W3UZN .....	26
6, 12, 120 v supply using kit-available parts.		
<b>Shock</b> .....	Peggy Bates .....	28
New facts on electric shock, or what to do until rigor mortis sets in.		
<b>Propagation Charts</b> .....	Dave Brown K2IGY .....	30
What bands what time to where . . . probably.		
<b>Three Tubes, Five Watts, Six Meters</b> .....	Capt. John J. Sury K8NIC/5 .....	32
How to get on Six in a hurry.		
<b>How To Be An Amateur</b> .....	John W. Campbell, Jr. W2ZGU ..	34
For adults only. Children under 16 not admitted.		
<b>Testing the Heath GC-1A</b> .....	73 Staff .....	38
Well, well! A transistorized communications receiver!		
<b>Modulation Fundamentals</b> .....	Bob Schoening WØTKX .....	42
This is our big technical article for the month.		

<b>Misc.:</b>		<b>Staff:</b>
Editorial .....	4	editor-publisher .....
New Products .....	31, 41	Wayne Green W2NSD
Next Month .....	25	production manager .....
Policies .....	25	David Fish
Letters .....	41	associate editor .....
Subscriptions .....	63	Jim Kyle K5JKX
Ham Bulletins .....	65	associate editor .....
Ham Convention .....	52	Don Smith W3UZN
Ad Index .....	62	associate editor .....
Technical Broadcasts .....	56	Jim Morrissett W8BAJ/K20LK
Table of Contents .....	3	contributing editor .....
		John Campbell W2ZGU
		contributing editor .....
		Jean Shepherd K2ORS

73 (Title registered U. S. Post Office) is published monthly by Amateur Radio Publishing, Inc. Executive and editorial offices at 1379 East 15th Street, Brooklyn 30, New York. Telephone: INGersoll 9-6957.

Application for entry as second-class matter is pending.

Subscription rates: U. S. A. and possessions, APO, FPO, Canada and Mexico; one year \$3.00; two years \$5.00; three years \$7.00. Foreign: one year \$4.00; two years \$7.00.

Printed in the U. S. A. Entire contents copyright 1960 by Amateur Radio Publishing, Inc.



# .....de W2NSD

*Please understand that this is Volume 1, Number 1 of 73. It is NOT perfect—it isn't even anywhere as good as I'd like it to be. But, all things considered, a major miracle has been worked and this issue IS in print.*

## Feedback

*We both have a vested interest in 73 being as interesting as possible. You can help me keep my finger on your pulse by sending a postcard every month listing the articles in the order of your interest. I will publish results of this monthly survey as an encouragement to the authors. The top author each month will get, in addition to the compliment, a check from us for 50% of his original payment. Thus your vote each month will serve to help me in the selection of future articles and will encourage good writers both with plaudits and some extra cash!*

## Writing For 73

ONE of the first moves in planning the publication of 73 was to get in touch with past authors of ham articles and explain to them that there was a new magazine coming and that it needed articles. To encourage them we established the firm policy of paying for all articles immediately upon acceptance. This encouraged quite a few, as you can see in this issue, and as you will see in the subsequent issues.

There must be a lot more of you with interesting ideas to communicate. Naturally we prefer technical and construction articles, but if it is interesting and hammy we'll probably shell out. One author has hustled us for over \$1000 so far and shows no sign of drying up yet.

## Suggested Procedure

If you're in doubt about whether we'll buy or not just send in an outline and, if possible, some pictures. We'll probably OK it. Try to get the best pictures you can and type it up double spaced (use a dictionary).

## Laboratories Needed

Readers and manufacturers both expect us to run the same old tests on new equipment and write up pleasant little blurbs which carefully sidestep the obvious shortcomings of the gear and repeat almost verbatim the specifications published in the ads. I have tried running honest reports on equipment in the past only to meet mountains of emotion from the manufacturers and their advertising agencies and

apathy from the readers. This was obviously not the correct approach.

After much stewing over this problem I think I have an answer that will satisfy everyone . . . even me. Unfortunately, even with the twenty-four year collection of radio debris around the shack I don't have the necessary equipment to do the job of testing that I have in mind. And any of you chaps with an inclination to do something helpful for us all suitably equipped? You'd need a pretty good 'scope, dummy loads for various power levels, an rf voltmeter, an ac ammeter, a KW Variac for line voltage tests, an audio oscillator, frequency meter, antenna tuner, etc. This would enable you to run fairly good checks on a transmitter. The receiver tester would have to have different gear.

What I want is a thorough technical listing of the facts about the equipment. For a transmitter we want to know the list price, weight, size, tubes used, bands covered, ac power on standby, ac power under full load, heating under full load, input to final, output power, efficiency, frequency stability during transmit, drift during standby, antenna switching provisions, compatibility with other commercial gear, how well fused, how well the operator is protected from electrocution, ease of servicing, TVI, ease of tuning, ease of band-changing, calibration of VFO (if any), resetability of VFO, backlash of VFO dial, spotting switch, high voltage on standby, high voltage under full load, interlocked, overload relay or protection, 108 volt test, 132 volt line test, audio response, shipping weight, connecting wires supplied, driving power required (amplifiers) on various bands, etc.

Then comes the objective on-the-air activity with the rig for a couple of weeks to get the feel of it. By this time the writer should be able to turn out quite a piece, listing the statistics and pointing up the more positive aspects of the equipment in a general commentary.

We need the same treatment for receivers and other ham items. Anybody interested? The pay is miserable. All those who do not volunteer take one step backwards.

## Our Advertisers

It takes a lot of personal interest in the hobby for an advertiser to run an ad in a brand new ham magazine. He has to put aside questions about what this will cost him in dollars per thousand readers and how much duplication he is getting of readership in other ham magazines. He already has his budget allocated for a long time ahead and this means an extra unexpected expense which may well bring little return.

Since it is advertising revenues that make it possible for magazines to be published we all owe a lot of gratitude to the handful of

(Continued on page 25)



from **EICO**® ... a completely new

# CITIZENS BAND TRANSCEIVER

that meets  
FCC regulations\*

\*EICO premounts, prewires, pretunes, and seals the ENTIRE transmitter oscillator circuit to conform with FCC regulations (Section 19.71 subdivision d). EICO thus gives you the transceiver in kit form that you can build and put on the air without the supervision of a Commercial Radio-Telephone Licensee!

designed  
by Hams...  
for Hams...

to the highest  
Ham standards

#760:  
117 VAC  
Kit  
**\$59.95**  
Wired  
**\$89.95**



Kit **\$69.95**  
#761: 117 VAC & 6 VDC  
#762: 117 VAC & 12 VDC  
incl. mtg. bracket (Pat. Pend.) **\$99.95**

Highly sensitive, selective SUPERHET (not regenerative) receiver with 5½ dual function tubes and RF stage. Continuous tuning over all 23 bands. Exclusive Super-Hush® noise limiter. AVC. 3" x 5" PM speaker. Detachable ceramic mike. 5 Watt xtal-controlled transmitter. Variable "pi" network matches most popular antennas. 12-position Posi-Lock® mounting bracket. 7 tubes and 1 xtal (extra xtals available). Covers up to 20 miles. License available to any citizen over 18 — no exams or special skills required; application form supplied free. Antennas optional.

Additional crystals \$3.95 each.

Most EICO distributors offer budget terms.



**NEW! 60-WATT CW TRANSMITTER #723**  
Kit \$49.95 Wired \$79.95  
Ideal for novice or advanced ham needing low-power, stand-by rig. 60W CW, 50W external plate modulation. 80 through 10 meters.



**COLOR & MONO DC-5MC LAB & TV 5" OSCILLOSCOPE #460**  
Kit \$79.95 Wired \$129.50  
**5" PUSH-PULL OSCILLOSCOPE #425** Kit \$44.95 Wired \$79.95

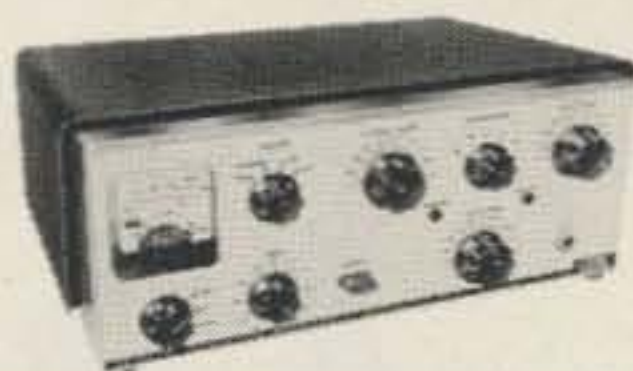

**90-WATT CW TRANSMITTER\* #720** Kit \$79.95 Wired \$119.95  
\*U. S. Pat. No. D-184,776  
"Top quality" — ELECTRONIC KITS GUIDE. Ideal for veteran or novice. 90W CW, 65W external plate modulation. 80 through 10 meters.



**PEAK-TO-PEAK VTVM #232**  
Kit \$29.95 Wired \$49.95  
**VACUUM TUBE VOLTMETER #221**  
Kit \$25.95 Wired \$39.95

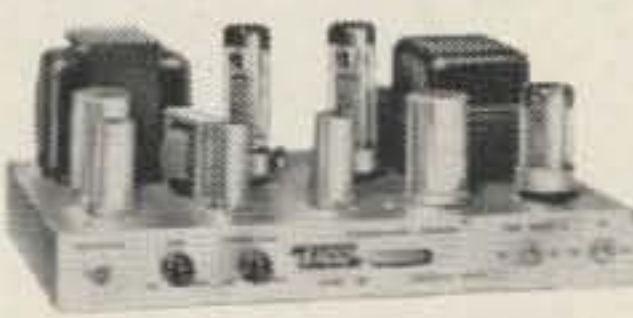

**HIGH-LEVEL UNIVERSAL MODULATOR-DRIVER #730**  
Kit \$49.95 Wired \$79.95  
Delivers 50W undistorted audio. Modulates transmitters having RF inputs up to 100W. Unique over-modulation indicator. Cover E-5 \$4.50.



**RF SIGNAL GENERATOR #324 (150kc-435mc)**  
Kit \$26.95 Wired \$39.95  
**TV-FM SWEEP GENERATOR & MARKER #368**  
Kit \$69.95 Wired \$119.95

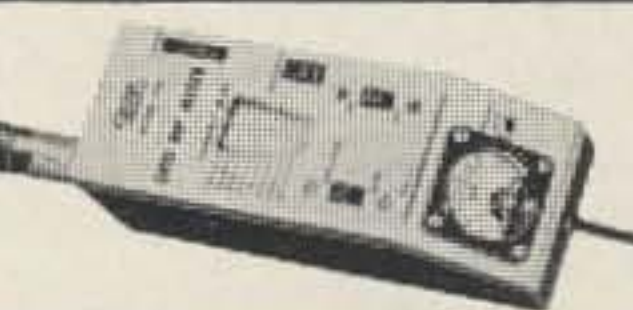

**GRID DIP METER #710**  
Kit \$29.95 Wired \$49.95  
Includes complete set of coils for full band coverage. Continuous coverage 400 kc to 250 mc. 500 ua meter.



**DYNAMIC CONDUCTANCE TUBE & TRANSISTOR TESTER #666**  
Kit \$69.95 Wired \$109.95  
**TUBE TESTER #625**  
Kit \$34.95 Wired \$49.95

**EICO**®  
33-00 Northern Blvd.,  
Long Island City 1, N. Y.

EICO, 33-00 N. Blvd., L.I.C. 1, N.Y. Show me how to save 50% on 72 models of top-quality:  Ham Gear  Test Instruments  Hi-Fi  Send free Short Course for Novice License. Send free catalog and name of neighborhood EICO distributor.

Name.....  
Address.....  
City.....Zone.....State.....  
Add 5% in the West.



# It pays to insist on **PR** crystals

STANDARD OF EXCELLENCE SINCE 1934

## AMATEUR TYPES

### 40 and 80 Meters, PR Type Z-2

Rugged. Low drift, fundamental oscillators. High activity and power output. Stands up under maximum crystal currents. Stable, long-lasting;  $\pm 500$  cycles.....**\$2.95 Net**

### Third Overtone, PR Type Z-9A

Hermetically sealed; calibrated 24,000 to 24,666 and 25,000 to 27,000 Kc.,  $\pm 3$  Kc.; .050" pins.....**\$4.95 Net**

### 6 Meters, PR Type Z-9A

Fifth overtone; for operating directly in 6-meter band; hermetically sealed; calibrated 50 to 54 Mc.,  $\pm 15$  Kc.; .050" pins.  
**\$6.95 Net**

## CITIZENS BAND CLASS "D" Type Z-9R, Transmitter

FCC assigned frequencies in megacycles: 26.965, 26.975, 26.985, 27.005, 27.015, 27.025, 27.035, 27.055, 27.065, 27.075, 27.085, 27.105, 27.115, 27.125, 27.135, 27.155, 27.165, 27.175, 27.185, 27.205, 27.215, 27.225; calibrated to .005%. (Be sure to specify manufacturer of equipment).....**\$2.95 Net**

## CITIZENS BAND CLASS "D" Type Z-9R, Receiver

Specify I.F. frequency, also whether receiver oscillator is above or below transmitter frequency. Calibrated to .005%. (Be sure to specify manufacturer of equipment.)  
**\$2.95 Net**

### Type Z-9R, Radio Control

FCC assigned frequencies in megacycles: 26.995, 27.045, 27.095, 27.145, 27.195, 27.255; calibrated to .005%. (Be sure to specify manufacturer of equipment).....**\$2.95 Net**

## COMMERCIAL TYPES

Commercial Crystals available from 100 Kc. to 70 Mc. Prices on request.

### Type Z-1, MARS and CAP

Official assigned frequencies in the range. Calibrated to .005%. 1600 to 10000 Kc.....**\$3.45 Net**

### Type Z 1, TV Marker

Channels 2 thru 13....**\$6.45 Net**

4.5 Mc. Intercarrier,

.01% ..... **\$2.95 Net**

5.0 Mc. Signal Generator,

.01% ..... **\$2.95 Net**

10.7 Mc. FM, IF,

.01% ..... **\$2.95 Net**

### Type Z-6A, Frequency Standard

To determine band edge. To keep the VFO and receiver properly calibrated.

100 Kc. ... **\$6.95 Net**



Z-6A



### Type 2XP

Suitable for converters, experimental, etc. Same holder dimensions as Type Z-2.

1600 to 12000 Kc., (Fund.)  $\pm 5$  Kc.....**\$3.45 Net**

12001 to 25000 Kc. (3rd Overtone)  $\pm 10$  Kc.....**\$4.45 Net**

ALL PR CRYSTALS ARE UNCONDITIONALLY GUARANTEED.  
ORDER FROM YOUR JOBBER.

**PETERSEN RADIO CO., Inc. 2800 W. Broadway**  
COUNCIL BLUFFS, IOWA

EXPORT SALES: Royal National Corporation, 250 W. 57th Street, New York 19, N. Y., U. S. A.



CELEBRATING

25

YEARS OF SERVICE



Leo I. Meyerson, WØGFQ

AT THE "House the Hams Built"

# Amateur Supermart

NOVICE

TECHNICAL

ADVANCED AMATEUR

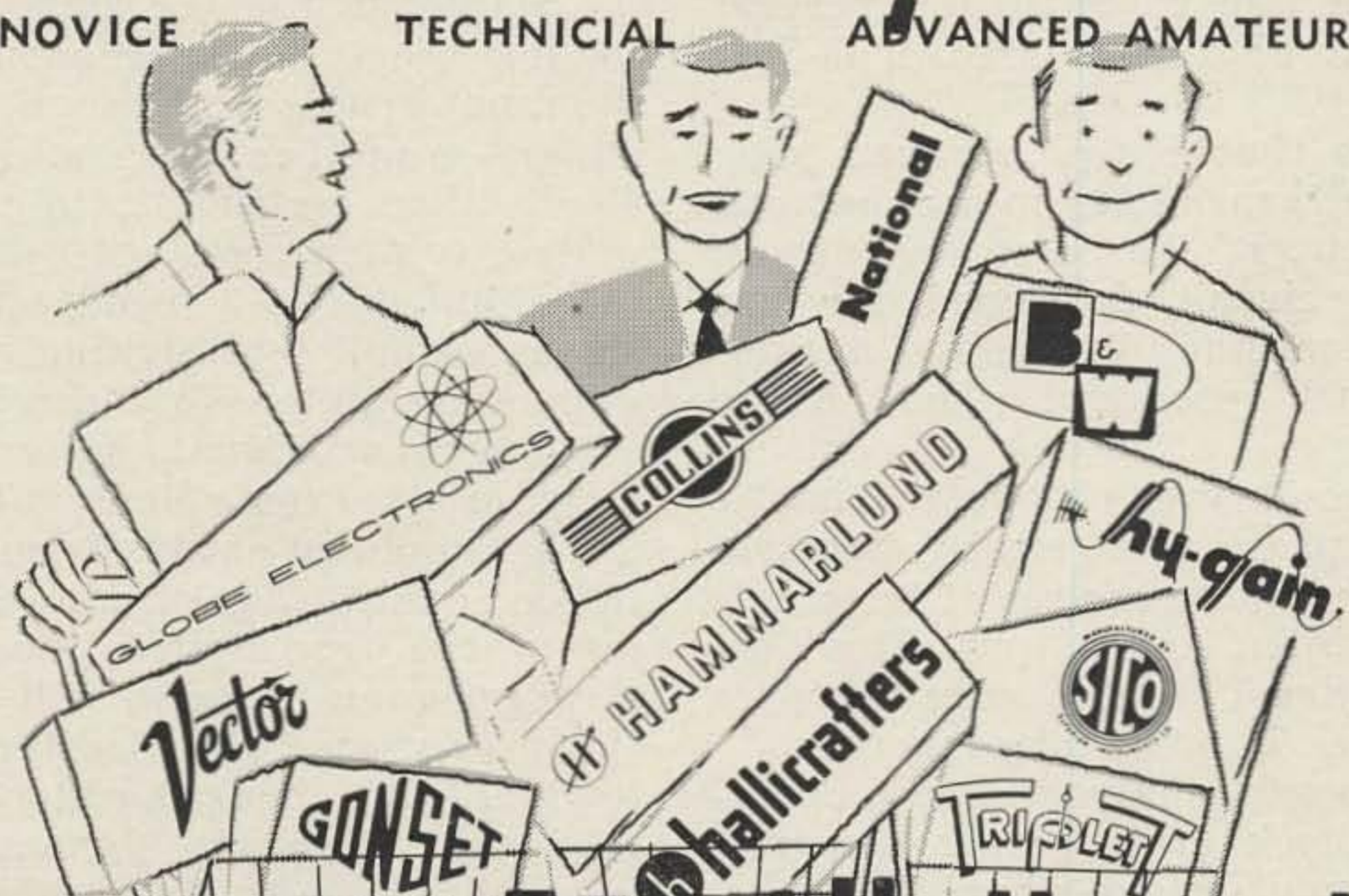

## Headquarters For All Ham Needs

NOW WITH OUR EXCITING **NEW** Liberal Time Payment Plan



### RECONDITIONED EQUIPMENT

With nearly 800 items continually in stock and a turnover of nearly 500 pieces each month, World Radio offers the Economy-Minded the finest in used gear, sent to you in "like factory new" condition. Incidentally, this large turnover allows us to offer the Nation's best Trades, too.

JUST OFF THE PRESS FREE 1961

*25th Anniversary*

CATALOG

200 Pages of Top Ham Bargains

Send for Yours TODAY!



CELEBRATING 25 YEARS OF SERVICE

# WRL

## WORLD RADIO LABORATORIES

3415 W. BROADWAY • PHONE 32 8-1851 • COUNCIL BLUFFS, IOWA

73

DEAR LEO: PLEASE RUSH  NEW CATALOG  FREE RECONDITIONED EQUIPMENT LISTS  ENCLOSED IS MY \$.50 FOR RADIO REFERENCE MAP

NAME: \_\_\_\_\_ CALL \_\_\_\_\_

ADDRESS: \_\_\_\_\_ CITY & STATE: \_\_\_\_\_



# The Audio Booster

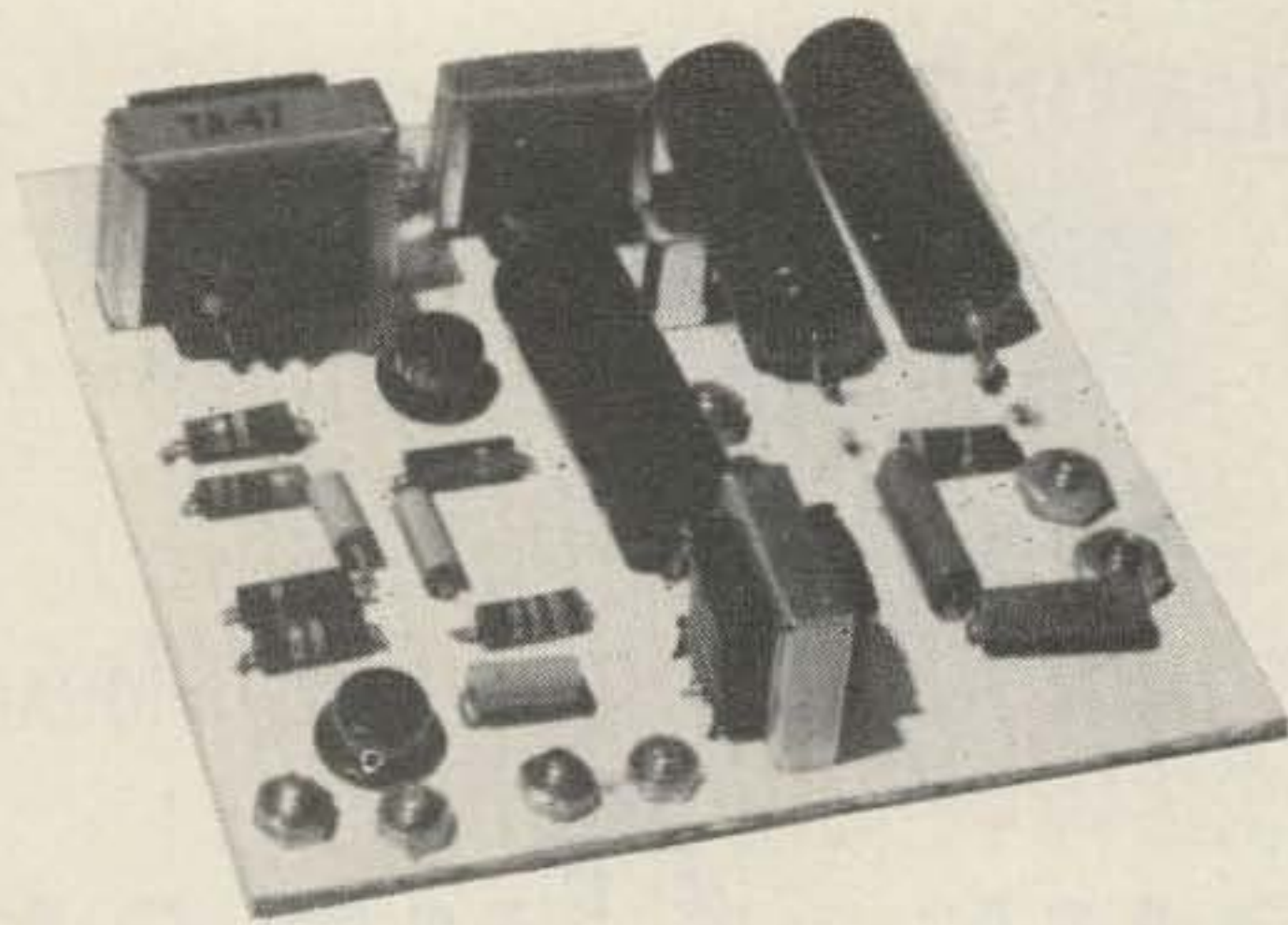

Jim Kyle, K5JKX/6  
11953 Cameo Place  
Granada Hills, Calif

How would you like to have 100 percent modulation at all times, instead of just on peaks?

Here's a gadget that hangs between your mike plug and the transmitter input that can do just that for you<sup>1</sup>. It's based on an unusual telephone-repeater circuit developed for use on a 26-mile intercom line. Addition of a gain-controlling channel produced The Audio Booster.

The original circuit was unique in that it amplified signals passing in either direction over the line, and had only one set of terminals which doubled as input and output. This feature has been retained, in case your rig puts an audio signal back into the microphone.

The quickest way to analyze circuit operation is to take a look at the block diagram, Fig. 1, and the input-bridge simplified schematic, Fig. 2, while reading the following paragraphs.

<sup>1</sup>You don't really want to adjust it that way, though. It would wipe out all amplitude variation, leaving only the frequency components to carry your voice, and the result is completely unintelligible!

Looking at Fig. 1, you'll see that a signal coming from the microphone passes through the input-bridge to the input sides of both amplifiers. Amplifier No. 1 boosts the signal some 40 db, then rectifies it to produce a positive control voltage. This control voltage is applied to Amplifier No. 2 to adjust its gain. With a strong signal, representing an audio peak, the gain of Amplifier No. 2 can be reduced to zero. With a weak signal, however, Amplifier No. 2 can produce some 50 db gain.

The amplified output from No. 2 is returned to the input-bridge circuit, from which it goes on to the transmitter. You can see that a strong signal, or peak, will not be affected by the presence of the Booster. Weaker signals, or "valleys", though, will receive some 40 db of boost. Since the dynamic range of your microphone's output is probably only about 20 to 25 db, this means that you have the ability to turn speech "inside out" amplitude-wise, if you like. By adjustment of the limiting threshold control in the AGC line, however, you can keep the signal right side up while reducing the dynamic range to only 3 or 4 db if you like.

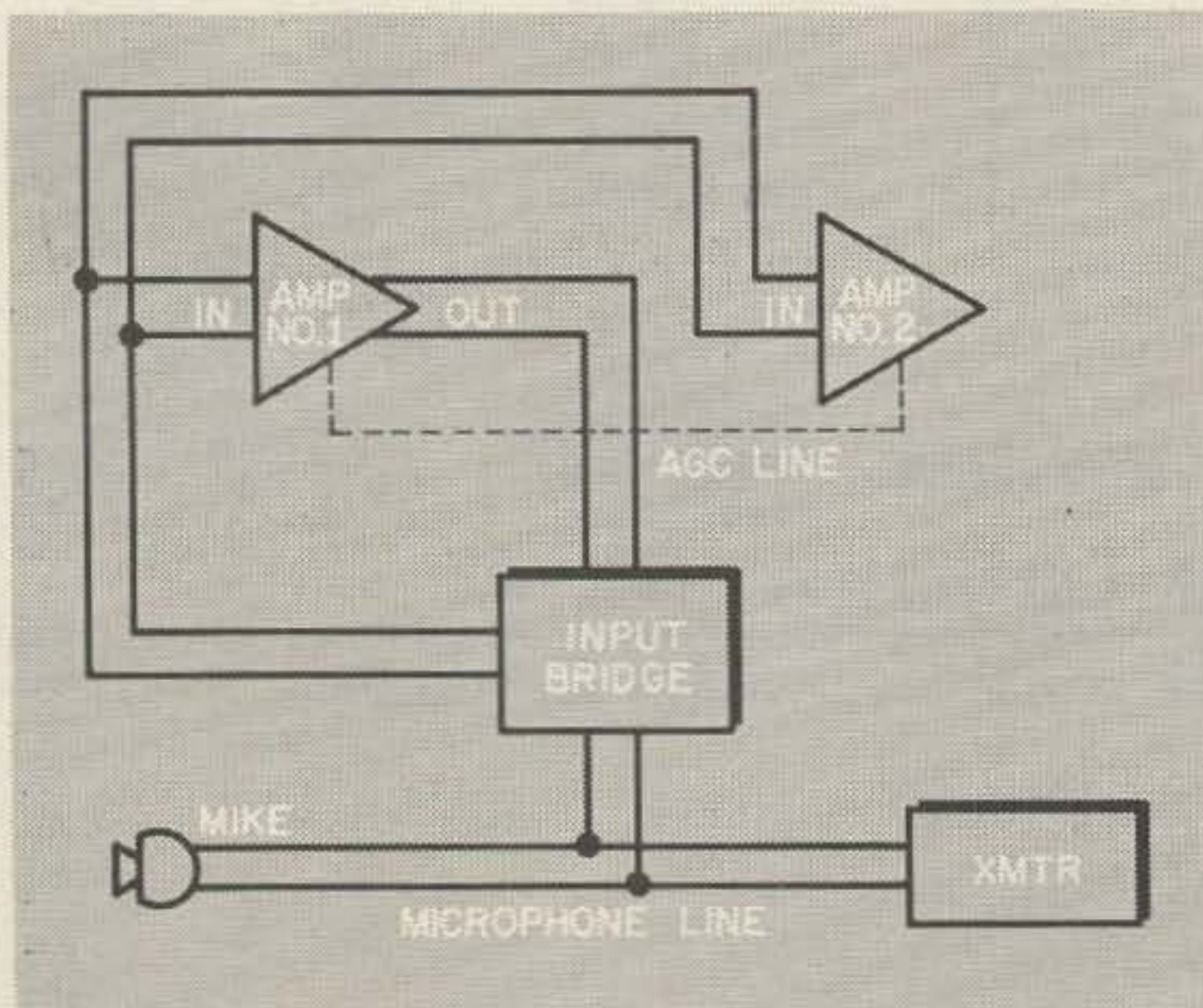

Fig. 1. Block diagram of the Audio Booster and its tie-in to your audio system. Operation is explained in the text.

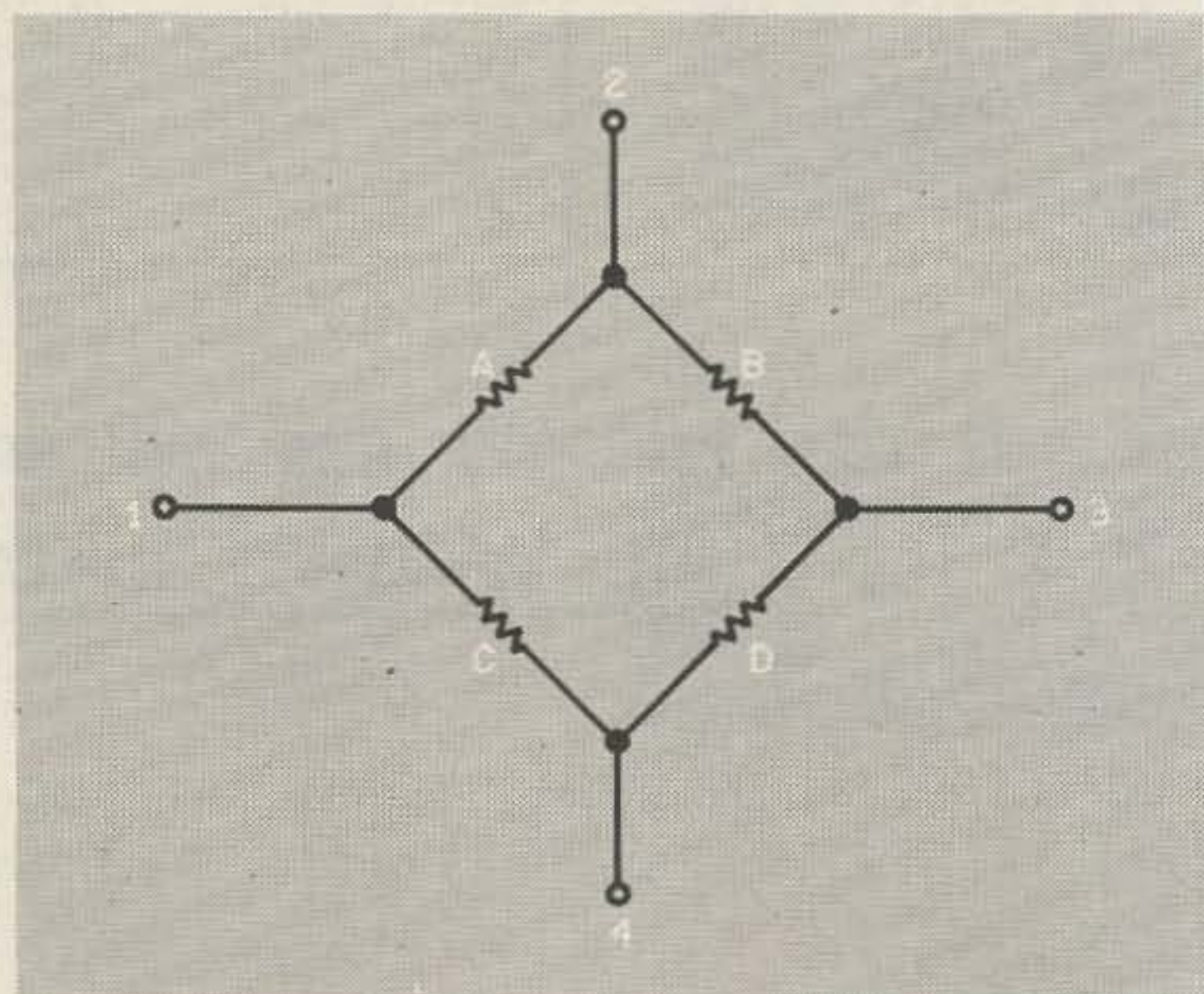
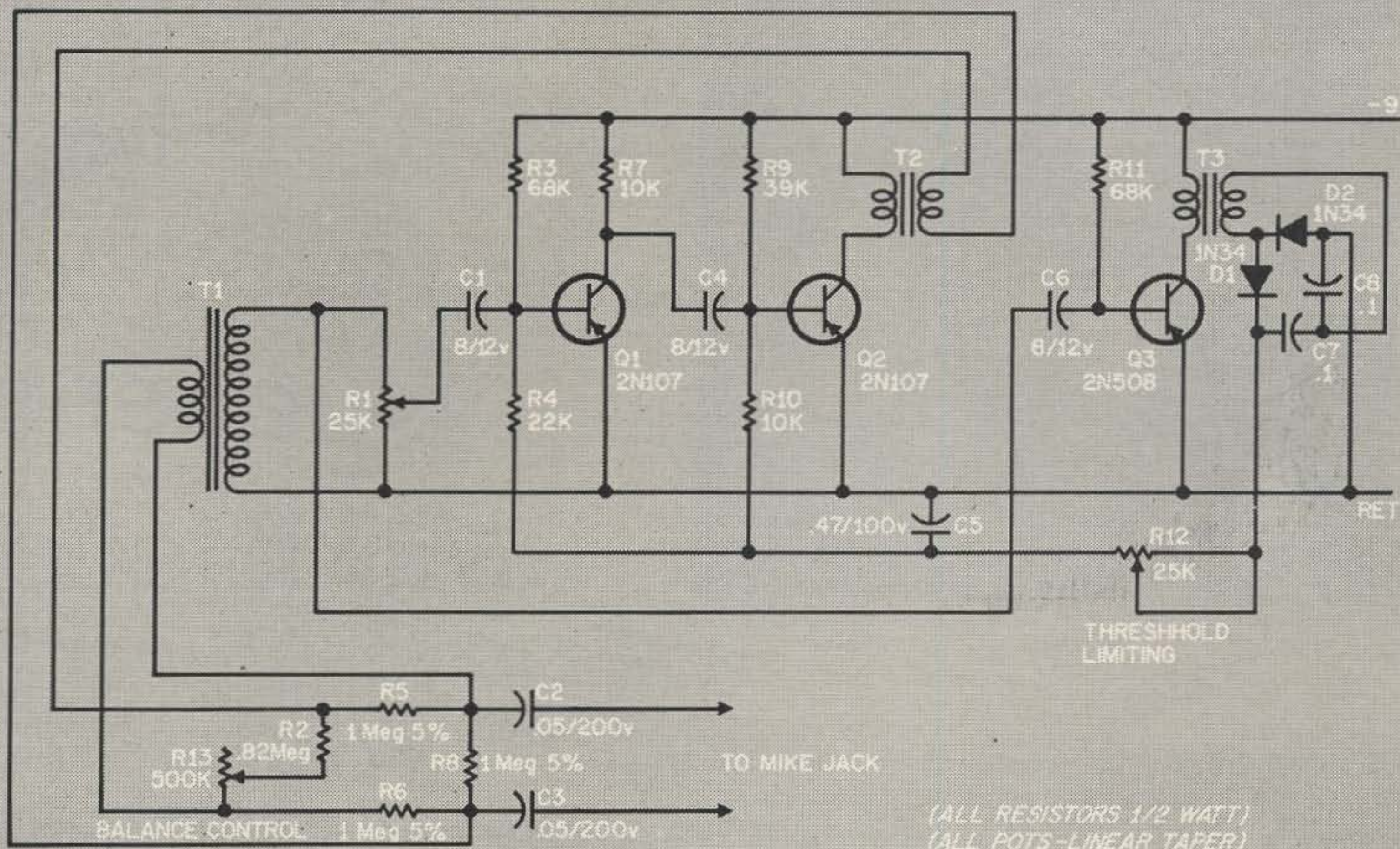

Fig. 2. Input-bridge circuit, simplified schematic diagram. If all resistance are equal, the bridge is balanced.





#### PARTS LIST

##### Transformers:

T1— Transistor input transformer, primary impedance .2 meg, secondary impedance 1 K (Stancor TA-47 with primary and secondary connections reversed, or equivalent)

T2— Transistor interstage transformer, primary impedance 10 K, secondary impedance .16 meg (Stancor TA-32 or equivalent)

T3— Transistor interstage transformer, primary impedance 10 K, secondary impedance 200 ohms (Stancor TA-34 or equivalent)

The input-bridge circuit is the feature borrowed from the airfield intercom design. Fig. 2 will probably look familiar to you as a Wheatstone bridge. The bridge, when balanced, produces infinite isolation between terminals 1 and 3 and terminals 2 and 4, and vice versa. However, if a signal is coupled across arm A only, it will show up at both sets of terminals. Conversely, a signal fed in at either pair of terminals will show up in arm A.

Therefore, arm A can be connected across an audio line, and any signal appearing on the line will show up at all four terminals of the bridge. Let's hook 1 and 3 up to the input of an amplifier, and 2 and 4 to the output<sup>2</sup>. Now, any signal coming in on the line will go to the amplifier input. After it has been amplified, it will come back in to the opposite and isolated bridge terminals, and be returned to the line from whence it came. Still, input and output of the amplifier are isolated and oscillation will not develop.

Theoretically, there's no limit to the amplification you can obtain with one of these. In practice, about 40 db. is the limit, since that's

approaching the limit of isolation in a practical bridge circuit. If the line is non-reactive, and if you provide a fine balance adjustment (R13 in Fig. 3) and take care in construction to minimize stray coupling, a few more decibels may be squeezed out.

The only thing to watch out for in construction of the Booster is stray coupling around the bridge. This may limit your usable gain and consequently the compression ratio of the gadget. Otherwise, construction is according to usual transistor practices. An LMB No. 143 box chassis provides plenty of room for components. Locking-type potentiometers are recommended, but they're expensive. H. H. Smith lock nuts for standard volume controls work just as well.

To put the booster in operation, first hook it across the input of an amplifier connected to a speaker. R1, the floor level control, should be at minimum setting and the AGC line should be temporarily grounded to remove all control voltage from the boosting amplifier (connect a jumper from the base end of R12 to the return line).

Slowly advance R1 toward maximum. At some point, unless you're lucky and have per-

<sup>2</sup>Notice that both input and output of the amplifier must be isolated from ground. This means that transformer coupling is a must when using this circuit.



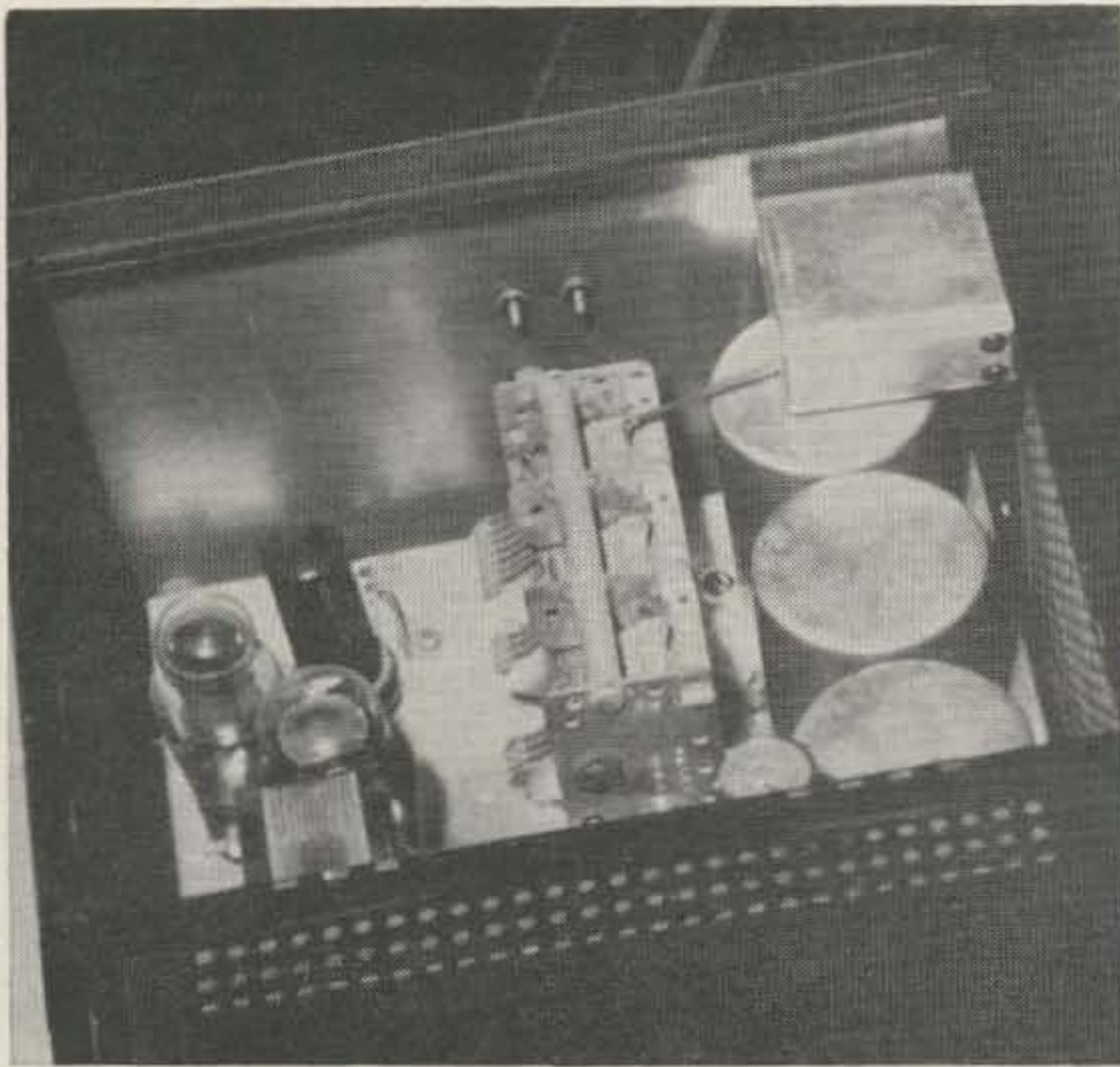

# Something New in Frequency Modulation

R. E. Baird, W7CSD  
Oregon Technical Institute

**T**HE production of a new and strange kind of variable capacitor recently came to the attention of the writer. This capacitor takes the form of a semiconductor, is about the size of a germanium diode, and is available in sizes from 7 to 100 mmfd. The strange thing about this little gadget is that the capacity is a function of a dc bias voltage impressed across it. The manufacturer, Pacific Semiconductors Inc., Culver City, California, use a standard voltage of four volts as the 100% capacity rating point. It may be seen from the curve in Fig. 1 that at zero voltage the capacity is about 250% and at 100 volts the capacity has dropped to 20% of the 4 volt value. *Caution:* A reverse polarity voltage should never be used and any superimposed ac peak must not go on the other side of zero.

As soon as you get the full import of the above you begin to get ideas. The "Varicap," for such is its trade name, has many possibilities. The first one the writer thought of was an FM modulator.

## The Modulator

It is fairly obvious that the Varicap as part of the frequency determining circuit in a self excited oscillator would vary the frequency in accord with its bias voltage. It was decided to use the Varicap in conjunction with a Meissner Signal Shifter to achieve FM. A close check with an oscilloscope revealed that the peak voltage across the frequency determining grid tank of the oscillator might run as high as 20 volts. Since a bias voltage in excess of 20 volts is not in the portion of the curve most usable for this purpose, it was decided that a 5 mmfd ceramic would be put in series with the 50 (approx) mmfd Varicap across the tank as shown in Fig. 2. This gives a voltage division leaving less than 2 volts rf across the Varicap which can be biased with 3 or 4 volts dc.

The modulator was constructed as shown in the illustrations and connected across the grid tuning condenser in the Signal Shifter with

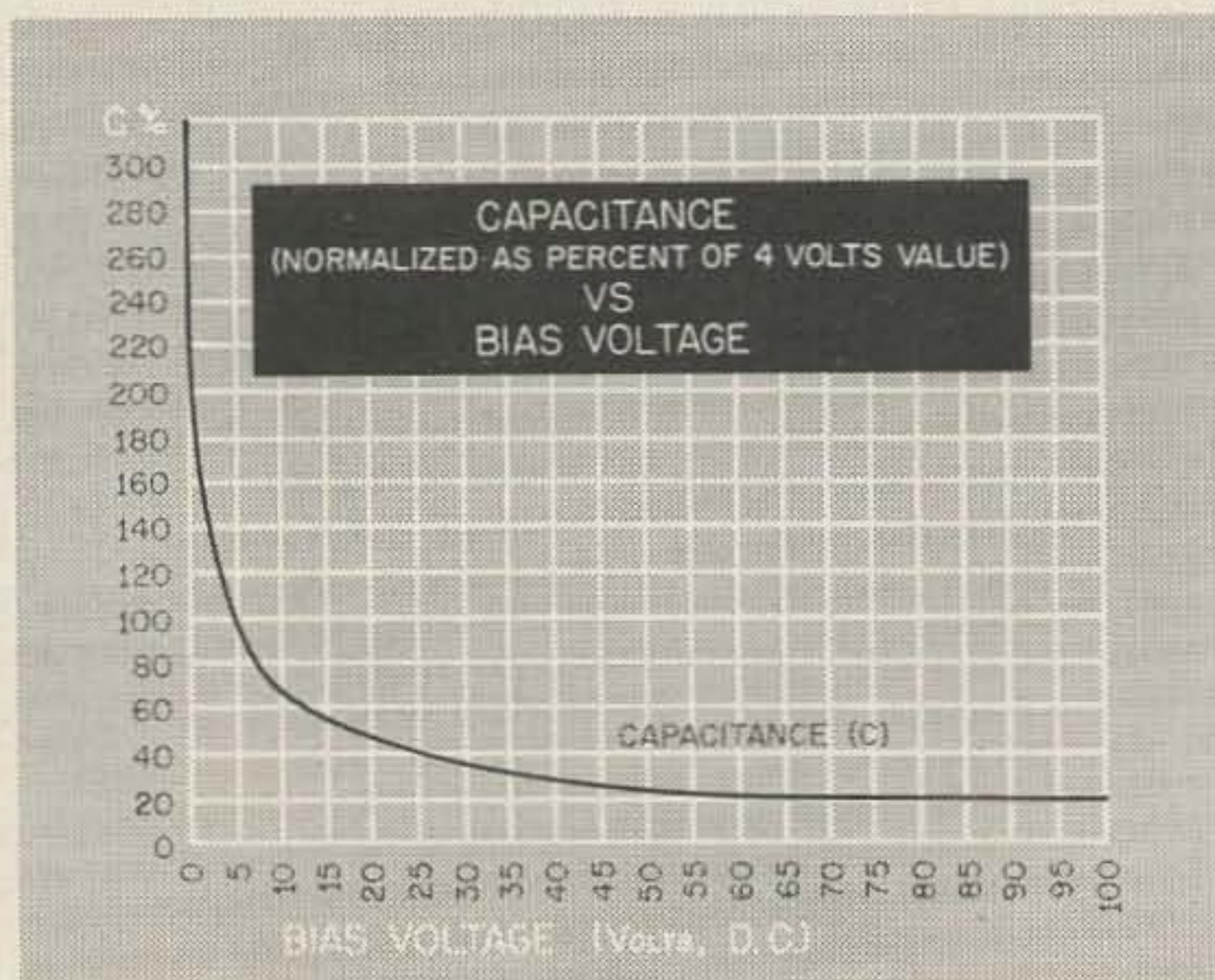

← Fig. 1 Courtesy of Pacific Semiconductors, Inc., 10451 West Jefferson Boulevard, Culver City, California Fig. 2 ↓

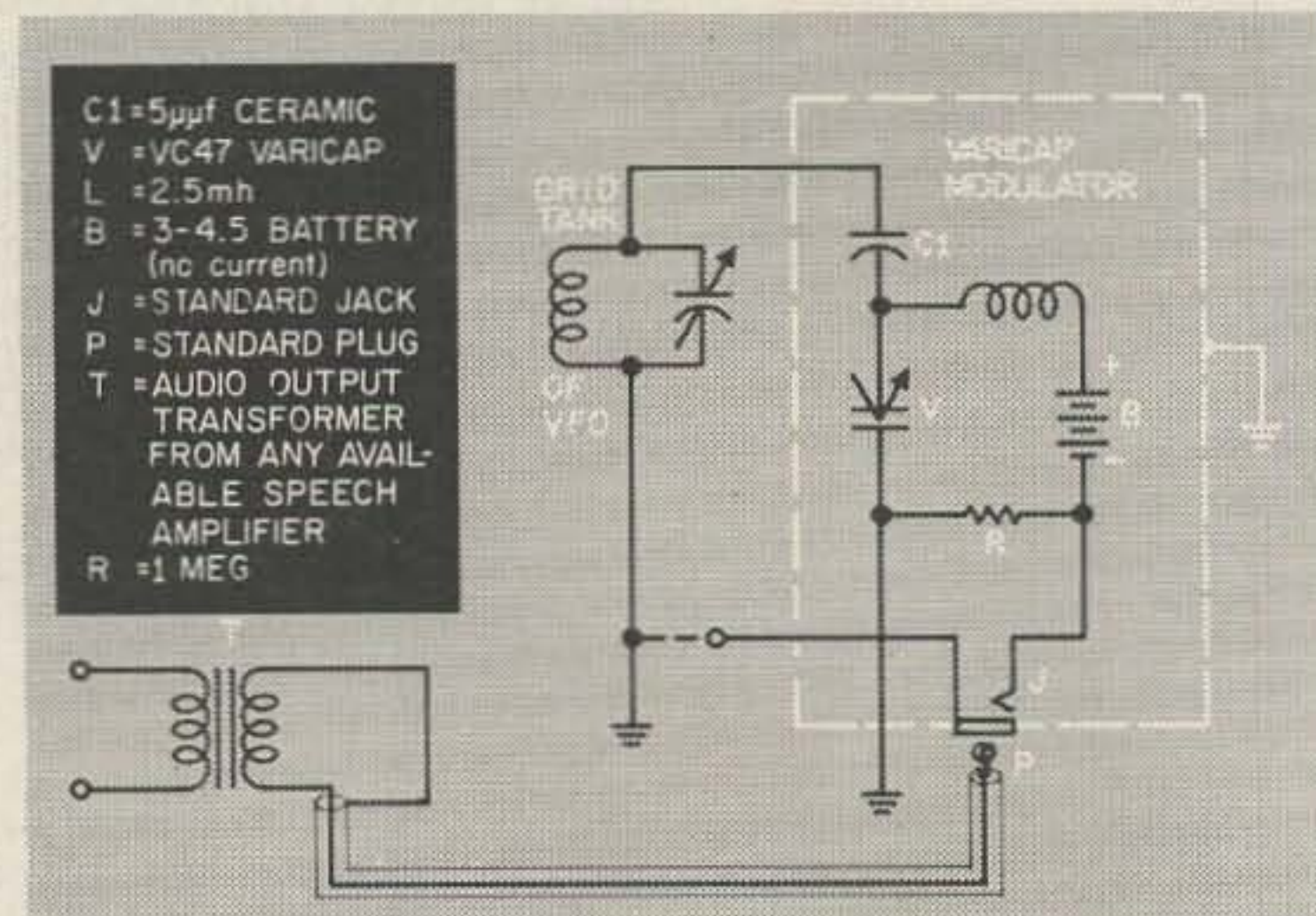



audio input jack in the side of the cabinet. Tests indicated rather high quality speech, even using slope detection. In the shifter shown the oscillator frequency is 10.5 mc and output is on 21 mc. This in turn feeds a 400 watt power amplifier.

### Side bands

For amateur use NFM has been defined as FM which takes up the same band width as conventional AM. The Varicap offers an unusual possibility in that the size of one side band may be greatly reduced. If the Varicap is biased at the knee of the curve, approximately four volts, a reduction of 2 volts will raise the capacity 50% while an increase of 2 volts will decrease the capacity only about 10%. With an ac signal it will be seen that the lower side band will be much wider than the upper side band; in fact, the upper side band almost disappears. You might say we have single side band FM, with carrier. If the bias is reduced to less than 3 volts, side bands approach the same size.

### Quantitative Tests

The writer had never used FM in ham radio before, so it seemed that some tests as to its



effectiveness were in order.

Using a dummy antenna and tone modulation the transmitter was adjusted for 100% AM. An HQ-160 located about 100 yards distant was then adjusted so that the audio output indicated by a VTVM was 1 volt, when tuned for maximum signal. Without changing any volume control on the HQ-160, the AM was removed, and FM substituted. Tuned for maximum slope detection the audio measured .9 volts. The side band was observed to be 3 kc wide. This is certainly a pretty good argument for FM. For the CW man wanting to go on phone the economy would be hard to beat.

It just so happened that the power amplifier used was a pair of suppressor grid modulated 4E27A tubes. As such, in order to get

100% AM it is necessary to run at a high negative voltage on the suppressors and very inefficient carrier conditions. A second test was run with the suppressor grids grounded. This of course doubled the input and the efficiency giving about four times as much carrier power (with the tubes running cooler). The measured audio voltage at the output of the HQ-160 was exactly 2 volts. So it would seem that the FM has an efficiency modulated AM system beat by a ratio of 2 to 1. This assumes, of course, that the power supply can deliver the extra power. If such is the case the amplifier will put out twice as much talk power on FM as it will on efficiency modulated AM.

### On the Air Tests

On the air tests have left nothing but satisfaction. Reports continually are received "I wouldn't have known it was FM if you hadn't told me." Comparison of AM and FM same carrier level have been just about a dead heat and with the power upped, as indicated above, the FM is way ahead.

One very peculiar report which has left the writer puzzled is that many hams who have received other FM signals say that FM by this method is much cleaner and easier to copy.



You would think that FM is FM no matter how you get it, but such seems not to be the case. Possibly the curve presented by the rate of change of capacity better complements the selectivity curve of most receivers than does reactance tube modulation or some other method. Discriminator detection has been reported as excellent.

The Varicap makes a first class FM modulator embodying simplicity itself. The reader might be interested to know that a high impedance mike driving a single transistor will operate the Varicap modulator. A kilowatt transmitter with one transistor as the only stage of audio is a little unusual to say the least. We will perhaps see many other uses for the Varicap in the future. [7] [3]



**I**N the past few years, since the VHF operations took deep roots, many manufacturers, together with some of the braver amateurs embarked on a rather new idea of building and marketing converters for most frequencies in the amateur spectrum. Each one claimed better performance, more gadgets and a lower price. Some of the manufacturers incorporated expensive tubes, others used common tubes with tricky dolled up circuits claiming ridiculously low noise figure that could only be achieved by parametric amplifiers or tunnel diodes.

The consensus of opinion among many brethren is that the more tubes and gadgets that are splattered in the circuit, the better the performance. Nothing is farther from the truth in the majority of cases. Of course there are circuits with desirable gadgets that can be found in many good converters whose specs

sibilities of using a common drug-store variety of tubes to do a man size job in the VHF region. Making a page by page search in the tube manuals for data and curves on various inexpensive tubes, the 6U8 offered favorable answers and was given the acid test by building a 144 mc converter around them. Several circuits and components lay-outs were tried and evaluated in the frequency range of 50 mc to 220 mc and working models built. Upon completion of these models and optimizing of their circuits, reduction of components and miniaturization was undertaken for simplicity, space saving and reduction in cost. As you will notice, there are no superfluous gimmicks, rf chokes or expensive feed-thru capacitors that are almost universally used in commercial gear. These items were completely ignored by proper parts lay-out and point to point wiring that is clean and straight forward.

# Bantam Converters

John Wonsowicz, W9DUT  
4227 N. Oriole Avenue  
Norridge 34, Illinois

can be checked and found as advertised. But there are many on the market that do not meet the advertised claims although they possess the same number of components or perhaps even more gadgets. Now, how is one to know without first buying and suffering with the unit until something better, or at least different, comes along for another bitter experience? That type of operation is not too bad for those that can easily afford it, but how about the ham with a limited budget and a burning desire to own something good the first time?

This article was written especially for those who want the most for their dollar and personal satisfaction in constructing a fine unit capable of maximum performance with the minimum of components. The simple bantam converters herewith described, we sparked about two years ago while exploring the pos-

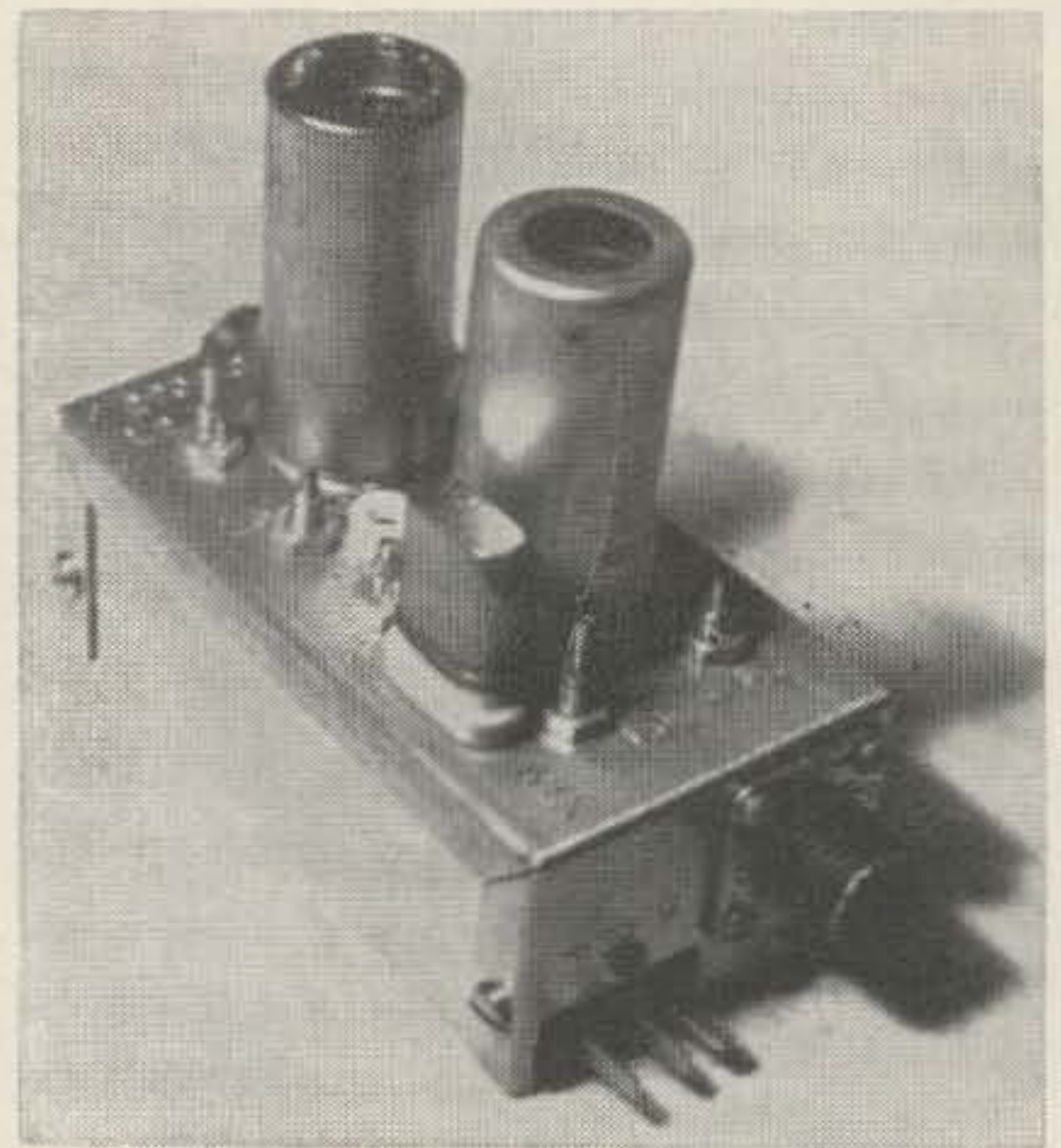

## Lay-out

The mechanical lay-out of all converters except the 220 mc are identical, and a typical chassis lay-out will serve them all. Coil forms are  $\frac{3}{8}$ " O.D. C.T.C. slug tuned and all bias resistors and isolation resistors are typical. However, the by-pass capacitors and coupling capacitors are chosen for optimum performance at the operating frequencies and these are indicated in the parts list.

In laying out the mini-box chassis care must be exercised not to deviate from dimensions given for they are important in so far as proper coupling between coils and good shielding between input and output circuits is concerned. The mini-box chassis is a Bud product, No. CU-3016 ( $4\frac{1}{4} \times 2\frac{1}{4} \times 1\frac{1}{2}$ ) natural finish aluminum. The shield, as seen in the photo, is  $\frac{1}{32}$ " brass plate shaped and cut



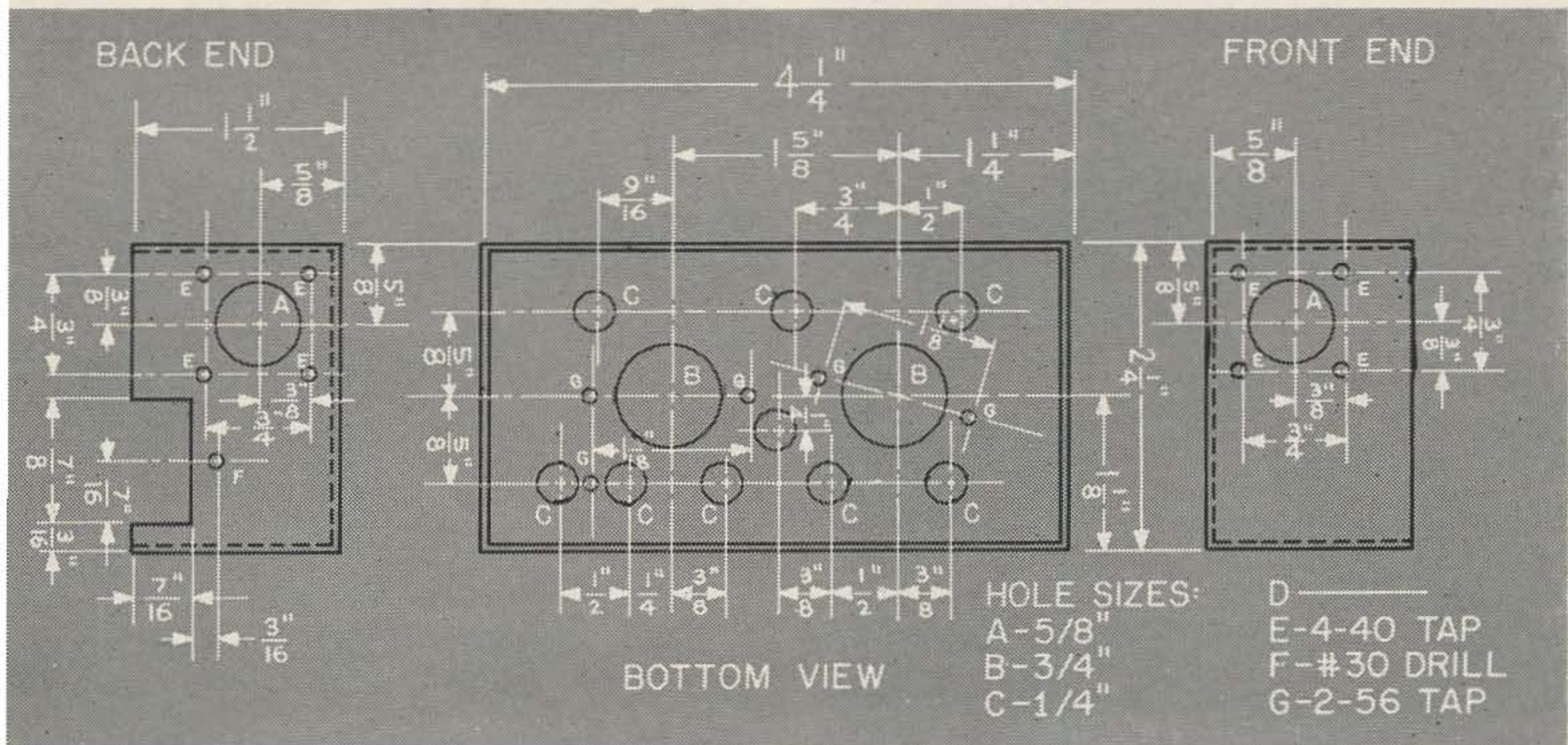

ut for the tube socket and mounted as shown in the drawing. It is held in place by two -56 screws and soldered to the center of the tube socket. This also serves as a low resistance ground plate to which all components returning to ground are soldered.

The mechanical difference in the 220 mc converter is the addition of another 3/16" hole for an extra coil and slight juggling of other parts to fit the same type of chassis. This can be seen in the full size drawings.

### Circuits

In describing the circuits let's start with the highest frequency converter first, the 220 mc unit. In this converter, as in all others, the first tube, a 6U8, performs two functions.

The triode section is used as a low noise grounded grid amplifier and the pentode section is used as a mixer. The signal is fed through the variable capacitor C1 to a tap on the cathode coil L1 which is slug tuned, and the amplified signal at the plate of L2 is inductively coupled by the close proximity of the coils to the grid of the mixer. The grid is coupled to the coil by 13 mmf capacitor and a test point separated by two 470K resistors is provided for measuring oscillator injection, as will be explained in "testing". The plate of the mixer is tuned to 13 mc the if frequency and the output is link coupled for low impedance output to the receiver. Incidentally, this 13 mc if coil is 3/8" od C.T.C., the same size form as in all other converters.

The second 6U8 is a generator that provides

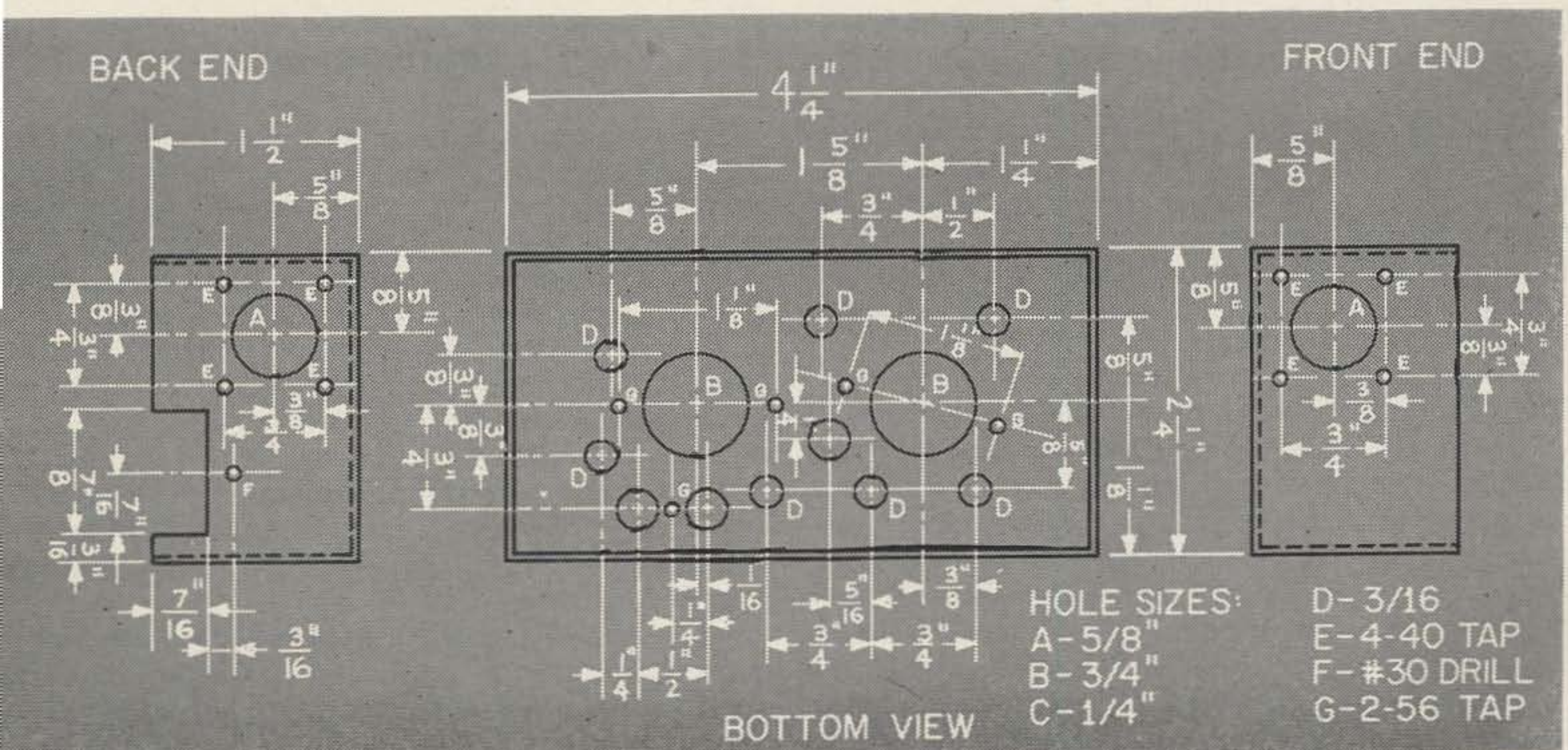



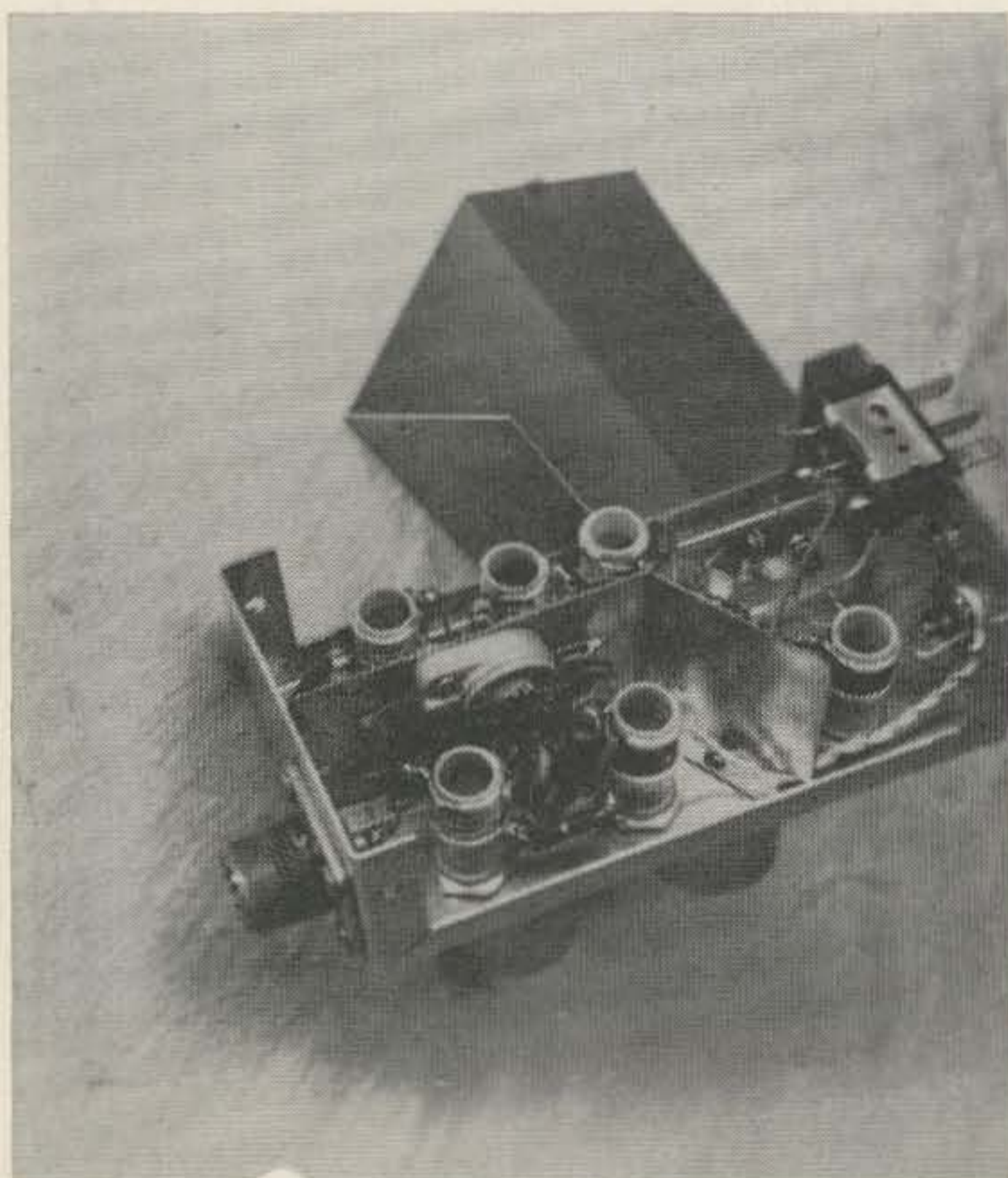

SHIELD DETAILS

three functions in one envelope; oscillator, tripler and doubler. The grid of the pentode section and its screen is used as a third overtone crystal oscillator. The screen is tuned to slightly higher than the crystal frequency of 34.5 mc. The signal appearing at the screen has a harmonic content strong enough so that the plate circuit can pick off the third harmonics and is tuned to 103.5 mc. This output is then capacitively coupled to the grid of the triode section and the plate of this triode is tuned to the second harmonic making it resonant at 207 mc. This signal, beating with the incoming signal of 220 mc produces an if frequency of 13 mc. Since the receiver tunes from 13 to 18 mc a coverage of 220 to 225 mc is achieved.

The 108, 144, and 152 mc converters use  $\frac{3}{8}$ " od coil forms in all circuits and the first 6U8 performs the same function as in the 220 mc unit. However, the second 6U8 differs in that it is used as an oscillator in the triode section and a tripler in the pentode section, as shown in the schematic.

The 50 mc and lower frequency converters differ from the above by isolation of the crystal oscillator only. The triode section is used as the straight through crystal oscillator operating on the crystal fundamental frequency, and the pentode section is tuned to the oscillator frequency and controlled by adjusting the core in the output coil L5 for proper injection voltage to the mixer, by slightly detuning it. For best signal-to-noise ratio and best sensitivity of all these converters it

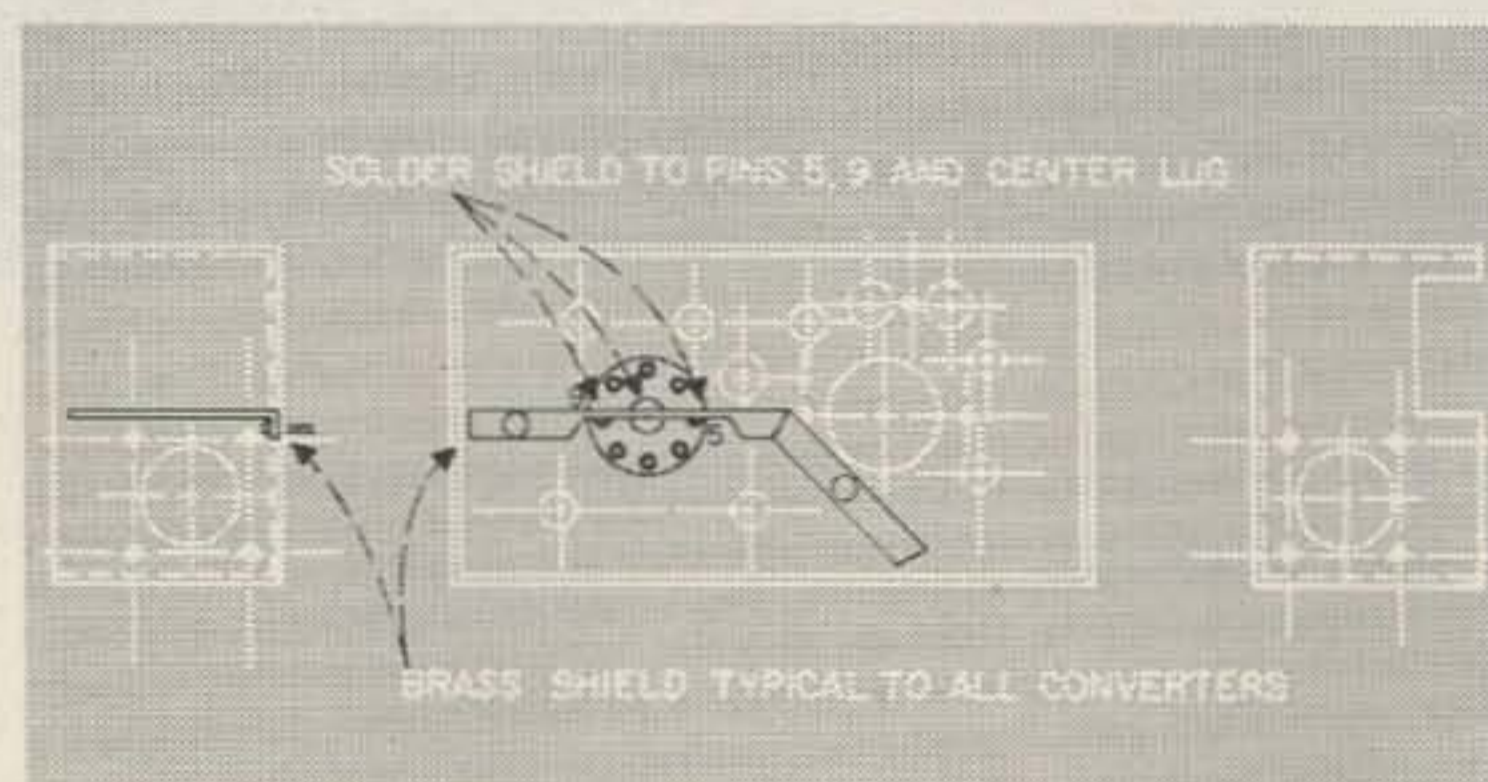
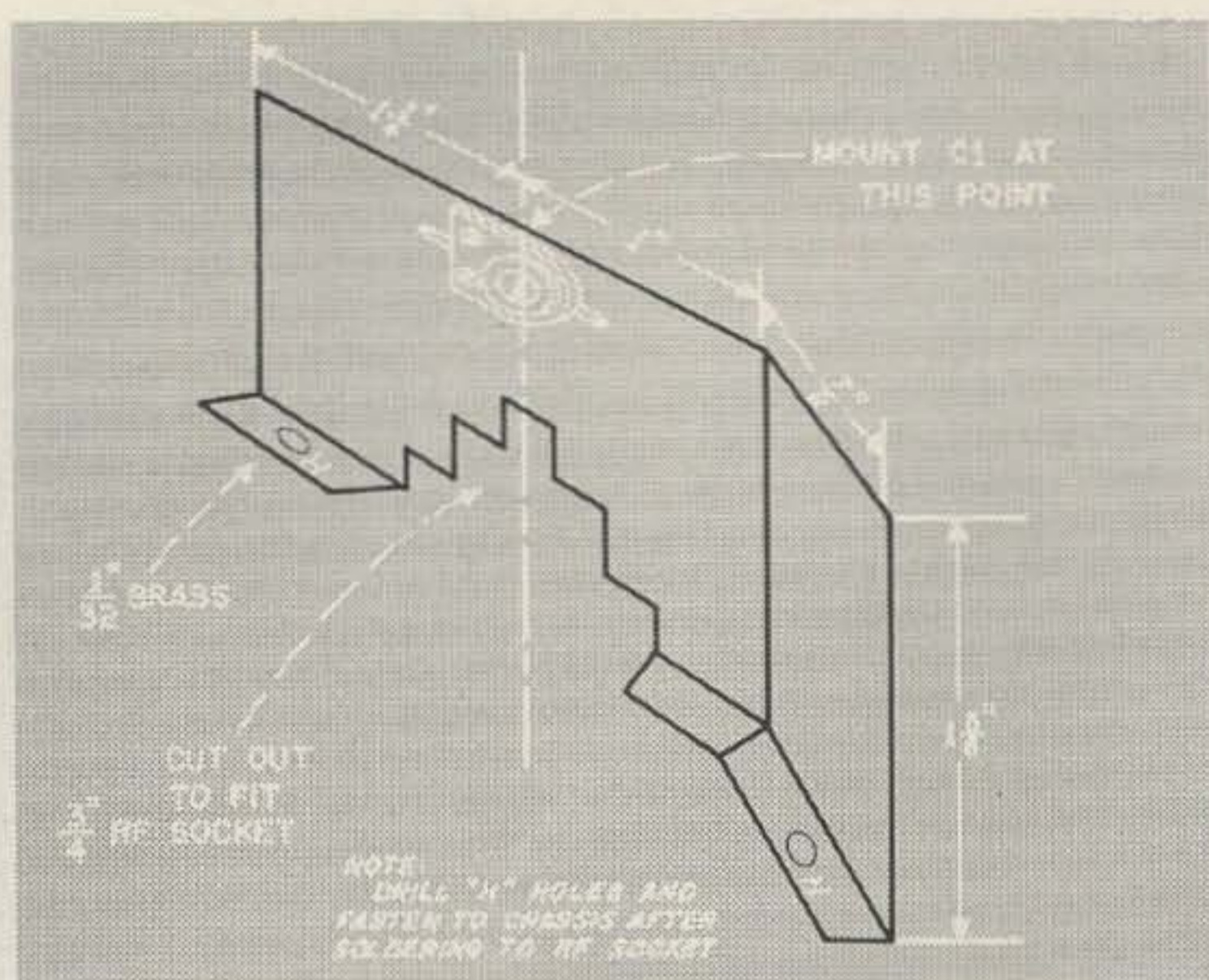

was found that injection voltage of .6 to .8 volts at the test point measured with a Simpson Model 260 Volt-Ohmmeter was optimum. Higher or lower injection brought higher noise or lower sensitivity.

Although the author has built converters below 50 mc, the coil data is not given since most commercial receivers tune up to 30 mc. However, those interested in constructing converters below this range should use a grid dipper for resonating the coils and pick out the size and type of coils as a starter from the coil chart given under the heading of Res. Freq.

### Construction

The construction of these converters is quite simple and components are inexpensive. However, proper sequence of parts placement is important for ease of assembly. Bear in mind that all components except the coils are placed and soldered in their respective positions; then make up the coils for the desired band, secure them to the chassis and solder in the necessary parts to the coils.

*Step one.* After the chassis has been layed out and drilled, fasten in the two sockets orienting them as shown. Next fasten in the brass shield soldering it to the center lug and pins 5 and 9 of the rf socket.

*Step two.* Fasten the antenna, if output and power connectors into place as shown in the photo and make the necessary connections to them.



Step three. Solder in the resistors and capacitors.

Step four. Secure and solder in the coils. This sequence proved to be best for the many converters that have been built and eliminated the scorching of components with the soldering iron or leaving cold solder joints in hard to get at places.

### Tuning

Tuning of all converters is rather typical; only slight deviations may be necessary on some frequencies, and these will be apparent to the builder.

Let's start tuning the most popular one, the 144 mc converter. If a grid dipper is handy, the entire unit can be closely tuned and then peaked on the air. However, to optimize the performance, a noise generator should be used. Assuming that neither is on hand let's start by setting the cores in all coils about half way; next, insert the negative lead of your Volt-Ohmmeter into the test jack and the positive lead to chassis. Set the Volt-meter to its lowest dc range. Connect the antenna to the input and if output to your receiver tuned to 14 mc. Apply power to the converter; 150 volts

B+ and notice if your receiver S-meter kicks up with additional noise. If not, the oscillator is not working and the osc. core should be adjusted to slightly higher frequency. While adjusting this core observe the S-meter for a slight swing or listen to your speaker for an increase in noise, then leave the core set at this position. If the oscillator kicks out a good signal the voltmeter at the test point will also indicate a slight reading. Now, observing the voltmeter, tune the tripler coil L5 for the highest reading. Next, tune in a signal on your receiver and peak the rest of the coils for the loudest signal. After all coils are tuned, return to the tripler coil L5 and adjust the injection voltage for .6 to .8 volts. At this point the signal appears cleanest. During this adjustment it may be necessary to slightly touch up on the mixer grid coil L3. After this is done and the signal is tuned in, try playing with the cathode coil L1 and the series antenna capacitor C1, juggling them for the best signal-to-noise ratio.

In the 220 mc converter the tripler coil L7 should be peaked for the highest indication on the meter and left alone. Then juggle for injection voltage between the doubler coil L5,

(Continued on page 46)

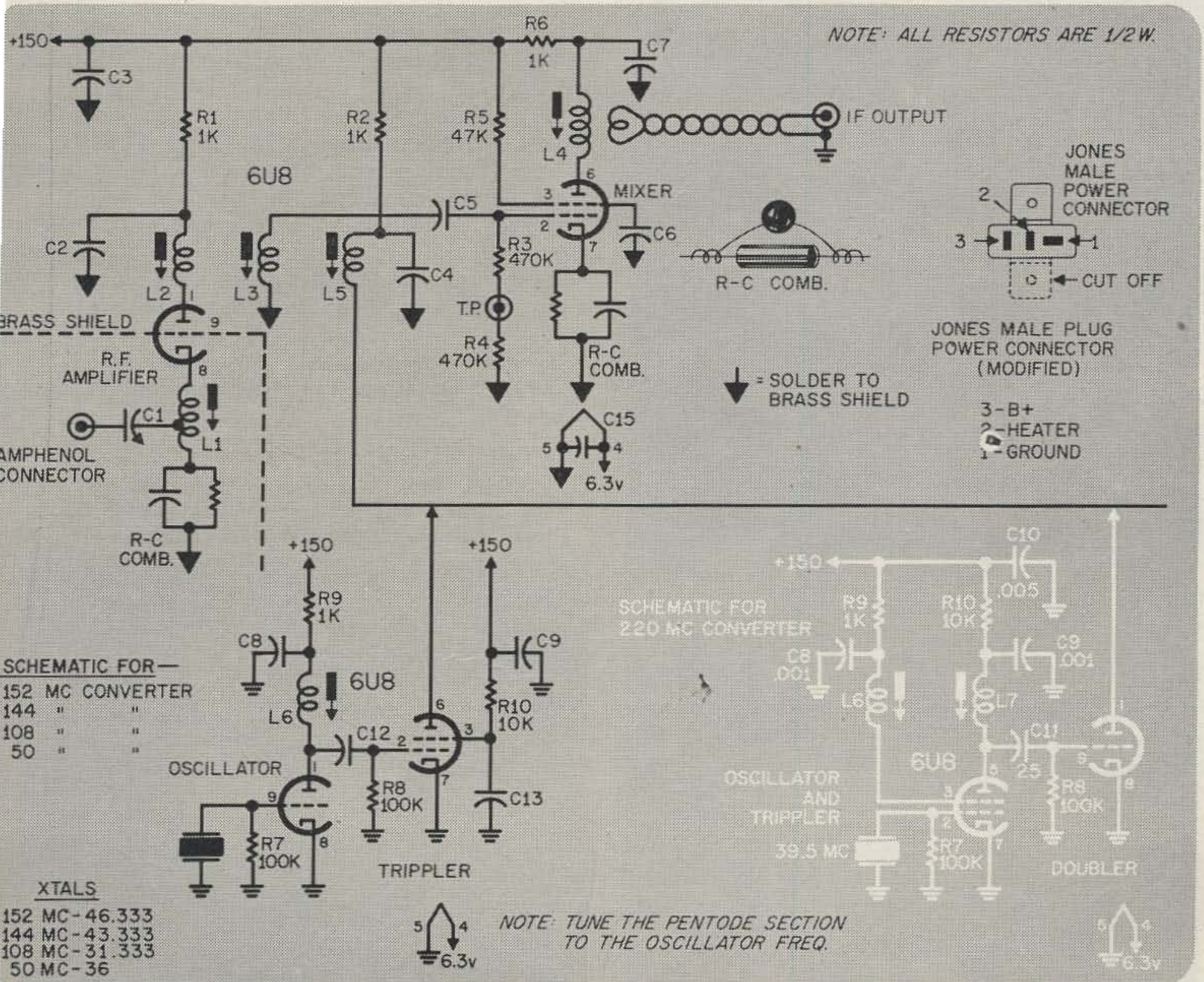



# The Risky Hobby of Hamming

SOME folks think that hams are the world's worst athletes, but the truth is that amateur radio has put the daring young man on the flying trapeze in second place. The cause for the confusion may be that magazines usually picture a ham reclining in a plush swivel chair surveying a table full of gear, not giving the slightest hint that there is more to the game than meets the eye. How is the casual reader to know that the limp-looking guy in the photograph spent half the day wrapped around the weaving top of a 100-foot tower juggling a handful of tools and a fifteen pound rotator in a gale wind? As a general rule, it's safe to say that for every set of call letters heard on the bands, somebody huffed and puffed to tie a long wire or install a beam antenna.

"My XYL worries about extra pounds," says one limber fellow, "but all I have to do to stay trim is run up and down my tower a couple times a day."

Hams can still buy life insurance, but there are certainly lots less hazardous hobbies. The wildest game of tiddly-winks results in nothing worse than a sore tiddling finger, but anybody

← Worried about a few extra pounds? K9AMD advocates tower-climbing for loss of weight.

Part I of a 3-part Story:  
W9EHH, Mike Hrindak, of Gary, Indiana, is "up a tree." With a beam antenna, lead-in, and tools, he's wondering "What'll I do now?" ↓





Carole F. Hoover K9AMD  
401 East Wood Street  
Hillsboro, Illinois

who takes an unchartered flight from a sloping roof or slippery pole may end up in enough plaster casts for an army to autograph.

Most neighbors beat it to the nearest window when "that electronic nut next door" starts scaling his roof or tower. The antics they see for free in his back yard beat television by a mile. A paid human fly won't tote thirty pounds of wobbling metal elements through tree limbs and power lines without a safety net below but a ham will, and gladly. Of course, the same fellow would shudder if offered a "risky" job like painting the house, and his wife has long since given up the perilous thought of getting him to fix the leaky roof.

Compared to a red-hot signal report from Formosa or Nepal, the danger of a compound fracture is nothing, so without batting an eye, amateur radio operators scramble over rooftops, scale towers, and shinny up tree trunks to get their antennas in the best possible places. Answering the call of the wild blue yonder, they can be spotted almost anywhere, anytime. In fact, if you see some sky-high object that isn't a bird, plane, or an out-of-orbit astronaut, it's probably a ham. [73]

Part 2—something's caught! Jim, K9RUH, another Gary Ham, goes up to see if he can help get his buddy untangled. (Who says hams don't get exercise?)

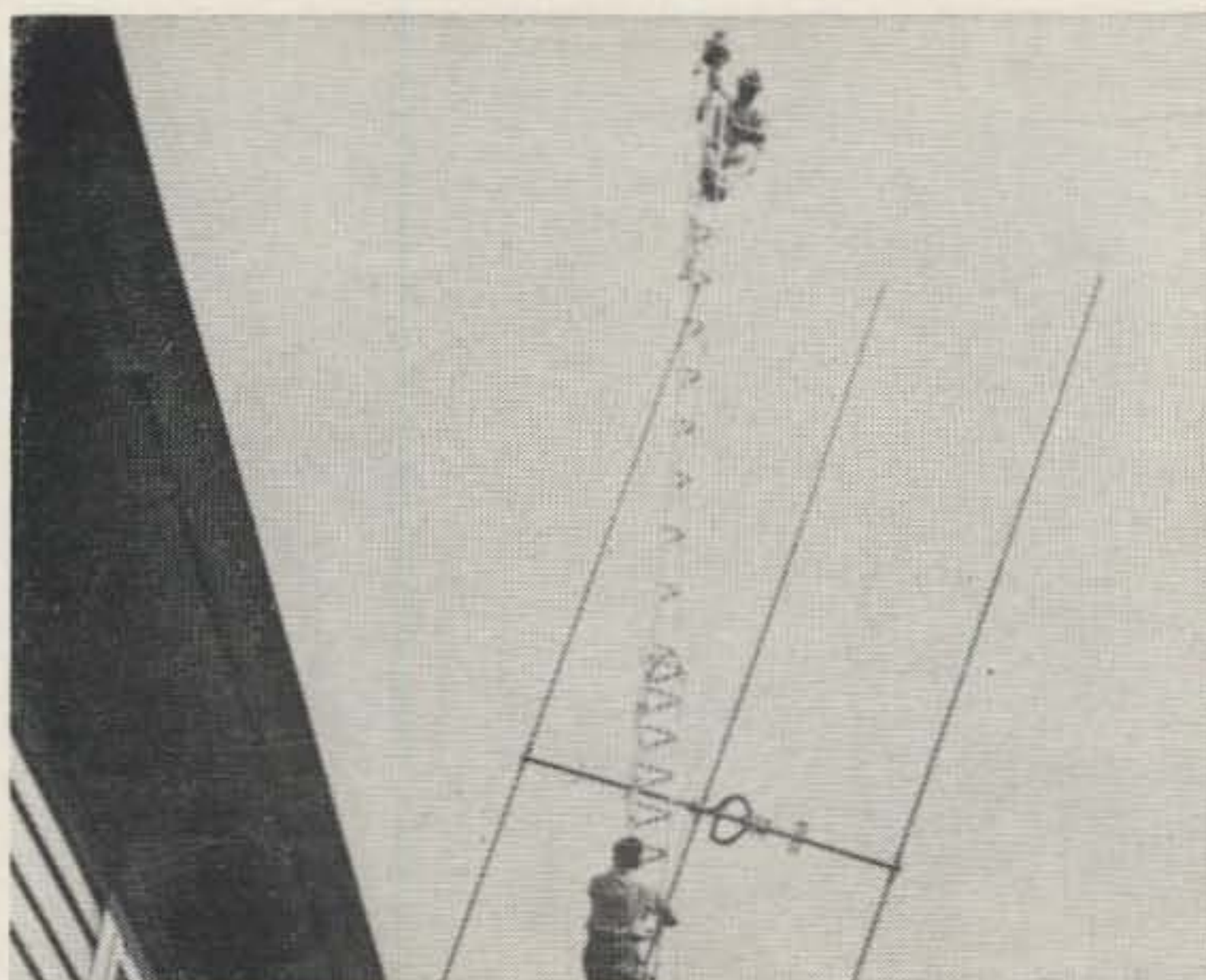

On top of the tower, Dick Pattie, W9VWJ, isn't quite sure what he'll do when the 20 meter beam reaches his height, but he'll give it all he's got. This is just one example of the "great sport" of amateur radio.

W9EZA, Dan Hoover, of Hillsboro, Illinois, is a typical ham dare-devil. Repairing the lead-in wire of his antenna 40 feet up is nothing, but he wouldn't think of doing a dangerous job like fixing the leaky roof.



Part 3—Mike is making progress now, but he has to leave the bean behind. When he gets to the top of the pole, he'll worry about the antenna. (This story has a happy ending as Mike has worked a lot of DX since this sunny day in Gary.)

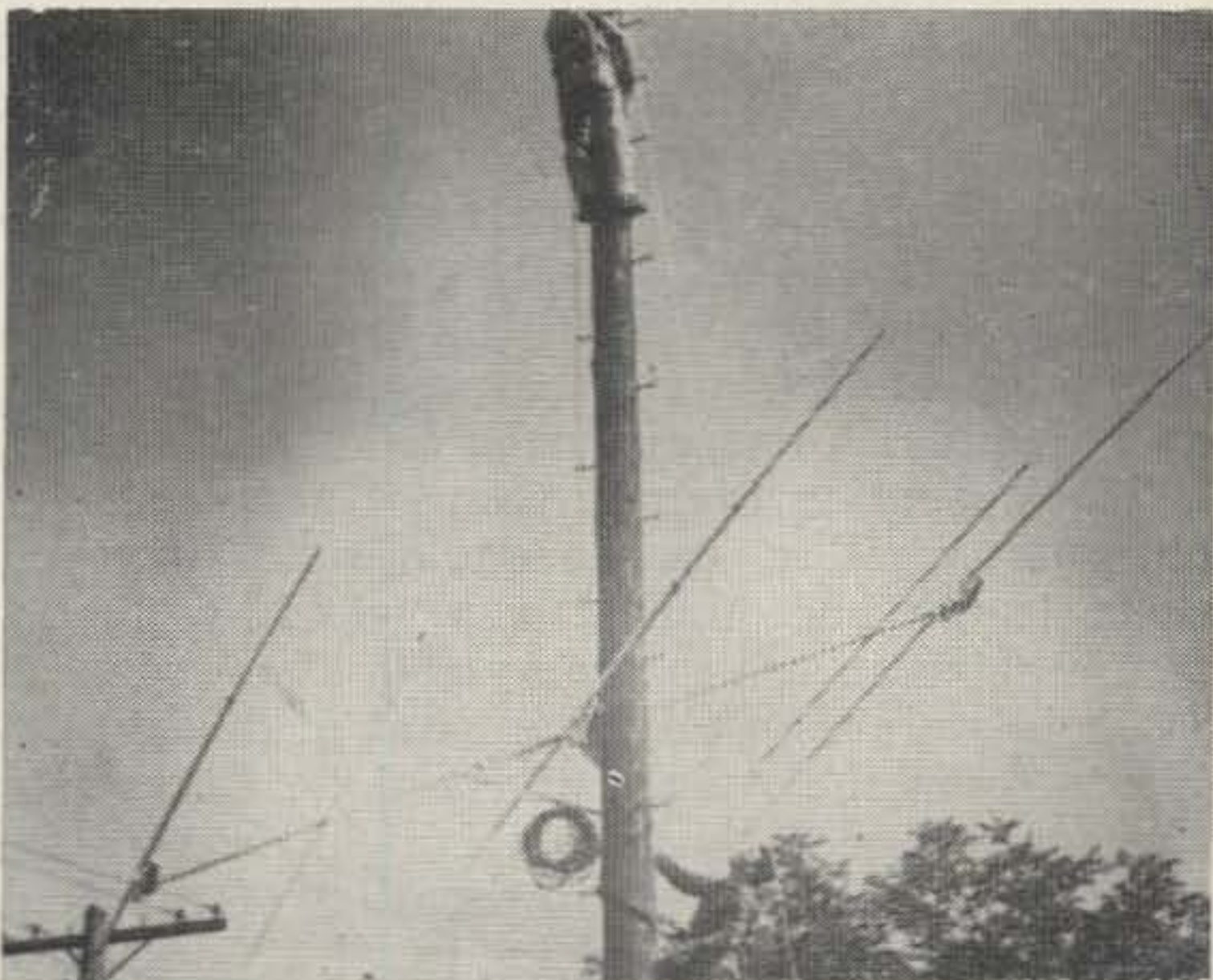





# Tubeless Electronic Key

How would you like to try something old, with a new twist? Here is an item that will stir the imagination of many a cw operator, who can't afford to sink a weeks wages into one of those "new fangled" gadgets called an Electronic Key. The offspring of my junk box is shown in the photograph; a tubeless, transistorless Electronic Key. How does it sound? I'll bet you can't distinguish it from one of those high price jobs!

The key has its own built-in power supply, and forms the dot and dash characters through the use of high impedance relays operating in simple RC time constant circuits. The dots and dashes are self-completing, and the spaces are automatically formed between the characters.

If the component values shown in the circuit diagram are used, the speed range of the unit will be approximately 10 to 25 wpm. However, after reading the circuit analysis (which follows) it will become clear that a circuit of this type can be modified to cover almost any speed range simply by changing the component values of the RC time constant, character forming circuits.

## Circuit Analysis

Line power (115 v 60 cy) is applied to terminals 1 & 2 on the terminal strip. The conventional  $\frac{1}{2}$  wave rectifier power supply supplies approximately 90 v dc, which drops to about 75 v dc when the unit is keyed. Terminals 3, 4, and 5 on the terminal strip are wired to the key. Terminal 3 energizes the DASH relay (K1), terminal 4 is the common lead to the key, which supplies B+ power to terminals 3 or 5, depending upon the position of the key, and terminal 5 energizes the DOT relay (K3).

The operation of both the dot and dash circuits are similar. In the dot circuit, however, the actual speed of K3 is controlled by the potentiometer across the relay coil. The capacitor (C5) introduces a slight amount of delay helping to form the weight of the dots. Otherwise, the operation of the dot and dash circuits are identical; thus, only the operation of the dash circuit will be discussed in detail.

When terminal #4 is shorted to terminal #3 (the key being pushed to select a dash), dc power will be passed through a set of normally closed contacts on relay K2 (the space relay) directly to the coil of relay K1 (the dash relay), energizing relay K1 and charging capacitor C3. When K1 energizes, contacts on K1 apply dc power to the coil of K2, energizing K2 and charging capacitor C4. Another set of K1 contacts close, keying the transmitter. When K2 energizes, the dc power is removed from terminal #4 through action of another set of now open K2 contacts (assuming that the key is being held in the dash position). DC power is thus removed from K1. However, K1 does not release immediately due to the charge held by capacitor C3. When the charge

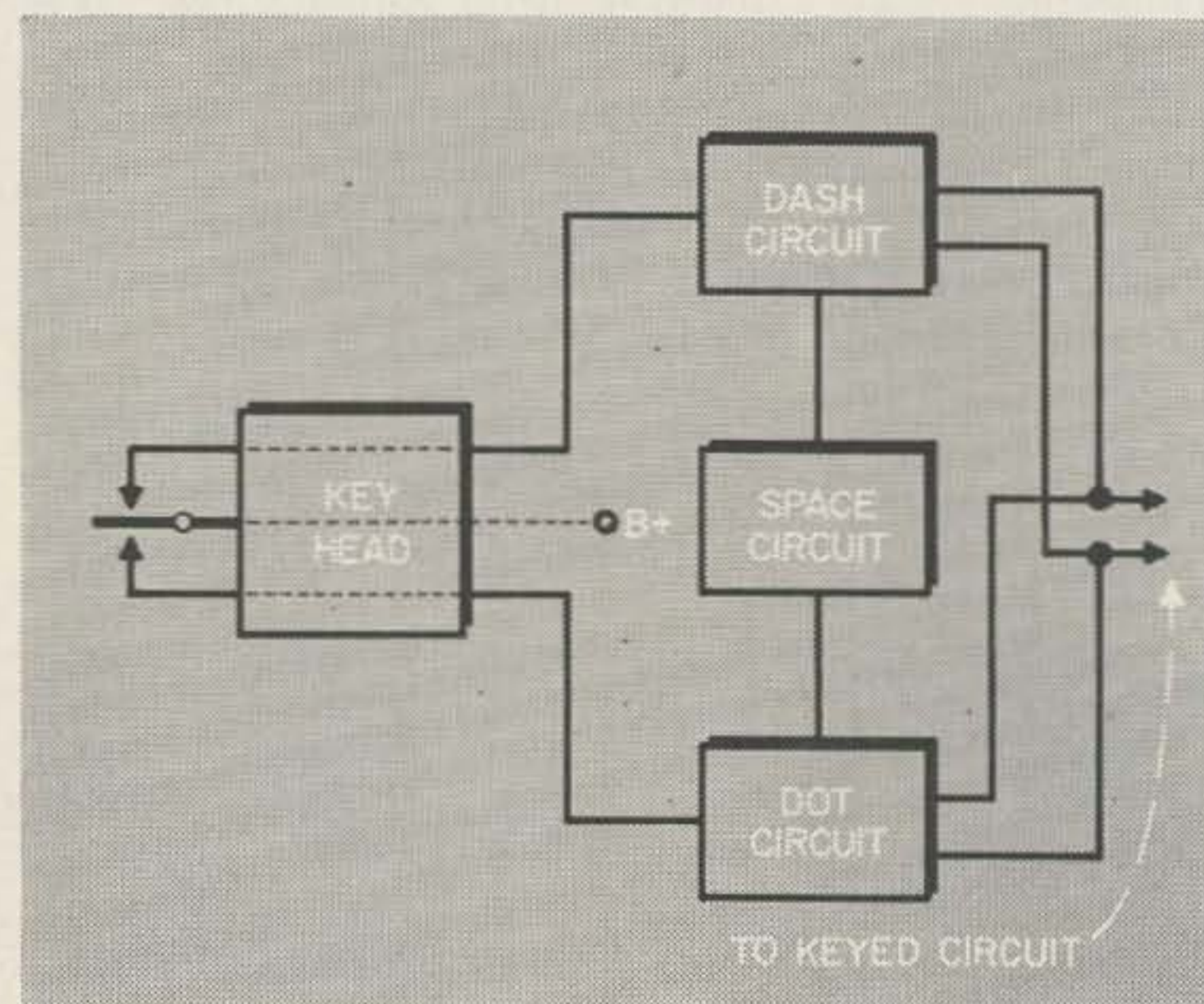

on capacitor C3 has fallen below the hold-in voltage of K1 (the time required depends upon the setting of P1), K1 de-energizes, breaking the transmitter circuit and removing dc power from the coil of relay K2. Relay K2 does not release immediately, due to the charge on capacitor C4 (the time interval depends upon the setting of P2). The set of K2 contacts in series with terminal #4 thus prevents B+ power from reaching the coil of K1 until C4 has fallen below the hold-in voltage of coil K2. When K2 does de-energize, K1 immediately fires



David L. Cabaniss WITUW  
 165 Matthews Street  
 RFD #2, Bristol, Conn.

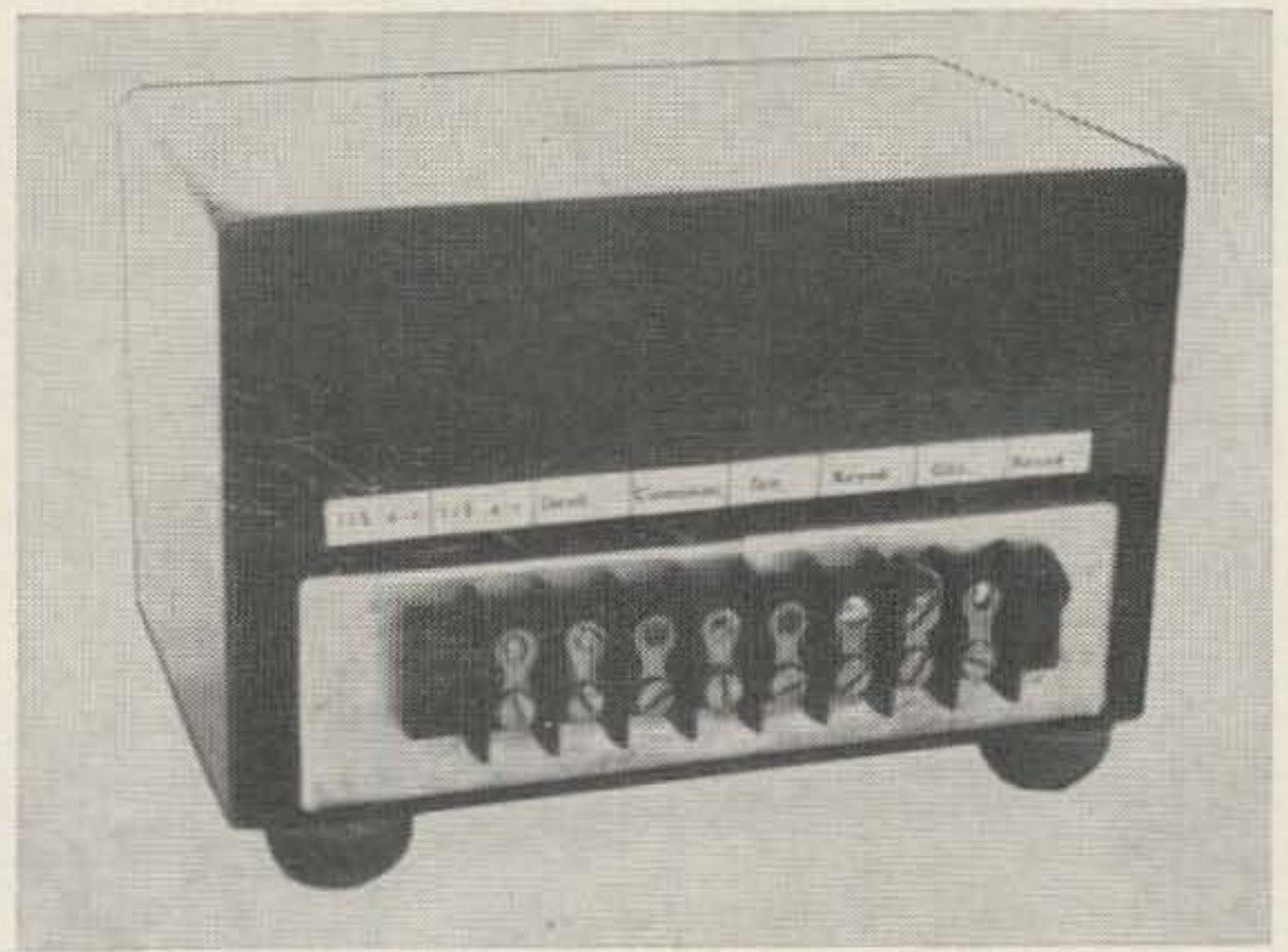

again, and the cycle is repeated, provided the key is held closed.

Relay K3 (the dot relay) operates in the same manner as relay K1, in conjunction with relay K2, except for the differences pointed out earlier.

Normally open contacts on both K1 and K3 are wired in parallel across terminals #6 and #8, to which the keyed circuit is connected.

In some speed ranges, capacitor C5 does not control the actual weight (or length) of the dot character. The weight (or length) of the dot character is controlled by the shunting effect of P3, changing the pull-in and drop-out point of K3.

The extra set of contacts on K2 (see terminal #4) are not necessary, but were wired in

parallel with the other set of K2 contacts because they were available and were used to help prolong relay life.

The power supply, as explained before, is a conventional 1/2 wave type. Although the circuit diagram shows 2 filament transformers back-to-back, a single isolation transformer may be used if one is available. If an isolation transformer is used, the pilot light should, of course, be changed to operate on 115 v ac.

Four factors should be pointed out when discussing the operation of this key. They are listed as follows:

1. Due to the mechanical and electrical limitations of the relays, complete coverage of the "speed range" is not

(Continued on page 56)

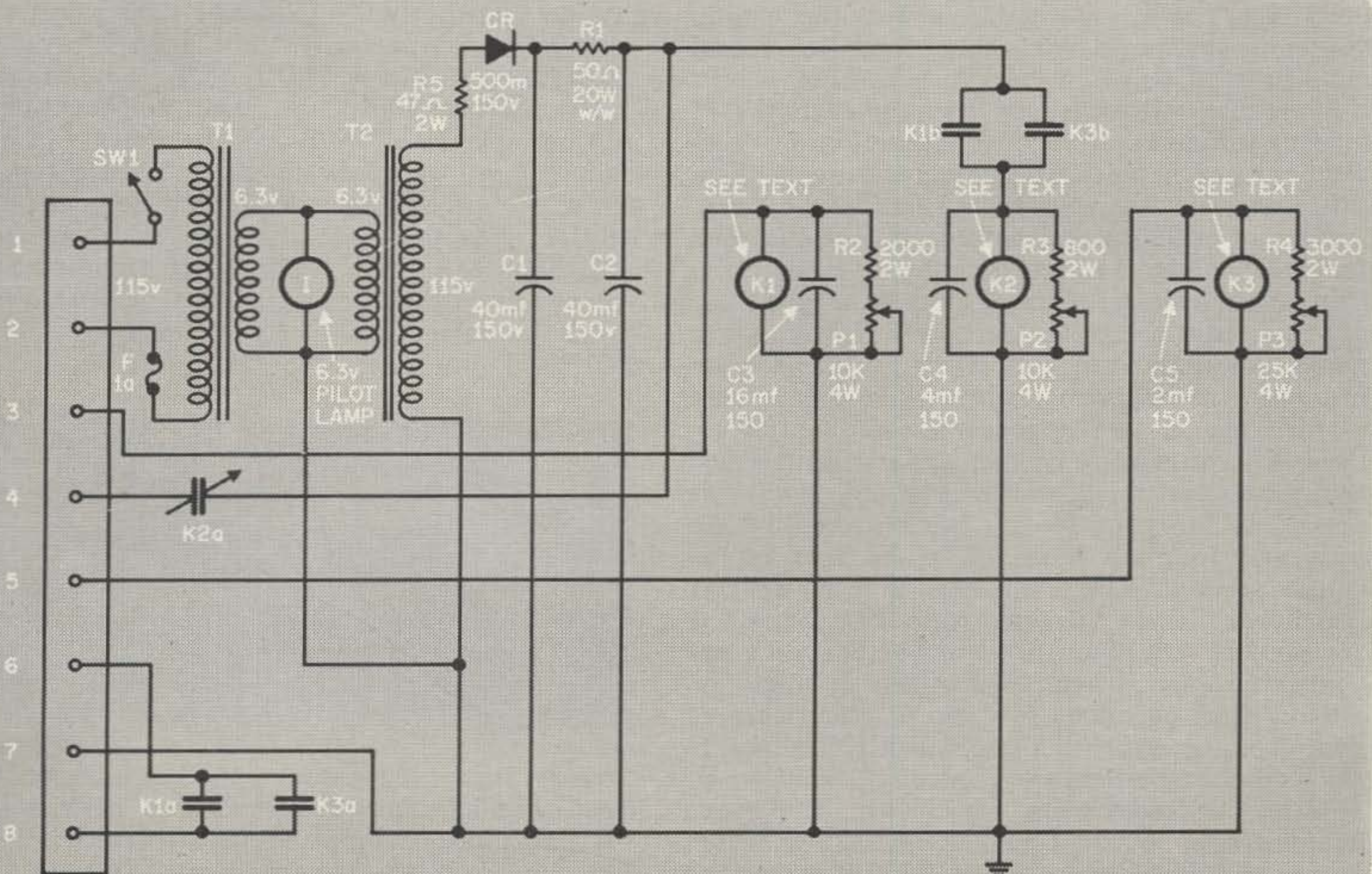



# A Digest of Surplus



Gordon E. Hopper, WIMEG  
75 Kendall Ave.  
Framingham, Mass.

## Radio Equipment

**A**RMY surplus radio equipment—today, after some twelve years of seeing ads and reading articles, even books, on it, we find is still with us. This article is written mainly to assist those who wish to experiment with commercially built equipment. It is a well-known fact that making changes in amateur commercially built gear will materially affect the resale value of the piece (as the author has found out the hard way).

If you are the type of ham who thinks of making changes in the construction or performance of a piece of commercial gear, then, this article is for you. If you desire the satisfaction of seeing a piece of equipment designed for a specified service revamped into something that you, as a ham, can make good use of, then this article is for you. If you are a newcomer and want to get on the air with a minimum of cabbage outlay, then this article is for you. If you have read complicated articles on converting surplus gear and decided there was too much work involved, then this article is for you. If you have looked into a unit and found a maze of cables and multi-contact unidentified connectors and thought "I can never figure this out" then this article is for you. If you are a MARS member with unconverted gear, then this article is for you.

Now that everyone is digging out pieces of gear bought years ago, or getting ready to take off for their nearest surplus supplier, or starting to read more closely the numerous surplus ads, let us consider one thing. Most hams who have never converted any gear have refrained probably because they don't know

where to start the job. This article will identify the power connectors of a few of the most usable and most easily obtained pieces. It will not show you how to completely convert a unit, but it will save you many hours of circuit tracing by showing you where to apply voltages. Once you get the unit operating then changes can be made to adapt it to your use.

The first connector to be shown is that of a BC-603, an FM receiver built like the proverbial brick battleship, designed to operate 20-27.9 mc. Articles in September and October 1958 CQ tell you how to get this receiver up to six meters AM, a formidable achievement. Applying voltages to the power connector, with no other changes, will get this receiver operating in the service it was designed for. Make the power supply connections to a Jones S-318CCT plug.

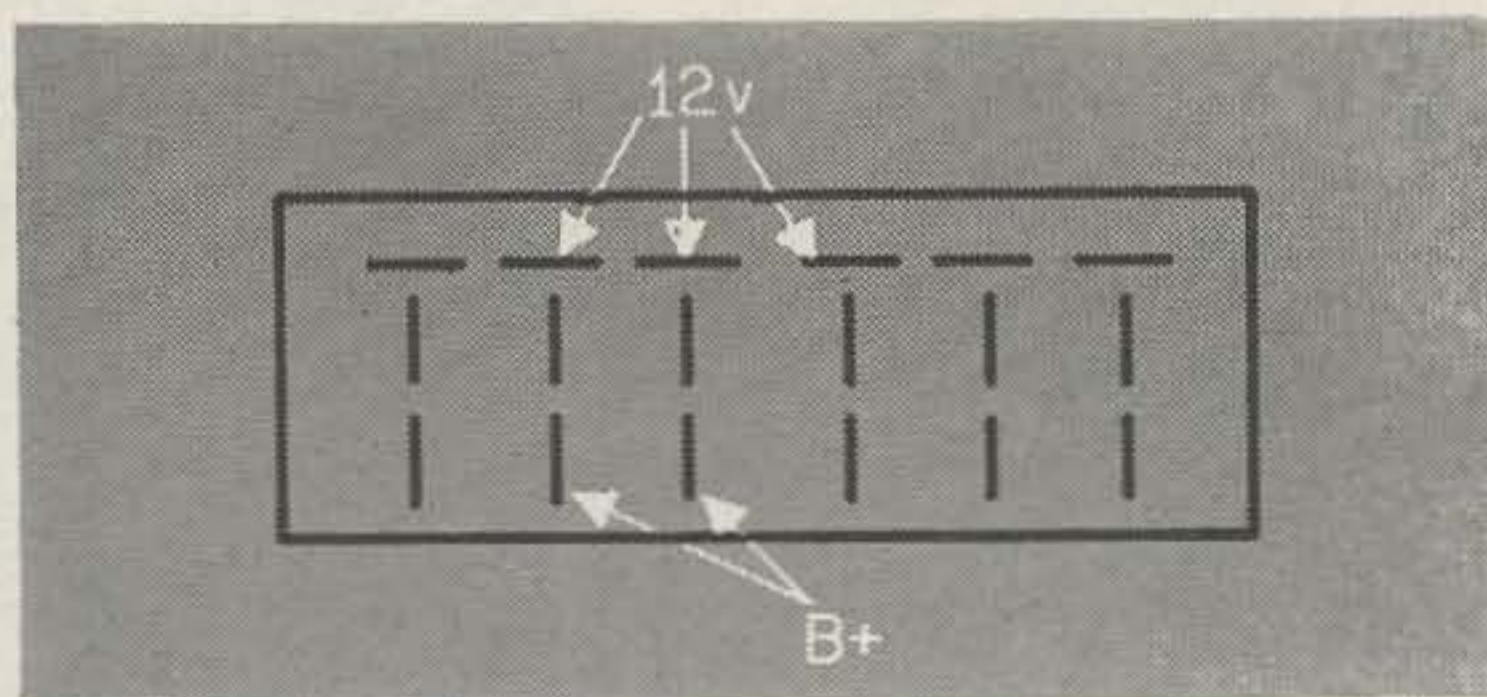

Next is the connector on the rear of the RBM-3 and RBM-4 receivers. The RBM-3 covers 2 to 20 mc. while the RBM-4 covers 20 to 2000 kc. Both are superhets and require only the addition of power supplies.



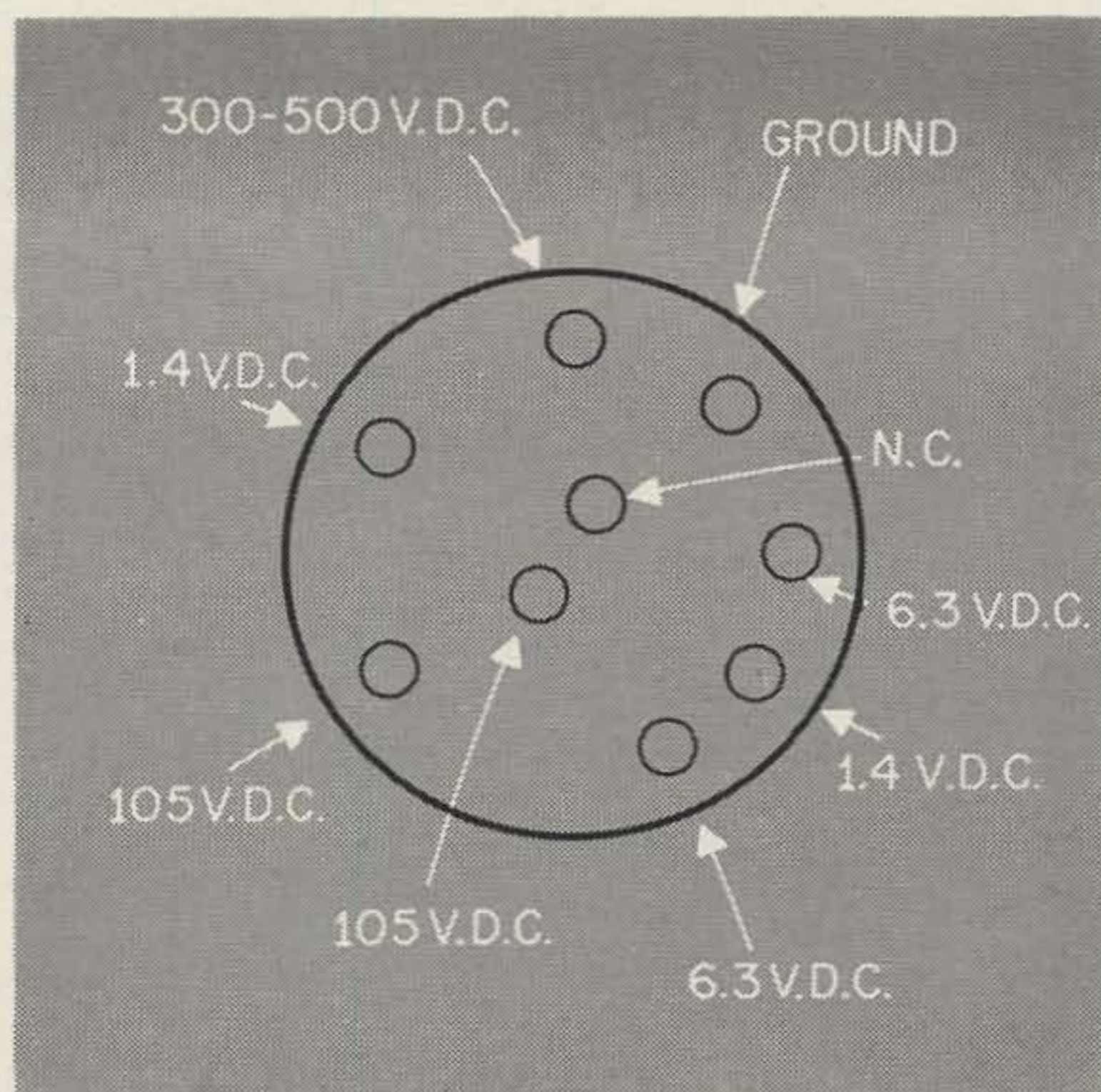
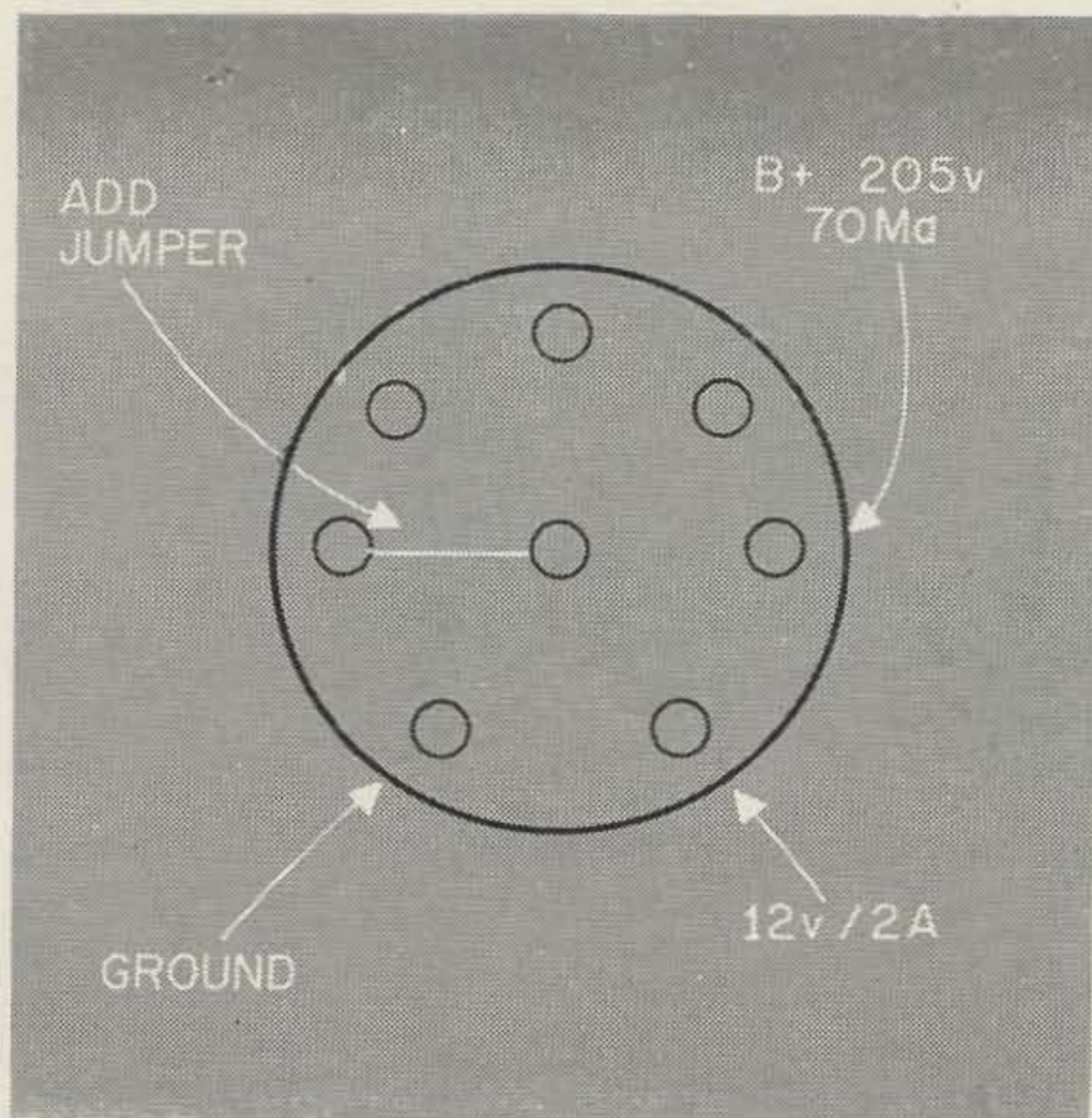

Now comes the BC-1306. This is a transmitter and receiver housed in one unit covering 3800 to 6500 kc. phone and cw. It requires an external dc power supply and no modifications. This unit has recently appeared on the surplus market and the following connector identification together with a suitable power supply should be of interest to these who are members of Army MARS who have not tried it yet. The author used a connector from a

defunct BC-375E, however, suitable connectors can be obtained from Fair Radio Sales, 132 South Main St., Lima, Ohio, and from Connector Corp. of America, 137 Hamilton St., New Haven, Conn. Also worth nothing is the fact that a 6/12/24 volt mobile supply, PE-237, is available from the same Fair Radio Sales and also from Telemarine Communications, 140 West Broadway, N. Y. C.

(Continued on page 57)

A Suitable Power Supply for the BC 1306

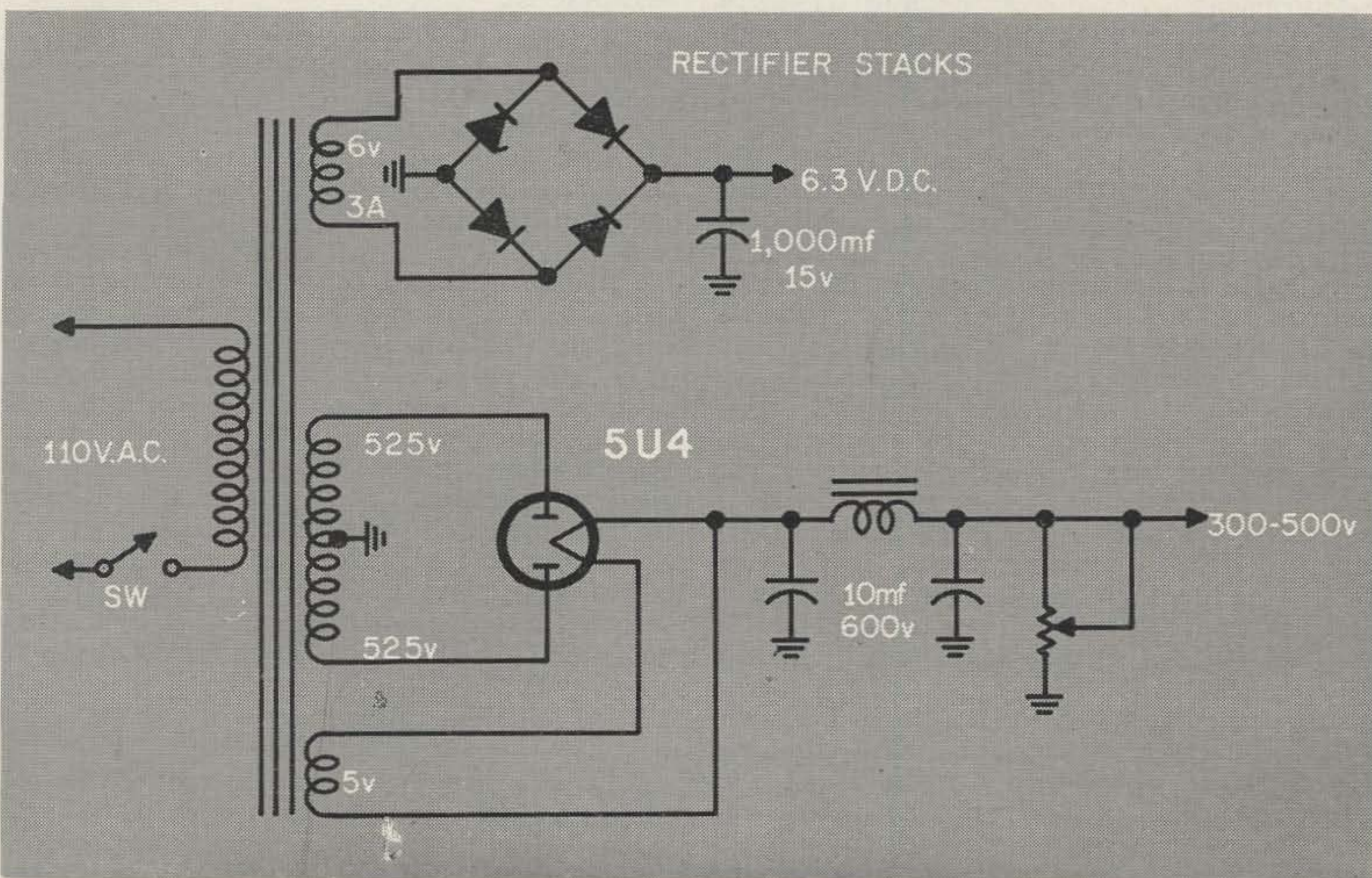



Roy A. McCarthy, K6EAW  
737 W. Maxxim Ave.  
Fullerton, California



"The Capacity Meter is a compact yet versatile test instrument."

# Direct Reading Capacity Meter

OF all the various methods of capacity measurement, the direct reading capacity meter has the greatest appeal from the standpoint of operating convenience and rapidity of measurement. The capacity meter is of course a great help to those who have difficulty remembering the myriad of color codes, as well as those of us who may have color perception deficiencies. Equally useful is the ability to measure the capacity of a length of coax cable to determine if there is a break close to the end where it is easily accessible for repair. Odd lengths of antenna can also be readily measured to enable calculating the amount of series inductance needed for resonance at lower than the natural resonant frequency of the antenna. Many other odd jobs can be quickly accomplished with the aid of a portable capacity meter, such as measuring stray wiring capacitance, locating breaks close to the surface in coils, breaks in line cords, etc. An ohmmeter will tell you a cord or cable is open, but a capacity meter will tell you where.

The instrument was transistorized to add to the convenience of operation and eliminate the need for power cords, or waiting for it to warm up and settle down. Along this same line, the meter is large and easy to read accurately, and the small case with a carrying

handle compares favorably with most standard multimeters.

## Ranges

Four basic ranges were provided, calibrated at full scale by means of the built-in standard capacitors of 100 mmfd, 1000 mmfd, .01 mfd, and .1 mfd. By means of the built in standards and the calibration control other ranges may be used to increase the ease of measurement. For example, a capacity which read just off scale on one range would be slightly above 1/10 scale on the next range. Instead, by re-adjusting the calibration control, so the calibrating capacitor read  $\frac{1}{2}$  of full scale, an unknown capacitor just slightly larger can be readily determined, using a mental multiplier of two. Although the author's instrument has an apparent residual capacity of about 0.8 mmfd, capacitors as low as 1 mmfd can be measured if this residual capacity is allowed for and subtracted from the indicated reading.

## Accuracy

The accuracy, as well as the cost of the instrument will depend mainly on the basic meter selected and the four standard or selected capacitors. The transistors are fairly



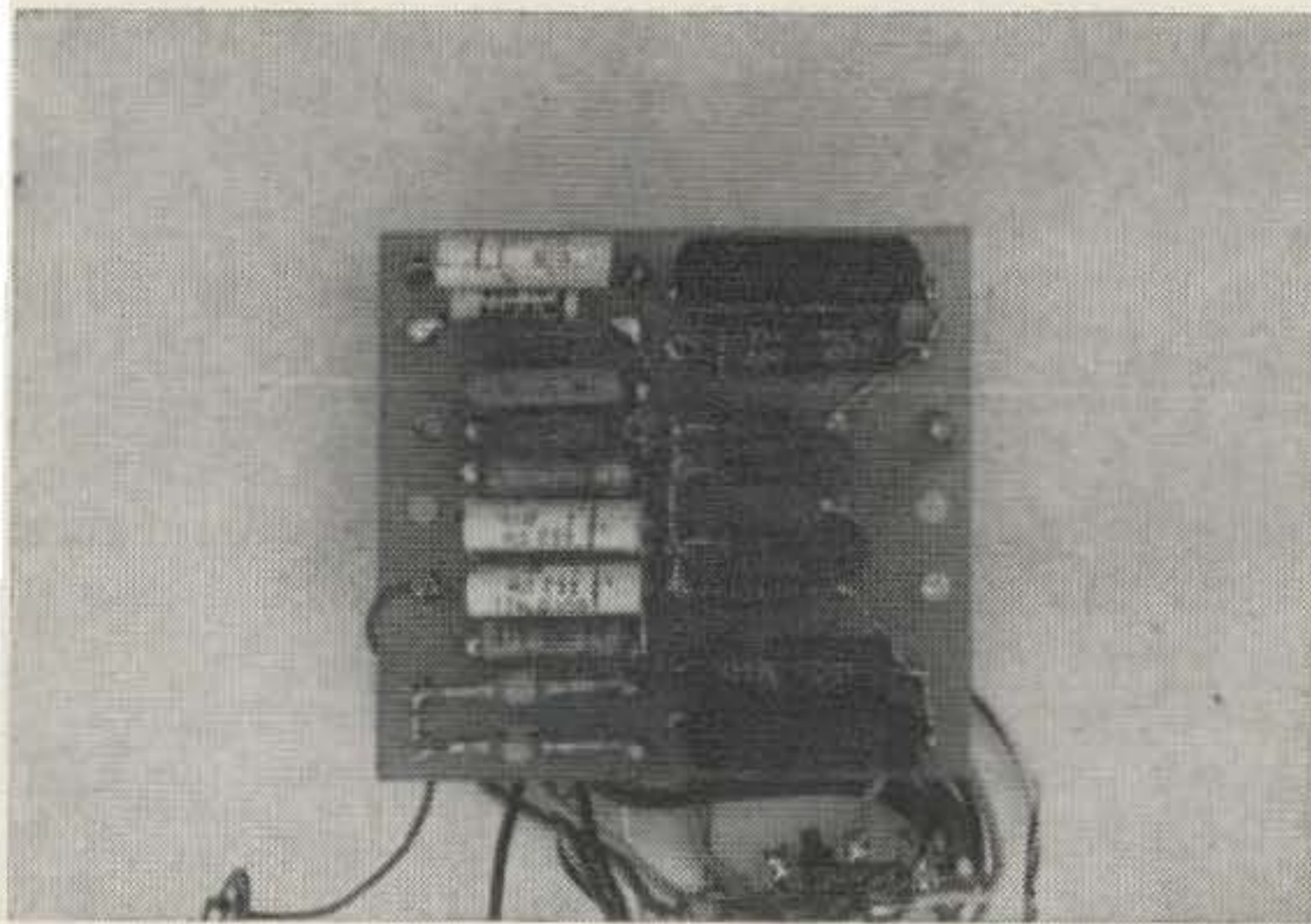

Use of a component board greatly simplifies wiring, with connections made to the underside of the board.

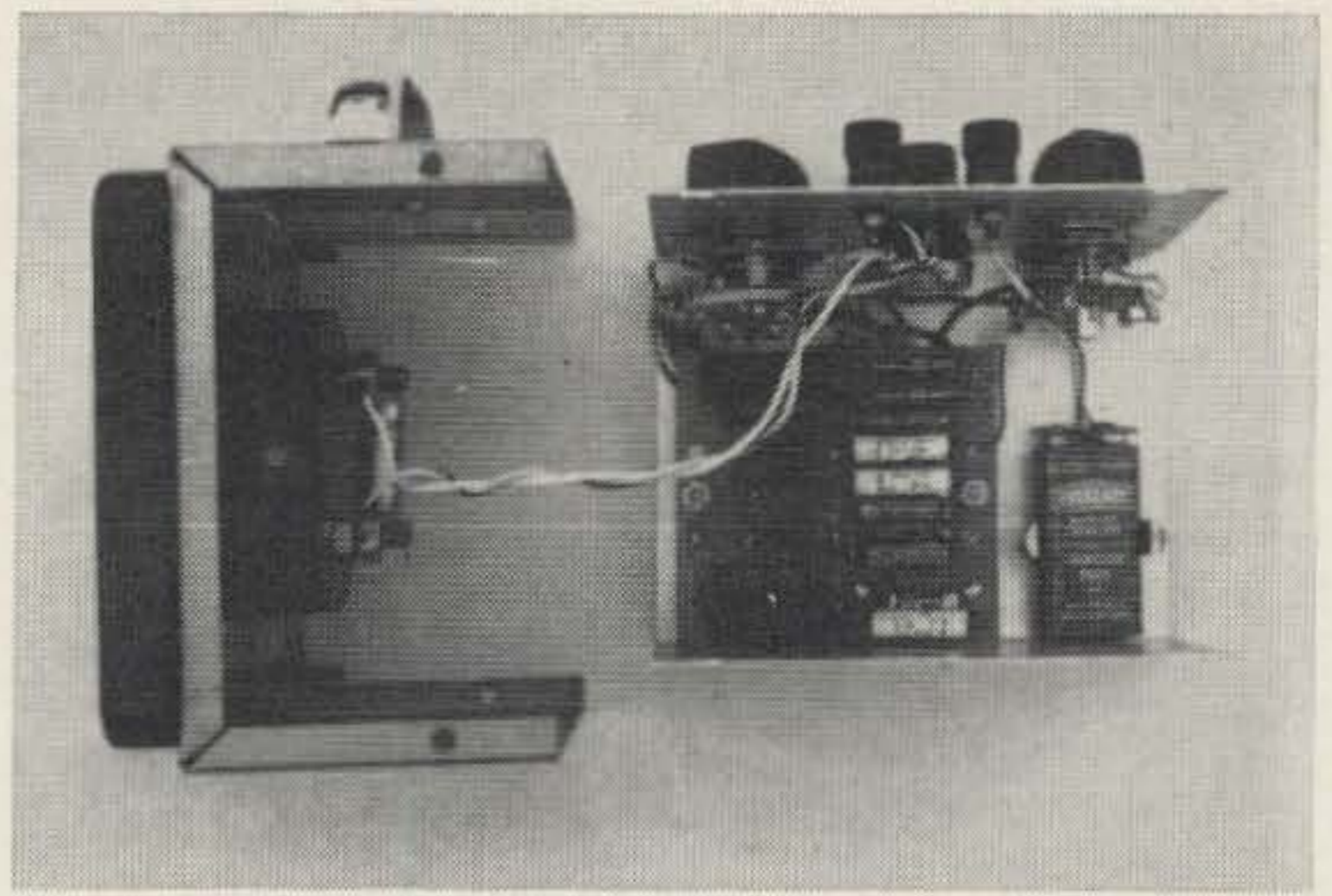

Inside view of the capacity meter shows the compact construction made possible by use of miniature components.

inexpensive rf or if type PNP units. The mercury battery shown in the photographs is not really a necessity for any dry-cell type can be used if it has enough voltage and can maintain a steady full scale reading on all operating ranges. The multivibrator used in the circuit is quite stable, hardly changing frequency over wide supply voltage variations, and in any case each range is normally calibrated by the built-in standards before use. The author obtained 1.0% of full scale accuracy on the three higher ranges, and 3 to 4% of full scale accuracy on the 100 mmfd range. This does not mean that a very low capacity may be off 3 or 4 mmfd, since zero is mechanically set

by the meter adjustment screw. The error was greatest near the center of the scale.

### Theory of Operation

The circuit operates by measuring the amount of charge which the capacitor under test receives by the application of a square-wave from the multivibrator. A pair of diodes in a simple rectifier circuit enable a microammeter to be used as the indicator. Since the amount of charge on a capacitor, with a given voltage applied, is directly proportional to the

(Continued on page 41)

Fig. 1. By proper wiring the residual capacity indication is easily reduced below 1 mmfd.

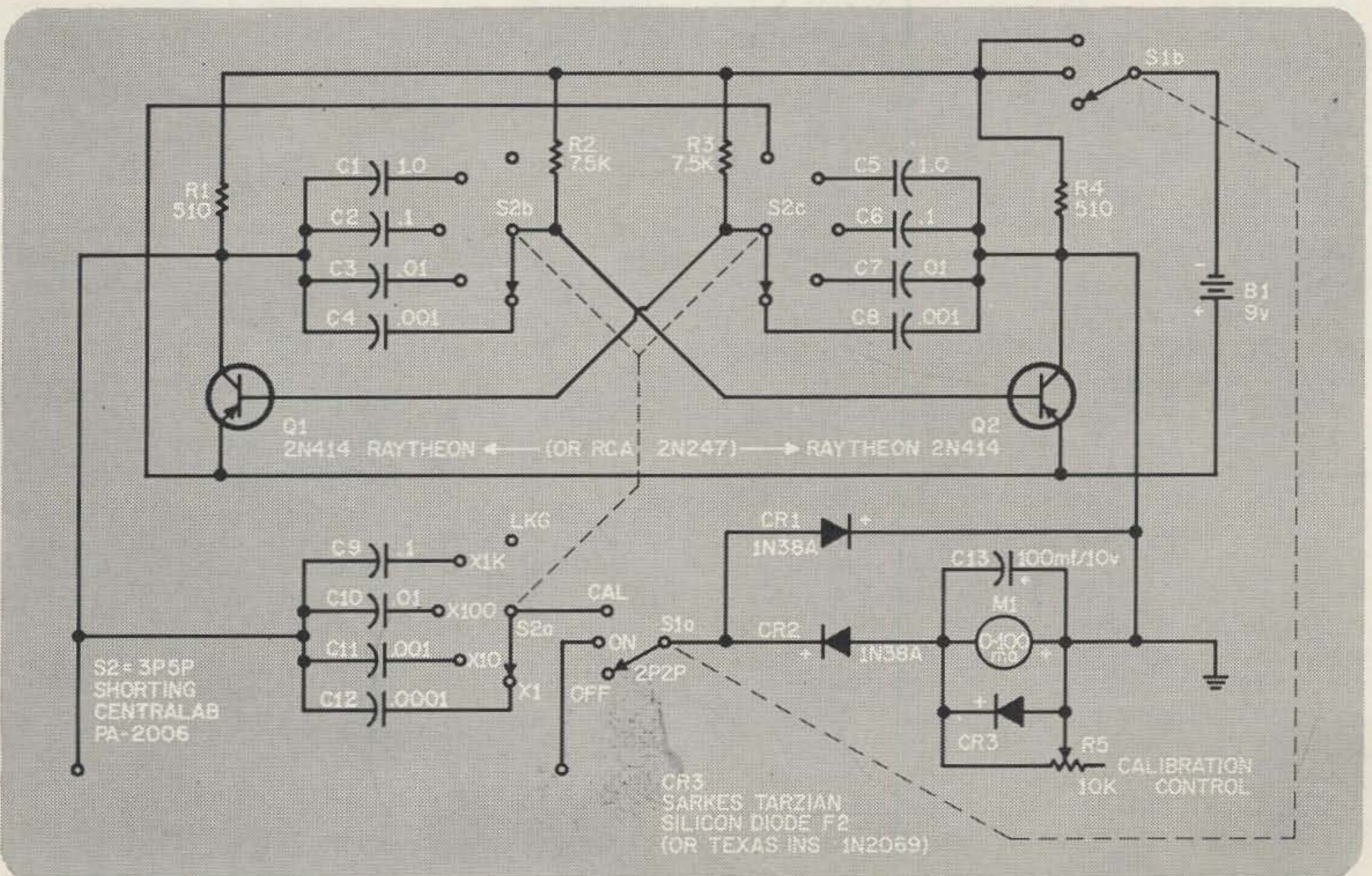



**T**RAFFIC through the medium of the "phone patch" is becoming increasingly popular and is another service added to the already long list of those provided by the radio amateur.

Disregarding the technical aspects of the "phone patch", this type of traffic is tricky to handle. This is due to the human element injected by the usually uninitiated person on the other end of the telephone line. There are several do's and don'ts that are well worth your attention if you handle or intend to handle this type of traffic.

Before placing the telephone call, be sure you have all of the necessary information; that is, the addressee's name and complete phone number, as well as the name of the originator. You should also check to see if there is any toll charge involved. If there is, be sure to get the approval of the originator before placing a collect call.

cause of amateur radio. Who knows, this person may be the one who's giving the "ham", two doors down the block from him, multiple fits with his TVI complaints. Don't miss the chance. Explain briefly, but thoroughly, what is going to take place. Be sure to mention that, as a radio amateur, both you and the operator of the originating station are proud and happy that your hobby permits you to perform this service for him. Also, inform him that there is no charge or obligation on his part.

Determine whether or not he is familiar with "phone patch" operation. If not, instruct him as to the procedure you wish him to follow and to speak slowly and clearly so that his voice may be easily understood at the receiving station.

After switching the "patch" into the circuits, it may be advisable to turn it back to the originating station. This is particularly useful when the person is not used to "patch-

## "Gotta' Phone Patch?"

Ken Johnson W6NKE  
21835 Rodax Street  
Canoga Park, California

The "phone patch" should not be switched into your station's circuits while you are placing the call. In some cases, your transmitter will be on the air and the initial remarks made by the party you are calling may be confusing or even disastrous. For example, the following reaction of surprise could happen. Suppose you've just informed the person on the other end of the line that his old service buddy, Joe, is going to talk to him through your amateur radio station. "Joe! My old buddy, Joe", the voice on the other end of the line says, "the h— you say! I haven't heard from that dogface for ten years. Put him on so's I can hear his d— old ugly voice".

See what I mean? It may read funny but can't you just see yourself frantically snatching at the switches?

This, too, is important while placing a collect call. Most telephone operators seem to be familiar with amateur radio and phone patches. It has been my experience that all of them are cooperative. However, occasionally it becomes necessary to explain what you are trying to do and it's needless to put the ensuing conversation on the air. Also, her placement of the call may create some excitement and confusion on the part of the addressee until he understands what is going on. There is the possibility of unnecessary embarrassment if your patch is in the circuit during this time.

When you have the addressee on the line, you have one of the most desirable situations possible to do a little publicity work for the

ing". It shifts the responsibility of starting the conversation to the originator who has had plenty of time to think of what he wants to say.

Carefully monitor the conversation from beginning to end. Remember that there are definite regulations as to the type of traffic that may be handled via amateur radio. Remember also the type of language that may

(Continued on page 54)





(... de W2NSD from page 4)

advertisers that you see in these pages. Make this generosity worth their while... read the ads carefully... send for more information on their products... give them a boost... maybe even drop them a card of appreciation.

And when you write to them *be sure to tell 'em you saw it in 73.*

### Coming Up

Naturally we wanted to put a lot of goodies in this first issue of 73. But we were careful not to unbalance it at the expense of future issues. Here are some of the articles scheduled for the November issue that may be of interest to you:

**"VHF Receiver"** This is a rather complete basic receiver that is designed to go with the *Bantam Converters* described in this issue. It gives you everything you could ask. This is quite an elaborate construction article, running to five pages, but you'll have a heck of a job fighting off the urge to build when you see it.

**"Four Band Crystal Converters"** This is a combination product report and construction article which shows how to use the International Crystal converters to good advantage. In this package we find the 20-15-10-6 meter converters all built into one band-switching converter unit, complete with power supply.

**"An FM VFO Exciter"** A BC-459 is converted into an FM VFO for use on 10, 6 and 2 meters, using either narrow-band or wide-band FM. With more and more FM turning up in our ham VHF bands it is nice to have an exciter around that will generate a usable signal for either FM or AM type VHF receivers.

**"Notes On Mobile Power"** Higher power from the car using an alternator and a three-phase power supply. Output is 520 volts at 500 ma.

**"Stop That Noise"** In this issue we have a good technical article on modulation. In November we go into detail on the subject of noise limiters and give the circuits of all the popular types, complete with an interesting discussion of the advantages and disadvantages of each.

**"\$5 Frequency Meter"** Two transistors are used in a new type of circuit which will probably be turning up in a commercial unit very shortly. This will give you a direct reading of any frequency in the ranges of 300 cps, 1 kc, 3 kc, 10 kc, and 30 kc. If this article doesn't get you to the work bench then you're an out and out non-building type ham.

There will be about ten other articles. We don't want to give away the whole thing right here. It will be a good issue and worth well over the yearly subscription price all by itself.

# Policies

Here are the basic policies which will guide 73.

**Policy #1:** We are not mad at anybody.

**Policy #2:** Amateur Radio, in its dual role as a means of arousing the interest of youngsters and providing the basic training for entry into the field of electronics, one of the largest and most promising fields we can see ahead, and as one of the most important means of communications between the peoples of the world on a people-to-people basis instead of through the press or government channels, is probably the most important hobby in the world today. We can keep it important by being aware of what is going on in our hobby and by being technically up to date. 73 Magazine is dedicated to bringing into focus the frontiers of amateur radio. It will strive to broaden the technical interest of the amateurs and to encourage them to higher technical attainments and abilities by means of technical and construction articles written by the best talent available.

**Policy #3:** Few talented writers have continued to buck the present system whereby they either receive nothing for their efforts or else have to wait from one to three years for minimal pay. 73 has established the policy of paying for all accepted articles with immediate cash. This seems to be bringing new life to the field for we are receiving top notch articles by some of the best authors in the hobby.

**Policy #4:** It is our intention, the SEC permitting, to open the ownership of Amateur Radio Publishing, Inc., to interested amateurs so that the ownership of the magazine can be widespread and the magazine will be truly owned and run entirely by licensed hams. 73 is being run under a very tight economy until the break-even point of 15,000 circulation is reached.

**Policy #5:** We intend to encourage and promote the publication of bulletins to bring specialized operating news of the many facets of amateur radio: VHF, RTTY, DX, Traffic Handling, TV, etc. The Club Bulletin of Marvin Lipton VE3DQX will be one of the first under this program. This publication, which is sent to the editors of all known ham club bulletins to provide them with a means of exchanging ideas, should be back in business this fall.





Do you have need for a 6 or 12 volt power supply for your new Citizens Band transceiver or amateur rig? Would you also like to use the same supply for line voltage operation? Do you have a six volt automobile now and have held off building a mobile supply because you are going to buy a new car with a 12 volt system in the near future? Here is a power supply which will fit these requirements and more!

The power supply shown in the photos has these features:

1. The supply will operate from 6 or 12 volts dc and 120 volts ac.
2. NO circuit changes are required to change from one input voltage to another!
3. The supply has built-in change over relay, permitting B+ output voltage to be switched from receiver to transmitter.
4. This B+ change over may be accomplished by throwing the switch marked "HI VOLTAGE," or it may be done from a remote location.
5. The antenna is also switched from receiver to transmitter when this switch is thrown.
6. A green pilot lamp indicates when the power supply is on and a red one lights when the supply has been switched from receiver to transmitter.

This changing from one input voltage to another is accomplished by making a separate power cord for each input voltage. As can be seen in the photographs and the diagram, an 18 prong Jones plug is used as the input voltage connection. Depending on what input voltage is desired, a Jones plug is wired for the connections required for that voltage. For using the supply on all three input voltages, three different cords are made. The connections for each input voltage are shown in the table.

Output from the supply is approximately 275 volts dc at 100 ma, more than ample for many Citizens Band rigs which do not have this three way feature, as well as a number

# DeLuxe Three-Way Power Supply

Donald A. Smith W3UZN  
P.O. Box 45  
Hagerstown, Maryland

of amateur transmitters. If desired, the supply can be used to operate your favorite communications receiver in your car. Many of these receivers are provided with a connector on the rear of the chassis for just such a purpose.

The supply uses the parts from two basic kits available from International Crystal Co. in Oklahoma City. The additional parts required are listed in the parts list. These two kits are used rather than purchasing the parts individually because the power Xformer is special, and the cost of the individual parts is considerably higher than the price of the two kits. The total price of the Deluxe Three-Way Supply should be around \$35.00, if you have no parts on hand.

Note that only one Jones power connector comes with the kit. It may of course be wired for any of the three input voltages. Additional plugs may be purchased from International, or from your local parts supplier. The part number is Jones S-318-CCT. Amphenol UHF jacks are used for the antenna connectors to keep losses to a minimum. These are positioned on the rear of the box chassis as shown in the photos.

(Continued on page 46)



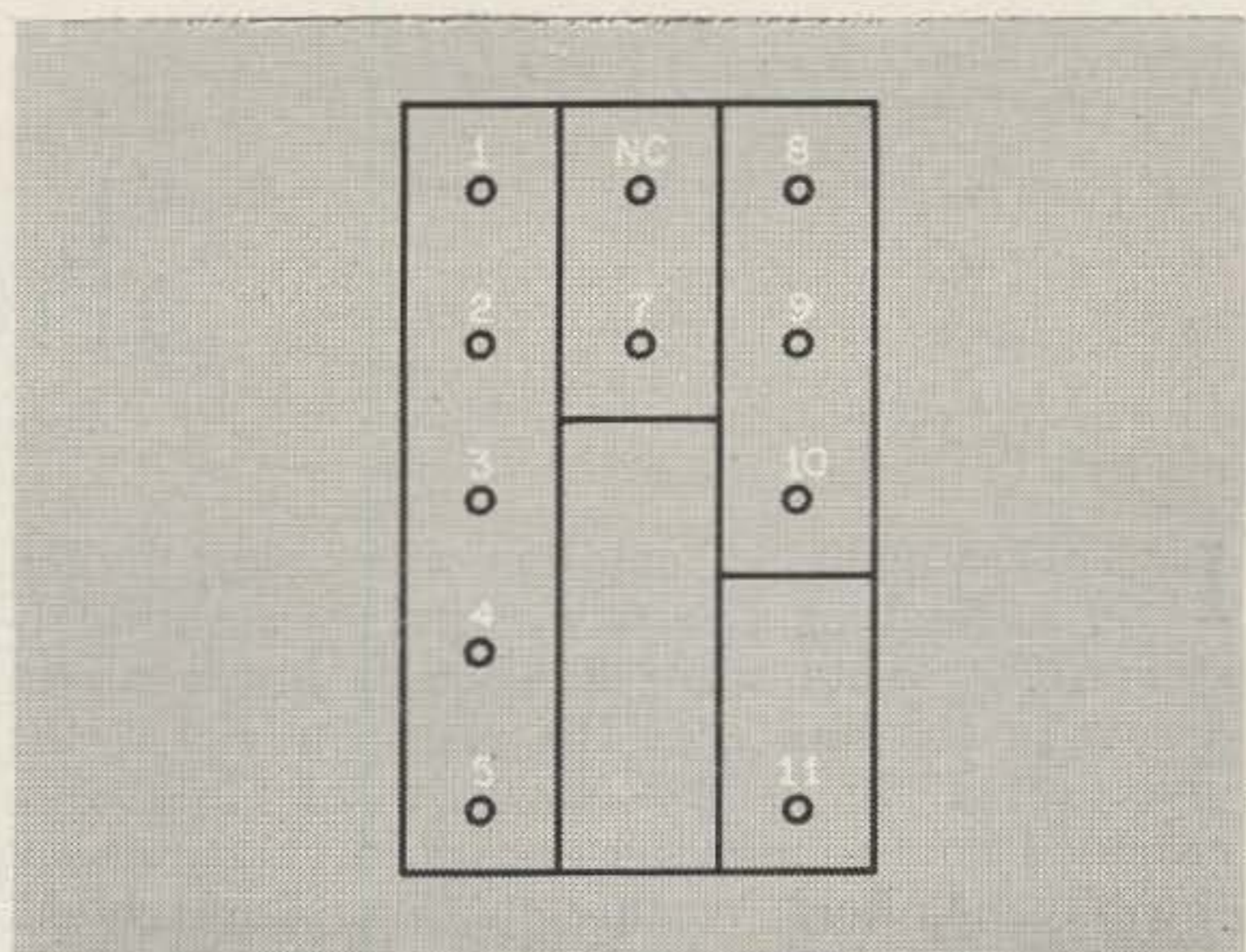
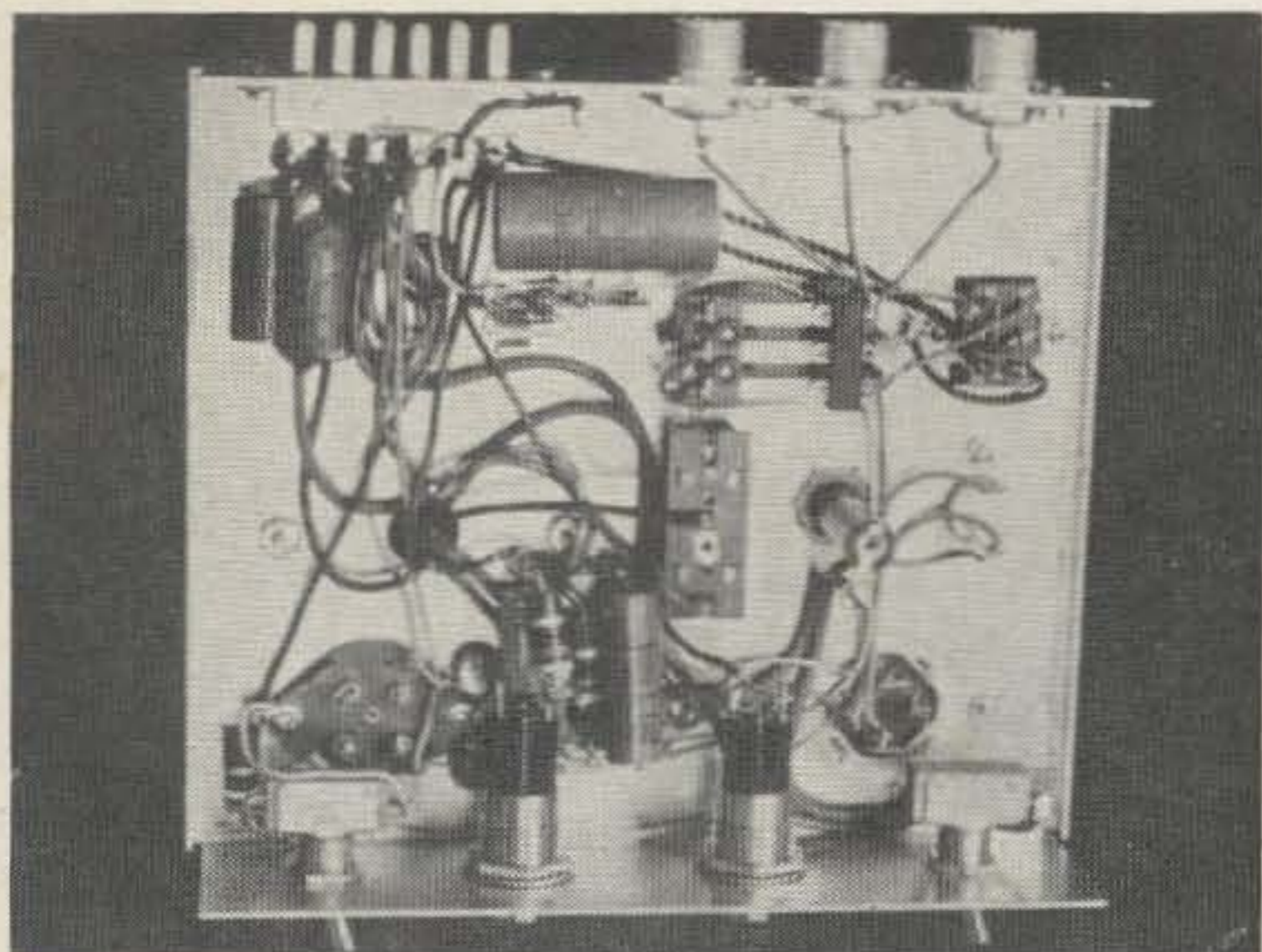

View, Facing Relay Connections (Relay Has No Numbers)

CONNECTIONS FOR INPUT VOLTAGE POWER PLUGS—

6 Volts dc

6 Volt "Hot" lead (May be either + or -) Pin 1  
6 Volt Ground lead—Pin 14

Place Jumpers between the following pins

- 2 & 5
- 6 & 8
- 8 & 11
- 7 & 10
- 9 & 12
- 5 & 17
- 15 & 18
- 15 & 16

12 Volts dc

12 Volt "Hot" lead (May be either + or -) Pin 1  
12 Volt Ground lead—Pin 14

Place Jumpers between the following pins

- 2 & 5
- 6 & 9
- 9 & 10
- 5 & 18

120 Volt ac

Line cord, one lead to Pin 1 and the other to Pin 4

Jumpers between the following pins

- 2 & 3
- 13 & 17
- 15 & 18

PARTS LIST

- 1—Three way basic power supply kit, PW-2F.
- 1—Relay Kit for above.  
(The above from International Crystal Co., 18 N. Lee St., Oklahoma City, Okla.).
- 1—L.M.B. Box chassis No. 20.
- P1—Jones #S-306AB, 6 prong power output plug.
- S1—S2 Single pole, single throw toggle switches.
- J1—J2—J3 Amphenol UHF connectors, #83-1R.
- P1—P2 Dialco #81410-111 Jeweled pilot lamp holders. Red for P2 (transmitter) and green for P1.
- R4—47 ohm, 2 watt resistor.
- R5—47 ohm, 2 watt resistor.
- R6—7.5 ohm, 10 watt resistor.
- NOTE: All other parts are supplied with the two kits listed above.

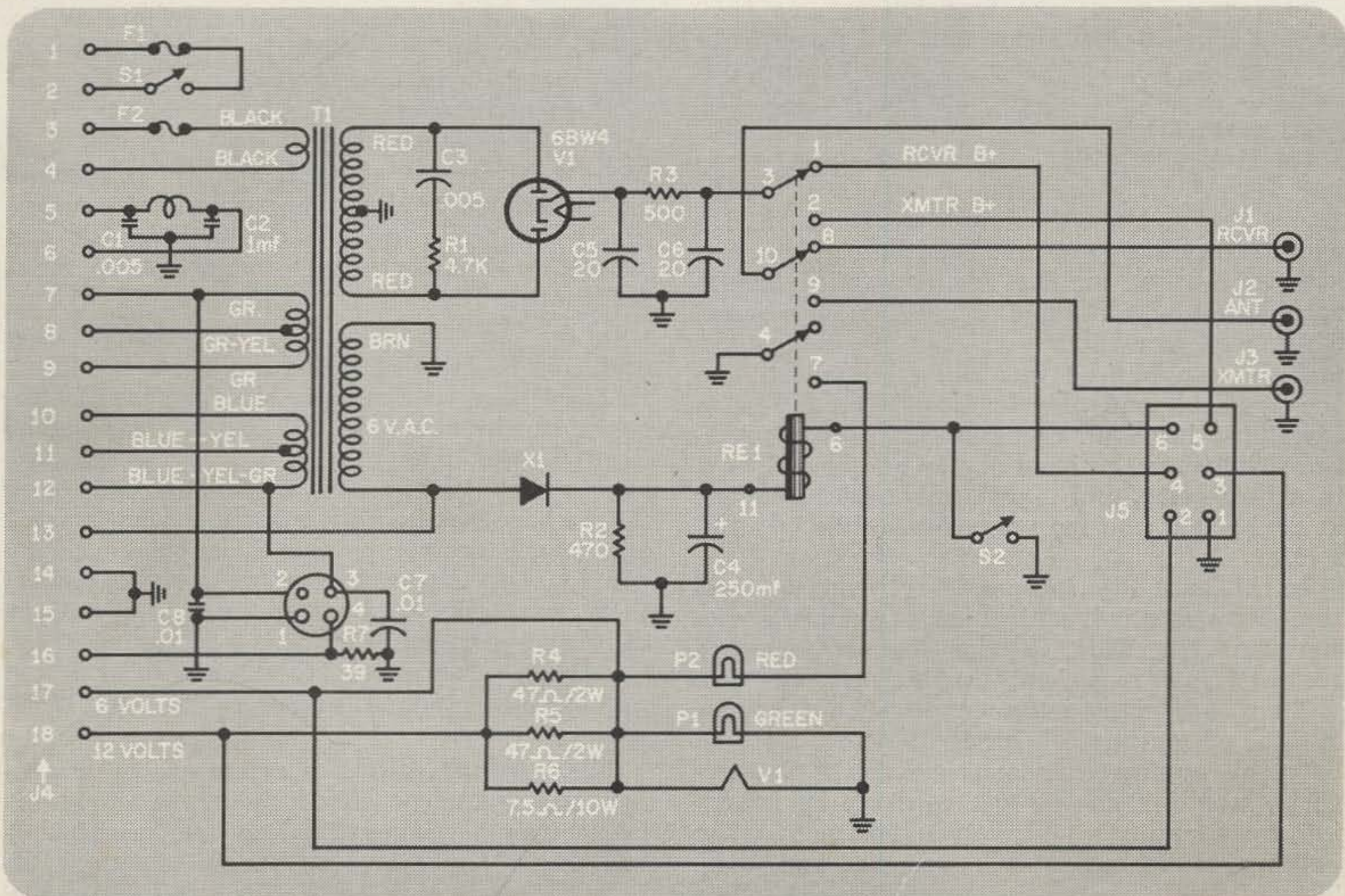



# Shock

Peggy Bates

IN 1917 a squad of soldiers was being drilled on a field at Niagara, during a thunderstorm. Bayonets were fixed, and stood up in a row in the hands of the men. Suddenly, the unexpected happened—a bolt of lightning crackled down from the darkened skies, struck the bayonet held by the end man, and rolled, a blue flame, down the entire row, to that held by the man at the other end of the line.

Every man in that row was knocked unconscious for a while, but the two men on either end of the line failed to recover. Upon examination, they showed all recognized signs of death . . . no breathing, no eye reflex, and no heartbeat.

The officer in charge thought that this would provide a good opportunity for the men to practice artificial respiration, and instructed them to work over one of the bodies, then left the field to return to headquarters. A few hours later, one of his men came running, breathless, to announce that the "body" they had been practicing on was exhibiting a remarkable reluctance to die, and was sitting up and insisting upon the fact that he was alive at the top of his lungs.

This was one of the first intimations that victims of electrical shock may not necessarily be dead at all, but may be revived through immediate and prolonged application of artificial respiration.

On May 20th, 1927, a young lineman working for the hydro came into contact with 26,000 volts at 2 o'clock in the afternoon. He was unconscious, and not breathing. However, he was lowered on the ground, and artificial respiration was started by fellow employees. This was continued on the floor of the ambulance while he was being transported to the hospital, and also on boards on top of a cot at the hospital. Communication was established between the local doctor and consultants in a large city, and it was not until 10 o'clock at night that the man was breathing by himself.

In this case, *eight hours* of artificial respiration were applied continuously until the victim revived. This is the longest case of resuscitation from electrical shock on record.

There are many instances of such dramatic revival of victims of electrical shock, and yet only this summer, a man visiting Orillia, Ontario, standing on the wet concrete surrounding a swimming pool received 110 volts while helping to install a PA system, and died. There is no indication in the newspaper report

of the incident that any attempt was made to revive him.

Every year, approximately 100 radio hams die through their hobby in the United States alone, and many others through other forms of electrical shock. Were these people really dead? How many of them would be alive today if artificial respiration had been started at once and continued until *rigor mortis*—the only unmistakable sign of death—set in?

The victim of electrical shock will look just as "dead" as a victim of drowning or of gas asphyxiation—dead enough to convince even doctors and coroners. One drowning victim in Canada was indeed pronounced dead four times by the same physician, and yet revived after eight hours of artificial respiration applied by relatives and neighbors who refused to give up hope. Today, some 30-odd years later, that victim is still alive.

The Health League of Canada became interested in the matter of reviving apparently drowned persons in 1938, under the leadership of the late Sir Frederick Banting, and were impressed by the similarity between revival of drowning victims and those of electrical shock. The League collaborated with the late Willis MacLachlan, of the Ontario Hydro Commission, which body had been actively interested in the matter since 1917.

It was discovered that while it still held true that revival depended upon immediate and prolonged application of artificial respiration in the case of both electrical shock and drowning victims, there were some important differences.

In the case of drowning, victims have been revived who have been under the water for periods of up to half an hour. In the case of electrical shock, *no such long period is possible*. Resuscitation must be started as *immediately* after the contact as possible. It has been found that where artificial respiration was started within one minute of the electrical shock, 90 per cent of the victims were revived; where there was a delay of six minutes, only 10 per cent were revived. Victims of electrical shock have been returned to life after a delay of ten minutes, but the chances of revival lower with the delay.

The outward deathlike symptoms of drowning and electrical shock seem the same—no breathing, no eye reflex, and no perceptible heartbeat. However, the inside story is different. Death may come through a laryngeal



spasm in drowning, and the victim dies through asphyxiation—or, as often occurs, the victim may *seem* dead, but the heart is still beating, not normally, but in a state of fibrillation, detectable only with the use of an electrocardiograph, an indication that life is still actually present, although the victim is often given up for dead, and no attempt made to revive him.

With electrical shock, the respiratory nerve center is paralyzed. The current in its passage through the body damages the sensitive nerve cells of the respiratory center. They become paralyzed and insensitive both to the accumulation of carbon dioxide and the lack of oxygen in the blood. No stimuli are sent to the respiratory muscles, and breathing stops. Here again, are the symptoms of "death" which are apparent in cases of drowning victims—symptoms which have prevented attempts at revival which may well save the victims' life.

The nerve cells tend to recover if they have an adequate supply of oxygen. An adequate supply of oxygen depends not only upon effective artificial respiration, but also upon the presence of circulation—in other words, the heart must be beating.

In some cases, where the victim has been well grounded, and the current passes directly to the heart, revival may be impossible. However, as in the case of drowning, the heart may beat so gently, that a doctor cannot pick up the beat with his stethoscope, and the victim may yet be alive.

This beat, in electrical shock, and although the heart may have received the current, may yet be effective enough to provide sufficient circulation to provide oxygenated blood to the nerve cells in the brain, but the *heart itself needs oxygen*. It is essential, therefore, that artificial respiration be started *at once*, in order that supplies of oxygen be made available both to the heart and to the nerve centers in the brain.

Two methods of artificial respiration are used by electrical utilities companies—the Holger-Nielsen, where the operator works facing the prone body of the victim, and the Schaeffer, where the operator works astride the victim. Of the two, the Schaeffer is considered the most effective, for in cases of electrical shock the blood had a tendency to leave the upper part of the body, and concentrate around the abdominal region. The Schaeffer method is most effective in recirculating the blood to the upper parts of the body more swiftly than the Holger-Nielsen.

Once again, though, much depends upon circumstances. If a man has been shocked while working on a pole, chances are that the upper part of his body will be burned too badly to bear handling—in which case the Schaeffer method is employed. If the reverse is the case, then the Holger-Nielsen is used. It is interest-

ing to note that in the entire experience of the Ontario Hydro—Electric Power Commission no person has yet been successfully revived from electrical shock through the use of a mechanical resuscitator. These machines, of varying kinds, have been of use in the case of drowning victims, but never in the case of electrical shock.

Hard and fast rules cannot be laid down in electrical shock—depending upon the circumstances, 30 volts can kill—or as has been shown, a man can survive 26,000 volts.

The main thing is that victims will look dead, and may remain so, if immediate help is not given—and *kept up until rigor mortis sets in*. This is so important that the Ontario Hydro insists upon every member of its 17,000 work force knowing how to apply artificial respiration. All those working directly with electrical apparatus must have regular practice sessions, and the head office staff can take lessons during vacation periods. They all have instructions not to cease until rigor mortis sets in. It is interesting to note that in the annals of men, women and children who have been revived from drowning or gas asphyxiation, the life saved has been due to the prompt action of a Hydro employee who has been in the neighborhood at the time.

A wife or friend, coming into the room and finding the ham prone on the floor, looking extremely dead, is apt to run for the doctor, or waste time screaming. Don't do this! Death may really come in the time it takes to run upstairs, look up the telephone number, and dial.

Take a stick, remove all wires touching the "body"—and start working! The ham you save may be your own!

### The Schaeffer Method

- 1) Turn victim on stomach with head slightly lower than feet.
- 2) Make sure mouth is clear for breathing.
- 3) Extend both arms beyond head. Bend one at elbow and place victim's cheek on back of hand.
- 4) Straddle victim and place hands on victim's back, fingers close together over the lower ribs.
- 5) Keeping your elbows straight rock forward and bring your shoulders over the heel of your hands, bearing down on the victim's back and lower ribs to expel air from the lungs.
- 6) Rock backward to an upright position, removing the hands without a push. This permits the air to enter the lungs.
- 7) Allow about two seconds for each move, five seconds per complete cycle (12 to the minute).
- 8) Continue without interruption to rhythm until normal breathing is resumed or until rigor mortis sets in. [7] [3]



# PROPAGATION CHART

## EASTERN UNITED STATES TO:

G.M.T.	00	01	02	03	04	05	06	07	08	09	10	11	12	13	14	15	16	17	18	19	20	21	22	23	24
ALASKA																									
ARGENTINA																									
AUSTRALIA																									
CANAL ZONE																									
ENGLAND																									
GERMANY																									
HAWAII																									
INDIA																									
JAPAN																									
MEXICO																									
PHILIPPINE'S																									
PORTO RICO																									
SOUTH AFRICA																									
U.S.S.R.																									

## CENTRAL UNITED STATES TO:

G.M.T.	00	01	02	03	04	05	06	07	08	09	10	11	12	13	14	15	16	17	18	19	20	21	22	23	24
ALASKA																									
ARGENTINA																									
AUSTRALIA																									
CANAL ZONE																									
ENGLAND																									
GERMANY																									
HAWAII																									
INDIA																									
JAPAN																									
MEXICO																									
PHILIPPINE'S																									
PORTO RICO																									
SOUTH AFRICA																									
U.S.S.R.																									

## WESTERN UNITED STATES TO:

G.M.T.	00	01	02	03	04	05	06	07	08	09	10	11	12	13	14	15	16	17	18	19	20	21	22	23	24
ALASKA																									
ARGENTINA																									
AUSTRALIA																									
CANAL ZONE																									
ENGLAND																									
GERMANY																									
HAWAII																									
INDIA																									
JAPAN																									
MEXICO																									
PHILIPPINE'S																									
PORTO RICO																									
SOUTH AFRICA																									
U.S.S.R.																									

LEGEND

7 MC

14 MC

21 MC

28 MC



# Propagation Charts

These charts are to be used as a guide to ham band openings for the month of October, 1960 to the various countries listed. I will be interested to hear of your results in using these charts and to know what other areas you might wish included in future charts.

**T**O HAVE reliable communications between any two points we must choose a frequency that is low enough to be reflected from the upper layers of the ionosphere and yet not so low that ionospheric absorption makes it necessary to run excessive power. Too high a frequency, one that is above the Maximum Usable Frequency (MUF), will skip over the intended receiving point.

We can predict the MUF by interpretation of charts made by the National Bureau of Standards' Central Radio Propagation Laboratory. From these charts I have made up three

Advance Forecast: October 1960  
Good: 2-6, 8-10, 13-16, 18-20, 28-31.

David A. Brown K2IGY  
60 New York Avenue  
West Hempstead, N. Y.

charts covering transmission from eastern, central, and western United States to various countries. The bands listed are MUFs and a higher band will not work for the time period listed. Lower bands will work, but not nearly as well. Times are GMT, not local time. [7] [3]

Fair: 1, 7, 12, 17, 21-22, 26-27.  
Bad: 11, 23-25.

## New Products

### Allied Catalog

This is a little redundant since Allied has taken a full page ad in this issue (bless their heart) to try to get this catalog into your hands. They don't carry every brand of equipment, but you will be hard put to discover what obscure brands they have omitted. This is, as far as we know, the most complete radio parts and equipment catalog put out by any distributor. Where else can you get 444 pages of interesting reading absolutely free? The new Knight-Kit line of ham gear is worth looking into also . . . like their 400 watt transmitter kit and a whole bunch of other items. But don't tell 'em you're writing in from this paragraph, point out that it was their ad that forced you to write . . . **their ad in 73** on page 64.

### National 270

Somehow, down through the years, there seems to have been a welter of receivers that have hit the market with much hoopla, only to disappear from all but the most educated of memories in a short time. This is particularly true of the medium priced receivers. The specs on the 270 look mighty good. This may well be a receiver that will be with us for a while. It looks good, has all of the features we need for ham communications, and is strictly a ham-band (80 thru 6) receiver. If you want to have all the facts to mull over drop a line (mentioning this reference) to National Radio Company, Melrose 76, Mass. The price tag reads \$249.95 plus 7.98% more for a matching speaker.





Capt. John J. Sury K8NIC/5  
 139 Nebraska Road  
 Dyess AFB, Texas

Tube Tube Tube  
 Tube Tube Tube  
 Watt Watt Watt Watt Watt  
 Watt Watt Watt Watt Watt  
 Meter Meter Meter Meter Meter  
 Meter Meter Meter Meter Meter

**T**HREE tubes, five watts, six meters. And this li'l 'ol peanut whistle really puts out a bird call: I've worked over 30 miles with an indoor halo antenna plus many fine DX sessions when the band opened. Which isn't bad for a little handful of stuff which knocks together in a couple hours and won't even slim down that big fat wallet of yours to where it will stop wearing out your back pocket.

Simplicity, simplicity. An overtone oscillator and power amplifier occupy one set of tube prongs with the number 6CX8 above them. There may be a good pentode-tetrode tube around, but since I didn't have one I used a 6AU6 speech amplifier with a 6AQ5 Heising modulator. What you lose in modulation you

make up in savings when you price a cheap filter choke for the executive position usually occupied by a modulation transformer. No one will ever notice the difference anyway, so why fuss about it.

While not much artistic effort went into the layout, it is electronically OK and may be imitated by you if you are in a rubber stamp mood, or if you're not sure enough of yourself to venture off the beaten paths. A 5" X 7" X 2" aluminum chassis was used.

The oscillator coil was made by winding five turns of #28 enamel coated wire on a Cambridge (CTC) slug tuned coil form type LS5 (or equivalent). The coil is shunted with a 5 mmfd ceramic capacitor. L2 is five turns

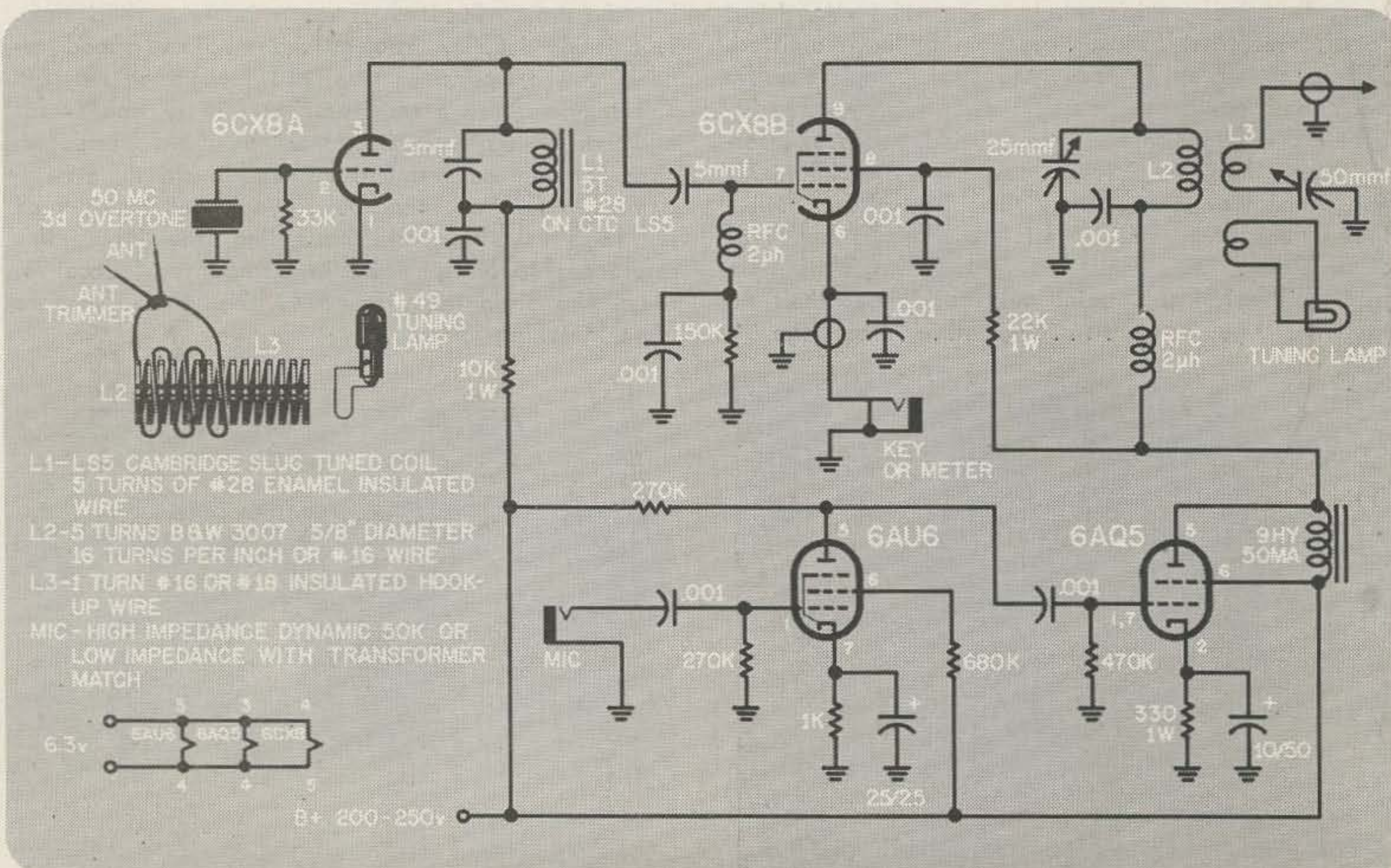



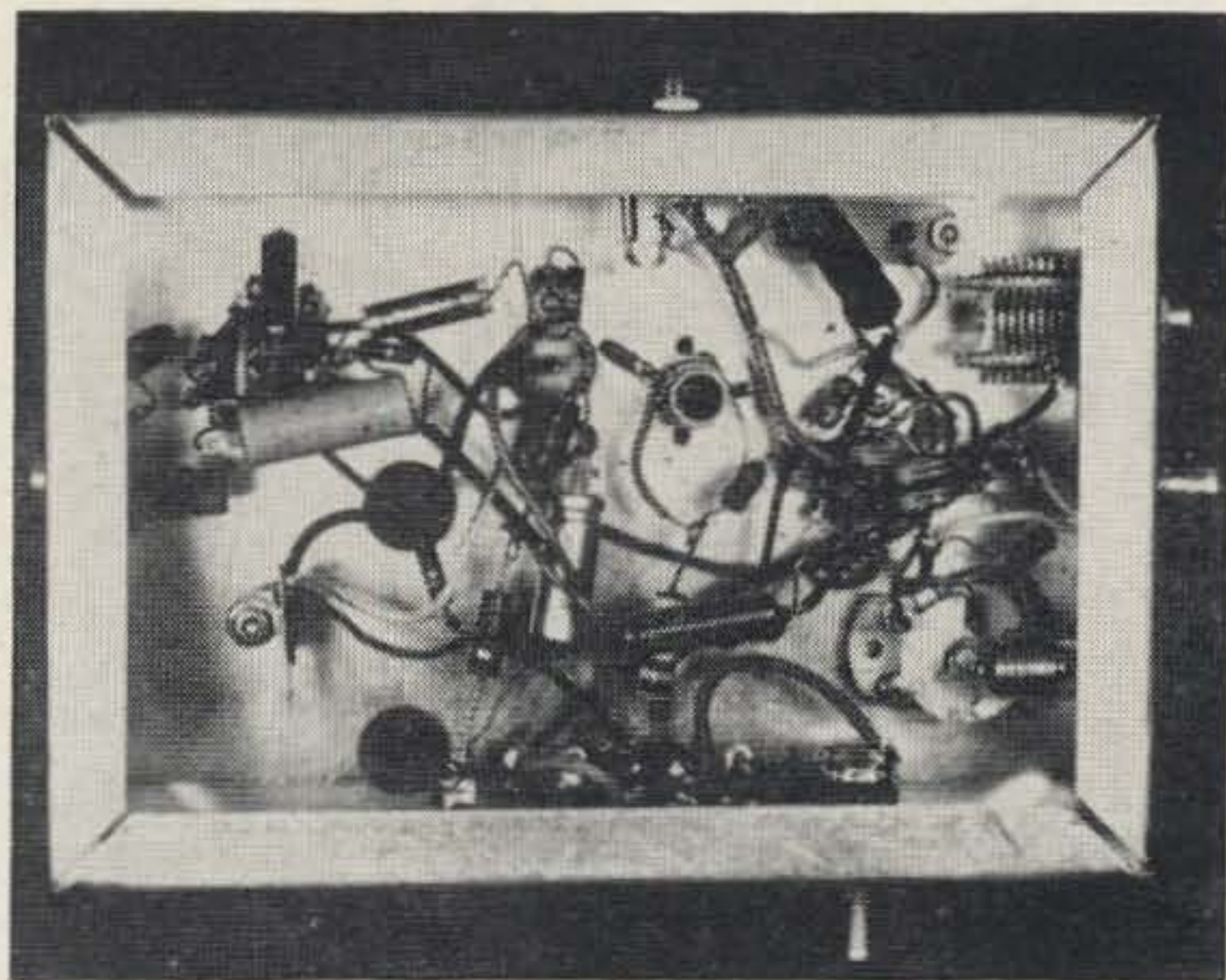
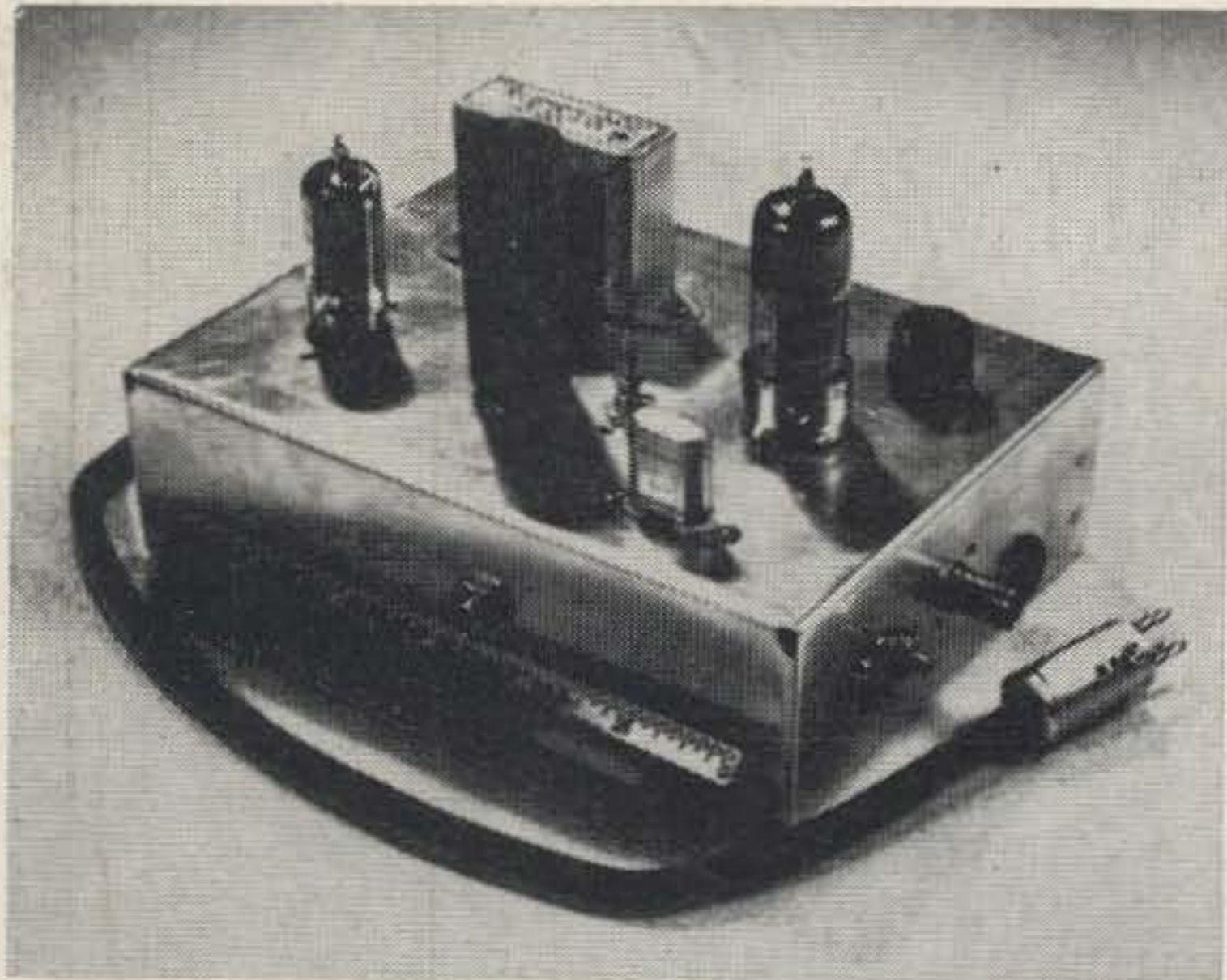

Photographs taken by S/Sgt. Wilson Dodson, Dyess Air Force Base.

of a B&W #3007 or Air Dux 516T coil ( $\frac{5}{8}$ " diameter, 16 turns to the inch, #16 wire). The antenna coupler is one turn of solid hook-up wire.

Since there will be fairly high voltage on the choke leads it is prudent to grommetize the feedthrough hole.

**Power Supply.** Surely you must have something around that will give 200-250 vdc @ 90 ma. With 250 v you will have an input of 5 watts (20 ma) to the PA section of the 6CX8. This may go up to 25 ma with modulation.

**Tuning** is easy. You can always build in several dollars worth of panel meters, but you get the same end results by making a #49 pilot lamp and soldering it to a  $\frac{3}{4}$ " loop of

hook-up wire. Hold the loop close to L1 and adjust the slug for maximum brightness. Next hold it near the final coil and tune the final tank and antenna trimmer for maximum brightness. An rf wattmeter or field-strength meter will also tell you all you need to know for tuning.

The rig is designed for a high impedance dynamic mike and will give plenty of punch with most of the inexpensive ones on the market. Ditto crystal mikes. Just about any type of antenna will load up easily. A halo is fine for general ragchewing, a beam is better for DXing. Give the rig a try and join the local gang on six meters, you'll get a lot of fun out of it.

1713

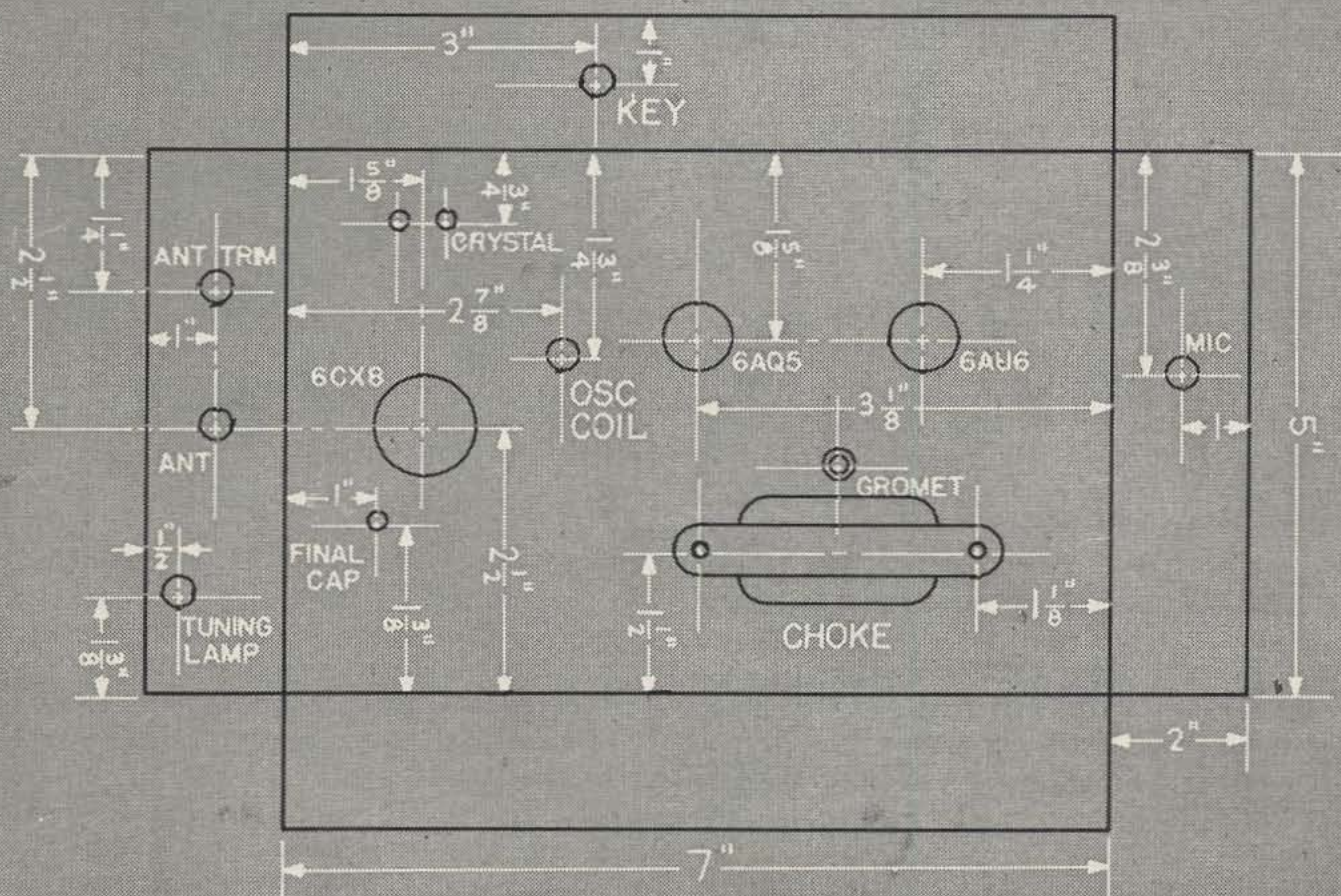



# How To Be An Amateur

John W. Campbell W2ZGU

THE good amateur—that is, the amateur who is useful in causing progress in the field he's in—has certain basic characteristics that are the same, no matter what that field may be. He may be an amateur in radio, electronics, chemistry, painting, or anything else; to be useful he must have a certain basic code—the Code of the Amateur.

A Good Amateur is . . .

1. Ignorant.
2. Egocentric.
3. Impractical.
4. Disrespectful of authority.
5. Materialistic, or pragmatic — not idealistic-theoretical.
6. Inconsistent.
7. Illogical.
8. Discontented.
9. Aggressive.
10. Unfair.

Every one of those characteristics, you no doubt noticed, is generally considered anti-social. The Good Amateur *is* anti-social; he's egocentric, and enjoys his own company, his own work, more than the best chit-chat of the cocktail-party group that is, of course, the highest ideal of the extrovert-social type. The Amateur is anti-social, in that he *likes*—actually *enjoys!*—thinking! He actually prefers using his brains to flapping his jaw; he normally thinks *before* opening his mouth. This is, of course, anti-social, because it imposes the necessity of thinking on those around him—which naturally makes them very uncomfortable. They're not used to it.

The Amateur is Ignorant; this is necessary, because he wants to learn—and you can't learn something you already know. The thing that makes an amateur's ignorance so useful, however, is that you can't learn if you already *think* you know, either. The old line about "It ain't all them things you don't know that causes trouble; it's them things you do know that ain't so." The Amateur is ignorant, and escapes that trouble. Throughout history, amateurs have been lousing things up for professionals by doing what everyone who knew anything about the business knew was impossible . . . until the amateur, who didn't know any better, did it.

Like "Mad Anthony Wayne", during the Revolution—the amateur soldier. He attacked a perfectly impregnable British position. Any-

one with military knowledge knew it was impregnable, because there were sheer, 300-foot cliffs protecting it on three sides, making attack from those directions impossible. "Mad Anthony", not knowing any better, lead his men up the Pallisades at night, and cleaned out the British.

The Amateur has to be Egocentric. That is, nobody's going to pay him for all the hard work he does, so he'd better enjoy what he's doing because it pleases *him*. All his work will, 99.99% of the time, yield nothing but discarded materials, and passed time. In the course of ten years, an Amateur may spend \$10,000 on his hobby, wind up with \$2 worth of junk, and nothing else . . . except the self-satisfying fun he had doing it.

That, by the way, is one of the ways in which the Amateur is impractical and unfair. Amateurs happily tackle a research project that has one chance in 10,000 of succeeding, spend ten years and \$10,000 on it. Obviously, this is economically unsound; no professional research organization would consider so risky a venture; it would be economic suicide. For one thing, the Amateur in question may be a \$100,000-a-year executive in a major corporation; he's worth that to his company, because of the extremely high level of judgment he has. That high ability to judge, to select between alternatives, is being applied in his hobby—the \$10,000 worth of material he invests in his hobby is nothing compared to the \$1,000,000 worth of highly trained judgement he's also investing!

But the Amateur can, of course, charge off all those expenses, all the investment of time, effort, energy and money, to "Entertainment". It's a head-I-win-tails-you-lose set-up; if his research does not yield the desired result—it still yields ten years of fine entertainment.

This is very unfair competition from the viewpoint of the professional, who has to charge all the time, effort, and money invested to "expenses"—he can't call it "entertainment". The Amateur's research project, in other words, can never wind up bankrupt—in the red—a net loss. The fun of doing it, not the result, is the main product; any workable result is, then, pure gravy—a bonus over and above the call of entertainment.

Time and time again in the history of Science, the great break-throughs have been made by amateurs; the great breakthroughs always



will, for all time to come, be made by amateurs. The reason's simple: a true Amateur can tackle a problem with no reasonable hope of success, and not suffer any loss. No professional can do so.

The essence of a breakthrough discovery, however, is that *it could not have been predicted*, on the basis of previously known facts. Pasteur, a chemist, not a biologist or doctor, achieved the great breakthrough in medical-biological science—the discovery of germ disease. It could not have been predicted beforehand. No one could have, a year previously, reasoned that investigation of microscopic life-forms would be the way to solve the problem of disease.

Put it this way: Today, in the race for space, we need something a darned sight better than rockets. Rockets can never be developed to an economically practical method of commercial use of space; chemical-fueled rockets must consume tons of starting fuel for every pound of pay-load put into space. Nuclear, or photon rockets can never be used to take off from Earth—the exhaust from such a rocket motor necessarily has an appalling energy intensity. It would slag down half a county behind it as it thrust itself up into space.

We *must* develop either an anti-gravity device, or a true space-drive—some kind of a device that can sink its claws into the structure of empty space, and climb like a squirrel going up a tree.

No professional will ever achieve such a breakthrough invention; if Dr. Quiddius Q. Quidnunk of the Research & Development division of the Brontosauric Manufacturing Company does turn up as the discoverer—you can bet he did it as a hobby-amateur project, not in his official capacity as an R&D man for Brontosauric.

The reason's easy to see. Given: We want an anti-gravity device. It's worth \$500,000,000 to the company that gets it. With a prize that size dangling, surely it pays to do research on it!

It would indeed . . . . . if someone could suggest someplace to start!

In 1935, Dr. Robert A. Millikan, one of the world's top atomic physicists, said it would be "250 years, at least" before we could release atomic energy. He was wrong by 243 years. What he meant was that as of 1935, no one had the slightest idea where to start looking for the answer! In 1940, they did know where to start; uranium-235 was the starting point. It took only two years to get an engineering device, once that was known.

The Amateur, because it's "entertainment", can start looking for the place-to-start; he doesn't have to wait for it to be discovered before launching his research.

The great Bell Laboratories had, of course, been looking for some way of amplifying elec-

trical signals for years, before that kid, Lee de Forest came up with the triode vacuum tube. The transcontinental telephone line was impossible until an amplifier was invented. Bell needed one, knew they needed one, and couldn't imagine where to start looking for one, of course.

There's a lot of government-sponsored research being done today; Commissions, Authorities, Departments and Divisions of the government set up boards, committees, and Agencies to assign research projects.

Let's imagine that government-sponsored research had been common throughout the history of the United States, and consider the probability that a government agency would have made the actually-correct assignment. The boards must, of course, act logically, with careful consideration of the opinions of the authorities in the field. Project assignments must be allotted fairly, logically, on the basis of the best available theoretical knowledge.

Would they, then, have assigned:

1. Development of a rapid, long-distance communication technique to a second-rank portrait painter by the name of Sam Morse?
2. Development of a technique for voice communication to an obscure teacher of the deaf in the Boston area, Alex Bell?
3. Development of a heavier-than-air flying machine to a two-man bicycle shop in Ohio?

Other projects would not have been assigned at all, by a committee which, not being amateur, was logical, had respect for authorities in the field, and acted on theoretical grounds. They would never, for instance, have assigned the project of developing an electric lighting system to anybody; it was proven mathematically by top physicists of the time, that such things could never be practical. The reason is one any radio ham can understand:—It was "known" that the maximum energy-transfer in an electrical circuit was achieved when the resistance of the generator equaled the resistance of the load. Therefore, in an electric lighting system, one-half of the energy would be dissipated in the generator, and only half would be available for lighting. This made the maximum possible efficiency 50% — but worse, it meant that, for any sizable electric system, a tremendous amount of heat would be generated in the dynamo. Large machines would be impossible, because they would simply melt themselves into scrap.

It's most certainly true that if modern generators weren't 99% efficient, they would melt themselves into scrap. It's hard enough to get rid of 1% of ten megawatts, or 100 megawatts of heat; if the learned authorities had been properly respected by Edison, he'd have recognized the futility of inventing incandescent



lights.

The Amateur can, of course, expect all kinds of trouble when he *does* achieve something. The Learned Authorities assure him he's a crackpot; not infrequently the said Learned Authorities have the police arrest him to protect the public from his phoney racket. Alexander Graham Bell was arrested for trying to sell stock in his telephone company, I understand. Louis Pasteur threw his future into jeopardy when he first used his anti-rabies treatment on some Russians who had been bitten by rabid wolves. No M.D. would give them the treatment; Pasteur was not an M.D. and risked trial for murder if one of his patients died. (Things are different now; under modern laws, Pasteur would have been jailed for curing the dying patients. Now it's illegal to try to cure someone, successfully or not, unless you're a licensed M.D.)

It's interesting to realize that three of the most famous criminals in history were, technically, amateurs. Jesus, Galileo and George Washington were all, technically, criminals and amateurs. (Jesus defied the theocratic laws of the Jewish government; Galileo taught, without being properly accredited by the orthodoxy of his time, and Washington was, of course, defying the British Crown, as an amateur statesman-general. Meanwhile, Ben Franklin, amateur diplomat, was doing a bang-up job in France, to England's most acute annoyance.)

A considerable amount of aggressive determination is, therefore, a *sine-qua-non* requirement for the Good Amateur. He can expect a battle when he does achieve his goal.

Obviously, he's achieved it illogically. If it could be achieved logically, from the accepted facts, professionals would have beaten him to it. The criminal-amateur must have achieved the goal by some illogical, unfair step. ("Unfair", when looked at closely, means "You did it by a method I didn't consider proper!" Obviously, if the professional had considered the method proper, and had tried it, he'd have beaten the amateur to the punch.)

Go back and check over the ten points that make for the Good Amateur, and you'll see why they are necessary. If he weren't discontented, of course, he wouldn't be trying to do something that "can't be done", or trying to do better a thing that can be done.

But the Good Amateur must be practical in one respect; he must not seek to compete with the professional on any fair, even-stein basis. He must always seek some underhanded, unfair trick. The amateur must not waste his time-effort-money on trying to do what the professional lab can do a thousand times better, faster, and easier. Don't build your own voltmeter . . . unless you want to learn, by actual building, what a voltmeter really is. Then, of course, you're really building your own knowledge-understanding, not a voltmeter.

You simply can't wind as perfect a moving coil, or make as precise and perfectly aligned bearings, as a huge production machine-complex can; it's inefficient to try. Don't try to make your own transistors. Don't try to solve any problem that the professional research labs are working on *in the way the pro labs are trying*.

The pro labs are now, just as an example, trying to find a better method of long-distance communication. They've sent up that Echo satellite reflector; they've investigated troposphere scatter, they've explored single sideband, pulse code modulation, pulse time modulation, a thousand variations. Don't compete; you'd be "fighting fair", and would be sure to lose.

Be unfair; try finding out how telepathy works. Solve that one, and you'll junk all the multi-megabuck projects the pros have invested in. No pro researcher can tackle the problem, because, of course, it's one of those things that you can't tell where to start working.

Legend has it that Alexander cracked the Gordian Knot problem by slashing through the knot with his sword. Now there's an interesting thing about this; any amateur knows that it's a damn sight easier to untangle a snarl of wire that has only two ends than one that's been cut in two and has about 50 ends. The two-ended knot you can, at least, start *here*, and know that, by simply keeping at it, you'll necessarily come out *there*.

Any pro lab can beat you six ways from zero on that sort of problem; they've got electronic computers, large staffs, and megabucks to grind away at the starting end, and follow it through.

The one that stops the pros, though, is the Gordian Knot after Alexander slashed through. It's got 100 ends, none of which can lead to "the" end.

The real fundamental research scientist is a Good Amateur; that's why government research programs simply can't do a decent job of supporting true basic research. To be truly basic research, the project must *not* know where it's going to wind up, it must *not* know how it's going to get there, and must *not* be logically deductible from known factors.

The "tunnel diode" was the result of a Good Amateur type experiment; the result obtained not only could not have been predicted by previous knowledge—previous knowledge specifically predicted that it couldn't happen! Since it is theoretically impossible for electrons to travel at the speed of light, it could be shown that, theoretically, no electronic mechanism can have signal-transit times as short as light-speed would make possible.

Happily thumbing its minisucle nose at theory, the tunnel diode is an electronic device with signal-transit velocity equal to light-speed.

It also violates all proper transistor solid-



state semi-conductor theoretical approaches. To be any good, a solid-state semi-conductor must have very, *very*, VERY little impurity—"doping"—in it. The tunnel diode results from doping the germanium or silicon like crazy. Do the wrong thing—that's what works!

In the early days, the hams got short-wave radio going by doing wrong things like taking the carefully manufactured tubes right out of their carefully cemented on bases, and soldering the leads directly into their circuits.

The real motto of the amateur must be, "Never give a pro an even break! Be unfair!"

To be a Good Amateur, don't compete with the pros—do what no pro would ever think of doing. And be egocentric—whatever project you pick, pick it because you like it, not because somebody says it is your duty. That way, you're playing the heads-I-win-tails-you-lose game; no matter whether your project succeeds or not, you'll have had a hell of a lot of fun! Tackle the absolutely impractical projects—the ones where you'll have no pro competition. And always disregard Authorities; of course they're sure it's impossible. If they weren't they'd have gone after it themselves. A thing can be economically impossible for professional research—and be completely practical for the happy little amateur. Lord knows climbing Mt. Everest is economically impossible in any profit-and-loss sense. What possible financial profit can be made up there?

And the amateur doesn't have to explain *why* his gadget works; to hell with theory! Be pragmatic; simply use it. Show *that* it works, and let the red-hot theoreticians worry about *why* if they want to.

Also, be ready and willing to be completely inconsistent at any moment. If, one day, while working on a new idea for a two-meter half-kilowatt rig, that you've told everybody is going to be a two-meter transmitter, said unit should suddenly start rising off the bench and floating up toward the ceiling—be inconsistent! Say, "I'm building an anti-gravity machine," and if somebody protests that you said it was a radio transmitter—why, point out that it obviously *is* an anti-gravity machine, so, obviously, that's what you were actually building. That's common sense, isn't it? Why should you care that it consumes a full gallon, and peeps out with only 2 watts on 2? It floats, doesn't it?

Always be willing to change your project if something better slugs you along the way. Like George Baekland; he was trying to synthesize some complex organic chemical, when his chemicals in the apparatus clobbered, turned into goo, and finally set into a solid mess. Efforts to clean his apparatus of the stuff proved totally futile; he couldn't dissolve the mess in anything he could find; it just sat there sneering at all his high-power solvents.

Of course, other chemists had had similar sad accidents, and had had to throw away not

only their chemicals, but their apparatus as well. Baekland was by no means the first to wind up with a mess that nothing known to chemistry would remove.

Baekland was simply the first to be a Good Amateur about it; he was inconsistent. "I," he decided, "am *not* synthesizing 1, 2-alpha, betaomicron after all. I'm synthesizing something as useful as the fabled Universal Solvent—the Universal Insoluble! Since I can't get rid of the damn stuff . . . there must be somebody that wants a material that stubborn, so I'll sell it." With that inconsistency of approach, things were easy. It was a snap to remove the apparatus from the mass of bakelite—the glass would break, or dissolve in hydrofluoric acid.

Remember, too, that Bell was working to invent the "musical telegraph"—what we now know as carrier-frequency telegraphy—when he got the wrong result. He was a Good Amateur, and immediately decided he was inventing a telephone instead of a musical telegraph.

There are lots of patents to be gained by seeing how *bad* a job you can do. The body-capacitance burglar-alarm, for instance, is the worst possible approach to a stable VFO exaggerated and patented. Almost anything that is *extremely* one thing or another has some useful application. Vide Bakelite. Transistors tend to be very temperature-sensitive; they make wonderful high-sensitivity thermometers because of that. The R-C oscillators such as the multivibrator are horribly unstable . . . which makes them wonderfully useful as frequency multipliers and/or dividers. Being inherently unstable, they'll happily lock in with the frequency of any nearby oscillator.

Each of the characteristics I've listed as necessary to the Good Amateur is considered anti-social. Each of them is . . . in the wrong place, or wrong degree. But be inconsistent about that, too; in the right place, and right degree, each of them is tremendously useful.

I do not, for instance, recommend disrespect of Authorities when they say "The human organism does not normally operate well after being connected to a 2000 volt power supply."

It is also necessary to respect authorities in another sense; they should be respected just as you should respect rattlesnakes, mules' heels, and dynamite. They frequently have power, and should be treated accordingly.

The crackpot is the bird who not only fails to respect authority, but also fails to respect good judgement.

The Good Amateur, of course, fulfills the only useable definition of a Genius: "A Genius is a crackpot who makes money at it."

Naturally . . . because "makes money at it" is simply another way of saying "has an idea which is economically sound and workable."

Remember that almost any crackpot can *get* a patent; it takes a genius to get one *and sell it!*





Donald A. Smith, W3UZN  
Associate Editor  
P.O. Box 45  
Hagerstown, Maryland

# Testing the Heath Mohican (GC-1A) Transistor Communications Receiver

PERHAPS you can imagine the doubts which would build up in your mind if you were to take on the job of writing something good about a one hundred dollar "Communications" receiver. Add to this, that it is transistorized and you've had sour experiences with previously available amateur transistor gear.

After the receiver had been assembled (Heath sells *kits*, you know), which took me about 30 hours, the receiver was ready for alignment. I followed the rather complete and thorough instructions provided. Alignment requires a signal generator (like the Heath SG-7) and a VTVM (like the Heath V-7a). Once aligned, I antenna'd it with the whip which comes with the kit and started tuning to determine the magnitude of the disaster.

HMMM, Well, what do you know? HMMM. HMMMMMMMMMM! Well I'll be darned! By George! Hey! This thing is really something. The advertised specs of 2 microvolts sensitivity (except on the broadcast band), were found to be quite conservative, even on the ten meter band where most receivers are strangely quiet. This little box of parts held its own right alongside of receivers costing up to twice as much. Let's see what makes it tick.

The biggest secret is probably in the front end. After all, if it doesn't have it up front, it doesn't have it. Three transistors are used in the front end. One for rf amplifier, one each for oscillator and mixer. These transistors are not run of the mill jobs, but are good at frequencies up to 100 mc! Thus it's not much

of a problem getting performance up to 30 mc. The way the front end layout was designed helps to keep leads short. The transistors are mounted on shields and the band change switch is installed through these shields.

By using adjustable coils in the front end, plus trimmer capacitors, fairly constant sensitivity across the dial is obtained. This eliminates the "dead spots" that we all have experienced.

What about selectivity? The figures are 3 kc to the half power point (6 db down), which is made possible by the use of "transfilters". These little jobs are unusual in that they do the job of an if transformer, crystal filter and coupling capacitor, but are none of these. They are somewhat similar to a crystal lattice filter in their operation, though not as efficient. They give much better selectivity than could be achieved from standard if transformers, are rugged and never need adjustment! (Though they have been used by the Signal Corps, this is the first commercial application of them).

What's the line up? 10 transistors, 3 germanium diodes, 2 compensating diodes and 1 voltage regulating Zener diode are used. This gives an rf stage, a separate oscillator and mixer, three if stages, a diode detector, an audio driver and a push-pull output stage. A separate transistor is used for the variable BFO. Diodes are used for automatic noise limiter and AVC.

And that's not all! A Zener diode is used



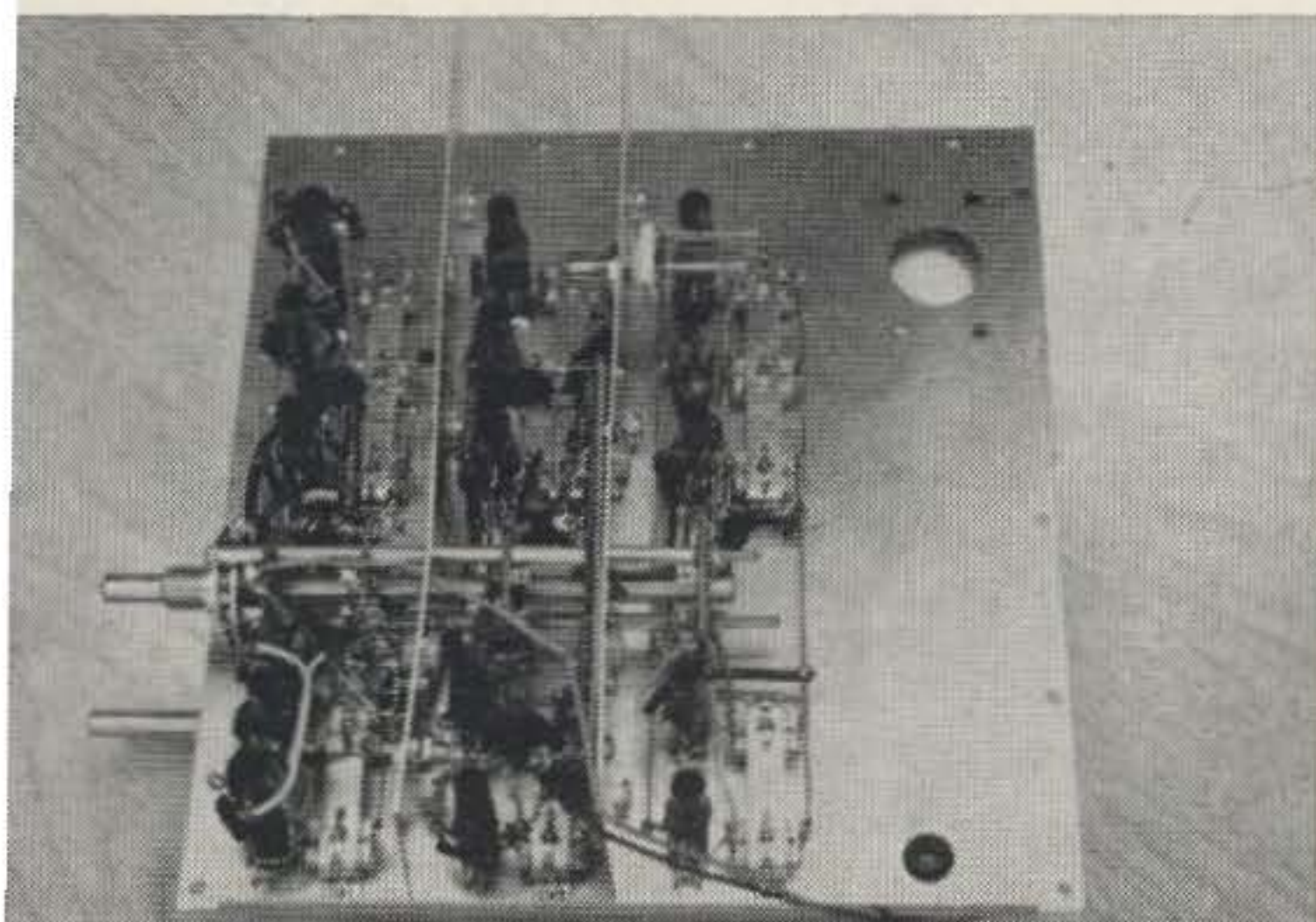

The *rf* section is constructed first. Note that all parts are mounted on a flat sheet, simplifying construction.

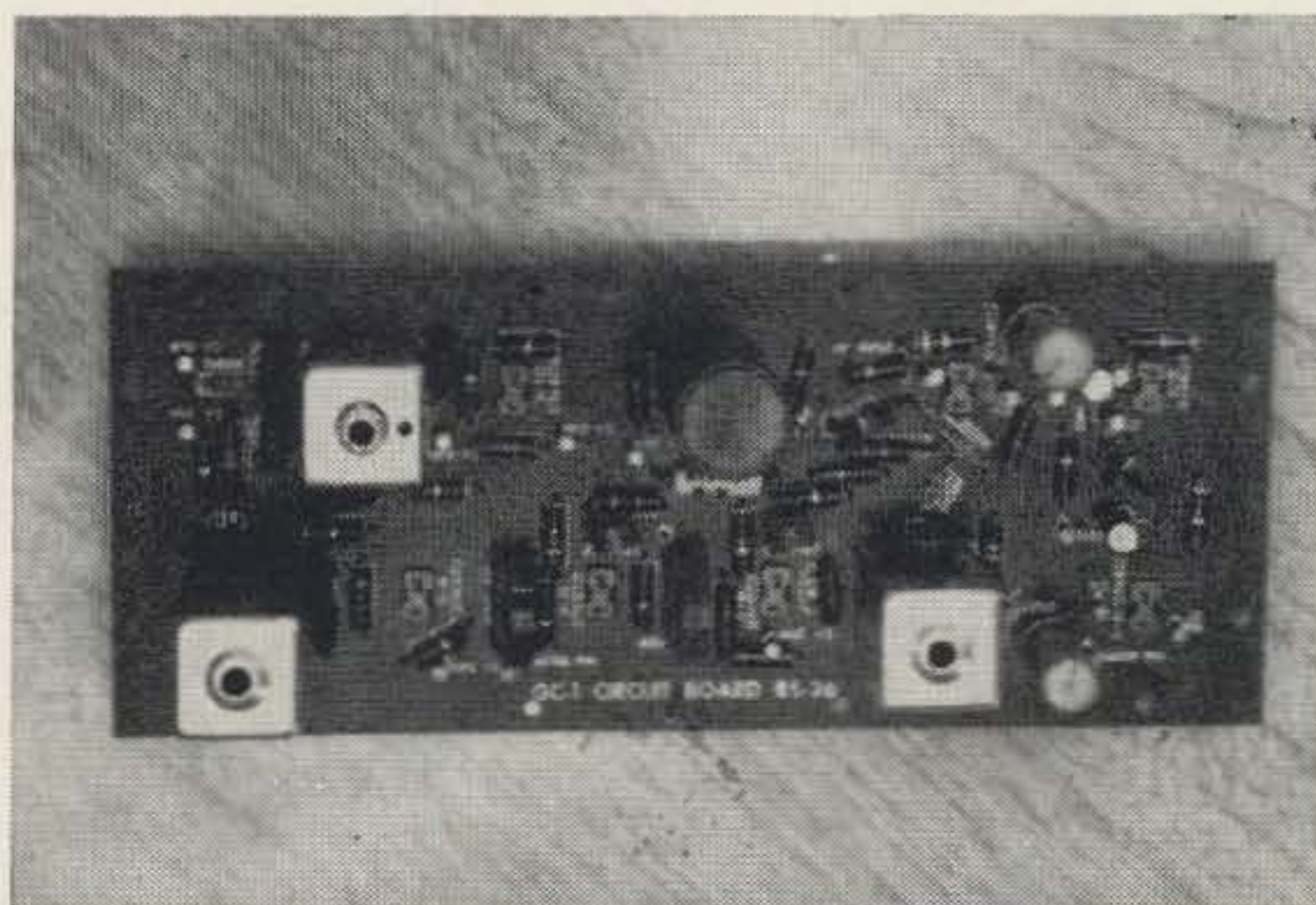

A printed circuit board is used for mounting and wiring of the *if* and audio sections of the receiver.

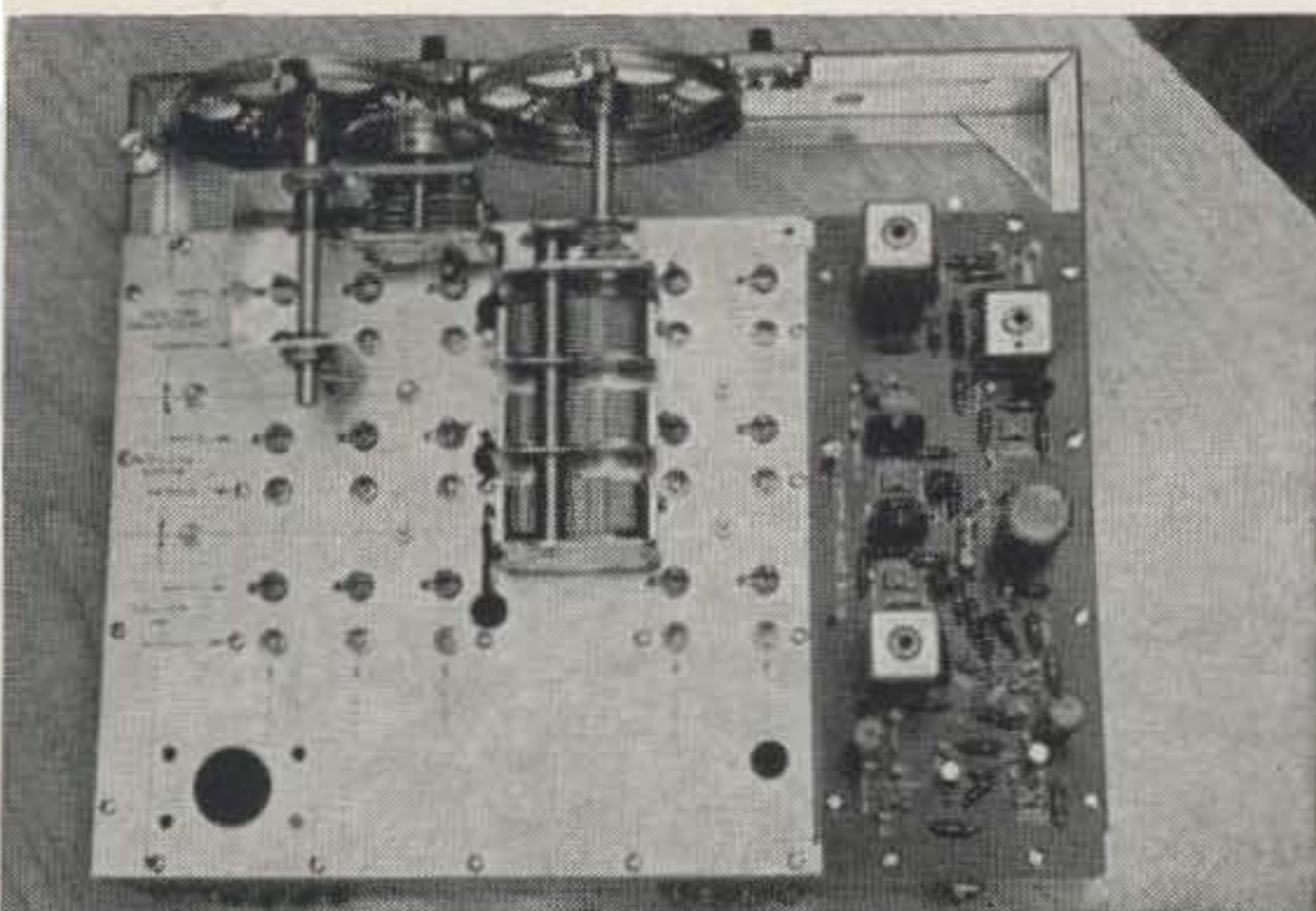

The completed *rf* section and the printed circuit board are mounted on the main chassis and wired to each other.

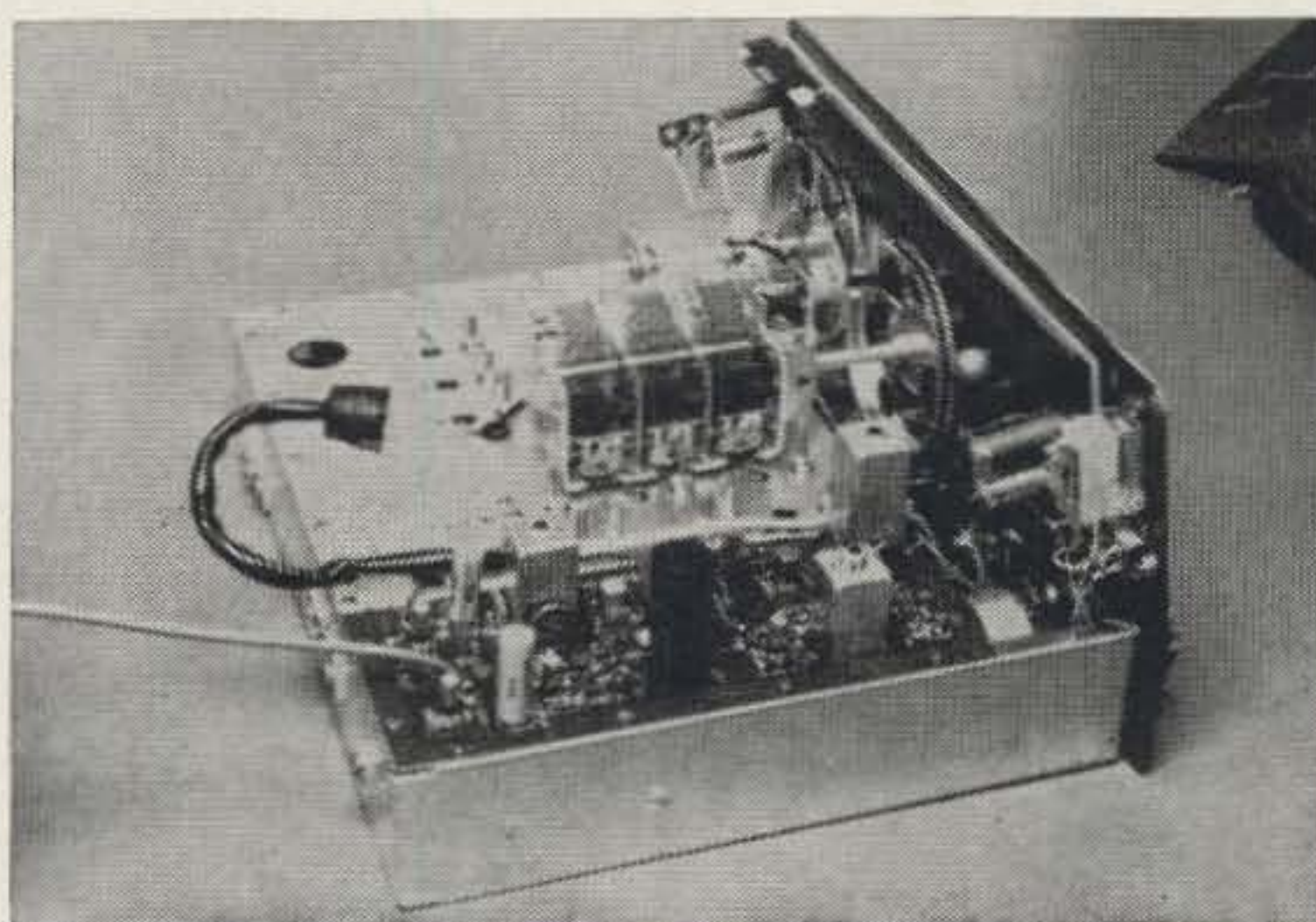

Completed receiver, cabinet removed. Wire going off to the left connects to speaker mounted in cabinet. Large hole in upper left corner is where "Whip" antenna goes.

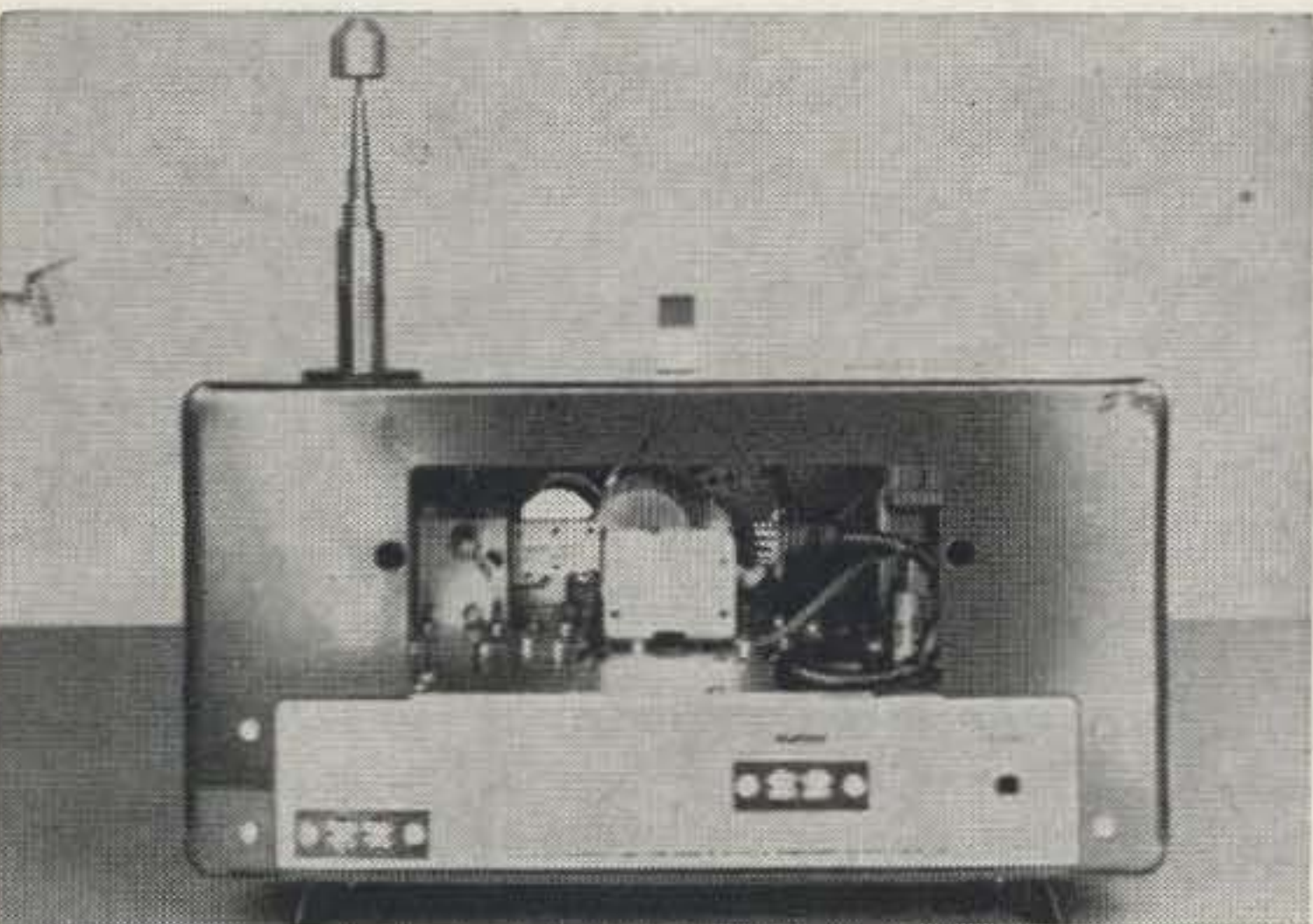

Rear of completed receiver with power supply removed. Plug shown in the cut-out, is power plug which is plugged into power supply.

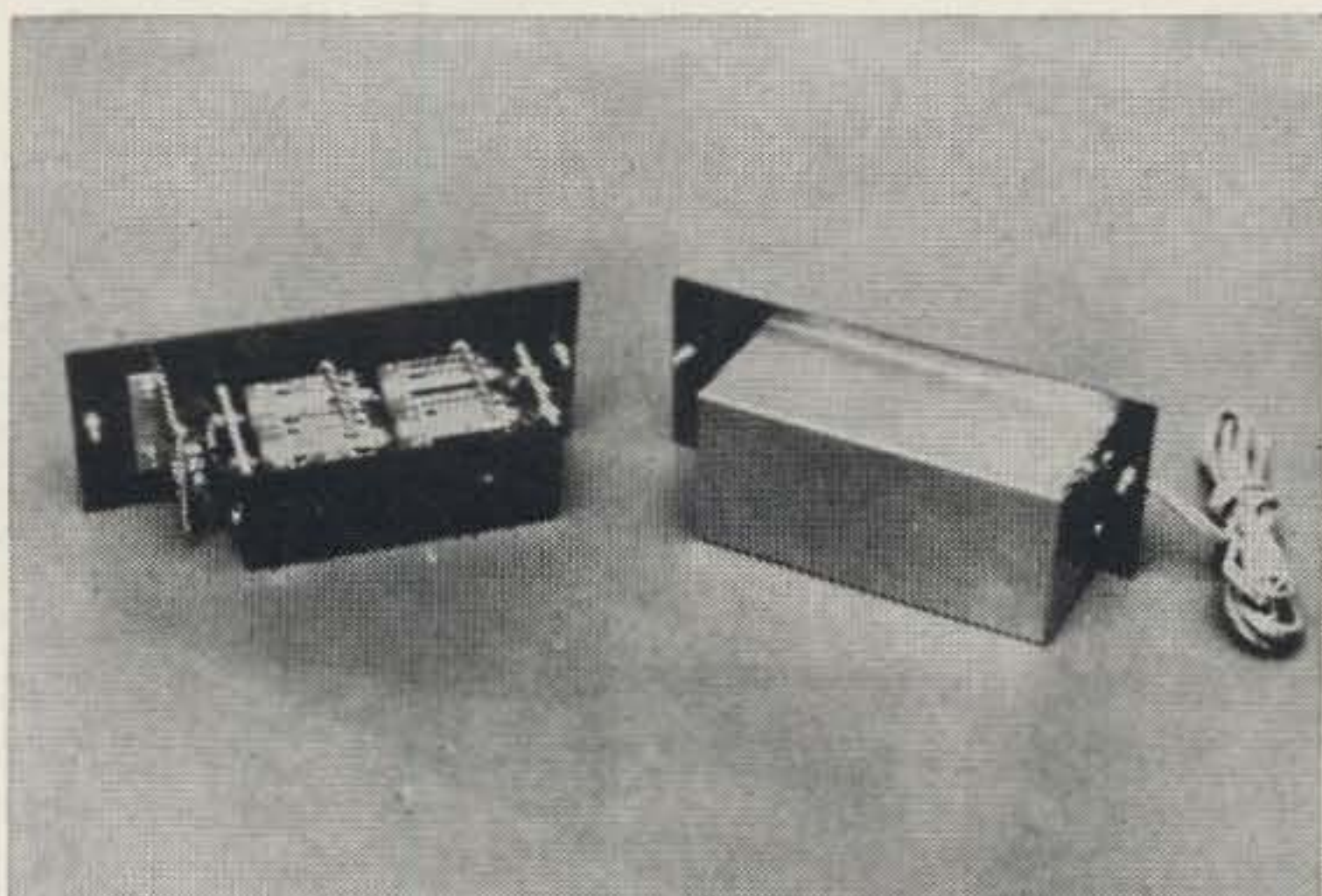

Battery supply on left is furnished with the kit, (less batteries). The supply on the right is *ac* operated supply which is purchased separately, if desired.

as a voltage regulator for the local oscillator. -6.8 volts is applied from the diode to the transistor oscillator base, holding drift down to a *very* low amount. It is the nature of a Zener diode that when a voltage is applied to the diode backwards, reverse current is very low. If the voltage should exceed this amount, the breakdown potential of the diode occurs

and the reverse current through the diode increases, bring the voltage back down to the pre-set amount, which is -6.8v in our case.

Another interesting circuit is in the push-pull audio output stage. Two 1N2326 compensating diodes are used, one in each of the output stages, connected to the transistor base circuits. These diodes have a negative tem-



perature coefficient so that as the transistors increase in temperature (as class B transistor output stages do) the diodes will compensate for this increase. By so doing, excessive battery drain is prevented and audio quality is maintained.

These same two diodes also act like voltage regulators, which is important for battery life. As the batteries begin to fall off, they compensate for it (within certain limits, of

rate section. Steel is also used for the main chassis and the cabinet.

The tuning capacitors (both the bandspread and main tuning capacitors), have anti-backlash gears which are quite effective in providing good vernier tuning. The bandspread, by the way, is good.

Construction begins with the assembling of the front end and the printed circuit board which contains the if stages, audio noise lim-

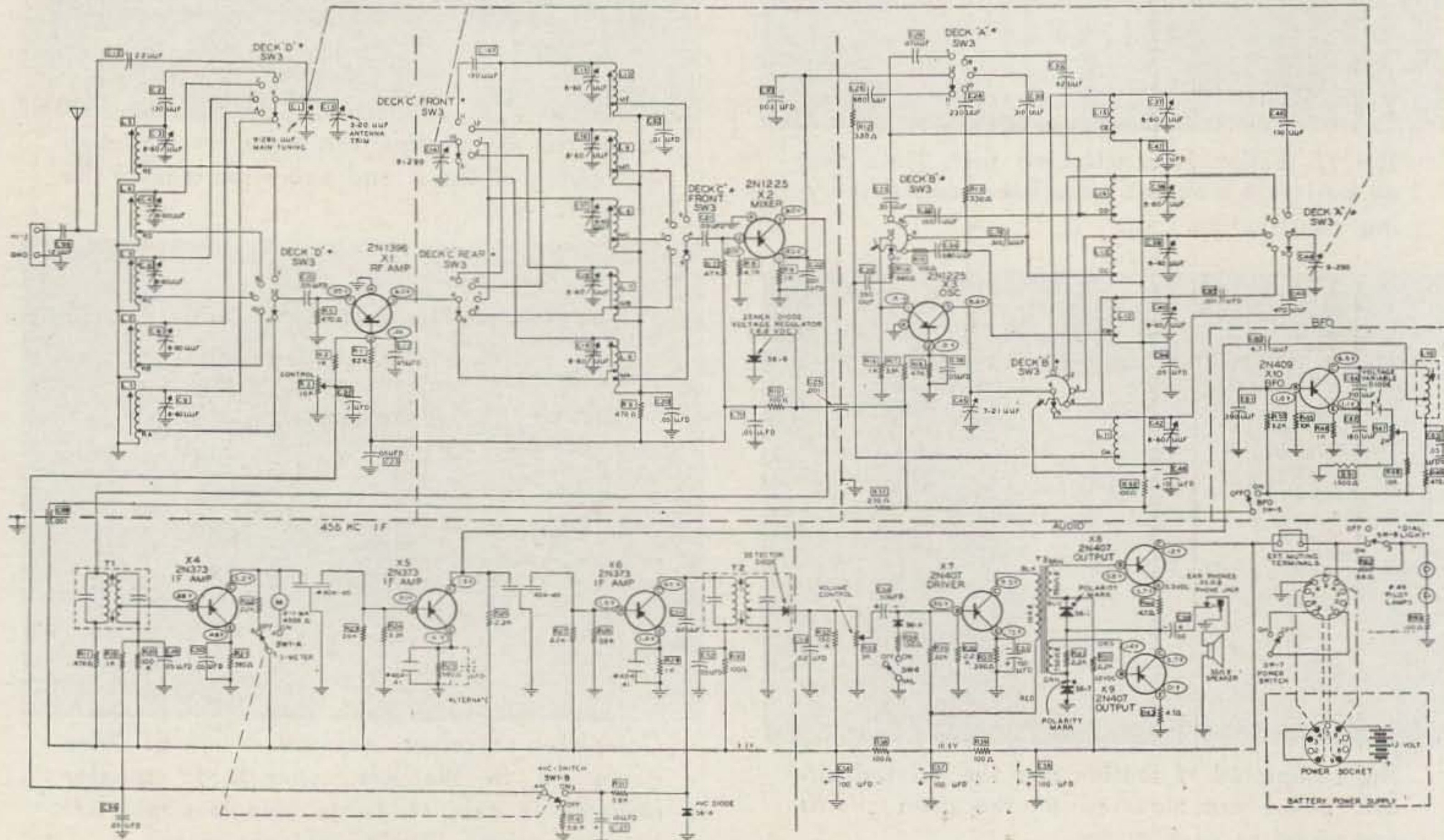

course). Perhaps you have noticed how the audio becomes distorted as soon as the battery voltage begins to decrease a little in your transistor portable.

By using a push-pull class B output stage more than enough audio is available. A 35 ohm (low impedance) phone jack is provided on the rear of the receiver chassis. The volume is considerably lower if high impedance ear-phones are used.

Ordinary flashlight batteries of the "C" size are used and they last up to 400 hours! Replacement costs you less than one dollar. Not bad eh? If you intend using the receiver mostly for shack operation an ac power supply is available for \$9.95 which fits in the space provided for the battery case.

### Mechanical Aspects

Steel construction gives excellent mechanical and electrical stability. The front end is built on a single sheet of steel, simplifying to some extent this important part of the receiver. The coils, trimmers, band-switch, shields and transistors are built on this plate as a sepa-

rate section. Steel is also used for the main chassis and the cabinet. Tuning capacitors and front panel follow. No difficulty was experienced.

### In Use

The GC-1A was tested rather thoroughly using the built-in whip, the regular station antennas, and at beach parties. It pulls 'em in no matter how you use it. After several weeks of constant use I was convinced that it did everything I wanted or expected it to do. The selectivity and sensitivity were fine, it worked well on SSB (though a product detector would be somewhat easier to use, of course), and it was a gem for use with my 6 and 2' meter converters.

The spring loaded pilot lamp switch lets you light up the dials when needed and conserves the batteries for more important uses of the amperes.

A close look at the photos will tell you all about the controls on the receiver. It has about everything you really need, including the S-meter. Quite a bundle for the low price and one you'll have a ball with if you give it a try.



## (CAPACITY METER from page 23)

capacitance, the scale is linear and there is no need for other than full-scale calibration. Hence, a variable resistor, R5 in Fig. 1, is used to shunt a bit of extra current around the meter, to allow for battery aging and also to eliminate the necessity of setting the multi-vibrator exactly on frequency.

By operating the MV at four fixed frequencies, in decades, the range of operation covers practically all small color-coded capacitors. The frequencies used are 100 cycles, 1 kc, 10 kc and 100 kc.

The MV, in Fig. 1, has three possible states of normal operation. They are: Q1 conducting and Q2 cut off, or Q2 on and Q1 cut off, or a transitional state where both conduct. When the power switch, S1, is first turned on either Q1 or Q2 starts to conduct more readily than the other due to inherent circuit unbalance. Due to the regenerative action of the cross coupled amplifiers one or the other soon is

driven to saturation, with the opposite amplifier cut off by the large positive bias developed by the charge on the coupling capacitor. The plus charge drains off toward the B— thru the base bias resistor, and at about  $-0.1$  volts of base bias, the cut off transistor then conducts, and regeneration quickly causes this transistor to become saturated, with the opposite one cut off. This process repeats itself at a rate governed mainly by the base bias resistors, R2 and R3 in Fig. 1, and the inter-coupling capacitors, C1 thru C8. The result is more or less a square-wave. A capacitor, Cx, is connected across the terminals J1 and J2 with the instrument turned on. When Q1 is conducting and Q2 is cut off, Cx is charged to practically the full battery voltage thru CR1. On the next half cycle Cx discharges thru CR2 and the meter, M1, and recharges again in the opposite polarity, to the supply potential. The result is, of course, a

(Continued on page 50)

## New Product



## Telrex Catalog

Drop a card to Telrex Labs, Asbury Park, New Jersey and ask for their catalog PL-77. They've listed rather complete data on 100 different ham band antennas that they manufacture, priced from \$6.50 for a 10 Meter Mini-Bowtie to \$985 for a four band 10-15-20-40 Meter array. And, say, when you're writing, be sure to tell 'em about 73.

## Letters to the Editor

CAN I  
at  
MY AGE  
Become a  
Hotel Executive?

Dear Leader:

Just a note to remind you that we retired air marshalls and admirals tending our beds of flowering concubines and scarlet pandemoniums in the Golden Sunset west of the smog bank—uh, where was I? Anyhow don't forget to enter our subscription and bill us when you get that magazine for adult amateurs printed and passed by the post office, the legion of decency and Alexander King. Hope you haven't reneged on the project, Wayne, there's so much good hard work to be done. Meanwhile, hang onto the boat and let the water support most of your weight.

Ken Cole W7IDF  
Vashon, Washington

To: Herr Wayne Green

Dear Wayne:

What Hoppen? Here I sit, patiently waiting for the appearance of "73". Put me on the list to start with Vol. 1, No. 1. I will take any long-term subs deal you come up with, assuming that your original figures of \$3 a year, five for two years, etc. Five years for ten bucks? I'll take it. How about a "Lifetime" deal for, say, 25 bucks? We both gamble—you bet that I don't live too long and I bet that 73 does. (I am damned well sure that any good technical magazine will survive and make money.) . . .

73 es all that rot,  
Fritz Hervey W9IHU  
Chilton, Wisconsin

Dear Mr. Green:

Briefly, more power to you.

By keeping the technical level above that of the beginner, but below that of the professional (each of which has his own specialized literature now), the magazine should be a success. A format of technical articles rather than of operating details should have considerable appeal. Might I suggest, however, that you nevertheless have a variety. CW and FSK right through to sideband and antennas. Although I'm not really a desk jockey, it seems to me that intelligent component and equipment manufacturers would be most willing to buy space in the mag. . . .

Jim W5SUC  
Ft. Rucker, Alabama

Dear Wayne,

I am very happy to hear about 73 Magazine, and I want to wish you every success. Your proposed editorial policy sounds like just what is needed in a ham radio magazine. I realize that I am probably in the minority, but I don't like to see ham radio becoming so "commercialized." Most beginning hams today seem to be concerned mainly with which factory built equipment to buy. Maybe they shouldn't be blamed for this, after being subjected to a barrage of advertising, but somebody should tell them that this is a technical hobby, and there won't be much justification for our use of the amateur bands if we degenerate into a bunch of "citizen's band broadcasters" who never build any equipment, and have to send the rig back to the factory for repairs. I hope 73 sells plenty of advertising space, but at the same time, if it can steer hams into doing more experimenting and construction work, I'm all for it. Please put me down as a charter subscriber.

I hope I have understood the first paragraph of your letter correctly, with regard to emphasizing technical and construction articles, and will be eagerly awaiting your first issue. I might even whip up a few articles myself for your consideration. Lots of luck!

R. V. McGraw W2LYH



# Modulation Fundamentals

Robert W. Schoening, W $\phi$ TKX  
10040 Brookside Avenue  
Minneapolis 20, Minn.

**M**ODULATION systems used by radio amateurs today are increasingly complex. Perhaps in attempting to understand them all, we have neglected the fundamentals. Whatever the reason, the bases of amplitude modulation are widely misunderstood. The same basic theory applies to all the variations of AM, no matter how many sidebands or carriers are transmitted. Here, then, is a review of the AM picture, with a glimpse of the future of radiotelephony.

First, let us define a few terms. "*Splatter*" is a somewhat ambiguous expression, but as used here it means "side-frequencies corresponding to components which are not present at the output of the modulator." Side-frequencies which correspond to audio frequencies which are not in the original intelligence, but are produced somewhere in the audio system of a radiotelephone transmitter, are not necessarily malignant, and will not be termed splatter here.

"*Carrier shift*" is a disease properly defined as any "change in carrier amplitude during modulation". In spite of widespread misinterpretations, there is a great deal of difference between carrier shift and simple asymmetry of the modulating function. Of course, carrier shift implies nothing with respect to carrier frequency . . . only its amplitude. "Positive carrier shift" is an increase in carrier amplitude during modulation, while "negative carrier shift" is the opposite. A change in carrier amplitude (in voltage or current) is indicated by a change in the *average* voltage or current output of the transmitter when amplitude modulated. Remember that while the rms antenna current (and hence the rms voltage) increases during modulation, and while the peak antenna voltage and current double on 100% positive modulation peaks, the average values should remain constant.

"*Downward modulation*" is negative carrier shift so severe that the decrease in carrier output is greater than the sideband power produced by modulation. With downward modulation a decrease in total power output occurs when modulation is applied and the antenna ammeter (or neon bulb) kicks down instead of up.

"*Radiated modulating power*" is a good description of sideband power. The more of this that actually gets to the receiver detector, the greater the volume of sound produced at the loudspeaker. In order to be useful, the audio produced at the receiver should be that which contributes to intelligibility. There are two types of sideband power which do no good: the power contained in sidebands which do not get to the detector due to receiver selectivity; and the power, which, when detected, merely excites the loudspeaker cone without contributing to the intelligibility. For this reason, simply increasing the radiated modulating power is no assurance that the signal will "get out" better. Even a decrease in total sideband power may improve signal reception on a selective receiver at a distant point, if the sideband components remaining are rearranged to do their job properly.

It is important to remember (as if the SSB contingent would allow us to forget) that the carrier's function in AM is only to accommodate the intelligence-bearing components. Leaving sideband power and distribution unchanged and increasing the carrier power will make absolutely no change in the volume at the receiver. Did you ever try this and find that the signal became weaker as you increased the carrier thus decreasing the modulation percentage? If so, you forgot to disable the avc, so that the receiver's gain was reduced as you fed in more carrier. There is some advantage, however, to a strong carrier. The signal will not overmodulate itself so



asily when selective fading is encountered at the receiver, and the heterodynes from adjacent carriers may seem less objectionable. There are, in spite of some semi-serious allegations to the contrary, absolutely no logical arguments in favor of reducing the carrier unless the power saved can be utilized in increasing the radiated modulating power, as with SSB.

Methods of extending the positive modulation peaks do not, as has been suggested, offer more sideband power without splatter; nor do they necessarily improve the received signal's intelligibility. Any system which produces carrier shift must produce splatter; moreover splatter may exist without carrier shift.

The normal dc plate input to the final radio frequency amplifier produces the carrier. For this reason, carrier shift can occur only if this dc power changes as the result of modulation, or if the efficiency of the modulated (or linear) amplifier does not behave according to the requirements for the type of modulation used. Since dc cannot "get through" a transformer, nothing we do in the audio system short of overmodulation can possibly cause carrier shift. No matter how lop-sided or distorted the modulating waveform becomes in the modulator, it cannot produce splatter as we define it. We automatically rule out defective modulation transformers, autotransformers and choke coupling, of course.

A pure ac wave is one which has an average value of zero because the two alternations enclose exactly equal areas. The two alternations need not be the same shape nor have the same peak amplitude; however if the peak of one alternation goes farther from zero than that of the other, the lower alternation's values stay near their peak longer. When such a waveform is used to modulate a radio frequency wave, the maximum increase and decrease in rf wave amplitude need not be equal, but if the increase (positive modulation peak) is greater, the decrease (negative modulation peak) must last longer. Since the average increase and decrease are then equal, the average amplitude of the rf voltage is unchanged from its unmodulated level—no carrier shift occurs. When we view "modulated envelope" patterns on an oscilloscope, we do not see the individual rf cycles, but only the envelope (whose height is proportional to the peak to peak rf voltage) as it varies in amplitude at some rate corresponding to the modulating function. The top or bottom outline of the envelope corresponds to the actual modulating waveform, whether or not this is the modulator's output waveform. A linear detector receiving the signal will produce an output voltage in this form.

If no modulation is applied, the rf envelope height remains constant as in Fig. 1-A. Fig. 1-B shows the envelope sinusoidally modulated at about 70%, and if nothing unsanitary hap-

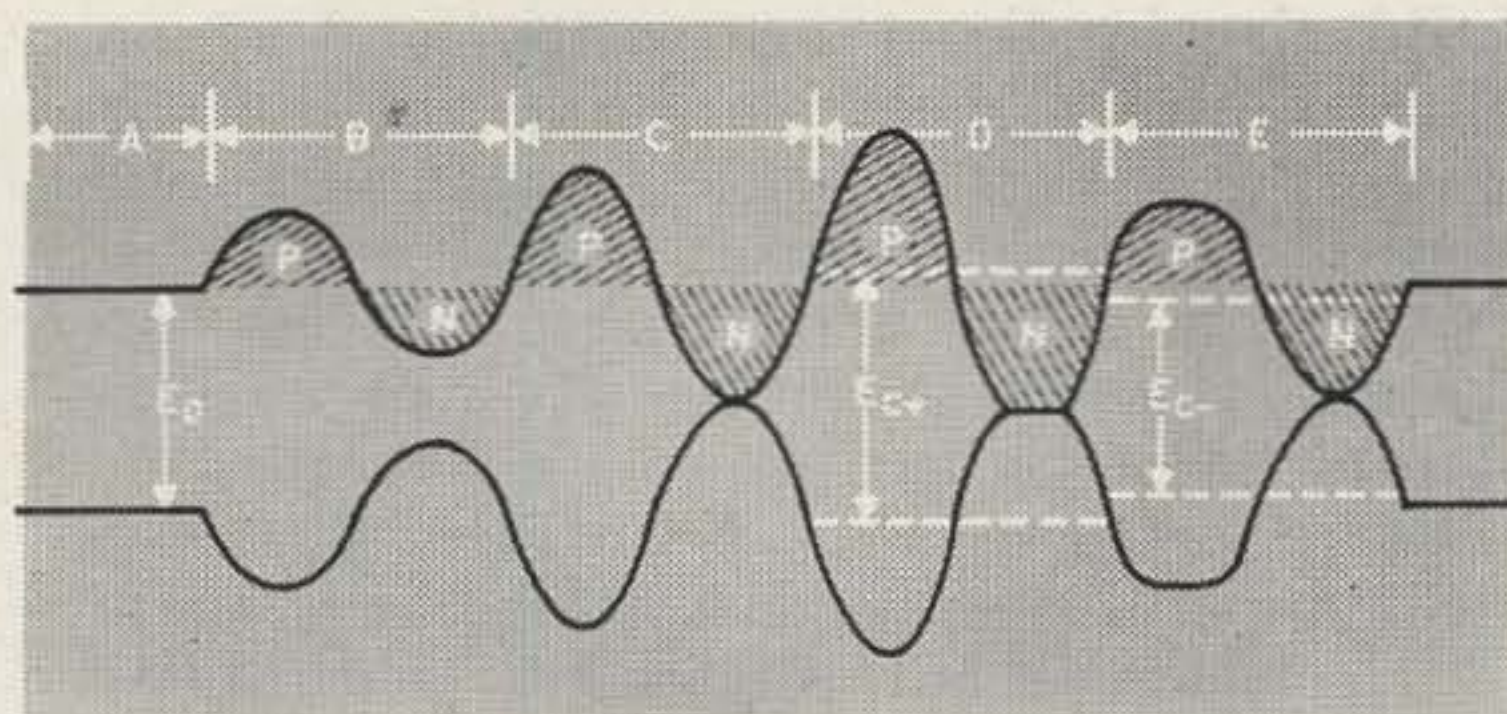

Fig. 1

pens in the process, the positive peaks (P) and the negative peaks (N) will include precisely the same area. The average height of the rf wave envelope is still  $E_c$ , just as it was with no modulation.

With a good transmitter, we should be able to increase the amplitude of the modulating signal to obtain 100% modulation (Fig. 1-C) while still maintaining an average amplitude of  $E_c$ : no carrier shift.

If the transmitter is capable of extended positive peak modulation (and few really are), a further increase in the modulation gives the pattern of Fig. 1-D. Here the transmitter shuts itself off for a brief portion of the negative peak, so that the positive peaks' areas (P) are greater than those of the negative peaks (N). Now the average rf amplitude increases to  $E_{c+}$ : positive carrier shift. The clipped negative peaks represent a source of vicious splatter. Their sharp corners correspond to modulating frequencies much higher than the actual output of the modulator, and the resulting sidebands are much farther from the carrier than normal. Modulating frequencies this high would not ordinarily be passed by the modulation transformer, so that the broadening will be more severe than that which audio distortion alone could cause.

If the transmitter distorts the positive peaks, splatter may also be produced. In Fig. 1-E the negative peak is the same as 1-C, but the flattened positive peak makes area P less than area N, so that a negative shift in carrier amplitude occurs, and the average rf amplitude becomes  $E_{c-}$ . Actually this flattening is usually more gradual than in 1-D, so the signal may not be quite as broad. It can still clutter up several adjacent channels, however.

Let us consider the causes of condition 1-E. First the flattening did not occur in the audio system, for if it had, the modulation transformer would have automatically made areas P and N equal and no carrier shift could have occurred. The wave might have looked almost the same on the 'scope, but the areas would have been re-distributed symmetrically around the average amplitude,  $E_c$ .

With plate modulation, positive modulation peaks occur when the positive audio alternation adds to the dc plate voltage to increase the plate voltage on the modulated rf amplifier stage. During this peak, plate current



should rise in direct proportion, and rf amplifier efficiency should remain constant. Insufficient reserve of cathode emission could prevent a linear increase in plate current. Perhaps the rf amplifier uses a screen grid tube and the screen voltage (which has considerably more effect on plate current than the plate voltage) is not being increased along with the plate voltage. Maybe the tube is running too close to cut-off bias, so that while it remains in class C on negative peaks (reduced plate voltages), it enters class B or even class A as the plate voltage rises. This could produce a drop-off in efficiency on the positive peaks. Remember that "cut-off bias" is proportional to plate voltage, so that an rf amplifier with bias beyond cut-off and 1000 volts on the plate may be running at less than cut-off when the plate voltage doubles as on positive peaks of 100% amplitude modulation.

A very common cause of negative carrier shift in this sort of stage is insufficient rf grid drive. Excitation may suffice for the normal unmodulated plate voltage, but on positive modulation peaks the limit of possible plate current (a function of load impedance and plate voltage) increases, so that more drive is necessary to maintain full plate efficiency during these peaks.

If Fig. 1-E represents the output of a linear rf amplifier or a grid-modulated stage, other causes suggest themselves. In these systems, the rf amplifiers' plate efficiency must approximately double on positive modulation peaks, so if the grid drive is too high, the unmodulated efficiency will run too high and the positive peaks must suffer. Some relief is available here by using a lower plate load impedance to raise the limit of plate current. By juggling drive and loading, we can usually restore the positive peak.

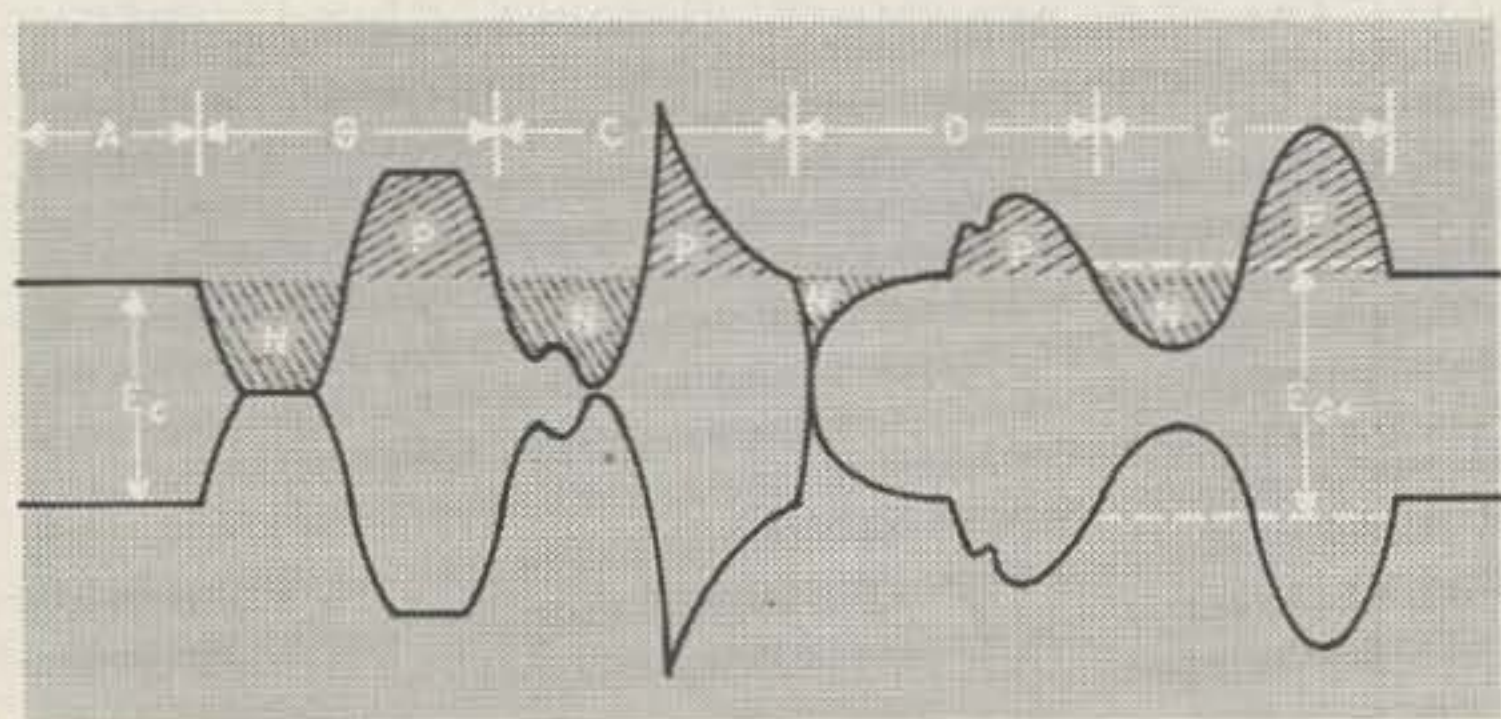

Fig. 2

Figure 2-B shows that two wrongs don't make a right. Here a rare combination of circumstances has resulted in overmodulation without carrier shift, since positive peak flattening exactly matches the negative clipping caused by overmodulation. The average rf amplitude is unchanged from its unmodulated value (Fig. 2-A). Splatter, however, is abundant . . . the modulator is putting out a sine wave. What if the modulator's output waveform actually was that shown? In that case we would have no splatter by our definition,

although the wave would occupy exactly the same spectrum and include the same interference potential. Remember, however, that modulation with this sharp-cornered waveform would be in some special service (hardly telephony unless the modulating frequency is a very low one), and a suitable spectrum assignment would be provided.

Figures 2-C and 2-D show the reasoning behind "extended positive peak" modulation. Voice and music modulation often produces waveforms with unequal peaks. Here a waveform of that type is shown; 100% modulating a radio wave, first in one polarity and then in the other. The drawing is intended to indicate that in both cases the positive peak (P) and the negative peak (N) include the same area. In Fig. 2-C however, the smaller peak is applied negatively, and (assuming again that the transmitter can handle the extended positive peak) modulation in the positive direction can actually exceed 125% without splatter. No carrier shift exists. If, as in Fig. 2-D, the modulating signal is applied in the opposite polarity, the gain control must be backed off, and the sideband power decreased accordingly to prevent negative peak overmodulation, carrier shift, and splatter. The correct polarity for your particular voice may be found by reversing any two wires in the audio system . . . or even, with some types of microphones, by speaking into the other side of the microphone. The pattern is most easily interpreted for voice modulation if a slow linear sweep (under 100 cycles) is applied to the horizontal plates and the transmitter's rf output sample directly to the vertical plates of the 'scope.

Even if your voice waveform exhibits as much unbalance as in Fig. 2-C, there is a very good possibility that your transmitter cannot handle the extension of positive peaks, for the reasons listed in reference to Fig. 1-E. If you decide to carry the extension farther than can be done by finding the favorable audio polarity, systems have been evolved where a sine wave output from the modulator causes extended positive peak modulation as in Fig. 2-E. We recognize this as carrier shift, and we must admit that it will produce splatter since the modulated wave outline does not conform to the modulator's output waveform. There is a possibility that, if not carried to excess, the spurious side-frequencies produced will not cause serious adjacent channel interference. We have no assurance that the additional sideband power that we attain in this way will not be objectionable, or that it will contribute to intelligibility at the receiver. Systems of this sort which have been suggested in amateur publications do not guarantee against adjacent channel interference even though the negative peaks are not clipped; nor do they put all the extra sideband power through the selective portions of the receiver.



er into the detector. Only by shaping the modulating signal *before* it gets through the modulation transformer, and by carefully distributing its content through the desired audio range can we be sure (assuming a healthy rf amplifier system in the transmitter) that by enhancing the sideband power transmitted, we really improve the signal.

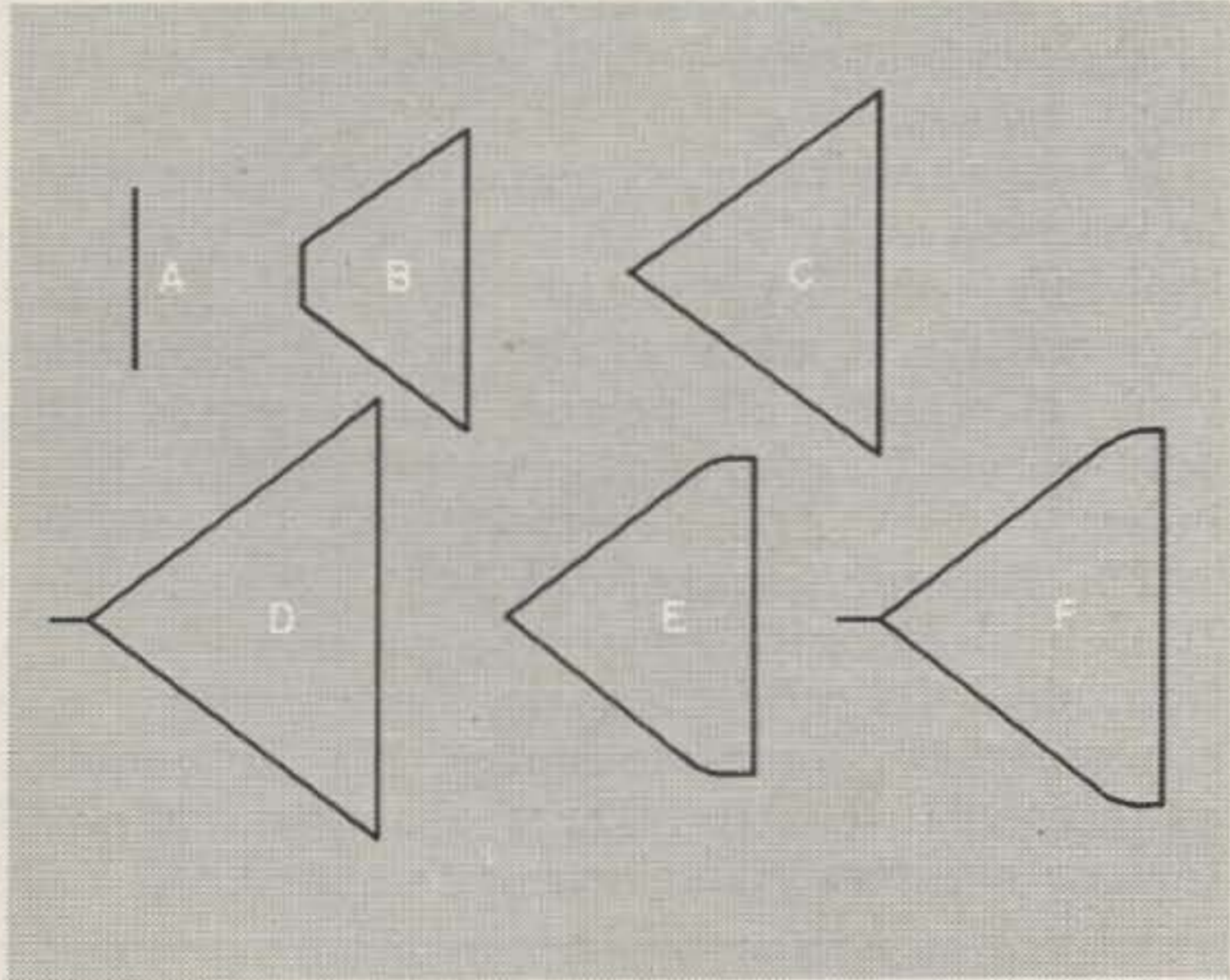

Fig. 3 — 1

Before we make any suggestions, let us review the 'scope patterns by inspecting their corresponding trapezoidal displays. Fig. 3-A, of course, represents the trapezoidal pattern for no modulation. Figs. 3-B, C, D, and E correspond to Figs. 1-B, C, D, and E respectively. Fig. 3-F shows the highly improbable case outlined as a modulated envelope in Fig. 2-B. Drawn to the same scale, Fig. 3-G, in its entirety, is larger (by the cross-hatched area) than 3-C. Due to the greater peak amplitudes obtained with the extended positive peak modulation encountered in the corresponding Fig. 2-C. The shaded triangle of 3-G shows the reduction of positive peaks necessary to prevent overmodulation with improperly polarized audio (2-D). You may have noticed that any bends or corners in the non-parallel sides of our trapezoid represent carrier shift. In 3-D, E, and F, the departures from linearity are abrupt. In 3-H, the bending is gradual, but carrier shift still exists, reflecting the condition (2-E) of artificially extended positive peaks.

Trapezoidal patterns are useful for monitoring voice modulation, but they must be produced correctly to prevent misleading indications. If the audio wave used for horizontal deflection is taken from any point in the audio system other than the secondary of the actual modulation transformer, non-linearities may appear which do not indicate carrier shift. If, on the other hand, the audio deflection is obtained from a detector which rectifies the rf signal, perfect linearity might be indicated even though carrier shift exists. It is often inconvenient or even dangerous, especially with plate modulation, to sample the

secondary of the modulation transformer, but this is the only way to get a coherent trapezoid. Readers unfamiliar with these common 'scope displays are advised to look up the connections required in any reference book or handbook covering radiotelephony, and to examine the corresponding patterns shown here, piece by piece, until the relationship is clear.

How can we increase our radiated modulating power without producing side frequencies which are either redundant or unsportsmanlike? It must be done within the audio system, and our old friends clipping and filtering seem to offer the best path for telephone communications. Filtering alone can improve intelligibility by removing lows (long on power which clutters up your audio channel's capabilities, and short on intelligibility). The experts recommend taking out everything below 300 cycles. If this is done, your voice quality will not be appreciably affected, but you will be able to advance the gain control to get more sideband power corresponding to the important audio areas. If you want to go all the way (good for DX but a little extreme for local rag-chewing), attenuate everything below 800 cycles.

Removing the high frequencies above 2500 or 3000 cycles should be done at the last possible point in the audio system; the modulation transformer. This will not, in fact, affect the sound of your voice noticeably—try singing 2500 cycles and see. The components filtered out will be, for the most part, distortion products. If filtering takes place too early, subsequent audio stages may re-introduce high frequency distortion components which while not splatter (by our definition) can cause side-frequencies which your neighbors will resent. Most communications-quality modulation transformers drop off quite well by themselves around 5000 cycles, so "building out" the windings with a bit of shunt capacitance can take care of the highs; especially if low-level filtering is also employed.

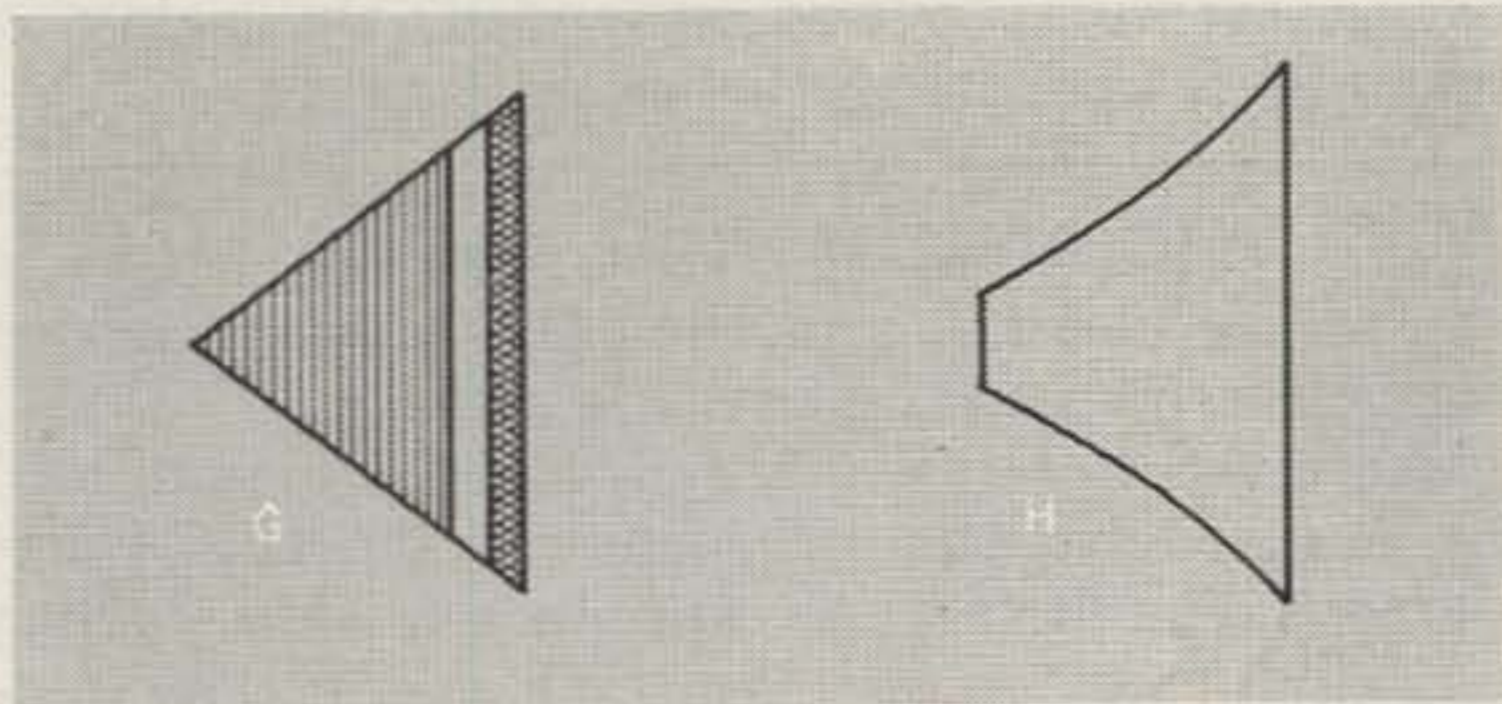

Fig. 3 — 2

Peak-clipping can give tremendous sock to a signal, by increasing average sideband power to a level which would require perhaps ten times as much carrier power were clipping not employed. Volume compression without clipping (as used by broadcasters) can at

(Continued on page 54)



#### (AUDIO BOOSTER from page 9)

fect balance to begin with, oscillation will develop. Adjust R13, the balance control, until the howls stop. Advance R1 some more, re-adjusting R13 as necessary, until it becomes impossible to stop oscillations by adjusting R13. This will mark the usable limit of the Booster's gain.

Adjust your transmitter for 100 percent modulation on peaks, using your favorite method of monitoring modulation depth. Then remove the short from the Booster's AGC line and connect it to the microphone input using a Y-type connector. Set the limiting threshold control, R12, at maximum resistance.

Say a few words and check modulation depth. Advance R12 toward minimum resistance until your voice begins to sound like a

<sup>3</sup>At this point, your voice will have long since ceased to sound natural. Our objective in this adjustment is to set the limiting threshold so that the booster completely washes out all amplitude variation in the signal (see note 1). Operating adjustment to regain naturalness in the voice is made with R1.

#### (POWER SUPPLY from page 27)

A circuit breaker device is used for power supply protection when the supply is used on the 120 volt ac line. If a short should exist in your equipment, loading the supply too heavily, it will cut out, removing the ac supply voltage. To reset it, simply press the bottom on top of the cut-out. On dc operation a fuse is used instead. The circuit layout is not at all critical, though the wires from UHF jacks to the relay should be kept short.

Notice that all outputs from the supply, (filament and B+ voltage, as well as relay), are brought out of the supply through the use of a 6 terminal Jones socket. Terminal #6 is used to control the B+ - Antenna change over relay. If you desire to operate the change over relay from a location other than the chassis of the supply it is only necessary to connect a lead from #6 through a switch to ground. When terminal #6 is grounded, the relay is energized, operating the changeover.

#### (CONVERTERS from page 15)

the mixer coil L3, and then the antenna series capacitor C1 and the cathode coil L1.

After you have aligned the unit you will be amazed by the performance of this inexpensive converter. As simple as it is, it has out-performed many fancy brothers using expensive tubes and many more components.

The noise generator, using a 5722 Sylvania diode, used for evaluation was built and carefully calibrated by the author, using the circuit and method of calibration from the VHF handbook by William I. Orr and H. G. Johnson. The sensitivity tests were made with a Measurements Corporation signal generator Model 80.

monotone without inflection<sup>3</sup>. Lock R12 at that position and advance R1 toward minimum resistance until the sound of your voice is satisfactory again. All operating adjustments after initial calibration are made with R1, which can be marked in db. of limiting if desired. At minimum resistance of R1 the Booster is effectively out of the circuit, while at the maximum usable setting compression ratio will be in the neighborhood of 25 db (depending upon your mike).

If you're using a scope to check your modulation, you should at this point be able to see the difference between the modulation percentage with and without the Booster. So far as your effective talk-power is concerned, that gets boosted right along with the modulation index.

The Booster is not limited to AM use, either. It will work with any type of voice modulation, since its only effect on the waveform is to compress the dynamic range. No distortion is generated in the Booster; consequently, no filters or splatter chokes are necessary. [7] [3]

The change-over relay, which is a 6 volt dc type, operates on any of the three input voltages. This is accomplished with a miniature power supply to furnish the proper voltage. Looking at the diagram you will see that a small rectifier, X1, is connected to the 6 volt winding of the power transformer, T1. On 120 volt ac operation, the 6 volts ac is rectified by X1 and filtered into good dc by R2 and C4 for the relay. On 6 and 12 volt dc operation, even though no filament voltages are furnished by the power transformer, X1 and its filter circuit is still receiving 6 volts ac, permitting operation of the relay on all three input voltages.

The power supply shown has been used in both 6 volt and 12 volt cars and in a 12 volt airplane! It has been used extensively on 120 volts ac as well. Neither the vibration of mobile operation, nor the constant changing from one input supply voltage to another has caused any trouble with the unit. [7] [3]

Tests performed and evaluated on many typical converters in the frequency range of 220, 144, 108, and 50 mc the averages are as follows:

FREQUENCY	NOISE FIGURE	SENSITIVITY
220 mc	5½ db	.2 µv
144 mc	4½ db	.1 µv
108 mc	4 db	.1 µv
50 mc	3½ db	.1 µv

In conclusion the author wishes to extend his thanks to Joe Kwetnewski W9UTD for his excellent photography. [7] [3]

COIL DATA is on page 47 —————>



**CAPACITOR VALUES  
FREQUENCIES OF CONVERTERS  
(W9DUT CONVERTERS)**

C	M.C. 220	M.C. 152	M.C. 144	M.C. 108	M.C. 50	50 M.C. and Lower		TRIMMER
C 1	4-35	4-35	4-35	4-35	4-35	MMF	CERAMIC	
C 2	270	470	470	.001	.001	RMC	TYPE B	
C 3	.001	.001	.01	.01	.01	"	" B	
C 4	270	470	470	.001	.001	"	" B	
C 5	13	15	27	33	50	"	" NPO	
C 6	.001	.001	.001	.01	.01	"	" B	
C 7	.001	.001	.001	.01	.01	"	" B	
C 8	.001	.001	.001	.01	.01	"	" B	
C 9	.001	---	---	---	---	"	"	
C10	.005	.005	.01	.01	.02	"	" B	
C11	25	---	---	---	---	"	"	
C12	---	25	33	50	50	"	" NPO	
C13	---	470	470	680	.001	"	" B	
C14	---	.005	.01	.01	.02	"	" B	
C15	.001	.001	.001	.001	.001	"	" B	

**RC COMBINATION**

R-	68Ω	68Ω	68Ω	68Ω	68Ω	(R. F. AMPLIFIER) (CATHODE BIAS) (AND MIXER BIAS)	
C-	270	470	470	.001	.001	RMC	TYPE B

**RESISTOR VALUES  
ALL RESISTOR 1/2 WATT**

**COIL DATA**

Coil	Res. Freq. M.C.	No. Turns	Wire Size	Length of Winding	All Coil Forms CTC Slug Tuned	
<b>(220 M.C. CONVERTER)</b>						
O.D. Inches						
L1 1/4	220	3	#22	1/4"	Space	wound (Tap at 1 1/4T)
L2 "	220	2 1/2	"	1/4"	"	"
L3 "	220	2	"	3/16"	"	"
L4 3/8	13	45	#30		Close	(2T Link at Cold End)
L5 1/4	207	4	#22	5/16"	Space	"
L6 "	34.5	23	#30		Close	"
L7 "	103.5	4	#24	5/16"	Space	"
<b>(144 M.C. CONVERTER)</b>						
O.D. Inches						
L1 3/8	144	3 1/2	#22	5/16"	Space	wound (Tap at 1 1/4T)
L2 "	144	3	"	1/4"	"	"
L3 "	144	4	"	1/4"	"	"
L4 "	14	40	#30		Close	(2T Link at Cold End)
L5 "	130	4 1/2	#22	1/4"	Space	"
L6 "	43.+	12	#24		Close	"
<b>(152 M.C. CONVERTER)</b>						
O.D. Inches						
L1 3/8	152	3	#22	1/4"	Space	wound (Tap at 1T)
L2 "	152	2 1/2	"	1/4"	"	"
L3 "	152	3	"	1/4"	"	"
L4 "	13	45	#30		Close	(2T Link at Cold End)
L5 "	139	4	#22	5/16"	Space	"
L6 "	46.+	10	#24		Close	"
<b>(108 M.C. CONVERTER)</b>						
O.D. Inches						
L1 3/8	108	6	#22	3/8"	Space	wound (Tap at 2T)
L2 "	108	5	"	3/8"	"	"
L3 "	108	7	"	3/8"	"	"
L4 "	14	40	#30		Close	(2T Link at Cold End)
L5 "	94	6	#24	3/8"	Space	"
L6 "	31.+	26	#30		Close	"
<b>(50 M.C. CONVERTER)</b>						
O.D. Inches						
L1 3/8	50	10	#24		Close	wound (Tap at 3T)
L2 "	50	12	"		"	"
L3 "	50	12	"		"	"
L4 "	14	40	#30		"	(2T Link at Cold End)
L5 "	36	16	#24		"	"
L6 "	36	11	"		"	"



**6****10****15****20****meters**

With the *Exclusive*  
**MINI-PRODUCTS' 4-BANDER**

*Featuring --*

4 BANDS ..... Small size . . .  
 Light enough for any  
 TV Rotor .....

**Model B-24**  
**2 elements**

Amateur Net  
**\$54.95\***

*Features*

- Four Bands — 6, 10, 15, 20
- Maximum element length 11'-6", boom 6'-10"
- Turning radius 7'
- Weight — 11 lbs.
- Gain — comparable to any antenna of equivalent size
- SWR — Less than 2:1 on all bands
- 6061-T6 aluminum elements and boom
- 1" diameter elements for maximum band width
- Can be assembled in smallest garage

†Patent Pending

• For the ham with limited space and those desiring maximum efficiency in the smallest size, Mini-Products takes pride in introducing the *first* truly Miniaturized multiband antenna, using the new Multiple-Hat principle† a new concept in Multiband antennas which provides coverage of any number of bands within a two octave range with a single antenna.

End loading employed on all bands—universally accepted by antenna designers as the most efficient method of miniaturizing and maintaining the high radiation resistance and radiator current necessary for effective radiation.

**Model M-4 MOBILE**

Amateur Net **\$16.95\***

*Features*

- Four Bands — 6, 10, 15, 20
- Overall height — 5'-8"
- Up to 5 db. gain over base loaded antenna's of equivalent height
- SWR — Less than 2:1 on all bands
- 1" diameter Radiator for maximum band width
- 3/8-24 base stud — Fits all standard mobile mounts

\*NOTE—Pennsylvania residents add 4% Sales Tax

**Mini-Products, Inc.**

Ask for them at your favorite distributor or order direct from:  
 1001 WEST 18th ST., ERIE, PENNSYLVANIA







(CAPACITY METER from page 41)

current indication on the meter, the exact value depending upon the supply voltage, the capacity of Cx, and the rate at which this charge and discharge effect takes place.

In order to protect the meter from damage due to shorted capacitors, CR3, a silicon diode biased in its forward conduction direction, was included. This limits the maximum voltage across the meter to about 0.5 or 0.6 volts. The meter movement itself was thus protected, but spikes due to the capacitor charge caused erroneous readings when the diode conducted prematurely. To prevent this, C13 was included, and in addition C13 provides damping which further prevents meter damage.

In actual use, the range switch is set to a position which gives an on-scale reading. The power switch is then set to CALIBRATE, and R5 is set to give a reading of 100. Then switch back to ON, read the meter, and use the appropriate multiplier indicated on the range switch. Since leaky capacitors would give erroneous indications, a leakage test position was included on the range switch. For this test, Q1 is cut off, Q2 conducting, and the full battery voltage connected across J1 and J2. Any indication of course means a defective capacitor.

### Construction

The entire circuit including the battery and a 4½ inch panel meter was built into a 3 x 4 x 5 inch LMB chassis box. Most of the components were mounted on a piece of 1/16 inch

epoxy glass board, using eyelets and jumper wires. Use of 100 volt rating capacitors helped cut down the size. The 9 volt mercury battery was mounted in a clip from a cabinet latch. The current drain is in the order of 20 ma, and the required voltage slightly above 6 volts, so a 7.5 or 9.0 volt dry battery could be substituted if desired.

The range switch, S2, should be of the shorting type to prevent the multivibrator from stopping when switching ranges, which would require turning the power switch off, then on again. Aside from the usual precautions to observe polarity of the diodes and battery, the only critical wiring is in the need for short direct leads to J2 from the power switch, and from the power switch, S2, to CR1 and CR2. The capacity of the lead to the standard 100 mmfd capacitor, C12, was about 3 mmfd in the authors instrument, and was allowed for in the selection process. The standard capacitors (C9-10-11-12) were measured on an accurate bridge, and were padded where necessary to obtain the correct value. All other capacitors can be whatever is on hand in the range required, either paper or mylar dielectric type being suitable. For reduction of stray capacity effects a ground from the meter circuit to the case is quite essential. Only type 2N414 and 2N247 transistors have been tried, but similar types should be satisfactory. The silicon diodes recommended for CR3 were the least expensive available, and other types should do as well. Use of decals helps improve the appearance and operating convenience of the unit, but if the meter case is opened, use care to avoid dust or other damage. [7] [3]

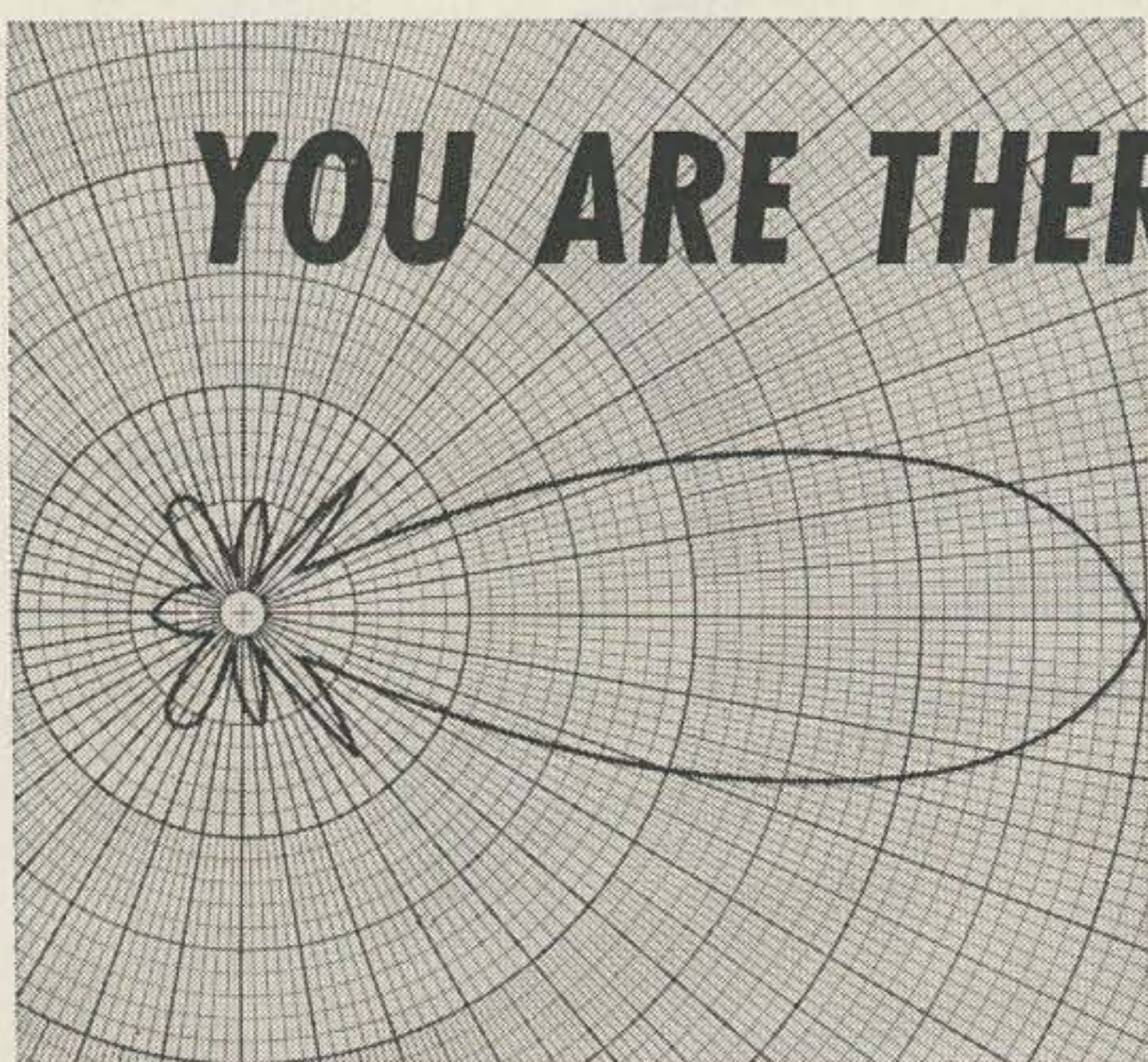

**YOU ARE THERE!**

with *Telrex*

**“TRI-BAND”  
SYSTEMS**

There's long term dependability, scientific leadership, world-wide respected performance plus quality of material too, at a price even the modest budget can afford.

**Enjoy superior performance . . .**

You're always a "step ahead" with Telrex. Arrays available from \$5.95 to \$12,000. Dollar-for-dollar better in every way. Send for technical bulletins, today!



*Telrex* LABS.  
COMMUNICATION & TV  
ANTENNAS SINCE 1921

ASBURY PARK 40  
NEW JERSEY, U.S.A.

Telephone:  
PRospect 5-7252



# SOLAR SYSTEM VI

## SIX METER TRANSCEIVER

### RECEIVER

Better than  $1/2$  microvolt sensitivity.  
10 kc selectivity (6 db down).  
Double conversion for selectivity, image rejection.

Voltage regulated oscillators for stability.  
Up to 5 watts audio output for external speaker.

Self contained speaker.

Large 6:1 vernier dial for easy tuning.

Jack for headset output.

Built-in noise limiter.

Spotting switch for zeroing receiver and transmitter.

### TRANSMITTER

12 Watts input to a 5763.

High efficiency plate and screen modulation for maximum "punch."

Uses popular and inexpensive 8 mc crystals (FT-243 holders).

Provision for VFO operation.

Press-to-talk.

Metered.

Microphone: crystal, ceramic or carbon

50-75 ohm output (will match standard auto receiving whip).



# SOLAR ELECTRONICS

Corp. 149 Wooster Street  
New York 12, New York



## New York Convention

October 15th

The Hudson Amateur Radio Council is masterminding the first ham radio convention in New York City in well over ten years. While this is billed as a Hudson Division ARRL Convention, it is actually expected to be larger than even the biggest of past National ARRL Conventions.

There will be a full day of technical discussions and forums on just about every amateur specialty and interest (RTTY-SSB-VHF-Antennas-ARRL-YL-CD-MARS-Traffic-DX-etc<sup>2</sup>). Most of the major manufacturers of ham equipment will be there to explain the details of their latest pride and joy. Prizes? Wow! The whole works will culminate in a banquet with Jean Shepherd K2ORS as Master of Ceremonies and Bill Orr W6SAI as the major speaker.

See you all October 15th, Statler-Hilton Hotel, starting at 9 A.M. 73 will have a booth where you can bring friends and get them to subscribe to 73.

### SIX METER RECEIVER

MODEL 505A—50-54mc

*Here's the ideal low-cost receiver to start your six or two meter station*

- Excellent sensitivity with stable superregenerative detector
- Built-in 110 volt AC power supply
- Fully transformer operated, no voltage doubler
- Compact, fully enclosed in cabinet—only 3 inches high
- RF stage for increased sensitivity and isolation
- Send-receive switch for muting receiver
- Band set capacitor for full 4mc bandspread
- Features stable operation and dependability

Model 505A, 506A, KIT, complete as above: \$29.95 • WIRED: \$49.95

**MOBILE OPERATORS:** Model 505A, 506A are available with mobile power supply instead of AC supply at slight additional charge.

*Send for data on the complete line of NEIL 2, 6 and 10 meter fixed station, mobile, and portable receivers, transmitters and transceivers.*

SEE YOUR DEALER, OR ORDER FROM

**THE NEIL COMPANY**

1336 Calkins Rd. • BAker 5-6170 • Pittsford, N. Y.

### TWO METER RECEIVER

MODEL 506A—144-148mc

**\$29<sup>95</sup>**

*only 3 inches high*





# HAMMARLUND HX-500

## SSB TRANSMITTER



**\$695.00** Amateur net.

ASK YOUR DEALER—  
OR WRITE FOR DETAILS



Established 1910

# HAMMARLUND

MANUFACTURING CORPORATION, INC.  
460 W. 34th STREET, NEW YORK 1, N. Y.

A DIVISION OF TELECHROME

- A 100-watt SSB transmitter for amateur and commercial use on the 3.5, 7, 14, 21 and 28 to 30 MCS bands.
- Separate dial scale for each band, or portion of 10  $\lambda$  band.
- All crystal included for all amateur bands — nothing extra to buy.
- Frequency readability to 200 cps, or better.
- Stability after warm-up better than 100 cps.
- Provides choice of upper, lower, double sideband, CW, FM, FSK for RTTY plus 40 cycle identification keyed shift.
- ALC adjustable to prevent overdrive.
- 50 ohm fixed pi output.
- Built-in antenna changeover with receiver antenna input connection.
- Adjustable RF level controls output power when employed with high power linear.
- Carrier suppression 50 db or better.
- Unwanted sideband suppression 50 db or better.
- 3rd and 5th order distortion products down 30 db or better.
- Spurious frequencies down 50 db or better.
- T.V.I. suppressed.
- VOX and anti-VOX controls conveniently located on front panel.
- Key and mike input provided on front panel.
- RF level meter range 60 db with adjustable sensitivity control.
- Self-balancing diode balanced modulator.
- Overall audio response 300 to 2300 cps.
- Shaped CW keying.
- FM-FSK center frequency adjustment on front panel.
- 60 kcs filter type SSB generator.
- Provision for metering final plate current.
- Unitized construction.



TAPETONE'S NEW  
WTC-432,  
3/4 METER,  
LOW-NOISE,  
CRYSTAL  
MIXER  
CONVERTER



**NEWEST  
CONVERTER  
ON THE MARKET . . .**

This advanced design approach, seldom used by amateurs but widely used in commercial UHF receivers, achieves outstanding performance. It consists of a double-tuned cavity preselector, followed by a crystal mixer and low-noise IF preamplifier.

**SPECIFICATIONS:**

NOISE FIGURE: 6.0 DB  
GAIN: 20 DB  
IMAGE REJECTION: GREATER THAN 50 DB  
IF REJECTION: GREATER THAN 80 DB  
TUBE COMPLIMENT: 1N21E, 6BC4, 6BC4,  
12AT7, 6AK5

**STANDARD MODELS AVAILABLE:**

WTC-432 IF OUTPUT FREQUENCY 50-54 MC.  
WTC-432A IF OUTPUT FREQUENCY 51-55 MC.  
WTC-432N IF OUTPUT FREQUENCY 30.5-34.5 MC.  
WTC-432C IF OUTPUT FREQUENCY 28-32 MC.

PRICE \$119.50 (ANY MODEL)

ALSO AVAILABLE: WTC-1296, PRICE \$134.50

**TAPETONE, INC.** 10 ARDLOCK PLACE,  
WEBSTER, MASS.

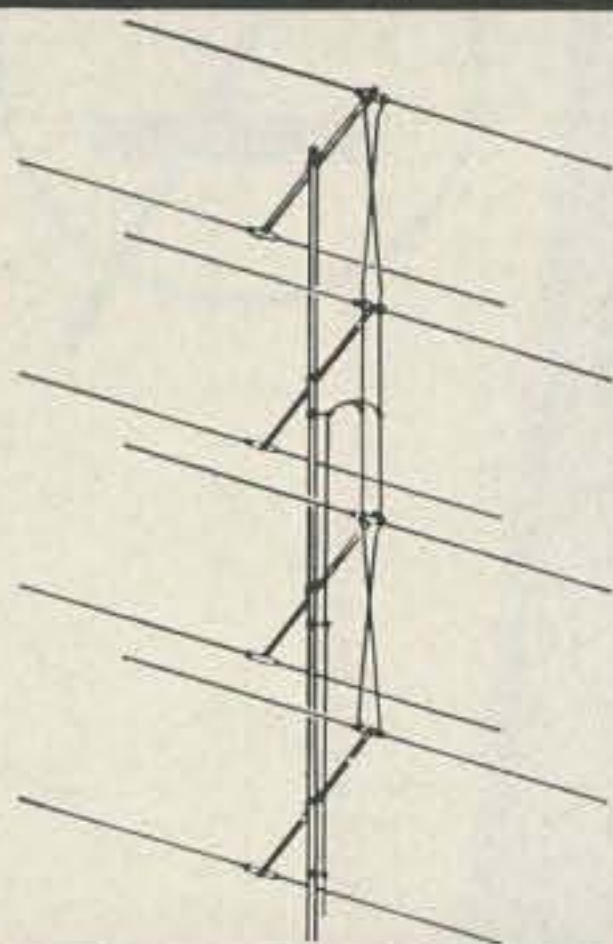

**NEW**

**VHF**

**COLLINEAR ARRAYS**

430 Mc. 16 El. \$ 9.85  
220 Mc. 16 El. 12.85  
144 Mc. 16 El. 16.00

also available with  
32 and 64 elements

SEE YOUR DISTRIBUTOR or  
write for free catalog

**CUSHCRAFT**

621 HAYWARD ST.  
MANCHESTER, N. H.

**SURPLUS BUYS**

RG-8/U Co-Ax Jumpers (2 ft.) W/PL259 on ea. end.3 for \$2.00  
Panel Meter 0-200 Mil D.C. 3" Round—New ..... \$3.95  
Panel Meter 0-200 Mil D.C. 3" Round—New ..... \$3.95  
Snap-out Antenna—An-131A—13 ft. Extended ..... \$1.00  
Acorn Tubes—954, 955, 956—Any six ..... \$1.00  
OB-2 Miniature VR Tube ..... 3 for \$2.00  
Audio Amplifier BC 1141-C—W/case, schematic, tubes.. \$2.95  
BC-733—10 Tube UHF recvr—compl. W/tubes, dyna. and  
conversion (C. Q. Mag.) for 2 and 6 meters. 12x7x15.  
Clean ..... \$5.95  
2 Volt Plastic Case Wet cell. BB-S4A—Shipped dry—New \$2.95  
Carter 6V. Dynamotor—405V.—270 Ma. Br. new. 7x4x3.. \$5.95  
Kellogg Hand Set (Grey) Brand new type W/coil cord.. \$5.95  
Telephone Dial—Standard—Latest type—New. .... \$3.95  
Relay—12VDC—DPDT—Sealed—Clare SK-13001—New... \$1.95  
Relay—11,000 ohms—DPDT—Sealed—Hughes 950016  
(Pulled, new gear) ..... \$1.95  
Relay—12VDC—DPDT—Open Frame. Price 901—New.. \$ .69  
Relay—6VAC—DPDT—Open Frame. Kellogg ..... \$1.49  
Relay—5,000 ohms—DPDT—Open Frame. Kellogg ..... \$1.89  
Relay—24VDC—4PDT—Sealed—26SA12A—Pulled—New . \$1.95  
Relay—26.5VDC—DPDT—Sealed—Allied MHX-61—  
Pulled—New ..... \$1.95  
Earphones—10,000 ohms—Murdock H-58/U—New/w PL-55 \$2.95  
Earphones—300 ohms—HS-30 (plug into ears)—New.... \$1.29  
Selsyns—115v-60 cy—Type 6G—Heavy Duty—Clean—Pair \$5.95

**REX RADIO SUPPLY** 84 Cortlandt St., N.Y. 7, N.Y.

**(PHONE PATCH from page 24)**

be used. Occasionally during the excitement of hearing from a friend or loved one, the person may blurt out some expression that violates the FCC rules. If this happens, "hit the switch", then firmly but courteously inform him of the regulations regarding such action.

Try not to let the conversation drag. Once in a while a little well timed prompting on your part will eliminate the long and embarrassing pauses that appear when the parties are not used to the "phone patch" system.

Upon conclusion of the patch, again assure the person that there is no charge or obligation involved and that this service is part of the enjoyment that you and your fellow operators get from their hobby.

As to "phone patch" procedure, this may vary between stations. However, the most practical for AM is to have each party say "over" as he finishes talking. This signals each operator to switch from "send" to "receive" without the necessity of signing each time.

Patches should have a reasonable time limitation. If the traffic is of a critical nature and time consuming, don't forget to break for station identification at the proper period of time.

Since the advent of the "phone patch", many operators have been personally involved in dramatic and touching situations. This is especially true of the patches run between members of our Armed Forces and their families at home. From both a technical and service standpoint, each amateur operator should attempt to handle "phone patch" traffic with all the efficiency and courtesy possible. Here again is another chance to benefit humanity through the most fabulous hobby of all—Amateur Radio. [7] [3]

**(MODULATION from page 45)**

least double the radiated modulating power without objectionable distortion. In either case, the modulator will be furnishing more average power than if no limiting were employed, so that extra power-handling capability must be available in the audio system. Normal design limits usually allow your modulator at least 3 db of this reserve without modification.

When clipping is used, filtering must follow to ease the rate of change represented by the flattened audio peaks. When carried to an unusual degree, audio quality becomes less pleasant at first, (who wants to sound pleasant and be buried by QRM?) and then intelligibility begins to suffer. Going beyond this point is useless when the signal is received normally, but there is some indication that a special translation system used at the receiver can reclaim speech waveforms clipped well beyond intelligibility. Perhaps this is a route worth exploring for future applications.

With single-sideband suppressed-carrier radiotelephony, the clipping and filtering tech-



niques are even more rewarding, since the additional radiated modulating power is concentrated in one sideband where most of it must find its way to the detector which will then give even more push to the loudspeaker cone.

What other means might we find to narrow and intensify our radio telephone signals? What about suppressing the audio carrier generated by your vocal chords? Speech, when analyzed, consists of the generation of an audible tone which is amplitude, frequency, and phase modulated, simultaneously, at a syllabic rate. The syllables themselves are sub-audio and if only their information were transmitted our radio telephone signals could be as narrow as fast telegraphy. Speech can be re-built around a mechanically-generated tone as is done by persons whose vocal chords do not function. This sort of speech is monotonous, but perfectly readable. The main obstacle with transmitting only the syllabic information and re-inserting the audio tone at the receiver is the loss of un-voiced sounds: the hissing and clicking which contributes to intelligibility, and requires a wider-range audio system than purely syllabic modulation would allow. At any rate, here's a project to consider.

Already with us is the multiple channel AM transmitter which can use a single carrier for several simultaneous communications. Present bandwidth requirements for these systems are quite reasonable. The Kahn AM stereo system for example, occupying no more spectrum than a single dual-sideband station modulating with similar audio frequencies. Broadband systems such as FM broadcasting and television, permit the use of subcarriers (as with FM multiplexing or color television) for a considerable quantity of useful information, and with no increase in bandwidth. Amateurs haven't found much use for these techniques yet. Perhaps some of the ham families could use a single transmitter with channels labelled "his" and "hers".

Let us, first of all, concentrate our intelligence-bearing sidebands into as narrow a band as possible, and put as much power as possible into this band. This should be done before the modulation transformer. The time is here when, even with a single sideband, we must do this to keep pace with the competition. As present techniques become fully exploited, let us thoroughly analyze any new ideas which come along and even develop systems of our own. With present communications speeds in the thousands-of-words-per-minute rate available, it's hard to justify even a six kilocycle bandwidth for simply talking. The CW operator is an artist who does not have to justify his methods on scientific bases. The phone man, however, should have some technical achievements of which he can be proud. Let's get busy: don't wait for the commercial manufacturers to do it! [72]

## SPECIALS FOR THE MONTH

**Prop-Pitch Motors.** Large type. These units are the heaviest type of the 3 sizes which were formerly available. (FOB, Ga. via economical motor freight) \$39.00.

**Mobile Transmitter . . .** Uses 5618 crystal oscillator into CBS-5516 amplifier. Modern design. Only 7 lbs. net wt. including built-in enclosed in aluminum cabinet (5½"H x 8"W x 8"D). Furnished w/crystal that doubles near 10 meter band. Requires slight & easy modifications for 10 meter operation. A real deal. \$13.95.

**VHF Transmitter . . .** Perfect for 2 meter and/or 1¼ meter conversion. Late, modern design. Uses two 6201's into single Amperex 6360 twin tetrode. Xmtr only 4" x 4" x 11". Only 3¾ lbs. See Sept. 1960 issue of "CQ" magazine (Page 82 & 83) for detailed conversion to 2 meters. Get 20 watts on 2 meters with ease. This is the best value we have ever had. Furnished complete with Battery pack and connection cable. \$15.00.

**The Whole Wide World or USA in third dimension.** Beautiful colored plastic relief maps. Self-framed. Ideal for Den or Shack. Conversion piece. Educational. 28½" x 18½" . . . \$9.95, 26" x 41" . . . \$24.95, 42" x 60" . . . \$49.95. (Specify USA or World Map.)

**Glas-Line.** Non-Metallic Guy Line—Perfect flexible insulator—Revolutionizes Ham Radio & TV Antenna Systems. (Eliminates need for Glass "Break-up" insulators.) 100' Spool \$3.75, 600' Reels \$17.84.

**Brand New B & W Model 381 TR Switch.** Perfect for SSB or CW Break-In. Matches 52-75 Ohm coaxial line. Handles full KW. Switchable Band change for optimum performance. 80-10 Meters. \$60.00.

**New B & W Converter Transformer Model TT-120W.** Rugged precision xfmr for home-built Power Supplies. 12 V. input. 120 Watts. 500 V. @ 200 Ma. (Bridge Rectifier), or 250 V. @ 200 Ma. (winding C.T.) or a combination of both voltages using a maximum of 120 watts of current. \$15.25.

**Hammarlund Receivers in stock HQ100C, HQ110C, HQ145C.** Brand new. Excellent trade-ins offered.

Thousands of electronic TUBE TYPES IN STOCK. SEND US YOUR TUBE REQUIREMENTS AND WE WILL QUOTE.

SEND FOR OUR LATEST CATALOG.  
... FULL OF BARGAINS ON HAM  
GEAR, COMPONENTS, TUBES, ETC.

**BARRY ELECTRONICS CORP.**

512 Broadway, N.Y.C. 12, N. Y. Dept. 76



## Technical Broadcasts

The Air Force MARS has a very interesting technical series going every Sunday afternoon. This month the subject is semi-conductors. Time: 2 pm to 4 pm. Tune in and listen. The frequencies are: 3295 kc, 7540 kc, and 15,715 kc.

- Oct. 2—Walter S. Miller (Arma Corp.), The Diode
- Oct. 9—C. D. Simmons (Philco), Transistor Parameters
- Oct. 16—Bud Merrihew (Philco), Transistor Circuits
- Oct. 23—John Ekiss (Philco), Tunnel Diode Applications
- Oct. 30—Charles Gray (Philco), Transistor Applications

(ELECTRONIC KEY from page 19)

practical in a single unit. With the components shown in the circuit diagram, the speed range of the unit is approximately 10 to 25 wpm. Speeds above this range may be obtained simply by changing the component values of the time constant circuits forming the characters. A switching arrangement could be inserted to perform this function, but for simplicity sake it was omitted (and 25 wpm is almost my tops anyway!).

2. When changing speeds, all three potentiometers must be adjusted to ob-

tain the desired speed and weight of keying at the chosen speed. If the controls were ganged, the unit *would not* be as versatile.

3. Potter & Brumfield LM-11 (5K coil) relays are used in my particular unit. However, any high speed plate relay with a high impedance coil should operate satisfactorily. Relays with tail spring adjustments should be used so that additional control of the pull-in and drop-out point of the relays may be obtained when adjusting the key, prior to using it on the air.
4. When all relay adjustments have been completed the adjustments should be locked with a drop of glue.

The unit shown in the photograph is built on a 5"x7"x2" chassis. The cabinet is home brew (aluminum), and was made to fit this particular unit. All connections to this unit are made at the terminal strip bolted to the back of the chassis.

One word of caution: The key terminals are hot (90v dc), so a suitable lucite or plastic shield should be used.

### The Key Head

The key head used with an electronic key is essentially a SPDT switch. Recently there have been several of these put on the market. The Vibroplex Company has the Vi-

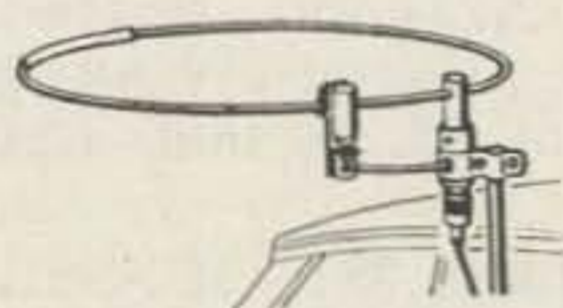

2-METER

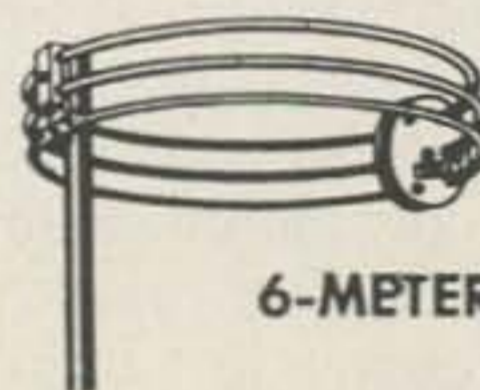

6-METER

## HALO ANTENNAS

**F**ixed and Mobile, for both 6 and 2 meters, by the pioneers in horizontal polarization for mobile communications.

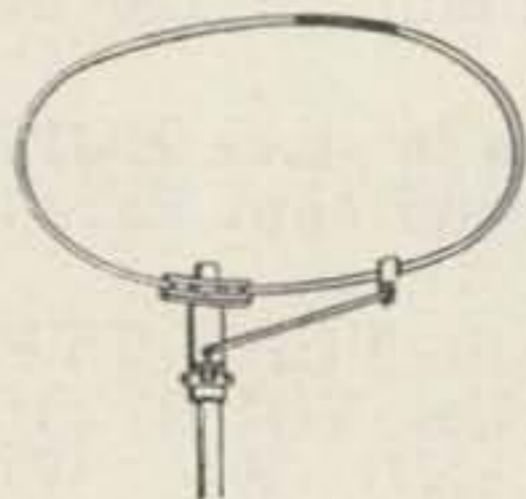

6-METER

**H**i-Par also manufactures a quality line of antennas for amateur, TV, FM and commercial services.

AT YOUR  
DISTRIBUTORS  
OR  
WRITE DIRECT

HI-PAR PRODUCTS CO. ♦ FITCHBURG, MASS.



brokeyer which sells for \$15.95 and the Electrophysics Corporation has the Autronic Key for \$16.95. Both of these units will work well with this keyer.

A cheaper solution is to convert your bug. This can be done easily by the addition of an extra terminal. On the bug the dot and dash contacts are connected together. All you have to do to convert for an electronic keyer is run the dot and dash contacts to separate terminals. Connect the dash contact to Terminal #3, the key arm to #4 and the dot contact to #5. This will put 115 vdc between the key base and ground so it is a good idea to make a lucite shield to keep you from being electrocuted.

Adjustment of the key is simple. Move the vibrator weight as far as it will go toward the key handle and tighten the thumb screw. Adjust the dot contact until it just touches the dot contact on the arm. Turn the dot contact screw 1/4 turn counter-clockwise. The dot and dash stops should be adjusted to suit your own fist.

The author has been using this unit for about 5 months now, and the results are gratifying! This unit was also used in the well known 24 hour grind, Field Day, a good test for any piece of gear, and is still going strong! Hope to work you soon with your new Tubeless Electronic Key. 73

(SURPLUS from page 21)

Interested in UHF? Here is a beauty. ASB-5 or CPR-46ACJ. Originally a radar receiver, and following the conversion in Oct. 1956 CQ you will have a gem of a receiver on 420 mc.

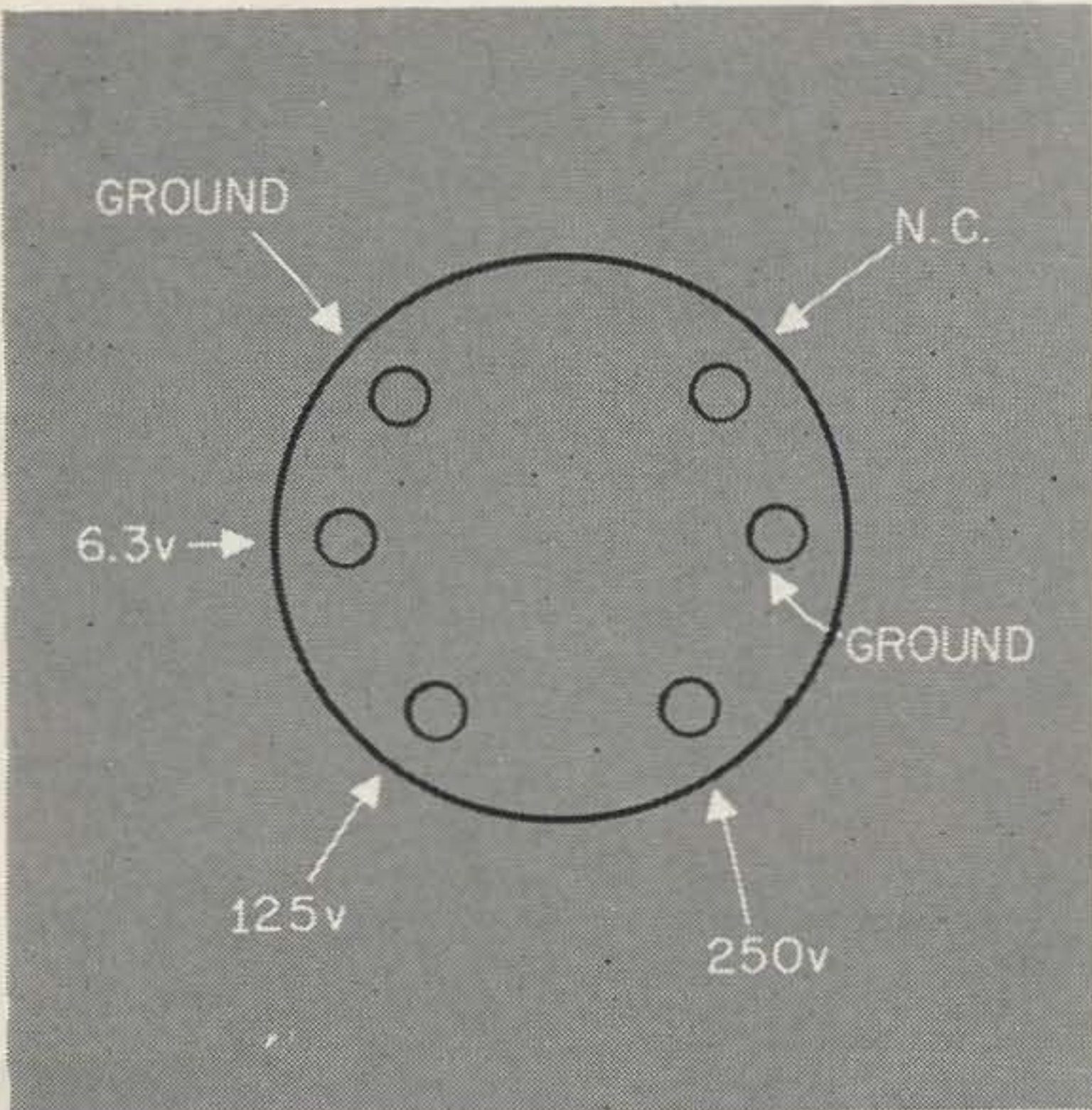

In case anyone is interested in using only the receiver section separated from the complete unit, here are the receiver rear deck connections. Use a Jones plug here.

## THE NEW **P & H** LA-400-C 800 WATTS PEP SSB LINEAR AMPLIFIER



### NOW 800 WATTS PEP FOR ONLY \$164.95 THE "BEST BUY" YET

NEW modern styling! NEW high efficiency 3 element band-switching pi net. Puts more power into any antenna or load from 50-70 ohms. For SSB, DSB, Linear AM, PM, CW and FSK. All bands 80-10 meters. May be driven to 800 WATTS PEP SSB with popular 100 watt SSB exciters. Uses four modified 1625's in grounded grid. On customer's order, will be furnished with 837's. (note: 1625's and 837's are not directly interchangeable, since sockets are different.) Typical P&H Low Z untuned input. TVI suppressed. Parasitic Free. Meter reads grid drive, plate current, RF amps output. Heavy duty power supply using 816's. NEW modernistic grey cabinet measures approx. 9" x 15" x 10 1/2". Panel is recessed. WANT TO SAVE MONEY? BUY IT IN KIT FORM. It's a breeze to assemble and wire. BEFORE YOU BUY — SEE THE NEW LA-400-C AT YOUR DEALERS.

LA-400-C Kit complete with tubes.....\$164.95  
LA-400-C Wired and Tested.....\$219.95

**P & H** ELECTRONICS INC.  
424 Columbia Lafayette, Ind



## VIBRO-KEYER

**Only \$15.95**

The Vibroplex Company has a boon for those amateurs that need the mechanical end of an electronic keyer. The Vibro-Keyer is constructed in line with the high-quality workmanship for which Vibroplex has long been famous. The unit has large, non-corroding contacts, heavy beige colored base, colorful red finger and thumb pieces, and smooth, easy operating trunion lever. It is adjustable to any amateur's taste. Only \$15.95.

THE VIBROPLEX CO., INC., 833 Broadway, N. Y. 3, N. Y.



# MOBILE POWER SUPPLY

MODEL  
A12/600/200

NOW  
**\$59.50**

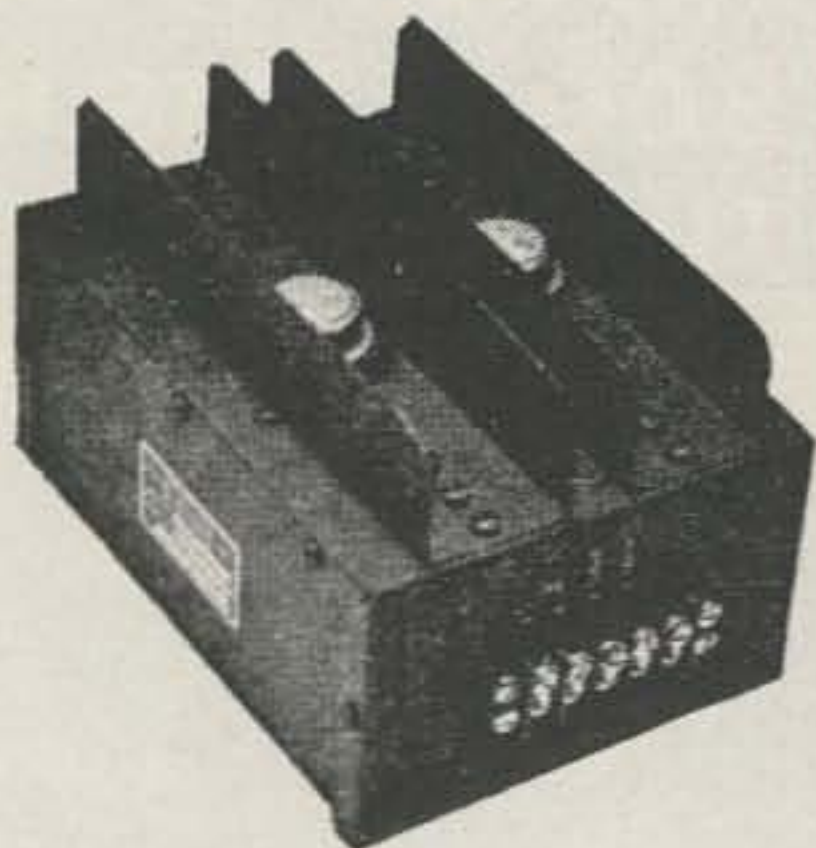

This 12V input dc to dc transistorized converter is conservatively rated for continuous output of 120 watts at 600V or 300V, or any combination of 600 and 300 volt loads totaling 120 watts.

High efficiency, small size, and light weight, plus freedom from maintenance, conserve your battery and increase the enjoyment of mobile operation.



**ELECTRONICS DIVISION  
GLOBE INDUSTRIES, INC.**

525 MAIN STREET  
BELLEVILLE, NEW JERSEY

# R-F WATTMETER

Model PCA-1

**\$14.95**

## FEATURES

- Tuning Citizens Band Xmtrs
- Tuning Low Power Ham Rigs
- Tuning Mobile Xmtrs Police-Fire-Taxi-Bus-Ham
- Tuning Antennas
- Checking Modulation Quality



## SPECIFICATIONS

- Reads Power to 10 Watts
- Field Strength Meter
- Modulation Monitor
- Built-in 10 Watt 52 Ohm Load

Manufacturers reps and distributors interested in a few extra pennies please write.

Order through your local parts distributor or send direct to:

**PRECISION COMMUNICATIONS  
ACCESSORIES**

674 Eighth Ave., New York 36, New York

1.5V D.C.



N.C.

105v

Another UHF band? The R-1/ARR-1 when converted will turn out to be a 220 mc converter with a 50 mc I.F. Complete conversion for this unit can be found back in January 1949 Radio and Television News.

6.3v

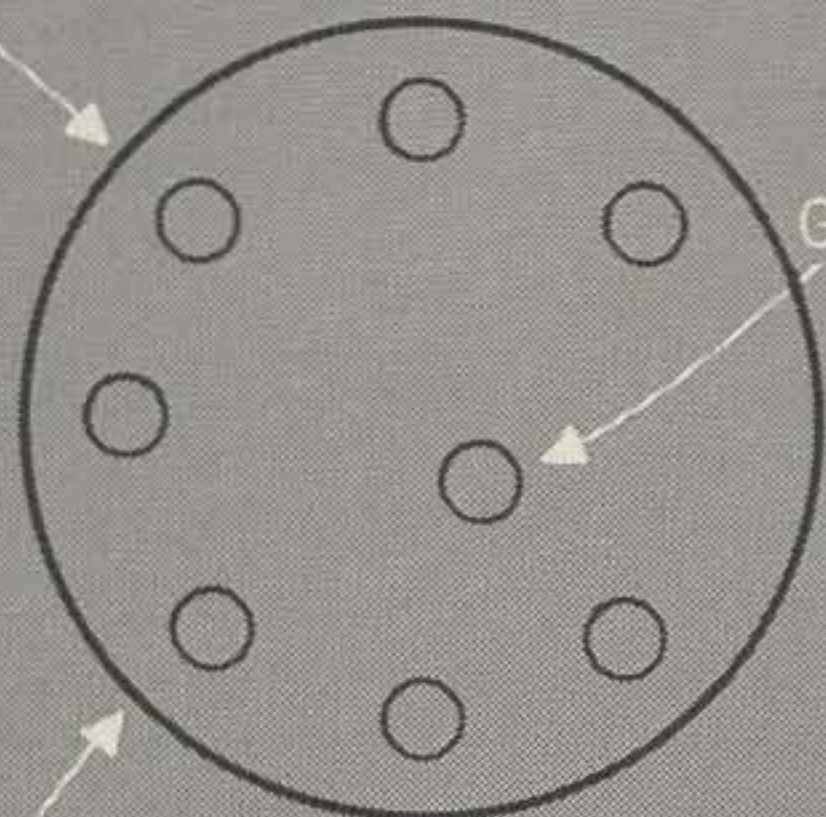

GROUND

150-180v  
REGULATED

Here is the ever-popular BC-625A (SCR-522). The complete conversion is in July 1947 CQ and information on how to put it on 220 mc is covered in November 1953 CQ.

1-BIAS

150v

3+4-300v

200Ma

2-FILAMENT

13v

8-GROUND

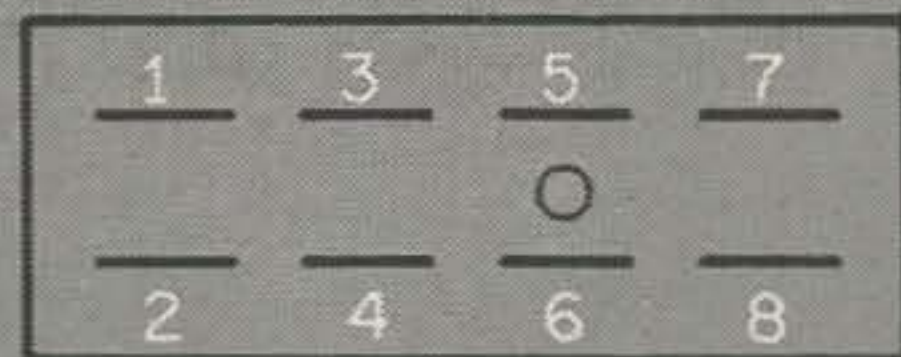

And the well-known BC-221 frequency meter.

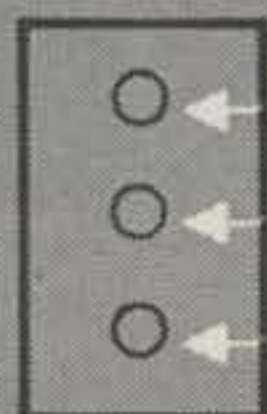

135v REG.

GROUND

6.3v



Now, the ARC-5 transmitter series. Readily available and capable of fifty watts on cw, a nice unit for the new general. These will operate on 80 and 40, can be converted to work on 20 and one model can be changed to a two or six meter vfo. A wealth of information on the ARC-5 can be found in the CQ publication "Command Sets".

ARC-5

- 1-GROUND
- 2-12 V.D.C.
- 3-300v REG.
- 4-18V.D.C.
- 5+6-12 V.A.C.
- 7-470 V.D.C.

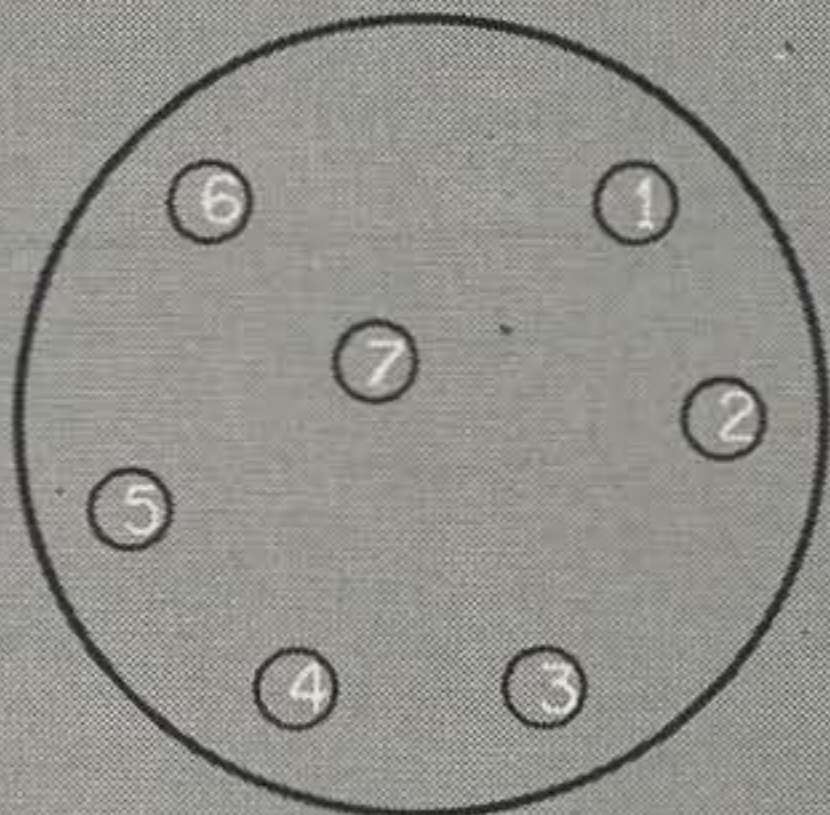

BC-348

- 3-24v
- 1+5- 500 \_ \_ OUTPUT XFMR
- 7- GROUND
- 2+6-B+

And finally, the RAK-7 receiver. This is a low-frequency TRF receiver and has been issued to Army MARS members. You didn't get the manual either, did you?

REAR

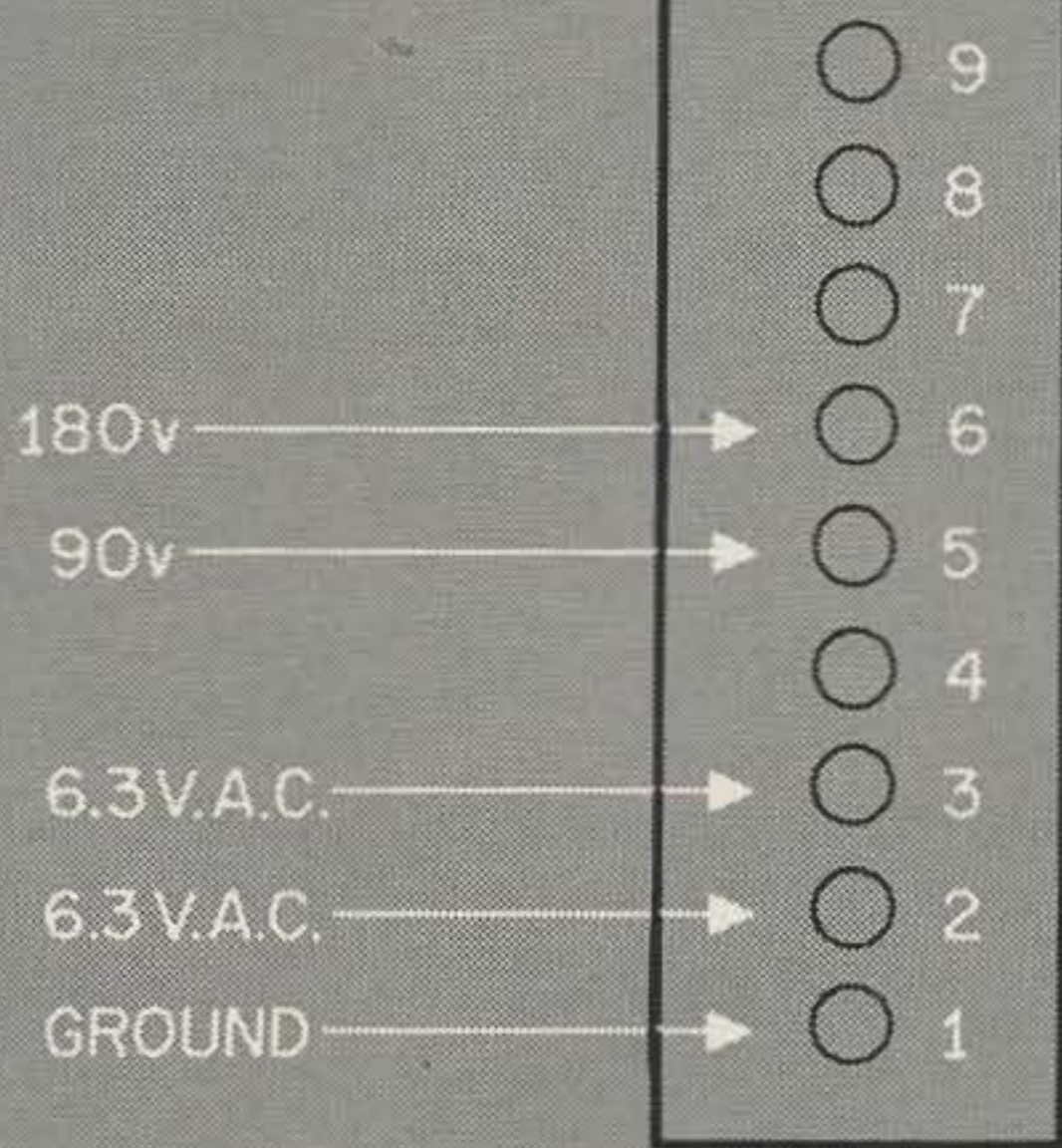

FRONT

So, now you have the easy way to do it. The author is not an expert on war surplus, but he has had the units mentioned in operating condition. If you are a newcomer, if you like to experiment and if you like to operate ham radio, investigate the surplus field, it is a lot of fun. 73

# For Sale

TV Cameras, Panadaptors, Receivers, Transmitting Tubes, Transistors, SSB Gear.

We also stock:

- Gonset
- Solar
- National
- Tech-Craft
- International Crystal
- Johnson
- UTC
- Westinghouse
- Tungsol Transistors
- Premier
- Polycom
- Cushcraft
- B & W Coils
- Illumtronics Coils
- Bliley Crystals
- Amateur Call Books
- ARRL Publications
- Radiart Rotators
- Hy-Gain
- Mosley Antennas
- Dow Key Relays
- RME
- Bell Tape Decks and Amplifiers
- Dynakit
- Eico
- Paco
- Precision Test Equipment

Write for bargain list.

## Spera Electronic Supply

37-10 33rd St., Long Island City I, N. Y.  
 STillwell 6-2199                      STillwell 6-2190

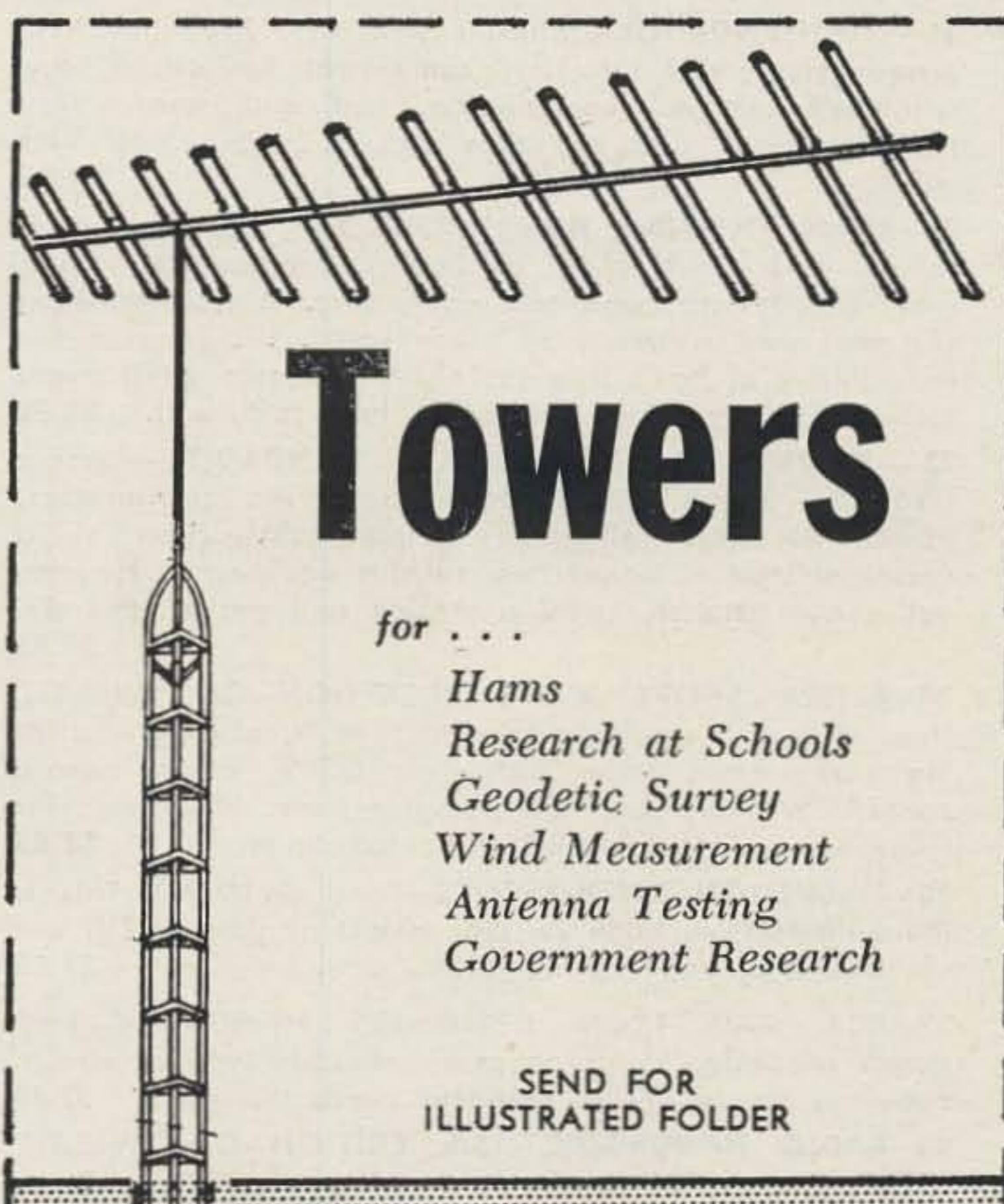

# Towers

for . . .

- Hams*
- Research at Schools*
- Geodetic Survey*
- Wind Measurement*
- Antenna Testing*
- Government Research*

SEND FOR ILLUSTRATED FOLDER

**KTV Tower**  
 AND COMMUNICATION COMPANY  
 P. O. BOX 294, SULLIVAN, ILLINOIS



# Radio Bookshop

SOME three years ago one of our more obscure amateurs got the notion that since there were specialized nautical bookshops for the yachty gang and sports car bookshops for the adult hot-rodders, that there just might be a need for a radio bookshop for amateurs. After three years of exhaustion providing good service to the few people who answered the monthly ads it became obvious that the idea was a fiasco. Unfortunately he was in too deep by this time. What had started as a few books in the vestibule at home had grown to overwhelming stacks, imported computers, stopwatches, and an amazing variety of goodies.

So, the next time you feel the need for expanding your library, check through this list. A hamshack isn't really complete without a good collection of reference books.

- 1—ELECTRONICS & RADIO ENGINEERING**—Terman. One of the most complete text books ever printed. 1078 pages. Theory, but easy on the math. **\$14.50**
- 2—ELECTRICAL ENGINEERING HANDBOOK**—McIlwain. Formulas, tables, circuits. A real handbook. 1618 pages. **\$10.00**
- 5—ANTENNAS**—Kraus (W8JK). The most complete book on antennas in print, but largely design and theory, complete with math. **\$11.50**
- 10—I, LIBERTINE**—Shepherd (K2ORS). Racy 35¢ book, a best-seller. Specially priced for you at . . . **50¢**
- 20—RTTY HANDBOOK**—Kretzman (W2JTP). A-Z of ham Teletype. Very popular book, low supply. **\$3.00**
- 21—VHF HANDBOOK**—Johnson (W6QKI). Types of VHF propagation, VHF circuitry, component limitations, antenna design and construction, test equipment. Very thorough book and one that should be in every VHF shack. **\$2.95**
- 22—BEAM ANTENNA HANDBOOK**—Orr (W6SAI). Basics, theory and construction of beams, transmission lines, matching devices, and test equipment. Almost all ham stations need a beam of some sort . . . here is the only source of basic info to help you decide what beam to build or buy, how to install it, how to tune it. **\$2.70**
- 23—NOVICE & TECHNICIAN HANDBOOK**—Stoner (W6TNS). Sugar coated theory: receivers, transmitters, power supplies, antennas; simple construction of a complete station, converting surplus equipment. How to get a ham license, build a station and get on the air. **\$2.85**
- 24—BETTER SHORT WAVE RECEPTION**—Orr (W6SAI). How to buy a receiver, how to tune it, align it; building accessories; better antennas; QSL's, maps, aurora zones, CW reception, SSB reception, etc. Handbook for short wave listeners and radio amateurs. **\$2.85**
- 28—TELEVISION INTERFERENCE**—Rand (W1DBM). This is the authoritative book on the subject of getting TVI out of your rigs and the neighbors sets. **\$1.75**
- 32—RCA RADIOTRON DESIGNERS HANDBOOK**—1500 pages of design notes on every possible type of circuit. Fabulous. Every design engineer needs this one. **\$7.50**
- 40—RADIO HANDBOOK, 15th EDITION**—Orr (W6SAI). This is far and away the best amateur radio handbook ever printed. Over 800 pages. **\$7.50**
- 45—CURTA COMPUTER**. The world's smallest computer. Send for detailed information. Makes the slide rule look sick. Like a big Monroe computer only hand size. **\$125.00**
- 47—PRACTICAL ELECTRONICS**—Hertzberg (W2DJJ). Almost solid with pictures. Touches lightly on many aspects of electronics: ham radio, TV, transistor radios, hi-fi, microwaves, trouble-shooting, Novice station, antennas, test equipment, etc. **\$2.50**
- 48—BASIC ELECTRONICS**—Covers subject completely. Written for use with RCA Institute training course. **\$9.25**
- 49—ELECTRONIC COMMUNICATION**—Shrader. Huge book aimed at giving all information necessary for FCC commercial and amateur licenses. **\$13.00**
- 50—MICROMINIATURIZATION**—This is the standard text on the subject. Don't see how a company library can be without this one. Everything is going to have to be built smaller, you know. **\$11.00**
- 52—HOW TO READ SCHEMATIC DIAGRAMS**—Marks. Components & diagrams; electrical, electronic, ac, dc, audio, rf, TV. Starts with individual circuits and carries through complete equipments. **\$3.50**
- 53—BASIC ELECTRONIC TEST PROCEDURES**—Turner. This book covers just about every possible type of electronic test equipment and explains in detail how to use it for every purpose. Testing: audio equipment, receivers, transmitters, transistors, photocells, distortion, tubes, power . . . etc. **\$8.00**
- 54—HAM RADIO HANDBOOK**—Hertzberg (W2DJJ). This is a lavishly illustrated book to interest people in the hobby of ham radio. Tells how to get your ticket, select a receiver and transmitter, learn the code. Pictures and info on just about every commercial piece of ham equipment. Better than a catalog. **\$2.50**
- 55—TRANSISTOR CIRCUIT HANDBOOK**—Simple, easy to understand explanation of transistor circuits. Dozens of interesting applications. **\$4.95**
- 56—RADIO TELEPHONE LICENSE MANUAL**—Smith (W6BCX). Brand new question and answer study guide for FCC commercial licenses. **\$5.00**
- 57—QUAD ANTENNAS**—Orr (W6SAI). Theory, design, construction and operation of cubical quads. Build-it yourself info. Feed systems, tuning. **\$2.85**
- 58—ANTENNAS FOR CITIZENS RADIO**—Orr (W6SAI). General coverage, mobile and directional antennas for 27 mc. band. Build & tune 'em. **\$1.00**
- 69—S-9 SIGNALS**—Orr (W6SAI). A manual of practical, detailed data covering design and construction of highly efficient, inexpensive antennas for the amateur bands that you can build yourself. **\$1.00**
- 70—CITIZENS RADIO CALL BOOK**—Lists all calls issued until January 1960, plus lots of CB info. **\$3.95**
- 71—CITIZENS RADIO CALL BOOK SUPPLEMENT**—Calls from January 1960 until July 1960. **\$3.95**
- 72—ABC'S OF HAM RADIO**—Pyle (W7OE). Designed for the Novice ham. Includes all of the information needed to qualify for the Novice License. 112 pages. **\$1.50**



**73-101 WAYS TO USE YOUR HAM TEST EQUIPMENT**—Middleton. Grid-dip meters, antenna impedance meters, oscilloscopes, bridges, simple noise generators, and reflected power meters are covered. Tells how to chase trouble out of ham gear. 168 pages. **\$2.50**

**74-HANDBOOK OF ELECTRONIC TABLES & FORMULAS**—Formulas & laws, constants, standards, symbols and codes. Math tables, misc. data. **\$2.95**

**75-BUILD-A-WARD QSL ALBUM**—Mount your prize QSL's in this album. Room for 100 cards in each album plus labels for just about all possible operating awards. A fine way to show off your cards. **\$1.95**

**76-MODERN OSCILLOSCOPES & THEIR USES**—Ruiter. Second edition. Shows what a 'scope is, what it does and how to use it for radio, TV, transmitters, etc. 346 pages. **\$6.50**

**77-BASIC ELECTRICAL MEASUREMENTS**—Stout. Second edition. Covers aids to computation, measurement of resistance, galvanometers, shunts, standard cells, potentiometers, alternating current bridges, mutual inductance measurements, bridge accessories, instrument transformers, magnetic measurements . . . and lots more. **\$11.65**

**78-INTRODUCTION TO ELECTRICAL CIRCUITS**—Jackson. Deals with exactly what electronics and electrical engineering technicians need to know. Complete coverage of electrical circuit theory, from beginning level. Develops concepts of current, voltage, resistance, work, and power. Shows how to expand basic concepts to solve elaborate direct and alternating current networks used in modern electrical and electronic circuitry. **\$11.65**

**79-TRANSISTOR PROJECTS**—Skip the theory and start having fun. Radios: self powered, shirt pocket, regenerative, carrier-power, headphone. Instruments and accessories: sine-square wave generator, preamps for VTVM's, gain checker, shortwave calibrator, phase shifter, substitution box. Plus remote transistor ear, electronic compass, simple oscillator, lamp control, multi-impedance amplifier, electronic counter, portable power supply . . . etc. **\$2.90**

**80-SURPLUS RADIO CONVERSION MANUAL VOLUME NO. I** (second edition). This book gives circuit diagrams, photos of most equipment, and rather good and complete conversion instructions for the following: BC-221, BC-342, BC-312, BC-348, BC-412, BC-645, BC-946B, SCR-274N 453A series receivers conversion to 10 meter receivers, SCR-274N 457A series transmitters (conversion to VFO), SCR-522 (BC-624 and BC-625 conversion to 2 meters), TBY to 10 and 6 meters, PE-103A, BC-1068A/1161A receiver to 2 meters, Surplus tube index, cross index of A/N tubes vs. commercial types, TV & FM channels. **\$2.50**

**81-SURPLUS RADIO CONVERSION MANUAL VOLUME NO. II**. Original and conversion circuit diagrams, plus photos of most equipments and full conversion discussion of the following: BC-454/ARC-5 receivers to 10 meters, AN/APS-13 xmtr/rcvr to 420 mc, BC-457/ARC-5 xmtrs to 10 meters, Selenium rectifier power units, ARC-5 power and to include 10 meters, Coil data-simplified VHF, GO-9/TBW, BC-357, TA-12B, AN/ART-13 to ac winding charts, AVT-112A, AM-26/AIC, LM frequency meter, rotators, power chart, ARB diagram. **\$2.50**

**82-SURPLUS RADIO CONVERSION MANUAL VOLUME NO. III**—Original and conversion diagrams, plus some photo of these: 701A, AN/APN-1, AN/CRC-7, AN/URC-4, CBY-29125, 50083, 50141, 52208, 52232, 52302-09, FT-ARA, BC-442, 453-455, 456-459, BC-696, 950, 1066, 1253, 241A for xtal filter, MBF (COL-43065), MD-7/ARC-5, R-9/APN-4, R23-R-28/ARC-5, RAT, RAV, RM-52 (53), Rt-19/ARC-4, SCR-274N, SCR-522, T-15/ARC-5 to T-23/ARC-5, LM, ART-13, BC-312, 342, 348, 191, 375. Schematics of APT-5, ASB-5, BC-659, 1335A, ARR-2, APA10, APT-2. **\$2.50**

**83-THE SURPLUS HANDBOOK, VOLUME I**—Receivers and Transmitters. This book consists entirely of circuit diagrams of surplus equipment and photos of the gear. One of the first things you really have to have to even start considering a conversion of surplus equipment is a good circuit diagram. This book has the following: APN-1, APS-13, ARB, ARC-4, ARC-5, ARC-5 VHF, ARN-5, ARR-2, ASB-7, BC-222, -312, -314, -342, -344, -348, -603, -611, -624 (SCR-522), BC-652, -654, -659, -669, -683, -728, -745, -764, -799, -794, BC-923, -1000, -1004, -1066, -1206, -1306, -1335, BC-AR-231, CRC-7, DAK-3, GF-11, Mark II, MN-26, RAK-5, RAL-5, RAX, Super Pro, TBY, TCS, Resistor Code, Capacitor Color Code, JAN/VT tube index. **\$3.00**

**84-SURPLUS SCHEMATIC HANDBOOK**—This, too, is a book of schematics . . . and just a hint of conversion strategy here and there. Contains: APA38, APN1, APR1, APR2, APS13, ARB, ARC1, ARC3, ARC4, ARC5, ARC5VHF, ARJ, ARK, ATJ, ARN7, ARR2, ART13, ASB7, AS81GR, ATK, BCAR231, AC189, BC-191, 221, 312, 342, 314, 344, 348, 375, 438, 474A, 603, 610, 611, 620, 640, 645, 652, 653, 654, 659, 683, 684, 728, 733, 745, 779, 794, 906, 969, 1000, 1004, 1023, 1206, 1335, BN, BP, C3, F3, CRC7, CRO-208, CRT3, DAE, GF-11, GO9, GRR5, I122, I177, I208, JT350A, LM, MD7, MN26, PRC6, PRS3, R174, RAK, RAL, RAO, RAS, RAX, RBH, RBL, RBM, RBS, RC56, RC57, DC, DR, RDZ, SCR-274, 284, 288, 300, 506, 522, 578, 585, 593, 608, 610, 624, 628, SPR-1, SPR2, TBS99, TEW, TBY, TCK, TCS, TG34, TS34AP, TS251UP, VRC-8-9-10, VVX-1. **\$2.50**

**85-SO YOU WANT TO BE A HAM**—Hertzberg (W2DJJ). Second edition. Good introduction to the hobby. Has photos and brief descriptions of almost every commercially available transmitter and receiver, plus accessories. Lavishly illustrated and readable. **\$2.95**

Handy order form for people who don't mind ripping their magazines to pieces.

1	2	5	10	20	21	22	23	24	28	32	40
45	47	48	49	50	52	53	54	55	56	57	58
69	70	71	72	73	74	75	76	77	78	79	80
81	82	83	84	144	145	149	152	153	154	157	161
163	168	169	170	172	173	174	175	177	178	181	185

Circle the book numbers you wish to order. Please include cash, check, money order . . . or something we can deposit in the bank.

Name: ..... Call: .....

Address: .....

City: ..... Zone: ..... State: .....

Radio Bookshop, 1379 East 15th Street, Brooklyn 30, New York



# FREE Catalog

OF THE WORLD'S FINEST  
ELECTRONIC GOV'T  
SURPLUS BARGAINS



Receivers, Transmitters, Microphones,  
Meters, Headsets, Amplifiers, Gen-  
erators, Test Equipment, Telephone Equip-  
ment, Motors, Dynamotors, Power Supplies,  
Antennas, Cable, Transformers, Inverters,  
Etc.-Etc.

Address Dept. 73

**Fair Radio Sales**  
2133 ELIDA RD.  
Box 1105 • LIMA, OHIO

## • HAM-SWAP •

The FASTEST way to buy, sell or swap Ham Gear!

\$1 a year brings you 24 issues of bargains galore—  
PLUS the "Fastest Way in the World" to profitably  
dispose of your old or excess parts and equipment.  
FREE ad certificate and latest edition returned im-  
mediately if you send \$1 NOW to:

HAM-SWAP, Inc., 35-F East Wacker Dr., Chicago 1, Ill.

## TELETYPEWRITER EQUIPMENT

Model 14, 15, 19, 26 & 28 Teletype Machines, Tele-  
writer Receiving Converter and others.  
Collins 51J Receivers .54-30.5 mc.

For general information & equipment list write:

**Tom W1AFN, Alltronics-Howard Co.**  
BOX 19, BOSTON 1, MASS. Richmond 2-0048

**WANTED:** New, current, and slightly used  
(old timer) Hams to take ad-  
vantage of New England's *only*  
*exclusive Ham outlet*, handling all of the most popu-  
lar new and used amateur items. We buy, sell,  
trade, swap, rent, and service Ham gear only. For  
the best deal around—try Bob Graham, W1KTJ.

**Graham Company**, 505 Main Street, Reading,  
Massachusetts. Tel. RE 2-4000.

ONLY  
**\$18.00**  
plus 10%  
Fed. Tax

## 24-HOUR DIAL ELECTRIC CLOCK

Big 15" illuminated dial for easy reading. Handsome and  
durable with glass crystal, aluminum case and stainless  
steel bezel. Ideal as a gift.

SEND CHECK OR MONEY ORDER TO:

**SCIENTIFIC INDUSTRIES, Inc.**

15 Park Street, Dept. 73-10, Springfield 3, Massachusetts  
or write for Free Literature

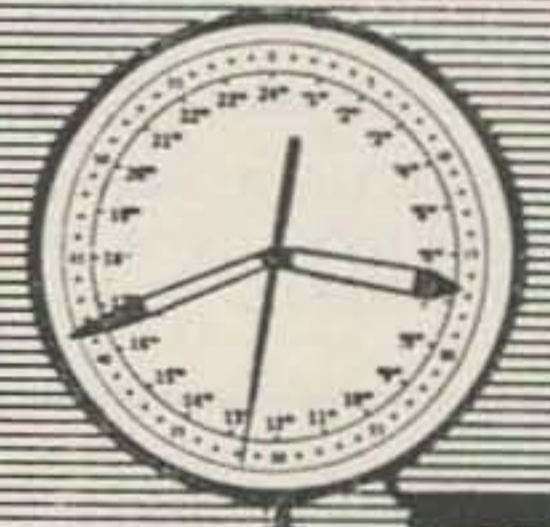

## Advertisers Index

Allied Radio Corp. ....	64
Altronics-Howard Co. ....	62
Barry Electronics Corp. ....	55
Central Electronics, Inc. ....	49
Cush-Craft .....	54
EICO .....	2
Fair Radio Sales .....	62
Globe Industries, Inc. ....	58
Graham Co. ....	62
Hammarlund Mfg. Corp. Inc. ....	53
Ham-Swap, Inc. ....	62
Hi-Par Products Co. ....	56
International Crystal Mfg. Co. ....	Cover I, 1
KTV Tower and Communication Co. ....	59
Mini-Products, Inc. ....	48
National Co., Inc. ....	Cover 4
Neil Co., The .....	52
P & H Electronics Inc. ....	57
Precision Communications Accessories ....	58
Peterson Radio Co. Inc. ....	7
Radio Bookshop .....	60, 61
Radio Amateur Callbook Inc. ....	62
Rex Radio Supply Co. ....	54
R-F Wattmeter .....	58
Scientific Industries, Inc. ....	62
Spera Electronics Supply .....	59
Solar Electronics Corp. ....	51
Tapetone, Inc. ....	54
Telrex Labs .....	50
Technical Material Corp. ....	5
Vibroplex Co. Inc., The .....	57
World Radio Labs .....	6

**NEW ISSUES  
JUST OUT**

**ORDER YOUR CALLBOOKS NOW!**

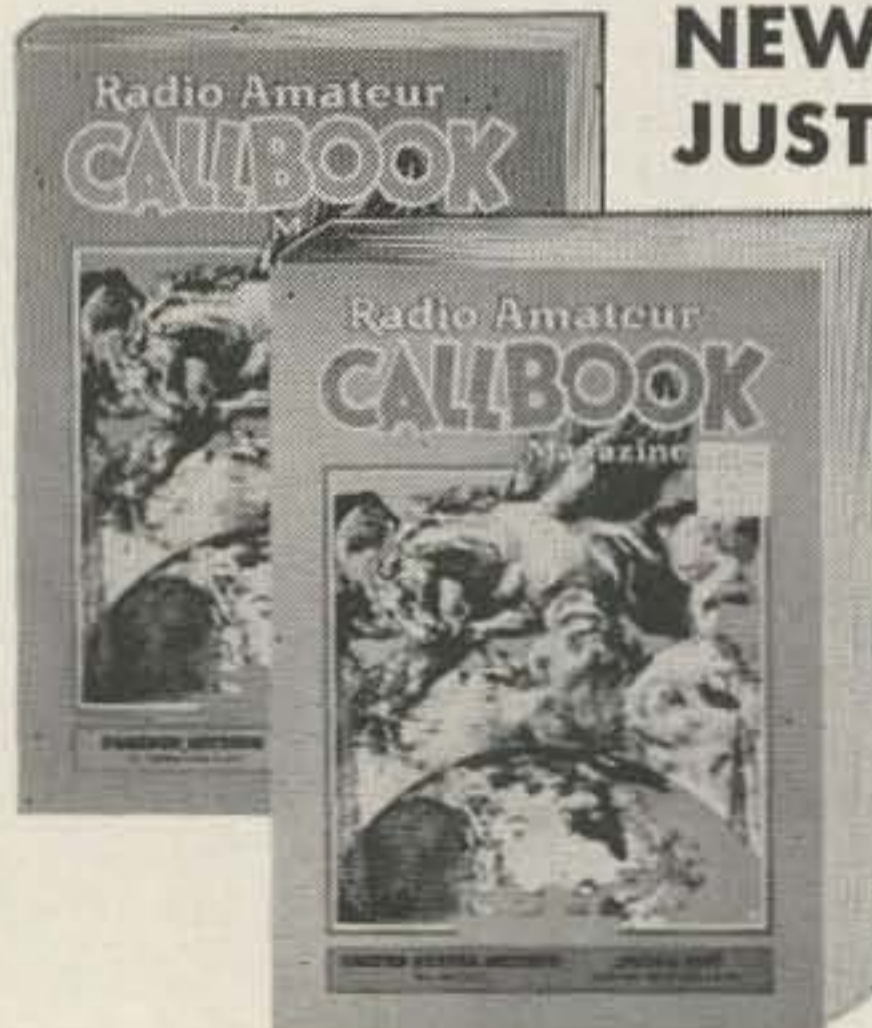

**United States Section** listing all K & W calls (over 215,000). Nearly  
14,000 newly licensed radio amateurs added since the previous issue.

Single copy \$5.00 postpaid (add 25¢ per copy outside U.S.A.)

**Foreign Section** listing radio amateurs throughout the world, out-  
side the 50 United States—up to date.

Single copy \$3.00 postpaid (add 25¢ per copy outside U.S.A.)

On sale at your favorite radio parts distributor, or direct from the  
publisher.

**RADIO AMATEUR CALLBOOK, Inc.**

4844 Fullerton Avenue, Chicago 39, Illinois, Dept. ST



# Subscriptions

I'VE written quite a few heart-rending subscription ads down through the years. Now I'm faced with my moment of greatest need and I can't think of anything clever to get you to chuckle while you're filling out a check or standing in that long line at the post office to buy a money order. There's no need for me to explain all of the problems that face a new publication. Briefly put, it is this: no circulation means no advertising; no advertising means no money; no money means the publisher takes a long walk on a short pier. So, if you're going to put off subscribing then at least come down and watch my bubbles.

73 is distributed via direct subscription and through some of the more cooperative radio parts distributors. We cannot, at this time, afford to go on the newsstands. This means that word of this new magazine will have to be spread through you, the reader. If you like this first issue and some of the ideas expressed here please tell your friends about the magazine and get them to subscribe. We have some attractive gift cards in case you want to surprise someone who has done something for you.

The first 10,000 subscribers will receive Charter Subscriber cards, giving the date of their original subscription.

73 Subscription: \$3.00 one year; \$5 two years; \$7 three years. DX: Add \$1.00 per year.

Send to: 73 Magazine, 1379 East 15th St., Brooklyn 30, N. Y.

Name .....	Call .....
Address .....	
City .....	Zone ... State .....
.... years.	Start with issue .....

Name .....	Call .....
Address .....	
City .....	Zone ... State .....
.... years.	Start with issue .....

Name .....	Call .....
Address .....	
City .....	Zone ... State .....
.... years.	Start with issue .....



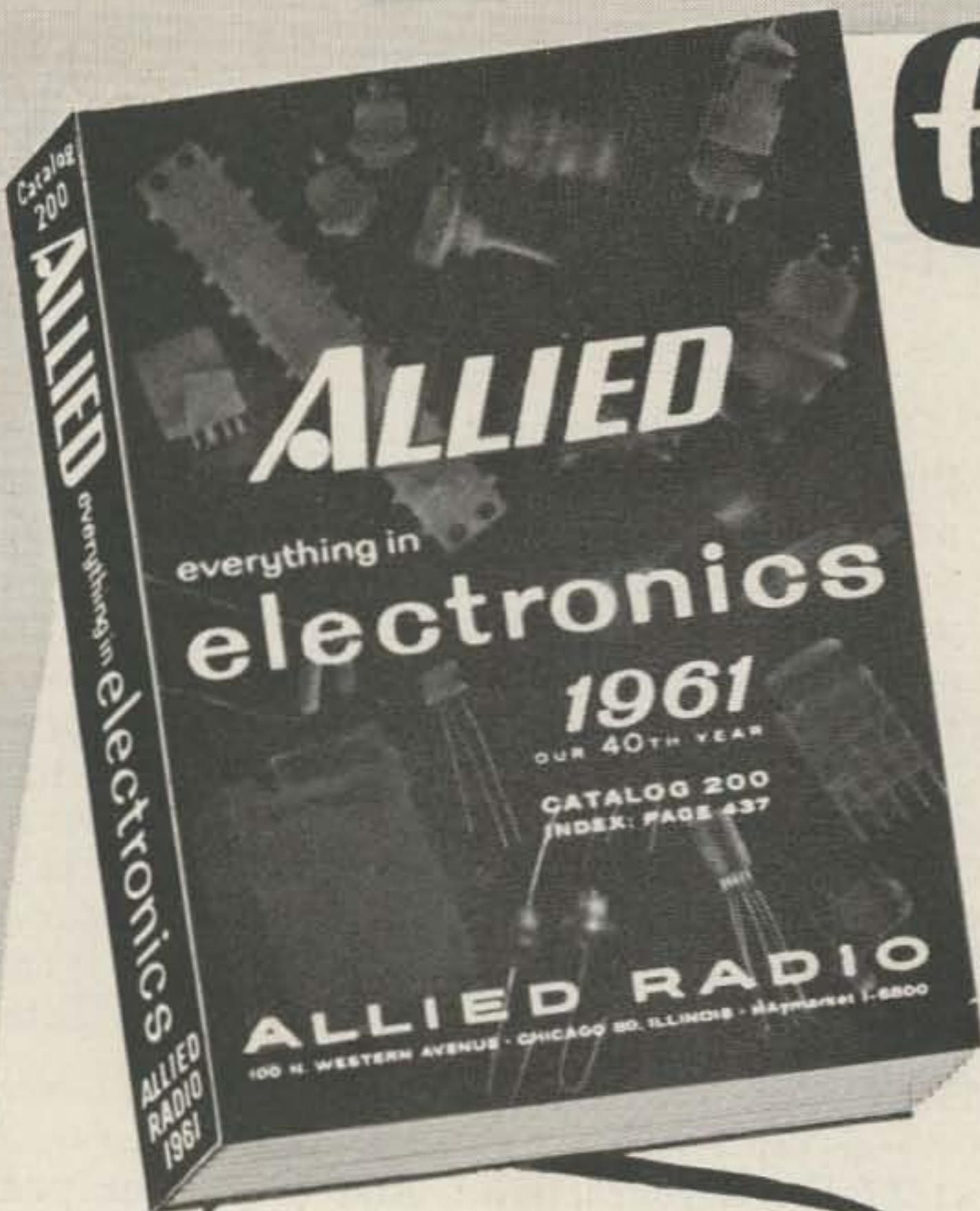

**free**

send for the

**ALLIED**

**VALUE-PACKED 1961  
ELECTRONICS CATALOG**

444 PAGES • MOST COMPLETE

*Everything* IN ELECTRONICS

**FOR THE AMATEUR**

Write for the 1961 ALLIED Catalog—the most widely used electronic supply source for Amateurs. You'll want it handy always—to fill all your station equipment needs—to supply you with *everything* in electronics at lowest, money-saving prices. Features the largest and latest selection of:

- Ham Receivers
- Ham Transmitters
- Station Supplies
- Electron Tubes
- Semiconductors
- Test Instruments, Meters
- Knight-Kit® Equipment
- Everything in Stereo Hi-Fi
- Recorders & Accessories
- Everything in Electronic Parts, Tools & Tech Books

For *everything* in electronics, get the 444-page 1961 ALLIED Catalog now!

**ALLIED RADIO**

*serving the Amateur for over 40 years*

**get every  
buying advantage:**

**FOR THAT BEST DEAL** on the new equipment you want, write or call Jim Sommerville, W9WHF, c/o ALLIED or stop in at our Ham Shack and meet Joe Huffman, W9BHD; Joe Gizzi, W9HLA; Jack Schneider, W8CZE...

**HAM-TO-HAM HELP**—Our staff of 35 Hams will go all-out to give you the help you want, whether you write, call or visit us in person. You'll like the friendly attention and interest you get *all-ways* at ALLIED.

**ONLY \$2 DOWN**

on orders up to \$50; only \$5 down on orders up to \$200; only \$10 down over \$200. Up to 24 months to pay!

**one order to Allied  
fills the whole bill**

Save time, effort and money; fill all your electronic supply needs from your 1961 Allied Catalog.



send for  
**FREE  
CATALOG**

ALLIED RADIO, Dept. 50-K  
100 N. Western Ave., Chicago 80, Ill.

Send me the FREE 1961 ALLIED Catalog

Name \_\_\_\_\_

Address \_\_\_\_\_

City \_\_\_\_\_ Zone \_\_\_\_\_ State \_\_\_\_\_



# Other Ham Publications

ONE of our basic policies, as you will see on page 6, is to encourage the publication of specialized ham bulletins and papers. Here are listed some that we can heartily recommend.

**HAM-SWAP.** Published by Ham-Swap, Inc., 35 East Wacker Drive, Chicago 1, Illinois. Editor is Ed Shuey, K9BDK. Subs are \$1 per year by 3rd class mail, \$3 for 1st class, \$5 airmail, and \$7.20 special delivery. Published twice a month. Contains classified ads entirely. This is your best bet for an inexpensive way to sell or swap some gear in a hurry. Within two weeks people are answering your ad.

**FLORIDA RTTY BULLETIN.** Fred W. DeMotte W4RWM, P.O. Box 6047, Daytona Beach, Florida. \$3 per year including membership in Florida RTTY Society. Mostly operating news with a bit of technical info now and then. All TT men should be getting this.

**SOUTHERN CALIFORNIA RTTY BULLETIN.** Merrill L. Swan W6AEE, 372 West Warren Way, Arcadia, California. \$2.75 per year, not including membership in Society. Operating news and some technical articles. This is the oldest TT bulletin going. All TT men should also get this one. Monthly.

**73 HAM CLUB BULLETIN.** Marvin Lipton VE3DQX, 311 Rosemary Road, Toronto 10, Ontario, Canada. Sent free to all editors of ham club bulletins monthly to keep them abreast of what is going on with all the other ham clubs. This is an excellent source of news for putting together your club bulletins. To subscribe to this news bulletin just send a copy of your own club bulletin to Marvin.

**WESTERN RADIO AMATEUR.** Don Williamson W6JRE, 10517 Haverly Street, El Monte, California. Monthly. Subs are \$2 per year, \$3.50 for two years, \$5 for three years. Operating news of west coast activity, columns on DX, SSB, YL, and some articles. 48 pages.

**SIDEBANDER.** Official organ of the Single Sideband Amateur Radio Association, 12 Elm Street, Lynbrook, L. I., N. Y. Subs include membership to SSBARA: \$3 per year. Monthly. Primarily operating news and chit-chat for the SSB DX gang. Columns by W8YIN, K5MWU, K6EXT and occasional technical info.

**THE MONITOR.** Mar-Jax Publishers, 507 West Davis Street, Dallas 8, Texas. \$1 a year, 3 years for \$2.50. Monthly. Largely operating news. Columns: YL, Club Meetings, Arkansas News, Mississippi News, Florida News, DX, Missouri News, MARS, California News, Louisiana News, VHF News, Oklahoma News, Rio Grande Valley News, Novice News.

**VHF AMATEUR.** 67 Russell Avenue, Rahway, New Jersey. \$2 year, \$3.50 two years, \$5 three years. Monthly. Operating news for VHF men. Some technical info.

**DX-QSL News Letter.** Clif Evans, K6BX, Box 385, Bonita, California. Published quarterly. 40¢ each; Annual subscription \$1.25 (four copies) by first class mail (\$1.50 for DX stations). Lists all QSL Bureaus, managers for rare DX stations, etc.

**DIRECTORY OF CERTIFICATES AND AWARDS.** Clif Evans, K6BX, Box 385, Bonita, Cal. Complete Directory plus one year of revisions (quarterly) \$3.50. Add 50¢ for 1st class mail; \$1 for airmail; DX stations 1st class mail add \$1.25. Needless to say, this is the most complete collection of data on the hundreds of certificates and awards available.

**DX BULLETIN.** Don Chesser W4KVX, RFD 1, Burlington, Kentucky. DX news in depth. \$5.00 per yr. weekly.



with built-in PRODUCT DETECTOR

# NC 270



## THE "COSMIC BLUE" NATIONAL'S NEW HAMBAND RECEIVER

This newest and finest precision double conversion amateur receiver with 6 meter coverage, brings you an ease of sideband tuning previously available only in the most expensive equipment. The NC-270 features an exclusive "Ferrite Filter" for instant upper-lower SSB selection and a degree of selectivity to conquer even the toughest AM and CW signal conditions. The solid  $\frac{1}{8}$ " steel panel, ceramic coil forms, double-spaced tuning gang, and full ventilation cabinet combine to give mechanical and thermal stability that will surprise even the most critical operator. Even the color of the NC-270 is outstandingly different, National's new duo-tone "Cosmic Blue." Write for detailed specifications.

**Only \$24.99 down\***



*And National Radio's patented "Flip Foot" makes operating the NC-270 so easy.*

Suggested cash price: \$249.95. NTS-3 Matching Speaker. \$19.95 (slightly higher west of the Rockies and outside the U.S.A.). \*Most National distributors offer budget terms and trade-in allowances.

**NATIONAL RADIO COMPANY, INC.**



A WHOLLY OWNED SUBSIDIARY OF NATIONAL CO., INC.

MELROSE 76, MASS.

Export: AD AURIEMA, INC., 85 Broad St., New York, N. Y.

Canada: CANADIAN MARCONI CO., 830 Bayview Ave., Toronto 17, Ont.

SPECIFICATIONS SUBJECT TO CHANGE WITHOUT NOTICE