



Electronics

Radio

Television

Radar

UNITED ELECTRONICS LABORATORIES

LOUISVILLE

KENTUCKY

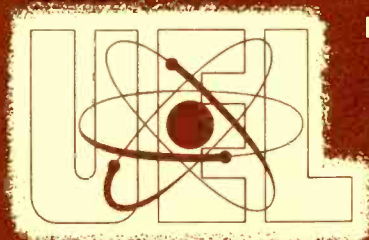

REVISED 1968

COPYRIGHT 1956 UNITED ELECTRONICS LABORATORIES

**TRANSISTOR AND TUBE NUMBERING SYSTEMS
AND BASING ARRANGEMENTS**

ASSIGNMENT 22

ASSIGNMENT 22

TRANSISTOR AND TUBE NUMBERING SYSTEMS AND BASING ARRANGEMENTS

Most of the assignments up to this point in the training program have served to create familiarization with the **theory of operation** of electronic circuits and their circuit components such as transistors and vacuum tubes. This assignment is included to serve a somewhat different purpose. It is the function of this assignment to give information concerning the **physical properties** associated with transistors and vacuum tubes. In particular, this assignment should serve to provide an insight into the use of the transistor and vacuum tube manuals which have been supplied to you. While studying this assignment, copies of these two manuals should be kept handy for easy reference. When various transistors or vacuum tubes are referred to in this assignment, always look up this type of transistor or tube in the appropriate manual and thereby become accustomed to using these reference guides.

The information that is found in transistor and tube manuals is of great value to an electronics technician. There are more than 5,000 different types of transistors on the market and many hundreds of different types of vacuum tubes. No electronics technician can remember all of the information about these individual transistors and tubes. As we shall learn in this assignment, there are several methods of bringing the element lead connections out of transistors and there is no single, standard method for bringing the elements of tubes to certain pins on the tube socket. To illustrate this point, the control grid on one tube might connect to the No. 2 pin on its socket, whereas the cathode of another tube might connect to pin No. 2 of its socket and the heater of still a third tube might connect to the No. 2 pin on its socket. For this reason, if no other, the use of transistor and vacuum tube manuals is almost indispensable in the servicing of electronics equipment.

The Transistor Manual

Before proceeding with this assignment, take some time to look over the transistor manual to observe first the type of material covered in the manual. It will be found that, in addition to giving specific data on various transistors and semiconductor devices, the manual includes some very valuable general information on these subjects. Plan to spend several hours—not necessarily at this time, but within the next few weeks—studying this general information. Take note that the manual explains the basic theories of semiconductor devices,

the materials employed, and circuit configurations. Transistor characteristics and applications are also given in the manual in addition to the information presented on other devices such as silicon rectifiers, silicon controlled rectifiers, tunnel diodes, etc. The bulk of this information applies to the semiconductor devices manufactured by all different companies, so that it is general information relative to semiconductor devices.

The main portion of the transistor manual gives technical data on transistors, and another section deals with diodes and other semiconductor devices manufactured by RCA. We will consider this technical data more completely a little later in this assignment.

Another section toward the back of the transistor manual is entitled "Outlines." This section illustrates the physical appearance of the various units as well as the arrangement of the leads. Following this is a section dealing with circuits in which various types of radios, tuners, pre-amplifiers, audio amplifiers, etc., are shown. These diagrams will be found to be of great value later in the training program when the various types of circuits illustrated here will be more familiar.

Numbering Systems Used With Transistors And Semiconductors

It is unfortunate that there is no universally employed system for numbering transistors and other semiconductor devices. There actually is a system which is employed on a widespread scale but it will be found that there are many, many deviations from this system.

RCA employs the standardized numbering system almost universally. Let us look at the technical data section of the transistor manual to get an understanding of the most widely used system. After this we will discuss some of the variations.

Under the standard system, **diodes** (silicon rectifiers and germanium rectifiers) **start with 1N** followed by several numbers and letters. An example of this is the 1N249C silicon rectifier. Find the information on this diode in your transistor manual. What page incorporates this information? _____. The number 249 part of this numbering arrangement has no particular significance except that it indicates, in a general way, the order in which the units were developed.

In this standardized system, the numbers assigned to most **transistors start with 2N**, which is then followed by several numbers or numbers and letters. An example of this is the 2N1183 transistor. Some special transistors are now being manufactured with a numbering system starting with **3N**. A glance toward the back of the technical data in the transistor manual will reveal that RCA does not always follow the standard numbering system. Note for example the power transistor numbered 40022.

While many companies employ the standard numbering system, it will be found that a wide variety of other numbers are used. Some of these result from the fact that the units are manufactured by special means or have other special characteristics. These numbers range from such letter-number combinations of CK1020 to 50M175Z5. The variety is almost endless—so much so that it is virtually impossible for the average electronics parts house to stock even a large percentage of the number of transistors and other semiconductor components that are available. For this reason, many cross-reference charts are used in electronics supply houses so that a technician can be supplied with a substitute semiconductor device in case the exact replacement is not available. This type of non-standardization is much more prevalent in the semiconductor and transistor field than in the case of vacuum tubes.

Glance at the descriptions given in the transistor manual for various types of transistors; two general categories can be seen—transistors, and power transistors. Although there is no definite dividing line between these two categories, it will be found that a transistor which is designed to dissipate less than 100 milliwatts (.1 watt) will usually be categorized as a transistor while one which is designed to handle above 100 milliwatts is categorized as a power transistor.

The physical appearance of power transistors is often quite different from that of other transistors. This arises from the fact that, as we have already learned in the training program, heat is produced when electrical power is expended in any device. Any transistor produces a certain amount of heat, but when the amount of power being handled is quite small, the heat is not of great consequence. In the case of a power transistor, however, the heat produced is of great consequence because transistor characteristics are affected to a considerable degree by changes in heat. For this reason, most power transistors are quite large in comparison with other transistors; most of them ranging in diameter from approximately $\frac{2}{3}$ inch to $1\frac{1}{4}$ inches. It will also be found that most power transistors have one of the elements—usually the collector—internally connected to the metal case of the transistor.

Power transistors will usually incorporate a **heat sink**. This term “heat sink” is easily understood by comparing it to a kitchen sink, which, of course, provides a space for catching the water which is used in the kitchen and running it off. In a power transistor, the heat from the transistor itself is conducted to the heat sink which then provides a means of dissipating the heat generated in the transistor. Generally, the heat sink is a special heat-conducting material, with transistor heat being conducted to the metal chassis of the particular amplifier. In some cases, such as with industrial electronics equip-

ment and computers, blowers are provided so that air circulation removes the heat away from the heat sink. In some of the more elaborate equipment—some circuitry used in missiles and computers—small electronic refrigeration systems are provided for cooling the heat sinks so that the transistors will not overheat.

Transistor Basing, or Transistor Terminal Arrangements

Most of the transistors on the market have three leads extending from the transistor case; some have four leads, however, and some—particularly the power transistors—have two leads. To get a better picture of this, refer to the **Outlines** section of the transistor manual. These outlines show the physical appearance of various transistors. These transistor outlines are accepted industry-wide, and there might be 200 different transistors, manufactured by 50 different companies, using the TO-1 outline, or package, as it is sometimes called. (Incidentally, the TO part of the TO-1 designation stands for **Transistor Outline**.) Note that the TO-1 outline relates to a transistor that is approximately $\frac{1}{4}$ inch in diameter, a little less than $\frac{1}{2}$ inch in height, and has three leads which are $1\frac{1}{2}$ inches in length. These leads protrude from the bottom of the transistor case in a triangular pattern.

Now look at the TO-5 Outline. Would a transistor employing this package have a larger, or smaller, diameter than one using the TO-1 package? LARGER
How would its height compare with one using the TO-7 package? SMALLER

Now let us look at some of the lead, or terminal arrangements which are employed. Transistors employing the TO-5 transistor package have three leads arranged in a triangular pattern somewhat similar to the TO-1 arrangement but the spacing of the TO-5 leads is greater.

Notice further that the TO-40 package has three leads extending from the bottom of the transistor, but in this case the leads are short, being approximately only .2 of an inch in length and they are arranged in a straight row.

The TO-7 package houses a transistor with four leads arranged in a row, whereas the TO-12 package is a transistor with four leads arranged in a circular pattern.

A power transistor that incorporates but two leads is illustrated by the TO-3 package. The TO-36 package illustrates another power transistor that has two active terminals and an indexing pin.

This information regarding the basing arrangement of transistors is not really as confusing as it would seem from the foregoing information. To illustrate this point, let us cite specific examples. Refer to the 2N1180 transistor in the technical data section of the transistor manual. It will be noted that

it is housed in a TO-45 package. It should also be noted that: Pin 1 connects to the emitter, Pin 2 connects to the base, Pin 3 connects to the shield or case of the unit, and Pin 4 connects to the collector. Now refer to the TO-45 Outline and see how to identify the leads. Leads 1, 2, and 3 are close together and lead No. 4 is spaced farther away. This lead—No. 4—is the **collector**. Pin No. 1 is the **emitter** and pin No. 2 the **base**.

Now refer to the 2N104 transistor. The technical data shows that it has three terminals. Look at the indicated outline—the TO-40 package—which houses this transistor. **The pin which is by itself is once again the collector**; of the two pins that are close together, the first one is the emitter, the second one is the base.

Continuing this reference to the transistor manual, note that the 2N109 has the same physical arrangement as the 2N104 we have just considered. The same is true for the 2N139 and the 2N140. Now refer to the 2N173 which is a **power** transistor. As indicated, Lug No. 1 is the base and Lug No. 2 the emitter. The collector connects to the case. To understand the terminal arrangement for this transistor, refer to the TO-36 Outline. Note that there is an **index pin** on this transistor case. **In all transistors which have index pins, the terminals are counted in a clockwise direction from the index pin.**

Now look at the TO-5 Outline. Do you see the indicated **index tab** on this type? _____. Note that the terminals are counted in a **clockwise** direction from this **index** tab.

On the TO-1 package, you will observe that there is no index pin, or tab. However, if the transistor is held as shown in the diagram, it will be noted that there is an "opening," or space, between the two bottom terminals (between pins 1 and 3). The terminal pins are identified by counting in a clockwise direction from this "opening."

This same technique would be applied to a transistor such as the one typified by the 2N274. Once again, it should be noted that there are three active leads on this transistor and that the case or shell of the transistor is connected to a lead for grounding purposes. The TO-44 Outline shows the arrangement and it can be observed that the active pins are identified just as we have been discussing with the center lead being the shell or grounding lead.

Now refer to the 2N1224 transistor in the technical data section. This transistor has three active connections, with a connection to the shield or case. Reference to the TO-33 Outline shows that the same numbering procedure as we have discussed previously applies. **Counting in a clockwise direction from the index tab**, the pins are 1, 2, 3, and 4 so that the various connections can be easily identified.

Continue to apply this technique to any or all of the transistors listed in the transistor manual until it is possible to identify each lead without

difficulty. This exercise should indicate the importance of having a transistor manual available when working with transistorized equipment.

There have been a number of transistors manufactured in which the three leads project from the bottom of the transistor in a row and the spacing between them is uniform. Most of these were manufactured before it became customary to provide indexing tabs to determine the manner in which to count the pins. In most instances transistors like this will be color coded with a **red dot adjacent to the collector lead.**

Transistor Sockets

Many transistors have long leads and the transistors are soldered directly into their associated circuitry rather than using them in transistor sockets. Even transistors with long leads, however, are sometimes used in sockets. In such cases, the leads are usually cut off to a more suitable length of perhaps $\frac{1}{2}$ inch. Power transistors are **always** used in sockets and, as has already been mentioned, heat sinks are almost always employed to aid in removing heat from these transistors.

A variety of transistor sockets are shown in Figure 1. Many transistor sockets have the pin numbers stamped on them; but if they do not, the socket pins are read from the bottom in a manner just as was explained in connection with the transistors themselves.

The Receiving Tube Manual

Now we will turn our attention to the receiving tube manual which deals with both vacuum and gas-filled tubes. Let us first glance at the manual to determine what general information is included before considering specific things regarding the tubes themselves. It will be noted that this tube manual, as was the case with the transistor manual, provides a great deal of information of a general nature.

One section of the tube manual deals with the manner in which electrons are emitted and the general construction of electron tubes. A great deal of information is provided on electron tube applications as well as installations.

Most of the tube manual deals with technical data which provides specific information on a great many types of vacuum tubes. A little further back in the manual will be found additional general information, including a section with information on resistance-coupled amplifiers. This is followed by an **outlines** section which gives the physical sizes and shapes of vacuum tubes. Following this is a section dealing with circuits, which includes diagrams of radios, FM tuners, hi-fi amplifiers, stereo amplifiers, power supplies, etc. All of this shows that this manual provides a lot of information of a general nature which will prove very valuable to you as an Electronics Technician. It is suggested that sometime in the future a number of hours should be spent going over this information in the tube manual. Also if at any time

during future work in the training program a question arises regarding vacuum tube or gas-filled tube applications, it is suggested that reference be made to this tube manual. Obviously, the more familiar one becomes with the manual and the information contained therein, the greater can be the assistance obtained from this reference manual.

Vacuum Tube Outlines

Over the years the processes of manufacturing vacuum tubes have gone through a constant period of development and improvement. During this time the physical size of vacuum tubes has in general decreased, while the shape has also changed considerably.

Refer to the **outlines** section of the vacuum tube manual. In particular look at the tubes labeled ST12, ST14, and ST16. Once vacuum tubes had passed the experimental stage and went into mass production, this is the type of a tube shape which was very widely employed. The next general shape which was adopted is shown as the T9 Outline. Close on the heels of this development were the metal tubes as illustrated in the three large metal type outlines. These were then followed by the miniature glass tubes as shown in the T5 ½ and T6 ½ Outlines. The most recent developments are tubes such as those illustrated in the T12 Outlines, and the small metal tube illustrated. Most of these tube styles will be found in widespread use with the exception of the ST12, 14, and 16 styles.

Receiving Type Vacuum Tube Sockets

There are five different kinds of sockets in use with the various receiving type vacuum tubes. These are the **standard**, **octal**, **lock-in** or **loctal**, **miniature**, and **nuvistor**. Of these sockets, the standard type was the one which was used with the tubes employing the ST12, 14, and 16 outlines. Although none of these tubes and their associated sockets are being used in equipment of new design, there is still a relatively large number of them employed in various circuits and for this reason it is necessary that an Electronics Technician have some knowledge of them.

There are several types of tube pin arrangements which are classed under the heading of standard sockets. These are; (1) the standard 4 pin, (2) the standard 5 pin, (3) the standard 6 pin, (4) the small 7 pin, and (5) the large 7 pin. Figure 2 sketches bottom views of the arrangement of the pins on these five types of standard sockets.

In all of these types of sockets except the 5 pin, the two heater or filament pins are of a larger diameter than the other tube pins, and because of this they may be identified very easily. Figure 3(A) shows a bottom view of a 4-prong standard socket. Figure 3(B) shows a bottom view of a standard 5 prong socket and Figure 3(C) shows the top view of a standard 6 prong

socket. (The particular sockets shown in Figure 3 are quite thin, and are often called **wafer** sockets by technicians.)

The numbering system for the tube socket pins of **standard** sockets is given in Figure 2. Here is a summary of this base pin numbering system. When the tube or tube socket is held upside down and with the two heavy heater pins toward the observer, the left heater pin is always "number 1", and going around in a **clockwise** direction, the next pin to it is the "number 2 pin", the next one is number 3 and so on. This system of numbering continues until the other (right hand) heater pin is reached. The right hand heater pin then bears a number which is the same as the total number of pins on the tube base. Look at the various tube bases illustrated in Figure 2 and see if you understand this numbering system perfectly. For example, look at the 6 pin tube socket. This is a bottom view of this tube socket. With the two large heater pins nearest the observer, it will be noticed that the left large heater pin is number 1, then continuing in the clockwise direction, we see the pins number 2, 3, 4, 5, and 6. Number 6 being, of course, the other heater pin.

The 5 pin socket does not have heater pins which are larger than the other pins, but has non-uniform spacing of the pins as may be seen in Figure 2. The heater pins are opposite the pin which is widely separated from the others. The left hand heater pin is the "number 1" pin and the other pins are numbered around clockwise, as shown in Figure 2. Be sure that you understand this base pin numbering system. In most cases, these numbers are **not** marked on the bottom of the tube sockets; therefore the electronics technician must know how to determine which of these socket pins bears a definite number.

Remember that the counting is done from the left hand heater pin in a clockwise direction when looking at the **BOTTOM** of the socket, or of the tube. If the **TOP** of the tube socket is being examined, it will be found that the numbering system will go from the right hand heater pin around in a counterclockwise direction. This is not introduced at this point to confuse you, but rather to illustrate the fact that it makes a great deal of difference whether you are looking at the top of a tube socket or the bottom of the tube socket when determining which pin is which. It is a good policy to always look at the bottom of the tube socket and count from the left hand heater pin in a clockwise direction.

In order to determine which tube element each base pin of a standard base tube connects to, your tube manual should be consulted. For example, look up the type 30 tube in your tube manual. Turn back in the tube manual, past the information on specific tubes and there find the section labeled "Types for Replacement Use." These are listed numerically by the first number, so check through this list to find the type 30 tube. Notice that it gives the Outline number as well as the basing diagram number. What basing diagram number do you find for the type 30 tube? _____. At the very back of the section dealing with tubes for replacement use, the

basing diagrams can be found. Look up the proper diagram for the type 30 tube. Notice that the Number 1 and Number 4 pins on this tube connect to the filament of the tube. The number 2 pin connects to the plate of this tube, and the number 3 pin connects to the grid of this tube. Now look at the type 27 tube. This is a 5 prong tube. Pins number 1 and number 5 connect to the heater on this tube. Pin number 2 is the plate connection, pin number 3 is the grid connection, and pin number 4 is the cathode connection of this tube. Thus we see, that once the tube base numbering system as illustrated in Figure 2 is familiar, it is a simple matter to look up the tube in question in the tube manual to determine which element is connected to a given pin on this tube base.

Octal Sockets

The type of tube base which was employed very widely by tubes of more modern design is the **octal** type of base. This type of tube base is shown in Figure 4. Figure 4(A) is a diagram of the bottom view of an octal socket showing the pin numbering system. Figure 4(B) is a top view of an octal wafer socket, and Figure 4(C) is the bottom view of the same socket. Figure 4(D) is the top view of a molded octal socket. The wafer sockets are made from small pieces, or wafers, of an insulating material similar to bakelite in which holes have been punched for the socket pins to be added. The molded sockets are made from a molded plastic ceramic and the socket pins are then added. Both of these types of sockets will be found in equipment of modern design.

The octal tube bases have provisions for 8 pins as indicated in Figure 4. The diameter of these pins is smaller than the diameter of the small pins on the standard sockets. Octal tubes are provided with a central locating lug near the center of the tube. There is a projection extending from the center of the tube straight downward. This projection is approximately one-quarter of an inch in diameter and is round except for a key which is located on it. The slot provided in the tube base for this key is shown in Figure 4(A) and can also be seen in the other figures illustrated in Figure 4. Although the tube socket pins on the octal tubes are all of the same diameter and spacing, the tube can be inserted in the socket in only one direction due to this "key".

The pin numbering system for octal bases and sockets is shown in Figure 4(A). With the tube socket turned upside down and viewed with the key toward the observer, the numbering system starts at the first pin to the left of the key. As in the standard socket, the numbering sequence is **clockwise**. On certain tubes when less than 8 pins are needed, the unnecessary pins are omitted from the tube itself and the spacing of the remaining pins is not changed. Thus any octal tube will fit any octal socket regardless of the number of pins it has.

Refer to the type 6SJ7 tube in your tube manual. This is an octal base tube as can be determined from the diagram of the tube in the tube manual. Notice that the key is between the number 1 and the number 8 pins, and that

the numbering runs from the pin at the left of this key in a clockwise direction around to 8 which is the pin to the right of the key. In this tube, the number 1 pin is labelled S and this is the shield which is built into the tube. In a great number of octal base tubes, the number 1 pin is the shield which should be grounded at the chassis. The number 2 and 7 pins of this tube are connected to the heater, the number 4 pin is connected to the control grid, the number 6 pin is connected to the screen grid (or G_2 as it is called in the diagram), and the number 3 pin connects to the suppressor grid (or G_3 as it is called in the diagram). The plate of this tube is connected to the number 8 pin, and the cathode is connected to the number 5 pin. Now contrast this with the 6K6GT tube. Notice in this case that the number 1 pin is labelled NC which means no connection. The numbers 2 and 7 pins are connected to the heater, the number 5 pin is connected to the control grid, the number 3 pin connects to the plate, and the number 4 pin connects to the screen grid. The suppressor grid connects internally to the cathode. Since there are no more elements in this tube, the number 6 pin has been omitted entirely, but notice that the spacing of the remaining pins is the same as the spacing on the 6SJ7. That is, the number 7 pin is in the same position as the number 7 pin on the 6SJ7. In spite of the fact that the number 6 pin has been omitted, it is counted in on the numbering system of the tube's base pins.

The octal type of socket has proved to be a very efficient arrangement. Although this socket and basing arrangement was introduced a number of years ago, many, many, of these are still found in modern equipment.

Loctal Sockets

The next type of tube base which achieved popularity was the loctal or lock-in type. With this type of base, the internal elements of the tube are sealed directly into the glass seat or base to which is attached the enclosing shield. The stiff terminal lead wires project directly through the glass seat and at the same time form the actual base pins, thus eliminating the necessity for separately soldered base pins. At the bottom of the glass envelope is fitted a shallow metal container which forms a metal reinforcing band around the glass envelope, and also incorporates a central round guide or locating lug as shown in Figure 5(A). This lug has a groove near the bottom which is similar to an ordinary phone plug, and when this tube is plugged into a loctal socket, a spring catch or ring in the central metal sleeve for the tube socket snaps into this groove and holds the tube securely in the socket.

The loctal tube base also has 8 pins (which, as we have said, are the terminal lead wires from the elements) uniformly spaced around the central locating lug. There is a guide key on the central locating lug of a loctal tube, similar to the one on an octal tube. The pins have a still smaller diameter than those used on the octal base tubes, and they will not fit into an octal socket (or vice versa) but require their own special loctal socket which is designed with a special central metal sleeve to take the locating lug. Although all 8 pins are normally incorporated on these tubes, if one or more are

eliminated, the spacing and numbering of the remaining pins will remain unchanged.

The bottom view of a loctal socket is shown in Figure 5(B). The tube pin numbering system for this type of socket is the same as for octal tubes (From number 1 to 8 in a clockwise direction beginning at the locating key when viewed from the bottom of the socket).

The construction of the loctal tube was developed to produce a strong rugged tube capable of withstanding severe shocks and vibrations such as would occur in automobiles, aircraft, and portable radio receivers. In order to supply additional support for some of the elements in tubes which would otherwise have unused base pins, one of the otherwise unused pins is often used as an extra support for some electrode. The result is that two of these pins are electrically common to one element. In receivers which employ these tubes, the standard, or usual, pin is normally wired into the receiver circuit, and the additional pin is left unconnected at the tube socket, although this may not always be the case.

Since these loctal tubes are held securely in their sockets, it is sometimes rather difficult to remove them. Care should be exercised in removing these tubes, for, if they are roughly twisted or jerked when being removed, they may crack around the base and shatter in the technicians hand. To remove a loctal tube from its socket, a **slight offside** pressure should be exerted against it to disengage the locating lug from the socket spring connection; then the tube may be pulled straight out easily.

The loctal type of socket did not reach a high degree of acceptance. As a result, even though these tubes will be encountered occasionally in today's equipment, they are rather rare.

Miniature Sockets

The series of tubes, called **miniature** tubes, have been developed which are much smaller than the other types of tubes. These tubes have a maximum overall length of only $2\frac{1}{8}$ inches and a diameter of approximately $\frac{3}{4}$ inch, making them very popular for applications where a minimum of space is desirable. The decrease in physical size was accomplished by eliminating the usual base, and by bringing the element connecting wires directly through the glass at the bottom of the base. Thus, as in the case of the loctal tube, the wires supporting the elements serve as the tube pins. The socket used for these tubes is of a special size with seven holes to take the pins.

Figure 6(A) shows an illustration of a typical miniature tube, and Figures 6(B), 6(C) and 6(D) show the miniature tube sockets (bottom view). Let us consider the 7-pin socket, shown in Figure 6(B), first. All of the tube socket pins on this type of tube are evenly spaced except in one case. Between the number 1 and the number 7 pin, there is more space than between the other pins. This is used as the key for the numbering system and also prevents the tube from being plugged into its socket in any but the

correct manner. The numbering of the pins proceeds from number 1 which is at the left of the wide space when the socket is viewed from the bottom, to number 7, in a clockwise direction as illustrated in Figure 6(B).

Many types of miniature tubes have been designed to meet certain specific requirements found in television receivers and in electronic equipment. Typical examples of seven-pin miniature tubes are the 6AQ6, 6AU6, 12AL5, and 12AT6.

As the use of miniature tubes became increasingly popular, design applications have required miniature tubes with more than seven pins. For this reason, many miniature tubes have been placed on the market which have nine pins in the base. The bottom view of such a socket is shown in Figure 6(C). An example of a tube employing this nine-prong miniature base is the 12AU7 tube. Look up this tube in the tube manual; this will show that it would be impossible for this miniature tube to be designed with a seven-prong base. Other examples of nine-pin miniature tubes are the 12AV7, the 12BH7, the 19T8, etc. The nine-pin miniature tube socket is often called a **noval** socket. As Figure 6(C) reveals, the arrangement of the pins on the 9-pin miniature socket was the same general procedure as that on the 7-pin socket—that is, more space is present between the number 1 and the number 9 pin to serve as the guide, and the numbering proceeds in a clockwise direction from pin 1 to pin 9.

As transistors came into being, the tube manufacturers, quite naturally, gave serious thought to changes which they might make to keep vacuum tubes competitive with transistors. One of them is the development of the 12-pin miniature tube which often incorporates as many as three different vacuum tubes within one envelope. The added pins, of course, make it possible to bring all of the elements out for connections. Figure 6(D) shows the arrangement employed with the 12-pin miniature tubes and it will be seen that it is similar to the arrangement used with other miniature tubes. A space is provided between pin number 1 and pin number 12 which serves as the guide, and the numbering proceeds in a clockwise direction (when the bottom of the socket is used) from the pin 1, which is directly to the left of the guide space, in a clockwise direction to pin 12. This type of tube base is sometimes referred to as a **duodecar** socket which really means “two plus ten”.

One of the newest innovations in the vacuum tube field, which was made primarily to put vacuum tubes in a more competitive position with transistors, is the nuvistor type tube which is manufactured by RCA. This is a metal tube which is quite small—actually not much larger than many transistors. Look this up in the Outlines section of your manual, under metal types.

The basing arrangement for the nuvistor is entirely different than any other previously manufactured tube. As will be noted from the outline section, there are two projections which extend from the metal case of the tube down opposite sides even further than the tube pins themselves. One of these projections is a little less than $\frac{1}{8}$ of an inch wide and the other is a little less

than $\frac{1}{4}$ inch. The wider of these two serves as the guide when determining the pin arrangement.

Look through the tube manual to find a nuvistor tube. The 6DV4 is a typical one but others will also be found.

First, however, look at the schematic symbol and note the small tip shown protruding from the bottom part of the main tube symbol. This is the large indexing lug which protrudes straight down from the outside edge of the metal enclosure for the tube. Now refer to Figure 7 and observe the manner in which the pins are arranged on this tube is more simple than would appear at first glance. The tube is arranged so that the pins are in four concentric circles. Look at Figure 7(A) which shows how to identify the pins on the outside circle. Once again we start with the indexing lug and count around in a **clockwise** direction. The first pin is number 1, the second pin number 2, and the third pin is number 3. Since there are only three pins in each circle, this completes the first circle. Figure 7(B) shows how to determine the pins on the second circle and it will be seen that we continue the process which was started in Figure 7(A). We have gone around the outside circle in a clockwise direction to pin number 3. We now skip to the second circle of pins and continue in a **clockwise direction**. The first pin we encounter is pin number 4, then going on around we find pin numbers 5 and 6, which completes the second circle of pins. Then we skip to the next circle and continue in a clockwise direction counting pin 7, pin 8, and then 9 as illustrated in Figure 7(C). This completes the third ring at which time we jump to the inside ring and, continuing in a clockwise direction, we encounter pins 10, 11 and 12 as shown in Figure 7(D). With this explanation in mind, again look at the complete diagram of the nuvistor socket as given in the tube manual and check around the circles and determine how the pins are read. This will reveal that although the arrangement looks rather confusing at first, it is actually quite simple.

In addition to these receiving tubes, there are several types of vacuum tubes which have been constructed for special applications such as hearing aids, etc. One of these was called the "Junior Bantam." This type tube employed a special, small, 5-pin socket. Other hearing-aid tubes are called "sub-miniature" and do not have a tube base. Instead, flexible wires come out of the tube at one end and these wires are soldered directly to the circuit. In addition to these types of tube sockets, there are special tube sockets for special type tubes, such as the picture tubes in television receivers, the pickup tubes in television cameras, etc. Due to the complexity of some of these tubes, some of the sockets have as many as twenty pins. Since these types of sockets will be encountered very rarely, we will not concern ourselves with them in this discussion.

In addition to the connections which are made to the base pins on tubes, there are sometimes connections made to the top of tubes. Referring to the outline section once again, several tube styles are shown with connections to the top. When this type of arrangement is employed, it is generally the

plate cap which connects to the top of the tube, although this is not universal. In older tube styles the control grid connection was sometimes made to the top of the tube. To illustrate the manner in which the schematic symbol indicates the connection to the top of the tube, refer to the 6CB5A tube in the technical data section of the tube manual. Notice the fact that the plate electrode in the tube is shown connecting to a little square portion of the symbol labeled "P." This represents the top cap on the tube.

The information which has been presented at this time should have given a complete understanding of the physical arrangements of vacuum tubes. Leaf through the tube manual, stopping at various points to look at the schematic symbol and to determine from the technical data the outline of the tube. Then look up in the outline section to make sure that, through the use of the tube manual, the physical arrangements employed for any tube in the manual can be determined.

Type-Number Designation System

The first vacuum tubes were called by a name rather than by a number, for example, Dr. DeForest's **Audion** which was mentioned in a previous assignment. A little later, with the development of a great number of tubes, a numbering system came into use. Most of these original tubes are completely out of use at the present. However, some of the tubes which became popular about 1925 are still in use. We shall list them in groups under the filament voltage ratings of the various types.

5 volt filament tubes	2 volt filament tubes	2.5 volt filament tubes	6.3 volt filament tubes		
01	30	45	36	42	75
01A	31	56	37	64	76
01AA	32	57	38	65	77
01B	34	58	39	67	78
01C			41		79
71A					

Practically all tubes designed since 1933 employ the EIA (Electronic Industries Association) type-number designation system. This system should be completely understood, for in most instances, the "type-number" itself gives considerable information regarding the construction and purpose of a tube.

Under this system, three or four symbols are used to give a tube an identifying type-number. These are: (1) a first numeral (or group of numerals), (2) one or more distinguishing letters, (3) a last numeral, and (4) a letter suffix is sometimes used.

The first numeral, (or group of numerals), indicates the approximate filament or heater voltage of the tube. In order to avoid the use of decimals in these numbers, the number used is usually that of the next lower **even**

volts. There are exceptions to this statement which will be pointed out. To illustrate the use of this first numeral, let us consider a tube such as the 6F6. Look this tube up in your tube manual. Notice, in the tube manual that the heater voltage for this tube is listed as 6.3 volts. To eliminate the use of the decimal, **the first numeral used in most 6.3 volt tubes is 6.** Check through your tube manual, noting the wide variety of tubes whose number starts with 6. Also, check a number of these and keep in mind that each of these tubes requires 6.3 volts for their filament or heater.

The numeral **2** is used as the first symbol in a designation system for tubes which require approximately 2.5 volts on their filaments—for example, the 2AH2 tube. Refer to the tube manual and you will find that the filament voltage for this tube is 2.5 volts. Also, notice that the other tubes whose number starts with 2 require filament voltages of slightly more than 2 volts. In a like manner, the numeral **5** is used for 5 volt tubes (like the 5Y3GT), the numeral **12** is used for 12.6 volt tubes (like 12BT3), the numeral **25** is used for tubes whose filament voltage is 25 volts, 35 for 35 volt tubes, and so on. For your own benefit, look up the 70L7 tube and determine what its filament or heater voltage is, and also the 117N7 tube to determine its filament voltage.

The exceptions to this rule are necessary, due to the fact that conflict would result if this system were used in some cases. For example, we have indicated that the numeral **2** is used for 2.5 volt tubes. There are a number of tubes made to operate at a filament or heater voltage of 2 volts. For this reason the numeral **1** is used to indicate tubes whose filament voltage is below 2.1 volts. An example of such a tube is the 1H4-G. Also, in accordance with the rule as stated above, tubes such as the 1A7-GT which have 1.4 volts in their filaments are designated with the numeral **1**.

Another exception to this rule is the loctal base tube. To distinguish the loctal tube types from the octal type, the numeral **7** is used to indicate 6.3 volt loctal tubes and the numeral **14** is used to indicate 12.6 volt loctal tubes. Examples of these are the 7H7 and the 14C7. Look these two tubes up in the tube manual to check the filament voltage for each.

The letter (or letters) following this first numeral indicates the function of the tube and distinguishes one tube type from another which may happen to have the same numerals. For example, the letter in the type number is the only thing which distinguishes between the type numbers of the 6K7 and the 6J7 tubes. These letters are assigned to the tubes in alphabetical sequence as the tubes are designed, starting at **A** for all types of tubes except rectifier tubes. In the case of rectifier tubes, this alphabetical assignment is made starting with **Z** and working backwards. The number of tube types which have been manufactured now has become so large that two letters are employed in the type-numbers of most tubes. Examples of this type might include the 18FW6A, the 25EC6, and the 12SK7GT.

The last number in the EIA standard number indicates the number of useful elements which are brought out to terminals. Notice this does not

indicate the number of tube pins, but rather indicates the number of useful elements which are brought out to terminals. For example, the filament of a tube is always brought out to at least two pins, yet it is only one element. To illustrate the use of this last numeral in the numbering system, refer to the 2A6 tube in the tube manual. The 6 at the end of this number indicates that there are six useful elements which are brought out to terminals. These are the heater, the cathode, the control grid, the plate and the two diode plates. To further illustrate the use of this number, refer to the 6DS5 tube. This tube has 5 elements brought out to pins on the tube base. These are the heater, the cathode, the control grid, the screen grid, and the plate. In this particular tube, the third grid—the suppressor grid—is not brought out to an external terminal, but is connected to the cathode inside of the tube. Since it is not brought out to an external terminal, it is not counted in the numbering system. To further clear up the use of this last numeral in the numbering system, refer in your tube manual to the type 6GN8 tube. Unfortunately, it will be found that this last numeral is not always used according to this system as outlined. Check through a number of tubes in the tube manual to see which ones agree with this outline.

With the introduction of both glass and metal tubes of the same electrical characteristics, the use of letter suffixes in the tube type-number became quite common. Several of these suffixes are now in use and they indicate some of the physical characteristics of the tube. The widely used suffixes are the **G** and **GT** suffix. The suffix **G** denotes a tube with a glass envelope and octal base which is equivalent to this same tube number in a metal tube. The **G** type of tube has the glass envelope with the curved sides as may be seen in the outline section. The tubes with the **GT** suffix are a glass envelope equivalent of metal tubes and have a glass envelope which has straight sides. To illustrate these two types, look up the 6J8-G in the tube manual and the 6DG6GT. Refer to the outline section, as indicated in the description of these two tubes, to determine the difference in the type of glass envelope used in these two tubes. As a general rule, the electrical characteristics of the **G** and **GT** types of tubes are the same as those of their metal equivalents (if such an equivalent tube exists), except for differences in the stray capacitances which exist within the tube and the shielding properties of the tube. For example, the 6K7, the 6K7-G and the 6K7-GT all represent tubes with the same electrical characteristics, but the 6K7 is a metal tube, the 6K7-GT is a glass tube with a dome shaped bulb and an octal base, and the 6K7-GT is a glass tube with a short tubular envelope and an octal base. In many types of tubes, the **G** and the **GT** tubes are interchangeable, and when such is the case, the **G** types have been discontinued. To indicate this, the **GT** type of tube is sometimes marked "GT/G".

If this EIA tube-type designation system is kept in mind, it is usually possible to figure out the main information about a tube from a study of its type-number. For example, the 2A3 tube must be a 2.5 volt filament type of tube. The tube is not a rectifier tube because it has the letter **A**. Since the last letter in the tube type is **3**, we know that there are three useful elements

brought out to its terminals. This tells us that the tube must be a triode with a 2.5 volt filament. In the same manner, the tube type 25Z5 tells us by its first numerical group, "25", that the filament or heater operates at approximately 25 volts; by the letter Z, that the tube is a rectifier; and by the final number, "5", that the tube has five connected elements. Check this tube in the tube manual where it will be learned that this is true. It is a rectifier tube that has two plates, two cathodes, and one common heater.

Information concerning many types of tubes cannot be deduced this easily from the numbering system, but in all cases, the first number will at least supply the filament or heater voltage. A study of the type-numbers and the specifications of some of the tubes listed in the tube manual will aid in understanding this system.

Pilot Lamps and Dial Lamps

While we are studying the numbering system of vacuum tubes and vacuum tube filament circuits, let us also find out what will need to be known about pilot lamps and dial lamps.

In the early radio receivers, dial lamps were used merely as on-off indicators. As the design of radio receivers was improved, dial lamps were also used to illuminate the translucent type of tuning dials, volume control scales, wave-band indicators, in certain types of tuning meters, and in various flash-tuning arrangements, etc. In modern electronics equipment pilot lamps, or miniature and sub-miniature lamps, as they are often called, are used for countless purposes. For this reason, many types of pilot lamps having various filament designs, bulb sizes and shapes, base designs, voltage ratings, current ratings, etc., have been developed to meet the requirements of these various applications.

Just as many different companies manufacture vacuum tubes, so do many different companies manufacture miniature lamps. Figure 8 presents information on the miniature lamps manufactured by the General Electric Company. Note that various bulb and base styles are shown in Figures 8(A) through (R). Check through the information provided in the charts and you will note that in addition to a wide variety of shapes, styles, and bases, that the miniature lamps are manufactured in a wide variety of voltage and current ratings. To illustrate the use of this material, note that the #49 pilot lamp has a shape as illustrated in Figure 8(B) requires 2 volts for its proper operation and will draw .06 ampere, or 60 milliamperes of current. Similarly, the #158 bulb has the arrangement as shown in Figure 8(B) and requires 12 volts at .24 ampere for proper operation.

Just as it is impossible for an Electronics Technician to remember detailed information regarding the various types of vacuum tubes and transistors available, so it is impossible to remember all the information regarding pilot lamps. However, it is advisable to devote a few moments of your time to analyzing the information presented in Figure 8 carefully to obtain a good overall knowledge of miniature and subminiature lamps.

Vacuum Tube Filament or Heater Circuits

As we have learned in a previous assignment, the purpose of the filament is to emit electrons in the directly-heated cathode type tube, or to heat the cathode which emits the electrons in an indirectly-heated cathode type tube. The filament is merely a resistance which obeys **Ohm's Law** in all respects. This resistance becomes hot when current is passed through it. The heat causes electrons to be emitted from this hot filament or cathode. There are many ways in which the filament circuit may be connected, some of which will be illustrated in this assignment.

To obtain a clear picture of filament circuits, let us trace back to the beginning of electronics—to the early days of radio. The tubes used in the early types of battery operated radio receivers were directly-heated filament types such as the 01A and the 00A tubes. These tubes were generally operated in parallel from a storage battery with a series rheostat to regulate the filament voltage to the desired level. This filament circuit is shown in Figure 9. The filament voltage for these tubes was 5 volts. The 1.3 volt drop (6.3 – 5) was obtained from the rheostat as shown in Figure 9.

When indirectly-heated cathode type tubes employing a-c heaters became popular, they eliminated the need for the filament batteries. The heaters of these tubes obtained their heater voltage from the 110 volt a-c supply through a step-down transformer. The early sets employed a power transformer with several windings. One of these secondary windings supplied the high voltage to be rectified (changed to d-c) for the plate circuits of the vacuum tubes. The other windings supplied voltages for the filament circuits. The filament circuit for such a receiver is shown in Figure 10. One secondary winding supplied 5V. for the rectifier filament, one winding supplied 1.5V. for the type 26 tube, one supplied 2.5V for the type 27 tube, and the fourth low voltage winding supplied 5V. for the type 71A tube. Each secondary winding adds to the cost of manufacturing a transformer, and therefore, such a transformer was expensive. About 1933, when a great variety of 6.3 volt filament tubes were placed on the market by the tube manufacturers, it became possible to use 6.3 volt filament tubes throughout the radio with the exception of the rectifier tube. The filament circuit for such a radio is shown in Figure 11. Notice that there are fewer windings on this transformer and therefore it is much cheaper to manufacture. This arrangement is still widely used in the larger, more expensive radio receivers of today, in the TV receivers, and in practically all electronics equipment utilizing vacuum tubes.

Because many rural communities were not supplied with a 110-volt a-c voltage, radio sets were designed to operate from packs of dry cell batteries before the advent of transistors. These sets employed tubes requiring low values of filament current, so that the useful life of the filament battery will be as long as possible. The tube filaments were normally operated in parallel, and in sets of early design, 2-volt tubes were employed. The difficulty encountered in this case was that the voltage of the filament battery changed over a fairly wide range during the life of the battery. To compensate for this

changing voltage, **ballast** tubes were used between the battery and the tube filament circuit as shown in Figure 12. These components were called **ballast tubes** because they were in glass or metal envelopes similar to vacuum tubes and plugged into vacuum tube sockets. They were not vacuum tubes in the normal sense of the word, but were merely resistors. Ballast tubes have been employed mainly in battery powered receivers and to a certain extent in a-c and a-c d-c receivers. They were constructed to have the special operating characteristic of greatly decreasing their resistance if the current flowing through them tended to decrease.

To illustrate the operation of a ballast tube, let us suppose that the battery voltage shown in Figure 12 would begin to decrease due to aging of the battery. Under these conditions, the current drawn by the vacuum tubes' filament circuit would tend to decrease, since Ohm's Law says that for a constant resistance, the current would decrease if the voltage decreased. However, as the current starts to decrease, the resistance of the ballast resistor itself will decrease considerably, and consequently, there will be a **smaller voltage drop across the ballast resistor**. This will cause a greater portion of the battery voltage to be applied to the filament circuit, which is the desired thing in this case, since the battery voltage was falling.

A-C D-C Receivers

It was mentioned that receivers utilizing a power transformer as illustrated in Figure 11, were cheaper than those using the type of power transformer illustrated in Figure 10. But even the reduction in price, which was accomplished by simplifying the filament circuit, was fairly small so that the power transformer was still the most expensive component in a radio receiver. For this reason, radio receiver circuits have been designed which operate from the a-c power line but which do not use power transformers. These sets are commonly called a-c d-c sets, since they may also be operated from the 110 volt d-c power lines which are still used in a few communities. (Since transformers cannot be operated from a d-c source, the transformer type of receiver cannot be used in these communities.) In the a-c d-c type of circuit, the filament voltage will add up to as near 117 volts as possible. The difference between the designed filament voltage of the tubes and 117 volts can be obtained through the use of a dropping resistor. Notice that in the a-c d-c type of receiver, since the tube filaments are in series, the current rating for each filament must be the same or some provision must be made for bypassing the extra current around some of the tubes.

An early series filament a-c d-c circuit is shown in Figure 13. If the tubes shown in this circuit are looked up in the tube manual, it will be found that the filament voltage of the 25Z5 and the 43 is 25 volts each. The 75, the 6D6 and the 6A7 are each 6.3 volts. The total of these five tubes is 69 volts. The filament current of these tubes is .3 ampere. The 160 ohm resistor provided a voltage drop of approximately 48 volts, giving a total voltage drop in the circuit of approximately 117 volts.

In early types of a-c d-c radio receivers, a voltage-dropping resistor, consisting of a wire wound type of resistor mounted in a convenient position under the chassis, was employed for reducing the line voltage to the value needed for the series filament circuit. However, due to the poor ventilation conditions existing under the chassis, most of the heat developed in this resistor was communicated directly to the chassis and surrounding parts, such as capacitors, coils, etc. This caused the capacitors, coils, and other parts to fail much sooner than otherwise would be the case. For this reason, the under-chassis mounting proved unsatisfactory.

The next step was to incorporate this **voltage-dropping** resistor as a third wire on the attachment cord leading to the set. This put the heat-producing resistor outside of the set chassis and provided better radiation for getting rid of the heat. However, several objections to these cords became apparent. In case of a break or other trouble in the resistance element, access to it was rather inconvenient since the entire cord has to be unsoldered from the set, and a new one soldered into place for the replacement. In addition to this, if the cord was rolled up or became tangled, dangerous temperatures often developed due to the concentration of the heat in one place. Furthermore, there was a very definite fire hazard associated with this cord since it was usually passed over or under rugs, etc.

The next type of voltage-dropping resistor which came into use, consisted of the resistor element mounted on an ordinary tube base and surrounded with a perforated, cylindrical metal casing for good heat conduction and radiation. This type of construction made it possible to mount the resistor on top of the chassis, where the heat could be radiated more easily without damage to other vital parts in the receiver. It also removed the high temperatures from the line cord and thereby reduced the fire hazard. These resistors were readily accessible for testing, and the plug-in feature made their replacement a simple matter. Also, with all of the connections made to the socket prongs under the chassis, no **hot leads** or high voltage contacts were exposed. When metal tubes came into use, a straight sided metal tube envelope was put into service with these resistors. This made a very compact unit which could be conveniently replaced, and the metal envelope formed an excellent heat radiator. An octal base was generally employed, with as many prongs as were necessary for making the required connections to the wire wound resistance element inside.

Since the tube manufacturers have perfected a large variety of vacuum tubes with almost every conceivable filament voltage such as 35 volts, 45 volts, 19 volts, etc., the use of dropping resistors has become more and more rare in circuits of modern design. For example, a-c d-c receivers have used the filament circuit shown in Figure 14. In this filament circuit, the sum of the filament voltage of all of the tubes will equal approximately 120 volts. For this reason, no series resistor is needed. As was mentioned previously, in these series filament circuits, all of the filaments must have the same current requirements.

Figure 14 also illustrates another point regarding a-c d-c filament or

heater circuits. Very often the rectifier tubes employed in these circuits will incorporate a tapped heater or filament so that a pilot lamp can be connected in parallel with the low voltage portion of the tapped heater resistance. To illustrate this point, look up the 35Z5 tube in the tube manual. Note that the entire heater voltage for this tube is 35 volts and that this entire heater is connected between pins 2 and 7 on the tube socket. Also notice that the pilot lamp section is a tapped section of this heater and is connected between pins 2 and 3 on the tube socket. A type #40 or #47 pilot lamp connected in parallel with this section will operate at slightly less than normal brilliance, which is desirable in this case as it will prolong the life of the pilot lamp. Look up other rectifier tubes with high voltage heater circuits in your manual to note similar arrangements.

In the past years, there has been a great demand for portable radios. In general, these consist of three types: (1) transistor portables which, of course, present no filament problems, (2) the "personal" type, which was usually very compact and operated from its own self-contained pack of dry cell batteries, and (3) the a-c d-c battery type. This type contained a switch so that the radio could be operated either as a battery operated radio, in which case the power was supplied by self-contained batteries, or the set could be operated by throwing the switch on the power-line position. In this case, the power for the circuit was obtained through a rectifier circuit. Due to the fact that these types of sets were operated from batteries, low-drain filament types of tubes were used.

Figure 15 shows a typical filament circuit in one of the sets which could be operated from either the power line or self-contained batteries. In this diagram, only the filament circuit and filament battery have been shown. In addition to the filament battery that is shown, the set also had a B battery for supplying the plate voltage when operating from batteries. If these tubes in Figure 15 are looked up in the tube manual, it will be found that each requires 1.4 volts at .05 amperes of current. With the four tubes connected in series as shown in Figure 15, this would require 5.6 volts at .05 amperes. When the switch is placed in the battery position in Figure 15, the 8 ohm resistor will be connected between this filament string and the 6 volt battery. By applying Ohm's Law, we may find the voltage drop across the 8 ohm resistor to be .4 of a volt. In this position, then, 5.6 volts are left for the filament string, which will of course apply the proper voltage to each tube. When the switch is thrown to the line position, in addition to this 8 ohm dropping resistor, the 2200 ohm dropping resistor is also connected in the filament circuit. If Ohm's Law is again applied, it will be found that the voltage drop in this resistor will be 110 volts. Thus, we see that with this arrangement the proper filament voltage is again applied to these four tubes.

As has been mentioned, an arrangement as illustrated in Figure 11 where the filament or heater circuits for the tube are operated from a winding on a power transformer is more expensive than series filament arrangements. In general, this arrangement is considered to be a more rugged type circuit

arrangement that will provide longer life than the series filament circuits. Thus, it will be found that most industrial electronics equipment which employs vacuum tubes will use a modification of the circuit shown in Figure 11, so that parallel filament arrangement is used. On the other hand, the expense involved in furnishing power transformers is such that other equipment, where long life is not as important as price—for example television receivers—will employ series filament arrangements. Figure 16 shows the filament arrangement for a typical television receiver. It is suggested that the tube manual be used to look up the filament voltage and current for each of the tubes in this arrangement (the 20HP4 is the picture tube which has a 6.3 volt, .6A heater). Use Ohm's Law to determine the voltage drop across the 48 ohm series resistor and then add up the various voltage drops in the circuit to see how near this arrangement comes to 117 volts.

Summary

This assignment should serve to give an overall view of the physical arrangement of transistors and vacuum tubes, as well as the filament circuits employed with vacuum tubes. The information which has been presented is of a general nature and has been included primarily to acquaint you with the transistor manual and the tube manual so that you will be in a position to use these manuals properly while proceeding with the training program. As has been mentioned, you should plan to devote several hours to each of these manuals, studying the technical information provided in them in order to be able to make full use of this material in the future.

How To Pronounce

(Note: the accent falls on the part shown in CAPITAL letters)

loctal	LOCK-tuhl
octal	OKK-tuhl
wafer	WAY-fer

TEST QUESTIONS

Use a multiple-choice answer sheet for your answers to this assignment.

The questions on this test are of the multiple-choice type. In each case four answers will be given, one of which is the correct answer, except in cases where two answers are required, as indicated. To indicate your choice of the correct answer, **mark out** the letter opposite the question number on the answer sheet which corresponds to the correct answer. For example, if you feel that answer (A) is correct for question No. 1, indicate your preference on the answer sheet as follows:

1. ~~(A)~~ (B) (C) (D)

Submit your answers to this assignment immediately after you finish them. This will give you the greatest possible benefit from our personal grading service.

NOTE: You will need to use your Transistor Manual and Tube Manual as a reference for most of these questions.

- Which two of the following are **Incorrect**: (Check two)
 - The heater current for a 18GD6A tube is .1 ampere.
 - The 6SQ7 uses an octal base.
 - ~~(C)~~ The heater voltage for a 19HV8 tube is approximately 8 volts.
 - ~~(D)~~ The 6X4 is an amplifier tube.
- A 2N408 transistor has:
 - ~~(A)~~ 2 output terminals (the collector is grounded to the case).
 - (B) 3 output terminals arranged in a triangular pattern.
 - (C) 3 output terminals arranged in a row.
 - ~~(D)~~ 4 output terminals arranged in a row.
- In a 2N1631 transistor the terminal lead which is farthest away from the other two leads is the:
 - ~~(A)~~ collector.
 - (B) base.
 - (C) emitter.
 - (D) shield or case of the transistor.
- On a transistor with an index tab:
 - (A) The terminals are numbered in a counter-clockwise direction from the index tab.
 - ~~(B)~~ The terminals are counted in a clockwise direction from the index tab.
 - (C) There is no relation between the position of the index tab and the numbering of the terminals.
 - (D) The index tab is Terminal No. 1, the next terminal is number 2, etc.
- The 2N1848A is a:
 - (A) power transistor.
 - (B) a transistor (that is not a power transistor).

- (C) a silicon controlled rectifier.
 (D) twin diode.
6. A transistor which employs the TO-1 package has the following physical dimensions:
TRAN TO-1
- (A) approximately $\frac{1}{4}$ inch in diameter, a little less than $\frac{1}{2}$ inch in height, and leads approximately 1.5 inches long.
 (B) a little more than $\frac{1}{3}$ inch in diameter, approximately $\frac{1}{4}$ inch in height, and leads approximately 1.5 inches along.
 (C) a little more than $\frac{1}{3}$ inch in diameter, a little more than $\frac{1}{3}$ inch in height, and leads approximately 1.5 inches long.
 (D) approximately $\frac{1}{4}$ inch in diameter, a little less than $\frac{1}{2}$ inch in height, and leads approximately $\frac{1}{5}$ inch long.
7. When looking at the bottom of a tube socket, the numbering system:
10000
- (A) proceeds clockwise from the key.
 (B) proceeds counterclockwise from the key.
 (C) moves clockwise from the key for the first four pins and counterclockwise from the key for pins 5 through 8.
 (D) can always be determined by pin number stamping on the tube socket.
8. In the 6SN7 tube, the 6 indicates:
- (A) that there are six active elements in the tube.
 (B) that the tube was first developed in 1956.
 (C) that the heater voltage for the tube is approximately 6 volts.
 (D) that the tube is an amplifier—not a rectifier.
9. What is the type of tube socket called that has a metal ring which locks around the guide pin to hold the tube in place?
- (A) Loctal.
 (B) Octal.
 (C) Noval.
 (D) Standard.
10. In a miniature tube, the guide in numbering the base pins is:
- (A) the wide space between two of the pins, as compared to the spacing between the other pins.
 (B) a guide key similar to the one on an octal tube, except it is smaller.
 (C) a guide key similar to the one on a loctal tube, except it is smaller.
 (D) the heater pins which are larger in diameter than the other pins.

TRANSISTOR SOCKETS

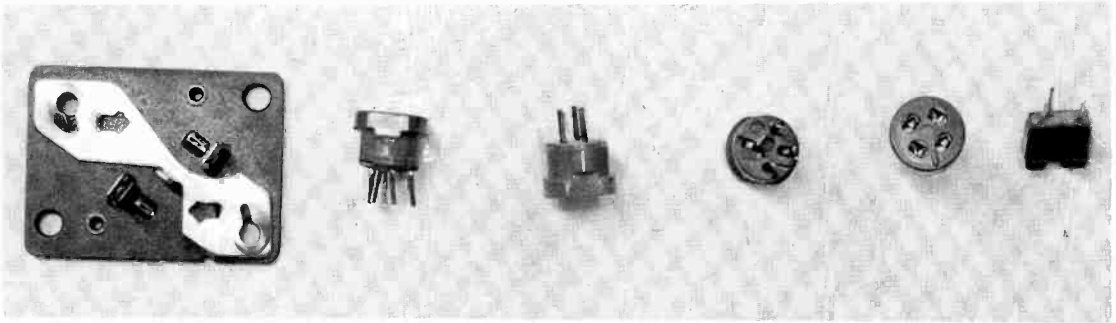

FIGURE 1

STANDARD SOCKETS BOTTOM VIEWS

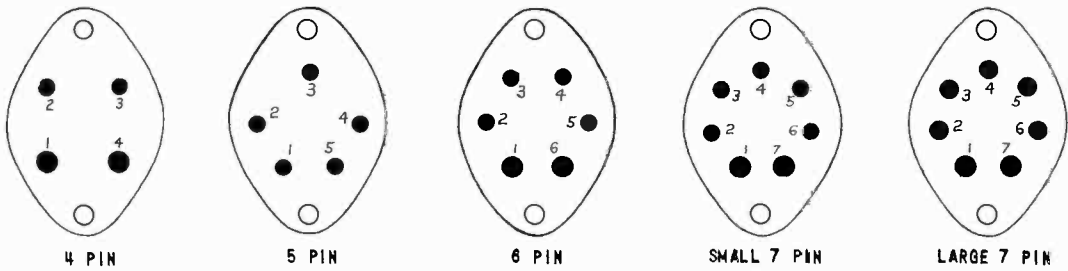

FIGURE 2

WAFER TYPE STANDARD SOCKETS

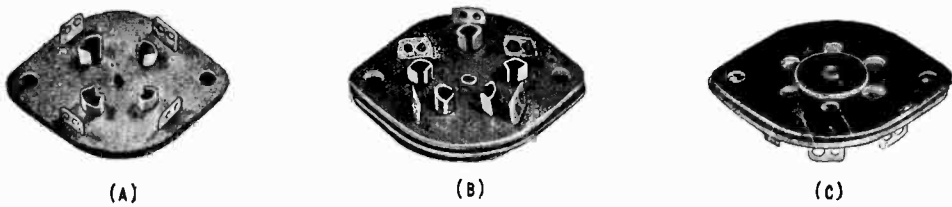

FIGURE 3

OCTAL SOCKETS

WAFER TYPE

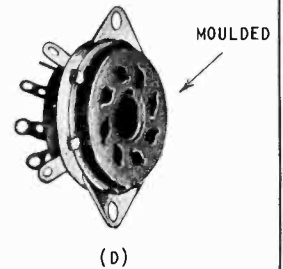
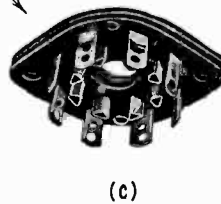
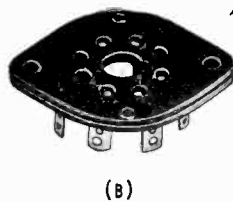
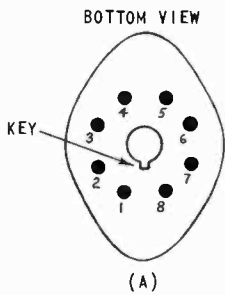
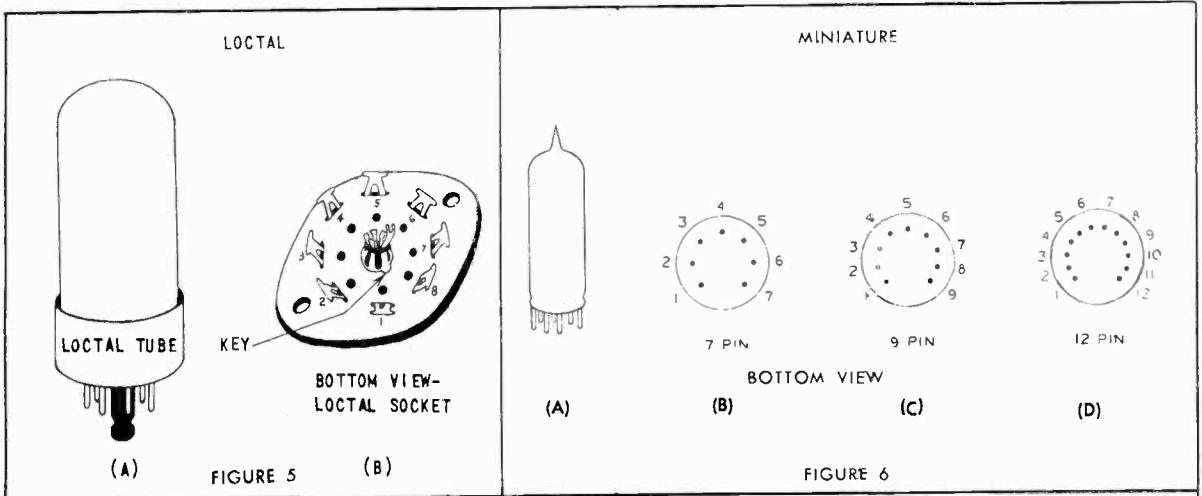
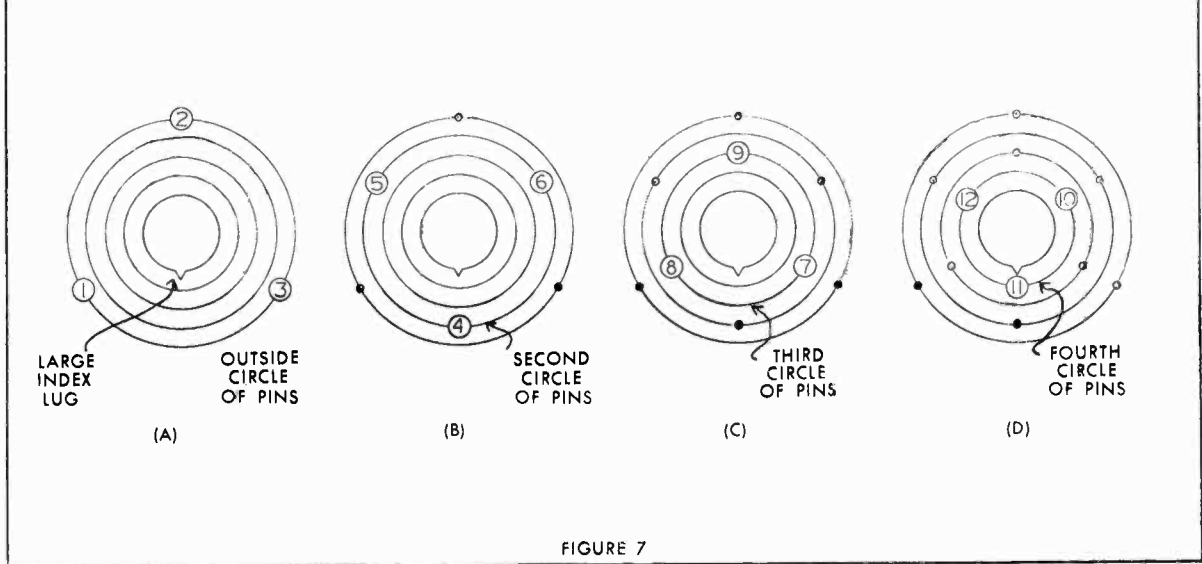

FIGURE 4



HOW THE PINS ARE NUMBERED ON A NUVISTOR TUBE



MINIATURE LAMPS

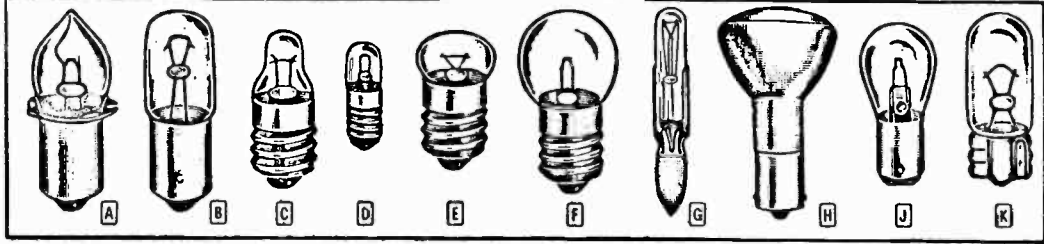

ABBREVIATIONS USED TO DESCRIBE BASE AND BULB STYLES

BASE CONFIGURATIONS: Bay.—bayonet. Cond.—candelabra. D.C.—double contact. F.—flanged. Mid.—midget. Pref.—prefocused. S.C.—single contact. BULB STYLES: B—lemon. G—globe. FE—flat end. R—reflector. S—straight end. T—tubular. TL—lens end, tubular.

GENERAL-PURPOSE MINIATURE LAMPS

*Switchboard slide-type base.

Mfr's Type	Fig.	Volts	Amps	Base
PR-2	A	2.4	.50	S.C., F.
PR-3	A	3.6	.50	S.C., F.
PR-4	A	2.3	.27	S.C., F.
PR-6	A	2.47	.30	S.C., F.
PR-7	A	3.7	.30	S.C., F.
PR-12	A	5.95	.50	S.C., F.
PR-13	A	4.75	.50	S.C., F.
6	J	6.4	3.9	D.C. Bay.
8	J	8.0	2.2	D.C. Bay.
12	.	6.3	.15	Min. 2-pin
13	F	3.7	.30	Screw
14	F	2.5	.30	Screw
24E	G	24	.035	Tel. Slide*
24X	G	24	.035	Tel. Slide*
27	F	4.9	.30	Screw
39	B	6.3	.36	Bayonet
40	B	6.8	.15	Screw
41	B	2.5	.50	Screw
43	B	2.5	.50	Bayonet
44	B	6-8	.25	Bayonet
45	B	3.2	.35	Bayonet
46	B	6-8	.25	Screw
47	B	6-8	.15	Bayonet
48	B	2.0	.06	Screw
48C	G	48	.035	Tel. Slide*
49	B	2.0	.06	Bayonet
50	F	6-8	1 c.p.	Screw
51	F	6-8	1 c.p.	Bayonet
52	F	14.4	.10	Screw
53	F	14.4	.12	Bayonet
55	F	6-8	2 c.p.	Bayonet
57	F	12	2 c.p.	Bayonet
63	F	6-8	3 c.p.	S.C. Bay.
67	F	12	4 c.p.	S.C. Bay.
67K	F	13.5	4 c.p.	Cand.
71K	F	22	.18	Cand.
81	F	6-8	6 c.p.	S.C. Bay.
82	F	6-8	6 c.p.	D.C. Bay.
112	C	1.2	.22	Screw
136	G	1.3	.60	Screw
158	B	12	.24	Wedge
159	K	6.3	.15	Wedge
222	C	2.2	.25	Screw
223	E	2.2	.25	Screw
224	C	2.15	.22	Special
233	F	2.3	.27	Screw
248	F	2.5	.80	Screw
259	B	6.3	.25	Wedge
313	B	28	.17	Bayonet
327	D	28	.04	S.C. Mid.
328	D	6	.20	S.C. Mid.
330	D	14	.08	S.C. Mid.
344	D	10	.014	S.C. Mid.
345	D	6	.04	S.C. Mid.
363	F	14	.20	Bayonet

GENERAL-PURPOSE MINIATURE LAMPS (Cont'd)

Mfr's Type	Fig.	Volts	Amps	Base
405	F	6.5	.50	Screw
406	F	2.6	.30	Screw
407	F	4.9	.30	Screw
425	F	5	.50	Screw
428	F	12.5	.25	Screw
431R	F	14	.25	Bayonet
432	F	18.0	.25	Screw
433	F	18	.25	Bayonet
502	D	5.1	.15	Screw
509K	F	24	.18	Cand.
605	F	6.1	.50	Screw
1383	H	12	.20w	S.C. Bay.
1445	F	18	.15	Bayonet
1446	F	12	.20	Screw
1447	F	18.0	.15	Screw
1449	F	14	.20	Screw
1458	F	20	.25	Bayonet
1474	B	14	.17	Screw
1477	B	24	.17	Screw
1487	B	12-16	.20	Screw
1488	B	14	.15	Bayonet
1493	B	6.5	2.75	D.C. Bay.
1630	J	6.5	2.75	D.C. Pref.
1651	J	5	.60	S.C. Bay.
1763	J	6.1	4.1	S.C. Pref.
1768	D	6	.20	Mid. Screw
1769	D	2.5	.20	S.C. Mid.
1813	B	14.4	.10	Bayonet
1815	B	12-16	.20	Bayonet
1816	B	13	.33	Bayonet
1819	B	28	.04	Bayonet
1820	B	28	.10	Bayonet
1822	B	36	.10	Bayonet
1828	B	37.5	.05	Bayonet
1829	B	28	.07	Bayonet
1835	B	55	.05	Bayonet
1847	B	6.3	.15	Bayonet
1869	D	10	.014	S.C. Mid.
380	P	6.3	.04	S.C. Mid., F.
381	P	6.3	.20	S.C. Mid., F.
382	P	14	.08	S.C. Mid., F.
755	N	6.3	.15	Min. Bay.
756	N	14	.08	Min. Bay.
757	N	28	.08	Min. Bay.
2180	R	6.3	.04	Wire Term.
2181	R	6.3	.20	Wire Term.
2182	R	14	.08	Wire Term.
680	M	5	.060	Wire Term.
682	L	5	.060	S.C. Bay.
683	M	5	.060	Wire Term.
685	L	5	.060	S.C. Bay.
715	M	5	.115	Wire Term.
718	L	5	.115	S.C. Bay.
2128	M	3	*.0125	Wire Term.



NEW 100,000-HOUR SUBMINIATURE LAMPS

Last about 12 years! Wire-terminal types have solder-dipped leads, size, $\frac{1}{4} \times \frac{1}{8}$ " dia. Others have brass bases; $\frac{1}{4} \times \frac{1}{8}$ " dia. Bulb style, T-1. For uses where space is critical, service difficult. $\pm 10\%$. * $\pm 20\%$.

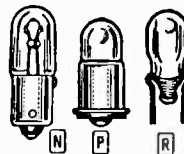

NEW 50,000-HOUR LAMPS

Design-life is over 5 years—average lifetime is 50,000 hours. Reliable performers come in three industry-standard sizes and physical configurations. Actual life is determined by environmental conditions—vibration, shock, temperature, voltage fluctuations.

FIGURE 8

THE FILAMENT CIRCUIT IN RADIO OF EARLY DAYS

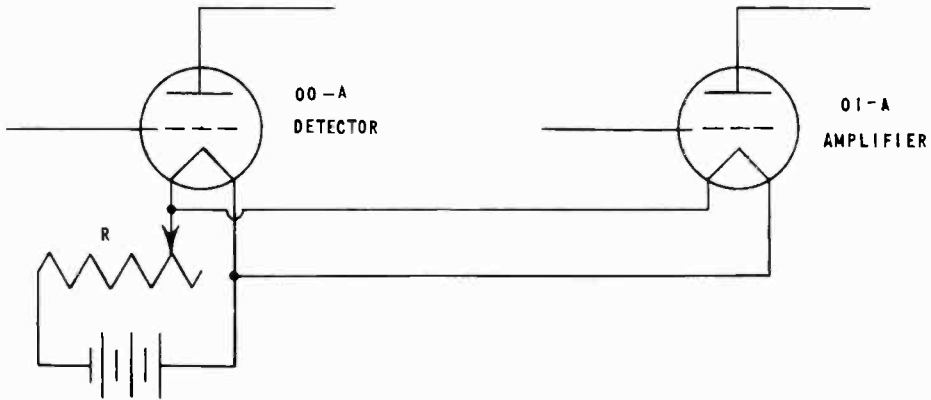

FIGURE 9

AN HISTORIC DEVELOPMENT IN FILAMENT CIRCUITS

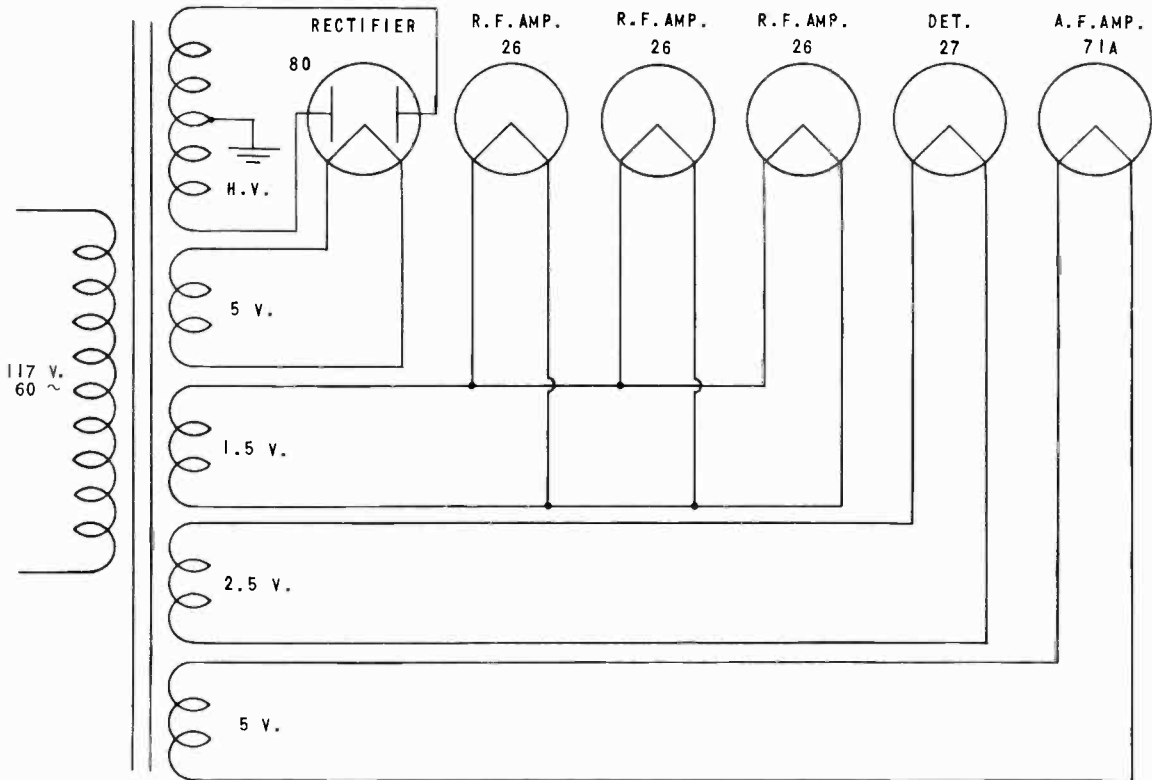

FIGURE 10

A MORE PRACTICAL FILAMENT CIRCUIT

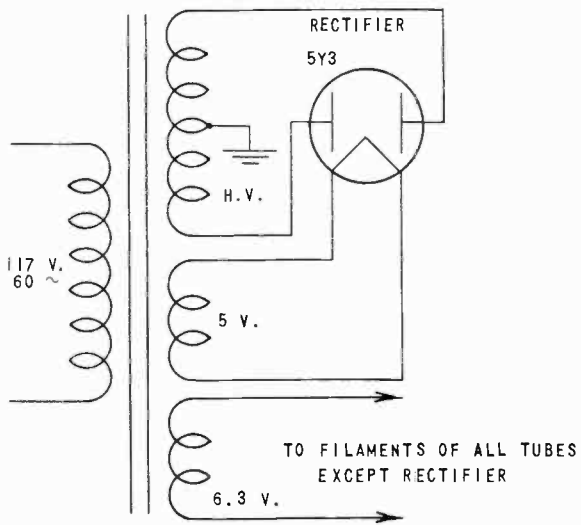

FIGURE 11

AN EARLY BATTERY OPERATED CIRCUIT

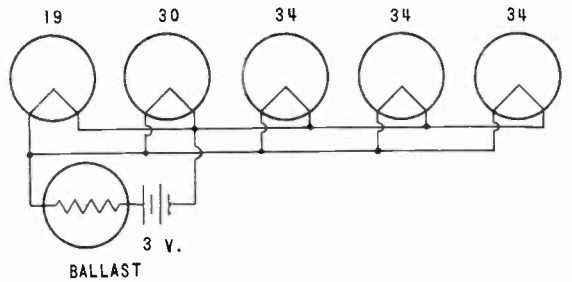

FIGURE 12

AN EARLY AC-DC CIRCUIT

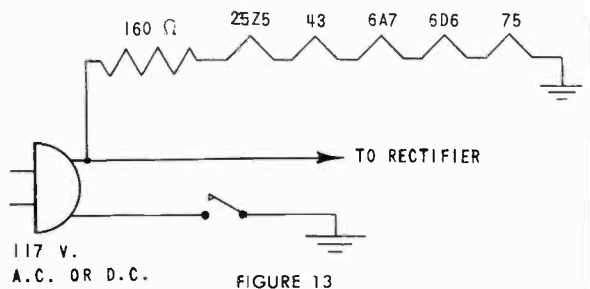

FIGURE 13

AC-DC HEATER CIRCUIT REQUIRING NO DROPPING RESISTOR

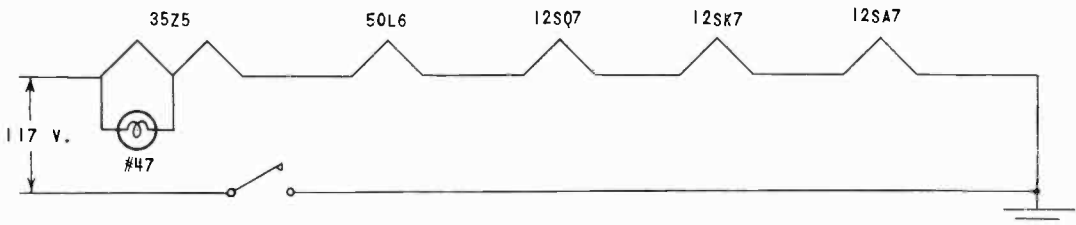
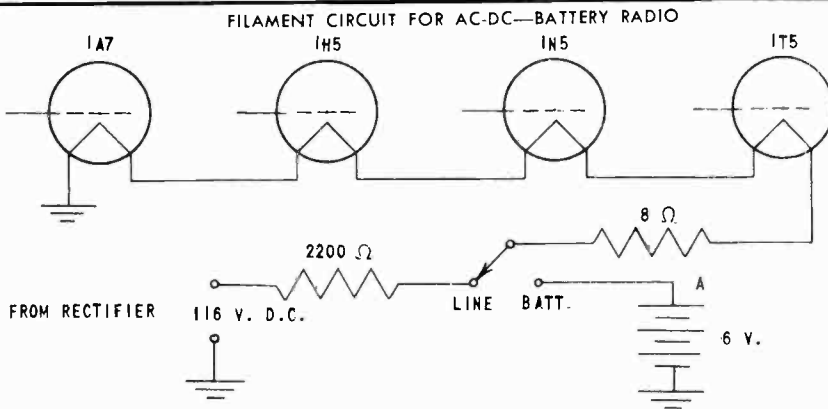

FIGURE 14



A SERIES-FILAMENT ARRANGEMENT FOR A TV SET

