

# HOW RADIO TUBES OPERATE

**LESSON  
3 R**



# RADIO-TELEVISION TRAINING SCHOOL, INC.

5100 SOUTH VERMONT AVENUE • LOS ANGELES 37, CALIFORNIA, U. S. A.

## HOW RADIO TUBES OPERATE

If you recall the principal things about which we talked in the preceding lesson, it is correct to say that you know why all radio tubes operate, although you do not as yet know just how they operate. All tubes operate because, within the tubes, electrons emerge from a conductor (the cathode) and travel through space to another conductor (the plate). While the electrons are in the tube space we may control their flow in almost any way that we desire. We may prevent the flow from commencing, and we may stop it after it has commenced. We may regulate the rate of flow within wide limits. We may divert the flow from one electrode and force it to enter another one. It is possible to make electrons start toward

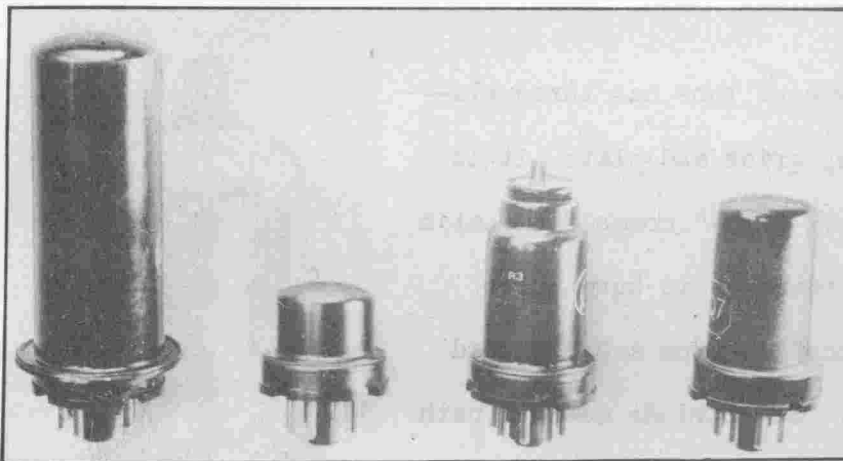

Radio receiving tubes which have metal envelopes.

FIG. 1.

to start, stop, and regulate the rate of electron flow in solid conductors as well as in tubes. But, by using a tube, we can accomplish these and all of the other kinds of controls by using a controlling force or power so small that it hardly can be measured. With tubes we can vary the flow rate in a fraction of a millionth of a second. In tubes there is none of the arcing and sparking that occurs when control is by means of mechanical switching; there is no noise, no vibration, and none of the mechanical wear that makes other controls lose their precision.

If you look at a list of radio tubes you will see there the specifications or characteristics of hundreds of different types. The differences between types

one electrode, then turn around and go backward. We may make the electrons swing back and forth in the space and eventually enter any selected electrode. These are but a few of the things that tubes will do.

It is entirely possible

are chiefly in size, in the electron flow rates which may be handled, in the number and arrangements of the "grids" that are between the cathode and the plate, and in the manner in which connections are arranged on the tube bases. To begin at random to study all of the types of tubes would lead only to confusion. It is fortunate that every type has at least one electrode (cathode) through which electrons enter the tube, another electrode (plate) from which they leave the tube, and a space through which electrons flow from cathode to plate.

To control the electron flow by actions that take place inside of the tube itself, there must be, in all ordinary radio tubes, at least one other element placed in the space between cathode and plate. This third element is the one called the grid or the control grid. This is the general type of tube which we shall study first.



FIG. 2. A radio transmitting triode which is 40 inches high.

Because this type of tube has three elements: cathode, gride and plate, it is called a triode. "Tri-" comes from Latin or Greek words meaning "to have three parts", and "-ode" is from a Greek word meaning a path. So a triode means a path in which there are three parts. In similar fashion, an electr-ode means a path for electricity.

Were a tube to have only two elements, a cathode and plate, the tube would be called a diode; because di- means two.

In some tubes there are four elements, and they are called tetrodes, because tetra- means four. Many tubes have five elements, and are called pentodes because penta- means five.



FIG. 3.

The outside of the pentode tube, showing the glass envelope and control grid cap.

There are scores of types of triodes, and of each of the other general types mentioned. Triodes may differ in size, in the kind of envelope, in power handling

ability, in base pin arrangements and connections, and in other details. But all triodes have a cathode, a control grid, and a plate as their active elements, and all triodes operate according to the same basic principles. When we know how electron flow is handled in the construction, including a cathode, a control grid, and a plate, we know the operating principles of all triodes.

When we know, in addition, the purpose and action of a fourth element, we know the operating principles of all tetrodes. And when we know the purpose and action of the fifth electrode, we know the operating principles of all pentodes.

#### CONSTRUCTION OF A TUBE

Before discussing the operation of a triode we shall examine the construction of a tube having five elements, which means that the tube is a pentode. We select the pentode because, just now, we are interested in getting acquainted with the parts that go into all kinds of tubes, and are interested in the actual appearance and relative sizes and positions of these parts.

The external appearance of our pentode is shown by Fig. 3. It has a glass envelope, which many people call a bulb. At the top of the envelope is a metallic cap on which will fit a clip attached to a wire conductor leading to the external circuits. Inside the tube this cap connects to the control grid. All of the other internal elements of the tube are connected to the base pins.

Practically all of the air and other gases have been pumped out of the envelope after the elements and their supports were inserted, and the envelope has been sealed. The pressure of air in our homes and out of doors is about 14.7 pounds on every square inch of surface. So much air is pumped out of the envelope that the internal pressure is down to about  $1/400,000$  of one ounce per square inch. The tube is "evacuated" for two principal reasons. The practical absence of gases, or gas molecules and atoms, leaves the electrons to travel across a fairly clear path inside the tube. This is one reason. The other is that many of the gases in air eventually would combine with substances in the elements and supports to cause corrosion.

In Fig. 4 we have removed the glass envelope, leaving the control grid cap supported by its wire connection which leads down to the grid. Now we see quite

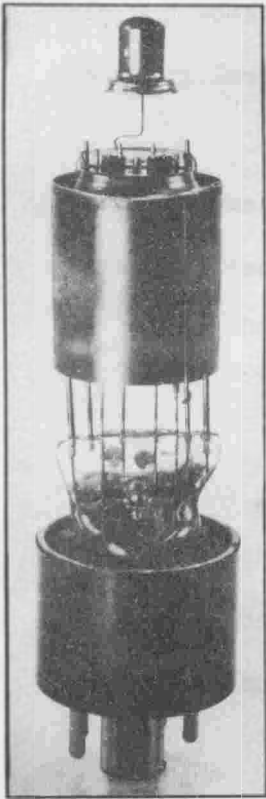

FIG. 4.  
The envelope has been removed to show the internal shield.

clearly a metallic cylinder which encloses all other elements. This cylinder is a shield which prevents electric fields around the tube from passing into the element spaces where they would interfere with other fields which we shall produce around the elements. We learned something about the principle of shielding in an earlier lesson, also looked at some applications of shielding. Here we see another application of the principle.



FIG. 5.  
With the shield removed we see the plate.

In Fig. 5 we have removed the shield and have exposed the plate, which is another metallic cylinder. Note how all of the elements are supported by rather large wires which are embedded in a glass "press".

In the complete tube this press is a portion of the envelope. Conductive connections for the tube elements are completed from the base pins through the supporting wires to the tube elements. Above and below the plate are discs of thin mica which keep the supports and elements correctly spaced apart while insulating the supports from one another.

In Fig. 6 we have removed the plate. At the center of the remaining elements can be seen the cylindrical cathode. Around the cathode are three separate spirals of fine wire. These are the three grids used between the cathode and plate of a pentode tube. The three grids, together with the cathode and plate, make up the five elements for this general type of tube.

Now, instead of talking about the three grids and the cathode from the out-

side to the inside we shall go all the way to the inside of the cathode and work outward.



FIG. 6.

Taking away the plate exposes three grids, with the cathode at the center.

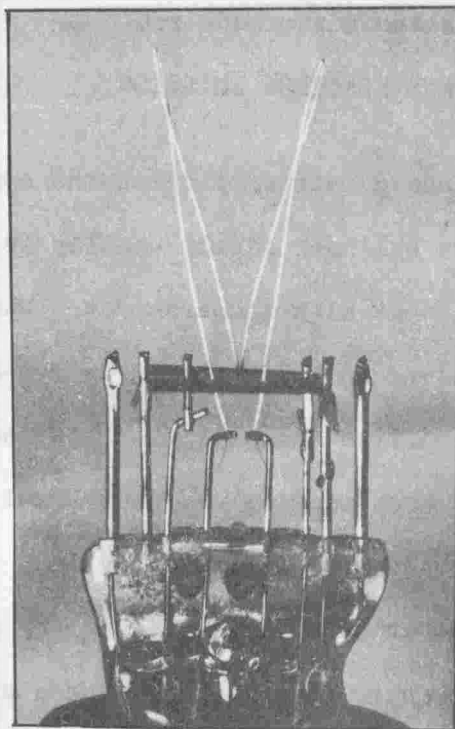

FIG. 7.

This is the heater, with its strands spread apart.

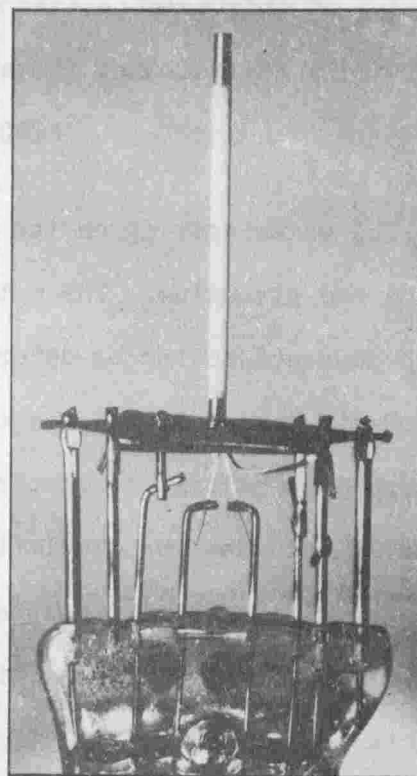

FIG. 8.

Here is the cathode, inside of which is the heater.

When we get down to the last part in the collection of active elements, we come to the heater which is pictured, quite a bit enlarged, in Fig. 7. As we know, the sole purpose of the heater is to raise the temperature of the cathode. The temperature of the heater itself is raised by electron flow or electric current through the heater conductor, but this flow in the heater is entirely separated from the electron flow that takes place from cathode to plate through the spaces in the grid spirals. You can see that the ends of the heater are connected to two of the wires coming up through the glass press. These two wires are connected to two of the base pins to which, through the socket, are connected conductors in the heater circuit.

The heater conductor is small enough so that, when pushed into a bundle of parallel strands, it goes inside of the cathode pictured in Fig. 8. You can see

where the heater conductor goes up into the bottom of the cathode, which is a cylinder of thin metal coated on the outside with substances from which electrons are readily emitted when these substances are made red hot.

#### CATHODES AND ELECTRON EMISSION

The white coating on the cathode consists of compounds containing the metals barium and strontium. The metallic cylinder itself usually is made of nickel, which does not soften or deteriorate at high temperatures. When such a coated cathode is heated to a temperature around 1,300 to 1,400 degrees Fahrenheit there are great quantities of electrons emitted from the outer surface. There are other kinds of cathodes, used chiefly in broadcasting and industrial types of tubes, which are made of the metal tungsten alloyed with a little thorium. These must be heated to about 3,000 degrees F. Still other tubes have cathodes of pure tungsten. These must be heated to about 4,000 degrees or even higher temperature.

Electrons are emitted from the cathode, and pass into the surrounding evacuated space, because heat energy added to the electrons in the cathode makes many of those electrons go so fast that they escape from the atoms. The cathode coating materials are selected because they permit free electrons to pass through their surfaces more easily than do most other materials.

Some of the emitted electrons are almost instantly pulled back into the cathode, because the place from which they emerged is momentarily left with a deficiency of electrons, which means a positive charge. But, on the whole, a great many electrons remain in the space around the cathode surface. These electrons are negative charges, and so, in the space around the cathode we have a negative charge. It is called the space charge. The space charge is negative, and the electrons coming out of the cathode are negative. Therefore, the space charge repels the emerging electrons and, after the space charge is formed, it limits the rate at which electrons are emitted from the cathode surface.

Now supposing that we put a plate around the outside of the cathode, and give the plate a positive charge. This means making the plate positive with reference

to the cathode. All that we need do to keep the plate positively charged and the cathode negatively charged is connect the plate to the positive terminal and the cathode to the negative terminal of the same source. We have the conditions of

Fig. 9.

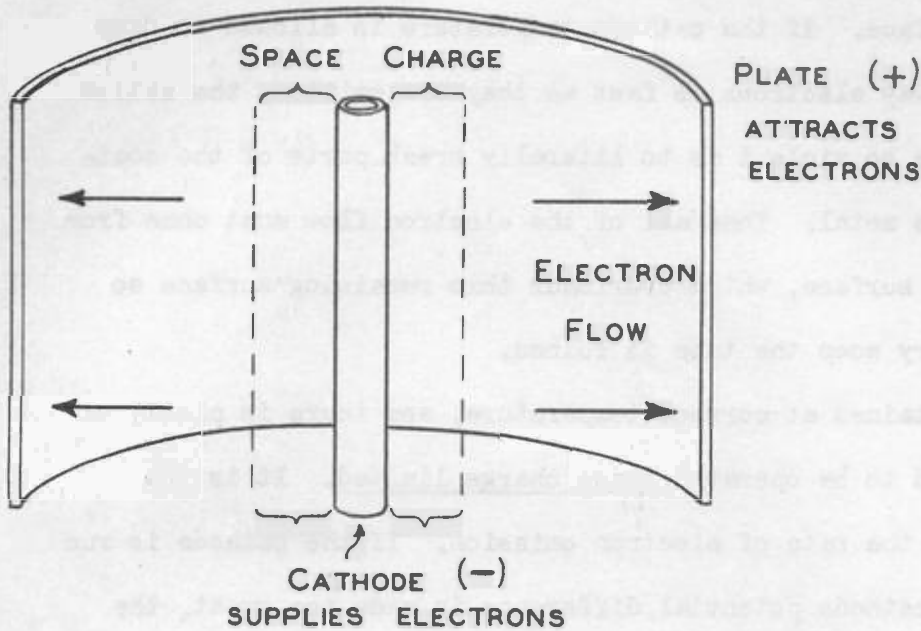

FIG. 9.

The electrons emitted from the cathode form the negative space charge.

The positive charge on the plate attracts negative electrons from the space charge, and these electrons go to and into the plate. Removal of electrons from the space charge weakens that charge, and it has less repelling effect on electrons

coming out of the cathode. Then electrons from the cathode replenish the supply in the space charge and the action continues.

The rate at which electrons flow from cathode to plate in any particular tube depends on two things: on the rate at which electrons are forced out of the cathode into the space charge, and on the potential difference between cathode and plate. This latter is a measure of the strength of the positive charge on the plate. When the cathode is cold, there is practically no emission. As the cathode temperature is raised the electrons are forced out in greater and greater quantities for any given length of time. So the hotter we make the cathode, the greater will be the rate of electron flow (in amperes or milliamperes) from cathode to plate provided that we don't ruin the cathode surface by overheating it. As the plate potential is made more and more positive with reference to the cathode, more and more electrons will be drawn from the space charge to the plate in a given time,



and the greater will be the rate of electron flow through the tube.

Right here we may as well talk about some practical matters of tube operation. The cathode must be kept hot enough to emit electrons fast enough to maintain the space charge, that is, the plate must draw electrons from the space charge, not directly from the cathode surface. If the cathode temperature is allowed to drop so low that the plate takes away electrons as fast as they are emitted, the action at the cathode surface becomes so violent as to literally break parts of the coating away from the cathode base metal. Then all of the electron flow must come from the smaller remaining cathode surface, which overloads this remaining surface so that it breaks away -- and very soon the tube is ruined.

When the cathode is maintained at correct temperature, and there is plenty of space charge, the tube is said to be operated space charge limited. It is the space charge that is limiting the rate of electron emission. If the cathode is run too cool, or if the plate-to-cathode potential difference is made too great, the space charge disappears. Tubes sometimes are tested under this condition for ability of the cathode to emit electrons, but they never are operated this way for reception.

The cathode temperature depends on the temperature of the heater. The temperature of the heater depends on the rate of electron flow (current) maintained in the heater. The correct rate of flow, also the potential difference applied to the heater for maintaining this rate, always are specified in the ratings for a tube. For example, you will find many tubes rated for a heater current of 0.3 ampere and for a heater potential difference (or voltage) of 6.3 volts.

#### ONE-WAY ELECTRON FLOW

It is important that you get firmly fixed in your mind that electron flow in all tubes always is from cathode to plate, and never for an instant is from plate to cathode unless the tube has broken down.

This direction of flow will result when the plate is maintained positive and the cathode negative with reference to each other; because negative electrons are repelled by the negative cathode (and space charge) and are attracted by the posi-

tive plate.

But even though the cathode is made positive and the plate, negative, there will be no reverse flow unless the plate-to-cathode potential difference is made so great as to form an arc or a discharge inside the tube; and that ends the useful life of the tube. Otherwise there can be no reverse flow because the plate does not normally emit any electrons. The plate does not emit electrons because it is heated only by radiation from the cathode and by energy in electrons flowing into the plate surface, and the temperature does not become high enough to get electron emission out of the tungsten, molybdenum, Nichrome, nickel, and other materials of which plates are made.

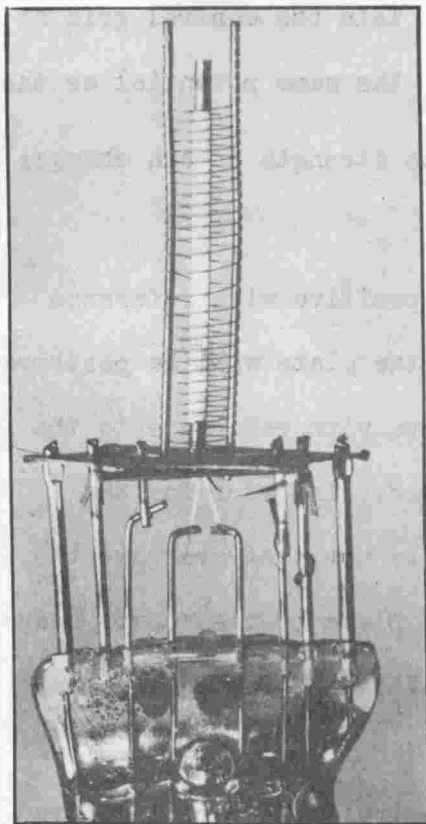

FIG. 10.  
The control grid is supported just outside the cathode.

#### THE CONTROL GRID

Now we may take one more step in putting together our pentode tube. This step will be placing the control grid around the cathode as in Fig. 10. This grid, as we have noted before, is a spiral of small wire that completely enclosed the electron emitting surface of the cathode. The control grid is so close around the cathode that this grid surrounds nearly all of the negative space charge which is composed of negative electrons emitted from the cathode.

For the time being we shall ignore whatever effects may be produced by the other two grids which later will be put into the tube, and consider only what would happen with the cathode, the control grid, and the plate. These three elements would form a triode. The reason that we may ignore the other grids is that their purposes are only to overcome certain difficulties which arise in the operation of a triode. These difficulties will be discussed later. The triode is the basic type of radio tube. All

other types are modifications which have been found advantageous in securing maximum performance from present-day types of receivers.

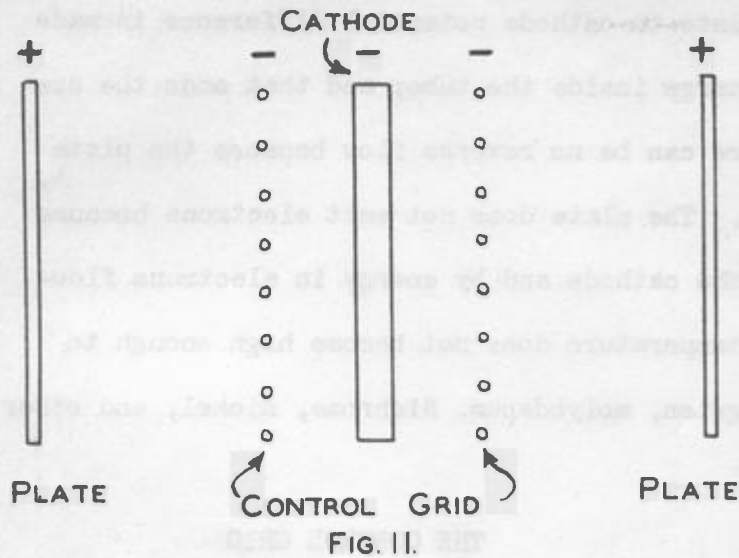

Here both the cathode and control grid are negative, while the plate is positive.

With their potentials alike, the charges or the strength of the charges on the grid and cathode will be alike.

The plate will be maintained at a potential which is positive with reference to the cathode, and with the grid at cathode potential, the plate will be positive with reference to the grid -- or the grid will be negative with reference to the plate, which is saying the same thing the other way around. In order for the plate to pull electrons out of the space charge, the plate now must overcome the effect of the grid. Part of the attractive force of the plate is used up in overcoming the opposing force of the grid, and the rate of electron flow cathode to plate is less than as though the grid were not present.

The next step will be to make the potential of the control grid more negative than the potential of the cathode. In order to work with some definite values of potential, we shall take the potential of the cathode as zero with reference to the potentials of all other elements in the tube. That is, the potential of the cathode, whatever this potential may be, will be taken as our reference point for all other potentials in the tube. This is somewhat similar to taking "sea level" as the reference point for geographical elevations and depressions. We say that a

If we could cut vertically downward through the center of the tube, the plate, the cathode, and the turns of wire in the control grid would have the relative positions shown by Fig. 11. Supposing that now we maintain the control grid at the same potential as the

certain locality is so many feet "above sea level," and that another is so many feet "below sea level."

We might, in some certain tube, maintain the control grid at a potential 4 volts more negative than the cathode, and the plate at a potential 150 volts more positive than the cathode. Then we would say that the grid is 4 volts negative, and we would say that the plate potential or plate voltage is 150 volts.

Now the plate must overcome the added 4-volt negative charge (or potential) on the grid. We might conclude that this would be equivalent to making the plate 4 volts less positive than before, but this would be incorrect. The grid is so much closer to the cathode and to the main body of the space charge than is the plate that changes of potential on the grid are many times as effective as equal changes of plate potential in controlling or changing the rate of electron flow. In commonly used tubes the effect of the grid might be 15 times that of the plate. Then making the grid 4 volts more negative than before would have the same effect on electron flow as making the plate 15 times 4, or 60 volts less positive.

Were the grid in the tube we are talking about to be made 10 volts negative (always with reference to the cathode potential) and were the grid 15 times as effective as the plate, the result would be equivalent to reducing the plate potential by 150 volts. The plate has been assumed only 150 volts positive to begin with, and so the grid would completely counteract the attractive force of the plate and there would be no electron flow from cathode to plate. We would, in effect, have reduced the plate potential to zero.

Let's look into this matter of grid potential a little further. In Fig. 12 have been drawn the grid circuit and the plate circuit for the tube. The tube is represented by the standard symbol for any kind of triode. In this symbol the envelope is represented by a circle. The plate is shown by a solid horizontal line near the top of the circle. The grid is shown by a broken line (representing the open spiral of wire). The cathode is shown by a horizontal line with downward extensions partially covering the heater, which is represented by an inverted V-

shaped line. There is no need for showing the external connections to the heater, because the heater takes no direct part in electron flow through the tube space.

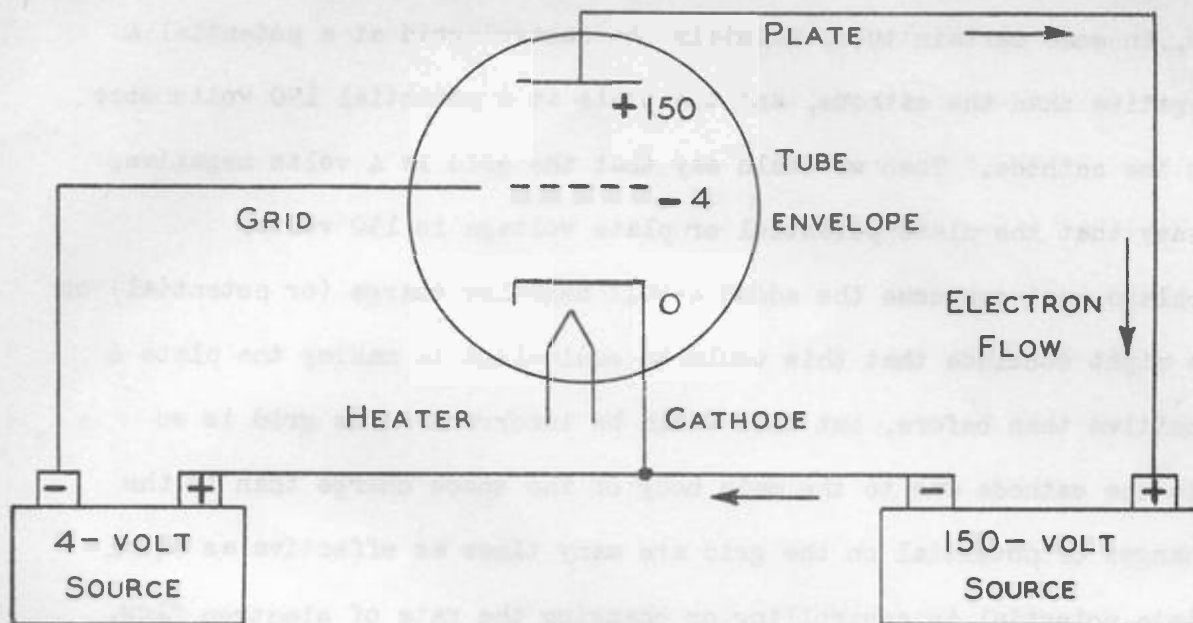

The plate is shown connected to the positive terminal of a source which furnishes a potential difference

FIG.12.

The plate circuit and the grid circuit, with the tube represented by its symbol.

of 150 volts, and the cathode is connected to the negative terminal of this same source. This makes the charge on the plate 150 volts positive with reference to the charge on the cathode, and emitted electrons will flow from cathode to plate.

The grid is shown connected to the negative terminal of a source which furnishes a potential difference of 4 volts, and the positive terminal of this source is connected to the cathode. Then the grid has a charge 4 volts more negative than the cathode, or the cathode has a charge 4 volts more positive than the grid, whichever way you wish to say it.

Electrons now will flow from the negative terminal of the 150-volt source to the cathode, from cathode to plate, back to the positive terminal of the same source, and through the source from positive to negative; continuing thus around and around the "plate circuit".

What about electron flow in the grid circuit, which includes the four-volt source, the connections to grid and cathode, and these two elements, together with the space between them inside of the tube? Will there be electron flow in this circuit? You can figure out the answer. The grid is negative and the electrons

in the space charge are negative. Both the grid and the electrons have negative charges. Negative charges do not attract each other; on the contrary they repel each other. So no electrons from the cathode and the space charge get into the grid, and there can be no electron flow in the grid circuit. All that the 4-volt source has to do is maintain a negative potential or negative charge on the grid. There is no electron flow through this source.

With no electron flow in the grid circuit or in the source which is part of the circuit, no energy is added to electrons in this circuit and no work is done by the electrons, which do not flow but remain in the conductors. Here we have means for controlling the rate of electron flow in the plate circuit, yet we do no work and consume no power in effecting this control. By making the grid potential more or less negative, with reference to the cathode, we may regulate electron flow in the plate circuit all the way from zero to maximum possible flow, and use no power in doing so. No other means for control can compare with this one for efficiency.

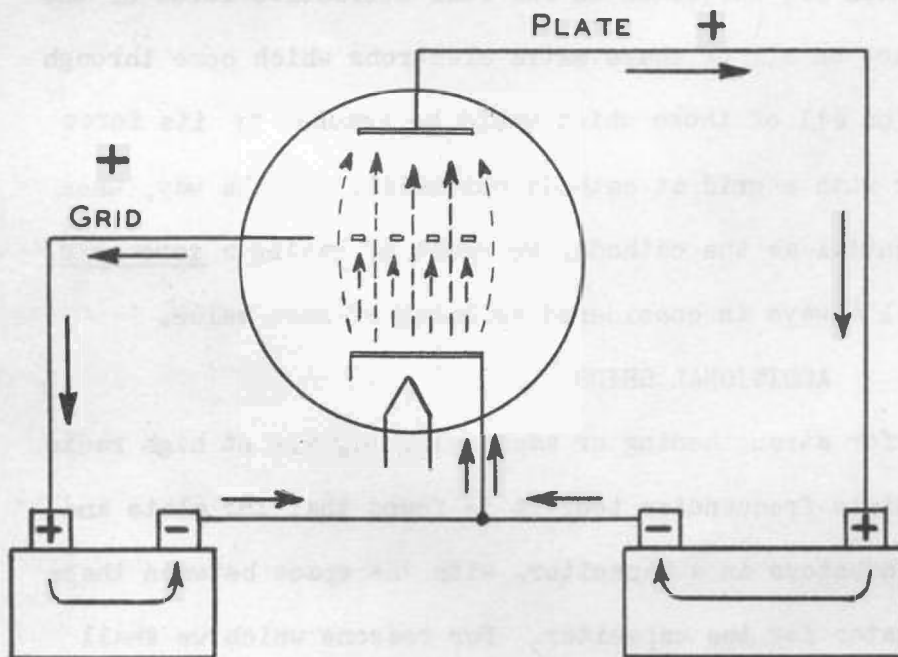

FIG. 13.

Electrons flow into the grid when the grid is positive.

grid positive with reference to the cathode. The positive grid attracts electrons from the space charge and the cathode just as does the positive plate. The small

In Fig. 13 we have reversed the connections to the source, which is in the grid circuit, now connecting the grid to the positive terminal and connecting the negative terminal to the cathode.

This makes the

wire in the grid has but small surface area compared with the area of the plate, and for this reason would receive fewer electrons than the plate. But the grid is so much closer to the cathode and space charge that for any given area and degrees of charge, it attracts and receives more electrons than does the plate.

When the grid is positive, some of the electrons from the space charge go into the grid, through the connected circuit and the source in this circuit, back to the cathode, and into the space charge again. We have electron flow in the grid circuit. Energy is put into the electrons in the source and is used in the remainder of the circuit. So work is done and power is used. Only under certain special conditions are control grids operated with positive charges on them.

A positive grid permits a great increase of electron flow in the plate circuit as compared to the flow with a negative grid. This is because the positive grid attracts electrons with enough force to bring them up to high speed at the position of the grid. Most of these electrons fly right through the spaces between turns of the grid wire and then are subjected to the full attractive force of the plate. Thus the plate can act on all of these extra electrons which come through the grid, as well as acting on all of those which would be reached by its force even with a negative grid or with a grid at cathode potential. By the way, when the grid is at the same potential as the cathode, we speak of having a zero grid, because the cathode potential always is considered as being of zero value.

#### ADDITIONAL GRIDS

When operating triodes for strengthening or amplifying signals at high radio frequencies, and at intermediate frequencies too, it is found that the plate and the grid act like the two conductors in a capacitor, with the space between these elements acting as the insulator for the capacitor. For reasons which we shall discover later, the potentials in the plate circuit then get back into the grid circuit, or, to state it more precisely, the electric field around the plate reacts on the electric field around the grid. This was the cause of most of the squealing and howling in early types of radio receivers when attempting to amplify

weak incoming signals.

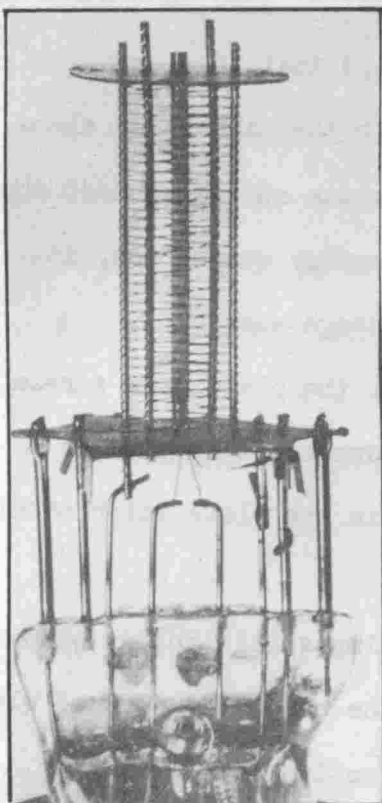

FIG. 14.  
The screen grid has been placed outside of the control grid.

a positive potential. Then the screen grid helps pull electrons out of the space charge and through the control grid. By the time these electrons get to the screen grid they are traveling so fast that nearly all of them go right through the screen grid and then are attracted by the plate, while only a relatively few enter the screen grid to form an electron flow in its circuit.

A tube having a cathode, a control grid, a screen grid, and a plate is, of course, a tetrode -- because it has four active elements. Such tubes are called also screen grid tubes.

To separate the fields of the plate and the grid an additional element is placed between the first two. This extra element has been added to our tube in Fig. 14. It is called a screen grid. The word screen means the same as shield, and so this added grid is a shield, and sometimes has been called a shield grid. The screen grid consists of an open spiral of fine wire which permits electrons from the space charge to be pulled through the spaces between turns by the attractive force of the plate once the electrons gain enough speed to shoot through the spaces between turns in both the control grid and screen grid. To give the

electrons the necessary speed, the screen grid is maintained at

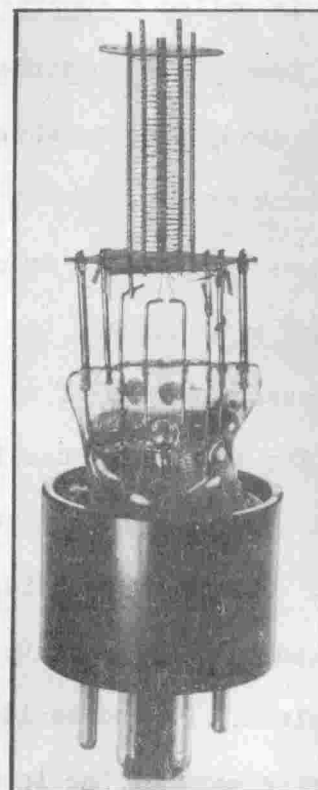

FIG. 15.  
Here is the tube completed as far as the screen grid.



Screen grid tubes developed troubles of their own. They did succeed in preventing reaction between the fields of the plate and the control grid, but electrons go through the screen so fast and hit the plate so hard that they actually knock extra electrons right out of the plate. The energy in the high-speed electrons is sufficient to give electrons in the plate enough extra energy so that the plate electrons emerge into space. No matter where extra energy comes from, it will let electrons fly away from their atoms if there is enough energy.

A great many of the electrons which are knocked out of the plate in a screen grid tube are attracted to the positive screen, and they form electron flow in the screen circuit while reducing the number of electrons in the plate which should be forming electron flow in the plate circuit.

This fault of the screen grid tube is overcome by adding still another element, which is called a suppressor grid, because it suppresses the undesired flow of electrons from plate to screen grid. In Fig. 15 is shown the entire tube with its screen grid, just as shown with the upper part magnified in Fig. 14. Now if you look back at Fig. 6, and compare it with Fig. 15, you will see how the suppressor grid has been placed around the outside of the screen grid. This places the suppressor grid between the screen grid and the plate. Like the other grids, the suppressor is made of an open spiral of fine wire.

The suppressor usually is maintained at the same potential as the cathode, which is a potential that is highly negative with reference to the plate potential. The suppressor is so negative with reference to the plate that electrons knocked out of the plate are repelled by the suppressor and made to go back into the plate. Of course it is true also that the relatively negative suppressor prevents many of the loosened electrons from ever leaving the plate in the first place.

Now we have five active elements: a cathode, a control grid, a screen grid, a suppressor grid, and a plate. A tube with five elements is a pentode, so here is the completed pentode tube. Most of the tubes used in radio receivers are

either pentodes or triodes, and this is true also of most of the other apparatus in all branches of radio. Later on we shall have a lot more to do with both triodes and pentodes.

### TUBE SYMBOLS

The standard symbols for all types of radio tubes are made up in much the same

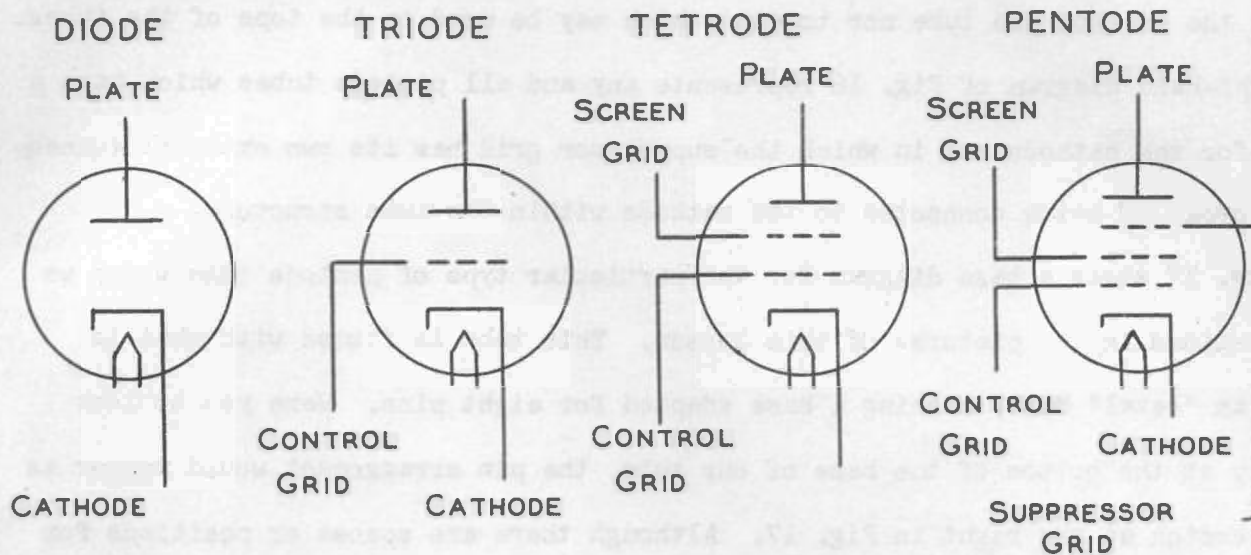

FIG. 16.  
Symbols for the four general types of tubes when constructed with beater cathodes.

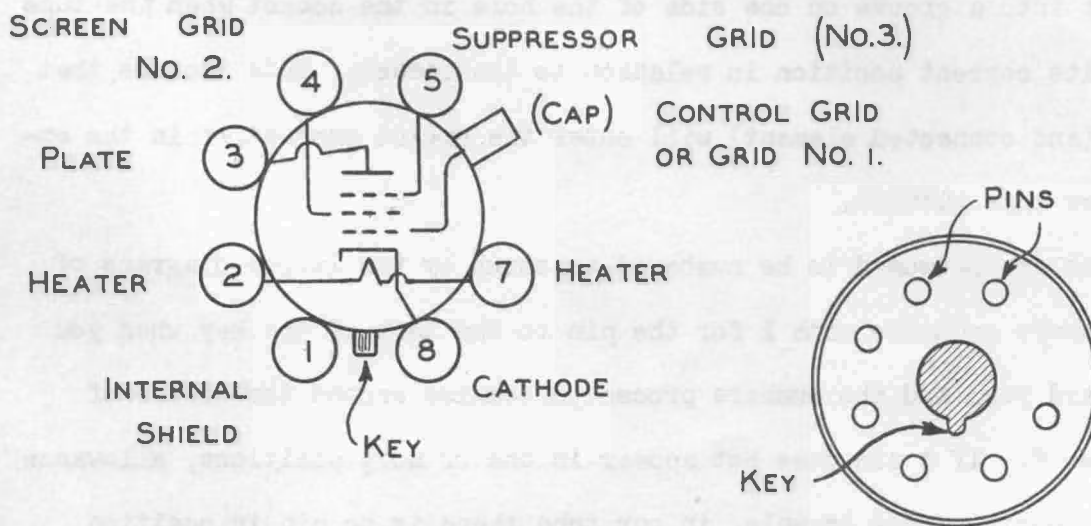

FIG. 17.  
This is a base diagram for the pentode tube.

Note that the control grid always is next to the cathode,

general way as the symbol for a triode which we have seen in preceding diagrams. Fig. 16 shows such symbols for a diode, a triode, a

and the plate farthest from the cathode. The grid nearest the cathode often is spoken of as grid No. 1, the grid next farther from the cathode as grid No. 2, and so on for as many grids as there are between cathode and plate.

Symbols such as shown by Fig. 16 indicate the number and kind of elements within the tubes, but they do not show the actual connections of these elements to certain pins on the base of the tube nor to caps which may be used on the tops of the tubes. The right-hand diagram of Fig. 16 represents any and all pentode tubes which have a heater for the cathode and in which the suppressor grid has its own external connection instead of being connected to the cathode within the tube structure.

Fig. 17 shows a base diagram for the particular type of pentode tube which we have examined in the pictures of this lesson. This tube is fitted with what is called an "octal" base, meaning a base adapted for eight pins. Were you to look directly at the bottom of the base of our tube, the pin arrangement would appear as in the sketch at the right in Fig. 17. Although there are spaces or positions for eight pins, only seven pins are on this base. In the center of the base is a cylindrical extension that fits down into a hole in the socket for this tube. On one side of this extension is a raised lengthwise ridge called the locating key. This key will fit into a groove on one side of the hole in the socket when the tube is rotated into its correct position in relation to the socket. This insures that the correct pin (and connected element) will enter the socket connection in the external circuit for that element.

The base pins are presumed to be numbered as shown by the larger diagrams of Fig. 17. The numbers commence with 1 for the pin to the left of the key when you hold the key toward you, and the numbers proceed clockwise around the circle of pins to pin number 8. If a pin does not appear in one or more positions, allowance is made in the numbering. For example, in our tube there is no pin in position number 6, and so we have only pins numbered 1, 2, 3, 4, 5, 7 and 8. The numbers do not actually appear on the base or on the pins; you are supposed to be acquainted with the system. Pin numbers do appear on tube base diagrams.

In the base diagram of Fig. 17 pin number 1 connects to the internal shield shown in Fig. 4. This shield is not one of the "active elements" of the tube, and often is not represented in either the tube symbol or its base diagram. Pin number 2 connects to one end of the heater, number 3 goes to the plate, number 4 goes to the screen grid, which may be called grid No. 2. Then pin number 5 goes to the suppressor grid (grid No. 3), there is no pin number 6, pin 7 goes to the other end of the heater, and pin 8 goes to the cathode. The control grid of the tube (or grid No. 1) connects to the top cap which is indicated as shown on the base diagram.

When making wiring connections to the socket terminals for certain types of tubes, you either have to know the base pin arrangement by heart or else look in a chart of tube base diagrams so that you may make correct circuits. Tube makers publish base diagrams for all of their tubes, and such diagrams always are readily available from the makers, their dealers, and from radio parts supply stores.

#### SYMBOLS FOR DIAGRAMS

It is not only the tubes which are represented by symbols in radio wiring diagrams, but also nearly all of the other parts in general use. Standard symbols, and some others in general use, are shown by Fig. 18. Some explanations relating to a few of these symbols are in order. First of all, you don't have to draw a symbol just as it is shown here in order to have it correct. For example, referring to the center column, the number of loops drawn in the coil for an inductor makes no particular difference, and has no relation to the number of turns in the actual coil. Similarly with the symbol for a battery, in the right-hand column; the number of long and short lines has no particular relation to the number of cells that are in the battery.

You will see that arrows or arrowheads anywhere on a symbol nearly always mean that the value of the part may be adjusted, or that it is variable. This appears in the symbols for resistors, inductors, and capacitors. The word inductor means, practically the same as the word coil. Coils possess the electrical property called inductance (which we shall study later on) and when the coils are used to provide inductance in a circuit they are called inductors.

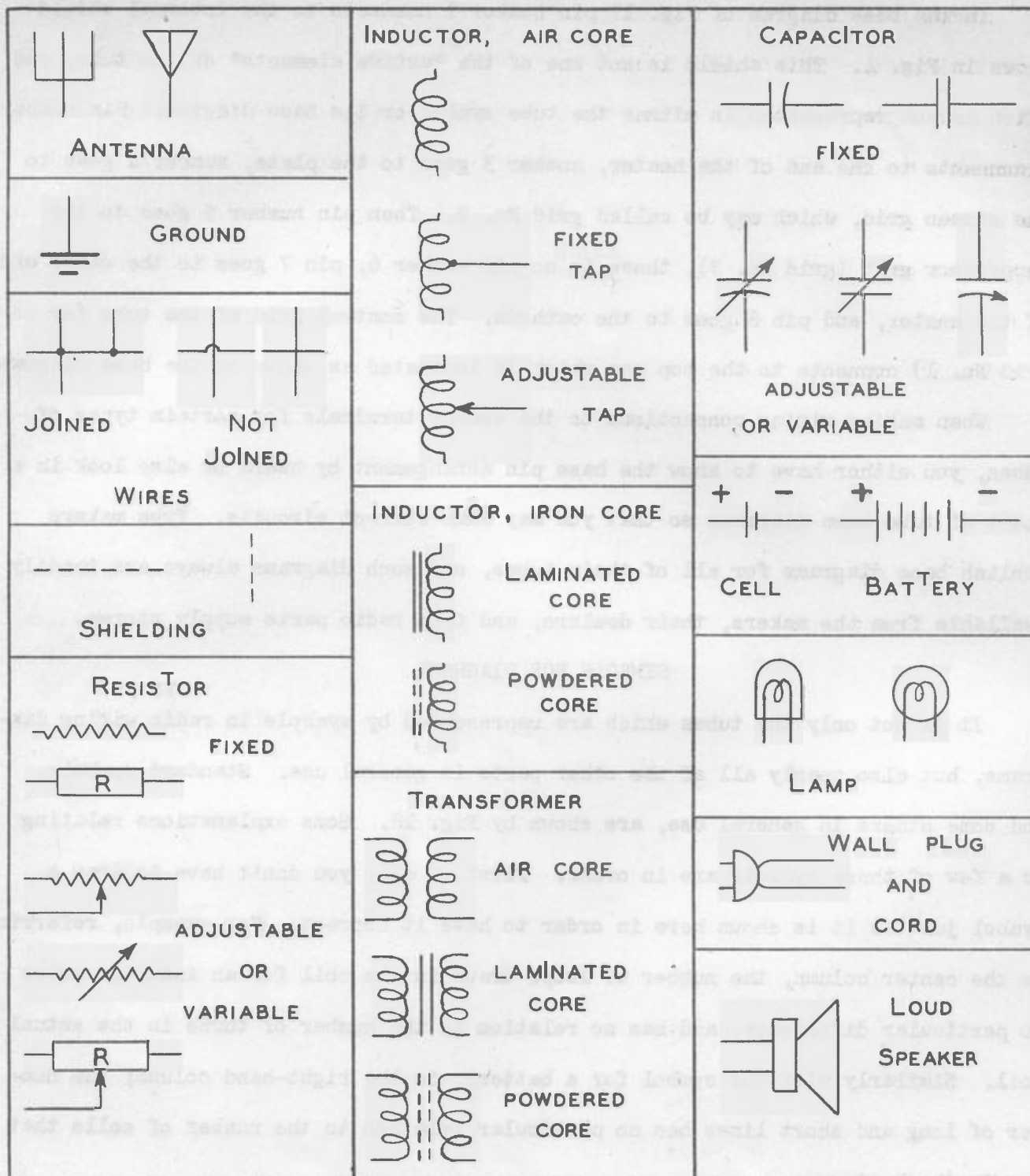

FIG.18.

Radio symbols which are most commonly used.

When we come to use circuit diagrams and wiring diagrams in following lessons, you may refer back to this sheet, if necessary, until you recognize each symbol.

Should you become familiar with all of these radio symbols, and then have to con-

sult industrial electrical diagrams, such as motor wiring diagrams, there will be some confusion. For instance, the zig-zag line that means a resistor in a radio diagram usually means a coil or winding or inductor in an industrial diagram. And our symbol for a fixed capacitor which has two straight lines (upper right-hand corner of Fig. 18) represents a contactor in an industrial diagram. A contactor is an electrically operated switch, or an automatic switch.

With reference to the types of cores in inductors and transformers, an air core means that there is no iron inside of the windings. There may be supporting forms made of insulation, or even of non-magnetic metals, but so far as action of inductors and transformers is concerned, these supports might as well be air, and we speak of an air core construction. A laminated core is one made up of many thin sheets of solid iron or steel. A powdered iron core means one formed by finely divided particles of iron held in an insulating compound. Some of the i-f transformers pictured in a preceding lesson have powdered iron cores.

#### FILAMENT CATHODES

In all of the tubes which we have examined, the temperature of the cathode is raised by heat coming from a separate heater member of the tube. There is no electrical connection between the cathode and the heater, and the heater does not emit electrons which go through the tube space to the plate. Such tubes are said to have heater cathodes.

Were we to coat the heater with the same kinds of electron-emitting substances used for separate cathodes, then leave off the separate cathode, the heater might be used as the electron-emitting cathode. Not only might this be done, but in all of the earlier tubes and in a large percentage of those used today it is done. Then we have what is called a filament cathode to distinguish it from the heater cathode. Many call a filament cathode simply a filament, which it was called in all tubes before the coming of the heater-cathode types.

Back in Figs. 12 and 13 we have a circuit including a tube which has a heater

cathode. In Fig. 19 we have the same circuit drawn for a triode tube having a filament cathode. The filament cathode is heated by electron flow forced through

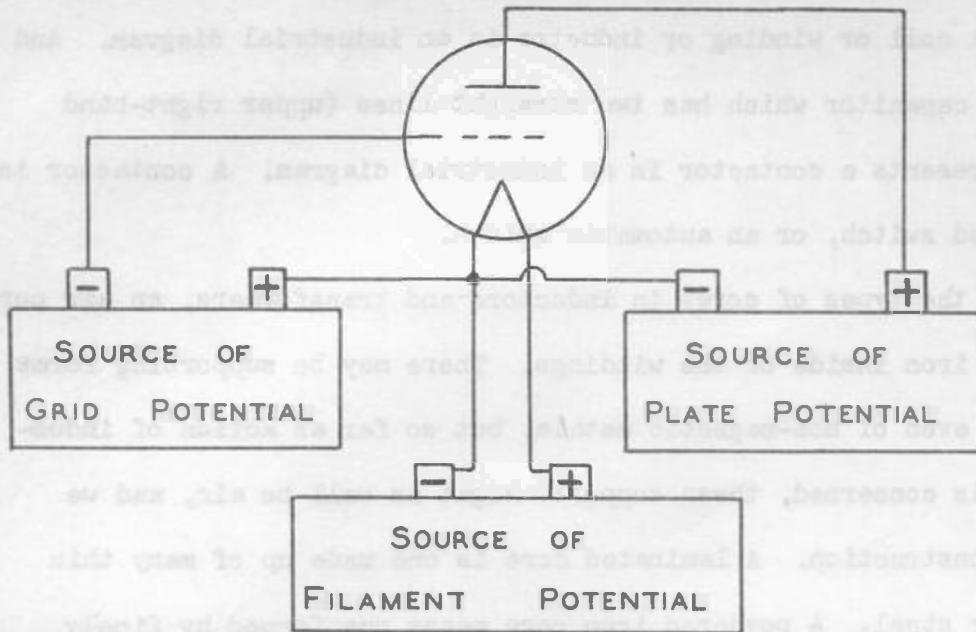

FIG.19.

The plate circuit, the grid circuit, and the filament heating circuit for a filament cathode type of triode.

source. None of these electrons leave the filament cathode to go through the tube space to the plate; all of their work is expended in heating the filament cathode.

The plate circuit and the grid circuit in Fig. 19 are connected to the end of the filament cathode which is connected also to the negative terminal of the filament source. Electrons from the negative terminal of the source of plate potential enter this end of the filament cathode and spread through the cathode until they are emitted from the cathode surface into the space charge. From the space charge these electrons go to the plate and then back to the positive terminal of the plate potential source, just as with any other tube.

The grid, or control grid, is connected to the negative terminal of the source of grid potential, and the positive terminal of this source is connected to the filament cathode. Thus the control grid is maintained at a potential which is negative with reference to that of the cathode -- which is just what happens when we are using a heater cathode.

In Fig. 16 are shown symbols for four general types of tubes which have heater cathodes. In Fig. 20 are shown the same four general types as they are represented

it by the potential difference of the source of filament potential. All of the electrons that leave the negative terminal of this source pass through the filament cathode and return to the positive terminal of this

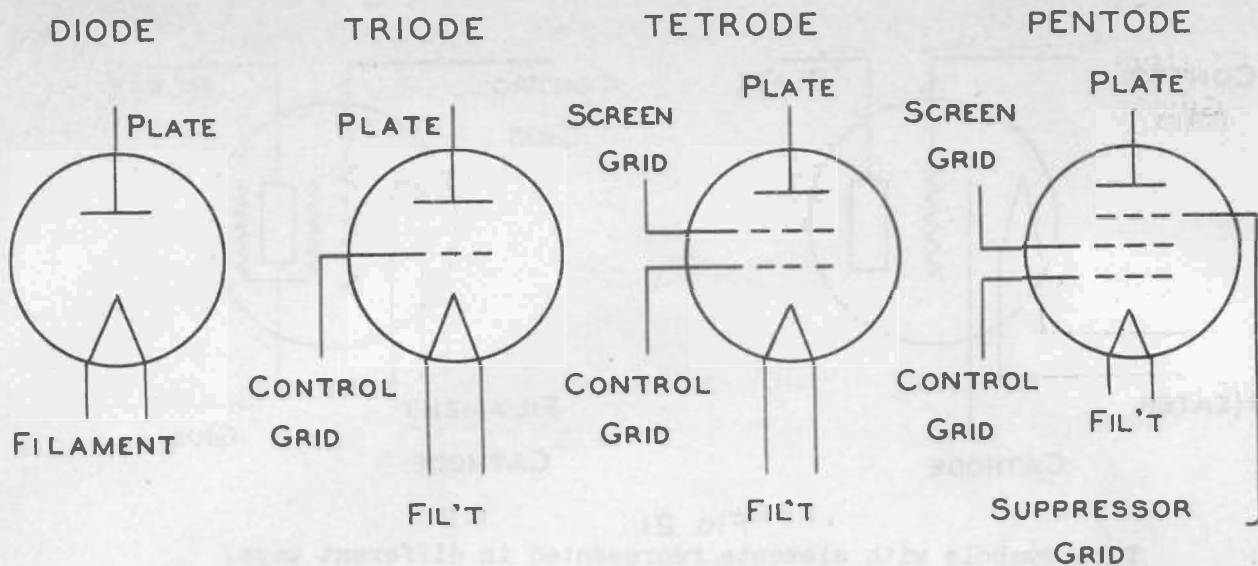

FIG. 20.  
 Symbols for the four general types of tubes as constructed with filament cathodes.

when having filament cathodes. Compare the symbols in the two figures and you will see that the only differences between tubes of the same general type are in the substitution of filament cathodes for heater cathodes.

#### OTHER SYMBOLS FOR TUBES

In the tube symbols which have been shown up to this point the plates are represented by straight horizontal lines, all of the grids are represented by broken lines, the heater cathodes are shown by horizontal lines with turned down ends, and either the heaters or the filament cathodes are shown by lines of inverted V-shape. These are not the only ways of representing the various kinds of elements in tube symbols.

At the left in Fig. 21 is a symbol for a triode having a heater cathode, and at the right is a symbol for a tetrode, or screen grid tube, having a filament cathode. The plates are represented by rectangles. All kinds of grids are shown by zig-zag lines which are intended to represent the turns of the spirals in the grids. Separate cathodes may be shown either by straight lines or by curved lines, while heaters or filaments may be shown with round-topped loops or with inverted V's.



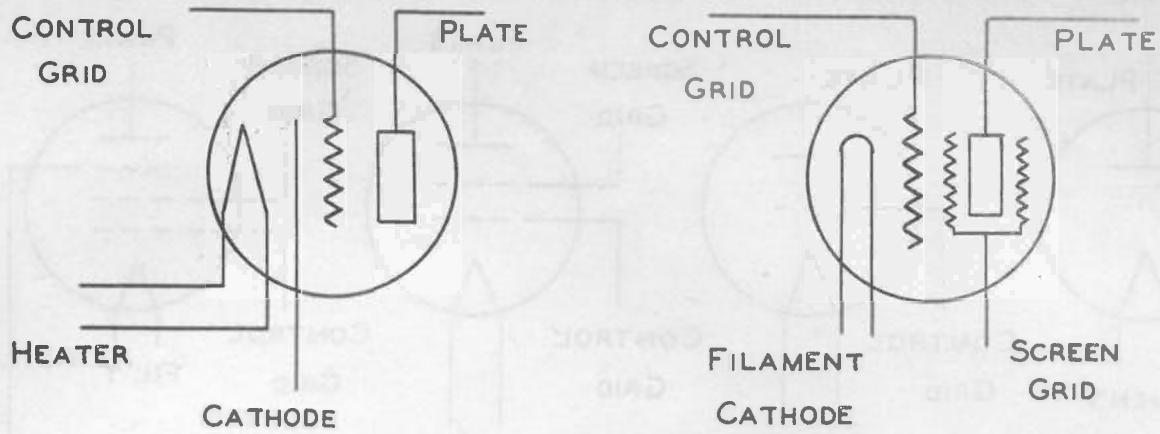

FIG. 21.  
Tube symbols with elements represented in different ways.

### METAL ENVELOPES

Several types of tubes having metal envelopes are pictured in Fig. 1. We may note that tube symbols do not indicate whether the tube represented has a metal envelope or a glass envelope. Most types of tubes are made in two styles, one having a metal envelope and the other a glass envelope. The types of elements are the same in either case, and there is no difference between the principles according to which the elements perform.

Fig. 22 shows the internal construction of one RCA pentode tube which has a metal envelope. Number 1 on the drawing is the metal envelope, made of steel with the joints welded to make vacuum-tight seals. Numbers 2 and 3 are spacers and insulators held by the support number 4. Number 5 is the control grid which is just outside of the cathode 6, and around the outside of which is screen grid 7. Within the coated cathode is the heater numbered 8. The suppressor grid is numbered 9, and the plate, partially cut away, is numbered 10.

Part number 11 is of a substance called the "getter" which, when vaporized by heat, absorbs and retains most of the gases which remain inside the envelope after it has been pumped down to establish the vacuum. Number 12 is a shield around the stem. Number 13 is one of the inserts carrying conductors through the glass seal numbered 14, all carried by the header number 15. At number 16 is shown the glass-button stem seal. Number 17 is a cylindrical base shield, while 18 is the skirt

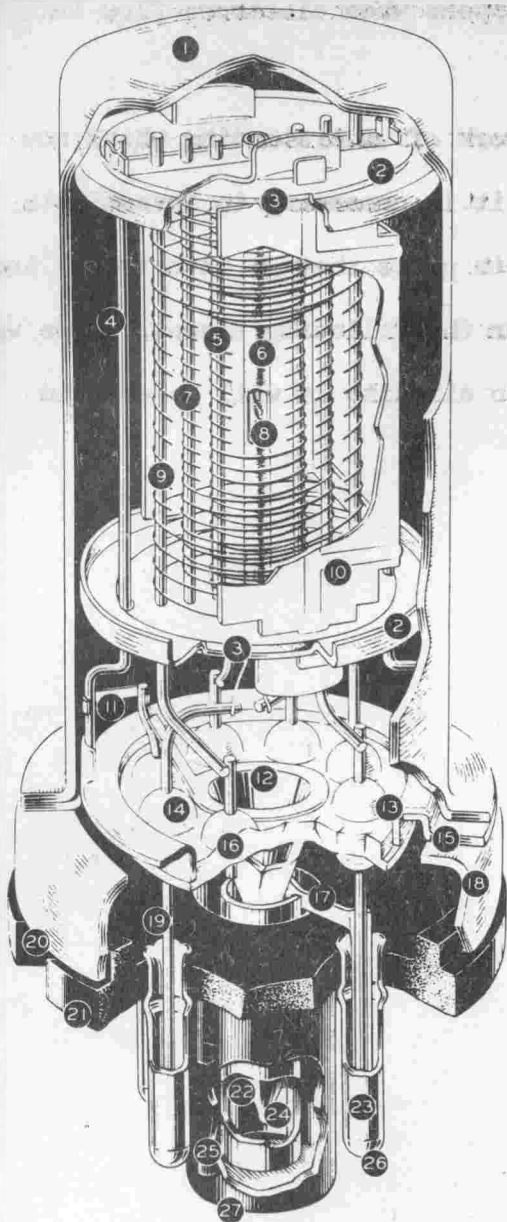

FIG. 22.  
The internal construction of one style of RCA pentode having a metal envelope.

antenna to loud speaker with little difficulty.

But in spite of all this, it must be confessed that the gaps in your radio knowledge still are wide and deep. For instance, while we have learned a great deal about electron flow through tubes and sources, we have not yet gotten any useful work from this flow. Merely to have electrons go through a tube, some conductors, and a source, doesn't get very far in the reception and amplification of

around the header. One of the lead wires extending down into the base pins is marked 19. Number 20 is the crimped lock onto the base 21. Number 22 is a tube through which air and other gases are pumped out of the envelope. One of the base pins is marked 23. Number 24 is the exhaust tip for the exhaust tube marked 22. The aligning key on the base is marked 25. This is the key indicated in Fig. 17. Number 26 is the solder which fastens the lead wires in the base pins, while also making good electrical connection. Number 27 is the downward extension of the base on which is the aligning key.

#### THE NEXT STEP

We have become familiar with a great variety of radio parts, with why they are needed and, in a general way, how they meet the needs. We have become particularly well acquainted with radio tubes, with how they operate, and why. No longer should you feel strange in this new field of radio, for you know much of its language, and can find your way from

radio signals. For that part we must learn what happens when electrons flow in resistors, inductors, and capacitors.

Of course, it was essential to lay the groundwork of understanding which now is nearly complete. But we are at the point where it is necessary to investigate complete radio circuits rather than only the separate parts that go into them. And so it is radio circuits that will be the subject for the following lesson. Once we master the operation of the principal kinds of radio circuits it will be easy to hook them together and watch them do useful work.